

The 9th Congress of the
**EUROPEAN ACADEMY OF PAEDIATRIC
SOCIETIES**

EAPS

October 7-11, 2022
Barcelona & Online

A Joint Scientific and Educational Event of
EAP, ESPNIC and ESPR

ABSTRACT VOLUME



eaps2022.kenes.com



9TH CONGRESS OF THE EUROPEAN ACADEMY OF PAEDIATRIC SOCIETIES

ISBN: 978-2-88971-024-9

DOI: 10.3389/978-2-88971-024-9

Citation: The European Academy of Paediatrics (EAP), The European Society for Paediatric Research (ESPR), The European Society of Paediatric and Neonatal Intensive Care (ESPNIC). (2022).

9th Congress of the European Academy of Paediatric Societies.

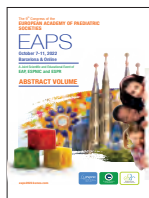

October 7–11, 2022, Barcelona & Online

The abstracts in this collection have not been subject to any Frontiers peer review or checks, and are not endorsed by Frontiers. They are made available through the Frontiers publishing platform as a service to conference organizers and presenters. The copyright in the individual abstracts is owned by the author of each abstract or his/her employer unless otherwise stated. Each abstract, as well as the collection of abstracts, are published under a Creative Commons CC-BY 4.0 (attribution) licence (<https://creativecommons.org/licenses/by/4.0/>) and may thus be reproduced, translated, adapted and be the subject of derivative works provided the authors and Frontiers are attributed.

For Frontiers' terms and conditions please see <https://www.frontiersin.org/legal/terms-and-conditions>.

Table of Contents

- 195 Welcome to the 9th Congress of the European Academy of Paediatric Societies**
- 196 Invited Speaker Abstracts**
- 197 E. Frier, R. Reynolds, S. Stock:** Antenatal steroids and outcome
- 199 T. Dassios:** Systemic steroids in evolving BPD
- 200 I. Shavit:** How can we optimally cope with acute pain?
- 201 M. Shefler Gal, S. Gamsu, R. Jacob, D. Cohen, I. Shavit:** Reduction of ileocolic intussusception under sedation or anesthesia: A systematic review of complications
- 203 J. Menzies:** Approaches for success: Enhancing staff engagement with research
- 205 A. Hoskote:** Management - Early recognition and treatment of cardiogenic shock in children
- 206 k. Størdal:** Over prescription in gastroesophageal reflux - An unnecessary medicalisation?
- 207 R. Witlox:** Congenital lung lesions
- 209 M. Carter:** Recognition and treatment of MIS-C
- 210 S. Ashkenazi:** The challenge of antibiotic stewardship in Europe
- 211 H. Szajewska:** Panelist: Rethinking probiotics in pediatrics facing new evidence
- 212 D. Wolke:** Recap preterm platform
- 213 V. Jaddoe:** Early life stressors and life course health. The lifecycle project - EU child cohort network

- 214 D. Trevisanuto:** Laryngeal mask use
- 215 D. Sharkey:** Technology in the delivery room
- 216 S. Ash:** Paediatric cancer patients: Are they ever cured? A long-term care plan for the primary care paediatrician
- 218 C. Buysse:** Therapeutic hypothermia in critically ill children: Where are we now?
- 219 S. Iacobelli:** Fluid and electrolytes in parenteral nutrition
- 220 W. Mihatsch, M. Saenz De Pipaon:** Calcium and phosphorus requirements of preterm infants
- 222 J. Latour:** Secrets and scents of caring: From seclusion to separation
- 224 L. Zimmermann:** Common diseases in premature children
- 225 T. Stiris:** Premature babies after discharge: How to optimize follow up in the community
- 226 K. Joosten:** 'Zooming out' using clinical data in nutritional research
- 227 K. Brown:** Improving outcomes after cardiac surgery: Examples in collaborative learning
- 228 A. Hoskote:** Improving outcomes after ECMO and VADs
- 229 J. Wambach:** Lung transplant in congenital surfactant disease
- 231 O. Danhaive, M. Kuzniewicz:** Surfactant in late preterm infants
- 233 M. Brenner:** Managing children with complex needs in primary care - Where to next?
- 234 B. Wettergren:** The art of shared decision making in paediatrics

- 235 Y. Singh:** Evidence based international guidelines on use of pocus in neonatal and pediatric intensive care unit – What's next?
- 236 J. Lemson:** Advances in multi-modal hemodynamic monitoring for infants and children
- 237 S. Faust:** Clinical trials in paediatrics
- 238 G. Greisen:** Clinical trials in neonatology
- 239 S. Walker:** When pain nerves misfire - Assessment and management of neuropathic pain in children
- 241 N. Najafi:** Treatment regimens of acute pain and chronic pain
- 242 M. Di Nardo:** Updates in paediatric ECMO
- 243 K. Brown :** Long term outcome of ECMO patients
- 244 V. Mclin:** Congenital portosystemic shunts - Identification and therapy
- 245 D. Schneider, I. Brecht, A. Ferrari:** Rare tumors in children - Recognition and individualized therapy
- 247 I. Valenzuela:** Phenotype first approach
- 248 F. Santos-Simarro:** Genotype first approach
- 249 R. Hady-Cohen:** Extension of the field of paediatrics to fetal life-fetal neurology as a paradigm
- 251 D. Craiu, C. Motoescu, C. Pomeran, D. Barca, C. Iliescu:** Early diagnosis of autoimmune encephalitis - What a pediatrician should know
- 253 J. Martins:** The cardiologists' point of view

- 254 J. Mendes:** The palliativist's point of view
- 255 Ö. Tekşam:** Revising treatment guidelines of status epilepticus in light of emerging evidence
- 257 R. Velasco:** Point of care technologies driving improved patient care and flow in paediatric emergency medicine
- 258 P.D. Topaloglu:** New immunosuppressive agents in lupus nephritis
- 259 S. Marks:** New immunosuppressive agents in anca associated vasculitis
- 260 U. Aden, N. Padilla:** Neuronal connectivity in the preterm brain
- 261 C. Buysse:** Long-term outcomes after paediatric sepsis – The patient journey
- 262 O. Gawronski:** Paediatric early warning scoring – The art and science
- 263 J.-C. Mercier:** The roots of adult diseases are in the pediatric age spectrum: What is the role of the pediatrician?
- 264 K. De Bijl-Marcus, F. Mossel, A. Van Den Hoogen, B. Pluut, S. Verbeek, K. Ahaus, M. Benders, M. Buljac:** Early discharge planning improves safe transfer, (Perspectives from parents and health professionals)
- 266 S. Kudchadkar:** Time to abandon benzodiazepines in the intensive care unit?
- 267 S. Kudchadkar:** Implementing an early mobilisation programme in the PICU

- 268 Joan Calzada-Hernández:** 5 Cases of pediatric vasculitis
- 269 A. Ravelli:** Differential diagnosis of arthritis in children
- 270 T. Austin:** NeuroNICU: Hope or hype
- 271 T. Arichi:** Assessing brain function in early human development with fMRI
- 272 R. Slater:** Measuring pain in neonates
- 273 A. Bhatt:** Current clinical practice vs regulatory evidence
- 275 S. Barak:** Panelist
- 277 C. Tosin, P. Chincholo, P. Biban:** Staff wellbeing: Implementing evidence based approaches to support well-being initiatives
- 278 J. Manning:** Preventing and managing family-staff conflict in the PICU
- 279 I. Sukhotnik:** The conservative approach to acute appendicitis: Pros and cons
- 280 J. Zeitlin:** The consequences of IUGR in the term infant
- 281 O. Baud:** IUGR in the preterm infant
- 282 J. Urbano:** Choosing vasoactive drugs in 2022 – A physiology based approach for infants and children
- 283 A. Amigoni:** Vaso-active drugs when on ECMO or CRRT
- 284 F. Valla:** Balanced solutions vs crystalloids – Which is better?
- 285 C. Milesi:** How does HFNC work?
- 286 A. Medina Villanueva:** Using HFNC in patients: When and how – A practical approach

- 288 A. Hoskote:** Cardiac intensive care provision for neonates and children across Europe
- 289 A. Valiulis:** Childhood wheezing: What is new?
- 291 A. Bush:** Cystic fibrosis: Is it a vanishing disease?
- 292 A. Axelin:** Core outcomes measures of family-centred care: Are we measuring the right thing?
- 293 J. Latour:** Music therapy to improve outcome
- 294 J. Nijman:** Possibilities and pitfalls of ai in the PICU
- 295 R. De Jonge:** Using big data to predict patient outcome
- 296 A. Smits:** State of the art drug treatment
- 298 R. Flint:** Individualized medicine in newborns
- 299 Y.M. López Fernández:** A paediatric specific pards definition: What have we learned?
- 300 M. Ijland:** Ventilator-induced diaphragm dysfunction
- 301 S. Kolaček:** Food allergy
- 303 P. Ramnarayan:** How COVID-19 is changing the ICU world – Implications for future paediatric trials
- 305 M. Johnson:** Preterm infants growth
- 306 H. Van Goudoever:** Body composition
- 307 N. Najafi:** Procedural sedation by anesthesiologists
- 308 J. De Graaff:** Non-invasive methods for sedation in children
- 309 D. Gómez Andrés, M. Alvarez-Molinero, L. Costa Comellas, L. Ventura, E. Toro, F. Munell:** Spinal muscular atrophy

- 310 A. Nascimento Osorio:** Duchenne muscular dystrophy
- 311 A. Lacerda:** Symptom control in children with cancer
- 312 M. Agud De Dios:** Symptom control in children with neurological conditions
- 313 A. Soriano-Arandes, A. Perramon, C. Andrés, J. Antoñanzas, J. Vila, M. Chiné, N. Visa-Reñé, A. Gatell, N. Worner, M. Vilà De Muga, M. Biosca, G. Ricós, P. Serrano, C. Valldepérez, N. Rius, G. Ruiz, R. Conti, M. Poblet, R. Capdevila, N. Magro, X. Bruna, M. Villalobos, E. Mora, A. Moreira, O. Salvadó, R. Martin, M. Planells, I. Soler, E. Lera, A. Sánchez, E. Solà, Z. Lobato, A. Vidal, N. López, M. Ruiz, B. Pujol, D. Canadell, A. Martínez-Mejías, I. Zambudio, L. Sanz, E. Macià, M. Esteller, I. Sau, M.À. Rifà, L. Aulet, P. Sala, E. Alcover, M. Coma, M. Marco, C. Franco-Jarava, P. Soler-Palacin, D. López-Codina, A. Anton, C. Prats:** SARS-CoV-2 and other respiratory viruses in childhood: Predictive models for their diagnosis and epidemiological evolution
- 317 Q. Bassat:** Biomarkers of endothelial activation for the risk stratification and prognosis anticipation of febrile patients
- 319 G. Greisen:** Selection criteria, effect sizes, and outcome measures in neonatal clinical trials: How do we find what we are looking for?
- 320 J. Mendes:** Ethical challenges when researching with children
- 321 I. Barber:** Imaging of child abuse
- 322 J. Muchart:** Advances in paediatric brain imaging in epilepsy
- 323 J. Kostenzer, C. Von Rosenstiel-Pulver, J. Hoffmann, A. Walsh, S. Mader, L. Zimmermann:** Infant and family-centred developmental care (IFCDC) in times of COVID-19 – A global parent survey

- 325 A. Van Den Hoogen:** Supporting mums and dads in odd times – Going the extra mile during COVID-19
- 326 N.R. Van Veenendaal, A. Deierl, F. Bacchini, K. O'Brien, L. Franck:** Supporting parents as essential caregivers during the SARS-CoV-2 pandemic and beyond
- 327 M.G. Ariceta:** New advances of complement blockade in aHUS
- 329 F. Emma:** The role of complement blockade in C3 glomerulonephritis
- 330 I. Iglesias Serrano:** Interstitial lung disease in children
- 331 S. Rovira Amigo:** Primary ciliary dyskinesia
- 332 Z. Gyorgyi:** The effect of the COVID-19 pandemic on medical training
- 333 T. Kakourou:** Skin problems in children: Cautious with cortisone?
- 334 M. Benders:** Brain injury in CHD babies: Neuroprotective strategies for a better outcome
- 335 S. De Wildt:** The use of PK/PD models in the PICU
- 336 G. Gunnlaugsson:** Current challenges in global child health
- 337 C. Milesi:** High-flow nasal canula: The holy grail?
- 338 J.C. Lopez-Gutierrez:** Vascular malformations
- 339 I. Geiger, S. Mader, L. Zimmermann, J. Kostenzer, V. Matthäus:** European standards of care for newborn health – Revision and new standards
- 340 C. Härtel, B. Hüning:** Transition from hospital to home: Recommendations for discharge planning

- 341 D. Wolke:** How follow-up findings up to adulthood can inform us about content of follow-up standards in childhood
- 343 A. Lapillonne:** Feeding the late and moderately preterm infant
- 344 J. Boardman:** Socioeconomic deprivation and the preterm infant: How does it affect outcome?
- 345 M. Emonts:** Recurrent infections, when to worry
- 346 N. Hartwig:** Lumps and bumps are they dangerous
- 347 Y. Singh:** Point of care ultrasound: A tutorial for neonates and children
- 348 A. Te Pas:** What is new in neonatal resuscitation?
- 349 J. Del Castillo:** What is new in paediatric resuscitation?
- 350 L. Marino:** Nutritional assessment and identifying 'at risk' patients
- 351 C. Jotterand Chaparro:** How to avoid and treat refeeding syndrome
- 353 L. Chalak:** Neurovascular coupling in mild HIE
- 354 M. Vento:** Effect of donor human milk on microbiota
- 356 M. Saenz De Pipaon:** Colonization of preterm infant gastrointestinal tract
- 358 A. Amigoni, S. De Wildt:** Panelist: A practical approach
- 359 S. Janmohamed:** What are the new approaches
- 360 S. Jain:** Maternal hypertension during pregnancy is associated with an increased risk of brain abnormalities on MRI at term-equivalent age in very preterm infants

- 362 J. Latour:** Nurses as change drivers to reduce the painful procedures in the NICU
- 364 A. El-Khuffash:** Effect of breastfeeding on cardiac function
- 365 M. Fumagalli, P. Schiavolin, D.A. Amerotti, G. Ardemani, C. Bonfanti, F. Mosca:** Therapeutic intervention in preterm brain injury
- 367 A. Mazur:** Influence of social media and self-esteem
- 369 O. Magen:** Utilizing AI and data to promote proactive and preventative medicine
- 370 N. Robertson:** Adjunct therapies for neonatal encephalopathy
- 371 N. Van Der Aa:** Imaging and long term memory following neonatal brain injury
- 372 J. Lepeule:** Air pollution, ambient temperature and perinatal and children health
- 373 J. Labrecque:** How to emulate a target trial with observational data in perinatal and paediatric epidemiology
- 374 M. Blennow:** Telemedicine support for NICU care in LMIC
- 375 S. Thayyil:** Management of HIE in LMI countries
- 376 V. Vida, A. Guariento:** Congenital heart defects 2023 and beyond
- 378 S. De Wildt:** AKI and drug dosing
- 379 A. Amigoni:** Drug dosing during ECMO
- 380 L. Tume:** Translating result from clinical trials into daily practice
- 381 R. Bacelos Silva:** Overcoming the hurdles from non-invasive ventilation

- 383 R. Pressler:** Classification and management of neonatal seizures
- 385 A. Arzimanoglou:** Update on the management of paediatric epilepsy
- 386 S. Iacobelli:** Fluid management in the critically ill neonate
- 387 J. Lemson:** Fluid management in the critically ill child in the PICU
- 388 J-C. Holm:** A new paradigm in providing care to children and youth living with obesity and its related complications
- 390 A. Kelly:** New pharmacological treatments of childhood obesity
- 391 N. Disma:** Complications during anesthesia in children and neonates; results of the APRICOT and NECTARINE
- 392 J. Mendes:** Why?
- 393 J. Schneider:** COVID-19–related care measures: The role of face masks in the recognition of emotions by pre-school children
- 395 L. Provenzi:** From separation to reparation: Psychobiology of pandemic-related stress in the first 1000 days
- 397 P. Kuhn:** Developmental care during COVID 19 pandemic: Promoting attachment between parents and neonates despite the COVID-19 pandemic
- 398 L. Dimeglio, E. Beli, C. Beam:** Circadian mechanisms in diabetes
- 400 S. Sendžikaite:** Pathophysiology of the major congenital heart diseases and possible susceptibility to COVID-19 infection

- 401 L. Tume:** Getting your proposal funded
- 402 J. Mattsson:** Getting patients involved in trial design
- 404 F. Valla:** Fluids in the PICU – Which, when and how much. An evidence-based approach
- 405 E. Dempsey:** Update on cord clamping
- 406 L. Schrier:** Off label drugs in children
- 407 S. Del Torso, L. Dembinski, A. Turska Kmiec, A. Mazur:** The young athlete - Things we must remember
- 409 R. Wösten – Van Asperen:** The paediatric haem-onc patient in the PICU: Do we need to do everything?
- 410 C. Poets:** Intermittent hypoxia and late outcome
- 411 T.-Y.M. Lo:** Outcome after traumatic brain injury- Kidsbrain it
- 413 S. De Wildt:** Pharmacology of obese and adolescent patients in the PICU
- 414 A. Christoforou:** Signs to catch; which need urgent referral?
- 415 A. Greenough:** The Bengt Robertson award lecture: Bengt Robertson award lecture: Early origins of respiratory disease
- 417 T. Stephenson:** What can we learn from COVID; the clock study of long COVID in children
- 418 A. González Aumatell:** What happened to the general paediatric population? Delayed diagnosis due to lock down
- 420 B. Manley:** Nasal high flow to improve intubation success and safety in neonates: The shine trial
- 422 A. Lavizzari:** Forced oscillation technique
- 424 T. Szczapa:** Heliox for neonatal ventilation

- 425 M. Campbell-Yeo:** Neonatal pain assessment
- 426 M. Eriksson:** Best evidence on non-pharmacological and pharmacological interventions
- 427 A. Medina Villanueva:** How to ventilate the obstructive patient
- 430 V. Modesto I Alapont, A. Medina Villanueva:** Strategies to limit mechanical power
- 431 J. Menzies:** Making the PICU a healing environment
- 432 P.F. Hoyer:** Risk groups for developing hypertension
- 433 P. Brodin:** Immune development in infants
- 434 P. Gressens:** Stem cells to influence preterm brain development: Are we getting closer to therapeutic intervention?
- 435 P. Fraaij:** What can we expect from viruses in the next 10 years
- 436 L. Pérez Jurado:** Diagnostic yield of sequential multi-omics in a program for undiagnosed rare diseases
- 438 M. Zilbauer:** Epigenetic signatures, single cell RNA Sequencing and organoids - On the road to identify the pathogenesis of IBD
- 439 B.-K. Koo:** Genetic engineering in gut organoids for cystic fibrosis and stem cell research
- 440 M. Turner:** Panelist
- 441 R. De Jonge:** Big data and machine learning in intensive care: Beyond the prediction of outcome
- 442 J. Rivière:** Immunological consequences of biological therapies: The Era of Secondary Immune Deficiencies (SID)

443 Long Oral Abstracts

- 444 M. Budisteanu, S. Papuc, A. Erbescu, L. Albulescu, C. Burloiu, E. Andrei, L. Mateescu, F. Linca, D. Ioana, C. Nedelcu, A. Glangher, F. Rad, A. Arghir:** Recurrent deletions in autism spectrum disorders
- 446 P. Ventura, X. Herrero, M. Torrabias, Z. Bosch, R. Corripio, A. Escribano, B. Suarez, C. Freire:** Exposure to phenolic endocrine disruptors and early thelarche
- 449 L. Wiyono, A. Larasati, N. Ghitha, D. Clarisa:** Carbohydrate counting implementation on pediatric type 1 diabetes mellitus: Systematic review & meta-analysis
- 451 P. Marzuillo, D. Iafusco, S. Guarino, A. Di Sessa, A. Zanfardino, A. Piscopo, C. Luongo, D. Capalbo, M. Verde, F. Aiello, E. Miraglia Del Giudice, A. Grandone:** Euthyroid sick syndrome and its association with metabolic and kidney complications in children with type 1 diabetes mellitus onset
- 453 B. Gustus, V. Hipsher, A. Leshem, M. Rachmiel:** The use of audio-visual modality prior to endocrine stimulation tests is effective in reducing children's fear of the procedure
- 455 Q. Wang, Y. Morikawa, S. Akahoshi, K. Miyata, H. Sakakibara, T. Matsushima, Y. Koyama, T. Obonai, T. Kaneko, M. Miura:** Follow-up duration of echocardiography in patients with Kawasaki disease with no initial coronary aneurysms
- 458 M. Opezzo, M. Schwab, C. Mueller:** Accuracy of caloric estimation in adolescents in the midwestern united states
- 460 S.B. Selman, R. Distefano, J. Dilworth-Bart, J. Brooks-Gunn:** Stability in routines during the preschool period and associations with child well-being

- 462 Y. Jin:** Thrombocytopenia and morbidity in pediatric post-cardiotomy veno-arterial extracorporeal membrane
- 464 F. Sperotto, M. Daverio, D. Gregori, A. Dorste, A. Amigoni, R. Thiagarajan:** Incidence, outcome, and risk factors of in-hospital cardiac arrest and associated mortality in pediatric critically ill cardiac patients: A systematic review and meta-analysis
- 467 B. Oliveira, I. Custódio, F.E. Lima, S. Florencio, G. Lima, K.K. Mesquita, A. Rodrigues, P.N. Pinheiro, M. Diógenes, M.G. Fontenele, M.W. Ventura, A.P. Queiroz:** Adolescents with covid-19 in northeastern brazil: Clinical and demographic profile
- 469 I.I. Nila Utama, R. Amalia, D. Muktiarti, H. Sjakti:** Desensitization in etoposide hypersensitivity: A case report
- 471 L. Macdarby:** Exploring the challenges of amplitude integrated EEG for seizure detection in pediatric patients
- 473 L. Bermúdez Barrezueta, A. Martínez De Azagra Garde, S. Belda Hofheinz, A. Rodríguez-Núñez, S. Bobillo Pérez, M. Nieto Faza, J. Collado Caparrós, R. Díaz Soto, J. Trastoy Quintela, M. Santiago Lozano, E. González Río, I. Sánchez Ganfornina, D. Sanz Álvarez, M. Palacios Loro, E. Gómez Sánchez, L. Artacho González, R. Montero Yéboles, L.J. Ferrero De La Mano, A. Arias Felipe, M. Iglesias Bouza, C. Rey Galán, A. Alcaraz Romero:** Thrombotic microangiopathies in spanish pediatric intensive care units. The matucip registry
- 476 A. Ntavoura, M. Prapa, E. Christakou, K. Straka, C. Tsiagklani, I. Gotsi, P. Poulos, D. Paraschou, C. Barbaressou:** Post-Transplant lymphoproliferative disorder related to Epstein-Barr viral infection

- 478 R. Rameshkumar, A.V.S. Mukarjee, S. Krishnamurthy:** Survival and long term kidney outcome of children starting kidney replacement therapy in the pediatric intensive care unit
- 480 B. Pisavadia, H. Weststrate, E. Harris, B. Chick, N. Owen, M. Nordlander, J. Young, K. Jamieson:** The 'Safe' Checklist: Improving the safety and quality of X-ray imaging on the neonatal intensive care unit. A single centre multi-professional quality improvement project
- 483 N. Poonai, D. Cohen, D. Macdowell, R. Mistry, S. Mintegi, S. Craig, D. Roland, M. Miller, I. Shavit:** Sedation and analgesia for reduction of paediatric ileocolic intussusception: A multinational cross-sectional study
- 485 A. Katheria, E. Clark, B. Yoder, C. Martin, F. Vora, D. Rittenberg, B.H. Law, G. Schmölzer, S. Lakshminrusimha, M. Underwood, M. Mohamed, S. Sheth, Y. Gollin, M. Rice, L. Ghormli, J. Mazela, M. Tomlinson,, J. Kaempf, A. Morales, M. Varner, J. Mercer, D. Poettler, Y. Vaucher, K. Baker, W. Rich, P. Wozniak, N. Finer, W. El-Naggar:** Umbilical cord milking in non-vigorous infants: A pragmatic cluster-randomized crossover trial
- 487 M. Aita, G. De Clifford-Faugère, S. Colson, N. Feeley:** Comparisons of nurses' perceptions of developmental care practices between neonatal units in Canada and France
- 489 G. Laporte, G. De Clifford-Faugère, A. Lavallée, M. Aita:** Assessing family resilience in the NICU: Results from a COSMIN systematic review of the family resilience assessment scale adaptations

- 491 S. Rao, J. Tan, R. Leigh, F.-S. Chou, A. Pham:** Machine learning of respiratory outcome predictions in premature infants born at < 30 weeks gestation based on developmental origins of bronchopulmonary dysplasia
- 495 S. Rao, R. Leigh, J. Tan, H.-W. Yeh, F.-S. Chou:** Differential oxygenation index trajectories for bronchopulmonary dysplasia of various grades in infants born less than 32 weeks' gestation
- 498 M. Furqan, N. Laher, M. Chidiac, Z. Hall, M. Salama, G. Ola, A. Kumar, A. O'Reilly, E. Isweisi, G. Semova, A. Branagan, J. Meehan, E. Molloy:** Treatment of hyperkalaemia in the neonate
- 500 E. Csabi, P. Benedek:** The risk for cognitive consequences in children with sleep-disordered breathing
- 502 A. Schibler, D. Franklin, F. Babl, E. Oakley, M. Jones, M. Borland, J. Neutze, J. Acworth, S. Craig, B. Gannon, D. Shellshear, H. Mccay, A. Wallace, T. Hoepfner, M. Wildman, J. Mattes, T. Pham, L. Miller, A. Williams, S. O'Brien, S. Lawrence, M. Bonisch, K. Gibbons, J. Waugh, S. Hobbins, S. Grew, R. Fahy, S. Dalziel:** Early nasal high-flow for children with acute hypoxaemic respiratory failure: A randomised controlled trial
- 504 A. Hamud:** Diabetic ketoacidosis fluid management in children: Systematic review and meta-analyses
- 506 S. Özkan, M. Aksoy, F. Tas Arslan:** Investigation of pediatric nurses' views, attitudes and behaviors on family-centered care during the pandemy

- 508 S. Bichali, J.-B. Baudalet, M.-E. Lampin, O. Domanski, H. Reumaux, A. Delarue, M. Recher, J. Soquet, F. Dubos, S. Leteurtre, A. Houeijeh, F. Godart:** Diagnosis delay is associated with cardiogenic shock in pediatric inflammatory multisystem syndrome temporally associated with SARS-COV-2 (PIMS-TS)
- 510 N. Cohen, R. Gigi, S. Haberman, T. Capua, A. Rimón:** Risk factors for failure of closed forearm fracture reduction in the pediatric emergency department
- 512 N. Cohen, G. Test, Y. Pasternak, D. Singer- Harel, S. Schneeweiss, S. Ratnapalan, S. Schuh, Y. Finkelstein:** Opioids safety in pediatric procedural sedation with ketamine
- 514 V. Lovatel, E. Rodrigues, L. Otero, E. Kós, B. Da Silva, R.D.C. Tavares, A.P. Bueno, T. Fernandez:** Rare chromosomal alterations in pediatric myelodysplastic syndrome
- 516 S.C. Ferraz, R. Aldeia Da Silva, I. Magalhães, C. Silva, M. Costa:** 1p31.1 Microdeletion including only NEGR1 gene
- 518 M. Bašković, L. Vucković, M. Borić Krakar, A. Kljenak, N. Benco Kordić, A. Rešić:** Influence of obesity in children with supracondylar fractures requiring surgical treatment
- 520 P. Chandrasekharan, S. Gugino, J. Helman, N. Bradley, L. Nielsen, M. Bawa, A. Mari, A. Prasath, C. Blanco, M. Rawat, S. Lakshminrusimha:** Can ventilation with an intact umbilical cord optimize transition & ameliorate systemic oxidative injury when 100% oxygen is used during preterm resuscitation?
- 523 M. Bawa, S. Gugino, J. Helman, N. Bradley, L. Nielsen, A. Prasath, C. Blanco, M. Rawat, P. Chandrasekharan:** Should we focus on ventilation alone rather than ventilation & chest compressions during neonatal resuscitation for bradycardia?

- 528 C. Reuter, F. Ehlers, P. Vana, H. Küster:** Effectiveness and safety of plastic wraps used during the initial care of preterm infants in the delivery room
- 531 S. Ansari, N. Ashayeri, S. Ghazavi:** The prevalence of complementary medicine use in supportive care in pediatric patients with cancer
- 533 A. Sofijanova, O. Jordanova, S. Bojadzieva:** Diagnostic values of S 100B protein for early diagnostic of brain injury in newborns
- 535 R. Kirk, C. Chipperfield:** “Why did you come to ed today?” - Exploring parental reasons for attending the children’s emergency department to optimise patient care
- 537 A.-M. Brennan, S. Fenton, J. Wilkinson, B. Murphy:** Modelled nutrition system for the transition phase safely delivers international nutrient recommendations in very low birthweight (VLBW) preterm infants
- 539 K. Davies, C. Morgan:** The relationship between parenteral leucine intake and plasma leucine in very preterm infants dependent on parenteral nutrition. A systematic review
- 541 N. Read, J. Menzies, B. Scholefield:** The impact of weekly debrief sessions to support the implementation of an early rehabilitation and mobilisation programme on picu: The permit study
- 543 L. Passini, R. Layese, M.L. Keller, G. Dassieu, C. Jung, A. Reynaud, S. Le Bouedec, E. Audureau, L. Caeymaex:** Error disclosure in neonatal intensive care: A multicenter prospective observational study
- 545 C.-J. Van Der Perk, L. Van De Riet, M. Alsem, H. Van Goudoever, J. Maaskant:** Prognostic factors influencing parental empowerment after discharge of their hospitalized child: A cross-sectional study

- 547 M. Sentenac, A. Smith-Longee, J. Zeitlin, S. Johnson, A. Aubert:** Early childhood education of children born very preterm in Europe: Results from the ships cohort
- 549 V. Siffredi, M.C. Liverani, L. Freitas, C. Borradori Tolsa, P. Hüppi, R. Hà-Vinh Leuchter:** Corpus callosum structural characteristics in very preterm children and adolescents: Developmental trajectory and relationship to cognitive functioning
- 551 M. Farhan, J. Bennett, A. Cram, N. Mccallion, F. O'Brien:** Compatibility of parenteral nutrition solutions with intravenous medications in neonates and paediatrics
- 554 E. Temizsoy, G. Uysal, N. Karadag:** The effect of feeding model with chronobiological approach on growth parameters and discharge time in preterm infants: Randomized controlled study
- 556 F. Valla, E. Cercueil, C. Morice, L. Tume, L. Bouvet:** Point of care gastric ultrasound confirms the inaccuracy of gastric residual volume measurement by aspiration in critically ill children: Gastriped study
- 559 M. De Man:** Acceptability and practicality of a new prenatal course for parents expecting a child with severe congenital heart disease.
- 561 F. Ferrari, D. Bonacina, I. Pelliccioli, V. Punzi, G. Tricella, F. Stefano, E. Bonanomi:** Pediatric index of mortality 3 (PIM3): Is it time to update?
- 564 N. Levy, J. Koppel, O. Kaplan, H. Yechiam, K. Shahar-Nissan, N. Kuchinski Cohen, I. Shavit:** Severity and incidence of multisystem inflammatory syndrome in children during 3 SARS-CoV-2 pandemic waves in israel

- 566 V. Gaertner, S. Minocchieri, T. Muehlbacher, D. Bassler, J. Thomann, C. Rüegger:** Prophylactic surfactant nebulization for the early aeration of the preterm lung – A randomized clinical trial
- 569 T. Iwashita Lages, E. Orlandin, P. De Moraes, A. Junior, T. Bastos, F. Celini, M. Nakamura, M. Amato, W. Goncalves-Ferri:** Evaluation of minime invasive surfactant therapy to preterm infants administrated with a fraction of inspired oxygen of more than 40% monitored by electrical impedance tomography
- 572 M. Peers De Nieuwburgh, M. Hunt, K. Hayes, I. Randazzo, P. Chandrasekaran, F. Debiève, O. Danhaive, M. Davey, A. Flake, J.W. Gaynor, D. Frank:** Isolated chronic fetal hypoxia results in delayed lung development and maturation using an extrauterine womb lamb model
- 574 J. Mathew, T. Ahuja, M. Jayashree, M. Seear:** Randomized controlled trial comparing addition of non-invasive positive pressure ventilation (BiPAP or CPAP) versus pharmacotherapy alone, in children with acute exacerbation of asthma
- 577 C. Stephens, B. Mcnamara, N. Mcsweeney, D. Murray, O. O'Mahony, B. Walsh, G. Boylan:** Postnatal epilepsy following EEG confirmed neonatal seizures
- 579 Ruta Navardauskaite, Daiva Borkiene, Kristina Ilgudaite, Egle Ramanauskiene, Lina Jankauskaite:** Clinical case coordinator: Improving health care service for rare disease pediatric patients
- 582 A. Ghiță-Blujdescu, A.E. Băetu, A. Damașcan, C. Tănase, R. Florin, E. Ștefan:** Correlation between novel biomarkers and pocus derived CI and SVRI
- 584 H. Goldenberg, T. Wells, S. Gillen, B. Sharon:** Pediatric long covid

- 587 M. Vestager, G. Greisen, M. Lühr Hansen:** Alternative consent methods used in the SafeBoosC-III trial
- 589 J. Gould, M. Makrides, T. Sullivan, P. Anderson, A. Mcphee, R. Gibson, M. Sharp, J. Cheong, G. Opie, J. Travadi, P. Davis, J. Bednarz, L. Doyle, K. Simmer, C. Collins:** IQ AT 5-Years' corrected age: A follow-up of the N3RO randomised controlled trial of docosahexaenoic acid in preterm infants born
- 591 N. Meesters, T. Dilles, J. Van Rosmalen, G. Van Den Bosch, S. Simons, M. Van Dijk:** Comfortneo scale: A reliable and valid instrument to measure prolonged pain in neonates?
- 593 N. Samonenko, O. Okhotnikova, N. Gorovenko:** Experience of conducting specific treatment for patients with lysosomal storage diseases in Ukraine during hostilities
- 595 D. Pereira, E. Loftus, J. Hughes, A.A. Monavari, E. Treacy, I. Borovickova, J. Brady, P. Mayne, E. Crushell, I. Knerr:** Paediatric medical and developmental outcomes after 50 years of newborn screening for classical galactosaemia in Ireland
- 597 C. Guivarch, C. Dubel-Jam, A. Cissé, A. Camier, M.-A. Charles, B. Heude, B. De Lauzon-Guillain:** Moderating effect of early feeding practices in the association between child's genetic susceptibility to obesity and growth
- 599 R. Flint, N. Yalcin, S. Simons, K. Allegaert:** The effects of pharmacogenetics on pharmacokinetics and pharmacodynamics in infants: A systematic literature review
- 601 B. Suriñach Ayats, J.M. Valle-T.Figueras, E. Turon-Viñas, A. Devolder-Nicolau, E. Coca-Fernandez, S. Brió-Sanagustin, S. Boronat-Guerrero:** Encephalitis in children in a tertiary spanish hospital. Etiology, clinical presentation and neurological outcomes

- 603 A. De Silvestro, S. Chin On, J. Sieker, B. Reich, W. Knirsch, J. Nijman:** Challenges in treatment of congenital heart disease in preterm and low birthweight neonates – Results of the European association brain in congenital heart disease (EUR-ABC)
- 605 A. Pociute, G. Laucaitytė, M. Farook, A. Dagys, L. Jankauskaitė:** Biomarkers NAP-2 and P-selectin potential in an early diagnosis of severe bacterial infection in pediatric emergency
- 607 C. Tan, C. Vermont, U. Von Both, E. Carrol, M. Emonts, M. Van Der Flier, R. De Groot, J. Herberg, B. Kohlmaier, M. Levin, E. Lim, I. Maconochie, F. Martinon-Torres, R. Nijman, M. Pokorn, I. Rivero-Calle, M. Tsolia, W. Zenz, D. Zavadska, H. Moll:** Insight in febrile children attending european emergency departments by emergency medical services: An observational multicenter study
- 609 M. Mila, A. Zampetoglou, V. Askiti, M. Kourkounakis, A. Kourkounakis:** Review of nutcracker syndrom in children
- 611 K. Goeral, R. Fuiko, M. Olischar, K. Klebermass-Schrehof, A. Berger, G. Kasprian:** MRI-Based prognostication in preterm neonates with intraventricular hemorrhage
- 614 Z. Vesoulis, S. Trivedi, H. Morris, R. Mckinstry, Y. Li, A. Mathur, Y. Wu:** Deep learning to optimize MRI prediction of motor outcomes after HIE
- 617 E. Szakmár, C. Andorka, T. Seszták, E. Varga, M. Szabó, Á. Jermendy:** Comparative evaluation of MRI scoring systems predicting neurodevelopmental outcomes in infants with hypoxic ischemic encephalopathy
- 619 A. Meiere, L. Smane, A. Kivite-Urtane, L. Kļaviņa, I. Račko, I. Roģe, J. Pavare:** Online survey to identify long COVID symptom profile in paediatric patients

- 621 J. Isaza-Correa, L. Kelly, L. Ryan, J. Allen, J. Jones, D. Huggard, E. Ryan, B. Freyne, C. O Mhaoldhomnaigh, S. Geoghehan, P. Gavin, T.R. Leahy, K. Butler, E. Molloy:** Children with multisystem inflammatory syndrome (MISC): Endotoxin tolerant immunophenotype
- 623 W.Y.E. Chia, L. Tume:** How long are we fasting children for extubation?
- 625 B. Gelbart, B. Mcsharry, C. Delzoppo, S. Erickson, K. Lee, W. Butt, M. Rea, X. Wang, J. Beca, A. Kazemi, F. Shann:** Pragmatic randomised trial of corticosteroids and inhaled adrenaline for bronchiolitis in children in intensive care (DAB Trial)
- 627 K.R. Thekkan, G. Bottari, C. Cecchetti, E. Tiozzo, O. Gawronski:** Cold debriefing implementation for in-hospital paediatric cardiac arrests: Quality improvement project
- 629 G. Podadera Bravo, F. Guerrero Del Cueto, A. Lendínez Jurado, J. Blasco-Alonso, R. Gil Gómez, J.M. Camacho Alonso:** Prognostic factors on the clinical evolution of children with immersion accidents admitted to a paediatric intensive care unit
- 631 A. Noone, K. Dowling, E. Ahern, D. O'Boyle, B. Hammer Bech, T. Brink Henriken, L. Gallagher, A. Khashan, D. Murray, J. English:** Predictive biomarkers for autism spectrum disorder: A proteomics profiling study in the cork baseline birth cohort
- 633 A. Gallagher, J. Lyons, U. Murtagh:** Autism friendly phlebotomy
- 635 G. Maneenil, K. Chuaikaew, A. Thatrimontrichai:** Survival of infants with persistent pulmonary hypertension of the newborn: 12-year experience

- 637 M. Romijn, A. Van Kaam, D. Fenn, L. Bos, C. Van Den Akker, J. Cerullo, P. Brinkman, W. Onland:** Exhaled volatile organic compounds for the detection of bronchopulmonary dysplasia in preterm infants
- 640 J. Meneses, A. Ishigami, J. Alves:** NIPPV as a rescue therapy for preterm infants with RDS who fail initial NCPAP
- 643 K. Saelim:** The accuracy of initial assessment score for mortality prediction in pediatric septic shock
- 645 L. Morin, M. Hall, D. De Souza, L. Guoping, R. Jabornisky, N. Shime, S. Ranjit, P. Giholm, J. Zimmerman, L. Sorce, A. Argent, N. Kissoon, P. Tissieres, S. Watson, L. Schlapbach:** The current and future state of pediatric sepsis definitions: An international survey
- 647 G. Sefton, E. Carrol, B. Carter, S. Lane, F. Mehta, C. Eyton-Chong, S. Siner, D. Jones, C. Lambert, L. Evans:** In-Patient emergency transfer to critical care; critical deterioration event (CDE) metric and Children's Resuscitation Intensity Scale (CRIS) for predicting Length of Stay (LOS) and mortality
- 650 M. Soeteman, T. Kappen, M. Van Engelen, M. Marcelis, E. Kilsdonk, M. Van Den Heuvel-Eibrink, E. Nieuwenhuis, W. Tissing, M. Fiocco, R. Wösten – Van Asperen:** Validation of a modified bedside pediatric early warning system score for detection of clinical deterioration in hospitalized pediatric oncology patients: A prospective cohort study
- 653 J. Rørbech, C.S. Jensen, P. Dreyer, S. Herholdt-Lomholdt:** Beyond objective measurements: Nurses' identification of hospitalised pediatric patients at risk of clinical deterioration: A qualitative study

- 655 A. Österroos, L. Lindström, P. Wikman, A. Forslund, A.-K. Wikström, I. Sundström Poromaa, F. Ahlsson:** Maternal BMI and gestational weight gain and early childhood growth trajectories
- 657 T. Fuschlberger, E. Leitz, G. Esser, F. Voigt, R. Schmid, V. Mall, A. Friedmann:** Early childhood development over time - An example of the importance of regularly reviewing milestones and developmental patterns
- 659 M. Andersen, B. Smith, M. Murra, S. Nielsen, H.-C. Slotved, T. Henriksen:** Strains of group B streptococcus (*Streptococcus agalactiae*) and their clinical course in early and late onset infant disease
- 661 J.N. Larsen, H. Hansson, S. Beck, V. Zoffmann:** Single-family rooms in a neonatal intensive care unit: A thematic analysis of experiences from parents and nurses
- 663 B. Geven, J. Maaskant, J. Woensel, S. Verbruggen, E. Ista:** Barriers and facilitators of early mobilization programs in dutch pediatric intensive care units
- 665 E. Ista, C. Traube, M. De Neef, J. Schieveld, H. Knoester, M. Molag, S. Kudchadkar, J. Strik:** Risk factors for delirium in children: A systematic review and meta-analysis
- 667 A. Van Der Geest, J. Hordijk, S. Verbruggen, I. Vanhorebeek, F. Guiza, P. Wouters, G. Van Den Berghe, K. Joosten, K. Dulfer:** Predictors for health-related quality of life in critically ill children and their parents 4-years after pediatric intensive care admission
- 669 R. Bosch, T. Alderliesten, M. Lenderink, K. Van Loon, J. Nijman:** Near infrared spectroscopy in congenital heart disease: A systematic review of associations with neurodevelopmental, renal and gastro-intestinal outcomes

- 672 T. Holm-Weber, S. Mohanakumar, L. Thorup, M. Christensen, V. Hjortdal:** Octreotide stimulates lymphatic activity in vitro but not in vivo a cross over study
- 675 J. Maspero, M. Antila, N. Jain, A. Deschildre, L. Bacharier, A. Altincatal, E. Laws, B. Akinlade, S. Siddiqui, J. Jacob-Nara, Y. Deniz, P. Rowe, D. Lederer, M. Hardin:** Dupilumab reduced exacerbations and improved lung function and asthma control in children with uncontrolled, moderate-to-severe asthma and baseline high/medium Inhaled corticosteroid (ICS) Dose
- 679 T. Guilbert, L. Bacharier, A. Deschildre, W. Phipatanakul, A. Altincatal, L. Mannent, E. Laws, B. Akinlade, R. Gall, J. Jacob-Nara, Y. Deniz, P. Rowe, D. Lederer, M. Hardin:** Improved lung function with Dupilumab vs placebo in children with uncontrolled, moderate-to-severe asthma and elevated type 2 biomarkers
- 682 F. Haslbeck, K. Müller, T. Karen, J. Meerpohl, J. Loewy, D. Bassler:** Musical and vocal interventions to improve neurodevelopmental outcomes for preterm infants: A cochrane intervention review
- 684 K. Ormston, J. Latour, S. Mitra, K. Gallagher:** The impact of music therapy on infants with perinatal brain injury and their caregivers: A systematic review
- 686 F. Haslbeck, L. Schmidli, M. Adams, H.U. Bucher, G. Natalucci, D. Bassler:** Creative music therapy and long-term neurodevelopmental outcomes in preterm infants at age two and five years: Results of a controlled, feasibility trial
- 688 R. Zoodsma, R. Bosch, T. Alderliesten, C. Bollen, T. Kappen, E. Koomen, J. Nijman:** Machine learning for automated discovery of clinical deterioration in paediatric intensive care patients with congenital heart disease: Aberration detection

- 692 E. Koomen, N. Schoeber, J. Nijman, T. Kappen:** Prediction of the patient status in paediatric intensive care patients with congenital heart disease
- 694 A. Amigoni, R. Comoretto, H. Ocagli, F. Izzo, M.C. Mondardini, P. Biban, P. Piastra, G. Lorenzoni, M. Martinato, D. Gregori, A. Wolfler, S.G. Tipnet:** Italian network of pediatric intensive care units (TIPNet) registry: 10 years' experience
- 696 F. Keij, S. Schouwenburg, R. Kornelisse, T. Preijers, F. Mir, P. Degraeuwe, L. Stolk, I. Reiss, K. Allegaert, G. Tramper-Stranders, B. Koch, R. Flint:** Oral and intravenous amoxicillin in neonates: A population pharmacokinetic model
- 698 Y. Wu, S. Voller, D. Roofthoof, D. Tibboel, S. Simons, R. Flint, C. Knibbe:** Birthweight and postnatal age are important predictors for paracetamol clearance in preterm neonates
- 700 T. Hundscheid, W. De Boode, B.T. Study Group:** Expectant management is non-inferior to early pharmacological treatment for patent ductus arteriosus in extreme prematurity
- 702 J. Meena, J. Kumar, J. Yadav:** Incidence, predictors, and outcome of acute kidney injury in children with diabetic ketoacidosis: A systematic review
- 704 E. Christakou, E. Mpourazani, M. Prapa, K. Straka, M. Gianniki, L. Anastasia, S. Konstantakopoulos, C. Tsiagklani, C. Barbaresou:** Ventilator-associated pneumonia in a pediatric intensive care unit: A single centre retrospective study
- 706 M. Ijland, A. Beukman, J. Van Doorn, J. Lemson, J. Doorduyn, L. Heunks:** Evaluation of respiratory muscle echodensity during mechanical ventilation in critically ill children

- 708 N. Mclean, R. Taylor, L. Daniels, J. Haszard, C. Conlon, K. Beck, P. Von Hurst, L. Te Morenga, J. Mcarthur, R. Paul, A. Cox, E. Jones, I. Katiforis, K. Brown, M. Casale, M. Rowan, R. Jupiterwala, A.-L. Heath:** Baby food pouch use among 7-10-month-old infants: The first foods New zealand study
- 710 A. Abou Assi, A. Cissé, J. Bernard, S. Lioret, B. Heude, M.-A. Charles, B. De Lauzon-Guillain:** Infant formula dietary specifications and child growth in the ELFE birth cohort study
- 712 E. Chikova-Iscener, V. Duleva, L. Rangelova, P. Dimitrov:** Comparison of the nutritional status of 7-years-old Bulgarian schoolchildren using two international standards
- 714 A. Chattopadhyay, S. Singla, D. Saikia:** Overlapping spectrum of severe multi inflammatory syndrome amidst endemic tropical infections – A comparative study from a north Indian pediatric intensive care unit
- 717 D. Surmann, N. Rochow, M. Noseworthy, B. Defrance, C. Fusch:** Establishment of a fetal MRI method to measure the body composition for the development of fetal fat mass and fat-free mass trajectories
- 720 M. Izquierdo Renau, E. García González, C. Balcells Esponera, B. Del Rey Hurtado De Mendoza, I. Iglesias Platas:** Very preterm infants at term equivalent age (TEA) show different body composition than term infants at birth
- 723 A. Young, T. Cole, G. Cheng, H. Phan, S. Ennis, R. Beattie, M. Johnson:** Changes in the growth of very preterm infants in England 2006-2018
- 726 G. Regiroli, L. Pezza, R. Centorrino, B. Loi, N. Yousef, R. Ben-Ammar, D. De Luca:** Continuous venous-venous hemo-filtration (CVVH) with carpediem for neonates with multisystem organ failure (MSOF): Our experience

- 729 E. Segers, M. Ketelaar, M. De Man, L. Schoonhoven, E. Van De Putte, A. Van Den Hoogen:** How to support children to express their preferences around small invasive medical procedures: Childrens' and parents' perspectives
- 731 E. Segers, A. Van Den Hoogen, M. De Man, L. Schoonhoven, E. Van De Putte, M. Ketelaar:** How to meet coping strategies and preferences of children around invasive medical procedures: Perspectives of professionals
- 733 P. Van Dommelen, O. Van Dijk, J.A. De Wilde, P.H. Verkerk:** Early detection of Duchenne muscular dystrophy based on developmental milestones
- 735 E. Turon-Viñas, F. Castillo-Gómez, E. Moliner Calderon, E. Carbonell Estarellas, A. Turon-Viñas, L. Armendáriz, N. Rabella, M. Del Cuerpo Casas, S. Boronat-Guerrero:** Enterovirus infection associated neurologic disease in a tertiary hospital in Spain: Clinical characteristics, risk factors and outcomes
- 737 E. Carbonell Estarellas, E. Turon-Viñas, E. Moliner Calderon, F. Castillo-Gómez, L. Armendáriz Lacasa, A. Turón Viñas, M. Del Cuerpo Casas, N. Rabella, S. Boronat-Guerrero:** Enterovirus infection associated neurologic disease in a pediatric population in Spain: Correlation between clinical characteristics and genotyping
- 739 M. Laulhé, C. Dumaine, D. Chevenne, F. Laye, A. Faye, S. Auvin, M. Strullu, J. Viala, J. Hogan, V. Houdouin, J. Léger, D. Simon, J.C. Carel, C. Storey, S. Guilmin-Crepon, L. Martinerie:** Glucocorticoid-induced adrenal insufficiency: Monitoring by morning cortisol values avoids unnecessary LD-SST in children
- 741 F. Pizzo, A. Di Nora, R. Leonardi, L. Licciardello, P. Sciacca, C. Giuseppe:** Evaluation of a Kawasaki disease risk model for predicting coronary artery aneurism in the COVID-19 era in children

- 745 S. Ojha, J. Dorling, E. Mitchell, S. Oddie, M. Johnson, C. Gale:** Implementing two-stage consent pathway in neonatal trials
- 748 D. Odd, S. Stoianova, J. Kurinczuk, T. Williams, G. Rossouw, V. Sleep, P. Fleming, K. Luyt:** The contribution of newborn health to child mortality across England
- 751 H. Haspels, A. De Lange, M. Alsem, K. Joosten, M. De Hoog, C. Van Karnebeek, J. Van Woensel, B. Sandbergen, J. Maaskant:** Optimizing research to improve transitional care for children with complex medical needs: The development of a core outcome set
- 753 A. Hahn, A. Burrell, H. Chaney, I. Sami, A. Koumbourlis, R. Freishtat, K. Crandall, E. Zemanick:** Pathway analysis of beta-lactam pharmacokinetics and antibiotic spectrum on recovery of pulmonary function in persons with cystic fibrosis experiencing pulmonary exacerbation
- 755 N. Beirne, M. Healy:** COVID-19 Related admissions to paediatric intensive care in Ireland
- 757 E. Coca-Fernandez, E. Turon-Viñas, S. Brió-Sanagustin, R.A. Burgueño-Rico, M. Rodríguez- Martínez, E. Carbonell-Estarellas, M. Espinet-Pedrol, L. Dougherty-De Miguel, J.M. Valle-T.Figueras, S. Boronat-Guerrero:** Status epilepticus in COVID
- 759 F. Tirelli, M. Soliani, F. Calabrese, C. Giraud, G. Martini, A. Meneghel, F. Zulian:** Connective tissue nevus misdiagnosed as juvenile localized scleroderma
- 761 M. Louka, M. Valari:** Guttate psoriasis triggered by perianal streptococcal dermatitis: A report of two cases
- 763 M. Nijman, J. Breur, L. Cuijpers, M. Wilmlink, R. Stegeman, J. Nijman, N. Jansen, M. Benders, M. Lequin, N. Claessens:** Perioperative mammillary body injury in congenital heart disease

- 765 A. Remón Pérez:** Plasma biomarkers of brain injury and the relationship with altered neuroimaging in neonates with congenital heart disease undergoing cardiac surgery
- 767 M. Thy, S. Urien, F. Foissac, N. Bouazza, A. Béranger, G. Lui, F. Lesage, S. Renolleau, J.-M. Treluyer, M. Oualha:** Meropenem and piperacillin population pharmacokinetics and dosing regimen optimization in critically ill children receiving continuous renal replacement therapy
- 769 N. De Cacqueray, D. Hirt, Y. Zheng, E. Bille, P.-L. Léger, J. Rambaud, J. Toubiana, A. Chosidow, S. Vimont, D. Callot, L. Chouchana, A. Béranger, J.-M. Treluyer, S. Benaboud, M. Oualha:** Cefepime population pharmacokinetics and dosing regimen optimization in critically ill children with different renal functions
- 771 D. Odd, I. Wolfe, J. Kurinczuk, D. Odd, S. Stoianova, T. Williams, K. Luyt:** Childhood deaths in England, modifiable factors, and social deprivation
- 774 J.A. Neto, A. Lemos, A. Martins, A. Maia, D. Bordalo:** The impact of the pandemic on sports: A school-based study
- 776 L. Bermúdez Barrezueta, M. Pons Ódena, J. Mayordomo Colunga, M. Miñambres Rodríguez, A. Vivanco Allende, Y.M. López Fernández, J. Valencia Ramos, M. Mendizábal Diez, A. Palacios Cuesta, S. Reyes Domínguez, M. García Teresa, J. López González, L. Artacho González, M. Jiménez Villalta, Z. Gorostizaga Gomezz, L. Oviedo Melgares, J.L. Unzueta Roch, M. Rives Ferreiro, S. Fernández Lafever, J. Trastoy Quintela, M. Cuervas-Mons Tejedor, A. Jiménez Olmos, I. Gil Hernández, S. Gutiérrez Marqués, E. González Salas, A. Pino Vázquez:** Discomfort and sedatives use during non-invasive ventilation in children with acute respiratory failure

- 779 M. Vedrenne-Cloquet, S. Khirani, L. Griffon, C. Collignon, S. Renolleau, B. Fauroux:** Work of breathing during noninvasive ventilation in severe acute bronchiolitis
- 782 N. Maas-Van Schaaijk, T. Dijk, M. Benthum, A. Van Zwol:** Long-term morbidity of paediatric intensive care unit admission for bronchiolitis
- 784 S. Shanmugavadivel, J.-F. Liu, D. Buonsenso, T. Davis, D. Roland:** Assessing healthcare professionals' identification of paediatric dermatological conditions in darker skin tones
- 787 G. Sashidharan:** Challenges in caring for a neonate with rare congenital skin condition: A NICU experience
- 791 M.A. Ryan, S. Mathieson, V. Livingstone, E. Dempsey, G. Boylan:** Developmental outcome of a healthy moderate to late preterm infant group versus a term born infant group
- 794 T. Desplanches, J. Fresson, J. Zeitlin:** Cause of neonatal death after moderate and late preterm birth by level of care of the delivery hospital in france
- 796 D. Pfurtscheller, B.C. Schwabegger, N. Höller, G. Pichler, C. Wolfsberger, L. Mileder, B. Urlesberger:** Correlation between arterial blood pressure and regional cerebral oxygen saturation in moderate and late preterm neonates during transition
- 798 A. Flynn, R. Finnegan, N. Allen, S.A. Lynch, A. Lyons, K. Gorman:** Founder mutation in otog causing non-syndromic sensorineural hearing loss in irish traveller families
- 800 L. Ruiz-Guzman, N. Rodriguez-Bailon, M.M. Escudero-Hernández, M. Hernández-Ortega, M. Matilla-Munt, L. Rubira-Felices, A. Leiva-Prieto:** Benefits of a tongue tie unit in paediatric primary health care service

- 802 T. Nordvik, E. Schumacher, A. Server, A. Pripp, P. Larsson, G. Løhaugen, T. Stiris:** Relationship between term equivalent age mri, early postnatal eeg and neurocognitive outcomes in preterm children
- 804 S. Somanadhan, H. Mcaneney, L. Pelentsov, A. Sweeney, A. Awan, T. Kroll, S. McNulty:** Measuring the supportive care needs of parents of children with a range of rare diseases in Ireland
- 806 H. Mcaneney, C. Davies, A. De Brun, D. Sheppard-Lemoine, R. Nuggehalli Krishna, S. Somanadhan:** Interventions that mitigate psychosocial risk children face in a pandemic: A rapid realist review
- 808 T. Colaizy, A. Das, B. Poindexter, B. Vohr, E. Bell, K. Kennedy, W. Carlo, M. Walsh:** Toddler-age neurodevelopmental outcomes of elbw infants fed pasteurized donor human milk or preterm infant formula, a randomized clinical trial
- 810 Eyal Elron, Shai Haimi-Cohen, Lital Oz Alcalay, Lama Chagla, Shay Ehrlich, Adi Ziv, Amir Erps, Rotem Tal, Gabriel Chodick, Liat Ashkenazi-Hoffnung:** Risk factors for malignancy in subacute or chronic cranio-cervical lymphadenopathy in children
- 813 A. Tessari, F. Sperotto, F. Pece, G. Pettenuzzo, N. Porcellato, E. Poletto, M.C. Mondardini, A. Pettenazzo, M. Daverio, A. Amigoni:** Efficacy and safety of continuous infusion of ketamine as an adjuvant for sedation in the PICU: Results from the ketamine infusion sedation study (kiss)
- 816 A.E. Băetu, A. Ghiță-Blujdescu, A. Damașcan, C. Tănase, R. Florin, E. Ștefan:** Prediction of sepsis progression in septic shock in pediatric intensive care unit - A machine learning perspective

- 819 R. Pang, C. Meehan, G. Norris, A. Avdic-Belltheus, A. Mintoft, M. Sokolska, F. Torrealdea, A. Bainbridge, K. Martinello, X. Golay, N. Robertson:** Melatonin reduces white matter injury in the inflammation-amplified hypoxia-ischaemia newborn piglet model of neonatal encephalopathy
- 822 S. Owen, J. Menzies, S. Pontefract:** Medication interruptions and behaviour management strategies on paediatric intensive care unit (PICU): An observational study
- 826 C.M. Moore, A. D'Amore, S. Fustolo-Gunnink, C. Hudson, A. Newton, B. Lopez-Santamaria, A. Deary, R. Hodge, V. Hopkins, A. Mora, C. Llewelyn, V. Venkatesh, R. Khan, K. Willoughby, W. Onland, K. Fijnvandraat, H. New, P. Clarke, E. Lopriore, T. Watts, S. Stanworth, A. Curley:** Higher prophylactic platelet transfusion thresholds in preterm infants are associated with increased adverse outcomes at two years corrected age
- 828 S. Kurul, N. Van Ackeren, T. Goos, C. Ramakers, J. Been, R. Kornelisse, I. Reiss, S. Simons, H.R. Taal:** Introducing heart rate variability monitoring combined with biomarker screening into a level iv nicu: A prospective implementation study
- 831 F. Keij, R. Kornelisse, N. Hartwig, K. Allegaert, I. Reiss, G. Tramper-Stranders:** Efficacy and safety of intravenous-to-oral switch therapy in neonates with a probable bacterial infection: Rain study
- 833 T.C. Kwok, N. Batey, K.L. Luu, A. Prayle, D. Sharkey:** Systematic review, meta-analysis and external validation of prediction models of bronchopulmonary dysplasia in very premature infants

- 836 S. Arthur Rhedin, C. Lundholm, A. Horne, A. Smew, E. Caffrey Osvald, A. Haddadi, T. Alfvén, R. Kahn, P. Król, T.S.P.M.-C. Consortium, B. Brew, C. Almqvist:** Risk factors for multisystem inflammatory syndrome in children – A population-based cohort study
- 838 L. Löfberg, O. Stephansson, N. Razaz, L. Hellström-Westas, E. Olhager, A. Farooqi, F. Serenius, T. Abrahamsso:** Among extremely preterm infants, postnatal betamethasone treatment during the neonatal period is associated with increased risk of neurodevelopment impairment at 6.5 years of age
- 840 M. Gsöllpointner, F. Eibensteiner, M. Thanhaeuser, B. Jilma, R. Ristl, A. Berger, N. Haiden:** Iron intake during the first year of life in preterm infants on early solid foods: A secondary analysis of a prospective, randomized two-arm intervention study
- 844 S. Mehra, B. Shah, A. Sethi, R. Puri, S. Nimbalkar:** Down syndrome detection through graphical analysis of facial dysmorphic features in newborn children with ethnicity/ racial slicing: - An AI/ML-based approach
- 846 C.S. Jensen, M. Lisby, H. Kirkegaard, M. Ingerslev:** Signs and symptoms, apart from vital signs, that trigger nurses' concerns about deteriorating conditions in hospitalized pediatric patients: A scoping review
- 848 M. Filippa, M. Nardelli, E. Della Casa, A. Berardi, O. Picciolini, S. Meloni, C. Lunardi, A. Cecchi, A. Sansavini, L. Corvaglia, E. Scilingo, F. Ferrari:** Early vocal contact impacts on preterm infants' vagal activity during hospitalization
- 850 A. Schuermans, T. Den Harink, B. Raman, R. Smillie, M. Alsharqi, A. Mohamed, W. Lapidaire, A. Van Deutekom, P. Leeson, A. Lewandowski:** Significant and differing impact of preterm birth on the right and left atria in adulthood

- 852 L. Zhou, T. Yawno, A. Sutherland, Y. Pham, S. Miller, C. McDonald:** Combined human umbilical cord blood-derived mononuclear cells and cord-tissue derived mesenchymal stem cells for inflammation-Induced preterm brain injury
- 854 H. Kvanta, N. Padilla, U. Aden:** Low grade IVH and PDA ligation were related to altered regional brain volumes at school age in a cohort of extremely preterm children
- 856 V. Siffredi, M.C. Liverani, D. Van De Ville, L. Freitas, C. Borradori Tolsa, P. Hüppi, R. Hà-Vinh Leuchter:** Mindfulness-based intervention in preterm young adolescents: Benefits on neurobehavioural functioning and its association with white-matter microstructural changes
- 858 A. Holmgren, A. Niklasson, L. Gelander, A. Nierop, K. Albertsson-Wikland:** A novel pubertal height reference aligned for the individual variation in the timing of pubertal growth
- 861 K. Dowling, D. O'Boyle, L. Gallagher, A. Khashan, B. Hammer Bech, T. Henriksen, D. Murray, J. English:** Discovery metabolomics of cord blood for biomarker discovery: A study in the danish national birth cohort
- 863 E. Orhan, D. Gozen:** The effect of virtual reality on pain experienced by school-age children during venipuncture: Randomized controlled study
- 865 S. Bele, M. Santana:** Integrating pediatric patient-reported outcomes and experience measures in Canada's largest province-wide, fully integrated health system
- 867 L. Siderius, L. Kyeremateng, R. Braamburg:** Global mother – Child data sets to unlock digital records
- 869 C. Wild, N. Rawiri, K. Taiapa, Y. Anderson:** Data as power: The rights of children and their families in health data sharing and linkage

- 871 F. Garcia Marin, P.J. Català Robert, A. Muñoz Avila, M.A. Motta Calderon, B. Ochoa Fernández, M. Rahal Khouri, M.J. Lopez Pérez, L. Palomo Alameda, E. García Menor, M.J. De Ibarrondo Guerrica-Echevarría, S.A. Fernández Cebrián, E. Garcia Aguilar, F.J. Hidalgo Bermejo, C. Nieto Magro:** Benefits of a new liquid formulation of a multistrain synbiotic in infants with acute diarrhea of probable viral origin
- 874 H. Zhang, K. Harvey-Jones, V. Verma, F. Lange, I. Tachtsidis, S. Mitra:** Complexity of broadband near infrared spectroscopy signals in term newborn infants relates to outcome following neonatal encephalopathy
- 877 N. Labusek, Y. Mouloud, C. Köster, V. Börger, U. Felderhoff-Müser, I. Bendix, B. Giebel, J. Herz:** Therapeutic efficacy of extracellular vesicles derived from immortalized and clonally expanded mesenchymal stromal cells in neonatal hypoxic-ischemic brain injury
- 879 T. Nguyen, E. Purcell, M. Smith, L. Zhou, G. Jenkin, S. Miller, C. McDonald, A. Malhotra:** Umbilical cord blood-derived cell therapy for perinatal brain injury: A systematic review & meta-analysis of preclinical studies
- 881 A. Morgan, L. Marchand-Martin, S. Twilhaar, C. Diguisto, L. Foix L'Hélias, F. Goffinet, M. Kaminski, G. Bréart, X. Durrmeyer, B. Khoshnood, J. Zeitlin, P.Y. Ancel:** Intensity of perinatal care for extremely preterm births and neurodevelopmental outcomes at 5.5 years of age: Evidence from the epipage-2 cohort study
- 883 D. Elalfy, R. Fahiem:** Thinking out of the box: Relation between inflammatory blood ratios and severity of attention deficit hyperactivity disorder (ADHD)

- 885 M.-D. Ginga, D. Toader, A. Maris, L. Bodea, M. Militaru, B. Lucian, M. Andrei, S. Cainap:** The challenges of MIS-C: A case report series of pediatric patients presenting with cardiac symptoms
- 887 C. Okelly, C. Cronin, H. Keohane, L. Flores Villarta, J. Trujillo Wurttele:** Telemedicine as an educational tool for caregivers regarding auto-injectors and anaphylaxis management (TEAAM): A helping hand moving forward
- 890 J. Allen, J. Isaza-Correa, L. Kelly, A. Melo, A. Mahony, D. McDonald, E. Molloy:** Lymphocyte, neutrophil and monocyte function and cytokine responses in children with severe neurological impairment: Effect of lipopolysaccharide
- 892 V. Herdea, R. Ghionaru, P. Tarciuc, E. Costiug, L. Barbacariu, C. Pop, L. Comnea, I. Brinza, C.C. Mirauta, E. Egri, C. Lanba, S. Rus, S. Cioc, D. Herdea, E. Leibovitz, S. Diaconescu:** From measles epidemic to SARS COV-2 pandemic- vaccine coverage analysis for romanian children under 1 year of age- what's next?
- 894 Helen Brotherton, Abdou Gai, Bunja Kebbeh, Yusupha Njie, Georgia Walker, Abdul K Muhammad, Saffiatou Darboe, Mamadou Jallow, Buntung Ceesay, Ahmadou Lamin Samateh, Cally J Tann, Simon Cousens, Anna Roca, Joy E Lawn:** Impact of early kangaroo mother care versus standard care on survival of mild-moderately unstable neonates
- 897 R. Pang, C. Meehan, G. Norris, A. Avdic-Belltheus, A. Mintoft, M. Sokolska, F. Torrealdea, A. Bainbridge, X. Golay, J. Barks, N. Robertson:** Azithromycin reduces injury following inflammation-amplified hypoxia-ischaemia in the piglet model: A repurposed therapy for Imics?
- 900 T. Burke, G. Bou Saba, A. Taylor, H. Wadhwa, E. Ng, M. Dundek, K. Opondo, D. Garcia, N. Roodaki, R. Moshiro, M. Mkonyi:** Feasibility of a novel ultra-low-cost bubble cpap system for global access to quality noninvasive neonatal respiratory support

- 902 A.K. Møller Nielsen, V. Hjortdal, L.A. Larsen:** Atrial septal defects, arrhythmias and a novel TBX5 gene variant
- 904 P. Parekh, N. Mediratta:** Preparing for the unexpected; introducing paediatric cardiac arrest huddles in accident and emergency
- 906 N. Freudenthal, N. Müller:** Urinary NT-proBNP values in paediatric congenital heart disease
- 908 M. Thy, J. Naudin, M. Genuini, S. Leteurtre, M. Oualha:** Anti-infective prescription practices in children undergoing renal replacement therapy: A multicenter survey
- 910 A. Little, J. Menzies, B. Scholefield, H. Child, N. Milburn:** Early rehabilitation and mobilisation (ERM) discussion and planning: A four year audit of PICU ward rounds
- 913 F.I. Esenay, Z. Yurdakul:** Development of the assessment scale for oral feeding readiness -(ASPOFR)
- 915 N. Mitra, T. Austin:** Towards a stratified approach to the diagnosis of neonatal seizures: Combining electroencephalography (EEG), magnetic resonance imaging (MRI) and rapid whole genomic sequencing (WGS)
- 918 L. Marchetto, L. Zanetto, D. Padrin, R. Comoretto, A. Amigoni, M. Daverio:** Outcomes of pediatric fluid-refractory septic shock according to different inotropic or vasoactive strategies: A systematic review and meta-analysis
- 921 A. Holmgren, S. Nejat, S. Edvinsson Sollander, N. Durbeej, A. Fäldt:** Overweight and obesity increased among swedish pre-school children during the COVID-19 pandemic
- 923 H. Bakker, S. Cochius-Den Otter, J. Mulder:** Treatment of hypertensive crisis in children: Nitroprusside vs. Nidcardipine

- 925 M.A. Garcia De Avila, V. Martins, J. Francisco, J. Bastoni Da Silva, J. Bertho, G. Silva, S. Nilsson:** Construction and validation of the 2D digital brazilian version of the children`s anxiety questionnaire
- 928 N. Decembrino, F. D'Amico, E. Muratore, S. Turrone, P. Muggeo, R. Mura, K. Perruccio, V. Vitale, S. Recupero, M. Zecca, A. Prete, F. Venturelli, D. Leardini, P. Brigidi, R. Masetti, S. Cesaro, D. Zama:** Oral lactoferrin supplementation reduces gut microbiome dysbiosis in pediatric oncohaematologic patients during induction chemotherapy
- 930 V.A.A. Beunders, M.E. Koopman-Verhoeff, M. Vermeulen, P.W. Jansen, A.I. Luik, I.P.M. Derks, I. Reiss, K. Joosten, V. Jaddoe:** Sleep, 24-hour activity rhythms and cardiometabolic risk factors in school-age children
- 932 K. Gallagher, R. Hayes-Worthington, J. Meek, N. Marlow, K. Chant:** Parental experiences of webcam use in neonatal care: A qualitative study
- 934 C. Schwarz, M. O'Sullivan, M. O'Sullivan, K. Kreutzer, L. Langanky, C. Maiwald, C. Poets, A. Franz:** Deviation of two pulse oximeters in preterm infants – Post-hoc analysis of an prospective randomized cross-over study on automatic oxygen control
- 936 O.A. Koyu, Y.E. Bulut, H.H. Bağcı, G. Barlas:** Examining the factors influencing childhood obesity: What has changed during the pandemic?
- 938 P. Catalano, J. Walker:** Minimally invasive nasal airway surgery can reduce adhd in children with sleep disordered breathing
- 940 A. Bilgin, K. Heinonen, N. Baumann, D. Wolke, K. Räikkönen:** Early childhood regulatory problems and diurnal salivary cortisol in young adulthood

- 942 F.I. Esenay, Ü. Erdem:** Determining the most common nursing diagnoses in children with MIS-C
- 944 C. Stein-Zamir, N. Abramson, H. Shoob:** The childhood vaccination programme attainment during the COVID-19 global pandemic
- 947 P.B. Nielsen, H. Olesen, C.S. Jensen:** Parent experiences when their child is diagnosed with cystic fibrosis in the newborn screening program
- 949 L. Butragueño-Laiseca, S. De La Mata, S. Fernández Lafever, S. Mencía, J. Del Castillo, J. López González, R. González Cortés, J. Urbano, M. Santiago Lozano:** Red blood cells transfusion rate reduction after implementing a transfusion score in a pediatric intensive care unit
- 951 J. Miller, A. Dewar, A. Wignell, P. Davies:** The effect of paediatric acute potassium chloride corrections on serum potassium concentration
- 953 J. Svedenkrans, M. Wilander, O. Andersson:** Cord clamping time and jaundice requiring phototherapy – Time to reconsider the risk?
- 955 N. Höller, C. Wolfsberger, E. Prethaler, G. Pichler, B. Urlesberger:** Feasibility and impact of physiological based cord clamping (PBCC) on very low birth weight infants during the first 72 hours after birth
- 957 S. Mukhopadhyay:** Magnesium in severe pneumonia and association with clinical severity (using press and modified piro scoring system) and adverse outcomes
- 961 X. Wang, E. De Groot, M. Tataranno, A. Van Baar, F. Lammertink, M. Benders, J. Dudink:** Active sleep as an early predictor of structural brain development in extremely and very preterm infants

- 964 S. Montazeri Moghadam, P. Nevalainen, N. Stevenson, S. Vanhatalo:** Sleep state trend: An automated measure for aeg monitors in the newborn
- 966 M.A. Ryan, S. Mathieson, V. Livingstone, E. Dempsey, G. Boylan:** Sleep state organisation of moderate to late preterm infants in the neonatal unit
- 970 T. Lesar, M. Tomić, A. Cvitković Roić, A. Vrtarić, N. Nikolac Gabaj, S. Čimić, S. Kraljević Šimunković:** Blood test abnormalities in patients with eating disorders
- 972 S. Brió-Sanagustin, G.M. Fraga-Rodríguez, E. Coca-Fernandez, M. Rodríguez- Martínez, F. Castillo-Gómez, R.A. Burgueño-Rico, L. García-Marzo, E. Turon-Viñas, A. Devolder-Nicolau, S. Boronat-Guerrero:** Acute kidney injury in allogenic hematopoietic stem cell transplantation in the PICU
- 974 K. Piatek, J. Taulu, V. Parikka, L. Lehtonen, H. Soukka:** Edi signal as a diagnostic and monitoring tool in apnea of prematurity
- 977 V. Gaertner, A. Waldmann, P. Davis, D. Bassler, L. Springer, D. Tingay, C. Rüegger:** Lung volume changes during apneas in preterm infants on non-invasive respiratory support
- 979 L. Borenstein-Levin, A. Haj, A. Riskin, O. Hochwald, A. Kugelman:** Oxygenation instability during tube feeding among premature infants supported with non-invasive ventilation
- 981 O. Almossawi, A. Friend, L. Palla, R. Feltbower, S. Sardo-Infiri, S. O'Brien, K. Harron, S. Nadel, B. De Stavola:** Is there a sex difference in mortality rates in paediatric intensive care units: A systematic review
- 984 E. Shaw, N. Davis, C. Dorsett, H. Rhodes:** Working together for children and their families: A multidisciplinary approach towards withdrawal of life-sustaining treatment within the paediatric critical care unit (PCCU)

- 986 N. Donisanu Peñaranda, E. Herrera Hidalgo, O. Moyano Leiva, D. Navarro Molina, J.M. Camacho Alonso:** Traumatic brain injury (TBI) in a Pediatric Intensive Care Unit (PICU): Epidemiology and predicting risk factors for poor outcome
- 988 S. Sharma, S. Bhosle, A. Kulkarni, C. Dhamne:** Review of mortality in immunocompromised children due to septic shock associated with multi-drug resistant organisms: Case series
- 990 Y. Miyahara, M. Kono, S. Miura, A. Kawaguchi:** The effectiveness and safety of various methods of post-pyloric feeding tube placement and verification in infants and children
- 992 O. Almossawi:** Mortality in picu and its apparent association with sex
- 994 F. Babl, D. Herd, M. Borland, A. Kochar, B. Lawton, J. Hort, A. West, S. George, M. Zhang, K. Velusamy, F. Sullivan, E. Oakley, A. Davidson, S. Hopper, J. Cheek, R. Berkowitz, S. Hearps, C. Wilson, A. Williams, H. Elborough, D. Legge, M. Mackay, K. Lee, S. Dalziel:** Prednisolone for bell's palsy in children: A randomised, double-blind, placebo-controlled, multicentre trial
- 996 S. Sethi, S. Jangra, V. Ashok, J. Ram, V. Saini:** Efficacy of intranasal atomized dexmedetomidine versus oral melatonin in prevention of emergence delirium in children undergoing ophthalmic surgery with sevoflurane – A randomised double-blind study
- 998 T.C. Kwok, L. Szatkowski, D. Sharkey:** Impact of timing of commencing postnatal dexamethasone on respiratory outcomes in very premature infants – A population-based cohort study and propensity score weighting analysis

1001 Short Oral Abstracts**1002 S. Cochius-Den Otter, M. Honkoop, L. Van Den Berg, A. Ville, N. Hunfeld, J.-C. Diehl, U. Kraemer, S. Verbruggen:**

Going green: Waste collection and analyses in pediatric intensive care

1004 C. Magner, K. Hore, M. Tan: Cybersecurity awareness, cyberattacks and critical care staff**1006 F. Tran Mau-Them, A.-S. Denommé-Pichon, H. Safraou, A. Vitobello, A. Ziegler, M. Jeanne, Y. Duffourd, E. Tisserant, P. Garret, V. Couturier, V. Bourgeois, C. Poe, C. Racine, A. Garde, J. Delanne, S. Nambot, R. Olaso, J.-F. Deleuze, A. Boland, B. Fin, A.-L. Bruel, S. Moutton, M. Gorce, M. Barth, L. Pasquier, M. Nizon, M. Vincent, M. Fradin, A. Lavillaureix, C. Quelin, Y. Capri, J. Van-Gils, T. Busa, B. Isidor, A. Toutain, D. Bonneau, S. Sigaudy, P. Callier, A. Sorlin, L. Faivre, C. Philippe, C. Thauvin:** Fastgen, the French national implementation of centralized and outsourced trio genome sequencing in neonatal or pediatric intensive care units: an affordable strategy for all**1008 K. Kumar, A. Plunkett:** Carbon footprint of travel to work survey**1010 Z. Rahmaty, J. Manning, M.-H. Perez, A.-S. Ramelet:** Conceptualizing post intensive care syndrome in pediatric survivors and their families with the lens of bioecological theory of human development**1012 A. Jousse, V. Zupan Simunek, V. Sartorius, N. Yousef:** Post-NICU follow-up. should we be assessing the long term psychological impact in parents?

- 1014 B. Geven, E. Ista, J. Van Woensel, F. Van Etten - Jamaludin, S. Verbruggen, J. Maaskant:** The first step in the development of a core outcome set for early mobilization trials in critically ill children: A systematic review
- 1016 A. Almutairi, A. Gavine, A. Mcfadden:** A focused ethnographic study on kangaroo care of preterm infants in Saudi Arabia
- 1018 S. Shaw, M. Mahgoub, C. Chamberlain-Parr, R. Ellis, L. Tume:** Long stay patients on paediatric intensive care unit (PICU): Defining the problem
- 1020 A. Sellmer, V. Hjortdal, B. Hammer Bech, T. Brink Henriken:** Cardiovascular biomarkers are associated with morbidity and mortality in very preterm neonates: A cohort study
- 1022 J. Meena, C. Thomas, J. Kumar:** Diagnostic performance of biomarkers in childhood acute kidney injury: A meta-analysis
- 1024 F. Lammertink, M. Benders, E. Hermans, M. Tataranno, J. Dudink, C. Vinkers, M. Van Den Heuvel:** The role of preterm birth and postnatal stress in neonatal structural brain development
- 1026 N. Padilla, A. Escrichs, H. Kvanta, H. Lagercrantz, M. Kringelbach, G. Deco, U. Aden:** Neonatal clinical complications lead to immature patterns of brain dynamics
- 1028 T. Muehlbacher, R. Schaefer, C. Buss, C. Bühler, T. Schmitz:** Watch it grow: High-resolution ultrasound of the preterm cerebellum in serial transnuchal scans
- 1030 C. Stephens, D. O'Boyle, B. Walsh, G. Boylan, D. Murray:** The use of a machine learning algorithm in the early prediction of hypoxic ischaemic encephalopathy in infants

- 1034 T. Lehtonen, E. Vesti, L. Haataja, A. Nyman, K. Uusitalo, M. Leinonen, S. Setänen:** Peripapillary retinal nerve fiber layer thickness and macular ganglion cell layer volume in association with motor and cognitive outcomes in 11-year-old children born very preterm
- 1036 L. Williams, A. Sherif, E. Reynolds, A. Regan, M. Cardenas, S. Nath:** Safety of non-invasive respiratory support on the paediatric wards: A single centre experience
- 1038 A. Pavel, J. O'Toole, S. Mathieson, E. Dempsey, V. Livingstone, D. Murray, W. Marnane, G. Boylan:** Heart rate variability predicts early electroencephalography grade in infants with hypoxic-ischaemic encephalopathy
- 1041 J. Jaekel, K. Heinonen, N. Baumann, A. Bilgin, R. Pyhala, C. Sorg, K. Räikkönen, D. Wolke:** Crying, sleeping and feeding problems in early childhood and mood disorders and partner support in adulthood
- 1044 P. Parekh, N. Mediratta:** The ripple effect; a regional multilevel teaching innovation introduced via virtual mock examinations
- 1046 A. Alirezaei, S. Dehghani, M. Latifi, E. Pourhossein, J. Brierley:** Pediatrics organ donation in Iran
- 1049 V. Biagioli, G. Manzi, A. Liburdi, R. Mascolo, V. Kania, G. Spitaletta, O. Gawronski, R. Ricci, E. Vellone, T. Grimaldi Capitello, V. Vanzi, G. Rocco, M. Salata, E. Tiozzo, I. Dall'Oglio:** Self-care in children and young people with complex chronic conditions: Scale development and content validity

- 1052 G. Spitaletta, V. Biagioli, A. Liburdi, G. Manzi, F. Greco, R. Mascolo, O. Gawronski, R. Ricci, E. Tiozzo, E. Vellone, T. Grimaldi Capitello, M. Salata, M. Raponi, I. Dall'Oglio:** A qualitative study exploring self-care in children and young people living with complex chronic conditions
- 1054 P.F. Poh, M. Carey, J.H. Lee, J. Manning, J. Latour:** Impact of ethnicity on parental health outcomes after childhood critical illness: A mixed-methods systematic review
- 1056 C. Grandjean, M.-H. Perez, Z. Rahmaty, M.-C. Maitre, A.-S. Ramelet:** Family functioning of parents throughout the hospitalization of their chronic critically ill child
- 1058 H. Wataker, E. Nestaas, R. Asbjørnsen:** Virtual home care for premature and sick newborns: Parents' experiences and results from a feasibility pilot trial
- 1060 L. De Proost, A. De Boer, E. Verhagen, I. Reiss, M. Hogeveen, R. Geurtzen, J. Verweij:** Do we really need guidelines at the limit of viability? A mixed methods approach to study the care providers' and prematurely born adults' perspective
- 1062 T. Chapron, V. Pierrat, G. Caputo, M. Letouzey, E. Kermorvant, A. Barjol, G. Le Meur, V. Benhamou, L. Marchand-Martin, P.Y. Ancel, H. Torchin:** Preterm birth and ophthalmological impairments at 51/2 years: Epipage-2 cohort study
- 1064 C. Phibbs, M. Passarella, S. Schmitt, A. Martin, S. Lorch:** Estimates of how changes in the number of infants treated in a neonatal intensive care unit affects mortality and major morbidity for very preterm infants

- 1066 A. Mitha, R. Chen, N. Razaz, S. Johansson, O. Stephansson, M. Altman, J. Bolk:** Effects of gestational age from 32 to 41 weeks at birth on long-term neurodevelopmental outcomes – A Swedish national population-based study
- 1068 A. Aubert, R. Costa, S. Johnson, U. Aden, M. Cuttini, C. Koopman-Esseboom, H. Varendi, M. Zemlin, V. Pierrat, J. Zeitlin:** Risk factors associated with movement difficulties and cerebral palsy among five-year-old children born extremely preterm in a European cohort
- 1070 A. Mitha, L. Marchand-Martin, J.-C. Rozé, P. Kuhn, I. Leray, M. Kaminski, V. Pierrat:** Early skin-to-skin contact and neurodevelopmental outcome at 5 years in very preterm infants: the epipage-2 cohort study
- 1072 M.-C. Lin:** Association of antibiotics exposure during pregnancy with childhood atopic diseases
- 1074 L. Pezza, N. Yousef, B. Loi, R. Centorrino, S. Shankar-Aguilera, V. Sartorius, D. De Luca, G. Regiroli :** Oxygenation and lung aeration at diagnosis and overtime in RDS and TTN
- 1077 B. Loi, G. Regiroli, R. Centorrino, D. De Luca:** Prone positioning of neonates with different types of lung injury: Effect on respiratory function and hemodynamics
- 1080 C. Danan, L. Caeymaex, C. Jung, M. Tauzin, G. Dassieu, F. Decobert:** The instrumental dead space: A glass ceiling for extremely low birth weight infants?

- 1082 R. Moreau, N. Yousef, A. Harlaux, N. Poteaux, E. Letamendia, D. De Luca:** Premasim using in-situ simulation to decrease the risk of hypothermia in the extremely preterm infant
- 1084 A. Van Zwol, M. Brienne, M. Ijland, S. Litjens:** Feasibility of hydrotherapy as part of early mobilisation in paediatric critical care
- 1086 B. Jones, L. Tume:** How many chest x-rays are requested to confirm nasogastric tube placement on a paediatric ICU?
- 1088 R. Leonardi, F. Pizzo, L. Licciardello, G. Parisi, P. Betta, P. Sciacca:** Electrocardiographic and echocardiographic follow-up in children with mild-moderate SARS-COV2 infection
- 1090 E.-E. Makridi, T. Kamilari, A. Kyriakopoulou, A. Vlachodimitropoulou, D. Margoni, M.-E. Bompou, E. Botsa:** Prevalence of co-infections in pediatric patients with COVID19 during the third pandemic wave
- 1092 O. Jordanova, V. Tasic, A. Sofijanovska, S. Bojadzieva, A. Janchevska, N. Abazi :**The diagnostic value of new biomarkers in early diagnosis of parenchymal kidney damage in pediatric patients
- 1094 M. Lubián-Gutiérrez, Y. Marín-Almagro, Y. Sánchez-Sandoval, A. Zuazo-Ojeda, S. Lubián-López, I. Benavente-Fernández:** Corpus callosum size and maturation related to long-term outcome at school age in children born preterm
- 1096 S. Gardner, R. Daniels, L. Yarlott:** Does a direct paediatric specialist to families instant messaging advice service work? Juno - a pilot
- 1098 K. Kamphorst, B. Oosterloo, E. Van 'T Riet, L. Reichwein, A. Vlieger, R. Van Elburg:** The association between exposure to antibiotics in the first week of life and later otitis media: The INCA study

- 1100 M. Davis, S. Davis, C. Davis:** Intussusception and rotavirus vaccine: Time to update guidance?
- 1102 F. Kipfmüller, F. Pugnali, B. Bo, A. Müller, N. Patel:** Early postnatal ventricular disproportion predicts outcome in congenital diaphragmatic Hernia
- 1104 W. Finstad, E. Livingston, V. Beausejour Ladouceur, J. Sorbara, A. Vandermorris:** Mental health and the prescription of QTC-prolonging medications in gender diverse adolescents
- 1106 V. Verma, F. Lange, C. Meehan, A. Mintoft, G. Norris, E. Campbell, K. Tucker, K. Harvey-Jones, G. Boylan, N. Robertson, I. Tachtsidis, S. Mitra:** Impact of neonatal seizures on brain temperature
- 1109 H. Ozdemir Koyu, G. Algül, N. Altay, E. Kilicarlan Törüner:** Hope experiences in parents of children with cancer and affecting factors
- 1111 M. Abdellatif, A.A.F. Abozaid, P.S. Shah, N. Dhouibi, T. Nguyen-Khac, R. Khleif, M.N. Luu, D.K. Quyen, A. Mohareb, G. Vaghela, Z.A. Khan, H.N. Pham, A.M. Makram, N.T. Huy:** Fenofibrate combined with phototherapy for neonatal jaundice: A systematic review and meta-analyses
- 1113 S. Abdullateef, V. Rae, B. Jordan, A. Mcllellan, J. Escudero, V. Nenadovic, T.-Y.M. Lo:** A window in the brain: Novel quantitative seizure detection with minimal density EEG montage
- 1115 H. Küster, A. Fischer, A. Kahmann, O. Ströbel, E. Koch:** smartNIV – A sensor-patch for synchronized non-invasive ventilation of preterm infants

- 1118 A. Lavizzari, C. Veneroni, N. Sirianni, B. Bonomi, M. Colnaghi, F. Mosca, R. Dellacà:** A randomized cross-over trial of non-invasive neurally adjust respiratory assist versus nasal intermittent positive pressure ventilation at equal peak inspiratory pressure in preterm infants
- 1120 J. Baumgartner, D. Klotz, H. Schneider, S. Schumann, H. Fuchs:** Ultrashort inspiratory times homogenize ventilation distribution in an inhomogeneous two-compartment model of the neonatal lung
- 1122 K. Wendel, M. Aas, G. Gunnarsdottir, T. Nordvik, D. Fugelseth, M. Domellof, T. Stiris, S. Moltu:** Effect of arachidonic and docosahexaenoic acid supplementation on respiratory outcomes in preterm infants
- 1125 S. Cramer, J. Dekker, H. Salverda, R. Koster, R. Tan, S. Hooper, A. Te Pas:** Automated mechanical stimulation in response to cardiorespiratory events in preterm infants; a feasibility trial
- 1127 S. Baldursdottir, E. Palleri, S. Donaldsson, T. Drevhammar, B. Jonsson:** Respiratory outcomes after initial stabilization with a new system using nasal prongs versus standard T-piece with face mask
- 1129 R. Dvorsky, F. Rings, L. Rössler, L. Kumer, P. Steinbauer, K. Bibl, H. Schwarz, V. Ritschl, G. Schmölzer, A. Berger, T. Werther, M. Wagner:** Real-time intubation and ventilation feedback in a randomized controlled simulation study
- 1131 S. Gupta, E. Juszczak, N. Subhedar, P. Hardy, J. Wyllie, A. Kelsall, S. Johnson, S. Sinha, D. Field:** Does selective early treatment of PDA with ibuprofen reduce death or bpd at 36 weeks in extreme preterm babies? A randomised trial (Baby Oscar trial)

- 1135 R. Parladori, V. Paoletti, S. Galletti, G. Malvezzi, L. Castellini, L. Corvaglia, S. Martini:** Effect of caffeine maintenance on cardiovascular and cerebral haemodynamics in very preterm infants during postnatal transition
- 1137 A. Smith, O. Franklin, E. Mocanu, N. Mccallion, A. El-Khuffash:** Assessment of myocardial function in infants conceived by assisted reproductive technologies using deformation imaging over the first year of age
- 1141 Vera Balog, Barbara Vatai, Lóránt Krisztián Kátai, Sarolta Trinh, Miklós Szabó, Ágnes Jermend:** Continuous non-invasive hemodynamic monitoring of neonates undergoing hypothermia
- 1144 S. Gomez-Quintana, V. Shelevytska, G. Caracciolo, A. Factor, E. Popovici, A. Temko:** Hearttone: An accurate, objective decision support tool for detecting congenital heart disease using phonocardiograms and artificial intelligence
- 1146 S. Ojha, A. Al-Turkait, L. Szatkowski, I. Choonara:** Management of patent ductus arteriosus in very preterm infants in England and Wales – A retrospective cohort study
- 1150 R. Ascherl, U. Wurst, U. Thome:** Antebrachial peripheral venous catheters have longer dwell times in neonates – Analysis of 17910 peripheral lines
- 1152 E. Van Blankenstein, T. Sodiwala, S. Jawad, J. Lanoue, N. Modi, S. Uthaya, C. Battersby:** Two-year outcome data from the national neonatal research database for preterm infants born over a 10-year period in England and Wales 2008-2017
- 1154 R. Connors, K. Tan, V. Sackett, L. Zhou, P. Pharande, A. Malhotra:** Assessing the utility of neonatal screening assessments in early diagnosis of cerebral palsy in preterm infants

- 1156 S. Benum, K.A. Aakvik, L. Jussinniemi, M. Kulmala, A. Jørgensen, E. Kajantie, K.A. Evensen:** Gross motor abilities in adults born preterm with very low birth weight: A longitudinal study of two birth cohorts
- 1158 A. Aubert, R. Costa, S. Johnson, U. Aden, V. Pierrat, M. Cuttini, M. Männamaa, I. Sarrechia, A. Van Heijst, R. Maier, M. Sentenac, J. Zeitlin:** Health-related quality of life among five-year-old extremely preterm children with motor disorders
- 1160 S. Groene, K. Stegmeijer, R. Tan, S. Steggerda, M. Haak, F. Slaghekke, A. Roest, B. Heijmans, E. Lopriore, J. Van Klink:** The life-long effect of fetal growth restriction: Neurodevelopmental outcome in growth discordant identical twins
- 1162 Y. Kaul, U. Aden, K. Stjernqvist, A. Farooqi, F. Serenius:** Lower intelligence in children born extremely preterm does not fully account for every day functioning deficits as perceived by parents: The express study
- 1165 D. Nosko, L. Brostrom, J. Bolk, U. Aden, M. Ortqvist:** The prevalence of minor neurological dysfunction reduces with increasing age in children born extremely preterm
- 1167 C. Trousson, A. Bourmaud, A. Toumazi, V. Biran, O. Baud:** Neurodevelopment outcomes at age 5 years after prophylactic hydrocortisone in extremely preterm infants
- 1169 M. Van Dijk, E. Ista:** Four-in-one: A comprehensive checklist for pain, undersedation, iatrogenic withdrawal and delirium assessment in the PICU: A Delphi study

- 1171 W. Voor Den Dag, R. Verkamman, M. Van Dijk, E. Ista:** A comprehensive checklist for pain, undersedation, iatrogenic withdrawal and delirium assessment in the PICU: A pilot study
- 1173 R. Stenkjaer, I. Egerod, M. Moszkowicz, G. Greisen, E. Ista, S. Herling, J. Weis:** Clinical application of “Sophia observation withdrawal symptoms - pediatric delirium” screening tool Danish version: A feasibility study
- 1175 B. Bagheri, B. Taherkhanchi, S. Salarian:** Impact of oral clonidine on duration of opioid and benzodiazepine use in mechanically ventilated children
- 1177 I. Macdonald, S. Alvarado, L. Gomez Tovar, M. Martson, E. Favre, V. Chanez, A. Trombert, M.-H. Perez, A.-S. Ramelet:** Evaluation of clinical practice guidelines for the management of pain, sedation, delirium and withdrawal for use in pediatric intensive care units: A systematic review
- 1179 K. Vehar, R. Vettorazzi:** Parent’s perspective on family centered care in neonatal and pediatric intensive care units in Slovenia
- 1181 J. Mattsson:** Does the tracheostomy interfere with attachment?
- 1183 C. Sahlén Helmer, U. Thornberg, T. Abrahamsson, E. Mörelius:** Mothers’ experiences of the EACI- A new early collaborative intervention focusing on parent-infant interaction in the neonatal period
- 1185 M. Sentenac, J. Zeitlin:** Are cognitive outcomes after very preterm birth worsening, stagnating or improving? a meta-analysis

- 1187 A. Gill, P. Nydert:** Exploring medication practices with regards to ten-fold dosing errors between two paediatric hospitals
- 1189 K. Størdal, M. Lyamouri, K. Mårild, R. Nielsen:** Use of proton pump inhibitors in Scandinavian infants: An observational study
- 1192 L. Martinez, D. Gray, L. Workman, M. Nicol, H. Zar:** Early-life tuberculosis disease and long-term impact on child health: A prospective birth cohort study
- 1193 K. Plėšnytė- Čapkauskienė, B. Aukštuolytė, J. Radzevičienė, B. Lukšaitė:** Exploring differences in social atom diagrams of children and adolescents aged 7 to 17 with diagnosed psychiatric disorders and of general population
- 1195 T. Van Der Zanden, N. Smeets, M. De Hoop, M. Schwerzel, H.J. Huang, L. Barten, J. Van Der Heijden, J. Freriksen, A. Horstink, I. Holsappel, M. Mooij, M. De Hoog, S. De Wildt** Off-label, but on-evidence? A review of the evidence of pediatric pharmacotherapy
- 1197 N. Zampieri, G. Scirè, A. Giambanco, F. Camoglio:** Single port surgery in pediatric age: 5 years experience
- 1199 H. Keohane, C. Cronin, L. Flores Villarta, C. Okelly, J. Trujillo Wurttle:** Teaching children with food allergy to manage anaphylaxis: Caregivers' perspectives
- 1201 M. Mendonca, D. Wolke:** Born too soon for romance? An individual participant data meta-analysis of romantic and sexual relationships in adults born very preterm

- 1203 C. Menezes, T. Costa, C. Brás, P. Sousa, A. Mendes, R. Amorim, M.-S. Faria, C. Mota:** Comparing cystatin C- and creatinine-estimated glomerular filtration rates in pediatric patients with neurogenic bladder-associated kidney disease
- 1205 C. Broderick Farrell, L. Zgaga, C. Taut:** Study of factors associated with sleep duration in healthy infants aged 9 months
- 1207 C. Matthews, R. Aziza, E. Alessandrini, S. Ranmal, Z. Zhou, E.H. Davies, C. Tuleu:** Use of video data and facial landmark analysis as an objective assessment of palatability for paediatric medicine
- 1209 E. Fernandez Fernandez, M. Mac Giolla Eain, M. Joyce, R. Macloughlin:** Aerosol drug delivery performance from vibrating mesh and jet nebulisers in a spontaneously breathing paediatric model
- 1211 F. Guerrero Del Cueto, I. Leiva Gea, A. Ortiz Ortigosa, J. Ramos Fernandez, B. Carazo Gallego, A. Cordón Martínez, E. Núñez Cuadros:** Microbiology, risk factors and adverse outcomes in bronchiolitis admissions during the SARS-COV2 pandemic: Experience in a tertiary paediatric hospital
- 1214 C.Y.M. Lam, S.Y.D. Lam:** COVID-19, the omicron variant and its association with croup in children, a single center study in Hong Kong
- 1216 M. Filippa, S. Loukas, J. Sa De Almeida, L. Lordier, D. Grandjean, D. Van De Ville, P. Hüppi:** Voice or instrumental music? newborns' early discrimination of vocal and instrumental melodies: A fMRI based dynamic effective connectivity study

- 1218 F. Nejsum, R. Wiingreen, R. Maastrup, C. Torp-Pedersen, E. Løkkegaard, B. Hansen:** Admission to a neonatal ward and subsequent exclusive breastfeeding at one and four months among late-preterm, early-term and term infants: A nationwide register-based cohort study
- 1220 M. Rossholt, M. Bratlie, K. Wendel, M. Aas, G. Gunnarsdottir, D. Fugelseth, T. Stiris, M. Domellof, K. Størdal, S. Moltu:** A standardized feeding protocol for extremely preterm infants ensured recommended nutrient intakes and prevented growth faltering
- 1224 A. Branagan, C. Murphy, I. Bodnarova, S. Feyereislova, I. Berka, J. Miletin, Z. Stranak:** Influence of routine gastric residual assessment in preterm neonates on time taken to reach full enteral feeding (the grass trial) – A randomised control trial
- 1226 M. Thanhaeuser, F. Eibensteiner, M. Kornsteiner-Krenn, M. Gsöllpointner, S. Brandstetter, U. Koeller, M. Huber-Dangl, C. Binder, A. Thajer, B. Jilma, A. Berger, N. Haiden:** Preterm infants on early solid foods and iron status in the first year of life – A secondary outcome analysis of a randomized controlled trial
- 1228 S. Alm, M. Domellof, E. Stoltz Sjöström:** Prevalence and risk factors for feeding problems in infants born extremely preterm in a Swedish population based cohort
- 1230 C. Borràs-Novell, A. Herranz Barbero, C. Balcells Esponera, M. López-Abad, V. Aldecoa-Bilbao, M. Izquierdo Renau, I. Iglesias Platas:** Variability in macronutrient enteral intakes from human milk in very premature infants
- 1232 A. Marshall, A. Scrivens, J. Bell, L. Linsell, J. Yong, M. Sadarangani, E. Juszczak, C.C. Roehr:** NeoCLEAR: A multicentre RCT investigating techniques to improve lq success in neonates

- 1234 E. Giannoni, V. Dimopoulou, C. Klingenberg, L. Naver, V. Nordberg, A. Berardi, S. Helou, G. Fusch, J. Bliss, D. Lehnick, N. Guerina, J. Seliga-Siwecka, P. Maton, D. Lagae, J. Mari, J. Janota, P. Agyeman, R. Pfister, G. Latorre, G. Maffei, K. Størdal, T. Strunk, M. Stocker:** Antibiotic exposure during the first postnatal week and incidence of early-onset neonatal sepsis: an international study
- 1237 A.M. Van Den Berg, O.A.G. Medina, R.T. Bartels, M. Benders, D.C. Vijlbrief:** Early detection of late-onset sepsis in very preterm infants, is the answer in the data?
- 1239 T. Barsan Kaya, O. Surmeli Onay, O. Aydemir, A.N. Tekin:** 10-Year single center experience with colistin therapy in NICU
- 1243 C. Härtel, V. Bossung, M. Lupatsii, S. Graspeuntner, S. Waschina, J. Rupp:** Timing of antimicrobial prophylaxis for cesarean section is critical for gut microbiome development in term born infants
- 1245 N. Deianova, S. El Manouni El Hassani, E. Struijs, E. Jansen, A. Bakkali, M. Van De Wiel, W. De Boode, C. Hulzebos, A. Van Kaam, E. D'Haens, D.C. Vijlbrief, M. Weissenbruch, W. De Jonge, M. Benninga, H. Niemarkt, N. De Boer, T. De Meij:** Association between duration of early empiric antibiotics and necrotizing enterocolitis and late-onset sepsis in preterm infants: A multicenter cohort study
- 1247 T. Dierikx, H. Van Laerhoven, S. Van Der Schoor, C. Nusman, C. Lutterman, R. Vliegenthart, T. De Meij, M. Benninga, W. Onland, A. Van Kaam, D. Visser:** The diagnostic accuracy of presepsin in early-onset neonatal sepsis: A prospective cohort study

1250 Poster Discussion Abstracts

- 1251 B. Beqo, P. Gasparella, C. Flucher, E. Haxhija:** Surgery is still an important alternative to beta blockers for treatment of children with complicated infantile hemangiomas
- 1253 N. Zampieri, A. Errico, S. Vinco, I. Dando:** Response to chorionic gonadotropin treatment of cryptorchid patients after orchiopexy: prediction of the effect by using patients' derived gubernaculum in vitro model
- 1255 S. Rusu, K. Polak, I. Vidal Gil, M. Herrera Llobat, M. Llanas Marco:** Antibiotics in acute appendicitis: does one protocol fits all areas?
- 1257 M. Pathak, T. Motiwala, A. Sinha, R. Saxena, K. Rathod, A. Jadhav:** Knowledge about surgical wound care among parents of pediatric surgical patients in India
- 1259 L. andreozi, F. Rossetti, G. Bacci, M. Raspi, M. Pignotti, L. Pierantoni, D. Zama, M. Lanari, A. Messeri:** Efficacy of rectal ketamine and midazolam for procedural sedation in children undergoing ocular tonometry
- 1261 O. Gawronski, C. Gagliardi, C. Bochicchio, C. Cecchetti, A. Rossi, M. Di Nardo, C. De Ranieri, T. Satta, V. Sansone, E. Tiozzo, I. Dall'Oglio, F. Cancani:** Staff's perception of the implementation the picu-diary in an italian pediatric intensive care unit: a qualitative study
- 1263 A. Zanin, C. Agosto, A. Divisic, F. Rusalen, M. Cooper, P. Lazzarin, F. Benini:** Triggers for palliative care team activation in the pediatric intensive care: a 10 years retrospective study
- 1265 N. Tran Vu, P. Tissieres, L. Morin:** Adherence to septic shock guidelines and outcome: an analysis over three decades of purpura fulminans

- 1267 M. Rodríguez Martínez, S. Brió-Sanagustin, F. Castillo-Gómez, E. Coca-Fernandez, E. Turon-Viñas, J. Salazar Quiroz, R.A. Burgueño-Rico, S. Boronat-Guerrero:** AIR Team SEM: our experience
- 1269 S. Groene, I. Gremmen, E. Van Zwet, A. Roest, M. Haak, J. Van Klink, E. Lopriore, B. Heijmans, C. De Bruin:** Childhood catch-up growth after fetal growth restriction in a unique cohort of discordant, genetically identical twins
- 1271 A. Scrivens, N. Reibel, L. Heeger, S. Stanworth, E. Lopriore, H. New, C. Dame, K. Fijnvandraat, E. Deschmann, M. Aguar, K. Brække, F. Cardona, F. Cools, R. Farrugia, S. Ghirardello, J. Lozar Krivec¹⁸, K. Matasova, T. Mühlbacher, U. Sankilampi, H. Soares, M. Szabó, T. Szczapa, G. Zaharie, C.C. Roehr, S. Fustolo-Gunnink:** Survey of transfusion practices in preterm infants in Europe
- 1274 M. Sinelli, E. Zannin, S. Ornaghi, E. Acampora, D. Doni, R. Menichini, M.L. Ventura:** Intrauterine growth restriction (IUGR) and low birth weight increase the risk for acute kidney injury (AKI) in preterm infants
- 1276 D. Klotz, A. Wesółowska, E. Bertino, G. Moro, J.-C. Picaud, A. Gayà, G. Weaver:** The legislative framework of donor human milk and human milk banking in Europe
- 1278 M. Koolen, M. Vermeulen:** Identifying incidence, timing and potential risk factors for early hypoglycemia in very preterm infants
- 1281 L. Ahmed, C. Hughes, A. Gupta, G. Vemuri:** Newborn record documentation audit
- 1283 J. Lister, J. Lee, J. Chubb, C. Harrison, J. Oldfield, E. Harrison:** Improving neonatal thermoregulation throughout critical care transport

- 1285 S. Manopunya, N. Pattanapolrath, S. Kosarat, V. Khuwuthyakorn, M. Pomrop, W. Tantiprabha:** The optimal timing for surgical ligation of patent ductus arteriosus after failed indomethacin in very preterm infants: a 12-year retrospective cohort study
- 1287 H. Cruickshank, M. Rudnicka:** Cerebral palsy rates of children born before 32 weeks gestation at the Simpson Centre for Reproductive Health in Edinburgh from 2009-2019
- 1289 H. Cruickshank, S. offer:** The use of asynchronous video to support neonatal follow-up services
- 1291 N. Decembrino, M. Di Pietro, E. Malerba, A. Longo, M. Gallo, C. Mattia, M. Marletta, M.A. Conversano, M.C. Caracciolo, A. Saporito, V. Di Benedetto, T. Avitabile, P. Betta:** Risk factors in the development of ROP: a 10-year retrospective study
- 1293 K. Johnson, J. Broughan, D. Cave:** Improving neonatal care using data from the national congenital anomaly and rare disease registration service (NCARDS).
- 1296 J. Bolk, K. Källén, A. Farooqi, M. Hafström, V. Fellman, U. Aden, F. Serenius:** Perinatal risk factors for developmental coordination disorder in children born extremely preterm
- 1298 H. Ehrhardt, R. Maier, U. Aden, A. Aubert, E.S. Draper, A. Gudmundsdottir, H. Varendi, T. Weber, M. Zemlin, J. Zeitlin:** Is the APGAR score predictive of poor cognitive and motor outcomes at five year of age among children born extremely preterm?
- 1300 C. Montgomery, S. Setänen, Y. Kaul, F. Serenius:** Associations between Bayley-III fine and gross motor scores at 2.5 years with the movement ABC-2 manual dexterity, aiming and catching and balance at 6.5 years

- 1302 D. Cañizo, S. Hadley, M. Pérez, A. Rivas, S. Benito, M.L. Rossi, J. Sanchez-De-Toledo, M. Camprubí:** Regional cerebral oxygen saturation and serum biomarkers to predict neurological outcome in children undergoing cardiac surgery
- 1304 M. Velilla Aparicio, N. Carreras, T. Agut, A. Alarcon, A. García-Alix:** Maturational amplitude-integrated electroencephalographic (AEEG) changes in very preterm infants
- 1306 A. Mistry, N. Davey, D. Sharkey:** Improving neonatal hypoxic encephalopathy hypothermic care with active cooling during transport and at birth centre: UK regional transport data 2011-2021
- 1309 H. Kvanta, N. Padilla, U. Aden:** Extremely preterm birth is related to altered regional brain volumes at school age
- 1311 M. Johansson, L. Hellström-Westas, Y. Kaul, C. Montgomery, O. Kochukhova:** Visual perception and social ability in children born very and extremely preterm
- 1313 S. Mathieson, V. Livingstone, F. Magarelli, M. O'Sullivan, J. O'Toole, G. Lightbody, W. Marnane, S. Raurale, G. Boylan:** Expert analysis compared to automated analysis of EEG for the prediction of outcome in neonatal hypoxic ischaemic encephalopathy
- 1315 J. Thió Casals, A. Pi Compañó, J. Salazar Quiroz, M. Pujol Sanjuán, E. Moliner Calderon, A. Turon-Viñas, J. Serralabós-Ferré, J. Casas Resa, L. Català Altarriba, S. Boronat-Guerrero:** Star anise poisoning as a cause of infant seizures
- 1317 K. Seddiki, L. Benhafssa:** Diagnosis of fetal cerebral malformations. contribution of MRI about 202 cases

- 1319 A. Chandran, A. Conte, K. Elayar, A. Khan, S. Mehta, F. Miah, R. Nagaraj, E. Oworu, J. Park, L. Saliba, V. Sivarajan, S. Suri, E. Tandanu, J. Coppel, J. Kearney, S. Herbert:** Teaching programme to help school students recognise and manage asthma exacerbations
- 1321 M. Shefler Gal, S. Gamzu, R. Jacob, D. Cohen, I. Shavit:** Reduction of ileocolic intussusception under sedation or anaesthesia: a systematic review of complications
- 1323 J. English, D. O'Boyle, K. Dowling, E. Ahern, L. Pawley, S. Al Khalaf, B. Hammer Bech, T. Brink Henriken, R. Anney, L. Lopez, L. Gallagher, A. Khashan:** From biomarkers to biological pathways in autism: a systematic review and multi-omics bioinformatics analysis highlight neuroimmune and metabolic networks implicated
- 1325 M. Zoabi, I. Shavit, N. Kvatinsky:** Evaluation of a point-of-care ultrasonography decision-support algorithm for the diagnosis of transient synovitis in the pediatric emergency department
- 1327 A. Hoffelner, M. Wagner, A. Lietz, J. Kraller:** Dose-response of virtual reality training of pediatric emergencies in a randomized simulation-based setting
- 1329 G.B. Jensen, F. Ahlsson, A. Elfvin, L. Naver, M. Domellof, T. Abrahamsson:** Nordic study on human milk fortification in extremely preterm infants (n forte): a randomised controlled trial
- 1331 S. Ünal, N. Demirel, M. Durukan-Tosun, İ. Celik, A.Y. Bas:** Evaluation of multi organ failure in infants with mild perinatal asphyxia

- 1333 N. Decembrino, S. Pergolizzi, G. Anima, C. Mattia, M. Marletta, M.A. Conversano, A. Saporito, M.C. Caracciolo, G. Palano, M. Fragalà, S. Ambrogio, F. Sottile, C. Galletta, S. Costanzo, C. Carpinato, P. Betta:** Maternal RBCs alloantibodies in breast milk: clinical relevance in early and late neonatal haemolytic anemia
- 1335 S. Kausch, J. Brandberg, J. Qiu, J. Isler, R. Sahni, K. Fairchild, J. Moorman, Z. Vesoulis, D. Lake, B. Sullivan:** Cardiorespiratory signature of late-onset neonatal sepsis: development and external validation of a prediction model in 3 neonatal ICUs
- 1338 H.S. Hwang, S.H. Shin, S. Park, E.-K. Kim, H.-S. Kim:** Urinary calcium/creatinine ratio for predicting nephrocalcinosis in preterm infants
- 1340 B. Sullivan, S. Kausch, D. Alexopoulos, C. Smyser, Z. Vesoulis:** Cardiorespiratory instability and reactivity correlate with brain volume at term-equivalent age in very low birth weight infants
- 1344 D. Bossen, M. Flierman, M. Jeukens, V. Vijn, R. Engelbert:** The development of an online information platform to support parents of very and moderate preterm born infants
- 1346 B. Beqo, S. Tschauner, P. Gasparella, E. Haxhija:** Subcutaneous granuloma annulare can be distinguished from subcutaneous vascular anomalies by the epifascial mound sign in the imaging
- 1348 D. Jansen, H. Vervoort, J. De Zeeuw, M. Edelstein, J. Essa-Hadad, Y. Gorelik, M. Ganczak, D. Filakovska Bobakova, P. Karnaki, I. Hussein, S. Mounier-Jack:** Health system barriers experienced by European underserved children and adolescents in vaccinating against measles and/or human papillomavirus (HPV)

- 1350 A. Horodisteanu-Banuh, N. Revenco, O. Cirstea, D. Savoschin, D. Bujor, A.-M. Balanuta:** Impact assessment of the immunization with pneumococcal conjugate vaccine (PCV13) on respiratory morbidity and mortality among under-five children in Moldova
- 1352 E. Sanches, Y. Van De Looij, C. Dennez, J. Mairesse, L. Baud, Q. Barraud, O. Baud, G. Courtine, S. Sizonencko:** Intensive rehabilitative protocol restores gait dysfunction caused by experimental cerebral palsy in rats – modulation of cortical hyperexcitability as a mechanism of rehabilitation
- 1354 L. O’Sullivan, T. Casey, M. De Haan, N. Marlow, D. Murray:** Validation of the CogniTOT touchscreen tool for the assessment of early executive function
- 1356 B. Ayres, L. Asim, L. Pickard:** Teenage matters: using adolescent questionnaires to assess the health and well-being concerns of young people presenting to the emergency department
- 1358 C.O. Marginean, M.O. Sasaran, C. Banescu, L.E. Melit:** The role of NLRP3 RS10754558 in children with gastritis
- 1360 F. Blangis, D. Malorey, C. Gras-Le Guen, N. Vabres, G. Picherot, P. Ricaud, M. Chalumeau, E. Launay:** Suboptimal care pathway before a diagnosis of severe physical abuse in young children: a confidential inquiry in Western France
- 1362 L. Bermúdez Barrezueta, M. Gutiérrez Zamorano, M. Brezmes Raposo, I. Sanz Fernández, L. Sáez García, P. López Casillas, C. Fernández García-Abril, M. Benito Gutiérrez, M. Pino Velázquez, V. Matias, A. Pino Vázquez:** Epidemiology of acute bronchiolitis in COVID-19 time

- 1364 J. Chudleigh, P. Holder, K. Southern, J. Bonham, A. Simpson, F. Fusco, S. Morris, E. Olander, H. Chinnery, F. Ulph, L. Moody:** Parents experiences of receiving positive newborn bloodspot screening results in England: results of the respond study
- 1366 N. Nazi:** How can we improve the quality of health assessments of children who are in the social care system?
- 1368 N. Hapnes, A. Vatne, H.J. Stensvold, I. Dalen, H.J. Guthe, R. Støen, A.K. Brigtsen, A. Rønnestad, C. Klingenberg:** Association between early empirical antibiotics and adverse clinical outcomes in very preterm infants – a nationwide study from 2009-2018
- 1370 M. Letouzey, J. Delannoy, J. Aires, J.-C. Rozé, L. Foix-L'Hélias, E. Lorthé, M.-J. Butel:** Early antibiotic exposure in very preterm infants and gut microbiota at one month of life
- 1372 Z. Huncikova, A. Vatne, H.J. Stensvold, B. Salvesen, R. Støen, A.K. Brigtsen, A. Lang, K. Øymar, A. Rønnestad, C. Klingenberg:** Late-onset sepsis - pathogen distribution and adverse outcomes in a national cohort of very preterm infants during 2009-2018
- 1374 E. Malchau Carlsen, K. Dungu, A. Lewis, L. Aunsholt, S. Trautner, G. Greisen, B. Hansen, U. Nygaard:** Switch from intravenous to oral antibiotic treatment of term babies with early onset infection: a Danish prospective multicenter cohort study
- 1377 M. Thanhaeuser, F. Eibensteiner, M. Kornsteiner-Krenn, M. Gsöllpointner, S. Brandstetter, U. Koeller, M. Huber-Dangl, C. Binder, A. Thajer, B. Jilma, A. Berger, N. Haiden:** Preterm infants on early solid foods and vitamin d status in the first year of life – a secondary outcome analysis of a randomized trial

- 1379 D. Healy, R. Chioma, J. Panaviene, B. Walsh, E. Dempsey:** Blood sampling from umbilical arterial catheters may be associated with decreased flow in the superior mesenteric artery
- 1381 C. Ekström, B. Zimmermann, N. Ortenlöf, M. Iennaco, D. Boas, N. Barton, M. Gram, D. Ley:** Induced plasma hyperosmolarity causes a substantial increase in cerebral blood flow in the preterm rabbit pup
- 1383 S. Ahmed, N. Hounsome, N. Drenchev, J. Fernandez, H. Rabe:** Benefits of family integrated care (ficare) in neonatal intensive care units (NICU): a systematic review
- 1385 F. Forth, F. Hammerle, J. König, M. Urschitz, P. Neuweiler, E. Mildenerger, A. Kidszun:** Parental perception of optimistic vs. pessimistic prognostic framing in the neonatal ICU – a randomized controlled crossover trial (THE COPE-TRIAL)
- 1387 R. Fleming, K. Wheeler, M. Stewart:** Minimising parent-baby separation during neonatal retrievals - an insight into current practice in Victoria, Australia
- 1389 C. Roberts, Y. Brian, D. Tantanis, D. Blank, S. Badurdeen, K. Crossley, M. Kluckow, A. Gill, E. Camm, R. Galinsky, N. Songstad, C. Klingenberg, S. Hooper, G. Polglase:** Evaluating the efficacy of endotracheal epinephrine administration at standard versus high dose during resuscitation of severely asphyxiated newborn lambs
- 1393 C. Frank, T. Reicherzer, M.-L. Herrmann, B. Ackermann, M. Mandl, H. Nahrstaedt, D. Bergholz, J. Gruetzner, W. Braun, U. Thome, A. Flemmer, M. Klemme:** Detection and automatic processing of transcutaneous diaphragmatic EMG

- 1396 W. El-Naggar, S. Mitra, T. Disher, B. Parish, C. Woolcott, T. Hatfield, D. Mcmillan, J. Dorling:** Milking of the cut-cord during stabilization of very preterm infants: a randomized controlled trial (The MOCC Study)
- 1399 M. Kahvo:** Assessing the safety and efficacy of waveform capnography in ventilated neonates undergoing road transfer
- 1401 C. Wolfsberger, E. Pichler-Stachl, N. Höller, B.C. Schwabegger, B. Urlesberger, G. Pichler:** May cerebral oxygenation immediately after birth predict long-term outcome in preterm neonates with a birth weight ≤ 1500 grams and/or gestational age ≤ 32 weeks?
- 1405 A. Mistry, R. Calthorpe, J. Firth, M. Akeroyd, D. McNally, D. Sharkey:** Noise exposure during neonatal ambulance transport: in-vivo assessment of current and newer attenuation methods
- 1408 R. Simpson, T. Partridge, A. Leslie, D. Morris, D. McNally, J. Crowe, D. Sharkey:** Crowdsourcing vibration and noise exposure during inter-hospital transport using smartphone technology: improving safety with intelligent routing
- 1411 A. Keller, A. Boukai, O. Feldman, R. Diamand, I. Shavit:** Comparison of three intraosseous access devices for resuscitation of term neonates: a randomised simulation study
- 1413 E. Van Blankenstein, L. Smith, G. Fox, S. Seaton, M. Martinez-Jimenez, P. Stavros, C. Battersby:** Trends in active management and neonatal outcomes of babies born at 22-24 weeks gestation in England and Wales, 2017-2021
- 1415 A. Hurley, C. Harrison:** Feasibility of transcutaneous CO₂ monitoring in neonatal transport

- 1417 R. Maastrup, K. Holm, H. Haslund-Thomsen, J. Weis, M. Eg, B. Noergaard, C.S. Jensen, A. Broedsgaard, H. Hansson:** Pain assessment and treatment in hospitalized infants, children and young people
- 1419 Ö. Karakaya Suzan, N. Cinar:** Development and psychometric evaluation of early period mother-infant bonding indicators assessment scale
- 1421 I. Van Ooijen, K. Annink, J. Dudink, T. Alderliesten, F. Groenendaal, M. Tataranno, M. Lequin, H. Hoogduin, F. Visser, A. Raaijmakers, D. Klomp, E. Wiegers, M. Benders, J. Wijnen, N. Van Der Aa:** Vital signs, temperature and comfort scale scores in infants during ultra-high-field MR imaging
- 1423 J. Ten Barge, G. Van Den Bosch, N. Meesters, K. Allegaert, C. Arribas, G. Cavallaro, F. Garrido Martinez Salazar, G. Raffaelli, M. Vermeulen, S. Simons:** Current pain management practices for necrotizing enterocolitis in european neonatal intensive care units
- 1426 N. Meesters, G. Van Den Bosch, J. Van Het Hof, M. Benders, M. Tataranno, I. Reiss, A. Van Kaam, S. Simons, M. Van Dijk:** Quantification of stress exposure in very preterm infants: development of the neo-stress score
- 1428 A. Aija, J. Leppänen, L. Aarnos, M. Hyvönen, L. Toome, L. Lehtonen:** Parents' vocal contact in the neonatal unit and infant's face preference at 7 months
- 1430 S. Jarvis, G. Richardson, K. Flemming, L. Fraser:** Numbers, conditions, demographics and medical complexity of young people with life-limiting conditions reaching transition age in England - repeated cross-section study

- 1432 E. Burke, M. Bonadonna, T. Bolger, S. Koe:** Emergency fish tales
- 1434 K. Voutsadaki, F. Ladomenou, G. Vlachaki:** Observational study of respiratory syncytial virus (RSV) bronchiolitis admissions to a tertiary hospital before and during COVID-19 pandemic
- 1436 M.-K. Lehto, L. Reitala, S. Kekomäki, E. Dos Anjos, S. Silvestre, E. Gomes, M. Cruzeiro, A. Mejias, T. Pelkonen, O. Ramilo:** Bacterial pathogens identified in blood and pleural fluid cultures among paediatric pneumonia and empyema patients in Luanda (Angola)
- 1439 C. Totaro, L. Pierantoni, C. Biagi, A. Dondi, E. Manieri, L. Betti, M. Mancini, M. Lanari:** Differences in bronchiolitis management among infants discharged from pediatric emergency department and admitted to hospital: a ten-year monocentric retrospective study
- 1441 A. Cardoso Pinto, L. Ranasinghe, S.S. Budhathoki, J. Seddon, E. Whittaker:** Drop in routine childhood vaccinations during the Covid-19 pandemic in low- and middle-income countries: what are the causes of the disruption?
- 1443 C. Orazulume:** Audit on timing of brain imaging in the post-resuscitation care of paediatric patients following cardiac arrest
- 1446 C. Fouquerel, I. Vaugier, B. Mbieleu, A. Essid, A. Bakayoko, J. Zini, E. Beltaief, M. Guillon, A. Fayssoil, A. Perrier, J. Bergounioux:** Tracheostomy in children with neurological or neuromuscular disease: retrospective observational cohort study

- 1448 A. Holban, O. Turcu, A. Rotari:** The knowledge of parents about the role of antibiotic treatment in acute respiratory infections
- 1450 S. Ajanovic, Á. Navarro, R. Quesada, J. Jiménez, M. Lopez, E. Valverde, M. Ybarra, M.C. Bravo, D. Muñoz, J. Munera, B. Salas, T. Agut, N. Carreras, A. Alarcon, M. Iriondo, C. Luaces Cubells, A. Pellicer, F. Cabañas, C. Calvo Rey, Q. Bassat:** Meningitis screening based on a novel, non-invasive, transfontanelar ultrasound device using machine learning techniques: a proof-of-concept study
- 1452 C. Wild, A. Maclean, Z. Skea, S. Nettleton, K. Hunt, S. Ziebland:** Disrupted childhoods: a qualitative study of the experiences of children with long covid
- 1454 M. Adjibade, L. Vigneron, M.-A. Charles, B. Heude, B. De Lauzon-Guillain:** Characteristics of infant formula consumed in the first months of life and risk of allergy in the Eden mother-child cohort
- 1456 V. Saini, S. Sethi, J. Ram, B. Khullar:** Intranasal dexmedetomidine versus intranasal midazolam via mucosal atomization device for prevention of emergence agitation in pediatric cataract surgery under sevoflurane: a randomized controlled trial
- 1458 L. Flores Villarta, T. Ah Hang, C. Cronin, S. Hanley, J. Hourihane, M. Sexton, J. Trujillo Wurttel:** A decade of milk ladder in Ireland: are we achieving our goals?
- 1460 M. Jacques, F. Lorton, M.-N. Dufourg, C. Bois, E. Launay, T. Siméon, J. Raude, C. Gras-Le Guen, D. Lévy-Brühl, M.-A. Charles, M. Chalumeau, P. Scherdel:** Determinants of incomplete vaccination in 2-year-olds: from the French nationwide ELFE cohort

- 1462 E. Nebati, C. Diaz, J. Ray:** A quality improvement project: improving the standards of care for children less than 5 year old presenting to emergency department with fever
- 1464 D. Shen, F. Vermeulen, A. Debeer, K. Lagrou, A. Smits:** Viral respiratory infection epidemiology in young children during the COVID-19 pandemic: a single center analysis from a Belgian university hospital
- 1466 M. Ouederni, T. Lamouchi, I. Benfraj, S. Rekaya, M. Said, S. Frigui, Y. Chebbi, R. Kouki, F. Mellouli, M. Bejaoui, A. Wafa, M. Benkhaled:** Impact of serum igg level on infections in patients with primary antibody deficiencies receiving intravenous immunoglobulins
- 1468 C. Meehan, A. Mintoft, R. Pang, G. Norris, E. Campbell, K. Tucker, A. Avdic-Belltheus, C. Blain, J. Straube, T. Atkinson, N. Robertson:** Pharmacokinetics and safety of high and low-dose caffeine citrate in a piglet model of inflammation-augmented hypoxia-ischaemia
- 1472 L. Hansen, T.C.K. andelius, H. andersen, M. andersen, M. Pedersen, R. Pinnerup, S. Schaaning, K.V. Seiersen, N. Bøgh, E. Hansen, C. Laustsen, K. Kyng, T. Henriksen:** The effect of remote ischemic postconditioning in moderate to severe hypoxia-ischemia on MR markers of brain injury; a newborn piglet model
- 1475 C. Ekström, B. Holmqvist, N. Ortenlöf, X. Wang, N. Barton, M. Gram, D. Ley:** Evaluation of the preventive effects of IGF-1/IGFBP-3 on the development of glycerol-induced intraventricular hemorrhage in a preterm rabbit pup model

- 1477 S. Stærke-Balling, M. andersen, H. andersen, L. Hansen, T.C.K. andelius, L. Schwendimann, P. Gressens, K. Kyng, T. Henriksen:** The effect of therapeutic hypothermia in lipopolysaccharide-sensitized hypoxia-ischemia on cerebral immunohistochemical markers of brain damage: a study in newborn piglets
- 1479 M. Richter, A. Fischer, C. Köster, N. Labusek, K. Mülling, U. Felderhoff-Müser, I. Bendix, J. Herz:** Neutrophil plasticity and function in neonatal hypoxic-ischemic brain injury
- 1481 H.S. Høg, T.C.K. andelius, M. andersen, L. Hansen, H. andersen, K. Kyng, T. Henriksen:** Plasma lactate and severity of brain injury in neonatal piglet models of hypoxia-ischemia – a pooled study analysis
- 1483 A. Bainbridge, P. Taribagil, H. Century, V. Verma, A. Huertas-Ceballos, K. Pegoretti Baruteau, L. Srinivasan, X. Golay, F. Torrealdea, M. Sokolska, G. Kendall, N. Robertson, S. Mitra:** Individual metabolite impairment in cerebral deep grey matter relates to outcome following neonatal encephalopathy
- 1486 N. Ortenlöf, S. Vallius, H. Karlsson, C. Ekström, B. Holmqvist, N. Barton, D. Ley, M. Gram:** Insulin-like growth factor-1/insulin-like growth factor binding protein-3 activates the insulin-like growth factor-1 receptor at the choroid plexus in the preterm rabbit brain
- 1488 K. Harvey-Jones, F. Lange, A. Bainbridge, G. Bale, C. Meehan, A. Avdic-Belltheus, F. Torrealdea, X. Golay, M. Sokolska, G. Kendall, N. Robertson, I. Tachtsidis, S. Mitra:** Development of a cot-side optical translational tool for the stratification of injury and prediction of neurological outcome in neonatal encephalopathy

- 1491 K. Kürner, K. Goeral, A. Atkinson, S. Brandstetter, A. Toncheva, M. Kabesch, C. Apfelbacher, M. Melter, B. Seelbach-Göbel, A. Berger, J. Kuhle, S. Wellmann:** Increased serum values of neuro-axonal damage marker NFL in neonates delivered vaginally as compared to those delivered via caesarean section
- 1493 E. Ng, T. Burke, M. Dundek:** Evaluation of a low flow oxygen blender system for global access
- 1495 A. Moreira Echeverria, E. Berbel Palau, J.M. Solis Baltodano, M.T. Sandino Martinez:** Review of social work consult from emergency room during pandemic
- 1497 N. Revenco, A. Horodisteanu-Banuh, O. Cirstea, D. Savoschin, A.-M. Balanuta, D. Bujor:** Protective and risk factors for pneumonia in small children from republic of Moldova: a case control study
- 1499 V.A.A. Beunders, M.E. Koopman-Verhoeff, M. Vermeulen, C.C.V. Silva, P.W. Jansen, A.I. Luik, I. Reiss, K. Joosten, V. Jaddoe:** Fetal and infant growth patterns, sleep and 24-hour activity rhythms. a population-based prospective cohort study in school-age children
- 1501 C. Cronin, J. Trujillo Wurttele:** The adrenaline auto injector administration technique of caregivers and paediatric patients with food allergies
- 1504 E. Van Twist, S. Yang, K. Joosten, G. Heesch, I. Mathijssen:** Effect of severe obstructive sleep apnea on pulse transit time in children with syndromic craniosynostosis during sleep
- 1506 E. Blamey, K. Davies, R. Bhatt, E. Al-Abadi, H. Singh Mudhar, M. Henry:** An unusual case of vasculitis, presenting with lymphadenopathy and lacrimal gland swelling one week after Pfizer Covid-19 vaccination

- 1508 L. Van Camp, L. Hoste, E. Vermeiren, S. Moniotte, A. Bael:** Paediatric subspecialties in Belgium: past, present and future
- 1512 J. Upadhyaya, K. Tandon, S. Nimbalkar, M. Patel:** A cross sectional study for acceptance and intent to uptake covid 19 vaccine by adolescents in Anand district
- 1514 P. Garcia-Canadilla, A. Isabel Roquero, E. Aurensanz, F. Miguel, A. Valls Esteve, D. Ormazabal, F. Llanos, J. Sanchez-De-Toledo:** CORTEX - ECARE: High value care approach for the management of pediatric patients with congenital heart disease after surgery
- 1516 R. Amorim-Figueiredo, R. Valsassina, A.M. Garcia, T. Milheiro Silva, C. Gouveia, A. Pereira Lemos, M.J. Brito:** Multisystem inflammatory syndrome in children - what happens during and after the disease?
- 1518 M. Pathak, S. Krishnamurthy, A. Sinha, S. Nayak, K. Rathod, A. Jadhav, R. Saxena:** Implementation of early discharge protocol after laparoscopic appendectomy for pediatric uncomplicated acute appendicitis
- 1521 W. Bae, A. Choi, K. Kim, S. Kim:** Validity of the new triage system implemented in all pediatric emergency departments in Korea
- 1523 S. Duncan, L. Hedayatrad, T. Stewart, E. Marks, C. Walker, S.-J. Paine:** Utilising compositional data analysis to investigate 24-hour time-use behaviours and obesity outcomes in New Zealand children
- 1525 J. Choi, R. De Vries, A. Yusuf, S. Vogrin, M. Wright, C. Collins, J. Wong, J. Kaufman:** Urine trouble. the changing aetiology and antibiogram of paediatric urinary tract infections - an 8 year retrospective cohort study

- 1527 N. Jiménez-Luque, I. Benavente-Fernández, Y. Sánchez-Sandoval:** Parental competences in Spanish families with young children: role of needs of children and psychosocial context
- 1529 S. Shanmugavadivel, J.-F. Liu, A. Ball-Gamble, A. Polanco, K. Vedhara, D. Walker, S. Ojha:** A modified E-Delphi consensus process to inform a clinical guideline for suspected bone and abdominal tumours in children and young people
- 1531 R.A. Alexe, A.-I. Marin, R. Minciuna, R. Tureschi, V. Plaiasu, M. Craiu, M. Covacescu:** A lysosomal storage disease hidden behind a respiratory tract infection
- 1533 R.A. Alexe, A.-I. Marin, R. Minciuna, R. Tureschi, S. Maria-Teodora, R. Alina, C. Talpiga, V. Plaiasu, M. Covacescu:** Understanding a rare cause for an apparently common acute hepatitis
- 1535 C. Stephens, S. Mathieson, B. Mcnamara, N. Mcsweeney, R. O'Brien, O. O'Mahony, G. Boylan, D. Murray:** Feasibility of early EEG monitoring in the paediatric emergency department setting
- 1537 A. Zanin, P. Beatrice, P. Michele, M. Silvia, T. Serena, C. Lorenzo, T. Raffaello, V. Michael, M. Lucrezia, S. Gabriele, P. Cogo:** Stronger together: a multidisciplinary simulation based approach to improve pediatric emergency education
- 1539 A. Mckiernan, J. Balfe, B. Zuro, S. Guerin:** Achieving integrated psychosocial care in a children's hospice: an evaluation of a psychosocial care forum

- 1541 D. Simões, T. Moreira, D. Bordalo, A. Maia:** Macrocephaly: diagnosis and approach in a tertiary center
- 1543 M. Ezzati, S. Mazhar, E. Hassan, E.M. Okey-Udah:** There is an unmet requirement of a comprehensive epilepsy service to identify associated mental health and behavioural problems in children with epilepsy
- 1545 N.T. Minh Duc, M. Abdellatif, H.T. Nam Giang, S. Powell, Z.A. Khan, S.Y. Fadel, P.A. Vu, D.A. Farrag, D.T. Kim Quyen, R. Mahabir, S. Mahabir, S.T.M. Alhady, N.T. Huy:** The association between assisted reproductive techniques and IQ of preschool children: a systematic review and meta-analysis
- 1548 K. Demiroren, T. Gürcan Pamukçu, M. Şen:** Optimal management of children who ingested batteries: a prospective observational study
- 1550 A. Krijger, E. Steenbergen, L. Schiphof-Godart, C. Van Rossum, J. Verkaik-Kloosterman, L. Elstgeest, S. Ter Borg, H. Raat, K. Joosten:** Clusters of lifestyle behaviours and their associations with socio-demographic characteristics in Dutch toddlers
- 1552 M. Boldor, C. Vittot, T. Tromeur, P. Mauran:** A rare bacteria causing aortitis unmasking coarctation of the aorta: a paediatric case report
- 1554 K. Gunnarsdottir, M. Falk, S. Donaldsson, T. Drevhammar, B. Jonsson:** Do newborn infants exhale through the CPAP system? secondary analysis of a randomised cross-over trial
- 1557 H. Ozdemir Koyu, E. Kilicarslan Törüner:** The effect of technology-based interventions in pediatric oncology: an integrative review of evidence

- 1559 H. Ozdemir Koyu, E. Kilicarslan Törüner:** The effect of empowerment programs for parents of children with cancer: a systematic review
- 1561 E. Westin, M. Sund Levander:** Parent's experiences of their children suffering febrile seizures - a qualitative interview study
- 1563 Poster Viewing Abstracts**
- 1564 V. Mundeshi, N. Chinchankar:** A case series of scimitar syndrome - with varied presentations
- 1567 A. Liaskou, K. Straka, E. Christakou, C. Tsirogianni, C. Tsiagklani, D. Paraschou, C. Barbaressou:** Presentation of cardiac arrhythmias after infection with the novel covid-19
- 1569 M. Castelão, M. Pereira, M. Mota, M. Mata, M. Abecasis, J. Neves, R. Anjos:** Prenatal diagnosis of coarctation of the aorta reduces preoperative illness severity and morbidity
- 1571 A. Ntavoura, M. Prapa, E. Christakou, C. Tsirogianni, M. Gianniki, E. Mpourazani, L. Anastasia, D. Paraschou, C. Barbaressou:** Rare pediatric cases of covid-19 associated pulmonary embolism
- 1573 I. Bakalli, E. Celaj, E. Kola, M. Zguri, I. Gjeta, D. Klironomi:** Challenges encountered in diagnosing and treating mis-c
- 1575 R. Ben Rabe, N. Missaoui, S. Atitallah, S. Yahyaoui, O. Bouyahya, S. Mazigh, S. Boukthir:** Cardiac involvement in multisystem inflammatory syndromedue to sars cov 2 in tunisian pediatric population
- 1577 S. Mukhopadhyay, A. Singh:** Acute liver failure as a prominent presentation in misc due to covid-19 infection

- 1579 M. Simou, F. Jannan, M. Khalfi, S. Gueroum, B. Atak:** Prognostic factor of diabetic ketoacidosis in the pediatric intensive care unit
- 1581 A. Liaskou, E. Christakou, K. Straka, P. Poulos, C. Barbaressou:** Cerebral encephalopathy with pontine myelinolysis in a case of central diabetes insipidus after neurosurgery
- 1583 M. Gianniki, E. Christakou, C. Tsirogianni, E. Mpourazani, K. Straka, C. Tsiagklani, I. Gotsi, P. Poulos, D. Paraschou, C. Barbaressou:** Acute pancreatitis, hypertriglyceridemia and diabetic ketoacidosis in a 5-year-old boy following l-asparaginase/dexamethasone therapy for acute lymphoblastic leukemia
- 1585 L. Martirosyan, V. Manukyan, H. Hakobyan, S. Brutyan, M. Melkonyan, V. Asoyan, H. Apresyan, A. Minasyan:** The rate of neonatal mortality and that's relation with a season of the year
- 1587 L. Martirosyan, V. Manukyan, H. Hakobyan, S. Brutyan, M. Grigoryan, M. Melkonyan, V. Asoyan, H. Apresyan, A. Minasyan:** Epidemiological analysis of patients in nicu of muratsan uhc during january-june 2017, yerevan, ra
- 1589 D. Alexander, M. Quirke, J. Greene, K. Hill, C. Doyle, M. Brenner, K. Masterson:** "We are pushing the limits": clinicians' perceptions of bioethics services when considering long-term ventilation for a child
- 1591 M. Sdougka, E. Volakli, A. Violaki, M. Svirkos, S. Kalamitsou, P.-E. Mantzafleri, E. Karakeke, E. Zakyntinos:** Bioethical considerations for end-of-life decisions in greek critically ill children

- 1593 J. Greene, M. Quirke, D. Alexander, C. Doyle, M. Brenner:** Initiating long-term ventilation for a child: navigating complex decision-making with parents
- 1595 A. Martín, M. Soler, V. andrino:** Impact of training caregivers of tracheostomised children in a paediatric intensive care unit
- 1597 O. Horlenko, L. Prylypko, B. Halay, L. Halay, G. Beley, F. Horlenko:** The degree of determinism of variability of important clinical and laboratory parameters in chronic pancreatitis
- 1599 A. Liaskou, K. Straka, E. Christakou, E. Mpourazani, I. Gotsi, C. Barbaressou:** A case report of acute hepatic failure with hyperammonemia and hyperbilirubinemia in the setting of chemotherapy, treated with coupled plasma filtration adsorption (cpfa)
- 1601 A. Ortiz Ortigosa, D. Navarro Molina, J. Blasco-Alonso, F. Guerrero Del Cueto, R. Gil Gómez, J.M. Camacho Alonso:** Acute liver failure in pediatric intensive care
- 1603 A. Rasouli, S. Ilia, M. Raissaki, G. Briassoulis:** Correlation of catabolism and nutritional support indices of pediatric icu patients with clinical characteristics and outcome endpoints
- 1605 S. Bhosale, A. Kulkarni, J. Divatia, A. Narkhede:** Outcomes of pediatric renal replacement therapy amongst oncology children admitted to intensive care unit
- 1607 S. Friedman, I. Ayalon, B. Meidan, E. Sadot:** Diagnosis of inferior vena cava thrombosis facilitated by point of care ultrasound (pocus) in the pediatric intensive care unit (picu)
- 1610 E. Mpourazani, C. Tsirogianni, E. Christakou, C. Oikonomopoulou, E. Goussetis:** Clinical characteristics and outcome of patients undergoing hematopoietic stem cell

transplantation (hsct) admitted to a pediatric intensive care unit (picu).

- 1613 L. Martirosyan, V. Manukyan, H. Hakobyan, S. Brutyan, M. Melkonyan, V. Asoyan, H. Apresyan, A. Minasyan:** Analyzing the death formula of neonates up to 1 month hospitalized in neonatal icu of muratsan uhc within 2017.
- 1615 D. Bonacina, I. Pellicoli, F. Ferrari, C. Pellegrinelli, C. Fornasari, G. Giudici, E. Bonanomi:** Early infections after pediatric liver transplantation: a 5 years single-centre experience
- 1618 E. Celaj, I. Bakalli, M. Zguri, D. Sala, I. Gjeta, E. Kola:** Role of biomarkers for early diagnosis of sepsis and prediction of outcome in critically ill children
- 1620 P.R. Deshwal, N.S. Reddy, R. Fathima, M. Aggarwal, P. Tiwari:** Risk factors or predictors of developing ciprofloxacin, trimethoprim/sulfamethoxazole and third-generation cephalosporin resistance in e. Coli infections relative to control patients: a systematic review and meta-analysis
- 1622 P. Kenderessy, N. Mikusova, O. Petrik:** Prolonged and continuous infusion of time-dependent antibiotics - preliminary data from new picu therapeutic protocol
- 1624 E. Christakou, V. Dimitropoulou, S. Konstantakopoulos, E. Mpourazani, C. Tsiagklani, C. Barbaresou:** Massive rhabdomyolysis with acute kidney injury (aki) secondary to influenza a virus infection: a case report
- 1626 E. Mpourazani, E. Christakou, M. Prapa, K. Spyridopoulou, G. Paradeisis, C. Barbaresou:** Prevalence and clinical impact of vancomycin-resistant

enterococci colonization in critically ill pediatric patients in a greek picu.

- 1629 C. Neokleous, K. Sialou:** Fatal encephalitis and cerebellitis with fulminant brain oedema in a previously healthy child caused by human herpesvirus 6
- 1632 A. Ntavoura, C. Tsiagklani, M. Gianniki, A. Stelianidi, M. Prapa, E. Mpourazani, D. Paraschou, C. Barbaressou:** Epstein – barr virus (ebv) associated severe clinical presentations in pediatric intensive care unit (picu)
- 1634 M. Sdougka, E. Iosifidis, E. Karakeke, A. Violaki, E. Volakli, M. Svirkos, S. Kalamitsou, P.-E. Mantzafleri, K. Moustakidou Papadaki, A. Nikolaidou, C. Zarras, E. Roilides:** Use of biofire®filmarray pneumonia panel for detection of pathogens in lower respiratory tract specimens in critically ill children
- 1636 A. Sofijanova, O. Jordanova, S. Bojadzieva:** Procalcitonin levels in corellation with il-6 and crp for early diagnosis of sepsis in newborns
- 1638 C. Tsiagklani, M. Prapa, K. Straka, E. Christakou, M. Gianniki, A. Ntavoura, I. Gotsi, P. Poulos, D. Paraschou, C. Barbaressou:** Mucormycosis: different clinical cases in a pediatric intensive care unit (picu)
- 1640 C. Tsiagklani, M. Prapa, K. Straka, E. Michailoudi, E. Christakou, M. Gianniki, A. Ntavoura, I. Gotsi, P. Poulos, D. Paraschou, C. Barbaressou:** A case of acute hydrocephalus: complication of listeria monocytogenes meningitis in an 8-year-old oncology patient

- 1642 K. Wilson, H. Groves, S. Mcvea, J. Richardson:** Bedside point of care testing for respiratory pathogens in paediatric intensive care; a feasibility study.
- 1644 M. Daverio, G. Cortina, A. Jones, A. Deep:** Continuous kidney replacement therapy (ckrt) practices in the pediatric intensive care units across europe: an espic survey amongst 20 european countries
- 1646 R.A. Burgueño-Rico, E. Turon-Viñas, E. Coca-Fernandez, S. Brió-Sanagustin, E. Carbonell Estarellas, F. Castillo-Gómez, M. Rodríguez- Martínez, S. Boronat-Guerrero:** Pediatric stroke code. Experience in a 3rd level center
- 1648 E. Goula, C. Lymperatou, C. Tsimakidi, E. Kotsi, A. Tsiaila, M. Vasilopoulou:** Febrile seizures as first clinical presentation of focal cortical dysplasia in a 3,5-year-old girl
- 1650 A. Pi-Compañó, M. Espinet-Pedrol, R.A. Burgueño-Rico, E. Coca-Fernandez, S. Brió-Sanagustin, L. Sanchez, B.M. Anson, J. Branera, E. Turon-Viñas, S. Boronat-Guerrero:** Case report: acute ischemic stroke in a child due to tica occlusion treated successfully with endovascular treatment
- 1652 E. Sfeir, J. Zini, A. Bakayoko, E. Beltaief, A. Essid, B. Mbieleu, S. Quijano, J. Bergounioux:** About 9 cases of respiratory support in pediatric jeune syndrome and clinical evolution
- 1654 C. Tsirogianni, A. Liaskou, K. Straka, E. Christakou, M. Prapa, P. Poulos, D. Paraschou, C. Barbaressou, V. Dimitropoulou, E. Mpourazani:** A rare case of guillain-barré syndrome post covid-19 infection in a young male patient
- 1656 A. Parry, A. Knight:** Can we use ward nurses (as picu nurses) for a predicted rsv surge?

- 1658 K. Amanzoui, A. Erragh, H. Salem, S. Kallouch, A. Chlilek:** The consumption of antibiotics in pediatric resuscitation
- 1660 K. Amanzoui, K. El Fakhr, A. Erragh, A. Afif, S. Kallouch, A. Chlilek:** Evaluation of the management of intoxications in pediatric intensive care unit
- 1662 K. Amanzoui, A. Erragh, A. Raja, K. El Fakhr, S. Kallouch, A. Chlilek:** Therapeutic de-escalation in probabilistic antibiotherapy in pediatric resuscitation
- 1664 F. Caino De Oliveira, W. Brunow De Carvalho, L. Valquer Trevisol, R. Aguiar Salvador:** Mucopolysaccharidosis type vi airway obstruction due glycosaminoglycans after an elective procedure
- 1667 A. Greco, F. Leo, F. Di Dio, G. Gargano:** Prenatal onset chylothorax, chylopericardium and mediastinal avm in newborn with heterozygous variant of the *rasa1* gene: management challenges
- 1670 C. Lymperatou, A. Tsialla, E. Siouti, I. Vasilopoulou, O. Giannouli, S. Kostaridou, M. Vasilopoulou:** Postinfectious bronchiolitis obliterans (pibo) in a toddler following an adenovirus and rsv lower respiratory coinfection
- 1673 L. Seidler Nussenbaum, J. Raya Muñoz, B. De Paz Vaquero, Y. Peña Lopez, X. Nuvials Casal, J. Balcells:** Percutaneous tracheostomy performed in a pediatric intensive care unit
- 1675 M. Gianniki, E. Christakou, K. Straka, M. Prapa, E. Mpourazani, C. Tsiagklani, A. Stelianidi, P. Poulos, D. Paraschou, C. Barbaressou:** Status asthmaticus in a tertiary pediatric intensive care unit: a 4 years' experience

- 1677 M. Pasha, S. Alshehri, V. Peter:** Pediatric rapid response team (rrt) assessment decreased code blue events – a single centre experience in a large tertiary centre
- 1679 S. Shaw, M. Mahgoub, C. Chamberlain-Parr, R. Ellis, L. Tume:** Long stay patients on paediatric intensive care unit (picu): exploring clinical nurses perceived challenges
- 1681 S. Shaw, M. Mahgoub, C. Chamberlain-Parr, R. Ellis, L. Tume:** Long stay patients on paediatric intensive care unit (picu): exploring medical and nurse practitioners perceived challenges
- 1683 M. Rohouma, L. Liveing, A. Hill, G. Harlow, M. Zoha, C. Silvestre:** Respiratory support with non-invasive ventilation (niv) and humidified high flow nasal cannula (hhfnc) during inter-facility transfers- a safety and feasibility case review.
- 1685 L. Kenworthy, N. Reilly, P. Jirasek:** Evaluation of a sedation protocol and weekly sedation ward rounds in paediatric intensive care
- 1687 F. Sperotto, A.-S. Ramelet, M. Daverio, M.C. Mondardini, F. Von Borell, S. Brenner, D. Tibboel, E. Ista, H. Cihlářová, A. Amigoni:** Iatrogenic withdrawal syndrome and delirium monitoring and treatment in pediatric intensive care units across europe: an espic survey
- 1689 R. Stenkjaer, S. Herling, I. Egerod, J. Weis, M. Van Dijk, S. Kudchadkar, A.-S. Ramelet, E. Ista:** Development of a non-pharmacologic delirium management bundle in pediatric intensive care units
- 1691 D. Sinjeri, D. Belina:** Scimitar syndrome, anal atresia and inspiratory stridor- is it a potentially new genetic syndrome?

- 1693 E. Christakou, V. Dimitropoulou, M. Gianniki, S. Konstantakopoulos, K. Straka, M. Prapa, C. Tsiagklani, C. Barbaressou:** Characteristics and outcome of children with inhalation injury admitted to a pediatric intensive care unit
- 1695 A. Stelianidi, K. Straka, E. Christakou, C. Tsirogianni, M. Prapa, S. Kouni, V. Dimitropoulou, E. Michailoudi, E. Vaggelakoudi, I. Gotsi, P. Poulos, D. Paraschou, C. Barbaressou:** Abusive head trauma in infancy: 3-year experience in a tertiary picu
- 1697 J. Dirks, J. Pagel, J. Marißen, L. Reichert, M.I. Fortmann, D. Viemann, K. Glaser, E. Herting, H. Morbach, C. Härtel:** Development of cellular immunity in extremely preterm infants
- 1699 F. Lohrmann, P. Henneke:** Skin infections uncover division of labor in tissue macrophages
- 1701 A. Abbas, G. Holder, L. Whitticase:** Paracetamol for closure of patent ductus arteriosus: experience from a regional neonatal unit
- 1703 A. Bhattacharya, A.C. Massolo, S. Kirolos, F. Kipfmüller, N. Patel:** Pathophysiological phenotypes in congenital diaphragmatic hernia: frequency and relationship to disease severity
- 1706 A. Bhattacharya, A.C. Massolo, S. Kirolos, F. Kipfmüller, N. Patel:** Left ventricular rotational mechanics in congenital diaphragmatic hernia
- 1708 B. Bo, L. Lemloh, L. Schröder, N. Patel, A. Müller, F. Kipfmüller:** Tricuspid regurgitation characteristics and outcome prediction in neonates with congenital diaphragmatic hernia

- 1710 L. Bradford, A. Gupta, A. Mukherjee:** Neonatal hypotension: are we still treating numbers?
- 1712 R. Chioma, D. Finn, B. Walsh, C. Reynolds, D. O'Sullivan, V. Livingstone, D. Healy, E. Dempsey:** Modelling of routine echocardiographic and clinical data for early prediction of bpd or death in very preterm infants
- 1715 M.C. Escobar-Diaz, M. Pérez-Cruz, M. Arraez, M.-M. Cascant-Vilaplana, A. Albiach-Delgado, J. Kuligowski, M. Vento, N. Masoller, O. Gómez, M. Camprubí, J. Sanchez-De-Toledo:** Increased oxidative stress biomarkers in fetuses with transposition of the great arteries
- 1717 M.C. Escobar-Diaz, M.L. Rossi, C. Ruiz Herguido, C. De La Torre, J. Bech, M. Camprubí, J. Sanchez-De-Toledo:** Omic tools for improving diagnosis of left-sided obstructive lesions
- 1719 A. Ghanchi, N. Derridj, J. Cohen, D. Bonnet, M. Rahshenas, L. Salomon, B. Khoshnood:** Early mortality in infants born with severe neonatal-operated congenital heart defects and low or very-low birthweight: systematic review and meta-analysis
- 1721 R. Hernandez Benitez, R. Medina Zamora, M. Gerardo Del Hoyo:** Blood pressure in healthy term and late preterm newborns in mexico city
- 1723 N. Höller, C. Wolfsberger, B.C. Schwabegger, D. Pfurtscheller, B. Urlesberger, G. Pichler:** Comparability of peripheral muscle foe and ftoe in neonates
- 1725 S.-L. Jan, M.-C. Lin:** Transcatheter arterial embolization in a newborn with cervical kaposiform hemangioendothelioma and kasabach-merritt phenomenon

- 1727 M. Khalil, H. Coakley, H. Jhala, A. Singh:** Improved survival rates with changed postnatal management of congenital diaphragmatic hernia.
- 1729 H.N. Lee, E. Jung:** Outcomes of hydrocortisone use in congenital diaphragmatic hernia
- 1731 H. Michel, H. Ragnarsdottir, L. Manduchi, F. Laumer, E. Oezkan, J. Vogt, S. Wellmann:** A deep learning approach to predict pulmonary hypertension in neonates using 2d-echocardiography videos
- 1733 E.S. Wiggins, S. Bin Ihsan, T.-J. Liu, C. Black, A. Purewal, B. Punniyakotty, B. Moran, M. Ashwin, P. Maguire, G. Semova, E. Isweisi, J. Meehan, E. Roche, A. Branagan, E. Molloy:** Cardiac biomarkers in neonatal encephalopathy: blood and echocardiographic
- 1735 M. Morton, A. Onibere:** Service review of pda assessment and management in north wales
- 1737 C. Murphy, N. Bussmann, D. Staunton, N. Mccallion, O. Franklin, A. El-Khuffash:** Patent ductus arteriosus treatment with paracetamol may lead to an increase in pulmonary vascular resistance
- 1739 S. Patel:** Case series of pulmonary hypertension and outcome in a quaternary centre.
- 1741 A. Pearce, M. Rajimwale, P. Nath:** A regional survey of use of neonatal functional echocardiography to develop a training programme
- 1743 N. Rajaraman, M. Noureldein, H. Gowda:** Observational study of current practice on patent ductus arteriosus (pda) management and outcomes in a tertiary neonatal intensive care unit (nicu) in the united kingdom

- 1745 N. Rajaraman, M. Noureldein, H. Gowda:** Early vs late patent ductus arteriosus (pda) treatment in extremely premature neonates- observational study in a tertiary neonatal intensive care unit (nicu) in united kingdom
- 1747 A. Rivas Piorno, D. Cañizo, A. Remón Pérez, M. Perez Cruz, J. Sanchez-De-Toledo, M. Camprubí:** Assessment of the corpus callosum by ultrasound in patients with congenital heart disease
- 1749 S. Schaaning, L. Hansen, T.C.K. andelius, H. andersen, M. Pedersen, R. Pinnerup, T. Henriksen, K. Kyng:** The effect of remote ischemic postconditioning on cardiac function after hypoxia-ischemia in a newborn piglet model
- 1751 C. Schwarz, J. O'Toole, D. Healy, J. Panaviene, V. Livingstone, E. Dempsey:** Association between electrical cardiometry in the transitional period and short-term outcome in very preterm infants
- 1754 J. Svedenkrans, A. Sand, E. Hetting, V. Strandvik, O. andersson:** Cord clamping time and placental transfusion in cesarean sections: an observational multicenter study
- 1756 M. Ten Westenend, M. Schokking, W. De Boode:** Creating and implementing a pan-european governance structure for a training programme in neonatologist performed echocardiography: a participatory design project
- 1758 L. Van Loo, K. Allegaert, E. Levtchenko, Z. Zhang, J. Staessen, A. Raaijmakers:** Perfused boundary region as a biomarker for endothelial integrity in healthy controls and extremely low birth weight survivors in early adolescence
- 1760 J. Berg, L. Thies-Lagergren, J. Svedenkrans, S.M. Larsson, J. Samkutty, H. Rabe, O. andersson:** Umbilical cord clamping practice in the covid-19 pandemic

- 1763 A. Agarwal, A. Behl, S. Yadav:** Has the covid-19 pandemic influenced multimedia screen time of children aged 6 months to 5 years?
- 1765 A.M. Bradeanu, C. Taran, M. Iancu, L.C. Stanciu, I. Ercuta:** Severe neonatal sars cov 2 infection: case report
- 1767 M.G.. Conti, S. Terreri, G. Terrin, F. Natale, C. Pietrasanta, R. Brunelli, V. Papaevangelou, F. Midulla, L. Petrarca, R. Carsetti, A. Angelidou:** Sars-cov-2 infection vs vaccination in pregnancy: implications for maternal and infant immunity
- 1769 A. Pysariev, T. Kurilina, Y. Marushko, I. Aubekerova, V. Turchenyuk:** Modifications in placenta of women with sars-cov-2 infection and the state of their newborns
- 1771 J.I. Pijoan-Zubizarreta, J. Pérez-López, C. Ribes-Bautista, F. Camba-Longueira, M.C. López-Herrera, J. De Frutos-Pecharromán, B. Loureiro:** Impact of the first wave of the covid-19 pandemic on the functioning of inberbac-neo neonatal units.
- 1773 G. Rojas, M. Aslam, C. Uy:** Correlation of maternal and cord blood sars-cov-2 immunoglobulin levels in covid-19 during pregnancy
- 1775 M. Tatal, O. Surmeli Onay, K. Yolcu, T. Barsan Kaya, O. Aydemir, A.N. Tekin:** Newborns born to sars-cov-2 infected mothers exhibit a milder clinical presentation than newborns with transient tachypnea
- 1778 D. Wojciechowska, A. Basiukajć, K. Wróblewska-Seniuk, J. Mazela, T. Szczapa:** Sars-cov-2 infection - a new life-threatening disease in neonatal intensive care unit.

- 1780 V. Burckhardt Bravo, T. Kunze Küllmer, C. Werner Ratto, T. Barros Vial, H. Villalón Urrutia:** Dermoepidermic tear after vacuum assisted delivery, ¿a risk-free procedure?
- 1782 K.A. Aakvik, S. Benum, K. Räikkönen, M. Tikanmäki, E. Kajantie, P. Hovi, S. Harris, B. Darlow, P.J. Mork, M. Indredavik, K.A. Evensen:** Association between physical activity and cognitive function in adults born very preterm or with very low birth weight: an individual participant meta-analysis
- 1784 H. Ahmed, M. Ahmed, H. Klonin, R. Alia:** Quantitative evaluation of the noise level in a tertiary neonatal unit in the uk
- 1787 M. Aslamzai, O. Faizi:** Prevalence and risk factors for apnea of prematurity in hospitalized preterm neonates of kabul city: an analytic cross-sectional study.
- 1789 M. Bastos Gomes, E. Sousa, A. Costa Azevedo, M. Fonte, E. Proença, A. Almeida, A.M. Alexandrino, A. Guedes, S. Domingues, A. Novo:** Survival and neurodevelopmental outcome among 23 to 26 weeks preterm infants: experience of a level iii hospital
- 1791 N. Rickman, C. Mayer, S. Vatolin, C. Tokat, P. Macfarlane, C. Bearer:** Ethanol exposure in a rodent model of preterm neonates leads to respiratory control dysfunction in female but not male rat pups
- 1793 A. Bijlsma, V.A.A. Beunders, I. Van Beijsterveldt, D. Dorrepaal, A. Hokken-Koelega, I. Reiss, K. Joosten, M. Vermeulen:** Sleep and 24-hour rhythm characteristics in preschool children born very preterm compared to their full-term peers
- 1795 A. D'Souza:** The impact of postnatal growth on neurodevelopmental outcomes in extremely preterm infants

- 1797 L. Fernández De Gamarra-Oca, N. Ojeda, J.M. Ontañón, B. Loureiro, A. Gómez-Gastiasoro, J. Peña, N. Ibarretxe-Bilbao, M.A. García-Guerrero, L. Zubiaurre-Elorza:** Brain volumetric differences in low-risk prematurity during young adulthood
- 1799 L. Fernández De Gamarra-Oca, H. Kvanta, D. Nosko, M. Strindberg, E. Eklöf, N. Ojeda, L. Zubiaurre-Elorza, N. Padilla, U. Aden:** Discrete white matter abnormalities in extremely preterm born children were related to cortical thickness
- 1801 M. Filippa, D. Benis, A. Adam-Darque, P. Hüppi, D. Grandjean:** Preterm infants voice processing is mediated by voice familiarity
- 1803 M. Filisetti, D. Cattarelli, S. Bonomi:** Neurodevelopmental assessment with griffiths scale at pre-school age of children with positional plagiocephaly followed in an early intervention program based on the osteopathic integrated approach
- 1805 M. Filisetti, D. Cattarelli, S. Bonomi:** Neurodevelopmental assessment with griffiths scale at pre-school age of children with positional plagiocephaly followed in an early intervention program based on the osteopathic integrated approach
- 1807 N. Halbmeijer, M. Merkus, W. Onland, A. Van Kaam:** Clinical effect modifiers of long-term outcome in ventilated very preterm infants treated with systemic hydrocortisone
- 1811 M. Hanson:** Efficacy and safety of early screening methods in neonates with risk factors for developmental dysplasia of hip in a rural setting
- 1813 T. Hurley, M. O’Dea, A. Branagan, P. Stewart, S. Tamgumus, D. Mockler, K. Kyng, E. Molloy:** Serum

biomarkers to predict long-term outcome in neonatal encephalopathy; a systematic review and meta-analysis

- 1815 R. Itoshima, A. Oda, R. Ogawa, T. Yanagisawa, T. Hiroma, T. Nakamura:** Microcephaly at birth as a potential predictor of poor long-term prognosis in infants weighing 500 grams or less: a retrospective cohort study
- 1817 G. Jee, S.J. Kotecha, M. Chakraborty, S. Kotecha, D. Odd:** Birthweight and long-term neurodevelopmental outcomes across all gestations: is bigger better?
- 1819 S.H. Kim, J.H. Hwang, J. Jeong, H.N. Lee, J.M. Lee, B.S. Lee, E.A.-R. Kim, K.-S. Kim, E. Jung:** Association of moderate hypothermia at admission with short-term and long-term outcomes in extremely low birth weight infants
- 1821 O. Kochukhova, Y. Kaul, M. Johansson, A. Geeb Karimi, J. Wikström, L. Hellström-Westas:** Ventricle enlargement is associated to gaze scanning patterns and affect recognition in 12-year-old children born very preterm
- 1823 S. Kurul, F. Beckers, C. Ramakers, R. Kornelisse, I. Reiss, S. Simons, H.R. Taal:** Inflammation, sepsis severity and long-term outcomes of neonatal sepsis in preterm neonates
- 1825 K. Upatissa, S. Mahadevan-Bava, S. Afridi:** Two year outcome of preterm babies born less than 30 weeks gestation in a level 2 neonatal unit(nnu)
- 1828 C. Marín-Córdoba, M. Morey-Olivé, A. Montaner-Ramón, F. Camba-Longueira, P. García-Manau, M.T. Avilés García, M.Á. Sánchez-Duran:** Aetiologies, treatment and outcome of antenatally diagnosed hydrops fetalis: a tertiary centre's experience over ten years.
- 1830 M. Morey-Olivé, C. Marín-Córdoba, F. Camba-Longueira, A. Montaner-Ramón, C. Rodó Rodríguez, S. Arévalo**

Martínez: Perinatal outcomes among live-born babies to women with prenatal diagnosis of hydrops fetalis: a tertiary centre's experience over ten years.

- 1832 M. Ryan, J. McIntyre, S. Johnson, S. Ojha:** Feasibility of using a parent-report questionnaire for two-year neurodevelopmental follow-up in infants born at 30-34 weeks' gestational age (ga)
- 1835 V. Giordano, S. Stummer, C. Lindtner, R. Fuiko, A. Berger, K. Pichler:** Behavioral outcome of very low birthweight infants with neonatal sepsis at 5 years of age
- 1837 J. Roelants, M. Vermeulen, S. Willemsen, J. Been, A. Koning, A. Eggink, K. Joosten, I. Reiss, E. Steegers, R. Steegers-Theunissen:** Embryonic size and growth measured on three-dimensional ultrasound scans using virtual reality techniques and adverse birth outcomes: the rotterdam periconception cohort
- 1839 J. Sa De Almeida, S. Loukas, S. Martin-Brevet, L. Vasung, D. Van De Ville, D.-E. Meskaldji, P. Hüppi:** Resting-state functional connectivity and angiogenesis-related genes co-expression in preterm infants' cortical development
- 1841 E. Sousa, M. Bastos Gomes, A. Costa Azevedo, E. Proença, A. Guedes, A.M. Alexandrino, A. Novo, S. Domingues:** Survival and neurodevelopmental outcomes in extremely low birth weight preterm infants after two years of corrected age - a level iii hospital analysis
- 1843 B. Stevens, M. Bueno, M. Ballantyne, M. Campbell-Yeo, C. Estabrooks, S. Gibbins, D. Harrison, C. McNair, S. Riahi, J. Squires, A. Synnes, A. Taddio, C. Victor, J. Yamada:** The impact of repeated administration of sucrose on long-term neurodevelopment of preterm infants at 36 months corrected age

- 1845 P. Thwaites, L. Hofer, U. Held, D. Bassler, G. Natalucci:** Outcome of very preterm born infants after periventricular haemorrhagic infarction (option study)
- 1847 Y.-C. Lin, L.-W. Chen, C.-H. Chu, H.-J. Chen, S.-M. Kao, C.-C. Huang:** Early-life morbidities and thyroid-stimulating hormone levels in extremely preterm infants
- 1849 O.P. Rozakea, L. Mentessidou, E. Kassari, K. Karantzas, G. Tsiolaki, A. Pana, G. Kourousi, M. Chantziopalti, T. Bachou, D. Delis:** Unusual clinical presentation of congenital hypothyroidism as pseudo-obstruction
- 1852 S. Sahnoud, R. Alia, S. Gupta:** Adrenal suppression in neonates receiving steroids for respiratory management
- 1854 C. Augusto De Lima, D. Alves Da Costa Canella, S. Silva Sabino, S. Silva Sabino, S. Silva Sabino, O. Augusto Freire Campos, E. Gonçalves Silva, M. De Lima Alves, M. Evelyn Da Silva, E. Fellipe Capini De Almeida Tavares, T. Calegari:** Epidemiology of neonatal tetanus: the brazilian reality
- 1856 C. Augusto De Lima, D. Alves Da Costa Canella, S. Silva Sabino, S. Silva Sabino, S. Silva Sabino, M. Evelyn Da Silva, O. Augusto Freire Campos, M. De Lima Alves, E. Gonçalves Silva, E. Fellipe Capini De Almeida Tavares, T. Calegari:** Notifications of february typhoid cases in children in the period 2009 to 2019
- 1858 A. Ego:** Validity of hospital discharge summaries for identifying hypoxic-ischemic encephalopathy
- 1860 T. Eyo, H. Gowda:** A single centre perinatal outcomes following extreme preterm birth before 27 weeks gestation pre and post adoption of the bam framework.
- 1863 Z. Frimpong, R. Turkson, E. Bioh, M. Boateng, M. Osei-Bonsu, H. Doshi, K. Donda, N. Parmar, P. Bhatt, F. Dapaah-**

Siakwan: Resource utilization among periviable preterm infants in the united states, 2009-2018

- 1865 C. Gale, S. Jawad, A. King, H. Robberts, A. Forster, N. Modi, M. Turner, T. Van Staa, C. Cole, K. Stanbury, K. Ougham, J. Dorling, E. Juszczak:** Withholding enteral feeds around packed red cell transfusion to prevent necrotising enterocolitis in preterm neonates (wheat): a multi-centre pilot trial
- 1867 M.C. Gauci, G. Di Cataldo, C. Gammeri, F. Gambilonghi, C. Mattia, M.G. Scuderi, V. Di Benedetto, P. Betta:** Neonatal and maternal risk factors of fetal abdominal wall defects
- 1869 C. Girard, J. Zeitlin, N. Marlow, M. Norman, F. Serenius, E.S. Draper, S. Johnson, V. Benhammou, P.Y. Ancel, K. Maršál, K. Källén, A. Morgan:** Impact of maternal pre-pregnancy bmi on neonatal outcomes of infants born extremely preterm
- 1872 A. Hurley, C. Harrison:** Outcomes of live born infants with trisomy 13 and trisomy 18.
- 1874 A. Hurley, C. Harrison:** Trisomy 13 and 18 outcome trends
- 1876 A. Hocquette, A. Pulakka, J. Metsälä, K. Heikkilä, E. Kajantie:** Association between risk of infant death and birthweight percentile defined by intrauterine or birthweight charts according to gestational age in the finnish medical birth register
- 1878 D. Odd, H. White, M. Lyon, T. Gaunt, D. Lawlor:** Predicting hypoxic-ischaemic encephalopathy: conventional risk factors compared to agnostic machine learning
- 1881 C. Phibbs, C. Smith-Hughes, S. Schmitt, M. Passarella, S. Lorch:** Who is in the nicu? A population-level descriptive

analysis of the types of infants admitted to the nicu their contributions to total patient days

- 1883 A. Singh, S. Mukhopadhyay:** Evolving epidemiology of neonatal candidiasis and its impact, outcomes and sequelae in neonates admitted in nicu: a prospective study from a tertiary centre in india
- 1887 G. Zaharie, T. Drugan, M. Hasmasanu, A. Tutu, I. Rotar, D. Muresan, F. Zaharie, M. Vintan, L. Blaga, M. Matyas:** Morbidity and mortality in preterms babies below 28 weeks of gestation from mothers with chorioamionities
- 1889 J. Syltern, L. Ursin:** “Hope and not hope”: what information do parents want for shared decision-making at the border of viability?
- 1891 M.-R. Ballard, U. Banerjee, D. Thakur, B. Bhojnagarwala:** Introduction of multi-disciplinary facilitated education sessions for families and parent centred ward rounds: overcoming challenges imposed by the covid-19 pandemic
- 1894 L. Bracken, A. Gill, K. Johnson, N. Mccallion, B. Cleary, M. Peak, C. Barker, N. Caldwell, F. Gaffney, S. Morris, E. Neary, M. Turner, R. Corry, J. Clark, C. Sutton, J. Murphy, R. Dore, F. O’Brien:** Paddington study - parent co-designed drug information for parents and guardians taking neonates home– an e-survey of healthcare professionals
- 1896 R. Clements, D. Edwards, E. Hoyle:** Family integrated care (ficare): parent feedback in the implementation phase
- 1899 S. Cromie, A. Stobo, D. Sweet:** Delivery room skin-to-skin– a quality improvement project to increase the number of preterm infants offered a delivery room cuddle

- 1902 M. Cuttini, E. Forcella, G. Abate, A. Lainè, I. Sarrechia, S. Ebinger, J. Lebeer, R. Maier:** Parental long-term memories of time in nicu after a very preterm birth: a qualitative study in four european countries.
- 1904 A. De Boer, M. De Vries, M. Hogeveen, J. Verweij, R. Geurtzen:** Parental values in prenatal decision-making regarding treatment options after birth at the limits of viability: results of a scoping review
- 1906 A. De Boer, L. De Proost, M. De Vries, M. Hogeveen, J. Verweij, R. Geurtzen:** What do premature born adults regard as important values in decision-making regarding treatment after birth at the limits of viability? Results of a focus-group study
- 1908 E. De Groot, C. Sam, M.A. Ryan, O. Verschuren, M. Benders, J. Dudink, A. Van Den Hoogen:** Neonatal sleep, knowledge and care practices in dutch neonatal healthcare: a survey.
- 1911 K. Ganzijeva, E. Zekaite-Vaisniene, R. Tameliene:** Parents' knowledge of sudden infant death syndrome among newborns born in lithuania in 2020
- 1914 A. Gill, L. Bracken, K. Johnson, N. Caldwell, B. Cleary, M. Peak, C. Barker, N. Mccallion, F. Gaffney, S. Morris, E. Neary, M. Turner, R. Corry, F. O'Brien:** Paddington study - parent/carer co-designed drug information for parents and guardians taking neonates home – parent/carer feedback
- 1917 K. Hunt, A. Hassan:** Investigating confidence in antenatal counselling for prematurity by uk non-consultant doctors and annps

- 1919 K. Hunt, A. Hassan:** Investigating confidence in antenatal counselling in various scenarios by uk non-consultant doctors and annps
- 1921 N. Jiménez-Luque, E. Ruiz-González, I. Benavente-Fernández, S. Lubián-López, Y. Sánchez-Sandoval:** Influence of medical risk and perinatal factors on parenting of mothers and fathers with very preterm infants
- 1923 J. Latour, A. Axelin, J. Kostenzer, M. Campbell-Yeo, A. Van Den Hoogen:** Developing a core outcome set and outcome measures of family-centred care in neonatal care: the cousin study proposal
- 1925 L. Moore:** Designing and implementing listening out for zigzags sibling support-a level 3 nicu experience
- 1927 E. Mörelius, C. Sahlén Helmer, E. Theodorsson, U. Thornberg:** An early intervention to support parent-infant interaction in the neonatal intensive care unit (nicu) and the effects on saliva cortisol co-regulation
- 1929 B. Moreno-Sanz, M. Antón, M.T. Montes, P. Álvarez, M. Sánchez-Holgado, M. Cabrera, A. Pellicer:** Impact of family integrated care on level iiic nicu: improvement of clinical outcomes of prematures and others newborns with complex neonatal conditions
- 1931 C. Murphy, D. Henderson, M. Theubo, R. O'Toole, M. Boyle, N. Mccallion:** Antenatal counselling in prematurity: parent and practitioner perspectives'
- 1933 N. O'Hanrahan, T. Condon, E. Molloy:** Outcomes of infants born to irish travellers
- 1935 S. Kirolos, L. Sutcliffe, M. Giatsi Clausen, C. Abernethy, S. Shanmugalingam, N. Bauwens, J. Orme, K. Thomson, R. Grattan, N. Patel:** Evaluation of an asynchronous video diary service to support family involvement in neonatal care

- 1938 K. Ruhe, A. Van Den Hoogen, T. Bröring - Starre, J. Wielenga, M. Weissenbruch:** Getting a grip in the middle of chaos: preparing for preterm parenthood during a high-risk pregnancy – parental experiences and needs
- 1940 N. Sehr Ansari, A. Colucci, X. Ye, L. Franck, C. Tomlinson, K. O'Brien:** A pilot study of family integrated care (ficare) in critically ill term and preterm infants in the nicu: ficare plus
- 1942 C. Young, A. Vuckovic, A. Le Brun, J. Mortiaux:** Implementation of family-centered developmental care in the nicu: what are the obstacles to parental participation?
- 1944 A. Mohammad Khuzaini, H. Abdul Halim, V.J. Yap:** Diazoxide-induced worsening liver injury in a neonate with liver impairment
- 1946 M. Annunziata, M. Brunetti, A.N. Della Gatta, G. Pilu, L. Corvaglia, S. Martini:** Association between abnormal antenatal doppler and gastrointestinal outcomes in preterm infants.
- 1948 P. Challis, L. Björklund, A. Elfvin, M. Norman, E. Normann, M. Domellof, T. Abrahamsson:** Increase of necrotizing enterocolitis over a decade: a swedish population-based cohort study of extremely low gestational age infants
- 1950 C.-C. Chen, Y.-C. Hsu, Y.-H. Lin, M.-C. Lin, T.-M. Wang, C.-T. Hsu:** The relationship between gut microbiome and feeding tolerance in preterm infants
- 1952 P. Morais, T. Lages, E. Orlandin, A. Junior, T. Bastos, B. Cavaşin, K. Barszcz, D. Aragon, C. Ferreira, W. Goncalves-Ferri:** Mild controlled hypothermia is effective for nec treatment in preterm infants less than 27 weeks of gestational age.
- 1954 P. Morais, T. Iwashita Lages, E. Orlandin, A. Junior, T. Bastos, W. Goncalves-Ferri, C. Ferreira, D. Aragon:** Mild

controlled hypothermia to treatment of nec moderate and severe in vlbw infants: neotherm project

1956 R. Hill: The effects of frenotomy on breastfeeding symptoms, infant feeding and gastrointestinal health

1958 A. Mitha, S. Krut, S. Bjurman, A. Rakow, S. Johansson: Neonatal morbidities and feeding tolerance outcomes in very preterm infants, before and after introduction of probiotics supplementation

1960 D. Klerk, L. Van Avezaath, J. Hulscher, E. Kooi: Fetal-neonatal exposure to antibiotics and nec development, a systematic review and meta-analysis

1962 Z. Kozłowska, Z. Owsiańska, I. Miechowicz, T. Szczapa: Performance of splanchnic nirs oximetry monitoring in the very low birth weight preterm infants

1964 O. Mazur, A. Konoplińska, T. Chekotun, I. Kyslova, N. Chornopyschuk: The role of serum epidermal growth factor in the development of neonatal jaundice

1966 N. Memon, C. Lee, A. Herdt, E. Eckman: Plasma biochemical and lipid panel analysis of neonatal rats exposed to phytosterols in lipid emulsions

1968 E. Ogundipe, E. Demertzi: Comparison of the first meconium microbiota: is it related to maternal lcpufa?

1970 J. Rodriguez-Fanjul, S. Terroba Seara, C. Sorribes, D. Fernandez, A. Pou, S. Fuentes, I. Oulego-Erróz: Impact of neonatologist's performed bedside ultrasound on early diagnosis and management of necrotizing enterocolitis: a before-after controlled study

1972 O. Ozen, S. Yurttutan, M. Ozkars, C. Acıpayam, S. Kırık, M. Kılınç, F. Başturk: Vitamin d deficiency in newborns with prolonged jaundice

- 1974 P. Alvarez Garcia, D. Ramiro Cortijo, M.T. Montes, B. Moreno-Sanz, A. Esteban Romero, M. Ybarra, M. Cordeiro, E. Valverde, J. Fontecha, R. Gibson, M. Saenz De Pipaon:** Randomized controlled trial of early docosahexaenoic acid and arachidonic acid enteral supplementation in very preterm infants
- 1976 C. Balcells-Esponera, I. Cubells-Serra, C. Borràs-Novell, M. López-Abad, A. Basseda-Puig, M. Izquierdo Renau, A. Herranz Barbero, I. Iglesias Platas:** Hormone content in preterm human milk: influence of maternal characteristics and impact on infant growth
- 1978 L. Beckham, D. Batra, M. Haggag:** Neonatal hyperglycaemia in extremely preterm infants: a single service experience in nottingham england
- 1981 H. Blair, A. Davidson, A. Ajiboye:** Post discharge fortifier improves breastfeeding rates for preterm infants
- 1983 E. Brazier, C.-L. Chadwick, A. Lakshmanan, C. Proctor, S. Latchford, J. Bradshaw:** Reducing the time of colostrum administration to babies on nicu through a qi project
- 1985 N. Carpay, K. Kamphorst, T. De Meij, J.G. Daams, A. Vlieger, R. Van Elburg:** Microbial effects of supplemented prebiotics, probiotics and synbiotics after caesarean section or exposure to antibiotics in the first week of life: a systematic review
- 1987 N. Carpay, K. Kamphorst, T. De Meij, J.G. Daams, A. Vlieger, R. Van Elburg:** Clinical effects of supplemented prebiotics, probiotics and synbiotics after caesarean section or exposure to antibiotics in the first week of life: a systematic review

- 1989 L. Lücke, N. Rochow, K. Knab, S. Schäfer, J. Zimmermann, A. Szakacs-Fusch, C. Fusch:** Assessment of body composition in preterm infants during hospital
- 1992 M. Gsöllpointner, F. Eibensteiner, M. Thanhaeuser, B. Jilma, R. Ristl, A. Berger, N. Haiden:** Vitamin d intake during the first year of life in preterm infants on early solid foods: a secondary analysis of a prospective, randomized intervention study
- 1996 K. Holte, E. Nygaard, C. Ramstad, C. Lie, A. Grøvslien, K. Størdal:** Macronutrients in human milk before and after six months of lactation
- 1998 E. Janson, P. Van Beek, J. Dudink, R. Van Elburg, M. Willemse, L. Hortensius, C. De Theije, N. Van Der Aa, M. Benders:** The influence of nutrition on white matter development in preterm infants: a scoping review
- 2000 S. Kappel, P. Sangild, A. Ahnfeldt, V. Jóhannsdóttir, L. Soernsen, L. Bak, C. Friborg, S. Möller, G. Zachariassen, L. Aunsholt:** Bovine colostrum fortification of human milk affects bowel habits in preterm infants (forticolos study)
- 2002 M. Lithoxopoulou, A. Karagkiozi, C. Tsakalidis, E. Drogouti, G. Mitsiakos, I. Chatziioannidis, E. Diamanti:** Microbiological screening in pasteurized donor human milk.
- 2004 I. Lygerou, S. Ilia, E. Hatzidaki, M. Miliaraki, G. Briassoulis:** Effect of nutritional support and energy-protein balance on growth indices and outcome in premature infants
- 2006 H. Resvick, B. Hartman, O. Dasilva, J. Madill:** The impact of a multidisciplinary post-discharge infant nutrition clinic on breastfeeding rates and growth trajectories in premature and low birth weight infants.

- 2008 N. Rochow, I. Prothmann, K. Knab, S. Schäfer, J. Zimmermann, A. Szakacs-Fusch, C. Fusch:** Fortification with freeze-dried breast milk in preterm infants ≥ 31 weeks of gestation – growth and safety
- 2011 S. Beck, C. Fusch, J. Däbritz, G. Fusch, N. Forghani, B. Salewski, K. Wutzke, N. Rochow:** Protein metabolism in preterm and term infants using a ^{15}N -tracer and the nitrogen balance method: a pilot-study
- 2014 A. Ahuja, D. Sikriwal, R. Mallaiah:** Effect of pasteurization on different fatty acids in human milk - a prospective observational study from a developing country
- 2016 M. Simonsen, S. Søndergaard, L. Aunsholt, P. Sangild, G. Zachariassen:** Calcium and phosphate supplementation for very preterm infants fed two different type of fortifiers
- 2018 O. Surmeli Onay, M. Tural, T.D. Sarılar, A. Cakil Saglik, M. Bilgin, O. Aydemir, A.N. Tekin, M. Velipasaoglu, H.M. Tanır:** Does it matter how to feed (drip or intermittent) for splanchnic oxygenation in intrauterine growth retarded preterm infants? A prospective randomized study
- 2021 D. Tuncel, A. Çoban, N. Yeğın, E. Kirit, G. Tosun, L. Bilgin, B. Yaşa, Z. Ince:** Maternal tacrolimus use and breast feeding: fight or flight?
- 2023 M. Meneses, M. Dias, J. Santos, S. Peixoto:** Congenital nasal pyriform aperture stenosis: a rare cause of neonatal respiratory distress
- 2025 K. Saito, E. Nishimura, T. Swa, F. Namba, J. Cao, J. Ramson, T. Lavin, E. Ota, J.P. Vogel:** Antenatal corticosteroids for special populations of women at risk of imminent preterm birth: a systematic review and meta-analysis

- 2028 T. Boles, S. Sosa Saenz, M. Heenan, C. Samuel, P. Mtenthaonga, R. Mjumira, M. Valle, R. Johnston, J. Bailey, K. Payea, V. Meka, R. Miros, Z. Oden, R. Richards-Kortum, Q. Dube, K. Kawaza:** Evaluation of low-cost warming mattress to aid in thermoregulation of newborns in low-resource settings
- 2030 K. Wilson, J. Kajjimu, S. Kapur:** Utilising advancements in online technology to provide remote resuscitation training in developing countries
- 2032 G. Zaharie, M. Hasmasanu, A. Tutu, I. Rotar, I. Taranu, G. Nemeti, D. Muresan, C. Lucaciu, F. Zaharie, A. Canpean, M. Matyas:** Teenage mothers and their newborns - a romanian study
- 2034 A. Aune, G. Vartdal, L. Gierman, G.D. Jimenez, H. Bergseng, E. Darj:** Development and validation of a smartphone-based screening tool for neonatal jaundice
- 2036 E. Moliner Calderon, L. Català Altarriba, J. Thió Casals, M.J. García Borau, I. Badell Serra, A. Remacha Sevilla:** Infantile pyknoctytosis as cause of hemolytic anemia: a case report
- 2038 C.M. Celini, C.J.M. Celini, M. De Mattos, W. Goncalves-Ferri, F.P. Martins Celini:** Congenital kaposiform hemangioendothelioma of the leg: report of a rare case of fatal vascular tumor.
- 2040 J. Cookson, R. Mistry, A. Mcmillan, K. Jamieson:** Dat positive neonates: developing a guideline and parent information leaflet in a level 2 local neonatal unit
- 2044 A. Cuartero, N. Torre, M. Sardà, D. De Luis, C. Figaró, G. Vallès, M. Domingo:** Central catheter-associated thrombosis in neonates

- 2046 Y. King, D. Jayasinghe:** Identification of perinatal anaemia by umbilical cord blood gas analysis
- 2048 S.M. Larsson, T. Ulinder, A. Rakow, M. Vanpee, K. Sävman, I. Hansen Pupp, A. Hellström, D. Ley, O. andersson:** Not all red blood cells are equal -endogenous erythrocytes with high load of haemoglobin are lost during first 14 postnatal days after extremely preterm birth.
- 2051 R. Morales Painamil, M. Teresa-Palacio, A. Argudo, M. Alsina Casanova, J. Gonzalez De Aledo-Castillo:** Absence of foetal haemoglobin due to bone marrow suppression secondary to anti-kell alloimmunisation: a case report
- 2055 S. Pandit:** Cord blood bilirubin albumin ratio as an early predictor of neonatal hyperbilirubinemia
- 2057 N. Reibel, A. Scrivens, L. Heeger, E. Lopriore, H. New, S. Stanworth, C.C. Roehr, E. Deschmann, K. Fijnvandraat, H. Van Der Staij, N. Houben, S. Fustolo-Gunnink, C. Dame:** Survey of practices on the use of iron and erythropoietin in preterm infants in europe
- 2059 E. Seager, S. Hannam, M. Chalia:** Neonatal outcome of transient abnormal myelopoiesis in a quaternary centre: a 6-year experience.
- 2061 M. Wilander, O. andersson, J. Svedenkran:** Delayed cord clamping at an extended time did not increase risk of hyperbilirubinemia.
- 2064 B. Yaşa, E. Kirit, Z. Ince, G. Tosun, N. Yeğın, L. Bilgin, A. Çoban:** Normal percentiles of coagulation parameters in preterm infants

- 2066 M. Al-Beltagi, E. Hantash:** Neonatal pertussis. Do corticosteroids help? Case report
- 2069 T. Barsan Kaya, M. Tatal, O. Surmeli Onay, O. Aydemir, A.N. Tekin:** Hypoxic-ischemic encephalopathy during rsv infection in a late preterm infant
- 2071 J. Becerra Hervás, E. Moliner Calderon, N. Rabella, E. Turon-Viñas, J. Figueras-Aloy, S. Boronat-Guerrero:** Role of enteroviruses in the etiology of neonatal meningitis
- 2073 L. Blaga, O. Fufezan, M. Hasmasanu, M. Matyas, G. Zaharie:** Congenital sepsis complicated by cerebral sinovenous thrombosis
- 2075 M. Faizan, E. Molloy, A. Yeo, A. McMahon, I. Khalid, E. Roche, A. Branagan, E. Isweisi, G. Semova, M. Fadel, P. Gavigan, S. O' Neill:** Necrotising enterocolitis: an overview of potential biomarkers and inflammatory responses
- 2078 A. Butt, D. Batra:** Incidence, presentation and outcomes of postnatal cmv infection in preterm neonates
- 2080 A. Carmona, M. Arola, P. Gonzalez, P. Ventura, D. Esteban, R. Porta, G. Ginovart:** Impact of a clinical observation-based algorithm for early-onset neonatal sepsis screening in a third-level hospital
- 2082 M. Cernada, A. Pinilla-Gonzalez, I. Lara-Cantón, L. Torrejón-Rodríguez, A. Parra-Llorca, M. Aguar, J. Kuligowski, M. Vento:** Early molecular markers of ventilator-associated pneumonia in bronchoalveolar lavage in preterm infants
- 2084 N. Davis, N. Imolya, P. Kigozi:** Does a sepsis risk calculator for early onset neonatal sepsis reduce antibiotics without compromising safety? A retrospective audit at uk tertiary neonatal centre

- 2086 C. Gammeri, M.C. Gauci, G. Di Cataldo, F. Gambilonghi, C. Mattia, M. Marletta, M.C. Caracciolo, P. Betta:** The use of presepsin (p-sep) versus pct and crp: a new inflammatory marker in neonatology
- 2088 S. Meylan, N. Asper, J. Regina, L. Griess, F. Rosa-Mangeret, M. Stocker, M. Schuler-Barazzoni, E. Giannoni:** Evaluation of sepsis awareness in neonatal UNITS
- 2090 J. Groucutt, M. Nash:** Visualisation of the transmission of microbial particles in the neonatal intensive care UNIT
- 2094 I. Heijting, L. Van Lissum, S. Jansen, M. Overbeek, V. Bekker, A. Tostmann, J. Hopman, W. De Boode, M. Hogeveen:** Nosocomial infections in neonatal care: a scoping review of the surveillance case definitions used for blood stream and central-line associated infections
- 2096 O. Horlenko, Y. Chuhran, L. Prylypko, G. Kossey, O. Pushkarenko, N. Sochka, M. Peresta, L. Pushkash, K. Voronych:** Markers of inflammatory response in infants with intrauterine infection from mothers with identified torch infection
- 2098 D. Kainth, A. Gupta, A. Sachdeva, R. Agarwal, M. Kapoor, T. Sethi, J. Sankar:** Development and validation of a prediction model based on machine learning for early recognition of culture-proven sepsis in newborns in low- and middle-income countries
- 2100 Z. Stranak, P. Korček:** Highly sensitive cardiac troponin t is significantly increased in preterm infants with early onset sepsis and hypotension
- 2102 M. Lithoxopoulou, E. Papacharalampous, E. Drogouti, I. Chatziioannidis, G. Mitsiakos, C. Tsakalidis, E. Diamanti:**

Risk factors for s. Aureus colonization among hospitalized infants in NICU.

- 2104 J. Meneses, C. De Lima, J. Alves, L. Carvalho:** Maternal and neonatal outcomes of sars-cov-2 infection: a comparative study from brazil
- 2106 J. Meneses, C. Oliveira, M. Ferraz:** Severe maternal covid 19 affects maternal-infant bonding and breastfeeding
- 2108 M. Salman, E. Molloy, J. Meehan, E. Roche, G. Semova, A. Cadden, L. Alazawi, S. Ram, A. Silver, R. O'Farrell Tyler, S. Almajed, D. Doran, L. Byrne, A. Branagan, E. Isweisi:** Long-term neurodevelopmental outcomes of neonatal sepsis: a systematic review
- 2110 J. Salazar Quiroz, M. Ramon Jiménez, J. Thió Casals, B. Suriñach-Ayats, J. Becerra Hervás, E. Moliner Calderon:** Abscessification of a cephalohematoma as a cause of persistent fever in a newborn
- 2115 R. Wilar, S. Gunawan, J. Rompis, S. Rondonuwu, M. Sulistio:** Factors associated with mortality of neonatal sepsis
- 2117 A. Thatrimontrichai, K. Singkhamanan, P. Thongsuksai:** Oral care by mother's own milk or sterile water in very-low-birthweight infants until oral feeding: a randomized TRIAL
- 2119 D. Valenzuela-Stutman, A. Maccioni Romero, P. Astudillo Paredes:** Prophylactic fluconazole protocol in very low birth weight infants for invasive candidiasis prevention in a south american neonatal intensive care UNIT.
- 2121 O. Vlasova, K. Vlasova, O. Koloskova:** Clinical significance of environmental factors for the course of neonatal sepsis
- 2123 C. Descloux, S. Waldvogel, P.-A. Crisinel, T. Ferry, A. Truttmann:** "Severe and unusual sars-cov-2 infection

in a one month old newborn as primary manifestation of congenital central hypoventilation syndrome.”

- 2125 T. Holota, T. Znamenska, O. Vorobiova, V. Kryvosheieva:** Analysis of acylcarnitine profile in newborns based on the results of expanded neonatal screening
- 2127 R. Neumann, L. Canova, S. Schulzke:** Incidence and risk factors of late-onset hypoglycemia in extremely preterm infants
- 2129 A. Perez, M. Heine, K. Thiele, A. Wieczorek, N. Felber, S. Thoma, P. Arck, J. Heeren:** Longterm metabolic risk and senescence in adults born very preterm
- 2131 B. Sousa, L. Delgado, D. Valente-Silva, A. Bandeira, B. Sampaio:** When osteogenesis imperfecta meets osteopenia of prematurity
- 2133 E. Keles Gulnerman, P. Wintermark, F. Groenendaal, N. Borloo, A. Smits, A. Laenen, D. Mekahli, P. Annaert, S. Şahin, M.Y. Oncel, V.Y. Chock, D. Armangil, E. Koc, M.R. Battin, A. Frymoyer, K. Allegaert:** Postnatal serum creatinine patterns in neonates undergoing therapeutic hypothermia for neonatal encephalopathy compared to a reference dataset in near-term CASES
- 2136 B. Martínez Estradé, M. Ramon Jiménez, M.J. García Borau, J. Salazar Quiroz, E. Moliner Calderon, G.M. Fraga-Rodríguez:** Atypical hemolytic uremic syndrome as cause of renal failure in a preterm: case report
- 2138 A. Celebi, O. Aydemir, D. Gunes, H. Ozen, T. Barsan Kaya, A. Kavaz Tufan, O. Surmeli Onay, A.N. Tekin:** Acute kidney injury in preterm and intrauterine growth restricted newborns: what's the best criteria for diagnosis?

- 2143 O. Trampleasure, C. Longley, N. Liow, R. Ayling, M. Sinha, A. Sinha:** Incidence and outcome of neonatal acute kidney injury (aki) based on modified kidney disease improving global outcomes (kdigo) criteria
- 2145 T.C.K. andelius, L. Hansen, R. Pinnerup, H. andersen, E. Hansen, N. Bøgh, H. Hagberg, E. Rocha-Ferreira, K. Kyng, C. Laustsen, T. Henriksen:** Hyperpolarized ^{13}C magnetic resonance imaging after neonatal hypoxia-ischemia and therapeutic hypothermia; a newborn piglet MODEL
- 2147 L.M. Baak, N. Van Der Aa, A. Verhagen, J. Dudink, C. Nijboer, M. Benders, N. Wagenaar:** Early predictors of long-term outcome in perinatal arterial ischemic stroke (pais): a meta-analysis and systematic review.
- 2149 A. Batista, A. Rivas, D. Cañizo, J. Sanchez-De-Toledo, M. Camprubí:** Cerebral flow in infants with congenital heart disease; monitoring with us-doppler during admission
- 2152 C. Tokat, N. Rickman, M. Janampalli, S. Vatolin, C. Flask, B. Erokwu, C. Bearer:** Magnetic resonance imaging findings in gunn rat model of preterm hyperbilirubinemia
- 2155 D. Gallo, L. Marconi, I. Bresesti, A. Bossi, M. Agosti:** Cranial ultrasound findings in small for gestational infants at TERM
- 2157 J. Buchmayer, G. Kasprian, K. Klebermass-Schrehof, A. Berger, K. Goeral:** Mri based reference values for 2d quantitative brain measurements in a cohort of extremely preterm infants
- 2160 M. Buckingham, B. Dixon, S. Harris, N. Austin:** Retrospective cohort study of infants with hypoxic-ischaemic encephalopathy admitted to christchurch nicu and the correlation of hie changes on early and late mri brain SCANS

- 2163 M.E. Campo, M. Valera, J. Tavošnanska, M.L. Failla, L. Roldan, G. Saa, M. Toma, R. Cimbaro Canella:** Nb with hie treated with hypothermia: analytical observation in a cohort of a nicu of buenos aires's city and determinants of death and/or brain injury
- 2165 J. Cangemi, S. Galletti, V. Paoletti, L. Corvaglia, S. Martini:** Association between intraventricular hemorrhage severity and antenatal, perinatal and postnatal clinical factors in preterm infants.
- 2168 N. Carreras, M. Velilla, A. García-Alix, C. Skilhan, A. Alarcon, T. Agut:** Application of an ultrasonographic brain maturation score for preterm infants
- 2171 D. Clifford, D. O'Boyle, A. Garvey, E. Dempsey, S. Costelloe, J. Bierau, G. Boylan, B. Walsh, D. Murray:** Serum alanine alteration in perinatal asphyxia and neonatal hypoxic-ischaemic encephalopathy
- 2173 C. Descloux, V. Ginet, J.-P. Puyal, C. Gengler, A. Truttman:** « Characterization of cell death after periventricular hemorrhagic infarction in premature human neonates »
- 2175 S. Eventov Friedman, H. Azzam, I. Erlichman:** Predictive measures of head ultrasound (hus) performance in the evaluation of subgaleal hemorrhage in neonates
- 2177 C. Folques, N. Faria, R. Moinho, C. Pinto, L. Carvalho:** Surgical drainage in preterm newborns with peri-intraventricular hemorrhage
- 2179 C. Fraga, C. Viveiros, S. Soares, S. Duarte-Costa, A. Azevedo:** Neonatal hypertonia: an uncommon CASE
- 2181 A. Franz, H. Yapicioglu-Yildizdas, E. Taskin, A. Yaman, Y. Celik, H. Simsek, S. Hamitoglu, N. Aydinol, E. Keles Gulnerman, M. Keller, M. Benders, K. Annink,**

- F. Groenendaal, L. Hellström-Westas, O. Saugstad, N. Marlow, H.-P. Daigner, M. Kohl, R. Meyer, A. Plum, C. Steins-Rang, G. Weiss, P. Bartmann:** Asphyxia associated metabolite biomarker investigation (aambi) study: short-term clinical outcomes and at the age of 22 to 42 months
- 2185 A. Kage, D. Wertheim, I. Lancoma-Malcolm, C. Francia, D. Shah:** Monitoring of seizures in newborns in a tertiary centre
- 2188 I. Lagerström, D. Daugeliene, J. Bolk, S. Cnattingius, B. Skiöld, M. Altman, S. Johansson:** Risk of therapeutic hypothermia in infants with suspect birth asphyxia
- 2190 J. Langeslag, K. Berendse, J.G. Daams, M. Leeflang, W. Onland, A. Van Kaam, T. De Haan:** Clinical prediction models and predictors for death or adverse neurodevelopmental outcome in term newborns with hypoxic ischemic encephalopathy: a systematic review and evidence MAP.
- 2192 V. Lehnerer, A. Badura, O. Romantsik, R. Guzman, S. Wellmann, M. Bruschetti:** Systematic review and meta-analysis of preclinical studies on mesenchymal stem cell therapy in perinatal arterial ischemic stroke
- 2194 R. Lima, J. Lopez, M. Tataranno, C. Koopman-Esseboom, H. Swanenburg De Veye, F. Lammertink, F. Groenendaal, N. Van Der Aa, J. Dudink, M. Benders:** Association between socioeconomic status, brain growth and 5 years neurodevelopmental outcomes of extremely preterm infants
- 2196 A. Bell, T. Yawno, A. Watt, I. Dudink, A. Sutherland, Y. Pham, S. Miller, A. Malhotra:** Endothelial progenitor cell administration promotes neurovascular unit development in growth restricted and appropriately grown fetal LAMBS

- 2198 C. Han-Menz, G. Whiteley, R. Evans, A. Malhotra:** Systemic postnatal corticosteroids and mri measurements of corpus callosum and cerebellum in extremely preterm infants
- 2200 S. Obst, J. Herz, M. Möbius, M. Rudiger, U. Felderhoff-Müser, I. Bendix:** Evaluation of the therapeutic potential of msc treatment in a combined model of hyperoxia-mediated developmental brain and lung injury
- 2202 M. Akin, F. Sarı, B. Ceran, D. Bozkaya, E. Okman, E. Dizdar:** Anterior cerebral artery resistive index measurement and early cerebral nirs recording in very premature infants: is there an association?
- 2204 S. O’Riordan, D. O’Sullivan, F. Maloney, N. Mcsweeney:** L1cam mutation with varying imaging features: a case series
- 2206 C. Parmentier, M. Lequin, T. Alderliesten, N. Van Der Aa, J. Dudink, M. Benders, J. Harteman, C. Koopman-Esseboom, L. De Vries, F. Groenendaal:** Neonatal and 3-month cranial mri in relation to neurodevelopment in hypoxic-ischemic encephalopathy
- 2208 A. Pavel, V. Livingstone, S. Mathieson, E. Dempsey, D. Murray, G. Boylan:** Temporal evolution of electrographic seizures in neonates with hypoxic-ischaemic encephalopathy during and after therapeutic hypothermia treatment
- 2211 A. Pavel, J. O’Toole, S. Mathieson, V. Livingstone, E. Dempsey, D. Murray, G. Boylan:** The characteristics of neonatal seizures in moderate and severe hypoxic-ischaemic encephalopathy
- 2214 M. Pedersen, T.C.K. andelius, H. andersen, M. andersen, N. Bøgh, C. Omann, K. Kyng, T. Brink Henriken:** Correlation between heart rate variability and severity of brain injury measured by intracerebral glycerol in a newborn piglet model of hypoxic-ischemic encephalopathy

- 2216 S. Gomez-Quintana, F. O'Sullivan, A. Factor, E. Popovici, A. Temko:** Sonif.Ai: empowering the medical professional with fast and accurate interpretation of neonatal EEG
- 2218 A. Rela, S. Jary, C. Lea, P. Blair, W. Hollingsworth, A. Whitelaw, K. Luyt, D. Odd:** Quality of life of preterm infants with intra-ventricular haemorrhages at a 10-year follow up: an observational STUDY
- 2220 E. Ruiz-González, M. Lubián-Gutiérrez, N. Jiménez-Luque, A. Segado Arenas, S. Lubián-López, I. Benavente-Fernández:** Early brain growth in very low birth weight infants related to term-equivalent magnetic resonance imaging
- 2223 K.V. Seiersen, H. andersen, M. andersen, T.C.K. andelius, M. Pedersen, B. Løfgren, S. Ringgaard, K. Kyng, T. Henriksen:** Cerebral mri and mrs in newborn piglets with and without seizures in a lipopolysaccharide-sensitized hypoxic cardiac arrest MODEL
- 2225 M. Serdar, M. Gallert, K. Kempe, M. Rizazad, J. Herz, U. Felderhoff-Müser, I. Bendix:** Establishment of a double-hit model of maternal inflammation and postnatal hyperoxia to investigate the therapeutic potential of mesenchymal stem CELLS
- 2227 L. Shipley, I. Bloor, D. Sharkey:** Adverse impact of short term whole body vibration, as experienced during neonatal ambulance transport, on the developing brain: a mechanism for injury?
- 2229 T. Sljivancanin Jakovljevic, Z. Mikovic, S. Mihailovic, J. Martic, J. Kojovic, T. Lazic Mitrovic:** Intraventricular hemorrhage in full-term newborns with different etiologies: case series
- 2231 Z. Vesoulis, A. Kodidhi, M. Riley:** The influence of late prematurity on the encephalopathy exam of infants with HIE

- 2234 Z. Vesoulis, H. Whitehead, D. Swofford, S. Liao:** Impaired cerebral vasomotion in the setting of increased cerebral oxygen extraction
- 2238 N. Wadström, V. Árnadóttir, M. Breindahl, B. Hallberg, B. Skiöld:** Intra-hospital transportation of extremely preterm infants, incidence of intraventricular haemorrhages and neurodevelopmental impairment at 24 months corrected AGE
- 2240 A. Kage, D. Wertheim, I. Lancoma-Malcolm, C. Francia, D. Shah:** Physiological recording parameter changes associated with seizures in newborns
- 2242 M. Ahmed, R. Eltahir, S. Javed, N. Mansoor, T. Mansoor, K. Bhavra, T. Reynolds:** Retinopathy of prematurity and risk factors
- 2244 S. Wyton, F. Terry, C. Perez Fernandez, A. Singh, H. Wood:** Excellence reporting in a neonatal intensive care unit during covid-19 ERA
- 2246 R. Chase, A. Morris, C. Williams, A. Singh:** Review of potential for neonatal organ and tissue donation
- 2248 I. Galloway, C.C. Roehr, R. Bhatia, K. Tan:** Withdrawal or withholding of life sustaining treatment in extremely preterm neonates
- 2250 K. Allegaert, W. Chu, T. Dorlo, A. Huitema:** The complex purine metabolism in asphyxiated allopurinol-treated neonates: an albino observation
- 2252 P. Arı, E. Arun Özer, M. Arun:** Analysis of drug information of prescribed medicines and potential drug incompatibles in neonatal intensive care UNIT

- 2254 A. Ari, E. Arun Özer, M. Arun:** Evaluation of drug utilization in neonatal intensive care unit in turkey
- 2256 K. Chant, N. Marlow:** Perinatal risk factors for hearing LOSS
- 2258 H. Cihlářová, R. Janča, K. Allegaert, P. Pokorna:**
Prospective validation of the paracetamol dosage regimen in extremely low birth weight neonates following major abdominal surgery
- 2260 V. Siljehav, A. Gudmundsdottir, J. Tjerkaski, A. Aubert, M. Cuttini, C. Koopman-Esseboom, J. Zeitlin, U. Aden:**
Ino use in the very preterm ships cohort was related with mortality and neurodevelopmental impairments
- 2262 E. De Saeger, A. Debeer, A. Smits:** Need for improved management of iatrogenic withdrawal from analgosedatives in nicu patients with congenital diaphragmatic hernia: a retrospective analysis
- 2264 V. Schoenfeld -Silva, G. Hida, F.J. Ropero Pelaez, G. Rodrigues Taniguchi, S. Taniguchi:** Liver transplantation, pregnancy and births
- 2266 S. Branco, I. Pais-Cunha, I. Vivas, J. Oliveira, I. Mazedo, A.L. Santos:** Congenital dacryocystocele: a case report
- 2270 K. Mekki, N. Kolsi, N. Hamida, S. Kacem, A. Gargouri:**
Congenital arhinia: a rare CASE
- 2273 S. Lim, S.H. Shin, S. Park, H.J. Yang, Y.H. Jung, C.W. Choi, E.-K. Kim, H.-S. Kim:** Growth and developmental outcome of twin preterm infants according to the chorionicity and weight discordancy
- 2275 S. Ünal, C. Kara, N. Demirel, S. Petriçli, S. Kavurt, E. Uzlu, M. Durukan-Tosun, A.Y. Bas:** Ocular hemorrhages in neonates with metabolic/mixed acidosis

- 2278 D. O'Boyle, A. Noone, L. Gallagher, T. Brink Henriken, A. Khashan, B. Hammer Bech, J. English:** Machine learning to identify autism risk in infancy: a study in the danish national birth cohort.
- 2280 K. Anwar, A. Kabir, N. Yasmin, M. Hassan, F. Anne, N. Keya, D.M. Khan, T. Biswas, A. Asad, M. Tanzil:** Prevention and control of childhood tuberculosis: recent findings on parental perceived-knowledge, attitudinal-trend and practice level from south-western bangladesh using a mixed method STUDY
- 2282 B. Barzilay, Y. Labes, T. Smolkin:** Maternal follow-up duration during pregnancy impact on prognosis of vlbw infants
- 2284 P. Heuvink, N. Van Dokkum, H. Bouma, K. Kraft, A. Bos, P. Krabbe:** Parent-reported quality of life in nicu graduates in the first year after birth: a prospective cohort STUDY
- 2286 J. Wright, A. Hurley, R. Toone, L. Deriu:** Examining the age at diagnosis of developmental dysplasia of the hips for patients not identified up by the uk's current screening programme
- 2288 A. Alonso-Ojembarrena, L. Rodeño-Fernández, V. Aldecoa-Bilbao, R. Gregorio-Hernández, A. Concheiro-Guisán, J. Rodriguez-Fanjul:** Lung ultrasound signs of extubation failure in extremely preterm infants with evolving bronchopulmonary dysplasia
- 2290 T. Bastos, T. Iwashita Lages, P. Morais, E. Orlandin, A. Junior, F. Celini, D. Aragon, C. Calixto, C. Ferreira, W. Goncalves-Ferri:** Evaluation of nih calculator to corticosteroid use for avoid bronchopulmonary dysplasia to very low birth weight infants in a Imics.
- 2292 R. Bhatt, H. Clark, K. Babla, G. Kendall, L. Dyet, S. Hines, I. Mawson, A. Taune, L. Casanueva, J. Hodges,**

- S. Shanmugalingam, S. D'Souza, C. Singh, J. Meek:** Bpd an emerging pandemic in neonatal medicine - learning from a london neonatal network
- 2294 S. Chellen, R. Masters, P. Saha, S. Mulla:** Implementation of point of care lung ultrasound at a tertiary neonatal UNIT
- 2296 R. Turkson, M. Boateng, D. Webster, G. Kodua, K. Danso, N. Parmar, H. Doshi, P. Bhatt, K. Donda, F. Dapaah-Siakwan:** Epidemiological characteristics, clinical course, and outcomes of neonates with pneumothorax in the united states
- 2298 K. Danso, G. Kodua, R. Turkson, M. Boateng, M. Osei-Bonsu, H. Doshi, N. Parmar, P. Bhatt, K. Donda, F. Dapaah-Siakwan:** Type, frequency, and timing of surgical interventions in preterm infants with bronchopulmonary dysplasia in the united states
- 2302 P. De Silva, R. Javed, H. Gowda:** Unplanned extubations in a tertiary neonatal intensive care unit (nicu) – incidence and causes
- 2304 H. Salverda, S. Cramer, C. Schmeits, J. Van Der Plas, A. Te Pas, J. Dekker:** Optimising oxygenation of preterm infants during respiratory support by fine-tuning automatic titration of oxygen
- 2306 G. Di Cataldo, C. Gammeri, M.C. Gauci, F. Gambilonghi, C. Mattia, M.A. Conversano, A. Saporito, P. Betta:** Respiratory outcomes following less invasive surfactant administration in late preterm infants: a comparative STUDY
- 2308 F. Dittgen, C. Wegele, N. Rafat, T. Schaible, A. Perez Ortiz:** Impact of time point of extracorporeal membrane oxygenation on mortality and morbidity in congenital diaphragmatic hernia

- 2310 M. Docksey, L. Bradley, L. Green, P. Satodia:** Does 'less invasive surfactant administration' technique reduce the need for mechanical ventilation without increasing adverse events in preterm neonates with respiratory distress syndrome?
- 2312 S. Eventov Friedman, T. Adler Heltovsky, A. Gileles-Hillel, I. Erlichman:** Trends in ventilation modes and their impact on the incidence of bronchopulmonary dysplasia (bpd) in very low birth weight (vlbw) infants
- 2314 N. Gangaram-Panday, W. Van Weteringen, S. Willemsen, D. Rizopoulos, A. Tintu, I. Reiss:** Refining the oxyhemoglobin dissociation curve for clinical oxygen management in premature infants
- 2316 D. Goel, S. Rao, A. Wilson, A. O'Donnell:** Keep the chin up: evidence-based standardised care pathway for infants with pierre robin sequence (PRS)
- 2318 S.S. Hedegaard, R. Kristensen, C.K. Schmidt, N. Breindahl, E. Bay, A. Lando, C. Heiring, E. Malchau Carlsen, L. Aunsholt:** Lisa versus insure – implementing a new procedure
- 2320 M.-L. Herrmann, H. Nahrstaedt, M. Mandl, T. Reicherzer, C. Frank, A. Flemmer, M. Klemme, U. Thome, W. Braun, B. Ackermann:** Breathing synchronous changes in cervical bioimpedance in preterm infants
- 2322 M. Ito, F. Namba, S. Kato, M. Saito, N. Miyahara, E. Ota, H. Nakanishi:** Identification of risk factors for severe bronchopulmonary dysplasia in extremely premature infants: a scoping review
- 2324 A. Janulionis, E. Viršilas, A. Valiulis, A. Liubsys:** Electrical impedance tomography based evaluation of the aeration of

the lungs of newborns born naturally and through the section cesarea

- 2326 A. Junior, A. Bernardes, T. Iwashita Lages, E. Orlandin, T. Bastos, P. De Morais, W. Goncalves-Ferri:** Preterm infants spontaneous ventilation feasibility and ventilatory repercussions the during high-frequency oscillatory ventilation.
- 2329 L. Karpinski, K. Szczepanska, P. Niedbalski, I. Miechowicz, H. Slawska, J. Mocha, J. Mazela, S. Simonson:** Brain oxygenation and bioelectrical function in newborns receiving aerosolized lucinactant (aerosurf)
- 2332 H. Kim, C.W. Choi:** The effect of incompletely administered antenatal corticosteroids on neonatal pulmonary outcomes in late preterm infants
- 2335 A. Borgi, K. Ben Cheikh, A. Louati, A. Ayari, A. Hajji, C. Haj Hssine, K. Menif, A. Bouziri, N. Ben Jaballah:** The clinical effects of high frequency oscillatory ventilation in the treatment of neonatal severe distress.
- 2337 L. Markasz, H. Mobini-Far, R. Sindelar:** Postnatal col4a1 expression in the developing human LUNG
- 2340 Y. Minamitani, R. Hayashi, S. Oka, A. Uchiyama, M. Wada, K. Okazaki, M. Kondo, N. Nagano, Y. Soeno, H. Maruyama, Y. Ito, F. Namba:** High flow nasal cannula versus ncpap, feeding tolerance in preterm infants: a secondary analysis of the nippn STUDY
- 2342 E. Ó Briain, E. Molloy, J. Meehan, A. Branagan, D. Mockler, G. Fitzgerald, G. Semova, E. Isweisi, E. Roche, A. O'Byrne, L. Alomairi, J. Dowling, L. Mulkerrin, L. Coyle, J. Kiernan, J. Lynch:** Evidence-based use of diuretics in bronchopulmonary dysplasia: a systematic review

- 2344 V. Mundeshi, N. Chinchankar, A. Sharma:** Congenital nasal pyriform aperture stenosis(cnpas) – a rare cause of respiratory distress in neonates and its implications.
- 2348 R. Naples, A. Fenton, M. Brodlie, S. Harigopal, C. O'Brien:** Diaphragm electrical activity during weaning of nasal high flow therapy in preterm infants
- 2350 S. Nobile, N. Salce, A. Sbordone, M.L. Patti, A. Perri, S. Fattore, M. Tana, L. Giordano, G. Prontera, G. Vento:** Diaphragmatic ultrasound to assess dysfunction during mechanical ventilation (mv) in newborns
- 2353 M. Akin, B. Ceran, E. Okman, F. Sari, E. Dizdar:** Systemic inflammatory indices as predictors of lung maturation in preterm infants born before 32 weeks of gestation
- 2355 E. Orlandin, T. Iwashita Lages, A. Junior, P. Morais, T. Bastos, F. Celini, M. Nakamura, M. Amato, W. Goncalves-Ferri:** Positive end-expiratory pressure effects in infants on non-invasive ventilation monitored by electrical tomography impedance are not associated with fraction of inspired oxygen and respiratory distress.
- 2358 D. Oudshoorn, M. Vermeulen, R. Knol, A. Te Pas, S. Cochius-Den Otter, M. Schnater, I. Reiss, P. Dekoninck:** Continuous oxygen saturation index measurements as early predictor of outcomes in congenital diaphragmatic hernia
- 2361 T. Panneflek, K. Kuypers, G. Polglase, S. Hooper, T. Van Den Akker, A. Te Pas:** The effect of clinical chorioamnionitis on respiratory effort in premature infants at birth: a retrospective case-control STUDY
- 2363 A. Perez Ortiz, A. Glauner, F. Dittgen, T. Doniga, N. Rafat, T. Schaible:** Chronic lung disease following neonatal

extracorporeal membrane oxygenation. A single center experience.

- 2365 A. Sett, K. Kenna, G. Foo, R. Sutton, E. Perkins, M. Sourial, S. Rogerson, B. Manley, P. Davis, P. Pereira-Fantini, D. Tingay:** Quantitative lung ultrasound detects real-time changes in total and regional lung volume in the preterm LAMB
- 2367 J. Rogulska, K. Wróblewska - Seniuk, R. Śmigiel, J. Szydłowski, T. Szczapa:** Diagnostic challenges in neonatal respiratory distress – abca3 mutation as a cause of inherited surfactant deficiency.
- 2369 A. Scholten, R. Van Leuteren, F. De Jongh, A. Van Kaam, G.J. Hutten:** Diaphragm activity measured with standard cardiorespiratory monitoring electrodes
- 2371 A. Scholten, Z. Zhan, H. Niemarkt, M. Vervoorn, R. Van Leuteren, F. De Jongh, A. Van Kaam, E. Van Den Heuvel, G.J. Hutten:** Non-inferiority study on the performance of a wireless, non-adhesive belt for cardiorespiratory monitoring in neonates
- 2373 L. Mileder, J. Schmid, F. Reiterer, B.C. Schwabegger, B. Urlesberger:** Utilization and effects of non-synchronized biphasic nasal cpap in preterm neonates below 29 weeks of gestation
- 2375 M. Tauzin, F. Decobert, C. Jung, X. Durrmeyer, C. Treussart, L. Caeymaex, C. Danan:** Relative humidity during high frequency oscillatory ventilation compared to intermittent positive pressure ventilation in extremely preterm neonates: an in-vitro and in-vivo observational STUDY
- 2377 P. Toso, M. Faunes, M. Alvarez, A. Toso, A. Gonzalez, S. Campbell:** Effects of two rates of mechanical dorsal

stimuli on the respiratory drive, pain scale and sleep architecture in healthy preterm: pilot study.

- 2379 E. Williams, N. Bednarczuk, O. Kaltsogianni, T. Dassios, A. Greenough:** Fetal haemoglobin during the postnatal period of infants born preterm
- 2381 Y. Seo, M.-Y. Oh, S. Kim, M.S. Kim, S.K. Yum:** Morbidities associated with pulmonary circulation and adverse respiratory outcomes in very-low-birthweight infants affected by pulmonary hypoplasia
- 2383 C. Zaat, L. Duijts, T. Karramass, S. Ballink, I. Reiss, M. Pijnenburg:** Burden of disease after discharge from the neonatal intensive care unit and hypoxic challenge test failure in infants with bronchopulmonary disease
- 2385 N. Aikman, E. Coombe, D. Edwards, L. Levingston, M. Mok, D. Prasad, K. Purnell, E. Hoyle, J. Hurst:** Maintaining normothermia in preterm infants following stabilisation with an intact umbilical cord - a quality improvement project (qip) in a uk neonatal intensive care UNIT.
- 2387 I. Anwunah, O. Olaore, N. Singh:** Antenatal counselling for preterm deliveries less than thirty-four weeks gestational age: a quality improvement initiative aimed at improving the delivery of information given to parents.
- 2390 E. Arasteh, J. Dudink, T. Alderliesten:** Developing an automatic artifact correction approach based on empirical mode decomposition (emd) for near-infrared spectroscopy (nirs) signals among pre-term infants
- 2392 N. Breindahl, M. Tolsgaard, C.C. Roehr, T. Szczapa, L. Gagliardi, M. Vento, R. Støen, K. Bohlin, A. Van Kaam, D. Klotz, X. Durrmeyer, T. Han, A. Katheria, P. Dargaville,**

- T. Brink Henriken, L. Aunsholt:** Consensus on training and assessment of less invasive surfactant administration competence: an international delphi survey
- 2394 S.M. Cheng:** Development and evaluation of an evidence-based intervention protocol for the prevention of hypothermia of the preterm infants in delivery room and after admission to NICU
- 2396 Z. Demiri, L. Kryeziu, U. Zeka, I. Bilić Čače:** Diagnostics and treatment approach in premature neonates below 30th week of gestation. A comparison study between two neonatal centers in rijeka and prishtina
- 2398 E. Stoltz Sjöström, I. Zamir, J. Dušek:** Consequences of implementations of nutritional care bundle in infants born before 32 gestational WEEKS
- 2400 G. Elley, K. Jamieson:** Improving preterm cranial ultrasound surveillance in a local neonatal intensive care unit. A single centre quality improvement project
- 2403 E. Foulerton, S. Clarke, K. Parnell:** Developing virtual education across a neonatal network: therapies in action
- 2406 C. Granger, R. Naples, R. Tinnion:** Reducing unplanned extubation in neonatal intensive CARE
- 2408 J. Seliga-Siwecka, J. Ulan-Drozdowska, A. Zwijacz, B. Grochowski:** Projected application of the sepsis risk calculator versus screening for early onset sepsis based on national guidelines for the polish population: a cost analysis
- 2410 V. Heesters, H. Van Zanten, V. Heijstek, S. Jansen, D. Van Valkenburg, A. Te Pas, R. Witlox:** Video-reflection of acute neonatal interventions

- 2412 I. Hunt, S. Shehabi, C. Hiatt, N. Tsonchev, N. Singh:** A quality improvement project aim to produced sustained reduction case numbers of esbl colonisation by improving infection control practices in the neonatal UNIT
- 2414 K. Ibrahim, S. Mulla:** Neonatal super 60 project
- 2416 A. Shaw, C. Jackson:** Introduction of delivery room glucogel to reduce rates of admission hypoglycaemia in preterm neonates
- 2418 C.Y. Lai, M. Cawsey:** An audit on neonatal jaundice management at a specialist maternity hospital
- 2421 A. Le Brun, A. Thiriar, M. Kennes, P. Clément, A. Vuckovic:** Predictors of compliance to neurodevelopmental follow after preterm birth: a 10-year observational cohort STUDY
- 2423 H. Mcbain, S. Tuvey, A. Glover-Williams, N. Menzies, S. Hedge, S. Bates, A. Smith-Collins, K. Luyt:** Reducing preterm mortality & brain injury: the periprem (perinatal excellence to reduce injury in premature birth) care pathway
- 2426 C. Macdougall, T. Austin, S. Hoodbhoy, R. Chaudhary, J. Arthur:** Implementing multiple parallel changes on a nicu: the experience of the rosie preterm bundle
- 2428 M. Carpenter, M. Scott, P. Nath, N. Singh:** Improving and sustaining time to antibiotic administration for neonates at risk of early onset neonatal infection (eons) using quality improvement methodology
- 2431 S. Williamson, A. Pearce, N. Singh:** Pushing the boundaries of quality improvement on the neonatal UNIT
- 2433 L. Bradley, A. Pearce, M. Wasif, N. Singh:** Project peep: a respiratory quality improvement project.

- 2435 J. Poppe, R. Smorenburg, T. Goos, H.R. Taal, I. Reiss, S. Simons:** Development of a web-based oxygenation viewer for preterm neonates at the NICU
- 2437 J. Poppe, S. Fitzgibbon, H.R. Taal, S. Loudon, A. Tjiam, C.C. Roehr, I. Reiss, S. Simons, C. Hartley:** Prediction of severe retinopathy of prematurity using physiological data in preterm neonates
- 2439 M. Rasmussen, M. Lühr Hansen, G. Greisen:** Feasibility of the web-based training and certification of clinical staff for the randomised clinical trial safeboosc-III
- 2441 L. Ruiz-Guzman, L. López-García, E. Ciriza-Barea, M.D.M. Ruiz-Calderón, M. García-Howard:** Ankyloglossia: a new medical subject
- 2443 H. Schwarz, K. Bibl, L. Kumer, J. Leutgeb, P. Steinbauer, T. Werther, K. Klebermass-Schrehof, A. Berger, M. Wagner:** Virtual bedside teaching of neonatal interventions and subsequent quality improvement utilizing video recordings
- 2445 C. Onu, S. Latremouille, A. Paul, W. Basfar, A. Ali, E. Senechal, D. Precup, G. Sant'Anna:** What's wrong, baby? An acoustic analysis of cry triggers in newborns
- 2449 E. Senechal, E. Jeanne, L. Tao, R. Kearney, W. Shalish, G. Sant'Anna:** Wireless monitoring devices in hospitalized children: a scoping review
- 2453 H. Turner, V. Monnelly:** First attempt neonatal intubation success rates are low: a 2 year single centre retrospective review
- 2456 N. Veeraraghavan, S. Kiani, V. Ponnusamy:** Successful quality improvement project to introduce intact cord

stabilisation in preterm infants of less than 32 weeks gestation
– a uk nicu experience

- 2458 T. Eyo, M. Wasif, L. Pilcher, N. Singh, P. Nath:** The hi 5s: an inter professional quality improvement initiative using lean methodology to improve staff experience on post natal ward and nipe clinic
- 2461 A. Young, E. Hassanin, L. Miall, A. Fane De Salis, I. Ibrahim, J. Peniston, T. Kinkead:** Reducing unplanned neonatal extubations; a quality improvement initiative
- 2464 M. Bawa, S. Gugino, J. Helman, N. Bradley, L. Nielsen, A. Prasath, J. Nair, S. Lakshminrusimha, M. Rawat, P. Chandrasekharan:** Initiating resuscitation with 100% oxygen & titration achieved a heart rate of 100 & preductal saturation of 80% faster in an asphyxiated preterm ovine MODEL
- 2468 C. Blanco, M. Bawa, A. Prasath, A. Mari, S. Gugino, J. Helman, N. Bradley, J. Nair, S. Lakshminrusimha, P. Chandrasekharan, M. Rawat:** Randomized trial of 21%, 50% and 100% inspired oxygen during chest compressions in neonatal resuscitation
- 2471 S. Sotirakos, S. Bocchinfuso, R. Tobin, C. Pearson, C. Mckenna, A. Hakim, E. Visser, C. O’Hare, E. Isweisi, G. Semova, J. Meehan, E. Roche, A. Branagan, D. Mockler, E. Molloy:** Difficult airway simulation in neonates: a systematic review
- 2473 J. Buchmayer, L. Wisgrill, M. Schneider, T. Werther, K. Goeral, A. Berger, G. Schmölzer, M. Wagner:** Cardiopulmonary resuscitation of an extremely low birth weight infant using high-frequency oscillation ventilation

- 2475 S. Duarte Costa, C. Fraga, A. Azevedo, A. Portela:** Inter-hospital transfers: the reality of a level ii hospital
- 2477 M. Escalante, P. Hayler:** Design of a checklist for teaching and assessment of neonatal endotracheal intubation for pediatric residents
- 2479 L. Geraghty, G. Gambacorta, L. Smiles, C. O'Donnell:** A randomised, crossover study of standard laryngoscope and two videolaryngoscopes (acutronic infant view & c-mac) for endotracheal intubation of newborn mannequins
- 2482 J. Groucutt, D. Aguirre, S. Henry, L. Williamson, D. Wright, A. Joynes, C. Perez Fernandez:** Simulating preterm birth in the community
- 2486 J. Groucutt, D. Aguirre, S. Henry, A. Joynes, L. Williamson, D. Wright, C. Perez Fernandez:** Simulating obstetric and neonatal emergencies in the community
- 2490 V. Heesters, R. Visser, K. Kuypers, S. Van Groningen, R. Witlox, A. Te Pas:** Ultrasonography of the vocal cords in preterm infants during neonatal transition at birth; an observational STUDY
- 2492 K. Kuypers, A. Hopman, S. Cramer, R. Visser, S. Hooper, A. Te Pas:** The effect of first and subsequent mask applications on breathing and heart rate in preterm infants at BIRTH
- 2494 K. Iwanaga:** A study of usability in a telemedicine system for neonatal transport and resuscitation education using wearable devices in JAPAN
- 2496 S. Kiani, N. Veeraraghavan, V. Ponnusamy:** Effective thermoregulation during non-invasive stabilisation with intact cord in extreme preterm infants of < 32 weeks - experience of a uk neonatal UNIT

- 2499 F. Kreuzer, M. Mandl, W. Braun, M. Haller, J. Schwindt, W. Becker, A. Flemmer, M. Klemme:** Synchronized noninvasive ventilation in neonatal transport- scottie
- 2501 U. Szuwarska, A. Kornacka, I. Miechowicz, J. Mazela, T. Szczapa:** Knowledge of neonatal delivery room management among health care professionals at different levels of referral in poland
- 2504 H. Küster, G. Bauerschmitz, F. Hartmann:** Prospective observational study and european-wide survey on the second golden hour of life - the time between delivery room care and admission to the NICU
- 2506 C. Ni Chathasaigh, E. O'Curraín, A. Curley:** Neonatal airway skills and equipment; a national irish survey
- 2508 M. O'Dea, M. Saito-Benz, G. Tremblay, R. Trawber, S. Resnick, J. Tan, J. Davis:** Does cerebral tissue oxygenation vary in neonates retrieved by road and air? A prospective between subject analysis using near infrared spectroscopy (nirs) in western australia.
- 2510 A. Prasath, S. Gugino, J. Helman, N. Bradley, L. Nielsen, M. Bawa, C. Blanco, A. Torrealba, B. Mathew, M. Rawat, P. Chandrasekharan:** Should we wait to initiate chest compressions if a newborn is born with no heartbeat?
- 2515 M. Ramon Jiménez, M.J. García Borau, E. López Bernal, J. Becerra Hervás, J. Salazar Quiroz, E. Moliner Calderon:** Role of the electrocardiogram in neonatal resuscitation: report of two CASES
- 2517 C. Roberts, C. Hwang, D. Blank, S. Badurdeen, K. Crossley, M. Kluckow, A. Gill, E. Camm, R. Galinsky, Y. Brian, S. Hooper, G. Polglase:** Abdominal compression to

raise diastolic blood pressure during resuscitation of asystolic newborn LAMBS

- 2520 M. Sousa Dias, M. Meneses, M. Araújo, B. Neves, A. Azevedo, C. Ferraz, S. Peixoto:** Newborn life support: risk factors for advanced resuscitation
- 2522 F. Steiner, S. Cody, M. Berry, M. Saito-Benz:** Introduction of servo-controlled cooling during neonatal retrieval for infants with hypoxic ischaemic encephalopathy: new zealand experience
- 2524 L.N. Trulsen, N. Songstad, C. Klingenberg:** A population-based 27-year study of neonatal air transport in north norway.
- 2526 J. Van Den Berg, J. Van Den Berg, S. Håkansson:** Transport risk index of physiologic stability: a validation for swedish conditions a validation for swedish conditions
- 2528 L. Harrison:** Reducing procedural pain in the neonatal intensive care UNIT
- 2530 M. Tauzin, B. Gouyon, D. Hirt, R. Carbajal, J.-B. Gouyon, A.-C. Brunet, M. Ortala, S. Goro, C. Jung, X. Durrmeyer:** Prospective pharmacoepidemiologic study of analgesic, sedative, anesthetic, and paralytic prescriptions in 30 french nicus from 2014 to 2020
- 2532 N. Ben Saad, M. Belhaj Mansour, H. Ben Ameer, N. Ben Kraiem, H. Zitouni, M. Ben Dhaou, R. Mhiri:** Urethrocutaneous fistula repair after distal hypospadias surgery
- 2534 E. Domingo Lagman, M. Alsina Casanova, I. De Haro Jorge, C. Carrasco Carrasco, M. Teresa Palacio:** Neonatal gastric perforation and non-invasive mechanical ventilation

- 2536 A. Hoffsten, H. Engstrand Lilja, H. Mobini-Far, R. Sindelar, L. Markasz:** Defa6 and guca2a as tissue markers in necrotizing enterocolitis
- 2539 R. Jones, M. Chalia, S. Hannam:** Effect of covid-19 pandemic on investigation and treatment of neonates with bilious vomiting
- 2541 S. Kacem, S. Ammar, E. Krichen, M. Hbaieb, K. Mekki, H. Zitouni, R. Mhiri:** Primary segmental volvulus in newborns
- 2543 S. Kutty, N. Kottarakou, S. Quinn, J. Kutty:** Challenges in the assessment of scrotal swelling and discolouration in neonates
- 2545 R. Coomey, L. Alabbasi, C. Lim, J. Rice, A. Dass, A. Fairhurst, S. Marsh, N. Tuite, E. Isweisi, G. Semova, A. Branagan, D. Mockler, J. Meehan, E. Roche, E. Molloy:** Modes of ventilation in intubated preterm infants: a systematic review
- 2547 J. Salazar Quiroz, E. Moliner Calderon, G.M. Fraga-Rodríguez, M.J. García Borau, B. Martínez Estradé, S. Boronat:** Midgut volvulus and possible association with nphs1 mutation: case report
- 2549 S. Trinh, G. Tovishazi, L. Bogner, L. Kátai, E. Maka, V. Balog, M. Szabó, Á. Jermendy, B. Hauser:** The use of laryngeal mask airway reduces postoperative ventilatory need in preterm infants undergoing rop laser treatment
- 2552 J. Wright, A. Hurley, R. Toone, L. Deriu:** Comparing age at diagnosis and the need for surgical intervention in infants with developmental dysplasia of the HIPS
- 2554 M. Janampalli, I. Held, N. Rickman, S. Vatolin, K. Alagramam, C. Bearer:** Brainstem auditory evoked

response abnormalities in a rodent model of preterm infant hyperbilirubinemia

- 2557 B.F. Elsedawi, N. Samson, C. Nadeau, A. Charrette, A. Lehoux, É. Fortin-Pellerin, J.-P. Praud:** Laryngeal chemoreflexes and cardiorespiratory events under non-invasive nasal respiratory support in preterm LAMBS
- 2560 J. Heyer, C. Hoyos-Banchón, F. Schubert, R. Sommer, T. Orlikowsky, U. Steinseifer, S. Jansen, M. Schoberer:** Exit procedure simulation through an umbilical cord cannulation SETUP
- 2562 A. Marouane, R. Olde Keizer, M. Kerstjens, C. Deden, K. Lichtenbelt, T. Jonckers, M. Vervoorn, M. Vreeburg, L. Henneman, L. De Vries, R. Sinke, R. Pfundt, S. Stevens, P. andriessen, R. Lingen, M. Nelen, H. Scheffer, D. Stemkens, C. Oisterwijk, H. Kristian, P. Amstel, W. Zelst, G. Frederix, L. Vissers, W. De Boode:** Rapid exome sequencing as a first-tier test in neonates with suspected genetic disorder: results of a prospective multicenter clinical utility study in the netherlands
- 2564 S. Setänen, H. Merisaari, V. Saunavaara, L. Haataja, L. Lehtonen, K. Lahti, P. Ngum, R. Parkkola:** Association of dti findings between term and 13 years in very preterm infants - a prospective cohort STUDY
- 2566 L. Zhou, C. Mcdonald, T. Yawno, G. Jenkin, S. Miller, A. Malhotra:** Umbilical cord blood-derived stem cell collection is feasible for autologous therapy in extremely preterm infants
- 2568 A. Ekim, Z. Akozlu:** Investigation of the relationship between body mass index and sleep quality of adolescents

- 2570 A. Ekim, N. Sisman:** Use of cam in childhood asthma: a sistematik review
- 2572 E. Ardahan Akgul, I. Kaya, H. Yıldırım Sarı, S. Özbodur Yıldırım, O.N. Sariosmanoglu:** Pressure ulcer prediction in pediatric patients: a machine learning MODAL
- 2574 J. Armah, A. Diji, J. Dompim, C. Ahoto, H. Budu, C. Poku, E. Boateng:** Quality-of-life in adolescents with sickle cell disease in urban ghana: a cross-sectional study.
- 2576 E. Ardahan Akgul, F. Yardimci, D. Demir, F. Soyulu:** Effect of topical propolis on burn healing in experimental burn MODEL
- 2578 R. Acal Jimenez:** Interprofessional undergraduate education: a foundational necessity. Are we ready?
- 2580 A. Badura, S. Wellmann:** Motor developmental interventions in preterm infants during nicu stay – what do we KNOW?
- 2582 C. Dyekjær, B. Hviid, L. Skovholm, C.S. Jensen:** My hospital friend wheely
- 2584 T. Ikeda, H. Odawara, S. Ajisaka, S. Miyamoto, K. Kamata:** Development of a method for evaluating emotional responses by skin temperature
- 2586 P. Potmesilova, M. Potmesil:** Application and benefits of basal stimulation® in newborns and infants with atypical development
- 2588 G. Flankegård, E. Mörelius, P. Rytterström:** Parents experiences of childhood functional constipation
- 2590 M. Jensen, C.S. Jensen, S. Angel:** “A constant vigilance. Parents’ experiences of being hospitalized in a pediatric ward with their chronically ill child”

- 2592 K. Lima, J. Sousa, R. Lima, F. Vasconcelos, L. Brito, R. Melo, L. Barbosa:** Educational intervention combined with brief motivational interview to promote self-efficacy for breastfeeding: randomized clinical TRIAL
- 2594 K. Paulauskaitė, A. Vaškelytė, V. Grigaliūnienė:** Family room – satisfaction with care after caesarean section
- 2596 E. Akansalinkum:** The challenges of teenage mothers in breastfeeding
- 2598 T.G. Melesse, J.P.C. Chau, M.A. Yimer:** Understanding the perceptions and experiences of children undergoing chemotherapy and their caregivers.
- 2600 C.S. Jensen, M. Eg:** The challenges of confidentiality: the experiences of young people, and their parents, admitted to children's WARDS
- 2602 S. Owen, J. Menzies, S. Pontefract:** Paediatric intensive care (picu) health care professionals' views on medication interruptions and their management
- 2604 W. Leeuwenburgh-Pronk:** A good death, dying on the WARD
- 2606 C. Angelhoff, T. Faresjö, A.L. Sundell:** Insomnia symptoms and quality of life in preschool children with severe caries
- 2608 V. Grigaliūnienė, I. Kliūzienė, A. Vaškelytė:** Parents' experiences and expectations after a child's suicide attempt
- 2610 T.G. Melesse, J.P.C. Chau:** Cognitive-behavioural intervention to improve psychological wellbeing and quality of life among children with haematological malignancies receiving chemotherapy: study protocol for randomised controlled trial.

- 2612 G. Sashidharan:** Intimate partner violence: impact on maternal mental health and neonatal well being.
- 2615 A. Ehara:** Relationship between the presence of inter-municipal cooperation to provide daycare services for children with mild illness and geographic, financial, and demographic factors
- 2617 E. Buccione, D. Scarponcini Fornaro, S. Palombaro, M. Colonna, D. Gil Mendez, V. Palumbo, L. Di Pietro, S. Di Valerio:** Bladder temperature as control temperature in neonates undergoing targeted temperature management: a case report
- 2619 J.P.C. Chau, S.H.S. Lo, V.W.Y. Lee:** Evaluation of an interprofessional simulation education module on preventing and managing neonatal extravasation injuries
- 2621 Á. Nagy, I. Jánoki, Á. Zarándy, P. Földesy, J. Varga, M. Szabó:** Computer vision based neonatal behavior stage detection and classification
- 2623 F. Alsaggaf, I. Coyne:** Chronic pain experience among adolescents in saudi arabia: "pain is affecting my LIFE"
- 2625 M. Bastos Gomes, I. Cardoso, A.L. Carvalho, I. Pinto, F. Aguiar, M. Rodrigues, I. Brito:** Pediatric sapho syndrome – case series of a tertiary UNIT
- 2627 T. Sousa, T. Costa, J. Silvestre:** Nothing about us without us. The voice of paediatric cancer patients and survivors in portugal
- 2629 B. De andrade, A. Feio, J. Faria, A. Santos, A. Pereira, P. Fonseca:** Adolescence and sexually transmitted infections: a silence topic.

- 2631 D. Henriques Pinto, R. Ramos, M. Santos:** When being obese and pre-adolescent is a problem
- 2633 B. Mungala, C. Contractor, H. Parmar, R. Amrutiya, D. Sharma, U.S. Singh:** Assessment of stress level among adolescents of class 12th science, commerce, and arts streams in 6 higher secondary schools of anand, gujarat, INDIA
- 2635 V. Nwatah, P. Ahmed, L. Audu, S. Okolo:** Socio demographic determinants of measures of cognitive function of early adolescent students in abuja, nigeria
- 2637 G. Pintos-Morell, S. Chocron-Benzaquen, P. Arango-Sancho, R. Bou-Torrent, A. Barreda-Bonis, Y. Olmedilla-Ishishi, B. Soler-López, C. Gómez-Alonso, E. Casado-Burgos:** Team project: consensus recommendations for transition from pediatric to adult medicine in patients with metabolic bone diseases
- 2639 A. Rodrigues, L. Torres, I. González, R. Oliveira:** A rare cause of primary amenorrhea in adolescence – case report
- 2641 C. Cronin, C. Okelly, H. Keohane, L. Flores Villarta, J. Trujillo Wurttele:** The use of different brands of adrenaline auto-injector among caregivers of children with food allergies: a cross – sectional descriptive STUDY
- 2643 V. Cvejaska Cholakovska:** Insulin resistance in children with asthma
- 2645 T. De Vries, C. Rollema, E. Van Roon:** Optimising administration of nasal corticosteroids
- 2647 A. Devolder-Nicolau, D. Encarnación, J. Casas, B. Suriñach-Ayats, L. Armendáriz Lacasa, G. Garcia Del Cerro, S. Boronat-Guerrero:** Frequent anaphylaxis

treated with omalizumab in a patient with nsaid-exacerbated respiratory disease.

- 2649 E. Abdelhamid, A.S. El Refay, A.A. Elkhatib, S. El Nagar, L. Sherif, N. Mehanna:** Microbiota and potential asthma markers: a case control study in a sample of egyptian children
- 2651 L. Gianolio, A. Sala, A. Mari, F. Zunica, V. Giudici, V. Fabiano, G.V. Zuccotti:** Un unusual case of macrophage activation syndrome
- 2653 D. Grammenou, E. Valavani, E.-I. Vourli, I. Tassiou, A. Anastasiou-Katsiardani:** A 5-year retrospective study of children hospitalized with food allergy in a secondary hospital of central greece
- 2655 M. Ouederni, T. Lamouchi, S. Rekaya, I. Ben Fraj, M. Said, R. Kouki, M. Bejaoui, F. Mellouli, M. Ben Khaled:** Digeorge syndrome: clinical and immunological features
- 2657 S. Mamouzi, F.Z. Souid, D. Dahlouk:** Allergy to cow's milk proteins: search for ige specific to cow's milk special case of a polyallergic infant.
- 2659 R.-G. Miulescu, A. Dinulescu, D. Păcurar, A. Voicu, F. Șandru, G. Ion:** An unconventional approach of tubulointerstitial nephritis and uveitis – case report
- 2661 J. Oliveira, I. Vivas, D. Pinto, F. Teixeira, A.R. Araújo:** Not always atopic dermatitis
- 2666 A.C. Pantazi, T. Chisnoiu, C. Mihai, A. Balasa, L. Mihai, C.E. Frecus, A. Ungureanu, V. Cuzic, A.D. Pinzaru:** Severity scoring of atopic dermatitis (scorad index) and bronchial hyperreactivity in children

- 2668 S. Ricci, L. Lodi, M. Calamini, G.M. Poggi, C. Azzari:** Paediatric immunological screening for children with medical complexity
- 2670 S. Shaaban, A. Hamdy, M. Amin, H. Hussein, A. Emil, O. El-Asheer, A. Mahfouz, S. Gad, T. Barakat, S. Tawfik, M. Abozekri, G. Bebars:** Acceptance, safety and tolerability of neocate® syneo® in cmpa infants: egypt experience
- 2672 S. Sheridan, N. Jameel, A.M. Murphy:** The collapsed infant – a rare cause: food protein-induced enterocolitis syndrome (fpies)
- 2674 M. Stracuzzi, C. Vanetti, M. Clerici, G.V. Zuccotti, D. Trabattoni, V. Giacomet:** Role of booster dose in a x-linked agammaglobulinemia adolescent sars-cov-2 infected
- 2676 T. Tansavatdi, B. Dardaranonda:** Rupatadine treatment in childhood allergic rhinitis
- 2678 D. Valente-Silva, L. Leite De Almeida, A. Maia, S. Jacob:** A common drug, with an uncommon clinical manifestation
- 2680 R. Álvarez Pérez, J. Manchola-González, J.R. Serra-Grima, I. Badell Serra:** Improvement in maximal oxygen consumption after a physical exercise program in child survivors of acute lymphoblastic leukemia undergoing chemotherapy
- 2682 J. Bittencourt, G. Scheinbein, G.K. Gonçalves, M.G. Rodrigues-Machado:** Arterial stiffness indices, pulse wave velocity and central pulse pressure, are able to discriminate obese and non-obese children
- 2684 N. Bouayed Abdelmoula, B. Abdelmoula:** Familial pseudo-recessive long qt syndrome: a three-generation tunisian pedigree

- 2686 N. Bouayed Abdelmoula, B. Abdelmoula:** Genetics of familial left ventricular noncompaction cardiomyopathy in sfax, tunisia
- 2688 E. Aurensanz, P. Cassanello, P. Garcia-Canadilla, S. Cesar, M. Gorostegui, J. Sanchez-De-Toledo:** Assesmtment of cardiac function in pediatic oncological patients undergoing chemotherapy treatment
- 2690 P. Cassanello, B. Moscoso, J. Carretero, F. Zuccarino, S. Congiu, J. Mayol, J.M. Caffarena-Calvar:** The chiari network: an embryonic remnant causing intermintent hypoxemia in a 2-months old infant.
- 2694 P. Cassanello, E. Aurensanz, P. Garcia-Canadilla, S. Cesar, M. Gorostegui, J. Sanchez-De-Toledo:** Left atrial function in pediatic oncological patients before and after completing chemotherapy.
- 2696 T. Chisnoiu, A. Balasa, A.C. Pantazi, C. Mihai:** Assessment of growth failure in children with congenital heart disease
- 2698 I. Palii, P. Daniela, I. Rodoman, S. Sciuca:** The efficiency of combining target therapy with bosentan and sildenafil in children with pulmonary arterial hypertension
- 2700 J. Armah, A. Diji, J. Dompim, S. Baffour, H. Budu, C. Poku, E. Boateng, D. ofori:** Sickle cell disease among children in ghana: recounting the experiences of caregivers
- 2702 A. Greco, P. Cassanello, F. Zuccarino, S. Planas, B. Moscoso, S. Congiu, J. Mayol, J.M. Caffarena-Calvar, J. Carretero:** Appearances deceive. A rare cause of right ventricular outflow tract obstruction.
- 2706 A.M. Jurca, C.-C. Olteanu, C. Bulescu, A. Barsan, M. Goicea, B. Ciocca, O. Lazar, M. Chira:** Look beyond the

brain: case report of an intracardiac rhabdomyoma in an infant with early onset epilepsy

- 2708 Y.-E. Kulchytska, T. Marushko, T. Kurilina, O. German:** Health self-evaluation using questionnaire in paediatric patients with primary hypercholesterolemia
- 2710 J. Martins, S. Laranjo, P. Silva Cunha, F. Morgado:** Usefulness and accuracy of the smartwatch in the diagnosis of cardiac arrhythmias in children
- 2712 M. Mihalec, D. Bartoniček, D. Šarić, D. Dilber:** Wide qrs complex tachycardia camouflaging wpw syndrome: a case report of a healthy soccer player without previous ecg recordings
- 2714 M.L. Rossi, M.C. Escobar-Diaz, S. Hadley, P. Randanne, I. Jordan, J. Sanchez-De-Toledo:** Is pulmonary hypertension a risk factor for poor outcomes in bronchiolitis?
- 2716 J. Serralabós-Ferré, G. Garcia Del Cerro, J.M. Valle-T-Figueras, M. Espinet-Pedrol, J.M. Romero, R. Tejedor, E. Bramon, N. Vilalta Seto, S. Boronat:** Intermittent claudication in an adolescent: suspected antiphospholipid syndrome. An open case for differential diagnosis
- 2720 J. Shah, B. Bhojnagarwala:** Aberrant central venous catheter (cvc) courses and undiagnosed congenital heart disease (chd): role of point of care ultrasound (pocus) and chd screening.
- 2723 M. Tankoska:** Association between cardiometabolic factors and ejection fraction in healthy obese children
- 2725 D. Toader, D. Lazar, O. Racz, A. Borlean, B. Lucian, G. Tita, S. Cainap:** The need for scrutiny in paediatric dilated cardiomyopathies: why the differential diagnosis should extend beyond the acute phase.

- 2727 V. Urbanová, K. Rücklová:** Early detection of cardiovascular risk factors in children.
- 2729 K. Polak, A.P. Fariña Ruíz, F. Portela Torron, R. Bellot Fernández, C. Rubio Iglesias, S. Rusu, M. Rivero Falero, S. Romero Ramírez, B. Reyes Milan, I. Vidal Gil:** Transfer of a patient or a surgeon? Pilot project: transfer of the surgeon from the reference center to the hospital without on-site pediatric cardiac surgery.
- 2731 D. Webster, G. Kodua, K. Danso, S. Mensah, N. Parmar, K. Donda, P. Bhatt, F. Dapaah-Siakwan:** Trends in cardiac arrhythmias among pediatric hospitalizations with cannabis use in the united states, 2009-2019
- 2734 M.-C. Zammit, J. Swain, V. Grech, R. Farrugia:** Flecainide - an intravenous alternative to amiodarone for refractory paediatric supraventricular reentry tachycardia?
- 2736 M. Ahmed, R. Ogunleye:** Evaluation of parents' experience of remote consultations since covid-19 pandemic
- 2738 A. Ajose, C. Akinde, A. Ilo, Y. Shittu, A. Robert, T. Durojaiye:** Parental knowledge, attitude and willingness to vaccinate their children against covid-19 infection in nigeria.
- 2740 A. Gatell, E. Alcover, J. Balaguer, T. Pérez-Porcuna, E. Fortea, D. Rodà, P. Álvarez, O. Salvadó:** Evolution of emotional and behavioral symptoms during the 2020-2021 school year in the context of the covid-19 pandemic
- 2742 E. Alcover, A. Gatell, J. Balaguer, T. Pérez-Porcuna, O. Salvadó, P. Álvarez, D. Rodà, E. Fortea:** Use of the sdq questionnaire to assess child and adolescent mental health during the 2020-2021 school year in the context of the covid-19 pandemic

- 2744 M. Bašković, A. Čizmić, M. Bastić, B. Župančić, M. Žganjer, L. Zaninović:** The impact of the covid-19 pandemic on the most common diagnoses in pediatric surgery
- 2746 I. Camelo, G. Ntolkeras, E. Peacock-Chambers, J. Patel:** Multisystem inflammatory syndrome in children (mis-c) with neurological symptoms, an under recognized presentation at admission: case series from two tertiary health care centers
- 2748 R. Mansfield, O. Oremakinde, N. Khambati, S.D. Sia, T. Champion-Smith:** A retrospective cohort analysis of the clinical course of sars-cov-2-positive infants
- 2750 D. Ciortea, M. Ursu, R. Cebuc, R. Goroftei, A. Nechita, M. Matei:** New diagnostic perspectives in paediatric patients with hydroelectrolytic disorders due to covid-19
- 2752 A. Dinulescu, A. Păsărică, E. Smădeanu, C. Becheanu:** Digestive disease at the covid patients in a tertiary-level hospital
- 2754 A. Dinulescu, A. Păsărică, E. Smădeanu, C. Becheanu:** A group of paediatric covid 19 patients analyzed by AGE
- 2756 A. Fedorczak, N. Ziełńska, P. Nosek, K. Mikołajczyk, J. Lisiak, K. Zeman:** Comparison of covid-19 and rsv infection courses in children under 36 months hospitalized in paediatric department in fall and winter season 2021/2022
- 2758 K. Goyal, P. Kukreja, S. Neshat:** Profile of patients with pims – ts with medium term follow up- a tertiary care hospital experience with in the UK
- 2762 S. Loemba, M.-J. Dore-Bergeron, P. Laforce, J. Paquette, A. Lacroix, M.-F. Langlet, B. Grou, E. D. Trottier:** “Tout doux”: providing french-speaking canadians families with adequate tools and resources on vaccination for their children in the context of a pandemic.

- 2764 V. Matias, M. Gutierrez, I. Sanz, M.D. Calvo, A. Cubillo, B. Pacho, J. Sanchez, C. Montero, J.M. Eiros:** Antibodies against sars-cov-2. Does the children covid-19 burden of disease reflect the reality of their seroprevalence?
- 2766 T. Harashchenko, Y. Antypkin, T. Umanets, V. Lapshyn, T. Kaminska, S. Stryzhak:** The association between vitamin d levels and the clinical severity of covid-19 among ukrainian children
- 2768 S. Kalyanshettar:** Post covid cerebellar ataxia. A case series
- 2770 L. Leite De Almeida, I. Pais-Cunha, D. Valente-Silva, S. Geraldés Paulino, A. Assunção, D. Rabiço-Costa, A. Reis-Melo, M. Tavares, R. Rocha:** Impact of the covid-19 pandemic on a pediatric emergency department
- 2772 S. Balaguette, C. Caderoly, L. Kovacic, A. Mallard, B. Muanza, P. Desprez, J. Helene-Pelage, E. Janky:** Multi-system inflammatory syndromes (mis-c) secondary to covid and/or dengue in paediatric population in guadeloupe
- 2774 Y. Marushko, T. Marushko, Y.-E. Kulchytska:** Malnutrition in paediatric patients with primary dyslipidaemia due to dietary compliance
- 2776 S. Mdimegh, S. Ghorbel, A. Tej, N. Soyah, R. Kebaili, M. Abdelbari, H. Ben Belgacem, S. Tilouche, J. Bouguila, L. Boughamoura:** Neurological complications with sars cov-2 infection in pediatric patients
- 2778 F. Mirghani Ahmed Ali, A. Masai, M. Hassan:** Corticosteroid use in a child with covid-19 induced acute respiratory distress syndrome: a case report
- 2780 I. Tassiou, V. Mouratoglou, M. Kopanou, A. Anastasiou-Katsiardani:** Retrospective-epidemiological study of children with mis-c, in a secondary hospital of central greece (12th/2020-12th/2021)

- 2782 R. Natale, S. Messiah, Y. Agosto, M. Ma:** Childcare teacher functioning over the 2-year course of the covid-19 pandemic.
- 2784 M. Odeh, F. Al-Khori, A. Khalil, M. Hassan:** Incidental finding of ground glass appearance in ct chest in a symptomatic infant with covid-19 disease: unusual case report
- 2787 L.-M. Olăroiu, R. Iorga, R.-G. Miulescu, D. Păcurar, M. Pavelescu, I. Dijmărescu:** Henoch schönlein purpura – is it a mild condition?
- 2789 S. Florencio, B. Oliveira, F.E. Lima, E.A. Brito, E.S. Melo, L. Barbosa, M.G. Fontenele, M. Diógenes, M.W. Ventura, G. Lima, M. Araujo, A.P. Queiroz:** Covid-19 in children from northeastern brazil: demographic and clinical profile
- 2791 M. Diógenes, B. Oliveira, F.E. Lima, G. Lima, S. Florencio, M.G. Fontenele, M.W. Ventura, A.P. Queiroz, I. Silva Junior:** Covid-19 pandemic: changes in children’s school routine
- 2793 S. Pasarica, A. Dinulescu, C. Becheanu, E. Smădeanu:** The respiratory symptomatology associated with covid-19 disease in paediatric patients
- 2795 N. Phung:** Risk factors for disease severity and mortality of children with covid-19: a study at a vietnamese children’s hospital
- 2797 L. Pigeaud:** Acute alcohol intoxication in dutch adolescents before, during, and after the first covid-19 lockdown
- 2799 K. Plėšnytė- Čapkauskienė, L. Kilaitė, B. Paškevič, B. Lukšaitė, J. Radzevičienė:** A pediatric case of covid-19 multisystem inflammatory syndrome with neuropsychiatric symptoms

- 2801 A. Rebelo, R. Cunha, L. Sá, T. Oliveira, J. Lorenzo:** Cutaneous reaction to covid-19 vaccine
- 2805 I. Silva Junior, A.P. Queiroz, B. Oliveira, M. Diógenes, S. Florencio, L. Figueiredo, N.L. Albuquerque, P. Oliveira, J. Pereira, F.E. Lima:** Death of children with severe acute respiratory syndrome by covid-19 in brazil
- 2807 I. Silva Junior, A.P. Queiroz, B. Oliveira, N.L. Albuquerque, L. Figueiredo, P. Oliveira, M. Diógenes, J. Pereira, S. Florencio, F.E. Lima:** Clinical characteristics of brazilian children diagnosed with severe acute respiratory syndrome by covid-19 after two years of pandemic
- 2809 I. Silva Junior, A.P. Queiroz, B. Oliveira, M. Diógenes, S. Florencio, L. Figueiredo, N.L. Albuquerque, P. Oliveira, J. Pereira, F.E. Lima:** Hospitalization of brazilian children diagnosed with severe acute respiratory syndrome by covid-19
- 2811 D. Toader, A. Mititelu, R. Babici, M. Vintan, A. andrei, S. Cainap:** The diagnostic struggles of mis-c: confounding factors or real concerns?
- 2813 M. Ursu, D. Ciortea, M. Arbune, A. Nechita, M. Matei, C. Dodul:** Newly diagnosed type i diabetes and covid-19 pandemic
- 2815 G. Venckuté, L. Jankauskaitė, G. Laucaitytė, K. Ganzijeva, E. Hansted, A. Šnipaitienė, R. Kėvalas:** Prevalence of sars-co-v-2 antibodies in asymptomatic children with unexplained symptoms
- 2817 M. Rázquin Arias, Z. Daoud Pérez, P. Ventura, A. Díaz Conradi:** The impact of covid-19 lockdown on children with recurrent wheezing and asthma in SPAIN

- 2819 Z. Yazdanpanahi, M. Hajfoghaha, N. Nasabeh:** Children's mental health and covid-19
- 2821 D. Belamri, N. Boutalbi, L. Boustil, H. Sehab, N. Bouchair:** Johnson's stevens syndrome induced by carbamazepine: a case report
- 2823 K. Grounds, G. Cura:** Re-activation of alopecia areata in a 12-year-old following pfizer- biontech covid 19 vaccination
- 2825 O.-E. Frasinariu, M. Cozorici, I. Vasiliu, V. Sreanga, L. Trandafir:** Epidermolysis bullosa - a family metter
- 2827 N. Jameel, S. Sheridan, B. Finn, A.M. Murphy:** Genotype, phenotype correlation of incontinentia pigmenti; a case report
- 2829 I. Mazedo, S. Alves, S. Ramos, C. Zilhão:** Parry romberg syndrome: a pediatric case report
- 2834 M.Ç. Menteşe, S. Şahin, A. Günalp, F. Haşlak, M. Yildiz, A. Adroviç, K. Barut, Ö. Kasapçopur:** Amyopathic juvenile dermatomyositis with widespread calcinosis at disease onset: a case report
- 2837 C. Morais, S. Catarino, A. Nogueira, A. Maia:** Segmental achromic nevus – an uncommon clinical TYPE
- 2840 L.-M. Olăroiu, R. Iorga, I. Dijmărescu, G. Brînză, D. Păcurar:** Severe skin damage in a patient with ulcerative colitis: two diseases or ONE?
- 2842 A.E.C. Silva, A. Azevedo, S. Miranda, C. Silva, S. Martins, S.C. Silva:** Multiple malherben's calcifying epitheliomas
- 2847 B. Abdelmoula, N. Bouayed Abdelmoula:** Down syndrome: a monocentric STUDY

- 2849 M. Anastasakis, I. Galonaki, C. Doitsidis, M. Mitroudi, C. Panteli, I. Patoulas:** Hematometra due to hymenal atresia
- 2851 J. Blom, E. Bisagno, Z. Linde-Ozola, D. Morva, M. Rozsa, D. Bou Mosleh, A. Kandate, N. Laszlo, G.L. De Fazio, A. Cadamuro, D. Varga-Sabján, D. Wuyts, S. Dierickx:** Developing a blended-learning training for childcare professionals to screen, refer and provide trauma-sensitive care for children exposed to domestic violence
- 2853 S. Cromie, S. Kapur, N. Kirk, J. Johnston, R. Mcbay-Doherty, C. Lafferty, D. Mclaughlin, J. Wallace, N. McMahan, J. Richardson:** Stepping up - a regional simulation education programme designed to support and enhance the skills of level 1 trainees in 'stepping up' to middle grade.
- 2855 I. Eiras, L. Abelha, I. Magalhães, S.C. Ferraz, S. Miranda, C. Silva, F. Martins, D. Rocha:** Global psychomotor developmental delay: a rare etiology
- 2857 S.C. Ferraz, I. Magalhães, L. Abelha, I. Eiras, S. Miranda, M. Costa:** Superman syndrome
- 2859 D. Henriques Pinto, A. Rebelo, S.S. S. Rodrigues, M. Azevedo, V. Monteiro:** Down syndrome: characterization of the children followed in the development consultation of our hospital
- 2861 E. Fisch-Gomez, V. Siffredi, M.C. Liverani, C. Borradori Tolsa, R. Hà-Vinh Leuchter, P. Hüppi:** Regional brain gray matter concentration correlates to neurobehavior in very preterm children and adolescent
- 2864 Y.R. Jin, L.-Y. Lin:** Exploring relationships between motor skills performance and self-care abilities in young children with ASD

- 2866 M. Kherkheulidze, N. Khavlashvili, E. Kandelaki, D. Abelashvili:** Developmental outcomes of low birth infants
- 2868 E. Kandelaki, M. Kherkheulidze, N. Khavlashvili:** Developmental problems in children with atopic dermatitis
- 2870 R. Mccarthy, S. McCormack, D. Mcdonald:** Multi-disciplinary management of rett syndrome: an audit of compliance with consensus guidelines
- 2872 S. Abdelhafeez, C. Loh, K. Cahill, N. Crawley, S. Murray, R. Huijsdens, S. Alam-Shoushtari, N. Essa, E. Isweisi, G. Semova, A. Branagan, J. Meehan, E. Roche, E. Molloy:** Dog ownership and childhood development
- 2874 C. Morais, R. Quental, L. Lourenço, M. Guardiano, C. Silva, M. Leão:** Ank2 variant in a child with autism spectrum disorder and epilepsy
- 2876 B. Mota, C. Silva, C. Costa, L. Lourenço, T. Campos, E. Rodrigues:** Sylver-russel syndrome – recurrent hypoglycemia: the diagnostic KEY
- 2878 M. Pereira, D. Baptista, M. Rocha, C. Sá:** Trigenocephaly associated with genetic syndrome - craniosynostosis 4 (crs4)
- 2880 E. Pourreza, B.C. Cengiz, N.B. Yaradanakul, A. Duyan Çamurdan, G. Bora Taş, M. Zinnuroğlu, S. Gürses:** Spatiotemporal evolution of infants' foot pressure during learning of standing
- 2884 M. Ribeiro, M. Nogueira, A.R. Soares, S. Costa:** Glass syndrome
- 2886 A. Rodrigues, L. Torres, L. Salicio:** Developmental delay in an institutionalized child – case report

- 2888 E. Sousa, M.A. Passas, H. Santos, J.B. Silva, T. Pena, A.C. Maia, C. Madureira:** Learning disabilities - a retrospective STUDY
- 2890 E. Tsekoura:** Impact on mental health of children with asd, adhd, slds and their families in greece due to covid 19 pandemic social isolation.
- 2892 T. Waldheim, O. Rybalko:** Kinesio taping effectiveness of treatment juvenile idiopathic scoliosis
- 2894 W. Zheng, R. Chotipanvithayakul:** Home-based sensory stimulation program improves developments of preterm infants in southwest china: A randomized controlled TRIAL
- 2896 A. Alassaf, S. Aqeilan, H. Fataftah, R. Odeh:** Impact of covid-19 pandemic lockdown on the incidence of central precocious puberty in female children in jordan
- 2898 M. Arham, H. Sattar, M. Arish:** Van wyk-grumbach syndrome: an early and unusual presentation
- 2900 H. Sattar, M. Arham, M. Arish:** Self-prescribed topical steroid application at routine diaper change leading to iatrogenic cushing syndrome in an infant: a case report from a developing country
- 2902 A. Barmpakou, S.-Z. Siska, K. Kakleas, A. Santou, I. Orfanou, C. Kanaka-Gantenbein:** A systemically well 10-year-old boy with persistent cervical lymphadenopathy for the last twelve months.Infection or something to worry?
- 2904 A. Beqiri Jashari, A. Janchevska, F. Doksimovski, I. Ahmeti, B. Teov, H. Nestorov, N. Laban, E. Sukarova-Stefanovska, Z. Gucev, D. Plasevska-Karanfilska:** Alstrom syndrome (alms) with early vision and hearing affection

- 2906 F. Doksimovski, H. Nestorov, A. Beqiri-Jashari, V. Tasic, D. Plasevska-Karanfilska, B. Teov, Z. Gucev, M. Gorgievska, A. Janchevska:** Gnatodiaphyseal dysplasia without jaw lesions in two generations
- 2908 S. Branco, I. Mazedá, B. Vieira, I. Vivas, E. Coelho:** Mody: a rare mutation
- 2910 S. Branco, I. Vivas, B. Vieira, I. Mazedá, E. Coelho:** A rare thyroid disorder
- 2912 I. Coyne, J. Surdey, B. Sleath, M. Hughes, M. Murphy, S. Rafferty, S. Pembroke, S. Rogerson, V. Burke, M. Brenner, D. Cody, C. Hilliard, E. Roche:** Acceptance of a pre-clinic visit intervention to engage and empower adolescents with type 1 diabetes mellitus in clinic encounters with doctors
- 2914 A. Janchevska, V. Tasic, V. Jovanovska, S. Antonievska, O. Jordanova, Z. Gucev, D. Plashevska-Karanfilska:** Noonan syndrome-like disorder in a 1-year-old BOY
- 2916 M. Torkovska, S. Antonievska, B. Teov, A. Beqiri-Jashari, F. Doksimovski, H. Nestorov, O. Jordanova, V. Tasic, Z. Gucev, A. Janchevska:** A 13-year-old boy with klinefelter syndrome and hashimoto thyroiditis
- 2918 L. Leite De Almeida, M.M. Resende, P. Gomes Pereira, M. Martins, L. Santos:** A clinical case of galactorrhea in a female adolescent
- 2920 C.I. López Aldunate, M. Mass-Lindenbaum, G. Revecó Pérez, H. Villalón Urrutia:** Early onset pediatric systemic lupus erythematosus: case report.
- 2922 P. Marzuillo, G. Rivetti, A. Di Sessa, M. De Lucia, P.L. Palma, E. Miraglia Del Giudice, C. Polito, S. Guarino:**

Height-estimated basal creatinine in diagnosing acute kidney injury in children with type 1 diabetes mellitus ONSET

- 2924 M. Nikolaou, M. Binou, S. Bampalitsa, E. Kollia, I.-A. Vasilakis, M. Dolianiti, C. Kanaka-Gantenbein:** Infant with disorders of sex development (dsd): initial approach and evaluation
- 2926 F.Z. Souid:** Grave's disease following hashimoto thyroiditis
- 2928 X. Liu, J. Wang, Z. Li:** Research progress on the relationship between vitamin d deficiency and central precocious puberty
- 2930 C. Augusto De Lima, S. Silva Sabino, S. Silva Sabino, S. Silva Sabino, M. De Lima Alves, E. Gonçalves Silva, D. Alves Da Costa Canella, E. Fellipe Capini De Almeida Tavares, M. Evelyn Da Silva, O. Augusto Freire Campos, T. Calegari:** Epidemiological analysis of zika virus cases in children and adolescents in brazil
- 2932 A. Deghebo, Y. Okwaraji, Z. Tigabu, L.Å. Persson, K. Gelaye:** Spatial distributions of common childhood illnesses, healthcare utilisation and associated factors in ethiopia: evidence from 2016 ethiopian demographic and health survey
- 2934 M. Honskus, P. Křížová:** Molecular analysis of cc11 isolates from invasive meningococcal disease from the czech republic, 1993–2020
- 2936 M. Inziani, F. Adung'O, E. Obimbo, F. Onyango, S. Inoue, K. Morita, M. Mwau:** Clinical, behavioural, and environmental factors associated with yellow fever, dengue, chikungunya, and west Nile virus exposure in children in teso sub county, western kenya.

- 2938 P. Křížová, M. Honskus:** Detailed molecular characterization of neisseria meningitidis isolates by whole genome sequencing (wgs), czech republic, 2010–2019
- 2940 M. andrejeva, G. Megelinskiene, A. Valiulis, J. Korabliovienė, A. Valiulis:** Questionnaire based survey for the detection of gaps of paediatric tuberculosis knowledge among physicians and medical students
- 2942 E. Neziri, L. Sadedini, M. Kapllanaj, S. Demiraj, M. Kurti:** A case of acute rheumatic fever in a 14 year old GIRL
- 2944 I. Pais-Cunha, L. Leite De Almeida, T. Magalhães, A. Maia:** Orofacial clefts and ocular anomalies: 30 years of experience of a multidisciplinary group in a tertiary hospital in portugal
- 2946 L. Qatipi:** A study on factors influencing vaccine hesitancy in albania
- 2948 F. Rodríguez Acosta, C. Salinas, P. Acuña, S. Franco, G. Florentín, R. Guillén:** Genes encoding enterotoxins m, n, o, u detections in isolates of staphylococcus aureus collected from the paraguayan paediatric population in the year 2017
- 2951 T. Hubble:** Respecting the child’s legal voice: has the best interests test incorporated an element of substituted judgment in medical decision-making?
- 2953 W. Leeuwenburgh-Pronk:** Through different eyes, a paradigm shift regarding treatment of trisomy 18
- 2955 M. Quirke, D. Alexander, J. Greene, C. Walsh, M. Brenner:** Factors that influence a clinician’s decision to support the initiation of invasive long-term ventilation for a young child: a factorial survey
- 2957 T. Sousa, T. Costa:** The mourning of a lifetime doesn’t fit into five DAYS

- 2959 C. Genna, K.R. Thekkan, C. Geremia, M. Di Furia, A. Campana, I. Dall'Oglio, E. Tiozzo, O. Gawronski:** Parents' process of recognition and response to clinical deterioration of their children with medical complexity at home: a grounded theory
- 2961 C. Gomes Pereira, S. Nogueira Machado, R. Lages Pereira, A. Rebelo, M. Salgado:** Fever phobia – where are we NOW
- 2963 C. Gomes Pereira, B. De Sousa, A. Fernandes:** Parents' knowledge about sudden infant death syndrome
- 2965 S. Loemba, M.-J. Dore-Bergeron, P. Laforce, J. Paquette, A. Lacroix, M.-F. Langlet, E. Trempe, K. Gatuso, B. Grou, E. D. Trottier:** Tout doux: an institutional initiative to reduce pain and distress management related to procedures
- 2967 R. Gupta:** Role of virtual mdt in managing paediatric safeguarding
- 2969 M. Ezzati, O. Ozieh, F. Yousif, A. Abdelgadir, M. Higgins-Abrago:** Missing opportunities in outpatient clinic and paediatric emergency department to discuss about childhood obesity
- 2971 R. Martin, E. Di Mauro, M. Dell'Anna, C. Trapani, M. Parpagnoli:** Early onset of psychological support for families of children with complex needs.
- 2973 P. Patel, S. Nimbalkar, J. Ganjiwale, T. Manavalan:** Self medication in children less than 5 years of AGE
- 2975 C.-J. Van Der Perk, P. Burger, R. Gemke, J. Maaskant:** Parents' experiences and perspectives of their child's sleep quality during hospitalization

- 2977 C. Wild, N. Rawiri, E. Willing, P. Hofman, Y. anderson:** Childhood obesity and healthy lifestyle change: a global perspective from new zealand
- 2979 S. Zakariah, A. Afrane, T. Beattie:** Factors associated with favoring parental presence during cardiopulmonary resuscitation among doctors involved in the emergency care of children in a tertiary hospital in GHANA
- 2981 I. Abdelgadir, E. Twum-Barimah, M. Gordon, E. Langholz, L. Gluud, G. Aali, A. Akobeng:** Tranexamic acid for upper gastrointestinal bleeding - systematic review and meta-analysis
- 2985 M. Anastasakis, I. Galonaki, C. Doitsidis, M. Mitroudi, C. Panteli, I. Patoulis:** Bilocular cystic ileal duplication: case report
- 2987 O. Belei, L. Olariu, T. Marcovici, I. Enatescu, O. Marginean:** The role of vitamin d supplementation in children with inflammatory bowel diseases
- 2989 S. Bojadzieva, A. Sofijanova, O. Jordanova, S. Jancevska:** Changes of the pro-inflammatory cytokines in children with inflammatory bowel disease
- 2991 F. Dhillip:** A rare presentation of h.Pylori infection in children
- 2993 R. Iorga, I. Dijmărescu, L.-M. Olăroiu, D. Păcurar:** Crohn's disease and primary adrenal insufficiency – could there be a connection?
- 2995 M. Dimitrovska-Ivanova, A. Kostovski, B. Sonja, L. Jovceski, N. Jordanova Cepreganova, E. Josifoska, E. Simonovska, A. Murtezani:** Crohn's colitis in a 10 year old BOY

- 2998 S.C. Ferraz, I. Magalhães, A. Costa Azevedo, M. Costa, H. Antunes, I. Martinho:** Recurrent vomiting and autism spectrum disorder
- 3000 O.-E. Frasinariu, I. Miron, I. Ciongradi, M. Panzaru, E. Cojocar, L. Trandafir:** Sars cov 2 - a possible cause of primary biliary colangitis in a 2 month old BABY?
- 3002 Y.F. Lee, M.C. Wu, S.K. Ma:** Association of early childhood constipation and risk of autism spectrum disorder in taiwan: real-world evidence from a nationwide population-based cohort study.
- 3005 I. Mallassi, M. Tfifha, S. Nouir, F. Majdoub, S. Mabrouk, J. Chemli, S. Abroug:** Wilson disease in children: a serie of 7 CASES
- 3007 M.R. Mitakidou, T. Dassios, A. Dhawan, N. Papalexopoulou, A. Gupta, A. Greenough:** A single centre study on fat free mass in a teenage population with cystic fibrosis: what really affects IT?
- 3009 I. Zakharova, A. Darma, B. Hegar, R.T. Ng, S.Y. Chong, E. Toro-Monjaraz, M. Hasosah, M. Cetinkaya, C.M. Chow, L. Muhardi, U. Kudla, D. Delsing, L.N. West, K. Huysentruyt, Y. Vandenplas:** Insights on indicators for gut health for infants and toddlers (0-36 months) from an electronic survey among various healthcare professionals in seven countries
- 3012 J. Ndzo:** Fulminant liver failure in a teenager secondary to an intentional mixed drug overdose, requiring a liver transplant.
- 3014 K. Nigam, V. Patil:** Ct imaging evaluation of hepatoblastoma: pre and post neoadjuvant chemotherapy and correlation with clinical and pathological findings.
- 3016 N. Nikchevska, R. Simeonov:** Case report of ongoing cmv infection at the time of kasai portoenterostomy

- 3018 A. Oyegunle, N. Kottarakou, J. Kutty:** Cholestatic jaundice and epstein-barr virus infection in children
- 3020 A.C. Pantazi, A. Balasa, T. Chisnoiu, C. Mihai, C.E. Frecus, L. Mihai, V. Cuzic, A.K. Mustafa, S. Castelo Da Graça, B. Plaka, A.D. Pinzaru, A. Ungureanu:** Composition of gut microbiota in overweight children in the first 3 years of LIFE
- 3022 J. Pereira-Nunes, S.C. Teixeira, G. Reis, N. Gaspar, C. Espinheira, E. Trindade:** Pediatric-onset chronic liver disease and adult care transition - a 45 patients' cohort STUDY
- 3024 P. Sousa, S. Correia-De-Oliveira, C. Gomes Pereira, H. Ferreira, A. Lopes, M. Salgado:** Oral ondansetron in the pediatric emergency department - friend or FOE?
- 3026 Y. Wang, J. Wang:** Progress in the study of health-related quality of life (HRQOL) for functional abdominal pain in children
- 3028 M. Al-Beltagi, H. Abutalib, K. Elmanaie, M. Kaushal, M. Abdellatif, S. Tomaraei, A. Surka, A. Shabaan, A. Silva, M. Ali:** Evaluation of acceptance, safety and tolerability of aptamil advance®: early experience in the united arab emirates, qatar, oman, kuwait, and bahrain
- 3030 J. Ambroszkiewicz, J. Gajewska, W. Klemarczyk, G. Rowicka, M. Chetchowska:** Serum albumin and prealbumin levels in relation with bone metabolism markers in prepubertal children
- 3032 D.T. Anton Paduraru, A.S. Boccec, A.E. Coman:** Study on eating habits of children and adolescents before and during the covid 19 pandemic
- 3034 A. Aswin, A. Aswin, A. Safitri:** Association between infectious disease and hygiene practice with stunting in children aged 6-24 months

- 3036 M. Balhara:** Examining the association between pediatric binge eating disorder and high ultra-processed foods consumption
- 3038 S. Bartova, M.P. Giner, F.-P. Martin, S. Moco, N.P. Hays, F. Gambin, L. Fernández, S. Marco, J.-P. Godin, J.-C. Picaud:** Impact of infant formulas with age-adapted or static protein concentrations compared to breast milk on urinary metabolite profile at age 1 and 3 months
- 3040 D. Belamri, D. Djighader, N. Boutalbi, N. Bouchair:** Knowledge, attitudes, and practices of women on exclusive breastfeeding (eb) in annaba (algeria)
- 3042 R. Ben Rabe, N. Toulgui, N. Missaoui, S. Yahyaoui, O. Bouyahya, S. Mazigh, S. Boukthir:** Prevalence of dyslipidemia in children with type 1 diabetes mellitus
- 3044 D.S. Khan, J. Das, Z. Lassi, Z. Bhutta:** Nutritional status and dietary intake of school-age children and early adolescents: systematic review in a developing country and lessons for the global perspective
- 3046 C. Kidd, L. Marino, B. Rothman, G. O'Connor:** A national survey of dietetic support, tube feeding and breastfeeding advice for infants with single ventricle cardiac physiology
- 3048 M. Kinoshita, E. Khoo, M. Nezafat, A. Branagan, K. Allen, S. Young, G. Avalos, A. Dumitrescu, J. Costa, G. Kearney, E. Molloy, S. Brennan, N. McCallion, A. Doolan:** Breastfeeding education: medical students knowledge and confidence
- 3051 C. Le Roy, N.P. Hays, C. Monnard, J. Korbinian Vogt, P. Myers, A. Eklund, J. Ramos-Nieves, E. Estorninos:** Gut

microbiome responses to two different complementary feeding regimens in healthy infants: secondary results from a single-blind, randomized, controlled TRIAL

- 3053 M. Lozano-Casanova, L. Collado, A. Gutierrez-Hervas, C. Grainger, M.A. AVECILLA, I. Sospedra:** Safe and alternative new complementary feeding method: baby-led introduction to solids (bliss)
- 3055 O. Rybalko, T. Waldheim:** Correlation between hypocalcemia and skeletal disorders in the late preterm children
- 3057 J. Bhardwaj, Msc., U.L.M.D.M. Schätzer, N. Moser, Bsc., P.U.P.D.D.F. Hoppichler:** 10 years dairy-check: results of a long-term study on the sugar content of dairy products
- 3059 P.B. Preissler, Msc., U.L.M.D.M. Schätzer, J. Bhardwaj, Msc., P.U.P.D.D.F. Hoppichler:** The association between stress and the consumption of sweet beverages in adolescents during the pandemic
- 3061 B. Soyilmaz, I. Vassallo, E. Pakalynte, A. Ibáñez Navarro, A. Lau:** Investigation of regional variation of hmo levels in mature MILK
- 3063 H.A. Tajuddin:** Breastfeeding counselors networking program (bcnp) as a social & behaviour change communication (sbcc) intervention to improve breastfeeding rate in malaysia
- 3065 M. Von Hafe, M. Borges-Canha, J. Chaves, J. Neves, S. Corujeira, A. Varela, J. Preto, P. Freitas, D. Carvalho:** Comparison of the impact of bariatric surgery performed at pediatric age versus young adults

- 3067 Q. Zhang, X. Wan, P.-Y. Cheung, F. Lin, H. Huang, Y. Deng:** Early aggressive enteral feeding advancement on premature infants at 30-34 weeks in CHINA
- 3070 I. Camelo, R. Pieciak, I. Castro-Aragon, B. Setty, H. Chang, M. Betke, L. Etter, J. Li, R. Thompson, C. Gill:** Correlation between chest x ray (cxr) and point of care ultrasound (pocus) findings in children diagnosed with rsv infection by nasopharyngeal rt-pcr: the zambia experience
- 3072 M. Chetchowska, J. Jurczewska, J. Gajewska, D. Szostak-Węgierek, E. Rudnicka, M. Ołtarzewski, J. Ambroszkiewicz:** Glutathione status in young women with polycystic ovary syndrome
- 3074 A. Tarantino, P. Amadio, E. Chapin, G. Salvatori, I. Dall'Oglio:** Breastfeeding preparedness during humanitarian emergencies. A review of online resources available for the population
- 3076 A. Tarantino, E. Chapin, P. Amadio, G. Salvatori, I. Dall'Oglio:** Breastfeeding and humanitarian emergency contents to ensure population's preparedness: a survey on childbirth preparation courses
- 3078 F. Marchetti, P. Amadio, A. Giusti, G. Salvatori, I. Dall'Oglio:** Training on breastfeeding protection, promotion and support in humanitarian emergencies, a pilot observational study among humanitarian organizations
- 3080 I. Eiras, L. Abelha, A.I. Sequeira, A. Rego, B. Sousa, C. Dias, I. Soro, D. Rocha:** Kabuki syndrome
- 3082 C. Delambert, I. Santos, B. Moreira, A.M. Pereira, P. Sauretti, L. Carvalho, C. Fonseca:** Repercussions of the nutritional status of zinc in children and adolescents with down syndrome.

- 3084 M. Couto, J. Oliveira, C. Delambert, L.C. Antunes, J. Corrente, A. Prearo, T. Goldberg, C. Fonseca:** Early motor and thyroid intervention improves motor function in children with down syndrome.
- 3086 C. Fonseca, C. Delambert, L. Carvalho, A.M. Pereira, E. Cyrino:** Comprehensive health care for children and adolescents with congenital (non-genetic) diseases: the experience of an assistance service.
- 3088 N. Kemps, H. Moll, J. Zachariasse:** A review of paediatric early warning scores in low- and middle-income countries
- 3090 B. Koshy, M. Srinivasan, S. Gopalakrishnan, V.R. Mohan, R. Scharf, S. John, R. Beulah, J. Muliylil, G. Kang:** Is childhood resilience associated with early childhood factors?
- 3092 J.A. Neto, A. Lemos, M. Garcia, M. Madureira, J. Laranjeiro, J. Spratley, A. Maia:** Recurrent choking: parental anxiety or vascular anomaly?
- 3094 B. Pitekova, S. Szoradova, S. Tarnokova, L. Podracka, J. Stanik:** Acid-base disorders in children with acute vomiting
- 3096 N. Shavlakadze, I. Pkhakadze, T. Dolaberidze:** Lead, vitamin “d” and hemoglobin in children living in west georgia
- 3098 S.C. Teixeira, Â. Martins, J.A. Paiva, P. Poeta:** Antibiotic prescription in children by paediatricians and family doctors
- 3100 N. Kemps, S. Unger, E. Ledger, H. Mark, H. Moll, J. Zachariasse:** A pediatric early warning score to recognize serious illness in a lower middle-income country
- 3102 R. Zakaria, H. Amor, A. Baali:** Body image perceptions and self-esteem among a moroccan group of adolescents

- 3104 M. Amir, M. Aye, M. Borumand:** Covid-19 a cause of abnormal clotting in children
- 3106 S. Ansari, M. Shampour, S. Ghazavi:** Congenital factor vii deficiency presenting with isolated recurrent hematuria: a case report
- 3108 H. Barreto Henriksson, A. Hellström, A. Nilsson, S. Frändberg:** A five year look-back of bacterial species intermittently detected in cord blood UNITS
- 3110 H. Ben Belgacem, A. Ben Taieb, M. Ben Guedria, N. Soyah, M. Abdelbari, S. Ghorbel, R. Kebaili, A. Tej, J. Bouguila, S. Tilouche, L. Boughamoura:** Prevalence of endocrine complications in transfusion-dependent thalassemia
- 3112 F. Caino De Oliveira, R. Oliveira Faxina, N.B. De Alcantara Ferreira Garrido, P. Rute Moutinho, W. Brunow De Carvalho:** Giant hepatic hamartoma in a 2-year-old child: a case report
- 3115 T. Chisnoiu, A.C. Pantazi, A. Balasa, L. Mihai, C.E. Frecus, C. Mihai:** Iron deficiency-a risk factor for febrile seizures in children
- 3117 T. Sousa, T. Costa:** The importance of partnerships between patient associations and healthcare professionals in achieving the best levels of healthcare
- 3119 O. Dorosh, I. Tsymbalyuk-Voloshyn, O. Vorobel, A. Stepanyuk, O. Kozlova, K. Bodak, L. Dubey, M. Troyanovsky:** Iodine deficiency as a risk factor of malignant blood diseases in children
- 3121 A. Fraga, S. Miranda, C. Sousa, A. Maia, Í. Maia:** Myofibroma, a rare benign TUMOR

- 3123 A. Fraga, S. Silva, F. Leite, A. Maia, Í. Maia:** Fibrolamellar hepatocellular carcinoma – a five-year surveillance case report
- 3125 A. Fraga, S. Silva, A. Maia, F. Leite, Í. Maia:** When the kidney is a cannonball to the LUNGS
- 3127 S. Gamadia, M. Aye:** Non-spherocytic haemolytic anaemia of unknown cause in a caucasian boy- a clinical report
- 3129 I. Tassiou, M. Vroutsi, D. Grammenou, V. Mouratoglou, A. Anastasiou-Katsiardani:** A 3 year epidemiological retrospective study of hematological malignancies found in hospitalized children in a secondary hospital (central greece 2019-2022)
- 3131 L. Harrison:** Improving blood transfusion prescribing and reducing blood transfusion risks in paediatric oncology patients
- 3133 Z. Hejji, M. Hassan:** Resolution of high risk classification of infantile hemangioma in a newborn child; will close observation play a part in treating these infantile hemangiomas?
- 3137 Y. Jeong, S. Shahid, B. Ribeiro, M. Borumand, M. Aye:** The indications and use of coagulation screening and clotting tests in paediatric patients
- 3139 T. Lamouchi, M. Ben Khaled:** A case report of neonatal lymphoblastic leukemia revealed by a macrophage activation syndrome
- 3141 T. Lamouchi, M. Ben Khaled:** Risk factors for developing central-lines associated infections in infants receiving chemotherapy for acute leukemia and bone marrow transplant

- 3143 M. Ouederni, M. Said, S. Rekaya, I. Ben Fraj, T. Lamouchi, Y. Chebbi, S. Frigui, A. Wafa, F. Mellouli, M. Ben Khaled:** Hematopoietic stem cell transplantation in omenn syndrome
- 3145 M. Mascaró Ginard, M. Torrent Español, M. Freixas Bermejo, J. Thió Casals, B. Suriñach Ayats, X. González Rioja, J. Serralabós-Ferré, E. Martínez-Ferrer, M.T. Moina Anguera De Sojo, S. Boronat-Guerrero:** Megaloblastic anemia and hypogammaglobulinemia in a vegan child. The importance of well-planned DIET
- 3147 S. Nogueira Machado, B. De Sousa, C. Gomes Pereira, M. Do Bom-Sucesso, M. Santalha:** Deep cervical infantile hemangioma: a dilemma approach
- 3150 L. Oyuke:** The impact of health insurance coverage and outcomes among patients diagnosed with burkitt lymphoma in western KENYA
- 3152 P. Prasertsan, T. Chotsampancharoen:** The risk factors for tumor lysis syndrome in childhood leukemia: a singer-center study from southern thailand
- 3154 C. Rhaymi, A. Chaibi:** Assessment of knowledge and drug adherence of oral chemotherapy for acute lymphoblastic leukemia
- 3156 S.C. Teixeira, J. Azevedo, J. Carvalho:** Abnormal gait in a child: a clue for a systemic disease
- 3158 D. Yeginbergenova, A. Zhailaubayeva, L. Manzhuova:** Problems in the diagnosis of hemophagocytic lymphohistiocytosis in kazakhstan
- 3160 T. Abdul-Rahman, A.A. Wireko, V. Horbas:** Development of zinc deficiency in children with a course of community-acquired pneumonia

- 3162 M. Acuña, D. Benadof, K. Yohannessen, Y. Leiva:**
Prevalence of s. Aureus infection in a chilean pediatric hospital and associated factors, including social determinants
- 3164 D. Akpeki, L. Howlett, J. Harbet, S. Todd, I. Okike:**
Antimicrobial stewardship: is there a role for patients and their carers in a children's hospital
- 3166 Y. Badla:** Children exposed and not infected with hiv in the wilaya of tlemcen: evolutionary aspects
- 3168 A. Barmpakou, G. Kolovakis, S.-Z. Siska, K. Kakleas, A. Santou, I. Orfanou:** 2 1/2-month-old male with cough, coryza and inability to extend the right lower limb-an unusual, but important to diagnose condition
- 3170 C. Kunze Küllmer, C. Werner Ratto, V. Burckhardt Bravo, T. Barros Vial, H. Villalón Urrutia:** Costal osteomyelitis secondary to bcg in an immunocompetent pediatric patient. Case report
- 3172 D. Belamri, N. Boutalbi, L. Boustil, H. Sehab, N. Bouchair:**
Acute diarrhea in infants: a pathology still relevant in algeria
- 3174 H. Ben Belgacem, H. Ajmi, J. Bouguila, M. Abdelkafi, L. Boughamoura, S. Abroug:** Tuberculous lymphadenitis in children: a retrospective study on clinical and therapeutic features
- 3176 E. Berbel Palau, A. Moreira, M.T. Sandino Martinez, J.M. Solis Baltodano, R. Rubio Casino:** Invasive streptococcus pneumoniae infection in secondary hospital: cases on the last 6 years.
- 3178 Z. Brian Ngokwe, N.K. Gimel Stephane, N.N. David Bienvenue, B.M. Charles:** Case report; cancrum oris(noma) and hemiparesis in a young female patient at the yaoundé university teaching hospital

- 3180 J. Camarasa De Masdevall, J. Marcè Igual, L. Herrero, J. Candel Pau, A. Bilbao Garitagoitia, M.N. Lopez Segura:** Severe acute respiratory syndrome coronavirus 2 (sars-cov-2) reinfection in children: a retrospective STUDY
- 3182 J.P.C. Chau, S.H.S. Lo, L. Butt, K.C. Choi:** Adaption of the modified carolina hpv immunisation attitudes and beliefs scale to measure perceptions of hpv vaccination among female adolescents
- 3184 J.P.C. Chau, S.H.S. Lo, L. Butt, V.W.Y. Lee, G.C.Y. Lui, A.Y.L. Lau:** Tackling hpv vaccine hesitancy: an exploration of community myths and misconceptions of hpv and hpv vaccination
- 3186 M. Dimitrovska-Ivanova:** Unusual case of acute viral hepatitis in a 5 year old GIRL
- 3188 J.A. Guanzon, T. Dawson, H. Coakley, J. Ejim, O. Oyewu:** Are children with meningitis receiving the correct CARE?
- 3190 A.S. Harjanti, I. andarini, S. Nugraha:** Relationship of nutritional status to patient's mortality in children's community-acquired pneumonia in dr. Moewardi hospital
- 3192 L. Herrero, J. Candel, J. Camarasa De Masdevall, S. Maya, A. Alier, M.N. Lopez Segura:** Severe community-acquired methicillin-resistant staphylococcus aureus (ca-mrsa) infection: an increasingly common threat
- 3194 L. Herrero, J. Camarasa De Masdevall, S. Ramis, O. Martin Sole, M.N. Lopez Segura:** Aerococcus urinae cystitis and bladder diverticulum in a 6 year-old BOY
- 3196 M. Hussein, S. Suliman, N. Wall, A. Prior, C. Purcell:** Pneumococcal bloodstream infection in a tertiary paediatric hospital - a 12 year retrospective descriptive STUDY

- 3198 N. Jameel, A.M. Murphy:** Coping with uncertainty
- 3200 J. John, K. K, A. Satapathy, S. Sahu, B. Behera, B. Padhy:** Oral azithromycin versus doxycycline in the treatment of children with scrub typhus without complications – a randomised controlled TRIAL
- 3202 R. Komitova, A. Kevorkyan, J. Kalchev:** Varicella cerebellitis - four-year retrospective study IN
- 3204 M. Kherkheulidze, T. Kutubidze, G. Bibilashvili, P. Lursmanishvili:** Cases of critical pertussis
- 3206 N. Fundano, S. Kutty, S. Mujeeb, J. Kutty:** Herpetic whitlow of big TOE
- 3208 R. Lages Pereira, S. Nogueira Machado, L. Macedo, A. Osório, J. Correia-Pinto, A. Lobo:** Adolescent hip pain: a case report
- 3210 S.H.F. Lai, C.I. Kuok, P.P.K. Ho, W.H. Chan, Y.S. Yau:** Clinical features and severity predictors of mycoplasma pneumoniae infection in hospitalised children in hong KONG
- 3212 S.H.S. Lo, J.P.C. Chau, L. Butt, K.C. Choi:** Parental vaccine hesitancy: translation and validation of scales to measure hpv and hpv vaccination knowledge, beliefs, and attitudes among chinese parents
- 3214 J. Mahdavi, R. Ghasemikhah:** Clinical and paraclinical findings in pediatrics with inflammation of the gastrointestinal tract due to enterobius vermicularis infection: a systematic review
- 3216 S. Mangarule, S. Prashanth, A. Kawade, I.V. Padmavathi, V.N. Tripathi, M.D. Ravi, S. Palkar, R. Singh, R. Shetty, M. Mitra, P. Kudyar, J. Leclercq, V.J. Midde, K. Varghese, S.R. Kandukuri, D. Kukian, F. Noriega:** Antibody persistence

following primary series with dtwp-ipv-hb-prp~t versus separate dtwp-hb-prp~t and ipv vaccines and response to a booster dose of dtwp-ipv-hb-prp~t in healthy indian toddlers

- 3218 Y. Marushko, O. Khomych, T. Hyshchak, G. Shchegel, A. Olefir, V. Khomych, O. Malezhik, L. Popova:** Justification of the method of acoustic diagnostics of preschool children with community-acquired pneumonia using the device “trembita-corona”
- 3220 Y. Marushko, T. Hyshchak, T. Marushko, O. Khomych:** Experience in the use of a herbal expectorant with thymus vulgaris and hedera helix in preschool children with acute bronchitis and atopic background
- 3222 I. Mazedá, B. Vieira, S. Branco, J. Pinho, M.J. Dinis, G. Oliveira:** Group b streptococcus late-onset disease and contaminated breast milk – a case report
- 3224 C. Morais, R. Curval, J. Pereira-Nunes, S. Martins, A. Reis-Melo, C. Faria, M. Tavares:** Orbital cellulitis in pediatrics – a five-year review
- 3226 B. Mota, C. Morais, M.D.R. Cunha, D. Simões, I. Vivas, A. Reis-Melo, R. Vaz, S. Rebelo, M. Tavares:** Complicated acute mastoiditis – in search of the etiologic AGENT
- 3228 M. Novo, T. Monteiro, E. Schortenschi, M. Pereira, M. Amado:** Periorbital edema and severe thrombocytopenia in epstein-barr virus infection: two case-reports
- 3230 Y. Ersozlu, C. Canpolat, G. Yalcin, M. Ozen:** Covid-19 evaluation in pediatric hematology oncology patients
- 3232 E. Veiga, Á. Veiga, N. Moliterno, J. Pacheco, G. Cordeiro, A.C. Dominguez, P. Valente, S. Cordeiro, I. Silva:** Characteristics of pediatric hospitalizations for respiratory

diseases from march-2020 to march-2022 occurred in a reference teaching hospital, rio de janeiro, brazil

- 3234 E. Veiga, Á. Veiga, N. Moliterno, J. Pacheco, G. Cordeiro, A.C. Dominguez, I. Silva, M. Neves, F. Moliterno:** Pediatric hospitalizations for respiratory diseases that occurred in a teaching public hospital, rio de janeiro, brazil, in the last 6 years.
- 3236 I. Pais-Cunha, I. Vivas, I. Mazedo, S. Branco, M.J. Dinis, G. Nogueira Oliveira:** Varicela zoster virus infection and immunoglobulin a vasculitis – a rare finding
- 3242 E. Paskaleva - Georgieva:** Tuberculosis in childhood. Polyserosistis.
- 3243 M. Pedro, M. Caldas, T. Magalhães, A.S. Esteireiro, C. Gomes:** A perinealsandpaper-like erythematous eruption
- 3246 R. Prato, F. Fortunato, R. Cutrera, S. Esposito, S. Giuffrida, G.V. Zuccotti, D. Martinelli:** Data gap analysis and current medical needs to support respiratory syncytial virus (rsv) prevention strategies in italy: input from a panel of experts
- 3248 N. Righi:** The particularities of encephalitis and meningoencephalitis in children in batna algeria
- 3250 N. Righi:** Acute disseminated encephalomyelitis and co-infections about a child in batna algeria
- 3252 N. Righi:** An excetional case of meningoencephalitis due to coinfections by enterovirus and streptococcus pneumoniae in an infant batna algeria
- 3254 L. Sanchez, S. Rungmaitree, P. Kosalaraksa, W. Jantarabjenjakul, J. Leclercq, Y. Yaiprayoon, V.J. Midde, K. Varghese, S. Mangarule, F. Noriega:** Immunogenicity and safety of a dtwp-ipv-hb-prp~t vaccine

administered with routine pediatric vaccines in healthy infants in thailand

- 3256 M.I. Sánchez Códez, K. Moyer, I. Benavente-Fernández, O. Ramilo, A. Mejias:** Importance of viral quantitation in children with rhinovirus infections: interference with other respiratory viruses and disease severity
- 3258 A.E.C. Silva, A. Azevedo, S. Miranda, C. Silva, S. Martins:** Case series in a portuguese tertiary level hospital: admissions for pediatric varicella infections
- 3260 E. Skenderi:** Mediterranean spotted fever in the spectrum of pediatric fever with rashes
- 3264 M. Stracuzzi, V. Giacomet:** The paradox of medical therapy in tuberculous lymphadenitis
- 3266 L. Lenghart, N. Ouldali, K. Honeyford, Z. Bogнар, S. Bressan, D. Buonsenso, L. Da Dalt, T. De, R. Farrugia, I.K. Maconochie, H. Moll, R. Oostenbrink, N. Parri, D. Roland, K. Rose, E. Akyuz Ozkan, F. Angoulvant, C. Aupiais, C. Barber, M. Barrett, R. Basmaci, S. Castanhinha, A. Chiaretti, S. Durnin, P. Fitzpatrick, L. Fodor, B. Gomez, S. Greber-Platzer, R. Guedj, F. Hey, L. Jankauskaitė, D. Kohlfuerst, I. Mascarenhas, A.M. Musolino, Z. Pucuka, S. Reis, A. Rybak, P. Salomon, M. Schaffert, K. Shahar-Nissan, M.C. Supino, Ö. Tekşam, C. Turan, R. Velasco, R. Nijman, L. Titomanlio:** Respective role of non-pharmaceutical interventions on bronchiolitis outbreaks
- 3268 I. Vivas, S. Branco, I. Cunha, J. Oliveira, G. Oliveira, P. Botelho:** Unusual neck mass in a teenage boy – a case report
- 3271 S. Waugh, P. Vallabhaneni:** A tale of two infections in ONE!

- 3273 L. Yin, C. Lundborg, D. Wu, J. Yang, H. Alvesson, J. Cai, T. Lu, Q. Xie, G. Marrone:** Association between pediatric tuina (massage) and the incidence of acute respiratory tract infections in children at guangdong provincial hospital, southern china: a retrospective cohort STUDY
- 3275 M. Zantiotou, A. Kyriakopoulou, S. Karageorgos, T. Pappa, I. Farakla, E. Mpotsa:** Epidemiology of pediatric viral infections during the third covid 19 pandemic WAVE
- 3277 A.L. Carvalho, M. Bastos Gomes, I. Cardoso, T. Campos, E. Rodrigues, M. Rodrigues, I. Brito:** Progressive pseudorheumatoid dysplasia – a rare arthropathy of childhood
- 3281 T. Conijn, C. De Roos, H. Vreugdenhil, F. Wijburg, E. Van Dijk, L. Haverman:** Effectiveness of time-limited eye movement desensitization reprocessing therapy for parents of children with a life-limiting illness: a randomized clinical TRIAL
- 3283 D.L. Juarez-Flores:** Mitochondrial diseases in latin america, epidemiology and quality of life indicators.
- 3285 S. Gunawan, V. Pateda, C. Prayogo, Y. Arif Putra:** The prevalence of hypovitaminosis d in indonesian children
- 3287 M.M. Resende, L. Leite De Almeida, P. Campos, I. Sobreira, P. Garcia:** What an unpleasant smell: a case report of fish odor syndrome.
- 3289 S. Sheridan, N. Jameel, A.M. Murphy:** A familial case of leigh disease in an infant – a case report
- 3291 G. Grech, M. Shoukry:** Posterior urethral valves: recent advances of management and outcomes

- 3293 I. Magalhães, S.C. Ferraz, C. Silva, S. Miranda, V. Gonçalves, I. Maciel, A. Carneiro:** The use of ambulatory blood pressure monitoring in pediatrics: a local hospital experience
- 3295 S. Mamouzi, M. Smara:** The anti-c1q antibody as a marker of lupus nephritis in children.
- 3297 L. Reaney:** An unusual case of hyponatraemic seizure secondary to primary polydipsia
- 3299 C. Silva, S. Miranda, I. Magalhães, A.E.C. Silva, S.C. Ferraz, F. Martins, A. Carneiro:** Short stature: when the guilty is not so obvious
- 3301 M. Szymanek-Szwed, E. Wajszczuk, K. Załęska-Oracka, J. Samotyjek, B. Jurkiewicz:** Robot-assisted retrograde intrarenal surgery in children – own experiences.
- 3303 B. Abdelmoula, N. Bouayed Abdelmoula:** Spinal muscular atrophy and genetic screening TOOLS
- 3305 L. Abelha, S.C. Ferraz, I. Eiras, I. Magalhães, M. Costa, M. Leão:** Genetic diagnosis of intellectual disability
- 3310 R. Aldeia Da Silva, A. Ferreira, C. Magalhães, M. Rodrigues, H. Silva, C. Ferreira, C. Garcez:** A different aura – stroke mimic case report
- 3312 A. Arafat, A. Wageeh:** Epileptic encephalopathy in children: a glimpse into its black BOX
- 3314 T. Barros Vial, B. Pizarro Stanke, C. Werner Ratto, H. Villalón Urrutia, C. Kunze Küllmer, V. Burckhardt Bravo:** Functional hemihyposomatognosia in infants: about a CASE
- 3316 B. Teov, Z. Gucev, G. Kungulovski, Z. Mitrev, A. Janchevska, A. Beqiri-Jashari, F. Doksimovski:**

Compound heterozygosity in cerebellar ataxia, mental retardation, and disequilibrium syndrome 4 (camrq4)

- 3318 M. Caldas, M. Pedro, M. Viegas, C. Mendonça, A.S. Esteireiro:** When you get more than you bargained FOR
- 3320 A. Diaz Gomez, E. Roe Crespo, S. Bernal Noguera, C. Serra Juhe, A. Pintor Ojeda, S. Luna Marine, R. Esmel Vilomara, E. Tobajas Torrubiano, M. Torrent Español, M. Gomez Chiari, G.M. Fraga-Rodríguez, H. Iznardo Ruiz, E. Turon-Viñas, S. Boronat-Guerrero:** The importance of a multidisciplinary genodermatosis committee
- 3322 M. Espinet Pedrol, F. Castillo-Gómez, E. Coca-Fernandez, M. Rodríguez- Martínez, S. Brió-Sanagustin, S. Boronat-Guerrero:** Fever and headache without infectious CAUSE
- 3324 M.C. Gauci, R. Leonardi, C. Gammeri, G. Di Cataldo, M. Ruggieri, A.D. Praticò:** Focal epilepsies in childhood: clinical aspects, eeg and neuroimaging
- 3326 N. Gogatishvili, T. Tkemaladze, S. Kasradze:** Familial case of slc6a1-related disorder with diverse clinical presentation
- 3328 C. Gomes Pereira, B. De Sousa, S. Nogueira Machado, S. Soares, C. Magalhães:** Rare genetic condition mimicking cerebral PALSY
- 3330 K. Polak, M. Herrera Llobat, L. Martín Viota, D. González Barrios, C. Solís Reyes, A.K. Rolo Álvarez, D.D.C. Montesino Delgado, A. Dominguez Coello:** A rare iatrogenic association of carbamazepine-induced syndrome of inappropriate antidiuretic hormone secretion with an acute symptomatic seizures in pediatric patient with epilepsy.
- 3332 N. Jameel, S. Sheridan, A.M. Murphy:** Genotype, phenotype correlation of scn2a mutation; a case report

- 3334 O. Kazeem, V. Wardley, A. Fiaz:** The curious case of an infant with scalp swelling
- 3336 R. Leonardi, M. Lo Bianco, M.C. Gauci, A.D. Praticò, M. Ruggieri:** Anti-glycine receptor encephalitis in children: a systematic review
- 3338 C.I. López Aldunate, M. Mass-Lindenbaum, G. Reveco Pérez, H. Villalón Urrutia:** Rapid response to management with vigabatrin in an infant with west's syndrome: case report.
- 3340 I. Magalhães, S.C. Ferraz, C. Silva, A.E.C. Silva, C. Silva, S. Miranda, A. Carneiro:** Pelvic lipomatosis: case report of a 10-year-old girl with chronic pelvic PAIN
- 3342 I. Mallassi, M. Tffifha, S. Mdimagh, S. Nouir, F. Majdoub, S. Mabrouk, J. Chemli, S. Abroug:** Anti nmda-r encephalitis in children: a serie of 3 CASES
- 3344 E. Martínez-Ferrer, E. Turon-Viñas, E. Coca-Fernandez, A. Díaz-Gómez, M. Mascaró Ginard, M.T. Moina Anguera De Sojo, J. Serralabós-Ferré, S. Boronat-Guerrero:** Paraneoplastic autoimmune encefalitis with anti-hu antibodies, a rare entity in the pediatric population
- 3346 D. Navarro Molina, N. Donisanu Peñaranda, A. Extraviz Moreno, A. Ortiz Ortigosa, J. Ramos Fernandez:** Epidemiology and aetiology of acute ataxia in paediatric emergencies: 12 years experience in a third-level hospital
- 3348 S. Zuberi, E. Ogden, M. Hutchison, N. Patel, J. Shetty:** Clinical utility of a secure, carer recorded, clinical video transfer system for paediatric neurology: a model for asynchronous clinical video.
- 3350 M. Pedro, M. Caldas, M. Viegas, C. Caetano, B. Marques:** A mind-blowing ct scan of the HEAD

- 3352 J. Pires, M. Vila-Real, F. Santos:** The child with acute encephalitis: experience of the last decade
- 3354 K. Plėšnytė- Čapkauskienė, L. Kilaitė, J. Radzevičienė, B. Lukšaitė, R. Samaitienė -Aleknienė, R. Praninskienė:** Hallucination related to seizure or atypical manifestation of acute polymorphic psychotic episode: a case study of a thirteen-year-old GIRL
- 3356 A. Rebelo, A.I. Martins, S. Rodrigues, J. Pereira, S. Aires:** Huge arachnoid cyst presented with bilateral sixth cranial nerve PALSY
- 3359 M. Ribeiro, C. Curto, S. Gama, M. Figueiredo:** Oculogyric crisis
- 3361 J.H. Ryu, S.H. Shin, J.M. Ko, E.-K. Kim, H.-S. Kim:** Clinical and genetic characteristics of six korean patients with kleefstra syndrome
- 3365 L. Sizgoric, Z. Gjergja, S. Delin, M. Kovac Sizgoric, Z. Sabol:** Erythropoietic protoporphyria, epilepsy and syringomyelia: a case report
- 3367 L. Sizgoric, M. Kovac Sizgoric, J. Stepan Giljevic, T. Grmoja, S. Delin, F. Jadrijevic Cvrlje, G. Krakar:** Moyamoya syndrome - a rare complication of neurofibromatosis type 1
- 3369 M. Sousa Dias, M. Meneses, N. Rodrigues:** Primary familial erythromelalgia – a clinical diagnosis
- 3372 A.S. El Refay, M. Youssef, E. Eldin, M. Abushady, N. El Baroudy, A. Gouda, W. Nazim:** Phthalate exposure and pediatric asthma: a cross- sectional study in a sample of egyptian children

- 3374 L. Erickson, A. Ricketts, J. Marshall, K. Nelson, P. Churchill, D. Wolff, R. Steele:** Enterprise-wide innovation initiative to improve pediatric remote patient monitoring outcomes
- 3376 A. Gite:** Changing the paradigm - improving reflective practice and patient care by learning from complaints
- 3378 S. Goff, P. Lindenauer, A. Ash, J. Krishnan, E. Decou, K. Geissler:** Impact of value-based health care reform on pediatric asthma quality of care and disparities in the U.S
- 3380 S. Mahesh, P. Satodia, S. Brown, S. Rashid:** Awareness and use of point of care handheld ultrasound devices amongst paediatric trainees.
- 3382 V. Naguleswaran, K. Zia, K. Ominu-Evbota:** An audit assessing appropriate breaks for paediatric junior doctors in a dgh to avoid staff fatigue and safeguard patient safety
- 3386 L. Ruiz-Guzman, C. Gonzalez-Rodriguez, I. Marcos-Marcos, A. Padro, V. Pleguezuelos-Hernández, P. Giménez-Bonafé:** New subject on breastfeeding at the university of barcelona
- 3388 J. Tan:** The use of melatonin among paediatric population in child and family health centre axe street
- 3390 I. Vivas, J. Oliveira, S. Branco, I. Pais-Cunha, G. Nogueira Oliveira, I. Mazedo:** An infant with a 3 day fever and a neck rash - a case report
- 3392 M. Dell'Anna, A. Tamborino, C. Trapani, L. Facchini, M. Parpagnoli:** A case of an unrecognized fracture in a patient with severe disability

- 3394 M. Dell'Anna, A. Tamborino, C. Trapani, L. Facchini, M. Parpagnoli:** A multidisciplinary approach to the treatment of residue of perinatal suffering: a case report
- 3396 M. Dell'Anna, A. Tamborino, C. Trapani, L. Facchini, M. Parpagnoli:** A persistent cardiac defect in a premature girl with dysmorphic features.
- 3398 A. Haddick, B. Rafferty, K. Stefkova, A. Sweeney, S. Gosling, D. Gates, N. Thompson, J. Richardson:** Sunflower course - bringing paediatric end-of-life care teaching to trainees
- 3400 T. Magalhães, M. Pedro, M. Viegas, G. Croca, D. Soares:** Trisomy 18, a clinical case of long survival
- 3402 M. Feighery, I. Korotchikova:** Leukotriene-modifying agents and neuropsychiatric events in clinical paediatric practice: prevalence, physician awareness and pharmacovigilance within the irish primary care setting
- 3404 S. Ghazavi:** Efficacy and safety comparison of two brands of triptorelin in treatment of idiopathic central precocious puberty
- 3406 J. Lee, W. Jeon, Y. Ko:** Symptom and clinical staging on acute l-thyroxine poisoning in children
- 3408 G. Sethi, P. Kachroo, D. Nair, M. Cavinato:** Paracetamol microfine particle-based suspension for enhanced stability and precise dosing
- 3410 A. Al Saleh:** The prevalence and types of childhood vaccination administration errors
- 3412 M. Angeli, P. Vorgia, V. Sakkalis, N. Tzanakis, E. Galanakis:** Contactless infant monitoring – a pilot STUDY

- 3414 M. Angeli, G. Rouva, P. Vorgia, V. Sakkalis, N. Tzanakis, E. Galanakis:** Infant home monitoring – current situation and future perspectives
- 3416 I. Bakalli, D. Cela, M. Biqiku, E. Celaj, E. Kola, M. Zguri, I. Gjeta, D. Klironomi:** Atraumatic splenic rupture as the initial and only manifestation of covid-19
- 3418 E.M. Bikou, M. Michael, A. Gite:** Primary care guidelines and referral pathways - design of a website to assist primary care professionals and improve patient outcome
- 3420 S. Bilal:** Proper hand hygiene practices have a great impact on the reduction of hospital-acquired bloodstream infection among pediatric oncology patients at indus hospital karachi pakistan
- 3423 S. Goff, B. Brooks, M. Dacosta, J. Bromberg, L. Vernacchio, H. Walter:** Integration of behavioral health care in pediatric primary care settings
- 3425 E. Kandelaki, N. Khavlashvili, M. Kherkheulidze:** Low birth weight and preterm - connection with respiratory illness
- 3427 Z. Likopa, A. Kivite-Urtane, J. Pavare:** Effect of c reactive protein point-of-care testing and family physician education on antibiotic prescribing for children with acute respiratory illnesses in primary care in latvia
- 3429 K. Lima, R. Lima, R. Colares, A. Veras, D. Rocha, T. Távora, L. Barbosa:** Health literacy of parents/caregivers of children accompanied in asthma program
- 3431 K. Lima, E. Mendes, R. Lima, M. Santos, V. Ruiz, L. Barbosa:** Educational booklet and brief motivational interview to reduce the occurrence of diarrhea in children under FIVE

- 3433 E. Manoleva Nikolovska:** Increased number and changed clinical presentation of certain viral infections in children after lockdown caused due to covid-19 pandemic in north macedonia
- 3435 E. Manoleva Nikolovska, A. Manolev:** Diagnostic challenges associated with mononucleosis in young children up to 6 YEARS
- 3437 Y. Morikawa, H. Sakakibara, M. Miura:** Efficacy of live attenuated vaccines after two doses of intravenous immunoglobulin therapy for kawasaki disease
- 3439 M. Pereira, C. Magalhães, C. Patraquim:** Hyperphosphatasemia in infancy – what diagnosis?
- 3441 A. Sharma, A. Shastri:** Delayed diagnosis of severe iron deficiency anaemia in a 14-month-old boy: the collateral effects of covid-19 pandemic
- 3443 J. Blom, P. Sarti, C. Colliva:** Predicting the pathways of adolescents with chronic disease at high-risk for mental health problems: a dynamic network approach mapping digitally collected data to stratify RISK
- 3445 S. Derin, M. Ersin, S.B. Selman, C. Gercek:** Internet addiction in adolescents with attention-deficit/hyperactivity disorder: associations with parental depression and anxiety
- 3447 S. Fritsch, J. Van Cleave, D. Keller:** Utilization of echo (extension of community health outcomes) series to increase pediatric primary care providers' ability to assess and treat behavioral health concerns
- 3449 W. Jbilou, F. Aftahi, Y. Asbai, H. Serhani, G. Benjelloun:** Behavioral treatment of phagophobia in a 6-year-old CHILD

- 3451 O. Kasim Aldaleel, S. Ibrahim, A. Saleh:** Effect of low frequency pulsed electromagnetic field therapy on autistic children, a new potential therapy case reports
- 3453 S. Lau-Jensen, B. Asschenfeldt, S. Eskildsen, V. Hjortdal:** Brain mri in young adults with simple congenital heart defects and adhd symptoms
- 3455 T. Nadiradze, S. Bakhtadze, N. Khachapuridze:** Autism spectrum disorder and event related potentials
- 3457 A. Sala De La Concepcion, P. Ventura, A. De Francisco Profumo, L. Subirana, M. Giralt Lopez, I. Francia Guil, M. Mendez Hernandez:** Impact of the covid19 pandemic in suicide attempts in adolescents
- 3460 V. Slijepcevic Saftic:** Toxic stress and neurodevelopment-could symptoms of toxic stress imitate a neurodevelopmental disorders?
- 3462 Y.S. Sung, L.-Y. Lin:** Activity participation and emotion regulation among young children with autism spectrum disorder.
- 3464 S. Usmani, M. Mehendale, A. Malik, N. Ashraf:** The role of epigenetics and nr3c1 in the development of psychopathology later in life of children and adolescents facing bullying
- 3466 A. Malik, S. Usmani:** Propensity of adolescent substance use disorder in body dysmorphic disorder
- 3468 S. Usmani, M. Mehendale, N. Walia:** Non-pharmacological treatment modalities for adhd in children and adolescents: a scoping review

- 3470 J. Van Cleave, D. Keller, S. Fritsch:** Coppcap: colorado pediatric psychiatry consultation & access program: data and lessons learned to DATE
- 3472 S. Bektas, A.E. Askin, Z. Aktug, F.Z. Manap, K.N. Ozekinci, B. Aktura, M. Basibuyuk, N. Karabayir:** Beliefs and practices towards teething symptoms among parents
- 3474 L. Sezen Pehlivan, B. Aktura, S. Bektas, M. Basibuyuk, N. Karabayir:** The relationship between the mother's body mass index and vitamin b12 levels and anthropometric measurements of the newborns
- 3476 A. Bowe, A. Staines, F. Mccarthy, G. Lightbody, D. Murray:** Predicting low cognitive ability at age 5 – feature selection using machine learning methods and birth cohort DATA
- 3478 E. Candela, A. Dondi, J. Lenzi, S. Sureshkumar, F. Morigi, C. Biagi, M. Lanari:** A national italian survey on social determinants of health and distance learning during the first wave of sars-cov-2.
- 3480 C. Casavant, R. Wahlen:** Taking a sexual history of gender diverse youth: a qualitative study of their needs towards healthcare professionals
- 3482 M. Dertli, E. Ozen, E. Hashimov, E. Onaran, B. Aktura, M. Basibuyuk, N. Karabayir:** Knowledge and experiences of families regarding the use of amber necklaces
- 3484 J. Chudleigh, F. Fusco, P. Holder, J. Bonham, K. Southern, A. Simpson, L. Moody, E. Olander, H. Chinnery, F. Ulph, S. Morris:** Cost analysis of delivering positive newborn screening results comparing existing practice versus innovative, co-designed strategies from the respond STUDY

- 3486 K. Gogberashvili:** Vitamin d status correlations with il-6 and il-10 levels in pediatric pneumonia
- 3488 M.R. Hernández-Soto, I. Escalona Labella, J.A. Donaire-Granado, S. Sicre Alonso, L. Luque-Romero:** Process results of a health program for children and adolescents in a rural health district
- 3490 J. Chudleigh, P. Holder, J. Bonham, A. Simpson, L. Moody, F. Fusco, S. Morris, E. Olander, H. Chinnery, F. Ulph, K. Southern:** Parents' views of co-designed interventions to improve communication of positive newborn bloodspot screening results
- 3492 J. Kontak, S. Kirk:** The process of child and youth engagement in school health promotion: a scoping review protocol
- 3494 L. Luque-Romero, A. Alonso Bueno, M.T. Jiménez Gómez-Casero, J.M. Sáenz Lussagnet, M.R. Hernández-Soto, J.A. Donaire-Granado:** Is an educational intervention enough to change the habits in young people?
- 3496 A.B. Machado De Almeida, N. Oliveira:** Impact of the covid-19 pandemic on child cancer treatment in brazil
- 3498 K. Rimarova:** Anthropometric predictors of systolic and diastolic blood pressure considering intersexual differences in the group of selected schoolchildren
- 3500 A. Sproule, J. Wallace, R. Moore, J. Richardson, A. Thompson, A. Livingstone:** Safe ni: introducing practical paediatric safeguarding training in northern ireland

- 3502 F. Giannisi, S. Totska, I. Toulia, S. Tsotoulidis:** Changes in young athletes' exercise, diet quality and sleep routine during covid -19 pandemic
- 3504 A. Walsh, R. Clarke, E. Molloy, C. Ní Cheallaigh, C. Hensey:** Paediatric inclusion health: providing equitable healthcare for children experiencing social adversity
- 3506 A. Walsh, R. Clarke, E. Molloy, C. Ní Cheallaigh, C. Hensey:** Identified health needs of roma children through outreach paediatric services
- 3508 G. Toschi Vespasiani, L. Pierantoni, G. Stera, L. andreozi, C. Totaro, M. Lanari:** Management of croup among italian pediatricians: a national survey
- 3510 A. Angelova, I. Paskaleva, R. Komitova, M. Atanasova, K. Ketev, G. Lengeova, J. Kalchev, T. Dimcheva, M. Murdjeva:** Diagnostic performance of multiplex pcr pneumonia panel and its role in pediatric pneumonia management
- 3510 L. Armendáriz Lacasa, F. Castillo-Gómez, G. Garcia Del Cerro, F. Thorndike, M. Freixas Bermejo, S. Boronat-Guerrero:** Necrotizing pneumonia. Review of the cases in a third-level hospital.
- 3515 H. Ben Belgacem, S. Tilouche, M. Barkallah, N. Soyah, M. Abdelbari, S. Ghorbel, R. Kebaili, A. Tej, J. Bouguila, L. Boughamoura:** High flow nasal cannula therapy in infants with severe bronchiolitis
- 3517 A. Duyndam, M. De Neef, R.J. Houmes, J. Smit, R. Klein-Blommert, M. Van Gestel, R. Pheil, M. Ijland, J. Van Rosmalen, J. Van Woensel, J. Lemson, D. Tibboel, M. Van Dijk, E. Ista:** Does a nurse-led weaning protocol with a

spontaneous breathing trial in critically ill children lead to a shorter duration of ventilation? A multi-center STUDY

- 3519 J. Faria, A. Feio, B. andrade, F. Rocha, D. Ferreira:** Recurrent spontaneous pneumothorax: typical biotope and idiopathic etiology
- 3521 M. Galea, C. Schembri, R. Farrugia:** Management of wheezing in children aged >1 year at the paediatric emergency department
- 3523 L. Jankauskaitė, U. Kubiliūtė, L. Štendelytė, E. Gelšvartaitė:** Pre-pandemic and pandemic patterns of respiratory diseases referred to pediatric emergency: experience from lithuanian university of health sciences hospital
- 3525 I. Juskiene, N. Prokopciuk, A. Valiulis:** Impact of covid-19 pandemic on indoor air pollution in primary schools and risk of pollution related effects on child health
- 3527 S. Mdimegh, J. Bouguila, M. Ben Guedria, R. Kbaili, A. Tej, N. Soyah, S. Ghorbel, M. Abdelbari, H. Belgacem, M. Abdelkafi, S. Tilouche, L. Boughamoura:** Foreign body aspiration in children in tunisia
- 3529 S. Patel, P. Vallabhaneni:** Evaluating the impact of covid-19 on respiratory infections and presentations in a district general hospital
- 3531 E. Poluzioroviene, J. Chorostowska-Wynimko, A. Valiulis:** Incidence of alpha-1 antitrypsin pi*s and pi*z alleles in the lithuanian cohort of wheezing children
- 3533 K. Ruangnapa, W. Anuntaseree, K. Saelim, P. Prasertsan, M. Puwanant, S. Dissaneevate:** Treatment and outcome of chylothorax in children: 20-year experience of a single institute

- 3535 B.B. Yilmaz:** Diaphragm eventration; a rare cause of respiratory distress in infants
- 3537 M. Ahmed, J. Koh:** Improving clinical documentation: introduction of electronic health records in paediatrics
- 3539 S. Brown:** Point-of-care ultrasound scanning in paediatric post-graduate training: a survey of practice and trainee perspectives
- 3541 S. Cavallari, A. Khan:** Audit of referrals to specialist developmental CLINIC
- 3543 S. Goff, E. Decou, K. Wallace, C. Gilson, A. Kranz:** Barriers and facilitators to pediatric fluoride varnish application in primary care medical offices in the united states: a qualitative study
- 3545 L. Haverman, C.-J. Van Der Perk, B. Geven, L. Teela, M. Meulekom, M.A.J. Luijten, K. Fijnvandraat, J. Maaskant:** Dreams of emma children's hospital
- 3547 L. Haverman, K. Dulfer, M. Oude Voshaar, R. Kalf, A. Beurskens:** A national standardized set of pediatric generic pros and prompts for pediatric medical specialist care in the netherlands: A consensus based co-creation approach
- 3549 A. Holmgren, A. Niklasson, L. Gelerand, A. Nierop, K. Albertsson-Wikland:** Novel pubertal weight and bmi references aligned for the individual variation in the timing of pubertal GROWTH
- 3551 A. Jones, M. Tajik, J. Martin, E. Freeman, J. Banks, A. Mckeown, A. Philpott, R. Cole, M. Nash, C. Muhaso, S. Arul:** Damage control surgery pathway: a strengths-based quality improvement project

- 3553 E. Kennard:** Implementation of a departmental greatix system
- 3555 L. Pickard, N. Kerdegari, T. Busari, C. Curtis:** Anti-microbial but pro-learning: the impact of paediatric antimicrobial stewardship meetings on patient care and team development
- 3557 R. Magee, D. Magee:** The root of the problem: paediatric dentistry in northern ireland, a multidisciplinary team approach
- 3560 F. Mahler, K. Cheng, I. Lutsar, B. Nafria, S. Breitenstein, G. Vassal, J. Claverol, N. Noel Palacio, R. Portman, G. Pope, M. Bakker, T. Van Der Geest, C. 4C Expert Group Leads, M. Turner, S. De Wildt:** Improve your paediatric trial through multi-disciplinary expert advice of conect4children
- 3562 M. Tofani, M. Mustari, D. Di Lallo, M. Salata, L. Cantonetti, M. Raponi, E. Tiozzo:** Managing complex chronic conditions in children through the lens of icf-cy: a pilot STUDY
- 3564 J. O’Gorman, J. Clarke, M. Robinson:** “Spending a penny but keeping it clean”: reducing the rate of contaminated non-invasive urine samples in the paediatric department
- 3567 S. Patel, K. Gurnett, P. Vallabhaneni:** Teaching in the DARK
- 3569 S.C. Rohani-Montez, J. Bomberger:** Education needs in diagnosing rare diseases in pediatrics: a clinician SURVEY
- 3571 K. Tan, J. Wong, J. Badron, J.H. Lee, S. Ganapathy:** Return visits (rvs) to the paediatric emergency department (ped) within 72hours
- 3573 J. Tan, M. Raji, M. Tanwar, A. O Grady:** Streamlining case loads in specialist school- north east LONDON

- 3575 F. Van Der Velden, L. Gills, J. Broadey, L. Hayes, E. Roberts, J. Courtney, J. Ball, M. Emonts, E. Lim:** Biobanking and consenting to research: a qualitative thematic analysis of young people's perspectives
- 3577 L. Subirana, P. Ventura, L. Sumoy:** Use of natural language processing for quality assessment of electronic health records of patients under 36 months with fever without source in the emergency department.
- 3579 D. Ward, S. Mooney:** Onsite dispensing improved winter pressures in a tertiary children's hospital during the covid pandemic
- 3582 L. Riddick, S. Hancock, S. Davies:** Status epilepticus - a 2 year review of children referred to the yorkshire critical care transport network (embrace)
- 3584 G. Sefton, E. Carrol, B. Carter, S. Lane, F. Mehta, C. Eyton-Chong, C. Lambert, S. Siner, D. Jones, L. Evans:** Development and whole hospital evaluation of an end-to-end real-time situation awareness solution for in-patient deterioration for children in hospital: the detect STUDY
- 3586 S.R. Kim, J. Park:** Safety and efficacy of pediatric sedation protocol for painless diagnostic examination in a pediatric emergency room of a single tertiary hospital
- 3588 S. Librov, I. Shavit:** Serious adverse events in pediatric procedural sedation before and after the implementation of a pre-sedation checklist
- 3590 S. Ali, M. Hassan:** Congenital elbow venous malformation: a rare presentation in a previously healthy CHILD
- 3592 M. Anastasakis, I. Galonaki, C. Doitsidis, M. Mitroudi, C. Panteli, I. Patoulas:** A characteristic finding for diagnosing idiopathic scrotal edema. Description of 2 CASES.

- 3594 M. Bašković, L. Zaninović, I. Sansović, A.M. Meašić, A. Katušić Bojanac, D. Ježek:** Do we treat undescended testes on TIME!?
- 3596 H. Ben Ameer, H. Zitouni, S. Ammar, E. Krichen, M. Ben Dhaou, R. Mhiri:** A large mediastinal lipoblastoma: a rare cause of acute respiratory compromise
- 3598 H. Ben Ameer, H. Zitouni, M. Hbaieb, A. Chaabouni, M. Ben Dhaou, S. Boujelben, R. Mhiri:** Management of pediatric gastrointestinal neoplasms
- 3600 H. Ben Ameer, M. Hbaieb, H. Zitouni, E. Krichen, M. Ben Dhaou, R. Mhiri:** Urinary tract infection following surgical management of vesicoureteral reflux in children
- 3602 N. Ben Kraiem, H. Zitouni, H. Ben Ameer, M. Hbaieb, C. Rahma, S. Ammar, M. Ben Dhaou, R. Mhiri:** Variations in timing of elective orchidopexy
- 3604 N. Ben Saad, M. Belhaj Mansour, H. Ben Ameer, R. Dghaies, M. Ben Dhaou, R. Mhiri:** Predictive factor of operability of the pyeloureteral obstruction in children
- 3606 N. Ben Saad, M. Belhaj Mansour, H. Ben Ameer, R. Dghaies, M. Ben Dhaou, R. Mhiri:** Treatment of anterior hypospadias: comparison of different surgical techniques (about 276 CASES)
- 3608 M. Caldas, M. Pedro, M. Viegas, T. Magalhães, A. Bicho:** Uncovering the PENIS
- 3612 J. Ceradini, I. Aloï, S. Frediani, A. Accinni, C. Brusco, A. Inserra, M. Raponi:** The use of telemedicine for early discharge after appendectomy in children

- 3614 G. Degiorgio, M. Shoukry:** Complications in laparoscopic appendicectomy in children - a national paediatric study in MALTA
- 3617 B. Hammou, R. Rebiha, H. Fatema, H. Hafida, H. Faycel, M. Nouria:** Feminized génitoplastie: experience of pediatric urology department oran, algeria
- 3619 B. Hammou, H. Hafida, H. Fatema:** What is to be done, how to proceed with PMDS?
- 3621 B. Hammou, G. Laya, H. Fatema, R. Rebiha, M. Nouria, H. Faycel:** Inguinal hernia;open surgery vs laparoscopy
- 3623 S. Kacem, S. Ammar, S. Sallemi, K. Mekki, N. Ben Hmida, H. Zitouni, R. Mhiri:** Newborns enterostomies: characteristics and outcomes
- 3625 B.K. Najoua, C. Rahma, M. Zouari, K. Emna, B.D. Mahdi, R. Mhiri:** Morbidity and mortality factors in anorectal malformations
- 3627 B.K. Najoua, C. Rahma, M. Zouari, N. Ben Saad, M. Ben Dhaou, R. Mhiri:** What could be hidden by small-bowel intussusceptions in children?
- 3629 K. Polak, M. Herrera Llobat, I. Vidal Gil, M. Llanas Marco, S. Rusu:** Is dietl's crisis an under-reported clinical entity? Case report and review of literature
- 3631 K. Polak, S. Rusu:** Pelvic ganglioneuroma presents as a nonmedical responding primary enuresis – case REPORT
- 3633 S. Soares Cardoso, M. Cordoeiro, A. Oliveira, S. Reis, J. Antunes, P. Horta, A. Pipa, C. Salgado:** Hydrometrocolpos and hematocolpos: clinical presentation at two extremes of pediatric AGE

- 3637 E.-S. Sung:** Pediatric tracheotomy in infants: based on 8 years of experience at a pediatric tertiary center in south KOREA
- 3639 E. Valavani, I. Tassiou, S. Makri, A. Anastasiou-Katsiardani:** Acute urinary retention in a 13-year-old male adolescent; a rare manifestation of acute appendicitis
- 3641 N. Zampieri, G. Scirè, F. Camoglio:** Quality of life and anorectal malformations: a single centre experience.
- 3643 C. Cassidy, J. Kontak, J. Pidduck, A. Higgins, S. anderson, S. Best, A. Grant, E. Jeffers, S. Macdonald, A. Mireault, L. Rowe, R. Walls, J. Curran:** Health care provider perspectives of barriers and facilitators to the transition from pediatric to adult care: a behavioural analysis using the com-b model of behaviour
- 3645 P. Mirabelli:** Pediatrics biobanks for improving translational and clinical research for children.
- 3647 D. Vecchio, M. Rossi, I. Rana, P.S. Buonomo, G. Battafarano, V. De Martino, M. D'Agostini, O. Porzio, C. Cipriani, S. Minisola, R. De Vito, M.V. Gonfiantini, M. Macchiaiolo, A. Jenkner, A. Bartuli, A. Del Fattore:** Regulatory t cells' stimulation inhibits osteoclastogenesis in gorham-stout disease
- 3649 N. Bee, S. Sweeney, D. Kampman:** The use of simulation for training in major incident management in a tertiary paediatric hospital
- 3651 N. Cohen, A. Davis, G. Test, D. Singer–Harel, Y. Pasternak, S. Beno, D. Scolnik:** Evaluation of activation criteria in paediatric multi-trauma
- 3653 A.C.H. Fung, H.H.T. Wong, W.C. Dai, K.K.Y. Wong:** Epidemiology and change in pattern of traumatic injuries in children visiting emergency department during covid era in

hong kong: a retrospective single-institutional serial cross-sectional STUDY

- 3655 H. Ironton, A. Paessler, K. Fowler, K. Patel:** The importance of a multidisciplinary review in identifying paediatric burns suspicious of inflicted injury.
- 3657 N. Keenan, A. Rahman:** Self inflicted extensive subcutaneous emphysema and pneumomediastinum in an adolescent MALE.
- 3660 R. Kirk, C. Chipperfield:** To ed, or not to ed - learning from missed opportunities in the paediatric emergency department
- 3662 A. Paessler, H. Ironton, K. Fowler, K. Patel:** Identifying children presenting with burns with associated concerns about lack of supervision or neglect: a single-centre retrospective REVIEW
- 3664 I. Pasternak, L. Bilder, S. Librov, Z. Gutmacher, I. Shavit:** Adverse events during sedation for oro-dental trauma in an israeli paediatric emergency department
- 3666 L. Riddick, B. Basu:** Can we introduce nurse led discharge into the paediatric emergency department for minor head injuries?
- 3668 A. Bilgin, Ö. Tekşam:** Assessment of the pediatric early warning score and the pediatric risk of hospital admission score ii in the pediatric emergency observation ROOM
- 3670 E. Güngör, K. Karli Oguz, G. Halililoglu, D. Yalnizoglu, Ö. Tekşam:** Factors associated with clinically important neuroimaging findings in children presenting to the pediatric emergency department
- 3672 A. Trombetta, S. Pintaldi, R. Dall'Amico, E. Barbi, M. Canton:** Girls with cognitive impairment are at high risk of ovariectomy for delayed recognition of adnexal torsion

Welcome to the 9th Congress of the European Academy of Paediatric Societies

The 9th Congress of the European Academy of Paediatric Societies (EAPS 2022), took place in Barcelona and Online in October 2022, under our congress motto “Shaping the Future of Child Health. The combined efforts and talents of the best and brightest minds in paediatrics have turned this biannual event into a major educational and research platform, attracting high quality scientific presentations that have subsequently appeared in high-impact journals. A central feature of the Congress are the free scientific papers presenting new information from all areas of paediatric medicine and child health. Submitted abstracts to EAPS 2022 will facilitate robust debates, thoughtful conversations and fruitful collaborations, with the future of paediatrics being greatly enhanced as a result. The promotion and advancement of high-quality paediatric care and training worldwide has a powerful advocate in EAPS 2022.

LIST OF ORGANIZERS

The European Academy of Paediatrics (EAP)

The European Society for Paediatric Research (ESPR)

The European Society of Paediatric and Neonatal Intensive Care (ESPNIC)

INVITED SPEAKER ABSTRACTS

IS001 / #48

Educational Symposium

Educational Symposium 01: Current evidence: Steroids and neonatal outcome - (ESPR)

08-10-2022 08:00 - 08:50

Antenatal steroids and outcome

E. Frier^{1*}, R. Reynolds², S. Stock³

¹University of Edinburgh, Mrc Centre for Reproductive Health, Edinburgh, United Kingdom

²University of Edinburgh, Centre for Cardiovascular Science, Edinburgh, United Kingdom

³University of Edinburgh, Usher Institute, Edinburgh, United Kingdom

For 30 years, antenatal corticosteroids (ACS) have been the standard of care for women at risk of imminent preterm birth (PTB). Robust, high-certainty evidence indicates that timely administration of ACS before imminent PTB reduces the most significant adverse outcomes from PTB, regardless of resource setting. Despite widespread global use of ACS, significant knowledge gaps surround their safety, long-term effects, optimal timing and dosage. Almost half of women given ACS give birth outside the “therapeutic window” and remain undelivered over 7 days later. The population offered ACS has expanded over time, and ranges from women at 22 to 38 weeks’ gestation, with singleton or multiple pregnancies, even when the absolute risk of impending delivery is relatively low. Additionally, most trials included in the recent Cochrane systematic review on ACS before PTB were undertaken over 25 years ago, during a different era of neonatal care. Overtreatment with ACS is a concern, as evidence emerges of risks of potentially unnecessary ACS exposure. In this presentation, I will review the current evidence for the short- and long-term benefits and safety of ACS exposure for neonates and children. I will consider the major ongoing challenges surrounding ACS administration, and discuss potential strategies to overcome them. Key findings from the “Co-OPT ACS cohort”, the largest international birth cohort to date comprising data on ACS exposure and on perinatal and childhood outcomes, will be discussed. This cohort was created by the Consortium

for the Study of Pregnancy Treatments (Co-OPT) to address key research questions on ACS, through linkage and harmonisation of population-based data on mothers, babies and children. It contains 2.28 million pregnancies and babies from 3 continents; its large scale and international representation enables review of rare outcomes, such as perinatal mortality, and longitudinal follow-up allows comprehensive evaluation of neonatal and childhood outcomes associated with ACS.

IS002 / #49 is 065

Educational Symposium

Educational Symposium 01: Current evidence: Steroids and neonatal outcome - (ESPR)

08-10-2022 08:00 - 08:50

Systemic steroids in evolving BPD

T. Dassios*

Department of Women & Children's Health, King's College London, London, United Kingdom

In the past few decades the neonatal community has achieved the gradual decrease of the threshold of viability and an increased survival of all extremely preterm infants. These events explain the rising incidence of chronic respiratory morbidity in these infants with immediate life-limiting effects and life-long consequences in the survivors. Postnatal corticosteroids are commonly administered systemically to prevent and treat evolving or established bronchopulmonary dysplasia (BPD) in mechanically ventilated prematurely-born infants. Despite historical reservations and some reluctance to use systemic steroids in everyday clinical care, systemic corticosteroids administered late (after 7 days) have been proven to reduce neonatal mortality and BPD without increasing the risk of necrotising enterocolitis or the combined risk of death and cerebral palsy. In this session we will aim to summarise their intended mechanism of action and their numerous side effects focusing on the potential impact of these potent systemic agents on normal development. We will also review recent evidence that highlight an enhanced understanding of their mechanism of action. Finally we will attempt to summarise the current evidence with a view to answer three practical questions: Which agents have been studied and how do they differ in how they influence clinical outcomes? When are they best administered and are they less or more beneficial if given earlier or later in evolving BPD? How can they be administered and is some route more efficient than the others in reducing the incidence of respiratory morbidity without increasing the incidence of severe neurodevelopmental impairment?

IS003 / #59

Educational Symposium

Educational Symposium 02: Educational symposium: Acute pain, how to deal with it in the emergency department (EAP)

08-10-2022 08:00 - 08:50

How can we optimally cope with acute pain?

I. Shavit*

Hadassah Medical Center, Pediatrics, Jerusalem, Israel

Appropriate pediatric pain assessment and management in the Pediatric Emergency Department (PED) is an important aspect of care. Under-treatment of pain has been reported in many studies as a persistent problem, and there are still large gaps in our knowledge, depriving children of adequate analgesia. Studies that have examined analgesic administration in the PED found that multiple factors were independently associated with inadequate pain management: age and sex, presenting complaint, pain severity, triage score, time of arrival, ethnicity and race, crowding, and even type of insurance. One way to overcome the problem of inadequate analgesia is to establish a triage nurse-initiated analgesia (TNIA) protocol that empowers nurses to administer analgesics early and without physician authorization. In adults, TNIA has been shown to be associated with decreased time to provision of analgesia and improved patient satisfaction. **An overview of current research of TNIA in pediatrics, will be presented.**

IS004 / #60

Educational Symposium

Educational Symposium 02: Educational symposium: Acute pain, how to deal with it in the emergency department (EAP)

08-10-2022 08:00 - 08:50

Reduction of ileocolic intussusception under sedation or anesthesia: A systematic review of complications

M. Shefler Gal^{1*}, S. Gamsu², R. Jacob³, D. Cohen⁴, I. Shavit⁵

¹Pediatric Emergency Department, Kaplan Medical Center, Rehovot, Israel

²Shamir Medical Center, Pediatric, Beer Yaakov, Israel

³Pediatric Emergency Department, Haemek Medical Center, Afula, Israel

⁴Pediatric Emergency Department, Nationwide Children's Hospital, Columbus, United States of America

⁵Pediatric Emergency Department, Rambam Health Care Campus, Haifa, Israel

BACKGROUND

Despite the increased use of sedation in children undergoing stressful procedures, reduction of ileocolic intussusception (RII) is usually performed on awake children without any form of sedation.

OBJECTIVE

To evaluate the incidence of severe complications of RII under sedation or anaesthesia.

DESIGN

A systematic review including English language original articles of any date.

PATIENTS

Children undergoing RII (pneumatic or hydrostatic) under sedation or anesthesia.

DATA SOURCES

Ovid, Embase, Scopus, PubMed, the Cochrane Database of Systematic Reviews and the internet search engine Google Scholar. Three authors independently reviewed each article for eligibility. The Newcastle-Ottawa Scale was used to assess the quality of included studies. The primary outcome was the incidence of intestinal perforation during RII. The secondary outcomes were the incidence of sentinel adverse events defined as death, cardiopulmonary resuscitation, permanent neurological deficit and pulmonary aspiration syndrome.

RESULTS

The search yielded 368 articles. Nine studies with 1391 cases were included in the analysis. Of the nine studies, six had a score of ≤ 6 stars in the Newcastle-Ottawa Scale assessment, indicating low-to-moderate quality. Propofol-based sedation was used in 849 (59.2%) cases; 5 (0.6%) had intestinal perforation. Intestinal perforation was not reported in patients who were sedated with other sedatives. One patient had pulmonary aspiration syndrome.

CONCLUSIONS

Although caution remains warranted, current data suggest that the incidence of severe complications due to RII under sedation or anesthesia is low. Due to the lack of prospective data, it is difficult to ascertain the exact incidence of severe complication.

IS005 / #61

Educational Symposium

Educational Symposium 03: Roles and responsibilities of paediatric and neonatal critical care nurses (ESPNIC)

08-10-2022 08:00 - 08:50

Approaches for success: Enhancing staff engagement with research

J. Menzies*

Birmingham Women's and Children's NHS Foundation Trust, Paediatric Intensive Care Unit, Birmingham, United Kingdom

Organisations which are research active are known to have better patient outcomes, increased patient satisfaction, improved organisational efficiency and also improved staff satisfaction and staff retention. Despite the many benefits of research, there are reports from across all health care disciplines of challenges to being involved with research and developing a career as a research-active professional. Research activity is often not seen as core business and is often perceived by organisations to be an optional 'extra'. Barriers to staff involvement in research include lack of time, lack of skills and awareness, lack of training and opportunities, lack of funding, lack of organisational support and lack of research culture; with increased challenges identified for Nurses, Midwives and Allied Health Professional (NMAHPs). Helpfully there are increasing numbers of publications identifying strategies and means to overcome barriers and support staff engagement with research. Examples include initiatives to engage clinical staff in local research delivery, schemes which provide funded (protected) time and support, schemes which help with mentorship and supervision, training and development opportunities to gain practical experience of research and schemes to enhance academic links with universities and clinical academic development. The creation and

implementation of innovative schemes such as these creates a workforce who are research aware and active, a strong research culture and promotes patient access to clinical research.

IS006 / #56

Educational Symposium

Educational Symposium 04: Management of cardiogenic shock in children before the child is in the intensive care unit (ESPNIC)

08-10-2022 08:00 - 08:50

Management - Early recognition and treatment of cardiogenic shock in children

A. Hoskote*

Great Ormond Street Hospital for Children NHS Foundation Trust, Paediatric Cardiac Intensive Care, London, United Kingdom

The talk will cover the causes of acute decompensated heart failure in children including viral myocarditis focussing on early recognition, treatment and advanced mechanical circulatory support. The pitfalls in diagnosis, the challenges in recognition and management before ICU and the outcomes will be covered in detail with an opportunity for Q & A.

IS007 / #57**Educational Symposium****Educational Symposium 05: Excessive use of medication in the treatment of gastroesophageal reflux disease (EAP)****08-10-2022 08:00 - 08:50****Over prescription in gastroesophageal reflux - An unnecessary medicalisation?****k. Størdal****University of Oslo, Institute of Clinical Medicine, Oslo, Norway*

Proton pump inhibitors (PPIs) are potent drugs to control symptoms caused by gastric acid in the upper gastrointestinal tract. PPIs are recommended by international pediatric guidelines as the most effective drugs in gastroesophageal reflux disease, used both as a diagnostic test based on symptom relief after 4-8 weeks and for continued treatment when necessary. In infants the guidelines do however not recommend PPIs as part of the diagnostic process due to a high proportion with transient physiologic reflux symptoms and the difficulties in interpretation based on symptoms only. Systematic reviews of several controlled trials in infants fail to identify any benefit compared to placebo. In Norway and Sweden the use of PPIs in infants has increased by more than five-fold from 2007 to 2020. Denmark has seen an even higher use with more than 80 prescriptions per 1000 infants in 2017, but the use has decreased by 42% in 2020. For Norway and Sweden, a change in international guidelines has not until now resulted in any appreciable change in the ever-increasing use. Side effects of early and long-term PPI use are of concern, with influences of the gut and airway microbiota and risk of gastrointestinal and respiratory tract infections. Moreover, a slightly increased risk of fractures and adverse food reactions calls for caution in liberal use of PPIs. Clearly, PPIs in infants presenting with transient regurgitation without symptoms warranting investigation should be avoided and represents an unnecessary medicalization.

IS008 / #53

Educational Symposium

Educational Symposium 06: State of the art in congenital lung disease (ESPR)

08-10-2022 08:00 - 08:50

Congenital lung lesions

R. Witlox*

Leiden University Medical Center, Neonatology, Leiden, Netherlands

Primary fetal lung and airway anomalies are rare. Recognition and understanding of these lesions has improved over the last decades mainly due to improvements in prenatal ultrasound. With the introduction of fetal therapy options an increasing number of children survive with larger and more severe forms of fetal pleural effusion (FPE), congenital pulmonary airway malformations (CPAM) and bronchopulmonary sequestrations (BPS). In this presentation I will discuss the current views on etiology and pathophysiology of fetal lung lesions, the various pre- and postnatal management options (including fetal interventions) and report on the perinatal and neonatal outcome as well as what is known on long-term outcome.

IS009 / #50**Educational Symposium****Educational Symposium 07: Educational symposium - Covid-19 infections in children (ESPNIC)****08-10-2022 08:00 - 08:50****Recognition and treatment of MIS-C****M. Carter***

King's College London/Assistance-Publique Hopitaux de Paris, Paediatric Intensive Care/Réanimation Pédiatrique, London/Paris, United Kingdom

MIS-C was described during the first wave of the Covid-19 pandemic. Clinical features included features of systemic inflammation shared with Kawasaki disease in approximately half of patients, reduced left ventricular function requiring vasoactive support in approximately 75% of patients, coronary artery aneurysms in approximately 10% of patients, and gastrointestinal pain in most patients. Laboratory features included raised inflammatory markers, disordered coagulation and raised cardiac biomarkers. Most patients were respiratory PCR negative, but serum IgG positive for SARS-CoV-2. This, in addition to a time lag of approximately 4 weeks from peak SARS-CoV-2 transmission to peak MIS-C presentation, suggested that MIS-C was a post-infectious disease. Immunologically, MIS-C is characterised by high numbers of activated immature neutrophils in peripheral blood, decreased antigen presentation, and widespread T and B cell lymphopaenia. B cells show a germinal centre independent B cell response. Some groups have suggested a role for auto-inflammation with the identification of self-reactive antibodies. Compelling data have identified a subset of activated T cells expressing specific T cell receptor sequences, which may be exploited to improve diagnosis of MIS-C and requires further investigation. Treatment includes intravenous IgG (IVIg), corticosteroids and monoclonal antibodies (to IL-1, IL-6 or TNF-alpha), and for differential diagnoses (e.g. toxic shock syndrome). There is no evidence of clinically important improvements in outcome between groups of children treated with IVIg, corticosteroids or

both in propensity-score matched cohorts. Recent data suggest a decline in the incidence of MIS-C relative to SARS-CoV-2 infection in children; however, the Covid-19 pandemic continues to surprise us.

IS010 / #64**Educational Symposium****Educational Symposium 08: Antibiotic prescription and use. Differences in current practices across Europe (EAP)****08-10-2022 08:00 - 08:50****The challenge of antibiotic stewardship in Europe****S. Ashkenazi****Ariel University, Pediatrics, Ariel, Israel*

Antibiotic awareness among physicians aims to encourage best practices of antibiotic use among health workers and policy makers to avoid the further emergence and spread of drug-resistant infections. Antimicrobial stewardship is a coordinated program that promotes the appropriate use of antimicrobials, improves patient outcomes, reduces microbial resistance, and decreases the spread of infections caused by multidrug-resistant organisms. The purpose of the antibiotic stewardship programs can be summarized as using antibiotics only when needed, with the most suitable antibiotic agent, with the right dose, at the right time and for the appropriate duration. Major components of the programs are adequate personnel, activities, education and preparation of guidelines. To address the challenge of antibiotic stewardship in Europe, we conducted a survey of such programs in European countries that are represented in European Academy of Pediatrics (EAP) with a final goal of harmonizing antimicrobial stewardship among EAP member countries.

IS011 / #317**Educational Symposium****Educational Symposium 09: Pros and cons:
Probiotics (EAP)****08-10-2022 08:00 - 08:50****Panelist: Rethinking probiotics in pediatrics
facing new evidence****H. Szajewska****Department of Paediatrics, The Medical University of Warsaw, Warsaw, Poland*

'Are probiotics money down the toilet? Or worse?' asked the authors of an article in JAMA, one of the best medical journals. 'Probiotics don't do much for most people's gut health despite the hype' – media reported. These are just two examples of the recent critical approach to probiotics. Is the critique substantiated? In many countries, the probiotic industry is big business, often with aggressive marketing causing uncertainty about whether or not to use probiotics. If yes, when and how should probiotics be used? How does one choose a probiotic? The purpose of this presentation is to summarize current evidence on probiotics' efficacy and safety to help healthcare professionals make evidence-based decisions on the use of probiotics. Recent guidelines developed by the European Society for Paediatric Gastroenterology, Hepatology and Nutrition will be presented. The question as to what to do when recommendations from medical societies are not in agreement will be addressed. Considering that probiotics have strain-specific effects, the focus will be on data on individual probiotic strains, not on probiotics in general. At the conclusion of this presentation, audience members should be familiar with some of the indications for use of individual probiotic strains in pediatric patients.

IS012 / #66**Educational Symposium****Educational Symposium 10: Educational symposium - The future of federated research for infant and child health (ESPR)****08-10-2022 08:00 - 08:50****Recap preterm platform****D. Wolke****Department of Psychology, University of Warwick, Coventry, United Kingdom*

Very preterm (< 32 weeks gestation; VPT) or very low birth weight birth (< 1500g birth weight; VLBW) births account for up to half of perinatal and infant deaths, children with impairments and disabilities and more than a third of the health and educational budgets for children across Europe. The overall aim of the RECAP preterm Project is to improve the health, development and quality of life of these children and adults by developing the RECAP preterm Cohort Platform, a sustainable, geographically diverse and multidisciplinary database of national and European cohorts of babies born very preterm or with very low birth weight (VPT/ VLBW cohorts). This network contains cohorts constituted over a 30 year time span and is designed to optimize the use of population data for research and innovation in healthcare, social and education policy. Pooling data from 24 very preterm cohorts provides exciting opportunities to generate new knowledge about the consequences of preterm birth. The project partners have created 11 interesting Modules to provide you with an overview of very preterm cohorts and collaborative research principles and techniques (see E-learning course). Furthermore, the Happ-e, an electronic cohort study for adults born preterm was launched in several languages was launched. This presentation provides a short overview of the completed www.recap-preterm.eu with some selected results with implications of care. Information of how to collaborate with this federated data base will be provided.

IS013 / #67

Educational Symposium

Educational Symposium 10: Educational symposium - The future of federated research for infant and child health (ESPR)

08-10-2022 08:00 - 08:50

Early life stressors and life course health. The lifecycle project - EU child cohort network

V. Jaddoe*

Erasmus MC - Sophia Children's Hospital, Pediatrics, Rotterdam, Netherlands

Early life is an important window of opportunity to improve health across the full lifecycle. An accumulating body of evidence suggests that exposure to adverse stressors during early life leads to developmental adaptations, which subsequently affect disease risk in later life. Also, geographical, socio-economic, and ethnic differences are related to health inequalities from early life onwards. To address these important public health challenges, many European pregnancy and childhood cohorts have been established over the last 30 years. Combining data will lead to the possibility of identifying smaller effect estimates, and the opportunity to better identify risk groups and risk factors leading to disease across the lifecycle across countries. The EU Child Cohort Network, established by the Horizon2020-funded LifeCycle Project, brings together nineteen pregnancy and childhood cohorts, together including more than 250,000 children and their parents. A large set of variables has been harmonised and standardized across these cohorts. The harmonized data are kept within each institution and can be accessed by external researchers through a shared federated data analysis platform using the R-based platform DataSHIELD. The EU Child Cohort Network has an open character. All protocols for data harmonization and setting up the data analysis platform are available online. The EU Child Cohort Network creates great opportunities for researchers to use data from different cohorts, during and beyond the LifeCycle Project duration. It also provides a novel model for collaborative research in large research infrastructures with individual-level data.

IS014 / #164

ESPR Session

ESPR Session 01: Update on research in neonatal resuscitation

08-10-2022 10:30 - 11:50

Laryngeal mask use

D. Trevisanuto*

Department of Woman's and Child's Health, University Hospital of Padova, Padova, Italy

Approximately, 3-5% of neonates require face-mask (FM) ventilation at birth; 1% need tracheal intubation. These procedures require specific skills which are difficult to master. Short-term training on the use of the laryngeal mask (LMA) in neonates seems to be effective, easier, and faster. Since Dr. Brain's original model, there have been great technical improvements of supraglottic airway devices (SAD) thanks to the continuous requests and suggestions of everyday users. Now, a supraglottic airway device (SAD) is indicated in operating rooms, obstetrics, emergency and intensive care units, and pre-hospital settings. Three reviews and meta-analyses have clearly demonstrated the superiority of the (LMA) over the FM in terms of effective PPV and reduction of endotracheal intubation rate, but not of critical outcomes (i.e. mortality, and hypoxic-ischemic encephalopathy). Included RCTs were almost exclusively conducted in middle and low resource settings, while data from high resource settings are lacking and represent a gap in knowledge. In the last three decades, the LMA used as an adjunct during neonatal resuscitation has gained its "reputation". Actually, the LMA can be considered in place of the FM for PPV at birth. In addition, a growing body of evidence from animal and adult studies supports its role during advanced cardio-pulmonary resuscitation, but these findings remain to be demonstrated during neonatal resuscitation. A recent European survey showed that an LMA was available in 249 out of 446 (56%) European delivery wards, but was used as the first interface when facing a newborn in need of PPV at birth by only 1 (0.2%) of respondents. Implementation of education and training on LMA use remains a priority for healthcare givers involved in the care of neonates.

IS015 / #165

ESPR Session

ESPR Session 01: Update on research in neonatal resuscitation

08-10-2022 10:30 - 11:50

Technology in the delivery room

D. Sharkey*

University of Nottingham, Centre for Perinatal Research, School of Medicine, Nottingham, United Kingdom

Unlike in the neonatal intensive care unit, neonatologists have been slow to adopt technologies in the delivery room. There are many reasons for this including: 1) devices not developed for newborn care, 2) devices unsuitable for the unique environment of the delivery room, 3) sterility issues for surgical births, 4) niche market failing to attract investment and development, and 5) poor understanding of the unique transitional period from fetus to newborn. Not until 2010 did the first monitoring technology make it into the ILCOR newborn resuscitation guidelines. In the last 10 years we've seen a dramatic increase in the use of technologies to support care of high-risk infants at birth. Many delivery room technologies are used for monitoring. This paper will discuss the current state-of-the-art with respect to delivery room technologies with a focus on those developed specifically for the newborn population, as opposed to those developed for adults and simply modified to suit newborns. Next, we will explore the newer technologies making their first steps into delivery room care and those under development that are just over the horizon. Technologies can both enhance and hinder the care we deliver. We must be mindful of human factors, avoiding distractions from the baby in our care, the importance of team dynamics and the context within our own settings where technologies may not be suitable. We are moving from an era of advanced to futuristic newborn resuscitation where medical technologies will ensure we deliver the best care for the best outcome.

IS016 / #81**EAP Session****EAP Session 02: Cancer survivor: What to do with them or what is the role of the primary care paediatrician****08-10-2022 10:30 - 11:50****Paediatric cancer patients: Are they ever cured? A long-term care plan for the primary care paediatrician****S. Ash****Rambam Health Care Campus, Pediatric Hematology Oncology and Bone Marrow Transplantation, Haifa, Israel*

More than 84% of all children diagnosed with cancer will experience long-term survival or cure. Many childhood cancer survivors (CCS) are at risk for developing late effects over their lifetime such as heart failure, infertility, second malignancies, neurocognitive deficits, early mortality, and adverse quality of life. Long-term follow-up of CCS is essential for prevention, early detection, and management of subsequent late effects. Several guidelines from groups worldwide have been developed to guide both primary clinicians and paediatric oncologists on the long-term follow-up. Among these, the International Late Effects of Childhood Cancer Guideline Harmonization Group (IGHG) guidelines is a consorted effort of several national guideline-groups and the PanCareSurfFup consortium to harmonize the prominent international guidelines for follow-up of CCS. Since 2013, many IGHG guidelines have been published by topic (for example, breast cancer surveillance, fertility preservation, cardiomyopathy surveillance). The IGHG is an ongoing work, based on systematic literature reviews with updates based on current evidence being published every few years. Survivorship care plans are currently recommended as standard of care in many countries. One example is the survivorship passport (Surpass) developed by the Pancare, SIOP and other

groups in Europe, available in paper and electronic formats. The transition of the long term cancer childhood survivors from childhood healthcare system to adult medicine is a proactive, planned, coordinated and multidisciplinary process. It includes the medical, psychosocial, educational and vocational needs of the long term survivors and their families, with emphasis on promotion of healthy lifestyle and self-management skills. Several models of care have been proposed for the long-term follow-up of children and adult survivors of childhood cancer, most emphasize collaboration of primary physicians, survivorship clinics and oncologists. Effective communication of knowledge between paediatric and adult primary care, paediatric oncologists and the survivors are key for successful long-term follow up of CCS.

IS017 / #84**ESPNIC Session****ESPNIC Session 03: Protecting the brain****08-10-2022 10:30 - 11:50****Therapeutic hypothermia in critically ill children:
Where are we now?****C. Buysse****Corinne Buysse, pediatric intensivist, Erasmus Medical Center, Picu, Rotterdam, Netherlands*

The aim of therapeutic hypothermia (TH) in critically ill children is to minimize secondary neurologic injury and improve outcome due to multiple mechanisms, including amelioration of excitotoxicity, oxidative stress and mitochondrial dysfunction. TH is an effective neuroprotective therapy for newborns with moderate-to-severe hypoxic – ischemic encephalopathy associated with a decrease in mortality or poor long-term outcome, such as cerebral palsy and severe neuropsychological impairment. Also in critically ill children, such as after cardiac arrest, severe traumatic brain injury, refractory status epilepticus, TH is often applied. Possible adverse effects related to TH include cardiac arrhythmia, electrolyte imbalance, infection, coagulopathy, and hypotension with rewarming. Prospective, multicenter studies are necessary with focus on homogeneous patient sample, monitoring of biomarker responses to TH (e.g. neuron-specific enolase), pharmacokinetics of medications (e.g., anticonvulsants) during TH, standardized monitoring and diagnostics (e.g. continuous seizure monitoring and brain imaging), and effect of TH on long-term outcome of critically ill children.

IS018 / #77

ESPR Session

ESPR Session 04: All you need to know about electrolytes

08-10-2022 10:30 - 11:50

Fluid and electrolytes in parenteral nutrition

S. Iacobelli*

Reunion Island University Hospital, France, Picu-nicu-neonatology, Saint Pierre Cedex, France

Parenteral nutrition is a compounded therapy mixed from numerous components, including water and electrolytes. Prescribing the most adapted fluid intakes in PN can be challenging in neonatology. Indeed, a certain volume of water is needed to maintain body homeostasis, cardiovascular and kidney function, and a certain fluid volume is needed to provide adequate nutritional intake, but in several morbidities and in various clinical situations these volumes may not be equal: 1) Even when intravenous, artificial nutrition is required outside the context of critical illness, most newborn infants receiving parenteral nutrition are concurrently experiencing shifts of fluids and electrolytes between intracellular, extracellular and vascular compartments; 2) Disturbances in electrolyte, fluid and acid-basic balance may occur due to underlying morbidities or physiologic immaturity of renal function; 3) The optimal water intake may differ depending on macronutrient intakes, with higher intakes of protein likely requiring higher fluid intakes; 4) Water needs show considerable inter- and intra-individual variation, especially in preterm infants; 5) Serious short- and middle-term morbidities may result from fluid overload and electrolytes imbalance during early postnatal life. All these facts should be considered for the daily order of water and electrolyte intakes and a prompt adaptation of fluid prescription in the PN may be necessary, according to changes in infant water balance, hydration status and renal function. Some research gaps concerning water and electrolyte intakes during parenteral nutrition in newborn infants are currently identified and should be addressed in future investigations and randomized controlled trials.

IS019 / #78

ESPR Session

ESPR Session 04: All you need to know about electrolytes

08-10-2022 10:30 - 11:50

Calcium and phosphorus requirements of preterm infants

W. Mihatsch^{1,2*}, M. Saenz De Pipaon³

¹Ulm University, Pediatrics, Ulm, Germany

²Neu-Ulm University of Applied Sciences, Health Management, Neu-Ulm, Germany

³Universidad Autonoma de Madrid, Pediatrics, Madrid, Spain

BACKGROUND

Given current up to date Ca and P recommendations for enteral nutrition, preterm infants, especially VLBW, fail to achieve a bone mineral content (BMC) equivalent to term infants. During the first 3 years of life, most notably in light at term equivalent age (Z score <-2) VLBW infants', BMC does not catch up. In adults born preterm with VLBW or SGA, lower adult bone mass, lower peak bone mass, and higher frequency of osteopenia/osteoporosis have been found, implying an increased risk for future bone fractures. Therefore, the aim of the present presentation is to provide guidance for enteral mineral intake for improving bone mineral accretion in preterm infants.

METHODS

Current preterm infant mineral recommendations together with fetal and preterm infant physiology of mineral accretion will be reviewed to provide recommendations for improving bone mineral accretion.

RESULTS

Current Ca and P recommendations systematically underestimate the needs of preterm infants, especially for Ca.

CONCLUSION

Higher enteral fortifier/formula mineral content or individual supplementation are required. Higher general mineral intake (especially Ca) will most likely improve bone mineralization in the whole group of preterm infants and possibly the long-term bone health. However, the nephrocalcinosis risk may increase in some infants with high Ca absorption. Therefore, individual additional enteral Ca and/or P supplementations may be the ideal solution improve current fortifier/formula mineral provision.

IS020 / #162

ESPNIC Session

ESPNIC Session 05: The changing landscape of the paediatric intensive care unit

08-10-2022 10:30 - 11:50

Secrets and scents of caring: From seclusion to separation

J. Latour^{1,2*}

¹University of Plymouth, Faculty of Health, Plymouth, United Kingdom

²Department of Nursing, Hunan Children's Hospital, Changsha, China

This session aims to discuss the secrets and scents of caring. The 'secrets' of caring will be discussed by explaining the role, impact, and effect of inter-professional shared decision-making.^[1] This will also include the current views of ethical training of nurses and doctors in end-of-life care, ethical dilemmas and related options of training and education.^[2,3] The 'scents' (and sensitivity) of caring will be explained including the views of all stakeholders in the care of critically ill infants and children, including the very specific role of fathers.^[4,5] The flavour of the scents will generate a blossom that will not be forgotten by the delegates when leaving this session. At the end of the session the delegates have discovered a range of activities that are important to address and to deliver excellent care to critically ill infants, children and their families. Take home message: Crack on and tell me at the next EAPS congress what you have done in excellent care delivery.

REFERENCES

- [1] Michalsen A, Long AC, Ganz FD, White DB, Jensen HI, Metaxa V, Hartog CS, **Latour JM**, et al: Inter-professional shared decision-making in intensive care units: a systematic review and recommendations from an expert-panel. *Crit Care Med* 2019;47(9):1258–1266.
- [2] den Boer MC, Zanin A, **Latour JM**, Brierley J: Paediatric Residents and Fellows Ethics (PERFEct) survey: Perceptions of European trainees regarding ethical dilemmas. *Eur J Peds*. 2022;181(2):561–570.

- [3] Fielding N, **Latour JM**, Kelsey J: Experiences of paediatric end-of-life simulation in undergraduate children's nursing students: A qualitative study. *Clin Sim Nurs*. 2022;65:18-25.
- [4] Dall'Oglio I, Mascolo R, Portanova A, ... **Latour JM**, FCC Italian NICUs Study Group: Staff perceptions of Family-Centered Care in Italian Neonatal Intensive Care Units: A multicenter cross-sectional study. *Children*. 2022, 9, 1401.
- [5] Baldoni F, Ancora G, **Latour JM**: Being the father of a preterm-born child: Contemporary research and recommendations for NICU staff. *Front Peds* 2021;9:724992

IS021 / #74

EAP Session

EAP Session 06: Follow up of ex premature babies in primary care, what are the pitfalls

08-10-2022 10:30 - 11:50

Common diseases in premature children

L. Zimmermann*

EFCNI, Medical Director, Munich, Germany

There is consistent evidence that preterm birth is associated with a higher risk of adverse long-term sequelae. Overall, the earlier a baby is born, the more impaired the fetal growth during pregnancy, and the more severe neonatal complications, the higher the risk for long-term disability. However, also moderate-late preterm infants may have problems, which are frequently underestimated. As neonatologist and Medical Director of a European parent organization, the European Foundation for the Care of Newborn Infants (EFCNI; <https://www.efcni.org/>), I want to bridge the professional and parent perspectives. Together with many professional and parent organisations and stakeholders, EFCNI has developed European Standards of Care for Newborn Health (ESCNH; <https://newborn-health-standards.org/standards/standards-english/>) on 11 major topics, including 13 standards on "follow-up and continuing care". Parents should be involved in the care and decisions for their baby from the very start, following the principles of Infant and Family Centered Developmental Care. This is followed by integral discharge management and support during the transition period from hospital to home. Multidisciplinary collaboration and coordination of care between professionals in different healthcare settings is necessary. Growth, feeding, general health, visual, hearing, and speech difficulties, as well as cognitive, behavioral and motor development, and medical complications of prematurity, are addressed. Additionally, assessment of mental health should be included, as both, infants born very preterm and their parents are at increased risk for mental health problems. Also, the risk for developing late-life "cardiometabolic disease" is increased in children and adults born very preterm.

IS022 / #73

EAP Session

EAP Session 06: Follow up of ex premature babies in primary care, what are the pitfalls

08-10-2022 10:30 - 11:50

Premature babies after discharge: How to optimize follow up in the community

T. Stiris^{1,2*}

¹University of Oslo, Institute of Clinical Medicine, Faculty of Medicine, Oslo, Norway

²Department of Neonatal Intensive Care, Oslo University Hospital, Ullevål, Oslo, Norway

Emphasis of the guidelines after discharge of prematurely born infants aim to increase the parent's confidence and ability to support their children. This can be done by meeting their concerns and uncertainties with relevant mapping of the child and the child family needs, and by taking necessary measures. It is recommended that premature children will be offered targeted follow-up in both in primary and secondary healthcare systems. The follow-up of the individual should be adjusted to the degree of prematurity and complications related to birth and the neonatal period. In many countries The Directorate of Health and Social Affairs' professional have developed guidelines expressing what we consider good practice outlining the "time slots" and contents for following up visitations. Professional guidelines provide recommendations and advice based on evidence-based knowledge. The guidelines are intended as an aid in the balances the health providers have to do to achieve good quality and good practice. Different outlines of guidelines will be approved from country to country, depending on how the healthcare system is set up. It is worth noticing that Guidelines are usually advisory; not mandatory.

IS023 / #75**ESPNIC Session****ESPNIC Session 07: The use of big data in PICU nutrition research****08-10-2022 10:30 - 11:50****'Zooming out' using clinical data in nutritional research****K. Joosten****ErasmusMC-Sophia Children's Hospital, Pediatric Intensive Care, Rotterdam, Netherlands*

Critical illness is hallmarked by different phases of disease; the acute, stable and recovery phase. Each phase is characterized by clinical symptoms, requirement of vital support and alterations of the neuro-endocrine, immunological and metabolic system. While a recent randomized trial of nutritional support for critically ill children admitted to the pediatric intensive care (PICU) found that delaying parenteral nutrition led to favorable clinical outcomes, there is no randomized trial evidence to address more complex but important questions, such as the optimal timing and total quantity of nutritional support. Machine learning models may assist to distinguish the different phases of disease and to come to a model that predicts a personalized course of disease and nutritional support regime. Both static and dynamic parameters have to be taken into account. Previously, some studies have developed machine learning models to assist medical decision making in the PICU, including mortality prediction, sepsis, cardiac arrest and acute kidney injury. Concerning the use of machine learning models for prediction of different phases of disease clinical data have to be combined with traditional markers (eg markers of inflammation, body composition) and new biomarkers (eg metabolomics, proteomics). It has to be debated which of these markers are needed to come to a sufficient prediction model. Furthermore, clinical outcome parameters on the short term and long term have to be defined to relate phases of disease and nutritional support with these outcome parameters.

IS024 / #85

ESPNIC Session

ESPNIC Session 08: Outcomes in cardiac intensive care – A multidimensional approach

08-10-2022 10:30 - 11:50

Improving outcomes after cardiac surgery: Examples in collaborative learning

K. Brown*

Cardiac Intensive Care Unit, Great Ormond Street Hospital NHS Foundation Trust, London, United Kingdom

Children and infants who undergo surgery for congenital heart disease are highly complex with variation in underlying health conditions, cardiac complexity and age/weight. The types of surgery and interventions that such children require are challenging, and span a wide spectrum of procedures. In this situation children may experience complications and other hurdles, as they recover from surgery. The transparent reporting of a range of outcome metrics can provide opportunities for collaborative learning, with important potential benefits for outcomes.

IS025 / #86

ESPNIC Session

ESPNIC Session 08: Outcomes in cardiac intensive care – A multidimensional approach

08-10-2022 10:30 - 11:50

Improving outcomes after ECMO and VADs

A. Hoskote*

Great Ormond Street Hospital for Children NHS Foundation Trust, Paediatric Cardiac Intensive Care, London, United Kingdom

The talk will cover the important initiatives in improving outcomes after ECMO and VADs, and in particular focus on survival and neurodevelopmental outcomes. The non-modifiable and modifiable factors in the ICU and post discharge for long term sustained outcomes will be explored. The strategies in optimising outcomes for children on ECLS from the time of referral, the ECLS journey and post ECLS will be discussed.

IS026 / #87

ESPR Session

ESPR Session 09: New takes on respiratory care in the NICU

08-10-2022 10:30 - 11:50

Lung transplant in congenital surfactant disease

J. Wambach*

Washington University School of Medicine, Pediatrics, Saint Louis, United States of America

BACKGROUND

Infants with congenital surfactant disorders due to pathogenic variants in the *SFTPB*, *SFTPC*, *ABCA3* and *NKX2-1* genes often present with respiratory failure shortly after birth. Medical therapies are limited, non-specific and generally ineffective. Infant lung transplantation is the definitive treatment option for progressive respiratory failure.

OBJECTIVE

To review the diagnostic approach, indications, short- and long-term outcomes for lung transplantation for infants with congenital surfactant disorders.

RESULTS

Congenital surfactant disorders should be considered for late preterm and term infants with persistent respiratory failure after a week of life. Diagnosis is increasingly made via genetic panel testing or whole exome sequencing and may obviate the need for lung biopsy, which can be associated with significant morbidity. Indications for lung transplantation include progressive respiratory failure refractory to chronic mechanical ventilation and medical

therapies, no significant impairment of other organs including neurologic assessment, weight greater than 3.5kg and a psychosocial support system including identified caregivers. Short-term morbidities include early graft dysfunction, infection and surgical complications. Long-term morbidities include cognitive and motor developmental delays, hearing loss, growth impairment, post-transplant lymphoproliferative disorder and chronic lung allograft dysfunction. The 1-year survival for transplanted infants is ~80% and the 5-year survival is ~60%, similar to infants and children who undergo lung transplantation for other indications.

CONCLUSIONS

Lung transplant is an accepted therapy for infants with congenital surfactant disorders and progressive respiratory failure. Post-lung transplant morbidities and mortality remain substantial.

IS027 / #88**ESPR Session****ESPR Session 09: New takes on respiratory care in the NICU****08-10-2022 10:30 - 11:50****Surfactant in late preterm infants****O. Danhaive^{1,2*}, M. Kuzniewicz³**¹*Saint-Luc University Hospital, UCLouvain, Pediatrics, Brussels, Belgium*²*University of California San Francisco Benioff Children's Hospital, Pediatrics, San Francisco, United States of America*³*Kaiser Permanente, Division of Research, Oakland, United States of America*

Late preterm infants (LPI) demonstrate higher respiratory morbidity than term infants. Although most clinical evidences in surfactant replacement therapy derive from studies in very premature infants, with more widespread use of less-invasive surfactant administration (LISA), surfactant is increasingly given in this older gestational age population. Yet, little is known regarding short- and long-term respiratory outcomes and appropriateness/cost-effectiveness of surfactant replacement therapy in LPI. We conducted a large population-based study examining respiratory support and outcomes in a cohort of 19,810 infants born at 30-36 weeks (2012-2018). Antenatal steroid rate was 47.5%, and >90% under 34w. 23.7% received respiratory support in the first 3 days, mostly non-invasive and ≥ 12 h. Surfactant administration was limited, with >10% only in 30-31w infants. However, the majority of doses (60.7%) were used in 32-36w infants, given the higher representation of older infants in the cohort. Using inverse-probability-weighted regression adjustment, we showed no significant protective effect on surfactant inpatient mortality or chronic lung disease at discharge, nor in readmission rate and respiratory medications in the 1st year of life. The lack of efficiency of surfactant replacement in this cohort suggests that respiratory morbidity is not fully due to endogenous surfactant insufficiency in LPI. Retained fetal lung fluid and abnormal respiratory function may play a role in early course,

and ongoing lung development alterations may impact long-term outcomes. Surfactant replacement mostly based on Xray and/or oxygen threshold may not be efficient nor cost-effective, and newer techniques such as lung ultrasonography may allow better targeting of surfactant therapy in LPI.

IS028 / #89**EAP Session****EAP Session 10: The integrated health and social approach in children with chronic diseases: Is complex care of children with chronic diseases possible in the community healthcare?****08-10-2022 10:30 - 11:50****Managing children with complex needs in primary care - Where to next?****M. Brenner***

UCD College of Health Sciences, UCD School of Nursing, Midwifery and Health Systems, Dublin, Ireland

This presentation examines the tension between what is possible in the acute setting, in an era of technological solutionism, and the support subsequently required, to support children with complex and integrated care needs, and their families, in primary care. Drawing on early findings from the TechChild project, the presentation initially focuses on factors that influence critical interventions in the acute setting that lead to the life-changing care of a child in the family home. Current models of care for these children in the primary setting are then examined, mapped against principles and standards of care and informed by the voice of service users and their families. Key innovations in supportive integrated care are discussed with implications for healthcare, bioethics, education, parenting and policy making.

IS029 / #90

EAP Session

EAP Session 10: The integrated health and social approach in children with chronic diseases: Is complex care of children with chronic diseases possible in the community healthcare?

08-10-2022 10:30 - 11:50

The art of shared decision making in paediatrics

B. Wettergren*

Gävle Hospital, Paediatrics, Gävle Sjukhus, Sweden

Shared decision-making (SDM) means that health-care providers do not take medical decisions in isolation. Instead, a provider involves patients in the decision-making process. Health care providers are the experts on testing and treatments. Patients are the experts on what matters to them. This is also applicable in the field of paediatrics. The younger adolescents or children are, the more parents, or guardians, must act as surrogate decision-makers. The need for SDM in paediatrics is heightened by the fact that today's parents, and adolescents, are more informed in medical topics through easy access to web-based knowledge and consultations. A contrary challenge arises when parents have low literacy and numeracy skills and possible cultural backgrounds where only a doctor's paternalistic decision-making is expected. Adapting to individual circumstances is therefore of great importance when implementing SDM in paediatrics. There is a lack of evidence-based research on how to optimise SDM in paediatrics. Based on 50 years of paediatric clinical experience, prerequisites for succeeding in the art of SDM include the health provider being well educated, having good communication skills (able to listen and explain), as well as a genuine interest in patients and in patients' social circumstances and cultural contexts. A trusting relationship must be created. Continuity in follow-up is also crucial for success. Short case-stories will be presented, highlighting the gradual shift, over the years, from a paternalistic approach to SDM. Within paediatrics, we have been among the forerunners introducing patient involvement and informed consent in clinical practise.

IS030 / #91

ESPNIC Session

ESPNIC Session 11: Haemodynamic monitoring in the PICU

08-10-2022 10:30 - 11:50

Evidence based international guidelines on use of pocus in neonatal and pediatric intensive care unit – What's next?

Y. Singh*

Cambridge University Hospitals, Neonatology/Paediatric Cardiology, QQ, United Kingdom

Point of care ultrasound (POCUS) provides in providing anatomical, physiological and hemodynamic information in real time which can help in making physiologic based clinical decisions. It can help in making timely and accurate diagnosis, and provide specific targeted intervention. POCUS is rapidly being adopted in the neonatal and paediatric intensive care practice. Evidence-based guidelines for the use of POCUS in critically ill neonates and children endorsed by the ESPNIC have been published. There is an urgent need of standardised POCUS training curriculum, standardised POCUS courses based upon the curriculum and need of POCUS certification/accreditation.

IS031 / #92**ESPNIC Session****ESPNIC Session 11: Haemodynamic monitoring in the PICU****08-10-2022 10:30 - 11:50****Advances in multi-modal hemodynamic monitoring for infants and children****J. Lemson****Radboud university medical center, Intensive Care Medicine, Nijmegen, Netherlands*

Multi-modal hemodynamic monitoring can be of great benefit regarding hemodynamic treatment for children in shock. We will answer the question what monitoring methods are available, how efficient they are what modalities are recommended by recent guidelines. Furthermore we will discuss the most recent technical developments.

IS032 / #106

Interdisciplinary Session

Interdisciplinary Session 01: Finding a scientific basis for paediatric medicine

08-10-2022 15:00 - 16:30

Clinical trials in paediatrics

S. Faust*

University of Southampton, Nhr Southampton Clinical Research Facility, Southampton, United Kingdom

Clinical trials in children are essential for best disease prevention, diagnosis and treatment. Huge progress has been made in recent years to ensure that new medicines are tested in children and young people (CYP) as drugs are developed for adult care. However, the “business” of clinical trials has become increasingly bureaucratic, burdensome and more difficult to deliver in the context of routine clinical care. Difficulties are exacerbated in CYP as funding for both adaptive trials and for trials with smaller target populations are much harder to achieve than for adult conditions. The COVID-19 pandemic has shown us that new ways of working are possible if academics, regulatory agencies public funders and industry work together to create a new environment. This work is urgent to develop the best interventions or combinations of interventions for CYP. The talk will explore examples of innovative practice during and after the pandemic and consider some key changes to the clinical trials environment that could accelerate and enhance the ability to conduct paediatric clinical trials.

IS033 / #107**Interdisciplinary Session****Interdisciplinary Session 01: Finding a scientific basis for paediatric medicine****08-10-2022 15:00 - 16:30****Clinical trials in neonatology****G. Greisen****Rigshospitalet, Neonatology, Copenhagen, Denmark*

In 1952 William Silverman published the results of the randomised clinical trial that ended unrestricted use of oxygen in preterm infants, in 1992 Jack Sinclair's book on effective neonatal care included 650 systematic reviews, the neonatal group is a prominent part of the Cochrane collaboration, and yet in 2007 we found that only 19 out of 176 reviews concluded that there was clear evidence of benefit and in seven there was clear evidence of no effect or of harm. This is in dire contrast with the number of interventions that are routinely used in current neonatal practice. It is also in contrast with the steadily improving survival rates. It probably reflects the nature of neonatology as rooted in an intensive care paradigm: 'Support organ functions while waiting for recovery', i.e. it is constituted by many small elements with practical and short-sighted goals. The history of neonatology, however, includes several iatrogenic epidemics, caused by ill-advised routine use of treatment, of which the ROP epidemic and CP caused by overuse of postnatal steroids are best known. The heading of the problem may be 'gain now, pay later'. Side effects may only appear years later as the child grows and matures. Good neonatal trials should combine the search for firm evidence of benefit in the short term with sufficient evidence of long-term safety.

IS034 / #95

Interdisciplinary Session

Interdisciplinary Session 03: Acute and chronic pain in children (ESPA Session)

08-10-2022 15:00 - 16:30

When pain nerves misfire - Assessment and management of neuropathic pain in children

S. Walker*

UCL GOS Institute of Child Health, Paediatric Pain Research Group, Clinical Neurosciences, London, United Kingdom

Neuropathic pain is defined as pain due to a disease or lesion of the somatosensory nervous system.¹ Causes can include trauma/surgery, peripheral neuropathies (eg. chemotherapy), neurological disease, and genetic disorders (eg. Fabry disease, sodium channelopathies). In children, neuropathic pain can be severe and persistent, difficult to recognise and manage, and associated with significant pain-related disability.² Recognition based on clinical history and sensory descriptors is challenging in young children, but screening tools are increasingly utilised at older ages. Confirmatory tests can identify the disease or lesion of the somatosensory nervous system resulting in neuropathic pain, but feasibility and interpretation may be influenced by age-dependent changes.¹ Quantitative sensory testing identifies specific mechanism-related sensory profiles;² brain imaging is a potential biomarker of alterations in central processing and modulation of both sensory and affective components of pain; and genetic analysis can reveal known and new causes of neuropathic pain.¹ Pharmacological management is largely extrapolated from trials in adults, and management by an interdisciplinary pain management team is often required to improve physical and emotional function.

REFERENCE

1. Walker SM. Neuropathic pain in children: Steps towards improved recognition and management. *EBioMedicine*. 2020;62:103124.
2. Verriotis M, Peters J, Sorger C, Walker SM. Phenotyping peripheral neuropathic pain in male and female adolescents: pain descriptors, somatosensory profiles, conditioned pain modulation, and child-parent reported disability. *Pain*. 2021;162(6):1732-1748.

IS035 / #96

Interdisciplinary Session

Interdisciplinary Session 03: Acute and chronic pain in children (ESPA Session)

08-10-2022 15:00 - 16:30

Treatment regimens of acute pain and chronic pain

N. Najafi*

Universitair Ziekenhuis Brussel (UZ Brussel), Anesthesiology and Perioperative Medicine, Brussels, Belgium

Limited evidence is available on how to improve the quality of care and pain management in acute and chronic settings in paediatrics. When pain is recognized appropriately and treated accordingly, the transition of acute pain as a symptom to chronic pain as a disease in its own may be modified. Although the underlying factors, appearance and outcome might be different in children than in adults, there is an increased awareness and belief that chronic pain in children is common. The experience of pain in each individual is unique, subjective, and may be beyond the actual and potential tissue damage. It may be perceived as a complex multifactorial entity from the social, emotional, psychological and environmental perspectives. Therefore, effective pediatric pain management requires a multidisciplinary approach and involves using multimodal analgesia and also non-pharmacological modalities such as physiotherapy, psychological and integrative therapies. In addition, it should be focused on an individual patient-centered care.

IS036 / #295**Interdisciplinary Session****Interdisciplinary Session 04: Everything you need to know about neonatal and paediatric ECMO: Referral, benefits and risks, and follow-up****08-10-2022 15:00 - 16:30****Updates in paediatric ECMO****M. Di Nardo***

Bambino Gesù Children's Hospital, Pediatric Critical Care, Children's Hospital Bambino Gesù, Rome, Italy

The use of extracorporeal life support (ECLS) for the pediatric and neonatal population continues to grow. In the last decade, there have been dramatic improvements in the technology and safety of ECLS that have broadened the scope of its application overcoming some previous absolute contraindications. We will review the evolving landscape of ECLS, including its expanding indications and shrinking contraindications. It will also describe traditional and hybrid cannulation strategies as well as changes in circuit components such as servo regulation, non-thrombogenic surfaces, and the potential use of paracorporeal lung-assist devices. Finally, it will outline the modern approach to managing a patient on ECLS, including anticoagulation, sedation, rehabilitation, nutrition, and staffing.

IS037 / #296**Interdisciplinary Session****Interdisciplinary Session 04: Everything you need to know about neonatal and paediatric ECMO: Referral, benefits and risks, and follow-up****08-10-2022 15:00 - 16:30****Long term outcome of ECMO patients****K. Brown***

Cardiac Intensive Care Unit, Great Ormond Street Hospital NHS Foundation Trust, London, United Kingdom

Extracorporeal membrane oxygenation (ECMO) is used to support the sickest of our patients with cardiopulmonary failure. This includes a wide range of children from neonates with acute hypoxic respiratory failure from a range of causes, to children with sepsis and other causes of cardiopulmonary failure and children of all ages with heart disease. ECMO is used at times for management of cardiac arrest that is refractory to conventional resuscitation. Survival outcomes after paediatric ECMO are strongly linked to case mix variables. These critically ill children are at heightened risk of brain injury and neurodevelopmental difficulties affecting later life. In this talk I will cover long term outcomes of paediatric ECMO patients since a better understanding of these concepts is vital for taking PICU survivorship to the next level.

IS038 / #101

Interdisciplinary Session

Interdisciplinary Session 05: Orphan disease in children (ESPGHAN Session)

08-10-2022 15:00 - 16:30

Congenital portosystemic shunts - Identification and therapy

V. Mclin*

University Hospitals Geneva, Swiss Pediatric Liver Center, Geneva, Switzerland

Congenital portosystemic shunts are rare vascular malformations that can present at any age through any number of clinical signs and symptoms. The purpose of this presentation is to summarize clinical presentation and raise awareness in order to decrease diagnostic delay.

IS039 / #102

Interdisciplinary Session

Interdisciplinary Session 05: Orphan disease in children (ESPGHAN Session)

08-10-2022 15:00 - 16:30

Rare tumors in children - Recognition and individualized therapy

D. Schneider^{1*}, I. Brecht², A. Ferrari³

¹Klinikum Dortmund, University Witten/Herdecke, Clinic of Pediatrics, Dortmund, Germany

²University Tübingen, Clinic of Pediatric Oncology and Hematology, Tübingen, Germany

³Istituto Nazionale dei Tumori, Pediatric Oncology, Milano, Italy

All pediatric cancers are rare but still, there is a heterogeneous group of extremely infrequent tumors that can be grouped together as very rare tumors (VRTs). These are characterized not only their low incidence but also the fact that for a long time, most have neither been registered by pediatric oncology study groups nor enrolled into prospective clinical trials. Thus, they have been orphan diseases for a long time. During the last two decades, several national study groups have specifically focused on VRTs, initiating prospective clinical registries, consultation platforms and building international networks. Among the latter, the European Cooperative Study Group on Pediatric Rare Tumors (EXPeRT) is providing access to a virtual tumor board (vrt.cineca.it) and has recently established a common European registry for VRTs. Moreover, EXPeRT has developed internationally harmonized recommendations for diagnosis and therapy of VRTs. With these initiatives, registration rate of VRTs has risen significantly, so that VRTs now account for >5% of all registered childhood cancers. VRTs can be grouped into distinct epidemiological groups: Some characteristic pediatric VRTs almost exclusively develop during childhood (e.g. pancreatoblastoma) and specific pediatric oncology strategies have to be applied. Besides, there is a heterogeneous group of typical adult cancers presenting at a young age. Among these, a significant proportion develop in the

context of genetic predisposition. Moreover, they are often clinically distinct from their adult counterparts and may thus require a specific therapeutic approach. In this context, deep genetic analysis of tumor tissue may open new perspectives for innovative individualized therapies, e.g. mutation directed pathway inhibition or immunotherapy with PD-1 inhibitors. In summary, as most pediatric oncologists will see a specific VRT only once in a lifetime, strong networking is mandatory: To establish the correct diagnosis and to allow for an individualized therapy based on interdisciplinary consultation. Supported by Deutsche Kinderkrebsstiftung.

IS040 / #103

Interdisciplinary Session

Interdisciplinary Session 06: Diagnosis of genetic syndromes in children (Catalan paediatric society session)

08-10-2022 15:00 - 16:30

Phenotype first approach

I. Valenzuela*

Hospital Vall d'Hebron, Clinical and Molecular Genetics, Barcelona, Spain

Monogenic disorders have traditionally been studied by ascertaining individuals phenotypically and then identifying etiologic genetics variation. Whole-exome sequencing (WES) has revolutionized clinical genetics by providing a comprehensive method for patient evaluation. With the decreasing cost of WES, a genotype-first approach whereby individuals are studied based on their genetic variation has emerged as a powerful tool. WES diagnostic rates vary from 25 to 50%, depending on the case series, allowing also new disease-gene identification and insights into the phenotypic and genetic heterogeneity of several disorders. But WES is a complex method, and data loss is possible at each step. Pathogenic variants in known disease-causing genes may be missed because of decreased coverage, locus-specific features such as GC-rich regions, homopolymeric repeats, sequencing biases, and indels that are >20–50 nucleotides. For Mendelian disorders in which single-nucleotide variants and small indels are possible, the prevalent thinking is that if coverage of the genes of interest by WES is adequate, the disorders have been effectively excluded. Here we present selected cases to underscore the importance of deep phenotyping as main guide to genetic diagnosis. These cases illustrate potential pitfalls of WES/NGS testing and the importance of phenotype-guided molecular testing in yielding diagnoses.

IS041 / #104

Interdisciplinary Session

Interdisciplinary Session 06: Diagnosis of genetic syndromes in children (Catalan paediatric society session)

08-10-2022 15:00 - 16:30

Genotype first approach

F. Santos-Simarro*

Hospital Universitario Son Espases, Clinical Genetics, Palma, Spain

The diagnosis of genetic diseases by classical cytogenetic or molecular techniques has traditionally been very limited, hampered by the high clinical and genetic heterogeneity, achieving a low diagnostic yield. This strategy always required an approach guided by the patient's phenotype. In recent years, with the progressive application in diagnosis of genomic technologies, initially arrays and specially next generation sequencing techniques (gene panels, whole exome sequencing; WES or whole genome sequencing; WGS), the paradigm has been shifting towards an approach based on the genotype in which a diagnosis is established based on the findings of the molecular investigations in conjunction with the clinical characteristics of the patient. This has enabled the identification of new genes, new specific genetic disorders and the diagnosis of patients with less distinctive phenotypes.

In this session I will present practical examples of cases where a genotype-based diagnostic algorithm has been applied illustrating the usefulness of this diagnostic approach.

IS042 / #112**Interdisciplinary Session****Interdisciplinary Session 07: What a paediatrician should know: Clues from paediatric neurology cases (EPNS Session)****08-10-2022 15:00 - 16:30****Extension of the field of paediatrics to fetal life-fetal neurology as a paradigm****R. Hady-Cohen****Wolfson Medical Center, Pediatric Neurology, Tel Aviv, Israel*

In recent years the field of Pediatrics has expanded to involve fetal life. Pediatric cardiologists, nephrologists, gastroenterologists, endocrinologists, and neurologists are called to counsel parents when prenatal ultrasound depicts fetal anomalies. In the last 20 years Fetal Neurology Clinics have been established throughout the world to diagnose brain anomalies in utero and to give appropriate counselling to parents. Fetal Neurology combines Prenatal Diagnosis, Pediatric Neurology, and Genetics. It involves demonstration by neurosonography and MRI of CNS anomalies, pediatric neurology counselling regarding the clinical implications and genetic counselling regarding the possible gene involved. The evaluation during the first visit includes: assessment of the fetal brain, a full fetal systemic scan, establishment of structural abnormalities, team discussion, formulation of prognosis and initial counselling of the parents. According to the findings the mother is referred for additional tests: fetal MRI, genetic studies and evaluation for infections. Following the tests, the mother returns to the Fetal Neurology Clinic for follow up and the concluding consultation. When necessary additional specialists in appropriate fields are invited (i.e Neurosurgery, Neonatology). When the counselling suggests the possibility of pregnancy termination, a social worker is asked to join. If the parents elect termination, an autopsy is performed, and the parents later receive the results and counselling regarding future pregnancies.

When the pregnancy continues, the pediatric neurologist follows the child's development and the neurologic examination. In this talk we will discuss the Fetal Neurology Clinic as a paradigm for development of fetal clinics in other fields of Pediatrics.

IS043 / #113

Interdisciplinary Session

Interdisciplinary Session 07: What a paediatrician should know: Clues from paediatric neurology cases (EPNS Session)

08-10-2022 15:00 - 16:30

Early diagnosis of autoimmune encephalitis - What a pediatrician should know

D. Craiu^{1,2*}, C. Motoescu^{1,2}, C. Pomeran², D. Barca^{1,2}, C. Iliescu^{1,2}

¹Department of Neurosciences, Carol Davila University of Medicine and Pharmacy Bucharest, Pediatric Neurology Discipline, Bucharest, Romania

²Alexandru Obregia Center of Expertise of Rare Pediatric Neurological Disorders, full EpiCARE member, Pediatric Neurology Clinic, Bucharest, Romania

Autoimmune encephalitis are a recently recognised group of disorders in which autoantibodies are produced against a variety of brain proteins, the most known being against N-methyl D-aspartate receptors. Initially described as a paraneoplastic syndrome in adult ovarian teratoma, it is clear today that it affects mostly young adults and children as non-paraneoplastic syndrome. Due to variate clinical presentations, these disorders are still under-recognised and diagnosed leading to excessive diagnostic tests and treatment delay.

Autoimmune encephalitis typically start subacute with a prodromal phase of malaise evolving to the psychotic phase with cognitive impairment, speech and memory problems, bizarre behavioural changes, hallucinations, aggressivity, agitation, associated or not with therapy resistant epileptic seizures and a movement disorder with facial motor movements resembling tics followed by severe chorea. Many times the symptoms are discrete at onset and isolated, or may fluctuate in intensity leading to diagnostic delay.

The aim of this lecture is to present the typical clinical features and workup in autoimmune encephalitis and to underline clues of clinical evolution and symptoms associations which may lead to an early recognition and testing for these disorders avoiding unnecessary extensive workup.

IS044 / #93**Interdisciplinary Session****Interdisciplinary Session 08: Palliative management of children diagnosed with single ventricle (EAPC Session)****08-10-2022 15:00 - 16:30****The cardiologists' point of view****J. Martins****Pediatric Cardiology Department, Hospital de Santa Marta, Lisbon, Portugal*

Palliative care of children diagnosed with single ventricle: The cardiologist's point of view The author will attempt to answer two questions: Why is palliative care of children diagnosed with single ventricle (SV) congenital heart disease (CHD) an important theme? What can the perspective of the Pediatric Cardiologist add? CHD affects about 1% of newborns. Despite significant advances in management, CHD remains the most common cause of infant death in developed countries. Most of these children have the diagnosis of SV, which carry a significant risk of early mortality and substantial morbidity throughout their lifespan. Due to the intense care needed, palliative care should be routine for these patients and their families. After a very brief review of the current results of management for patients with SV CHD, the presenter will address the most significant specific concerns regarding end-of-life palliative care for patients with SV CHD: surveys of its implementation, timing of palliative care institution, quality of life, symptomatic control (e.g., pain, dyspnea), transplant, and ethical dilemmas related to potentially futile treatments.

IS045 / #94

Interdisciplinary Session

Interdisciplinary Session 08: Palliative management of children diagnosed with single ventricle (EAPC Session)

08-10-2022 15:00 - 16:30

The palliativist's point of view

J. Mendes*

ERISA SCHOOL - IPluso, Lisbon, Nursing Education, Agualva, Portugal

Children diagnosed with single ventricle and their families face a wide range of challenges during the course of illness. Despite curative improved interventions and technological development increasing survival rate, children often experience a higher risk of morbidity and death in childhood. Palliative care addresses the unmet holistic needs of children and their families during all the disease trajectories and can be seen as an extra layer of care. Early palliative care, ideally introduced since the moment of diagnosis, alongside disease-oriented care is crucial to enhancing the quality of life and addressing suffering. Although more complex palliative care needs demand the approach of a specialized PPC team, key basic components and principles can be provided by regular health care teams in all different settings where the children might be: obstetrics, neonatal and pediatric ICU, operating room, primary care or home care. Thus, palliative care contributions might include additional competencies in early conversations, coordination of care, advance care planning with revisited order as needed, symptom management, creating memories, end of life care and bereavement care. Palliative and cardiac care professionals play an important role in the delivery of the key components of palliative care. Further research education and training are needed to enhance the experience of quality of care delivered in such challenging situations.

IS046 / #108**Interdisciplinary Session****interdisciplinary Session 09: Paediatric emergency medicine updated (EUSEP Session)****08-10-2022 15:00 - 16:30****Revising treatment guidelines of status epilepticus in light of emerging evidence****Ö. Tekşam****Hacettepe University, Pediatrics/Pediatric Emergency Medicine, Ankara, Turkey*

Status epilepticus is the most common neurological emergency in children and early treatment is critical to reducing morbidity and mortality. It has been defined as more than 30 minutes of either continuous seizure activity or two or more cumulative seizures without full recovery of consciousness between seizures. Today, it is known that early treatment is more effective in stopping prolonged seizures. A timely approach could be important as much as a specific pharmacological intervention. Therefore, status treatment protocols have used a 5-minute definition to minimize the risk of prolonged seizures. In recent years, many different guidelines in use are published and these guidelines are similar in many ways except for some minor variations. All the treatment guidelines recommend the use of benzodiazepines as the first-line agents including either diazepam, lorazepam, or midazolam. Because there are many evidence-based studies that they have comparable antiseizure efficacy. However, there is currently poor evidence regarding which second-line agent to use in children. Recently, there are well designed, multi-center randomized-controlled studies aimed at determining the optimal second-line therapy for children with SE. In those studies, it seems that Levetiracetam is neither more effective nor safer than phenytoin. On the other hand, some of these studies were done in a high-resource setting. But it is difficult to apply their results to the patients in hospitals with low resources. When revising treatment guidelines of SE, these settings must be taken into

account for managing pediatric SE. Finally, studies have still investigated the best approaches for effective treatment in children with SE. In addition, an introduction of bedside electroencephalography in the earliest phases of emergency care is promising for more targeted interventions.

IS047 / #109**Interdisciplinary Session****Interdisciplinary Session 09: Paediatric emergency medicine updated (EUSEP Session)****08-10-2022 15:00 - 16:30****Point of care technologies driving improved patient care and flow in paediatric emergency medicine****R. Velasco****Hospital Universitario Rio Hortega, Pediatric Emergency Unit, Valladolid, Spain*

Overcrowding is a common problem in emergency departments (ED), both general and pediatric. ED crowding leads to a deterioration in the quality of care received by patients, as well as an increased risk of adverse events and higher burn-out levels in the ED staff. Within the care process, the main key points for improving the flow of care are the time between triage and attention by the doctor, the performance of complementary tests, requests for consultations with other specialists, and hospital admissions. In recent years, the development of point-of-care techniques has made it possible to perform several complementary tests in the ED itself, thus reducing the time required in this part of the process and improving patient flow, in many cases from the triage stage itself. In this lecture, we will review some of these point-of-care techniques, and we will consider some of those that may be available shortly.

IS048 / #97**Interdisciplinary Session****Interdisciplinary Session 11: Recent advances in the treatment of glomerulonephritis (ESPN Session)****08-10-2022 15:00 - 16:30****New immunosuppressive agents in lupus nephritis****P.D. Topaloglu****Hacettepe University School of Medicine, Pediatric Nephrologist and Rheumatologist, Ankara, Turkey*

Childhood-onset SLE is characterized by a more active disease course and more frequent renal involvement compared with adult-onset SLE. Lupus nephritis (LN) is a major cause of mortality and morbidity both in adult and pediatric patients. Renal involvement has been reported to occur in 25–80% of pediatric SLE patients, either as an initial presentation or later in the disease course. In recent years there have been significant improvements in the diagnosis and treatment protocols for LN. However, the rate of renal remission is still suboptimal and the progress of LN is more aggressive in childhood, it is necessary to treat it properly. Glucocorticoids are still the most common drugs used to treat cSLE, and hydroxychloroquine is recommended for nearly all cSLE patients. In LN strict control of proteinuria and blood pressure is required with angiotensin-converting enzyme inhibitor and angiotensin receptor blockers. Mycophenolate mofetil or intravenous cyclophosphamide is suggested as induction therapy for LN classes III and IV. Calcineurin inhibitors appear to be another good option for cSLE patients with LN. Regarding B-cell-targeting biologic agents, rituximab may be used for refractory LN patients in combination with another immune suppressive drug. Furthermore belimumab was recently approved by the FDA for cSLE treatment, in children aged > 5 years. Anti-interferon therapies could be alternative treatments for pediatric patients with severe interferon-mediated inflammatory disease in the future. In contrast to adult LN, the data regarding long-term prognosis of pediatric LN are still very limited. Since the progress of LN is more aggressive in childhood, it is necessary to treat it properly.

IS049 / #98

Interdisciplinary Session

Interdisciplinary Session 11: Recent advances in the treatment of glomerulonephritis (ESPN Session)

08-10-2022 15:00 - 16:30

New immunosuppressive agents in anca associated vasculitis

S. Marks*

Department of Paediatric Nephrology, University College London Great Ormond Street Institute of Child Health, London, United Kingdom

Many clinicians rarely see children and young people presenting with anti-neutrophil cytoplasmic antibody-associated vasculitis (AAV). Treating children with AAV can be difficult with increasing immunosuppressive medications available in 2022. This lecture will include an overview of presentation of patients together with evidence-based recommendations for the management of AAV including granulomatosis with polyangiitis (GPA), microscopic polyangiitis (MPA), and eosinophilic granulomatosis with polyangiitis (EGPA). This will be highlighted with cases together with an overview of the literature with published data and systematic literature reviews focusing on how children and young people present, how to monitor their renal involvement and response to treatment.

IS050 / #196**ESPR Session****ESPR Session 12: Connectomics of the developing brain****08-10-2022 17:00 - 17:55****Neuronal connectivity in the preterm brain****U. Aden*, N. Padilla***Dept of Women's and Children's Health, Karolinska Institute, Stockholm, Sweden*

It is well known that children born extremely preterm, even in the absence of overt brain injury, are at increased risk for later cognitive, motor and behavioral difficulties that impact school performance and life. Using MRI, the impact of preterm birth on structural and functional organization of the developing brain has been investigated. The core topological features of the structural brain connectome are observed also in preterm born neonates, but at the same time they have decreased cortical-subcortical connectivity. The intrinsic functional networks in the human brain are also referred to as resting state networks, where precursors have been identified as early as in fetuses and preterm born in the second trimester. Although functional network topology to a large extent is preserved in preterm born infants, connectivity profiles has been shown to be altered. During childhood, the whole-brain structural and functional organization, is clearly different from the brain organization in term born children. The capability of brain regions to propagate local neural activity to the whole-brain network (*intrinsic ignition*) and the hierarchy of processing are thought to be fundamental for cognitive performance. Our recent report shows that global brain dynamics in children born extremely preterm are characterized by reduced intrinsic ignition events and altered hierarchy, with a predominance of primary sensory areas driving information processing, as opposed to full term controls, where the higher order networks drive processing. The disruption of brain dynamics during development, might lead to alternative developmental trajectories and subsequent brain dysfunction. These studies have implications for the potential understanding and future design of interventions for the cognitive difficulties in children born extremely preterm.

IS051 / #114

ESPNIC Session

ESPNIC Session 18: Life after sepsis

08-10-2022 17:00 - 17:55

Long-term outcomes after paediatric sepsis – The patient journey

C. Buysse*

Corinne Buysse, pediatric intensivist, Erasmus Medical Center, Picu, Rotterdam, Netherlands

The pathophysiological processes in pediatric sepsis may result in impairment of microvascular blood flow to the tissues leading to multiple organ failure. Fortunately mortality has decreased in recent years due to centralisation of PICU, introduction of vaccines, improvement of awareness and clinical guidelines for children with sepsis. As a consequence, the proportion of survivors with moderate or severe physical and/or (neuro)psychological sequelae has increased significantly, both short-term and long-term. Possible physical and/or (neuro)psychological sequelae are; skin scarring due to purpura, orthopaedic sequelae (amputation, lower limb-length discrepancy), neurological impairment (mental retardation with epilepsy, hearing loss), chronic renal failure, unfavourable health-related quality of life scores, neuropsychological impairments. A standard follow-up clinic should be organized as standard of care for septic shock survivors in order to provide adequate quality of care, both during their stay in the PICU and after PICU discharge. This follow-up has to be done by a multidisciplinary team including a pediatric intensivist and psychologist. Finally, structured multidisciplinary follow-up has financial implications; it requires structured resources.

IS052 / #121**ESPNIC Session****ESPNIC Session 19: Recognising life-threatening deterioration****08-10-2022 17:00 - 17:55****Paediatric early warning scoring – The art and science****O. Gawronski****Bambino Gesù Children's Hospital IRCCS, Medical Directorate, Rome, Italy*

Pediatric Early Warning Scores are interventions that operate as parts of whole hospital processes for the recognition and response to deteriorating children admitted to pediatric wards, including the organizational policies established on communication, escalation and staff training. PEWS are widely used despite the limited evidence on the effect on patient outcomes. When delivered in association to Rapid Response Systems there is some evidence of improved clinical outcomes, including children's unexpected deaths. On the other hand a randomized cluster clinical trial showed a significant effect of the BedsidePEWS on critical deterioration events but not on all cause hospital mortality. Successful implementation of PEWS may be influenced by PEWS characteristics and social-organizational factors. The type of trigger system or score, its complexity, predictive validity and adaptiveness to the local context may affect the system's uptake and ultimately its effect. PEWS implementation require organizational cultures promoting staff engagement in its customization, ward processes supporting team situational awareness and staff's continuing education on the prevention and escalation of care of deteriorating children. Electronic PEWS providing decision support and real time data available to entire teams are currently being researched and seem particularly promising in supporting the recognition and response to deteriorating children. Shared outcome measures including upstream measures, such as process, culture, parental involvement or situational awareness measures might support the process of evaluating PEWS.

IS053 / #122

EAP Session

EAP Session 20: Early origin of diseases- What is the role of the paediatrician

08-10-2022 17:00 - 17:55

The roots of adult diseases are in the pediatric age spectrum: What is the role of the pediatrician?

J.-C. Mercier*

Université de Paris, Paediatrics, Paris, France

There is good evidence that morbidity and mortality increase for adolescents following the move from paediatric to adult services. Effective transition has been shown to improve long-term outcomes. Central to this transition is a holistic programme that addresses the medical, psychological and social needs of the adolescent. Although the health systems are quite diverse between European countries and elsewhere, and numerous chronic diseases including rare diseases are identified during childhood, several studies have evaluated transition in the context of a specific medical condition, including diabetes mellitus, renal transplant, cancer, sickle cell disease, cystic fibrosis, epilepsies, mental health, degenerative muscular disorders, congenital heart diseases, arthritis, HIV, etc. Several key factors have consistently emerged for a successful transition: 1) the critical role of the paediatrician in planning the transition; 2) a full adhesion of the adolescent; 3) a smooth process with ideally joint outpatient clinics involving both the paediatrician and adult specialist; 4) a clear explanation of the disease and prospects of care/cure in the future; 5) a proactive psychological and social support, as the adolescent age is often characterised by both a sense of independence and loss of autonomy from parental authority. Many recommendations and/or questionnaires have been proposed for implementing a successful transition, including the "Triple Aim", "Ready Steady Go", HEADSS items, and NICE recommendations. Thus, adequate management of chronic illnesses in adolescence requires improving the transition process between children's to adults' services. The role of the paediatrician is central to achieve a smooth and successful transition.

IS054 / #245**ESPR Session****ESPR Session 21: Impact of discharge planning****08-10-2022 17:00 - 17:55****Early discharge planning improves safe transfer,
(Perspectives from parents and health
professionals)****K. De Bijl-Marcus^{1*}, F. Mossel², A. Van Den Hoogen¹, B. Pluut³,
S. Verbeek¹, K. Ahaus³, M. Benders¹, M. Buljac³**¹University Medical Center Utrecht, Neonatology, Utrecht, Netherlands²University of Humanistic Studies, Care Ethics, Utrecht, Netherlands³Erasmus University Rotterdam, Erasmus School Health Policy & Management, Rotterdam, Netherlands**BACKGROUND**

Transfer of infants from tertiary (NICU) to secondary neonatal care (SNC) departments is complex and often occurs under time pressure and a high workload.

AIMS

(1) The investigation and promotion of (perceived) safety during transfer by parents and caregivers from NICU and SNC departments. (2) Securing the outcomes in a learning culture.

METHOD

We conducted an appreciative action research and performed a Functional Resonance Analysis Method to visualize the transfer process as imagined versus working practice. The project group created improvement actions through: (1) focus group meetings (n=6) and interviews (n=16). (2) prospective

evaluation (surveys) of transfers by parents, ambulance personnel and caregivers of NICU and SNC departments. (3) surveys among parents (n=170) whose child had been transferred previously. (4) survey of perceived safety culture (NICU) at three time points.

RESULTS

Survey evaluations showed no difference in the perception of safety between parents and caregivers. In most cases, parents and caregivers thought safety was not compromised during transfer. Personnel of the SNC and parents often judged the timing of transfer suboptimal. Parents indicated that they felt less than optimally prepared for the transfer. Action research resulted in several improvement actions, like brochures, a transition conversation and tools for optimizing team reflexivity.

CONCLUSION

Parents and caregivers generally feel that safety is ensured during the transfer of infants from NICU to SNC departments. A standardized way of preparing parents and formal and informal collaboration/communication between referring and receiving facilities is essential in ensuring (the perception) of safety during this transfer process.

IS055 / #124**ESPNIC Session****ESPNIC Session 22: Thinking outside the box****08-10-2022 17:00 - 17:55****Time to abandon benzodiazepines in the intensive care unit?****S. Kudchadkar****Johns Hopkins University School of Medicine, Anesthesiology and Critical Care Medicine, Baltimore, United States of America*

Analgesia and sedation are foundational components of pediatric critical care. While opioids and benzodiazepines were indeed first-line for analgosedation in mechanically ventilated children, recent studies have demonstrated the potential harm of these medications for the developing brain and short and long-term functional outcomes. In this talk, Dr. Kudchadkar will present the current data surrounding use of benzodiazepines for sedation in the pediatric ICU and strategic approaches for optimizing sedation using nonpharmacologic interventions and multimodal analgosedative techniques to optimize liberation from mechanical ventilation and the PICU.

IS056 / #134**Educational Symposium****Educational Symposium 12: Paediatric critical care – Going beyond the usual suspects (ESPNIC Session)****09-10-2022 08:00 - 08:50****Implementing an early mobilisation programme in the PICU****S. Kudchadkar***

Johns Hopkins University School of Medicine, Anesthesiology and Critical Care Medicine, Baltimore, United States of America

Early mobilisation in the pediatric intensive care unit for critically ill infants and children is safe and feasible, with multiple potential benefits. However, mobilisation is often delayed due to concerns of patient safety and workload for staff. In this presentation, Dr. Kudchadkar will present the landscape of acute rehabilitation across the globe in PICUs and provide interprofessional strategies for optimizing “illness doesn’t mean stillness” for every child, every day.

IS057 / #131**Educational Symposium****Educational Symposium 13: Childhood vasculitides, how can we diagnose vasculitides in children/acute arthritis (EAP)****09-10-2022 08:00 - 08:50****5 Cases of pediatric vasculitis****Joan Calzada-Hernández****Department of Pediatrics, Pediatric Rheumatology Unit. Hospital Sant Joan de Déu, Barcelona, Spain*

Certain vasculitides are more common in childhood whereas ediatricians have already suggested classification criteria for IgA Vasculitis (IgAV) (Henoch Schonlein purpura (HSP)), Granulomatous Polyangiitis (GPA (Wegener Granulomatosis (WG)), Takayasu Arteritis (TA), Polyarteritis nodosa (PAN), Kawasaki disease (KD) and pediatric Behçet disease. In this session the first case will be IgAV (HSP), discussing the course and management of the disease in detail. The second case will be an infant with KD, in whom treatment options will be reviewed for severe cases. The SHARE recommendations will also be presented when discussing management. The third patient will be a child with a deficiency of ADA2 mimicking PAN. The fourth patient will be a TA patient presenting with unusual features whereas the final patient will be GPA (WG). Management and treatment of these patients will also be presented.

IS058 / #132**Educational Symposium****Educational Symposium 13: Childhood vasculitides, how can we diagnose vasculitides in children/acute arthritis (EAP)****09-10-2022 08:00 - 08:50****Differential diagnosis of arthritis in children****A. Ravelli****IRCCS Istituto Giannina Gaslini, Scientific Direction, Genoa, Italy*

The occurrence of arthritis in a child or an adolescent is common and may pose considerable diagnostic challenges. Although in most instances joint complaints are secondary to benign and transient disorders, in some cases articular symptoms may be due to a serious illness. Joint involvement may, indeed, be secondary to numerous and heterogeneous conditions, which include traumatic diseases, infectious or post-infectious illnesses, rheumatologic diseases, benign or malign neoplasms, clotting disorders, orthopaedic conditions, and psychogenic disorders. The correct diagnosis of the cause of arthritis requires a careful clinical evaluation, which includes a family and personal history, the careful examination of affected joints and a general physical exam. Selected laboratory tests and appropriate imaging investigations can be of great help in identifying the etiology of articular illness. In my lecture, I will present five cases of arthritis and will highlight, for each of them, the distinctive features and the main diagnostic clues.

IS059 / #263**Educational Symposium****Educational Symposium 14: NeuroNICU:
monitoring or neuroprotection (ESPR)****09-10-2022 08:00 - 08:50****NeuroNICU: Hope or hype****T. Austin****Department of Paediatrics, Cambridge University Hospitals NHS Foundation Trust, Cambridge, UK*

Brain injury remains one of the major unsolved problems in neonatal care, with survivors at high risk of lifelong neurodisability. It is unlikely that a single intervention can ameliorate neonatal brain injury, given the complex interaction between pathological processes, developmental trajectory, genetic susceptibility, and environmental influences. However, a coordinated, interdisciplinary approach to understand the root cause enables early detection, and diagnosis with enhanced clinical care offering the best chance of improving outcomes and facilitate new lines of neuroprotective treatments. This presentation takes a historical look at the development of adult neurocritical care and asks whether lessons can be learnt in the emerging field of neonatal neurocritical care. The brain orientated approach to the management of newborn infants at high risk of brain injury is divided into three categories: term infants with neonatal encephalopathy and seizures, extremely preterm infants and infants with rare neurological conditions which present in the neonatal period. Each group present unique challenges in terms of diagnosis, monitoring and treatment in the NICU. Developments in neuroimaging and neuromonitoring are explored as is the application of rapid whole genome sequencing to enable rapid diagnosis and the provision of integrated care bundles to optimise management of high risk infants.

IS060 / #264**Educational Symposium****Educational Symposium 14: NEURONICU:
monitoring or neuroprotection (ESPR)****09-10-2022 08:00 - 08:50****Assessing brain function in early human
development with fMRI****T. Arichi****Department of Perinatal Imaging & Health, King's College London, London, United Kingdom*

During the perinatal period, the human brain undergoes a rapid, complex, but highly programmed sequence of maturation during which the fundamental framework of the brain's lifelong organisation of structural and functional connections is established. The importance of this period is emphasised by the effects of acquired injury on this process, with clear implications of neurodevelopment as demonstrated by the increased rates of difficulties seen in infants born preterm or those with neonatal central nervous system pathology. Furthermore, it is increasingly recognised that the pathophysiology underlying psychiatric illness and neurodevelopmental conditions like autism, likely has its origins in the perinatal period. Recent advances in MRI methods, and particularly functional MRI, now enable detailed study of how brain activity first emerges during this crucial stage of early life. In addition to providing insight into how the brain's intrinsic framework of functional connections is established, the derived measures can also inform about the maturational trajectory of how different brain emerge (such as sensory processing or higher order cognitive processes), which can be linked to detailed measures of the developing brain's macro and microstructure. In this talk, the fundamentals of fMRI methodology will be discussed and the specific challenges of acquiring fMRI data from young infants considered. We will consider some of the insights that fMRI can provide about early brain development and pathology, and consider where the field could potentially move in the coming years. Finally, we will consider what can be learnt using new technologies such as ultra low field MR imaging.

IS061 / #127**Educational Symposium****Educational Symposium 15: Tips for optimising pain management in neonates (ESPR)****09-10-2022 08:00 - 08:50****Measuring pain in neonates****R. Slater****Department of Paediatrics, University of Oxford, DU, United Kingdom*

Infant pain has both short-term and long-term negative consequences but is under-treated and poorly understood, representing a significant clinical problem. Although hospitalised infants require frequent medical procedures, our understanding of the development of pain-related brain circuitry is poor, and evidence-based treatment options are relatively limited. Adequate pain treatment requires mechanistic understanding of the structural and functional development of human nociceptive circuitry. This is fundamentally important given infants cannot describe their pain, and we are reliant on alternative methods to quantify their pain experience. In this talk I will describe how recent scientific and technological advances in neonatal brain imaging can provide a platform to ask how intrinsic brain network connectivity affect noxious-evoked brain activity, behaviour and ultimately pain perception in the developing infant nervous system. I will describe how brain-imaging methods that have been used to provide insight into how noxious information is transmitted to the infant brain and how these approaches can be used in clinical trials to assess the analgesic efficacy of pharmacological and non-pharmacological pain-relieving interventions. I will describe a neonatal MRI study, where resting-state and diffusion MRI have been used to investigate inter-individual variability in noxious-stimulus evoked brain activity, and will highlight the impact of early-onset inflammation on neonatal pain sensitivity both during the acute inflammatory state and after the inflammation has resolved.

IS062 / #128**Educational Symposium****Educational Symposium 15: Tips for optimising pain management in neonates (ESPR)****09-10-2022 08:00 - 08:50****Current clinical practice vs regulatory evidence****A. Bhatt****Department of Paediatrics, University of Oxford, Oxford, United Kingdom*

The availability of licensed, paediatric medicines lags behind those for adults, and the younger the child, the fewer approved drugs are available. Given that most drugs, including simple analgesics, used in neonatal units are used off-label, it is important that drug information be obtained in neonates to address gaps in knowledge. This will lead to improved neonatal care, consistently applied use of drug formularies and potentially in neonatal medicines labelling. Healthcare professionals use their best judgement treat individuals in front of them. They are often left with no other option than to prescribe medicines outside the approved conditions for age, indication, dose, frequency and/or duration of use. Unapproved drug modification or compounding in pharmacies can also occur. Off-label and unlicensed drug use may result in altered efficacy rates and an increased risk of unintended harm. Regulators use a different logic when deciding to approve a drug or indication which needs a justification for an optimal dose for an intended population, supported by an appropriate clinical study with valid endpoints. Regulators often require a totality of evidence. However, there remain significant challenges, including a lack of basic science knowledge of disease mechanism for some conditions affecting neonates, an appropriate application of extrapolation and dose-ranging studies to paediatric populations. Nevertheless, collaborative research through paediatric trial networks, consortia and public-private partnerships, an increase in understanding of disease characteristics, variability

of children within target groups, characteristics of drug substance, pharmacogenomics, immunogenicity and deeper understanding of the drug product will equip clinicians with increased evidence resulting in greater confidence to manage their patients even in the absence of a sponsor seeking formal regulatory approval.

IS063 / #303

Educational Symposium

Educational Symposium 16: Debate - Pros and cons: Tongue tie (EAP)

09-10-2022 08:00 - 08:50

Panelist

S. Barak*

Dana-Dwek Children's Hospital, Pediatrics, Tel Aviv, Israel

I will start by saying that I am definitely for simple scissors frenotomies in cases of prominent anterior membrane tongue tie and that I think that in newborns with "classic ankyloglossia" the procedure should be performed as soon as possible as, if left untreated, the infant might hurt the mothers nipples and cause potential damage. Having said that, I believe that the current frenotomy epidemics is morally, medically, ethically and professionally unjustified and wrong. It is true that on the one hand the classic anterior tongue-tie, affecting 3-4% of newborns, has been typically overlooked by old clinicians as a cause of breastfeeding difficulty, and thus proper diagnosis and treatment were delayed or not given. But on the other hand, the present situation of overt promotion of surgical release of "posterior tongue-tie", "upper lip-tie" and "buccal tie" is, to say the least an exaggerated if not inappropriate medicalised intervention for breastfeeding problems. Promotion and support of breastfeeding is a painstaking blend of art and science. The efforts to enhance the performance of the breastfeeding mother and her baby's competence shouldn't be replace or easily sacrificed to the seduction of the medicalised silver bullet of unnecessary cutting. I will present in this pannel my position, that true systematic reviews show only weak evidence that frenotomies benefit breastfeeding babies and that while they are likely to underestimate the benefits of treating classic tongue-tie, they overestimate any benefits from frenotomy for posterior tongue-tie, because of definitional confusion. Research put forward to support the benefits of oral surgery is severely methodologically flawed. The results of pre-and post-frenotomy

questionnaires and chart reviews, are often provided by high profile providers of tongue surgery who promote the concepts of “posterior” tongue-tie, “upper-lip” tie and “aerophagia induced reflux” internationally even though these methodologies are notoriously prone to interpreter bias.

IS064 / #129

Educational Symposium

Educational Symposium 17: Staff and family well-being in the intensive care unit (ESPNIC)

09-10-2022 08:00 - 08:50

Staff wellbeing: Implementing evidence based approaches to support well-being initiatives

C. Tosin^{1*}, P. Chinchio², P. Biban³

¹University Hospital of Verona, Pediatric Intensive Care, Verona, Italy

²University of Verona, Medicine, Verona, Italy

³University Hospital, Pediatric Intensive Care, Verona, Italy

The etymology of the word manager comes from the Latin manus, meaning "hand." On this basis a manager should "take by the hand" his team, supervising and providing the necessary expertise. A nurse leader should foster this culture. Nowadays a nurse leader (NLs) plays a key role in running the frequent crisis and it's crucial to identify the way those could be handled. An amount of evidence regarding Health Care Workers (HCWs) and their reaction to a organization-related critical event have been published. Nevertheless, NLs involved in the crisis are often unable to know all latest evidence based strategies, lacking the potential benefit of advice and suggestions from other's experience in guiding their staff. The first aim of this work is to summarize which topics a nurse leader has to consider when dealing with a crisis. Secondly, the authors synthesize some strategies to approach these items. To deal promptly with crisis, NLs should define an efficient and effective Communication System, crucial in realizing all the other items. Without clear and prompt dissemination of information, the nursing group can't be compliant. Nurse leaders ought to know that during a crisis there is a need for greater supervision and control of all procedures actuation. Moreover, NL should support individuals as well as the entire staff group guaranteeing equally emotional and practical support. The development of nurses' training sessions will be a powerful helping in facing difficult situations. Collaborative decision-making, as well as effective and efficient communication, is a central theme in achieving better, endorsed and durable outcomes.

IS065 / #130**Educational Symposium****Educational Symposium 17: Staff and family well-being in the intensive care unit (ESPNIC)****09-10-2022 08:00 - 08:50****Preventing and managing family-staff conflict in the PICU****J. Manning***

Nottingham University Hospitals NHS Trust/University of Nottingham, Nottingham Children's Hospital/Centre for Children and Young People Health Research, Nottingham, United Kingdom

Paediatric critical care is a highly demanding and emotionally charged environment and specialty for those delivering and in receipt of care. High acuity and uncertainty, coupled with difficult decisions, grief, stress, and fatigue contribute to the PICU being a place where conflict can occur. This session will explore and conceptualise family-staff conflict within the PICU exploring modifiable and non-modifiable factors. The role of the family, the paediatric critical care team, and other health, social care and education professionals in preventing, minimising, and managing conflict will be discussed.

IS066 / #136**Educational Symposium****Educational Symposium 18: Appendicitis-conservative or surgical approach (EAP)****09-10-2022 08:00 - 08:50****The conservative approach to acute appendicitis: Pros and cons****I. Sukhotnik****Ichilov Hospital, Tel-aviv Sourasky Medical Center, Tel Aviv, Israel*

Since its introduction more than a century ago, appendectomy has remained the gold standard treatment for acute appendicitis. During the past decade, non-operative management (NOM) for simple acute appendicitis (SAA) in children has been proven safe with non-inferior complications rate. This systematic review was carried out to compare the efficacy and recurrence between initial NOM strategy and appendectomy in children with SAA following the Preferred Reporting Items for Systematic Reviews and Meta-Analyses (PRISMA) statement. Systematic searches of the PubMed, Cochrane Library, Embase, Web of science and Google Scholar databases. It was found that initial success rate of NOM for SAA in children is relatively high (more than 90%) and recurrence rate of appendicitis in NOM is relatively low (approximately 62-81 % of children who were treated nonoperatively did not require appendectomy after months of follow-up). Furthermore, the rate of complication was comparable in both treatment groups, and NOM did not appear to be associated with an increased risk of complications. NOM is feasible and cost-effective. Antibiotic therapy can be given safely in children with SAA. Large randomized trials are required to compare the long-term clinical efficacy of NOM vs appendectomy and to establish the characteristics of patients with SAA who are the best candidates for NOM.

IS067 / #137**Educational Symposium****Educational Symposium 19: If intra uterine growth is not optimal what is the impact? (ESPR)****09-10-2022 08:00 - 08:50****The consequences of IUGR in the term infant****J. Zeitlin***

Inserm, Université Paris Cité, Obstetrical Perinatal and Pediatric Epidemiology Research Team, Epopé, Paris, France

Late fetal growth restriction (FGR), commonly defined as FGR diagnosed after 32 weeks of gestational age, is less severe than early onset FGR, more complex to detect and less is known about its long-term consequences. A growing body of research suggests significant long-term neurodevelopmental consequences for infants affected by late FGR, including several recent systematic reviews and large population-based studies. This presentation will review this epidemiological literature to date and interpret its results in light of the difficulties of defining fetal growth restriction, determining its natural history during pregnancy and ascertaining whether observed associations of low weight with poor childhood neurological outcomes reflect causal relationships or other mechanistic pathways. Understanding these challenges is necessary for providing accurate information about prognosis to parents, identifying risk groups that could benefit from postnatal follow-up and early intervention programmes and for setting the agenda for aetiological research.

IS068 / #138**Educational Symposium****Educational Symposium 19: If intra uterine growth is not optimal what is the impact? (ESPR)****09-10-2022 08:00 - 08:50****IUGR in the preterm infant****O. Baud^{1,2*}**¹Inserm U1141, Developmental Neuroscience, Paris, France²Hôpitaux Univ Genève, Pediatrics, Geneva, Switzerland

Every year, 30 million infants worldwide are delivered after intra-uterine growth restriction (IUGR) and 15 million are born preterm. These two complications are the leading causes of ante/perinatal stress and brain injury responsible for neurocognitive and behavioral disorders in more than 9 million children each year. Our understanding of the clinical progression of IUGR including the neurodevelopmental outcomes has increased due to improved imaging techniques, such as Doppler and MRI. Both prematurity and IUGR are associated with perinatal systemic inflammation, identified to be the best predictor of subsequent neurological impairments. Perinatal inflammation, a key factor associated with vulnerability of the developing brain, is recognized to activate microglia, the resident macrophages of the central nervous system. Microglial cells can acquire distinct phenotypes in response to antenatal (IUGR) and perinatal (preterm birth) insults that allow them to not only disrupt developmental processes, ie. myelination, synaptic pruning, or axonal growth but also support repair and regeneration. IUGR may also potentiate some critical severe complications following preterm delivery involved in the abnormal trajectory of the brain maturation. The purpose of this talk is to recapitulate the evidence of noxious interaction IUGR and prematurity for the developing brain with a special focus on neuroinflammation and hormonal imbalance. The identification of therapeutic target to normalized microglia reactivity exposed to these two adverse conditions in the early phase of life is key to prevent the development of neurological disorders later in life.

IS069 / #139**Educational Symposium****Educational Symposium 20: Vasoactive drugs –
What's new? (ESPNIC)****09-10-2022 08:00 - 08:50****Choosing vasoactive drugs in 2022 – A physiology
based approach for infants and children****J. Urbano****Hospital General Universitario Gregorio Marañón, Pediatric Critical Care Medicine, Madrid, Spain*

Inotropes do not fix everything. They might help to improve the hemodynamic situation, although treating the leading cause if the cardiovascular derangement is essential. The choice of the correct vasoactive drug must be individualized and oriented to the underlying problem, specially focused on the status of systemic and pulmonary vascular resistances, and cardiac output (CO). Knowing the physiology of the heart and vascular system, the correct interpretation of hemodynamic monitoring, the pathophysiology of the underlying disease, and the side effects of the vasoactive drugs, would lead us to the correct choice of the cardiovascular support. Some physiological aspects of the systolic and diastolic phases of the heart cycle, and the components that participate in the cardiac output and delivery of oxygen, would help us to understand why some combinations are preferred over others. Inotropes are useful to increase contractility, although increasing the myocardial oxygen demand too, which should be matched with the oxygen supply. In the long term, some may induce the apoptosis of myocardial cells. Vasoconstrictors are used to increase vascular resistance and thus blood pressure, however they would jeopardize the stroke volume of a ventricle with a limited contractility, by increasing the afterload. End-organ tissue perfusion markers are preferred over arbitrary CO goals for titration of therapy. Perfusion pressure (that could be roughly approached by the gradient between mean arterial pressure and central venous pressure) is useful to guide the therapy.

IS070 / #140

Educational Symposium

Educational Symposium 20: Vasoactive drugs – What's new? (ESPNIC)

09-10-2022 08:00 - 08:50

Vaso-active drugs when on ECMO or CRRT

A. Amigoni*

Department of Mother and Child Health, University Hospital of Padova, Picu, Padova, Italy

ECMO and CRRT are extracorporeal devices adopted in critically ill patients, in some cases together. Vasoactive drugs are frequently necessary in these patients due to hemodynamic and /or respiratory insufficiency or to multiple organ failure. During V-A ECMO vasoactive drugs continue to be administered in the first hours and usually minimized subsequently. During V-V ECMO inotropes can be necessary during all the treatment, also if the improvement of the oxygenation may reduce the hemodynamic insufficiency especially through the improving of coronary perfusion. In the phase of weaning from the V-A or V-V support vasoactive drugs may be used to keep the patient at the best organ perfusion performance during a such critical process. In CRRT, vasoactive drugs are often administered. Frequently, doses are increased at the beginning of the treatment due to the possible hypotension during the connection phase. The use of special filters, usually adopted with CRRT devices, has been reported to reduce the need of inotropes due to the mechanism of absorption of cytokines and other toxins and inflammatory molecules. PK of drugs can be altered in extracorporeal devices: Volume of distribution increases, clearance decreases, $T_{1/2}$ increases. Lipophilicity, protein binding and Volume of distribution are drug characteristics involved in PK modification along with other factors such as fluid loss, PH, PCO₂, temperature, O₂. Moreover, drug absorption, distribution, excretion can be altered due to patients' organ failure. Some inotropes have been evaluated in ex-vivo or in vivo studies, but literature is scarce and definitive recommendations are not available.

IS071 / #142**Educational Symposium****Educational Symposium 21: Fluid is drug (ESPNIC)****09-10-2022 08:00 - 08:50****Balanced solutions vs crystalloids – Which is better?****F. Valla^{1,2,3*}**¹*Hospices Civils de Lyon, Pediatric Intensive Care, Lyon-BRON, France*²*Hospices Civils de Lyon, Pediatric Intensive Care, BRON, France*³*Lyon university children hospital, Hospices Civils de Lyon, Pediatric Intensive Care, Bron, France*

Normal saline 0.9% is an isotonic solution commonly prescribed as an intravenous maintenance fluid therapy (IV_MFT), even if its chloride content is quite different from the chloride plasma concentration. Hyperchloremia is frequently associated with its use in acutely and critically ill children and has been associated with increased morbidity-mortality. The composition of balanced solutions is close to plasma electrolyte concentrations: the excess of chloride content is reduced by the addition of other organic anions such as lactate, acetate, malate, gluconate or citrate. Some of these organic anions will serve as buffers as they are bicarbonate precursors. ESPNIC metabolism endocrinology and nutrition section conducted a systematic review and meta-analysis to assess the role of balanced solutions. This project was conducted by a multidisciplinary expert group following the SIGN grading method to produce guidelines. Five databases were searched for studies, in acutely and critically children, published until November 2020. A series of recommendations was derived and voted on by the expert group to achieve consensus through two voting rounds. 11 studies met the inclusion criteria, and 3 recommendations could be produced. Outcome reporting was inconsistent among studies. Consensus within the expert group was high, but recommendations generated were based on a heterogeneous level of evidence. Main recommendations are to favor the use of balanced isotonic solutions over standard crystalloids in most hospitalized children. Lactate buffer should be used with caution in case of liver failure.

IS072 / #143

Educational Symposium

Educational Symposium 22: High-flow nasal cannula: How and when? (ESPNIC)

09-10-2022 08:00 - 08:50

How does HFNC work?

C. Milesi*

CHU Arnaud de Villeneuve, Picu, Montpellier, France

High flow oxygen with adequate humidity requires an open system; the cannula must not cover more than half of the nostril diameter. HFNC reduces the breathing effort, it decreases the airway resistance and improves inspiratory flow within the upper airway, and thus it can reduce the breathing effort. It improves the muco-ciliary function, compared with dry and cold airflow HFNC reduces the bronchoconstriction. It improves the wash out of the nasopharyngeal dead space. It reduces rebreathing, and CO₂ removal. It provides a positive pressure to the airway creating a "gentle CPAP" effect. Nevertheless, this effect is not essential and HFNC should not be used for lung recruitment.

IS073 / #144**Educational Symposium****Educational Symposium 22: High-flow nasal cannula: How and when? (ESPNIC)****09-10-2022 08:00 - 08:50****Using HFNC in patients: When and how – A practical approach****A. Medina Villanueva****Hospital Universitario Central de Asturias, Paediatrics (PICU), Oviedo, Spain*

In recent years, the ease of application and safety of HFNC has meant it has spread to treat different paediatric conditions (such as: bronchiolitis, asthma and pneumonia). The clinical results of this change in care are highly controversial.

There are 8 systematic reviews and meta-analysis which included 3 to 27 studies comparing HFNC with low-flow nasal cannula (LFNC) and/or NIV. The general conclusions suggest that HFNC is safe as an initial therapy in the respiratory management of bronchiolitis. HFNC can be superior to LFNC in terms of treatment failure, but it is not cost-effective as a primary treatment. In addition, HFNC appears to be associated with a higher risk of treatment failure and possibly, an increased risk of intubation and mortality in comparison to CPAP.

There are only two RCTs comparing HFNC vs LFNC in patients with asthmatic crisis in the Paediatric emergency department which show any clinical benefits, nor did it diminish the stay time.

Chisti et al published a RCT in patients with hypoxemic respiratory failure secondary to pneumonia. The failure of the treatment and mortality were lower in the bubble CPAP group compared to conventional oxygen therapy or HFNC. This study had to be stopped before finalising the recruitment due

to the clear benefit of CPAP over the rest. Modesto et al in a Bayesian analysis found that HFNC has a higher mortality than bubble CPAP in these patients.

In conclusion, the indication for HFNC should be individualised and there should never be a delay to start other more effective therapies. This is of paramount importance in situations of moderate and severe respiratory failure.

Table 1

Author	Journal	N	Conclusions
Lin J	Arch Dis Child. 2019;104:564-576	9	OAF is safe as an initial respiratory management, but the evidence is still lacking to show benefits for children with bronchiolitis compared with SOT or nCPAP.
Morcel E	Eur J Pediatr. 2020;179:711-718	7	HFNC is a safe mode of respiratory support that can be positioned between SOT and nCPAP . HFNC seems the most appropriate rescue therapy for children with bronchiolitis who are not adequately supported by SOT. There are insufficient data to support the use of HFNC therapy for all children with bronchiolitis admitted to hospital because of hypoxemia and respiratory distress.
Tung G	J Trop Pediatr. 2021;67:fmaa128	27	CPAP for the initial respiratory management significantly benefit children with bronchiolitis. the delivery of CPAP by helmet may be a better choice. More high-quality research is needed to confirm the conclusion.
Dalydd C	BMJ Open Respir Res. 2021;8:e000844	23	OAF is superior to SOT in terms of treatment failure and there is no significant difference between OAF and CPAP in terms of treatment failure . The results suggest OAF is safe to use in acute hospital settings.
Zhao X	Front Pediatr. 2021;9:759297	6	OAF appears to be associated with higher risk of treatment failure and possibly, an increased risk of need for intubation and mortality .
Cataño-Jaramillo ML	Med Intensiva (Engl Ed). 2022;46:72-80	3	In moderate/severe bronchiolitis CPAP demonstrated a lower risk of therapeutic failure and a longer time to failure. But more adverse events like nasal injury. There were no differences in other variables.
Cao J	Transl Pediatr. 2022 Apr;11:547-555	7	HFNC treatment provides the same improvement in arterial oxygen partial pressure as standard oxygen therapy or transnasal positive airway pressure treatment , but it is significantly better at improving the respiratory rate of children with bronchiolitis
Buonifia JA	Pediatr Pulmonol. 2022 Sep 13.	5	CPAP is cost-effective, over the HFNC , in infants with severe-moderate bronchiolitis in Colombia. Our study provides evidence that should be used by decision-makers to improve clinical practice guidelines and should be replicated to validate their results in other countries.

IS074 / #157**ESPNIC Session****ESPNIC Session 23: Do we really need separate cardiac intensive care units?****09-10-2022 11:00 - 12:20****Cardiac intensive care provision for neonates and children across Europe****A. Hoskote***

Great Ormond Street Hospital for Children NHS Foundation Trust, Paediatric Cardiac Intensive Care, London, United Kingdom

This talk will cover the current landscape of cardiac intensive care provision for neonates and children in Europe. The results of the international European survey of demographics, distribution of the type of advanced care provision, training and research focus in the paediatric ICUs that care for children with heart disease will be described. The heterogeneity of care provision and the scope for future initiatives such as standardisation of paediatric cardiac ICU training, QI collaboratives, and developing a research forum and the vital role of societies such as ESPNIC and allied interdisciplinary societies will be explored. An opportunity for collaboration across Europe using the ESPNIC as a platform for engagement will be highlighted.

IS075 / #160

EAP Session

EAP Session 24: Preschool wheezing symposium

09-10-2022 11:00 - 12:20

Childhood wheezing: What is new?

A. Valiulis*

Institute of Clinical Medicine, Vilnius University Faculty of Medicine, Clinic of Children's Diseases, Vilnius, Latvia

BACKGROUND AND AIMS

Almost 14 years have elapsed from the first publication and 8 years from the revised version of the ERS Guidelines on preschool wheezing (Brand P, 2008 & 2014). Our survey aimed to evaluate what has been perceived as the most important research developments during the years after the 2014 Guideline renewal.

METHODS

Letters with the request to indicate the 3 most important publications in the preschool wheeze adding a short comment on the choice were sent to opinion-leading academic pediatric pulmonologists including active co-authors of the ERS Guidelines.

RESULTS

Answers from 11 (H index 43-115) of 30 invited pediatric pulmonologists were received. There was almost no consensus in the selected papers. In contrast, looking at the comments on the choices there were more similarities than differences. The major recent research developments indicated were

as follows: no distinctions in lower airway inflammation between multiple trigger wheeze and episodic viral wheeze (1), rhinovirus, but not RSV caused acute bronchiolitis can be a marker for chronic asthma and response to OCS (2), first successful attempt to personalize wheeze therapy was done with old instruments – skin prick tests and blood eosinophil count (3), more evidence that some phenotypes of preschool wheeze can be related to the COPD (4), cluster analysis is a new instrument to move from phenotype to endotype based stratification, indicating the necessity to change the taxonomy (5).

CONCLUSIONS

More than a decade after the publication of the first ERS Guidelines we are still a long way from understanding and management of the preschool wheezing syndromes.

IS076 / #161**EAP Session****EAP Session 24: Preschool wheezing symposium****09-10-2022 11:00 - 12:20****Cystic fibrosis: Is it a vanishing disease?****A. Bush***

Imperial College and Royal Brompton Hospital, Paediatric Respiratory Medicine, London, United Kingdom

The landscape of CF care has been transformed by newborn screening and the advent of gene subtype specific modulator therapies. However, Paediatricians forget CF exists at their patients' peril! Diagnosis There are numerous screening protocols across Europe, and none are perfect. The diagnosis may be missed for multiple reasons, including failure to collect the blood spot, laboratory error, and that the screening test was genuinely non-diagnostic, especially in pancreatic sufficient CF. Thus alertness to the possibility in children with atypical 'asthma', recurrent respiratory infections and bronchiectasis is essential. Treatment Many CFTR mutations are amenable to modulator and potentiator therapies, but not those with Class I (no CFTR synthesized) and Class VII (no mRNA produced) mutations. Also, although patients with phe508del are dramatically improved by triple therapy, this is not necessarily true for other Class II mutations, for whom standard CF therapy is all that can be offered, and continued meticulous attention to detail is essential. Furthermore, with the exception of ivacaftor, molecular therapies are not licensed in babies. Although the aim must be starting modulator treatment at diagnosis, for most babies we must deploy standard therapies to preserve nutrition and lung function for at least 2 years. Also, we do not yet have the evidence to know what standard treatments can be stopped when modulators are started. Finally, although modulators reduce CF complications, they do not abolish them. Paediatricians and patients must continue to take CF seriously!

IS077 / #154**ESPR Session****ESPR Session 25: New focus of family-centred care****09-10-2022 11:00 - 12:20****Core outcomes measures of family-centred care:
Are we measuring the right thing?****A. Axelin****Department of Nursing Science, University of Turku, University of Turku, Finland*

Family-centered care (FCC), defined as a partnership between the family and NICU staff, is considered the current evidence-based practice in neonatal nursing. The aim of FCC is infant well-being and optimal health. This goal is achieved through shared responsibility and negotiation between staff and parents, parent autonomy and control, and support for the family. FCC interventions have been shown to improve the quality of FCC, parent-infant closeness, parenting skills, knowledge, and self-efficacy. These positive changes can be linked to improved infant outcomes, such as weight gain, shorter length of hospital stay, and fewer readmissions. Most important, FCC interventions have improved parental mental health (e.g., stress, depression), which in its turn has resulted in improved parent-infant interaction and improved infant long-term developmental outcomes. The measured outcomes and measurement tools used are various and many. In addition, the relationships between outcomes are not well studied. Donabedian's framework for assessing the quality of care provides one systematic approach to examine the relationships among FCC outcomes. The framework consists of 1) structure (context of care) (e.g., unit architecture, staff education/skills and resources), 2) processes (actions) (e.g., degree of parent participation, parent-staff interaction), and 3) outcomes (effects of FCC) (e.g., parent and infant health and well-being). Outcomes are considered the most important indicators of quality, and they should be defined by families. In this presentation, I will suggest some core outcomes for structure, processes, and outcomes. In addition, I will critically evaluate the commonly used tools' validity and reliability to measure these outcomes.

IS078 / #155**ESPR Session****ESPR Session 25: New focus of family-centred care****09-10-2022 11:00 - 12:20****Music therapy to improve outcome****J. Latour^{1,2*}**¹University of Plymouth, Faculty of Health, Plymouth, United Kingdom²Department of Nursing, Hunan Children's Hospital, Changsha, China

This session aims to discuss the barriers and enablers of delivering music therapy in the PICU and NICU. The session will be interactive to generate a wider debate on non-pharmacological interventions such as music therapy. The session will also clarify the terms of 'music therapy' and 'music intervention', which is a common misunderstanding. The session will explain the role of music therapist in PICU and/or NICU. At the end of the session the delegates will be convinced that delivering any form of music therapy or music intervention is beneficial for the health outcomes of critically ill infants and children. Take home message is: There are no barriers in playing music, just do it! And don't forget to involve parents to make to a personalised music intervention.

REFERENCES

Liu MH, Zhu LH, Peng JX, Zhang XP, Xiao ZH, Liu QJ, Qiu J, **Latour JM**: Effect of Personalized Music Intervention in Mechanically Ventilated Children in Pediatric ICU: A Pilot Study. *Pediatr Crit Care Med* 2020;21(1):e8-e14.

Latour JM; Kentish-Barnes N, Jacques T, Wysocki M; Azoulay E; Metaxa V: Improving the Intensive Care experience from the perspectives of different stakeholders. *Critical Care*. 2022;26:218.

Zhang R, Tang Q, Zhu HL, Ming X, Peng MX, Zhang N, Xiong EY, Chen HM, Chen LK, Luo D, Li X, Latour JM; Testing a family supportive end of life care intervention in a Chinese neonatal intensive care unit: A quasi-experimental study with a non-randomized controlled trial design. *Front Pediatr*. 2022;10:870382.

IS079 / #220**ESPNIC Session****ESPNIC Session 26: Using artificial intelligence in the daily care of critically ill children****09-10-2022 11:00 - 12:20****Possibilities and pitfalls of ai in the PICU****J. Nijman****University Medical Center Utrecht, Pediatric Intensive Care, Utrecht, Netherlands*

Every second, ever-increasing amounts of electronical data are acquired in pediatric and neonatal intensive care unit (ICU) patients. Artificial intelligence (AI) can be used to detect patterns in these clinical data streams, facilitating diagnostic and prognostic modelling on big datasets. Implementation of such models in daily ICU practice may for example, provide new means of monitoring, risk prediction and 24/7 decision support. Successful examples of the application of AI on ICU data include mortality and cardiac arrest prediction and the identification of new sepsis phenotypes. A hallmark of clinical ICU data is its time-dependency. Conventional statistical methods may be less suitable to analyse these big clinical time series data. However, application of advanced AI techniques also has challenges, which are mostly related to model complexity and the use of unlabelled observational data. Commonly applied AI, such as deep learning, may result in highly complex models, which take considerable computing power to develop and limits implementation in daily clinical care. Furthermore, AI-based ICU models are mostly based on observational time series (e.g. vital parameters, laboratory measurements, etc.), which provide several challenges to the statistical modelling. These include heterogeneity (e.g. age- and weight-based differences), missing data (e.g. an infrequently measured laboratory parameters versus a per-second heart frequency), repeated measurements, and confounding, such as treatment effects. Despite these challenges, AI techniques provide new possibilities for the pediatric and neonatal ICU population. To accelerate actual clinical implementation, minimal complexity and prospective validation of new AI models should be pursued.

IS080 / #221**ESPNIC Session****ESPNIC Session 26: Using artificial intelligence in the daily care of critically ill children****09-10-2022 11:00 - 12:20****Using big data to predict patient outcome****R. De Jonge****Department of Pediatrics and Pediatric Surgery, Erasmus MC, Intensive Care Unit, Rotterdam, Netherlands*

The use of big data and AI to predict outcome in clinical care is booming. With the increasing access to extensive datasets of patient data and improving machine learning techniques possibilities seem endless. But what are the pitfalls in the development, validation and use of prediction models built with machine learning? How can the quality of the data be evaluated and monitored? Which outcomes lend themselves well for machine learning, and is performance of these models better than classic clinical assessment of caregivers? Are there specific pain points for using machine learning in pediatrics and pediatric critical care? In this presentation, an overview of the fast moving field of machine learning in pediatrics will be provided and will these questions be addressed.

IS081 / #148**ESPR Session****ESPR Session 27: Optimizing therapeutics in preterm infants****09-10-2022 11:00 - 12:20****State of the art drug treatment****A. Smits***

Department of Development and Regeneration Ku Leuven, University Hospitals Leuven, Neonatal Intensive Care Unit, Leuven, Be, Belgium

Challenges in innovative neonatal pharmacology research Pharmacotherapy is an important tool to prevent and cure medical conditions. Treating the neonatal population is hereby challenging, due to fast physiological changes both within and between neonates impacting drug disposition (pharmacokinetics, PK) and drug effects (pharmacodynamics, PD). Pharmacokinetics handles the concentration-time relation of a drug (hereby distinguishing absorption, distribution, metabolism, and excretion), while PD handles the concentration-effect relationship. Consequently, developmental physiology needs to be considered during drug treatment and drug development. Predictive PK/PD modeling approaches can guide drug dosing in this patient population. However, prospective validation of model-based drug dosing regimens is a necessary step towards precision dosing. The sequential approach to achieve this, will be illustrated with frequently used antibiotic drugs like aminoglycosides and glycopeptides. The implementation of innovative model-informed precision dosing tools in clinical care further adds to reach the optimal dose, at each time, for each individual neonate. Besides development, also non-developmental factors impact neonatal PK/PD. To illustrate the effect of disease on neonatal PK/PD, the condition of perinatal asphyxia treated with therapeutic hypothermia will be discussed. The search for optimal drug dosing, the challenges of physiology-based PK modeling (I-PREDICT project)*, and of conducting clinical research in this field will be handled. Finally, the

hurdles (e.g. inclusion rates) as well as opportunities (e.g. neuromonitoring for PD evaluation) which can be experienced in (long term outcome) drug trials are illustrated.

**The research line on clinical pharmacology during therapeutic hypothermia is supported by FWO Flanders (I-PREDICT project, G0D0520N).*

IS082 / #149**ESPR Session****ESPR Session 27: Optimizing therapeutics in preterm infants****09-10-2022 11:00 - 12:20****Individualized medicine in newborns****R. Flint^{1,2*}**

¹Department of Pediatrics, Erasmus MC-Sophia Children's Hospital, Division of Neonatology, Rotterdam, Netherlands

²Department of Hospital Pharmacy, Erasmus University Medical Center, Rotterdam, Netherlands

Precision medicine can be defined as a structured approach to treat or prevent specific diseases based on inter-individual variability in genes (like polymorphisms), diseases (like gender, comorbidity), environment (like drug exposure, nutrition), or lifestyle (like stress). This concept also holds the promise to improve management (prevention or treatment) and subsequent outcome in critically ill newborns. Precision medicine (subgroup approaches) hereby serves as go between empirical (one treatment fits all) or stratified medicine (e.g., disease state or sex), and individualized (every newborn is unique) medicine. The translation to individualized dosing utilizes drug attributes (e.g., narrow therapeutic index, PK/PD variability), disease state characteristics (e.g., extent of morbidity and/or mortality) as well as patient-specific factors (e.g., organ function, gene variants), to optimize drug therapy. Several approaches for individualization of pharmacotherapy have already been implemented, although they still leave room for further optimization: 1) Therapeutic Drug Monitoring, 2) Availability of high frequency efficacy or safety data, 3) Combinations of parameters in algorithms to predict risks and treatment success. To really make the transformation from personalized pharmacotherapy to individualized, a significant improved evaluation of therapy is required. We need to be able to agree on better outcomes for effectiveness of treatment, what are the specific targets for neonates and for preterms? Besides, the awareness for safety is yet lacking, are we familiar with the side-effects to be expected with each drug and drug-drug interactions?

IS083 / #158**ESPNIC Session****ESPNIC Session 29: Update in paediatric respiratory critical care****09-10-2022 11:00 - 12:20****A paediatric specific pards definition: What have we learned?****Y.M. López Fernández****Cruces University Hospital, Pediatric Critical Care, Bilbao, Spain*

Acute Respiratory Distress Syndrome (ARDS) is a heterogeneous clinical syndrome that contributes to still high rates of mortality and long-term disability. Data from a study of 145 international pediatric intensive care units (ICUs) highlight that more than 3% of children admitted to ICUs meet this definition of ARDS, with an overall mortality of 17%, although higher than 30% for severe ARDS. In addition, some PARDS-related studies have shown that the application of PALICC criteria varies markedly among PICUs, and data suggest that noncompliance with recommendations, especially regarding ventilator management, is associated with increased mortality.

For years, pediatric clinicians have relied on adult-oriented criteria to diagnose ARDS in children until 2015, when the Pediatric Acute Lung Injury Consensus Conference (PALICC) came out with a specific definition for pediatric ARDS (PARDS) and clinical guidelines for its management. However, the large amount of knowledge published on ARDS in previous years demands a refinement of the definition of ARDS and an update of the clinical guidelines. In addition, a wider application of the PALICC criteria in the pediatric ICUs is strongly needed. Therefore, a new PALICC-2 was convened with the aim of providing a contemporary update of the definition of ARDS.

IS084 / #159**ESPNIC Session****ESPNIC Session 29: Update in paediatric respiratory critical care****09-10-2022 11:00 - 12:20****Ventilator-induced diaphragm dysfunction****M. Ijland****Radboud University Medical Center, Department of Intensive Care Medicine, Nijmegen, Netherlands*

Ventilator-induced diaphragm dysfunction develops in the majority of mechanically ventilated critically ill adults and may be associated with prolonged duration of mechanical ventilation, difficult weaning and even increased mortality. Growing evidence also supports the development of critical illness-associated diaphragm weakness in critically ill children. Research in this field with the focus on the critically ill child will be discussed. Several mechanisms can potentially lead to ventilator-induced diaphragm dysfunction, including ventilator over-assistance, under-assistance, eccentric contractions and end-expiratory shortening. Besides mechanical ventilation, other risk factors for critical illness-associated diaphragm weakness have been identified and will be mentioned. In addition, respiratory monitoring techniques to facilitate a diaphragm-protective ventilation approach will be discussed.

IS085 / #153

EAP Session

EAP Session 30: How early life infections and gluten amount may modulate the risk of celiac disease

09-10-2022 11:00 - 12:20

Food allergy

S. Kolaček*

Children's Hospital Zagreb, Referral Center for Pediatric Gastroenterology, Hepatology and Nutrition, Zagreb, Croatia

Food allergy is defined as an immunologically mediated clinical response that occurs reproducibly upon exposure to a specific food. It affects children and adults with an increasing prevalence which varies from 3% to 10%, often lasting throughout the life. It is therefore an important public health problem which impairs quality of life and incurs a high economic burden. In the majority of developed countries 90% of all food allergic reactions are caused by only 8 food allergens: cow's milk, soya, egg, fish, shellfish, peanut, tree-nuts and wheat. Although a precise etiopathogenesis is still unravelled, an interaction of specific genes with environmental factors, mediated by epigenetic mechanisms, provides a plausible explanation. A dual allergen exposure hypothesis proposes that if the first exposure to food allergens occurs epicutaneously, instead via intestinal mucosal immune system, it is associated with food allergy development. Diagnosis should be based on a diagnostic elimination of the potentially offending food allergens, followed by a challenge test. If there is a clear history of the severe immediate reaction, diagnosis could be made without the challenge. Strict dietary avoidance of incriminated allergens is the only well-established management strategy. Concerning primary prevention of food allergy, avoidance of food allergens is not efficacious during pregnancy or lactation, and is therefore not recommended. Similarly, timely

introduction of diversified diet, including early introduction of allergenic foods (however not before 17 weeks of life), is commonly recommended by the current guidelines not only in healthy infants but also in infants with atopic predisposition.

IS086 / #79

ESPNIC Session

ESPNIC Session 31: How COVID-19 impacts clinical trials in the paediatric intensive care unit

09-10-2022 11:00 - 12:20

How COVID-19 is changing the ICU world – Implications for future paediatric trials

P. Ramnarayan*

Surgery and Cancer, Imperial College London, London, UK

The COVID-19 pandemic has been a transformative event in the history of modern medicine. As a pandemic, all parts of the world were affected, and there was an urgent imperative for countries to work together across boundaries rapidly to share knowledge, create guidelines, enter patients into clinical trials and generate translatable findings. Large international clinical trials such as SOLIDARITY were established by the WHO, which showed that remdesivir, hydroxychloroquine and other new drugs had no beneficial effects on mortality. Older, more established drugs such as dexamethasone and tocilizumab were repurposed for the treatment of COVID-19, and were shown in the RECOVERY and REMAP-CAP platform trials to save lives. The crucial importance of clinical trials to rapidly generate evidence to support treatment decisions was highlighted throughout the pandemic. However, when it came to the novel paediatric inflammatory multisystem syndrome MIS-C, the opportunities that COVID-19 trials provided for adults were not fully capitalised on - no randomised trials of the commonly used treatments, immunoglobulin and steroids, were ever reported, leaving a large evidence gap in paediatric critical care. Looking to the future, lessons from the pandemic would dramatically improve our ability to conduct and complete paediatric clinical trials. First, the pandemic has highlighted the importance of building links between established research networks in various regions to rapidly step up and collaborate if and when another urgent health problem presented itself in the future. Second, the experience of platform trials such

as REMAP-CAP in testing multiple interventions within the same framework to generate knowledge rapidly (rather than running several sequential trials, which are costly and resource-intensive) has shown how our trials can benefit from adopting a platform approach where possible. Finally, the era of biomarker-driven stratified clinical trials is coming, and adding bioresources as part of future clinical trials is going to be imperative for our speciality.

IS087 / #71**ESPR Session****ESPR Session 32: Growth & body composition****09-10-2022 11:00 - 12:20****Preterm infants growth****M. Johnson***

Department of Neonatal Medicine, University Hospital Southampton NHS Foundation Trust, Southampton, United Kingdom

Infants born before 32 weeks' postmenstrual age are at a high risk of growth failure. International guidelines have long recommended that they match the growth of an equivalent fetus, despite the challenges posed by ex utero life and comorbidities of prematurity. Whether such a target is desirable in terms of both short and longer term outcomes remains the subject of debate. There may be potential neurodevelopmental benefits of enhanced growth during the neonatal period, but at the same time work in term infants suggests that rapid growth in early life may increase the risk of non-communicable diseases such as metabolic syndrome in adulthood. Defining a pattern of growth which optimises outcomes in preterm infants is therefore complex. This talk will explore current approaches to growth assessment in preterm infants, and the use of different growth charts and standards in this context. Recent evidence for definitions of optimal growth in preterm infants in relation to outcomes will also be explored, together with the evidence around current patterns of growth in preterm infants, current recommendation for nutrient intake in these infants, and how these can be achieved. Potential strategies for approaching and optimising growth in preterm infants will also be discussed.

IS088 / #72**ESPR Session****ESPR Session 32: Growth & body composition****09-10-2022 11:00 - 12:20****Body composition****H. Van Goudoever****Amsterdam UMC, Emma Children's Hospital, Amsterdam, Netherlands*

The prevalence of childhood obesity and overweight has increased tremendously over the last 2 decades. The prevalence among European children aged 2 to 13 years has been estimated at 21.3% as of 2016. The first months of life represent an important window for the programming of obesity. Infant feeding may permanently alter the risk of obesity, and has therefore been a key focus of many observational and intervention studies. There is evidence to suggest that protein intake during the first months of life has long-lasting effects on growth, body composition, and obesity risk. A potentially effective strategy to target obesity is reduction of protein intake in early life. This presentation will focus on evidence of such interventions on alterations in body composition throughout early childhood.

IS089 / #183**Interdisciplinary Session****Interdisciplinary Session 13: Procedural sedation
(ESPA Session)****09-10-2022 15:00 - 16:30****Procedural sedation by anesthesiologists****N. Najafi****Department of Anaesthesia and Perioperative Medicine, University Hospital Brussel, Brussel, Belgium*

The increasing number of procedures and their complexity in pediatrics have significantly increased the needs and the involvement of several providers to optimize performance of procedural sedation and analgesia (PSA). PSA has clearly invaluable benefits to children, their parents and professional care providers and it should be considered as a multidisciplinary activity. In this respect, the contribution of both pharmacological and non-pharmacological modalities also needs to be underlined. Practical issues however, may make PSA challenging and may compromise peri-procedural safety. The learning objectives of this talk are how to improve safety and to overcome barriers that are related to 1) Child's profile, 2) Procedure- related considerations, 3) Positioning of child during procedure, 4) Appropriate locations for PSA, and 5) Requirements for institutional facilities.

IS090 / #184**Interdisciplinary Session****Interdisciplinary Session 13: Procedural sedation (ESPA Session)****09-10-2022 15:00 - 16:30****Non-invasive methods for sedation in children****J. De Graaff****Erasmus MC, Anesthesiology, Rotterdam, Netherlands*

Sedation has been suggested a less invasive alternative technique for general anaesthesia and is defined as a drug induced state which varies in depth and can also be provided by non-anaesthesiologists. The depth of sedation is a continuum from minimal sedation/analgesia, while being responsive to verbal commands, to deep sedation while unresponsive to pain stimulation and maintaining spontaneous ventilation as well as cardiovascular function, and ending with general anaesthesia. This continuum reflects the practical difficulty to distinguish deep sedation from general anaesthesia. Sedation can be administered via multiple routes, such as the oral, rectal, or intranasal route. Traditionally, tracheal intubation or laryngeal mask should not be necessary for sedation. The drugs and protocols described in current literature for sedation illustrates an uncertainty as to which agents should be utilized. There is a broad mix of diagnostic and therapeutic procedures varying between electro-encephalogram (EEG), dental procedures, gastroscopy, PICC placement, CT, and MRI. However, each indication for sedation has typical conditions and requirements which differ most importantly in time, intensity of stimuli and effect of movement. At last, sedation techniques using intravenous infusion have been shown to be suitable, but less desirable for children because of the invasive procedure of intravenous cannulation. This lecture will provide an overview of the existing literature concerning sedation of children aged 0-8 years for procedures using minimal-invasive pharmacological techniques.

IS091 / #187**Interdisciplinary Session****Interdisciplinary Session 14: Early diagnosis and new therapies in neuromuscular diseases (Catalan paediatric society session)****09-10-2022 15:00 - 16:30****Spinal muscular atrophy****D. Gómez Andrés^{1*}, M. Alvarez-Molinero¹, L. Costa Comellas¹, L. Ventura¹, E. Toro², F. Munell¹**¹Hospital Universitari Vall d'Hebron, Child Neurology, Barcelona, Spain²Hospital Universitari Vall d'Hebron, Pediatric Rehabilitation, Barcelona, Spain

Spinal muscular atrophy (SMA) is a rare, genetic, neurodegenerative disorder that is featured by severe progressive axial, limb, respiratory and bulbar weakness that reflect the loss of spinal and brainstem motor neurons. It is produced by the lack of SMN expression due to mutations in the SMN1 gene (mainly, homozygous deletions). Several therapeutic strategies have recently emerged and changed the devastating landscape we used to have in this disorder. Different approaches have been developed for increasing SMN expression. Antisense oligonucleotides and small molecules to modify the defective expression of SMN by SMN2 gene and viral gene therapy have been introduced in the management of these patients allowing long-term replacement of SMN expression. SMN-independent approaches are now under research. SMA can now be considered as a paradigm of the success for the development of useful strategies with a high impact on the natural history of pediatric neurologic disorders, but also as an example of the challenges which we will have to face in the years to come. Our objective in this presentation is to show the audience the different therapeutic approaches we have now in SMA therapeutics and the likely advances we will have in the early future, but also discuss the challenges and barriers that we are facing (cost, complexity, ethical problems, newborn screening,...) and how we think we will be able to tackle them.

IS092 / #188**Interdisciplinary Session****Interdisciplinary Session 14: Early diagnosis and new therapies in neuromuscular diseases (Catalan paediatric society session)****09-10-2022 15:00 - 16:30****Duchenne muscular dystrophy****A. Nascimento Osorio****Neuromuscular Unit, Neurology Department, Hospital Sant Joan de Déu, Barcelona, Spain*

Duchenne muscular dystrophy is an X-linked recessive neuromuscular disorder with onset in infancy, characterized by a progressive muscle weakness, with an incidence of 1 in 3500-6000 newborn males. It is caused by mutation of the DMD gene, which encodes dystrophin, a sub-sarcolemmal protein essential for the stability of the muscle membrane. Genetic defects of the DMD gene are divided into deletions (65%), duplications (5.10%) and punctual mutations (10-15%). There is currently no curative treatment. The multidisciplinary medical care and corticosteroids indicated in early stages of the disease have been shown to modify the natural history of the disease, but persistent loss of muscle tissue and function and premature death are inevitable. Several clinical trials have been conducted in the last 10 years but only few molecules have shown a modest effect on delaying disease progression. In this context, one of the most promising therapeutic strategies for DMD is represented by adeno-associated virus (AAV)-mediated gene therapy. DMD gene therapy is based on the administration of exogenous micro-dystrophin, a miniature version of the dystrophin gene that lacks unnecessary domains and encodes a truncated but functional dystrophin protein. Safety and long-term impact are the main challenge to move forward in the coming years. We must be prepared to face the era of gene therapy, as it is essential to know the advantages and limitations, to manage the expectations of patients, relatives and the health care system. Through this presentation I will make an update regarding the situation of gene therapy in Duchenne muscular dystrophy and the challenges for the coming years.

IS093 / #168**Interdisciplinary Session****Interdisciplinary Session 15: Symptom control in complex chronic conditions (EAPC Session)****09-10-2022 15:00 - 16:30****Symptom control in children with cancer****A. Lacerda****Instituto Português de Oncologia de Lisboa Francisco Gentil, Pediatrics, Lisboa, Portugal*

Children with cancer experience a high symptom burden, from the beginning of illness throughout treatment and eventually to end of life. This simple fact adds to the distress faced by families and contributes to short- and long-term psychosocial effects, in some cases akin to posttraumatic stress disorder. As such, it is of the utmost importance that the interdisciplinary team caring for the child with cancer is attentive to symptom control, either these arise from the disease itself or represent adverse effects from treatments (chemotherapy, surgery, radiotherapy, immunotherapy). Pain is the most common symptom, followed by gastrointestinal ones (nausea, vomiting, mucositis, constipation,...), but fatigue, sleep disturbance, anxiety and depression also take their toll in the daily life of children with cancer. The first steps for a successful approach are awareness and evaluation – the team must not only recognize the presence and severity of the symptom but also its relevance to the child and family's quality of life, and thus systematically address and measure symptoms. This is key not only to call attention to problems that may be improved upon but also to monitor the effect of interventions. Other critical aspects are the possibility of preventing some treatment-related side effects and the fostering of child-family education and empowerment. In this talk, we will review the most common symptoms thru the disease trajectory of children with cancer, discuss how to evaluate them and present the most common effective preventative or therapeutic interventions, including complementary and integrative treatments.

IS094 / #169**Interdisciplinary Session****Interdisciplinary Session 15: Symptom control in complex chronic conditions (EAPC Session)****09-10-2022 15:00 - 16:30****Symptom control in children with neurological conditions****M. Agud De Dios****Hospital Universitario Niño Jesús, Unidad De Atención Integral Paliativa Pediátrica, Madrid, Spain*

Children with severe neurological conditions suffer from multiple symptoms which impact their quality of life. Symptom control may be challenging in a heterogeneous population, which includes many rare diseases, progressive conditions without curative therapy, and oftentimes children without a definitive diagnosis. As speech is frequently impaired, attention must be paid to behaviors that express discomfort and thorough examination is necessary to find their underlying cause. Chronic pain may affect up to 70% of children with cerebral palsy. Multimodal analgesia, beyond pharmacological treatment of nociceptive pain, is a fundamental tool to face the often multifaceted sources of pain of these children. New insights concerning treatment of neuropathic and mixed pain, and the role of adjuvants, continue to evolve, yet evidence remains scarce. Treatment of seizures, spasticity, dystonia and dysautonomia must be driven by aims considering the best child's interest and balancing risks and benefits. Eventually, children with severe neurological conditions may deteriorate from disease progression or suffer from frailty even in static lesions such as cerebral palsy. Therefore, respiratory symptoms may become the most burdensome and eventually deadly complications and require thorough assessment. Decision-making in this situation, especially regarding ventilation, becomes challenging. In recent years, much attention has been paid to digestive tract symptoms in this population, as interrelation between the gut and the central nervous system becomes increasingly recognized.

IS095 / #175**Interdisciplinary Session****Interdisciplinary Session 16: Update in infectious diseases (Catalan pediatric society session)****09-10-2022 15:00 - 16:30****SARS-CoV-2 and other respiratory viruses in childhood: Predictive models for their diagnosis and epidemiological evolution**

A. Soriano-Arandes^{1*}, A. Perramon², C. Andrés³, J. Antoñanzas², J. Vila⁴, M. Chiné⁵, N. Visa-Reñé⁶, A. Gatell⁷, N. Worner⁴, M. Vilà De Muga⁸, M. Biosca⁹, G. Ricós¹⁰, P. Serrano⁷, C. Valdepérez⁷, N. Rius¹¹, G. Ruiz¹², R. Conti¹³, M. Poblet¹⁴, R. Capdevila⁹, N. Magro¹⁵, X. Bruna¹⁶, M. Villalobos¹⁷, E. Mora¹⁸, A. Moreira¹⁹, O. Salvadó²⁰, R. Martín²¹, M. Planells²², I. Soler²³, E. Lera⁴, A. Sánchez²⁴, E. Solà²⁵, Z. Lobato²⁶, A. Vidal²⁷, N. López²⁸, M. Ruiz²⁹, B. Pujol³⁰, D. Canadell³¹, A. Martínez-Mejías¹⁵, I. Zambudio³², L. Sanz³³, E. Macià³⁴, M. Esteller³⁵, I. Sau³⁶, M.À. Rifà³⁷, L. Aulet³⁸, P. Sala³⁹, E. Alcover⁴⁰, M. Coma⁴¹, M. Marco⁴², C. Franco-Jarava⁴³, P. Soler-Palacin¹, D. López-Codina², A. Anton³, C. Prats²

¹Hospital Universitari Vall d'Hebron, Paediatric Infectious Diseases and Immunodeficiencies Unit, Barcelona, Spain

²Universitat Politècnica de Catalunya, Physics, Castelldefels, Spain

³Hospital Universitari Vall d'Hebron, Microbiology, Barcelona, Spain

⁴Hospital Universitari Vall d'Hebron, Paediatrics, Barcelona, Spain

⁵Institut Català de la Salut, Abs Almacelles, Almacelles, Spain

⁶Hospital Universitari Arnau de Vilanova, Paediatrics, Lleida, Spain

⁷Institut Català de la Salut, Equip Pediatria Territorial Alt Penedès-garraf, Vilanova i la Geltrú, Spain

⁸Institut Català de la Salut, Pediatria Línia Pediàtrica Horta, Barcelona, Spain

⁹Institut Català de la Salut, Abs Les Borges Blanques, Borges Blanques, Spain

¹⁰Institut Català de la Salut, Equip De Pediatria Drassanes, Barcelona, Spain

¹¹Hospital Universitari Sant Joan de Reus, Paediatrics, Reus, Spain

¹²Pediatria dels Pirineus S.C.C.L.P., Cap La Seu D'urgell, La Seu d'Urgell, Spain

¹³Parc Taulí Hospital Universitari, Paediatrics, Sabadell, Spain

¹⁴Institut Català de la Salut, Equip Territorial Pediàtrica Sabadell Nord, Sabadell, Spain

- ¹⁵*Consorti Sanitari de Terrassa, Paediatrics, Terrassa, Spain*
- ¹⁶*Institut Català de la Salut, Eap Baix Berguedà, Puigreig, Spain*
- ¹⁷*Institut Català de la Salut, Cap Concòrdia, Sabadell, Spain*
- ¹⁸*Hospital Mútua de Terrassa, Paediatrics, Terrassa, Spain*
- ¹⁹*Hospital de Martorell, Paediatrics, Martorell, Spain*
- ²⁰*Institut Català de la Salut, Cap Llibertat Reus, Reus, Spain*
- ²¹*CAP Marià Fortuny, Paediatrics, Reus, Spain*
- ²²*Institut Català de la Salut, Eap El Clot-sant Martí, Barcelona, Spain*
- ²³*Institut Català de la Salut, Eap Navàs-balsareny, Balsareny, Spain*
- ²⁴*CAP Les Hortes, Paediatrics, Barcelona, Spain*
- ²⁵*Institut Català de la Salut, Eap Vic Nord, Vic, Spain*
- ²⁶*Hospital Althaia Manresa, Paediatrics, Manresa, Spain*
- ²⁷*Consorti Sanitari del Maresme, Paediatrics, Mataró, Spain*
- ²⁸*Hospital Universitari del Mar, Paediatrics, Barcelona, Spain*
- ²⁹*Hospital General Universitari de Vic, Paediatrics, Vic, Spain*
- ³⁰*Hospital General de Granollers, Paediatrics, Granollers, Spain*
- ³¹*Institut Català de la Salut, Cap Barberà Del Vallés, Barberà del Vallés, Spain*
- ³²*Hospital Universitari Igualada, Paediatrics, Igualada, Spain*
- ³³*Institut Català de la Salut, Cap Seròs, Lleida, Spain*
- ³⁴*Institut Català de la Salut, Cap Manlleu, Manlleu, Spain*
- ³⁵*CAP L'Aldea-Camarles-L'Ampolla, Paediatrics, Tortosa, Spain*
- ³⁶*Institut Català de la Salut, Eap Santa Coloma De Farners, Girona, Spain*
- ³⁷*Institut Català de la Salut, Eap Tona, Vic, Spain*
- ³⁸*EAP Vic Sud, Paediatrics, Vic, Spain*
- ³⁹*Hospital General de Catalunya, Paediatrics, Sant Cugat del Vallés, Spain*
- ⁴⁰*Hospital Tremp-Pallars, Paediatrics, Tremp, Spain*
- ⁴¹*Hospital Universitari Joan XXIII, Paediatrics, Tarragona, Spain*
- ⁴²*Institut Català de la Salut, Cap Maragall, Barcelona, Spain*
- ⁴³*Department of Immunology, Hospital Universitari Vall d'Hebron, Barcelona, Spain*

BACKGROUND

Clinical characteristics of SARS-CoV-2 infection are mostly mild and nonspecific. Additionally, we do not know how will be the epidemiological interaction of SARS-CoV-2 and other respiratory viral infections (RVI) over next years. We aimed to determine the new epidemiological patterns of COVID-19 and other RVI to understand their dynamics providing predictive models, and to build up a profile of children with COVID-19 to differentiate it from other RVI.

METHODS

Data analysis of weekly incidence for SARS-CoV-2 and other RVI was used for the adaptation of the models to the new epidemiological context. We created a clinical predictive model following deep learning techniques, and prospective observational studies of children with COVID-19 and/or other RVI provided virological, immunological, and severity data to determine the strains, biomarkers, and severity factors in this population, respectively.

RESULTS

For the epidemiological model, a Gompertz equation was adjusted to SARS-CoV-2, RSV and Influenza (figure), with successful fittings for different epidemic waves and a reliable short-term prediction capability ($R^2 > 0.9$). For the clinical model, AUROC=0.65 was obtained to predict a COVID-19 diagnosis in children using a machine learning algorithm. Absence of high-grade fever and loss of taste or smell were the major predictors of COVID-19 in younger and older children, respectively.

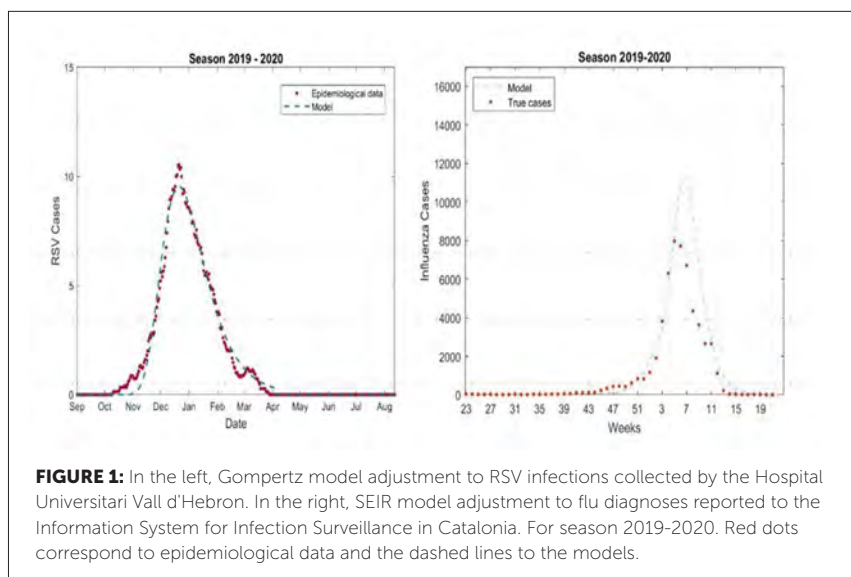

CONCLUSIONS

Empirical models to predict RVI epidemic waves have a good performance. The accuracy of clinical models was lower than expected but can provide a diagnosis when epidemiological data on the risk for COVID-19 is unknown. Multidisciplinary professional networks are needed for clinical interpretation of the data.

IS096 / #176**Interdisciplinary Session****Interdisciplinary Session 16: Update in infectious diseases (Catalan pediatric society session)****09-10-2022 15:00 - 16:30****Biomarkers of endothelial activation for the risk stratification and prognosis anticipation of febrile patients****Q. Bassat****Barcelona Institute for Global Health, Isglobal, Barcelona, Spain*

Fever is the leading reason to seek healthcare globally, with over 1 billion cases of febrile illness occurring in children annually. The vast majority of infections are uncomplicated and self-limited and can be treated conservatively. A few (<1%) are life-threatening but are often challenging to identify early in the course of illness. Our project challenges the current *status quo* and inefficiencies of triaging practices. We propose to develop and validate **a rapid triaging tool** to determine, objectively, quantitatively and with high precision those patients at risk of dying, so as to prioritize their care. **The breakthrough solution lies in the ENDOTHELIUM**, a newly recognized **in vivo biosensor**, which plays a critical role in our defense against pathogens. Endothelial cell activation and subsequent loss of integrity is **a common pathway of injury in several life-threatening infections**, including sepsis, malaria, or even COVID-19. Measuring specific mediators of this pathway (sTREM-1, Ang2, etc.) at first clinical presentation can reliably identify individuals at risk of dying, irrespective of the disease causing the fever, and more robustly than previously known predictors such as clinical algorithms or "classic" biomarkers. Importantly, these pathways are also "druggable", thus allowing the testing or re-purposing of specific interventions to improve outcome. We will design and produce a RTT (glucometer-like) that quantitatively measures the two markers with best predictive performance (sTREM-1 and Ang2). We will then incorporate it into

2 clinical trials (to be done in Mozambique, Gabon and Ethiopia) to 1) verify the improved performance of the proposed PoC RTT in risk-stratifying and predicting mortality among paediatric patients when compared to standard of care, and 2) test whether a specific intervention (**nutritional supplementation of L-Citrulline**), guided by biomarker results, improves (vs. placebo) long-term outcomes and survival after hospital discharge. Hereby, we will review the state-of-the-art on biomarkers and project protocol.

IS097 / #233

Interdisciplinary Session

Interdisciplinary Session 17: Research with children - Benefits and pitfalls (EAPC and ESPR Session)

09-10-2022 15:00 - 16:30

Selection criteria, effect sizes, and outcome measures in neonatal clinical trials: How do we find what we are looking for?

G. Greisen*

Rigshospitalet, Neonatology, Copenhagen, Denmark

The nature of the dilemma is 'What is really important and what can we realistically do?' Insufficient statistical power is the primary reason for meta-analyses of the effect of neonatal interventions to conclude that there is low evidence of benefit. A common ambition is to demonstrate improved outcomes after the neonatal period, typically at two years of age – or even later. But to demonstrate, say an improved chance of survival without moderate-or-severe neurodevelopmental deficit from 80% to 85% requires 2500 participants at 90% power. Who would embark on a large trial with less than 90% chance of finding an important effect? Even smaller effects may be worthwhile. Another dilemma is that we want to do the trial in a strictly defined type of patients to address a well-defined pathology, and this may mean that it will be hard to recruit the necessary numbers of participants. Or that we want to make sure that outcomes are measured to the very best standard, so only a few NICUs can join a multicenter trial. Much time and energy should be spent in finding the best compromise among these constraints. Perhaps more randomised trials should aim at establishing evidence for the effect of intervention at smaller steps in the causal pathways.

IS098 / #234**Interdisciplinary Session****Interdisciplinary Session 17: Research with children - Benefits and pitfalls (EAPC and ESPR Session)****09-10-2022 15:00 - 16:30****Ethical challenges when researching with children****J. Mendes****ERISA SCHOOL - IPluso, Lisbon, Nursing Education, Aqualva, Portugal*

Conducting research in the pediatric age might confront clinicians and researchers with additional ethical challenges. Children can be acknowledged as one of the most vulnerable populations, especially in the scenario of a life-threatening or a life-limiting condition and in end-of-life care. This vulnerability status claims the researcher's responsible for the protection of the vulnerable. This presentation with focuses on some of the main challenges in designing and developing research in pediatrics in a broader way. Some of the challenges can include: the decision for the topic on analysis and the study design (the small numbers of children and the need for developmentally appropriate outcome measures in different ages, balance between potential benefits and burdens), the informed consent (the complexities of promoting children autonomy, according to with their cognitive status and age, and parental involvement and family decision making as needed) or the submission to the IRB (framing special ethical and regulatory protections for children). Research in children is essential. Ethical concerns, respecting the main regulatory documents, national and international, are one of the most important aspects to be aware of when planning and developing research in pediatrics.

IS099 / #231

Interdisciplinary Session

Interdisciplinary Session 18: Update in paediatric radiology (Catalan paediatric society)

09-10-2022 15:00 - 16:30

Imaging of child abuse

I. Barber*

Hospital Sant Joan de Déu, Diagnostic Imaging, Esplugues de Llobregat, Spain

Child abuse or nonaccidental trauma is a major problem worldwide and diagnostic Imaging has a key role in its diagnosis. The triad consisting of subdural hematoma, metaphyseal fracture, and posterior rib fractures is very characteristic of the battered child syndrome. Fractures of long bones in patients who have yet begun to walk should also alert to possible child abuse. Lesions that are highly specific for abuse, such as classic metaphyseal fractures or posterior rib fractures, can be difficult to demonstrate radiographically and are usually clinically occult. The American College of Radiology (ACR) and the European Society of Pediatric Radiology protocols recommend obtaining a high-resolution X-ray skeletal survey. It is important to use X-ray systems that give high resolution images with low kilovoltage (50-70 kVp) and appropriate milliamperage. A skeletal survey consisting of a series of images collimated to each body region is recommended for all children under the age of two years in whom abuse is suspected. A follow-up skeletal survey about two weeks after the initial survey is useful for detecting new fractures and for assessing the consolidation of others, which helps in dating the lesions. Head injuries are the leading cause of death in abused children. Although computed tomography is the first neuroimaging technique in nonaccidental trauma, magnetic resonance imaging of the head and spine can better characterize brain injuries and can help to estimate the age of the lesions.

IS100 / #232**Interdisciplinary Session****Interdisciplinary Session 18: Update in paediatric radiology (Catalan paediatric society)****09-10-2022 15:00 - 16:30****Advances in paediatric brain imaging in epilepsy****J. Muchart****Hospital Sant Joan de Déu - Barcelona, Diagnostic Imaging, Esplugues de Llobregat, Spain*

Epilepsy is one of the most common neurological disorders in children. Together with electro-clinical analysis, neuroimaging plays a key role in its diagnosis and management. Neuroimaging can help in identifying the pathological substrate as well as aiding in accurate localization of the seizure onset area. We will review state-of-the-art structural and functional imaging techniques, advanced imaging modalities and combined postprocessing algorithms.

IS101 / #181

Interdisciplinary Session

Interdisciplinary Session 19: Infant and family-centred developmental care before and during the COVID-19 pandemic (EFCNI Session)

09-10-2022 15:00 - 16:30

Infant and family-centred developmental care (IFCDC) in times of COVID-19 – A global parent survey

J. Kostenzer*, C. Von Rosenstiel-Pulver, J. Hoffmann, A. Walsh, S. Mader, L. Zimmermann

European Foundation for the Care of Newborn Infants, Scientific Affairs, München, Germany

INTRODUCTION

This global study explores parents' experiences regarding the impact of the restrictions on key characteristics of infant and family-centred developmental care (IFCDC) during the first year of the COVID-19 pandemic.

METHODS

For this cross-sectional study, a pre-tested online survey with 52 questions and translated into 23 languages was used to collect data between August and November 2020. Parents of preterm or sick infants born during the pandemic and receiving special/intensive care were eligible for participation. Data analysis included descriptive statistics and statistical testing based on different levels of restrictive measures.

RESULTS

In total, 2103 participants from 56 countries provided interpretable data. Fifty-two percent of respondents were not allowed to have another person present during birth. Percentages increased with the extent of restrictions in the respondents' country of residence. Twenty-one percent of total respondents indicated that no-one was allowed to be present with the infant receiving special/intensive care. The frequency and duration of permitted presence largely depended on the extent of restrictions. The more restrictive the policy measures were, the more the respondents worried about the pandemic situation during pregnancy and after birth.

CONCLUSION

COVID-19 related restrictions severely challenged evidence-based cornerstones of IFCDC, such as separating parents/legal guardians and their newborns. Our findings must therefore be considered by public health experts and policy makers alike to reduce unnecessary suffering, calling for a zero separation policy. In cooperation with the EFCNI COVID-19 Zero Separation Collaborative Group.

IS102 / #458

Interdisciplinary Session

Interdisciplinary Session 19: Infant and family-centred developmental care before and during the COVID-19 pandemic (EFCNI Session)

09-10-2022 15:00 - 16:30

Supporting mums and dads in odd times – Going the extra mile during COVID-19

A. Van Den Hoogen*

University Medical Center Utrecht, Wilhelmina Childrens Hospital, Neonatology, Utrecht, Netherlands

Parenting is one of the most important jobs anyone can do. Every step in parenting brings questions, uncertainties and difficult choices. However clear conversations about challenges of parenting are not often discussed—especially it is difficult when a parent or child is struggling.

This session aims to discuss parenting support during COVID time and the extra mile caregivers went. This also include recent literature of research done in this COVID 19 period but also how creative the extra mile was given to moms and dads. It also give some examples of how practice was done.

At the end of the session the delegates have discovered the importance of involving parents in care and supporting them even when times are tough. Take home message: in time of crisis and reduced visitation, it needs to be ensured that creative and innovative thinking and acting is necessary. Peer support among parents is key.

IS103 / #459**Interdisciplinary Session****Interdisciplinary Session 19: Infant and family-centred developmental care before and during the COVID-19 pandemic (EFCNI Session)****09-10-2022 15:00 - 16:30****Supporting parents as essential caregivers during the SARS-CoV-2 pandemic and beyond****N.R. Van Veenendaal^{1,2*}, A. Deierl³, F. Bacchini⁴, K. O'Brien⁵, L. Franck⁶**¹AmsterdamUMC, Pediatrics, Amsterdam, Netherlands²Department of Neonatology, OLVG, Amsterdam, Netherlands³Imperial College Healthcare NHS Trust, Neonatology, London, United Kingdom⁴Canadian Premature Babies Foundation, Na, Etobicoke, Canada⁵Mount Sinai Hospital, Neonatology, Toronto, Canada⁶University of California San Francisco, School of Nursing, San Francisco, United States of America

At the beginning of 2020, as a consequence of the SARS-CoV-2 pandemic and paucity of knowledge around SARS-CoV-2, hospitals and healthcare systems acted swiftly to put in place measures intended to reduce viral spread. Much of the focus was on adult care. The essential and irreplaceable benefits of parental caregiving in neonatal and pediatric services were often not considered. The SARS-CoV-2 pandemic response resulted in significant changes in neonatal unit policies and restricting parents' access and participation in neonatal care. Breastfeeding, parent-infant bonding, participation in caregiving, parent mental health and staff stress were negatively impacted. We will review the evidence supporting the safety of maintaining family integrated care practices and the negative effects of restricting parental participation in neonatal care during the SARS-CoV-2 pandemic. We will highlight how to respond in a better way to future health emergencies and we will discuss how we can (re)instate families as full partners in neonatal care delivery.

IS104 / #185

Interdisciplinary Session

Interdisciplinary Session 21: Recent advances in complement blockade (ESPN Session)

09-10-2022 15:00 - 16:30

New advances of complement blockade in aHUS

M.G. Ariceta*

University Hospital Vall d'Hebron, Pediatric Nephrology, BARCELONA, Spain

Atypical hemolytic uremic syndrome (aHUS) is an ultrarare disease, with an incidence of 1-9:1.000.000 caused by dysregulation of the alternative complement (C³) pathway at the surface of endothelial cells. Pathogenic mechanism is explained by increased C3 convertase production and/or reduced degradation that results in excessive C3b deposits on the endothelium membrane surface, local C5 activation and C5b-9 or terminal complement complex formation, and subsequently cell lysis. aHUS is a disease characterized by thrombotic microangiopathy (TMA) which is defined by the concurrent triad of non-immune microangiopathic hemolytic anemia, thrombocytopenia, and vital organ damage, most frequently the kidney. The course of the disease is characterized by recurrence episodes alternated with remission periods. Clinical manifestations may be very heterogeneous due potential systemic involvement. aHUS can be sporadic or familial (10-15% of cases), and at least in 50–60% of aHUS patients an inherited and/or acquired C³ anomaly is observed. Natural history of the disease was characterized by severe outcome. Approximately, 29 and 56% of children and adults with aHUS, respectively, progressed to renal failure or died within one year. In addition, those with preserved renal function continued suffering relapses, 30% within the first year after disease onset. Recurrence after kidney transplant with early graft loss was the rule in most cases. Eculizumab is the first in class complement blocker drug, effective in every specific C³ anomaly in patients with aHUS. Eculizumab has changed the natural history of aHUS, substantially improving patient survival and outcome from the historic treatment with plasma exchange or infusion. However, eculizumab treatment administered every 2 weeks

on maintenance could be intrusive for patient life. Recently, Ravulizumab a new complement C5 inhibitor, which was engineered from eculizumab, has demonstrated similar efficacy than eculizumab but sustained C5 inhibition, that allows dosing every 4-8 weeks.

IS105 / #186**Interdisciplinary Session****Interdisciplinary Session 21: Recent advances in complement blockade (ESPN Session)****09-10-2022 15:00 - 16:30****The role of complement blockade in C3 glomerulonephritis****F. Emma***Division of Nephrology, Bambino Gesù Children's Hospital, Rome, Italy*

C3 glomerulopathies (C3G) are a group of rare glomerular diseases characterized by C3 depositions in the glomeruli. Two different entities that can be recognized by electron microscopy. In "C3 glomerulonephritis" (C3GN) deposits are restricted to the sub-endothelial space and to the mesangium, whereas in dense deposit disease (DDD) C3 depositions are predominantly intramembranous. In addition, atypical forms of acute post-streptococcal glomerulonephritis are also classified as C3G. From the histological standpoint, the disease may present as membranoproliferative, mesangioproliferative, crescentic and/or endocapillary glomerulonephritis. They are caused by a dysregulation of the complement alternative pathway that occurs primarily in the fluid phase. The complement defect may be caused by autoantibodies (C3 nephritic factor, C5 nephritic factor, C4 nephritic factor, Anti-CFH, Anti-CFB, Anti-C3b) or by genetic pathogenic variants of complement factors (CFH, C3, CFI, MCP/CD46, CFHR) causing unrestricted activation of the complement cascade. Treatment of C3G is often symptomatic and includes the use of prednisone, mofetil micofenolate, calcineurin inhibitors, and ACEi/ARBs, in particular in patients with significant glomerular inflammation, proteinuria, and/or autoantibodies. More recently, understanding the physiopathology of C3G diseases has led to develop new strategies to block selectively the alternative complement pathway at the C3 or at the C5 convertase levels. These approaches are still under investigation and will be illustrated.

IS106 / #240**Interdisciplinary Session****Interdisciplinary Session 22: Update in paediatric pulmonology (Catalan pediatric society)****09-10-2022 15:00 - 16:30****Interstitial lung disease in children****I. Iglesias Serrano****Hospital Universitari Vall d' Hebron, Neumología Pediátrica Y Fibrosis Quística, Barcelona, Spain*

Interstitial lung diseases or diffuse parenchymal lung diseases refer to a group of heterogeneous respiratory disorders, that are rare in children, and can cause high morbidity from the early stages of life. Although its definition and classification has always been a challenge, we mainly refer to illnesses that present with dysfunction or damage of those components included in gas exchange such as respiratory bronchioles, the pulmonary alveoli and the extracellular matrix and cells, including those pulmonary vascular disorders that can masquerade pulmonary parenchymal diseases. Its prevalence in children is lower than in adults. However, it seems to have been underestimated since recent studies showed an incidence up to 8 new cases per million children every year, and a prevalence of 46 cases per million children. The clinical manifestations vary from severe and acute respiratory failure to milder and insidious symptoms, including shortness of breath, dry cough or failure to thrive, or even being asymptomatic. Besides the usual physical respiratory findings such as tachypnoea, inspiratory crackles, pectum excavatum and retractions, other manifestations suggestive of underlying systemic diseases should be searched (joint pain, rashes, neurological or abdominal abnormalities). The main diagnostic tools in the diagnosis evaluation of these disorders are: chest imaging (High Resolution Computed Tomography), pulmonary function tests, bronchoalveolar lavage, lung biopsy and blood tests (for screening of immune and genetic diseases). The general management involves respiratory support to avoid hypoxemia and hypoventilation, optimal nutrition and immunizations. Pharmacological therapy includes steroids, hydroxychloroquine, macrolides and other immunosuppressive and antifibrotic agents.

IS107 / #241

Interdisciplinary Session

Interdisciplinary Session 22: Update in paediatric pulmonology (Catalan pediatric society)

09-10-2022 15:00 - 16:30

Primary ciliary dyskinesia

S. Rovira Amigo*

Hospital Materno-Infantil Vall d'Hebron, Paediatric Pulmonology Department, Barcelona, Spain

Primary ciliary dyskinesia (PCD) is a rare disease, occurring in 1/7,500 newborns. It is characterized by an alteration in ciliary structure and function that prevents the correct clearance of respiratory secretions. Clinical manifestations include productive cough, chronic rhinitis, recurrent otitis, recurrent bronchitis and pneumonias, bronchiectasis, male infertility, situs inversus (50%), and heterotaxy (6-12%). This disease is difficult to diagnose, and the process is based on a combination of different tests. The European Respiratory Society propose nasal nitric oxide (nNO) as a screening test (low levels), and a combination of these techniques for the diagnosis: High-speed videomicroscopy (HSVM), which analyzes ciliary beat frequency and pattern, Transmission Electron Microscopy (TEM) to analyze the cilia ultrastructure and genetic tests (at present, just over 50 genes associated with PCD are described). Immunofluorescence study of ciliary proteins is a promising technique, although it has not yet been included in the diagnostic recommendations. Currently, there aren't specific guidelines for PCD management. Its management includes pulmonary treatments to improve mucociliary clearance and prevent infections and oto-rhino-sinusoidal treatments.

IS108 / #192**ESPNIC Session****ESPNIC Session 34: COVID-19 collateral damage****09-10-2022 17:00 - 17:55****The effect of the COVID-19 pandemic on medical training****Z. Gyorgyi****ESPNIC, Trainee Representative, Budapest, Hungary*

Why is it worth staying for a COVID-related talk at the very end of this long day? Because there is a story with a silver lining. We would like to get you inspired using an innovative new format. We would like to unfold how a global pandemic actually brought our medical community closer despite isolation, hardship and despair. We would like to proudly show you the perspectives of our learners, educators and science communicators. Our goal is to make sense of how this pandemic shows us a brighter future in medical education.

IS109 / #193

EAP Session

EAP Session 35: Paediatric dermatology

09-10-2022 17:00 - 17:55

Skin problems in children: Cautious with cortisone?

T. Kakourou*

First Department of Pediatrics, National and Kapodistrian University of Athens, Athens, Greece

Since their introduction in the early fifties topical corticosteroids (TCS) are the cornerstone treatment for atopic dermatitis and are also indicated for other dermatoses such as vitiligo, psoriasis, lichen planus, discoid lupus erythematosus, contact and/or allergic contact dermatitis. They are grouped based on their potency e.g. mild, moderate, potent and very potent. Historically, the greater the potency of a TCS, the greater the risk of side effects which may be cutaneous (e.g. atrophy, telangiectasia, striae, focal hypertrichosis, hypopigmentation) or systemic (e.g. suppression of the hypothalamic-pituitary-adrenal axis, retardation of growth and development). Proper use of TCS in children to minimize the risk of side-effects involves using low to mid potency TCS, limiting the monthly amount (≤ 15 gr in infants, ≤ 30 gr in children, $\leq 60-90$ gr in adolescents), tapering the dose and frequency, intermittent use in flares, selection of a proper vehicle based on the type, location and extent of lesions. Nonetheless, the new generation of topical corticosteroids, (methylprednisolone aceponate 0.1% ointment, fluticasone propionate 0.05% cream, mometasone furoate 0.1% cream or lotion), have increased potency without apparent increased risk of side events. They can be safely used on the body continuously for 3 - 4 weeks, from the age of 4 months, one year and two years respectively. Therefore, the concern of TCS use in children today is not as much their safety, but rather the historically grounded "corticophobia" of not only their caregivers but also health professionals which leads to poor compliance and treatment failure.

IS110 / #251**ESPR Session****ESPR Session 36: Outcome following congenital heart disease****09-10-2022 17:00 - 17:55****Brain injury in CHD babies: Neuroprotective strategies for a better outcome****M. Benders****UMC Utrecht, Neonatology, Utrecht, Netherlands*

Perinatal and perioperative brain injury is a fundamental problem in infants with severe congenital heart disease undergoing neonatal cardiac surgery with cardiopulmonary bypass. An impaired neuromotor and neurocognitive development is encountered and associated with a reduction in quality of life. New neuroprotective drugs during surgery are described to reduce brain injury and improve neurodevelopmental outcome. the aim of the talk is to provide a systematic review and best-evidence synthesis on the effects of neuroprotective and neuroregenerative strategies on brain injury and neurodevelopmental outcome in congenital heart disease infants requiring cardiac surgery with cardiopulmonary bypass.

IS111 / #191**ESPNIC Session****ESPNIC Session 37: Pharmacology it is!****09-10-2022 17:00 - 17:55****The use of PK/PD models in the PICU****S. De Wildt****Radboud UMC, Pharmacology & Toxicology, Nijmegen, Netherlands*

Pharmacokinetics (PK) describes the journey of a drug throughout the body over time and is governed by 4 main processes: absorption, distribution, metabolism and excretion (ADME). Gaining knowledge on the PK of drugs is important, as the concentration of a drug on the site of action governs its effect². Subtherapeutic or low concentrations can cause a reduced or lack of effect, while supratherapeutic or high concentrations can lead to dose-related drug toxicity. One important determinant of drug exposure is body size, as most children have a smaller body size than adults, so most pediatric doses are corrected for body size. Although body size is an important difference between neonates, children and adults, a child is not merely a small adult. Almost all processes involved in ADME show developmental patterns throughout childhood. Besides growth and developmental processes, pathophysiological factors and initiated treatments can also have a major influence on PK. These changes in PK are most pronounced in critically ill patients, where the pathophysiological changes appear to be more pronounced. Severe illness can cause organ dysfunction. PK of drugs can be affected by extracorporeal circuits like kidney replacement therapy or extracorporeal membrane oxygenation. For patients in the pediatric ICU both developmental changes and pathophysiological effects play a role in drug disposition, making it an incredibly challenging patient group to dose correctly. The goal of this presentation is for the audience to develop a better understanding of drug disposition and effect in critically ill children and how pharmacokinetics-pharmacodynamics can aid to optimize pharmacotherapy in critically ill children.

IS112 / #190**EAP Session****EAP Session 38: Global child health****09-10-2022 17:00 - 17:55****Current challenges in global child health****G. Gunnlaugsson****University of Iceland, Faculty of Sociology, Anthropology and Folkloristics, Reykjavik, Iceland*

The UNCRC gives all children the inherent right to life (Art. 6) and the enjoyment of the highest attainable standard of health and access to health services (Art. 24). Nonetheless, in 2020, five million children did not survive until five years (U5MR), and almost half of those died within the first month of life. Further, additional 1.5 million children died before reaching 20 years of age. These numbers hide striking inequalities and inequities to quality services across and within countries and continents; in 2020, there was an almost 60-fold gap between countries with the lowest and the highest U5MR. This gap calls for various actions to improve child health, including prevention and curative care; for adolescents, rights-based sexual and reproductive health services are needed and respectful provision of mental health care. Cross-cutting issues shaped by globalisation and socio-economic determinants include child abuse and neglect, children on the move, children in armed conflict, and nuclear threats. The COVID-19 pandemic has affected all population groups but exposed and compounded existing inequalities among the haves and have-nots. Ongoing climate change and the risk of irreparable damage to life on Earth have galvanised children with pleas to global leaders for immediate action. Children have a right to voice (Art. 12) and freedom of expression (Art. 13) in matters that concern them, and researchers need to apply methods that favour their voices. Nurturing care of children and adolescents is crucial if they are to flourish and prosper, as spelt out in the Sustainable Development Goals.

IS113 / #194

ESPNIC Session

ESPNIC Session 39: Alternative non-invasive respiratory support modes

09-10-2022 17:00 - 17:55

High-flow nasal canula: The holy grail?

C. Milesi*

CHU Arnaud de Villeneuve, Picu, Montpellier, France

High flow oxygen with adequate humidity requires an open system. This ventilation system first used in neonatology conquered the “quest” and the heart of neonatologists! It was a simple system, easy to install, easy to monitor and above all extremely well tolerated. Undeniably its use has spread with great success in relay of intubation and in preconditioning of intubation. In pediatrics, its use with bronchiolitis quickly spread with conflicting results. “Holy grail”... yes if we are expecting oxygenation! “Holy grail” ... probably not if we are expecting a reduction of the work of breathing or a lung recruitment.

IS114 / #195**ESPR Session****Spanish paediatric association session 40:
Vascular malformations****09-10-2022 17:00 - 17:55****Vascular malformations****J.C. Lopez-Gutierrez****La Paz Children's Hospital, Head. Pediatric Reconstructive Surgery and Vascular Anomalies Center, Madrid, Spain*

Historically, the treatment of vascular anomalies has been mainly surgical and endovascular, with limited and poorly effective medical treatments. However, recent genetic characterization findings of vascular anomalies has increased the number of pharmacological therapeutic options available, reducing the need for procedures with high risk of complications and sequels, and improving patients' quality of life in the long term. Propranolol for infantile hemangiomas and rapamycin for kaposiform hemangioendothelioma and tufted angiomas represent respectively the first therapeutical option for the most frequent vascular tumors. Thanks to the discovery of the molecular pathways and the mutations that cause many vascular malformations, some drugs previously used in oncology have recently proved to be effective for the individualized management of these malformations. Many of them are caused by somatic PIK3CA mutations, activating the PIK3/Akt/mTOR path which promotes cell proliferation, growth, angiogenesis, and protein synthesis. Therefore mTOR inhibitors as rapamycin or alpelisib play a major role in the management of lymphatic or lymphatic-venous anomalies. In the same way KRAS, NRAS, BRAF, and MAP2K1 mutations have been found in arteriovenous malformations. MEK1 inhibitors, like trametinib, are showing promising results in patients with unresectable high flow anomalies. Clinical trials are currently under development with basic science research becoming more relevant making tremendously exciting the futur of this field of pediatric medicine.

IS115 / #309

ESPR Session

ESPR Session 41: Improve and assess the outcome of preterm infants - Can standards help? (EFCNI)

09-10-2022 17:00 - 17:55

European standards of care for newborn health – Revision and new standards

I. Geiger*, S. Mader, L. Zimmermann, J. Kostenzer, V. Matthäus

European Foundation for the Care of Newborn Infants, Scientific Affairs, Munich, Germany

The European Standards of Care for Newborn Health (ESCNH) were developed in an interdisciplinary European collaboration with a focus on the treatment and care of preterm and ill newborns. As reference standards, the ESCNH serve as a basis for the creation of national guidelines, protocols, or legislation. As neonatal care is a fast-developing area, the ESCNH are updated regularly and new standards of yet neglected or uprising medical areas are being developed. The first revision of 20 standards of care started in 2021. In line with contemporary literature, the revision process was accompanied by an open public and a targeted expert consultation. We received over 250 completed questionnaires of more than 60 individuals through the public consultation. Furthermore, 23 specialists in the respective field reviewed the standards in the course of the expert consultation. Subsequently, the original standards were revised by the author team based on the consolidated comments of both consultations. Next to the revision of the already existing set of standards, six new standards are currently being developed by interdisciplinary teams: cord management of (1) term and (2) preterm infants, (3) immunisation, (4) diagnosis and management of NEC, (5) quality indicators and (6) error management/safety reporting. The new standards will be launched later this year. Regular revisions and the development of new standards are needed to continuously improve quality and to increase recognition of the ESCNH to ultimately advance their implementation across Europe.

IS116 / #460**ESPR Session****ESPR Session 41: Improve and assess the outcome of preterm infants - Can standards help? (EFCNI)****09-10-2022 17:00 - 17:55****Transition from hospital to home:
Recommendations for discharge planning****C. Härtel*, B. Hüning***University Children's Hospital of Würzburg, Pediatrics, Würzburg, Germany*

Families should receive a comprehensive discharge management plan to facilitate transition from the hospital to home. We present current recommendations. The goal is to support the family of high-risk infants following discharge from hospital, to ensure continuity of care, full vaccination, and to avoid unnecessary re-hospitalisation. Early discharge of very preterm infants is possible without adverse effects if decided on the basis of the infant's physical maturation and competency (e.g. feeding, temperature control, respiratory stability), rather than a certain body weight or gestational age. To minimise their high vulnerability to infections, very preterm infants should receive full-dose vaccinations at their chronological age as opposed to their corrected age, even if they are still hospitalised. In addition, family members and other close contacts of the preterm infant should be up-to-date with their vaccinations (preventive concept of "cocooning"). Discharge management is complex and requires careful timing and planning, and should be commenced as early as possible by a multidisciplinary team to ensure continuity of care. Evaluation of discharge readiness has to address the infant as well as the family and community/healthcare system that ensure continuing care. (3) Parental education and psychosocial support are key elements of continuous discharge management. Successful preparation for discharge improves outcomes of very preterm infants in the transition from hospital to home, reduces the length of hospital stay, healthcare usage and costs.

IS117 / #461**ESPR Session****ESPR SESSION 41: Improve and assess the outcome of preterm infants - can standards help? (EFCNI)****09-10-2022 17:00 - 17:55****How follow-up findings up to adulthood can inform us about content of follow-up standards in childhood****D. Wolke****Department of Psychology, University of Warwick, Coventry, United Kingdom*

Much of current routine follow-up and longitudinal outcome research is focussed on functional outcomes such as physical impairments. I will review evidence from research of adult outcomes after very preterm (VP; <32 weeks' gestation) or very low birthweight (VLBW; < 1500g birth weight). The major accomplishments across the life course are to build relationships with parents, siblings and then peers outside the home. With sexual maturity, there is the development of first sexual and romantic relationships while acquiring the means to live independently. Ability to support oneself financially, being employed and having supportive social relationships across different phases of life are strongly related to happiness and life satisfaction. Those born VP/VLBW are more likely, as a group, to experience poor peer and less romantic and sexual relationships and more likely to have periods of unemployment and support by social benefits. Furthermore, some areas of functions such as cognitive function in childhood are more strongly associated with life course outcome than others. But, what are there protective factors that may alter life course outcomes? I will provide emerging evidence that VP/VLBW outcomes are strongly affected by the family we are born into, parental interaction, whether peers are supportive or bully and how early education of VP/VLBWE is managed. I propose that routine and research follow-up needs

to go beyond descriptive assessment of child function and should include assessments of family, parenting, sibling and peer relationships. Furthermore, care between medically aligned and educational professions needs to be more closely integrated and complimentary.

IS118 / #116**ESPR Session****ESPR Session 42: Late pre-term****09-10-2022 17:00 - 17:55****Feeding the late and moderately preterm infant****A. Lapillonne****Necker-Enfants Malades University Hospital, Neonatal Intensive Care Unit, Paris, France*

Late or moderately preterm (LMPT) infants represent the largest population of preterm infants. These infants have unique, often unrecognized, vulnerabilities that predispose them to high rates of nutritionally related morbidity and hospital readmissions. This lecture will aim to provide guidance on how to feed infants born LMPT, and identify gaps in the literature and research priorities.

IS119 / #203**Educational Symposium****Educational Symposium 24: Navigation in long-term outcome assessment (ESPR)****10-10-2022 08:00 - 08:50****Socioeconomic deprivation and the preterm infant: How does it affect outcome?****J. Boardman****University of Edinburgh, Mrc Centre for Reproductive Health, Edinburgh, United Kingdom*

Social gradients are powerful determinants of cognitive and socio-emotional development in the general population but their importance for shaping development after preterm birth (PTB) is less certain because PTB itself is associated with atypical brain development, and social factors are seldom considered as explanatory variables in their own right in this population. Professor Boardman will discuss evidence from multiple data sources - neuro-imaging, record-linkage of epidemiological data, eye-tracking, and responses to the Still-Face Paradigm - which indicate that socioeconomic status is associated with atypical brain development and injury, social cognition, emotion regulation, and language abilities of preterm children, respectively. He will consider the biological pathways that could embed social factors in brain development. These observations indicate that socioeconomic status is an important determinant of outcome across the whole gestational age range, and they challenge the paradigm that prematurity outweighs non-medical determinants of health in preterm children. Policies that reduce childhood deprivation could lead to improved pre-school outcomes and potentially avoid the propagation of disadvantage across the life course, including for children born preterm.

IS120 / #206**Educational Symposium****Educational Symposium 25: Problems in primary paediatrics (EAP)****10-10-2022 08:00 - 08:50****Recurrent infections, when to worry****M. Emonts***

Newcastle upon Tyne Hospitals NHS Foundation Trust, Great North Children's Hospital, Paediatric Immunology, Infectious Diseases & Allergy, Newcastle upon Tyne, United Kingdom

Infections are a common presentation in childhood. Some children get a few while others experience multiple recurrent infections. When should you worry, what factors to take into account, what is the role of exposure? Children attending nursery or growing up in large families are more likely to be exposed. The recent pandemic has confirmed the major role of physical interaction in transmission of viruses and the effect of social distancing and increased hand hygiene on the prevention of this transmission. Children growing well despite their infections are probably okay. Those who have failure to thrive or other signs of organ failure are the ones to look out for. Organ failure can come in different phenotypes: hearing loss resulting in delayed speech development, gut failure with chronic diarrhoea, and ultimately failure to thrive and even developmental delay. Some children with defective immune systems have severe eczema. While the frequency of infection can be a warning sign, this is also true for single infections of a certain phenotype, such as liver abscesses, or infection with certain pathogens, such as BCGitis or other opportunistic infections, and abnormal basic laboratory parameters. An overview of warning signs, and symptoms, diagnostic approaches and management of more common problems will be discussed.

IS121 / #322**Educational Symposium****Educational Symposium 25: Problems in primary
paediatrics (EAP)****10-10-2022 08:00 - 08:50****Lumps and bumps are they dangerous****N. Hartwig****Department of Pediatrics, Franciscus Gasthuis & Vlietland, Rotterdam, Netherlands*

Lumps and bumps are common problems in children. Differential diagnosis is specifically dependent on age, presenting symptoms and anatomical site. The vast majority are benign of origin and are the result of trauma, infection or inflammation. Malignant lumps and bumps are rare but need to be recognized early. In these situations correct diagnosis should not be delayed or missed leading to decreased prognosis. Doppler ultrasound is the most appropriate approach when clinical diagnosis cannot be made at a glance. It provides rapid information on size, shape, location, content and vascularity without necessity of sedation. When there is still doubt about the exact diagnosis surgery and pathology need to be involved.

IS122 / #213**Educational Symposium****Educational Symposium 26: Point of care ultrasound: A tutorial for neonates and children (ESPNIC)****10-10-2022 08:00 - 08:50****Point of care ultrasound: A tutorial for neonates and children****Y. Singh****Cambridge University Hospitals, Neonatology/Paediatric Cardiology, QQ, United Kingdom*

Point of care ultrasound (POCUS) provides in providing anatomical, physiological and hemodynamic information in real time which can help in making physiologic based clinical decisions. It can help in making timely and accurate diagnosis, and provide specific targeted intervention. POCUS is rapidly being adopted in the neonatal and paediatric intensive care practice. Evidence-based guidelines for the use of POCUS in critically ill neonates and children endorsed by the ESPNIC have been published.

IS123 / #204**Educational Symposium****Educational Symposium 27: Implementing the updated resuscitation guidelines (ESPNIC)****10-10-2022 08:00 - 08:50****What is new in neonatal resuscitation?****A. Te Pas****Leiden University Medical Center, Neonatology, Leiden, Netherlands*

Most very preterm infants need some form of resuscitation to survive the transition to newborn life. During this very vulnerable stage of life, inappropriate interventions increase the risk of death or long-term disability. To reduce the risk of lung and cerebral injury, the type of respiratory support in infants at birth has shifted from invasive (endotracheal intubation) to non-invasive ventilation (face mask). However, this shift has occurred without any scientific knowledge on the complexities of ventilating very preterm infants non-invasively. Recently was demonstrated that the larynx retains its fetal mode of function after birth and closes when the infant is not breathing, which blocks air from entering the lung. As the larynx only opens during a breath, the ability of NIV to assist lung aeration, depends on whether the infant is breathing. The solution to this complex problem is simple: **optimise and support the infant's breathing**. During this presentation I will discuss the latest insights in the control of breathing at birth and how interventions affect breathing drive.

IS124 / #205**Educational Symposium****Educational Symposium 27: Implementing the updated resuscitation guidelines (ESPNIC)****10-10-2022 08:00 - 08:50****What is new in paediatric resuscitation?****J. Del Castillo^{1,2*}**¹*Hospital Universitario Gregorio Marañón, Pediatric Intensive Care, Madrid, Spain*²*Hospital General Universitario Gregorio Marañón, Pediatric Intensive Care Unit, Madrid, Spain*

Pediatric cardiac arrest is a rare event. It's happening can be sometimes prevented, as it occurs as the result of accidents and severe illnesses. Caring for the rapidly deteriorating child is always a challenge. Survival rates for both out-of-hospital and in-hospital cardiac arrests have not increased in the past 10 years and are always lower than desired. Changes in resuscitation guidelines have focused on the believe that implementing some differences can impact outcomes. Recovery with no neurological damage is the main aim of resuscitation. International guidelines in pediatric resuscitation have recommended the implementation of some changes in every link of the chain of survival. Throughout this session, we will overview the major challenges to assess during resuscitation and discuss the different recommendations and the questions that are still to be solved. We will approach the controversies and try to define together a joint strategy to provide future guidelines with evidence in our goal of improving survival to cardiac arrest.

IS125 / #198**Educational Symposium****Educational Symposium 28: Educational symposium-refeeding syndrome in the PICU (ESPNIC)****10-10-2022 08:00 - 08:50****Nutritional assessment and identifying 'at risk' patients****L. Marino****Southampton Children's Hospital, Paediatric Intensive Care Unit, YD, United Kingdom*

Although the European Society of Enteral and Parenteral Nutrition (ESPEN) recommends the use of nutritional screening in hospitalised children, there is no standardised approach as to how this should be completed. The terms "nutrition screening" and "nutritional assessment", are often used interchangeably, although relate to quite different processes. Nutritional screening is a process to identify patients who are already malnourished or at risk of becoming so. Nutritional assessment refers to the characterisation of specific nutritional problems. Nutritional risk is affected by a multitude of factors including; nutritional and disease state, requirements and intake, amongst others. The purpose of this talk will be to consider the differences between nutrition screening and nutrition assessment, to review factors associated with nutrition risk and finally, to explore considerations to ensure nutrition deficits are managed and that nutrition support is continued until nutrition goals are achieved.

IS126 / #199**Educational Symposium****Educational Symposium 28: Educational symposium-refeeding syndrome in the PICU (ESPNIC)****10-10-2022 08:00 - 08:50****How to avoid and treat refeeding syndrome****C. Jotterand Chaparro***

University of Applied Sciences and Arts Western Switzerland HES-SO, Nutrition and Dietetics, Carouge, Switzerland

In critically ill children, early enteral nutrition is recommended, but it may expose children at risk of refeeding syndrome, an acute metabolic disturbance that occurs after reintroduction of nutrition. The main physiological problems are deficiencies of thiamine, phosphate, magnesium and potassium. The refeeding syndrome can manifest as a mild electrolyte disorder or a severe electrolyte disorder leading, without supplementation, to severe organ failure and death. In 2020, the American Society for Parenteral and Enteral Nutrition (ASPEN) published consensus recommendations for identifying patients with or at risk for refeeding syndrome. ASPEN Criteria for identifying patients at risk include, in particular, children who are malnourished, those with recent weight loss, fat or muscle loss, low energy intake, and/or abnormal serum potassium, phosphorus, or magnesium concentrations. The ASPEN clinical definition of refeeding syndrome includes a significant electrolyte disturbance ($\geq 10\%$ decrease in phosphorus, potassium, and/or magnesium) and/or organ dysfunction resulting from a decrease in any of these elements and/or due to thiamine deficiency, occurring within 5 days of reintroducing calories. The approaches to avoid causing refeeding syndrome and those for its treatment are often the same. On admission, nutritional status should be assessed, including anthropometric measurements and diet history, to identify at-risk patients. These latter should receive more progressive energy intake and be monitored more closely for electrolyte abnormalities. Treatment of established refeeding syndrome should be aimed at correcting underlying

electrolyte abnormalities and may include a reduction in energy intake. Treatment should include supplementations, which depends on the severity of the refeeding syndrome.

IS127 / #207**Educational Symposium****Educational Symposium 30: Educational symposium - Management of mild hypoxic ischaemic encephalopathy (ESPR)****10-10-2022 08:00 - 08:50****Neurovascular coupling in mild HIE****L. Chalak***

UT Southwestern Medical Center, Etal Neurological Neonatal Intensive Care and Fetal and Neonatal Neurology Fellowship Training Program, United States of America

Neonatal neuroprotection strategies are still in development and few therapies have withstood the long transition from pre-clinical to Phase III trials. Therapeutic hypothermia has transformed the landscape of treatment of hypoxic ischemic encephalopathy and remains the only proven intervention to mitigate poor neurodevelopmental outcomes in infants with moderate and severe encephalopathy. However, for mild HIE who were not included in the trials, the fundamental question of how to manage remains problematic. While this topic persisted in yearly panels, commentaries and opinions, no new RCT data have emerged to support or refute treatment. We will summarize new biomarkers to guide patient selections at birth. A standardized protocol that includes neuroimaging and neurodevelopmental follow-up is proposed when providing care for any infant with HIE irrespective of its initial severity and decisions of cooling. Further we investigate community stakeholder perspectives surrounding the science and treatment of mild HIE. Stakeholder engagement and new biomarkers should be compass in designing the next generation of clinical trials for treatment of mild HIE.

IS128 / #210**Educational Symposium****Educational Symposium 31: Unravelling microbiota in the neonatal period (Spanish neonatal society)****10-10-2022 08:00 - 08:50****Effect of donor human milk on microbiota****M. Vento****Health Research Institute La Fe, Neonatal Research Group, Valencia, Spain*

Preterm microbial colonization is affected by gestational age, antibiotic treatment, type of birth, but also by type of feeding. Breast milk has been acknowledged as the gold standard for human nutrition. In the absence of their mother's own milk (MOM), pasteurized donor human milk (DHM) could be the best available alternative due to its similarity to the former.

OBJECTIVE

Was to determine the impact of DHM upon preterm gut microbiota admitted in a referral neonatal intensive care unit (NICU).

DESIGN

A prospective observational cohort study of 69 neonates <32 weeks of gestation; birth weight 1,500 g. Neonates were classified into 3 groups: MOM, DHM, or formula. Fecal samples were collected when full enteral feeding (defined as 150 cc/kg/day) was achieved. Gut microbiota composition was analyzed by 16S rRNA gene sequencing.

RESULTS

No differences in microbial diversity and richness were found. Preterm infants fed MOM showed a significantly greater presence of Bifidobacteriaceae and lower of Staphylococcaceae, Clostridiaceae, and Pasteurellaceae compared to preterm fed DHM. Preterm infants fed DHM showed closer microbial profiles to preterm fed their MOM. Inferred metagenomic analyses showed a higher presence of Bifidobacterium genus in the mother's milk group was related to enrichment in the Glycan biosynthesis and metabolism pathway that was not identified in the DHM or in the formula-fed groups.

CONCLUSION

DHM favors an intestinal microbiome more similar to MOM than formula despite the differences between MOM and DHM. This may have potential beneficial long-term effects on intestinal functionality, immune system, and metabolic activities.

IS129 / #211**Educational Symposium****Educational Symposium 31: Unravelling microbiota in the neonatal period (Spanish neonatal society)****10-10-2022 08:00 - 08:50****Colonization of preterm infant gastrointestinal tract****M. Saenz De Pipaon****La Paz University Hospital, Neonatology, Madrid, Spain*

Preterm infants admitted at NICU are initially colonized by homogeneous microbial communities, most of them from the nosocomial environment, which subsequently evolve according to the individual conditions. Our results demonstrate the hospital epidemiology pressure, particularly during outbreak situations, on the gut microbiota establishing process. In short-term hospitalization, length is by far the determinant factor for the early colonization of preterm infants. As nasogastric enteral feeding tubes populations reflect the bacterial populations that are colonizing the preterm in a precise moment, their knowledge could be useful to prevent the dissemination of antibiotic-resistant strains. Intestinal dominance by *Serratia* spp. plays a role in outbreaks and extraintestinal spread. We evaluate efficacy of Infloran™ probiotic preparation in reducing necrotizing enterocolitis (NEC) and late-onset sepsis (LOS) in extremely preterm infants. The period of probiotic administration was associated with an increased incidence of NEC after adjusting for neonatal factors, with a reduction in the LOS rate. Infants received *Bifidobacterium breve* PS12929 and *Lactobacillus salivarius* PS12934. Phylum Firmicutes dominated in nearly all fecal samples while *L. salivarius* PS12934 was detected in all the infants at numerous sample collection points and *B. breve* PS12929 appeared in five fecal samples. Probiotic supplementation with *L. salivarius* PS11603 and *B. longum* PS10402 enhanced an earlier colonization of

Lactobacillus and Bifidobacterium in preterm infants' guts in 5 and 1 week respectively. A higher number of infants were colonized by Lactobacilli with the probiotics' intake at the end of the study. Oral administration of human insulin modifies the gut microbiota in preterm infants.

IS130 / #212**Educational Symposium****Educational Symposium 32: Critical Care
Pharmacology: Why and how (ESPNIC)****10-10-2022 08:00 - 08:50****Panelist: A practical approach****A. Amigoni^{1*}, S. De Wildt^{2*}**

¹Department of Mother and Child Health University Hospital, Universital Hospital of Padova, Padova, Italy

²Radboud university medical center, Pharmacology and Toxicology, Intensive Care, Nijmegen, Netherlands

Pharmacokinetic and pharmacodynamics of drugs adopted in pediatric population require knowledge and accuracy. If patients are in critical condition, organ insufficiency and drug interactions due to multiple treatments make the situation harder. In PICU the use of drugs is complex and difficult especially in some areas and it may cause adverse effects if it is not accurate (inefficacy, organ failure development, or medical errors). Altered pharmacokinetics have been reported in patients with sepsis or burns. Acute Kidney Insufficiency is a key factor to be considered in drug prescription and adjusting. Extracorporeal treatments (ECMO, CRRT) need to modify drug dosage considering the changed pharmacokinetics of many adopted molecules (analgesics and sedatives, antibiotics, antifungals, anticonvulsants, immunomodulators..) Pharmacology is an essential part in PICU. Knowledge of pharmacology should be further developed and improved.

IS131 / #201

Educational Symposium

Educational Symposium 33: Educational symposium - Hemangioma (EAP)

10-10-2022 08:00 - 08:50

What are the new approaches

S. Janmohamed*

University Hospital Brussels (UZ Brussel), Dermatology, Brussels, Belgium

This presentation will give an overview of the diagnosis, pathogenesis, and management of Infantile Hemangioma (IH). After the session, the participant should know the different forms of IH and its differential diagnosis. The participant should be aware of syndromes with IH and know when further examination is necessary. The pathogenesis will be discussed, focusing on recent advances. Finally, the management will be discussed (no treatment, topical treatment, oral treatment) and tools will be discussed to assess the severity and activity of IH. The presentation will end with 3 cases to test the knowledge of the participant.

IS132 / #2490**Young Investigator Awards****ESPR young investigators presentations****10-10-2022 09:00 - 10:00****Maternal hypertension during pregnancy is associated with an increased risk of brain abnormalities on MRI at term-equivalent age in very preterm infants****S. Jain****Division of Neonatology, Cincinnati Children's Hospital, Cincinnati, USA***BACKGROUND**

Studies of term infants with maternal hypertensive disorders of pregnancy (HDP) indicate poorer neurodevelopmental outcomes than those without HDP. Reported effects on very preterm (VPT) infants are inconsistent. Here we evaluate the effects of HDP on brain structural abnormalities in VPT infants using MRI at term-equivalent age.

OBJECTIVE

To evaluate the effects of HDP on brain injury in very preterm (VPT) infants using structural MRI at TEA.

STUDY DESIGN

This prospective, multicentric study enrolled 395 VPT infants between 2016-2019. Infants were imaged between 39-44 weeks postmenstrual age. Brain abnormality was assessed using the Kidokoro global brain abnormality score.

Infants classified as HDP-exposed if mother had chronic or gestational hypertension/pre-eclampsia. Multivariable linear regression was performed controlling for histologic chorioamnionitis, antenatal steroids, magnesium sulfate, and sex to identify the independent effects of HDP on infant brain abnormality.

RESULTS

Of 395 VPT infants, 42.5% were HDP-exposed. The two groups were statistically similar except for incidence of chorioamnionitis (HDP: 15.5%, non-HDP: 38.3%) and antenatal magnesium therapy (HDP: 88.7%, non-HDP: 80.6%). In unadjusted analyses, median Kidokoro scores between the groups were not significantly different. In multivariable analyses, HDP-exposed infants had significantly higher scores than those without HDP, independent of our confounders.

CONCLUSIONS

Maternal HDP is a significant risk factor for early brain abnormalities in VPT infants.

IS133 / #146

ESPNIC Session

ESPNIC Session 44: Nurses leading pain reduction in the intensive care unit

10-10-2022 11:00 - 12:20

Nurses as change drivers to reduce the painful procedures in the NICU

J. Latour^{1,2*}

¹University of Plymouth, Faculty of Health, Plymouth, United Kingdom

²Department of Nursing, Hunan Children's Hospital, Changsha, China

This session aims to discuss the role of nurses in delivering nurse-led interventions to reduce pain in critically ill infants in the NICU. The interactive session will engage delegates to determine the current practice of painful procedures.^[1,2] The delegates will be challenged to think out of the box. As an example; not delivering family-centred care to the full extend is potentially an emotional painful procedure for parents.^[3] At the end of the session the delegates have discovered a range of activities and interventions that are important to ease pain in infants and families in NICU.^[4] Take home message is: Think outside the box and involve all stakeholders to provide comfort care to critically ill infants.

REFERENCES

- [1] Ryan L, Plötz FB, van den Hoogen A, **Latour JM**, et al: Neonates and COVID-19: state of the art. *Pediatric Research*. 2022;91(2):432-439.
- [2] Tume, L, van den Hoogen A, Wielenga JM, **Latour JM**: An electronic Delphi study to establish pediatric intensive care nursing research priorities in 20 European countries. *Pediatr Crit Care Med*. 2014;15(5):e206-e213.

- [3] Poh PF, Sng QW, **Latour JM**, et al: Pediatric Critical Care Nursing Research Priorities in Asia: An eDelphi Study. *Pediatr Crit Care Med*. Online ahead of print 15 July 2022.
- [4] **Latour JM** Kentish-Barnes N, Jacques T, Wysocki M; Azoulay E; Metaxa V: Improving the Intensive Care experience from the perspectives of different stakeholders. *Critical Care*. 2022;26:218.

IS134 / #225**ESPR Session****ESPR Session 45: Long term effects of prematurity****10-10-2022 11:00 - 12:20****Effect of breastfeeding on cardiac function****A. El-Khuffash****Royal College of Surgeons in Ireland, Paediatrics, Dublin, Ireland*

Premature infants have impaired cardiovascular function that persists into adulthood. Preterm infants exhibit impaired systolic and diastolic dysfunction that is intolerant of the adverse loading conditions experienced during the early neonatal period. Young adults born premature demonstrate a unique cardiac phenotype characterized by reduced biventricular volume, relatively lower systolic and diastolic function, and a disproportionate increase in muscle mass. This may clinically manifest by an increased risk of cardiovascular incidents, hypertension, and reduced exercise tolerance. Those consequences appear to result from early postnatal cardiac remodelling due to premature birth and associated comorbidities. Recent evidence suggests that early exposure to breast milk slows down or even arrests those pathophysiological changes, thereby mitigating the long-term adverse effects of premature birth on cardiovascular health. In this talk article, we discuss the role of breast milk in preventing cardiovascular disease in infants born premature. We explore the emerging evidence and examine the possible mechanistic pathways mediating this phenomenon. Furthermore, we aim to demonstrate the vital role of early breast milk exposure in preventing cardiovascular disease in preterm infants.

IS135 / #226**ESPR Session****ESPR Session 45: Long term effects of prematurity****10-10-2022 11:00 - 12:20****Therapeutic intervention in preterm brain injury****M. Fumagalli^{1,2*}, P. Schiavolin², D.A. Amerotti², G. Ardemani²,
C. Bonfanti¹, F. Mosca^{1,2}**

¹Fondazione IRCCS Ca' Granda Ospedale Maggiore Policlinico, Neonatal Intensive Care Unit, Milano, Italy

²Department of Clinical Sciences and Community Health, University of Milan, Milan, Italy

Acquired perinatal brain injuries in prematurely born infants are a leading cause of lifelong disability with social, emotional and financial implications, and still represent a challenge for neonatologists as no therapeutic options have been implemented into clinical practice. Injuries to the preterm brain include diffuse white and grey matter damage which underlie a spectrum of connectivity impairments. Given the relevant role of inflammation in the pathogenesis of preterm brain injuries, immune-modulatory interventions may have a potential to support recovery¹. Potential therapeutic interventions include stem cells (and derived exosomes) that seem to reduce perinatal brain injury although evidence is based on highly heterogeneous preclinical and clinical studies and effective protocols for each type of injury and stem cells still need to be defined². Erythropoietin (EPO) at high doses has anti-apoptotic, anti-inflammatory and antioxidant properties with possible neuroprotective and neuroregenerative effects on the brain¹. However, the optimal EPO regimen is still unknown and a recent large randomized multi-center trial in extremely preterm infants did not demonstrate a beneficial effect of EPO on the risk of severe neurodevelopmental impairment at 2y³. Neonates and infants have remarkable brain plasticity that reflects the capability of the brain to modify by adapting to environmental exposure and underlies the damage-induced processes of brain reorganization⁴. Early evidence-based interventions, focused on parental involvement, multisensory stimulation and

enriched environment may enhance neurodevelopment⁵ in brain injured preterms despite the correct combination of interventions and the timing in relation to the onset, nature, and degree of injury need to be further explored.

REFERENCES

- [1] Ophelders DRMG, Gussenhoven R, Klein L et al. Preterm Brain Injury, Antenatal Triggers, and Therapeutics: Timing Is Key. *Cells* 2020;9:1871
- [2] Passera S, Boccazzi M, Bokobza C et al. Therapeutic potential of stem cells for preterm infant brain damage: Can we move from the heterogeneity of preclinical and clinical studies to established therapeutics? *Biochem Pharmacol* 2021;186:114461
- [3] JuulSE, Comstock BA, Wadhawan R et al. A Randomized Trial of Erythropoietin for Neuroprotection in Preterm Infants. *N Engl J Med* 2020 Jan 16;382(3):233-243
- [4] Morgan C, Fetters L, Adde L et al. Early Intervention for Children Aged 0 to 2 Years With or at High Risk of Cerebral Palsy: International Clinical Practice Guideline Based on Systematic Reviews. *JAMA Pediatrics* 2021;175(8):846-858
- [5] Fontana C, Marasca F, Provitera L et al. Early maternal care restores LINE-1 methylation and enhances neurodevelopment in preterm infants. *BMC Medicine* 2021;19:42

IS136 / #228

EAP Session

EAP Session 46: Common problems in adolescence/ adolescent health in 2021 - An update

10-10-2022 11:00 - 12:20

Influence of social media and self-esteem

A. Mazur*

Department Pediatric, Medical College of University of Rzeszow, Pediatric Endocrinology and Diabtetes, Rzeszów, Poland

Social comparison is an instrumental piece in explaining how the media may influence people's perceptions of their body image and their self-esteem. The aim of this lecture is to identify the impact of social media on the health of children and young people. Many studies have been conducted to investigate the positive and negative aspects of social media. Some studies focused on the information that positive feedback on social profiles enhanced adolescents' social self-esteem and well-being, whereas negative feedback decreased their self-esteem and well-being. There is an association between the use of social media and self-esteem and body image. The cause and effect of this association is difficult to determine but is likely to be related on the nature of the young person. Cyberbullying is deliberately using digital media to communicate [1] false, embarrassing or hostile information about another person. It is the most common online risk for all young people and is a peer-to-peer risk. Young people on social media sites are also more prone to risk-taking behaviour that may place their health at risk. Year per year is growing knowledge of the impact of social media on younger children. This lecture seeks to alert care givers to the potential benefits and dangers of social media networking by children and young adults and urge researchers to improve theoretical understanding in this field, raise societal awareness and offer practical guidance to those in positions of responsibility including health practitioners, parents and site developers.

REFERENCES

- [1] Fung IC, Blankenship EB, Ahweyevu JO, Cooper LK, Duke CH, Carswell SL, Jackson AM, Jenkins JC 3rd, Duncan EA, Liang H, Fu KW, Tse ZTH. Public Health Implications of Image-Based Social Media: A Systematic Review of Instagram, Pinterest, Tumblr, and Flickr. *Perm J*. 2020;24:18.307. doi: 10.7812/TPP/18.307. Epub 2019 Dec 6. PMID: 31852039 Free PMC article. Review.
- [2] Vannucci A, Simpson EG, Gagnon S, Ohannessian CM. Social media use and risky behaviors in adolescents: A meta-analysis. *J Adolesc*. 2020 Feb;79:258-274. doi: 10.1016/j.adolescence.2020.01.014. Epub 2020 Feb 1. PMID: 32018149
- [3] Gray KM, Squeglia LM. Research Review: What have we learned about adolescent substance use? *J Child Psychol Psychiatry*. 2018 Jun;59(6):618-627. doi: 10.1111/jcpp.12783. Epub 2017 Jul 17. PMID: 28714184 Free PMC article. Review.
- [4] Forte A, Sarli G, Polidori L, Lester D, Pompili M. The Role of New Technologies to Prevent Suicide in Adolescence: A Systematic Review of the Literature. *Medicina (Kaunas)*. 2021 Jan 26;57(2):109. doi: 10.3390/medicina57020109. PMID: 33530342 Free PMC article. Review.
- [5] Taquette SR, Monteiro DLM. Causes and consequences of adolescent dating violence: a systematic review. *J Inj Violence Res*. 2019 Jul;11(2):137-147. doi: 10.5249/jivr.v11i2.1061. Epub 2019 Jul 2. PMID: 31263089 Free PMC article.
- [6] Henry N, Powell A. Technology-Facilitated Sexual Violence: A Literature Review of Empirical Research. *Trauma Violence Abuse*. 2018 Apr;19(2):195-208. doi: 10.1177/1524838016650189. Epub 2016 Jun 16. PMID: 27311818 Review.
- [7] Brand S, Lemola S, Mikoteit T, Holsboer-Trachsler E, Kalak N, Bahmani DS, Pühse U, Ludyga S, Gerber M. [Sleep and Psychological Functioning of Children and Adolescents - a Narrative Review]. *Prax Kinderpsychol Kinderpsychiatr*. 2019 Feb;68(2):128-145. doi: 10.13109/prkk.2019.68.2.128. PMID: 30757973 Review. German.

IS137 / #214

EAP Session

EAP Session 47: How can big data/artificial intelligence be incorporated/used in primary care

10-10-2022 11:00 - 12:20

Utilizing AI and data to promote proactive and preventative medicine

O. Magen*

Clalit Research Institute, Ai Driven Medicine, Tel Aviv, Israel

Primary care is practiced, predominantly, in a reactive manner; patients present and receive care in response to findings. In contrast to this model, proactive healthcare involves active management of the patient population with the aim of disease prevention. At Clalit, the largest health care organization in Israel, C-Pi (Clalit Proactive-Preventive Intervention) has been developed and deployed, specifically, to deal with challenges preventing physicians and nurses from delivering proactive healthcare. The platform presents lists of 'target populations' - patients with increased predicted risk of specific outcomes across the clinical spectrum (e.g. diabetic or cardiovascular patients) to physicians, nurses and other healthcare practitioners. These lists focus on patients with the highest personalized risk, as generated using machine learning or directly from personal data from Clalit's rich electronic medical record (EMR). The risk is integrated with up-to-date clinical recommendations derived from up-to-date guidelines. At a time when medical systems are being placed under increasing economic strain due to an ageing population, growing patient expectations and unprecedented growth of the medical arsenal, it is vital for healthcare organizations to be able to manage their resources at utmost efficiency. This paradigm shift is happening these days in Israel, using C-Pi platform.

IS138 / #217**ESPR Session****ESPR Session 48: Early brain injury in neonates and children****10-10-2022 11:00 - 12:20****Adjunct therapies for neonatal encephalopathy****N. Robertson****University College London, Institute for Women's Health, London, United Kingdom*

Despite treatment with therapeutic hypothermia (HT) in developed countries, only ~50% of babies with moderate-severe neonatal encephalopathy (NE) survive without cerebral palsy or neurocognitive impairment. Novel, safe and effective adjunct therapies are needed. Treatment needs to target each phase of the evolving injury. In the last 2 years we have learned much. In 2021, the HELIX trial suggested that HT is not safe and effective in LMIC, where the main burden (>96%) of NE occurs. In 2022, the results of the HEAL trial, using Epo as an adjunct with cooling in a large Phase III RCT, suggested that Epo does not augment HT protection. There is increased understanding around sex dimorphism and the different cell death pathways in males and females; will neuroprotection be different according to sex? There are several ongoing neonatal neuroprotection trials in high income settings. In my talk I will focus on two main neuroprotective therapies to be used as adjuncts with HT: Melatonin and Mesenchymal Stem Cells (MSC). Melatonin is a powerful antioxidant with robust protection at pharmacological levels in preclinical models as a single agent and combined with HT. I will discuss the translational pathway and plans for Phase I/II RCTs. I will also discuss our large animal studies with human umbilical MSC given intranasally as an adjunct with HT. I will discuss promising therapeutic agents for use in LMIC as single or combined therapies, in particular Azithromycin. Where will we be in 5 years? I will discuss steps we need to take to optimize neuroprotection over the next 5-10 years. Factors that need to be considered include: (i) timing of therapy (early or late or both); (ii) adequate therapeutic levels and importance of PK studies; (iii) sex specific therapies; (iv) cooling or no cooling.

IS139 / #218**ESPR Session****ESPR Session 48: Early brain injury in neonates and children****10-10-2022 11:00 - 12:20****Imaging and long term memory following neonatal brain injury****N. Van Der Aa****Dep of Neonatology, University Medical Center Utrecht, Utrecht, Netherlands*

Neonatal brain injury is frequently encountered in the setting of the neonatal intensive care unit. In the term born infant, hypoxic ischemic injury is the most common type of brain injury. This may occur following perinatal asphyxia, but can also be observed in infants with congenital heart disease. Such brain injury may significantly affect neurodevelopmental outcome, including memory function. The aim of this presentation is to provide an overview of memory function following common patterns of neonatal brain injury in term infants and review how memory function is correlated with neonatal MRI and MRI in childhood.

IS140 / #222**ESPR Session****ESPR Session 49: The environment and perinatal and child health****10-10-2022 11:00 - 12:20****Air pollution, ambient temperature and perinatal and children health****J. Lepeule****INSERM, Public Health, Grenoble, France*

Air pollution is a complex mixture of compounds present in gaseous (e.g. nitrogen oxides) or particulate (e.g. fine particles) form, directly emitted by the different sources of pollution or formed in the atmosphere as a result of chemical reactions. Numerous epidemiological studies have highlighted the effects of exposure to air pollutants on cardiovascular and respiratory mortality and morbidity. In the DOHaD (Developmental Origins of Health and Diseases) context, the last 20 years have seen an increasing number of publications reporting adverse effects of prenatal and early postnatal exposure to air pollution. Maternal exposure to air pollution and post-natal exposure of the child can have short-term effects on birth weight or prematurity, but also long-term effects on the development of the child. In the context of climate change, there is also an increasing number of studies conducted on heat stress during pregnancy and its impact on the fetus. The mechanisms that could explain the effects of fetal exposure to environmental pollutants on subsequent health are poorly documented, but several avenues are being explored. One hypothesis is that environmental pollutants may influence epigenetic programming and the expression of certain genes (via epigenetic alterations), which would then modify the risk of disease occurrence in the short or long term. In addition to being potential biomarkers of exposure and effect, epigenetic marks, and more generally epigenetic epidemiology, represent an opportunity to identify the mechanisms of action of environmental exposures on health.

IS141 / #223**ESPR Session****ESPR Session 49: The environment and perinatal and child health****10-10-2022 11:00 - 12:20****How to emulate a target trial with observational data in perinatal and paediatric epidemiology****J. Labrecque****Department of Epidemiology, Erasmus University Rotterdam, Rotterdam, Netherlands*

Target trial emulation imagines an ideal randomized trial and then tries to emulate it as closely as possible with observational data. We demonstrate that for many perinatal research questions there is no single ideal trial of universal public health interest and discuss how considerations of eligibility criteria, protocol specifications and follow-up time for a hypothetical trial of interest inform the best practices for data collection, design, and analysis in an observational study. For example, the eligibility criteria in an ideal trial of the effect of *quitting* smoking during pregnancy on childhood outcomes would only enroll women who were smokers prior to pregnancy; thus, emulating this trial with observational data should likewise restrict to women who report smoking pre-pregnancy. A hypothetical trial could also specify instructions regarding smoking behaviour post-pregnancy (i.e. whether to resume smoking), which can modify the effect of smoking during pregnancy on childhood outcomes. To illustrate these distinctions and their importance in practice, we analyze multiple trial analogues of the effect of quitting smoking during pregnancy on childhood health outcomes in the Generation R Study, each answering a different causal question and requiring a different analysis. The trial analogues address the effect of smoking cessation during pregnancy among women who smoked pre-pregnancy, but vary the instructions on women's smoking behaviors post-pregnancy. Framing perinatal epidemiologic studies as target trials can clarify which study designs and analyses correspond to which public health interventions.

IS142 / #307**ESPR Session****ESPR Session 51: Global health in paediatrics****10-10-2022 11:00 - 12:20****Telemedicine support for NICU care in LMIC****M. Blennow****Karolinska Institutet and University hospital, Neonatology, Stockholm, Sweden*

Medecins Sans Frontiers (MSF, Doctors Without Borders) is an NGO providing medical assistance to people affected by conflict, epidemics, disasters, or exclusion from healthcare. MSF runs projects in 48 countries worldwide. The MSF Telemedicine breaks down geographical barriers, allowing medical teams to remotely consult a network of medical expertise. Consultations using a dedicated platform are available to the local staff 24/7 and include experts in most medical specialties, all with personal experience from field work in low and middle income countries.

IS143 / #308**ESPR Session****ESPR Session 51: Global health in paediatrics****10-10-2022 11:00 - 12:20****Management of HIE in LMI countries****S. Thayyil****Imperial College London, Brain Sciences, HS, United Kingdom*

Over 90% of the hypoxic ischemic encephalopathy disease burden occurs in low and middle-income countries. However, therapeutic hypothermia, the standard treatment for hypoxic ischemic encephalopathy in high income countries is ineffective and potentially harmful in low and middle-income countries. In this talk I will discuss the clinical heterogeneity of infants with hypoxic ischemic encephalopathy in high income and low and middle-income countries, and why and how this affects hypothermic neuroprotection, and future directions.

IS144 / #219**EAP Session****EAP Session 52: Updates in paediatric cardiology****10-10-2022 11:00 - 12:20****Congenital heart defects 2023 and beyond****V. Vida^{1*}, A. Guariento***Universita degli Studi di Padova, Cardiac Thoracic and Vascular Sciences, Padua, Italy***BACKGROUND AND AIMS**

Only a century ago the heart and the great vessels were not surgically approachable and any pathology affecting these structures that required surgery inevitably led to a poor prognosis. Notions of biomedical engineering are now integral part of any modern surgeon's curriculum. A potential turning points in heart surgery is mainly related to imaging techniques and digital reconstruction.

METHODS

Cardiologists and cardiac surgeons were among the first to take an interest in and adopt three-dimensional (3D) reconstruction techniques in order to improve clinical outcomes and patient care. At present many large centers have already engineers dedicated to the reconstruction and printing of complex clinical cases. This allows for a personalized approach leading to pre-operative planning and counseling that has been shown to improve clinical outcomes and even mortality. Images are mainly derived from magnetic resonance imaging, computerized tomography and ultrasonography.

RESULTS

3D printed models have proven their usefulness in a wide range of diseases. Preoperative counseling has proved particularly useful in the pediatric world to explain and raise awareness among parents about the diseases affecting their children. A recent application in this regard is the use of 3D printed hearts derived from fetal imaging, a very promising application of 3D printing. More recently, virtual reality entered the medical field as a simulated experience that can be similar or completely different from the real world. Over the years, a huge number of applications have been made in the medical field such as surgical simulation, which has been shown to significantly improve surgical performance.

CONCLUSIONS

The future of pediatric and congenital heart surgery will increasingly depend on preoperative surgical planning and the development of prosthetic substitutes for a fully personalized approach. 3D reconstruction shows great potential in this field, leading to enormous changes in the prognosis and treatment of our patients.

IS145 / #215**ESPNIC Session****ESPNIC Session 53: Dosing durings during extra-corporeal modalities****10-10-2022 11:00 - 12:20****AKI and drug dosing****S. De Wildt***

Radboud University Medical Center, Pharmacology and Toxicology, Intensive Care, Nijmegen, Netherlands

Critically ill children and neonates are at risk for acute kidney injury (AKI), which leads to the sudden derangement of glomerular filtration rate (GFR). It is a frequent and serious condition that is an independent risk factor for prolonged mechanical ventilation, extended stay in the intensive care unit (ICU) and higher mortality. Also, AKI negatively affects a patient's long-term prognosis. Furthermore, there is growing evidence that augmented renal clearance (ARC), which is enhanced kidney perfusion and glomerular hyperfiltration, is more prevalent in critically ill children than previously thought. As altered GFR affects fluid and electrolyte management, and requires dose adaptation for drugs cleared by the kidneys, accurate and timely diagnosis of both AKI and ARC is crucial. First, the challenges of AKI and ARC diagnosis in critically ill children will be discussed, including pros and cons of different eGFR formulas to aid dosing in AKI and ARC patients. Next, the impact of AKI and ARC on drug disposition will be shown, and the results of the NeoDose project. In this project, the Dutch Pediatric Formulary developed dosing guidelines for children with renal insufficiency, which were implemented in the Netherlands, as well as through the Norwegian, Austrian and German affiliates of the Formulary. Finally, the concept of model-informed dosing and model-informed precision dosing will be presented, including state of art implementation in pediatric intensive care.

IS146 / #216

ESPNIC Session

ESPNIC Session 53: Dosing durings during extra-corporeal modalities

10-10-2022 11:00 - 12:20

Drug dosing during ECMO

A. Amigoni*

Department of Mother and Child Health, University Hospital of Padova, Picu, Padova, Italy

Extracorporeal devices modify PK of drugs, so prescription during this treatment remains a challenge. During ECMO treatment were reported: increased Volume of distribution, due to increased circulating blood volume and drug extraction by the circuit; decreased clearance, due to renal and/or hepatic insufficiency; increased T_{1/2} due to renal and/or hepatic insufficiency. Fluid loss, PH, PCO₂, Temperature, O₂ may contribute to change PK. Lipophilicity, protein binding and Volume of distribution are drug characteristics mostly involved in these mechanisms. Moreover, drug absorption, distribution, excretion can be altered due to patients' organ failure. As a result of all these mechanisms, a modification in drug concentration possibly results. Drug dosing is particularly recommended for drugs with possible toxicity or for drugs with a narrow range of efficacy. Some molecules present both characteristics, for example antibiotics and antifungal. Meropenem shows a decrease in serum concentration whereas other antifungal drugs remain stable during ECMO treatment. Voriconazole, micafungine are highly absorbed in the circuit whereas fluconazole and caspofungine are not extracted. Anticonvulsants, anticoagulation and, particularly, immunosuppressant drugs should be kept within a strict range of serum concentration to obtain their effect. Anticoagulation is routinely monitored during ECMO treatment. Particularly for immunosuppressants serum level is unpredictable and accurate dosing is mandatory. Also, amiodarone, is highly extracted in the circuit so the dosing is recommended. Analgesic and sedatives are usually not monitored although highly absorbed in the circuit. According to literature, morphine is the most stable molecule and should be preferred during ECMO treatment.

IS147 / #361

ESPNIC Session

ESPNIC Session 54: Nurses should lead practice change in the intensive care unit

10-10-2022 11:00 - 12:20

Translating result from clinical trials into daily practice

L. Tume*

University of Salford, School of Health & Society, Manchester, United Kingdom

This interactive talk will discuss how and why translating evidence from trials into clinical practice is challenging in pediatric critical care. It will then present some practical ways and facilitators for getting research into practice using the example of the recent ESPNIC Nutrition guidelines for the critically ill child.

IS148 / #362**ESPNIC Session****ESPNIC Session 54: Nurses should lead practice change in the intensive care unit****10-10-2022 11:00 - 12:20****Overcoming the hurdles from non-invasive ventilation****R. Bacelos Silva****Hospital Professor Doutor Fernando Fonseca, EPE, Pícu/nícu, Lisbon, Portugal***BACKGROUND**

Non-invasive ventilation (NIV) has clear advantages over invasive ventilation and is increasing in use in the pediatric setting. However, there is still barriers and some reluctance to utilise this ventilation mode.

AIMS

To identify barriers and facilitators to using NIV in children.

A literature review was conducted through using databases (Pubmed Central, Scielo, Biomed Central, Science Direct), employing the keywords "Noninvasive ventilation", "Pediatric", "Children", "Intensive Care Unit" and "Treatment Failure". Primary and secondary research papers were selected, between the years 2010 and 2021.

40 articles were identified that met the inclusion criteria. From these studies, potential barriers to the use of NIV in children were highlighted, related to a lack of broader scientific studies in the pediatric area, a deficit in the variety of suitable materials (age-appropriate interfaces and specific ventilator circuits) and deficiencies in healthcare professional training and education around NIV. Possible solutions identified included an adoption of predictive factors

of success and failure of NIV, through careful monitoring, allowing a good patient selection and adoption of properly timed interventions. Moreover, it was identified the need of an investment in better NIV technology and more diverse material, combined with skilled training and education of staff around NIV, with establishment of well-defined operating protocols.

Several barriers and facilitators for the use of NIV in children have been identified to consider and address.

IS149 / #235**Interdisciplinary Session****Interdisciplinary Session 24: Seizure management? What's new – Updates on epilepsy management and status****10-10-2022 15:00 - 16:30****Classification and management of neonatal seizures****R. Pressler****UCL Institute of Child Health, Clinical Neuroscience, London, United Kingdom*

Neonatal seizures are the most common neurological emergency in neonates and remain challenging to both clinicians and researchers as they are difficult to diagnose and difficult to treat requiring a multidisciplinary approach.

The new ILAE neonatal seizure classification provides a novel, evidence-based framework for the diagnosis and classification of neonatal seizures that integrates clinical signs and electroencephalographic findings to specify varying levels of diagnostic certainty. This classification uses the same framework and terminology as the 2017 ILAE seizure classification but is tailored towards neonates. All neonatal seizures are considered of focal onset and should be confirmed electrographically. Seizure types include motor events (automatisms, clonic, epileptic spasms, myoclonic, sequential, tonic) or non-motor events (autonomic, behavior arrest) or are electro-graphic only. It allows the user to choose the degree of detail when classifying seizures while taking underlying pathophysiological mechanisms into account.

There is substantial variability in management given limited data available to inform evidence-based management approaches. A clinical practice guideline working group of the ILAE is currently updating the WHO/ILAE Neonatal Seizure management guideline published in 2011 Recommendations include

the choice of first-line and second-line treatment, duration of treatment, the effect of therapeutic hypothermia on seizure burden and use of pyridoxine. Results of these evidence and consensus-based recommendations will be presented which are expected to be published end of this year.

IS150 / #236**Interdisciplinary Session****Interdisciplinary Session 24: Seizure management? What's new – Updates on epilepsy management and status****10-10-2022 15:00 - 16:30****Update on the management of paediatric epilepsy****A. Arzimanoglou***

University Hospitals of Lyon, France and San Juan de Dios Barcelona Children's Hospital, Paediatric Epilepsy, Lyon, France

The epilepsies are a group of heterogenous disorders across all ages, where **epileptic seizures are the presenting symptom and have an impact on neurodevelopment, quality of life and mortality**. They affect at least 6 million people in Europe; 65% individuals will respond to antiseizure drugs or enter spontaneous remission in their lifetime. Of the remaining two million, one third could benefit from a well conducted pre-surgical evaluation and epilepsy surgery. In addition, a significant number will have presented with a distinctive rare epilepsy syndrome/disease for which the prognosis for control of seizures and neurodevelopmental outcome is extremely poor. The International League Against Epilepsy recently released a series of publications on nosology of the epilepsies. Based on those publications we will present a review of current best practices in epilepsy care and treatment. Age at onset and aetiologies will be taken under consideration. Antiseizure medication characteristics and indications for early pre-surgical evaluation will be presented.

IS151 / #242**Interdisciplinary Session****Interdisciplinary Session 25: Fluid management in the critically ill child****10-10-2022 15:00 - 16:30****Fluid management in the critically ill neonate****S. Iacobelli^{1,2*}***¹Reunion Island University Hospital, France, Picu-nicu-neonatology, Saint Pierre, France**²Reunion Island University Hospital, France, Picu-nicu-neonatology, Saint Pierre Cedex, France*

Fluid management in the critically ill neonate has a major impact on lung and renal function, and it may influence duration of illness and survival. With rare exceptions regarding antenatal conditions of dehydration, during the first week of life healthy neonates are expected to have a negative fluid balance of up to 5-10% of total body water. The goal for fluid and electrolyte management for these infants is to allow contraction of extracellular fluid content (ECF), but avoiding dehydration and while maintaining cardiovascular and renal function. It is not easy to define the optimal target of this negative balance for some sick, ELWB infants and near-term or term neonates with critical morbidities. Indeed, such patients admitted to NICUs may undergo an authentic phase of acute illness, where they may need fluid therapy for resuscitation or reestablishment of adequate intravascular volume and a variable amounts of "obligatory" fluid intake as part of their management (nutrition, drugs..). This makes that they are at risk of fluid accumulation, which is in turn associated with increased risk of serious morbidities and death. Fluid overload (FO) in the NICU is understudied, especially during the first week of life. Moreover, there is a lack of consensus on the best definition and on the gold-standard method to assess FO in critically ill neonates, as both these challenges can be confounded by the attended physiologic contraction of ECF content, and the attended postnatal growth after the transition phase, which are both measured as weight variations compared to birth.

IS152 / #243**Interdisciplinary Session****Interdisciplinary Session 25: Fluid management in the critically ill child****10-10-2022 15:00 - 16:30****Fluid management in the critically ill child in the PICU****J. Lemson****Radboud university medical center, Intensive Care Medicine, Nijmegen, Netherlands*

Fluid administration remains an interesting topic in the care for critically ill children. Both hypovolemia and hypervolemia with edema formation can cause harm and may lead to a worse outcome. We will discuss the pediatric intensivists view on fluid management at the bedside, what tools we have to guide fluid therapy and how efficient they are. Lastly we will try to answer the question what the best approach to fluid management at the PICU might be.

IS153 / #229**Interdisciplinary Session****Interdisciplinary Session 26: New prospects on the management of childhood obesity (ESPE Session)****10-10-2022 15:00 - 16:30****A new paradigm in providing care to children and youth living with obesity and its related complications****J-C. Holm***

The Children's Obesity Clinic, European Centre for Obesity Management, Holbaek University Hospital, Denmark

Obesity in children and adolescents is a growing pandemic with enormous health related suffering and expenses. Our group has previously published that 50% of children and adolescents living with obesity and an average age of 11.5 years exhibit pre- or overt hypertension, 31% exhibit steatosis, 28% exhibit dyslipidaemia, 45% exhibit sleep apnoea, and 18% exhibit pre-diabetes. The HOLBAEK model has been shown to reduce the degree of obesity in 75% of patients as well as reducing related complications including hypertension, dyslipidaemia, steatosis, sleep apnoea, parental degree of obesity, appetite, and bullying and increase quality of life, mood and body self-esteem. These results are based on an investment of 5 hours of health-care professional time per patient per year. Further, results are independent on socioeconomic class, degree of obesity prior treatment, sugary intakes, impaired glucose tolerance, disturbed eating, a genetic risk score for obesity and familial predisposition. Within the last decade, The HOLBAEK Study has accumulated +8.000 patients and controls in the paediatric age range and conducted multiple studies including the genome, virome, proteome, metagenome, and lipidome, utilizing machine learning techniques with an aim to predict disease and treatment outcomes. We have diagnosed patients having Melanocortin 4 receptor, leptin receptor and other mutations, and

have generated genetic and polygenic risk scores, including a genetic risk score of steatosis associating with both steatosis and cardiometabolic risk factors in children. Furthermore, we have through consortia collaborations contributed to the identification of novel genes associating with obesity in childhood and cardiovascular disease in adulthood.

IS154 / #230**Interdisciplinary Session****Interdisciplinary Session 26: New prospects on the management of childhood obesity (ESPE Session)****10-10-2022 15:00 - 16:30****New pharmacological treatments of childhood obesity****A. Kelly***

University of Minnesota, Department of Pediatrics and Center for Pediatric Obesity Medicine, Minneapolis, United States of America

Lifestyle modification therapy serves as the foundation of pediatric obesity treatment, yet many children and adolescents need additional help to manage their weight. Anti-obesity medications target core biological processes driving appetite, satiety, and cravings, allowing children and adolescents to better adhere to healthy lifestyle recommendations. Glucagon-like peptide-1 receptor agonists (GLP-1 RAs) have emerged as an important class of anti-obesity medication, and liraglutide 3mg daily was recently approved by the European Medicines Agency and the United States Food and Drug Administration for the treatment of adolescent obesity. Additional GLP-1 RAs, which may offer greater weight loss, are currently being evaluated for safety and efficacy in adolescents with obesity. A recent trial in the United States evaluating the combination of phentermine and topiramate demonstrated clinically significant BMI reduction with an acceptable side effect profile, similar to results of adult obesity trials. Treatment responses to all types of obesity interventions, including pharmacotherapy, can be highly variable, and precision medicine approaches can help identify which anti-obesity medications are the safest and most effective for each individual patient.

IS155 / #237

Interdisciplinary Session

Interdisciplinary Session 27: Safety and complications after anesthesia in children (ESPA Session)

10-10-2022 15:00 - 16:30

Complications during anesthesia in children and neonates; results of the APRICOT and NECTARINE

N. Disma*

Istituto Giannina Gaslini, Anesthesiology, Head of Research Unit, Genoa, Italy

APRICOT and NECTARINE are large prospective cohort studies promoted by ESAIC.

IS156 / #171**Interdisciplinary Session****Interdisciplinary Session 28: Perinatal palliative care - Why and how (EAPC Session)****10-10-2022 15:00 - 16:30****Why?****J. Mendes****ERISA SCHOOL - IPluso, Lisbon, Nursing Education, Aqualva, Portugal*

Perinatal Palliative Care (PPC) is a recent area of development in the palliative care discipline but has rapidly increased all over the world. The first programs started in the late '80s, and at the present, Perinatal Hospice and Palliative care list more than 300 programs in 22 countries, with a major focus on Anglo-Saxon countries. In modern societies, there is a higher prevalence of perinatal and neonatal conditions with palliative care needs, since diagnosis, frequently during pregnancy. Evidence shows that when there is a choice for PPC, families accessing these programs increase significantly. There is also an important raising in children living with life-limiting conditions and facing complex medical needs under the first year of age. PPC development of services and programs is a WHO demand to promote universal health coverage. There is a growing number of pathways, research and recommendations in PPC, but there is still a lack of programs and specific perinatal referrals worldwide. The majority of programs are very recent and show significant differences that must be addressed by research: settings, healthcare team composition, training and education, eligibility criteria, domains of care, reimbursement mechanisms and quality indicators and parental satisfaction predictors. PPC takes place in an area not used to the language of palliative care, such as obstetrics. So, there is a need for universal health education for all professionals involved in the care of families from pregnancy to neonatal care. The education should address all the important and basic topics of care, including a deep reflection on the new ethical scenarios raised from PPC development.

IS157 / #375**Interdisciplinary Session****Interdisciplinary Session 29: COVID-19 pandemic: Implications for developmental care (EADCARE/ AESSD Session)****10-10-2022 15:00 - 16:30****COVID-19–related care measures: The role of face masks in the recognition of emotions by pre-school children****J. Schneider****Department Woman-mother-child, University Hospital Center of Lausanne, Lausanne, Switzerland***INTRODUCTION**

During the COVID-19 pandemic, staff working in pre-school education were asked to wear facemasks, prompting worries about the ability of young children to recognize the emotions of their caretakers. For pictures without facemasks, preschoolers between 36-72 months of age had correct recognition response rates between 11.8% and 13.1%, whereas children between 7-13 years had worse emotions recognition, when showing pictures with digitally added facemasks compared to pictures without facemasks. Our objective was to study the impact of facemasks on emotion recognition of preschool children.

METHODS

We created a dataset of 90 pictures of adults with and without facemasks, imitating joy, anger, or sadness. Children in nine day-care centres were seated in front of a computer and shown the pictures in succession. Children could either name the imitated emotion, or point on a card showing emoticons of these three emotions.

RESULTS

The sample consisted of 278 children (girls 48.6%, $M_{\text{age}}=52.3$ months, $SD_{\text{age}}=9.6$ months). The global correct response rate was 43.4%. Emotions imitated with facemask were less recognised (41.9%) than when showed without facemask (45.0%, $\chi^2=25.6$, $p< 0.001$). There was no significant sex difference for the global correct response rate, nor anger and joy. Boys identified sadness (25.6%) more often than girls did (22.3%, $\chi^2=12.2$, $p<0.001$).

DISCUSSION

Facemasks had a statistically significant but clinically weak impact on the correct response rate for all children, which should be reassuring for car-givers. Further studies are needed to investigate the role of facemasks in other aspects of development and with children with developmental issues.

IS158 / #376**Interdisciplinary Session****Interdisciplinary Session 29: COVID-19 pandemic: implications for developmental care (EADCARE/ AESSD Session)****10-10-2022 15:00 - 16:30****From separation to reparation: Psychobiology of pandemic-related stress in the first 1000 days****L. Provenzi^{1,2*}**¹*IRCCS Mondino Foundation, Child Neurology and Psychiatry Unit, Pavia, Italy*²*Department of Brain and Behavioral Sciences, University of Pavia, Pavia, Italy*

Humans beings are born to be wired. Infants have innate skills to coordinate behaviors, emotional states, and neurophysiology with caregivers. At the same time, our inborn capacity to be interactional makes us also highly sensitive to conditions in which our social wires are challenged, interrupted, and broken. The COVID-19 pandemic is an unprecedented traumatic experience that has resulted in many different challenges to our social wires and the psychological effects may be especially important for individuals who are experiencing periods of heightened neuroplasticity and openness to environmental stimulations, such as women and infants the first thousand days after conception. For this reason, in April 2020 we launched the MOM-COPE project to study the psychobiological consequences and the adaptation response of mothers and infants in a pandemic time. The project engaged ten neonatal units in Italy. Self-report, biological (DNA methylation) and observational measures have been collected from birth to 12 months, according to a longitudinal and prospective study design. Findings to date suggest that (a) prenatal pandemic-related stress may increase dramatically the risk of depression and anxiety in mothers, (b) this altered maternal psychological state may associate with a less-than-optimal caregiving environment, (c) prenatal pandemic-related stress may also contribute to the epigenetic regulation of stress-related genes

in the infants, and (d) both altered caregiving environment and epigenetic changes contribute to programming behavioral development trajectories of infants during the first months of life. The implications of this project will be discussed, highlighting the impact for clinicians, researchers, policymakers, and citizens.

IS159 / #377**Interdisciplinary Session****Interdisciplinary Session 29: COVID-19 pandemic: Implications for developmental care (EADCARE/ AESSD Session)****10-10-2022 15:00 - 16:30****Developmental care during COVID 19 pandemic: Promoting attachment between parents and neonates despite the COVID-19 pandemic****P. Kuhn****Pediatrics, University Hospital of Strasbourg, Strasbourg, France*

Social distancing was the only option available during the COVID-19 pandemic until a vaccine was developed. However, this had a major impact on human relationships and bonding between parents and neonates was/is a major concern. Separation during this health emergency could have lifelong consequences for offspring, and there are even greater concerns if newborn infants are sick or vulnerable and need intensive care. We addressed the issue on how bonding was safely supported and maintained without risking infecting neonates, by comparing the international guidelines and the safe actions that were proposed within those frameworks.

IS160 / #174**Interdisciplinary Session****Interdisciplinary Session 30: Circadian mechanisms in medicine (ESPE Session)****10-10-2022 15:00 - 16:30****Circadian mechanisms in diabetes****L. Dimeglio^{1*}, E. Beli², C. Beam³**¹Indiana University, Pediatrics, Indianapolis, United States of America²Queens University Belfast, Wellcome Wolfson Institute For Experimental Medicine, Belfast, United Kingdom³Department of Biomedical Sciences, Western Michigan University, Kalamazoo, United States of America

The “circadian clock” coordinates human physiology with the daily light/dark cycle. For persons living with type 1 diabetes (T1D) and type 2 diabetes (T2D), this clock is essential for proper metabolic control. Glucose metabolism is under strong circadian control, peaking in the circadian night in persons without diabetes. Glucose tolerance is lower in the evening than morning, possibly due to decreases in both insulin sensitivity and beta cell function. In persons with diabetes, insulin requirements vary by time of day. Many metabolic processes including the pancreatic islet transcriptome, insulin secretion and insulin action exhibit circadian patterns. Circadian rhythms also affect immune responses and circadian disruption has been linked to an increased likelihood of diabetes complication development. “CLOCK” and “BMAL1”, the primary clock gene promoters of transcription, play important roles in diabetes. Disruption of either leads to hypoinsulinemia and diabetes. BMAL1 is also required for beta cell compensatory expansion, survival and metabolic adaption to diet-induced obesity in mice. Non-clock gene factors are also implicated, e.g., circadian misalignment in shift workers increases diabetes risk. Mice exposed to constant light have diminished glucose-stimulated insulin secretion. These mechanisms likely involve the dysregulation of hormones and energetics as the circadian clock machinery controls,

and is itself controlled, by both hormones and metabolic status. Non-clock gene related circadian dysregulation in murine diabetes models has also been associated with the appearance and progression of complications and possibly reduced efficacy of targeted immunotherapies. Peripheral circadian clocks regulate immune cell trafficking. We have shown human circadian rhythm alterations in immune populations thought to be key to T1D pathogenesis. Despite significant progress, Type 1 diabetes ("T1D") remains an unpreventable and uncured disease. Current therapeutic approaches seek to optimize glycaemia and/or to halt autoimmune pancreatic beta cell destruction. Ultimately, therapeutic approaches designed to ameliorate disrupted circadian patterns may also prove valuable.

IS161 / #99**Interdisciplinary Session****Interdisciplinary Session 31: COVID-19 Infection and congenital heart disease patients (AEPCC Session)****10-10-2022 15:00 - 16:30****Pathophysiology of the major congenital heart diseases and possible susceptibility to COVID-19 infection****S. Sendžikaite****Institute of Clinical medicine, Vilnius University, Lithuania, Pediatric Centre, Vilnius, Lithuania*

The COVID-19 pandemic has had a huge influence in almost all areas of life, affecting societies, economics, and health care systems worldwide. The paediatric cardiology community is no exception. As the challenging battle with COVID-19 continues, Paediatric Cardiologists receive many questions regarding COVID-19 in Congenital Cardiology setting. The aim of this presentation is to give an updated information regarding COVID-19 and congenital heart diseases based on continuous monitoring and evaluation of scientific papers, as well as to frame a discussion on how to take care of our patients during this unprecedented crisis. As the times are changing quickly and information regarding COVID-19 is very dynamic, continuous collection of evidence will help guide constructive decision-making.

IS162 / #363

Interdisciplinary Session

Interdisciplinary Session 32: Nurses as research leaders

10-10-2022 15:00 - 16:30

Getting your proposal funded

L. Tume*

University of Salford, School of Health & Society, Manchester, United Kingdom

This practical and interactive talk will focus on why obtaining research funding is beneficial, where you could look (broadly) for funding, how you need to write your grant application to be successful and lastly what are the common pitfalls and reasons that grant applications are unsuccessful.

IS163 / #364**Interdisciplinary Session****Interdisciplinary Session 32: Nurses as research leaders****10-10-2022 15:00 - 16:30****Getting patients involved in trial design****J. Mattsson***

Astrid Lindgrens Childrens Hospital, Karolinska University Hospital, Sweden, Childrens Pmi, Stockholm, Sweden

Research on children/young people's participation and participation in care is limited. The existing research has shown that children's participation in care varies, as does the way in which they participate. Factors that limit children's participation in care include factors such as not knowing the care staff, difficulty contacting care staff, not wanting to hear negative decisions, fear of being ignored or not being believed. It has also been shown that in many cases nurses do not take the child's expressions and reactions seriously but are guided by myths or intuition. Other problems are that they do not treat the child as a whole person with specific needs. According to the Health Care Act, children and young people must be involved in decisions concerning treatment and care. They also have the right to information about their illness and treatment in such a way that they understand the meaning of what has been said and can make well-informed decisions. The purpose was to increase young people's participation in in care in collaboration between young people and care staff. The purpose is also to describe and evaluate this process. This study is based on the constructivist assumption that the findings are co-created by the researcher and the participants in the study and the sociocultural perspective, meaning knowledge is seen as a creation in interaction with the subjects and the context. This research, which involves both the researchers and the participants in close collaboration, is a central feature of action research. We created a panel of 7 adolescent's between 13-18 years of age who have regular contact with the children's and young

people's hospital and a panel of health care workers. The two panels discuss the same topics, involvement, but do not meet until the end of the research. Using this research strategy, we aimed to disclose the gap between the real and ideal and uncover the area of improvement. The present study arose from a "problem-driven" perspective, that is, that the research was motivated by clinical issues. Researchers who start from this perspective attack a "real-world problem". This means that the researcher is looking for something of significance for the practical context in which the researcher is active, but which is hidden. The data collection is based on a special group of informants with a specific experience. Their relationship to the situation and the problem is crucial in order to obtain data. The results conveyed involvement in the health care process in diverse ways and to a different depth. This is highlighted in the theme *Clarity* with the under themes *Security* and *Being accepted*. However, the theme *Exclusion* with the under-theme *Rejection* revealed a non-caring approach where no caring relation could be established.

IS164 / #249**ESPNIC Session****ESPNIC Session 55: Fluids in the PICU****10-10-2022 17:00 - 17:55****Fluids in the PICU – Which, when and how much.
An evidence-based approach****F. Valla^{1,2*}**¹*Hospices Civils de Lyon, Pediatric Intensive Care, Bron, France*²*Lyon University Children Hospital, Hospices Civils de Lyon, Pediatric Intensive Care, Bron, France*

There is no clear consensus on intravenous maintenance fluid therapy (IV-MFT) prescribing in acutely and critically ill children and practices vary a lot among health care professionals, as shown in a recent international survey published by Morice et al. (2022). ESPNIC metabolism endocrinology and nutrition section conducted a systematic review and meta-analysis to answer five main questions about IV-MFT: i) the indications for use ii) the role of isotonic fluid iii) the role of balanced solutions iv) IV fluid composition (calcium, magnesium, potassium, glucose and micronutrients) and v) the optimal amount of fluid. This project was conducted by a multidisciplinary expert group following the SIGN grading method to produce guidelines. Five databases were searched for studies that answered these five questions, in acutely and critically children, published until November 2020. A series of recommendations was derived and voted on by the expert group to achieve consensus through two voting rounds. 56 studies met the inclusion criteria, and 16 recommendations could be produced. Outcome reporting was inconsistent among studies. Consensus within the expert group was high, but recommendations generated were based on a heterogeneous level of evidence. Main recommendations are to favor enteral/oral hydration whenever possible, to use balanced isotonic solutions providing glucose, to restrict IV-MFT infusion volumes (compared to Holliday and Segar formula) in most hospitalized children and to regularly monitor plasma serum glucose, electrolyte levels and fluid balance.

IS165 / #248**ESPR Session****Espr Session 56: Cord clamping****10-10-2022 17:00 - 17:55****Update on cord clamping****E. Dempsey^{1,2}**¹*University College Cork, Infant Research Centre, Cork, Ireland*²*Department of Paediatrics & Child Health, University College Cork, Cork, Ireland*

Our understanding of the physiology of neonatal adaptation and the associated importance of cord management strategies has increased substantially over the last 10 years, much of this as a result of excellent animal studies. As the clinical evidence increases supporting various cord management strategies, many international organisations have now endorsed delayed cord clamping as the primary cord management strategy for the term and preterm infant. However, many questions remain to be answered in this important aspect of care. In this presentation we will review some of the key animal work in this area, and review the clinical evidence supporting various practices including delayed cord clamping, umbilical cord milking, physiological based cord management, and delayed cord clamping with resuscitation in the preterm infant. We will explore both short term physiological benefits, and longer term health benefits of the various strategies employed. We will also explore which technique may be best for the non vigorous term newborn.

IS166 / #250**EAP Session****EAP Session 57: Off label drugs in children****10-10-2022 17:00 - 17:55****Off label drugs in children****L. Schrier****Princess Máxima Center for Pediatric Oncology, Pediatric Oncology, Utrecht, Netherlands*

Despite important regulatory initiatives, efforts (and successes) by pharma and academia, and advances in both basic science and pediatric clinical trials, there is (still) a lack of available medicines with an appropriate drug label for neonates, children and adolescents. Pediatricians and other health care professionals have the professional duty to choose medicines that are in the best interest of their individual patient, regardless if these are on-label or off-label. An important reason for use of off-label medicines is to improve access to (innovative) treatments or to address unmet medical needs and patient preferences, especially when no other options are available. The professional setting (both legal and paralegal) does not limit the right of prescribers to prescribe on-label medicines only, as this would in many cases lead to a conflict of professional duties. Therefore, in practice, at the national level, off-label use of medicines is often ethically and legally 'accepted' under restrictions. There is consensus that off-label is considered to be rational and clinically appropriate if the benefits outweigh the risks. However, guidance on how to assess this balance is limited. During this presentation, an overview of challenges related to off-label drug use will be given and practical approaches to prescribing off-label medicines to children, including dose selection, will be offered.

IS167 / #247**EAP Session****EAP Session 59: Sport in the adolescent age and anorexia****10-10-2022 17:00 - 17:55****The young athlete - Things we must remember****S. Del Torso^{1*}, L. Dembinski², A. Turska Kmiec³, A. Mazur⁴**¹*ChildCare WorldWide, Association, Padova, Italy*²*Medical University of Warsaw, Pediatric Gastroenterology and Nutrition, Warsaw, Poland*³*Children's Memorial Health Institute, Cardiology, Warsaw, Poland*⁴*University of Rzeszow, Medical Faculty, Rzeszow, Poland*

Physical activity is essential for children's optimal physical, emotional, and psychosocial development. Moreover, in combination with healthy eating habits, it reduces the risk of obesity and diet-related diseases, potentially increasing life's length and quality. However, despite these benefits, fewer than 50% of children and adolescents in most European countries meet WHO recommendations for adequate physical activity. On the other hand, sports activity can sometimes pose a threat to health and even life associated with the occurrence of congenital disabilities symptoms, comorbidities, and increasing problems with doping and overuse of supplements in youth sport. The youth athletes who desires to compete at higher levels often train longer, harder, and with intense dedication which presents unique challenges to the developing athlete's body risk of overuse injuries and increased risk for overtraining syndrome. Therefore, apart from promoting sports activity, paediatricians should have an essential role in pre-participation physical evaluation and follow-up, which primary objective is to screen for potentially life-threatening conditions. Such screening is also increasingly required by legal and insurance requirements. Particular attention should be paid to adolescents who practice the extreme sports that are gaining in popularity but carry a raised health risk. Although approximately 10% of athletes have a significant finding during the screening, only $\leq 2\%$ of athletes are ultimately

disqualified from sports participation. This lecture will discuss sports activity classifications, and recommended diagnostic examinations during the pre-participation physical evaluation and follow-up visits. Problems related to physical activity in children with chronic diseases will also be presented.

IS168 / #246**ESPNIC Session****ESPNIC Session 60: The changing face of the PICU patient****10-10-2022 17:00 - 17:55****The paediatric haem-onc patient in the PICU: Do we need to do everything?****R. Wösten – Van Asperen****Department of Pediatric Intensive Care, University Medical Center Utrecht/Wilhelmina Children's Hospital, Utrecht, Netherlands*

Pediatric cancer patients admitted to a pediatric intensive care unit (PICU) form a unique population with specific critical care needs due to their underlying malignancy and treatment-related toxicities. Development of intensified and new treatment protocols have revolutionized oncology in the past decade and pediatric 5-year all-cancer survival currently has progressed to almost 80%. These treatment protocols are however associated with severe side effects. Given the improved survival rates and advances in therapeutic options, it is expected that in the near future more pediatric cancer patients will require treatment at the PICU for cancer-related complications, treatment-related toxicities, and severe infections. Our ability to identify cancer patients likely to benefit from PICU management is still limited. Granular data on risk factors for PICU admission, PICU resource utilization, and patient outcomes are still lacking. Time-limited trials have been one of the major changes regarding ICU admission of adult cancer patients. The strategy consists of unlimited ICU management with a full-code status for a limited period. During this time, everything should be done. Subsequently, the continuation or introduction of life-sustaining therapies in patients whose conditions worsen may not be beneficial. Patients and their families are essential partners in all decisions. Whether such trials may help guide decision-making at the PICU need to be determined.

IS169 / #123**ESPR Session****ESPR Session 61: Oxygen and outcome****10-10-2022 17:00 - 17:55****Intermittent hypoxia and late outcome****C. Poets****Tuebingen University, Dept. of Neonatology, Tuebingen, Germany*

This review is on potential associations between intermittent hypoxia (IH) and impaired neurodevelopment in infants and children. In extremely preterm infants (<28 wk gestation), such an association has been established based on a secondary analysis of Canadian Oxygen Trial data. These showed, in 997 infants, that the odds of developing cognitive or language impairment at 18 months corrected age were 3 times higher in infants who were in the highest decile for the proportion of time spent with events where pulse oximeter saturation (SpO_2) was <80% for ≥ 1 min. during their first 10 postnatal weeks compared to those who had very few intermittent hypoxemia (IH) events after birth. In older term and preterm infants, the occurrence of 5 or more events with prolonged apnea and bradycardia during home monitoring was associated with 5 points less on the mental development index of the Bayley-II scales. For older children, associations between sleep-disordered breathing and impaired cognition/academic achievements have also been established, but not consistently, and it remains unclear whether this association is primarily mediated via IH or via sleep deprivation resulting from frequent apnea-induced arousals. Animal data show that IH may cause apoptosis particularly in the hippocampus. Although we need to stress that associations cannot prove causality, current evidence provides support for IH to be detected and prevented early. Future studies should focus on IH rather than on apnea/bradycardia.

IS170 / #244**ESPNIC Session****ESPNIC Session 62: What happens to our PICU patients****10-10-2022 17:00 - 17:55****Outcome after traumatic brain injury- Kidsbrain it****T.-Y.M. Lo****Royal Hospital for Children and Young People, Paediatric Critical Care, Edinburgh, United Kingdom***BACKGROUND & AIMS**

Data visualisation techniques are useful to better understand the impact of intracranial pressure (ICP) and cerebral perfusion pressure (CPP) dose-responses on brain trauma outcome in adults. We aim to better understand how ICP and CPP dose-responses impact on childhood brain trauma outcome.

METHODS

Prospectively collected minute-by-minute physiological data of 199 paediatric brain trauma patients from KidsBrainIT, an EU grant funded multi-national multi-centre paediatric brain trauma research initiative, were analysed. The relationships between the 6 months post-injury global outcome and episodes of elevated ICP and low CPP were visualised in respectively 3D colour-coded plots (i.e. the ICP and CPP dose-response visualisation plots).

RESULTS

The ICP dose-response plot confirmed a transitional curve delineating the duration and intensity of those higher ICP episodes associated with worse

outcome from episodes of lower degree of intracranial hypertension associated with better outcome. Transition to worse outcomes above ICP of 18 mmHg occurred at 4 minutes, but ICP of 20 mmHg or more was not tolerated at all. Paediatric CPP dose-response visualisation plots confirmed for the first time, like adults, an almost exponential transition curve separating the episodes of CPP associated with better outcomes from episode of low CPP associated with worse outcome.

CONCLUSIONS

Dose-response visualisation plots for ICP and CPP are respectively useful in better understand their impact on childhood brain trauma outcome. To improve outcome after childhood brain trauma, ICP of 20 mmHg or more must be avoided. The relationships between CPP tolerance thresholds, different ages, and cerebrovascular reactivity warrant further investigations.

IS171 / #253**ESPNIC Session****ESPNIC Session 64: Weight matters****10-10-2022 17:00 - 17:55****Pharmacology of obese and adolescent patients in the PICU****S. De Wildt****Radboud UMC, Pharmacology & Toxicology, Nijmegen, Netherlands*

The rates of overweight and obesity are skyrocketing in both adults and children. It is even forecasted that 51% of the world population will be obese by 2030. It is well known that obesity has influence on drug distribution and metabolism. In children, both obesity and development impact drug disposition, but the exact interplay is still unclear and individualized dosing guidelines are missing. This knowledge gap puts the obese children at risk of drug treatment failure or drug toxicity. Optimal weight-based dosing strategies vary by drug and age, but investigating every prescribed medicine is not feasible. A proposed dosing strategy in obese children is allometric scaling. Allometric scaling refers to dosing based on body size scaled to a fixed exponent. However, it remains unclear which anthropometric measure of size is most appropriate for scaling, and it is likely that none of the measures of size will be appropriate for all drugs. Moreover, in critically ill children, drug disposition also shows variability due to critical illness, like edema, acute kidney injury, augmented renal clearance and inflammation. The interplay between age, obesity and critical illness poses the prescribing pediatric intensivist and pharmacist for a difficult task to tailor dosing to the individual patient.

Learning objectives of this presentation will be: Understand the impact of age, disease and obesity on drug disposition in critically ill, obese children Understand the complexity of its interplay Discuss the role of therapeutic drug monitoring to optimize dosing in this vulnerable population

IS172 / #254**EAP Session****EAP Session 65: Ophthalmological problems in children****10-10-2022 17:00 - 17:55****Signs to catch; which need urgent referral?****A. Christoforou****LaserVision Eye Center, Oph, Nicosia, Cyprus*

It is always a challenge either for the paediatrician or the physician at the emergency unit to evaluate a child with eye complaints. It is essential that the physician can detect those conditions that can lead to permanent vision loss and sometimes to suspect that eye problems might be the sign of an underlying systemic disease. The paediatrician must become familiar to perform basic eye evaluation with a minimum of technology. Signs and symptoms like white pupil (leucocoria), diplopia, proptosis, amblyogenic conditions (strabismus, refractive errors, ptosis), papilledema, ocular trauma of either the lids or the orbit with severe intraocular damage, severe eye infections especially when the cornea is involved, headaches, nausea, vomiting should be evaluated and referred urgently. The final diagnosis by the specialist include vision threatening diseases like cataract, glaucoma, iritis, herpetic keratitis, severe ocular trauma, amblyopia and life threatening conditions like retinoblastoma, severe orbital cellulitis or any condition involved with high intracranial pressure with ocular manifestation (brain tumors). The first physician to see a child in case of an eye emergency can be of enormous value in preventing and treating visual or even life threatening conditions so urgent or emergency referral of such cases must not be missed.

IS173 / #290**Bengt Robertson Award****The bengt robertson award session****10-10-2022 18:00 - 19:00****The bengt robertson award lecture: bengt robertson award lecture: Early origins of respiratory disease****A. Greenough^{1,2*}**

¹King's College London, Department of Women and Children's Health, London, United Kingdom

²NIHR Biomedical Research Centre, Guy's and St Thomas' Nhs Foundation Trust and King's College London, London, United Kingdom

Chronic respiratory morbidity is unfortunately common in childhood, particularly in those born very prematurely and who had bronchopulmonary dysplasia (BPD). Affected infants can suffer lung function abnormalities even into adolescence and adulthood. They have airways obstruction which may not respond to bronchodilators. The lung function abnormalities are associated with wheeze and reduced exercise tolerance. Moderately and late prematurely born children may also have increased respiratory morbidity being more likely to asthma and have RSV lower respiratory tract infections than term born peers.

Being born small for gestational age (SGA) may reduce the likelihood of RDS, but SGA infants are more likely to develop BPD and have respiratory problems in the first two years. Antenatally administered endotoxin in animal models resulted in a reduced number of alveoli which were larger in volume. A systematic review of 158 studies has demonstrated that chorioamnionitis is significantly associated with BPD development. Males compared to females have worse outcomes on the neonatal unit and through childhood, for example at 11 to 14 years more males had low lung function. Interestingly, post puberty "BPD" women rather than men were more likely to have asthma and be short of breath on exercise. At an older age, women but not men, had an increased

risk of obstructive lung disease and asthma with decreasing gestational age and birthweight. Increased exposure to antenatal corticosteroids, postnatal surfactant and non-invasive ventilation does not appear to have influenced lung function at follow up. Very few randomised controlled trials of ventilation modes have incorporated long term follow up. At 11 to 14 years of age, those entered into the UKOS trial had superior lung function and educational attainment if they had been supported by high frequency oscillation rather than conventional ventilation (CMV). An invitro study demonstrated the likely mechanism was that the CMV group had been exposed to greater cyclical mechanical stretch resulting in higher cytokine release which can decrease angiogenesis and alveolarization. At 16 to 19 years, however, there were no significant differences in lung function between the two groups suggesting that there had been catch up lung growth in the CMV group. Whether that is maintained merits testing. Postnatal corticosteroid exposure on the neonatal unit, however, has been associated with poorer lung function at 11 to 14 years and, between 11 to 14 and 16 to 19 years, a decline in lung function occurred rather than the increase expected through puberty. As prematurely born infants never reach the same level of lung function as those born at term, postnatal corticosteroid administration may put individuals at increased risk of the early onset of chronic obstructive lung disease. Long term follow up of prematurely born children is required if we are to understand their lung function trajectory and the impact of interventions.

IS174 / #261**Educational Symposium****Educational Symposium 34: COVID-related adverse effects on paediatric population (EAP)****11-10-2022 08:00 - 08:50****What can we learn from COVID; the clock study of long COVID in children****T. Stephenson***

UCL Great Ormond Street Institute of Child Health, Population, Policy & Practice, London, United Kingdom

Whilst acute COVID-19 has generally been milder in children and young people (CYP) compared to adults, there is concern that they may suffer long-term symptoms. There is a need to define the clinical phenotype, CYP most at risk, the natural course of the condition and evaluate preventive and therapeutic strategies for both mental health and physical symptoms. Systematic reviews have found the frequency of the majority of reported persistent symptoms is similar in SARS-CoV-2 positive cases and controls, although generally slightly more common in children and young people infected with SARS-CoV-2. The CLoCk study is a cohort study of SARS-CoV-2 PCR-positive CYP aged 11-17 years, matched by month of test, age, sex, and geographical area to SARS-CoV-2 test-negative CYP. Factors associated with persisting, impairing symptoms include increased number of symptoms at the time of testing, female sex, older age, worse self-rated physical and mental health, and feelings of loneliness pre-infection. There remains much uncertainty about the prevalence, natural history, risk factors, mechanisms and outcomes of long COVID in CYP. Nevertheless, we are better informed now than in 2020 when estimates of long COVID CYP ranged from 1%-51% after SARS-CoV-2 infection. Whilst some CYP are severely affected and incapacitated long after the initial illness, the majority of studies show a milder phenotype in CYP. This talk will highlight the importance of a control group in studies following SARS-CoV-2 infection, the need for case definitions and continuing research.

IS175 / #262**Educational Symposium****Educational Symposium 34: COVID-related adverse effects on paediatric population (EAP)****11-10-2022 08:00 - 08:50****What happened to the general paediatric population? Delayed diagnosis due to lock down****A. González Aumatell****Pediatrics, Hospital Germans Trias i Pujol, Barcelona, Spain*

The COVID-19 pandemic has led us to a great and rapid change in our society. Although children and adolescents are somewhat less likely to experience severe symptoms from COVID-19, the pandemic has caused widespread and profound disruptions in their daily life with no immediate return to previous baselines leading to impact in many aspects of their health. One of the short-term consequence is been diminished the access to care with less developmental surveillance and decreased immunization rates. Another foreseeable and concerning consequence related to physical health is nutrition, in particular an increase in food insecurity, therefore an increase of childhood obesity. This situation also may lead to a most serious consequence, a failure to timely identify child abuse or maltreatment. It is also known that increased screen time, school closures, and stay-at-home orders during the COVID-19 pandemic have likely had a negative impact on children's development leading to a delay in the identification and intervention of learning and other developmental problems. As the COVID-19 pandemic continues, and it is causing major physical, psychological, educational, development, behavioural and social health consequences, several steps can be taken by paediatricians and caregivers to address the short-term and long-term health needs of children. Screening tools and instruments used by paediatricians must be developed to identify high-risk groups, including children with severe psychological burdens, toxic home environments, unaddressed

developmental concerns, or perhaps simply, children who struggle with return to previous routines and expectations once things begin to return to a new baseline. It is needed to identify and evaluate any additional COVID-related challenges and concerns that adversely impact the growth and development of children and adolescents.

IS176 / #257**Educational Symposium****Educational Symposium 35: Educational symposium - New techniques in the care of newborn lungs (ESPR)****11-10-2022 08:00 - 08:50****Nasal high flow to improve intubation success and safety in neonates: The shine trial****B. Manley****The Royal Women's Hospital, Newborn Research Centre, Parkville, Australia***BACKGROUND**

Neonatal endotracheal intubation is a critical procedure, but first attempt success rates are low and desaturation is common. Nasal high-flow (nHF), which delivers high gas flows via nasal cannulae, extends time to desaturation in healthy children and adults undergoing elective intubation under general anaesthesia.

METHODS

This multicentre, randomised controlled trial compared nHF with standard care in neonates undergoing oral endotracheal intubation in the delivery room or neonatal unit. Intubations were randomised individually, and stratified by site, premedication use and postmenstrual age (<28 weeks; >28 weeks). The primary outcome was successful intubation on the first attempt without physiological instability (absolute decrease in peripheral oxygen saturation >20% from pre-intubation baseline, and/or bradycardia <100 bpm).

RESULTS

251 intubations in 202 infants were included in the primary intention-to-treat analysis. Infants had a median (interquartile range) postmenstrual age of 27.9 (26.3-32.1) weeks and weight of 920 (712-1499) grams at the time of intubation. Successful first attempt intubation without physiological instability occurred in 62/124 (50.0%) intubations in the nHF group, compared with 40/127 (31.5%) in the standard care group (adjusted risk difference 17.6%, 95% confidence interval 6.0% to 29.2%; number needed to treat for benefit 6 infants, 95% confidence interval 4 to 17 infants, Table 2). Successful intubation was more common in the nHF group than the standard care group (68.5% and 54.3% respectively; adjusted risk difference 15.8%, 95% confidence interval 4.3% to 27.3%).

CONCLUSIONS

The use of nHF during neonatal intubation improves the likelihood of first attempt successful intubation without physiological instability.

IS177 / #125**Educational Symposium****Educational Symposium 38: All you need to know about new techniques in neonatal lung disease (ESPR)****11-10-2022 08:00 - 08:50****Forced oscillation technique****a. Lavizzari***

Fondazione IRCCS Cà Granda, Ospedale Maggiore Policlinico- Università degli Studi di Milano, Neonatal Intensive Care Unit, Milan, Italy

The Forced Oscillation Technique (FOT) (or Respiratory Oscillometry) measures the mechanical properties of the respiratory system (airways, lung tissue and rib cage) by applying a forcing signal at high frequency and small amplitude to the opening airways. The FOT differs from other techniques for assessing respiratory mechanics because of its ease of use at the bedside, non-invasivity (no muscle paralysis is required, nor the introduction of invasive devices such as an oesophageal balloon), and the applicability to uncooperative subjects. Respiratory mechanics by FOT can be obtained in patients mechanically ventilated or in high-frequency oscillatory ventilation or spontaneously breathing. Modern mechanical ventilators have integrated the possibility to assess respiratory mechanics by FOT without disconnecting the patients from the ventilatory circuit. In adult medicine, respiratory oscillometry allows tailoring mechanical ventilation (PEEP optimization) and follow-up of patients with chronic respiratory diseases (asthma, BPCO) to predict re-exacerbations and tailoring treatment. Recently the European Respiratory Society published the standard references for Respiratory Oscillometry in adult and pediatric patients. Thanks to its non-invasivity and no need for patients cooperation, the FOT is a valuable tool for the clinical management of the respiratory issues of the newborn infant. During the talk, we will discuss how the FOT can be applied in neonatology: - to improve knowledge of respiratory physiology in the clinical and preclinical setting - to guide the lung

recruitment at birth - to tailor the ventilator setting (e.g. PEEP optimization)
- to follow up with patients and predict long term respiratory outcomes - to
tailor pharmacological treatment such as surfactant therapy.

IS178 / #126**Educational Symposium****Educational Symposium 38: All you need to know about new techniques in neonatal lung disease (ESPR)****11-10-2022 08:00 - 08:50****Heliox for neonatal ventilation****T. Szczapa****2nd Department of Neonatology, Poznań University of Medical Sciences, Poznań, Poland*

Heliox (helium-oxygen) is a special gas mixture that may be used instead of standard air-oxygen for neonatal ventilatory support. Unique physical properties of Heliox (e.g. low density) allow for improved gas flow and diffusion. The presentation will cover pathophysiologic rationale for the use of this mixture in the newborn and summarize available data regarding applications of Heliox in the NICU. Mechanisms of action and practical aspects of Heliox delivery will be also discussed; future research directions for neonatal use of Heliox will be proposed.

IS179 / #259**Educational Symposium****Educational Symposium 37: Latest insights in neonatal pain management (ESPR)****11-10-2022 08:00 - 08:50****Neonatal pain assessment****M. Campbell-Yeo^{1,2,3*}**¹*Dalhousie University, School of Nursing, Faculty of Health, Halifax, Canada*²*Departments of Pediatrics and Psychology & Neuroscience, Dalhousie University, Halifax, Canada*³*IWK Health Centre, Centre for Pediatric Pain Research, Halifax, Canada*

All infants undergo ubiquitous painful procedures during early life and those that are ill or born preterm requiring neonatal intensive care undergo on average 10 procedures daily, most receiving sub-optimal management. This untreated pain is associated with immediate and longer-lasting adverse outcomes. One challenge to optimal neonatal pain management is the inability of infants to self-report. While consistent age-appropriate pain assessment has been linked with better pain management, evidence suggests that pain is not routinely assessed. Challenges remain regarding consensus on what are the optimal pain indicators to assess pain, how to best ensure health care provider pain assessment competence, how to integrate routine pain assessment into practice, and the role of parents in pain assessment. During this didactic and interactive presentation, the latest evidence addressing these challenges will be reviewed and participants will also have the opportunity to practice interactive pain assessment. The aim of the session will be to highlight the current state of evidence for optimal neonatal assessment, strategies to facilitate practice uptake and to identify areas for future research.







IS180 / #260**Educational Symposium****Educational Symposium 37: Latest insights in neonatal pain management (ESPR)****11-10-2022 08:00 - 08:50****Best evidence on non-pharmacological and pharmacological interventions****M. Eriksson****Örebro University, School of Health Sciences, Örebro, Sweden*

Over the last decades there has been an almost exponential increase in pediatric pain research, both clinical and pre-clinical studies, aiming at improving pain management for children in all ages. In many areas there is now enough evidence on how to minimize pain and the problem is low grades of clinical implementation. Children don't get the pain alleviation they are entitled to, due to lack of resources, lack of guidelines or lack of interest. In other areas we still need to find the best methods for the specific population and the specific situation and pain type. This lecture will give some examples of recent studies on pharmacological and non-pharmacological interventions and bring forward the latest evidence. The objective is to inspire the audience to better uptake of the latest knowledge in the clinical work, and also to start collaborative research in areas where better evidence is needed.

IS181 / #255**Educational Symposium****Educational Symposium 36: Using respiratory physiology to ventilate the patient (ESPNIC)****11-10-2022 08:00 - 08:50****How to ventilate the obstructive patient****A. Medina Villanueva****Hospital Universitario Central de Asturias, Paediatrics (Picu), Oviedo, Spain*

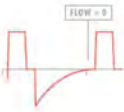
In Obstructive diseases due to an increase in R, time constant (τ) is longer as it takes longer to fill or empty the lung unit. It may lead to incomplete exhalation causing air-trapping. Accurately the existence of air-trapping and its particular kind is key when adjusting the mechanical ventilation programming (Table 1 and Figure 1).

Table 1: Air-trapping mechanisms

Name		Mechanism	Causes	Flow-time curve	Expiratory pause	Treatment
Dynamic auto-PEEP		Time dependent dynamic air-trapping	Asthma			↑ Te
Non-dynamic auto-PEEP	Measurable	PEEP dependent air-trapping due to distal collapse (Venturi effect)	Prematurity BPD Bronchiolitis COPD			↑ PEEP
	Non-measurable	PEEP dependent air-trapping unidirectional valve mechanism due to secretions	Bronchiolitis MAS Asthma			

Source: Figure and table reproduced from: ESPNIC/SECIP Handbook of Paediatric and Neonatal Mechanical ventilation

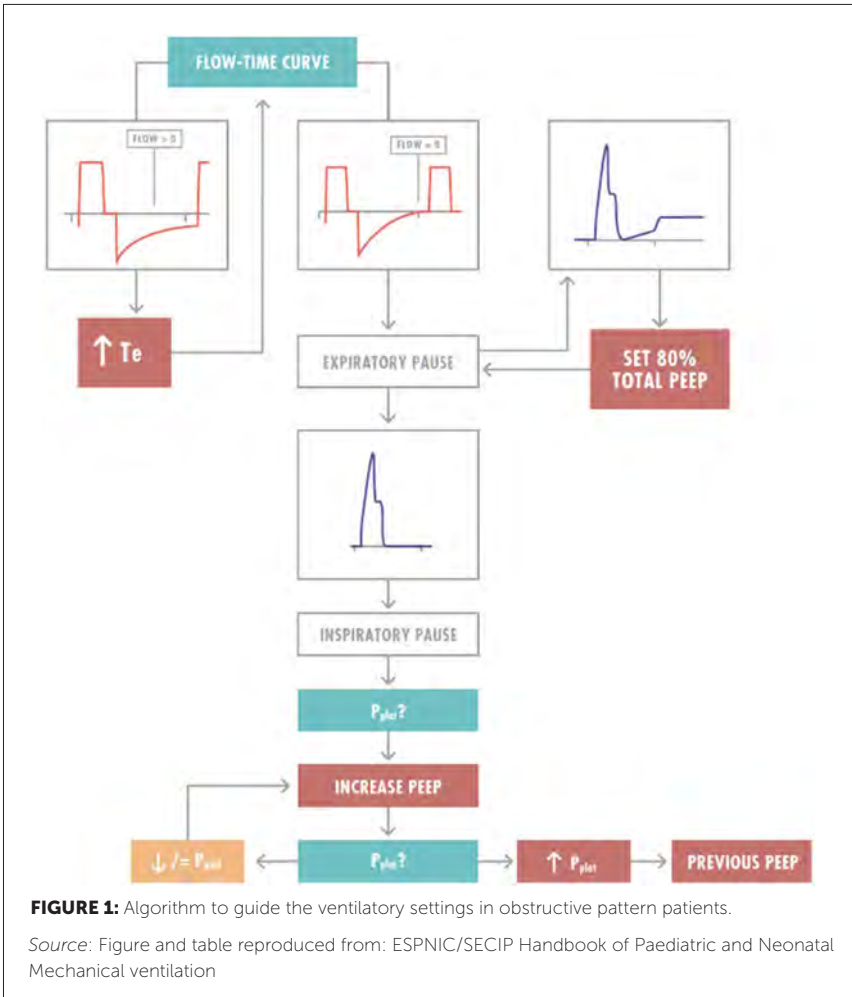

If dynamic air-trapping is present the ventilation strategy aims for minimal minute ventilation allowing some degree of permissive hypercapnia and an optimal I:E ratio that allows complete expiration. Traditionally, high inspiratory flow using constant flow (VC modes) to overcome airway resistance and long expiratory times have been recommended. The rationale to use

constant flow is that with high inspiratory flows, the inspiratory time would be reduced allowing more time for exhalation.

The presence of a collapse of the wall of the distal airway or secretions can produce dependent PEEP air-trapping. The PEEP degree aims to permeabilise the distal airway. The PEEP that achieves the lowest Pplat should be programmed which would mean that the lung volume at the end of inspiration (VEI) would be reduced and, consequently, the incidence of non-dynamic air-trapping.

IS182 / #256**Educational Symposium****Educational Symposium 36: Using respiratory physiology to ventilate the patient (ESPNIC)****11-10-2022 08:00 - 08:50****Strategies to limit mechanical power****V. Modesto I Alapont^{1*}, A. Medina Villanueva²**¹*Dept Anesthesiology, Rocafort (València), Hospital Universitari i Politècnic La Fe., Pícu. Spain*²*Hospital Universitario Central de Asturias, Paediatrics, Pícu, Oviedo, Spain*

Mechanical Power (MP) is an emerging concept in the field on Mechanical Ventilation. It summarizes the potential for Ventilator Induced Lung Injury (VILI) in the ergotrauma theory, based on concepts from rheology and materials science. In this talk we will explain the fundamentals of materials science and its application to the knowledge of lung physiopathology. Also we will conjecture the possibility of lowering VILI production by lowering MP applied to the lungs. And finally, we will show the evidence that points in this direction, based in animal studies but also in clinical studies and meta-analysis of randomized trials.

IS183 / #268**Educational Symposium****Educational Symposium 40: From a toxic to a healing PICU environment (ESPNIC)****11-10-2022 08:00 - 08:50****Making the PICU a healing environment****J. Menzies***

Birmingham Women's and Children's NHS Foundation Trust, Paediatric Intensive Care Unit, Birmingham, United Kingdom

Survival rates for children and young people (CYP) admitted to Paediatric Critical Care following critical illness or injury have improved worldwide. However, whilst mortality has reduced, there is recognition that morbidity has increased, conceptualised with paediatric survivors as Post Intensive Care Syndrome- Paediatric (PICS-p). The core focus of the PICS-p framework is on the child, recognising that PICU admission can have a significant impact on the child's physical, cognitive, emotional and social health, possibly for decades. Health care professionals working within PICU need to create a holistic, healing environment with interventions to promote the physical, cognitive, emotional and social health of the CYP and family. There is a growing evidence base about how the PICU environment can be modified to optimise patient recovery; from ward layout, access to natural light, management of artificial lighting, minimisation of unit activity, noise reduction, access to bathroom facilities, staffing and visiting policies. There is also guidance to optimise PICU patient recovery and outcomes, including 'bundles' to promote successful extubation, assessment and management of pain, sedation and delirium, early rehabilitation and mobilisation and family engagement and empowerment. Making changes to the physical environment and changing the culture of patient management requires collaboration and involvement from the whole multi-disciplinary team. ICU survivorship has become a top concern and methods to optimise child and family recovery and outcomes need to be prioritised by PICU health care professionals.

IS184 / #266**Educational Symposium****Educational Symposium 39: Paediatric hypertension (EAP)****11-10-2022 08:00 - 08:50****Risk groups for developing hypertension****P.F. Hoyer****University Duisburg Essen, Klinik Für Kinderheilkunde Ii, Essen, Germany*

Arterial hypertension has a significant impact on morbidity and mortality in adult patients. In many patients, arterial hypertension begins during childhood. Despite the fact that the prevalence is about 3 % during childhood, it is often not recognized because it is asymptomatic or blood pressure is not taken, and end-organ damage may take time. However, uncontrolled high blood pressure accelerates organ damage. Therefore, the knowledge of patient groups at risk who might develop arterial hypertension is of utmost importance for early intervention. A prerequisite is the knowledge of the definition of arterial hypertension, how to measure blood pressure in different age groups and the application of normal values. The risk for the development of arterial hypertension depends on underlying diseases like obesity, parenchymal kidney diseases, renal vascular diseases, kidney failure, dialysis, and transplantation. Some cardiac diseases, endocrine disorders, systemic diseases, and pediatric tumors may be associated with arterial hypertension. Many drugs like glucocorticosteroids, antidepressants, contraceptives, and calcineurin inhibitors increase blood pressure. High salt intake, industrially prepared food, "junk food," as well as energy drinks, and drug abuse should also be considered confounding factors for increased risks for arterial hypertension. The knowledge of the age prevalence is also helpful for establishing and classifying the correct diagnosis. The underlying causes of arterial hypertension in premature babies and newborns differ significantly from those of older children. The pathophysiology explaining arterial hypertension will direct the approach for adequate therapy and blood pressure control.

IS185 / #274**Plenary Session****Plenary talk 05****11-10-2022 09:00 - 10:00****Immune development in infants****P. Brodin****Department of Women's and Children's Health, Karolinska Institutet, Solna, Sweden*

The Brodin lab develops and applies systems level methods for profiling human immune systems in health and disease. The lab focuses on understanding human immune variation and its origins early in life and the influence on environmental exposures in shaping immune systems in young children. The technological advances also enable better understanding of immune mediated diseases and the personalized application of treatments guided by immune system states of individual children. At the EAPS 2022 meeting, dr Brodin will describe his most recent data on immune system development and regulation in children.

IS186 / #273**Tomorrow's World Session****Tomorrow's World 01: Future intervention for brain development****11-10-2022 10:30 - 11:30****Stem cells to influence preterm brain development: Are we getting closer to therapeutic intervention?****P. Gressens****Inserm, Neurodiderot, Paris, France*

Researchers around the world are testing stem cells for the treatment of acquired perinatal brain injuries, including in preterm neonates who are at high risk to develop motor, cognitive and behavioral deficits. The presentation will summarize and discuss the preclinical and clinical studies performed in the last ten years in the field of brain injury linked to prematurity. We will underline the heterogeneity of previous and on-going preclinical and clinical studies in terms of used stem cells, animal models, route and time of administration, and the subsequent difficulty this creates in reaching a valid consensus for future developments and establishment of a potentially revolutionary therapeutics for many preterm neonates.

IS187 / #276**Tomorrow's World Session****Tomorrow's World 02: Lessons learnt from COVID-19****11-10-2022 10:30 - 11:30****What can we expect from viruses in the next 10 years****P. Fraaij****Pediatrics, Erasmus MC Sophia Children's Hospital, Rotterdam, Netherlands*

It is difficult, if not impossible, to make accurate predictions about the future. However, findings from the past and present sometimes give a good clue. I therefore think it is safe to say that outbreaks with emerging or reemerging infections (often viruses) will remain to be a reality in our (medical) lives in times to come, with "new" pandemics to be expected. Even with the SARS-CoV-2 pandemic still ongoing new threats have already been encountered, like the monkeypox outbreak in countries where the disease is not endemic and the elusive acute hepatitis cases of unknown aetiology in children. I will discuss some past outbreaks and show the general driving force behind these. In addition my talk will address the role of, but also, the lack of data from children during these outbreaks. I will provide some suggestions on how I think we can improve collection of data in children during outbreaks. Finally, depending what the season will bring, I will discuss what is circulating at the time of EAPS 2022.

IS188 / #279**Tomorrow's World Session****Tomorrow's World 03: Omics in paediatric medicine****11-10-2022 10:30 - 11:30****Diagnostic yield of sequential multi-omics in a program for undiagnosed rare diseases****L. Pérez Jurado^{1,2,3*}**¹*Universitat Pompeu Fabra, Medicine and Life Sciences, melis, Barcelona, Spain*²*Hospital del Mar, Genetics, Barcelona, Spain*³*CIBERER, Program in Pediatric Genetics, Barcelona, Spain***PURPOSE**

Overview of a program to facilitate the diagnosis of patients with undiagnosed rare disease (RD) through the systematic collaborative analysis of previously inconclusive data with or without ulterior sequential multi-omics.

METHODS

Participation of clinicians and experts in multiple fields. Reanalysis of standardized phenotypic profiles and genomic data (exomes and genomes) from approved patients with undiagnosed RDs. Systematic analysis to identify relatedness, runs of homozygosity, SNVs, Indels and CNVs, including mosaicisms. Data are collated and shared with a Genome-Phenome Analysis Platform (GPAP and RD-Cat) adapted for the project, enabling collaborative interpretation and reanalyses.

RESULTS

Reanalysis of previous data allowed to diagnose 19% of patients, mainly by novel gene-disease associations (43%), improved bioinformatic analysis (20%),

standardized phenotyping and matchmaker exchange (20.7%). New genomes provided a diagnostic yield of 36-52%, improved by 10-15% in selected cases with additional transcriptome and/or methylome analyses, and additional success rate was achieved by periodic collaborative reanalyses of open data.

CONCLUSION

The standardized collation of phenome and genome data, including sequential multi-omics in selected cases, through a user-friendly platform bring together otherwise scattered data and expertise. This efficient collaborative analysis and interpretation can finalize the diagnostic odyssey for a significant proportion of undiagnosed patients with RDs and facilitate the implementation of Genomic Medicine for RDs in the clinical setting.

IS189 / #270**Tomorrow's World Session****Tomorrow's World 04: Translational research in paediatrics (ESPGHAN Session)****11-10-2022 10:30 - 11:30****Epigenetic signatures, single cell RNA Sequencing and organoids - On the road to identify the pathogenesis of IBD****M. Zilbauer****Cambridge University, Paediatric Gastroenterology, Cambridge, United Kingdom*

The intestinal epithelium as the most inner layer of the human intestine plays a critical role in maintaining homeostasis. Indeed, altered function of this single cell layer has been linked to the development of related pathologies including the inflammatory bowel diseases (IBD) Crohn's Disease (CD) and Ulcerative Colitis. Constant exposure to a wide range of luminal antigens requires the epithelium to balance barrier function against harmful contents with tolerance towards essential nutrients and beneficial microbes. Complex cross talk between host epithelium and adjacent gut microbiota as well as exposure to other antigens implicates the potential role of epigenetic mechanisms that operate at the interface between environmental factors and the cellular genome. In recent years we have been investigating the role of DNA methylation as one of the main epigenetic mechanisms in regulating intestinal epithelial cell function. We have identified distinct, epithelial cell specific DNA methylation changes in the intestinal epithelium of children diagnosed with IBD. Using patient derived intestinal epithelial organoids (IEOs) allowed us to investigate functional implications of epigenetic changes and correlate them to clinical phenotype. Furthermore, applying single cell RNS sequencing to both primary epithelium and patient derived organoids provides unique opportunities to enhance our understanding of IBD pathogenesis.

IS190 / #271**Tomorrow's World Session****Tomorrow's World 04: Translational research in paediatrics (ESPGHAN Session)****11-10-2022 10:30 - 11:30****Genetic engineering in gut organoids for cystic fibrosis and stem cell research****B.-K. Koo****Institute for basic science, Center for Basic Science, Daejeon, Republic of Korea*

The identification of LGR5+ intestinal stem cells helped us to understand various aspects of adult stem cells and led to the establishment of primary 3D intestinal organoid culture system from mouse and human tissues. This novel culture system faithfully recapitulates various aspects of the intestinal epithelium *in vitro* with remarkable long-term expansion capacity and genetic stability. Thus, the model is recognised as a suitable *in vitro* model system for genetic studies. To exploit all the potential of this culture, protocols have been fully optimised for primary establishment, maintenance, cryopreservation, plasmid transfection and viral transduction. A number of examples will be shown to introduce how to apply CRISPR technology and organoid models for genetic studies, including simultaneous paralogue knockout, functional genetic screening and precise gene correction.

IS191 / #281**Tomorrow's World Session****Tomorrow's World 05: Preparing paediatric medicine for 2050: What do we need?****11-10-2022 10:30 - 11:30****Panelist****M. Turner^{1,2*}**¹Liverpool Neonatal Partnership, Liverpool Women's Nhs Ft, Liverpool, United Kingdom²University of Liverpool, Institute of Life Course and Medical Sciences, Liverpool, United Kingdom

There are many opportunities for the future of paediatrics including new and improved patterns of care, medicines, technology, and data. Some, but not all, of these opportunities will benefit babies, children, young people, and their families. We need to avoid wasting resources on ineffective, harmful, or expensive approaches to care. We need to implement opportunities effectively. To exploit these opportunities, we need to know about the benefits, harms, and costs of each opportunity through effective evaluation. Evaluation needs to be centred on the needs and voices of babies, children, young people, and their families. Effective evaluation requires structured assessment that is fit for purpose, proportionate, and transparent. The nature of data that contributes to evaluation needs to be high quality, based on standards, and easily available for reuse (in line with FAIR principles and respect for data privacy). The processes of data collection need to be efficient and minimise burdens on study participants, researchers, and sites. Clear implementation needs to be planned during the evaluation of an opportunity. The expertise to meet all these needs is available through Clinical Research Networks. It is essential to generalise access to high quality evaluation in paediatric medicine. Clinical research networks in paediatrics and rare diseases are available across all paediatric specialties and need to link widely with industry and academic researchers. We need to develop team science while recognizing individual contributions.

IS192 / #285**Tomorrow's World Session****Tomorrow's World 06: Artificial intelligence in
paediatrics – The future is now****11-10-2022 10:30 - 11:30****Big data and machine learning in intensive care:
Beyond the prediction of outcome****R. De Jonge***

*Erasmus MC, Intensive Care Unit, Department of Pediatrics and Pediatric Surgery,
Rotterdam, Netherlands*

Big data science and the use of machine learning in (critical care) medicine undergoes an exponential growth. One of the more used applications of these new techniques is prediction of outcomes, used among other things for prognostication and early warning of undesirable events, like sepsis, ARDS or kidney failure. But there are many more interesting applications for the analyses of big data sets, like dashboarding, quality control or sleep monitoring. This presentation aims to give an impression of some exciting developments in the use of high resolution big data sets in (pediatric) intensive care.

IS193 / #275**Tomorrow's World Session****Tomorrow's World 07: Hot topics in immunology****11-10-2022 10:30 - 11:30****Immunological consequences of biological therapies: The Era of Secondary Immune Deficiencies (SID)****J. Rivière***

Hospital Universitari Vall d'Hebron (HUVH), Vall d'Hebron Research Institute (VHIR), Pediatric Infectious Diseases and Immunodeficiencies Unit., Barcelona, Spain

Since the 1990s, recombinant molecules have been developed and approved exponentially. In the last decade, more than 50% of the new orphan indication approval has been for biological drugs. The use of biologics to modulate the immune system has become a common therapeutic approach to treat and control inflammatory disorders. Their effectiveness has been demonstrated beyond doubts in many cases, but their immunological consequences and long-term effect are yet to be well determined. Although, biologic therapies do not cause a global immunosuppression as seen in traditional immunosuppressive therapy, they can compromise host response to certain pathogens and lead to serious infections. The usual suspects will be presented, focussing mainly on representative examples such as: anti-B cell therapy, complement blockade therapy, intestinal inflammatory therapy and JAK-inhibitors. Their mechanism of action and side effects will also be discussed focussing on infection risk and immunological consequences. The management of drug-induced secondary immunodeficiencies may include the use of immunoglobulin replacement therapy, prophylactic antivirals and antibiotics. In the era of immunoglobulin shorten supply, secondary immunodeficiencies need to be better defined to select the most suited approach for each patient.

LONG ORAL ABSTRACTS

LO001 / #1402

Pre-Recorded Oral Session

Pre-Recorded virtual orals: EAP Session - Autism - An increasing problem?

Recurrent deletions in autism spectrum disorders

M. Budisteanu^{1,2*}, S. Papuc¹, A. Erbescu¹, L. Albulescu¹, C. Burloiu³, E. Andrei⁴, L. Mateescu⁴, F. Linca², D. Ioana², C. Nedelcu², A. Glangher², F. Rad⁴, A. Arghir¹

¹*Victor Babes National Institute of Pathology, Medical Genetics Laboratory, Splaiul Independentei, Romania*

²*Prof. Dr. Alex. Obregia Clinical Hospital of Psychiatry, Psychiatry Research Laboratory, Bucharest, Romania*

³*Prof. Dr. Alex. Obregia Clinical Hospital of Psychiatry, Pediatric Neurology, Bucharest, Romania*

⁴*Prof. Dr. Alex. Obregia Clinical Hospital of Psychiatry, Child and Adolescent Psychiatry, Bucharest, Romania*

BACKGROUND AND AIMS

Autism spectrum disorders (ASDs) are a group of severe and complex neurodevelopmental disorders. The advances of genome-wide technologies, such as chromosomal microarray and next generation sequencing, allowed the discovery of new microdeletion and microduplication syndromes. We report on nine patients with rare chromosomal deletions and ASD as part of complex phenotypes.

METHODS

The probands belong to a group of patients referred to our clinic and laboratory with ASD as main feature. A complete clinical evaluation was performed with focus on neurologic, psychiatric, and psychological evaluation with specific autism tests (ADOS, ADI-R). Array-based comparative genomic hybridization (array-CGH) was performed using 180K platform (Agilent Technologies).

RESULTS

The analysis of 200 genomic profiles detected pathogenic or likely pathogenic deletions in nine patients. Both syndromic/recurrent and rarely reported regions were affected by deletions: 2q23.1, 2q24.3, 3q12.3q13.33, 6q12, 11q23.3q24.1, 11q24.1q24.3, 15q13.1q13.3, 15q21.2q22.2 and 15q24.1q24.2. The deletions ranged from ~27 Kb to 16,9 Mb, with a median of 3.3 Mb. All this patients presented complex phenotypes, including developmental delay/intellectual disability, dysmorphic features, neurological problems.

CONCLUSIONS

Our data illustrates the utility of array-CGH in the investigation of patients with autism, specifically in the context of complex phenotypes. Accurate molecular definition of breakpoints and gene content facilitates the understanding of chromosomal mechanisms of occurrence and may contribute to the identification of potential therapeutic targets.

LO002 / #1643**Pre-Recorded Oral Session****Pre-Recorded virtual orals: EAP Session - Common problems in adolescence/Adolescent health in 2021 - An update****Exposure to phenolic endocrine disruptors and early thelarche****P. Ventura^{1*}, X. Herrero², M. Torrabias³, Z. Bosch⁴, R. Corripio⁵, A. Escribano⁶, B. Suarez⁷, C. Freire⁷**¹Hospital Germans Trias i Pujol, Pediatrics, Badalona, Spain²Corporacion de Salut del Maresme i la Selva, Pediatria, Calella, Spain³hospital universitari de Vic, Pediatria, vic, Spain⁴Hospital Hm Nens, Pediatria, barcelona, Spain⁵Hospital de Sabadell, Pediatria, sabadell, Spain⁶Hospital Clínico Universitario Virgen de la Arrixaca, Pediatria, murcia, Spain⁷instituti de investigacion biosanitaria de granada, Ibs Granada, granada, Spain**BACKGROUND AND AIMS**

Early exposure to endocrine disrupting environmental pollutants (EDs) with estrogenic action could influence the age of onset of thelarche and/or puberty in girls.

OBJECTIVE

To explore differences in the levels of exposure of phenolic EDs with potential estrogenic/anti-androgenic activity (bisphenols/parabens/benzophenones) between girls with early thelarche and healthy girls without this condition.

METHODS

Multicenter, case-control study carried out in different geographical areas of Spain. A group of 110 cases and 97 controls was recruited between 2018-2021.

Phenols		Cases (N=110)	Controls (N=97)	p-value	OR	95%CI	
BPA	DF (%)	100	93.0	0.008	1.73	1.25-2.40	
	Median (µg/L)	6.90	3.11	<0.001			
BPS	DF (%)	6.4	1.0	0.047			
	Median	<LD	<LD	–			
BPF	DF (%)	0	0	–			
	Median	<LD	<LD	–			
Parabens	MPB	DF (%)	98.2	96.9	0.55	1.02	0.85-1.22
		Median	14.18	9.51	0.45		
	EPB	DF (%)	47.3	53.6	0.36	0.89	0.77-1.04
		Median	<LD	0.97	0.53		
	PPB	DF (%)	68.2	56.7	0.088	0.87	0.71-1.06
		Median	0.30	0.19	0.53		
BPB	DF (%)	11.8	15.5	0.44			
	Median	<LD	<LD	–			
Benzophenones	BP-1	DF (%)	72.7	56.7	0.016	1.04	0.89-1.23
		Median	0.98	0.23	0.06		
	BP-3	DF (%)	90.9	83.5	0.109	1.09	0.93-1.29
		Median	2.96	2.30	0.07		
	BP-6	DF (%)	0	0	–		
		Median	<LD	<LD	–		
	BP-8	DF (%)	42.7	21.6	0.001		
		Median	<LD	<LD	–		
OH-BP	DF (%)	74.5	74.2	0.96			
	Median	0.40	0.35	0.77			

LD: Limit of detection

*Adjusted for hospital, age, BMI z-score, and urinary creatinine

In urine samples collected concentrations of three bisphenols (bisphenol A(BPA)/S(BPS)/F(BPF)), four parabens (methyl-(MPB), ethyl-(EPB)/propyl-(PPB)/butyl-paraben(BPP)) and six UV filters from the benzophenone family (BP1/BP3/BP6/BP8/4OHBP). A structured questionnaire was administered to the parents to collect sociodemographic and lifestyle data. In the group of cases, hormonal parameters, bone age and pelvic ultrasound were also determined. Associations were examined by unconditional logistic regression models adjusted for hospital, age, BMI z-score, and urinary creatinine.

RESULTS

The participants had a mean age of 6.7(1.6) years. At least one EDs was detected in 99% of all samples tested. The cases presented higher concentrations of BPA, MPB, PPB, BP1, BP3 and 4OHBP, the difference being statistically significant only in BPA.

CONCLUSIONS

Phenolic EDs have been detected in practically all the samples analyzed, indicating that there is widespread exposure to EDs in school-age girls. Urinary concentrations of BPA, a compound with demonstrated estrogenic action, appear to be higher in girls with early thelarche. It is necessary to continue studying the possible influence of exposure to EDs on the risk of precocious thelarche and puberty.

LO003 / #1474**Pre-Recorded Oral Session****Pre-Recorded virtual orals: EAP Session - Type 1 diabetes****Carbohydrate counting implementation on pediatric type 1 diabetes mellitus: Systematic review & meta-analysis****L. Wiyono*, A. Larasati, N. Ghitha, D. Clarisa***Universitas Indonesia, Faculty of Medicine, Jakarta, Indonesia***BACKGROUND AND AIMS**

Type 1 diabetes mellitus – the one most commonly found amongst children – is not currently curable, but can be managed properly to maintain a patient's quality of life. One of its treatments includes carbohydrate counting. This systematic review and meta-analysis aimed to evaluate the efficacy of HbA1c reduction with carbohydrate counting in children with type 1 diabetes mellitus.

METHODS

Seven studies were assessed, with the primary outcome being glycemic control (HbA1c changes). We searched the following electronic databases: ProQuest, PubMed, Scopus, and ScienceDirect. The quality of studies included was assessed using RoB for RCTs and JBI Critical Appraisal Checklist for observational and cross-sectional studies. Quantitative analyses were made and extrapolated into a forest plot.

RESULTS

A total of 1693 articles were identified, and four reviewers independently screened titles and abstracts. Of the 36 articles screened, 34 articles were

found to be eligible, and 32 were excluded because outcomes and study designs were not suitable. Nine articles were included in the final analysis. Meta-analysis showed that there was a reduction in HbA1c in the carbohydrate counting group as compared to the control group. The meta-analysis has shown the cumulative effect on the mean difference of -0.55 (95% CI: -0.81 ; -0.28 , p -value <0.0001). While all studies exhibit similar results with mean difference reduction favoring the interventional group, the heterogeneity analysis showed the I^2 value of 88%, implying the high heterogeneity of the meta-analysis.

CONCLUSIONS

The meta-analysis showed evidence favouring the use of carbohydrate counting in the management of DMT1.

LO004 / #397

Pre-Recorded Oral Session

Pre-Recorded virtual orals: EAP Session - Type 1 diabetes

Euthyroid sick syndrome and its association with metabolic and kidney complications in children with type 1 diabetes mellitus onset

**P. Marzuillo*, D. Iafusco, S. Guarino, A. Di Sessa, A. Zanfardino,
A. Piscopo, C. Luongo, D. Capalbo, M. Verde, F. Aiello,
E. Miraglia Del Giudice, A. Grandone**

Department of Woman, Università degli Studi della Campania Luigi Vanvitelli, Child and of General and Specialized Surgery., Naples, Italy

BACKGROUND AND AIMS

Euthyroid sick syndrome (ESS) refers to changes in thyroid tests during critical illness and is associated to negative outcomes. We evaluated i) the association of ESS with severity indexes of type 1 diabetes mellitus (T1DM) onset such as diabetic ketoacidosis (DKA), renal tubular damage (RTD), acute kidney injury (AKI), and acute tubular necrosis (ATN); ii) the influence of ESS on timing to recover AKI.

METHODS

This is a prospective observational study. AKI was defined according to the KDIGO criteria. RTD was defined by abnormal urinary beta-2-microglobulin and/or neutrophil gelatinase-associated lipocalin and/or tubular reabsorption of phosphate < 85% and/or fractional excretion of Na(FENa) > 2%. ATN was defined by RTD+AKI. 161 children were followed-up after 14 days from T1DM onset. The patients who did not recover from AKI/RTD were followed-up 30 and 60 days later. The thyroid hormones were measured at T1DM onset and after 6-12 months. ESS was defined when FT3 and/or FT4 were decreased and TSH levels were normal or decreased.

RESULTS

ESS was found in 60/161 patients (37.3%) and was more prevalent among patients with DKA, AKI, RTD and ATN compared with patients without these conditions. FT3 was inversely correlated with serum triglycerides and creatinine, and urinary calcium/creatinine ratio and NGAL. DKA and ATN were significantly associated to ESS at adjusted analysis. Patients with euthyroidism showed an earlier recovery from AKI than those with ESS ($p=0.02$). ESS spontaneously disappeared in all patients.

CONCLUSIONS

ESS prevalence was higher in patients showing complications of severe T1DM onset. Patients with ESS showed a slower recovery from AKI compared to those without ESS.

LO005 / #2505**Pre-Recorded Oral Session****Pre-Recorded virtual orals: EAP Session - Type 1 diabetes****06-10-2022 08:00 - 23:59****The use of audio-visual modality prior to endocrine stimulation tests is effective in reducing children's fear of the procedure****B. Gustus*, V. Hipsher, A. Leshem, M. Rachmiel***Shamir Medical Center, Pediatric Endocrinology, Zerifin, Israel***BACKGROUND AND AIMS**

Medical procedures that use needles are a common source of anxiety for children. Intravenous catheterization for blood sampling, as performed during endocrine stimulation tests, is one such procedure. The use of audio-visual modalities relieves anxiety among children during painful procedures. To evaluate the benefit of an audio-visual modality (AVM) as an explanatory tool for pre-procedural instruction to children prior to endocrine stimulation tests.

METHODS

This case-control study is based on a prospective follow-up of clinic practices. From January 2018, all the children who underwent endocrine stimulation tests at Shamir (Assaf-Harofe) Medical Center, or their parents, were asked to fill satisfaction questionnaires, as part of clinical practice. As of January 2020, all the children received similar pre-test explanations by a cartoon (AVM group) instead of orally by a nurse (control group). The outcome parameters compared between the groups included satisfaction from the explanation according to 10 questions on a 1-5 scale (1 indicated the greatest satisfaction), and response on a 6-point pain scale.

RESULTS

The AVM group included 105 patients, 46% males, mean age 8.61 ± 3.75 years. The control group included 73 patients, 39% males, mean age 9.42 ± 3.29 years. Patients from the AVM compared with the control group reported a lower level of fear after explanation (1.90 vs. 2.36 $p=0.002$), rated the explanations as more detailed and clearer (1.19 vs. 1.40 $p=0.006$), and felt they had received all the required explanations (1.12 vs. 1.33 $p=0.004$).

CONCLUSIONS

Using AVM prior to endocrine stimulation tests may improve children's experience from the procedure.

LO006 / #449**Pre-Recorded Oral Session****Pre-Recorded virtual orals: EAP Session - Updates in paediatric cardiology****06-10-2022 08:00 - 23:59****Follow-up duration of echocardiography in patients with Kawasaki disease with no initial coronary aneurysms****Q. Wang^{1*}, Y. Morikawa², S. Akahoshi², K. Miyata³, H. Sakakibara⁴, T. Matsushima⁴, Y. Koyama³, T. Obonai⁵, T. Kaneko², M. Miura³**¹Machida Municipal Hospital, Pediatrics, Tokyo, Japan²Tokyo Metropolitan Children's Medical Center, Clinical Research Support Center, Tokyo, Japan³Tokyo Metropolitan Children's Medical Center, Cardiology, Tokyo, Japan⁴Tokyo Metropolitan Children's Medical Center, General Pediatrics, Tokyo, Japan⁵Tama-Hokubu Medical Center, Pediatrics, Tokyo, Japan**BACKGROUND AND AIMS**

To evaluate the optimal duration of echocardiographic follow-up in patients with Kawasaki disease without an initial coronary aneurysm.

METHODS

In this single-center, retrospective, observational study, we reviewed the results of follow-up echocardiography in children with Kawasaki disease enrolled in the Prospective Observational Study on Stratified Treatment with Immunoglobulin Plus Steroid Efficacy for Kawasaki Disease from a children's hospital. The main enrollment criterion was the absence of coronary aneurysms, defined as a maximum z-score (Z_{max}) ≥ 2.5 , in the proximal right coronary artery and the proximal left anterior descending artery within 9

days from treatment initiation. The primary outcome was Zmax on follow-up echocardiography at up to 5 years.

RESULTS

Among 386 patients, 106 (27.5%) received prednisolone with intravenous immunoglobulin for first-line therapy, and 57 (14.8%) showed a poor response. Zmax declined over 5 years (Figure). Echocardiography at 1 month detected 9 patients with a Zmax ≥ 2 , including 3 (0.8%) with coronary aneurysms requiring additional antithrombotic treatment and observation. Of 7 patients (1.8%) with normal echocardiographic findings at 1 month but a Zmax ≥ 2 later, 2 were lost to follow-up and 5 experienced spontaneous resolution, but none of the 7 patients required any change in management.

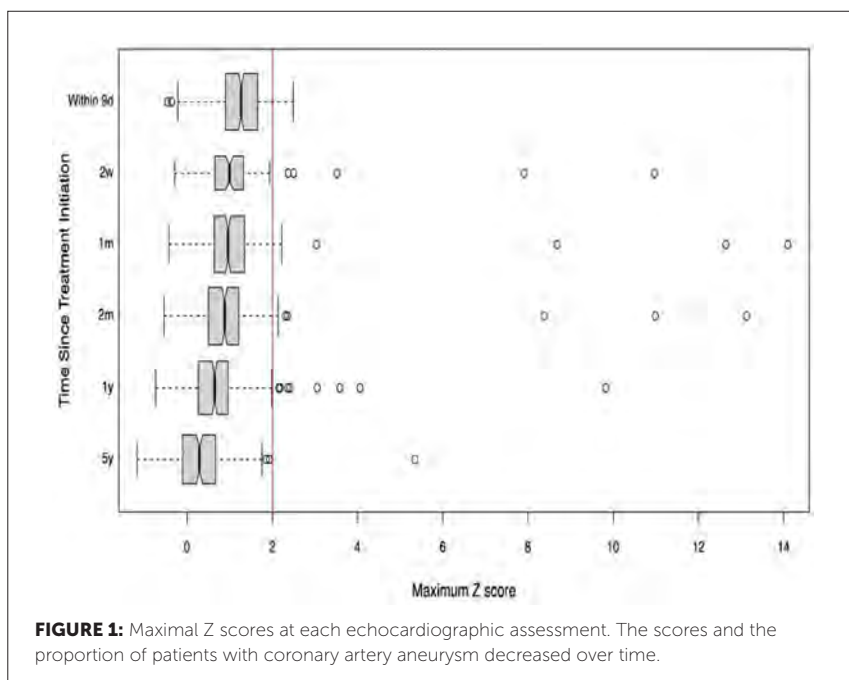

CONCLUSIONS

The optimal duration of echocardiographic follow-up may be 1 month in patients with no initial coronary aneurysms and a $Z_{max} < 2$ at 1 month. Coronary artery abnormalities observed after 1 month are rare and mostly benign in this category of patients.

LO007 / #1572**Pre-Recorded Oral Session****Pre-Recorded virtual orals: EAP Session - Sport in the adolescent age and anorexia****Accuracy of caloric estimation in adolescents in the midwestern united states****M. Oppedazzo¹, M. Schwab², C. Mueller^{3*}**¹stanford university, Medicine, stanford, United States of America²USCF, Surgery, San Francisco, United States of America³stanford university, Surgery, stanford, United States of America**BACKGROUND AND AIMS**

During adolescence, individuals' relationship with food can change dramatically, particularly as they begin to assume more autonomy for their food selections. Such changes in eating behaviors can result in disordered eating patterns which may persist throughout life and lead to negative health consequences. In the present study we assess the nutritional beliefs and food perceptions of healthy adolescents in a midwestern high school. We examined accuracy of calorie estimates for a variety of foods and how these relate to psychological perceptions of health.

METHODS

During a routine health class, 257 high school students (Mean age 15.5) were asked to rate a variety of foods (orange juice, coca-cola, hamburger, beans) on the Food Healthfulness Questionnaire (FHQ). Participants also completed the Health Mindset Scale (HMS) and were asked questions about their weight and dieting behaviors.

RESULTS

Healthy adolescents showed good consistency in their calorie estimates for all food items ($p < .01$). However, these calorie estimates were generally inaccurate with only 27% of participants able to give correct calorie counts for the food items. 47% of participants under-estimated calories, while 12% over-estimated. Age was significantly related to calorie ratings with older students being more likely to over-estimate ($p < .05$).

CONCLUSIONS

In this study we reveal that adolescents' calorie estimates tend to be inaccurate, with many students underestimating the caloric content of common foods. These inaccuracies may play an important role in understanding how adolescents perceive the foods they eat. Further investigations are needed to determine how these perceptions are created and how they can be altered.

LO008 / #710**Pre-Recorded Oral Session****Pre-Recorded virtual orals: EAP Session: Global child health****Stability in routines during the preschool period and associations with child well-being****S.B. Selman^{1*}, R. Distefano², J. Dilworth-Bart¹, J. Brooks-Gunn²**¹*University of Wisconsin-Madison, Human Development and Family Studies, Madison, United States of America*²*Teachers College, Columbia University, National Center for Children and Families, New York, United States of America***BACKGROUND AND AIMS**

A large body of research has documented the importance of routines for children's development. However, few studies have considered the role of developmental timing of routines. The present study examined the extent to which stability in routines across the preschool period is linked to children's cognitive and socioemotional skills.

METHODS

We used Year 3 and Year 5 data from the Fragile Families and Child Wellbeing Study (N = 2353; female = 48%). Child routines were measured through maternal reports of routines, including household chores, play, mealtime, and bedtime. Using a mean-split approach, children were categorized into "low" or "high" routines at each time point, which resulted in four groups based on timing and amount of routines: stable-high, increase, decrease, or stable-low. At Year 5, children completed a vocabulary test and parents reported on children's attentional, externalizing, internalizing problems, and social skills.

RESULTS

After controlling for a set of confounding variables, children in the stable-high group had significantly lower attentional and externalizing problems than the other three groups (β s range from .13 to .22, $p < .05$), as well as higher social skills (β s range from -.12 to -.21, $p < .05$).

CONCLUSIONS

These findings replicate previous work documenting associations between routines and child functioning and highlight the potential importance of stability in routines across early childhood. Children who had consistently high routines demonstrated better socioemotional skills compared to those with varying levels of routines and children with low routines across the preschool period.

LO009 / #1319**Pre-Recorded Oral Session****Pre-Recorded virtual orals: ESPNIC session - Do we really need separate cardiac intensive care units?****Thrombocytopenia and morbidity in pediatric post-cardiotomy veno-arterial extracorporeal membrane****Y. Jin***

Department of Cardiopulmonary Bypass, Chinese Academy of Medical Sciences and Peking Union Medical College, Fuwai Hospital, Beijing, China

BACKGROUND AND AIMS

Platelets play an important role in hemostasis. Thrombocytopenia after cardiopulmonary bypass (CPB) is associated with increased morbidity and mortality. This study explores the effects of the maximum single-day platelets drop percent and the duration of platelets drop on complications and outcomes in ECMO failed to wean from CPB.

METHODS

We retrospectively analyzed 65 pediatric post-cardiotomy patients (aged <18 years) who directly transitioned from CPB to ECMO, from January 2010 to June 2020. They were divided into survivors (n = 34) and non-survivors (n = 31) according to in-hospital mortality. We compared the incidence of various complications and outcomes between groups. Furthermore, we examined the associations between the maximum single-day platelets drop percent and the duration of platelets drop during ECMO, morbidity and blood product transfusion.

RESULTS

The maximum single-day platelets drop percent had predictive value for hemolysis and circuit change; the duration of platelets drop could predict hemolysis, severe acute kidney injury (AKI) and neurological dysfunction. Moreover, the correlations between them and peak plasma-free hemoglobin, peak serum creatinine, transfusion of red blood cell, platelets and fresh frozen plasma and chest-tube drainage were significant. Multivariate logistic regression analysis identified that the maximum single-day platelets drop percent was positively correlated with hemolysis, and the duration of platelets drop was positively associated with AKI.

CONCLUSIONS

The platelets drop contributed to hemolysis and AKI in pediatric post-cardiotomy ECMO failed to wean from CPB. Various complications occurred together with thrombocytopenia during ECMO, leading to poor prognosis. We need more scientific evidence and clinical practice in the future.

LO010 / #2307**Pre-Recorded Oral Session****Pre-Recorded virtual orals: ESPNIC Session - ECPR to the rescue****Incidence, outcome, and risk factors of in-hospital cardiac arrest and associated mortality in pediatric critically ill cardiac patients: A systematic review and meta-analysis**

F. Sperotto^{1*}, M. Daverio², D. Gregori³, A. Dorste¹, A. Amigoni², R. Thiagarajan¹

¹Boston Children's Hospital, Harvard Medical School, Cardiology, Boston, United States of America

²Department of Women and Children's Health, University Hospital of Padua, Padova, Italy

³Department of Cardiac, University Hospital of Padua, Thoracic and Vascular Sciences and Public Health, Padova, Italy

BACKGROUND AND AIMS

Critically-ill cardiac patients are at high risk of ineffective circulation, arrhythmias, and cardiac arrest (CA). We systematically reviewed data on incidence of in-hospital CA, associated mortality, and risk factors in children with cardiac disease admitted to the intensive care unit.

METHODS

Systematic review and meta-analysis (inception -Sept2021; PROSPERO CRD42020156247, Figure 1a). Random effects meta-analysis was used to compute pooled proportions and ORs. Meta-regression adjusted for type of study (registry vs cohort) and diagnostic category (surgical vs general cardiac) was used to evaluate trends in incidence and mortality.

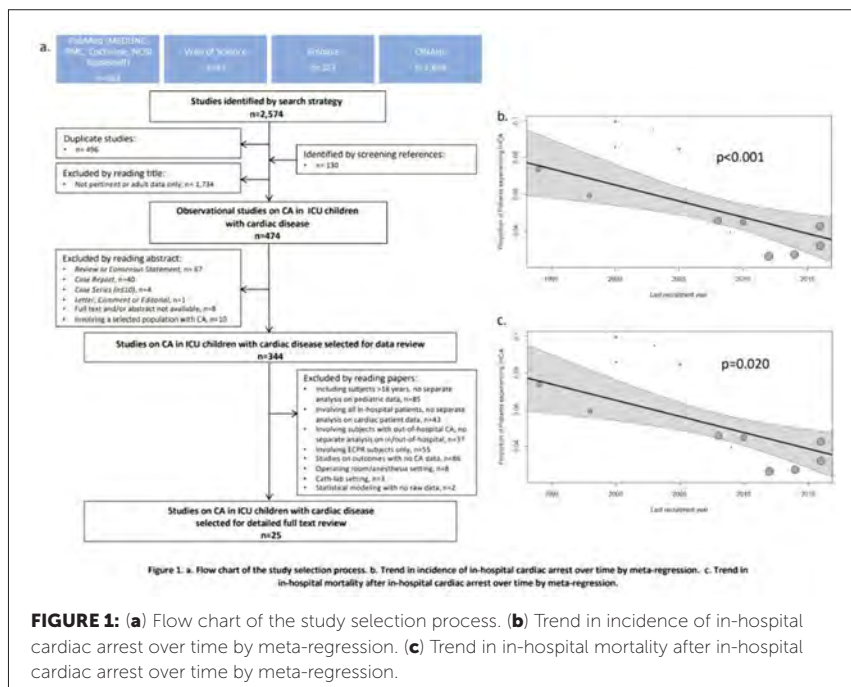

FIGURE 1: (a) Flow chart of the study selection process. **(b)** Trend in incidence of in-hospital cardiac arrest over time by meta-regression. **(c)** Trend in in-hospital mortality after in-hospital cardiac arrest over time by meta-regression.

RESULTS

Of the 2,574 studies identified, 25 were included (126,087 children, 5,185 CAs). Ninety-five percent of studies were good or fair in quality. Five percent (95%CI: 4-7%) of patients experienced CA. In centers with ECMO expertise, 21% (95%CI: 15-28%) underwent E-CPR. Thirty-five percent of patients (95%CI: 27-44%) did not reach ROSC. The pooled in-hospital mortality rate was 54% (95%CI: 47-62%). Both incidence of CA and in-hospital mortality significantly decreased ($p<0.001$ and $p=0.020$, Figure 1b&c), while the proportion of patients achieving ROSC did not change ($p=0.572$). Main risk factors for CA and mortality were neonatal age, prematurity, genetic syndrome, uni-ventricular physiology, arrhythmias, comorbidities, pre-operative mechanical ventilation or ECMO, and higher surgical complexity.

CONCLUSIONS

A non-negligible proportion (5%) of critically-ill cardiac pediatric patients experience CA. Incidence and associated in-hospital mortality are significantly decreasing over time; however, the percentage of patients achieving ROSC did not change. Strong effort should be made in improving prevention and resuscitation strategies in this delicate cohort of patients.

LO011 / #1495

Pre-Recorded Oral Session

Pre-Recorded virtual orals: ESPNIC Session - Life after sepsis

Adolescents with covid-19 in northeastern brazil: Clinical and demographic profile

B. Oliveira^{1*}, I. Custódio², F.E. Lima¹, S. Florencio¹, G. Lima¹, K.K. Mesquita¹, A. Rodrigues¹, P.N. Pinheiro¹, M. Diógenes¹, M.G. Fontenele¹, M.W. Ventura¹, A.P. Queiroz¹

¹Department of Nursing, Federal University of Ceará, Fortaleza, Brazil

²Messejana Hospital Dr Carlos Alberto Stuart Gomes, Sesmt, Fortaleza, Brazil

BACKGROUND AND AIMS

COVID-19 presented greater severity and lethality in older adults, people with comorbidities, and smokers. However, severe cases and deaths have also been reported in adolescents. The objective was to identify the clinical and demographic characteristics of adolescents diagnosed with COVID-19 in Northeastern Brazil.

METHODS

A cross-sectional study was carried out using public data from e-SUS Notifica system, a platform created by the Brazilian Ministry of Health for notifications of Influenza Syndromes. The sample consisted of 226,896 adolescents aged 10 to 18 years old, diagnosed with COVID-19 between March 2020 and August 2021.

RESULTS

Most adolescents were female (N= 125,143, 55.15%), aged between 15 and 18 years (N= 147,892, 65.20%) and lived in the countryside (N=188,997, 83.30%), with the largest proportion in the state of Bahia (N=61,681, 27.18%). Concerning the clinical profile, 27,057 (11.9%) of the cases were asymptomatic, while 199,839 (88.1%) had symptoms such as fever (N= 94,385, 47.2%), cough (N= 90,767, 45.4 %), sore throat (N=76,881, 38.5%) and headache (N=64,435, 32.2%). Among the closed cases, the most prevalent outcome was cure (N=139,815). However, deaths were also reported (N=124).

CONCLUSIONS

Most adolescents from the Northeast region of Brazil, with COVID-19, presented mild symptoms of the disease. However, deaths have also been reported. It is important to monitor the infection to identify severe symptoms and intervene early. We thank the Coordination for the Improvement of Higher Education Personnel (CAPES Brazil) and the National Council for Scientific and Technological Development (CNPq, process no. 402170/2020-2).

LO012 / #2242

Pre-Recorded Oral Session

Pre-Recorded virtual orals: ESPNIC Session - Outcomes in cardiac intensive care – A multidimensional approach

Desensitization in etoposide hypersensitivity: A case report

I.I. Nila Utama*, R. Amalia, D. Muktiarti, H. Sjakti

Department of Child Health, Cipto Mangunkusumo Hospital, Faculty of Medicine, Universitas Indonesia, DKI Jakarta, Indonesia

BACKGROUND AND AIMS

Etoposide is a cytotoxic agent, which has been used in the treatment of a variety of malignant conditions. Hypersensitivity reactions to etoposide have been reported from 2% to 51%. The aim for this study is to report the outcome of a patient who underwent etoposide desensitization protocol.

METHODS

All the data was collected from the electronic medical record.

RESULTS

A 15-year-old girl with left germ cell tumor of ovarium stage IV was admitted for chemotherapy. The patient has no history of drugs or food allergies. During the first administration of etoposide the patients experienced generalized erythematous rashes, chest pain, shortness of breath and palpitations. The infusion was stopped immediately and she was treated as an anaphylaxis reaction. The patient must receive five courses of etoposide consequently. Because there is no alternative drug, we administered etoposide using the

modified six-step etoposide desensitization by Winifred. The desensitization started with 0.01% dose of etoposide along with steroid and antihistamine as premedication. On the next day, the patient received etoposid in a continuous drip for 10 hours at concentration of 0.2 mg/mL. The drugs successfully administered without any adverse event.

CONCLUSIONS

Six step etoposide desensitization can be used for a patient who had experienced etoposide hypersensitivity reaction.

LO013 / #1781

Pre-Recorded Oral Session

Pre-Recorded virtual orals: ESPNIC Session - Protecting the brain

Exploring the challenges of amplitude integrated EEG for seizure detection in pediatric patients

L. Macdarby*

Children's Health Ireland at Crumlin, Intensive Care, Dublin, Ireland

BACKGROUND AND AIMS

Amplitude integrated EEG (aEEG) is a mainstay of care in neonatal intensive care units (NICU). Despite increasing use outside the NICU, there are knowledge gaps in relation to the normative characteristics of aEEG, and its accuracy in identifying seizures in older children. Our objective is to evaluate the sensitivity and specificity of neonatal aEEG seizure identification criteria for seizure-recognition in older children.

METHODS

120 pediatric EEG recordings were assembled, comprising 30 studies with seizures and 90 without. Seizure-containing studies were annotated in detail to describe number of seizures, their duration, distribution and spread. Two-channel aEEG (C3-P3, C4-P4) recordings were generated, blinded and independently reviewed without reference to the raw EEG trace. Seizures were reported according to the Hellstrom-Westas criteria for detection of neonatal seizures. Diagnostic accuracy of aEEG for seizure recognition was calculated. Logistic regression was used to identify factors associated with correct seizure identification on aEEG.

RESULTS

Median patient age was 6.1 years. Abnormal recordings featured 123 discrete seizures in total. Status epilepticus (SE) was evident by EEG in 13 cases. Using neonatal seizure recognition criteria, aEEG had a sensitivity of 43% and specificity of 75%. aEEG identified SE in only 38% of the 13 reported cases, although seizures were correctly identified in 84% of this subpopulation. Seizures were more likely to be missed by aEEG when < 1 minute.

CONCLUSIONS

aEEG neonatal seizure detection criteria have a poor sensitivity for detecting aEEG seizures in older children mainly due to short duration of seizures in this population. Time compression eliminates detection of short seizures.

LO014 / #1045

Pre-Recorded Oral Session

Pre-Recorded virtual orals: ESPNIC Session - The changing face of the PICU patient

Thrombotic microangiopathies in spanish pediatric intensive care units. The MATUCIP registry

L. Bermúdez Barrezueta¹, A. Martínez De Azagra Garde², S. Belda Hofheinz³, A. Rodriguez-Nunez^{4*}, S. Bobillo Pérez⁵, M. Nieto Faza⁶, J. Collado Caparrós⁷, R. Diaz Soto⁸, J. Trastoy Quintela⁵, M. Santiago Lozano⁹, E. González Río¹⁰, I. Sánchez Ganfornina¹⁰, D. Sanz Álvarez⁹, M. Palacios Loro¹¹, E. Gómez Sánchez¹², L. Artacho González¹³, R. Montero Yéboles¹⁴, L.J. Ferrero De La Mano¹⁵, A. Arias Felipe³, M. Iglesias Bouza², C. Rey Galán¹⁶, A. Alcaraz Romero¹⁷

¹Hospital Clínico Universitario de Valladolid, Pediatrics. División de Pediatric and Neonatal Intensive Care, Valladolid, Spain

²Hospital Universitario Niño Jesús, Pediatric Intensive Care Unit, Madrid, Spain

³Hospital Doce de Octubre, Pediatric Intensive Care Unit, Madrid, Spain

⁴Hospital Clínico Universitario Santiago de Compostela, Pediatric Intensive Care Unit, Santiago de Compostela, Spain

⁵Hospital Sant Joan de Deu, Pediatric Intensive Care Unit, Barcelona, Spain

⁶Hospital Universitario Cruces, Pediatric Intensive Care Unit, Bilbao, Spain

⁷Hospital Clínico Universitario Virgen de la Arrixaca, Pediatric Intensive Care Unit, Murcia, Spain

⁸Complejo Hospitalario U. de La Coruña, Pediatric Intensive Care Unit, La Coruña, Spain

⁹Hospital Universitario Gregorio Marañón, Pediatric Intensive Care Unit, Madrid, Spain

¹⁰Hospital Universitario Virgen del Rocío, Pediatric Intensive Care Unit, Sevilla, Spain

¹¹Hospital Universitario de Navarra, Pediatric Intensive Care Unit, Pamplona, Spain

¹²Hospital Universitario de Burgos, Pediatric Intensive Care Unit, Burgos, Spain

¹³Hospital Universitario de Málaga, Pediatric Intensive Care Unit, Málaga, Spain

¹⁴Hospital Universitario Reina Sofía, Pediatric Intensive Care Unit, Córdoba, Spain

¹⁵Hospital Universitario de León, Pediatric Intensive Care Unit, León, Spain

¹⁶Hospital Universitario Central de Asturias, Pediatric Intensive Care Unit, Oviedo, Spain

¹⁷Hospital Universitario de Getafe, Paediatrics. Division of Nephrology, Getafe, Spain

BACKGROUND AND AIMS

Thrombotic microangiopathies (TMA) are rare entities with renal, hematological, neurological and cardiovascular involvement. Children may present nonspecific but severe symptoms/signs requiring PICU admission. Our objective was to evaluate the initial diagnosis, therapies, complications, and PICU outcomes of pediatric TMA in Spain.

METHODS

A prospective, multicenter, observational registry was conducted in twenty Spanish PICU from January 2017 to December 2021. Children older than 1 month with TMA were included and followed until PICU discharge.

RESULTS

Ninety-seven patients were enrolled (51% female). Median age and weight were 2.6 years [IQR 1.6 – 6] and 13.9 Kg [IQR 11 – 21.5], respectively. Common initial clinical manifestations were: gastrointestinal (70.4%), respiratory (14.3%), fever (5.1%), neurological (3.1%), and other (7.1%). Microangiopathic hemolytic anemia was present in 92 patients (95%), thrombocytopenia in 93 (96%) and renal failure in 91 (94%). TMA were classified as: Shiga toxin-associated hemolytic uremic syndrome (STEC-HUS) 54%, probable STEC-HUS 4%, *Streptococcus pneumoniae*-HUS 14%, atypical HUS 14%, secondary TMA 10% and thrombotic thrombocytopenic purpura 4%. Hematological and renal parameters of patients are shown in figure 1. Eighty-five (87.6%) developed hypertension, 47 digestive, 22 respiratory, 25 neurological and 12 cardiac manifestations. Fifty-nine (60.8%) required renal replacement therapy and 4 plasma exchange. Nineteen (19.6%) received eculizumab. Median PICU stay was 9 days [IQR: 5 – 17]. Two children (2.1%) died.

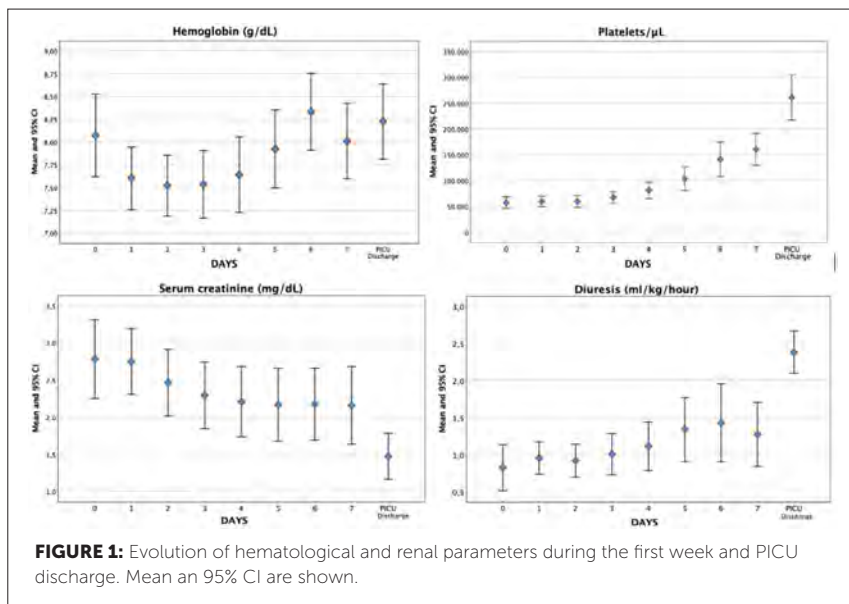

CONCLUSIONS

The MATUCIP registry shows the clinical variability of TMA admitted to the PICU. Early differential diagnosis and general and/or specific treatment are essential to improve the high morbidity and mortality of these severe entities.

LO015 / #1434**Pre-Recorded Oral Session****Pre-Recorded virtual orals: ESPNIC Session - The changing face of the PICU patient****Post-Transplant lymphoproliferative disorder related to Epstein-Barr viral infection**

A. Ntavoura*, M. Prapa, E. Christakou, K. Straka, C. Tsiagklani, I. Gotsi, P. Poulos, D. Paraschou, C. Barbaressou

Aghia Sophia Children's Hospital, Pediatric Intensive Care Unit, Athens, Greece

BACKGROUND AND AIMS

Post-transplant lymphoproliferative disorder (PTLD) is a group of conditions of uncontrolled proliferation of lymphoid cells as a consequence of extrinsic immunosuppression after transplantation (solid organ transplantation or haemopoietic stem cell-HSCT). EBV, a common virus, may lead to life-threatening complications, especially in post-transplantation children.

METHODS

We present a case series study of 6 pediatric patients with EBV-related PTLD admitted in our PICU, between 2012 and 2021.

RESULTS

Patients were mostly male (n=5/6, 83.3%), with a median age of 7 years (IQR 3.25-12.5). 66.6% (n=4) were HSCT patients, and all were EBV positive. They presented with an early onset PTLD (<1year post-transplantation), while timing of diagnosis may vary (< 2 years or 5-10 years post-transplant). The incidence of PTLD varies by transplanted solid organ or HSCT. Clinical symptoms were nonspecific and related to the site of lymphoid mass.

Lung involvement, as was observed in 5 of our patients (83.4%), is the most critical, as it can lead to ARDS. Diagnosis is based on histopathological examination. Our patients received treatment, involving mechanical ventilation, as long as reduction of immunosuppression, rituximab and chemotherapy, according to the international guidelines. PTLD has poor survival rate, with a mortality rate of 66.7% (n=4), due to acute respiratory failure, in our case series.

CONCLUSIONS

PTLD is a major complication after transplantation in children, with recipient EBV seronegativity increasing the risk. Intensity of immunosuppression and age affect its pathogenesis. However, reduced immunosuppression alone can lead to complete remission in some cases.

LO016 / #591**Pre-Recorded Oral Session****Pre-Recorded virtual orals: ESPNIC Session -
Update in critical care nephrology and hepatology****Survival and long term kidney outcome of
children starting kidney replacement therapy in
the pediatric intensive care unit****R. Rameshkumar*, A.V.S. Mukarjee, S. Krishnamurthy***Jawaharlal Institute of Postgraduate Medical Education and Research (JIPMER), Pediatrics,
Puducherry, India***BACKGROUND AND AIMS**

To study the survival long-term kidney outcome in children who received kidney replacement therapy (KRT) in a pediatric intensive care unit (PICU).

METHODS

Ambidirectional cohort study was conducted in a tertiary care institute from Jan-2015 to Dec-2020. Children aged ≤ 12 -yr who underwent kidney replacement therapy [peritoneal dialysis (PD), continuous kidney replacement therapy (CKRT), and hemodialysis (HD)] were enrolled. Outcome (survived/died) and status of kidney function on follow-up (minimum of 6-to 12-month) were studied. Acute kidney injury was defined using KDIGO criteria.

RESULTS

A total of 117 patients underwent KRT (PD-53.8%, n=63; CKRT-23.1%, n=27; HD-14.5%, n=17; ≥ 2 -modalities-8.6%, n=10). Thirty-seven (31.6%) and 80 (68.4%) were survived and died respectively. Median (IQR) PRISM-III and age

was 14 (10-21) and 18-month (5-72) respectively. Multiorgan dysfunction was present at admission in 39.3%, shock was in 75.2% and 83.8% received mechanical ventilation. At first follow-up [median (IQR) 6-month (5-8)], abnormal kidney function was present in 8.1% (n=3/37) [stage-I, n=1; stage-II, n=1; stage-III, n=1]. All three patient had stage-1 hypertension. The microscopic hematuria and albuminuria in one patient each respectively. At second follow-up [median (IQR) 16-month (12-21)], abnormal kidney function was present in 2.7% (n=1/37) patient [stage-II, n=1].

CONCLUSIONS

Abnormal persistent kidney function was noted in 2.7% during long-term follow-up among survivors who underwent kidney replacement therapy in the pediatric intensive care unit.

LO017 / #2043**Pre-Recorded Oral Session****Pre-Recorded virtual orals: ESPNIC Session - Update in paediatric respiratory critical care****The 'Safe' Checklist: Improving the safety and quality of X-ray imaging on the neonatal intensive care unit. A single centre multi-professional quality improvement project**

B. Pisavadia^{1*}, H. Weststrate¹, E. Harris², B. Chick¹, N. Owen², M. Nordlander², J. Young², K. Jamieson¹

¹Neonatal Department, Whittington Health NHS Trust, London, United Kingdom

²Radiology Department, Whittington Health NHS Trust, London, United Kingdom

BACKGROUND AND AIMS

X-rays on the Neonatal Intensive Care Unit (NICU) are an essential tool for diagnostic and procedural purposes. A neonate may undergo multiple X-rays during admission, making this population vulnerable to risk of cumulative radiation exposure. There is lack of local and national guidance on NICU X-ray imaging and anecdotal concern over poor quality imaging leading to diagnostic dilemma or repeat imaging. This project aimed to: - Quantify number of X-rays requiring repeat - Identify modifiable contributory factors - Assess the impact of a checklist (Figure 1) on increasing quality of X-rays and reducing repeats.

METHODS

Retrospective data collection for all X-rays performed on a level 2 NICU between Nov-Dec 2021. Implementation of a pre-X-ray checklist (Figure 1), based on identified modifiable factors and key safety features, with reaudit thereafter.

Neonatal **'SAFE'** X-Ray Checklist

Radiographer to check boxes at bedside before proceeding with X-ray
PLEASE TICK ALL THE BOXES THAT APPLY

S	Settings	<input type="checkbox"/> Verify X-Ray Request <input type="checkbox"/> Type of X-Ray (Please Specify) <input type="checkbox"/> Indication <input type="checkbox"/> Positive Patient Identification (3 Identifiers: patient ID, name, DOB) <input type="checkbox"/> Battery for cassette operational
A	Artefacts	Removed/repositioned away from X-ray field: <input type="checkbox"/> Lights <input type="checkbox"/> ECG Leads <input type="checkbox"/> Nasogastric Tube <input type="checkbox"/> Nappy <input type="checkbox"/> Gel Pillows/Pads <input type="checkbox"/> Temperature Probe <input type="checkbox"/> Blankets <input type="checkbox"/> Metalwork <input type="checkbox"/> Other (Please specify)
F	Final Checks	<input type="checkbox"/> X-ray Plate Positioned in Middle of Tray <input type="checkbox"/> Correct sized cassette selected <input type="checkbox"/> Baby Positioned in Optimal Position Over Cassette <input type="checkbox"/> Anatomical Marker Placed <input type="checkbox"/> Neonatal Staff Member Present to Hold Position if required <input type="checkbox"/> Lead apron offered
E	Evaluate & Export	<input type="checkbox"/> X-ray satisfactory: Y/N (Please select) <input type="checkbox"/> Need for Repeat <input type="checkbox"/> No. of Repeats and Reason <input type="checkbox"/> Checklist Scanned onto PACS

FIGURE 1: Pre-X-ray Checklist.

RESULTS

Phase I: 79 X-rays were performed. 15 (19%) were repeated, most commonly for positioning (n=6) and patient motion (n=5). No patients had a pre-X-ray anatomical marker, but all had a post-X-ray marker. Data collection on the impact of the checklist continues at time of submission but is anticipated to

show significant improvement in quality and safety and has proved acceptable to healthcare professionals.

CONCLUSIONS

Sub-optimal X-ray imaging can result in unnecessary repeat X-rays with potential health and safety implications. Efforts to minimize radiation exposure to vulnerable neonates are essential. Safety checklists are increasingly used in clinical practice and present a simple measure to support this, as demonstrated in this project. Further research to create national guidelines for neonatal imaging would be beneficial.

LO018 / #2739

Pre-Recorded Oral Session

Pre-Recorded virtual orals: ESPNIC Session - pharmacology it is!

Sedation and analgesia for reduction of paediatric ileocolic intussusception: A multinational cross- sectional study

**N. Poonai^{1*}, D. Cohen², D. Macdowell³, R. Mistry⁴, S. Mintegi⁵,
S. Craig⁶, D. Roland⁷, M. Miller¹, I. Shavit⁸**

¹Children's Hospital - London Health Sciences Centre, Paediatrics, Dorchester, Canada

²Pediatric Emergency Department, 4. Nationwide Children's Hospital, Columbus,
United States of America

³Nationwide Children's Hospital, Paediatrics, Columbus, United States of America

⁴University of Colorado School of Medicine, Paediatrics, Aurora, United States of America

⁵University of the Basque Country, Paediatric Emergency Medicine, Bilbao, Spain

⁶Monash University, Paediatrics, Clayton, Australia

⁷Emergency Department, Leicester Royal infirmary, Paediatric Emergency Medicine Leicester
Academic (pema) Group, Leicester, United Kingdom

⁸Technion-institute of technology, 1. rappaport Faculty of Medicine, haifa, Israel

BACKGROUND AND AIMS

Ileocolic intussusception is an important cause of intestinal obstruction in children. Timely reduction of intussusception is standard of care. It is believed to be distressing but usually performed without sedation due to controversies surrounding increased risks of intestinal perforation and failed reduction. We sought to characterize practice patterns related to sedation and analgesia for reduction of ileocolic intussusception in children.

METHODS

We conducted a medical record review of children 4-48 months who underwent attempted reduction of ileocolic intussusception from January 1, 2017,

to December 31, 2019, in 86 institutions in 14 countries. The primary outcomes were sedation and analgesia within 120 minutes of the reduction. Bivariate and multivariable models explored the relationship with perforation and failed reduction.

RESULTS

We included 3203 patients [2054/3203 (64.1%) males; median (IQR) age of 17 months (9,27)]. 346/3203 (10.8%), 466/3203 (14.5%), and 208/3203 (6.5%) patients received sedation, analgesia, or both, respectively. Perforation was uncommon (13/3165; 0.4%). In the bivariate analysis, perforation was not significantly associated with analgesia [OR:1.77;95%CI:0.48,6.44;p=0.389] or sedation [OR:0.69;95%CI:0.09,5.30;p=0.719]. In the adjusted analysis, perforation was not significantly associated with analgesia plus sedation [OR:1.25;95%CI:0.55,2.82;p=0.593] or number of reduction attempts [OR:0.95;95%CI:0.77,1.17;p=0.621]. Failed reduction occurred in 484/3184(15.2%) attempts and in the adjusted analysis, significantly associated with age [OR:1.05(per month increase);95%CI:1.03,1.06;p<0.001], time to reduction [OR:0.96(per hour increase);95%CI:0.94,0.99;p=0.002], analgesia plus sedation [OR:2.33;95%CI:1.43,3.80;p<0.001], and pre-existing gastrointestinal anomaly [OR:4.00;95%CI:1.37,11.73;p=0.011] but not analgesia alone [OR:1.33;95%CI:0.92,1.92;p=0.131] or type of reduction [OR:1.13(hydrostatic versus air);95%CI:0.79,1.61;p=0.513].

CONCLUSIONS

Findings of this large multinational cohort suggest that children may be safely administered sedation or analgesia for reduction of ileocolic intussusception.

LO019 / #814

Pre-Recorded Oral Session

Pre-Recorded virtual orals: ESPR Session - Cord Clamping

Umbilical cord milking in non-vigorous infants: A pragmatic cluster-randomized crossover trial

A. Katheria^{1*}, E. Clark², B. Yoder³, C. Martin⁴, F. Vora⁴, D. Rittenberg⁵, B.H. Law⁶, G. Schmölzer⁶, S. Lakshminrusimha⁷, M. Underwood⁸, M. Mohamed⁹, S. Sheth¹⁰, Y. Gollin¹¹, M. Rice¹², L. Ghormli¹², J. Mazela¹³, M. Tomlinson¹⁴, J. Kaempf¹⁵, A. Morales¹, M. Varner², J. Mercer¹, D. Poeltler¹, Y. Vaucher¹⁶, K. Baker¹, W. Rich¹, P. Wozniak¹, N. Finer¹, W. El-Naggar¹⁷

¹Sharp Mary Birch Hospital for Women & Newborns, Neonatology, san diego, United States of America

²University of Utah School of Medicine, Maternal Fetal Medicine, Salt Lake City, United States of America

³University of Utah School of Medicine, Neonatology, Salt Lake City, United States of America

⁴LLUCH, Loma Linda, Loma Linda, United States of America

⁵Dalhousie University, Obstetrics, Halifax, Canada

⁶University of Alberta, Neonatology, Alberta, Canada

⁷Professor and Chair, University of California Davis Children's Hospital, Davis, United States of America

⁸Emeritus Professor, University of California Davis Children's Hospital, Davis, United States of America

⁹Department of Neonatology, Cleveland Clinic Children's, Vice Chair, Cleveland, United States of America

¹⁰Medical Faculty Associates, Obstetrics, Washington DC, United States of America

¹¹Sharp Mary Birch Hospital for Women & Newborns, Perinatology, san diego, United States of America

¹²George Washington University, Biostatistics, Washington DC, United States of America

¹³Poznan University of Medical Science, Poznan University of Medical Science, poznan, Poland

¹⁴Providence St. Vincent Medical Center, Providence St. Vincent Medical Center, Oregon, United States of America

¹⁵Medical Director - Value, Research, Innovation, Providence St. Vincent Medical Center, Oregon, United States of America

¹⁶UCSD, Neonatology, san diego, United States of America

¹⁷Dalhousie University, Neonatology, Halifax, Canada

BACKGROUND AND AIMS

In non-vigorous term/late-preterm infants, early cord clamping (ECC) remains the usual approach. Umbilical cord milking (UCM) may be an alternative. We tested whether UCM, compared to ECC, reduces NICU admission risk based on predefined criteria.

METHODS

A pragmatic cluster-randomized crossover trial of infants born at ≥ 35 weeks gestation from 10 Neonatal Intensive Care Units (NICUs) in 3 countries. Non-vigorous newborns at birth were assigned to UCM or ECC according to their hospital randomization assignment. Deferred consent was obtained to implement the intervention. Baseline characteristics and outcomes were collected following delayed informed consent.

RESULTS

Among 16,234 screened newborns, 1780 were eligible, 1730 had primary outcome data for analysis (97% of eligible; 872 UCM, 858 ECC) via informed or waived consent. NICU admissions did not differ significantly between UCM (23%) and ECC (28%) groups (OR 0.69, 95% CI 0.41-1.14). UCM was associated with lower odds of an abnormal 1-minute Apgar score (Apgar ≤ 3 30% vs 34%, OR 0.72, 95%CI 0.56-0.92; Apgar 4-6 33% vs 36% OR 0.74, 95%CI 0.58-0.95), and decreased need for therapeutic hypothermia (3% vs 4%, OR 0.57, 95% CI 0.33-0.99). No safety (death, intraventricular hemorrhage, or exchange transfusion) difference was observed (0.1% UCM, 0.7% ECC).

CONCLUSIONS

UCM did not reduce NICU admission compared with ECC in non-vigorous newborns. UCM may improve 1-minute Apgar scores and reduce respiratory support and the need for therapeutic hypothermia. Given its safety and potential efficacy, UCM may be considered for non-vigorous term/late-preterm newborns.

LO020 / #1516

Pre-Recorded Oral Session

Pre-Recorded virtual orals: ESPR Session - Impact of discharge planning

Comparisons of nurses' perceptions of developmental care practices between neonatal units in Canada and France

M. Aita^{1,2*}, G. De Clifford-Faugère^{1,2}, S. Colson³, N. Feeley^{4,5}

¹Université de Montréal, Faculty of Nursing, Montréal, Canada

²CHU Sainte-Justine Research Centre, Fetomaternal and Neonatal Pathologies, Montreal, Canada

³Université de Montréal, Faculté Des Sciences Médicales Et Paramédicales, Marseille, Canada

⁴McGill University, Ingram School of Nursing, Montreal, Canada

⁵Jewish General Hospital, Centre for Nursing Research and Lady Davis Institute, Montreal, Canada

BACKGROUND AND AIMS

Worldwide variations may exist across neonatal units related to the developmental care (DC) nursing practices. A comparison between Canadian and French neonatal units could highlight these variations to harmonize DC practices and promote preterm infants' health outcomes locally and internationally. The aim of this study was to compare nurses' perceptions of four DC practices: family-centered care (FCC), skin-to-skin contact (SSC), environmental control, as well as pain assessment and management between NICUs in Canada and France.

METHODS

A sample of 202 nurses with at least 6 months of NICU experience and speaking French or English were recruited in this comparative study. A total of 109 nurses were recruited from two NICUs in Canada and 93 from two NICUs in France. Nurses completed different questionnaires about their perceptions of FCC, SSC, environmental control of light and sound, in addition to pain assessment and management in NICUs.

RESULTS

French nurses had more optimal perceptions about FCC in the NICU compared to Canadian nurses. For SSC, Canadian nurses had less favorable attitudes and less favorable perceptions related to education and training in addition to implementation compared to the French nurses. Nurses from Canada were more satisfied with environmental sound and light levels compared to nurses in France. French nurses had more favorable attitudes and perceptions about infants' pain, they used more pain assessment signs and performed more management interventions than Canadian nurses.

CONCLUSIONS

Our study offers benchmarking comparisons between DC nursing practices in Canada and France and offers guidance to improve health outcomes of preterm infants worldwide.

LO021 / #1591

Pre-Recorded Oral Session

Pre-Recorded virtual orals: ESPR Session - Impact of discharge planning

Assessing family resilience in the NICU: Results from a COSMIN systematic review of the family resilience assessment scale adaptations

G. Laporte^{1,2*}, G. De Clifford-Faugère^{1,2}, A. Lavallée³, M. Aita^{1,2}

¹CHU Sainte-Justine Research Centre, Fetomaternal and Neonatal Pathologies, Montreal, Canada

²Université de Montreal, Faculty of Nursing, Montreal, Canada

³Department of Pediatrics, Columbia University Irving Medical Center, Nurture Science Program, New York City, United States of America

BACKGROUND AND AIMS

Anchored in a family-centered care perspective, assessing family resilience in the NICU could provide insight into strengths and challenges families may experience throughout their hospitalization. This assessment may enable professionals to identify areas for implementing tailored interventions to support families and positively impact their well-being and their health. A recent systematic review identified the Family Resilience Assessment Scale (FRAS) as the most reliable instrument for assessing family resilience, which has been adapted cross-culturally worldwide. A COSMIN systematic review is needed to evaluate the adapted versions' psychometric qualities to further recommend their use in the NICU.

METHODS

Nine databases were searched to identify articles published since 2005. A two-reviewer methodology was followed for screening, extraction and risk of bias assessment. Following COSMIN's updated criteria for good measurement properties, eight measurement properties were evaluated.

RESULTS

Twenty-six articles described ten cross-cultural adaptations of the FRAS in seven different languages. Only five adaptations (50%) were forward and backward translated. All adaptations reported sufficient internal consistency, and factor analysis yielded various scale structures, ranging from 32 to 66 items, divided into three to six subscales. Internal consistency was reported for all studies, and structural validity was tested nine times. Seven studies tested construct validity, two verified test-retest reliability and only one study evaluated responsiveness.

CONCLUSIONS

Most psychometric properties were often within acceptable range with sometimes limited evidence for validity. Still, all identified versions of the FRAS will require further validation to fully assess their measurement properties before recommendation for practice and research in the NICU.

LO022 / #2052

Pre-Recorded Oral Session

Pre-Recorded virtual orals: ESPR Session - New takes on respiratory care in the NICU

Machine learning of respiratory outcome predictions in premature infants born at < 30 weeks gestation based on developmental origins of bronchopulmonary dysplasia

S. Rao^{1*}, J. Tan², R. Leigh³, F.-S. Chou³, A. Pham⁴

¹Loma Linda University Children's Hospital, Neonatology, Loma Linda, United States of America

²Huckleberry Labs Inc., Senior Data Scientist, Irvine, United States of America

³Loma Linda School of Medicine, Medical School, Loma Linda, United States of America

⁴University of California, San Diego, Research Assistant, La Jolla, United States of America

BACKGROUND AND AIMS

Bronchopulmonary dysplasia (BPD) remains a significant challenge. As a multifactorial disease, BPD has been shown to be associated with various maternal and antenatal factors, which are then reflected as the severity of illness in the preterm infants' immediate postnatal life. Current understanding of BPD pathophysiology points towards a developmental origin of BPD, which may be proportionate to the degree of irreversible insult during fetal lung development. We developed random forest prediction models based on this concept by combining perinatal and respiratory support data in the first 14 days of life.

METHODS

This is a single-center retrospective study from 2013 to 2019 with subjects born at less than 30 weeks' gestation randomly split into training (80%) and testing (20%) datasets. Perinatal features and respiratory mode

at each 24-hour interval for the first 14 intervals were extracted from electronic medical records. A random forest (RF) algorithm was used to train perinatal and respiratory data separately, followed by developing a final ensemble model. Model performance was assessed by receiver's operating characteristics (ROC).

RESULTS

Table 1 shows demographic summarization. Figure 1 shows model performance for each RF model developed using perinatal data and respiratory data. Figure 2 demonstrates the final ensemble models with ROC area under the curve between 0.87-0.91 for the training dataset, and between 0.83-0.867 for the testing dataset, respectively.

Table 1

	No bronchopulmonary dysplasia	Bronchopulmonary dysplasia
Total number, n (%)	258 (44.5%)	322 (55.5%)
Female sex, n (%)	149 (57.8%)	137 (42.5%)
Race/ethnicity, n (%)		
White	61 (23.6%)	65 (20.1%)
Black	46 (17.8%)	48 (14.9%)
Hispanic	127 (49.2%)	178 (55.3%)
Asian	15 (5.8%)	19 (5.9%)
Other	9 (3.5%)	12 (3.7%)
Maternal smoking, n (%)	18 (7.0%)	34 (10.6%)
Gestational age in weeks (median [IQR])	28.4 (27.1 – 29.1)	26.3 (24.9 – 27.9)
Birth weight z-score, mean (sd)	0.36 (0.94)	-0.11 (0.99)

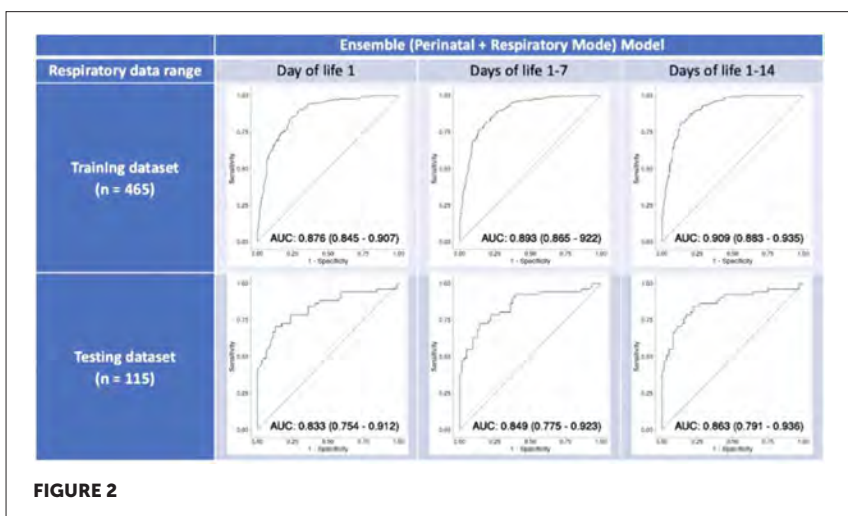
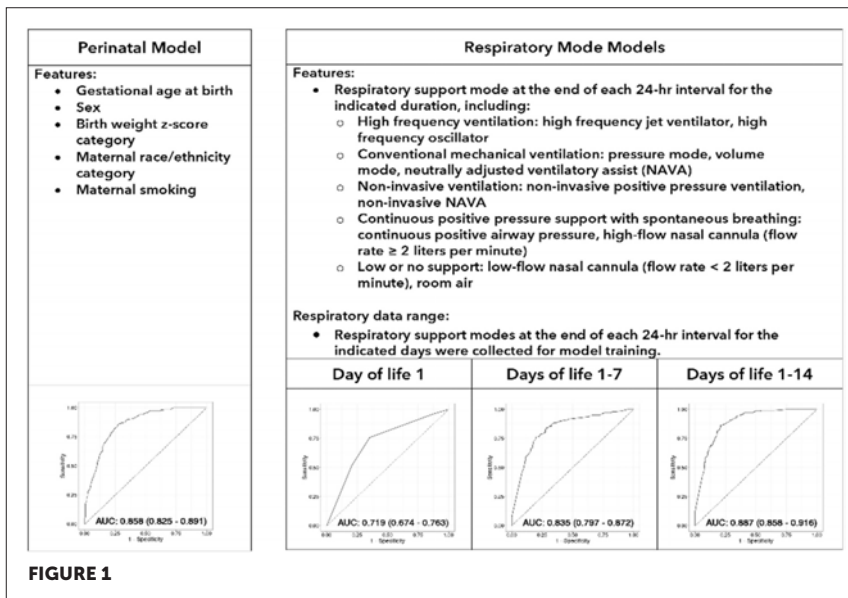

CONCLUSIONS

Model performance was adequate, with perinatal data playing a significant role, reaffirming the developmental origins of BPD. This model may be further developed into a prediction tool for BPD.

LO023 / #2048

Pre-Recorded Oral Session

Pre-Recorded virtual orals: ESPR Session - PPHN - What's new

Differential oxygenation index trajectories for bronchopulmonary dysplasia of various grades in infants born less than 32 weeks' gestation

S. Rao^{1*}, R. Leigh², J. Tan³, H.-W. Yeh⁴, F.-S. Chou²

¹Loma Linda University Children's Hospital, Neonatology, Loma Linda, United States of America

²Loma Linda School of Medicine, Medical School, Loma Linda, United States of America

³Huckleberry Labs Inc., Senior Data Scientist, Irvine, United States of America

⁴Division of Health services and Outcomes Research, Research, Kansas City, United States of America

BACKGROUND AND AIMS

Bronchopulmonary dysplasia (BPD) remains a significant challenge. Distinct patterns of fraction of inspired oxygen trajectories (FiO₂) early in life has been shown to correlate with BPD, but FiO₂ did not capture full respiratory status. Our aim was to assess whether the oxygenation index (OI) trajectories during early postnatal life were distinct among various BPD grades.

METHODS

A single-center retrospective study with data from babies born at less than 32 weeks' gestation between 2018 and 2020 for OI calculation and BPD grading were performed. Given non-linear trajectory patterns of OI, we utilized the generalized additive mixed modeling (GAMM) technique for modeling. OI values were log-transformed prior to modeling for better normal distribution approximation. Patient-specific intercepts and slopes were allowed. An interaction term to account for BPD grades was introduced. The differences in expected OI trajectories between grades were then calculated.

RESULTS

Table 1 contains demographic summary. Expected trajectories of log-transformed OI for each BPD grade and their differences between grades are shown in Figure 1 and 2, respectively. The results showed higher expected OI

Table 1: Study population demographics characteristics

BPD Grade*	All	No BPD (Grade 0)	Grade 1 BPD	Grade 2 BPD	Grade 3 BPD or Died
Number, n (%)	337	120	93	84	40
Male sex, n (%)	189 (56)	58 (48)	52 (56)	56 (67)	23 (58)
Race/ethnicity, n (%)					
White	52	20	9	17	6
Black	48	23	10	12	3
Hispanic	205	68	68	48	21
Asian	19	6	6	5	2
Other	12	3	0	2	7
Gestational age in week, median (interquartile)	27.1 (25.3 – 28.7)	28.4 (27.4 – 29.7)	26.3 (24.7 – 28.0)	26.1 (24.4 – 27.7)	24.4 (23.6 – 27.1)
Birth weight in grams, mean (sd)	971 (361)	1,203 (316)	902 (322)	782 (262)	827 (391)

*BPD grades were defined as:
 Grade 0: no BPD
 Grade 1: nasal cannula at 36 weeks CGA
 Grade 2: non-invasive positive pressure ventilation at 36 weeks CGA
 Grade 3: invasive respiratory support at 36 weeks CGA

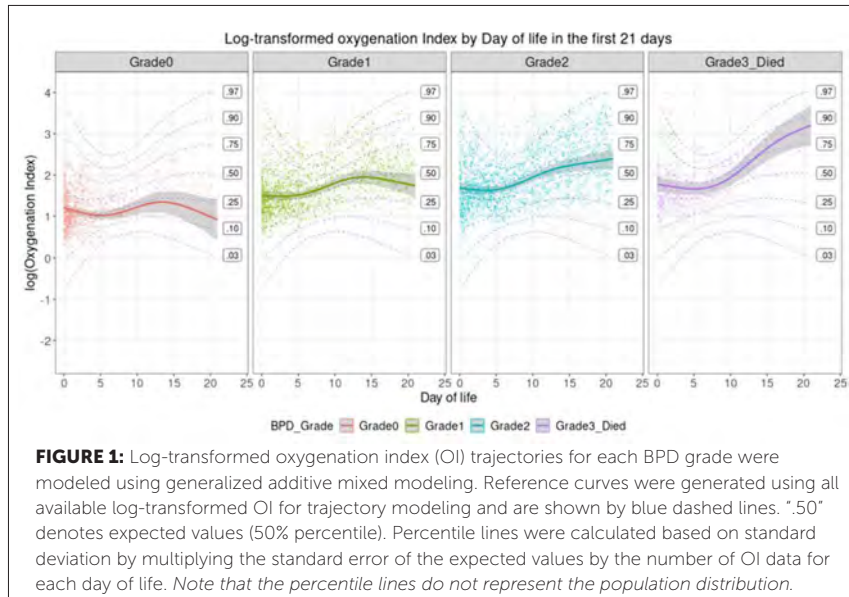

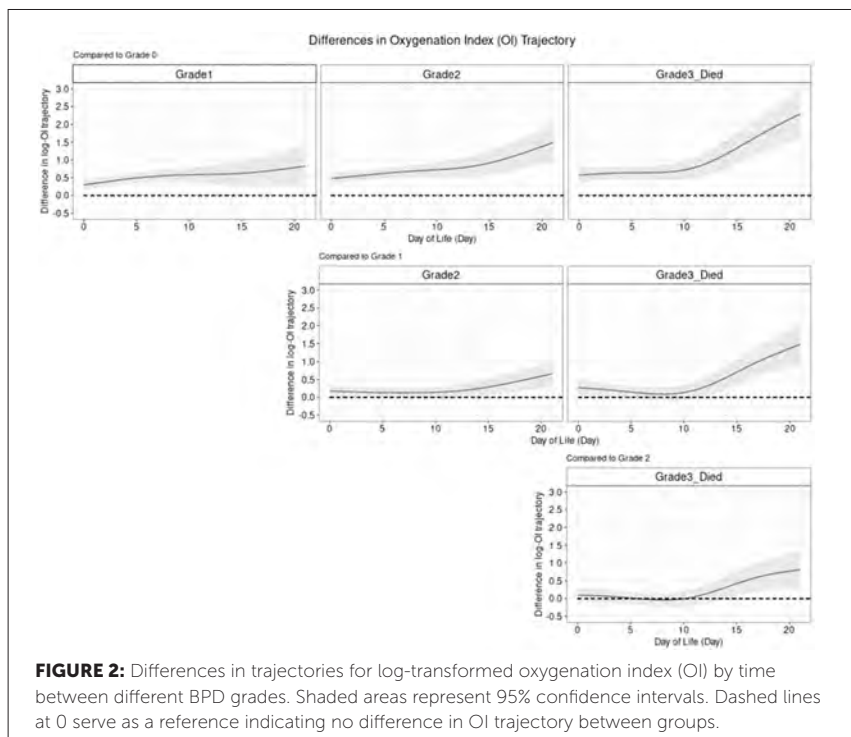

trajectories in all BPD grade groups compared to the no-BPD group (Grade 0) during the 1st week of life. Moreover, the distinctions in the expected OI trajectories among Grade 1-3 became apparent after 14 days of life.

CONCLUSIONS

OI trajectories differ among BPD grades in early postnatal life. OI trajectories in the first three weeks of life may be used to predict BPD grades and to guide therapeutic interventions.

LO024 / #1569**Pre-Recorded Oral Session****Pre-Recorded virtual orals: ESPR Session - All you need to know about electrolytes****Treatment of hyperkalaemia in the neonate**

**M. Furqan^{1*}, N. Laher¹, M. Chidiac¹, Z. Hall¹, M. Salama¹, G. Ola¹,
A. Kumar¹, A. O'Reilly¹, E. Isweisi^{2,3,4,5,6,7,8}, G. Semova^{2,3,4,6,7,8,9,10},
A. Branagan^{1,2,3,4,6,7,10}, J. Meehan^{2,6,7,8,11,12}, E. Molloy^{2,4,5,6,7,11,13,14,15,16,17,18,19}**

¹Trinity College Dublin, Paediatrics, Dublin, Ireland

²Tallaght, Children's Health Ireland At Tallaght, Dublin, Ireland

³Children's Health Ireland at Crumlin, Paediatrics, Dublin, Ireland

⁴Coombe Women & Infants University Hospital, Neonatology, Dublin, Ireland

⁵Prof of Paediatrics, Trinity College Dublin, Dublin, Ireland

⁶Trinity College Dublin, Trinity Research In Childhood Centre, Dublin, Ireland

⁷Trinity College Dublin, Discipline of Paediatrics, School of Medicine, Dublin, Ireland

⁸Children's Health Ireland at Tallaght, Paediatrics, Dublin, Ireland

⁹Trinity College Dublin, the University of Dublin, School of Medicine, Dublin, Ireland

¹⁰Trinity Research in Childhood Centre, Trinity College Dublin, Dublin, Ireland

¹¹Trinity College Dublin, School of Medicine, Dublin, Ireland

¹²Children's Health Ireland at Tallaght, Tallaght, Dublin, Ireland

¹³Coombe Women and Infants Hospital, Neonatology, Dublin, Ireland

¹⁴Trinity College Dublin, Trinity Translational Medicine Institute, Dublin, Ireland

¹⁵Trinity College Dublin, School of Medicine, Discipline of Paediatrics, Dublin, Ireland

¹⁶Children's Health Ireland at Crumlin, Infectious Diseases and Immunology, Dublin, Ireland

¹⁷Trinity College Dublin, Trinity Research in Childhood Centre (tricc), Dublin, Ireland

¹⁸Children's Health Ireland at Tallaght, Neonatology, Dublin, Ireland

¹⁹Children's Health Ireland at Crumlin, Neonatology, Dublin, Ireland

BACKGROUND AND AIMS

Hyperkalaemia is more common in extremely low birth weight infants and is associated with high mortality in the neonatal population. We aimed to systematically review literature on the treatment of hyperkalaemia in neonates.

METHODS

A peer reviewed search was conducted using Embase, Pubmed and Cochrane databases according to PRISMA guidelines. The search identified literature on therapeutic interventions for the treatment of hyperkalaemia in newborns (≤ 4 weeks of life). Data was extracted on study design, sample size, patient demographics, primary treatments and adjunctive treatments, and outcomes.

RESULTS

A total of 519 titles were identified with 67 texts for full paper review. A final 10 articles met our inclusion criteria. Primary treatments that were identified included salbutamol, glucose/insulin infusion, potassium exchange resins and peritoneal dialysis. Adjunctive treatments included sodium bicarbonate and calcium gluconate. All 5 treatment methods identified showed efficacy in the reduction of serum potassium levels in neonates. Nebulized salbutamol demonstrated superior efficacy and safety in comparison to other treatments in multiple studies. Hyperkalaemia associated with congenital endocrine disorders, including congenital adrenal hyperplasia and pseudohypoaldosteronism, was also reported. Treatment involved the use of hydrocortisone and fludrocortisone in conjunction with standard treatment methods.

CONCLUSIONS

Improved insight into the aetiology of hyperkalaemia would assist in planning optimal management to improve outcomes.

LO025 / #544**Pre-Recorded Oral Session****Pre-Recorded virtual orals: Interdisciplinary session - Circadian Mechanisms in medicine (ESPE Session)****The risk for cognitive consequences in children with sleep-disordered breathing****E. Csabi^{1*}, P. Benedek²**

¹*Department of Cognitive and Neuropsychology, University of Szeged, Institute of Psychology, Egyetem utca, Hungary*

²*Heim Pal National Pediatric Institute, Sleep Laboratory, Budapest, Hungary*

BACKGROUND AND AIMS

Sleep-disordered Breathing (SDB) is a spectrum disorder ranging from primary snoring to obstructive sleep apnea (OSA). One of the most common sleep disorders in childhood however remarkably little is known of the effect of SDB on memory functions. The aim of our study is to investigate the cognitive consequences of SDB compared to children with no history of sleep disorders.

METHODS

The SDB group consisted of sixteen children with SDB (average age: 8.56 years, SD: 2.31; 6females/10males) six of them with OSA and ten of them with primary snoring. The control group consisted of sixteen healthy participants (average age: 8.75 years, SD: 1.44; 8females/8males). The control and the SDB groups were matched on age and gender. We used story recall to measure explicit memory and Alternating Serial Reaction Time Task to examine implicit memory. There were two sessions: a learning phase and a testing phase, separated by a 12-hour offline period with sleep.

RESULTS

Our data showed that children with SDB exhibited impaired explicit memory performance both in the learning and testing phase compared to the control group. In contrast to these results, we found intact implicit memory in SDB group.

CONCLUSIONS

These findings suggest that sleep disorders in childhood have a different effect on different memory processes and give us insight into how sleep disturbances affect the developing brain.

LO026 / #585**Pre-Recorded Oral Session****Pre-Recorded virtual orals: Interdisciplinary session - Finding a scientific basis for paediatric medicine****Early nasal high-flow for children with acute hypoxaemic respiratory failure: A randomised controlled trial**

A. Schibler^{1*}, D. Franklin², F. Babl³, E. Oakley³, M. Jones⁴, M. Borland⁵, J. Neutze⁶, J. Acworth⁷, S. Craig⁸, B. Gannon⁹, D. Shellshear⁷, H. Mccay¹⁰, A. Wallace¹¹, T. Hoepfner⁵, M. Wildman¹², J. Mattes¹³, T. Pham¹⁴, L. Miller⁷, A. Williams³, S. O'Brien⁵, S. Lawrence⁶, M. Bonisch¹⁵, K. Gibbons¹⁴, J. Waugh¹⁶, S. Hobbins¹⁷, S. Grew¹⁸, R. Fahy¹⁷, S. Dalziel¹⁵

¹Wesley Medical Research Institute, Paediatrics, Brisbane, Australia

²Department of Emergency Medicine, Gold Coast University Hospital, Southport, Gold Coast, Australia

³Department of Emergency Medicine, Royal Children's Hospital, Melbourne, Australia

⁴Bond University, Faculty of Health Sciences and Medicine, Gold Coast, Australia

⁵Department of Emergency Medicine, Perth Children's Hospital, Perth, Australia

⁶Department of Emergency Medicine, Kidz First Middlemore Hospital, Auckland, New Zealand

⁷Department of Emergency Medicine, Queensland Children's Hospital, Brisbane, Australia

⁸Department of Emergency Medicine, Monash Medical Centre, Melbourne, Australia

⁹The University of Queensland, Centre for the Business and Economics of Health, Brisbane, Australia

¹⁰Waikato Hospital, General Paediatrics, Hamilton, New Zealand

¹¹Department of Emergency Medicine, Waikato Hospital, Hamilton, New Zealand

¹²Department of Emergency Medicine, The Townsville University Hospital, Townsville, Australia

¹³John Hunter Children's Hospital, General Paediatrics, Newcastle, Australia

¹⁴The University of Queensland, School of Medicine, Brisbane, Australia

¹⁵Department of Emergency Medicine, Starship Children's Health, Auckland, New Zealand

¹⁶Ipswich Hospital, General Paediatrics, Brisbane, Australia

¹⁷Children's Emergency and Paediatric Departments, The Prince Charles Hospital, Brisbane, Australia

¹⁸Redcliffe Hospital, General Paediatrics, Brisbane, Australia

BACKGROUND AND AIMS

Nasal high-flow therapy in hypoxic infants with bronchiolitis has been shown to reduce the requirement to escalate care. The efficacy of high-flow in children with acute hypoxaemic respiratory failure outside bronchiolitis is unknown.

METHODS

Children aged 1-4 years of age with acute hypoxaemic respiratory failure in 14 Australian and New Zealand emergency departments were randomly assigned (1:1) to receive either nasal high-flow (NHF) or standard-oxygen therapy (SOT). The oxygen therapy could not be masked for obvious reasons, but the investigators remained blinded until outcome data was locked. Primary outcome was length of hospital stay. Secondary outcomes included length of oxygen therapy and intensive care admission. Analyses were performed on an intention-to-treat (ITT) population. Recruitment is closed and the study registered with anzctr.org.au, ACTRN12618000210279.

RESULTS

Commencing Dec 18, 2017, to 22 March 2020 1,567 children (n=753 NHF, n=764 SOT) were enrolled at 14 sites and included in the ITT analysis. Length of hospital stay was significantly longer in the NHF group with a median of 1.77 days (interquartile range [IQR], 1.03 to 2.80) versus 1.50 days (IQR 0.85 to 2.44) in the SOT group (adjusted hazards ratio [aHR] 0.83 (95% confidence interval [CI], 0.75 to 0.92; $P < 0.001$). Length of oxygen therapy was significantly longer in the NHF group with a median of 1.07 days (IQR, 0.50 to 2.06) versus 0.75 days (IQR, 0.35 to 1.61) in the SOT group (aHR 0.78; 95% CI, 0.70 to 0.86). Greater ICU admissions occurred in the NHF group (n=94, 12.5%) compared to the SOT group (n=53, 6.9%; give effect estimate, 95% CI and p value).

CONCLUSIONS

NHF used as the initial primary oxygen therapy in children with acute hypoxaemic respiratory failure and aged 1-4 years did prolong length of hospital stay compared to SOT.

LO027 / #1983**Pre-Recorded Oral Session****Pre-Recorded virtual orals: Interdisciplinary session - Fluid management in the critically ill child****Diabetic ketoacidosis fluid management in children: Systematic review and meta-analyses****A. Hamud****Emergency Department, Sidra Medicine, DOHA, Qatar***BACKGROUND AND AIMS**

Diabetic Ketoacidosis (DKA) is a serious complication of type 1 Diabetes Mellitus (DM), which may lead to significant morbidity and mortality. The aim is to compare the safety and efficacy of liberalised versus conservative intravenous fluid (IV fluid) regimens in the management of DKA in children.

METHODS

Databases from inception to January 2022: MEDLINE, EMBASE, CINAHL, and the Cochrane Central Register of Controlled Trials (CENTRAL) were included. Only randomised controlled trials that included children aged under 18 years were assessed. Two reviewers performed data assessment and extraction. Three studies out of 1536 citations were included in this review.

RESULTS

The outcomes are the time to the recovery from the DKA; the frequency of PICU admissions; development of brain oedema; reduction in (Glasgow Coma Scale) GCS; development of acute kidney injury; and all-cause mortality.

We included 3 RCTs (n=768). No evidence of differences were noted in the episodes of GCS reduction (RR= 0.6, 95% CI 0.32 to 1.44), development of brain oedema (RR= 0.66, 95% CI 0.11 to 3.94), or the duration to the recovery (MD= 2.17, 95% CI -1.84 to 6.19, I² = 99%). Time to hospital discharge, adverse or serious adverse events were comparable in the two studied groups.

CONCLUSIONS

There is low to very low certainty of evidence that the rate of IV fluid administration in DKA has no effects on the development of brain oedema or injury, duration of hospital stay or the risk of adverse or serious adverse events.

LO028 / #2247**Pre-Recorded Oral Session****Pre-Recorded virtual orals: Interdisciplinary session - Nurses as research leaders****Investigation of pediatric nurses' views, attitudes and behaviors on family-centered care during the pandemic****S. Özkan^{1*}, M. Aksoy², F. Tas Arslan³**¹Selcuk University Faculty of Nursing, Child Health and Diseases Nursing, Konya, Turkey²Lokman Hekim Akay Hospital, Neonatal Intensive Care Unit, Ankara, Turkey³Selcuk University, Nursing Faculty, Konya, Turkey**BACKGROUND AND AIMS**

Family-centered care, which is a basic care model in pediatric nursing. The study was conducted to investigate the views, attitudes and behaviors of pediatric nurses regarding family-centered care during the pandemic process.

METHODS

The sample size was calculated by G-power, and was determined as 103 pediatric nurses. Questionnaire Form; Questionnaire on Knowledge, Attitudes and Behaviors about Family-Centered Care During the Pandemic Process; Caring Behaviors Inventory were used during online data collection between March-July 2021. Descriptive statistics, Kruskal Wallis H Test, Mann-Whitney U test were used to analyze the data.

RESULTS

The age range was 21 to 42 with a mean age of 28.36 ± 5.169 . The majority of the nurses were women, working in general pediatric clinics, and had a bachelor degree. The nurses stated that there was a regulation and protocol regarding family-centered care (46.6%), and family-centered care (64.1%) in the institution. Also, the nurses reported that family-centered care practice decreased in the Covid-19 pandemic (48.5%). The mean score of the nurses from the Caring Behaviors Inventory was high (5.19 ± 0.86); it was determined that the nurses' status of having a child, working time in the Covid pandemic and changes in family-centered care practices in the pandemic were significantly related to the mean score of Caring Behaviors Inventory by the nurses ($p < 0.05$).

CONCLUSIONS

The Covid-19 pandemic has had a significant impact on the professional roles and responsibilities of pediatric nurses, because of this some main concepts in pediatric nursing (such as Family-centered care) need to be reconsidered.

LO029 / #2673**Pre-Recorded Oral Session****Pre-Recorded virtual orals: Interdisciplinary session - Nurses as research leaders****Diagnosis delay is associated with cardiogenic shock in pediatric inflammatory multisystem syndrome temporally associated with SARS-COV-2 (PIMS-TS)**

S. Bichali^{1*}, J.-B. Baudelet¹, M.-E. Lampin², O. Domanski¹, H. Reumaux³, A. Delarue¹, M. Recher², J. Soquet⁴, F. Dubos³, S. Leteurtre², A. Houeijeh¹, F. Godart¹

¹University Hospital Center Lille, Cardio-pediatrics, LILLE, France

²CHRU Lille, Pediatric Icu, Lille, France

³University Hospital Center Lille, Pediatric Emergency, LILLE, France

⁴University Hospital Center Lille, Cardiac Surgery, LILLE, France

BACKGROUND AND AIMS

Diagnosis delay leads to an increased risk of coronary artery aneurysms in Kawasaki disease. In pediatric inflammatory multisystem syndrome temporally associated with SARS-CoV-2 (PIMS-TS), diagnosis delay could be associated with severity. This study aims to test the hypothesis that a long time to diagnosis is associated with shock in PIMS-TS.

METHODS

A single-center observational study was conducted between May 2020 and April 2022. Children with a PIMS-TS diagnosis meeting WHO criteria were included. A long time to diagnosis was defined as 6 days or more. Outcomes were assessed on cardiogenic shock defined by the need for inotropes (dobutamine, milrinone, adrenaline). Vasoplegic shock was defined by the need for fluid bolus > 20 ml/kg and/or vasopressor (noradrenaline).

RESULTS

Thirty-two children were included in the study. One child was excluded due to previous vaccination against COVID-19. The median time to diagnosis was 5.3 [4.0-6.3] days. Children with a long time to diagnosis (n=13), compared with those with a short time to diagnosis (n=18), had more often cardiogenic shock (8 children (57%) versus 0 child (0%) respectively, $p<0.001$) but as frequent vasoplegic shock (3 children (17%) versus 3 children (23%) respectively, $p=0.68$). Children with a long time to diagnosis, compared with those with a short time to diagnosis, were older (10 [8-11] years old versus 7 [5-9] years old respectively, $p=0.03$). No child needed mechanical ventilation nor ECMO.

CONCLUSIONS

Diagnosis delay is associated with cardiogenic shock in PIMS-TS. Early diagnosis and treatment are crucial to avoid the use of inotropes and limit morbidity, especially in older children.

LO030 / #2624**Pre-Recorded Oral Session****Pre-Recorded virtual orals: Late breaking orals****Risk factors for failure of closed forearm fracture reduction in the pediatric emergency department****N. Cohen^{1*}, R. Gigi², S. Haberman¹, T. Capua¹, A. Rimon¹**

¹*Pediatric Emergency Department, Tel Aviv Sourasky Medical Center affiliated to the Sackler Faculty of Medicine, Tel Aviv University, Tel Aviv, Israel*

²*Pediatric Orthopaedic Surgery Department, Tel Aviv Sourasky Medical Center affiliated to Sackler Faculty of Medicine, Tel Aviv University, Tel Aviv, Israel*

BACKGROUND AND AIMS

It is widely accepted that nonoperative treatment is the primary approach to most forearm shaft fractures in children. The indication for a non-operative or an operative management of forearm shaft fractures is a matter of prevailing controversy. We aimed to explore risk factors for failure of forearm fracture closed reduction in the pediatric emergency department (ED), and to suggest indications for initial surgery.

METHODS

This retrospective cohort study included all patients aged 0-18 years who presented to our pediatric ED with an extra articular forearm fracture treated with closed reduction between 5/2017 and 4/2021. We explored risk factors for procedural failure, defined as a need for surgical intervention within 6 weeks of the closed reduction attempt.

RESULTS

Of 375 patients (median age 8.1 years, 294 males [78.2%]), 44 patients (11.7%) sustained a reduction failure, of whom 42 (95.5%) had both radius and ulna fractures. Of the 259 patients with fractures of both bones, the following

parameters were independent predictors for reduction failure: refracture (adjusted odds ratio [aOR] 17.6, $p < 0.001$), open fracture (aOR 10.1, $p = 0.007$), midshaft fracture (aOR 2.6, $p = 0.004$), radial translation rate $\geq 37\%$ in either plane (aOR 5.1, $p = 0.004$), and age ≥ 10 years (aOR 2.9, $p = 0.01$).

CONCLUSIONS

Most pediatric forearm fractures can be successfully managed by closed reduction in the ED. Two-bone fractures had the strongest association with reduction failure. We propose a risk score for reduction failure which can serve as a decision-making tool.

LO031 / #2623

Pre-Recorded Oral Session

Pre-Recorded virtual orals: Late breaking orals

Opioids safety in pediatric procedural sedation with ketamine

N. Cohen^{1,2*}, G. Test², Y. Pasternak², D. Singer- Harel², S. Schneeweiss², S. Ratnapalan², S. Schuh², Y. Finkelstein²

¹Pediatric Emergency Department, Tel Aviv Sourasky Medical Center, Tel Aviv, Israel

²Department of Pediatrics, Pediatric Emergency Department, Division of Pediatric Emergency Medicine, Hospital for Sick Children, University of Toronto, Toronto, Canada

BACKGROUND AND AIMS

Ketamine is the most commonly used agent for pediatric procedural sedation in the emergency department (ED). Previous research on ketamine related adverse events is inconsistent, particularly regarding its safety with concomitant use of opioids. We aimed to explore risk factors of ketamine-related adverse events in children undergoing procedural sedation in the emergency department (ED), with focus on safety of pre- and intra-procedural opioids.

METHODS

We conducted a retrospective cohort study of all children 0-18 years old who underwent procedural sedation with intravenous ketamine alone, or in combination with an opioid, at a tertiary-care pediatric emergency department between June 1st, 2018, to August 31st, 2020. We explored predictors of serious adverse events (SAEs), desaturation or respiratory intervention, and vomiting.

RESULTS

Of 1,164 included children (694 males, 59.6%; median age 5.0 years [IQR 2.0-8.0]), 80 (6.8%) vomited, 63 (5.4%) had a desaturation or required respiratory

interventions and six (0.5%) had SAEs. Pre- and intra-procedural opioids were not independent predictors of sedation-related adverse events. A concurrent respiratory illness (aOR 3.73 [95% CI 1.31-10.60], $P=0.01$), dental procedure (aOR 3.05 [1.25-7.21], $P=0.01$) and a higher total ketamine dose (aOR 1.75 [1.21-2.54], $P=0.003$) were independent predictors of desaturation or respiratory interventions. A higher total ketamine dose (aOR 1.86 [1.16-2.98], $P=0.01$) and older age (aOR 1.15[1.07-1.24], $P<0.001$), were independent predictors of vomiting.

CONCLUSIONS

Pre- and intra-procedural opioids do not increase the likelihood of sedation-related adverse events. SAEs are rare during pediatric procedural sedation with ketamine in the ED.

LO032 / #1595**Pre-Recorded Oral Session****Pre-Recorded virtual orals: Interdisciplinary session - Orphan disease in children (ESPGHAN Session)****Rare chromosomal alterations in pediatric myelodysplastic syndrome****V. Lovatel^{1*}, E. Rodrigues¹, L. Otero¹, E. Kós¹, B. Da Silva¹, R.D.C. Tavares², A.P. Bueno³, T. Fernandez¹**

¹Cytogenetic Department, Instituto Nacional de Câncer, Bone Marrow Transplantation Center, Rio de Janeiro, Brazil

²Outpatient Department, Instituto Nacional de Câncer, Bone Marrow Transplantation Center, Rio de Janeiro, Brazil

³Universidade Federal do Rio de Janeiro, Faculty of Medicine, Pediatric and Puericulture Martagão Gesteira Institute, Rio de Janeiro, Brazil

BACKGROUND AND AIMS

Pediatric myelodysplastic syndromes (p-MDS) are clonal disorders of hemato-poietic stem cells characterized by ineffective hematopoiesis leading to blood cytopenias and a high incidence of progression to acute myeloid leukemia (AML). Pediatric MDS has a variable clinical course and a difficult to diagnose. In this sense, cytogenetic analysis has an essential role in diagnosis, classification, and prognosis. Abnormal karyotypes are present in 50-70% of p-MDS, presenting mainly chromosomal losses and gains. The chromosome 7 monosomy is the most frequent alteration, associated with poor prognosis. However, there are rare cytogenetic alterations which its prognosis is still unknown. The aim of this study was to investigate uncommon cytogenetic alterations in p-MDS and correlate the clinical outcome.

METHODS

The cytogenetic analyses were performed by GTG banding and fluorescence in situ hybridization (FISH).

RESULTS

We studied 200 p-MDS between 1996 and 2022 in a Brazilian single institution. Hyperdiploid karyotypes were observed in five children (2.5%): one had refractory cytopenia of children (RCC), three MDS with excess of blasts (MDS-EB), and one with MDS-EB in transformation (MDS-EB-t). Biclonal alterations were presented in four patients (2%): three had RCC and one MDS-EB. Chromosome translocations were identified in two patients (1%). The t(4;7) (p16,p15) and t(5;8)(q32,q22) were presented in MDS-EB-t with evolution to AML. All patients with these rare alterations presented a poor prognosis and were indicated for hematopoietic stem cell transplantation (HSCT).

CONCLUSIONS

The study of rare cytogenetic alterations in p-MDS is important to aid in the prognosis and early indication of HSCT.

LO033 / #1680**Pre-Recorded Oral Session****Pre-Recorded virtual orals: Interdisciplinary session - Diagnosis of genetic syndromes in children (Catalan paediatric society session)****1p31.1 Microdeletion including only NEGR1 gene****S.C. Ferraz^{1*}, R. Aldeia Da Silva², I. Magalhães¹, C. Silva¹, M. Costa¹**¹Unidade Local de Saúde do Alto Minho, Paediatrics, Viana do Castelo, Portugal²Hospital de Braga, Paediatrics, Braga, Portugal**BACKGROUND AND AIMS**

The NEGR1 gene is associated with neuronal growth, proliferation, and differentiation. Interstitial deletions of chromosome 1p31 including only NEGR1 gene are extremely rare and clinical findings included intellectual disability, hypertonia, failure to thrive, short stature, obesity, microcephaly, broad nasal tip, tendency for an open mouth, micrognathia, high-arched palate, short neck, fifth finger clinodactyly, and tapering fingers.

METHODS

We report a case of a 5-year old male with global development delay and developmental verbal dyspraxia. Past medical and birth history were uneventful. He had a familiar history of speech disorder. He presented with microdontia and hypodontia, tendency for an open mouth, a high-arched palate, and a broad nasal bridge.



FIGURE 1: 5 year-old boy with dysmorphic facies, microdontia and hypodontia, tendency for an open mouth, high-arched palate, broad nasal bridge and low implanted ears.

RESULTS

Etiologic evaluation was carried out and on array-CGH it was found a 382 kb deletion of chromosome 1p31.1, which included two of the seven exons of the NEGR1 gene.

CONCLUSIONS

This finding allows a better clinical follow-up of the patient, providing adequate genetic counselling to this family. This mutation is yet of uncertain significance, but some associations have been reported that are consistent with this case's clinical manifestations. Array-CGH has become a valuable tool for the diagnosis of small genomic rearrangements containing few genes and, in some cases, only one gene.

LO034 / #674**Pre-Recorded Oral Session****Pre-Recorded virtual orals: Interdisciplinary session - New prospects on the management of childhood obesity (ESPE Session)****Influence of obesity in children with supracondylar fractures requiring surgical treatment**

M. Bašković^{1*}, L. Vucković¹, M. Borić Krakar¹, A. Kljenak¹, N. Benco Kordić², A. Rešić²

¹Department of Pediatric Surgery, Children's Hospital Zagreb, Zagreb, Croatia

²Department of Pediatrics, Children's Hospital Zagreb, Zagreb, Croatia

BACKGROUND AND AIMS

Obesity in childhood is a growing problem for the health and well-being of the child. The prevalence of overweight and obesity in children increased dramatically. The aim of our study was to determine whether the proportion of obese children, hospitalized for surgical treatment of supracondylar humerus fracture, was higher in complete displacement fractures.

METHODS

The primary outcome of the study was to determine the cumulative number of all supracondylar fractures and their distribution. The secondary outcome was to determine whether there was a statistically significant difference in relation to the observed parameters depending on gender. The tertiary outcome was to determine the proportion of children, depending on their percentile, in Gartland II and Gartland III type of injury.

RESULTS

The distributions according to the observed parameters were as follows; age (months) [mean \pm SD = 88.11 \pm 32.48], height (cm) [123.44 \pm 16.77], weight (kg) [27.04 \pm 11.12], body mass index [17.11 \pm 3.04], percentile [56.79 \pm 32.34]. The relative difference, in the proportion of Gartland type III injuries, in children weighing above the 85th percentile, compared to children weighing below the 85th percentile was 15.17% (boys: 5%, girls: 37.49%).

CONCLUSIONS

Our research found that there is undoubtedly a relative difference in the proportion of Gartland type III injuries in overweight and obese children, compared to children whose weight is below the 85th percentile.

LO035 / #855**ESPR Session****ESPR Session 01: Update on research in neonatal resuscitation****Can ventilation with an intact umbilical cord optimize transition & ameliorate systemic oxidative injury when 100% oxygen is used during preterm resuscitation?**

P. Chandrasekharan^{1*}, S. Gugino¹, J. Helman¹, N. Bradley¹, L. Nielsen¹, M. Bawa¹, A. Mari¹, A. Prasath¹, C. Blanco¹, M. Rawat¹, S. Lakshminrusimha²

¹Jacobs School of Medicine and Biomedical Sciences at the University at Buffalo, Pediatrics/neonatology, Buffalo, United States of America

²University of California Davis, Pediatrics/neonatology, Sacramento, United States of America

BACKGROUND AND AIMS

Fifty percent of preterm infants are born with a heart rate (HR) of <100 bpm. Not achieving a HR of ≥ 100 bpm & saturation (SpO₂) of $\geq 80\%$ by 5 min places them at a higher risk of morbidity/mortality. The use of 100% O₂ is not recommended in preterm resuscitation due to oxygen toxicity.

AIM

To study the effect of 100% O₂ during resuscitation/ventilation (PPV) with & without an intact umbilical cord using preterm lambs.

METHODS

Preterm lambs randomized to **a) AXDCC** - asphyxiated (HR <100 bpm), PPV & delayed cord clamping, **b) AXECC** - Ax, early cord clamping & PPV,

c) NoAXDCC - non-Ax, PPV & DCC, **d) NoAXECC** - non-Ax, ECC & PPV. **DCC duration was 5 min**. The **primary outcome** - incidence of HR ≥ 100 bpm & SpO₂ $\geq 80\%$ by 5 min. **O₂ titrated down from 100% in all groups based on SpO₂**. Transition data were collected.

RESULTS

In NoAXDCC, 100% achieved the primary outcome, compared to 83%(NoAXECC), 86%(AXDCC), 57%(AXECC) . By 5 min, the SpO₂ was higher in all DCC groups with lower O₂ exposure (Fig1B, Fig1C). The highest PaO₂ was seen with NoAXECC (Fig1D). PaCO₂ was lower with DCC along with higher peak pulmonary & carotid flow (Fig2A,B,C). At 5 min, no significant difference was observed in oxidative marker (Fig2D).

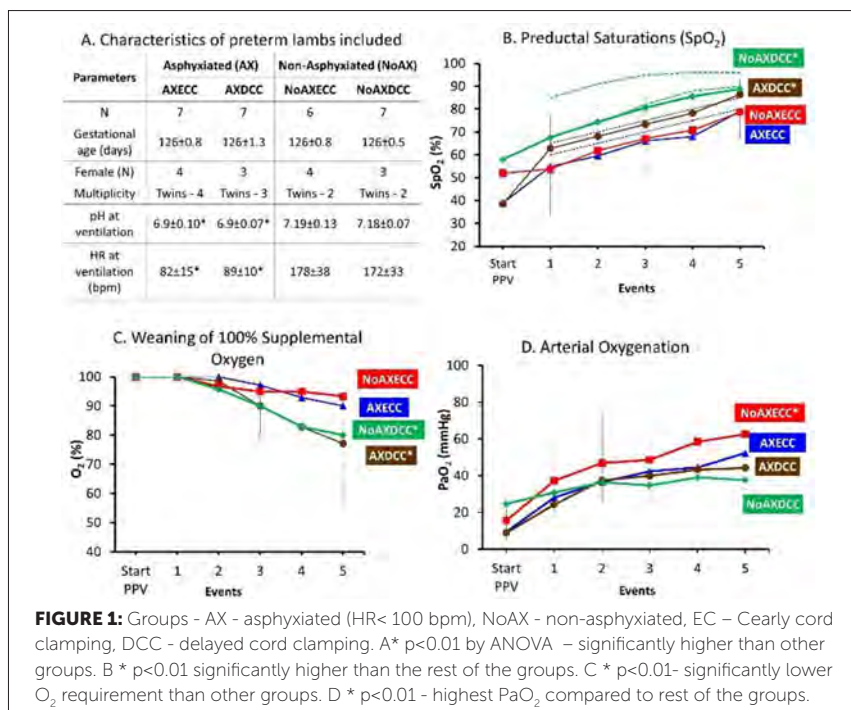

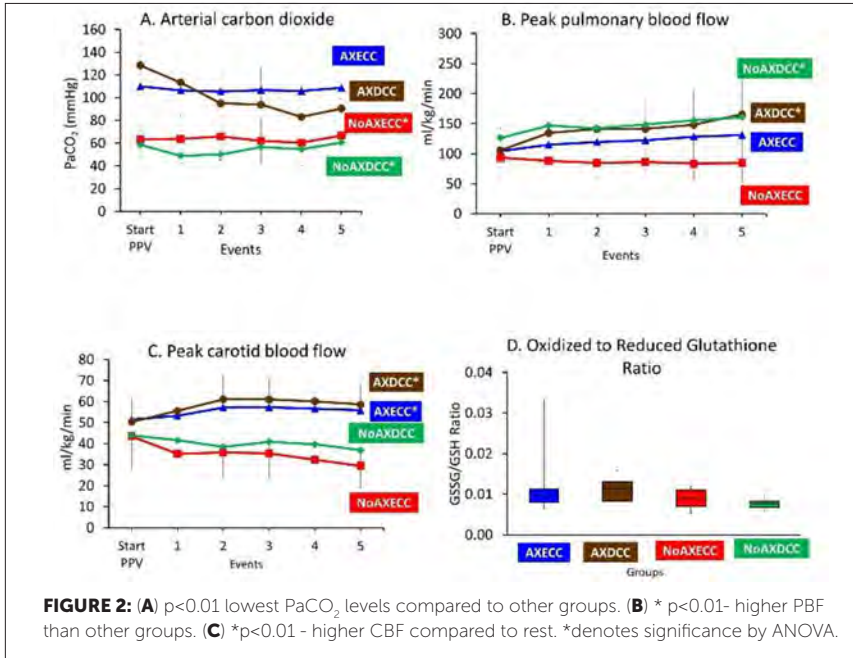

CONCLUSIONS

The primary outcome was achieved in 100% of the NoAxDCC group. In both NoAxDCC & AxDCC preterm lambs, initial use of 100%, increased peak pulmonary blood flow, with lower O_2 exposure, improving CO_2 without any change in oxidative stress markers.

LO036 / #650

ESPR Session

ESPR Session 01: Update on research in neonatal resuscitation

08-10-2022 10:30 - 11:50

Should we focus on ventilation alone rather than ventilation & chest compressions during neonatal resuscitation for bradycardia?

M. Bawa*, S. Gugino, J. Helman, N. Bradley, L. Nielsen, A. Prasath, C. Blanco, M. Rawat, P. Chandrasekharan

Jacobs School of Medicine and Biomedical Sciences at the University at Buffalo, Pediatrics/ neonatology, Buffalo, United States of America

BACKGROUND AND AIMS

Current ILCOR guidelines recommend initiating chest compressions(CC) when heart rate(HR) is < 60 bpm after 30s of effective ventilation. While CC provides circulatory support, its efficacy in neonatal bradycardia remains unknown. Adequate ventilation(PPV)could reduce the need for CC and improve overall outcomes.

AIMS

To evaluate current recommendations: ventilation & CC(HR < 60 bpm) vs. ventilation alone and initiate CC only if HR = 0 on i)timing of ROSC ii)frequency of requiring CC iii)gas exchange & hemodynamics using a term bradycardia ovine model.

METHODS

Near-term lambs(138-140d) were randomized to control/study groups after instrumentation(Fig1A). Data from 6 lambs in each group was included. The

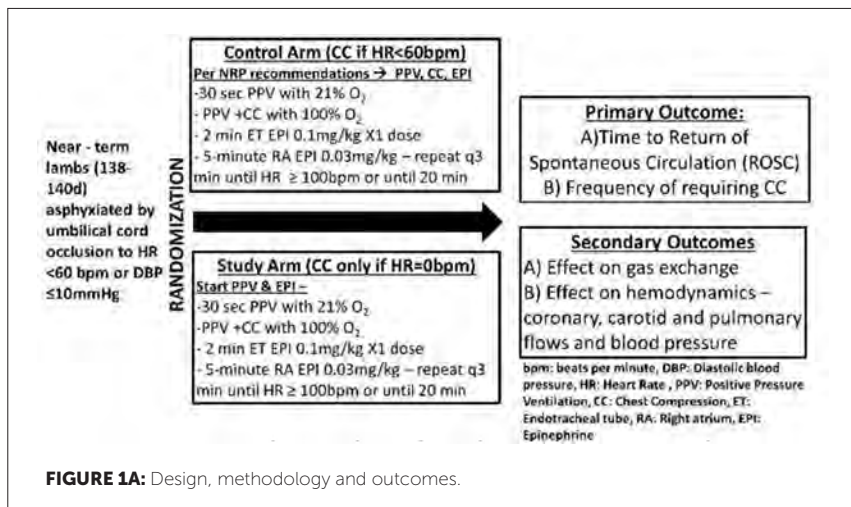

Parameters	Control (N=6)	Study (N=6)
Gestational age (days)	139 ± 0.4	139 ± 0.5
Birth weight (kg)	3.69 ± 0.4	3.38 ± 0.57
Sex (N)	M=3, F=3	M=6
Multiplicity	Singleton =1 Twins=5	Singleton =1 Twins=3 Triplets=1 Quadruplet=1
Heart rate at resuscitation (bpm)	57 ± 9	59 ± 6
pH	7.24 ± 0.05	7.27 ± 0.05
PaCO ₂ (mmHg)	61 ± 8	60 ± 12
PaO ₂ (mmHg)	18 ± 1	23 ± 3
Time to ROSC (min)	3 ± 2	1.6 ± 1

Data represented as average and standard deviation. ROSC: Return of Spontaneous Circulation

FIGURE 1B: Demographics and baseline characteristics at randomization.

timing & incidence of ROSC, need for CC, blood gas parameters, peak coronary (CoBF), peak left carotid (CaBF), peak left pulmonary blood flow (PBF) were recorded.

RESULTS

Fig 1B shows characteristics of lambs. Time to achieve ROSC was non significantly shorter in the study group. In the study group, 1/6 lambs required CC with a significant difference in rates of CC(6/6, $p = 0.015$). The asynchronous CC in the control group led to the loss of intrinsic activity before ROSC(Fig2A).

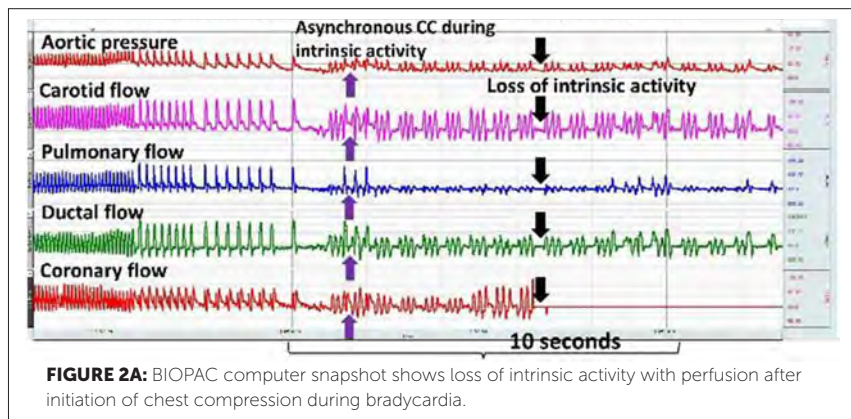

Timeline	Control (N=6)			Study (N=6)		
	pH	PaCO ₂ (mmHg)	PaO ₂ (mmHg)	pH	PaCO ₂ (mmHg)	PaO ₂ (mmHg)
Baseline	7.2 ± 0.1	61 ± 8	18 ± 1	7.2 ± 0.1	60 ± 12	23 ± 4
Asphyxia	6.9 ± 0	128 ± 0	14 ± 0	6.8 ± 0	150 ± 0	7 ± 0
PPV	6.9 ± 0	115 ± 13	12 ± 2	6.9 ± 0	93 ± 28	17 ± 8
CC pre-EPI	6.9 ± 0.1	84 ± 23	30 ± 17	6.9 ± 0	86 ± 6	46 ± 18
CC post-EPI	6.9 ± 0	117 ± 9*	19 ± 14*	7.0 ± 0.1	68 ± 16	108 ± 21
ROSC	6.9 ± 0.1	94 ± 18*	54 ± 12*	7.2 ± 0	47 ± 5	148 ± 53
5 min	7.0 ± 0.2	76 ± 37	189 ± 78	7.2 ± 0.1	38 ± 15	144 ± 86
10 min	7.1 ± 0.2	45 ± 29	110 ± 71	7.2 ± 0.1	41 ± 9	91 ± 61
15 min	7.3 ± 0.1	35 ± 13	96 ± 71	7.2 ± 0.1	33 ± 5	107 ± 54
20 min	7.3 ± 0.1	33 ± 11	74 ± 41	7.3 ± 0.1	31 ± 6	85 ± 20
25 min	7.2 ± 0.1	31 ± 12	85 ± 48	7.3 ± 0.1	34 ± 16	104 ± 27
30 min	7.2 ± 0.1	47 ± 6	58 ± 18	7.2 ± 0.1	42 ± 19	71 ± 27

Data represented as average ± standard deviation. * $p < 0.01$ by t-test.

FIGURE 2B: The gas exchange before, during and after resuscitation in control and study groups are shown here.

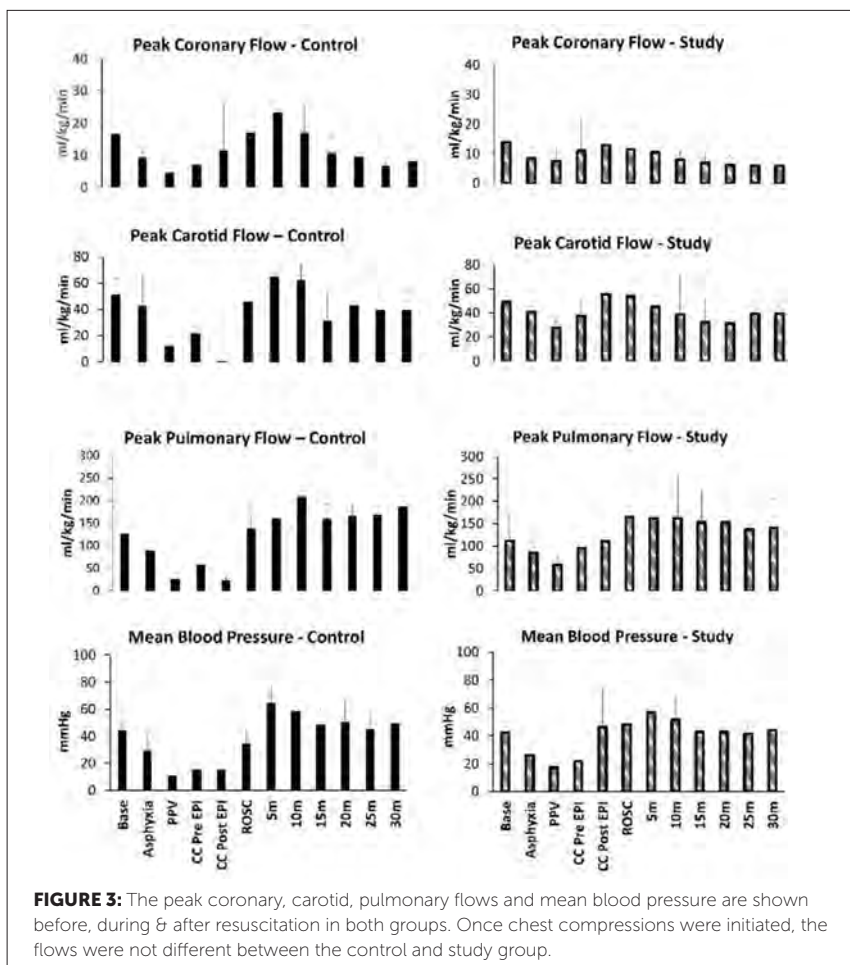

At ROSC, the study group had significantly lower arterial carbon dioxide as well as higher arterial oxygenation signifying better gas exchange with effective ventilation (Fig 2B). The peak CoBF, CaBF, PBF were lower in the control group during CC (Fig 3).

CONCLUSIONS

Our pilot study suggests that optimizing ventilation for bradycardia during resuscitation could reduce the need for CC & improve gas exchange in a term ovine model.

LO037 / #466**ESPR Session****ESPR Session 01: Update on research in neonatal resuscitation****08-10-2022 10:30 - 11:50****Effectiveness and safety of plastic wraps used during the initial care of preterm infants in the delivery room****C. Reuter¹, F. Ehlers², P. Vana², H. Küster^{3*}**¹Universitäts-Kinderklinik Köln, Neonatology, Köln, Germany²Göttingen University, Institut Für Physikalische Chemie, Göttingen, Germany³University Medicine Göttingen, Neonatology, Göttingen, Germany**BACKGROUND AND AIMS**

International guidelines recommend using plastic wrap or bags for temperature management during delivery room care of preterm infants for more than 20 years. However, to date, no data on safety and efficacy of such wraps are available.

METHODS

Protection against heat and moisture loss was tested on a random sample of wraps used in nearby NICUs. Two cylinders of 548 g and 983 g were wrapped in one layer wrap and the cooling time measured.

Microbiological safety was investigated in 27 consecutive VLBW preterms (birth-weight 1055 ± 322 g, gestational age 27.7 ± 2.6 weeks). A defined piece of wrap from the infant's back was excised, rinsed, and the eluate cultured.

Environmental testing was performed by surface sampling, settle-plates and airborne collection.

RESULTS

The most effective wrap extended the time to cool by 2 °C by one-third for the core and 100 % for the surface (*figure 1*). The least effective wrap resulted in faster heat loss than using no wrap. This wrap was made of polyurethane, which contains potentially toxic and narcotic monomers (*figure 2*). Heat and water retention did not correlate with wrap thickness (*figure 2*).

After a contact time of 53±10 minutes, microbiological cultures were positive in 24 of 27 wraps, while controls were all sterile. The environmental tests were all negative.

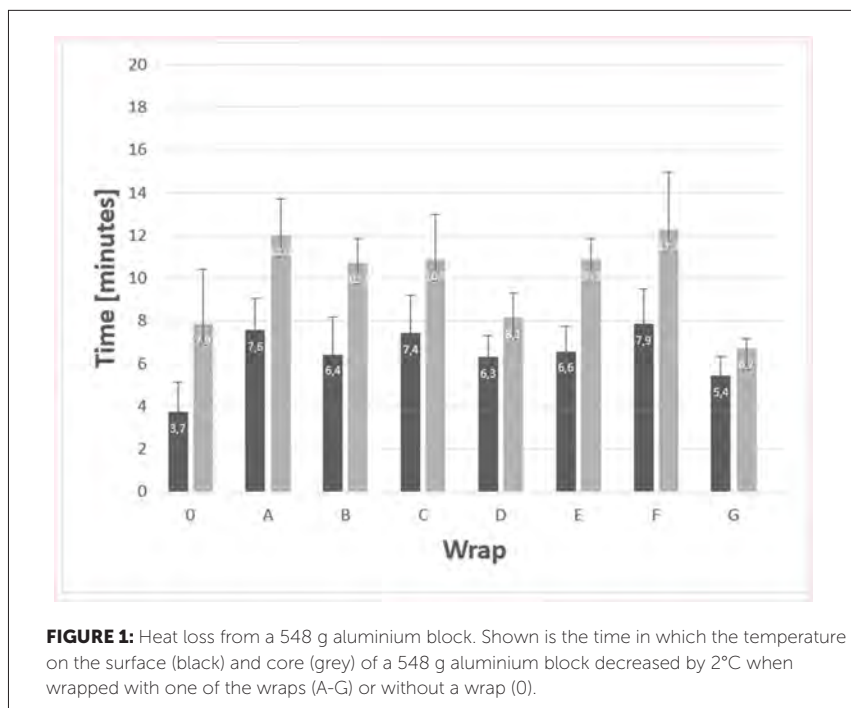

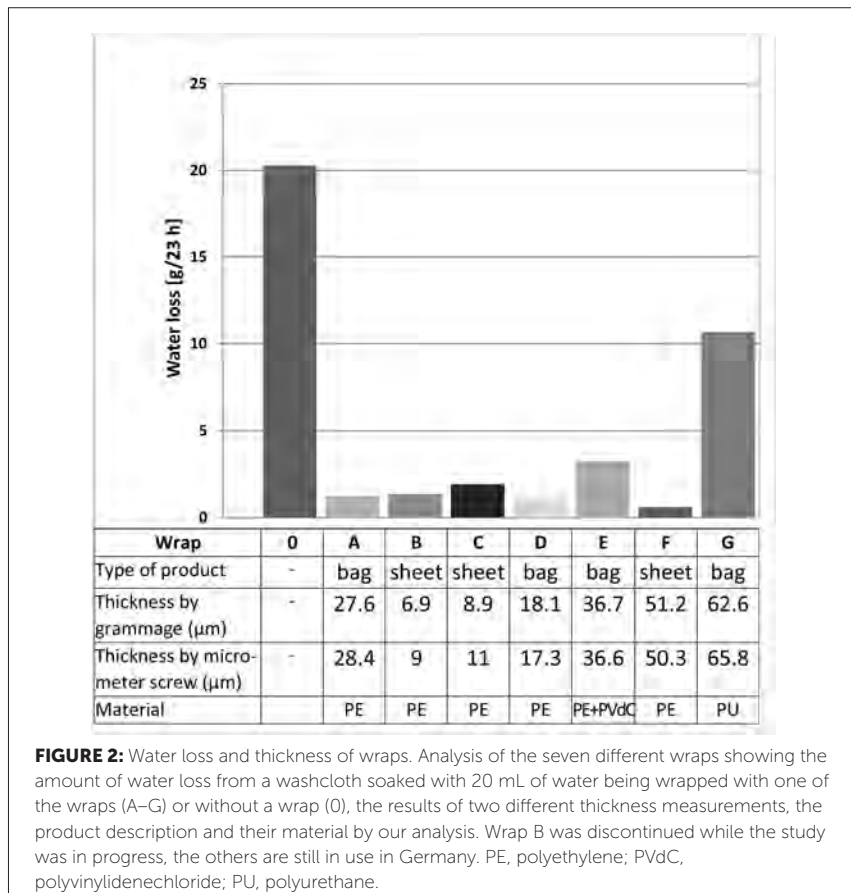

CONCLUSIONS

This first analysis of the effectiveness and safety of plastic wraps shows that a careful selection is important. Wraps containing polyurethane should not be used as they are counterproductive due to their purpose in e.g. breathable clothing. Plastic wraps should not be left on the skin of premature infants for long periods.

LO038 / #406

EAP Session

EAP Session 02: Cancer survivor: What to do with them or what is the role of the primary care paediatrician

08-10-2022 10:30 - 11:50

The prevalence of complementary medicine use in supportive care in pediatric patients with cancer

S. Ansari^{1*}, N. Ashayeri², S. Ghazavi³

¹*Iran University, Hematology, Tehran, Iran*

²*Iran University of Medical Science, Oncology, Tehran, Iran*

³*Azad University, Pharmacy, Tehran, Iran*

BACKGROUND AND AIMS

Survival rates of pediatric cancer patients are rapidly increasing over the last decade due to the advent of new anti-cancer treatments. But during illness, survivors experience multitude of symptoms such as pain, fatigue, anxiety, depression, insomnia and nausea/vomiting. So, in order to relieve these symptoms, the use of complementary therapies is increasing in these patients. We aimed to assess the epidemiological aspects of using complementary medicine for childhood cancers in a referral children hospital in Iran.

METHODS

The data of children suffering different types of cancers and underwent chemotherapy at Ali-e-Asghar children hospital in Tehran in 2018 were collected retrospectively.

RESULTS

We asked all parents about use of different types of complementary medicine (herbal medicine, acupuncture, massage therapy and homeopathy). The application of integrative medicine before the disease was expressed by 51.6% that significantly increased to 77.4% following disease occurrence. The most prevalent type that was used by patients was herbal medicine. The most reason for using integrative medicine was expressed to be the better controlling chemotherapy side effects (83.3%) and the most common cause for not using integrative medicine was lack of enough knowledge about the benefits or disadvantages of such medicine. Only 18 out of 48 mothers (37.5%) reported the self-usages of integrative medicine to their physicians.

CONCLUSIONS

Two-third of mothers uses integrative medicine for their cancerous children. The most reason for using integrative medicine is its ability to better controlling chemotherapy side effects. Only one-third of mothers reported the use of integrative medicine among their children to physicians. So it is important for physician to ask these patients about use of complementary medicine and inform them about some drug interaction.

LO039 / #2119**ESPNIC Session****ESPNIC Session 03: Protecting the brain****08-10-2022 10:30 - 11:50****Diagnostic values of S 100B protein for early diagnostic of brain injury in newborns****A. Sofijanov^{1*}, O. Jordanov², S. Bojadzieva³**¹University Children Hospital-Skopje, Intensive Care Unit, Skopje, North Macedonia²University Children Hospital-Skopje, Clinical Biochemistry (Hematology, Biochemistry Immunology, Allergology), Skopje, North Macedonia³University Children Hospital-Skopje, Gastroenterology, Skopje, North Macedonia**BACKGROUND AND AIMS**

The measurement of noninvasive biochemistry markers S100B protein may enable the screen newborns for brain injury and monitor the progression of disease. An earlier diagnosis may lead to a larger therapeutic window who can identify injured brain regions, assess the efficacy of neuroprotective strategies procedures and improve neonatal outcome when clinical and radiological signs are still silent. The aim of this study was to evaluate the diagnostic values of S100B in newborns for early diagnostic of brain injury.

METHODS

In this, we included 120 newborns admitted in the Intensive care Unit at the University Children's Hospital in Skopje divided into a two groups examination group (N=70) and control group (N=50) A serum blood sample was obtained from each patient at three different time-points: 24h post-injury, 4th and 7th day after the admission.

RESULTS

S100B protein levels on the first day of admission in the examination group and the control group of newborns there is statistical significance of $p < 0.005$, which points to the existence of a significant statistical difference between the two groups in terms of the concentration of S100B protein on the first day of admission. Furthermore, these levels increase along the following two measurements starting at the 24h time-point after injury (AI) which is the 4th and the 7th day after the admission.

CONCLUSIONS

S100B protein is a good indicator of starting brain injury in newborns, especially in the first 24h after birth and is a good indicator for early intervention.

LO040 / #2669

ESPNIC Session

ESPNIC Session 03: Protecting the brain

08-10-2022 10:30 - 11:50

“Why did you come to ED today?” - Exploring parental reasons for attending the children’s emergency department to optimise patient care

R. Kirk*, C. Chipperfield

Department of Paediatric Emergency Medicine, Lister Hospital, East and North Herts NHS Trust, Hertfordshire, United Kingdom

BACKGROUND AND AIMS

As the demand within paediatric emergency departments (PED) increases, our aim was to gather direct feedback from parents to understand if there were missed opportunities prior to attending our district general hospital (UK).

METHODS

Parents were invited to complete an anonymous survey during triage, completed over a 24-hour period. Questions focused on reasons for attendance and if attempts were made to access other services.

RESULTS

-92 patients in a 24-hour period; of which 48 parents completed the survey. -50% were not aware of alternative pathways for minor illnesses/injuries (e.g. urgent care centres); 33% found PED more convenient to attend. -70% had called the UK medical advice telephone line (111) prior to attending – of which 71% had been directed to PED. -42% had seen a primary care doctor about

the same issue in the preceding 72 hours. -18% required urgent medical attention from triage. -53% were minor illnesses with normal observations at triage that didn't necessarily require the expertise of PED and may have been managed in another setting.

CONCLUSIONS

There is evidence that parents are trying to do the right thing by their child and are often directed to PED for self-limiting minor illnesses due to lack of knowledge of other options available. -Anecdotally parents struggle to identify which urgent care setting is appropriate for their child, often relying on direction from primary care and medical telephone advice lines. -We advocate implementing local public health awareness initiatives to highlight the non-PED options available for minor illnesses.

LO041 / #2285**ESPR Session****ESPR Session 04: All you need to know about electrolytes****08-10-2022 10:30 - 11:50****Modelled nutrition system for the transition phase safely delivers international nutrient recommendations in very low birthweight (VLBW) preterm infants****A.-M. Brennan^{1*}, S. Fenton², J. Wilkinson¹, B. Murphy³**¹Department of Clinical Nutrition & Dietetics, Cork University Maternity Hospital, Cork, Ireland²Department of Pharmacy, Cork University Hospital, Cork, Ireland³Department of Neonatology, cork University Maternity Hospital, Cork, Ireland**BACKGROUND AND AIMS**

Optimal nutrition during the transition-phase [TN-P; 40-120mL/kg/d enteral feed volumes (EFVs)] as VLBW preterm infants progress from exclusive par-enteral to enteral nutrition has not yet been achieved, impacting their growth and neurodevelopment. Using nutrient modelling to ensure nutrient delivery within international recommended ranges throughout TN-P, we developed a novel nutritionally complete system incorporating 2 Standardised Parenteral Nutrition (SPN) products and a TN-P protocol that maps EFVs to SPN volumes. The aim of this study is to assess safety, efficacy and, demonstrate real-time measurement of nutrition delivery with this system.

METHODS

Prospective evaluation of a modelled nutrition system in a tertiary neonatal unit over 19-months (2018/19). All preterm infants <32 weeks and / or <1.5kg were included. Biochemical data, actual EFVs and SPN volumes were collected

daily as part of routine care and used to determine safety and nutrient delivery, with growth measured weekly.

RESULTS

127 infants [mean (SD) BW 1.15 (0.39) kg, GA 28.1 (2.7) weeks] received 823 parenteral nutrition days in the first week of life, of which 93% was SPN. No clinically significant biochemical derangements were observed. At EFVs of 40, 60, 80 and 100mL/kg/d, the mapped SPN volumes were achieved in 97, 100, 92 and 97% of infants, respectively, corresponding to international nutrient recommendations i.e. combined protein intake 3.5-4.5g/kg/d. 78% of infant's growth was 'optimal' (z-score loss ≤ 0.8) and 13% 'adequate' (z-score loss 0.9-1) from birth to discharge.

CONCLUSIONS

This innovative nutrition system is clinically proven to safely deliver optimal nutrition, measurable in real-time, throughout the TN-P to support growth.

LO042 / #1980**ESPR Session****ESPR Session 04: All you need to know about electrolytes****08-10-2022 10:30 - 11:50****The relationship between parenteral leucine intake and plasma leucine in very preterm infants dependent on parenteral nutrition. A systematic review****K. Davies^{1*}, C. Morgan²**¹*Department of Women's and Children's Health, University of Liverpool, Liverpool, United Kingdom*²*Liverpool Women's Hospital, Neonatal Unit, Liverpool, United Kingdom***BACKGROUND AND AIMS**

Very preterm neonates (VPN) are dependent on parenteral nutrition (PN) from birth. Recent evidence from sick term infants indicates immediate provision of parenteral amino acids (AA) may increase sepsis risk. Inhibition of autophagy is a proposed mechanism. Leucine is a potent activator of the mTOR pathway, increasing protein synthesis but inhibiting autophagy. High plasma essential AA levels (including leucine) suggest overprovision by parenteral AA formulations. We have published systemic review methodology that calculates the optimal content of arginine, a deficient AA. This was adapted to investigate the relationship between parenteral leucine intake and plasma leucine levels in VPN.

METHODS

Cochrane, PubMed, Scopus and Web of Science were searched regardless of study design, excluding review articles. Articles reporting actual parenteral AA intake and plasma leucine concentration after day 3 were eligible. A data

extraction form was designed for this review. Quality assessment used a custom-designed tool and the GRADE framework.

RESULTS

Twelve articles met inclusion criteria ($n = 650$ VPN). The dose-concentration relationships of leucine content (%) and absolute leucine intake (g/kg/d) with plasma leucine concentration ($\mu\text{moles/L}$) showed significant, moderate, positive correlations ($p < 0.05$). Regression analysis indicated absolute intake was a stronger predictor. Subgroup analysis revealed neither study design nor the analytical method used for AA analysis affected plasma leucine levels.

CONCLUSIONS

In VPN, there is a linear relationship between plasma leucine level and absolute intake (Figure 1). Leucine content of neonatal PN should be reduced to 8-9g/100g AA to achieve reference plasma AA levels. The methodology can be applied to all essential AA.

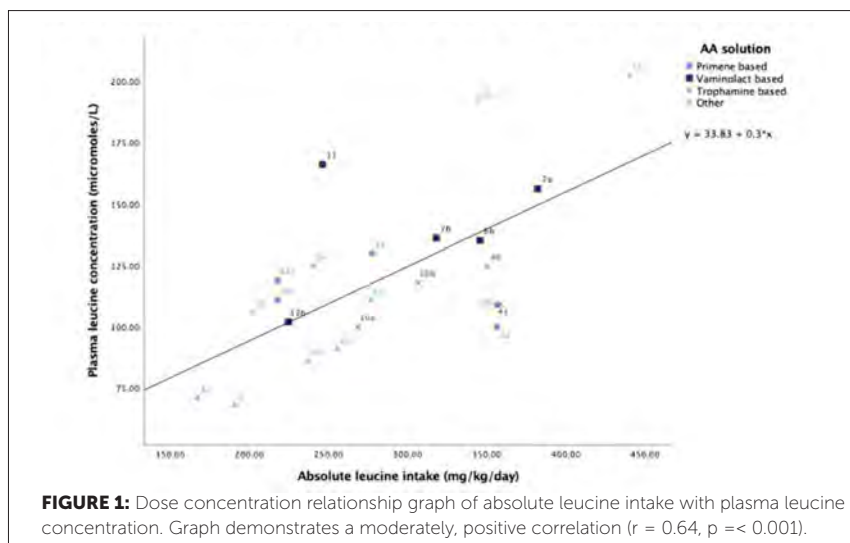

Keywords: Leucine, Parenteral Nutrition, Very Preterm Neonates

LO043 / #1125

ESPNIC Session

ESPNIC Session 05: The changing landscape of the paediatric intensive care unit

08-10-2022 10:30 - 11:50

The impact of weekly debrief sessions to support the implementation of an early rehabilitation and mobilisation programme on PICU: The permit study

N. Read*, J. Menzies, B. Scholefield

Birmingham Children's Hospital, PICU, Birmingham, United Kingdom

BACKGROUND AND AIMS

The NIHR HTA funded feasibility study of Early Rehabilitation and Mobilisation (Paediatric Early Rehabilitation and Mobilisation during InTensive care (PERMIT) study) required an implementation evaluation of this complex intervention. Weekly debrief sessions were important to monitor progress. We aimed to evaluate the impact of debriefs on trial performance, recruitment and team engagement.

METHODS

Following Research Ethics Committee approval study debriefs (research nurse, facilitator led, workshops) were run once per week per site for 20 weeks with consenting multi-disciplinary site champions via Zoom. Sessions used a structured interview schedule drawing on Normalisation Process Theory (Implementation Science). Anonymous notes were made, imported and analysed using NVivo 12.

RESULTS

The three PICUs engaged with 48 debriefs in total even during periods of extreme service pressure (site one: 20/20, site 2: 17/20, site 3: 11/11 (reduced from 20 because of delayed contract and shorter study duration)). Debriefs impacted trial performance by i) enabling all sites to implement the PERMIT programme successfully; ii) recruit the ten patients per site to time and target; iii) engage with study modification; iv) improve future trial methodology; iv) feedback endorse debriefs as an invaluable source of support, providing timely guidance from the trial team: "Debriefs have been very useful, really supportive process." (Site three).

CONCLUSIONS

Weekly debrief sessions were important to aid understanding of the implementation process of a complex intervention and research teams to deliver to time and target. This method has utility in future trials to enhance understanding of the barriers and facilitators to changing practice.

LO044 / #1207**ESPNIC Session****ESPNIC Session 05: The changing landscape of the paediatric intensive care unit****08-10-2022 10:30 - 11:50****Error disclosure in neonatal intensive care: A multicenter prospective observational study****L. Passini¹, R. Layese², M.L. Keller¹, G. Dassieu¹, C. Jung³, A. Reynaud⁴, S. Le Bouedec⁵, E. Audureau², L. Caeymaex^{1*}**¹CHI Creteil, Nicu, Creteil, France²University Paris Est Creteil, Inserm, Imrb, Cepia Team, Creteil, France³CHI Créteil, Clinical Research Center, Créteil, France⁴Association, Sos Préma, Neuilly sur Seine, France⁵CHU Angers, Nicu, Angers, France**BACKGROUND AND AIMS**

Surveys based on hypothetical situations suggest that health care providers agree that disclosure of errors and adverse events to patients and families is an obligation, but do not always disclose them. Real-life disclosure rates and reasons for the choice have not been studied. Our objective was to measure the proportion of errors disclosed by neonatal intensive care units (NICU) professionals to parents and identify motives/barriers to disclosure.

METHODS

Observational prospective study nested in a randomized controlled trial (Sepreven;NCT02598609), disclosure was unrelated to the intervention tested. 10 NICUs in France with a 20-month follow-up, including the patients with NICU stay ≥ 2 days, parental non-opposal and with ≥ 1 error. Outcomes

was the rate of error disclosure by type, severity, timing, motives for (non) disclosure, perceived parental reaction to disclosure.

RESULTS

Among 1822 errors (1019 patients), 752 (41%) were disclosed. Independent risk factors for nondisclosure were nighttime discovery of error (odds ratio [OR], 2.25; 95% CI, 1.70–2.97), less severe error-related outcome (mild consequence: OR, 3.66; 95% CI; 2.01–6.67; no consequence: OR, 15.96; 95% CI, 8.53–29.86), a shorter interval between admission and error (OR, 1.01; 95% CI, 1.00–1.02), and a lower gestational age (<28 weeks: OR, 1.92; 95% CI, 1.25–2.94; 28 to 32 weeks: OR, 1.88, 95% CI, 1.23–2.87). The most frequent reported reasons for nondisclosure were parental absence at error discovery and a perceived lack of serious consequence.

CONCLUSIONS

NICU professionals disclosed only some errors to parents. The risk factors for nondisclosure suggest that family-centered care would improve disclosure.

LO045 / #753

ESPNIC Session

ESPNIC Session 05: The changing landscape of the paediatric intensive care unit

08-10-2022 10:30 - 11:50

Prognostic factors influencing parental empowerment after discharge of their hospitalized child: A cross-sectional study

C.-J. Van Der Perk^{1*}, L. Van De Riet¹, M. Alsem^{1,2}, H. Van Goudoever¹, J. Maaskant^{1,3}

¹Amsterdam UMC location University of Amsterdam, Pediatrics, Amsterdam, Netherlands

²Amsterdam UMC location University of Amsterdam, Rehabilitation Medicine, Amsterdam, Netherlands

³Amsterdam UMC location University of Amsterdam, Data Science and Epidemiology, Amsterdam, Netherlands

BACKGROUND AND AIMS

There is a growing number of children with medical complexity (CMC). After hospitalization, care often has to be continued at home, making transitional care very important. However, many parents do not feel empowered in their role as caregiver for the child. To move forward in this field, we explored prognostic factors associated with parental empowerment after discharge of hospitalized children.

METHODS

In a cross-sectional study, we collected data on potential prognostic factors found in the literature, and on parental empowerment scores, collected digitally, two weeks after discharge, by means of the Family Empowerment Scale (FES). Multiple linear regression analyses were performed to explore the associations between the prognostic factors and the FES scores.

RESULTS

Data from 228 patients and their parents were analyzed. Out of twelve factors included in the study, three showed significant associations with parental empowerment. Parents of CMC felt more empowered compared to parents of children with less complex conditions ($\beta=0.20$, $p=0.00$). We found a positive association between the age of the child and parental empowerment ($\beta=0.01$, $p=0.00$). Employed couples felt more empowered compared to unemployed couples ($\beta=0.30$, $p=0.00$). These three variables explained 11% of variance in the FES scores.

CONCLUSIONS

Parental empowerment is associated with the patient's age, child's medical complexity, and parental employment status. Attention should be paid to the discharge preparation of parents of children with less medical complexity. Awareness is required for parents of younger children and parental employment status, because they are at risk for lower parental empowerment.

LO046 / #1515

EAP Session

EAP Session 06: Follow up of ex premature babies in primary care, what are the pitfalls

08-10-2022 10:30 - 11:50

Early childhood education of children born very preterm in Europe: Results from the ships cohort

M. Sentenac¹, A. Smith-Longee^{1*}, J. Zeitlin¹, S. Johnson², A. Aubert¹

¹Inserm, Epopé, Paris, France

²Department of Health Sciences, University of Leicester, Leicester, United Kingdom

BACKGROUND AND AIMS

Early childhood education offers opportunities for stimulation in multiple developmental domains and its positive impact on long-term outcomes and wellbeing are well documented. Few studies have focused on early education in children born very preterm (VPT; <32 weeks of gestation) who are at higher risk of neurodevelopmental disorders and poor educational outcomes. This study aimed to define and describe of the provision of early education at five years of age for children born VPT in European countries, and to investigate the determinants of receipt of early education.

METHODS

Data come from the population-based EPICE/SHIPS cohort of children born VPT in 2011/2012 in 19 regions from 11 European countries. Perinatal data were collected from medical records and information on early education child health and development from parental questionnaires at five years. Indicators characterising early education and school support/services were first harmonised across countries.

RESULTS

Among 6,759 eligible children, 3,687 (55%) were followed-up at five years (mean gestational age 28.8 weeks). At five years, almost all VPT children were in school, but educational program (preschool/primary), fulltime/part-time attendance and type of school support/services differed by country. Almost one in four children received special educational support (country range: 13% to 34%). Among children identified with motor, cognitive or behavioural deficits, 77%, 65% and 59% were receiving services, respectively.

CONCLUSIONS

There is marked variation in approaches to early education in Europe. This provides a valuable opportunity to explore its impact on neurodevelopment and well-being of children born VPT in future studies.

LO047 / #1823

EAP Session

EAP Session 06: Follow up of ex premature babies in primary care, what are the pitfalls

08-10-2022 10:30 - 11:50

Corpus callosum structural characteristics in very preterm children and adolescents: Developmental trajectory and relationship to cognitive functioning

V. Siffredi^{1*}, M.C. Liverani², L. Freitas¹, C. Borradori Tolsa¹, P. Hüppi², R. Hà-Vinh Leuchter¹

¹Geneva University Hospital, Child Development Lab, Geneva, Switzerland

²University of Geneva, Faculty of Medicine, Geneva, Switzerland

BACKGROUND AND AIMS

Previous studies suggest that structural alteration of the corpus callosum, i.e., the largest white matter commissural pathway, occurs after a preterm birth in the neonatal period and lasts across development. The present study aims to unravel corpus callosum structural characteristics across childhood and adolescence in very preterm (VPT) individuals, and their associations with general intellectual, executive and socio-emotional functioning.

METHODS

Neuropsychological assessments, T1-weighted and multi-shell diffusion MRI were collected in 79 VPT and 46 full term controls aged 6 to 14 years. Volumetric, diffusion tensor and neurite orientation dispersion and density imaging (NODDI) measures were extracted on 7 callosal portions using TractSeg. A multivariate data-driven approach (partial least squares correlation) and an age normative modelling approach were used to explore associations between callosal characteristics and neuropsychological outcomes.

RESULTS

The VPT and a full-term control groups showed similar trends of volume and white-matter maturation over time, i.e., increase FA and reduced ODI, in all callosal segments, that was associated with increase in general intellectual functioning. However, using age-related normative modelling, findings show atypical pattern of callosal development in the VPT group, with reduced callosal maturation over time that was associated with poorer general intellectual and working memory functioning, as well as with lower gestational age.

CONCLUSIONS

Callosal maturation appear to deviate from normative expectation with reduced maturation over time but also with an atypical developmental trajectory. Atypical developmental trajectory of callosal maturation was associated with poorer general intellectual and working memory functioning as well as with greater prematurity.

LO048 / #668**ESPNIC Session****ESPNIC Session 07: The use of big data in PICU nutrition research****08-10-2022 10:30 - 11:50****Compatibility of parenteral nutrition solutions with intravenous medications in neonates and paediatrics****M. Farhan^{1*}, J. Bennett², A. Cram², N. Mccallion^{1,3}, F. O'Brien⁴**¹Rotunda Hospital, Neonatology, Dublin, Ireland²Pfizer, R&D, UK, Sandwich, United Kingdom³Royal College of Surgeons in Ireland, Paediatrics, Dublin, Ireland⁴Royal College of Surgeons in Ireland, School of Pharmacy and Biomolecular Sciences, Dublin, Ireland**BACKGROUND AND AIMS**

Evidence and data supporting the concomitant administration of intravenous medication (IVM) with parenteral nutrition solutions (PNS) are scarce. However, despite incompatibility risks, it is common paediatric practice to administer IVM with PNS especially in neonates, where there are often challenges with vascular access. Co-administration may be required due to limited fluid allowances and need for uninterrupted nutritional support. There are few experimental studies or systematic reviews on this topic in paediatrics.

This project aimed to identify and analyse available evidence concerning compatibility and/or stability between PNS and IVM in all Paediatric age groups, to understand the complexity of underwriting PNS compatibility with IVM, produce an IVM/PNS compatibility table to summarise available information for clinical use, and to use results to design further laboratory compatibility trials in the future.

METHODS

Search; electronic search of MEDLINE®, CINAHL®, and Cochrane library® databases. MEDLINE database from 1946 to June 2021, with no search limitations, using terms and keywords about of PNS, IVM, and compatibility or incompatibility. Cochrane library® was searched for reviews concerning compatibility and/or stability between parenteral nutrition solution and par-enteral drugs.

MEDLINE® and CINAHL® searches identified 925 and 64 publications, respectively. There were no relevant Cochrane reviews. Titles and abstracts were screened for data on compatibility/incompatibility, and/or stability/instability of PNS with IVM and duplicates removed. 227 articles underwent full text review of which 95 were eligible for inclusion, and 5 further articles were identified from article references.

Data on author, publication year, study objective and design, environment and settings, form(s) and concentration(s) of IVM(s) used in the study, type(s) and composition of PNS(s) used, compatibility results, and recommendations of the study were captured and documented. Weakness and strength of evidence was recorded.

RESULTS

This study identified compatibility data for 189 intravenous medications. Most reported compatibility assessment for IVM against multiple types of PNS. 22 studies reported on neonatal and paediatric practices. Antibiotics were the most frequent drug category tested (37 studies). H2-Receptor antagonists were the second commonest (21 studies). Intravenous cardiovascular medications

Table 1: Drug compatibility/incompatibility table

Drug Compatibility / Incompatibility Table									
2-in-1: solutions containing amino acids, glucose, electrolytes, ± water soluble vitamins, ± trace elements. Lipid: solutions containing fatty acids, ± fat soluble vitamins, ± water soluble vitamins. 3-in-1: solutions containing amino acids, glucose, fatty acids, electrolytes, ± fat soluble vitamins, ± water soluble vitamins, ± trace elements. C: compatible. I: incompatible. C/I: studies showing both compatibility and incompatibility with evidence favouring compatibility. I/C: studies showing both compatibility and incompatibility with evidence favouring incompatibility. †: strong evidence. ‡: weak evidence. ††: accepted. †††: further evidence required. ††††: some tested solutions are missing some basic nutritional components. ...: No data available. ...†: compatibility depends on drug concentration and or PNS composition.									
Drug	Compatibility		References favouring compatibility	References favouring incompatibility	Drug	Compatibility		References favouring compatibility	References favouring incompatibility
	2-in-1	3-in-1				2-in-1	3-in-1		
Acetaminofen	I			77, 98	Albucin	C	F	75	98, 99
Amphotericin B				12, 88, 98, 111	Cyclosporin	C†	C†	15, 30, 58, 75	94, 95, 98†
Aspirin	I		C	9	Digoxin	C	I	17, 19, 71, 80, 98	
Atorvastatin				12, 88, 98, 111	Flucloxacillin	C†	I	27, 75, 98	97, 98†
Chloramphenicol				75, 98, 99, 104	Zidovudine	C	C	75, 80, 87, 98	

(inotropes) were an important category of medication used with parenteral nutrition solutions. Central nervous system agents were the third most commonly studied class, and their compatibility status was largely dependent on drug concentration. All findings were summarised in a compatibility/incompatibility table, reporting compatibility of an IVM against the type of PNS tested. The strength of evidence from different studies was evaluated and conflicting evidence assessed.

CONCLUSIONS

Generation of compatibility data between IVM and PNS is a complex task, as compatibility is affected by multiple factors. The interpretation and the clinical application of the compatibility results that have been reported in this systematic review should be approached with caution, as these results reflect the unique parameters used during testing. These include the brand and concentrations of the IVM used, the type and composition of the PNS, and experimental conditions. Some medications demonstrated a reassuring profile of compatibility based on multiple well-designed studies, however, most of the PNS used were adult type formulas so may not be applicable to neonatal or paediatric preparations. This systematic review highlights the lack of evidence-based data in neonatal and paediatric patients, requiring well-designed experimental studies targeting commonly used medications and TPN preparations in this cohort.

LO049 / #1925**ESPNIC Session****ESPNIC Session 07: The use of big data in PICU nutrition research****08-10-2022 10:30 - 11:50****The effect of feeding model with chronobiological approach on growth parameters and discharge time in preterm infants: Randomized controlled study****E. Temizsoy^{1*}, G. Uysal², N. Karadag³**

¹Health Sciences University Zeynep Kamil Women and Children Diseases Training and Research Hospital, Neonatal Intensive Care Unit, Üsküdar, Turkey

²Sakarya University of Applied Sciences, Faculty of Health Sciences, Sakarya, Turkey

³Department of Pediatrics, Zeynep Kamil Maternity and Children's Training and Research Hospital-Istanbul, University of Health Sciences, Istanbul, Turkey, Division of Neonatology, Istanbul, Turkey

BACKGROUND AND AIMS

The circadian rhythm is an internal 24-hour cycle regulated by endogenous molecules. Breast milk contains different biological peptides according to this cycle. Chrononutrition is a feeding model that adjusted to match each individual's biological clock. This study aimed to evaluate the effect of the chronobiological feeding model on growth parameters and discharge time of preterm infants.

METHODS

A prospective, randomized controlled trial was conducted in a tertiary neonatal intensive care unit between October 2021 and March 2022. Enrolled preterm infants were randomized to receive either chrononutrition (intervention group=45) or standard feeding (control group=46). Data were collected using the infant's follow-up form and Fenton growth curves.

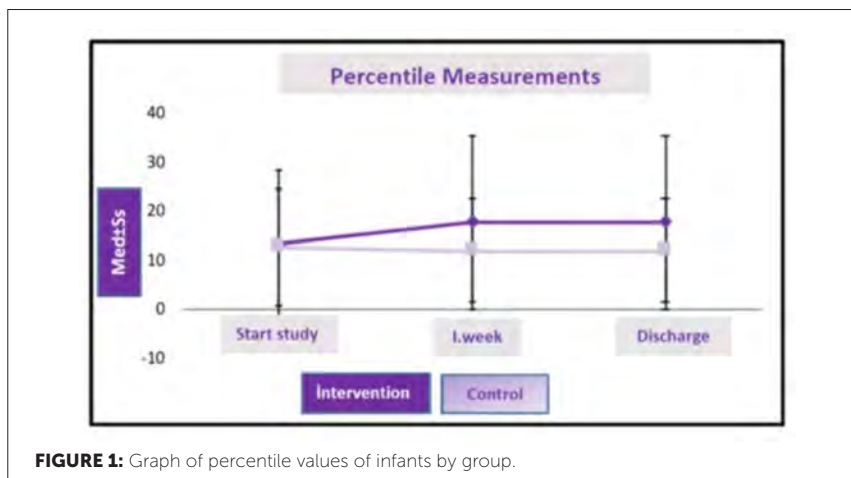

FIGURE 1: Graph of percentile values of infants by group.

RESULTS

Among 91 neonates, the median of gestational week and birth weight were 33 weeks (31-36) and 2100gram (1400-2500), respectively. There was no statistically significant difference in demographical findings between the intervention and control groups ($p>0.05$). The weight gain at discharge was statistically significantly higher in the intervention group ($p=0.002$). There was no statistically significant difference in growth parameters at discharge ($p>0.05$). However, the percentile measurements at discharge were higher in the intervention group ($p=0.004$), (Figure-1). The discharge time of preterm infants after full enteral feeding was statistically faster and the hospitalization time was shorter in the intervention group than in the control group ($p=0.001$).

CONCLUSIONS

The chronobiological feeding model affects the weight gain and discharge time of hospitalized preterm infants and increased the percentile measurements at discharge. Further studies needed to elucidate the effect of the chronobiological feeding model on various outcomes of preterm infants.

Keywords: Chronobiology, Circadian Rhythm, Nutrition, Preterm

LO050 / #1963**ESPNIC Session****ESPNIC Session 07: The use of big data in PICU nutrition research****08-10-2022 10:30 - 11:50****Point of care gastric ultrasound confirms the inaccuracy of gastric residual volume measurement by aspiration in critically ill children: Gastriped study****F. Valla¹, E. Cercueil¹, C. Morice^{1*}, L. Tume², L. Bouvet³**¹Lyon university children hospital, Hospices Civils de Lyon, Pediatric Intensive Care, Bron, France²University of Salford, School of Health & Society, Manchester, United Kingdom³Department of Anesthesiology and Intensive Care, Hospices Civils de Lyon, Bron, France**BACKGROUND AND AIMS**

No consensus exists on how to define enteral nutrition tolerance in critically ill children and the relevance of gastric residual volume (GRV) is debated. The use of point of care ultrasounding (POCUS) is increasing among intensivists, gastric POCUS may offer a bedside tool to assess feeding tolerance. Our main objective was to assess the ability of gastric aspiration to empty the stomach and provide an accurate estimation of gastric volume and emptiness status.

METHODS

A prospective observational study was conducted in a pediatric intensive care unit. Children on mechanical ventilation and enteral nutrition were included. Gastric POCUS was performed to assess gastric contents and gastric volume was calculated as per Spencer formula. GRV was aspirated and measured. A second set of gastric POCUS measurements was performed. The ability of GRV measurement to empty the stomach was compared to POCUS findings.

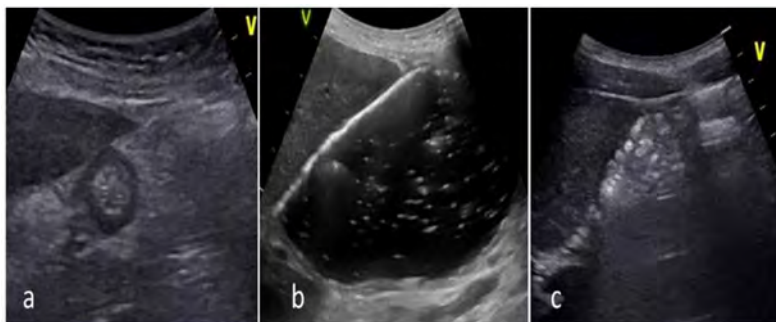

FIGURE 1

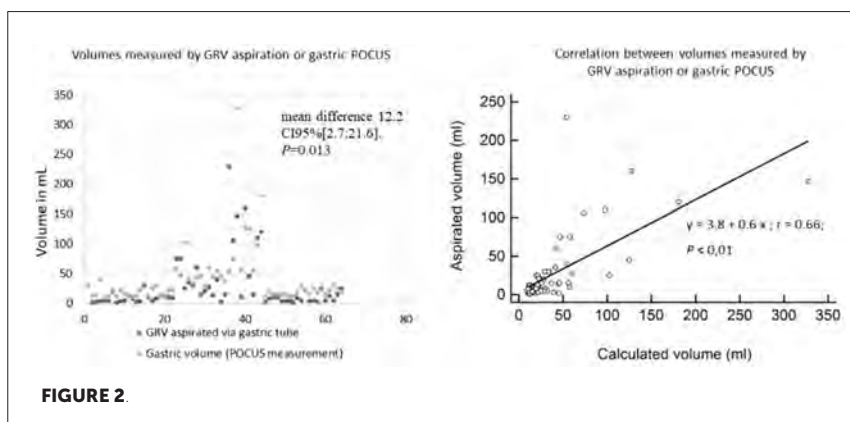

FIGURE 2

Both GRV and POCUS gastric volumes were compared with clinical signs of enteral feeding intolerance.

RESULTS

Data from 64 children were analyzed. Gastric volumes were decreased between the POCUS measurements performed pre and post GRV aspiration (full stomach $n=59$ (92.2%) decreased to $n=46$ (71.9%), $P=0.001$; gastric

volume: 3.18 (2.40-4.60) mL/kg decreased to 2.65 (1.57-3.57), $P<0.001$). The stomach was not empty after GRV aspiration in 46/64 (71.9%). There was no association between signs of enteral feeding intolerance and the GRV obtained, nor with gastric volume measured with POCUS.

CONCLUSIONS

GRV aspiration failed to empty the stomach and appeared unreliable as a measure of gastric emptiness. Gastric POCUS needs further evaluation to confirm its role.

LO051 / #595**ESPNIC Session****ESPNIC Session 08: Outcomes in cardiac intensive care – A multidimensional approach****08-10-2022 10:30 - 11:50****Acceptability and practicality of a new prenatal course for parents expecting a child with severe congenital heart disease.****M. De Man****UMCU WKZ, Children, Utrecht, Netherlands***BACKGROUND**

Congenital heart disease (CHD) is the most common birth defect worldwide. Of these children, 25% have severe CHD that requires one or more interventions within the first year of life. Research stresses the importance of accurate information and counselling by a prenatal health team after a prenatal CHD diagnosis, to prepare parents for the difficult times ahead. However, little is known about how to offer this information and to support and counsel the parents. In this study, a prenatal course was designed based on literature. The course was piloted in a large academic hospital setting.

AIM

To determine feasibility of a prenatal course for parents expecting a child with CHD.

METHODS

The course consisted of four two-hour meetings every two weeks. Practicality was measured with a narrative description of the organization and participation

in the course. Acceptability was measured with a questionnaire with closed and open questions.

RESULTS

Eight parents were recruited for the course. Practicality of the prenatal course was low, due to difficulties with reaching parents and recruiting for the course. However, the acceptability of the course was high, as parents reported being highly satisfied with the content.

CONCLUSIONS

Adapting the course in co-creation with parents and professionals to improve its fit with the population may greatly increase its practicality. Promising ways of improving the course might be offering (parts of) the course online, developing an information app, and making information videos and virtual reality clips.

LO052 / #2150**ESPNIC Session****ESPNIC Session 08: Outcomes in cardiac intensive care – A multidimensional approach****08-10-2022 10:30 - 11:50****Pediatric index of mortality 3 (PIM3): Is it time to update?****F. Ferrari^{1*}, D. Bonacina¹, I. Pellicoli¹, V. Punzi², G. Tricella³, F. Stefano³, E. Bonanomi¹**¹ASST Papa Giovanni XXIII, Pediatric Intensive Care Unit, BG, Italy²University of Milano, School of Medicine and Surgery, Milano, Italy³Institute for Pharmacological Research Mario Negri IRCCS, Giviti Coordinating Center, Ranica, Italy**BACKGROUND AND AIMS**

PIM3 is the international standard mortality prediction model used in Pediatric Intensive Care Units (PICUs) that was defined on 2013 (1). Our aim is to evaluate the performance of PIM3 on a single center cohort of pediatric patients over the last 10 years.

METHODS

PIM3 score was calculated on data of 3851 consecutive children (<16 years old) admitted to our PICU between 2012 and 2021 and registered on PROSAFE database. Calibration of PIM3 was assessed considering PICU outcome through the application of calibration belts; discrimination was measured by the area under the ROC curve.

RESULTS

The ability of PIM3 score to estimate PICU mortality in our population was limited: the mean PIM3 risk of death at PICU discharge was significantly higher than the observed for the entire cohort (202 vs 183, O/E 0.91, 0.8-1.01, $p < 0.001$) (Figure 1) and in most subgroups. Otherwise, PIM3 showed good discrimination ability (AUC 0.843) (Figure 2). Our case mix was comparable with the PIM 3 validation one.

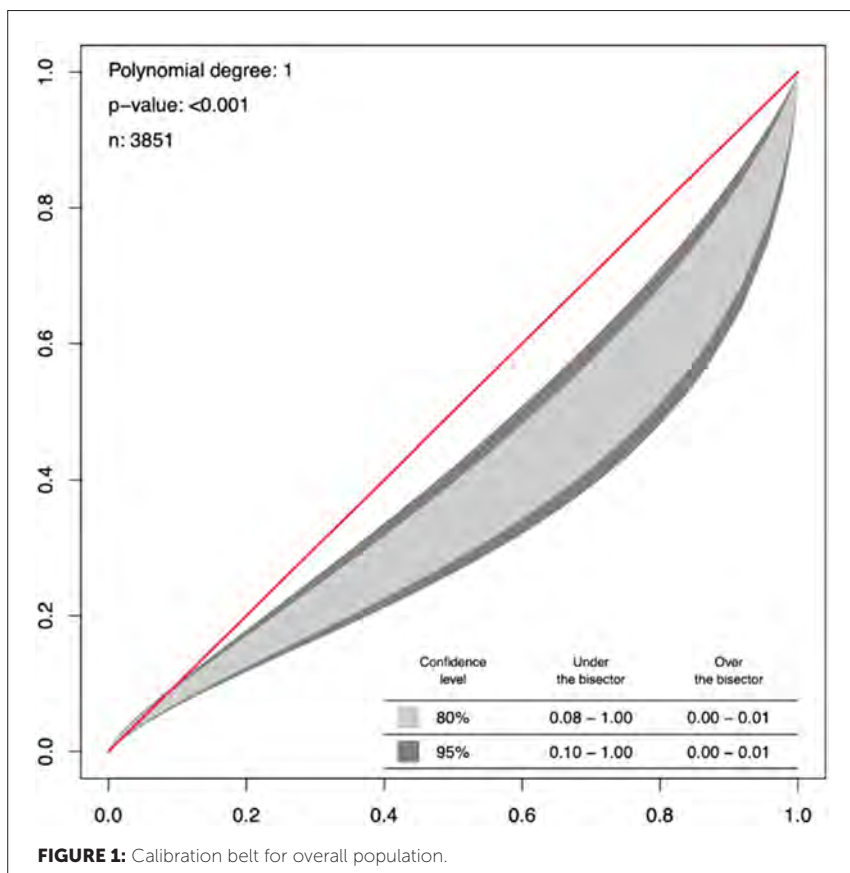

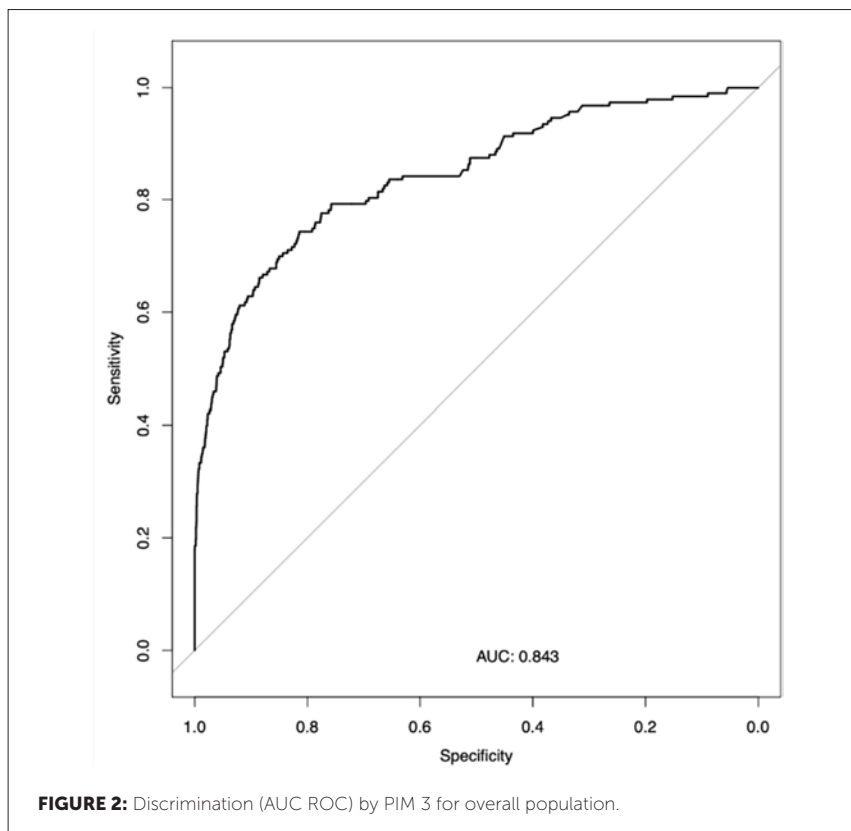

FIGURE 2: Discrimination (AUC ROC) by PIM 3 for overall population.

CONCLUSIONS

Overprediction of death limits PIM3 performance in the population of our PICU. In order to properly evaluate our PICU performance over time, we advocate an update of PIM3 score.

LO053 / #2527**ESPNIC Session****ESPNIC Session 08: Outcomes in cardiac intensive care – A multidimensional approach****08-10-2022 10:30 - 11:50****Severity and incidence of multisystem inflammatory syndrome in children during 3 SARS-CoV-2 pandemic waves in israel****N. Levy^{1*}, J. Koppel², O. Kaplan³, H. Yechiam⁴, K. Shahar-Nissan⁵, N. Kuchinski Cohen⁶, I. Shavit¹**¹*Pediatric Emergency Department, Rambam Health Care Campus, Haifa, Israel*²*Pediatric Emergency Department, Sheba Medical Center, Tel Hashomer, Israel*³*Pediatric Emergency Department, Soroka Medical Center Beer Sheva, Israel*⁴*Pediatric Emergency Department, Meir Medical Center, Kfar Saba, Israel*⁵*Emergency Department, Schneider Children's Medical Center, Petah Tikva, Israel*⁶*Pediatric Emergency Department, Hillel Yaffe Medical Center, Hadera, Israel***BACKGROUND AND AIMS**

Multisystem inflammatory syndrome in children (MIS-C) is a serious complication of SARS-CoV-2 infection. A previous study found that the proportion of individuals with severe illness declined after the first wave. In Israel, the O variant started to spread in November 2021. We assessed the incidence of MIS-C and described its severity nationally during the Alpha (A), Delta (D), and Omicron (O) variant waves.

METHODS

A prospective, multicenter cohort study. Data of all patients under 18 with MIS-C were collected from 14 Israeli hospitals during 16 weeks of each wave and severity parameters were analyzed. National data were obtained from the Israel Ministry of Health registry, and statistical analysis was performed.

RESULTS

MIS-C was diagnosed in 171 patients. Cardiac outcomes were more favorable during the O wave. Admission to the ICU occurred in 34 participants (57.6%) during the A wave, 39 (49.4%) during D, and 7 (21.2%) during O. The median hospital length of stay was 2 days shorter during O than in A and D. Vasopressors were used in 22% of patients during A, 17.7% during D, and 6% during O, and mechanical ventilation was used in 8.5% of patients during A, 8.9% during D, and 0% during O. There was a higher incidence of MIS-C during A (IRR, 14.34 [95% CI, 9.81-20.96]) and D (IRR, 12.94 [95% CI, 8.90-18.81]) compared with O.

CONCLUSIONS

MIS-C during the Omicron wave was less severe than during the Alpha or Delta waves. In addition, its incidence rate during the Omicron wave was lower than during the Delta and Alpha waves.

LO054 / #658**ESPR Session****ESPR Session 09: New takes on respiratory care in the NICU****08-10-2022 10:30 - 11:50****Prophylactic surfactant nebulization for the early aeration of the preterm lung – A randomized clinical trial****V. Gaertner¹, S. Minocchieri², T. Muehlbacher¹, D. Bassler¹, J. Thomann¹, C. Rüegger^{1*}**¹Department of Neonatology, University Hospital Zurich, Zurich, Switzerland²Department of Neonatology, Kantonsspital Winterthur, Winterthur, Switzerland**BACKGROUND AND AIMS**

Background and aims Surfactant nebulization (SN) is a promising non-invasive route of surfactant application in preterm infants but prophylactic SN has never been described so far. Consequently, physiological as well as clinical effects are unclear. We aimed to determine whether prophylactic SN improves early lung aeration.

METHODS

Masked (parents, health-care providers), parallel, randomized clinical trial in the delivery room (DR) (Clinicaltrials.gov; NCT04315636). Infants born between 26^{0/7} and 31^{6/7} weeks gestation were randomized to positive distending pressure alone or positive distending pressure with additional SN (200mg/kg; poractant alfa) using a customized vibrating membrane nebulizer.

SN commenced with the first application of a facemask immediately after birth. Primary outcome was the difference in end-expiratory lung impedance (Δ EELI) from birth to thirty minutes after birth. Secondary outcomes included physiological and clinical outcomes until discharge.

RESULTS

Primary outcome data were analyzed from 32 infants (n=16/group). Thirty minutes after birth, Δ EELI was not significantly higher in infants with SN vs controls [median (IQR): 25 (7 to 62) AU/kg vs 10 (0 to 26) AU/kg, $p=0.21$]. However, Δ EELI was consistently increased over the first 24 hours after SN (Figure 1). There were no differences in cardiorespiratory and clinical parameters and in the rate of adverse events.

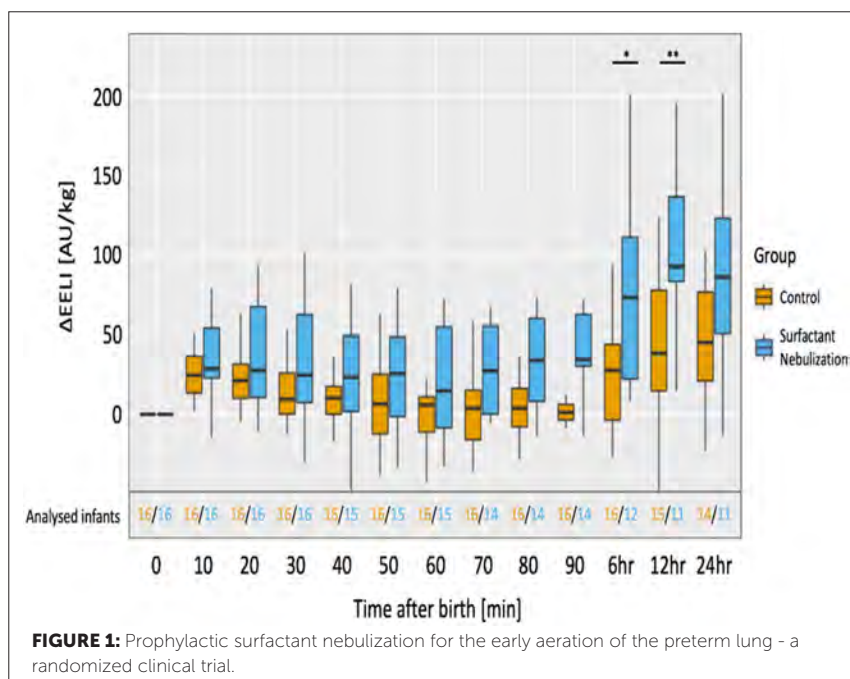

FIGURE 1: Prophylactic surfactant nebulization for the early aeration of the preterm lung - a randomized clinical trial.

CONCLUSIONS

Prophylactic SN in the DR did not significantly affect Δ EELI 30 minutes after birth. However, lung aeration was consistently improved in the intervention group for the first 24 hours after birth. Prophylactic SN in the DR was feasible and safe. There were no differences in clinical outcomes.

LO055 / #1292

ESPR Session

ESPR Session 09: New takes on respiratory care in the NICU

08-10-2022 10:30 - 11:50

Evaluation of minime invasive surfactant therapy to preterm infants administrated with a fraction of inspired oxygen of more than 40% monitored by electrical impedance tomography

T. Iwashita Lages^{1*}, E. Orlandin¹, P. De Moraes¹, A. Junior¹, T. Bastos¹, F. Celini¹, M. Nakamura², M. Amato³, W. Goncalves-Ferri¹

¹Ribeirão Preto Medical School– University of São Paulo, Neonatology, Ribeirao Preto, Brazil

²Timpel Medical, Timpel, Sao Paulo, Brazil

³University of São Paulo, Cardiopulmonary, Sao Paulo, Brazil

BACKGROUND AND AIMS

The best threshold to indicate surfactant therapy is unclear; the current more common indication is through a fraction of inspired oxygen (FiO₂). The present study aimed to assess the effects of minimally invasive surfactant therapy – MIST according to oxygen needs, using electrical impedance tomography (EIT).

METHODS

An observational, prospective study. Fourteen preterm infants < 32 weeks of gestational age with RDS on continuous positive airway pressure (CPAP) were included. Two groups: MIST with FiO₂ ≤ 40% (N=6) and > 40% (N=8). Enlight 1800 (Timpel, Brazil) was used to monitorization for one hour before and after surfactant.

RESULTS

After surfactant administration, the increase in EELZ was significant in both groups, presenting a trend to better EELZ and Delta Z in the $FiO_2 < 40\%$, and the EELZ gain was better in posterior zones with lower oxygen needs. Also, lower delta Z was noted in this group, which is probably, associated with lower volume tidal needs.

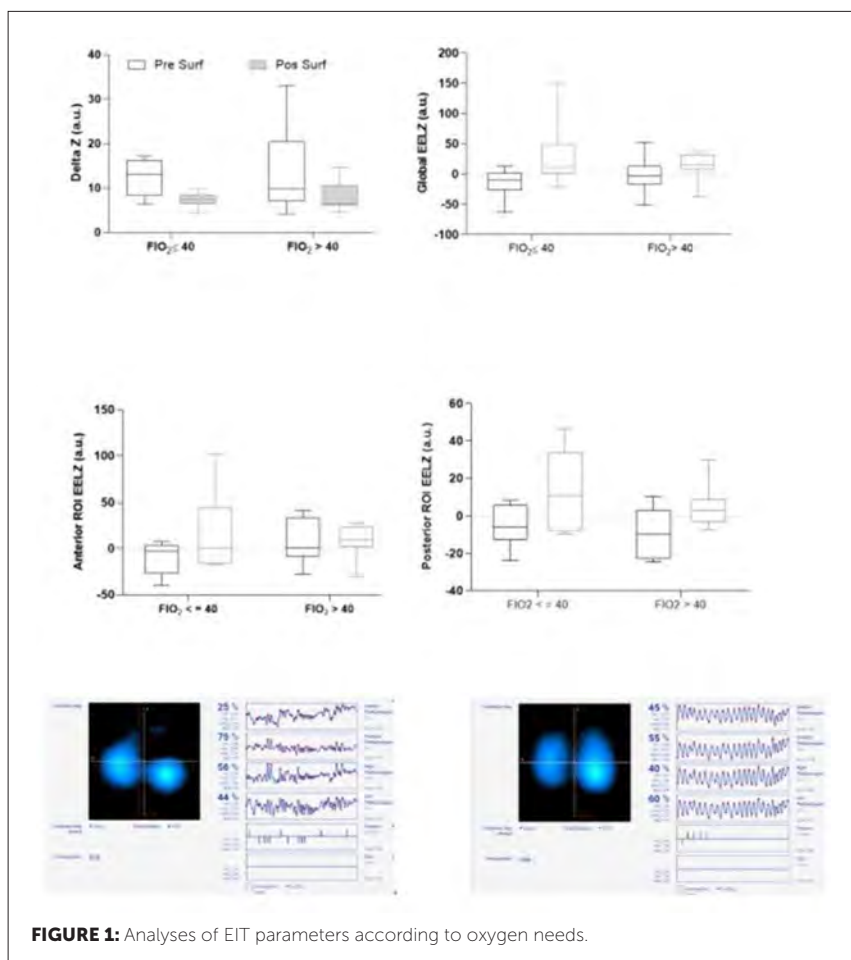

FIGURE 1: Analyses of EIT parameters according to oxygen needs.

CONCLUSIONS

MIST improves the EELZ in preterm infants. The MIST with $\text{FiO}_2 \leq 40\%$ presented a trend to better outcomes regarding ventilation distribution. Further research, with more samples, is necessary to confirm these results.

LO056 / #2638**ESPR Session****ESPR Session 09: New takes on respiratory care in the NICU****08-10-2022 10:30 - 11:50****Isolated chronic fetal hypoxia results in delayed lung development and maturation using an extrauterine womb lamb model****M. Peers De Nieuwburgh^{1*}, M. Hunt¹, K. Hayes², I. Randazzo², P. Chandrasekaran³, F. Debiève⁴, O. Danhaive⁵, M. Davey⁶, A. Flake², J.W. Gaynor¹, D. Frank³**¹Children's hospital of Philadelphia, Cardiac Surgery, Philadelphia, United States of America²Children's hospital of Philadelphia, Fetal Research Center, Philadelphia, United States of America³Children's hospital of Philadelphia, Cardiology, Philadelphia, United States of America⁴Saint-Luc University Hospital, UCLouvain, Obstetrics, Bruxelles, Belgium⁵Saint-Luc University Hospital, UCLouvain, Pediatrics, Brussels, Belgium⁶Vitara Biomedical inc., Preclinical Research, Philadelphia, United States of America**BACKGROUND AND AIMS**

The impact of isolated fetal hypoxia on lung development is unclear. Animal models have not been able to achieve fetal hypoxia without concurrent reductions in nutritional delivery or increased maternal stress. In this study, we aim to study lung development and maturation during isolated fetal hypoxia using an extrauterine womb to control oxygen delivery to the fetus.

METHODS

Following cesarean section delivery, preterm lambs (105-110 days gestational age) were supported on an EXTra-uterine Environment for Neonatal Development (EXTEND) system under normoxic or hypoxic conditions for

either 7 days (N=5 per group) or 17 days (N=4 per group). Hypoxia was achieved by decreasing oxygen delivery by 35% below normal levels. Lung structure was evaluated using light microscopy and computer-assisted stereology techniques. Surfactant gene expression was quantified by RT-PCR.

RESULTS

Hypoxia for 7 days decreased ($P=0.018$) alveolar septum volume and increased ($P=0.042$) alveolar airspace volume. Alveolar septum and airspace volumes tended to decrease following 17 days of hypoxia. The mean linear intercept tended to increase in hypoxic animals. Surfactant protein expression and production machinery were impaired by hypoxia. SP-C, ABCA3, and LPCAT expression tended to decrease after 7 days and significantly decreased after 17 days of hypoxia (SP-C: $P=0.012$, ABCA3: $P=0.01$, and LPCAT: $P=0.049$).

CONCLUSIONS

These preliminary data demonstrate that isolated fetal hypoxia impacts both structural and biochemical lung development which may contribute to the higher incidence of perinatal respiratory failure and bronchopulmonary dysplasia observed in IUGR infants.

LO057 / #911**EAP Session****EAP Session 10: The integrated health and social approach in children with chronic diseases: Is complex care of children with chronic diseases possible in the community healthcare?****08-10-2022 10:30 - 11:50****Randomized controlled trial comparing addition of non-invasive positive pressure ventilation (BiPAP or CPAP) versus pharmacotherapy alone, in children with acute exacerbation of asthma****J. Mathew^{1*}, T. Ahuja¹, M. Jayashree¹, M. Seear²**

¹Postgraduate Institute of Medical Education and Research, Advanced Pediatrics Centre, Chandigarh, India

²BC Childrens' Hospital, Pediatrics, Vancouver, Canada

BACKGROUND AND AIMS

Among children with acute exacerbation of asthma, to compare efficacy and tolerability of non-invasive ventilation (BiPAP or CPAP) added to pharmacotherapy, versus pharmacotherapy alone.

METHODS

The study was approved by Institutional Ethics Committee, and children were enrolled with parental written, informed consent. Inclusion: Children >24 months old with acute asthma (defined per Seear 2014) having PRAM score >4 after first hour of standard management (oxygen, 3 doses nebulized salbutamol, one dose systemic steroid, supportive care). Exclusions: Clinical diagnosis of bronchiolitis, pneumonia, respiratory failure at presentation,

contraindication to BiPAP, current tracheostomy, heart disease, craniofacial abnormality, pneumothorax. Computer-generated randomization and serially numbered, opaque, sealed envelopes, were used to allocate children to BiPAP, CPAP, or control groups. BiPAP was delivered via face mask with IPAP/EPAP: 10-15/5cmH₂O, titrated to achieve tidal volume 5ml/kg). CPAP was delivered via face mask with starting pressure 8cmH₂O (increased to 10cmH₂O if unsatisfactory response). Control group received only pharmacotherapy. All groups received continuous salbutamol nebulization, and 6 hourly inhaled Ipratropium. Therapy was escalated to intravenous magnesium sulphate (four doses at 6 hour intervals), intravenous aminophylline, and/or assisted ventilation (as required). PRAM was measured every 60 minutes. The key outcomes were time to achieve PRAM ≤ 3 , and treatment failure (PRAM remaining static or increasing over 2 consecutive hours, intolerance to BiPAP/CPAP, respiratory failure requiring intubation and/or invasive ventilation).

RESULTS

Please see Figure 1.

Group		Age (yr)	PRAM at presentation	PRAM at end of 1 st hr	Time to PRAM <3	Rx failure	Intolerance to NIV
BiPAP (n=48)	Median (IQR)	6 (3,9)	6 (5,7)	5 (4,6)	3 (2,4)	5/48 (10.4%)	3/48 (6.3%)
	Range	2-11	3-11	3-8	1-9		
CPAP (n=48)	Median (IQR)	5 (3,9)	6 (5,8)	5 (4,6)	3 (2,5)	7/48 (14.6%)	3/48 (6.3%)
	Range	2-12	3-12	3-12	2-11		
Control (n=48)	Median (IQR)	6 (3,7)	6 (4,7)	4 (4,5)	3 (2,4)	3/48 (6.3%)	NA
	Range	2-11	3-11	3-9	2-24		
There were no statistically significant differences for any of the comparisons							

FIGURE 1: Comparison of baseline characteristics and outcomes.

CONCLUSIONS

Non-invasive ventilation (BiPAP or CPAP) added to pharmacotherapy at the end of first hour of treatment, was not superior to standard pharmacotherapy alone.

LO058 / #2063**EAP Session****EAP Session 10: The integrated health and social approach in children with chronic diseases: Is complex care of children with chronic diseases possible in the community healthcare?****08-10-2022 10:30 - 11:50****Postnatal epilepsy following EEG confirmed neonatal seizures****C. Stephens^{1,2*}, B. Mcnamara³, N. Mcsweeney^{1,4}, D. Murray^{1,2}, O. O'Mahony⁴, B. Walsh^{1,2,5}, G. Boylan^{1,2}**¹Department of Paediatrics and Child Health, University College Cork, Cork, Ireland²INFANT Research Centre, University College Cork, Ireland³Department of Neurophysiology, Cork University Hospital, Cork, Ireland⁴Department of Paediatric Neurology, Cork University Hospital, Cork, Ireland⁵Department of Neonatology, Cork University Maternity Hospital, Cork, Ireland**BACKGROUND AND AIMS**

Neonatal seizures are a common neurological emergency. We aim to determine the incidence of postnatal epilepsy (PNE) following EEG confirmed seizures.

METHODS

A retrospective single-centre observational study of term infants at risk of seizures admitted to the NICU at Cork University Maternity Hospital, Ireland between 2003–2019. Included infants were; 1) 37 weeks' gestation, with 2) 2 hours EEG monitoring and 3) had follow up. Infants that died in the neonatal period were excluded.

RESULTS

311 infants were included. The most frequent diagnoses were Hypoxic Ischaemic Encephalopathy (HIE) (71.4%), stroke (4.5%) and genetic/metabolic encephalopathy (3.9%). 75 (24.1%) infants developed electrographic seizures, and 21(6.8%) developed PNE. Of infants with PNE, 16 (76.2%) had electrographic seizures in the neonatal period. Infants with electrographic seizures were at higher risk for PNE than infants who did not seize (21.3% vs 2.1%). The diagnoses associated with PNE were; HIE (n=11), genetic/metabolic encephalopathies (n=7), encephalopathy of unknown origin (n=2), other (n=1). Despite HIE being the commonest condition associated with seizures in the neonatal period, only 9.4% of infants with moderate and severe HIE developed PNE. In contrast, 58% with genetic/metabolic encephalopathy developed PNE. Four infants developed epilepsy in the neonatal period (SCN2A; n=2, KCNQ2; n=1, Inborn Error of Metabolism;n=1), eleven within one year, and six beyond infancy. Eight infants with PNE died in childhood.

CONCLUSIONS

Epilepsy is a serious neurological complication following neonatal encephalopathy. Genetic/metabolic encephalopathies were associated with the highest risk of PNE. Neonatal electrographic seizures present a clear risk for PNE, particularly in infants with genetic/metabolic encephalopathy.

LO059 / #1154

EAP Session

EAP Session 10: The integrated health and social approach in children with chronic diseases: Is complex care of children with chronic diseases possible in the community healthcare?

08-10-2022 10:30 - 11:50

Clinical case coordinator: Improving health care service for rare disease pediatric patients

Ruta Navardauskaite^{1,2}, Daiva Borkiene¹, Kristina Ilgaudaite^{1,3}, Egle Ramanauskiene^{1,4}, Lina Jankauskaite^{1,4*}

¹Hospital of Lithuanian University of Health Sciences (LSMU) Kauno Klinikos; Coordinating center for Rare and undiagnosed diseases

²Department of Endocrinology, Medical Academy, Lithuanian University of Health Sciences, Kaunas, Lithuania

³LSMU, Department of pediatric neurology

⁴LSMU, Department of pediatrics

INTRODUCTION

Rare diseases are frequently chronic affecting multiple organ systems. Those patients require periodic and continuous medical evaluation. Due to the high workload of the health care system, accessibility is difficult following negative consequences for health outcomes related to delayed investigation or treatment. Thus, our University Hospital began implementation of clinical case coordinator (CC) for the patients with rare diseases.

METHODS

CC service was implemented in December 2021 with main function of patient referral to certain rare disease expert. Quality questionnaire was created and

provided for patients to evaluate previous experience and current situation of referral. Data were analyzed December 2021–March 2022. We collected: total number of consultations needed (different medical experts), registration method, region of origin, waiting duration in days until consultation, and between consultation of different experts. We evaluated patients' service satisfaction level. Statistics were calculated with SPSS 27.0; $p < 0.05$ was considered significant.

RESULTS

In total, 150 pediatric patients used CC service (Fig. 1). 90% of patients registered by phone, 10% by email. Patients were from whole country. Average duration from a day of registration to the specialist consultation was 13.41 ± 6.8 d. It was significantly shorter compared to previous experience (1–3 mo). Patients needed 1–6 specialists: 1 specialist–60%, 2 specialists–20%, 3–10%, >3–10% of patients. Consultations of more than 1 specialist were fulfilled within 1–2 d. Customers' satisfaction of CC service was evaluated as excellent–85% (of all respondents), very good–10%, good–5%.

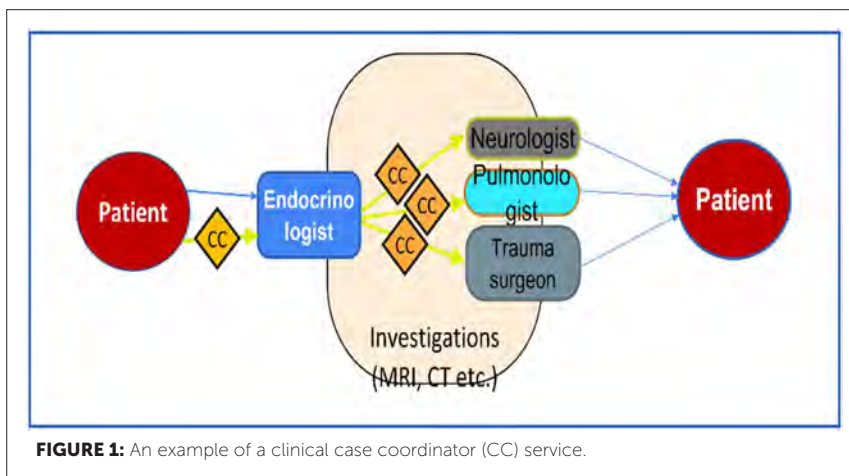

FIGURE 1: An example of a clinical case coordinator (CC) service.

CONCLUSIONS

Our data show the important role of CC which led to a significant decrease in waiting duration until referral to a specialist. Most of the patients did find the CC role excellent.

LO060 / #1563**ESPNIC Session****ESPNIC Session 11: Haemodynamic monitoring in the PICU****08-10-2022 10:30 - 11:50****Correlation between novel biomarkers and pocus derived CI and SVRI****A. Ghiță-Blujdescu^{1*}, A.E. Băetu^{2,3}, A. Damașcan³, C. Tănase¹, R. Florin³, E. Ștefan³**

¹*Emergency Clinical Hospital Bucharest "Floreasca", Anesthesia and Intensive Care, Bucharest, Romania*

²*University of Medicine and Pharmacy "Carol Davila Bucharest", Anesthesia and Intensive Care, Bucharest, Romania*

³*Emergency Clinical Hospital for Children "Grigore Alexandrescu" Bucharest, Anesthesiology and Intensive Care, Bucharest, Romania*

BACKGROUND AND AIMS

Using the traditional compartmentalized approach to diagnosing a patient, creates a time dissociation between clinical findings and consultative radiology and echography, especially when time is of the essence. The aim of this study is to validate novel inflammatory markers using the known hemodynamic pattern of sepsis.

METHODS

The study is prospective, observational and includes patients under the age of 18 admitted to the Grigore Alexandrescu Emergency Clinical Hospital for Children. The following paraclinical data from admission were considered: complete blood count and derived inflammatory markers: neutrophils/lymphocytes (NLR), platelets/lymphocytes(PLR), monocytes/lymphocytes(MLR),

hemoglobin/lymphocytes(HLR), hemoglobin/platelet (HPR) and systemic inflammatory index (SII). Cardiac index values and systemic vascular resistance indexed with POCUS-derived data were also considered. Statistical analysis was performed with GraphPad Prism 9.1.

RESULTS

The study includes 60 middle-aged children (5.44 ± 3.2 years). Descriptive statistics reveal the following average values of the studied ratios: NLR (9.41 ± 9.15), PLR (247.1 ± 186.5), MLR (1.056 ± 0.77), SII (3646 ± 3158), HLR (9.168 ± 6.634). Mean value is 3.2 ± 0.7 l/min/m² and for SVRI (1291 ± 243.1 dyne*sec*cm⁵/m²). The best correlation that the cardiac index has is with PLR ($r=0.38$, $p=0.003$), followed by HLR ($r=0.33$, $p=0.01$) and SII ($r=0.25$, $p=0.02$). SVRI showed negative correlations with NLR ($r=-0.76$, $p<0.0001$), SII ($r=-0.68$, $p<0.0001$), HLR ($r=-0.53$, $p<0.0001$) and PLR ($r=-0.53$, $p<0.0001$).

CONCLUSIONS

Novel inflammatory biomarkers (NLR, SII, HLR, PLR) correlate very well with the hemodynamic pattern of sepsis and since they are easy to obtain they should be considered in daily practice.

LO061 / #2568**ESPNIC Session****ESPNIC Session 11: Haemodynamic monitoring in the PICU****08-10-2022 10:30 - 11:50****Pediatric long covid****H. Goldenberg¹, T. Wells², S. Gillen², B. Sharon^{2*}**¹University of Minnesota, Medical School, Minneapolis, United States of America²University of Minnesota, Pediatrics, Minneapolis, United States of America**BACKGROUND AND AIMS**

Pediatric SARS-CoV-2 infection is usually mild and self-limiting but for some patients symptoms persist, impacting their daily functioning. **Long Covid** is emerging as a chronic consequence of Covid-19, in all age groups. Our aims were to identify children with **Long Covid** and describe their illness, to better understand this syndrome.

METHODS

Between April 2020 and June 2022, more than 200 children were referred to a designated clinic for Covid related concerns. We identified **Long Covid** according to WHO definitions to generate a cohort and collect demographic and clinical data [figure 1].

RESULTS

We identified 71 children (age 3-18yr) with Long Covid [figure 1]. The most common symptom reported was exertional fatigue, followed by headache, myalgia/arthralgia, abdominal pain, brain fog/difficulties concentrating, anosmia/dysgeusia, anxiety/depression, palpitation, dizziness, dyspnea, nausea,

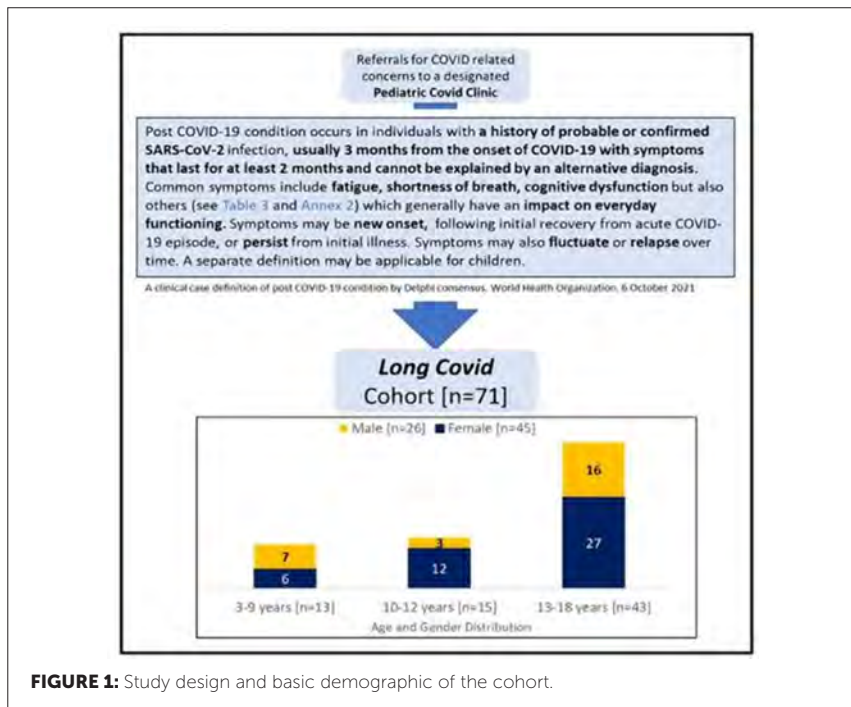

FIGURE 1: Study design and basic demographic of the cohort.

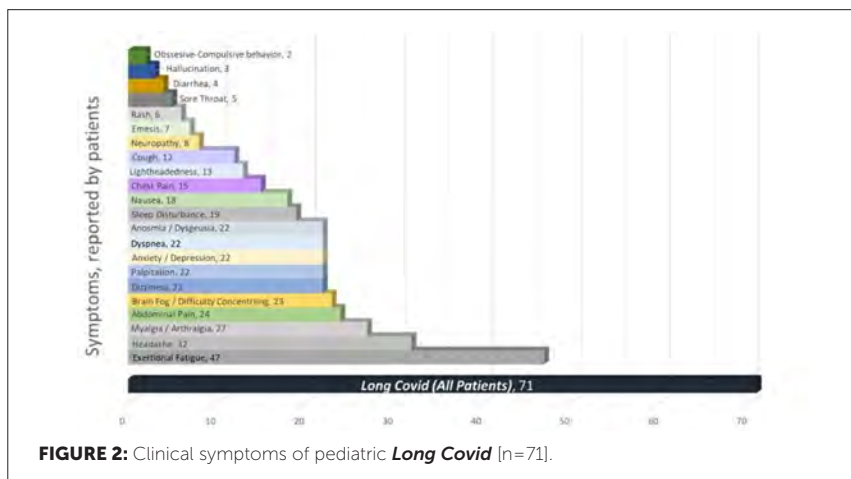
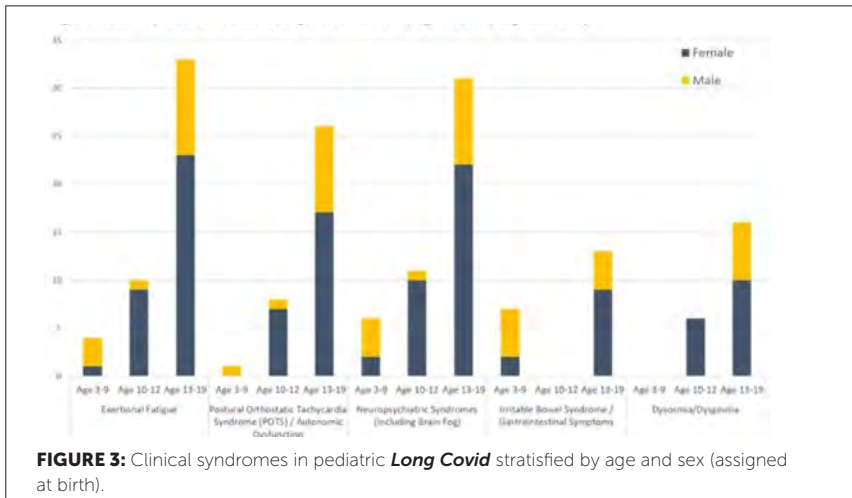

FIGURE 2: Clinical symptoms of pediatric Long Covid [n=71].



lightheadedness, cough, and chest pain [figure 2]. Other notable presentations include neuropathy, and new onset psychiatric symptoms (hallucination and/or obsessive-compulsive disorder). We identified constellation of symptoms that were diagnostic of specific syndromes, including Postural orthostatic tachycardia syndrome (POTS), Irritable bowel syndrome (IBS), and neuropsychiatric diseases. We also observed a group of patients with chronic anosmia/dysgeusia causing decrease appetite and weight loss.

CONCLUSIONS

Children infected with SARS-CoV-2 may develop a complex and chronic disease, and teenage girls are at higher risk. Pediatric Long Covid is reminiscent of Myalgic Encephalomyelitis/Chronic Fatigue Syndrome, supporting the hypothesis that SARS-CoV-2 may trigger this condition. Millions of children worldwide are at risk and pediatricians should be aware of its features and impact. Further research is crucial in order to promote recognition and offer management options.

LO062 / #897**Interdisciplinary Session****Interdisciplinary Session 01: Finding a scientific basis for paediatric medicine****08-10-2022 15:00 - 16:30****Alternative consent methods used in the SafeBoosC-III trial****M. Vestager, G. Greisen*, M. Lühr Hansen***Department of Neonatology, Rigshospitalet, Copenhagen, Denmark*

On behalf of the SafeBoosC-consortium

BACKGROUND AND AIMS

The use of prior informed consent is the norm in clinical trials. Monitoring of cerebral oxygenation is already clinical routine in many Neonatal Intensive Care Units (NICU). Due to the urgency, and to ease enrollment and improve representation of the population, deferred consent and opt-out were also accepted in the SafeBoosC-III trial. The aim of this study was to evaluate the use of different consent methods in SafeBoosC-III.

METHODS

We invited all principal investigators to join this study. We collected information on the types of consent used, enquiries raised by research ethics boards, time from application to ethics approval, and reports on concerns or complaints from staff or parents that arose during the trial.

RESULTS

Of 61 hospitals, 43 used prior informed consent, five used both prior, deferred consent and opt-out. Five used prior and deferred consent, six used deferred consent and only one used deferred consent and opt-out. In nine NICUs, the research ethics boards raised enquiries towards the applied consent method; in six and one respectively, the use of 'opt-out and deferred consent was denied. Median time to decision by the research ethics boards was 34 days (IQR 15-100). Twelve concerns were reported, mainly regarding the use of prior informed consent. In 18 cases, the parents did not give deferred consent, and the infants were lost to follow-up.

CONCLUSIONS

Deferred consent and the opt-out method proved feasible to use in SafeBoosC-III, but there were trial-methodological and ethical problems.

LO063 / #947

Interdisciplinary Session

Interdisciplinary Session 01: Finding a scientific basis for paediatric medicine

08-10-2022 15:00 - 16:30

IQ AT 5-Years' corrected age: A follow-up of the N3RO randomised controlled trial of docosahexaenoic acid in preterm infants born

J. Gould^{1*}, M. Makrides¹, T. Sullivan¹, P. Anderson², A. Mcphee¹, R. Gibson¹, M. Sharp³, J. Cheong⁴, G. Opie⁵, J. Travadi⁶, P. Davis⁴, J. Bednarz¹, L. Doyle⁷, K. Simmer⁸, C. Collins¹

¹South Australian Health and Medical Research Institute, Sahrri Women and Kids, North Adelaide, Australia

²Monash University, Turner Institute for Brain and Mental Health, School of Psychological Sciences, Melbourne, Australia,

³King Edward Memorial Hospital, Neonatal Directorate, Perth, Australia

⁴Royal Women's Hospital, Neonatal Medicine, Melbourne, Australia

⁵Mercy Hospital for Women, Neonatal Services, Melbourne, Australia

⁶Royal Darwin Hospital, Nicu, Darwin, Australia

⁷Department of Obstetrics and Gynaecology, Royal Women's Hospital, Melbourne, Australia

⁸The University of Western Australia, Neonatal Research, Perth, Australia

BACKGROUND AND AIMS

The peak accumulation of docosahexaenoic acid (DHA) into neural tissue occurs throughout the last trimester of pregnancy during the fetal brain growth spurt. Infants born <29 weeks' gestation are ex-utero during this period and have an increased risk of cognitive impairment. This study aimed to determine whether supplementing infants born <29 weeks' gestation with DHA improves cognition.

METHODS

Infants born <29 weeks' gestation were randomised to receive an enteral DHA supplement (providing 60 mg/kg/day of DHA) or a control emulsion (without DHA) from within 3 days of their first feed to 36 weeks' post menstrual age. Children were invited to undergo the Wechsler Preschool and Primary Scale of Intelligence (4th edition) at five years' corrected age. The primary outcome was the Full-Scale Intelligence Quotient (FSIQ). Analyses were conducted according to the intention to treat principle and missing data were addressed using multiple imputation.

RESULTS

Of the 656 children that survived to five years corrected age (mean gestation 27 weeks, SD 1 week; mean birth weight 933g, SD 225g), FSIQ was available for 480 (73%); 241 in the DHA group, 239 control group). Following imputation, children in the DHA group (n=323) had a significantly higher FSIQ (mean 95.4, SD 17.3) compared with children in the control group (n= 333; mean 91.9, SD 19.1; adjusted mean difference 3.5, 95% confidence interval 0.4 to 6.5, P=0.03).

CONCLUSIONS

Meeting estimated in utero DHA levels during the neonatal period is one of the few strategies to improve FSIQ for infants born <29 weeks' gestation.

LO064 / #1096

Interdisciplinary Session

Interdisciplinary Session 03: Acute and chronic pain in children (ESPA Session)

08-10-2022 15:00 - 16:30

Comfortneo scale: A reliable and valid instrument to measure prolonged pain in neonates?

N. Meesters¹, T. Dilles², J. Van Rosmalen^{3,4}, G. Van Den Bosch¹, S. Simons¹, M. Van Dijk^{1,5*}

¹Department of Pediatrics, Erasmus MC - Sophia Children's Hospital, Division of Neonatology, Rotterdam, Netherlands

²University of Antwerp, Nursing and Midwifery Sciences, Centre for Research and Innovation in Care, Faculty of Medicine and Health Sciences, Antwerp, Belgium

³Department of Biostatistics, Erasmus MC, Rotterdam, Netherlands

⁴Department of Epidemiology, Erasmus MC, Rotterdam, Netherlands

⁵Department of Pediatric Surgery, Pediatric Intensive care, Erasmus MC – Sophia Children's Hospital, Rotterdam, Netherlands

BACKGROUND AND AIMS

The COMFORTneo scale, consisting of seven behavioral items, was newly designed to measure neonates' prolonged pain, and in an earlier study showed preliminary reliability and validity. We further studied the reliability and validity of this scale.

METHODS

This prospective observational study evaluates four clinimetric properties of the COMFORTneo scale. The intra-rater reliability was determined from NICU nurses' assessments of neonates' pain from three representative video fragments at two different time points. The inter-rater reliability and construct validity were determined from NICU nurses' assessments of pain in five different neonates with the COMFORTneo scale and numeric rating scales

(NRS) for pain and distress. Assessments were made simultaneously with, but independently of, the principal investigator. Lastly, pain scores using another instrument (N-PASS) were correlated with COMFORTneo scores during 50 paired measurements to further evaluate the construct validity.

RESULTS

Intra-rater reliability: Twenty-two nurses assessed pain intensity in the video fragments twice within 4 to 10 weeks with the COMFORTneo, resulting in an ICC of 0.70. Inter-rater reliability: The ICC for 310 paired COMFORTneo scores together with 62 nurses was 0.93. Construct validity: The correlation between the COMFORTneo and the NRS pain and NRS distress was 0.34 and 0.72, respectively. The correlation between the N-PASS and COMFORTneo was 0.70 in 50 assessments.

CONCLUSIONS

Until more advanced multimodal pain measurement techniques are available in clinical practice, the COMFORTneo can be used to reliably and validly assess pain in preterm and term NICU patients.

LO065 / #1662**Interdisciplinary Session****Interdisciplinary Session 05: Orphan disease in children (ESPGHAN Session)****08-10-2022 15:00 - 16:30****Experience of conducting specific treatment for patients with lysosomal storage diseases in Ukraine during hostilities****N. Samonenko^{1,2*}, O. Okhotnikova¹, N. Gorovenko³**

¹Department of Pediatrics No 1, National University of Health of Ukraine named after P.L. Shupika, Kyiv, Ukraine

²National Spasioslased Children Hospital "OKHMATDYT", Center of Orphan Disease, Kyiv, Ukraine

³Institute of Genetic and Regenerative Medicine, Genetic, Kyiv, Ukraine

BACKGROUND AND AIMS

Lysosomal storage diseases (LSDs) are inborn errors of metabolism characterized by the accumulation of substrates in excess in various organs cells due to the defective functioning of lysosomes. They cause dysfunction of those organs where they accumulate and contribute to great morbidity and mortality. Important conditions for the effective treatment are early onset and its continuity.

METHODS

This is a prospective observational study. The provision of treatment to 154 patients with LSDs during hostilities in Ukraine in 2022 was analyzed. The share of patients who needed to be relocated, the need to relocate medicines, the main threats and barriers to providing specific care was determined.

RESULTS

Before the start of hostilities 154 patients in Ukraine received enzyme replacement therapy. Among them with Gaucher, Fabry, Pompe diseases, Mucopolysaccharidosis. During the first month of hostilities 20% went to other countries. The main share of which were children with Pompe disease - 15% and Gaucher disease - 31%. At that time 6% required internal relocation. 7% do not have access to treatment. 3% changed the place of treatment to small medical centers.

CONCLUSIONS

The main obstacles to medical care were panic, lack of quick decisions on the movement of medicines, lack of access to hospitals, threat to life directly from hostilities. All this brought to the fore the work of the attending physician, who became the coordinator. The decisions made to move 25% of drugs to safe regions, the issuance of drugs on the hands of patients allowed to receive treatment in a rapidly changing situation.

LO066 / #1880**Interdisciplinary Session****Interdisciplinary Session 05: Orphan disease in children (ESPGHAN Session)****08-10-2022 15:00 - 16:30****Paediatric medical and developmental outcomes after 50 years of newborn screening for classical galactosaemia in Ireland****D. Pereira^{1*}, E. Loftus¹, J. Hughes¹, A.A. Monavari¹, E. Treacy², I. Borovickova³, J. Brady³, P. Mayne³, E. Crushell¹, I. Knerr¹**

¹Children's Health Ireland at Temple Street, National Centre for Inherited Metabolic Disorders, Dublin, Ireland

²Mater Misericordiae University Hospital, Adult Metabolic Service (ncimd), Dublin, Ireland

³National Newborn Screening Laboratory, Children's Health Ireland at Temple Street, Dublin, Ireland

BACKGROUND AND AIMS

Classical Galactosaemia (CG) is an inborn error of carbohydrate metabolism. Newborn Screening for CG began in the Republic of Ireland in 1972. In untreated neonates, CG leads to a multi-organ toxicity with life-threatening symptoms. In Ireland, two forms of neonatal screening occur. High risk infants are fed lactose- and galactose-free formula until their test on day 1 is resulted. All other infants are fed as per parental preference and are screened on day 3-5¹. While immediate or early implementation of a strict lactose-free diet together with medical interventions will usually address the acute medical complications, long-term complications may occur².

METHODS

We reviewed retrospectively and anonymized the clinical outcomes of our CG cohort using our hospital database. Institutional ethical approval was granted

in advance. Patient demographic information, developmental assessment results, and key health indicators were analysed.

RESULTS

In our CG screening population, 95% were alive at 18years, 4% had died (most of non-galactosemia related issues), and 3% were lost to follow-up or moved abroad. The most common co-morbid conditions were speech and language delay, learning disability, short stature, hearing loss, ovarian failure, Friedrich's ataxia and prematurity. Almost half of the population had speech and language delay at 5 years, and a third had learning difficulties or a developmental disability diagnosed before 18 years.

CONCLUSIONS

High risk and routine newborn screening for CG have reduced the mortality rate of the disorder, and early medical and dietetic intervention is a success story. However, long-term medical and developmental challenges still exist for this patient cohort.

LO067 / #1144**Interdisciplinary Session****Interdisciplinary Session 06: Diagnosis of genetic syndromes in children (Catalan paediatric society session)****08-10-2022 15:00 - 16:30****Moderating effect of early feeding practices in the association between child's genetic susceptibility to obesity and growth****C. Guivarch¹, C. Dubel-Jam¹, A. Cissé¹, A. Camier¹, M.-A. Charles^{1,2}, B. Heude¹, B. De Lauzon-Guillain^{1*}**¹Université Paris Cité, Inserm, Inrae, Cress, Paris, France²Unité mixte Inserm-Ined-EFS ELFE, Ined, Aubervilliers, France**BACKGROUND AND AIMS**

A short breastfeeding duration and an early complementary food introduction are considered as risk factors of obesity. A recent study suggested that breastfeeding could moderate the association between child's genetic susceptibility to obesity (BMI-GRS) and later growth, but studies are lacking. Our objective was to assess whether breastfeeding or age at complementary food introduction could moderate the association between child's BMI-GRS and growth.

METHODS

A BMI-GRS score was calculated using 16 SNPs, among 1085 children from the EDEN mother-child cohort. Breastfeeding duration and age at complementary food introduction were calculated using questionnaires completed at birth, 4, 8 and 12 months. Weight and length data were collected from child's health booklet at each follow-up and clinical exams. Individual growth

curves were modelled. The outcome considered was 6-year BMI. Interactions between BMI-GRS and early feeding practices were assessed using multi-variable linear regression models. Analyses were further stratified if relevant.

RESULTS

BMI-GRS was positively associated with 6-year BMI, only among children who were never breastfed ($\beta=0.09$ [0.03; 0.16] vs $\beta=0.02$ [-0.01; 0.06] among breastfed children, $p_{\text{interaction}} = 0.06$). Age at complementary food introduction did not moderate the association between child's BMI-GRS and 6-year BMI ($p_{\text{interaction}} = 0.9$).

CONCLUSIONS

The association found in the literature between breastfeeding and a lower risk of obesity could partly be explained by the fact that breastfeeding moderates the association between child's BMI-GRS and later BMI. Further studies are needed to investigate the biological mechanisms that could explain this result.

LO068 / #1255**Interdisciplinary Session****Interdisciplinary Session 06: Diagnosis of genetic syndromes in children (Catalan paediatric society session)****08-10-2022 15:00 - 16:30****The effects of pharmacogenetics on pharmacokinetics and pharmacodynamics in infants: A systematic literature review****R. Flint^{1,2*}, N. Yalcin^{2,3}, S. Simons⁴, K. Allegaert^{2,5}**

¹Department of Pediatrics, Erasmus MC-Sophia Children's Hospital, Division of Neonatology, Rotterdam, Netherlands

²Department of Hospital Pharmacy, Erasmus University Medical Center, Rotterdam, Netherlands

³Department of Clinical Pharmacy, Hacettepe University, Faculty of Pharmacy, Ankara, Turkey

⁴Department of Pediatrics, Sophia Children's Hospital, Division of Neonatology, Rotterdam, Netherlands

⁵Department of Pharmaceutical and Pharmacological Sciences, KU Leuven, and Department of Development and Regeneration, Leuven, Belgium

BACKGROUND AND AIMS

Pharmacogenetics is a powerful tool to understand variability in drug exposure, efficacy, tolerability, and toxicity. We aimed to identify signals on the impact of pharmacogenetics (PG) on pharmacokinetics (PK) and –dynamics (PD) in newborns and infants (<1 year).

METHODS

A structured search was performed (Medline, Embase, WoS). Applying PRISMA guidelines, studies were selected based on predefined inclusion criteria (infants, PG data, any trial). In addition, the Pediatrix top 100 drug (Stark,J

Pediatr,2022) was screened in PubMed [drug+pharmacogen*+(newborn OR infant)].

RESULTS

789 records were screened, 55 retained. On phase I polymorphisms, significant signals for CYP2A6 (dexmedetomidine PK), CYP2D6 (tramadol, dextromethorphan, ritonavir, dihydrocodeine PK/PD), CYP2B6 (nevirapine PK), CYP3A5 (tracrolimus PK), CYP2C8/2C9 (phenytoin PK, coumarin PD, indomethacin ductus PD), CYP2C18 (coumarin PD) and CYP2C19 (pantoprazole, omeprazole) were selected. On phase II, signals on GSTM1 (busulfan PK, neuroblastoma PD), NAT1 (neuroblastoma PD), NAT2 (isoniazid PK, neuroblastoma PD, trimethoprim PD), UGT1A9 (acetaminophen PK) or UGT2B7 (morphine PK) were retained. On transporters, OCT1 (morphine, tramadol PK), MRP3 (morphine), ABCG2 (topotecan), ABCB1 (omeprazole PK, tacrolimus PK and PD (nephrotoxicity, infectious complications), leukemia outcome, opioid-induced urinary retention), MRD1 (tacrolimus PK, leukemia outcome) were found. On (post)receptor mechanisms, signals on KCNJ6, OPRM1, PNOC and COMT (opioids PD), vitamin D binding protein (PK and PD), VKORC1 (coumarin), NR1I2 (nevirapine), and TNF and MAPK8 (immune response HBV vaccine, PD) were retrieved.

CONCLUSIONS

This landscaping effort displays a diverse, but fragmented picture of significant signals of PG on PK/PD in newborns and infants. How to translate these data to clinical practice remains underexplored.

LO069 / #1625**Interdisciplinary Session****Interdisciplinary Session 07: What a Paediatrician Should Know: Clues from paediatric neurology cases (EPNS Session)****08-10-2022 15:00 - 16:30****Encephalitis in children in a tertiary spanish hospital. Etiology, clinical presentation and neurological outcomes****B. Suriñach Ayats^{1*}, J.M. Valle-T.Figueras², E. Turon-Viñas¹, A. Devolder-Nicolau², E. Coca-Fernandez³, S. Brió-Sanagustin⁴, S. Boronat-Guerrero¹**¹*Paediatrics Department, Hospital de la Santa Creu i Sant Pau, Barcelona, Spain*²*Hospital de la Santa Creu i de Sant Pau, Infectious Diseases, Barcelona, Spain*³*Hospital de la Santa Creu i de Sant Pau, Paediatric Intensive Care, Barcelona, Spain*⁴*Hospital Sant Pau, Paediatric Intensive Care, Barcelona, Spain***BACKGROUND AND AIMS**

Encephalitis is a potentially serious disease caused by different etiologies, which are sometimes difficult to diagnose. However, reaching a correct diagnosis can change the management and prognosis of affected patients. The aim is to describe the etiology, clinical presentation and neurological outcomes of our patients.

METHODS

All patients diagnosed with encephalitis between 2010 and 2022 in our hospital were retrospectively reviewed. Epidemiological and clinical data, ancillary tests (microbiological and immunological studies, electroencephalography and neuroimaging) and outcomes were analyzed.

RESULTS

Eighty-one patients were included. The most frequent symptoms were fever (75%) and decreased consciousness (50%). In 69.1% of patients an etiological diagnosis was achieved. Forty-four children had an infectious etiology, of whom enterovirus (54,5%) and human herpesvirus 6 (13,6%) were the predominant cause in immunocompetent and immunocompromised children, respectively. Microbiological tests in cerebrospinal fluid (viral PCR and cultures) were positive in only 29,6% of patients and other samples were needed to diagnose the rest of the patients. Twelve patients had an autoimmune etiology, of whom 2 had positive anti-NMDAR, 3 anti-MOG and 1 anti-Hu antibodies, respectively. 22.2% of patients had neurological sequelae, which were especially related to herpes simplex virus 1 or an immunocompromised state.

CONCLUSIONS

There is a high percentage of confirmed etiological diagnosis in our series. Viral encephalitis is the most frequent etiology; however, autoimmune encephalitis should not be forgotten. A comprehensive approach, including brain magnetic resonance, microbiological studies in CSF, nasopharyngeal samples and feces, and immunological tests are needed to establish the etiological diagnosis.

LO070 / #1170**Interdisciplinary Session****Interdisciplinary Session 08: Palliative Management of children diagnosed with single ventricle (EAPC Session)****08-10-2022 15:00 - 16:30****Challenges in treatment of congenital heart disease in preterm and low birthweight neonates – Results of the European association brain in congenital heart disease (EUR-ABC)****A. De Silvestro¹, S. Chin On^{2*}, J. Sieker³, B. Reich³, W. Knirsch¹, J. Nijman²**¹University Children's Hospital Zurich, Pediatric Cardiology, Pediatric Heart Center, Zurich, Switzerland²University Medical Center Utrecht, Pediatric Intensive Care, Utrecht, Netherlands³German Heart Center, Pediatric Cardiology and Congenital Heart Disease, Munich, Germany**BACKGROUND AND AIMS**

Treatment of congenital heart disease (CHD) in preterm and low birthweight (LBW) neonates is challenging due to need of early intervention. This study aimed to investigate cardiac and neurodevelopmental (ND) outcomes within the EUR-ABC.

METHODS

From 2016 to 2020, preterm (<37 weeks gestational age (GA)) and LBW neonates (<2500g) with CHD requiring therapeutic cardiac intervention (surgery or catheter) within first year of life (YOL) from three European academic centres were included. Solitary PDA closure was excluded. Medical data and ND outcome during first YOL were collected.

RESULTS

312 Neonates (51% male) were included. 241 (77%) were preterm, and 263 (84%) LBW. Median (IQR) GA was 35.4 weeks (33.1-36.9), birthweight 2090g (1657-2400). Cardiac diagnosis included biventricular CHD without (n=215) and with aortic arch obstruction (n=63), and univentricular CHD without (n=17) and with aortic arch obstruction (n=17). 119 (38%) Patients had cyanotic CHD. Cardiac intervention was performed at median (IQR) 61 days (11-153), 41.7 weeks (37.9-56.4) postmenstrual age, with 3300g bodyweight (2375-5175). 256 Patients (89%) underwent surgery, 11% (n=31) catheter interventions. Mortality pre- and post-intervention in the first YOL was 8% and 10%, respectively. Perioperative neuroimaging using ultrasound was standard of care, while MRI was rarely used (~10% pre- and post-intervention). ND outcome data at one YOL was available in 64 patients (25%).

CONCLUSIONS

The high mortality confirms the high-risk of current population. Therapeutic cardiac intervention was preferably performed at term with bodyweight >3kg. Low availability of ND data justifies prospective assessment of structural neuroimaging, neuromonitoring and functional ND outcome.

LO071 / #1214**Interdisciplinary Session****Interdisciplinary Session 09: Paediatric emergency medicine updated (EUSEP Session)****08-10-2022 15:00 - 16:30****Biomarkers NAP-2 and P-selectin potential in an early diagnosis of severe bacterial infection in pediatric emergency****A. Pociute^{1*}, G. Laucaitytė², M. Farook³, A. Dagys⁴, L. Jankauskaitė²**¹Vilnius University, Medical Academy, Vilnius, Lithuania²Lithuanian University of Health Sciences, Pediatrics, Kaunas, Lithuania³Lithuanian University of Health Sciences, Medical Academy, Kaunas, Lithuania⁴Lithuanian University of Health Sciences, Pediatric Intensive Care, Kaunas, Lithuania**BACKGROUND AND AIMS**

Early recognition of severe bacterial infection(SBI) is essential for preventing progression to more severe forms and lethal outcomes. Specific early markers are missing.We analyzed novel platelet and neutrophil biomarkers in early viral infections(VI),bacterial infections(BI)(included SBI and sepsis)

METHODS

We performed a prospective pilot study of 68 children(1 month to 5 years) presenting to pediatric emergency department up to12 hours from the first episode of fever with SIRS.Cases were classified in groups:VI,BI(not SBI),SBI. SBI was classified into sepsis and no sepsis SBI.CBC, CRP were analyzed. Serum was collected,NAP-2(CXCL-7),PF-4(CXCL-4),serotonin,sP-selectin were investigated to analyze neutrophil-platelet interaction.

RESULTS

68 children were included. 42 (61.8%) had VI, 10 (14.7%) BI, 16 (23.5%) SBI, 4 had sepsis. WBC and Neu were higher in BI ($p=0.0001$, $p<0.0001$, respectively). Values were within normal range, CRP-in SBI ($p=0.0017$). The highest expression of CXCL7 observed in sepsis (100.4 ± 5.82 pg/ml) with a significant difference compared to VI, BI, other SBI ($p=0.002$, $p=0.024$, $p=0.017$). CXCL7 concentration >95.04 pg/ml demonstrated sensitivity of 81.25%, specificity of 75% to distinguish sepsis compared to other causes of SIRS (AUC = 0.91, $p=0.006$). With CXCL7 value of >81.20 pg/ml the likelihood ratio (LR) to predict SBI was 2.05 (AUC = 0.64, $p=0.08$). Higher CXCL4 values were in VI compared to sepsis, however it wasn't sensitive nor specific ($p=0.0774$). Serotonin showed no difference in groups. All bacterial samples had significantly higher sP-selectin values than VI (58.13 [39.80-68.45] vs 30.12 [13.74-43.78], $p=0.0003$); sepsis compared to other groups had higher values ($p=0.018$). With the cut-off value of 59.59 pg/ml the LR to predict sepsis was 3.17 (AUC 0.8471, $p=0.017$). The combination of sP-selectin and NAP-2 had sensitivity of 100%, specificity of 87% (AUC 0.960, $p=0.002$) to predict sepsis.

CONCLUSIONS

The combination of sP-selectin and NAP-2 presented to be promising to distinguish sepsis from other cases. More data are needed to confirm this assumption.

LO072 / #715**Interdisciplinary Session****Interdisciplinary Session 09: Paediatric emergency medicine updated (EUSEP Session)****08-10-2022 15:00 - 16:30****Insight in febrile children attending european emergency departments by emergency medical services: An observational multicenter study**

C. Tan^{1*}, C. Vermont², U. Von Both³, E. Carrol⁴, M. Emonts⁵, M. Van Der Flier⁶, R. De Groot⁶, J. Herberg⁷, B. Kohlmaier⁸, M. Levin⁷, E. Lim⁵, I. Maconochie⁹, F. Martin-Torres¹⁰, R. Nijman⁷, M. Pokorn¹¹, I. Rivero-Calle¹⁰, M. Tsolia¹², W. Zenz⁸, D. Zavadska¹³, H. Moll¹

¹Erasmus Medical Center - Sophia Children's Hospital, General Pediatrics, Rotterdam, Netherlands

²Erasmus MC-Sophia Children's Hospital, Pediatric Infectious Diseases and Immunology, Rotterdam, Netherlands

³Dr. von Hauner, Division of Paediatric Infectious Diseases, München, Germany

⁴University of Liverpool, Institute of Infection, Veterinary and Ecological Sciences Liverpool, Liverpool, United Kingdom

⁵Newcastle upon Tyne Hospitals NHS Foundation Trust, Great North Children's Hospital, Paediatric Immunology, Infectious Diseases & Allergy, Newcastle upon Tyne, United Kingdom

⁶Amalia Children's Hospital, Paediatric Infectious Diseases and Immunology, Nijmegen, Netherlands

⁷Imperial College London, Section of Paediatric Infectious Diseases, London, United Kingdom

⁸Medical University of Graz, General Pediatrics, Graz, Austria

⁹Imperial College Healthcare Trust NHS, Paediatric Emergency Medicine, London, United Kingdom

¹⁰Hospital Clinico Universitario de Santiago de Compostela, Genetics, Vaccines, Infections and Paediatrics Research Group, Santiago de Compostela, Spain

¹¹University Medical Centre Ljubljana, Department of Paediatric Infectious Diseases and Faculty of Medicine, Ljubljana, Slovenia

¹²P. and A. Kyriakou Children's Hospital, Pediatrics, Athens, Greece

¹³Children's clinical university hospital, Pediatrics, Riga, Latvia

BACKGROUND AND AIMS

Children constitute 6-10% of all patients attending the Emergency Department (ED) by Emergency Medical Services (EMS). However, inappropriate EMS use in children occurs in 20-40% with fever as an important risk factor. This study aims to provide insight in febrile children attending European EDs by EMS, and to examine inappropriate EMS use.

METHODS

This study is part of an observational multicenter study assessing management and outcome of febrile children in twelve European EDs. Inappropriate EMS use was defined as the absence of markers of urgency: high triage urgency, advanced diagnostics, treatment and admission. Multivariable logistic regression was performed for the association between EMS use and markers of urgency with adjustment for the confounders age, gender, visiting hours, presenting symptoms and ED. Additionally, the association between presenting symptoms and inappropriate EMS use was analysed.

RESULTS

5433 children (15%, range across EDs 0.1-42%) attended the ED by EMS. They were more frequently triaged as high urgent, ill appearing, and more often had neurological symptoms than children in the non-EMS group. The association between EMS use and markers of urgency remained significant after adjustment. Inappropriate EMS use occurred in 1046 children (19%, range across EDs 1-59%). The neurological group had least inappropriate EMS use (aOR 0.3, 95%CI 0.2 – 0.4), whereas the respiratory group had most inappropriate EMS use (aOR 1.4 95%CI 1.2 – 1.6).

CONCLUSIONS

There is large practice variation in EMS use in febrile children attending European EDs, with 19% of EMS use being inappropriate. Children with respiratory symptoms had most inappropriate EMS use.

LO073 / #2060**Interdisciplinary Session****Interdisciplinary Session 11: Recent advances in the treatment of Glomerulonephritis (ESPN Session)****08-10-2022 15:00 - 16:30****Review of nutcracker syndrom in children****M. Mila^{1*}, A. Zampetoglou¹, V. Askiti¹, M. Kourkounakis²,
A. Kourkounakis³**¹*Aglaja Kyriakou Children's Hospital, Nephrology, Goudi Athens, Greece*²*Oncology Hospital of Athens "O Agios Savvas", Orthopedic, Athens, Greece*³*General Hospital of Athens "G.Gennimatas", B' Internal Medicine, Athens, Greece***BACKGROUND AND AIMS**

This study aims to highlight the importance of the syndrome in the differential diagnosis of hematuria and proteinuria in children. Compression of the left renal vein between the superior mesenteric artery and the aorta causes the Nutcracker Syndrome. The main symptoms are hematuria of non-glomerular origin and orthostatic proteinuria.

METHODS

Twelve children aged 3 to 15 years were studied retrospectively. The parameters taken into account were gender, age, symptoms, concomitant problems, body mass index and laboratory findings. The diagnosis was made after an ultrasound study with a pulsed Doppler.

RESULTS

12 children were studied during the period 2010 to 2022, 50% were boys, the mean age was 8.6 years and of these 83.3% (n = 10) had a major symptom of proteinuria, three also presented microscopic hematuria, one presented as the only symptom macroscopic hematuria and one was asymptomatic, as a random ultrasound finding. The range of proteinuria in the initial control ranged from 252 mg / 24 hours to 1.2 g / 24 hours. It is noted that in one case the 24-hour urine albumin reached up to 1.92g. Two of the children were found to be underweight while all the others had normal BMI. Three children had concomitant problems, cystourethral reflux, nephroblastoma and Wilms tumor. Therapeutic intervention was performed based on the size of the proteinuria (> 500mg / 24h) with ramipril. Complete remission of the syndrome was observed in 5 children over time.

CONCLUSIONS

Nutcracker syndrome, although rare, should be investigated before performing a kidney biopsy to diagnose proteinuria.

LO074 / #1071**ESPR Session****ESPR Session 12: Connectomics of the developing brain****08-10-2022 17:00 - 17:55****MRI-Based prognostication in preterm neonates with intraventricular hemorrhage****K. Goeral^{1*}, R. Fuiko¹, M. Olischar¹, K. Klebermass-Schrehof¹, A. Berger¹, G. Kasprian²**¹Department of Pediatrics and Adolescent Medicine, Medical University of Vienna, Vienna, Austria²Department of Radiology, Medical University of Vienna, Vienna, Austria**BACKGROUND AND AIMS**

Intraventricular hemorrhage (IVH) is the most frequent form of intracranial hemorrhage in preterm patients and is a major problem in neonatal intensive care medicine. Our group recently published an magnetic resonance imaging (MRI)-based scoring system especially for infants born preterm with IVH with high correlation and strong predictive ability regarding later cognitive and motor outcome. The objective of this study was to compare our total MRI score to the Kidokoro score, which is a frequently used scoring system in neonatal intensive care medicine, created for the entire premature population.

METHODS

This study is a retrospective observational cohort study including preterm patients with IVH and a gestational age <32 weeks born at the Medical University of Vienna, Austria. All MRIs performed around term-equivalent age were included and evaluated using our total MRI score as well as the Kidokoro score. The predictive ability regarding neurodevelopmental outcome (Bayley Scales of Infant Development, cerebral palsy) at 2-3 years of age was evaluated.

RESULTS

Our total MRI score shows higher area under the curve values compared to the Kidokoro score for cognitive and motor development (Figure 1A). Similar results can be found for the outcome cerebral palsy (Figure 1B).

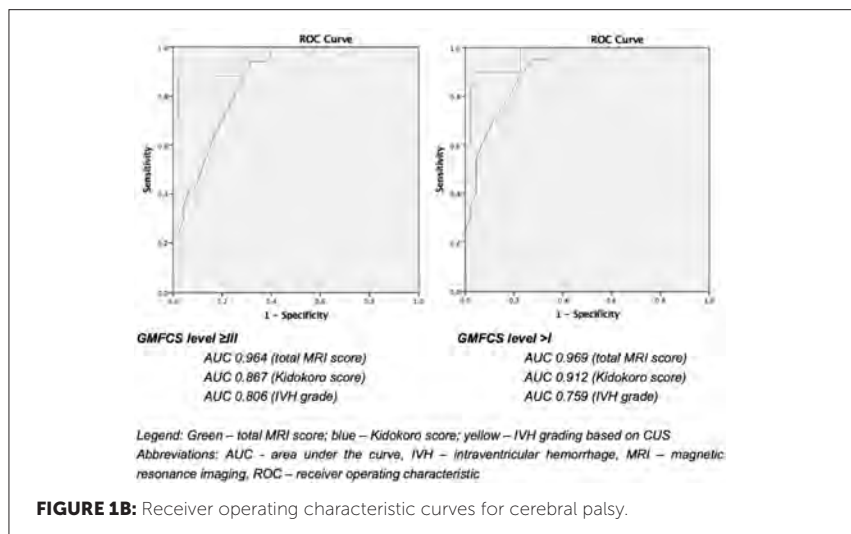
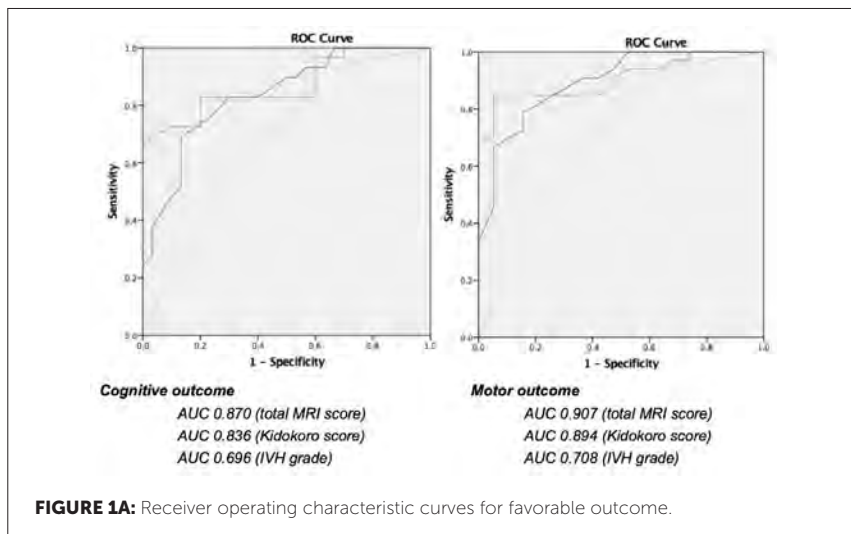

CONCLUSIONS

Our MRI-based scoring system can be used as a reliable prognostic indicator for cognitive and motor development in this specific patient group and thereby allows improved neurodevelopmental outcome prediction, individually tailored parental counselling, and clinical decision making.

LO075 / #1816**ESPR Session****ESPR Session 12: Connectomics of the developing brain****08-10-2022 17:00 - 17:55****Deep learning to optimize MRI prediction of motor outcomes after HIE****Z. Vesoulis^{1*}, S. Trivedi², H. Morris³, R. Mckinstry⁴, Y. Li⁵, A. Mathur⁶, Y. Wu⁷**¹Washington University in St. Louis, Pediatrics, St. Louis, United States of America²Northwestern University, Pediatrics, Chicago, United States of America³Children's National, Neonatology, Washington DC, United States of America⁴Washington University, Radiology, St. Louis, United States of America⁵UCSF, Radiology, San Francisco, United States of America⁶Saint Louis University, Pediatrics, St. Louis, United States of America⁷UCSF, Neurology, San Francisco, United States of America**BACKGROUND AND AIMS**

MRI is the gold standard for prediction of neurodevelopmental outcome after hypoxic-ischemic encephalopathy (HIE), however, published scoring systems are complex, do not include clinical data, and may contain duplicative or conflicting elements. Our objective was to use deep learning to identify the optimal set of clinical and imaging features for predicting motor outcomes after HIE.

METHODS

We identified a multi-institutional cohort of infants ≥ 36 weeks gestational age (GA) with moderate-severe HIE, who received therapeutic hypothermia, and T1/T2/DWI imaging. Motor impairment was defined as Bayley-III motor score < 85 or Alberta Infant Motor Scale $< 10^{\text{th}}$ centile at 12-24 months.

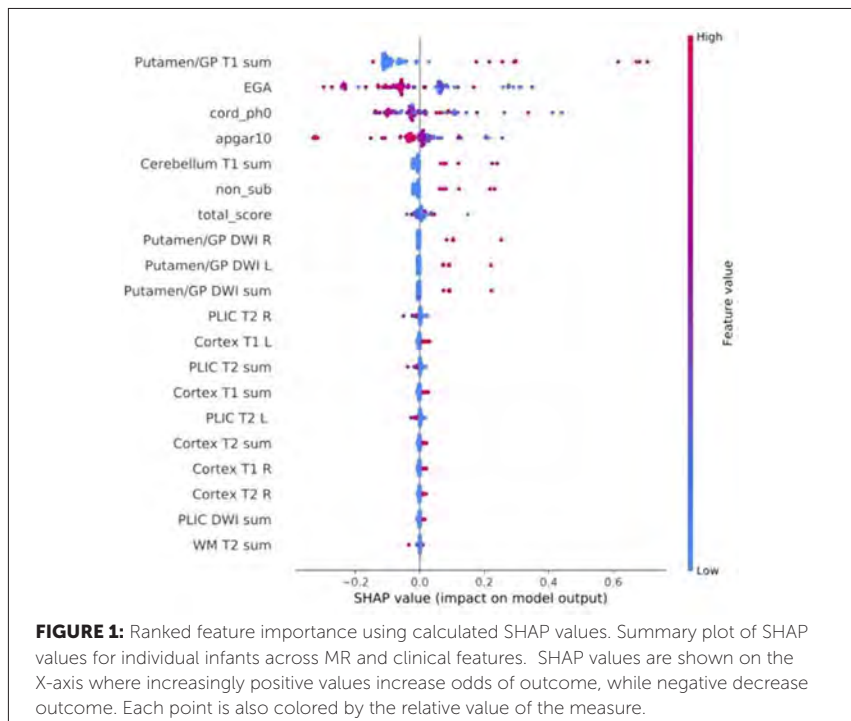

All MRIs were scored using a validated system which grades injury in 8 regions of each hemisphere across three sequences. A gradient-boosted deep learning model was used to identify the importance of each clinical and imaging feature. Feature selection was used to eliminate low-value features (Figure 1). The optimal feature set was used to train and test a deep neural network using 5-fold cross validation.

RESULTS

117 infants were identified with a mean GA=38.6 weeks, median cord pH=7.01, and a median 10-min Apgar=5. Motor impairment was noted in 23/117 (20%) of infants. Putamen/globus pallidus T1, GA, and cerebellum T1 were the most informative features. Feature reduction improved model accuracy from 79% (48 MRI feature model to 85% (three-feature model, Figure 2)).

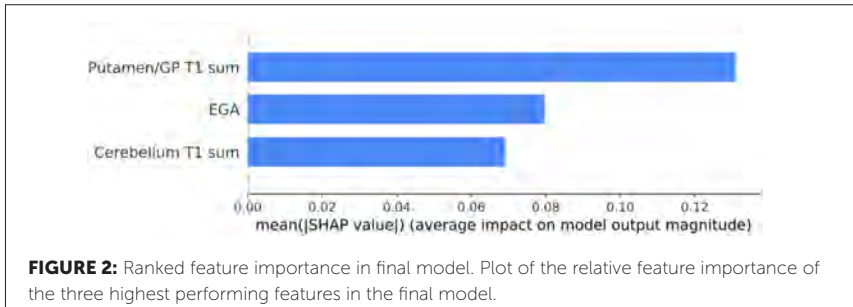

CONCLUSIONS

Deep learning can identify the most important imaging and clinical features for predicting motor outcome after HIE in this dataset. Our model predicted adverse motor outcomes in study patients with 85% accuracy using only three features.

LO076 / #1037**ESPR Session****ESPR Session 12: Connectomics of the developing brain****08-10-2022 17:00 - 17:55****Comparative evaluation of MRI scoring systems predicting neurodevelopmental outcomes in infants with hypoxic ischemic encephalopathy****E. Szakmár^{1*}, C. Andorka¹, T. Seszták², E. Varga², M. Szabó¹,
Á. Jermendy¹**¹*1st Department of Pediatrics, Semmelweis University, Budapest, Hungary*²*Semmelweis University, Medical Imaging Centre, Budapest, Hungary***BACKGROUND AND AIMS**

Barkovich and Weeke scoring systems were developed to quantify brain injury in infants with hypoxic ischemic encephalopathy (HIE). Our aim was to compare the predictive value of two MRI scoring systems for adverse motor, cognitive and composite outcomes in infants receiving hypothermia (TH) for HIE.

METHODS

This single center retrospective cohort study included infants who received TH for HIE between 2013 and 2019. Post-rewarming brain MRI images were evaluated according to Barkovich and Weeke scoring systems. Follow-up was performed using Bayley II test at 2 years of age. Adverse cognitive and motor outcomes were defined as mental developmental index (MDI) and the psychomotor developmental (PDI) < 70. Composite outcome was defined as death or test score < 70 in any domain. Receiver Operating Characteristics (ROC) curve was used to calculate area under the curve (AUC).

Table 1: The predication of adverse outcomes based on Barkovich and Weeke scoring systems

	Adverse cognitive outcome MDI < 70 (n=37/153)				Adverse motor outcome PDI < 70 (n=41/153)				Composite outcome (n=53/162)			
	AUC	Cutoff	Sens	Spec	AUC	Cutoff	Sens	Spec	AUC	Cutoff	Sens	Spec
Weeke	0.81	6	76%	66%	0.79	6	71%	65%	0.81	12	57%	93%
Barkovich	0.73	1	62%	74%	0.69	2	49%	81%	0.73	2	57%	88%

Composite outcome: Death or Bayley II score < 70 in any domain

AUC: area under the curve; MDI: mental developmental index; PDI: the psychomotor developmental

RESULTS

A total of 162 infants were included. MRI studies were carried out at a median 4.7 days of life [IQR 3.5; 6.2]. Brain injury was detected with higher frequency using Weeke score compared to Barkovich (71% vs. 35%, $p < 0.001$). Weeke scoring system performed better in predicting adverse motor, cognitive and composite outcomes (Table 1).

CONCLUSIONS

MRI can serve as a bridging biomarker and a surrogate end point for neurodevelopmental outcome, so it is crucial to quantify brain injuries based on standardized scoring systems.

LO077 / #1707**EAP Session****EAP Session 13: Decline in diseases in the paediatric population during the pandemic, is there anything to be learned****08-10-2022 17:00 - 17:55****Online survey to identify long COVID symptom profile in paediatric patients****A. Meiere^{1,2*}, L. Smāne^{2,3}, A. Kivite-Urtane⁴, L. Kļaviņa², I. Račko², I. Roģe², J. Pavare^{2,3}**¹Department of Paediatrics, Riga Stradins University, Riga, Latvia²Department of Pediatrics, Children's Clinical University Hospital, Riga, Latvia³Department of Pediatrics, Riga Stradins University, Riga, Latvia⁴Department of Public Health and Epidemiology, Institute of Public Health, Riga Stradins University, Riga, Latvia**BACKGROUND AND AIMS**

Children with acute SARS-CoV-2 infection have low rates of hospitalization or death, but there is significant number of children with long COVID symptoms – prevalence is from 4% to 66%. Aim of the study - create a specialized online survey to identify more precisely and quickly children with long COVID-19 who need specific medical help.

METHODS

Study design - prospective cohort study. From 1st of November 2021 to 28th of March 2022 paediatric patients (<18 years) were enrolled in the study >4 weeks after laboratory-confirmed SARS-CoV-2 infection. All respondents participated voluntarily, self-reported data through freely available online survey. To present the data descriptive statistics were used.

RESULTS

All together 220 respondents full-filled online survey - 43.2% (n=95) were boys, 56.8% (n=125) - girls. Mean age was 8.16 years. Symptoms were analysed in 4 age groups. In age group <1.5 years (8.2% (n=18)) – most frequent symptoms were irritability 50%, mood swings 50%, persistent cough 33.3%, loss of appetite 33.3%. In age group 1.5-5 years (25.9% (n=57)) – persistent cough 54.4%, mood swings 43.9%, irritability 42.1%. In age group 6-10 years (34.5% (n=76)) – fatigue 56,6% (p<0.008), abdominal pain 55.3%, headache 50%, mood swings 50%. In age group 11-18 years (31,4% (n=69)) – fatigue 56.6% (p<0.001), abdominal pain 55.3%, headache 50%, mood swings 50%.

CONCLUSIONS

The long-COVID symptoms are evident in paediatric patients and affect children's health in physical and emotional dimension. An online survey is a great way to reach and identify patients who need specific medical help as soon as possible in case of long COVID.

LO078 / #1525**EAP Session****EAP Session 13: Decline in diseases in the paediatric population during the pandemic, is there anything to be learned****08-10-2022 17:00 - 17:55****Children with multisystem inflammatory syndrome (MISC): Endotoxin tolerant immunophenotype****J. Isaza-Correa^{1,2,3}, L. Kelly^{1,2,3}, L. Ryan³, J. Allen^{1,2,3}, J. Jones⁴, D. Huggard³, E. Ryan³, B. Freyne⁴, C. O Mhaoldhomnaigh⁴, S. Geoghehan⁴, P. Gavin⁴, T.R. Leahy⁴, K. Butler⁴, E. Molloy^{1,2,3,4,5,6,7*}**¹Trinity College Dublin, Trinity Translational Medicine Institute, Dublin, Ireland²Trinity College Dublin, Trinity Research in Childhood Centre (tricc), Dublin, Ireland³Trinity College Dublin, School of Medicine, Discipline of Paediatrics, Dublin, Ireland⁴Children's Health Ireland at Crumlin, Infectious Diseases and Immunology, Dublin, Ireland⁵Coombe Women and Infants Hospital, Neonatology, Dublin, Ireland⁶Children's Health Ireland at Crumlin, Neonatology, Dublin, Ireland⁷Children's Health Ireland at Tallaght, Neonatology, Dublin, Ireland**BACKGROUND AND AIMS**

MISC is a complex disorder affecting children weeks after SARS-CoV-2. We aimed to study the changes in the systemic innate immune response in children with MISC.

METHODS

Immune cells from children with MISC (n=12; 5-13 years) and control children (n=14, 5-15 years) were analysed by flow cytometry for CD11b (cell activation & migration) and Toll-like receptor (TLR)-4 (lipopolysaccharide recognition, LPS)

in neutrophils (CD66b+) and subpopulations of monocytes (CD14/CD16) stimulated without/with LPS. Changes in subpopulations of lymphocytes (CD3+, CD19+, CD56+, CD4+, CD8+, TCR Vdelta 1+, TCR Vdelta 2+) were also evaluated. Thirteen serum cytokines (IL-1 α , IL-1 β , IL-2, IL-6, IL-8, IL-10, IL-1ra, TNF- α , TNF- β , IFN- γ , VEGF, Epo and GM-CSF) and mRNA levels of inflammasome molecules NLRP3, ASC and IL-1 β were evaluated.

RESULTS

Children with MISC had significantly decreased CD11b neutrophil and monocyte expression following LPS stimulation compared to controls with no differences in TLR4. CD11b and TLR4 was significantly reduced on classical and non-classical monocytes stimulated with LPS in children with MISC. CD3+ and NK cells were significantly decreased and B cells proportions increased in children with MISC. IL-6, IL-10, TNF- β and VEGF serum cytokines increased at basal level, with significantly increased TNF- β with LPS in children with MISC compared to controls. IL-1RA and EPO were decreased at baseline and post-LPS in children with MISC. NLRP3 and ASC mRNA were similar with reduced IL-1 β in children with MISC post-LPS.

CONCLUSIONS

Immune tolerance or trained immunity was prominent in children with MISC and may be amenable to therapeutic intervention.

LO079 / #1531**ESPNIC Session****ESPNIC Session 14: Getting data in paediatric mechanical ventilation****08-10-2022 17:00 - 17:55****How long are we fasting children for extubation?****W.Y.E. Chia*, L. Tume***Alder Hey Children's Hospital, Picu, Liverpool, United Kingdom***BACKGROUND AND AIMS**

Enteral nutrition is considered the first choice of nutrition support in children following paediatric intensive care unit (PICU) admission. Fasting for planned extubation is undertaken with the rationale to have an 'empty stomach' and reduce the risk of aspiration. We wanted to see if our fasting times complied with our local guidance based on national guidance.

METHODS

A retrospective chart review in a single UK mixed cardiac and general PICU, to assess the time of fasting the time of elective extubation 01/09/2021 to 30/11/2021.

RESULT

135 patients with a median age 10.6 months (IQR 1.8-60.4) were included, with 169 elective extubation events. The median fasting time was 5.5 hours (IQR 3.5 – 11) and the mean start time for fasting for extubation was 1000 hours (SD 5.4). 37% of children were extubated between 6am – 12pm and 36% between 12pm and 1700 hours and fewer 27% overnight. Three patients

fed post-pylorically were fasted unnecessarily. The local guideline for fasting before extubation is: 3 hours for infants <1-year receiving breast milk; 4 hours for infants <1-year and all others receiving formula feeds.

CONCLUSIONS

Actual fasting times still exceeded that recommended by our guidance, and this can impact adversely on energy target achievement in critically ill children. Even these guidelines for fasting are based on healthy children eating a normal diet undergoing elective sedation/anaesthesia and not critically ill children. Newer techniques such as gastric point-of-care ultrasound (POCUS) may be able to individualise fasting times for the child if an empty stomach at extubation is indeed required.

LO080 / #2586**ESPNIC Session****ESPNIC Session 14: Getting data in paediatric mechanical ventilation****08-10-2022 17:00 - 17:55****Pragmatic randomised trial of corticosteroids and inhaled adrenaline for bronchiolitis in children in intensive care (DAB Trial)****B. Gelbart^{1,2,3*}, B. Mcsharry⁴, C. Delzoppo³, S. Erickson⁵, K. Lee⁶, W. Butt³, M. Rea⁴, X. Wang⁶, J. Beca⁴, A. Kazemi⁷, F. Shann³**¹Departments of Paediatrics and Critical Care, University of Melbourne, Melbourne, Australia²Murdoch Children's Research Institute, Honorary Fellow, Melbourne, Australia³Royal Children's Hospital, Paediatric Intensive Care Unit, Parkville, Australia⁴Starship Children's Hospital, Paediatric Intensive Care Unit, Auckland, New Zealand⁵Perth Children's Hospital, Paediatric Intensive Care Unit, Perth, Australia⁶Murdoch Children's Research Institute, Clinical Epidemiology and Biostatistics Unit, Melbourne, Australia⁷Middlemore Hospital, Intensive Care Unit, Middlemore, New Zealand**BACKGROUND AND AIMS**

To determine whether the combination of systemic corticosteroids and nebulised adrenaline, compared to standard care, reduces the duration of positive pressure support in children with bronchiolitis admitted to intensive care.

METHODS

We performed a pragmatic, multi-centre, open-label, randomised trial between July 2013 and November 2019 in children less than 18 months old with a clinical diagnosis of bronchiolitis. The intervention group received the equivalent of 13 mg/kg prednisolone over three days then 1 mg/kg daily

for three days, plus 0.05 ml/kg of nebulised 1% adrenaline made up to 6 ml with 0.9% saline via jet nebuliser and mask using oxygen at 12 l/min every 30 minutes for five doses, then 1-4 hourly for three days, then as required for three days. The primary outcome was clinician-managed duration of positive pressure support in intensive care defined as high-flow nasal-prong oxygen, nasopharyngeal continuous positive airway pressure or mechanical ventilation.

RESULTS

210 children received positive pressure support. In the corticosteroid-adrenaline group, 107 children received positive pressure support for a geometric mean of 26 (95% confidence interval [CI], 22 to 32) hours compared with 40 (95% CI, 33 to 47) hours in 103 controls, adjusted ratio 0.66 (95% CI, 0.51 to 0.84), $p=0.001$. In the intervention group, 41 (38%) children experienced at least one adverse event, compared with 39 (38%) in the control group.

CONCLUSIONS

In children with severe bronchiolitis, the duration of pressure support was reduced by regular treatment with systemic corticosteroids and inhaled adrenaline compared with standard care.

LO081 / #2274**ESPNIC Session****ESPNIC Session 15: ECPR to the rescue****08-10-2022 17:00 - 17:55****Cold debriefing implementation for in-hospital paediatric cardiac arrests: Quality improvement project****K.R. Thekkan^{1*}, G. Bottari², C. Cecchetti², E. Tiozzo¹, O. Gawronski¹**

¹*Bambino Gesù Children's Hospital IRCCS, Nursing and Allied Health Professional Development, Continuing Education and Research Unit, Medical Directorate, Rome, Italy*

²*Department of Emergency, Bambino Gesù Children's Hospital IRCCS, Pediatric Intensive Care Unit, Acceptance and General Pediatrics, Rome, Italy*

BACKGROUND AND AIMS

Clinical event debriefing aims to identify optimal and sub-optimal performance to improve quality of care. Cold Debriefings (CD) of In Hospital Cardiac Arrests (IHCA) are a useful tool to improve the management of paediatric patients in cardiac arrests and their survival.

METHODS

Prospective observational study of Cold Debriefings of IHCAs in a tertiary care paediatric hospital. IHCAs monitoring was performed through an electronic registry completed by intensivists. The content of CDs was analyzed through descriptive qualitative analysis. A satisfaction survey was sent to all healthcare providers (HCP) who attended a CD.

RESULTS

A total of 50 CDs was conducted by Zoom from January 2019 to April 2022 for IHCA that occurred in critical care settings (64%) or inpatient wards (36%). Each CDs was attended by a mean of 5 HCPs, primarily intensivists (24%), ward physicians (19%) and nurses (39%). The following themes emerged during CDs: IHCA prevention, situation awareness, resource utilization and readiness, technical skills, communication, leadership and teamwork, parent's management. Suggestions for improvement included simulation training in advanced CPR skills and equipment utilization. Most participants reported the CDs were interesting (94%), useful for quality improvement (70%) and would recommend them to other colleagues (95%).

CONCLUSIONS

The CDs implementation program is applicable and useful to identify strengths and weaknesses in IHCA management. Satisfaction for CDs among health-care professionals in this context was high.

LO082 / #1998**ESPNIC Session****ESPNIC Session 15: ECPR to the rescue****08-10-2022 17:00 - 17:55****Prognostic factors on the clinical evolution of children with immersion accidents admitted to a paediatric intensive care unit****G. Podadera Bravo¹, F. Guerrero Del Cueto^{1*}, A. Lendínez Jurado¹, J. Blasco-Alonso², R. Gil Gómez³, J.M. Camacho Alonso³**¹Hospital Regional Universitario de Málaga - Hospital Materno Infantil, Paediatrics, Málaga, Spain²Hospital Regional Universitario de Málaga - Hospital Materno Infantil, Paediatric Gastroenterology and Nutrition Unit, Paediatrics, Málaga, Spain³Hospital Regional Universitario de Málaga - Hospital Materno Infantil, Paediatric Intensive Care Unit, Málaga, Spain**BACKGROUND AND AIMS**

Search for a predictive model for the evolution and prognosis of patients admitted to the PICU after drowning.

METHODS

Retrospective study of patients in a PICU between 2007 and 2021, analysing the characteristics of the accident, clinical and laboratory data to identify poor prognostic factors (death or sequelae) using multivariate analysis and logistic regression.

RESULTS

76 patients; 4.6±3.4 years; 63.2% male. 59.2% in summer; 89.5% in fresh water; immersion time 5.71±3.80 minutes (58.7% >5 minutes). 69% received

basic CPR, with 50% responding after ≥ 5 minutes; 77.6% required advanced CPR, with 17% not responding. 37.3% with hypothermia and 48.5% with cyanosis. 42.3% initially hemodynamically unstable, 32.7% severe coagulopathy, 43.8% $\text{pH} \leq 7.10$, and 83.8% hyperlactacidemia (6.1 ± 5.1 mmol/L); 38.2% unreactive/hyporeactive mydriasis. 85.7% required mechanical ventilation. 23.7% died and 13.1% had permanent sequelae, mainly neurological. Those with poor outcomes (death or sequelae) had a lower initial pH (6.95 ± 0.21 vs 7.17 ± 0.13 , $p < 0.0001$), longer immersion time (7.8 ± 4.2 vs 4.5 ± 2.9 , $p = 0.001$), lower Glasgow-comma scale (GCS) (4.2 ± 1.4 vs 9.1 ± 3.1 , $p < 0.0001$), higher lactate (11.0 ± 6.2 vs 3.8 ± 2.3 , $p < 0.0001$) and higher Orlowski score (3.1 ± 0.9 vs 1.4 ± 1.0 , $p < 0.0001$). To predict adverse outcomes, an Orlowski score of 3 has a sensitivity of 88% and a specificity of 85% (PPV 74.5%), OR 30.0 (95% CI 8.1-110.3). 58.7% of patients with $\text{GCS} < 8$ (OR 2.4 (95% CI 1.7-3.4)) and 52.4% of lactate > 3.7 (OR 15.4 (95% CI 1.7-3.4)) had unfavourable prognosis.

CONCLUSIONS

Clinical presentation on arrival at the hospital, characteristics of the immersion and action at the accident site influence the evolution. Main prognostic factors: $\text{GCS} < 8$, lactate > 3.7 , Orlowski score ≥ 3 .

LO083 / #1771**EAP Session****EAP Session 16: Autism - An increasing problem?****08-10-2022 17:00 - 17:55****Predictive biomarkers for autism spectrum disorder: A proteomics profiling study in the cork baseline birth cohort****A. Noone^{1,2*}, K. Dowling^{2,3}, E. Ahern^{1,2}, D. O'Boyle^{1,2}, B. Hammer Bech⁴, T. Brink Henriken⁵, L. Gallagher⁶, A. Khashan^{2,7}, D. Murray^{8,9}, J. English^{2,10}**¹University College Cork, Anatomy and Neuroscience, Cork, Ireland²University College Cork, Infant Research Centre, Cork, Ireland³Department of Anatomy and Neuroscience, University College Cork, Cork, Ireland⁴Dept. of Public Health, Aarhus University, Aarhus, Denmark⁵Department of Pediatrics, Aarhus University Hospital, Aarhus N, Denmark⁶Trinity College Dublin, Trinity Institute of Neuroscience, Dublin, Ireland⁷University College Cork, School of Public Health, Cork, Ireland⁸Department of Paediatrics and Child Health, Cork University Hospital, Cork, Ireland⁹INFANT Research Centre, University College Cork, Cork, Ireland¹⁰INFANT Research Centre, University College Cork, Anatomy and Neuroscience, Cork, Ireland**BACKGROUND AND AIMS**

There is a lack of understanding about the aetiology of Autism and children are not diagnosed reliably until they are at least 3 to 4 years of age. Henceforth, there is an urgent need for the identification of biomarkers for the prediction of Autism.

AIM

To identify protein biomarkers in cord blood to aid the early identification of infants with Autism.

METHODS

Participants were recruited from the Cork BASELINE Birth Cohort (<http://www.baselinestudy.net/>). Proteomic profiling was undertaken on cord blood plasma from 22 ASD cases vs 44 neurotypical(NT) controls. Immunodepletion was undertaken using an Affinity Removal System (MARS) coupled to a high-performance liquid chromatography (HPLC) system. Protein fractions underwent tryptic digestion and desalting prior to analysis on the Bruker TimsTof Pro for label-free LC-MS/MS. Label-free quantification for biomarker discovery was performed in Max Quant.

RESULTS

Preliminary results have profiled 252 cord blood plasma proteins for differential protein expression between Autism cases and NT controls. Of these, 131 proteins are uniquely expressed in cord blood plasma, in comparison to adult plasma. Protein networks profiled for differential expression include coagulation, stress response, complement activation and immune response. Machine learning classification and cross validation to create logistic regression and random forest models in R (Version 4.1.1) is underway for prediction of autism outcome.

CONCLUSIONS

We undertook the first proteomic profiling of cord blood plasma from children who later received a diagnosis of Autism. The markers identified in this study will shed light on the molecular mechanisms implicated in the pathophysiology of Autism.

LO084 / #901

EAP Session

EAP Session 16: Autism - An increasing problem?

08-10-2022 17:00 - 17:55

Autism friendly phlebotomy

A. Gallagher*, J. Lyons, U. Murtagh

Children's Health Ireland, Paediatrics, Dublin, Ireland

BACKGROUND AND AIMS

Children with autism spectrum disorder (ASD) have similar medical requirements to their neurotypical peers. Sensory sensitivities and overstimulating environments make minor medical procedures such as phlebotomy particularly difficult, causing significant distress for children and their families. An autism friendly phlebotomy service attempts to reduce upset and anxiety with use of social stories, play specialists and Entonox as required. Entonox is a ready-to-use gas mixture consisting of 50% nitrous oxide and 50% oxygen, with analgesic properties and a short half-life, making it suitable sedation for minor procedures in children.

METHODS

Online referrals are collated at central referrals at Children's Health Ireland. For suitable children a phone call is made to parents to discuss child's specific needs. Social stories and practice packs are sent to families. All records are kept in the patient's chart. All staff involved completed online training in use of Entonox. On the day of the appointment children and their families are met by the medical, nursing and play specialist staff. Use of distraction and relaxation techniques as well as Entonox gas allows for calm and painless phlebotomy.

RESULTS

To date clinics have been carried out with good success. This quality improvement project will continue until July 2022. Based on results from a pilot project completed in January 2021, we expect similar success from this project.

CONCLUSIONS

The use of social stories, play and distraction techniques as well as Entonox can considerably enhance experience of phlebotomy for children with ASD and their families. Autism friendly phlebotomy service should be continued and expanded.

LO085 / #1343**ESPR Session****ESPR Session 17: PPHN: What's new****08-10-2022 17:00 - 17:55****Survival of infants with persistent pulmonary hypertension of the newborn: 12-year experience****G. Maneenil¹, K. Chuaikaew^{1*}, A. Thatrimontrichai²**¹Department of Pediatrics, Faculty of Medicine, Prince of Songkla University, Songkhla, Thailand²Prince of Songkla University, Pediatrics, Songkhla, Thailand**BACKGROUND AND AIMS**

Persistent pulmonary hypertension of the newborn (PPHN) is a serious neonatal condition characterized by elevated pulmonary vascular resistance, resulting in severe hypoxemia, and associated with high mortality and morbidities. This study aimed to determine the survival rate of infants diagnosed with PPHN over the last 12 years at our center.

METHODS

A retrospective study was conducted in neonates diagnosed with PPHN between January 2010 and December 2021 at the neonatal intensive care unit of Songklanagarind Hospital. Inhaled nitric oxide (iNO) was introduced in 2013, and the survival rates between two periods (2010–2012 and 2013–2021) were compared.

RESULTS

A total of 234 neonates with PPHN were identified during the period. The overall survival rate was 77.3%. The 10-day and 30-day survival rate were 79.8% (95% confidence interval [CI]: 74.8–85.1) and 77.2% (95%CI: 71.8–83.1), respectively.

The survival rate in the era after the use of iNO was significantly higher than in the era before the use of iNO (83.9% vs 55.5%, $P < 0.001$). The 10-day survival rate in the era before and after the use of iNO were 59.3% (95%CI: 47.5–73.9) and 86.0% (95%CI: 81.1–91.3), $P < 0.001$. The survival rates of PPHN with transient tachypnea of the newborn, meconium aspiration syndrome, pneumonia, respiratory distress syndrome, and congenital diaphragmatic hernia were 97.6%, 81.1%, 76.6%, 75%, and 17.6%, respectively.

CONCLUSIONS

The use of iNO therapy was associated with dramatic improvement of survival rate in neonates with PPHN. PPHN with congenital diaphragmatic hernia had a poor prognosis in our study.

LO086 / #1338**ESPR Session****ESPR Session 17: PPHN: What's new****08-10-2022 17:00 - 17:55****Exhaled volatile organic compounds for the detection of bronchopulmonary dysplasia in preterm infants****M. Romijn^{1,2*}, A. Van Kaam^{1,2}, D. Fenn^{3,4}, L. Bos^{3,4}, C. Van Den Akker^{1,2}, J. Cerullo⁴, P. Brinkman^{3,4}, W. Onland^{1,2}**¹Amsterdam UMC location University of Amsterdam, Neonatology, Amsterdam, Netherlands²Amsterdam UMC, Amsterdam Reproduction & Development Research Institute, Amsterdam, Netherlands³Amsterdam UMC locatie University of Amsterdam, Respiratory Medicine, Amsterdam, Netherlands⁴Amsterdam UMC location University of Amsterdam, Laboratory of Experimental Intensive Care and Anaesthesiology, Amsterdam, Netherlands**BACKGROUND AND AIMS**

Early identification of which preterm infants on non-invasive respiratory support are at high-risk for developing bronchopulmonary dysplasia (BPD) is troublesome. Volatile organic compounds (VOCs) in exhaled breath could be potential biomarkers for respiratory diseases. This study aims to investigate the predictive power of exhaled breath VOCs for BPD development in preterm infants.

METHODS

Exhaled air was collected from preterm infants born <30 weeks' gestation at 7 days postnatal age. Ion-fragments resulted from Gas-Chromatography–Mass-Spectrometry analysis, were used to derive a VOC prediction model using sparse Partial Least Square analysis and thereafter internally validated by bootstrapping for the outcome moderate or severe BPD. The predictive

and calibration performances of a logistic regression model based solely on clinical predictors from the NICHD model were compared against a model including both clinical and VOC predictors.

RESULTS

Breath samples from 87 infants with a mean gestational age of 26.8(\pm 1.5) weeks were included for VOC model development, of whom 21 (24.1%) developed moderate/severe BPD. The VOC model showed a c-statistic of 0.92 (95% confidence interval 0.84-0.99) for the prediction of BPD, and a mean accuracy of 0.72 (min-max 0.54-0.85) after bootstrapping. Addition of VOCs to clinical predictors resulted in significant improvement of predicting BPD compared to clinical predictors alone (p-value 0.007, c-statistic 0.95 versus 0.83 respectively), and improvement of calibration (Figure 1).

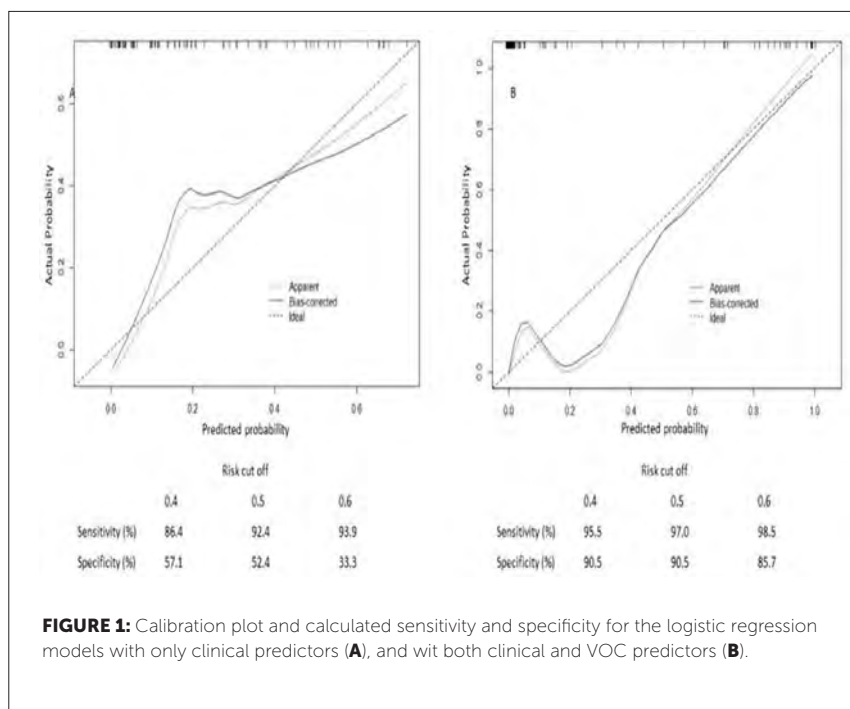

FIGURE 1: Calibration plot and calculated sensitivity and specificity for the logistic regression models with only clinical predictors (A), and with both clinical and VOC predictors (B).

CONCLUSIONS

This study showed for the first time, that VOCs in exhaled air collected during non-invasive respiratory support early after birth, are high potential biomarkers for predicting BPD.

LO087 / #2662**ESPR Session****ESPR Session 17: PPHN: What's new****08-10-2022 17:00 - 17:55****NIPPV as a rescue therapy for preterm infants with RDS who fail initial NCPAP****J. Meneses*, A. Ishigami, J. Alves***Instituto de Medicina Integral Prof Fernando Figueira, Neonatology, Recife, Brazil***BACKGROUND AND AIMS**

Nasal continuous airway pressure (NCPAP) and nasal intermittent positive pressure ventilation (NIPPV), minimize the adverse effects of MV. The advantages of NIPPV over NCPAP in post extubation and as primary respiratory support has been well established. There is a lack of research that evaluates NIPPV as a rescue therapy.

OBJECTIVE

To assess whether NIPPV as rescue therapy in NCPAP failure, reduces need of MV in infants with RDS.

METHODS

Cohort involving preterm infants, initially with NCPAP and who during the first 120 hours of life, failed and required NIPPV rescue. They were followed 72 hours after initiating NIPPV rescue and classified: success (no indication of MV) or failure (indication of MV)

RESULTS

Of 156 preterm infants, 85 (54.5%) were considered successful and 71 (45.5%) failed rescue NIPPV. NIPPV failure group had a significantly lower gestational age and birthweight, a higher SNAPPE II score, and greater use of surfactant ($p < 0.05$).

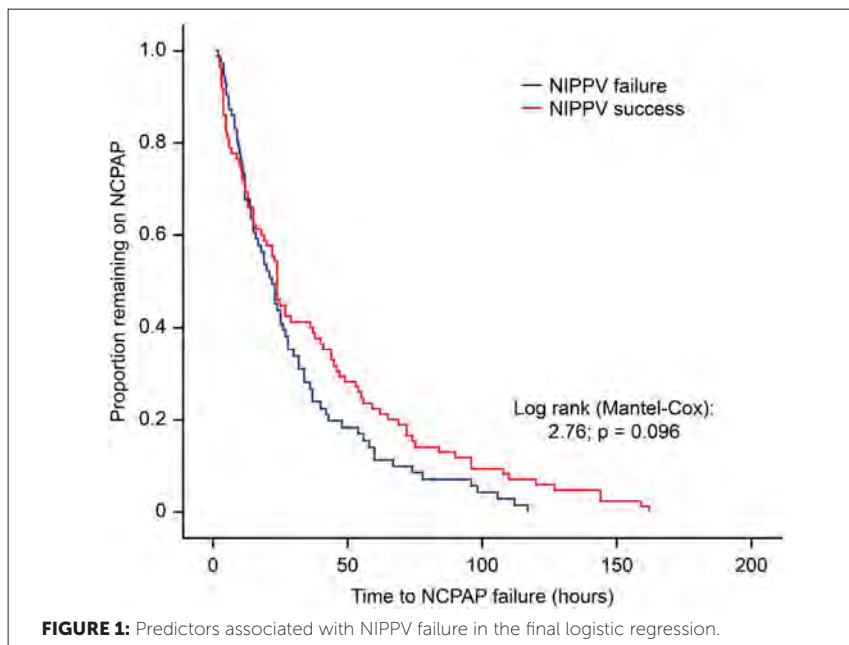

Table 1: Variables associated with NCPAP failure final logistic regression

VARIABLES	OR	OR (95%CI)	p value
Birthweight			0.02
< or = 1000g	2.37	1.17 - 4.82	
> 1000g	1.00	-----	
Surfactant			<0.001
yes	5.49	2.48 - 12.12	
no	1.00	-----	

A lower incidence of major morbidities as well as greater survival and survival without major morbidities were found in the success group. NIPPV failure had an earlier failure of initial NCPAP when compared to the success group ($p=0.09$) Fig1. In final logistic regression model, birthweight less or = 1000g and surfactant remained significant.

CONCLUSIONS

Successful rescue NIPPV decreased mechanical ventilation and morbidities in neonates who failed initial NCPAP.

LO088 / #1099**ESPNIC Session****ESPNIC Session 18: Life after sepsis****08-10-2022 17:00 - 17:55****The accuracy of initial assessment score for mortality prediction in pediatric septic shock****K. Saelim****Prince of Songkla University, Pediatrics, Songkhla, Thailand***BACKGROUND AND AIMS**

Sepsis and septic shock are life-threatening conditions, which cause significant mortality and morbidity in children around the world. Accurate, initial assessment parameters to classifying patient severity are very important and guide the physicians' management. Currently, there is no definite consensus for which score has the most accuracy. Hence, this study aimed to assess the accuracy of each initial assessment score: SIRS criteria, pSOFA and age adjusted qSOFA (a-qSOFA), for pediatric septic shock mortality prediction.

METHODS

This retrospective study was conducted in a tertiary university hospital. Patients who were diagnosed with septic shock or received treatment for septic shock; from 2014-2020, were included in this study. The primary outcome was the accuracy of initial score for in-hospital mortality prediction. The discrimination of each score performance used area under the receiver operating characteristic curve (AUROC).

RESULTS

From the 279 children included, 77 patients were non-survivors (27.6% mortality). The performance for in-hospital mortality prediction, pSOFA was the most accurate (AUROC 0.709) over a-qSOFA (AUROC 0.601) and SIRS criteria (0.527), respectively. For secondary outcomes the SIRS criteria had the highest AUROC to predict high vasoactive-inotropic drugs used (AUROC 0.667), followed by pSOFA and a-qSOFA, AUROC 0.637 and 0.540, respectively.

CONCLUSIONS

pSOFA has the highest prognostic accuracy for in-hospital mortality among SIRS criteria and a-qSOFA. Patients fulfilling SIRS criteria tended to use high inotropic drugs more than qSOFA and a-qSOFA.

LO089 / #2531**ESPNIC Session****ESPNIC Session 18: Life after sepsis****08-10-2022 17:00 - 17:55****The current and future state of pediatric sepsis definitions: An international survey****L. Morin^{1*}, M. Hall², D. De Souza³, L. Guoping⁴, R. Jabornisky⁵,
N. Shime⁶, S. Ranjit⁷, P. Giholm⁸, J. Zimmerman⁹, L. Sorce¹⁰,
A. Argent¹¹, N. Kissoon¹², P. Tissieres¹, S. Watson⁹, L. Schlapbach¹³**¹APHP PARIS SACLAY - HOPITAL BICETRE, Pediatric Intensive Care Unit, Le Kremlin-Bicêtre, France²Nationwide Children's Hospital, Pediatric Intensive Care, Columbus, United States of America³Hospital Universitario da Universidade de Sao Paulo, Pediatric Intensive Care, Sao Paulo, Brazil⁴Children's Hospital of Fudan University, Shanghai, China, Pediatric Intensive Care, Shanghai, China⁵Universidad Nacional del Nordeste, Pediatric Intensive Care, Corrientes, Argentina⁶Department of Emergency and Critical Care Medicine, Graduate School of Biomedical & Health Sciences, Hiroshima University, Japan, Pediatric Intensive Care, Hiroshima, Japan⁷Apollo Children's Hospital, Chennai, India, Pediatric Intensive Care Unit, Chennai, India⁸Child Health Research Centre, and Paediatric Intensive Care Unit, The University of Queensland, and

Queensland Children's Hospital, Brisbane, Australia, Child Health Research Centre, Brisbane, Australia

⁹Seattle Children's Hospital, University of Washington School of Medicine, Pediatric Intensive Care, SEATTLE, United States of America¹⁰Ann & Robert H. Lurie Children's Hospital, Pediatric Intensive Care, Chicago, United States of America¹¹Department of Paediatrics and Child Health, Red Cross War Memorial Children's Hospital, Pediatric Intensive Care, Cape Town, South Africa¹²British Columbia Women and Children's Hospital, Pediatric Intensive Care, Vancouver, Canada¹³Department of Intensive Care and Neonatology, University Children's Hospital Zurich, Zurich, Switzerland**BACKGROUND AND AIMS**

Definitions for pediatric sepsis were established in 2005 without data-driven criteria. It is unknown whether the more recent adult Sepsis-3 definitions meet the needs of providers caring for children. We aimed to explore the use and applicability of criteria to diagnose sepsis and septic shock in children across the world.

METHODS

This is an international electronic survey of clinicians distributed across international and national societies representing pediatric intensive care, emergency medicine, pediatrics, and pediatric infectious diseases. Respondents stated their preferences on a 5-point Likert scale.

RESULTS

There were 2835 survey responses analyzed, of which 48% originated from upper- middle income countries, followed by high income countries (38%) and low or lower-middle income countries (14%). Abnormal vital signs, laboratory evidence of inflammation, and microbiologic diagnoses were the criteria most used for the diagnosis of "sepsis." The 2005 consensus definitions were perceived to be the most useful for sepsis recognition, while Sepsis-3 definitions were stated as more useful for benchmarking, disease classification, enrollment into trials, and prognostication. The World Health Organization definitions were perceived as least useful across all domains. Seventy one percent of respondents agreed that the term sepsis should be restricted to children with infection-associated organ dysfunction.

CONCLUSIONS

Clinicians around the world apply a myriad of signs, symptoms, laboratory studies, and treatment factors when diagnosing sepsis. The concept of sepsis as infection with associated organ dysfunction is broadly supported. Currently available sepsis definitions fall short of the perceived needs. Future diagnostic algorithms should be pragmatic and sensitive to the clinical settings.

LO090 / #2166**ESPNIC Session****ESPNIC Session 19: Recognising life-threatening deterioration****08-10-2022 17:00 - 17:55****In-Patient emergency transfer to critical care; critical deterioration event (CDE) metric and Children's Resuscitation Intensity Scale (CRIS) for predicting Length of Stay (LOS) and mortality****G. Sefton^{1*}, E. Carrol², B. Carter³, S. Lane⁴, F. Mehta⁵, C. Eyton-Chong⁶, S. Siner⁷, D. Jones⁷, C. Lambert⁸, L. Evans⁷**

¹Alder Hey Children's Nhs Foundation Trust, Institute of Infection, Veterinary and Ecological Sciences Liverpool, Liverpool, United Kingdom

²University of Liverpool, Institute of Infection, Veterinary and Ecological Sciences Liverpool, Liverpool, United Kingdom

³Department of Nursing, Edge Hill University, QP, United Kingdom

⁴Department of Medical Statistics, University of Liverpool, BX, United Kingdom

⁵Alder Hey Children's Nhs Foundation Trust, General Paediatrics, Liverpool, United Kingdom

⁶Alder Hey Children's Nhs Foundation Trust, Hdu, Liverpool, United Kingdom

⁷Alder Hey Children's Nhs Foundation Trust, Clinical Research Business Unit, Liverpool, United Kingdom

⁸University of Liverpool, Detect Study, Liverpool, United Kingdom

BACKGROUND AND AIMS

International variation in the threshold for admission to critical care make it challenging to compare research studies with that outcome. The critical deterioration (CD) metric, defined as transfer to the intensive care unit (ICU) followed by noninvasive or invasive mechanical ventilation or vasopressor infusion within 12 hours, has been used as a proximate outcome for evaluating Rapid Response Team performance. The Children's Resuscitation Intensity Scale (CRIS) was used to describe the stabilisation following deterioration and

as a proxy measure for the timeliness of transfer to critical care. The NIHR funded DETECT study (ISRCTN61279068) explored the relationship of these measures on outcome in a 4 year cohort of critical deterioration.

METHODS

Data was prospectively collected for an interrupted time series of critical deterioration in a single paediatric hospital preceding, throughout implementation of an intervention and post intervention (March 2018 to February 2022). Data were categorised as a CDE (yes/no) and were categorised using the CRIS. SPSS 22 was used to evaluate associations with LOS and mortality.

RESULTS

1116 emergency transfers to critical care occurred. 872 (78%) met the criteria for CDE, occurring 18 times more frequently than cardiac arrest making it

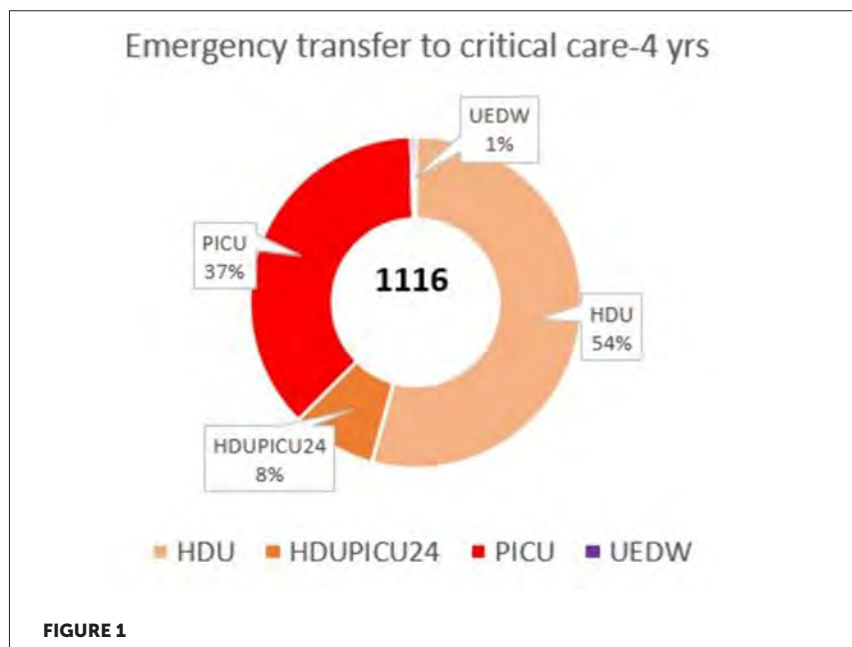

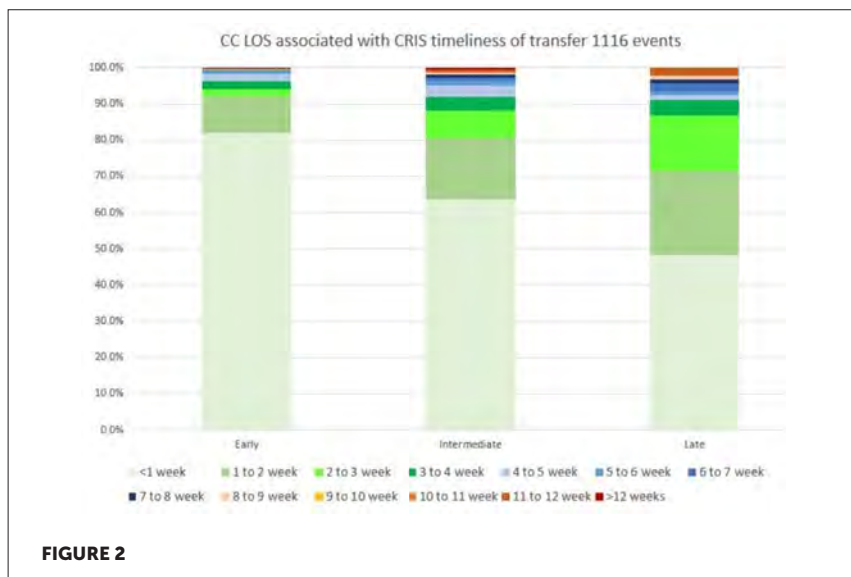

an appropriate outcome measure for evaluating the effectiveness of PEWS. CRIS categorisation showed that transfer were early 27%, intermediate 65% and late 8%, with clear differentiation in LOS between groups.

CONCLUSIONS

The Critical Deterioration Event metric is easy to capture and could standardise reporting of studies focused on in-patient deterioration. CRIS can be used as a proxy for timeliness of transfer to critical care.

LO091 / #788**ESPNIC Session****ESPNIC Session 19: Recognising life-threatening deterioration****08-10-2022 17:00 - 17:55****Validation of a modified bedside pediatric early warning system score for detection of clinical deterioration in hospitalized pediatric oncology patients: A prospective cohort study****M. Soeteman^{1*}, T. Kappen², M. Van Engelen¹, M. Marcelis¹, E. Kilsdonk¹, M. Van Den Heuvel-Eibrink¹, E. Nieuwenhuis³, W. Tissing^{1,4}, M. Fiocco^{1,5}, R. Wösten – Van Asperen⁶**¹Princess Máxima Center for Pediatric Oncology, Pediatric Oncology, Utrecht, Netherlands²Department of Anesthesiology, Wilhelmina Children's Hospital/University Medical Center Utrecht, Utrecht, Netherlands³Department of Pediatrics, Wilhelmina Children's Hospital/University Medical Center Utrecht, Utrecht, Netherlands⁴Department of Pediatric Oncology, University Medical Center Groningen, Groningen, Netherlands⁵Leiden University, Mathematical Institute, Leiden, Netherlands⁶Department of Pediatric Intensive Care, University Medical Center Utrecht/Wilhelmina Children's Hospital, Utrecht, Netherlands**BACKGROUND AND AIMS**

Hospitalized pediatric oncology patients are prone to clinical deterioration. Pediatric early warning system (PEWS) scores have not been prospectively validated for these patients. We determined the predictive performance of a modified BedsidePEWS score for clinical deterioration during an inpatient ward admission in pediatric oncology patients.

METHODS

This prospective cohort study was conducted in hospitalized pediatric oncology patients aged 0 to 18 years at the Dutch pediatric oncology national referral center. The association between PEWS score and unplanned PICU admission or cardiopulmonary resuscitation (CPR) was estimated by a Cox proportional hazard model. The predictive performance (discrimination and calibration) of the model was assessed by bootstrapping.

RESULTS

We included 1137 patients, of which 103 patients experienced 130 primary outcome events. The modified BedsidePEWS score was significantly associated with time to unplanned PICU admission or CPR (hazard ratio 1.65 (95%CI 1.59–1.72) per point increase). Discriminative ability was moderate, considering a discrimination-index close to zero and concordance-index of 0.83. Calibration was excellent (index-corrected slope of 0.99). Positive and negative predictive values at score cut-off 8, at which escalation of care is required, were 1.4% and 99.9%, respectively. Figure 1 displays PEWS scores

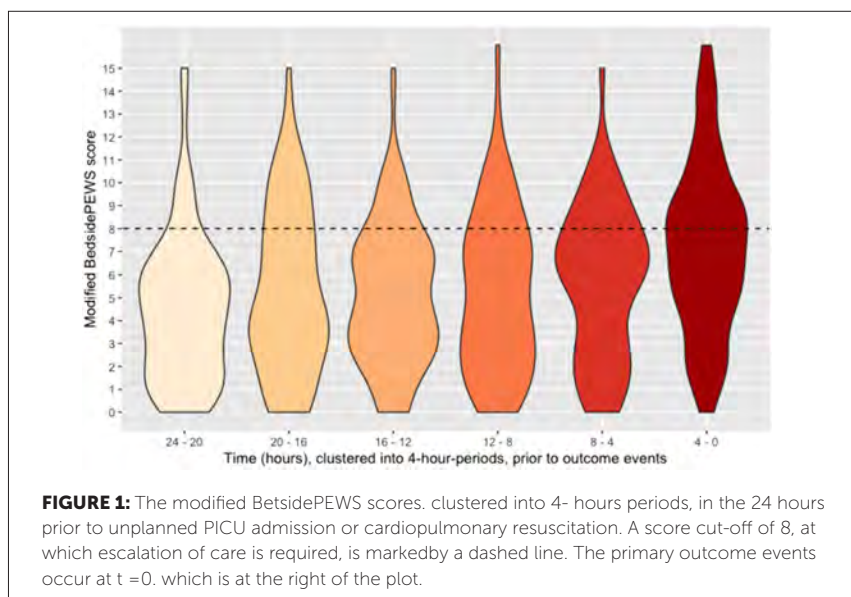

in the 24 hours prior to event. Patients requiring PICU transfer with PEWS scores below 8 typically had airway or neurological problems.

CONCLUSIONS

The modified BedsidePEWS score is a strong prognostic factor for time to unplanned PICU admission or CPR in pediatric oncology patients. The score may aid in clinical decision making for timing of escalation of care.

LO092 / #1395**ESPNIC Session****ESPNIC Session 19: Recognising life-threatening deterioration****08-10-2022 17:00 - 17:55****Beyond objective measurements: Nurses' identification of hospitalised pediatric patients at risk of clinical deterioration: A qualitative study****J. Rørbech^{1*}, C.S. Jensen^{1,2}, P. Dreyer³, S. Herholdt-Lomholdt⁴**¹*Department of Paediatrics and Adolescent Medicine, Aarhus University Hospital, Aarhus N, Denmark*²*Aarhus University Hospital, Research Center for Emergency Medicine, Aarhus N, Denmark*³*Aarhus University Hospital, Intensive Care, Aarhus N, Denmark*⁴*Nord University, Faculty of Nursing and Health Sciences, Bodø, Norway***BACKGROUND AND AIMS**

While the use of Pediatric Track and Trigger Tools as a standard to discriminate high level of urgency in pediatric care has received considerable attention, less focus has been given to other important factors such as nurses' clinical observations and judgement. The purpose of this study was to explore nurses' observational practice and focus on which non-measurable signs and symptoms nurses find important when identifying inpatient pediatric patients at risk of clinical deterioration.

METHODS

This was an inductive qualitative study based on an interpretive description methodology. Data were obtained through participant observation of experienced nurses working in a Danish pediatric unit and focus group interviews with pediatric nurses. Field notes were taken, and focus group interviews

were audio taped and transcribed. A thematic text condensation method was used to analyse data.

RESULTS

Findings revealed the following four main themes of non-measurable signs and symptoms that nurses find important when identifying children at risk of clinical deterioration: Colour and skin tone; sounds; movement patterns; behavioural signs.

CONCLUSIONS

This study suggest that pediatric patients show signs and symptoms that go beyond the objective measurements integrated in Pediatric Track and Trigger Tools and they should not be ignored as they are highly valuable to nurses who are responsible for observing inpatient pediatric patients at risk of clinical deterioration.

LO093 / #1229**EAP Session****EAP Session 20: Early origin of diseases- What is the role of the paediatrician****08-10-2022 17:00 - 17:55****Maternal BMI and gestational weight gain and early childhood growth trajectories****A. Österroos*, L. Lindström, P. Wikman, A. Forslund, A.-K. Wikström, I. Sundström Poromaa, F. Ahlsson***Department of Women's and Children's Health, Uppsala University, Uppsala, Sweden***BACKGROUND AND AIMS**

Childhood obesity is associated with high maternal BMI, but there are conflicting results about the link to gestational weight gain (GWG). We aimed to examine the relationship between GWG in mothers with varying pre-pregnancy BMI and childhood growth until five years of age, and the risk of overweight and obesity at four years.

METHODS

62,064 mother-child pairs from Uppsala County Mother and Child Cohort were divided into 15 groups according to maternal pre-pregnancy BMI and GWG. Postnatal growth patterns were analyzed with linear mixed regression models within maternal BMI-groups. Odds of overweight and obesity at four years of age was assessed with logistic regression analyses and adjusted for potential confounders.

RESULTS

GWG was positively associated with BMI z-score at birth. In children to underweight mothers, a decrease in BMI z-score from 1.5 to 5 years was seen for all GWG groups, while an increase in BMI z-score was seen in children to overweight and obese mothers for all GWG groups. The adjusted odds ratio (aOR) of overweight and obesity at 4 years was increased in children to normal weight mother with excessive GWG (aOR 1.19, 95% CI 1.02-1.39), and the highest in children to overweight and obese mothers with excessive GWG (aOR 2.01, 95% CI 1.76-2.31, and 3.95, 95% CI 2.98-5.20, respectively), compared with normal weight mothers with adequate GWG.

CONCLUSIONS

GWG affects size at birth, and excessive GWG increase the risk of overweight and obesity at 4 years of age in children to normal weight and overweight mothers.

LO094 / #1577**EAP Session****EAP Session 20: Early origin of diseases- What is the role of the paediatrician****08-10-2022 17:00 - 17:55****Early childhood development over time - An example of the importance of regularly reviewing milestones and developmental patterns****T. Fuschlberger^{1*}, E. Leitz², G. Esser³, F. Voigt², R. Schmid⁴, V. Mall², A. Friedmann²**¹Technische Universität München, Chair of Social Paediatrics, München, Germany²Technical University of Munich, Chair of Social Paediatrics, Munich, Germany³Universität Potsdam, Psychotherapie Und Interventionsforschung, Potsdam, Germany⁴Kinder- und Jugendarztpraxis, Chair of Social Paediatrics, Altötting, Germany**BACKGROUND AND AIMS**

Monitoring of a child's developmental status is an essential part of pediatric health care. Standardized developmental screenings are utilized to identify developmental delays so that therapeutic interventions can be offered as early as possible. Developmental test scores tend to change over time (Flynn effect) and may distort evaluation [1-3]. Hence, the regular review of developmental instruments is necessary.

METHODS

To determine possible changes in age when children reach developmental milestones over the past decades, we compared cross-sectional developmental data (cognition, language, motor skills, social development, daily-living skills) from children aged 0-47 months collected in 1984 and in 2018 in the course of the "Munich Functional Developmental Diagnostic (MFED1-4) new standardization study".

RESULTS

N = 2.147 children and their parents were included (1984 sample: N = 1.660; 51.6% male and 2018 sample: N = 487; 49% male). The sign test showed a significant difference ($p = .000$) in the MFED total score, and in the cognition and daily-living skills subscales.

CONCLUSIONS

The comparison of developmental data as measured by the MFED showed that children in 2018 achieve developmental milestones at an earlier age than children in 1984. This referred primarily to the developmental areas of cognition and daily-living skills and could be related to e.g. societal changes, such as changing parenting trends and values, and increased parental knowledge about child development and education [4-5]. A regular revision and re-norming of developmental test procedures is essential for an objective and reliable evaluation of child development.

REFERENCES

- [1] Flynn, J. R. (1984). The mean IQ of Americans: Massive gains 1932 to 1978. *Psychological Bulletin*, 95, 29–51.
- [2] Lynn, R. (2009): What has caused the Flynn effect? Secular increases in the Development Quotients of infants. *Intelligence*, 37 (1), 16–24.
- [3] Anderson, P. J., Burnett, A. (2017). Assessing developmental delay in early childhood - concerns with the Bayley-III scales. *Clin. Neuropsychol.*, 31(2), 371–381.
- [4] Jackson, M., Kiernan, K., & McLanahan, S. (2017). Maternal Education, Changing Family Circumstances, and Children's Skill Development in the United States and UK. *Ann Am Acad Pol Soc Sci*, 674(1), 59–84. doi:10.1177/0002716217729471
- [5] Roberts, E., Bornstein, M.H., Slater, A.M. and Barrett, J. (1999). Early cognitive development and parental education. *Inf. Child Develop.*, 8, 49–62.

CO-AUTOREN

- [1] Technische Universität München, Fakultät für Medizin, Lehrstuhl für Sozialpädiatrie
- [2] kbo Kinderzentrum München
- [3] Kinder- und Jugendarztpraxis Prof. Dr. med. R. Schmid & Dr. med. A. Hauptmann
- [4] Universität Potsdam & Prof. Esser - Psychotherapiepraxis für Kinder, Jugendliche und Eltern
- [5] Ascher, M., Christl, M., Czempel, M., Endlich, U., Fuhrer, C., Gehrke, M., Hollmann, M., Jäger, H., Kintscher, C., Kopf, M., Kühne, H., Lehmann, K., Mieth, K., Müller, J., Müller, St., Nied-Lang, B., Niegl, S., Ponstingl, E., Röckl, J., Schmidt, R., Schnurre, T., Schulz, D., Wenzel, K. & Wollwerth, R.

LO095 / #520

EAP Session

EAP Session 20: Early origin of diseases- What is the role of the paediatrician

08-10-2022 17:00 - 17:55

Strains of group B streptococcus (*Streptococcus agalactiae*) and their clinical course in early and late onset infant disease

M. Andersen^{1*}, B. Smith², M. Murra³, S. Nielsen⁴, H.-C. Slotved⁵, T. Henriksen¹

¹Aarhus University Hospital, Paediatrics and Adolescent Medicine, Aarhus, Denmark

²Hvidovre Hospital, Pediatrics, Hvidovre, Denmark

³Sygehus Lillebaelt, Clinical Microbiology, Vejle, Denmark

⁴Aarhus University, Biomedicine, Aarhus, Denmark

⁵Statens Serum Institut, Bacteria, Parasites, and Fungi, Copenhagen, Denmark

BACKGROUND AND AIMS

Surveillance of Group B *Streptococcus* (GBS, *Streptococcus agalactiae*) strains in infants and associated clinical characteristics may guide development of effective vaccines. Therefore, we aimed to investigate the association between GBS strains and clinical course in infant disease.

METHODS

We included GBS isolates from blood and cerebrospinal fluid of hospitalized Danish infants from 0-7 (EOGBS) and 8-90 (LOGBS) days of life between 1999 to 2009. Isolates were analyzed by serotyping and multilocus sequence typing with classification into clonal complexes (CC). Clinical outcomes were acquired by questionnaires completed by treating physician including information on sample type, disease onset, symptom severity, treatment duration, and mortality.

RESULTS

Among 212 GBS isolates, the most common strains were III/CC17 (34%), Ia/CC23 (15%), III/CC19 (12%), Ib/CC8-10 (6%), and V/CC1 (5%). Strain Ia/CC23 was associated with EOGBS, while strain III/CC17 was associated with LOGBS. Strain III/CC17 had highest percentage of samples from cerebrospinal fluid (26%), while III/CC19 had least (8%). Strain III/CC19 had highest mortality rate (22%) followed by Ia/CC23 (16%), Ib/CC8-10 (9%), III/CC17 (6%), and then V/CC1 (0%). No clear associations were found between strains and symptom severities and treatment duration.

CONCLUSIONS

Strain Ia/CC23 was associated with EOGBS and III/CC17 with LOGBS. Infection with III/CC17 often resulted in meningitis and III/CC19 in sepsis, while III/CC17 had 16% lower mortality rate compared with III/CC19; indicating that clinical course of serotype III is affected by the associated clonal complex. As several GBS strains were frequent and differences in clinical courses were found, this emphasizes the need for multimodal surveillance and vaccine targeting.

LO096 / #700**ESPR Session****ESPR Session 21: Impact of discharge planning****08-10-2022 17:00 - 17:55****Single-family rooms in a neonatal intensive care unit: A thematic analysis of experiences from parents and nurses****J.N. Larsen^{1*}, H. Hansson², S. Beck¹, V. Zoffmann³**¹*Copenhagen University Hospital, Neonatology, Copenhagen, Denmark*²*Copenhagen University Hospital, Paediatric and Adolescent Medicine, Copenhagen, Denmark*³*Copenhagen University Hospital, The Interdisciplinary Research Unit of Women's, Children's and Families' Health, Copenhagen, Denmark***BACKGROUND AND AIMS**

In 2021 part of the Neonatal Department University Hospital Copenhagen moved to a temporally unit with single-family rooms (SFR) due to damage by water. This gave us a unique possibility to explore what challenges and advantages we might face when moving into a new Children's Hospital in 2025 with SFR. Our study aimed to investigate the experiences of both parents and nurses with SFR.

METHODS

We conducted two focus group interviews in June 2021 in our department. Parents of newborns in SFR (n=6) participated in one interview (twenty-two invited). Nurses working in the department (n=5) participated in another interview (eleven invited). The participants were provided with a set of unfinished sentences which they completed in writing as self-reflection in preparation for the interview and we used a semi-structured interview guide. Interviews were analyzed using thematic analysis.

RESULTS

Six themes emerged 1) "A place for joy and sorrow", 2) "room for father and his voice", 3) "simulation of a home", 4) "attemptive opening to the world", 5) "worry in me" and 6) "sense of togetherness". The SFR made room for expressing feelings in private, family formation to begin, and a self-initiated attemptive opening to the world for the families. Fathers' role became more present in the SFR as they felt less limited. The nurses worried because of increased demands but also found a valuable sense of togetherness across the regular teams in the temporally unit.

CONCLUSIONS

The results indicate that SFR are beneficial for families, but nurses may have challenges with increased demands.

LO097 / #785**ESPNIC Session****ESPNIC Session 22: Thinking outside the box
08-10-2022 17:00 - 17:55****Barriers and facilitators of early mobilization programs in dutch pediatric intensive care units****B. Geven¹, J. Maaskant², J. Woensel¹, S. Verbruggen³, E. Ista^{3*}**

¹Amsterdam UMC, location University of Amsterdam, Pediatric Intensive Care Unit, Amsterdam, Netherlands

²Amsterdam UMC location University of Amsterdam, Pediatrics, Amsterdam, Netherlands

³Department of Pediatric Surgery, Erasmus MC – Sophia Children's Hospital, Pediatric Intensive Care, Rotterdam, Netherlands

BACKGROUND AND AIMS

Early mobilization of critically ill children, admitted on a Pediatric Intensive Care Unit (PICU), has been shown to be safe and feasible. However, mobility goals are not reached and barriers and facilitators of healthcare professionals directly involved in mobilizing critically ill children are largely unknown. Therefore, we explored barriers and facilitators regarding early mobilization of critically ill children as perceived by PICU staff.

METHODS

A survey study among PICU staff on seven PICUs in the Netherlands. The questionnaire consisted of 17 questions, exploring patient-, structural-, process- and culture-related factors potentially influencing early mobilization.

RESULTS

We invited 641 healthcare professionals, of whom 215 responded (33.5%): 159 (75%) nurses, 40 (19%) physicians, and 14 (6%) physical therapists. Early mobilization was perceived as potentially beneficial to shorten duration of

mechanical ventilation (86%), improve wake/sleep rhythm (86%) and shorten length of stay in the PICU (85%). Perceived barriers for early mobilization were hemodynamic instability (78%), risk of dislocation of lines/tubes (74%), and the level of sedation (62%). In addition, reluctance exists to mobilize patients on ECMO (63%) and patients with traumatic brain injury (49%). In total, 40.3% of PICU nurses stated that physical therapists provided enough support on their PICU, but 84.6% of the physical therapists believed support was sufficient.

CONCLUSIONS

Participating PICU staff perceived early mobilization potentially beneficial in improving patient outcomes, although too hazardous in certain patient groups. We identified barriers for early mobilization which should be addressed in implementation research projects in order to make early mobilization in critically ill children work.

LO098 / #1135**ESPNIC Session****ESPNIC Session 22: Thinking outside the box****08-10-2022 17:00 - 17:55****Risk factors for delirium in children: A systematic review and meta-analysis****E. Ista^{1*}, C. Traube², M. De Neef³, J. Schievelde⁴, H. Knoester³,
M. Molag⁵, S. Kudchadkar⁶, J. Strik⁴**¹Erasmus MC Sophia Rotterdam, Picu, Rotterdam, Netherlands²Weill Cornell Medical College, New York Presbyterian Hospital, Picu, New York, United States of America³Emma Children's Hospital Amsterdam UMC, location University of Amsterdam, Picu, Amsterdam, Netherlands⁴Department of Psychiatry and Psychology, Maastricht University Medical Center+ (MUMC+), Division of Child and Adolescent Psychiatry and Psychology, Maastricht, Netherlands⁵Knowledge Institute of the Dutch Association of Medical Specialists, -, Utrecht, Netherlands⁶Johns Hopkins University School of Medicine, Anesthesiology and Critical Care Medicine, Baltimore, United States of America**BACKGROUND AND AIMS**

Pediatric delirium is a neuropsychiatric syndrome caused by a complex interplay between predisposing risk factors (e.g., age, cognitive impairment), acute illness, and environmental triggers. Delirium is associated with substantial morbidity and mortality. In this systematic review, our objective was to describe risk factors for delirium in pediatric patients through a meta-analysis of clinical observational studies.

METHODS

We searched PubMed, Embase, Medline, OvidSP, Web- of-Science, Cochrane, and Google Scholar databases for relevant studies published between January 1, 1990 and December 15, 2021. Data were independently extracted by

two reviewers and pooled using a fixed-effect or random effects model as appropriate.

RESULTS

Of 1569 abstracts, 23 studies were included. We identified 54 risk factors studied in univariate analysis and 27 of these were associated with delirium in multivariate analyses. In pooled analyses, developmental delay (OR 3.98; 95%CI 1.54-10.26), need for mechanical ventilation (OR 6.02; 95%CI 4.43-8.19), use of physical restraints (OR 4.67; 95%CI 1.82-11.96), and receipt of either benzodiazepines (OR 4.10; 95%CI 2.48-6.80), opiates (OR 2.88; 95%CI 1.89-4.37), steroids (OR 2.02; 95%CI 1.47-2.77), or vasoactive medication (OR 3.68; 95%CI 1.17-11.60) were significantly associated with pediatric delirium.

CONCLUSIONS

In this meta-analysis, we identified demographic and clinical factors consistently associated with increased risk for pediatric delirium. This will enable clinicians to identify children at highest risk for developing delirium during their hospitalization, in order to target preventive measures.

LO099 / #2552**ESPNIC Session****ESPNIC Session 22: Thinking outside the box****08-10-2022 17:00 - 17:55****Predictors for health-related quality of life in critically ill children and their parents 4-years after pediatric intensive care admission****A. Van Der Geest¹, J. Hordijk², S. Verbruggen¹, I. Vanhorebeek³, F. Guiza³, P. Wouters³, G. Van Den Berghe³, K. Joosten¹, K. Dulfer^{1*}**¹Department of Pediatric Surgery, Erasmus MC - Sophia, Rotterdam, Netherlands²Erasmus MC - Sophia, Child and Adolescent Psychiatry/psychology, Rotterdam, Netherlands³Department of Cellular and Molecular Medicine, KU Leuven, 3. clinical Division and Laboratory of Intensive Care Medicine, Rotterdam, Netherlands**BACKGROUND AND AIMS**

Pediatric intensive care unit (PICU) survivors may be at risk for prolonged morbidities in physical, emotional, and social functioning interfering with daily life, assessed as health-related quality of life (HRQoL). Research into HRQoL in the general PICU cohort, in comparison with healthy community controls, using multi-factorial predictive models is lacking.

METHODS

This is a 4-years follow-up study of the multicenter pediatric early versus late parenteral nutrition in critical illness (PEPaNIC) trial. Parents of 684 critically ill children and 369 healthy control children completed the Child Health Questionnaire (CHQ-PF50) regarding their child and Short-Form (SF-12) regarding themselves. Demographical, patient characteristics, and PICU discharge variables were included as predictors in the backward selection regression models.

RESULTS

Parents reported worse HRQoL on 7/9 subscales in post-PICU survivors compared to healthy children, adjusted for baseline risk factors. Parents' mental HRQoL and family impact were worse in 5/6 subscales than in healthy control parents. Several child factors (higher age, European origin, male sex, syndrome, other than cardiac surgery diagnosis), PICU factors (higher PELOD score, new infection acquirement, more mechanical ventilatory support days, length of stay, elective admission), and family factors (parental occupational and educational level) were predictive for worse child's HRQoL and family/parental outcomes with explained variances between 3% and 20%.

CONCLUSIONS

Several demographical, upon PICU admission, and PICU discharge variables were predictive of worse HRQoL in critically ill children and their parents/family. This supports individualized psychosocial care interventions during PICU admission and at follow-up to ultimately improve outcomes in critically ill children and their parents.

LO100 / #1008

ESPNIC Session

ESPNIC Session 23: Do we really need separate cardiac intensive care units?

09-10-2022 11:00 - 12:20

Near infrared spectroscopy in congenital heart disease: A systematic review of associations with neurodevelopmental, renal and gastro-intestinal outcomes

R. Bosch^{1*}, T. Alderliesten¹, M. Lenderink¹, K. Van Loon², J. Nijman¹

¹University Medical Center Utrecht, Pediatric Intensive Care, Utrecht, Netherlands

²University Medical Center Utrecht, Anesthesiology, Utrecht, Netherlands

BACKGROUND AND AIMS

Near-infrared spectroscopy (NIRS) is frequently used in perioperative congenital heart disease (CHD). However, associations with organ-specific outcomes are unclear. The aim of this systematic review was to determine associations between perioperative NIRS and neurodevelopmental outcome (ND), acute kidney injury (AKI) and necrotizing enterocolitis (NEC) in pediatric CHD patients.

METHODS

According to the Preferred Items for Systematic Reviews and Meta-analysis principles, Embase and MEDLINE were searched without limitations, for 'congenital heart disease' and 'near infrared spectroscopy', without specifying outcomes. Studies investigating associations between cerebral NIRS and ND, renal NIRS and AKI or mesenterial NIRS and NEC, in perioperative pediatric CHD patients, were eligible. Risk of bias was assessed using the Cochrane Quality in Prognosis Studies tool.

RESULTS

An inclusion flowchart is shown in Figure 1. In total, 13, 12 and two studies with 871, 887 and 114 patients were eligible for ND, AKI and NEC, respectively, with conflicting results. The majority of the studies had moderate to high risk of bias. Although criteria for ND and AKI were similar between studies, high heterogeneity existed with regard to study populations and NIRS measurements. Although 9/13, 8/12 and 2/2 studies reported significant associations between NIRS measurements and ND, AKI and NEC, respectively, no meta-analysis could be performed, due to heterogeneity.

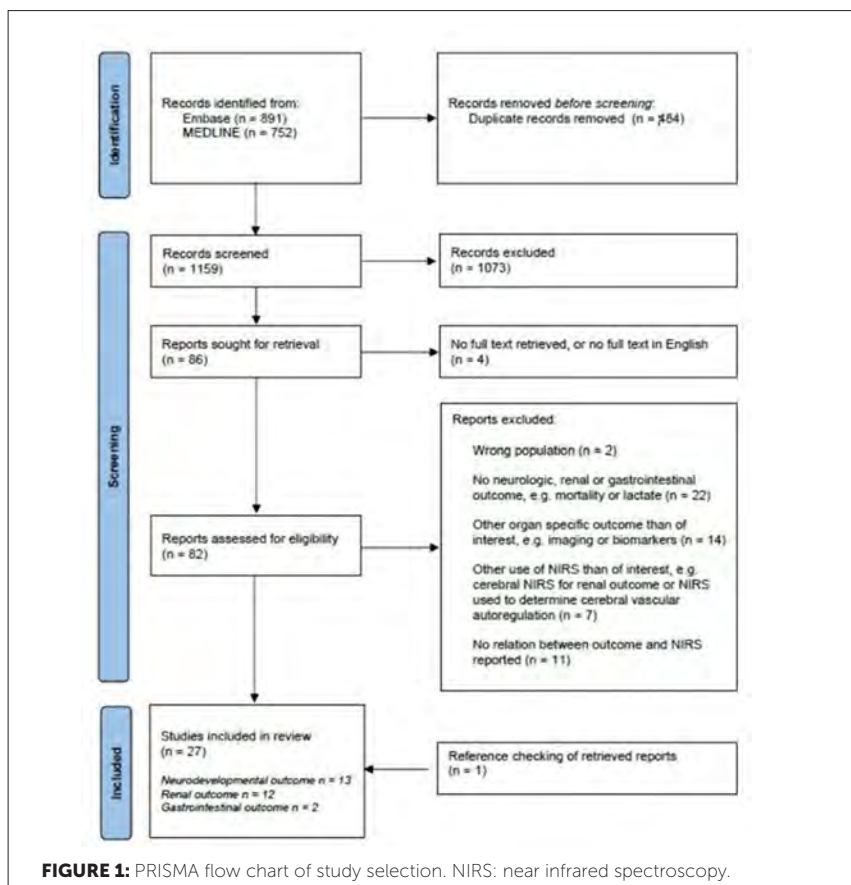

CONCLUSIONS

The available evidence is inadequate to either support or refute the clinical use of NIRS monitoring for ND, AKI and NEC. There is an urgent need for improvement of methodological quality and reduction of interstudy heterogeneity, for example, with uniform monitoring protocols.

LO101 / #1483**ESPNIC Session****ESPNIC Session 23: Do we really need separate cardiac intensive care units?****09-10-2022 11:00 - 12:20****Octreotide stimulates lymphatic activity in vitro but not in vivo a cross over study****T. Holm-Weber^{1*}, S. Mohanakumar², L. Thorup¹, M. Christensen³, V. Hjortdal¹**¹*Thoracic Surgery Department, Rigshospitalet, København Ø, Denmark*²*Department of Radiology, Aarhus University Hospital, Aarhus, Denmark*³*Bispebjerg Hospital, Clinical Pharmacology, Copenhagen, Denmark***BACKGROUND AND AIMS**

An impaired lymphatic system can initiate life-threatening conditions such as protein-losing enteropathy and plastic bronchitis. While surgical interventions are promising treatment options, a pharmacological option for lymphatic dysfunction is lacking. Octreotide is used clinically to facilitate chylothorax resolution in newborns. The mechanisms of octreotide is unclear: lowered lymph production and a change in lymphatic vessel contractility are speculated to be involved. In this study we explore the direct effect of octreotide ex and in vivo on the lymphatic vessels.

METHODS

Ex vivo: Human lymphatic vessels (thoracic duct and mesenteric) were mounted in a myograph. The effect of octreotide on force generation was assessed during acute and prolonged drug incubation. In vivo: Double-blinded cross-over study. Participants were intravenously infused with saline

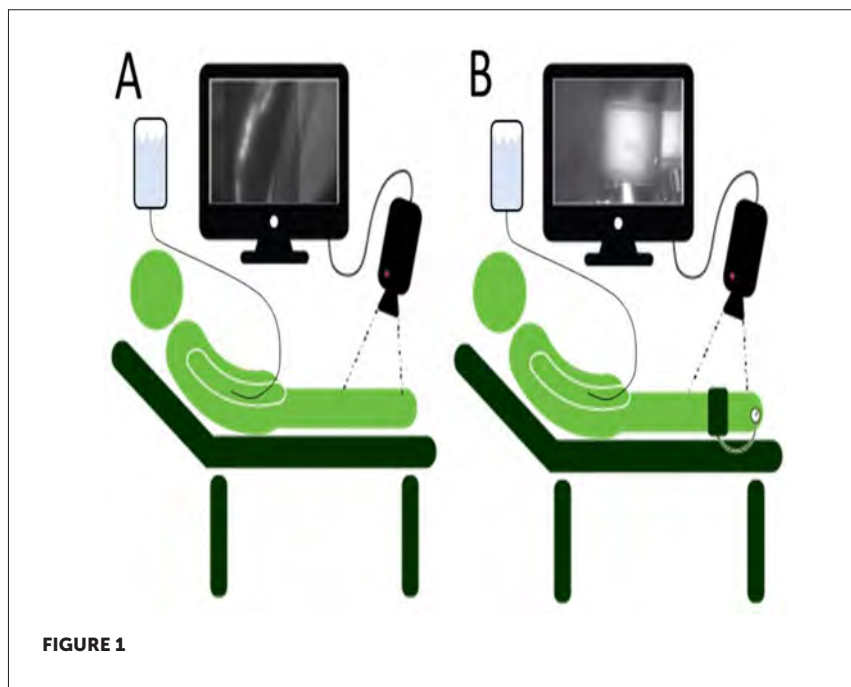

or octreotide at each respective investigation day. During infusion, NIRF were conducted to examine the octreotide effect on lymph rate and pressure.

RESULTS

Ex vivo study: Human thoracic duct ($n = 27$) revealed a stimulatory action of octreotide during acute and prolonged exposure in the thoracic duct vessels. In vivo study (healthy adults, $n = 16$) revealed no changes in lymph rate both during octreotide infusion (ANOVA, p -value = 1) and between the study dates (ANOVA, p -value = 0.58). The lymph pressure did not change between the study dates (t-test, p -value = 0.36).

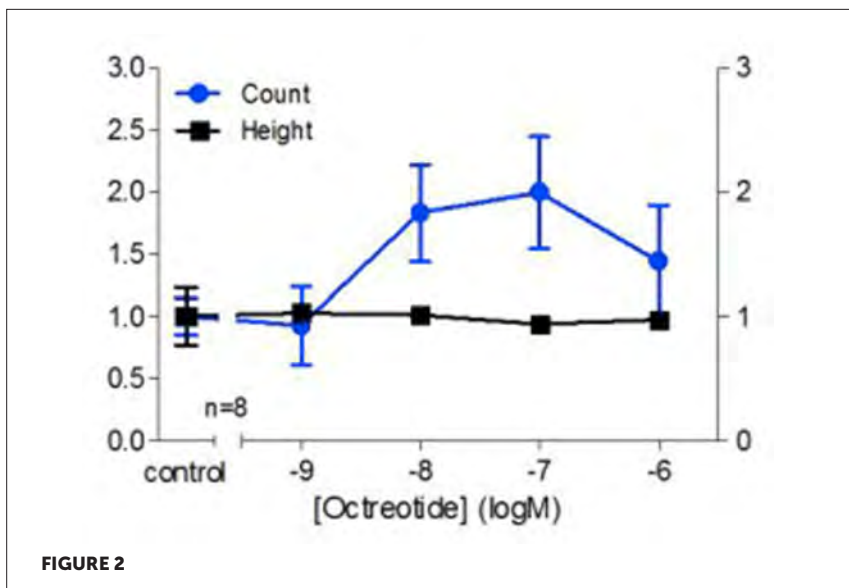

FIGURE 2

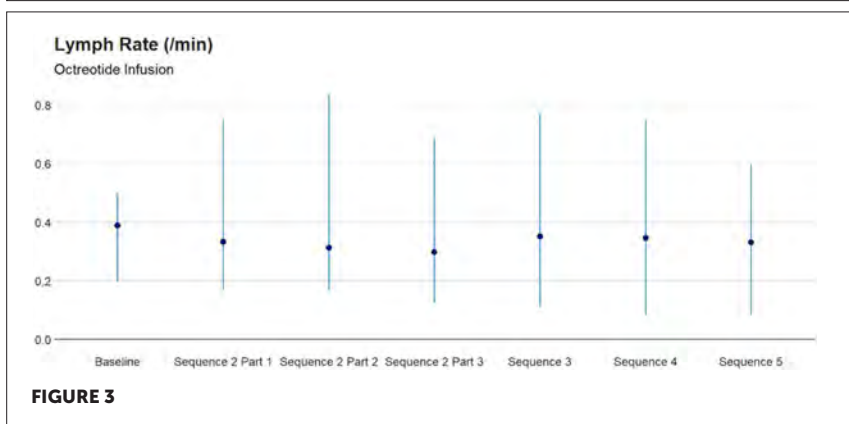

FIGURE 3

CONCLUSIONS

Octreotide increased lymphatic contractility ex vivo but had no measurable effect on lymphatic rate or pressure in vivo. We conclude that octreotide pharmacotherapy for chylous leaks is unlikely to be caused by modulation of lymphatic smooth muscle cell contractility.

LO102 / #1164

EAP Session

EAP Session 24: Preschool wheezing symposium

09-10-2022 11:00 - 12:20

Dupilumab reduced exacerbations and improved lung function and asthma control in children with uncontrolled, moderate-to-severe asthma and baseline high/medium Inhaled corticosteroid (ICS) Dose

J. Maspero¹, M. Antila², N. Jain³, A. Deschildre⁴, L. Bacharier⁵, A. Altincatal⁶, E. Laws⁷, B. Akinlade⁸, S. Siddiqui⁹, J. Jacob-Nara¹⁰, Y. Deniz¹¹, P. Rowe¹², D. Lederer¹³, M. Hardin^{14*}

¹Fundacion CIDEA, Clinical Investigation, Buenos Aires, Argentina

²Clínica de Alergia, Clinical Research, Sorocaba, Brazil

³Medical Department, Arizona Allergy and Immunology Research, Gilbert, United States of America

⁴Pediatric Allergy and Pulmonology Department, CHU Lille, Lille, France

⁵Monroe Carell Jr Children's Hospital at Vanderbilt University Medical Center, Division of Allergy, Immunology and Pulmonary Medicine, Nashville, United States of America

⁶Sanofi, Rare Blood Disorders, Cambridge, United States of America

⁷Sanofi, Dupilumab, Bridgewater, United States of America

⁸Regeneron Pharmaceuticals, Inc, Immunology & Inflammation, Tarrytown, United States of America

⁹Regeneron Pharmaceuticals, Inc, Immunology (Respiratory), Tarrytown, United States of America

¹⁰Sanofi, Allergy, & Gastroenterology, Bridgewater, United States of America

¹¹Regeneron Pharmaceuticals, Inc, Immunology Global Medical Franchise, Tarrytown, United States of America

¹²Sanofi, Global Medical, Immunology, Bridgewater, United States of America

¹³Regeneron Pharmaceuticals, Inc, Respiratory and Inflammation, Tarrytown, United States of America

¹⁴Sanofi, Respiratory, Allergy, GI Global Medical Affairs, Cambridge, United States of America

BACKGROUND AND AIMS

Dupilumab, a fully human mAb, blocks the shared receptor component for interleukin-4/13, key and central drivers of type 2 (T2) inflammation. In VOYAGE (NCT02948959), dupilumab had an acceptable safety profile

and showed clinical efficacy in children aged 6–11 years with uncontrolled, moderate-to-severe asthma. We assessed dupilumab efficacy by ICS dose at baseline in children with T2 asthma.

METHODS

Children (baseline ICS dose [GINA 2015]: medium-dose [n=198], high-dose [n=152]) received weight-based dupilumab 100/200mg q2w or placebo. In prespecified, multiplicity-controlled analyses, annualized severe exacerbation rate (AER) over the 52-week treatment period in the high-dose ICS group was evaluated. Other analyses were AER in the medium-dose ICS group and changes from baseline in pre-bronchodilator % predicted (pp) FEV₁ and

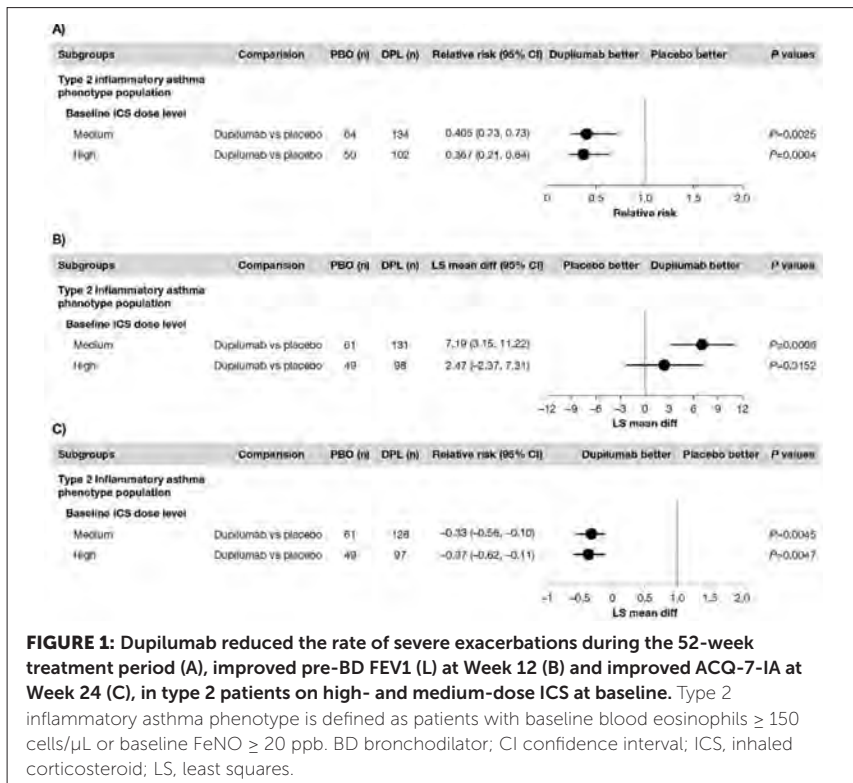

Interviewer-Administered 7Item Asthma Control Questionnaire (ACQ-7-IA) scores in both groups.

RESULTS

Baseline AER in dupilumab/placebo patients were 3.04/2.56 in the high-dose, and 2.28/1.88 in the medium-dose groups. Dupilumab vs placebo significantly reduced AER in the medium-dose (59.5%; $P=0.0025$) and high-dose (63.3%; $P=0.0004$) groups (Figure). LS mean change from baseline in pre-bronchodilator ppFEV₁ (L) at Week12 was significantly greater with dupilumab vs placebo in the medium-dose ICS group (LS mean difference 7.19 [3.15, 11.22]; $P=0.0006$) and numerically greater in the high-dose ICS group. Significant reductions were also seen in ACQ-7-IA scores at Week 24.

CONCLUSIONS

Dupilumab demonstrated clinical efficacy in both ICS groups, with significant reductions in AER and improvements in ACQ-7-IA scores in both groups, and significant/numeric improvements in ppFEV₁ in the medium-/high-dose ICS groups.

DISCLOSURES

Maspero JF: AstraZeneca, Sanofi – consultant; GSK, Menarini, Novartis, Uriach – speaker fees; Novartis – research grants; Antila MA: Abbott, Aché, AstraZeneca, Chiesi, EuroPharma, IPI-ASAC, Sanofi – speaker/consultant; AbbVie, AstraZeneca, EMS, EuroPharma, GSK, Humanigen, Janssen Novartis, Sanofi, Veru – research support. Jain N: AstraZeneca, Novartis, Optinose, Regeneron Pharmaceuticals, Inc., Sanofi – speaker/consultant; Circassia – consultant; Deschildre A: Aimmune Therapeutics, ALK, AstraZeneca, Boehringer Ingelheim, Chiesi, DBV Technologies, GSK, Nestlé, Novartis, Nutricia, Sanofi – speaker/consulting fees. Bacharier LB: AstraZeneca, GSK, Regeneron Pharmaceuticals, Inc., Sanofi – speaker fees; DBV Technologies, Cystic Fibrosis Foundation – data and safety monitoring board; NIH, Sanofi, Vectura – research support; Altincatal A, Laws E, Jacob-Nara JA, Rowe PJ, Hardin M: Sanofi – employees, may hold stock and/

or stock options in the company. Akinlade B, Siddiqui S, Deniz Y, Lederer DJ: Regeneron Pharmaceuticals, Inc. – employees and shareholders. Research sponsored by Sanofi and Regeneron Pharmaceuticals, Inc. ClinicalTrials.gov Identifier: NCT02948959. Medical writing/editorial assistance was provided by Éilis Sutton, PhD, of Excerpta Medica, funded by Sanofi and Regeneron Pharmaceuticals, Inc., according to the Good Publication Practice guideline.

LO103 / #1351

EAP Session

EAP Session 24: Preschool wheezing symposium

09-10-2022 11:00 - 12:20

Improved lung function with Dupilumab vs placebo in children with uncontrolled, moderate-to-severe asthma and elevated type 2 biomarkers

T. Guilbert¹, L. Bacharier², A. Deschildre³, W. Phipatanakul⁴,
A. Altincatal⁵, L. Mannent⁶, E. Laws⁷, B. Akinlade⁸, R. Gall⁹,
J. Jacob-Nara¹⁰, Y. Deniz¹¹, P. Rowe¹², D. Lederer¹³, M. Hardin^{14*}

¹Cincinnati Children's Hospital and University of Cincinnati, Asthma Center, Cincinnati, United States of America

²Vanderbilt University Medical Center, Division of Allergy, Immunology and Pulmonary Medicine, Nashville, United States of America

³CHU Lille, Clinical Recherche, Lille, France

⁴Harvard Medical School, Boston Children's Hospital, Boston, United States of America

⁵Sanofi, Biostatistics, Cambridge, United States of America

⁶Sanofi, Dupilumab, Chilli-Mazarin, France

⁷Sanofi, Dupilumab, Bridgewater, United States of America

⁸Regeneron, Inc., Immunology & Inflammation, Tarrytown, United States of America

⁹Regeneron, Inc., Immunology, Medical Affairs, Tarrytown, United States of America

¹⁰Sanofi, Global Medical Affairs, Bridgewater, United States of America

¹¹Regeneron, Inc., Global Medical Affairs, Tarrytown, United States of America

¹²Sanofi, Global Medical, Immunology, Bridgewater, United States of America

¹³Regeneron, Inc., Clinical Sciences, Respiratory and Inflammation, Tarrytown, United States of America

¹⁴Sanofi, Respiratory, Allergy, Gi Global Medical Affairs, Bridgewater, United States of America

BACKGROUND AND AIMS

Dupilumab, a fully-human monoclonal antibody, blocks the shared receptor component for interleukin-4/interleukin-13, key and central drivers of type 2 inflammation. In phase 3 VOYAGE, (NCT02948959), dupilumab showed significant improvements in pre-bronchodilator %predicted forced expiratory volume in 1 second (ppFEV₁) at Week 12 in children aged 6 to <12 years with

uncontrolled, moderate-to-severe type 2 asthma (baseline blood eosinophils ≥ 150 cells/ μ L or fractional exhaled nitric oxide ≥ 20 parts per billion) and had an acceptable safety profile. This post-hoc analysis evaluated the effect of dupilumab on ppFEV₁ categorical change at Week 52 vs baseline in patients who met criteria for type 2 inflammatory asthma.

METHODS

Patients were randomized 2:1 to add-on subcutaneous dupilumab 100/200 mg, or matched placebo, every 2 weeks based on body weight for 52 weeks. Proportion of patients with ppFEV₁ <80%, 80–84%, 85–89%, 90–94%, and $\geq 95\%$ at baseline and Week 52 were analyzed.

RESULTS

At Week 52, proportion of placebo (n=114) and dupilumab (n=236) patients with ppFEV₁ $\geq 95\%$ or 90–94% increased from baseline. Increase in proportion of patients with ppFEV₁ >95% from baseline to Week 52 was greater with dupilumab (8.1% to 31.8%) vs placebo (12.3% to 19.3%). Proportion of patients with ppFEV₁ <80% at Week 52 decreased with both placebo (51.8% to 31.6%) and dupilumab (49.2% to 20.8%) with greater decrease seen in the dupilumab group (Figure).

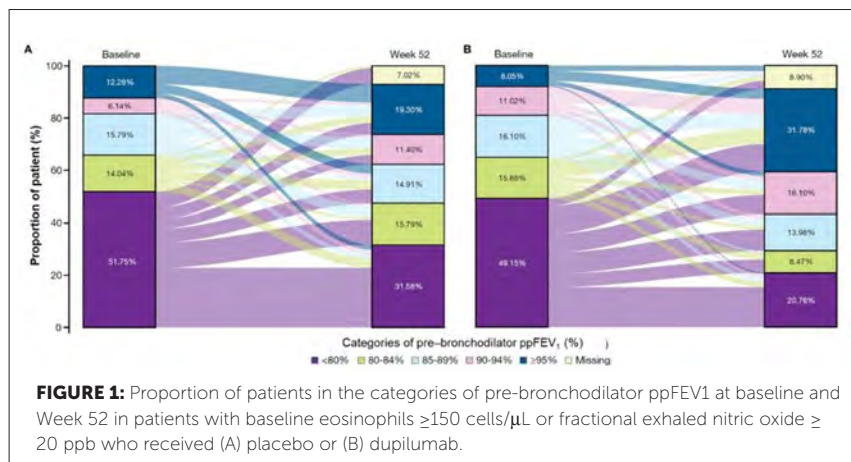

CONCLUSIONS

Dupilumab improved lung function as assessed by categorical change in ppFEV₁ and was associated with sustained improvement in paediatric patients with type 2 inflammatory asthma.

DISCLOSURES

Guilbert TW: American Board of Pediatrics, AstraZeneca, GSK, Novartis, Pediatric Pulmonary Subboard, Regeneron Pharmaceuticals, Inc., Sanofi, Teva – personal fees; AstraZeneca, NIH, Regeneron Pharmaceuticals, Inc., Sanofi – grants; UpToDate – royalties. **Bacharier LB:** AstraZeneca, GSK, Regeneron Pharmaceuticals, Inc., Sanofi – speaker fees; DBV Technologies, Cystic Fibrosis Foundation – data and safety monitoring board; NIH, Sanofi, Vectura – research support. **Deschildre A:** Aimmune Therapeutics, ALK, AstraZeneca, Boehringer Ingelheim, Chiesi, DBV Technologies, GSK, Nestlé, Novartis, Nutricia, Sanofi, Teva, Zambon – speaker/consulting fees. **Phipatanakul W:** Genentech, GSK for Asthma Therapeutics, Merck, Regeneron Pharmaceuticals, Inc., Sanofi – consulting and clinical trial support/medication support. **Altincatal A, Mannent LP, Laws E, Jacob-Nara JA, Rowe PJ, Hardin M:** Sanofi – employees, may hold stock and/or stock options in the company. **Akinlade B, Gall R, Deniz Y, Lederer DJ:** Regeneron Pharmaceuticals, Inc. – employees and shareholders. Research sponsored by Sanofi and Regeneron Pharmaceuticals, Inc. ClinicalTrials.gov Identifier: NCT02948959. Medical writing/editorial assistance was provided by Jo Mooij, PhD, of Excerpta Medica, and was funded by Sanofi and Regeneron Pharmaceuticals, Inc., according to the Good Publication Practice guideline.

LO104 / #1596**ESPR Session****ESPR Session 25: New focus of family-centred care****09-10-2022 11:00 - 12:20****Musical and vocal interventions to improve neurodevelopmental outcomes for preterm infants: A cochrane intervention review****F. Haslbeck^{1*}, K. Müller², T. Karen¹, J. Meerpohl³, J. Loewy⁴, D. Bassler¹**¹University and University Hospital Zurich, Neonatology, Zurich, Switzerland²Department of Pediatrics, University Hospital of Freiburg, Freiburg, Germany³University of Freiburg, Institute for Evidence in Medicine (for Cochrane Germany Foundation), Medical Center, Freiburg, Germany⁴Mount Sinai Hospital New York, Louis Armstrong Center for Music and Medicine, New York, United States of America**BACKGROUND AND AIMS**

Systematic reviews of mixed methodological quality have demonstrated ambiguous results for the efficacy of auditory stimulation in preterm infants. A more comprehensive and rigorous systematic review is needed to address controversies arising from apparently conflicting studies and reviews. We aimed to assess the overall efficacy of auditory stimulation for physiological and neurodevelopmental outcomes in preterm infants compared to standard care according to the standards of the Cochrane Collaboration.

METHODS

Our review includes randomized controlled trials with preterm infants and their parents evaluating any musical or vocal stimulation, provided live or recorded. Primary outcomes were a) change in mean infant oxygen saturation, b) Bayley Scales of Infant and Toddler Development scores at two years

of corrected age, and c) a change in the state of parental anxiety. Further physiological, social-emotional, neurodevelopmental short- and long-term outcomes in preterm infants and parental well-being were assessed.

RESULTS

A comprehensive data search was done until November 2021, including Cochrane Central Register of Controlled Trials, Ovid MEDLINE(R), PsycINFO, Web of Science; CINAHL. Data collection and analysis were performed according to the guidelines of Cochrane Neonatal in Covidence and RevMan5. Of 7577 screened studies, 26 trials were included recruiting 1027 infants and 189 parents. We will present the overall efficacy and impact of various musical and vocal intervention types, including unit of analysis, subgroup analysis, and sensitivity analysis results, incorporating the study's methodological quality.

CONCLUSIONS

The review should assist health professionals in making practical, evidence-based decisions about the use of musical and vocal interventions for preterm infants and their parents.

LO105 / #705**ESPR Session****ESPR Session 25: New focus of family-centred care****09-10-2022 11:00 - 12:20****The impact of music therapy on infants with perinatal brain injury and their caregivers: A systematic review****K. Ormston^{1*}, J. Latour², S. Mitra³, K. Gallagher⁴**

¹University College London Hospital/ Noah's Ark Children's Hospice, Neonatology/ Therapies, London, United Kingdom

²University of Plymouth, Faculty of Health, Plymouth, United Kingdom

³University College London, Neonatology, London, United Kingdom

⁴University College London, Institute for Women's Health, London, United Kingdom

BACKGROUND AND AIMS

Annually, 3000 infants are diagnosed with perinatal brain injury in England. Treatment for these infants necessitates minimal handling. Music Therapy (MT) can be carried out without handling. This review identified the impact of MT on infants with perinatal brain injury and their parents.

METHODS

Nine databases were used to identify studies following PRISMA guidelines. Search terms were combined into three categories: audio stimulation (MT), population (neonates) and condition (brain injury). Included studies were quality assessed using Cochrane ROB2, ROBINSI Tool and the Newcastle Ottawa Scale.

RESULTS

Nine studies were identified. Seven studies used parental voices (n=3 pre-recorded, n=4 live) and two studies instrumental music. Studies reported outcomes: reduction of infants' pain scores during procedures ($p < 0.01$) and cardiorespiratory events ($p = 0.03$), improved feeding ability (increase oral feeding rate, volume intake and feeds per day ($p < 0.001$) and larger amygdala volumes ($p = 0.006$) compared to control groups. Whilst vocal aspects of multimodal studies achieved the predetermined completion goal of 71% (5/7 days), in complex interventions infants with periventricular leukomalacia showed signs of stress which potentially resulted in an increase maternal anxiety in one study (state-trait inventory score $p = 0.04$).

CONCLUSIONS

The evidence suggest that MT is beneficial for infants with perinatal brain injury and their parents. Due to the complexity of care these infants and parents require on-going support. Further research is needed to understand the effect of MT on developmental outcomes and the support needs of parents.

LO106 / #1616**ESPR Session****ESPR Session 25: New focus of family-centred care****09-10-2022 11:00 - 12:20****Creative music therapy and long-term neurodevelopmental outcomes in preterm infants at age two and five years: Results of a controlled, feasibility trial****F. Haslbeck*, L. Schmidli, M. Adams, H.U. Bucher, G. Natalucci, D. Bassler***University and University Hospital Zurich, Neonatology, Zurich, Switzerland***BACKGROUND AND AIMS**

Creative Music Therapy (CMT) aims to relax, stabilize, and support preterm infants and their parents by providing family-centered infant-directed singing. We aimed to test feasibility in preparation for a randomized controlled trial and explore whether CMT would harm long-term neurodevelopment in extremely preterm infants (EPTs).

METHODS

In this controlled, prospective, longitudinal, feasibility trial we consecutively recruited 13 EPTs who received CMT 2-3 times per week while the remaining 34 EPTs received standard neonatal care. Socio-demographic data and perinatal complications were analyzed and compared between groups as risk factors. Cognitive, language, and motor indices of the Bayley Scales of Infant and Toddler Development at the 2-year follow-up (FU2) and KABC-II-Kaufman Assessment Battery for Children at the 5-year follow-up (FU5) were analyzed using Mann-Whitney-U-tests.

RESULTS

Among the 47 participants, 39 (83%) EPT were examined at two (FU2) and 29 (62%) at five years (FU5) of age. The rate of neurodevelopmental risk factors at birth between the two groups was similar or higher in the CMT group, except for a higher prevalence of ventricular dilatation and intraventricular hemorrhage in the standard treatment group. While there was no difference in the FU2 measures between the two groups, the Fluid-Crystallized Index of the KABC-II was significantly higher in the CMT than in the standard treatment group ($p < 0.05$).

CONCLUSIONS

While CMT was associated with better cognitive outcomes at five years of age and no treatment harm, the present findings must be interpreted with caution due to the small sample size and the non-randomized design of this study.

LO107 / #1055**ESPNIC Session****ESPNIC Session 26: Using artificial intelligence in the daily care of critically ill children****09-10-2022 11:00 - 12:20****Machine learning for automated discovery of clinical deterioration in paediatric intensive care patients with congenital heart disease: Aberration detection****R. Zoodsma^{1*}, R. Bosch¹, T. Alderliesten¹, C. Bollen¹, T. Kappen², E. Koomen¹, J. Nijman¹**¹University Medical Center Utrecht, Pediatric Intensive Care Unit, Utrecht, Netherlands²Department of Anesthesiology, University Medical Center Utrecht, Utrecht, Netherlands**BACKGROUND AND AIMS**

With an ongoing shift from Paediatric Intensive Care Unit (PICU)-wards to single-person rooms, monitoring of the patient's condition (outside the room) can become challenging, especially when combined with the complex physiology of perioperative congenital heart disease (CHD). Machine learning (ML) may support the medical team through automated detection of clinical aberrations. In this proof-of-concept study, a dual-approach aberration-detection algorithm in PICU patients with CHD was developed.

METHODS

Data of four vital parameters and cerebral rSO₂ of neonates with complex CHD admitted to the University Medical Center Utrecht, the Netherlands between 2002 and 2018 was used for training. Training-data was integrated into an algorithm, combining a Support Vector Machine that detects parameter combinations abnormal to this population, as well as significant

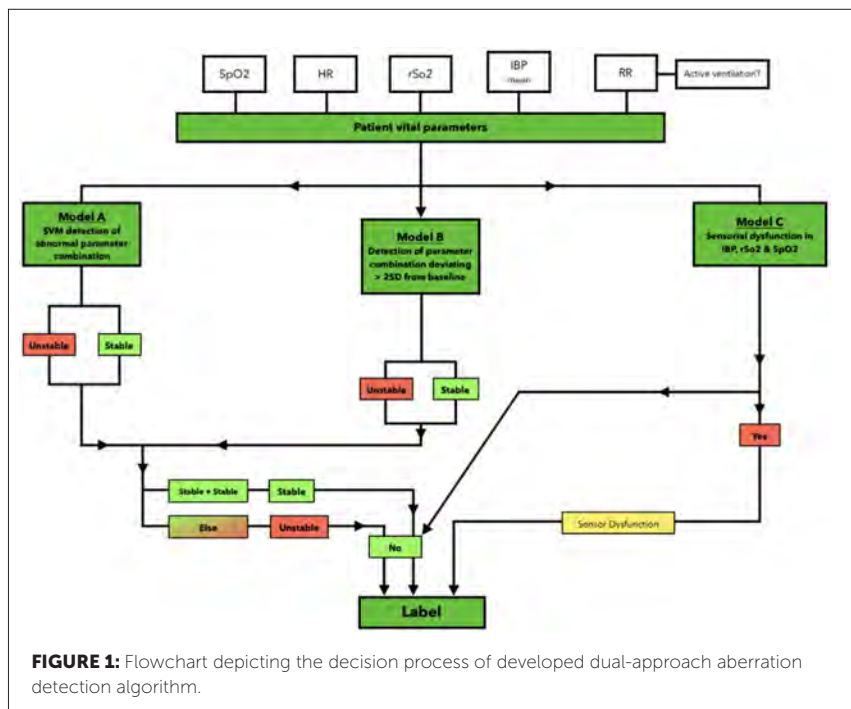

patient-specific baseline deviations (Figure 1). The algorithm was applied on test data from new patients and subsequently visualized. The labelling of aberrations was evaluated by a clinical expert team.

RESULTS

A respective 4600h and 229h in 78 and 10 neonates were used as training and test dataset. Four examples of patient-specific aberration detection visualizations are provided in Figure 2 & 3. Overall, the algorithm provided accurate detection in 90% of stable- and 71% of unstable episodes. Twenty-nine out of 101 clinical aberrations were missed in testing.

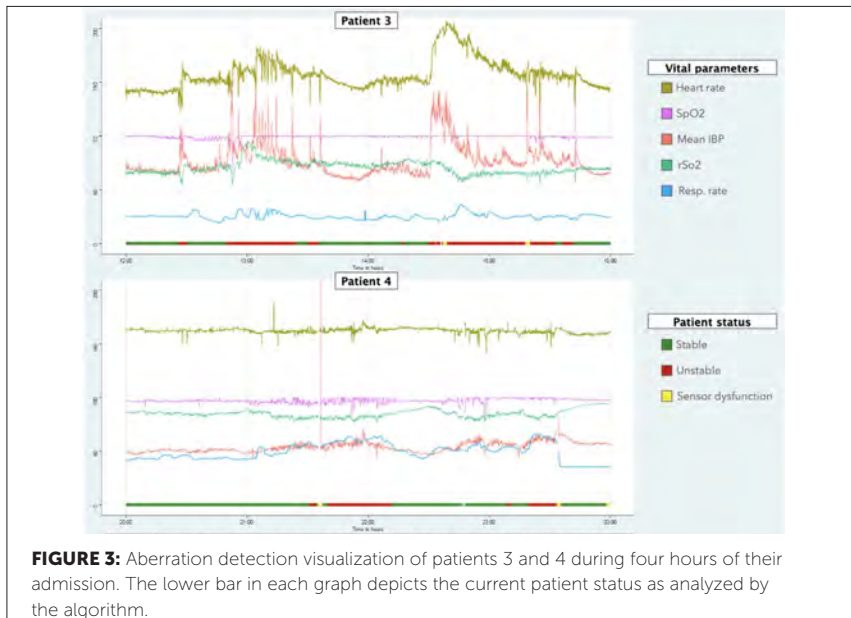
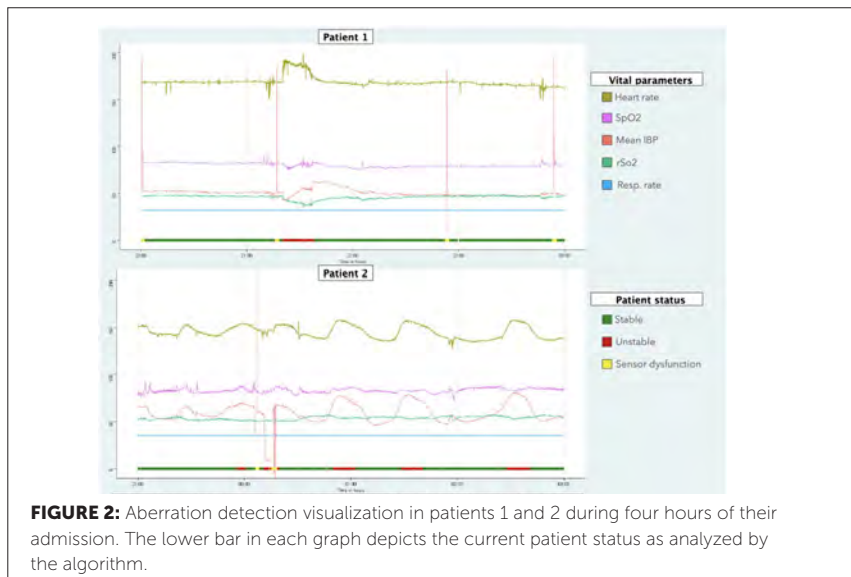

CONCLUSIONS

ML can be used to automatically classify big PICU monitor datasets, although accuracy should be improved and prospectively evaluated. ML-based classification algorithms in the PICU setting may, eventually, provide an addition to both conventional monitoring and the research-related processing of big datasets.

LO108 / #1473**ESPNIC Session****ESPNIC Session 26: Using artificial intelligence in the daily care of critically ill children****09-10-2022 11:00 - 12:20****Prediction of the patient status in paediatric intensive care patients with congenital heart disease****E. Koomen^{1*}, N. Schoeber², J. Nijman¹, T. Kappen³**¹UMCU Wilhelmina Childrens Hospital, Pediatric Intensive Care, Utrecht, Netherlands²Department of Information and Computing Sciences, University Utrecht, Utrecht, Netherlands³Department of Anesthesiology, University Medical Center Utrecht, Utrecht, Netherlands**BACKGROUND AND AIMS**

With the increasing wish for privacy and family-centered patient care in single-person rooms, monitoring the patient status and impact of interventions (i.e. medication) can become challenging. As a proof-of-concept, we aimed to predict a patient status (haemodynamic parameters) one hour in the future, in congenital heart disease patients.

METHODS

Clinical data of the patient's condition, i.e. haemodynamic parameters (Arterial Blood Pressure (ABP), Heart Frequency (HF) and Oxygen Saturation (SAT)), lab measurements and (separate) intervention data from 88 infants aged 0-1 year, with complex CHD admitted at the Pediatric Intensive Care Unit of the University Medical Centre Utrecht, The Netherlands between 2016 and 2018 were used in this study. This dataset was divided into one-hour time windows, on which the next hour haemodynamic parameters could be predicted. The

model was developed based on K-Means clustering combined with Symbolic Aggregation Approximation (SAX) to cluster the patient windows and predict future patient status.

RESULTS

A respective 77567 time windows were used to train and test the model to predict future changes in ABP, HF and SAT, The C-statistics were ABP 0.927, HF 0.923 and SAT 0.965 and Root Mean Squared error (RMSE) ABP 11.29 mmHg, HF 14.91 bpm and SAT 4.4%. The additional value of intervention data (i.e. inotropic medication) was very limited.

CONCLUSIONS

The trained model performed good with respect to prediction of the future patient status. However, the influence of interventions on this prediction could not be isolated as the interventions were too highly correlated with the parameters describing the patient status.

LO109 / #2168**ESPNIC Session****ESPNIC Session 26: Using artificial intelligence in the daily care of critically ill children****09-10-2022 11:00 - 12:20****Italian network of pediatric intensive care units (TIPNet) registry: 10 years' experience****A. Amigoni^{1*}, R. Comoretto², H. Ocagli³, F. Izzo⁴, M.C. Mondardini⁵, P. Biban⁶, P. Piastra⁷, G. Lorenzoni³, M. Martinato³, D. Gregori³, A. Wolfler⁸, S.G. Tipnet⁴**¹Department of Mother and Child Health University Hospital, University Hospital of Padova, Padova, Italy²Department of Public Health and Pediatrics, University of Turin, Turin, Italy³Department of Cardiac, University Hospital of Padova, Thoracic and Vascular Sciences and Public Health, Padova, Italy⁴Buzzi ASST FBF Sacco, Intensive Care, Milan, Italy⁵University Hospital IRCCS, Policlinico Sant'orsola, Bologna, Italy⁶University Hospital, Pediatric Intensive Care, Verona, Italy⁷University Hospital, A.Gemelli, Rome, Italy⁸University Hospital Gaslini, Anesthesia, Genova, Italy**BACKGROUND AND AIMS**

Pediatric registries create a connection among the centers involved to identify the best clinical practices, monitoring outcomes. The purpose of this work is to present the 10-years epidemiological data of the Italian Network of Pediatric Intensive Care Units (TIPNet).

METHODS

TIPNet is a permanent web-based register of a network of 29 Pediatric Intensive Care Units (PICU) since 2010. Each center collects prospectively demographic and clinical data through an online e-CRF. Data of the last 10 years (2012-2021) have been analyzed.

RESULTS

Overall, 30233 admissions have been collected from January 2012 to December 2021. 38% and 55% are children under one and three years of age, respectively. Yearly, 2500 to 3300 records have been collected with a mean of 3023 admissions. 48% of patients have a comorbidity. Respiratory diseases represent the main diagnostic category (25% of admissions). In the last 2 years, PICU admissions decreased and less than 20% of patients has been admitted with respiratory problems. Nearly half of the cohort required ventilatory support. The mean observed Pediatric Index of Mortality score (PIM 3) was 3.45 and the observed mortality was 3%. Standardized Mortality Ratio was 0.88.

CONCLUSIONS

From our data, it could be observed that more than half of patients admitted to PICU is less than 3 years old and almost half patients has one or more comorbidity. The effects of the pandemic on overall PICU hospitalizations and, in particular, for respiratory problems seem noteworthy. Overall mortality rate is lower than the expected one.

LO110 / #1173**ESPR Session****ESPR Session 27: Optimizing therapeutics in preterm infants****09-10-2022 11:00 - 12:20****Oral and intravenous amoxicillin in neonates: A population pharmacokinetic model****F. Keij^{1,2*}, S. Schouwenburg³, R. Kornelisse², T. Preijers³, F. Mir⁴, P. Degraeuwe⁵, L. Stolk⁵, I. Reiss², K. Allegaert^{3,6,7,8}, G. Tramper-Stranders^{1,2}, B. Koch³, R. Flint^{2,3}**¹Department of Pediatrics, Franciscus Gasthuis & Vlietland, Rotterdam, Netherlands²Department of Pediatrics, Erasmus MC-Sophia Children's Hospital, Division of Neonatology, Rotterdam, Netherlands³Department of Hospital Pharmacy, Erasmus University Medical Center, Rotterdam, Netherlands⁴The Aga Khan University, Section of Pediatric Infectious Disease, Pediatrics and Child Health, Karachi, Pakistan⁵Department of Clinical Pharmacy, Maastricht University Medical Center, Maastricht, Netherlands⁶Department of Development and Regeneration, KU Leuven, and Pharmaceutical and Pharmacological Sciences, Leuven, Belgium⁷Department of Pharmaceutical and Pharmacological Sciences, KU Leuven, Leuven, Belgium⁸University Hospitals Leuven, Neonatal Intensive Care Unit, Leuven, Belgium**BACKGROUND AND AIMS**

Oral antibiotic use is limited in neonates due to lack of evidence on the pharmacokinetics and uncertainties on absorption. Adequacy of amoxicillin treatment depends on the time during which the free drug concentration exceeds the minimal inhibitory concentration ($fT > MIC$). In neonates, $fT > MIC$ is recommended to be $\geq 50\%$. Our aim was to describe the pharmacokinetics of oral and intravenous amoxicillin in neonates, including bioavailability, and to provide dosing recommendations.

METHODS

This study pooled data from the RAIN study (a multicentre RCT on intravenous-to-oral switch therapy in neonates) with two other datasets, resulting in a cohort of 261 (79 oral, 182 intravenous) neonates with a median gestational age of 35.8 (24.9-42.4) weeks, postnatal age of 6.8 (0-55) days and body-weight of 2.6 (0.5-5) kg. The 938 blood samples were used for population pharmacokinetic modeling in NONMEM 7.4. A target of 50% $fT > MIC$ with an MIC of 8 mg/L (to cover Gram-negatives such as *E. coli*) was used to provide dosing recommendations.

RESULTS

A one-compartment model best described amoxicillin pharmacokinetics. An additional non-linear influence of postnatal and gestational age on amoxicillin clearance was identified. Bioavailability was 87%. Dosing simulations (20-100/ mg/kg/day) for a typical patient indicated that the lowest oral dosage to achieve 50% $fT > MIC$ was 50 mg/kg/day (MIC 8 mg/L), irrespective of daily dosing frequency (divided into two or three dosages).

CONCLUSIONS

This is the first combined intravenous and oral amoxicillin population pharmacokinetic description in neonates. We show that oral amoxicillin is well absorbed. Moreover, we provide guidance to further optimize dosing regimens in neonates with bacterial infections.

LO111 / #1745**ESPR Session****ESPR Session 27: Optimizing therapeutics in preterm infants****09-10-2022 11:00 - 12:20****Birthweight and postnatal age are important predictors for paracetamol clearance in preterm neonates****Y. Wu^{1*}, S. Voller^{1,2,3}, D. Roofthoof², D. Tibboel⁴, S. Simons², R. Flint^{2,5}, C. Knibbe^{1,2,6}**

¹Leiden University, Division of Systems Biomedicine and Pharmacology, Leiden Academic Centre for Drug Research, Leiden, Netherlands

²Department of Pediatrics, Erasmus MC-Sophia Children's Hospital, Division of Neonatology, Rotterdam, Netherlands

³Leiden University, Pharmacy, Leiden Academic Centre for Drug Research, Leiden, Netherlands

⁴Department of Pediatric Surgery, Erasmus MC - Sophia Children's Hospital, Pediatric Intensive Care Unit, Rotterdam, Netherlands

⁵Department of Hospital Pharmacy, Erasmus University Medical Center, Rotterdam, Netherlands

⁶Department of Clinical Pharmacy, St Antonius Hospital, Nieuwegein, Netherlands

BACKGROUND AND AIMS

Intravenous paracetamol (PCM) is increasingly used to control mild-to-moderate pain in preterm neonates. The aim of this study was to quantify the developmental changes in PCM disposition in preterm neonates.

METHODS

Two datasets were pooled and contained plasma PCM samples after single (n=283) or multiple (n=282) intravenous PCM doses (median 9 mg/kg, range 4-25) from 146 preterm neonates with median gestational age (GA) 27.7 (range 24.0-31.9) weeks, birth weight (BWb) 980 (462-1925) kg, postnatal age (PNA)

5.2 (0-78.8) days, and current weight (CW) 1023 (462-2193) g. The population pharmacokinetic (PopPK) analysis was performed using the NONMEM® 7.4.

RESULTS

The PK of PCM was best described by a 2-compartment model. Clearance of PCM (0.14 L/h for a neonate with median BWb and PNA) increased with BWb in a power function (exponent:0.942) and PNA in a linear function (slope: 0.0076 L/h/day). For neonates with the same BWb, clearance at day 7 and day 14 of PNA were 1.4 and 1.9 fold the clearance at day 1, respectively. At the same PNA, the clearance in neonates with BWb of 1000 and 1500 g were 1.92 and 2.2 fold that clearance of BWb 500g, respectively. The central PCM volume of distribution (0.99 L for a neonate with median CW) increased with CW in a power function (exponent 0.832).

CONCLUSIONS

The developed popPK model successfully described the pharmacokinetics of intravenous PCM in preterm neonates. BWb and PNA were important predictors for PCM clearance in preterm neonates and should be considered in future dosing guidelines.

LO112 / #2646**ESPR Session****ESPR Session 27: Optimizing therapeutics in preterm infants****09-10-2022 11:00 - 12:20****Expectant management is non-inferior to early pharmacological treatment for patent ductus arteriosus in extreme prematurity****T. Hundscheid*, W. De Boode, B.T. Study Group***Radboudumc Amalia Children's Hospital, Neonatology, Nijmegen, Netherlands***BACKGROUND AND AIMS**

Since pharmacological treatment of patent ductus arteriosus (PDA) fails to improve relevant clinical outcomes, expectant management is increasingly adopted. As previous trials had a high number of 'open label' treated infants in the placebo/control group non-inferiority of a (truly) expectant management is not proven. The BeNeDuctus trial aimed to prove non-inferiority.

METHODS

This multicenter, non-inferiority trial, randomly assigned extremely preterm infants with echocardiographically confirmed PDA (diameter >1.5mm and left-to-right transductal shunting) at 24-72 hours postnatal age to either expectant management or early pharmacological treatment. Non-inferiority of the primary composite outcome mortality or necrotizing enterocolitis Bell's stage IIa or higher, or moderate/severe bronchopulmonary dysplasia (BPD) at 36 weeks postmenstrual age was defined as an absolute risk difference (ARD) with a one-sided 95%-confidence interval (95%-CI) of less than +10%. The individual components are presented as ARD; two-sided 95%-CI.

RESULTS

273 patients (median gestational age 26 weeks; median birth weight 845 grams) were randomized. One patient (0.7%) in the expectant group received ibuprofen. In the expectant group, 46.3% (63/136) infants had the primary outcome, as compared to 63.5% (87/137) infants in the treatment group (ARD -17.2%; 95%-CI -7.4%). The incidence of moderate/severe BPD was significantly lower in the expectant management (33.3%), as compared to the treatment group (50.9%) (ARD -17.6; 95%-CI -30.2 to -5.0).

CONCLUSIONS

A truly expectant management for PDA in extreme prematurity is non-inferior to early pharmacological treatment for the primary outcome, mainly due to significant differences in the incidence of BPD in favor of expectant management.

LO113 / #2348**EAP Session****EAP Session 28: Type 1 diabetes****09-10-2022 11:00 - 12:20****Incidence, predictors, and outcome of acute kidney injury in children with diabetic ketoacidosis: A systematic review****J. Meena*, J. Kumar, J. Yadav***Post Graduate Institute of Medical Education and Research, Pediatrics, Chandigarh, India***BACKGROUND AND AIMS**

One third of children of type 1 Diabetes Mellitus manifests with diabetic ketoacidosis (DKA) in a volume-depleted state, which can lead to acute kidney injury (AKI). Therefore, a thorough knowledge of the incidence, risk factors, and outcome of AKI in pediatric DKA is desirable to improve the management and outcome.

METHODS

Protocol for this systematic review was registered in Prospero (CRD42022303200). We searched in three electronic databases (EMBASE, PubMed, and Web of Sciences), from inception to March 2022, for original studies reporting the AKI in children with DKA. Search strategies for the individual database were drafted using free text words and MeSH incorporating "acute kidney injury" and, 'diabetic ketoacidosis'. Primary outcome was the pooled incidence of AKI during DKA episodes. Predicting factors and outcome of AKI were the secondary outcomes. Pooled estimates were derived using random effect meta-analysis.

RESULTS

Seventeen studies assessing 3483 children (3826 DKA episodes) reported AKI during the DKA episode. The pooled incidence of any stage AKI during the DKA episode was 45% (95% CI: 39% to 51%). Only 5% (1% to 14%) of children with AKI received dialysis. Low serum bicarbonate, low corrected sodium, higher blood sugar and high blood urea nitrogen at presentation were some factors reported to be associated with the development of AKI.

CONCLUSIONS

We observed that AKI develop in almost half of DKA episodes and every fourth DKA episode was associated with severe AKI. Recovery rate from AKI is high in children but further studies are needed to assess the exact impact of AKI on long-term outcome.

LO114 / #2389**ESPNIC Session****ESPNIC Session 29: Update in paediatric respiratory critical care****09-10-2022 11:00 - 12:20****Ventilator-associated pneumonia in a pediatric intensive care unit: A single center retrospective study****E. Christakou, E. Mpourazani*, M. Prapa, K. Straka, M. Gianniki, L. Anastasia, S. Konstantakopoulos, C. Tsiagklani, C. Barbaresou***Agia Sofia Childrens Hospital, Picu, ATHENS, Greece***BACKGROUND AND AIMS**

Ventilator-associated pneumonia(VAP) is the second most common hospital-acquired infection among pediatric intensive care unit patients. Overall, VAP occurs in 3 to 10% of ventilated pediatric ICU patients. Pediatric VAP is associated with increased morbidity, antibiotic use, PICU cost, and PICU and hospital length of stay. Aim of this study was to describe the incidence, etiology and risk factors associated with VAP in children.

METHODS

Retrospective, observational, single-center study in the PICU of a tertiary-care university hospital. All critically ill children mechanically ventilated \geq 48 hours between October 2017-October 2019 were included.

RESULTS

141 pediatric patients mechanically ventilated \geq 48 hours were included. Among them 17 (12%) met clinical and radiologic Centers for Disease Control and Prevention criteria for VAP, with a prevalence of 8/1,000 mechanical ventilation (MV) days. 62% were female, with a median age of 4.2y (range 0.5y-14y). Median time from MV onset to VAP diagnosis was 8 days (range 4-15). Semiquantitative culture of tracheal aspirates was the most common microbiological technique. The most commonly isolated organisms were *Pseudomonas aeruginosa* (36%), *Staphylococcus aureus* (19%), *Klebsiella pneumoniae* (27%), *Enterobacter* spp. (15%) and *Stenotrophomonas maltophilia* (3%). Most of the tracheal isolates from patients with VAP grew polymicrobial cultures. Antibiotic therapy complied with adult guidelines. Patients with VAP had a longer median duration stay in ICU compared with patients without VAP, (22,5 v 8,6 days; $p < 0,001$) as well as a longer median duration of mechanical ventilation (13,8 v 7,2 days; $p < 0,05$). Univariate analysis showed that younger age, reintubation, immunosuppression/immunodeficiency, chronic pulmonary disease and mechanical ventilation > 5 days were risk factors for VAP. Among the 17 patients with VAP, 10 met adult ventilator-associated event's criteria.

CONCLUSIONS

VAP is associated with extended mechanical ventilation and in the PICU. More consistent and precise approaches to the diagnosis of pediatric VAP are needed in order to rapidly screen for ventilator-associated pneumonia in children.

LO115 / #1114**ESPNIC Session****ESPNIC Session 29: Update in paediatric respiratory critical care****09-10-2022 11:00 - 12:20****Evaluation of respiratory muscle echodensity during mechanical ventilation in critically ill children****M. Ijland¹, A. Beukman^{1*}, J. Van Doorn², J. Lemson¹, J. Doorduyn², L. Heunks³**¹*Department of Intensive Care Medicine, Radboud University Medical Center, Nijmegen, Netherlands*²*Donders Institute for Brain, Cognition and Behaviour, Neurology, Nijmegen, Netherlands*³*Erasmus Medical Center, Intensive Care, Rotterdam, Netherlands***BACKGROUND AND AIMS**

Mechanical ventilation leads to changes in thickness of the diaphragm and the expiratory muscles in critically ill children, but it is unclear whether these changes are reflected in muscle structure. This study aimed to evaluate changes in muscle structure of the diaphragm and expiratory muscles during mechanical ventilation in critically ill children, as assessed with echodensity. Secondary aims were the correlation between changes in respiratory muscle echodensity and changes in muscle thickness and fluid overload.

METHODS

Ultrasound images of the diaphragm and expiratory muscles were retrospectively analysed from 32 mechanically ventilated children and prospectively collected from 13 children without a history of mechanical ventilation.

Echodensity, muscle thickness and cumulative fluid balance were measured at baseline and day four of mechanical ventilation.

RESULTS

Changes in echodensity (both increases and decreases >10%) during mechanical ventilation were found for the diaphragm (33.3 % and 40.0%), rectus abdominis (40.0% and 30.0%), transversus abdominis (26.9% and 42.3%), obliquus externa (38.5% and 30.8%) and obliquus interna (26.9% and 34.6%). Baseline echodensity was significantly different for the m. rectus abdominis between the mechanical ventilated patients and controls (35.0 [27.5-40.0] vs 40.7 [34.8-48.3], $p=0.010$). No correlations were found between changes in echodensity and muscle thickness and cumulative fluid balance.

CONCLUSIONS

Changes in echodensity of the respiratory muscles occur during mechanical ventilation in critically ill children. In the absence of correlation with changes in respiratory muscles thickness and fluid accumulation, different underlying pathophysiological mechanisms may account for this.

LO116 / #937**EAP Session****EAP Session 30: How early life infections and gluten amount may modulate the risk of celiac disease****09-10-2022 11:00 - 12:20****Baby food pouch use among 7-10-month-old infants: The first foods New zealand study****N. Mclean^{1*}, R. Taylor², L. Daniels², J. Haszard³, C. Conlon⁴, K. Beck⁴, P. Von Hurst⁴, L. Te Morenga⁵, J. Mcarthur², R. Paul⁴, A. Cox², E. Jones⁶, I. Katiforis¹, K. Brown⁴, M. Casale⁴, M. Rowan², R. Jupiterwala⁴, A.-L. Heath¹**¹Department of Human Nutrition, University of Otago, North Dunedin, New Zealand²Department of Medicine, University of Otago, North Dunedin, New Zealand³University of Otago, Biostatistics Centre, Dunedin, New Zealand⁴Massey University, College of Health, Auckland, New Zealand⁵Massey University, Research Centre for Hauora And Health, Wellington, New Zealand⁶Massey University, College of Humanities and Social Sciences, Auckland, New Zealand**BACKGROUND AND AIMS**

Baby food “pouches” are becoming increasingly popular, however concerns have been raised that the way in which pouches are used may have implications for infant nutrition, health and development. We have investigated the use of baby food pouches in 7-10-month-old infants in the first large study of pouch use internationally.

METHODS

We analysed data from the First Foods New Zealand (FFNZ) study, an observational study of 625 New Zealand infants aged 7-10 months. Pouch use

was assessed by questionnaire. Infants were defined as a current “frequent” user if their parent reported they were given food from a pouch at least 5 times per week (in the past month). Logistic regression was used to explore predictors of frequent pouch use.

RESULTS

Most infants (79%, n=492) had used pouches on at least one occasion; 28% (n=174) were current frequent users. Although the majority of infants (58%, 272 of 468) who had used a pouch in the past month were always fed the pouch contents via a spoon, a notable proportion (17%, 77 of 468) were mostly or always fed directly from the nozzle. The most commonly reported reasons for using pouches were because they are easy to use (63%, n=309), practical (54%, n=264), and take less time (36%, n=178). Predictors of frequent pouch use will be presented.

CONCLUSIONS

Use of baby food pouches is common in New Zealand infants. The FFNZ study is investigating the links between the frequent use of baby food pouches and nutrition and health outcomes.

LO117 / #1155**EAP Session****EAP Session 30: How early life infections and gluten amount may modulate the risk of celiac disease****09-10-2022 11:00 - 12:20****Infant formula dietary specifications and child growth in the ELFE birth cohort study****A. Abou Assi^{1*}, A. Cissé¹, J. Bernard¹, S. Lioret¹, B. Heude¹, M.-A. Charles^{1,2}, B. De Lauzon-Guillain¹**¹Université Paris Cité, Inserm, Inrae, Cress, Paris, France²Unité mixte Inserm-Ined-EFS ELFE, Ined, Aubervilliers, France**BACKGROUND AND AIMS**

The evidence regarding the potential influence of infant formula (IF) dietary specifications on child growth remains scarce. Our aims were to examine, under real-life conditions, the associations between different IF dietary specifications and child growth.

METHODS

Analyses involved 6,106 children from the ongoing French nationwide ELFE cohort. Among formula-fed infants, the brand and the name of the IFs consumed were collected from the parents at the 2-month interview. According to their ingredient list and nutritional composition, several IF dietary specifications were considered: protein hydrolysis level, vegetable proteins, thickening, probiotics or prebiotics enrichment, and long-chain polyunsaturated fatty acids (LCPUFA) enrichment. The associations between IF specifications and child BMI from 6 months to 7 years were assessed by linear regression models

adjusted for known confounders, including parental BMI. Child weight status at 7 years, according to IOTF cut-offs, was also examined using multinomial logistic regression models.

RESULTS

Most IF dietary specifications were not related to BMI from 6 months to 7 years. Consuming a thickened (vs non-thickened) formula at age 2 months was related to a higher BMI up to 2 years in boys, but not in girls. It was also related to a lower probability of being underweight at 7 years (OR[95%CI]=0.75[0.61;0.92]), but not of being overweight (0.85 [0.61;1.19]).

CONCLUSIONS

In the ELFE cohort, the growth of formula-fed infants was not related to the protein hydrolysis level, enrichment in pre or probiotics, or in LCPUFA of IF. The associations between thickened formula and growth need to be confirmed in other studies.

LO118 / #1357**EAP Session****EAP Session 30: How early life infections and gluten amount may modulate the risk of celiac disease****09-10-2022 11:00 - 12:20****Comparison of the nutritional status of 7-years-old Bulgarian schoolchildren using two international standards****E. Chikova-Iscener^{1*}, V. Duleva¹, L. Rangelova¹, P. Dimitrov²**¹National Center of Public Health and Analyses, Food and Nutrition, Sofia, Bulgaria²National Center of Public Health and Analyses, Health Promotion and Disease Prevention, Sofia, Bulgaria**BACKGROUND AND AIMS**

Childhood obesity is a growing public health problem that requires adequate assessment of the nutritional status of children on national and international level. The aim of the present study is to perform comparative analysis of the nutritional status of a nationally representative sample of 7-years-old schoolchildren in Bulgaria through the application of two international standards.

METHODS

A cross-sectional survey among 7-years-old schoolchildren in Bulgaria was carried out in 2019 on nationally representative effective sample of 3051 students. The data collection followed the protocol developed by World Health Organization (WHO) as part of the WHO European Childhood Obesity Surveillance Initiative (COSI). Height and weight were measured by trained examiners with standardized anthropometric equipment. The nutritional

status is assessed by an anthropometric indicator Body mass index-for-age (BMI/A) following the WHO Growth Reference 2007 and the International Obesity Task Force (IOTF) Standard 2012.

RESULTS

The results demonstrate serious mismatch when classifying underweight - 2,6% of the children according to WHO standard vs 8,8% according to IOTF. Significant differences are observed for the prevalence of obesity – 15% WHO vs. 10,1% IOTF. When differentiated by sex the biggest observed variance is for obesity among boys 17% WHO vs. 9,3% IOTF and for underweight among girls 2,2% WHO vs. 10,2% IOTF.

CONCLUSIONS

The two international standards differ in their assessment of the nutritional status of the target population. IOTF classifies underweight as a serious public health issue (>5% of the children) while WHO provides aggravated picture of the obesity epidemic.

LO119 / #1881**ESPNIC Session****ESPNIC Session 31: How covid-19 impacts clinical trials in the paediatric intensive care unit****09-10-2022 11:00 - 12:20****Overlapping spectrum of severe multi inflammatory syndrome amidst endemic tropical infections – A comparative study from a north Indian pediatric intensive care unit****A. Chattopadhyay*, S. Singla, D. Saikia***Chacha Nehru Bal Chikitsalaya, Pediatric Intensive Care, New Delhi, India***BACKGROUND AND AIMS**

The clinical presentation of severe Multi inflammatory syndrome in children (MISC) and certain infectious diseases causing septic shock often overlap. This study aims to compare the clinical and inflammatory markers between the endemic infections (Typhoid fever, Dengue and Leptospirosis) versus MISC.

METHODS

This was a retrospective chart review of children (aged ≤ 12 years), admitted to PICU between May 1, 2020 and December 31, 2021. Children fulfilling the case definition of MIS-C published by World Health Organization (WHO) or Centers for Disease Control and Prevention (CDC) were categorised as Group 1. Children diagnosed with endemic infections (Typhoid, Dengue and Leptospirosis) were included in Group 2.

RESULTS

Hemoglobin and arterial blood pH at 12 hours of admission were significantly lower in patients with MISC (Group 1) compared to patients with tropical infections (Group 2) ($P < 0.02$). In contrast, total white blood cells, absolute neutrophil count, platelet count and C- reactive protein were significantly higher in patients with MISC as compared to Group 2 patients ($P < 0.001$).

Table 1. Comparison of lab parameters in patients with MISC versus those with tropical infections.

Variables	MISC (n=26)	Tropical infections (n=13)	p value
Hemoglobin at admission (gm/dl)	9.7 (5.8, 13.1)	11.3 (6.4, 7.5)	0.019
Total Leucocyte count (/cu.mm)	14,600 (2400, 36,600)	7670 (4280, 26700)	0.048
Absolute Neutrophil Count (/cu.mm)	8658 (312, 32574)	3536 (770, 8056)	0.0004
C- Reactive protein (mg/L)	184 (1.3, 495)	11.6 (2.1, 555)	0.003
Lactate Dehydrogenase (IU)	476.5 (80, 6004)	2423 (405, 4265)	0.052

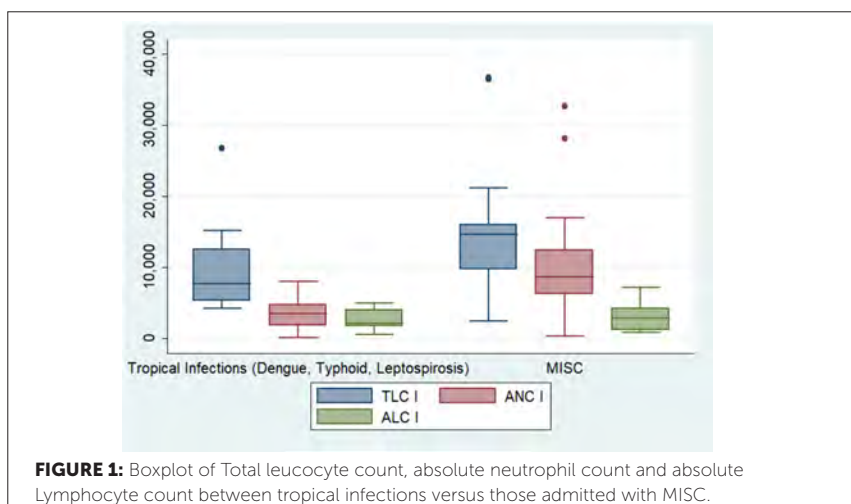

CONUSIONS

Awareness about MISC as a close mimic to endemic tropical infections will help channelise healthcare resources in an appropriate manner.

LO120 / #1710**ESPR Session****ESPR Session 32: Growth & body composition****09-10-2022 11:00 - 12:20****Establishment of a fetal MRI method to measure the body composition for the development of fetal fat mass and fat-free mass trajectories****D. Surmann¹, N. Rochow^{1*}, M. Noseworthy², B. Defrance³, C. Fusch¹**¹*Dept. of Pediatrics, Paracelsus Medical University, Pediatrics, Nuremberg, Germany*²*McMaster University, Electrical and Computer Engineering, Hamilton, Canada*³*McMaster University, Obstetrics & Gynecology, Hamilton, Canada***BACKGROUND AND AIMS**

To optimize growth of preterm infants, reference values for the body composition (BC) of healthy fetuses is required. A non-invasive method to measure fetal BC could be fetal MRI (fetMRI). To date, no approach for fetal BC assessment has been validated. This study aims to develop a method to measure fetal BC with MRI and to review risk factors of fetMRI.

METHODS

This study measured the BC in infants with planned cesarean section. MRI examination was performed pre-and postnatally. Additionally, air-displacement-plethysmography was conducted on the newborn. For MRI absolute quantitation was done using (i) a calibration phantom (Fig.1) and (ii) by using subcutaneous fat tissue, urine, and amnion fluid as internal reference for 0 and 100%fat. Regression equations of voxel intensity and

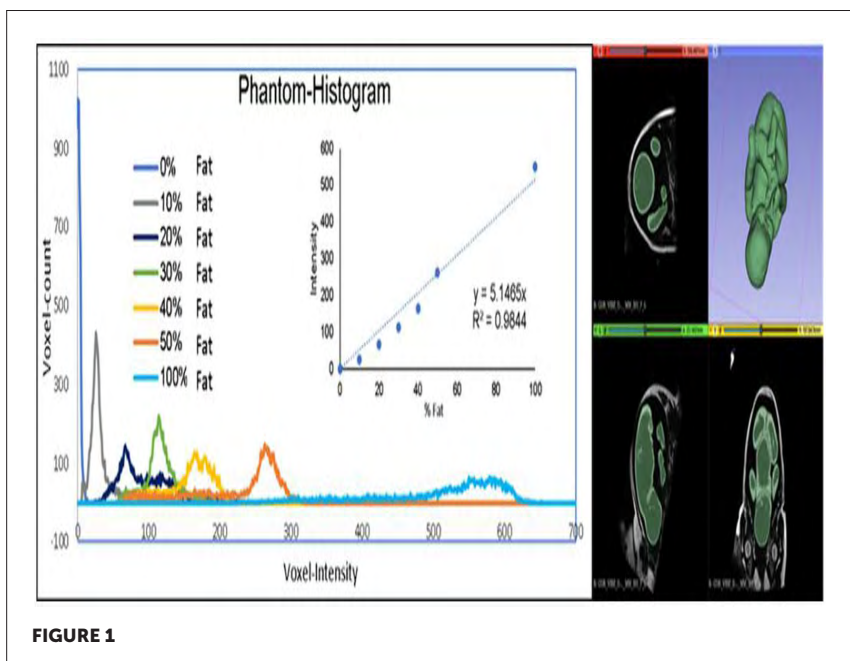
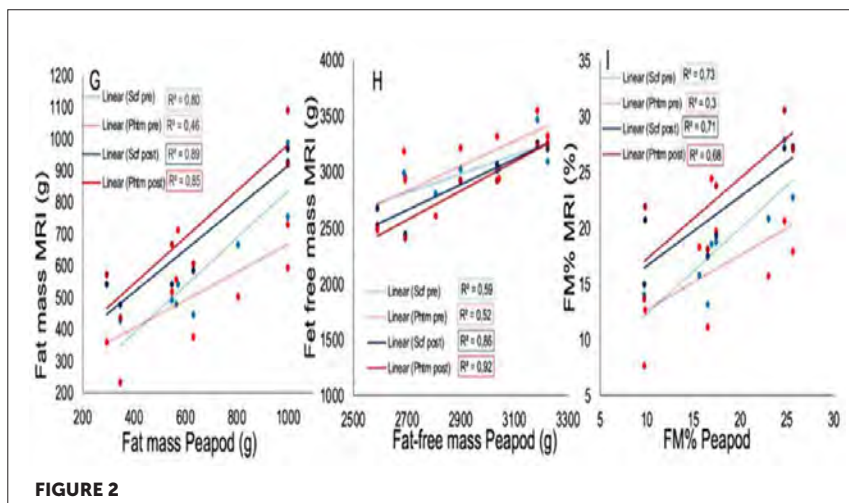

FIGURE 1

%fat were used to calculate BC. A review for with the search term 'fetal MRI safety' was performed.

RESULTS

In total, BC was analyzed in 9 infants using either the subcutaneous fat- or the Phantom reference approach. The subcutaneous fat (Scf) referenced method outperformed the Phantom (Phtm) approach (Fig.2). A literature review could not identify long-term risk on the human fetus.



CONCLUSIONS

The literature review shows that fetal MRI is safe for the human fetus. Further, our validation study shows that fetal MRI could be used to assess fetal BC. In the future, fetal MRI should be employed in longitudinal studies during pregnancy to establish reference data for fetal body composition.

LO121 / #1512**ESPR Session****ESPR Session 32: Growth & body composition****09-10-2022 11:00 - 12:20****Very preterm infants at term equivalent age (TEA) show different body composition than term infants at birth****M. Izquierdo Renau^{1*}, E. García González², C. Balcells Esponera¹, B. Del Rey Hurtado De Mendoza¹, I. Iglesias Platas¹**¹Hospital Sant Joan de Déu, Neonatology, Esplugues de Llobregat, Spain²Hospital Universitario Nuestra Señora de la Candelaria, Neonatology, Santa Cruz de Tenerife, Spain**BACKGROUND AND AIMS**

Preterm infant's growth at term equivalent age (TEA) should be like term infants at birth. Assessing body composition in clinical settings is not easy. Body ratios, circumferences and skinfolds are used as clinical proxys. The distribution of corporal adiposity might be determinant on long-term outcomes.

METHODS

Case-control study: cases were very preterm infants (VPI) admitted in our unit, controls were healthy term infants. At discharge, weight, length and head circumference (HC) were measured; as well as body circumferences (thoracic, abdominal and mid-upper arm) and skinfolds (bicipital, tricipital, subscapular and abdominal). Ponderal and body mass indexes were calculated also, as were body ratios (weight-to-length, waist-to-length and arm fat-to-circumference).

RESULTS

24 controls and 71 cases, with a similar sex distribution, were included. GA in controls was similar to PMA of cases. Weight, length and HC z-scores in cases were lower than in controls (-1,35 vs -0,157; -1,38 vs -0,09; -0,47 vs 1,05 respectively; p value <0,001 in all cases). While we found no differences in abdominal circumference, arm and thoracic were lower in cases. Skinfolds were significantly higher in the case group (figure). Body ratios are show in the table.

Mean(SD)	Weight-to-length (kg/m)	Waist-to-length (cm/cm)	P value
Case	5,16(0,65)	0,68(0,045)	<0,001
Controls	6,11(0,97)	0,64(0,043)	<0,001

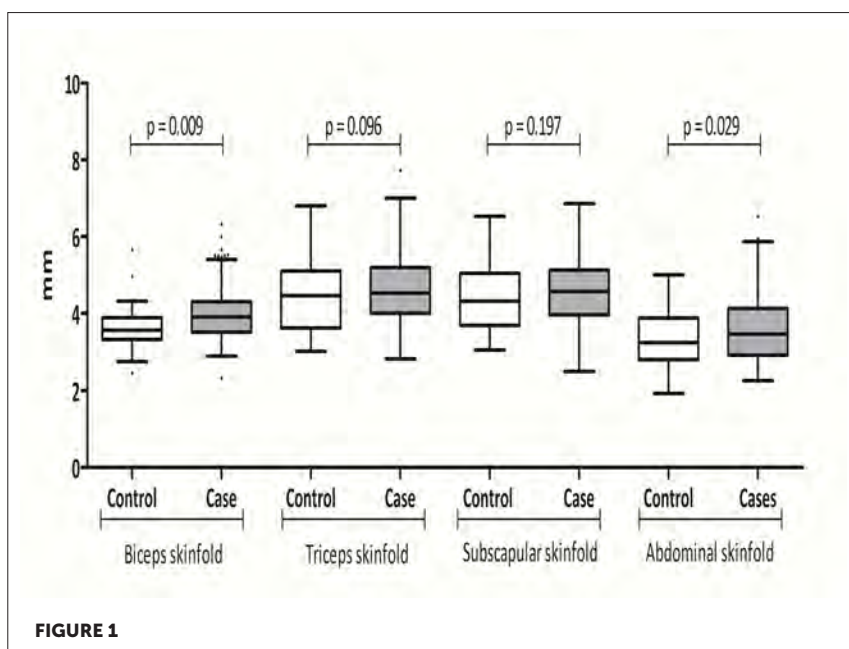

FIGURE 1

CONCLUSIONS

Although VPI at TEA are smaller than term infants, indicators of fat mass are higher. Whether this is due to imbalanced postnatal nutrition or growth or is a reflect of physiological fat mass accretion after birth remains a question for long term follow up.

LO122 / #1216

ESPR Session

ESPR Session 32: Growth & body composition

09-10-2022 11:00 - 12:20

Changes in the growth of very preterm infants in England 2006-2018

**A. Young^{1,2*}, T. Cole³, G. Cheng⁴, H. Phan⁴, S. Ennis⁴, R. Beattie⁵,
M. Johnson^{1,2}**

¹Neonatal Research Department, NIHR Southampton Biomedical Research Centre, Southampton, United Kingdom

²Department of Neonatal Medicine, University Hospital Southampton NHS Foundation Trust, Southampton, United Kingdom

³Policy & Practice Dept, UCL GOS Institute of Child Health, Population, London, United Kingdom

⁴University of Southampton, Genomic Informatics Group, Southampton, United Kingdom

⁵Dept of Paediatric Gastroenterology, University Hospital Southampton NHS Foundation Trust, Southampton, United Kingdom

BACKGROUND AND AIMS

Infants born preterm are known to grow more slowly than those in utero of the same gestation, resulting in downward crossing of centile lines on a standard growth chart before term equivalent age (TEA). We aimed to compare weight gain from birth to 36 weeks postmenstrual age in very preterm infants in England born during two eras (2006-2011 and 2014-2018) and to assess demographic and care factors influencing weight gain.

METHODS

Growth data and clinical information for all infants born before 32 weeks postmenstrual age during 2014-2018 in England and submitted to the National Neonatal Research Database (NNRD) were gathered (29,687 infants). Growth data from a previous study of the 2006-2011 era were re-analysed

(3,288 infants). Growth patterns were modelled using the SuperImposition by Translation And Rotation (SITAR) approach, with infants grouped by gestational age. Multiple linear regression was used to assess factors influencing change in weight SD score from birth to 36 weeks postmenstrual age.

RESULTS

For infants born before 28 weeks gestational age, weight gain was faster in 2014-2018 than in 2006-2011 (see figure). This effect was not present for later born infants. After adjustment for gestation, birthweight and other perinatal factors, delivery in a level 3 neonatal centre was associated with a slightly smaller fall in weight SD score (0.08 SD less, 95% CI 0.06 to 0.09).

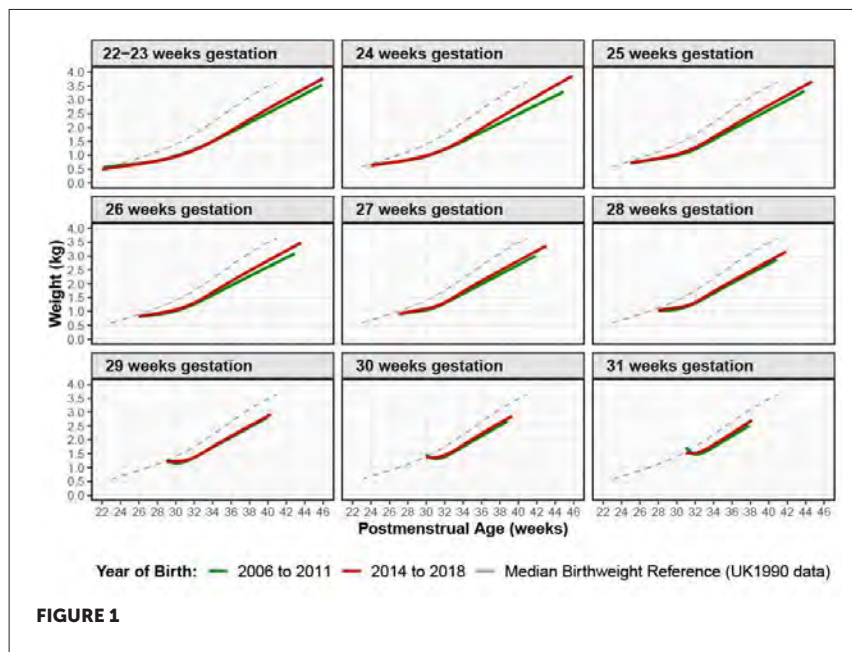

CONCLUSIONS

Weight gain for extremely preterm infants was faster during 2014-2018 than during 2006-2011. However, weight gain remains slower than would be expected for an equivalent fetus in utero (see figure).

LO123 / #1187**ESPNIC Session****ESPNIC Session 33: Update in critical care nephrology and hepatology****09-10-2022 11:00 - 12:20****Continuous venous-venous hemo-filtration (CVVH) with carpediem for neonates with multisystem organ failure (MSOF): Our experience****G. Regiroli^{1*}, L. Pezza¹, R. Centorrino^{1,2}, B. Loi^{1,2}, N. Yousef¹, R. Ben-Ammar¹, D. De Luca^{1,2}**

¹A.Beclere* Medical Center, Paris Saclay University Hospital, APHP – Paris, Division of Pediatrics and Neonatal Critical Care, Clamart, France

²Paris Saclay University, South Paris Medical School, Paris, France

BACKGROUND AND AIMS

Multisystem organ failure (MSOF) in neonates is a systemic inflammatory response leading to a progressive organ dysfunction and death. MSOF is characterized by the failure of two, or more, organs including cardiovascular, respiratory, renal, suprarenal, hepatic, hematologic and central nervous system. Cardio-Renal Pediatric Dialysis Emergency Machine (C.A.R.PE.DI.E.M.) is a device providing CVVH dedicated to neonates and infants weighting at least 2 kg. No data are available so far regarding the use of CVVH for neonatal MSOF.

METHODS

We aimed to retrospectively report our experience using CARPEDIEM in neonates with MSOF treated CVVH. Data are presented as median and confidence interval.

RESULTS

8 neonates (median gestational age: 37 [35.2-38.8]; median birth weight: 2540g [2080-3090]) with MSOF and hemodynamic instability (median Vasoactive-Inotropic Score: 50 [38.5-141.5]) received 14 CVH sessions (318 h), using 0.15 and 0.25m² hemofilters. The patients presented septic shock (n=1), AKI (n=8), hypoxic ischemic encephalopathy (n=6), cardiomyopathy (n=2), severe ARDS (n=1), DIC (n=3), distributive shock (n=5). CVH was conducted using a 4.5 Fr and 5.5 Fr double-lumen central vascular access allowing overall median blood flow of 8.9 ml/kg/min [6.6-10.6]. Circuits were primed with NaCl 0.9%, using heparin anticoagulation. No sessions were stopped secondary to a filter clotting. CVH efficaciously allowed blood purification as blood K⁺ (p=0.06), lactate (p=0.005) and creatinine (p=0.005) were lower after the sessions (Fig1) without aggravation of hemodynamic instability. Two neonates survived; deaths were eventually secondary underlying diseases.

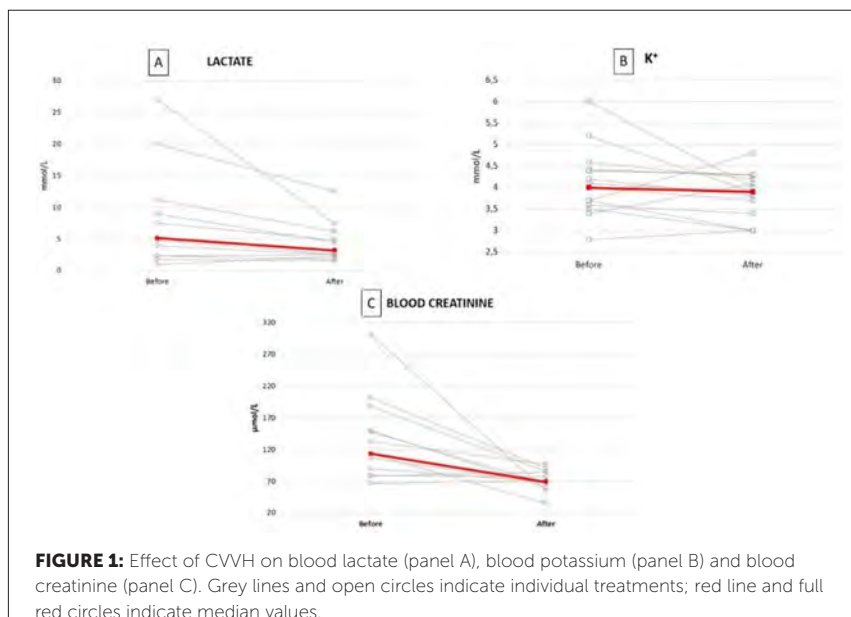

CONCLUSIONS

CWH is safe and promising to support vital function in neonatal MOSF.

LO124 / #1398**Interdisciplinary Session****Interdisciplinary Session 13: Procedural sedation (ESPA Session)****09-10-2022 15:00 - 16:30****How to support children to express their preferences around small invasive medical procedures: Childrens' and parents' perspectives****E. Segers^{1*}, M. Ketelaar², M. De Man^{1,3}, L. Schoonhoven⁴,
E. Van De Putte¹, A. Van Den Hoogen⁵**¹University Medical Center Utrecht - Wilhelmina's Children Hospital, Children, Utrecht, Netherlands²University Medical Center Utrecht, Center of Excellence for Rehabilitation Medicin; Brain Center Rudolf Magnus, Utrecht, Netherlands³UMCU WKZ, Children, Utrecht, Netherlands⁴University Medical Center Utrecht, Nursing Science, Julius Center, Utrecht, Netherlands⁵Department of Neonatology, University Medical Centre Utrecht - Wilhelmina Children's Hospital, Utrecht, Netherlands**BACKGROUND AND AIMS**

Invasive medical procedures in hospitals are major sources of stress in children, causing pain and fear. Non-pharmacological interventions are indispensable in an effective approach to minimize pain and fear. However, these interventions must be personalized to be effective. This qualitative study aimed to get insight into children's and parents' experiences, needs, and wishes in supporting children to express their preferences around small invasive medical procedures to decrease pain and fear.

METHODS

A qualitative study using thematic analysis was performed. Data were collected through semi structured interviews with children and parents of a

child who had undergone at least five small invasive medical procedures in the last year.

RESULTS

Nineteen children (8-18 years) and fourteen parents (two fathers and twelve mothers) were interviewed individually. In six cases, both child and parent of the same family were interviewed separately. From the data three themes emerged: the overarching theme "A personal process", and two more conditional themes: "To gain control" and "To feel trust". Subthemes in the Personal Process were Developing coping preferences and Expressing coping preferences. Children and parents reported it as an ongoing process, different for every child, with his own unique needs. Children and parents expected personalized attention and tailored support from professionals.

CONCLUSIONS

Professionals must combine professional skills with personal attention and respect for children's unique needs and boundaries in the process of searching and communicating coping preferences. This gives children and parents the feeling of control and trust during invasive medical procedures.

LO125 / #1416**Interdisciplinary Session****Interdisciplinary Session 13: Procedural sedation (ESPA Session)****09-10-2022 15:00 - 16:30****How to meet coping strategies and preferences of children around invasive medical procedures: Perspectives of professionals****E. Segers^{1*}, A. Van Den Hoogen², M. De Man¹, L. Schoonhoven³, E. Van De Putte¹, M. Ketelaar⁴**¹University Medical Center Utrecht - Wilhelmina's Children Hospital, Children, Utrecht, Netherlands²Department of Neonatology, University Medical Centre Utrecht - Wilhelmina Children's Hospital, Utrecht, Netherlands³University Medical Center Utrecht, Nursing Science, Julius Center, Utrecht, Netherlands⁴University Medical Center Utrecht, Center of Excellence for Rehabilitation Medicine; Brain Center Rudolf Magnus, Utrecht, Netherlands**BACKGROUND AND AIMS**

Children with negative previous procedural experiences have an increased risk of fear and distress, with psychological consequences for subsequent procedures and future health care behaviours. Gaining control and feeling trust are important aspects for children to decrease fear. To enable professionals providing personal care around medical procedures, a systematic, evidence-based approach that supports children in expressing their own preferences is needed. This study will gain insight into the experiences and needs of professionals involved in invasive medical procedures to meet the coping strategies and preferences of children undergoing these procedures.

METHODS

A qualitative design was used to get insight into professionals' perspectives. Data were collected through online focusgroups with different professionals involved in medical procedures, such as anaesthetists, laboratory staff, nurses and paediatricians.

RESULTS

Five focus groups, including 33 participants, were held. In each group, different disciplines participated. Professionals perceived they had to deal with four different actors during a medical procedure: themselves, the child, the parent and the organization. Each actor had its own needs and interests. They were aware of the child and parents' priority to gain control and to feel trust, nevertheless, they perceive organizational and personal aspects that hinder the addressing of these needs.

CONCLUSIONS

To give personalized care, professionals experience balancing between the needs, interests and priorities of themselves, children, parents and the organization around medical procedures. Scenario training could be an effective approach for professionals to develop skills to improve collaboration and to assess childrens' and parents' personal needs.

LO126 / #522**Interdisciplinary Session****Interdisciplinary Session 14: Early diagnosis and new therapies in neuromuscular diseases (Catalan paediatric society session)****09-10-2022 15:00 - 16:30****Early detection of Duchenne muscular dystrophy based on developmental milestones****P. Van Dommelen¹, O. Van Dijk², J.A. De Wilde², P.H. Verkerk^{1*}**¹TNO, Child Health, Leiden, Netherlands²Leiden University Medical Center, Public Health and Primary Care, Leiden, Netherlands**BACKGROUND AND AIMS**

Duchenne muscular dystrophy (DMD) is diagnosed at around 4-5 years of age. Our aim is to develop a tool based on developmental milestones that may contribute to the earlier detection of boys with DMD.

METHODS

As part of the case-control 4D-DMD study (Detection by Developmental Delay in Dutch boys with DMD), data on developmental milestones, symptoms and therapies for 76 boys with DMD and 12,414 boys from a control group were extracted from the health records of youth health care services and questionnaires. Multiple imputation, diagnostic validity and pooled backward logistic regression analyses with DMD (yes/no) as the dependent variable and attainment of 26 milestones until 36 months of age (yes/no) as the independent variable were performed. Descriptive statistics on symptoms and therapies were provided.

RESULTS

From two months onwards more cases failed to attain milestones compared to the control group ($p < 0.01$). A tool with seven milestones (pulls up to standing position, reacts to a verbal request, sits in stable position without support, crawls abdomen off the floor, walks alone, walks well alone, walks smoothly) assessed at specific ages between 12-36 months resulted in a sensitivity of 79% (95%CI:67-88%), a specificity of 95.8% (95%CI:95.3-96.2), and a positive predictive value of 1:268 boys.

CONCLUSIONS

Delay in DMD is already apparent at a very early age. A tool based on developmental milestones assessed in the period from 12 to 36 months may be helpful in identifying boys with DMD.

LO127 / #1425

Interdisciplinary Session

interdisciplinary Session 14: Early diagnosis and new therapies in neuromuscular diseases (Catalan paediatric society session)

09-10-2022 15:00 - 16:30

Enterovirus infection associated neurologic disease in a tertiary hospital in Spain: Clinical characteristics, risk factors and outcomes

E. Turon-Viñas^{1*}, F. Castillo-Gómez¹, E. Moliner Calderon², E. Carbonell Estarellas³, A. Turon-Viñas⁴, L. Armendáriz³, N. Rabella⁵, M. Del Cuerpo Casas⁵, S. Boronat-Guerrero⁶

¹Hospital Sant Pau., Paediatric Intensive Care, Barcelona, Spain

²Pediatrics Department, Hospital de la Santa Creu i Sant Pau, Neonatology. Barcelona, Spain

³Paediatrics Department, Hospital de la Santa Creu i Sant Pau, Barcelona, Spain

⁴Hospital De La Santa Creu I Sant Pau, Pediatrics Emergency Room, Barcelona, Spain

⁵Microbiology Department, Hospital de la Santa Creu i Sant Pau, Section of Virology, Barcelona, Spain

⁶Hospital Sant Pau., Child Neurology, Barcelona, Spain

BACKGROUND AND AIMS

Enteroviruses are a frequent cause of central nervous system infection in children. Infection can be asymptomatic, or symptoms can range from mild to severe. However, the risk factors for developing severe neurological involvement are not well understood. Our aim was to analyze characteristics associated with severe neurological involvement in children with neurological disease in enterovirus infection.

METHODS

Retrospective study of children admitted to our hospital from 2009 to 2019. Epidemiological and clinical data, and results of ancillary tests were analyzed.

RESULTS

174 patients were included, with a mean age of 3.1 years (0.2-5.1 years). According to the World Health Organization case definition for neurological complications in hand, foot and mouth disease, 82.8% had aseptic meningitis, 8.6% encephalitis, 5.7% brainstem encephalitis, 1.7% autonomic nervous system dysregulation and 0.6% encephalomyelitis. Age between 6 months and 2 years ($p<0.001$), the appearance of neurological symptoms within the first 12 hours from infection onset ($p<0.001$), the presence of skin rash ($p=0.012$) and hand, foot and mouth disease ($p=0.025$) were statistically associated to severe neurological involvement. Enterovirus was detected by RT-PCR in cerebrospinal fluid in 93% of patients with aseptic meningitis, but only in 33% of patients with encephalitis. In those who were negative, feces and nasopharyngeal fluids were needed to confirm diagnose.

CONCLUSIONS

In children between 6 months to 2 years of age who develop neurological signs—associated with a non-specific skin rash or HFMD—within the first 12 hours from onset, a broad and early microbiological study should be considered.

LO128 / #1428**Interdisciplinary Session****Interdisciplinary Session 14: Early diagnosis and new therapies in neuromuscular diseases (Catalan paediatric society session)****09-10-2022 15:00 - 16:30****Enterovirus infection associated neurologic disease in a pediatric population in Spain: Correlation between clinical characteristics and genotyping****E. Carbonell Estarellas^{1*}, E. Turon-Viñas², E. Moliner Calderon³, F. Castillo-Gómez², L. Armendáriz Lacasa¹, A. Turón Viñas⁴, M. Del Cuerpo Casas⁵, N. Rabella⁵, S. Boronat-Guerrero⁶**¹Paediatrics Department, Hospital de la Santa Creu i Sant Pau, Barcelona, Spain²Hospital Sant Pau., Paediatric Intensive Care, Barcelona, Spain³Pediatrics Department, Hospital de la Santa Creu i Sant Pau, Neonatology, Barcelona, Spain⁴Hospital De La Santa Creu I Sant Pau, Pediatrics Emergency Room, Barcelona, Spain⁵Microbiology Department, Hospital de la Santa Creu i Sant Pau, Section of Virology, Barcelona, Spain⁶Neurology Department, Hospital Sant Pau, Barcelona, Spain**BACKGROUND AND AIMS**

Enteroviruses (EV) are a frequent cause of infections in children. Some EV genotypes are more associated to neurological involvement. Risk factors for developing severe neurological involvement, however, are not well understood. Our aim was to analyze some characteristics of children admitted for neurological disease after enterovirus infection.

METHODS

Retrospective study of children admitted to our hospital with EV infection associated neurological disease from 2009 to 2019. Epidemiological and clinical data, and results of ancillary tests were analyzed.

RESULTS

174 patients were included. A total of 306 samples were obtained from CSF (n=172), nasopharyngeal fluids (n=72), and feces (n=62). Enterovirus was detected by RT-PCR in CSF in 93% of patients with aseptic meningitis, but only in 33% of patients with encephalitis. EV genotyping was performed in 69 patients. Eleven different genotypes were identified, being E-30 and EV-A71 the most frequent ones (24.6% each). E-30 accounted for 51.6% of aseptic meningitis all through the study period, while EV-A71 was detected in 54.5% of the encephalitic patients, but only observed after 2016. EV-A71 was frequent in children 6 months to 2 years old and presented with skin rash in 76.4% of them. EV-A71 was associated to severe neurological involvement ($p < 0.001$).

CONCLUSIONS

EV-A71 was the most frequent EV genotype associated to severe neurological involvement in our series. Children 6 months to 2 years of age, specially if presenting with skin rash, were at higher risk of developing this complication. Early and comprehensive diagnosis is needed to better manage these patients.

LO129 / #997**Interdisciplinary Session****Interdisciplinary Session 15: Symptom control in complex chronic conditions (EAPC Session)****09-10-2022 15:00 - 16:30****Glucocorticoid-induced adrenal insufficiency: Monitoring by morning cortisol values avoids unnecessary LD-SST in children****M. Laulhé^{1*}, C. Dumaine², D. Chevenne³, F. Laye⁴, A. Faye², S. Auvin⁵, M. Strullu⁶, J. Viala⁷, J. Hogan⁸, V. Houdouin⁹, J. Léger¹, D. Simon¹, J.C. Carel¹, C. Storey¹, S. Guilmin-Crepon⁴, L. Martinerie¹**¹Robert Debré Hospital, Pediatric Endocrinology, Paris, France²Robert Debré Hospital, General Pediatrics, Paris, France³Robert Debré Hospital, Biochemistry, Paris, France⁴Robert Debré Hospital, Clinical Epidemiology, Paris, France⁵Robert Debré Hospital, Pediatric Neurology, Paris, France⁶Robert Debré Hospital, Pediatric Haematology, Paris, France⁷Robert Debré Hospital, Pediatric Gastroenterology, Paris, France⁸Robert Debré Hospital, Pediatric Nephrology, Paris, France⁹Robert Debré Hospital, Pediatric Pneumology, Paris, France**BACKGROUND AND AIMS**

Adrenal insufficiency following chronic administration of glucocorticoids affects around 40% of the patients. In pediatrics, the diagnosis of glucocorticoid induced adrenal insufficiency (GI-AI) is based on the Low Dose Synacthen Test (LD-SST). However, it requires an intravenous line, medical survey, and a day hospitalization. We aimed to define morning cortisol thresholds to predict normal and pathologic responses to the LD-SST and avoid unnecessary tests.

METHODS

Patients aged 6 months to 18 years-old who underwent a LD-SST following administration of glucocorticoids during at least 3 weeks between 2016 and 2020 were recorded. An elevation of plasma cortisol 20 minutes after 1µg of Synacthen above 500 nmol/L ruled out adrenal insufficiency.

RESULTS

Considering the 91 patients included, 60% were diagnosed with GI-AI. Using a ROC curve (AUC 0.78), morning plasma cortisol levels under 144 nmol/L predicted GI-AI with a specificity of 94%, whereas GI-AI was ruled out when morning plasma cortisol value was superior to 317nmol/L with a sensitivity of 95%.

CONCLUSIONS

Morning cortisol values can be a safe tool to screen adrenal insufficiency after prolonged glucocorticoid treatment in children and could avoid 50% of unnecessary LD-SST.

LO130 / #2183**Interdisciplinary Session****Interdisciplinary Session 16: Update in infectious diseases (Catalan pediatric society session)****09-10-2022 15:00 - 16:30****Evaluation of a Kawasaki disease risk model for predicting coronary artery aneurism in the COVID-19 era in children****F. Pizzo*, A. Di Nora, R. Leonardi, L. Licciardello, P. Sciacca, C. Giuseppe***University of Catania, Pediatrics, Catania, Italy***BACKGROUND AND AIMS**

Kawasaki disease (KD) is an autoinflammatory, systemic vasculitis that leads to the development of coronary artery aneurysm (CAA). The present study evaluated the risk of coronary artery abnormality development using baseline demographic and laboratory, echocardiogram findings in covid e non-covid patients. We tried to establish a correlation of these values with the presence and persistence of coronary dilatation at three months defined as a Z score > 2.5.

METHODS

We recruited 89 children (mean age 2 years) M / F = 1.5 with KD who received standard therapy non-covid (68) and covid (21) from January 2021 to January 2022. The coronary arteries were evaluated with the z score at baseline and after three months. CAA was defined as a z score \geq 2.5. We report that age, z-score, number of platelets, and C-Reactive Protein (CRP) at baseline are correlated with the risk of persistence of CAA at three months.

RESULTS

We evaluated whether there was an increased risk of CAA at three months in both covid and non-covid populations. The cut-offs were evaluated for

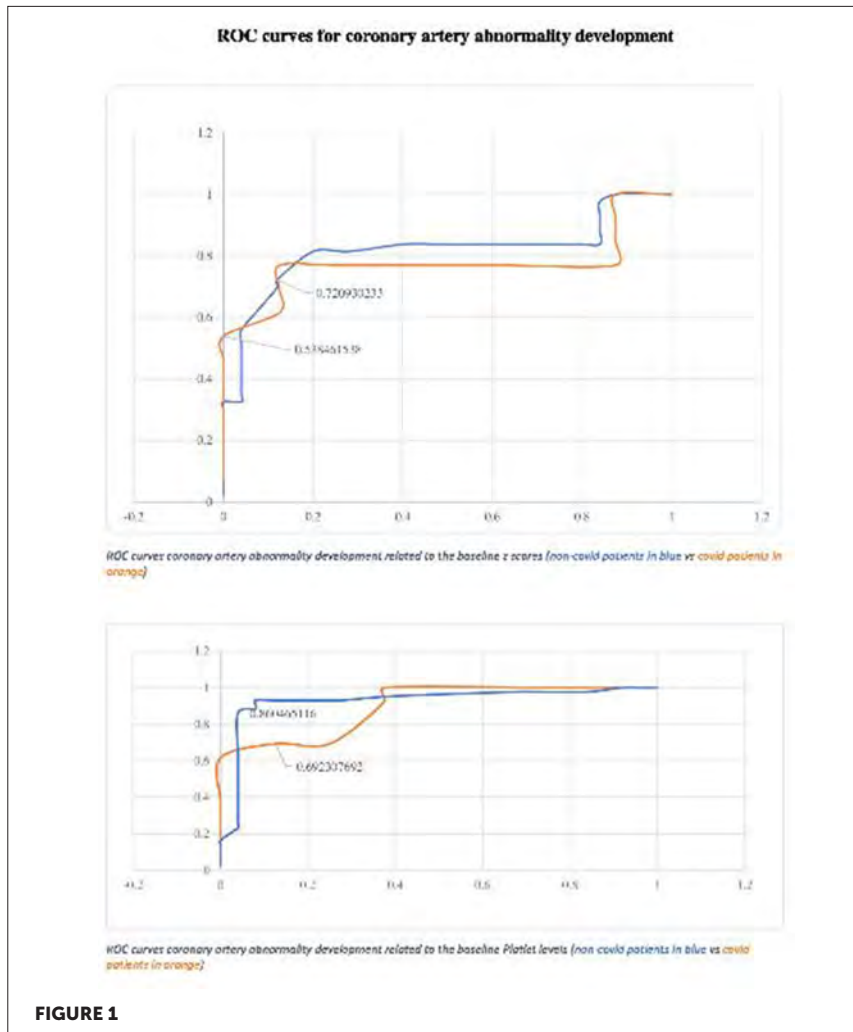

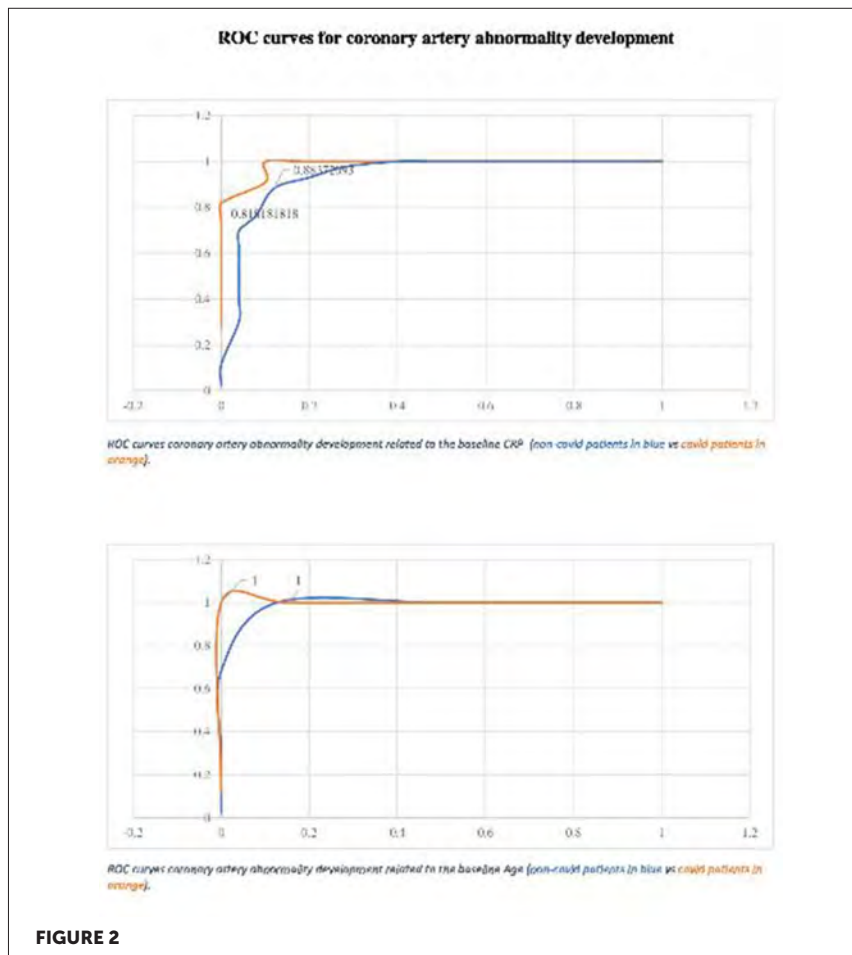

age, platelets, z-score, and CRP which exceeded are related to CAA. Age has the same sensitivity and specificity in predicting CAA at three months in both patients.

CONCLUSIONS

Age, z-score, platelets, and CRP are sensitive and specific parameters for the risk of CAA at three months. These parameters lose their predictive value in the covid population except for the age. The association of these variables in covid children for a risk model had not been evaluated.

LO131 / #1409**Interdisciplinary Session****Interdisciplinary Session 17: Research with children - benefits and pitfalls (EAPC and ESPR Session)****09-10-2022 15:00 - 16:30****Implementing two-stage consent pathway in neonatal trials****S. Ojha^{1*}, J. Dorling², E. Mitchell³, S. Oddie⁴, M. Johnson⁵, C. Gale⁶**¹University of Nottingham, School of Medicine, DENE, United Kingdom²University Hospitals of Southampton, Neonatal Intensive Care Unit, Southampton, United Kingdom³University of Nottingham, Nottingham Clinical Trials Unit, Nottingham, United Kingdom⁴Bradford Teaching Hospitals NHS Foundation Trust, Neonatal Intensive Care Unit, Bradford, United Kingdom⁵Department of Neonatal Medicine, University Hospital Southampton NHS Foundation Trust, Southampton, United Kingdom⁶Imperial College, Neonatal Data Analysis Unit, London, United Kingdom**BACKGROUND AND AIMS**

Informed consent is a prerequisite for ethical conduct of a clinical trial. Obtaining valid, informed consent during emergencies or sensitive periods such as when a woman has just had an unplanned premature delivery can be difficult and cause emotional distress.

METHODS

FEED1 is a randomised, multicentre RCT comparing full enteral milk feeds from day 1 with gradual feeding in 30–32 weeks' infants. Participants have to be randomised within 3 hours of birth. A two-stage consent pathway is being used (oral assent followed by later written consent) to make the

process less burdensome to families and more feasible for researchers. We provide examples of how this is being implemented and recommendations for approaches in future studies.

RESULTS

The consent pathway is discussed during site training: background, simulations with role-play, interactive discussions, and guidance on the oral assent conversation. All training materials are freely available at www.feed1.ac.uk. The minimum important information to include in an oral assent conversation is given in figure 1 with an example

DISCUSSION

Co-investigators conduct webinars assent/consent scenarios, role-play, and exploration of any concerns. An ethically approved animation for parents

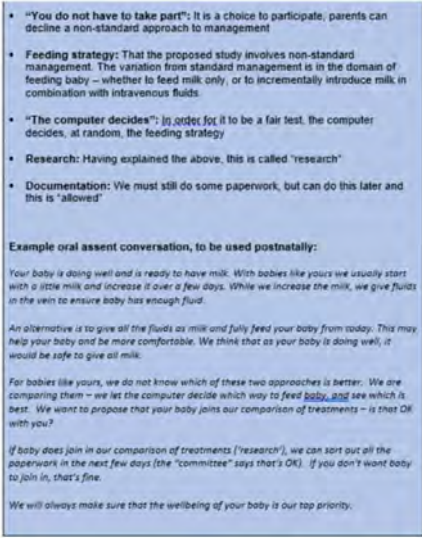

• “You do not have to take part”: It is a choice to participate, parents can decline a non-standard approach to management

• **Feeding strategy:** That the proposed study involves non-standard management. The variation from standard management is in the domain of feeding baby – whether to feed milk only, or to incrementally introduce milk in combination with intravenous fluids.

• “The computer decides”: In order for it to be a fair test, the computer decides, at random, the feeding strategy

• **Research:** Having explained the above, this is called ‘research’

• **Documentation:** We must still do some paperwork, but can do this later and this is ‘allowed’

Example oral assent conversation, to be used postnatally:

Your baby is doing well and is ready to have milk. With babies like yours we usually start with a little milk and increase it over a few days. While we increase the milk, we give fluids in the vein to ensure baby has enough fluid.

An alternative is to give all the fluids as milk and fully feed your baby from today. This may help your baby and be more comfortable. We think that as your baby is doing well, it would be safe to give all milk.

For babies like yours, we do not know which of these two approaches is better. We are comparing them – we let the computer decide which way to feed baby, and see which is best. We want to propose that your baby joins our comparison of treatments – is that OK with you?

If baby does join in our comparison of treatments (‘research’), we can sort out all the paperwork in the next few days (the ‘committee’ says that’s OK). If you don’t want baby to join in, that’s fine.

We will always make sure that the wellbeing of your baby is our top priority.

FIGURE 1: Minimum important information required during an oral assent conversation and example discussion. Created by authors Mitchell and Oddie, permission for reuse granted.

has been distributed to sites with QR code-cards enabling instant access using any internet-enabled device and is available on the trial website for information sharing.

CONCLUSIONS

Previous research has shown that the two-stage consent pathway is acceptable to parents and clinicians. The FEED1 experience demonstrates that sites require support and resources to implement it successfully. Early engagement with public and parent partners, “buy-in” for recruiting clinicians, and robust training and ongoing engagement activities are needed.

LO132 / #1156**Interdisciplinary Session****Interdisciplinary Session 17: Research with children - Benefits and pitfalls (EAPC and ESPR Session)****09-10-2022 15:00 - 16:30****The contribution of newborn health to child mortality across England****D. Odd¹, S. Stoianova¹, J. Kurinczuk², T. Williams¹, G. Rossouw¹, V. Sleaf¹, P. Fleming¹, K. Luyt^{1,3*}**¹University of Bristol, National Child Mortality Database, Bristol, United Kingdom²University of Oxford, Npeu, Oxford, United Kingdom³University of Bristol, Bristol Medical School, Bristol, United Kingdom**BACKGROUND AND AIMS**

To investigate how many deaths in the first 10-years of childhood are associated with neonatal illness, the specific neonatal conditions involved, and causation of death.

METHODS

Deaths between April 2019-March 2021(24-months), reported to the National Child Mortality Database(NCMD) were identified. Child death review data were linked with Neonatal care records(BadgerNet). Neonatal care was defined as receiving care in a neonatal unit after birth, in addition to those who died in the first day of life outside of a neonatal unit('Likely neonatal illness'). Population characteristics were identified, and then using a Poisson model, the relative mortality risk in three age categories(<1 year, 1-4 years and 5-9 years) estimated, stratified by neonatal illness, and by specific neonatal conditions. Populations at risk were estimated from ONS data.

RESULTS

4829 children died before their 10th birthday. Half(n=2406) occurred within the first 4-weeks of life. Overall, 71.6% of deaths had evidence of neonatal illness(82.7% of deaths <1 year, 38.4% between 1-4 years, and 27.3% between 5-9 years(Table-1)). Children with neonatal illness were 16-times (RR16.73(95%

Table 1: Neonatal conditions of all deaths of children aged less than 10 years in England, April 2019 to March 2021; split by their age at death

Characteristic	Stratified by Age at death			p-value
	<1 year	1-4 Years	5-9 Years	
All deaths	3730	659	440	-
Any Likely neonatal illness	3083 (82.7%)	253 (38.4%)	120 (27.3%)	<0.001
Specific Neonatal Conditions				
LBW (Term births only)	223 (6.0%)	24 (3.6%)	16 (3.6%)	0.011
Preterm	2244 (60.2%)	124 (18.8%)	61 (13.9%)	<0.001
Hypoxic-Ischaemic Encephalopathy	308 (8.3%)	18 (2.7%)	14 (3.2%)	<0.001
Congenital Abnormality	1503 (40.3%)	171 (26.0%)	75 (17.1%)	<0.001
Intracranial Haemorrhage	600 (16.1%)	19 (2.9%)	-	<0.001
NEC	401 (10.8%)	19 (2.9%)	-	<0.001

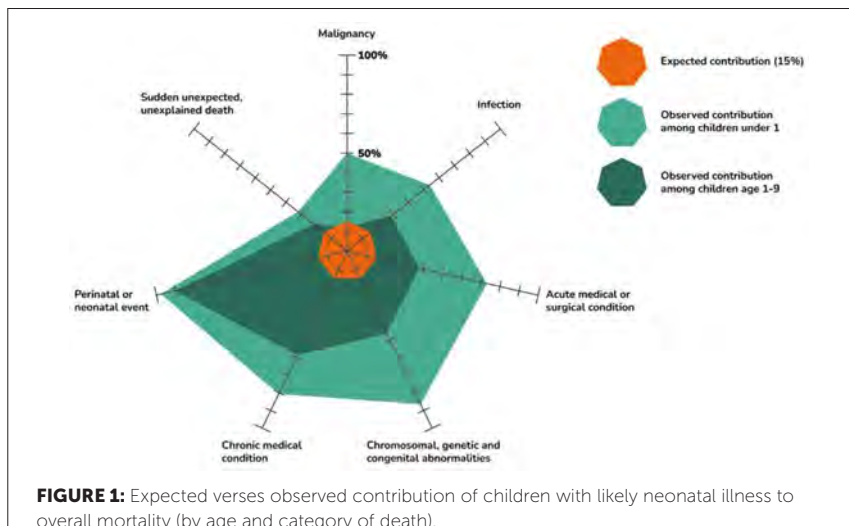

CI 15.68-17.87)) more likely to die before their 10th birthday than those without neonatal illness. Increased risk was seen in all age groups, (<1 year;RR 37.71(95%CI:34.23-41.55), between 1-4 years; RR3.70(95%CI:3.12-4.38), between 5-9 years RR2.08(95%CI:1.73-2.52).

CONCLUSIONS

For children (>22 weeks GA), the majority of deaths under 10-years occurred in the first year of life. However, a third of deaths in the next 4 years, and a quarter of deaths in children between 5-9 years of age were also linkable to neonatal illness.

LO133 / #1342**Interdisciplinary Session****Interdisciplinary Session 17: Research with children - Benefits and pitfalls (EAPC and ESPR Session)****09-10-2022 15:00 - 16:30****Optimizing research to improve transitional care for children with complex medical needs: The development of a core outcome set****H. Haspels^{1,2*}, A. De Lange³, M. Alsem^{3,4}, K. Joosten¹, M. De Hoog¹, C. Van Karnebeek⁵, J. Van Woensel², B. Sandbergen⁶, J. Maaskant^{3,7}**

¹Department of Pediatrics, Erasmus MC Sophia Children's Hospital, University Medical Center Rotterdam, Pediatric Intensive Care Unit, Rotterdam, Netherlands

²Department of Pediatrics, Amsterdam UMC location University of Amsterdam, Pediatric Intensive Care Unit, Amsterdam, Netherlands

³Department of Pediatrics, Amsterdam UMC location University of Amsterdam, Amsterdam, Netherlands

⁴Amsterdam UMC location University of Amsterdam, Rehabilitation Medicine, Amsterdam, Netherlands

⁵Department of Pediatrics and Human Genetics, Amsterdam UMC location University of Amsterdam, Emma Center for Personalized Medicine, Amsterdam, Netherlands

⁶Department of Pediatrics, Amsterdam UMC, Expert By Experience, Amsterdam, Netherlands

⁷Amsterdam UMC location University of Amsterdam, Data Science and Epidemiology, Amsterdam, Netherlands

BACKGROUND AND AIMS

Research in the field of transitional care from hospital to home (H2H) for Children with Medical Complexity (CMC) is hampered by the heterogeneity of outcomes. Our objective was to develop a Core Outcome Set (COS), that can be used to assess clinical trials evaluating CMC transitional care.

METHODS

The development process consisted of three phases: (1) a systematic review identifying all reported outcomes, (2) a modified three-round Delphi study in which different stakeholders (e.g. pediatricians, pediatric nurses, paramedics, psychologists and representatives of parents' interest groups) rated these outcome domains for inclusion in the COS, and (3) focus groups with CMC parents to validate the results of the Delphi study.

RESULTS

The systematic review identified 24 outcome domains for the Delphi survey. Sixty-seven experts consented to participate, overall response rates were 55%, 57% and 58% for each round. In the first round 12 additional outcomes were suggested by the experts. Consensus was defined as outcomes scoring >70% "strongly agree" plus "agree". The experts reached consensus on three core outcome domains: (1) The impact of a transitional intervention program on the number of children with well controlled disease management at home (e.g. preventable physical care), (2) Children's Quality of Life and (3) Impact on the life of families. The results of the focus groups and the final COS will be presented in October.

CONCLUSIONS

An evidence-informed COS based on international consensus, including healthcare professionals and parents of CMC has been developed. This COS is recommended for all future studies evaluating the H2H transition of CMC.

LO134 / #603**Interdisciplinary Session****Interdisciplinary Session 22: Update in paediatric pulmonology (Catalan pediatric society)****09-10-2022 15:00 - 16:30****Pathway analysis of beta-lactam pharmacokinetics and antibiotic spectrum on recovery of pulmonary function in persons with cystic fibrosis experiencing pulmonary exacerbation****A. Hahn^{1*}, A. Burrell², H. Chaney³, I. Sami³, A. Koumbourlis³, R. Freishtat⁴, K. Crandall⁵, E. Zemanick⁶**¹Children's National Hospital, Infectious Diseases, Washington, United States of America²Children's National Research Institute, Center for Genetic Medicine, Washington, United States of America³Children's National Hospital, Pulmonary and Sleep Medicine, Washington, United States of America⁴Children's National Hospital, Emergency Medicine, Washington, United States of America⁵George Washington University Milken Institute School of Public Health, Biostatistics and Bioinformatics, Washington, United States of America⁶University of Colorado Anschutz Medical Campus, Pediatrics, Aurora, United States of America**BACKGROUND AND AIMS**

Persons with cystic fibrosis (PwCF) suffer from recurrent pulmonary exacerbations (PEX) related in part to lung infection. *Prevotella* secrete beta-lactamases, which may influence recovery of lung function during PEX treatment. Our study aim was to evaluate the concerted association of beta-lactam pharmacokinetics (PK) and antibiotic spectrum on recovery of pulmonary function, influenced by microbial diversity (including *Prevotella* relative abundance) and beta-lactam antibiotic resistance.

METHODS

This was a retrospective study of PwCF treated with IV antibiotics for PEx between 2016-2020 at Children's National Hospital in Washington DC. Following metagenomic sequencing of sputum samples, PathoScope 2.0 and AmrPlusPlus were used for taxonomic assignment of sequences to bacteria and antibiotic resistance genes (ARGs). M/W Pharm was used for PK modeling. Structural equation modeling was performed in STATA/IC (v15.1).

RESULTS

Twenty-two PwCF experienced 43 PEx. The study cohort had a mean age of 14.6 yrs, 41% female, 59% White, 5% Black, 36% Hispanic, 45% F508del homozygous and 23% F508del heterozygous. We did not detect differences in the increase in percent predicted forced expiratory volume in one second (ppFEV1) at end of treatment compared to PEx based on beta-lactam PK (sufficient 13.6% vs insufficient 15.1%) or antibiotic spectrum (broad 11.5% vs narrow 16.6%). There was an inverse relationship between beta-lactam ARGs and Shannon diversity ($p=0.008$), the inverse Simpson index ($p=0.015$), increase in ppFEV1 ($p=0.083$).

CONCLUSIONS

Despite alterations in the microbial community, neither achieving therapeutic B-lactam PK nor using broad spectrum antimicrobials was associated with superior recovery of lung function compared with subtherapeutic PK and narrow spectrum antimicrobials.

LO135 / #1288**ESPNIC Session****ESPNIC Session 34: COVID-19 collateral damage****09-10-2022 17:00 - 17:55****COVID-19 Related admissions to paediatric intensive care in Ireland****N. Beirne*, M. Healy***Children's Health Ireland at Crumlin, Paediatric Intensive Care Unit, Dublin, Ireland***BACKGROUND AND AIMS**

To establish the number of admissions to Paediatric Intensive Care Units (PICU) in Ireland between January 1st 2020 and December 31st 2021 with an admitting diagnosis of COVID-19 +/- Paediatric Multisystem Inflammatory Syndrome – Temporally Associated with SARS-CoV-2 (PIM-TS). To further examine these admissions for: demographics; co-morbidities; interventions; length of stay; and, mortality.

METHODS

Case review of a standardised COVID-19 dataset from Paediatric Intensive Care Audit Network and Intellispace Critical Care and Anaesthesia of all children admitted to the Paediatric Intensive Care Units at Children's Health Ireland January 1st 2020 to December 31st 2021.

RESULTS

There were a total of 49 admissions to PICU in Ireland over the 24 month period (57% PIM-TS; 40% COVID-19 infection; 2% post-vaccine myocarditis). The mean age was 8-years old. The majority were White (75% White and

25% Black Asian Minority Ethnic). Over half (57%) were immunosuppressed. Interventions included: ventilatory support (38%); inotropic support (23%); steroids (35%); immunoglobulin (25%). The mean PICU length of stay (LOS) was 5 days. The mean hospital LOS was 19 days. No mortality was recorded at time of discharge from PICU.

CONCLUSIONS

COVID-19 related admissions to PICU represent <0.1% of children in Ireland and 1.6% of PICU admissions over this period. The majority of children with COVID-19 in Ireland to date have not required PICU admission and of those who did, all survived.

LO136 / #1208**ESPNIC Session****ESPNIC Session 34: COVID-19 Collateral damage****09-10-2022 17:00 - 17:55****Status epilepticus in COVID**

**E. Coca-Fernandez^{1*}, E. Turon-Viñas¹, S. Brió-Sanagustin¹,
R.A. Burgueño-Rico¹, M. Rodríguez- Martínez¹, E. Carbonell-Estarellas¹,
M. Espinet-Pedrol¹, L. Dougherty-De Miguel², J.M. Valle-T.Figueras³,
S. Boronat-Guerrero²**

¹Hospital de la Santa Creu i de Sant Pau, Paediatric Intensive Care, Barcelona, Spain

²Neurology Department, Hospital de la Santa Creu i de Sant Pau, Barcelona, Spain

³Hospital de la Santa Creu i de Sant Pau, Infectious Diseases, Barcelona, Spain

BACKGROUND AND AIMS

The role of SARS-CoV2 is well known in respiratory pathology, however there is also an implication in major neurological disease as status epilepticus (SE), among others.

METHODS

Prospective observational study of the pediatric patients admitted in the Pediatric Intensive Care Unit (PICU) with SE during COVID infection (March 2020 - March 2022).

RESULTS

There were 5 patients with SE and all of them were admitted during the sixth wave of COVID-19 pandemic in Spain. Average patient age was 19.2 months (range: 11-36 months). There were 4 boys and 1 girl. Three of them had a history of a single episode of febrile seizure. All patients had generalized

motor seizures. One of the five patients was diagnosed of COVID 2 weeks before, he restarted fever and developed SE; SARS-CoV2 PCR in a respiratory sample was positive and other infectious and autoimmune etiologies were ruled out. The rest of the patients developed SE during the first hours of the infection. All patients needed second line treatment to stop the SE (2 doses of benzodiazepines and one antiseizure medication (ASM)); one patient also needed a second ASM. Four patients showed full recovery and 1, persistent low decrease of consciousness, and he was later diagnosed with encephalitis. Although slower improvement, he also had a complete recovery.

CONCLUSIONS

COVID should be considered as a probable etiology of a SE in children; however, diagnose should rule out other etiologies and follow-up is needed to determine outcome of this COVID complication.

LO137 / #1490**EAP Session****EAP Session 35: Paediatric dermatology****09-10-2022 17:00 - 17:55****Connective tissue nevus misdiagnosed as juvenile localized scleroderma****F. Tirelli^{1*}, M. Soliani², F. Calabrese³, C. Girauda⁴, G. Martini¹,
A. Meneghel¹, F. Zulian¹**¹Rheumatology Unit - Department of Woman And Child Health, University of Padova, Padova, Italy²Department of Pediatrics, Azienda Socio Sanitaria Territoriale di Cremona, Cremona, Italy³Department of Cardiac, University of Padova, Thoracic, Vascular Sciences and Public Health, Padova, Italy⁴Department of Medicine, University of Padova, Padova, Italy**BACKGROUND AND AIMS**

Connective tissue nevi (CTN) are benign hamartomas of the dermis caused by excessive proliferation of collagen, elastin and proteoglycans. CTN can mimic juvenile localized scleroderma (JLS), a rheumatic skin disorder characterized by inflammation and fibrosis that requires aggressive immunosuppression. We aimed to describe relevant elements in the differential diagnosis between these conditions.

METHODS

Retrospective analysis of children referred to our Center for JLS who received a final diagnosis of CTN between 2001 and 2020.

RESULTS

Sixteen children (11 females), mean age at onset 4.4 years (range 2 - 9) were included. Fourteen were referred from other Centers for confirmed (12) or

suspected (2) diagnosis of JLS or fasciitis (2). Ten (62.5%) were on systemic treatment (3 methotrexate (MTX), 5 MTX+corticosteroid, 2 MTX+biologic) and 3 (18.8%) on topical corticosteroids. Erythema or other signs of skin inflammation were not noted. Skin induration involved upper limbs in 3/16 (18.7%) and lower limbs in 13/16 (81.3%), 6 displaying associated lesions in the ipsilateral trunk. Inflammatory markers and autoantibodies were negative in all patients. Thermography was normal in 15/16, one showed mild homogeneous hyperthermia of the lesion, not typical for JLS. Pathology examination of skin biopsies confirmed the absence of inflammatory infiltrate and allowed a final diagnosis of non-familial collagenoma in 10 (62.5%), mixed CTN in 4 (25%) and familial CTN in 2 (12.5%). Mean diagnostic delay was 5 years (range 1-15).

CONCLUSIONS

Absence of clinical and histological inflammatory features of the skin lesions, absence of autoantibodies and normal thermography are essential elements for differentiating CTN from JLS.

LO138 / #2672**EAP Session****EAP Session 35: Paediatric dermatology****09-10-2022 17:00 - 17:55****Guttate psoriasis triggered by perianal streptococcal dermatitis: A report of two cases****M. Louka*, M. Valari**

First Department of Pediatrics, "Aghia Sophia" Children's Hospital, Medical School, National and Kapodistrian University of Athens, Athens, Greece

BACKGROUND AND AIMS

Guttate psoriasis (GP) is a distinctive form of psoriasis that affects mostly children. It is usually associated with streptococcal pharyngitis, although there are only a few cases reporting its association with perianal streptococcal dermatitis (PSD). PSD is a superficial bacterial infection which typically presents with a well-demarcated perianal erythema, pruritus and defecation disorders. We report two cases of pediatric patients with GP following a preceding PSD.

METHODS

The diagnosis of PSD was confirmed by taking a perianal swab for culture for Group A beta-hemolytic streptococcus (GABHS) and rapid antigen detection test (RADT).

RESULTS

Case 1 was a 4-year-old boy who presented with a two-week history of diffuse salmon-pink papules all over his body, perianal erythema and painful defecation, without constipation. Case 2 was a 7-year-old girl who had drop-like

erythematous-squamous papules and small plaques on her trunk and upper extremities, perianal erythema and concomitant vulvovaginitis. Perianal swabs from both patients were positive for GABHS. Culture and RADT of pharyngeal swab did not detect any pathogen. Both patients were treated with amoxicillin for 14 days combined with daily application of topical steroid cream. All symptoms subsided without relapse in the ensuing 6 months.

CONCLUSIONS

We conclude that in cases of GP in children, the perianal area must be examined for streptococcal infection. PSD is often misdiagnosed resulting in prolonged discomfort for patients. In our cases, all clinical manifestations improved after treatment with oral antibiotics.

LO139 / #1237**ESPR Session****ESPR Session 36: Outcome following congenital heart disease****09-10-2022 17:00 - 17:55****Perioperative mammillary body injury in congenital heart disease****M. Nijman^{1,2*}, J. Breur², L. Cuijpers¹, M. Wilmink², R. Stegeman^{1,2}, J. Nijman³, N. Jansen^{3,4}, M. Benders¹, M. Lequin⁵, N. Claessens¹**

¹Wilhelmina Children's Hospital, University Medical Center Utrecht, Neonatology, Utrecht, Netherlands

²Wilhelmina Children's Hospital, University Medical Center Utrecht, Pediatric Cardiology, Utrecht, Netherlands

³Wilhelmina Children's Hospital, University Medical Center Utrecht, Pediatric Intensive Care, Utrecht, Netherlands

⁴Beatrix Children's Hospital, University Medical Center Groningen, Pediatric Intensive Care, Groningen, Netherlands

⁵University Medical Center Utrecht, Radiology, Utrecht, Netherlands

BACKGROUND AND AIMS

Infants with critical congenital heart disease (CCHD) are at risk for cognitive impairments, including memory deficits. The mammillary bodies (MB) are important for memory function and are sensitive to hemodynamic fluctuations. We aimed to analyze the incidence of MB injury in neonatal CCHD and its association with clinical characteristics and other acquired brain injuries.

METHODS

We included infants with CCHD who required surgery with cardiopulmonary bypass within the first 6 weeks of life. Infants with a gestational age <36 weeks or genetic disorder were excluded. Pre- and postoperative cerebral magnetic

resonance imaging (MRI) were reviewed for MB injury, defined as acute injury (i.e., signal abnormality on T1-, T2-, and diffusion-weighted imaging) or atrophy (i.e., decreased protrusion on sagittal T1-weighted imaging). In addition, all MRIs were scored for ischemic injury (white matter injury, stroke, hypoxic-ischemic watershed injury), hemorrhagic injury, and sinovenous thrombosis.

RESULTS

A total of 74 infants were included. Of those, 61 (82%) were prenatally diagnosed with CCHD. MB injury was present in 5 (7%) infants preoperatively vs. 44 (60%) postoperatively ($p < 0.0001$). Preoperative MB injury was associated with a postnatal CCHD diagnosis ($p = 0.029$) and lower birthweight ($p = 0.045$). Postoperative MB injury correlated with new postoperative brain injury ($p = 0.008$), specifically with new postoperative white matter injury ($p = 0.029$).

CONCLUSIONS

MB injury frequently occurs in neonatal CCHD, predominantly after cardiac surgery, and is associated with lower birthweight, postnatal CCHD diagnosis, and other ischemic brain injury. To gain more insight into consequences of MB injury, forthcoming studies should include long-term cognitive and memory functioning.

LO140 / #1611**ESPR Session****ESPR Session 36: Outcome following congenital heart disease****09-10-2022 17:00 - 17:55****Plasma biomarkers of brain injury and the relationship with altered neuroimaging in neonates with congenital heart disease undergoing cardiac surgery****A. Remón Pérez****Hospital Sant Joan de Déu, Nicu, Esplugues de Llobregat, Spain***BACKGROUND AND AIMS**

In the last decades, the survival of patients with congenital heart disease (CHD) has improved and as a result, it has shown up the high incidence of adverse neurologic outcome in these patients. Brain injury biomarkers (BIB) are useful to predict high-risk patients. The aim of this study is to determine the relationship between the main magnetic resonance imaging (MRI) alterations in the postoperative period and the levels of the neuronal biomarkers.

METHODS

Prospective observational study. Forty-four newborns that underwent cardiac surgery during the first month of life were included. MRI was performed per clinical protocol postoperatively. Images were reviewed for multifocal (watershed, white matter injury (WMI)) and focal injury (stroke, single white matter lesion). Two BIB, S100B protein and neuron-specific enolase (NSE), were collected during the perioperative period.

RESULTS

In our study, the prevalence of brain injury in MRI was 41.86%, being WMI the more frequent presentation (25%). No significant differences were detected considering the different congenital heart defects or kind of surgery. Levels of both BIB increase immediately after surgery, especially S100B protein ($p < 0.001$). Neonates with stroke presented increased levels of both BIB. WMI was associated with increased levels of NSE with a cut-off value of 45 mg/dl for prediction.

CONCLUSIONS

Patients with CHD present a high prevalence of brain injury in the postoperative MRI. WMI is the most prevalent alteration and post-operative values of NSE could be useful to identify high-risk patients. Post-operative BIB were also increased in patients with ischemic stroke.

LO141 / #1790**ESPNIC Session****ESPNIC Session 37: Pharmacology it is!****09-10-2022 17:00 - 17:55****Meropenem and piperacillin population pharmacokinetics and dosing regimen optimization in critically ill children receiving continuous renal replacement therapy****M. Thy^{1,2}, S. Urien¹, F. Foissac¹, N. Bouazza¹, A. Béranger³, G. Lui⁴, F. Lesage², S. Renolleau², J.-M. Treluyer^{1,5}, M. Oualha^{1,2*}**¹Université de Paris, Pharmacology and Drug Evaluation In Children and Pregnant Women Ea7323, Paris, France²Hôpital Necker-Enfants malades, Pediatric Intensive Care Unit, Paris, France³AP-HP, Pediatric Icu - Necker Hospital, Paris, France⁴AP-HP, Service De Pharmacologie Clinique, Hôpital Cochin, Paris, France⁵Hopital Cochin - APHP, Pharmacology Department, Paris, France**BACKGROUND AND AIMS**

High variability in critically ill children receiving Continuous Renal Replacement Therapy (CRRT) increases the risk of inadequate concentrations. We aimed to develop a meropenem (MRP) and piperacillin (PIP) population pharmacokinetic (PK) model in this population and to find optimal dosing regimens.

METHODS

MRP and PIP PK were investigated using a non-linear mixed-effect modeling approach and Monte Carlo simulations to determine optimal therapeutic dosing regimens.

RESULTS

Respectively, for MRP and PIP, 27 children with an age of 4 [0-11] y.o., body weight (BW) of 16 [7-35] and 32 children with a median (IQR) age

Table 1: Meropenem and Piperacillin dosing regimens suggestions for a PK target of 100% $ft >_{4xMIC}$ under CRRT

Dosing regimens suggestions for a target of 100% $ft >_{4xMIC}$

Meropenem			CRRT			
Type of RRT	Q _{eff} (ml/h)		500	1000	1500	2000
MIC (mg/L)	0.125	0 (or after HDI)	20mg/kg then 50 mg/kg/d CI			
	0.25					
	0.5	20 mg/kg/d				
	1					
	2					
	4	40 mg/kg/d				
	8		40mg/kg then 120mg/kg/d CI			

Piperacillin		0	0.06	0.5
Q _u (ml/kg/h)	MIC (mg/L)			
0.125	MIC (mg/L)	75 then 50 mg/kg q8h	75mg/kg then 200 mg/kg/d CI	
0.25				
0.5				
1				
2				
4				
8		100 then 70 mg/kg q8h	120mg/kg then 400 mg/kg/d CI	
16				

of 2 y.o. [0–11], BW of 15 kg (6–38), receiving CRRT were included. For both MRP and PIP, concentration-time courses were best described by one-compartment model with first-order elimination with body weight (BW) and CRRT flow (Q_d) for MRP and residual diuresis (Q_u) for PIP as covariates explaining the lower between-subject variabilities on volume of distribution (V) and clearance (CL). For a 70-kg subject patient *i*, the final equations were: -For MRP: $CL_i = (CL_{pop} \times (BW_i/70)^{0.75}) \times (Q_d/1200)^{0.4}$, where CL_{pop} and V_{pop} are 6 L/h and 35 L respectively.

-For PIP: $V_i = V_{pop} \times (BW/70)^1$ and clearance (CL) : $CL_i = (CL_{pop} \times (BW_i/70)^{0.75}) \times (Q_u/0.06)^{0.12}$, where CL_{pop} and V_{pop} are 7 L/h and 53 L respectively. After simulations, we suggested dosing regimens for a target of 100% $ft >_{4xMIC}$ in Table. 1.

CONCLUSIONS

Optimal antibiotic exposure in critically ill children under CRRT needs adaptation of doses to CRRT flow rate for MRP and to residual diuresis for PIP.

LO142 / #1043

ESPNIC Session

ESPNIC Session 37: Pharmacology it is!

09-10-2022 17:00 - 17:55

Cefepime population pharmacokinetics and dosing regimen optimization in critically ill children with different renal functions

N. De Cacqueray^{1*}, D. Hirt², Y. Zheng², E. Bille³, P.-L. Léger⁴, J. Rambaud⁴, J. Toubiana⁵, A. Chosidow⁶, S. Vimont⁷, D. Callot², L. Chouchana², A. Béranger¹, J.-M. Treluyer², S. Benaboud², M. Oualha¹

¹Necker Hospital, Picu, Paris, France

²Pharmacology Department, Hopital Cochin - APHP, Paris, France

³Necker Hospital, Microbiological Laboratory, Paris, France

⁴Trousseau Hospital, Picu, Paris, France

⁵Necker Hospital, General Pediatrics, Paris, France

⁶Trousseau Hospital, General Pediatrics, Paris, France

⁷Saint Antoine Hospital, Microbiological Laboratory, Paris, France

BACKGROUND AND AIMS

Cefepime is commonly used in pediatric intensive care units (PICUs), where unpredictable variations in the patients' pharmacokinetic (PK) variables may require drug dose adjustments. The objectives of the present study were to build a population PK model for cefepime in critically ill children and to optimize individual initial dosing regimens.

METHODS

Children (aged from 1 month to 18 years; bodyweight >3 kg) receiving cefepime were included. Cefepime total plasma concentrations were measured using high performance liquid chromatography. Data were modelled

using non-linear, mixed-effect modeling software, and Monte Carlo simulations were performed with a PK target of $100\% fT_{>MIC}$.

RESULTS

Fifty-nine patients (median (range) age: 13.5 months (1.1 month-17.6 years)) and 129 cefepime concentration measurements were included. The cefepime concentration data were best fitted by a one-compartment model. The selected covariates were body weight with allometric scaling and estimated glomerular filtration rate on clearance. Mean population values for clearance and volume were $1.21 \text{ L}\cdot\text{h}^{-1}$ and 4.8 L , respectively. According to the simulations, a regimen of $100 \text{ mg}\cdot\text{kg}^{-1}\cdot\text{day}^{-1}$ q12h over 30 min or $100 \text{ mg}\cdot\text{kg}^{-1}\cdot\text{day}^{-1}$ as a continuous infusion was more likely to achieve the PK target in patients with renal failure and in patients with normal or augmented renal clearance, respectively.

CONCLUSIONS

Appropriate cefepime dosing regimens should take renal function into account. Continuous infusions are required in critically ill children with normal or augmented renal clearance, while intermittent infusions are adequate for children with acute renal failure. Close therapeutic drug monitoring is mandatory, given cefepime's narrow therapeutic window.

LO143 / #1159**EAP Session****EAP Session 38: Global child health****09-10-2022 17:00 - 17:55****Childhood deaths in England, modifiable factors, and social deprivation****D. Odd¹, I. Wolfe², J. Kurinczuk³, D. Odd⁴, S. Stoianova⁴, T. Williams⁴, K. Luyt^{4*}**¹University of Bristol, National Child Mortality Database, North Petherton, United Kingdom²King's Health Partners, Institute for Women's and Children's Health, London, United Kingdom³University of Oxford, Npeu, Oxford, United Kingdom⁴University of Bristol, National Child Mortality Database, Bristol, United Kingdom**BACKGROUND AND AIMS**

Report the patterns of social deprivation in relation to childhood(0-18 years) mortality -identify where health, social or education policy interventions may be best targeted.

METHODS

Using ONS data the decile of deprivation(DD) was derived from the deceased children's residential address and population distribution was derived; predicting the number of children of each age and sex in each area, and its rural/urban status. Mortality risk was derived using a Poisson-regression model. The number, proportion, and evidence of trend of modifiable factors, across each DD was derived; and the relationship of deprivation and child mortality compared between deaths with, or without, modifiable factors.

RESULTS

2,688 deaths were reviewed (01-04-2019 to 31-3-2020). There was evidence of increasing mortality risk for each increase in DD(RR 1.08(1.07-1.10)). Comparing mortality risk in the most deprived five deciles with the least deprived five deciles, gave a population attributable risk fraction of 21.2%(95%CI 16.7%-25.4%). There was strong evidence that the number and proportion of deaths with modifiable factors increased with increasing measures of deprivation; with 24.2% of deaths in the least deprived, compared with 35.1% in the most having modifiable factors ($p_{\text{trend}} < 0.001$; Figure-1). Deaths with modifiable factors showed a stronger social gradient (Table-1).

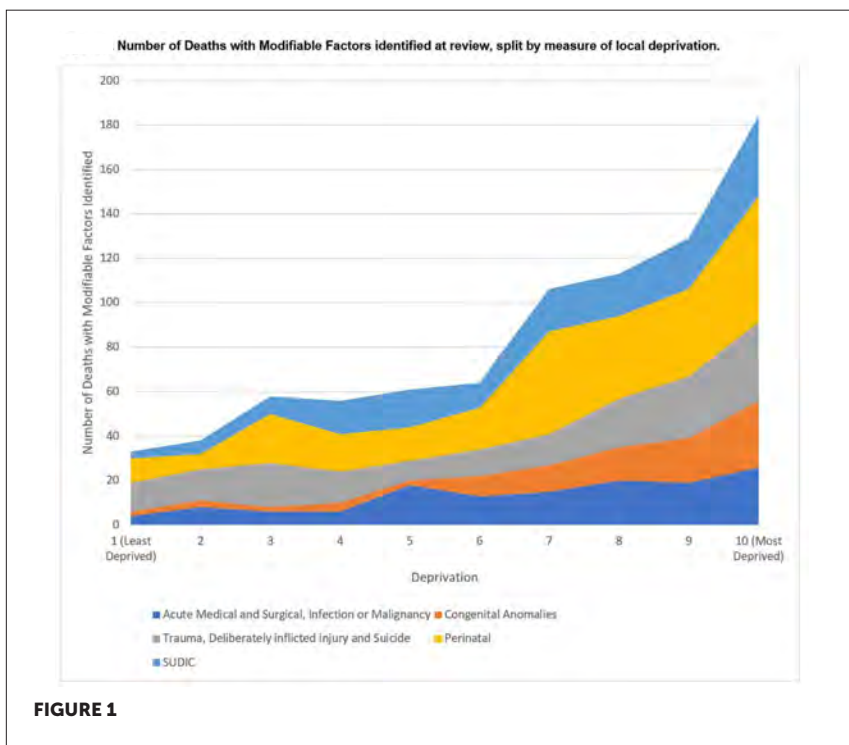

Table 1: The number of deaths with identified modifiable factors; and the relative risk of death for each increasing deprivation decile with, or without them, split by category of death

Category of Death	Percentage of deaths with modifiable factors	Relative risk of death for increasing deprivation decile*		P-value
		Death without Modifiable Factors	Deaths with Modifiable Factors	
All Deaths	842 (31.3%)	1.07 (1.05-1.08)	1.12 (1.09-1.15)	<0.001
Split by Category of Death				
Acute Medical and Surgical	42 (24.6%)	1.05 (0.98-1.12)	1.10 (0.98-1.24)	0.815
Congenital Anomalies	99 (14.9%)	1.11 (1.07-1.15)	1.27 (1.16-1.40)	0.001
Chronic Medical	21 (15.7%)	1.09 (1.01-1.17)	1.14 (0.96-1.35)	0.597
Deliberately inflicted injury	43 (70.5%)	1.08 (0.90-1.29)	1.12 (0.99-1.26)	0.911
Infection	61 (35.5%)	1.07 (1.00-1.15)	1.20 (1.07-1.33)	0.126
Malignancy	11 (5.2%)	0.99 (0.94-1.05)	1.15 (0.91-1.46)	0.181
Perinatal	270 (32.0%)	1.06 (1.03-1.10)	1.09 (1.04-1.14)	0.015
SUDIC	157 (75.1%)	1.02 (0.92-1.12)	1.14 (1.07-1.21)	0.045
Suicide	59 (57.8%)	1.01 (0.90-1.12)	1.04 (0.95-1.14)	0.317
Trauma	79 (68.1%)	1.00 (0.89-1.12)	1.07 (0.99-1.17)	0.743

* Adjusted for age, sex, region and rural/urban area

CONCLUSIONS

There was a clear gradient of increasing child mortality across England as measures of deprivation increase. Over a fifth of all child deaths may be avoided if the most deprived half of the population had the same mortality as the least deprived. Children dying in more deprived areas may have a greater proportion of avoidable deaths.

LO144 / #2704**EAP Session****EAP Session 38: Global child health****09-10-2022 17:00 - 17:55****The impact of the pandemic on sports: A school-based study****J.A. Neto^{1*}, A. Lemos¹, A. Martins¹, A. Maia², D. Bordalo¹**¹*Centro Hospitalar S João, Pediatrics, Porto, Portugal*²*Department of Pediatrics, Centro Hospitalar e Universitário São João, Porto, Portugal***BACKGROUND AND AIMS**

Physical activity (PA) is important for children and adolescents to develop physical and cognitive-behavioral skills. Screen time and sedentary lifestyle, combined with the pandemic situation, has led to a drastic drop-in sports activity. This study aimed to evaluate the factors that influenced sports practice and the return to sports practice after confinement.

METHODS

An inquiry to evaluate PA outside of school was applied in several schools in Porto and Viseu (Portugal) districts to be filled in by parents and elementary school students, from April to June 2022.

RESULTS

330 students participated, age between 6 and 15 years old, with a similar distribution between sexes and with 28 reporting comorbidities. About 1/3 of parents were physically active. 186 children had PA outside of school, 43% of which were competitive sports. Parents' PA (father $p < 0.01$; mother $p < 0.01$)

and education (father $p < 0.01$; mother $p < 0.01$) influenced sports practice. 91% of the students stopped PA during the confinement period, of which 23% did not resume it. Parental PA (father $p = 0.03$; mother $p = 0.02$) and competitive sports practice ($p = 0.05$) had a statistically significant influence on post-confinement return to sports. The only factor that influenced an earlier return to sports was the practice of competitive sports ($p < 0.01$).

CONCLUSIONS

Sports are important for creating bonds, something that has been interrupted by the COVID-19 pandemic. It is important to recognize the factors that influence sports practice so that children and adolescents are reintroduced to PA to bring them closer to a healthier life from a physical and mental point of view.

LO145 / #1067**ESPNIC Session****ESPNIC Session 39: Alternative non-invasive respiratory support modes****09-10-2022 17:00 - 17:55****Discomfort and sedatives use during non-invasive ventilation in children with acute respiratory failure**

L. Bermúdez Barrezueta¹, M. Pons Ódena^{2*}, J. Mayordomo Colunga³, M. Miñambres Rodríguez⁴, A. Vivanco Allende⁵, Y.M. López Fernández⁵, J. Valencia Ramos⁶, M. Mendizábal Diez⁷, A. Palacios Cuesta⁸, S. Reyes Domínguez⁴, M. García Teresa⁹, J. López González¹⁰, L. Artacho González¹¹, M. Jiménez Villalta¹², Z. Gorostizaga Gomez⁵, L. Oviedo Melgares⁸, J.L. Unzueta Roch⁹, M. Rives Ferreiro⁷, S. Fernández Lafever¹⁰, J. Trastoy Quintela², M. Cuervas-Mons Tejedor⁶, A. Jiménez Olmos¹³, I. Gil Hernández¹³, S. Gutiérrez Marqués¹⁴, E. González Salas¹⁵, A. Pino Vázquez¹

¹Hospital Clínico Universitario de Valladolid, Pediatrics. División of Pediatric and Neonatal Intensive Care, Valladolid, Spain

²Hospital Sant Joan de Deu, Pediatric Intensive Care Unit, Barcelona, Spain

³Hospital Universitario Central de Asturias, Pediatric Intensive Care Unit, Oviedo, Spain

⁴Hospital Clínico Universitario Virgen de la Arrixaca, Pediatric Intensive Care Unit, Murcia, Spain

⁵Cruces University Hospital, Pediatric Critical Care, Bilbao, Spain

⁶Hospital Universitario de Burgos, Pediatric Intensive Care Unit, Burgos, Spain

⁷Hospital Universitario de Navarra, Pediatric Intensive Care Unit, Pamplona, Spain

⁸Hospital Universitario Doce de Octubre, Pediatric Intensive Care Unit, Madrid, Spain

⁹Hospital Infantil Universitario Niño Jesús, Pediatric Intensive Care Unit, Madrid, Spain

¹⁰Hospital General Universitario Gregorio Marañón, Pediatric Intensive Care Unit, Madrid, Spain

¹¹Hospital Universitario de Málaga, Pediatric Intensive Care Unit, Málaga, Spain

¹²Hospital Reina Sofía, Pediatric Intensive Care Unit, Córdoba, Spain

¹³Hospital Universitario Miguel Servet, Pediatric Intensive Care Unit, Zaragoza, Spain

¹⁴Hospital Universitario de León, Pediatric Intensive Care Unit, Leon, Spain

¹⁵Hospital Universitario de Salamanca, Pediatric Intensive Care Unit, Salamanca, Spain

BACKGROUND AND AIMS

Children with acute respiratory failure (ARF) undergoing non-invasive ventilation (NIV) may experience discomfort, requiring sedation. Our objective was to evaluate the factors related to discomfort and the need for sedation in children with ARF supported by NIV.

METHODS

A prospective, multicenter, observational study was conducted in sixteen Spanish PICUs from January to December 2021. Children <5 years of age with ARF undergoing NIV during more than 2 hours were included. Demographic, clinical data and sedatives were collected. Discomfort was serially evaluated using the COMFORT-B scale and was defined as a value >22 points.

RESULTS

A total of 346 ARF episodes undergoing NIV were included (57% males). Median age and weight were 2 months [IQR 1-16] and 5.9 Kg [IQR 4-10], respectively. Discomfort was observed in 40.2% patients at NIV initiation, in 7.2% at 6 hours and 4.6% at 24 hours (figure). In the adjusted analysis, male gender (OR 1.76; CI95% 1.09 – 2.94), higher baseline heart rate (OR 1.03; CI95% 1.02 – 1.05) and ventilator asynchrony (OR 3.08; CI95% 1.79 – 5.28) were associated with discomfort. Sedation was administered in 207 episodes (47%). The factors associated with the need for sedation were: higher

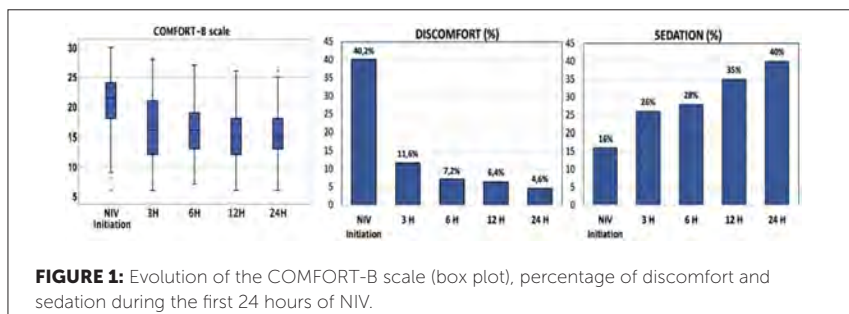

FIGURE 1: Evolution of the COMFORT-B scale (box plot), percentage of discomfort and sedation during the first 24 hours of NIV.

COMFORT-B scale (OR 1.18; CI95% 1.11 – 1.25), baseline respiratory rate (OR 1.03; CI95% 1.01 – 1.05) and PRISM-III Score (OR 1.21; CI95% 1.10 – 1.34).

CONCLUSIONS

Discomfort was observed more frequently at NIV initiation and was associated with ventilator asynchrony, tachycardia and male gender. The use of sedatives was related to discomfort, baseline tachypnea, and clinical severity.

LO146 / #1190**ESPNIC Session****ESPNIC Session 39: Alternative non-invasive respiratory support modes****09-10-2022 17:00 - 17:55****Work of breathing during noninvasive ventilation in severe acute bronchiolitis****M. Vedrenne-Cloquet^{1,2*}, S. Khirani², L. Griffon², C. Collignon¹, S. Renolleau¹, B. Fauroux²**¹Hôpital Necker-Enfants malades, Pediatric Intensive Care Unit, Paris, France²Hôpital Necker-Enfants malades, Children Noninvasive Ventilation and Sleep Unit, Paris, France**BACKGROUND AND AIMS**

Our aim was to compare the work of breathing (WOB) during continuous positive airway pressure (CPAP) and NIPPV in infants with acute bronchiolitis.

METHODS

Infants < 6 months with acute bronchiolitis were included in the first 24 hours of noninvasive respiratory support (NRS). NRS was initiated according to local practice: CPAP +7 cmH₂O (CPAPClin) was the first line setting, with NIPPV (NIPPVClin), being reserved for CPAP failure. Oesophageal and gastric pressures were measured using a nasogastric catheter (Gaeltec™). The study started with a first period with the baseline NRS (CPAP or NIPPV). After 5-min of spontaneous breathing, a second period was performed with the other NRS. Within each period, a first recording was performed with the clinical settings (Clin) and a second with a physiological setting (Phys) aiming at normalizing WOB. For CPAPPhys, the CPAP level was increased from 6 to 10 cmH₂O; for NIPPVPhys, initial inspiratory pressure was set at +4 cmH₂O above CPAP, and progressively increased, with triggers set to optimize synchronization.

The “optimal” NRS was associated with the best reduction in clinical symptoms, $P_{TC}CO_2$ (Sentec™), and estimated WOB (mean oesophageal pressure-time product (PTP_{ES})/min) over 10 stable breaths).

RESULTS

Twenty children were included. Twelve had baseline CPAP: CPAP remained the optimal mode in 7, whereas NiPPV was superior in 5. Eight had baseline NIPPV: NIPPV remained the optimal mode in 2, whereas CPAP was superior in 6 (Figure).

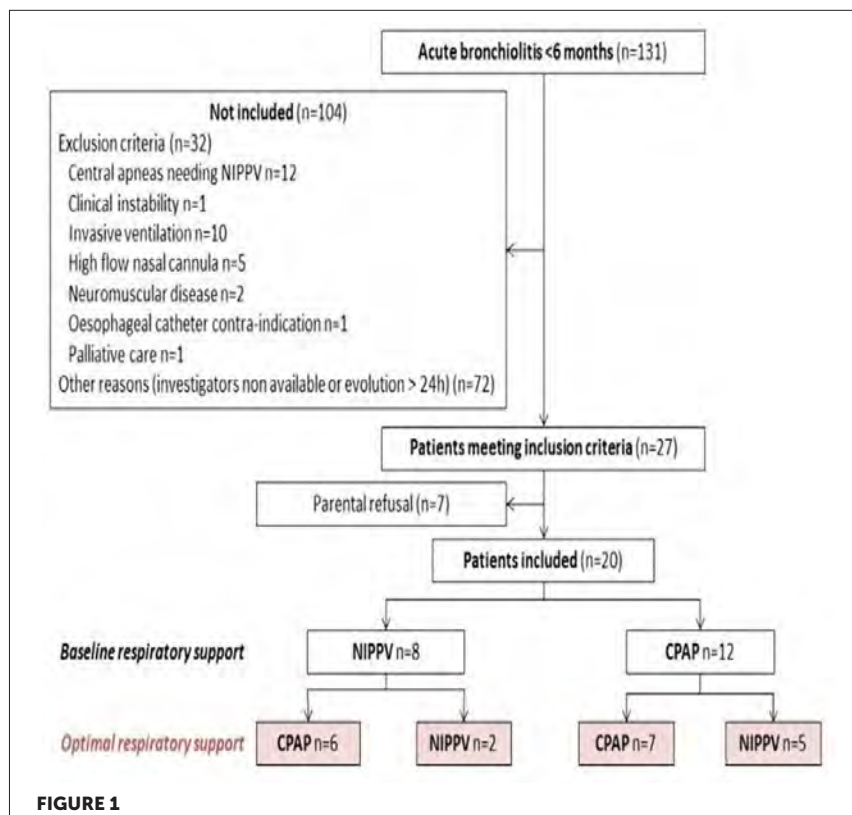

FIGURE 1

CONCLUSIONS

CPAP is associated with a decrease in WOB in the majority of patients with bronchiolitis. NIPPV may be superior in some infants.

LO147 / #560**ESPNIC Session****ESPNIC Session 39: Alternative non-invasive respiratory support modes****09-10-2022 17:00 - 17:55****Long-term morbidity of paediatric intensive care unit admission for bronchiolitis****N. Maas-Van Schaaijk¹, T. Dijk², M. Benthum², A. Van Zwol^{2*}**¹*Radboudumc, Medical Psychology, Nijmegen, Netherlands*²*Radboudumc, Paediatric Intensive Care, Nijmegen, Netherlands***BACKGROUND AND AIMS**

Survival rates of children admitted to the Paediatric Intensive Care Unit (PICU) improved due to advances in medical care. As mortality declined, new issues of morbidity emerged. Studies on long-term morbidity are often conducted in heterogenous patient groups. This heterogeneity precludes drawing strict conclusions concerning the relation between PICU admission and long-term outcome. A homogenous patient group - in terms of history, age, treatment, and course - is formed by children with bronchiolitis. The current aim was to evaluate long-term morbidity of PICU admission for children with bronchiolitis (a homogenous patient group) and their parents/caregivers and to identify risk factors for parental psychological outcomes.

METHODS

Prospective cohort study conducted three to seven months after Radboudumc PICU admission for bronchiolitis. Proxy evaluation of The child's Health-Related Quality of Life (HRQoL) and parental Post-Traumatic-Stress-Disorder (PTSD), anxiety, depression, distress and risk factors were evaluated by means of validated questionnaires.

RESULTS

Children (n=34, age at admission 0.3-8 months) scored significantly worse on lung and abdominal problems compared to normative data ($p<.001$). Parents (n=49, 32 mothers and 17 fathers) had a frequency of PTSD 6.1%, anxiety 18.8%, depression 6.1% and distress 14.6% after the PICU admission of their child. Previous psychological treatment was a risk factor for anxiety and distress.

CONCLUSIONS

This study showed that after PICU admission for bronchiolitis the child's HRQol and parental psychological state is altered. Acknowledgement of risk factors and of long-term outcomes might be helpful to initiate timely interventions to reduce morbidity in both children and parents.

LO148 / #418**ESPR Session****Spanish paediatric association session 40: Vascular malformations****09-10-2022 17:00 - 17:55****Assessing healthcare professionals' identification of paediatric dermatological conditions in darker skin tones****S. Shanmugavadivel^{1*}, J.-F. Liu¹, D. Buonsenso², T. Davis³, D. Roland⁴**

¹University of Nottingham, Academic Unit of Population and Lifespan Sciences, Nottingham, United Kingdom

²Department of Woman and Child Health and Public Health, Fondazione Policlinico Universitario A. Gemelli IRCCS, Rome, Italy

³Paediatric Emergency Department, Royal London Hospital, London, United Kingdom

⁴Emergency Department, Leicester Royal Infirmary, Paediatric Emergency Medicine Leicester Academic (pemla) Group, Leicester, United Kingdom

BACKGROUND AND AIMS

The impact of the lack of skin tone diversity of medical education images on health care professionals (HCPs) and patients are not well studied. The aim of this study was to assess the diagnostic knowledge of HCPs and correlate this with confidence and training resources used.

METHODS

An online multiple-choice quiz of 10 images selected from 56 diagnoses was developed. Participant's demographic/professional background, training

resources, and self-confidence in diagnosing skin conditions were collected. Differences in quiz results between subgroups and correlations between respondents' experience, self-reported confidence and quiz results were assessed.

RESULTS

Mean score of 432 international participants was 5.37 (SD 1.75). 11% (n=47) reached 80% pass mark. Sub-analysis showed no difference by continent of practice ($p=0.270$), ethnicity ($p=0.397$), profession ($p=0.599$), skin tone representation in training resources ($p=0.198$) or confidence ($p=0.400$). A significant difference was observed in specialty ($p=0.01$), highest in dermatologists (6.77 SD1.48) and lowest in allied healthcare professionals (4.73 SD1.95). There was a weak correlation between experience and self-reported confidence (Spearman's $\rho=0.286$). No correlation was observed between quiz scores and confidence or experience ($\rho=0.087$ and 0.076 , respectively). Of the diagnoses, cafe-au-lait macules were most recognised (95%). Identification of other important diagnoses are shown in Figure 1.

Diagnosis	Total	Correct	Correct %	
Infected eczema	64	42	66%	
Meningococcal septicaemia	61	37	61%	
Hand, foot and mouth disease	117	69	59%	
Measles	52	27	52%	
Henoch-Schonlein purpura	95	47	49%	
Urticaria	71	31	44%	
Pityriasis versicolor	184	80	43%	
Eczema	205	83	40%	
Herpes simplex virus	259	99	38%	
Scabies	249	67	27%	
Kawasaki disease	40	6	15%	

FIGURE 1

CONCLUSIONS

This is the first study assessing identification of paediatric skin conditions in different skin tones internationally. Correct identification, even of common/important paediatric conditions was poor suggesting a possible difference in knowledge across different skin tones. There is an urgent need for further prospective study and to improve representation of all skin tones to ensure equity in patient care.

LO149 / #1446**ESPR Session****Spanish paediatric association session 40:
Vascular malformations****09-10-2022 17:00 - 17:55****Challenges in caring for a neonate with rare
congenital skin condition: A NICU experience****G. Sashidharan****University Hospitals Coventry and Warwickshire, Neonatal, Coventry, United Kingdom***BACKGROUND AND AIMS**

Neonate with severe Harlequin Ichthyosis was admitted to our NICU. Many staff members were overwhelmed and distressed seeing the baby under so much pain and discomfort. During debrief session it was suggested to seek staff's opinions. Aim of the survey was to evaluate and understand staff responses about a rare congenital genetic condition.

METHODS

An online survey was sent to all neonatal team members. Anonymised responses were gathered electronically.

RESULTS

Out of 44 participants, who responded majority (>70%) were anxious caring for the baby. 35% would like to be contacted prior to shift to prepare mentally to care for a neonate with a distressing condition. More than 90% staff expressed interest in attending training. All staff members who cared for the baby felt supported. During debrief 3 main domains were identified. For the

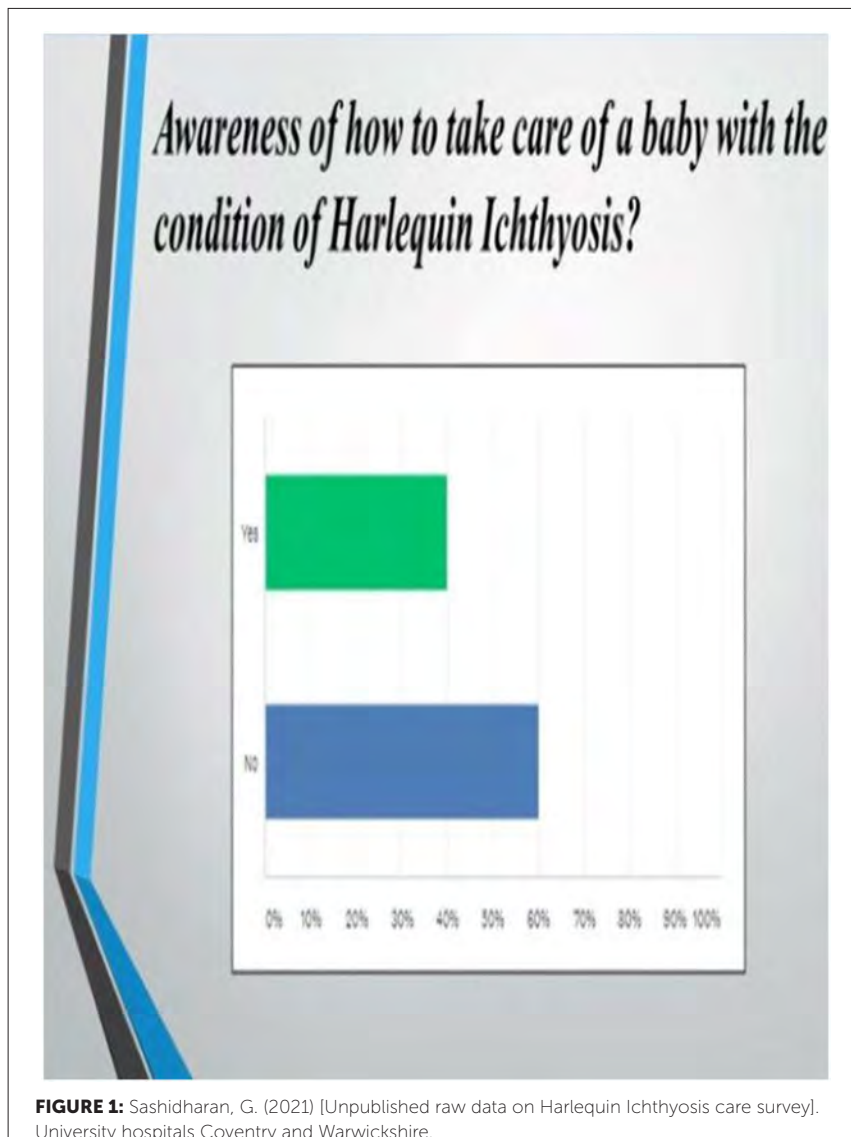

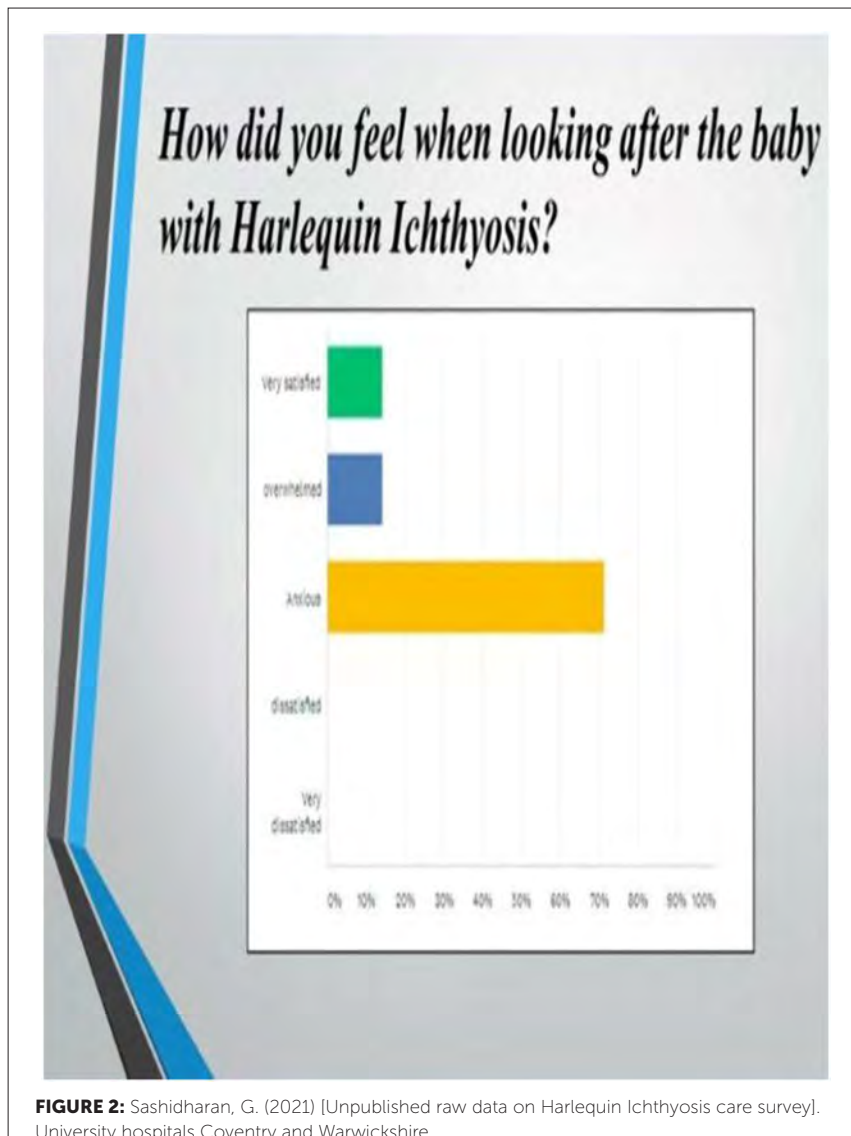

neonate it was skin and eye care, temperature, hydration, infection prevention and comfort. For parents psychological support is essential with cognitive-behavioural and existential psychotherapy to manage the emotional distress. For staffs, require education, training and knowledge about rare congenital conditions and mental health wellbeing champion. We now have teaching sessions to educate team members about resources and alleviate the associated stress and anxiety.

CONCLUSIONS

Establishing regular teaching sessions for team members helps but is equally challenging to maintain for rare congenital conditions. Detailed explanation by a professional has an important role in reducing stress and anxiety levels of the parents.

LO150 / #1264**ESPR Session****ESPR Session 42: Late pre-term****09-10-2022 17:00 - 17:55****Developmental outcome of a healthy moderate to late preterm infant group versus a term born infant group****Mary Anne Ryan^{1,2,3*}, Sean R Mathieson^{1,2}, Vicki Livingstone^{1,2}, Eugene M Dempsey^{1,2,3}, Geraldine B Boylan^{1,2}**¹INFANT Centre, University College Cork, Ireland²Department of Paediatrics and Child Health, University College Cork, Ireland³Department of Neonatology, Cork University Maternity Hospital, Wilton, Cork, Ireland

*maryanne.ryan@ucc.ie

BACKGROUND AND AIMS

Moderate to late preterm (MLP) infants (32-36+6 weeks gestational age at birth) are the largest and fastest growing proportion of the preterm infant population. The availability of developmental outcome data in healthy MLP infants is often hindered by the belief that these infants are low risk hence little developmental surveillance. This study describes the developmental outcomes of healthy MLP infants at 18 months corrected age and a healthy term control (TC) group.

METHODS

MLP infants were recruited in the neonatal unit between July 2017 and September 2018 as part of a study monitoring sleep. A healthy TC group were recruited during the same period. Both groups had a development assessment (Griffiths III) at 18 months.

RESULTS

101 MLP and 97 TC infants were recruited to this study with 75 MLP and 92 TC infants returned at 18 months. Overall general development scores were significantly lower in the MLP infant group (median (IQR): 112(108-122)) than in the TC group (median (IQR): 122(112-127), $p < 0.001$). Scoring of Griffiths was standardised based on a healthy term control group ($n=174$) with a mean=119 and SD=10. A score of less than 1 SD below the mean i.e. 109 was considered abnormal. A total of 29% (22/75) of the MLP group had an abnormal outcome, 7% ($n=5$) with severe delay, 4% ($n=3$) with moderate delay and 19% ($n=14$) with mild delay.

Table 1: Demographical data of moderate to late preterm infant group and term control infant group at 18 months assessment

	MLP infant group (n=75)	Term Control group (n=92)	
	Median (IQR)	Median (IQR)	p-value
Maternal age in years	35.00(33.00-39.00)	35.00(32.00-37.00)	0.189
Birth Weight (Kg)	2.07(1.80-2.40)	3.58(3.29-3.83)	<0.001
Head Circumference at birth(cm) ¹	31.80(30.50-32.80)	35.30(34.50-36.10)	<0.001
*Age at 18 months appointment(months)	19.68(19.32-20.50)	18.46(18.17-18.72)	<0.001
Weight at 18 months (Kg) ¹	11.36(10.75-12.40)	11.50(10.70-12.60)	0.518
Height at 18 months(cm) ¹	81.65(79.43-84.00)	83.00(80.00-85.00)	0.079
Head Circumference at 18 months (cm) ¹	48.00(47.00-48.50)	48.80(47.53-49.50)	<0.001
	n(%)	n(%)	
Sex			0.091
	male 35(46.7)	55(59.8)	
	female 40(53.3)	37(40.2)	
Pregnancy			-
	Singleton 38(50.7)	92(100)	
	Multiple 37(49.3)	0(0)	

Kg: Kilogram, cm: centimetres, IQR: interquartile range. P-values calculated from Mann-Whitney U test with the exception of Sex where the chi-squared test was used

* Delay in 18 months assessment for MLP ($n=14$) infants due to Covid restrictions

¹Missing data as not recorded in electronic health record or failure to obtain at 18 months. In MLP group missing data included : weight at 18 months($n=4$), Head circumference ($n=6$) Height ($n=1$). In term control group missing data included birth Head Circumference ($n=4$) and at 18 mths included Weight($n=4$), head circumference ($n=16$) and height ($n=3$)

Table 2: Griffiths III developmental quotient(DQ) score in general development and in each subscale of development of both the healthy moderate to late preterm infant group and term born infant group at 18 months

Griffiths Mental Developmental Scales at 18 months

	MLP infant group (n=75)	Term Control group (n=92)	
	Median (IQR)	Median (IQR)	p-value
GD: General Development	112(108-122)	122(112-127)	<0.001
Subscale A: Foundations of learning	110(97-118)	114(105-122)	0.002
Subscale B: Language and Communication	106(96-114)	109(99-117)	0.286
Subscale C: Eye hand co-ordination	109(103-118)	118(109-122)	<0.001
Subscale D: Personal Social / Emotional development	115(108-122)	122(117-125)	<0.001
Subscale E: Gross Motor development	124(112-130)	135(126-135)	<0.001

MLP: Moderate to late preterm.

P-value from Mann-Whitney U test.

A p-value <0.05 is statistically significant

Table 3: Developmental outcome of Moderate to late preterm (MLP) infant group as assessed by Griffiths III mental development scales

Outcome of MLP infant group	n (%)
Normal Outcome (>109) ¹	53 (70.7)
Abnormal Outcome	22 (29.3)
Mild delay, One SD below mean (100-109)	14 (18.7)
Moderate delay, two SD below the mean (90-99)	3 (4.0)
Severe delay, three SD below the mean (0-89)	5 (6.7)

¹Scoring of Griffiths was standardised based on a healthy term control group (mean=119, SD=10)

CONCLUSIONS

MLP infants are at risk of adverse developmental outcome. Results of this study support careful surveillance of the developmental trajectory of MLP infants.

LO151 / #1494**ESPR Session****ESPR Session 42: Late pre-term****09-10-2022 17:00 - 17:55****Cause of neonatal death after moderate and late preterm birth by level of care of the delivery hospital in france****T. Desplanches*, J. Fresson, J. Zeitlin**

INSERM UMR 1153, Obstetrical, Perinatal and Pediatric Epidemiology Research Team (Epopé), Center for Epidemiology and Statistics Sorbonne Paris Cité, DHU Risks in pregnancy, Paris Descartes University, Paris, France

BACKGROUND AND AIMS

Studies on the organisation of perinatal care have focused primarily on very preterm births because of their high mortality. However, moderate and late preterm births (32-36 weeks' gestational age (GA)) may also benefit from initiatives to regionalise delivery care. We aimed to describe deaths at 32-36 weeks' GA by cause and level of care of the maternity hospital.

METHODS

We used hospital discharge summaries covering all deliveries in France from January 2014 to November of 2015 and linked neonatal deaths (<28 days) to cause of death certificates using probabilistic methods.

RESULTS

89,745 (6.1%) of 1,458,955 live births occurred at 32-36 weeks as did 459 of 2810 neonatal deaths (mortality rate: 5.1‰ live births versus 0.6‰ at term).

Principal causes were perinatal causes (203, 44.2%), congenital anomalies (168, 36.6%), other diseases (29, 6.3%), sudden infant death (21, 4.6%) and unknown/unlinked (38, 8.3%). The mortality rate from perinatal causes was 2.4‰, over 10 times higher than at term (0.2‰). Most deaths from congenital anomalies (82%) occurred in level 3 units (with a neonatal intensive care unit); for perinatal causes, 52% of deaths occurred after birth in a level 3, 23%/19% in levels 2A/B (with special neonatal nurseries), and 6% in level 1 units (no neonatal unit).

CONCLUSIONS

Mortality from perinatal causes remains high for babies born at 32 to 36 weeks of GA. Studies on the circumstances and factors related to these deaths are needed to assess whether better regionalisation for some risk groups could reduce mortality.

LO152 / #1549**ESPR Session****ESPR Session 42: Late pre-term****09-10-2022 17:00 - 17:55****Correlation between arterial blood pressure and regional cerebral oxygen saturation in moderate and late preterm neonates during transition****D. Pfurtscheller¹, B.C. Schwabberger¹, N. Höller¹, G. Pichler¹,
C. Wolfsberger², L. Mileder³, B. Urlesberger³**¹Department of Neonatology, Medical University of Graz, Graz, Austria²Department of Pediatrics and Adolescent Medicine, Division of Neonatology, Graz, Austria³Department of Paediatrics and Adolescent Medicine, Medical University of Graz, Division of Neonatology, Graz, Austria**BACKGROUND AND AIMS**

The aim of the present study was to investigate the influence of arterial blood pressure on cerebral regional oxygen saturation (crSO₂) and cerebral fractional tissue oxygen extraction (cFTOE) in preterm neonates within the first few minutes after birth.

METHODS

Secondary outcome parameters from prospective observational studies were analyzed. Preterm neonates with a continuous measurement of crSO₂ using near-infrared spectroscopy in combination with an oscillometric blood pressure measurement in the 15th minute after birth were included. The neonates were divided into two groups depending on respiratory support during immediate postnatal transition. CrSO₂ and cFTOE were correlated with systolic (SABP), diastolic (DABP) and mean arterial blood pressure (MABP).

RESULTS

Twenty-five and 22 preterm neonates with a gestational age of 34.4 ± 1.6 and 34.5 ± 1.5 weeks with and without respiratory support were included, respectively. Preterm neonates with respiratory support showed a significantly positive correlation of SABP, DABP, MABP with crSO₂ and significantly negative correlation with cFTOE: SABP (p-value: crSO₂= 0.021; cFTOE= 0.027), DABP (p-value: crSO₂= 0.009; cFTOE= 0.013), MABP (p-value: crSO₂= 0.015; cFTOE= 0.029). In comparison, no significant correlation of arterial blood pressure (SABP, DABP, MABP) with crSO₂ and cFTOE could be observed in preterm neonates without respiratory support.

CONCLUSIONS

In late and moderate preterm neonates with respiratory support crSO₂ and cFTOE correlated with arterial blood pressure. Such a correlation was not found in infants without respiratory support. These findings suggest, that passive pressure-dependent cerebral perfusion was present in neonates with respiratory support, indicating an impaired cerebral autoregulation.

LO153 / #1594**EAP Session****EAP Session 43: What is new in the ent domain?****09-10-2022 17:00 - 17:55****Founder mutation in OTOG causing non-syndromic sensorineural hearing loss in irish traveller families****A. Flynn^{1*}, R. Finnegan², N. Allen³, S.A. Lynch⁴, A. Lyons¹, K. Gorman^{2,5}**¹Department of Paediatrics, University Hospital Galway, Galway, Ireland²Department of Paediatric Neurology, CHI at Temple Street, Dublin, Ireland³National University of Ireland Galway, School of Medicine, Galway, Ireland⁴CHI at Crumlin, Clinical Genetics, Dublin, Ireland⁵University College Dublin, School of Medicine and Medicinal Science, Dublin, Ireland**BACKGROUND AND AIMS**

Deafness is a common multifactorial disorder with numerous underlying causes (genetic, infectious, trauma). Greater than 100 genes have been identified in non-syndromic sensorineural hearing loss (SNHL), and 70% follow a recessive inheritance pattern. OTOG (MIM: 604487, chr11:17,547,258-17,646,043) encodes otogelin, a non-collagenous protein specific to the inner ear. Pathogenic variant in OTOG result in mild-to-moderate non-syndromic SNHL. To date, only 12 families (26 individuals), have been reported in the literature.

METHODS

We report seven families from the Irish Travelling Community (15 individuals), with a recurrent homozygous variant in OTOG (c.3700C>T; p.Arg1234*) resulting in non-syndromic SNHL. The median current age is 5 years (range: 1-30 years). Over half the individuals (n=11) were referred for investigations after

failed new-born hearing screening, with others referred due to speech delay. All individuals have a mild to moderate SNHL, with characteristic U-shaped or down-sloping audiogram. The SNHL was non-progressive. There were no features of vestibular dysfunction. 3 had additional development delay, related to pathogenic CNV in one individual.

RESULTS

This is the largest cohort published to date and the first case series of Irish Traveller individuals with SNHL due to homozygous variant in OTOG (c.3700C>T;p.Arg1234*). This is a founder mutation with the Irish Travellers and clinicians need to ensure that this is requested in infants who fail new-born screening from this ethnicity. Similar to previously reported cases of OTOG-associated SNHL, deafness in our cohort was non-progressive mild-moderate SNHL.

CONCLUSIONS

This case series is the largest cohort of OTOG patients(n=15) reported to date and highlights a founder mutation in OTOG in the Irish Traveller population causing mild-moderate SNHL.

LO154 / #1995**EAP Session****EAP Session 43: What is new in the ent domain?****09-10-2022 17:00 - 17:55****Benefits of a tongue tie unit in paediatric primary health care service****L. Ruiz-Guzman*, N. Rodriguez-Bailon, M.M. Escudero-Hernández, M. Hernández-Ortega, M. Matilla-Munt, L. Rubira-Felices, A. Leiva-Prieto***Institut Catala Salut, Cap 17 Setembre, El Prat de Llobregat, Spain***BACKGROUND AND AIMS**

Breastfeeding is the ideal method of feeding. Ankyloglossia is a disturbing factor in breastfeeding. It generates in the mother: pain, cracks due to friction and mastitis and in the baby affectation of lactation, including weight loss, ineffective suction, and other disorders in the medium and long term.

The referral of babies to hospitals has delays in the intervention that lead to the termination of breastfeeding before the desired time.

We create the Ankyloglossia Ambulatory Intervention Unit: UDIADEAN in Primary Health Care service. Our objective is to find out if breastfeeding improved since the implementation of the Unit. Quantify other benefits of the intervention in primary care versus referral hospital.

METHODS

Cross-sectional descriptive study (Nov 2016–December 2021). Study of the 710 newborns diagnosed with ankyloglossia in the municipality. Indicators:

prevalence of breastfeeding at 3 months, days of intervention delay and economic cost.

RESULTS

Of the 2,137 newborns registered in the 2016-2020 census, a total of 645 underwent surgery, indicating an incidence of 30.18%. The percentage of breastfeeding at 3 months is 68.41%. The economic cost per intervention in UDIAEAN is 190 euros per baby. In the hospital, it is 538 euros. The delay for the intervention in the Hospital has been around 3 1/2 months while in UDIADEAN it has been 1 week.

CONCLUSIONS

UDIADAN provides benefits for users due to the speed of the intervention, ease of follow-up and improvement in breastfeeding, and for the institution due to the economic benefit and giving visibility to the great work of Primary Care professionals.

LO155 / #1222**Late Breaking Orals****Late breaking orals 01****09-10-2022 17:00 - 17:55****Relationship between term equivalent age mri, early postnatal eeg and neurocognitive outcomes in preterm children****T. Nordvik^{1,2*}, E. Schumacher², A. Server³, A. Pripp⁴, P. Larsson⁵, G. Løhaugen⁶, T. Stiris^{1,2}**¹University of Oslo, Institute of Clinical Medicine, Faculty of Medicine, Oslo, Norway²Department of Neonatal Intensive Care, Oslo University Hospital, UllevålOslo, Norway³Department of Radiology and Nuclear Medicine, Oslo University Hospital, Rikshospitalet, Section of Neuroradiology, Oslo, Norway⁴Oslo University Hospital, Oslo Center of Biostatistics and Epidemiology, Research Support Services, Oslo, Norway⁵Department of Neurosurgery, Oslo University Hospital, Rikshospitalet, Oslo, Norway⁶Department of Pediatrics, Sørlandet Hospital, Arendal, Arendal, Norway**BACKGROUND AND AIMS**

Predicting impairment in preterm children is challenging. Our aim is to explore the association between standard MRI at term-equivalent age and neurocognitive outcomes in late childhood and to assess whether addition of early postnatal EEG improves prognostication.

METHODS

40 infants with gestational age 24+0 - 30+6 were included in the study. The children were monitored with multichannel EEG for 72 hours after birth. Total absolute band power for the delta band on day 2 was calculated. Standard MRI was performed at term equivalent age and scored according

to Kidokoro scoring system. At 10-12 years of age we evaluated neurocognitive outcomes with Wechsler Intelligence Scale for Children 4th edition, Vineland adaptive behavior scales 2nd edition and Behavior Rating Inventory of Executive Function. We performed linear regression analysis to examine the association between outcomes and MRI and EEG respectively. We further performed multiple regression analysis to explore the combination of MRI and EEG.

RESULTS

There is a significant association between global brain score and composite outcomes of WISC and Vineland test, but not the BRIEF test. The adjusted R^2 is 8.8 and 7.8% respectively. For EEG adjusted R^2 is 35.7 and 14.9% respectively. When combining MRI and EEG data adjusted R^2 changes to 34.8 for WISC and 15.5% for the Vineland test.

CONCLUSIONS

There is an association between TEA MRI and neurocognitive outcomes in late childhood. Adding EEG to the model improves the explained variance, but combining EEG and MRI data does not increase the explained variance over EEG alone.

LO156 / #2567**Late Breaking Orals****Late breaking orals 01****09-10-2022 17:00 - 17:55****Measuring the supportive care needs of parents of children with a range of rare diseases in Ireland****S. Somanadhan^{1*}, H. Mcaneney¹, L. Pelentsov², A. Sweeney³,
A. Awan³, T. Kroll¹, S. McNulty³**¹University College Dublin, UCD School of Nursing, Midwifery & Health Systems, Dublin, Ireland²University of South Australia, Nursing, AD, Australia³Children Health Ireland, Psychology, Dublin, Ireland**BACKGROUND AND AIMS**

Rare diseases are individually rare, but collectively these conditions are common. 50-75% of all rare diseases affect children, and 30% of children with a rare disease die before their fifth birthday. These conditions are affecting more than 300,000 people across Ireland. Many people living with a rare disease experience chronic debilitating illnesses with significant unmet health, social, psychological, and educational needs.

AIMS

To evaluate the supportive care needs of parents of children with a range of rare diseases in Ireland.

METHODS

A survey was promoted *via* social media across Ireland in 2021 to capture and measure the overall support needs of parents of children with rare diseases

in Ireland by using the validated Parental Needs Scale for Rare Diseases (PNS-RD).

RESULTS

107 responses were received, 98% were from biological parents, and 87% were female. Most reported visiting the hospital 5-10 times yearly (but some as much as 30) and 77% reported that the child with RD has special education needs, and 42% reported that their child has medically complex care needs. The PNS-RD mean $M=48.62$, (95%CI 44.5-52.7); constructed from the four components (each out of 25) i) Understanding of the disease $M=9.01$, (95%CI 7.5-10.5), ii) Working with health professionals $M=13.68$, (95%CI 12.0-15.4), iii) Emotional issues $M=13.22$, (95%CI 12.0-14.5) and iv) Financial needs $M=12.94$, (95%CI 11.2-14.6).

CONCLUSIONS

Overall, parents are confident about dealing with their child's rare diseases however, the emotional and psychological impacts of having a child with a rare disease remain a significant burden for many parents.

LO157 / #2545**Late Breaking Orals****Late breaking orals 01****09-10-2022 17:00 - 17:55****Interventions that mitigate psychosocial risk children face in a pandemic: A rapid realist review****H. Mcaneney^{1*}, C. Davies¹, A. De Brun¹, D. Sheppard-Lemoine², R. Nuggehalli Krishna³, S. Somanadhan¹**¹University College Dublin, UCD School of Nursing, Midwifery & Health Systems, Dublin, Ireland²University of Windsor, Faculty of Nursing, Windsor, Canada³Monash University, Monash Sustainable Development Institute, Melbourne, Australia**BACKGROUND AND AIMS**

The COVID-19 pandemic and ensuing restrictions affected all ages, but especially children and young people (CYP), who experienced increased psychosocial risks due to prolonged confinement and uncertainty. This study sought to develop programme theory (PT) regarding protective mechanisms to mitigate the psychosocial risks CYP face in a pandemic.

METHODS

Six iterative stages of a rapid realist review (RRR) were undertaken to address the research question "What are the interventions that mitigate the psychosocial risks that children face in a pandemic?". A RRR interprets the context, mechanism and outcomes (CMOs), to determine the 'what works for whom and why'. A global expert panel advised and refined the RRR protocol.

RESULTS

On 5th August 2021 searches were conducted and returned (after duplicates) 3937 articles, resulting in 19 articles for inclusion. A range of interventions were found (sport, mindfulness, arts, helplines, social media, peer, pets), undertaken across the globe (Australia, Canada, China, Ireland, Israel, Liberia, Spain, Turkey, UK, USA); from which PTs were developed. Findings include intervention activities be adaptive in delivery to retain positive worth within the community or to include the family; ability to connect for social support; a 'safe space' beyond the family/school to reflect and express feelings; interventions providing a structured programme resulting in the promotion of coping strategies; and interventions are accessible and resource neutral.

CONCLUSIONS

Refinement through the expert panel (CYP from Ireland and India and policy and practice experts) strengthens the overall quality and relevance of this review. PTs provide policymakers with a framework for future tailored intervention design.

LO158 / #2546**Late Breaking Orals****Late breaking orals 01****09-10-2022 17:00 - 17:55****Toddler-age neurodevelopmental outcomes of elbw infants fed pasteurized donor human milk or preterm infant formula, a randomized clinical trial****T. Colaizy^{1*}, A. Das², B. Poindexter³, B. Vohr⁴, E. Bell¹, K. Kennedy⁵, W. Carlo⁶, M. Walsh⁷**¹University of Iowa, Pediatrics, Neonatology, 8807 Jpp, Iowa City, United States of America²RTI International, Biostatistics, Rockville, MD, United States of America³Emory University, Pediatrics, Atlanta, GA, United States of America⁴Brown University, Pediatrics, Providence, RI, United States of America⁵University of Texas Southwestern, Pediatrics, Houston, TX, United States of America⁶University of Alabama Birmingham, Pediatrics, Birmingham, AL, United States of America⁷NICHD, Neonatal Research Network, Bethesda, MD, United States of America**BACKGROUND AND AIMS**

Maternal milk in preterm infants may improve developmental outcomes compared to preterm formula. We tested the hypothesis that EP infants fed donor human milk have better neurodevelopmental outcomes at 22-26 months than those fed formula.

METHODS

Randomized, double-blind clinical trial of preterm formula and fortified donor milk among infants < 29 weeks with minimal/no maternal milk in the NICHD Neonatal Research Network. Diet was administered through hospital discharge or 120d of age. Infants were assessed at 22-26 mo adjusted age with Bayley Scales of Infant and Toddler Development, 3rd edition. Primary outcome was

the cognitive subscale score; infants who died assigned the lowest score. Mean scores were compared using generalized linear modeling, with pre-planned adjustment for center, age at randomization, and birthweight groups.

RESULTS

483 infants were randomized, 239 in donor milk and 244 in preterm formula. Median GA was 26w and median BW was 840g in both groups. Mean cognitive score did not differ by diet, 81 (sd 17) in donor milk group, 81 (sd 17), effect size -0.77, (95% CI -3.93- 2.39). Infants fed donor milk experienced slower weight gain but comparable head and length gain. Necrotizing enterocolitis was reduced in the donor milk (4.2%) compared to the formula group (9%) vs., RR 0.45 (95% CI 0.24-0.84), though no statistically significant differences were observed in the composite outcome of NEC or death before discharge.

CONCLUSIONS

Among extremely preterm infants without maternal milk, donor milk did not affect neurodevelopmental outcomes but reduced necrotizing enterocolitis compared to infants fed preterm formula among survivors.

LO159 / #2600**Late Breaking Orals****Late breaking orals 01****09-10-2022 17:00 - 17:55****Risk factors for malignancy in subacute or chronic crano-cervical lymphadenopathy in children****Eyal Elron^{1*}, Shai Haimi-Cohen¹, Lital Oz Alcalay¹, Lama Chagla¹, Shay Ehrlich¹, Adi Ziv¹, Amir Erps¹, Rotem Tal¹, Gabriel Chodick³, Liat Ashkenazi-Hoffnung^{1,2}**¹Day Hospitalization Department, Schneider Children's Medical Center of Israel, Petach Tikva, Israel²Sackler Faculty of Medicine, Tel Aviv University, Tel Aviv, Israel³Maccabi Institute for Research and Innovation (Maccabitech), Maccabi Healthcare Services, Tel Aviv, Israel**BACKGROUND AND AIMS**

Isolated subacute or chronic crano-cervical lymphadenopathy is a common finding among pediatric patients. Malignant etiology accounts for only a minority of cases; yet its evaluation requires an invasive intervention for definitive diagnosis. Therefore, the aim of this study was to describe the risk-factors for malignancy in these children, in order to aid clinicians in identifying high-risk patients requiring a surgical biopsy and prevent unnecessary surgical interventions in low-risk children.

METHODS

Data were retrospectively obtained of children with a diagnosis of isolated subacute (2 to 6 weeks) or chronic (> 6 weeks) lymphadenopathy, from January 2008 to November 2020, at an ambulatory clinic at the Schneider Children's Medical Center. Univariate and multivariate analyses of risk-factors for malignancy were performed.

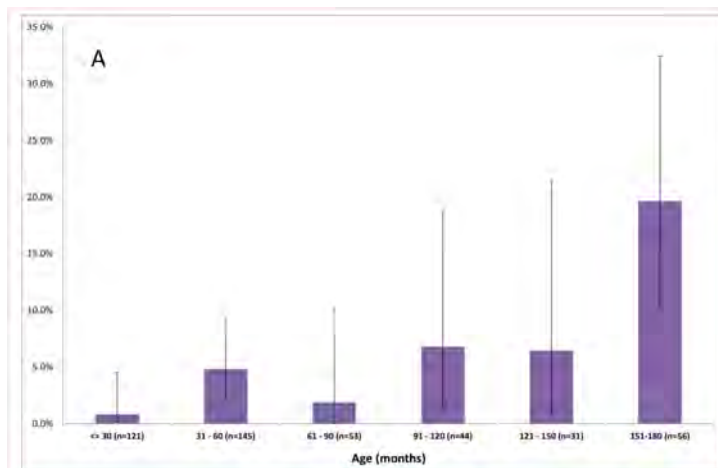

FIGURE 1A: Multivariate analysis by linear regression for risk for malignancy according to patient age. Age greater >12 years old had a 20% risk for malignancy versus a risk less than <1% in patients that were 2.5 years old.

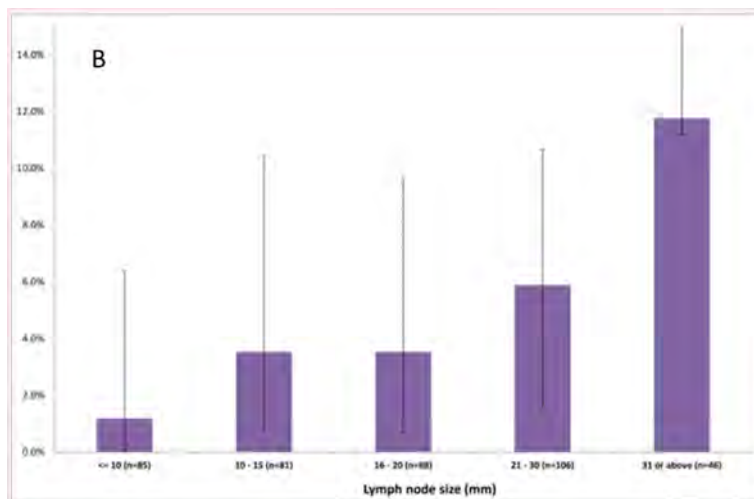

FIGURE 1B: Multivariate analysis by linear regression for risk for malignancy according to Lymph node size. An enlarged Lymph node above 30mm in diameter had a risk of malignancy X10 higher than a lymph node under 10mm.

RESULTS

During the study period, 450 children at a median age of 4.1 years (IQR= 2.4 – 8.6) were included. Of these, 25 (5.5%) were eventually diagnosed with a malignancy. Factors associated with malignancy by univariate analysis included referral by ENT specialist versus referral by a family physician or pediatrician, patient age, size and location of node, systemic signs, and abnormal imaging studies. However, fever, night sweats, pruritus, and laboratory workup were not. Multivariate analysis identified only two risk-factors for malignancy: patient age and size of lymph node [age>151 months: 19.6% malignancy (CI 9.5%-12.8%; size>31 mm: 11.8% malignancy (CI 0.6%-25.3%)].

CONCLUSIONS

Patient age and size of a subacute or chronically enlarged cranio-cervical lymph node may aid to identify children at high-risk for malignancy, in whom a surgical intervention should be strongly considered.

LO160 / #1062

Young investigator awards

ESPNIC young investigators presentations

10-10-2022 09:00 - 10:00

Efficacy and safety of continuous infusion of ketamine as an adjuvant for sedation in the PICU: Results from the ketamine infusion sedation study (kiss)

**A. Tessari¹, F. Sperotto², F. Pece³, G. Pettenuzzo¹, N. Porcellato¹,
E. Poletto³, M.C. Mondardini⁴, A. Pettenazzo¹, M. Daverio¹,
A. Amigoni¹**

¹Department of Women and Children's Health, University Hospital of Padua, Padova, Italy

²Department of Cardiology, Boston Children's Hospital, Harvard Medical School, Boston, United States of America

³Pediatric Intensive Care Unit, San Bortolo Hospital Vicenza, Vicenza, Italy

⁴University Hospital IRCCS, Policlinico Sant'orsola, Bologna, Italy

OBJECTIVES

We aimed to evaluate Ketamine efficacy in ensuring comfort and sparing conventional drugs when used as an adjuvant for analgesia and sedation in the PICU as a continuous infusion (≥ 12 hours), as well as its safety profile.

DESIGN

Observational prospective study.

SETTING

tertiary-care PICU.

PATIENTS

Patients <18years who received ketamine for ≥ 12 hours between January 2019, and July 2021.

INTERVENTIONS

None.

MEASUREMENTS AND MAIN RESULTS

Seventy-seven patients (median age 16 months, IQR 7-43) were enrolled. Twenty-six percent of patients (n=20) were paralyzed. The median dosages of ketamine were between 15 (IQR 15-20) and 30 mcg/kg/min (IQR 20-50). At 24h of ketamine infusion, values of CBS were significantly lower compared with values pre-ketamine ($p < 0.001$). Simultaneously, dosages/kg/h of opioids

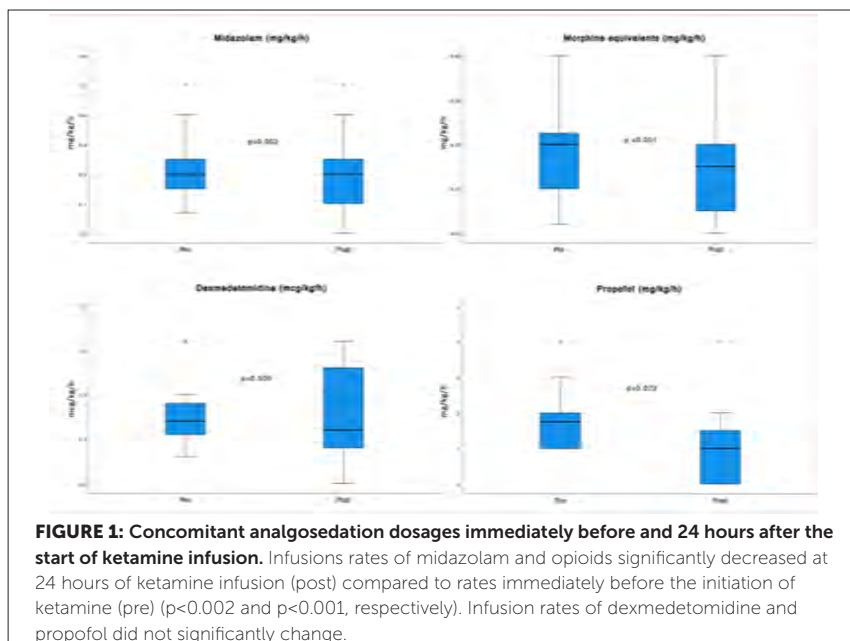

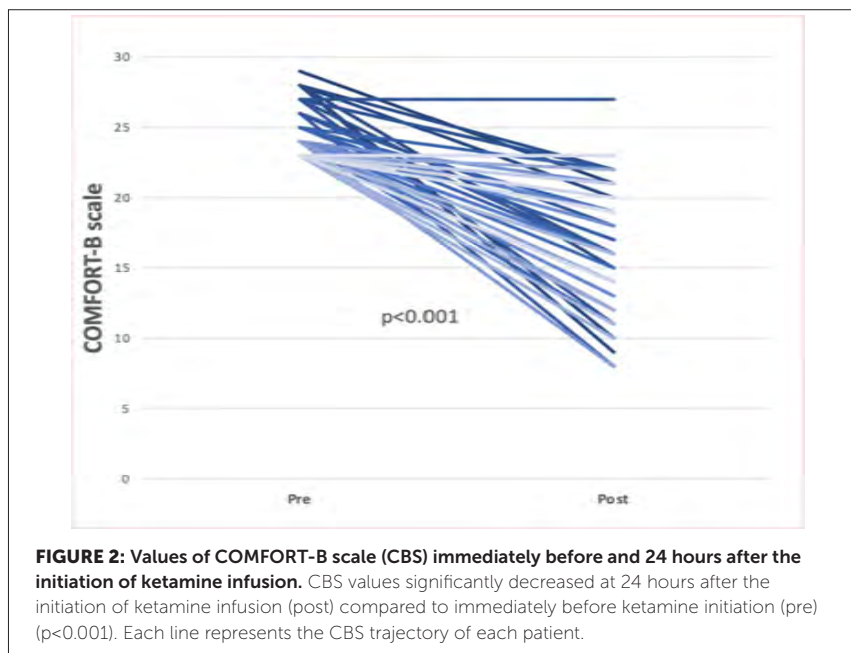

and benzodiazepines significantly decreased at 24 h ($p < 0.001$ and $p = 0.002$, respectively), while dosages/kg/h of propofol and dexmedetomidine did not significantly change. Among paralyzed patients, 13 (65%) did not require an increase of concomitant analgesedation within 24h hours after ketamine introduction. Overall, 55/77 (71%) of patients responded to ketamine. The mean and maximum ketamine infusion dosages were significantly higher in the non-responders ($p = 0.021$ and 0.028 , respectively). Eleven patients had AEs potentially related to ketamine (hypersalivation, systemic hypertension, dystonia/dyskinesia, tachycardia, agitation), and 6 patients required intervention (dose reduction, suspension, or pharmacologic therapy). None of the patients developed delirium during ketamine infusion.

CONCLUSIONS

Ketamine used as a continuous infusion in the PICU is able to ensure comfort and spares the use of opioids and benzodiazepines. AEs are relatively rare, minor, and easily reversible.

LO161 / #1220**Young investigator awards****ESPNIC young investigators presentations****10-10-2022 09:00 - 10:00****Prediction of sepsis progression in septic shock in pediatric intensive care unit - A machine learning perspective****A.E. Băetu^{1,2*}, A. Ghiță-Blujdescu³, A. Damașcan², C. Tănase³,
R. Florin², E. Ștefan²**

¹University of Medicine and Pharmacy "Carol Davila Bucharest", Anesthesia and Intensive Care, Bucharest, Romania

²Emergency Clinical Hospital for Children "Grigore Alexandrescu" Bucharest, Anesthesiology and Intensive Care, Bucharest, Romania

³Emergency Clinical Hospital Bucharest "Floreasca", Anesthesia and Intensive Care, Bucharest, Romania

BACKGROUND AND AIMS

Septic shock is a life-threatening condition that has been reported as one of the most common pathologies specific to intensive care. The main purpose of this paper is to predict the evolution of sepsis in septic shock using complete blood count and echocardiography at the admission of children in intensive care.

METHODS

This prospective, observational study includes children hospitalized in the Pediatric Intensive Care Unit of "Grigore Alexandrescu" Emergency Clinical Hospital for Children who met the criteria for sepsis. In addition to demographic data, values of serum lactate, base excess, procalcitonin (PCT), C-reactive protein (PCR) and complete blood count, the following ratios were taken into account: neutrophils/lymphocytes(NLR), platelets/lymphocytes(PLR),

monocytes/lymphocytes (MLR), hemoglobin/lymphocytes(HLR), hemoglobin/platelets(HPR) and systemic inflammatory index(SII). From the ultrasound data the values of cardiac index(CI) and systemic vascular resistance index(SVRI) were derived. Principal component analysis was performed using the BioVinci 2.0 program.

RESULTS

Out of 72 children with sepsis (mean age=7.4±5.85 years), 20 developed septic shock in the first 48 hours after admission to intensive care. To principal component 1 (eigenvalue=7.19,variance=23.97%) contributed significantly: NLR (loading= 0.922), SII(loading= 0.833), PLR(loading= 0.748) and SVRI(loading=-0.709). To principal component 2(eigenvalue=4.02,variance=13.42) contributed significantly: RDW (loading=0.621), HPR(loading=-0.506), HLR(loading=-0.249). The algorithm generated from the decision tree of BioVinci has an area under curve(AUC) of 0.96. This algorithm outperformed the human-based scoring methods such as qSOFA, pSOFA(pediatric), SOFA, MEWS and SIRS.

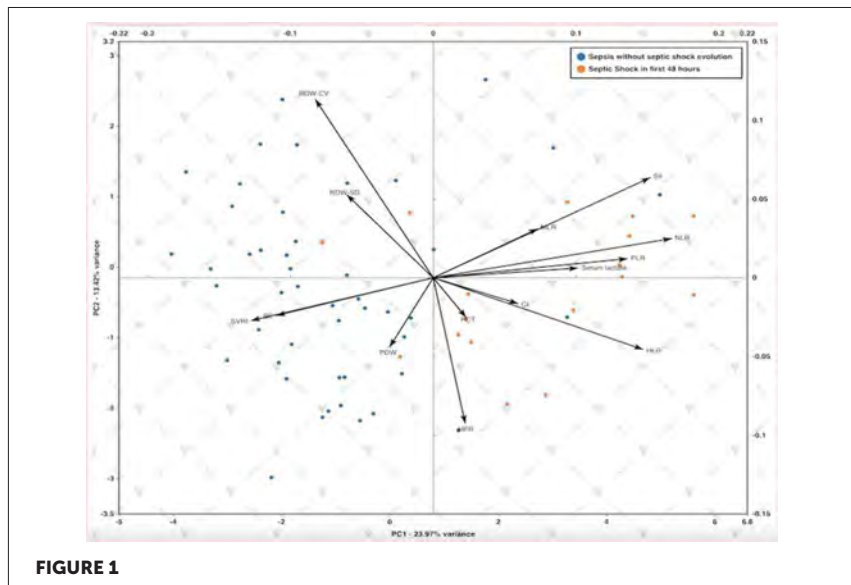

CONCLUSIONS

The evolutionary trend of sepsis in septic shock can be very accurately predicted using the algorithm based on novel inflammatory biomarkers and echocardiography.

LO162 / #893

Young Investigator Awards

ESPNIC young investigators presentations

10-10-2022 09:00 - 10:00

Melatonin reduces white matter injury in the inflammation-amplified hypoxia-ischaemia newborn piglet model of neonatal encephalopathy

R. Pang^{1*}, C. Meehan¹, G. Norris¹, A. Avdic-Belltheus¹, A. Mintoft¹, M. Sokolska², F. Torrealdea², A. Bainbridge², K. Martinello¹, X. Golay³, N. Robertson^{1,4}

¹UCL, Neonatology, Institute For Women's Health, London, United Kingdom

²Department of Medical Physics and Biomedical Engineering, University College London Hospital NHS Trust, London, United Kingdom

³University College London, Institute of Neurology, London, United Kingdom

⁴University of Edinburgh, Centre for Clinical Brain Sciences, Edinburgh, United Kingdom

BACKGROUND AND AIMS

In Sub-Saharan Africa, infection/inflammation are risk factors for neonatal encephalopathy (NE) (Tann 2018). Findings from the HELIX trial suggests therapeutic hypothermia (HT) is ineffective in this setting (Thayyil 2021). Following inflammation-amplified hypoxia-ischaemia (AS-HI) in newborn piglets, where white matter (WM) injury predominates as seen in LMICs, we observed no neuroprotection with HT (Martinello 2020), highlighting the need for alternative therapies. Preclinical studies demonstrate melatonin has robust protection following HI, therefore we aimed to assess its safety and efficacy after IA-HI.

METHODS

Piglets underwent IA-HI injury by *E. coli* lipopolysaccharide pre-sensitisation, carotid artery occlusion and FiO_2 reduction. After 1h, piglets were randomised

to vehicle (n=10) or melatonin (ethanol-free) (n=8), repeated at 24h and 48h. Continuous electroencephalogram (aEEG) and ^1H Magnetic Resonance Spectroscopy Lactate/N-acetylaspartate (Lac/NAA) peak ratio were acquired at 60h. Piglets were euthanised at 65h and brain assessed by immunohistochemistry.

RESULTS

There were no differences in insult severity between groups. Therapeutic levels (15-30mg/L) were achieved within 3h with no systemic hypotension.

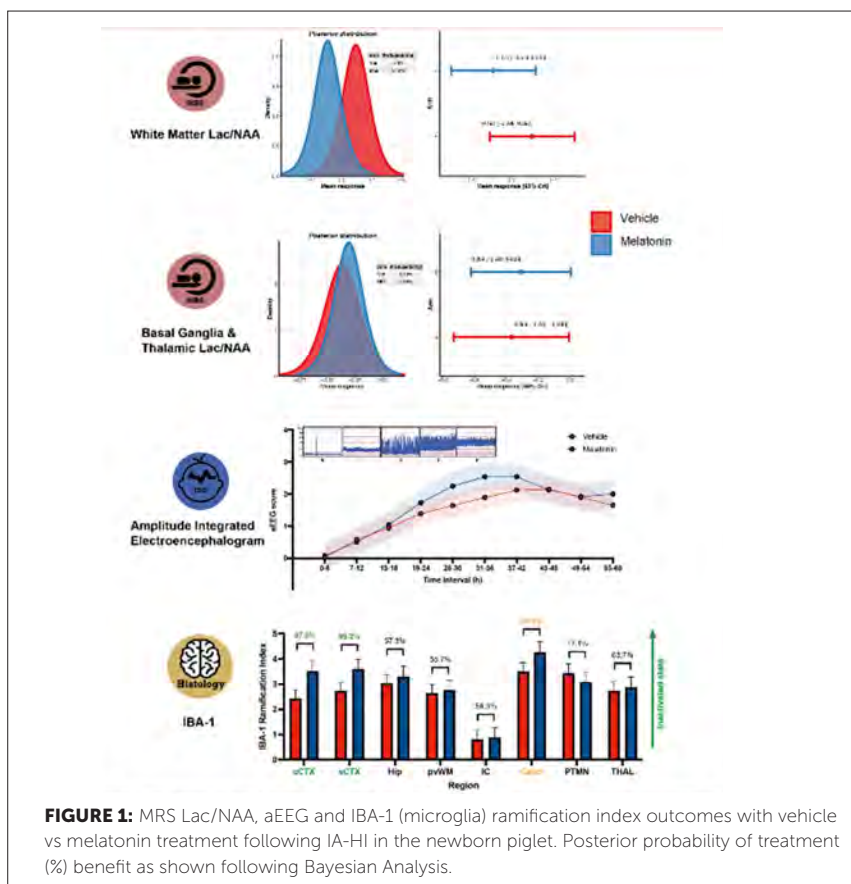

FIGURE 1: MRS Lac/NAA, aEEG and IBA-1 (microglia) ramification index outcomes with vehicle vs melatonin treatment following IA-HI in the newborn piglet. Posterior probability of treatment (%) benefit as shown following Bayesian Analysis.

Melatonin reduced mean Lac/NAA by -0.35 (95%CI, -0.86 - 0.15) Log_{10} units in the WM and -0.05 (95%CI, -0.33 - 0.43) in the BGT voxel (Figure). Bayesian analysis using non-informative priors indicated a 90.8% and 40.2% probability of treatment superiority in the WM and BGT regions respectively. Melatonin significantly suppressed microglial activation (IBA-1) in 2 cortical regions (Figure). No significant improvement in aEEG activity was observed.

CONCLUSIONS

Melatonin reduced WM injury, the predominant region of injury seen in LMICs. Ethanol-containing formulations show improved protection and require further assessment in this model. Study was funded by Wellbeing of Women (RG2222).

LO163 / #1580**Young Investigator Awards****ESPNIC young investigators presentations****10-10-2022 09:00 - 10:00****Medication interruptions and behaviour management strategies on paediatric intensive care unit (PICU): An observational study****S. Owen^{1,2*}, J. Menzies³, S. Pontefract⁴**

¹Birmingham Children's Hospital, Paediatric Intensive Care Unit Research, Birmingham, United Kingdom

²Birmingham Health Partners, College of Medical and Dental Sciences, Birmingham, United Kingdom

³Birmingham Women's and Children's NHS Foundation Trust, Paediatric Intensive Care Unit, Birmingham, United Kingdom

⁴University of Birmingham, Clinical Pharmacy and Therapeutics, Birmingham, United Kingdom

BACKGROUND AND AIMS

Interruptions occur frequently in clinical environments increasing the risk of errors and adding cognitive burden to Registered Nurses (RNs). There is sparse evidence and understanding of behaviour management strategies used by RNs to manage medication interruptions.

AIM

To observe and assess the behaviour management strategies used to manage medication interruptions on PICU.

METHODS

An observational study of the medication process on a 31 bedded UK PICU was conducted 11/11/21 to 26/11/21. A data collection tool was developed, piloted

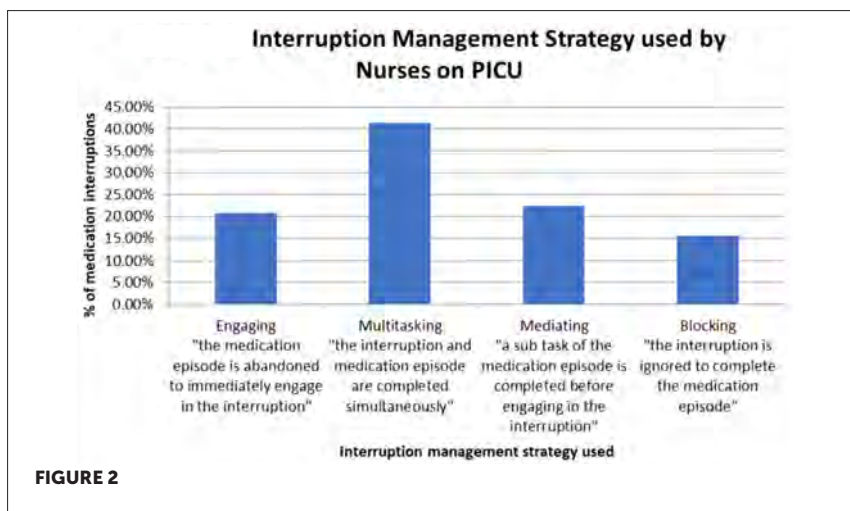
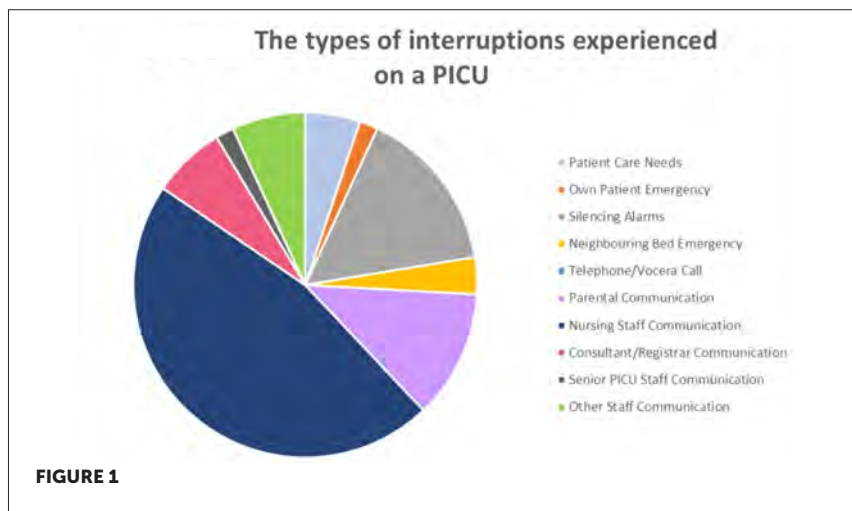

and used by trained observers. Types of interruption observed (Figure 1) and the management strategy utilised by nurses; engaging (abandoning medication), multi-tasking (simultaneous completion and dealing with interruption), mediating (partial completion of medication) or blocking (interruption ignored), (Figure 2),

were collected. Qualitative data was collected by the observers to allow the authors to analyse the appropriateness of the strategies retrospectively.

RESULTS

32 medication episodes were observed with 58 interruptions. The most frequent reason for interruptions was communication (74%, $n=43$), with nursing communication accounting for 47% ($n=27$) of episodes. 62% ($n=36$) of observed interruptions were assessed as being managed inappropriately. Nurses found managing communication interruptions (e.g. nursing, parental and health care professionals) challenging (Figure 3). They mainly adopted a multi-tasking approach (49%, $n=22$) and only 21% ($n=9$) of these episodes were managed appropriately.

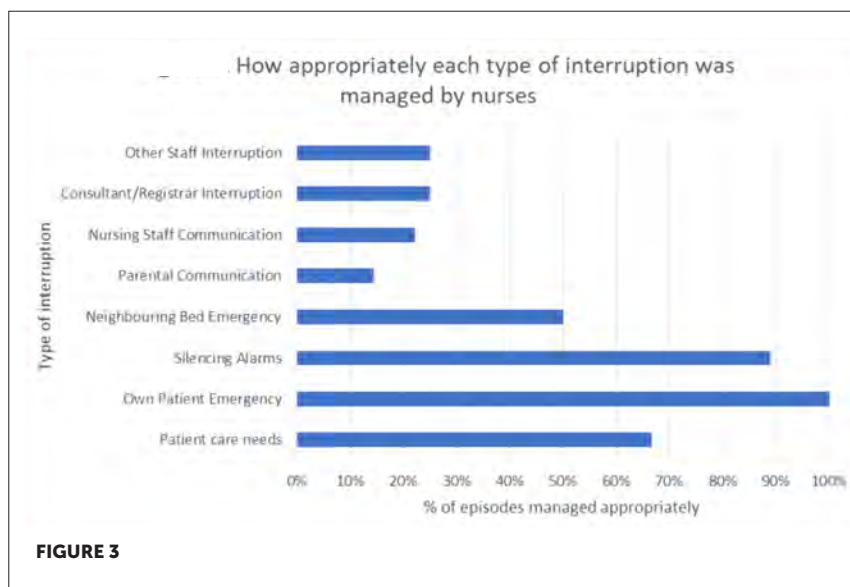

CONCLUSIONS

PICU RNs managed 21% of episodes appropriately when independently assessed. Education about appropriate behaviour management strategies is required, particularly focused on communication-based interruptions with further research to evaluate the effectiveness of training.

LO164 / #1378**Young Investigator Awards****ESPR young investigators presentations****10-10-2022 09:00 - 10:00****Higher prophylactic platelet transfusion thresholds in preterm infants are associated with increased adverse outcomes at two years corrected age****C.M. Moore^{1*}, A. D'Amore², S. Fustolo-Gunnink³, C. Hudson⁴, A. Newton⁴, B. Lopez-Santamaria⁵, A. Deary⁴, R. Hodge⁴, V. Hopkins⁴, A. Mora⁴, C. Llewelyn⁴, V. Venkatesh², R. Khan⁶, K. Willoughby², W. Onland⁷, K. Fijnvandraat³, H. New⁸, P. Clarke⁹, E. Lopriore¹⁰, T. Watts⁵, S. Stanworth¹¹, A. Curley¹**¹National Maternity Hospital, Neonatology, Dublin, Ireland²Cambridge University Hospitals NHS Foundation Trust, Paediatrics, Cambridge, United Kingdom³Sanquin, Research, Amsterdam, Netherlands⁴NHS Blood and Transplant, Clinical Trials Unit, Bristol, United Kingdom⁵Evelina Hospital, Neonatology, London, United Kingdom⁶University Maternity Hospital Limerick, Neonatology, Limerick, Ireland⁷Amsterdam UMC, location University of Amsterdam, Neonatology, Amsterdam, Netherlands⁸NHS Blood and Transplant, Paediatric Transfusion, London, United Kingdom⁹Norwich and Norfolk University Hospitals, Neonatology, Norwich, United Kingdom¹⁰Department of Neonatology, Leiden University Medical Center, Leiden, Netherlands¹¹National Health Service (NHS) Blood and Transplant, Transfusion Medicine, Bristol, United Kingdom**BACKGROUND AND AIMS**

In 2019 the PlaNeT-2/MATISSE multicentre randomised trial reported that a higher platelet transfusion threshold ($50 \times 10^9/L$) in preterm neonates <34 weeks of gestation compared to a lower one ($25 \times 10^9/L$) was associated with significantly increased mortality or major bleeding. We now report on neurodevelopmental outcomes at two years corrected age.

METHODS

Neurodevelopmental outcomes were assessed using formal assessment tools and/or parent reporting assessment. A favourable outcome was given if a child was alive at two years of age and did not have any of the following: cerebral palsy that impaired independent walking; cognitive impairment >2 standard deviations below the mean; severe seizure disorder; hearing impairment not corrected by hearing aids; or bilateral cortical visual impairment with no useful vision.

RESULTS

Follow-up data were available for 92% (601 out of 653) eligible children. Of the 296 infants assigned to the higher threshold group, 147 (50%) infants died or survived with significant neurodevelopmental impairment, as compared with 120 (39%) of the 305 infants assigned to the lower threshold group (odds ratio 1.54, adjusted for gestational age and presence of intrauterine growth restriction as covariates, and centre adjusted using a random effect; 95% confidence interval, 1.09-2.17; $P=0.017$).

CONCLUSIONS

Neonates randomised to a higher platelet transfusion threshold of $50 \times 10^9/L$ compared to $25 \times 10^9/L$ had a higher rate of death or significant neurodevelopmental impairment at two years corrected age. There is no evidence that prophylactic platelet transfusion reduces bleeding and increasing evidence that it causes harm which continues into childhood.

LO165 / #1119**Young Investigator Awards****ESPR young investigators presentations****10-10-2022 09:00 - 10:00****Introducing heart rate variability monitoring combined with biomarker screening into a level iv nicu: A prospective implementation study****S. Kurul^{1*}, N. Van Ackeren¹, T. Goos¹, C. Ramakers², J. Been¹, R. Kornelisse¹, I. Reiss¹, S. Simons¹, H.R. Taal¹**¹Erasmus MC, University Medical Center-Sophia Children's Hospital, Neonatology, Rotterdam, Netherlands²Erasmus MC, University Medical Center, Clinical Chemistry, Rotterdam, Netherlands**BACKGROUND AND AIMS**

Late-onset neonatal sepsis (LONS) is a major complication in preterm neonates. Early recognition, by means of heart rate variability (HRV) monitoring, could help to guide early therapy and thereby improve outcome. The aim of this study was to investigate the association between the implementation of a local HRV-monitoring guideline in a level-IV NICU on mortality, measures of sepsis severity, frequency of sepsis testing and antibiotic usage among very preterm neonates.

METHODS

In January 2018 a guideline was implemented for early detection of LONS using HRV monitoring combined with determination of inflammatory biomarkers. Data on all patients admitted with a gestational age at birth of <32 weeks were reviewed in the period January 2016-June 2020 (n=1,135; n=515 pre-implementation, n=620 post-implementation)). Outcomes of interest were (sepsis-related) mortality, sepsis severity (neonatal sequential organ failure assessment (nSOFA)), sepsis testing and antibiotic usage.

Differences before and after implementation of the guideline were assessed using logistic and linear regression analysis for binary and continuous outcomes respectively. All analyses were adjusted for gestational age and sex.

RESULTS

Mortality within 10 days of a sepsis episode occurred in 39 (10.3%) and 34 (7.6%) episodes in the pre- and post-implementation period respectively ($P=0.13$). The nSOFA course during a sepsis episode was significantly lower in the post-implementation group ($P=0.01$). We observed significantly more blood tests for determination of inflammatory biomarkers, but no statistically significant difference in number of blood cultures drawn and in antibiotic usage between the two periods.

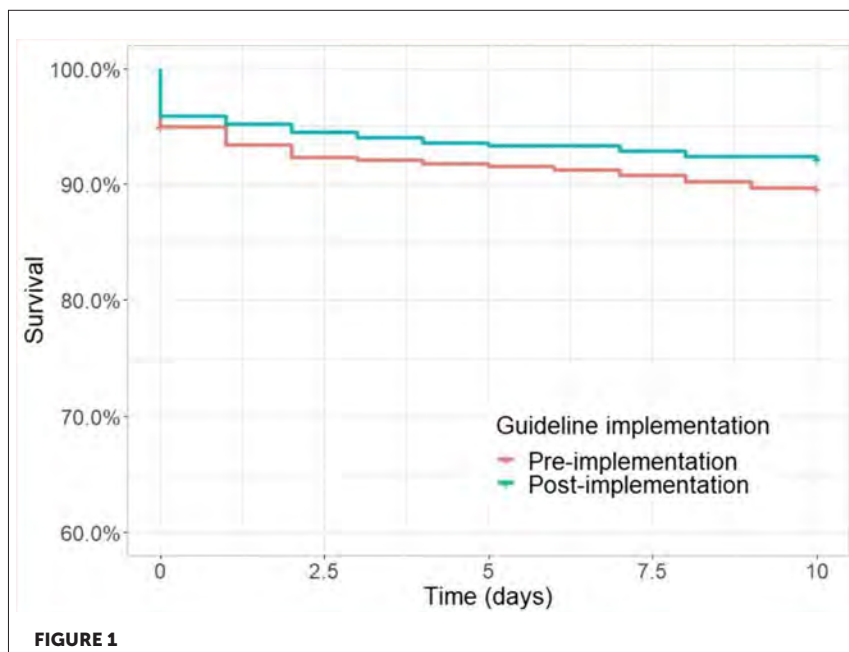

CONCLUSIONS

Implementing HRV monitoring with determination of inflammatory biomarkers might help identify patients with sepsis sooner, resulting in reduced sepsis severity, without an increased use of antibiotics or number of blood cultures.

LO166 / #1134**Young Investigator Awards****ESPR young investigators presentations****10-10-2022 09:00 - 10:00****Efficacy and safety of intravenous-to-oral switch therapy in neonates with a probable bacterial infection: Rain study****F. Keij^{1,2*}, R. Kornelisse², N. Hartwig¹, K. Allegaert^{3,4,5,6}, I. Reiss², G. Tramper-Stranders¹**¹*Department of Pediatrics, Franciscus Gasthuis & Vlietland, Rotterdam, Netherlands*²*Department of Pediatrics, Erasmus MC-Sophia Children's Hospital, Division of Neonatology, Rotterdam, Netherlands*³*Department of Development and Regeneration, KU Leuven, and Pharmaceutical and Pharmacological Sciences, Leuven, Belgium*⁴*Department of Clinical Pharmacy, Erasmus MC, Rotterdam, Netherlands*⁵*Department of Pharmaceutical and Pharmacological Sciences, KU Leuven, Leuven, Belgium*⁶*University Hospitals Leuven, Neonatal Intensive Care Unit, Leuven, Belgium***BACKGROUND AND AIMS**

Neonatal intravenous-to-oral antibiotic switch therapy is not yet practiced in high-income settings due to uncertainties on exposure and safety. We therefore aimed to evaluate the efficacy and safety of an early intravenous-to-oral antibiotic switch compared to a full course of intravenous antibiotics in neonates with a probable bacterial infection.

METHODS

We conducted a multicentre, randomised controlled, non-inferiority trial. Neonates (postmenstrual age >35+0 weeks, 0-28 days old) in whom prolonged antibiotic treatment was indicated because of a probable bacterial

infection, were randomly assigned to switch to oral amoxicillin/clavulanic acid suspension (4:1; 75+18.75/mg/kg/day tid) or continue on intravenous antibiotics. Both groups were treated for seven days. The primary outcome was bacterial (re)infection within 28-days after treatment completion. Secondary outcomes included side effects and duration of hospitalization.

RESULTS

From February 2018 until May 2021, 510 neonates were included: 255 were assigned to the oral and 255 to the intravenous treatment group. The (re)infection rate was 0.4% in both groups. There was no significant difference in reported side effects (50.0% vs. 44.8%). Median duration of hospitalization was significantly shorter in the oral treatment group (3.4 days vs. 6.8 days).

CONCLUSIONS

An early intravenous-to-oral antibiotic switch is not inferior to a full course of intravenous antibiotics in neonates with probable bacterial infection and is not associated with more adverse events. The use of oral antibiotics results in a significant shorter hospitalization.

LO167 / #835**Young Investigator Awards****ESPR young investigators presentations****10-10-2022 09:00 - 10:00****Systematic review, meta-analysis and external validation of prediction models of bronchopulmonary dysplasia in very premature infants****T.C. Kwok^{1,2*}, N. Batey², K.L. Luu³, A. Prayle^{1,4}, D. Sharkey^{1,2}**¹University of Nottingham, Centre for Perinatal Research, Nottingham, United Kingdom²Nottingham University Hospitals NHS Trust, Nottingham Neonatal Service, Nottingham, United Kingdom³Nottingham Maternity Service, Nottingham University Hospitals NHS Trust, Nottingham, United Kingdom⁴Nottingham University Hospitals, NihR Nottingham Biomedical Research Centre, Nottingham, United Kingdom**BACKGROUND AND AIMS**

Bronchopulmonary dysplasia (BPD) is a complex multifactorial prematurity-related respiratory disease requiring personalised care. Prediction models can identify high-risk infants for targeted preventative treatments. The study aims to assess published BPD prediction models to identify the most promising model for clinical practice and research.

METHODS

Prediction models using predictors routinely assessed before two weeks of age in very premature infants were included. Two reviewers independently screened, assessed and extracted data from eligible studies. Meta-analysis of externally validated models was performed. Eligible models were externally

validated in our retrospective national cohort of 62,864 very premature infants born between 2010-2017 in England and Wales.

RESULTS

From the 7,628 records identified, 53 models were reported from 64 studies recruiting 274,107 infants. 35 (55%) studies recruited infants pre-2010; 39 (61%) were single-centre studies. 60 (94%) studies had high risk of analysis bias with calibration not assessed (55 (86%) studies) and small sample size (37 (58%) studies). Following meta-analysis of 22 BPD and 11 BPD/death composite models, the Laughon 2011 NICHD day one model was most promising in predicting BPD and death with fair discrimination (C-statistics 0.76 (95% CI 0.70–0.81) and good calibration (moderate evidence) (Figure 1). The six models externally validated in our national cohort had similar discrimination (C-statistics 0.70–0.90) but poor calibration (Figure 2).

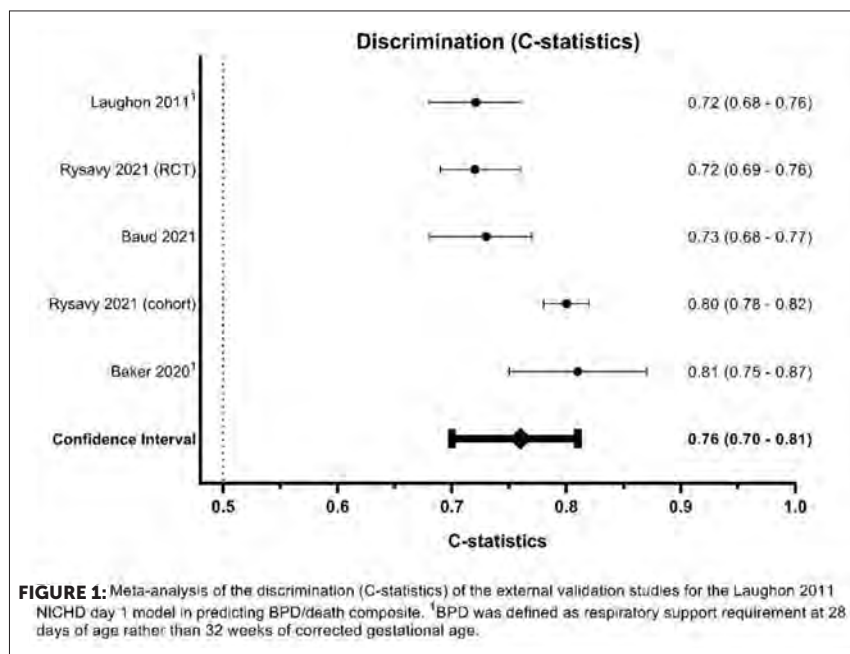

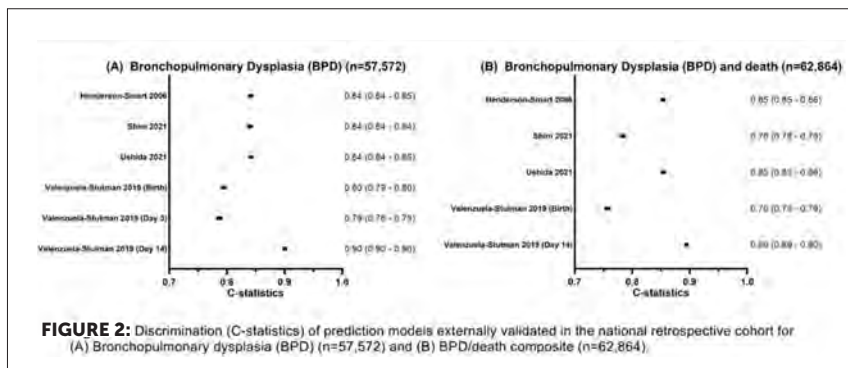

CONCLUSIONS

BPD prediction models still lack external validation, calibration and impact assessment. Contemporary, validated, well-calibrated and dynamic models are needed to support clinical decision making in this high-risk population.

LO168 / #1813**Young Investigator Awards****EAP young investigators presentations****10-10-2022 09:00 - 10:00****Risk factors for multisystem inflammatory syndrome in children – A population-based cohort study****S. Arthur Rhedin^{1,2*}, C. Lundholm², A. Horne^{3,4}, A. Smew²,
E. Caffrey Osvald^{2,5}, A. Haddadi¹, T. Alfvén^{1,6}, R. Kahn^{7,8}, P. Król⁷,
T.S.P.M.-C. Consortium⁸, B. Brew^{2,9}, C. Almqvist^{2,5}**

¹Sachs' Children and Youth Hospital, Stockholm, Sweden, Pediatric Emergency Unit, Stockholm, Sweden

²Department of Medical Epidemiology and Biostatistics, Karolinska Institutet, Stockholm, Sweden

³Department of Women's and Children's Health, Karolinska Institutet, Stockholm, Sweden

⁴Department of Paediatric Rheumatology, Astrid Lindgren Children's Hospital, Karolinska University Hospital, Stockholm, Sweden

⁵Astrid Lindgren Children's Hospital, Karolinska University Hospital, Pediatric Allergy and Pulmonology Unit, Stockholm, Sweden

⁶Department of Global Public Health, Karolinska Institutet, Stockholm, Sweden

⁷Department of Paediatrics, Lund University, Clinical Sciences Lund, Lund, Sweden

⁸Lund University, Wallenberg Centre for Molecular Medicine, Lund, Sweden

⁹University of New South Wales, National Perinatal Epidemiology and Statistics Unit, Centre for Big Data Research in Health, Sydney, Australia

BACKGROUND AND AIMS

Although severe acute COVID-19 is rare in children, the disease is temporally associated with the novel post-infectious condition multisystem inflammatory syndrome in children (MIS-C). The aim of the study was to assess risk factors for MIS-C with the aim to identify vulnerable children.

METHODS

A register-based cohort study including all children and adolescents <19 years born in Sweden between March, 2001- December, 2020 was performed. Data on sociodemographic risk factors and comorbidities were retrieved from national health and population registers. The outcome was MIS-C diagnosis according to the Swedish Pediatric Rheumatology Quality Register during March 1, 2020 – December 8, 2021. Hazard ratios (HRs) and 95% confidence intervals (CIs) were calculated using Cox regression analysis. Incidence rates per 100 000 person-years were calculated assuming a Poisson distribution.

RESULTS

Among 2 117 443 children included in the study, 253 children developed MIS-C, corresponding to an incidence rate of 6.8 (95% CI: 6.0-7.6) per 100 000 person-years. Male sex (HR 1.65, 95% CI: 1.28-2.14), age 5-11 years (adjusted HR 1.44, 95% CI: 1.06-1.95 using children 0-4 years as reference), non-Swedish origin of parents (HR 2.53, 95% CI: 1.93-3.34), asthma (aHR 1.49, 95% CI: 1.00-2.20), obesity (aHR 2.15, 95% CI: 1.09-4.25) and life-limiting conditions (aHR 3.10, 95% CI: 1.80-5.33) were associated with MIS-C. Children 16-18 years had a reduced risk for MIS-C (aHR 0.45, 95% CI: 0.24-0.85).

CONCLUSIONS

Knowing these risk populations might facilitate identification of children with MIS-C and potentially guide targeted public health interventions. Nevertheless, the absolute risks for MIS-C were very low.

LO169 / #2061**Young Investigator Awards****EAP young investigators presentations****10-10-2022 09:00 - 10:00****Among extremely preterm infants, postnatal betamethasone treatment during the neonatal period is associated with increased risk of neurodevelopment impairment at 6.5 years of age****L. Löfberg^{1*}, O. Stephansson², N. Razaz², L. Hellström-Westas³, E. Olhager⁴, A. Farooqi⁵, F. Serenius³, T. Abrahamso¹**¹Department of Paediatrics, Department of Biomedical and Clinical Sciences (bkc), Linköping, Sweden²Department of Medicine Solna, Karolinska Institutet, Division of Clinical Epidemiology, Stockholm, Sweden³Department of Women's and Children's Health, Uppsala University, Uppsala, Sweden⁴Department of Paediatrics, Institution of Clinical Science, Lund University, Lund, Sweden⁵University of Umeå, Unit of Pediatrics, Institute of Clinical Sciences, Umeå, Sweden**BACKGROUND AND AIMS**

Administration of corticosteroid to decrease extubation failure during the neonatal period in extremely preterm (EPT) infants (GA<28+0) is still controversial. Dexamethasone has been associated with impaired cognitive development and cerebral palsy. Betamethasone is used as a rescue treatment according to Swedish guidelines. Long-term adverse effects of betamethasone have not been evaluated in previous studies.

METHODS

A prospective cohort study, including all EPT infants (22+0-26+6) in Sweden born 2004-2007 (the EXPRESS trial). In total 441 children completed 6,5 years follow up, of those 115 children were treated with betamethasone and 314 children were not treated. Children treated with other corticosteroids

(hydrocortisone and prednisolone, n=12) were excluded. The primary outcome was neurodevelopment impairment (NDI) at 6,5 years of age, defined as a composite of cerebral palsy, and impairment in cognition, neuromotor function, hearing and vision. Adjusted odds ratios (aORs) and 95% confidence intervals (CIs) were estimated using Logistic regression.

RESULTS

Children treated with betamethasone were more likely to have NDI at 6.5 years of age (49% of children treated compared with 26% of children not treated, $p < 0.001$). Treatment with betamethasone was associated with 1.9-fold higher odds of NDI at 6.5 years of age (aOR=1.9, 95% ci 1.1-3.2). The results remained similar after matching with propensity scores on background factors with near identical distribution of confounders (40% vs. 24%, $p = 0.004$).

CONCLUSIONS

Among extremely preterm infants' postnatal treatment with betamethasone is associated with increased risk of neurodevelopment impairment at 6,5 years of age.

LO170 / #445**Young Investigator Awards****EAP young investigators presentations****10-10-2022 09:00 - 10:00****Iron intake during the first year of life in preterm infants on early solid foods: A secondary analysis of a prospective, randomized two-arm intervention study****M. Gsöllpointner^{1*}, F. Eibensteiner², M. Thanhaeuser², B. Jilma¹, R. Ristl³, A. Berger², N. Haiden¹**¹Department of Clinical Pharmacology, Medical University of Vienna, Vienna, Austria²Department of Pediatrics and Adolescent Medicine, Medical University of Vienna, Comprehensive Center for Pediatrics, Vienna, Austria³Medical University of Vienna, Center for Medical Statistics, Informatics and Intelligent Systems, Vienna, Austria**BACKGROUND AND AIMS**

Preterm infants are at higher risk of developing iron deficiency. Thus, this study aims to investigate iron intake during complementary feeding (CF) in very low birth weight (VLBW) infants.

METHODS

This is a secondary outcome analysis of a randomized, intervention trial in VLBW infants. Infants were randomized to an early or late CF group (introduction between 10th-12th or 16th-18th week corrected for term) and, in addition to formula or breastfeeding, fed a standardized CF concept. Iron intake was assessed using monthly 3-day dietary records from 3 until 12 months (M3-M12) corrected for term. Infants received 2-3 mg/kg/d iron supplementation until meat was fed on a regular basis. Iron intake was compared with

mixed-effects models accounting for possible correlations between siblings and other covariates (e.g. sex).

RESULTS

Dietary records could be assessed in 80% (71/89) of infants in the early and 72% (63/88) in the late group. There was no difference in mean dietary iron

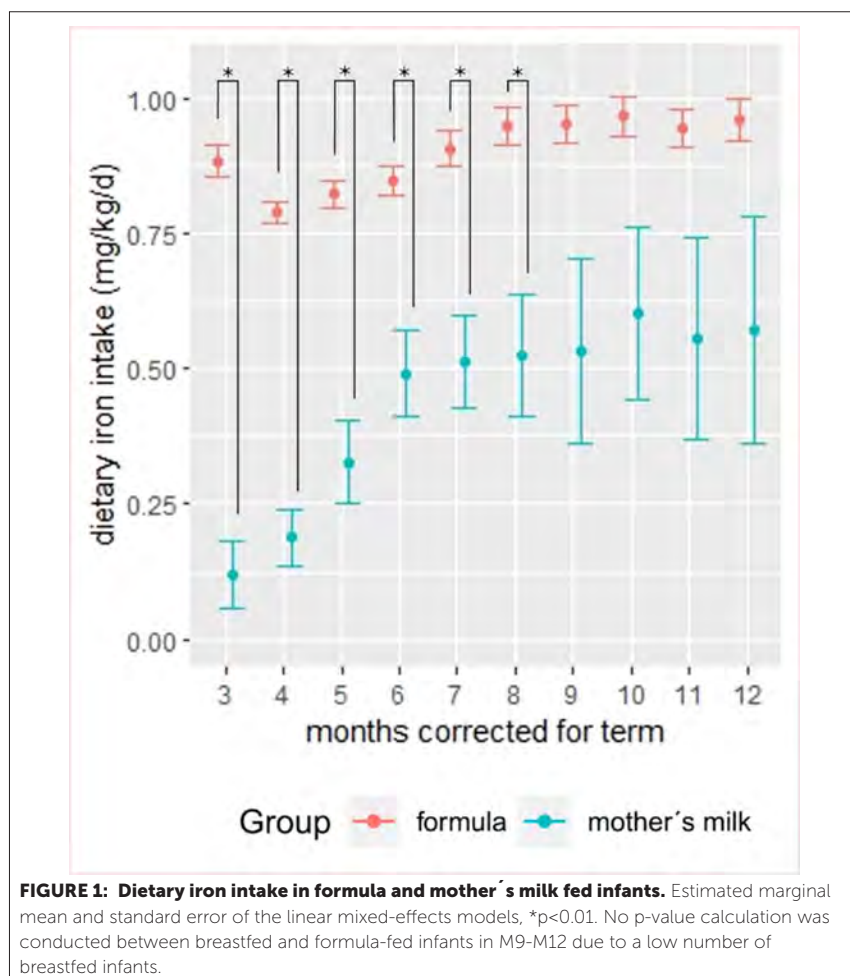

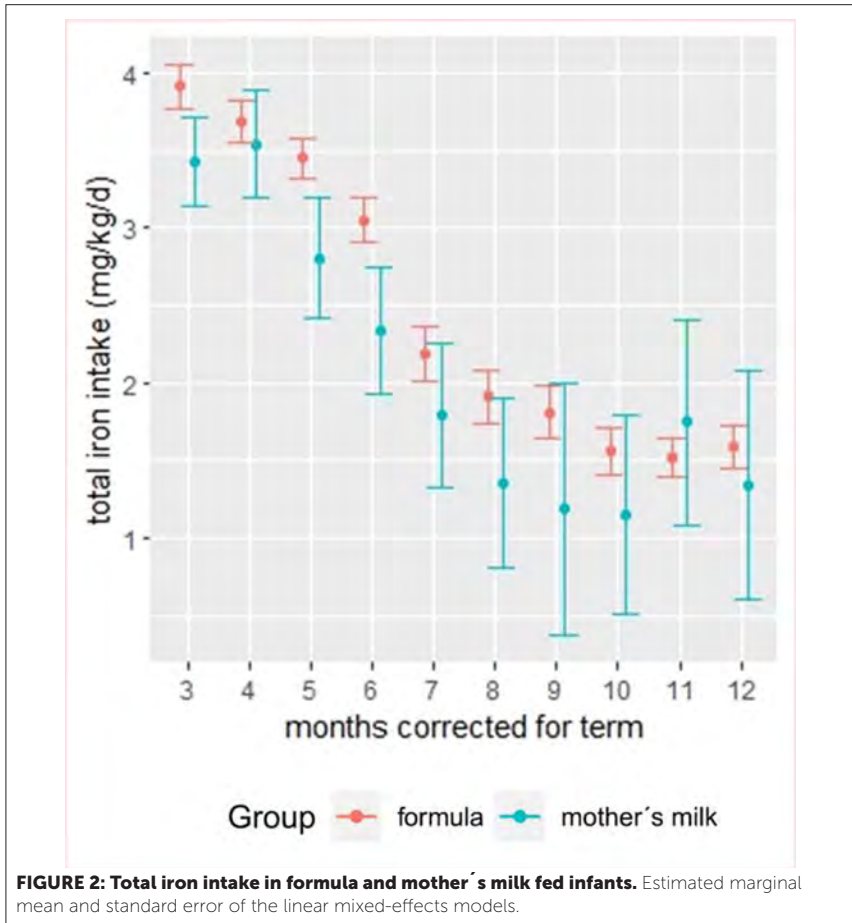

intake between groups. However, breastfed infants had significantly lower mean dietary iron intake in M3-M8. (Figure 1) Iron supplementation compensated this effect, however there was still a trend towards lower total iron intake in breastfed infants. (Figure 2) ESPGHAN iron intake recommendations (2-3 mg/kg/d) were not met in M8-M12 regardless of feeding type even though meat was already introduced.

CONCLUSIONS

Dietary iron intake was significantly different between breastfed and formula-fed infants and iron reference values were not met from M8 onwards. Thus, prolonged iron supplementation regardless of feeding type and higher iron supplementation in breastfed infants should be considered.

LO171 / #540**Young Investigator Awards****EAP young investigators presentations****10-10-2022 09:00 - 10:00****Down syndrome detection through graphical analysis of facial dysmorphic features in newborn children with ethnicity/ racial slicing: - An AI/ ML-based approach****S. Mehra^{1*}, B. Shah², A. Sethi³, R. Puri⁴, S. Nimbalkar⁵**¹The Shriram Millennium School, High School, Noida, India²Pramukhswami Medical College, Central Research Services, Anand, India³Yatharth Hospital Noida, Pediatrics, Noida, India⁴Sir Ganga Ram Hospital, Institute of Medical Genetics & Genomics, New Delhi, India⁵Department of Neonatology, Pramukhswami Medical College, Anand, India**BACKGROUND AND AIMS**

Background Down Syndrome is associated with high mortality in India, due to non-diagnosis/ late-diagnosis caused by unavailability of qualified doctors and/ or lack of access to expensive medical/ diagnostic facilities – especially in rural India. Using AI/ML graphical pattern recognition tools, relevant facial points can be extracted from children's photographs, facial anomalies can be identified, and probability of Down Syndrome affliction can be predicted. Objective The objectives of this research are to assess the suitability of AI/ ML models for first-level screening of Down Syndrome and to assess the accuracy of Race-specific AI/ML models v/s a Unified AI/ML model (encompassing all Races).

METHODS

Trained Google's Cloud Vision AutoML Image Classification model with ~2000 photographs of Down Syndrome positive children and ~3000

photographs of Down Syndrome negative children. Used a subset of 300 images, 100 each of Asian, Caucasian and Other-Race children to train and test three Race Specific Models. Compared these results against a Unified Model trained and tested with the same 300 images.

RESULTS

The CloudML model trained with ~5,000 images initially achieved: Sensitivity - 94.6%, Specificity - 96.9%, Accuracy - 96.0%. Upon optimizing confidence threshold to 0.1, model maximized Sensitivity at 99.6%, Specificity dropped to 93.8%, Accuracy maintained at 96.0%. Each of the Race specific models trained with 100 images each, after optimization, yielded perfect scores on Sensitivity, Specificity and Accuracy of 100% each. Against this, the Unified model with 300 images yielded overall Accuracy of 98% (100% Sensitivity, 83% Specificity for Caucasian children and 100% Sensitivity, 100% Specificity for Asian/ Other children).

CONCLUSIONS

Post optimization, this model can be used as an effective post-natal screening tool for Down Syndrome detection. Preliminary results indicate that Race specific models can achieve even higher Accuracy, Sensitivity and Specificity.

LO172 / #1579**ESPNIC Session****ESPNIC Session 44: Nurses leading pain reduction in the intensive care unit****10-10-2022 11:00 - 12:20****Signs and symptoms, apart from vital signs, that trigger nurses' concerns about deteriorating conditions in hospitalized pediatric patients: A scoping review****C.S. Jensen^{1,2*}, M. Lisby¹, H. Kirkegaard¹, M. Ingerslev³**¹Aarhus University Hospital, Research Center for Emergency Medicine, Aarhus N, Denmark²Department of Paediatrics and Adolescents, Aarhus University Hospital, Aarhus N, Denmark³Department of Neurology, Rigshospitalet, Copenhagen, Denmark**BACKGROUND AND AIMS**

Clarifying the signs and symptoms that trigger nurses' concern about paediatric patients' conditions could help them take actions based on their intuitive feelings in the early stages of deterioration. This scoping review aimed to identify and map the signs and symptoms—apart from vital signs—that trigger nurses' concerns about the deteriorating conditions of hospitalized pediatric patients.

METHODS

A scoping review was conducted in accordance with the Joanna Briggs Institute methodology. Six databases, including MEDLINE, CINAHL, Embase, Scopus, Swemed, and ProQuest Dissertations and Theses databases, were searched systematically. Of 5,795 citations, seven matched the inclusion criteria.

RESULTS

Objective observations, such as the patient's color, pain level changes, and behavioral observations, were identified as signs that would trigger nurses' concerns. Nurse's intuitive feelings or gut feelings when seeing a patient was also identified as an important factor for identifying a deteriorating pediatric patient. A "gut feeling" was described as both a reaction to patient signs and a feeling based on the nurse's intuition gained through experience. The signs or symptoms that would trigger this "gut feeling" were not identified.

CONCLUSIONS

The evidence on identifying signs and symptoms that trigger nurses' concerns about the deteriorating conditions of hospitalised paediatric patients is sparse. Thus, further research is needed to elaborate on this important element of paediatric nursing.

LO173 / #945**ESPNIC Session****ESPNIC Session 44: Nurses leading pain reduction in the intensive care unit****10-10-2022 11:00 - 12:20****Early vocal contact impacts on preterm infants' vagal activity during hospitalization****M. Filippa^{1*}, M. Nardelli², E. Della Casa³, A. Berardi⁴, O. Picciolini⁵, S. Meloni⁵, C. Lunardi⁶, A. Cecchi⁷, A. Sansavini⁸, L. Corvaglia⁹, E. Scilingo¹⁰, F. Ferrari⁴**¹University of Geneva, Psychology and Educational Sciences, Geneva, Switzerland²Bioengineering and Robotics Research Centre E. Piaggio, Bioengineering, Pisa, Italy³University Hospital of Modena, Medicine, Modena, Italy⁴Department of Medical and Surgical Sciences, University Hospital of Modena, Modena, Italy⁵IRCCS Ca' Granda Ospedale Maggiore Policlinico, Pediatric Physical Medicine & Rehabilitation Unit, Milano, Italy⁶Department of Neurosciences, Careggi University Hospital of Florence, Florence, Italy⁷Careggi University Hospital of Florence, Division of Neonatology, Florence, Italy⁸Department of Psychology, University of Bologna, Bologna, Italy⁹Department of Medical and Surgical Sciences, University of Bologna, Bologna, Italy¹⁰Dipartimento Di Ingegneria Dell'informazione, University of Pisa, Pisa, Italy**BACKGROUND AND AIMS**

Early parental interventions in the Neonatal Intensive Care Units (NICUs) have beneficial effects on preterm infants' short and long-term outcomes. The aim of this study was to investigate the effects of Early Vocal Contact (EVC)—singing and speaking—on preterm infants' vagal activity and autonomic nervous system (ANS) maturation.

METHODS

In this multi-center randomized clinical trial, 34 stable preterm infants, born at 25–32 weeks gestational age, were randomized to either the EVC group or control group, where mothers did not interact with the babies but observed their behavior. Heart Rate Variability (HRV) was acquired before intervention (pre-condition), during vocal contact, and after it (post condition).

RESULTS

No significant effect of the vocal contact, singing and speaking, was found in HRV when the intervention group was compared to the control group. However, a significant difference between the singing and the pre and post conditions, respectively, preceding and following the singing intervention, was found in the Low and High Frequency power nu, and in the low/high frequency features ($p = 0.037$). By contrast, no significant effect of the speaking was found.

CONCLUSIONS

Maternal singing, but not speaking, enhances preterm infants' vagal activity in the short-term, thus improving the ANS stability. Future analyses will investigate the effect of enhanced vagal activity on short and long-term developmental outcomes of preterm infants in the NICU.

LO174 / #1947**ESPR Session****ESPR Session 45: Long term effects of prematurity****10-10-2022 11:00 - 12:20****Significant and differing impact of preterm birth on the right and left atria in adulthood****A. Schuermans^{1,2*}, T. Den Harink^{2,3}, B. Raman^{4,5}, R. Smillie⁴,
M. Alsharqi^{2,6}, A. Mohamed^{2,7}, W. Lapaire², A. Van Deutekom^{2,8},
P. Leeson^{2,5}, A. Lewandowski^{2,4,5}**¹Department of Cardiovascular Sciences, KU Leuven, Leuven, Belgium²University of Oxford, Oxford Cardiovascular Clinical Research Facility, Oxford, United Kingdom³Department of Paediatric Cardiology, University of Amsterdam, Amsterdam, Netherlands⁴University of Oxford, Oxford Centre for Clinical Magnetic Resonance Research, Oxford, United Kingdom⁵Oxford University Hospitals, Nhs Foundation Trust, Oxford, United Kingdom⁶Department of Cardiac Technology, Imam Abdulrahman Bin Faisal University, Dammam, Saudi Arabia⁷Department of Diagnostic Imaging & Applied Health Sciences, Universiti Kebangsaan Malaysia, Kuala Lumpur, Malaysia⁸Department of Paediatrics, Erasmus MC-Sophia Children's Hospital, Rotterdam, Netherlands**BACKGROUND AND AIMS**

Preterm birth affects 10% of live births and is associated with an altered left ventricular (LV) and right ventricular (RV) phenotype and increased cardiovascular disease risk in young adulthood. As left atrial (LA) and right atrial (RA) volume and function are known predictors of cardiovascular outcomes, we investigated whether these were altered in preterm-born young adults.

METHODS

Preterm-born and term-born adults aged 18 to 39 years underwent cardiovascular magnetic resonance imaging. LA and RA maximal and minimal volumes

(absolute, indexed to body surface area, and as a ratio to ventricular volumes) were obtained to study atrial morphology, while LA and RA stroke volume, strain, and strain rate were used to assess atrial function. Secondary analyses consisted of between-group comparisons based on degree of prematurity.

RESULTS

Absolute and indexed LA volumes were similar between preterm-born ($n=200$) and term-born adults ($n=266$). However, LA maximal to LV end-diastolic volume ratio was elevated in preterm-born adults (0.447 ± 0.092 vs 0.413 ± 0.096 , $P<0.001$). For the RA, all absolute and indexed volumes were smaller in preterm-born compared to term-born adults, including RA maximal to RV end-diastolic volume (0.418 ± 0.098 vs 0.442 ± 0.092 , $P=0.012$). Additionally, RA deformation was globally increased in preterm-born adults, possibly indicating functional compensation for the smaller RA. LA and RA changes were observed across gestational ages in the preterm group but were greatest in those born very-to-extremely preterm.

CONCLUSIONS

Preterm-born adults show changes in LA and RA structure and function, which may indicate subclinical cardiovascular disease. Further research into underlying mechanisms, opportunities for interventions, and their prognostic value is warranted.

LO175 / #1331**ESPR Session****ESPR Session 45: Long term effects of prematurity****10-10-2022 11:00 - 12:20****Combined human umbilical cord blood-derived mononuclear cells and cord-tissue derived mesenchymal stem cells for inflammation-Induced preterm brain injury****L. Zhou^{1,2,3*}, T. Yawno^{1,3,4}, A. Sutherland⁵, Y. Pham⁵, S. Miller^{3,4}, C. Mcdonald³**¹Monash University, Paediatrics, Clayton, Australia²Monash Children's Hospital, Monash Newborn, Clayton, Australia³The Ritchie Centre, Hudson Institute of Medical Research, Monash University, Melbourne, Australia⁴Monash University, Obstetrics and Gynaecology, Clayton, Australia⁵Hudson Institute of Medical Research, TRC, Clayton, Australia**BACKGROUND AND AIMS**

Inflammation is a key mediator of preterm brain injury, resulting in neuro-disabilities like cerebral palsy. We aimed to investigate the combined anti-inflammatory effects of cord-tissue derived mesenchymal stem cells (UC-MSCs) and umbilical cord blood mononuclear cells (UCB-MNCs) in an ovine model of inflammation-induced preterm brain injury.

METHODS

Fetal sheep were instrumented at 0.65 gestation and administered lipopolysaccharide (LPS 200mg; n=9) to induce inflammation, daily for three days. 100x10⁶ UCB-MNCs and 10x10⁶ UC-MSCs (n=9) were administered I.V. 6h after last LPS dose, or saline in controls (n=8). Brains were collected 7 days

after cell administration and examined for cell death (Caspase-3), white matter development, oligodendrocytes (Olig-2), microglial activation (IBA-1), astrogliosis (GFAP), and white matter integrity (CNPase) by immunohistochemistry in subcortical (SCWM) and periventricular white matter (PVWM).

RESULTS

LPS administration resulted in more cell death in the SCWM (mean (SEM) 13.21(2.11) vs. 7.10(1.33) cells/field, $p=0.03$), reduced oligodendrocytes in the SCWM (17.71(2.56) vs. 29.81(1.81) cells/field, $p=0.002$) and decreased density of myelinating axons (CNPase) in the PVWM ($1.66(0.24) \times 10^7$ vs. $7.06(0.58) \times 10^7$ a.u., $p=0.001$) compared to controls. Compared to LPS alone, cell treated fetuses showed reduced activated microglia in the PVWM (29.77(5.40) vs. 10.02(1.35) cells/field, $p=0.004$), and reduced astrogliosis in the SCWM ($2.45(0.23) \times 10^7$ vs. $4.37(0.47) \times 10^7$ a.u.). There was increased density of CNPase in the PVWM ($3.62(0.26) \times 10^7$ vs. $1.66(0.24) \times 10^7$ a.u., $p<0.001$) in cells-treated fetuses compared to LPS alone.

CONCLUSIONS

Combined treatment with UCB-MNCs and UC-MSCs was associated with reduction in inflammation and restoration of white matter integrity following exposure to LPS in a model of inflammation-induced preterm brain injury.

LO176 / #1733**ESPR Session****ESPR Session 45: Long term effects of prematurity****10-10-2022 11:00 - 12:20****Low grade IVH and PDA ligation were related to altered regional brain volumes at school age in a cohort of extremely preterm children****H. Kvanta*, N. Padilla, U. Aden***Dept of Women's and Children's Health, Karolinska Institute, Stockholm, Sweden***BACKGROUND AND AIMS**

Previous research have shown regional volumetric differences at term age for children born preterm and extremely preterm (EPT) with and without neonatal risk factors (Padilla et al 2015, Filan et al 2010, Alexander et al 2018). Little is known about volumetric differences associated with specific neonatal conditions for children born EPT during childhood. The aim was to investigate if children born EPT with and without predefined perinatal risk factors had regional volumetric differences at 10 years of age.

METHODS

Children born EPT (n=51) in Stockholm without focal brain lesions during 2004-2007 were included. We compared children with any ROP and no ROP, IVH grade I-II and no IVH, PDA ligation and no PDA, PDA ligation and PDA treated with ibuprofen, children born \leq GA 25+5 and \geq GA 26+0 weeks. T1 weighted MRI images were pre-processed using the SPM algorithm and then compared with voxel-based morphometry adjusting for sex, gestational age and intracranial volume.

RESULTS

Children born EPT with IVH grade I-II had reduced GM volume in the left hippocampus compared to children with no IVH. Children with PDA ligation had increased grey matter volumes in the occipital lobe. Children with any ROP compared to no ROP and children born \leq GA 25+5 compared to \geq GA 26+0 weeks did not have regional volumetric differences. (Figure 1.)

CONCLUSIONS

Some but not all neonatal risk factors investigated resulted in limited, but long-lasting, regional brain changes possibly standing for alterations in typical brain trajectories during development.

LO177 / #1822**EAP Session****EAP Session 46: Common problems in adolescence /adolescent health in 2021 - An update****10-10-2022 11:00 - 12:20****Mindfulness-based intervention in preterm young adolescents: Benefits on neurobehavioural functioning and its association with white-matter microstructural changes****V. Siffredi¹, M.C. Liverani¹, D. Van De Ville², L. Freitas¹,
C. Borradori Tolsa¹, P. Hüppi¹, R. Hà-Vinh Leuchter^{1*}**¹Geneva University Hospital, Child Development Lab, Geneva, Switzerland²Ecole Polytechnique Fédérale de Lausanne, Institute of Bioengineering, Lausanne, Switzerland**BACKGROUND AND AIMS**

Very preterm (VPT) young adolescents are at high risk of executive, behavioural and socio-emotional difficulties. Previous research has shown significant evidence of the benefits of mindfulness-based intervention (MBI) on these abilities. This study aims to assess the association between the effects of MBI on neurobehavioral functioning and changes in white-matter microstructure in VPT young adolescents who completed an 8-week MBI program.

METHODS

Neurobehavioural assessments and multi-shell diffusion MRI were performed before and after MBI in 32 VPT young adolescents. Combined diffusion tensor imaging and neurite orientation dispersion and density imaging (NODDI) measures were extracted on well-defined white matter tracts (TractSeg). A multivariate data-driven approach (partial least squares correlation) was used

to explore associations between behavioural and microstructural MBI-related changes.

RESULTS

Our finding showed an enhancement of global executive functioning in daily life after MBI that was associated with a general pattern of significant increase in fractional anisotropy (FA) along with a decrease in orientation dispersion index (ODI) in white-matter tracts involved in executive processes. This pattern of increase FA and decrease ODI was also negatively associated with gestational age at birth, i.e., microstructural changes in FA and ODI after MBI was particularly marked in adolescents with lower gestational age.

CONCLUSIONS

In VPT young adolescents, the enhancement in executive functioning observed after an MBI was associated with white-matter microstructural changes in tracts involved in executive processes, in particular for the most vulnerable adolescents. MBI appears to be a promising tool for enhancing executive functioning and white-matter brain plasticity in a vulnerable population such as VPT adolescents.

LO178 / #1069**EAP Session****EAP Session 46: Common problems in adolescence /adolescent health in 2021 - An update****10-10-2022 11:00 - 12:20****A novel pubertal height reference aligned for the individual variation in the timing of pubertal growth****A. Holmgren^{1,2*}, A. Niklasson², L. Gelande², A. Nierop³, K. Albertsson-Wikland³**¹Halmstad hospital, Paediatrics, Halmstad, Sweden²University of Gothenburg, Paediatrics, Gothenburg, Sweden³University of Gothenburg, Physiology/endocrinology, Gothenburg, Sweden**BACKGROUND AND AIMS**

Growth references traditionally describe growth in relation to chronological age. Despite the broad individual variation of pubertal maturation, references related to biological age have been lacking. Hence, growth references and growth charts for the adolescent period have been of limited usefulness both for monitoring individual growth and for research. To fill this gap, we aimed to develop a novel pubertal height reference for improved growth evaluation during the adolescent years.

METHODS

Longitudinal length/height measures were obtained from 1,572 healthy Swedish children (763 girls) born at term to non-smoking mothers, a subgroup of GrowUp1990Gothenburg cohort. A total height reference was constructed from Quadratic-Exponential-Puberty-Stop (QEPS)-function-estimated heights

from individual height curves that had been aligned for time/age at onset of pubertal growth (5% of P-function growth). References that separated growth into specific pubertal heightSDS (P-function growth) and basic heightSDS (QES-function growth) were generated.

RESULTS

References (cm and SDS) are presented for total height, and height divided to that specific to puberty and to basic growth arising independently of puberty. The usefulness of the new pubertal growth reference was explored by identifying differences in the underlying growth functions due to differences in pubertal height gain for children of varying body mass, height, and different pubertal timings (Figure 1).

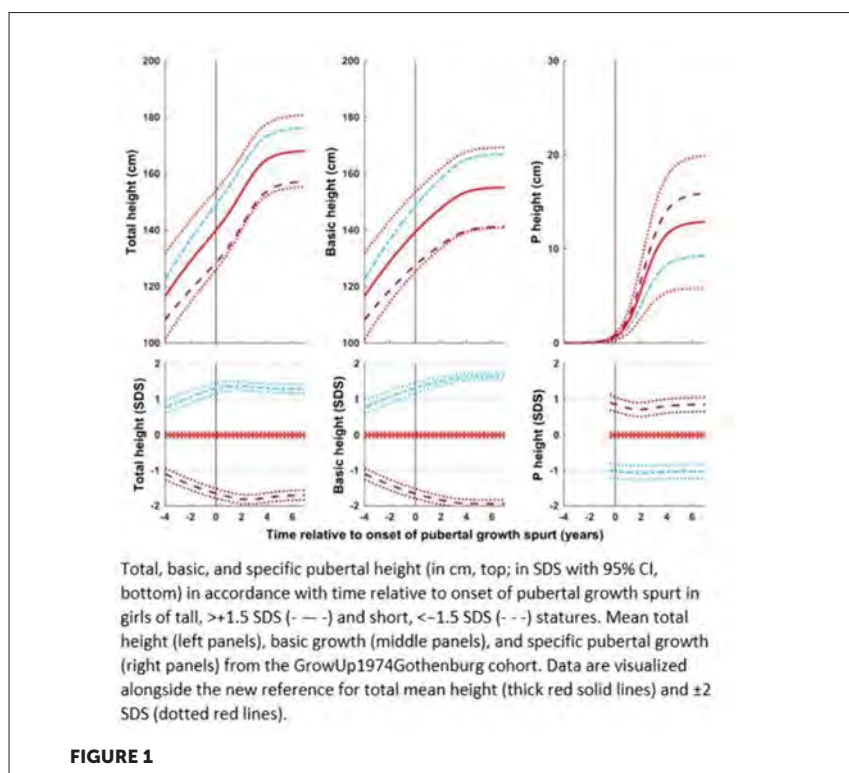

CONCLUSIONS

A novel type of height reference allowing alignment of individual growth curves, based on the timing of the pubertal growth spurt was developed using QEPS-model functions. This represents a paradigm shift in pubertal growth research and growth monitoring during the adolescent period.

LO179 / #1690**EAP Session****EAP Session 47: How can big data/artificial intelligence be incorporated/used in primary care****10-10-2022 11:00 - 12:20****Discovery metabolomics of cord blood for biomarker discovery: A study in the danish national birth cohort****K. Dowling^{1,2}, D. O'Boyle^{1*}, L. Gallagher³, A. Khashan⁴,
B. Hammer Bech⁴, T. Henriksen⁵, D. Murray⁶, J. English⁷**¹University College Cork, Infant Research Centre, Cork, Ireland²Department of Anatomy and Neuroscience, University College Cork, Cork, Ireland³Trinity College Dublin, Trinity Institute of Neuroscience, Dublin, Ireland⁴Dept. of Public Health, Aarhus University, Aarhus, Denmark⁵Aarhus University Hospital, Paediatrics and Adolescent Medicine, Aarhus, Denmark⁶INFANT Research Centre, University College Cork, Cork, Ireland⁷INFANT Research Centre, University College Cork, Anatomy and Neuroscience, Cork, Ireland**BACKGROUND**

Autism Spectrum Disorder (ASD) is a neurological disorder that affects sensory processing and verbal/nonverbal language abilities. Children are not diagnosed until 3-4 years when communication skills lag behind peers. Hence, there is a need for diagnostic biomarkers which predict ASD at a younger age.

AIM

Our aim is to develop a metabolomic assay in cord blood to identify infants at risk of ASD who could benefit from early intervention.

METHODS

Participants: Cord blood from Danish National Birth Cohort (DNBC) was profiled for biomarker discovery. Our nested case:control study assessed 275 children with ASD vs 275 gender matched neurotypical controls. Analysis: Liquid chromatography-tandem mass spectrometry (LC-MS/MS) was performed on Waters ACQUITY LC-SYNAPT G2-S. Progenesis-QI (Nonlinear Dynamics v2.4) aligned peaks and searched databases (e.g. Human Metabolome Database, KEGG) to match mass-to-charge values to chemical names. Peak data were exported to R and Python3 to explore machine learning (ML) algorithms which select biomarkers that discriminate between ASD and neurotypical outcomes.

RESULTS

We profiled 1892 compounds and 20 clinical/lifestyle variables from the DNBC to identify the top metabolite and clinical features predictive of ASD. The top20 discriminatory metabolites as ranked by ML classifiers random forest and logistic regression models were selected for confirmation using analytical standards. Validation of biomarkers by LC-MS/MS on Waters Xevo TQMS is underway in independent samples from DNBC and Cork BASELINE Birth Cohort.

CONCLUSIONS

The markers identified in this study shed light on the molecular mechanisms implicated in the pathophysiology of ASD. Future work will focus on validating these putative markers.

LO180 / #608

EAP Session

EAP Session 47: How can big data/artificial intelligence be incorporated/used in primary care

10-10-2022 11:00 - 12:20

THE effect of virtual reality on pain experienced by school-age children during venipuncture: Randomized controlled study

E. Orhan^{1*}, D. Gozen²

¹Education Department, Koc University Hospital, Istanbul, Turkey

²Pediatric Nursing Department, Istanbul University-Cerrahpasa Florence Nightingale Faculty of Nursing, Istanbul, Turkey

BACKGROUND AND AIMS

The use of virtual reality as a non-pharmacologic method may enable children to tolerate invasive procedures in a hospital setting easily and feel less pain. This study aimed to determine the effect of using a VR headset during venipuncture on pain level, heart rate and oxygen saturation values in children age 7-12 year-old.

METHODS

This was a randomized controlled experimental study. This study included 102 children who visited the vaccination room of a pediatric outpatient clinic of a university hospital. Before venipuncture, state anxiety and pain scores of the children were evaluated. The children in the experimental group wore virtual reality headsets during venipuncture. The children in the control group underwent standard venipuncture procedure. Pain scores were evaluated again in both groups after the venipuncture. Before, during and after the venipuncture, pulse and oxygen saturation values were measured.

RESULTS

It was determined that post-venipuncture pain mean scores were significantly lower in experimental group than those of the children in the control group ($Z = -6.574$; $p = 0.001$). The mean heart rate during the procedure was significantly lower in the experimental group than in the control group ($p = 0.026$; $t = -2.265$).

CONCLUSIONS

It was determined that post-venipuncture pain mean scores were significantly lower in experimental group than control group. Virtual reality is effective to reduce the pain of children during venipuncture. Virtual reality headsets may provide a comfortable intervention process for painful procedures. The virtual reality headsets may be recognized as effective instruments to reduce the pain level of children.

LO181 / #1038**EAP Session****EAP Session 47: How can big dat/artificial intelligence be incorporated/used in primary care****10-10-2022 11:00 - 12:20****Integrating pediatric patient-reported outcomes and experience measures in Canada's largest province-wide, fully integrated health system****S. Bele^{1,2,3*}, M. Santana^{1,2,3}**¹Department of Pediatrics, University of Calgary, Calgary, Canada²Alberta Strategy for Patient Oriented Research Support Unit, Patient Engagement Team, Calgary, Canada³Department of Community Health Sciences, University of Calgary, Calgary, Canada**BACKGROUND AND AIMS**

Implementing Patient-reported Outcome Measures (PROMs) and Patient-reported Experience Measures (PREMs) is an effective way to deliver patient- and family-centered care (PFCC). Alberta Health Services (AHS) is Canada's largest and fully integrated health system, but PROMs and PREMs are not integrated into routine pediatric clinical care. Thus, this study investigated the current uptake, barriers, and enablers for integrating PROMs and PREMs in Alberta's pediatric healthcare systems.

METHODS

Pediatric clinicians and academic researchers with experience and interest in using PROMs and PREMs were invited to complete a quantitative survey to understand the current uptake and knowledge of using pediatric PROMs and PREMs in Alberta. Additionally, key stakeholders were qualitatively interviewed to understand their perspectives on the current challenges in implementing pediatric PROMs and PREMs within AHS.

RESULTS

28 participants completed the quantitative survey. Participants work as pediatric clinicians within (AHS) or as researchers in academic institutions. There is much diversity in the mode of administration and types of pediatric PROMs and PREMs currently being used in Alberta. The primary analysis of 14 qualitative interviews shows that most participants acknowledge the importance of using PROMs and PREMs to provide PFCC, but some of them raised the issue of a lack of clear guidelines on using PROMs data in clinical care to improve healthcare delivery. The absence of system-level support, such as integration within electronic medical records systems, is considered a significant system-level challenge.

CONCLUSIONS

The findings from this study from Canada's largest integrated health system could apply to other pediatric healthcare settings worldwide.

LO182 / #1197

EAP Session

EAP Session 47: How can big data/artificial intelligence be incorporated/used in primary care

10-10-2022 11:00 - 12:20

Global mother – Child data sets to unlock digital records

L. Siderius^{1*}, L. Kyeremateng¹, R. Braamburg²

¹Youth Health Care, Youth Health Care, Almere, Netherlands

²Stichting Rare Care World, Board, Loosdrecht, Netherlands

BACKGROUND AND AIMS

The United Nations Sustainable Development Goals are supported by the uptake of international ISO standards. The International Patient Summary, ISO 27269:2021, defines the core dataset to achieve continuity and coordination of healthcare. At present health, data are locked in vendor dependent electronic records. The key is to give people easy access to their own data to help them understand their health and make more informed choices. The aim is to illustrate how global harmonized interoperable standards give access to necessary data.

METHODS

At a home visit, the nurse observed several skeletal deformities in 2 week old newborn. At 4 weeks during a routine health check achondroplasia was suspected and confirmed by DNA investigation. It was difficult for parents to understand why during pregnancy and after birth, these features were not mentioned. Requirements for exchanging the Birth Care data are available. The use case describes a profile of a child with a congenital anomaly detected before birth.

RESULTS

International digital profile achondroplasia mother-child

	Observation	Standard
29 weeks Prenatal	Short Femur	LOINC Fetal Femur diaphysis [Length] US
4 weeks	Large head	LOINC Head Occipital-frontal circumference by Tape measure
4 weeks	Short	LOINC Body height Measured
6 weeks	Achondroplasia (clinical)	2022 ICD-10-CM Diagnosis
10 weeks	Achondroplasia	Orphacode OMIM

CONCLUSIONS

The use case demonstrates how an international mother-child data profile provides a continuity of care to ensure appropriate guidance and practical support in primary child healthcare to leave no child behind.

LO183 / #1655

EAP Session

EAP Session 47: How can big data/artificial intelligence be incorporated/used in primary care

10-10-2022 11:00 - 12:20

Data as power: The rights of children and their families in health data sharing and linkage

C. Wild^{1*}, N. Rawiri², K. Taiapa², Y. Anderson³

¹University of Oxford, Primary Care Health Sciences, Oxford, United Kingdom

²University of Auckland, Paediatrics: Child and Youth Health, Auckland, New Zealand

³Curtin University, Faculty of Health Sciences, Perth, Australia

BACKGROUND AND AIMS

Child health data sharing and linkage has increased rapidly, along with increased secondary use of data in predictive analytics and models. While there is potential for societal and health gains when utilising large data sets, this also poses privacy and consent challenges, which appears relatively unknown to the public. Our aim was to understand the views of children, youth and their parents with regards to child health data storage, linkage and consent for data use.

METHODS

We undertook five focus groups (26 participants) with children, teenagers and their parents/caregivers, informed by Kaupapa Māori theory principles (a decolonising response to systemic racism and its continuous effects on health outcomes). We covered six key domains: health data and information, data sovereignty, storage, sharing, linkage and consent. Data was analysed thematically.

RESULTS

Firstly, health data was described as a unique and evolving “Health Story” – representing more than “just a number”. Secondly, data represented power that allowed families to actively participate in their health journeys, with additional work required of families to navigate significant asymmetry of information within the health system. Finally, informed consent for child data use and linkage was conceived as an active relationship built on trust.

CONCLUSIONS

Findings suggest that a trusting relationship between health professionals and patients can facilitate open data sharing. This dynamic relationship must be revisited if intentions for data use change and when children reach an age where they can consent for themselves. Fair and informed consent processes have the potential to be healing relationships within the health system.

LO184 / #1162

EAP Session

EAP Session 47: How can big data/artificial intelligence be incorporated/used in primary care

10-10-2022 11:00 - 12:20

Benefits of a new liquid formulation of a multistrain synbiotic in infants with acute diarrhea of probable viral origin

F. Garcia Marin¹, P.J. Català Robert², A. Muñoz Avila³, M.A. Motta Calderon⁴, B. Ochoa Fernández⁴, M. Rahal Khouri⁴, M.J. Lopez Pérez⁵, L. Palomo Alameda⁶, E. García Menor⁷, M.J. De Ibarrondo Guerrica-Echevarría⁸, S.A. Fernández Cebrián⁹, E. Garcia Aguilar¹⁰, F.J. Hidalgo Bermejo^{10*}, C. Nieto Magro¹⁰

¹Hospital Virgen del Mar, Pediatrics, Madrid, Spain

²Centro Médico MEDInfant, Pediatrics, Barcelona, Spain

³Consultorio Médico Dr. Antonio Muñoz Ávila, Pediatrics, Madrid, Spain

⁴Hospital San Rafael, Pediatrics, Madrid, Spain

⁵Centro Médico Valdebernardo, Pediatrics, Madrid, Spain

⁶Centro Médico Oporto, Pediatrics, Madrid, Spain

⁷Hospital Universitario del Sureste, Pediatrics, Madrid, Spain

⁸Centro HBN39 Especialidades Médicas, Pediatrics, Madrid, Spain

⁹Clínica Pediátrica Fernández Cebrián, Pediatrics, Orense, Spain

¹⁰Medical Department, ITF Research Pharma S.L.U., Madrid, Spain

AIMS

To assess the clinical benefit offered by a 7-multistrain synbiotic (probiotics+prebiotics) over standard measures for the management of acute diarrhea of probable viral etiology in infants.

METHODS

Multicenter, prospective, randomized, and controlled study, enrolling infants ≤ 2 years with acute diarrhea of less than 48 hours of evolution. Children were randomized into: Control group (CG) receiving only diet and oral rehydration therapy and Synbiotic group (SG) receiving, in addition, a liquid 7-multistrain synbiotic (*Lactobacillus casei*; *Lactobacillus rhamnosus GG*; *Streptococcus thermophilus*; *Bifidobacterium breve*; *Lactobacillus acidophilus*; *Bifidobacterium infantis*; *Bifidobacterium bulgaricus* plus Fructooligosaccharides) for 7 days. Study endpoints include evolution and resolution of diarrhea (WHO's definition: ≥ 3 loose or liquid stools/day), feces consistency (Bristol scale), treatment tolerability and adherence.

RESULTS

75 children were recruited [SG (n=40), CG (n=35)] and completed the 7-day treatment period. SG experienced less diarrhea (≥ 3 loose or watery stools/day for ≥ 3 consecutive days), 70.0% vs. 88.6% of patients in CG; $p = 0.0502$.

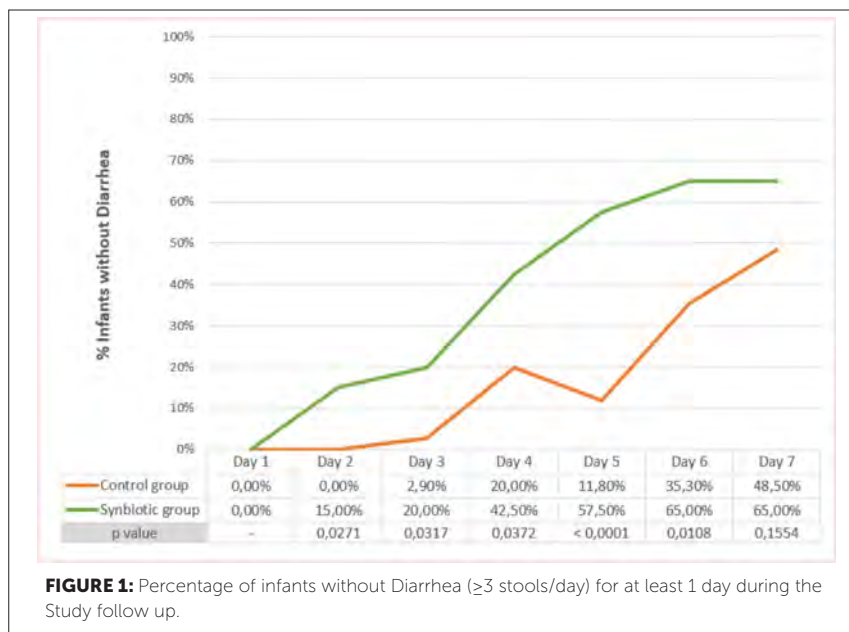

FIGURE 1: Percentage of infants without Diarrhea (≥ 3 stools/day) for at least 1 day during the Study follow up.

Evolution of diarrhea improvement across the study is shown in Figure 1. Number of days with diarrhea -median (IQR 25-75)- were reduced in SG, 4 days (3-6.5) vs 6 days (5-7) in CG ($p=0.002$), with a lower duration of diarrhea episode -median (IQR 25-75)- (SG: 3 days (2-5), CG: 5 days (4-7); $p=0.0006$). Rate of recovery from diarrhea at the end of the study was higher for children receiving synbiotic, 85.0% (34/40), compared to control, 54.3% ($n=19/35$); $p=0.0036$.

CONCLUSIONS

Synbiotic therapy improved the evolution and recovery from the diarrhea in children ≤ 2 years, providing additional benefit to standard supportive measures in the management of acute diarrhea of suspected viral origin.

Keywords: Diarrhea, probiotic, synbiotic, *Lactobacillus rhamnosus GG*, Prodefen

LO185 / #2372**ESPR Session****ESPR Session 48: Early brain injury in neonates and children****10-10-2022 11:00 - 12:20****Complexity of broadband near infrared spectroscopy signals in term newborn infants relates to outcome following neonatal encephalopathy****H. Zhang¹, K. Harvey-Jones², V. Verma³, F. Lange⁴, I. Tachtsidis⁵, S. Mitra^{6*}**¹University College London, Institute for Neurology, London, United Kingdom²University College London, Institute for Women's Health, London, United Kingdom³Institute for Women's health, University College London, Neonatology, London, United Kingdom⁴University College London, Medical Physics and Bioengineering, London, United Kingdom⁵Department of Medical Physics and Biomedical Engineering, University College London, London, United Kingdom⁶Institute for Women's Health, University College London, Neonatology, London, United Kingdom**BACKGROUND AND AIMS**

Decreased complexity of brain near infrared spectroscopy signals have been associated with poor outcome both for intraventricular haemorrhage in pre-term infants and in traumatic brain injury in adults. This study aims to evaluate the complexity of broadband near infrared spectroscopy (BNIRS) signals in relation to outcome following neonatal encephalopathy (NE). BNIRS is a novel brain monitoring and imaging technique developed recently to monitor cerebral mitochondrial oxidative metabolism along with cerebral oxygenation and haemodynamics.

METHODS

Data were collected from 22 term neonates (36-44 weeks) who underwent hypothermia after neonatal encephalopathy. BNIRS monitoring performed at 48 hours of life. Multiscale system entropy (MSE) was adopted to assess the complexity of five BNIRS signals: oxy- and deoxy- haemoglobin (HbO₂ and HHb), haemoglobin total (THb), Haemoglobin difference (HbD) and cytochrome c oxidase (oxCCO) over one hour of recordings for each infant. Thalamic Lac/NAA on proton magnetic resonance spectroscopy was used as the outcome biomarker with a cut off 0.39. Group analyses were performed using Wilcoxon matched pair test.

RESULTS

Thirteen infants had good outcome (Lac/NAA <0.39), nine had poor outcome (Lac/NAA ≥0.39). Higher signal complexities were noted with better outcome for all brain signals (figure 1). Sample entropy was significantly

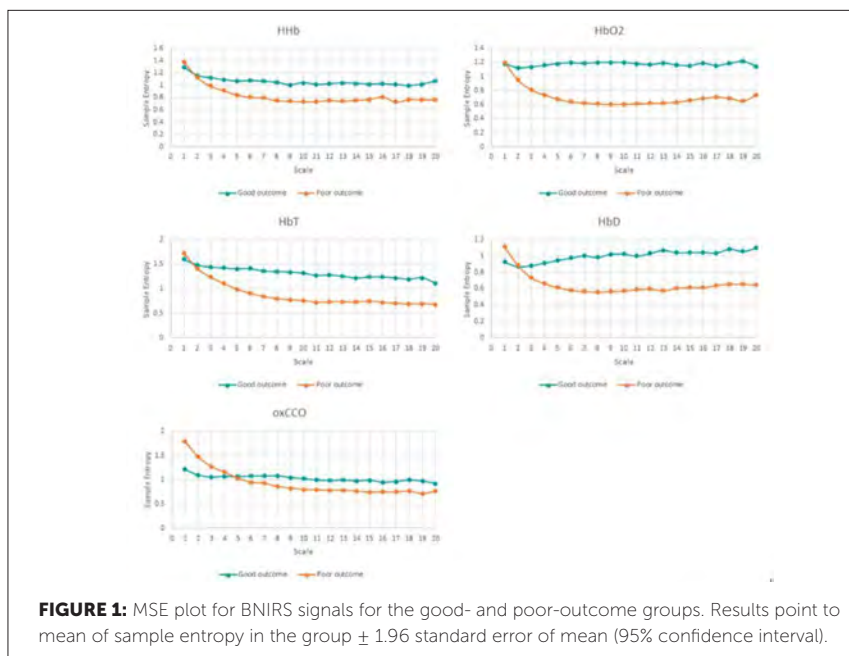

different between the two outcome groups following NE (two tailed P value <0.0001 for HbO₂, HHb and HbD, 0.04 for oxCCO).

CONCLUSIONS

Loss of BNIRS signal complexity following NE was significantly correlated with poor outcome following NE. Complexity analysis of brain signals can be a useful tool for early assessment of injury severity and predict outcome following NE.

LO186 / #1000

ESPR Session

ESPR Session 48: Early brain injury in neonates and children

10-10-2022 11:00 - 12:20

Therapeutic efficacy of extracellular vesicles derived from immortalized and clonally expanded mesenchymal stromal cells in neonatal hypoxic-ischemic brain injury

N. Labusek^{1*}, Y. Mouloud², C. Köster¹, V. Börger², U. Felderhoff-Müser¹, I. Bendix¹, B. Giebel², J. Herz¹

¹Department of Pediatrics I, University Hospital Essen, Neonatology and Experimental Perinatal Neurosciences, Essen, Germany

²University Hospital Essen, Institute for Transfusion Medicine, Essen, Germany

BACKGROUND AND AIMS

Neonatal encephalopathy caused by hypoxia ischemia (HI) is a leading cause of childhood mortality and disability. Stem cell-based therapies seem promising to prevent long-term neurological deficits. Previous work in neonatal HI revealed unexpected risks of mesenchymal stromal cell (MSC) therapy due to interaction with the brains' microenvironment. However, MSCs are supposed to mediate their therapeutic effects in a paracrine mode via extracellular vesicles (EV).

METHODS

Nine-day-old C57BL/6 mice were exposed to HI through ligation of the right common carotid artery followed by 1 hour hypoxia (10% oxygen). MSC-EVs were administered at day 1, 3 and 5 after HI via intraperitoneal (i.p.) and intranasal (i.n.) application followed by analyses of brain tissues at day 7. Due to

a limited lifespan of MSCs, we also investigated therapeutic effects of EVs derived from immortalized and clonally expanded MSCs (ciMSCs).

RESULTS

Both, i.p. and i.n. administration of MSC-EVs reduced HI-induced brain injury with a significant advantage of i.n. over i.p. administration. Therapeutic efficacy of ciMSC-EVs was comparable to EVs from corresponding primary MSCs, resulting in reduced HI-induced striatal brain injury. Intranasal delivery of ciMSC-EVs decreased neuronal loss, reduced micro- and astroglia activation and promoted oligodendrocyte maturation.

CONCLUSIONS

Our data suggest that i.n. administration of MSC-EVs is a promising therapy for neonatal HI. The possibility of using ciMSC-EVs opens up new avenues for the standardized manufacturing of clinical grade EV products, an important prerequisite for routine clinical application and scale up production to industrial levels, circumventing problems associated with MSC-EV heterogeneity.

LO187 / #862**ESPR Session****ESPR Session 48: Early brain injury in neonates and children****10-10-2022 11:00 - 12:20****Umbilical cord blood-derived cell therapy for perinatal brain injury: A systematic review & meta-analysis of preclinical studies****T. Nguyen¹, E. Purcell¹, M. Smith², L. Zhou¹, G. Jenkin², S. Miller², C. Mcdonald², A. Malhotra^{1*}**¹Monash University, Paediatrics, Clayton, Australia²Monash University, Obstetrics and Gynaecology, Clayton, Australia**BACKGROUND AND AIMS**

Perinatal brain injury is a major contributor to neonatal morbidity, mortality and long-term adverse neurodevelopment outcomes. Umbilical Cord Blood (UCB)-derived cell therapy, which involves the use of multipotent stem cells isolated from UCB, is showing promise in pre-clinical models, and early-phase clinical trials are now underway. We aimed to systematically review and analyse the evidence for UCB-derived cell therapy for perinatal brain injury from preclinical studies.

METHODS

A combined search strategy was used to search for eligible studies in MEDLINE, PubMed and other databases. Two authors independently screened studies, performed risk of bias assessment and completed data extraction. A meta-analysis of different brain related outcomes was then conducted according to grey matter (GM) and white matter (WM) structures. Data was

synthesised using Review Manager (5.4.1) software and expressed as standardised mean difference (SMD) with 95% confidence intervals (CI), using a random effects model.

RESULTS

Systematic search of literature yielded a total of 1150 citations and after review, 50 studies (7 large, 43 small animal) were included. Administration of UCB-derived cells in animal models of perinatal brain injury significantly improved brain outcomes across several domains including: apoptosis (GM, SMD 1.14 (0.48,1.81), $P=0.0008$), (WM, 1.74 (0.86, 2.62), $P=0.0001$), astrogliosis (GM, 0.76 (0.26,1.26), $P=0.003$), (WM, 1.14 (0.45, 1.82), $P=0.001$), long-term motor function (0.73 (0.26,1.21), $P=0.003$), neuroinflammation, neurogenesis, oligodendrocyte number and infarct volume.

CONCLUSIONS

Systematic review and meta-analysis of pre-clinical literature demonstrates that UCB-derived cell therapy is an efficacious treatment in animal models of perinatal brain injury, with benefits seen across a range of domains.

LO188 / #1488**ESPR Session****ESPR Session 49: The environment and perinatal and child health****10-10-2022 11:00 - 12:20****Intensity of perinatal care for extremely preterm births and neurodevelopmental outcomes at 5.5 years of age: Evidence from the epipage-2 cohort study****A. Morgan^{1,2*}, L. Marchand-Martin¹, S. Twilhaar¹, C. Diguisto^{1,3},
L. Foix L'Hélias^{1,4}, F. Goffinet^{1,5}, M. Kaminski⁶, G. Bréart¹, X. Durrmeyer^{1,7},
B. Khoshnood¹, J. Zeitlin¹, P.Y. Ancel¹**

¹Center for Research in Epidemiology and Statistics (CRESS), INSERM, INRA, Paris Cité University, Obstetrical Perinatal and Pediatric Epidemiology Research Team, Epopé, Paris, France

²UCL EGA Institute for Women's Health, Neonatology, London, United Kingdom

³Centre Hospitalier Régional Universitaire Tours, Maternité Olympe De Gouges, Tours, France

⁴Assistance Publique des Hôpitaux de Paris, Service De Néonatalogie, Hôpital Armand Trousseau, Paris, France

⁵Assistance Publique des Hôpitaux de Paris, Maternité Port Royal, Paris, France

⁶Université de Paris, Epidemiology and Statistics Research Center/cress, Inserm, Inra, Paris, France

⁷Hôpital Intercommunal de Créteil, Neonatal Intensive Care Unit, Créteil, France

BACKGROUND AND AIMS

Active perinatal management is associated with survival without moderate-severe neurodevelopmental disability (NDD) at 2 years of age for extreme preterm (EP: <27 weeks gestational age (GA)) births. Subtle deficits become apparent later. We investigated 5.5 year outcomes according to intensity of perinatal care in EP-born children.

METHODS

Births in EPIPAGE-2, a 2011 French national prospective cohort, from 22 to 26 weeks GA with a live fetus at maternal admission to a level 3 hospital were included. Intensity of perinatal care was assigned according to hospital of birth, categorised into low, medium and high intensity groups using the ratio of 24–25 weeks GA babies admitted to neonatal intensive care to fetuses of the same GA alive at maternal admission. Mild and moderate-severe NDD (motor, sensory, cognitive, and behavioural deficits) were assessed at 5.5 years.

RESULTS

126 of 358 (35.2%) children from low, 140 of 380 (36.8%) from medium and 207 of 374 (55.3%) from high intensity hospitals survived. Children born in high compared to low intensity hospitals had less mild (36.1% versus 47.4%, OR=0.44, 95% CI 0.23 – 0.85) or moderate-severe (21.2% versus 26.6%, OR=0.44, 95% CI 0.19 – 1.03) NDD and higher Movement Assessment Battery for Children v2 (mean difference 1.4, 95% CI 0.3 – 2.5) and IQ scores (mean difference 4.4, 95% CI 0.1 – 8.6). There were no differences between medium and low intensity hospitals, or for behaviour.

CONCLUSIONS

Higher intensity of perinatal care is associated with less NDD and better motor and cognitive abilities in 5.5 year old EP-born children.

LO189 / #1620

EAP Session

EAP Session 50: New aspects in paediatric immunology

10-10-2022 11:00 - 12:20

Thinking out of the box: Relation between inflammatory blood ratios and severity of attention deficit hyperactivity disorder (ADHD)

D. Elalfy^{1*}, R. Fahiem²

¹Faculty of Post Graduate Childhood Studies, Ain-Shams University, Child Health and Nutrition, Cairo, Egypt

²Faculty of Post Graduate Childhood Studies, Ain-Shams University, Phoniatrics, Cairo, Egypt

BACKGROUND AND AIMS

ADHD is one of the commonest psychiatric and phoniatic disorders, presenting in 5.9%– 7.1% of childhood worldwide. The blood neutrophil/lymphocyte ratio (NLR), platelet/ lymphocyte ratio (PLR), and monocyte/ lymphocyte ratio (MLR), have recently been used as indicators of a systemic inflammatory response. Some studies have reported high inflammatory markers in ADHD. To assess the relationship between inflammatory blood ratios and severity of ADHD symptoms.

METHODS

This case-control study enrolled 113 ADHD medication-free cases diagnosed by DSM- 5 with an age range of 6-12.4 yrs; attending outpatient clinics of the Center of Special Needs, Faculty of Postgraduate Childhood Studies, Ain Shams University, Cairo, Egypt. They were matched with 93 healthy control children that were both physically and mentally free of the same

socio-demographic characteristics of the case group. Conners' parents' Rating Scale (CPRS) was applied to all of them to assess the severity of the symptoms. Inflammatory blood ratios were done for all the studied groups including the following ratios: Platelets/ lymphocytes, Monocytes/ lymphocytes, Neutrophil/ lymphocytes.

RESULTS

The inflammatory blood ratios were statistically significantly higher in cases than in control. There was a positive correlation between CPRS scores and the inflammatory blood ratios among the ADHD group.

CONCLUSIONS

The severity of ADHD symptoms was associated with higher levels of inflammatory ratios which could provide insights that will guide future ADHD treatment.

LO190 / #1454**EAP Session****EAP Session 50: New aspects in paediatric immunology****10-10-2022 11:00 - 12:20****The challenges of MIS-C: A case report series of pediatric patients presenting with cardiac symptoms****M.-D. Ginga^{1*}, D. Toader¹, A. Maris¹, L. Bodea¹, M. Militaru¹, B. Lucian², M. Andrei², S. Cainap³**¹Second Department of Pediatrics, Clinical Emergency Hospital of Children, Cluj-Napoca, Romania²Department of Pediatrics, Emergency Regional Hospital 'Constantin Opris', Baia Mare, Romania³Department of Pediatrics, University of Medicine and Pharmacy 'Iuliu Hatieganu', Cluj-Napoca, Romania**BACKGROUND AND AIMS**

Multisystemic inflammatory syndrome in children (MIS-C) is a novel condition temporally associated with SARS-CoV2 infection. Cardiovascular involvement is prominently marked by acute myocardial injury/myocarditis and the development of coronary artery aneurysms.

METHODS

We bring in front of you three cases of multisystemic inflammatory syndrome, associated with SARS-CoV-2 infection, which presented with such severe cardiac symptoms that needed intensive care treatment.

RESULTS

Two of the patients presented with acute coronary syndrome (intense chest pain, shortness of breath, ST-segment elevation) and the third one's symptoms resembled a toxic shock starting with digestive signs and hemodynamic instability. The cardiac ultrasound revealed local kinetic disorders, hypokinesia and major decrease of left ventricle function (LVEF=30%). Cardiac enzymes were extremely elevated: troponins over 3000ng/ml and NTproBNP up to 28.000pg/ml, also increased levels of acute phase-reactants and fibrin degradation products. The mainstays of treatment were inotropic support with noradrenaline and dobutamine, immunoglobulins, steroids, anticoagulants, anti aggregation drugs and antibiotic therapy. All three cases made a spectacular recovery with a swift remission of the inflammatory syndrome and normalisation of the cardiac enzymes and function.

CONCLUSIONS

Acute myocarditis with intense systemic inflammation and atypical Kawasaki disease is an emerging severe pediatric condition following SARS-CoV2 infection. Early recognition of this disease is needed and referral to an expert centre is recommended.

LO191 / #1472**EAP Session****EAP Session 50: New aspects in paediatric immunology****10-10-2022 11:00 - 12:20****Telemedicine as an Educational tool for caregivers regarding Auto-injectors and Anaphylaxis Management (TEAAM): A helping hand moving forward****C. Okelly^{1*}, C. Cronin², H. Keohane², L. Flores Villarta², J. Trujillo Wurttele^{1,2,3}**¹*Cork University Hospital, Paediatrics, Cork, Ireland*²*Department of Paediatrics and Child Health, University College Cork, Cork, Ireland*³*Cork University Hospital, Infant Research Centre, Cork, Ireland***BACKGROUND AND AIMS**

Caregiver education regarding adrenaline auto-injector (AAI) administration and anaphylaxis management is an important method of improving anaphylaxis outcomes¹. During Covid-19, face-to-face caregiver education opportunities were drastically reduced following implementation of virtual clinics. We wish to assess whether virtual education sessions can improve caregiver knowledge and AAI administration.

METHODS

TEAAM is a prospective, interventional study. Potential participants were identified from outpatient clinic lists and were invited to complete a pre-intervention questionnaire. Those eligible were then enrolled in an online education session involving AAI administration assessment, videos displaying correct

AAI administration and anaphylaxis management information, followed by re-assessment of caregiver AAI technique. Caregivers then completed a post-intervention questionnaire which assessed satisfaction and improvement of knowledge.

RESULTS

151 participants have been enrolled to date and 37(24.5%) have completed the education session and post-intervention questionnaire. There was a statistically significant increase in anaphylaxis management knowledge following educational intervention (average score 82% vs 90%, $p>0.05$). AAI administration technique was marked based on observation of key steps outlined in figure 1. Scores increased from 69.95% to 95% following instruction. There was no statistically significant difference in score improvement between brands of AAI used, time since last training or number of times AAI had been administered. 97.3% found the session useful. Perceived benefits are displayed in figure 2. Only 1 participant believed face-to-face interaction would be superior.

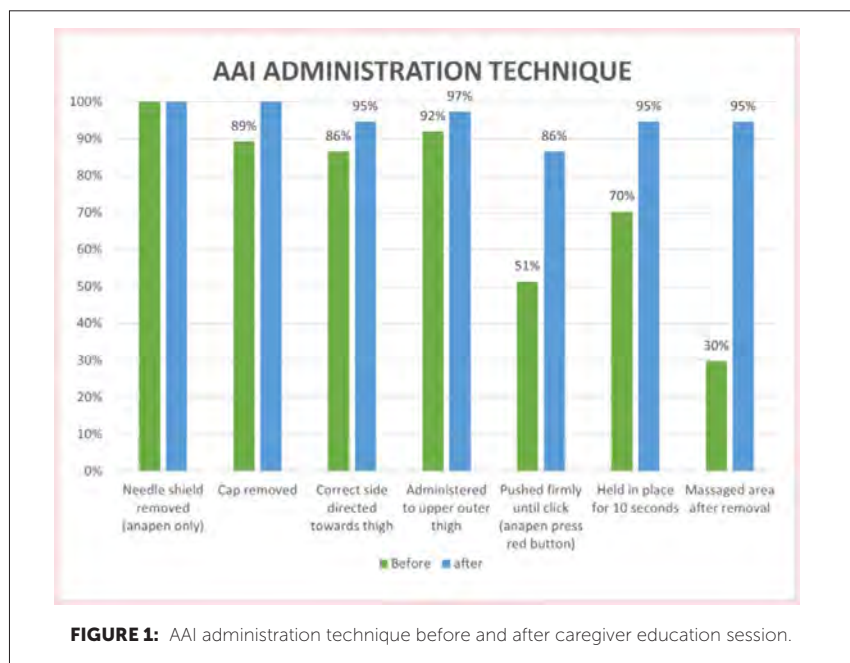

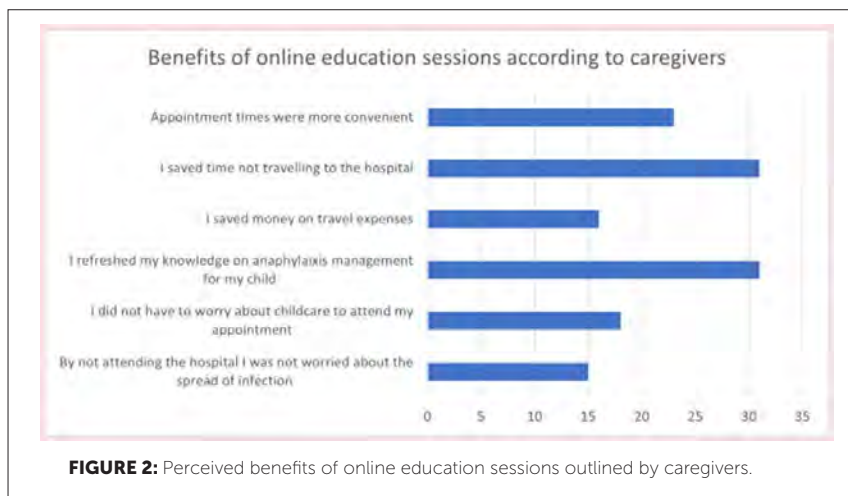

CONCLUSIONS

Caregiver performances pre-intervention were above average, and improvements post-intervention were comparable with face-to-face education^{2,3}. Overall satisfaction levels were high. Virtual instruction regarding anaphylaxis management and AAI administration appears to be a safe, effective tool for caregiver education.

REFERENCES

- [1] Kapoor, S., Roberts, G., Bynoe, Y., Gaughan, M., Habibi, P. and Lack, G. (2004), Influence of a multidisciplinary paediatric allergy clinic on parental knowledge and rate of subsequent allergic reactions. *Allergy*, 59: 185-191. <https://doi.org/10.1046/j.1398-9995.2003.00365.x>
- [2] El Turki, A., Smith, H., Llewellyn, C., & Jones, C. J. (2017). A systematic review of patients', parents' and healthcare professionals' adrenaline auto-injector administration techniques. *Emergency medicine journal : EMJ*, 34(6), 403–416. <https://doi.org/10.1136/emmermed-2016-205742>
- [3] American Academy of Pediatrics (1990) Committee on School Health Guidelines for urgent care in school. *Pediatrics*

LO192 / #1683**EAP Session****EAP Session 50: New aspects in paediatric immunology****10-10-2022 11:00 - 12:20****Lymphocyte, neutrophil and monocyte function and cytokine responses in children with severe neurological impairment: Effect of lipopolysaccharide****J. Allen^{1,2,3*}, J. Isaza-Correa^{1,2,3}, L. Kelly^{1,2,3}, A. Melo¹, A. Mahony⁴, D. Mcdonald⁴, E. Molloy^{1,3,5,6,7,8,9}**¹Trinity College Dublin, School of Medicine, Discipline of Paediatrics, Dublin, Ireland²Trinity College Dublin, Trinity Translational Medicine Institute, Dublin, Ireland³Trinity College Dublin, Trinity Research in Childhood Centre (tricc), Dublin, Ireland⁴Children's Health Ireland at Tallaght, Paediatrics, Dublin, Ireland⁵Trinity College Dublin, Discipline of Paediatrics, School of Medicine, Dublin, Ireland⁶Coombe Women and Infants University Hospital, Neonatology, Dublin, Ireland⁷Children's Health Ireland at Tallaght, Neonatology, Dublin, Ireland⁸Coombe Women and Infants Hospital, Neonatology, Dublin, Ireland⁹Children's Health Ireland at Crumlin, Neonatology, Dublin, Ireland**BACKGROUND AND AIMS**

Infection related morbidity and mortality is higher in children with neurodevelopmental disorders. We aimed to evaluate the effects of lipopolysaccharide (LPS) on lymphocytes, neutrophils, monocytes, and cytokines in children with Severe Neurological Impairment (SNI) compared to age and sex-matched controls.

METHODS

Whole blood samples were incubated in the presence or absence of lipopolysaccharide (10ng/ml). Cytokines were analysed by ELISA from isolated serum.

Neutrophils (CD66b+), monocyte subsets (based on degree of CD14 and CD16 positivity), B cells (CD3-/CD19+), NK cells (CD3-/CD56+), and T cells (CD3+) were analysed by flow cytometry. TLR-4, CD66b and CD11b are proteins involved in immune cell activation, migration, and adhesion, and were used as markers of activation.

RESULTS

Children with SNI and age-matched controls (n=14 each) participated. Total and CD8+ T-cells, and monocytes were lower at baseline in children with SNI ($p=0.02$, $p=0.0031$ & $p=0.0002$ respectively). CD66b hyporesponsiveness to LPS was seen in the SNI cohort ($p=0.0017$). TLR-4 expression in total and classical monocytes was hyper-responsive to LPS in children with SNI ($p=0.04$ & $p=0.03$ respectively). GM-CSF increased in the control group ($p=0.04$) but not in the group of children with SNI ($p=0.07$). Interleukin-6 in the SNI cohort was hyporesponsive to LPS ($p=0.012$). The SNI cohort had a larger increase in erythropoietin in response to LPS than the comparison group ($p=0.0068$).

CONCLUSIONS

We have demonstrated significant differences in immune regulation in children with SNI. These findings may partially explain increased infection-related morbidity and mortality, and tertiary neurological injury in this population, providing a potential therapeutic target.

LO193 / #2076**EAP Session****EAP Session 50: New aspects in paediatric immunology****10-10-2022 11:00 - 12:20****From measles epidemic to SARS COV-2 pandemic- vaccine coverage analysis for romanian children under 1 year of age- what's next?****V. Herdea^{1*}, R. Ghionaru², P. Tarciuc³, E. Costiug², L. Barbacariu², C. Pop⁴, L. Comnea², I. Brinza², C.C. Mirauta³, E. Egri², C. Lanba², S. Rus², S. Cioc², D. Herdea², E. Leibovitz⁵, S. Diaconescu⁶**

¹George Emil Palade University of Medicine, Pharmacy, Science, and Technology of Targu Mures, Targu Mures, Romania, Family Medicine, Tg Mures, Romania

²Romanian Association for Pediatric education in Family Medicine, Family Medicine, Bucharest, Romania

³Family Medicine, Romanian Association for Pediatric education in Family Medicine, Bucharest, Romania, Family Medicine, Bucharest, Romania

⁴Iuliu Hateganu University of Medicine and Pharmacy Cluj, Family Medicine, Cluj, Romania

⁵Faculty of Health Sciences, Ben-Gurion University of the Negev, Beer-Sheva, Israel, Pediatrician, Israel

⁶Titu Maiorescu University of Medicine and Pharmacy, Bucharest, Pediatrician, Bucuresti, Romania

BACKGROUND AND AIMS

Infectious disease control can be achieved if the vaccine coverage (VC) exceeds 95%. The last decades showed a declining trend in the VC which could lead to severe outbreaks of infectious diseases. The study analyses the determinants of VC in children aged 0-1 year, monitored high-risk epidemiological periods.

METHODS

A retrospective observational cohort study were developed in primary care offices (the main Romanian vaccinators) which the data regarding vaccination

of children under 1 year of age in the period 2019.01-2019.06 (Measles epidemics) and 2020.01-2020.06 (COVID-19 pandemic) were followed. 2.850 children from 2019 and 2.823 children from 2020, were selected, the data on immunization results and the determinants of parents' decisions regarding vaccination were evaluated.

RESULTS

During 2019- 2020, VC has followed a declining trend. For each type of vaccine included in the National Immunisation Program, the most affected age groups were infants from 9-12 months in both years ($p < 0.05$) with a significant reduction of VC in 2020 vs 2019. Our data show hesitant parents- 2019- 25%, 2020- 35%, denial of vaccination-7%- 2019, 10%- 2020, fear regarding side effects of vaccines, infodemic, anti-vaxxers' online campaigns, negative Media stories regarding potential side-effects of vaccination, are at the forefront of determinants parents' decisions regarding vaccination of their infants.

CONCLUSIONS

The low VC produced in the years of epidemic and pandemic can induce the recurrence of severe infectious diseases. Permanent awareness educational campaigns regarding infectious disease risk are needed, empowerment of the primary care physicians preventive activity, immunization management based on national regulatory legislation assumed by political decisions.

LO194 / #933**ESPR Session****ESPR Session 51: Global health in paediatrics****10-10-2022 11:00 - 12:20****Impact of early kangaroo mother care versus standard care on survival of mild-moderately unstable neonates**

Helen Brotherton^{1,2*}, Abdou Gai², Bunja Kebbeh², Yusupha Njie², Georgia Walker¹, Abdul K Muhammad², Saffiatou Darboe², Mamadou Jallow², Buntung Ceesay², Ahmadou Lamin Samateh³, Cally J Tann^{1,4,5}, Simon Cousens¹, Anna Roca², Joy E Lawn¹

¹Department of Infectious Disease Epidemiology & MARCH Centre, London School of Hygiene & Tropical Medicine (LSHTM), Keppel Street, London, UK

²MRC Unit The Gambia at LSHTM, Atlantic Road, Fajara, The Gambia

³Ministry of Health, Gambia Government, Banjul, The Gambia

⁴MRC/UVRI & LSHTM Uganda Research Unit, Plot 51-59 Nakiwogo Road, Entebbe, Uganda

⁵Neonatal Medicine, University College London Hospitals NHS Trust, 235 Euston Rd, London, UK

BACKGROUND AND AIMS

Complications of preterm birth are the most common direct cause of mortality in children under 5 years, causing >1 million deaths per year, predominantly in low-resource settings. Kangaroo Mother Care (KMC) is a recommended package of care for stable newborns but an evidence gap exists for early use prior to stability, with potential for high impact from improved family centred care. This trial aimed to investigate clinical effects of early KMC (eKMC) for mild-moderately unstable neonates <2000g in a low-resource setting. Objectives included: 1) Effect on survival; 2) Effect on other clinically important outcomes such as weight gain and infection; 3) Safety of KMC prior to stability and exploration of mechanisms of effect.

METHODS

This non-blinded pragmatic randomised clinical trial was conducted at the only teaching hospital in The Gambia. Eligibility criteria included weight <2000g and age 1 – 24h with exclusion if stable or severely unstable as per protocol criteria. Neonates were randomly assigned to receive either standard care (control), including KMC once stable at >24h after admission, versus continuous KMC initiated <24h after admission (intervention). Randomisation was stratified by weight with twins in the same arm. The primary outcome was all-cause mortality at 28 postnatal days, assessed by intention to treat analysis. Secondary outcomes included: time to death; hypothermia and cardiorespiratory stability at 24h; exclusive breastfeeding at discharge; suspected infection between 3–28d; weight gain at 28d and admission duration. The trial was prospectively registered at www.clinicaltrials.gov (NCT03555981).

RESULTS

Recruitment occurred from 23rd May 2018 to 19th March 2020. Among 1,107 neonates screened for participation 279 were randomly assigned, 139 (42% male [n=59]) to standard care and 138 (43% male [n=59]) to the intervention with two participants lost to follow up and no withdrawals (figure 1). The proportion dying

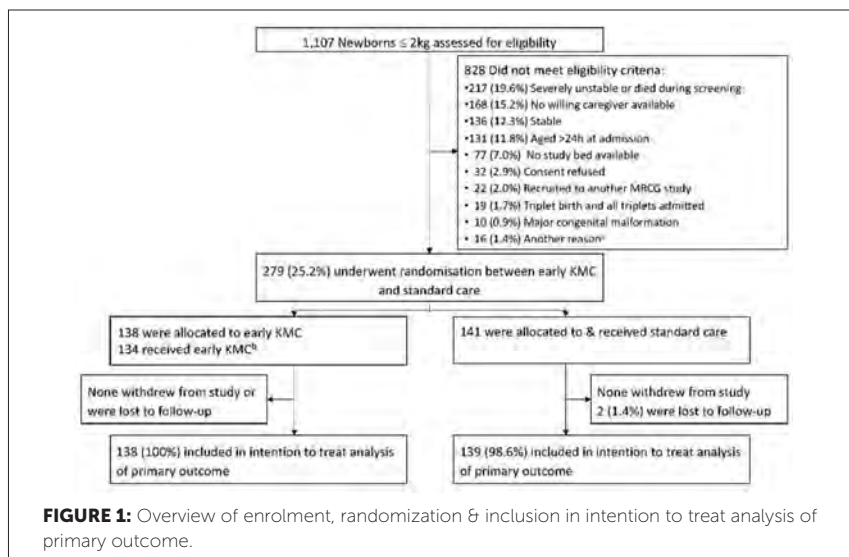

Table 1: Effect of KMC before stabilization on primary and secondary outcomes

	Standard care	KMC before stabilization	Effect estimate (95% CI)	P value
All-cause mortality at 28 days, N*(%)	34/139 (24)	29/138 (21)	RR= 0.84 (0.55 – 1.29)	0.423
Time to death (h), median (IQR)	N=141 34 deaths 98.5 (29 – 132)	N=138 29 deaths 90 (65 – 172)	HR= 0.83 (0.30 – 1.33)	0.447
aSCRIP score at 24h of enrolment, median, (IQR)	N=135 5 (4 – 6)	N=134 5 (4 – 5)	MD=0.05 (-0.25 – 0.16)	0.667
Hypothermia (T<36.5°C) at 24h of enrolment, N*(%)	55/135 (40)	51/134 (38)	RR= 0.93 (0.69 – 1.26)	0.654
Exclusive breastfeeding* at discharge, N*(%)	105/107 (98)	107/109 (98)	RR= 1.0 (0.96 – 1.04)	0.985
Clinically suspected infection from 3 – 28 days, N*(%) [†]	21/141 (15)	28/138 (20)	RR= 1.36 (0.81 – 2.25)	0.240
Blood culture confirmed infection [†] from 3 – 28 days, N*(%)	4/141 (3)	6/138 (4)	RR= 1.53 (0.65 – 3.64)	0.333
Duration of admission (days), mean (SD)	N=106 16.3 (10.0)	N=108 16.6 (11.1)	MD =0.3 (-60.5 – 75.1)	0.833
Weight gain at 28d (g/day), mean (SD)	N=101 12.5 (12.1)	N=103 10.3 (10.1)	MD 2.2 (-5.28 – 0.81)	0.150

within 28d was 24% (34/139, control) vs 21% (29/138, intervention)(risk ratio 0.84, 95% CI 0.55 – 1.29, $p=0.423$)(Table 1). There were no between-arm differences for secondary outcomes or serious adverse events (28/139 (20%) for control and 30/139 (22%) for intervention, none related). One-third of intervention neonates reverted to standard care for clinical reasons, most frequently severe instability, apnoea and severe jaundice. Intervention fidelity was low with median daily skin-to-skin duration 6.9h/day, versus the intended target of 18h/day.

CONCLUSIONS

We did not find evidence that early KMC prior to stability is associated with improved survival or clinical outcomes in a resource limited setting. However, interpretation of this is limited due to a small sample size resulting from halving of pre-trial neonatal mortality rates, highlighting the substantial survival gains possible from implementation of existing recommended small and sick newborn care. Implementation and safety insights from this trial have value for further development of the intervention and wider roll-out of KMC. Further mortality and safety data are needed from varying low and middle-income neonatal unit contexts before global policy changes can be recommended.

LO195 / #679**ESPR Session****ESPR Session 51: Global health in paediatrics****10-10-2022 11:00 - 12:20****Azithromycin reduces injury following inflammation-amplified hypoxia-ischaemia in the piglet model: A repurposed therapy for lmics?****R. Pang^{1*}, C. Meehan¹, G. Norris¹, A. Avdic-Belltheus², A. Mintoft¹, M. Sokolska³, F. Torrealdea³, A. Bainbridge³, X. Golay⁴, J. Barks⁵, N. Robertson^{1,6}**¹*UCL, Neonatology, Institute for Women's Health, London, United Kingdom*²*University College London, Institute for Women's Health, London, United Kingdom*³*Department of Medical Physics and Biomedical Engineering, University College London Hospital NHS Trust, London, United Kingdom*⁴*University College London, Institute of Neurology, London, United Kingdom*⁵*Departments of Pediatrics, University of Michigan, Michigan, United States of America*⁶*University of Edinburgh, Centre for Clinical Brain Sciences, Edinburgh, United Kingdom***BACKGROUND AND AIMS**

Co-existing infection/inflammation increases the risk for neonatal encephalopathy (NE) in sub-Saharan Africa (Tann 2018). Therapeutic hypothermia (HT) is ineffective in LMIC, where sentinel events are uncommon and white matter injury predominates (Thayyil 2021). In newborn piglets, we observed no protection with HT following inflammation-amplified hypoxia-ischaemia (IA-HI) (Martinello 2021). Alternative therapies are needed. Azithromycin has immunomodulatory properties and shows robust protection in the Rice-Vannucci model (Barks 2019, 2020). Our aim was to assess safety and efficacy of azithromycin in piglets after IA-HI.

METHODS

Piglets underwent IA-HI injury by *E. coli* lipopolysaccharide pre-sensitisation, carotid artery occlusion and FiO_2 reduction. After 1h, piglets were randomised

to vehicle (n=10) or azithromycin (n=7), repeated at 24h and 48h. Continuous electroencephalogram (aEEG) and ^1H Magnetic Resonance Spectroscopy Lactate/N-acetylaspartate (Lac/NAA) peak ratio were acquired at 60h. Piglets were euthanised at 65h and brain assessed by immunohistochemistry.

RESULTS

We observed no difference in insult severity between groups. Azithromycin 20mg/kg achieved plasma levels of $\sim 3000\text{ng/mL}$ with no QTc prolongation.

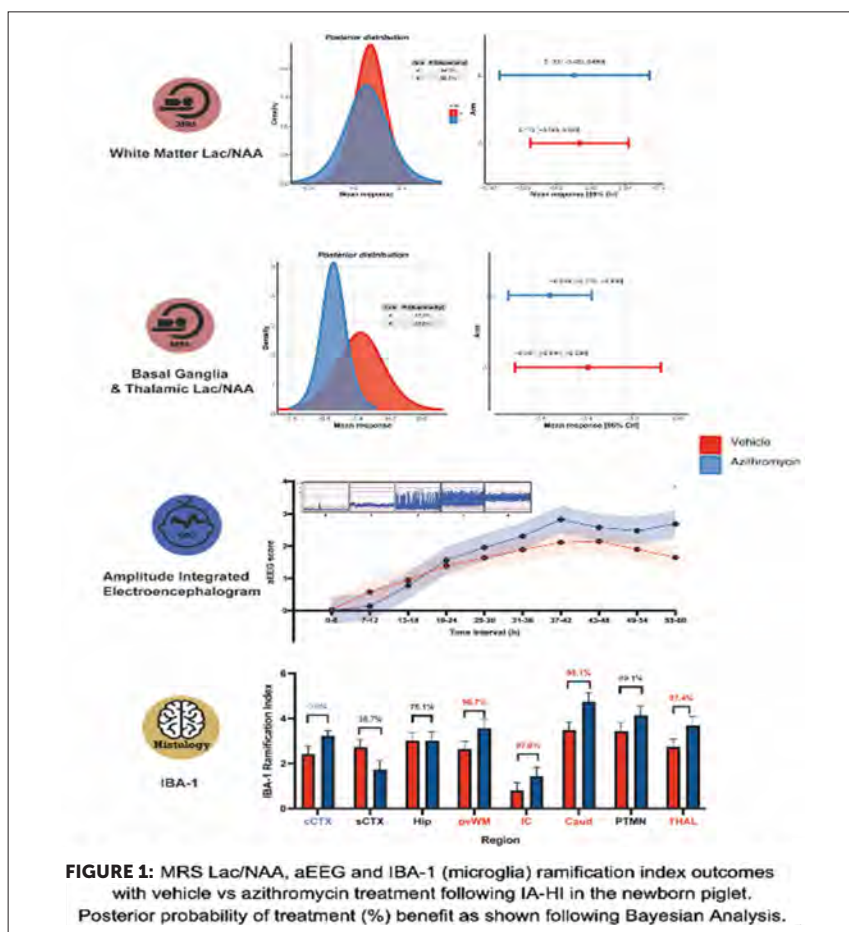

FIGURE 1: MRS Lac/NAA, aEEG and IBA-1 (microglia) ramification index outcomes with vehicle vs azithromycin treatment following IA-HI in the newborn piglet. Posterior probability of treatment (%) benefit as shown following Bayesian Analysis.

Azithromycin reduced mean Lac/NAA by -0.17 (95%CI, -0.56 - 0.22) Log_{10} units in the BGT and -0.04 (95%CI, -0.05 - 0.05) in the WM voxel (Figure). Bayesian analysis using non-informative priors indicated an 82.8% and 55.1% probability (Pr(superiority)) of Lac/NAA reduction in the BGT and WM respectively. On aEEG, cerebral activity at 55-60h significantly improved (Pr(Superiority)=95.5%). Azithromycin significantly suppressed microglial activation (IBA-1) in four regions (Figure).

CONCLUSIONS

Azithromycin shows promise in reducing BGT injury after IS-HI, however dose optimisation to achieve levels of 10,000ng/mL (tolerated in preterm infants) may further improve outcomes. Study was funded by Gates Foundation (INV-002322).

REFERENCES

- [1] Tann, C.J., et al., Perinatal risk factors for neonatal encephalopathy: an unmatched case-control study. *Arch Dis Child Fetal Neonatal Ed*, 2018. 103(3): p. F250-F256.
- [2] Thayyil, S., et al., Hypothermia for moderate or severe neonatal encephalopathy in low-income and middle-income countries (HELIX): a randomised controlled trial in India, Sri Lanka, and Bangladesh. *Lancet Glob Health*, 2021. 9(9): p. e1273-e1285.
- [3] Martinello, K.A., et al., Hypothermia is not therapeutic in a neonatal piglet model of inflammation-sensitized hypoxia-ischemia. *Pediatr Res*, 2021.
- [4] Barks, J.D.E., et al., Azithromycin reduces inflammation-amplified hypoxic-ischemic brain injury in neonatal rats. *Pediatr Res*, 2021.
- [5] Barks, J.D.E., et al., Repurposing azithromycin for neonatal neuroprotection. *Pediatr Res*, 2019. 86(4): p. 444-451.

LO196 / #2133**ESPR Session****ESPR Session 51: Global health in paediatrics****10-10-2022 11:00 - 12:20****Feasibility of a novel ultra-low-cost bubble cpap system for global access to quality noninvasive neonatal respiratory support****T. Burke¹, G. Bou Saba^{2*}, A. Taylor², H. Wadhwa², E. Ng², M. Dundek², K. Opondo², D. Garcia³, N. Roodaki³, R. Moshiro⁴, M. Mkonyi⁴**¹*Massachusetts General Hospital, Emergency Medicine and Pediatrics, Boston, United States of America*²*Vayu Global Health Foundation, Implementation Science, Medford, United States of America*³*Ilocos Regional Medical Center, Neonatology, San Fernando, Philippines*⁴*Muhimbili National Hospital, Pediatrics, Dar es Salaam, Tanzania***BACKGROUND AND AIMS**

One million neonates succumb to respiratory insufficiency each year worldwide. The novel Vayu b-CPAP System was developed to treat neonates and infants with Respiratory Distress Syndrome (RDS), pneumonia, COVID-19, and other causes of severe respiratory distress. The Vayu b-CPAP System does not require electricity or compressed air, is easy to use, is in use in 14 countries, and was granted Regulatory authorization in multiple countries.

METHODS

A Mixed Methods study was conducted to assess implementation and integration of Vayu b-CPAP Systems at Muhimbili National Hospital, Tanzania; Kenyatta National Hospital, Kenya; and Ilocos Training and Regional Medical Center in the Philippines. Characteristics of all patients treated with Vayu b-CPAP Systems were collected. An interview guide was developed in an

iterative fashion and snowballing was used to interview healthcare workers until thematic saturation. Interviews were transcribed, coded, and analyzed using NVivo.

RESULTS

Across the three facilities, 704 neonates were treated with Vayu b-CPAP Systems for an average duration of 6.9 days. Survival to wean was 86% and RDS was the most common (82%) indication for b-CPAP treatment. Healthcare workers perceived Vayu b-CPAP Systems as essential for treating neonatal respiratory distress at MNH. Key reasons were: 1) Ease of use in assembly, application, maintenance, monitoring, and troubleshooting. 2) Positive patient outcomes such as reduced mortality rates. Respondents favored the devices' ultra-low cost, portability, ability to work without electricity, and simple maintenance.

CONCLUSIONS

Healthcare workers viewed the Vayu b-CPAP Systems as essential to their clinical care and recommended them for widespread use.

LO197 / #1349**EAP Session****EAP Session 52: Updates in paediatric cardiology****10-10-2022 11:00 - 12:20****Atrial septal defects, arrhythmias and a novel TBX5 gene variant****A.K. Møller Nielsen^{1*}, V. Hjortdal¹, L.A. Larsen²**¹Department of Cardiothoracic Surgery, Rigshospitalet, Copenhagen, Denmark²University of Copenhagen, Institute of Cellular and Molecular Medicine, Copenhagen, Denmark**BACKGROUND AND AIMS**

Patients with atrial septal defect (ASD) have increased mortality and morbidity. This can only be partly explained by hemodynamic changes caused by the ASD, suggesting additional underlying causes. Patients with an ASD have an increased burden of pathogenic gene variants in ASD related genes, indicating genetics as an important etiologic factor. This study aimed to investigate genetic associations in familial ASD and comorbidities.

METHODS

In a cohort with familial ASD we identified a family with ASD present in 12 family members in three generations. We performed whole exome sequencing on five family members older than 18 years to detect the causative gene variant in this family and evaluated phenotype.

RESULTS

We identified a novel pathogenic variant within the T-box domain of TBX5 (F232L) in all affected family members over 18 years of age. They presented with diverse cardiac phenotypes including heart failure and arrhythmias. Two

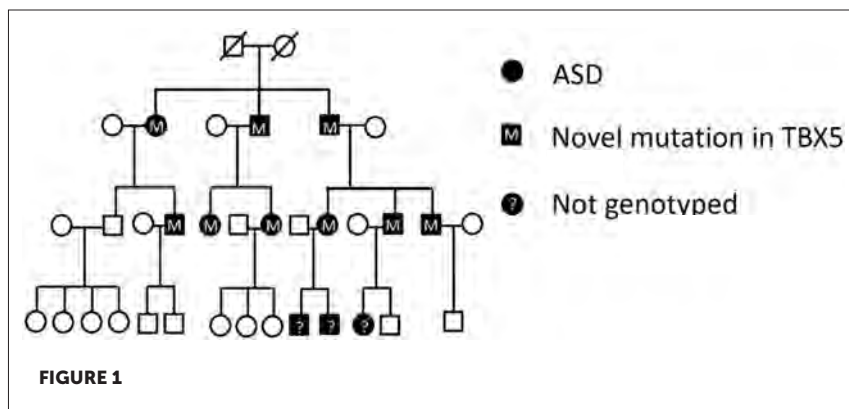

carriers needed a pacemaker. Skeletal malformations were subtle with small hands as the only visible malformation. These findings propose Holt-Oram syndrome.

CONCLUSIONS

We report a novel variant in *TBX5* in a family with Holt-Oram Syndrome, characterized by septal defects, severe cardiac arrhythmias and mild skeletal malformations. Clinical awareness of family history, arrhythmias, and heart failure in patients with familial ASD is important and may lead to timely treatment and uncover patients with Holt-Oram Syndrome.

LO198 / #849**EAP Session****EAP Session 52: Updates in paediatric cardiology****10-10-2022 11:00 - 12:20****Preparing for the unexpected; introducing paediatric cardiac arrest huddles in accident and emergency****P. Parekh, N. Mediratta****Northwick Park Hospital, Paediatrics, London, United Kingdom***BACKGROUND AND AIMS**

A huddle is a short, scheduled and structured meeting to ensure patient safety. It is a rare but devastating presentation when a toddler is brought into Accident & Emergency (A&E) peri-arrest during handover, leading to semi-organised chaos. The Resuscitation Council UK guidelines state that "every hospital should have a resuscitation team" that "meets at the beginning of every shift". Learning from our experiences and other service models during COVID-19 pandemic, we developed a Cardiac Arrest Huddle for A&E to enable us to prepare for the unexpected.

METHODS

The Huddle is a one-page laminated document placed in Paediatric A&E. The Paediatric Registrar allocates themselves to "Leader" and team members to "Airway & Breathing", "Circulation & Access", "Chest Compressions" and "Scribe" roles. This promotes essential leadership skills. The Nurse-in-Charge allocates 1-2 nurses to "Monitor & Drugs".

RESULTS

Prior to implementation, a survey showed 69% had not always known their roles in a cardiac arrest. 92% and 100% felt their confidence and teamwork would improve with pre-allocated roles respectively. After 6 months of using the Huddle, 100% either "always" or on "most occasions" knew their role during a resuscitation. 100% felt the Huddles improved teamwork, 80% felt it saved time before the "2222" call was made and 100% felt pre-allocation of roles increased efficiency.

CONCLUSIONS

The Cardiac Arrest Huddle is available in all acute departments and has proved successful across multiple levels from clinical and patient safety to education and training. It prompts us to recommend that other DGHs may benefit from adopting a similar model.

LO199 / #1344**EAP Session****EAP Session 52: Updates in paediatric cardiology****10-10-2022 11:00 - 12:20****Urinary NT-proBNP values in paediatric congenital heart disease****N. Freudenthal*, N. Müller***University Hospital Bonn, Paediatric Cardiac ICU, Bonn, Germany***BACKGROUND AND AIMS**

NT-proBNP has gained relevance as a biomarker in children with congenital heart disease (CHD) and is increasingly represented in paediatric guidelines. Obvious advantages of urinary sampling include the avoidance of traumatization and the ability to transfer collection to homecare or facilities with no paediatric expertise.

METHODS

The correlation between urinary and serum values in children and the potential age dependency were examined with samples from 33 children (newborns – 3.4 years). Due to the different scales of the results which were significantly higher in serum than in urine, values were log transformed to allow for direct linear correlation. In the next step the utility of isolated urinary NT-proBNP in the ambulatory diagnosis of CHD was investigated. A total of 202 children were recruited (103 controls without CHD, 99 with CHD, of which 27 had already undergone biventricular repair).

RESULTS

The correlation coefficient for serum and urine values was 0,723 (blood/urine) and improved to $R^2=0.814$ when NT-proBNP was corrected to creatinine concentration in the sample. Healthy controls had significantly lower urinary NT-proBNP values than children with haemodynamically relevant CHD and those who underwent biventricular repair with no residual findings on echocardiography. A ROC analysis for the diagnosis of CHD using urinary NT-proBNP showed an area under the curve of 0.807. This could be improved to 0.831 when Ross-Class was factored in.

CONCLUSIONS

Urinary NT-proBNP values show great promise and could represent a new simple non-invasive biomarker for children with congenital heart disease.

LO200 / #1818**ESPNIC Session****ESPNIC Session 53: Dosing durings during extra-corporeal modalities****10-10-2022 11:00 - 12:20****Anti-infective prescription practices in children undergoing renal replacement therapy: A multicenter survey****M. Thy¹, J. Naudin², M. Genuini², S. Leteurtre³, M. Oualha^{1*}**¹AP-HP, Pediatric Icu - Necker Hospital, Paris, France²AP-HP, Pediatric Icu - Robert Debré Hospital, Paris, France³CHRU Lille, Pediatric Icu, Lille, France**BACKGROUND AND AIMS**

The need of renal replacement therapy (RRT) in septic children may occur and add variability leading to unpredictable anti-infective concentrations with risks of treatment failure, toxicity and emergence of multidrug resistant bacteria. We aim to better understand anti-infective prescription practices in children undergoing RRT.

METHODS

An online survey was sent via email to physicians working in French-speaking pediatric intensive care units (PICU). The survey form assessed the characteristics of the PICU, practices of RRT, anti-infective prescription and therapeutic drug monitoring.

RESULTS

From 04/2021 to 05/2021, 26 different centers including 21 French centers answered (88% of response rate for French PICU > 4 beds). Every PICU used

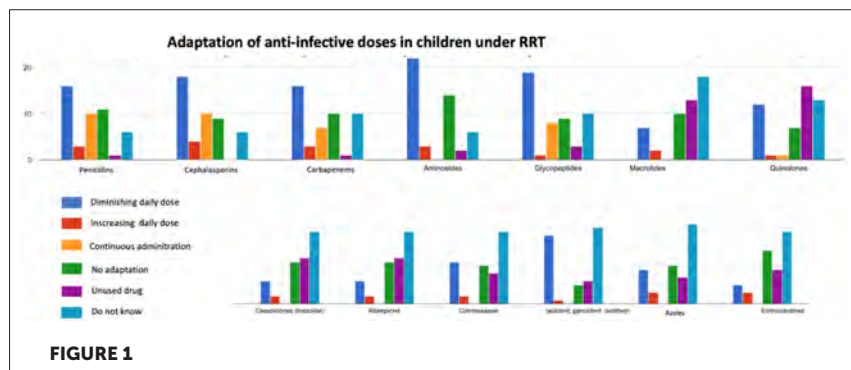

continuous RRT with mainly Prismaflex® machine. Adaptation of anti-infective prescriptions to RRT were declared in 23 (89%) PICU according to the molecular weight in 6 (26%), to protein binding in 6 (26%), to lipo/hydrophilic nature in 4 (17%), to elimination routes in 15 (65%). The anti-infective were adapted to the residual diuresis in 9 (41%) PICU, to the RRT flow in 6 (26%) and to the type of RRT used in 15 (65%) with great variability (Fig. 1). Most of the centers ($n=20$, 77%) used therapeutic drug monitoring under RRT, systematically for betalactams in 18 (69%), for aminoglycosides in 22 (92%), for glycopeptides in 21 (84%). Obstacles for monitoring were mainly ($n=11$, 42%) the delay for the results and the absence of on-site laboratory ($n=8$, 31%).

CONCLUSIONS

Our survey reported great variability of anti-infective prescription practices in children undergoing RRT pointing out the need for specific guidelines.

LO201 / #1275**ESPNIC Session****ESPNIC Session 54: Nurses should lead practice change in the intensive care unit****10-10-2022 11:00 - 12:20****Early rehabilitation and mobilisation (ERM) discussion and planning: A four year audit of PICU ward rounds****A. Little^{1*}, J. Menzies¹, B. Scholefield², H. Child², N. Milburn¹**¹*Birmingham Women's and Children's NHS Foundation Trust, Paediatric Intensive Care Unit, Birmingham, United Kingdom*²*Birmingham Children's Hospital, Picu, Birmingham, United Kingdom***BACKGROUND AND AIMS**

Early rehabilitation and mobilisation (ERM), defined as activity (active or passive) within the first 72hours of a PICU admission, requires daily multi-disciplinary review and planning. We conducted multiple audit cycles measuring occurrence of ERM discussion and planning during medical ward-rounds on a 31 bedded UK PICU.

METHODS

A data collection tool informed by literature was developed and piloted prior to programme launch (2018), post-launch (2019) and three years' post-launch (2021). Data collection was conducted by a trained observer during morning and afternoon ward-rounds and included a review of ERM discussion and documented daily plan. Challenges to sustaining the ERM programme were gathered during team discussions as part of planning for a programme re-launch (2021).

RESULTS

In 2018 ERM was rarely mentioned (10%, 12/120) during ward-rounds; particularly for intubated patients. This situation improved significantly in 2019 to 41% (61/147), however this improvement was not sustained in 2021 (19%, 23/121) (see Figure 1). Sustaining the ERM programme was challenging due to a number of factors; the challenge of high staff turnover (2019–2020), loss of programme leadership (2019–2020); Winter pressures (Nov 2019–Feb 2020; Nov 2020–Feb 2021), the impact of COVID, staff re-deployment (Jan–March 2021) and reduced education (2020–2021) (see figure 1).

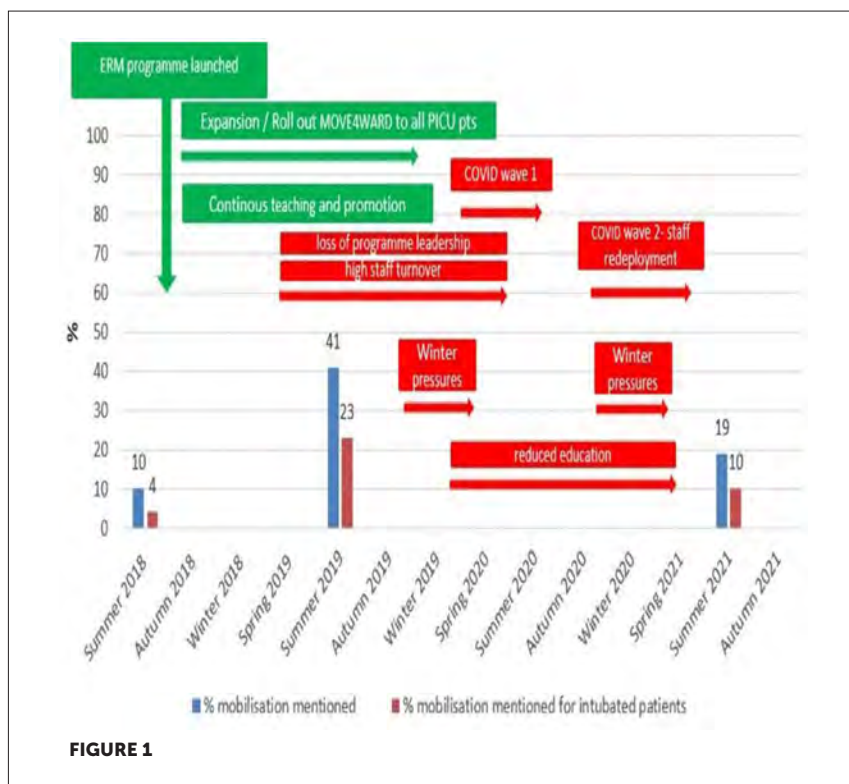

CONCLUSIONS

Despite considerable efforts launching a PICU ERM programme, by 2021 there was reduced ERM within daily ward-round discussions, attributed to challenges of staff turnover and reduced education and training opportunities. Building on this staff training has focused on integrating ERM within ward rounds, bedside teaching and developing champions to support and sustain practice changes.

LO202 / #1843

ESPNIC Session

ESPNIC Session 54: Nurses should lead practice change in the intensive care unit

10-10-2022 11:00 - 12:20

Development of the assessment scale for oral feeding readiness -(ASPOFR)

F.I. Esenay^{1*}, Z. Yurdakul²

¹Ankara University, Faculty of Nursing, Ankara, Turkey

²Dr. Abdurrahman Yurtaslan Ankara Oncology Training and Research Hospital, Palliative Care, Ankara, Turkey

BACKGROUND AND AIMS

The study was planned to develop measurement tool for assessing the readiness of preterm infants to transition to oral feeding, with the aim of preventing the difficulties experienced by healthcare professionals in making an objective decision on the time to initiate oral feeding in preterm infants. The study aimed to development of the Assessment Scale For Oral Feeding Readiness (ASPOFR).

METHODS

This was an observational, cross-sectional methodological study to develop an instrument in Ankara University Cebeci Research and Training Hospital Newborn Intensive Care Unit in Ankara, Turkey. 153 preterm infants (79 girls and 74 boys) were enrolled and assessed by ASPOFR regarding their oral feeding readiness. The study was carried out in three phases: reviewing the literature and creating an item pool (Phase 1), receiving expert feedbacks (Phase 2), and validating the content (Phase3).

RESULTS

The content validity ratio of the scale items ranged from 0.85 to 1.00 and the content validity index was 0.98. The Cronbach's alpha for the ASPOFR scores was 0.938. ROC was 95.5%, and an optimal cut-off value of ASPOFR was 20 (sensitivity: 96,23, specificity: 90,20).

CONCLUSIONS

ASPOFR has been verified to be an effective and accurate instrument to determine the initiation of oral feeding in preterm infants.

LO203 / #2207**Interdisciplinary Session****Interdisciplinary Session 24: Seizure management? What's new – Updates on epilepsy management and status****10-10-2022 15:00 - 16:30****Towards a stratified approach to the diagnosis of neonatal seizures: Combining electroencephalography (EEG), magnetic resonance imaging (MRI) and rapid whole genomic sequencing (WGS)****N. Mitra^{1*}, T. Austin²**¹Cambridge University Hospitals, Neonatology, Cambridge, United Kingdom²Cambridge University Hospitals NHS FoundationTrust, Neonatal Intensive Care Unit, Cambridge, United Kingdom**BACKGROUND AND AIMS**

Neonatal seizures are difficult to identify and pose diagnostic and management challenges. The aim was to see how the combination of a short duration EEG, rapid WGS and MRI influenced management.

METHODS

A single centre, retrospective review was undertaken of infants aged 32 - 44 weeks corrected gestation admitted to a tertiary level neonatal unit between 2016 and 2021 with suspected clinical seizures. Only infants who had standard short duration EEG (1 hour), MRI and WGS were included in further analysis.

RESULTS

Of 196 charts screened (Figure 1), 45 patients were stratified into 5 groups: suspected HIE (30/45); seizures of uncertain aetiology (7/45); perinatal stroke (1/45); infection (4/45); and congenital brain anomaly (3/45). 6/18 infants with suspected HIE demonstrated seizures on EEG, of which 4/6 had electrographic only seizures. MRI findings were confirmatory of HIE (14/30); normal (10/30), atypical for HIE (2/30) and haemorrhage (4/30). In the group with seizures of uncertain aetiology (7/52), WGS identified genetic epilepsy (n=3), and metabolic diagnosis (n=1); EEG confirmed myoclonus (n=1); MRI identified positive findings in the remaining 2. In the infant with perinatal stroke EEG was suggestive of a diagnosis. EEG identified seizures in 1/4 infants with infection and excluded seizures in all the infants with congenital brain anomaly.

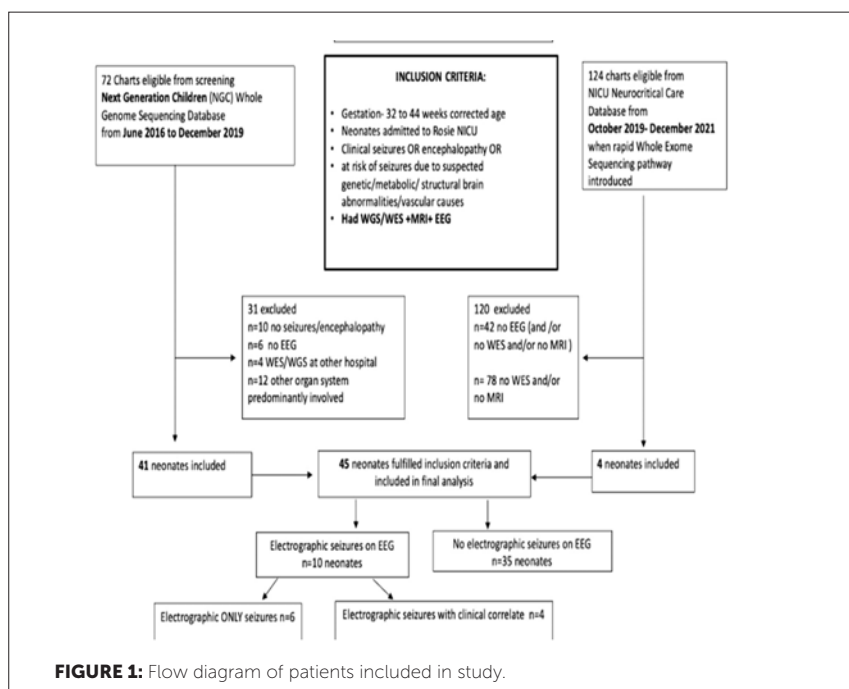

CONCLUSIONS

In neonates with clinically suspected seizures, short duration EEG has a low diagnostic pick-up rate; continuous EEG is likely to improve diagnostic accuracy. Rapid WGS and MRI can help inform the diagnosis and subsequent management, especially when aetiology is unclear.

LO204 / #1513**Interdisciplinary Session****interdisciplinary Session 25: Fluid management in the critically ill child****10-10-2022 15:00 - 16:30****Outcomes of pediatric fluid-refractory septic shock according to different inotropic or vasoactive strategies: A systematic review and meta-analysis****L. Marchetto¹, L. Zanetto¹, D. Padrin¹, R. Comoretto², A. Amigoni¹, M. Daverio¹***¹Department of Women and Children's Health, Pediatric Intensive Care Unit, University Hospital of Padua, Padova, Italy**²Department of Public Health and Pediatrics, University of Turin, Turin, Italy***BACKGROUND AND AIMS**

The management of fluid-refractory septic shock (FRSS) requires inotropic or vasoactive agents for hemodynamic support. Currently, it is unclear which first-line inotrope or vasoactive drug is the best choice in children. Our aim was to determine the association between different inotropic or vasoactive strategies and specific outcomes in FRSS patients.

METHODS

Systematic review and meta-analysis: five electronic databases have been searched for randomized controlled trials and observational cohort studies reporting outcomes of children with FRSS undergoing inotropic and/or vasoactive therapy. Only studies reporting separate data on outcomes according to different agents have been selected. Primary outcome was all-cause mortality. Data about drugs dosages, hospital and ICU length of stay, and adjunctive therapies have been collected and considered as secondary outcomes.

RESULTS

Of the 22,716 identified articles, 13 met inclusion criteria, including a total of 996 children (Figure 1). Four studies included 652 patients receiving a single

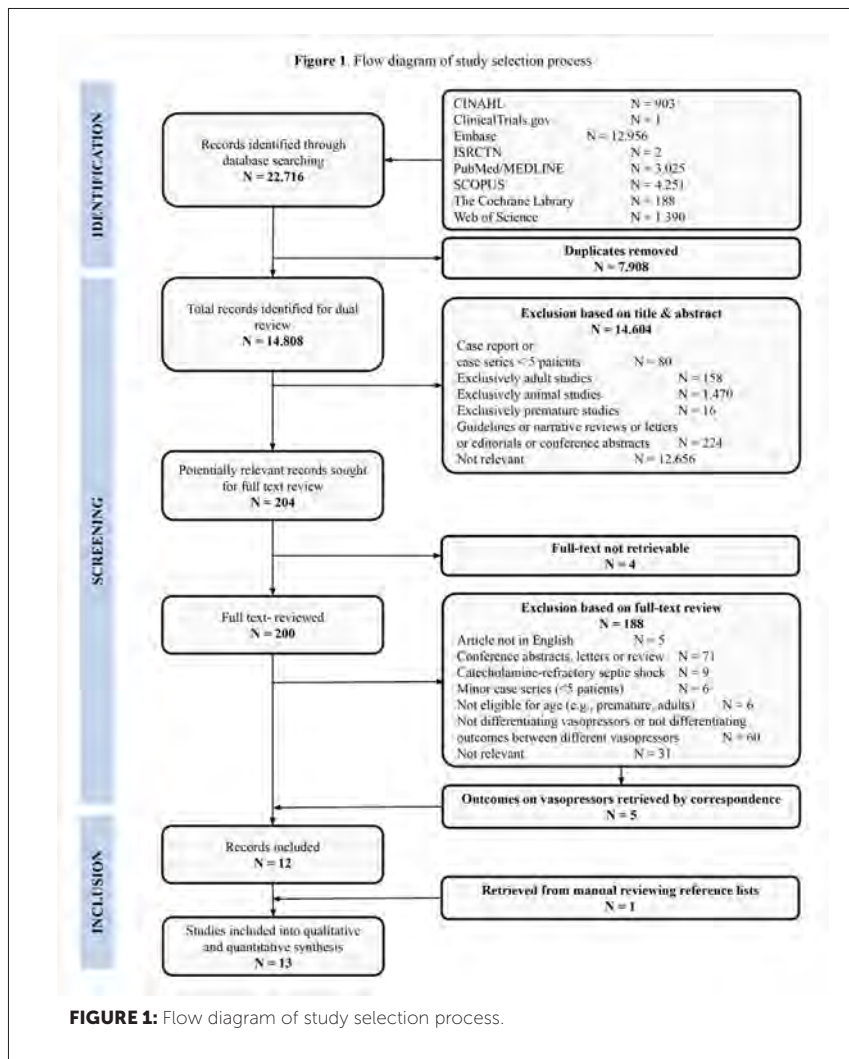

FIGURE 1: Flow diagram of study selection process.

vasoactive agent. Of these, 361 received dopamine, 175 epinephrine, and 116 norepinephrine. Preliminary results show a higher overall mortality in the former group (up to 58%), than in the norepinephrine one (17%). Three-hundred-forty-four patients received two vasoactive agents, with highest mortality among those receiving norepinephrine plus vasopressin (58%). Secondary outcomes were variably reported between studies. Steroids were the most frequent adjunctive therapies, used in 14% to 100% of patients.

CONCLUSIONS

Literature on the topic is highly heterogenous, with scarce data on outcomes of different inotropic and vasoactive agents. The final results of random-effect meta-analyses will allow to assess for differences in outcomes between agents used.

LO205 / #1283**Interdisciplinary Session****interdisciplinary Session 26: New prospects on the management of childhood obesity (ESPE Session)****10-10-2022 15:00 - 16:30****Overweight and obesity increased among swedish pre-school children during the COVID-19 pandemic****A. Holmgren^{1,2*}, S. Nejat³, S. Edvinsson Sollander³, N. Durbeej³,
A. Fäldt³**¹Gothenburg University, Paediatrics, Gothenburg, Sweden²Halmstad Hospital, Paediatrics, Halmstad, Sweden³Department of Public Health and Caring Sciences, Uppsala University, Uppsala, Sweden**BACKGROUND AND AIMS**

The COVID-19 pandemic has had wide effects on child health globally. Increased prevalence of childhood obesity has been observed during the pandemic. The absence of a formal societal lockdown during the pandemic, made Sweden stand out compared to other countries. This study aimed to examine changes in BMI among preschool children in Sweden before and during the COVID-19 pandemic.

METHODS

Retrospective population based cross-sectional study, with longitudinal follow-up for a portion of the children. The study included 25049 children from three Swedish regions, with growth measures at three- (n=16237), four- (n=14437) and five-years of age (n=11 711). Care Need Index was used as a socioeconomic parameter at health centre level.

RESULTS

There was an increase in BMI in children aged three ($p=0.028$), and four ($p <.001$) during the COVID-19 pandemic. Obesity in three-year-old girls increased from 2.8% to 3.9%. Four-year-olds increased in obesity (both sexes), overweight (girls) and the prevalence of underweight decreased in boys. No change in BMI was observed in five-year-olds. Children in areas with the lowest socioeconomic status had higher risk of obesity, increasing from 2.4% to 4.4% during the pandemic, overweight increased from 9.5% to 12.4%.

CONCLUSIONS

Overweight and obesity increased among three-four year old Swedish, especially for children attending child health centres in areas with lower socioeconomic status. The COVID-19 pandemic is likely to have affected health behaviours negatively in Swedish preschool children. Our results expose the need for extended efforts directed to prevent childhood obesity, especially targeting lower socioeconomic areas.

LO206 / #2205

Interdisciplinary Session

Interdisciplinary Session 27: Safety and complications after anesthesia in children (ESPA Session)

10-10-2022 15:00 - 16:30

Treatment of hypertensive crisis in children: Nitroprusside vs. Nidcardipine

H. Bakker^{1*}, S. Cochijs-Den Otter¹, J. Mulder²

¹*Intensive Care and Department of Pediatric Surgery, Erasmus MC Sophia Children's Hospital, Rotterdam, Netherlands*

²*Erasmus MC Sophia Children's Hospital, Pediatric Nephrology, Rotterdam, Netherlands*

BACKGROUND AND AIMS

Hypertensive crisis in the pediatric intensive care unit can lead to severe morbidity and mortality. Currently, the optimal treatment for hypertensive crisis in children is not well known. Recent studies in adults suggest that nicardipine might be more beneficial compared to nitroprusside. The aim of this study is to evaluate the therapeutic use and effectiveness of nitroprusside and nicardipine in hypertensive crisis in children.

METHODS

A single-center retrospective study was done in a tertiary hospital on the pediatric intensive care unit. Between July 2017 and February 2021, 80 children were treated with nitroprusside and 10 children were treated with nicardipine. Medical records were reviewed for therapy indications, prescription of other antihypertensive drugs and therapeutic effectiveness.

RESULTS

Treatment indication of nitroprusside and nicardipine was severe hypertension in all patients. Etiology of hypertension was diverse, the majority of the patients had a secondary cause of hypertension. Of the 10 children treated with nicardipine, 9 children were previously treated with nitroprusside without adequate therapeutic response. Preliminary analyses show that treatment with nicardipine had better therapeutic response in these children. In both medications, no severe side effects were observed.

CONCLUSIONS

The preliminary results of this study suggest that nicardipine might be more effective in lowering blood pressure in hypertensive crisis in children compared to nitroprusside. Larger prospective studies are needed to evaluate this hypothesis.

LO207 / #725**Interdisciplinary Session****interdisciplinary Session 27: Safety and complications after anesthesia in children (ESPA Session)****10-10-2022 15:00 - 16:30****Construction and validation of the 2D digital brazilian version of the children`s anxiety questionnaire****M.A. Garcia De Avila^{1*}, V. Martins¹, J. Francisco¹, J. Bastoni Da Silva², J. Bertho², G. Silva¹, S. Nilsson³**¹São Paulo State University - UNESP, Nursing, Botucatu, Brazil²Universidade Federal de Palmas, Nursing, Botucatu, Brazil³University of Gothenburg, Institute of Health and Care Sciences, Gothenburg, Sweden**BACKGROUND AND AIMS**

The Children`s Anxiety Questionnaire (CAQ), was created in Sweden and contained four items with four images of facial expressions (happy/content, calm/relaxed, tense/nervous, and worried/afraid) with three response options, each representative of a different level of emotional intensity (a little=1, some=2, and a lot=3). The CAQ in Brazilian Portuguese was recently validated and demonstrated satisfactory results among professionals and children. To develop and validate the Brazilian printed version of the CAQ in a 2D digital format.

METHODS

Study multicentric conducted in Brazil involved the validation by a committee of 51 nurses. A content validity index (CVI) was used to measure the proportion or percentage of nurses` agreement.

RESULTS

Content validity indices were 0.96 and is available at www.enfermagemeduca.com.br. The CAQ was successfully validated and considered suitable and user-friendly by nurses. The next step is the validate with children.



CONCLUSIONS

This study has implications for nursing practice, providing a user-friendly tool that can facilitate humanized care, improve communication, Identify anxiety in children, and corroborate the paediatric care plan.

LO208 / #2609**Late Breaking Orals****Late breaking orals 02****10-10-2022 15:00 - 16:30****Oral lactoferrin supplementation reduces gut microbiome dysbiosis in pediatric oncohaematologic patients during induction chemotherapy****N. Decembrino^{1*}, F. D'Amico², E. Muratore³, S. Turroni⁴, P. Muggeo⁵, R. Mura⁶, K. Perruccio⁷, V. Vitale⁸, S. Recupero⁹, M. Zecca¹⁰, A. Prete¹¹, F. Venturelli¹², D. Leardini³, P. Brigidi², R. Masetti³, S. Cesaro⁸, D. Zama¹³**

¹*Mother and Child's Health Department, AOU Policlinico G. Rodolico San Marco Catania, Neonatal Intensive Care Unit, Catania, Italy*

²*Department of Medical and Surgical Sciences (dimec), University of Bologna, Bologna, Italy*

³*IRCCS Azienda Ospedaliero-Universitaria di Bologna, Pediatric Oncology and Hematology "Ialla Seràgnoli", Bologna, Italy*

⁴*Department of Pharmacy and Biotechnology, University of Bologna, Unit of Microbiome Science and Biotechnology, Bologna, Italy*

⁵*Pediatric Hematology and Oncology Department, University of Bari, Bari, Italy*

⁶*Pediatric Hematology and Oncology Department, "A Cao" Microcitemic Pediatric Hospital, "Botzu" Medical Center, Cagliari, Italy*

⁷*Pediatric Hematology and Oncology Department, "Santa Maria della Misericordia" Hospital, Perugia, Italy, Pediatric Hematology and Oncology Department, Perugia, Italy*

⁸*Mother and Child's Health Department, University Hospital of Verona, Italy, Pediatric Hematology and Oncology, Verona, Italy*

⁹*Fondazione IRCCS Policlinico San Matteo, Pavia, Italy, Paediatric Haematology/oncology, Pavia, Italy*

¹⁰*Pediatric Hematology and Oncology Department, Fondazione IRCCS Policlinico San Matteo, Pavia, Italy, Pavia, Italy*

¹¹*University of Bologna, Pediatric Oncology and Hematology "Ialla Seràgnoli", Bologna, Italy*

¹²*Department of Experimental, University of Bologna, Bologna, Italy, Diagnostic and Specialty Medicine (dimes), Bologna, Italy*

¹³*IRCCS Azienda Ospedaliero-Universitaria di Bologna, Pediatric Emergency Unit, Bologna, Italy*

BACKGROUND AND AIMS

Gut microbiome (GM) dysbiosis in cancer patients has been associated with increased rate of complications including febrile neutropenia (FN), severe infections, increased relapse rate, reduced survival. Lactoferrin (LF), a bioactive glycoprotein of bovine and human milk, has shown anti-inflammatory, immunomodulatory and antimicrobial activities. In preterm neonates, bovine LF (bLF) administration reduced late-onset sepsis and necrotizing enterocolitis. The Supportive Care Working Party of the Italian Association of Pediatric Hematology Oncology (AIEOP) promoted a multicentric study on the potential of bLF administration in reducing FN in hematologic malignancies. Here we report data on the bLF impact on GM.

METHODS

Multicentric randomized, double-blind, placebo-controlled trial. We enrolled pediatric patients with hematologic malignancies (ALL,AML,NHL), randomized 1:1 to receive bLF or placebo during induction chemotherapy. GM was profiled before and after two weeks of oral administration of bLF 200 mg/die (Mosiatic®, Pharmaguida, Italy) or placebo, through next-generation 16S rRNA gene sequencing.

RESULTS

34 patients enrolled from 6 centers. Groups were homogeneous in age, diagnosis and distribution among centers. No differences were observed between groups in antibiotic use in the 30 days prior to therapy and during induction chemotherapy. In patients receiving placebo alpha diversity decreased over time, with an increase in pathobionts (*Enterobacteriaceae* and *Enterococcaceae*). LF administration promoted the maintenance of GM diversity, prevented overabundance of pathobionts and increased health-associated taxa with reduced febrile neutropenia (57.1% vs. 90% in the placebo group; $p = 0.04$). No adverse effects were registered.

CONCLUSIONS

Lactoferrin may represent a promising adjunct to current therapeutic strategies in hematologic patients. Further studies are warranted.

LO209 / #2534**Late Breaking Orals****Late breaking orals 02****10-10-2022 15:00 - 16:30****Sleep, 24-hour activity rhythms and cardiometabolic risk factors in school-age children****V.A.A. Beunders^{1*}, M.E. Koopman-Verhoeff², M. Vermeulen¹, P.W. Jansen², A.I. Luik², I.P.M. Derks², I. Reiss¹, K. Joosten³, V. Jaddoe⁴**

¹Department of Pediatrics, Erasmus MC Sophia Children's Hospital, University Medical Center Rotterdam, Division of Neonatology, Rotterdam, Netherlands

²Erasmus MC Sophia Children's Hospital, Child and Adolescent Psychiatry/psychology, Rotterdam, Netherlands

³Department of Pediatrics, Erasmus MC Sophia Children's Hospital, University Medical Center Rotterdam, Pediatric Intensive Care Unit, Rotterdam, Netherlands

⁴Erasmus MC - Sophia Children's Hospital, Pediatrics, Rotterdam, Netherlands

BACKGROUND AND AIMS

Disturbed sleep and 24-hour activity rhythms are linked to adverse cardio-metabolic profiles in adults and adolescents, and these associations may originate in early life. We aimed to study associations of sleep and 24-hour rhythms with cardiometabolic risk factors in school-age children.

METHODS

This cross-sectional population-based study comprised 894 children aged 8-11 years from the Generation R Study. Sleep (duration, efficiency, number of awakenings, time awake after sleep onset) and 24-hour activity rhythms (social jetlag, interdaily stability, intradaily variability) were assessed using tri-axial wrist actigraphy for nine consecutive nights. Cardiometabolic risk

factors included adiposity (body mass index Z-score, fat mass index using dual-energy-X-ray-absorptiometry, visceral fat mass and liver fat fraction using magnetic resonance imaging), blood pressure and blood markers (glucose, insulin, lipids). We adjusted for season, age, sociodemographics and lifestyle factors.

RESULTS

Each increase in interquartile range (IQR) of nightly awakenings (2 times) was associated with -0.12 SD (95% CI -0.21 ; -0.04) lower body mass index and 0.15 mmol/L (0.10;0.21) higher glucose. Among boys, an increase in IQR of intradaily variability (0.12) was associated with higher fat mass index ($+0.07$ kg/m², 95% CI 0.03;0.11) and visceral FM ($+0.08$ gr, 0.02;0.15). We observed no associations with blood pressure or clustering of cardiometabolic risk factors.

CONCLUSIONS

Already at school-age, greater fragmentation of the 24-hour activity rhythm is associated with general and organ adiposity. In contrast, more nightly awakenings were associated with lower BMI. Optimizing 24-hour activity rhythms may help to reduce obesity from childhood onwards, particularly in boys.

LO210 / #2560**Late Breaking Orals****Late breaking orals 02****10-10-2022 15:00 - 16:30****Parental experiences of webcam use in neonatal care: A qualitative study****K. Gallagher^{1*}, R. Hayes-Worthington², J. Meek³, N. Marlow⁴,
K. Chant⁴**¹University College London, Ega Institute for Women's Health, London, United Kingdom²University College London Hospitals NHS Trust, Neonatal Unit, DB, United Kingdom³University College London Hospital, Neonatology, London, United Kingdom⁴University College London, Institute for Women's Health, London, United Kingdom**BACKGROUND AND AIMS**

Webcam technology in neonatal units facilitates live streaming of infants to support parental and family bonding when they are unable to be physically present with their baby. This study aimed to explore the experiences of parents of infants previously admitted for neonatal care and who used webcam technology to view their baby in real-time.

METHODS

Qualitative semi-structure interviews were conducted with parents of infants previously admitted for neonatal care on a tertiary level neonatal unit in the UK in 2021. Interviews were conducted virtually, transcribed verbatim and uploaded into NVivo V10 to facilitate analysis. Thematic analysis by two independent researchers was undertaken to identify themes representing the data.

RESULTS

Nineteen participants representing 17 families took part in the interviews. Thematic analysis identified 8 basic themes which were grouped into 3 organizational themes: (1) family integration of the baby (2) implementation of the web camera service and (3) parental control.

CONCLUSIONS

Webcams can support parent-infant attachment however clear and consistent information from healthcare professionals is required to minimise anxiety around viewing their baby online. Integration of webcams into Family Integrated Care may help to support their use in practice and facilitate parental partnership in their baby's care.

LO211 / #2679**Late Breaking Orals****Late breaking orals 02****10-10-2022 15:00 - 16:30****Deviation of two pulse oximeters in preterm infants – Post-hoc analysis of an prospective randomized cross-over study on automatic oxygen control****C. Schwarz^{1*}, M. O’Sullivan², M. O’Sullivan³, K. Kreutzer¹,
L. Langanky¹, C. Maiwald¹, C. Poets¹, A. Franz^{1,4}**¹Department of Neonatology, University Children’s Hospital Tübingen, Tübingen, Germany²University College Cork, Infant Research Centre, Cork, Ireland³Luxembourg Institute of Health, Transversal Translational Medicine, Strassen, Luxembourg⁴University Hospital Tübingen, Center for Pediatric Clinical Studies, Tübingen, Germany**BACKGROUND AND AIMS**

Continuous monitoring of arterial hemoglobin oxygen saturation by pulse-oximetry (SpO₂) guides oxygen titration in preterm infants. Nevertheless, infants spend a significant proportion of time (%time) outside their SpO₂ target-range, which can be further complicated by lack of SpO₂ precision. We evaluated the interchangeability of pulse-oximeters, including the effects of their averaging-time.

METHODS

Post-hoc analysis of recordings from two identical pulse-oximeters (recording and controlling device; Radical-7, Masimo SET V7.8.0.1, USA) from an unblinded prospective randomized-controlled automatic-oxygen-control (AOC) cross-over study designed to compare %time in SpO₂ target-range between a) two

AOC algorithms, and b) two averaging-times of the controlling SpO₂ signal (2s vs 8s) with routine manual control. The main outcome of this analysis was the %time with a SpO₂ difference of $\geq 3\%$ -points [%time(Δ SpO₂ $\geq 3\%$)] between controlling and recording devices.

RESULTS

Twenty-four infants receiving non-invasive respiratory support were analyzed (median gestational age at birth 25.3 weeks; age at randomization 30 days). %time(Δ SpO₂ $\geq 3\%$) was similar between the 3 setups: median=29% (Q1=19% to Q3=49%) during routine manual control (both pulse-oximeters with 2s averaging-time), 32% (27% to 44%) during AOC (both with 2s averaging-time), and 31% (26% to 38%) AOC (recording/controlling pulse-oximeter with 2s and 8s averaging-time).

CONCLUSIONS

Irrespective of SpO₂-averaging-time or oxygen control method, readings of two identical pulse-oximeters in the same patient are not interchangeable. They differ by $\geq 3\%$ for 1/3 of the time, indicating relevant imprecision of pulse-oximetry. This may affect clinical interpretation of SpO₂ and oxygen targeting, potentially leading to adverse events following SpO₂-guided interventions.

LO212 / #2550**Late Breaking Orals****Late breaking orals 02****10-10-2022 15:00 - 16:30****Examining the factors influencing childhood obesity: What has changed during the pandemic?****O.A. Koyu^{1*}, Y.E. Bulut², H.H. Bağcı³, G. Barlas¹**¹Ministry of Health General Directorate of Public Health, Field Epidemiology, Ankara, Turkey²Health Science University, Public Health, Ankara, Turkey³Ankara Provincial Health Department, Public Health, Ankara, Turkey**BACKGROUND AND AIMS**

Childhood obesity is a public health problem that causes a significant increase in personal, social and economic burden worldwide in recent years. In addition, there is a syndemic relationship between obesity and COVID 19. The aim of this study is to examine childhood obesity and the factors influencing it.

METHODS

This study was planned as cross-sectional. Data were collected from primary school second grade students and their parents between March and May 2022 in the capital city of Turkey. Data were collected by making anthropometric measurements using the information form and the International Physical Activity Questionnaire (IPAQ-S). Descriptive statistics, correlation and OR (95% CI) were used in the analysis of the data. The children's body mass index Z scores were calculated using the R "anthroplus" package program. Ethical approval was obtained.

RESULTS

The obesity rate in selected primary school 2nd grade students was %19.8. The mean score of the IPAQ-S was 2.96 ± 0.03 and the mean score of the sub-dimension that evaluates the level of activity at school was 3.78 ± 0.90 . There was a significant difference between the time spent in front of the screen and the frequency of physical activity in distance education and face-to-face education periods ($p < 0.01$). Mothers' BMI (OR=1.07), fathers' BMI (OR=1.12), child's gender (OR=0.52), chronic disease status (OR=0.44), weekly physical activity frequency (OR=2.22) and the time spent watching TV series, movies during the distance education period (OR=1.32) was associated with childhood obesity.

CONCLUSIONS

Evidence-based intervention studies that guide health policies are needed and recommended in order to prevent and control childhood obesity of countries.

LO213 / #557**Interdisciplinary Session****Interdisciplinary Session 30: Circadian mechanisms in medicine (ESPE Session)****10-10-2022 15:00 - 16:30****Minimally invasive nasal airway surgery can reduce adhd in children with sleep disordered breathing****P. Catalano*, J. Walker***St Elizabeth's Medical Center/ Tufts University, Otolaryngology, Brighton, United States of America***BACKGROUND AND AIMS****INTRODUCTION**

Attention Deficit Hyperactivity Disorder (ADHD) is estimated to occur in 10% of children in general, and in 50% of children who exhibit sleep disordered breathing (SDB). The hyperactivity is related to adrenaline secretion during sleep to assist breathing through the airway obstruction. SDB is characterized by intermittent airway obstruction resulting in episodic hypoxia, sleep fragmentation, mouth breathing, and sleep deprivation. In our study, we compare the changes ADHD behavior before and after targeted upper airway surgery for SDB in children.

METHODS

A prospective pilot study to evaluate the effect of targeted nasal surgery on improving ADHD symptoms in children with SDB. 96 children with ADHD symptoms and SDB were included. The validated NOSE score and Barkley

Deficits in Executive Functioning Scale were compared at baseline and 6 months after surgery. Parents completed the assessment tools.

RESULTS

96 patients aged 6-17 years (M 89%; F 11%) completed the study. For ages 6-11 years, 44% of children showed normalization of their behavior, and another 20% improved between to 75-99% of normal. For children ages 12-17 years, these numbers were 17% and 67%, respectively. 10% of children had their ADHD worsen after surgery. Combined, 37.7% of children normalized their ADHD behavior, and another 26% improved to between 75-99% of normal. NOSE scores were also significantly improved after surgery ($p < .05$). There were no surgical complications in this study.

CONCLUSIONS

Targeted minimally invasive upper airway surgery in children with SDB and ADHD symptoms can significantly improve their nasal breathing and executive functioning.

LO214 / #1403**Interdisciplinary Session****interdisciplinary Session 30: Circadian mechanisms in medicine (ESPE Session)****10-10-2022 15:00 - 16:30****Early childhood regulatory problems and diurnal salivary cortisol in young adulthood****A. Bilgin^{1,2*}, K. Heinonen^{3,4}, N. Baumann^{2,5}, D. Wolke^{2,6}, K. Räikkönen⁴**¹*University of Kent, Psychology, Canterbury, United Kingdom*²*Department of Psychology, University of Warwick, Coventry, United Kingdom*³*Tampere University, Psychology, Tampere, Finland*⁴*University of Helsinki, Psychology, Helsinki, Finland*⁵*University of Leicester, Health Sciences, Leicester, United Kingdom*⁶*University of Warwick, Warwick Medical School, Coventry, United Kingdom***BACKGROUND AND AIMS**

There is evidence that early childhood multiple or persistent regulatory problems (RPs; crying, sleeping, or feeding problems) are associated with behavioural problems in adulthood. However, it is unclear whether early multiple or persistent RPs are associated with increased hypothalamic-pituitary-adrenal (HPA) axis activity in adulthood. Thus, we investigated if multiple or persistent RPs in early childhood are associated with young adulthood diurnal salivary cortisol, which is a marker of HPA-axis activity.

METHODS

Participants were 308 individuals from the Arvo Ylppö Longitudinal Study (Finland) who were assessed at 5, 20, and 56 months for RPs, and in adulthood for salivary cortisol. The mean age of participants in adulthood was 25.37 years (SD= 0.60). Saliva samples for cortisol analyses were collected at

awakening, 15 and 30 minutes after awakening, 10:30 am, 12:00 pm, 5:30 pm and at bedtime during one day. We conducted random coefficients mixed model regression controlling for sex, BMI in adulthood, and parental education level. Further, the analyses were repeated for those who had multiple and persistent RPs separately.

RESULTS

There were 61 participants who had multiple or persistent RPs in early childhood, including 38 who had multiple and 27 who had persistent RPs. Our findings revealed no significant associations between early multiple or persistent RPs and diurnal salivary cortisol in young adulthood. Similarly, there were no significant associations when we repeated the analyses separately for those who had multiple and persistent RPs.

CONCLUSIONS

Early RPs might not have an influence on salivary cortisol during young adulthood.

LO215 / #1842**Interdisciplinary Session****interdisciplinary Session 31: COVID-19 infection and congenital heart disease patients (AEPCC Session)****10-10-2022 15:00 - 16:30****Determining the most common nursing diagnoses in children with MIS-C****F.I. Esenay^{1*}, Ü. Erdem²**¹Ankara University, Faculty of Nursing, Ankara, Turkey²Ankara University, Pediatric Hospital, Ankara, Turkey**BACKGROUND AND AIMS**

Because the MIS-C syndrome is new in the literature and the data and experience on nursing care is limited, nurses may have difficulties in planning the care process. The aim of the study is to determine the most common nursing diagnoses by evaluating the functional health patterns of inpatients with the diagnosis of MIS-C.

METHODS

This was a cross-sectional, single-center, descriptive and observational research. The population of this study will consist of children who were admitted to the pediatric infection service of a University Children's Hospital with a diagnosis of MIS-C between 1 May 2021-1 February 2022. Inclusion criteria were to be under the age of 18, diagnosed with MIS-C, and volunteering to participate in the study. Data Collection Tools was "Introductory Information Form", "Functional health patterns evaluation form" and "Nursing process form"

RESULTS

12 common nursing diagnosis from NANDA Taxonomy II are included. The collection of data in line with the FHP model has provided a comprehensive overview of the patients.

CONCLUSIONS

The results of this study will be an evidence-based resource to determine the most common nursing diagnoses in children with this diagnosis and to guide nurses' care planning. In this way, standardized nursing care plans can be created. Thus, it is thought that the quality of nursing care of patients will increase.

LO216 / #2703**Interdisciplinary Session****Interdisciplinary Session 31: COVID-19 infection and congenital heart disease patients (AEPC Session)****10-10-2022 15:00 - 16:30****The childhood vaccination programme attainment during the COVID-19 global pandemic****C. Stein-Zamir^{1*}, N. Abramson², H. Shoob²**¹*The Hebrew University of Jerusalem, Faculty of Medicine, Jerusalem, Israel*²*Ministry of health, Faculty of Medicine, Jerusalem, Israel***BACKGROUND AND AIMS**

Childhood vaccinations prevent morbidity and mortality from vaccine-preventable diseases. Routine childhood vaccinations in Israel are included in the National Health Insurance Law. Community-based clinics provide free vaccination to all children. During the COVID-19 pandemic, the global routine Vaccination Coverage (VC) declined. We aimed to assess VC in Israel and in Jerusalem, a district with recurrent vaccine-preventable diseases' outbreaks before and during the COVID-19 pandemic.

METHODS

Vaccination data for 2017-2022 were retrieved from the National Immunization Registry. The vaccines evaluated were Diphtheria, Tetanus, acellular Pertussis, polio, Haemophilus influenzae b (DTaP-IPV-Hib4: dose 4) and Measles-Mumps-Rubella/Measles-Mumps-Rubella-Varicella (MMR/MMRV1) scheduled at 12 months. The national population is 9.2 million, children (0-17 years) consist a third of the population. The national birth cohort is 185,000 and 35,000 in the Jerusalem district.

RESULTS

The overall national **Vaccination coverage** is adequate. A trend of decline in VC has been observed during the pandemic years, nationally and prominently in the Jerusalem district. The decline was more noticeable in the DTaP-IPV-Hib4 vaccine dose 4 than in MMR /MMRV1. **The Vaccination coverage data are presented in figure 1.**

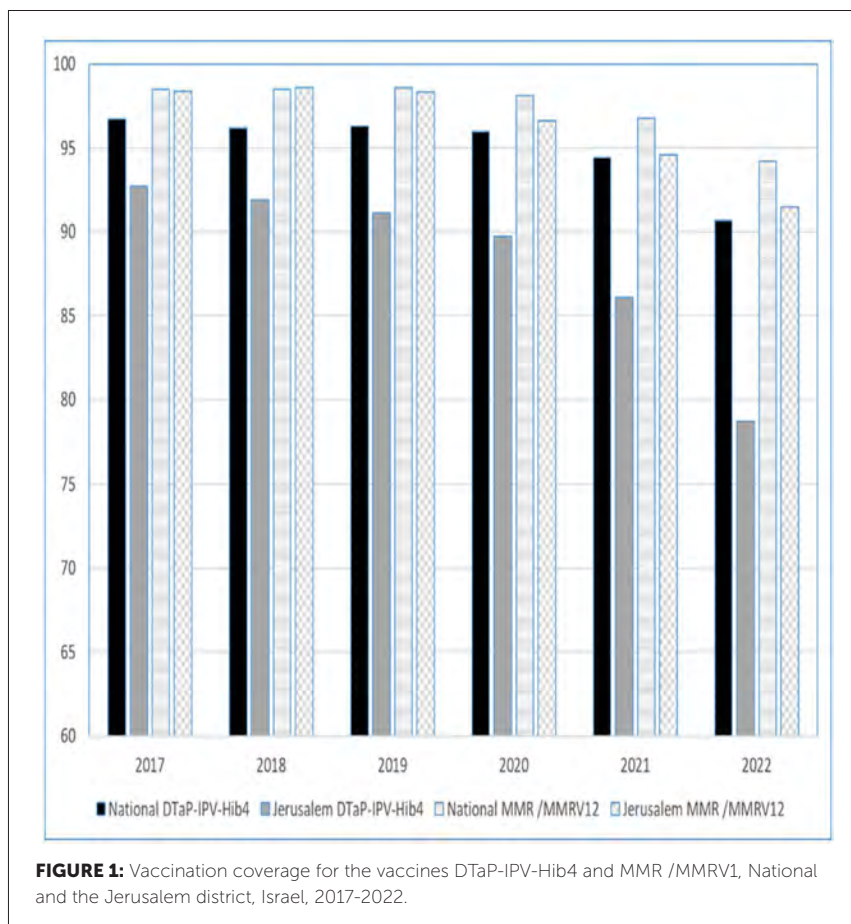

FIGURE 1: Vaccination coverage for the vaccines DTaP-IPV-Hib4 and MMR /MMRV1, National and the Jerusalem district, Israel, 2017-2022.

CONCLUSIONS

Vaccinations gaps and delays, despite appropriate up-to-date coverage, have been reported from many countries and deepened during the global COVID-19 pandemic. While aggregated vaccination coverage rates are high, disaggregated data reveal gaps amid population groups. Community-based health education campaigns to advance awareness about and trust in childhood vaccines and sustainable public health programs are essential. Our challenge is to improve and sustain routine childhood vaccination rates.

LO217 / #1341**Interdisciplinary Session****Interdisciplinary Session 32: Nurses as research leaders****10-10-2022 15:00 - 16:30****Parent experiences when their child is diagnosed with cystic fibrosis in the newborn screening program****P.B. Nielsen^{1*}, H. Olesen¹, C.S. Jensen^{1,2}**¹*Department of Paediatrics and Adolescent Medicine, Aarhus University Hospital, Aarhus, Denmark*²*Aarhus University Hospital, Research Center for Emergency Medicine, Aarhus N, Denmark***BACKGROUND AND AIMS**

The widespread implementation of newborn screening represents a paradigm shift in the diagnostic pathway for families having a child diagnosed with cystic fibrosis (CF). The aim of this study was to gain knowledge regarding the everyday life experiences of parents after having a child diagnosed with CF.

METHODS

The study takes a phenomenological-hermeneutical approach. Narrative semi-structured interviews with the parents of 16 newborn children were conducted and thematic content analysis was used to identify key themes. Participant observations and field notes were used to complement interview data.

RESULTS

The analysis revealed three themes: First, when getting the diagnosis, there was a profound difference in the parents' experience depending on whether the diagnosis was communicated by a medical doctor from the CF team or by a pediatrician at another hospital. Second, during the initial meeting and the subsequent relationship with the CF team, the knowledge and calmness that the doctors and nurses exhibited meant everything to the parents; most families voiced that they did not wish to be hospitalized, and reflecting on this retrospectively they felt that this was the right decision. Third, regarding everyday life post-diagnosis, most parents described having anxiety and concern for their child's future.

CONCLUSIONS

Upon receiving a diagnosis of cystic fibrosis for their child, parent experiences highlight important elements that ought to be implemented into the patient's continuity of care. In particular, the cystic fibrosis specialist team is of fundamental importance to the parental ability to accept and cope with the diagnosis and the new living conditions.

LO218 / #2154**ESPNIC Session****ESPNIC Session 55: Fluids in the PICU****10-10-2022 17:00 - 17:55****Red blood cells transfusion rate reduction after implementing a transfusion score in a pediatric intensive care unit****L. Butragueño-Laiseca^{1*}, S. De La Mata¹, S. Fernández Lafever², S. Mencía², J. Del Castillo², J. López González², R. González Cortés¹, J. Urbano³, M. Santiago Lozano¹**¹Hospital Universitario Gregorio Marañón, Pediatric Intensive Care Unit, Madrid, Spain²Hospital General Universitario Gregorio Marañón, Pediatric Intensive Care Unit, Madrid, Spain³Hospital General Universitario Gregorio Marañón, Pediatric Critical Care Medicine, Madrid, Spain**BACKGROUND AND AIMS**

Red-blood cells (RBC) transfusions are common in PICU and have been identified as an independent morbimortality risk factor. Although a restrictive transfusion practice is currently recommended, an overuse of RBC is not uncommon. The aim is to compare RBC transfusion practices before and after the implementation of a transfusion protocol with a transfusion score in a third level PICU.

METHODS

Pre- vs. post-interventional study. Data was collected prospectively and all children admitted to the unit during the two study periods were included. During the preintervention phase (twelve months, 2019), clinicians prescribed transfusions based on their clinical judgement without local protocols or other indications. During 2020, an anemia management and transfusion protocol was developed and implemented in the Unit. The protocol includes a transfusion score created from a predictive model after analyzing preintervention transfusions. Transfusion data was then collected in the postintervention phase (twelve months, 2021).

Parameter	Result	Points
Vasoactive-Inotropic Score (VIS)	> 25	6
Lactate	> 2 mmol/L	4
Age	< 12 months	3
SvO2	< 65% (non-cyanotic) < 50% (cyanotic)	3
< 6 points: monitoring and consider other treatments for anemia (iv iron, EPO)		
≥ 6 points: consider transfusion		

RESULTS

During 2019, 351 patients were admitted vs 352 patients in 2021. 65% of patients presented anemia during admission in the first period vs 60% in the second period. 249 RBC transfusions were indicated to 68 patients (19.4% of admitted patients) in 2019. After implementing the transfusion protocol and score, the number of RBC transfusions dropped to 173 (-30.5%, $p < 0.05$), with a reduction in the percentage of transfused patients to 13% ($p < 0.05$). Preintervention global transfusion hemoglobin threshold was 8.6 g/dl, which dropped to 7.6 g/dl ($p < 0.001$) after the implementation of the protocol.

CONCLUSIONS

Implementing a transfusion protocol and score seems effective to reduce RBC transfusions and hemoglobin threshold.

LO219 / #559**ESPNIC Session****ESPNIC Session 55: Fluids in the PICU****10-10-2022 17:00 - 17:55****The effect of paediatric acute potassium chloride corrections on serum potassium concentration****J. Miller^{1,2*}, A. Dewar², A. Wignell^{2,3}, P. Davies^{1,2}**¹University of Nottingham, School of Medicine, Nottingham, United Kingdom²Nottingham Children's Hospital, Paediatric Critical Care Unit, Nottingham, United Kingdom³Pharmacy Department, Nottingham Children's Hospital, Nottingham, United Kingdom**BACKGROUND AND AIMS**

The risks of intravenous potassium administration increase with the concentrated, short timespan infusions used in acute correction of hypokalaemia. The effect of such corrections on serum potassium concentration is unknown in children. We aimed to define the increment achieved in children following infusion of 0.4 mmol/kg potassium chloride over one hour. Secondary outcomes included whether pre-infusion age, weight, sex, Na⁺, K⁺, HCO₃⁻, Mg²⁺, glucose, pH; diagnostic category, and time of sampling post-infusion affected potassium increment.

METHODS

All potassium chloride infusions administered over 56 months on a tertiary Paediatric Intensive Care unit were included. Only acute corrections at 0.4 mmol/kg over one hour were included. Serum electrolyte measurement was by blood gas and laboratory analyses.

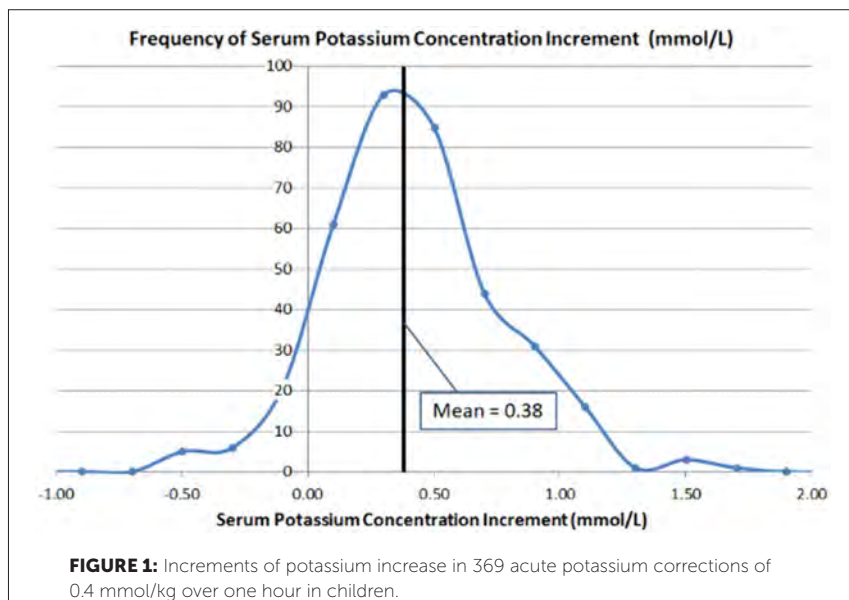

RESULTS

135 patients with 369 individual infusions (220 in males, 149 in females) were analysed. Mean age, weight and pre-infusion K^+ were 4.79 years, 16.9kg, and 2.71 (± 0.33) mmol/L respectively. The mean potassium increment was 0.38 (SD ± 0.36) mmol/L, (95% CI, 0.34 to 0.41), giving an increment/dose ratio of 0.95. 14 (3.8%) infusions incremented >1 mmol/L, 6 (1.6%) >1.2 mmol/L, and 3 (0.81%) >1.5 mmol/L. The maximum post-infusion serum potassium was 4.60 mmol/L. Potassium increment was not affected by pre-infusion age, weight, sex, Na^+ , K^+ , HCO_3^- , Mg^{2+} , glucose, pH, or diagnostic category. Increment was maintained at least 3 hours post infusion.

CONCLUSIONS

Infusing 0.4 mmol/kg of potassium chloride over one hour raises serum potassium by 0.38 mmol/L, the effect lasting at least 3 hours. There were no instances of post-infusion hyperkalaemia. Increment was not affected by any other measured factors.

LO220 / #2315**ESPR Session****ESPR Session 56: Cord clamping****10-10-2022 17:00 - 17:55****Cord clamping time and jaundice requiring phototherapy – Time to reconsider the risk?****J. Svedenkrans^{1*}, M. Wilander¹, O. Andersson^{2,3}**¹*Department of Clinical Sciences, Lund University, Pediatrics, Lund, Sweden*²*Department of Clinical Sciences, Lund University, Skåne University Hospital, Pediatrics, Lund, Sweden*³*Department of Clinical Sciences, Lund University, Lund, Sweden***BACKGROUND AND AIMS**

Delaying cord clamping for 2-3 minutes in vigorous term infants is well known to provide better iron stores, higher hematocrit levels and improved neurodevelopment. However, in systematic reviews, an elevated risk of jaundice requiring phototherapy is commonly declared as a possible complication. The aim of this study was to analyze the correlation between cord clamping time and bilirubin levels as well as need for phototherapy in a large group of vaginally born infants.

METHODS

Pooled data from four studies on cord clamping. Data on cord clamping time and phototherapy treatment were collected prospectively. Bilirubin was measured either in serum or transcutaneously in conjunction with the metabolic screen.

RESULTS

Data from 1821 infants (50.4% boys) were analyzed. Mean (SD) gestational age and birth weight were 40.0 (1.2) weeks and 3582 (467) g respectively. Cord clamping was performed at a median (IQR) time of 313 (180-435) sec. A total of 28 (1.5%) infants were treated with phototherapy. There was no correlation between cord clamping time and bilirubin level ($B=0.000$, $p=0.989$). Median (IQR) cord clamping time was 300 (180-478) sec in infants treated with phototherapy and 316 (180-435) sec in infants not treated with phototherapy ($p=0.962$). Cord clamping time had no correlation to need for phototherapy, (OR 1.00, 95% CI: 0.998-1.002, $p=0.851$).

CONCLUSIONS

No correlation between cord clamping time and bilirubin levels or requirement of phototherapy was found in this large cohort of 1821 vaginally delivered infants. The authors suggest that delayed cord clamping can be practiced without extra concerns regarding jaundice.

LO221 / #1969**ESPR Session****ESPR Session 56: cord clamping****10-10-2022 17:00 - 17:55****Feasibility and impact of physiological based cord clamping (PBCC) on very low birth weight infants during the first 72 hours after birth****N. Höller*, C. Wolfsberger, E. Prethaler, G. Pichler, B. Urlesberger***Department of Pediatrics and Adolescent Medicine, Division of Neonatology, Graz, Austria***BACKGROUND AND AIMS**

The present observational study investigated the feasibility of physiological based cord clamping (PBCC) and its impact on very low birth weight [VLBW] infants during the first 72 hours after birth.

METHODS

VLBW infants (<32 weeks gestational age [GA]) with a birth weight [BW] <1500g were included. Neonates delivered with PBCC were matched according to GA (\pm 1 week) and BW (\pm 100g) to neonates with routine care (control-group) and a cord clamping time of 30–60sec. Neonates of the PBCC-group were stabilised after birth with an intact cord using a mobile and heated resuscitation table (Concord birth trolley, Rotterdam, Netherlands). Routine monitoring parameters (heart rate [HR], arterial oxygen saturation [SpO₂], fraction of inspired oxygen [FiO₂], mean arterial blood pressure [MABP]) were recorded and compared between the two groups.

RESULTS

54 VLBW infants (PBCC n=27; control n=27) were included. Mean GA of the PBCC-group was 27.4 ± 1.9 weeks and 27.4 ± 1.8 weeks in the control-group (p-value 0.869), mean BW was 912 ± 288 g and 915 ± 285 g (p-value 0.964), respectively. Cord clamping time was 191 ± 78 sec in the PBCC-group. HR was lower in the PBCC-group during the first three days after birth, reaching significance during 11 hours. All other monitoring parameters did not reveal any significant differences between the two groups.

CONCLUSIONS

PBCC is feasible and has no negative influence on cardiorespiratory stability in VLBW infants during the first 72 hours after birth, compared to routine delayed cord clamping. The lower HR in the PBCC-group suggests higher blood volume due to intact cord resuscitation.

LO223 / #357**EAP Session****EAP Session 57: Off label drugs in children****10-10-2022 17:00 - 17:55****Magnesium in severe pneumonia and association with clinical severity (using press and modified piro scoring system) and adverse outcomes****S. Mukhopadhyay****King George Medical University, Pediatrics, Lucknow, India***BACKGROUND AND AIMS**

Magnesium is essential for the energy production and synthesis of DNA, RNA, and proteins. Hypomagnesemia is associated with the increased release of endothelin and proinflammatory cytokines and increased pyroptosis as Mg inhibits the non-canonical pyroptosis. This is a strong association of hypomagnesemia and mortality due to the upregulation of inflammatory cytokines (tumor necrosis factor-alpha, interleukin-6).

OBJECTIVES

Primary objective is to assess magnesium levels in patients with severe pneumonia and its association with clinical severity and adverse outcomes. The secondary objective is to study the association of serum calcium and phosphorus levels controlling for nutritional status.

METHODS

110 patients admitted with severe community-acquired pneumonia were enrolled. Their blood samples were collected and assessed for serum magnesium using the selectra PRO M autoanalyzer. Data collected was used for 2

prospective scoring systems modified PIRO score and PRESS scoring system. ROC was generated for respective scores. Logistic regression analysis was done for determining the determinants of mortality. After obtaining results of serum magnesium, the recruited patients were divided into two groups, group A (low serum magnesium <1.7mg/dl), and group B (serum magnesium level \geq 1.7mg/dl), for further evaluation.

RESULTS

Hypomagnesemia (<1.7mg/dl) was found to be present in 52 /110 (47.3%). Vaccination status (OR 4.17), longer duration of hospital stays (>30 days) (OR-1.9), poor feeding (OR-3.03), arterial saturation <90%, presence of danger signs (OR-4.57) were significantly associated ($p < 0.05$) with hypomagnesemia. The mean PRESS score of patients in group A was 3.52 ± 1.15 and patients of group B were 2.66 ± 1.25 . The mean PIRO score of patients of group A was 4.38 ± 2.43 and group B 2.55 ± 1.97 . The adverse outcomes mechanical ventilation (61.5%), prolonged use of oxygen >14days (63.5%), persistent of fever (65.4%), appearance of danger signs (42.3%) shock (36.5%), mortality (58%) was higher in patients of group A and statistically significant (<0.001).

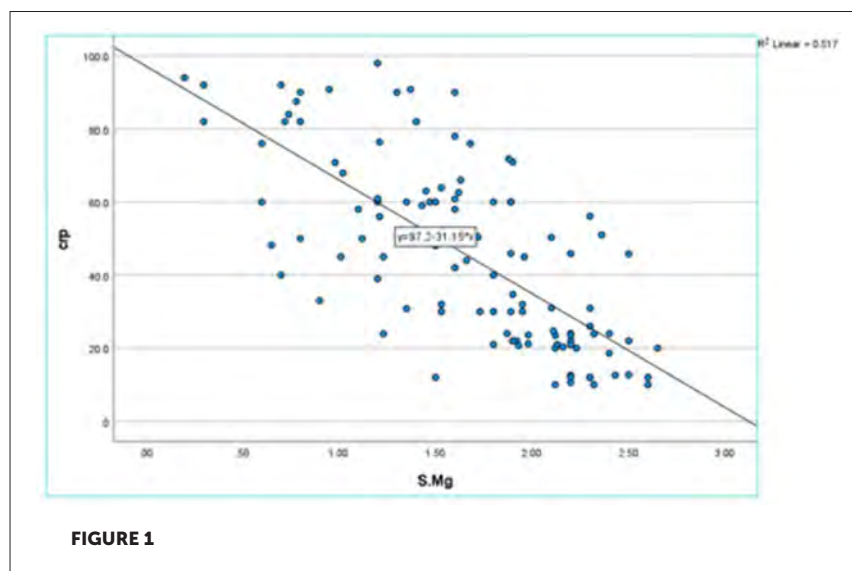

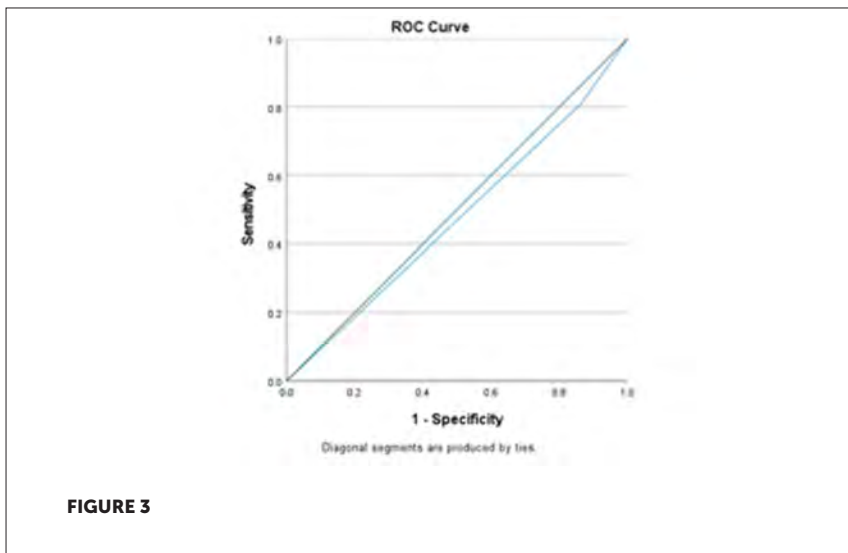
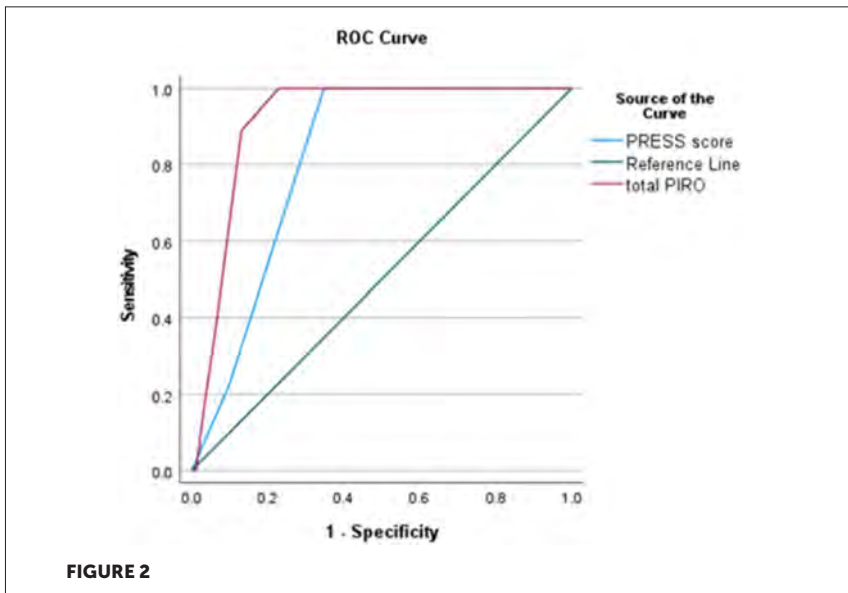

Predictors of mortality in severe pneumonia (using logistic regression analysis)

	OR	95% CI	p-value
PRESS>3	11.3	3.56-35.86	<0.001
PIRO >3	10	2.78-35.63	<0.001
Mg	14.86	4.11-53.71	<0.001
<90% spO2 in room air	7.67	2.78-21.26	<0.001

A simple linear regression was calculated to predict CRP based on serum magnesium. CRP increased by 31.15mg/dl for each mg/dl dec in serum magnesium. The AUC for the modified PIRO score for prediction of mortality was 0.816 and for the modified PIRO score was 0.917. AUC for magnesium was 0.473. There was a strong negative correlation between magnesium levels and adverse outcomes as seen by Pearson correlation.

We found that controlling for hypoxia, hypomagnesemia is an independent risk factor for mortality in patients with severe pneumonia. There was a strong positive correlation between magnesium and serum calcium and phosphorus as seen by the Pearson correlation.

CONCLUSIONS

Serum magnesium levels were decreased in 47.3% of patients with severe pneumonia (52/110). This is a strong association of hypomagnesemia with mortality according to our study and hypomagnesemia is an independent indicator of mortality, hence serum magnesium should be screened regularly in the PICU and should be supplemented to patients with prolonged mechanical ventilation.

LO224 / #2114**ESPR Session****ESPR Session 58: Preterm birth****10-10-2022 17:00 - 17:55****Active sleep as an early predictor of structural brain development in extremely and very preterm infants****X. Wang^{1*}, E. De Groot¹, M. Tataranno^{1,2}, A. Van Baar³, F. Lammertink¹, M. Benders^{1,2}, J. Dudink^{1,2}**¹*Wilhelmina Kinderziekenhuis (WKZ), UMC Utrecht, Neonatology, Utrecht, Netherlands*²*University Medical Center Utrecht, Brain Center, Utrecht, Netherlands*³*Utrecht University, Child and Adolescent Studies, Utrecht, Netherlands***BACKGROUND AND AIMS**

Extremely-to-very preterm (EVP) birth (<30 weeks of gestation age, GA) disrupts typical trajectories of brain development. Assumedly, sleep is essential for the formation and development of brain tissues. Therefore, this study aimed to determine the potential of preterm sleep-wake characteristics to serve as early predictors for structural brain maturation at term-equivalent age (TEA) in EVP infants.

METHODS

A total of 66 EVP infants who received vital sign monitoring over five to seven consecutive days between 29–32 weeks' postmenstrual age (PMA) and underwent T2-weighted magnetic resonance imaging at TEA were enrolled in this study. The sleep data were obtained using an automated sleep staging algorithm based on vital signs. Four sleep-wake parameters were estimated: total sleep time (TST), active sleep (AS) and quiet sleep (QS) percentage of TST, and percentage of awake time. To quantify structural brain development,

we performed volumetric tissue segmentation on the T2-weighted images, extracting five tissue classes of clinical interest: white matter (WM), cortical gray matter, ventricles, cerebellum and brain stem. The associations between the sleep-wake parameters and brain volumes were examined using multiple linear regression analyses, with adjustment for potential confounding factors: GA at birth, PMA at scanning, and sex.

RESULTS

The regression analyses results showed that a higher AS percentage of TST related significantly with increased total relative WM volume ($B=0.008$, $CI_{95\%}$ [0.003, 0.012], $P<0.001$; Partial $R = 0.41$) (See Figure).

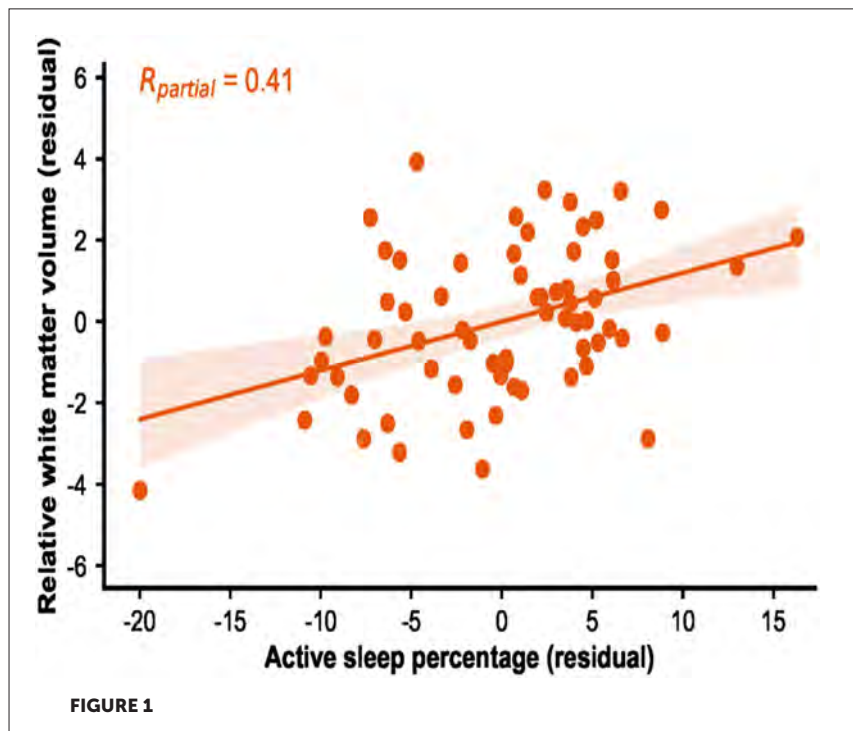

CONCLUSIONS

Our findings demonstrate for the first time the predictive value of AS percentage during preterm period for WM development at TEA in EVP infants.

ESPR Session

ESPR Session 58: Preterm birth

10-10-2022 17:00 - 17:55

Sleep state trend: An automated measure for a EEG monitors in the newborn

**S. Montazeri Moghadam^{1,2*}, P. Nevalainen², N. Stevenson³,
S. Vanhatalo^{1,2}**

¹Department of Physiology, University of Helsinki, Helsinki, Finland.

²Department of Clinical Neurophysiology, BABA Center, Children's Hospital, Helsinki University Hospital, Helsinki, Finland.

³Brain Modelling Group, Qimr Berghofer Medical Research Institute, Brisbane, Australia

BACKGROUND AND AIMS

Monitoring of fluctuations in sleep states (a.k.a. sleep-wake cycles) is an essential component in the newborn aEEG monitoring, however it has been challenging to recognize them reliably either clinically or from the aEEG trend. Here, we aimed to develop a Sleep State Trend (SST), a transparent and intuitive visualization of sleep states, using a deep learning -based classification of the raw (a)EEG recordings.

METHODS

We designed and trained a convolutional neural network (CNN) to detect quiet sleep states from single EEG signals. The algorithm was trained with an aEEG recordings from 30 near-term neonates (total 943.7 hours) and validated using clinical gold standard (N=30), a dataset with polysomnographic recordings.

RESULTS

Accuracy of quiet sleep detection was ~90%, when all bipolar signals were used. Single channel accuracy was 85-86%, and the external validation dataset

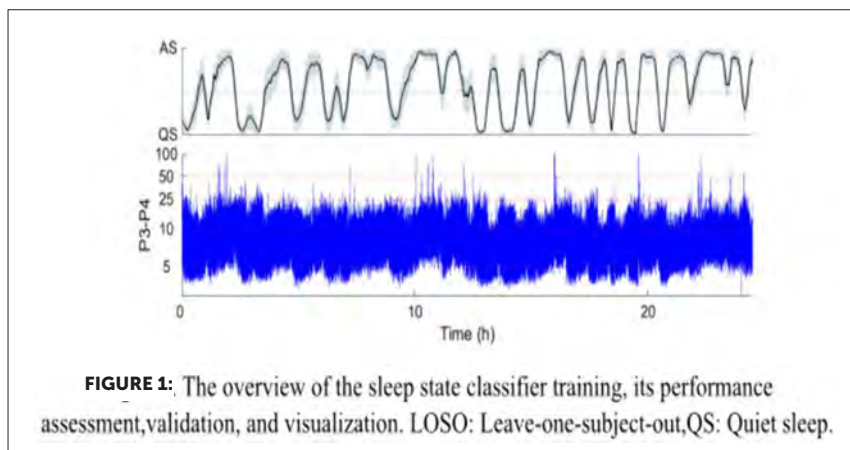

showed a good generalization (overall accuracy of 81%) despite different EEG derivations. The classifier outputs could be visualized with SST, a continuous trend that shows the likeliest sleep state as well as the confidence in classifications for a bedside quality assessment (Figure 1).

CONCLUSIONS

A reliable detection of quiet sleep is possible from single (a)EEG channels, and the result can be readily visualized as an intuitive and transparent SST output in the bedside aEEG monitors. The results hold promise for substantially improving the sleep-oriented care in the neonatal intensive care unit.

LO226 / #1801**ESPR Session****ESPR Session 58: Preterm birth****10-10-2022 17:00 - 17:55****Sleep state organisation of moderate to late preterm infants in the neonatal unit****M.A. Ryan^{1,2,3*}, S. Mathieson^{1,2}, V. Livingstone^{1,2}, E. Dempsey^{1,2,3}, G. Boylan^{1,2}**¹*INFANT Centre, University College Cork, Cork, Ireland*²*Department of Paediatrics and Child Health, UCC, Cork, Ireland*³*Department of Neonatology, Cork University Maternity Hospital, Cork, Ireland***BACKGROUND AND AIMS**

Sleep is a prerequisite for normal neural network development, synaptogenesis and synaptic plasticity, particularly during the accelerated period of brain development that occurs in the last trimester. Sleep architecture reflects brain maturation. This prospective observational study describes the nocturnal sleep architecture of healthy moderate to late preterm (MLP) infants in the neonatal unit at 36 weeks postmenstrual age (PMA).

METHODS

Healthy MLP infants (n=98) had overnight continuous video electroencephalography (vEEG) for a minimum 12 hours at 36 weeks PMA. All sleep states were identified and annotated based on behavioural observation and visual analysis of EEG also incorporating vital recorded including ECG and respirations. The total sleep time (TST), duration of active sleep (AS), quiet sleep (QS) and indeterminate sleep (IS) periods were calculated.

RESULTS

The TST in the 12-hour period was median (IQR) 7.09 (IQR 6.61-7.76) hrs less than expected with 4.58 (3.69-5.09) hours in AS, 2.02 (1.76-2.36) hours in QS and 0.65 (0.48-0.89) hours in IS. The total duration of AS was significantly lower in infants born at lower GA ($p=0.007$) whilst the duration of individual QS periods was significantly higher ($p=0.001$). Moderate to late preterm infants who were exclusively fed orally at 36 weeks had a shorter total sleep time and less AS compared to infants that were fed via nasogastric tube.

Table 1: Behaviour, EEG and aEEG during sleep states

	Active Sleep (AS)	Quiet Sleep (QS)	Indeterminate Sleep (IS)	Wakefulness
Behaviour	Eyes closed, may open slightly, +/- REM Range of intermittent sporadic motor activity Low motor activity +/- Myoclonic twitching Upper and lower limb movement Occasional sucking movements Quiet and low muscle tone between movements Irregular shallow respiration, variable heart rate	Eyes closed-no eye movement Infant lying still / atonia May have some mouth/ sucking motion May have slight startle, jerk More difficult to rouse Respirations slower, more regular than AS Decreased heart rate variability than in AS	Periods of opening/closing eyes Slow eye movements Slow startles Intermittent sucking Regular respirations	Eyes open May be quiet, still or active Fussing or crying High intensity gross motor movements Irregular respirations with movement Variable irregular heart rate
EEG activity	Continuous activity above a threshold of 25V Less than 3 seconds voltage attenuation <25 v mainly high frequency >8 Hz, low/mixed amplitude (30-70 V) Artefact with movement	Periods of discontinuity evident in QS High amplitude bursts 50-300 μ V, minimum 3 secs Inter-burst intervals decrease with advancing PMA Artefact with movement	Continuous activity high voltage (100-200 V)	Similar to AS in quiet wakefulness Mixed continuous activity Increased artefact with movement Duration increasing with advancing age
aEEG activity	Lower amplitude represented by narrower portion of band Normal: a lower margin > 5 V and upper margin > 10 V	High amplitude represented by wider portion of band Lower margin <5 V in QS	Variable bandwidth No discriminated on aEEG	Quiet wakefulness displayed similar to AS High amplitude activity with movement

Table 2: Demographics	
	Median (IQR)
Maternal age (years)	34.5(31.0-37.3)
Birth gestation (weeks)	34.0(33.0-35.0)
Gestation at time of EEG (weeks)	36.1(35.6-36.6)
Head Circumference at birth (cm)	32.00(30.75-32.90)
Apgar at 5 min	9(9-10)
Birth weight (kg)	2.10(1.87-2.40)
Weight at the time of vEEG (kg)	2.26(2.02-2.47)
Postnatal age at the time of vEEG (days)	10.50(4.75-14.00)
Sleep cycles per infant per night	6.0(6.0-7.3)
	n(%)
Ethnicity – Irish	88(89.8)
Pregnancy	
Multiple	47(48.0)
Singleton	51(52.0)
Sex	
Male	52(53.1)
Female	46(46.9)
Accommodation at time of monitoring	
Cot	80(81.6)
Incubator	18(18.4)
Mode of overnight feeding/ infant	
All Oral feeds	61(62.2)
All nasogastric tube feeds (NGT)	1(1.0)
Mixed feeding (Oral and NGT)	36(36.7)

Table 3: Total sleep time (TST) as per sleep state and by groups

	TST (Hours)	^a p value	AS (Hours) median (IQR)	^a p value	% AS median (IQR)	^b p value	QS (Hours) median (IQR)	^a p value	% QS Median (IQR)	^b p value	IS (Hours) median (IQR)	^a p value	% IS median (IQR)	^b p value
Overall	7:09:05.63-7:76	0.343	4:50:15.69-5:09	0.007	63.87(56.25-67.4)	0.087	2:52:17.76-2:36	0.122	27.88(24.26-34.24)	0.653	0:48:00-0:30	0.563	6.33(5.40-12.24)	0.229
Birth Gestational Age group (weeks)		0.343		0.007		0.087		0.122		0.653		0.563		0.229
32w-33w	6:06:06-7:34		3:08:12.8-4:38		36.22(9.43-64.79)		3:07:38.2-3:20		33.33(26.63-36.00)		0:48:00-0:30		9.53(8.36-11.09)	
33w-34w	7:00:04-8:13		4:70:43.5-5:15		63.01(54.49-68.29)		2:47:17.0-2:46		29.14(24.68-32.77)		0:54:01.54-0:36		7.23(5.31-12.92)	
34w-36w	6:50:05-8:7:38		4:42:33.45-5:70		64.11(51.20-68.33)		2:04:17.0-2:7		27.62(21.39-34.84)		0:46:01.40-0:34		9.80(5.90-12.83)	
35w-37w	7:50:01-7:32		4:27:46.6-5:08		64.94(50.49-66.88)		1:56:11.70-2:35		26.33(21.63-30.81)		0:40:01.17-0:47		8.87(5.11-11.78)	
38w-42w	7:17:49-8:14		4:19:14.5-4:48		61.99(57.62-67.25)		1:52:11.43-2:55		26.15(21.63-34.21)		0:54:01.37-0:47		7.35(5.44-11.26)	
Sex		0.908		0.491		0.2		0.089		0.329		0.865		0.825
Male (n=52)	7:06:03-7:73		4:38:17.0-5:24		64.33(53.40-69.52)		1:55:17.1-2:28		26.55(23.08-31.81)		0:44:01.48-0:38		8.43(6.06-11.38)	
Female (n=48)	7:21:06-7:53		4:40:24.6-5:06		61.76(54.25-65.77)		2:44:28.2-2:49		29.59(25.84-35.09)		0:49:01.09-0:31		9.23(6.78-11.49)	
Accommodation		0.271		0.79		0.335		0.071		0.263		0.481		0.668
Control (n=8)	7:03:02-7:73		4:43:37.0-5:15		63.78(56.23-66.22)		1:59:17.1-2:31		27.86(21.63-34.26)		0:57:01.48-0:36		9.23(6.78-11.26)	
Incubator (n=18)	7:30:04-7:53		4:15:40-4:58		60.68(55.44-65.16)		2:24:19.2-2:51		27.88(26.18-34.19)		0:40:01.49-0:39		8.43(6.09-11.38)	
Mode of feeding ^c		<0.001		0.003		0.433		0.291		0.473		0.652		0.299
Oral (n=1)	6:49:30-7:15		4:20:18.5-4:46		63.25(53.49-68.05)		3:01:17.5-3:33		27.60(24.62-34.66)		0:45:01.67-0:48		8.68(6.42-11.81)	
Mixed (n=36)	7:57:04-8:20		4:41:47.4-5:32		61.09(59.21-67.01)		2:04:17.2-2:52		27.65(22.76-30.92)		0:50:01.58-0:37		8.03(6.04-11.49)	

AS: active sleep; QS: quiet sleep; IS: indeterminate sleep; TST: total sleep time; IQR: interquartile range. ^aThe percentage (%) for each infant is the percentage of TST in each sleep state. Duration in hours expressed as median (interquartile range). ^bp < 0.05 is considered significant. ^cThe p-value calculated from the Kruskal-Wallis test was used for gestational age and a p-value calculated from Mann-Whitney test was used for sex, accommodation and mode of feeding. ^dOne infant fed exclusively via NGT tube and eliminated from mode of feeding analysis (n=37).

CONCLUSIONS

Overnight continuous video EEG at 36 weeks PMA showed sleep state architecture is dependent on birth GA. Infants with a lower birth GA have less AS and more QS which may have implications for later neurodevelopment.

LO227 / #929**EAP Session****EAP Session 59: Sport in the adolescent age and anorexia****10-10-2022 17:00 - 17:55****Blood test abnormalities in patients with eating disorders****T. Lesar^{1*}, M. Tomić², A. Cvitković Roić³, A. Vrtarić⁴, N. Nikolac Gabaj⁴, S. Čimić⁵, S. Kraljević Šimunković⁵**¹Center for pediatric medicine Helena, Pediatric Gastroenterology, Zagreb, Croatia²Vuk Vrhovac University Clinic for Diabetes, Endocrinology and Metabolic Diseases, Merkur University Hospital, Ophthalmology, Zagreb, Croatia³Department of Pediatrics, Faculty of Medicine, Josip Juraj Strossmayer University Osijek, Osijek, Croatia⁴Department of Clinical Chemistry, Sestre Milosrdnice University Hospital Center, Zagreb, Croatia⁵Department of Removable Prosthodontics, School of Dental Medicine, University of Zagreb, Zagreb, Croatia**BACKGROUND AND AIMS**

It is often challenging to diagnose eating disorders (ED) in time because patients hide their disease. However, many signs may indicate the development of ED. Some signs are obvious, such as malnutrition, while others are less obvious, such as changes in blood tests. This study aimed to determine the differences in serum concentrations of total amylase, electrolytes, total protein, albumin, iron, ferritin, vitamin B12, 25-OH vitamin D and folic acid between pediatric patients with ED and control subjects.

METHODS

101 subjects with a mean age of 14.34 ± 1.99 were included in this cross-sectional study; 50 patients with ED and 51 control subjects. Subjects in both

groups did not differ statistically significantly by age ($p = 0.261$). Serum analyses were performed.

RESULTS

Serum concentrations of total amylase ($p=0.052$), magnesium ($p=0.007$), albumin ($p<0.001$), ferritin ($p<0.001$), and vitamin B12 ($p<0.001$) were marginally or significantly higher, while the concentration of total proteins ($p=0.017$) and folic acid ($p=0.018$) were significantly lower in patients with ED than in control subjects. Other electrolytes, 25-OH vitamin D and iron concentrations in serum did not significantly differ between the examined groups ($p>0.05$).

CONCLUSIONS

The study showed the differences in the blood tests that could indicate the development of ED. Early recognition of these differences in the presence of other symptoms of ED can undoubtedly contribute to earlier diagnosis of ED and better treatment success.

LO228 / #1112**ESPNIC Session****ESPNIC Session 60: The changing face of the PICU patient****10-10-2022 17:00 - 17:55****Acute kidney injury in allogenic hematopoietic stem cell transplantation in the PICU**

S. Brió-Sanagustin^{1*}, G.M. Fraga-Rodríguez², E. Coca-Fernandez¹, M. Rodríguez- Martínez¹, F. Castillo-Gómez¹, R.A. Burgueño-Rico¹, L. García-Marzo¹, E. Turon-Viñas¹, A. Devolder-Nicolau², S. Boronat-Guerrero¹

¹Hospital Sant Pau, Paediatric Intensive Care, Barcelona, Spain

²Hospital Sant Pau., Nephrology Paediatric., Barcelona, Spain

BACKGROUND AND AIMS

Renal dysfunction is a major complication of allogenic hematopoietic stem cell transplantation (alloHSCT). The risk of kidney damage are directly related to the conditioning method, previous comorbidities and basal creatinine levels.

METHODS

Descriptive retrospective study of renal complications presented by paediatric patients undergoing alloHSCT, admitted to PICU for 10 years.

RESULTS

A total of 112 patients undergoing 132 alloHSCT are analyzed. 54/112 patients were admitted to PICU(48%). Age: 0.5-17years (average: 8.57), Type of alloHSCT: 19 related(haploidentical 13) and 49unrelated. The 54 patients

needed 68 PICU admissions. Causes of admission: respiratory failure(41.1%), neurological disorders(22.7%), sepsis(21.2%), acute kidney injury(AKI) (6%) and liver failure(6%). pSOFA:5.67, PELOP-2:5.55, OPRISM:12.97. Patients showed at admission a significant increase in creatinine($p=0.007$) and a decrease in glomerular filtration($p < 0.001$). AKI affected 32 children, 11stage KDIGO1, 4stage KDIGO2 and 7stage KDIGO3. Significant differences in admission mortality were found in patients with KDIGO3($p=0.036$), in the multivariate study, they've and increased probability of death(OR:6.08, $p=0.014$). During the stay at PICU, 27 patients presented AKI. 6 KDIGO1, 10 KDIGO2 and 26 KDIGO3. 27patients require dialysis techniques(40.9%): Continuous renal replacement(27), conventional dialysis(1), combined techniques(3). Mean duration days of therapy: 19.56 ± 18.14 days. Significant differences in mortality were found in patients with AKI($p=0.002$), KDIGO 3($p=0.011$) and those in need of dialysis($p < 0.001$). Average stay: 27.35days. Survival: 41.7% at 11years.

CONCLUSIONS

Children requiring PICU admission after alloHSCT have a significant increase in creatinine levels and a significant decrease in glomerular filtration on admission. In multivariate analysis, the highest degree of acute kidney disease (KDIGO 3) is a risk factor significantly associated with mortality.

LO229 / #1011**ESPR Session****ESPR Session 61: Oxygen and outcome****10-10-2022 17:00 - 17:55****Edi signal as a diagnostic and monitoring tool in apnea of prematurity****K. Piatek^{1,2*}, J. Taulu^{2,3}, V. Parikka^{1,2}, L. Lehtonen^{1,2}, H. Soukka^{1,2}**¹University of Turku, Faculty of Medicine, Turku, Finland²Department of Pediatrics and Adolescent Medicine, Turku University Hospital, Turku, Finland³Department of Pediatrics, Satakunta Central Hospital, Pori, Finland**BACKGROUND AND AIMS**

Apnea is a cessation of breathing that may cause bradycardia and desaturation. Monitoring devices use peripheral oxygen saturation and heart rate as proxies of apnea, rather than directly measuring the pause in breathing. The signal of the electrical activity of the diaphragm (Edi signal) represents neural respiratory drive and can be used to monitor breathing patterns. This study used the Edi signal to detect and quantify the number of central respiratory pauses.

METHODS

We performed 12-hour-long registrations of vital signs including Edi signal of infants born ≤ 32 gestational weeks. Edi signal data were analyzed with dedicated software.

RESULTS

A total of 39 infants born at a median age of 30+4 weeks and with a birth weight of 1370 g were included in the study. Their apnea registrations were

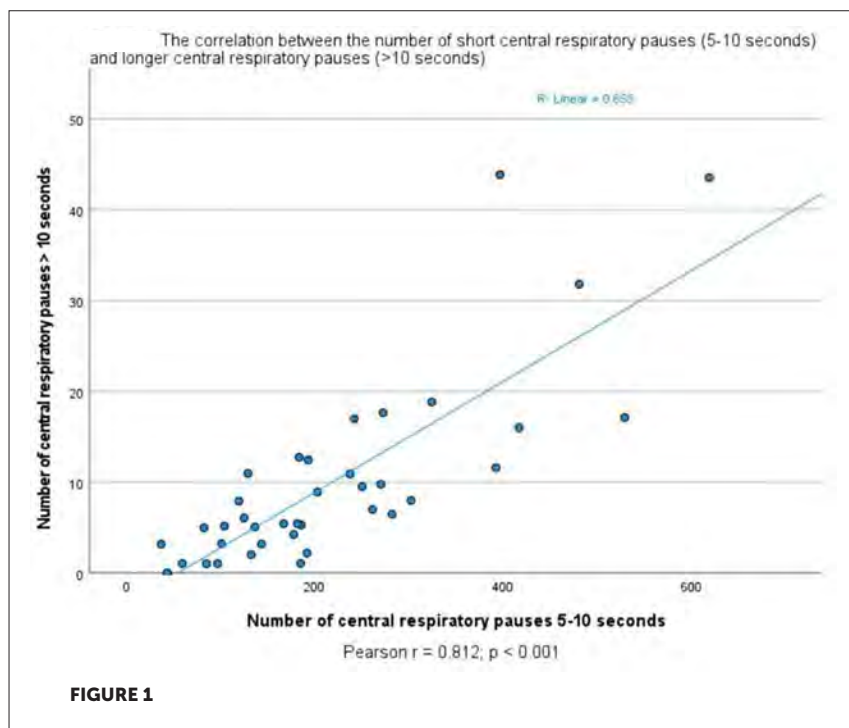

performed at a median postmenstrual age of 35+4 weeks. Based on the Edi signal analysis, 1019 (median) respiratory pauses lasted for 2-5 seconds, 185 pauses lasted for 5-10 seconds, and six pauses lasted for 10-15 seconds. The number of short respiratory pauses (5-10 seconds) was strongly correlated with the number of longer respiratory pauses (>10 seconds). The number of very short respiratory pauses (2-5 seconds) showed only a weak correlation with the number of respiratory pauses longer than 10 seconds.

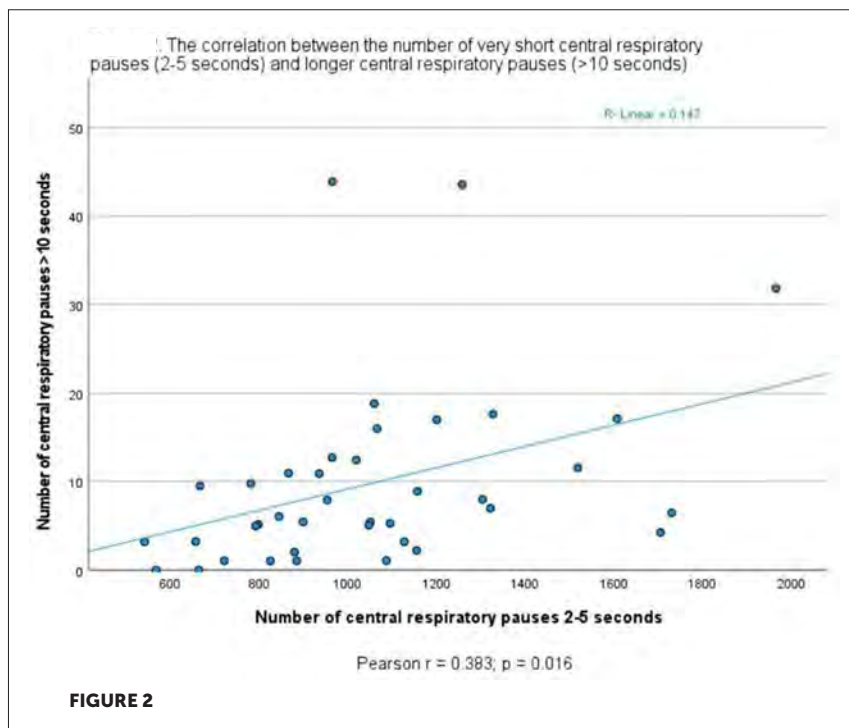

CONCLUSIONS

It is clinically important that the appearance of short central respiratory pauses indicates a risk for long respiratory pauses. Future studies will evaluate the relationship between short respiratory pauses and apnea with bradycardia. This might help to identify infants not ready for discharge home.

LO230 / #1233

ESPR Session

ESPR Session 61: Oxygen and outcome

10-10-2022 17:00 - 17:55

Lung volume changes during apneas in preterm infants on non-invasive respiratory support

**V. Gaertner¹, A. Waldmann², P. Davis³, D. Bassler¹, L. Springer⁴,
D. Tingay⁵, C. Rüegger^{1*}**

¹Department of Neonatology, University Hospital Zurich, Newborn Research, Zurich, Switzerland

²Department of Anesthesiology and Intensive Care Medicine, Rostock University Medical Center, Rostock, Germany

³The Royal Women's Hospital, Newborn Research Centre, Parkville, Australia

⁴Department of Neonatology, University Children's Hospital, Tübingen, Germany

⁵Murdoch Children's Research Institute, Neonatal Research, Parkville, Australia

BACKGROUND AND AIMS

Non-invasive high-frequency oscillatory ventilation (nHFOV) may be effective in treating apnea of prematurity. However, the mechanisms underpinning this benefit are unclear.

METHODS

Electrical impedance tomography (EIT) data from a randomized crossover trial comparing nHFOV with nasal continuous positive airway pressure (nCPAP) were screened to identify apneas ≥ 10 seconds. Oscillatory volumes (V_{Osc}) during apneas were identified using a band-pass filter at 8 and 16 Hz (set frequency during nHFOV and second harmonic). End-expiratory lung impedance (EELI) and tidal volumes (V_T) were calculated before and after apneas. Oxygen saturation (SpO_2) and heart rate (HR) were extracted for 60 seconds after apneas.

RESULTS

In 30 preterm infants, 213 apneas were identified. During apneas, V_{Osc} were detectable during nHFOV. EELI decreased significantly during apneas [Δ EELI nCPAP: -8.0 (-11.9 to -4.1) AU/kg, $p < 0.001$; Δ EELI nHFOV: -3.4 (-6.5 to -0.3), $p = 0.03$] but recovered over the first five breaths after apneas. Compared with before apneas, V_T was increased for the first breath after apneas during nCPAP [ΔV_T : 7.5 (3.1–11.2) AU/kg, $p = 0.001$]. Falls in SpO_2 and HR after apneas were greater during nCPAP compared with nHFOV [Mean difference (95% CI): SpO_2 : 3.6 (2.7 to 4.6) %, $p < 0.001$; HR: 15.9 (13.4 to 18.5), $p < 0.001$].

CONCLUSIONS

Apneas were characterized by a significant decrease in EELI which was regained over the first breaths after apneas, mediated by a larger V_T of the first breath. Apneas were followed by a considerable drop in SpO_2 and HR, particularly during nCPAP, leading to longer episodes of hypoxemia during nCPAP. Transmitted oscillations during nHFOV may explain these benefits.

LO231 / #887**ESPR Session****ESPR Session 61: Oxygen and outcome****10-10-2022 17:00 - 17:55****Oxygenation instability during tube feeding among premature infants supported with non-invasive ventilation****L. Borenstein-Levin^{1*}, A. Haj¹, A. Riskin², O. Hochwald¹, A. Kugelman¹**¹Rambam Medical Center, Neonatology, Haifa, Israel²Bnai Zion Medical Center, Neonatology, Haifa, Israel**BACKGROUND AND AIMS**

Very-low-birthweight (VLBW) premature infants experience frequent desaturation episodes during the first weeks of life. The length of tube feeding, among VLBW infants supported by non-invasive ventilation (NIV), might influence the incidence of desaturation episodes as bolus feeding might increase gastrointestinal reflux, while in continuous feeding, the inability to vent the stomach during feeding may lead to gaseous abdominal distention and hinder ventilation.

AIM

To compare oxygenation instability, as documented by the SpO₂ histograms, around bolus versus continuous feeding among VLBW premature infants, supported with NIV.

METHODS

A randomized prospective study. VLBW supported with NIV were randomized to receive 3 consecutive feeds of bolus-continuous-bolus or con-

tinuous-bolus-continuous feeding in random order. Two-hour histograms were recorded, documenting oxygenation stability during the two hours in which the infant was continuously fed (continuous feeding) or fed by bolus (30-minutes of feeding, followed by 30-minutes with a closed gastric tube, followed by 1hour of gastric venting with an open gastric tube).

RESULTS

Twenty-four infants were included in our study (14-NIPPV, 1-CPAP, 9-HHHFNC). Mean(SD) GA -27.0 ± 1.6 , BW 820 ± 168 g. Seventy-two histograms were obtained- 36-during bolus and 36-during continuous feeding. No differences in min-max FiO_2 and number of apnea events were observed. Time spent in SpO_2 90-94%, <80%, <90% and >95% was comparable during bolus and continuous feeding. When analysing the effect of changing from bolus to continuous and continuous to bolus per infant, no differences in oxygenation stability was observed too.

CONCLUSIONS

Among VLBW infants supported with NIV, oxygenation instability, as documented by SpO_2 histograms, was comparable between bolus and continuous feeding.

LO232 / #569**ESPNIC Session****ESPNIC Session 62: What happens to our PICU patients****10-10-2022 17:00 - 17:55****Is there a sex difference in mortality rates in paediatric intensive care units: A systematic review****O. Almosawi^{1*}, A. Friend², L. Palla^{3,4}, R. Feltbower⁵, S. Sardo-Infirri⁶, S. O'Brien⁷, K. Harron¹, S. Nadel⁷, B. De Stavola¹**

¹UCL Great Ormond Street Institute of Child Health, Population, Policy and Practice, London, United Kingdom

²Birmingham Children's Hospital, Paediatric Oncology, Birmingham, United Kingdom

³department of Public Health and Infectious Diseases, University of Rome La Sapienza, Rome, Italy

⁴Nagasaki University, Institute of Tropical Medicine, Nagasaki, Japan

⁵University of Leeds, Leeds Institute for Data Analytics, Leeds, United Kingdom

⁶Department of Medical Statistics, The Royal Marsden Hospital, London, United Kingdom

⁷Imperial Healthcare NHS Trust, Children's Services, London, United Kingdom

BACKGROUND AND AIMS

Mortality rates in childhood are lower in females than males. However, for children admitted to Paediatric Intensive Care Units (PICU), mortality is reported to be lower in males, although males have higher admission rates into PICU. Our primary aim is to estimate the difference in mortality rates between males and females aged 0-18 years, who die in PICU.

METHODS

Any study that reported the rates of mortality in children admitted to intensive care by sex were eligible for inclusion. Our peer reviewed search strategy was described in our previously published protocol.

RESULTS

We identified 124 eligible studies (Figure 1) of which, 114 reported counts of deaths by sex which give a population of 278,274 children; 121,800 (44%) females and 156,474 males (56%). The mortality rate for females was 5,614/121,800 (4.61%), and for males 6,828/156,474 (4.36%). Females had higher OR of mortality, see Table 1. Only five studies reported sex as the primary exposure, thus meeting our criteria for quality assessment (Figure 2).

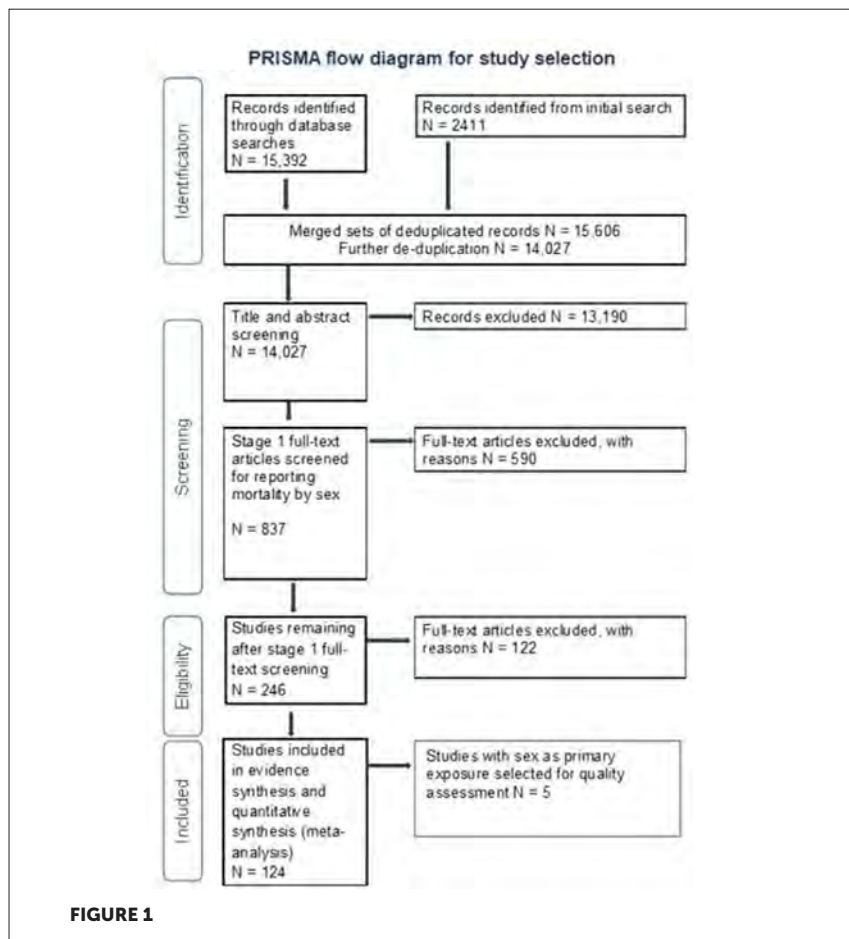

FIGURE 1

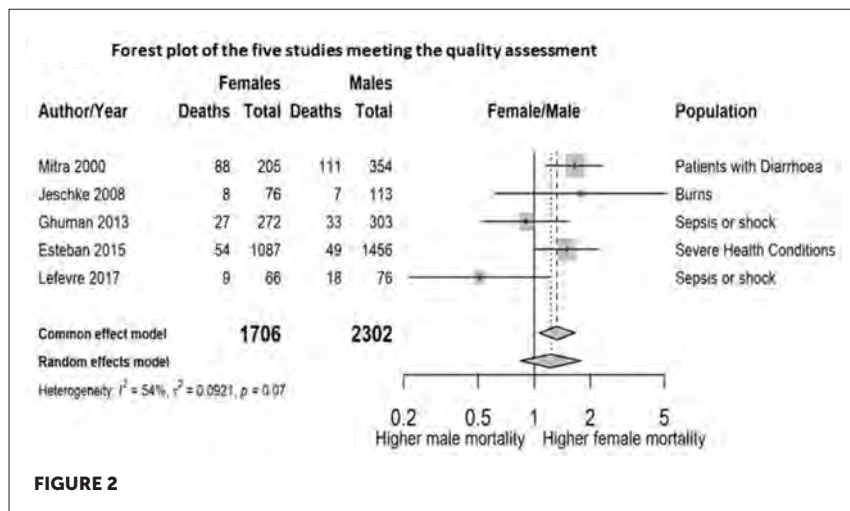

Table 1: Summary of pooled analyses

Pooled studies	Female/Male OR, 95%-CI	
	Fixed	Random
114 studies reporting numbers of deaths by sex	1.11 (1.06; 1.15)	1.14 (1.03; 1.26)
35 studies reporting on whole PICU population	1.07 (1.02; 1.12)	1.13 (1.02; 1.26)
27/35 studies with whole PICU population and age 0-18	1.06 (1.01-1.11)	1.10 (1.00; 1.21)

CONCLUSIONS

Our review shows that whilst more male children are admitted to PICU, female children are more likely to die in PICU. Pooled analyses whether fixed or random effects, show higher female mortality in PICU relative to male mortality

LO233 / #1739**ESPNIC Session****ESPNIC Session 62: What happens to our PICU patients****10-10-2022 17:00 - 17:55****Working together for children and their families: A multidisciplinary approach towards withdrawal of life-sustaining treatment within the paediatric critical care unit (PCCU)****E. Shaw^{1*}, N. Davis², C. Dorsett³, H. Rhodes¹**

¹Queens Medical Centre, Nottingham University Hospitals NHS Trust, Paediatric Critical Care Unit, Nottingham, United Kingdom

²Lincoln County Hospital, United Lincolnshire Hospitals NHS Trust, General Paediatrics, Lincoln, United Kingdom

³Queens Medical Centre, Nottingham University Hospitals NHS Trust, Paediatric Palliative Care, Nottingham, United Kingdom

BACKGROUND AND AIMS

Thanks to continuing medical developments, children are thriving with diagnoses previously felt to be unsurvivable. There will always be children who reach a critical juncture where consideration should be given as to whether continuing life-sustaining treatment (LST) is in their best interest. These are complex, ethically challenging decisions, yet within Nottingham Children's Hospital (NCH) there is a lack of guidance to support this process. We aimed to design and implement an inclusive guideline to support exemplary decision making and palliative care during withdrawal of life-sustaining treatment on PCCU.

METHODS

Key professionals, including palliative care nurses, intensivists, pharmacists, hospice teams, chaplaincy, and parents were identified and consulted. Authors met with stakeholders to collate guidance and produce a document to support healthcare professionals to fulfil the needs of children and families approaching the end of life (EOL).

RESULTS

A comprehensive, patient centred guideline has been produced. Users are supported to recognise and communicate the need for re-orientation of care and a framework is provided to create a unique, holistic EOL plan. Alongside pharmacy approved drug formularies designed to optimise symptom management at the EOL, there is clear guidance for clinicians regarding proceedings and support after a child's death.

CONCLUSIONS

By consulting and collaborating with the wider multi-disciplinary team a comprehensive, holistic, patient-centred guideline has been produced which promotes sensitive, compassionate and dignified withdrawal of LSTs within PCCU. This has been well received within NCH and further evaluation will be undertaken to understand the impact of this guideline on both families and staff.

LO234 / #2171**ESPNIC Session****ESPNIC Session 62: What happens to our PICU patients****10-10-2022 17:00 - 17:55****Traumatic brain injury (TBI) in a Pediatric Intensive Care Unit (PICU): Epidemiology and predicting risk factors for poor outcome****N. Donisanu Peñaranda^{1*}, E. Herrera Hidalgo², O. Moyano Leiva², D. Navarro Molina², J.M. Camacho Alonso²**¹Hospital Regional Universitario de Málaga - Hospital Materno Infantil, Paediatrics, Málaga, Spain²Hospital Materno-Infantil de Málaga- Hospital Regional Universitario de Málaga, Paediatrics, Málaga, Spain**BACKGROUND AND AIMS**

In developed countries, severe trauma injury is one of the main causes of morbimortality in children. Its prognosis is highly variable and its development difficult to predict. Our aim is to identify eventual predicting risk factors of poor outcome [brain death (BD) and moderate-severe neurological sequelae (NS)].

METHODS

Observational retrospective study of patients admitted to PICU for TBI between 2009 and 2021. Epidemiological, clinical and radiological variables were analyzed using multivariate and bivariate analysis.

RESULTS

89 patients (77.5% male); 75 months (RIC:21-133.5). 33.7% had severe brain injury according to GSC (<8). 42.7% required evacuating surgery and 19.1% urgent craniectomy. The most common NS were altered consciousness (44.9%), aphasia (9%), hemiparesis (7.9%), limb paresis (6.4%) and visual disturbance (5.6%). Intraparenchymatous hemorrhage (25.8%) OR 3.7 (95% CI 1.2-11.4); bradycardia (16.9%) OR 4.1 (95% CI 1.1-14.9); and brain swelling (30.3%) OR 4.2 (95% CI 1.4-12.4) had an increased risk of severe NS. 7 patients evolved to BD. At greater risk were those with pupillary alterations [(OR 21.6; 95% CI 1.42 -328.69); and no trunk reflexes (OR 19.3; 95% CI 1.01 -367.24)]. 30.7% had signs of cerebral edema (CD) (loss of gray-white matter differentiation, effacement of sulci and/or basal cisterns) and this was related to both NS (55.7% vs 18% $p < 0.0001$) and BD (25.9% vs 0% $p < 0,001$).

CONCLUSIONS

Early brain swelling is a predicting risk factor of both BD and NS, while focal lesions such as intraparenchymal hemorrhage increase the risk of severe neurological sequelae. Severe clinical onset may progress to brain death.

LO235 / #825**ESPNIC Session****ESPNIC Session 63: Getting rid of toxins****10-10-2022 17:00 - 17:55****Review of mortality in immunocompromised children due to septic shock associated with multi-drug resistant organisms: Case series****S. Sharma*, S. Bhosle, A. Kulkarni, C. Dhamne***Tata Memorial Hospital, Anaesthesiology, Critical Care and Pain, Mumbai, India***BACKGROUND AND AIMS**

Mortality and morbidity of septic shock in immunocompromised children is high. We aim to understand its causal and modifiable factors for quality improvement by reviewing three month's mortality of children admitted in our intensive care.

METHODS

We prospectively reviewed the three month mortality in children with cancer admitted to the intensive care unit of a tertiary care centre. Sepsis is the leading cause of morbidity and mortality in this cohort. We studied the microbiology data of isolates from blood, respiratory tract, wound, and drain; along with their sensitivity pattern to antibiotics. Every mortality was discussed in multidisciplinary meeting to highlight areas of improvement including trigger criteria to shift the child to ICU, optimal resuscitation, management of septic shock, choice of antibiotic, source control, organ support, etc.

RESULTS

Out of 125 admissions, 18.4 % of children died in the ICU. Children admitted for medical reasons had worse outcome as opposed to those admitted post surgery. The most common cause of death was septic shock with considerable proportion of neutropenic sepsis. Multidrug resistant *E. coli* and *Klebsiella pneumoniae* were the most frequent isolates followed by *Pseudomonas* and *Enterococcus* species. These were most sensitive to ceftriaxone-sulbactam-EDTA and tigecycline. The gram positive cocci were sensitive to cefotaxime, linezolid and teicoplanin.

CONCLUSIONS

There is predominance of gram negative sepsis in cancer patients with multi-drug resistant isolates. The study of common isolates, their sensitivity patterns, success of clearance and patient outcomes can guide our future choice of empirical antibiotic. Early identification and appropriate resuscitation are critical for better outcomes in paediatric critical care unit.

LO236 / #864**ESPNIC Session****ESPNIC Session 64: Weight matters****10-10-2022 17:00 - 17:55****The effectiveness and safety of various methods of post-pyloric feeding tube placement and verification in infants and children****Y. Miyahara^{1*}, M. Kono¹, S. Miura², A. Kawaguchi³**¹*Tokyo Women's Medical University Hospital, Intensive Care Medicine, Tokyo, Japan*²*Teikyo University Graduate School of Public Health, Public Health, Tokyo, Japan*³*CHU Sainte Justine, University of Montreal, Pediatrics, Montreal, Canada***BACKGROUND AND AIMS**

Post-pyloric tube feeding is often used in pediatrics, aiming for the improvement of feeding tolerance when observing hypomotility and delayed gastric emptying. This is a systematic review of methods of post-pyloric tube placement to clarify the advantages and problems of each method in children.

METHODS

We conducted a literature search to identify RCTs and quasi-RCTs involving children under the age of eighteen who require enteral nutrition. We searched CENTRAL, MEDLINE, EMBASE, and CINAHL, following the methodology for data collection and analysis in the Cochrane Handbook for Systematic Reviews. This review sought to include any methods for facilitating feeding tube placement.

RESULTS

Among 15,670 papers extracted from the four databases, following the primary screening and duplicates removals, eight studies met the inclusion criteria. Six were single-center studies, and two were the study conducted in two sites. Primary interventions examined were prokinetic drugs in three studies, air injection into the stomach in three studies, pH monitoring device in one study, and magnetic tracking device in two studies. There was one study involving two interventions. When comparing controls with any types of methods, the initial success rate ranged from 62% to 97% in the intervention group, and 44% to 81% in the control group.

CONCLUSIONS

We found better success rates in any type of intervention, compared to the control group. Due to the heterogeneity in study subjects and interventional methods, and the small number of studies for each method, no strong conclusions could be made as to which method was the best.

LO237 / #1481**ESPNIC Session****ESPNIC Session 64: Weight matters****10-10-2022 17:00 - 17:55****Mortality in PICU and its apparent association with sex****O. Almassawi***

UCL Great Ormond Street Institute of Child Health, Population, Policy and Practice, London, United Kingdom

BACKGROUND AND AIMS

Research in paediatric intensive care (PICU) is important for improvements in the care delivered to critically ill children. Most studies conducted in PICU report in-PICU mortality as a summary statistic or an estimate such as a risk ratio. These estimates are at times adjusted for other variables, however, none of these studies report any reasons for the selection of the adjustment covariates. When pooling these mortality rates by sex, we observe a higher rate of PICU mortality for females compared to males. This apparent increase in female mortality is not well understood. The aim of this research is to apply causal reasoning to understand if the apparent increase of female mortality in PICU is driven by bias resulting from the selection of patient population in PICU, or there is a real effect of sex on mortality in PICU.

METHODS

We selected all PICU admissions in England from 1/1/2010 to 31/12/2019. We linked these records to Hospital Episode Statistics records for these children, to their mortality records, and to their mothers' records. We defined our causal estimand to be the adjusted risk ratio in PICU mortality for females compared to males. We selected the variables for the adjusted risk ratio using Directed Acyclic Graphs. We demonstrate the use of Targeted Learning

(causal machine learning) and compare it to traditional methods such as regression adjustment and the G-formula.

RESULTS

Female sex can lead to higher risk of mortality in PICU.

CONCLUSIONS

To study PICU mortality, careful selection of confounders is needed to avoid biased estimates.

LO238 / #1840**EAP Session****EAP Session 65: Ophthalmological problems in children****10-10-2022 17:00 - 17:55****Prednisolone for bell's palsy in children: A randomised, double-blind, placebo-controlled, multicentre trial****F. Babl^{1*}, D. Herd², M. Borland³, A. Kochar⁴, B. Lawton⁵, J. Hort⁶, A. West⁷, S. George⁸, M. Zhang⁹, K. Velusamy¹⁰, F. Sullivan¹¹, E. Oakley¹², A. Davidson¹³, S. Hopper¹², J. Cheek¹, R. Berkowitz¹³, S. Hearps¹³, C. Wilson¹³, A. Williams¹, H. Elborough¹, D. Legge¹⁴, M. Mackay¹³, K. Lee¹⁵, S. Dalziel¹⁶**¹Department of Emergency Medicine, Royal Children's Hospital, Melbourne, Australia²Emergency Dept, Queensland Children's Hospital, Brisbane, Australia³Emergency Dept, Perth Children's Hospital, Perth, Australia⁴Emergency Dept, Women's & Children's Hospital, Adelaide, Adelaide, Australia⁵Emergency Dept, Logan Hospital, Brisbane, Australia⁶Emergency Dept, The Children's Hospital at Westmead, Sydney, Australia⁷Emergency Dept, Monash Health, Melbourne, Australia⁸Emergency Dept, Gold Coast University Hospital, Southport, Australia⁹Emergency Dept, John Hunter Hospital, Newcastle, Australia¹⁰Emergency Dept, Townsville Hospital, Townsville, Australia¹¹University of St Andrews, School of Medicine, Edinburgh, United Kingdom¹²Emergency Dept, Royal Children's Hospital, Melbourne, Australia¹³Murdoch Children's Research Institute, Clinical Sciences, Melbourne, Australia¹⁴Pharmacy Dept, Royal Children's Hospital, Melbourne, Australia¹⁵Dept of Paediatrics, University of Melbourne, Melbourne, Australia¹⁶Children's Emergency Dept, Starship Children's Hospital, Auckland, New Zealand**BACKGROUND AND AIMS**

Corticosteroids can be used to treat idiopathic facial paralysis (Bell's palsy) in children, but their effectiveness is uncertain. To determine if prednisolone improves recovery of children with Bell's palsy at one month.

METHODS

Double-blind, placebo-controlled, randomised trial of prednisolone in children presenting to ED with Bell's palsy. Patients 6 months to <18 years, recruited <72 hours after symptom onset, were randomly assigned to receive 10 days of treatment with oral prednisolone (1 mg/kg) or placebo. The primary outcome: complete recovery of facial function at 1 month on the House-Brackmann scale. Secondary outcomes: facial function, adverse events and pain to 6 months.

RESULTS

Between October 2015 to August 2020, 187 children were randomised (94 to prednisolone and 93 to placebo) and included in the intention-to-treat analysis (Table 1). At 1 month, the proportions of patients who had recovered facial function were 49% (n=43/87) in the prednisolone group compared with 57% (n=50/87) in the placebo group (risk difference -8.1%, 95% CI -22.8 to 6.7; adjusted odds ratio [aOR] 0.7, 95% CI 0.4 to 1.3). At 6 months these proportions were 99% (n=77/78) for prednisolone and 93% (n=76/82) for placebo respectively (risk difference 6.0%, 95% CI -0.1 to 12.2; aOR 3.0 95% CI 0.5 to 17.7) (Figure 1). There were no serious adverse events and little evidence for group differences in secondary outcomes.

CONCLUSIONS

In children with Bell's palsy the vast majority recover without treatment. The study does not provide evidence that early treatment with prednisolone improves complete recovery.

LO239 / #944**EAP Session****EAP Session 65: Ophthalmological problems in children****10-10-2022 17:00 - 17:55****Efficacy of intranasal atomized dexmedetomidine versus oral melatonin in prevention of emergence delirium in children undergoing ophthalmic surgery with sevoflurane – A randomised double-blind study****S. Sethi*, S. Jangra, V. Ashok, J. Ram, V. Saini***Post Graduate Institute of Medical Education and Research, Anaesthesiology, Chandigarh, India***BACKGROUND**

Melatonin and dexmedetomidine have been used as paediatric premedication to decrease emergence delirium. The effectiveness of oral melatonin, compared to intranasal atomized dexmedetomidine, for emergence delirium is not well studied.

AIMS

To study the efficacy of preoperative intranasal atomized dexmedetomidine versus oral melatonin in children scheduled for ophthalmic surgery under sevoflurane.

METHODS

Design: Prospective, randomised and double-blind trial Setting: Ophthalmology operating theatres, university teaching hospital, April 2021 to October 2021 Patients: A total of 120 children undergoing ophthalmic surgery with sevoflurane anaesthesia were included. Intervention: Patients were randomized to receive preoperative intranasal dexmedetomidine $2 \mu \text{kg}^{-1}$ via an atomizer device (dexmedetomidine group) or oral melatonin 0.5mg kg^{-1} (melatonin group), 45 minutes before surgery. Outcomes measured: The primary outcome was the incidence of emergence delirium assessed by the Paediatric Anaesthesia Emergence Delirium scale. Secondary outcomes included preoperative sedation, quality of inhalational induction, postoperative sedation and pain.

RESULTS

The incidence of emergence delirium was lower in the dexmedetomidine group as compared to the melatonin group (17% vs 37%, relative risk 0.45, 95% CI: 0.24 to 0.88; $p=0.01$). Children in the dexmedetomidine group were more sedated following premedication and in the post anaesthesia care unit ($p<0.05$). The postoperative pain scores were lower in the dexmedetomidine group compared to the melatonin group (0[0-3] vs 2.5[0-4], $p=0.01$). The requirement and dose of rescue fentanyl analgesia postoperatively was comparable between the two groups.

CONCLUSIONS

Intranasal atomized dexmedetomidine, compared to oral melatonin, significantly reduced emergence delirium in pediatric ophthalmic surgeries with sevoflurane anaesthesia.

LO240 / #1570**Bengt Robertson Award****The bengt robertson award session****10-10-2022 18:00 - 19:00****Impact of timing of commencing postnatal dexamethasone on respiratory outcomes in very premature infants – A population-based cohort study and propensity score weighting analysis****T.C. Kwok*, L. Szatkowski, D. Sharkey***University of Nottingham, Centre for Perinatal Research, Nottingham, United Kingdom***BACKGROUND AND AIMS**

Postnatal dexamethasone (PND) is used in high-risk infants from eight days old to aid extubation and reduce bronchopulmonary dysplasia (BPD). However, the optimal timing for commencing PND is unclear. We explored the association of the timing of commencing PND on respiratory outcomes in very premature infants.

METHODS

Routinely recorded data from infants born below 32 weeks gestational age in England and Wales from 2010–2020 were extracted. PND use was defined as more than two consecutive days of treatment commenced in invasively ventilated infants between eight days old and 35⁺⁶ weeks corrected gestational age. Three infant groups were formed based on the timing PND was commenced (2–3, 4–5 and ≥ 6 weeks old). Propensity scores were estimated using generalised boosted models. A-priori variables amongst the groups were balanced using inverse probability of treatment weighting (IPTW). Treatment effects were estimated using doubly robust regression.

RESULTS

Of the 80,761 infants within the overall cohort, 1,237, 1,359 and 888 infants received PND at 2–3, 4–5 and ≥6 weeks old respectively with balanced variables after IPTW. Compared to infants receiving PND at 2–3 weeks old, infants in the ≥6 weeks group had higher odds of severe BPD and death (OR 1.44 (95% CI 1.12–1.86)), longer duration of invasive ventilation (mean difference 18.9 days (95% CI 16.6–21.3)) but similar respiratory support requirement at discharge (OR 1.24 (95% CI 0.99–1.55)) (Figure).

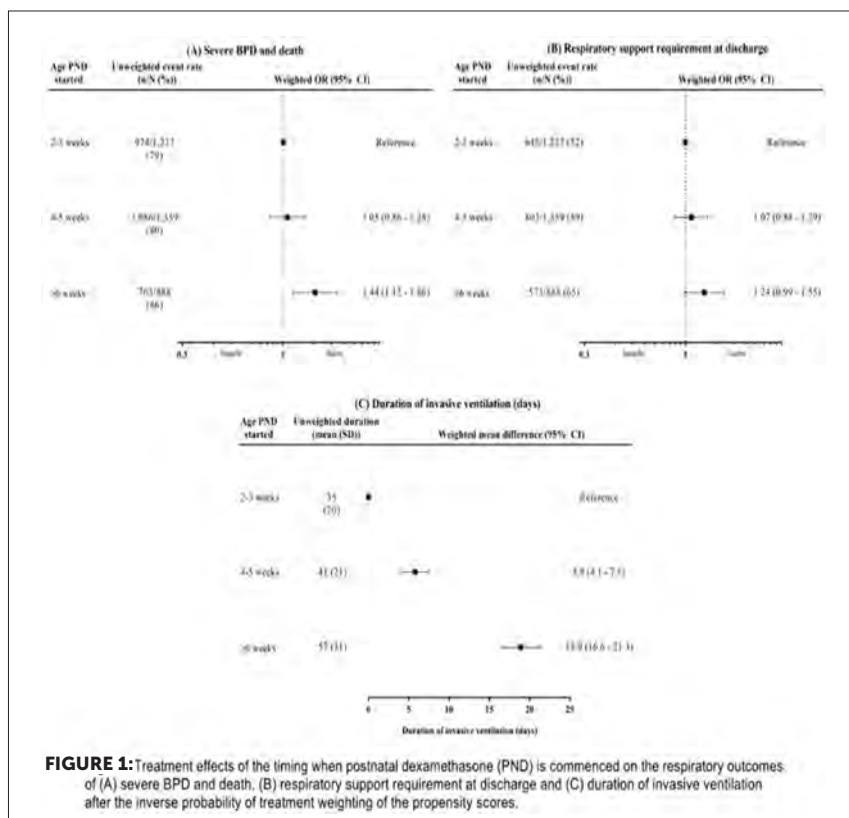

FIGURE 1: Treatment effects of the timing when postnatal dexamethasone (PND) is commenced on the respiratory outcomes: of (A) severe BPD and death, (B) respiratory support requirement at discharge and (C) duration of invasive ventilation after the inverse probability of treatment weighting of the propensity scores.

CONCLUSIONS

In well-balanced groups, infants commencing PND beyond 5 weeks old have a higher risk of death and BPD. The optimal timing of commencing PND remains to be established.

SHORT ORAL ABSTRACTS

SO001 / #2294**Short Oral Session****Short Oral Session 01: ESPNIC: Sustainability in healthcare****08-10-2022 12:00 - 13:00****Going green: Waste collection and analyses in pediatric intensive care****S. Cochius-Den Otter^{1*}, M. Honkoop², L. Van Den Berg², A. Ville², N. Hunfeld³, J.-C. Diehl², U. Kraemer¹, S. Verbruggen¹**

¹Erasmus MC Sophia Children's Hospital, Intensive Care and Department of Pediatric Surgery, Rotterdam, Netherlands

²Delft University of Technology, Faculty of Industrial Design Engineering, Delft, Netherlands

³Erasmus MC, Department of Intensive Care and Hospital Pharmacy, Rotterdam, Netherlands

BACKGROUND AND AIMS

The Dutch health care system is responsible for 7% of the national CO₂ footprint, and has agreed to achieve climate goals as defined by the United Nations and by the "Green Deal" for the healthcare sector. Insight in waste production (amount) and composition (type) is essential to move towards a more circular PICU. The aim of this project was to analyse the waste produced during four days in our PICU.

METHODS

The tertiary PICU is a 28 bed ICU in four units, divided in (1) short stay, (2) cardiothoracic care, (3) general PICU and (4) long stay. Waste was collected for four days and the trash bags were counted. Per day, waste from one of the units was separated by hand and categorised and weighted.

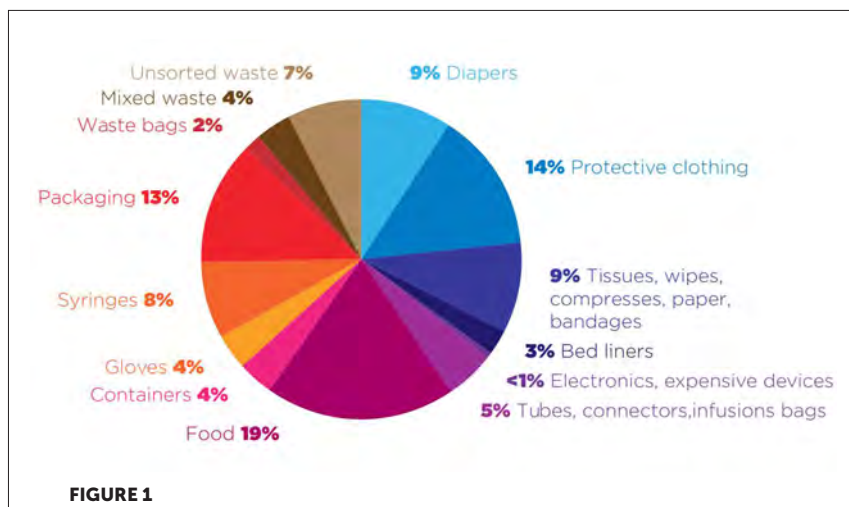

RESULTS

The total amount of waste was 26,9kg/day, with a significant difference between the four units (0.6 - 7.2 bags/patient/day). The amount of waste per category was similar between units, with a high percentage of food products, protective clothing and medical product packaging (figure 1). Fluid containing bottles such as formula were responsible for a large part of the food products. Six percent of the waste consisted of unused items.

CONCLUSIONS

The amount of waste in our tertiary multidisciplinary PICU was large, differed between type of patients and was lower in short-stay patients. This small study can be used as a hotspot analysis to help gain awareness in our unit, reduce waste, and increase recycling in short term practical changes.

SO002 / #2142**Short Oral Session****Short Oral Session 01: ESPNIC: Sustainability in healthcare****08-10-2022 12:00 - 13:00****Cybersecurity awareness, cyberattacks and critical care staff****C. Magner^{1*}, K. Hore², M. Tan²**¹University College Dublin, Nursing, Dublin, Ireland²Childrens Health Ireland at Crumlin, Paediatric Intensive Care, Dublin, Ireland**BACKGROUND AND AIMS**

Cybersecurity in the healthcare sector is crucial given the sensitivity of healthcare information, and the impact of a security breach on services and vulnerable service users. Weak security systems, the extensive interconnect-edness of medical devices and the value of healthcare data make healthcare organisations attractive targets for cyber criminals. Despite this, investment in cybersecurity in healthcare often lag behind other industries. IT users play a vital role in the success or otherwise of a cyberattack. On 14th May 2021, the Irish Healthcare System experienced a criminal cyberattack, through the infiltration of IT systems using Conti Ransomware. This was the most serious cyberattack on an Irish state organisation, and the devastating impact continues to be felt.

AIM

This study aims to investigate the level of cybersecurity awareness among critical care staff, and their IT behaviours to assess the level of risk this poses to the security of the IT system.

METHODS

This multicentre cross-sectional, descriptive observational study will include critical care staff working at 6 sites (4 ICUs and 2 PICUs) in Ireland. Professional and demographic information will be collected, as well as information about participants IT behaviour and level of awareness of cybersecurity using a validated tool.

RESULTS

Healthcare organisations must be aware of the risk associated with HCP behaviour and awareness to proactively protect themselves against malicious attacks.

CONCLUSIONS

This study will provide information about how to direct resources appropriately to enhance information security infrastructure, and inform staff training regimes.

SO003 / #339**Short Oral Session****Short Oral Session 01: ESPNIC: Sustainability in healthcare****08-10-2022 12:00 - 13:00****Fastgen, the French national implementation of centralized and outsourced trio genome sequencing in neonatal or pediatric intensive care units: an affordable strategy for all**

F. Tran Mau-Them^{1*}, A.-S. Denommé-Pichon¹, H. Safraou¹, A. Vitobello¹, A. Ziegler², M. Jeanne³, Y. Duffourd¹, E. Tisserant¹, P. Garret¹, V. Couturier¹, V. Bourgeois¹, C. Poe¹, C. Racine⁴, A. Garde⁴, J. Delanne⁴, S. Nambot⁴, R. Olaso⁵, J.-F. Deleuze⁵, A. Boland⁵, B. Fin⁵, A.-L. Bruel¹, S. Moutton⁴, M. Gorce², M. Barth², L. Pasquier⁶, M. Nizon⁷, M. Vincent⁷, M. Fradin⁶, A. Lavillaureix⁶, C. Quelin⁶, Y. Capri⁸, J. Van-Gils⁹, T. Busa¹⁰, B. Isidor⁷, A. Toutain³, D. Bonneau¹¹, S. Sigaudy¹⁰, P. Callier¹², A. Sorlin¹, L. Faivre⁴, C. Philippe¹, C. Thauvin¹

¹CHU Dijon, Unité Fonctionnelle 6254 Innovation En Diagnostic Génomique Des Maladies Rares, Dijon, France

²CHU Angers, Biochemistry and Genetics Department, University Hospital of Angers, Angres, France

³CHU Tours, Service De Génétique Médicale, Tours, France

⁴CHU Dijon, Centre De Référence Maladies Rares "anomalies Du Développement Et Syndromes Malformatifs", Dijon, France

⁵CNRGH, Plateforme De Production En Génomique Humaine, Centre National De Recherche En Génomique Humaine, Evry, France

⁶CHU Rennes, Service De Génétique Clinique, Rennes, France

⁷Chu Nantes, Service De Génétique Médicale, Nantes, France

⁸CHU Robert Debré, Unité Fonctionnelle De Génétique Clinique, Paris, France

⁹CHU Bordeaux, Service De Génétique Médicale, Bordeaux, France

¹⁰CHU Marseille, Unité De Génétique Clinique Prénatale, Marseille, France

¹¹CHU Angers, Service De Génétique, Angres, France

¹²CHU Dion, Laboratoire De Génétique Chromosomique Et Moléculaire, Dijon, France

BACKGROUND AND AIMS

The leading causes of death in infants in intensive care units are congenital abnormalities and genetic disorders that are very clinically and genetically heterogeneous. Obtaining a rapid etiologic diagnosis for infants with precociously severe disease of unknown prognosis remains a major challenge, while guiding the medical decision is crucial. We aimed to evaluate the feasibility of centralized and outsourced trio genome sequencing in newborns/infants requiring urgent diagnosis at a national level, and the enhancement of quality metrics in term of delay and change of management.

METHODS

Over a 36 months period, we included newborns and infants admitted in neonatal or pediatric intensive care units with probable genetic disease and an urgent need for etiological diagnosis to guide medical care. We first establish the milestones of our trio Genome Sequencing (GS) processes in 37 patients, and then enhanced our processes in 55 additional patients.

RESULTS

Trio-GS was performed in first intention in 92 patients from 13 different French centers. We identified the causative variants in 46/92 (50%), variants of unknown significance (VUS) in 15/92 (16%). The median delay from clinician inquiries to molecular diagnostic report was of 29 days. Medical management was modified in 19/55 positive patients.

CONCLUSIONS

Centralization and outsourcing trio-GS increase delay compare to local solutions. Semi-rapid trio-GS represents a valuable opportunity for patients in an urgent care context with change of management in at least 35%. Semi-rapid trio-GS also reduces the cost compare to rapid trio-GS.

SO004 / #1307**Short Oral Session****Short Oral Session 01: ESPNIC: Sustainability in healthcare****08-10-2022 12:00 - 13:00****Carbon footprint of travel to work survey****K. Kumar*, A. Plunkett***Birmingham Children's Hospital, Paediatric Intensive Care, Birmingham, United Kingdom***BACKGROUND AND AIMS**

Climate change poses a threat to our health and the planet. NHS(National health services) contributes to 4% of UK's carbon emissions and staff commute to work accounts for 4% of it. The aim of this study was to estimate the carbon costs of commuting to work for staff members of a tertiary level PICU.

METHODS

Data was anonymously collected by a questionnaire sent via google forms to 389 members of the PICU team and participation was voluntary. Algorithms from the traffic Scotland website(<https://trafficscotland.org/carboncalculator/>) were used to estimate carbon footprint.

RESULTS

Eighty-eight members responded (23%) with data analysed for 85 due to missing responses. Registered nurses(50%) were the largest group followed by fellows(32%), consultants(15%) and others(3%). Common modes of commute were, cars(65%), rail(12%), Bus/walk(10%each) and cycling(3%). Median distance to work was 7miles(IQR 4.5-16miles). Daily distance travelled vs

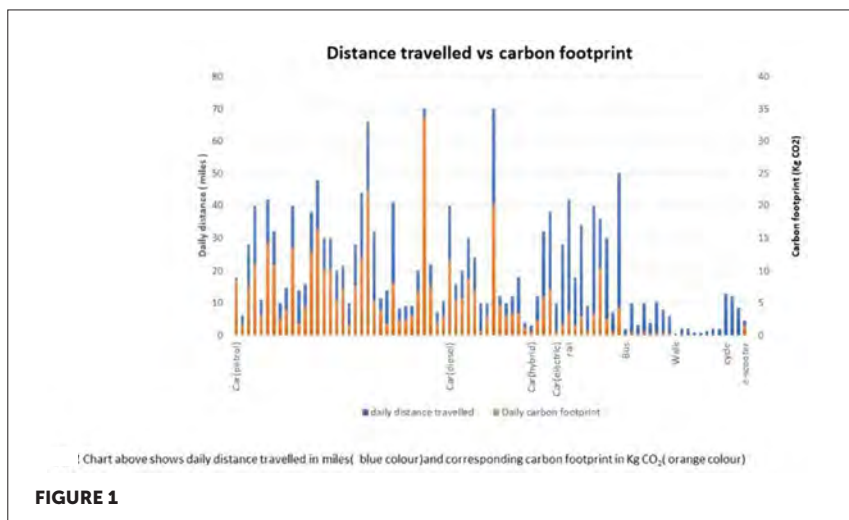

carbon footprint is shown in Fig 1. Total distance travelled by staff annually was estimated as 319170 miles with a carbon footprint of 75032 Kg CO₂. Alternative feasible modes of transport chosen were buses (23%), trains (21%), cycles (18%) and walking (5%). This would translate to carbon savings (23180 Kg CO₂ annually), which could run 349 ventilators for 91 days across all UK PICU's. Concerns about flexibility and convenience of alternative mode of travel were the biggest barriers to change.

CONCLUSIONS

Alternative modes of travel for the purpose of commuting to work may reduce the carbon footprint of the PICU's. The NHS could incentivize alternative modes of transport - e.g. by providing facilities and "help to buy" schemes.

SO005 / #1387**Short Oral Session****Short Oral Session 02: ESPNIC - Outcome following intensive care****08-10-2022 12:00 - 13:00****Conceptualizing post intensive care syndrome in pediatric survivors and their families with the lens of bioecological theory of human development****Z. Rahmaty^{1*}, J. Manning², M.-H. Perez³, A.-S. Ramelet⁴**

¹University Hospital of Lausanne and University of Lausanne, Department of Biology and Medicine, Institute of Higher Education and Research In Healthcare, lausanne, Switzerland

²Nottingham University Hospitals NHS Trust / University of Nottingham, Nottingham Children's Hospital / Centre For Children and Young People Health Research, Nottingham, United Kingdom

³University Hospital of Lausanne, Département Femme-mère-enfant Soins Intensifs Et Intermédiaires De Pédiatrie, lausanne, Switzerland

⁴University Hospital of Lausanne and University of Lausanne, Department of Biology and Medicine, Institute of Higher Education and Research in Healthcare, Lausanne, Switzerland

BACKGROUND AND AIMS

In 2018, in response to high comorbidities after PICU hospitalization, PICS-p framework was developed offering a new understanding of the long-term impact of critical illness on children's physical, emotional, cognitive and social health with different recovery trajectory, as well as physical and psychosocial health of their parents and siblings. While the PICS-p framework defines important PICU outcomes and their trajectories, the Bioecological Theory of Human Development (BTHD) can provide a comprehensive theoretical guide for potential factors influencing these outcomes. BTHD is a set of systems: microsystem (interaction with close people), mesosystem (family, ICU), and exosystems (community and society) with various degrees of influence on the child with the intrapersonal characteristics at the center. BTHD also, emphasizes on the bidirectional influence of child, and their close people

on each other's. This study aims to conceptualize PICS trajectories in dyads of child-family in the context of systems around them.

METHODS

A conceptual mapping combining PICS-p and BTHD theoretical assumptions and possible relations to study PICS in child and families.

RESULTS

The PICS-p permitted to identify four outcome domains of PICU hospitalization in child-family dyads. The BTHD helped us to identify influential factors: intrapersonal (demographic, health, clinical), parent and sibling characteristics, behaviors and interactions, ICU mortality, ICU routine cares and educations, available community and social resources and network specifications.

CONCLUSIONS

Knowing the complex nature of the PICS we addressed the change of outcomes over time, influence of child and family on each other and the comprehensive context they live in.

SO006 / #1709**Short Oral Session****Short Oral Session 02: ESPNIC - Outcome following intensive care****08-10-2022 12:00 - 13:00****Post-NICU follow-up. should we be assessing the long term psychological impact in parents?****A. Jousse, V. Zupan Simunek, V. Sartorius, N. Yousef***

**A.Beclere* Medical Center, Paris Saclay University Hospital, APHP – Paris, Division of Pediatrics and Neonatal Critical Care, Clamart, France*

BACKGROUND AND AIMS

Parental mental health has a significant impact on parent-infant interactions. Difficulties in bonding may increase the risk for developmental, emotional and behavioral difficulties. Early intervention is effective in reducing symptoms in parents of preterm infants. We aimed to evaluate persisting signs of post traumatic stress disorder (PTSD) and depression in parents of preterm infants or infants with birth asphyxia up to 18 months corrected gestational age (CGA).

METHODS

A monocentric prospective study in a level 3 NICU. Preterm infants and infants with birth asphyxia underwent assessment with Bayley-III scales at 9M and/or 18M CGA. Parents were assessed with The EPDS questionnaire for depression, and the IES-R for PTSD.

RESULTS

30 infants were assessed at 9-18M CGA. Bayles-III scores: Motor 82.7 (± 22), Language 82.9 (± 16.8), Cognitive 87.1 (± 21.5). For mothers: EPDS $>10 = 7/30$, and IES-R $>24 = 29/30$ ($>36 = 10/30$, IES-R $>24 = 19/30$) which correlate only with motor scores ($p = 0.012$), but not language or cognitive. For fathers: IES-R $>24 = 15/22$ ($>36 = 4/22$, IES-R $>24 = 11/22$). Correlation between parents was significant ($0.7 p < 0.001$).

CONCLUSIONS

Preterm birth and life-threatening situations such as birth asphyxia are important risk factors for parental PTSD. In this study, signs of moderate or severe PTSD and/or depression persisted long after NICU discharge in both parents. Little is known on PTSD in fathers and its impact on family dynamics and quality of post NICU life. Early systematic screening and treatment of NICU parents seems important. A family centered approach during post-NICU follow-up may reveal otherwise hidden information on parental psychological health which may be important to help better support infant neuropsychological development.

SO007 / #784**Short Oral Session****Short Oral Session 02: ESPNIC - Outcome following intensive care****08-10-2022 12:00 - 13:00****The first step in the development of a core outcome set for early mobilization trials in critically ill children: A systematic review****B. Geven¹, E. Ista^{2*}, J. Van Woensel¹, F. Van Etten - Jamaludin³, S. Verbruggen², J. Maaskant⁴**

¹Amsterdam UMC, location University of Amsterdam, Pediatric Intensive Care Unit, Amsterdam, Netherlands

²Erasmus MC – Sophia Children's Hospital, Department of Pediatric Surgery, Pediatric Intensive Care, Rotterdam, Netherlands

³Amsterdam UMC, location University of Amsterdam, Research Support, Medical Library, Amsterdam, Netherlands

⁴Amsterdam UMC location University of Amsterdam, Pediatrics, Amsterdam, Netherlands

BACKGROUND AND AIMS

Early mobilization in critically ill children has only prospectively been investigated in small trials varying in design, outcomes and measurement tools. To move forward in this field of research, the development of a Core Outcome Set (COS) is needed. The aim of this study is to execute a systematic review to create an overview of reported outcomes about early mobilization, as the first step in the development of a COS.

METHODS

We searched PubMed, Embase, Cochrane library and CINAHL, with no filter on design or language. Two reviewers assessed titles, abstracts and full texts

independently. Studies were selected when any outcomes of early mobilization were described. Data extraction was performed by one reviewer and verified by the other reviewer. Seven domains, recommended by the COMET initiative, were used to categorize the outcomes: death, physiological, life impact, resource use, adverse events, process indicators, and staff.

RESULTS

In total 2,536 titles were screened and 21 studies were included. Extraction of data resulted in 40 outcomes. We found outcomes in all seven domains. The outcome 'length of stay' (domain resource use) was reported most frequently. Also adverse events and mobilization activities as process indicators were well reported. In the domain life impact 'quality of life' was often chosen, but outcomes on functionality were less common.

CONCLUSIONS

The literature derives a variety of outcomes. We will assess the outcomes in focus groups with parents/caregivers of former PICU patients. A Delphi study among experts will be executed to reach consensus on the final COS.

SO008 / #1063**Short Oral Session****Short Oral Session 02: ESPNIC - Outcome following intensive care****08-10-2022 12:00 - 13:00****A focused ethnographic study on kangaroo care of preterm infants in Saudi Arabia****A. Almutairi^{1,2*}, A. Gavine², A. Mcfadden²**¹King Saud bin Abdulaziz University for Health Sciences, College of Nursing, Jeddah, Saudi Arabia²University of Dundee, School of Health Sciences, Dundee, United Kingdom**BACKGROUND AND AIMS**

A review of the literature revealed the need to explore the experiences and perceptions of parents and health care providers (HCPs) of Kangaroo Care (KC) for preterm infants. This study aimed to explore the experiences and perceptions of parents and HCPs of KC for preterm infants in Saudi hospitals.

METHODS

A focused ethnographic approach was used in a large neonatal unit in Saudi Arabia. So far, 85 hours of observation, seven interviews with parents, 12 interviews and one focus group with HCPs (N=16), and documentary analysis were conducted. Data are being analysed using Braun and Clarke's reflexive thematic analysis (2019).

RESULTS

Preliminary findings indicated that HCPs and parents were positive towards KC; however, participants identified potential obstacles and facilitators of its practice. Ambiguity regarding suitability of KC for high-risk infants, lack

of accommodation for parents, language difficulties, staff rotations, and the covid-19 pandemic were believed to hinder HCPs from optimally supporting KC. These challenges are exacerbated by parents' lack of knowledge of KC, lack of privacy, cultural background, and stigma associated with fathers' participation in KC. The need for standardised protocols and promoting KC from community services or prenatal clinics were also highlighted. Furthermore, field notes revealed that parents were not frequently involved in KC, which seems intrinsically paradoxical given the aims of KC protocol.

CONCLUSIONS

Kangaroo care in Saudi Arabia should be promoted to increase its practice. Involvement of parents could help to reduce cultural barriers and social stigma surrounding the father's role in KC.

SO009 / #970**Short Oral Session****Short Oral Session 02: ESPNIC - Outcome following intensive care****08-10-2022 12:00 - 13:00****Long stay patients on paediatric intensive care unit (PICU): Defining the problem****S. Shaw^{1*}, M. Mahgoub¹, C. Chamberlain-Parr¹, R. Ellis¹, L. Tume^{2,3}**¹*Alder Hey Childrens Hospital, Critical Care, Liverpool, United Kingdom*²*University of Salford, School of Health & Society, Manchester, United Kingdom*³*Alder Hey Children's Hospital, Picu, Liverpool, United Kingdom***BACKGROUND AND AIMS**

Advances in PICU therapies has led to an increase in patient survival and potentially a subgroup of children with longer PICU stays. Long stay patients (LSP) can impact on resource allocation and may have increased morbidity and mortality.

AIMS

To describe the current profile of LSP and very long stay patients (VLSP) in one large UK mixed general and cardiac PICU and ECMO centre in the UK.

METHODS

A retrospective cohort study of all patients admitted to PICU between January 2019 and December 2021. LSP were defined as staying >7 days and VLSP >28 days. Descriptive statistics were used to describe the cohort.

RESULTS

1894 children were admitted in this time period with 385 (20.3%) staying > 7days of which 56 (14.5%) stayed >28days. The median length of stay (LOS) was 12 days (IQR 8- 20) and the median age 144.5 days (IQR 31- 701). of these 385, most had congenital heart disease (CHD) and were admitted following cardiac surgery (22.8%); or for a cardiac medical condition (16.3%); or with respiratory failure with a known CHD (16.8%). Children receiving ECMO represented (11.6%) of LSP and hemofiltration (6.7%). Most, 86.2% children survived to PICU discharge.

CONCLUSIONS

Around a fifth of all PICU admissions stayed > 7 days compared to the median of 3 days across all UK PICUs (PICANet 2021). Children with CHD are over-represented in the LSP population.

SO010 / #1471**Short Oral Session****Short Oral Session 02: ESPNIC - Outcome following intensive care****08-10-2022 12:00 - 13:00****Cardiovascular biomarkers are associated with morbidity and mortality in very preterm neonates: A cohort study****A. Sellmer^{1*}, V. Hjortdal², B. Hammer Bech³, T. Brink Henriken⁴**¹Aarhus University Hospital, Department of Paediatrics and Adolescent Medicine, Aarhus N, Denmark²University of Copenhagen, Dept. of Cardiothoracic Surgery, Copenhagen, Denmark³Aarhus University, Dept. of Public Health, Aarhus, Denmark⁴Aarhus University Hospital, Department of Paediatrics (intensive Care Neonatology), Aarhus, Denmark**BACKGROUND AND AIMS**

Biomarkers may facilitate the identification of very preterm neonates that have the greatest risk of intraventricular hemorrhage (IVH), pulmonary hemorrhage, necrotizing enterocolitis (NEC), bronchopulmonary dysplasia (BPD) or death. We aimed to investigate the association between mid regional proadrenomedullin (MR-proADM), N-terminal pro b-type natriuretic peptide (NT-proBNP), mid regional pro-atrial natriuretic peptide (MR-proANP), C-terminal pro endothelin-1 (CT-proET1) and copeptin and morbidity and mortality and furthermore early onset problems in very preterm neonates.

METHODS

In a cohort including 139 neonates born at a gestational age below 32 weeks we collected data on morbidity and mortality and on early onset problems (need for mechanical ventilation, early onset sepsis, respiratory

distress syndrome and patent ductus arteriosus). Echocardiography was performed on day 3 and 6 and blood samples were collected day 3.

RESULTS

Higher plasma values of MR-proANP, NTproBNP and copeptin was associated with increased risk of BPD or death. and higher plasma values of MR-proANP, NT-proBNP, and MR-proADM was associated with increased risk of IVH. Furthermore, early onset clinical problems including mechanical ventilation, early onset sepsis, respiratory distress syndrome and patent ductus arteriosus at day three was associated with higher plasma levels of these markers.

CONCLUSIONS

Biomarkers may be valuable in order to identify very preterm neonates at risk of severe morbidity or death and thereby have the potential to have great impact on patient monitoring, treatment, and follow-up in a very vulnerable population.

SO011 / #2360**Short Oral Session****Short Oral Session 02: ESPNIC - Outcome following intensive care****08-10-2022 12:00 - 13:00****Diagnostic performance of biomarkers in childhood acute kidney injury: A meta-analysis****J. Meena^{1*}, C. Thomas², J. Kumar¹**¹*Post Graduate Institute of Medical Education and Research, Pediatrics, Chandigarh, India*²*Department of Pediatrics, Government Medical College, Alappuzha, Pediatrics, Kerala, India***BACKGROUND AND AIMS**

Early accurate recognition of acute kidney injury in children may improve morbidity and mortality. Novel non-invasive biomarkers ushered a new era that may allow early recognition of AKI.

METHODS

This meta-analysis aimed to quantitatively synthesize the diagnostic performance of biomarkers in predicting AKI. We searched PubMed, EMBASE, and Web of Sciences for studies published till January 2022. Search terms included acute kidney injury, pediatrics, adolescent, and biomarker. Cohort and cross-sectional studies evaluating various biomarkers in predicting AKI were included. We followed PRISMA-DTA guidelines and used the QUADAS-2 tool for quality assessment. The hierarchical summary receiver operating characteristic (HSROC) model was used to synthesize the summary estimates of diagnostic parameters.

RESULTS

Overall, thirty-five studies were included in this meta-analysis. Urinary NGAL showed summary sensitivity, specificity, and AUC of 0.75 (95% CI, 0.61–0.86), 0.84 (0.73–0.91), and 0.87 (0.84–0.89) respectively for the prediction of AKI in children who underwent cardiac surgery. In the setting of the intensive care unit (ICU) AUC was 0.81 (0.77–0.84) for the prediction of AKI. Similarly, the AUC of serum NGAL for ICU and cardiac surgery patients was 0.83 (0.80–0.86) and 0.92 (0.90–0.94), respectively. We observed a pooled AUC of 0.83 (0.79–0.86) for serum cystatin C in an ICU setting in the prediction of AKI. The AUC of IL-18 for predicting AKI was 0.73 (0.69–0.77).

CONCLUSIONS

Pooled evidence suggests that NGAL and serum cystatin C have good predicting ability and may have potential role in early recognition of patients at higher risk of AKI in routine clinical practice.

SO012 / #1414**Short Oral Session****Short Oral Session 04: ESPR - Brain imaging in neonatal brain injury****08-10-2022 12:00 - 13:00****The role of preterm birth and postnatal stress in neonatal structural brain development****F. Lammertink^{1*}, M. Benders¹, E. Hermans², M. Tataranno¹, J. Dudink¹, C. Vinkers³, M. Van Den Heuvel⁴**

¹University Medical Center Utrecht, Wilhelmina Children's Hospital, Department of Neonatology, Utrecht, Netherlands

²Radboud University Medical Center, Donders Institute For Brain, Cognition, Nijmegen, Netherlands

³Amsterdam UMC, Vrije Universiteit Amsterdam, Amsterdam Neuroscience, Department of Psychiatry, Amsterdam, Netherlands

⁴Amsterdam UMC, Amsterdam Neuroscience, Department of Child Psychiatry, Amsterdam, Netherlands

BACKGROUND AND AIMS

Preterm birth disrupts the emerging foundations of the brain's architecture, and the continuum of early-life stress-provoked alterations reaches from a healthy adaptation with resilience to severe vulnerability and maladjustment with psychopathology. The current study examined how structural brain development is affected by a stressful extra-uterine environment and whether changes in topological architecture at term-equivalent age could explain the increased vulnerability for behavioral symptoms during early childhood.

METHODS

Longitudinal changes in structural brain connectivity were quantified using diffusion-weighted imaging (DWI) and tractography in preterm born infants (gestational age <28 weeks), imaged at 30 and/or 40 weeks of gestation

(N=145, 43.5% female) and a global index of postnatal stress was determined based on the number of invasive procedures during hospitalization (e.g., heel lance).

RESULTS

Higher stress levels impaired structural connectivity growth in a sub-network of 48 connections ($p = 0.003$), including the amygdala, insula, hippocampus, and posterior cingulate cortex. Findings were replicated in an independent validation sample (N=123, 39.8% female, n=91 with follow-up). Furthermore, classifying infants into vulnerable and resilient based on having more or less internalizing symptoms at 2-5 years of age (Child Behavior Checklist, n=71) revealed lower connectivity in vulnerable relative to resilient individuals ($p < 0.001$).

CONCLUSIONS

Our findings suggest that higher stress exposure during NICU admission is associated with slower growth in regions such as the amygdala, hippocampus, insula, and posterior cingulate cortex. Importantly, resilience following postnatal stress might be characterized by a potential compensatory or innate ability to preserve global brain connectivity.

SO013 / #659**Short Oral Session****Short Oral Session 04: ESPR - Brain imaging in neonatal brain injury****08-10-2022 12:00 - 13:00****Neonatal clinical complications lead to immature patterns of brain dynamics****N. Padilla^{1*}, A. Escrichs², H. Kvanta¹, H. Lagercrantz¹, M. Kringelbach³, G. Deco², U. Aden¹**¹Karolinska Institute, Dept of Women's and Children's Health, Stockholm, Sweden²Universitat Pompeu Fabra, Center for Brain and Cognition, Barcelona, Spain³University of Oxford, Dept. of Psychiatry, Oxford, United Kingdom**BACKGROUND AND AIMS**

Extremely preterm (EPT) children are exposed to clinical complications during the neonatal period which may impact the brain network dynamics. The aim is to relate network-dynamics-brain measures at 10-years to the presence of neonatal morbidity.

METHODS

33 EPT (<28 semanas de EG) and 28 term-children were scanned at 10 years of age. Intrinsic-ignition (propagation of neural information at rest) and metastability (switching between patterns of functional connectivity) were calculated in the default-mode-DMN, dorsal-attention-DAN, and salience-SN networks. We compared groups with and without: Oxygen at 36-weeks, use of inotropes, use of mechanical ventilation, patent-ductus-arteriosus (PDA), PDA-pharmacologically treated, and PDA-surgically treated. A general lineal model analysis was performed, ignition and metastability measures as dependent variable and group status as the independent factor. Gestational-age was used as covariate when appropriate. Pearson-correlations were performed.

RESULTS

In the whole sample, the gestational-age was positively correlated with ignition and metastability in the DMN ($p=0.017$, and $p=0.010$), and with ignition in the SN ($p=0.047$). Birth-weight was positively correlated with ignition ($p=0.032$) and metastability ($p=0.025$) in the DMN. Children who used inotropes (DMN metastability, $p=0.017$), had PDA pharmacologically (DAN ignition, $p=0.015$; DAN metastability, $p=0.047$), or surgically treated (DAN metastability, $p=0.016$), and used Oxygen after 36-weeks (DAN-ignition, $p=0.041$) showed significantly lower ignition and metastability compared to those without the condition.

CONCLUSIONS

Neonatal morbidity affects the brain development leading to more immature dynamic patterns of brain functioning during late childhood. The identification of modifiable risk factors at an early time point has the potential to improve continued clinical management in the preterm population.

SO014 / #1054**Short Oral Session****Short Oral Session 04: ESPR - Brain imaging in neonatal brain injury****08-10-2022 12:00 - 13:00****Watch it grow: High-resolution ultrasound of the preterm cerebellum in serial transnuchal scans****T. Muehlbacher^{1,2*}, R. Schaefer¹, C. Buss³, C. Bühner¹, T. Schmitz¹**¹Charité University Hospital, Neonatology, Berlin, Germany²University Hospital Zurich, Department of Neonatology, Zurich, Switzerland³Charité University Hospital, Institute of Medical Psychology, Berlin, Germany**BACKGROUND AND AIMS**

Very preterm infants are prone to cerebellar injury and impeded cerebellar growth. The posterior fossa is most commonly imaged via ultrasound through the mastoid fontanel. Using an alternative approach via the foramen magnum enables sonographic examination with a high-resolution linear probe. The goal of the study was to validate transnuchal ultrasound by comparing measurements of the transverse cerebellar diameter (TCD) via both acoustic windows.

METHODS

Retrospective analysis of ultrasound scans over a one year period from 2018 to 2019 in a tertiary NICU in very low birth weight infants (VLBW). TCD measurements obtained from sonography via foramen magnum and mastoid fontanel were correlated to validate transnuchal ultrasound. TCD from first scan plotted against gestational age reflects prenatal cerebellar growth, while TCD from serial scans was analyzed for postnatal cerebellar growth.

RESULTS

TCD measurements via the two acoustic windows showed a very high correlation ($r's = 0.981$). Cerebellar growth was linear both prenatally (+0.173 cm per week, $r = 0.908$, $p < 0.001$) and postnatally (+0.169 cm, $r = 0.920$, $p < 0.001$). The latter was significantly lower than the former (median -0.06 cm, $p < 0.05$), resulting in cerebellar growth restriction.

CONCLUSIONS

Transnuchal ultrasound in VLBW infants is feasible and allows for monitoring cerebellar growth.

SO015 / #1175**Short Oral Session****Short Oral Session 04: ESPR - Brain imaging in neonatal brain injury****08-10-2022 12:00 - 13:00****The use of a machine learning algorithm in the early prediction of hypoxic ischaemic encephalopathy in infants****C. Stephens^{1,2*}, D. O'Boyle^{1,2}, B. Walsh^{1,2,3}, G. Boylan^{1,2}, D. Murray^{1,2}**¹Department of Paediatrics and Child Health, University College Cork, Ireland²INFANT Research Centre, University College Cork, Ireland³Department of Neonatology, Cork University Maternity Hospital, Ireland**BACKGROUND AND AIMS**

Hypoxic Ischaemic Encephalopathy (HIE) is the leading cause of morbidity and mortality in infants worldwide. Early diagnosis and prompt initiation of neuroprotective strategies can be challenging given its dynamic nature. We aim to validate the use of a machine learning algorithm in correctly identifying infants with HIE from infants at risk of neonatal encephalopathy from other causes.

METHODS

This was a secondary analysis of clinical data from ANSeR I and ANSeR II studies. Term infants had continuous EEG recordings for neurological concern in the first few days of life. Using five clinical variables; Apgar score at 1 and 5 minutes, first postnatal pH, lactate and base deficit, logistic regression(LR) and random forest(RF) models were examined for their ability to differentiate between HIE and non-HIE through the calculation of a probability index(PI).

RESULTS

243 infants were included, 151(62.1%) with HIE. The most common pathology for the non-HIE group was genetic/metabolic encephalopathies, 19 (7.8%), followed by stroke, 18 (7.4%) The optimum model for prediction of HIE was the RF model, the calculated PI in the HIE group was 0.91(0.68-0.98) versus 0.03

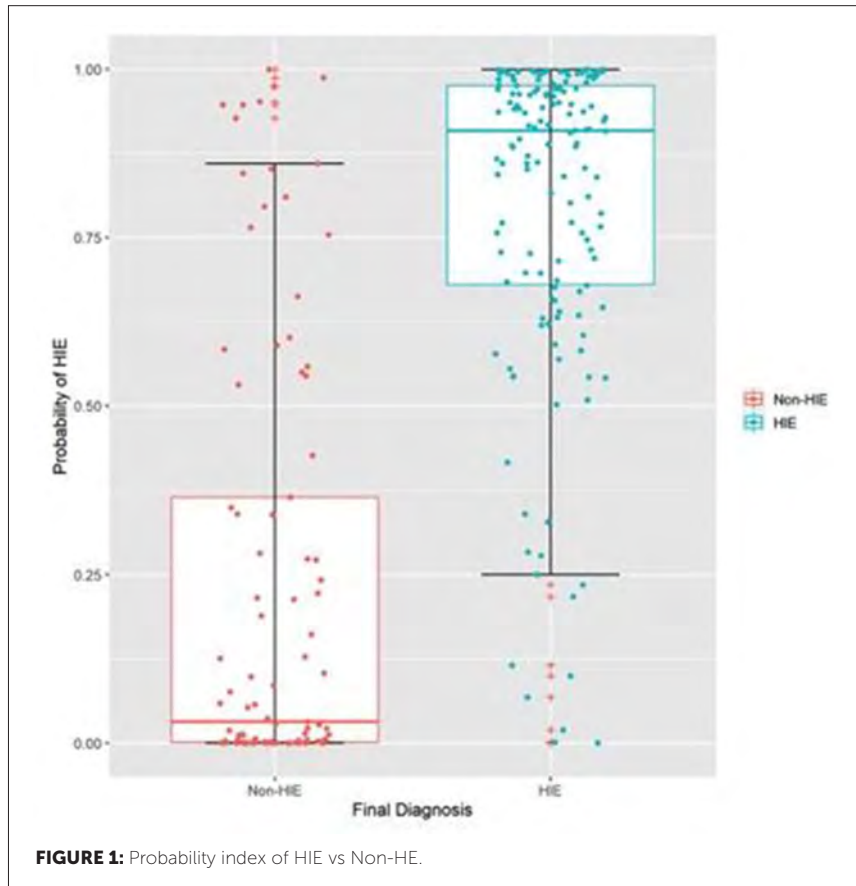

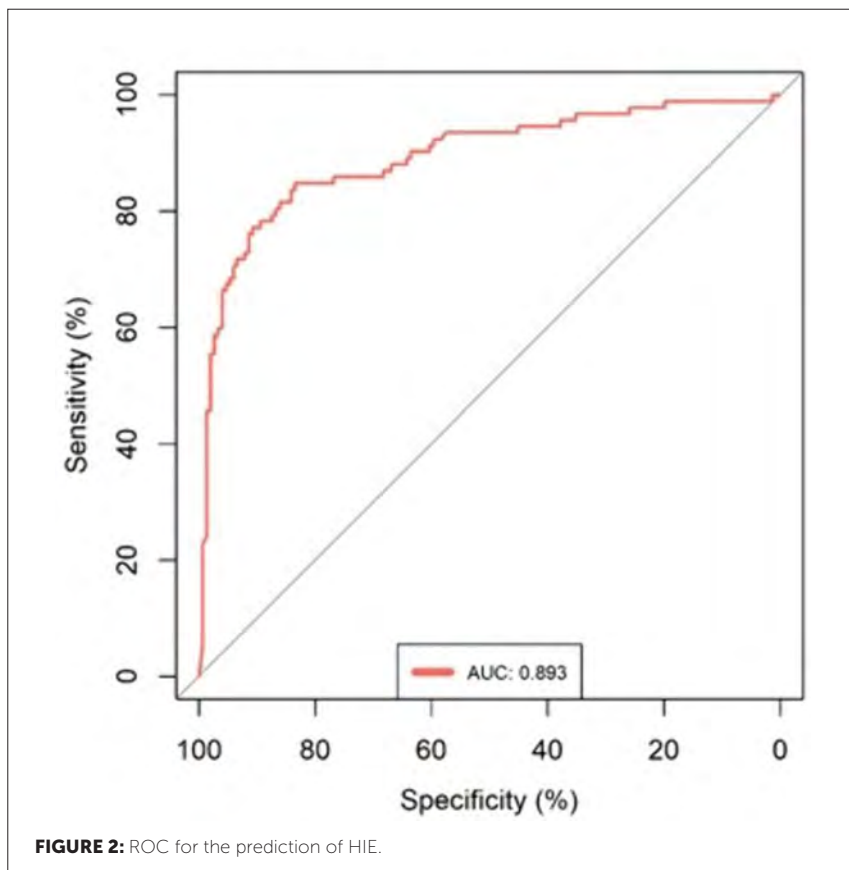

(0.00-0.36) in the non-HIE cohort, accuracy 85.6%, $p < 0.001$ (Figure 1). The AUC for the prediction of HIE = 0.893, 95% CI (0.85-0.94), $p < 0.001$ (Figure 2). of the infants with HIE, 137/151(90.7%) were correctly identified in comparison to 71/92 (77.2%) of infants without HIE.

CONCLUSIONS

Machine learning may be useful for identifying HIE soon after birth, differentiating from alternative causes of neonatal encephalopathy, and may act as an adjunct in clinical decisions around eligibility for therapeutic hypothermia.

SO016 / #974**Short Oral Session****Short Oral Session 04: ESPR - Brain imaging in neonatal brain injury****08-10-2022 12:00 - 13:00****Peripapillary retinal nerve fiber layer thickness and macular ganglion cell layer volume in association with motor and cognitive outcomes in 11-year-old children born very preterm****T. Lehtonen¹, E. Vesti¹, L. Haataja², A. Nyman³, K. Uusitalo⁴, M. Leinonen^{5*}, S. Setänen⁶**¹University of Turku, Department of Ophthalmology, Turku, Finland²University of Helsinki, Department of Pediatric Neurology, Helsinki, Finland³University of Turku, Department of Psychology, Turku, Finland⁴University of Turku, Department of Pediatric Neurology, Turku, Finland⁵Ocusweep, Department of Ophthalmology, Turku, Finland⁶University of Turku and Turku University Hospital, Pediatric Neurology and Pediatrics, Turku, Finland**BACKGROUND AND AIMS**

Prematurity is associated with altered retinal thickness and long-term neurodevelopment. We aimed to study the association between ophthalmological and motor and cognitive outcomes in 11-year-old children born very preterm.

METHODS

This study is part of a prospective cohort study of very preterm infants (birth weight ≤ 1500 grams/gestational age < 32 weeks) born between 2001 and 2006 in Turku University Hospital, Finland. At 11 years of age, the ophthalmological

assessment included a retinal optical coherence tomography (OCT) examination of the PRNFL and the macular GCL. The motor performance was assessed with the Movement Assessment Battery for Children - Second Edition (Movement ABC-2), and the cognitive outcome with the Wechsler Intelligence Scale for Children – Fourth edition (WISC-IV).

RESULTS

141 children were included. The mean (SD) average PRNFL was 95 μm (10.2 μm). The mean (SD) macular GCL volume was 0.34 mm^3 (0.03 mm^3). Higher PRNFL thickness associated with higher percentiles for total scores in the motor assessment ($b=0.5$, 95%CI 0.1-0.8, $p=0.01$) and higher macular GCL volume with higher scores in the cognitive assessment ($b=1.4$, 95%CI 0.5-2.3, $p=0.002$), also when adjusted for gender, birth weight z-score, and major brain pathology at term.

CONCLUSIONS

The associations between higher average PRNFL thickness and better motor performance as well as higher macular GCL volume and better cognitive performance refer to more generalized changes in the brain of 11-year-old children born very preterm. Retinal OCT examinations might provide a deeper insight than mere eyesight in long-term neurodevelopmental follow up of children born very preterm.

SO017 / #1303**Short Oral Session****Short Oral Session 05: EAP - Paediatric potpourri -
There is something for everyone 01****08-10-2022 12:00 - 13:00****Safety of non-invasive respiratory support on the
paediatric wards: A single centre experience****L. Williams, A. Sherif*, E. Reynolds, A. Regan, M. Cardenas, S. Nath***Royal Cornwall Hospital Trust, Paediatrics, Truro, United Kingdom***BACKGROUND AND AIMS**

Non-invasive respiratory support (NRS) was traditionally used in PICUs and HDUs however, with busy transport teams and unavailability of PICU beds, the use of NRS on paediatric wards may be unavoidable. We describe a cohort of patients cared for using NRS on our paediatric ward, which is geographically remote from a PICU to describe the safety of use by reporting adverse events, transfers to PICU and the incidence of intubation.

METHODS

This is a retrospective observational study of all paediatric patients who received one or more modes of NRS (HFNC, CPAP and BiPAP) from the start of January 2019 until the end of December 2020 on the paediatric wards and HDU at Royal Cornwall Hospital Trust due to acute illness. Data was collected from the trust database and patient's notes.

RESULTS

68 admissions were eligible for analysis; 30.8% with a diagnosis of bronchiolitis. 66.2% had known co-morbidities. Most patients were started on HFNC

(77.94%). 17.6% required escalation to another mode, 2.9% required intubation and this was within 24 hours. 11.7% of patients required transfer to ITU, the majority within the first 24 hours (62.5%). 38 adverse events were recorded, with the most common being work of breathing, followed by agitation with no significant correlation to intubation or transfers.

CONCLUSIONS

This study shows that NIV can be used safely on a ward setting minimising the need for transfer or intubation. Adverse events did not correlate with escalation of NRS, intubation or transfer. As this is a single centre retrospective study further data is required.

SO018 / #1774**Short Oral Session****Short Oral Session 05: EAP - Paediatric potpourri
- There is something for everyone 01****08-10-2022 12:00 - 13:00****Heart rate variability predicts early
electroencephalography grade in infants with
hypoxic-ischaemic encephalopathy****A. Pavel^{1,2}, J. O'Toole^{1,2}, S. Mathieson^{1,2}, E. Dempsey^{1,2},
V. Livingstone^{1,2}, D. Murray^{1,2}, W. Marnane^{2,3}, G. Boylan^{1,2}**¹University College Cork, Department of Paediatrics and Child Health, Cork, Ireland²University College Cork, Infant Research Centre, Cork, Ireland³University College Cork, School of Engineering, Cork, Ireland**BACKGROUND AND AIMS**

Heart rate variability(HRV) has previously been assessed as a biomarker for brain injury and prognosis in neonates. Our aim was to develop HRV prediction models to assess early electroencephalography(EEG) background severity in neonatal hypoxic-ischaemic encephalopathy(HIE).

METHODS

This analysis included infants with HIE recruited as part of two European multi-centre cohort studies, with ECG-EEG monitoring before 12 hours of life. HRV features and EEG background were assessed using the earliest 1-hour epoch of ECG-EEG monitoring. HRV was expressed in time, frequency, complexity features. EEG background was graded from 0-normal, 1-mild, 2-moderate, 3-major abnormalities to 4-inactive. Clinical parameters within 6 hours of birth were collected (intrapartum complications, foetal distress,

gestational age, mode of delivery, gender, birth weight, Apgar at 1 and 5, assisted ventilation at 10 minutes). Using logistic regression analysis, prediction models for EEG severity were developed for HRV and clinical information, separately and combined.

RESULTS

From 101 infants, 46(46%) had normal-mild and 66(54%) had moderate-severe EEG background. The HRV model (AUROC 0.837(0.759-0.914), sensitivity 63.6%, specificity 91.3%, PPV 89.7%, NPV 67.7%) had similar performance with the clinical model (AUROC 0.836(0.759-0.914), sensitivity 87.3%, specificity 67.4%, PPV 76.2%, NPV 81.6%). However, combining HRV with clinical data improved performance, AUROC 0.895(0.832-0.958), sensitivity 74.6%, specificity 95.7%, PPV 95.3%, NPV 75.9%. Figure 1.

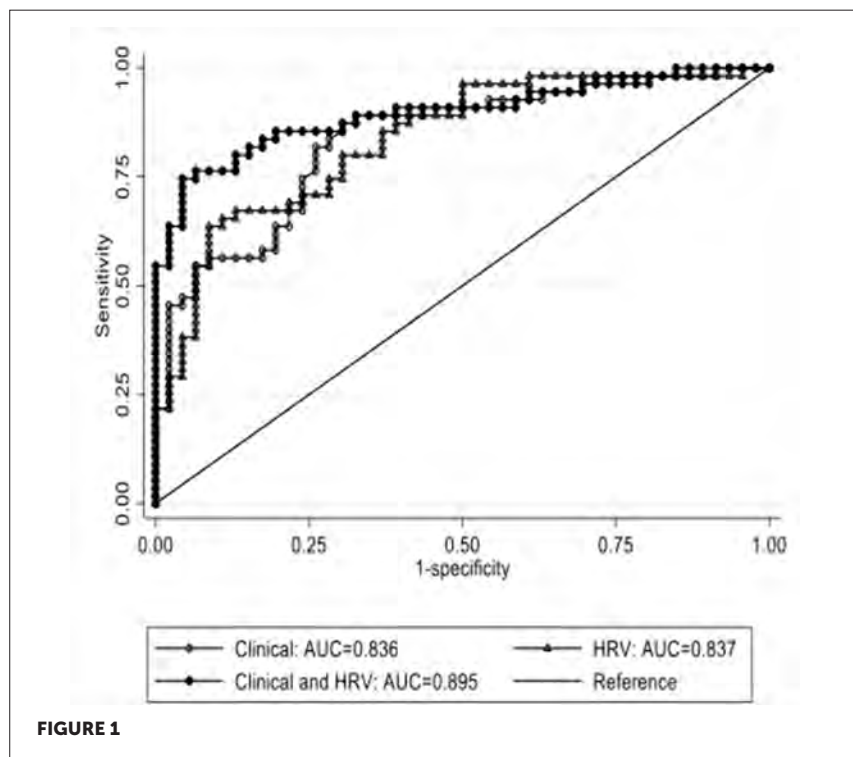

CONCLUSIONS

A combined model of HRV and clinical information accurately predicted EEG severity in HIE within hours of birth. This might be beneficial in helping to assess the severity of encephalopathy in settings where neonatal EEG monitoring is not available or feasible.

SO019 / #598**Short Oral Session****Short Oral Session 05: EAP - Paediatric potpourri
- There is something for everyone 01****08-10-2022 12:00 - 13:00****Crying, sleeping and feeding problems in early
childhood and mood disorders and partner
support in adulthood****J. Jaekel^{1,2,3}, K. Heinonen⁴, N. Baumann^{3,5}, A. Bilgin^{5,6}, R. Pyhala⁷,
C. Sorg⁸, K. Räikkönen⁷, D. Wolke⁹**¹University of Warwick, Psychology, Coventry, United Kingdom²University of Oulu, Psychology, Oulu, Finland³University of Leicester, Health Sciences, Leicester, United Kingdom⁴Tampere University, Psychology, Tampere, Finland⁵University of Warwick, Department of Psychology, Coventry, United Kingdom⁶University of Kent, Psychology, Kent, United Kingdom⁷University of Helsinki, Psychology, Helsinki, Finland⁸Technical University of Munich (TUM), Neuropsychiatry and Neuroimaging, Munich, Germany⁹University of Warwick, Department of Psychology, Stratford-upon-Avon, United Kingdom**BACKGROUND AND AIMS**

Multiple or persistent crying, sleeping, or feeding problems in early childhood (regulatory problems, RPs) are associated with emotional problems in adulthood. It remains unknown whether early RPs are associated with clinical disorders in adulthood. Our aim was to test (a) whether young adults who had early RPs are at increased risk of any mood disorder or lower social support compared with individuals without any RPs; and (b) whether social support from romantic partners is associated with protection from mood disorders.

METHODS

Data from two prospective geographically defined longitudinal studies in Germany ($n=297$) and Finland ($n=342$) were included ($N=639$; see Figure 1). RPs were assessed from 5 to 56 months with the same standardized parental interviews and neurological examinations. In young adulthood (24-30 years), mood disorders were assessed with diagnostic interviews and social support via self-report. Hypotheses were tested using logistic regressions, models were controlled for cohort membership, participant sex, assessment age, gestation at birth, and socioeconomic status.

RESULTS

Individuals with early RPs ($n=132$) were not at increased risk of any mood disorder (Odds ratio (OR) = 1.63, 95% CI=[0.95–2.81]), but they reported less social support from romantic partners than their peers without any RPs (OR=0.62 [0.41–0.95]). Social support from romantic partners was associated with a lower risk of any mood disorder in both groups (OR=0.54 [0.33–0.88]).

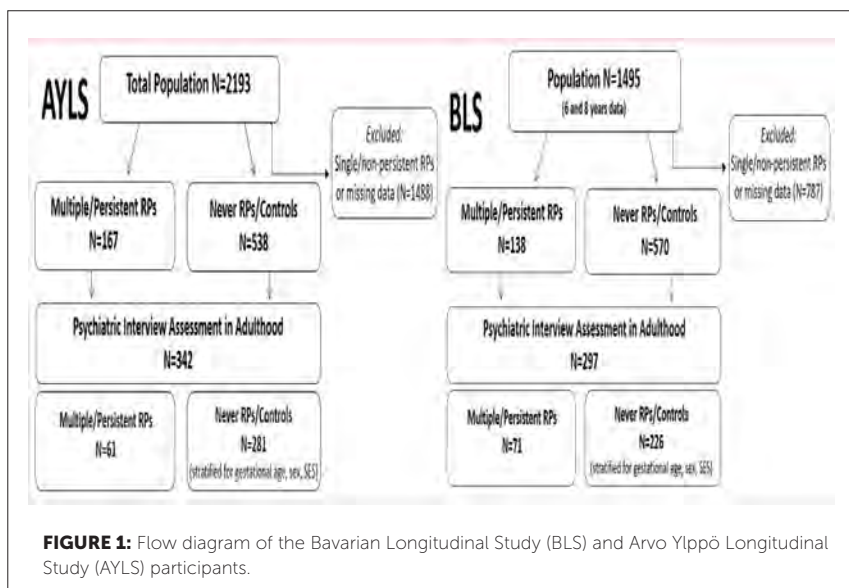

CONCLUSIONS

We did not find an increased risk for mood disorders among young adults with a history of early RPs. Social support from romantic partners can help protect from mood disorders.

SO020 / #850**Short Oral Session****Short Oral Session 05: EAP - Paediatric potpourri
- There is something for everyone 01****08-10-2022 12:00 - 13:00****The ripple effect; a regional multilevel teaching
innovation introduced via virtual mock
examinations****P. Parekh, N. Mediratta****Northwick Park Hospital, Paediatrics, London, United Kingdom***BACKGROUND AND AIMS**

Royal College of Paediatrics and Child Health (RCPCH) adapted to provide virtual examinations allowing training progression. Consequently, candidates applying for membership clinical examinations were required to modify their previously acquired skills and convey them through a screen. RIPPLE is a registrar-led regional teaching program. It's a cost-free contribution to medical education where peer-led teaching is primary. Over the pandemic, it runs as a six-week intensive block of virtual sessions adapted to the RCPCH blueprint. Paediatric specialists volunteer to teach on a virtual platform. We designed virtual mock examinations and invited six junior trainees as roleplayers for the stations. They gained insight into examination structure, virtual adaptations and mark schemes.

METHODS

26 candidates participated in RIPPLE for February 2022 intake. They were offered 1.5hour individualised mock examinations under strict timing. A development, extended clinical, communication and video station were conducted and marked. 22/26 were allocated slots and given personalised feedback and written scores.

RESULTS

100% candidates reported the mocks were of excellent relevance and quality. 90% found the timing excellent. 90% described the quality of feedback as excellent. 100% revealed that their chances of passing improved after attending the mocks. 100% of trainee roleplayers gained insight into the clinicals and confirmed that they were "more confident" and "felt passing is now an achievable target".

CONCLUSIONS

This program has been tailored to the needs of candidates so they're not disadvantaged during the pandemic. RIPPLE mock examinations were described as an excellent tool for passing membership examinations, with the benefit of providing training for prospective candidates.

SO021 / #884**Short Oral Session****Short Oral Session 05: EAP - Paediatric potpourri
- There is something for everyone 01****08-10-2022 12:00 - 13:00****Pediatrics organ donation in Iran****A. Alirezai¹, S. Dehghani^{2,3}, M. Latifi², E. Pourhossein², J. Brierley^{4*}**

¹Department of Nephrology, Shahid Modarres Hospital, Shahid Beheshti University of Medical Sciences, Tehran, Iran

²Organ Procurement Unit, Sina Hospital, Tehran University of Medical Sciences, Tehran, Iran

³Iranian Tissue Bank & Research Center, Tehran University of Medical Sciences, Tehran, Iran

⁴Consultant Intensive Care & Director of Paediatric Bioethics, Great Ormond St Hospital For Children, London, United Kingdom

BACKGROUND AND AIMS

Organ donation rates have been stable while the waiting list has grown rapidly, around the world. This article reviews pediatric organ donation in Iran.

METHODS

Patient data were gathered retrospectively from an organ donation by checklist including demographical data, CPR history, cause of brain death, blood group, the number of brain death confirmation, number of organs recovered, and the number of solid organs transplanted. All data were analyzed using SPSS16 software.

RESULTS

There were 349 deceased organ donors in Iran 2018-20 under the age of 18 years. 181 (51.9%) died from head trauma with a mean age of 11.58 ± 5.65

Pediatric donor demographics are shown in Table 1.

Table 1: Pediatric donor demographics during 2018-2020					
<i>Variable</i>		<i>2018</i>	<i>2019</i>	<i>2020</i>	<i>P value</i>
		<i>N= 128</i>	<i>N=125</i>	<i>N=96</i>	
		Mean ±SD	Mean ±SD	Mean ±SD	
Age		11.78 ±5.77	11.78 ±5.77	11.74 ±5.59	0.63
		Median (14)	Median (14)	Median (14)	
BMI		20.99 ±5.63	21.24 ±5.37	21.78 ±6.96	0.061
		Median (21.07)	Median (21.48)	Median (21.35)	
		<i>Frequency(%)</i>	<i>Frequency(%)</i>	<i>Frequency(%)</i>	
Gender	Female	41 (32)	42(33.6)	31 (32.3)	0.96
	Male	87 (68)	83 (66.4)	65(67.7)	
Blood Group	A	36 (28.1)	36 (28.8)	28 (29.1)	0.99
	AB	12 (9.4)	10 (8)	6 (6.3)	
	B	31 (24.3)	31 (24.8)	21 (21.9)	
	O	49 (38.2)	48 (38.4)	41 (42.7)	
Cause of Brain death	CVA	14 (10.96)	25(20)	16(16.8)	0.001
	Poisoning	5 (3.9)	5(4)	14(14.6)	
	Hypoxia	31 (24.21)	30 (24)	14(14.6)	
	Trauma	76(59.37)	64(51.2)	45(46.8)	
	Brain Tumor	2 (1.56)	1 (0.08)	7(7.2)	
	Smoking	2 (1.6)	2 (1.6)	2 (2.1)	0.94
	Blood Pressure	2 (1.6)	2(1.6)	0 (0)	0.17
	Diabetes	1 (0.8)	1 (0.8)	0(0)	0.42
	CPR	40 (31.3)	37 (29.6)	23(24)	0.47
	Shocked	6 (4.7)	2 (1.6)	2(2.1)	0.005

(median 14) years. Significant differences were found in relation to the cause of brain death ($P < 0.001$) and whether the child was in shock ($P < 0.005$). Significant differences were found in relation to the cause of brain death and gender ($P < 0.013$), BMI ($P < 0.001$), age $P < (0.001)$. 605 kidneys and 308 livers were transplanted from 349 donors, whilst at the same time on the waiting list, there were 326 patients who needed kidney transplants and 138 patients who needed liver transplants. (2018-2020).

CONCLUSIONS

Iran performs relatively well in paediatric organ donation, though due to a lack of specialist centers for children, and a lack of general acceptance

of paediatric donation by some professionals and families, many potential donors do not donate, meaning other children on the waiting list die. The establishment of specialized management centers for deceased donation in children under 18 years old might increase organ donation.

SO022 / #1422**Short Oral Session****Short Oral Session 06: ESPNIC - Family centered care****08-10-2022 12:00 - 13:00****Self-care in children and young people with complex chronic conditions: Scale development and content validity**

V. Biagioli¹, G. Manzi¹, A. Liburdi¹, R. Mascolo², V. Kania³, G. Spitaletta¹, O. Gawronski¹, R. Ricci¹, E. Vellone⁴, T. Grimaldi Capitello⁵, V. Vanzi⁶, G. Rocco⁷, M. Salata⁸, E. Tiozzo¹, I. Dall'Oglio¹

¹Bambino Gesù Children's Hospital, IRCCS, Professional Development, Continuing Education and Research Service, Rome, Italy

²Bambino Gesù Children's Hospital, IRCCS, Paediatric Semi-intensive Care Area/unit, Rome, Italy

³Bambino Gesù Children's Hospital, IRCCS, Paediatric Emergency Department, Rome, Italy

⁴University of Rome "Tor Vergata", Department of Biomedicine and Prevention, Rome, Italy

⁵Bambino Gesù Children's Hospital, IRCCS, Unit of Clinical Psychology, Rome, Italy

⁶Bambino Gesù Children's Hospital, IRCCS, University Department of Paediatrics, Rome, Italy

⁷Nursing Professional Order of Rome, Centre of Excellence For Nursing Scholarship, Rome, Italy

⁸Bambino Gesù Children Hospital IRCCS, Center For Pediatric Palliative Care, Rome, Italy

BACKGROUND AND AIMS

Self-care in children and young people with complex chronic conditions (CYPCCC) includes self-care maintenance (behaviours to maintain the stability of the condition), self-care monitoring (behaviours to monitor symptoms), and self-care management (response to symptoms). This study aimed to develop a new tool measuring self-care behaviours in CYPCCC and the contribution of their parents for different developmental ages.

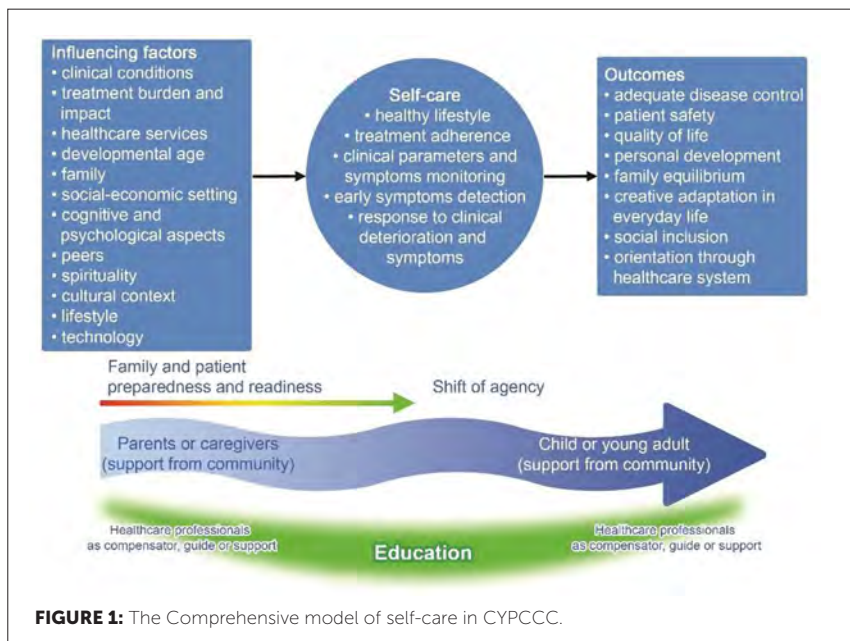

METHODS

The scale was developed according to COSMIN criteria and was based on the Comprehensive model of self-care in CYPCCC (Figure 1). An initial pool of items was developed based on the findings of a literature review on self-care instruments and a qualitative study exploring self-care in CYPCCC. First, we developed the version for CYPCCC aged 8-13 years. We asked 8 expert health professionals to rate the relevance of each item during semi-structured interviews to assess comprehensibility and comprehensiveness. The Item and Scale- Content Validity Indices (I-CVI, S-CVI) were calculated.

RESULTS

Overall, we developed 10 versions of the self-care scale (3 for patients, 3 proxy, and 4 for parents' contribution). The age groups were as follows: 6 months-7 years, 8-13 years, 14-18 years, 19-24 years. The 8-13 years scale

included 30 items: 12 for self-care maintenance, 12 for self-care monitoring, and 6 for self-care management. Item CVI ranged between 0.875 and 1; the SCVI was 0.929.

CONCLUSIONS

The self-care scale for CYPCCC aged 8-13 years showed good content validity. The measurement of self-care behaviours can be helpful to inform and design educational interventions to empower CYPCCC and their family.

SO023 / #1440**Short Oral Session****Short Oral Session 06: ESPNIC - Family centered care****08-10-2022 12:00 - 13:00****A qualitative study exploring self-care in children and young people living with complex chronic conditions****G. Spitaletta¹, V. Biagioli^{1*}, A. Liburdi¹, G. Manzi¹, F. Greco², R. Mascolo³, O. Gawronski¹, R. Ricci¹, E. Tiozzo¹, E. Vellone⁴, T. Grimaldi Capitello⁵, M. Salata⁶, M. Raponi⁷, I. Dall'Oglio¹**

¹Bambino Gesù Children's Hospital, IRCCS, Professional Development, Continuing Education and Research Service, Rome, Italy

²University of Rome "La Sapienza", Department of Communication and Social Research, Rome, Italy

³Bambino Gesù Children's Hospital, IRCCS, Paediatric Semi-intensive Care Area/unit, Rome, Italy

⁴University of Rome "Tor Vergata", Department of Biomedicine and Prevention, Rome, Italy

⁵Bambino Gesù Children's Hospital, IRCCS, Unit of Clinical Psychology, Rome, Italy

⁶Bambino Gesù Children Hospital IRCCS, Center For Pediatric Palliative Care, Rome, Italy

⁷Bambino Gesù Children Hospital IRCCS, Health Directorate, Rome, Italy

BACKGROUND AND AIMS

Promoting self-care in the pediatric population with complex chronic conditions is essential to support families, improve their quality of life and increase autonomy during the developmental age. This qualitative study aimed to explore the self-care behaviors in children and young people with complex chronic conditions and the contribution to self-care of the family and network of the context of life.

METHODS

We interviewed children aged 8+, young people, parents, siblings, healthcare professionals, and operators of life contexts using individual interviews or

focus groups. The enrollment took part from the departments of Bambino Gesù Children's Hospital. The enrollment, the signing of the informed consent, and the data collection were carried out remotely due to the pandemic. Transcripts were collected in a large size corpus which was processed with the Emotional Text Mining method.

RESULTS

We enrolled 104 participants (patients from 6 months to 24 years old). We determined nine clusters aggregated in five macro-thematic categories: self-care management, shift of agency, self-care support in the everyday life, daily life self-care, and treatment adherence.

CONCLUSIONS

The results show both the critical issues and the useful resources to identify, plan, and provide personalized services in different contexts. These resources include the implementation of home care with a case-manager nurse to improve the safety, the family's quality of life and decrease the admissions to emergency departments; the promotion of coping strategies and psychological support programs; the adjustment of the treatment regimen to the children/young people lifestyle.

SO024 / #1921**Short Oral Session****Short Oral Session 06: ESPNIC - Family centered care****08-10-2022 12:00 - 13:00****Impact of ethnicity on parental health outcomes after childhood critical illness: A mixed-methods systematic review****P.F. Poh^{1*}, M. Carey¹, J.H. Lee², J. Manning³, J. Latour¹**¹University of Plymouth, School of Nursing and Midwifery, Faculty of Health, Plymouth, United Kingdom²KK Women's and Children's Hospital, Children's Intensive Care Unit, Singapore, Singapore³Nottingham University Hospitals NHS Trust / University of Nottingham, Nottingham Children's Hospital / Centre For Children and Young People Health Research, Nottingham, United Kingdom**BACKGROUND AND AIMS**

The impact of ethnicity on parental outcomes following childhood critical illness is unclear. We aimed to develop an aggregated synthesis of existing evidence to understand the impact of ethnicity on parental outcomes post-PICU.

METHODS

Thirteen databases were searched up to November 2021. Two reviewers independently screened for papers describing ethnic differences in parental health outcomes after PICU discharge and extracted data on health outcomes and experiences. A convergent segregated mixed-methods approach was used.

RESULTS

Eight quantitative and eight qualitative studies were included. Among 1529 parents included, 1064 (72%) were White. Ethnic minority parents were less likely to participate, or complete, a long-term follow-up study. Mixed emotional

health outcomes were observed. Ethnic minority parents reported worst short-term outcomes for post-traumatic stress symptoms (17% White vs 36% Black, $p=.03$) and depression (mean (SD): 4.29 (3.47) vs 7.00 (5.87), $p<.05$) for up to 3 months after discharge and no differences in the prevalence for post-traumatic stress disorder at 6 months and beyond. No differences were reported for parental satisfaction between White and parents of minority ethnicity. From the qualitative data, five synthesized themes were identified: challenges in regaining normalcy; long-term psychological impact after PICU; coping behaviours; changes in relationships; and utilisation of health support and services.

CONCLUSIONS

Current evidence is limited in the inclusion and measurement of parental outcomes from different ethnicities post-PICU. Ethnic inclusiveness in long-term PICU research may aid the understanding of parental health outcomes and close the gap in health disparity.

SO025 / #2253**Short Oral Session****Short Oral Session 06: ESPNIC - Family centered care****08-10-2022 12:00 - 13:00****Family functioning of parents throughout the hospitalization of their chronic critically ill child****C. Grandjean^{1,2*}, M.-H. Perez², Z. Rahmaty¹, M.-C. Maître²,
A.-S. Ramelet^{1,2}**

¹Institute of Higher Education and Research in Healthcare, Faculty of Medicine and Biology, Lausanne University, Lausanne, Switzerland

²Pediatric Intensive Care Unit, Department Woman-mother-child, Lausanne University Hospital, Lausanne, Switzerland

BACKGROUND AND AIMS

When pediatric intensive care unit (PICU) hospitalization is prolonged or repeated, it can have a significant negative impact on the functioning of the whole family. As family health play a key role in the child's emotional and psychological adjustment and recovery, it is essential to focus on the wellbeing of families of a chronic critically ill child (CCI) to enhance child health outcomes. This study aimed to evaluate the functioning of families of CCI children throughout the PICU hospitalization and to identify associated factors of better family functioning.

METHODS

A prospective longitudinal study in parallel with a qualitative descriptive design were used. Data were collected during and after hospitalization, in families of a CCI child hospitalized in 8 PICUs in Switzerland, using self-reported questionnaire and a semi-structured interview.

RESULTS

A total of 199 mothers and fathers completed the questionnaire, and 31 interviews were performed. Family functioning was low during the first days of hospitalization ($M=64$ [$SD=17$]) and significantly lower after 30 days of hospitalization ($M=55$ [$SD=17$], $p=0.002$). Mothers reported more physical and emotional family dysfunction than fathers after PICU discharge. Parents reported the multi-faceted of family life: living in hospital, the roles of relatives, the parents as a couple, and the siblings. Pre-existing low child's quality of life (coef= 0.34 , $p<0.001$) and financial difficulties (coef= -9.36 , $p=0.037$) were associated with family dysfunction.

CONCLUSIONS

This study highlighted the importance of the consideration of the child and family as a system and the needs for implementing patient- and family-centered care approach.

SO026 / #2292**Short Oral Session****Short Oral Session 06: ESPNIC - Family centered care****08-10-2022 12:00 - 13:00****Virtual home care for premature and sick newborns: Parents' experiences and results from a feasibility pilot trial****H. Wataker^{1*}, E. Nestaas², R. Asbjørnsen³**¹*Vestfold Hospital Trust, Neonatal Intensive Care, Tønsberg, Norway*²*University of Oslo, Institute of Clinical Medicine, Oslo, Norway*³*Vestfold Hospital Trust, Dept of Research and Innovation, Tønsberg, Norway***BACKGROUND AND AIMS**

Premature and sick new-borns often experience long hospital lengths of stay. For some families, this causes logistic challenges when separated from the family at home. Vestfold Hospital Trust introduced Virtual Home Care (VHC), allowing the infant and parents to undertake the last part of the hospital follow-up at home. VHC utilizes digital technology for remote clinical follow-up.

AIMS

This study aimed to evaluate preliminary results with respect to parental confidence, usability, and feasibility of virtual support for neonatal homecare.

METHODS

This pilot study includes 22 of the 25 families with infants >34 weeks that received VHC between November 2021 and April 2022. The group had access to a digital platform for reporting measurements made at home. The platform automatically transferred measurements to the infant's hospital journal. In addition,

they received video consultations. The groups had access to tailored information to support self-management. The families completed two questionnaires four weeks after completing the VHC follow-up.

RESULTS

Parents reported high confidence using the VHC. Readmission rates were low 2/22 (7%). Preliminary results also show high breastfeeding rate for the premature group, 80 % of those with gestational age 32-36 weeks were breastfed. The digital platform was according to the parents easy to use, they were satisfied with the digital consultations.

CONCLUSIONS

VHC can provide safe and seamless care to parents of premature and sick newborns. The parents preferred remote care as an alternative to extended hospital stays and regular discharge. Premature infants using VHC had high rates of breastfeeding.

SO027 / #816**Short Oral Session****Short Oral Session 06: ESPNIC - Family centered care****08-10-2022 12:00 - 13:00****Do we really need guidelines at the limit of viability? A mixed methods approach to study the care providers' and prematurely born adults' perspective****L. De Proost^{1*}, A. De Boer², E. Verhagen³, I. Reiss⁴, M. Hogeveen⁵, R. Geurtzen⁵, J. Verweij²**¹Erasmus MC, Medical Ethics, Neonatology and Obstetrics, Rotterdam, Netherlands²LUMC, Obstetrics, Leiden, Netherlands³UMCG, Pediatrics, Groningen, Netherlands⁴Erasmus MC Sophia Children's Hospital, University Medical Center Rotterdam, Department of Pediatrics, Division of Neonatology, Rotterdam, Netherlands⁵Radboudumc, Neonatology, Nijmegen, Netherlands**BACKGROUND AND AIMS**

There is international variation with respect to treatment guidelines, decision-making and counseling at the limit of viability. Guidelines may be based on (1) gestational age (GA), (2) GA 'plus' other factors such as weight, sex, antenatal corticosteroids, (3) or the estimated prognosis. It could also be argued that (4) no guideline is needed at all. In the Netherlands, there was always a GA-based guideline. The current guideline dates back to 2010 and is currently under revision. The aim of this study is to identify the views of (I) health care professionals (mostly physicians and nurses) (HCPs) and (II) prematurely born adults on treatment guidelines at the limit of viability.

METHODS

(I) A questionnaire was sent to HCPs. (II) Focusgroup studies were conducted with prematurely born adults. The data are currently being analyzed by two researchers.

RESULTS

(I) 769 questionnaires were returned (38%), of which 297 were complete. The majority of respondents (73%) preferred a GA-plus guideline, over a prognosis-based (17%), a GA-based (6%) or no guideline (3%). Differences in treatment were considered acceptable when based upon parental values and or preferences, but not when they were based upon the physician or the hospital. (II) Four focusgroups were conducted with 5-6 participants each, born between 24 and 30 weeks GA in the period 1965-2002. Initial analysis shows particular support for a GA-plus guideline.

CONCLUSIONS

Guideline preference for Dutch HCPs and prematurely born adults seems similar and is based upon GA plus other prognostic factors. This insight is important for the current revision of the guideline.

SO028 / #358**Short Oral Session****Short Oral Session 07: ESPR - Perinatal epidemiology****08-10-2022 12:00 - 13:00****Preterm birth and ophthalmological impairments at 51/2 years: Epipage-2 cohort study****T. Chapron^{1,2*}, V. Pierrat^{1,3}, G. Caputo², M. Letouzey^{1,4},
E. Kermorvant⁵, A. Barjol², G. Le Meur⁶, V. Benhamou¹,
L. Marchand-Martin¹, P.Y. Ancel¹, H. Torchin^{1,7}**

¹University of Paris, INSERM, INRAE, Cress, Obstetrical Perinatal and Pediatric Epidemiology Research Team, Epopé, Paris, France

²Rothschild Foundation Hospital, Pediatric Ophthalmology Department, PARIS, France

³CHU Lille, Department of Neonatal Medicine, Lille, France

⁴Poissy Saint Germain Hospital, Department of Neonatal Medicine, Poissy, France

⁵AP-HP, Necker-Enfants malades University Hospital, Department of Neonatal Medicine, Paris, France

⁶CHU Nantes, Clinique Ophtalmologique, Nantes, France

⁷Cochin-Port Royal Hospital, FHU PREMA, APHP, Department of Neonatal Medicine, Paris, France

BACKGROUND AND AIMS

To report prevalence of visual and oculo-motor impairments at 5½ years among children born preterm in 2011.

METHODS

Design: Population based cohort study, EPIPAGE-2. Setting: France,. Patients: 4441 children aged 5½ born at 24-34 Weeks' Gestation (WG); Interventions: Medical examination and parental report Main outcome measures: Imputed prevalence of refractive errors, strabismus and binocular visual acuities.

RESULTS

Among 4441 children, 2718 (weighted-percentage 58.7%) were clinically assessed. Refractive errors were reported in 43.1% (95% confidence interval 37.6-48.4), 35.2% (32.7-37.6) and 28.4% (25.0-31.8) of children born at 24-26, 27-31, 32-34 WG ($p < .001$), respectively; Strabismus rates were respectively 19.5% (14.6-24.4), 14.8% (12.9-16.7), 8.3% (6.2-10.4) ($p < .001$). Severe/moderate visual deficiencies (visual acuity $< 3.2/10$) were present in 1.7% (0.2-3.3) of children born at 24-26WG and in less than 1% for other groups. A sub-optimal visual acuity (5/10-6/10) was measured for 40.6% (35.3-45.8) of children born at 24-26WG, 35.8% (33.5-38.1) at 27-31WG and 33.7% (30.4-37.0) at 32-34WG, 59.7% (53.9-65.4) in term-born children. Cerebral Palsy at age 5^{1/2} was strongly associated with visual deficiencies and sub-optimal visual acuity. Associations between ROP during neonatal period and ophthalmological impairments were not observed.

CONCLUSIONS

In this large cohort of preterm born children we report high prevalence of refractive errors and strabismus even in children born very and moderately preterm, supporting a specific attention for these children. High prevalences of suboptimal visual acuity, even with glasses, at the age of reading and writing acquisitions could represent an additional challenge for these children.

SO029 / #834**Short Oral Session****Short Oral Session 07: ESPR - Perinatal epidemiology****08-10-2022 12:00 - 13:00****Estimates of how changes in the number of infants treated in a neonatal intensive care unit affects mortality and major morbidity for very preterm infants****C. Phibbs^{1*}, M. Passarella², S. Schmitt³, A. Martin², S. Lorch²**

¹Palo Alto VA Healthcare System, Health Economics Resource Center, Menlo Park, United States of America

²Children's Hospital of Pennsylvania, Neonatology, Philadelphia, United States of America

³Stanford University School of Medicine, Pediatrics, Stanford, United States of America

BACKGROUND AND AIMS

Numerous studies have demonstrated lower mortality and morbidity when high-risk infants deliver at a hospital with a high-level and/or high-volume neonatal intensive care unit (NICU). However, many high-risk infants do not deliver in such settings. The aim was to carefully evaluate the relationship between volume of very preterm infants (GA < 32 weeks (VPT)) and mortality and major morbidity.

METHODS

Retrospective cohort study of all VPT infants born in California, Pennsylvania, South Carolina, and Missouri from 1995–2015 using birth certificates linked to maternal and infant hospital administrative records (N=218,206). Multivariable logistic regression determined the association between hospital annual VPT

deliveries and mortality or mortality plus major morbidity (BPD, NEC, IVH, ROP) after adjusting for demographics, clinical risks, and a hospital fixed effect.

RESULTS

41.1% of VPT infants delivered at NICUs with volume < 50 VPT/year, while 26.7% delivered at a NICU caring for at least 100 VPT/year. Compared to NICUs with a VPT volume of at least 100, risk-adjusted mortality was 10-30% higher ($p < 0.05$) at hospitals with < 50 VPT/year, while mortality plus major morbidity was 10-60% higher ($p < 0.01$) for all NICUs with VPT volume < 100; the added risk increasing as volume decreased for both outcomes.

CONCLUSIONS

VPT infants have improved rates of both survival and the combined outcome of mortality or major morbidity when they deliver at hospitals with higher volume NICU. Volume thresholds vary by outcome. These more precisely estimated effects of NICU volume will help guide policy on the regionalization of NICUs.

SO030 / #1240**Short Oral Session****Short Oral Session 07: ESPR - Perinatal epidemiology****08-10-2022 12:00 - 13:00****Effects of gestational age from 32 to 41 weeks at birth on long-term neurodevelopmental outcomes – A Swedish national population-based study****A. Mitha^{1,2,3*}, R. Chen¹, N. Razaz¹, S. Johansson¹, O. Stephansson¹, M. Altman¹, J. Bolk^{1,4}**

¹Karolinska Institutet, Department of Medicine Solna, Division of Clinical Epidemiology, Stockholm, Sweden

²CHU Lille, Department of Emergency Medicine, Pediatric and Neonatal Intensive Care Transport Unit, Lille, France

³Université de Paris, Epidemiology and Statistics Research Center/cress, Inserm, Inra, Paris, France

⁴Sachs' Children and Youth Hospital, Det of Clinical Science and Education, Stockholm, Sweden

BACKGROUND AND AIMS

Moderate and late preterm children comprise the largest group of preterm children. To assess long-term neurodevelopmental outcomes among children born moderately (32-33 weeks) and late (34-36 weeks) preterm, early term (37-38 weeks) and late term (41 weeks) compared with full-term children (39-40 weeks).

METHODS

This nationwide population-based cohort study included 1 281 690 non-malformed liveborn singleton infants from 32 to 41 weeks between 1998 and

2012 in Sweden. Adjusted hazard ratios (aHRs) were calculated for motor and cognitive developmental impairments, epileptic disorders, hearing and visual disabilities diagnosed up to 16 years of age.

RESULTS

A total of 5 899 children were diagnosed with motor morbidity, 27 371 with cognitive, 11 870 with epileptic, 20 393 with hearing, and 19 700 with visual morbidity during follow-up. As compared with children born at 39-40 weeks, aHRs of respectively moderate and late preterm children were higher for: motor morbidity 3.09 (2.68 to 3.56), 1.71 (1.51 to 1.94); cognitive morbidity 1.43 (1.30 to 1.57), 1.30 (1.22 to 1.39); epileptic morbidity 1.52 (1.31 to 1.75), 1.18 (1.07 to 1.31); hearing morbidity 1.36 (1.21 to 1.53), 1.11 (1.02 to 1.20); and visual morbidity 1.61 (1.44 to 1.80), 1.39 (1.28 to 1.50). Risks for adverse neurodevelopmental outcomes were highest at 32 weeks, and gradually declined until 41 weeks.

CONCLUSIONS

Moderate and late preterm children are at increased risks of adverse neurodevelopmental outcomes. Our findings reinforce the need of preventing preterm delivery, and may help professionals and families to a better risk assessment.

SO031 / #1389**Short Oral Session****Short Oral Session 07: ESPR - Perinatal epidemiology****08-10-2022 12:00 - 13:00****Risk factors associated with movement difficulties and cerebral palsy among five-year-old children born extremely preterm in a European cohort****A. Aubert¹, R. Costa², S. Johnson³, U. Aden⁴, M. Cuttini⁵, C. Koopman-Esseboom⁶, H. Varendi⁷, M. Zemlin⁸, V. Pierrat⁹, J. Zeitlin¹**

¹Université Paris Cité, Inserm, INRAE, Centre for Research In Epidemiology and Statistics (cress), Obstetrical Perinatal and Pediatric Epidemiology Research Team, Epopé, Paris, France

²Universidade do Porto, Epiunit, Instituto De Saúde Pública, Porto, Portugal

³University of Leicester, Department of Health Sciences, Leicester, United Kingdom

⁴Karolinska Institute, Dept of Women's and Children's Health, Stockholm, Sweden

⁵Bambino Gesù Children's Hospital, IRCCS, Clinical Care and Management Innovation Research Area, Rome, Italy

⁶University Medical Center Utrecht, Neonatology, Utrecht, Netherlands

⁷University of Tartu, Tartu University Hospital, Tartu, Estonia

⁸Saarland University Hospital, Department of General Pediatrics and Neonatology, Homburg, Germany

⁹University of Paris, INSERM, INRAE, Cress, Obstetrical Perinatal and Pediatric Epidemiology Research Team, Epopé, Paris, France

BACKGROUND AND AIMS

Extremely preterm born children (EPT, <28 weeks' gestational age (GA)) have higher risks of motor impairment than their term-born peers. Cerebral palsy (CP) affects about 10% of children and movement difficulties (MD) are common among children without CP. These conditions have different aetiologies and less is known about the clinical risk factors for MD without CP. This study aimed to compare the perinatal, neonatal and social characteristics of children with CP and with non-CP significant MD.

METHODS

Data on children born EPT and followed-up at five years in a European cohort from 11 countries (N=1,021) were used. We included children with a CP diagnosis (n=100) and with non-CP significant MD (Movement Assessment Battery for Children-2nd edition $\leq 5^{\text{th}}$ percentile; n=224). Children without MD ($>15^{\text{th}}$ percentile; n=366) served as a comparison group. Associations with clinical and social risk factors were assessed using multinomial logistic regression.

RESULTS

Having a young mother, low GA and male sex were similarly associated CP and significant MD, when compared to children without MD. Lower maternal education and birthweight $<3^{\text{rd}}$ percentile were associated with significant MD only, while Apgar <7 was associated with CP only. Severe brain lesions were major risk factors for CP, which was also associated with other severe neonatal morbidities, whereas these were less or not associated with significant MD. Bronchopulmonary dysplasia increased risks for both outcomes by a comparable magnitude.

CONCLUSIONS

CP and non-CP MD have different perinatal and neonatal risk factor profiles, with fewer perinatal risk factors for non-CP MD.

SO032 / #1231**Short Oral Session****Short Oral Session 07: ESPR - Perinatal epidemiology****08-10-2022 12:00 - 13:00****Early skin-to-skin contact and neurodevelopmental outcome at 5 years in very preterm infants: the epipage-2 cohort study****A. Mitha^{1,2*}, L. Marchand-Martin², J.-C. Rozé³, P. Kuhn⁴, I. Leray⁴, M. Kaminski², V. Pierrat^{2,5}**

¹CHU Lille, Department of Emergency Medicine, Pediatric and Neonatal Intensive Care Transport Unit, Lille, France

²Université de Paris, Epidemiology and Statistics Research Center/cress, Inserm, Inra, Paris, France

³Nantes University Hospital, Department of Neonatal Medicine, Nantes, France

⁴University of Strasbourg, Department of Neonatal Medicine, Strasbourg, France

⁵CHU Lille, Department of Neonatal Medicine, Lille, France

BACKGROUND AND AIMS

Long-term effects on neurodevelopment of Skin-to-Skin Contact (SSC) for very preterm infants are still debated. To evaluate association of early SSC on neurodevelopmental outcomes at 5^{1/2} years among very preterm infants.

METHODS

Using the national population based EPIPAGE-2 cohort, exposition to SSC during the first week of life was evaluated by a propensity score analysis based on individual and unit characteristics with inverse probability of treatment weighting approach. Outcomes were full-scale-intelligence-quotient (Wechsler Preschool and Primary Scale of Intelligence, 4th edition), behavior (strengths and difficulties questionnaire) and social communication difficulties (social communication questionnaire) among 2 561 infants born between 24 and 31 weeks and survivors at 5^{1/2} years.

RESULTS

Among survivors, 1 581 (61.8%) were exposed to SSC during the first week of life (range among neonatal units from 15 to 75%). At 5^{1/2} years, SSC was associated with an increased full-scale-intelligence-quotient +1.8 points (+0.0 to +3.6); and with trends for lower scores of behavioral difficulties -0.4 points (-1.1 to +0.4) and social communication difficulties -0.3 points (-0.8 to 0.2).

CONCLUSIONS

Early SSC during the first week of life among very preterm infants was associated with increased full-scale-intelligence-quotient at 5^{1/2} years. Variability of practices among units deserves attention. Further evaluation of the dose-effect is needed.

SO033 / #889**Short Oral Session****Short Oral Session 07: ESPR - Perinatal epidemiology****08-10-2022 12:00 - 13:00****Association of antibiotics exposure during pregnancy with childhood atopic diseases****M.-C. Lin****Children's Medical Center, Taichung Veterans General Hospital, Children's Medical Center, Taichung, Taiwan***BACKGROUND AND AIMS**

Antibiotics are commonly used medication during pregnancy. Although they may be necessary to be used, they can change both the microbiota in both mothers and children. The worldwide incidences of childhood atopic diseases increase in recent decades. Our aim of this study was to investigate the association of antibiotics exposure during pregnancy and the occurrence of atopic diseases in children.

METHODS

This is a cohort study. The data source was Taiwan's National Health Insurance Research Database (NHIRD). From 2004 to 2010, after excluded multiple delivery (n= 15540), preterm delivery (n= 68,779) and death before age of 5 years (n=2,368), a total of 906,942 children were included in the final study population. Those mothers were divided to antibiotic exposure group (n=484,202) and non-exposure group (n=422,740). Those children were followed up at least 6 years after birth. Multiple logistic regression models was used to adjust potential confounding factors including maternal age, mode of delivery, maternal comorbidity, maternal allergic disease, pregnancy-related complication, and neonatal gender.

RESULTS

Antibiotic exposure during pregnancy was associated with higher risk of childhood asthma (1.08, 95% CI 1.07 to 1.09), allergic rhinitis (1.10, 95% CI 1.09 to 1.11) and atopic dermatitis (1.12, 95% CI 1.12 to 1.13). To analyze the risk according to the stratifications of antibiotics exposure times revealed a dose-dependent effect.

CONCLUSIONS

Antibiotic exposure during pregnancy might be associated with childhood atopic diseases. The causal-relationship was further strengthened by the dose-dependent effect.

SO034 / #1032**Short Oral Session****Short Oral Session 08: ESPNIC - Neonatal ventilation****09-10-2022 12:30 - 13:30****Oxygenation and lung aeration at diagnosis and overtime in RDS and TTN****L. Pezza¹, N. Yousef¹, B. Loi^{1,2}, R. Centorrino^{1,2}, S. Shankar-Aguilera¹, V. Sartorius¹, D. De Luca^{1,2}, G. Regiroli^{1*}**

¹A.Beclere* Medical Center, Paris Saclay University Hospital, APHP – Paris, Division of Pediatrics and Neonatal Critical Care, Clamart, France

²Paris Saclay University, South Paris Medical School, Paris, France

BACKGROUND AND AIMS

Respiratory Distress Syndrome (RDS) and Transitory Tachypnea of the Newborn (TTN) are common types of neonatal respiratory failure. Our aim was to evaluate the evolution of overtime oxygenation and ultrasound-assessed lung aeration in neonates affected by RDS or TTN.

METHODS

A single-center prospective cohort study was carried out in an academic tertiary NICU. Neonates were eligible if diagnosed with TTN or RDS according to Montreux consensus criteria (1). Lamellar bodies in gastric aspirate were counted. The neonatal Lung Ultrasound Score (LUS),(2) ventilation data and blood gas parameters were recorded at the admission and then at H6, H12, H24, H72 of life, or post surfactant administration (if any). Data were analyzed with multivariate RM-ANOVA.

RESULTS

69 neonates with RDS and 58 with TTN were included. Basic population data are resumed in Figure 1. Lamellar body count was similar between the two cohorts ($p=0.540$). Conversely, at admission and overtime, LUS and

	RDS (69)	TTN (58)	<i>p</i>
Gestational Age (weeks)	29.4 (3.5)	32.6 (3.4)	< 0.001
Birth weight (g)	1403 (709)	1914 (806)	<0.001
Male sex	37 (53%)	37(64%)	0.329
Prenatal steroids	49(71%)	40(69%)	0.854
Cesarian Section	42(61%)	36(62%)	0.890
Birth lactates (mmol/L)	3.6 (2.2)	3.6 (2.1)	0.457
5' Apgar Score	8 [7-9]	9 [8-10]	0.0026
Surfactant	60(87%)	0(0%)	<0.001
Lamellar bodies	24 [14-44]	28[14.5-54]	0.540
LUS	10.5 (2.3)	4.9 (2.9)	<0.001

FIGURE 1: Basic population data.

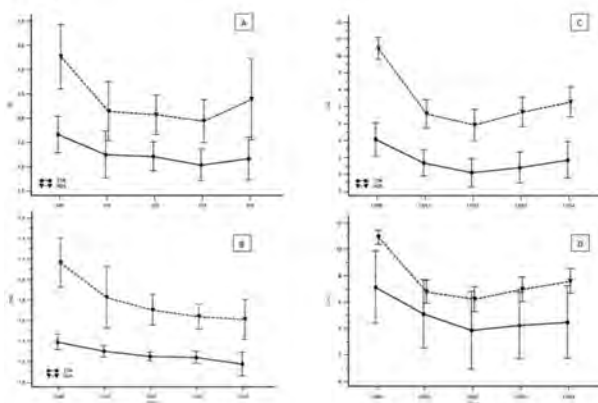

FIGURE 2: Oxygenation and lung aeration through time in neonates with RDS and TTN.

Oxygenation is expressed as Oxygenation Index (OI, panel **A**) and Oxygen Saturation Index (OSI, panel **B**); circles and triangles represent mean values, T-bars indicate 95% confidence interval. Lung aeration assessed by lung ultrasound score (LUS) in the whole study population (panel **C**) and subgroup analysis on patients with RDS (panel **D**) who received surfactant (dashed line) and who didn't receive surfactant (continuous line); circles and triangles represent mean values, T-bars indicate 95% confidence interval.

oxygenation metrics were significantly worse in RDS than in TTN (all $p < 0.001$; Fig. 2A, B and C). Within the RDS subgroup, neonates needing surfactant had a LUS significantly higher than neonates who did not need surfactant replacement ($p < 0.001$, Fig. 2D). Within the same subgroup oxygenation index ($p = 0.238$), and oxygen saturation index were not significantly different between neonates requiring surfactant or not whereas LUS ($p = 0.09$).

CONCLUSIONS

LUS remains a useful tool to discriminate RDS from TTN and the need of surfactant replacement. Oxygenation index and oxygen saturation index showed significant differences between RDS and TTN.

SO035 / #921

Short Oral Session

Short Oral Session 08: ESPNIC - Neonatal ventilation

09-10-2022 12:30 - 13:30

Prone positioning of neonates with different types of lung injury: Effect on respiratory function and hemodynamics

B. Loi^{1,2}, G. Regiroli^{1*}, R. Centorrino^{1,2}, D. De Luca^{1,2}

¹A.Beclere* Medical Center, Paris Saclay University Hospital, APHP – Paris, Division of Pediatrics and Neonatal Critical Care, Clamart, France

²Paris Saclay University, South Paris Medical School, Paris, France

BACKGROUND AND AIMS

Investigate the physiological respiratory and hemodynamic effects of prone positioning in neonates with different types of lung injury. We hypothesize that prone positioning may improve respiratory function.

METHODS

This is a prospective, quasi-randomized, observational, crossover, physiologic cohort study. Over a 12h-period, infants were allocated to switch between supine and prone position every 6h. We analyzed data of two timepoints (T0 and T6h) from patients who switched from supine to prone (SP-period) and from prone to supine (PS-period). Enrolled cases were: severe restrictive pattern (according to Montreux definition (NARDS), n=55); mild restrictive pattern (preterm recovering after surfactant replacement, n=56); mixed pattern (evolving BPD (CPIP), n=50). For each timepoint were measured: lung aeration (by semiquantitative Lung Ultrasound Score), SpO₂, transcutaneous PtcO₂/PtcCO₂, cardiac output (by electrical cardiometry), mean arterial

pressure (MAP), heart rate and perfusion index. Data were analyzed with multivariate RM-ANOVA considering as covariates the type of lung injury and the initial patients' position.

RESULTS

In the whole population, lung aeration and gas exchange measurements significantly improved with pronation. Cardiac output, perfusion index, MAP and HR changes with pronation although remaining within physiological values (Fig.1). The type of lung injury is significantly associated with all measured

Fig 1	From prone to supine (PS-period)						From supine to prone (SP-period)					
	P-T0	P-T6h	p	S-T0	S-T6h	p	S-T0	S-T6h	p	P-T0	P-T6h	p
LIUS	11.7±3.4	12.5±3.6	< .001	10.8±3.6	9.1±2.5	< .001	10.6±2.7	8.6±1.8	< .001	9.9±1.9	10.8±2.1	< .001
pl IIS	19.1±6.1	15.5±5.3	< .001	16.3±5.0	18.2±3.7	< .001	16.9±5.8	18.7±3.6	< .001	17.0±4.2	14.1±3.3	< .001
PtcCO ₂ (mmHg)	52.5±13.5	42.3±7.3	< .001	45.3±4.1	48.5±3.3	< .001	52.3±10.2	57.9±8.4	< .001	53.7±14.2	49.9±14.4	< .001
Oxygen Index	14.8±10.8	8.6±5.5	< .001	11.2±7.6	13.5±8.7	< .001	11.2±9.4	13.7±11.3	< .001	11.9±10.1	8.2±7.0	< .001
PaO ₂ /FiO ₂	135±63	211±71	< .001	155±48	126±38	< .001	114±65	120±55	< .001	139±64	194±76	< .001
SpO ₂ /FiO ₂	293±106	331±108	< .001	289±87	250±76	< .001	329±102	297±109	< .001	339±105	382±106	< .001
Oxygen SpO ₂ Index	6.2±4.2	5.4±3.7	< .001	6.0±3.8	6.8±4.2	< .001	4.5±3.6	5.2±4.0	< .001	4.4±3.5	3.8±3.2	< .001
PA-PtcO ₂	161±121	125±109	< .001	154±106	185±110	< .001	126±93	144±102	< .001	123±89	90±77	< .001
PtcO ₂ /PA	0.28±0.15	0.41±0.16	< .001	0.39±0.11	0.24±0.09	< .001	0.30±0.15	0.26±0.15	< .001	0.29±0.15	0.42±0.17	< .001
CO (ml/min)	0.41±0.17	0.32±0.12	< .001	0.37±0.13	0.44±0.15	< .001	0.38±0.11	0.46±0.16	< .001	0.44±0.16	0.35±0.08	< .001
Perfusion Index	0.58±0.29	0.55±0.28	< .001	0.56±0.20	0.59±0.20	< .001	0.49±0.18	0.41±0.07	< .001	0.41±0.06	0.39±0.06	< .001
MAP (mmHg)	43±11	39±9	< .001	43±9	48±6	< .001	40±8	49±5	< .001	47±5	45±4	< .001
Heart rate (bpm)	147±17	153±14	< .001	148±12	145±11	< .001	126±102	297±109	< .001	156±11	158±9	< .001

FIGURE 1

	RDS			NARDS			CPIP		
	PPΔ _{0-6h}	SSΔ _{0-6h}	p	PPΔ _{0-6h}	SSΔ _{0-6h}	p	PPΔ _{0-6h}	SSΔ _{0-6h}	p
LIUS	3.0±0.2	-3.7±0.3	< .001	5.0±0.3	-1.1±0.3	< .001	1.7±0.4	-1.9±0.5	< .001
PtcCO ₂ (mmHg)	6.9±1.0	-3.7±0.2	< .001	11.9±1.3	-3.0±0.2	< .001	11.1±0.9	-3.3±0.1	< .001
Oxygen Index	1.2±0.3	-1.0±0.1	< .001	10.1±1.5	-3.1±0.2	< .001	4.4±1.3	-2.5±0.2	< .001
PaO ₂ /FiO ₂	-50.5±11.7	29.9±1.4	< .001	-82.8±11.0	25.3±2.4	< .001	-95.8±20.7	38.1±2.9	< .001
SpO ₂ /FiO ₂	-23.4±4.4	39.2±1.2	< .001	-38.2±3.8	30.1±3.4	< .001	-59.7±5.4	51.3±3.4	< .001
CO (ml/min)	0.06±0.0	-0.06±0.0	< .001	0.11±0.0	-0.08±0.0	< .001	0.07±0.0	-0.07±0.0	< .001
Perfusion Index	0.02±0.0	-0.04±0.0	< .001	0.03±0.0	-0.03±0.0	< .001	0.02±0.0	-0.04±0.0	< .001
MAP (mmHg)	1.5±0.9	-5.9±0.3	< .001	4.2±0.4	-4.2±0.5	< .001	4.2±0.7	-3.7±0.9	< .001
Heart rate (bpm)	-4.7±0.6	3.2±0.3	< .001	-6.8±0.7	2.3±0.3	< .001	-7.2±0.7	2.1±0.3	< .001

FIGURE 2

parameters (all $p < 0.001$). Effects are more pronounced in NARDS (Fig.2). The values of most parameters are also significantly associated with initial position.

CONCLUSIONS

Prone positioning significantly improves lung aeration and gas exchange. Effects are more evident in NARDS but are also occurring in neonates with RDS or CPIP. Prone positioning causes no significant hemodynamic changes.

SO036 / #993**Short Oral Session****Short Oral Session 08: ESPNIC - Neonatal ventilation****09-10-2022 12:30 - 13:30****The instrumental dead space: A glass ceiling for extremely low birth weight infants?****C. Danan^{1*}, L. Caeymaex¹, C. Jung², M. Tauzin¹, G. Dassieu¹, F. Decobert¹**¹CHI Creteil, Nicu, Creteil, France²CHI Creteil, Clinical Research Center, Creteil, France**BACKGROUND AND AIMS**

When ventilating extremely low birth weight infants (ELBW), clinicians face the problem of instrumental dead space (IDS). Since IDS is often larger than tidal volume (V_T), more aggressive ventilation is necessary to achieve CO_2 clearance. Continuous tracheal gas insufflation (CTGI) can wash out CO_2 from IDS and might have an impact on O_2 and water vapor transport. The objectives were to test the impact of IDS on the transport of CO_2 , O_2 and humidity and the ability of CTGI to remedy the IDS problem in ELBW.

METHODS

A lung test was ventilated using variable pressure levels to obtain a V_T from 1.5 to 5 ml. To test CO_2 clearance, pressure was adjusted to obtain an identical $EtCO_2$ at the lung test exit. Time to go from a FiO_2 of 21% to 95% in the lung-test and backward was measured. Humidity was measured at the Y-piece and in the lung test. Measures were done for each V_T , with and without CTGI.

RESULTS

A 3ml V_T was the threshold below which CO_2 , O_2 and humidification were affected without CTGI. CTGI allowed a reduction of the V_T necessary to maintain the same $EtCO_2$ and a reduction of the time to reach the desired FiO_2 . The relative humidity dropped between the Y-piece and the lung-test without CTGI and was restored with CTGI.

CONCLUSIONS

Reduction of IDS seems mandatory for CO_2 , O_2 and water vapor transport. CTGI improved CO_2 clearance, time to reach desired FiO_2 and airway humidification and, thus, may be an interesting lung-protective strategy in ELBW.

SO037 / #1760**Short Oral Session****Short Oral Session 09: ESPNIC****09-10-2022 12:30 - 13:30****Premasim using in-situ simulation to decrease the risk of hypothermia in the extremely preterm infant****R. Moreau¹, N. Yousef^{1*}, A. Harlaux¹, N. Poteaux², E. Letamendia¹, D. De Luca¹**

¹A.Beclere* Medical Center, Paris Saclay University Hospital, APHP – Paris, Division of Pediatrics and Neonatal Critical Care, Clamart, France

²University of Strasbourg, Faculté De Sciences De L'education, Strasbourg, France

BACKGROUND AND AIMS

The care of the extremely low gestational infant (ELGA) is challenging, and requires a high level of skill and teamwork. Hypothermia and the time to surfactant administration after birth are both associated with outcomes in the ELGA. We wished to evaluate the impact of a targeted multiprofessional in-situ simulation program (PREMASIM) focusing on the "Golden Hour" (the first hour after admission to the NICU) on the rates of hypothermia and time to surfactant administration.

METHODS

A monocentric, retrospective, mixed-methods study to evaluate the impact of in-situ simulation training focusing on the "Golden Hour" on hypothermia and the time to surfactant administration after birth. Main QI was patient temperature at the end of the "Golden Hour". Secondary outcome was time to surfactant administration.

RESULTS

130 team members underwent interprofessional in-situ simulation targeting the management of the ELGA infant during the 'Golden Hour' over 17 months. Results after training showed improvement in body temperature (36.4°C [35.7-36.9] versus 35°C [34-36]; $P < 0.0001$) and a decrease in time to surfactant administration (2.5h [2.5-3] versus 3.5h [3-4] $P = 0.001$). The study also included a qualitative analysis of the related learning processes and behavioral changes observed in relation to the simulation sessions. Improvement in team work and communication were observed after team training.

CONCLUSIONS

In this study, in-situ training led to a decrease in the rates of hypothermia and reduced time to surfactant administration. Multiprofessional in-situ simulation training can lead to change in behaviors and can have an impact on patient outcomes.

SO038 / #602**Short Oral Session****Short Oral Session 09: ESPNIC****09-10-2022 12:30 - 13:30****Feasibility of hydrotherapy as part of early mobilisation in paediatric critical care****A. Van Zwol^{1*}, M. Brienne², M. Ijland³, S. Litjens³**¹Radboudumc, Paediatric Intensive Care, Nijmegen, Netherlands²Radboudumc, Paediatric Physiotherapy, nijmegen, Netherlands³Radboud University Medical Center, Department of Intensive Care Medicine, Nijmegen, Netherlands**BACKGROUND AND AIMS**

Mortality rates of children admitted to the Paediatric Intensive Care Unit (PICU) declined over the past decades, leading to new issues of morbidity. Studies focusing on long-term morbidity after PICU admission showed problems such as Intensive Care Unit (ICU)-acquired muscle weakness. In order to prevent muscle weakness the implementation of early mobilisation programs in PICU's is gaining attention. Hydrotherapy (physiotherapy in a pool) is a unique way, to prevent muscle weakness and stimulate movements and has previously been found to be safe and feasible in adult ICU patients. So far no cases of PICU patients receiving hydrotherapy have been described. The current aim is to describe feasibility of hydrotherapy in a PICU patient.

METHODS

Case report conducted at the PICU of a tertiary care hospital in the Radboudumc, Nijmegen the Netherlands. Clinical course and feasibility of hydrotherapy is described in a paediatric ventilated patient.

RESULTS

A 5 year old child with pre-existing muscle weakness was admitted to our PICU with respiratory failure due to pneumonia. After inability to wean from the ventilator, therapy focused on improving respiratory muscle strength and hydrotherapy sessions for improving overall muscle strength where started (while intubated and on the ventilator) as part of our early mobilisation program. The child clinically improved and was successfully weaned from respiratory support after 3.5 weeks of invasive mechanical ventilation.

CONCLUSIONS

This case report showed that hydrotherapy, as part of our early mobilisation program was found to be feasible in a ventilated PICU patient.

SO039 / #971**Short Oral Session****Short Oral Session 09: ESPNIC****09-10-2022 12:30 - 13:30****How many chest x-rays are requested to confirm nasogastric tube placement on a paediatric ICU?****B. Jones^{1*}, L. Tume^{1,2}**¹Alder Hey Children's Hospital, Picu, Liverpool, United Kingdom²University of Salford, School of Health & Society, Manchester, United Kingdom**BACKGROUND AND AIMS**

Portable chest x-rays (CXR) are frequently performed on paediatric ICU, representing increased background radiation and moderate cost. We wanted to ascertain how many CXRs were performed to confirm nasogastric tube (NGT) position and to establish any need for investment in alternative means of achieving position confirmation.

METHODS

A retrospective review of electronic health records was undertaken in a single large mixed cardiac and general PICU in the UK. CXR requests for every patient admitted to PICU over a six-month period were retrospectively screened to identify reference to NGT position. Only requests specifically for NGT position were included; routine post-operative and CXRs for other indications (even if NGT mentioned) were excluded.

RESULTS

In total 473 patient records were screened. 23/473 patients (4.9%) had a CXR specifically to confirm NGT position. The median (IQR) age was 163 days

(12.5-218 days). Their reasons for admission were varied with the most common being post-op cardiac, and respiratory. Over half (57%) of CXRs were performed because a gastric aspirate could not be obtained. All 23 patients only had a single CXR to confirm NGT position, with the mean total CXR per patient during ICU admission 4.4 (SD 2.6).

CONCLUSIONS

Few children in PICU required a CXR just to confirm NGT position. We did not identify any patient groups or characteristics who required more CXRs to confirm NGT position. Overall, we considered this an acceptable frequency and much less than that reported in an adult ICU population.

SO040 / #2111**Short Oral Session****Short Oral Session 10: EAP - Paediatric potpourri
- For everyone 02****09-10-2022 12:30 - 13:30****Electrocardiographic and echocardiographic
follow-up in children with mild-moderate SARS-
COV2 infection****R. Leonardi*, F. Pizzo, L. Licciardello, G. Parisi, P. Betta, P. Sciacca***University of Catania, Pediatrics, Catania, Italy***BACKGROUND AND AIMS**

Cardiac alterations associated with COVID-19 have been described even in children. We investigated the possible late cardiovascular involvement in children with past paucisymptomatic SARS-CoV2 infection.

METHODS

A single centre retrospective study was performed including 120 children with previous mild COVID-19 disease, infected from the first wave on. We excluded patients with MISC.

RESULTS

The median age was 8 years: 57,5% of male and 42,5% of female. The mean of the period between infection and the cardiologic follow-up was 5,05 months. We divided our cohort into 3 groups: asymptomatic (20%), paucisymptomatic (58%) and moderate (20%). 8 on 120 patients (6%) complained palpitations as post-covid sign, sinusual arrhythmias were seen in 35 (29%) children (only two

with tachyarrhythmias). The HR of all the cohort was within normal limits for age (median 90 bpm), only one patient had supraventricular tachyarrhythmia. PR interval: in almost all the patients it was within normal range for age. We noted a tendency to shortening, but only two patients had an effective shortening. All the patients had normal value of EF%, FS%, TAPSE; we noted PAPS>20 mmHg in 14 patients and a PAPS>24 mmHg in 2 patients. The median PAPS was 15 mmHg. We found mitral regurgitation in 4 patients (3,33%), mild mitral insufficiency (1 patient) and thinning of foramen ovale (1 patient). No coronary abnormalities were detected.

CONCLUSIONS

Cardiac evaluation of paediatric patients with previous covid-19 disease is mandatory to assess late cardiac symptoms due to cardiac viral tropism: in our series we had only slight but significant cardiac involvement.

SO041 / #2112**Short Oral Session****Short Oral Session 10: EAP - Paediatric potpourri
- For everyone 02****09-10-2022 12:30 - 13:30****Prevalence of co-infections in pediatric patients
with COVID19 during the third pandemic wave****E.-E. Makridi^{1*}, T. Kamilari², A. Kyriakopoulou²,
A. Vlachodimitropoulou², D. Margoni², M.-E. Bompou², E. Botsa²**

¹*Aghia Sophia Children's Hospital, National and Kapodistrian University of Athens, Athens, Greece,
First Department of Pediatrics, Medical School, Athens, Greece*

²*Aghia Sophia Children's Hospital, National and Kapodistrian University of Athens, Athens, Greece,
First Department of Pediatrics, Athens, Greece*

BACKGROUND AND AIMS

Despite low levels of morbidity among pediatric population infected with COVID19, a significant proportion still requires hospital care. Examining the presence of co-infections is vital in determining patients' management. Objectives of our study were to report the prevalence of identified co-infections among COVID19 hospitalized patients and examine the potential risk factors associated with specific types of pathogens.

METHODS

We performed a single-tertiary center retrospective cohort study on a sample of 214 children hospitalized with COVID19 in one pediatric ward from April 2021 to April 2022 who were identified to have a co-infection during their admission through laboratory investigations.

RESULTS

Out of 214 children, 20 (9.3%) were reported to have another confirmed pathogen. Urinary tract infection was found to be the most common co-infection (35%) followed by *adenovirus* (15%) and *respiratory syncytial virus* (15%). Other identified pathogens were *H.influenza*, *S.enterica*, *Y. enterocolitica*, *Rotavirus*, *Paeruginosa*, *L.donovani* and *H.metapneumovirus*. The majority of patients (75%) were noted to be under the age of < 1 year. Furthermore, a correlation between COVID19 remission (high cycle threshold value of RT-PCR) and presence of co-infections was identified.

CONCLUSIONS

Our findings demonstrated that a non-negligible number of patients admitted with COVID19 infection was infected with other pathogens. Despite the predominance of the SarsCov2 virus during the pandemic, a high level of suspicion should be maintained regarding the presence of co-infections. Evidence of multiple pathogens is crucial in determining patient prognosis and optimal disease management.

SO042 / #2121**Short Oral Session****Short Oral Session 10: EAP - Paediatric potpourri
- For everyone 02****09-10-2022 12:30 - 13:30****The diagnostic value of new biomarkers in early diagnosis of parenchymal kidney damage in pediatric patients****O. Jordanova^{1*}, V. Tasic², A. Sofijanov³, S. Bojadzieva⁴,
A. Janchevska⁵, N. Abazi²**

¹University Children Hospital-Skopje, Clinical Biochemistry (hematology, biochemistry Immunology, Allergology), Skopje, North Macedonia

²University Children Hospital-Skopje, Nephrology, Skopje, North Macedonia

³University Children Hospital-Skopje, Intensive Care Unit, Skopje, North Macedonia

⁴University Children Hospital-Skopje, Gastroenterology, Skopje, North Macedonia

⁵University Children's Hospital, Medical Faculty, Endocrinology and Genetics, Skopje, North Macedonia

BACKGROUND AND AIMS

Vesicoureteral reflux (VUR) is a congenital malformation leading to parenchymal kidney damage in childhood. The aim of this study was to assess the diagnostic value of urine neutrophil gelatinase-associated lipocalin (NGAL) and serum cystatin C as a rapid and non-invasive method in the diagnosis of renal parenchymal damage in pediatric patients with VUR in correlation with serum creatinine and urinary β₂ microglobulin.

METHODS

In this study we included 50 pediatric patients at the University Children Hospital-Skopje. Patients are divided into two groups: a study group included 25 patients with VUR and a control group included 25 healthy patients with

enuresis and innocent murmur. The biomarkers were taken at the time of diagnosis and after that at controls.

RESULTS

The study showed female predominance in both groups (72% vs 52%) and with a mean age of 8.17 ± 2.24 years. In the study group grade III, IV, V, VUR were found in 25%, 73%, and 2% of the pediatric patients, respectively. Urine NGAL and serum cystatin C were statistically significantly increased in patients with VUR compared with the control group ($p < 0.001$). A statistically significant positive correlation was found between urine NGAL and cystatin C in serum in correlation with serum creatinine ($p < 0.001$), as well as between urine NGAL and cystatin C in serum in correlation with b2 microglobuline ($p < 0.001$).

CONCLUSIONS

Urinary NGAL and serum cystatin C are a sensitive and predictive marker for early diagnosis of renal parenchymal damage.

SO043 / #2127**Short Oral Session****Short Oral Session 10: EAP - Paediatric potpourri
- For everyone 02****09-10-2022 12:30 - 13:30****Corpus callosum size and maturation related to long-term outcome at school age in children born preterm****M. Lubián-Gutiérrez^{1,2*}, Y. Marín-Almagro²,
Y. Sánchez-Sandoval^{2,3}, A. Zuazo-Ojeda^{2,4}, S. Lubián-López^{2,5,6,7},
I. Benavente-Fernández^{2,5,6,7}**¹*Puerta del Mar University Hospital, Division of Neurology, Department of Pediatrics, Cádiz, Spain*²*Biomedical Research and Innovation Institute of Cádiz (INIBICA), Research Unit, Cádiz, Spain*³*University of Cádiz, Psychology, Cádiz, Spain*⁴*Puerta del Mar University Hospital, Radiology, Cádiz, Spain*⁵*Puerta del Mar University Hospital, Division of Neonatology, Department of Paediatrics, Cádiz, Spain*⁶*University of Cádiz, Area of Paediatrics, Department of Child and Mother Health and Radiology, Medical School, Cádiz, Spain*⁷*Puerta del Mar University Hospital, Department of Paediatrics, Cádiz, Spain***BACKGROUND AND AIMS**

Corpus Callosum (CC) is the biggest well delimited white matter structure in central nervous system. Our purpose was to study the long-term development of white matter using diffusion tensor imaging (DTI) and growth of the CC, as a white matter biomarker, in children who were very low birth weight preterm infants (VLBWI).

METHODS

Transversal observational study including expreterm children assessed at 6-10 years-old with MRI and clinical assessments. We measured total CC

length, segmentary linear measurements, total and segmentary areas of CC and fractional anisotropy (FA) values of white matter. We compared the CC measurements of those with normal outcome (IQ \geq 85 in the Wechsler Intelligence Scale for Children (WISC), Movement Assessment Battery for Children-2 (MABC-2) total at or over the 15th centile and with normal MRI) versus those with adverse outcome (IQ<85 or MABC-2 or abnormal MRI findings).

RESULTS

We included 125 children, 67 (53,6%) with normal and 58 (46,4%) with adverse outcome. We found differences between groups in CC height in the splenium (10,37 mm (1,63) vs 9,28 mm (2,47); $p=0,02$) and in splenium FA (0.89 (0.54) vs 0.84 (0.11); $p=0,01$). After adjusting by birth gestational age and age at MRI, we found the CC posterior area to be associated with IQ ($p=0,0014$; $R^2_{adj}=0,13$) and manual dexterity ($p=0,02$; $R^2_{adj}=0,08$).

CONCLUSIONS

At age of 6-10 years-old in children who were VLBWI, growth and maturation of posterior part of CC is associated with cognitive and motor outcomes. CC posterior area is related to IQ and manual dexterity at that age.

SO044 / #2203**Short Oral Session****Short Oral Session 10: EAP - Paediatric potpourri
- For everyone 02****09-10-2022 12:30 - 13:30****Does a direct paediatric specialist to families
instant messaging advice service work? Juno -
a pilot****S. Gardner, R. Daniels, L. Yarlott****Forward Clinical Limited, Juno Family Healthcare Advice, London, United Kingdom***BACKGROUND AND AIMS**

Juno was a novel instant-messaging platform facilitating clinical chats between Paediatricians and parents. It developed during the pandemic to provide easy access to quality care when families were scared to attend Healthcare facilities and to reduce the burden on NHS services in normal times. To: Investigate user satisfaction with this novel approach via verified metrics as well as quantitative feedback. Look at feedback workshops improving the service. Look at how Clinicians' recruitment could support those not in full-time Hospital Medicine to work remotely and expand the service.

METHODS

Users fed-back within chats and rated individual chats out of 5 and were also encouraged to leave reviews on the App Store. Workshops asked families what would improve the service and some suggestions were rapidly implemented. Juno looked at who might want to work remotely in this way to target recruitment.

RESULTS

Of 5,579 users and 4,058 chats over 15 months the App Store had 16 full 5* reviews and an overall rating of 4.96/5 and in-app post-chat rating of 4.96/5. Written feedback showed that it was valued for: instant response, empathy of clinicians, quality of advice. Workshop feedback led to embedded Clinician bios with photographs and ability to upload video. Recruitment included those not in full-time work for multiple reasons as those who might want to engage with this remote work.

CONCLUSIONS

Users showed highly positive satisfaction with this novel method of access. Many clinicians unable to work to full capacity could be enticed to maintain skills or develop a new remote career.

SO045 / #2276**Short Oral Session****Short Oral Session 10: EAP - Paediatric potpourri
- For everyone 02****09-10-2022 12:30 - 13:30****The association between exposure to antibiotics
in the first week of life and later otitis media: The
INCA study****K. Kamphorst^{1,2*}, B. Oosterloo¹, E. Van 'T Riet³, L. Reichwein¹,
A. Vlioger², R. Van Elburg¹**¹Amsterdam UMC location University of Amsterdam, Department of Pediatrics, Amsterdam, Netherlands²St. Antonius Hospital, Department of Pediatrics, Nieuwegein, Netherlands³University Medical Center Utrecht, Department of Strategy and Policy, Utrecht, Netherlands**BACKGROUND AND AIMS**

Objectives: The pathophysiology of otitis media (OM) is poorly understood, but changes in the nasopharyngeal microbiome, immune system, and presence of allergies have all been associated with it. These, in turn, can be affected by early-life antibiotic exposure. This study aimed to determine if antibiotic treatment in the first week of life in children born at term was associated with an increase in acute otitis media (AOM) and otitis media with effusion (OME) in the first 4-6 years of life.

METHODS

A prospective birth cohort of 436 term-born infants was followed up at 4-6 years of age. Parents reported (recurrent) AOM and OME via online questionnaires, sent to parents of 418 eligible children. Doctors' diagnoses were collected after additional informed consent. Multivariate logistic regression analysis was used to study the association.

RESULTS

Of the 436 infants, 151 infants received antibiotics in the first week of life. In total, 341 (82%) questionnaires and 308 (74%) doctor's diagnoses were collected, resulting in parent-reported and doctor-diagnosed AOM 45% and 30%, and OME 10% and 6%, respectively. Antibiotic treatment in the first week of life was not significantly associated with parent-reported nor doctor-diagnosed (recurrent) AOM and OME in the first 4-6 years of life.

CONCLUSIONS

Antibiotic treatment in the first week of life was not associated with AOM and OME in the first 4-6 years of life in this cohort. More insight into the pathophysiology of OM is warranted to determine whether antibiotic-induced microbiome changes play a role in the susceptibility to OM.

SO046 / #2303**Short Oral Session****Short Oral Session 10: EAP - Paediatric potpourri
- For everyone 02****09-10-2022 12:30 - 13:30****Intussusception and rotavirus vaccine: Time to
update guidance?****M. Davis*, S. Davis, C. Davis***Royal Hospital for Children Glasgow, Paediatric Surgery, Glasgow, United Kingdom***BACKGROUND AND AIMBONE S**

Rotavirus vaccine was introduced to the infant vaccination programme in the UK in 2013. There was concern that this would lead to an increased incidence of intussusception and Government websites warn of this. Data on infant intussusception in the West of Scotland (WoS) before and after introduction of the vaccine were compared to assess this concern.

METHODS

Retrospective case note study of all 366 patients (231 infants) admitted to the major paediatric surgery unit serving the WoS over a 22 year period (1998 to 2019) with a diagnosis of intussusception. Data were analysed by pre- and post-vaccination eras (1998-2012 and 2013-2019). Vaccination rates and birth data were obtained from Childhood Immunisation Statistics Scotland annual reports and Information Statistics Division, National Services Scotland.

RESULTS

Intussusception incidence decreased over the study period by an average of 0.7 cases per year, 95% CI (-0.92, -0.45), $p < 0.001$. Intussusception in infants

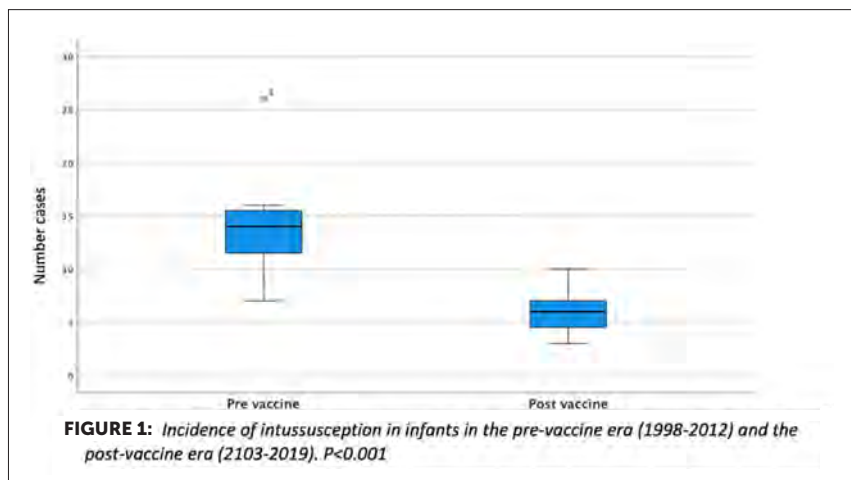

decreased from an average of 12.6 in the pre-vaccination era to 6.0 in the post-vaccination era ($P < 0.001$, Figure 1). Uptake of completed rotavirus vaccination for the study group was between 92.8% to 93.4% over the relevant period. There were no significant changes in birth rates over the study period.

CONCLUSIONS

Despite introduction of the rotavirus vaccine for infants in 2013 and the high uptake, the incidence in infants has continued to fall since the vaccination programme was introduced. This suggests that the theoretical increased risk of intussusception post vaccination is not supported. official advice should reflect this.

SO047 / #2705**Short Oral Session****Short Oral Session 11: Late breaking****09-10-2022 12:30 - 13:30****Early postnatal ventricular disproportion predicts outcome in congenital diaphragmatic Hernia****F. Kipfmüller^{1*}, F. Pugaloni², B. Bo¹, A. Müller¹, N. Patel³**¹University Children's Hospital Bonn, Neonatology and Pediatric Intensive Care, Bonn, Germany²Ospedale Bambinu Gesu, Neonatology, Rome, Italy³Royal Hospital for Children, Neonatology, Glasgow, United Kingdom**BACKGROUND AND AIMS**

Left ventricular (LV) hypoplasia and right ventricular (RV) dilatation are features of cardiac dysfunction commonly observed during early postnatal life in neonates with congenital diaphragmatic hernia (CDH). Ventricular disproportion might be an important part of the CDH pathophysiology determining outcome. Our aim was to evaluate ventricular disproportion defined by an abnormal RV end-diastolic diameter to LV end diastolic diameter ratio (RV_D/LV_D) as predictor for outcome in CDH.

METHODS

Echocardiograms of CDH neonates admitted to our institution between January 2011 and March 2021 obtained within 6-12 hours of life were reviewed. RV_D/LV_D was measured from an echocardiographic apical 4-chamber view. In-hospital mortality was defined as primary clinical endpoint and need for extracorporeal membrane oxygenation (ECMO) was used as secondary endpoint.

RESULTS

RV_D/LV_D was measured in 340 neonates (150 non-CDH, 190 CDH neonates). RV_D/LV_D in control neonates ranged between 0.8 and 1.09 independent of gestational age. In CDH neonates, an RV_D/LV_D of 1.1 (ventricular disproportion) was defined as optimal cut-off for predicting the primary and secondary endpoint. 88 CDH neonates (46.3%) presented evidence of ventricular disproportion on echocardiogram. Mortality was 46.7% in patients with and 12.7% in patients without $RV_D/LV_D \geq 1.1$ ($P < 0.001$). Need for ECMO occurred more frequently in patients with $RV_D/LV_D \geq 1.1$ (70.5% versus 24.5%, $P < 0.001$). Using multivariate regression analysis, $RV_D/LV_D \geq 1.1$ remained independently associated with death and need for ECMO.

CONCLUSIONS

Ventricular disproportion is a frequent finding during early postnatal life in CDH neonates and is independent associated with mortality and need for ECMO in CDH neonates.

SO048 / #2730**Short Oral Session****Short Oral Session 11: Late breaking****09-10-2022 12:30 - 13:30****Mental health and the prescription of QTC-prolonging medications in gender diverse adolescents****W. Finstad^{1*}, E. Livingston², V. Beausejour Ladouceur³, J. Sorbara⁴, A. Vandermorris⁵**¹*The University of Toronto, Paediatrics, Toronto, Canada*²*The Hospital for Sick Children, Research Volunteer, Toronto, Canada*³*The Hospital for Sick Children, Cardiology, Toronto, Canada*⁴*The Hospital for Sick Children, Endocrinology, Toronto, Canada*⁵*The Hospital for Sick Children, Adolescent Medicine, Toronto, Canada***BACKGROUND AND AIMS**

Gender diverse adolescents often experience comorbid depression and anxiety. Currently, selective serotonin reuptake inhibitors are first-line pharmacotherapy for depression or anxiety, and leuprolide acetate is a mainstay of treatment for adolescents experiencing gender dysphoria. Both SSRIs and leuprolide acetate have been associated with an increased risk of QTC-prolongation. This project aims to assess the prevalence of mental health diagnoses, neurodevelopmental diagnoses, and QTC-prolonging medication use in patients attending the Transgender Youth Clinic (TYC) at SickKids.

METHODS

Study participants who attended the TYC clinic were identified through retrospective chart review. Eligible patient charts were reviewed for demographic information, comorbid diagnoses, and medications.

RESULTS

312 (51.1%) patients reported comorbid anxiety and 266 (43.5%) reported depression. 104 (17.1%) had a comorbid diagnosis of attention deficit hyperactivity disorder, 37 (6.1%) had a comorbid diagnosis of autism spectrum disorder, 31 (5.1%) had a comorbid diagnosis of obsessive-compulsive disorder, and 18 (3.1%) had a comorbid diagnosis of an eating disorder. 74 (12.1%) of all patients were on no QTc-prolonging medications, whereas 254 (41.6%) were on one, 208 (34%) were on two, 59 (9.7%) were on three, and 16 (2.6%) were on 4 or more QTc-prolonging medications.

CONCLUSIONS

There is a high prevalence of co-morbid mental health and neurodevelopmental diagnoses within the TYC. Consequently, a high number of patients are prescribed 1 or more QTc-prolonging medications, however no evidence currently exists to guide ECG screening. Moving forward, we will use descriptive statistics to determine the frequency of QTc-prolongation in this patient population to establish a basis for future ECG screening practices.

SO049 / #2777**Short Oral Session****Short Oral Session 11: Late breaking****09-10-2022 12:30 - 13:30****Impact of neonatal seizures on brain temperature****V. Verma^{1*}, F. Lange², C. Meehan³, A. Mintoft³, G. Norris³, E. Campbell⁴, K. Tucker⁴, K. Harvey-Jones⁵, G. Boylan⁶, N. Robertson⁵, I. Tachtsidis⁷, S. Mitra⁸**

¹Institute for Women's health, University College London, Neonatology, London, United Kingdom

²University College London, Medical Physics and Bioengineering, London, United Kingdom

³UCL, Neonatology, Institute For Women's Health, London, United Kingdom

⁴University College London, Neonatology, Institute for Women's Health, London, United Kingdom

⁵University College London, Neonatology, London, United Kingdom

⁶University College Cork, Infant Centre, Cork, Ireland

⁷University College London, Department of Medical Physics and Biomedical Engineering, London, United Kingdom

⁸Institute for Women's Health, University College London, Neonatology, London, United Kingdom

BACKGROUND AND AIMS

Brain tissue temperature is a dynamic balance between heat production from metabolism and heat loss via thermoregulatory process. Seizures are common neurological emergencies in newborns and cause further injury of developing brain. Seizures produce an increase in cerebral metabolism and likely to lead to an increase in brain temperature. This study aims to assess the possibility of monitoring brain temperature at the cot side using optical technologies and investigate the impact of seizures on brain temperature (BT).

METHODS

Seizures were induced using bicuculine (4mg/kg) in 2 white male piglets and were continuously monitored with a combined optical platform and continuous video EEG. The novel optical platform combines broadband near-in-

fared spectroscopy (BNIRS) and diffuse correlation spectroscopy (DCS) that can monitor cerebral mitochondrial metabolism (cytochrome-c-oxidase), oxygenation and microvascular blood flow. We propose a novel algorithm based on the linear temperature-dependent changes in NIR water absorption spectra on BNIRS to estimate the tissue temperature.

RESULTS

Both rectal and brain temperature dropped soon after seizure induction. Subsequently, a significant increase in BT was noted (0.3122°C at 1.5h, 95%

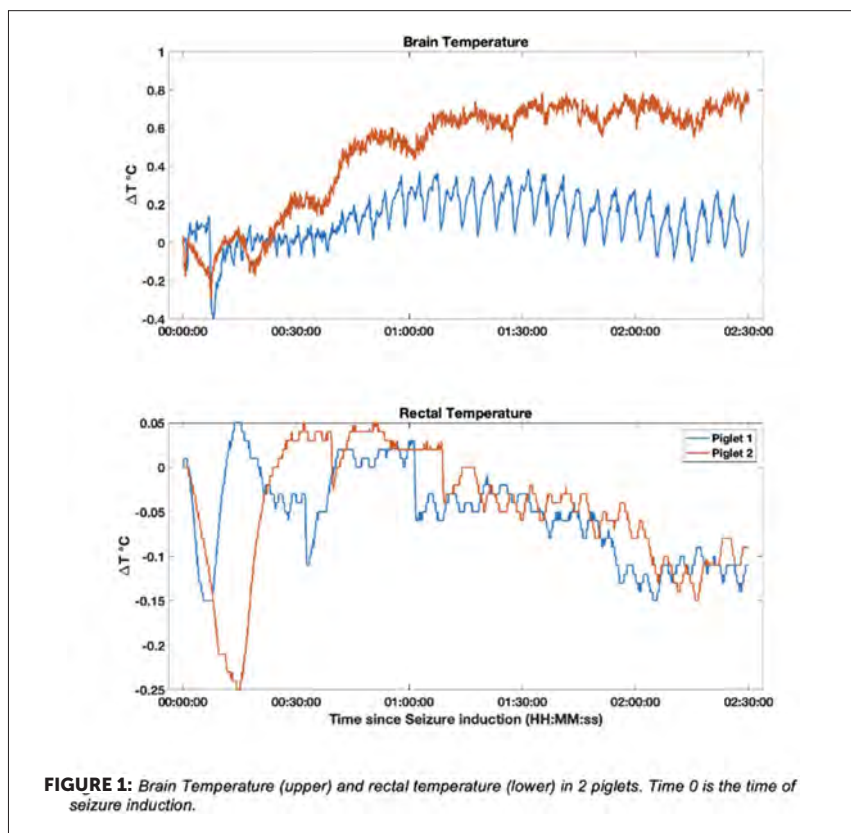

CI: 0.3207 to 0.3237°C), while rectal temperature (RT) decreased followed by a recovery and a mild increase from baseline with a trend to decrease over time. 1.5h after the seizure induction, RT is significantly reduced by -0.1048°C (95% CI: -0.1035 to -0.1061°C) (figure 1).

CONCLUSIONS

We demonstrated the possibility of using optical monitoring to measure BT in a preclinical model of neonatal seizures. BT increased significantly following neonatal seizures, although RT was noted to gradually decrease over time.

SO050 / #2554**Short Oral Session****Short Oral Session 11: Late breaking****09-10-2022 12:30 - 13:30****Hope experiences in parents of children with cancer and affecting factors****H. Ozdemir Koyu^{1*}, G. Algül², N. Altay¹, E. Kilicarlan Törüner¹**¹Gazi University Faculty of Health Sciences, Paediatric Nursing Department, Ankara, Turkey²Gazi University, Hospital, Ankara, Turkey**BACKGROUND AND AIMS**

Childhood cancers cause many physical, emotional, social and spiritual problems in children and their parents. Hope is a concept that provides internal guidance that supports coping in parents of children with cancer. This study was planned to evaluate the experience of hope and influencing factors in parents of children with cancer.

METHODS

In this cross sectional and relational study, the data were collected in March-July 2022 in the pediatric oncology-haematology ward of a university hospital in the center of Anatolia. The study included 120 parents of children with cancer. Data were collected with the child and parent descriptive form, the Herth Hope Index, the Connor-Davidson Resilience Short Form, and the Spiritual Well-Being Scale. In the analysis of the data; correlation, multiple linear regression analysis was used. Ethical approval was obtained for the study.

RESULTS

In the study, 57.5% of the parents were mothers. The mean age of the children was 9.46 ± 5.00 years. The diagnosis of ALL in 30.8% of the children and

the mean duration of treatment was 20.42 ± 13.75 month. Herth Hope Index mean was 33.90 ± 5.65 out of 48, Connor-Davidson Resilience mean was 24.18 ± 5.28 out of 48, and Spiritual Well-Being Scale mean was 117.80 ± 13.38 out of 145. Multiple linear regression analysis, child's gender ($\beta = -0.16$), number of children ($\beta = -0.16$), diagnosis of cancer ($\beta = -0.24$), resilience ($\beta = 0.31$), and spiritual well-being of the parents ($\beta = 0.40$) were the determining factors affecting parents' hope experiences.

CONCLUSIONS

The hope experience parents of children with cancer and the factors affecting it will be evaluated and will guide the interventions to be planned for coping and empowerment parents throughout the cancer trajectory.

SO051 / #2596**Short Oral Session****Short Oral Session 11: Late breaking****09-10-2022 12:30 - 13:30****Fenofibrate combined with phototherapy for neonatal jaundice: A systematic review and meta-analyses****M. Abdellatif^{1*}, A.A.F. Abozaid², P.S. Shah³, N. Dhouibi⁴,
T. Nguyen-Khac⁵, R. Khleif⁶, M.N. Luu⁷, D.K. Quyen⁸, A. Mohareb⁹,
G. Vaghela¹⁰, Z.A. Khan¹¹, H.N. Pham¹², A.M. Makram¹³, N.T. Huy¹⁴**¹Starcare Hospital, Department of Pediatrics, Muscat, Oman²Ain Shams University, Faculty of Medicine, Cairo, Egypt³Mount Sinai Hospital and University of Toronto, Department of Pediatrics, Toronto, Canada⁴University of Tunis El Manar, Faculty of Medicine of Tunis, Tunis, Tunisia⁵University of Medicine and Pharmacy at Ho Chi Minh City, Faculty of Medicine, Ho Chi Minh City, Viet Nam⁶Xavier University, School of Medicine, Oranjestad, Aruba⁷University of Medicine and Pharmacy at Ho Chi Minh City, Department of Internal Medicine, Ho Chi Minh City, Viet Nam⁸University of Medicine and Pharmacy at Ho Chi Minh City, Faculty of Medicine, Ho Chi Minh City, Viet Nam⁹Aswan University, Faculty of Medicine, Aswan, Egypt¹⁰GMERS Medical College, Gandhinagar, Gujarat, India¹¹Shadan Institute of Medical Sciences, India¹²Faculty of Medicine, University of Milan, Italy¹³Imperial College London, School of Public Health, London, United Kingdom¹⁴Nagasaki University, School of Tropical Medicine and Global Health, Nagasaki, Japan**BACKGROUND AND AIMS**

Jaundice in newborns is one of the most common global health problems. Many trials have examined the effect of fenofibrate in addition to phototherapy. Our aim was to study the efficacy and safety of fenofibrate when combined with phototherapy as a treatment for neonatal hyperbilirubinemia.

METHODS

A detailed search in 12 databases was done for eligible randomized clinical trials comparing fenofibrate plus phototherapy with phototherapy alone or with placebo in neonates.

RESULTS

Nine RCTs including 700 neonates were included. There was a significant difference in the mean change of total serum bilirubin at 12, 24, 36, 48 and 72 hours ((MC -0.46; 95% CI -0.61, -0.31), (MC -1.1; 95% CI -1.68, -0.52), (MC -2.06; 95% CI -2.20, -1.91), (MC -2.15; 95% CI -2.74, -1.56), and (MC -1.13; 95% CI -1.71, -0.55) respectively). The fenofibrate group had a shorter duration of phototherapy (MD -14.36 hours; 95% CI -23.67, -5.06) and a shorter hospital stay (MD: -1.4 days; 95% CI: -2.14, -0.66). There was no significant difference in the overall risk of complications (RR: 0.89; 95% CI: 0.54, 1.46) or the need for exchange transfusion (RR: 0.58; 95% CI: 0.12, 2.81) between the two groups.

CONCLUSIONS

Fenofibrate may safely be used alongside phototherapy to treat neonatal jaundice. Larger RCTs are warranted to investigate and confirm these findings.

SO052 / #2612**Short Oral Session****Short Oral Session 11: Late breaking****09-10-2022 12:30 - 13:30****A window in the brain: Novel quantitative seizure detection with minimal density EEG montage****S. Abdullateef¹, V. Rae², B. Jordan³, A. Mclellan³, J. Escudero⁴,
V. Nenadovic⁵, T.-Y.M. Lo^{1,2}**¹University of Edinburgh, Usher Institute, School of Medicine, Edinburgh, United Kingdom²Royal Hospital for Children and Young People, Paediatric Critical Care, Edinburgh, United Kingdom³Royal Hospital for Children & Young Person, Neurology Department, Edinburgh, United Kingdom⁴University of Edinburgh, Institute for Digital Communications, Edinburgh, United Kingdom⁵BrainsView.Inc, -, Toronto, Canada**BACKGROUND AND AIMS**

Seizures can alter brain connectivity and can be detected by calculating non-linear features on multi-channels electroencephalograms (EEG). Using quantitative methods of seizure detection is currently not generally translated into clinical use in paediatric critical care settings because it requires a minimum of 24 EEG channels, which is not deliverable without a round-the-clock neurophysiology service. Therefore, we analyse the potential of Phase Synchrony (PS) and cross-channel coherence amplitude (CA) as seizure markers and test their performance in 8-channels and 4-channels EEG montage. We aim to deliver an innovative seizure detection algorithm that can accurately detect seizures using only 4-channels and 8-channels EEG montage.

METHODS

We extracted two nonlinear features, PS and CA, from the EEG signals using only 8 and 4-channels of the 64-channels fully anonymised routinely collected paediatrics EEG (n = 40). Seizures identified using only one feature (PS-only

or CA-only) and revised (combined PS + CA) seizure detection algorithms were then compared with the gold-standard neurologist-identified seizure markings on the EEG to determine if the new algorithm offers enhanced seizure detection performance.

RESULTS

The combination of two features (PS + CA) achieved higher performance compared to using one feature for both EEG montages. The accuracy, specificity, and false alarm rates for 8 and 4-channels are 77.2% and 76.5%, 82.2% and 83.4%, and 0.23 and 0.21, respectively.

CONCLUSIONS

Quantitative ictal activity can be captured with as few as 4 EEG channels using our seizure detection algorithm. A larger-scale validation study is required to ascertain its performance before facilitating clinical translation.

SO053 / #497

Short Oral Session

Short Oral Session 12: ESPR - Research updates in respiratory management

09-10-2022 12:30 - 13:30

smartNIV – A sensor-patch for synchronized non-invasive ventilation of preterm infants

H. Küster¹, A. Fischer², A. Kahmann³, O. Ströbel⁴, E. Koch⁵

¹University Medicine Göttingen, Neonatology, Göttingen, Germany

²Activoris GmbH 35285 Gemünden (Wohra), Germany

³msg DAVID GmbH 38106 Braunschweig, Germany

⁴Löwenstein Medical GmbH 56130 Bad Ems, Germany

⁵TU Braunschweig, Institut für Mikrotechnik (IMT) 38124 Braunschweig, Germany

BACKGROUND AND AIMS

Studies have shown that both synchronized and noninvasive ventilation are strategies that improve outcome in preterm infants. Consequently, the combination of these two techniques - synchronized noninvasive ventilation – could be the optimal and thereby most frequently used form of ventilation if appropriate equipment would be widely available. Current devices for synchronized noninvasive ventilation such as Graseby capsule or NAVA have significant drawbacks in clinical practice, and the results of prospective studies are not convincing.

METHODS

A new method to trigger non-invasive ventilation has been developed using a flexible sensorpatch (*figure 1*). Placed on the lower chest it follows the typical movements caused by spontaneous breathing (*figure 2*). These movements are analyzed by artificial intelligence to detect a trigger signal for a ventilator and to derive a 3D impression of the infant's thorax.

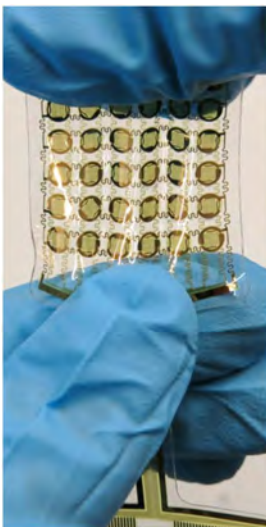

FIGURE 1: Sensorpatch Bendable and stretchable sensorpatch with 36 individual sensors.



FIGURE 2: Sensorpatch attached to a dummy Shown is one of the configurations used for in-vitro testing.

RESULTS

Extensive in vitro and in vivo tests ensured the sensorpatch to be reliable, durable, skinfriendly, non-toxic, non-allergenic, non-carcinogenic and sterile. When applied to premature infants, the sensorpatch was easily applicable and removable without affecting the skin. Using this sensorpatch and adaptive artificial intelligence, the infant's breathing can be detected and automatically analyzed to generate a trigger signal for a conventional ventilator.

CONCLUSIONS

This new sensorpatch can be used to trigger non-invasive ventilation with any modern ventilator. It could also provide 3D images of the infant's thorax to serve as a diagnostic tool. The sensorpatch may help to improve short- and long-term outcome of premature infants.

This project, called smartNIV, is funded by the German Federal Ministry of Education and Research (BMBF).

SO054 / #878**Short Oral Session****Short Oral Session 12: ESPR - Research updates in respiratory management****09-10-2022 12:30 - 13:30****A randomized cross-over trial of non-invasive neurally adjust respiratory assist versus nasal intermittent positive pressure ventilation at equal peak inspiratory pressure in preterm infants****A. Lavizzari^{1*}, C. Veneroni², N. Sirianni¹, B. Bonomi², M. Colnaghi¹, F. Mosca¹, R. Dellacà²**¹Fondazione IRCCS Cà Granda, Ospedale Maggiore Policlinico, Neonatal Intensive Care Unit, Milan, Italy²Politecnico di Milano University, Dipartimento Di Elettronica, Informazione E Bioingegneria – Deib Laboratorio Di Tecnologie Biomediche – Techres Lab, Milan, Italy**BACKGROUND AND AIMS**

Non-invasive Neurally Adjust Ventilatory Assist (NIV-NAVA) has shown potential benefits over other non-invasive modes in preterm infants. This study compares NIV-NAVA with Nasal Intermittent Positive Pressure Ventilation (NIPPV) at equal Peak Inspiratory Pressure (PIP) on breathing patterns, lung mechanics and infants' comfort.

METHODS

We included infants <37 weeks' gestation receiving non-invasive respiratory support. The mean PIP was computed over a 20-minute recording in NIV-NAVA mode. Infants were exposed to a random sequence of NIV-NAVA and NIPPV at the previously determined PIP. We obtained breathing patterns parameters from ventilator recordings; at the end of each one-hour step, we assessed lung mechanics by respiratory oscillometry and infants' comfort by the Comfort B scale.

RESULTS

19 infants with a median[IQR] gestational age of 30.0[29.5; 32.0] weeks and birth weight 1190[954; 1348] g were enrolled. We reported the main outcomes in table 1.

Table 1

Outcome, mean(SD)	NIV-NAVA	NIPPV
Tidal Volume, ml	7.1(2.8)	7.8(4.7)
Electrical Activity of the diaphragm (Edi) peak, uV	5.7(2.1)	7.6(4.4)*
Respiratory rate, bpm	59.8(12.9)	46.4(19.6)*
tcpCO ₂ - mmHg	43.0(5.3)	44.5(5.3)*
Oscillatory Resistance - cmH ₂ O *s/L	85.8 (36.9)	95.5(69.2)
Oscillatory Reactance - cmH ₂ O *s/L	-40.0[-47.9; -31.5]	-40.1[-45.2; -28.6]
Comfort B score	15.6(3.5)	18.8 (5.2)*
The mean(SD) or median[IQR] of the mean individual values were compared between the modes as appropriate (Wilcoxon signed-rank test or paired t-test). * p < 0.05 versus NIV-NAVA		

CONCLUSIONS

Patients' oscillatory mechanics did not change between the two modes, however, when compared at equal PIP, NIV-NAVA showed improved CO₂ exchange with lower fatigue marker and better patients comfort than NIPPV.

SO055 / #2365**Short Oral Session****Short Oral Session 12: ESPR - Research updates in respiratory management****09-10-2022 12:30 - 13:30****Ultrashort inspiratory times homogenize ventilation distribution in an inhomogeneous two-compartment model of the neonatal lung****J. Baumgartner¹, D. Klotz¹, H. Schneider¹, S. Schumann², H. Fuchs^{1*}**

¹Faculty of Medicine, University of Freiburg, Center for Pediatrics, Division of Neonatology and Pediatric Intensive Care Medicine, Medical Center, Freiburg, Germany

²Faculty of Medicine, University of Freiburg, Department of Anesthesiology and Critical Care, Medical Center, Freiburg, Germany

BACKGROUND AND AIMS

Inhomogeneous lung ventilation and pulmonary air leaks are common adverse effects of mechanical ventilation in preterm infants suffering from respiratory distress syndrome. We hypothesized that shortening of inspiratory times can improve the homogeneity of lung aeration. We assumed that ultrashort inspiratory times lead to a full build-up of pressure in regions with low compliance while maintaining incomplete filling of regions with high compliance.

METHODS

We connected a two-compartment model of the lung with different compliances of the two compartments to a neonatal ventilator. Pressures and flow rates were measured separately for each compartment at inspiratory times ranging from 0.1 to 0.8 s and various combinations of tidal volumes.

RESULTS

An inspiratory time of 0.8 s resulted in near total pressure equalization between the airway pressure and the two compartments, as 97% of the maximum applied peak pressure was reached in the low compliance compartment and 95% in the high compliance compartment. The distribution of the tidal volume was proportional to the compartment compliance. Ultrashort inspiratory times lowered the peak pressure and tidal volume in the high compliance compartment but maintained higher pressure and volume in the low compliance compartment. An inspiratory time of 0.2 s resulted in a peak pressure of 80% of peak airway pressure in the low compliance compartment and in 61% of peak airway pressure in the high compliance compartment ($p < 0.001$).

CONCLUSIONS

Ventilation with ultrashort inspiratory times may improve homogeneity of air distribution in inhomogeneous lungs of ventilated preterm or term infants.

SO056 / #1449**Short Oral Session****Short Oral Session 12: ESPR - Research updates in respiratory management****09-10-2022 12:30 - 13:30****Effect of arachidonic and docosahexaenoic acid supplementation on respiratory outcomes in preterm infants****K. Wendel^{1*}, M. Aas², G. Gunnarsdottir², T. Nordvik², D. Fugelseth³, M. Domellof⁴, T. Stiris³, S. Moltu²**¹Oslo University Hospital, Department of Neonatal Intensive Care, Oslo, Norway²Oslo University Hospital, Ullevål, Department of Neonatal Intensive Care, Oslo, Norway³University of Oslo, Institute of Clinical Medicine, Faculty of Medicine, Oslo, Norway⁴Umea University, Department of Clinical Sciences, Pediatric Unit, Umea, Sweden**BACKGROUND AND AIMS**

Studies have suggested that supplementation with docosahexaenoic acid (DHA) to very preterm infants might be associated with an increased risk of bronchopulmonary dysplasia (BPD). This study aimed to investigate the effect of enteral supplementation containing both arachidonic acid (ARA) and DHA on short-term respiratory outcomes in very preterm infants.

METHODS

In a randomized double-blind clinical trial; the ImNuT (Immature, Nutrition, Therapy) study, infants with gestational age less than 29 weeks were randomized to receive a daily enteral supplementation with ARA 100 mg/kg and DHA 50 mg/kg (ARA:DHA group) or medium chain triglycerides (MCT) oil (control group), from second day of life to 36 weeks postmenstrual age (PMA). Respiratory outcomes included incidence of BPD, duration of respiratory support and mean oxygen demand (FiO₂) from birth up to 40 weeks PMA.

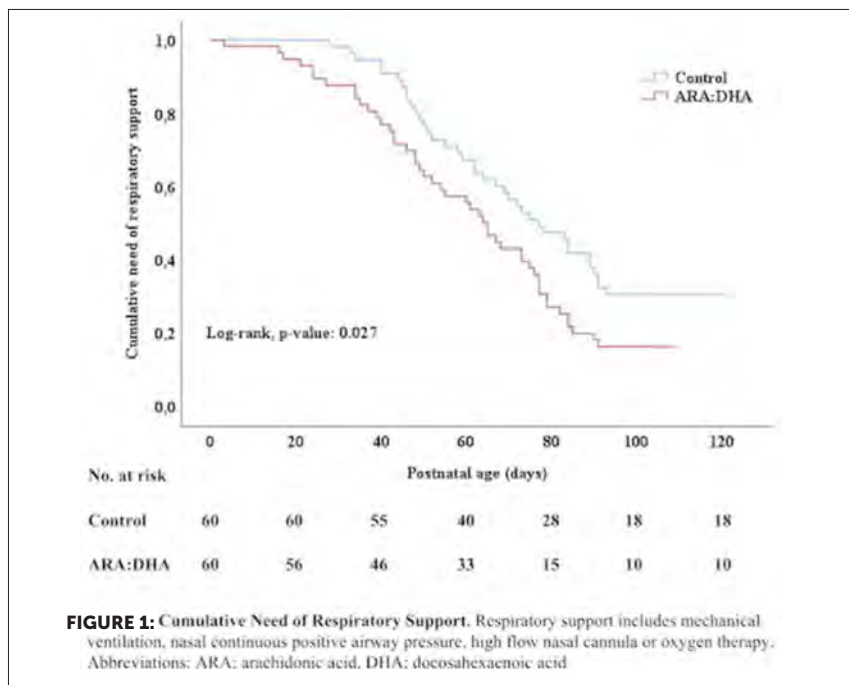

RESULTS

A total of 120 infants were included in the study, 60 infants with mean (SD) gestational age 26.6 (1.7) were randomized to the ARA:DHA group and 60 infants with mean (SD) gestational age 26.2 (1.7) to the control group. Supplementation with ARA and DHA led to a significant reduction in number of days with respiratory support (mean (95% CI) 63.4 (56.6-71.3) vs 80.6 (72.4-88.8); p-value= 0.03) (figure 1) and a lower oxygen demand (FiO_2) (mean (95% CI) 0.26 (0.25-0.28) vs 0.29 (0.27-0.30); p-value= 0.03) compared to control treatment. The incidence of BPD did not differ between the treatment groups, RR (95% CI) 0.78 (0.54-1.13).

CONCLUSIONS

Supplementation with ARA and DHA to preterm infants might have a beneficial effect on respiratory outcomes.

SO057 / #2071**Short Oral Session****Short Oral Session 12: ESPR - Research updates in respiratory management****09-10-2022 12:30 - 13:30****Automated mechanical stimulation in response to cardiorespiratory events in preterm infants; a feasibility trial****S. Cramer^{1*}, J. Dekker¹, H. Salverda¹, R. Koster¹, R. Tan¹, S. Hooper², A. Te Pas¹**¹Leiden University Medical Center, Neonatology, Leiden, Netherlands²Hudson Institute of Medical Research, The Ritchie Centre, Clayton, Australia**BACKGROUND AND AIMS**

Spontaneous breathing in preterm infants typically follows an irregular pattern resulting in apnea, bradycardia and/or hypoxia. Tactile intervention of the nurse has been recommended and applied for years but comes with response delays. We developed 'BreatheBuddy', a device which provides direct, automated mechanical tactile stimulation in response to clinical alarms with the aim to shorten cardiorespiratory instability. Stimulation is applied by actuating two little vibrating balloons just after each other, resulting in a soft stroking sensation. This study evaluates the safety and feasibility of the BreatheBuddy.

METHODS

A randomized cross-over study was performed in 16 preterm infants born at <30 weeks of gestation receiving non-invasive respiratory support. The BreatheBuddy was applied around thorax (Fig 1.) for two consecutive periods of 24 hour each; one period of standard care and one period of BreatheBuddy stimulation in addition to standard care.

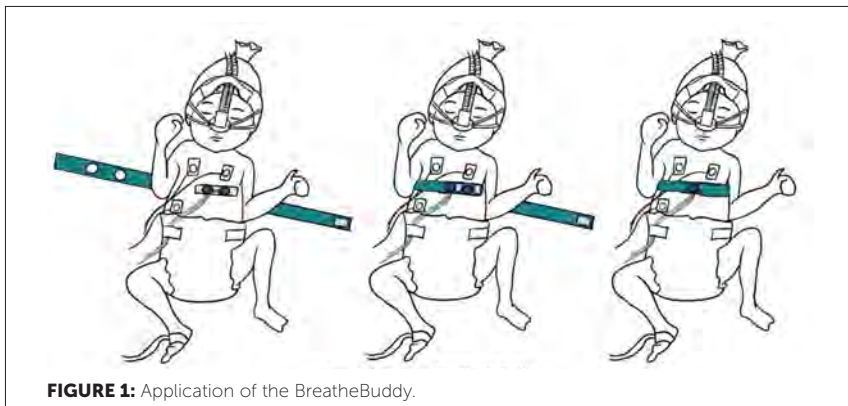

RESULTS

16 infants (born at $26^{2/7}$ ($\pm 1^{2/7}$) weeks gestation) were included at a post-natal age of 8.5 (4 -11) days. In 2/16 infants the study was terminated prematurely (one infant small pressure lesion stage 1, good recovery; and one infant cyanotic spells). The comfort scores were similar during BreatheBuddy and control period (10.3 (10.3-11.1) vs 10.5 (10.1-11.2), $p=0.85$). Overall, the BreatheBuddy detected 98% (98%-98%) of the alarms announced by the patient monitor, followed by mechanical stimulation within a second.

CONCLUSIONS

Providing direct automated mechanical stimulation using the BreatheBuddy appears safe and feasible as a potential method to shorten apnea, bradycardia and hypoxia in preterm infants.

SO058 / #2369**Short Oral Session****Short Oral Session 12: ESPR - Research updates in respiratory management****09-10-2022 12:30 - 13:30****Respiratory outcomes after initial stabilization with a new system using nasal prongs versus standard T-piece with face mask****S. Baldursdottir^{1*}, E. Palleri¹, S. Donaldsson², T. Drevhammar³, B. Jonsson²**¹Karolinska University Hospital, Neonatology Dept., Stockholm, Sweden²Karolinska Institutet, Dept. of Women's and Children's Health, Stockholm, Sweden³Östersund Hospital, Anaesthesiology Dept., Stockholm, Sweden**BACKGROUND AND AIMS**

The multicenter CORSAD randomized clinical trial found that initial respiratory support with a new system that has low imposed work of breathing and nasal prongs reduced delivery room intubations in extremely preterm infants when compared to standard T-piece with face mask. The aim of this single center follow up was to describe respiratory outcomes and other neonatal morbidities until 36 weeks postmenstrual age in infants born before 28 weeks gestational age that received initial respiratory support with the new system vs T-piece.

METHODS

A follow-up study of all extremely preterm infants that were born in the Karolinska University Hospital during 2016-2020 and included in the CORSAD trial. Information on type and duration of respiratory support, surfactant administration, BPD and other neonatal morbidities was gathered.

RESULTS

In total, 94 infants with a median GA 25.3 weeks, 54.2% female, were included in the CORSAD trial in Stockholm. In the new system group 28.3% were intubated in the delivery room compared to 54.2% in the T-piece group ($p=0.008$) and significantly fewer infants in the new system group received mechanical ventilation during the first 7 days, 63.0% compared to 81.3% ($p=0.045$) in the T-piece group. The difference was primarily seen in the subgroup of infants born at 24-25 weeks GA. There was no difference in the rate of bronchopulmonary dysplasia or death.

CONCLUSIONS

Infants stabilized with the new system had lower rates of delivery room intubation and mechanical ventilation during the first week of life. There was no difference in the rate of bronchopulmonary dysplasia or death.

SO059 / #464

Short Oral Session

Short Oral Session 12: ESPR - Research updates in respiratory management

09-10-2022 12:30 - 13:30

Real-time intubation and ventilation feedback in a randomized controlled simulation study

R. Dvorsky¹, F. Rings¹, L. Rössler¹, L. Kumer¹, P. Steinbauer¹, K. Bibl¹, H. Schwarz¹, V. Ritschl², G. Schmölzer³, A. Berger¹, T. Werther¹, M. Wagner^{1*}

¹Medical University of Vienna, Department of Pediatrics and Adolescent Medicine, Comprehensive Center For Pediatrics, Vienna, Austria

²Medical University of Vienna, Center for Medical Statistics, Informatics and Intelligent Systems, Vienna, Austria

³Royal Alexandra Hospital, Centre for the Studies of Asphyxia and Resuscitation, Neonatal Research Unit, Edmonton, Canada

BACKGROUND AND AIMS

Recently, feedback devices, such as a respiratory function monitor and a videolaryngoscope, have been increasingly used for simulation-trainings but also clinically. These devices provide objective feedback on airway-management-quality and allow for optimization of techniques. However, there is little evidence on the most effective application of feedback devices for optimal teaching effects. Therefore, this study aimed to determine the most effective application of these feedback devices for educational purposes.

METHODS

This study was a randomized controlled simulation-based trial with a total of 167 participants. Participants completed a simulation-training, ventilating and intubating a newborn manikin. Participants were randomized into

three groups: in group A the feedback devices were not visible, in group B the feedback devices were only visible for the supervisor, in group C they were visible for both the participant and the supervisor. The percentage of ventilations within the ideal tidal volume target-range (4-8ml/kg) and the number of intubation attempts were defined as primary outcomes.

RESULTS

Group C produced the highest percentage of ventilations within the ideal tidal volume target-range (group A 31.1% vs group B 51.0% vs group C 63.6%, $p < 0.001$). Intubation success was highest in group C (A vs B $p < 0.001$, A vs C $p < 0.001$, B vs C $p 0.018$).

CONCLUSIONS

Participants with access to feedback monitors showed a significantly higher ventilation quality and significantly more success during intubations than compared with any other group. This indicates, that the design of future simulation-trainings and clinical teaching can be significantly improved by use of feedback devices.

SO060 / #1468

Short Oral Session

Short Oral Session 13: ESPR - Research updates on cardiac care

09-10-2022 12:30 - 13:30

Does selective early treatment of PDA with ibuprofen reduce death or bpd at 36 weeks in extreme preterm babies? A randomised trial (Baby OSCAR trial)

S. Gupta¹, E. Juszczak², N. Subhedar^{3*}, P. Hardy², J. Wyllie⁴, A. Kelsall⁵, S. Johnson⁶, S. Sinha⁴, D. Field⁷

¹University Hospital of North Tees, Pediatrics - Neonatology, Stockton-on-Tees, United Kingdom

²National Perinatal Epidemiology Unit, Npeu Trials Unit, Oxford, United Kingdom

³Liverpool Womens NHS trust, Neonatology, Liverpool, United Kingdom

⁴James Cook University Hospital, Neonatology, Middlesbrough, United Kingdom

⁵Addenbrooks Hospital, Neonatology, Cambridge, United Kingdom

⁶University of Leicester, Department of Health Sciences, Leicester, United Kingdom

⁷University of Leicester, Neonatology, Leicester, United Kingdom

BACKGROUND AND AIMS

Presence of a PDA at 72 hours after birth in extreme premature babies is associated with an increased risk of death and complications of prematurity. Functional echocardiography (fEcho) can be used in the first 3 days after birth to identify babies with a large pre-symptomatic PDA. The objective of this study was to evaluate whether early targeted treatment of a large PDA (diagnosed by fEcho) in extreme preterm babies with ibuprofen improves short term health outcomes.

METHODS

Baby-OSCAR is a UK multi-centre placebo-controlled randomised trial in babies between 23⁺⁰-28⁺⁶ weeks' gestation. With parental consent, eligible babies were screened using fEcho. Babies with large PDA were randomised

within the first 72 hours after birth using web-based randomisation with minimisation. Babies received either i.v. ibuprofen at dose 10-5-5 mg/kg 24 hours apart or matched placebo (0.9% normal saline). The primary outcome was a composite of death or moderate to severe BPD at 36 weeks PMA. The trial was funded by the UK NIHR and Ethics approval was obtained. Statistical analysis by intention-to-treat was performed using Stata 17®.

RESULTS

Of 3848 babies screened with fEcho, 653 infants were randomised: 326 to ibuprofen and 327 to placebo. Infant baseline characteristics were similar between the study groups (Table 1). There was no evidence of differences in

Table 1: Infant characteristics

	Ibuprofen (n = 326)	Placebo (n = 327)
Born in care/neg centre, n (%)	273 (84.3)	277 (86.0)
Postnatal age at randomisation (hours)*, median (IQR)	57.5 [15.1 to 55.6]	55.8 [13.5 to 56.7]
< 12 hours, n (%)	2 (0.6)	2 (0.6)
12 to < 24 hours, n (%)	15 (4.6)	14 (4.3)
24 to < 48 hours, n (%)	80 (24.5)	82 (25.0)
48 to < 72 hours, n (%)	211 (64.3)	217 (66.1)
Gestational age at birth (weeks)*, mean (SD)	26.1 (1.5)	26.1 (1.6)
25 to < 26 weeks, n (%)	185 (57.0)	150 (46.0)
26 to < 27 weeks	108 (32.9)	127 (38.7)
> 27 weeks, n (%)	2	5 (1.5)
Mode of delivery, n (%)		
Vaginal birth – cephalic	141 (43.5)	139 (42.0)
Vaginal birth – breech	50 (15.4)	46 (14.2)
Caesarean section before onset of labour	83 (25.6)	80 (24.6)
Caesarean section after onset of labour	50 (15.4)	58 (17.9)
Main cause of preterm birth, n (%)		
Premature labour (intact or ruptured membranes) (PROM)	110 (34.0)	107 (32.7)
Premature labour (without PROM)	116 (35.8)	118 (36.0)
Abruption haemorrhage [†]	34 (10.5)	30 (9.2)
Hyper-tension [‡]	8 (2.5)	8 (2.5)
Preeclampsia [‡]	8 (2.5)	11 (3.4)
Septic [§]	7 (2.2)	6 (1.8)
Other maternal illness	10 (3.1)	5 (1.5)
Obstetric intervention for fetal reasons	31 (9.6)	27 (8.3)
Birth weight (kg), mean (SD)	3.0 (0.4)	3.0 (0.4)
Sex*, n (%)		
Male	162 (49.6)	175 (53.5)
Female	164 (50.4)	152 (46.5)
Baby is one of a multiple pregnancy[¶], n (%)	28 (8.6)	37 (11.3)
Families in the trial (sets of multiples or singletons), n		
Multiple sets in the trial, n	24	30
CRS II (with/without temperature), N	238	252
Mean (SD)	11.1 (2.6)	10.9 (2.7)
Median [IQR]	11.0 [9.2 to 13.0]	11.0 [9.2 to 13.0]
Outgoing	2%	2%
Size of PDA*, median (IQR)	2.2 [1.9 to 2.5]	2.2 [1.5 to 2.6]
≥ 1.5 mm and < 2.0 mm, n (%)	34 (10.4)	32 (9.8)
≥ 2.0 mm and < 3.0 mm, n (%)	203 (62.0)	207 (63.3)
≥ 3.0 mm, n (%)	89 (27.2)	88 (26.9)
Mode of respiratory support at randomisation*, n (%)		
Invasive ventilation (by ET tube)	206 (63.2)	204 (62.4)
Non-invasive respiratory support ^{**}	116 (35.8)	115 (35.2)
Receiving no mechanical ventilation or pressure support ^{**}	2 (0.6)	3 (0.9)
Receiving Inotropes ^{††} , n (%)	44 (13.5)	37 (11.3)

* Including a centrally line shunt glucose 1.5-4.9

† Normal CRP, nasal ventilation, humidified high flow nasal cannula therapy, or low flow oxygen (< 1 L/min)

‡ Hypertension, low flow oxygen (< 1 L/min), or ambient oxygen

Table 2: Trial outcomes (Tested)

	Ibuprofen (n = 324)	Placebo (n = 322)	Adjusted effect estimate ¹ (95% CI)	p-value
Primary outcome (Death or Mod/Severe BPD at 36 weeks PMA); n (%)	220 (69.2%)	202 (63.5%)	1.09 (0.98 to 1.20)	0.104
Death by 36 weeks; n (%)	44 (13.6%)	33 (10.3%)	1.32 (0.92 to 1.90)	0.128
Mod or Severe BPD at 36 weeks PMA; n (%)	176/274 (64.2%)	169/285 (59.3%)	1.09 (0.96 to 1.23)	0.178
Any intraventricular haemorrhage (IVH), n (%)	137 (42.3)	132 (41.0)		
Grade I/II without ventricular dilatation	92 (28.4)	98 (30.4)		
Severe IVH (grade III/IV) ²	45 (13.9)	34 (10.6)	RR 1.30 (0.93 to 1.82)	0.126
Cystic PVL, n (%)	15 (4.6)	9 (2.8)	RR 1.62 (0.69 to 3.83)	0.268
Baby treated for Retinopathy of prematurity (ROP)³, n (%)	45 (13.9)	45 (14.0)	RR 0.98 (0.68 to 1.42)	0.911
Significant pulmonary haemorrhage⁴, n (%)	24 (7.5)	18 (5.6)	RR 1.39 (0.70 to 2.77)	0.353
Missing	2	0		
Diagnosed with pulmonary hypertension, n (%)	18 (5.6)	20 (6.2)		
Missing	0	1		
NEC Bell stage II and above⁵, n (%)	41 (12.7)	41 (12.7)	RR 1.01 (0.67 to 1.51)	0.980
Missing	1	0		
Closed or non-significant PDA (< 1.5mm) at around 3 weeks of age, confirmed by ECHO, n (%)	176 (55.5)	117 (37.0)	RR 1.50 (1.30 to 1.74)	<0.001
Missing	7	6		
Any open-label treatment⁶, n (%)	46 (14.2)	96 (29.8)		
Open-label treatment of a symptomatic PDA by surgical treatment, n (%)	9 (2.8)	31 (9.6)	RR 0.29 (0.18 to 0.47)	<0.001
Discharge home on oxygen, n (%)	130 (41.3)	123 (39.2)	RR 1.06 (0.92 to 1.22)	0.423
Missing	9	8		

¹ Adjusted for size of PDA at randomisation, gestational age at birth, age at randomisation, sex, multiple birth, mode of respiratory support at randomisation, receiving inotropes at time of randomisation, and centre as a random effect, and clustered by siblings to account for correlation between multiple births

² With ventricular dilatation or intraparenchymal abnormality

³ In at least one eye

⁴ Fresh blood in endotracheal tube with increase in respiratory support

⁵ Confirmed by radiography and/or histopathology

⁶ For descriptive purposes only

primary and secondary outcomes, except reduced need for surgical ligation in ibuprofen compared to placebo group respectively (Table 2).

CONCLUSIONS

We found no evidence of reduction in death or moderate-severe BPD with early selective treatment of large PDA with ibuprofen in extreme preterm infants.

SO061 / #1606**Short Oral Session****Short Oral Session 13: ESPR - Research updates on cardiac care****09-10-2022 12:30 - 13:30****Effect of caffeine maintenance on cardiovascular and cerebral haemodynamics in very preterm infants during postnatal transition****R. Parladori^{1*}, V. Paoletti², S. Galletti³, G. Malvezzi⁴, L. Castellini⁴, L. Corvaglia³, S. Martini³**¹University of Bologna, Specialty School of Pediatrics, Bologna, Italy²IRCCS AOU Bologna, Neonatal Intensive Care Unit, Bologna, Italy³University of Bologna, Department of Medical and Surgical Sciences, Bologna, Italy⁴University of Bologna, Medical School, Bologna, Italy**BACKGROUND AND AIMS**

Caffeine is widely used for the prophylaxis of prematurity-related apnoeas. While the effect of caffeine load has been previously investigated, little is known on maintenance doses. We aimed to evaluate the effect of caffeine maintenance on cardiovascular and cerebrovascular haemodynamics in very preterm infants during postnatal transition.

METHODS

Infants <32 weeks' GA were enrolled if receiving caffeine treatment. Intraventricular haemorrhage and unstable haemodynamic status were exclusion criteria. Combined monitoring of NIRS (NIRO-200nx, Hamamatsu Phototonics), pulse oximeter (Radical7, Masimo Corporation) and electrical velocimetry (ICON, Osypka Medical) was performed over the first 72h.

The following parameters were recorded: heart rate (HR), cardiac output, stroke volume, cardiac contractility, systemic vascular resistance (SVR), cerebral (cTOI) and peripheral oxygenation, cerebral fractional oxygen extraction (cFTOE), cerebrovascular reactivity (measured as the correlation coefficient between cTOI and HR). ICM+® software (Cambridge Enterprise Ltd.) was used for synchronized data recording and cFTOE/TOHRx calculation. Wilcoxon signed-rank test was used to compare 2-hourly averaged parameters before and after caffeine (=5mg/kg) administration.

RESULTS

Seventy-nine infants (median GA: 30 [IQR 27-31] weeks, median BW: 1200 [IQR 873-1438] g) were included. Concomitant treatments, respiratory support and cardiovascular status did not change before and after caffeine administration. Significantly increased systemic vascular resistance ($p=0.004$) and improved cerebrovascular reactivity ($p=0.034$) were observed after caffeine administration. No difference was found in the other parameters.

CONCLUSIONS

Caffeine at maintenance doses has a slight but significant impact on cerebrovascular reactivity and systemic vascular tone, while cardiac parameters seem to be not influenced by this treatment.

SO062 / #581**Short Oral Session****Short Oral Session 13: ESPR - Research updates on cardiac care****09-10-2022 12:30 - 13:30****Assessment of myocardial function in infants conceived by assisted reproductive technologies using deformation imaging over the first year of age****A. Smith^{1*}, O. Franklin², E. Mocanu³, N. Mccallion¹, A. El-Khuffash¹**¹*The Rotunda Hospital, Neonatology, Dublin, Ireland*²*Children's Health Ireland at Crumlin, Cardiology, Dublin, Ireland*³*The Royal College of Surgeons in Ireland, Department of Obstetrics, School of Medicine, Dublin, Ireland***BACKGROUND AND AIMS**

There is emerging evidence of cardiovascular remodelling and functional impairment in individuals conceived via Assisted Reproductive Technologies (ART). The aim of this study was to serially assess myocardial function and pulmonary vascular resistance (PVR) in infants conceived via ART over the first year of age and to compare them to a cohort of spontaneously conceived controls.

METHODS

This was a prospective, observational study. Echocardiography was performed at Day 2, 6 months and 1 year of age. Biventricular function was assessed by deformation analysis. Pulmonary artery acceleration time (PAAT) and left ventricular (LV) eccentricity index (LVEI) provided measurements of PVR.

RESULTS

Fifty infants conceived via ART were compared to 50 spontaneously conceived controls. There were no differences in baseline infant demographics between the two groups. At 1 year of age right ventricular (RV) basal and RV mid cavity diameters were higher in the ART group. PAATI was lower and LVEI higher in the ART group at 6 months and 1 year (Figure 1). In the ART group, LV global longitudinal strain, LV systolic strain rate, LV early diastolic strain rate and RV free wall strain were lower on Day 2, 6 months, and 1 year of age in comparison to the control group (all $p < 0.05$) (Figure 2). Within the ART group, on linear regression, maternal age, the type of ART treatment or egg characteristics did not influence PVR, LV or RV function (Table 1).

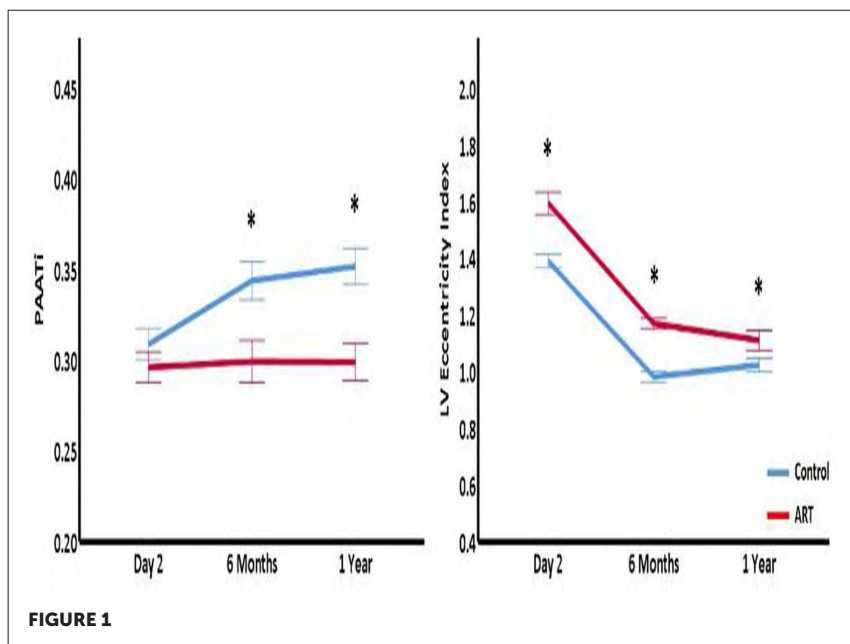

FIGURE 1

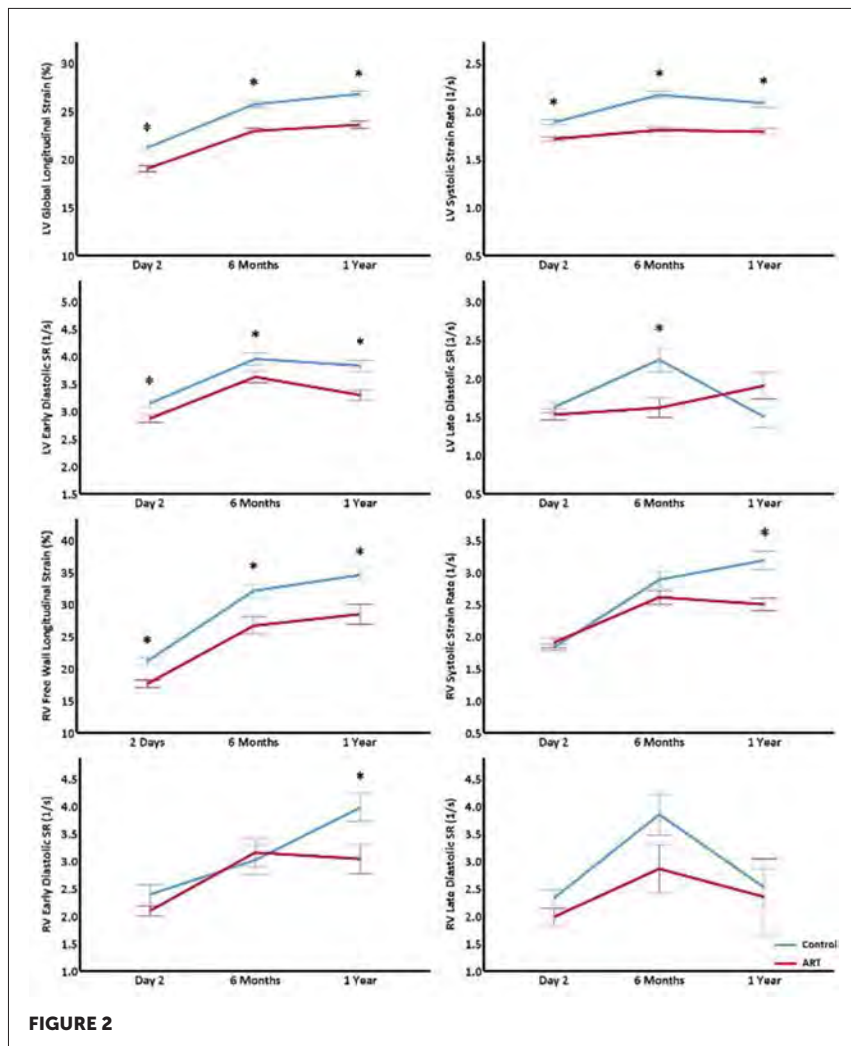

Table 1: Linear Regression Analysis in the ART Cohort.

Outcome	PAATi		LV Strain		RV Strain	
	β	p	β	p	β	p
Maternal Age	0.29	0.36	0.37	0.38	0.24	0.57
Donor Egg	0.12	0.66	-0.04	0.88	-0.19	0.63
Donor Sperm	0.16	0.20	-0.20	0.30	-0.06	0.82
ICSI	-0.01	0.62	-0.26	0.18	0.05	0.85
Frozen Embryo	0.15	0.54	0.07	0.76	-0.03	0.93

β : Standardised beta coefficient; PAATi: pulmonary artery acceleration time indexed to right ventricular ejection time; LV: left ventricle; RV: right ventricle.

CONCLUSIONS

Our findings suggest that greater cardiovascular surveillance of ART conceived infants may be warranted.

SO063 / #2180**Short Oral Session****Short Oral Session 13: ESPR - Research updates on cardiac care****09-10-2022 12:30 - 13:30****Continuous non-invasive hemodynamic monitoring of neonates undergoing hypothermia****Vera Balog*, Barbara Vatai, Lóránt Krisztián Kátai, Sarolta Trinh, Miklós Szabó, Ágnes Jermend***1st Department of Paediatrics, Semmelweis University, Budapest, Hungary***INTRODUCTION**

Hemodynamic instability is common in neonates undergoing therapeutic hypothermia (TH). Non-invasive circulatory monitoring may be helpful in guiding the therapy. Cardiac function may provide cues for neurodevelopmental outcome.

AIMS

Providing an analysis of cardiac function during TH and its relation to neurodevelopmental outcome.

METHODS

In a prospective, observational study, 26 neonates were enrolled, between 2016-2019. Heart rate (HR), stroke volume (SV), cardiac output (CO) data was recorded continuously with a hemodynamic monitor. Neurological outcome was assessed at 2 years using the BSID II. scale. Good outcome was >70 points on psychomotor and mental scale. Features of cardiac function graphs were described to perform logistic regression modeling for outcome prediction.

RESULTS

14 (54%) patients had good and 12 (46%) had poor outcome. During TH, the mean HR of the good outcome group was significantly lower than the poor outcome group's ("HR_TH" feature: $86\pm 13/\text{min}$ vs. $104\pm 18/\text{min}$, $p = 0.01$). During rewarming HR increased similarly in both groups (Figure 1). SV showed a slowly increasing trend (Figure 2). At the end of TH, SV of the good outcome group was significantly higher than the poor outcome group ("SV_TH" feature 1.55 ± 0.23 mL/kg vs 1.29 ± 0.30 mL/kg, $p = 0.035$). CO was similar in both groups (134 ± 36 mL/kg/min vs 136 ± 27 mL/kg/min, Figure 3). Based on multiple regression modeling "HR_TH" was independently associated with neurological outcome ($p=0.023$).

CONCLUSIONS

Based on continuous hemodynamic monitoring, patients with poor outcome have lower SV and higher HR to achieve similar CO to patients with good outcome during TH. HR during TH is an independent predictor of outcome.

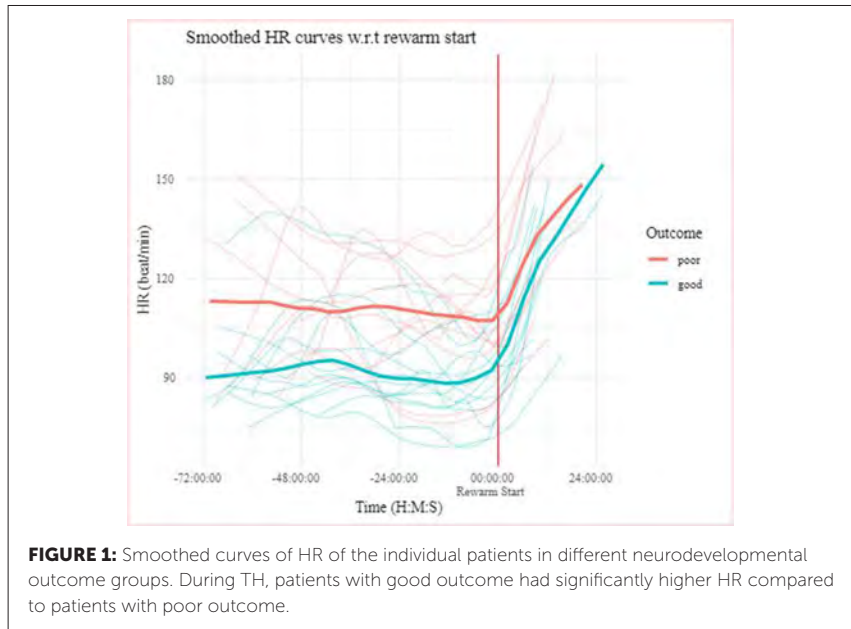

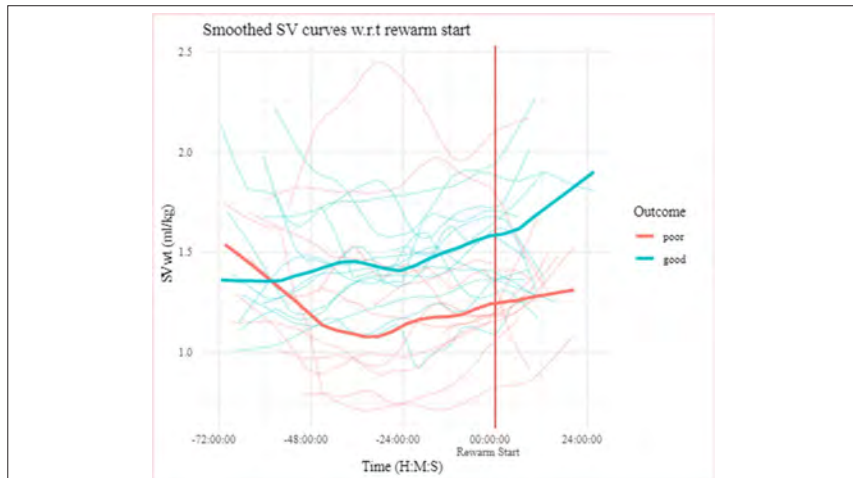

FIGURE 2: Smoothed curves of SV of the individual patients in different neurodevelopmental outcome groups. The SV curves showed a slow, continuous increase unaffected by rewarming. At the end of TH, SV of the good outcome group was significantly higher compared to the poor outcome group.

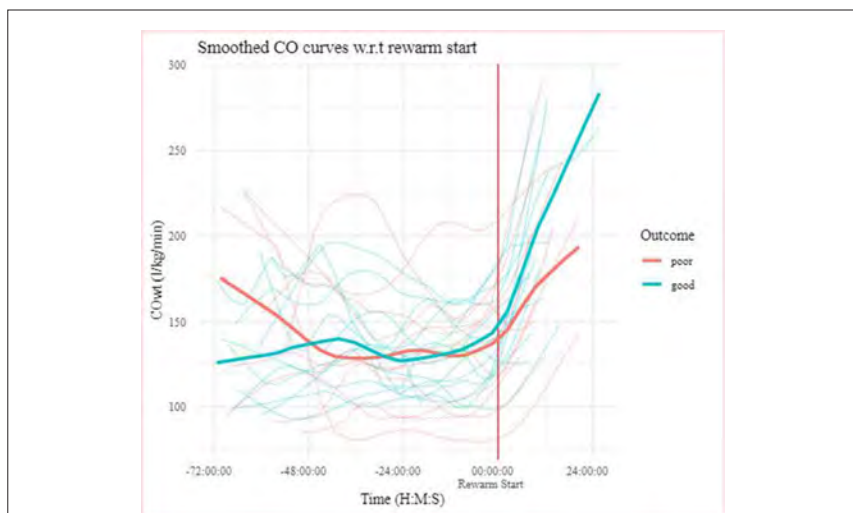

FIGURE 3: Smoothed curves of CO of the individual patients in different neurodevelopmental outcome groups. There is no difference in the CO increase between the groups.

SO064 / #2380**Short Oral Session****Short Oral Session 13: ESPR - Research updates on cardiac care****09-10-2022 12:30 - 13:30****Hearttone: An accurate, objective decision support tool for detecting congenital heart disease using phonocardiograms and artificial intelligence****S. Gomez-Quintana¹, V. Shelevytska², G. Caracciolo¹, A. Factor³, E. Popovici^{1*}, A. Temko¹**¹University College Cork, Electrical and Electronic Engineering, Cork, Ireland²Dnipropetrovsk Medical Academy of Health, Faculty of Postgraduate Education, Dnipro, Ukraine³University College Cork, Anatomy and Neuroscience, Cork, Ireland**BACKGROUND AND AIMS**

The current diagnosis of CHD in neonates relies on echocardiography. Auscultation which is used for routine screening for CHD is subjective, with some heart abnormalities not always audible. This work aims at developing an objective clinical decision support tool based on AI to facilitate the differentiation of sounds with signatures of PDA/CHDs, in clinical settings.

METHODS

The heart sounds are recorded with a digital stethoscope, pre-processed and segmented, followed by extraction of various representative features to parametrise four heart-sound intervals. The features are then fed into an AI model which is trained to estimate the probability of PDA/CHDs. The system is evaluated on a large clinical dataset of heart sounds from 265 term and

late-preterm newborns recorded within the first six days of life. The AI-based method is compared with an experienced neonatologist, and both are contrasted against the ultrasound ground truth.

RESULTS

The developed system reaches an area under the curve (AUC) of 78% at detecting CHD and 77% at detecting PDA. The obtained results for PDA detection compare favourably with the level of accuracy achieved by an experienced neonatologist when assessed on the same cohort. The developed system has a strong potential to augment and support the clinical decision.

CONCLUSIONS

The developed system for automated detection of CHD/PDA signatures in sound clips can be used for efficient prioritisation of candidates for ultrasound assessment in low-resource settings. The models are implemented as a cloud service and on an edge device capable of intercepting digital stethoscope signals.

SO065 / #542**Short Oral Session****Short Oral Session 13: ESPR - Research updates on cardiac care****09-10-2022 12:30 - 13:30****Management of patent ductus arteriosus in very preterm infants in England and Wales – A retrospective cohort study****S. Ojha^{1*}, A. Al-Turkait², L. Szatkowski¹, I. Choonara¹**¹University of Nottingham, School of Medicine, DENE, United Kingdom²Dasman Diabetes Institute, Diabetes Centre, Dasman, Kuwait**BACKGROUND AND AIMS**

Optimal management of Patent Ductus Arteriosus (PDA) in preterm infants remains an unresolved controversy. We aimed to describe PDA treatments in <32 weeks' gestational age (GA) infants in England and Wales (2010 to 2017).

METHODS

Retrospective cohort study of data from the National Neonatal Research Database.

RESULTS

28.3% (n=16,440/58,108) had a PDA (Figure 1A&B). After adjustment for GA, sex and birth weight z-score, infants with PDA had higher odds of BPD, NEC

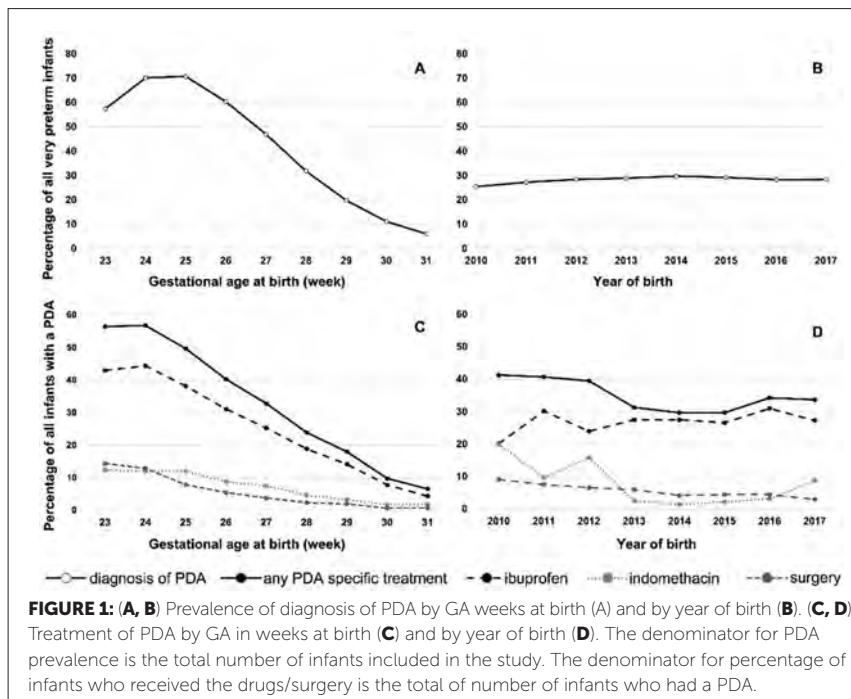

and late onset sepsis. Although the percentage of infants who died before discharge was higher among infants with PDA (11.6%) than among those who did not (8.3%), after adjustment for confounders, the odds of death were reduced in the group that had PDA (aOR (95% CI), 0.30 (0.27 to 0.32)). 34.8% (n=5,721; 9.8% of total VPTs) received a PDA-specific treatment (Figure 1C&D) Figure 1. The characteristics and clinical outcomes of all <32 weeks' infants who were treated and those who were not treated are compared in Table 1 and that of <28 weeks' GA infants in Table 2.

CONCLUSIONS

28% of VPT infants were diagnosed to have a PDA and, of them, over a third were treated with ibuprofen, indomethacin, and/or surgical closure. Ibuprofen was the most frequently chosen drug. In 2017, Ibuprofen was >3X more frequently used than indomethacin (27.3% vs. 8.8%). Those who were treated had higher adjusted odds of adverse outcomes although this may be due to

Table 1: Infants born at <32 weeks' gestational age with a patent ductus arteriosus (PDA) who received treatment vs. those who did not in England and Wales from 2010 to 2017.

Infant characteristics	Not treated	Treated	p-value for difference
n (%)	10,791 (65.6)	5,721 (34.8)	
Females, n (%)	5,056 (47.2)	2,635 (46.1)	0.003
Gestational age at birth (weeks), median (IQR)	27 (26-29)	26 (24-27)	<0.001
Birth weight (in g), mean (SD)	1,032 (327)	851 (241)	<0.001
Birth weight z-score, mean (SD)	-0.14 (0.97)	-0.17 (0.88)	0.072
Length of stay (days), median (IQR)	75 (51-96)	97 (73-120)	<0.001
Adverse outcomes	Not treated	Treated	Adjusted OR (95% CI) ^a
Bronchopulmonary dysplasia, n (%)	2,948 (27.5)	2,519 (44.0)	1.49 (1.39 to 1.60) ^b
Necrotising enterocolitis, n (%)	784 (7.0)	433 (7.6)	0.73 (0.64 to 0.83) ^b
Late onset sepsis, n (%)	5,856 (54.6)	4,315 (75.4)	1.64 (1.52 to 1.77) ^b
Death before discharge, n (%)	1,195 (11.1)	709 (12.4)	0.65 (0.58 to 0.73) ^b

IQR, interquartile range; PDA, patent ductus arteriosus; SD, standard deviation; OR, odds ratio; 95% CI, 95% confidence interval
^aadjusted for sex, gestation age and birthweight z-score <-2SD
^bp<0.05 with Bonferroni correction

Table 2: Infants born at <28 weeks' gestational age with a patent ductus arteriosus (PDA) who received treatment vs. those who did not in England and Wales from 2010 to 2017.

Infant characteristics	Not treated	Treated	p-value for difference
n (%)	5,718 (54.9)	4,700 (45.1)	
Females, n (%)	2,647 (46.3)	2,187 (46.5)	0.807
Gestational age at birth (weeks), median (IQR)	26 (25-27)	25 (24-26)	<0.001
Birth weight (in g), mean (SD)	837 (190)	786 (174)	<0.001
Birth weight z-score, mean (SD)	-0.12 (0.87)	-0.13 (0.83)	0.544
Length of stay (days), median (IQR)	88 (69-110)	103 (81-125)	<0.001
Adverse outcomes	Not treated	Treated	Adjusted OR (95% CI) ^a
Bronchopulmonary dysplasia, n (%)	2,112 (36.9)	2,212 (47.1)	1.42 (1.31 to 1.54) ^b
Necrotising enterocolitis, n (%)	578 (10.1)	399 (8.5)	0.72 (0.63 to 0.82) ^b
Late onset sepsis, n (%)	3,847 (67.3)	3,702 (78.8)	1.61 (1.47 to 1.76) ^b
Death before discharge, n (%)	974 (17.0)	651 (13.9)	0.59 (0.53 to 0.66) ^b

IQR, interquartile range; PDA, patent ductus arteriosus; SD, standard deviation; OR, odds ratio; 95% CI, 95% confidence interval
^aadjusted for sex, gestation age and birthweight z-score <-2SD
^bp<0.05 with Bonferroni correction

confounding by indication where sicker infants are more likely to be treated for their PDA and also more likely to experience the adverse outcomes.

SO066 / #2131**Short Oral Session****Short Oral Session 13: ESPR - Research updates on cardiac care****09-10-2022 12:30 - 13:30****Antebrachial peripheral venous catheters have longer dwell times in neonates – Analysis of 17910 peripheral lines****R. Ascherl*, U. Wurst, U. Thome***Leipzig University Medical Center, Neonatology, Leipzig, Germany***BACKGROUND AND AIMS**

Peripheral venous catheters (PVC) are common in the NICU. Understanding factors increasing their dwell time (DT) seems useful to reduce pain caused by PVC (re-)placement. We investigated associations between insertion site and DT.

METHODS

Data extraction from routine electronic patient records all patients admitted to our NICU between 10/2007 and 11/2021 (N=9767) was funded by German Ministry of Research (BMBF-01ZZ1803D). All PVCs were examined, abdominal site was excluded due to small sample size. DT was put into time-to-event analysis and stratified by birthweight (small<1500g, large \geq 1500g).

RESULTS

A total of 17910 PVCs were included. Half of admissions had at least one PVC (49.2%); patients with lower birthweight significantly more often so (75.7% vs.

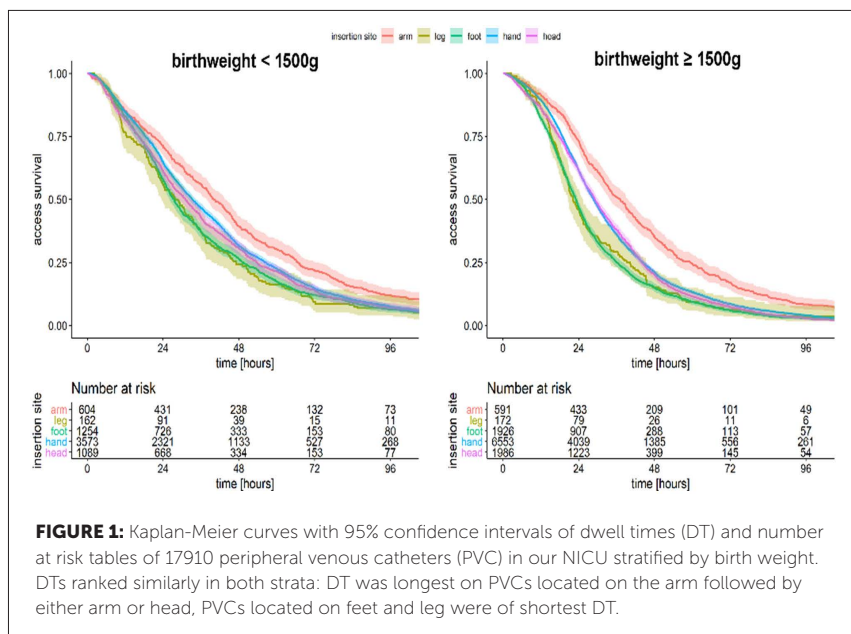

44.6%, $X^2=522, p<0.0001$). Mean number of PVCs per admission was 1.88 ± 3.02 . In those that had PVCs those of lower birthweight had significantly more PVCs (5.48 vs. 2.98, $t(1420)=17.39, p<0.0001$) and their DT was longer (32.1h vs. 27.8, $X^2=233, p<0.0001$). Site had an influence on DT ($X^2(4)=191.4, p<0.0001$). This difference was also present in the strata. PVCs on the arm had a longer median DT of 38.8 hours (95%CI=36.6-40.5) (small 40.0h, large 37.1) than all other sites combined ($X^2=112, p<0.0001$). Those located on feet were of shorter DT ($X^2=87.7, p<0.0001$). Same was true within strata.

CONCLUSIONS

Our median DT of 29.1 hours (all sites) was within the range of previous reports (26 to 57 hours). If one has a choice of possible PVC sites seeming equally easy to attain, the arm may be best. However, median DT is shorter than most therapy regimens possibly justifying PICCs.

SO067 / #2090**Short Oral Session****Short Oral Session 14: ESPR - Neurological outcome following early brain injury****09-10-2022 12:30 - 13:30****Two-year outcome data from the national neonatal research database for preterm infants born over a 10-year period in England and Wales 2008-2017****E. Van Blankenstein^{1,2*}, T. Sodiwala¹, S. Jawad¹, J. Lanoue¹, N. Modi^{1,2}, S. Uthaya^{1,2}, C. Battersby^{1,2}**¹Imperial College London, Primary Care & Public Health, London, United Kingdom²Chelsea and Westminster Hospital, Neonatology, London, United Kingdom**BACKGROUND AND AIMS**

UK guidance recommends infants born <30 weeks' gestation receive a developmental assessment at age two years, corrected for prematurity. The National Neonatal Research Database (NNRD) holds data for neonatal inpatient admissions, and two-year follow-up. This study examines two-year data for infants born <30 weeks' gestation.

METHODS

This retrospective observational study included infants born <30 weeks' gestation between 2008-2017, cared for in England or Wales, who survived to hospital discharge. All data were extracted from the NNRD. Presence of a two-year record, results of neurodevelopmental assessments, and whether a detailed neurodevelopmental assessment was recorded (e.g. Griffiths Developmental Scale) were examined. A multiple logistic regression model examined factors influencing likelihood of a two-year record being present.

RESULTS

38,143 infants were included. 26,389 (69%) had a two-year record in the NNRD, which improved from 38% (births in 2008) to 82% (2017). 21,696 (57%) records included health or developmental data. For infants with a two-year record, developmental outcomes were 71-80% complete. 4% had an auditory impairment at two years, 8% neuromotor impairment, 9% vision impairment, 27% communication impairment and 27% developmental delay. 39% had a detailed developmental assessment recorded. Later birth year, earlier gestation, higher index of multiple deprivation decile, higher level of unit at discharge and having >1 provider of care increased probability of a two-year record being present.

CONCLUSIONS

Two-year neurodevelopmental outcomes are commonly reported in research on prematurity. This study describes their completeness in the NNRD, a dataset with whole-population coverage. Deriving outcomes from this routinely-collected data could improve feasibility and cost of research.

SO068 / #939**Short Oral Session****Short Oral Session 14: ESPR - Neurological outcome following early brain injury****09-10-2022 12:30 - 13:30****Assessing the utility of neonatal screening assessments in early diagnosis of cerebral palsy in preterm infants****R. Connors¹, K. Tan^{1,2}, V. Sackett³, L. Zhou^{1,2*}, P. Pharande², A. Malhotra^{1,2}**¹Monash University, Paediatrics, Clayton, Australia²Monash Children's Hospital, Monash Newborn, Melbourne, Australia³Monash Children's Hospital, Allied Health, Melbourne, Australia**BACKGROUND AND AIMS**

Early diagnosis of cerebral palsy (CP) in high-risk infants is possible at 3–4 months' corrected age (CA) using standardised assessments. We aimed to assess the utility of neonatal screening assessments – writhing general movements (GMs) and Hammersmith Neonatal Neurological Examination (HNNE) – to predict CP/high-risk status in extremely preterm infants.

METHODS

Retrospective cohort study of high-risk preterm infants (born <29 weeks' gestation and/or birthweight <1000g) attending an Early Neurodevelopment Clinic. Data from neonatal assessments were compared with CP/high-risk diagnosis at 3–4 months' CA, fidgety GMs, and Hammersmith Infant Neurological Examination (HINE) using logistic regression, linear regression, and Spearman rank correlation.

RESULTS

Two hundred and two preterm infants (median gestational age 27.3 [IQR 25.4–28.3] weeks, mean birthweight 870.3 [SD 248.4] grams) were included. 26 (12.8%) infants received CP/high-risk diagnoses. Reduced gestational age (OR=0.78; $p=0.029$, 95% CI 0.26–0.97) and abnormal writhing GMs (OR 1.56; $p=0.019$, 95% CI 1.07–2.27) were significantly predictive of CP/high-risk diagnosis using (parsimonious model) univariate logistic regression. Significance was reduced with multivariate analysis (OR=0.67; $p=0.068$, 95% CI 0.44–1.03), (OR=1.44; $p=0.087$, 95% CI 0.95–2.20). HNNE was significantly correlated with both HINE ($p=0.00$, 95% CI 0.31–0.56) and fidgety GMs ($p=0.012$, 95% CI 0.32–0.04) using Spearman's rho. Linear regression confirmed HNNE was highly predictive of HINE (coefficient 0.82; $p=0.00$, 95% CI 0.48–1.15). Writhing GMs did not significantly correlate with either fidgety GMs ($p=0.723$, 95% CI -0.12–0.17) or HINE ($p=0.173$, 95% CI -0.24–0.04).

CONCLUSIONS

Writhing GMs were predictive of CP/high-risk diagnosis in preterm infants. Additionally, HNNE significantly correlated with both fidgety GMs and HINE.

SO069 / #1336**Short Oral Session****Short Oral Session 14: ESPR - Neurological outcome following early brain injury****09-10-2022 12:30 - 13:30****Gross motor abilities in adults born preterm with very low birth weight: A longitudinal study of two birth cohorts****S. Benum^{1*}, K.A. Aakvik¹, L. Jussinniemi^{2,3}, M. Kulmala^{3,4}, A. Jørgensen⁵, E. Kajantie^{2,3,6}, K.A. Evensen^{1,7,8,9}**

¹Norwegian University of Science and Technology (NTNU), Department of Clinical and Molecular Medicine, Trondheim, Norway

²Oulu University Hospital and University of Oulu, Pedego Research Unit, Oulu, Finland

³Finnish Institute for Health and Welfare, Public Health Promotion Unit, Helsinki/Oulu, Finland

⁴Helsinki University, Helsinki University Eye and Ear Hospital, Helsinki, Finland

⁵Norwegian University of Science and Technology (NTNU), Department of Neuroscience and Movement Science, Trondheim, Norway

⁶Helsinki University Hospital and University of Helsinki, Children's Hospital, Helsinki, Finland

⁷Oslo Metropolitan University, Department of Physiotherapy, Oslo, Norway

⁸Trondheim Municipality, Unit for Physiotherapy Services, Trondheim, Norway

⁹Childrens's Clinic, St. Olavs Hospital, Trondheim University Hospital, Trondheim, Norway

BACKGROUND AND AIMS

Gross motor problems are evident in children and adolescents born preterm with very low birth weight (VLBW: ≤ 1500 g). There is however little knowledge about gross motor abilities in individuals born preterm with VLBW entering mid-adulthood. The aim of this study was to investigate gross motor abilities in adults born preterm with VLBW.

METHODS

Data was collected in a prospective study of two birth cohorts with harmonized methods; the Helsinki Study of Very Low Birth Weight Adults (HeSVA) cohort and the Norwegian University of Science and Technology (NTNU) Low Birth Weight Life cohort. A total of 113 VLBW adults born preterm (47 men) and 147 term born controls (62 men) between age 31 and 42 had their gross motor abilities assessed using the High-level mobility assessment tool (HiMAT). The HiMAT consists of eight subtests (walk, backward walk, walk on toes, walk over obstacles, run forward, skip, hop forward and bound on preferred leg). A total score of 0-32 points was calculated for each participant. Results were adjusted for age, sex and cohort.

RESULTS

The VLBW group had poorer performance on all HiMAT subtests compared to controls. Mean total HiMAT score was 22.9 points (SD 4.6) in VLBW adults compared with 25.9 points (SD 3.1) in controls ($p < 0.001$; mean difference 2.8; 95% CI 1.9-3.7).

CONCLUSIONS

Adults born preterm with VLBW had poorer gross motor abilities than term born controls. This may indicate that motor impairments in this group are not only present in early life, but also extends into adult life.

SO070 / #1533**Short Oral Session****Short Oral Session 14: ESPR - Neurological outcome following early brain injury****09-10-2022 12:30 - 13:30****Health-related quality of life among five-year-old extremely preterm children with motor disorders****A. Aubert^{1*}, R. Costa², S. Johnson³, U. Aden⁴, V. Pierrat⁵, M. Cuttini⁶, M. Männamaa⁷, I. Sarrechia⁸, A. Van Heijst⁹, R. Maier¹⁰, M. Sentenac¹¹, J. Zeitlin¹²**

¹Université Paris Cité, Inserm, INRAE, Centre For Research In Epidemiology and Statistics (cress), Obstetrical Perinatal and Pediatric Epidemiology Research Team, Epopé, Paris, France

²Universidade do Porto, Epiunit, Instituto De Saúde Pública, Porto, Portugal

³University of Leicester, Department of Health Sciences, Leicester, United Kingdom

⁴Karolinska Institute, Dept of Women's and Children's Health, Stockholm, Sweden

⁵University of Paris, INSERM, INRAE, Cress, Obstetrical Perinatal and Pediatric Epidemiology Research Team, Epopé, Paris, France

⁶Bambino Gesù Children's Hospital, IRCCS, Clinical Care and Management Innovation Research Area, Rome, Italy

⁷Institute of Clinical Medicine, University of Tartu, Department of Paediatrics, Tartu, Estonia

⁸Faculty of Medicine & Health Sciences, University of Antwerp, Department of Medicine & Population Health, Antwerp, Belgium

⁹Radboud University Medical Center, Department of Neonatology, Nijmegen, Netherlands

¹⁰Philipps University Marburg, Children's Hospital, University Hospital, Marburg, Germany

¹¹Inserm, Umr1153 - Epopé, Paris, France

¹²INSERM UMR 1153, Obstetrical, Perinatal and Pediatric Epidemiology Research Team (Epopé), Center for Epidemiology and Statistics Sorbonne Paris Cité, DHU Risks in pregnancy, Paris Descartes University, Paris, France

BACKGROUND AND AIMS

Motor disorders resulting from extremely preterm birth (EPT; <28 weeks' gestation) can limit daily activities, schooling and social relationships. Cerebral palsy (CP) affects about 10% of children and non-CP movement difficulties

(MD) are highly prevalent, although they tend to be under-diagnosed, especially in children without other developmental difficulties. We investigated the association between motor disorders and health-related quality of life (HRQoL) among five-year-old children born EPT.

METHODS

We included children at age five from a population-based EPT cohort born in 2011-2012 in 11 European countries (N=1,021). Children without CP were classified using the Movement Assessment Battery for Children-2nd edition as having significant MD ($\leq 5^{\text{th}}$ percentile of standardised norms) or being at risk of MD (6th-15th percentile). Parents reported on CP diagnoses and HRQoL using the Pediatric Quality of Life InventoryTM. We used linear regression to compare HRQoL scores by motor status adjusting for social characteristics.

RESULTS

Children born EPT with CP, significant MD and at risk of MD had lower adjusted HRQoL total scores [95% confidence intervals] than those without MD: -26.3 [-31.1; -21.5], -9.3 [-12.3; -6.3] and -5.3 [-8.0; -2.6]. Decreases were greater for physical scores: -35.4 [-42.9; -27.9], -12.0 [-16.2; -7.9] and -5.5 [-9.1; -1.8] than psychosocial scores: -20.9 [-25.4; -16.4], -7.7 [-10.7; -4.8] and -5.3 [-8.0; -2.5]. These differences persisted after exclusion of children with other developmental difficulties.

CONCLUSIONS

Motor disorders among 5-year-old children born EPT were associated with lower HRQoL, even among children with less severe motor difficulties and without other developmental difficulties.

SO071 / #2116**Short Oral Session****Short Oral Session 14: ESPR - Neurological outcome following early brain injury****09-10-2022 12:30 - 13:30****The life-long effect of fetal growth restriction: Neurodevelopmental outcome in growth discordant identical twins****S. Groene^{1*}, K. Stegmeijer¹, R. Tan¹, S. Steggerda¹, M. Haak², F. Slaghekke², A. Roest¹, B. Heijmans³, E. Lopriore⁴, J. Van Klink¹**¹Leiden University Medical Center, Willem-alexander Children's Hospital, Leiden, Netherlands²Leiden University Medical Center, Obstetrics, Leiden, Netherlands³Leiden University Medical Center, Biomedical Data Sciences, Leiden, Netherlands⁴Leiden University Medical Center, Department of Neonatology, Leiden, Netherlands**BACKGROUND AND AIMS**

Singletons born after fetal growth restriction (FGR) are at an increased risk of poor neurodevelopmental outcome. FGR singletons are generally compared to appropriately-grown singletons, inherently biased by obstetrical, parental and genetic factors. A study population of discordant identical twins that share a single placenta (monochorionic (MC)) naturally eliminates these confounders.

METHODS

All MC twins with selective fetal growth restriction (sFGR) born between 2002-2017 were eligible. Cognitive performance was evaluated using two standardized age-appropriate tests, producing a full scale intelligence quotient (FSIQ). Motor functioning was assessed using a standardized neurological examination. A composite outcome of neurodevelopmental impairment (NDI) was

used, subdivided into: mild NDI defined as FSIQ<85, minor neurological dysfunction or cerebral palsy grade 1 or mild visual/hearing impairment; and severe NDI defined as FSIQ<70, severe neurological dysfunction or severe visual/hearing impairment.

RESULTS

The median gestational age at birth was 33.9 (31.3-36.0) weeks for the 47 twin pairs, with median birth weights of 1400 (1111-1875) grams in the smaller twin and 2003 (1600-2680) grams in the larger twin. The median age at participation was 11 (8-13) years. Median FSIQ was 94 (86-101) for the smaller twin and 100 (92-108) for the larger twin ($p<0.0001$). The smaller twin had a 4.8 higher odds (95% CI 1.6-14.1) of mild NDI (36% (17/47)) compared to the larger twin (11% (5/47), $p=0.005$).

CONCLUSIONS

As the described mild impairments can impede children in their daily functioning, we recommend standardized long-term follow-up including neurodevelopmental testing for MC twins with sFGR and singletons with FGR to facilitate early identification of children at risk.

SO072 / #2398**Short Oral Session****Short Oral Session 14: ESPR - Neurological outcome following early brain injury****09-10-2022 12:30 - 13:30****Lower intelligence in children born extremely preterm does not fully account for every day functioning deficits as perceived by parents: The express study****Y. Kaul^{1*}, U. Aden², K. Stjernqvist³, A. Farooqi⁴, F. Serenius¹**¹*Uppsala University, Department of Womens and Childrens Health, Uppsala, Sweden*²*Karolinska Institute, Dept of Women's and Children's Health, Stockholm, Sweden*³*Lund University, Department of Clinical Sciences, Lund, Sweden*⁴*University of Umeå, Unit of Pediatrics, Institute of Clinical Sciences, Umeå, Sweden***BACKGROUND**

Children born extremely preterm (EPT, <27 weeks' gestational age) face challenges in multiple domains. Low normal intelligence is associated with other abilities vital for adaptive functioning in daily life. Few studies investigated if functions of memory, language and perception are affected above and beyond intelligence.

AIMS

To examine if parents' perception of developmental functions in daily life is fully explained by intelligence in 6.5-year-old EPT children.

METHODS

Population-based Swedish national study of all children born EPT in 2004-2007. At 6.5 years, parental ratings of perception, memory, language and social skills were assessed by the Five to Fifteen Questionnaire in 232 EPT children without neurodevelopmental disabilities (i.e., children with severe intellectual, sensory or motor disability were excluded) and 371 controls. Intelligence was assessed with the Wechsler Intelligence Scale for Children, Fourth Edition. Mean comparisons by Incidence Rate Ratios (95% CI) were adjusted for social background, gender and intelligence.

RESULTS

	Adjusted for back-ground factors	Adjusted for background factors + cognition
Perception	1.48 (1.27-1.72)***	1.29 (1.09-1.59)**
Visual perception	3.04 (1.99-4.66)***	1.87 (1.21-2.87)**
Body perception	1.58 (1.16-2.16)***	1.50 (1.04-2.17)*
Perception of space	1.79 (1.32-2.43)***	1.62 (1.15-2.37)**
Memory	1.53 (1.24-1.89)***	1.33 (1.05-1.67)*
Social skills	1.60 (1.20-2.14)**	1.51 (1.01-2.25)*
Language	1.81 (1.44-2.29)***	1.44 (1.12-1.85)**
Comprehension	1.63 (1.25-2.15)***	1.21 (0.91-1.61)
Expressive skills	2.08 (1.54-2.81)***	1.56 (1.12-2.17)**
Communication	1.99 (1.45-2.73)***	1.62 (1.13-2.32)**

*** p<.001; ** p<.01; * p<.05

CONCLUSIONS

Differences were attenuated when adjusted for intelligence, but most remained significant. Difficulties in daily functioning in extremely preterm born is not fully explained by intelligence level.

SO073 / #1215**Short Oral Session****Short Oral Session 14: ESPR - Neurological outcome following early brain injury****09-10-2022 12:30 - 13:30****The prevalence of minor neurological dysfunction reduces with increasing age in children born extremely preterm****D. Nosko^{1*}, L. Brostrom², J. Bolk³, U. Aden⁴, M. Ortqvist²**¹Universitets Sjukhuset Örebro, Barn Och Ungdomskliniken, Örebro, Sweden²Karolinska Institutet, Dept of Women's and Children's Health, Solna, Sweden³Sachs' Children and Youth Hospital, Det of Clinical Science and Education, Stockholm, Sweden⁴Karolinska Institute, Dept of Women's and Children's Health, Stockholm, Sweden**BACKGROUND AND AIMS**

Even if most children born extremely preterm (EPT) do not develop cerebral palsy, they still face a high risk of more subtle neurological and motor impairments, such as Minor Neurological Dysfunction (MND). A simplified version of Touwen's Neurological Examination has previously been used to assess MND in children born EPT at the age of 5-6 years. Our aims were 1) to explore the prevalence of MND in children born EPT and term-born controls at 12 years. 2) to examine the trajectory of MND between 6,5 and 12 years and the association between MND and motor function in children born EPT.

METHODS

106 children (EPT n=62, term n=44) were assessed at 12 years, all previously examined at 6,5 years. Assessments included a simplified version of

Touwen's Neurological Examination and the Movement Assessment Battery for Children – 2nd ed.

RESULTS

Twenty-seven children born EPT (44%) were assessed as having MND compared with 4 in the control group (9%) ($p < 0.001$). Between 6,5 and 12 years the number of children with MND decreased from 37 to 27 ($p = 0.007$). Children with MND had significantly lower MABC-2 total test scores at 12 years, compared to those who did not: median (range) 57 (32-79) vs. 75 (43-99), respectively ($p < 0.001$). The same was shown for all subscales; manual dexterity ($p < 0.001$), aiming/catching ($p = 0.004$) and balance ($p = 0.004$).

CONCLUSIONS

MND is related to motor function and is a persistent problem for children born EPT in early adolescence compared to term-born controls. However, the prevalence reduces with increasing age.

SO074 / #538**Short Oral Session****Short Oral Session 14: ESPR - Neurological
outcome following early brain injury****09-10-2022 12:30 - 13:30****Neurodevelopment outcomes at age 5 years after
prophylactic hydrocortisone in extremely preterm
infants****C. Trousson¹, A. Bourmaud², A. Toumazi², V. Biran¹, O. Baud^{3,4*}**¹APHP, Neonatal Intensive Care Unit, Paris, France²APHP, Inserm U1123 and Cic-ec 1426, Paris, France³Inserm U1141, Developmental Neuroscience, Paris, France⁴Hôpitaux Univ Genève, Pediatrics, Geneva, Switzerland**BACKGROUND AND AIMS**

Prophylactic hydrocortisone (HC) has been shown to improve survival without bronchopulmonary dysplasia (BPD), one of the most frequent complications following extremely preterm delivery. We report an assessment of neurodevelopmental outcomes of the trial cohort at 5 years of age.

METHODS

This is a prespecified secondary analysis of the PREMILOC randomized clinical trial. Extremely preterm infants were randomly assigned to receive a placebo or hydrocortisone. The primary outcome was the Full Intelligence Quotient based on WPPSI (Wechsler Preschool and Primary Scale of Intelligence).

RESULTS

Among 109 surviving children recruited at Robert-Debré Children's hospital (Paris), outcome data were available for 42/56 infants (75%) in HC group and

41/53 (77%) in the placebo group. Mean scores were not significantly different between the two groups on full IQ (HC: 91.9 [SD, 13.9]; placebo: 86.3 [SD, 15.4]; mean difference, 5.7; 95%CI, -1.0 to 12.3; $P = .10$) in crude analysis. The working memory index was significantly better in the HC group (HC: 93.0 [SD, 9.5]; placebo: 88.3 [SD, 9.2]; mean difference, 4.7; 95%CI, 0.2 to 9.2; $P = .05$). In a multivariate logistic regression including potential confounding variables, HC treatment was found to be significantly associated with a greater chance to survive at 5 years of age with a full IQ > 90 compared to the placebo (aOR [95%CI]: 7.48 [1.76; 31.83]; $P = .006$).

CONCLUSIONS

This exploratory analysis provides reassuring data regarding the long-term neurodevelopmental safety of prophylactic HC in extremely preterm infants.

SO075 / #1429**Short Oral Session****Short Oral Session 15: ESPNIC - Delirium and withdrawal****10-10-2022 12:30 - 13:30****Four-in-one: A comprehensive checklist for pain, undersedation, iatrogenic withdrawal and delirium assessment in the PICU: A Delphi study****M. Van Dijk^{1*}, E. Ista²**

¹*Pediatric Intensive care, Erasmus MC – Sophia Children’s Hospital, Rotterdam, Department of Pediatric Surgery, Rotterdam, Netherlands*

²*Erasmus MC – Sophia Children’s Hospital, Department of Pediatric Surgery, Pediatric Intensive Care, Rotterdam, Netherlands*

BACKGROUND AND AIMS

In pediatric intensive care, assessment of pain, undersedation, iatrogenic withdrawal syndrome and delirium include overlapping symptoms which makes it difficult to decide why a child is not comfortable. Validated assessment tools are available but regular assessment of multiple instruments may be challenging with time-constrained staff.

METHODS

We performed a two-round Delphi study among experts working in PICUs worldwide to determine which cues should be included in a new holistic instrument that incorporate the assessment of the four conditions.

RESULTS

In the first Delphi round, 38 of the 48 enrolled participants (79%) completed the questionnaire; in the second round 32 of 48 (67%). In the second round 46 items from 8 categories (e.g. facial, vocal/verbal, body movements, Sleep /behavioral state, posture/muscle tone, agitation, physiological and contextual) were considered relevant. Thirty-three of the 46 items (72%) were considered relevant for pain, 24 for undersedation (52%), 35 for IWS (76%) and 28 (61%) for pediatric delirium. Thirteen items (28%) were considered relevant for all four conditions; eleven items (24%) were considered relevant for only one condition.

CONCLUSIONS

Our Delphi study is the first step in developing a 4-in-1 comprehensive checklist to assess pain, undersedation, iatrogenic withdrawal syndrome and delirium in a holistic manner. Further validation is needed before the checklist can be applied in practice. In future, the application of the mosalC checklist could help determine what condition is most likely to cause a child's discomfort and at the same time help reduce the PICU nurses' registration burden.

SO076 / #2395**Short Oral Session****Short Oral Session 15: ESPNIC - Delirium and withdrawal****10-10-2022 12:30 - 13:30****A comprehensive checklist for pain, undersedation, iatrogenic withdrawal and delirium assessment in the PICU: A pilot study****W. Voor Den Dag, R. Verkamman, M. Van Dijk, E. Ista****Erasmus MC – Sophia Children's Hospital, Department of Pediatric Surgery, Pediatric Intensive Care, Rotterdam, Netherlands***BACKGROUND AND AIMS**

Different scales are used to assess pain, undersedation, iatrogenic withdrawal syndrome (IWS) and delirium in critically ill children. These scales include overlapping symptoms. Therefore, combining the information into one scale could be efficient. Based on an international Delphi study we developed the mosalC-checklist, a tool covering the four conditions. In the current study we aimed to test the feasibility of the mosalC-checklist.

METHODS

We performed a prospective pilot study in PICU patients. A research nurses and a bedside nurse observed simultaneously a patient. The research nurse assessed with the mosalC-checklist and the nurse the COMFORT-behavior (sedation/pain), NRS (pain), and SOS-PD (IWS and/or delirium) scale. Feasibility was defined as the duration to complete the mosalC-checklist. Further, correlations were calculated between the mosalC-checklist conditions and the and COMFORT-behavior, NRS, or SOS-PD scale.

RESULTS

We included 11 patients, aged 2 months to 16 years. None of the patients was scored for pain, withdrawal, or delirium by the bedside nurses. Time to complete the mosalC-checklist ranged from 2:30 to 4:30 minutes. The correlation with the COMFORT-behavior score and number of positive symptoms of the condition 'sedation' of the mosalC-checklist was 0.82. Symptoms of the mosalC-checklist were mostly observed in the categories: facial expression (e.g. grimacing, frowning), sleep & behavior state (e.g. sleeplessness, lack of attentiveness), body movements (Kicking or legs drawn up, movements of arms and/or legs, and agitation (anxious, irritability).

CONCLUSIONS

The mosalC-checklist is feasible to observe pain, undersedation, IWS and delirium in PICU patients. Further validation is needed before the checklist can be applied in practice.

SO077 / #590**Short Oral Session****Short Oral Session 15: ESPNIC - Delirium and withdrawal****10-10-2022 12:30 - 13:30****Clinical application of “Sophia observation withdrawal symptoms - pediatric delirium” screening tool Danish version: A feasibility study****R. Stenkjaer^{1*}, I. Egerod², M. Moszkowicz³, G. Greisen¹, E. Ista⁴, S. Herling⁵, J. Weis¹**¹Rigshospitalet, Department of Intensive Care for Infants and Toddlers, Copenhagen, Denmark²Rigshospitalet, Department of Intensive Care, Copenhagen, Denmark³Bispebjerg, Research Unit At Child and Adolescent Mental Health Center, Copenhagen, Denmark⁴Erasmus MC – Sophia Children’s Hospital, Department of Pediatric Surgery, Pediatric Intensive Care, Rotterdam, Netherlands⁵Rigshospitalet, The Neuroscience Centre, Copenhagen, Denmark**BACKGROUND AND AIMS**

Critically ill children risk developing delirium potentially causing discomfort and suffering. Intensive care delirium has a fluctuating course complicating detection. The aims of the present study were investigating the feasibility of: 1) using the Danish version of Sophia Observation Withdrawal Symptoms - Pediatric Delirium (SOS-PD) screening tool in clinical practice, and 2) comparing SOS-PD performance to a child psychiatrist’s assessment using the diagnostic criteria as a reference standard.

METHODS

We used a descriptive and comparative design. First aim: Bedside nurses were asked to evaluate their experience of using the SOS-PD. Second aim: We compared the SOS-PD performance with the child psychiatrist assessment in 50 children aged 4 weeks to 18 years.

RESULTS

Nurses found the Danish version of the SOS-PD applicable and easy to use. Of the 50 children included, 13 were diagnosed with delirium by the child psychiatrist. Consistency was found between the SOS-PD score and the child psychiatrist's assessment (88%). We found 3 false-negative and 3 false-positive SOS-PD cases. The false-negative cases could be explained by the differences in time periods for the assessments. SOS-PD assessments covered the past four hours, whereas the psychiatric assessments covered the past 24 hours. We assume the false-positive cases represent an acceptable inconsistency between the two assessment methods.

CONCLUSIONS

The Danish version of the SOS-PD appeared suitable for identifying pediatric delirium. Our results emphasized the importance of assessment at least once during each nursing shift to ensure delirium detection around the clock due to the fluctuating course of delirium.

SO078 / #1948**Short Oral Session****Short Oral Session 15: ESPNIC - Delirium and withdrawal****10-10-2022 12:30 - 13:30****Impact of oral clonidine on duration of opioid and benzodiazepine use in mechanically ventilated children****B. Bagheri^{1*}, B. Taherkhanchi², S. Salarian³**¹*Semnan University of Medical Sciences, Pharmacology, Tehran, Iran*²*Erfan Niayesh Hospital, Pediatrics, Tehran, Iran*³*Imam Hossein Hospital, Intensive Care, Tehran, Iran***BACKGROUND AND AIMS**

Long term use of opioids and benzodiazepines are associated with important untoward effects. Our goal was to study clonidine addition to total doses of fentanyl and midazolam and duration of ventilation in pediatric ICU (PICU).

METHODS

This randomized, double-blind, placebo-controlled trial was conducted in PICU of Mofid Children Hospital. Hundred children aged from 2 to 15 years were randomized 1:1 to 5 µg/kg oral clonidine every 6 hours plus 1-5 µg/kg/hr IV fentanyl and 0.05- 0.1 mg/kg/hr IV midazolam or placebo plus 1-5 µg/kg/hr fentanyl and 0.05- 0.1 mg/kg/hr midazolam.

RESULTS

A total of 96 patients were studied. The mean age was 12 years with an excess of females (59.5%vs 40.5%). At baseline, no significant differences were

observed in patients' characteristics. Patients in placebo group received more midazolam and fentanyl compared with patients in intervention group. Mean total dose of midazolam was 4.3 ± 2.2 mg in the placebo group and 2.7 ± 2.9 mg in the intervention group ($P < 0.05$). Mean total dose of fentanyl was 34.4 ± 23.1 μ g in the placebo group and 18.9 ± 10 μ g in the intervention group ($P < 0.01$). No significant differences were observed in duration of ventilation and length of ICU stay. No case of severe adverse events was seen.

CONCLUSIONS

This trial showed that clonidine addition appeared to reduce ICU stay but had no effect on duration of mechanical ventilation. Due to low cost and availability, clonidine can be considered as an adjunct to the sedatives in PICU.

SO079 / #752**Short Oral Session****Short Oral Session 15: ESPNIC - Delirium and withdrawal****10-10-2022 12:30 - 13:30****Evaluation of clinical practice guidelines for the management of pain, sedation, delirium and withdrawal for use in pediatric intensive care units: A systematic review****I. Macdonald^{1*}, S. Alvarado^{1,2}, L. Gomez Tovar^{1,3}, M. Martson^{1,2}, E. Favre^{1,4}, V. Chanez², A. Trombert⁵, M.-H. Perez^{1,2}, A.-S. Ramelet^{1,2}**

¹University of Lausanne, Institute of Higher Education and Research In Healthcare - Department of Biology and Medicine, Lausanne, Switzerland

²Lausanne University Hospital, Department Woman-mother-child, Lausanne, Switzerland

³Universidad Surcolombiana, Faculty of Health, Neiva, Colombia

⁴Lausanne University Hospital, Adult Intensive Care Unit, Lausanne, Switzerland

⁵Lausanne University Hospital and University of Lausanne, Medical Library, Lausanne, Switzerland

BACKGROUND AND AIMS

Analgesia and sedative medications are commonly used in critically ill children to ensure comfort and safety. Yet, their prolonged use can lead to delirium and withdrawal. Several clinical practice guidelines (CPGs) are available yet their quality and applicability in the pediatric intensive care unit have not been established. This systematic review aimed to identify and appraise the quality of CPGs for management of pain, sedation, delirium and iatrogenic withdrawal.

METHODS

Searches were conducted in four electronic databases, guideline repositories and websites of professional societies to identify CPGs published from

2010 to date. CPGs were included if applicable to the pediatric intensive care population (newborns to 18 years old) and included recommendation(s) for assessment of at least one of the four conditions. To assess quality of CPGs, two independent reviewers used the Appraisal of Guidelines for Research and Evaluation (AGREE) II instrument. Quality of CPGs was based on domain scores, high quality = all domains scored >60%, medium quality 30% to 60%, and low quality = at least one domain scored <30%.

RESULTS

Following screening of 14799 records, 13 CPGs were included. Using the AGREE II domain thresholds, no CPG achieved high quality, three were medium quality and 10 were low quality. CPGs scored highest in the domain of 'scope and purpose' (average 62.2%) and lowest in the 'applicability' domain (average 27.7%).

CONCLUSIONS

This review demonstrates that current CPGs have varied methodological quality and more effort is needed to improve the reporting of the development process.

SO080 / #1637**Short Oral Session****Short Oral Session 16: ESPNIC - Family centered care 02****10-10-2022 12:30 - 13:30****Parent's perspective on family centered care in neonatal and pediatric intensive care units in Slovenia****K. Vehar, R. Vettorazzi****University of Ljubljana, Faculty of Health Sciences, Ljubljana, Slovenia***BACKGROUND AND AIMS**

Family centered care is an innovative construct that focuses on partnership between patient, family, and healthcare workers, with intention of empathetic, effective, and quality healthcare. The aim of this research was to study how elements of family centered care are implemented in NICU and PICU in Slovenia.

METHODS

In research a structured questionnaire was used, based on questionnaire by Institute for Family Centered Care.

RESULTS

Sample consisted of 122 parents. Units' policy restricts 24-hour presence of the parents with the child. Parents are satisfied with the level of communication, but they wish to be informed better. Most of the parents had an opportunity to be involved in the care for their child. Parents find the most important concept to be sharing information and the least important

concept to be collaboration – it is also the least represented concept in the clinical environment. Older parents find it less important to have financial support, but they think privacy is important more. Parents with a higher level of education find it more important to be with their child, they value timely communication and being able to express their worries. Parents who have more children find it less important, that fathers are treated equally.

CONCLUSIONS

Elements of family centered care are implemented inconsistently in Slovenian NICUs and PICUs. There is a prioritizing need for education of healthcare workers and further research about family centered care.

SO081 / #393**Short Oral Session****Short Oral Session 16: ESPNIC - Family centered care 02****10-10-2022 12:30 - 13:30****Does the tracheostomy interfere with attachment?****J. Mattsson***

Astrid Lindgrens Childrens Hospital, Karolinska University Hospital, Sweden, Childrens Pmi, Stockholm, Sweden

BACKGROUND

Children with tracheostomy have a large need for medical care such as medical apparatus, constant surveillance, and assistance. This can potentially affect not only the child but also its parents and the whole family. Despite this large need, there is little information and research on the experiences of parents and their lives and how the tracheostomy affects the interaction with their child.

AIM

The aim of this study was to uncover how parents' experience of the interaction with their child is affected by the child's tracheostomy.

METHODS

The study is an empirical interview study in which data was analyzed with a phenomenologically inspired method, intended to investigate parents' experiences more deeply.

RESULTS

Three overarching themes that affected the interaction were identified: inner stressors, outer stressors, and safety. The study showed that the parents experience their situation as both difficult and full of stress, which also affected the interaction with their child in both obvious and subtle ways.

CONCLUSIONS

Parents of children with tracheostomies experience that the interaction with their child is affected by the tracheostomy in several different ways. The results of this study may hopefully be used to inform and improve the care for children with tracheostomies and their families.

SO082 / #817**Short Oral Session****Short Oral Session 16: ESPNIC - Family centered care 02****10-10-2022 12:30 - 13:30****Mothers' experiences of the EACI- A new early collaborative intervention focusing on parent-infant interaction in the neonatal period****C. Sahlén Helmer^{1*}, U. Thornberg¹, T. Abrahamsson², E. Mörelius³**¹Linköping University, Department of Health, Medicine and Caring Sciences, Linköping, Sweden²Linköping University, Department of Biomedical and Clinical Sciences, Linköping, Sweden³Edith Cowan University, School of Nursing and Midwifery, Joondalup, Australia**BACKGROUND AND AIMS**

To support attachment and infants' development, high quality parent-infant interaction is important. The Early Collaborative Intervention was developed to support interaction between moderate to late preterm infants and their parents. The preterm infant's subtle cues are discussed when parents are performing an everyday care-taking procedure and instant feedback is delivered to give the parents the opportunity to notice, interpret and respond to cues immediately. The aim was to explore mothers' experiences of the intervention.

METHODS

A qualitative interview study with mothers experienced with the intervention.

RESULTS

The data generated two main themes describing the mothers' feelings aroused during the intervention and the experiences of the knowledge gained

from the intervention. The mothers experienced the intervention to affect their perception of the preterm infants' behavior and how this awareness positively affected their communication with the infant as well as the parents' mutual discussions regarding the infant.

CONCLUSIONS

The intervention was found to be helpful for the mothers in their growing motherhood and it felt strengthening for their relationship with the other parent. The mothers felt supported in how to be attentive to their preterm infant's individualized needs and that helped them optimize the care and create comfort both for themselves and their infant.

SO083 / #2305**Short Oral Session****Short Oral Session 17: EAP - The diversity of
paediatrics****10-10-2022 12:30 - 13:30****Are cognitive outcomes after very preterm birth
worsening, stagnating or improving? a meta-analysis****M. Sentenac*, J. Zeitlin**

*Université Paris Cité, Inserm, INRAE, Centre for Research in Epidemiology and Statistics (cress),
Obstetrical Perinatal and Pediatric Epidemiology Research Team, Epopé, Paris, France*

BACKGROUND AND AIMS

Studies on the impact of very preterm birth (VPT) birth on cognition have concluded that cognitive outcomes have not improved since the 1990s. This study aimed to evaluate the trends over time in studies published up to March 2022.

METHODS

All primary studies from five systematic reviews investigating the consequences of VPT birth on childhood IQ before 2018 were included and literature searches were extended to March 2022. Information on country of origin, birth years, gestational age and/or birth weight selection criteria and relevant results were extracted. Pooled standardized mean difference (SMD) in intelligence quotient (IQ) between full term and VPT children were estimated and plotted against birth year using cubic spline modeling.

RESULTS

A total of 237 primary studies reporting results from 135 unique VPT cohorts (including 36 from the extended search) were identified. Birth years varied

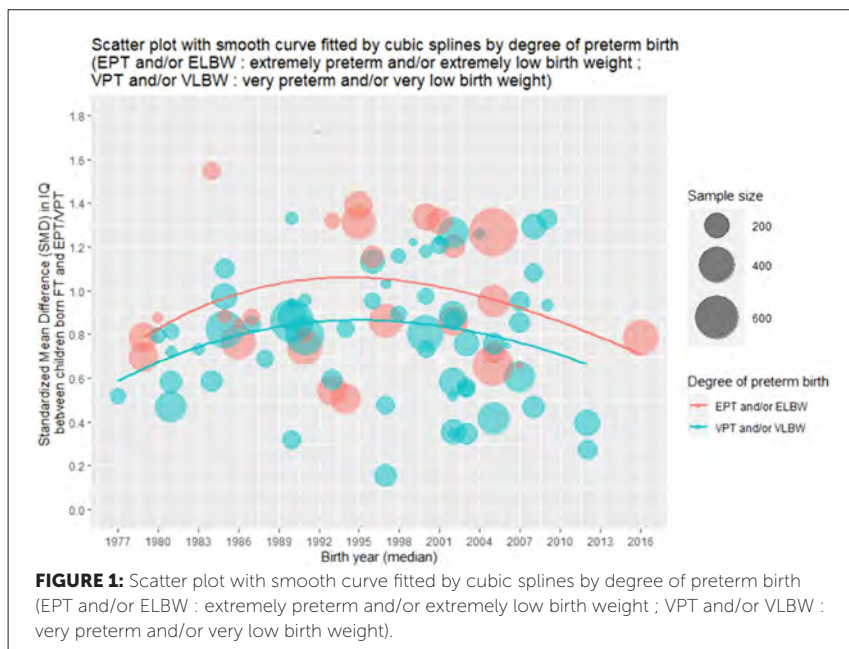

between 1977 and 2016, with 50% with the birth year ≥ 1998 . 46% of cohorts were from Europe. The SMD for children born VPT (<32 weeks/ <1500 g) was 0.74 (79 cohorts; equivalent to a deficit of 11 points, 95%CI 0.67; 0.82) whereas this was 0.95 (28 cohorts; 14 IQ points; 95%CI 0.84;1.07) for extremely preterm (EPT, <28 / <1000 g). Cubic spline model showed an inverted U-shape relationship between median birth year and the SMDs (figure) with effect sizes reducing since the mid-90s.

CONCLUSIONS

Differences in cognition between FT and EPT/VPT may have increased in the 1990s before starting to decline in more recent years, with a different inflection point for EPT and VPT births.

SO084 / #2328**Short Oral Session****Short Oral Session 17: EAP - The diversity of paediatrics****10-10-2022 12:30 - 13:30****Exploring medication practices with regards to ten-fold dosing errors between two paediatric hospitals****A. Gill^{1*}, P. Nydert^{2,3}**

¹Alder Hey Children's NHS Foundation Trust, Paediatric Medicines Research Unit, Liverpool, United Kingdom

²Karolinska University Hospital, Astrid Lindgren's Children's Hospital, Stockholm, Sweden

³Karolinska Institutet, Department of Clinical Science, Intervention and Technology, Stockholm, Sweden

BACKGROUND AND AIMS

Ten-fold dose errors pose a significant risk to children. The aim of this study was to explore ten-fold errors reported in two hospitals (Sweden and England) and establish any differences in practice which may impact the likelihood of ten-fold errors.

METHODS

This was an ecological study. All medication incidents reported in two one-year periods (2017 and 2020) were reviewed. Data including drug name, location, error-type and whether the error reached a patient or not were extracted from the free-text of ten-fold errors reported.

RESULTS

3,596 medication errors were reported. 132 (3.7%) involved a ten-fold error of which 68 reached a patient (53%). The overall rate of ten-fold errors/admission was the same for both hospitals (0.13%), however the rate of ten-fold errors/admission reaching patients differed (0.05% vs 0.1%). In both hospitals, critical care areas reported the most ten-fold errors and opioids were most frequently involved. Prescribing errors were most frequent in the English hospital and administration errors in the Swedish hospital. Processes for prescribing and administration in the hospitals were different.

CONCLUSIONS

The differences identified between the hospitals included; near-miss reporting, double-checking practices, neonatal and cardiovascular care and prescribing (paper vs electronic systems). The similarities between the hospitals were the overall rate of ten-fold error reporting, the drugs involved and administration errors reaching patients. Comparing hospital medication errors is not recommended due to cultural and organizational aspects, but with a no-blame, careful ecological approach, the information can be used to generate hypothesis for improvement work.

SO085 / #2385**Short Oral Session****Short Oral Session 17: EAP - The diversity of paediatrics****10-10-2022 12:30 - 13:30****Use of proton pump inhibitors in Scandinavian infants: An observational study****K. Størdal^{1,2*}, M. Lyamouri¹, K. Mårild³, R. Nielsen⁴**¹University of Oslo, Institute of Clinical Medicine, Fredrikstad, Norway²Oslo University Hospital, Department of Pediatrics and Adolescence Medicine, Oslo, Norway³Queen Silvia Children's hospital, Department of Pediatric Gastroenterology, Gothenburg, Sweden⁴Odense University Hospital, Hans Christian Andersen Children's Hospital, Odense, Denmark**BACKGROUND AND AIMS**

There is weak evidence that the use of proton pump inhibitors (PPIs) in infancy alleviates non-specific complaints of irritability and spitting often attributed to gastroesophageal reflux. Current international guidelines suggest restrictive use in infants, and we therefore aimed to study temporal trends in the use in this age group.

METHODS

This is an observational population-based study of infants (0-11 months) living in Norway, Sweden and Denmark in 2007-2020. We utilised nation-wide registers for pharmaceuticals to study dispensed prescriptions of PPIs. The three countries have approximately 240 000 births annually, and data collected over 14 years provided a total of 3.3 million observed years.

RESULTS

Since 2007, the use of PPI in infancy showed a marked increase in all three countries (Figure). In 2020, PPI use was highest in Denmark (46/1000/year),

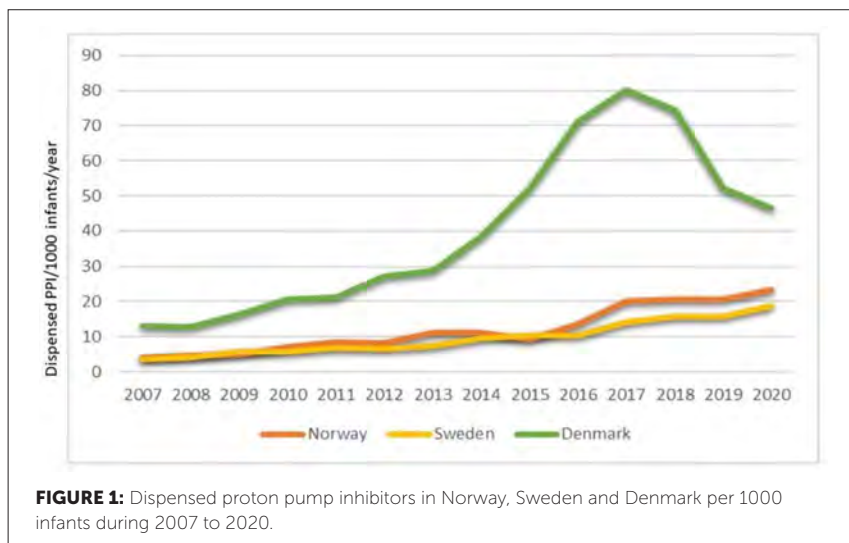

however this has decreased by 42% since 2017. There was a more than five-fold increase in the number of dispensed prescriptions of PPI in Norway and Sweden. The use increased steadily from 2007 until 2020 reaching 23 and 19 dispensed prescriptions per 1000 children per year.

CONCLUSIONS

Despite international recommendations against routine PPI use in infancy, its use in Norway, Sweden and Denmark has increased several-fold over the past two decades. While the reason for the notable increased PPI use in Scandinavian infants cannot be ascertained from our data, this large variation in time and geography likely indicates an unwarranted use.

SO086 / #2459**Short Oral Session****Short Oral Session 17: EAP - The diversity of paediatrics****10-10-2022 12:30 - 13:30****Early-life tuberculosis disease and long-term impact on child health: A prospective birth cohort study****L. Martinez^{1*}, D. Gray², L. Workman², M. Nicol², H. Zar²**¹*Boston University, Department of Epidemiology, Boston, United States of America*²*Red Cross War Memorial Children's Hospital and SA-MRC unit on Child & Adolescent Health, Department of Paediatrics and Child Health, University of Cape Town, South Africa***BACKGROUND AND AIMS**

There is growing concern that post-tuberculosis sequelae and morbidity are substantial but no studies have included children or controlled for predisposing factors prior to disease.

METHODS

We prospectively followed children in a South African birth cohort study. Children were followed for growth, general health, intercurrent wheezing, and tuberculosis using a range of diagnostic tests including culture, Xpert MTB/RIF, chest radiography, symptom screening, and physical examinations. Lung function was assessed in unsedated children at 6 weeks, 1 year, and then annually until 5 years of age. Testing included tidal breathing, exhaled nitric oxide (eNO), and multiple breath washout measures.

RESULTS

Of 1,068 included participants, a total of 25,096 lung function (15,577 tidal breathing, 2,083 eNO, and 7,436 multiple breath washout) and 11,364 anthropometric (5,720 weight and 5,644 length) assessments were performed during follow-up. Tuberculosis was associated with subsequent impaired lung function and lower anthropometric measurements at 5 years of age including tidal volume (-9.32 mL; 95% CI, -14.89, -3.75), length-for-age z-scores (-0.40; 95% CI, -0.68, -0.11), weight-for-age z-scores (-0.30; 95% CI, -0.59, -0.01), and BMI z-scores (-0.54; 95% CI, -0.83, -0.25). Children developing tuberculosis <1 year of age were more likely to wheeze after 1 year (AOR, 2.3; 95% CI, 1.0–5.4) and have recurrent wheezing (AOR, 5.8; 95% CI, 1.1–30.4) during childhood. Lung involvement in chest X-rays modified these relationships.

CONCLUSIONS

Tuberculosis in early childhood has long term detrimental general and lung health effects, even after controlling for pre-existing factors.

SO087 / #401

Short Oral Session

Short Oral Session 17: EAP - The diversity of paediatrics

10-10-2022 12:30 - 13:30

Exploring differences in social atom diagrams of children and adolescents aged 7 to 17 with diagnosed psychiatric disorders and of general population

K. Plėšnytė- Čapkauskienė^{1*}, B. Aukštuolytė², J. Radzevičienė¹, B. Lukšaitė¹

¹Vilnius university hospital Santaros Klinikos, Child Development Center, Vilnius, Lithuania

²Druskininkai Primary Health Care Center, Mental Health Department, Druskininkai, Lithuania

BACKGROUND AND AIMS

This paper explores the diagnostic potential of social atom diagrams in clinical psychiatric diagnostic of patients aged 7 to 17. The study's main focus was on comparing the social atom diagrams between the study group and general population as well as revealing connections between psychiatric disorders and diagrams' unique features.

METHODS

A retrospective case-control study was conducted. The paper focused on comparing the properties in social atom diagrams of children/adolescents in the age group of 7-17 with psychiatric disorders to that of the general population of the same age. Overall 332 diagrams of social atom were analyzed. Control group included 274 diagrams while clinical group consisted of 58 charts. The patients in clinical group were all treated in Vilnius university Hospital,

Child Development center in duration from 12/2019 to 05/2020. Sample's sociological data was considered as well as features of SoA diagrams. Descriptive statistics criteria Spearman's rank correlation, Mann-Whitney and Chi-square tests were used. With statistical significance level being $p < 0,05$.

RESULTS

Numerous characteristics of both clinical and control groups have been observed in social atom diagrams. Evaluation of comprehensive visual structure features proposes that SoA can be used in practice as a diagnostic tool. An in depth analysis is required for more certain results.

CONCLUSIONS

Significant differences in SoA between clinical and control groups were found. These findings reinforce the approach to social atom diagrams as a valuable instrument in clinical psychiatric diagnostic.

SO088 / #440**Short Oral Session****Short Oral Session 18: EAP - Paediatric potpourri 01****10-10-2022 12:30 - 13:30****Off-label, but on-evidence? A review of the evidence of pediatric pharmacotherapy****T. Van Der Zanden^{1*}, N. Smeets¹, M. De Hoop², M. Schwerzel¹, H.J. Huang¹, L. Barten¹, J. Van Der Heijden¹, J. Freriksen¹, A. Horstink¹, I. Holsappel², M. Mooij³, M. De Hoog³, S. De Wildt¹**¹Radboud UMC, Pharmacology & Toxicology, Nijmegen, Netherlands²Royal Dutch Pharmacist Association, Drug Information Centre, Den Haag, Netherlands³ErasmusMC -Sophia Childrens Hospital, Pediatrics, Rotterdam, Netherlands**BACKGROUND AND AIMS**

Despite international legislation to address unmet pediatric medical needs, many drugs are still prescribed off-label to the pediatric population. Although off-label drug use not supported by high level of evidence is potentially harmful, a comprehensive overview of the quality of the evidence pertaining off-label drug use in children is lacking.

METHODS

The Dutch Pediatric Formulary provides best evidence-based dosing guidelines for drugs used in children and represents overall pediatric prescribing. For each drug- indication-age group combination, we scored the highest available level of evidence: authorized drug use (summary of product characteristics, SmPC), systematic review or meta-analysis, randomized controlled trial (RCT), comparative research, non-comparative research, or consensus-based expert opinions. For records that were based on selected guidelines the original sources were not reviewed. These records were scores as guideline.

RESULTS

A total of 774 drugs included 6426 records. of all off-label records (n=2718), 14% were supported by high quality evidence (4% meta-analysis or systematic reviews, 10% RCTs of high quality), 20% by comparative research, 14% by non-comparative research, 37% by consensus-based expert opinions and 15% by selected guidelines. 58% of all records were authorized, increasing with age from 30% in preterm neonates (n=110) up to 64% in adolescents (n=1630).

CONCLUSIONS

Many have advocated that off-label use is only justified when supported by a high level of evidence. We show that this prerequisite would seriously limit available drug treatment for children. Our data identify the drugs and therapeutic areas for which clinical evidence is clearly missing and could therefore drive the global research agenda.

SO089 / #535**Short Oral Session****Short Oral Session 18: EAP - Paediatric potpourri 01****10-10-2022 12:30 - 13:30****Single port surgery in pediatric age: 5 years experience****N. Zampieri*, G. Scirè, A. Giambanco, F. Camoglio***University of Verona, Woman and Child Hospital, Pediatric Surgical Unit, Surgery, Dentistry Paediatrics and Gynaecology, Verona, Italy***BACKGROUND AND AIMS**

In recent years, evolution of surgery has led to laparoscopy and then to single port surgery. In pediatric age, single port surgery is still under discussion; the aim of this study is to report our experience with a new device used in the past 5 years.

METHODS

A retrospective analysis of first 350 cases was performed collecting the data of all patients treated with this new device from 2017. Epidemiological data, diagnosis, operative times and complications were analyzed. Post-operative pain was compared with standard laparoscopy. Also cosmetic results were compared to standard laparoscopy.

RESULTS

A total of 350 procedures were performed during the study period. The age range was 1-17 years. The conversion rate was 3.4% (12 patients) including 3 conversion to traditional laparoscopy and to laparotomy. Pain management

was comparable to traditional laparoscopy. The complication rate was 3.2%, in one case leading to re-do surgery. All the cases in our Unit were successfully completed, with complications mainly related to the original pathology rather than to the technique itself. at follow-up (3 months), cosmetic results were better for single port surgery respect to standard laparoscopy, for both patients and parents (patients aged > 6 years).

CONCLUSIONS

The learning curve for this device and for single port surgery proved to be functional as for standard laparoscopy. In this study, we reported surgical indications for the use of single port laparoscopy discerning favorable and unfavorable procedures; A proven superiority of this technique over traditional laparoscopy is yet to be defined, but single port surgery has proved to be a safe and easy tool to reduce invasiveness of procedures in pediatric surgery with better cosmetic results.

SO090 / #572**Short Oral Session****Short Oral Session 18: EAP - Paediatric potpourri 01****10-10-2022 12:30 - 13:30****Teaching children with food allergy to manage anaphylaxis: Caregivers' perspectives****H. Keohane^{1*}, C. Cronin¹, L. Flores Villarta², C. Okelly²,
J. Trujillo Wurttele²**¹University College Cork, School of Medicine, Cork, Ireland²Cork University Hospital, Paediatrics, Cork, Ireland**BACKGROUND AND AIMS**

Anaphylaxis is rising in prevalence amongst children and is managed with allergen avoidance and adrenaline auto-injector(AAI) use. This study seeks to determine at what age caregivers start to teach their children to recognise anaphylaxis and use AAI, the factors affecting this, how this compares to EAACI guideline's recommendation of age 11-13 and who they believe should teach their child.

METHODS

An online questionnaire was distributed to a convenience sample of 500 caregivers of paediatric allergy patients in Cork University Hospital. Statistical analysis was performed using Stata.

RESULTS

123 responses to the questionnaire were received. Ages indicated were: <6 years for teaching recognition of anaphylaxis symptoms(65.9%) and 9-11 years for teaching to self-inject an AAI(44.7%). History of severe anaphylaxis

(94.3%), the child's ability to describe reasons to inject adrenaline(87.8%) and demonstrate AAI use(82.1%) were the most common "very important" readiness factors identified. Almost half of caregivers were "not confident"(8.94%) or "somewhat confident"(40.65%) in training their child to use AAI and the majority believed paediatric allergy specialists(30.89%) and nurses(37.40%) should be responsible for this. Caregivers with higher household incomes identified themselves more frequently as the party responsible for training their children to use AAI($p=0.04$).

CONCLUSIONS

Caregivers begin to transfer the responsibility of anaphylaxis recognition and AAI use to their children significantly younger than the EAACI recommended age. Caregivers expressed suboptimal confidence in teaching their children to use AAI. Further evaluation is necessary to improve guidelines, enabling clinicians to train and support caregivers during this transition.

SO091 / #606**Short Oral Session****Short Oral Session 18: EAP - Paediatric potpourri 01****10-10-2022 12:30 - 13:30****Born too soon for romance? An individual participant data meta-analysis of romantic and sexual relationships in adults born very preterm****M. Mendonca^{1,2*}, D. Wolke^{2,3}**

¹University of Leicester, Department of Neuroscience, Psychology and Behaviour, Leicester, United Kingdom

²University of Warwick, Department of Psychology, Coventry, United Kingdom

³University of Warwick, Warwick Medical School, Coventry, United Kingdom

BACKGROUND AND AIMS

Individuals born very preterm (<32 weeks of gestation; VP) or very low birth weight (<1500g; VLBW) have been found to be less likely to experience romantic relationships. However, it is unknown whether neonatal complications, sex, neurosensory impairments or social factors may explain the association of VP/VLBW with less romantic and sexual relationships. This was investigated in the present study.

METHODS

Individual participant data (IPD) were obtained from 11 prospective cohort studies of individuals born VP/VLBW and term-born controls contributing to the 'Research on European Children and Adults Born Preterm (RECAP-preterm)' consortium. The combined dataset comprised 1,583 VP/VLBW and 1,641 term-born adults. IPD meta-analyses were performed for indicators of romantic and sexual relationships using a one-stage approach.

RESULTS

Adults born VP/VLBW (≥ 18 years old) were less likely to be in a romantic relationship (OR, 0.49; 95% CI, 0.31, 0.76), to marry/cohabitate (OR, 0.70; 95% CI, 0.53, 0.92), or to have experienced sexual intercourse (OR, 0.23; 95% CI, 0.13, 0.41). When sexually active, VP/VLBW participants were more likely to have their first sexual intercourse after the age of 18 (OR, 1.93; 95% CI, 1.24, 3.01). Among VP/VLBW adults, being male or having any neurosensory impairment (NSI) decreased the likelihood to experience romantic and sexual relations.

CONCLUSIONS

VP/VLBW birth decreases the likelihood of having romantic and sexual relationships in adulthood. The likelihood of not experiencing these relationships is higher for VP/VLBW adults who are male or have NSI. This has important implications for fertility and wellbeing of VP/VLBW adults.

SO092 / #2605**Short Oral Session****Short Oral Session 18: EAP - Paediatric potpourri 01****10-10-2022 12:30 - 13:30****Comparing cystatin C- and creatinine-estimated glomerular filtration rates in pediatric patients with neurogenic bladder-associated kidney disease****C. Menezes^{1*}, T. Costa², C. Brás³, P. Sousa⁴, A. Mendes¹, R. Amorim⁵, M.-S. Faria², C. Mota²**

¹Centro Materno Infantil do Norte - Centro Hospitalar Universitário do Porto, Department of Pediatrics, Porto, Portugal

²Centro Materno-Infantil do Norte - Centro Hospitalar Universitário Do Porto, Department of Pediatrics, Pediatric Nephrology Unit, Porto, Portugal

³Hospital Prof. Dr. Fernando Fonseca, Department of Nephrology, Amadora, Portugal

⁴Hospital Senhora da Oliveira - Guimarães, Pediatrics, Guimarães, Portugal

⁵Centro Hospitalar Universitário Do Porto, Department of Physiatry, Porto, Portugal

BACKGROUND AND AIMS

Patients with neurogenic bladder (NB) have a high risk of developing chronic kidney disease (CKD). Due to their lower muscle mass, the estimation of glomerular filtration rate (eGFR) using creatinine (Cr) may be overestimated and delay the diagnosis of renal failure. We aim to compare eGFR calculated by different formulas based on creatinine and/or cystatin C (CysC) in children with NB, and the differences found between patients unable to walk independently, with lower muscle mass and underdeveloped lower limbs, and patients able to walk independently, with more developed lower limb musculature.

METHODS

Data on pediatric patients with NB and CKD stage 1 and 2, were collected. The eGFR was calculated using CKiD-Cr, CKiD-CysC, Zappitelli-CysC, Schwartz combined-Cr/CysC and Zappitelli combined-Cr/CysC.

RESULTS

Forty-seven patients were evaluated, 74.5% CKD stage 1, median age of 14.1 years, 59.6% had lipo/myelomeningocele. When compared with CKiD-Cr, CysC-based formulas showed lower eGFR ($p<0.05$), (CKiD-CysC ($p<0.001$), Zappitelli-CysC ($p<0.001$), Schwartz combined-Cr/CysC ($p<0.001$) and Zappitelli combined-Cr/CysC ($p<0.05$)). When CKiD-CysC was used, 68% of patients moved to a more advanced CKD stage. In patients unable to walk independently, with lower muscle mass, (55.3%) the median eGFR using CKiD-Cr (118.52) and Schwartz combined-Cr/CysC (91.97) were higher ($p<0.05$) than in the other group (91.23, 82.80). No differences ($p>0.05$) were found between the two groups using the other formulas (CKiD-CysC (78.38 vs 74.08)).

CONCLUSIONS

In patients with NB and poor muscle mass, CKiD-Cr formula may overestimate renal function. CysC-based formulas may be more reliable in these patients, especially in those with greater muscular atrophy.

SO093 / #1879**Short Oral Session****Short Oral Session 19: EAP - Paediatric potpourri 02****10-10-2022 12:30 - 13:30****Study of factors associated with sleep duration in healthy infants aged 9 months****C. Broderick Farrell*, L. Zgaga, C. Taut***Trinity College Dublin, School of Medicine, Dublin, Ireland***BACKGROUND AND AIMS**

The aim of this study was to investigate the factors which are associated with total sleep duration in healthy infants at the age of 9 months, in particular: gender, birth weight, breastfeeding length and social class.

METHODS

We examined health aspects of Wave 1 of the Infant Cohort of Growing Up in Ireland, which is a national longitudinal study of Irish children. A large number of covariates were investigated as potential predictors for sleep duration based on existing literature on the subject. Chi-square tests were carried out for univariable analyses of the association between sleep duration and all of the categorical variables. T-tests of differences in the mean and 95% confidence interval estimations were carried out for each of the continuous variables. All variables were considered in the initial linear regression model. Insignificant variables were excluded from the final model.

RESULTS

Heavier birth weight was significantly associated with longer sleep duration (β coefficient 0.0001; 95% confidence interval (95% CI) 0.0001, -0.0002;

p-value <0.001). Longer sleep duration was associated with later introduction of formula (β coefficient -0.001; 95% CI -0.002, 0; p-value 0.0253), and longer breastfeeding length (β coefficient 0.002; 95% CI 0.001, 0.003; p-value <0.001). We found that if a child was breastfed for 100 days, sleep duration on average increased by approximately 12 minutes per day.

CONCLUSIONS

Our findings indicate that longer sleep duration in infancy is significantly associated with a longer period of breastfeeding.

SO094 / #1934**Short Oral Session****Short Oral Session 19: EAP - Paediatric potpourri 02****10-10-2022 12:30 - 13:30****Use of video data and facial landmark analysis as an objective assessment of palatability for paediatric medicine****C. Matthews¹, R. Aziza^{2*}, E. Alessandrini³, S. Ranmal³, Z. Zhou³, E.H. Davies¹, C. Tuleu³**¹Aparito, Data Science, Wrexham, United Kingdom²Aparito, Data Science, Coventry, United Kingdom³University College London, School of Pharmacy, London, United Kingdom**BACKGROUND AND AIMS**

For orally-administered drugs, palatability is key in determining patient acceptability and treatment compliance. Therefore understanding children's taste sensitivity and preferences can support formulators in making paediatric medicines more acceptable. Moreover collecting data in the home setting allows for natural behaviour, with minimal burden for participants. Presently, we explore if the application of computer-vision techniques to videos of children's reaction to gustatory taste strips can provide an objective assessment of palatability.

METHODS

Primary school children tasted four different flavoured strips: no taste, bitter, sweet and sour (UCL REC 4612/029). Data was collected at home, under the supervision of a guardian, with responses recorded using the Aparito Atom5™ app and smartphone camera. Participants scored each strip on a 5-point hedonic scale. Facial landmarks were identified in the videos, and

quantitative measures such as changes around the eyes, nose and mouth were extracted, to train models to classify strip taste and score.

RESULTS

We received 215 videos and 252 self-reported scores from 64 participants. The hedonic scale elicited expected results: children like sweetness, dislike bitterness and have varying opinions for sourness. We observed a wide facial variation across participants in the magnitude, onset and duration of reactions. Challenges resulting from home-recorded videos are lack of standardisation and inability to provide timely feedback.

CONCLUSIONS

This study into children's taste specificities can improve the measurement of paediatric medicine acceptability. An objective measure of how children feel about the taste of medicines has great potential in helping find the most palatable formulation.

SO095 / #1945**Short Oral Session****Short Oral Session 19: EAP - Paediatric potpourri 02****10-10-2022 12:30 - 13:30****Aerosol drug delivery performance from vibrating mesh and jet nebulisers in a spontaneously breathing paediatric model****E. Fernandez Fernandez^{1*}, M. Mac Giolla Eain², M. Joyce²,
R. Macloughlin²**¹*Aerogen Ltd, Medical Affairs, Galway, Ireland*²*Aerogen Ltd, R&D, Science and Emerging Technologies, Galway, Ireland***BACKGROUND AND AIMS**

Nebuliser selection impacts the efficiency of aerosol therapy in the treatment of respiratory diseases in paediatric patients. Here, we assess the performance, in terms of drug delivery, residual drug volume and concentration, of a vibrating mesh nebuliser (VMN) and a jet nebuliser (JN) in combination with a facemask in a simulated spontaneously breathing paediatric patient.

METHODS

3mL of 0.83mg/mL Salbutamol (GSK, IRE) was nebulized using two nebulisers: a VMN/aerosol chamber/valved facemask (Aerogen Solo/Ultra at 2LPM, Aerogen, IRE) and a JN/open aerosol facemask (AirLife MistyFast at driving flow rate of 8LPM, Vyaire, US). A head model (5-year-old) was connected via a filter (Respirgard, Vyaire, US) to a breathing simulator (ASL5000, Ingmar, US) set to simulate a normal paediatric, Vt 300mL, BPM 20 and I:E 1:2, breath pattern. Drug delivery and residual concentration are expressed as a percentage of the nominal dose and determined using UV-spectroscopy at 276nm. Residual volume was determined gravimetrically.

RESULTS

are displayed as the mean \pm SD in the table below.

Nebuliser Type	VMN	JN	P-value
Drug delivered (%)	30.75 \pm 2.19	6.45 \pm 0.59	<0.0001
Residual Drug (mL)	0.03 \pm 0.04	1.30 \pm 0.14	0.0003
Residual drug concentration (mg/mL)	N/A	0.91 \pm 0.02	N/A

CONCLUSIONS

Across both nebuliser types, the VMN delivered a statistically significantly larger drug dose, with less drug remaining in the medication cup. For the JN, the drug concentration increased post nebulisation from 0.83 to 0.91mg/mL. This study highlights the clinical relevance of nebuliser choice on aerosol drug delivery.

SO096 / #1970

Short Oral Session

Short Oral Session 19: EAP - Paediatric potpourri 02

10-10-2022 12:30 - 13:30

Microbiology, risk factors and adverse outcomes in bronchiolitis admissions during the SARS-CoV2 pandemic: Experience in a tertiary paediatric hospital

F. Guerrero Del Cueto^{1,2*}, I. Leiva Gea^{1,2,3}, A. Ortiz Ortigosa²,
J. Ramos Fernandez^{2,3}, B. Carazo Gallego⁴, A. Córdón Martínez²,
E. Núñez Cuadros^{2,3}

¹Universidad de Málaga, Facultad de Medicina, Málaga, Spain

²Hospital Regional Universitario de Málaga (Málaga Mother and Child Hospital, Paediatrics, Málaga, Spain

³Instituto de Investigación Biomédica de Málaga (Biomedical Research Institute of Málaga),

Multidisciplinary Paediatric Group, Málaga, Spain

⁴Hospital Regional Universitario de Málaga (Málaga Mother and Child Hospital), Paediatrics, Infectious Diseases, Málaga, Spain

BACKGROUND AND AIMS

Seasonality of bronchiolitis changed during the SARS-CoV2 pandemic. This study compares microbiology, risk factors and adverse outcomes in 2020-2021 hospitalizations versus 2010-2015.

METHODS

Ambispective observational study: acute-bronchiolitis (ICD-10-J21) hospitalizations (ABH) in children <2 years in a tertiary paediatric hospital.

Multiplex-PCR detections in nasopharyngeal swabs (01/Apr/2020-31/Dec/2021) compared to pre-pandemic (01/Apr/2010-31/Mar/2015) microbiological trends.

Risk factors (sex, age, prematurity, pre-existing conditions, microbiology) examined with chi-squared and logistic regression for adverse outcomes:

length of stay (LOS)>5 days, intensive care unit (PICU) admission and bacterial superinfection (BSI).

RESULTS

1024 pre-pandemic ABH (annual average=204.8, SD=18.78; 46.2 ABH/10000 children <2 years emergency consultations), December-January peak.

Winter 2020: only 11 admissions (94.6% reduction). Summer-autumn peak April-Dec/2021: 171 ABH (52.24 ABH/10000).

No significant differences in RSV proportion (pre-pandemic: 789/1024 (77.1%) versus pandemic:148/182 (81.3%); $p=0.16$). Epidemiological trends and microbiological detections are shown in Figure 1.

20/106 (18.87%) pandemic codetections, 90% with RSV, not associated with adverse outcomes. Adverse outcomes in each period are analysed in Table 1, and significant risk factors in Table 2.

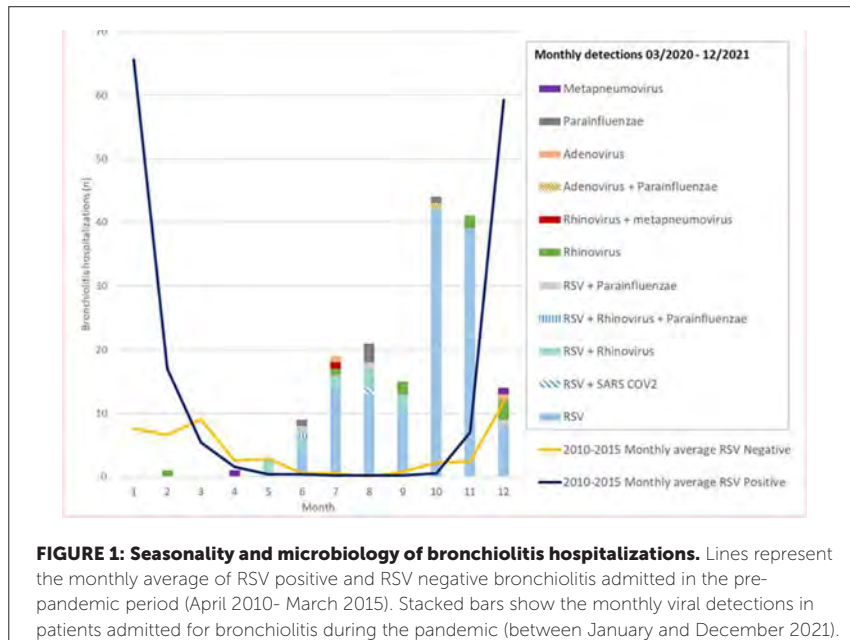

Table 1: Adverse outcomes

	Pre-pandemic	Pandemic	p
LOS>5 days	436(42.6%)	55(30.2%)	0.002
BSI	153(15.3%)	30(16.5%)	0.681
Pneumonia	107(10.69%)	12(6.70%)	NS
Urinary-tract infection	29(2.90%)	2(1.12%)	NS
Bacteriemia	16(1.6%)	3(1.68%)	NS
Otitis-media (AOM)	1(0.1%)	6(3.35%)	0.000
PICU	85(8.3%)	18(9.9%)	0.48

Table 2: Risk factors

	Pre-pandemic	Pandemic
PICU	<ul style="list-style-type: none"> •Prematurity <28 weeks: p=0.000, OR=15.15 (95%CI 4.39-52.28) •Prematurity 29-34 weeks: p=0.000, OR=4.67 (95%CI 2.41-9.03) •Prematurity 35-36 weeks: p=0.005, OR=2.58 (95%CI 1.33-5.03) •Bronchopulmonary dysplasia: p=0.000, OR=42.74 (95%CI 12.29-148.73) •Age <1 month: p=0.000, OR=3.33 (95%CI 1.72-6.46) 	NS
LOS>5 days	<ul style="list-style-type: none"> •Age <1month: p=0.002, OR=2.5 (95%CI 1.41-4.60) •Prematurity: p=0.000, OR=2.3 (95%CI 1.41-3.7) 	NS
BSI	<ul style="list-style-type: none"> • Female: p=0.008, OR=1.66 (95%CI 1.14-2.42) •Age <1month: p=0.002, OR=2.036 (95%CI 1.29-3.21) 	<ul style="list-style-type: none"> •Female: p=0.027, OR=2.74 (95%CI 2.12-6.71)

CONCLUSIONS

- After an absent 2020 bronchiolitis season, there was an extemporaneous summer-autumn 2021 outbreak; main agents RSV and rhinovirus.
- Longer pre-pandemic LOS and higher incidence of AOM; other adverse outcomes not significantly different.
- Risk factors for PICU and LOS in pre-pandemic period: prematurity and age, not significant during pandemic; only female sex for bacterial superinfection.

SO097 / #2024**Short Oral Session****Short Oral Session 19: EAP - Paediatric potpourri 02****10-10-2022 12:30 - 13:30****COVID-19, the omicron variant and its association with croup in children, a single center study in Hong Kong****C.Y.M. Lam*, S.Y.D. Lam***Tuen Mun Hospital, Department of Paediatrics & Adolescent Medicine, Hong Kong, Hong Kong PRC***BACKGROUND AND AIMS**

The 5th wave of the COVID-19 pandemic in Hong Kong was dominated by the omicron BA.2 variant, which may have more upper airway involvement affecting children. This pilot study aims at analysing any associations between the COVID-19-omicron-variant and croup in children.

METHODS

This retrospective study reviewed electronic medical records of all patients admitted to Tuen Mun Hospital of Hong Kong from 1 January 2018 to 31 March 2022 with diagnostic code of croup (ICD-10 code J05.0). Patients were categorised into the Non-COVID period (1 January 2018 - 31 December 2019); COVID-pre-omicron period (1 January 2020 - 31 December 2021) and COVID-omicron period (1 January 2022- 31 March 2022). Their disease associations and severity were compared through incidence rates, Westley Croup Severity Score, length of hospital stay, medications use, respiratory support and intensive care unit admissions.

RESULTS

The rate of croup patients infected by COVID-19 in the COVID-omicron period (90%) was much higher than those in COVID-pre-omicron period (3.6%, $p < 0.001$). Meanwhile, these patients also had higher Westley Scores (moderate + severe disease: COVID-omicron: 56.7%; COVID-pre-omicron: 20.4%; $p = 0.002$; Non-COVID: 24.2%, $p < 0.001$), longer length of hospital stay (median: COVID-omicron 3.00 days; COVID-pre-omicron: 2.00 days, $p < 0.001$, Non-COVID: 2.00 days, $p = 0.033$), and higher dexamethasone requirements (mean: COVID-omicron = 0.78mg/kg; COVID-pre-omicron = 0.48mg/kg, $p < 0.001$; Non-COVID = 0.58mg/kg, $p = 0.006$) while compared to croup patients in COVID-pre-omicron period and non-COVID period respectively.

CONCLUSIONS

The omicron variant of COVID-19 is a significant contributing factor to croup and can lead to more severe disease in children of Hong Kong.

SO098 / #2107**Short Oral Session****Short Oral Session 19: EAP - Paediatric potpourri 02****10-10-2022 12:30 - 13:30****Voice or instrumental music? newborns' early discrimination of vocal and instrumental melodies: A FMRI based dynamic effective connectivity study****M. Filippa^{1V}, S. Loukas², J. Sa De Almeida², L. Lordier², D. Grandjean³, D. Van De Ville⁴, P. Hüsppi^{2,5}**¹University of Geneva, Psychology and Educational Sciences, Medicine, Geneva, Switzerland²University of Geneva, Faculty of Medicine, Geneva, Switzerland³University of Geneva, Psychology and Educational Sciences, Geneva, Switzerland⁴Ecole Polytechnique Fédérale de Lausanne, Institute of Bioengineering, Lausanne, Switzerland⁵Geneva University Hospital, Child Development Lab, Geneva, Switzerland**BACKGROUND AND AIMS**

Newborn infants show early specialization in treating human voices, but little is known whether this specialization is only for speaking or also for singing voices. 45 newborns were scanned using functional magnetic resonance imaging while listening to a melody (without words) sang by a female voice (voice condition) or played by a musical instrument: a flute (instrument condition).

METHODS

To explore the dynamic task-based effective-connectivity, we employed psychophysiological interaction of co-activation patterns (PPI-CAPs) analysis with auditory cortices as seeds regions to investigate moment-to-moment changes in task-driven modulation of brain activity.

RESULTS

Our findings revealed unique, condition-specific, dynamically occurring PPI-CAPs. Based on the PPI effects, the auditory cortex during the voice condition co-activates with cortical sensorimotor, salience, and right temporal gyrus, while during the instrument condition the auditory cortex with the visual and the superior frontal areas. Both stimuli activate the precuneus and posterior cingulate, with a concomitant deactivation of the salience network, only for the instrumental condition. In line with adult studies, the singing voice condition, activating the somatomotor network, evokes proprioceptive and motor aspects of the auditory perception, in addition to the salience network - filtering relevant elements of the vocal stimulus. The right temporal gyrus - sensitive to speech stimuli - is activated only by singing voice in a lateralized manner.

CONCLUSIONS

Distinct brain activations for instrumental and vocal melodies were found in newborns. When sang, the same melody activates brain regions evoking body experience and regions important for filtering of relevant stimuli, in comparison to instrumental melodies.

SO099 / #573**Short Oral Session****Short Oral Session 20: ESPR - Nutrition matters****10-10-2022 12:30 - 13:30****Admission to a neonatal ward and subsequent exclusive breastfeeding at one and four months among late-preterm, early-term and term infants: A nationwide register-based cohort study****F. Nejsum^{1*}, R. Wiingreen¹, R. Maastrup², C. Torp-Pedersen³, E. Løkkegaard⁴, B. Hansen¹**¹Nordsjællands Hospital, Hillerød, Department of Pediatrics, Hillerød, Denmark²Rigshospitalet, Copenhagen, Department of Neonatology, Copenhagen, Denmark³Nordsjællands Hospital, Hillerød, Department of Cardiology and Clinical Research, Hillerød, Denmark⁴Nordsjællands Hospital, Hillerød, Department of Gynaecology and Obstetrics, Hillerød, Denmark**BACKGROUND AND AIMS**

Although approximately 8% of the Danish birth cohort with gestational age (GA) ≥ 35 weeks are admitted to a neonatal ward shortly after birth, evidence is inadequate regarding implications for breastfeeding. We aimed to investigate the associations between neonatal ward admission and exclusive breastfeeding (EBF) 1 and 4 months postpartum stratified by GA divided in late-preterm (GA 35-36 weeks), early-term (GA 37-38 weeks) and term (GA >38 weeks) infants.

METHODS

A register-based, cohort study including all live-born infants in Denmark in 2014-2015 with GA ≥ 35 weeks. All Danish parents receive free home visits by health visitors throughout their infants' first year, and from these visits data on EBF are reported to The Children's Database. We linked EBF data

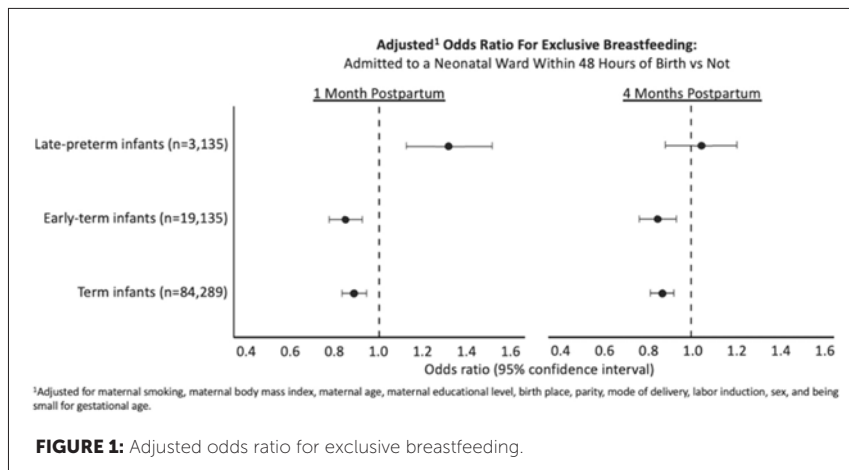

with other registers held by Statistics Denmark. Multiple logistic regression analyses estimated the associations between neonatal ward admission and EBF stratified by GA, adjusted for confounders.

RESULTS

The study population comprised 106,559 infants. The odds of EBF 1 and 4 months postpartum were decreased in the group admitted to the neonatal ward. However, among late-preterm infants ($n=3,135$) neonatal ward admission was associated with increased odds of EBF 1 month postpartum (1.30; 95%CI 1.12-1.51), as opposed to among early-term ($n=19,135$; 0.89; 95%CI 0.83-0.94) and term infants ($n=84,289$; 0.84; 95%CI 0.77-0.92). The trend seemed to persist 4 months postpartum (Figure 1).

CONCLUSIONS

Neonatal ward admission is associated with decreased EBF among early-term and term infants, whereas the opposite is the case for late-preterm infants, indicating that this group benefits from approaches to breastfeeding support in neonatal wards.

SO100 / #1361**Short Oral Session****Short Oral Session 20: ESPR - Nutrition matters****10-10-2022 12:30 - 13:30****A standardized feeding protocol for extremely preterm infants ensured recommended nutrient intakes and prevented growth faltering****M. Rossholt^{1,2*}, M. Bratlie^{1,2}, K. Wendel¹, M. Aas¹, G. Gunnarsdottir², D. Fugelsest^{1,3}, T. Stiris^{1,3}, M. Domellof⁴, K. Størdal^{2,3}, S. Moltu¹**¹Oslo University Hospital, Ullevål, Department of Neonatal Intensive Care, Oslo, Norway²Oslo University Hospital, Department of Pediatrics and Adolescence Medicine, Oslo, Norway³University of Oslo, Institute of Clinical Medicine, Faculty of Medicine, Oslo, Norway⁴Umeå University, Department of Clinical Sciences, Pediatrics, Umeå, Sweden**BACKGROUND AND AIMS**

Nutrition is a cornerstone of postnatal care in extremely preterm infants. This study aimed to evaluate the efficacy and safety of a standardized feeding protocol on nutritional intakes and growth among infants < 29 weeks gestation.

METHODS

121 infants participated in a randomized controlled trial (the ImNuT trial, NCT03555019) at Oslo University Hospital. A standardized feeding protocol was implemented to reduce variations in nutritional practice and ensure accommodation to international guidelines on enteral and parenteral nutrition. Detailed information on actual nutritional intakes, growth and biochemistry was prospectively collected and assessed from birth to 36 weeks postmenstrual age (PMA).

RESULTS

Median (range) gestational age and birth weight were 26⁺⁶ (22⁺⁶, 28⁺⁶) weeks and 798 (444, 1485) g. Energy and macronutrient intakes progressively increased from birth through transition to exclusive enteral feeds (Fig.1a-c). Parenteral nutrition was weaned at median (IQR) day 11 (9, 14) when nutritional requirements were met by exclusively enteral feeds. Infants exhibited median (IQR) weight loss of 7.8% (5.7, 11.6) and regained birth weight at day 8 (7, 11). Average velocity in weight, length and HC from birth to 36 weeks PMA were in accordance with target growth rates, median (IQR) 15.8 (14.7, 17.7) g/kg/d, 1.1 (0.98, 1.3) cm/week and 0.82 (0.83, 0.89) cm/week. At 36 weeks PMA, only 3% of infants exhibited moderate growth faltering (decline in z-score weight > 1.2 from birth) and none severe.

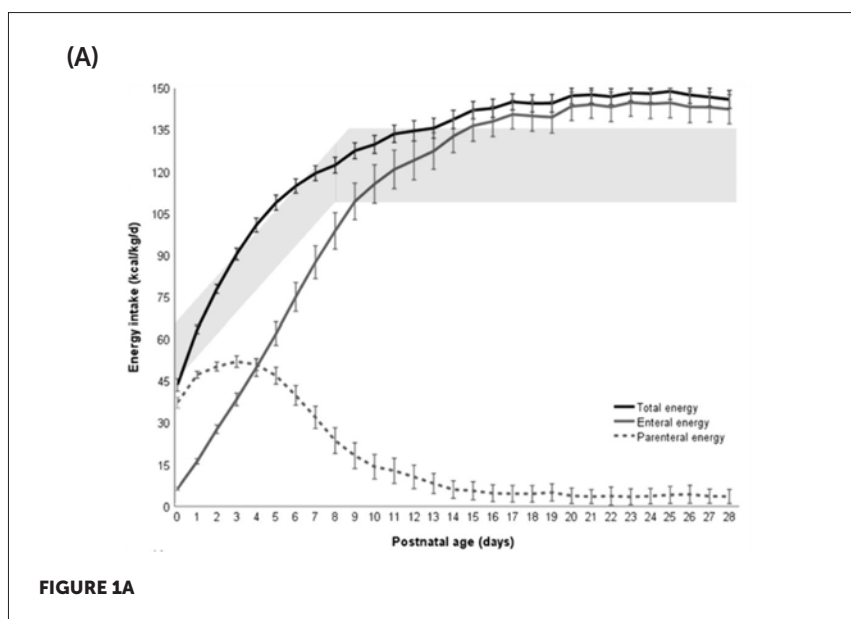

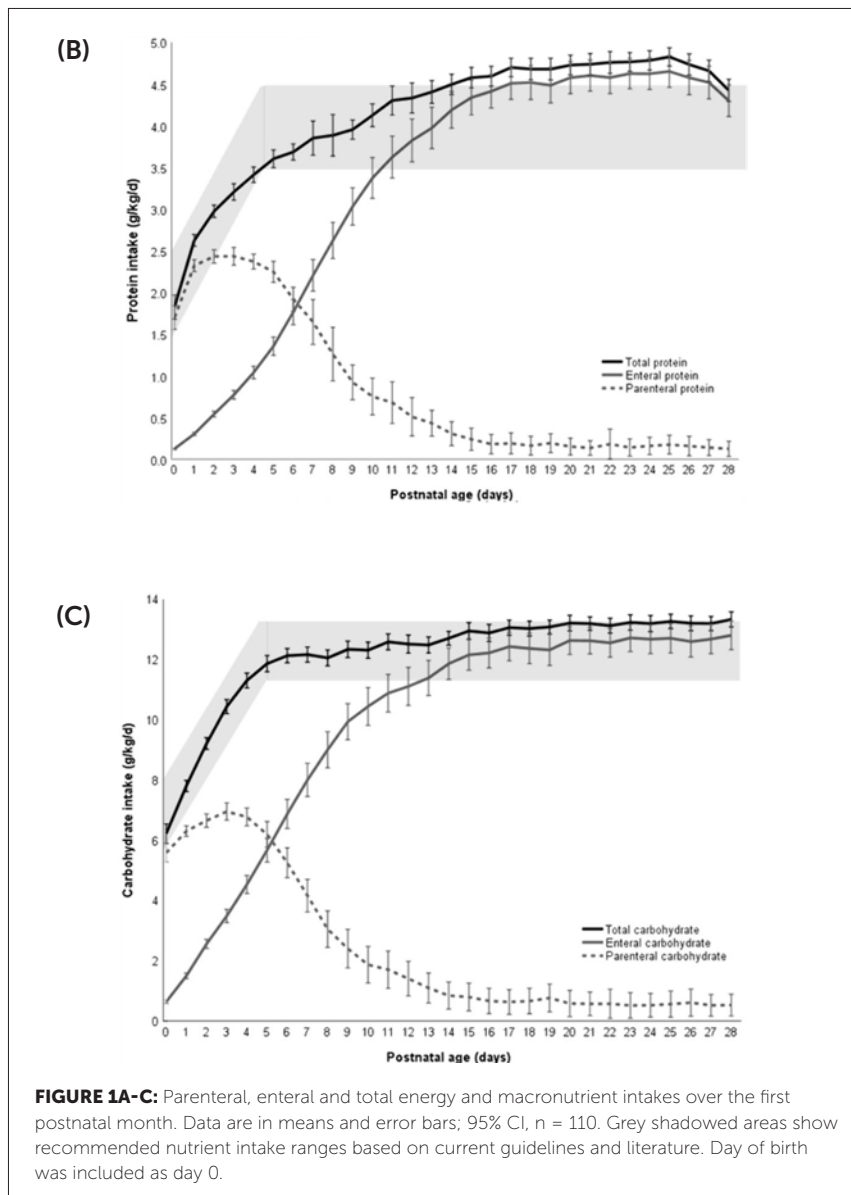

CONCLUSIONS

The standardized feeding protocol was well tolerated, ensured nutrient intakes in line with recommendations and prevented growth faltering in infants < 29 weeks gestation.

SO101 / #605**Short Oral Session****Short Oral Session 20: ESPR - Nutrition matters****10-10-2022 12:30 - 13:30****Influence of routine gastric residual assessment in preterm neonates on time taken to reach full enteral feeding (the grass trial) – A randomised control trial****A. Branagan^{1*}, C. Murphy¹, I. Bodnarova², S. Feyereislova²,
I. Berka², J. Miletin¹, Z. Stranak²**¹*Coombe Women & Infants University Hospital, Neonatology, Dublin, Ireland*²*Institute for the Care of Mother and Child, Prague, Czech Republic, Neonatology, Prague, Czech Republic***BACKGROUND AND AIMS**

Gastric residual measurement, the evaluation of stomach contents, is routinely performed prior to feeding preterm infants. Historically, large residuals have been seen as an indication of necrotising enterocolitis. Residual measurement may lead to a diagnosis of feed intolerance, leading to withholding feeds delaying achievement of full feeds. Our aim was to investigate if the exclusion of routine checks of gastric residuals would impact the time to full enteral feeding in preterm infants.

METHODS

A multicentre randomised controlled trial was performed. Clinically stable infants between 26+0 and 30+6 weeks gestation, appropriate for gestational age and <1.5kg were eligible. Infants were randomized to intervention arm (no monitoring of gastric aspirates) or control arm (routine care). Primary outcome was achievement of full enteral feeds (100ml/kg/day) by day 5. Secondary outcomes: withholding of feeds, duration of central access and parenteral nutrition, incidence of complications of prematurity.

RESULTS

Eighty-eight infants were included in an intention to treat analysis, 45 in intervention arm and 43 in control arm with no imbalances in baseline characteristics. Regarding the primary outcome, 33 (73.3%) infants in the intervention group and 32 (74.4%) infants in the control group reached full feeds by day 5 of life ($p=0.91$). There was no difference in median time to full feeds or any of the predefined secondary outcomes.

CONCLUSIONS

There was no difference in time to full feeds when gastric residuals assessment was excluded. In the absence of clinical benefit it may be appropriate to only monitor residuals when clinical concern arises.

SO102 / #1042**Short Oral Session****Short Oral Session 20: ESPR - Nutrition matters****10-10-2022 12:30 - 13:30****Preterm infants on early solid foods and iron status in the first year of life – A secondary outcome analysis of a randomized controlled trial****M. Thanhaeuser^{1*}, F. Eibensteiner¹, M. Kornsteiner-Krenn¹, M. Gsöllpointner², S. Brandstetter¹, U. Koeller³, M. Huber-Dangl¹, C. Binder¹, A. Thajer¹, B. Jilma², A. Berger¹, N. Haiden²**

¹Medical University of Vienna, Department of Pediatrics and Adolescent Medicine, Comprehensive Center For Pediatrics, Vienna, Austria

²Medical University of Vienna, Department of Clinical Pharmacology, Vienna, Austria

³Klinik Hietzing, Viennese Gesundheitsverbund, Department of Laboratory Medicine, Vienna, Austria

BACKGROUND AND AIMS

Aim of this study was to examine whether two different timepoints of introduction of solid foods in preterm infants have an impact on ferritin and other hematologic parameters important for iron status in the first year of life.

METHODS

The study is a secondary outcome analysis of a prospective, randomized, two arm intervention trial of very low birth weight (VLBW) infants randomized to an early (10-12th week of life corrected age) or a late (16-18th week of life corrected age) complementary feeding group. Blood samples were taken at 6 weeks, 6 months, and 12 months corrected age. Infants were supplemented with iron polymaltose (2-3 mg/kg/day) until iron rich solid foods were fed on a regular basis.

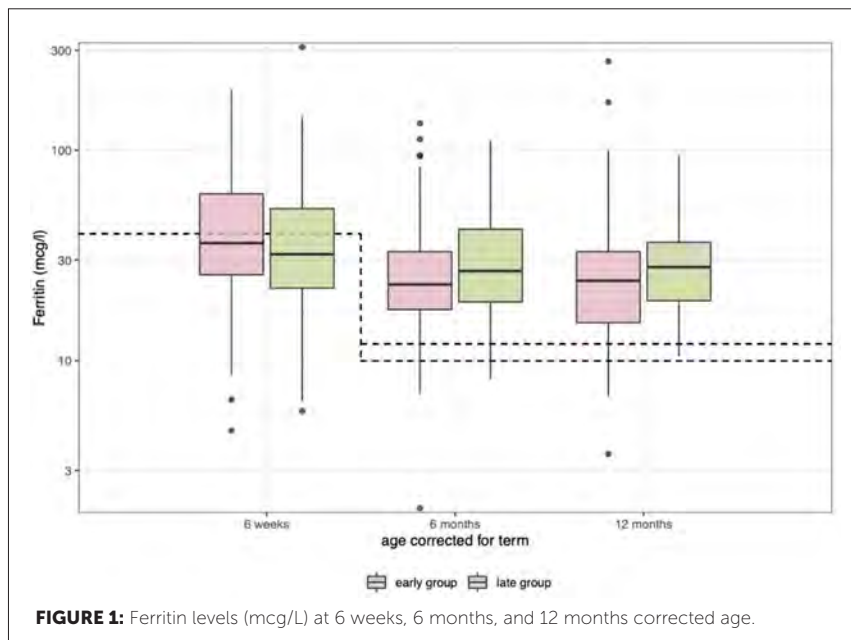

RESULTS

In total, data of 89 infants of the early group and 88 infants of the late group were available for analysis. The primary outcome ferritin showed no differences between groups throughout the first year of life, as did all other parameters (hematocrit, erythrocyte indices, transferrin, transferrin saturation, soluble transferrin receptor, iron). At 12 months corrected age, incidence of iron deficiency (serum ferritin <12 mcg/L) was significantly higher in the early feeding group.

CONCLUSIONS

The timepoint of introduction of solid foods had no impact on ferritin levels and other hematologic parameters important for iron status in the first year of life of VLBW preterm infants but showed a higher incidence of iron deficiency at 12 months corrected age in the early feeding group.

SO103 / #2096**Short Oral Session****Short Oral Session 20: ESPR - Nutrition matters****10-10-2022 12:30 - 13:30****Prevalence and risk factors for feeding problems in infants born extremely preterm in a Swedish population based cohort****S. Alm^{1*}, M. Domellof², E. Stoltz Sjöström³**¹Umeå University, Department of Clinical Sciences, Paediatrics, Umeå, Sweden²Umeå University, Department of Clinical Sciences, Pediatric Unit, Umeå, Sweden³Umeå University, Department of Food, Nutrition and Culinary Science, Umeå, Sweden**BACKGROUND AND AIMS**

Although it has been described that preterm infants have a high risk of developing feeding problems after discharge there is a lack of population-based studies in infants born extremely preterm. The objectives of this study were to assess the incidence of feeding problems up to 2.5 years post discharge among a population-based cohort of infants born extremely preterm in Sweden (EXPRESS), and identify perinatal risk factors for later feeding problems.

METHODS

Data on clinical diagnoses related to feeding problems were obtained from the Swedish Patient Register for all 432 infants from the EXPRESS cohort who took part in the follow-up programme. The main outcome was feeding problems and/or underweight at 2.5 years.

RESULTS

We found that 66 infants (19%) had feeding problems after discharge up until 2.5 years and/or underweight at 2.5 years. The strongest risk factors

for feeding problems were the number of days treated with mechanical ventilation during the first eight postnatal weeks, with an OR of 1.59 (CI 95% 1.286-1.976) and the Clinical Risk Index for Babies-score, with an OR of 1.14 (CI 95% 1.034-1.261). A ROC analysis showed that a duration of more than ten days in mechanical ventilation had the highest sensitivity and specificity for predicting post discharge feeding problems.

CONCLUSIONS

Diagnosed feeding problems are common in infants born extremely preterm. The strongest perinatal risk factor for later feeding problems was early treatment with mechanical ventilation lasting for more than ten days. Identifying infants at risk of post discharge feeding problems might be useful for targeting of nutritional support.

SO104 / #1431**Short Oral Session****Short Oral Session 20: ESPR - Nutrition matters****10-10-2022 12:30 - 13:30****Variability in macronutrient enteral intakes from human milk in very premature infants****C. Borràs-Novell^{1*}, A. Herranz Barbero¹, C. Balcells Esponera²,
M. López-Abad², V. Aldecoa-Bilbao¹, M. Izquierdo Renau²,
I. Iglesias Platas²**¹Hospital Clínic de Barcelona, Neonatology, Barcelona, Spain²Hospital Sant Joan de Déu, Neonatology, Esplugues de Llobregat, Spain**BACKGROUND AND AIMS**

Slow growth is common in very preterm infants, partially due to insufficient provision of protein and energy. We aimed to analyze how this can be impacted by variability in macronutrient content of human milk.

METHODS

Mothers and Very Premature Infants were eligible if milk production was over baby's feeding volumes and the infant was free from underlying or other life-threatening conditions. Composition aliquots from 24-hour milk pools were measured with a mid-infrared analyzer (MIRIS Human Milk Analyzer®, Uppsala, Sweden) on weeks 1, 2 and 4 and a single morning sample on week 3. Patients received standard fortification. Milk intakes and supplementation were extracted from clinical charts. Calculations were based on that week's measurement or an estimation from reference values. Data analysis was carried out with SPSS (Social Package for Social Sciences) v25.

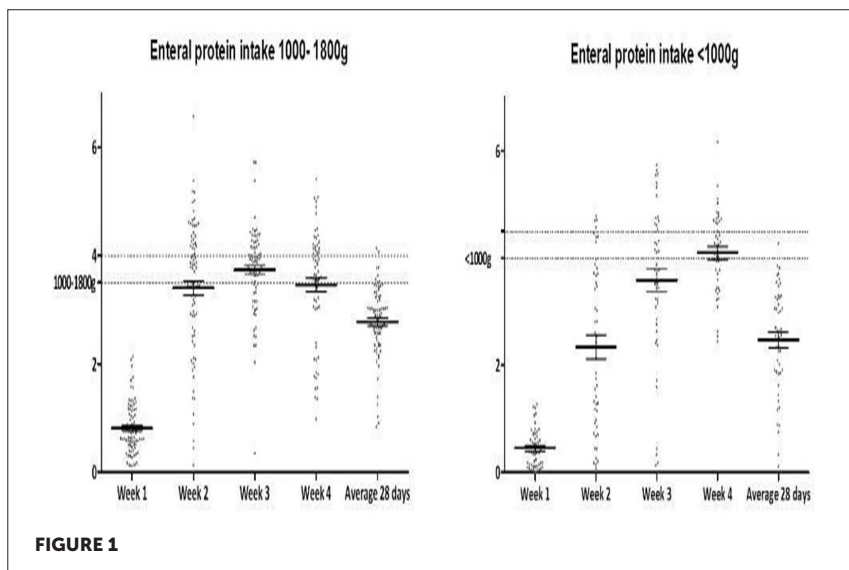

FIGURE 1

RESULTS

117 mothers and 130 infants (20 twins) participated. Mean gestational age was 28.7 ± 2.3 and mean birth weight 1163 ± 383 g. By week 4, milk was the sole source of nutrition in 95% of patients. From those on exclusive enteral nutrition on day 28 (71/72 ≥ 1000 g and 44/46 < 1000 g), between one quarter (< 1000 g) and one third (≥ 1000 g) were receiving an enteral protein supply under the ESPGHAN recommendations (Figure 1), while this was 15% in ELBW and 27% in ≥ 1000 g in the case of energy.

CONCLUSIONS

Under standard fortification protocols, very preterm infants often receive nutrient supplies below ESPGHAN recommendations.

SO105 / #2469**Short Oral Session****Short Oral Session 21: ESPR: Infection immunology****10-10-2022 12:30 - 13:30****NeoCLEAR: A multicentre RCT investigating techniques to improve LP success in neonates****A. Marshall¹, A. Scrivens^{2,3}, J. Bell³, L. Linsell³, J. Yong², M. Sadarangani^{4,5}, E. Juszczak³, C.C. Roehr^{2,3*}**

**E Juszczak, & CC Roehr, on behalf of the 'The NeoCLEAR Collaborative Group'.*

¹Oxford University Hospitals NHS Foundation Trust, John Radcliffe Hospital, Headley Way, Headington, Department of Paediatrics, Oxford, United Kingdom

²Oxford University Hospitals NHS Foundation Trust, John Radcliffe Hospital, Headley Way, Headington, Newborn Care Unit, Oxford, United Kingdom

³National Perinatal Epidemiology Unit (NPEU) Clinical Trials Unit, Nuffield Department of Population Health, University of Oxford, Old Road Campus, Headington, Oxford, Oxford, United Kingdom

⁴BC Children's Hospital Research Institute, Vancouver, Vaccine Evaluation Center, BC, Canada

⁵University of British Columbia, 4480 Oak St, Vancouver, BC, Department of Pediatrics, Vancouver, Canada

BACKGROUND AND AIMS

Lumbar punctures (LP) are common procedures in neonates but success rates are <60%. Modifications to traditional technique include sitting position and 'early' or 'late' stylet removal. We aimed to determine the optimal LP technique in newborn infants.

METHODS

Multicentre 2x2 factorial pragmatic RCT, at 21 UK neonatal & maternity units. Infants requiring LP (corrected gestational age 27⁺ to 44⁺ weeks, working weight > 1,000g) were randomised to sitting or lying position, and to early or late stylet removal. The trial was powered to detect 10% absolute risk

difference in primary outcome: Percentage of infants with successful LP (CSF containing $< 10,000$ red cells/mm³).

RESULTS

Of 1082 infants randomised, 1076 were fully followed. Most were term babies (950/1076, 88.3%), recruited < 3 days old (936/1076, 87.0%). Baseline characteristics were balanced across groups. For the primary outcome, sitting position was significantly more successful than lying (346/543 (63.7%) vs 307/533 (57.6%), adjusted risk ratio (aRR) 1.11 (95% CI 1.01 to 1.21, $p=0.027$; number needed to treat = 16 (95% CI 9 to 34)). There was no significant difference in success rate between early and late stylet removal (338/545 (62.0%) vs 315/531 (59.3%), aRR 1.04 (95% CI 0.95 to 1.15, $p=0.391$). Resource outcomes were identical. All techniques were generally well tolerated and safe.

CONCLUSIONS

Sitting position resulted in increased chances for successful LP compared to lying, the timing of stylet removal did not significantly affect LP success. These results should be globally relevant, strongly supporting the implementation of sitting technique for neonatal LP.

SO106 / #819**Short Oral Session****Short Oral Session 21: ESPR: Infection
immunology****10-10-2022 12:30 - 13:30****Antibiotic exposure during the first postnatal
week and incidence of early-onset neonatal
sepsis: an international study****E. Giannoni^{1*}, V. Dimopoulou¹, C. Klingenberg^{2,3}, L. Naver⁴,
V. Nordberg⁴, A. Berardi⁵, S. Helou⁶, G. Fusch⁵, J. Bliss⁷, D. Lehnick⁸,
N. Guerina⁷, J. Seliga-Siwecka⁹, P. Maton¹⁰, D. Lagae¹¹, J. Mari¹²,
J. Janota^{13,14}, P. Agyeman¹⁵, R. Pfister¹⁶, G. Latorre¹⁷, G. Maffei¹⁸,
K. Størdal¹⁹, T. Strunk²⁰, M. Stocker²¹**

¹Lausanne University Hospital and University of Lausanne, Department Mother-woman-child, Clinic of Neonatology, Lausanne, Switzerland

²University Hospital of North Norway, Department of Pediatrics and Adolescence Medicine, Tromsø, Norway

³UiT-The Arctic University of Norway, Tromsø, Paediatric Research Group, Faculty of Health Sciences, Tromsø, Norway

⁴Karolinska Institutet, Department of Neonatology, Karolinska University Hospital and Department of Clinical Science, Intervention and Technology, Stockholm, Sweden

⁵Policlinico University Hospital, Neonatal Intensive Care Unit, Mother and Child Department, Modena, Italy

⁶McMaster Children's Hospital, McMaster University, Hamilton Health Sciences, Division of Neonatology, Department of Pediatrics, Hamilton, Canada

⁷Women & Infants Hospital of Rhode Island, Warren Alpert Medical School of Brown University, Department of Pediatrics, Rhode Island, United States of America

⁸University of Lucerne, Biostatistics and Methodology, Ctu-cs, Department of Health Sciences and Medicine, Luzern, Switzerland

⁹Medical University of Warsaw, Department of Neonatology and Neonatal Intensive Care, Warsaw, Poland

¹⁰Clinique CHC-Montlegia, groupe santé CHC, Service Néonatal, Liège, Belgium

¹¹CHIREC-Delta Hospital, Neonatology and Neonatal Intensive Care Unit, Brussels, Belgium

¹²University of Szeged, Department of Paediatrics, Szeged, Hungary

¹³Neonatal Unit, Department of Obstetrics and Gynecology, Motol University Hospital Prague, Prague, Czech Republic

¹⁴Thomayer University Hospital, Department of Neonatology, Prague, Czech Republic

¹⁵Inselspital, Bern University Hospital, University of Bern, Department of Pediatrics, Bern, Switzerland

¹⁶Geneva University Hospitals and Geneva University, Neonatology and Paediatric Intensive Care Unit, Geneva, Switzerland

¹⁷Ecclesiastical General Hospital F. Miulli, Neonatology and Neonatal Intensive Care Unit, Acquaviva delle Fonti, Italy

¹⁸Policlinico Riuniti Foggia, Neonatology and Neonatal Intensive Care Unit, Foggia, Italy

¹⁹University of Oslo, Institute of Clinical Medicine, Fredrikstad, Norway

²⁰King Edward Memorial Hospital, Neonatal Directorate, Child and Adolescent Health Service, Perth, Australia

²¹Children's Hospital Lucerne, Department of Pediatrics, Lucerne, Switzerland

BACKGROUND AND AIMS

Appropriate use of antibiotics is life-saving in early-onset neonatal sepsis (EOS), but overuse of antibiotics is associated with adverse effects. We aimed to compare exposure to antibiotics and incidence of EOS in different networks and countries.

METHODS

We conducted a large international study quantifying antibiotic exposure started in the first postnatal week, incidence of culture-proven EOS and mortality in infants born at a gestational age ≥ 34 weeks between 1.1.2014 and 31.12.2018.

RESULTS

Thirteen networks in eleven countries from Europe, North America, and Australia participated in the study, reporting on 757'979 infants born ≥ 34 weeks. The proportion of neonates started on antibiotics was 2.86% (95% CI 2.83-2.90). Median duration of treatment was 9 days (IQR 7-14) for infants with EOS, and 4 days (IQR 3-6) for those without EOS. This led to an antibiotic exposure of 135 days/1000 livebirths (IQR 134-136). Incidence of EOS was 0.49/1000 livebirths (95% CI 0.45-0.55). Mortality in EOS cases was 3.2% (95% CI 1.66-5.52). Overall, 58 neonates were started on antibiotics and 273 antibiotic days were administered for one case of EOS. We observed wide variations in antibiotic exposure and EOS incidence among the thirteen networks.

CONCLUSIONS

Antibiotic exposure in the first postnatal week is considerable, and disproportionate compared to the incidence of EOS and sepsis-related mortality. Wide variations in the burden of disease and the burden of therapy highlight the importance of reporting on both dimensions, setting the base for benchmarking, quality improvement initiatives and future interventional studies.

SO107 / #1113**Short Oral Session****Short Oral Session 21: ESPR: Infection immunology****10-10-2022 12:30 - 13:30****Early detection of late-onset sepsis in very preterm infants, is the answer in the data?****A.M. Van Den Berg^{1*}, O.A.G. Medina², R.T. Bartels², M. Benders¹, D.C. Vijlbrief¹**¹*Wilhelmina Children's Hospital, Neonatology, University Medical Center, Utrecht, Netherlands*²*University Medical Center Utrecht, Digital Health, Utrecht, Netherlands***BACKGROUND AND AIMS**

Preterm infants are prone to neonatal infections such as late-onset sepsis (LOS). The consequences are severe and potentially life-threatening. Unfortunately, often LOS presents with unspecific symptoms, and early screening laboratory tests have limited diagnostic value. Aim of our study was to build a predictive algorithm to aid doctors in earlier detection of LOS in very preterm infants.

METHODS

In a retrospective cohort study, all consecutively admitted preterm infants (GA \leq 32 weeks) from 2008 until 2019 were included. Infants were classified according to blood culture results, currently the gold standard, in LOS and control patients. Routinely and continuously measured oxygen saturation and heart rate were extracted from electronic medical records to generate features. Care was taken to not include variables indicative of existing LOS suspicion. Timing of blood culture served as proxy for LOS-onset. An equivalent timestamp was generated in GA-matched controls. Two machine learning

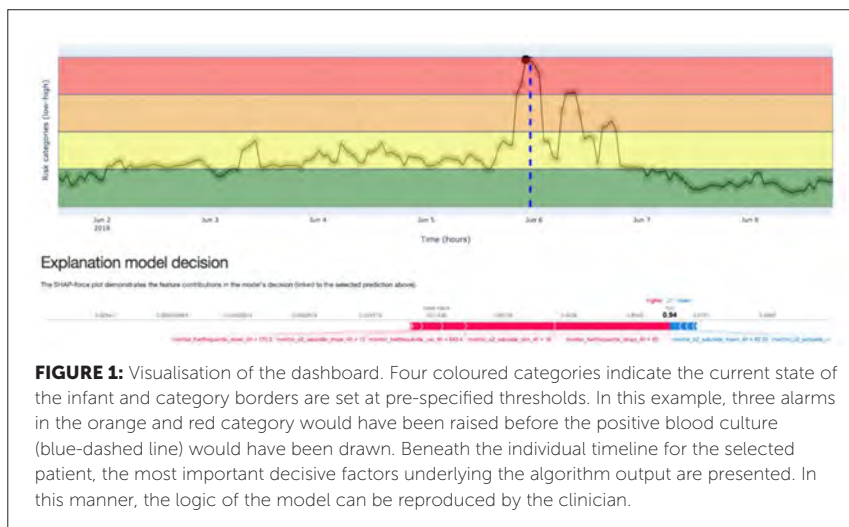

techniques (Generalized Additive Model and Logistic Regression) were used to build a classification algorithm up to 24 hours before blood culture. Hourly predictions were generated for the total hospitalization period.

RESULTS

389 infants with LOS were GA-matched to 1501 controls, median GA was 28.1 and 30.3 weeks, respectively. The algorithm yielded an AUC of 0.76 ($p < 0.05$) at $t = 0$. Sensitivity and specificity were 77% and 63%, respectively. Hourly predictions were plotted against a dashboard.

CONCLUSIONS

Our algorithm based on routinely collected data can potentially accelerate clinical decisions, even with relatively restricted inputs. Prospective validation is needed to prove benefit in clinical practice.

SO108 / #2216**Short Oral Session****Short Oral Session 21: ESPR: Infection
immunology****10-10-2022 12:30 - 13:30****10-Year single center experience with colistin
therapy in NICU****T. Barsan Kaya*, O. Surmeli Onay, O. Aydemir, A.N. Tekin***Eskisehir Osmangazi University, Faculty of Medicine, Department of Pediatrics, Division of Neonatology, Eskisehir, Turkey***BACKGROUND AND AIMS**

Colistin (colistimethate sodium), a cationic polypeptide antibiotic of the polymyxin class has been reused due to its potent antimicrobial activity against multidrug-resistant Gram-negative bacteria and the lack of new antibiotics. The purpose of this study was to assess the critically ill infants treated with colistin in the neonatal intensive care unit (NICU) and the predisposing factors for the emergence of acute kidney injury (AKI) following colistin treatment.

METHODS

This was a case-control study that included newborn infants with proven or suspected nosocomial infections in the NICU of Eskişehir Osmangazi University Hospital in Turkey between January 2012 and March 2022. Over the same time period, the clinical and laboratory characteristics and outcomes of patients who received colistin therapy were compared to patients who received other antimicrobial agents.

RESULTS

Seventy seven patients were in colistin group (ColG) and 77 patients were in control group (CG). The demographic and clinical characteristics of the study groups were similar (Table 1). Hyponatremia, hypokalemia, hypophosphatemia,

Table 1: The demographic and clinical characteristic of Colistin group and Control group

	Colistin Group (n=77)	Control Group (5=77)	p Value
Gestational age (week)**	30 (26-34.5)	29 (27-33)	0.89
Male gender, n (%)	43 (55.8%)	50 (64.9%)	0.24
Birth weight (g)**	1130(977.5-1312.5)	985 (876-1231)	0.70
Cesarean section delivery, n(%)	61 (79.2%)	70 (90.9%)	0.14
Apgar score at 5 th minute**	7(6-8)	8(7-8)	0.662
Perinatal asphyxia (pH<7,BE<-12), n(%)	6(7.7%)	11 (14.2%)	0.33
Respiratory distress syndrome, n(%)	48 (62.3%)	47(61.0%)	0.78
Intraventricular hemorrhage, (grade, III and IV), n (%)	15 (19.4%)	12 (15.5%)	0.52
Retinopathy of prematurity, n(%)	12(15.5%)	11(14.2%)	0.91
Invasive mechanic ventilation*, n (%)	49 (63.6%)	9(11.6%)	<0.01
Total parenteral nutrition*, n(%)	56 (72.7%)	49 (63.6%)	0.22
Previous surgery (within 1 month), n(%)	15 (19.4%)	4 (5.1%)	0.07
Central venous catheter*n (%)	55 (71.4%)	41 (53.2%)	0.02
Length of hospital stay (days)*	91.2±49.4	68.2±42.5	0.002
Outcome			
Early case mortality, n(%)	7	2	0.16
Overall case mortality, n(%)	27	4	<0.01

*within 1 week before onset of infection Data are expressed as mean ±SD, Medium (Q1-Q3), or number (%)

Table 2: The clinical outcomes and laboratory findings of Colistin Group and Control Group

	Colistin Group (n=77)	Control Group (n=77)	P value
Age at onset of infection (days)*	44.10±31.05	29.76±26.24	0.02
Concomitant nephrotoxic agents used with colistin [n(%)]			
Diuretic	20(25%)	3(3%)	<0.001
Aminoglycosid	14 (18%)	11 (14%)	0.662
Vancomisin	47 (61%)	66 (85%)	0.01
Amphoteterisin B	13 (16%)	1 (1%)	0.02
Cephalosporin	6 (7%)	33 (42%)	<0.01
Acute kidney injury n(%)	20(25%)	1 (1%)	<0.01
Laboratory			
C-reactive protein*	34.53±54.85	23.92±28.4	0.13
Blood urea nitrogen(mg/dl)**	10.0(7.5-14.85)	8.80(6.72-21.57)	0.01
Creatinine(mg/dl)**	0.42(0.29-0.52)	0.43(0.28-0.55)	0.373
Urinary output*	3.27±0.89	3.62±0.74	0.05
Hyponatremia(<135mEq/L)	32/76	10/74	<0.01
Hypopotasemia (<3.5 mEq/L)	28/76	10/74	0.02
Hypophosphatemia (3.5mg/dl)	29/76	14/72	0.02
Hypomagnesia(<1.6 mg/dl)	19/50	8/53	0.016

hypomagnesia, and AKI were all more common in the ColG compared to the CG ($p < 0.05$) (Table 2). The most important finding in our study was the higher incidence of AKI and mortality in ColG, as well as the increasing nephrotoxic effect of other medicines when used in conjunction with colistin.

CONCLUSIONS

During colistin therapy, newborn infants must be closely monitored for AKI. Clinicians should be aware of an increased incidence of hyponatremia, hypokalemia, hypophosphatemia, hypomagnesia, AKI, and its consequences in infants given colistin. As awareness increases, harmful effects will decrease.

SO109 / #2397**Short Oral Session****Short Oral Session 21: ESPR: Infection immunology****10-10-2022 12:30 - 13:30****Timing of antimicrobial prophylaxis for cesarean section is critical for gut microbiome development in term born infants****C. Härtel^{1*}, V. Bossung², M. Lupatsii³, S. Graspentner³, S. Waschina⁴, J. Rupp³**¹University of Würzburg, Pediatrics, Würzburg, Germany²University of Lübeck, Obstetrics, Lübeck, Germany³University of Lübeck, Microbiology and Infectious Diseases, Lübeck, Germany⁴University of Kiel, Nutrinformatics, Kiel, Germany**BACKGROUND AND AIMS**

Animal models imply that the perinatal exposure to antibiotics has a substantial impact on microbiome establishment of the offspring. We aimed to evaluate the effect of timing of antimicrobial prophylaxis for cesarean section before versus after cord clamping on gut microbiome composition of term born infants.

METHODS

We performed an exploratory, single center randomized controlled clinical trial. We included forty pregnant women with elective cesarean section at term. The intervention group received single dose intravenous cefuroxime after cord clamping (n = 19), the control group single dose intravenous cefuroxime 30 minutes before skin incision (n = 21). The primary endpoint

was microbiome signature of infants and metabolic prediction in the first days of life as determined in meconium samples by 16S rRNA gene sequencing. Secondary endpoints were microbiome composition at one month and 1 year of life.

RESULTS

In meconium samples of the intervention group, the genus *Staphylococcus* pre-dominated. In the control group, the placental cross-over of cefuroxime was confirmed in cord blood. A higher amino acid and nitrogen metabolism as well as increased abundance of the genera *Cutibacterium*, *Corynebacterium* and *Streptophyta* were noted (indicator families: *Cytophagaceae*, *Lactobacilaceae*, *Oxalobacteraceae*). Predictive models of metabolic function revealed higher 2-fucosyllactose utilization in control group samples. In the follow-up visits, a higher abundance of the genus *Clostridium* was evident in the intervention group.

CONCLUSIONS

Our exploratory randomized controlled trial suggests that timing of antimicrobial prophylaxis is critical for early microbiome engraftment but not antimicrobial resistance emergence in term born infants.

SO110 / #1262**Short Oral Session****Short Oral Session 21: ESPR: Infection immunology****10-10-2022 12:30 - 13:30****Association between duration of early empiric antibiotics and necrotizing enterocolitis and late-onset sepsis in preterm infants: A multicenter cohort study**

**N. Deianova^{1*}, S. El Manouni El Hassani², E. Struijs³, E. Jansen³,
A. Bakkali³, M. Van De Wiel⁴, W. De Boode⁵, C. Hulzebos⁶,
A. Van Kaam⁷, E. D'Haens⁸, D.C. Vijlbrief⁹, M. Weissenbruch¹⁰,
W. De Jonge¹¹, M. Benninga², H. Niemarkt¹², N. De Boer¹³, T. De Meij¹⁴**

¹Amsterdam UMC - Emma Children's hospital, Pediatric Gastroenterology, Amsterdam, Netherlands

²Amsterdam UMC - Emma Children's hospital, Pediatric Gastroenterology, Amsterdam, Netherlands

³Amsterdam UMC, Clinical Chemistry, Amsterdam, Netherlands

⁴Amsterdam UMC, Epidemiology & Data Science, Amsterdam Public Health Research Institute, Amsterdam, Netherlands

⁵Radboudumc Amalia Children's Hospital, Neonatology, Nijmegen, Netherlands

⁶Beatrix Children's Hospital, University Medical Centre Groningen, Groningen, The Netherlands, Division of Neonatology, Department of Paediatrics, Groningen, Netherlands

⁷Amsterdam UMC location University of Amsterdam, Neonatology, Amsterdam, Netherlands

⁸Isala hospital, Amalia Children's Center, Department of Neonatology, Zwolle, Netherlands

⁹Wilhelmina Children's Hospital, Neonatology, University Medical Center, Utrecht, Netherlands

¹⁰Amsterdam University Medical Centers, Neonatology, Amsterdam, Netherlands

¹¹Amsterdam UMC, Amsterdam Gastroenterology & Metabolism (AGEM) Research Institute, Tytgat Institute, Amsterdam, Netherlands

¹²Máxima Medical Center, Neonatology, Veldhoven, Netherlands

¹³Amsterdam UMC, Vrije Universiteit Amsterdam, Amsterdam Gastroenterology Endocrinology Metabolism (AGEM) Research Institute, Department of Gastroenterology and Hepatology, Amsterdam, Netherlands

¹⁴Amsterdam UMC location Vrije Universiteit Amsterdam, Pediatric Gastroenterology, Amsterdam, Netherlands

BACKGROUND AND AIMS

Infants developing necrotizing enterocolitis (NEC) have a different metabolomic profile compared to controls. The potential of specific metabolomics, i.e. amino acids and amino alcohols (AAA), as early diagnostic biomarkers for NEC is largely unexplored.

METHODS

In this multicenter prospective case-control study, longitudinal fecal samples from preterm infants (born before 30 weeks of gestation) developing severe NEC (Bell's stage IIIA/IIIB) 1-3 days before diagnosis were analyzed by targeted high-performance liquid chromatography (HPLC) and compared to samples from gestational and postnatal age-matched controls.

RESULTS

Thirty-one NEC cases (15 NEC IIIA;16 NEC IIIB) with 1:1 matched controls were included. Preclinical samples of infants with NEC were characterized by five increased essential amino acids – isoleucine, leucine, methionine, phenylalanine and valine. Lysine and ethanolamine ratios were lower prior to NEC, compared to control samples. A multivariate model was rendered based on isoleucine, lysine, ethanolamine, tryptophan and ornithine, modestly discriminating cases from controls (AUC 0.67; $p < 0.001$).

CONCLUSIONS

Targeted HPLC pointed to several specific AAA alterations in samples collected 1-3 days before NEC onset, compared to controls. Whether this reflects metabolic alterations and has a role in early biomarker development for NEC, has yet to be elucidated.

SO111 / #1165

Short Oral Session

Short Oral Session 21: ESPR: Infection immunology

10-10-2022 12:30 - 13:30

The diagnostic accuracy of presepsin in early-onset neonatal sepsis: A prospective cohort study

T. Dierikx^{1,2,3,4*}, H. Van Laerhoven⁵, S. Van Der Schoor⁵, C. Nusman^{1,3}, C. Lutterman⁶, R. Vliegthart^{1,3}, T. De Meij^{2,4}, M. Benninga^{4,7}, W. Onland^{1,3}, A. Van Kaam^{1,3}, D. Visser^{1,3}

¹Amsterdam UMC location University of Amsterdam, Neonatology, Amsterdam, Netherlands

²Amsterdam UMC location Vrije Universiteit Amsterdam, Pediatric Gastroenterology, Amsterdam, Netherlands

³Amsterdam UMC, Amsterdam Reproduction & Development Research Institute, Amsterdam, Netherlands

⁴Amsterdam UMC, Amsterdam Gastroenterology Endocrinology Metabolism, Amsterdam, Netherlands

⁵OLVG, Pediatrics and Neonatology, Amsterdam, Netherlands

⁶Flevoziekenhuis, Pediatrics, Almere, Netherlands

⁷Amsterdam UMC location University of Amsterdam, Pediatric Gastroenterology, Amsterdam, Netherlands

BACKGROUND AND AIMS

Due to a lack of accurate diagnostic tools and non-specific symptoms of neonatal early-onset sepsis (EOS), infants are often unnecessarily treated with antibiotics directly after birth. We aimed to determine the diagnostic accuracy of Presepsin for EOS in both term and preterm infants.

METHODS

In this prospective multicentre cohort study, all infants receiving antibiotics for suspected EOS were consecutively included. Presepsin concentrations

were determined in cord blood and in blood samples collected at the time of sepsis evaluation and 3, 6, 12 and 24 hours afterwards. Diagnostic accuracy measures for clinical EOS were calculated for the different time points.

RESULTS

In total, 333 infants were included of whom 169 were born preterm. At sepsis evaluation the area under the curve was 0.84 (95% confidence interval (CI) 0.73-0.95) in premature born infants and 0.60 (95% CI 0.50-0.70) in term born infants (Figure 1). A cut-off value of 645 pg/mL resulted in a sensitivity of 100% and specificity of 54% in premature infants. Presepsin concentrations were stable during the first 24 hours after sepsis evaluation.

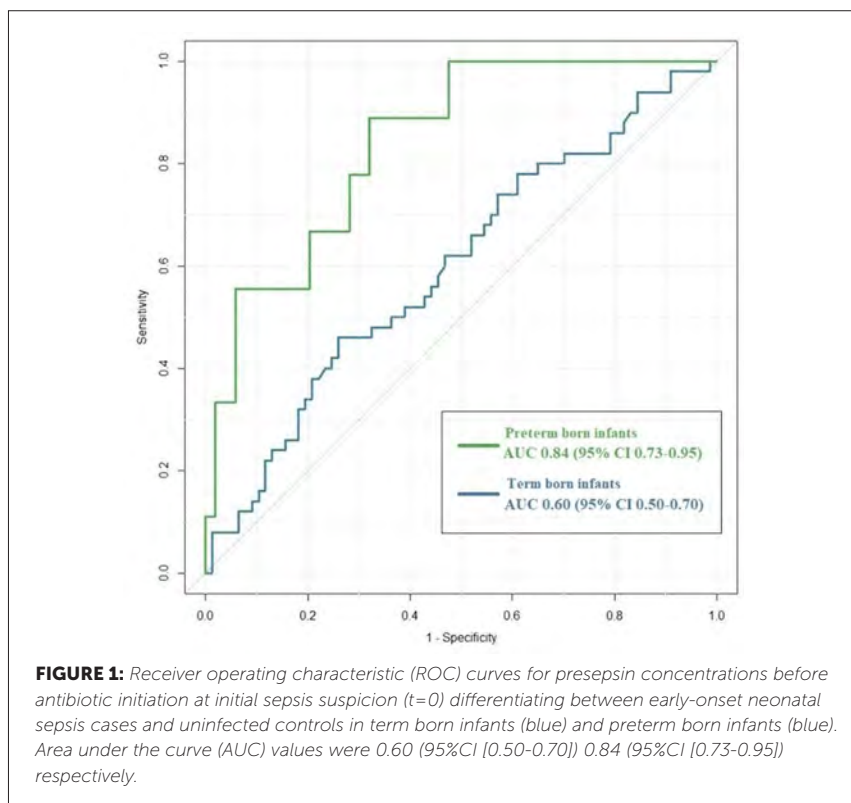

CONCLUSIONS

Presepsin seems to be an early and reliable biomarker in preterm infants and can be used to guide clinicians when to start or withhold antibiotics directly at sepsis evaluation, potentially halving antibiotic overtreatment. The diagnostic accuracy in term born infants was moderate. Future studies need to determine whether implementation of Presepsin as bedside point-of-care test is feasible and if this would lead to a safe decrease in the overtreatment with antibiotics in preterm infants.

POSTER DISCUSSION ABSTRACTS

PD001 / #652**E-poster Discussion Session 01: EAP - Paediatric surgery****08-10-2022 12:00 - 13:00****Surgery is still an important alternative to beta blockers for treatment of children with complicated infantile hemangiomas****B. Beqo^{1,2*}, P. Gasparella², C. Flucher², E. Haxhija²**¹Harvard Medical School, Boston Children's Hospital, Boston, United States of America²Medical University of Graz, Pediatric and Adolescent Surgery, Graz, Austria**BACKGROUND AND AIMS**

Propranolol is currently the first-line treatment for infantile hemangiomas (IH). The aim of this study was to evaluate the reasons for other treatment options for children with IH.

METHODS

We retrospectively analyzed complete hospital charts of all children who were referred to us for evaluation and treated for IH from 2005 to 2020. Data was analyzed by descriptive statistics.

RESULTS

From 2318 children referred to us for evaluation during the study period 592 children (25%) received treatment. Neodym-YAG laser (55%) was the main treatment for IH until 2009 followed by surgery (36%) and cortisone administration (9%). From 2011 only oral propranolol (n=268; 74%) and surgery (n=95; 26%) were used for treatment of IH. We identified 4 groups of patients receiv-

ing surgical intervention: 1) patients with bleeding and ulceration, and IH size appropriate for surgical resection (15%); 2) patients whose parents preferred surgical treatment as opposed to propranolol (19%); patients who presented late and surgery was the only option for removal of IH before the age of 3 years (29%); and 4) patients with residual scar tissue and excision after the 3rd year of life (37%) with or without previous medical treatment. Interestingly, all patients in groups 3 and 4 had combined cutaneous-subcutaneous IH.

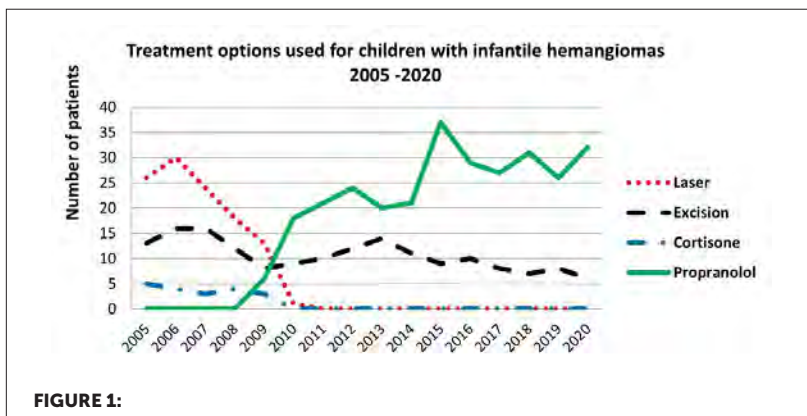

FIGURE 1:

CONCLUSIONS

Introduction of propranolol for treatment of children with complicated IH eliminated the need for laser treatments under general anesthesia. Our data show that surgery is still an important option for treatment of children with complicated IH, and that it is especially often used for IH with combined cutaneous-subcutaneous extension.

PD002 / #534

E-poster Discussion Session 01: EAP - Paediatric surgery

08-10-2022 12:00 - 13:00

Response to chorionic gonadotropin treatment of cryptorchid patients after orchiopexy: prediction of the effect by using patients' derived gubernaculum in vitro model

N. Zampieri^{1*}, A. Errico², S. Vinco², I. Dando²

¹University of Verona, Woman and Child Hospital, Pediatric Surgical Unit, Surgery, Dentistry, Paediatrics and Gynaecology, Verona, Italy

²University of Verona, Department of Neurosciences, Biomedicine and Movement Sciences, University of Verona, Verona, Italy

BACKGROUND AND AIMS

Cryptorchidism has a significant incidence among newborns and orchiopexy represents the treatment of choice, preferably performed within 2-3 years of life. Human chorionic gonadotropin (hCG) is proposed as postoperative adjuvant therapy to improve the functional recovery of gonads. The aim of this study is to understand the molecular rationale of the treatment for each patient by evaluating clinical aspects together with molecular analysis performed on patient's derived tissue.

METHODS

Para-testicular (i.e.gubernaculum) biopsies (about 10mm³) were obtained during orchiopexy on 4 pediatric patients. Cells derived from tissue disaggregation have been cultured and amplified in vitro by following a protocol optimized by our laboratory (recently published) to perform molecular studies and analysis of response to hCG treatment.

RESULTS

Through a protocol optimized by our group, we demonstrate that disaggregation of gubernaculum biopsies allows to obtain viable primary cells that grow in culture for at least 3 months (Fig.1): these cells express hCG-specific receptor (LHR) (Fig.2) and respond to hCG treatment. Indeed, gubernacular cells treated in vitro with hCG increase their proliferation (Fig.3) and vascularization (Fig.4) compared to untreated cells from the same patient. Interestingly, cells derived from younger patients (pt#3,#20) better respond to hormonal stimulation.

CONCLUSIONS

The comparison of in vitro response to hCG with the clinical evaluation of testicular parenchyma after treatment opens the way to the preliminary in vitro evaluation of hCG effects for a personalized therapy.

PD003 / #1732**E-poster Discussion Session 01: EAP - Paediatric surgery****08-10-2022 12:00 - 13:00****Antibiotics in acute appendicitis: does one protocol fits all areas?****S. Rusu¹, K. Polak^{2*}, I. Vidal Gil², M. Herrera Llobat², M. Llanas Marco²**¹Hospital Universitario Nuestra Señora de Candelaria, Pediatric Surgery, Santa Cruz de Tenerife, Spain²Hospital Universitario Nuestra Señora de Candelaria, Pediatric, Santa Cruz de Tenerife, Spain**BACKGROUND AND AIMS**

Background: Antibiotic treatment in acute complicated appendicitis should be tailored to the sensitivity of the peritoneal fluid culture, result that is often available 48-72 hours post-operatively. Commonly, it correlates with the gut microbiota, which can vary between different areas. Local bacterial epidemiology conducted studies could provide a more adequate initial empirical antibiotic treatment.

METHODS

In our centre, the APSA antibiotics protocol is applied for acute appendicitis, which includes cefoxitin, gentamicin, and metronidazole as first-line in complicated cases. We reviewed retrospectively all children who underwent appendicectomy between 2017 and 2021. Data analysed included demographics, type of acute appendicitis, result of intra-operative culture results and correlation with the antibiotics prescribed.

RESULTS

356 children were identified that had a median course of 5 days of antibiotics (1-16 days). In 94 (30%) cases peritoneal fluid was sent for culture with 69/94 positive. The most frequent isolated was *Escherichia Coli*, followed by *Bacteroides Fragilis*, *Pseudomonas spp*, *Streptococcus viridans*, *Streptococcus anginosus*, *Klebsiella spp*. Sixty-three out of 69 were sensitive to Amoxicillin/Clavulanic Acid, Ciprofloxacin (with oral equivalent) and Gentamicin. Infectious complications post-operatively developed in 12 children: 9 had peritoneal collections (2 cases with no initial culture, 6 with multi-sensitive *E. coli* or *Pseudomonas*, 1 with Cefoxitin-Gentamicin resistant *E. coli*) and 5 wound infections (none had intra-operative swabs). Antibiotics were escalated to Meropenem in 10 cases due to clinical status (none had infectious complications).

CONCLUSIONS

The majority of our patients had multi-sensitive bacterial culture, with antibiotics that have oral options. A regionally tailored protocol should be considered.

PD004 / #913

E-poster Discussion Session 01: EAP - Paediatric surgery

08-10-2022 12:00 - 13:00

Knowledge about surgical wound care among parents of pediatric surgical patients in India

M. Pathak^{1*}, T. Motiwala², A. Sinha², R. Saxena², K. Rathod²,
A. Jadhav²

¹AllIMS Jodhpur, Pediatric Surgery, Jodhpur, India

²AllIMS JODHPUR, Pediatric Surgery, JODHPUR, India

BACKGROUND AND AIMS

Aim: To evaluate the knowledge about surgical wound care among parents of pediatric surgical patients in India

METHODS

Parents of the patients undergoing elective surgeries with surgical incision length less than 3 cm were surveyed preoperatively using a questionnaire (English or Hindi) having 26 questions related to wound healing, dressings, complications, use of antibiotics and resumption of day-to-day activities postoperatively. The questions from the survey were also answered by five different pediatric surgeons and their responses were used as a standard to compare the responses from the parents.

RESULTS

Seventy parents were surveyed in this prospective study for 6 months. There was complete concordance of response among surgeons. However, there

was significant discordance of response between surgeons and parents. The most concerning features of wound infection were identified only by 67 % of the patients with 13% of parents having no idea about it. Almost half of the parents did not expect to send their child to school before 2 weeks and 43.3 % of the parents expected their child to resume physical activities on or after 6 weeks. Surprisingly, 63.3% of parents felt that antiseptics are needed to clean the wound postoperatively. In sharp contrast to our modern practices, more than 50% parents feel that water or soft diet can be started only 24 hours following surgery. Most parents (70% and 83.3%) feel that number of stitches and eating a particular type of food can affect wound healing.

CONCLUSIONS

The knowledge about surgical wound care is lacking among care givers in India.

PD005 / #894

E-poster Discussion Session 01: EAP - Paediatric surgery

08-10-2022 12:00 - 13:00

Efficacy of rectal ketamine and midazolam for procedural sedation in children undergoing ocular tonometry

L. andreozi^{1*}, F. Rossetti², G. Bacci³, M. Raspi², M. Pignotti²,
L. Pierantoni¹, D. Zama¹, M. Lanari¹, A. Messeri⁴

¹IRCCS Azienda ospedaliero-Universitaria di Bologna, Pediatric Emergency Unit, Department of Medical and Surgical Sciences, Via Massarenti, Italy

²Meyer Children's Hospital, Pain Service and Palliative Care, Florence, Italy

³Pediatric Ophthalmology Unit, Meyer Children's Hospital, Florence, Italy

⁴Azienda USL Toscana Centro, Coordination of Palliative Care, Florence, Italy

BACKGROUND AND AIMS

Measuring the intraocular pressure (IOP) can be challenging in children. Ocular tonometry (OT) is often performed under general anesthesia (GA). To date, no studies have investigated procedural sedation for OT outside the operating room (OR). Primary aim of our study was to investigate the effectiveness of rectal ketamine and midazolam outside the OR, compared to GA by the Pediatric Sedation State Scale (PSSS), in a cohort of pediatric patients undergoing OT. Secondary aims were sedation safety and rectal ketamine effect on IOP.

METHODS

We prospectively enrolled children undergoing OT, receiving sedation with rectal ketamine and midazolam at Meyer Children's Hospital. We recorded patients' characteristics and procedural data (PSSS, duration, adverse events

– AEs-, IOP). Data (procedural duration, IOP) regarding patients' previous OT performed under GA were retrospectively collected and compared to current records.

RESULTS

Twenty patients were enrolled for a total of 23 sedations. Median (IQR) age was 28.5 (20.1-41.2) months. Median (IQR) doses of ketamine and midazolam were 4 (3.8-4.3) and 0.35 (0.31-0.37) mg/kg, respectively. Sedation was successful (PSSS=2-3) in 96% of cases. No serious AEs were reported. Median (IQR) time to discharge was shorter than that in GA [4.5 (4.1-4.9) vs 10.0 (7.0-26.0) hours; p 0.003]. Eventually, median (IQR) IOP values were similar to those under GA without ketamine [15.0 (12.0-16.0) vs 15.0 (13.0-16.0) mmHg, $p>0.05$].

CONCLUSIONS

Procedural sedation with rectal ketamine and midazolam outside the OR is a safe and effective alternative to GA for children undergoing OT. Rectal ketamine at 4 mg/kg does not affect IOP.

PD006 / #2774**E-poster Discussion Session 02: Late breaking intensive care****08-10-2022 12:00 - 13:00****Staff's perception of the implementation the picu-diary in an italian pediatric intensive care unit: a qualitative study****O. Gawronski¹, C. Gagliardi^{2*}, C. Bochicchio¹, C. Cecchetti³, A. Rossi⁴, M. Di Nardo², C. De Ranieri⁴, T. Satta², V. Sansone¹, E. Tiozzo¹, I. Dall'Oglio¹, F. Cancani²**

¹*Ospedale Pediatrico Bambino Gesù, Nursing and Allied Health Professional Development, Continuing Education and Research Unit, Medical Directorate, Rome, Italy*

²*Bambino Gesù Children's Hospital IRCCS, Emergency and General Pediatrics, Rome, Italy*

³*Bambino Gesù Children's Hospital IRCCS, Pediatric Intensive Care Unit, Department of Emergency, Acceptance and General Pediatrics, Rome, Italy*

⁴*Bambino Gesù Children's Hospital IRCCS, Clinical Psychology, Rome, Italy*

BACKGROUND AND AIMS

PICU diaries are used worldwide. While parents' perception of PICU diaries is known, PICU healthcare providers' (HCPs) experience with this tool is seldom described. The aim of this study is to describe HCPs' perception of PICU diaries at a large Italian tertiary care pediatric hospital.

METHODS

Qualitative study. PICU diaries were used for patients sedated and mechanically ventilated for >48 hours at a 6 bed PICU. Data was collected by semi-structured focus groups and interviews of PICU nurses, physicians and physiotherapists. Thematic analysis was performed.

RESULTS

Three focus groups and 4 interviews with PICU HCPs were conducted in June 2021 after a 10 months' implementation of PICU diaries. HCPs reported the relevance of PICU diaries for parents' expression of their emotions and experiences related to their child's admission as well as for HCPs' self-awareness and understanding of parent's experiences through shared narration. PICU diaries are described as useful communication tools between the family, the child and HCPs, promoting mutual understanding and partnership. Barriers to HCPs' diary writing were lack of space, lack of time, limited sense of ownership, emotional labor and fear of legal consequences.

CONCLUSIONS

HCPs perceive PICU diaries as beneficial for parents and the healthcare team, potentially supporting the implementation of Family Centered models of Care. The findings reported in this study can support the development of implementation strategies to prevent the challenges to diary writing in the healthcare team, enhancing their uptake in the PICU setting.

PD007 / #2738**E-poster Discussion Session 02: Late breaking intensive care****08-10-2022 12:00 - 13:00****Triggers for palliative care team activation in the pediatric intensive care: a 10 years retrospective study****A. Zanin^{1*}, C. Agosto¹, A. Divisic¹, F. Rusalen¹, M. Cooper², P. Lazzarin¹, F. Benini¹**¹University of Padua, Department of Women's and Children's Health, Padua, Italy²St Mary's Hospital, Imperial College Healthcare NHS Trust, Department of Paediatric Intensive Care, London, United Kingdom**BACKGROUND AND AIMS**

Pediatric Palliative Care (PPC) within pediatric intensive care units (PICUs) benefits decision-making, symptom control, patient and family support before and after the end of life (EoL) care. It is not clearly defined which are the "triggers" of the activation of a tertiary PPC team in the intensive care. Our aim is to determine how many patients were referred to our regional PPC service and if the screening tools proposed by the literature coincide to our referral criteria.

METHODS

This retrospective review of patients referred to the Regional Center of PPC of Veneto Region, in Italy over a period of 10 years (January 1, 2010 to December 31, 2021), focused on a descriptive summaries of demographic, clinical variables, and patient circumstances at the time of referral and during eventual EoL. The timing from the first referral to the service activation was also detailed.

RESULTS

A total of 812 patients was collected, 73 of them were referred by the PICU and 36 died. Most common diagnoses were syndromic and congenital conditions (50,7%). At time of referral all these patients were unknown to the PPC team and 12% were referred between admission and death. The most common cause of referral was the management of tracheostomy and/or long term ventilation. The median time from the referral to the activation of the PPC service was 30 days.

CONCLUSIONS

Successful implementation of PPC should be consider in order to guarantee equity in the access to palliative care which represents an important quality metric for PICU and PC teams.

PD008 / #2532**E-poster Discussion Session 02: Late breaking intensive care****08-10-2022 12:00 - 13:00****Adherence to septic shock guidelines and outcome: an analysis over three decades of purpura fulminans****N. Tran Vu¹, P. Tissieres¹, L. Morin^{2*}**¹APHP, Paris Saclay - Bicetre Hospital, Pediatric Intensive Care Unit, Le Kremlin Bicetre, France²Réanimation pédiatrique - Hopital Bicetre, Pediatric Intensive Care Unit, Le Kremlin-Bicetre, France**BACKGROUND AND AIMS**

Management of septic shock has changed over the last three decades, in line with international guidelines from the American Critical Care Medicine and the Surviving sepsis campaign. The impact the publication of those guidelines had on the actual management and outcome of children with septic shock is unknown. This study explores the association between the publication of guidelines for septic shock and mortality.

METHODS

Retrospective monocentric cohort of children admitted to the pediatric intensive care unit for septic shock secondary to purpura fulminans from 1 January 1990 to 31 December 2019. The management characteristics of these patients were compared to the "at the moment" and the 2020 guidelines for septic shock management. The adherence to these guidelines and the associated 28-day mortality were compared.

RESULTS

Over 30 years, 112 patients were admitted for purpura fulminans, and 19 (17%) died. Six recommendations were evaluated, including airways and ventilatory support, type of fluid expansion, the volume of initial fluid expansion before vasopressor initiation, type of first-choice vasopressor or inotrope, use of hydrocortisone, and delay for antibiotics. Sixty-one patients followed $\geq 5/6$ "at the moment" bundles and had a mortality of 13%, versus 48 (23% mortality, $p=0.28$). Twenty-six patients were managed according to $\geq 5/6$ 2020 guidelines with a mortality of 8.3% versus 86 (20% mortality, $p=0.24$).

CONCLUSIONS

Guidelines for optimal management of pediatric septic shock changed significantly over three decades. Improved adherence to the guidelines, neither in force at the moment nor the latest, was not associated with an improved outcome.

PD009 / #2548**E-poster Discussion Session 02: Late breaking intensive care****08-10-2022 12:00 - 13:00****AIR Team SEM: our experience****M. Rodríguez Martínez^{1,2,3*}, S. Brió-Sanagustin³, F. Castillo-Gómez³, E. Coca-Fernandez³, E. Turon-Viñas³, J. Salazar Quiroz³, R.A. Burgueño-Rico³, S. Boronat-Guerrero⁴**¹Medical Emergency Service, Pediatric Air Transport, Barcelona, Spain²Medical Emergency Service. Hospital Sant Joan de Deu, Pediatric Ground Transport, Esplugues de Llobregat, Spain³Hospital de la Santa Creu i Sant Pau, Pediatric Intensive Care, Barcelona, Spain⁴Hospital de la Santa Creu i Sant Pau, Paediatrics Department, Barcelona, Spain**BACKGROUND AND AIMS**

Neonatal and pediatric air transport is one of the most important resources for the transfer of patients who require urgent hospital care, allowing a comfortable transfer and ensuring rapid transport from areas of difficult access, being of vital importance in time-dependent pathologies. This is an action that is not exempt from risks and complications.

METHODS

Retrospective, descriptive analysis of patients between 0 and 15 years transferred by a pediatric air unit from 2015 to 2021 included. The data was analyzed using the SPSS Statistics 25 program.

RESULTS

Transfers studied: 211. Pediatric 56.5% and 43.5% neonates. Mean age: 1.09 ± 2.48 years, weight: 7.5 ± 7.47 Kg, and transfer time: 170.84 ± 77.62 min. The most frequent pathology: respiratory (41.8%). Eighty-two percent required respiratory support, 28.9% low or high flow oxygen, 27.1% non-invasive ventilation and 26.3% invasive ventilation. Thirty-one percent respiratory support was escalated and 7% were intubated by the transfer team. Pediatric patients received more support with FNAG than neonates ($p < 0.001$). Neonatal patients required more intubations than pediatric patients ($p = 0.04$). Neonatal required more central venous accesses than pediatric ($p < 0.001$). 13.8% required vasoactive support. Some type of incidence occurred in 18 transfers (7.8%), no differences between neonates and pediatric ($p = 0.93$).

CONCLUSIONS

Respiratory complications are the most frequent. Pediatric patients received more support with FNAG than neonatal patients, however this group required more intubation and central venous access. It should be noted that during 2020, despite the decrease in respiratory pathology, a similar number of transfers was maintained as in previous years.

PD010 / #2108

E-poster Discussion Session 03: ESPR - Improving quality of care 1

08-10-2022 12:00 - 13:00

Childhood catch-up growth after fetal growth restriction in a unique cohort of discordant, genetically identical twins

S. Groene^{1*}, I. Gremmen¹, E. Van Zwet², A. Roest¹, M. Haak³, J. Van Klink¹, E. Lopriore¹, B. Heijmans², C. De Bruin¹

¹Leiden University Medical Center, Willem-alexander Children's Hospital, Leiden, Netherlands

²Leiden University Medical Center, Biomedical Data Sciences, Leiden, Netherlands

³Leiden University Medical Center, Obstetrics, Leiden, Netherlands

BACKGROUND AND AIMS

In research on postnatal catch-up growth after fetal growth restriction (FGR), FGR singletons are often compared to appropriately-grown controls. This study design is biased by genetic predisposition. Monochorionic (MC) twins with selective FGR (sFGR) eliminate this bias as they are genetically identical, while also being discordant in fetal growth. We aim to evaluate to what extent catch-up growth occurs in the smaller twin.

METHODS

All MC twins with sFGR born between 2002-2017 were eligible. Growth measurements (height, weight, body mass index (BMI), head circumference) were performed at follow-up. Detailed growth curves documented by a systematic primary care system were collected. A mixed-effects model was used to assess within-pair standard deviation score (SDS) difference in height, BMI and head circumference and individual height SDS relative to target height SDS.

RESULTS

Forty-seven twin pairs were included. At the time of the last measurement smaller twins had a lower height SDS (-0.6 vs. -0.3, $p<0.0001$), lower weight SDS (-0.5 vs. -0.1, $p<0.0001$) and lower head circumference SDS (-0.5 vs 0.2, $p<0.00001$) compared to larger twins. Smaller twins catch-up to a height within their target range within 8-10 years. Differences in height, BMI and head circumference generally persisted, with smaller twins remaining smaller (91%), lighter (93%) and lower in head circumference (88%) than their larger co-twins ($p<0.0001$).

CONCLUSIONS

Monozygotic twins with sFGR growing up in a similar postnatal environment, maintain a modest but significant difference in height, weight and head circumference all throughout childhood, indicating a persistent, perturbing effect of an adverse intrauterine environment on life-long growth.

PD011 / #2299**E-poster Discussion Session 03: ESPR - Improving quality of care 1****08-10-2022 12:00 - 13:00****Survey of transfusion practices in preterm infants in Europe**

A. Scrivens¹, N. Reibel², L. Heeger^{3*}, S. Stanworth⁴, E. Lopriore⁵, H. New⁶, C. Dame², K. Fijnvandraat⁷, E. Deschmann⁸, M. Aguar⁹, K. Brække¹⁰, F. Cardona¹¹, F. Cools¹², R. Farrugia¹³, S. Ghirardello¹⁴, J. Lozar Krivec^{18¹⁵}, K. Matasova¹⁶, T. Mühlbacher¹⁷, U. Sankilampi¹⁸, H. Soares¹⁹, M. Szabó²⁰, T. Szczapa²¹, G. Zaharie²², C.C. Roehr²³, S. Fustolo-Gunnink²⁴

¹Oxford University Hospitals NHS Foundation Trust, John Radcliffe Hospital, Department of Neonatology, Oxford, United Kingdom

²Charité Universitätsmedizin Berlin, Department of Neonatology, Berlin, Germany

³Leiden University Medical Center, Neonatology, Leiden, Netherlands

⁴National Health Service (NHS) Blood and Transplant, Transfusion Medicine, Bristol, United Kingdom

⁵Leiden University Medical Center, Department of Neonatology, Leiden, Netherlands

⁶NHS Blood and Transplant, Paediatric Transfusion, London, United Kingdom

⁷Amsterdam University Medical Center, Pediatrics, Amsterdam, Netherlands

⁸Karolinska Institutet, Department of Neonatology, Stockholm, Sweden

⁹La Fe University and Polytechnic Hospital, Neonatology, Valencia, Spain

¹⁰Oslo University Hospital, Neonatal Intensive Care, Ullevål, Oslo, Norway

¹¹Medical University Vienna, Pediatrics, Vienna, Austria

¹²Universitair Ziekenhuis Brussel, Neonatology, Brussels, Belgium

¹³Mater Dei Hospital, Neonatology, Malta, Malta

¹⁴Fondazione IRCCS Ca' Granda Ospedale Maggiore Policlinico, Neonatology, Milan, Italy

¹⁵University Medical Center Ljubljana, Neonatology, Ljubljana, Slovenia

¹⁶Martin University Hospital, Neonatology, Martin, Slovak Republic

¹⁷Universitätsspital Zürich, Neonatology, Zurich, Switzerland

¹⁸Kuopio University Hospital and University of Eastern Finland, Neonatology, Kuopio, Finland

¹⁹Centro Hospitalar Universitário de São João, Neonatology, Porto, Portugal

²⁰Semmelweis University, Department of Obstetrics and Gynecology (division of Neonatology Ist Department of Pediatrics), Budapest, Hungary

²¹Poznań University of Medical Sciences, 2nd Department of Neonatology, Poznań, Poland

²²UMF Iuliu Hatieganu, Neonatology, Cluj Napoca, Romania

²³Nuffield Department of Population Health, University of Oxford, National Perinatal Epidemiology Unit, Oxford, United Kingdom

²⁴Sanquin Blood Supply Foundation, Center For Clinical Transfusion Research, Amsterdam, Netherlands

BACKGROUND AND AIMS

Preterm infants commonly receive red blood cell (RBC), platelet and fresh frozen plasma (FFP) transfusions. The aim of this Neonatal Transfusion Network survey was to describe current transfusion practices in Europe, and to compare our findings to three recent randomized controlled trials to understand how clinical practice relates to the trial data.

METHODS

From October to December 2020, we performed an online survey among 597 neonatal intensive care units (NICUs) caring for infants with a gestational age < 32 weeks in 18 European countries.

RESULTS

Responses from 343 NICUs (response rate: 57%) are presented and showed substantial variation in clinical practice. For RBC transfusions, 70% of NICUs transfused at thresholds above the restrictive thresholds tested in the recent trials and 22% below the restrictive thresholds. For platelet transfusions, 57% of NICUs transfused at platelet count thresholds above $25 \times 10^9/L$ in non-bleeding infants with a gestational age <28 weeks, while the $25 \times 10^9/L$ threshold was associated with a lower risk of harm in a recent trial. FFP transfusions were administered for coagulopathy without active bleeding in 39% and for hypotension in 25% of NICUs. Transfusion volume, duration, and rate varied by factors up to several fold between NICUs.

CONCLUSIONS

Transfusion thresholds and aspects of administration vary widely across European NICUs. In general, transfusion thresholds used tend to be more liberal compared to data from recent trials supporting the use of more restrictive thresholds. Further research is needed to identify the barriers and enablers to incorporation of recent trial findings into neonatal transfusion practice.

PD012 / #2318**E-poster Discussion Session 03: ESPR - Improving quality of care 1****08-10-2022 12:00 - 13:00****Intrauterine growth restriction (IUGR) and low birth weight increase the risk for acute kidney injury (AKI) in preterm infants****M. Sinelli^{1*}, E. Zannin¹, S. Ornaghi², E. Acampora², D. Doni¹, R. Menichini¹, M.L. Ventura¹**¹FMBBM, San Gerardo Hospital, Neonatal Intensive Care Unit, Monza, Italy²San Gerardo Hospital, Fondazione MBBM, Obstetrics and Gynecology Department, Monza, Italy**BACKGROUND AND AIMS**

Preterm birth alters nephrogenesis and reduces total nephron number. Specifically, very low birth weight (VLBW) infants are more susceptible to AKI. IUGR seems to worsen nephron loss, but only a few studies have investigated its role in renal impairment. We investigated whether preterm infants with low estimated fetal weight (EFW) or birth weight (BW) z-score are at an increased risk of developing AKI.

METHODS

We performed a retrospective study including VLBW infants admitted to our center between January 2016 and December 2021. Neonatal AKI was defined according to KDIGO classification, based on diuresis contraction and/or creatinine elevation. We used multivariable linear regressions to verify the association between AKI and gestational age (GA), BW z-score, EFW z-score, and hemodynamically significant patent ductus arteriosus (PDA). As BW z-score and EFW z-score are collinear, we developed two separate models.

RESULTS

We included 297 VLBW infants in the analysis, with a median (IQR) GA = 29.4 (27.4, 31.3) weeks, BW = 1152 (870, 1360), BW z-score = -0.53 (-1.67, 0.28), EFW z-score = 0.00 (-2.12, 0.00). AKI was diagnosed in 34 (11%) patients, 58 (20 %) had PDA. AKI was significantly associated with both BW z-score (beta (std. error) = -0.09 (0.03), $p=0.001$) and EFW z-score (beta = -0.04 (0.02), $p = 0.016$), after adjusting for GA and PDA.

CONCLUSIONS

Our data suggest that low BW z-score and EFG z-score could represent adjunctive risk factors for renal impairment in preterm babies.

PD013 / #2234**E-poster Discussion Session 03: ESPR - Improving quality of care 1****08-10-2022 12:00 - 13:00****The legislative framework of donor human milk and human milk banking in Europe****D. Klotz^{1*}, A. Wesółowska², E. Bertino³, G. Moro⁴, J.-C. Picaud⁵, A. Gayà⁶, G. Weaver⁷**

¹Center for Pediatrics, Division of Neonatology and Pediatric Intensive Care Medicine, Medical Center-university of Freiburg, Freiburg, Germany

²Laboratory of Human Milk and Lactation Research, Regional Human Milk Bank In Holy Family Hospital At Warsaw, Department of Medical Biology, Faculty of Health Science, Medical University, Warsaw, Poland

³Neonatal Unit, Turin University, City of Health and Science, Turin, Italy

⁴Associazione Italiana, Delle Banche Del Latte Umano Donato, Milan, Italy

⁵University of Freiburg, Faculty of Medicine, University of Freiburg, Center For Pediatrics, Division of Neonatology and Pediatric Intensive Care Medicine, Medical Center, Freiburg, Germany

⁶Banc de Teixit, F. Banc De Sang I Teixits De Les Illes Balears, Institut D'investigacio Sanitaria Illes Balears (idisba), Barcelona, Spain

⁷The Human Milk Foundation, Rothamsted Institute, Hertfordshire, United Kingdom

BACKGROUND AND AIMS

DHM has been identified as a subject with widely differing regulatory approaches in different European countries and no regulation in some. Up to date, no information about the actual legal regulation and classification is available from the literature. The aim of this study is to describe the current legislative regulations of donor human milk (DHM) within European countries, to assess its legislative context and its impact in relation to donor milk banking.

METHODS

Cross-sectional survey addressing 29 national European milk-banking representatives from July 2020 to February 2021.

RESULTS

Representatives from 26 national European DHM services with a total number of 239 milk banks replied. The legal classification and regulatory status of DHM were defined in 9/26 areas of jurisdiction (35%). In those nine countries, DHM was classified as either food product (n=6), product of human origin according to a blood, tissue, cell regulation (n=2) or as medicinal product (n=1). However, most legislations did not provide a comprehensive framework concerning DHM and adherence to legislative regulations differed. In the remaining 17 countries, DHM remained unclassified and was not subjected to any legislative regulation. Most participants considered a classification as a separate entity (n=13), a classification according to BTC (n=7) or as a food product (n=1) as the most suitable category for DHM in their respective country. Interestingly, national medical guidelines for the use of DHM are available in only 11 countries.

CONCLUSIONS

The use of DHM is mostly unregulated in Europe. Unequivocal legislative frameworks concerning DHM may be supportive in increasing its utilization rate.

PD014 / #1013**E-poster Discussion Session 03: ESPR - Improving quality of care 1****08-10-2022 12:00 - 13:00****Identifying incidence, timing and potential risk factors for early hypoglycemia in very preterm infants****M. Koolen^{1*}, M. Vermeulen²**¹Erasmus MC, Sophia Childrens Hospital Nicu, Rotterdam, Netherlands²Erasmus MC Sophia Children's Hospital, University Medical Center Rotterdam, Department of Pediatrics, Division of Neonatology, Rotterdam, Netherlands**BACKGROUND AND AIMS**

To determine incidence, timing and potential risk factors associated with hypoglycemia in the first day of life in very premature infants.

METHODS

This retrospective cohort study included all infants born before 32 weeks of gestation between 1 July 2017 and 31 December 2020 in the Erasmus MC Sophia Children's Hospital (Rotterdam, the Netherlands). Excluded were those who died within 24 hours after birth or with no blood glucose data available. We collected maternal and neonatal characteristics as well as all routine glucose values for the first 24 hours. Risk factors for hypoglycemia (glucose < 2.6 mmol/l) were selected using logistic regression with stepwise backward elimination and time-to-event after birth with Kaplan-Meier survival analysis.

RESULTS

of 714 infants included (median gestational age 29.3 weeks, mean weight 1200 grams), 137 (19%) had at least one episode of hypoglycemia, with a median time-to-event of 125 minutes [95%-CI 105-216] (figure 1). Independent risk factors for hypoglycemia included two maternal (insulin-dependent diabetes [OR 2.8; 95%-CI 1.3-6.1]; antenatal steroid administration [OR 1.7, 95%-CI 1.1 - 2.7]), and four neonatal factors (no IV-glucose administration in delivery room [OR 6.1, 95% CI-3.2-11.7], gestational age in weeks [OR 1.3, 95% CI-1.2-1.5], small-for-gestational-age [OR 2.6, 95%-CI 1.4-4.8], and no respiratory support (versus non-invasive support) [OR 2.3, 95%-CI 1.0-5.3]).

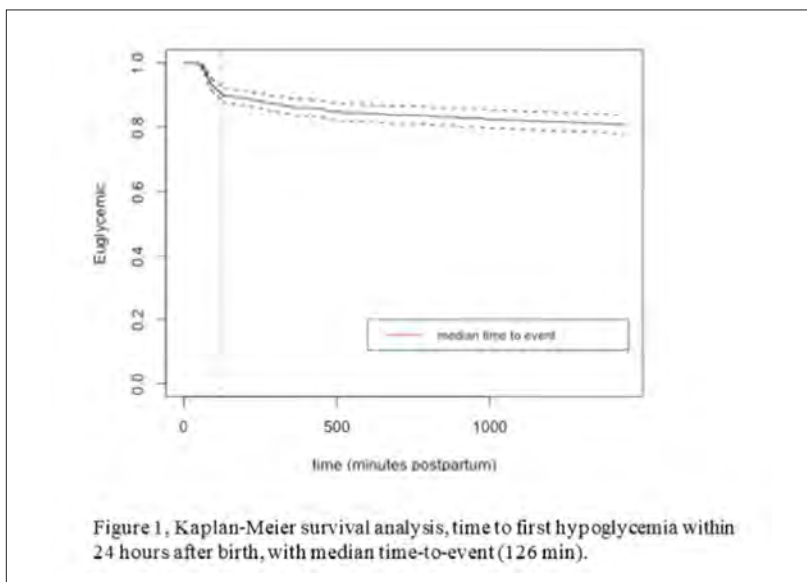

CONCLUSIONS

Six risk factors were identified for hypoglycemia in the first 24 hours of life in these very preterm infants, of which early administration of IV glucose and

respiratory support are modifiable factors which may need more attention in clinical guidelines.

PD015 / #2627**E-poster Discussion Session 03: ESPR - Improving quality of care 1****08-10-2022 12:00 - 13:00****Newborn record documentation audit****L. Ahmed^{1*}, C. Hughes¹, A. Gupta², G. Vemuri¹**¹Manchester University NHS Foundation Trust, Neonatology, Manchester, United Kingdom²St Mary's Hospital, Neonatal Unit, Manchester, United Kingdom**BACKGROUND AND AIMS**

Lack of documentation of maternal medical history, delivery details and the postnatal management plan can lead to serious missing of neonatal care. The current newborn admission sheet used at Wythenshawe (level2) and Oxford Road Campus (level3) sites was reviewed. The baby's sheet has a layout made in a simple format. This sheet contains maternal and neonatal sections. The audit was conducted to review the quality of documentation in the current neonatal admission sheet used in the trust.

METHODS

Joint work between the neonatal team at Wythenshawe and The Oxford Road campuses within the same trust. The Data were collected from 50 sheets selected randomly for babies in the NICU, postnatal wards, and transition care. Nine standards: five in the neonatal section and four in the maternal section. Completion of documentation was the main targeted standard.

RESULTS

DOB, TOB, gestation and sex were completed in 95% of the notes. Resuscitation documented in 80%. Mode of delivery, birth weight, and vita-

min K administration completed in 82-83%. Apgar scores and delayed cord clamping completed in 72-74%. Medical record number and the neonatal plan completed in 50%. Maternal septic risk factors and intrapartum antibiotics status completed in 48-52%. Antenatal steroids status was noted in 82%. Maternal blood group, DAT, anti-D status, serology and medical history completed in 72-74%.

CONCLUSIONS

The action plans include circulating the audit through the neonatal and maternity leaders, re-educate the staff during the induction program and ward rounds, circulating the outcome of this audit to the guideline developer for review, and finally, re-audit after 6 months.

PD016 / #2661**E-poster Discussion Session 03: ESPR - Improving quality of care 1****08-10-2022 12:00 - 13:00****Improving neonatal thermoregulation throughout critical care transport****J. Lister¹, J. Lee², J. Chubb¹, C. Harrison¹, J. Oldfield^{1*}, E. Harrison¹**¹Sheffield Children's NHS Foundation Trust, Embrace Transport, Sheffield, United Kingdom²Sheffield Children's hospital, Embrace Transport, Barnsley, United Kingdom**BACKGROUND AND AIMS**

Neonatal hypothermia is a known contributor to infant morbidity and mortality due to late onset sepsis, bronchopulmonary dysplasia, necrotising enterocolitis (NEC), poor neurological outcome, PPHN, and increased duration of mechanical ventilation. Preterm and low birth weight infants are at higher risk due to high body surface area to mass ratio, immature skin and lack of adipose tissue. Normothermia in the neonatal population is considered 36.5-37.5 degrees Celsius. Transport increases the risk of hypothermia Previous data identified that a high number of babies immediately post-surgery were hypothermic. This project aims to decrease the number of babies who were hypothermic after surgery and during transport

METHODS

A core QI team were developed including transport and theatre personnel. Temperature measurements were collated at defined times in the surgical care pathway. A education package was developed and strategies highlighted to improve babies' temperature at different point in their care: Ambient temperature of the operating theatre was increased, Use of warm fluids, Use of a warming mattress, Use of a knitted hat throughout the operation Central

temperature monitoring. A transport care bundle was also developed to improve overall consistency of the transport team's approach to thermoregulation in terms of incubator temperatures, use of humidity, heating devices and temperature probe placement.

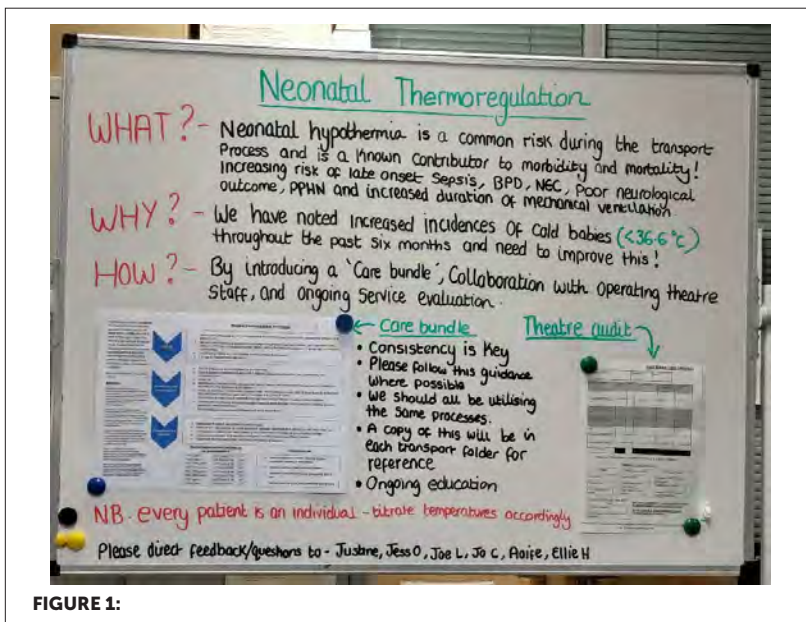

FIGURE 1:

RESULTS

Run charts six-months pre and post intervention demonstrate improvement in the incidence of neonatal hypothermia.

CONCLUSIONS

Early indicators suggest that implementation of a care bundle and collaboration with operating theatres, improves the incidence of neonatal hypothermia during the transport process.

PD017 / #2760**E-poster Discussion Session 04: Late breaking neonatology 01****08-10-2022 12:00 - 13:00****The optimal timing for surgical ligation of patent ductus arteriosus after failed indomethacin in very preterm infants: a 12-year retrospective cohort study****S. Manopunya***, N. Pattanapolrath, S. Kosarat, V. Khuwuthyakorn, M. Pomrop, W. Tantiprabha*Faculty of Medicine, Chiang Mai University, Department of Pediatrics, Chiang Mai, Thailand***BACKGROUND AND AIMS**

Stepwise management of hemodynamically significant PDA (hsPDA) and optimal timing for surgical ligation are still debated. This study aimed to compare in-hospital outcomes between early and late surgical ligation after failed indomethacin in very preterm infants.

METHODS

This retrospective cohort study was conducted in preterm infants born before 32-week gestational age (GA) and underwent surgical ligation of hsPDA after failed indomethacin between January 2006 and December 2018. Patients with congenital anomalies, cardiac defects or could not be tolerated with indomethacin were excluded. We divided our patients into two groups: early ligation (EL) for whom underwent surgery within 21 days after hsPDA diagnosis and late ligation (LL) for those who underwent surgery later. Baseline characteristics and in-hospital outcomes were compared. Logistic regression analysis was used to determine factors associated with poor outcomes.

RESULTS

Seventy preterm infants were enrolled with mean GA and birth weight of 27.6 ± 2.3 weeks and 888.7 ± 216.3 grams, respectively. The baseline characteristics were not different in terms of GA, birth weight, gender, and presurgical co-morbidities. EL had significantly higher incidence of BPD (92% VS 81%, p-value=0.008) and composite outcome of death and/ or severe BPD (63% VS 27%, p-value=0.013). Although the overall mortality rate was 11.4%, there was no significant difference between the two groups. Early surgical ligation was a significant independent factor for death and/ or severe BPD (OR = 3.55, 95% CI= 1.06-11.91).

CONCLUSIONS

Surgical hsPDA ligation is a safe backup procedure for very preterm infants who failed indomethacin. Performed surgery after 21 days of hsPDA diagnosis might decrease poor in-hospital outcomes.

PD018 / #2728**E-poster Discussion Session 04: Late breaking neonatology 01****08-10-2022 12:00 - 13:00****Cerebral palsy rates of children born before 32 weeks gestation at the Simpson Centre for Reproductive Health in Edinburgh from 2009-2019****H. Cruickshank^{1*}, M. Rudnicka²**¹NHS Lothian, Physiotherapy, Edinburgh, United Kingdom²NHS Lothian, Neonatology, Edinburgh, United Kingdom**BACKGROUND AND AIMS**

Preterm babies (<32wks) are followed up and assessed at 2 years corrected age (CA) according to UK guidelines. Changes in neonatal practice have translated into improving survival rates, the impact on specific neurodevelopmental outcomes such as cerebral palsy (CP) remains unclear.

Aim: Assess the trends in CP of this cohort and subsequent functional impairment as measured by gross motor function classification system (GMFCS).

METHODS

Babies born in Edinburgh between 2009-2019 with a gestation of 22-31+6wks were included. Babies were invited for 2 year follow up and classified with routine assessment or information gathered from referring hospitals.

RESULTS

1402(90%) livebirths survived to 2 years CA. Babies were followed up for 2yr CA, with 81% complete data, of these 6% were diagnosed with cerebral palsy. GMFCS rates and severity remained similar over 10 years, despite the increase survival of babies with lower gestations and lower birthweights. 22% of babies with a confirmed diagnosis of CP at 2 years of age had GMFCS 1. 3% of babies classified as GMFCS 1 had signs of ASD or Learning difficulties.

CONCLUSIONS

Consistent approach to follow up with an interprofessional team demonstrates it is possible to obtain high rates of 2yr follow up data allowing for accurate analysis of trends and identification of those needing extra support. CP rates in Edinburgh are comparable with other units worldwide, the degree of severity of CP remained unchanged over 10 years. This is likely multifactorial with the introduction of antenatal and perinatal bundles and the multidisciplinary approach to early intervention offered to this cohort.

PD019 / #2521**E-poster Discussion Session 04: Late breaking neonatology 01****08-10-2022 12:00 - 13:00****The use of asynchronous video to support neonatal follow-up services****H. Cruickshank^{1*}, S. offer²**¹NHS Lothian, Physiotherapy, Edinburgh, United Kingdom²NHS Highland, Physiotherapy, Edinburgh, United Kingdom**BACKGROUND AND AIMS**

Neonatal follow up services provide ongoing specialist assessment and support to families of babies born prematurely or with other medical complications that increase risk of adverse developmental outcomes. Prechtl's General Movement Assessment (GMA) forms a core component of the clinical pathway and typically involves capturing a two minute video recording of an infant's unstimulated movement in the supine position as part of the first clinic appointment. The video is reviewed by a clinician with specialist training to look for a subtle feature described as "fidgety movements". This assessment performed at 10-16 weeks post-term age provides reassurance about normal development and assists in the early detection of emerging neurological disorders such as Cerebral Palsy. Aim: 1. Develop, trial and evaluate vCreate in Neonatal Follow-Up across Scotland.

METHODS

Quality improvement methodology was used to plan, implement and refine the clinical pathway, the administrative support processes and the vCreate platform at each stage.

RESULTS

Use of vCreate effectively facilitated use of the GMA as a standard component of the clinical pathway without the need for a face-to-face review. An example of technology enabled care that provides ongoing advantages to the neonatal follow-up pathway with no additional financial resource if the Unit is already using the sister platform vCreate Neonatal.

CONCLUSIONS

Completion of the GMA *in advance* provided a focus for further assessment and discussion. Enhanced the clinician's ability to respond to concerns raised by parents between scheduled appointments. Facilitated a secure method of seeking a second opinion from another centre Provides a valuable resource for teaching

PD020 / #2716

E-poster Discussion Session 04: Late breaking neonatology 01

08-10-2022 12:00 - 13:00

Risk factors in the development of ROP: a 10-year retrospective study

N. Decembrino^{1*}, M. Di Pietro², E. Malerba², A. Longo², M. Gallo³, C. Mattia¹, M. Marletta¹, M.A. Conversano⁴, M.C. Caracciolo⁵, A. Saporito⁴, V. Di Benedetto⁶, T. Avitabile², P. Betta⁴

¹AOU Policlinico G. Rodolico San Marco Catania, Neonatal Intensive Care Unit, Catania, Italy

²University of Catania, General Surgery and Surgical Specialities, Catania, Italy

³APSS Trento, Ophthalmology, Trento, Italy

⁴University of Catania, Pediatrics, Catania, Italy

⁵University of Catania, Department of Neonatology, Catania, Italy

⁶University of Catania, Pediatric Surgery, Catania, Italy

BACKGROUND AND AIMS

To evaluate rate and severity of ROP in a large sample of preterms, and determine the factors related to its development.

METHODS

Clinical charts of all preterm inborns hospitalized at the Neonatal Intensive Care Unit of the Policlinic of Catania from January 1, 2009 till December 31, 2018, were reviewed. ROP stage and location, treatments, maternal and infant risk factors were evaluated.

RESULTS

Among the 899 preterm inborns examined (mean gestational age 32.9 ± 2.3 weeks), 149 (16.6%) developed bilateral ROP (92 stage 1, 44 stage 2 and 13 stage 3); 66 (5.6%) received a bilateral retinal laser treatment. Three eyes with zone I ROP 1 also received intravitreal ranibizumab. Multivariate analysis revealed that factors related to ROP development were gestational age ($p < 0.001$), birthweight ($p < 0.001$), assisted ventilation duration ($p < 0.001$), multiple birth ($p = 0.003$), erythropoietin administration ($p = 0.005$). In the decision-tree analysis the most significant predictive factor was the gestational age ($P < 0.001$); secondary predictive factors were, in newborns with gestational age 29-31 weeks, erythropoietin administration ($p = 0.001$), and in those with gestational age 32-34 weeks, birthweight lower than 2090 grams ($p < 0.001$); in this latter group, tertiary predictive factor was a patent ductus arteriosus ($p = 0.043$).

CONCLUSIONS

In our study the incidence of ROP is greater than 10%; half of patients required laser treatment. Besides well known factors, such as gestational age and birthweight, other more individual factors, like duration of assisted ventilation, erythropoietin administration, multiple birth and patent ductus arteriosus were identified. In premature newborns, an individualized evaluation and follow-up taking into account these factors is recommended.

PD021 / #2508**E-poster Discussion Session 04: Late breaking neonatology 01****08-10-2022 12:00 - 13:00****Improving neonatal care using data from the national congenital anomaly and rare disease registration service (NCARDS).****K. Johnson^{1*}, J. Broughan², D. Cave³**

¹Leeds Teaching Hospitals NHS Trust, Leeds Neonatal Service, Leeds General Infirmary, Leeds, United Kingdom

²National Disease Registration Service, National Congenital Anomaly and Rare Disease Registration Service, Leeds, United Kingdom

³Leeds Teaching Hospitals NHS Trust, Leeds Children's Hospital, Leeds, United Kingdom

BACKGROUND AND AIMS

NCARDS is a registration service that collects and quality assures data on congenital anomalies and rare diseases in England. NCARDS also provides data to EUROCAT; the European network of population-based registries for the epidemiological surveillance of congenital anomalies. Using national level data on severe congenital heart disease we aim to describe the prevalence of severe congenital heart disease from 2015 – 2019 in England and use this as an exemplar to explore how national level registry data can improve clinical care.

METHODS

Using NCARDS data the prevalence of severe congenital heart disease in 2015-2019 in reporting regions of NCARDS was calculated per 10,000 births.

RESULTS

The Table below shows the total birth prevalence of severe CHD in England 2015 - 2019.

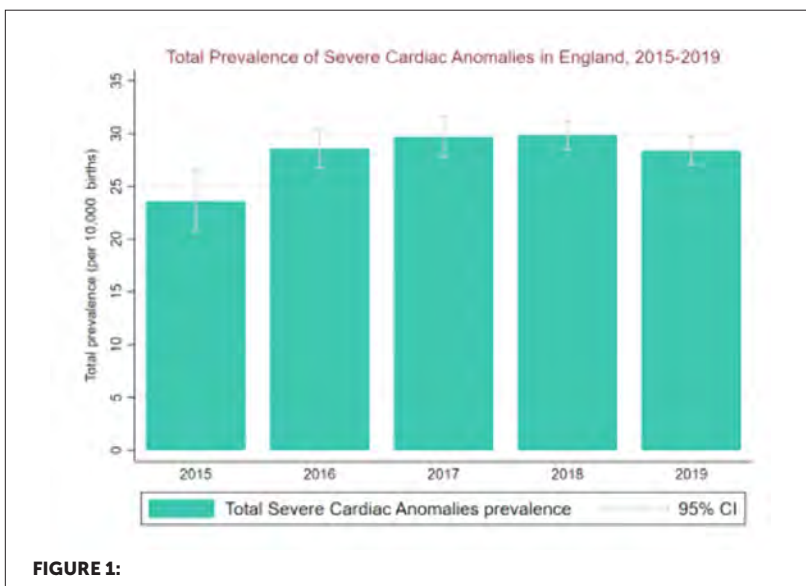

CONCLUSIONS

Our data show the current prevalence of severe congenital heart disease in England; NCARDRS can link this data to other routinely collected data building a clinical picture of severe CHD before and after birth and in childhood. As a result of the longitudinal information created by long term linked data perinatal counselling and services offered in the perinatal period alongside paediatric care can be refined and improved. NCARDRS' ability to provide national prevalence data on the condition along with linkage to multiple other data sources provides an opportunity to obtain valuable information on the potential causes of not just congenital heart disease but other congenital anomalies. By working together with other registries through

EUROCAT such information and improvements in care can be explored on a Europe wide scale.

PD022 / #2161**E-poster Discussion Session 05: ESPR - Neurology of the newborn****08-10-2022 12:00 - 13:00****Perinatal risk factors for developmental coordination disorder in children born extremely preterm****J. Bolk^{1*}, K. Källén², A. Farooqi³, M. Hafström⁴, V. Fellman⁵, U. Aden⁶, F. Serenius⁷**

¹Karolinska Institutet, Department of Medicine Solna, Division of Clinical Epidemiology, Stockholm, Sweden

²Lund University, Centre of Reproductive Epidemiology, Lund, Sweden

³University of Umeå, Unit of Pediatrics, Institute of Clinical Sciences, Umeå, Sweden

⁴University of Gothenburg, Unit of Pediatrics, Institute of Clinical Sciences, Gothenburg, Sweden

⁵Lund university, Department of Clinical Sciences, Lund, Sweden

⁶Karolinska Institute, Dept of Women's and Children's Health, Stockholm, Sweden

⁷Uppsala University, Department of Women's and Children's Health, Uppsala, Sweden

BACKGROUND AND AIMS

Developmental coordination disorder (DCD) is common in extremely preterm born children. We aimed to evaluate the contribution of gestational age and perinatal risk factors to risk for DCD in extremely preterm children.

METHODS

The participants were part of the nationwide prospective cohort study the Extremely Preterm Infants in Sweden Study (EXPRESS). There were 226 children born before 27 gestational weeks and without major neurodevelopmental disabilities at 6.5 years. Outcome was DCD, defined as \leq 5th percentile on the Movement Assessment Battery for Children-Second Edition. Using univariable and stepwise multivariable logistic regression with odds ratios

(ORs) and 95% confidence intervals (CIs) perinatal risk factors for DCD were evaluated.

RESULTS

DCD was present in 84/226 (37.2%) children. Multivariable odds ratios (95% CIs) were significant for mother's age at delivery; 1.73 (1.07-2.80), preeclampsia; 2.79 (1.14-6.80), mother born in a non-Nordic country; 2.23 (1.00-4.99), gestational age, increment per week; 0.70 (0.50-0.99) and retinopathy of prematurity (ROP); 2.48 (1.26-4.87). Postnatal steroids exposure (2.24 (1.13-4.46) and mechanical ventilation (1.76 (1.06-2.09) were independent risk factors when added to the model in separate analyses. The final model at discharge explained 26% of the risk for DCD - maternal factors, preeclampsia, ROP, and mechanical ventilation remained significantly associated with DCD; gestational age became non-significant.

CONCLUSIONS

Risk of DCD in extremely preterm born children is multifactorial, is associated with gestational age largely mediated by ROP, maternal factors, preeclampsia and neonatal interventions. However, perinatal risk factors only explained a moderate portion of the risk for DCD.

PD023 / #2197**E-poster Discussion Session 05: ESPR - Neurology of the newborn****08-10-2022 12:00 - 13:00****Is the APGAR score predictive of poor cognitive and motor outcomes at five year of age among children born extremely preterm?****H. Ehrhardt^{1*}, R. Maier², U. Aden³, A. Aubert⁴, E.S. Draper⁵, A. Gudmundsdottir⁶, H. Varendi⁷, T. Weber⁸, M. Zemlin⁹, J. Zeitlin¹⁰**

¹Justus-Liebig-University Gießen, Department of General Pediatrics and Neonatology, Gießen, Germany

²Philipps University Marburg, Children's Hospital, University Hospital, Marburg, Germany

³Karolinska Institute, Dept of Women's and Children's Health, Stockholm, Sweden

⁴Université Paris Cité, Inserm, INRAE, Centre For Research In Epidemiology and Statistics (cress), Obstetrical Perinatal and Pediatric Epidemiology Research Team, Epopé, Paris, France

⁵University of Leicester,, Department of Health Sciences, Leicester, United Kingdom

⁶Karolinska Institutet, Department of Women's and Children's Health, Stockholm, Sweden

⁷University of Tartu, Tartu University Hospital, Tartu, Estonia

⁸University of Copenhagen, Faculty of Health and Medical Sciences, Copenhagen, Denmark

⁹Saarland University Hospital, Department of General Pediatrics and Neonatology,, Homburg, Germany

¹⁰Center for Research in Epidemiology and Statistics (CRESS), INSERM, INRA, Paris Cité University, Obstetrical Perinatal and Pediatric Epidemiology Research Team, Epopé, Paris, France

BACKGROUND AND AIMS

The Apgar score, developed for rapid assessment and clinical triage of newborns at birth, has been shown in recent studies to be predictive of longer-term neurological outcomes in the general population and among preterm neonates. However, its predictive value for extremely preterm (EP, <28 weeks' of gestational age (GA)) infants has not been evaluated.

METHODS

822 EP infants followed-up at five years were included from a prospective birth cohort in 11 European countries. Outcomes were the intelligence quotient (IQ) and motor function using the Movement Assessment Battery for Children-2nd edition (MABC-2). Linear regression models evaluated the association with Apgar at 5 minutes, modeled as a continuous exposure, adjusting for perinatal factors (GA, small for GA, infant sex), severe neonatal morbidities (brain lesions, necrotizing enterocolitis, retinopathy of prematurity, bronchopulmonary dysplasia) and sociodemographic factors (maternal age, foreign-birth and education). All models adjusted for country.

RESULTS

The mean (SD) GA was 25.9 (1.1) with a mean Apgar score of 7.5 (1.9); 24% had an Apgar <7. In unadjusted models, a one-point increase in Apgar was associated with higher IQ ($\beta=1.0$, $P=.002$) and MABC-2 ($\beta=1.4$, $P<.001$). Adjustments for perinatal factors attenuated these associations ($\beta=0.64$, $P=.05$ and $\beta=1.00$, $P=.002$, respectively). The association with IQ was no significant, but persisted for motor function after adjustment on neonatal morbidities ($\beta=0.52$, $P=.11$ and $\beta=0.81$, $P=.01$) and social factors ($\beta=.19$, $P=.59$ and $\beta=1.1$, $P=.002$).

CONCLUSIONS

Movement function in EP at five years of age but not IQ was independently associated with the Apgar score at 5 minutes.

PD024 / #2387**E-poster Discussion Session 05: ESPR - Neurology of the newborn****08-10-2022 12:00 - 13:00****Associations between Bayley-III fine and gross motor scores at 2.5 years with the movement ABC-2 manual dexterity, aiming and catching and balance at 6.5 years****C. Montgomery^{1*}, S. Setänen², Y. Kaul¹, F. Serenius¹**¹*Uppsala University, Department of Women's and Children's Health, Uppsala, Sweden*²*University of Turku and Turku University Hospital, Pediatric Neurology and Pediatrics, Turku, Finland***BACKGROUND AND AIMS**

Extremely preterm birth increases the risk for motor impairment. The Bayley Scales of Infant and Toddler Development-3rd edition (Bayley-III) is the most commonly used follow-up method. The motor index, comprising fine and gross motor subscales, is reported to underestimate the rate of later motor impairment. However, little is known about the validity of the subscales. We aimed to examine whether the Bayley-III motor subscales at 2.5 years in children born extremely preterm (EPT, <27 gestational weeks) is associated with motor performance evaluated with the Movement Assessment Battery for Children - Second Edition (Movement ABC-2) at 6.5 years.

METHODS

A Swedish population-based cohort of EPT children born in 2004-2007 was prospectively followed up. Children with cerebral palsy at 2.5 years were excluded. The association of the Bayley-III motor index and fine and gross

motor scales with the Movement ABC-2 was explored using the manual dexterity, aiming and catching, balance scales as well as composite scores.

RESULTS

At both ages, 282 (133 girls) EPT children were assessed. Bayley-III fine motor scale explained 21% ($p < 0.001$) of the variance of the Movement ABC-2 manual dexterity subscores. The Bayley-III gross motor scale explained 4.0% ($p < 0.001$) and 1.0% ($p = 0.05$) of the variance of the Movement ABC-2 aiming and catching and balance subscores. The Bayley-III motor index explained 18% of the Movement ABC-2 composite scores ($p < 0.001$).

CONCLUSIONS

The Bayley-III motor index, performed at 2.5 years is associated with the Movement ABC-2 at 6.5 years in EPT children. Fine motor function accounted for the larger part of the association.

PD025 / #1651**E-poster Discussion Session 05: ESPR - Neurology of the newborn****08-10-2022 12:00 - 13:00****Regional cerebral oxygen saturation and serum biomarkers to predict neurological outcome in children undergoing cardiac surgery****D. Cañizo^{1*}, S. Hadley², M. Pérez³, A. Rivas¹, S. Benito⁴, M.L. Rossi⁵, J. Sanchez-De-Toledo⁵, M. Camprubi¹**¹Hospital Sant Joan de Déu, Neonatology, Barcelona, Spain²Boston Children's Hospital, Pediatrics, Boston, United States of America³Hospital Sant Joan de Déu, Psychology, Barcelona, Spain⁴Hospital Sant Joan de Déu, Intensive Care Unit, Barcelona, Spain⁵Sant Joan de Deu Hospital, Pediatric Cardiology, Barcelona, Spain**BACKGROUND AND AIMS**

One of the most prevalent morbidities in patients with congenital heart disease (CHD) is neurocognitive impairment. Noninvasive cerebral regional oxygen saturation (CrSO₂) in the perioperative period is extensively used. Serum biomarkers (SB) such s100B protein and lactate have also been described to predict brain damage. The aim of this study was to evaluate the capacity of CrSO₂ and SB after cardiac surgery (CS) to predict neurodevelopmental outcome (NO).

METHODS

Patients 6 months or younger, undergoing CS were included in this prospective, observational study. We recorded CrSO₂ in the perioperative period and the amount of time below 40&50% was calculated. SB were collected after

surgery at 0- and 72-hours. NO at 24 month of age was assessed with Bayley Scales of Infant Development or Vineland test.

RESULTS

Forty-six patients were included. CrSO₂ values during surgery do not seem to have an impact on NO. Twenty-four hours after CS, time of CrSO₂<40% was a good indicator of NO (AUC of 0.677, p=0.017), with a cut-off of 49 minutes. If we include levels of s100B at 72-hours and lactate after surgery the predictive AUC increased to 0.897 (p=0.033). Time of CrSO₂<50% was also a strong indicator of NO (AUC 0.749, p=0.032), similarly, levels of s100B at 72 hours and lactate after surgery increased the AUC to 0.8409 (p=0.052).

CONCLUSIONS

Time of CrSO₂< 40%&50% 24 hours after CS combined with levels of lactate and s100B 72-hours after surgery are a great tool to predict NO in children with CHD.

PD026 / #2281**E-poster Discussion Session 05: ESPR - Neurology of the newborn****08-10-2022 12:00 - 13:00****Maturational amplitude-integrated electroencephalographic (AEEG) changes in very preterm infants****M. Velilla Aparicio^{1*}, N. Carreras¹, T. Agut^{1,2}, A. Alarcon^{1,3}, A. García-Alix²**¹Hospital San Joan de Déu, Institut de Recerca Sant Joan de Déu, Neonatology, Barcelona, Spain²Fundación Nene, Neonatology, Madrid, Spain³University of Barcelona, Pediatrics, Barcelona, Spain**BACKGROUND AND AIMS**

Preterm brain maturation is echoed by changes in aEEG. Studies exist on normal aEEG values and changes with increasing GA/PMA. Updated large-scale studies using state-of-the-art monitors are lacking, and questions remain regarding parameters with the greatest clinical applicability. Aims: To describe developmental changes in aEEG in very preterm infants. To assess the usefulness of available and novel aEEG parameters to ascertain brain maturity.

METHODS

Prospective study conducted in two tertiary NICUs (2019-2020). Three-hour recordings from 75 preterm infants (<32w GA) were obtained on postnatal D3, and weekly thereafter until 36w PMA/discharge. Infants with congenital cerebral pathology were excluded. 352 of 465 aEEG traces were randomly selected for this preliminary analysis. aEEG parameters were blindly assessed, and their correlation with PMA was examined by Spearman's rank correlation analysis.

RESULTS

With increasing PMA, duration of continuous pattern (N=136) increased ($r=.492; P<.001$), cycling (N=352) became more mature ($r=.474; P<.001$) and the bandwidth span (N=352) narrowed ($r=.430; P<.001$) as the lower border amplitude (N=127) risen ($r=.243; P=.006$) and the upper border amplitude of the narrowest part of the trace (N=127) dropped ($r=-.431; P<.001$). Total Burdjalov score (N=352) increased with PMA ($r=.490; P<.001$). The number of pattern changes per hour (N=136) showed an inverse correlation with PMA ($r=-.213; P=.013$).

CONCLUSIONS

aEEG monitoring on a weekly basis is feasible and may be used for bedside neurophysiological surveillance of brain maturation and its disruption in pre-term infants. Continuity, cycling and aEEG maturational scoring correlate with PMA. A distinct feature of the most immature infants is variation between aEEG patterns.

PD027 / #2363**E-poster Discussion Session 05: ESPR - Neurology of the newborn****08-10-2022 12:00 - 13:00****Improving neonatal hypoxic encephalopathy hypothermic care with active cooling during transport and at birth centre: UK regional transport data 2011-2021****A. Mistry^{1*}, N. Davey², D. Sharkey¹**

¹University of Nottingham, Centre For Perinatal Research, School of Medicine, Nottingham, United Kingdom

²Centre Neonatal Transport Service, University Hospitals of Leicester, Leicester, United Kingdom

BACKGROUND AND AIMS

Background Neonatal hypoxic ischaemic encephalopathy (HIE) is the leading cause of near-term/term related brain-injury. Therapeutic hypothermia (TH) for HIE improves disability-free survival. Compared with passive cooling, servo-controlled active-TH is more effective at maintaining therapeutic temperatures. In the UK, 38% of HIE births are initially passively cooled and rely on active-TH by transport services or tertiary cooling centres. Aims: assess how the rollout of active-TH by a regional transport service and referring centres impacts hypothermic care in HIE.

METHODS

Evaluation of HIE transfers using prospectively recorded data from 2011-2021 covering the UK East Midlands neonatal transport service. Infants with HIE receiving passive-TH(Epoch-1) and active-TH(Epoch-2) during transfer were identified. Epoch-2 subgroup analysis compared infants from referring centres with and without active-TH commenced prior to transport team arrival. Infant

temperature at team arrival, departure and admission to tertiary centre, as well as age to TH, were compared.

RESULTS

A total of 391 infants with HIE required transfer; therapeutic temperatures were better maintained in infants at departure (96% vs 54%, $P<0.001$) and on admission (98% vs 61%, $P<0.001$) for active-TH vs passive-TH respectively during transfer (Figure). In Epoch-2, infants with active-TH commenced at their birthing centre ($n=32$), 83.9% achieved target temperature range prior to transport team arrival vs 26.3% ($n=155$) with passive-TH (OR 14.6, 95%CI 5.44-36.2; $P<0.001$); 100% of active-TH infants reached target temperature within 6-hours of birth vs 83% passive-TH.

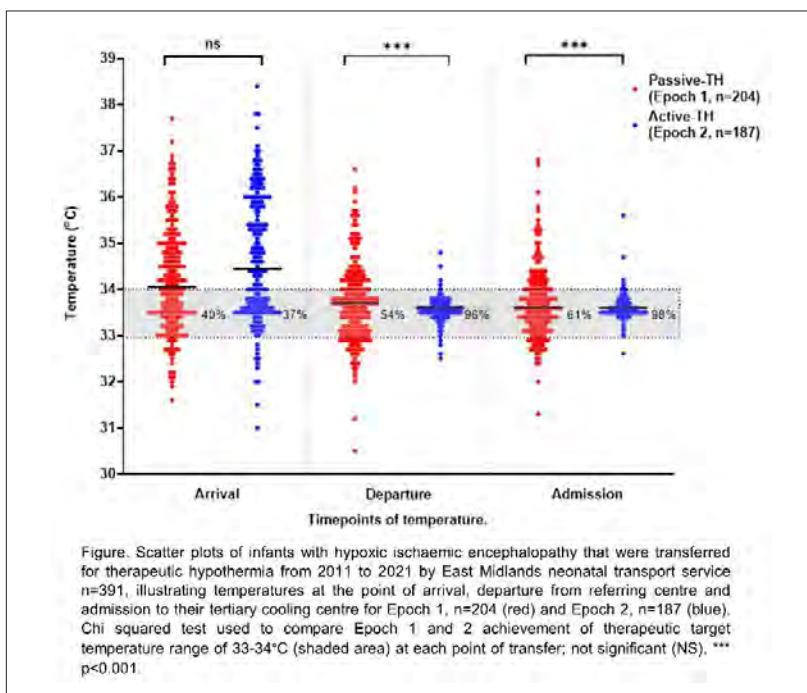

Figure. Scatter plots of infants with hypoxic ischaemic encephalopathy that were transferred for therapeutic hypothermia from 2011 to 2021 by East Midlands neonatal transport service $n=391$, illustrating temperatures at the point of arrival, departure from referring centre and admission to their tertiary cooling centre for Epoch 1, $n=204$ (red) and Epoch 2, $n=187$ (blue). Chi squared test used to compare Epoch 1 and 2 achievement of therapeutic target temperature range of 33-34°C (shaded area) at each point of transfer; not significant (NS), *** $p<0.001$.

CONCLUSIONS

Conclusion Adoption of active-TH for neonatal transport teams and in non-tertiary centres improves temperature management of infants undergoing TH and could potentially improve outcomes.

PD028 / #888**E-poster Discussion Session 05: ESPR - Neurology of the newborn****08-10-2022 12:00 - 13:00****Extremely preterm birth is related to altered regional brain volumes at school age****H. Kvanta*, N. Padilla, U. Aden***Karolinska Institute, Dept of Women's and Children's Health, Stockholm, Sweden***BACKGROUND AND AIMS**

At term age children born extremely preterm (EPT) had reduced GM volume mainly in the temporal lobes bilaterally, but also in the pre-and post-central gyri among other regions compared to term born controls. There were WM decreases adjacent to the GM changes (Padilla et al 2015). Also, GM volume increases were found in the occipital cortex. The aim was to investigate the regional volumetric differences between children born EPT and term born controls at 10 years of age.

METHODS

Children born extremely preterm (EPT) in Stockholm between 2004-2007 were called to an MRI examination at age 10 and 51 EPT children without focal brain were included, along with 38 term born controls. Images were pre-processed and segmented according to the SPM algorithm. T1-weighted images from the EPT group and the term born controls were compared using voxel-based morphometry, and analyses were adjusted for sex and intracranial volume.

RESULTS

The children born EPT exhibited significant regional volumetric changes for both GM and WM. (Figure 2). The reduced GM volume was mainly concentrated in the superior temporal lobes bilaterally, but also, multiple clusters of increased GM volume were found in the occipital cortex. Reduced GM volume was found in the right posterior cingulate cortex, and increased GM in the anterior cingulate cortex. The WM reductions and increases were mainly localized adjacent to the GM changes.

CONCLUSIONS

The pattern of regional volumetric changes found at term age in children born EPT seem to be stable to a large extent.

PD029 / #2015**E-poster Discussion Session 05: ESPR - Neurology of the newborn****08-10-2022 12:00 - 13:00****Visual perception and social ability in children born very and extremely preterm****M. Johansson^{1*}, L. Hellström-Westas¹, Y. Kaul¹, C. Montgomery¹, O. Kochukhova²**¹Uppsala University, Department of Women's and Children's Health, Uppsala, Sweden²Uppsala University, Institution of Psychology, Uppsala, Sweden**BACKGROUND AND AIMS**

Children born at 28-31 gestational weeks (very preterm, VPT) or <28 gestational weeks (extremely preterm, EPT), have risk of social difficulties, which is not fully explained by neonatal factors. Deficits in basic visual- and social perception may contribute to social problems. A core measurement of social perception is ability to recognize a human gait from a moving pattern reduced to coherently moving dots (biological motion, BM). Aims: To investigate performance on basic visual perception of inanimate figures and social perception of human BM and its associations with social ability in children born preterm and full term (FT).

METHODS

At 12 years, VPT (n=53), EPT (n=25) and FT control (n=50) children's detection of human BM was measured with a Tobii eye tracker, basic perception with the Beery-Buktenica Visual Perception subtest and social ability with the Social Responsiveness Scale.

RESULTS

VPT and EPT children had poorer basic ($p=.02$, $p=.002$ respectively), and BM perception ($p=.004$, $p=.007$ respectively), compared to the FT group and had higher prevalence of social ability deficits. In the EPT group basic perception was associated with social ability ($\beta=.33$) even when controlling for neonatal factors. The FT group's social ability was related to BM ($\beta=.45$).

CONCLUSIONS

Children born preterm showed deficits in basic and social perception compared to FT peers. In the EPT group basic perception had an association to social ability. In contrast, BM was associated to social ability in the FT group. Fundamental perception may be an important part of social ability in children born EPT.

PD030 / #1507**E-poster Discussion Session 05: ESPR - Neurology of the newborn****08-10-2022 12:00 - 13:00****Expert analysis compared to automated analysis of EEG for the prediction of outcome in neonatal hypoxic ischaemic encephalopathy****S. Mathieson*, V. Livingstone, F. Magarelli, M. O'Sullivan, J. O'Toole, G. Lightbody, W. Marnane, S. Raurale, G. Boylan***University College Cork, Infant, Cork, Ireland***BACKGROUND AND AIMS**

The background EEG has prognostic value in neonatal HIE and automated grading may assist clinicians. Automated algorithms are tested against expert grades, however experts may not be consistent. Here we compare the performance of our EEG grading algorithm DELPHI against that of an EEG expert to predict a ground truth; neurodevelopmental outcome at 2 years.

METHODS

EEG was acquired from term infants at risk of seizure from 2 European multi-centre cohort studies (ANSeR). Infants with HIE and outcome were extracted. One hour EEG epochs at 6, 12, 24, 36, 48 hours were scored (4 grades) for severity by an EEG expert and DELPHI. Outcome was measured at 2 years of age to give a dichotomous outcome. Binary logistic regression was used to determine the prognostic value of the scores at the various timepoints and AUROC values for expert vs algorithm compared statistically.

RESULTS

183 neonates (mild-62, moderate-85, severe-36) were included. Both expert and algorithm scores predicted outcome at 12 to 48 hours ($p < 0.001$), but not 6 hours. The highest AUROC (95%CI) for the expert scores [0.732 (0.647-0.816)] and the algorithm [0.701 (0.616 - 0.786)] were seen at the 24 hour timepoint. There was no statistical difference between AUROC values for expert and algorithm at any time point ($p = 0.162-0.883$).

CONCLUSIONS

Results show that DELPHI achieved comparable performance to an expert to predict outcome. The timing of optimal prognostic value is in keeping with previous studies showing the highest prognostic value of the EEG between 24 and 48 hours in the era of cooling.

PD031 / #2713**E-poster Discussion Session 05: ESPR - Neurology of the newborn****08-10-2022 12:00 - 13:00****Star anise poisoning as a cause of infant seizures****J. Thió Casals*, A. Pi Compañó, J. Salazar Quiroz, M. Pujol Sanjuán, E. Moliner Calderon, A. Turon-Viñas, J. Serralabós-Ferré, J. Casas Resa, L. Català Altarriba, S. Boronat-Guerrero***Hospital de la Santa Creu i Sant Pau, Neonatology. Pediatrics Department, Barcelona, Spain***BACKGROUND AND AIMS**

Infant seizures can be caused by a variety of pathologies such as infections, trauma, metabolic derangements, neurologic conditions, toxic ingestions, among others. Toxics are less common but potentially fatal. Chinese Star Anise (*Illicium verum*) is a common spice traditionally used by many cultures as a remedy for infant colic. When used in high doses or when contaminated with Japanese Star Anise (*Illicium anisatum*) has been related to neurotoxicity and gastrointestinal disturbances.

METHODS

Case report.

RESULTS

18 day-year-old girl admitted in the emergency department for vomiting, irritability, and abnormal movements. Corresponds to a full-term well-controlled pregnancy with no relevant perinatal history. On her arrival several self-resolving episodes of limb tonicities, facial flushing and ocular nystagmus were observed. She was transferred to NICU for monitoring and study.

Exams including laboratory tests, ammonia, lumbar puncture, transfontanelar ultrasound and brain function monitor were performed, showing unremarkable results. Cefotaxime, ampicillin, and acyclovir were initially started but discontinued after test results. It was administered a phenobarbital bolus due repeated episodes of seizures. Video-electroencephalogram showed no evidence of further electrical or clinical crisis. Although at admission it was asked about medications history, it was not until it was inquired specifically about herbal intake that the family revealed the consumption of star anise tea prepared by the grandmother, solving the case.

CONCLUSIONS

There is no current antidote or specific treatment for star anise consumption, consisting only in supportive care. This case remarks the importance of including toxic ingestion such as star anise within the differential diagnosis of infant seizures.

PD032 / #2509

E-poster Discussion Session 05: ESPR - Neurology of the newborn

08-10-2022 12:00 - 13:00

Diagnosis of fetal cerebral malformations. contribution of MRI about 202 cases

K. Seddiki^{1,2*}, L. Benhafssa¹

¹Central hospital of Army, Radiology and Medical Imaging, ALGEIRS, Algeria

²Central hospital of Army, Pediatric and Neonatology office, Algiers, Algeria

BACKGROUND AND AIMS

To study the sensitivity and specificity of ultrasound and fetal MRI in the diagnosis of fetal cerebral malformations

METHODS

Prospective study of 202 parturients whose prenatal diagnosis of anomaly of the central nervous system in the fetus was carried out by ultrasound then correlated with fetal MRI or anatomopathology (when possible) using epidemiological methods(sensitivity and specificity test

RESULTS

The average age was 30 years. In the obstetrical antecedents, we find the notion of multiparity in 55% and abortion in 12%. The main ultrasound sign is ventriculomegaly: 75 cases or 37.18%. The MRI results are dominated by: normal MRI (47 cases or 23.26%). Chiari malformation type 2: 26 cases or 12.87%, polymalformative syndrome (20 cases or 9.9%). Ultrasound sensitivity was significant in ventriculomegaly, ACC, DW (67 to 97%) and low in Arnold Chiari

malformations (18%) while the specificity was significant only in the ventriculomegaly, compared to those of MRI which were very significant (99 to 100).

CONCLUSIONS

The indication of Fetal cerebral MRI remain indisputable in certain malformative pathologies both to confirm the diagnosis and to look for other associated anomalies such as gyration anomalies

PD033 / #2708

E-poster Discussion Session 06: Late breaking paediatrics 01

08-10-2022 12:00 - 13:00

Teaching programme to help school students recognise and manage asthma exacerbations

A. Chandran¹, A. Conte^{1*}, K. Elayar¹, A. Khan¹, S. Mehta¹, F. Miah¹, R. Nagaraj¹, E. Oworu¹, J. Park¹, L. Saliba¹, V. Sivaranjan¹, S. Suri¹, E. Tandanu¹, J. Coppel², J. Kearney², S. Herbert³

¹Kings College University, Medical Student, London, United Kingdom

²Asthma Innovation Research (registered charity no. 1168495), Charity Trustee, London, United Kingdom

³Kings College Hospital, Medicine, London, United Kingdom

BACKGROUND AND AIMS

The National Review of Asthma Deaths 2014 highlighted that up to 80% of paediatric deaths due to asthma occurred out of hospital. Therefore parents, children, and teachers should be educated about managing asthma. However, asthma education remains absent at all stages of the school curriculum. Asthma Innovation Research (AIR) is a charity that provides such education to schools.

METHODS

In March 2022, 13 Year 2 medical students delivered teaching aimed at school age children. Nationally, 8 schools were included in the programme with children between the ages of 6 and 14. They received presentations on Asthma, with particular emphasis on the recognition of an asthma exacerbation and initial pre-hospital treatment (call for help/999 and give blue inhaler). Children's knowledge was tested with the same quiz both before and after teaching.

RESULTS

The pre- and post-teaching quiz received 841 and 623 responses. We demonstrated an improvement in inhaler knowledge; 96% students knew the function of a 'blue inhaler' after the presentation compared to only 58% beforehand similarly for the 'brown inhaler' 91% understood its function afterwards, compared to only 33% at the beginning. Prior to the teaching, 33% of students were unable to recognise an asthma exacerbation which improved to 9% and 24% didn't know how to manage someone having an exacerbation which improved to 8%.

CONCLUSIONS

These findings suggest that asthma education in schools has a potential role to play in the prevention of asthma deaths and that medical students represent low cost options for a teaching programme across the UK.

PD034 / #2678**E-poster Discussion Session 06: Late breaking paediatrics 01****08-10-2022 12:00 - 13:00****Reduction of ileocolic intussusception under sedation or anaesthesia: a systematic review of complications****M. Shefler Gal^{1*}, S. Gamzu², R. Jacob³, D. Cohen⁴, I. Shavit⁵**¹Kaplan Medical Center, Pediatric Emergency Department, Rehovot, Israel²Shamir Medical Center, Pediatric Emergency Department, Beer Yaakov, Israel³Haemek Medical Center, Pediatric Emergency Department, Afula, Israel⁴4. Nationwide Children's Hospital, Pediatric Emergency Department, Columbus, United States of America⁵Hadassah Medical Center, Pediatrics, Jerusalem, Israel**BACKGROUND AND AIMS**

Background Despite the increased use of sedation in children undergoing stressful procedures, reduction of ileocolic intussusception (RII) is usually performed on awake children without any form of sedation.

Objective To evaluate the incidence of severe complications of RII under sedation or anaesthesia

Main outcome measures The primary outcome was the incidence of intestinal perforation during RII. The secondary outcomes were the incidence of sentinel adverse events defined as death, cardiopulmonary resuscitation, permanent neurological deficit and pulmonary aspiration syndrome.

METHODS

Design A systematic review including English language original articles of any date.

Patients Children undergoing RII (pneumatic or hydrostatic) under sedation or anaesthesia.

Data sources Ovid Embase, Scopus, PubMed, the Cochrane Database of Systematic Reviews and the internet search engine Google Scholar.

Data extraction Three authors independently reviewed each article for eligibility. The Newcastle-Ottawa Scale was used to assess the quality of included studies.

RESULTS

The search yielded 368 articles. Nine studies with 1391 cases were included in the analysis. of the nine studies, six had a score of ≤ 6 stars in the Newcastle-Ottawa Scale assessment, indicating low-to-moderate quality. Propofol-based sedation was used in 849 (59.2%) cases; 5 (0.6%) had intestinal perforation. Intestinal perforation was not reported in patients who were sedated with other sedatives. One patient had pulmonary aspiration syndrome

CONCLUSIONS

Although caution remains warranted, current data suggest that the incidence of severe complications due to RII under sedation or anaesthesia is low. Due to the lack of prospective data, it is difficult to ascertain the exact incidence of severe complication

PD035 / #2798**E-poster Discussion Session 06: Late breaking paediatrics 01****08-10-2022 12:00 - 13:00****From biomarkers to biological pathways in autism: a systematic review and multi-omics bioinformatics analysis highlight neuroimmune and metabolic networks implicated****J. English^{1,2*}, D. O'Boyle¹, K. Dowling¹, E. Ahern¹, L. Pawley¹, S. Al Khalaf³, B. Hammer Bech⁴, T. Brink Henriken⁵, R. Anney⁶, L. Lopez⁷, L. Gallagher⁸, A. Khashan³**¹University College Cork, Anatomy and Neuroscience, Cork, Ireland²University College Cork, Infant Research Centre, Cork, Ireland³University College Cork, School of Public Health, Cork, Ireland⁴Aarhus University, Dept. of Public Health, Aarhus, Denmark⁵Aarhus University Hospital, Department of Paediatrics (intensive Care Neonatology), Aarhus, Denmark⁶Cardiff University, Division of Psychological Medicine and Clinical Neurosciences, Cardiff, United Kingdom⁷Maynooth University, Department of Biology, Maynooth, Ireland⁸Trinity College Dublin, Trinity Institute of Neuroscience, Dublin, Ireland**BACKGROUND AND AIMS**

Hundreds of studies have profiled for blood-based biomarkers of Autism, yet, to date, a comprehensive overview of the biomarkers identified is lacking. We aimed to consolidate the literature, summarise proteomic and metabolomics blood-based biomarkers, and perform a multi-OMICS bioinformatics analysis of the molecular pathways implicated in Autism.

METHODS

Following a pre-registered PRISMA protocol, MEDLINE, EMBASE and Scopus databases were searched, by two reviewers, who independently screened articles. Studies included were cohort or case-control articles published as primary peer-reviewed studies, using Autism Spectrum Disorder (ASD) as the outcome measure. More than 1000 articles were screened, and papers which included subjects with a confirmed clinical diagnosis of ASD (ICD-10, DSM-IV, DSM-V ADOS, ADI-R, CARS or 3DI criteria), and measured protein/metabolite levels in blood were included.

RESULTS

We reviewed 86 proteomics studies and 48 metabolomics studies in individuals with ASD, as well as 7 studies which investigated maternal mid-gestation biomarkers of Autism. Pathway analysis revealed an enrichment of proteins linked to stress response/inflammation, and consistently implicated the IL-17a pathway, although our proteogenomic analysis in GWAS data using MAGMA found no evidence to implicate the IL-17a pathway at the level of the genome. Furthermore, the proteomics data pointed to altered Complement and Coagulation Signalling, and Cell Adhesion, with converging evidence from both proteomics and metabolomics datasets to implicate altered Arginine-, Glutathione- and Arachidonic Acid- metabolism.

CONCLUSIONS

This is the first review to systematically consolidate proteomics and metabolomics evidence to pinpoint the biological pathways implicated in Autism.

PD036 / #2677**E-poster Discussion Session 06: Late breaking paediatrics 01****08-10-2022 12:00 - 13:00****Evaluation of a point-of-care ultrasonography decision-support algorithm for the diagnosis of transient synovitis in the pediatric emergency department****M. Zoabi^{1*}, I. Shavit², N. Kvatinsky²**¹*Technion Institute of Technology, Rappaport Faculty of Medicine, Haifa, Israel*²*Rambam Medical Center, Pediatrics, Haifa, Israel***BACKGROUND AND AIMS**

The diagnosis of transient synovitis, a self-limiting inflammation of the hip joint is one of exclusion. We evaluated the performance of point-of-care ultrasound-decision support algorithm (POCUS-DSA) to diagnose transient synovitis.

METHODS

This retrospective analysis included 621 Emergency Department (ED) patients in whom the POCUS-DSA was applied between January 01, 2014 and December 31, 2019. A diagnosis of transient synovitis was made for any patient with hip joint effusion who had spontaneous resolution of symptoms on 5-7 days follow up.

RESULTS

Patients had a mean (standard deviation) age of 5.5 (1.9) years and a male/female ratio of 429/192. The sensitivity, specificity, positive predictive value, negative predictive value, positive likelihood ratio, and negative likelihood ratios were 90.9% (95% confidence interval [CI]: 88.3-93.1), 78.6% (95% CI: 59.0-91.7), 98.9% (95% CI: 97.6-99.6), 71.0% (95% CI: 59.5-80.9), 4.2 (95% CI: 2.3-8.9), and 0.12 (95% CI: 0.08-0.16), respectively. Blood investigations were required in 48 (7.8%) children. Six patients with hip effusion were incorrectly diagnosed as transient synovitis, two had Legg-Calvé-Perthes disease. All the six patients were correctly diagnosed on follow-up visits and completely recovered.

CONCLUSIONS

Study findings suggest that the diagnostic algorithm accurately identified transient synovitis in the ED, and seems to be safe. The low number of children who underwent blood investigations is a potential benefit of the POCUS-DSA. This study is the first to suggest a rule-in diagnostic tool for transient synovitis, instead of one of exclusion.

PD037 / #2780**E-poster Discussion Session 06: Late breaking
paediatrics 01****08-10-2022 12:00 - 13:00****Dose-response of virtual reality training of
pediatric emergencies in a randomized
simulation-based setting****A. Hoffelner¹, M. Wagner^{2*}, A. Lietz¹, J. Kraller³**¹Medical University of Vienna, Department of Pediatrics, Wien, Austria²Medical University of Vienna, Comprehensive Center For Pediatrics, Department of Pediatrics and Adolescent Medicine, Division of Neonatology, Pediatric Intensive Care and Neuropediatrics, Wien, Austria³Medical University of Vienna, Department For Pediatrics, Vienna, Austria**BACKGROUND AND AIMS**

The aim of this study is to determine the effect of different VR training intervals on individual performance, in order to facilitate the optimal implementation of virtual reality devices into medical training.

METHODS

Participants will be divided into 3 intervention groups. Group A will conduct a monthly refresher VR training. Group B trains two times, every three months. Group C only has an initial VR exercise. Afterwards all participants have a final assessment.

RESULTS

Participants conducting monthly VR training improved their performance significantly ($p=0.035$) compared to the two other groups, training two times every three months or rather only the initial VR exercise, where no statistically significant improvements could be observed.

CONCLUSIONS

Continuous VR simulation trainings significantly improved participants' performance in an emergency scenario. One-month intervals were associated with significant increases in performance compared to a three-month interval, as well as the control group. Additional studies would be necessary to correlate these improvements to different study populations, or further adapt the VR simulation.

PD038 / #2803**E-poster Discussion Session 07: Late breaking neonatology 02****08-10-2022 12:00 - 13:00****Nordic study on human milk fortification in extremely preterm infants (n forte): a randomised controlled trial****G.B. Jensen¹, F. Ahlsson², A. Elfvin^{3,4}, L. Naver^{5,6}, M. Domellof⁷, T. Abrahamsson^{1*}**¹Linköping University, Department of Biomedical and Clinical Sciences, Linköping, Sweden²Uppsala University, Department of Women's and Children's Health, Uppsala, Sweden³University of Gothenburg, Department of Pediatrics, Göteborg, Sweden⁴Region Västra Götaland, Sahlgrenska University Hospital, Queen Silvia Children's Hospital, Department of Paediatrics, Gothenburg, Sweden⁵Karolinska Institutet, Department of Clinical Science, Intervention, and Technology, Stockholm, Sweden⁶Karolinska University Hospital, Department of Neonatal Medicine, Stockholm, Sweden⁷Umea University, Department of Clinical Sciences, Pediatric Unit, Umea, Sweden**BACKGROUND AND AIMS**

The aim was to evaluate whether the use of human milk-based, as compared with bovine-based, multinutrient fortifier reduced the prevalence of necrotizing enterocolitis (NEC), sepsis and mortality in extremely preterm infants (EPT) exclusively fed with human milk when targeted fortification was employed.

METHODS

A randomised-controlled multi-centre trial comparing a human breast milk-based fortifier (HMF) with a standard bovine protein-based fortifier (BMF) in 229 EPT infants (born before gestational week 28+0) fed human breast milk (mother's own milk and/or donor milk). The infants were randomised

before reaching 100 mL/kg/day in oral feeds. The intervention continued until postmenstrual week 34+0. The primary outcome was a composite of NEC, culture-proven sepsis or death.

RESULTS

The results of the intention-to-treat analyses:

	HMF (n=115)	BMF (n=114)	p
Composite of NEC, culture-proven sepsis and mortality, n (%)	41 (35.7%)	39 (34.2%)	0.82*
NEC II-III, n (%)	8 (7.0%)	9 (7.9%)	0.79*
Death, n (%)	7 (6.1%)	13 (11.4%)	0.15*
Culture-proven sepsis, n (%)	33 (28.7%)	28 (24.6%)	0.48*
Bronchopulmonary dysplasia	60 (55.6%)	66 (54.7%)	0.18*
Retinopathy of prematurity stage III-V, n (%)	29 (25.7%)	25 (22.7%)	0.61*
Time to reach full enteral feeds (150 mL/kg/day), days, median (IQR)	10 (8-15)	10 (8-15)	0.27**

*chi-square; **Mann-Whitney U

FIGURE 1:

CONCLUSIONS

Human milk-based, as compared with bovine-based, multinutrient fortifier did not reduce NEC, sepsis and mortality in EPT infants exclusively fed human milk. Possible confounders such as the impact of gestational age and the start and the degree of fortification will be further elucidated and presented.

PD039 / #2764**E-poster Discussion Session 07: Late breaking neonatology 02****08-10-2022 12:00 - 13:00****Evaluation of multi organ failure in infants with mild perinatal asphyxia****S. Ünal^{1*}, N. Demirel², M. Durukan-Tosun¹, İ. Celik¹, A.Y. Bas²**¹University of Health Sciences, Neonatology/pediatrics, Ankara, Turkey²Ankara Yıldırım Beyazıt University, Department of Pediatrics, Division of Neonatology, Ankara, Turkey**BACKGROUND AND AIMS**

Infants with perinatal asphyxia carry the risk of organ failure other than brain regardless of severity of asphyxial insult. Fetal diving reflex is the main reason of this consequence. We aimed to evaluate the presence of organ failure other than brain in mild asphyxiated newborns.

METHODS

Data were retrospectively recorded. Study period was 01.01.2020 - 01.01.2022. Late preterm and term Infants admitted to NICU were included if $\text{pH} < 7.10$ and $\text{BE} < -12$ mmol/l in the first hour. Organ failure was accepted as follows; respiratory insufficiency (invasive mechanical ventilation or non invasive ventilation > 12 hours), hepatic insufficiency ($\text{AST} > 100$ iu/dl, $\text{ALT} > 50$ iu/dl), renal insufficiency (according to KDIGO criteria) myocard depression (Ejection fraction: $< \%70$ and shortening fraction $< \%40$, or pulmonary hypertension), gastrointestinal insufficiency (enteral intolerance, necrotizing enterocolitis), hematolojik system disfunction (leucocytosis, leucocytopenia, normoblastopenia, thrombocytopenia)

RESULTS

65 infants included (gestational age 39 (37-40) weeks and birth weight 3040 (2655-3380) grams). The incidence of organ failure were as follows; respiratory insufficiency: 76.9 %, hepatic insufficiency: 20.0 %, coagulopathy: 18.5%, renal insufficiency: 9.2%, hematologic problems: 7.7%, gastrointestinal problems: 3.0%, cardiac depression and/or pulmonary hypertension: 3.0%. Necrotizing enterocolitis was not developed in included infants. Two infants required coagulopathy treatment. None of the infants received platelet transfusion. All infants discharged.

CONCLUSIONS

The results showed that organs other than brain are at risk of being affected by the process of perinatal asphyxia. While the most common affected organ system was found to be respiratory system, hepatic functions and coagulopathy should also be evaluated.

PD040 / #2720**E-poster Discussion Session 07: Late breaking neonatology 02****08-10-2022 12:00 - 13:00****Maternal RBCs alloantibodies in breast milk: clinical relevance in early and late neonatal haemolytic anemia****N. Decembrino^{1*}, S. Pergolizzi², G. Anima², C. Mattia³, M. Marletta⁴, M.A. Conversano³, A. Saporito³, M.C. Caracciolo⁴, G. Palano⁴, M. Fragalà⁴, S. Ambrogio⁴, F. Sottile⁴, C. Galletta⁴, S. Costanzo², C. Carpinato⁵, P. Betta³**¹AOU Policlinico G. Rodolico San Marco Catania, Neonatal Intensive Care Unit, Catania, Italy²University of Catania, Laboratory of Immunology and Transfusion, Catania, Italy³University of Catania, Pediatrics, Catania, Italy⁴University of Catania, Department of Neonatology, Catania, Italy⁵University of Catania, Department of Neonatology, Catania, Italy**BACKGROUND AND AIMS**

We know that all classes of immunoglobulins are present in maternal breast milk (MBM), contributing to neonatal passive immunity. When maternal alloimmunization occurs against fetus/newborn's red blood cells (RBCs), such antibodies, present in MBM, could be absorbed by newborn's enterocytes and support/exacerbate RBCs destruction (Hemolytic Disease of Fetus and Newborn, HDFN). Autoimmune haemolytic anaemias (AIHA) are rare and usually idiopathic. Our aim was to exclude the diagnosis of AIHA in newborns of mothers with low titer alloantibodies in serum/plasma or apparently negative antibodies screening but high antibody titer in MBM.

METHODS

In the Immuno-Haematological laboratory (SIMT) of Catania University Hospital "G. Rodolico", maternal serum/plasma, baby's serum/plasma/eluante and MBM were tested and compared for the presence of RBC alloantibodies or isohemagglutinins using Ortho Surgiscreen0,8%, Panel C, Panel C ficin-treated, Ortho Gel Cards (IgG, neutral, reverse), Ortho Affirmagen0,8%, liquid anti-IgG anti-IgA anti-IgM AHG for antibodies screening, identification and titration, ELU-KIT (Immucor) and 56°C heat-elution to elute DAT positive newborns.

RESULTS

We report 5 cases of newborns with jaundice, positive Direct Antiglobulin Test (DAT), negative liver disease indices, in whom we identified the same alloantibodies (noABO HDFN) or high titre anti-A or anti-B isohemagglutinins (ABO HDFN) against babies' RBCs on MBM, serum/plasma and eluates.

CONCLUSIONS

HDFN sustained by antibodies in MBM should be considered in the differential diagnosis of severe or prolonged HDFN. Exclusion of autoimmune etiology, early recognition of antibodies against neonate's RBC in MBM and promptly interruption of breast-feeding are important in cases with detrimental progression of HDFN.

PD041 / #2763**E-poster Discussion Session 07: Late breaking neonatology 02****08-10-2022 12:00 - 13:00****Cardiorespiratory signature of late-onset neonatal sepsis: development and external validation of a prediction model in 3 neonatal ICUs****S. Kausch¹, J. Brandberg², J. Qiu², J. Isler³, R. Sahni³, K. Fairchild¹, J. Moorman², Z. Vesoulis⁴, D. Lake², B. Sullivan^{1*}**¹University of Virginia School of Medicine, Pediatrics, Charlottesville, United States of America²University of Virginia School of Medicine, Medicine, Charlottesville, United States of America³Columbia University Vagelos College of Physicians and Surgeons, Pediatrics, New York City, United States of America⁴Washington University in St. Louis, Pediatrics, St. Louis, United States of America**BACKGROUND AND AIMS**

Heart rate characteristics aid early detection of late-onset sepsis (LOS), but respiratory data contain additional signatures of illness due to infection. Predictive models using cardiorespiratory data may improve early sepsis detection. We hypothesized that heart rate (HR) and oxygenation (SpO₂) data contain signatures that improve continuous sepsis risk prediction over HR or demographics alone.

METHODS

We analyzed cardiorespiratory data from very low birth weight (VLBW, <1500g) infants admitted to three NICUs. We developed and externally validated four machine learning models to predict LOS using features calculated every 10m: mean, standard deviation, skewness, kurtosis of HR and SpO₂, and

their cross-correlation. We compared feature importance, discrimination, calibration, and dynamic risk prediction across models and cohorts. We built models of demographics and HR or SpO₂ features alone for comparison with HR-SpO₂ models.

RESULTS

In total, 302 sepsis events in 2,494 infants were analyzed. Cohort characteristics were similar among the three sites. Performance, feature importance, and calibration (Figure 1) were similar among modeling methods. All models had favorable, dynamic external validation performance (Figure 2). The HR-SpO₂ model performed better than models using either HR or SpO₂ alone (Figure 2 & 3). Demographics improved the discrimination of all physiologic data models but dampened their dynamic performance (Figure 2 & 3).

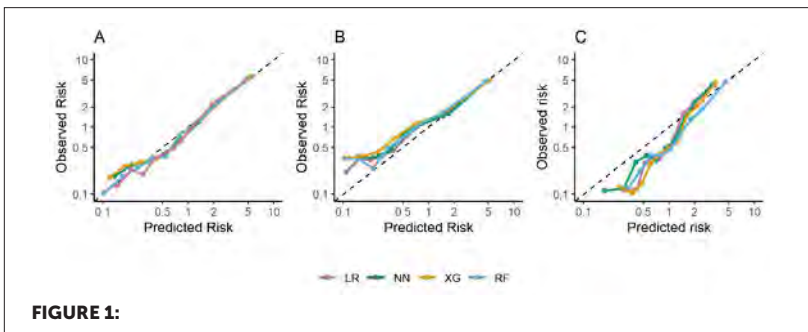

FIGURE 1:

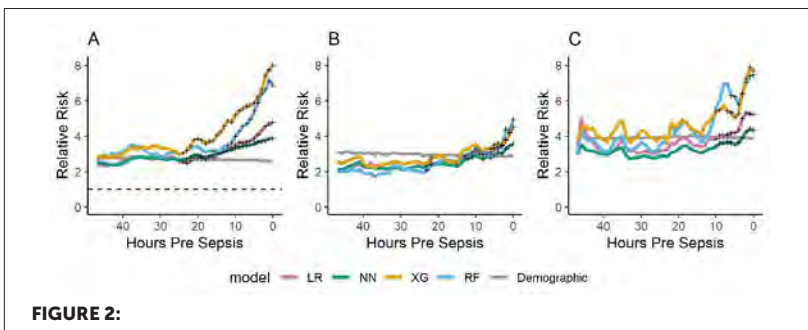
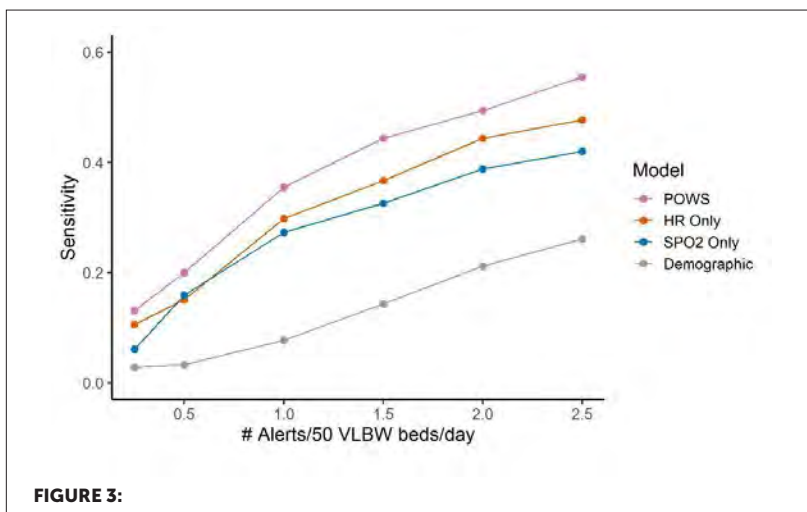

FIGURE 2:



CONCLUSIONS

Cardiorespiratory signatures detect LOS in VLBW infants at 3 NICUs. Demographics risk-stratify, but predictive modeling with both HR and SpO2 features provides the best dynamic risk prediction.

PD042 / #2732**E-poster Discussion Session 07: Late breaking neonatology 02****08-10-2022 12:00 - 13:00****Urinary calcium/creatinine ratio for predicting nephrocalcinosis in preterm infants****H.S. Hwang^{1*}, S.H. Shin², S. Park², E.-K. Kim², H.-S. Kim²**¹Seoul National University Children's Hospital, Pediatrics, Seoul, Korea, Republic of²Seoul National University Children's Hospital, Pediatrics, Seoul, Korea, Republic of**BACKGROUND AND AIMS**

The objective of the study was to explore whether urinary calcium/creatinine ratio (Ca/Cr) could be predictor for nephrocalcinosis in preterm infants.

METHODS

This single center retrospective study included preterm infants who were born less than 30 weeks of gestation from 2018 to 2021 and had record of monthly urinary Ca/Cr. Infants with surgical condition of gastrointestinal tract and infants with congenital anomalies were excluded. Those without renal ultrasonography after 4 weeks of postnatal age and infants who died before 4 weeks of age were excluded. Nephrocalcinosis was diagnosed with ultrasonography by experienced pediatric radiologist. Study population was categorized into infants with nephrocalcinosis and those without nephrocalcinosis.

RESULTS

of 100 infants, prevalence of nephrocalcinosis was 25%. There were no differences in gestational age (27.6 vs. 27.1 weeks, $p=0.814$) and birthweight (970 vs. 820 gram, $p=0.130$) between two groups. There were no differences in Apgar score at 1 and 5 minutes, sex and mode of delivery between two groups. Urinary Ca/Cr at 4 weeks was higher in the nephrocalcinosis group compared with no nephrocalcinosis group (1.18 vs. 0.78 mg/mg, $p=0.002$) Multivariate logistic regression analysis adjusted for gestational age and sex showed that urinary Ca/Cr at 4 weeks was significantly associated with nephrocalcinosis (adjusted OR 2.920 95%CI 1.289-6.611). The most appropriate cutoff value of urinary Ca/Cr at 4 weeks for predicting nephrocalcinosis was 1.02 mg/mg with sensitivity of 68.0%, specificity of 74.7% and area under the curve of 0.705.

CONCLUSIONS

Urinary Ca/Cr at 4 weeks of postnatal age could be predictor for nephrocalcinosis in preterm infants.

PD043 / #2747**E-poster Discussion Session 07: Late breaking neonatology 02****08-10-2022 12:00 - 13:00****Cardiorespiratory instability and reactivity correlate with brain volume at term-equivalent age in very low birth weight infants****B. Sullivan^{1*}, S. Kausch¹, D. Alexopoulos², C. Smyser², Z. Vesoulis³**¹University of Virginia School of Medicine, Pediatrics, Charlottesville, United States of America²Washington University in St. Louis, Neurology, St. Louis, United States of America³Washington University in St. Louis, Pediatrics, St. Louis, United States of America**BACKGROUND AND AIMS**

Cardiorespiratory deterioration is common in very low birthweight (<1500g) infants. This period of critical brain growth and development may be impacted by insults such as sepsis and hypoxia. The physiological response to illness manifests through autonomic signaling, detected as changes in heart rate (HR) and oxygenation (SpO₂). We hypothesize that limited autonomic activity and reactivity may indicate poor cardiovascular autoregulation, increasing the risk of cerebral hypoxic-ischemia, the fundamental basis for preterm brain injury, and is correlated with decreased brain growth at term equivalent age (TEA).

METHODS

We analyzed a cohort of preterm infants (n=12) with TEA MRI and continuous HR/SpO₂ data. Cardiorespiratory control was quantified in 10-min windows using a validated multi-feature logistic regression model called pulse oximetry warning score (POWS), where low mean POWS represents decreased activity and low standard deviation (SD) POWS represents decreased reactivity. Using T2-weighted images, total cortical surface area (CSA), gray matter, white mat-

ter, and total brain volume were calculated using a semi-automated pipeline. We used Spearman correlation to evaluate the relationship between mean and SD of POWS with brain volumetrics.

RESULTS

Infants analyzed had a representative range of POWS values from birth to NICU discharge (Fig1). Increasing SD POWS correlated with increasing mean CSA, gray matter, and total brain volume (Fig2). Mean POWS also correlated with gray matter volume (Fig3).

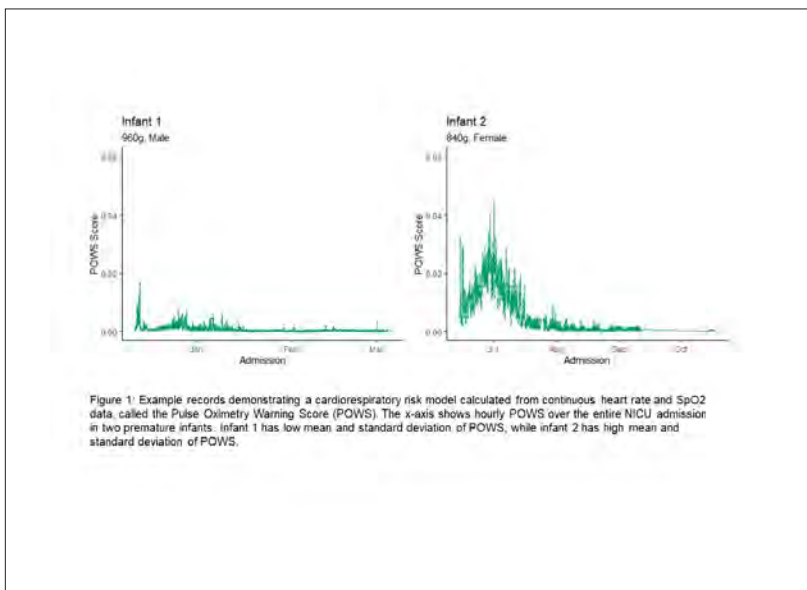

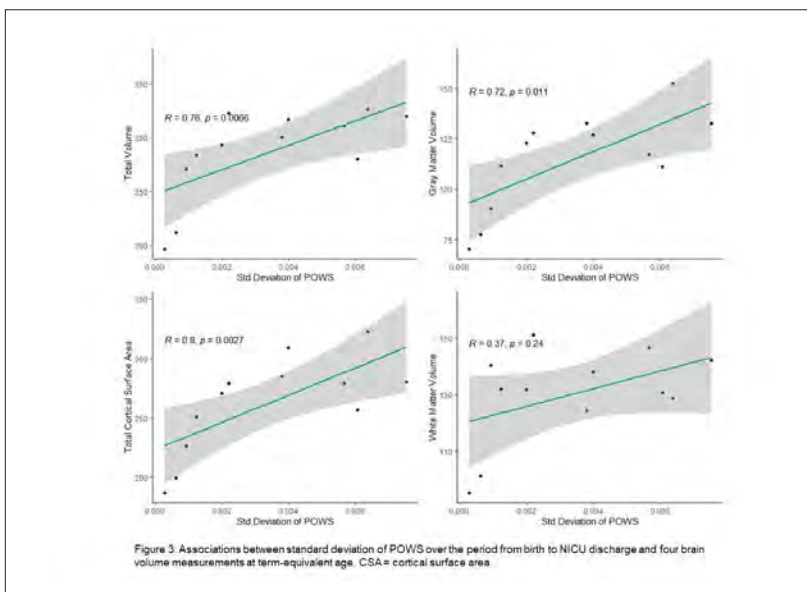
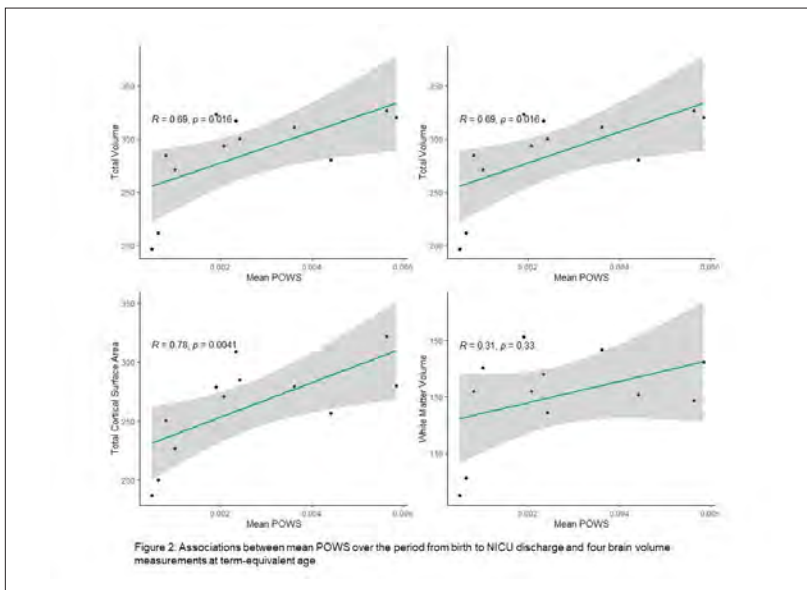

CONCLUSIONS

Autonomic activity and reactivity, expressed through mean and SD POWS, correlated with higher brain growth at TEA in preterm infants. These results generate hypotheses that warrant further study as potential tools to predict neurologic outcomes.

PD044 / #2645**E-poster Discussion Session 07: Late breaking neonatology 02****08-10-2022 12:00 - 13:00****The development of an online information platform to support parents of very and moderate preterm born infants****D. Bossen^{1*}, M. Flierman², M. Jeukens², V. Vijn³, R. Engelbert¹**¹Amsterdam University of Applied Sciences, Faculty of Health, Amsterdam, Netherlands²Amsterdam UMC, Department of Rehabilitation Medicine, Amsterdam, Netherlands³Amsterdam University of Applied Sciences, Faculty of Digital Media and Creative Industries, Amsterdam, Netherlands**BACKGROUND AND AIMS**

Parents of preterm born infants experience challenges when transitioning home, including the struggle to feel confident in their capacity to parent. Attuned information provision is a prerequisite for self-efficacy and empowerment and has been linked to positive parenting outcomes. The internet is an important source to obtain information regarding topics like prematurity, development and specific health problems. However, parents experience problems to find and understand appropriate health information with respect to their preterm born infant. Especially parents with low health literacy skills. Therefore our aim is to develop an inclusive digital information platform for and in cocreation with parents of premature infants and paediatric physical therapists (eTOP).

METHODS

To generate ideas and content for eToP module, we first conducted interviews with parents (n=10) and performed three online co-creation sessions

with parents (n=14) and paediatric physical therapists (N=8). The data were analyzed through an inductive thematic approach. The analyses resulted in several main topics. With respect to these topics, experts were consulted and asked to generate text-based information content. The information content was then reviewed by the research team and included in the first prototype of the eTOP module.

RESULTS

11 themes were identified to be important, including general health issues, motor development, regulation, feeding, sleeping, prematurity, general development, long term outcomes, parenthood, going back to work and professionals.

CONCLUSIONS

Based on the topics we developed the first version of the eTOP module. In the next two months we will develop and test a second version which will be presented at the EAPS congress.

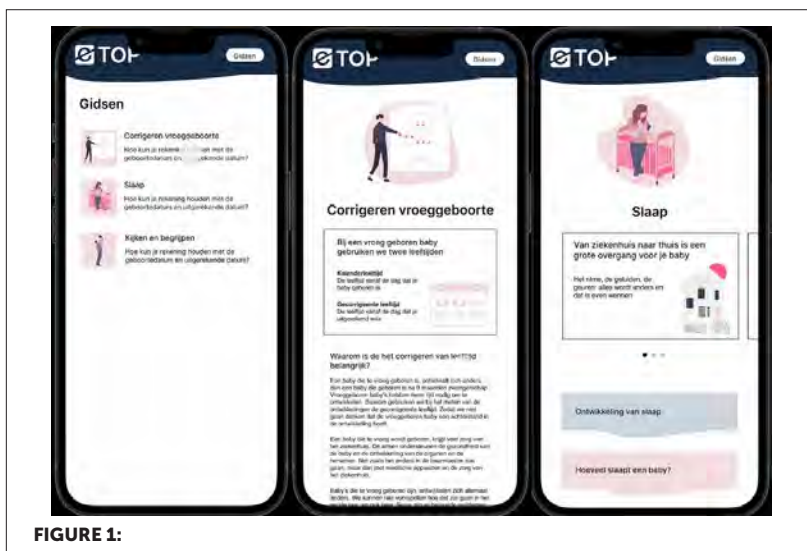

FIGURE 1:

PD045 / #1560**E-poster Discussion Session 08: EAP - Paediatric potpourri - for everyone 01****09-10-2022 12:30 - 13:30****Subcutaneous granuloma annulare can be distinguished from subcutaneous vascular anomalies by the epifascial mound sign in the imaging****B. Beqo^{1,2*}, S. Tschauner³, P. Gasparella², E. Haxhija²**¹Harvard Medical School, Boston Children's Hospital, Boston, United States of America²Medical University of Graz, Pediatric and Adolescent Surgery, Graz, Austria³Medical University of Graz, Div. of Pediatric Radiology, Department of Radiology, Graz, Austria**BACKGROUND AND AIMS**

Subcutaneous granuloma annulare (SGA) is a benign self-limiting granulomatous disease occurring exclusively during childhood. The accurate diagnosis often requires a biopsy due to the difficulties to distinguish SGA from subcutaneous vascular anomalies (SVA). In this study we evaluated the imaging of SGA and SVA with the aim of finding clues for accurate diagnosis without the need for surgery.

METHODS

A retrospective analysis of the hospital records of all children diagnosed with SGA and SVA between 01.01.2001–31.12.2021 was performed. Data was analyzed by descriptive statistics.

RESULTS

We identified 28 patients (20girls) with SGA at a median age of 3.75years (range 1–12.5years). Ten patients presented with multiple lesions. Out of 41 lesions, 26 were located on the lower extremities (63%). Twelve SGA-patients (43%) received an MRI. Surgery was conducted in 18(64%) SGA-patients. SVA were diagnosed in 67 patients (28girls) with a median age of 4years (range 0.1–18years). SVA were commonly located on the upper extremity (63%) and less on the lower leg (10%). MRI was done in 47 SVA-patients (70%) and 57 of them received surgery (85%). A retrospective review of imaging led to the discovery of the characteristic shape of SGA lesions, resembling a homogenous epifascial mound with broad fascial base extending centrally into the subdermal/dermal tissue (arrowheads). This distinguished clearly SGA lesions from SVA lesions, which are irregular and cystic in shape (arrows).

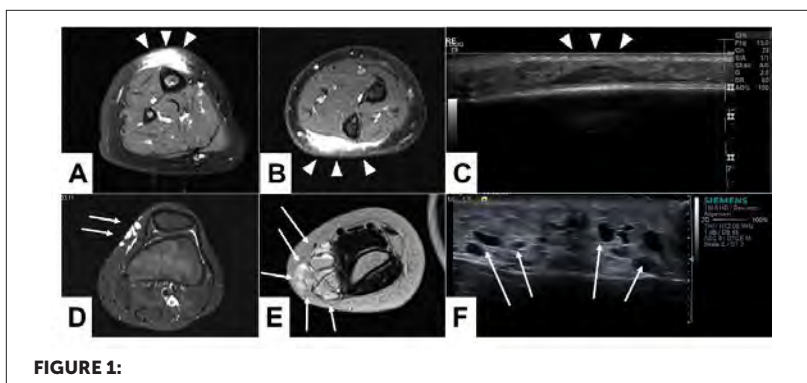

CONCLUSIONS

The “Epifascial Mound Sign” is a specific imaging shape for SGA, which clearly distinguishes this disease from other subcutaneous lesions. Recognition of this novel diagnostic sign should enable clinicians to easily establish SGA diagnosis without further invasive diagnostic procedures.

PD046 / #1598**E-poster Discussion Session 08: EAP - Paediatric potpourri - for everyone 01****09-10-2022 12:30 - 13:30****Health system barriers experienced by European underserved children and adolescents in vaccinating against measles and/or human papillomavirus (HPV)****D. Jansen^{1*}, H. Vervoort², J. De Zeeuw², M. Edelstein³, J. Essa-Hadad³, Y. Gorelik³, M. Ganczak⁴, D. Filakovska Bobakova⁵, P. Karnaki⁶, I. Hussein⁷, S. Mounier-Jack⁸**

¹University Medical Center Groningen, Department of General Practice and Elderly Care Medicine, Groningen, Netherlands

²University Medical Center Groningen, Health Sciences, Groningen, Netherlands

³Bar-Ilan University, Azrieli Faculty of Medicine In The Galilee, Safed, Israel

⁴University of Zielona Gora, Department of Infectious Diseases Collegium Medicum, Zielona Gora, Poland

⁵Univerzita Pavla Jozefa Safarika, Department of Health Psychology and Research Methodology, Košice, Slovak Republic

⁶Prolepsis, Department of European and International Research Projects, Kifisia, Greece

⁷National Institute for Health and Welfare, Infectious Disease Control and Vaccinations, Helsinki, Finland

⁸London School of Hygiene and Tropical Medicine, Department of Public Health and Policy, London, United Kingdom

BACKGROUND AND AIMS

Vaccine uptake in most minority or ethnic paediatric communities in Europe is lower compared to the general population. Research so far mainly focused on beliefs and attitudes toward vaccination, and less on exploring how the health care system contributes and responds to these beliefs and attitudes. Aim of RIVER-EU (Reducing Inequalities in Vaccine uptake in the European region – Engaging Underserved communities) is to collect evidence on health

system barriers and enablers among underserved communities (migrant community, Greece; Turkish females and Moroccan females, the Netherlands; Ukrainian minority, Poland in Poland and Roma community, Slovakia) and vulnerable communities that achieve high vaccine uptake despite being considered underserved (Somali community, Finland; Arab community, Israel and Bangladeshi community, United Kingdom).

METHODS

A systematic review and qualitative studies (interviews and focus groups) to collect in-depth information about health system barriers to vaccination against MMR (measles, mumps, rubella) and Human Papillomavirus (HPV) in the underserved communities, high uptake communities and among health care professionals.

RESULTS

Preliminary results show several health system barriers, such as limited access to vaccination services, limited information on vaccines, insufficiently trained healthcare professionals (insufficient knowledge of other ethnic, religious or cultural minorities), insufficient knowledge among healthcare professionals about, for example, the effectiveness of the vaccine. An overview of health system enablers will be presented.

CONCLUSIONS

This study provided insight in health system barriers and enablers regarding vaccination. The evidence generated will serve as a basis for interventions and guidance to improve uptake among underserved communities in Europe.

PD047 / #1644**E-poster Discussion Session 08: EAP - Paediatric potpourri - for everyone 01****09-10-2022 12:30 - 13:30****Impact assessment of the immunization with pneumococcal conjugate vaccine (PCV13) on respiratory morbidity and mortality among under-five children in Moldova****A. Horodisteanu-Banuh¹, N. Revenco^{1,2}, O. Cirstea^{1,2}, D. Savoschin¹, D. Bujor^{1,2*}, A.-M. Balanuta^{1,2}**¹*Institute for Maternal and Child Healthcare, Pediatric Scientific Laboratory, Chisinau, Moldova*²*"Nicolae Testemitanu" State University of Medicine and Pharmacy, Department of Pediatrics, Chisinau, Moldova***BACKGROUND AND AIMS**

The study was carried out within the project "Impact of immunization on childhood respiratory morbidity and mortality in the Republic of Moldova" (project code 20.80009.8007.08) which was aimed to assess the impact of vaccination against pneumococcal infection on the respiratory morbidity and under-five mortality in children.

METHODS

The level of childhood immunization with PCV13 and health statistics data were analyzed based on information developed and published annually by the National Agency for Public Health.

RESULTS

The pneumococcal vaccine PCV13 was first introduced for use in all children in the Republic of Moldova in 2013. Vaccine coverage of infants with PCV13 varies between 29% and 71% in 2014-2015 years and 84.1% and 85.5% in 2020 and 2021, accordingly. During this period, the incidence rates of respiratory diseases have been steadily declining: from 923 and 867.8 cases per 1000 children in the first year of life in 2014 and 2015 years to 583.9 and 544 cases per 1000 children in 2020 and 2021; and from 731 and 716.9 cases per 1000 children under five years of age in 2014 and 2015 years to 448.2 and 501.5 cases per 1000 children in 2020 and 2021, accordingly. The under-five childhood mortality rates caused by acute respiratory infections declined by 6.6%.

CONCLUSIONS

Implementation of the routine immunization against pneumococcal infection in the Republic of Moldova was associated with a significant decline of morbidity and mortality levels by respiratory diseases in children under five years of age.

PD048 / #1798**E-poster Discussion Session 08: EAP - Paediatric potpourri - for everyone 01****09-10-2022 12:30 - 13:30****Intensive rehabilitative protocol restores gait disfunction caused by experimental cerebral palsy in rats – modulation of cortical hyperexcitability as a mechanism of rehabilitation****E. Sanches¹, Y. Van De Looij², C. Dennez¹, J. Mairesse¹, L. Baud³, Q. Barraud³, O. Baud¹, G. Courtine³, S. Sizonenko^{1*}**¹Geneva University Hospital-Scholl of Medicine, Pediatrics, Gynecology & Obstetrics, Geneva, Switzerland²EPFL Lausanne, Biomedical Imaging Centre, Lausanne, Switzerland³EPFL, Centre For Neuroprosthetics, Geneva, Switzerland**BACKGROUND AND AIMS**

Cerebral Palsy (CP) causes motor and cognitive disability in children. Experimental CP has been shown to cause cortical damage, hypomyelination and functional impairments. HABIT-ILE (Hand and Arm Bimanual Intensive Training Including Lower Extremity) intensive rehabilitation based in sensori-motor training and decreases motor impairments, induces plastic changes in white matter tract, however, the molecular substrates for the recovery unknown Using a CP rat model, we tested a HABIT-ILE like strategy using the combination (EETT) of treadmill training (TT) and environmental enrichment (EE) and assessed brain function, macro and microstructure and expression of neuroprotective factors.

METHODS

Pregnant Wistar rats were injected with LPS (E18-E19). At P0, pups were exposed to anoxia. From postnatal day 2 to 21, hindlimbs movements were restricted for 16h/day. HABIT-ILE like rehab (EETT), TT and EE lasted from P21 to P28. 3D gait analysis was performed, Rota-Rod (RR) and brain Functional Ultrasound (FUS) were performed at P28. Brain tissue was collected for ex-vivo MRI, histological analysis and protein expression

RESULTS

CP group had worse performance in RR and impaired gait. EETT rescued partially motor performance in RR and in the gait. Ex-vivo DTI/NODDI showed altered brain microstructure in CP not reversed by EETT. FUS revealed hyper-connectivity in CP among brain regions reversed by EETT. CPETT group had preservation of myelination in the corpus callosum and decreased astrogliosis in cortex and hippocampus. Moreover, EETT showed increased BDNF signaling, interfering in inflammatory processes and decreasing cortical excitatory dysfunction induced by CP.

CONCLUSIONS

Translational HABIT-ILE (EETT) reversed hind limbs dysfunction and promoted tissue rescue in experimental CP through multiple molecular mechanisms, supporting the concept of early-intense physical rehabilitation

PD049 / #1830**E-poster Discussion Session 08: EAP - Paediatric potpourri - for everyone 01****09-10-2022 12:30 - 13:30****Validation of the CogniTOT touchscreen tool for the assessment of early executive function****L. O'Sullivan^{1*}, T. Casey¹, M. De Haan², N. Marlow³, D. Murray¹**¹University College Cork, Department of Paediatrics and Child Health, Cork, Ireland²UCL, Great Ormond Street Institution of Child Health, London, United Kingdom³UCL, Institute For Women's Health, London, United Kingdom**BACKGROUND AND AIMS**

Current methods of cognitive assessment for young children are time consuming and heavily reliant on the language ability of the child. Touchscreen technology allows assessment through play without verbal instruction. Aims: To determine the internal reliability of the CogniTOT touchscreen for assessment of early executive function.

METHODS

A cohort of typically developing children aged 22-30mths were assessed using the BSID-III and the CogniTOT application. Output included an overall score, and seven subdomains scores for processing speed, selective attention, working memory, problem solving, acquired learning, cognitive shift, and sustained attention. Overall reliability was assessed using Cronbach's alpha and inter-item reliability was used to assess individual subscales.

RESULTS

104 of 111 children (mean age 26 months, SD 1.62), passed the first three trial items of the CogniTOT and were included in this analysis. Internal consistency of the CogniTOT total score was high ($\alpha = .893$). Good inter-item reliability was seen for processing speed (0.248), selective attention (0.247), working memory (0.280), acquired learning (0.166) and cognitive shift (0.211). Children with BSID-III cognitive composite score <90 had a significantly lower CogniTOT total score compared to children scoring >90 , (median (IQR) = 19(12.25-22.75) vs 22(20-24), $p = .024$). Cognitive composite scores correlated significantly with the CogniTOT total score ($p = 0.011$) as well as the working memory ($p = 0.008$), acquired learning ($p = 0.009$) and sustained attention ($p = 0.009$) subdomains.

CONCLUSIONS

The CogniTOT touchscreen application shows strong internally consistency as a nonverbal assessment of early executive function.

PD050 / #1145**E-poster Discussion Session 08: EAP - Paediatric potpourri - for everyone 01****09-10-2022 12:30 - 13:30****Teenage matters: using adolescent questionnaires to assess the health and well-being concerns of young people presenting to the emergency department****B. Ayres^{1*}, L. Asim², L. Pickard³**¹King's College London, Undergraduate Medicine, London, United Kingdom²King's College Hospital NHS Foundation Trust, Emergency Medicine, London, United Kingdom³King's College Hospital NHS Foundation Trust, Paediatrics, London, United Kingdom**BACKGROUND AND AIMS**

Working with adolescents in the Emergency Department (ED) during the pandemic, we recognised the impact upon this group and the need for greater support to address their mental health and social needs. We launched an Adolescent Questionnaire (AQ) for 13-17 year olds. Our aim was to explore their issues and plan our services to better meet adolescents' needs.

METHODS

Data from AQs collected over 5 weeks, including demographics, education, home, support networks, mental and sexual health.

RESULTS

27 Jan – 2 Mar 2022 70 AQs completed: commonest age 15y, 71% female (6% transgender/nonbinary). 37% presented with mental health complaints, but

overall 44% were unhappy with their mental health: 48-51% lonely, depressed or anxious, 44% had considered self-harm and 34% considered suicide. 74% had a safeguarding concern (including 1/2 those with physical health presentations), 26% unhappy at home, 26% had a social worker, 16% felt unsafe online but most felt safe with peers. 13% unhappy with their sexuality, 13% had been pressured into sex, one individual was offered payment for sex. 1/3 presented out of hours. 40% received follow up with mental health services, others with social care, a small number with youth workers (YW) or primary/secondary care.

CONCLUSIONS

There is unmet adolescent mental health and social need that ED practitioners, with the support of YWs, are able to uncover and support: the AQ gives a prompt, structure and mechanism to unmask issues among adolescents in the ED. That 1/3 presented out of hours underlines the importance of support mechanisms throughout the 24 hours.

PD051 / #1158**E-poster Discussion Session 08: EAP - Paediatric potpourri - for everyone 01****09-10-2022 12:30 - 13:30****The role of NLRP3 RS10754558 in children with gastritis****C.O. Marginean^{1*}, M.O. Sasaran², C. Banescu³, L.E. Melit¹**

¹George Emil Palade University of Medicine, Pharmacy, Sciences and Technology Targu Mures, Pediatrics I, Targu Mures, Romania

²George Emil Palade University of Medicine, Pharmacy, Sciences and Technology Targu Mures, Pediatrics Iii, Targu Mures, Romania

³George Emil Palade University of Medicine, Pharmacy, Sciences and Technology Targu Mures, Genetics, Targu Mures, Romania

BACKGROUND AND AIMS

The NOD-like receptor family, pyrin domain-containing 3 (NLRP3) is an important complex reported to participate in the pathogenesis of several chronic inflammatory diseases like arthritis and colitis, but its increased expression was also reported in gastric cancer. The aim of this study was to assess the role of NLRP3 rs10754558 in children with H. pylori-induced gastritis, non-H. pylori gastritis and healthy controls.

METHODS

We performed a study on 269 children admitted to a Pediatrics Clinic from Romania, who presented with dyspeptic symptoms (e.g. abdominal and/or epigastric pain, nausea, vomiting, heartburn, etc.), aged between 1 and 18 years, without any history of chronic disorders or recent infectious disease. All children underwent anamnesis, clinical exam, laboratory tests, upper digestive endoscopy and genetic testing.

RESULTS

Our sample was divided into 3 groups according to the histopathological exam: group 1 – 51 children with *H. pylori*-induced gastritis, group 2 – 103 children with *H. pylori*-negative gastritis, and group 3 – control group, 115 children without any histopathological changes. The mean age was similar between the three groups, with a predominance of female gender. We found a significant association between the risk for developing gastritis and both rural area and poor living condition ($p=0.0100/ p<0.0001$). We found no significant differences between the three groups and NLRP3 rs10754558 gene polymorphisms ($p=0.5570$). We identified significant differences only for CC variant genotype of NLRP3 rs10754558 and leucocytes, neutrophils, eosinophils, as well as ALT ($p=0.0185, p=0.0379, p=0.0483, p=0.0356$).

CONCLUSIONS

Children that carry the CC variant genotype of NLRP3 rs10754558 might express a more severe degree of systemic and local inflammation in the setting of gastritis.

PD052 / #1167**E-poster Discussion Session 08: EAP - Paediatric potpourri - for everyone 01****09-10-2022 12:30 - 13:30****Suboptimal care pathway before a diagnosis of severe physical abuse in young children: a confidential inquiry in Western France****F. Blangis^{1*}, D. Malorey^{1,2}, C. Gras-Le Guen^{1,2}, N. Vabres³, G. Picherot⁴, P. Ricaud⁵, M. Chalumeau¹, E. Launay¹**

¹Université Paris Cité, Inserm, Centre for Research in Epidemiology and Statistics (CRESS), Perinatal and Pediatric Obstetrical Epidemiology Research Team, Paris, France

²Inserm, Epopé, Paris, France

³Nantes University Hospital, Unité D'accueil Des Enfants En Danger, Nantes, France

⁴Nantes University Hospital, Pediatric Department, Nantes, France

⁵Nantes University Hospital, Department of Pediatric Emergency Care, Nantes, France

BACKGROUND AND AIMS

An optimal care pathway for child physical abuse (CPA) is of paramount importance to minimize its long-term consequences. We aimed to assess the optimality of the care pathway in western France by means of a confidential inquiry.

METHODS

Two independent experts retrospectively reviewed the medical records of all children <6 years old who were hospitalized in the Nantes regional university hospital from 2016 to 2018 and reported to the authorities for suspected severe CPA. The experts assessed whether the care pathway was optimal in comparison with current guidelines and identified the main types of suboptimality.

RESULTS

Among the 94 included children (median age 8 months). The main clinical features of CPA that led to a report to the authorities were bruises or hematoma (53%), intra-cranial injuries (21%), and/or fractures (24%); 18 children (19%) were admitted in the intensive care unit and one died. Among the 35 (37%) care pathways judged suboptimal by the experts, 2 non-exclusive main types were identified: (i) "diagnosis delay" (n=16), defined as a previous medical visit(s) when signs or symptoms of CPA did not lead to a report to the authorities or an adequate referral, and (ii) "ineffective secondary prevention" (n=21), defined as a previous report to child protection services for the included children or a sibling.

CONCLUSIONS

Suboptimal care pathways for severe CPA were frequent in the studied population, and 2 main types were identified: diagnosis delay or ineffective secondary prevention. Prospective multicentre studies are needed to confirm this alarming result.

PD053 / #1366**E-poster Discussion Session 08: EAP - Paediatric potpourri - for everyone 01****09-10-2022 12:30 - 13:30****Epidemiology of acute bronchiolitis in COVID-19 time****L. Bermúdez Barrezueta^{1*}, M. Gutiérrez Zamorano¹, M. Brezmes Raposo¹, I. Sanz Fernández¹, L. Sáez García¹, P. López Casillas¹, C. Fernández García-Abril¹, M. Benito Gutiérrez¹, M. Pino Velázquez¹, V. Matias², A. Pino Vázquez¹**

¹Hospital Clínico Universitario de Valladolid, Pediatrics. División of Pediatric and Neonatal Intensive Care., Valladolid, Spain

²Hospital Clínico Universitario de Valladolid, Pediatrics. Division of Neonatology, Valladolid, Spain

BACKGROUND AND AIMS

The COVID-19 pandemic has changed the circulation of viruses associated with acute bronchiolitis. We analyzed the epidemiology of bronchiolitis admissions during the COVID-19 pandemic compared with 8 previous epidemic seasons.

METHODS

An observational study was performed, including infants admitted with bronchiolitis in a tertiary hospital during 2 periods: COVID-19 pandemic (15 March-2020 – 31 March-2022) and pre-pandemic (1 September-2012 – 14 March-2020). Demographic and clinical data were collected.

RESULTS

A total of 558 patients were hospitalized with bronchiolitis (58% males). Median age and weight were 2.6 months [1.4 – 5] and 5.3 Kg [4.2 – 6.7], respectively. Respiratory syncytial virus was the most frequent etiological agent. In the pre-pandemic period, there were 486 admissions for bronchiolitis (mean: 61 per season). The beginning and end of each epidemic season ran from November to April. During the COVID-19 pandemic, there were no patients hospitalized for bronchiolitis in autumn–winter 2020–2021. The outbreak was delayed until spring–summer 2021 and was smaller than in previous winter epidemic seasons, with only 24 admissions. The 2021–2022 epidemic season began in early October and continues in March–2022 with 49 admissions recorded. During the pandemic, the 2 outbreaks occurred almost continuously, causing a prolonged epidemic of bronchiolitis with a higher percentage of PICU admissions (22,3% vs 39.7%; $p=0.001$).

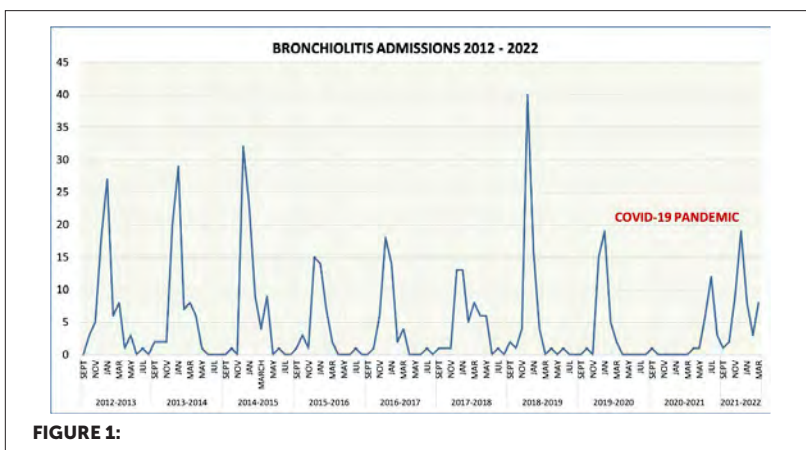

CONCLUSIONS

We observed a change in the seasonality of bronchiolitis during 2 years of COVID-19 pandemic, with an unusual small outbreak in the spring–summer 2021 that continued with the outbreak of the 2021–2022 season, a phenomenon that has not been observed in pre-pandemic times.

PD054 / #1388**E-poster Discussion Session 08: EAP - Paediatric potpourri - for everyone 01****09-10-2022 12:30 - 13:30****Parents experiences of receiving positive newborn bloodspot screening results in England: results of the respond study****J. Chudleigh^{1*}, P. Holder¹, K. Southern², J. Bonham³, A. Simpson¹, F. Fusco⁴, S. Morris⁴, E. Olander⁵, H. Chinnery⁶, F. Ulph⁷, L. Moody⁸**

¹King's College London, Florence Nightingale Faculty of Nursing, Midwifery and Palliative Care, London, United Kingdom

²University of Liverpool, Women's and Children's Health, Liverpool, United Kingdom

³Sheffield Children's NHS Foundation Trust, Pharmacy, Diagnostics and Genetics, Sheffield, United Kingdom

⁴University of Cambridge, Department of Public Health and Primary Care, Cambridge, United Kingdom

⁵City, University of London, Centre For Maternal and Child Health, London, United Kingdom

⁶St. Mary's University, Faculty of Sports, Health and Applied Science, London, United Kingdom

⁷University of Manchester, Division of Psychology and Mental Health, Manchester, United Kingdom

⁸Coventry University, Centre For Arts, Memory and Communities, Coventry, United Kingdom

BACKGROUND AND AIMS

Communicating newborn bloodspot screening (NBS) results to parents is a delicate task that should be carefully and appropriately crafted to prepare for a range of outcomes. Poor or inappropriate communication can lead to negative sequelae. The ReSPoND study aimed to explore parents' experiences of receiving a positive NBS result for the nine screened conditions in England.

METHODS

Filmed, narrative interviews were undertaken with 21 parents; 13 mothers and 8 fathers of 14 children who had received a positive NBS result.

RESULTS

Seven themes emerged: Methods and content of the initial communication; attributes of the health professional (HP) communicating the positive NBS result; parental reactions; anticipation of the first clinic appointment; impact of the diagnosis on family and friends; suggested improvements for communication of positive NBS results and views of NBS.

CONCLUSIONS

Parents valued the NBS programme. However, there continues to be variability in terms of the methods used and HPs involved in communicating positive NBS results which could influence parents' experiences. Parents valued the knowledge and experience of condition specific specialists. Provision of information following communication of a NBS result including signposting to reliable sources of information may address parental concerns and help prepare them for their first appointment with the clinical team. Acknowledgements: This project was funded by the National Institute for Health Research Health Services and Delivery Research (NIHR HS&DR) Programme (project number 16/52/25). The views expressed are those of the authors and not necessarily those of the NIHR or the Department of Health and Social Care.

PD055 / #2513**E-poster Discussion Session 08: EAP - Paediatric potpourri - for everyone 01****09-10-2022 12:30 - 13:30****How can we improve the quality of health assessments of children who are in the social care system?****N. Nazi***

North East London Foundation Trust, Paediatrics, Barking, United Kingdom

BACKGROUND AND AIMS

Children in England are required by law to have a health assessment by a medical professional when they enter the social care system. Barking and Dagenham is an area of London with high levels of child poverty and health inequalities with over 400 children in care. An audit in 2020 identified poor levels of documentation in the health assessment reports and low numbers of children being referred for their health needs. A quality improvement project was designed to improve quality of the reports and referral processes.

METHODS

A series of interventions were implemented to improve quality of initial health assessment reports, including information gathering, developing a quality reporting auditing tool, training health professionals, peer supervision and development of referral pathways to health services and agencies. Post intervention, 10 random medical reports were selected of CYP who were seen for an initial health assessment between March to September 2021. A quality reporting audit tool was developed by medical professionals using national guidelines in the UK (NICE and DOH) for children in care as a benchmark.

RESULTS

Since the 2020 audit, there was improvement in documentation including information gathering (70%), health and development (100%), health promotion (100%), voice of the child or young person (100%) and risk assessment (70%). All reports had SMART recommendations in care plans and 100% were appropriately referred for further support of their health and wellbeing.

CONCLUSIONS

The interventions led to significant improvement in quality of health assessment reports for children in care. There was also an increased number of referrals made to health services and organisations.

PD056 / #642**E-poster Discussion Session 09: ESPR - Improving quality of care 2****09-10-2022 12:30 - 13:30****Association between early empirical antibiotics and adverse clinical outcomes in very preterm infants – a nationwide study from 2009-2018****N. Hapnes^{1,2*}, A. Vatne^{1,2}, H.J. Stensvold³, I. Dalen⁴, H.J. Guthe⁵, R. Støen⁶, A.K. Brigtsen³, A. Rønnestad^{3,7}, C. Klingenberg^{8,9}**¹Stavanger University Hospital, Neonatology Dept, Stavanger, Norway²University of Bergen, Department of Clinical Science, Bergen, Norway³Oslo University Hospital, Department of Neonatal Intensive Care, Clinic of Paediatric and Adolescent Medicine, Oslo, Norway⁴Stavanger University Hospital, Department of Research, Section of Biostatistics, Stavanger, Norway⁵Haukeland University Hospital, Department of Paediatrics and Adolescents Medicine, Bergen, Norway⁶St. Olav's University Hospital, Paediatric Department, Trondheim, Norway⁷University of Oslo, Medical Faculty, Institute For Clinical Medicine, Oslo, Norway⁸University Hospital of North Norway, Department of Pediatrics and Adolescence Medicine, Tromsø, Norway⁹UiT-The Arctic University of Norway, Tromsø, Paediatric Research Group, Faculty of Health Sciences, Tromsø, Norway**BACKGROUND AND AIMS**

Antibiotics are the most commonly prescribed medications in neonatal intensive care units. We aimed to identify if empirical antibiotic therapy in the first week of life in uninfected very preterm infants (VPIs) is associated with increased adverse outcomes.

METHODS

Norwegian population-based registry study from 2009-2018, including all VPIs (<32 weeks gestation) surviving first week of life without sepsis or intestinal perforation/necrotizing enterocolitis (NEC). Early antibiotic exposure was calculated as days with antibiotics in the first week of life. Primary outcomes were severe NEC, death after the first week of life, and the composite outcome "severe morbidity"; including severe NEC, severe bronchopulmonary dysplasia (BPD), late-onset sepsis, retinopathy of prematurity and cystic periventricular leukomalacia.

RESULTS

of 5296 live-born very preterm infants, 4932 (93%) were included. Antibiotics were started in first week of life in 3790/4932 (77%) infants, and was associated with higher adjusted odds ratios (aOR) of death (aOR 9.33; 95% confidence interval [CI] 1.10-79.5), severe morbidity (aOR 1.88; 95% CI 1.16-3.05), and severe BPD (aOR 2.17; 95% CI 1.18-3.98) compared to those not exposed. Antibiotics \geq 5 days were associated with higher odds of severe NEC (aOR 2.27; 95% CI 1.02-5.06). Each additional day of empirical antibiotics was associated with 14% higher aOR of death or severe morbidity and severe BPD.

CONCLUSIONS

Early and prolonged empiric antibiotic exposure is associated with death, severe NEC and severe BPD after the first week of life.

PD057 / #2195**E-poster Discussion Session 09: ESPR - Improving quality of care 2****09-10-2022 12:30 - 13:30****Early antibiotic exposure in very preterm infants and gut microbiota at one month of life****M. Letouzey^{1,2*}, J. Delannoy³, J. Aires³, J.-C. Rozé⁴, L. Foix-L'Hélias⁵, E. Lorthe⁶, M.-J. Butel⁵**

¹Université Paris Cité INSERM, Center of Research In Epidemiology and Statistics Cress - Epopé Team - Fhu Prema, PARIS, France

²Poissy Saint Germain Hospital, Department of Neonatal Medicine, Poissy, France

³Université Paris Cité, Inserm, Umr-s 1139

³phm, Fhu Prema, Paris, France

⁴Nantes University Hospital, Department of Neonatal Medicine, Nantes, France

⁵Trousseau Hospital, APHP, Sorbonne Université, Department of Neonatal Medicine, PARIS, France

⁶Geneva University Hospitals, Unit of Population Epidemiology, Department of Primary Care Medicine, Geneva, Switzerland

BACKGROUND AND AIMS

Early antibiotics are frequent in very preterm infants, even in the absence of risk factor for early-onset sepsis (EOS). In these infants, gut microbiota is highly variable with a major dysbiosis. Our aim was to assess the consequences of early antibiotics exposure on the establishment of the gut microbiota in very preterm infants without EOS risk factor.

METHODS

EPIFLORE is a prospective observational cohort study that included a stool sample collection during the fourth week after birth. Infants born at 22-31 weeks of gestation in 2011 were included as part of the French national population-based EPIPAGE-2 cohort. For the current study, we included infants

at low risk of EOS, so we excluded those born after preterm labor, preterm premature rupture of membranes, or clinical chorioamnionitis, or if mother received antibiotics during the last 72 hours before delivery. Early antibiotic exposure was defined as antibiotics started at Day 0 or Day 1 of life. Gut microbiota was analyzed by 16S ribosomal RNA gene sequencing and characterized using the Galaxy tools.

RESULTS

of the 69 newborns included, the mean (SD) GA was 29.3 (1.6) weeks. Despite the low risk of EOS, 15 received early antibiotics (21.7%). Early antibiotic treatment was associated with a low bacterial load in microbiota, a low alpha diversity (median normalization, Observed index, $p=0,039$), a decrease in *Escherichia-Shigella*, and a dominance of the cluster driven by *Staphylococcus* compared to non-antibiotic treated infants.

CONCLUSIONS

Early antibiotics administered to very preterm newborns without EOS risk factor affects gut microbiota at one month of life.

PD058 / #1251**E-poster Discussion Session 09: ESPR - Improving quality of care 2****09-10-2022 12:30 - 13:30****Late-onset sepsis - pathogen distribution and adverse outcomes in a national cohort of very preterm infants during 2009-2018****Z. Huncikova^{1,2*}, A. Vatne^{1,2}, H.J. Stensvold³, B. Salvesen⁴, R. Støen⁵, A.K. Brigtsen³, A. Lang⁶, K. Øymar¹, A. Rønnestad³, C. Klingenberg⁷**¹Stavanger University Hospital, Paediatric Department, Stavanger, Norway²University of Bergen, Department of Clinical Science, Bergen, Norway³Oslo University Hospital, Department of Neonatal Intensive Care, Clinic of Paediatric and Adolescent Medicine, Oslo, Norway⁴Haukeland University Hospital, Paediatric, Bergen, Norway⁵St. Olav Hospital, Paediatric, Trondheim, Norway⁶Akershus University Hospital, Paediatric Department, Lorenskog, Norway⁷University Hospital of North Norway, Department of Pediatrics and Adolescence Medicine, Tromsø, Norway**BACKGROUND AND AIMS**

Late-onset sepsis (LOS) in preterm infants is associated with increased mortality and long-term morbidity despite improvements in neonatal care. We aimed to identify the current burden of LOS among very preterm infants (VPis) in Norway.

METHODS

Norwegian population-based registry study from 2009-2018, including all live-born VPis (<32 weeks gestation). LOS was defined as a positive blood culture accompanied with clinical symptoms (culture-proven sepsis), or clinical symptoms of an infection leading to an elevated CRP and 5 days antibiotic

therapy, but no growth in the blood culture (culture-negative sepsis). Main outcomes of interest were causative pathogens, pathogen-specific sepsis-attributable mortality and risk of severe bronchopulmonary dysplasia (BPD).

RESULTS

of 5296 live-born VPIs, 493 (9.3%) infants had one or more episodes of culture-proven sepsis and 352 (6.6%) infants a culture-negative sepsis. A total of 582 culture-proven LOS episodes were caused by the following pathogens: Coagulase negative staphylococci (CoNS) 48.5%, other Gram-positive pathogens 31.4%, Gram-negative pathogens 18.0% and candida 1.9%. Sepsis-attributable mortality was highest in Gram-negative episodes (15/108; 14%) and markedly lower for all Gram-positive episodes incl. CoNS (16/465; 3.4%). After adjusting for CRIB2, gestational age and mechanical ventilation in first week of life there was an increased adjusted odds ratio (aOR) for severe BPD in both culture-negative sepsis cases (aOR 4.3, 95% CI 3.3-5.7) and culture-proven sepsis cases (aOR 2.9, 95% CI 2.3-3.8) compared to infants without sepsis.

CONCLUSIONS

LOS in VPIs contributes with a significant burden of disease and is associated with increased risk of development of severe BPD.

PD059 / #593**E-poster Discussion Session 09: ESPR - Improving quality of care 2****09-10-2022 12:30 - 13:30****Switch from intravenous to oral antibiotic treatment of term babies with early onset infection: a Danish prospective multicenter cohort study****E. Malchau Carlsen^{1*}, K. Dungu², A. Lewis³, L. Aunsholt¹, S. Trautner¹, G. Greisen¹, B. Hansen³, U. Nygaard²**

¹Copenhagen University Hospital Rigshospitalet, Department of Intensive Care For Infants and Toddlers, Copenhagen, Denmark

²Copenhagen University Hospital, Rigshospitalet, Department of Paediatrics and Adolescent Medicine, København Ø, Denmark

³Copenhagen University Hospital, Hillerød, Department of Neonatology, Hillerød, Denmark

BACKGROUND AND AIMS

Newborn babies with early onset infection (EOI) have routinely been treated with intravenous (IV) antibiotics even though pharmacokinetic studies have shown therapeutic serum concentrations of amoxicillin after oral administration. From 2018, oral home therapy with amoxicillin was recommended to patients with EOI in East Denmark, if the patient was clinically stable after 48 hours of IV antibiotics. We aimed to evaluate this change in recommendations.

METHODS

This prospective cohort study included EOI patients from all eight Neonatal Departments in East Denmark, from December 1, 2018 to November 30, 2020. Clinical data on all newborns who received antibiotics 0-72 hours

after birth were collected using the electronic medical record. The primary outcome was re-admission due to infection.

RESULTS

IV antibiotics was initiated in 835 newborns due to suspicion of EOI, corresponding to 1.4% of the newborn population (Flowchart 1). of the 554 patients who had a full course of antibiotics, 65(12%) received IV antibiotics and 489(88%) were switched to amoxicillin after a median of 61 hours. Two re-admissions due to infection occurred; one in the IV group and one in the amoxicillin group ($p=0.22$). The mean duration of hospital admission was significantly lower in the amoxicillin group (7.5 vs. 3.2 days; $p < 0.001$). Flowchart 1. Overview of use of antibiotics in newborns.

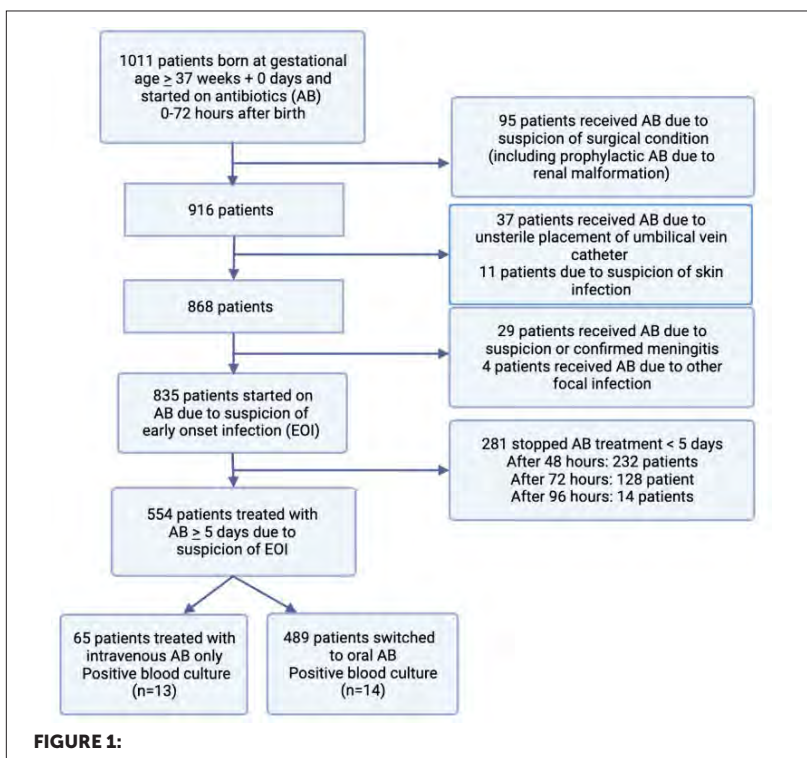

CONCLUSIONS

The majority of newborns treated for EOI were switched to oral amoxicillin. Oral therapy did not increase the risk of readmission due to infection. Further, oral antibiotics resulted in major shortening of hospital admission and hereby associated benefits.

PD060 / #1046

E-poster Discussion Session 09: ESPR - Improving quality of care 2

09-10-2022 12:30 - 13:30

Preterm infants on early solid foods and vitamin d status in the first year of life – a secondary outcome analysis of a randomized trial

M. Thanhaeuser^{1*}, F. Eibensteiner¹, M. Kornsteiner-Krenn¹,
M. Gsöllpointner², S. Brandstetter¹, U. Koeller³, M. Huber-Dangl¹,
C. Binder¹, A. Thajer¹, B. Jilma², A. Berger¹, N. Haiden²

¹Medical University of Vienna, Department of Pediatrics and Adolescent Medicine, Comprehensive Center For Pediatrics, Vienna, Austria

²Medical University of Vienna, Department of Clinical Pharmacology, Vienna, Austria

³Klinik Hietzing, Viennese Gesundheitsverbund, Department of Laboratory Medicine, Vienna, Austria

BACKGROUND AND AIMS

Aim of this study was to examine whether two different timepoints of introduction of solid foods in preterm infants have an impact on their levels of hydroxy-vitamin D and other parameters important for bone status in the first year of life.

METHODS

This is a secondary outcome analysis of a prospective, randomized, two arm interventional trial of very low birth weight (VLBW) infants randomized to an early (10-12th week of life corrected age) or a late (16-18th week of life corrected age) complementary feeding group. Infants received 650 IE of vitamin D supplementation until one year corrected age. Vitamin D status was assessed by serial blood samples taken at 6 weeks, 6- and 12-months corrected age.

RESULTS

In total, data of 89 infants of the early group and 88 infants of the late group were available for analysis. Mean birth weight was <1000g in both groups, respectively. There was a tendency to lower levels of serum 25 hydroxy vitamin D in the early group (figure 1; $p = n.s.$), but no differences were detected in serum levels of calcium, phosphorus, albumin, parathyroid hormone, and alkaline phosphatase). At 6 months corrected age, infants of the early group had a significantly higher incidence of vitamin D deficiency.

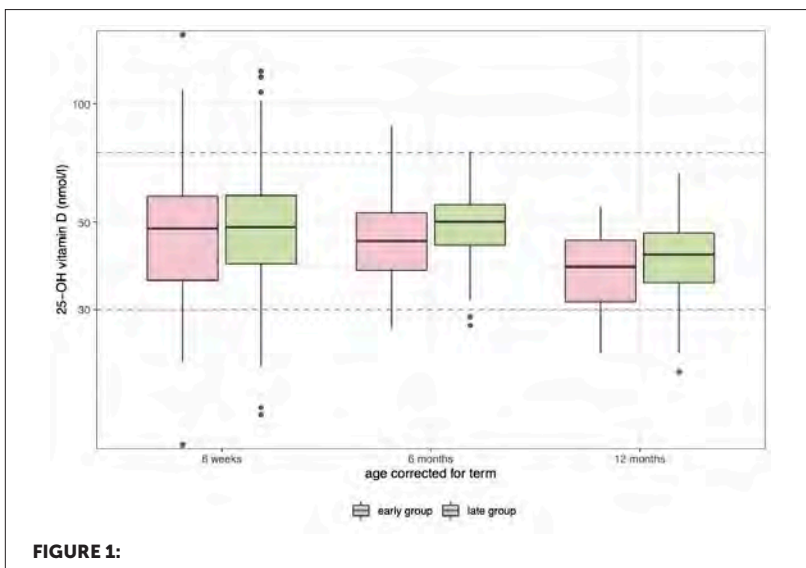

CONCLUSIONS

The timepoint of introduction of solid foods had no significant impact on 25-OH-vitamin D levels in the first year of life of VLBW preterm infants but vitamin D deficiency was significantly higher in the early group at 6 months corrected age.

PD061 / #1418

E-poster Discussion Session 09: ESPR - Improving quality of care 2

09-10-2022 12:30 - 13:30

Blood sampling from umbilical arterial catheters may be associated with decreased flow in the superior mesenteric artery

D. Healy^{1,2*}, R. Chioma^{1,2}, J. Panaviene^{1,2}, B. Walsh^{1,2}, E. Dempsey^{1,2}

¹University College Cork, Department of Paediatrics & Child Health, Cork, Ireland

²University College Cork, Infant Research Centre, Cork, Ireland

BACKGROUND AND AIMS

Umbilical arterial catheters (UAC) are commonly used in extremely preterm infants. The effect of UAC blood sampling on perfusion of abdominal organs is not known. We aimed to determine if the sampling procedure from a UAC alters blood flow through the superior mesenteric artery (SMA) or effects gut oxygenation.

METHODS

Neonates with gestational age <32 weeks and with a UAC in situ were eligible for this prospective observational pilot study. Major congenital abnormalities were exclusionary. Cerebral (C-rSO₂) and splanchnic (A-rSO₂) NIRS monitoring was commenced within 48 hours and continuously measured for a maximum of 72 hours. Ultrasound doppler measurements of SMA blood flow were taken at baseline (T0), during (T1), and after (T2) the sampling procedure. Median NIRS values were determined for a 2-minute period at each doppler timepoint. Paired statistical testing was employed to investigate differences between timepoints.

RESULTS

Preliminary results include assessments of eleven sampling procedures for four infants. In all cases, SMA blood flow and A-rSO₂ decreased during the procedure. SMA Blood flow (mean decrease(SD)=3.01(1.2)ml/kg/min, $p<0.001$), median A-rSO₂ (mean decrease(SD)=10.2(7.92)%, $p=0.045$), and median C-rSO₂ (mean decrease(SD)=1.86(1.86)%, $p=0.039$) decreased significantly between T0 and T1. Significant increases between T1 and T2 were seen for SMA flow (mean increase(SD)=3.3(2.24)ml/kg/min, $p=0.008$) and median A-rSO₂ (mean increase(SD)=14.0(7.35)%, $p=0.013$). T0 and T2 did not differ significantly.

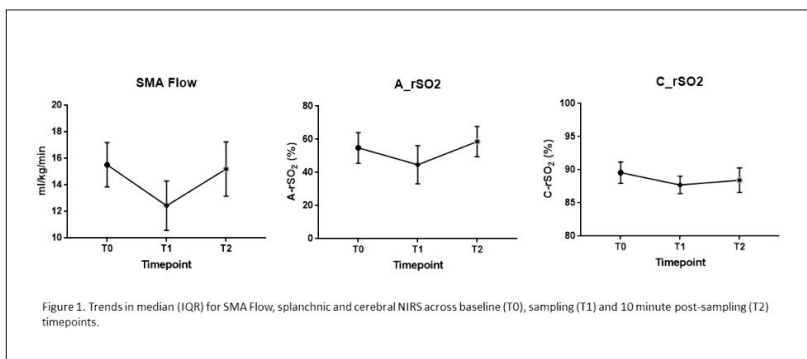

CONCLUSIONS

SMA flow and A-rSO₂ decreased during blood sampling from a UAC. This may have implications for gut perfusion in infants undergoing frequent blood sampling. Additional work is required to further describe the relationship between UAC sampling and gut perfusion.

PD062 / #1258

E-poster Discussion Session 09: ESPR - Improving quality of care 2

09-10-2022 12:30 - 13:30

Induced plasma hyperosmolarity causes a substantial increase in cerebral blood flow in the preterm rabbit pup

C. Ekström^{1*}, B. Zimmermann², N. Ortenlöf¹, M. Iennaco², D. Boas², N. Barton³, M. Gram¹, D. Ley¹

¹Lund University, Skåne University Hospital, Department of Clinical Sciences, Paediatrics, Lund, Sweden

²149 Medical Inc., 149 Medical, Worcester, United States of America

³Oak Hill Bio, Scientific Advisory Board, Boston, United States of America

BACKGROUND AND AIMS

Hyperosmolarity in plasma has been associated with development of cerebral intraventricular hemorrhage (IVH) following preterm birth, as yet, the cerebral blood flow (CBF) response to induced hyperosmolarity has not been systematically evaluated in the immature brain. We hypothesized that induced hyperosmolarity would lead to an increased CBF predisposing for vascular rupture and subsequent IVH. We therefore evaluated longitudinal relative changes in CBF using Near-Infrared-Doppler-Spectroscopy (NIRDS) in response to induced hyperosmolarity in the preterm rabbit pup.

METHODS

Preterm rabbit pups were delivered at E29. At 2 hours of age a NIRDS probe for non-invasive measurement of CBF was attached to the scalp for continuous recording up to 9 hours. Hyperosmolarity was induced by i.p. administration of a 50% glycerol at 3 hours of age. Heart rate, oxygen saturation and res-

piratory rate were measured intermittently. Plasma osmolality was measured at 0-24 hours post-glycerol administration.

RESULTS

Plasma osmolality increased from 275 to 365 mOsm/kg, peaked at 2 hours and decreased to baseline at 12-24 hours post-glycerol administration, as compared to control animals. CBF increased 2-3 fold, reaching a maximum level at 4-7 hours post-glycerol administration. Heart rate, saturation and breathing rate remained unaffected.

CONCLUSIONS

We demonstrate for the first time that induced plasma hyperosmolality leads to a significant increase in CBF during early postnatal life in a preterm physiology setting. Continued study will relate the magnitude of the CBF response to development of IVH. Understanding of the cerebrovascular pathophysiology in relation to hyperosmolality may provide important measures for the prevention of IVH following very preterm birth.

PD063 / #714**E-poster Discussion Session 09: ESPR - Improving quality of care 2****09-10-2022 12:30 - 13:30****Benefits of family integrated care (ficare) in neonatal intensive care units (NICU): a systematic review****S. Ahmed¹, N. Hounsome¹, N. Drenchev², J. Fernandez¹, H. Rabe^{1*}**¹University of Sussex, Brighton and Sussex Medical School, Brighton, United Kingdom²University Hospitals Sussex, Neonatology, Brighton, United Kingdom**BACKGROUND AND AIMS**

FICARE entails integrating parents into the routine care of their babies who are admitted to NICU. Reported benefits include reduced length of stay and improved parental bonding with reduced anxiety. The aim of this systematic review was to study the evidence on health and economic benefits of FICARE implementation.

METHODS

A systematic search via Ovid on Embase, Medline and the Cochrane library according to PRISMA guidance was conducted. Inclusion criteria were studies performed on NICU cohorts. Exclusion criteria were non English manuscripts or full text unavailable.

RESULTS

The search revealed 409 papers of which 28 were included in the systematic review: 14 randomised controlled trials, 3 pre-post intervention studies, 9

case control/cohort studies and 2 longitudinal/observational studies. Main outcome measures are listed in the table. Formal health economic costs analysis was mostly not reported.

Outcome measure	Number of studies	Reported benefits for FICARE group
Mortality	3	10%-19% reduction
Weight gain	7	5-15 g/d higher
Breast feeding on discharge rate	9	Up to 45% higher
Length of stay	6	10-12 days shorter

CONCLUSIONS

FICARE can potentially improve outcomes for parents and their babies. Thorough training of staff and parents is required so that all participants feel confident to provide FICARE. Information about health economic cost analysis is scarce and should be included into future studies.

PD064 / #1466**E-poster Discussion Session 09: ESPR - Improving quality of care 2****09-10-2022 12:30 - 13:30****Parental perception of optimistic vs. pessimistic prognostic framing in the neonatal ICU – a randomized controlled crossover trial (THE COPE-TRIAL)****F. Forth^{1,2*}, F. Hammerle³, J. König⁴, M. Urschitz⁴, P. Neuweiler⁵, E. Mildenberger¹, A. Kidszun⁶**

¹University Medical Center of the Johannes Gutenberg-University Mainz, Division of Neonatology, Center For Pediatric and Adolescent Medicine, Mainz, Germany

²University Medical Center of the Johannes Gutenberg-University Mainz, Dfg-research Training Group "Life Sciences - Life Writing", Institute For The History, Philosophy and Ethics of Medicine, Mainz, Germany

³University Medical Center of the Johannes Gutenberg-University Mainz, Department of Child and Adolescent Psychiatry and Psychotherapy, Mainz, Germany

⁴University Medical Center of the Johannes Gutenberg-University Mainz, Division of Pediatric Epidemiology, Institute of Medical Biostatistics, Epidemiology and Informatics (imbei), Mainz, Germany

⁵Johannes Gutenberg-University Mainz, Journalistisches Seminar, Mainz, Germany

⁶Inselspital, Bern University Hospital, University of Bern, Division of Neonatology, Department of Pediatrics, Bern, Switzerland

BACKGROUND AND AIMS

For parents in the neonatal ICU (NICU), prognostic information is key to setting realistic expectations for their infant's future, and to shared decision making. Parental perceptions of message framing in prognostic communication are insufficiently evaluated. Aim of the COPE-Trial was to examine parental preferences and effects of optimistic vs. pessimistic prognostic framing on parental perceptions.

METHODS

In a single-center, randomized, controlled crossover trial, parents of former very low birth weight infants (VLBWIs) were randomly assigned to view two standardized scripted video vignettes in different sequence. The two video vignettes each depicted an identical NICU physician disclosing the diagnosis and associated prognosis of a serious complication in a VLBWI to parents. Identical outcome estimates were, however, framed either as chance of survival and probability of good health (optimistic framing) or as risk of death and impaired survival (pessimistic framing).

RESULTS

Participants (N=220) preferred optimistic to pessimistic prognostic framing (89.1% vs. 10.9%; preference odds [95% CI]: 11.0 [6.28-19.1]; $P<.0001$). With optimistic compared to pessimistic framing, participants rated the physician as more professional ($P<.001$) and compassionate ($P<.001$), and both, they felt better informed about the prognosis ($P<.001$) and they perceived it as less unfavorable ($P<.001$). With optimistic framing, numerical estimates for survival, but not for impairment, were further more accurately recalled ($P=.002$ and $P=.161$). With optimistic compared to pessimistic framing, participants' prognostic expectations were more optimistic ($P<.001$) and more hopeful ($P<.001$).

CONCLUSIONS

In this trial, parents clearly preferred optimistic prognostic framing. Optimistic prognostic framing may result in a realistic expectation of survival, but not of impairment.

PD065 / #2636**E-poster Discussion Session 09: ESPR - Improving quality of care 2****09-10-2022 12:30 - 13:30****Minimising parent-baby separation during neonatal retrievals - an insight into current practice in Victoria, Australia****R. Fleming*, K. Wheeler, M. Stewart***Royal Children's Hospital, Paediatric Infant Perinatal Emergency Retrieval Service (piper), Melbourne, Australia***BACKGROUND AND AIMS**

Neonatal retrieval can be traumatic for families and often results in parent-baby separation. Family integrated care advocates parents as primary care givers and impact of transfer can be reduced by parental presence during retrieval. At the Victorian state-wide Paediatric Infant Perinatal Emergency Retrieval service (PIPER), we sought to obtain insight into current practice. Over a one-month period, we reviewed parental presence during neonatal retrievals and communication with parents unable to accompany their baby.

METHODS

A prospective study using a form-based survey with quantitative and qualitative analysis. Attending retrieval teams answered questions exploring parental presence and communication.

RESULTS

Data was available for 83 of 104 (80%) emergency neonatal retrievals. Babies were separated from at least one parent in all retrievals; mothers in 71 (86%), fathers in 69 (83%) and both parents in 57 (69%) of cases. In 19 (33%) of retrievals without parents, no option of travel was given, most commonly due to plane or ambulance capacity (37%). Parents given the opportunity to travel with their baby declined in 38 (59%) cases. Reasons included wishing to travel together and to have their own car (45%) or ongoing maternal admission (26%). Parents not accompanying their baby were contacted following arrival in 49 (86%) cases; 23 (47%) by phone call, 21 (43%) by SMS and 5 (10%) both.

CONCLUSIONS

This study provides valuable insight into reasons for separation. We speculate opportunity for digital technology such as video/photo messaging to enhance communication and reduce separation impact. Future work will explore this.

PD066 / #1314

E-poster Discussion Session 10: ESPR - Research updates in resuscitation

09-10-2022 12:30 - 13:30

Evaluating the efficacy of endotracheal epinephrine administration at standard versus high dose during resuscitation of severely asphyxiated newborn lambs

C. Roberts^{1*}, Y. Brian², D. Tantanis², D. Blank³, S. Badurdeen², K. Crossley², M. Kluckow⁴, A. Gill⁵, E. Camm², R. Galinsky², N. Songstad⁶, C. Klingenberg⁶, S. Hooper², G. Polglase²

¹Monash University, Department of Paediatrics, Clayton, Australia

²Hudson Institute of Medical Research, The Ritchie Centre, Clayton, Australia

³Monash Children's Hospital, Monash Newborn, Clayton, Australia

⁴University of Sydney, Northern Clinical School, Sydney, Australia

⁵University of Western Australia, Paediatrics, Perth, Australia

⁶UiT-The Arctic University of Norway, Tromsø, Paediatric Research Group, Faculty of Health Sciences, Tromsø, Norway

BACKGROUND AND AIMS

During neonatal resuscitation, epinephrine is given to achieve return of spontaneous circulation (ROSC). Intravenous (IV) administration is preferred, but IV access may not be immediately available. Endotracheal (ET) epinephrine administration is an alternative in current ILCOR recommendations. We aimed to assess ET-epinephrine at standard and high (10x currently recommended) doses, for achieving ROSC and maintaining physiological stability, in asystolic lambs.

METHODS

Near-term fetal sheep (0.93 gestation) were instrumented and randomised to 4 treatment groups: 5ml 0.9% IV saline placebo ('Saline', n=6), 0.02 mg/

kg IV-epinephrine ('IV', n=9), 0.1 mg/kg ET-epinephrine ('Standard ET', n=9), 1 mg/kg ET-epinephrine ('High ET', n=9). Lambs were asphyxiated until asystole, then resuscitated with ventilation, chest compressions, and a maximum of 3 treatment doses, and 2 IV-epinephrine rescue doses. After ROSC, lambs were ventilated for 60 minutes.

RESULTS

Rates of ROSC were: IV 100%, High ET 89%, Saline 67%, and Standard ET 67%. ROSC without rescue IV epinephrine occurred in 17% of saline and 0% of Standard ET lambs. After ROSC, three Standard ET lambs died before study end. Blood pressure during chest compressions is shown in Figure 1. Plasma epinephrine levels were elevated in both ET groups; with prolonged elevation in High ET lambs (Figure 2). Cortex microbleeds were increased in High ET lambs (Figure 3).

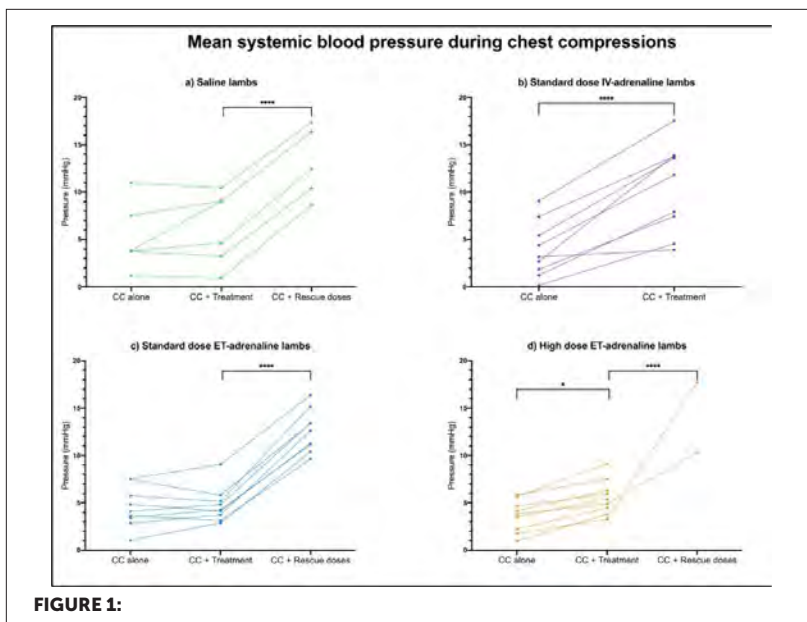
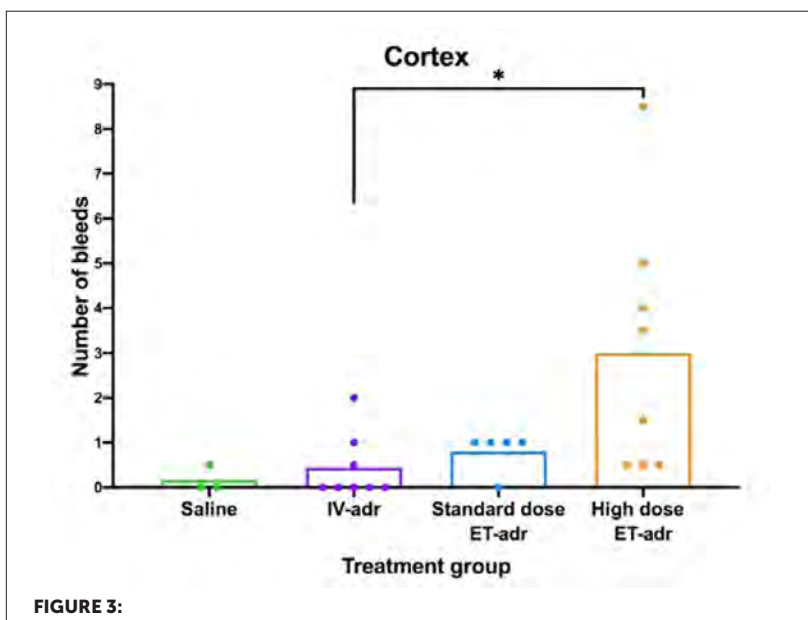
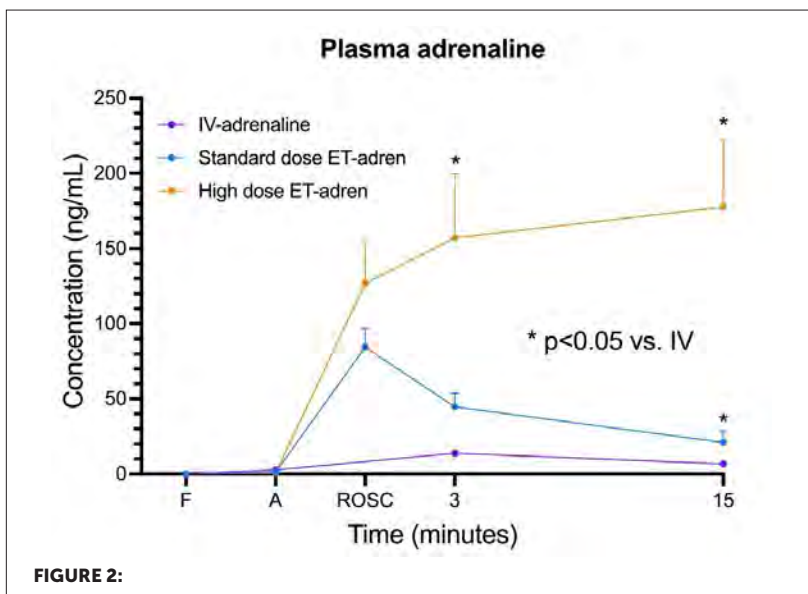

FIGURE 1:



CONCLUSIONS

We found the currently recommended dose of ET-epinephrine ineffective in achieving ROSC. Although high dose ET-epinephrine achieved ROSC, it increased cerebral micro-bleeds. Our findings call into question current recommendations for ET epinephrine use during neonatal resuscitation.

PD067 / #524

E-poster Discussion Session 10: ESPR - Research updates in resuscitation

09-10-2022 12:30 - 13:30

Detection and automatic processing of transcutaneous diaphragmatic EMG

C. Frank¹, T. Reicherzer^{1*}, M.-L. Herrmann², B. Ackermann², M. Mandl³, H. Nahrstaedt⁴, D. Bergholz⁴, J. Gruetzner⁴, W. Braun⁵, U. Thome², A. Flemmer¹, M. Klemme¹

¹Dr. von Hauner Children's Hospital of LMU Klinikum, Neonatology, Munich, Germany

²Universitätsklinikum Leipzig, Neonatology, Leipzig, Germany

³Ludwig-Maximilians-Universität München, Institut Für Medizinische Informationsverarbeitung Biometrie Und Epidemiologie (ibe), München, Germany

⁴Hasomed GmbH, Embedded Development, Magdeburg, Germany

⁵Fritz Stephan GmbH, Forschung Und Entwicklung, Gackebach, Germany

BACKGROUND AND AIMS

Transcutaneous EMG of the diaphragm (tdEMG, a potential trigger system for respirators) so far has only been used in physiological studies. In a proof-of-principle-approach, we evaluated the characteristics of tdEMG in a spontaneously breathing preterm infant and assessed best ways for real-time signal processing, filtering, and automatic detection of artefacts.

METHODS

Three signals tdEMG, Graseby Capsule, and Respiratory Inductance Plethysmography (RIPsum – abdomen & thorax) were assessed in a female preterm infant (730g BW). During non-invasive (sNIPPV) respiratory support (Sophie®; Fritz Stephan GmbH, Gackebach, Germany) tdEMG (Rehalngest® Hasomed GmbH, Magdeburg, Germany), RIP signals (QRip®-interface, Braebon, Kanata, Canada) and Graseby signal were recorded. All signals were

timestamped and stored using a modified Rehalngest-Software. Periods of unrest, apnoea and technical and biological artefacts were detected. This automated detection algorithm was validated by analogue confirmation using a video recorded during measurement.

RESULTS

Within 3:28h of recording 2:08h (62%) of regular breathing could be analysed. The Graseby signal detected 5184 breaths within this timespan. Out of these, we extracted 2516 breaths that showed a good quality in all three signals. The first signal to detect an inspiratory effort was tdEMG, followed by Graseby with a delay of 168.5 ± 97.2 ms between tdEMG and Graseby. The RIPsum signal followed the Graseby signal with a delay of 163.1 ± 87.7 ms.

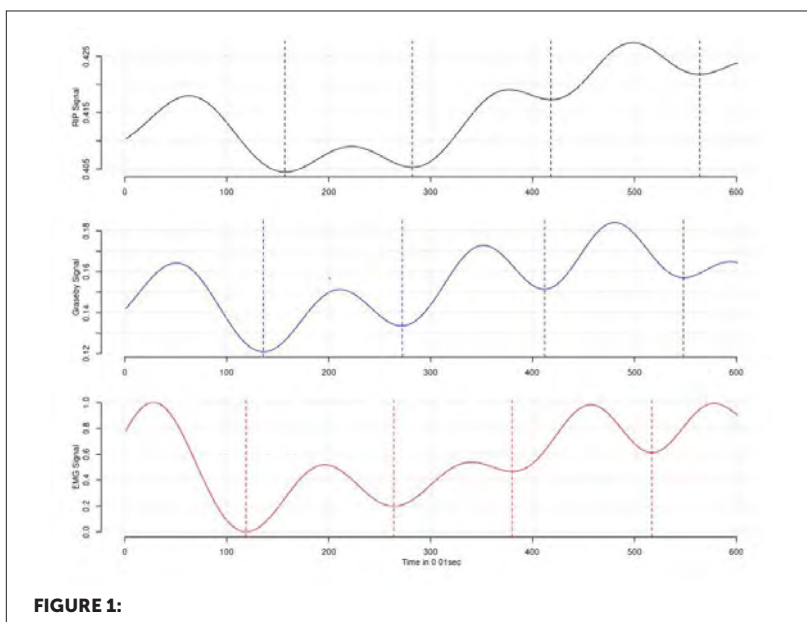

CONCLUSIONS

Our data indicate that it is feasible to detect and automatically process tdEMG signals in preterm infants. The next step in order to use tdEMG for ventilation control will be to refine the algorithm for automatic detection of artefacts and apnea.

PD068 / #1497**E-poster Discussion Session 10: ESPR - Research updates in resuscitation****09-10-2022 12:30 - 13:30****Milking of the cut-cord during stabilization of very preterm infants: a randomized controlled trial (The MOCC Study)****W. El-Naggar^{1*}, S. Mitra², T. Disher¹, B. Parish³, C. Woolcott⁴, T. Hatfield¹, D. Mcmillan¹, J. Dorling¹**¹Dalhousie University, Pediatrics, Neonatology, Halifax, Canada²Dalhousie University, Pediatrics, Halifax, Canada³Dalhousie University, Obstetrics & Gynecology, Halifax, Canada⁴Dalhousie University, Pediatrics, Halifax, Canada**BACKGROUND AND AIMS**

Delayed cord clamping (DCC) is recommended at birth but can be contraindicated or not recommended in certain situations. Milking of the long-cut cord (MOCC) while supporting breathing is proposed as an alternative to DCC. Aims: To investigate the feasibility of MOCC during stabilization of very preterm infants after birth.

METHODS

Infants born to eligible, consenting women presenting in preterm labor at <32 weeks' gestation were randomized to receive MOCC (one time while supporting breathing following 30 seconds of DCC to provide initial resuscitation steps) or DCC for 30-60 seconds (standard practice). Primary outcome was feasibility in terms of percentage recruitment, intervention compliance, safety, and study completion. Short-term clinical outcomes were collected. Analysis was by intention to treat.

RESULTS

Fifty infants were randomized to either MOCC (25) or DCC (25) (Figure). Baseline characteristics were similar. All infants completed the study. One infant in the MOCC group and five infants in the DCC group did not receive the allocated intervention. Median (IQR) time to cord milking was 62 seconds (54, 99) and median (IQR) length of the cut cord milked was 20 cm (14, 29). MOCC was not associated with statistically significant differences in adverse effects as compared to DCC (Table).

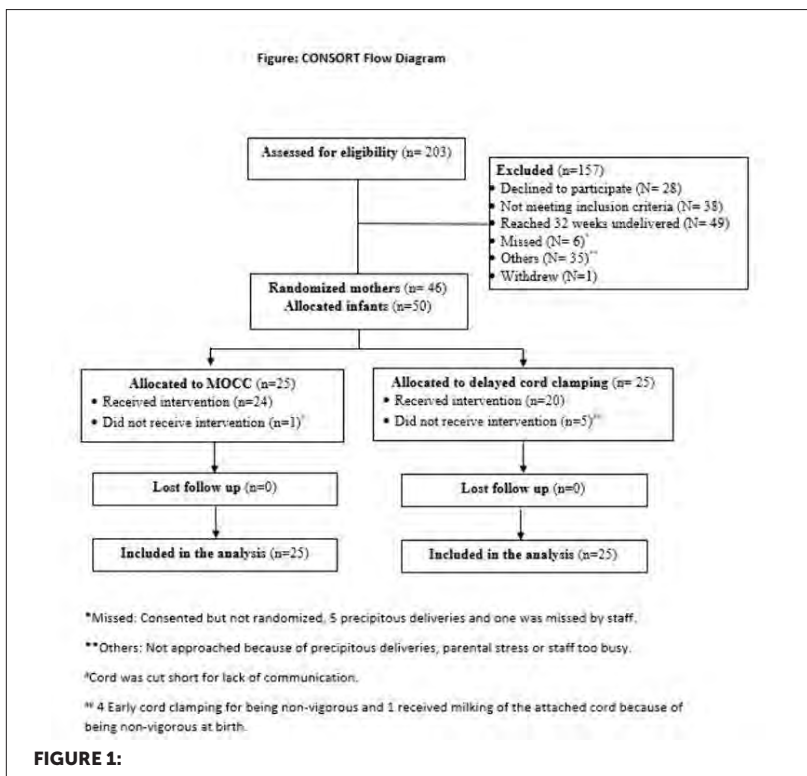

Table: Selected clinical outcomes

Outcome*	MOCC (n=25)	DCC (n=25)	p-value
Apgar score at 5 min, median (IQR)	8 (6, 8) (n = 25)	8 (6, 9) (n = 25)	0.53
Positive pressure ventilation, n (%)	15/25 (60%)	15/25 (60%)	0.89
Admission temperature, median (IQR)	37.0 (36.7, 37.3) (n=25)	37.0 (36.7, 37.2) (n=24)	0.78
Admission hemoglobin, mean (SD) g/dL	168 (26) (n = 25)	167 (25) (n = 24)	0.47
CRIB II score, median (IQR)	6.0 (4.0, 10.0) (n = 25)	5.0 (3.0, 9.0) (n = 25)	0.65
Hypotension in first 72 hours	1/25 (4.0%)	2/24 (8.3%)	0.20
Phototherapy	25/25 (100%)	24/25 (96%)	
Polycythemia (Hematocrit >0.65)	2/25 (8.0%)	1/24 (4.2%)	0.55
Hyperkalemia (K>7 mmol/L)	4/25 (16%)	3/24 (12%)	0.95
Blood transfusion during hospital stay	4/25 (16%)	5/25 (20%)	0.45
Necrotizing enterocolitis (confirmed)	1/23 (4.3%)	0/24 (0%)	
BPD (O2 at 36 weeks)	3/19 (16%)	4/19 (21%)	0.67
All grades IVH	8/25 (32%)	5/24 (21%)	0.40
Grade III and IV IVH or PVL	1/25 (4.0%)	1/24 (4.2%)	0.95
Late-onset Sepsis	2/23 (8.7%)	2/21 (9.5%)	0.85
ROP, stage 3 or treated (treated)	0/21 (0%)	0/21 (0%)	
Patent ductus arteriosus (medically treated)	6/25 (24%)	3/25 (12%)	0.28
Mortality	2/25 (8.0%)	2/25 (8.0%)	0.63

* Dichotomous data presented as n(%), continuous data presented as either mean (SD) or median (IQR).
IQR: inter-quartile range, CRIB: clinical risk index for babies, BPD: Bronchopulmonary dysplasia, IVH: Intraventricular hemorrhage, PVL: Periventricular leukomalacia, ROP: Retinopathy of prematurity.

CONCLUSIONS

Milking of the long-cut cord for one time after 30 seconds of DCC and while supporting breathing was feasible and not associated with significant adverse effects. A large RCT is required to assess the efficacy of this approach on clinical outcomes. It may be especially useful when immediate clamping is indicated.

PD069 / #1501**E-poster Discussion Session 10: ESPR - Research updates in resuscitation****09-10-2022 12:30 - 13:30****Assessing the safety and efficacy of waveform capnography in ventilated neonates undergoing road transfer****M. Kahvo****St Michael's Hospital, Neonatal Emergency Stabilisation and Transfer Team, Bristol, United Kingdom***BACKGROUND AND AIMS**

Waveform capnography (etCO₂) is standard of care in adult and paediatric intensive care. However, its use has not been widely adopted in the neonatal setting. The potential for auto-triggering of the ventilator with added deadspace and weight to the breathing system has led many to be hesitant in introducing this technology. The aim of this study therefore was to assess the safety and efficacy of etCO₂ in a neonatal population, by reviewing the rate of accidental extubations and episodes of hypocapnia (pCO₂ <4.0).

METHODS

This was a retrospective review of all ventilated neonates undergoing road transfer from 2017 - 2022. Patients were identified from a transport database and electronic notes reviewed. Data was collected on patient demographics, size of endotracheal tube, length of transfer, trend of etCO₂, and blood gas pCO₂.

RESULTS

627 patient transfer episodes with complete data were identified. 8% (51/627) had a $p\text{CO}_2 < 4.0\text{kPa}$ at the end of transfer. 76% (31/51) of those were also hypocapnic on their etCO_2 . There was no significant difference in the average gestation, weight or transfer time between neonates who were normocapnic and hypocapnic. There was one episode of extubation which was immediately recognised from the waveform capnograph.

CONCLUSIONS

In this cohort of ventilated neonates undergoing road transfer, the use of etCO_2 was safe and did not result in excessive rates of hypocapnia. Ongoing advances in neonatal-specific waveform capnography technology should lead the neonatal community to review the added benefits of this monitoring system.

PD070 / #1545**E-poster Discussion Session 10: ESPR - Research updates in resuscitation****09-10-2022 12:30 - 13:30****May cerebral oxygenation immediately after birth predict long-term outcome in preterm neonates with a birth weight ≤ 1500 grams and/or gestational age ≤ 32 weeks?****C. Wolfsberger*, E. Pichler-Stachl, N. Höller, B.C. Schwabegger, B. Urlesberger, G. Pichler***Division of Neonatology, Department of Pediatrics and Adolescent Medicine, Graz, Austria***BACKGROUND AND AIMS**

Preterm birth is associated with a higher risk of adverse long-term-outcome and mortality. The aim of this study was to evaluate whether cerebral-oxygenation during postnatal transition may predict long-term-outcome at two years in VLBW-neonates.

METHODS

Inclusion criteria for this post-hoc-analysis were: birth weight ≤ 1500 g, cerebral-regional-oxygen-saturation ($crSO_2$) measurements using near-infrared-spectroscopy during the first 15 minutes after birth and long-term-outcome assessment at a corrected age of two years ("Bayley-Scales-of-Infant-Development-III" (BSID-III)). $CrSO_2$ measurements were performed continuously during the first 15 minutes after birth and cerebral-fractional-tissue-oxygen-extraction ($cFTOE$) was calculated out of $crSO_2$ and arterial-oxygen-saturation (SpO_2). SpO_2 and heart rate (HR) were measured with pulse oximetry. Preterm neonates were stratified into two

groups according to the BSID-III Results impaired-outcome-group (BSID-III ≤ 70 , testing not possible due to severe cognitive impairment or mortality) and control group (age-appropriate-outcome/moderate-disability-group" (BSID-III > 70)). $crSO_2$, $cFTOE$, SpO_2 , HR and fraction-of-inspired-oxygen (FiO_2) were compared for the first 15 minutes after birth between the two groups.

RESULTS

42 preterm neonates (impaired-outcome-group $n=13$; control group $n=29$) were included (Table1). Gestational age was significantly lower in the impaired-outcome-group. $crSO_2$ was lower and $cFTOE$ higher in the impaired-outcome-group during the first 15 minutes after birth (Figure1 and 2). There were no significant differences in SpO_2 and HR between the two groups. No significant differences in FiO_2 between the two groups except for minute 11, with higher FiO_2 in the "impaired-outcome-group", were observed.

Table 1. Demographic and clinical data of 29 preterm neonates in the "age-appropriate outcome/moderate disability group" and "impaired outcome group". Data are presented as n(%) and median (IQR).

	Age-appropriate outcome/moderate disability group n=29	Impaired outcome group n=13	p-value
Gestational age (weeks)	30.6 (28.1-32.0)	24.8 (24.2-29.8)	0.009*
Birth weight (grams)	1250 (972-1390)	760 (670-1054)	0.001*
Female (n%)	15 (51.7)	4 (30.8)	0.207
Apgar 1	8 (7-8)	7 (5-8)	0.136
Apgar 5	9 (8-9)	8 (6-9)	0.204
Apgar 10	9 (9-9)	9 (8-9)	0.268
NapH	7.31 (7.29-7.33)	7.34 (7.27-7.38)	0.719
MAD (mmHg)	39 (33-49)	37 (26-41)	0.122
Chest compressions in DR	1 (3.4%)	0 (0%)	1.000
Epinephrine in DR	0 (0%)	0 (0%)	1.000
Surfactant in DR	13 (44.8%)	8 (61.5%)	0.317
Invasive RS	7 (24.1%)	7 (53.8%)	0.082
Non-invasive RS	19 (65.5%)	6 (46.2%)	0.237

Abbreviations: MAD = mean arterial blood pressure, DR = delivery room, RS = respiratory support, mmHg = millimeters of mercury

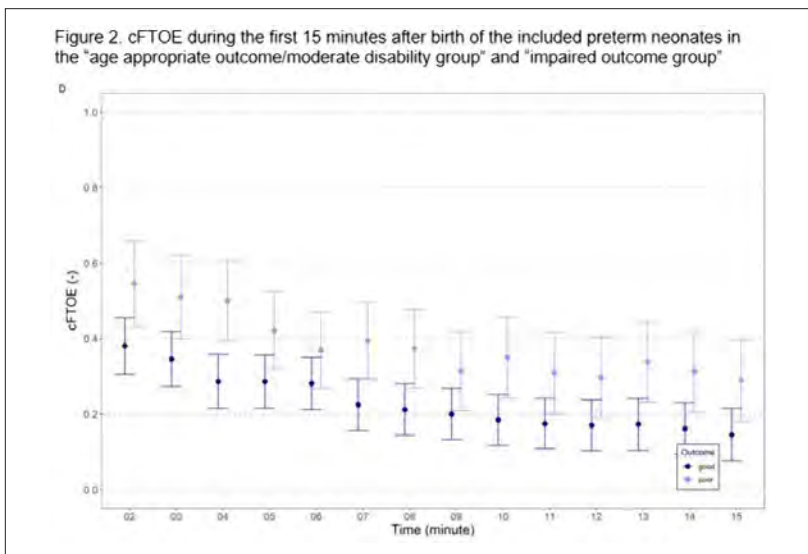
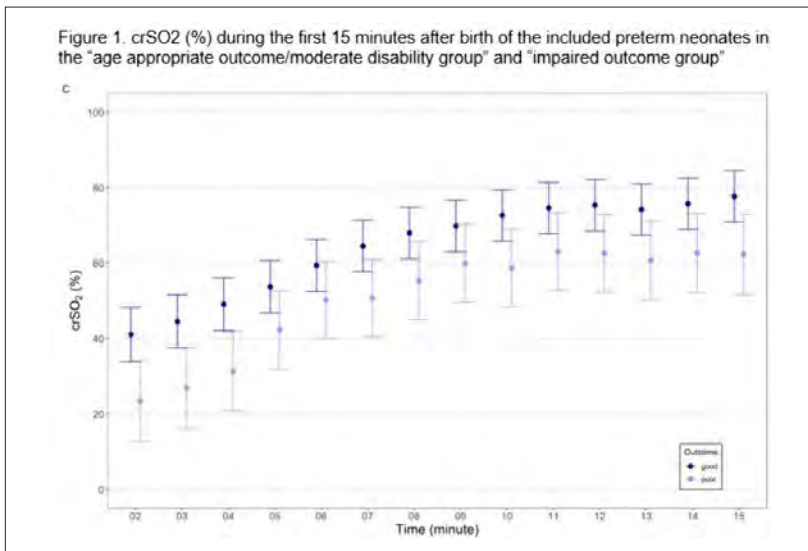

CONCLUSIONS

VLBW neonates with impaired long-term-outcome at two years had beside a lower gestational age also a lower crSO_2 immediately after birth, which might have contributed to the adverse outcome.

PD071 / #2199

E-poster Discussion Session 10: ESPR - Research updates in resuscitation

09-10-2022 12:30 - 13:30

Noise exposure during neonatal ambulance transport: in-vivo assessment of current and newer attenuation methods

A. Mistry^{1*}, R. Calthorpe¹, J. Firth², M. Akeroyd², D. McNally³,
D. Sharkey¹

¹University of Nottingham, Centre For Perinatal Research, School of Medicine, Nottingham, United Kingdom

²University of Nottingham, Hearing Sciences, Division of Mental Health and Clinical Neurosciences, School of Medicine, Nottingham, United Kingdom

³University of Nottingham, Faculty of Engineering, Nottingham, United Kingdom

BACKGROUND AND AIMS

Background The recommend noise levels within the neonatal intensive care unit (NICU) should be <45dBa, levels >80dBA are associated with hearing damage. Excessive NICU noise exposure is associated with negative effects on preterm infants including altered brain perfusion. Preterm infants undergoing early inter-hospital transport have higher rates of severe intraventricular haemorrhage, potentially linked to the transport environment. Noise levels during inter-hospital transfers are significantly higher than in the NICU. Aims: Quantify noise exposure during ambulance transfer and assess efficacy of sound-attenuating approaches in this setting.

METHODS

Using an experimental sound recording preterm manikin, noise-attenuating materials and existing products (term infant ear defenders, preterm Mini-Muffs,

incubator cover, headphones \pm active-noise cancelling (ANC)) were studied in-vivo during ambulance journeys ($n=23$). The mean \pm SD total A weighted decibels (dBA) are reported.

RESULTS

During ambulance transfer, noise levels were 73 ± 9 dBA outside and 66 ± 6 dBA inside the transport incubator, correlating with increasing ambulance speed. The incubator offered some noise attenuation lowering the dBA overall. Very little attenuation was noted with the incubator cover or ear protectors. Activation of ANC headphones were most effective reducing noise levels to <60 dBA for 77% of the time (Figure).

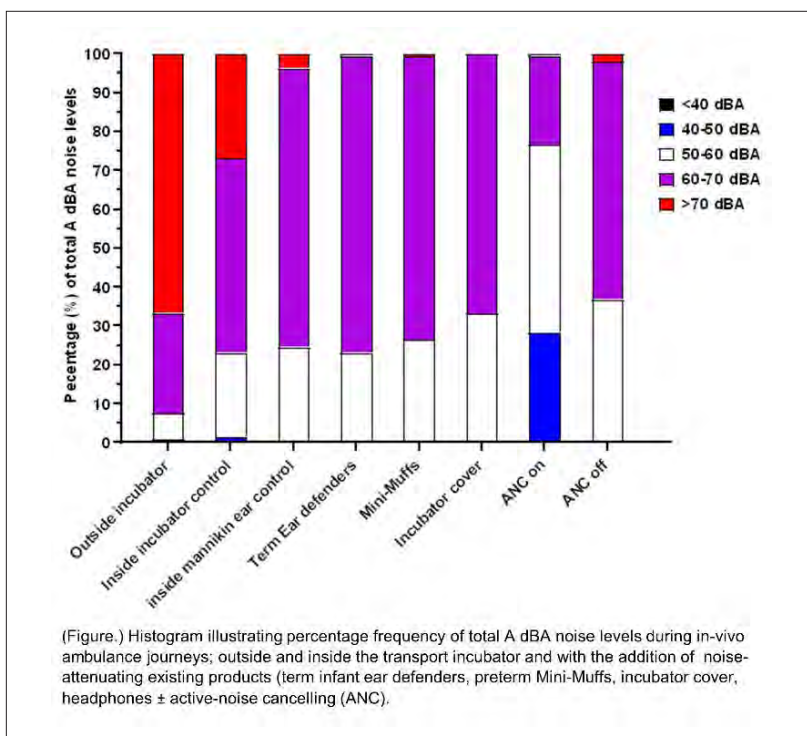

CONCLUSIONS

During neonatal ambulance transfer, staff and infants are exposed to noise levels in excess of recommended levels with periods >80dBA known to cause hearing injury. Existing approaches have little impact reducing noise exposure. ANC headphones demonstrated significant reductions and warrant further exploration into their suitability for development into a clinical device to make inter-hospital transport safer and potentially improve high-risk infant outcomes.

PD072 / #2155**E-poster Discussion Session 10: ESPR - Research updates in resuscitation****09-10-2022 12:30 - 13:30****Crowdsourcing vibration and noise exposure during inter-hospital transport using smartphone technology: improving safety with intelligent routing****R. Simpson^{1,2*}, T. Partridge³, A. Leslie^{2,4}, D. Morris³, D. McNally³, J. Crowe³, D. Sharkey^{2,4}**

¹Nottingham University Hospitals NHS Trust, Nottingham Children's Hospitals, Nottingham, United Kingdom

²University of Nottingham, Centre For Perinatal Research, School of Medicine, Nottingham, United Kingdom

³University of Nottingham, Department of Engineering, Nottingham, United Kingdom

⁴Nottingham University Hospitals NHS Trust, Nottingham Neonatal Service, Nottingham, United Kingdom

BACKGROUND AND AIMS

High-risk infants undergoing inter-hospital transport are more likely to have a worse outcome compared with inborn infants. Whole-body vibration (WBV) and noise during ambulance transport exceeds that deemed safe for well adults. Understanding and reducing these stressors could improve comfort and outcomes. We aimed to develop a calibrated smartphone app to monitor WBV, noise exposure and transport route.

METHODS

An android smartphone (Xiaomi Redmi5+, <€200), calibrated against industry standard noise/WBV meters, was used with an in-house developed app

to record routes and stressor exposures during neonatal ambulance journeys. Between Oct 2018-Oct 2020, the UK CenTre Neonatal Transport Team recorded smartphone data from their transport incubators. Speed correlation graphs and percentage time spent in ISO-2631 WBV comfort levels or noise domains were calculated.

RESULTS

1485 journeys were undertaken covering 81,901kms over 1319hrs and 946million datapoints. Noise exposure was $>70\text{dB(A)}$ for $\sim 60\%$ of the time and correlated with ambulance speed (Figure1). Over 70% of the time, WBV exceeded levels deemed safe for adults and correlated with vehicle speed (Figure2). Analysis of journeys between two tertiary neonatal centres demonstrated the importance of road type and surface with lower noise and WBV on non-motorway asphalt roads.

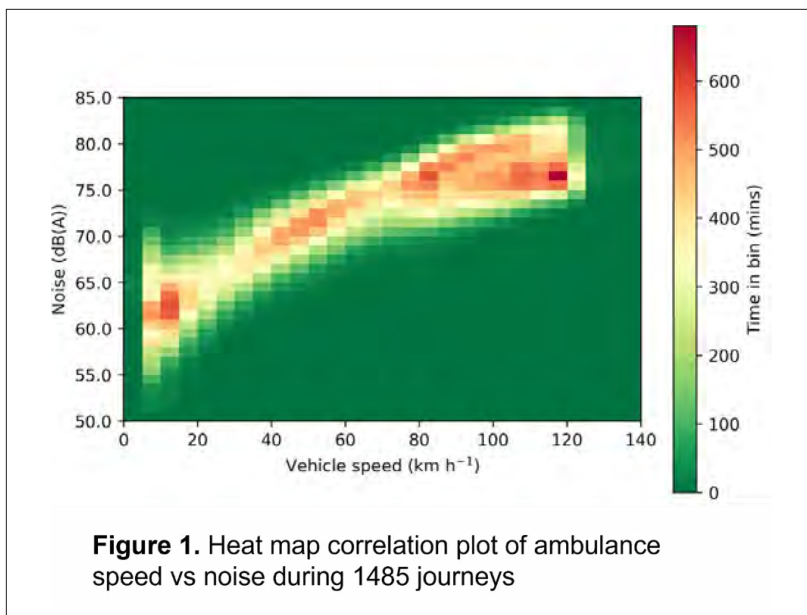

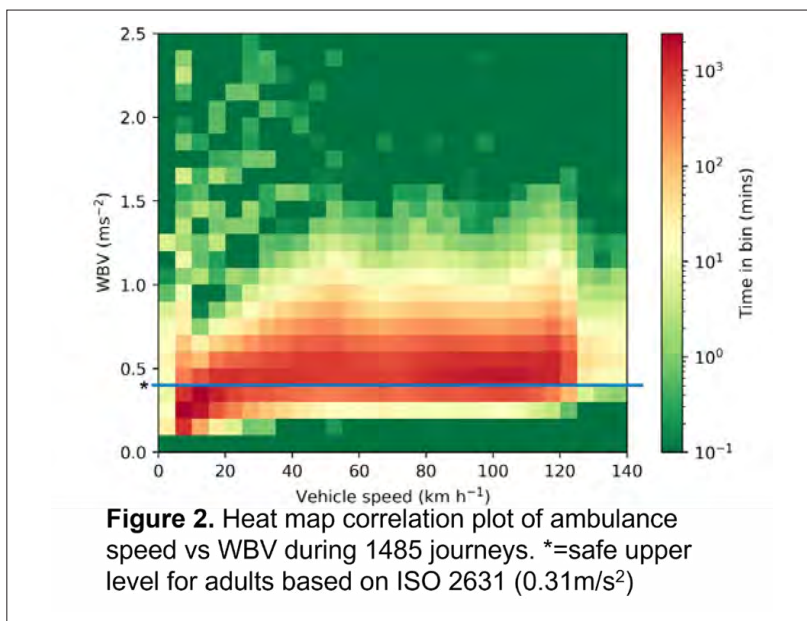

CONCLUSIONS

Neonatal ambulance transfer is associated with high, unsafe noise and WBV exposure that is likely to negatively impact on patient, staff and equipment. Crowdsourcing large amounts of these data is feasible and could allow better route planning, correlation with outcomes and innovative mitigation strategies to reduce these and improve outcomes for high-risk infants.

PD073 / #2688**E-poster Discussion Session 10: ESPR - Research updates in resuscitation****09-10-2022 12:30 - 13:30****Comparison of three intraosseous access devices for resuscitation of term neonates: a randomised simulation study****A. Keller¹, A. Boukai¹, O. Feldman^{1,2}, R. Diamand², I. Shavit^{1,2*}**¹*Technion Israel Institute of Technology, Rappaport Faculty of Medicine, Haifa, Israel*²*Rambam Health Care Campus, Pediatric Emergency Department, Haifa, Israel***BACKGROUND AND AIMS**

Intraosseous (IO) vascular access is a proven lifesaving procedure in the critical pediatric patient. While in neonates, umbilical venous catheterization (UVC) is common practice, it is rarely available and requires greater skill and time. As such, the IO route is indicated in neonatal resuscitation when UVC is not available. Currently, there have been no randomized controlled trials comparing different IO devices in neonates. To compare the success rates and ease of use of three IO access devices used in term neonates.

METHODS

A three-arm randomized controlled simulation study was conducted. Using an animal bone model, the one-attempt success rate of the NIO-I needle, the EZ-IO drill and the Jamshidi needle was compared. Study participants were Pediatric specialist and resident physicians. Uncooked Cornish Hen bones were used because of their similarity in measure to neonatal bones. Successful IO placement was defined as dyed fluid visualized flowing from the distal end of the bone cavity. Participants were then asked to record their perceived ease-of-use using a five-point Likert Scale.

RESULTS

The EZ-IO, NIO-I and Jamshidi groups included 30, 31, and 31 participants, respectively, with median (interquartile range) years of experience of 3 (2-5), 3 (2-6), and 4 (3-5) years. Participants had significantly lower one-attempt success rates with the EZ-IO drill than with the NIO-I and Jamshidi needles (14/30 (46.7%) vs 24/31 (77.4%); $p=0.016$, & 14/30 (46.7%) vs 25/31 (80.7%); $p=0.007$, respectively).

CONCLUSIONS

Although easier to use, the EZ-IO drill demonstrated lower success rates than the IO needles in establishing IO access on a neonatal bone model.

PD074 / #2721**E-poster Discussion Session 10: ESPR - Research updates in resuscitation****09-10-2022 12:30 - 13:30****Trends in active management and neonatal outcomes of babies born at 22-24 weeks gestation in England and Wales, 2017-2021****E. Van Blankenstein^{1,2*}, L. Smith³, G. Fox⁴, S. Seaton³, M. Martinez-Jimenez⁵, P. Stavros⁶, C. Battersby^{1,2}**¹Imperial College London, Primary Care & Public Health, London, United Kingdom²Chelsea and Westminster Hospital, Neonatology, London, United Kingdom³University of Leicester, Department of Health Sciences, Leicester, United Kingdom⁴Guy's and St. Thomas' NHS Foundation Trust, Children's Services, London, United Kingdom⁵Imperial College London, Department of Economics & Public Policy, London, United Kingdom⁶University of Oxford, Nuffield Department of Primary Care Health Sciences, Oxford, United Kingdom**BACKGROUND AND AIMS**

In 2019, the British Association of Perinatal Medicine (BAPM) updated their guidance from a recommendation of no survival-focused care for infants born <23⁺⁰ weeks, to recommending a risk-based approach from 22⁺⁰ weeks. We examine recent trends in England and Wales in management at delivery, and outcomes to neonatal discharge of infants born 22⁺⁰ to 24⁺⁶ weeks' gestation.

METHODS

Data on all babies alive at onset of labour born at 22⁺⁰ to 24⁺⁶ weeks' gestation between 01/01/2018–31/12/2021 and cared for in England & Wales were obtained from two national datasets: Mothers and Babies: Reducing Risk through Audits and Confidential Enquiries across the UK (MBRRACE-UK); National Neonatal Research Database (NNRD). We obtained characteristics,

whether survival-focused care was given and neonatal outcomes. We explored changes over two epochs (2018–2019 and 2020–2021), by gestation group.

RESULTS

At 22 weeks there was a similar number of babies alive at the onset of labour comparing 2020-2021 with 2018-2019 (448 v 449), but a 3-fold increase in babies receiving survival-focused care (40.8% v 13.1%), those admitted to a neonatal unit (29.9% v 8.7%) and surviving to neonatal discharge (6.5% v 2.4%). Higher proportions of babies born at 23 and 24 weeks received survival-focused care, were admitted, and survived to discharge. <5% difference was seen in these proportions between epochs.

CONCLUSIONS

Whilst little change was seen at 23 and 24 weeks, at 22 weeks a three-fold increase was seen in the proportions of babies given active management at delivery, admitted to the neonatal unit, and who survived to neonatal discharge.

PD075 / #2789**E-poster Discussion Session 10: ESPR - Research updates in resuscitation****09-10-2022 12:30 - 13:30****Feasibility of transcutaneous CO₂ monitoring in neonatal transport****A. Hurley¹, C. Harrison^{2*}**¹*Embrace, Embrace, Leeds, United Kingdom*²*Embrace, Embrace, Barnsley, United Kingdom***BACKGROUND AND AIMS**

Effective ventilation whilst maintaining normocarbia is important to minimize lung trauma&adverse cerebral outcomes. Alongside ventilation, it is important to reduce stress with minimal handling&reducing painful procedures, eg. blood gases where possible. Historically, ventilated neonates have end-tidal CO₂ monitoring or intermittent capillary gas sampling during transfer process. However, end-tidal CO₂ has poor correlation with blood gas CO₂. Transcutaneous CO₂ monitoring is continuous&has been shown to correlate better with blood gas CO₂s. Our study reviewed the use&effectiveness of transcutaneous CO₂ monitoring in neonatal transfers carried out by Embrace Transport Service, based in Yorkshire&Humber, UK

METHODS

6 month review of all ventilated neonatal transfers September 2021 to February 2022. Transport database identified all ventilated infants&then through case review, use of transcutaneous monitoring was identified and end tidal CO₂, blood gas CO₂ and transcutaneous CO₂ levels were compared.

RESULTS

171 babies eligible for review. Mean gestational age at time of transfer 32+4 (22+4 to 44+3). Mean weight 1895g (530 to 5636g). Transcutaneous CO₂ monitoring was used in 53% transfers, average gestational age 33+3 (26+3 to 44+3). Team leader for these transfers were 35% Advanced Nurse Practitioners, 26% medical trainees & 39% consultant led transfers. 47% transfers did not use transcutaneous CO₂ monitoring. Reasons were explored why this did not happen: 7% due to an equipment error, 4% due to lack of available equipment & 89% no documented reason why not used. Where TC monitoring was used, mean pre departure end tidal CO₂ 5.23, blood gas CO₂ 6.17 and transcutaneous CO₂ 6.6. On arrival mean end tidal CO₂ 5.18, blood gas CO₂ 5.58 & transcutaneous CO₂ 6.29

CONCLUSIONS

Transcutaneous monitoring is an accurate, useful & pain-free tool in monitoring neonatal CO₂ levels. It allows continuous monitoring of CO₂ levels & for ventilation adjustments to be made accordingly. Further work ongoing to promote use of Tc monitoring with an education package

PD076 / #1127**E-poster Discussion Session 11: ESPR - Pain management & comfort****09-10-2022 12:30 - 13:30****Pain assessment and treatment in hospitalized infants, children and young people****R. Maastrup^{1*}, K. Holm², H. Haslund-Thomsen^{3,4}, J. Weis¹, M. Eg⁵, B. Noergaard⁶, C.S. Jensen⁷, A. Broedsgaard⁸, H. Hansson⁹**¹Rigshospitalet, Copenhagen, Department of Neonatology, Copenhagen, Denmark²Hans Christian andersen Children's Hospital, Odense University Hospital, Dept. of Neonatology, Odense, Denmark³Aalborg University Hospital, Pediatric Department, Aalborg, Denmark⁴Aalborg University, Clinical Institute, Aalborg, Denmark⁵Viborg Regional Hospital, Paediatrics and Adolescents, Viborg, Denmark⁶Lillebaelt Hospital, University Hospital of Southern Denmark, Department of Paediatrics and Adolescent Medicine, Kolding, Denmark⁷Aarhus University Hospital, Department of Paediatrics and Adolescent Medicine, Aarhus, Denmark⁸Copenhagen University Hospital, Amager Hvidovre, Department of Paediatrics and Adolescent Medicine & Department of Gynecology and Obstetrics, Hvidovre, Denmark⁹Copenhagen University Hospital, Paediatric and Adolescent Medicine, Copenhagen, Denmark**BACKGROUND AND AIMS**

Pain in hospitalized infants, children and young people has previously been found to be undetected and undertreated. Knowledge on current pain assessment and treatment of hospitalized infants, children and young people is sparse. The aim was to investigate documented pain assessment and treatment among hospitalized infants, children and young people in Denmark and compare between neonatal and paediatric units.

METHODS

A cross-sectional retrospective multi-centre study was performed in 40 of 42 (95%) Danish neonatal and paediatric units three days in November 2020. Data was collected daily from the electronic medical records of all infants, children and young people who were admitted for at least 24 hours to a participating neonatal or paediatric unit during the study period.

RESULTS

A total of 846 24-hours audits were performed of which 52.6% were from neonatal units. Pain was assessed in 51.9% of the patients. More neonatal (57.8%) than paediatric patients (47.4%) were pain assessed ($p=0.003$). Paediatric patients more often received pain treatment (37.7%) than neonates (6.9%, $p<0.0001$) and more often had a pain treatment plan (50.8% vs. 10.2%, $p<0.0001$). Paediatric pain scores more frequently indicated pain (31.5%) than neonatal scores (14.8%, $p<0.0001$). Use of non-pharmacological treatment was documented in 6.3% of neonatal and paediatric patients.

CONCLUSIONS

Even though pain assessment was more frequently documented in neonatal patients, pain assessment is insufficient, and pain appears under-reported in Danish neonatal and paediatric units. Non-pharmacological treatment is seldom documented in hospital medical records.

PD077 / #1898**E-poster Discussion Session 11: ESPR - Pain management & comfort****09-10-2022 12:30 - 13:30****Development and psychometric evaluation of early period mother-infant bonding indicators assessment scale****Ö. Karakaya Suzan^{1*}, N. Cinar²**¹*Sakarya University, Faculty of Health Sciences, Department of Nursing, Sakarya, Turkey*²*sakarya university, Faculty of Health Sciences, Department of Nursing, sakarya, Turkey***BACKGROUND AND AIMS**

The purpose of this study is to develop the Early Period Mother-Infant Bonding Indicators Assessment Scale and to examine its validity and reliability.

METHODS

This is a cross-sectional, methodological, descriptive, and correlational study. This study was carried out with 143 mothers in the Sakarya Training and Research Hospital Maternity Service between February and April of 2021. The content validity of the scale was assessed by consulting 11 experts. Exploratory and confirmatory factor analyses were performed, and the tool's internal consistency and construct validity were analyzed.

RESULTS

For the mothers, the average age was 28.19 ± 5.71 . The Cronbach's alpha coefficient for the overall scale was 0.83, and the Cronbach's alpha values for the subscales were 0.85–0.80. As a result of the applied Pearson correlation

analysis, the correlations between the physical and emotional intimacy and exploration and striving subdimensions with the whole scale were found to be highly positive and statistically significant ($r = 0.919$, $r = 0.869$, $p < .005$). The exploratory factor analysis showed that the scale explained 55.59% of the total variance. The confirmatory factor analysis found that the *physical and emotional intimacy* and *exploration and striving* subdimension factor loads ranged from 0.53 to 0.75 and 0.59 to 0.77, respectively.

CONCLUSIONS

The two-factor, 13-item Early Period Mother-Infant Bonding Indicators Assessment Scale was confirmed to have sufficient reliability and validity.

PD078 / #1508

E-poster Discussion Session 11: ESPR - Pain management & comfort

09-10-2022 12:30 - 13:30

Vital signs, temperature and comfort scale scores in infants during ultra-high-field MR imaging

I. Van Ooijen^{1,2*}, K. Annink¹, J. Dudink¹, T. Alderliesten¹,
F. Groenendaal¹, M. Tataranno¹, M. Lequin², H. Hoogduin², F. Visser²,
A. Raaijmakers^{2,3}, D. Klomp², E. Wiegers², M. Benders¹, J. Wijnen²,
N. Van Der Aa¹

¹University Medical Center Utrecht, Neonatology, Utrecht, Netherlands

²University Medical Center Utrecht, Radiology, Utrecht, Netherlands

³Eindhoven University of Technology, Biomedical Engineering, Eindhoven, Netherlands

BACKGROUND AND AIMS

Cerebral MRI in infants is usually performed on 3T. 7T MRI increases the spatial resolution and improves the use of advanced imaging, including vascular and spectroscopic imaging. To assess safety, we previously modeled SAR and sound pressure levels. Here, we focus on the vital signs, temperature and potential effects of the main static magnetic field on the infant.

METHODS

Twenty clinically stable infants (gender: 10/10 M/F; gestational age: 33.01±1.54 weeks) without respiratory support, were scanned on 7T right after their clinical 3T MRI. All infants were sedated before 3T MRI. Vital signs (heart rate, oxygen saturation and respiratory rate), temperature (rectal, body and brain (from MRS data), COMFORT Scale (CS) scores and adverse events (AE's) were monitored throughout the process.

RESULTS

No changes in vital signs, temperature, CS scores (figure 1) and AE's were found in infants due to 7T MRI. One infant showed an increased CS during transport after 7T MRI, most likely due to being hungry, since the CS quickly normalized after feeding.

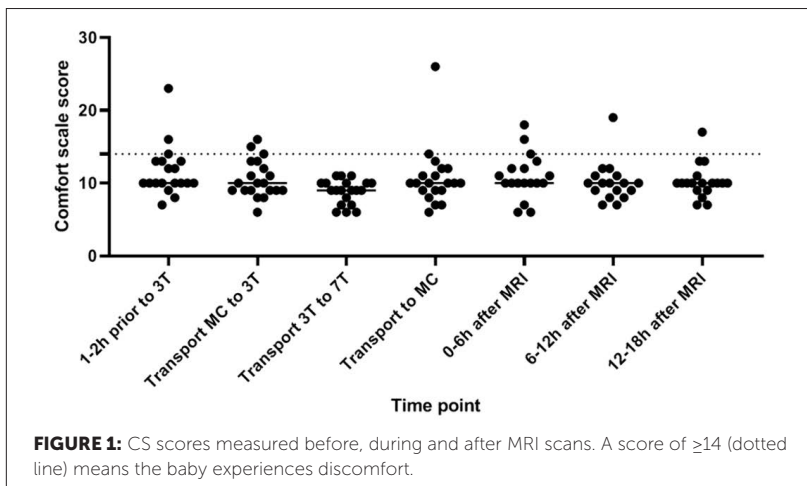

CONCLUSIONS

Ultra-high field strengths pose potential areas of risk for the infant. Here we show that 7T MRI in infants induces no significant changes in vital signs, temperature, CS scores and AE's. Therefore, in combination with our previous results, 7T MRI appears to be safe in infants without respiratory support. Future research should elucidate the advantages of 7T compared to 3T MRI, possibly improving diagnostic quality.

PD079 / #743**E-poster Discussion Session 11: ESPR - Pain management & comfort****09-10-2022 12:30 - 13:30****Current pain management practices for necrotizing enterocolitis in european neonatal intensive care units****J. Ten Barge^{1*}, G. Van Den Bosch¹, N. Meesters¹, K. Allegaert², C. Arribas³, G. Cavallaro⁴, F. Garrido Martinez Salazar³, G. Raffaelli^{4,5}, M. Vermeulen¹, S. Simons¹**

¹*Sophia Children's Hospital, Department of Pediatrics, Division of Neonatology, Rotterdam, Netherlands*

²*KU Leuven, Department of Development and Regeneration, and Pharmaceutical and Pharmacological Sciences, Leuven, Belgium*

³*Clínica Universidad de Navarra, Department of Pediatrics, Madrid, Spain*

⁴*Fondazione IRCCS Ca' Granda Ospedale Maggiore Policlinico, Neonatal Intensive Care Unit, Milan, Italy*

⁵*Università degli Studi di Milano, Department of Clinical Sciences and Community Health, Milan, Italy*

BACKGROUND AND AIMS

Necrotizing enterocolitis (NEC) is a highly painful neonatal complication that requires optimal pain assessment and individualized analgesic therapy. There is an utter lack of knowledge and no international guidelines for pain management in neonates with NEC. Therefore, this study aims to describe current pain management for NEC in European neonatal intensive care units (NICUs).

METHODS

An online survey was designed and conducted, on behalf of the ESPR Neonatal Pain Special Interest Group, to assess current practice in pain management for

NEC in European NICUs. The survey was distributed using national neonatal societies, digital platforms, and professional contacts. One neonatologist per NICU was required to complete the survey.

RESULTS

Out of the 259 responding unique European NICUs from 36 countries, 61% have a written standard protocol for analgesic therapy, 73% measure NEC patients' pain, and 92% treat NEC patients with intravenous analgo-sedatives. Initial analgesic therapy most commonly includes acetaminophen (70%), fentanyl (56%) or morphine (49%). In case of persisting pain, analgesic therapy is intensified by increasing the dose (92%), adding an extra analgo-sedative (53%) or switching to another analgo-sedative (23%). The used pain scale and analgesic therapy are considered adequate by 36% and 48% of NICU representatives, respectively. Frequently mentioned ways to optimize pain management are improved pain measurement, protocols, and better analgo-sedatives.

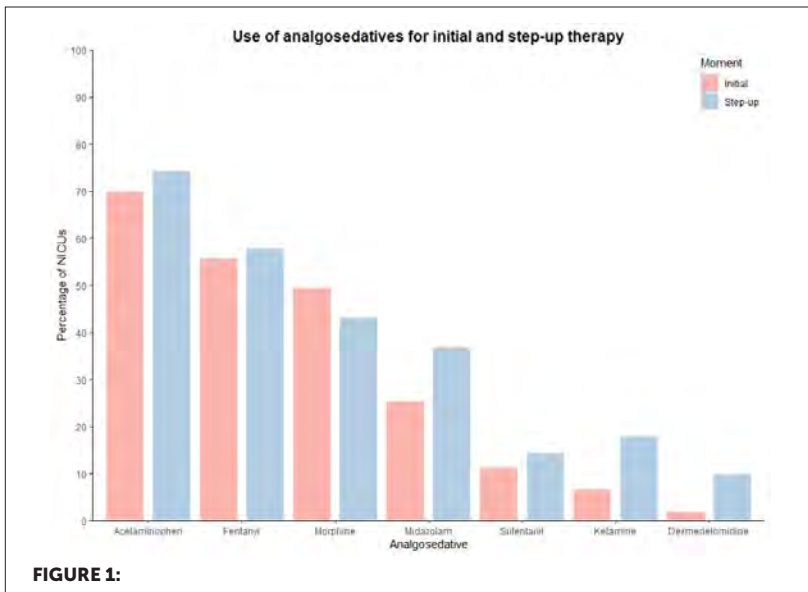

CONCLUSIONS

Various pain scales and analgesic therapy regimens are used to treat NEC patients in NICUs across Europe. Our results provide the first step towards international guidelines for better pain management in preterm neonates.

PD080 / #842**E-poster Discussion Session 11: ESPR - Pain management & comfort****09-10-2022 12:30 - 13:30****Quantification of stress exposure in very preterm infants: development of the neo-stress score****N. Meesters¹, G. Van Den Bosch^{1*}, J. Van Het Hof¹, M. Benders², M. Tataranno², I. Reiss¹, A. Van Kaam³, S. Simons¹, M. Van Dijk^{1,4}**

¹Erasmus MC - Sophia Children's Hospital, Department of Pediatrics, Division of Neonatology, Rotterdam, Netherlands

²University Medical Center Utrecht Brain Center, Department of Neonatology, Utrecht, Netherlands

³Amsterdam UMC location University of Amsterdam, Neonatology, Amsterdam, Netherlands

⁴Pediatric Intensive care, Erasmus MC - Sophia Children's Hospital, Rotterdam, Department of Pediatric Surgery, Rotterdam, Netherlands

BACKGROUND AND AIMS

Stress during NICU treatment has long-term negative consequences on the preterm infants' development. We developed an instrument to validly determine the cumulative level of stress exposure for preterm infants in a NICU.

METHODS

In this survey study, two consecutive questionnaires were sent to all nine NICUs in the Netherlands to be filled in by NICU nurses and physicians. First, respondents rated the relevance of 77 items encompassing potentially stressful procedures, commented on their comprehensibility and the comprehensiveness of the list. We calculated the content validity per item (CVI-I) and included only the relevant items in the second questionnaire in which the participants rated the stressfulness of the remaining items from 0 (not stressful) to 10 (extremely stressful). A stressfulness index (SI) was calculated for each included item represented as the median score.

RESULTS

Based on the CVI-I of the 77 items, step 1 resulted in a list of 38 relevant items to quantify stress in preterm infants during the first 28 days of life. The CVI-I for 34 of these items was 0.78 or higher. One of these items was split into two items and three items were added to improve comprehensiveness. The SI ranged from five to nine.

CONCLUSIONS

The NeO-stress score consists of stressful items including their severity index and was developed to determine cumulative stress exposure of preterm infants. Evaluating the cross-cultural validity and its ability to predict preterm infants at risk for the negative effects following stress might expand the possibilities for this instrument.

PD081 / #1430**E-poster Discussion Session 11: ESPR - Pain management & comfort****09-10-2022 12:30 - 13:30****Parents' vocal contact in the neonatal unit and infant's face preference at 7 months****A. Aija^{1,2}, J. Leppänen³, L. Aarnos⁴, M. Hyvönen⁵, L. Toome¹, L. Lehtonen^{2,6*}**¹Tallinn Children's Hospital, Department of Neonatal and Infant Medicine, Tallinn, Estonia²University of Turku, Department of Pediatrics, Turku, Finland³University of Turku, Department of Psychology and Speech-language Pathology, Turku, Finland⁴University of Turku, Department of Medicine, Turku, Finland⁵University of Turku, Department of Psychology, Turku, Finland⁶Turku University Hospital, Department of Pediatrics and Adolescent Medicine, Turku, Finland**BACKGROUND AND AIMS**

Parents' involvement in neonatal care is a promising approach to improve preterm infant's neurodevelopmental outcomes. We examined whether parental voice during neonatal care is associated with early social-cognitive development in preterm infants, assessed by an attentional preference for faces over non-face.

METHODS

A prospective clinical study was conducted in two neonatal units in Finland and Estonia including preterm infants born before 32 gestational weeks and their parents. The infant's language environment was assessed using 16-hour-recording and Closeness Diary data for 14 days during the first hospital stay. Holding of attention on faces and non-face patterns under condition of distraction was measured at the corrected age of 7 months.

RESULTS

A total of 63 preterm infants were included in the study. Infants were less likely to disengage their attention from faces (Med=.53) than patterns (Med=.18), $p < .001$, $d=0.84$, with no differentiation of parent (Med=.55) vs. unfamiliar adult (Med=.55) faces. Parent word count during the neonatal period was positively correlated with the preference for faces over patterns ($r = 0.30$, $p = .02$) and a preference for parent over unfamiliar adult faces ($r = .31$, $p = .01$). In separate analyses, mother word count was more strongly associated with infant face preference than father word count.

CONCLUSIONS

The results demonstrate an association between parental voice during the neonatal period and the development of attentional differentiation of faces and non-faces as well as familiar and unfamiliar faces. Parental voice has potential benefits on early social development in preterm infants.

PD082 / #1841**E-poster Discussion Session 12: EAP - Paediatric potpourri - for everyone 02****09-10-2022 12:30 - 13:30****Numbers, conditions, demographics and medical complexity of young people with life-limiting conditions reaching transition age in England - repeated cross-section study****S. Jarvis^{1*}, G. Richardson², K. Flemming¹, L. Fraser¹**¹University of York, Health Sciences, York, United Kingdom²University of York, Centre For Health Economics, York, United Kingdom**BACKGROUND AND AIMS**

There are increasing numbers of children with life-limiting conditions in England, in part due to increased survival times. There is a lack of information on how many reach ages at which they start transitioning to adult healthcare (14-19 years) and what their healthcare needs are, essential data for service planning. This study aimed to quantify the number of young people with life-limiting conditions in England reaching transition ages or their medical complexity.

METHODS

National hospital records in England were used to identify the young people aged 14-19 years from 2012/13 to 2018/19 with life-limiting conditions diagnosed in childhood. Indicators of medical complexity were assessed: number of conditions, number of main specialties of consultants involved, number of hospital admissions and Accident & Emergency Department visits, length of

stay, bed days and technology dependence (gastrostomies, tracheostomies). Overlap between measures of complexity was assessed.

RESULTS

There were 20363 14-19 year olds with life-limiting conditions childhood-diagnosed in 2012/13, rising to 34307 in 2018/19. There was evidence for increased complexity in numbers of conditions and specialties of consultants involved in care, but limited evidence of increases in average healthcare use per person or increased technology dependence. Healthcare use increased overall due to the increasing size of the population. There was limited overlap between measures of medical complexity.

CONCLUSIONS

The number of young people with life-limiting conditions reaching transition ages is increasing rapidly. Healthcare providers must allocate resources to deal with increasing demand and complexity. The transition must be managed well to limit healthcare resource use and improve experiences.

PD083 / #1866**E-poster Discussion Session 12: EAP - Paediatric potpourri - for everyone 02****09-10-2022 12:30 - 13:30****Emergency fish tales****E. Burke*, M. Bonadonna, T. Bolger, S. Koe**

Childrens Health Ireland at Tallaght, Emergency Department, Dublin, Ireland

BACKGROUND AND AIMS

To assess impact of the fish tank in the emergency department waiting room on child and parental anxiety levels while attending department.

METHODS

Questionnaires were distributed over four days in the paediatric ED. This excluded critically-ill patients who bypassed the waiting-room. Pictorial Faces Anxiety Scale¹ was used to quantify anxiety levels pre-hospital and again in waiting-room, across three age categories. We assessed level of interaction with tank, perceived impact on anxiety and whether the fish tank impacted perception of the hospital. Participants were invited to leave specific comments.

RESULTS

235 questionnaires were returned. Overall children were subjectively mild-moderately anxious pre-hospital. 94% parents reported the tank helped child's anxiety. 204/235 parents reported reduction in their own anxiety levels. 90% report that the waiting-room fish tank positively impacted their child's impression of the hospital, with largest impact in 6-10 year olds. 91% of 1-5

year olds & 92% 6-10 year olds engaged with tank. For children reportedly drawn to a particular colour, blue fish won across all age groups, with yellow in second place.

CONCLUSIONS

An overwhelmingly positive response was seen across all ages with reported alleviation in child and parental anxiety as result of the tank. The tank has a positive impact on children with sensory needs, with many parents commenting specifically on the positive sensory impact of the tank for their child with ASD or intellectual disability. The consistency of the permanent fish family seems to provide distraction, comfort and familiarity for children; in turn alleviating anxiety for families who attend our ED.

PD084 / #1981**E-poster Discussion Session 12: EAP - Paediatric potpourri - for everyone 02****09-10-2022 12:30 - 13:30****Observational study of respiratory syncytial virus (RSV) bronchiolitis admissions to a tertiary hospital before and during COVID-19 pandemic****K. Voutsadaki*, F. Ladomenou, G. Vlachaki**

Venizeleion General Hospital, Pediatrics, Heraklion, Greece

BACKGROUND AND AIMS

SARS-CoV-2 public health measures contributed to a significant shift in transmission of respiratory viruses including respiratory syncytial virus (RSV). Aim of this study was to examine the epidemiology of RSV bronchiolitis admissions during the COVID-19 pandemic in comparison with previous epidemic seasons.

METHODS

We conducted an observational study involving children 1m-16yrs old admitted to a tertiary hospital with PCR confirmed RSV bronchiolitis during two periods: pandemic COVID-19 (March 2020 – December 2021) (prospective study) and pre-pandemic (January 2017 – February 2020) (retrospective study). Demographics and clinical features were compared. Criteria for admission included respiratory distress, hypoxemia, poor feeding, or dehydration.

RESULTS

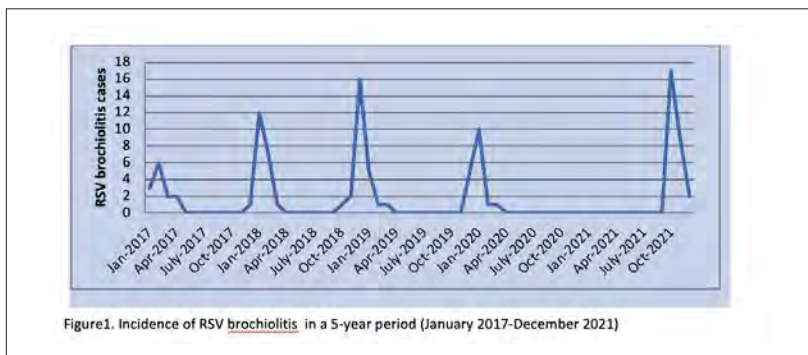

A total of 76 patients were admitted with RSV bronchiolitis during the pre-pandemic period (54% males, mean age 4.2 months; range 30 days – 13.3 months, mean length of stay 5.7 days). After a relative absence of cases during COVID quarantine, we observed an increase in RSV bronchiolitis cases (29 patients, 69% males, mean age 5.6 months; range 30 days-4 years, mean length of stay 4.8 days) and an unexpected early peak of RSV bronchiolitis admission in October-November in comparison to epidemic peaks in December-January in previous years (Figure1). There were no statistically significant differences regarding gender, age and disease severity between the two periods.

CONCLUSIONS

A change in RSV seasonality was observed during COVID-19 pandemic in Greece similarly to other countries. Preventive measures against SARS-CoV2 have probably contributed to reducing RSV transmission in the winter period 2020-2021, with an early outbreak in October-November 2021, which coincided with the relaxation of measures in Greece.

PD085 / #2004**E-poster Discussion Session 12: EAP - Paediatric potpourri - for everyone 02****09-10-2022 12:30 - 13:30****Bacterial pathogens identified in blood and pleural fluid cultures among paediatric pneumonia and empyema patients in Luanda (Angola)****M.-K. Lehto^{1,2*}, L. Reitala^{1,2}, S. Kekomäki², E. Dos Anjos³, S. Silvestre³, E. Gomes³, M. Cruzeiro³, A. Mejjas⁴, T. Pelkonen^{1,2,3}, O. Ramilo⁴**¹University of Helsinki, Faculty of Medicine, Helsinki, Finland²Helsinki University Hospital, Children's Hospital, Helsinki, Finland³Hospital Pediátrico David Bernardino, -, Luanda, Angola⁴Nationwide Children's Hospital, Division of Infectious Diseases, Department of Pediatrics, and Center For Vaccines and Immunity, Columbus, United States of America**BACKGROUND AND AIMS**

Community acquired pneumonia (CAP) is one of the most common causes of paediatric hospitalizations and mortality worldwide. Better knowledge of CAP aetiology will help identify more effective ways to prevent and manage the disease. We are currently studying transcriptomics in Angolan paediatric pneumonia and empyema patients. Here we report bacterial pathogens that were isolated from blood and pleural fluid cultures of the study patients.

METHODS

This is a prospective, observational study of children hospitalized with CAP or empyema in Hospital Pediátrico David Bernardino, Luanda. Patients were previously healthy children aged 2 months – 13 years. Children with sickle cell

disease or HIV were not excluded. Blood and pleural fluid bacterial cultures were performed at the study hospital.

RESULTS

342 children with discharge diagnosis of CAP or empyema (283 and 59, respectively) were enrolled between September 2019 and May 2021. Median age was 3.07 years in the CAP group and 3.08 years in the empyema group. Bacteria were isolated from blood cultures in 48/225 (19%) of CAP patients, and from 11/54 (20%) of empyema patients. 28/50 (58%) of pleural fluid cultures were positive in empyema group. Detected pathogens are summarized in Figure 1. The prevalence of gram-negative bacteria was significantly higher in pneumonia than in empyema patients (69% vs. 28%, $p < .001$) (Figure 2.).

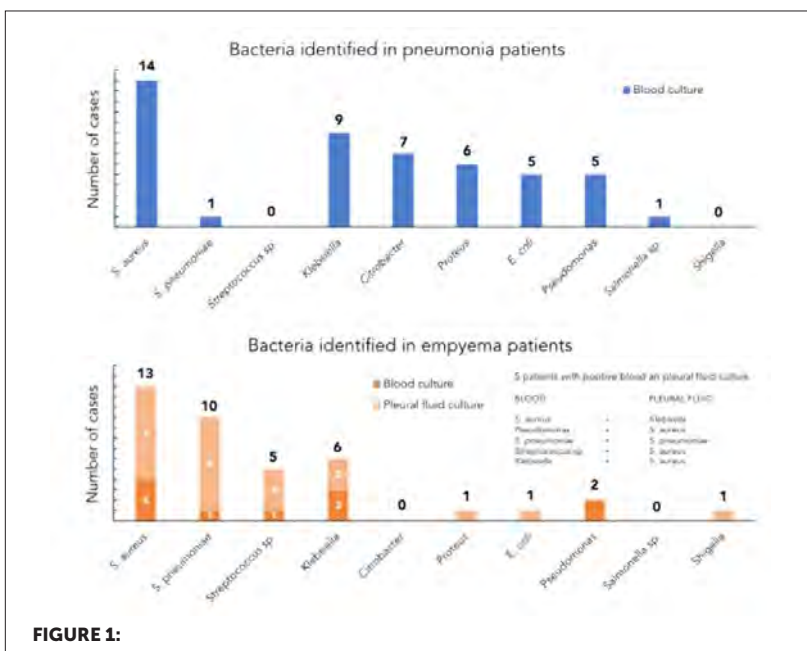

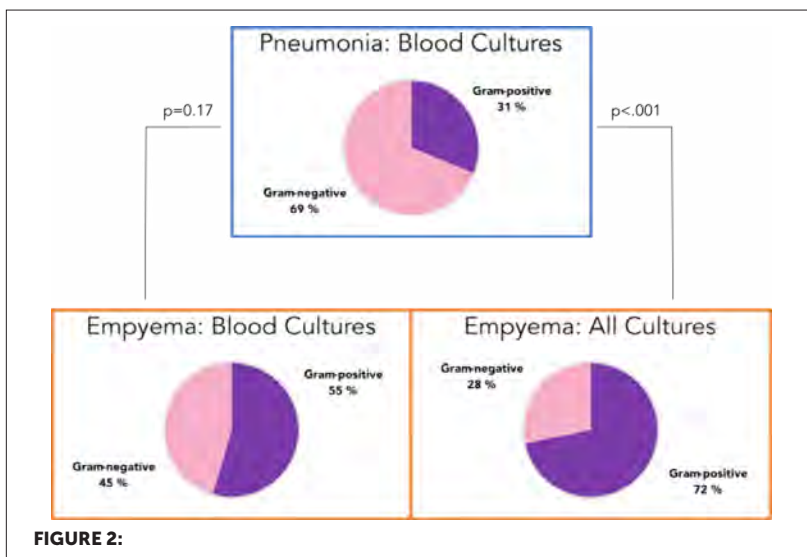

CONCLUSIONS

The prevalence of bacteremia was higher than usually reported in children hospitalized with CAP. Gram-negative bacteria predominated in blood cultures of patients with pneumonia. In contrast, gram-positive species were more common both in blood and pleural fluid cultures of empyema cases.

PD086 / #2035**E-poster Discussion Session 12: EAP - Paediatric potpourri - for everyone 02****09-10-2022 12:30 - 13:30****Differences in bronchiolitis management among infants discharged from pediatric emergency department and admitted to hospital: a ten-year monocentric retrospective study****C. Totaro^{1*}, L. Pierantoni², C. Biagi², A. Dondi², E. Manieri¹, L. Betti¹, M. Mancini¹, M. Lanari²**¹*Alma Mater Studiorum of Bologna, Specialty School of Paediatrics, Bologna, Italy*²*IRCCS Azienda Ospedaliero-Universitaria di Bologna, Paediatric Emergency Unit, Bologna, Italy***BACKGROUND AND AIMS**

Acute bronchiolitis is a viral lower respiratory tract infection in infants. International guidelines recommend supportive therapy and limiting laboratory and radiological exams. The aim of our study was to evaluate the impact of discharge from the pediatric emergency department (PED) on bronchiolitis management.

METHODS

We performed a retrospective chart review of infants <1 year who attended our PED for bronchiolitis from March 2010 to January 2020. We collected demographic, clinical data and administered treatments. Data were compared between children discharged home after evaluation in PED with hospitalized children. Multivariate analyses were performed to evaluate the influence of independent variables on therapy prescriptions.

RESULTS

We enrolled 3,201 patients. Median (IQR) age was 5.73 (3.1-9.0) months, 1,925 (60.1%) were males, 238 (7.4%) were born preterm. After PED evaluation, 1,640 (51.2%) infants were discharged home. Clinical conditions of hospitalized children were more severe than discharged infants and chest X-ray was performed in 729 (46.7%) vs 497 (30.3%) patients, respectively ($P<.001$). Discharge from PED was a significant independent risk factor for antibiotic prescription (OR 2.358, 95%IC 1.237-4.495, $P=.009$), but protective for corticosteroids (OR.368,95%IC.178-.761, $P=.007$), whereas it had no impact on salbutamol administration (OR 1.098, 95%IC.544-2.214, $P.794$).

CONCLUSIONS

Children discharged home after PED evaluation were more likely to receive antibiotics compared to hospitalized children. This finding could be due to a major concern of the clinicians about a possible worsening. Further efforts should be done on clinicians' and parents' education as well as on primary care-hospital integration, in order to avoid inappropriate management.

PD087 / #2072**E-poster Discussion Session 12: EAP - Paediatric potpourri - for everyone 02****09-10-2022 12:30 - 13:30****Drop in routine childhood vaccinations during the Covid-19 pandemic in low- and middle-income countries: what are the causes of the disruption?****A. Cardoso Pinto^{1*}, L. Ranasinghe², S.S. Budhathoki³, J. Seddon^{4,5}, E. Whittaker^{4,6}**¹Imperial College London, School of Medicine, London, United Kingdom²Imperial College London, Academic Foundation Doctor, London, United Kingdom³Imperial College London, Department of Primary Care and Public Health, School of Public Health, London, United Kingdom⁴Imperial College London, Section of Paediatric Infectious Disease, London, United Kingdom⁵Stellenbosch University, Department of Paediatrics and Child Health, Stellenbosch, South Africa⁶Imperial College Healthcare NHS Trust, Department of Paediatric Infectious Disease, London, United Kingdom**BACKGROUND AND AIMS**

The COVID-19 pandemic has disrupted health services worldwide; amongst them routine childhood vaccination programmes. Low- and middle-income countries (LMICs) have been particularly affected, widening previously existing inequalities in vaccination coverage. This study aims to understand the causes of disruptions to vaccination programmes in LMICs.

METHODS

A systematic review was performed using MEDLINE, Embase and Global Health via Ovid, CINAHL, Scopus and medRxiv. Cross-sectional or qualitative studies published in English, French, Portuguese, or Spanish from January 2020 onwards, exploring reasons for missed routine paediatric vaccinations

during the COVID-19 pandemic in LMICs were included. Reported causes and their frequency were extracted onto a pre-defined Excel spreadsheet. Extracted causes were given a descriptive code, merging similar results.

RESULTS

Among the 12 included studies, 14 causes were identified. Responses (n=4240) were mostly reported by parents or caregivers (73.7%), and healthcare professionals (HCPs) (25.5%). The most common cause was fear of COVID-19 (32.8%). Others included personal responses to the pandemic; namely avoiding leaving home (14.7%), transport issues (11.3%), lockdown policy (6.1%), financial issues (4.0%), HCPs unavailable (3.8%), closure of health services (3.7%), discouragement from others (3.7%), unawareness of vaccination service availability (3.0%), negative perception of vaccination (1.9%), inadequate personal protective equipment (1.9%), vaccine supply issues (1.7%), lack of guidance for HCPs (1.4%) and illness (0.6%).

CONCLUSIONS

Reported causes mostly stem from fear of contracting COVID-19 and personal responses towards the pandemic, rather than unavailable health-services. In future, nation leaders and health-services must ensure strong public health messaging to encourage attendance and uptake of routine childhood immunisations.

PD088 / #1874

E-poster Discussion Session 12: EAP - Paediatric potpourri - for everyone 02

09-10-2022 12:30 - 13:30

Audit on timing of brain imaging in the post-resuscitation care of paediatric patients following cardiac arrest

C. Orazulume*

Health Education England East Midlands, Paediatrics, Leicester, United Kingdom

BACKGROUND AND AIMS

Following cardiac arrest, brain imaging in the post-resuscitation care is vital to rule out precipitating factors or changes requiring acute intervention and for the extent of hypoxic ischaemic injury/prognostication. The Standard audited is the " Guideline on the Timing of Post-Cardiac Arrest Brain Imaging " in a UK hospital. **Brain Imaging Timing Guideline:** (1) CT Brain ASAP (2) MRI Brain between 2nd - 5th day, ideally on the 3rd day post-cardiac arrest **Aim:** To measure compliance for brain imaging timing in the post-resuscitation care of paediatric patients following cardiac arrest.

METHODS

Retrospective data collection from the medical notes of patients who were alive following a paediatric cardiac arrest call in a 20 month period from February 2020 to September 2021 in a UK hospital. The cardiac arrest calls reported to the hospital's incident reporting system were used for this audit. Audit Inclusion Criteria: (1) less than 16 years old (2) cardio-pulmonary resuscitation (CPR) for 3 or more minutes and required CPR drug and/or shock (3) no re-orientation of care.

RESULTS

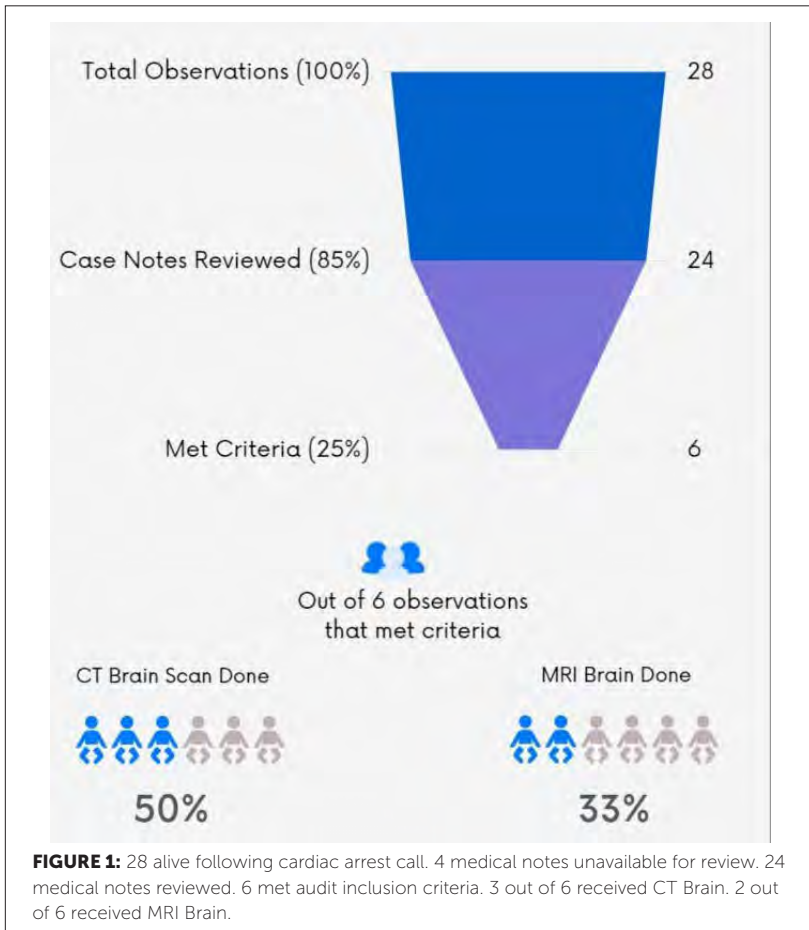

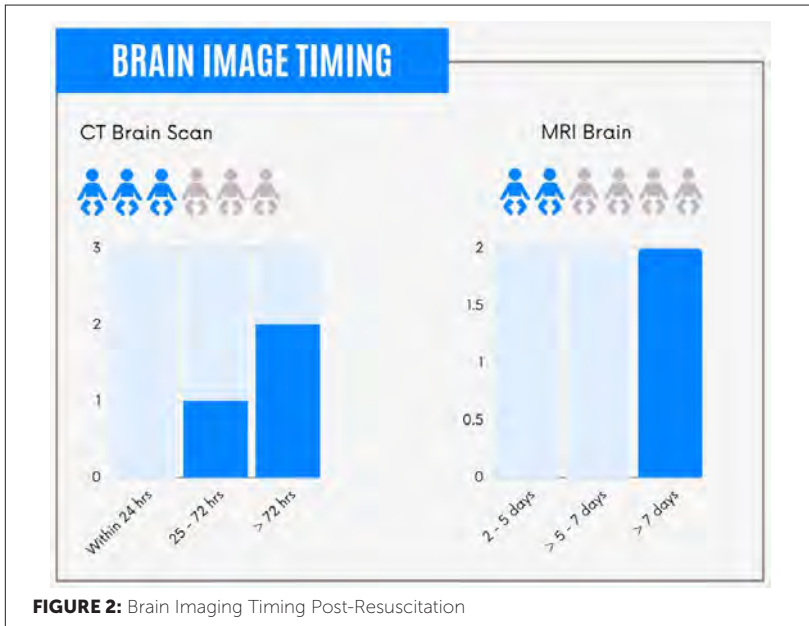

CONCLUSIONS

The result showed that for patients who met the audit inclusion criteria, there was non-compliance with MRI brain timing guidance, and less than 100% compliance in offering CT and MRI brain imaging in their post-resuscitation care.

PD089 / #2516**E-poster Discussion Session 12: EAP - Paediatric potpourri - for everyone 02****09-10-2022 12:30 - 13:30****Tracheostomy in children with neurological or neuromuscular disease: retrospective observational cohort study****C. Fouquerel^{1*}, I. Vaugier¹, B. Mbieleu¹, A. Essid¹, A. Bakayoko¹, J. Zini¹, E. Beltaief¹, M. Guillon², A. Fayssol³, A. Perrier¹, J. Bergounioux¹**¹Raymond Poincaré University Hospital (AP-HP), Departement of Pediatrics, Garches, France²Raymond Poincaré University Hospital (AP-HP), Departement of Pediatrics, Garches, France³Raymond Poincaré University Hospital (AP-HP), Intensive Care Unit, Garches, France**BACKGROUND AND AIMS**

Patients with neurological or muscular conditions account for a growing proportion of pediatric tracheostomies and may exhibit specific features compared to patients with respiratory or upper airway conditions. What are the characteristics and outcomes of pediatric patients who require tracheostomy for a neurological or muscular condition?

METHODS

We retrospectively included patients <18 years who had brain injury (BI), spinal-cord injury (SCI), or peripheral neurological or muscular disease and who underwent tracheostomy between October 2007 and March 2020 at our center. We compared features across the three groups.

RESULTS

of the 173 patients, 151 (87.2%) were followed-up on average 8 years; 20.3% had TBI, 15% SCI, and 64.7% peripheral disease. Mean age at tracheostomy was 7.7 years; 36 (21%) were younger than 1 year. Complications developed in 93 (54%) patients; two were fatal. The mortality rate was 20%. One year after tracheostomy, 161 (93%) patients were still ventilated. During follow-up, the decannulation rate was 21% overall but only 12% in the peripheral-diseases group ($P=0.00041$). Admissions for acute respiratory failure decreased significantly after tracheostomy, from 1.72 ± 1.49 to 0.67 ± 0.88 per year overall ($P<0.0001$) and from 2.04 ± 1.53 to 0.66 ± 0.90 per year in the peripheral-diseases group.

CONCLUSIONS

Compared to other pediatric patients who require tracheostomy, those with neurological or muscular diseases undergo the procedure at an older age. The complication and mortality rates are not higher. Tracheostomy significantly decreases hospital admissions for acute respiratory failure and may therefore deserve to be considered earlier.

PD090 / #2124**E-poster Discussion Session 13: EAP - Paediatric potpourri - for everyone 03****09-10-2022 12:30 - 13:30****The knowledge of parents about the role of antibiotic treatment in acute respiratory infections****A. Holban^{1*}, O. Turcu¹, A. Rotari²**¹State University of Medicine and Pharmacy "Nicolae Testemitanu", Pediatrics, Chisinau, Moldova²The Municipal Children's Hospital No. 1, Pediatrics, Chisinau, Moldova**BACKGROUND AND AIMS**

There is no doubt that antibiotics use for the control of infectious diseases is one of the most important achievements in the history of medicine. However excessive use of antibiotics has created many threats, the most important being bacterial resistance to antibiotics.

METHODS

The study included 207 parents (90.6% mothers and 9.4% fathers) who are caring for a child under five, who agreed to answer the WHO questionnaire for the assessment of knowledge, attitudes and practices with reference to antimicrobial resistance.

RESULTS

Most parents (76.2%) mentioned that antibiotics are different from anti-inflammatory drugs, although there were 49.9% who declared acetaminophen, ibuprofen, and ambroxol as antibacterial remedies. Only 28.0% of parents

agreed that antibiotics are not effective against viruses, and 65.0% of them had a misconception that antibacterial remedies can be used in acute viral infections in children. Paradoxically, 88.2% of parents did not associate their children's fever with the need for an antibiotic. The duration of antibiotic treatment was maintained by 63.8% of parents, another 20.0% of respondents stated that they can stop taking the antibiotic when the child's condition improves. More than half of the participants (66.2%) weren't aware that frequent and irrational use of antibiotics can cause resistance.

CONCLUSIONS

Our study highlighted major deficiencies in parental knowledge of antibiotic treatment in acute respiratory infections in children. More than half of the parents (65%) believe that antibiotics could cure acute viral infections and 66% of parents do not know that frequent administration of antibiotics increases the risk of antibiotic resistance.

PD091 / #2254**E-poster Discussion Session 13: EAP - Paediatric potpourri - for everyone 03****09-10-2022 12:30 - 13:30****Meningitis screening based on a novel, non-invasive, transfontanellar ultrasound device using machine learning techniques: a proof-of-concept study****S. Ajanovic^{1*}, Á. Navarro², R. Quesada², J. Jiménez², M. Lopez³, E. Valverde⁴, M. Ybarra⁴, M.C. Bravo⁴, D. Muñoz⁵, J. Munera⁵, B. Salas⁵, T. Agut⁶, N. Carreras⁶, A. Alarcon⁶, M. Iriondo⁶, C. Luaces Cubells⁵, A. Pellicer⁴, F. Cabañas³, C. Calvo Rey⁷, Q. Bassat¹**¹Barcelona Institute for Global Health (ISGlobal), Global Health and Paediatrics, Barcelona, Spain²Newborn Solutions, Barcelona Science Park, Barcelona (Spain), Neosonics, Barcelona, Spain³Quironsalud Madrid University Hospital. Madrid (Spain), Department of Pediatrics and Neonatology, Madrid, Spain⁴La Paz University Hospital, Madrid (Spain), Neonatology Department, Madrid, Spain⁵Sant Joan de Déu Hospital, Institut de Recerca Sant Joan de Déu, Universitat de Barcelona, Esplugues de Llobregat (Spain), Emergency Department, Esplugues de Llobregat, Spain⁶Sant Joan de Déu Hospital, Institut de Recerca Sant Joan de Déu, Universitat de Barcelona, Esplugues de Llobregat (Spain), Neonatology Department, Esplugues de Llobregat, Spain⁷La Paz University Hospital, Madrid (Spain), Pediatrics and Infectious Diseases Department, Madrid, Spain**BACKGROUND AND AIMS**

Meningitis is a life-threatening disease if not promptly diagnosed and treated. Signs and symptoms at presentation are unspecific, especially among young infants and newborns, justifying the need to perform lumbar punctures (LP) to obtain cerebrospinal fluid (CSF) for a laboratory-based confirmation. In high-income settings, 95% of the LPs are negative and up to 50% traumatic. Machine Learning models have proven to be effective for a broad collection of clinical applications. Our aim is to validate a transfontanellar ultrasound-based

technique to screen for meningitis, designed to non-invasively count white blood cells in the CSF of patients with criteria for a LP. The objectives are to modulate suspicion, minimize iatrogenesis and reduce the need of highly trained personnel.

METHODS

We prospectively recruited patients <1year, with a permeable fontanelle and a LP performed due to suspected meningitis from three Spanish University Hospitals (2021-2022). Images showing the backscatter pattern from the CSF were obtained using a customized ultrasonic probe, working at a central frequency of 20MHz. A Deep Learning model was trained to classify the CSF patterns according to the white blood cells count values obtained through the LP, setting a 30 cells/mL threshold to establish control and meningitis cases.

RESULTS

We recruited 14 participants, 6 with confirmed meningitis and 8 with a negative LP result. The device correctly classified the 6 meningitis cases and 6 out of 8 controls (2 false positive results).

CONCLUSIONS

Our device based on ultrasound images can effectively be used as a screening method to accurately rule out or confirm meningitis.

PD092 / #2409**E-poster Discussion Session 13: EAP - Paediatric potpourri - for everyone 03****09-10-2022 12:30 - 13:30****Disrupted childhoods: a qualitative study of the experiences of children with long covid****C. Wild^{1*}, A. Maclean², Z. Skea³, S. Nettleton¹, K. Hunt², S. Ziebland¹**¹University of Oxford, Primary Care Health Sciences, Oxford, United Kingdom²University of Stirling, Institute For Social Marketing, Stirling, United Kingdom³University of Aberdeen, Health Services Research Unit, Aberdeen, United Kingdom**BACKGROUND AND AIMS**

There are over a million people living with Post-acute sequelae of COVID-19, or Long Covid (symptoms persisting 12+ weeks following initial Covid infection) in the UK. Children's experiences and the wider impact on families have received little attention to date. The aim of this study was to understand the current challenges of children experiencing Long Covid and their parents regarding self-care, management, treatment and recovery.

METHODS

In-depth, narrative interviews with families were undertaken over video-call. Participants were children and adolescents (aged 10-18 years) and parents/caregivers of young children (<10 years) with Long Covid (n=40). Maximum variation sampling was used to ensure inclusion of a wide variety of experiences and views. Interviews focused on the development of Long Covid, its impact on daily family life and experiences accessing healthcare. Data were analysed thematically.

RESULTS

Three key challenges were identified. Children, adolescents and their families experienced difficulties engaging with care due to the continued contested nature of Long Covid, increasing pressures on the health system, and a lack of inter-sectoral coordination. A lack of consistent clinical management pathways results in participants seeking care elsewhere, and recovery for many families appears uncertain.

CONCLUSIONS

Long Covid presents a new challenge for paediatrics and wider primary care. Children and families' experiences provide unique insights into a complex condition that is being experienced at a time when evidence is evolving rapidly and health systems are increasingly strained. Prioritising their voices alongside clinical trials is vital in order to provide appropriate and supportive care.

PD093 / #749**E-poster Discussion Session 13: EAP - Paediatric potpourri - for everyone 03****09-10-2022 12:30 - 13:30****Characteristics of infant formula consumed in the first months of life and risk of allergy in the Eden mother-child cohort****M. Adjibade, L. Vigneron, M.-A. Charles, B. Heude, B. De Lauzon-Guillain***

Université Paris Cité, Inserm, Inrae, Cress, Paris, France

BACKGROUND AND AIMS

Data regarding the characteristics of infant formula consumed in relation to allergy risk are limited and inconclusive. This study aimed to evaluate whether the characteristics of infant formula consumed in the first months of life were associated with the risk of allergy in childhood.

METHODS

The study sample consisted of 1,089 formula-fed children from the EDEN mother-child cohort. Infant formula characteristics (long-chain polyunsaturated fatty acids (LCPUFA) enrichment, prebiotic/probiotic enrichment, and partially hydrolyzed proteins) were identified from the ingredients list of the formula consumed at age 4 months. Eczema, wheezing, food allergy, asthma, and allergic rhinitis up to 8 years were prospectively reported by parents, using the ISAAC questionnaires. Multiple logistic regression models were used to assess associations for each characteristic/outcome.

RESULTS

At 4 months, 6.7% of infants consumed LCPUFA-enriched formula, 31.7% prebiotic/probiotic-enriched formula and 12.9% partially hydrolyzed formula (pHF). Consumption of LCPUFA-enriched formula was associated with a lower risk of any allergy. Consumption of pHF was associated with a higher risk of allergic rhinitis in the overall sample, higher risk of any allergy and eczema among infants whose mothers had a history of allergy, and higher risk of food allergy among infants whose mothers had no history of allergy. Prebiotic and probiotic enrichment was not associated with allergies up to 8 years.

CONCLUSIONS

This observational study suggests that consumption of LCPUFA-enriched formula is associated with a lower risk of allergy, but not pHF consumption. Further studies are needed to confirm these results.

PD094 / #968**E-poster Discussion Session 13: EAP - Paediatric potpourri - for everyone 03****09-10-2022 12:30 - 13:30****Intranasal dexmedetomidine versus intranasal midazolam via mucosal atomization device for prevention of emergence agitation in pediatric cataract surgery under sevoflurane: a randomized controlled trial****V. Saini^{1*}, S. Sethi², J. Ram³, B. Khullar⁴**¹Post Graduate Institute of Medical Education and Research, Anaesthesiology, Chandigarh, India²Post Graduate Institute of Medical Education and Research, Anaesthesiology, Chandigarh, India³PGIMER, Ophthalmology, Chandigarh, India⁴PGIMER, Anaesthesiology, Chandigarh, India**BACKGROUND AND AIMS**

Emergence Agitation is a state of aggressive delirium that can occur temporarily in the process of emerging from anaesthesia and occurs most often during the early stages of emergence. Ocular surgeries have increased incidence of emergence agitation probably due to disturbed vision and eye patching upon waking up.

METHODS

Ours was a prospective, double-blind, randomized controlled trial which was undertaken in a tertiary care centre in North India. For our study, written informed consent was taken for children undergoing elective cataract surgery between the age group of 3 and 11 years. Group M received Intranasal Midazolam 0.2 mg per kg (max 5 mg) via MAD, 30 minutes before the surgery.

Group D received Intranasal Dexmedetomidine 2 microgram per kg via MAD, 30 minutes before the surgery. OUTCOME- The primary outcome of our study was the incidence of emergence agitation in the children undergoing cataract surgery under sevoflurane anaesthesia. The incidence of emergence agitation was measured by the PAED scale.

RESULTS

Primary outcome of our study i.e. Emergence Agitation was measured by the PAED scale. It was taken at various intervals in the PACU and the maximum PAED score was noted for that interval. The incidence of EA was more in the Midazolam group (22.4 %) as compared to dexmed group (10.2%).

CONCLUSIONS

The current study demonstrated that use of intranasal dexmedetomidine via MAD decreased the incidence of emergence agitation, lowered the preoperative anxiety, provided better sedation, better face mask acceptance as well as better parent satisfaction as compared to Midazolam via the same route.

PD095 / #667**E-poster Discussion Session 13: EAP - Paediatric potpourri - for everyone 03****09-10-2022 12:30 - 13:30****A decade of milk ladder in Ireland: are we achieving our goals?****L. Flores Villarta¹, T. Ah Hang¹, C. Cronin², S. Hanley³, J. Hourihane³, M. Sexton², J. Trujillo Wurttele^{2,4,5*}**¹University College Cork, Infant Research Centre, Cork, Ireland²University College Cork, Department of Paediatrics and Child Health, Cork, Ireland³Royal College of Surgeons in Ireland, Paediatrics, Dublin, Ireland⁴Cork University Hospital, Paediatrics, Cork, Ireland⁵Cork University Hospital, Infant Research Centre, Cork, Ireland**BACKGROUND AND AIMS**

Cow's milk protein allergy (CMPA) is one of the most common food allergies reported in the paediatric population. In Ireland, since 2011, CMPA is treated using the milk ladder, with good results. However, the management of CMPA is still debated around the world. The aim of this project is to evaluate the clinical features of the use of milk ladder approach in our cohort of infants.

METHODS

This is a retrospective descriptive study of a sample of 200 patients collected from 2011-2020. They were diagnosed clinically with CMPA confirmed by a SPT of ≥ 3 or a positive specific IgE for milk and they were all treated with milk ladder in the paediatric allergy service in Cork University Hospital (CUH).

RESULTS

The median age at diagnosis was 8 months and the existence of other conditions was commonly observed. Infants were commenced on the milk ladder at the age of 12 months and the median duration of the treatment was 12 months. 80.2% (154) of the subjects fully completed the reintroduction of the milk. 44.27% (85) patients had symptoms during treatment from the milk ladder being the skin-related symptoms the most prevalent. The duration of the symptoms is shown in Table 1. 21.9% (42) suffered at least 1 accidental exposure to milk and 5 children had anaphylaxis.

TABLE 1:

		Duration of Symptoms (months)			Cumulative
		Frequency	Percent	Valid Percent	Percent
Valid	First 6 steps	43	22.4	50.6	50.6
	Last 6 steps	31	16.1	36.5	87.1
	All 12 steps	11	5.7	12.9	100.0
	Total	85	44.3	100.0	
Missing	System	107	55.7		
Total		192	100.0		

CONCLUSIONS

Although allergic symptoms were commonly observed, most patients were able to maintain the reintroduction following simple directions. Therefore, we think that cow's milk could be safely reintroduced at home following the milk ladder after medical recommendations and a dietary plan.

PD096 / #910**E-poster Discussion Session 13: EAP - Paediatric potpourri - for everyone 03****09-10-2022 12:30 - 13:30****Determinants of incomplete vaccination in 2-year-olds: from the French nationwide ELFE cohort****M. Jacques^{1*}, F. Lorton¹, M.-N. Dufourg², C. Bois², E. Launay¹, T. Siméon², J. Raude³, C. Gras-Le Guen¹, D. Lévy-Brühl⁴, M.-A. Charles², M. Chalumeau¹, P. Scherdel¹**

¹Université Paris Cité, Inserm, Centre for Research in Epidemiology and Statistics (CRESS), Perinatal and Pediatric Obstetrical Epidemiology Research Team, Paris, France

²French Institute for Demographic Studies (Ined), Inserm, French Blood Agency, Elfe Joint Unit, Aubervilliers, France

³School of Public Health, Ehesp, Rennes, France

⁴French National Public Health Agency, Santé Publique France, Saint Maurice, France

BACKGROUND AND AIMS

Incomplete vaccination in the paediatric population is a growing public health issue in high-income countries, but its determinants are poorly understood. We aimed to assess the determinants of incomplete vaccination in 2-year-old children.

METHODS

Among the 18,329 children included in the 2011 ELFE French nationwide population-based birth cohort, we selected those for whom vaccination status was available at age 2 years. Incomplete vaccination was defined as ≥ 1 missing dose of recommended vaccines. Potential determinants of

incomplete vaccination were identified by using logistic regression, taking into account attrition and missing data.

RESULTS

of the 5,740 (31.3%) children analysed, 46.4% (95% confidence interval [CI] 44.6–48.0) were incompletely vaccinated. Factors independently associated with incomplete vaccination were having older siblings (adjusted odds ratio 1.18, 95% CI [1.03–1.34] and 1.28 [1.06–1.54] for one and ≥ 2 siblings, respectively, vs 0), residing in an isolated area (1.92 [1.36–2.75] vs an urban area), parents not following health recommendations or using alternative medicines (1.81 [1.41–2.34] and 1.23 [1.04–1.46], respectively, vs parents confident in institutions and following health recommendations), not receiving any visit from a maternal and child protection services nurse during the child's first 2 months (1.19 [1.03–1.38] vs ≥ 1 visit), and being followed by a general practitioner (2.87 [2.52–3.26] vs a paediatrician or a maternal and child protection services physician).

CONCLUSIONS

Incomplete vaccination was highly prevalent in the studied paediatric population and was associated with several socio-demographic, parental and healthcare service characteristics. These findings may help in designing targeted corrective actions.

PD097 / #2167**E-poster Discussion Session 13: EAP - Paediatric potpourri - for everyone 03****09-10-2022 12:30 - 13:30****A quality improvement project: improving the standards of care for children less than 5 year old presenting to emergency department with fever****E. Nebati*, C. Diaz, J. Ray**

Oxford University Hospitals NHS FT, Emergency Department, OX AL, United Kingdom

BACKGROUND AND AIMS

Fever is one of the most common reasons of children presenting to A&E. Managing many feverish children, we ran an audit looking at the management of the children against to NICE guideline. The aim of this project was to increase the percentage of feverish children having their timely initial assessment in 15 minutes, sepsis score calculated and having senior review.

METHODS

Driver diagrams were used to set out the aims, and PDSA cycle was used to facilitate change. Surveys used to collect information to identify the reasons of non-compliance to standards and teaching sessions were arranged to educate the staff. Posters were created to raise awareness. We trained 29 members of the staff. Weekly data was collected randomly, and the results was widely shared with the team.

RESULTS

The data was collected from electronic patient records. Out of 187 patients, only 34% of them had senior review, 24% had sepsis score and 36% had initial timely assessment in 15 minutes between May to August 21. After the interventions, the number of children having senior review had almost tripled to 90%. The percentage of children having sepsis score has doubled to 46%, whereas a decline has been identified in the number of children having initial assessment in 15 minutes from 51% to 35.5%. By improving the primary drivers, the percentage of children having timely initial assessment has increased on the snapshot of audit to 56.4% between February to March 22 in the second cycle.

CONCLUSIONS

This project has made a significant improvement in the management of feverish children in the emergency department.

PD098 / #2267**E-poster Discussion Session 13: EAP - Paediatric potpourri - for everyone 03****09-10-2022 12:30 - 13:30****Viral respiratory infection epidemiology in young children during the COVID-19 pandemic: a single center analysis from a Belgian university hospital****D. Shen^{1*}, F. Vermeulen², A. Debeer³, K. Lagrou⁴, A. Smits³**¹*KU Leuven, Faculty of Medicine, Leuven, Belgium*²*Department of Pediatrics, University Hospitals Leuven, Department of Development and Regeneration, KU Leuven, Leuven, Belgium*³*Neonatal Intensive Care Unit, University Hospitals Leuven, Department of Development and Regeneration KU Leuven, Leuven, Be, Belgium*⁴*Department of Laboratory Medicine and National Reference Centre for Respiratory Pathogens, University Hospitals Leuven, Department of Microbiology, Immunology and Transplantation, KU Leuven, Leuven, Belgium***BACKGROUND AND AIMS**

By use of nonpharmaceutical interventions (NPIs) to reduce the SARS-CoV-2 spread, surveillance studies reported a reduced occurrence of respiratory pathogens like influenza viruses (IAV & IBV) and respiratory syncytial virus (RSV). We hypothesized to observe this collateral benefit on viral respiratory infection epidemiology in young children.

METHODS

Respiratory samples of children (<6 years), presenting at the University Hospitals Leuven, Belgium, between April 2017 and April 2021 were retrospectively analyzed. The occurrence (positivity rate), and seasonal patterns of viral respiratory infections were described. Chi-squared or Fisher's exact

test were used to explore differences in occurrence between 2020-2021 and previous 12-month periods.

RESULTS

453 respiratory panels and 2567 single SARS-CoV-2 tests were included. IAV and IBV were not detected from March and January 2020, respectively. For IAV, positivity rate in 2020-2021 (0%, n=0) was significantly lower than 2018-2019 (12.4%, n=17) ($p<0.001$) and 2019-2020 (15.4%, n=19) ($p<0.001$). RSV occurrence was significantly lower in 2020-2021 (3.2%, n=3), compared to 2017-2018 (15.0%, n=15) ($p=0.006$), 2018-2019 (16.1%, n=22) ($p=0.002$) and 2019-2020 (22.8%, n=28) ($p<0.001$). The RSV (winter) peak was absent and presented later (March-April 2021). Positivity rate of parainfluenza virus 3 was significantly higher in 2020-2021 (11.8%, n=11) than 2017-2018 (1%, n=1). From March 2020 onwards, 20 SARS-CoV-2 cases (0.7%) were identified.

CONCLUSIONS

Compared to the 3 previous periods, no IAV and IBV cases occurred in the 2020-2021 study period, and RSV presented later. Consequently, introduction of NPIs seemed to impact viral infection epidemiology in young children, but continuation of surveillance is indicated.

PD099 / #2443**E-poster Discussion Session 13: EAP - Paediatric potpourri - for everyone 03****09-10-2022 12:30 - 13:30****Impact of serum igg level on infections in patients with primary antibody deficiencies receiving intravenous immunoglobulins****M. Ouederni^{1,2}, T. Lamouchi^{1*}, I. Benfraj¹, S. Rekaya¹, M. Said¹, S. Frigui³, Y. Chebbi³, R. Kouki¹, F. Mellouli¹, M. Bejaoui¹, A. Wafa¹, M. Benkhaled¹**¹Bone Marrow Transplant Center, Pediatrics, Tunis, Tunisia²University Tunis ElManar, Faculty of Medicine, Tunis, Tunisia³bone Marrow Transplant Center, Laboratory of Microbiology, Tunis, Tunisia**BACKGROUND AND AIMS**

Recurrent infection is the predominant presenting complaint for primary antibody deficiency (PAD) disorders. The benefit of immunoglobulin (IG) is unquestionable. The aim of our study is to establish infections profile and serum IgG trough concentration efficiency in preventing infections.

METHODS

forty patients with PAD were enrolled. Each of them benefited of IG replacement therapy with monitoring of residual serum IgG. Clinical and immunological data were retrospectively analyzed.

RESULTS

The mean age at diagnosis was 168 months [11;560] with a sex ratio of 1,85. The most common etiologies were CVID (42,5%) and XLA (17,5%). Infections occurred 2, 23 times/patient/year requiring hospitalization in 22,5 % cases (mean hospitalization duration was 8,8 days/patient/year) and anti biotherapy 1,1 times/patient/year. The most frequent infections were upper respiratory tract infections (1,15 times/patient/year) and pneumonia (0,57 times/patient/year). Bronchiectasis development occurred for 37,5% of patients. The mean IG maintenance dose was 542 mg/kg every 3 weeks with a mean serum IgG trough concentration of 9,6g/dl. Data analysis revealed that a serum IgG trough of 8.6 g/dl or higher was effective in preventing acute bacterial infections. This threshold was higher for patients with bronchiectasis (9,4g/dl).

CONCLUSIONS

No other therapy has been demonstrated to be as efficacious as IG in reducing the number and severity of infectious complications in pediatric patients with PAD. Our study suggests a threshold of 8,6g/dl residual serum IgG for optimal prevention of infections. The serum IgG trough target must be higher for patients with bronchiectasis.

PD100 / #848**E-poster Discussion Session 14: ESPR - Preclinical models of brain injury****10-10-2022 12:30 - 13:30****Pharmacokinetics and safety of high and low-dose caffeine citrate in a piglet model of inflammation-augmented hypoxia-ischaemia****C. Meehan^{1*}, A. Mintoft¹, R. Pang¹, G. Norris¹, E. Campbell¹,
K. Tucker¹, A. Avdic-Belltheus², C. Blain², J. Straube², T. Atkinson²,
N. Robertson¹**¹University College London, Neonatology, Institute For Women's Health, London, United Kingdom²University of Edinburgh, Neonatal Neuroprotection, The Roslin Institute, Edinburgh, United Kingdom**BACKGROUND AND AIMS**

Therapies for neonatal encephalopathy (NE) are urgently needed, particularly in LMICs where there are concerns around the safety and efficacy of therapeutic hypothermia (Thayyil, 2021). Caffeine citrate is a promising therapy, used routinely in babies for apnoea of prematurity with beneficial effects on outcome. Neuroprotective efficacy has been observed when given after hypoxia-ischaemia (HI) in rodent models (Alexander, 2013). We aimed to assess safety and PK of high and low dose intravenous caffeine citrate prior to studying neuroprotective efficacy in the newborn piglet model.

METHODS

Six newborn Large White piglets were administered intravenous caffeine citrate at either low dose (n=3) 20mg/kg at 1h, followed by 10mg/kg at 24h & 48h, or high dose (n=3) 60mg/kg at 1h, followed by 30mg/kg at 24h & 48h. Physiological parameters (MABP, HR, QTc, K+) were monitored for 54h.

Plasma samples were collected at intervals and concentration determined using Liquid Chromatography-Mass Spectrometry.

RESULTS

We observed no significant difference in physiological parameters between doses (figure 1), which were within normal range. One low dose animal developed arrhythmia during first dose administration. Plasma concentrations demonstrated a dose dependent increase with AUC_{54h} of 2,600mg/L*h (high) and 890mg/L*h (low), a 2.95-fold difference. There was accumulation of caffeine citrate with subsequent maintenance doses, achieving final concentrations of 70mg/L (high) and 24mg/L (low) at 54h.

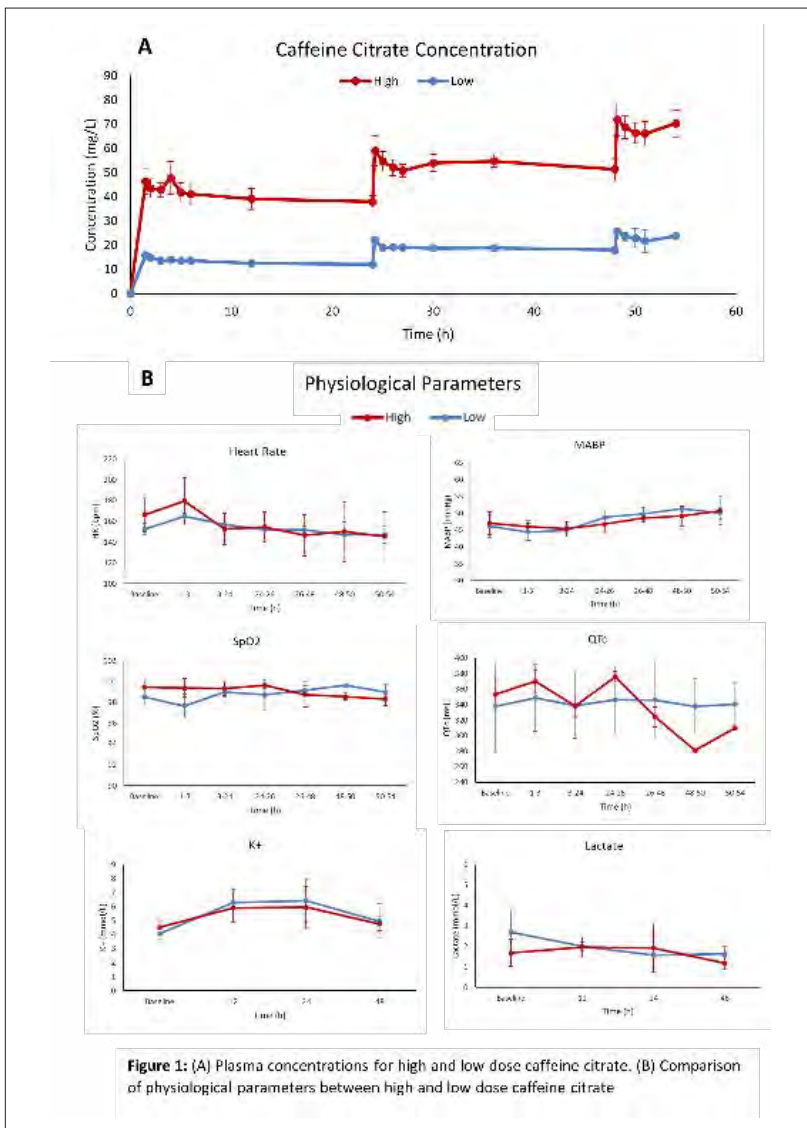

CONCLUSIONS

Adverse physiological effects were minimal with no physiological effect related to caffeine citrate plasma levels. As the optimal caffeine citrate concentration for neuroprotection after HI is unknown, both doses will be assessed for efficacy. Funding: Bill&Melinda Gates Foundation

PD101 / #1241**E-poster Discussion Session 14: ESPR - Preclinical models of brain injury****10-10-2022 12:30 - 13:30****The effect of remote ischemic postconditioning in moderate to severe hypoxia-ischemia on MR markers of brain injury; a newborn piglet model****L. Hansen^{1*}, T.C.K. andelius¹, H. andersen¹, M. andersen¹, M. Pedersen¹, R. Pinnerup¹, S. Schaaning¹, K.V. Seiersen¹, N. Bøgh², E. Hansen², C. Laustsen², K. Kyng¹, T. Henriksen¹**¹Aarhus University Hospital, Department of Pediatrics, Aarhus N, Denmark²Aarhus University Hospital, The Mr Research Centre, Aarhus, Denmark**BACKGROUND AND AIMS**

Remote ischemic postconditioning (RIPC) is a potential neuroprotective treatment for new-borns with hypoxic ischemic encephalopathy (HIE). MR Spectroscopy brain Lactate/N-Acetyl-Aspartate (Lac/NAA) ratio seems to improve with RIPC in hypoxic-ischemic (HI) piglets. The aim of this study was to investigate the neuroprotective effects of RIPC combined with therapeutic hypothermia (TH) in piglets.

METHODS

34 piglets were anaesthetized, subjected to a standardized global HI insult, and randomized to; RIPC+TH (n = 13), TH (n = 13), or normothermia (NT) (n = 8). RIPC was performed by occluding blood flow to both hind limbs for five minutes followed by five minutes of reperfusion in four cycles. RIPC was repeated after 12 and 24 hours. MRS/MRI was performed after 44 hours. Our primary outcome was the Lac/NAA ratio. Secondary outcomes were

measures of cerebral edema (ADC), oxygenation (BOLD), and blood flow (ASL) measured by MRI.

RESULTS

Baseline- and insult characteristics were similar between the groups. Three piglets died in each of the two treatment groups and four in the NT group. We found no difference between the three groups in brain Lac/NAA ratio (Fig. 1A) or in MRI measures of cerebral edema, oxygenation, and blood flow (Fig. 1B).

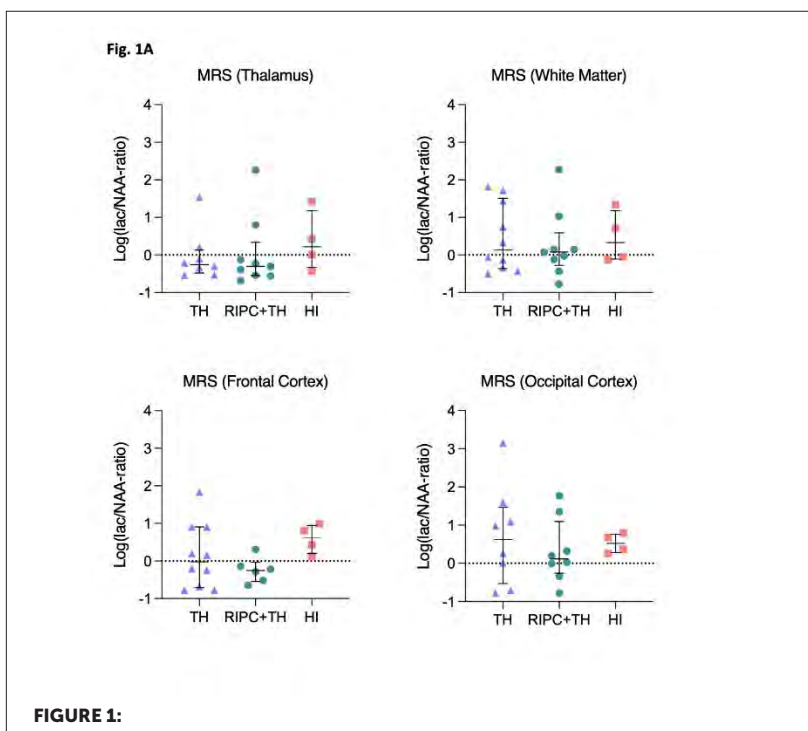

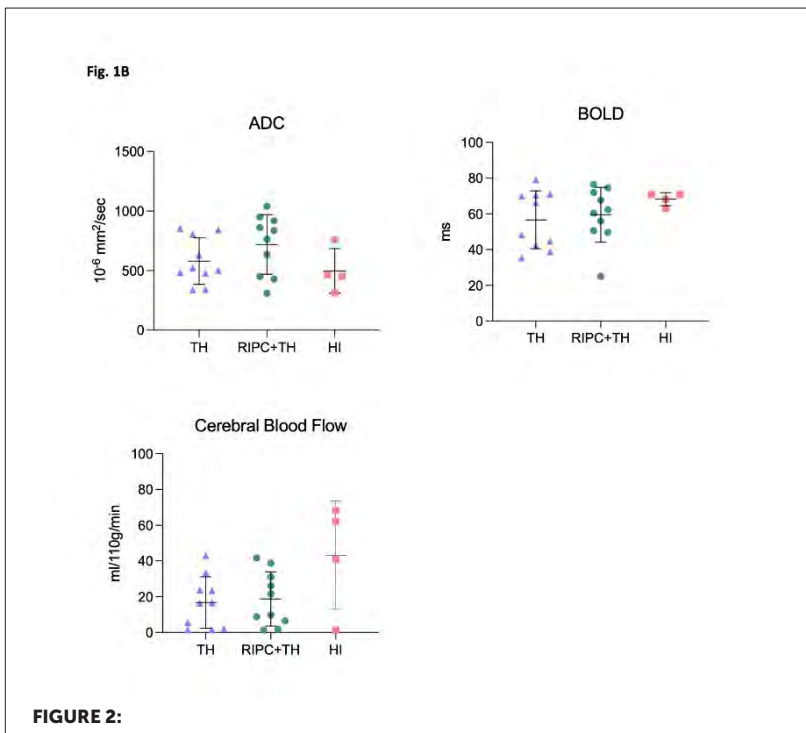

CONCLUSIONS

RIPC showed no added neuroprotective effect by various MR measures in combination with TH following HI in newborn piglets. Survival bias will be explored in more detail prior to presenting results due to the lack of difference MR measures between the HI only group and higher mortality in this group than in the two groups subjected to TH.

PD102 / #1248

E-poster Discussion Session 14: ESPR - Preclinical models of brain injury

10-10-2022 12:30 - 13:30

Evaluation of the preventive effects of IGF-1/IGFBP-3 on the development of glycerol-induced intraventricular hemorrhage in a preterm rabbit pup model

C. Ekström^{1*}, B. Holmqvist², N. Ortenlöf¹, X. Wang³, N. Barton⁴, M. Gram¹, D. Ley¹

¹Lund University, Skåne University Hospital, Department of Clinical Sciences, Paediatrics, Lund, Sweden

²ImageIT, Immunohistochemistry, Lund, Sweden

³Kvinnokliniken, SU/Östra, Department of Obstetrics and Gynecology, Göteborg, Sweden

⁴Oak Hill Bio, Scientific Advisory Board, Boston, United States of America

BACKGROUND AND AIMS

We aimed to investigate the potential for IGF-1/IGFBP-3 to prevent the occurrence of intraventricular hemorrhage (IVH), and to define a therapeutic window of intervention, in the preterm rabbit pup model of glycerol-induced IVH.

METHODS

Preterm rabbit pups were delivered by cesarean section on E29 (term 32 days), corresponding to a human brain maturation of approx. 24-28 weeks of gestation. IVH was induced by an i.p. administration of a 50% glycerol solution at 6 to 24-hours post-partum and verified by high-frequency ultrasound (HFU) at 24 and 48 hours. IGF-1/IGFBP-3 (8 mg/kg) (N=38) or saline (N=39) were s.c. administered from 3 hours of age and every 12 hours onwards. The extent

of the hemorrhage was scored in vivo by HFU and assessed post-mortem by histopathological examinations.

RESULTS

Rate of induced IVH was highest 6 hours after delivery (66%) with a decreasing incidence following glycerol administration at later time-points. Histopathologic evaluation confirmed the presence and distribution of the hemorrhage, as shown by HFU, and was similar in all groups. The occurrence of severe IVH was not reduced following IGF-1/IGFBP-3 administration. However, a decreased mortality in pups with IVH was seen following IGF-1/IGFBP-3 administration (12.5%), as compared to saline controls with IVH (30%). Notably, administration of IGF1/IGFBP-3 displayed an increased overall survival (97% vs 82% for saline), regardless of induced IVH.

CONCLUSIONS

A pronounced reduction in mortality in animals with severe IVH, as well as overall, was observed following IGF-1/IGFBP-3 administration. This finding indicates a considerable impact of IGF-1/IGFBP-3 on survival and justifies further investigations.

PD103 / #1514

E-poster Discussion Session 14: ESPR - Preclinical models of brain injury 10-10-2022 12:30 - 13:30

The effect of therapeutic hypothermia in lipopolysaccharide-sensitized hypoxia-ischemia on cerebral immunohistochemical markers of brain damage: a study in newborn piglets

**S. Stærke-Balling^{1*}, M. andersen¹, H. andersen¹, L. Hansen¹,
T.C.K. andelius¹, L. Schwendimann², P. Gressens², K. Kyng¹,
T. Henriksen¹**

¹Aarhus University Hospital, Department of Paediatric and Adolescent Medicine, Aarhus, Denmark

²Inserm, U1141, Paris, France

BACKGROUND AND AIMS

Therapeutic hypothermia (TH) is standard treatment for moderate to severe neonatal hypoxic-ischemic encephalopathy. While consensus exists on the neuroprotective effect, new studies question the efficacy of TH with concurrent inflammation caused by lipopolysaccharides from *Escherichia coli*. The aim of this study was to evaluate the effect of TH following lipopolysaccharide-sensitized hypoxia-ischemia (HI) in newborn piglets evaluated through quantification of cerebral immunohistochemical markers.

METHODS

We included 32 Danish landrace piglets of both sexes. The piglets received intravenous infusion of lipopolysaccharides for four hours, followed by 45 minutes of global HI titrated by amplitude-integrated electroencephalography and blood pressure. They were then randomised to either TH or supportive care only. The piglets were euthanized 14 hours after the HI insult. The outcome was immunohistochemical staining of ten brain regions (thalamus, periventricular white matter, parietal cortex, capsula interna, capsula externa, hippocampus, caudate nucleus, putamen, cerebellum white matter, and cerebellum granular layer) assessing anti-glial fibrillary acidic protein (GFAP), anti-ionizing adaptor protein 1 (IBA1), and cleaved-caspase 3 (CC3).

RESULTS

We found no difference in hypoxic-ischemic insult severity between the two groups. We found no statistically significant difference in GFAP, IBA1, or CC3 expression between the two groups in any region of the brain.

CONCLUSIONS

We found no indication of neuroprotection by TH following lipopolysaccharide-sensitized HI based on immunohistochemical markers 14 hours after the HI insult, suggesting that the effect of TH may be limited in HI combined with other inflammatory exposures. However, the short period from HI to immunohistochemical assessment limits the results.

PD104 / #1566**E-poster Discussion Session 14: ESPR - Preclinical models of brain injury****10-10-2022 12:30 - 13:30****Neutrophil plasticity and function in neonatal hypoxic-ischemic brain injury****M. Richter¹, A. Fischer², C. Köster², N. Labusek², K. Mülling², U. Felderhoff-Müser², I. Bendix², J. Herz^{2*}**¹Westfälische Wilhelms-Universität Münster, Institute of Experimental Pathology, Muenster, Germany²University Hospital Essen, Department of Pediatrics I, Neonatology and Experimental Perinatal Neurosciences, Essen, Germany**BACKGROUND AND AIMS**

Neonatal encephalopathy caused by hypoxia-ischemia (HI) is a major cause of death and disability in children. A major hallmark of HI pathophysiology is the infiltration of neutrophils into the injured brain. While we have recently proven the detrimental role of neutrophils in the early phase after HI, their impact on endogenous delayed regenerative processes is unknown.

METHODS

Nine-day-old C57BL/6 mice were exposed to HI. Using light sheet microscopy, immunohistochemistry and flow cytometry neutrophil infiltration and their phenotypical changes were analyzed 0.5, 1, 3, 7 and 10 days after HI. The functional role of neutrophils was assessed after early and late neutrophil depletion via anti-Ly6G administration. Brain tissues were analyzed via immunohistochemistry 10 days after HI. Long-term neurobehavioral outcome was evaluated 5 weeks after HI.

RESULTS

We observed a biphasic infiltration of neutrophils peaking 1 and 7 days after HI. Compared to day 1, brain-infiltrated neutrophils at day 7 demonstrated significantly decreased ROS production, accompanied by reduced expression of Ly6B and Ly6G on CD14⁺CD101⁻ neutrophils and an increased frequency of VEGFR1⁺CD49d⁺ neutrophils, both recently associated with neuroregenerative and angiogenic neutrophils. In contrast to neuroprotective effects of early neutrophil depletion, late depletion at the second infiltration peak increased HI-induced neuronal loss and neurobehavioral deficits, associated with a reduction of oligodendrocyte maturation and endothelial proliferation.

CONCLUSIONS

Our data indicate that early infiltrated neutrophils differ from late neutrophils in phenotype and function, with neutrophils in the delayed disease phase likely to contribute to secondary neuroprotection and endogenous regeneration.

PD105 / #1109

E-poster Discussion Session 14: ESPR - Preclinical models of brain injury

10-10-2022 12:30 - 13:30

Plasma lactate and severity of brain injury in neonatal piglet models of hypoxia-ischemia – a pooled study analysis

H.S. Høg*, T.C.K. andelius, M. andersen, L. Hansen, H. andersen, K. Kyng, T. Henriksen

Aarhus University Hospital, Department of Pediatrics, Aarhus N, Denmark

BACKGROUND AND AIMS

Early and reliable biomarkers reflecting the severity of hypoxic ischemic (HI) encephalopathy are wanted to predict long-term neurological outcomes and accelerate the translation of pre-clinical studies into clinical use. Magnetic resonance spectroscopy (MRS) has been proposed to yield robust biomarkers of long-term neurodevelopment.

The aim of this study was to investigate the association between early biochemical markers of HI insult severity and the severity of brain injury evaluated by MRS biomarkers.

METHODS

Data has been obtained from six different newborn HI piglet studies performed by our group. A total of 206 piglets were included. All piglets were anesthetized and exposed to a standardized HI insult with and without lipopolysaccharide-sensitization, with different post-insult interventions. Our primary early marker of brain injury was plasma lactate measured immediately after the insult. Severity of brain injury was determined by thalamic MRS at different time points (6 to 72 hours post insult).

RESULTS

Preliminary analyses from 168 piglets showed a correlation between p-lactate and thalamic lactate/N-acetylaspartate (Lac/NAA) ratios [$r = 0.3$, $p = 0.01$]. Piglets with a high p-lactate (upper quartile) had some 50% higher risk of high (upper quartile) Lac/NAA ratios [OR = 1.6, 95% CI 0.1;6.0] compared to those with low p-lactate.

CONCLUSIONS

We found a rather small correlation in the preliminary analyses between immediate post-insult p-lactate and thalamic MRS Lac/NAA ratios assessed 6-72h after the HI insult, and approximately 50% increased risk of a high Lac/NAA-ratio with high post-insult p-lactate values. Results from all 206 piglets will be presented.

PD106 / #1235**E-poster Discussion Session 14: ESPR - Preclinical models of brain injury****10-10-2022 12:30 - 13:30****Individual metabolite impairment in cerebral deep grey matter relates to outcome following neonatal encephalopathy****A. Bainbridge¹, P. Taribagil², H. Century³, V. Verma⁴, A. Huertas-Ceballos⁵, K. Pegoretti Baruteau⁵, L. Srinivasan⁵, X. Golay⁶, F. Torrealdea¹, M. Sokolska¹, G. Kendall⁵, N. Robertson⁷, S. Mitra^{8*}**

¹University College London Hospital NHS Trust, Department of Medical Physics and Biomedical Engineering, London, United Kingdom

²Royal Free London NHS Foundation Trust, Paediatrics, London, United Kingdom

³North Middlesex University Hospital NHS Trust, Paediatrics, London, United Kingdom

⁴Institute for Women's health, University College London, Neonatology, London, United Kingdom

⁵University College London Hospital, Neonatal Unit, London, United Kingdom

⁶University College London, Institute of Neurology, London, United Kingdom

⁷UCL, Neonatology, Institute For Women's Health, London, United Kingdom

⁸Institute for Women's Health, University College London, Neonatology, London, United Kingdom

BACKGROUND AND AIMS

Neonatal encephalopathy (NE) remains a significant cause of morbidity and mortality. Several MRI scoring systems and magnetic resonance spectroscopy (MRS) biomarkers have been used for outcome prediction. This study aims to estimate individual metabolite impairments in cerebral deep grey matter and assess the relationship to neurodevelopmental outcome.

METHODS

Data collected from 116 term neonates (36-44 weeks) after hypothermia in a 3T scanner within first 2 weeks after birth. MR imaging was obtained with

proton MRS using single voxel in the thalamus-basal ganglia region (PRESS). The data were analysed using a combined reference method: metabolite signals were weighted inversely to the standard deviation of each metabolite within the cohort and then summed to generate a reference value (CRef) against which the individual metabolites of interest can be ratioed. The metabolites included were Aspartate, Creatine (Cr), total Choline(tCho), total N-Acetylaspartate (tNAA), Taurine and Glutamate+glutamine (Glx). Neurodevelopmental assessment (BSID III) performed at 2 years; 'good' outcome classified as composite score 85 or above while 'poor' outcome indicated death or composite score <85.

RESULTS

20 infants died. tNAA, tLac, tCho and Cr were significantly different between the outcome groups in all domains ($p < 0.0001$) (table 1). Combining akaike Information criteria (AIC) for regression and AUC for the ROC curve, tNAA is the best predictor of outcome with cut off 0.018 (figure 1).

Table 1. Relationship of individual DGM metabolites with neurodevelopmental outcome

DGM metabolites	Motor outcome (Logistic regression p value)	Motor outcome Sensitivity	Motor outcome Specificity	Cognitive outcome (Logistic regression p value)	Cognitive outcome Sensitivity	Cognitive outcome Specificity	Language outcome (Logistic regression p value)	Language outcome Sensitivity	Language outcome Specificity
tLac	<0.0001	0.925	0.8874	<0.0001	0.9221	0.7941	<0.0001	0.8986	0.8108
tNAA	<0.0001	0.9875	0.8235	<0.0001	0.987	0.7647	<0.0001	1	0.7027
tCho	<0.0001	0.9125	0.6176	<0.0001	0.9091	0.6176	<0.0001	0.913	0.5946
Cr	<0.0001	0.975	0.6765	<0.0001	0.974	0.6471	<0.0001	0.9565	0.6216

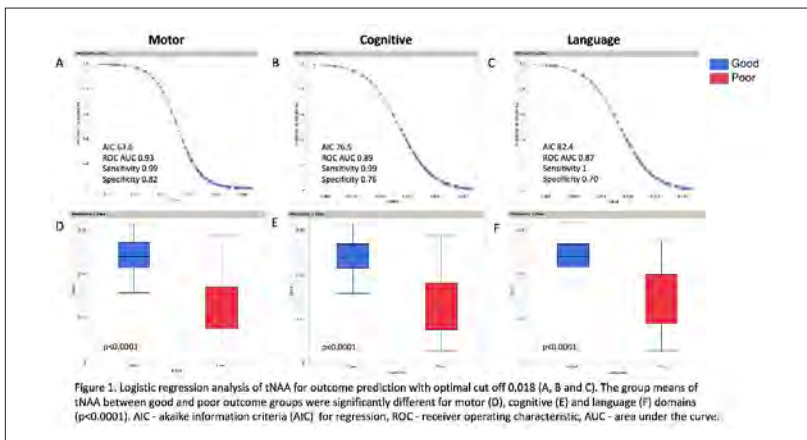

CONCLUSIONS

NE induces significant changes in cerebral energy metabolism. DGM tNAA is a robust predictor of outcome. The CRef analysis can be performed during post-processing and doesn't require extra scanning time, making it a clinically useful tool.

PD107 / #1016**E-poster Discussion Session 14: ESPR - Preclinical models of brain injury****10-10-2022 12:30 - 13:30****Insulin-like growth factor-1/insulin-like growth factor binding protein-3 activates the insulin-like growth factor-1 receptor at the choroid plexus in the preterm rabbit brain****N. Ortenlöf^{1*}, S. Vallius¹, H. Karlsson¹, C. Ekström¹, B. Holmqvist², N. Barton³, D. Ley¹, M. Gram¹**¹Lund University, Skåne University Hospital, Department of Clinical Sciences, Paediatrics, Lund, Sweden²ImageIT, Immunohistochemistry, Lund, Sweden³Oak Hill Bio Inc, Scientific Advisory Board, Boston, United States of America**BACKGROUND AND AIMS**

Insulin-like growth factor 1 (IGF-1) is essential in brain development. Rodent studies have shown that systemic IGF-1 can bind to, and translocate through, the choroid plexus (CP) into cerebrospinal fluid. However, previous studies have inferred that the transfer of systemic IGF-1 across the blood brain barrier is restricted, presenting a potential limitation for beneficial treatment effects within the brain. In this study we have performed a detailed characterization of the IGF-1/IGF-1 receptor (IGF-1R) activation and signaling pathway at the CP in the immature brain of the preterm rabbit pup.

METHODS

E29 rabbit pups were subjected to subcutaneous administration of labeled (FITC, biotin or Alexa Fluor-647) or unlabeled IGF-1/IGFBP-3 (8 mg/kg) and followed for 5 and 24 hours. Brains were perfused and investigated for pres-

ence of IGF-1 and interaction with the IGF-1R using confocal-, electron-, and light sheet microscopy. In addition, CP was collected and analyzed for IGF-1R activation using western blot.

RESULTS

IGF-1/IGFBP-3, conjugated with Alexa Fluor-647 or biotin, were found in the CP and the subfornical organ five hours post-administration. Immunolabeling for FITC-conjugated IGF-1 in electron microscopy revealed translocation of IGF-1/IGFBP-3 through the CP. Choroid plexus extracted from preterm rabbit pups exposed to systemically administered IGF-1/IGFBP-3 displayed activation, i.e. phosphorylation, of the IGF-1R downstream pathways MAP kinase and PI 3-kinase.

CONCLUSIONS

Blood-borne exposure of IGF-1/IGFBP-3 binds to and translocates across the choroid plexus as well as activates its IGF-1 receptor in the preterm rabbit brain. This indicates potential impact of systemically administered IGF-1/IGFBP-3 on the development of the immature brain.

PD108 / #1526**E-poster Discussion Session 14: ESPR - Preclinical models of brain injury****10-10-2022 12:30 - 13:30****Development of a cot-side optical translational tool for the stratification of injury and prediction of neurological outcome in neonatal encephalopathy****K. Harvey-Jones^{1*}, F. Lange², A. Bainbridge², G. Bale³, C. Meehan¹, A. Avdic-Belltheus¹, F. Torrealdea⁴, X. Golay⁵, M. Sokolska⁴, G. Kendall⁶, N. Robertson¹, I. Tachtsidis², S. Mitra¹**¹University College London, Institute For Women's Health, London, United Kingdom²University College London, Medical Physics and Bioengineering, London, United Kingdom³University of Cambridge, Department of Engineering and Physics, Cambridge, United Kingdom⁴University College London Hospital NHS Trust, Department of Medical Physics and Biomedical Engineering, London, United Kingdom⁵University College London, Institute of Neurology, London, United Kingdom⁶University College London Hospital, Neonatology, London, United Kingdom**BACKGROUND AND AIMS**

Neonatal encephalopathy (NE) carries a high burden of disease globally. A cot-side neuromonitoring tool that stratifies injury severity and predicts neurological outcome would support clinical care and emerging neuroprotective strategies. Using a hybrid broadband near-infrared spectroscopy and diffuse correlation spectroscopy (BNIRS-DCS) instrument to monitor brain mitochondrial metabolism (oxCCO), oxygenation (HbD) and perfusion (BFI) in both pre-clinical and clinical cohorts of neonatal encephalopathy, we aim to develop early biomarkers of brain injury severity and neurological outcome.

METHODS

Using the BNIRS-DCS instrument, 18 piglets were monitored continuously post induced hypoxic-ischaemic insult in a pre-clinical study and 11 infants undergoing therapeutic hypothermia in a clinical study of NE were monitored daily for up to 5 days. Wavelet reactivity indices between signals to denote autoregulatory function were correlated with early neurological outcome markers of ^1H MRS-derived Lactate/NAA (both studies) and histological TUNEL cell count (pre-clinical). Semblance between signals indicated their phase relationship, varying between -1 to +1.

RESULTS

Pre-clinical analysis showed metabolic (oxCCO-HbD semblance) and vascular (BFI-HbD semblance) reactivity correlated with Thalamic Lact/NAA, TUNEL cell count, insult severity and outcome severity group. Clinical analysis showed metabolic (oxCCO-HbD semblance) reactivity index on day 1 of life correlated with Thalamic Lact/NAA (Fig1).

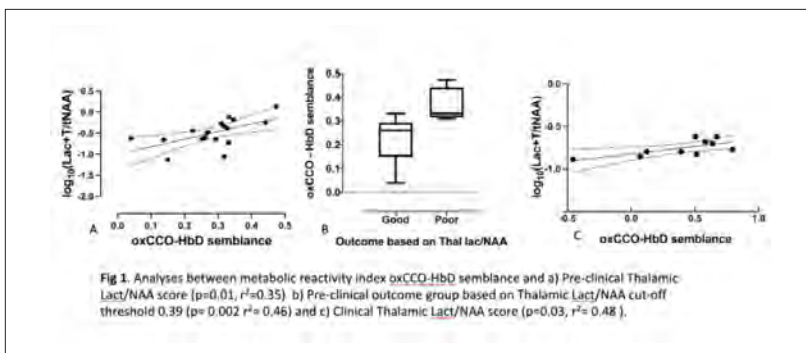

CONCLUSIONS

Early impairment of cerebral metabolic reactivity is predictive of outcome in both cohorts and of injury severity in the pre-clinical cohort. Vascular reactivity was also predictive of insult severity and outcome in the pre-clinical cohort.

These biomarkers require further validation in the ongoing clinical study with analysis including both short- and long-term outcomes.

PD109 / #2130**E-poster Discussion Session 14: ESPR - Preclinical models of brain injury****10-10-2022 12:30 - 13:30****Increased serum values of neuro-axonal damage marker NFL in neonates delivered vaginally as compared to those delivered via caesarean section****K. Kürner^{1*}, K. Goeral², A. Atkinson³, S. Brandstetter⁴, A. Toncheva⁴, M. Kabesch⁵, C. Apfelbacher⁶, M. Melter⁷, B. Seelbach-Göbel⁸, A. Berger⁹, J. Kuhle¹⁰, S. Wellmann¹**

¹University Children's Hospital Regensburg (KUNO), Hospital St. Hedwig of the Order of St. John, Department of Neonatology, Regensburg, Germany

²Medical University of Vienna, Department of Pediatrics and Adolescent Medicine, Vienna, Austria

³University Children's Hospital Basel (UKBB), Department of Paediatric Pharmacology and Pharmacometrics, Basel, Switzerland

⁴Hospital St. Hedwig of the Order of St. John, Research and Development Campus Regensburg, Regensburg, Germany

⁵University Children's Hospital of Regensburg (KUNO), Hospital St. Hedwig of the Order of St. John, Department of Pediatric Pneumology and Allergy, Regensburg, Germany

⁶Otto von Guericke-University Magdeburg, Institute of Social Medicine and Health Systems Research, Magdeburg, Germany

⁷University of Regensburg, University Children's Hospital of Regensburg (kuno), Regensburg, Germany

⁸Hospital St. Hedwig of the Order of St. John, Department of Obstetrics and Gynecology, Regensburg, Germany

⁹Medical University of Vienna, Division of Neonatology, Pediatric Intensive Care and Neuropediatrics, Department of Pediatrics, Vienna, Austria

¹⁰University Hospital Basel, Departments of Biomedicine and Clinical Research, Basel, Switzerland

BACKGROUND AND AIMS

Little is known about neonatal brain plasticity or the impact of birth mode on neurointegrity. As a reflection of neuroaxonal damage, the neuronal structural protein neurofilament light chain (NFL) has emerged as a highly specific

biomarker. Our purpose was to test the hypothesis that vaginal delivery is associated with increased NfL in neonates.

METHODS

NfL concentrations were measured using single molecule array immunoassay in umbilical cord serum from healthy term neonates enrolled in the prospective KUNO-Kids Health Study. NfL values were investigated for independent influencing factors using linear and logistic models, followed by post-hoc propensity score-matching.

RESULTS

of 665 neonates, n=470 (70.7%) were delivered vaginally and n=195 (29.3%) by cesarean section. Median serum NfL was significantly higher after vaginal delivery 14.4pg/mL (11.6–18.5) compared to primary 7.5pg/mL (6.1–8.9) and secondary cesarean delivery 9.3pg/mL (7.5–12.0). Multivariable logistic regression models showed delivery mode and gestational age to be independently associated with NfL. Propensity score-matching analysis confirmed that assisted vaginal delivery generated higher NfL compared to vaginal (non-assisted), while lowest levels were associated with cesarean section.

CONCLUSIONS

Our data confirm the significant impact of birth mode on neonatal NfL levels. The persistence of these differences and their potential long-term impact have yet to be investigated.

PD110 / #2118

E-poster Discussion Session 15: EAP - Paediatric potpourri - for everyone 04

10-10-2022 12:30 - 13:30

Evaluation of a low flow oxygen blender system for global access

E. Ng^{1*}, T. Burke², M. Dundek¹

¹Vayu Global Health Innovations, Engineering, Boston, United States of America

²Massachusetts General Hospital, Emergency Medicine and Pediatrics, Boston, United States of America

BACKGROUND AND AIMS

Safe and effective oxygen delivery methods are not yet globally accessible for infants and young children. A 2021 survey of sub-Saharan neonatal units found that 56% of neonatal units have no ability to blend air and oxygen, and only 1% have the ability to blend air and oxygen for every patient. With support from the US National Institute of Health, the Bill and Melinda Gates Foundation, and UNITAID/WHO a novel oxygen blender system was designed to accurately deliver concentration-controlled, oxygen-enriched air to infants and children up to age five. The system does not require compressed medical air, is compatible with both oxygen tanks and oxygen concentrators, and is ultra-low cost. This is the first study that tested the performance of the innovative system.

METHODS

The performance of the oxygen blender system was assessed *in vitro* based on delivered oxygen levels and flow rates with an oxygen tank, a nasal occlusion model, and an oxygen concentrator.

RESULTS

The measured %O₂ of the performance test was within $\pm 5\%$ of full scale (FS) of the target value across all flows and all nasal cannula. Occlusion testing indicated that 50% occlusion did not significantly affect the outputs of the system. The system was compatible with both oxygen tanks and oxygen concentrators.

CONCLUSIONS

The novel oxygen blender system accurately controls oxygen concentrations and blended air flow rates, and is compatible with both oxygen tanks and concentrators. This innovation may be a great opportunity for improved infant and child oxygen treatment worldwide.

PD111 / #2239**E-poster Discussion Session 15: EAP - Paediatric potpourri - for everyone 04****10-10-2022 12:30 - 13:30****Review of social work consult from emergency room during pandemic****A. Moreira Echeverria^{1,2*}, E. Berbel Palau², J.M. Solis Baltodano³, M.T. Sandino Martinez³**¹*Fundació Hospital Sant Joan de Déu de Martorell, Paediatrics, Martorell, Spain*²*Fundació Hospital Sant Joan de Déu de Martorell, Servei De Pediatria, Martorell, Spain*³*Hospital de Martorell, Paediatrics, Martorell, Spain***BACKGROUND AND AIMS**

Ever since pandemic started, many children have been in lock down at home with their parents. This has increased the risk for vulnerable children due to negligent parents. Aim Analyze clinical and epidemiological characteristics of consults related to child abuse. Evaluate Child Services actions. Compare characteristics between pre-pandemic and pandemic periods.

METHODS

Retrospective observational study, from March 2020 till June 2021. Children under 15 years old (yo) that consulted on the emergency room in which Social Work were contacted. Variables: sex, age, kind of abuse, possible abuser, companion.

RESULTS

During the studied period 18 consults were made from Emergency Room (ER) to Social Work (SW) (81% of the visits with suspected Child Abuse). In pre-pandemic period we had higher number of consults but lower rate of child abuse on the 2 previous years (42% of the visits). 56% were girls, according to age: 39%: 0-3 yo, 36%: 4-10yo, 25%: ≥ 11 . 67% were accompanied by one of their parents, in 86% of the cases one of them was the abuser. 11 cases where physical abuse, 2 sexual abuse, 2 abuse of substances, 1 unstructured family, 1 aggressiveness, 1 gender violence.

CONCLUSIONS

The most common consult was physical abuse on under 3 yo girls, one of the parents being the abuser. Lock-down during pandemic helped to hide child abuse. Schools and extracurricular activities help detecting and reporting Child Abuse. The connection between pediatrics in ER and SW is key to detection and follow-up of these cases.

PD112 / #919

E-poster Discussion Session 15: EAP - Paediatric potpourri - for everyone 04

10-10-2022 12:30 - 13:30

Protective and risk factors for pneumonia in small children from republic of Moldova: a case control study

N. Revenco^{1,2}, A. Horodisteanu-Banuh¹, O. Cirstea^{1,2}, D. Savoschin¹, A.-M. Balanuta^{1,2}, D. Bujor^{1,2*}

¹Mother and Child Institute, Pediatric Scientific Laboratory, Chisinau, Moldova

²"Nicolae Testemitanu" State University of Medicine and Pharmacy, Pediatrics, Chisinau, Moldova

BACKGROUND AND AIMS

Pneumonia still remains a major cause of morbidity and mortality affecting children younger than five years of age in lower-middle-income countries like Republic of Moldova. This study aims to identify risk and protective factors for pneumonia following the implementation of a pneumococcal vaccination program.

METHODS

A case control study was being carried out within the National project "The impact of immunization on the morbidity and mortality of children with respiratory diseases in the Republic of Moldova" (project code) - 20.80009.8007.08, among the mothers having under-5 years children who were admitted in the pediatric ward of within the Mother and Child Institute and the Municipal Children's Clinical Hospital no. 1 from Chisinau. A convenience sampling technique was used to select 50 children with pneumonia and 100 children with non-pneumonia diseases matched on age, sex and setting. The ques-

tionnaire included child-related factors (age, sex, birth history, breastfeeding, vaccination status) and environmental factors (indoor air pollution).

RESULTS

Logistic regression analysis confirmed that cigarette smoke exposure increased the odds of having pneumonia significantly (OR 2.6327; 95 % CI: 1.1507 to 6.0231; $P = 0.0219$) and also prematurity (OR 2.916495 % CI:1.0166 to 8.3663; $P = 0.0465$). Pneumococcal vaccine effectiveness against pneumonia was 77% (OR: 0.2384; 95% CI: 0.0872 to 0.6516; $P = 0.0052$).

CONCLUSIONS

These findings confirm the effectiveness of the pneumococcal vaccine against childhood pneumonia and also knowledge of significant independent risk factors can suggest pneumonia preventive strategies in small children.

PD113 / #2533**E-poster Discussion Session 15: EAP - Paediatric potpourri - for everyone 04****10-10-2022 12:30 - 13:30****Fetal and infant growth patterns, sleep and 24-hour activity rhythms. a population-based prospective cohort study in school-age children****V.A.A. Beunders^{1*}, M.E. Koopman-Verhoeff², M. Vermeulen¹, C.C.V. Silva³, P.W. Jansen², A.I. Luik¹, I. Reiss¹, K. Joosten⁴, V. Jaddoe³**

¹Erasmus MC Sophia Children's Hospital, University Medical Center Rotterdam, Department of Pediatrics, Division of Neonatology, Rotterdam, Netherlands

²Erasmus MC Sophia Children's Hospital, Child and Adolescent Psychiatry/psychology, Rotterdam, Netherlands

³Erasmus MC - Sophia Children's Hospital, Pediatrics, Rotterdam, Netherlands

⁴Erasmus MC Sophia Children's Hospital, University Medical Center Rotterdam, Department of Pediatrics, Pediatric Intensive Care Unit, Rotterdam, Netherlands

BACKGROUND AND AIMS

We aimed to explore associations of fetal and infant weight patterns and pre-term birth with sleep and 24-hour activity rhythm parameters at school-age.

METHODS

This prospective population-based study comprised 1327 children followed from birth to age 10-15 years. Fetal weight was estimated using ultrasound in the second and third trimester of pregnancy. Birth weight and gestational age were available from midwife registries. Infant weight was measured at 6, 12 and 24 months. Fetal and infant weight acceleration or deceleration were defined as a change of >0.67 SD between the corresponding age interval. At school-age, sleep duration, sleep efficiency, wake after sleep onset (WASO),

social jetlag, interdaily stability, and intradaily variability were assessed using tri-axial wrist actigraphy for nine consecutive nights.

RESULTS

Low birth weight (<2500 grams) was associated with 0.24 SD (95% confidence interval 0.04;0.43) longer sleep duration compared to normal weight. Compared to normal growth, growth deceleration in fetal life and infancy was associated with 0.40 SD (0.07;0.73) longer sleep duration, 0.44 SD (0.14;0.73) higher sleep efficiency and -0.41 SD (-0.76;-0.07) shorter WASO. A pattern of normal fetal growth followed by infant growth acceleration was associated with -0.40 SD (-0.61;-0.19) lower interdaily stability. Preterm birth was not associated with any sleep or 24-hour rhythm parameters.

CONCLUSIONS

Children with fetal and infant growth restriction had longer and more efficient sleep at school-age, which may be indicative of an increased need for sleep for maturational processes and development after a difficult start in life.

PD114 / #2580**E-poster Discussion Session 15: EAP - Paediatric potpourri - for everyone 04****10-10-2022 12:30 - 13:30****The adrenaline auto injector administration technique of caregivers and paediatric patients with food allergies****C. Cronin^{1*}, J. Trujillo Wurttle^{1,2,3}**¹University College Cork, Department of Paediatrics and Child Health, Cork, Ireland²Cork University Hospital, Paediatrics, Cork, Ireland³Cork University Hospital, Infant Research Centre, Cork, Ireland**BACKGROUND AND AIMS**

Many parents and patients with food allergies are unable to correctly administer an adrenaline auto injector (AAI) when assessed. The aim of this study is to review the current literature on caregiver's and paediatric patients' ability to use an AAI.

METHODS

Pubmed and Wiley Online Library, were used to conduct searches. After filters were applied and abstracts were screened for inclusion and exclusion criteria, 10 studies were selected to be reviewed.

RESULTS

The rate of successful AAI administration ranged from 5.6% to 85%, with a mean of 40%. Assessment tools varied from marking administration technique out of 3 to ten steps, and assessment methods varied from clinic assess-

ments, telephone surveys and online questionnaires. All four studies which compared the AAI administration technique of participants both before and after receiving an educational intervention found an improvement after the educational intervention. Factors which affected successful AAI administration included switching to a different AAI without receiving training, demonstration by a specialist allergist compared to a specialist or general practitioner, and membership in a lay organization or support group for allergy. Previous severe allergic reactions and time elapsed since last demonstration of AAI use were not found to relate to ability in AAI use.

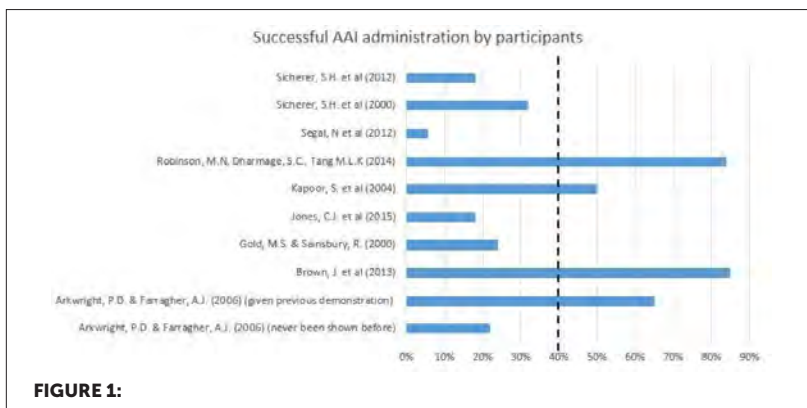
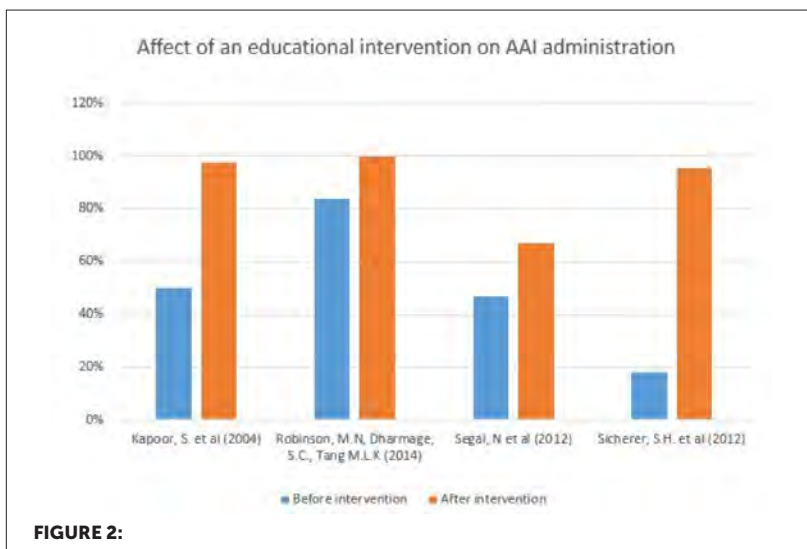

FIGURE 1:



CONCLUSIONS

This study highlights the need to validate an assessment tool for AAI administration, as assessment methods varied greatly among studies. A significant improvement in AAI use was found after an educational intervention, and further study should explore what are the best educational methods for parents and patients with food allergy.

PD115 / #2655**E-poster Discussion Session 15: EAP - Paediatric potpourri - for everyone 04****10-10-2022 12:30 - 13:30****Effect of severe obstructive sleep apnea on pulse transit time in children with syndromic craniosynostosis during sleep****E. Van Twist^{1*}, S. Yang², K. Joosten¹, G. Heesch¹, I. Mathijssen²**

¹Erasmus MC Sophia Children's Hospital, University Medical Center Rotterdam, Department of Pediatrics, Pediatric Intensive Care Unit, Rotterdam, Netherlands

²Erasmus MC-Sophia Children's Hospital, University Medical Center Rotterdam, Dutch Craniofacial Center, Department of Plastic and Reconstructive Surgery and Hand Surgery, Rotterdam, Netherlands

BACKGROUND AND AIMS

Obstructive sleep apnea (OSA) is common in children with syndromic craniosynostosis (SCS), especially during Rapid-Eye Movement (REM) sleep. In this prospective study, we explored the relation between Pulse Transit Time (PTT) and OSA in children with SCS and healthy controls.

METHODS

Prospective study in children (age < 18 years) with SCS and moderate – severe OSA ($\text{oAHI} \geq 5$) or no OSA ($\text{oAHI} < 1$) who underwent overnight polysomnography (PSG) were included. Children without SCS with a normal PSG were included as controls. Reference intervals for PTT were computed by non-parametric Bootstrap. Based on the RI of controls during REM sleep, the sensitivity and specificity of PTT to detect OSA were determined. In a linear mixed model the effects of gender, age, sleep stage and time from obstructive event on PTT were evaluated.

RESULTS

In total 74 children were included: 19 SCS with moderate – severe OSA, 30 SCS without OSA and 25 controls. Obstructive events occurred throughout all sleep with significant dips in PTT before and following an event (range: $-5.97 - -11.63$, $p < 0.05$). In SCS with OSA, PTT values were significantly lower across all sleep stages compared to SCS without OSA, but only across N1 compared to controls. Sensitivity and specificity of PTT to detect OSA during REM were 70.4% and 38.9%. The lowest PTT values were observed during N3.

CONCLUSIONS

In children with SCS, obstructive events occur throughout all sleep stages with reductions in PTT, albeit with limited sensitivity and specificity. Hence, PTT may aid in OSA monitoring.

PD116 / #2709**E-poster Discussion Session 15: EAP - Paediatric potpourri - for everyone 04****10-10-2022 12:30 - 13:30****An unusual case of vasculitis, presenting with lymphadenopathy and lacrimal gland swelling one week after Pfizer Covid-19 vaccination****E. Blamey^{1*}, K. Davies¹, R. Bhatt², E. Al-Abadi³, H. Singh Mudhar⁴, M. Henry²**¹The Royal Wolverhampton NHS Trust, General Paediatrics, Wolverhampton, United Kingdom²The Royal Wolverhampton NHS Trust, Ophthalmology, Wolverhampton, United Kingdom³Birmingham Children's Hospital, Paediatric Rheumatology, Birmingham, United Kingdom⁴Sheffield Teaching Hospitals NHS Foundation Trust, National Specialist Ophthalmic Pathology Service, Sheffield, United Kingdom**BACKGROUND AND AIMS**

Patient S, a previously well 16 year old male, presented to the Paediatric Admissions Unit with a history of bilateral lacrimal gland swelling and axillary lymphadenopathy, beginning one week after COVID-19 vaccination.

METHODS

ANA was weakly positive; but ANCA, double stranded DNA, Extractable Nuclear Antigen, and anti-cardiolipin antibody were negative. C3 & C4 levels were normal. IgG4 levels were also normal, although the sample was taken after significant steroid treatment. Orbital soft tissue histology demonstrated an acute-on-chronic small vessel vasculitis. Axillary biopsy demonstrated similar pathology, although without clear evidence of vasculitis. Imaging, including ultrasound and MRI aortogram, showed no evidence of large vessel vasculitic processes or malignancy.

RESULTS

Patient S was managed as a case of IgG4 related vasculitis. He was commenced on high dose steroids, which initially resolved his symptoms. Unfortunately, his eye symptoms and inflammatory markers worsened following tapered cessation of steroid therapy. At time of writing, he had been commenced on a course of mycophenolate mofetil. His symptoms were reported to the MHRA yellow card scheme.

CONCLUSIONS

Due to the prolonged nature of his symptoms, it is likely that Patient S' COVID-19 vaccination was not the sole driver of his disease process, although it is possible that the vaccination acted as a trigger for Patient S' subsequent vasculitis.

PD117 / #1519**E-poster Discussion Session 16: EAP - Paediatric potpourri - for everyone 05****10-10-2022 12:30 - 13:30****Paediatric subspecialties in Belgium: past, present and future****L. Van Camp^{1,2*}, L. Hoste^{1,3}, E. Vermeiren^{4,5}, S. Moniotte⁶, A. Bael⁷**¹Ghent University Hospital, Department of Pediatrics, Ghent, Belgium²Ghent University, Department of Pediatric Hematology-oncology (pho), Ghent, Belgium³Ghent University, Primary Immunodeficiency Research Lab (pir), Ghent, Belgium⁴Antwerp University, Department of Pediatrics, Antwerp, Belgium⁵GZA Sint-Vincentius Hospital, Department of Pediatrics, Antwerp, Belgium⁶Cliniques universitaires Saint Luc, Department of Pediatrics, Brussels, Belgium⁷ZNA Queen Paola Children's Hospital, Department of Pediatrics, Antwerp, Belgium**BACKGROUND AND AIMS**

As paediatrics is a constantly evolving specialty, the interest in subspecialties has increased over the last decades. However, for a long time, only three paediatric subspecialties had official recognition criteria in Belgium (haematology-oncology, neurology, and neonatology) and recently infectiology was added to the shortlist. Importantly, the number of recognized subspecialties is varying between European countries. With this study, we aim to provide insights into the preferences of future paediatricians to enhance standardisation of paediatric subspecialties on a European level.

METHODS

Between October 1st, 2021, and December 6th, 2021, the youth representatives of the Flemish Society of Paediatrics (Jong VVK) conducted a comprehensive survey on professional preferences among paediatric trainees and recently graduated paediatricians in Belgium. The survey included 34 questions and

statements with an emphasis on subspecialisation and (future) work perspectives. The answers were compared with data from similar surveys in other European countries.

RESULTS

The survey was completed by 287 respondents (Figure 1). This survey was the first to include data from all universities in Belgium. In line with previous surveys, 80% of the respondents indicated wanting to subspecialize or having subspecialized (Figure 2) and only 1% preferred working exclusively in private practice. The most preferred subspecialties were neonatology, pulmonology, and infectiology (Figure 3). Interestingly, for two out of three respondents, the presence of official recognition criteria would affect their ambition to subspecialise.

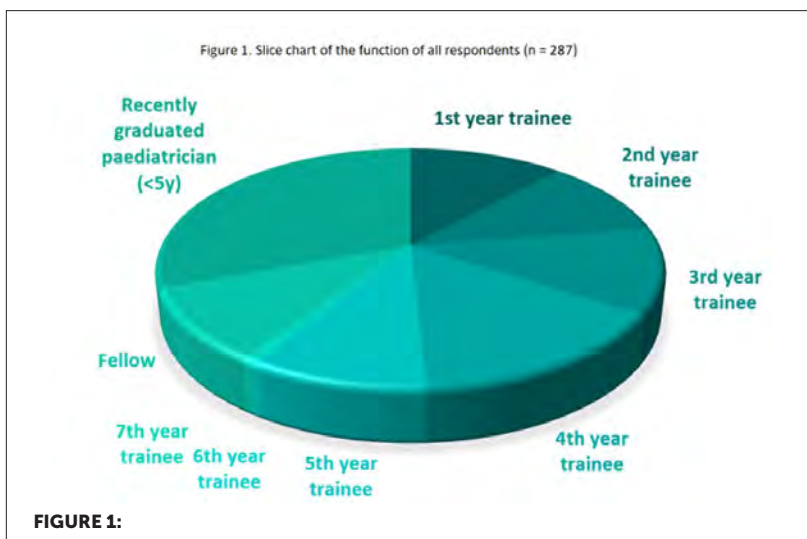

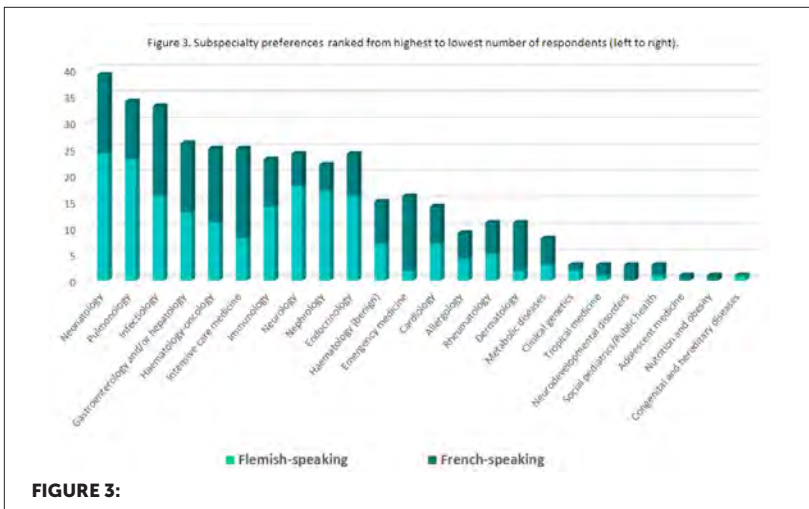
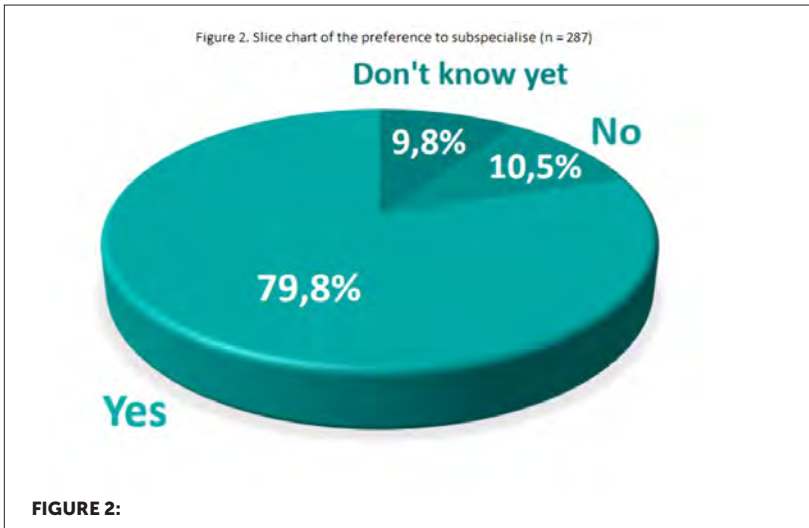

CONCLUSIONS

This unique dataset provides valuable insights into the future preferences of young paediatricians in Belgium. Better structuring of subspecialties is warranted to optimize the career flow of paediatricians.

PD118 / #744**E-poster Discussion Session 16: EAP - Paediatric potpourri - for everyone 05****10-10-2022 12:30 - 13:30****A cross sectional study for acceptance and intent to uptake covid 19 vaccine by adolescents in Anand district****J. Upadhyaya^{1*}, K. Tandon¹, S. Nimbalkar², M. Patel³**¹*Pramukhswami Medical College, Department of Pediatrics, Anand, India*²*Pramukhswami Medical College, Department of Neonatology, Anand, India*³*Bhaikaka University, Central Research Services, Anand, India***BACKGROUND AND AIMS**

Vaccine hesitancy is a challenging factor worldwide, amongst top 10 global concerns. Therefore, the characteristics of vaccine hesitancy were investigated in adolescents using results from an extensive, school-based survey of willingness to have COVID-19 vaccination, based on Health Belief Model(HBM), in students aged 10-14 years in Anand district, India.

METHODS

English medium schools in Anand were approached to conduct a cross sectional study. After assent, children filled a Questionnaire shared via Google form on web browser. Binary Logistic regression analysis was used to determine factors associated with definite intention to take COVID-19 vaccine. All significant explanatory factors from univariate analysis ($p \leq 0.05$) were entered into multivariate analysis. STATA 14.2 was used for analysis.

RESULTS

A total of 569 complete responses were received. The majority reported a definitely yes intent 408 (71.7%), followed by probably yes intent 82 (14.4%) for vaccination. Parent's education was significantly associated with intent (p value < 0.05). Within HBM domains, in Perceived benefits, less worried about catching COVID-19 ($p=0.007$) and less spread ($p=0.044$), in Cues to action, adequate information ($p=0.026$) was found significantly associated. In Binary logistic regression, only mother's education was found statistically significant (OR=4.2, 95% CI 1.2–15.1) for definite intention to take COVID-19 vaccine.

Scale	No. of items	Cronbach's Alpha
Perceived susceptibility	3	0.65
Perceived Severity	3	0.56
Perceived benefits	2	0.47
Perceived barriers	5	0.65
Cues to action	2	0.40

Scale reliability coefficient: 0.6981

CONCLUSIONS

Study showed the utility of HBM constructs in understanding COVID-19 vaccination intent. Large number of students showed intent to get vaccinated.

PD119 / #794**E-poster Discussion Session 16: EAP - Paediatric potpourri - for everyone 05****10-10-2022 12:30 - 13:30****CORTEX - ECARE: High value care approach for the management of pediatric patients with congenital heart disease after surgery****P. Garcia-Canadilla^{1*}, A. Isabel Roquero², E. Aurenanz², F. Miguel³, A. Valls Esteve⁴, D. Ormazabal⁵, F. Llanos⁵, J. Sanchez-De-Toledo²**

¹*Institut de Recerca Sant Joan de Déu, Cardiovascular Diseases and Child Development, Esplugues de Llobregat, Spain*

²*Hospital Sant Joan de Déu Barcelona, Department of Pediatric Cardiology, Esplugues de Llobregat, Spain*

³*Hospital Sant Joan de Déu Barcelona, Department of Engineering, Esplugues de Llobregat, Spain*

⁴*Institut de Recerca Sant Joan de Déu, Innovation In Health Technologies, Esplugues de Llobregat, Spain*

⁵*Hospital Sant Joan de Déu Barcelona, Department of Informatics, Esplugues de Llobregat, Spain*

BACKGROUND AND AIMS

Pediatric congenital heart disease (CHD) patients are at higher risk of postoperative complications and clinical deterioration either due to their underlying pathology or due to the cardiac surgery, contributing significantly to mortality, morbidity, hospital stay, hospital and family costs and quality of life. We present the preliminary results of CORTEX-Traffic light, a predictive system that Sant Joan de Déu (SJD) Barcelona Children's Hospital is developing to stratify the risk of deterioration of pediatric CHD patients after cardiac surgery.

METHODS

CORTEX-Traffic light is a scoring system that automatically extracts real-time data from EHR to stratify patient risk of clinical deterioration. This risk is rated via a traffic light scorecard allowing optimal decision-making.

RESULTS

254 children with a total of 294 episodes were monitored during a 1-year pilot study. of the 254 subjects, 41 (16.14%) experienced one or more adverse events (AE) on the ward, but only 8 (3.15%) were followed by an unplanned ward-to-ICU transfer. The average CORTEX-traffic light score of those children who experienced an unplanned ward-to-ICU transfer was significantly higher compared to controls (4.70 vs 2.27, $p = 0.019$). Moreover, the 1st year pilot study has also demonstrated a reduction of CHD ICU and hospital LOS by 7 and 8% respectively with associated hospital savings of 138k€.

CONCLUSIONS

Our preliminary results shows that CORTEX-Traffic light can help improve clinical outcomes, anticipating unwanted events, patient and professional experience at a lower cost.

PD120 / #875**E-poster Discussion Session 16: EAP - Paediatric potpourri - for everyone 05****10-10-2022 12:30 - 13:30****Multisystem inflammatory syndrome in children - what happens during and after the disease?****R. Amorim-Figueiredo*, R. Valsassina, A.M. Garcia, T. Milheiro Silva, C. Gouveia, A. Pereira Lemos, M.J. Brito**

Hospital Dona Estefânia, Centro Hospitalar Universitário de Lisboa Central, Pediatric Infectious Diseases Unit, Lisbon, Portugal

BACKGROUND AND AIMS

Multisystem inflammatory syndrome in children (MIS-C) emerged after the beginning of COVID-19 pandemics. Therefore, there is a lack of data about this entity, as well as possible sequelae at follow-up. Aim: To describe the characteristics of children admitted to a tertiary hospital and their follow-up.

METHODS

Observational, descriptive study of MIS-C patients from April 2020 to February 2022 (22 months).

RESULTS

We report 76 patients with MIS-C, the median age was 6,3 years [10 months-17,5 years], 69,7% were male and 22,4% (17/76) were admitted in the intensive care. At admission, 100% had fever, 90,8% gastrointestinal symptoms, and 72,4% mucocutaneous involvement. During hospitalization, cardiac involvement was verified in 92,1%, hepatitis in 60,5%, kidney involvement in 27,6%, respira-

tory involvement in 13,2% and neurologic involvement in 9,2%. All patients had high inflammatory markers and coagulopathy (100%), 89,2% hypoalbuminemia, 86,8% anemia, 76,3% neutrophilia, 73,7% high levels of lactate dehydrogenase, 64,5% lymphopenia, and 64,5% thrombocytosis. Treatment involved intravenous immunoglobulin (81,6%), corticotherapy (77,6%), anti-infective therapy (93,4%) and antiaggregation/anticoagulation (73,7%). Regarding the severity of the disease, 22,4% was mild (17/76), 55,2% moderate (42/76) and 22,4% severe (17/76). Changes were seen in thoracic x-ray (52,6%), abdominal ultrasonography (98,7%), electrocardiography (38,2%) and echocardiography (43,1%). At follow-up (61/76 was observed), 60,7% had cardiac changes, 29,5% DMSA scan changes and 8,2% pulmonary function changes. Physiotherapy was necessary in 14,8%, nutritional support in 16,4% and psychological support in 14,8%.

CONCLUSIONS

We describe the clinical presentation and short-term outcomes of MIS-C. Further studies are needed to understand if the changes observed at follow-up will be reversible.

PD121 / #920**E-poster Discussion Session 16: EAP - Paediatric potpourri - for everyone 05****10-10-2022 12:30 - 13:30****Implementation of early discharge protocol after laparoscopic appendectomy for pediatric uncomplicated acute appendicitis****M. Pathak^{1*}, S. Krishnamurthy¹, A. Sinha¹, S. Nayak¹, K. Rathod¹, A. Jadhav¹, R. Saxena²**¹AllIMS Jodhpur, Pediatric Surgery, Jodhpur, India²AllIMS Jodhpur, Pediatric Surgery, Jodhpur, India**BACKGROUND AND AIMS**

We conducted this study with the aim to implement the Enhanced Recovery After Surgery protocols (ERASP) after laparoscopic appendectomy for pediatric uncomplicated acute appendicitis in a developing country.

METHODS

At first, analysis of the duration of hospital stay and factors determining the prolonged stay was done. Parents, residents and anaesthetists were educated. Based on the factors affecting the delay in the discharge, we formulated an ERASP. (Figure 1). The duration of the hospital stays in patients successfully discharged under the ERAS protocol was compared to the Pre ERAS data. Parental satisfaction was assessed with a Likert scale.



RESULTS

There were 35 cases in the pre-ERAS group and 20 cases in post-ERAS group. We found a significant correlation between the timings of initiation of enteral feeds and the duration of post-operative and total stay in the pre-ERAS patients. There was significant decrease in the duration of the post-operative and total hospital stay following the implementation of the ERASP. (Table 1) No complications or readmissions were reported. Mean parental satisfaction was 8.9 (/10).

TABLE 1: Comparison of duration of hospital stay in pre-ERAS and post-ERAS cohorts.

Variables	Pre-ERAS retrospective data (Mean±SD)	Post-ERAS implementation (Mean±SD)	p-value
Age (years)	11.71±3.26	12.35±3.71	0.512
Preoperative hospital stay (hours)	20.54±15.92	20.92±14.70	0.930
Postoperative hospital stay (hours)	44.45±21.95	17.22±4.63	<0.0001
Total hospital stays (hours)	65.00±28.63	38.15±15.96	0.0003

CONCLUSIONS

ERASP implementation leads to a significantly shorter length of stay. It is safe and feasible in developing countries also, with similar rates of morbidity, readmissions, and parental satisfaction compared with conventional care.

PD122 / #951**E-poster Discussion Session 16: EAP - Paediatric potpourri - for everyone 05****10-10-2022 12:30 - 13:30****Validity of the new triage system implemented in all pediatric emergency departments in Korea****W. Bae^{1*}, A. Choi², K. Kim³, S. Kim²**¹*The Catholic University of Korea, Department of Emergency Medicine, Seoul, Korea, Republic of*²*The Catholic University of Korea, Department of Preventive Medicine and Public Health, Seoul, Korea, Republic of*³*Seoul National University College of Medicine, Department of Pediatrics, Seoul, Korea, Republic of***BACKGROUND AND AIMS**

Triage is essential for rapid and efficient intervention of patients visiting the emergency department(ED). In Korea, since 2016, pediatric Korean Triage and Acuity Scale (pedKTAS) has been implemented nationwide for the triage of pediatric patients visiting ED. The aim of this study was to evaluate the validity of pedKTAS applied to patients who visited the pediatric ED.

METHODS

This was a retrospective observational study of national registry data collected from all emergency medical centers and emergency medical institutions throughout Korea. We analyzed data from patients under the age of 15 who visited emergency departments nationwide from January 2016 to December 2019. The hospitalization rate and intensive care unit (ICU) admission rate were analyzed according to the triage level, and these results were compared with those of pediatric Canadian Triage and Acuity Scale (pedCTAS).

RESULTS

A total of 5,462,964 pediatric patients were included in the analysis. 11,547 (0.2%), 185,748 (3.4%), 1,725,375 (31.6%)

³, 049,212 (55.8%), and 491,082 (9.0%) patients with KTAS levels 1 to 5 were included, respectively. For KTAS levels 1 to 5, the hospitalization rates were 63.5%, 41.1%, 17.0%, 6.5%, and 3.7%, respectively, and the ICU admission rates were 14.4%, 6.0%, 0.3%, 0.1%, and 0.1%, respectively. Compared to the KTAS level 5, the odds ratios (95% CI) for hospitalization rate were 46.17 (44.32-48.11), 14.80 (14.54-15.06), 5.32 (5.24-5.40), and 1.88 (1.85-1.91) at KTAS levels 1

²

³, and 4, respectively, and the odds ratios (95% CI) of the ICU admission rate were 137.56 (124.87-151.55), 24.62 (22.68-26.73), 2.41 (2.22-2.62), and 0.67 (0.61-0.73), respectively.

CONCLUSIONS

In patients to whom pedKTAS was applied, there was a significant difference in hospitalization rate and ICU admission rate according to KTAS level. This suggests that pedKTAS helps to achieve rapid intervention according to the severity by appropriately reflecting the severity of pediatric patients visiting the ED.

PD123 / #1078

E-poster Discussion Session 16: EAP - Paediatric potpourri - for everyone 05

10-10-2022 12:30 - 13:30

Utilising compositional data analysis to investigate 24-hour time-use behaviours and obesity outcomes in New Zealand children

S. Duncan^{1*}, L. Hedayatrad¹, T. Stewart¹, E. Marks², C. Walker², S.-J. Paine²

¹Auckland University of Technology, School of Sport and Recreation, Auckland, New Zealand

²University of Auckland, Growing Up In New Zealand, Auckland, New Zealand

BACKGROUND AND AIMS

The time that children spend in physical activity (PA), sedentary behaviour (SB), and sleep each day (i.e., 24-hour time-use behaviours) is related to physical health outcomes. The aims of this study were (1) to compare children's time use across different sociodemographic groups, and (2) to examine associations between daily time use and obesity outcomes, including the identification of distinct behavioural clusters.

METHODS

Data from the 8-year wave of Growing Up in New Zealand were used (n = 623, age = 7.8 years). Dual Axivity AX3 accelerometers were used to measure time-use behaviours over seven consecutive 24-hour periods. Obesity measures included body mass index (BMI) z-score, waist circumference, and waist-to-height ratio. Compositional linear regression and isotemporal substitution were used to explore associations among behavioural and obesity-related outcomes.

RESULTS

Children spent 31.1%, 22.3%, 6.8%, and 39.8% of their time in SB, light PA, moderate-to-vigorous PA, and sleep (respectively). A significant negative (favourable) relationship was observed between light PA (relative to the remaining behaviours) and BMI z-score ($p = 0.005$), while time spent in SB, moderate-to-vigorous PA and sleep was not associated with any outcomes. For the activity type composition, time spent walking and running, relative to the other behaviours, had a significant negative association with BMI z-score ($p = 0.002$). Three distinct lifestyle behaviour clusters were identified separately for activity intensity and activity type compositions.

CONCLUSIONS

This study enhanced our understanding of time use in children from different sociodemographic backgrounds, and how these time-use behaviours are associated with obesity outcomes.

PD124 / #1087**E-poster Discussion Session 16: EAP - Paediatric potpourri - for everyone 05****10-10-2022 12:30 - 13:30****Urine trouble. the changing aetiology and antibiogram of paediatric urinary tract infections - an 8 year retrospective cohort study****J. Choi¹, R. De Vries², A. Yusuf², S. Vogrin¹, M. Wright^{1,2}, C. Collins³, J. Wong⁴, J. Kaufman^{1,2,5*}**¹University of Melbourne, Medicine, Melbourne, Australia²Western Health, Department of Paediatrics, Melbourne, Australia³Western Health, Department of Newborn Services, Melbourne, Australia⁴Dorevitch Pathology, Department of Pathology, Melbourne, Australia⁵Murdoch Children's Research Institute, Department of Paediatrics, Melbourne, Australia**BACKGROUND AND AIMS**

Urinary tract infections (UTIs) are common paediatric infections, with long term sequelae from suboptimal treatment. Antimicrobial resistance (AMR) and extended spectrum β -lactamase producing bacteria (ESBL-PB) in paediatric UTI are increasing globally. Increasing AMR could reduce the efficacy of empiric antibiotic recommendations from local clinical practice guidelines.

METHODS

A single-center retrospective cohort study of urinary isolates obtained from 0-16 year-olds during a 8-year period (January 2012 – June 2019). We analysed patient demographics, AMR patterns for identified uropathogens, risk factors associated with AMR, and empiric antibiotics prescribed by clinicians.

RESULTS

From 9240 urinary cultures over the study period, 2122 returned a positive isolate. The majority of positive samples isolated a gram negative bacteria (93.4%) with *Escherichia coli* as the most common uropathogen (69.8%). AMR for common oral agents was high for amoxicillin (52.7%), trimethoprim (30.0%) and cephalexin (26.3%). AMR for common intravenous (IV) agents was lower, gentamicin (4.1%) and ceftriaxone (18.0%). The overall rate of ESBL-PBs was 6.4% which increased from 2.5% to 9.3% over the study period. Risk factors for ESBL-PBs and increased AMR included prior use of antibiotics in the preceding week, males and anatomical abnormalities of the urinary tract.

CONCLUSIONS

Resistance to cephalexin (recommended empiric oral agent for paediatric UTI in our setting) was relatively high (26.3%) but resistance to gentamicin (recommended IV agent) was lower (4.1%). There was a high rate of ESBL-PBs that increased throughout the study period. This novel data can inform local prescribing and changes to future guidelines on empiric antibiotic prescribing for paediatric UTI are indicated.

PD125 / #1130

E-poster Discussion Session 16: EAP - Paediatric potpourri - for everyone 05

10-10-2022 12:30 - 13:30

Parental competences in Spanish families with young children: role of needs of children and psychosocial context

N. Jiménez-Luque^{1,2*}, I. Benavente-Fernández^{2,3,4}, Y. Sánchez-Sandoval^{1,2}

¹University of Cádiz, Psychology, Cádiz, Spain

²Biomedical Research and Innovation Institute of Cádiz (INIBICA), Research Unit, Cádiz, Spain

³Division of Neonatology, Department of Paediatrics, Cádiz, Spain

⁴University of Cádiz, Area of Paediatrics, Department of Child and Mother Health and Radiology, Medical School, Cádiz, Spain

BACKGROUND AND AIMS

There is currently a growing interest in the study of the family role in early childhood development. Positive parenting depends on three factors, according to the ecological model: psychosocial context, the child's needs and parental competences. This study aims to analyze parental competences in relation to psychosocial context and the needs of children aged 0 to 3 years in Spanish families.

METHODS

Parental Competences were measured with the Spanish adaptation of Scale Positive Parental Practices of the Caregiver (SP+C). We collected information through an ad hoc Sociodemographic Questionnaire about the parents (age, educational level, and gender) and their children (age, gender, disabilities, chronic diseases, type of birth (preterm/full-term), and whether they

receive Early Intervention). We used nonparametric tests to compare the SP+C scores.

RESULTS

We recruited 973 mothers and fathers. We found all subscales of SP+C associated to the child characteristics and/or psychosocial context variables. Among others, parents had higher daily involvement in preterm infants compared to full-term infants (3.67 ± 0.49 vs. 3.59 ± 0.47 ; $p = .021$). Mothers have significantly higher scores than fathers in all subscales except for parental self-care where fathers scored higher (2.23 ± 0.80 vs. 2.01 ± 0.68 ; $p = .019$). Parental age is negatively related with all parental competences.

CONCLUSIONS

Parental competences in Spanish families are related to children's needs and psychosocial context. Understanding these relations is the first step to proposing preventive intervention measures or adapting strategies that promote the positive parenting.

PD126 / #2565

E-poster Discussion Session 16: EAP - Paediatric potpourri - for everyone 05

10-10-2022 12:30 - 13:30

A modified E-Delphi consensus process to inform a clinical guideline for suspected bone and abdominal tumours in children and young people

S. Shanmugavadivel^{1*}, J.-F. Liu¹, A. Ball-Gamble², A. Polanco³,
K. Vedhara¹, D. Walker⁴, S. Ojha¹

¹University of Nottingham, Academic Unit of Population and Lifespan Sciences, Nottingham, United Kingdom

²Children's Cancer and Leukaemia Group, Ceo, GB, United Kingdom

³Children's Cancer and Leukaemia Group, Ppi, GB, United Kingdom

⁴University of Nottingham, Children's Brain Tumour Research Centre, UH, United Kingdom

BACKGROUND AND AIMS

The incidence of childhood cancer has risen by 15% since the 1990s. The overall five-year survival is 84% but bone and abdominal tumours have the lowest survival rates with many experiencing delays to diagnosis. This Delphi-consensus process was conducted to develop a new clinical guideline for CYP presenting with a suspected bone or abdominal tumour.

METHODS

Invitation emails were sent to healthcare professionals (HCPs) to join the Delphi panel. 65 statements were derived from evidence review by a multi-disciplinary team. Participants were asked to rank their agreement with the statements. Any statement achieving the pre-determined level of consensus (>70% agreement) was accepted. Statements not reaching consensus were rewritten and re-issued in a subsequent round.

RESULTS

133 healthcare professionals took part. All statements achieved consensus at the end of two rounds. 96 of 133 (72%) participants responded to the Round 1 (R1). 62 of 65 (94%) statements achieved consensus in R1 with 29 (47%) gaining more than 90% consensus. Three statements did not reach consensus scoring between 60.9 and 69.1%. All reached numerical consensus at the end of Round 2. One statement was deemed similar to another and so was omitted from the final list.

CONCLUSIONS

This consensus process has consolidated statements that will be included in a new clinical guideline for suspected bone and abdominal tumours for use in both primary and secondary care. This evidence base will be translated into awareness tools for the public as part of the Child Cancer Smart national awareness campaign.

PD127 / #2735**E-poster Discussion Session 17: Late breaking paediatrics 02****10-10-2022 12:30 - 13:30****A lysosomal storage disease hidden behind a respiratory tract infection****R.A. Alexe^{1*}, A.-I. Marin¹, R. Minciuna¹, R. Tureschi¹, V. Plaiasu¹, M. Craiu^{1,2}, M. Covacescu^{1,2}**¹INSMC "Alessandrescu-Rusescu", Paediatrics, Bucharest, Romania²"Carol Davila" University of Medicine and Pharmacy, Paediatrics, Bucharest, Romania**BACKGROUND AND AIMS**

Lysosomal acidic lipase (LAL) deficiency results in elevated serum lipids and accumulation of lysosomal esterified lipids. Pathogenic variants in the LIPA gene are causative for Cholesteryl ester storage disease and Wolman disease. The aim of this presentation is to highlight the importance of early diagnosis in treatable lysosomal storage disorders (LSD).

METHODS

We present the case of a 3 year-old girl with a history of recurrent lower respiratory tract infections, dyslipidemia, chronic hepatocytolysis and focal epilepsy suspected by LSD which was confirmed by lysosomal enzymatic screening and genetic testing (Whole Exome Sequencing-WES).

RESULTS

Clinical examination revealed normal somatic development, mild hepatosplenomegaly, hoarse voice, coarse facies and speech delay. Laboratory assess-

ment showed anemia, high values for total cholesterol, LDL-cholesterol level, triglycerides and a slightly increased AST level (aspartate aminotransferase). The peripheral blood smear revealed vacuolated lymphocytes. Radiographic examination of the thorax described pulmonary reticulonodular interstitial pattern. Lysosomal enzyme testing demonstrated decreased activity of LAL. A homozygous variant c.546 G>A of the *LIPA* gene was detected by WES. Parental carrier-testing was not performed.

CONCLUSIONS

LAL deficiency should be considered in a child presenting with dyslipidemia, hepatosplenomegaly and vacuolated lymphocytes, but other common clinical manifestations can be associated such as pulmonary and neurologic involvement. Multidisciplinary approach and genetic counseling are mandatory in such cases.

PD128 / #2753**E-poster Discussion Session 17: Late breaking paediatrics 02****10-10-2022 12:30 - 13:30****Understanding a rare cause for an apparently common acute hepatitis****R.A. Alexe¹, A.-I. Marin¹, R. Minciuna¹, R. Tureschi^{1*}, S. Maria-Teodora¹, R. Alina¹, C. Talpiga¹, V. Plaiasu¹, M. Covacescu^{1,2}**¹INSMC "Alessandrescu-Rusescu", Paediatrics, Bucharest, Romania²"Carol Davila" University of Medicine and Pharmacy, Paediatrics, Bucharest, Romania**BACKGROUND AND AIMS**

Hereditary fructose intolerance (HFI) is an autosomal recessive disorder caused by fructose-1-phosphate aldolase deficiency that leads to accumulation of fructose-1-phosphate in the liver, kidney and small intestine. Dietary restrictions can prevent chronic complications, therefore early diagnosis is highly important.

METHODS

We present the case of a 2 year-old boy who was referred to our emergency department for diarrhea, vomiting and acute hepatitis after administration of intravenous arginine-sorbitol solution. His medical history included failure to thrive, strong dislike for sweets and fruits, recurrent hepatocytolysis, hypertriglyceridemia and mild developmental delay. HFI was suspected and confirmed by NGS-based (Next Generation Sequencing) metabolic gene panel.

RESULTS

Clinical examination revealed pale skin, decreased body weight, hepatomegaly with increased consistency of the liver. Laboratory assessment showed significant hepatocytolysis, cholestatic syndrome and elevated triglycerides and ferritin. Infectious and autoimmune etiologies of acute hepatitis were ruled out. Echographic examination revealed mild hepatomegaly and right nephromegaly. Enzymatic screening for Pompe, Fabry and Gaucher diseases was negative. Molecular genetic testing identified two heterozygous variants c.524C>A p.(Ala175Asp), c.113-1_115del of the *ALDOB* gene and confirmed the clinical suspicion.

CONCLUSIONS

Sometimes behind a common clinical picture could be find a rare life threatening disorder if left untreated, so complex approach should be done to get the final diagnosis as soon as possible.

PD129 / #2653**E-poster Discussion Session 17: Late breaking paediatrics 02****10-10-2022 12:30 - 13:30****Feasibility of early EEG monitoring in the paediatric emergency department setting****C. Stephens^{1,2*}, S. Mathieson^{1,2}, B. Mcnamara³, N. Mcsweeney^{2,4}, R. O'Brien⁵, O. O'Mahony⁴, G. Boylan^{1,2}, D. Murray^{1,2}**¹*Infant Research Centre, University College Cork, Cork, Ireland*²*Department of Paediatrics and Child Health, University College Cork, Cork, Ireland*³*Department of Neurophysiology, Cork University Hospital, Cork, Ireland*⁴*Department of Paediatric Neurology, Cork University Hospital, Cork, Ireland*⁵*Emergency Department, Cork University Hospital, Cork, Ireland***BACKGROUND AND AIMS**

Status epilepticus is a frequent neurological emergency presenting to emergency departments(ED). We aimed to determine the feasibility of EEG application within twenty minutes of presentation, and the obtainment of good quality recordings with <25% artefact in the ED setting.

METHODS

Single centre prospective interventional feasibility study in Cork University Hospital, Ireland between July 2021 and June 2022. Two-channel continuous EEG monitoring was applied to children: 1) <16 years

2) GCS <11 or a reduction in baseline GCS.

RESULTS

Twenty patients were included, 60% males. Median age at presentation was 65.8 months, IQR (23.2-119.0). 50% had a diagnosis of epilepsy prior to presentation. 22% had a genetic condition with associated developmental delay. EEG was performed for status epilepticus (85%), suspected non-convulsive status (10%) and reduced GCS of unknown aetiology (5%). The mean length of recording was 93.1 minutes, SD(47.4). The mean time to EEG application was 41.3minutes SD(11.7). Eleven(55%) EEGs had < 25% artefact. The mean percent of artefact in all EEG recordings was 29.5% SD (23.2). of those who had > 25% artefact

³(33%) required airway management with subsequent lead displacement. 1(11%) had poor lead contact secondary to excessive sweating from a heat source. Excluding these cases, reduced the mean artefact to 23% in EEG recordings.

CONCLUSIONS

Early EEG monitoring can be achieved in an ED setting within one hour of presentation. Earlier application will require an on-site team trained in application. Improvements in portable EEG recording equipment is required to ensure ongoing monitoring during airway support.

PD130 / #2734

E-poster Discussion Session 17: Late breaking paediatrics 02

10-10-2022 12:30 - 13:30

Stronger together: a multidisciplinary simulation based approach to improve pediatric emergency education

A. Zanin^{1*}, P. Beatrice², P. Michele², M. Silvia³, T. Serena³, C. Lorenzo⁴, T. Raffaello², V. Michael², M. Lucrezia⁴, S. Gabriele³, P. Cogo²

¹University of Padua, Department of Women's and Children's Health, Padua, Italy

²University of Udine, Department of Pediatrics, Udine, Italy

³University of Udine, Department of Anesthesiology, Udine, Italy

⁴University of Udine, Department of Emergency Medicine, Udine, Italy

BACKGROUND AND AIMS

Most critical pediatric patients are initially referred and stabilized in the general emergency department (ED). Pediatric readiness relates to having appropriate equipment, medications, and adequate pediatric background. This can be especially challenging for adult doctors with less exposure to children. We developed a simulation training program dedicated to a multidisciplinary audience including emergency medicine, anesthesiologists and pediatric residents, focused on pediatric emergency management. The aim is to assess the improvement of theoretical knowledge, technical and non-technical skills of the attendees in a single or multi-disciplinary learning environment.

METHODS

We performed a prospective cohort study in the University Hospital of Udine (Italy) between January and July 2022. We recruited twelve residents from pediatrics, anesthesiology and emergency medicine. They were divided in

three homogeneous monodisciplinary groups according to their specialty and one "multi-disciplinary" group. Each group performed 12 pediatric scenarios followed by a debriefing session. The "mono-disciplinary" groups had debriefing performed by a single debriefer while the "multi-disciplinary" group had three experts, one of each specialization. Before and after the training program, each participant underwent one ad hoc questionnaire testing the theoretical knowledge and Mayo score for non-technical skills, and each team member was evaluated in their scenarios performance by three external raters.

RESULTS

Our results showed a global improvement in all groups, in both technical, theoretical and non-technical skills. The multi-disciplinary group showed the best improvement in non technical skills area.

CONCLUSIONS

Simulation based education involving multidisciplinary healthcare professionals, is crucial in improving the quality of care in the pediatric emergency department.

PD131 / #2644**E-poster Discussion Session 17: Late breaking
paediatrics 02****10-10-2022 12:30 - 13:30****Achieving integrated psychosocial care in a
children's hospice: an evaluation of a psychosocial
care forum****A. Mckiernan¹, J. Balfe^{2*}, B. Zuro², S. Guerin³**¹LauraLynn Ireland's Children's Hospice, Family Support Team, Dublin, Ireland²LauraLynn Ireland's Children's Hospice, Medical, Dublin, Ireland³University College Dublin, UCD School of Psychology, Dublin, Ireland**BACKGROUND AND AIMS**

Children's palliative care is a relatively new specialty in paediatric health care. As services evolve and expand, ongoing review of organisational processes and pathways is essential. In 2019, a psychosocial care pathway was developed in a Children's Hospice. The pathway was intended to provide evidence-based psychosocial triage to ensure targeted and responsive resource allocation, including weekly team meetings known as Psychosocial Care (PCF). An evaluation of PCF was conducted approximately 12 months after implementation of the pathway.

METHODS

The evaluation used Appreciative Enquiry, an approach to organisational change that focuses on strengths rather than weaknesses. Staff were asked to answer three open-ended questions in a survey about what was working well and what development opportunities existed.

RESULTS

13 team members responded to the survey, and the responses were analysed using the Thematic Analysis method. The analysis showed that PCF facilitates focused discussion of complex cases, promotes integrated teamwork and a holistic approach to care. Respondents rated PCF as effective because of its clarity, regularity, and promotion of emotional containment. Recommendations were made to simplify the referral form to facilitate accurate discussion about the most appropriate intervention for a child and family.

CONCLUSIONS

This evaluation demonstrates the clinical team's ongoing commitment to effective holistic care and the benefits of a regular psychosocial care forum in a children's hospice. Regular evaluation of services and review of pathways and processes in the hospice are ongoing.

PD132 / #2729**E-poster Discussion Session 17: Late breaking paediatrics 02****10-10-2022 12:30 - 13:30****Macrocephaly: diagnosis and approach in a tertiary center****D. Simões^{1*}, T. Moreira¹, D. Bordalo^{1,2}, A. Maia^{1,2}**¹*Centro Hospitalar de São João, Pediatric Department, Porto, Portugal*²*Faculty of Medicine of the University of Porto, Department of Gynaecology-obstetrics and Pediatrics, Porto, Portugal***BACKGROUND AND AIMS**

Macrocephaly refers to a large head size, defined as a head circumference (HC) >2 standard deviations above the mean or >97th centile for a given age, sex, and gestational age. Characterization a cohort of patients with macrocephaly and individualized clinical approach.

METHODS

Retrospective analysis of clinical data regarding patients referred due to macrocephaly between 2008 and 2021. Data collected included demographic information, physical/neurodevelopmental anomalies, clinical approach and final diagnosis.

RESULTS

A total of 94 children (68% male) were referred due to macrocephaly. Primary macrocephaly was present in 3 cases (3,2%). About 66% were referred during the first year of life and 30% during the second. Throughout evaluation,

measurement of parents HC and comparison between children and parents' standard scores was made in 19 cases (20%). Cognitive or behavioral disorders were found in 9,6% of cases. Neuroimaging was performed at least once in 65% of patients, the most common being transfontanelar ultrasound (52%), followed by magnetic resonance imaging (26%) and computed tomography (22%). Benign familial macrocephaly was the etiology in 87% of cases and relative macrocephaly in 7%. Hydrocephalus was present in 3% of cases and intracranial cysts in 4%. One case of Sotos Syndrome and one case of Greig Syndrome were also identified.

CONCLUSIONS

Measurement of head circumference during childhood is an important step in growth and development evaluation. Macrocephaly is a common condition and encompasses several clinical etiological entities. It is essential for clinicians to master the diagnostic approach and quickly recognize those that may necessitate urgent intervention.

PD133 / #2607

**E-poster Discussion Session 17: Late breaking
paediatrics 02**

10-10-2022 12:30 - 13:30

**There is an unmet requirement of a
comprehensive epilepsy service to identify
associated mental health and behavioural
problems in children with epilepsy**

M. Ezzati, S. Mazhar*, E. Hassan, E.M. Okey-Udah

Homerton Healthcare NHS Foundation Trust, Paediatric, London, United Kingdom

BACKGROUND AND AIMS

The chance of mental health and behavioural problems is five times more in children and young persons with epilepsy compared to general population, with an incidence of 30-50% compared to almost 10% in the general population.

METHODS

A retrospective study on 250 cases of epilepsy patient aged between 1-16 years old with epilepsy at Homerton Healthcare NHS Foundation Trust. Data were collected on age, sex, type of epilepsy, type of behavioural and/or mental health problem and any support received from CAMHS.

RESULTS

Almost 10% of patients were identified as having mental health or behavioural problem. Almost half of the cases were among patients between 13 to 16 years old. The youngest patient identified with behavioural problem was 3 years old. There was equal distribution between boys and girls. Among epileptic patients with mental health and behavioural problem 40% had focal seizures and anxiety was the most common mental health problem (64% of cases). Almost one third of patients with mental health problems were on lamotrigine, another one third on sodium valproate and only 15% were on levetiracetam. In 30% of children with mental health problem, patients were on multi antiepileptic medications.

CONCLUSIONS

Only 11% of our epileptic patients reported having mental health and/or behavioural problem which is well below the 30-50% reported incidence in literature. Missed opportunities to identify these children during their epilepsy follow up may be a contributing factor. There is an unmet need to have a Multidisciplinary team follow up clinic with a clinical psychologist during consultation.

PD134 / #2616**E-poster Discussion Session 17: Late breaking
paediatrics 02****10-10-2022 12:30 - 13:30****The association between assisted reproductive
techniques and IQ of preschool children: a
systematic review and meta-analysis****N.T. Minh Duc¹, M. Abdellatif^{2*}, H.T. Nam Giang³, S. Powell⁴,
Z.A. Khan⁵, S.Y. Fadel⁶, P.A. Vu⁷, D.A. Farrag⁸, D.T. Kim Quyen¹,
R. Mahabir⁹, S. Mahabir⁹, S.T.M. Alhady¹⁰, N.T. Huy¹¹**

¹University of Medicine and Pharmacy at Ho Chi Minh City, Faculty of Medicine, Ho Chi Minh City, Viet Nam

²Starcare Hospital, Department of Pediatrics, Muscat, Oman

³The University of Danang, School of Medicine and Pharmacy, Danang, Viet Nam

⁴American University of the Caribbean School of Medicine, Faculty of Medicine, Cupecoy, Sint Maarten (Dutchpart)

⁵Shadan Institute of Medical Sciences,., Hyderabad, India

⁶Suez Canal University, Faculty of Medicine, Ismailia, Egypt

⁷City Children's Hospital, General Surgery Department, Ho Chi Minh City, Viet Nam

⁸Aswan University, Faculty of Medicine, Aswan, Egypt

⁹McMaster University,., Ontario, Canada

¹⁰University of Gezira, Faculty of Medicine, Wad Medani, Sudan

¹¹Nagasaki University, School of Tropical Medicine and Global Health, Nagasaki, Japan

BACKGROUND AND AIMS

Infertility management has relied on IVF and ICSI for over 30 years. A number of concerns have been raised regarding the effects of assisted reproductive technology (ART) on offspring. We aimed to explore the intelligence quotient (IQ) score, in preschool children conceived after ART using the Wechsler Preschool and Primary Scale of Intelligence (WPPSI) scales.

METHODS

We used a systematic approach to search in nine electronic databases. We included original articles comparing ART with natural conception children using WPPSI scale

RESULTS

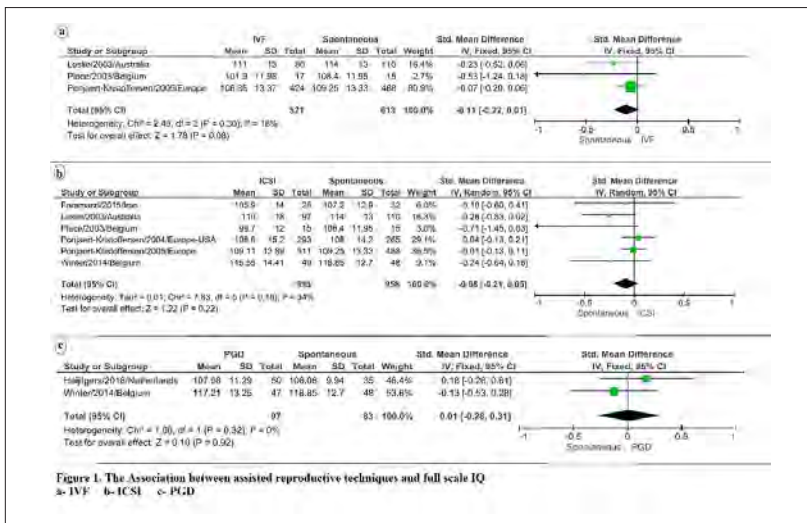

Nine studies were included in our review. The participant children were recruited from Belgium, Sweden, Denmark, Greece, UK, Iran, Netherland, Australia, and the USA. There was no statistically significant difference in full scale IQ between IVF, ICSI or PGD conceived children when compared to normal conception (SMD: (-0.11; 95% CI -0.22, 0.01), (-0.08; 95% CI -0.21, 0.05) and (-0.01; 95% CI -0.28, 0.31) respectively).

CONCLUSIONS

The impact of ART on the children's physical, mental, and psychological outcomes remains unclear because it bypasses all normal sperm selection. In our review, we found that IVF, ICSI, and PDG did not negatively affect the IQ of children when compared to those conceived naturally.

PD135 / #2574**E-poster Discussion Session 17: Late breaking paediatrics 02****10-10-2022 12:30 - 13:30****Optimal management of children who ingested batteries: a prospective observational study****K. Demiroren*, T. Gürcan Pamukçu, M. Şen**

University of Health Sciences, Yuksek Ihtisas Training and Research Hospital, Pediatric Gastroenterology, Bursa, Turkey

BACKGROUND AND AIMS

With the widespread use of lithium-ion batteries, battery ingestion is leading to serious complications and death with increasing frequency. In this study, children who ingested batteries, followed up in accordance with current guidelines, were evaluated.

METHODS

225 children admitted to the pediatric emergency department due to foreign body ingestion in a period of approximately 1 year were evaluated prospectively and observationally. 24 (10.7%) of the patients who ingested button and cylindrical batteries were included in the study.

RESULTS

of the patients, 62.5% were boys, with a mean age of 2.7 ± 1.4 years (range: 1-5 years). 87.5% of the patients ingested a button battery while the rest a cylindrical one. 87.5% of the patients were asymptomatic. In the radiological examination, 58.3% of the batteries were in the umbilical region. 66.7% of

the patients were hospitalized. While endoscopic procedure was not performed in half of the patients, the battery was removed from the esophagus with a rigid endoscope in 1 patient. Flexible endoscope was administered to the remaining 11 (45.8%) patients. While the batteries in the stomach were removed in 6 of them, the battery was not seen in 5 of them. Spontaneous exit was observed in 70.8% of the patients. No significant complication developed and no operation was required.

CONCLUSIONS

Early admission, early endoscopic removal in accordance with current guidelines and close follow-up will minimize complications. Endoscopic removal should be considered emergently in a case with a button battery lodged in esophagus and in any symptomatic case wherever it may be.

PD136 / #2620**E-poster Discussion Session 17: Late breaking
paediatrics 02****10-10-2022 12:30 - 13:30****Clusters of lifestyle behaviours and their
associations with socio-demographic
characteristics in Dutch toddlers****A. Krijger^{1*}, E. Steenbergen², L. Schiphof-Godart³, C. Van Rossum²,
J. Verkaik-Kloosterman², L. Elstgeest⁴, S. Ter Borg², H. Raat⁴,
K. Joosten¹**¹Erasmus MC, Department of Pediatrics and Pediatric Surgery, Rotterdam, Netherlands²National Institute for Public Health and the Environment, -, Bilthoven, Netherlands³University Medical Center Rotterdam, Department of Medical Informatics, Rotterdam, Netherlands⁴Erasmus MC, Department of Public Health, Rotterdam, Netherlands**BACKGROUND AND AIMS**

Insight into clustering of lifestyle behaviours may contribute to the development of effective prevention strategies. This study aimed to identify clusters of lifestyle behaviours in toddlers and assess associations with socio-demographic characteristics.

METHODS

We used data from the Dutch National Food Consumption Survey 2012-2016 and included 646 children aged 1-3 years. Based on 24-h dietary recalls and a questionnaire, a two-step cluster analysis was conducted to identify clusters in intake of fruit, vegetables, sugar-sweetened beverages and unhealthy snacks, physical activity and screen time. Multinomial logistic regression models assessed associations between socio-demographic characteristics and cluster allocation.

RESULTS

Three clusters emerged from the data. The 'relatively healthy cluster' demonstrated a high intake of fruit and vegetables, low sugar-sweetened beverage and unhealthy snack intake and low screen time. The 'active snacking cluster' was characterised by high unhealthy snack intake and high physical activity, and the 'sedentary sweet beverage cluster' by high intake of sugar-sweetened beverages and high screen time. Children aged 1 year were most likely to be allocated to the 'relatively healthy cluster'. Compared to children of parents with a high education level, children of parents with a low or middle education level were less likely to be in the 'relatively healthy cluster' but more likely to be in the 'sedentary sweet beverage cluster'.

CONCLUSIONS

Clusters of lifestyle behaviours can be distinguished already in children aged 1-3 years. To promote healthy lifestyle behaviour, efforts may focus on maintaining healthy behaviour in 1-year-olds and more on switching towards healthy behaviour in 2- and 3-year olds.

PD137 / #2621**E-poster Discussion Session 17: Late breaking paediatrics 02****10-10-2022 12:30 - 13:30****A rare bacteria causing aortitis unmasking coarctation of the aorta: a paediatric case report****M. Boldor^{1*}, C. Vittot², T. Tromeur², P. Mauran²**¹American Memorial Hospital, Marne, REIMS, France²American Memorial Hospital, Marne, Reims, France**BACKGROUND AND AIMS**

Background: *Abiotrophia defectiva*, a nutritionally deficient streptococcus commonly found in the oral cavity, is known as an endocarditis pathogen with embolic complications. In literature, it has been exceptionally proven to be an etiological factor in aortitis. We report an extremely rare case of infectious aortitis likely due to *A. defectiva*, with previously undiagnosed coarctation of the aorta.

METHODS

Case report: A 9-year-old boy with no significant past medical history presented to the emergency room with fever, hip pain and limping for one month. Physical examination revealed high blood pressure (135/85 mmHg) at the right arm, a left supraclavicular systolic murmur and an absence of femoral pulses. Pelvis radiographies and hip ultrasounds were normal. Multiple sets of blood culture isolated *A. defectiva*. Trans-thoracic echography confirmed clinical diagnosis of coarctation of the aorta. Positron emission tomography (PET) scan showed active aortitis just below the coarctation site and abnormal activity on the right hip (Figure 1). These infected locations were presuma-

bly caused by *A. defectiva*. In addition, a dental abscess was found and the causal tooth removed.

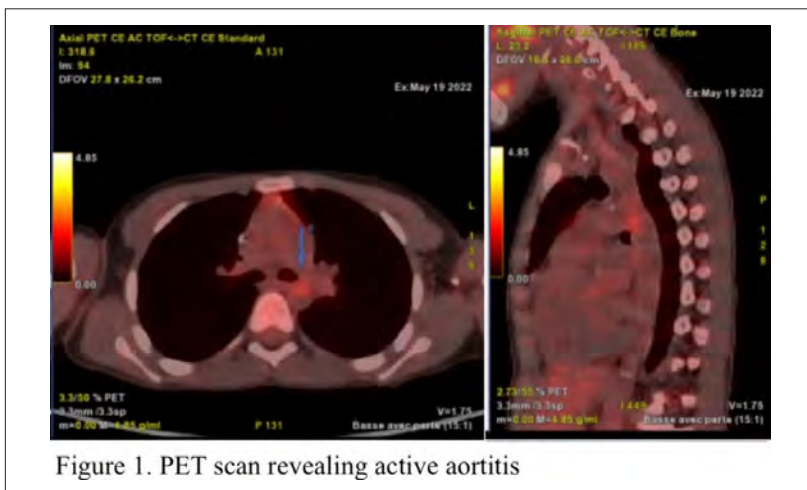

RESULTS

An intravenous antibiotic therapy was undertaken, with gentamycin for 15 days and ceftriaxone for 6 weeks, leading to healing of the infection, confirmed by a second PET scan. Then, the patient underwent surgical repair of coarctation.

CONCLUSIONS

DISCUSSION

A. defectiva is a well-known cause of endocarditis but an extremely rare cause of aortitis in children. Predisposing factors such as coarctation of the aorta should be considered and searched for by complete physical examination and transthoracic echocardiogram.

PD138 / #2520**E-poster Discussion Session 18: Late breaking mixed topics****10-10-2022 12:30 - 13:30****Do newborn infants exhale through the CPAP system? secondary analysis of a randomised cross-over trial****K. Gunnarsdottir^{1*}, M. Falk¹, S. Donaldsson¹, T. Drevhammar², B. Jonsson¹**¹Karolinska Institutet, Department of Women's and Children's Health, Solna, Sweden²Östersund Hospital, Anaesthesiology Dept., Stockholm, Sweden**BACKGROUND AND AIMS**

Using non-invasive ventilation (NIV) as respiratory support is the standard of care in neonatal settings. Early use of nasal Continuous Positive Airway Pressure (nCPAP) is recommended by WHO as an important intervention to reduce neonatal mortality. During nCPAP treatment, leakage is inevitable and can lead to reduced distending pressure. In current practice, neither leakage nor expiratory flow is measured which makes it difficult to assess if exhalation is through the device or entirely through leakages. We aim to examine if infants treated with nCPAP exhale through the system.

METHODS

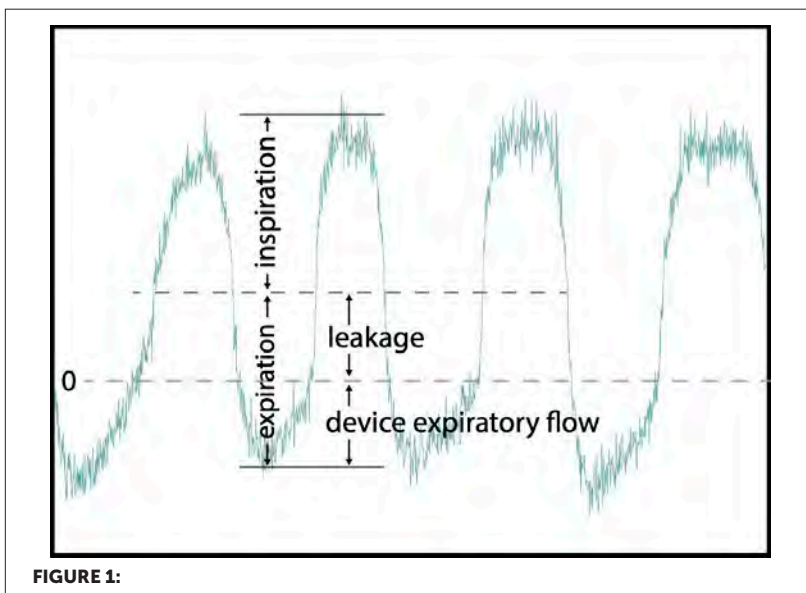

Secondary data analyses from the ToNIL trial on leakages during nasal CPAP treatment. We retrospectively examined respiratory curves for the 50 infants included in the trial, each measured with prongs and nasal masks. A flow recording was classified as exhalation through the system if more than 50% of all expirations showed reverse flow, each for a minimum duration of 0.1 seconds.

Mean gestational age (GA) was 34 weeks, median birth weight 1948 g, and mean age at measurement 6.5 days. Inclusion criteria; CPAP treatment and a GA of 28–42 weeks. Before the ToNIL trial was commenced it was ethically approved and registered at clinicaltrials.gov (NCT03586856).

RESULTS

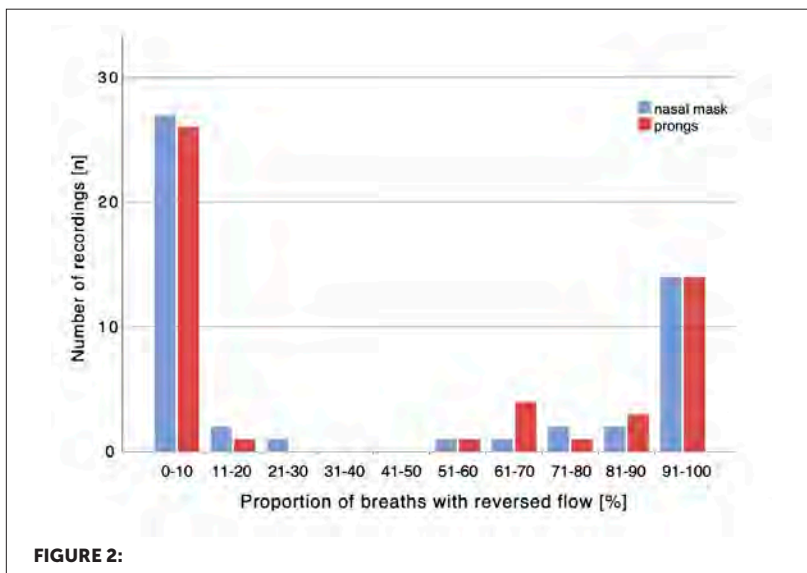

43 of 100 recordings showed reversed flow of more than 0.1 sec in >50% exhalations through the nCPAP system. 32/50 infants exhaled through the CPAP system in at least one recording with either interface.

CONCLUSIONS

During nCPAP treatment, infants exhale through the CPAP system and leakage is common. Measuring expiratory flows and leakages could be valuable in optimizing CPAP treatment.

PD139 / #2617**E-poster Discussion Session 18: Late breaking mixed topics****10-10-2022 12:30 - 13:30****The effect of technology-based interventions in pediatric oncology: a integrative review of evidence****H. Ozdemir Koyu*, E. Kilicarlan Törüner**

Gazi University Faculty of Health Sciences, Paediatric Nursing Department, Ankara, Turkey

BACKGROUND AND AIMS

Evidence shows that technology-based interventions are feasible and acceptable in pediatric oncology. However, studies in this area are limited. This review was planned to systematically examine the available evidence for the impact of technology-based interventions for children and their parents with a cancer.

METHODS

Studies published in English between 2017 and 2022 from CINAHL Plus with Full Text, Cochrane Library, PsycINFO, ProQuest, PubMed, Science Direct, Scopus and WoS databases were determined using a search strategy. In the literature review, six studies according to the criteria were examined in terms of the technology-based intervention, the duration of the intervention, the follow-up period, important findings and the theory used in the intervention.

RESULTS

In most of the studies examined, it was determined that the participants were between the ages of 10-18. It has been determined that technology-based interventions mostly consist of electronic health interventions such as web-based applications, virtual reality, digital games, and mobile health interventions. In the studies, it was determined that the intervention period ranged from 8-12 weeks, and the follow-up periods ranged from 4 weeks to 12 months. In studies for parents, it was observed that the intervention times varied between 10-12 weeks and the follow-up periods between 3-12 months. In most of the studies, it has been determined that technology-based interventions have positive effects on physical and psychological (symptom management, physical activity, stress, coping) problems in children. Technology-based interventions were found to have effects on parents' coping skills, psychosocial symptoms, resilience, self-efficacy.

CONCLUSIONS

Research is needed to obtain the best evidence for the effectiveness of technology-based interventions in pediatric oncology.

PD140 / #2726**E-poster Discussion Session 18: Late breaking mixed topics****10-10-2022 12:30 - 13:30****The effect of empowerment programs for parents of children with cancer: a systematic review****H. Ozdemir Koyu*, E. Kilicarslan Törüner**

Gazi University Faculty of Health Sciences, Paediatric Nursing Department, Ankara, Turkey

BACKGROUND AND AIMS

Children and parents diagnosed with cancer are affected physically, psychologically and socially in many dimensions during the cancer experience. In this process, children with cancer diagnosis and their parents need empowerment. Children diagnosed with cancer and their parents need to be empowered during the cancer experience. However, research on the empowerment programs in children and parents are limited. The aim of this systematic review was to evaluate the effectiveness of empowerment programs for children with cancer and their parents.

METHODS

In this systematic review; studies published in English between 2017-2022 from CINAHL, PubMed, Web of Science, Scopus databases were determined using a search strategy. In the systematic review, 6 studies in accordance with the criteria were examined in terms of the intervention, the duration of the intervention, important findings and the theory used in the intervention.

RESULTS

In most of the studies examined, it was determined that the programs aimed at empowering the parents of children diagnosed with cancer were planned based on technology based. These interventions mostly consist of web-based applications and mobile applications. In the studies, it was determined that the intervention period varied between 4-10 weeks, and the follow-up periods varied between 1 week and 6 months. In most studies, empowerment-based interventions have been found to have positive effects on parents' psychosocial symptoms (depression, stress, fear), resilience, coping and quality of life.

CONCLUSIONS

As a result of the investigations; Evidence-based intervention studies are needed to empowerment the parents of children with cancer and support their coping skills.

PD141 / #2507**E-poster Discussion Session 18: Late breaking mixed topics****10-10-2022 12:30 - 13:30****Parent's experiences of their children suffering febrile seizures - a qualitative interview study****E. Westin^{1*}, M. Sund Levander²**¹Region Kronoberg, Pediatrics Department, Växjö, Sweden²Linköping University, Division of Nursing Science, Faculty of Medicine, Linköping, Sweden**BACKGROUND AND AIMS**

Fever in children can be frightening for parents. One of the things they fear are febrile seizures which affect 2-5% of children between 0-5 years of age. Although simple febrile seizures are usually harmless, they are often perceived as life-threatening by parents. The pediatric nurse need to understand these parents in order to support them. The purpose of the study was to explore parents' experiences of their child suffering febrile seizures.

METHODS

A qualitative interview study in which 11 parents participated. The interviews contained open questions about their experiences during and after a febrile seizure. The interviews were transcribed and analyzed using latent content analysis.

RESULTS

The result consists of five themes: *Emotional experiences*

It was common for the parents to feel anxiety and fear due to not knowing what the child had suffered from and/or how dangerous it was. *Need for control*

During a chaotic situation, the parents described different ways of trying to regain control both during the seizure and afterwards. *Need for support*
The parents felt that they needed and received support from the other parent and from the healthcare system. *Need for acknowledgment*

The parents appreciated that the healthcare staff listened, gave them time and information. *Need for comfort*

The parents stated that it was important to get an explanation of what had happened and that their child's febrile seizure did not pose any danger to the child.

CONCLUSIONS

A febrile seizure can be a frightening experience. The pediatric nurse play an important role in supporting the parents.

POSTER VIEWING ABSTRACTS

EP001 / #2649**E-Poster Viewing - Intensive care AS01-03.
Cardiovascular & haemodynamics****A case series of scimitar syndrome - with varied presentations****V. Mundeshi¹, N. Chinchankar^{2*}**¹NHS Lothian, Paediatrics, Edinburgh, United Kingdom²NHS Lothian, Paediatric Critical Care, Edinburgh, United Kingdom**BACKGROUND AND AIMS**

Scimitar Syndrome is a rare congenital malformation, with anomalous pulmonary drainage into inferior vena cava, giving an appearance of a chest x-ray appearance of Turkish sword called Scimitar. often associated with hypoplasia of right lung, dextroposition of heart, hypoplasia of right pulmonary artery. We describe 3 cases, with varied presentations and outcomes.

METHODS

An Antenatally diagnosed case with right lung hypoplasia, post-natal imaging suggested hypoplastic right lung with abnormal bronchi, mixed blood flow to right lung, right pulmonary vein draining to IVC. An attempt to embolise abnormal vessel was unsuccessful. Infant needed non-invasive ventilation and sildenafil for pulmonary hypertension. A previously healthy 8-month-old presented with bronchiolitis, chest x-ray raised suspicion of dextrocardia, imaging suggested Scimitar, was weaned off from non-invasive ventilation and discharged with cardiology follow-up. 9 months old presented to Emergency department with apnoea, a chest x-ray showed cardiomegaly and abnormal vascular shadow, Cardiac catheterizations suggested scimitar with VSD, ASD, IVC stenosis and pulmonary hypertension. Child underwent multiple palliative surgeries with poor outcome.



Case 1 Chest X ray suggested hypoplastic right lung and Catheter Studies showed vessels feeding into right lower lobe arising from Aorta.

FIGURE 1:



Case 2: Chest X ray raised suspicion of dextrocardia, Chest CT suggested dextroposition of heart, hypoplasia of right lung and venous drainage of right lung to IVC

FIGURE 2:



Case 3. Chest X ray demonstrating Scimitar vein and seen on CT imaging.

FIGURE 3:

RESULTS

Scimitars can present from early childhood to late adulthood. Associated with other anomalies like VSD, ASD, pulmonary hypertension. Needs multi-disciplinary approach involving treatment for pulmonary hypertension and cardiac failure. Obliteration of abnormal arteries supplying lung to improve pulmonary hypertension. Surgical correction depends on anatomic features.

CONCLUSIONS

Natural history of Scimitar syndrome is variable and is complex with variable presentation ranging from asymptomatic with isolated findings and benign outcomes to severe heart failure, pulmonary hypertension, and associated anomalies leading to mortality. Outcomes depend on anatomical variations and the timing of diagnosis.

EP002 / #1585

E-Poster Viewing - Intensive care AS01-03. Cardiovascular & haemodynamics

Presentation of cardiac arrhythmias after infection with the novel covid-19

**A. Liaskou^{1*}, K. Straka², E. Christakou², C. Tsirogianni², C. Tsiagklani³,
D. Paraschou², C. Barbaressou²**

¹Aghia Sophia Childrens Hospital, Picu, Athens, Greece

²Aghia Sophia Children's Hospital, Paediatric Intensive Care Unit, Athens, Greece

³Aghia Sophia Children's Hospital, Picu, Athens, Greece

BACKGROUND AND AIMS

Patients with COVID19 present with symptoms and signs of respiratory tract infection; secondary cardiac disease, including tachyarrhythmias, with or without signs of myocardial injury, have been documented.

METHODS

We present 2 cases of cardiac arrhythmias after COVID infection that were hospitalised in our PICU

RESULTS

Case 1: A previously healthy 5-year old girl was admitted to PICU due to tachyarrhythmia, after being hospitalised in the paediatric ward due to fever and abdominal pain. Upon admission, the patient had HR:150/min; NT-proBNP level was 7490, whereas CK-MB and Troponine were in range. Initial ECG showed supraventricular tachycardia which subsided with antipyretics but subsequent studies showed Mobitz type 1 (Weckenbach) second degree AV block, which was not present at admission. NT-proBNP decreased until dis-

charge. The patient remained hemodynamically stable and was discharged to cardiology for further testing. Case 2: A previously healthy 18-month old boy presented with fever, supraventricular tachycardia (HR:250/min, BP:100/50 mmHg) and a history of COVID-19 infection. Upon admission, he received adenosine and amiodarone with poor clinical response and the patient was subsequently sedated and intubated so that cardioversion could be performed. He required 4 rounds of electrical cardioversion. Subsequently, he was transferred to cardiology where he presented with short episodes of supraventricular tachycardia although he was on treatment with amiodarone. He was transferred to a specialized center for further management.

CONCLUSIONS

Most studies show a wide spectrum of cardiac disease after infection with the COVID-19 and not all patients are affected in the same manner. Therefore, cardiac screening tests should be performed in all patients with COVID-19 infection and clinicians should be aware of the likelihood of myocardial injury and its clinical manifestations.

EP003 / #2442

E-Poster Viewing - Intensive care AS01-03. Cardiovascular & haemodynamics

Prenatal diagnosis of coarctation of the aorta reduces preoperative illness severity and morbidity

M. Castelão¹, M. Pereira², M. Mota^{1*}, M. Mata³, M. Abecasis⁴,
J. Neves⁴, R. Anjos³

¹Hospital De Santa Maria, Centro Hospitalar Universitário Lisboa Norte, Pediatrics, Lisbon, Portugal

²Hospital CUF Descobertas, Centro Da Criança E Do Adolescente, Lisbon, Portugal

³Hospital de Santa Cruz, Centro Hospitalar Lisboa Ocidental, Paediatric Cardiology Service, Lisbon, Portugal

⁴Hospital de Santa Cruz, Centro Hospitalar Lisboa Ocidental, Cardiothoracic Surgery Service, Lisbon, Portugal

BACKGROUND AND AIMS

Coarctation of the aorta (CoA) is a common congenital heart defect, accounting for 8% of congenital heart diseases. **Aim:** To investigate whether antenatal diagnosis of CoA results in an effective improvement in preoperative illness severity and mortality.

METHODS

Review of neonates with isolated CoA in a tertiary paediatric cardiology hospital, from October 1999 to November 2021. Patients with CoA associated with defects requiring correction were excluded. Pre and postnatal medical records were reviewed to determine survival and preoperative morbidity in the two groups. Markers of preoperative illness severity included age at surgery, aortic peak systolic gradient, Prostaglandin-E1 (PGE1) therapy, need for ventilatory or inotropic support and multiorgan dysfunction.

RESULTS

We studied 94 patients (68% male) with neonatal CoA; 36% (n=34) had antenatal diagnosis. Mean age at surgery 15.5 ± 2.3 days, mean weight 3222 ± 88.7 grams. Newborns with prenatal diagnosis were treated significantly earlier (9.8 ± 1.5 vs 18.8 ± 1.9 days; $p=0.002$), had lower peak systolic gradient (31.2 vs 46.1 mmHg; $p=0.003$), and required lower doses of PGE1 (<30 ng/kg/min; $p=0.001$). Both preoperative need for inotropic support and feeding intolerance were more common in the postnatally diagnosed group ($p=0.024$ and $p=0.022$, respectively). Early postoperative complications, including shock, prolonged mechanical ventilation, hypertension, and acute kidney injury, were more frequent in infants without antenatal diagnosis of CoA but did not reach statistical significance. No patient died until hospital discharge.

CONCLUSIONS

Prenatal diagnosis of CoA is associated with improved preoperative clinical condition, decreased morbidity, and earlier surgery. Prenatal diagnosis of coarctation is challenging but important to reduce risks and improve outcomes in this condition.

EP004 / #1456

E-Poster Viewing - Intensive care AS01-03. Cardiovascular & haemodynamics

Rare pediatric cases of covid-19 associated pulmonary embolism

**A. Ntavoura*, M. Prapa, E. Christakou, C. Tsirogianni, M. Gianniki,
E. Mpourazani, L. Anastasia, D. Paraschou, C. Barbaressou**

Agia Sofia Children's Hospital, Pediatric Intensive Care Unit, Athens, Greece

BACKGROUND AND AIMS

Pulmonary embolism (PE) is a rare and severe event in children with differences in pathophysiology, symptoms and management. Cytokine storm of COVID-19 infection induces blood coagulation cascade, contributing to hypercoagulation.

METHODS

We present 2 cases of PE associated with COVID -19 infection, admitted in our PICU.

RESULTS

Case 1: A previously healthy 11-year-old boy, was admitted to the hospital with fever, abdominal pain and vomiting. Based on his recent history with COVID-19 infection (twice during 5 months), blood exams revealed abnormal coagulation tests (d-dimers=6.7mg/dL) and elevated ferritin levels. A chest CT- scan with contrast demonstrated PE in interlobular and sub-segmental pulmonary arteries. Due to PE in the context of MIS-C, patient was admitted to PICU, where he remained hemodynamically stable and received LMWH, IVIg and methylprednisone. Further investigation was performed due to positive

family history of thrombophilia. Case 2: A 15-year-old male teenager exhibited pain in right hip joint, with DVT in femoral vein diagnosis from MRI scan. He tested positive for COVID-19 and presented fever, hemodynamic instability and respiratory distress syndrome. A chest CT – scan revealed PE and was transferred to PICU, where LMWH and warfarin was administered, with gradual improvement of his clinical condition.

CONCLUSIONS

Although PE is diagnosed less commonly in children, its occurrence is more frequent in children hospitalized with acute COVID -19 and MIS-C. Our patients had different clinical presentation and laboratory findings. High index of suspicion is required, while early initiation of anticoagulation therapy is essential for favourable outcome

EP005 / #704

E-Poster Viewing - Intensive care AS01-04. Covid-19

Challenges encountered in diagnosing and treating mis-c

I. Bakalli^{1*}, E. Celaj¹, E. Kola¹, M. Zguri², I. Gjeta¹, D. Klironomi³

¹UHC "Mother Theresa", Pediatrics, Tirana, Albania

²UHC "Mother Theresa", Radiology, Tirana, Albania

³Medical University of Vienna, Pediatrics, Vienna, Austria

BACKGROUND AND AIMS

With the increasing prevalence of SARS-COV 2 infections, more patients with multisystem inflammatory syndrome in children (MIS-C) are being reported worldwide. MIS-C is potentially life threatening and the optimal strategy for its treatment remains unknown and challenging. We'd like to share our experience treating children with MIS-C and talk about the challenges we've had diagnosing and treating these patients.

METHODS

This study included all children hospitalized to the PICU at UHC "Mother Theresa" in Tirana with the diagnosis of MIS-C between May 2020 and February 2022.

RESULTS

All children had a severe clinical presentation at admission, with cardiogenic shock, hypovolemic, distributive, or mixed features. Hypotension was present in all cases. In the first two cases, administering fluids in the amount recommended for distributive shock to correct hypotension, aggravated the

clinical condition, resulting in a significant increase in respiratory depression, despite the addition of inotropic drugs to the therapy. The administration of furosemide, along with inotrope, has resulted in clinical improvement. The echocardiography and ECG results were normal, whereas Troponin and Pro BNP levels were increased. We saw a significant improvement after the therapy with IVIG + corticosteroids (Dexamethasone or methylprednisolone pulse therapy). No additional therapy was required in any of the cases.

CONCLUSIONS

Fluid administration should be done with extreme caution, as shock can have hypovolemic, distributive, and cardiogenic features. Troponin and Pro BNP may aid in the diagnosis of MIS-C in cases where echocardiography and an ECG are normal. Treatment with IVIG plus methylprednisolone pulse therapy appears to be quite effective.

EP006 / #2190

E-Poster Viewing - Intensive care AS01-04. Covid-19

Cardiac involvement in multisystem inflammatory syndromedue to sars cov 2 in tunisian pediatric population

R. Ben Rabeh*, N. Missaoui, S. Atitallah, S. Yahyaoui, O. Bouyahya, S. Mazigh, S. Boukthir

University of Tunis El Manar, Faculty of Medicine of Tunis, Bechir Hamza Children's Hospital of Tunis, Pediatric Department C, Tunis, Tunisia

BACKGROUND AND AIMS

Multisystem inflammatory syndrome in children (MIS-C) caused concerns among pediatricians since its first description in May 2020. Cardiac involvement was the most serious complications. The aim of this study was to describe cardiac involvement and identify factors associated with cardiac complication in children with MIS-C.

METHODS

We conducted a retrospective record of all children diagnosed with MIS-C and admitted to the pediatric department C of Bechir Hamza's Children Hospital of Tunis (September 2020-December 2021). We used WHO's case definitions of MIS-C.

RESULTS

We enrolled 35 patients. Median age was 6 years. The highest incidence was during the 5th wave of Covid-19 in Tunisia which began in July 2021. Twenty patients had exposure with a person confirmed to covid 19. Median duration

of symptoms at admission was 5 days. Most common symptoms were: fever (35/35), abdominal pain (23/35), rash (22/35), conjunctivitis (21/35), vomiting (19/35), cheilitis (18/35) and tachycardia (17/35). Twenty one patients (60%) had cardiac involvement. Nine (25%) had cardiogenic shock and were put on vasopressive drugs. Four patients were admitted in ICU for a median duration of 5.5 days. Troponin levels were high in 16 patients. Cardiac ultrasounds found low left ventricular ejection fraction <55% (12/35), coronary arteries dilatation (5/35), pericardial effusion (4/35), aortic and mitral regurgitation (4/35). All patients received intravenous immunoglobulin, 30 received corticosteroids. No death occurred. Factors associated with cardiac complications were age >10 years ($p=0.021$) and time between symptom onset and hospitalization >7 days ($p=0.003$).

CONCLUSIONS

Cardiovascular dysfunction was common in our cohort. Cardiac involvement was associated with age and delayed diagnosis.

EP007 / #2722

E-Poster Viewing - Intensive care AS01-04. Covid-19

Acute liver failure as a prominent presentation in misc due to covid-19 infection

S. Mukhopadhyay*, A. Singh

King George Medical University, Pediatrics, Lucknow, India

BACKGROUND AND AIMS

Although some conventional presentations of novel coronavirus disease 2019 (COVID-19) have been reported, such as respiratory symptoms, weakness, and fever, unusual and unexpected presentations have also been identified, especially in children. We report a case of fulminant acute hepatic failure in a child caused by MISC with COVID-19.

METHODS

The patient had a high-grade fever for 7 days, 5 days of loose stools, and massive hematemesis (multiple episodes for 2 days). The patient had 1 episode of nasal bleeding 2 days back. There was no history of contact with covid 19-positive patient. The working diagnosis was "acute liver failure cause acute viral hepatitis. Vital signs were monitored, IV fluids were administered, and iv antibiotics were empirically started for the patient. Vasopressors (inj Adr@0.3ug/kg/min) was initiated after fluid resuscitation since the patient had arrived in a state of shock with weak pulses, cold extremities, and BP below the 5th centile. Blood tests were sent, and the preliminary results suggested severe anemia with an abnormal coagulation profile with raised S.Bil and SGOT/SGPT.

RESULTS

FFP and packed RBC components were administered to the patient as indicated. Covid Antibody was positive, and as infectious explanations for the aforementioned presentation had been ruled out by all pertinent studies, a diagnosis of MISC was obtained since it satisfied both the laboratory and clinical criteria. IVIG (2gm/kg) and intravenous methylprednisolone were initiated. Gradually over time, the patient's condition improved.

CONCLUSIONS

We present a rare case of COVID-19-related ALF. Rising LFT, INR, and increasing encephalopathy confirmed the diagnosis.

EP008 / #2758

E-Poster Viewing - Intensive care AS01-07. Endocrinology & diabetes

Prognostic factor of diabetic ketoacidosis in the pediatric intensive care unit

M. Simou¹, F. Jannan^{1*}, M. Khalfi¹, S. Gueroum¹, B. Atak^{1,2}

¹Chu Casablanca, Paediatric Reanimation, Casablanca, Morocco

²Centre Hospitalier Universitaire Ibn Rochd Casablanca, Anesthésie Réanimation Pédiatrique, Casa, Morocco

BACKGROUND AND AIMS

Mortality and prognostic factors of diabetic ketoacidosis in children in the intensive care unit

METHODS

In this work we tried to make a global analysis of this pathology. We conducted a retrospective study of 122 cases admitted to the pediatric intensive care unit at the Ibn Rochd University Hospital in Casablanca between January 2010 and January 2020. The different variables collected at admission were analyzed and compared between two groups: patients who died and those who survived.

RESULTS

The statistical analysis was performed with SPSS 21 software. 122 cases of diabetic ketoacidosis were identified. 68 boys and 74 girls with a sex ratio of 0.91. The average age was 7.61 years. Ketoacidosis was inaugural in 62% of cases, polyuro-polydipsic syndrome was found in all patients followed by digestive disorders in 55.6% of cases. The average GCS on admission was 12.

Shock was found in 17.6% of the cases and polypnoea with Kussmaul type respiration in 71.12% of the cases. The mean values of kalaemia and natraemia were close in both groups. Bicarbonates were below normal in all patients with an average of 6.37 mmol/l. The mortality was 15%.

CONCLUSIONS

The factors significantly influencing mortality were: altered state of consciousness, State of shock; Fever; Administration of ATB at the admission; Cerebral edema; Nosocomial infection; Use of mechanical ventilation, Administration of vasoactive drugs, Placement of a central KT. The factors for a worse outcome were: Altered state of consciousness, Cerebral edema, Nosocomial infection, Use of mechanical ventilation, Administration of vasoactive drugs.

EP009 / #1614

E-Poster Viewing - Intensive care AS01-07. Endocrinology & diabetes

Cerebral encephalopathy with pontine myelinolysis in a case of central diabetes insipidus after neurosurgery

A. Liaskou^{1*}, E. Christakou², K. Straka², P. Poulos², C. Barbaressou²

¹Aghia Sophia Childrens Hospital, Picu, Athens, Greece

²Aghia Sophia Children's Hospital, Paediatric Intensive Care Unit, Athens, Greece

BACKGROUND AND AIMS

Central pontine myelinolysis (CPM) is a solitary and symmetrical focus of demyelination in the central pons; lesions with similar characteristics but identified in the basal ganglia, thalamus and white matter of the cerebellum, termed extrapontine myelinolysis (EPM), can be associated with CPM. Both are uncommon disorders characterized by distinctive clinical features and typical findings on neuroimaging. Only a few cases are reported in the pediatric age group and are usually associated with rapid correction of hyponatremia.

METHODS

We present a case of myelinolysis precipitated by correction of a hyperosmolar state in a 14-year old patient.

RESULTS

A previously healthy 14-year old girl was admitted to PICU because of extreme hypernatremia ($\text{Na}=187\text{mEq/L}$), dysarthria, lethargy and confusion, 7 days after surgical excision of craniopharyngioma. Although the serum sodium levels were brought down gradually, the patient showed deterioration of her

neurological status and needed to be intubated; subsequent MRI imaging showed progression of demyelination and the lesions were located in both pontine and extrapontine sites. The patient eventually developed generalized cerebral oedema. Despite all conservative and surgical measures, there has been deterioration of the oedema and the patient was declared brain dead. After completion of the organ donor tests, she became an organ donor.

CONCLUSIONS

Although demyelination occurs more often after correction of hyponatremia, our case showed that it can also occur with hypernatremia, even with gradual correction of sodium levels and is associated with permanent neurologic symptoms and high mortality.

EP010 / #1443

E-Poster Viewing - Intensive care AS01-07. Endocrinology & diabetes

Acute pancreatitis, hypertriglyceridemia and diabetic ketoacidosis in a 5-year-old boy following l-asparaginase/dexamethasone therapy for acute lymphoblastic leukemia

M. Gianniki, E. Christakou, C. Tsirogianni*, E. Mpourazani, K. Straka, C. Tsiagklani, I. Gotsi, P. Poulos, D. Paraschou, C. Barbaressou

Aghia Sophia Children's Hospital, Paediatric Intensive Care Unit, Athens, Greece

BACKGROUND AND AIMS

Acute pancreatitis and Diabetic Ketoacidosis (DKA) are unusual adverse events following chemotherapy based on L-asparaginase and dexamethasone for acute lymphoblastic leukemia. Particularly, the triad Acute pancreatitis, Hypertriglyceridemia and Diabetic Ketoacidosis is even more rarely described in the literature.

METHODS

We present a 5-year-old Caucasian male patient, in induction therapy for acutelymphoblastic leukemia (ALL) with Vincristine, L-Asparaginase, doxorubicin and dexamethasone who was admitted to our Pediatric Intensive Care Unit (PICU) presenting with altered mental status, respiratory distress, abdominal pain and vomiting.

RESULTS

We report a case of a toddler, recently diagnosed with ALL, who presented with abdominal pain and breathing difficulty following chemotherapy with L-asparaginase. On subsequent evaluation, hyperglycemia, acidosis, ketonuria, low bicarbonate levels, hypertriglyceridemia, hyperamylasemia and hyperlipasemia were documented, and the diagnosis of diabetic ketoacidosis was made. In order to confirm the diagnosis of pancreatitis, an abdomen ultrasonogram and computed tomography were performed, which showed signs of necrotic pancreatitis. DKA was managed with fluid correction and insulin infusion, while pancreatitis was managed conservatively. The patient recovered completely without any major complications and he was discharged from PICU after 7 days.

CONCLUSIONS

The combination of DKA and pancreatitis is rare, but associated with significant morbidity and mortality. An early diagnosis is of a great value, so a close monitoring of blood glucose levels for hyperglycemia, as well as a high index of clinical suspicion for pancreatitis are recommended in patients with ALL receiving L-asparaginase.

EP011 / #370

E-Poster Viewing - Intensive care AS01-08. Epidemiology

The rate of neonatal mortality and that's relation with a season of the year

L. Martirosyan¹, V. Manukyan², H. Hakobyan², S. Brutyan²,
M. Melkonyan², V. Asoyan², H. Apresyan^{2*}, A. Minasyan³

¹YSMU, Infectious Diseases, Yerevan, Armenia

²Yerevan State Medical University, Infectious Diseases, Yerevan, Armenia

³Yerevan State Medical University, Coloproctology, Yerevan, Armenia

BACKGROUND AND AIMS

Increased early mortality among births in late spring and early summer has been noted in many scientific studies in many countries, so we also found this kind of correlation.

METHODS

We have done retrospective study at Muratsan UHC NICU,2014-2018(350 death cases) focused on the mortality rate. We combined two types of researches (neonatal deaths and neonatal morbidity after complicated pregnancy) and came up with some conclusions.

RESULTS

There are 96 hospitalized neonates during cold months (11,12,1,2), and 69 (71.8%) of them had pneumonia, and 109(77.9%) pneumonia cases in 140 hospitalized neonates during warm months (5,6,7,8). in warm months there are 40 more cases of pneumonia than in cold months, due to the fact that moms of newborns had their first trimester in winter, which is the most

common season of acute respiratory infections. Acute respiratory infections in first trimester enhance the possibility for congenital abnormalities genesis. We also have done another randomized study up to one month newborns and found out that 42(70%) children had pneumonia whose mothers (total 60) had respiratory viruses in different gestational ages.

CONCLUSIONS

As we found some correlations between intranatal pneumonia and viral infections during pregnancy, we suggest researchers to do some additional study in this field.

EP012 / #371

E-Poster Viewing - Intensive care AS01-08. Epidemiology

Epidemiological analysis of patients in nicu of muratsan uhc during january-june 2017, yerevan, ra

L. Martirosyan¹, V. Manukyan², H. Hakobyan², S. Brutyan²,
M. Grigoryan¹, M. Melkonyan², V. Asoyan², H. Apresyan^{2*},
A. Minasyan³

¹YSMU, Infectious Diseases, Yerevan, Armenia

²Yerevan State Medical University, Infectious Diseases, Yerevan, Armenia

³Yerevan State Medical University, Coloproctology, Yerevan, Armenia

BACKGROUND AND AIMS

Newborns who need intensive medical care are put in a neonatal intensive care unit (NICU). The NICU has advanced technology and trained healthcare professionals to give special care. The NICU of Muratsan University Hospital is Republican Centre and founded in 1997. Our purpose is to analyze the main characteristic of hospitalized neonates during 01.01.2017-01.01.2017.

METHODS

A randomized retrospective study included 133 medical charts. Exclusion criteria was cases with lethal outcome.

RESULTS

During aforementioned period 300 patients were admitted from which 33 patients died. Out of 133 patients 77(57.9%) was male and 56(42.1%) was female. The mean hospital stay was 15.7 days (min-1, max-64). The vast major-

ity of patients (91%) discharged with recovery and other 9% was transferred to other clinics. The distribution by provinces: Gegharkunik-22, Kotayk-20, Ararat-17, Lori-13, Syunik-10, Tavush-10, Aragatsotn-9, Armavir-4, Shirak-3, Vayots Dzor-3. There were 71(53.3%) patients from cities, 22(31%) of them from capital city Yerevan and others(46.7%) from villages. The most frequent diagnosis was pneumonia (87cases), further ones were bronchiolitis(14) and hemolytic disease of the newborn(7). We didn't find any information in medical charts about vaccination for HBV and TB which should be done according National Vaccination Program

CONCLUSIONS

We concluded that male-to-female ratio of morbidity was 1.4:1. The highest numbers of patients were from Yerevan(22 per 1.01million population), and Gegharkunik(22 per 235000) which is explained by presence of NICUs adjacent to the Maternity Homes in Yerevan and absence of specialized centers in Gegharkunik. The deficiency of neonatologists is a rising problem in Armenia.

EP013 / #833

E-Poster Viewing - Intensive care AS01-09. Ethics & law

“We are pushing the limits”: clinicians’ perceptions of bioethics services when considering long-term ventilation for a child

D. Alexander¹, M. Quirke¹, J. Greene¹, K. Hill², C. Doyle¹, M. Brenner^{3*}, K. Masterson¹

¹Trinity College Dublin, School of Nursing and Midwifery, Dublin, Ireland

²University College Dublin, School of Nursing, Midwifery and Health Systems, Dublin, Ireland

³UCD College of Health Sciences, UCD School of Nursing, Midwifery and Health Systems, Dublin, Ireland

BACKGROUND AND AIMS

Increasingly, long-term technological solutions are used to support children to sustain life. Ethical issues confronted by clinicians at the point of initiation of this technology are often challenging. However, scant data about the influences and interactions at this point of care delivery risk ethical considerations being driven by opinion or public debate more than empirical evidence, whilst the provision and uptake of clinical bioethics advice is inconsistent.

METHODS

Using a phenomenological framework for data collection and analysis, we explored the lived experiences of clinicians, and their perspectives on the clinical bioethical services they may encounter at the point of initiation of technology dependence for a child. We conducted unstructured interviews with 78 clinicians in four global sites (Ireland, Australia, Netherlands and the United States). Ethical approval was granted by the host institution.

RESULTS

Clinicians' perceptions of bioethics services were complex: encompassing personal, structural and relationship considerations. Inconsistency of provision of bioethics services and lack of clarity of their remit were perceived as negatives. Respect for the gravity and long-term consequences of decisions, and the ability to air and discuss different views and value-based judgements were seen as positive. Bioethics services also played a potentially important role in relationship development and communication with the child and family.

CONCLUSIONS

Bioethics services have the potential to provide valuable support to clinicians who face complex ethical issues at the time a child requires long-term ventilation to sustain life. However, the provision of this support, and the perception of clinicians towards bioethics services is inconsistent and poorly understood.

EP014 / #1922

E-Poster Viewing - Intensive care AS01-09. Ethics & law

Bioethical considerations for end-of-life decisions in greek critically ill children

M. Sdougka^{1*}, E. Volaki¹, A. Violaki¹, M. Svirkos¹, S. Kalamitsou¹, P.-E. Mantzafleri¹, E. Karakeke¹, E. Zakyntinos²

¹Hippokraton General Hospital, Pediatric Intensive Care Unit, Thessaloniki, Greece

²General University Hospital of Larisa, Intensive Care Unit, Larisa, Greece

BACKGROUND AND AIMS

The American Academy of Pediatrics (AAP) recommendations for Forgoing Life Sustaining Medical Treatment (FLSMT) were issued in 1994 and updated in 2017. The aim of the present study is to explore bioethical considerations on FLSMT of public Greek PICUs personnel.

METHODS

Cross sectional study based on a shaped questionnaire about the 15 recommendations of AAP on FLSMT. Data collected: Demographics and the responses to questionnaire based in a five-point Likert scale from 0 (totally disagree) to 4 (totally agree), $p < 0.05$.

RESULTS

135 participants, 49 doctors and 86 nurses, 90.4% women, mean age of 43.45 ± 8.78 years. 54.1% had completed postgraduate studies, 63.7% were parents and 65.9% were moderately religious. Less than half (47.4%) were familiar with the term FLSMT. Statistically significant greater knowledge of FLSM was recorded in consultants compared to nurses (70.3% vs. 37.2%, p

= 0.001), in holders of a postgraduate degree (54.8% vs. 38.7%, $p = 0.05$) and in participants with greater PICU working experience (137 vs. 110 months, $p = 0.01$). Statistically significant differences were also recorded depending on age (4/15), the status of doctor or nurse (7/15), the existence of postgraduate studies (3/15), previous PICU working experience (3/15).

CONCLUSIONS

Age, medical profession, level of education and long-term PICU working experience contributed significantly to a higher level of FLSMT agreement. The institutionalization of a legal framework and the adaptation of national guidelines set by the respective scientific societies are expected to lead to a further level of acceptance.

EP015 / #1160

E-Poster Viewing - Intensive care AS01-10. Family-centred care

Initiating long-term ventilation for a child: navigating complex decision-making with parents

J. Greene¹, M. Quirke¹, D. Alexander¹, C. Doyle², M. Brenner^{1*}

¹University College Dublin, School of Nursing, Midwifery and Health Systems, Dublin, Ireland

²Trinity College Dublin, School of Nursing and Midwifery, Dublin, Ireland

BACKGROUND AND AIMS

Children with complex and integrated care needs (CICN) are increasingly dependent on medical technology and parents, as central decision-makers, can encounter difficult ethical medical dilemmas. Discussions between physicians and parents at critical junctions, such as the commencement of invasive long-term ventilation (LTV), remains insufficiently investigated. For parents, navigating the complex decision-making arena is frequently daunting. To understand this process, a systematic scoping review was undertaken to examine the research conducted to date and uncover parental perspectives.

METHODS

A full systematic search of seven bibliographic databases and one search engine was conducted using the guidelines proposed by Arksey & O'Malley (2005) to identify studies with a qualitative element for inclusion. The final sample comprised of ten articles which were thematically analysed following Braun & Clarke's (2006) approach.

RESULTS

While three key themes were identified, the focus of this presentation is how parents navigate medical decision-making. The literature finds that parents play a pivotal role, but they frequently report feeling overwhelmed by the need to make quick decisions in the complex healthcare environment often without complete information.

CONCLUSIONS

Parents value a responsive and collaborative approach when making medical decisions regarding LTV for their child. Reflecting the wider literature, building a trusting relationship with the healthcare team facilitates informed ethical decision-making. When caring for a child with CICN, parents felt sharing stories of similar cases and timely information regarding long-term outcomes of LTV enabled them to make the best decisions for their child.

EP016 / #2280

E-Poster Viewing - Intensive care AS01-10. Family-centred care

Impact of training caregivers of tracheostomised children in a paediatric intensive care unit

A. Martín*, M. Soler, V. andrino

Hospital Sant Joan de Déu, Ucip, Esplugues, Spain

BACKGROUND AND AIMS

In recent years tracheostomy has become an increasingly frequent procedure in paediatrics. Structural alterations of the upper airway and the need for prolonged or chronic ventilatory support have become the main indications for paediatric tracheostomies. The purpose of this study is to describe how many children needed tracheostomy and the involvement of primary caregivers in their care.

METHODS

A retrospective descriptive study of patients requiring tracheostomy in a paediatric intensive care unit, during the period from 23 of July 2018 to 25 of April 2022.

RESULTS

A sample of 37 patients, which average age was 3.9 years, 25 boys and 12 girls and their average stay in the unit was 49.7 days. Congenital tracheomalacia, bronchopulmonary dysplasia and subglottic stenosis were the most frequent causes of requiring a tracheostomy. 100% of caregivers were included in the Training programme for children and families in the care of tracheostomised patients in a paediatric intensive care unit.

CONCLUSIONS

It is verified that early health education for the main caregivers of a paediatric patient with a tracheostomy is necessary to avoid prolonged stays in paediatric intensive care units and possible complications.

EP017 / #1141

E-Poster Viewing - Intensive care AS01-11. Gastroenterology & hepatology

The degree of determinism of variability of important clinical and laboratory parameters in chronic pancreatitis

O. Horlenko^{1*}, L. Prylypko², B. Halay³, L. Halay², G. Beley²,
F. Horlenko⁴

¹Uzhhorod National University, Pediatrics With Pediatrics Infections, Uzhhorod, Ukraine

²Uzhhorod National University, Internal Medicine, Uzhhorod, Ukraine

³Uzhhorod National University, Internal Medicine, Uzhhorod, Ukraine

⁴Uzhhorod National University, Surgical Diseases, Uzhhorod, Ukraine

BACKGROUND AND AIMS

Background The study of the pathogenetic mechanisms of abdominalgia formation and progression of exocrine pancreatic insufficiency(EPI) is a priority for medical scientists. The aims To investigate the degree of determinism in abdominalgia variation and level of Fecal Pancreatic Elastase-1(FE-1) depending on the level of inflammatory markers and antioxidants in the blood of Chronic Pancreatitis (CP) patients.

METHODS

110 patients with CP who were hospitalized in the therapeutic department of Khust Hospital during 2018-2020 were examined.

RESULTS

• Pain was registered in all examined patients. The average pain intensity according to the criteria of visual-analog scale was 6.13 ± 0.74 points. Statistical

regression analysis of input data shows that a significant effect on the severity of abdominal pain have leukocytes ($B=0.09$; $p=0.000005$), ESR ($B=0.06$; $p=0.000002$), α 1-antitrypsin ($B=0.78$; $p=0.0003$), cortisol ($B=0.0005$; $p=0.03$). Also, the formation of abdominal pain in CP is statistically significantly affected by low molecular weight non-enzymatic antioxidants: Bilirubin ($B=0.02$; $p=0.00004$), Urea ($B=0.11$; $p=0.0002$). The level of FE-1, as a highly specific marker of EPI, was 157.82 ± 7.28 $\mu\text{g/g}$, ie EPI varied in the moderate value. The regression analysis results present next significant effect on the FE-1 level modeling: α 1-antitrypsin ($B=-16.79$, $p=0.02$), IL-4 ($B=-16.76$; $p=0.04$), as indicator of inflammatory response and Bilirubin ($B=-0.34$, $p=0.04$)-as representative of the antioxidant protection system.

CONCLUSIONS

- Our study forms an idea of the dominant effect of certain parameters of the inflammatory response and the complex of antioxidant protection on the variability of the leading syndrome in the clinical course of CP (abdominal pain) and the formation of the level of FE-1.

EP018 / #1626

E-Poster Viewing - Intensive care AS01-11. Gastroenterology & hepatology

A case report of acute hepatic failure with hyperammonemia and hyperbilirubinemia in the setting of chemotherapy, treated with coupled plasma filtration adsorption (cpfa)

A. Liaskou^{1*}, K. Straka², E. Christakou², E. Mpourazani², I. Gotsi², C. Barbaressou²

¹*Aghia Sophia Childrens Hospital, Picu, Athens, Greece*

²*Aghia Sophia Children's Hospital, Paediatric Intensive Care Unit, Athens, Greece*

BACKGROUND AND AIMS

Coupled plasma filtration adsorption is an extracorporeal blood purification treatment, which combines a first stage of plasma separation and adsorption of cytokines/inflammatory mediators, followed by a second stage of haemofiltration for volume control and removal of small watersoluble mediators, by utilizing CVVH. Although it was originally developed for the treatment of sepsis, there are many additional applications (eg. hepatic failure, acute kidney injury) where there can be an advantage of having access to larger molecular weight toxins and avoiding the loss of important physiologic substances such as albumin.

METHODS

We present a case report where CPFA technique was used for treating hyperammonemia and persistent hyperbilirubinemia in a 16-year-old leukemic patient.

RESULTS

The patient was admitted in PICU with acute hepatic failure with hyperammonemia (>200mg/dl) and hyperbilirubinemia (total/direct: 34/29mg/dl) after chemotherapy. Upon admission, CVVHDF was initiated with moderate decrease in bilirubin levels (total/direct=28/24mg/dl) on day 7. Then, 1 treatment cycle of CPFA (6-h length) was used, showing a marked bilirubin reduction (approximately 45%), as well as a reduction of ammonia. CVVHDF was continued for 2 more days and after discontinuation bilirubin levels remained stable until discharge(=total 11mg/dl), whereas ammonia was within normal range(37µd/dl). The patient was discharged a few days later to oncology.

CONCLUSIONS

CPFA is a therapeutic tool that works based on plasma adsorption to provide depurative support for removing excess cytokines and inflammatory mediators, which has shown a higher amount of bilirubin binding in comparison with other extracorporeal therapies used for depuration.

EP019 / #2269

E-Poster Viewing - Intensive care AS01-11. Gastroenterology & hepatology

Acute liver failure in pediatric intensive care

**A. Ortiz Ortigosa¹, D. Navarro Molina^{2*}, J. Blasco-Alonso³,
F. Guerrero Del Cueto⁴, R. Gil Gómez⁵, J.M. Camacho Alonso⁶**

¹Hospital Regional Universitario, Pediatrics, Málaga, Spain

²Hospital Regional Universitario de Málaga, Department of Pediatrics, Malaga, Spain

³HRU Málaga, Pediatric Gastroenterology and Nutrition Unit, Pediatric Department, MALAGA, Spain

⁴Hospital Materno Infantil Malaga - Servicio andaluz de Salud, Paediatrics, Málaga, Spain

⁵Hospital Regional Universitario de Málaga - Hospital Materno Infantil, Paediatric Intensive Care Unit, Málaga, Spain

⁶Hospital Materno-Infantil de Málaga- Hospital Regional Universitario de Málaga, Paediatrics, Málaga, Spain

BACKGROUND AND AIMS

To analyze the causes of acute liver failure (ALF) in pediatric critical patients and its evolution.

METHODS

Retrospective study including pediatric patients admitted to the PICU between 2001 and, 2021 with a diagnosis of ALF. Epidemiological, clinical and analytical data, aetiology, treatment, stay and final evolution were collected.

RESULTS

90 cases were diagnosed; 21.1% due to primarily liver pathology and 71 appear within pathology multisystemic. 53 of them appeared between 2016 and 2021. Median age of debut is 1.8 years (IQR 0.3-5.6). 52.2% are women and 38.9% are of North African origin. Median PICU stay of 5 days (IQR 2-11.2). Transaminases affected in all, with a median ALT of 699 (IQR 155-2479); PT

28.8±13.3%; factor V was assessed in 56 cases (27±14%). Regarding the treatment, 92% received vitamin K, 79.7% plasma, and 66.3% N-acetyl- cysteine (NAC). 51.1% died (49.1% of the secondary). 52.1% had ALF accompanied by multi-organ failure, with 80% mortality in them. Only 28 patients presented hepatic encephalopathy. 75% of them dying compared to 40.3% of those without encephalopathy (p 0.02). of those who received NAC, 44% died compared to 63.3% of those who did not receive it (p 0.049). 6/69 cases were referred to a liver transplant reference center.

CONCLUSIONS

Incidence has increased in recent years, especially secondary cases. IHA should be assessed in case of severe systemic inflammatory response. Encephalopathy and FMO imply a high mortality rate. Although mortality of FHA has decreased thanks to the use of NAC, it remains high. Transplantation is sometimes the only treatment.

EP020 / #2573

E-Poster Viewing - Intensive care AS01-12. Nutrition

Correlation of catabolism and nutritional support indices of pediatric icu patients with clinical characteristics and outcome endpoints

A. Rasouli¹, S. Ilia^{2*}, M. Raissaki³, G. Briassoulis¹

¹School of Medicine, University of Crete, Postgraduate Program "Emergency and Intensive Care of Children, Adolescents and Young Adults", Heraklion, Greece

²School of Medicine, University of Crete, Picu, University Hospital, Heraklion, Greece

³School of Medicine, University of Crete, Radiology, Heraklion, Greece

BACKGROUND AND AIMS

To assess the nutritional status of critically ill children and assess whether their nutritional needs were met during PICU stay, and to compare their energy-protein balance with the catabolic status using the urea/creatinine (Ur/Cr) catabolism index.

METHODS

Clinical indicators, nutritional status, disease severity, and Ur/Cr index were compared with patients' caloric and protein coverage on Days 1, 3, 5, and 7. Calorie and protein intake amounts were compared with those recommended by ESPEN/ESPENIC guidelines and with clinical outcome indicators such as mortality and duration of hospitalization and mechanical ventilation.

RESULTS

Positive balance of Ur/Cr catabolism index was achieved by 40.4% out of 99 enrolled patients. Mortality was 2.5%. Patients upto day 7 had more negative

total caloric and protein balance compared to patients with positive difference in Ur/Cr ratio ($p=0.043$). Daily caloric and protein intake were significantly below that predicted by the ESPNIC/ESPEN guidelines and the Schofield equation in both groups. Predicted daily intake of calories and protein was significantly higher for the group at risk of undernutrition compared to their counterparts with a positive BMI z score ($p<0.001$). Calorie intake in both groups followed a significant upward trend from day 1 to day 7 ($p<0.001$). A negative energy balance (AUROC 0.68, $p=0.025$) emerged as strong predictor of deterioration of catabolism as indicated by the negative Ur/Cr ratio difference of day 7-1.

CONCLUSIONS

Patients at risk of malnutrition have significantly higher caloric and protein needs. Strong predictors of worsening catabolism are a negative total caloric balance and a hyper-inflammatory state upon admission.

EP021 / #2027

E-Poster Viewing - Intensive care AS01-14. Haematology, transfusion therapy & oncology

Outcomes of pediatric renal replacement therapy amongst oncology children admitted to intensive care unit

S. Bhosale^{1*}, A. Kulkarni², J. Divatia¹, A. Narkhede¹

¹Tata Memorial Hospital, Homi Bhabha National Institute Mumbai, Division of Critical Care Medicine, Department of Anesthesiology Critical Care Pain, Mumbai, India

²Tata Memorial Hospital, Homi Bhabha National Institute, Division of Critical Care Medicine, Department of Anesthesiology Critical Care Pain, Mumbai, India

BACKGROUND AND AIMS

Recent Improvement in Renal replacement therapy (RRT) techniques coupled with the realization that early supportive therapy may improve outcomes lead to increased use of RRT for critically ill children. We aimed to identify outcomes of Oncology children requiring RRT in Intensive care Unit

METHODS

A retrospective cohort study of oncology children (<18 years) in PICU who received RRT between Jan 2016 to Dec 2017 were identified. Data including age, primary and icu diagnosis, KDIGO stage, RRT modality & duration, ICU length of stay and survival were extracted.

RESULTS

During the study duration 35 oncology children underwent RRT in the ICU of which majority were with hematological malignancy (31/35). The overall Mortality rate was 45.7%. The median ICU LOS was 7 days in survivors (2-54

SD +/- 14.3 days) and 8 days in non survivors (2-23 SD +/-6.7 days). No Significant difference in Mortality was observed related to Age, underlying disease, mode and duration of RRT. On multivariate analysis mortality risk predictors identified were shock,(OR 11.72, 95% CI 0.56- 244.69, P =0.112), Acute Renal Failure (OR 0.15, 95% CI 0.024-0.92, P= 0.040) and Coagulopathy (OR 0.72 95% CI 0.01- 47.41 P= 0.882). Acute Renal failure remained as a significant predictor of mortality.

CONCLUSIONS

This study describes RRT practices and related outcomes in oncology children admitted to ICU. We identify important risk factors associated with poor outcomes which can help prognosticate oncology children requiring RRT admitted to ICU.

EP022 / #2100

E-Poster Viewing - Intensive care AS01-14. Haematology, transfusion therapy & oncology

Diagnosis of inferior vena cava thrombosis facilitated by point of care ultrasound (pocus) in the pediatric intensive care unit (picu)

S. Friedman^{1*}, I. Ayalon², B. Meidan², E. Sadot²

¹Dana-Dwek children hospital, Tel Aviv Sourasky Medical Center Sackler Faculty of Medicine, Tel Aviv University, Pediatric Intensive Care, Tel-Aviv, Israel

²Dana-Dwek Children Hospital, Tel Aviv Sourasky Medical Center, Pediatric Intensive Care, Tel-Aviv, Israel

BACKGROUND AND AIMS

Femoral central venous catheterization (CVC) is the main etiology of Inferior vena cava thrombosis (IVCT) in infants. IVCT may cause long term morbidity. We aim to demonstrate the importance of POCUS in early diagnosis of IVCT in the PICU.

METHODS

Case presentation

RESULTS

Case 1: A 2 weeks old male neonate, was referred for neurologic evaluation of hypoxic ischemic encephalopathy. On admission a right femoral CVC was noted without swelling of the right leg. His blood count demonstrated thrombocytopenia. Cardiac and IVC POCUS revealed a non-occluding IVCT (fig 1) extending from the rt iliac and femoral veins (fig 2). The CVC was removed and low molecular heparin (LMWH) started with no further propagation of the thrombosis and resolution of the thrombocytopenia.

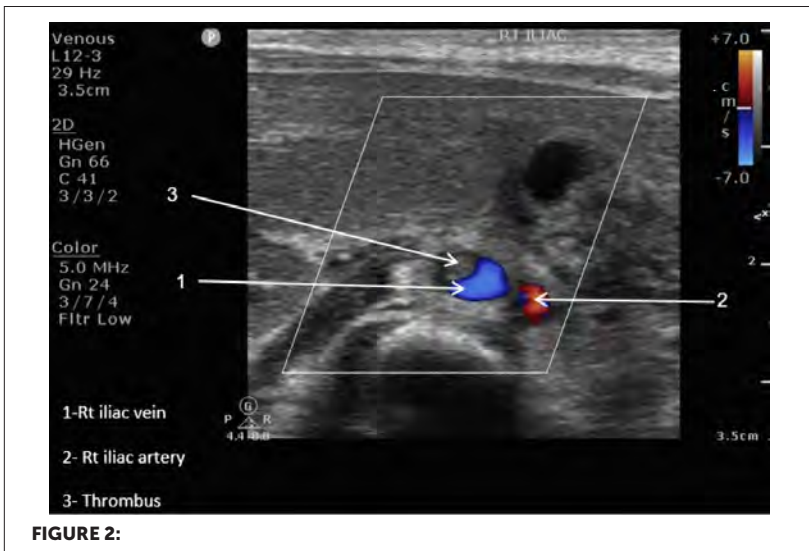

Case 2: A 3 months old female infant was referred for evaluation of dysmorphism and prolonged mechanical ventilation. She had only peripheral venous catheters. The blood tests results yielded thrombocytopenia as well as prolonged coagulation functions. Cardiac and IVC POCUS revealed a non occluding IVCT (fig 3). The patient was started on LMWH. The infant developed sepsis and multi-organ failure requiring cessation of the LMWH despite new thrombosis of the rt sub-clavian vein. Metabolic workup demonstrated elevated homocystein level and a possible diagnosis of congenital cobalamin C deficiency was made.



CONCLUSIONS

POCUS is a valuable tool in the PICU for detection of IVCT. As PICU physicians become adept at performing bedside POCUS we believe that the role of POCUS in improving diagnosis and treatment will increase.

EP023 / #1966**E-Poster Viewing - Intensive care AS01-14.
Haematology, transfusion therapy & oncology****Clinical characteristics and outcome of patients
undergoing hematopoietic stem cell
transplantation (hsct) admitted to a pediatric
intensive care unit (picu).**

**E. Mpourazani^{1*}, C. Tsirogianni¹, E. Christakou¹,
C. Oikonomopoulou², E. Goussetis²**

¹Agia Sophia Children's Hospital, Picu, Athens, Greece

²Agia Sophia Children's Hospital, Department of Hematopoietic Stem Cell Transplantation, Athens, Greece

BACKGROUND AND AIMS

The aim of this study was to investigate clinical characteristics of HSCT recipients requiring PICU admission in our center.

METHODS

Among 200 patients receiving allogeneic HSCT from January 2018-December 2021, 18 (9%) were admitted to PICU. In this retrospective study we tried to identify the main causes of admission, analyze the mortality and recognize factors for poor prognosis.

RESULTS

Main reasons for admission were respiratory failure (44,4%), CNS involvement (22,2%) and sepsis (16,6%). 11 patients (61,1%) died. Deaths were higher in patients with underlying malignant disease, relative donor transplant,

opportunistic infections (mainly CMV reactivation) and aGVHD. The only significant risk factor for poor prognosis was cGVHD (100% mortality rate).

Variable	Number(%)
Median age(years)	5
Range	0,5-16
Gender	
Male	11 (61,1%)
Female	7(38,9%)
Underlying Disease	
Malignant	11(61,1%)
AML	2
ALL	5
MDS	2
PHS	1
Neuroblastoma	1
Non-malignant	7(38,9%)
Hematologic Disease/anemias	2
PIDS	5
Transplant Type	
Related	4(23,5%)
Non-Related	14(76,5%)
a GVHD	12(66,6%)
c GVHD	5(27,7%)
CMV-reactivation	7(38,9%)
Other Opportunistic Infections	
BK	3
EBV	3
Adenovirus	2
Aspergillus	3
PCP	1
Median time from HSCT to PICU admission(days)	60
Range	19-300
PICU Admission cause	
ARF	8(44,4%)
Sepsis-Septic Shock	3(16,6%)
CNS Complications (infection, PRES, hemorrhage)	4(22,2%)
Other	2(11,7%)
Respiratory Support	
HFNC/ NIPPV	5(27,7%)
IPPV	15(83,3%)
Tracheostomy	2(11,1%)
Vasopressors	7(41,2%)
Outcome	
Discharge	7(41,2%)
Death	11(61,1%)
Median PICU LOS(days)	10
Range	2-300

FIGURE 1:

CONCLUSIONS

In this study, critically ill post- HSCT pediatric patients requiring intensive care had a high mortality rate. Development of chronic GVHD with multi-organ involvement was recognized as the leading cause for poor outcome.

EP024 / #369

E-Poster Viewing - Intensive care AS01-15. Infectious diseases

Analyzing the death formula of neonates up to 1 month hospitalized in neonatal icu of muratsan uhc within 2017.

**L. Martirosyan¹, V. Manukyan², H. Hakobyan², S. Brutyan²,
M. Melkonyan², V. Asoyan², H. Apresyan^{2*}, A. Minasyan³**

¹YSMU, Infectious Diseases, Yerevan, Armenia

²Yerevan State Medical University, Infectious Diseases, Yerevan, Armenia

³Yerevan State Medical University, Coloproctology, Yerevan, Armenia

BACKGROUND AND AIMS

The neonatal period (birth to 1 month) is a time of extensive and ongoing system transition from uterine environment to external world. Children face the highest risk of dying in their first month of life at an average global rate of 18 deaths per 1,000 live births in 2017. The major causes of neonatal deaths worldwide are infections which include sepsis and pneumonia. Our aim is to find correlations between causes of death.

METHODS

The retrospective study of medical charts of hospitalized patients at Muratsan University Hospital Complex(UHC) Neonatal ICU(NICU) was done. Our goal is to find out the percent deviation of each contributing factors from its unconditional probability.

RESULTS

There were 768 up to one month patients admitted at Muratsan UHC NICU within 2017, among them 69 have died. 67 from 69 have had different respiratory disorders such as respiratory distress syndrome, respiratory failure and pneumonia 54 cases(78%). Sepsis was diagnosed in 23 cases(33%), therefore 13 of 23(56.5%)were combined with necrotizing enterocolitis(total 22 cases of NEC), and 8(36.4%)cases of acute renal failure(total 18 cases of ARF). There were 24(34.8%) cases of different congenital cardiac defects and 5 cases of 24(21%) were combined with brain congenital anomalies(total 7 cases of congenital brain anomalies). There were 10(14.5%) cases of asphyxia, all of them had pneumonia and 3(30%) of them were combined with seizure(total 7(43%) cases of seizure which is 3 times more from unconditional probability of seizure). We also found out 13(65%) cases of intracranial hemorrhage combined with low gestational age below 32 weeks(total 20 case of intracranial hemorrhage).

CONCLUSIONS

The result showed there are correlations between diseases mentioned above. The death formula is approaching to global data. The most common causes of death were sepsis, pneumonia, NEC. We couldn't find any correlations between pneumonia and pneumothorax, gestation age and NEC.

EP025 / #2309

E-Poster Viewing - Intensive care AS01-15. Infectious diseases

Early infections after pediatric liver transplantation: a 5 years single-centre experience

D. Bonacina^{1*}, I. Pellicoli¹, F. Ferrari¹, C. Pellegrinelli², C. Fornasari³, G. Giudici⁴, E. Bonanomi¹

¹ASST Papa Giovanni XXIII, Pediatric Intensive Care Unit, BG, Italy

²University of Milano-Bicocca, School of Medicine and Surgery, Milano, Italy

³ASST Grande Ospedale Metropolitano, Anesthesia and Intensive Care, Milano, Italy

⁴University of Milano, School of Medicine and Surgery, Milano, Italy

BACKGROUND AND AIMS

Early infections represent one of the main causes of morbidity and mortality for paediatric patients receiving orthotopic liver transplantation (OLTx).

METHODS

Aim of this study is to describe incidence, epidemiology, risk factors and the clinical burden of early post-OLTx infections in the paediatric population of an Italian transplant referral centre over 5 years (2016-2020).

RESULTS

We included 135 OLTx performed on 123 paediatric patients. The median age was 1.4 years [0.7-8.4 years], with a median PELD of 15 [6-25]. Culture-proven infections were registered in 51.11% of patients. Clinical presentation was sepsis in 36.6% patients, septic shock in 9.8%. Potential risk factors are summarized in Table 1. We isolated 23 multidrug resistant bacteria (32%)(Figure 1)

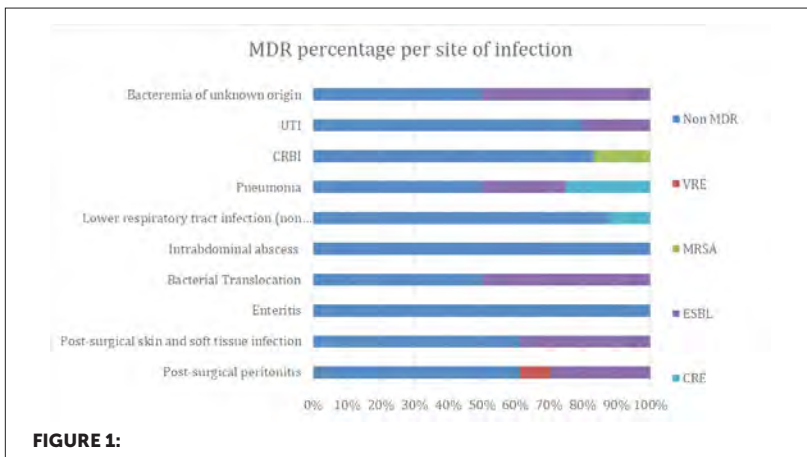

TABLE 1:

	No Infection	Infection	p-value
	N=66	N=69	
Age (years)	2.2 (0.8-12.0)	1.1 (0.6-6.3)	0.027
Weight (kg)	10.7 (7.5-32.0)	8.7 (6.7-17.8)	0.033
PELD	9.0 (0.0-21.0)	20.0 (10.0-30.0)	<0.001
Donor age (years)	20.9 (15.4-35.7)	36.2 (19.4-43.4)	0.009
Standard Antimicrobial Prophylaxis			0.001
No	15 (22.7%)	34 (49.3%)	
Yes	51 (77.3%)	35 (50.7%)	

Invasive ventilation days	1.0 (1.0-2.0)	2.0 (1.0-3.0)	<0.001
PICU LOS	5.0 (4.0-12.0)	14.0 (7.0-29.0)	<0.001
H LOS	31.0 (22.0-52.0)	59.0 (38.0-105.0)	<0.001
Biliodigestive Anastomosis Dehiscence			0.006
No	64 (97.0%)	57 (82.6%)	
Yes	2 (3.0%)	12 (17.4%)	
Intestinal Perforation			<0.001
No	66 (100.0%)	57 (82.6%)	
Yes	0 (0.0%)	12 (17.4%)	

CONCLUSIONS

Early infections were detected in half of the patients and were associated to a significant increase in PICU and hospital LOS. Bacteria are the most represented pathogens, among them we identified a significant percentage of MDR.

EP026 / #1455**E-Poster Viewing - Intensive care AS01-15.
Infectious diseases****Role of biomarkers for early diagnosis of sepsis
and prediction of outcome in critically ill children****E. Celaj^{1*}, I. Bakalli¹, M. Zguri², D. Sala¹, I. Gjeta¹, E. Kola¹**¹UHC "Mother Theresa", Pediatrics, Tirana, Albania²UHC "Mother Theresa", Radiology, Tirana, Albania**BACKGROUND AND AIMS**

Identifying sepsis in critical ill children as early as possible remain one of the biggest challenges in PICU. The aim of our study is to evaluate the application of biomarkers in early diagnosis as well as in determining the prognosis of sepsis in critical ill children at PICU.

METHODS

This is a prospective study for a period of 5 years. We evaluated all cases of sepsis, percentage of sepsis patients, the ratio of sepsis to total hospitalization in PICU, age, stages of sepsis and mortality. Biomarkers were evaluated for each patient included in the study.

RESULTS

The number of cases with sepsis who met the clinical and laboratory criteria for sepsis during the study period accounted 11% of children admitted to PICU with a mortality rate of 29.1%. The incidence of sepsis by age resulted in higher values in the age group 3-36 months with a mean age of 18 months. SIRS was present in 54.4% of cases, 6.6% septic shock and 3.89% MODS. High PCT values are associated with a 5.47 fold increase in the chance of having

sepsis. PCT and C-reactive protein were proved to be superior to WBC, PLT, ERS in early diagnosis of sepsis. High PCT values are also associated with increased mortality rates.

CONCLUSIONS

PCT and C-reactive protein levels are elevated in the context of sepsis and outperform other inflammatory indicators. High PCT readings are also linked to an increased risk of death.

EP027 / #943**E-Poster Viewing - Intensive care AS01-15.
Infectious diseases****Risk factors or predictors of developing
ciprofloxacin, trimethoprim/sulfamethoxazole
and third-generation cephalosporin resistance in
e. Coli infections relative to control patients: a
systematic review and meta-analysis**

P.R. Deshwal*, N.S. Reddy, R. Fathima, M. Aggarwal, P. Tiwari

National Institute of Pharmaceutical Education and Research (NIPER), Mohali, INDIA, Department of Pharmacy Practice, Mohali, India

BACKGROUND AND AIMS

The CDC estimates that by 2050, 10 million people a year could be dying as a result of AMR. Great level of resistance has been observed for trimethoprim/sulfamethoxazole followed by ciprofloxacin and 3rd generation cephalosporins in managing E. coli infections. This study aimed to identify risk factors for ciprofloxacin (Cip-REC), trimethoprim/sulfamethoxazole (TMP/SMX-REC) and 3rd generation- cephalosporin (TC-REC) resistance in Escherichia coli infections relative to controls patients.

METHODS

A systematic search was conducted using MEDLINE/PubMed and OVID/Embase databases to identify case-control and cohort studies, reporting risk factors for Cip-REC, TMP/SMX-REC and TC-REC infected patients. Random effect model was used to pool odds ratios (ORs) of developing resistant E.coli infection. This study was registered with PROSPERO (CRD42022297043).

RESULTS

A total of 23 studies, with 9891 participants, were included. Overall, 22, 8 and 11 risk factors were identified for developing Cip-REC, TMP/SMX-REC and TC-REC infections respectively. The prior antibiotic use [OR 3.19], recurrent urinary tract infection [OR 2.98], and nosocomial infection [OR 1.94] reported high pooled ORs for CipREC infection. Whereas for TMP/SMX-REC infection, major significant risk factors were genitourinary abnormalities [OR 2.91], previous antibiotic use in past 6 months [OR 2.76] and quinolone exposure [OR 1.50]. Further analysis unveiled potential factors for TC-REC infection; prior history of admission [OR 3.14], cephalosporin use [OR 2.45] and hemodialysis [OR 2.20].

CONCLUSIONS

The patients with prior antibiotic use, genitourinary abnormalities and prior history of admission face a greater risk of developing Cip-REC, TMP/SMX-REC and TC-REC infections respectively. Identification of modifiable risk factors could play an important role in prevention of resistant *E. coli* infection.

EP028 / #2785**E-Poster Viewing - Intensive care AS01-15.
Infectious diseases****Prolonged and continuous infusion of time-dependent antibiotics - preliminary data from new picu therapeutic protocol****P. Kenderessy*, N. Mikusova, O. Petrik**

Children Hospital Banska Bystrica, Paediatric Anaesthesia and Intensive Care, Banska Bystrica, Slovak Republic

BACKGROUND AND AIMS

The prolonged or continuous infusion of antimicrobial agents has been suggested as a means of optimizing therapy for infections. The prolonged or continuous infusion of time-dependent antibiotics maximizes the achievement of relevant therapeutic concentrations over time (*i.e.* PK) and enables the maximum action of the drug.

METHODS

We are presenting preliminary data from observational study and hospital protocol of prolonged/continuous infusion of time dependent antimicrobial agents. Primary target of new PICU protocol was maintain all time dependent antimicrobial agents above 4-times MIC level during the entire length of therapy. From April 2022 till June 2022, we recorded 45 levels of 12 patient with the risk of variable pharmacokinetics mainly for meropenem, piperacillin and linezolid. All level were taken before and 1 hour after new infusion started and level curve calculated.

RESULTS

From preliminary data we can say that maintain level of antibiotics above target is very challenging in PICU settings. In most cases recommended initial dosing is insufficient to achieve 4 MAC level and needed initial dose escalation (double dosing) followed by dosing de-escalation usually in 48 hours. Especially recommended dosing for linezolid is generally insufficient reach 4 MIC level

CONCLUSIONS

Treatment guidelines for time-dependent antimicrobial agents need to be supplemented by standardized measurement of levels especially in ICU settings and therapy of polyresistant bacterias.

EP029 / #2312**E-Poster Viewing - Intensive care AS01-15.
Infectious diseases****Massive rhabdomyolysis with acute kidney injury (aki) secondary to influenza a virus infection: a case report****E. Christakou¹, V. Dimitropoulou^{1,2}, S. Konstantakopoulos¹,
E. Mpourazani^{1*}, C. Tsiagklani^{1,3}, C. Barbaresou¹**¹*Agia Sofia Childrens Hospital, Picu, Athens, Greece*²*Aghia Sophia Children's Hospital, Paediatric Intensive Care Unit, Athens, Greece*³*Aghia Sophia Children's Hospital, Picu, Athens, Greece***BACKGROUND AND AIMS**

Influenza-associated rhabdomyolysis with myoglobinuria has been shown to complicate 3% of cases of myositis in children, which is more likely to be associated with influenza A infection, and has been associated with renal insufficiency requiring renal replacement therapy.

METHODS

We report a case of severe rhabdomyolysis and secondary AKI due to influenza A virus.

RESULTS

A previous healthy 14-year-old boy presented with generalized myalgia for three days with no fever or respiratory symptoms. For 24 hours prior to admission he had become aware of marked oligouria, passing very small volumes of dark brown urine and profound muscle weakness. Laboratory studies demonstrated elevated levels of serum creatinine (3mg/dl), urea (83mg/

dl),potassium(5,9mEq/L),aspartate aminotransferase(AST 8913U/L),alanine aminotransferase(ALT 2032U/L) along with significant elevated levels of serum creatine phosphokinase(CPK 400.000U/L).Nasopharyngeal swab sample was positive for Influenza A.ECG and cardiac echo were unremarkable.The patient was admitted to PICU and treated with intense hydration,urine alkalization,electrolytes disorders correction and oseltamivir.Ultrasound examination showed increased renal size and increased parenchymal echogenicity.Serum myoglobin was 47590µg/L.Few hours after admission continuous veno-venous hemodiafiltration(CVVHDF) was initiated and CPK levels declined rapidly. CVVHDF continued for 7 days due to ongoing rhabdomyolysis.Eight days after admission he regained limited urine output with subsequent falls in serum urea and creatinine and was discharged from PICU.The patient continued to require intermittent hemodialysis(HD) for a month and was able to be discharged home with follow-up with nephrology.He recovered renal function completely.

CONCLUSIONS

Consideration of this potentially life-threatening complication in patients presenting with influenza is important as clinical symptoms may be unspecific and early diagnosis leading to prompt treatment is essential.

EP030 / #1976**E-Poster Viewing - Intensive care AS01-15.
Infectious diseases****Prevalence and clinical impact of vancomycin-resistant enterococci colonization in critically ill pediatric patients in a greek picu.**

**E. Mpourazani^{1*}, E. Christakou¹, M. Prapa¹, K. Spyridopoulou²,
G. Paradeisis², C. Barbaresou¹**

¹Agia Sophia Children's Hospital, Picu, Athens, Greece

²Agia Sophia Childrens Hospital, Department of Microbiology, Athens, Greece

BACKGROUND AND AIMS

The aim of this study was the determination of VRE-colonization frequency in our PICU and its association with clinical characteristics.

METHODS

A retrospective analysis of rectal, pharyngeal, and bronchial bacterial carriage was performed from September 2019–October 2021. Laboratory results and clinical characteristics were reviewed and analyzed.

RESULTS

Throughout the study period 52 out of 450 patients (11,5%) admitted to PICU, were colonized with *Enterococcus spp.* 3,1% with VRE (26,9% of all isolates). *Enterococcus faecium* was the dominant resistant strain (83%) while *Enterococcus gallinarum* was isolated in only two specimens. All *Enterococcus faecalis* strains appeared sensitive to vancomycin. Concomitant teicoplanin resistance was frequent (83%). All VREs were in vitro

sensitive to linezolid. Our patient's median age was 2 years (35% less than 12 months). *Enterococcus spp.* was mainly isolated from rectal (45%) and pharyngeal (30%) swabs. The presence of traditional risk factors including severe underlying disease, malnutrition, prior long hospitalization, NICU stay, use of broad-spectrum antibiotics, malignancy, immunosuppression, HSPT and corticosteroid use was significantly higher among patients with VRE colonization. CRBSI and abdominal sepsis were found to be the main causes of admission, accounting for 50% and 42,5%, respectively. No correlation with longer LOS or mortality compared with *Enterococcus faecalis* colonization was found.

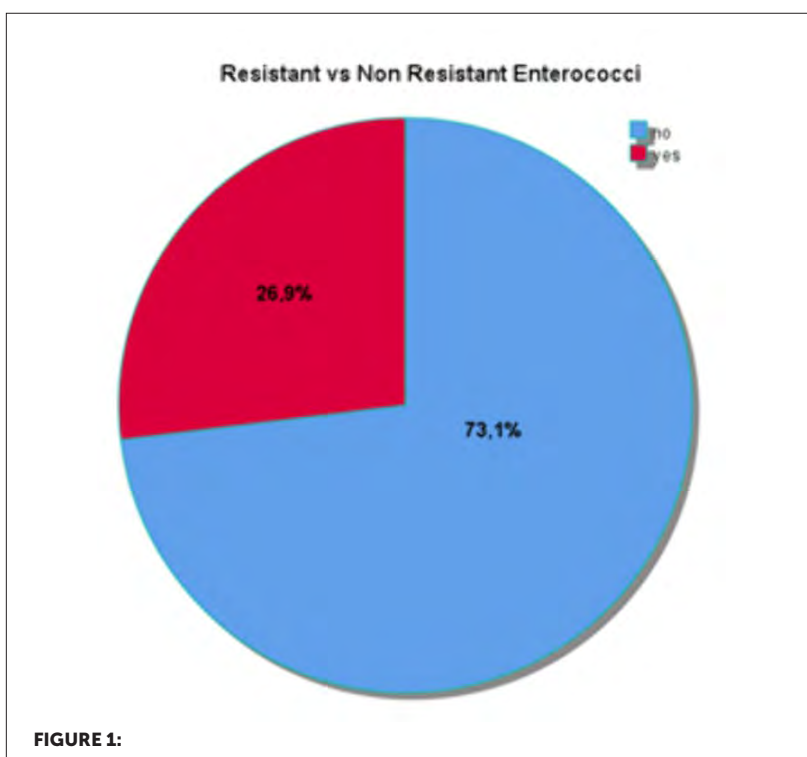

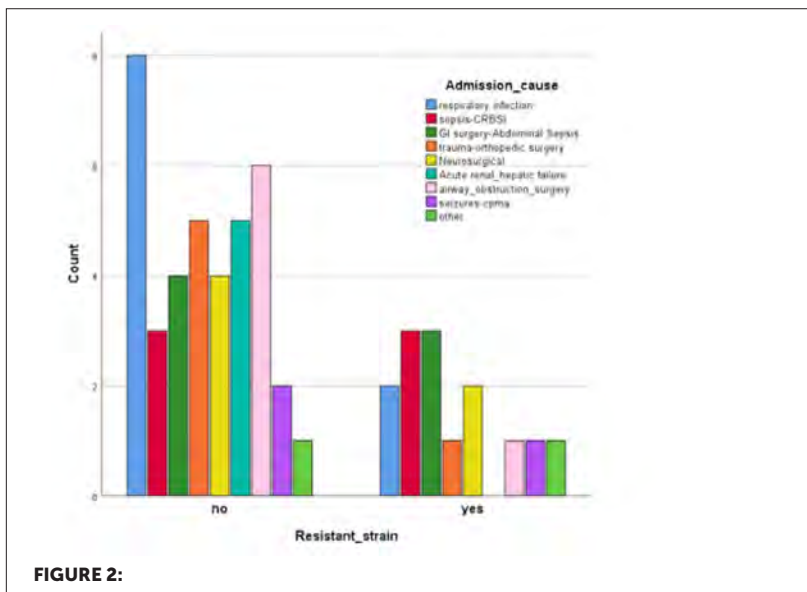
**FIGURE 2:**

CONCLUSIONS

We report a very low VRE-colonization prevalence among critically ill patients in our PICU. Traditionally associated risk factors for VRE colonization were confirmed in this analysis.

EP031 / #2731

E-Poster Viewing - Intensive care AS01-15.

Infectious diseases

Fatal encephalitis and cerebellitis with fulminant brain oedema in a previously healthy child caused by human herpesvirus 6

C. Neokleous*, K. Sialou

Archbishop Makarios III Hospital, Pediatric, Nicosia, Cyprus

BACKGROUND AND AIMS

In children Human Herpesvirus 6 (HHV-6) infection usually follows a benign course. Severe disease may be developed in immunocompromised children or in children with coinfection. We present a case of HHV-6 encephalitis and cerebellitis with fulminant brain oedema in a previously healthy child.

METHODS

A 28-months-old boy was presented with a history of 3 days fever and cough. Twelve hours prior to admission he had drowsiness. Physical examination revealed altered level of consciousness with Glasgow Coma Scale: 9/15 and pupils were fixed dilated. Laboratory findings showed positive C-Reactive-Protein: 43.17 mg/L.

RESULTS

Cefotaxime, vancomycin and acyclovir were started empirically. Brain Computed Tomography revealed oedema in the cerebellum and in the occipital lobes. Later he manifested seizures followed by respiratory arrest. He was resuscitated and intubated. Neuroprotection and hyperosmolar therapy were commenced. He developed signs of increased intracranial pressure.

Brain Magnetic Resonance Imaging identified extensive oedema in the cerebellum, herniation of the cerebellar tonsils and diffuse oedema in the frontal, parietal and occipital lobes. Decompressive craniectomy was performed. Methylprednisolone and intravenous immunoglobulin were given after surgery. The boy manifest diabetes insipidus and desmopressin was started. Forty-eight hours after admission he developed hemodynamic instability despite being on inotropes. Soon cardiac arrest and death occurred. HHV-6 was found in cerebrospinal fluid and blood by Polymerase Chain Reaction. Respiratory panel detected Adenovirus, Human Rhinovirus/Enterovirus, Respiratory Syncytial Virus, Parainfluenza 3.

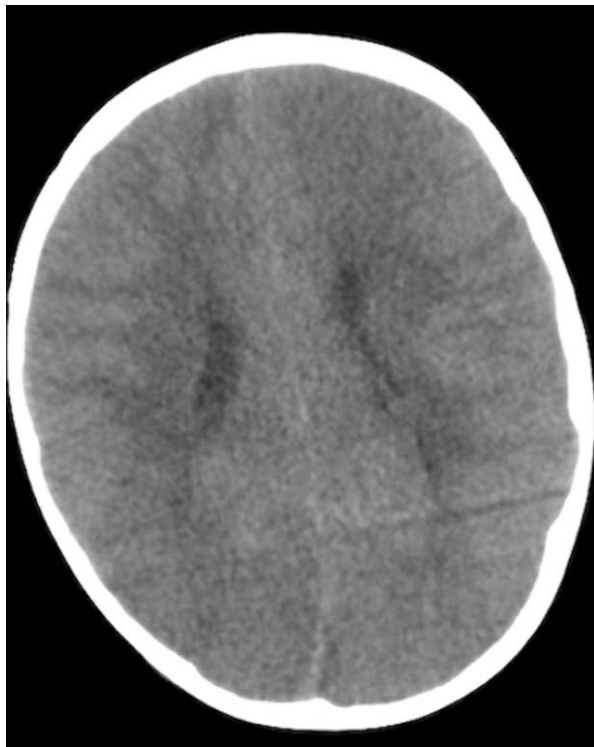
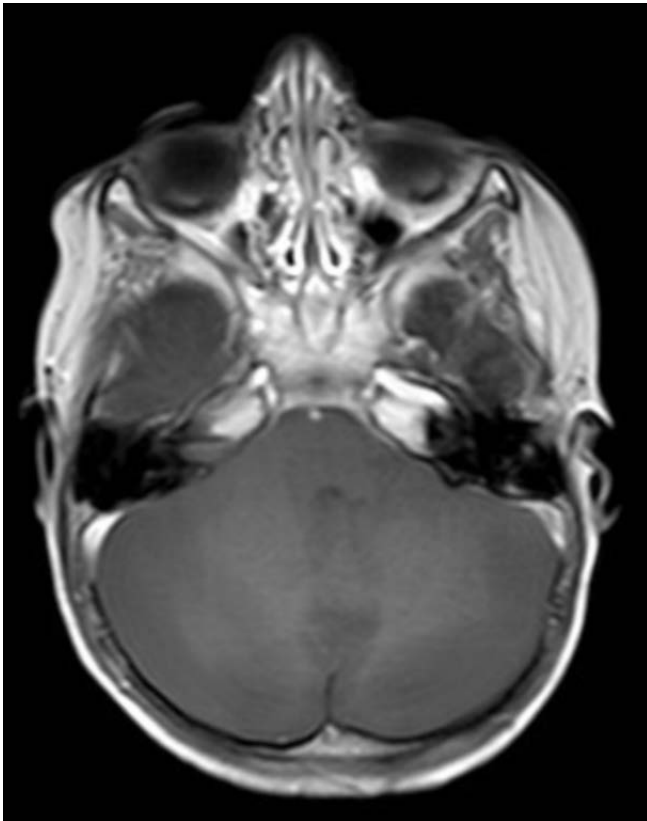

FIGURE 1:

**FIGURE 2:**

CONCLUSIONS

Encephalitis with brain oedema is an uncommon presentation of HHV-6 infection and must be treated aggressively. In literature were reported two cases of HHV-6 encephalitis with lethal fulminant brain oedema in previous healthy children. Our case is unique because the child was also presented with cerebellitis and the disease was triggered by coinfection of HHV-6 with other respiratory viruses.

EP032 / #2132**E-Poster Viewing - Intensive care AS01-15.****Infectious diseases****Epstein – barr virus (ebv) associated severe clinical presentations in pediatric intensive care unit (picu)**

A. Ntavoura*, C. Tsiagklani, M. Gianniki, A. Stelianidi, M. Prapa, E. Mpourazani, D. Paraschou, C. Barbaressou

Agia Sofia Children's Hospital, Pediatric Intensive Care Unit, Athens, Greece

BACKGROUND AND AIMS

Severe EBV infection in the PICU presents a wide clinical spectrum, including acute respiratory distress syndrome (ARDS), multiple organ failure, and viral-induced shock. It is a devastating process with severe mortality in both immunosuppressed and immunocompetent critically ill pediatric patients.

METHODS

A total of 13 children with severe EBV infection seen in PICU of Aghia Sophia Children's Hospital between 2010 and 2018 were retrospectively reviewed.

RESULTS

In our cases admitted in PICU females represented 61, 5%(n=8), with a median age of 7, 5 years (IQR 1, 5 – 17, 5). 6 of these presented ARDS and respiratory failure and needed mechanical ventilation, while 2 presented as acute myocarditis and cardiopulmonary arrest and 1 as encephalitis. Sepsis and infectious complications were the major causes for admission (n=5, 38.4%) in Hematopoietic Stem Cell Transplantation patients (HSCT). Non-immunocompromised patients exhibited high frequencies of detectable EBV

DNA on blood specimens, cerebrospinal fluid (CSF), BAL and bone marrow, performed with real-time PCR in 46 % (n=6). EBV infection complicated with multiple organ failure had a fatal outcome in 6 of our cases (53, 8%). A total of 53% of the patients (n=7) received intravenous treatment with rituximab.

CONCLUSIONS

The pediatric intensivist must remain abreast of the presence of severe complications of EBV and evaluate the risk factors associated with the development of life-threatening manifestations and high rate of mortality.

EP033 / #2062**E-Poster Viewing - Intensive care AS01-15.
Infectious diseases****Use of biofire®filmarray pneumonia panel for
detection of pathogens in lower respiratory tract
specimens in critically ill children**

**M. Sdougka^{1*}, E. Iosifidis², E. Karakeke¹, A. Violaki¹, E. Volaki¹,
M. Svirkos¹, S. Kalamitsou¹, P.-E. Mantzafleri¹, K. Moustakidou
Papadaki², A. Nikolaidou², C. Zarras³, E. Roilides²**

¹Hippokration General Hospital, Pediatric Intensive Care Unit, Thessaloniki, Greece

²Aristotle University of Thessaloniki

³rd Pediatric Department, Thessaloniki, Greece

³Hippokration Hospital of Thessaloniki, Microbiology Dept, Thessaloniki, Greece

BACKGROUND AND AIMS

The new Biofire® Filmarray Pneumonia Panel (BFP-BioMérieux, France) offers advantage against conventional cultures of respiratory tract specimens with rapid detection and quantification. The objective of this study is to evaluate the use of BFP and compare detection of pathogens in lower respiratory samples with conventional cultures in critically ill children with suspected pneumonia.

METHODS

A retrospective study was conducted in a polyvalent Pediatric ICU (PICU) located in a tertiary level general hospital in Northern Greece from 2019 to 2022. Children were included if an appropriate lower respiratory tract specimen was obtained for clinical evaluation and assessed by BFP. Results were compared with conventional respiratory sample cultures.

RESULTS

Sixty seven samples from 66 patients (median age 36mo, IQR 96mo) were assessed. BFP yielded a pathogen in 38 cases (5 cases included only viruses) and resistant genes in 12 cases (*mecA*, *bla*_{KPC}, *bla*_{VIM}, *bla*_{NDM}). In 23/45 (51.1%) cases BFP and culture were in agreement for bacterial identification; in 14 cases no bacteria were detected and in 9 cases the same pathogen was detected. In 10 cases culture was negative, whereas BFP was positive with *Hemophilus influenzae* (4 cases), *Staphylococcus aureus* (3 cases), *Pseudomonas aeruginosa* (3 cases), *Streptococcus pneumoniae* (2 cases), *Klebsiella pneumoniae* and *Acinetobacter baumannii* (1 case each). BFP found more or different pathogens than culture in 12 cases. A fair agreement was found (k score=0.35).

CONCLUSIONS

Assessment of BFP in critically ill children had a fair agreement with conventional cultures, but with greater sensitivity for bacterial pathogens and rapid identification of resistant genes.

EP034 / #2115

E-Poster Viewing - Intensive care AS01-15. Infectious diseases

Procalcitonin levels in corellation with il-6 and crp for early diagnosis of sepsis in newborns

A. Sofijanov^{1*}, O. Jordanova², S. Bojadzieva³

¹University Children Hospital-Skopje, Intensive Care Unit, Skopje, North Macedonia

²University Children Hospital-Skopje, Clinical Biochemistry (Hematology, Biochemistry Immunology, Allergology), Skopje, North Macedonia

³University Children Hospital-Skopje, Gastroenterology, Skopje, North Macedonia

BACKGROUND AND AIMS

Sepsis increases mortality and morbidity in newborns especially in preterm newborns so the timely use of antibiotic therapy is essential for life-threatening condition. The aims of this study was to evaluate and compared the diagnostic levels of procalcitonin (PCT) and interleukin-6 (IL-6) with that of C-reactive protein (CRP) within the first 12 h of admission, for reducing severe sepsis and septic shock in newborns.

METHODS

In this study we included all newborns with clinical signs and symptoms of sepsis vary by gestational age admitted in the Intensive care Unit at the University Children's Hospital in Skopje. PCT levels, IL-6 levels and CRP levels were measured the first 12 h of admission and 3-5 days after admission.

RESULTS

We evaluated 110 newborns with with clinical signs and symptoms of sepsis. There were 49 girls and 61 boys. The median gestational age was 34 - 40 GN \pm 2. The values of PCT at the fist 12 h of admission were high preterm

newborns than term newborns in correlation with IL-6 and CRP levels and that was the most common predisposing factor for severe sepsis and septic shock. The second measurement after 3-5 days is a parameter, who show us whether an appropriate antibiotic for the treatment is used, and develop of antibiotic resistants. The mortality rate was 19% and was significantly higher in the preterm newborns.

CONCLUSIONS

The values of PCT was the most useful biochemistry marker in preterm newborn with sepsis to prevent the development of severe sepsis and septic shock.

EP035 / #1401

E-Poster Viewing - Intensive care AS01-15. Infectious diseases

Mucormycosis: different clinical cases in a pediatric intensive care unit (picu)

**C. Tsiagklani*, M. Prapa, K. Straka, E. Christakou, M. Gianniki,
A. Ntavoura, I. Gotsi, P. Poulos, D. Paraschou, C. Barbaressou**

Aghia Sophia Children's Hospital, Paediatric Intensive Care Unit, Athens, Greece

BACKGROUND AND AIMS

Mucormycosis is a rare, opportunistic, potentially fatal infection mainly affecting immunocompromised patients, although cutaneous infection can occur in immunocompetent patients with traumatic injuries.

METHODS

We present 2 pediatric cases of mucormycosis admitted in our PICU.

RESULTS

Case 1: A 15-year-old girl was admitted to our hospital with an open Gustello IIIc tibia fracture following a traffic accident. She underwent external fixation and vascular reconstruction with autologous vein graft. She received several antibiotic regimens and underwent surgical debridement combined with VAC and skin grafting. 4 months post injury, skin cultures identified *Mucor circinelloides* and antifungal treatment was initiated. Patient's clinical course deteriorated and lower-limb amputation was decided. She was admitted in PICU postoperatively. Further evaluation for systemic mucormycosis was negative, while antifungal treatment was continued after discharge from

PICU. Case 2: A 2-year-old boy with acute myeloid leukemia was admitted in PICU due to severe clinical presentation with fever, focal seizures, respiratory distress and ascites. Antibiotic and antifungal treatment was initiated, EVD was inserted due to hydrocephalus and intercostal catheter was placed. Abdomen CT-scan revealed three lesions in the liver. Examination of body fluids revealed hyphomycetes and the biopsy of brain tissue detected *Mucor-Absidia corymbifera*. Patient received a 7-month antifungal treatment course with clinical improvement, but brain fibrosis and severe damage of the spinal cord developed.

CONCLUSIONS

The early diagnosis of mucormycosis is crucial. When mucormycosis is clinically apparent, is often too late to administer effective treatment.

EP036 / #1426**E-Poster Viewing - Intensive care AS01-15.****Infectious diseases****A case of acute hydrocephalus: complication of listeria monocytogenes meningitis in an 8-year-old oncology patient**

C. Tsiagklani*, M. Prapa, K. Straka, E. Michailoudi, E. Christakou, M. Gianniki, A. Ntavoura, I. Gotsi, P. Poulos, D. Paraschou, C. Barbaressou

Aghia Sophia Children's Hospital, Paediatric Intensive Care Unit, Athens, Greece

BACKGROUND AND AIMS

Listeria monocytogenes is a gram- positive bacteria, typically affecting neonates, pregnant women, elderly and immunocompromised patients. Listeria meningitis is associated with severe complications including sepsis, brain abscesses, meningitis, hydrocephalus and high mortality rate.

METHODS

We report a case of an 8-year-old girl on chemotherapy for B-cell acute lymphoblastic leukemia, with Listeria meningitis, requiring insertion of externalventricular drain (EVD) due to acute hydrocephalus.

RESULTS

Patient was admitted to our hospital due to fever and headache. CRP levels were elevated and blood and cerebrospinal fluid (CSF) cultures were positive for Listeria monocytogenes. Antibiotic therapy was promptly started, chemotherapy was discontinued, along with withdrawal of dexamethasone.

Clinical presentation was complicated by neurological deterioration with focal seizures, disturbance of consciousness and acute hydrocephalus. EVD was inserted and the patient was admitted to our PICU. During PICU hospitalization EVD replacement was required due to obstruction. Her consciousness level and motor function gradually improved, but major neurological sequelae developed. She received mechanical ventilation for 13 days, anticonvulsive treatment and remained hemodynamically stable although intermittent episodes of sinus bradycardia were observed. Blood and CSF cultures turned negative. She was discharged from PICU after a 17-day hospitalization continuing antibiotic treatment.

CONCLUSIONS

Early suspicion and recognition of *Listeria meningitis* is crucial for a positive outcome. Clinicians must perform close clinical monitoring of children at high risk and be aware of possible complications.

EP037 / #2702

E-Poster Viewing - Intensive care AS01-15. Infectious diseases

Bedside point of care testing for respiratory pathogens in paediatric intensive care; a feasibility study.

K. Wilson^{1*}, H. Groves², S. Mcvea¹, J. Richardson¹

¹Royal Belfast Hospital for Sick Children, Picu, Belfast, United Kingdom

²Royal Belfast Hospital for Sick Children, Infectious Diseases, Belfast, United Kingdom

BACKGROUND AND AIMS

Respiratory virus infections contribute significantly to Paediatric Intensive Care Unit (PICU) admissions. Laboratory PCR testing can take up to 24 hours with sample transport increasing result turnaround time (TAT) further.

METHODS

We aimed to assess the feasibility of bedside point-of-care (POC) testing for 15 viral and 4 bacterial respiratory pathogens using the BioFire RP2.1 EZ panel compared to laboratory testing at the Royal Belfast Hospital for Sick Children PICU. A retrospective review of POC tests performed between January and July 2022 inclusive was conducted.

RESULTS

100 POC tests were included; 48 tests returned positive (8 co-infections) with rhinovirus/enterovirus the most commonly isolated pathogen (56%). 22 POC tests (45.8%) had a corresponding positive result on laboratory testing. of the negative POC tests, 15 (28.8%) subsequently returned a positive laboratory result on respiratory sample testing: 14 detected respiratory pathogens not

included on the POC panel and 1 sample detected very low level rhinovirus positivity. All POC tests resulted within 45 minutes and were successfully completed by PICU medical staff on the first attempt. Average laboratory TAT for COVID-19 testing was 1 day. Remaining laboratory respiratory virus testing TAT ranged from 1 and 3 days.

CONCLUSIONS

Bedside POC testing for a panel of common respiratory pathogens is straightforward to perform by medical staff in a PICU setting. Discordant results between POC and laboratory testing in this context requires further investigation. The significant decrease in TAT compared to laboratory testing may facilitate faster patient cohorting, clinical decision-making and antimicrobial stewardship in the PICU.

EP038 / #2647**E-Poster Viewing - Intensive care AS01-17.
Nephrology****Continuous kidney replacement therapy (ckrt) practices in the pediatric intensive care units across europe: an espnic survey amongst 20 european countries****M. Daverio^{1*}, G. Cortina², A. Jones³, A. Deep⁴**

¹*Pediatric Intensive Care Unit - University Hospital of Padua, Department of Women and Children's Health, Padova, Italy*

²*Medical University of Innsbruck, Department of Pediatrics, Innsbruck, Austria*

³*Great Ormond Street Hospital, Department of Pediatrics, London, United Kingdom*

⁴*King's College Hospital NHS Trust, Pediatric Intensive Care Unit, London, United Kingdom*

BACKGROUND AND AIMS

CKRT is the preferred method of kidney support in children in the PICUs with lacking data on CKRT management in Europe. We describe the current CKRT practices across European PICUs.

METHODS

Online survey among 20 European countries (one response from each PICU) assessing CKRT organisational aspects, prescription, training/education and anticoagulation.

RESULTS

One-hundred-sixty-one PICUs (75% response rate) responded. The PICU team (77%) was mainly responsible for CKRT prescription/management while the PICU nurses for machine set-up (49%) and running (67%). Sixty-one percent

of PICUs' nurses received training to use CKRT with no need of certification in 36% of the PICUs. Circuit priming was performed with normal saline (67%); blood priming in children <10kgs (56%). A combination of pre-/post-dilution (41%) with a bicarbonate-base solution (73%) were mainly used for the replacement fluid with a filtration-to-dialysis ration of 50/50 (41%). Median CKRT dose was 35 mL/kg/h (IQR 30-50) in neonates and 30 (IQR 30-40) in children; minimum blood flow 20 mL/min (IQR 10-20) and maximum of 200 (IQR 150-250); maximum net ultrafiltration rate ranging 1-3 mL/kg/h. First-line anticoagulation was regional unfractionated heparin (41%) and citrate-base regional anticoagulation (35%) using ACT (53%) and aPTT (51%) to monitor anticoagulation. Liberation from CKRT was performed with a diuretic bolus+infusion (32%) or a diuretic bolus alone (19%). Follow-up to CKRT-patients after discharge was provided in 61% of the PICUs.

CONCLUSIONS

The results of this first survey on CKRT among European PICUs call for a concerted efforts on our community to streamline CKRT education, research and guidelines to reduce variation in practice.

EP039 / #2547

E-Poster Viewing - Intensive care AS01-18. Neurology

Pediatric stroke code. Experience in a 3rd level center

R.A. Burgueño-Rico^{1*}, E. Turon-Viñas¹, E. Coca-Fernandez¹, S. Brió-Sanagustin², E. Carbonell Estarellas³, F. Castillo-Gómez¹, M. Rodríguez- Martínez¹, S. Boronat-Guerrero⁴

¹Hospital Sant Pau., Paediatric Intensive Care, Barcelona, Spain

²Hospital Sant Pau, Paediatric, Barcelona, Spain

³Hospital de la Santa Creu i Sant Pau, Paediatrics Department, Barcelona, Spain

⁴Hospital Sant Pau., Paediatric, Barcelona, Spain

BACKGROUND AND AIMS

Stroke is a rare pathology in pediatrics. However, its early detection is vital for its management and minimization of sequelae. Therefore, structured plans are necessary to facilitate the fastest possible management of this illness. These codes aim to achieve high sensitivity, so false positives are common.

METHODS

In this review we will analyze the pediatric stroke codes received by a tertiary care hospital between March 2020 and May 2022. We will describe the initial presentation of these pictures (initial suspicion of stroke) and what the diagnosis was after carrying out the protocol.

RESULTS

A sample of twelve patients was obtained. The mean age was eleven years and four months (minimum of five months and maximum of seventeen). The final diagnoses were: three arteriovenous malformations (debut with right

hemiparesis, coma and headache progressing to coma). Four migraines with aura (visual deficit, hemianopsia, weakness with diplopia and hemiparesis), an intraventricular hemorrhage (lethargy), a hemorrhage on an encephalomalacia (dysarthria), an EMAD (right arm paresis) and two ischemic infarctions (focal status and hemiparesis with aphasia).

CONCLUSIONS

The existence of activation devices (stroke code) that optimize the management of serious time-dependent pathologies is necessary. However, the follow-up of the patients included in these codes shows that, despite presenting symptoms suggestive of stroke (often initially indistinguishable), in many cases the diagnosis is a pathology that requires different clinical management and with a different prognosis.

EP040 / #1195**E-Poster Viewing - Intensive care AS01-18.
Neurology****Febrile seizures as first clinical presentation of focal cortical dysplasia in a 3,5-year-old girl****E. Goula¹, C. Lymeratou^{1*}, C. Tsimakidi², E. Kotsi³, A. Tsialla¹, M. Vasilopoulou¹**¹Children Hospital of Penteli, Picu, Athens, Greece²Children Hospital of Penteli, Neurology Department, Athens, Greece³Children Hospital of Penteli, Department of Pediatrics, Athens, Greece**BACKGROUND AND AIMS**

Focal cortical dysplasias are common malformations of cerebral cortical development that are highly associated with refractory epilepsy. Seizures usually start in the first 5 years of life.

METHODS

A 3,5-year-old girl, with no medical history, was admitted to our PICU due to febrile seizures with left focal onset, progressing to generalized tonic-clonic and eventually to status epilepticus. The episode ceased after administration of phenytoin and midazolam and the patient regained level of consciousness a few hours later, although left focal signs persisted for a longer period. For the next 48 hours, occasionally she was agitated, with hallucinations and disorientation (delirium). Gradually, she recovered completely.

RESULTS

CSF was negative for viruses and bacteria. Blood culture at admission grew *Roseomonas mucosa*, with concurrent rise of inflammation markers. The

patient received ceftriaxone, acyclovir and levetiracetam with favorable response. EEG demonstrated slow wave activity in the right temporal and parietal lobe, with epileptiform discharges. Finally, the cerebral MRI posed the diagnosis, which indicated an extensive focal cortical dysplasia in the right temporal, parietal and occipital lobe, with midline shift and compression of the right lateral ventricle. No further immunology work-up due to *Roseomonas* bacteremia was proceeded, as there is no suspicion of primary immune deficiency at this point.

CONCLUSIONS

Focal cortical dysplasia is a main cause of drug-resistant epilepsy and it often requires surgical treatment. Surgical inaccessibility and failures are significant clinical drawbacks, but future is promising with neurostimulation techniques and innovative therapeutic approaches based on cellular models of neural activation or inhibition (mTOR inhibitors, ketogenic diet).

EP041 / #2776**E-Poster Viewing - Intensive care AS01-18.
Neurology****Case report: acute ischemic stroke in a child due to tICA occlusion treated successfully with endovascular treatment**

**A. Pi-Compañó^{1*}, M. Espinet-Pedrol^{2,3}, R.A. Burgueño-Rico¹,
E. Coca-Fernandez¹, S. Brió-Sanagustin², L. Sanchez⁴, B.M. Anson⁵,
J. Branera⁶, E. Turon-Viñas^{7,8}, S. Boronat-Guerrero⁹**

¹Hospital Sant Pau., Paediatric Intensive Care, Barcelona, Spain

²Hospital de la Santa Creu i de Sant Pau, Paediatric Intensive Care, Barcelona, Spain

³Hospital de Sant Pau, Department of Paediatrics, Barcelona, Spain

⁴Hospital Sant pau, Neurology, Barcelona, Spain

⁵Hospital Sant pau, Neuroradiology, Barcelona, Spain

⁶Hospital Sant pau, Intervencionism Radiology, Barcelona, Spain

⁷Hospital De La Santa Creu I Sant Pau, Neuropediatrics, Barcelona, Spain

⁸Hospital de la Santa Creu i Sant Pau, Pediatric Intensive Care, Barcelona, Spain

⁹Hospital de la Santa Creu i de Sant Pau, Neurology Department, Barcelona, Spain

BACKGROUND AND AIMS

Ischemic strokes in childhood are rare. Thrombolytic therapy with intravenous tissue plasminogen activator has been the main intervention for the management of pediatric stroke patients. Recently, successful endovascular treatments for acute ischemic stroke in children have been reported with increasing frequency, suggesting that mechanical thrombectomy can be a safe and an effective treatment. Our aim is to describe a case of a 15-year-old child with acute ischemic stroke due to terminal internal carotid artery (TICA) occlusion successfully treated with this procedure.

METHODS

Case report

RESULTS

15 years old child admitted in ER for the increase level of consciousness, falling to ground on mutism, Undergoing an urgent CT scan Where I left frontal cortical erasure Were reported an angio CT reporting TICA occlusion. An ischemic stroke concerning the medial cerebral artery (MCA) was evidenced and endovascular therapy was proposed. A dissection of TICA extending till MCA was observed and mechanical thrombectomy was done, persisting poor revascularization scenery and a stent retriever placement was proposed but finally it was discarded because another imaging was undergone and the íntimal flap was observed more attached to the artery wall with an excel-lent repermeabilisation. An ethiologyc study was done. Adjuvant antiagregant platelet bitherapy was continued to mechanical thrombectomy. Clinical course and RMI imaging were favourable and the patient was discharged from hospital to neurorrehabilitación center where he is recovering properly

CONCLUSIONS

Mechanical thrombectomy can be a safe and efective intervention

EP042 / #1987**E-Poster Viewing - Intensive care AS01-18.
Neurology****About 9 cases of respiratory support in pediatric
jeune syndrome and clinical evolution**

**E. Sfeir*, J. Zini, A. Bakayoko, E. Beltaief, A. Essid, B. Mbieleu,
S. Quijano, J. Bergounioux**

Raymond -Poincaré, Departement of Pediatrics, Garches, France

BACKGROUND AND AIMS

Jeune Syndrome or asphyxiating thoracic dystrophy is a rare genetic recessive disease belonging to the short rib polydactyly group (SRP) characterized by restricted bone growth. Shortened ribs present in this syndrome, lead to restricted thoracic expansion, hypoplastic lung development, severe respiratory compromise, and death. Latent, mild, and severe forms have been previously described. 70 % of infant with Jeune syndrome die in the first two years of life because of restrictive respiratory insufficiency. No clear consensus exists for the treatment of this restrictive lung disease. Optimized Non-Invasive Ventilation (NIV) early in life can promote alveolar multiplication and thoracic growth and can be a treatment modality for these patients.

METHODS

We propose a single center retrospective study about 9 cases of Jeune Syndrome.

RESULTS

The 9 cases of Jeune syndrome, had moderate to severe respiratory involvement for whom NIV and optimized respiratory assistance led to respiratory

autonomy. None of these patients had surgery and only one death occurred in the context of severe respiratory infection. Positive pressure ventilation played a major role in chest wall expansions in these patients and led to better growth palliating to chest wall hypoplasia and abnormal lung development and consequently a decrease in respiratory decompensation and insufficiency with better long term prognosis.

CONCLUSIONS

It is possible to use respiratory assistance very early after birth to prevent secondary respiratory failure and reduce death rate in patients with Jeune syndrome.

EP043 / #1639**E-Poster Viewing - Intensive care AS01-18.
Neurology****A rare case of guillain-barré syndrome post covid-19 infection in a young male patient**

C. Tsirogianni^{1*}, A. Liaskou², K. Straka¹, E. Christakou¹, M. Prapa¹, P. Poulos¹, D. Paraschou¹, C. Barbaressou¹, V. Dimitropoulou¹, E. Mpourazani¹

¹Aghia Sophia Children's Hospital, Paediatric Intensive Care Unit, Athens, Greece

²Aghia Sophia Childrens Hospital, Picu, Athens, Greece

BACKGROUND AND AIMS

Guillain Barré syndrome(GBS)is an acute inflammatory immune-mediated polyneuropathy characterized by rapidly progressing symmetrical ascending weakness and hypo-or areflexia establishing over days to weeks.It is typically a post-infectious autoimmune process leading to destruction of myelin.COVID-19 seems to act as a trigger;the mechanism of neurological manifestation can be explained by the presence of ACE-2 receptor in nervous system and skeletal muscles.

METHODS

We report the case of COVID-19 associated GBS in a young boy.

RESULTS

An 11-year-old boy,with unremarkable past medical history and asymptomatic COVID-19 infection 2 weeks ago,presented to our hospital with generalized weakness and unsteady gait.He showed progressive weakness of lower extremities evolving to the upper limbs over the last 10days.Physical

examination revealed absent tendon reflexes, weakness in the lower limbs greater than the arms, neuropathic pain and autonomic disorders with fluctuations of blood pressure and heart rate. He required intubation for airway protection due to loss of gag reflex and poor secretion control. MRI of the brain and spine revealed abnormal enhancement of the cauda equine. Lumbar puncture showed albuminocytologic dissociation (8 cells/mm^3 & protein level 320 mg/dL). The lumbar puncture, MRI and neurologic examination were all consistent with GBS. He was treated with intravenous immunoglobulin 2 gr/kg over 48 hours, showing improvement in the subsequent days. Results of SARS-CoV-2 PCR tests remained positive. He improved and was extubated 4 days later and remained in good condition.

CONCLUSIONS

This case reveals the wide scope of presentations of COVID-19 and post-infectious processes in children. Although more cases with epidemiological data should be studied to improve this neuro invasive potential, clinicians should constantly have a high level of suspicion for uncommon manifestations.

EP044 / #1108

E-Poster Viewing - Intensive care AS01-19. Organisation & safety

Can we use ward nurses (as picu nurses) for a predicted rsv surge?

A. Parry*, A. Knight

Alder Hey Childrens Hospital, Picu Education office, AP, United Kingdom

BACKGROUND AND AIMS

In rspnse to a sudden predicted RSV survey in 2022 (post COVID-19) the hospital plan was to utilise and upskill ward nurses to care for children in PICU. This gave the PICU team one week to train and prepare the staff and we aimed to evaluate the deployed staffs views of this training and experience.

METHODS

An electronic questionnaire was sent to deployed nurses evaluating their experience and training. This was combined with a Restorative Clinical Supervision session (RCS) held with Professional Nurse Advocate (PNA) where themes that arose from the questionnaire were discussed and reflected upon.

RESULTS

Twelve nurses were redeployed and trained up and 10/12 (83% completed the survey and attended the session), only 8 nurses provided consent for their answers to be shared. The common themes that emerged included: Excellent communication, fantastic teamwork, mutual respect between all levels of medical staff and nursing staff and outstanding patient care. They nurses said they felt valued and learnt care and skills they wouldn't ordinarily been exposed to. They perceived their confidence in recognising deteriora-

tion of patients in their own area had increased. The eight nurses (who gave consent) said they would consider returning to PICU if needed

CONCLUSIONS

Despite the limited timeframe to recruit and train these ward nurses to manage PICU patients, most staff were positive about their PICU experience.

EP045 / #2746**E-Poster Viewing - Intensive care AS01-21.
Pharmacology & therapeutics****The consumption of antibiotics in pediatric resuscitation****K. Amanzoui*, A. Erragh, H. Salem, S. Kallouch, A. Chlilek**

Chu Ibn Rochd Hospital, Anesthesia Resuscitation, Casablanca, Morocco

BACKGROUND AND AIMS

The emergence of antibiotic-resistant bacteria has become a worrying public health problem, particularly in intensive care settings. The monitoring of the consumption of antibiotics and their proper use is essential to contextualize medical practices.

METHODS

We quantified the consumption of antibiotics and its direct cost in the pediatric intensive care unit of the Abderrahim EL Harrouchi hospital of the CHU IBN ROCHD, through a retrospective study spread over 2 years (2016 and 2017) where all patients hospitalized during this period have been included. Data on antibiotic consumption are collected from the hospital pharmacy.

RESULTS

591 and 594 patients were hospitalized respectively during the years 2016 and 2017. Postoperative complications were the most frequent reason for admission in 2016, while in 2017, afebrile respiratory distress was the most frequent. The number of days of hospitalization carried out were 3082 in 2016 and 3238 in 2017. 3rd generation cephalosporins occupy the first place, Polymyxins come in second place. Pneumopathy represents the first indi-

cation for prescription of antibiotics in pediatric intensive care, followed by sepsis. The total direct cost of antibiotics consumed increased by 306%. In 2016, the total value is represented by imipenem and ceftriaxone while in 2017, it is represented by tigecycline.

CONCLUSIONS

Despite the low consumption of antibiotics recorded by the pediatric intensive care unit of our establishment, the development of an antibiotic therapy policy remains one of the essential strategies for the prevention of infections with multiresistant bacteria.

EP046 / #2769**E-Poster Viewing - Intensive care AS01-21.
Pharmacology & therapeutics****Evaluation of the management of intoxications in
pediatric intensive care unit**

K. Amanzoui*, K. El Fakhr, A. Erragh, A. Afif, S. Kallouch, A. Chlilek

Chu Ibn Rochd Hospital, Anesthesia Resuscitation, Casablanca, Morocco

BACKGROUND AND AIMS

A severe acute intoxication in pediatrics constitutes a public health problem of increasing concern in the whole world because of the increase in its frequency, the difficulty of its management and its morbi-mortality. The objective of our study is to determine the epidemiological characteristics of intoxications, to define the nature of the various incriminated toxic agents, describe the circumstances of their occurrence, their clinical and biological signs, to recall the initial management as well as what to do when faced with each toxic agent, and finally determine the best preventive approaches.

METHODS

Retrospective descriptive study 5 years from 2017 to 2021, on children under 15 years old hospitalized in the pediatric intensive care unit of the Abderrahim Harouchi children's Hospital of the CHU Ibn Rochd.

RESULTS

39 patients were admitted to the mother and child intensive care unit for acute intoxication, representing 1,32% of hospitalizations during the same period. The average age was 4,83 years. Pesticides were the most frequently incriminated toxic substances (51,3%). The majority of intoxications were accidental (76,9%).

On admission, the most frequent clinical signs were cardiovascular signs 97,9%. Symptomatic treatment was systematic on admission, intubation and artificial ventilation was necessary in 38,5%. 25,7% required antidote administration 84,6% of the patients had a favorable outcome, 6 deaths were recored with a mortality rate of 15,6%

CONCLUSIONS

Accidental domestic intoxications are frequent in toodlers. Circumstances in other age groups are often voluntary and pose the problem of psychological care to avoid recurrences. The best measure will remain prevention.

EP047 / #2765**E-Poster Viewing - Intensive care AS01-21.
Pharmacology & therapeutics****Therapeutic de-escalation in probabilistic
antibiotherapy in pediatric resuscitation**

K. Amanzoui, A. Erragh*, A. Raja, K. El Fakhr, S. Kallouch, A. Chlilek

Chu Ibn Rochd Hospital, Anesthesia Resuscitation, Casablanca, Morocco

BACKGROUND AND AIMS

The rational use of antibiotics is crucial to prevent the emergence of multi-resistant bacteria that can lead to therapeutic impasse, especially in intensive care units. The de-escalation strategy is therefore naturally advocated as part of a better use of antibiotics. We aimed to evaluate the applicability and impact of this strategy in the pediatric intensive care unit.

METHODS

We conducted a prospective study spread over 4 months in the pediatric intensive care unit of the CHU ibn rochd, including all patients under 15 years of age who had received probabilistic antibiotic therapy for more than 48 hours. Data analysis was performed using SPSS software

RESULTS

Out of 130 patients included in our study, 15,38% were de-escalated and 84,62% were not de-escalated. The yield of cultures was 39,9%. The clinical and biological deterioration rate after de-escalation was 10% vs 31,8% in the non-de-escalation group. Hospital mortality after de-escalation was 10%.

CONCLUSIONS

Antibiotic de-escalation appears to be a safe strategy to apply in critically ill children.

EP048 / #1496**E-Poster Viewing - Intensive care AS01-25.
Pulmonology****Mucopolysaccharidosis type vi airway obstruction
due glycosaminoglycans after an elective
procedure****F. Caino De Oliveira^{1*}, W. Brunow De Carvalho^{2,3}, L. Valquer
Trevisol², R. Aguiar Salvador³**¹*GRAACC, Picu, São Paulo, Brazil*²*Santa Catarina Hospital, Picu, São Paulo, Brazil*³*Santa Catarina Hospital, Picu, Sao Paulo, Brazil***BACKGROUND AND AIMS**

Mucopolysaccharidoses are a group of lysosomal diseases caused by the deficiency of one of the enzymes involved in the catabolism of glycosaminoglycans that leads to inflammatory response

METHODS

case report

RESULTS

A 13-year-old female with mucopolysaccharidosis Three days before admission, she underwent surgery in another hospital; she was extubated shortly after surgery and was discharged. she developed stridor, associated with respiratory discomfort she came to our hospital with high respiratory distress. Orotracheal intubation was performed with bronchoscopy; computed tomography of the neck was done, showing hypodensity involving soft tissue throughout the paratracheal tube. 14 days after admission, bronchoscopy was done without improvement of the condition. and tracheostomy was

done close to the carina due to the condition seen in the exam. On 8th postoperative day, presented respiratory failure with properly placed cannula, new emergency approach indicated, with a granuloma below the distal end of the cannula with 50% obstruction of the lumen. As there is no tracheostomy tube on the market with an adequate length to overcome the stenotic area, producing adaptation, using a number 8 tracheostomy tube, and an intubation tube 6 being fixed inside, being located beyond the stenosis. No new respiratory complications after the procedure

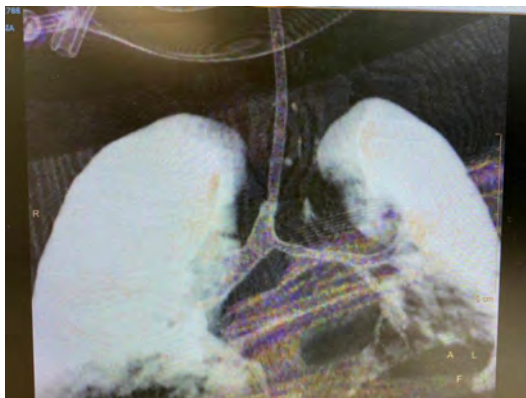
**FIGURE 1:****FIGURE 2:**

CONCLUSIONS

The accumulation of GAG in the oropharynx and airways in MPS VI is generally associated with narrowing of the trachea and bronchi, responsible for airway obstruction, as observed in the case described, and it is always necessary to consider this situation to avoid a risky condition as noted in the case description and be prepare for it.

EP049 / #917

E-Poster Viewing - Intensive care AS01-25. Pulmonology

Prenatal onset chylothorax, chylopericardium and mediastinal avm in newborn with heterozygous variant of the *rasa1* gene: management challenges

A. Greco^{1*}, F. Leo², F. Di Dio², G. Gargano²

¹University of Modena and Reggio Emilia, Department Mother & Child Neonatal Intensive Care Unit, Modena, Italy

²Department Mother & Child Neonatal Intensive Care Unit, Asmn Usl-irccs Hospital Reggio Emilia, Reggio Emilia, Italy

BACKGROUND AND AIMS

Congenital chylothorax is an accumulation of chyle within the pleural space, and may be detected prenatally or within the neonatal period. It is a rare condition and represents the most common cause of congenital pleural effusion during the neonatal period.

METHODS

Preterm female neonate (33w) born by cesarean section with a prenatal diagnosis of bilateral pleural and pericardial effusion with polyhydramnios treated with intra-uterine pleuro-amniotic shunt at 28w. In the first hours of life continuous suction pleural drainage was positioned and NIV was started. Chylothorax protocol was undertaken: total parental nutrition, continuous intravenous infusion of Octreotide and serial lung ultrasounds (LUS). During hospitalization pleural drainage had to be repositioned several times due to the formation of fibrin clots and membranes in pleural cavity (Figure 1 and 2); at 2 months old all therapies were stopped.



FIGURE 1:



FIGURE 1:

For a right pleural consolidation, a thoracoscopy-thoracotomy was performed to clean pleural cavity, detecting an angiomatous growth on the

pleural cavity referring to an AVM, treated with propranolol, embolization and surgical intervention. For congenital chylothorax and non-immune hydrops fetalis NGS clinical exome was performed finding a pathogenetic heterozygous variant of the RASA1 gene.

RESULTS

Due to relative rarity of congenital chylothorax evidence-based management and treatment choices are lacking. Serial LUS were performed to guide the clinical management and therapeutic adjustments providing additional information to traditional radiological investigations.

CONCLUSIONS

This case highlights that LUS, compared to the traditional radiological techniques, provides a serial quantitative and qualitative assessment of pleural effusion improving both pharmacological and interventional management.

EP050 / #1681**E-Poster Viewing - Intensive care AS01-25.
Pulmonology****Postinfectious bronchiolitis obliterans (pibo) in a toddler following an adenovirus and rsv lower respiratory coinfection****C. Lymeratou^{1*}, A. Tsialla¹, E. Siouti¹, I. Vasilopoulou¹, O. Giannouli¹, S. Kostaridou², M. Vasilopoulou¹**¹Children Hospital of Penteli, Picu, Athens, Greece²Children Hospital of Penteli, Pediatrics Clinic, Penteli, Greece**BACKGROUND AND AIMS**

Bronchiolitis obliterans is a rare chronic irreversible fibrosing lung disease characterized by small airways' obstruction. In children most cases are post-infectious. We describe the case of a toddler who developed PIBO after adenovirus and RSV co-infection.

METHODS

The 15-month-old boy was admitted with lower respiratory infection (adenovirus and RSV detected). 10 days later he was transferred to PICU due to respiratory insufficiency (tachypnea, wheezing, hypoxemia, hypercapnia). Treatment with broncodilators and corticosteroids failed, his respiratory state deteriorated and he needed 24/7 NIV for the next 3 months. He received methylprednisolone-pulse-therapy (30mg/kg) monthly and salbutamol inhalations. After each pulse there was a significant remission for about 20 days. Chest HRCT showed mosaic attenuation and air-trapping. Since other chronic pulmonary disease causes were excluded (α 1-antitrypsine deficiency, CF, etc), PIBO diagnosis was made. The following 2 months the patient was ventilated with NIV and High-Flow-Nasal-Cannula (HFNC) while on methylprednisolone.

lone-pulse 30mg/kg/month, azithromycin 3 days/week, montelukast and salbutamol/budesonide.



FIGURE 1:

RESULTS

3 years later his symptoms wax and wane; physical examination reveals crackles, intermittent wheezing and suprasternal retraction. He is receiving methylprednisolone-pulse every 6 weeks, azithromycin 3 days/week and MDI budesonide/formoterol. Home HFNC did not benefit him. During sleep he is on NIV, whereas when awake he is on nasal cannula oxygen-therapy (3L/

min). His growth is normal. Recently, an immunodulatory agent, mycophenolate mofetil, was added.

CONCLUSIONS

RSV and adenovirus are common pathogens in children, each with well-described complications. Both are recognized as PIBO causes. It is yet to be determined if a coinfection leads to more severe forms with worse outcome.

EP051 / #2157

E-Poster Viewing - Intensive care AS01-25. Pulmonology

Percutaneous tracheostomy performed in a pediatric intensive care unit

L. Seidler Nussenbaum¹, J. Raya Muñoz^{1*}, B. De Paz Vaquero¹,
Y. Peña Lopez¹, X. Nuvials Casal², J. Balcells¹

¹Vall D'hebron University Hospital, Picu, Barcelona, Spain

²Vall D'Hebron University Hospital, Icu, Barcelona, Spain

BACKGROUND AND AIMS

Tracheostomy has become a widely extended practice in pediatrics. Numerous benefits have been described in ventilatory management and decrease in the requirement of sedation associated with this technique. Percutaneous tracheostomy (PCT) is widely used as an alternative to surgical tracheostomy in ICU, but with very limited experience in pediatrics.

METHODS

A retrospective review of PCT performed between December 2014-December 2021 in a PICU of a tertiary hospital was done. Inclusion criteria: patients in whom this technique is performed in the PICU. For the analysis of results, we used percentages, median and IQR.

RESULTS

A total of 19 procedures in 18 patients were analyzed, 73.7% were male with age of 15yrs(13-16.2). The main indication was prolonged mechanical ventilation. The days from intubation to performing PCT were 19 days(15-26.5). Local risk factors: 2(10.5%) had a previous tracheostomy, 2 an anatomical

malformation. Systemic risk factors: 2 had coagulopathy and 4 (21%) thrombocytopenia(2 with ECMO). In all of them, a previous-US was performed. Early local complications:2/19 presented mild bleeding and 2/19 self-limited subcutaneous emphysema. Late complications(>1week):one granuloma, one dysphagia and one accidental decannulation. No deaths occurred in relation to the procedure. In 17/19 sedation could be completely withdrawn in 3.5days(1.2-7.5) Regarding the withdrawal of ventilatory support, except for one case, was possible to de-escalate to spontaneous support in 2days(0-8). In 11/19 respiratory support could be withdrawn at 18d(16.2-36). In 10/19 it was possible to decannulate without complications.

CONCLUSIONS

Elective TPC is a technique that must be consider in selected patients as alternative to the classic surgical approach

EP052 / #1420

E-Poster Viewing - Intensive care AS01-25. Pulmonology

Status asthmaticus in a tertiary pediatric intensive care unit: a 4 years' experience

M. Gianniki, E. Christakou, K. Straka, M. Prapa, E. Mpourazani, C. Tsiagklani*, A. Stelianidi, P. Poulos, D. Paraschou, C. Barbaressou

Aghia Sophia Children's Hospital, Paediatric Intensive Care Unit, Athens, Greece

BACKGROUND AND AIMS

Status asthmaticus (SA) may be life threatening, as it may lead to respiratory failure and may require pediatric intensive care unit (PICU) admission. The aim of this study is to report the clinical course and outcome of children with SA admitted to a tertiary PICU.

METHODS

This is a retrospective study of children with SA admitted to our PICU between May 2018 and January 2022.

RESULTS

Eight children with SA were included in this study. The enrolled patients were between 6 months and 13 years, with a median age of 4.25 years (IQR 1.75-11.25) and 75% were males (6/8). Half of the children had previous hospital admissions for asthma and the other 4/8 had past history of frequent use of inhaled bronchodilators, while 37.5% of the patients had family history of asthma. All patients were treated with intravenous steroids and nebulized β 2-agonists. A total of 50% received intravenous magnesium sulfate

and intravenous aminophylline, while only 3/8 patients received nebulized budesonide. 4/8 patients received oxygen therapy with non-rebreather mask, one needed non invasive mechanical ventilation and 3/8 children required invasive mechanical ventilation (MV). One pneumomediastinum occurred and all patients survived. Median PICU stay was 5.5 days (IQR 3.5-8.5); median duration of MV was 4 days. Pharyngeal swab PCR testing was positive for Enterovirus/Rhinovirus in 2/8 children and one was positive for RSV.

CONCLUSIONS

SA is associated with high morbidity and may be life-threatening. Primary prevention and early aggressive treatment of exacerbation are the most important steps in managing children with asthma.

EP053 / #2783

E-Poster Viewing - Intensive care AS01-26. Quality improvement

Pediatric rapid response team (rrt) assessment decreased code blue events – a single centre experience in a large tertiary centre

M. Pasha*, S. Alshehri, V. Peter

King Saud Medical City, Pediatric Icu, Riyadh, Saudi Arabia

BACKGROUND AND AIMS

According to studies, incidence of in-hospital resuscitation attempts in children's hospitals is 0.19 to 2.45 events per 1000 admissions. With early interventions, 61% of patients avoided unnecessary PICU admission. Aim: to summarize the code blue events reported in pediatric patients between January 2018 – April 2020 at our centre, as compared to data prior to implementation of RRT over preceding 2 years (January 2016 – December 2017).

METHODS

This is a retrospective cohort study involving children aged 0 - 14 years admitted to the pediatric hospital and underwent a code blue event, regardless of cause of admission.

Design: PI using standard improvement methodology tools

Study population: all pediatric patients admitted to pediatric hospital and underwent a code blue event, regardless of outcome. The Pediatric Early Warning Score was used as the tool to guide patient assessment, allowing early identification of those at risk for deterioration. Sample size: all patients admitted to pediatric hospital during study period.

INCLUSION CRITERIA:

All pediatric inpatients who underwent a code blue event requiring RRT activation irrespective of outcome.

EXCLUSION CRITERIA:

Stable pediatric inpatients

OUTCOME PARAMETERS:

Incidence of code blue events post intervention

RESULTS

442 patients in the wards had undergone rapid response activation since 2019. The hospital mortality rate decreased from 11% in 2016 and 7% in 2017 to 1.8% in 2019 after activation of RRT in January 2018.

CONCLUSIONS

The code blue events and mortality rate significantly dropped after implementation of rapid response system at our Children's Hospital.

EP054 / #988

E-Poster Viewing - Intensive care AS01-26. Quality improvement

Long stay patients on paediatric intensive care unit (picu): exploring clinical nurses perceived challenges

S. Shaw^{1*}, M. Mahgoub¹, C. Chamberlain-Parr¹, R. Ellis¹, L. Tume^{2,3}

¹Alder Hey Childrens Hospital, Critical Care, Liverpool, United Kingdom

²University of Salford, School of Health & Society, Manchester, United Kingdom

³Alder Hey Children's Hospital, Picu, Liverpool, United Kingdom

BACKGROUND AND AIMS

Background: There is an increasing proportion of long stay patients (LSP) in UK PICUs. LSP may present unique challenges for the nursing team. Aims: To explore clinical nurses' perceptions of the challenges faced with LSP and identify potential solutions and training needs.

METHODS

A 15 item cross sectional electronic survey sent to all PICU nurses in one UK mixed general and cardiac PICU and ECMO centre using google forms in March 2022. Nurses were asked to rate how they felt when allocated a LSP on a 1-7 Likert scale with 7 the most positive. Responses were downloaded to Excel for descriptive analysis.

RESULTS

55/151 (36.4%) completed the survey. The mean PICU experience was 10.5 years (SD 9.6) and most respondents were senior nurses (63.6%). The mean Likert score was 3.67 (SD 1.07) with the two main reasons for the score cited

as enjoying being part of the family dynamic (42%) and involving the family in the child's care (31%). The three perceived greatest clinical challenges in LSP were: achieving optimal sedation and preventing withdrawal; the repeated need for painful/ stressful procedures; patient care decisions are dispersed amongst many clinicians and specialist teams. A third of nurses felt the current method of allocating nurses to these children was not optimal, with 32% unsure.

CONCLUSIONS

LSP can present some challenges for the clinical care team, but overall responding nurses viewed caring for these children as positive, although further education on the issues for these children and families was suggested.

EP055 / #1021

E-Poster Viewing - Intensive care AS01-26. Quality improvement

Long stay patients on paediatric intensive care unit (picu): exploring medical and nurse practitioners perceived challenges

S. Shaw^{1*}, M. Mahgoub¹, C. Chamberlain-Parr¹, R. Ellis¹, L. Tume^{2,3}

¹Alder Hey Childrens Hospital, Critical Care, Liverpool, United Kingdom

²University of Salford, School of Health & Society, Manchester, United Kingdom

³Alder Hey Children's Hospital, Picu, Liverpool, United Kingdom

BACKGROUND AND AIMS

Background: There is an increasing proportion of long stay patients (LSP) in UK PICUs. LSP may present unique challenges for the medical team. Aim: To explore advanced nurse and medical practitioners' perceptions of the challenges faced with LSP and identify any potential solutions and training needs.

METHODS

A 13 item cross sectional electronic survey sent to all PICU doctors and advanced nurse practitioners in one UK mixed general and cardiac PICU and ECMO centre using google forms in March 2022. They were asked to rate how they felt when allocated a LSP on a 1-7 Likert scale with 7 the most positive. Responses were downloaded to Excel for descriptive analysis.

RESULTS

18/37 (48.6%) respondents completed the survey. The mean PICU experience was 15.2 years (SD 11.1) and most respondents were consultants (33.3%). The mean Likert score was 3.0 (SD 1.39) with the two main reasons for the score

cited as stress talking to these families on a daily or weekly basis (35.3%) and feeling caught in the middle between other medical teams involved in the LSP care (23.5%). The three perceived greatest clinical challenges in LSP were: patient care decisions are dispersed among many ICU clinicians and other teams involved; prolonged venous access issues; achieving optimal sedation whilst preventing withdrawal.

CONCLUSIONS

LSP can present some difficult situations for the clinical care team. Overall respondents viewed caring for these children as challenging and further education on the issues for these children and families was suggested.

EP056 / #2770

E-Poster Viewing - Intensive care AS01-27. Resuscitation & transport

Respiratory support with non-invasive ventilation (niv) and humidified high flow nasal cannula (hhfnc) during inter-facility transfers- a safety and feasibility case review.

M. Rohouma^{1*}, L. Liveing², A. Hill², G. Harlow³, M. Zoha², C. Silvestre³

¹University Hospitals of Leicester, Women and Children, LEICESTER, United Kingdom

²University Hospitals of Leicester, Comet, Leicester, United Kingdom

³Nottingham University Hospital, Picu & Comet, Nottingham, United Kingdom

BACKGROUND AND AIMS

Respiratory support with NIV and HHFNC during paediatric critical care transfers have been possible with the modern ventilators and the variable interfaces. Very little is known about the safety, feasibility and complications associated with such transfers. Aims: To conduct a pilot study of the safety of transferring paediatric patients on NIV/HHFNC.

METHODS

Electronic records from CoMET (Children's Medical Emergency Transport), located in the East Midlands, United Kingdom were retrospectively reviewed from April 2017 to June 2022 to identify those that required respiratory support and were transferred on NIV or HHFNC. Hamilton T1, Draeger with dual limb system and patients' own home ventilators were used. Next-day follow up of all transferred patients was analysed to identify those who needed intubation in the receiving units at 6 hours and 24 hours following admission.

RESULTS

During this period a total of 249 patients with a median age 8 months (1 day- 16 years) and median weight 7.1 Kg were transferred either on HHFNC or NIV. The number of patients moved on NIV has more than doubled since the service began from 27 patients (in 2017/18) to 65 patients (in 2021/22)- representing 8% and 17% of the total transfers respectively. 17 patients required invasive ventilation within 24 hours of transport, with 6 requiring intubation within 6 hours. There was no escalation in support or complications during transfer.

CONCLUSIONS

Transporting paediatric patients on NIV has become more common place as equipment advances and confidence in its safety grows. We recommend a multi- facility study to further explore its effectiveness and safety.

EP057 / #1024

E-Poster Viewing - Intensive care AS01-28. Sedation & analgesia

Evaluation of a sedation protocol and weekly sedation ward rounds in paediatric intensive care

L. Kenworthy*, N. Reilly, P. Jirasek

Alder Hey Children's Hospital, Picu, Liverpool, United Kingdom

BACKGROUND AND AIMS

Midazolam use in PICU is associated with increasing the risk of delirium and an increased prevalence of post-traumatic stress disorder within the paediatric population following discharge (Long et al, 2021). In September 2021 a new sedation algorithm combined with weekly multidisciplinary sedation ward rounds were introduced to try to reduce our midazolam usage. Aims To evaluate the impact of introducing a weekly sedation ward round in reducing Midazolam usage on a UK PICU.

METHODS

A retrospective before and after study, collecting data from electronic health records of sedative drugs in non-surgical children before (February 2021) and after (February 2022) the introduction of the new sedation algorithm and sedation ward round.

RESULTS

56 non-surgical patients admitted in February 2021, 18 patients (32%, age range 4 days old to 13 years median 4) received a continuous infusion of Midazolam in the first 24 hours of admission. After the introduction of the sedation ward round in December-January 2022, 15 out of 68 (22%, age

range 8 days old to 15 years 6 months, median 17) of children received a midazolam infusion within the first 24 hours.

CONCLUSIONS

The new sedation protocol combined with weekly sedation ward rounds has reduced our midazolam usage by 10% in non-surgical children.

EP058 / #1301

E-Poster Viewing - Intensive care AS01-28. Sedation & analgesia

Iatrogenic withdrawal syndrome and delirium monitoring and treatment in pediatric intensive care units across europe: an espnic survey

F. Sperotto^{1*}, A.-S. Ramelet², M. Daverio³, M.C. Mondardini⁴, F. Von Borell⁵, S. Brenner⁶, D. Tibboel⁷, E. Ista⁸, H. Cihlářová⁹, A. Amigoni³

¹*Boston Children's Hospital, Harvard Medical School, Cardiology, Boston, United States of America*

²*University of Lausanne, Institute of Higher Education and Research In Healthcare, Faculty of Biology and Medicine, Lausanne, Switzerland*

³*University Hospital of Padua, Department of Women and Children's Health, Padova, Italy*

⁴*University Hospital IRCCS, Policlinico Sant'orsola, Bologna, Italy*

⁵*Hannover Medical School, Hannover, Germany, Department of Pediatric Cardiology and Intensive Care Medicine, Hannover, Germany*

⁶*University Hospital Dresden, Dresden, Germany, Department of Pediatric and Adolescent Medicine, Dresden, Germany*

⁷*Erasmus MC Sophia Rotterdam, Picu, Rotterdam, Netherlands*

⁸*Erasmus MC – Sophia Children's Hospital, Department of Pediatric Surgery, Pediatric Intensive Care, Rotterdam, Netherlands*

⁹*Department of Pediatrics and Hereditary disorders, Department of Pediatric Surgery, Pediatric Intensive Care, Prague, Czech Republic*

BACKGROUND AND AIMS

Iatrogenic withdrawal syndrome (IWS) and delirium have emerged as risk factors for short and long-term adverse outcomes among children admitted to the pediatric intensive care unit (PICU). Observational multicenter data on IWS and delirium monitoring and management in Europe are missing. We aimed to evaluate current practices across European PICUs.

METHODS

Cross-sectional survey-based study querying 357 European PICUs. One response for each PICU was collected from January to April 2021.

RESULTS

Among 357 European PICUs, 215 responded (60% response rate) across 27 European countries. Fifty-seven percent of PICUs used protocols for analgesedation weaning. After >5 days of sedation, opioids and benzodiazepines were mostly weaned by 10-20% daily, while propofol and ketamine were suspended abruptly or weaned >20% daily. Only 77 (36%) of the PICUs used a mobilization protocol. IWS was monitored with a validated scale in 62% of the PICUs. The Withdrawal-Assessment-Tool-1 (40%) was the most used. IWS was assessed >once daily in 64% of PICUs, mainly by nurses (86%). First-line treatment for WS was mostly a rescue bolus and interruption of weaning (41%). Delirium was systematically monitored in 58% of the PICUs, mostly with the Cornell-Assessment-of-Pediatric-Delirium scale (28%) and assessed mainly by nurses (81%). Reported delirium first-line treatment was mostly dexmedetomidine (45%) or antipsychotic drugs (40%), with haloperidol (64%) being the preferred one.

CONCLUSIONS

This is the first survey providing data on current practice and gaps of knowledge on IWS and delirium in Europe. Monitoring and management were highly variable, suggesting that both education and consensus are needed.

EP059 / #656

E-Poster Viewing - Intensive care AS01-28. Sedation & analgesia

Development of a non-pharmacologic delirium management bundle in pediatric intensive care units

**R. Stenkjaer^{1*}, S. Herling², I. Egerod³, J. Weis¹, M. Van Dijk⁴,
S. Kudchadkar⁵, A.-S. Ramelet⁶, E. Ista⁷**

¹Rigshospitalet, Department of Intensive Care For Infants and Toddlers, Copenhagen, Denmark

²Rigshospitalet, The Neuroscience Centre, Copenhagen, Denmark

³Rigshospitalet, Department of Intensive Care, Copenhagen, Denmark

⁴Pediatric Intensive Care, Erasmus MC – Sophia Children’s Hospital, Rotterdam, Department of Pediatric Surgery, Rotterdam, Netherlands

⁵Johns Hopkins University School of Medicine, Anesthesiology and Critical Care Medicine, Baltimore, United States of America

⁶University of Lausanne, Institute of Higher Education and Research In Healthcare, Faculty of Biology and Medicine, Lausanne, Switzerland

⁷Erasmus MC – Sophia Children’s Hospital, Department of Pediatric Surgery, Pediatric Intensive Care, Rotterdam, Netherlands

BACKGROUND AND AIMS

Non-pharmacologic interventions might be effective to reduce the incidence of delirium in pediatric intensive care units (PICU). Our aim was to explore expert opinions and generate informed decisions regarding the content of a “Non-pharmacologic Delirium management Bundle” in PICU patients.

METHODS

A two-round online Delphi study was conducted from February to April 2021. PICU experts (nurses, physicians, researchers, physical therapists, play specialists, and occupational therapists) located in Europe, North America, South America, Asia, and Australia participated. We developed a questionnaire based

on the outcomes of a comprehensive literature search in the domains: 1) cognition support; 2) sleep support; and 3) physical activity support. Under these domains, we listed 11 strategies to promote support with 61 interventions. Participants rated the feasibility of each intervention on a 9-point Likert scale. A disagreement index and panel median were calculated to determine the level of agreement among experts. In the second round, participants reassessed the revised statements and ranked the interventions in each domain in order of importance for three age groups.

RESULTS

During the first Delphi round, 53 of 74 (72%) questionnaires were completed, and in the second round, 45 of 74 (61%) were completed. The highest ranked interventions across the age groups were: 1) developing a daily routine 2) adjusting light exposure according to the time of day 3) scheduling time for sleep, 4) providing eyeglasses and hearing aids if appropriate, 5) encouraging parental presence.

CONCLUSIONS

Based on expert consensus, we developed an age-specific non-pharmacologic delirium bundle of interventions to manage delirium in PICU patients.

EP060 / #711

E-Poster Viewing - Intensive care AS01-29. Surgery & anaesthesia

Scimitar syndrome, anal atresia and inspiratory stridor- is it a potentially new genetic syndrome?

D. Sinjeri^{1*}, D. Belina²

¹University of Zagreb, School of Medicine, Zagreb, Croatia

²University Hospital Centre Zagreb, Department of Cardiac Surgery, Zagreb, Croatia

BACKGROUND AND AIMS

Scimitar syndrome is a rare congenital malformation characterized by anomalous right pulmonary venous drainage into inferior caval vein, right lung hypoplasia and dextroposition of the heart. The prevalence is 1-3 per 100,000 live births. The name scimitar (Turkish sword) comes from a curved shadow formed by an abnormal vein on a chest x-ray. Clinical presentation is bimodal: the infantile form with high mortality and additional anomalies, and the adult form is often asymptomatic.

METHODS

A female infant (1.6 kg) was born by caesarean section from a twin pregnancy at 32 weeks of gestation. Due to anal atresia with rectovestibular fistula, a bipolar sigmoidostomy was immediately performed. After the uneventful extubation, inspiratory stridor, periodic hypoxemia and bradycardia developed in the 2nd week of life, and the child was resuscitated three times due to respiratory arrest.

RESULTS

Scimitar syndrome was diagnosed using the MSCT angiography which showed a hypoplastic right lung, anomalous right pulmonary vein with the inflow into the inferior vena cava, dextroposition of the heart and compressed trachea with innominate artery and aortic arch. At the age of five months, median sternotomy, total thymectomy and aortopexy were done to relieve tracheal pressure. Now, she is tracheotomized and breathes independently.

CONCLUSIONS

Anal atresia, tracheal compression, and stridor are not typical characteristics of Scimitar syndrome. The enlarged fontanelle and neurocranium compared to viscerocranium, delayed myelination, hypotonia, convergent strabismus, ocular flutter, low set ears, hypertelorism and failure to thrive are suggesting possible genetic association that requires further investigation.

EP061 / #2320

E-Poster Viewing - Intensive care AS01-31. Trauma & emergency medicine

Characteristics and outcome of children with inhalation injury admitted to a pediatric intensive care unit

E. Christakou, V. Dimitropoulou*, M. Gianniki, S. Konstantakopoulos, K. Straka, M. Prapa, C. Tsiagklani, C. Barbaresou

Agia Sofia Childrens Hospital, Picu, Athens, Greece

BACKGROUND AND AIMS

Inhalation injury is a serious consequence of a fire or an explosion, with potential airway compromise and respiratory complications. Our aim was to describe characteristics and outcomes of children with inhalational burn injury treated in our PICU.

METHODS

We present retrospectively 9 patients with inhalational burns who were admitted to the Pediatric Intensive Care Unit of a tertiary Children's Hospital between May 2019 and February 2022.

RESULTS

The study included 9 patients; 65% were male, with a median age of 11y (range 2y-14y). Main cause of burns was accidents involving fire/flame (68%) and the majority (67%) were exposed to fire in an enclosed space. 55% had decreased level of consciousness on admission. One patient suffered inhalation injury alone, while the rest had cutaneous burns $\geq 30\%$ TBSA. All patients were initially assessed by nasolaryngoscopy and were immediately intubated. 4 patients

had no hoarseness of voice or stridor and no erythema or swelling of the pharynx, on admission and were prophylactically intubated. Erythema / edema of upper airway was seen on nasoendoscopy on the second day in all patients. Only one patient underwent bronchoscopy. Complications related to airway management were common (78%), including pneumonia (4p), bronchospasm (5p), carbon monoxide toxicity (4p), ARDS (2p), bronchial obstruction (1p). The median duration of MV was 3 days (range 2-12d) and median PICU LOS was 6 days (range 4-23d). All patients were successfully extubated and discharged stable.

CONCLUSIONS

Inhalation injury results in specific complications related to airway management. These include thermal injury and swelling of the upper and lower airway, bronchospasm, bronchial obstruction with carbonaceous sputum plugs, pneumonia, acute respiratory distress syndrome (ARDS), carbon monoxide toxicity and cyanide toxicity. Hence we suggest the development and use of a standardised approach to management for this group of patients.

EP062 / #1617

E-Poster Viewing - Intensive care AS01-31. Trauma & emergency medicine

Abusive head trauma in infancy: 3-year experience in a tertiary picu

A. Stelianidi, K. Straka, E. Christakou, C. Tsirogianni*, M. Prapa, S. Kouni, V. Dimitropoulou, E. Michailoudi, E. Vaggelakoudi, I. Gotsi, P. Poulos, D. Paraschou, C. Barbaressou

Aghia Sophia Children's Hospital, Paediatric Intensive Care Unit, Athens, Greece

BACKGROUND AND AIMS

Abusive head trauma(AHT)refers to repeated acceleration-deceleration abusive injury with or without blunt head impact and constitutes the leading cause of death as a result of abuse in infancy.Head injuries are the most common cause of traumatic death in <2 years old so early diagnosis is essential but may prove challenging.The aim of this study is to describe our clinical experience of this entity.

METHODS

A retrospective observational study was performed in "Aghia Sophia" Children's hospital in Athens over a 3-year period(September 2018–December 2021).Six infants aged from 2 months to 5 ½ months old with AHT who were admitted to PICU with impaired level of consciousness,seizures or after cardiopulmonary resuscitation were included in this study.

RESULTS

of 6 infants with AHT, 3/5 (60%) were boys and the median age was 4 months. In all cases, emergency computed tomography of the brain was performed. In 2/5 (40%) cerebral oedema was demonstrated, in 2/5 (40%) subdural hematomas (in one case with occipital bone fracture) and in 1/5 (20%) epidural hematoma with parietal bone fracture. In 2/5 (40%) infants presented also with numerous retinal haemorrhages. In 4/5 (80%) of the cases neurosurgical procedure was performed urgently. Median PICU LOS was 9 days (5-45d). Among these infants, 4 survived with neurological sequelae and 1 died.

CONCLUSIONS

Diagnosis of AHT rests on the finding of unexplained injury to the skull, brain, and/or spinal cord in an infant who has no other medical explanation for their clinical presentation. Early recognition and diagnosis of AHT from emergency physicians is critical in order to achieve timely treatment and proper management of this life-threatening clinical entity.

EP063 / #1219

E-Poster Viewing - Neonatology AS02-02. Allergy & immunology

Development of cellular immunity in extremely preterm infants

J. Dirks^{1*}, J. Pagel^{2,3}, J. Marißen¹, L. Reichert¹, M.I. Fortmann^{2,3}, D. Viemann^{1,4}, K. Glaser⁵, E. Herting^{2,3}, H. Morbach¹, C. Härtel^{1,3}

¹University Children's Hospital Würzburg, Department of Pediatrics, Würzburg, Germany

²University Children's Hospital Lübeck, Department of Pediatrics, Lübeck, Germany

³German Center of Infection Research, Dzf, Lübeck/Hamburg/Borstel/Riems, Germany

⁴Hannover Medical School, Cluster of Excellence Resist (exc 2155), Hannover, Germany

⁵University Children's Hospital Leipzig, Department of Neonatology, Leipzig, Germany

BACKGROUND AND AIMS

The perspective on the ontogeny of the adaptive immune system has changed from a teleological concept of "immune maturation" to a theory of a layered immunity. In preterm infants, functionally different effector systems might be already operable being primed towards immediate responses elicited by the recognition of danger signals. Adult counterparts show a more antigen-restricted activation pattern to establish long-lasting memory. However, these insights are based on mice models, while human data, specifically in the context of preterm birth, are scarce.

METHODS

In the IRoN (Immunoregulation of the Newborn) study we aim at longitudinally assessing the development and composition of "layered immunity" in extremely preterm infants (EPI). We will analyze the role of environmental influences on cellular immunity and outcomes of this vulnerable population.

RESULTS

In a cohort of 382 infants, EPIs displayed increased frequencies of regulatory T cells (Treg), particularly in babies who developed bronchopulmonary dysplasia. The Treg compartment of EPI not only differs from adult Tregs but is also highly plastic, from an overall naïve Treg phenotype at birth to an activated Treg phenotype (CCR6+, HLA-DR+, and Ki-67+) on day 7 of life. We also found a strong bias to effector states in CD4+ and CD8+ T cells in week one.

CONCLUSIONS

Follow up data is currently collected and linked to clinical metadata and microbiota colonization (collected at multiple time points). Furthermore, we will deepen our observations by ex vivo single cell sequencing combined with high-throughput analysis of the T and B cell receptor repertoire.

EP064 / #2761

E-Poster Viewing - Neonatology AS02-02. Allergy & immunology

Skin infections uncover division of labor in tissue macrophages

F. Lohrmann*, P. Henneke

University Hospital Freiburg, Pediatrics and Adolescent Medicine, Freiburg, Germany

BACKGROUND AND AIMS

Macrophages (MAC) densely populate barrier tissues like the skin. They originate from either primitive or definitive hematopoiesis, yet they are largely renewed by monocyte-derived macrophages. In the tissue, they display substantial diversification with adaptation to microanatomical structures.

METHODS

We dissected *Irf8* deficiency, an inborn error of immunity, where severe monocytopenia is linked to mycobacterial tissue infections, by adapting single-cell transcriptomics, fate mapping, and imaging.

RESULTS

We found that in resting skin the majority of dermal MAC was indeed of monocyte origin. Monocyte-derived MAC were distinct from long-term resident MAC with respect to gene expression and localization, although the proportion of MAC which was never exchanged was substantially larger than previously appreciated (40%). In homeostasis dermal *Irf8*-deficient MAC exhibited striking plasticity to discretely diversify covering the vast majority of the transcriptional repertoire and ensuring density, even though the largest

cellular input was lost. In contrast, *Irf8* was essential for steering MAC density at the site of the mycobacterial infection, resulting from lacking recruitment of monocyte-derived macrophages. This situation uncovered a striking distribution of labor: Whereas recruited MAC took up bacteria and produce anti-mycobacterial iNos, resident MAC abstained from inflammation initiation and rather contributed to its resolution. On the single cell level, *Irf8* deficiency impacted on granuloma MAC transformation without restricting bacterial phagocytosis or expression of inflammatory genes.

CONCLUSIONS

In summary, tissue MAC exhibit striking plasticity to adapt to discrete tissue niches without need for incoming monocyte progenitors. Yet monocyte derived MAC are critical to expand the MAC repertoire in specific, here mycobacterial, infections.

EP065 / #1147

E-Poster Viewing - Neonatology AS02-03. Cardiovascular & haemodynamics

Paracetamol for closure of patent ductus arteriosus: experience from a regional neonatal unit

A. Abbas^{1*}, G. Holder², L. Whitticase²

¹University Hospital Coventry, Neonatology, Coventry, United Kingdom

²Birmingham Women's Hospital, Neonatology, Birmingham, United Kingdom

BACKGROUND AND AIMS

Paracetamol use for closure of patent ductus arteriosus (PDA) has been increasing since indomethacin became unavailable. Research suggests that paracetamol is as effective as ibuprofen, with a better short-term safety profile. However, there are concerns about long term neurotoxicity of paracetamol from various ecological and cohort studies. There is also lack of pharmacokinetic and pharmacodynamic data. We retrospectively reviewed the use of paracetamol in a regional neonatal unit where Ibuprofen is the first line treatment for PDA closure. We compared number of courses of each medication, rates of PDA closure and the reasons for Ibuprofen exclusion.

METHODS

Retrospective review of neonatal database – Badgernet between 01/01/2019 – 01/12/2020. We included all babies diagnosed with PDA born at gestational age <28 weeks.

RESULTS

92 babies were diagnosed with PDA, 45 babies received paracetamol alone, 11 Ibuprofen alone, 5 babies received both paracetamol and Ibuprofen. 5 babies treated with Ibuprofen and 1 baby treated with paracetamol did not complete full course due to adverse effects. PDA closure rate was 51.1% in paracetamol group and 54.5% in the ibuprofen group. Paracetamol use increased significantly over the course of study period.

CONCLUSIONS

Paracetamol appears to be as effective as Ibuprofen for PDA closure and its use is increasing as it has fewer short term side-effects. However, concerns remain about its long-term safety and best route, dosage and duration of action is not yet established. Ibuprofen use is often precluded based on soft contraindications.

EP066 / #1299

E-Poster Viewing - Neonatology AS02-03. Cardiovascular & haemodynamics

Pathophysiological phenotypes in congenital diaphragmatic hernia: frequency and relationship to disease severity

A. Bhattacharya^{1*}, A.C. Massolo², S. Kirolos¹, F. Kipfmüller³, N. Patel¹

¹Royal Hospital for Children, Neonatology, Glasgow, United Kingdom

²Sapienza University, Paediatrics, Rome, Italy

³Children's Hospital, University of Bonn, Department of Neonatology and Pediatric Intensive Care, Bonn, Germany

BACKGROUND AND AIMS

Congenital Diaphragmatic Hernia (CDH) is characterised by three underlying pathophysiologies: 1) pulmonary hypoplasia 2) pulmonary hypertension, and 3) left ventricular hypoplasia and dysfunction. The relative contribution of these to individual patient phenotype is not routinely characterised. This study aimed to describe the frequency and nature of early pathophysiological phenotypes in CDH.

METHODS

Retrospective single-centre cohort analysis of eligible CDH cases. Phenotypic classification based on physiological and echocardiographic parameters on day 1, using previously described cut-off values: Pulmonary hypoplasia (PHypo): lowest $p\text{CO}_2 > 60$ mmHg; Pulmonary hypertension (PH): PDA shunt bidirectional or right-to-left, AND either pre-ductal $\text{SpO}_2 < 85\%$ OR RV dysfunction (tissue Doppler RV $E' < 4.6$ cm/sec or RV Global Longitudinal Strain (GLS) $< -14\%$); LV dysfunction (LV Dysfx): LV GLS $< -16\%$. Uncategorized cases were labelled "mild" CDH. Outcomes were compared between phenotypic subgroups.

RESULTS

56 eligible cases were included. Phenotypic subgroups in order of frequency were "PH + LV Dysfx" (41%), "PH only" (32%), "PH + PHypo + LV Dysfx" (12%), "Mild CDH" (11%), and "LV Dysfx" (4%), Figure 1. "PH + PHypo + LV Dysfx" phenotype was associated with right-sided CDH, lower fetal lung volumes, and larger defects (100%). This phenotype exhibited higher mortality (29%), ECMO use (57%), and ventilation duration compared to other phenotypes. ECMO was not used in cases with "mild CDH" or "PH only". Figure 1: Frequency of CDH phenotypes

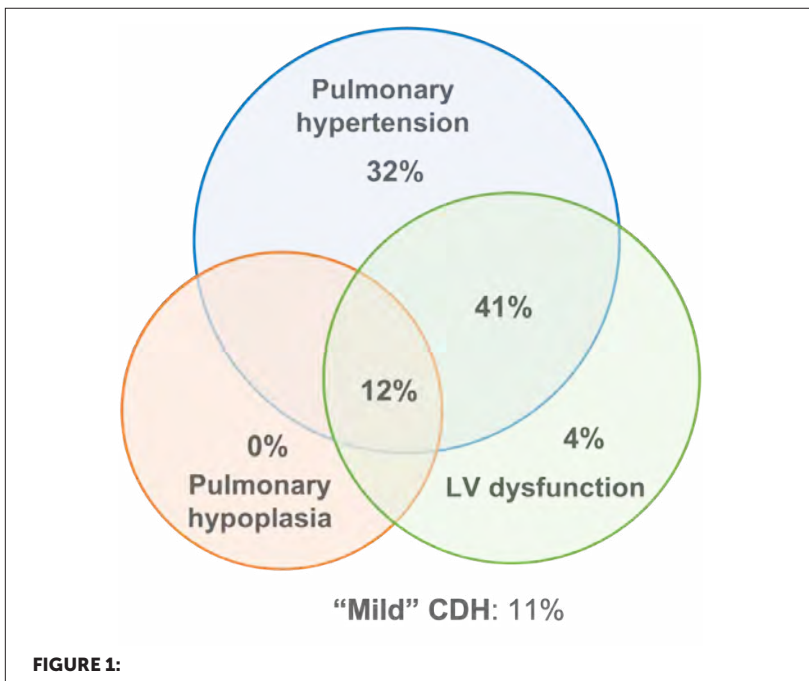

CONCLUSIONS

CDH patients exhibit variable early pathophysiological phenotypes. Characterising phenotypes may improve prognostication and guide targeted, physiology-based treatment strategies including use of ECMO.

EP067 / #1729**E-Poster Viewing - Neonatology AS02-03.
Cardiovascular & haemodynamics****Left ventricular rotational mechanics in
congenital diaphragmatic hernia****A. Bhattacharya^{1*}, A.C. Massolo², S. Kirolos¹, F. Kipfmüller³, N. Patel¹**¹Royal Hospital for Children, Neonatology, Glasgow, United Kingdom²Sapienza University, Paediatrics, Rome, Italy³Children's Hospital, University of Bonn, Department of Neonatology and Pediatric Intensive Care, Bonn, Germany**BACKGROUND AND AIMS**

Normal left ventricle (LV) systolic function involves circumferential and longitudinal shortening, and apical and basal rotation generating ventricular twist. Early LV dysfunction is a key component of congenital diaphragmatic hernia (CDH) pathophysiology. Impaired LV rotational dynamics may be an important contributor to cardiac performance and clinical phenotype in CDH. This study aimed to assess rotational dynamics in infants with CDH.

METHODS

Retrospective, single-center analysis of CDH cases 2017-21. Ventricular function data was obtained from 1st echocardiogram at <24 hrs of age. Speckle tracking analysis was used to derive left ventricular systolic global strain in longitudinal (GLS), circumferential (GCS), and radial (GRS) planes, and circumferential rotation at the base and apex. Twist was calculated as the difference in rotation between apex and base. Comparison was made with published normative control data.

RESULTS

Data were obtained in 38 cases. GLS, GCS, GRS were significantly reduced in CDH compared to controls, consistent with prior reports. Basal rotation was also significantly reduced in CDH ($0.41 \pm 6.97^\circ$ vs. $-2.0 \pm 1.4^\circ$, $p < 0.001$). There was no significant overall difference in LV twist in CDH compared to controls ($5.5 \pm 9.2^\circ$ vs. $4.1 \pm 2.2^\circ$, $p = 0.39$). Supra-normal twist values were observed in 14 (37%) of cases. Reduced twist was observed in 15 (39%) cases, Fig 1. Figure 1: LV GLS and Twist in CDH cases

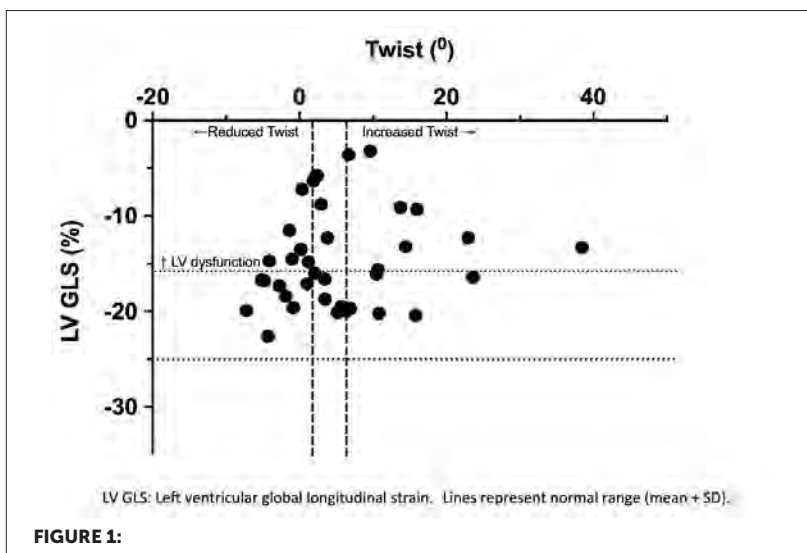

CONCLUSIONS

Measurement of LV rotational dynamics is feasible in CDH. Early postnatal abnormalities in ventricular strain are accompanied by reduced LV basal rotation. Increased apical rotation and twist may be compensatory mechanisms in the failing LV.

EP068 / #1178**E-Poster Viewing - Neonatology AS02-03.
Cardiovascular & haemodynamics****Tricuspid regurgitation characteristics and outcome prediction in neonates with congenital diaphragmatic hernia****B. Bo^{1*}, L. Lemloh¹, L. Schröder¹, N. Patel², A. Müller¹, F. Kipfmüller¹**¹Children's Hospital, University of Bonn, Department of Neonatology and Pediatric Intensive Care, Bonn, Germany²Royal Hospital for Children, Neonatology, Glasgow, United Kingdom**BACKGROUND AND AIMS**

Pulmonary hypertension (PH) is a major contributor to poor outcome in congenital diaphragmatic hernia (CDH). Early PH assessment is paramount and tricuspid regurgitation (TR) is routinely obtained during echocardiography. The ratio between the duration of the systolic and diastolic components of flow (S/D) has been proposed for risk-stratification in neonates, however its role in CDH newborns during transition is unclear.

METHODS

Echocardiograms were obtained within 24 hours of life in 158 CDH patients. TR was quantified using S/D. Cardiac function was characterized as normal, RV dysfunction, biventricular dysfunction. Primary outcome was need for ECMO, secondary was death.

RESULTS

Overall, need for ECMO was present in 44.9% and mortality was 26.6%. ROC analysis of S/D generated AUCs of 0.420 for need for ECMO ($p=0.084$) and

0.421 for mortality ($p=0.141$). S/D did not correlate with PH severity ($r=0.084$, $p=0.309$) nor with category of cardiac dysfunction ($r=0.040$, $p=0.624$). In the biventricular dysfunction group ($n=55$), median S/D was significantly different between those who did or did not need ECMO support (1.25 and 1.84 respectively, $p=0.018$). ROC analysis of S/D in the biventricular dysfunction group generated an AUC of 0.807 for need for ECMO ($p<0.001$). In the biventricular dysfunction group S/D <1.5 accurately predicted need for ECMO (sensitivity 83.3%; specificity 62.8%; PPV 93.1%; NPV 38.5%).

CONCLUSIONS

S/D ratio is a highly inaccurate outcome predictor during early transition in CDH neonates. In patients with biventricular dysfunction, higher S/D might reflect a lesser degree of dysfunction. Routine echocardiographic risk-stratification should focus on DA flow analysis and evaluation of cardiac dysfunction.

EP069 / #2302**E-Poster Viewing - Neonatology AS02-03.
Cardiovascular & haemodynamics****Neonatal hypotension: are we still treating numbers?****L. Bradford^{1*}, A. Gupta², A. Mukherjee²**¹*The University of Manchester, Faculty of Biology, Medicine and Health, Manchester, United Kingdom*²*St Mary's Hospital, Neonatal Unit, Manchester, United Kingdom***BACKGROUND AND AIMS**

Mean blood pressure (MBP) lower than gestational age is still used by neonatologists as the sole criterion to treat and define neonatal hypotension. A functional definition of hypotension was introduced to our neonatal unit in 2018. Our new clinical practice guideline considered underlying pathology, clinical signs, and correlation with gestation specific systolic BP and diastolic BP normograms. Cot-side assessment of clinico-biochemical markers of tissue hypoperfusion was emphasised. We therefore, aimed to evaluate clinical practice points in treating hypotension over a 1-year period.

METHODS

'Neonatal hypotension' was searched in our Badger neonatal database. Data on diagnosis, management rationale and treatment offered were obtained from case records.

RESULTS

5.07% (n=48) of our newborn babies were treated for hypotension. 100.00% (n=48) were treated based on mean BP lower than gestational age, whereas systolic and diastolic BP was considered in 12.50% of cases. Inotropes were

started citing hypotension in 73.38% of cases. Lactate as a bio-clinical marker was assessed in 93.75% of cases (n=45). Inotropes were started on average 4.1 hours from the recognition of hypotension. Stopping of inotropes post resolution of hypotension was highly variable (ranging from 3 to 104 hours). Cot-side echocardiogram was used in 54.17% (n=26) to allow individualised management.

CONCLUSIONS

Suboptimal MBP alone appears to be used as sufficient evidence to trigger initiating inotropes. A targeted assessment of the effects of low BP should preclude use of inotropes. The use of point of care echocardiogram may help in objective functional assessments and guiding treatment decisions. The process around stopping inotropes needs re-evaluation.

EP070 / #804**E-Poster Viewing - Neonatology AS02-03.
Cardiovascular & haemodynamics****Modelling of routine echocardiographic and clinical data for early prediction of bpd or death in very preterm infants**

**R. Chioma^{1*}, D. Finn^{1,2}, B. Walsh², C. Reynolds², D. O'Sullivan²,
V. Livingstone¹, D. Healy², E. Dempsey^{1,2}**

¹University College Cork, Infant Research Centre, Cork, Ireland

²University College Cork, Department of Paediatrics & Child Health, Cork, Ireland

BACKGROUND AND AIMS

Bronchopulmonary dysplasia (BPD) is a common complication of prematurity. Progressive respiratory deterioration in infants at high risk of BPD is correlated with PDA exposure. Early identification of these infants is important for early therapeutic decisions. This study aimed to design an early predictive model for BPD or death in preterm infants.

METHODS

A retrospective study of infants admitted to a tertiary NICU between January 2017 and November 2021 was conducted. Inclusion criteria were gestational age (GA) \leq 29 weeks and/or birthweight (BW) $<$ 1500 grams and echocardiography performed between 36 hours and 7 days of life. Exclusion criteria consisted of pulmonary hypertension and major congenital anomalies. The primary outcome was a composite of BPD and death.

RESULTS

The study included 101 infants. Median(IQR) GA was 27,6[24,6–29,6] weeks and BW was 900[675–1305] grams. Multivariable logistic regression identified three independently associated variables with BPD/death (BW, Respiratory

Severity Score, and flow pattern across the PDA). The multi-variable model had an area under the curve of 0,98 (95% CI 0,96-1, $p < .001$) for predicting BPD/death (Figure 1). Babies developing the primary outcome had a lower overall score than those who did not ($-4,1 [-6,1 -0,6]$ vs $4,3 [3,2 - 6,5]$, $P < .001$) (Figure 2). A cut-off of 0 had positive and negative predictive values of 95% of 91%, and sensitivity and specificity of 95% and 90%, respectively.

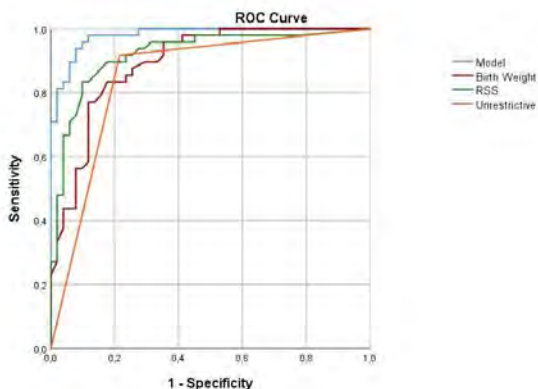
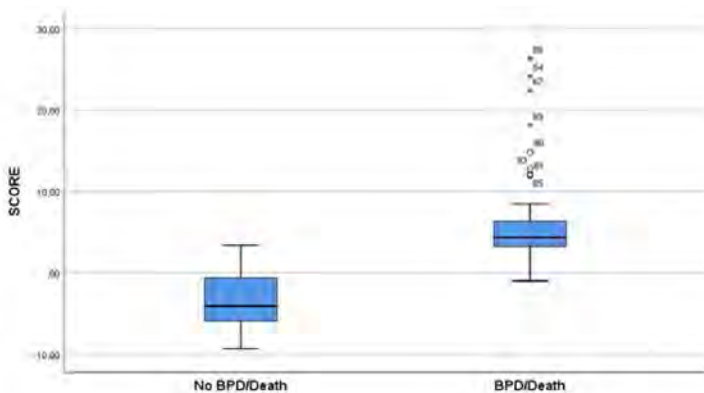
**FIGURE 1:****FIGURE 2:**

CONCLUSIONS

Our model allows early prediction of BPD/death. Its possible role in clinical decision-making requires further research.

EP071 / #2148

E-Poster Viewing - Neonatology AS02-03. Cardiovascular & haemodynamics

Increased oxidative stress biomarkers in fetuses with transposition of the great arteries

M.C. Escobar-Diaz^{1*}, M. Pérez-Cruz², M. Arraez², M.-M. Cascant-Vilaplana³, A. Albiach-Delgado³, J. Kuligowski⁴, M. Vento³, N. Masoller⁵, O. Gómez⁵, M. Camprubí⁶, J. Sanchez-De-Toledo¹

¹Hospital Sant Joan de Déu Barcelona, Department of Pediatric Cardiology, Esplugues de Llobregat, Spain

²hospital Sant Joan de Déu, Obstetrics, Barcelona, Spain

³Health Research Institute La Fe, Neonatal Research Group, Valencia, Spain

⁴La Fe University and Polytechnic Hospital, Neonatology, Valencia, Spain

⁵Hospital Clinic, Obstetrics, Barcelona, Spain

⁶Hospital Sant Joan de Déu, Neonatology, Barcelona, Spain

BACKGROUND AND AIMS

Fetuses with congenital heart disease (CHD) have circulatory changes that may lead to predictable blood flow disturbances that may affect normal brain development. Fetuses with CHD, especially those with transposition of the great arteries (TGA) have smaller brain circumference and white matter injury. Hypoxemia and hypoperfusion may alter the redox balance leading to oxidative stress (OS) that can be assessed measuring stable end-products. Our aims were to measure OS biomarkers (OSB) in a cohort of fetuses with CHD and compare them with controls, and to describe whether a relationship exist between OS and different types of CHD according to brain oxygen perfusion.

METHODS

OSB were measured in amniotic fluid in pregnancies with fetuses with (n= 41) and without CHD (n= 44). Birth head circumference (HC) was used as a neurodevelopment biomarker.

RESULTS

Compared to controls, CHD patients had a smaller HC at birth ($p=0.023$), especially those with TGA ($n=8$). No correlation between HC and OS biomarkers was found ($p=0.22$) but patients with a HC <10th percentile, presented increased levels of o-Tyr ($p=0.024$). CHD fetuses had higher levels of ortho-Tyrosine (o-Tyr) than controls ($p=0.0003$). Fetuses with TGA presented the highest levels of o-Tyr ($p=0.003$).

CONCLUSIONS

Fetuses with CHD showed increased OSB and lower HC when compared to controls, especially those with TGA. Our results suggest that increased levels of OSB are related with low brain oxygenation. Future studies with larger sample size are needed to investigate the role of OSB as early predictors of neurodevelopmental problems in CHD.

EP072 / #1762

E-Poster Viewing - Neonatology AS02-03. Cardiovascular & haemodynamics

Omic tools for improving diagnosis of left-sided obstructive lesions

M.C. Escobar-Diaz^{1*}, M.L. Rossi¹, C. Ruiz Herguido², C. De La Torre³, J. Bech³, M. Camprubí⁴, J. Sanchez-De-Toledo¹

¹Hospital Sant Joan de Déu Barcelona, Department of Pediatric Cardiology, Esplugues de Llobregat, Spain

²Sant Joan de Deu Research Institute, Research, Esplugues de Llobregat, Spain

³Josep Carreras Leukaemia Research Institute, Research Institute, Barcelona, Spain

⁴Hospital Sant Joan de Déu, Neonatology, Barcelona, Spain

BACKGROUND AND AIMS

Congenital Heart Disease (CHD) is the most common anomaly and a major contributor to early childhood morbidity and mortality. Within the spectrum of CHD are left-sided obstructive lesions (LSOLs), such as hypoplastic left heart syndrome (HLHS) and aortic coarctation (CoA). LSOLs range from mild to severe obstructive forms, requiring different complex surgical approaches that impact clinical outcomes. The current clinical decision-making tools to define a uni o biventricular pathway are based on fetal and neonatal echocardiographic parameters; however, there are no clear-cut criteria that guarantee the success of the surgical repair or palliation. Proteomics has emerged over the last decades as a potent high-throughput omics tools for systems biology approaches in complex diseases like CHD. This pilot study aimed to discover new biomarkers to improve LSOLs stratification.

METHODS

A quantitative mass spectrometry analysis was performed with plasma exosomes of amniotic fluid and umbilical cord blood (UCB) from 10 patients (4 HLHS and 6 CoA), and 5 controls.

RESULTS

The analysis of the amniotic fluid was not different compared to controls. In the analysis of UCB from the HLHS cohort, 16 proteins were up-regulated, specifically a family of collagens related to endocardial fibroelastosis universally present in the neonatal echocardiography in HLHS cohort. In the CoA cohort, 5 proteins were up-regulated. Interestingly, patients who had low left ventricle end-diastolic volume at birth developed multilevel LSOL later.

CONCLUSIONS

This pilot study opens up the possibility of considering proteomic data to aid in diagnosing patients with LSOLs, improving the follow-up and management of those patients.

EP073 / #2152

E-Poster Viewing - Neonatology AS02-03. Cardiovascular & haemodynamics

Early mortality in infants born with severe neonatal-operated congenital heart defects and low or very-low birthweight: systematic review and meta-analysis

A. Ghanchi^{1*}, N. Derridj^{1,2}, J. Cohen^{1,3}, D. Bonnet², M. Rahshenas¹, L. Salomon⁴, B. Khoshnood¹

¹Inserm 1153 (CRESS), Université Paris Cité, Epopé, Paris, France

²APHP, Université Paris Cité, Hôpital Necker-Enfants Malades, Department of Pediatric Cardiology, M3c-necker, Paris, France

³APHP, Université Paris Cité, Hôpital Necker-Enfants Malades, Department of General Pediatrics and Pediatric Infectious Diseases, Paris, France

⁴APHP, Université Paris Cité, Hôpital Necker-Enfants Malades, Department of Obstetrics and Fetal Medicine, Paris, France

BACKGROUND AND AIMS

Background: Congenital heart defects (CHD) are the most frequent congenital anomalies. Mortality outcomes of children with severe CHD and born with low or very-low birthweight (LBW and VLBW; birthweight <1500 and <2500 g, respectively) remain ambiguous.

Aims: To summarize early mortality outcomes of infants born with severe neonatal-operated CHD (i.e., hypoplastic left heart syndrome [HLHS], coarctation of the aorta [CoA], transposition of the great arteries [TGA], and total anomalous pulmonary venous return [TAPVR]) and LBW or VLBW.

METHODS

We searched Medline and Embase (from inception until October 2021) and included studies that evaluated early mortality in infants born with severe neonatal-operated CHD and LBW or VLBW. Risk of bias was assessed using the Critical Appraisal Skills Programme cohort checklist. Meta-analysis involved use of random-effects models. We explored variability in mortality across birthweight subgroups, CHD subtypes, and study designs

RESULTS

From 2035 reports, we included 26 studies in qualitative synthesis, and the meta-analysis included 11 studies (1658 CHD cases). Risk of bias was deemed low in 4/11 studies. Overall, mortality before discharge or within one month after surgery was 32% (95%CI 23%-40%, I^2 95%). Early mortality varied between VLBW and LBW infants (45% vs. 13%; $p=0.009$) and across CHD subtypes (HLHS 50%, TAPVR 47%, TGA 17%, CoA 14%; $p=0.03$). Mortality was higher in population-based studies (45% vs. 7%; $p=0.003$).

CONCLUSIONS

One-third of infants born with severe neonatal-operated CHD and LBW or VLBW will die within 30 days after surgery. Mortality varies substantially across infant and study characteristics

EP074 / #1783

E-Poster Viewing - Neonatology AS02-03. Cardiovascular & haemodynamics

Blood pressure in healthy term and late preterm newborns in Mexico City

R. Hernandez Benitez*, R. Medina Zamora, M. Gerardo Del Hoyo

Hospital Español, Neonatology, Mexico City, Mexico

BACKGROUND AND AIMS

Describe the measurements of systolic, diastolic and mean blood pressure in healthy term and late preterm newborns to establish normal values.

METHODS

Cross-sectional study carried out in the nursery of the Hospital Español, located in Mexico City. A sample of 551 healthy newborns were included in the study. Blood pressure (BP) measurements were taken within the first 48 hours of life with the oscillometric method. After the evaluation of normality, a descriptive analysis of the population and calculation of percentiles (25, 50 and 75) specific for each week of gestation was performed. All analyzes were performed in STATA v14.2.

RESULTS

Male newborns had a mean SBP value of 64.6 mmHg at week 35 of gestation, this value increased to 69.8 mmHg at week 40; the systolic blood pressure (SBP) value was 42.6 mmHg at week 35 of gestation, which decreased to 40.8 mmHg at week 40. The mean SBP values in female newborns were 65.5 mmHg at week 35, increasing to 73.5 mmHg at week 40; the diastolic blood

pressure (DBP) value at week 35 of gestation was 38 mmHg, increasing to 41.3 mmHg at week 40.

CONCLUSIONS

The BP values in healthy newborns are modified by the gestational age and sex of the patients. These results can serve as a reference for other physicians located in countries or cities with a similar altitude than the one in Mexico City.

EP075 / #1686

E-Poster Viewing - Neonatology AS02-03. Cardiovascular & haemodynamics

Comparability of peripheral muscle fo_e and ft_{oe} in neonates

N. Höller^{1*}, C. Wolfsberger^{1,2}, B.C. Schwabegger¹, D. Pfurtscheller¹,
B. Urlesberger³, G. Pichler¹

¹Medical University of Graz, Department of Neonatology, Graz, Austria

²Division of Neonatology, Department of Pediatrics and Adolescent Medicine, Graz, Austria

³Medical University of Graz, Division of Neonatology, Department of Paediatrics and Adolescent Medicine, Graz, Austria

BACKGROUND AND AIMS

In the literature peripheral-muscle-fractional-oxygen-extraction (pFOE) and peripheral-muscle-fractional-tissue-oxygen-extraction (pFTOE) are often equated, since both parameters are measured with near-infrared-spectroscopy (NIRS) and estimate oxygen extraction in the tissue. While pFOE is calculated out of peripheral-muscle-mixed-venous-saturation (pSvO₂), measured with NIRS and venous occlusion, and arterial oxygen saturation (SpO₂), measured with pulse oximetry, pFTOE is calculated from SpO₂ and peripheral-muscle-tissue-oxygenation-index (pTOI), measured with NIRS without occlusions. The aim of this study was to investigate the comparability of these two parameters in neonates.

METHODS

Term and preterm neonates with NIRS measurements of upper (UE) and lower extremities (LE), were included. pFOE and pFTOE were calculated using the equation $(SpO_2 - pSvO_2) / SpO_2$ and $(SpO_2 - pTOI) / SpO_2$, respectively. Both parameters were compared using Wilcoxon signed-rank test and Bland Altman plots for UE and LE.

RESULTS

379 NIRS measurements were included. Mean gestational age and birth weight were 34.6 ± 2.8 weeks and 2242 ± 701 g for UE and 34.9 ± 3.1 weeks and 2392 ± 782 g for LE measurements. pFOE was significantly higher than pFTOE in both locations (UE: pFOE 0.31 ± 0.06 , pFTOE 0.28 ± 0.06 , $p < 0.001$; LE: pFOE 0.30 ± 0.07 , pFTOE 0.27 ± 0.07 , $p < 0.001$). Bland-Altman plots revealed limited comparability. With increasing oxygen extraction, the mismatch between pFOE and pFTOE became more pronounced, with pFOE having higher values compared to pFTOE.

CONCLUSIONS

This study reveals limited comparability of pFOE and pFTOE in neonates, with significantly higher pFOE than pFTOE values of the upper and lower extremities.

EP076 / #733

E-Poster Viewing - Neonatology AS02-03. Cardiovascular & haemodynamics

Transcatheter arterial embolization in a newborn with cervical kaposiform hemangioendothelioma and kasabach-merritt phenomenon

S.-L. Jan*, M.-C. Lin

Children's Medical Center, Taichung Veterans General Hospital, Department of Pediatrics, Taichung, Taiwan

BACKGROUND AND AIMS

Kaposiform hemangioendothelioma (KHE) is a rare vascular tumor. When the Kasabach-Merritt phenomenon (KMP) is complicated, it can be serious and requires aggressive treatment. Surgical resection is considered to be the standard method for the treatment of vascular tumors, but it may be difficult to perform due to acute bleeding and severe coagulopathy in patients complicated with KMP. Medical treatments with corticosteroids, vincristine, and sirolimus have been suggested for the management of KHE; however, drugs take too long to correct coagulopathy with active bleeding. Transcatheter arterial embolization may be an alternative therapy for KHE KMP.

METHODS

A case of a 9-day-old newborn who underwent arterial embolization for KHE with KMP, combined with sirolimus treatment.

RESULTS

Transcatheter arterial embolization may be an alternative therapy. However, to the best of our knowledge, there are no case reports of such small infants

receiving arterial embolization to treat KHE. In the present case, a 9-day-old newborn underwent arterial embolization for KHE with KMP, combined with sirolimus treatment, and the outcome was favorable.

CONCLUSIONS

Our successful experience of treating KHE with KMP revealed that transcatheter arterial embolization is feasible and can be used as an alternative to surgical resection, even in small babies.

EP077 / #1059

E-Poster Viewing - Neonatology AS02-03. Cardiovascular & haemodynamics

Improved survival rates with changed postnatal management of congenital diaphragmatic hernia.

M. Khalil*, H. Coakley, H. Jhala, A. Singh

Birmingham Women's Hospital, Neonatal Unit, Birmingham, United Kingdom

BACKGROUND AND AIMS

Birmingham Women's Hospital Neonatal Intensive Care Unit is the designated regional centre for pre-surgical management of congenital diaphragmatic hernia (CDH). From 2010-2019, survival rate to discharge was 62%. With a new standardised guideline (2019), following 2015 European consortium consensus, changed practice included lower saturation targets, permissive hypercapnoea, conventional ventilation as first line ventilation strategy and normotension targets, avoiding excessive inotropic therapy. The aim of this study was to identify if the changed practice led to improved survival.

METHODS

Clinical information was extracted from Badgernet database on babies with CDH born between April 2019 and March 2022.

RESULTS

In the study cohort of 28 patients, survival rate improved from 62% to 71.4%. 78.5% were diagnosed at or before 28 weeks, 57.1% had liver in the thorax. of the 13 babies with antenatal genetics performed, 3 (23%) had abnormal microarray. In the postnatal management, 8 (28.5%) babies were escalated to high frequency oscillatory ventilation (HFOV) and 9 (32.1%) required inotropes.

of the babies who died (n=8) all were diagnosed before 30 weeks, with all but one having liver herniation in the thorax. One (12.5%) had right sided CDH and 2 (25%) had congenital anomalies. 7(87.5%) were escalated to HFOV.

CONCLUSIONS

CDH management, in line with the European consortium consensus guidelines, has led to an improved survival rate, with selective escalation to HFOV and inotropic therapy. In the babies who died, there were poor prognostic factors. On-going surveillance of practice is required to ensure continued improvement in outcomes.

EP078 / #987

E-Poster Viewing - Neonatology AS02-03. Cardiovascular & haemodynamics

Outcomes of hydrocortisone use in congenital diaphragmatic hernia

H.N. Lee*, E. Jung

Asan Medical Center, Pediatrics, Seoul, Korea, Republic of

BACKGROUND AND AIMS

To determine the outcome of patients with or without hydrocortisone (HCS) administration for in congenital diaphragmatic hernia (CDH), and to identify HCS responders for refractory hypotension.

METHODS

Newborns with CDH admitted to the NICU of tertiary referral hospital from January 2015 to April 2021 were enrolled, and their medical records were reviewed retrospectively. We analyzed whether the mortality and morbidity of patients differed depending on whether or not HCS was administered. In addition, the characteristics of the group that had a response to HCS for refractory hypotension were investigated.

RESULTS

of a total 121 patients, 68 (55.7%) received HCS. The mortality rate was higher in the group administered with HCS (36.8% vs. 7.5%, $p < 0.001$). The duration of invasive ventilator support was longer in the HCS-treated group (17 days vs. 10 days, $p = 0.026$). There were 28 responders (28/56, 50%) who were able to reduce the vasopressor dose within 72 hours after HCS administration, and their fetal observed to expected lung-to-head ratio (O/E LHR) was higher

than the non-responders (56.6% vs. 45.9%, $p=0.045$, cut off value 48.5%), and ultimately their survival rate was also higher (75% vs. 35.7%, $P=0.003$). Serum cortisol levels before HCS administration were not associated with survival, morbidity, and response to HCS.

CONCLUSIONS

In CDH, HCS administration is associated with lower survival rates and longer duration of ventilator support. A response to HCS administration for refractory hypotension can be expected with high fetal O/E LHR.

EP079 / #2038

E-Poster Viewing - Neonatology AS02-03. Cardiovascular & haemodynamics

A deep learning approach to predict pulmonary hypertension in neonates using 2d-echocardiography videos

H. Michel^{1*}, H. Ragnarsdottir², L. Manduchi², F. Laumer², E. Oezkan², J. Vogt², S. Wellmann¹

¹University Children's Hospital Regensburg (KUNO), Hospital St. Hedwig of the Order of St. John, Department of Neonatology, Regensburg, Germany

²ETH Zurich, Department of Computer Science, Zurich, Switzerland

BACKGROUND AND AIMS

Pulmonary hypertension (PH) in neonates and infants contributes significantly to morbidity and mortality. Echocardiography, the primary diagnostic tool is time-consuming and expertise-demanding, raising the need for an automated and streamlined approach. In this work, we present an interpretable multi-view video-based deep learning approach to predict PH using echocardiograms.

METHODS

The dataset for this work consisted of n=9700 2D-echocardiography video sequences from 194 examinations of neonates and infants, containing five different standard views each. Each echocardiography was visually graded by a pediatric cardiologist in none, mild and moderate to severe PH. We used spatio-temporal convolutional architectures for the prediction of PH from each view, and aggregated the predictions of the different views using majority voting. A stratified 10-fold cross-validation was performed, splitting the data randomly 10 times into 20% validation set and 80% training set.

RESULTS

Among the single-view methods, the parasternal short axis view showed the best performance in predicting the severity of PH. The use of multiple views increased the accuracy and robustness of the prediction with a mean F1-score (harmonic mean of precision and recall) of 0.84 when all five standard views were combined. For the binary detection of PH an accuracy of 0.92 was obtained already with a single view. We complemented the predictions with saliency maps which showed that the learned model focuses on clinically relevant cardiac structures.

CONCLUSIONS

The proposed approach allowed automated and interpretable assessment of PH in neonates. Further clinical evaluations of this new method regarding accuracy and correctness are needed.

EP080 / #1687

E-Poster Viewing - Neonatology AS02-03. Cardiovascular & haemodynamics

Cardiac biomarkers in neonatal encephalopathy: blood and echocardiographic

**E.S. Wiggins¹, S. Bin Ihsan¹, T.-J. Liu¹, C. Black¹, A. Purewal¹,
B. Punniyakotty¹, B. Moran¹, M. Ashwin¹, P. Maguire¹, G. Semova^{1,2,3},
E. Isweisi^{1,2,3}, J. Meehan^{1,2,3}, E. Roche^{1,2,3}, A. Branagan^{1,2,4},
E. Molloy^{1,2,3,4,5*}**

¹Trinity College Dublin, Discipline of Paediatrics, School of Medicine, Dublin, Ireland

²Trinity College Dublin, Trinity Research In Childhood Centre, Dublin, Ireland

³Tallaght, Children's Health Ireland At Tallaght, Dublin, Ireland

⁴Coombe Women and Infants University Hospital, Neonatology, Dublin, Ireland

⁵Children's Health Ireland at Crumlin, Neonatology, Dublin, Ireland

BACKGROUND AND AIMS

Neonatal encephalopathy (NE) is a leading cause of neonatal morbidity and mortality. Prompt diagnosis and prognosis assessment remain a challenge. Myocardial damage is the most common cause of mortality in NE (28-73%). Echocardiography and serum cardiac biomarkers correspond with cardiac function and injury in paediatric patients. The aim of this review is to investigate the role of serum cardiac biomarkers and echo-derived markers in identifying, assessing severity, and predicting outcomes in NE.

METHODS

We conducted a systematic search of full-length studies available in PubMed/ EMBASE until March 2022. Studies were screened using PRISMA guidelines. Qualitative synthesis was conducted, and data compilation followed the BestBETS template.

RESULTS

Our search yielded 584 studies. 73 were obtained for further review. 23 studies comprising 1595 participants met the inclusion criteria. Troponin levels were significantly elevated in non-survivors versus survivors ($p < 0.05$). Higher cutoffs of troponins for diagnosis yielded better sensitivity and specificity (>0.65 ng/dL: sensitivity 75%, specificity 73% vs. 1.2 ng/dL: sensitivity 95%, specificity 87.5%). Higher values of CK-MB and troponins were associated with increased Sarnat score severity. Impaired speckle index global longitudinal strain (GLS) was associated with increased mortality ($p < 0.05$) and negatively correlated with troponin ($p < 0.001$).

CONCLUSIONS

Current literature is mainly retrospective with high heterogeneity, so cause-effect relationships cannot clearly be demonstrated. Troponins demonstrate promising diagnostic and prognostic applicability. GLS may be the echocardiographic marker of most interest. Evaluating the efficacy of point-of-care troponin testing may allow applicability to lower resource settings.

EP081 / #329

E-Poster Viewing - Neonatology AS02-03. Cardiovascular & haemodynamics

Service review of pda assessment and management in north wales

M. Morton*, A. Onibere

Glan Clwyd Hospital, Neonatology, Bodelwyddan, United Kingdom

BACKGROUND AND AIMS

To evaluate the historic practice of echocardiographic assessment, and clinical management of Patent Ductus Arteriosus (PDA) in Neonates < 31 weeks gestation at the Sub Regional Neonatal Intensive Care Centre (SuRNICC) since it's opening and to determine the need for service improvement. There are no local guidelines currently in place for PDA and echocardiography is only performed if clinical suspicion of PDA.

METHODS

Retrospective review of all babies under 31 gestation admitted to SuRNICC with an echocardiographic diagnosis of PDA using BadgerNet Database between Feb 2018 – November 2020

RESULTS

of 141 babies admitted during this period, PDA was confirmed on echocardiography in 43 babies (30%). 31 babies had their first echo done at the SuRNICC and used for analysis. The median age of diagnosis was 10 days (3-31 days). Documentation of ductal characteristics was poor; Ductal size – 83.9%, La:Ao ratio – 48.4%. 19 babies required treatment (61.3%). The median age for

Ibuprofen was 12 days (4-26) and Paracetamol 18 days (9-34) 4 required more than one form of treatment (12.9%) and 3 required surgical closure (9.7%).

CONCLUSIONS

Historically assessment and management were not standardised nor optimised. We propose that by developing a working guideline, whilst awaiting further studies, which help identify key echo characteristics and guide in treatment options, we could both standardise and optimise assessment and treatment of PDA in Neonates in north Wales. A working guideline is now in place and a re-audit is currently ongoing.

EP082 / #500

E-Poster Viewing - Neonatology AS02-03. Cardiovascular & haemodynamics

Patent ductus arteriosus treatment with paracetamol may lead to an increase in pulmonary vascular resistance

**C. Murphy^{1,2*}, N. Bussmann¹, D. Staunton¹, N. Mccallion^{1,2},
O. Franklin³, A. El-Khuffash^{1,2}**

¹Rotunda Hospital, Neonatology, Dublin, Ireland

²Royal College of Surgeons in Ireland, Paediatrics, Dublin, Ireland

³Children's Health Ireland at Crumlin, Cardiology, Dublin, Ireland

BACKGROUND AND AIMS

The use of paracetamol for patent ductus arteriosus (PDA) closure has gained considerable interest with reported efficacy similar to ibuprofen. However, the potential side effects of this treatment are poorly understood. In an animal model, paracetamol has been shown to cause an increase in pulmonary vascular tone in vitro. The aim of this study was to evaluate if paracetamol administration for PDA closure increases pulmonary vascular resistance (PVR) in premature infants.

METHODS

This is a report of fifteen preterm infants from the PDA RCT (ISRCTN:13281214) who received open-label paracetamol for PDA closure. Echocardiography was performed before and after paracetamol treatment. off-line analysis was used to determine PDA characteristics, ventricular function and markers of PVR.

RESULTS

PDA closure was not achieved with paracetamol in these cases. However, an increase in PVR was noted following treatment, demonstrated by a reduction in the ratio of pulmonary artery acceleration time to right ventricular ejection time (PAATI) and an increase in left ventricular eccentricity index (LV EI) (all $p < 0.05$).

CONCLUSIONS

In this report, we present a possible association between paracetamol exposure in preterm infants for PDA closure and an increase in echocardiography-based markers of pulmonary vascular resistance. Future clinical trials of paracetamol for PDA closure should monitor pulmonary haemodynamics with serial longitudinal echocardiography to evaluate the longer term impact.

EP083 / #1491

E-Poster Viewing - Neonatology AS02-03. Cardiovascular & haemodynamics

Case series of pulmonary hypertension and outcome in a quaternary centre.

S. Patel*

Great Ormond Street Hospital, Neonatal Intensive Care, London, United Kingdom

BACKGROUND AND AIMS

Persistent pulmonary hypertension of the newborn (PPHN) affects approximately 2:1,000 live births. The cases of pulmonary hypertension (PH) requiring admission to a quaternary neonatal intensive care (NICU) are such, where PH is a secondary diagnosis or where medical management has been challenging with likely high morbidity and mortality rate. Aim: To study severity of disease and contributing factors to adverse outcome.

METHODS

This was a case series review of neonatal cases with PH from June 2020 until December 2021. Data was collected from the electronic patient records, laboratory, and genetic results. Medians and interquartile ranges (IQR) were calculated for continuous data. Chi-square analysis was employed to investigate clinical variables in relation to mortality.

RESULTS

Forty-one neonates were identified, 5 of which were admitted to NICU post extracorporeal membrane oxygenation (ECMO). The median gestational age was 37 weeks (IQR 32-39). Seventy-six per-cent (n=31) required high fre-

quency oscillatory ventilation with median time of 7 days (IQR 2-10). Inhaled nitric oxide was required in 83% of cases (n=34), with median time 10 days (IQR 4.25-17.75), and inotropic support in 95% (n=39) with median time 7 days (IQR 5-15). The mortality rate in the cohort was 39% (n=16) with the most statistically significant co-existing factors being underlying lung disease (p 0.04) and other conditions (p 0.02), such as underlying syndrome, exomphalos, necrotising enterocolitis.

CONCLUSIONS

Underlying lung disease, such as hypoplasia, and structural anomalies, and other conditions such as syndromes, exomphalos and necrotising enterocolitis were found to contribute significantly to the mortality of neonates with PH in this cohort.

EP084 / #703

E-Poster Viewing - Neonatology AS02-03. Cardiovascular & haemodynamics

A regional survey of use of neonatal functional echocardiography to develop a training programme

A. Pearce*, M. Rajimwale, P. Nath

University Hospital Coventry & Warwickshire, Neonatology, Coventry, United Kingdom

BACKGROUND AND AIMS

Neonatologist Performed Echocardiography (NPE) has become increasingly common as an adjunct to clinical examination in neonatal units. Functional echocardiography can enhance the understanding of pathophysiologic mechanisms and can be used to evaluate therapeutic interventions. Expert consensus statements emphasise establishing a structured training program. Our aim was to understand our regional practice in the West Midlands, United Kingdom, particularly regarding functional echocardiography to develop regional training in functional echocardiography.

METHODS

Cardiology-interested paediatricians and neonatologists in the West Midlands were contacted to complete a questionnaire regarding their background and specific echocardiography practices.

RESULTS

We received 21 responses from clinicians across the region. 19 reported that either they or another performed echocardiography on their unit. Most

respondents used echocardiography for haemodynamic assessment of patent ductus arteriosus, measuring the size (20), flow direction (17), doppler flow pattern (17) and left atrial/Aortic root ratio (19), diastolic flow reversal in aorta (16) and assessment of PPHN with TR jet velocity (18). There were significant gaps in techniques for cardiac function, with no respondents using speckle tracking and only 1/3 using MAPSE (6) and TAPSE (7). There were limited general haemodynamic techniques used such as SVC flow measurement (2) and output assessment using cross-sectional area/velocity time integral (6). 20 respondents were interested in further training in functional echocardiography.

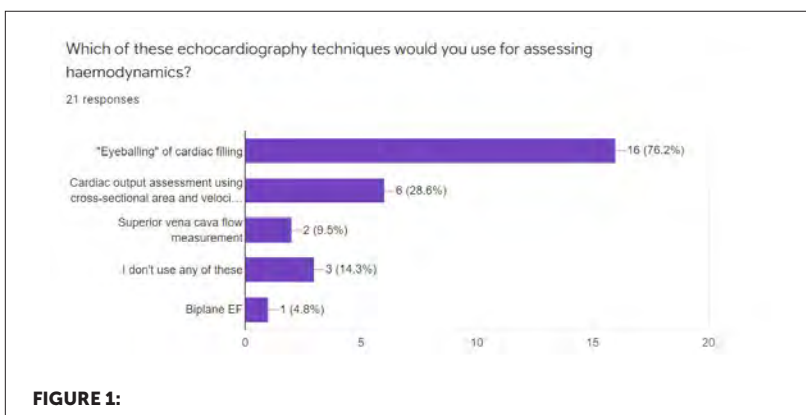

CONCLUSIONS

There are clear gaps in knowledge and application of functional echocardiography and a desire to learn more. We are, in conjunction with paediatric cardiology colleagues, designing a teaching programme involving workshops at each neonatal unit.

EP085 / #935

E-Poster Viewing - Neonatology AS02-03. Cardiovascular & haemodynamics

Observational study of current practice on patent ductus arteriosus (pda) management and outcomes in a tertiary neonatal intensive care unit (nicu) in the united kingdom

N. Rajaraman*, M. Noureldein, H. Gowda

Birmingham Heartlands Hospital, Neonatology, SS, United Kingdom

BACKGROUND AND AIMS

PDA in premature infants is associated with high morbidity and mortality. This study aims to determine the outcomes of extremely premature neonates with PDA within a tertiary NICU.

METHODS

Retrospective observational study of extremely premature neonates of gestational age (GA) 22+0 to 27+6 weeks, birth weight (BW) \leq 1000g between April-2020 and August-2021 (17-months) with confirmed PDA on echocardiogram. The outcomes studied were mortality, Intraventricular Hemorrhage(IVH), Necrotising Enterocolitis(NEC), duration of invasive ventilation and Bronchopulmonary Dysplasia(BPD).

RESULTS

51 neonates met the inclusion criteria. GA ranged from 23+3 to 27+4 weeks (mean= median= 25+4 weeks). Birth weight ranged from 420g to 990g (mean= 734g, median= 740g). 67% (35/51) of neonates received medical

treatment from day 2 to 17 (mean= median= D7) of life. The treated and non-treated group had a similar mean GA of 25+ 3 and 25+4 weeks respectively. However, the treated group had a lower mean birth weight of 713.1g (420g-980g) compared to 784g (500g-990g) in the non-treated group. Mean number of days of invasive ventilation was higher in the treated group (mean= 24.8 days) than the non-treated group (mean= 10.3 days).

TABLE 1:

Outcomes of extremely premature neonates with PDA (treated vs not treated)

PDA (n-51)	Mortality	IVH	NEC	BPD
Treated (n-35)	5.7%(2/35)	48.6%(17/35)	31.4%(11/35)	87.8%(29/33)
Not treated (n-16)	31.2%(5/16)	43.7%(7/16)	25%(4/16)	45.4%(5/11)

CONCLUSIONS

In our current practice of PDA management in extremely premature neonates, mean age of treatment is day 7. Treated group had lower mean BW than non-treated group. Higher mortality seen in non-treated group, but these numbers are small.

EP086 / #952

E-Poster Viewing - Neonatology AS02-03. Cardiovascular & haemodynamics

Early vs late patent ductus arteriosus (pda) treatment in extremely premature neonates- observational study in a tertiary neonatal intensive care unit (nicu) in united kingdom

N. Rajaraman*, M. Noureldein, H. Gowda

Birmingham Heartlands Hospital, Neonatology, SS, United Kingdom

BACKGROUND AND AIMS

Timing PDA treatment in premature neonates is a highly debated topic. This study aims to determine the outcomes of extremely premature neonates with haemodynamically significant (Hs) PDA who received early vs late medical treatment, within a tertiary NICU.

METHODS

Retrospective observational study of extremely premature neonates of gestational age (GA) 22+0 to 27+6 weeks and birth-weight (BW) \leq 1000g between April-2020 and August-2021 (17-months) with confirmed HsPDA on echocardiogram who received medical treatment. The outcomes studied were mortality, Intraventricular Hemorrhage (IVH), Necrotising Enterocolitis (NEC), duration of invasive ventilation and Bronchopulmonary Dysplasia (BPD). We defined early as starting medical treatment under or at 1-week of life and late as after 1-week.

RESULTS

During study period, early medical treatment was given to 19 patients (19/35=54.2%) between day 1 and 7 (mean=D4, median=D5) of life and 16 (16/35=45.7%) had late treatment between day 8 and 17 (mean=D11, median=D10). The mean GA and BW were lower in the early-treated group (mean GA=24+3 weeks, mean BW= 679g) than the late-treated group (mean GA=25+3 weeks, mean BW= 753g).

TABLE 1:

Outcomes of extremely premature neonates receiving early vs late PDA treatment

	Mean GA (weeks)	Mean BW (g)	Mortality	IVH	NEC	BPD	Mean Duration of invasive ventilation (days)
Early (n-19)	24 ⁺³	679	10.5%(2/19)	36.8%(7/19)	42.1%(8/19)	94.1%(16/17)	24
Late (n-16)	25 ⁺³	753	0%(0/16)	62.5%(10/16)	18.7%(3/16)	87.5%(14/16)	27

CONCLUSIONS

Though numbers are small, early treatment of HsPDA may reduce IVH and duration of invasive ventilation. NEC rates were higher in early treatment group but mean GA and BW were significantly lower. BPD rates were similar in both groups.

EP087 / #1642

E-Poster Viewing - Neonatology AS02-03. Cardiovascular & haemodynamics

Assessment of the corpus callosum by ultrasound in patients with congenital heart disease

**A. Rivas Piorno^{1*}, D. Cañizo², A. Remón Pérez¹, M. Perez Cruz³,
J. Sanchez-De-Toledo⁴, M. Camprubi²**

¹Hospital Sant Joan de Déu, Nicu, Esplugues de Llobregat, Spain

²Hospital Sant Joan de Déu, Nicu, Esplugues de Llobregat, Spain

³Hospital Sant Joan de Déu, Gynecology, Esplugues de Llobregat, Spain

⁴Hospital Sant Joan de Déu Barcelona, Department of Pediatric Cardiology, Esplugues de Llobregat, Spain

BACKGROUND AND AIMS

Congenital heart disease (CHD) are associated with adverse neurodevelopment. Many CNS alterations has been described in these patients, being white matter (WM) damage the most consistent pattern of brain injury. Corpus callosum (CC), a WM commissure, has been reported to be one of the main biomarkers to assess WM in fetuses with CHD. Our aim is to describe CC biometry in CHD newborns, and try to establish how the type of CHD and its surgery could influence in its development.

METHODS

Fifty-five newborns that underwent cardiac surgery during their first month of life were included. Brain ultrasound was performed previous to surgery and after surgery. CC was identified in the midsagittal plane as a slightly curved hypoechoic structure. offline evaluation measurements were done using a specific Matlab 2009b®. The analysis was performed grouping patients according to clinical variables such as CHD and the kind of surgery.

RESULTS

No significant differences in the biometry were detected in pre-surgical scans. After surgery, those CHD with aortic obstruction presented significantly smaller posterior part of the CC (posterior midbody, isthmus and splenium) ($p < 0.0308$). Interestingly, an increase in global area and by segments was found in those patients that underwent extracorporeal circulation during surgery ($p = 0.0124$).

CONCLUSIONS

Patients with CHD could present modifications in CC area, especially after surgery. Those with aortic obstruction had smaller posterior part of the CC, suggesting that hypoperfusion and cyanosis could modify CC development. Other changes in CC area could appear depending on the surgery and the CHD.

EP088 / #1040

E-Poster Viewing - Neonatology AS02-03. Cardiovascular & haemodynamics

The effect of remote ischemic postconditioning on cardiac function after hypoxia-ischemia in a newborn piglet model

S. Schaaning*, L. Hansen, T.C.K. andelius, H. andersen, M. Pedersen, R. Pinnerup, T. Henriksen, K. Kyng

Aarhus University Hospital, Department of Pediatrics, Aarhus, Denmark

BACKGROUND AND AIMS

Hypoxia-ischemia (HI) at birth compromises both the brain and cardiovascular system. The proposed neuroprotective effect of remote ischemic postconditioning (RIPC) may in part be mediated by effects on the heart and blood flow to the brain. Here, we examined how RIPC affects cardiac output and myocardial function after HI.

METHODS

Twenty-six newborn anaesthetized piglets were subjected to 45 minutes of global HI, then randomized to RIPC+TH (n=13) or TH (n=13). RIPC with four cycles of five minutes occlusion of blood flow to both hind limbs, followed by five minutes of reperfusion was repeated at 1½, 12 and 24 hours after HI. Echocardiography was performed before, during, and 1, 6, 24, and 44 hours after HI. Left- and right ventricular cardiac output (LVCO and RVCO) was averaged over of three measurements and indexed by weight. Myocardial function analysis by fractional shortening and 2D-speckle-tracking strain will be done.

RESULTS

Preliminary cardiac output data from 12 piglets are shown in Figure 1. Mean LVCO and RVCO were similar between treatment groups. After HI, intra-group LVCO variation increased in the RIPC+TH group compared to TH alone. RVCO increased with time after HI (not statistically significant). Complete data analysis including fractional shortening and strain is ongoing.

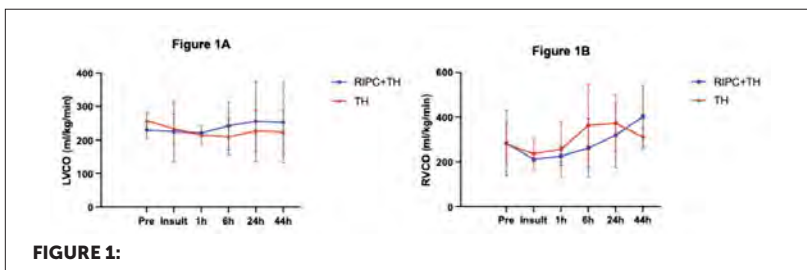

FIGURE 1:

CONCLUSIONS

In the preliminary analyses RIPC+TH compared to TH alone did not change CO after HI. Larger intra-group LVCO variation with RIPC+TH may indicate a variable effect of RIPC+TH on cardiac function. Further analysis will address the relative contributions of heart rate, stroke volume, and myocardial function.

EP089 / #1281

E-Poster Viewing - Neonatology AS02-03. Cardiovascular & haemodynamics

Association between electrical cardiometry in the transitional period and short-term outcome in very preterm infants

C. Schwarz^{1,2*}, J. O'Toole³, D. Healy³, J. Panaviene⁴, V. Livingstone^{2,5}, E. Dempsey^{3,5}

¹University Children's Hospital Tübingen, Department of Neonatology, Tübingen, Germany

²University College Cork, Department of Paediatrics and Child Health, Cork, Ireland

³University College Cork, Department of Paediatrics & Child Health, Cork, Ireland

⁴University College Cork, Infant Research Centre, Cork, Ireland

⁵University College Cork, Infant Research Centre, Cork, Ireland

BACKGROUND AND AIMS

Electrical cardiometry (EC) provides continuous non-invasive monitoring of cardiac output indexed to body weight (CI). The Aim of this study is to evaluate whether EC-derived CI up to 48 hours of life is associated with adverse outcome in preterm infants and to investigate if changes in CI over time.

METHODS

A observational study of preterm infants <32 weeks gestation age (GA) at a tertiary center was performed. Exclusion criteria included major congenital anomalies & refusal of parental informed consent. CI values were obtained using EC (Osypka Medical) starting as soon as possible after birth until 48 hours. Adverse outcome was predefined as death or brain injury (intracerebral hemorrhage/periventricular leukomalacia) within the first 2 weeks of life. Logistic regression models were used to investigate the association between median CI and clinical outcome. Linear mixed-effects models were fitted to investigate if the CI trajectory over time differed by clinical outcome.

RESULTS

53 preterm infants (see Tab. 1 for demographics) were included. The combined adverse outcome occurred in 21 infants. Median(IQR) CI was 241(197–275) for infants with an adverse & 198(175–227) for those with normal outcome (odds ratio (OR)(95%CI): 1.01(1.00–1.03), $p=.028$; after adjustment for GA:adjusted OR(95%CI): 1.01(1.00–1.02), $p=.219$). CI trajectory did not significantly differ for the outcome groups ($p=.352$, see Fig. 1). CI was found to increase over time (+17 mL/kg/min/ day, $p<.001$) and to be lower for very compared to extremely preterm infants (-39 mL/kg/min, $p=.002$)

Table 1: Baseline characteristics of study cohort and outcome groups

Variables	Outcome group		P value
	Adverse Outcome (n=21)	Normal Outcome (n=32)	
Gestational age [weeks]	25.1 (24.2 to 30.5)	30.1 (28.0 to 30.6)	.005
Birth weight [grams]	770 (645 to 1405)	1190 (891 to 1600)	.011
Sex [female]	13 (62%)	16 (50%)	.394
Multiples	4 (19%)	5 (16%)	.745
IUGR	1 (5%)	10 (31%)	.347
Antenatal steroids (completed)	12 (57%)	24 (75%)	.173
Antenatal MgSO ₄	16 (76%)	29 (91%)	.072
Mode of delivery [caesarean]	11 (52%)	24 (75%)	.089
Apgar Score min 5	7 (6 to 8)	8 (6 to 9)	.127
Primary Outcome components			
Death	4 (19%)		
Adverse crUS	20 (95%)	NA	
IVH grade 1	9 (45%)		
P/IVH grade ≥2	10 (50%)		
Extensive PVL	1 (5%)		

Results are presented as median (interquartile range) or counts n(%) as appropriate. IUGR Intrauterine growth restriction, CrUS cranial ultrasound, P/IVH peri-/intraventricular hemorrhage, PVL periventricular leukomalacia, NA not applicable, Combined adverse outcome had overlapping components between death and adverse crUS. Outcome groups compared using Mann-Whitney U test or χ^2 tests.

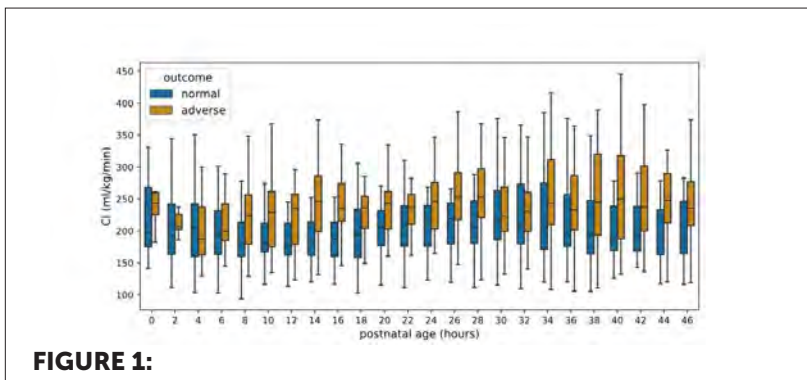

CONCLUSIONS

EC-derived CI in very preterm infants in the first 48 hours was not independently associated with adverse outcome.

EP090 / #1647**E-Poster Viewing - Neonatology AS02-03.
Cardiovascular & haemodynamics****Cord clamping time and placental transfusion in cesarean sections: an observational multicenter study****J. Svedenkrans^{1*}, A. Sand², E. Hetting², V. Strandvik¹, O. andersson¹**¹Lund University, Department of Clinical Sciences, Lund, Sweden²Karolinska Institutet, Department of Women's and Children's Health, Stockholm, Sweden**BACKGROUND AND AIMS**

To delay cord clamping implicates several advantages for the infant, without negative side effects. In elective cesarean sections, cord clamping time after 60 seconds is considered safe, but the optimal cord clamping time in relation to indication of the cesarean section is unknown. The aim of this study was to evaluate the effect of cord clamping time on placental transfusion in elective as well as emergency cesarean sections.

METHODS

Observational study on infants born at 35 gestational weeks or later. Indication for cesarean section, cord clamping time and estimated maternal blood loss was recorded at birth. Placentas were drained from remaining blood, and this blood was measured as an indirect proxy for placental transfusion. The relation between cord clamping time and remaining placental blood was analyzed.

RESULTS

Measurements were available for 78 placentas. of these, 10 were delivered after emergency cesarean section. Median (IQR) cord clamping time was 69 (32-106) sec, median (IQR) remaining blood in the placenta was 31 (0-62) ml. There was a significant correlation between cord clamping time in minutes and remaining placental blood in an adjusted linear regression model ($B=-4.08$, $p=0.012$).

CONCLUSIONS

An expectant management of cord clamping may improve placental transfusion in cesarean sections. Larger studies are needed to evaluate the importance of indication for cesarean section on placental transfusion.

EP091 / #1097**E-Poster Viewing - Neonatology AS02-03.
Cardiovascular & haemodynamics****Creating and implementing a pan-european
governance structure for a training programme in
neonatologist performed echocardiography: a
participatory design project****M. Ten Westenend^{1*}, M. Schokking², W. De Boode³**¹*Radboudumc, Paediatrics, Nijmegen, Netherlands*²*Radboudumc Amalia Children's Hospital, Paediatric Cardiology, Nijmegen, Netherlands*³*Radboudumc Amalia Children's Hospital, Neonatology, Nijmegen, Netherlands***BACKGROUND AND AIMS**

Neonatologist Performed Echocardiography (NPE) is increasingly used as a complement to the clinical hemodynamic assessment of newborn infants. Currently, no formal and accredited training programme has been implemented in Europe. For optimal clinical use, a systematic training programme is recommended by recent consensus papers. The aim is to create and implement a pan-European governance structure for a NPE training programme in a participatory design research.

METHODS

September 2021, the ESPR launched the NPE-project by installing a project group, consisting of a researcher, a paediatric cardiologist and NPE-neonatologists. The concept of Design Based Research (DBR) is used to build a NPE training programme, that ensures the highest quality of NPE in a structured, iterative, yet flexible way that fits the context of clinical practice.

RESULTS

In the first months an extensive project plan was created including all steps leading to a training programme. After description of the project plan, several NPE experts were interviewed throughout the world. In this phase, design requirements were investigated for the programme, including context, structure, needs, wishes, and themes. During the interviews both facilitators (need for structured training, enthusiasm, willingness for participation) and barriers were identified (time constraints, variability of context, legislation). Additional topics were certification, accreditation, application development, teaching styles and stakeholder involvement.

CONCLUSIONS

In conclusion, this project is enthusiastically received by experts. Although challenging, by investing in an effective project plan and selection of DBR, we are confident that a structured NPE training programme can be created.

EP092 / #914**E-Poster Viewing - Neonatology AS02-03.
Cardiovascular & haemodynamics****Perfused boundary region as a biomarker for endothelial integrity in healthy controls and extremely low birth weight survivors in early adolescence**

L. Van Loo^{1,2*}, K. Allegaert^{1,2,3}, E. Levchenko¹, Z. Zhang⁴, J. Staessen⁵, A. Raaijmakers^{1,2,6}

¹UZ Leuven, Department of Development and Regeneration, Leuven, Belgium

²KU Leuven, Department of Pharmaceutical and Pharmacological Sciences, Leuven, Belgium

³Erasmus MC, Department of Clinical Pharmacy, Rotterdam, Netherlands

⁴KU Leuven, Research Unit Hypertension and Cardiovascular Epidemiology, Leuven, Belgium

⁵Non-Profit Research Institute Alliance for the Promotion of Preventive Medicine, Non-profit Research Institute Alliance For The Promotion of Preventive Medicine, Mechelen, Belgium

⁶ZNA Antwerpen, Department of Pediatrics, Antwerpen, Belgium

BACKGROUND AND AIMS

Extremely low birth weight (ELBW) survivors are thought to have microvascular differences already described in kidney and retina, suggesting changes in endothelial integrity. A biomarker of endothelial integrity is Perfused Boundary Region (PBR), which measures glycocalyx thickness. The endothelial glycocalyx is a complex, highly versatile structure with essential roles in vascular integrity and function. We explored PBR patterns together with other microvascular markers in healthy controls and former ELBW children.

METHODS

In the PREMATCH cohort (87 healthy controls and 93 ELBW survivors), we assessed endothelial integrity by calculating PBR using side-stream dark field imaging, and several microvascular markers (blood pressure, estimated

glomerular filtration rate (eGFR), retinal imaging) in early adolescence. We explored differences between both groups, searched for perinatal characteristics influencing PBR and correlations between different microvascular markers.

RESULTS

First reference values for PBR (average 1.91 μm) in healthy children were generated, but PBR did not differ from ELBW survivors (1.88 μm) during early adolescence. In contrast, cases displayed higher blood pressure (Mean Arterial Pressure 83 vs 78 mmHg, $P < 0.001$), lower eGFR (79 vs 89 mL/min/1.73m², $P = 0.002$), and different vessel width and tortuosity (central retinal arteriolar equivalent 156 vs 171, central retinal venular equivalent 223 vs 232, arteriole-to-venule ratio 0.70 vs 0.74, and vascular tortuosity 1.12 vs 1.10, all $P < 0.001$).

CONCLUSIONS

We generated reference values for PBR in early adolescence. Despite some correlations between different microvascular parameters, there seem to be numerous confounders to propose PBR as biomarker for endothelial integrity.

EP093 / #2327**E-Poster Viewing - Neonatology AS02-04.
Covid-19****Umbilical cord clamping practice in the covid-19 pandemic****J. Berg¹, L. Thies-Lagergren², J. Svedenkrans³, S.M. Larsson⁴,
J. Samkutty⁵, H. Rabe⁵, O. andersson^{1*}**

¹Lund University, Skåne University Hospital, Department of Clinical Sciences, Pediatrics, Lund, Sweden

²Lund University, Department of Health Sciences, Lund, Sweden

³Lund University, Department of Clinical Sciences, Lund, Sweden

⁴Lund University, Department of Clinical Sciences, Paediatrics, Lund, Sweden

⁵University of Sussex, Brighton and Sussex Medical School, Brighton, United Kingdom

BACKGROUND AND AIMS

Background: Delayed umbilical cord clamping is associated with lower neonatal mortality, higher iron levels in infancy, and improved neurodevelopment. Concerns of mother-to-child COVID-19 transmission may have made health practitioners hesitant to perform delayed cord clamping at birth. Aim: To systematically examine how cord clamping practice has been reported in the literature during the COVID-19 pandemic.

METHODS

The protocol was registered at Prospero (199500). Medline, Embase, Cochrane database, Google Scholar, Web of Science, PubMed, EuropePMC pre-prints, NLM LitCovid and TRIP database were systematically searched from December 1, 2019 to July 2021. Two researchers independently reviewed the studies.

RESULTS

Fifty studies were included; 31 case reports, 3 case series, 7 prospective cohorts and 9 retrospective cohorts. In total, 1980 newborns were included.

The distribution of CC practice were: Delayed CC 472 (23.8%), early CC 805 (40.7%), CC practice not reported 703 (35.5%). Vertical transmission was reported in 76 (3.8%) cases: Delayed CC 5, early CC 23, CC practice not reported 48. Most studies (84 %) were conducted in high- or upper middle-income countries. The majority of studies (93.8%) from the World Health Organization (WHO) Western Pacific and Eastern Mediterranean Region reported early CC (Table and Figure).

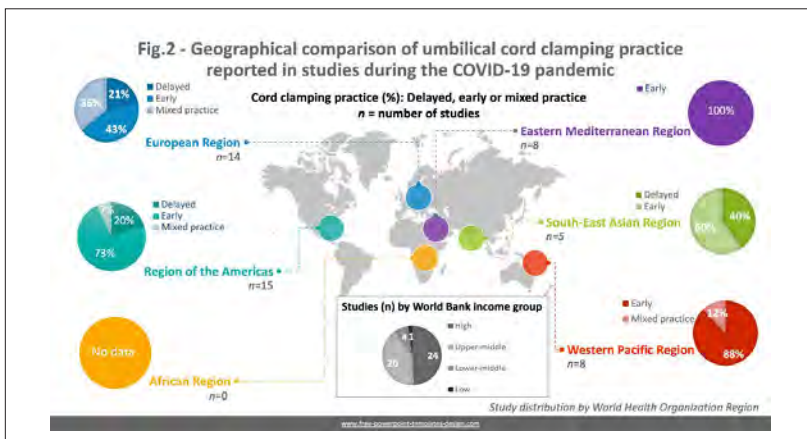
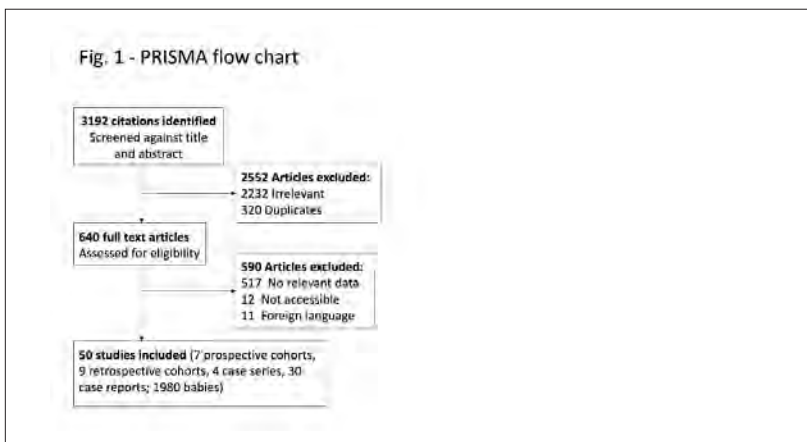

CONCLUSIONS

Early CC was reported almost twice as often as delayed CC in studies conducted during the COVID-19 pandemic, and was particularly common in the WHO Western Pacific and Eastern Mediterranean Regions. The high early CC levels may reflect an unjustified risk perception of vertical COVID-19 transmission.

EP094 / #454

E-Poster Viewing - Neonatology AS02-04. Covid-19

Has the covid-19 pandemic influenced multimedia screen time of children aged 6 months to 5 years?

A. Agarwal, A. Behl*, S. Yadav

Maulana Azad Medical College, Pediatrics, Delhi, India

BACKGROUND AND AIMS

To evaluate the multimedia screen time among children aged 6 months to 5 years during COVID times in Northern India along with factors associated with multimedia device usage, namely, age, sex, socioeconomic status, family structure, availability of multimedia devices, parental screen time, parental educational status and mother's employment status.

METHODS

Descriptive study Setting: This study was conducted from June 2020 to January 2021 in a medical college-affiliated hospital. Participants: Normally developing healthy children Procedure: Socio-demographic characteristics, screen viewing time and parental screen time were reported by parents via a structured interviewer-administered questionnaire. Outcomes: Primary outcome variable was screen time in relation to age. Secondary outcome variable was factors determining multimedia screen time in children

RESULTS

Average screen time among the 256 children (158 males, 98 female) was 70 minutes/day, which was lesser than studies during non-COVID times. The screen time of 69.7% children aged 6 months to 2 years and 49% of children

aged 2-5 years exceeded the WHO recommendations. 60.9% children had their first screen exposure before 2 years of age. Association was found between screen time and age (p-value 0.00, r 0.38), mother's screen time (p-value 0.04, r 0.22) and parental attitude towards multimedia usage time (p-value 0.006, r 0.17). There was no significant association of screen time with sex, socio-economic status, family structure, number of multimedia devices available per person, family structure, father's screen viewing time, mother's education and mother's occupational status.

CONCLUSIONS

Nearly 70% of children below 2 years and 25% of children aged 2-5 years exceeded the recommended screen time, with smartphone being the major contributor followed by television although it was less than non-covid times. There is need for media literacy among parents and emphasis on more active lifestyles.

EP095 / #879

E-Poster Viewing - Neonatology AS02-04. Covid-19

Severe neonatal sars cov 2 infection: case report

A.M. Bradeanu*, C. Taran, M. Iancu, L.C. Stanciu, I. Ercuta

Children's Emergency Hospital "Grigore Alexandrescu", Neonatal Intensive Care Unit, Bucharest, Romania

BACKGROUND AND AIMS

Most newborns tested positive for coronavirus have mild symptoms or none at all, but in rare cases, severe clinical course have been reported.

METHODS

We present 2 cases of severe neonatal SARS CoV 2 infections admitted in our unit during year 2021.

RESULTS

Case 1: baby boy born at 32 weeks, weight 1970g; tested PCR positive at 12 days of age and admitted in our hospital with feeding difficulties and drowsiness. In the following 24 hours he developed severe respiratory failure with hemodynamic instability; cardiac enzymes and echocardiogram were within normal range. Invasive mechanical ventilation was initiated together with sedation, pulmonary recruitment maneuvers, prone position ventilation and hemodynamic support; the management of the acute phase of the disease included Dexamethasone and specific anti-viral medication. The lung imaging was markedly pathologic with extensive lung tissue destruction, fibrosis and remodeling. He developed severe chronic lung disease and expired at 5 months of age. Case 2: baby boy born at 37 weeks via cesarian section,

weight 3460g; tested PCR positive at 9 days of age and admitted in our hospital with fever, grunting and drowsiness. Initially, he received respiratory support-HFNC and mask CPAP, with worsening respiratory insufficiency. He was intubated and mechanical ventilated for 4 days, extubated to HFNC with good respiratory outcome. The lab tests revealed increased inflammatory markers, D-Dimers, and cardiac enzymes. Echocardiogram noted left coronary artery dilatation and Aspirin therapy was initiated. The inflammation subsided, the cardiac enzymes normalized, but the LCA dilatation persisted. At 2 months after the infection, the LCA diameter was 1.7, decreased from 2.1 (Z score 1.5 from 2.1) and the baby was doing well with normal development.

CONCLUSIONS

Although severe infections with SARS COV2 are rare in newborns, they can cause severe lung damage or MIS-N with high mortality and increase morbidity

EP096 / #563

E-Poster Viewing - Neonatology AS02-04. Covid-19

Sars-cov-2 infection vs vaccination in pregnancy: implications for maternal and infant immunity

M.G.. Conti^{1*}, S. Terrieri², G. Terrin¹, F. Natale¹, C. Pietrasanta¹,
R. Brunelli¹, V. Papaevangelou³, F. Midulla¹, L. Petrarca⁴, R. Carsetti²,
A. Angelidou⁵

¹Sapienza University, Department of Maternal and Child Health, Rome, Italy

²Bambino Gesù Children's Hospital, Diagnostic Immunology Research Unit, Rome, Italy

³National and Kapodistrian University of Athens, Third Department of Pediatrics, Athens, Greece

⁴Sapienza University of Rome, Department of Translational and Precision Medicine, Rome, Italy

⁵Beth Israel Deaconess Medical Center, Harvard University, Department of Neonatology, Boston, United States of America

BACKGROUND AND AIMS

SARS-CoV-2 infection has been associated with adverse maternal and neonatal outcomes, yet uptake of SARS-CoV-2 vaccines during pregnancy and lactation has been slow. Thus, pregnant and lactating women and their infants remain susceptible to the virus. Our goal was to determine relative Ab presence in maternal serum and breastmilk (BM) after maternal perinatal SARS-CoV-2 infection or vaccination.

METHODS

We measured Spike-specific immunoglobulin G (anti-S IgG) and A (anti-S IgA) in serum and BM samples from 3 prospective mother-infant cohorts recruited in two academic medical centers. Primary aim was to determine the impact of maternal SARS-CoV-2 immunization vs infection and their timing on systemic and mucosal immunity.

RESULTS

The study included 28 mothers infected with SARS-CoV-2 in late pregnancy (INF), 11 uninfected mothers who received 2 doses of the BNT162b2 vaccine in the latter half of pregnancy (VAX-P) and 12 uninfected mothers who received 2 doses of BNT162b2 during lactation (VAX-L). VAX dyads had significantly higher serum anti-S IgG compared to INF dyads ($p < .0001$), while INF mothers had high BM:serum anti-S IgA ratios compared to VAX mothers ($p = .0001$). Median IgG placental transfer ratios were significantly higher in VAX-P compared to INF mothers ($p < 0.0001$). There was a significant positive correlation between maternal and neonatal serum anti-S IgG after vaccination ($r = 0.68$, $p = 0.013$), but not infection.

CONCLUSIONS

BNT161b2 vaccination in late pregnancy or lactation enhances systemic immunity through serum anti-S Ig, while SARS-CoV-2 infection more efficiently induces mucosal immunity through BM Ig production. New generation vaccines boosting mucosal immunity could provide additional protection to the mother-infant dyad.

EP097 / #1668**E-Poster Viewing - Neonatology AS02-04.
Covid-19****Modifications in placenta of women with sars-cov-2 infection and the state of their newborns****A. Pysariev¹, T. Kurilina^{2*}, Y. Marushko¹, I. Aubekerova³,
V. Turchenyuk²**

¹*O.O. Bohomolets Medical University, Kiev, Ukraine, Department of Pediatrics of Postgraduate Education, Kyiv, Ukraine*

²*Shupyk National Healthcare University of Ukraine, Pediatrics-2, Kyiv, Ukraine*

³*Shupk National Healthcare University of Ukraine, Neonatology, Kyiv, Ukraine*

BACKGROUND AND AIMS

The effects of SARS-CoV-2 infection during pregnancy have to be fully assessed in terms of both the effects on pregnancy and newborn's state. The aim was to perform histopathological examination of placenta in women who had SARS-CoV-2 infection during pregnancy in comparison with the state of newborns.

METHODS

During period 2019-2021, 73 pregnant women who underwent SARS-CoV-2 during gestation were monitored, with histopathological examination of placenta, as well as health of newborns.

RESULTS

27 women had positive PCR and clinical manifestations of SARS-CoV-2 infection intranatally (group 1), 28 women had antibody titers and data on transferred infection up to 20th weeks (group 2), 18 pregnant women had COVID-19 clinical and immunological data after 20th week (group 3). Standard

assessment of the state of newborns was performed. Women of group 1 had physiological delivery at term. In 20 women of group 1 71.4% and in half of group 3 a caesarean section at 28-35 weeks due to preterm placental abruption was provided. In placenta of group 1 were revealed dyscirculatory changes, hemorrhage/necrosis of chorionic lamel. Massive sclerosis of chorionic villi, focal fibrinoid necrosis, syncytiotrophoblast proliferation, fibrinoid deposition in intervillous space were in group 2. Fibrinoid necrosis with focal petrifications of chorionic and decidual lamel was determined. The placentas of group 3 showed changes similar to those in group 2, but with significant fibrinoid necrosis of decidual plate. All children had maladaptation syndromes of varying severity.

CONCLUSIONS

SARS-CoV-2 infection has an impact on state of placental tissue, causing chronic placental dysfunction with chorionitis, affecting newborn health.

EP098 / #2217

E-Poster Viewing - Neonatology AS02-04. Covid-19

Impact of the first wave of the covid-19 pandemic on the functioning of inberbac-neo neonatal units.

J.I. Pijoan-Zubizarreta¹, J. Pérez-López², C. Ribes-Bautista³, F. Camba-Longueira³, M.C. López-Herrera⁴, J. De Frutos-Pecharromán³, B. Loureiro^{5*}

¹Cruces University Hospital. Biocruces Bizkaia, Epidemiology Unit, Barakaldo, Spain

²Biocruces Bizkaia, Neonatal Epidemiology, Barakaldo, Spain

³Vall d'Hebron University Hospital, Neonatal Intensive Care Unit, Barcelona, Spain

⁴Cruces University Hospital, Neonatal Unit, Barakaldo, Spain

⁵Cruces University Hospital. Biocruces Bizkaia, Neonatal Unit, Barakaldo, Spain

BACKGROUND AND AIMS

Neonates have been relatively spared from severe infections by SARS-CoV2 virus, but little is known about changes in the routine functioning of NICUs during the irruption of the Covid-19 pandemic. We assessed its impact on 45 Spanish level III NICUs participating since 2019 in INBERBAC-Neo project (aimed at preventing CLABSI in VLBW infants).

METHODS

In the second half of 2020, a survey was administered to champions at each unit with a module aimed at assessing the impact of Covid-19 first wave on the NICU. Topics addressed were: need for structural changes, adapted clinical protocols, availability of disinfectant and protection equipment, respiratory support devices and changes in the available workforce. Virtual meetings were held with each champion to discuss unclear answers and have completed data.

RESULTS

Response rate was 100%. 62.2% of the NICUs made structural changes, mostly creating isolation areas and 11.1% adapted clinical protocols; 40.0% had limitations in the availability of disinfectants, 64.4% of individual barrier equipment and 4.4 % of ventilatory support devices. Only 3 NICUs (6.7%) had no reductions in daily staff. 44.4% diverted neonatologists, 66.7% nurses and 44.4% nursing auxiliaries to either adult ICUs or Covid-19 patients wards; 68.9% had limitations in access to IPC staff.

CONCLUSIONS

The first wave of Covid-19 substantially affected INBERBAC-Neo NICUs routine functioning, requiring structural and clinical adaptations, causing temporary shortages in hygiene, protective and support material and reductions in available staff. These changes also affected implementation of INBERBAC-Neo intended infection preventive bundles.

EP099 / #2431

E-Poster Viewing - Neonatology AS02-04. Covid-19

Correlation of maternal and cord blood sars-cov-2 immunoglobulin levels in covid-19 during pregnancy

G. Rojas*, M. Aslam, C. Uy

University of California Irvine, Pediatrics-division of Neonatology, Orange, United States of America

BACKGROUND AND AIMS

The extent of in-utero transmission of COVID-19 infection still remains unclear. Data on maternal transfer of anti-SARS-CoV-2 antibodies are limited. Understanding the dynamics of maternal antibody responses to SARS-CoV-2 infection during pregnancy and subsequent transplacental antibody transfer may influence neonatal management as well as maternal vaccination strategies. Aim is to evaluate SARS-CoV-2 antibodies in cord blood of infants born to mothers with active COVID-19 infection and better understand the correlation between maternal and neonatal SARS-CoV-2 antibody levels via cord blood validation.

METHODS

COVID-19(+) pregnant women were enrolled and COVID-19 negative were consented as control. Maternal blood were obtained at enrollment and cord blood collected at delivery. Clinical data were collected from mother-infant for baseline characteristics. Samples were analyzed using coronavirus antigen microarray containing immunologically significant antigens from SARS-CoV-2 which can detect SARS-CoV-2 immunoglobulin levels.

RESULTS

Forty mother-infant dyads were enrolled, 28 paired samples analyzed. 18/28 women were COVID-19 PCR(+) vs 10 COVID-19 PCR(-) at time of delivery. SARS-CoV-2 IgG antibodies were detected in cord blood of 14/18 infants (78%) born to women who were COVID-19 PCR(+). 8/10 infants (80%) born to COVID-19 PCR(-) also had SARS-CoV-2 IgG antibodies detected in their cord blood, all were born to women vaccinated with COVID-19 vaccine. IgM antibodies were detected in 6/18 (33%) of COVID PCR(+) women. No SARS-CoV-2 IgM antibodies were detected in cord blood.

CONCLUSIONS

SARS-CoV-2 IgG levels in cord blood correlated well with maternal levels. This study supports the efficient transfer of SARS-CoV-2 maternally-derived IgG antibodies that may provide neonatal protection from COVID-19 infection.

EP100 / #2642

E-Poster Viewing - Neonatology AS02-04. Covid-19

Newborns born to sars-cov-2 infected mothers exhibit a milder clinical presentation than newborns with transient tachypnea

M. Total, O. Surmeli Onay*, K. Yolcu, T. Barsan Kaya, O. Aydemir, A.N. Tekin

Eskisehir Osmangazi University, Faculty of Medicine, Department of Pediatrics, Division of Neonatology, Eskisehir, Turkey

BACKGROUND AND AIMS

Although results from real-time polymerase chain reaction (RT-PCR) indicated that newborns born to SARS-CoV-2-infected mothers were not generally infected, various respiratory symptoms resembling the infant's transient tachypnea might be observed. The aim of this study was to compare the clinical characteristics of term infants born to SARS-CoV-2-infected mothers with those of term infants suffering from transient tachypnea.

METHODS

A single-center, retrospective, observational cohort study including 72 newborns was conducted. The study group (SG) included term newborns born to SARS-CoV-2-infected mothers, whereas the control group (CG) included term newborns with transient tachypnea. The term newborns with congenital pneumonia, pulmonary hypertension, pneumothorax, proven sepsis, and respiratory distress syndrome requiring surfactant treatment were excluded.

RESULTS

Table 1. Prenatal, Natal and Postnatal Demographic and Clinical Characteristics of the Study and Control Groups.

Demographic, Clinical and Laboratory Characteristics	STUDY GROUP (Term infants born SARS-CoV-2 infected mothers) n=30	CONTROL GROUP (Term infants with Transient Tachypnea of Neonate) n=42	P value
Prenatal			
Maternal SARS-CoV-2 R-PCR at delivery	Positive	Negative	
Maternal hypertensive disorders	2	2	1.00
Maternal diabetes mellitus	4	9	0.56
Maternal asthma	2	1	0.56
Oligohydramnios	3	3	0.27
Abnormality in NST	1	2	1.00
Natal			
Gender (M/F)	19/11	18/24	0.14
Gestational age (wk)**	37.5 (37-38)	37 (37-38)	0.68
Birth weight (g)*	3267±473	2961±557	0.02
SGA	0	7	0.01
Type of delivery (V/C5)	3/27	5/37	1.00
Resuscitation in the delivery room	2	9	0.10
Apgar score (1st minute)**	9.5 (9-10)	9 (8-9)	0.006

TABLE 2:

Cord pH*	7.33±0.05	7.32±0.06	0.24
Cord HCO ₃ **	21.1(18.8-22.4)	20.5(19.05-22.4)	0.73
Cord base excess**	-4 (-5.4-1.97)	-4.2 (-5.7-2.8)	0.33
Cord lactate**	2.65 (2-3.7)	3.1(2.4-4.05)	0.15
Postnatal			
Newborn SARS-CoV-2 R-PCR at the first day of life	Negative	-	
Need for respiratory support (invasive-noninvasive)	8	34	<0.001
Duration of noninvasive mechanical ventilation (day)**	0(0-0.25)	0.5 (0.25-1)	<0.001
Duration of oxygen support (day) **	1 (1-2)	2 (1-3)	0.54
Duration of hospitalization (day)**	5 (3-8)	6 (4-11)	0.12
Hemoglobin**	18.05 (16.33-19.85)	18.0 (16.8-19.3)	0.93
White blood cell count**	17240(12410-19452)	15955 (13155-21017)	0.93
Neutrophil count**	7625 (5800-10260)	6615 (5140-10440)	0.57
Lymphocyte count**	5875(4690-6780)	6170 (5170-7550)	0.23
Platelet count**	253000(216250-316250)	301500(258500-354000)	0.014
Mean platelet volume**	10 (9.4-10.5)	9.30 (9-9.9)	0.004
C-reactive protein (CRP)**	1.5 (0.75- 4.65)	1.9 (1- 3.17)	0.55

*Median (Q1-Q3); **Median (Q1-Q3); SGA: small for gestational age; V: vaginal; C5: Cesarean section

The SG (30 newborns) and CG (42 newborns) were similar in prenatal characteristics, gender, gestational age, and cord blood gas analysis. In comparison to SG, the birth weight and Apgar score were significantly lower in CG, and SGA was more prevalent. All newborns delivered to SARS-CoV-2 infected mothers underwent two RT-PCR analyses of nasopharyngeal swab samples at intervals of 24 hours, and none were infected. The need of respiratory support was significantly higher, and the duration of noninvasive mechanical ventilation was significantly longer in CG. The durations of oxygen support and hospitalization were similar between groups. The laboratory analysis revealed that platelet count was significantly lower and mean platelet volume was significantly higher in SG than in CG (Table1).

CONCLUSIONS

The most significant finding is that newborns born to SARS-COV-2-infected mothers exhibit a milder clinical presentation than newborns with transient tachypnea.

EP101 / #925

E-Poster Viewing - Neonatology AS02-04. Covid-19

Sars-cov-2 infection - a new life-threatening disease in neonatal intensive care unit.

D. Wojciechowska^{1,2*}, A. Basiukajć¹, K. Wróblewska-Seniuk¹,
J. Mazela³, T. Szczapa¹

¹Poznan University of Medical Sciences, Department of Newborns' Infectious Diseases, Poznan, Poland

²Poznan University of Medical Sciences, Doctoral School, Poznan, Poland

³Poznan University of Medical Sciences, Department of Neonatology, Poznan, Poland

BACKGROUND AND AIMS

The COVID-19 pandemic has become a new threat to the newborns and young children. This is primarily due to the lack of vaccination possibility in this group of patients and lower acceptance level of the COVID-19 vaccine among pregnant women. The neonates are especially susceptible to this infection compared to older children and healthy young adults, with unique treatment challenges. This study aimed to evaluate the course of disease in a group of hospitalized neonates.

METHODS

Our study covered 19 patients hospitalized due to SARS-CoV-2 infection in a tertiary neonatal care unit in Poland. The infection was identified by RT-PCR and antigen tests. Clinical data was collected to determine the symptoms and predictors of disease severity in hospitalized neonates.

RESULTS

The study group consisted of 9 males and 10 females. The median age at infection was 18 days of life. The source of the disease were primarily symptomatic caregivers (63%) and nosocomial infection (21%). Most patients presented with fever (37,5%), respiratory failure, and appetite loss (15,6%). Less than 10% developed cough, nasal congestion, and rhinorrhoea. One patient suffered from diarrhea. We observed chest X-ray abnormalities in 5 patients, and also five patients required ventilatory support with non-invasive ventilation (NIV, nCPAP, HFNC). In one patient, the respiratory failure resulted in hypoxia and neurological sequelae.

CONCLUSIONS

SARS-CoV-2 infection in neonates is a new life-threatening disease that may cause respiratory failure. It is crucial to study effective treatment methods to address current concerns about neonatal care in the COVID-19 pandemic.

EP102 / #1315**E-Poster Viewing - Neonatology AS02-05.
Dermatology****Dermoepidermic tear after vacuum assisted
delivery, ¿a risk-free procedure?**

V. Burckhardt Bravo, T. Kunze Küllmer, C. Werner Ratto, T. Barros Vial*, H. Villalón Urrutia

Universidad de los andes, Pediatrics Department, Las Condes, Chile

BACKGROUND AND AIMS

The prevalence of assisted vaginal delivery varies from 1,5 to 15%. The most used techniques are Vacuum Extractor (VE) and Forceps. The Forceps technique has been widely used because of its simplicity, however Vacuum has been proved to reduce maternal morbimortality, bleeding loss and vaginal lesions. It has also shown neonatal benefits as immediate maternal attachment. The use of Vacuum has increased the risk of scalp abrasion or laceration, cephalohematomas, subgaleal and intracranial hemorrhages, which may result from the lack of experience doing this procedure.

METHODS

Objective: Present a case report of a newborn with a Vacuum assisted delivery with a dermoepidermal scalp tear, and review the use of this technique.

RESULTS

case report: We present a adequate-gestacional-age newborn who had a severe bradycardia in a prolonged expulsive period. The use of VE has been decided which results in a rapid delivery of the newborn with 3625gr and a 9/9 APGAR score. Physical examination discovered a scalp tear with dermis

exposure, without other cephalic deformities. The newborn was evaluated by plastic surgery, who clean and opposed the segment, with a fast scar formation, and subsequent healing.

CONCLUSIONS

The Vacuum is a great alternative for vaginal deliveries that require assistance, however it is not excent of risks, and must be performed by trained people. It requires an adequate selection of the patients and the implementation of training programs, since the inadequate use increases the risk of different and severe complications.

EP103 / #1391**E-Poster Viewing - Neonatology AS02-06.
Development****Association between physical activity and cognitive function in adults born very preterm or with very low birth weight: an individual participant meta-analysis**

K.A. Aakvik^{1*}, S. Benum¹, K. Räikkönen², M. Tikanmäki^{3,4}, E. Kajantie^{3,4,5}, P. Hovi^{4,5}, S. Harris⁶, B. Darlow⁶, P.J. Mork⁷, M. Indredavik¹, K.A. Evensen^{1,8,9,10}

¹Norwegian University of Science and Technology (NTNU), Department of Clinical and Molecular Medicine, Trondheim, Norway

²University of Helsinki, Department of Psychology and Logopedics, Helsinki, Finland

³Oulu University Hospital and University of Oulu, Pedego Research Unit, Oulu, Finland

⁴Finnish Institute for Health and Welfare, Public Health Promotion Unit, Helsinki/Oulu, Finland

⁵Helsinki University Hospital and University of Helsinki, Children's Hospital, Helsinki, Finland

⁶University of Otago Christchurch, Department of Pediatrics, Christchurch, New Zealand

⁷Norwegian University of Science and Technology, Department of Public Health and Nursing, Trondheim, Norway

⁸Oslo Metropolitan University, Department of Physiotherapy, Oslo, Norway

⁹Trondheim Municipality, Unit For Physiotherapy Services, Trondheim, Norway

¹⁰Children's Clinic, St. Olavs Hospital, Trondheim University Hospital, Trondheim, Norway

BACKGROUND AND AIM

Very preterm (VP <32 weeks of gestation) birth or very low birth weight (VLBW <1500 g) is associated with physical, mental, and developmental challenges during childhood which may persist into adulthood. We examined whether there was an association between leisure time physical activity (PA) and cognitive function in adults born VP/VLBW compared to term-born controls.

METHODS

As part of EU Horizon 2020 project: Research on European Children and Adults Born Preterm (RECAP Preterm), five cohorts provided pseudonymized individual participant data, comprising 595 VP/VLBW and 1940 term-born adults aged 21 to 29 years. Data included self-reported hours per week of moderate to vigorous leisure time PA (intensity >3 metabolic equivalents). In addition, full intellectual quotient (IQ) was assessed using Wechsler Adult Intelligence Scale/Wechsler Abbreviated Scale of Intelligence, and executive function using Behavior Rating Inventory of Executive Function (BRIEF-A). Adjustments were made for cohort, age and sex.

RESULTS

The VP/VLBW group reported 3.7 (SD 5.0) hours/week of moderate to vigorous leisure time PA compared with 6.5 (SD 2.8) hours in the control group ($p < 0.001$). The VP/VLBW group had lower IQ and higher BRIEF-A scores than controls, except for BRIEF-A Initiate. Less PA was associated with poorer cognitive function in both groups, but the association was stronger in the VP/VLBW group.

CONCLUSIONS

We found that PA was associated with cognitive function, especially in the VP/VLBW group. While this finding does not indicate causality, poorer cognitive function can be considered a risk factor for less leisure time PA.

EP104 / #2143**E-Poster Viewing - Neonatology AS02-06.
Development****Quantitative evaluation of the noise level in a
tertiary neonatal unit in the uk**

H. Ahmed*, M. Ahmed, H. Klonin, R. Alia

Hull University Teaching Hospitals, Neonatal Unit, Hull, United Kingdom

BACKGROUND AND AIM

Infants in the neonatal unit are subjected to stress, including high-intensity sound. Sound levels in NICUs range from 7 dB to 120 dB, often exceeding the maximum acceptable level of 45 dB, recommended by the American Academy of Paediatrics. In the UK, there is a 4-6% prevalence of hearing loss in children at 6 years of age who were born preterm, which is significantly higher than the background prevalence of hearing loss in healthy term infants. Aim:* To evaluate the background noise level within the infant's incubator and the number of hours where this exceeded AAP recommendations.

METHODS

-The noise level was recorded using a sound meter (Gain Express 2016 model SLM-25) placed inside an incubator in a variety of situations (e.g., vacant incubators, with infants receiving invasive or non-invasive respiratory support) -The average noise level and time duration where noise exceeded 45 dB were recorded.

RESULTS

-Noise level recorded with paired noise resources (see table1):

TABLE 1:

Noise level source	dBs produced
Monitor Alarm	65-85 dBs
Shutting incubator door	-50 dBs -75 dBs if not closed carefully
Telephone	60 dBs
Infusion Pump Alarm	55 dBs – 65 dBs (depend on distance to baby)
Telecom	55 dBs
Conversation	50-60 dBs 60-80 dBs (Laughter/Loud)
Dragging Trolleys and closing Pins	55-75 dBs

-Inside the incubator of a self-ventilating baby >>noise was recorded over 24 hours, the average Noise level was **53 dB** and daily hours where Noise exceeded 45 dBs was **19 hours out of the 24 hours**. -Noise level recorded in other situations:

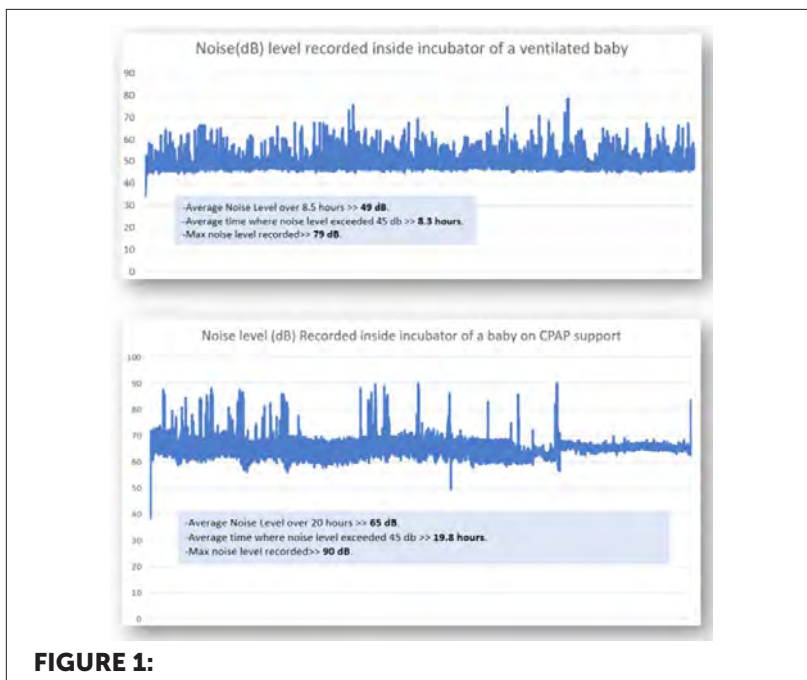

CONCLUSIONS

Our unit noise levels usually exceed 45dBA most of the time in variable situations with noticeably increased levels within incubators where infants received non-invasive ventilation. Further research can be done to evaluate physiological changes occurring during increased noise levels and further follow up for infants subjected to noise pollution during their neonatal inpatient course.

EP105 / #34

E-Poster Viewing - Neonatology AS02-06. Development

Prevalence and risk factors for apnea of prematurity in hospitalized preterm neonates of kabul city: an analytic cross-sectional study.

M. Aslamzai^{1*}, O. Faizi²

¹Kabul University of Medical Science, Department of Neonatology, Kabul, Afghanistan

²French Medical Institute for Mothers and Children Hospital, Neonatology, Kabul, Afghanistan

BACKGROUND AND AIM

Background: Apnea of prematurity (AOP) may be associated with significant adverse outcomes, but there is scientific gap regarding the prevalence and risk factors of this problem in Afghanistan. Objective: To determine the prevalence rate and risk factors for AOP in preterm neonates admitted to the French Medical Institute for Mothers and Children (FMIC) Hospital.

METHODS

This analytic cross-sectional study was conducted at the NICU of the FMIC Hospital in Kabul City, Afghanistan. Statistical analysis was performed by SPSS 20.

RESULTS

A total of 75 preterm newborns were enrolled in this study and the AOP were developed in 48% of them. ELBW preterm neonates had a 71.4% prevalence rate of such apnea, while in VLBW and LBW the rates were 47.4% and 36.4% respectively. Based on gestational age, the prevalence rates of apnea in the early and moderate preterm neonates were 55.6% and 52.8% respectively,

whilst also in late preterm neonates it was 42.8%. The AOP appeared more prevalent in boys (54.3%) than girls (45.7%). The preterm neonates in the apnea group versus the non-apnea group had the mean birth weight of ($1233.33 \pm 235.25\text{g}$ vs $1333.46 \pm 274.44\text{g}$, $90\%CI = -198 \text{ } -1.4$), mean maternal age of ($24.78 \pm 3.68\text{y}$ vs $26.62 \pm 4.58\text{y}$, $90\%CI = -3.44 \text{ } -0.23$) and RR of anemia (2.2, $P=0.05$).

CONCLUSIONS

The overall prevalence rate of AOP in preterm neonates was 48% and the highest rates were seen within extremely low birth weight and early preterm neonates. The lower neonatal birth weight, neonatal anemia and younger maternal age were found to be the risk factors for AOP.

EP106 / #2229

E-Poster Viewing - Neonatology AS02-06. Development

Survival and neurodevelopmental outcome among 23 to 26 weeks preterm infants: experience of a level iii hospital

M. Bastos Gomes*, E. Sousa, A. Costa Azevedo, M. Fonte, E. Proença, A. Almeida, A.M. Alexandrino, A. Guedes, S. Domingues, A. Novo

Centro Materno Infantil do Norte - Centro Hospitalar Universitário do Porto, Neonatal Intensive Care Unit, Porto, Portugal

BACKGROUND AND AIM

The viability limit for newborns has changed: survival rates above 50% at 24wks gestational age (GA) are frequently reported and many studies revealed over 80% at 26wks. Unfortunately, improvement in these rates often comes at the expense of severe neurodevelopmental sequelae and compromised quality of life. We reviewed survival and neurodevelopment outcome of 23-26wks preterm infants.

METHODS

Retrospective study of inborn infants with GA between 23-26wks, born between 2014-2018. Survival rate, main comorbidities at discharge and neurodevelopment assessment (including Griffiths Mental Development Scale Extended Revised II) after 2 years corrected age (CA) were evaluated.

RESULTS

of the 16210 live births, 84 (0.5%) were born between 23-26wks and 32 (38%) survived (23wks: 0%, 24wks: 11%, 25wks: 42% and 26wks: 61%). Median

birthweight (835g vs 653g) and median GA (26 vs 24wks) were higher in the survivor group ($p<0.001$). After 2 years CA, 7 children were lost or had no formal developmental assessment, 5 had major disability and 20 had minor/no disability. of those born at 26wks, 93% had minor or no disability.

CONCLUSIONS

In our study, newborns with at least 26wks GA are those who have >50% probability of surviving with minor/no disability. GA is higher than that found in other studies, but survival without disability at 26wks seems to be higher in our group. Ultimately, these preterms die more, but when they survive, it seems to be in better condition. Knowledge of this reality is important in providing information to parents and shared decision-making regarding newborns on the threshold of viability.

EP107 / #1542

E-Poster Viewing - Neonatology AS02-06. Development

Ethanol exposure in a rodent model of preterm neonates leads to respiratory control dysfunction in female but not male rat pups

N. Rickman, C. Mayer, S. Vatolin, C. Tokat, P. Macfarlane, C. Bearer*

Case Western Reserve University, Pediatrics, Cleveland, United States of America

BACKGROUND AND AIM

Fetal alcohol spectrum disorder (FASD) has been linked to microcephaly, mental retardation, and Sudden Unexpected Infant Death (SUID). Preterm infants are given ethanol excipients, have periods of apnea and experience higher rates of SUID. We investigated whether ethanol exposure disrupts central and peripheral mechanisms of respiratory neural control in neonatal rats.

METHODS

Postnatal day (P) 5 rats received 0.8 or 4.4 mg/g of ethanol or saline via IP injection. The ventilatory response to acute hypoxia (HVR; 10% O₂, 5 min) and hypercapnia (HCVR; 5% CO₂, 5 min) was measured using whole-body plethysmography 24 h later. Changes in ventilation during hypoxic and hypercapnic challenge (expressed relative to baseline normoxic ventilation) were measured.

RESULTS

Female saline injected rats exhibited a pronounced biphasic hypoxic ventilatory response, increasing minute ventilation during the 1st and 2nd minute

of hypoxia (Fig. 1A). The lowest dose of ethanol (0.8 mg/kg) had no effect on the biphasic HVR (Hx, Fig. 1A), whereas it was abolished by the higher dose. The HCVR was also abolished by 4.4 mg/kg of ethanol (HC). Between P7 and P13, the mortality in females was 38% and 0% in males. Males were relatively unaffected by ethanol (Fig. 1B).

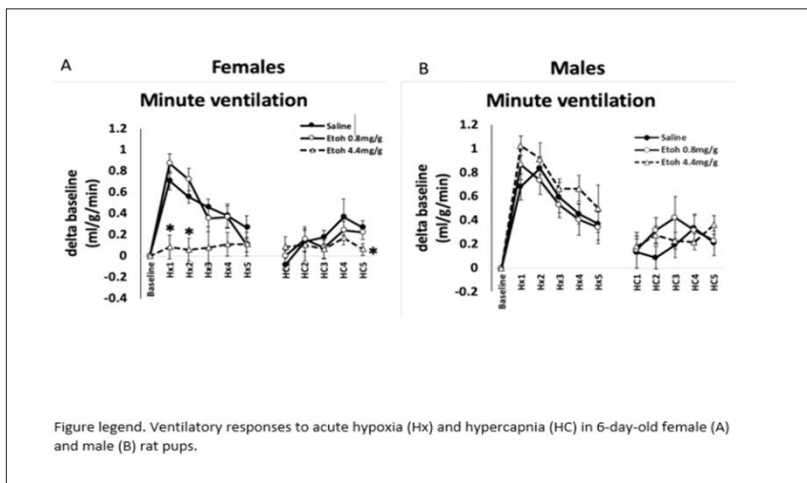

CONCLUSIONS

The effect on the early phase of the HVR implies functional impairment of peripheral mechanisms of neural control such as the carotid body chemoreceptors, while the attenuated hypercapnic response suggests deficits in central mechanisms. Such respiratory impairments and the associated mortality in females days after treatment could have implications for the increased risk of SUID following ethanol exposure.

EP108 / #587

E-Poster Viewing - Neonatology AS02-06. Development

Sleep and 24-hour rhythm characteristics in preschool children born very preterm compared to their full-term peers

A. Bijlsma^{1*}, V.A.A. Beunders¹, I. Van Beijsterveldt², D. Dorrepaal²,
A. Hokken-Koelega², I. Reiss¹, K. Joosten³, M. Vermeulen¹

¹Erasmus MC Sophia Children's Hospital, University Medical Center Rotterdam, Department of Pediatrics, Division of Neonatology, Rotterdam, Netherlands

²Erasmus MC Sophia Children's Hospital, University Medical Center Rotterdam, Department of Pediatrics, Subdivision of Endocrinology, Rotterdam, Netherlands

³Erasmus MC Sophia Children's Hospital, University Medical Center Rotterdam, Department of Pediatrics, Pediatric Intensive Care Unit, Rotterdam, Netherlands

BACKGROUND AND AIM

Insufficient sleep is an important risk factor for cardiometabolic diseases and impaired neurocognitive function in childhood. Sleep problems are most prevalent in the preschool period. Little is known about sleep of preterm-born children during this period. Therefore we compared sleep and 24-hour rhythms of preterm and full-term children aged 3 years.

METHODS

This prospective cohort study compared sleep characteristics of very-preterm infants (gestational age (GA) <30 weeks) to full-term controls. Sleep characteristics were assessed using two parent-reported validated questionnaires, a 5-day daily sleep-log and tri-axial wrist actigraphy (GENEActiv; Activinsights, UK). Regression analyses, with adjustment for sex, age and birthweight SD-score (BW-SDS) was done.

RESULTS

Ninety-seven preterm-born infants (42% female) and 71 term-born controls (56% female) were included. Median GA was 27+5 (interquartile range 26+3;29+0) versus 39+3 (38+4;40+4) weeks. BW-SDS was 0.14 (-0.40;0.70) and -0.26 (-0.80;0.20) in the preterm and control group respectively. The questionnaires showed a median nocturnal sleep duration of 11:00hh:mm (10:30;11:55) in the preterm versus 10:30hh:mm (9:30;11:00) in the control group ($p=0.01$). Preterm birth was associated with 43 minutes (95%CI 13;75, $p=0.005$) longer 24-hour (nocturnal+daytime) sleep duration. In 69 preterm-born and 55 full-term children actigraphy-data were available for at least 3 days. Only difference in wake-up time was observed, with preterm-born children waking up 23 minutes (95% CI 5;42, $p=0.02$) later than controls.

CONCLUSIONS

In our cohort, preterm-born children aged 3 years sleep longer and wake-up later than controls. Future studies should explore how these findings relate to cardiometabolic and neurodevelopmental outcomes of this vulnerable population.

EP109 / #2727

E-Poster Viewing - Neonatology AS02-06. Development

The impact of postnatal growth on neurodevelopmental outcomes in extremely preterm infants

A. D'Souza*

The University of Queensland, School of Medicine, Brisbane, Australia

BACKGROUND AND AIM

Infants born preterm, and especially those extremely preterm infants (EPTI) at <28 weeks' gestation, are at increased risk of growth restriction and neurodevelopmental impairment. Inadequate postnatal growth has been frequently linked to poor neurodevelopmental outcomes in early life. This study examines the impact of postnatal growth in EPTI on neurodevelopmental outcomes at 2 years' corrected age (CA).

METHODS

This is a retrospective study of 456 infants born at <29 weeks' gestational age or with birthweight of <1500g at the Royal Brisbane and Women's Hospital in Brisbane, Australia. Anthropometric data on weight and head circumference was collected at birth and discharge. Patel's exponential model was applied to calculate weight gain velocity, whilst growth in head circumference was estimated by a linear model. Neurodevelopmental outcomes were assessed using the Bayley Scales of Infant and Toddler Development-Third Edition (Bayley-III).

RESULTS

There was no relationship between postnatal growth rate and neurodevelopmental outcomes on initial analyses. With the data categorised into quartiles by birthweight, it was found that a significant relationship did exist, both for weight gain velocity and gain in head circumference, and each the five Bayley-III composite scores, but only for those infants in the first birthweight quartile. In the final multiple regression model using this quartile, weight gain velocity and change in head circumference were both significant predictors of outcome.

CONCLUSIONS

This study shows that postnatal growth is most important in predicting outcomes in those infants with the lowest birthweight. This supports efforts aimed at optimising growth in EPTI, with the hopes of ultimately improving their neurodevelopmental outcomes.

EP110 / #981

E-Poster Viewing - Neonatology AS02-06. Development

Brain volumetric differences in low-risk prematurity during young adulthood

L. Fernández De Gamarra-Oca^{1*}, N. Ojeda¹, J.M. Ontañón²,
B. Loureiro³, A. Gómez-Gastiasoro⁴, J. Peña¹, N. Ibarretxe-Bilbao¹,
M.A. García-Guerrero¹, L. Zubiaurre-Elorza¹

¹University of Deusto, Department of Psychology, Bilbao, Spain

²Galdakao-Usansolo Hospital, Magnetic Resonance Imaging Unit "osatek", Galdakao, Spain

³University Hospital Cruces, Division of Neonatology, Biocruces Health Research Institute, Barakaldo, Spain

⁴University of the Basque Country, Department of Basic Psychological Processes and Development, San Sebastian, Spain

BACKGROUND AND AIM

Deviations from normative brain volumetric development have been associated with perinatal factors and later cognition. Therefore, this study aims to identify long-term effects of preterm birth on brain volumetric development as well as the relationship between volumetric measures and cognitive functioning in young adults.

METHODS

T1-weighted MRI images of 33 low-risk preterm (30 to 36 weeks' gestational age (GA)) and 31 full-term individuals (37 to 42 weeks' GA) of both sexes and aged between 20 and 32 years old were analyzed with Freesurfer (v6.0.0). All participants underwent an extensive cognitive assessment.

RESULTS

Different results were not found in terms of cognitive functioning. Low-risk preterm young adults had smaller global cortex and gray matter volumes, whereas they exhibited a greater global cerebral white matter volume compared to the full-term group. Moreover, those born prematurely had lower regional volumetric values in the following areas: cerebellum white matter, cerebellum cortex, thalamus, caudate, pallidum, hippocampus, right amygdala, left accumbens, and anterior and posterior corpus callosum. Conversely, low-risk preterm-born group also displayed greater regional volumetric values in putamen and left amygdala. Lastly, low-risk preterm individuals presented a statistically significant positive correlation between cognitive functioning and global cortex volume, while their full-term peers did not display any correlation.

CONCLUSIONS

Our results suggest that low-risk prematurity has a mild impact on the development of several global and regional volumetric areas during young adulthood. Actually, preterm-born adults without a history of neonatal brain injury with a smaller global cortex volume also showed a poorer cognition.

EP111 / #2262

E-Poster Viewing - Neonatology AS02-06. Development

Discrete white matter abnormalities in extremely preterm born children were related to cortical thickness

**L. Fernández De Gamarra-Oca^{1*}, H. Kvanta², D. Nosko³,
M. Strindberg², E. Eklöf², N. Ojeda¹, L. Zubiaurre-Elorza¹, N. Padilla²,
U. Aden^{2,4,5}**

¹University of Deusto, Department of Psychology, Bilbao, Spain

²Karolinska Institute, Department of Women's and Children's Health, Stockholm, Sweden

³Örebro University Hospital, Department of Paediatrics, Örebro, Sweden

⁴Karolinska University Hospital, Department of Neonatal Medicine, Stockholm, Sweden

⁵Linköping University, Department of Biomedical and Clinical Sciences, Linköping, Sweden

BACKGROUND AND AIM

Most growth in cortical connections and complexity take place after 25 weeks and cognitive impairments are common among extremely preterm children. The aim of this study was to assess cortical thickness development in extremely preterm children with and without discrete white matter abnormalities.

METHODS

T1-weighted MRI images from forty-three children born before 27 weeks gestation and 30 controls ($M_{age}=10.34$ years; $SD_{age}=0.71$) were scored for discrete white matter abnormalities (see Nosko et al 2021) and analyzed with Freesurfer (v7.2.0).

RESULTS

Extremely preterm children with discrete white matter abnormalities had smaller bilateral mean cortical thickness compared to the full-term group. Extremely preterm children with and without discrete white matter abnormalities exhibited smaller cortical thickness in the bilateral-middle temporal, right-pars opercularis, right-pars orbitalis, right precentral, right-superior temporal, and left-inferior parietal gyri and left-superior temporal sulcus than full-term children.

CONCLUSIONS

Extremely preterm born children with discrete white matter abnormalities had reduced bilateral mean cortical thickness. Hence, rapid detection of discrete white matter abnormalities may identify suitable subjects for early interventions.

EP112 / #2198

E-Poster Viewing - Neonatology AS02-06. Development

Preterm infants voice processing is mediated by voice familiarity

M. Filippa^{1*}, D. Benis¹, A. Adam-Darque², P. Hüppi³, D. Grandjean¹

¹University of Geneva, Psychology and Educational Sciences, Geneva, Switzerland

²University of Geneva, Department of Clinical Neuroscience, Geneva, Switzerland

³University of Geneva, Faculty of Medicine, Geneva, Switzerland

BACKGROUND AND AIM

Understanding how prematurity and language or voice familiarity impact on language perception at birth becomes crucial to determine which brain regions support language processing, and how an atypical early sensory experience affects language-related brain areas.

METHODS

Ten preterm and ten full-term newborns underwent EEG recordings during the presentation of their mother's or a stranger's speech. The speech could be naturalistic (forward) or non-naturalistic (backward). Time-frequency decomposition was performed and task-related responses were analyzed following a topographical data driven clustering using General Linear Mixed model approaches.

RESULTS

Differential responses were observed in left and right temporal areas. In the left-temporal areas, a specific processing of the naturalistic mother compared to stranger speech was observed in low-frequency bands (theta and alpha

bands), but taking antagonistic forms in the two groups i.e. a power increase for full-term and a power decrease (theta) or maintenance (alpha) in preterm babies. Left-temporal low-beta activity presents, in full-term babies, in the forward condition, a power increase for the maternal voice and a decrease for the stranger voice, which were not observed in preterms. In the right-temporal scalp area, we observed in the low-beta and low-gamma bands a mother forward specific power-decrease in the preterm population specifically, with higher values for the mother backward, while terms were mostly activated by the most unfamiliar stimulus, the stranger backward voice.

CONCLUSIONS

The current study shows that the naturalistic mother voice elicits expected brain responses in the full-term newborns, which were different for preterms, both in the left and right temporal areas.

EP113 / #1374

E-Poster Viewing - Neonatology AS02-06. Development

Neurodevelopmental assessment with griffiths scale at pre-school age of children with positional plagiocephaly followed in an early intervention program based on the osteopathic integrated approach

M. Filisetti*, D. Cattarelli, S. Bonomi

ASST del Garda, Pediatrics and Neonatology, Desenzano del Garda, Italy

BACKGROUND AND AIM

Positional plagiocephaly is a clinical condition that refers to a newborn with a flattening of the occipital region of the head. An increasing number of studies show that positional plagiocephaly is a risk factor for developmental delay in some motor, sensorial and cognitive areas of development. This implies that children with this condition require early recognition and early intervention and should be monitored during their growth. The Service "Neurodevelopment Follow-up and Pediatric Osteopathy" at Desenzano del Garda Hospital (Italy) offer a program of early intervention based on the osteopathic integrated approach following the teachings of Dr. Frymann. Since 2011 the Service has taken care of more than 300 children with positional plagiocephaly, followed in the first 18 months of life. Clinical evaluation showed normal neurological profile at the end of the follow up. The aim of the study is to evaluate neurological assessment at preschool age in children with positional plagiocephaly who received this program of early intervention.

METHODS

After the request of the ethics committee and the consent of the parents, children underwent a neurodevelopmental assessment with the Griffiths III neurodevelopmental scale at preschool age (4-6 year)

RESULTS

of the evaluations are ongoing

CONCLUSIONS

It's important to consider the long term impact of a early intervention program, especially in children with positional plagiocephaly, a condition that could impact neurological development later in life Acknowledgements: Authors thanks Dr. Viola Frymann, founder of the Osteopathic Center for Children (San Diego, CA) and international reference for pediatric osteopathy, for teachings and guidance

EP114 / #1382

E-Poster Viewing - Neonatology AS02-06. Development

Neurodevelopmental assessment with griffiths scale at pre-school age of children with positional plagiocephaly followed in an early intervention program based on the osteopathic integrated approach

M. Filisetti*, D. Cattarelli, S. Bonomi

ASST del Garda, Pediatrics and Neonatology, Desenzano del Garda, Italy

BACKGROUND AND AIM

Positional plagiocephaly is a clinical condition that refers to a newborn with a flattening of the occipital region of the head. An increasing number of studies show that positional plagiocephaly is a risk factor for developmental delay in some motor, sensorial and cognitive areas of development. This implies that children with this condition require early recognition and early intervention and should be monitored during their growth. The Service "Neurodevelopment Follow-up and Pediatric Osteopathy" at Desenzano del Garda Hospital (Italy) offer a program of early intervention based on the osteopathic integrated approach following the teachings of Dr. Frymann. Since 2011 the Service has taken care of more than 300 children with positional plagiocephaly, followed in the first 18 months of life. Clinical evaluation showed normal neurological profile at the end of the follow up. The aim of the study is to evaluate neurological assessment at preschool age in children with positional plagiocephaly who received this program of early intervention.

METHODS

After the request of the ethics committee and the consent of the parents, children underwent a neurodevelopmental assessment with the Griffiths III neurodevelopmental scale at preschool age (4-6 year)

RESULTS

of the evaluations are ongoing

CONCLUSIONS

It's important consider the long term impact of a early intervention program, especially in children with positional plagiocephaly, a condition that could impact neurological development later in life Acknowledgements: Authors thanks Dr. Viola Frymann, founder of the Osteopathic Center for Children (San Diego, CA) and international reference for pediatric osteopathy, for teachings and guidance

EP115 / #638

E-Poster Viewing - Neonatology AS02-06. Development

Clinical effect modifiers of long-term outcome in ventilated very preterm infants treated with systemic hydrocortisone

N. Halbmeijer^{1,2*}, M. Merkus³, W. Onland^{1,2}, A. Van Kaam^{1,2}

¹Amsterdam UMC, location University of Amsterdam, Neonatology, Amsterdam, Netherlands

²Amsterdam UMC, Amsterdam Reproduction & Development Research Institute, Amsterdam, Netherlands

³Amsterdam UMC location University of Amsterdam, Epidemiology and Data Science, Amsterdam, Netherlands

BACKGROUND AND AIM

The SToP-BPD (Systemic Hydrocortisone To Prevent Bronchopulmonary Dysplasia in preterm infants) study is the first large double-blind placebo-controlled randomized trial investigating the safety and efficacy of systemic hydrocortisone initiated between 7-14 days of life in invasively ventilated preterm infants. The objective of the current study was to investigate if the effect of hydrocortisone on long-term outcome is modified by patient characteristics.

METHODS

Preterm infants were randomly assigned to systemic hydrocortisone (cumulative dose 72.5 mg/kg; n=182) or placebo (n=190). Exploratory subgroup analyses for the composite outcome death or neurodevelopmental impairment (NDI) at two years' corrected age (CA), and its components were performed using the risk factors gestational age, small for gestational age, respiratory index, sex and multiple birth.

RESULTS

Among 371 patients (mean gestational age 26 weeks) who completed the trial, the composite outcome death or NDI was available in 356 (96.0%) infants. Gestational age subgroup analyses revealed a reduced rate of death or NDI in hydrocortisone treated infants born before 27 weeks' gestation compared with the placebo group (54.6% vs. 66.2%; relative risk 0.82 [95%CI 0.68-0.995]; $p=0.02$ for interaction). This effect was also found for the component death (20.1% vs. 32.1%; relative risk 0.63 [95%CI 0.42-0.93]; $p=0.049$ for interaction) but not for the component NDI. No differential treatment effects were observed across the other subgroups (Figure 1).

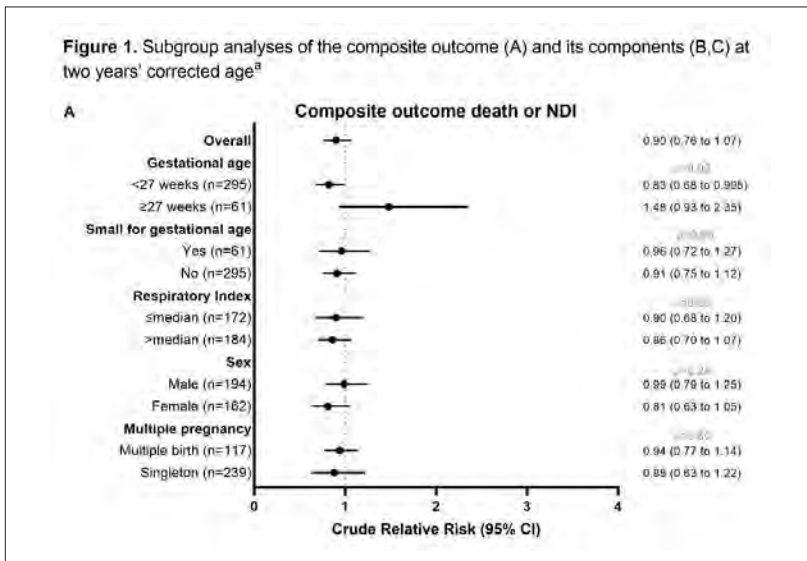

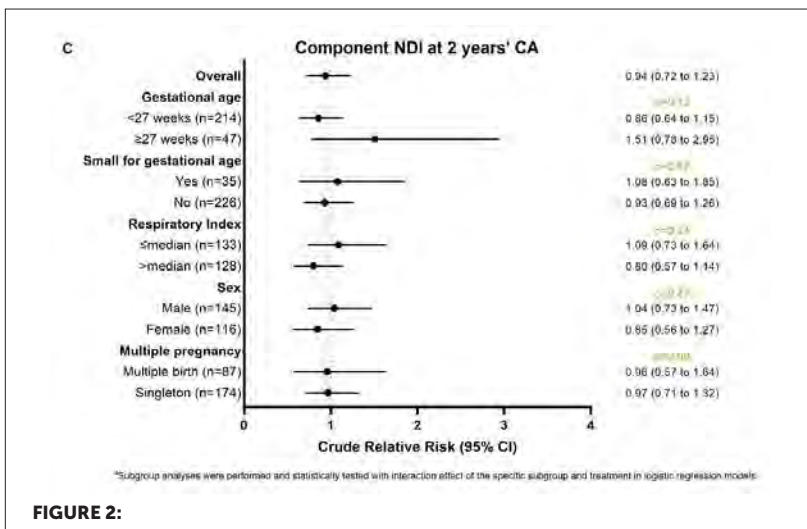
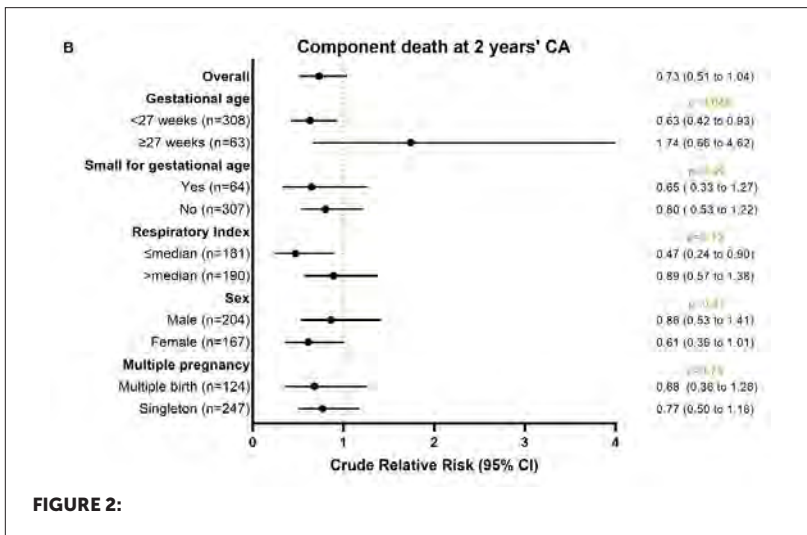

CONCLUSIONS

These results suggest that hydrocortisone improves survival in the subgroup of infants born before 27 weeks' gestation without increasing the risk of NDI at two years' CA.

EP116 / #2526

E-Poster Viewing - Neonatology AS02-06. Development

Efficacy and safety of early screening methods in neonates with risk factors for developmental dysplasia of hip in a rural setting

M. Hanson*

Tamworth Rural Referral Hospital, Department of Paediatrics, Tamworth, Australia

BACKGROUND AND AIMS

: Considerable variation in screening protocols for developmental dysplasia of the hip (DDH), controversy regarding the effectiveness of DDH screening, and lack of consensus regarding clinically significant imaging findings prompted this clinical audit to review the efficacy of screening protocols and practices for DDH at a rural referral hospital.

METHODS

Data was retrospectively gathered on a total of 355 patients who had been evaluated for DDH using hip ultrasound between June 2018 and June 2021. This data included clinical hip examination findings, the presence of DDH risk factors, findings on imaging up to four months of age, and any treatment received. Patients with first hip ultrasound > 4 months old, different US indication, and incomplete datasets were excluded.

RESULTS

Based on this study, patients with abnormal newborn hip examination were significantly more likely to have imaging findings of DDH (OR 3.313, 95%

CI 1.959-5.604). Additionally, females were 1.959 times more likely to have imaging findings of DDH (95 CI 1.065-3.603). Other factors classically considered to increase risk of DDH, such as breech birth and positive family history of DDH, were not shown to have any statistical significance. Very few patients in this cohort had severe DDH, and subgroup analysis was unable to be performed.

CONCLUSIONS

Overall, there remains inadequate evidence to determine the optimal indications for and means of screening for DDH. Further evaluation, particularly of patients with more severe cases of DDH, is required to obtain further clarity on these matters.

EP117 / #2233

E-Poster Viewing - Neonatology AS02-06. Development

Serum biomarkers to predict long-term outcome in neonatal encephalopathy; a systematic review and meta-analysis

T. Hurley^{1*}, M. O’Dea^{2,3,4,5}, A. Branagan¹, P. Stewart⁶, S. Tamgumus⁴, D. Mockler⁷, K. Kyng^{8,9,10,11}, E. Molloy^{1,12,13,14,15,16,17}

¹Trinity College Dublin, Paediatrics, Dublin, Ireland

²CWlUH, Neonatology, Dublin, Ireland

³Newborn Emergency Transport Service Western Australia, c/o Perth Children’s Hospital, Neonatology, Perth, Australia

⁴Coombe Women and Infants University Hospital, Neonatology, Dublin, Ireland

⁵Children’s Health Ireland, Crumlin, Neonatology, Dublin, Ireland

⁶Children’s Hospital Ireland, Temple Street, Paediatrics, Dublin, Ireland

⁷St. James’ Hospital, John Stearne Medical Library, Dublin, Ireland

⁸Aarhus University Hospital, Department of Pediatrics, Aarhus N, Denmark

⁹Aarhus University Hospital, Department of Pediatrics, Aarhus, Denmark

¹⁰Aarhus University Hospital, Department of Paediatric and Adolescent Medicine, Aarhus, Denmark

¹¹Aarhus University Hospital, Paediatrics and Adolescent Medicine, Aarhus, Denmark

¹²Trinity College Dublin, Trinity Translational Medicine Institute, Dublin, Ireland

¹³Coombe Women and Infants Hospital, Neonatology, Dublin, Ireland

¹⁴Trinity College Dublin, Discipline of Paediatrics, School of Medicine, Dublin, Ireland

¹⁵Trinity College Dublin, Trinity Research In Childhood Centre (tricc), Dublin, Ireland

¹⁶Children’s Health Ireland at Tallaght, Neonatology, Dublin, Ireland

¹⁷Tallaght, Children’s Health Ireland At Tallaght, Dublin, Ireland

BACKGROUND AND AIM

Neonatal encephalopathy (NE) biomarkers are important for early diagnosis, guiding prognosis, improved understanding of the disease pathophysiology, and identification of potential therapeutic agents. Many biomarkers have been investigated in recent years as potential prognostic markers, however none are used in routine clinical practice. We examined current evidence of serum biomarkers to predict long-term outcome in NE.

METHODS

The review was registered prospectively. EMBASE, PubMed, World of Science and the Cochrane Library databases were searched for studies that reported prognostic serum biomarkers in NE. Participants were dichotomised by groups into normal or adverse outcome, defined as death or abnormal neurodevelopmental outcome at >12 months of age. 2 reviewers independently completed the screening and data extraction. Risk of bias was completed using QUIPS tool. The mean difference in serum biomarkers between groups was calculated using a random effects model.

RESULTS

Literature search provided 3046 results. 98 studies of over 20 different biomarkers were eligible for qualitative synthesis, however only 41 studies could be included due to variation in biomarker measurement and reporting. Meta-analyses (MA) for serum IL-1 β , IL-6, NSE, TNF α , and S100 were completed. Serum IL-6, NSE, TNF α and were all lower in participants with normal outcome. However, there was substantial heterogeneity in the MA for both NSE and TNF α .

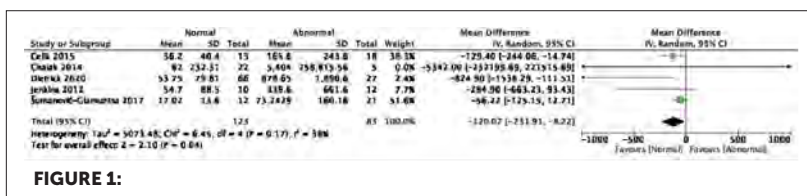

FIGURE 1:

CONCLUSIONS

Several biomarkers provide promising prognostic value in NE. Lower IL-6 is associated with normal long-term outcome in patients with NE. This relationship requires further evaluation. Many studies could not be included in a MA. Greater uniformity in biomarker reporting would allow improved evidence synthesis.

EP118 / #1269

E-Poster Viewing - Neonatology AS02-06. Development

Microcephaly at birth as a potential predictor of poor long-term prognosis in infants weighing 500 grams or less: a retrospective cohort study

R. Itoshima^{1,2,3*}, A. Oda^{1,4}, R. Ogawa^{1,4}, T. Yanagisawa¹, T. Hiroma^{1,4},
T. Nakamura^{1,4}

¹Nagano Children's Hospital, Division of Neonatology, Toyoshina, Japan

²University of Turku, Faculty of Medicine, Turku, Finland

³Turku University Hospital, Department of Pediatrics and Adolescent Medicine, Turku, Finland

⁴Nagano Children's Hospital, Life Science Research Center, Toyoshina, Japan

BACKGROUND AND AIM

The long-term prognosis in infants weighing ≤ 500 g is still unclear. This study aimed to assess the long-term outcomes in infants weighing ≤ 500 g and its association with microcephaly.

METHODS

A retrospective cohort study in a Level IV NICU in Japan. Infants who were born weighing ≤ 500 g between 2010 and 2019 were eligible. Those with a birth head circumference z score below -2 were classified in the Microcephaly group and the others in the Control group. The primary outcome was neurodevelopmental impairment (NDI) at 3 years of age. NDI was defined as having either a developmental quotient ≤ 70 , cerebral palsy, visual impairment, or hearing impairment.

RESULTS

Twenty-two infants were eligible: 6 in the Microcephaly and 16 in the Control group. The median (range) of gestational age and birth weight were 24^{2/7} weeks (22^{0/7}-29^{2/7}) and 428 g (258-498) in total. All eligible infants survived at 3 years of age. Compared with the Control group, the Microcephaly group had a higher incidence of NDI at 3 years of age (100% vs 37.5%, $P=.015$). In addition, microcephaly defined at due date or discharge was also significantly associated with a higher incidence of NDI ($P=.027$). The association was only significant in infants born at ≥ 24 weeks of gestation. No growth parameter showed a significant difference between the two groups at 3 years of age.

CONCLUSIONS

Microcephaly at birth and due date or discharge may be able to predict NDI at 3 years of age in infants weighing ≤ 500 g.

EP119 / #574

E-Poster Viewing - Neonatology AS02-06. Development

Birthweight and long-term neurodevelopmental outcomes across all gestations: is bigger better?

G. Jee^{1*}, S.J. Kotecha², M. Chakraborty^{2,3}, S. Kotecha^{2,3}, D. Odd^{3,4}

¹University Hospital of Wales, Paediatrics, Cardiff, United Kingdom

²Cardiff University, Child Health, Cardiff, United Kingdom

³University Hospital of Wales, Neonatology, Cardiff, United Kingdom

⁴Cardiff University, Population Health, Cardiff, United Kingdom

BACKGROUND AND AIM

Birthweight is the result of complex interactions between foetal, maternal, and environmental factors, and while a key predictor of perinatal morbidity and mortality, the impact of shifts in birthweight trends toward heavier infants is unknown. This study aims to assess if small (SGA) or large for gestational age (LGA) infants have worse long-term neurodevelopmental outcomes compared to infants with appropriate birthweights.

METHODS

Data was drawn from the Respiratory and Neurological Outcomes of Children Born Preterm study (RANOPs), a cross-sectional study of children across Wales. 7004 children with neurodevelopmental outcomes (median age 5, range 2-10 years), born from 23 weeks of gestation onwards were included. The primary neurodevelopmental outcome was parentally reported speech problems. Logistic regression was used to compare between LGA (>90th centile) and SGA (<10th centile) infants, and those with appropriate birthweights; adjusted for clinical and demographic confounders.

RESULTS

Although the adjusted OR was 1.28 (0.91-1.80) for infants born SGA and OR 0.95 (0.69-1.29) for LGA infants, this failed to reach statistical significance that these subgroups of infants were more likely to have long-term speech problems compared to infants born appropriate for gestational age (AGA). This study also found evidence suggesting potential long-term learning difficulties in infants born SGA (OR 1.73 (1.17-2.57)) and movement problems in infants born LGA (OR 1.83 (1.20-2.77)).

CONCLUSIONS

Infants born SGA or LGA do not have higher risks of speech problems in childhood when compared to infants with appropriate birthweights.

EP120 / #995

E-Poster Viewing - Neonatology AS02-06. Development

Association of moderate hypothermia at admission with short-term and long-term outcomes in extremely low birth weight infants

S.H. Kim*, J.H. Hwang, J. Jeong, H.N. Lee, J.M. Lee, B.S. Lee, E.A.-R. Kim, K.-S. Kim, E. Jung

Asan Medical Center, Department of Pediatrics, Seoul, Korea, Republic of

BACKGROUND AND AIM

Extremely low birth weight (ELBW) infants have premature thermoregulation and are easily exposed to hypothermia. We investigated the association of hypothermia at admission with short-term and long-term outcomes.

METHODS

Medical records of ELBW infants admitted to the neonatal intensive care unit at a tertiary medical center from June 2012 to February 2017 were retrospectively analyzed. Rectal body temperature was measured at admission. Moderate hypothermia was defined as admission temperature below 36°C.

RESULTS

Two hundred eight infants with gestational age of 26.4±2.3 weeks and birth weight of 746.7±154.9 g were included. Admission temperature ranged from 33.5°C to 36.8°C (median 36.1 °C). We performed univariate analyses of maternal and infant characteristics between moderate hypothermic and normothermic to mild hyperthermic infants. Vaginal delivery, lower gestational age, and lower birth weight were correlated with moderate hypothermia,

respectively. Logistic regression analyses, adjusted for confounders, showed that incidence of respiratory distress syndrome (RDS) and hemodynamically significant PDA (hsPDA) were associated with moderate hypothermia in ELBW infants. Moreover, abnormal mental developmental index scores of Bayley Scales of Infant Development-II at corrected age of 18 to 24 months of age were associated with moderate hypothermia, but not psychomotor developmental index, incidence of blindness, deafness, or cerebral palsy.

CONCLUSIONS

Moderate hypothermia at admission not only increases short-term neonatal morbidities such as RDS and hsPDA but also induces long-term neurodevelopmental impairment. Future large-scale multicenter studies are needed to clarify long-term consequences of admission hypothermia.

EP121 / #2338

E-Poster Viewing - Neonatology AS02-06. Development

Ventricle enlargement is associated to gaze scanning patterns and affect recognition in 12-year-old children born very preterm

O. Kochukhova^{1,2*}, Y. Kaul², M. Johansson², A. Geeb Karimi³, J. Wikström³, L. Hellström-Westas²

¹Uppsala University, Psychology, Uppsala, Sweden

²Uppsala University, Department of Womens and Childrens Health, Uppsala, Sweden

³Uppsala University, Radiology, Department of Surgical Sciences, Uppsala, Sweden

BACKGROUND AND AIM

Very preterm children are at risk of difficulties in recognition of facial expressions, which is an important ability in social visual perception. When visually scanning emotional faces, longer looking-time on the eyes (compared to the mouth) is associated with better affect recognition. Preterm periventricular brain injury is common and often affects the visual pathways and the posterior corpus callosum. **Aim:** To investigate if visual scanning strategies of emotional faces and affect recognition are associated to the morphology of lateral ventricles and visual pathways.

METHODS

Gaze scanning patterns were recorded with a Tobii eye tracker, during the NEPSY-II affect recognition subtest in 12-year-old children born <32 gestational weeks (n=24). Their ability to match emotional expressions and time spent on the eyes and mouth was compared to MRI-scan measures of the lateral ventricles and the posterior corpus callosum area.

RESULTS

The childrens' ability to identify similar emotional facial expressions correlated to ventricular enlargement both posteriorly ($r=-.394$, $p=.057$) and anteriorly ($r=-.444$, $p=.03$) and to a smaller posterior corpus callosum ($r=.468$, $p=.021$). The larger posterior part of the ventricles, the less time the children looked at the eyes ($r=-.69$, $p=.001$) and the more time they needed to reply ($r=.433$, $p=.035$).

CONCLUSIONS

Enlargement of the lateral ventricles and reduced volume of the posterior corpus callosum is associated with poorer affect recognition and less time spent on the eyes when scanning emotional faces. These findings may contribute to explain social problems in children born preterm.

EP122 / #1867

E-Poster Viewing - Neonatology AS02-06. Development

Inflammation, sepsis severity and long-term outcomes of neonatal sepsis in preterm neonates

S. Kurul^{1*}, F. Beckers¹, C. Ramakers², R. Kornelisse¹, I. Reiss¹,
S. Simons¹, H.R. Taal¹

¹Erasmus MC, University Medical Center-Sophia Children's Hospital, Neonatology, Rotterdam, Netherlands

²Erasmus MC, University Medical Center, Clinical Chemistry, Rotterdam, Netherlands

BACKGROUND AND AIM

Late-onset neonatal sepsis (LONS) is a major problem in the neonatal intensive care unit (NICU). LONS is associated with a hyper-inflammatory reaction, which might lead to neurodevelopmental impairment (NDI). We hypothesized that more severe inflammation has more adverse effects in later life. The aim was to investigate the association between inflammatory biomarkers (C-Reactive protein (CRP), procalcitonin (PCT) and interleukin-6 (IL-6)) and sepsis severity (neonatal Sequential Organ Failure Assessment (nSOFA)) and neurodevelopmental outcomes at 2 years.

METHODS

Data on all preterm neonates (gestational age at birth of <30 weeks) were reviewed from 2016 until 2019 (n=614). Outcomes of interest were NDI category (normal, mild, severe) and the motor and cognitive score on the Dutch-Bayley-Scales-of-Infant-and-Toddler-Development (Bayley-III-NL) assessed at the corrected age of 2 years. Logistic and linear regression analysis were used for categorical and continuous outcomes, respectively. All analyses were adjusted for gestational age, sex and birthweight-for-gestational age SD-score.

RESULTS

A total of 404 patients were eligible for analysis of which 187 (46.3%) experienced LONS. Maximum CRP levels were associated with lower motor and cognitive scores (effect estimate -0.034 points 95%CI(-0.067 - -0.001) and 0.032 points 95%CI(-0.061 - -0.004), respectively) and increase in severe NDI (OR 1.005, 95%CI(1.000 - 1.011)). High nSOFA scores (>4) were associated with lower motor scores (effect estimate -1.241, 95%CI(-2.457 - -0.260)) and mild NDI (OR 1.81, 95%CI(1.260 - 2.603)). There were no consistent associations between IL-6, PCT and the outcomes of interest.

CONCLUSIONS

High levels of inflammation and sepsis severity seem to be associated with neurodevelopmental outcomes in preterm neonates.

EP123 / #1153

E-Poster Viewing - Neonatology AS02-06. Development

Two year outcome of preterm babies born less than 30 weeks gestation in a level 2 neonatal unit(nnu)

K. Upatissa, S. Mahadevan-Bava*, S. Afridi

Dudley Group of Hospitals, Paediatrics, Dudley, United Kingdom

BACKGROUND AND AIM

NICE guideline NG72 (2017) recommends enhanced developmental surveillance for babies born <30 weeks gestation. The long-term follow up of these babies to assess neurodevelopmental-outcome remains a challenge for many NNUs. We reviewed data on survival and outcomes in acute and 2-year follow up care of preterm babies delivered in our level-2NNU. Aims: 1. To evaluate the immediate outcome of babies born less than 30 weeks gestation, 2. To assess the 2 year follow up and Bayley III development assessment, 3. To compare data with collected in 2015-2016.

METHODS

A retrospective data collection was done from neonates born <30 weeks gestation (January-December 2019) and admitted to our NNU. We compiled data from: a) Badgernet b) clinic follow up data c) 2 year exit Bailey development assessment. Babies were grouped: Group 1(born <27 weeks) transferred out to tertiary unit and Group 2(27-30 weeks) treated at LNU.

RESULTS

Total of 22 babies were included in the study. Demographics and immediate outcome data in Table 1.

TABLE 1:

		Group 1 <27weeks n=8 (36%)	Group 2 >27weeks n=14 (64%)
Total		8 (36%)	14 (64%)
RIP		2 (25%)	1 (7%)
Gender	Male:Female	2:5	9:6
Birth weight	500-750g	2(25%)	1(7%)
	751-1000g	2(25%)	2(14%)
	1001-1500g	2(25%)	8(57%)
	1501-2500g	0	3(21%)
Retinopathy		6 (33.3%)	1(8%)
IVH		4 (66.6%)	2 (15%)
CLD		5 (83.3%)	3(23%)
Home oxygen		5 (83.3%)	3(23%)
Home Tube Feeds		4(66.6%)	2(15%)

Bayley III Developmental Assessment outcome data are tabulated in Table 2.

TABLE 2:

Bayley outcome	Group 1 <27 weeks (n=6)	Group 2 >27 weeks (n=13)
Gross motor delay	2 (33%)	2 (15%)
Fine motor delay	1 (17%)	2 (15%)
Speech and language delay	2 (33%)	2 (15%)
Behavioral problems	-	2 (15%)
Visual impairment	-	-
Hearing problems	-	1 (8%)
Cerebral Palsy	1 (17%)	1 (8%)
Global Developmental delay	-	2 (15%)

CONCLUSIONS

Less preterm delivery in 2019 compared to 2015-2016. We attribute this to improved in-utero transfers. Survival was similar when compared to previous study. Less follow ups in 2019(COVID19 and logistics in parents visiting hospital might have contributed). Following previous study, team education on 2-year follow-up was carried out. This may have contributed to the improved present data(no discharges before 2years). Our audit reiterates:the need for a robust Neurodevelopmental-MDT-Clinic(neonatal and community teams), to improve standard of care, that will improve these babies to achieve their maximum-neurodevelopmental-potential.

EP124 / #932**E-Poster Viewing - Neonatology AS02-06.
Development****Aetiologies, treatment and outcome of antenatally diagnosed hydrops fetalis: a tertiary centre's experience over ten years.**

**C. Marín-Córdoba^{1*}, M. Morey-Olivé¹, A. Montaner-Ramón²,
F. Camba-Longueira², P. García-Manau³, M.T. Avilés García³, M.Á.
Sánchez-Duran³**

¹Vall d'Hebron University Hospital, Pediatrics, Barcelona, Spain

²Vall d'Hebron University Hospital, Neonatal Intensive Care Unit, Barcelona, Spain

³Vall d'Hebron University Hospital, Obstetrics, Barcelona, Spain

BACKGROUND AND AIM

Hydrops fetalis is a rare fetal condition with high mortality. The aim of this study is to determine the obstetric and perinatal outcomes of antenatally diagnosed HF, according to its aetiology and intrauterine treatment.

METHODS

Medical records of pregnant women with prenatal diagnosis of HF in a tertiary centre between 2011-2021 were reviewed retrospectively. Aetiologies, prenatal intervention and obstetric outcomes were recorded.

RESULTS

164 cases were included, most of them diagnosed at the second trimestre (56.1%). Invasive prenatal diagnosis was performed in 79.5% cases. The most common aetiologies were genetic disorders (37.5%), followed by unknown aetiology (16.4%), structural heart disease (11.6%), TORCH (7.9%), tachyar-

rhythmia (6.7%), anaemia (5.4%) and twin-to-twin transfusion syndrome (3.7%). 25.6% received intrauterine treatment: 10.4% cavity drainage/shunt, 6.7% intrauterine transfusion and 5.5% antiarrhythmic. Among all pregnancies, 74.4% were interrupted (26.2% miscarriage, 48.2% abortion). Pregnancies with a prenatal diagnosis of genetic or chromosomal disorders had higher rates of induced abortion than other aetiologies (69.3% vs. 48.2%). In pregnancies who received intrauterine treatment, 61.9% delivered live-born babies vs. 13.2% in those pregnancies without treatment ($p < 0.001$).

CONCLUSIONS

Despite advances in managing HF prenatally, obstetric and perinatal outcomes remain poor. The prognosis differs markedly depending on the underlying cause. It is essential to focus efforts on identifying the cause of the hydrops to determine its prognosis and assess the possibility of treatment.

EP125 / #1044**E-Poster Viewing - Neonatology AS02-06.
Development****Perinatal outcomes among live-born babies to women with prenatal diagnosis of hydrops fetalis: a tertiary centre's experience over ten years.****M. Morey-Olivé^{1*}, C. Marín-Córdoba¹, F. Camba-Longueira²,
A. Montaner-Ramón², C. Rodó Rodríguez³, S. Arévalo Martínez³**¹Vall d'Hebron University Hospital, Pediatrics, Barcelona, Spain²Vall d'Hebron University Hospital, Neonatal Intensive Care Unit, Barcelona, Spain³Vall d'Hebron University Hospital, Maternofetal Medicine, Barcelona, Spain**BACKGROUND AND AIM**

Hydrops fetalis (HF) is a rare condition with high mortality. The aim of this study was to explore perinatal and long-term outcomes following antenatal identification of HF and its predictors of prognosis.

METHODS

Medical records of 164 pregnant women with prenatal diagnosis of HF in a tertiary center between 2011 and 2021 were reviewed retrospectively. Prenatal intervention, clinical findings, aetiologies and outcomes of the live-born babies (LBB) were recorded.

RESULTS

Among 164 pregnancies, only 41 patients were born (56% with hydrops at birth). 75.6% were premature infants. The aetiologies with highest rates of LBB were tachyarrhythmia, immune hydrops, tumors and vasculolymphatic malformations. The highest incidence of adverse perinatal outcomes

was observed in structural heart disease (80% mortality in LBB). Favourable outcomes were observed in LBB with prenatal hydrops secondary to tachyarrhythmia or congenital infections (100% of survival). Rates of LBB were statistically significantly higher in pregnancies that received intrauterine treatment compared to those not treated/treatable (61% vs. 15%, $p=0.004$), as well as long-term survival (88% vs. 43.8%, $p=0.004$). 80% of newborns needed admission to NICU with an average length of stay of 39 days. Overall, 70% LBB had a long-term survival although 58% associated significant cardiovascular, renal or neurological morbidity.

CONCLUSIONS

Despite advances in managing HF, perinatal mortality is still significant, especially in untreatable causes of hydrops. Even among survivors significant morbidity is observed. These data are important in counselling families when HF is diagnosed antenatally.

EP126 / #1892**E-Poster Viewing - Neonatology AS02-06.
Development****Feasibility of using a parent-report questionnaire for two-year neurodevelopmental follow-up in infants born at 30-34 weeks' gestational age (ga)****M. Ryan¹, J. McIntyre², S. Johnson³, S. Ojha^{1,2*}**

¹University of Nottingham, Academic Unit of Population and Lifespan Sciences, School of Medicine, Nottingham, United Kingdom

²University Hospitals of Derby and Burton NHS Trust, Neonatal Intensive Care Unit, Children's Hospital, Derby, United Kingdom

³University of Leicester, Department of Health Sciences, Leicester, United Kingdom

BACKGROUND AND AIM

Preterm infants have significant risk of adverse neurodevelopmental outcomes with high health, social, and educational costs. While pathways exist for follow-up of extremely premature infants, more mature infants are not routinely assessed. We investigated the feasibility of using parent questionnaires to assess language, cognitive, and motor skills at 24 months corrected age for infants born at 30-34 weeks' GA.

METHODS

44 infants (21 female) were identified from Royal Derby Hospital's electronic patient records (EPR). Two were excluded (complex congenital conditions). Parents of 42 infants were offered paper or online questionnaires (Parent Report of Children's Abilities-Revised with motor components of the Ages and Stages-3). Basic demographic and clinical information were collected from EPRs.

RESULTS

We received 21/42 (57%) responses (4, uncontactable; 1 declined; 16 questionnaires not returned). 16/21 (76%) preferred online questionnaires with a greater response rate (online, 21/30 (70%) vs. paper 5/10 (50%)). There was no difference in clinical characteristics of responders vs. non-responders (Table 1). Non-responders had lower index of multiple deprivation scores. 3/21 had moderate/severe developmental delay (Table 1).

Table 1. Responses to 24mo corrected gestational age neurodevelopmental questionnaire for infants born at 30-34 weeks' gestational age

Comparison between responders and non-responders				
Characteristics	Responders N = 21	Non-responders N = 16		
Gestational age in weeks, median (IQR)	33 (31 to 4)	33 (32 to 33)		
Birth weight in grams, median (IQR)	2260 (1685 to 2500)	1961 (1565 to 2095)		
Females, n (%)	9 (43)	11 (69)		
Length of hospital stay in days, median (IQR)	17 (5 to 34)	18 (12 to 31)		
Co-morbidities, n(%)				
Respiratory distress syndrome	8 (38)	8 (50)		
Sepsis	1 (5)	1 (6)		
Necrotising enterocolitis	0	0		
Any intraventricular haemorrhage	0	0		
Maternal characteristics				
Age in years, median (IQR)	30 (26 to 35)	29 (26 to 36)		
Index of multiple deprivation score, median (IQR)*	13329 (7875 to 28196)	9386 (3040 to 14228)		
*p <0.05 for difference between responders and non-responders				
Neurodevelopmental scores of responders (n=21)				
	Median	IQR	Min	Max
Parent Report of Children's Ability- Revised				
Non-verbal cognition standard score *	101	93-110	53	124
Total language standard score*	93	82-101	53	119
* where standard scores have mean of 100 and SD of 15				
Ages and Stages Questionnaire-3 (motor scale only)				
Fine motor scale	50	45-60	30	60
Gross motor scale	55	50-60	40	60

CONCLUSIONS

Collection of 24 month outcomes is feasible using parental questionnaires, although response rate was low. Prospective engagement of families (at discharge with later reminders) could improve response rates. Non-responders were more likely to be from deprived backgrounds. More work is needed to engage underserved communities. Although more mature infants have lower burdens of adverse neurodevelopment compared to extremely preterm infants, some have moderate/severe delay. Follow-up is essential to ensure timely support can be provided.

EP127 / #708

E-Poster Viewing - Neonatology AS02-06. Development

Behavioral outcome of very low birthweight infants with neonatal sepsis at 5 years of age

V. Giordano, S. Stummer, C. Lindtner, R. Fuiko, A. Berger, K. Pichler*

Medical University of Vienna, Division of Neonatology, Pediatric Intensive Care and Neuropediatrics, Department of Pediatrics, Vienna, Austria

BACKGROUND AND AIM

Regardless of the improvements in the obstetric and neonatal intensive care, preterm infants are still at high risk for behavioral problems later in life. The spectrum, origin and potential risk factors of these problems have not been well elucidated yet. This study aimed to investigate neonatal sepsis as potential risk factor for adverse behavioral outcome in former very low birth weight infants (VLBWI) at the age of 5 years.

METHODS

In this retrospective observational study the influence of culture-proven neonatal sepsis on the behavioral outcome of VLBWI born at a gestational age < 32 weeks was analyzed at 5 years of age in a multivariable regression model. Behavior was assessed with the Child Behavior Checklist (CBCL). Neonatal morbidities, socioeconomic status and neurodevelopmental outcome served as covariates in the analysis.

RESULTS

312 VLBWI completed the study. 11% of them had experienced neonatal sepsis. Our study revealed neonatal sepsis to be a relevant risk factor for

both internalizing (emotional reactivity and anxiety/depression), as well as externalizing behavioral problems (oppositional and aggressive behavior) in this cohort of VLBWI. Low socioeconomic status and male gender were additional risk factors for adverse behavioral outcomes. There was no difference in neurocognitive development between infants with and without neonatal sepsis.

CONCLUSIONS

The presented study confirms that VLBWI are vulnerable to multiple behavioral disorders independent of their cognitive development. In contrast to former assumptions, the results of the study emphasize that not only postnatal environment but also neonatal morbidities, especially neonatal sepsis, have an impact on behavioral outcome of VLBWI at 5 years of age.

EP128 / #989

E-Poster Viewing - Neonatology AS02-06. Development

Embryonic size and growth measured on three-dimensional ultrasound scans using virtual reality techniques and adverse birth outcomes: the rotterdam periconception cohort

J. Roelants^{1*}, M. Vermeulen¹, S. Willemsen^{2,3}, J. Been^{1,2,4}, A. Koning^{2,5}, A. Eggink², K. Joosten⁶, I. Reiss¹, E. Steegers², R. Steegers-Theunissen^{1,2}

¹Erasmus MC Sophia Children's Hospital, University Medical Center Rotterdam, Department of Pediatrics, Division of Neonatology, Rotterdam, Netherlands

²Erasmus MC University Medical Center Rotterdam, Obstetrics and Gynecology, Rotterdam, Netherlands

³Erasmus MC University Medical Center Rotterdam, Biostatistics, Rotterdam, Netherlands

⁴Erasmus MC University Medical Center Rotterdam, Public Health, Rotterdam, Netherlands

⁵Erasmus MC University Medical Center Rotterdam, Department of Pathology, Rotterdam, Netherlands

⁶Erasmus MC Sophia Children's Hospital, University Medical Center Rotterdam, Department of Pediatrics, Pediatric Intensive Care Unit, Rotterdam, Netherlands

BACKGROUND AND AIM

Preterm birth, small for gestational age (SGA), and congenital anomalies are the most prevalent adverse birth outcomes, with lifelong health consequences. In the late first trimester, embryos at risk for an adverse birth outcome can be identified using two-dimensional ultrasonography (US). We assessed whether embryos at risk for adverse birth outcomes can be identified early in the first trimester by using three-dimensional (3D)-US.

METHODS

This prospective cohort study included pregnant women with reliable pregnancy dating. 3D-US scans were performed repeatedly between 6 and 13 weeks of gestation. Crown-rump length (CRL) and embryonic volume (EV) were measured using virtual reality (VR) techniques. Main outcome measure was adverse birth outcome; the composite outcome of SGA, preterm birth, congenital anomalies, stillbirth, or early neonatal mortality. Cross-sectional (embryonic size) and longitudinal (growth trajectories 6-13 weeks) regression analyses were performed.

RESULTS

We included 918 participants. From 7 weeks of gestation onward, CRL and EV were negatively associated with the odd of adverse birth outcome: a 1 mm smaller CRL at 7 weeks of gestation was associated with 14% higher odds of adverse birth outcome (adjusted odds ratio 0.86, 95% confidence interval 0.76 to 0.96, $p=0.008$). CRL growth trajectories were associated with adverse birth outcome.

CONCLUSIONS

Already very early in the first trimester of pregnancy, embryos at risk of adverse birth outcomes can be identified using 3D-US and VR. This expands the window of opportunity to identify embryos at risk from late to early first trimester, providing new possibilities to improve pregnancy outcome and health during the life-course.

EP129 / #2367

E-Poster Viewing - Neonatology AS02-06. Development

Resting-state functional connectivity and angiogenesis-related genes co-expression in preterm infants' cortical development

J. Sa De Almeida^{1*}, S. Loukas¹, S. Martin-Brevet¹, L. Vasung², D. Van De Ville³, D.-E. Meskaldji⁴, P. Hüppi⁴

¹University of Geneva, Department of Pediatrics, Geneva, Switzerland

²Boston Children's Hospital, Department of Medicine, Boston, United States of America

³Ecole Polytechnique Fédérale de Lausanne (EPFL), Institute of Bioengineering, Lausanne, Switzerland

⁴University of Geneva, Faculty of Medicine, Geneva, Switzerland

BACKGROUND AND AIM

Preterm infants show regional and age-specific resting-state functional MRI (rs-fMRI) activation patterns that are related to brain maturation. Since fluctuations in rs-fMRI signal intensity reflect cortical changes regarding levels of oxygenated blood flow supplying active neurons, we hypothesized that rs-BOLD (blood-oxygenation-level-dependent) variability may reflect angiogenesis-related maturity of intracerebral microvasculature.

METHODS

Publicly available data (<https://www.brainspan.org>) on prenatal to neonatal cortical expression of angiogenesis-related genes was used to assess regional cortical expression patterns. 22 very preterm infants have undergone a longitudinal rs-fMRI acquisition at 33 and 40 gestational weeks (GW). Average regional BOLD time-courses were extracted for each subject at each time-point and BOLD standard-deviation was estimated per cortical region using

the UNC neonatal atlas. The same cortical regions were assessed using both methods.

RESULTS

BOLD variability significantly increases from 33 to 40 GW in primary sensory and motor areas. The expression of the main angiogenic genes during the late fetal period, before 35 weeks GA, is particularly higher in the primary sensory and motor areas, in comparison to the other cortical regions and also to term age.

CONCLUSIONS

The expression of main angiogenic genes in primary sensory and motor cortical regions is evident during the late fetal period and precedes the BOLD variability increase observed from 33 GW to term-age in those regions. Such findings support that changes in BOLD variability between preterm and term periods might describe vascular hemodynamic changes determined by early angiogenesis and related to cerebrovascular maturation.

EP130 / #2405

E-Poster Viewing - Neonatology AS02-06. Development

Survival and neurodevelopmental outcomes in extremely low birth weight preterm infants after two years of corrected age - a level iii hospital analysis

E. Sousa*, M. Bastos Gomes, A. Costa Azevedo, E. Proença, A. Guedes, A.M. Alexandrino, A. Novo, S. Domingues

Centro Materno Infantil do Norte - Centro Hospitalar Universitário do Porto, Neonatal Intensive Care Unit, Porto, Portugal

BACKGROUND AND AIM

Over the past decades, clinical care improvement of preterm infants has resulted in increased survival, which might increase disability. We reviewed survival and neurodevelopmental outcomes of extremely low birth weight (ELBW) infants born in our institution.

METHODS

Retrospective analysis of all ELBW infants born between 2014-2018, evaluating demographic data, comorbidities and survival with major disability or minor/no disability. The Griffiths Mental Development Scale-Extended Revised II (GMDS-ER) was applied after two years of corrected age (CA).

RESULTS

Among the 16210 live-born infants, 154 were ELBW, of which 94 (61%) survived. Median birth weight was 840g vs 647g, and median gestational age was

28 weeks vs 25 weeks, survivors vs non-survivors, respectively. The median age of death was 3 days. of the survivors, 15 lost follow-up or did not perform GMDS-ER. of the 79 infants with complete assessment, 18% had major disability (deafness: 1; cerebral palsy: 1; developmental quotient (DQ)<70: 12) and 82% had minor/no disability. The median DQ was 88. Children with major disability had lower Apgar Score at the first minute, more extended length of hospitalization and lower head circumference at two years CA ($p<0,05$).

CONCLUSIONS

In our ELBW cohort, 61% survived and from those who maintained follow-up and underwent GMDS-ER, 82% had minor or no disabilities after two years CA. The median DQ in this group was lower than in the general population, but within 1 SD. These results are relevant for clinicians when providing counselling for families facing extremely preterm birth.

EP131 / #670

E-Poster Viewing - Neonatology AS02-06. Development

The impact of repeated administration of sucrose on long-term neurodevelopment of preterm infants at 36 months corrected age

B. Stevens^{1,2*}, M. Bueno², M. Ballantyne^{3,4}, M. Campbell-Yeo^{5,6}, C. Estabrooks⁷, S. Gibbins⁸, D. Harrison^{9,10}, C. Mcnair¹¹, S. Riahi², J. Squires^{10,12}, A. Synnes¹³, A. Taddio², C. Victor¹⁴, J. Yamada¹⁵

¹University of Toronto, Lawrence S. Bloomberg Faculty of Nursing & Faculties of Medicine and Dentistry, Toronto, Canada

²The Hospital for Sick Children, Child Health Evaluative Sciences, Toronto, Canada

³Holland Bloorview Kids Rehabilitation Hospital, N/a, Toronto, Canada

⁴University of Toronto, Lawrence S. Bloomberg Faculty of Nursing, Toronto, Canada

⁵Dalhousie University, Departments of Pediatrics and Psychology & Neuroscience, Halifax, Canada

⁶IWK Health Centre, Centre For Pediatric Pain Research, Halifax, Canada

⁷University of Alberta, Edmonton Health Clinic Academy, Edmonton, Canada

⁸Trillium Health Partners, Professional Practice, Mississauga, Canada

⁹University of Melbourne, Department of Nursing, Melbourne, Australia

¹⁰University of Ottawa, Faculty of Health Sciences, Ottawa, Canada

¹¹The Hospital for Sick Children, Pediatrics, Toronto, Canada

¹²Ottawa Hospital Research Institutes, Clinical Epidemiology Program, Ottawa, Canada

¹³University of British Columbia, Pediatrics, Vancouver, Canada

¹⁴University of Toronto, Institute For Clinical Evaluative Sciences (ices), Toronto, Canada

¹⁵Ryerson University, Daphne Cockwell School of Nursing, Toronto, Canada

BACKGROUND AND AIM

Preterm infants in the Neonatal Intensive Care Unit (NICU) undergo multiple painful procedures during hospitalization. Sucrose is commonly administered to mitigate procedural pain; however, long-term effects of repeated sucrose are unknown. Our goal was to examine the association of total sucrose volume and neurodevelopment of preterm infants at 36 months corrected age (CA).

METHODS

A longitudinal observational study was conducted in four level-III Canadian NICUs. Infants <32 weeks gestational age (GA) at birth and <10 days of life were included. Sucrose 24% (0.1ml) was administered prior to all skin-breaking procedures during the NICU stay and the total volume was calculated. Infants were assessed at 36 months CA using the Bayley Scales of Infant and Toddler Development (BSITD-III). The standardized mean score for each BTSID-III component was reported. Scores ≥ 85 are within normal limits.

RESULTS

60 infants completed the BSITD-III assessment (34 male, mean GA at birth 28.9 [± 2.2] weeks, mean birth weight (1,174.4 [± 359.3] grams). Infants received an average of 5.33 [± 5.58] mls of sucrose during the hospitalization for an average of 56.5 [± 89.1] painful procedures. The mean BSITD-III scores were within normal limits; cognitive 96.0 [± 9.2], language 101.4 [± 13.1], and motor 96.3 [± 14.3]. There was no statistically significant association between total sucrose volume and cognitive ($p=0.60$), language ($p=0.31$), and motor ($p=0.40$) scores in an adjusted model for birthweight and maternal depression.

CONCLUSIONS

Results do not indicate neurodevelopmental delay in preterm infants assessed at 36 months CA or any relationship with total sucrose volume during the hospital stay.

EP132 / #2344

E-Poster Viewing - Neonatology AS02-06. Development

Outcome of very preterm born infants after periventricular haemorrhagic infarction (option study)

P. Thwaites^{1*}, L. Hofer², U. Held², D. Bassler¹, G. Natalucci³

¹University of Zurich and University Hospital Zurich, Newborn Research, Department of Neonatology, Zurich, Switzerland

²University of Zurich, Department of Biostatistics At Epidemiology, Biostatistics and Prevention Institute, Zurich, Switzerland

³University of Zurich and University Hospital Zurich, Family Larsson-rosenquist Foundation Centre For Neurodevelopment, Growth and Nutrition of The Newborn and Newborn Research, Department of Neonatology, Zurich, Switzerland

BACKGROUND AND AIM

Assessment of risk factors for outcomes of very preterm infants (VPT) with periventricular haemorrhagic infarction (PVHI) is essential for parental counselling when considering withdrawing intensive care. We aimed to identify associations of neonatal cranial ultrasound (cUS) characteristics with no or mild neurodevelopmental impairment (no-NDI).

METHODS

This retrospective population-based cohort study used electronic cUS-data of infants with PVHI born at 24-31 weeks' gestation, without severe congenital malformations, in Switzerland in 2002-2014. PVHI were characterised according to published criteria, based on the cUS showing the highest injury level. Odds ratios (95% CI) of cUS characteristics for the outcome no-NDI at 2 years of corrected age were estimated using Firth logistic regression. Bias caused by outcome truncation due to death was assessed by sensitivity analysis for survivor average causal effects (SACE).

RESULTS

Among 290 VPT who developed PVHI (6% of 4956 eligible), cUS-data of 153 (53 female) were available: 77 died (79% after care withdrawal) and among survivors (all had follow-up), the no-NDI rate was 51%. The odds of having no-NDI were 0.24- (0.02 to 1.54), 0.19- (0.06 to 0.59) and 0.09- (0.00 to 0.95) fold lower with bilateral lesions, ≥ 3 territories involved, and midline shift, respectively. Sensitivity analysis revealed that the SACE in these estimates would be even more extreme.

CONCLUSIONS

This study shows a high rate of care withdrawal in VPT with PVHI and, among survivors, strong negative associations of three cUS characteristics of PVHI (bilateral lesions, midline shift, and ≥ 3 territories involved) with no-NDI. These findings may guide neonatal care.

EP133 / #1139

E-Poster Viewing - Neonatology AS02-07. Endocrinology & diabetes

Early-life morbidities and thyroid-stimulating hormone levels in extremely preterm infants

Y.-C. Lin¹, L.-W. Chen^{1*}, C.-H. Chu², H.-J. Chen¹, S.-M. Kao³, C.-C. Huang¹

¹National Cheng Kung University Hospital, College of Medicine, National Cheng Kung University, Department of Pediatrics, Tainan, Taiwan

²Tunghai University, Department of Statistics, Taichung, Taiwan

³The Chinese Foundation of Health, Neonatal Screening Center, Taipei, Taiwan

BACKGROUND AND AIM

Preterm infants have immature hypothalamus-pituitary-thyroid axis vulnerable to adverse exposures. We hypothesized that the distribution pattern of thyroid-stimulating hormone (TSH) is associated with specific neonatal morbidities in extreme prematurity without hypothyroidism.

METHODS

The multicenter population cohort analyzed 434 extremely preterm infants receiving TSH screening at 24-96 hours of age in 2008-2019. Infants were categorized by blood TSH levels into Group 1: TSH < 0.5 μ U/mL, Group 2: $0.5 \leq$ TSH < 2 μ U/mL, Group 3: $2 \leq$ TSH < 4 μ U/mL, and Group 4: TSH \geq 4 μ U/mL. Morbidities were graded using the modified Neonatal Therapeutic Intervention Scoring System, including respiratory distress syndrome (RDS) requiring ventilatory assistance, brain injury, hemodynamically-significant patent ductus arteriosus, necrotizing enterocolitis (NEC) and non-NEC gastrointestinal events, and infection and hypotension.

RESULTS

The four TSH groups differed significantly in proportions of mechanical ventilation usage ($P = 0.01$) and hypoxic respiratory failure ($P = 0.005$), and major brain injuries including high-grade intraventricular hemorrhage ($P = 0.007$) and periventricular leukomalacia ($P = 0.048$). Group 1 had higher severity scores for RDS (effect size 0.39 [95% CI 0.18 – 0.59]) and brain injury (0.36 [0.15 – 0.57]) than Group 2, which remained significant after adjusting for gestational age and the postnatal age at TSH screening (RDS: mean +0.46 points [95% CI 0.10 – 0.82]; brain injury: +0.33 [0.11 – 0.54]).

CONCLUSIONS

Low TSH levels in extreme prematurity were associated with severe RDS and brain injuries. TSH levels by newborn screening may represent the hypothalamus-pituitary-thyroid responses to a disturbed lung-brain axis in extreme prematurity.

EP134 / #2293

E-Poster Viewing - Neonatology AS02-07. Endocrinology & diabetes

Unusual clinical presentation of congenital hypothyroidism as pseudo-obstruction

O.P. Rozakea^{1*}, L. Mentesidou¹, E. Kassari¹, K. Karantzas¹, G. Tsiolaki¹, A. Pana², G. Kourousi¹, M. Chantziopalti¹, T. Bachou¹, D. Delis¹

¹General Children's Hospital P&A Kyriakou, A' Paediatric Clinic, Athens, Greece

²Agios andreas General Hospital, Nicu, Patras, Greece

BACKGROUND AND AIM

Congenital hypothyroidism appears in 1:4000-1:3000 of liveborn infants. It is usually asymptomatic soon after birth and diagnosed on mass pre-symptomatic testing of newborns. However, there can occasionally be symptoms from various systems. Specifically, from the GI, there can be delayed meconium passage, prolonged jaundice, bowel motility disorder, feeding intolerance or vomiting. The aim of the abstract is to present such a rare clinical demonstration of congenital hypothyroidism.

METHODS

A 21-day-old male infant was presented due to vomiting, diarrheas and abdominal flatulence.

RESULTS

Clinically the baby had flatulence, periodically more severe, watery stools (pseudo-diarrheas?) and refluxing. The initial testing for infection was negative, as was the abdominal ultrasound scan. However, on the abdominal X-ray (image 1) the bowel appeared full of air until before the orthosigmoid. Hence, a barium enema was performed (images 2,3), which suggested Hirschsprung's disease. Following that, the baby had a Swenson biopsy that was normal. At

the same time, TFTs were performed and, due to hypothyroidism, T_4 treatment was started and symptoms gradually receded.



FIGURE 1:

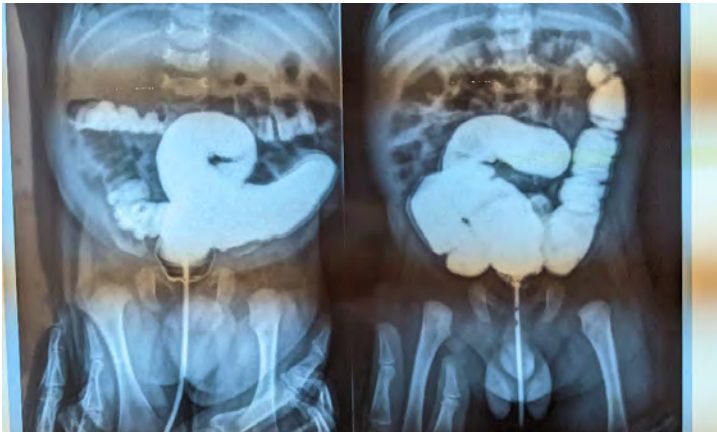
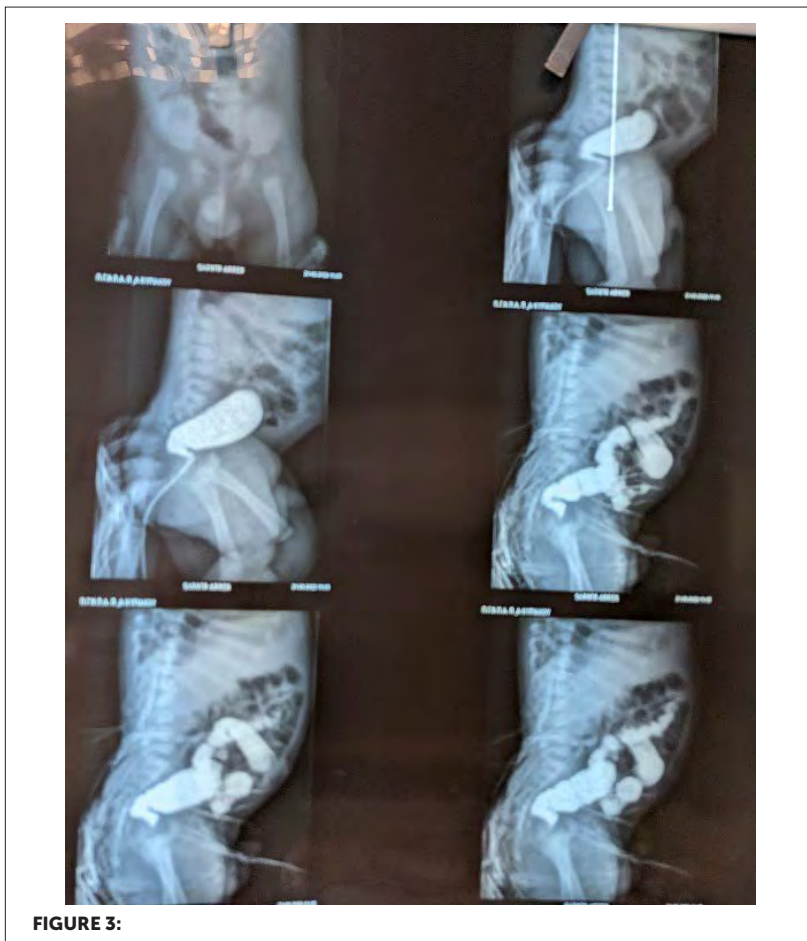

FIGURE 2:



CONCLUSIONS

1) Hirschsprung's disease might be suspected clinically and radiologically, nevertheless the diagnosis is histopathological. 2) In neonates with bowel motility disorder, there should be high suspicion for hypothyroidism, as it can even present as pseudo-obstruction.

EP135 / #1936**E-Poster Viewing - Neonatology AS02-07.
Endocrinology & diabetes****Adrenal suppression in neonates receiving
steroids for respiratory management****S. Sahmoud^{1,2*}, R. Alia³, S. Gupta¹**¹Hull Royal Infirmary, Paediatric Department, Hull, United Kingdom²Suez Canal university, Paediatric Department, Ismailia, Egypt³Hull Royal Infirmary, Neonatal Unit, Hull, United Kingdom**BACKGROUND AND AIM**

Exogenous glucocorticoids are associated with adrenal insufficiency. Prolonged courses of steroids and usage of supraphysiological doses increase the risk of adrenal suppression. We aimed at Identifying babies at risk of developing adrenal suppression due to steroid therapy as a respiratory management.

METHODS

Data base of neonates admitted to Hull Royal Infirmary neonatal unit (UK) between January 2019 and January 2021 was searched for all babies who received steroids for any reason or had respiratory conditions / chronic lung disease.

RESULTS

In the 2-year period, 41 babies received systemic steroids for different reasons. 25 babies (61%) received steroids for respiratory management. The majority had it to assist with weaning off respiratory support. The mean total duration of steroids courses was 22 days. Babies received different course including

DART, MINIDEX, MAXIDEX and / or inhaled Budesonide. 30% of babies had adrenal suppression following Short Synacthen Test. Out of these babies with adrenal suppression, 60% were asymptomatic, 14 % had hypotension and 28% had poor weight gain.

CONCLUSIONS

Steroids use for respiratory management in neonates is common practice. Many of these babies develop adrenal suppression. The majority can be asymptomatic. Risk assessment for screening and treating babies receiving steroids for respiratory management should be considered in all eligible babies.

EP136 / #1653**E-Poster Viewing - Neonatology AS02-08.
Epidemiology****Epidemiology of neonatal tetanus: the brazilian reality**

C. Augusto De Lima^{1*}, D. Alves Da Costa Canella², S. Silva Sabino³, S. Silva Sabino³, S. Silva Sabino⁴, O. Augusto Freire Campos³, E. Gonçalves Silva⁴, M. De Lima Alves⁴, M. Evelyn Da Silva³, E. Fellipe Capini De Almeida Tavares⁵, T. Calegari³

¹UFU, Faculty of Medicine, Uberlândia, Brazil

²Universidade Federal da Grande Dourados, Faculty of Medicine, Uberlândia, Brazil

³UFU, Faculty of Medicine, Uberlândia, Brazil

⁴UNIPAC, Health Department, Uberlândia, Brazil

⁵EMESCAM, Faculty of Medicine, Uberlândia, Brazil

BACKGROUND AND AIM

The aim of this study was to carry out an analysis descriptive and quantitative epidemiological analysis of neonatal tetanus cases in Brazil.

METHODS

This is an epidemiological, descriptive and quantitative study on neonatal tetanus in Brazil, using secondary data on the disease that were recorded in the Notifiable Diseases Information System (SINAN), from January 2007 to December 2016, from January 2007 to December 2016. of the Neonatal Tetanus Notification and Epidemiological Investigation Form, from the Brazilian Ministry of Health.

RESULTS

From 2007 to 2016, an annual average of 3.70 confirmed cases was observed in Brazil, with a significant downward trend. As for the region of occurrence, there was a predominance of the North (40.54%). The analysis of the age indicated in the notification forms showed that 43.24% of the occurrences in individuals with up to 6 days of life and 54.05% corresponded to ages between 7 and 14 days. The predominant maternal age was 25 to 29 years (26.49%) with low education (80.65%), predominance in the mixed race (60.00%) and in residents of rural areas (64.86%), with place of birth at home (65.71%) and it is noteworthy that the observed mortality rate was 60.61%.

CONCLUSIONS

The epidemiological profile showed that regional, social and Cultural events, especially in rural areas, are factors that prevent the eradication of cases. However, the number of cases is falling and the mortality rate has been non-existent in the last four years, demonstrating the expertise in terms of diagnosis and effective treatment on the part of the health team.

EP137 / #1717**E-Poster Viewing - Neonatology AS02-08.
Epidemiology****Notifications of february typhoid cases in children
in the period 2009 to 2019**

**C. Augusto De Lima^{1*}, D. Alves Da Costa Canella², S. Silva Sabino³,
S. Silva Sabino³, S. Silva Sabino⁴, M. Evelyn Da Silva³, O. Augusto
Freire Campos³, M. De Lima Alves⁴, E. Gonçalves Silva⁴, E. Fellipe
Capini De Almeida Tavares⁵, T. Calegari³**

¹UFU, Faculty of Medicine, Uberlândia, Brazil

²Universidade Federal da Grande Dourados, Faculty of Medicine, Uberlândia, Brazil

³UFU, Faculty of Medicine, Uberlândia, Brazil

⁴UNIPAC, Health Department, Uberlândia, Brazil

⁵EMESCAM, Faculty of Medicine, Uberlândia, Brazil

BACKGROUND AND AIM

To analyze and describe the epidemiological profile of typhoid fever in children aged zero to nine years in Brazil.

METHODS

Data were collected in the Hospital Information System (SIH). Data were collected on typhoid fever in children (from zero to nine years old), reported during the period from 2009 to 2019 in Brazil. The parameters used were: age group, confirmed cases, region of residence and sex.

RESULTS

In Brazil, from 2009 to 2019, a total of 1,238 cases of typhoid fever were confirmed, of which 260 (21%) are cases of children (from zero to nine years old). The highest incidence was in 2009 (63.8%) followed by 2011 (15%), with

a drop in the following years, in 2019 4 cases of typhoid fever were confirmed in this age group. In the analyzed period, the lowest number of records was in patients residing in the South and Midwest regions (0.7%) and the highest number was in residents of the North region (63.3%). As for gender, males were the most predominant (51.5%), and in the research there was a higher prevalence in the age group from 5 to 9 years (66.2%).

CONCLUSIONS

The cases of typhoid fever have been decreasing over the years, showing that it is possible to control and significantly reduce the number of cases with simple practices such as good food hygiene and access to adequate sanitation. health education, alerting the population about transmission, remembering to reinforce the means of direct contact (fecal-oral route) during children's play.

EP138 / #1587**E-Poster Viewing - Neonatology AS02-08.
Epidemiology****Validity of hospital discharge summaries for
identifying hypoxic-ischemic encephalopathy****A. Ego***

MISIT, Pôle Santé Publique, Grenoble Cedex, France

BACKGROUND AND AIM

Neonatal hypoxic ischemic encephalopathy (HIE) occurs in about 1 per 1000 births, and is a major cause of death and neurodevelopmental impairment among term infants. Hypothermia has recently improved these outcomes but population data are needed to monitor changes in care and prognosis. We sought to measure the validity of ICD-10 codes for HIE in hospital discharge data (HDD).

METHODS

The study linked HDD between September 2015 and March 2017 with the French population-based Lytonepal cohort of moderate and severe HIE at ≥ 34 weeks of gestation admitted to 68 French NICU. We examined the sensitivity and positive predictive value (PPV) of the ICD-10 code for HIE (P91.6) and then successively associated other codes: cerebral ischemia (P91.0), neonatal asphyxia (P21), seizures (P90) and hypotonia (P94.2).

RESULTS

Out of 1,157,846 births, 1,003 infants had confirmed HIE (0.87 per 1000 births, (95%CI 0.81-0.92)). 1,490 newborns had a code of P91.6 (1.29 per 1000 births, (95%CI 1.22-1.35)) of which 440 were confirmed cases (52% sensitivity, 30%

PPV). Including cerebral ischemia (P91.0) identified 2,208 cases, of which 533 were confirmed cases (63% sensitivity, 24% PPV); including neonatal asphyxia (P21) identified 49,449 cases, of which 693 were confirmed cases (82% sensitivity, 1% PPV); including seizures and hypotonia (P90 and P94.2) yielded 196,767 cases for a sensitivity of 84% and a PPV of 0.4%.

CONCLUSIONS

HIE is not reliably recorded in HDD. Future work should explore whether algorithms using other information (associated diagnoses, procedures, length/unit of hospitalisation) could improve HDD performance for identifying HIE.

EP139 / #772**E-Poster Viewing - Neonatology AS02-08.
Epidemiology****A single centre perinatal outcomes following extreme preterm birth before 27 weeks gestation pre and post adoption of the bapm framework.****T. Eyo*, H. Gowda**

University Hospitals Birmingham NHS Trust, Neonatal Intensive Care Unit, Bordesley Green East, United Kingdom

BACKGROUND AND AIM

In October 2019, the British Association of Perinatal Medicine (BAPM) published a framework of practice for perinatal care of extreme preterm. It offered risk stratification and preterm stabilization from 22 weeks onwards. Our level 3 NICU adopted this in May 2020. Aim: To compare the rates of Mortality, Bronchopulmonary dysplasia (BPD), Necrotising Enterocolitis (NEC); Grade 3 & 4 Intraventricular haemorrhages (IVH), pre and post adoption of BAPM framework.

METHODS

Retrospective observational study from September 2018 to January 2022. Data from pre-implementation epoch (20 months) was compared to post-implementation epoch (20 months). Data were collected from electronic badger and analysed on Microsoft Excel.

RESULTS

Total of 144 neonates born <27 weeks during study period. 66 were in pre-implementation epoch and 78 in post-implementation epoch. Mortality was

27% in both epochs. However, in the 24 & 25-weekers mortality fell by 14% and 22% respectively (Fig.1). NEC rates fell by 9% and BPD showed an overall 4 % decline. Large IVHs dropped by 2%.

TABLE 1:

Epochs	Total admissions	Death	NEC	BPD	IVH	Antenatal Steroids	Magnesium Sulphate
Pre	66	18 (27%)	22 (33%)	37 (77%)	13 (20%)	59 (89%)	46 (70%)
Post	78	21 (27%)	19 (24%)	42 (73%)	16 (18%)	67 (86%)	56 (71%)

CONCLUSIONS

More number of 22 and 23 weekers were admitted on post implementation epoch. Even though overall mortality remains same, mortality among 24 & 25 weekers gestation is reduced. Overall outcomes of NEC, BPD and IVH have improved.

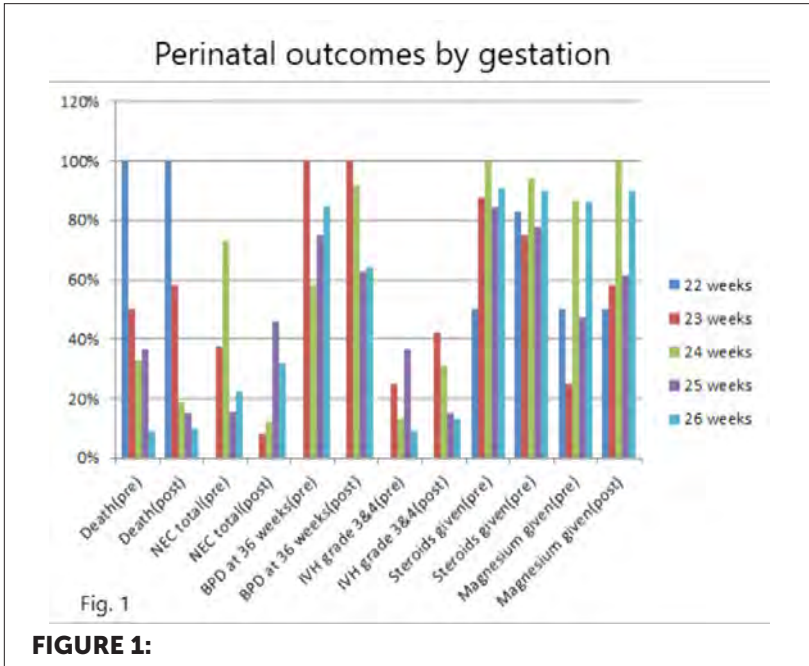

EP140 / #1738

E-Poster Viewing - Neonatology AS02-08. Epidemiology

Resource utilization among periviable preterm infants in the united states, 2009-2018

Z. Frimpong^{1*}, R. Turkson², E. Bih³, M. Boateng⁴, M. Osei-Bonsu⁵, H. Doshi⁶, K. Donda⁷, N. Parmar⁸, P. Bhatt⁹, F. Dapaah-Siakwan¹⁰

¹University of Ghana Hospital, Outpatients Department, Accra, Ghana

²Unaffiliated, Unaffiliated, Lowell, United States of America

³Carnegie Mellon University, Heinz College of Information Systems and Public Policy, Pittsburgh, United States of America

⁴Unaffiliated, Unaffiliated, Worcester, United States of America

⁵Unaffiliated, Unaffiliated, Lawrenceville, United States of America

⁶Children's Hospital of Southwest Florida, Pediatrics/neonatology, Fort Myers, United States of America

⁷University of South florida, Pediatrics/neonatology, Tampa, United States of America

⁸East Tennessee Children's Hospital, Pediatrics, Knoxville, United States of America

⁹United Hospital Center, Pediatrics, Bridgeport, United States of America

¹⁰Valley Children's Hospital, Neonatal Intensive Care Unit, Madera, United States of America

BACKGROUND AND AIM

While the survival of periviable preterm infants in the US has improved, the healthcare resource use associated with this has not been studied. We aimed to examine trends in the length of stay (LOS) and inflation-adjusted hospital cost (HC) for preterm infants born at ≤ 24 weeks gestation in the US from 2009 – 2018.

METHODS

This was a retrospective, repeated cross-sectional analysis of hospital discharges within the National Inpatient Sample for preterm infants ≤ 24 weeks gestation from 2009 – 2018. Infants with survival < 24 hours or implausible birthweights were excluded. The primary outcome was the changes over

time in LOS and HC. Linear regression was used for trend analysis. $P < 0.05$ was considered significant.

RESULTS

Among a total of 71,854 preterm infants ≤ 24 weeks, 37,603 (52.5%) survived the first 24hrs and were included in the study. Survival to discharge among those ≤ 23 weeks increased from 29.6% in 2009 to 41.7% in 2018 ($P < 0.001$). Survival to discharge for GA 24 weeks increased from 58.3% in 2009 to 65.9% in 2018 ($P < 0.001$). LOS increased 109 days (IQR, 91-127) in 2009 to 121days (IQR, 104-147) [adjusted odds ratio (aOR): 0.95 days, 95% CI: 0.53-1.38, $P < 0.001$]. Hospital cost increased from \$599,574 (IQR, 395,804 - 882,910) in 2009 to 1,175,863 (IQR, 800,703 - 1,732,835) [aOR \$80,919, 95% CI: \$71,892-89,947, $P < 0.001$].

CONCLUSIONS

Resource use for preterm infants ≤ 24 weeks gestation increased significantly in tandem with increased survival. This could inform changes in policy that adequately reimburses hospitals for the care of these infants.

EP141 / #2259

E-Poster Viewing - Neonatology AS02-08. Epidemiology

Withholding enteral feeds around packed red cell transfusion to prevent necrotising enterocolitis in preterm neonates (wheat): a multi-centre pilot trial

C. Gale^{1*}, S. Jawad¹, A. King², H. Robbarts¹, A. Forster³, N. Modi¹, M. Turner⁴, T. Van Staa⁵, C. Cole², K. Stanbury², K. Ougham¹, J. Dorling⁶, E. Juszczak⁷

¹Imperial College London, School of Public Health, London, United Kingdom

²National Perinatal Epidemiology Unit, Nuffield Department of Population Health, University of Oxford, Clinical Trials Unit, Oxford, United Kingdom

³James Cook University Hospital, Neonatal Unit, Middlesbrough, United Kingdom

⁴University of Liverpool, Institute of Life Course and Medical Sciences, Liverpool, United Kingdom

⁵University of Manchester, Division of Informatics, Imaging & Data Sciences, Manchester, United Kingdom

⁶University Hospitals of Southampton, Neonatal Intensive Care Unit, Southampton, United Kingdom

⁷University of Nottingham, Nottingham Clinical Trials Unit, Nottingham, United Kingdom

BACKGROUND AND AIM

Prevention of necrotising enterocolitis (NEC) is a research priority but requires recruitment of large numbers of preterm babies. Embedding trial processes within existing electronic health record (EHR) systems may increase trial recruitment and facilitate large trials. We tested the feasibility of an EHR-embedded multicentre neonatal trial to prevent NEC.

METHODS

A randomised, multicentre, pilot trial comparing two care pathways: continuing or withholding milk feeds around red cell transfusion in babies born

<30+0 gestational weeks. Participant identification, recruitment, randomisation and trial data collection were embedded within existing neonatal EHR systems; outcome data were extracted from routinely recorded data in the National Neonatal Research Database. A streamlined opt-out approach to consent was used. Primary feasibility outcomes were recruitment, retention, compliance, data completeness and accuracy; clinical outcomes included NEC. Registration ISRCTN62501859.

RESULTS

179 of 367 eligible babies (49%) were randomised in 11 United Kingdom neonatal units; 97 to continued feeds and 82 to withheld feeds arms; retention was 98.9% (177/179). Trial processes were successfully integrated into existing EHR systems; trial monitoring was limited by the use of routine data. Among babies that received a blood transfusion, compliance was 82.9% (68/82). Completeness and accuracy of primary and secondary clinical outcomes were high; severe NEC: completeness 100%, true positive 83.3%, false positive 2.4%. Severe NEC occurred in 7 (8.8%) and 5 (5.2%) of babies in withheld and continued feed arms.

CONCLUSIONS

Integration of trial processes into existing neonatal EHR systems and opt-out consent are feasible. These approaches are suitable to facilitate simpler, larger and more efficient neonatal trials.

EP142 / #1959

E-Poster Viewing - Neonatology AS02-08. Epidemiology

Neonatal and maternal risk factors of fetal abdominal wall defects

M.C. Gauci^{1*}, G. Di Cataldo², C. Gammeri², F. Gambilonghi²,
C. Mattia², M.G. Scuderi², V. Di Benedetto², P. Betta²

¹University of Catania, Pediatrics, Catania, Italy

²university of catania, Department of Pediatrics, catania (sicilia), Italy

BACKGROUND AND AIM

abdominal wall defects are congenital anomalies as the result of errors during embryologic development. The two main defects are omphalocele and gastroschisis. We know many risk factors, even if are not clear: the aim of the present study is to determine epidemiological aspects trying to identify some risk factors.

METHODS

This is a retrospective study in which we enrolled 10 patients hospitalized in NICU from 2014 to 2022 and we subjected the parents to an interview to assess any maternal, neonatal and environmental risk factors.

RESULTS

Six of the patients were affected by omphalocele and four of gastroschisis. The average maternal age is 30.4 years. The prevailing socioeconomic status of the mothers was medium-low. All mothers are Caucasian and the 40% of them were exposed to cigarette smoke during the period of conception, 50% to alcohol and none used drugs. Furthermore, 60% of mothers were exposed

to environmental pollutants, especially such as polychlorinated biphenyls (PCBs): 50% of women was exposed for business reasons, 40% had lived in the vicinity of asbestos constructions and electrical repeaters. Furthermore, 70% of mothers have an allergic predisposition to inhalants.

CONCLUSIONS

The young maternal age was not significant as a risk factor; while a large part of these has reported their exposure to alcohol. The strongest correlation that we have identified, although not significant, is that between the allergic predisposition of the mothers to inhaling agents and the exposure of these to environmental pollutants of an inhaling nature.

EP143 / #1373

E-Poster Viewing - Neonatology AS02-08. Epidemiology

Impact of maternal pre-pregnancy bmi on neonatal outcomes of infants born extremely preterm

C. Girard^{1*}, J. Zeitlin¹, N. Marlow², M. Norman^{3,4}, F. Serenius⁵, E.S. Draper⁶, S. Johnson⁶, V. Benhammou¹, P.Y. Ancel¹, K. Maršál⁷, K. Källén⁸, A. Morgan^{1,2}

¹Center for Research in Epidemiology and Statistics (CRESS), INSERM, INRA, Paris Cité University, Obstetrical Perinatal and Pediatric Epidemiology Research Team, Epopé, Paris, France

²University College London, Ega Institute For Women's Health, London, United Kingdom

³Division of Pediatrics, Department of Clinical Science, Intervention, and Technology, Stockholm, Sweden

⁴Karolinska University Hospital, Department of Neonatal Medicine, Stockholm, Sweden

⁵Uppsala University, Department of Women's and Children's Health, Uppsala, Sweden

⁶University of Leicester, Department of Health Sciences, Leicester, United Kingdom

⁷Skåne University Hospital, Lund University, Department of Obstetrics and Gynecology, Lund, Sweden

⁸Lund University, Centre of Reproductive Epidemiology, Lund, Sweden

BACKGROUND AND AIM

Extreme maternal body mass index (BMI) increases maternal, fetal, neonatal and child mortality and morbidity among term births. The effects of maternal BMI on extreme preterm (EP, <27 weeks gestational age (GA)) birth are poorly understood with discordant published results. We investigated the impact of pre-pregnancy BMI on offspring mortality and morbidity to discharge for EP births.

METHODS

Singleton births at 22-26 weeks GA with known maternal BMI (underweight (<18.5), normal (18.5-24.9), overweight (25.0-29.9) and obese (30.0+)) and a

live fetus at maternal hospital admission from the EXPRESS (Sweden, 2004-07), EPICure-2 (UK, 2006) and EPIPAGE-2 (France, 2011) prospective national birth cohorts were included. Survival without major morbidity to hospital discharge was assessed; secondary outcomes were neonatal morbidities (bronchopulmonary dysplasia, necrotising enterocolitis, severe brain injury, retinopathy of prematurity, persistent ductus arteriosus). Results were adjusted for cohort, GA, maternal age, parity and smoking.

RESULTS

140 babies were born to underweight, 1396 to normal, 719 to overweight and 556 to obese mothers, with significant differences between cohorts (figure). Following adjustment, there were no differences in survival without morbidity at discharge (normal weight 22% (reference); underweight 26%, OR 1.40, 95% CI 0.88 – 2.19; overweight 23% OR 1.07, 95% CI 0.84 – 1.37; obese 19% OR 0.94, 95% CI 0.71 – 1.24), nor with survival at discharge or neonatal morbidities. Stratifying by cohort, initial differences disappeared following adjustment for GA.

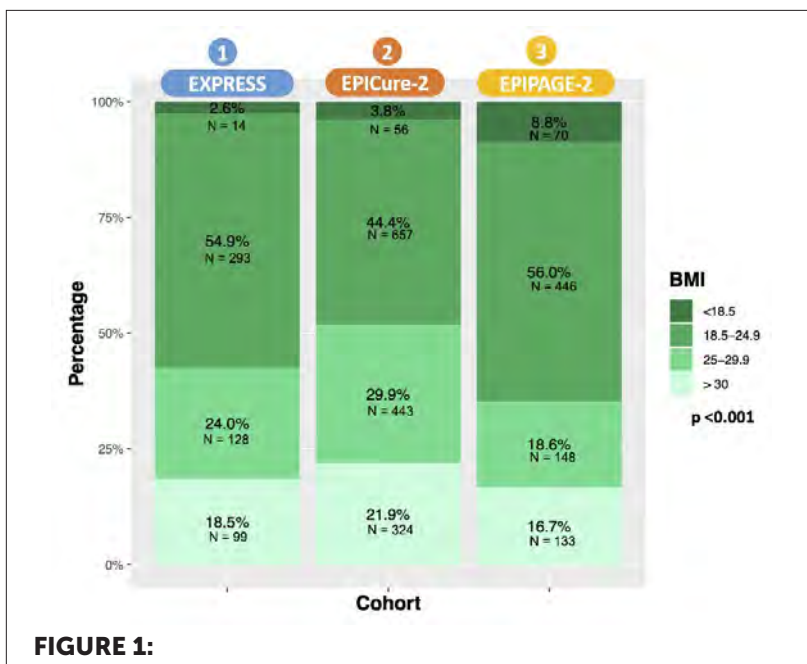

CONCLUSIONS

No associations were seen overall or per cohort between pre-pregnancy maternal BMI and survival without morbidity at discharge nor with neonatal morbidities.

EP144 / #2786**E-Poster Viewing - Neonatology AS02-08.
Epidemiology****Outcomes of live born infants with trisomy 13 and trisomy 18.****A. Hurley¹, C. Harrison^{2*}**¹Leeds Teaching Hospitals Trust, Neonatal Department, Leeds, United Kingdom²Leeds Teaching Hospitals Trust, Neonatal Department, EX, United Kingdom**BACKGROUND AND AIM**

After Trisomy 21, Trisomy 18 and 13 are the 2nd and 3rd commonest trisomies. Previously treated as lethal conditions with comfort care management. This attitude is changing with a more proactive management strategy. To optimise counselling for affected families, we carried out a review of the management and outcomes of live born infants with Trisomy 13 and 18 in a tertiary neonatal unit. Leeds is a busy NICU offering medical, surgical and cardiac care with over 10,000 births per year.

METHODS

All infants with T13 or T18 admitted to a large tertiary neonatal unit in Leeds, UK over a 10 year period from January 2010 to October 2020. Detailed case reviews were carried out using the standardized UK wide neonatal electronic database (badger.net) and patient electronic records.

RESULTS

18 patients were admitted. 9(50%)female, 9(50%)male. 5(28%)Trisomy 13 and 13(72%)Trisomy 18. 17%declined testing but had possible abnormalities on antenatal scan. 28%were antenatal diagnoses with 80%of these having doc-

umented perinatal plans. Mean gestational age at birth 35+6(27+2 to 41). Mean birth weight 1922g(790 to 2940g). 33%had comfort/palliative care, 39%had ICU treatment initiated then reorientated and 28%active management at discharge. 11%died on delivery suite,33%on the neonatal unit,33%discharged home,22%discharged to the hospice. 44%had palliative care involved. Overall89%mortality with mean age at death47.7days(hours to18months).11%-survival,1Trisomy 18(6 years) and 1Trisomy 13(3 years).

CONCLUSIONS

Numbers of these patients admitted to neonatal unit is low, and survival rate lower still. Future work is being done to support affected families before and after delivery, including palliative care involvement and ensuring families are fully informed of potential outcomes.

EP145 / #2787

E-Poster Viewing - Neonatology AS02-08. Epidemiology

Trisomy 13 and 18 outcome trends

A. Hurley¹, C. Harrison^{2*}

¹Embrace, Embrace, Leeds, United Kingdom

²Embrace, Embrace, UB, United Kingdom

BACKGROUND AND AIM

Trisomy 13 and 18 have historically been seen as lethal conditions, and management was comfort focused with no offer of surgery. More recent studies have demonstrated longer survival, and opinions are becoming more varied. Features of these trisomies can be detected on antenatal scans and confirmed with genetic testing. A proportion of families still choose to terminate the pregnancy with a diagnosis of Trisomy 13 or 18. We examined the data from the Yorkshire and Humber region, a densely populated area in the north of England, over a 10 year period to ascertain outcome for these pregnancies.

METHODS

A retrospective case review over a 10 year period (January 2010 to October 2020) of all cases of Trisomy 13 or Trisomy 18 referred to a tertiary fetal medicine centre covering the Yorkshire and Humber region. Outcome data reviewed from those cases that continued care in the tertiary centre after diagnosis.

RESULTS

In total 510 cases identified, 437 (86%) were antenatal diagnoses, 73 (14%) were fetal or postnatal results. 170 known outcomes. 119 (70%) underwent

a termination of pregnancy (TOP). 43 (25%) intrauterine deaths (IUD) or miscarriages. 8 live births, of these 1 is still alive at the age of 6years.

CONCLUSIONS

70% of antenatal diagnoses of Trisomy 13 and 18 end in termination of pregnancy, 25% in intrauterine death or miscarriage and 6% in live birth. Overall survival remains low, at 0.6-1% which is consistent with other studies

EP146 / #1708**E-Poster Viewing - Neonatology AS02-08.
Epidemiology****Association between risk of infant death and birthweight percentile defined by intrauterine or birthweight charts according to gestational age in the finnish medical birth register****A. Hocquette^{1*}, A. Pulakka², J. Metsälä², K. Heikkilä², E. Kajantie^{3,4,5,6,7,8}**¹INSERM, Université de Paris, Epopé, PARIS, France²Finnish Institute for Health and Welfare, Population Health Unit, Helsinki, Finland³University of Oulu, Pedego Research Unit, Oulu, Finland⁴Finnish Institute for Health and Welfare, Population Health Unit, Helsinki/Oulu, Finland⁵Norwegian University of Science and Technology (NTNU), Department of Clinical and Molecular Medicine, Trondheim, Norway⁶Finnish Institute for Health and Welfare, Public Health Promotion Unit, Helsinki/Oulu, Finland⁷Helsinki University Hospital and University of Helsinki, Children's Hospital, Helsinki, Finland⁸Oulu University Hospital and University of Oulu, Pedego Research Unit, Oulu, Finland**BACKGROUND AND AIM**

Newborns with a birthweight under the 10th percentile face higher risk of infant death and other complications, but questions persist whether this threshold applies to all gestational ages (GA) and all growth charts. This work aims to study the association between the risk of infant death and birthweight percentile, based on intra-uterine versus birthweight charts, by GA.

METHODS

Using data from the Finnish Medical Birth Register between 2006-2016, we included non-malformed singleton live births at 24-41⁺⁶ weeks of gestation (N=530,582). The association between risk of infant death and birthweight percentile, defined as a continuous variable using (1) Marsal's intra-uterine

and (2) Sankilampi's birthweight growth charts, was studied using generalized additive models stratified by GA categories (24-27⁺⁶, 28-31⁺⁶, 32-36⁺⁶, 37-38⁺⁶, 39-41⁺⁶ weeks' gestation). We compared the predicted probability of infant death for the 10th percentile with the percentile where the probability was lowest.

RESULTS

The predicted probability of infant death associated with a birthweight at the 10th percentile according to Marsal was 1.4 [1.1; 1.7] times higher than the minimum probability at 24-27⁺⁶ weeks, 1.0 [0.7; 1.4] at 28-31⁺⁶ weeks, 3.2 [2.4; 4.0] at 32-36⁺⁶ weeks, 2.7 [1.9; 3.6] at 37-38⁺⁶ weeks, and 2.3 [1.8; 2.8] at 39-41⁺⁶ weeks. When using Sankilampi charts, these values were 2.2 [1.7; 2.6], 1.3 [0.8; 1.8], 3.0 [2.2; 3.7], 2.4 [1.8; 3.1] and 2.0 [1.6; 2.4].

CONCLUSIONS

The association between birthweight percentile and the risk of infant death varies by chart and by GA.

EP147 / #402**E-Poster Viewing - Neonatology AS02-08.
Epidemiology****Predicting hypoxic-ischaemic encephalopathy:
conventional risk factors compared to agnostic
machine learning****D. Odd^{1*}, H. White², M. Lyon³, T. Gaunt³, D. Lawlor³**¹Cardiff University, Population Health, Cardiff, United Kingdom²North Bristol NHS Trust, Neonatology, Bristol, United Kingdom³University of Bristol, Bristol Medical School, Bristol, United Kingdom**BACKGROUND AND AIM**

Machine Learning (ML) algorithms to predict health outcomes is of interest, although require preparatory work and expertise to develop. The aim of this work is to identify if an agnostic automatic ML model can predict poor birth outcome, as well, or better than, conventional analysis with established risk factors.

METHODS

Data was from the US Collaborative Perinatal Project. 19,487 eligible infants were born between 1959 and 1962 (Testing Cohort), and 20,828 were born between 1963 and 1966 (Validation Cohort). Primary outcome was hypoxic-ischaemic encephalopathy (HIE). Secondary outcome was perinatal death. For the conventional analysis a logistic regression model was developed on the testing cohort, using 20 a-priori risk factors. The ML model was developed using all 385 data-points recorded. No data cleaning was performed before uploading to the Google AutoML platform.

RESULTS

For HIE, the ML model appeared to predict outcome similarly to the conventional model (AUC 0.70 (0.63-0.77) vs 0.70 (0.64-0.77), $p=0.987$), but better for prediction of perinatal death (0.79 (0.76-0.82) vs 0.61 (0.57-0.65), $p<0.001$). The ML model placed 34.4% (vs 28.8%) of HIE cases and 55.9% (vs 18.2%) of perinatal deaths in the highest risk decile.

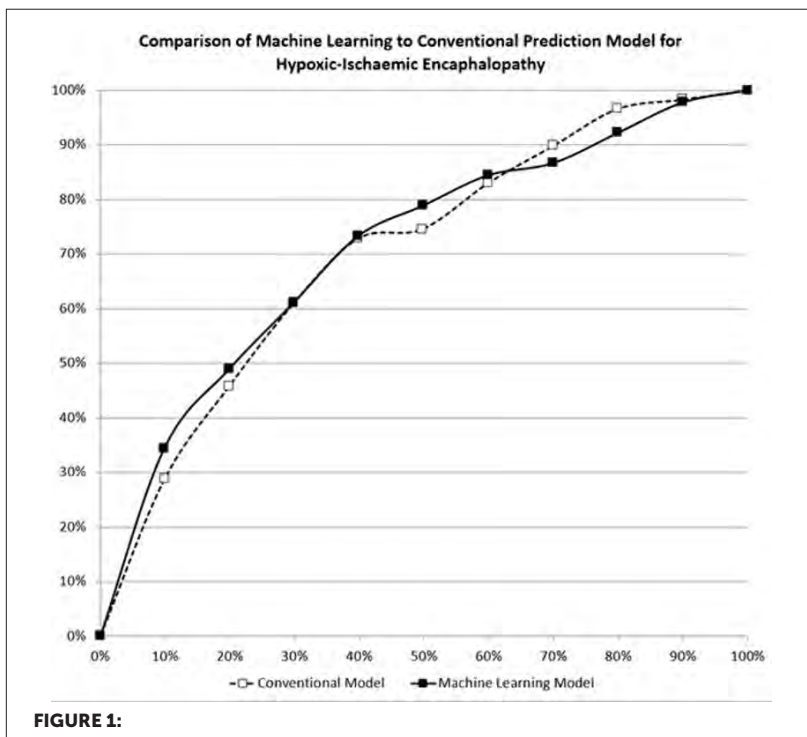

CONCLUSIONS

In this work, a machine learning model, with minimal data preparation, was able to match prediction from a targeted conventional analysis for HIE and

perform somewhat better for perinatal death. Automated ML models on contemporary routinely collected data may provide a real-time additional tool to prioritise observation or interventions in high risk groups; this should be explored.

EP148 / #840

E-Poster Viewing - Neonatology AS02-08. Epidemiology

Who is in the nicu? A population-level descriptive analysis of the types of infants admitted to the nicu their contributions to total patient days

C. Phibbs^{1*}, C. Smith-Hughes², S. Schmitt¹, M. Passarella³, S. Lorch³

¹Stanford University School of Medicine, Pediatrics, Stanford, United States of America

²University of California San Francisco, Epidemiology, San Francisco, United States of America

³Children's Hospital of Pennsylvania, Neonatology, Philadelphia, United States of America

BACKGROUND AND AIM

Over 10% infants born in the US receive some level of neonatal intensive care unit (NICU) care. The distribution of these infants by gestational age (GA), reasons for admission, how many have only minor conditions, and the relative contribution to total length of patient days are unknown.

METHODS

Retrospective cohort study of all infants born in Pennsylvania or South Carolina from 1996-2015 (N=2,284,498) using birth certificates linked to maternal and infant hospital administrative records with revenue codes used to identify who was admitted to any level of NICU care. We categorized infants by condition severity based on morbidity, LOS, and GA. Mild/minor conditions were mild hyperbilirubinemia, observation for suspected infection, mild hypoglycemia, neonatal abstinence syndrome, or mild respiratory support; moderate conditions included less serious but significant birth trauma, infection, respiratory complications, or neurological complications; severe conditions included GA<32, serious anomaly, use of ECMO, pulmonary hypertension, aspiration syndrome, or mechanical ventilation.

RESULTS

11.2% were admitted to a NICU; 14.5% were GA<32 weeks (46.5% of total days); 36.4% were GA 32-36 weeks (31.0% of days); and 49.2% were GA>36 weeks (22.5% of days). of the 65.1% who were GA>34 only 15.3% of these had a serious condition. Hyperbilirubinemia and observation for suspected infection were the most frequent mild conditions.

CONCLUSIONS

More than half of infants admitted to NICUs are near-term/term, and account for a lower relative proportion of total patient days. More than a quarter of near-term/term infants were admitted for mild conditions, the majority of which were for a single condition.

EP149 / #2577

E-Poster Viewing - Neonatology AS02-08. Epidemiology

Evolving epidemiology of neonatal candidiasis and its impact, outcomes and sequelae in neonates admitted in nicu: a prospective study from a tertiary centre in india

A. Singh^{1*}, S. Mukhopadhyay²

¹King George Medical University, Department of Pediatrics, Lucknow, India

²King George Medical University, Pediatrics, Lucknow, India

BACKGROUND AND AIM

Candida sepsis in NICU causes high morbidity, mortality, and long-term sequelae. This study aimed to determine the prevalence, speciation, anti-fungal susceptibility pattern, clinical profile of affected neonates, end-organ involvement, and outcome of neonates with candida sepsis.

METHODS

KGMU is a tertiary care referral hospital in northern part of India. Of the 1356 neonates admitted over 19 months period, sepsis was suspected in 596/1356. Neonates growing *Candida* in blood, CSF, or urine samples, were enrolled (n=62). Speciation was done using MALDI-TOF and Germ-Tube method.

RESULTS

Prevalence of candida sepsis was 4.57% of all NICU admissions. Amongst all, 85.9% isolates were non-albicans *Candida* (NAC) and 14.1% isolates were *C. albicans* (Fig_1). *Candida tropicalis* (23.4%) was the most com-

mon isolate. *Candida glabrata* displayed 100% resistance to Fluconazole. Resistance to Fluconazole(37.5%), Voriconazole(7.8%), Amphotericin-B(4.7%) was seen; no resistance was seen against Caspofungin(Fig_2). Important clinical features(Fig_3) were, positive sepsis screen(100%), prior antibiotics ≥ 5 days(79%), LOS(75.8%), lethargy(75.8%), metabolic acidosis(67.7%), feed intolerance(66.1%), tachypnoea(59.7%), increased FiO₂ requirement(46.8%), convulsion(41.9%), and concurrent bacterial sepsis(27.4%). Increased FiO₂ requirement(**OR=8.9**), metabolic acidosis(**OR=5.5**), and feed intolerance(**OR=5.07**) had a significant association with NAC infection. Amongst the 62 neonates, renal fungal balls(14.5%), meningitis(12.9%), endophthalmitis(3.2%), ventriculitis(1.6%), endocarditis(3.2%), and pneumonia(19.3%) were noted as end-organ involvement. The discharge and mortality rates were 43/62(69.3%) and 9/62(14.5%) respectively. Crude mortality attributable to candidiasis was 11.3%.

Fig_1: distribution of *Candida* isolates

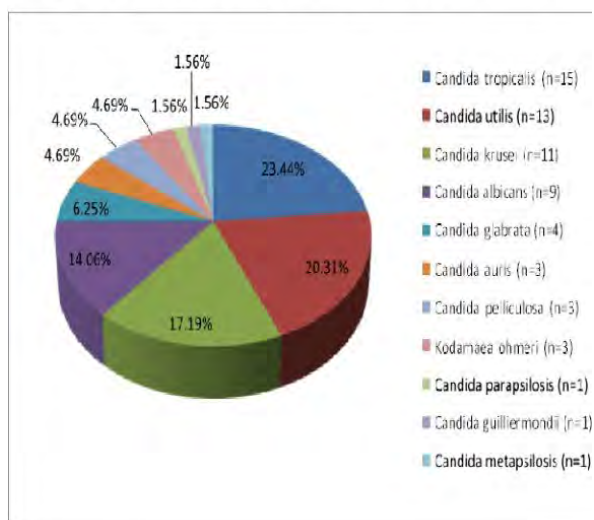

Figure xx: Sensitivity (%), resistance (%) and dose dependent sensitivity (%) pattern of candida isolates for antifungal agents.

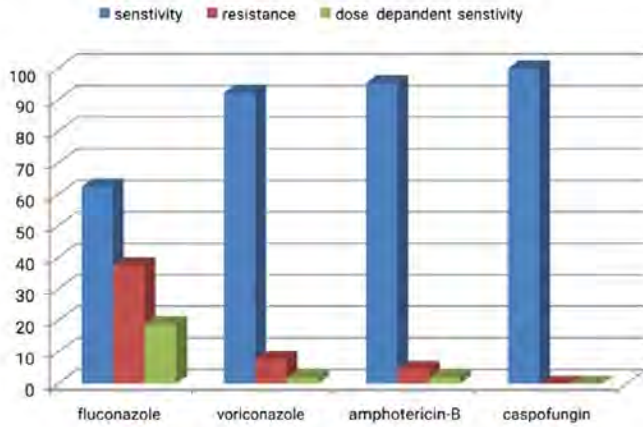
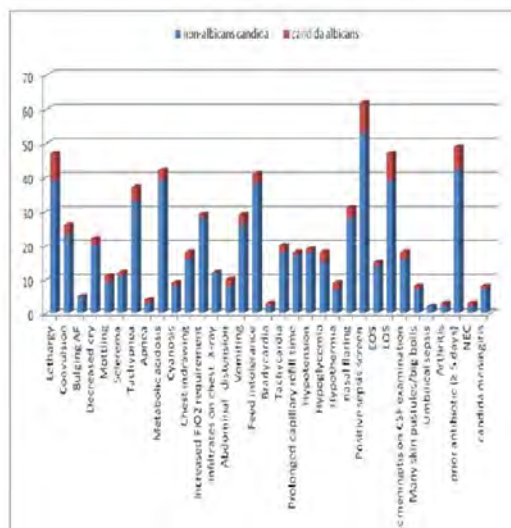

Figure xx: Clinical profile of neonates with candida sepsis.



CONCLUSIONS

Acquired as a nosocomial infection, candida sepsis causes a high burden of mortality and morbidity in neonates. The prevalence of NAC sepsis has increased with time, which necessitates its early identification and prevention as NAC species show higher antifungal resistance and are associated with dire consequences.

EP150 / #2241

E-Poster Viewing - Neonatology AS02-08. Epidemiology

Morbidity and mortality in preterms babies below 28 weeks of gestation from mothers with chorioamionities

**G. Zaharie^{1*}, T. Drugan², M. Hasmasanu², A. Tutu³, I. Rotar^{1,2},
D. Muresan¹, F. Zaharie⁴, M. Vintan⁵, L. Blaga², M. Matyas³**

¹University of Medicine and Pharmacy Iuliu Hatieganu Cluj, Mother and Child, Cluj Napoca, Romania

²University of Medicine and Pharmacy Iuliu Hatieganu Cluj, Biostatistics, Cluj Napoca, Romania

³County Emergency Clinical hospital, Neonatology, Cluj Napoca, Romania

⁴University of Medicine and Pharmacy Iuliu Hatieganu, Student, Cluj Napoca, Romania

⁵University of Medicine and Pharmacy Iuliu Hatieganu, Neurology, Cluj Napoca, Romania

BACKGROUND AND AIM

Chorioamnionitis, aside from the risk of fetal sepsis, the fetal inflammatory response may induce intraventricular hemorrhage, periventricular leukomalacia. The aim of the study is to analyze the morbidity and mortality at the prematures from mothers with chorioamnionitis (group A) compare with the group of prematures from mothers without (group B).

METHODS

The study is realized on 152 premature < 28 weeks of gestation admitted in a III-rd level unit, Cluj-Napoca, Romania; 15 premature (group A) were from mothers with chorioamnionitis. We evaluate the incidence of early and late complications: respiratory distress syndrome (RDS), intraventricular hemorrhage (IVH), early sepsis, periventricular leukomalacia (PVL), bronchopulmonary dysplasia (BPD), retinopathy of prematurity (ROP) and mortality. Statistical analysis was done with the IBM SPSS V25 program.

RESULTS

The GA was 25.714 ± 1.49 group A versus 25.713 ± 1.25 wks group B. Weight was $748.571 \text{g} \pm 174.08$ (A) vs $772.181 \text{g} \pm 130.364$ ($p > 0,5$). The incidence of chorioamnionitis was 9,86% in our study. FiO₂ was significant higher in the first day in group A 58.71 ± 19.07 % vs 45.27 ± 17.41 % ($p=0,009$). Early sepsis incidence was 42.76%. No significant differences for early and late complications. We observed a inverse correlation between the duration of PROM and the degree of IVH ($r=-0.31$). The mortality was no influenced by chorioamnionitis of the mothers. We observed the relative risk of death after pulmonary hemorrhage 2,349 times higher in the group from chorioamnionitis ($p=0,001$).

CONCLUSIONS

In our study early and late complications in the premature babies ≤ 28 weeks was no influenced by the mother's chorioamnionitis. The relative risk of deces by pulmonary hemorrhage was 2.34 times increased in chorioamnionitis group.

EP151 / #965

E-Poster Viewing - Neonatology AS02-09. Ethics & law

“Hope and not hope”: what information do parents want for shared decision-making at the border of viability?

J. Syltern^{1*}, L. Ursin²

¹Norwegian University of Science and Technology, Department of Clinical and Molecular Medicine, Trondheim, Norway

²Norwegian University of Science and Technology, Department of Public Health and Nursing, Trondheim, Norway

BACKGROUND AND AIM

Advances in neonatology have led to improved survival for periviable infants. Immaturity still carries a high risk of short- and long-term harms, and uncertainty turns provision of life support into an ethical dilemma. Shared decision-making with parents has gained ground. How can we enable parents to participate in these life-altering decisions? We performed an interview study to bring forth experiences and reflections of parents and health care personnel (HCP). In this abstract, we present parental suggestions on how to involve parents in decision-making when facing periviable birth.

METHODS

11 semi-structured interviews of 17 parents with decision-making experience at GA 22-24 weeks performed in Norway. Strategic recruitment was used to bring out experiences with diverse outcomes.

RESULTS

Parents emphasized the importance of being involved, wanting extensive information about what to expect in the NICU, during child- and adulthood. They appreciated written information, emotional support and several conversations, preferably with the same doctor. Lack of consistency between professionals was particularly distressing. The emotional turmoil and the lack of knowledge paired with a perceived parental role of saving their child challenged the possibility for balanced decisions, and many preferred decisions to be made by HCP, with guideline support. However, experienced parents with disabled children felt strongly that they should be given decision-making power.

CONCLUSIONS

When facing periviable birth, the parents in our study emphasized the need of a thorough information process with HCP. A supportive interprofessional periviability team, being able to express both "hope and not hope" was suggested to help parents in this difficult situation.

EP152 / #1691

E-Poster Viewing - Neonatology AS02-10. Family-centred care

Introduction of multi-disciplinary facilitated education sessions for families and parent centred ward rounds: overcoming challenges imposed by the covid-19 pandemic

M.-R. Ballard^{1*}, U. Banerjee¹, D. Thakur¹, B. Bhojnarwala²

¹Imperial College Healthcare NHS Trust, Neonatology, London, United Kingdom

²Medway NHS Foundation Trust, Neonatology, London, United Kingdom

BACKGROUND AND AIM

Collaborative partnerships with families are essential to providing high quality neonatal care, increasing engagement and empowering parents. The COVID-19 pandemic introduced multiple barriers to visiting NICU including hospital visitation allowances, limiting parents' time with their baby and interaction with staff. Regular parent led ward rounds and a family orientated multi-disciplinary education programme were implemented at Chelsea and Westminster Hospital, a tertiary level surgical neonatal unit, addressing several of these barriers.

METHODS

Parent questionnaires and multi-disciplinary team focus groups informed an 8-week pilot programme of socially distanced face-to-face family-orientated education sessions on NICU. Parents were regularly encouraged to participate and lead the medical ward round. Pre and post implementation questionnaires and feedback surveys for parents alongside staff surveys evaluated impact, with regular improvements made based on feedback, parent attendance and reported accessibility.

RESULTS

Parents completing questionnaires (n=15) had babies with length of stay 14 to 118 days and were all interested in attending education sessions. Parent reported confidence showed improvement across multiple areas (figure 1). Qualitative feedback reported parents feeling empowered, engaged in care and less anxious, with positive feedback for individual education sessions. Staff perception of parental involvement and confidence at discharge improved.

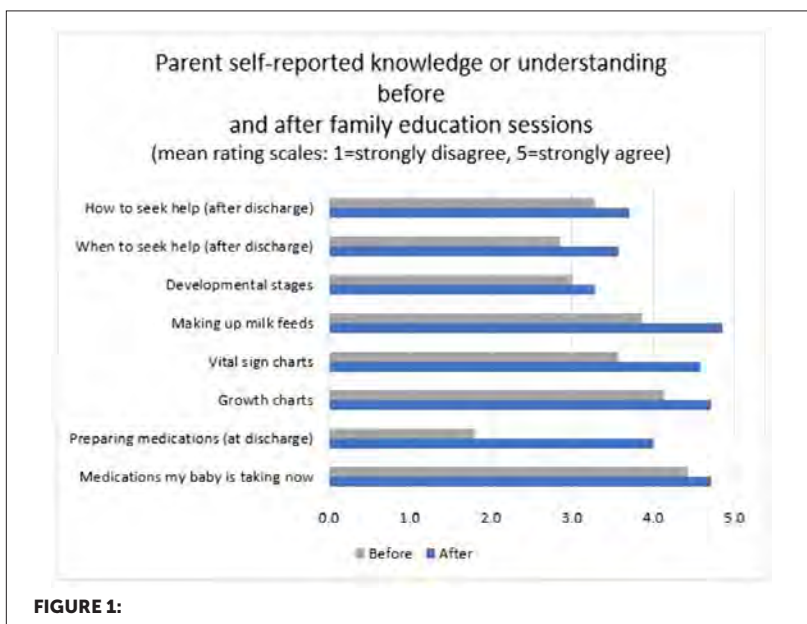

CONCLUSIONS

Barriers to developing collaborative partnerships with families can be overcome with implementation of novel strategies. Here, multi-disciplinary facilitated education sessions and parent supported ward rounds demonstrated improved parent engagement and confidence, with qualitative feedback

revealing positive benefits on parental anxiety. This is a positive step in developing family centred care despite the pandemic.

EP153 / #1698

E-Poster Viewing - Neonatology AS02-10. Family-centred care

Paddington study - parent co-designed drug information for parents and guardians taking neonates home – an e-survey of healthcare professionals

L. Bracken^{1*}, A. Gill¹, K. Johnson², N. McCallion³, B. Cleary⁴, M. Peak¹, C. Barker¹, N. Caldwell⁵, F. Gaffney⁴, S. Morris², E. Neary⁶, M. Turner⁷, R. Corry⁸, J. Clark¹, C. Sutton¹, J. Murphy⁸, R. Dore¹, F. O'Brien⁹

¹Alder Hey Children's NHS Foundation Trust, Paediatric Medicines Research Unit, Liverpool, United Kingdom

²Leeds Teaching Hospitals NHS Trust, Leeds General Infirmary, Leeds, United Kingdom

³Rotunda Hospital, Neonatology, Dublin, Ireland

⁴The Rotunda Hospital, Pharmacy, Dublin, Ireland

⁵Wirral University Teaching Hospital NHS Foundation Trust, Pharmacy, Wirral, United Kingdom

⁶Liverpool Womens Hospital NHS Foundation Trust, Neonatal Unit, Liverpool, United Kingdom

⁷University of Liverpool, Liverpool Womens Nhs Ft, Liverpool, United Kingdom

⁸PADDINGToN Study, Parent Representative, Liverpool, United Kingdom

⁹Royal College of Surgeons in Ireland, School of Pharmacy and Biomolecular Sciences, Dublin, Ireland

BACKGROUND AND AIM

The aim of this multicentre study was to obtain the views of healthcare professionals (HCPs) on the current provision of information about medicines used at home for parents on neonatal units in UK/Ireland.

METHODS

HCPs in the UK and Ireland were identified using a stakeholder map. An electronic survey was developed and circulated to HCPs involved in the care of neonates at the five study sites and shared on social media.

RESULTS

155 HCPs responded, 41% nurses, 34% pharmacists, 11% doctors, the remainder were a mixture of professions. The majority had over 5 years' experience. 58% were aware of medicines resources or information being used at their hospital, the most popular method being face to face information given individually, followed by written information. They were asked which HCPs were best placed to provide information about medicines. Nurses were most commonly selected (Figure 1). When asked about the best time to provide information, 'throughout the stay' was felt to be the most appropriate time. However, in practice they reported that information was typically given immediately prior to discharge. The move to Family Integrated Care at many units has led to improvements with many involving parents in the medicine administration process at a much earlier stage.

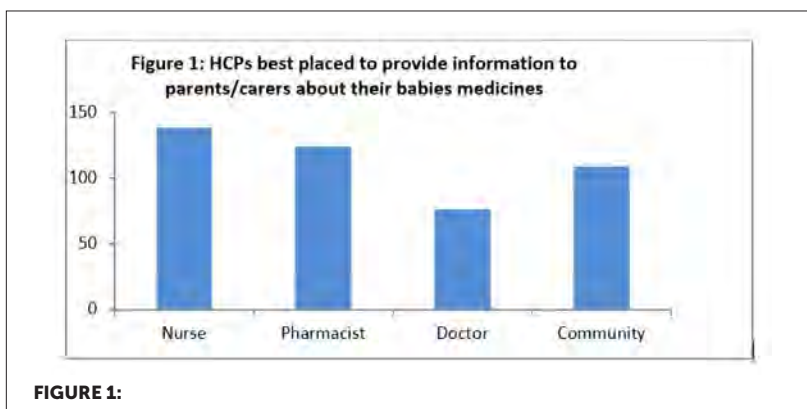

CONCLUSIONS

The results highlight the importance of the timing of information provision, involving parents at an earlier stage is helpful in preparation for discharge and may help to reduce parental anxiety.

EP154 / #1117

E-Poster Viewing - Neonatology AS02-10. Family-centred care

Family integrated care (ficare): parent feedback in the implementation phase

R. Clements*, D. Edwards, E. Hoyle

Liverpool Women's NHS Foundation Trust, Liverpool Neonatal Partnership, Liverpool, United Kingdom

BACKGROUND AND AIM

Our tertiary level unit are implementing FiCare as our standard of care due to its benefits for babies and families. We aimed to collect parent experiences of FiCare during the implementation phase to help us refine and develop this model of care.

METHODS

All babies discharged to their parents between 01/10/21-30/11/21 were identified (n=126). A survey was developed with contributions from parents and the trust communications department and was sent with a stamped addressed return envelope and a QR link to an online version. Data was collected, collated and analysed using the office Forms software.

RESULTS

We received 22 responses, all from English speaking mothers. 100% felt empowered to care for their baby during admission. 63% of inborn babies were cuddled by their mothers in the delivery room. 91% rated the friendliness of the unit 4-5/5 and 100% received regular updates about their baby, 95% felt able to ask questions. Feedback on our 'Skills passport' was that it was not user friendly.

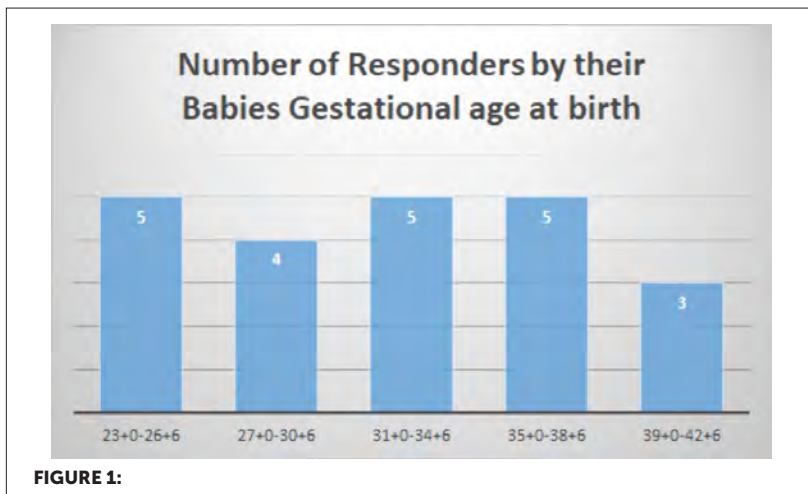

CONCLUSIONS

Overall experiences of FiCare were very positive. Feedback highlighted areas for development, including the importance of staff continuity and greater involvement of partners, and the need for a more family focussed skills passport which led to the development of our 'Baby Steps' cards. Retrospective data collection gave a low response rate and now will be collected prior to discharge. It is imperative that we capture feedback to understand the experiences of Partners and non-English speakers. Through repeated 'Plan Do Study Act' cycles we will continue to develop and embed FiCare.

EP155 / #830

E-Poster Viewing - Neonatology AS02-10. Family-centred care

Delivery room skin-to-skin– a quality improvement project to increase the number of preterm infants offered a delivery room cuddle

S. Cromie*, A. Stobo, D. Sweet

Royal Jubilee Maternity Hospital, Neonatology, Belfast, United Kingdom

BACKGROUND AND AIM

Early delivery room contact between a preterm infant and a parent is now offered more frequently among units in the UK, however it is not yet standard practice. Research has shown that early skin- to- skin contact in the delivery room provides cardiorespiratory and temperature stability for baby, confers long-term neurodevelopmental benefits, promotes breastfeeding and supports bonding. The aim of this project was to increase the number of neonates <34 weeks gestation offered a delivery room cuddle prior to transfer to NICU from baseline 23.5% (Sept-Oct 2021) to 50% by February 2022.

METHODS

We implemented various interventions including training in the use of the r-PAP device to the Neonatal team, creating protocols for use of the equipment and running simulation education sessions to increase familiarity and comfort with its use.



FIGURE 1:

RESULTS

53% of babies <34 weeks gestation experienced early skin to skin in delivery room prior to transfer to NICU. Gestational age ranged from 23+6 to 32+3 weeks and birth weight ranged from 586g to 1790g. None of the babies had a deterioration during the cuddle.

CONCLUSIONS

We improved our rates of infants being offered early skin to skin contact in delivery room with no documented deteriorations during the cuddle and utilising various modes of respiratory support. Further work will include humidification of the gases used in early respiratory support and feedback from parents on their experience of a delivery room cuddle.

EP156 / #2345**E-Poster Viewing - Neonatology AS02-10. Family-centred care****Parental long-term memories of time in nicu after a very preterm birth: a qualitative study in four european countries.**

M. Cuttini^{1*}, E. Forcella², G. Abate¹, A. Lainè³, I. Sarrechia⁴, S. Ebinger⁵, J. Lebeer⁴, R. Maier⁶

¹Bambino Gesù Children's Hospital, IRCCS, Clinical Care and Management Innovation Research Area, Roma, Italy

²Agenzia Italiana per la Cooperazione allo Sviluppo, Ufficio Iv – Sviluppo Umano, Roma, Italy

³INSERM UMR 1153, Obstetrical, perinatal and Pediatric Epidemiology Research, Paris, France

⁴Universiteit Antwerpen – Faculty of Medicine & Health Sciences, Family Medicine & Population Health, Antwerp, Belgium

⁵Philipps University Marburg, Children's Hospital, Marburg, Germany

⁶Philipps University Marburg, Children's Hospital, Marburg, Germany

BACKGROUND AND AIM

Time spent in NICU is stressful for parents. Little is known about persistence of their memories and related anxiety. Within the European SHIPS follow-up study, we collected spontaneous recalls of such experience.

METHODS

We interviewed 50 parents of 6-years old children in Italy, France, Germany and Belgium. Thematic analysis of interviews anonymous transcriptions was performed using NVivo software.

RESULTS

Parents talked about first visit to NICU: *"I had never seen a premature infant, and when I saw them...will that ever become a child? That was somehow a UFO"* (Mother, Germany) Memories about uncertainty regarding health and prognosis were still vivid: *"It was like that, the NICU. One day...everything is fine, a few hours later it turns to disaster, a step forward and two steps backwards."*(Father, France) Appreciation and gratitude for the staff were strong, yet: *"The children were completely taken out of your hands, and you had nothing more to say about them as parents...you have that feeling, as if they were not your own children..."* (Mother, Belgium). Parents may regain their role when important decisions must be made: *"They had found two brain hemorrhages...with part of the brain destroyed by blood. They told us repeatedly to stop treatment....we made another choice, to put all the chances on her side."* (Father, France)

CONCLUSIONS

Although our study focused on post-discharge follow-up, six years after admission parents were eager to talk about NICU stay. Communication and emotional support should be a crucial part of the care provided to families.

EP157 / #1539**E-Poster Viewing - Neonatology AS02-10. Family-centred care****Parental values in prenatal decision-making regarding treatment options after birth at the limits of viability: results of a scoping review****A. De Boer^{1,2*}, M. De Vries³, M. Hogeveen², J. Verweij¹, R. Geurtzen²**¹LUMC, Obstetrics and Gynaecology, Leiden, Netherlands²Radboudumc, Neonatology, Nijmegen, Netherlands³Institute for Computing and Information Sciences (iCIS), Radboud University Nijmegen, Nijmegen, Netherlands**BACKGROUND AND AIM**

Decision-making for infants born at the limits of viability is complex and preferably done together with parents. Shared decision-making is recommended and parental values guide these decisions; however, little is known about values parents hold. The aim of this study is to give an overview of all parental values described in literature.

METHODS

A scoping review was conducted to describe what is known about parental values, views or arguments playing a role in decision-making regarding treatment at the limits of viability. A systematic literature search was performed in six databases. Articles were included when reporting parental arguments or views in prenatal decision-making regarding early intensive care or palliative comfort care. Extracted data was discussed with a group of experts (psychologist (MdV), gynaecologist (EV), neonatologists (RG, MH)) and experienced parents of a 24-week born infant.

RESULTS

Twenty-two articles were included. Themes derived from the extracted data were: 'everything done', 'giving a chance', 'protect against burden of NICU-treatment', 'long-term outcomes for the child', 'long-term outcomes for the family-system', 'survival', 'religion and spiritual beliefs', 'hope', 'doing what is right', 'responsibility' and 'wanting the best'.

CONCLUSIONS

Literature reporting parental values influencing decision-making is scarce. Some parental views remained somewhat vague and open to interpretation, such as 'everything done' and 'hope'. The results raise the question to what extent feelings and intuitions rather than explicit deliberation about values guide decisions between early intensive care or palliative comfort care. Explicitly exploring and elaborating on parental views during prenatal counseling may increase our understanding and could potentially improve shared decision-making.

EP158 / #1502**E-Poster Viewing - Neonatology AS02-10. Family-centred care****What do premature born adults regard as important values in decision-making regarding treatment after birth at the limits of viability? Results of a focus-group study**

A. De Boer^{1,2*}, L. De Proost^{1,3,4,5}, M. De Vries⁶, M. Hogeveen², J. Verweij¹, R. Geurtzen²

¹LUMC, Obstetrics, Leiden, Netherlands

²Radboudumc, Neonatology, Nijmegen, Netherlands

³Erasmus MC, Department of Obstetrics and Gynecology, Rotterdam, Netherlands

⁴Erasmus MC, Department of Medical Ethics, Rotterdam, Netherlands

⁵Erasmus MC, Department of Neonatology, Rotterdam, Netherlands

⁶Institute for Computing and Information Sciences (iCIS), Radboud University Nijmegen, Nijmegen, Netherlands

BACKGROUND AND AIM

Decision-making for infants born at the limits of viability is complex and a shared decision-making approach is recommended. Parental values should guide decision-making, however little is known about what matters most to families in this decision. The perspective of prematurely born adults themselves are even more scarcely reported compared to the parental perspectives. This study focusses on the perspectives of premature born adults on what should be important in the decision-making at the limits of viability in the context of their experience of life.

METHODS

Focus group interviews with prematurely born adults were performed. Interviews were recorded, transcribed and qualitatively analyzed by two researchers (LP, AB).

RESULTS

We conducted four focus groups in the Netherlands, with 5-6 participants each, born between 24^{0/7}-30^{0/7} week gestation in the period 1965-2002. Initial analysis shows variation in themes, with partial recognition of parental values reported in literature found as a result of a systematic search in six databases, such as the themes 'potential disabilities' and 'quality of life' as relevant for decision-making. Premature born adults emphasize the need of attention on consequences of preterm birth in various areas in their further life, like basic healthcare, school and (psychological) care for their parents.

CONCLUSIONS

The vision of premature born adults is not yet included much in research. It is valuable to know what their opinion is about aspects regarding care of the extremely premature infants, because they are living with the consequences of premature birth.

EP159 / #2073

E-Poster Viewing - Neonatology AS02-10. Family-centred care

Neonatal sleep, knowledge and care practices in dutch neonatal healthcare: a survey.

E. De Groot^{1*}, C. Sam¹, M.A. Ryan^{2,3}, O. Verschuren⁴, M. Benders¹, J. Dudink^{1,5}, A. Van Den Hoogen¹

¹UMC Utrecht, Neonatology, Utrecht, Netherlands

²INFANT centre, UCC., Department of Neonatology, Cork University Maternity Hospital, Cork, Ireland

³INFANT Centre, University College Cork, Cork, Ireland

⁴University Medical Center Utrecht, Brain Center Rudolf Magnus, Utrecht, Netherlands

⁵University Medical Center Utrecht, Brain Center, Utrecht, Netherlands

BACKGROUND AND AIM

Developmental care is designed to optimize early brain maturation, by integrating procedures that support a healing environment. Protecting preterm sleep is important in developmental care. However, it is unclear to what extent (knowledge about) sleep is implemented in the day-to-day care at the NICU. Our aims include identifying the current state of knowledge about neonatal sleep and how it is transferred and adapted to practice.

METHODS

An online survey was distributed to Dutch healthcare professionals. Three categories of data were sought, including 1) demographics; 2) practical questions relating to sleep practices 3) knowledge questions relating to sleep physiology and importance of sleep. Relationships between variables were analyzed using Spearman's rho test and Cramer's V test. Furthermore, frequency tables and qualitative analyses were employed.

RESULTS

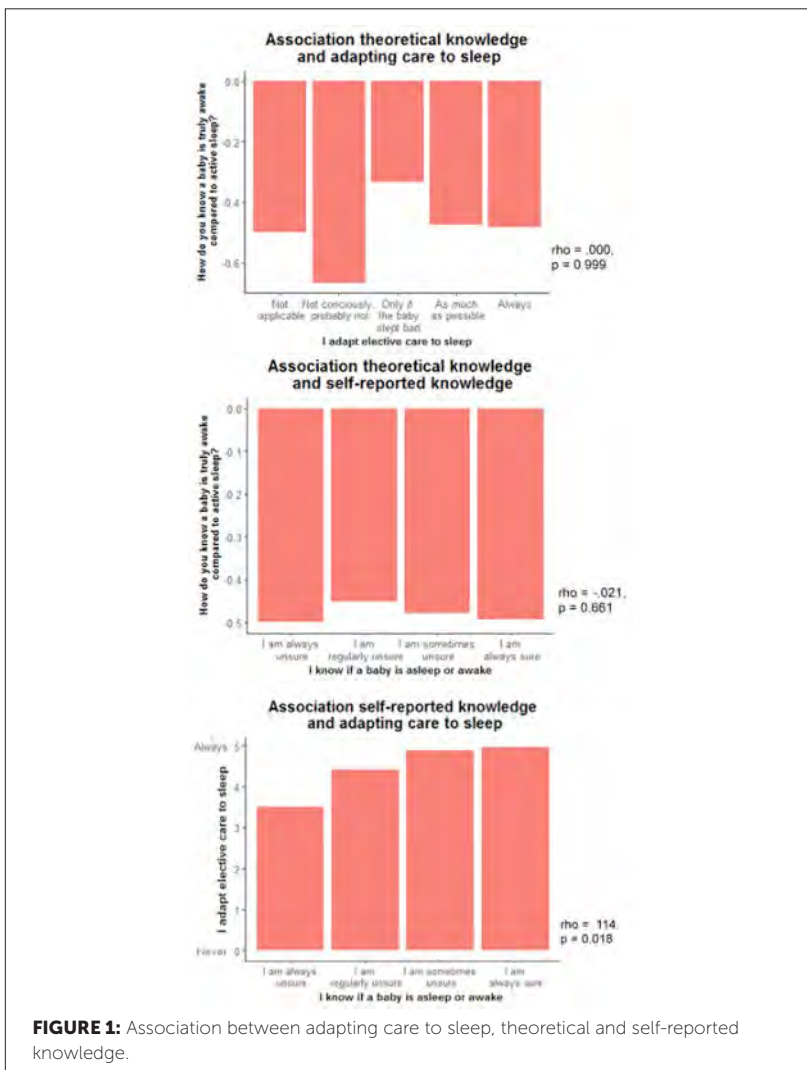

The survey was completed by 428 participants from 28 hospitals in nine Dutch cities. Results showed that whilst healthcare professionals reported sleep to be very important for (preterm) neonates they scored low on knowledge regarding sleep physiology. Most (91.8%) healthcare professionals adapted the timing of elective care procedures to sleep. Interestingly, theoretical knowledge is not associated with either self-reported knowledge or adapting care to sleep. However, higher self-reported knowledge is associated with a higher probability to adapt care to sleep (Figure 1). Finally, sleep is rarely discussed between colleagues (27.3% often/always discuss sleep) and during rounds (7.5-14.3% often/always discuss sleep).

CONCLUSIONS

Healthcare professionals adapt care to perceived sleep stages, however this sleep assessment is not based on scientific knowledge.

EP160 / #637

E-Poster Viewing - Neonatology AS02-10. Family-centred care

Parents' knowledge of sudden infant death syndrome among newborns born in Lithuania in 2020

K. Ganzijeva^{1*}, E. Zekaite-Vaisniene¹, R. Tameliene²

¹LUHS Kaunas Clinics, Pediatrics, Kaunas, Lithuania

²LUHS Kaunas Clinics, Neonatology, Kaunas, Lithuania

BACKGROUND AND AIM

To inform parents about the prevention of SIDS and to assess the knowledge of parents of newborns born in Lithuania in 2020 about SIDS.

METHODS

Online questionnaire including parents of babies aged 0-12 months. The total number of respondents was 2794, after excluding incomplete responses 2371 were analyzed.

RESULTS

The average age of the babies of the parents who completed the questionnaire was 6.7 (\pm 3.4) months. 87.1% of parents said that they knew what SIDS was, 12.4% had heard of it but didn't know exactly, 0.4% didn't know what SIDS was at all. 81.7% of respondents searched for information on SIDS, 18.3% haven't. 40.1% of respondents answered correctly that infants are most likely to develop SIDS between 2-4 months of age, while 48% of parents thought it was most likely to happen <2 months of age. 55.6% answered correctly that breastfeeding and regular visits to health professionals reduce the risk of SIDS. 67.7% said they lacked knowledge about SIDS. 92.5% of parents said that their GP or paediatrician hadn't talked to them about SIDS. People with a

university degree more often said they know what SIDS is ($p < 0.001$). Parents' knowledge is independent of the hospital where their child was born ($p < 0.5$), but it was related to parental age: older parents were more likely to say they knew what SIDS is ($p = 0.026$), also parents of older infants knew better what SIDS is ($p = 0.014$).

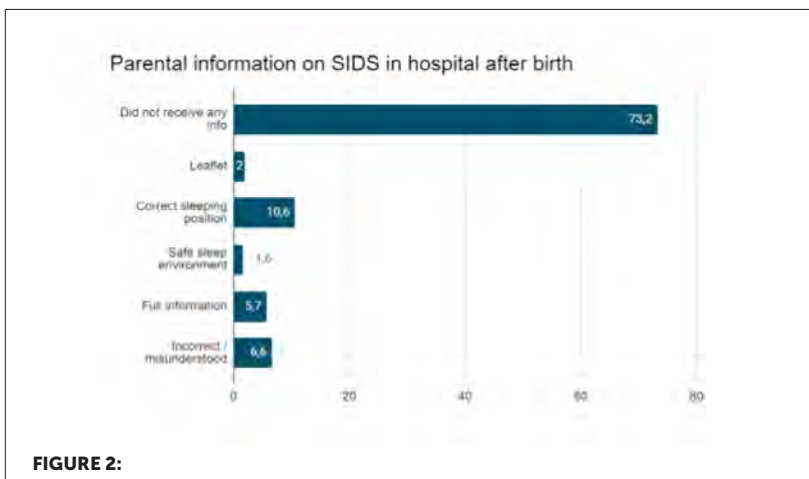
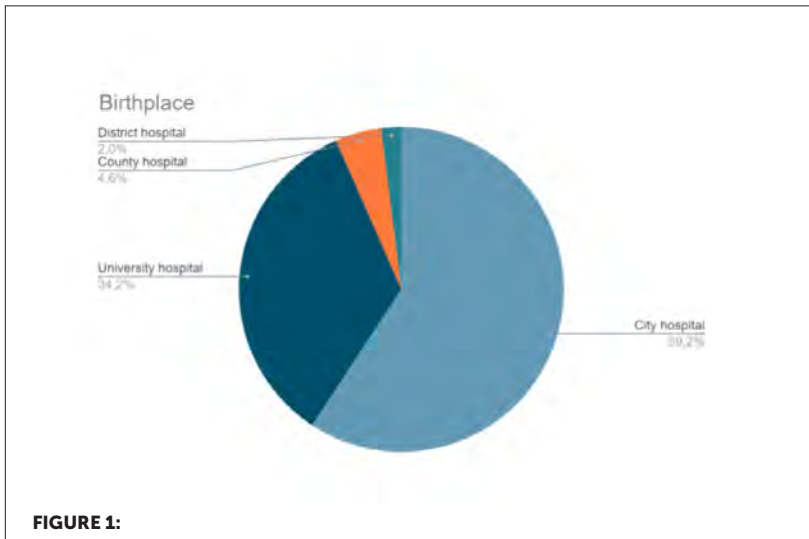

CONCLUSIONS

Parents report not receiving enough information about SID in the hospital and from GPs after delivery. Parents want to know more about SIDS, it is important to improve access to information.

EP161 / #1529**E-Poster Viewing - Neonatology AS02-10. Family-centred care****Paddington study - parent/carer co-designed drug information for parents and guardians taking neonates home – parent/carer feedback**

A. Gill^{1*}, L. Bracken¹, K. Johnson², N. Caldwell³, B. Cleary⁴, M. Peak¹, C. Barker¹, N. McCallion⁵, F. Gaffney⁴, S. Morris², E. Neary⁶, M. Turner⁷, R. Corry⁸, F. O'Brien⁹

¹Alder Hey Children's NHS Foundation Trust, Paediatric Medicines Research Unit, Liverpool, United Kingdom

²Leeds Teaching Hospitals NHS Trust, Leeds General Infirmary, Leeds, United Kingdom

³Wirral Hospital, Pharmacy, Wirral, United Kingdom

⁴The Rotunda Hospital, Pharmacy, Dublin, Ireland

⁵The Rotunda Hospital, Neonatology, Dublin, Ireland

⁶Liverpool Womens Hospital NHS Foundation Trust, Neonatal Unit, Liverpool, United Kingdom

⁷University of Liverpool, Liverpool Womens Nhs Ft, Leeds, United Kingdom

⁸PADDINGToN Study, Parent Representative, Liverpool, United Kingdom

⁹Royal College of Surgeons of Ireland, School of Pharmacy and Biomolecular Sciences, YN, Ireland

BACKGROUND AND AIM

PADDINGToN is a multi-centre study, inspired by parents who told us about challenges faced when giving medicines to their babies at home following a neonatal unit admission. Our aim was to co-design medicines information resources with parents/carers. These resources will reduce parental anxiety around using medicines and reduce the risk of harm from the incorrect use of medicines at home.

METHODS

Parents were recruited via social media, parent support groups, inpatient or clinic settings. Electronic-surveys were circulated and focus groups held with parents/carers of babies recently discharged from neonatal units.

RESULTS

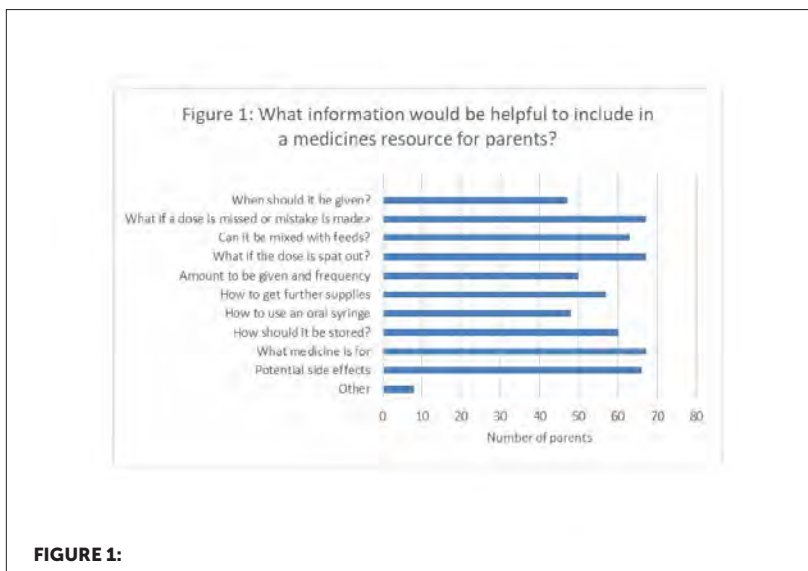

87 parents/carers completed the e-survey and 17 parents participated in focus groups. 72% parents/carers had no, or very little experience of giving medicines to children prior to their baby's hospital stay. 48% were administering 4 or more medicines on discharge but only 53% received information about medicines prior to this. 24% of parents/carers reported feeling stressed about giving medicines. Challenges with medicines following discharge were reported by 47%. E-survey findings were reflected and expanded upon, in the focus groups, with many reports of significant issues obtaining medicines following discharge. Printed information was most popular (57%). The content parents/carers wanted included in new resources is shown in Figure 1.

CONCLUSIONS

The results to date show there are significant shortfalls in the existing provision of information to parents/carers about giving medicines to their babies at home. The next stage of the study will utilise these findings in the co-design of new information resources about medicines.

EP162 / #2013

E-Poster Viewing - Neonatology AS02-10. Family-centred care

Investigating confidence in antenatal counselling for prematurity by uk non-consultant doctors and annps

K. Hunt¹, A. Hassan^{2*}

¹North Bristol Trust, Neonatal Medicine, NB, United Kingdom

²Croydon University Hospital, Paediatrics, YE, United Kingdom

BACKGROUND AND AIM

Introduction Antenatal counselling is an important part of perinatal care. There is little formal training available. We wanted to investigate the factors that affect how confident non-Consultant UK doctors and advanced neonatal nurse practitioners (ANNPS) feel when asked to perform antenatal counselling

METHODS

A web-based survey was circulated. Confidence level was assessed on a five point scale, with five being the most confident and one the least confident.

RESULTS

There were 100 responses to the survey, most of whom were working at Tier 2 or registrar level (78%) and in tertiary units (71%). The majority (58%) had received no formal training. 25% had never been observed carrying out counselling, and 56% had been observed 3 times or fewer. Confidence in antenatal counselling increased directly in line with increased gestational age, with an average score of 2.2 for <24 weeks and 4.4 by 32-34 weeks gestation. Factors associated with increased confidence when counselling

<24 weeks gestation were years of tertiary experience ($p=0.012$) and receipt of formal training ($p<0.01$).

CONCLUSIONS

Discussion In this cohort of relatively senior non-Consultant doctors working in tertiary centres, there was a wide variation in confidence levels when carrying out antenatal counselling in various scenarios. The majority had received no formal training and only minimal supervised practice before carrying out counselling alone. Further training and workplace based assessment may improve confidence in this important area.

EP163 / #2039

E-Poster Viewing - Neonatology AS02-10. Family-centred care

Investigating confidence in antenatal counselling in various scenarios by uk non-consultant doctors and annps

K. Hunt^{1*}, A. Hassan²

¹North Bristol Trust, Neonatal Medicine, NB, United Kingdom

²Croydon University Hospital, Paediatrics, YE, United Kingdom

BACKGROUND AND AIM

Introduction Antenatal counselling is an important part of perinatal care. There is little formal training available. We wanted to investigate the factors that affect how confident non-Consultant UK doctors and advanced neonatal nurse practitioners (ANNPS) feel when asked to perform antenatal counselling in a variety of scenarios.

METHODS

A web-based survey was circulated. Confidence level was assessed on a five point scale, with five being the most confident and one the least confident.

RESULTS

Confidence in antenatal counselling increased with increasing gestational age, from a mean score of 2.4 at <24 weeks gestation to 4.4 at 32-34 weeks gestation. Mean confidence was not high for counselling in congenital diaphragmatic hernia (3.0) or Trisomy 18 (2.9), but was higher in duct-dependent cardiac lesion (3.8). 82% of respondents were confident or very confident to discuss transfer of a premature infant to a tertiary centre. Free text com-

ments included desire for further supervised practice and formal training or simulation.

CONCLUSIONS

Discussion Confidence to perform antenatal counselling amongst non-Consultant doctors and ANNPs is varied depending on the situation, with higher confidence levels when discussing initial management of cardiac lesions or in later prematurity. These healthcare practitioners recognise a need for further formal training and supervision in this area to improve their confidence and skills.

EP164 / #831

E-Poster Viewing - Neonatology AS02-10. Family-centred care

Influence of medical risk and perinatal factors on parenting of mothers and fathers with very preterm infants

N. Jiménez-Luque^{1,2*}, E. Ruiz-González^{1,3}, I. Benavente-Fernández^{1,3,4}, S. Lubián-López^{1,3}, Y. Sánchez-Sandoval^{1,2}

¹Biomedical Research and Innovation Institute of Cádiz (INIBICA), Research Unit, Cádiz, Spain

²University of Cádiz, Psychology, Cádiz, Spain

³Division of Neonatology, Department of Paediatrics, Cádiz, Spain

⁴University of Cádiz, Area of Paediatrics, Department of Child and Mother Health and Radiology, Medical School, Cádiz, Spain

BACKGROUND AND AIM

Improved parental skills benefit the long-term development of preterm infants. However, some perinatal or medical factors at birth could influence the task of parenting. The aim of this study is to analyze whether perinatal or medical factors at birth influence the exercise of parenting in mothers and fathers with children from 18 months' corrected age who were born as very low birth weight infants (VLBWI).

METHODS

We measured Parental Competences in mothers (N=68) and fathers (N=58) of 83 VLBWI with the Scale of Positive Parental Practices of the Caregiver (SP+C). We studied the relation of these with perinatal characteristics and a Neonatal Medical Risk Index based on the presence of comorbidities during neonatal admission. We used Spearman' Rho for correlation and multiple regression analysis, by gender, to study the association of Parental Competences and clinical variables.

RESULTS

For mothers, among the different subscales of SP+C, only sensitivity was associated with a higher medical risk index ($Rho=.295$; $p<.01$) and lower birth weight ($Rho=-.206$; $p=.04$). A significant regression equation was found ($F(1,82)=7.652$, $p=.007$), with an R^2 of .085. Maternal sensitivity is predicted by infant medical risk ($\beta=.292$; $p<.01$). For fathers, no significant relations were found between parental competences and perinatal characteristics or medical risk.

CONCLUSIONS

Maternal sensitivity, but not paternal sensitivity, is associated with the medical risk of their preterm infant. These findings may support the idea that mothers of preterm infants develop greater sensitivity as a consequence of the increased demands of their infants at birth.

EP165 / #671

E-Poster Viewing - Neonatology AS02-10. Family-centred care

Developing a core outcome set and outcome measures of family-centred care in neonatal care: the cousin study proposal

J. Latour^{1,2*}, A. Axelin³, J. Kostenzer⁴, M. Campbell-Yeo⁵, A. Van Den Hoogen⁶

¹University of Plymouth, Faculty of Health, Plymouth, United Kingdom

²Hunan Children's Hospital, Department of Nursing, Changsha, China

³University of Turku, Department of Nursing Science, University of Turku, Finland

⁴European Foundation for the Care of Newborn Infants, Scientific Affairs, Munich, Germany

⁵Dalhousie University, School of Nursing, Faculty of Health, Halifax, Canada

⁶University Medical Centre Utrecht - Wilhelmina Children's Hospital, Department of Neonatology, Utrecht, Netherlands

BACKGROUND AND AIM

Inconsistency in reporting standardised outcome measures in neonatal trials has been highlighted. A recent review and meta-analyses of family-centred care (FCC) interventions demonstrated difficulties in comparing parent reported outcome measures due to not using standardised outcomes and instrument. The aim of this study is to develop a core outcome set (COS) and a set of standardised outcome measures with recommended time-points to evaluate FCC practices in neonatal care.

METHODS

A mixed-method study will be deployed: 1) Systematic review to identify outcomes reported in studies evaluating FCC in neonatal care; 2) e-Delphi study and stakeholder meeting to specify the principles of FCC for neonatal care; 3) e-Delphi study to define a COS for studies evaluating FCC interventions; 4) Systematic review to identify the psychometric properties of instruments

used in evaluating FCC interventions; 5) Stakeholders meeting to reach consensus on the final list of the COS and the outcome measures for studies evaluating FCC in neonatal care.

RESULTS

This project will have multiple results. First, a uniform definition and principles of FCC in neonatal care. Second, an identified and standardised COS to evaluate FCC interventions. Third, recommendations of a set of instruments, including the recommended time-points, to measure the core outcomes in neonatal trials evaluating FCC interventions.

CONCLUSIONS

A COS and a set of recommended outcome instruments can increase research engagement of all stakeholders, including parents and former patients, and strengthen the evidence base of family-centred care practices in neonatal care and might support its implementation across the world.

EP166 / #1993

E-Poster Viewing - Neonatology AS02-10. Family-centred care

Designing and implementing listening out for zigzags sibling support-a level 3 nicu experience

L. Moore*

University Hospital Coventry and Warwickshire, Neonatal Unit, Coventry, United Kingdom

BACKGROUND AND AIM

Background Mental health issues affect 1 in 6 children in UK including depression, anxiety and low self-esteem. It can be a direct response to what is currently happening in their lives. Traumatic events such as a premature sibling being born or bereavement can cause upset, panic and worry. Evidence shows 54% of parents noted behaviour of their older child was affected, 25% of parents said their older child became afraid of death or becoming unwell and 12% of parents said that their older child needed counselling. Aim To enhance the psychological wellbeing of siblings and families on the neonatal unit, help siblings feel involved and supported, to provide an insight into equipments and understanding the importance of talking about their feelings.

METHODS

On our NICU, we set up a special place for sibling to visit, play and learn. We created open discussions to help express and cope with a range of emotions and feelings. Methodology included art therapy and play. Team included Nurses, nursery nurse, siblings and parents. Designing a book "Listening out for ZigZags" Staff/sibling/parents survey Worry monster mascot called ZigZags encourages children to write or draw any questions or worries that they are feeling and feed to ZigZags allowing open discussions.

RESULTS

Qualitative feedback survey showed children are better prepared for visit with improved understanding of equipments and positive interactions with their sibling. Parents felt it allowed children space to talk, smile and share their feelings.

CONCLUSIONS

ZigZags improved whole family neonatal experience and showed positive valuable psychological support..

EP167 / #950

E-Poster Viewing - Neonatology AS02-10. Family-centred care

An early intervention to support parent-infant interaction in the neonatal intensive care unit (nicu) and the effects on saliva cortisol co-regulation

E. Mörelius^{1,2*}, C. Sahlén Helmer², E. Theodorsson³, U. Thornberg^{2,4}

¹Edith Cowan University, School of Nursing and Midwifery, Joondalup, Australia

²Linköping University, Department of Health, Medicine and Caring Sciences, Linköping, Sweden

³Linköping University, Department of Biomedical and Clinical Sciences, Linköping, Sweden

⁴Linköping University, Department of Behavioural Science and Learning, Linköping, Sweden

BACKGROUND AND AIM

High-quality interaction between parents and their infants facilitates a secure attachment and the development of a healthy stress system. Early interventions such as family-centered care and skin-to-skin contact, increase opportunities for interaction but do not necessarily improve the quality of the parent-infant interaction. The new EARly Collaborative Intervention (EACI) is individualized hands-on guidance to support parents in establishing a good quality of interaction with their preterm infants in the NICU. This study investigated the effects of EACI on saliva cortisol co-regulation for mother-infant dyads.

METHODS

A RCT approved by the Regional Ethical Board and registered with ClinicalTrials.gov. Families with preterm infants (GA 30-36 weeks) without major complications were randomised to standard care or EACI. EACI was provided to families during a care procedure starting in the NICU within 72h after birth, thereafter, repeated before discharge, and again at home. Saliva was col-

lected for cortisol on a subsample of 77 mother-infant dyads before and after exposure to different stressors at one and four months. The stressors were a bath at one month and a Still-face procedure at four months. Co-regulation was analysed with Spearman's rho.

RESULTS

There were no significant differences in birth characteristics between groups. There were significant correlations in saliva cortisol (baseline and response) in mother-infant dyads at one and four months in the intervention group but not in the standard care group.

CONCLUSIONS

EACI is an individualized hands-on guiding support that strengthens saliva cortisol co-regulation between parents and their preterm infants in the NICU.

EP168 / #1321

E-Poster Viewing - Neonatology AS02-10. Family-centred care

Impact of family integrated care on level iiic nicu: improvement of clinical outcomes of prematures and others newborns with complex neonatal conditions

B. Moreno-Sanz*, M. Antón, M.T. Montes, P. Álvarez, M. Sánchez-Holgado, M. Cabrera, A. Pellicer

La Paz University Hospital, Neonatology, Madrid, Spain

BACKGROUND AND AIM

The impact of Family Integrated Care(FICare) is almost limited to short-term neonatal outcomes in stable preterm infants. The purpose of this study is to report on the strengths of the program on level IIC(medical and surgical) NICU.

METHODS

Newborns suffering any condition for which NICU admission for at least 3 weeks was expected were considered eligible. Family primary caregivers were trained according to the program's curricula. Each case was matched by a control infant, admitted at the same time (contemporary control,CC), plus 2 infants (historical control, HC) born in the previous 3 years (before FICare site implementation).

RESULTS

Infant-family dyads of 80 preterm [median GA 28³wk (26¹-30⁵); median BW 1048g (827-1421)] and 26 term-infants with complex neonatal conditions entered the FICare program at a median postnatal age of 8 days. In the preterm group, breast milk feeding on admission ($p=0.037$) and at discharge ($p<0.001$) was higher in the FICare group compared to CC or HC; and rates of nosocomial infection ($p=0.048$) and use of emergency services within the first 6 months of discharge ($p<0.001$) were lower. Among term-infants, non-significant higher rates of breast milk feeding at admission (FICare 91.3%; CC 73.1%; HC 78.4%) and at discharge (FICare 94.1; CC 81.8%; HC 19.4%) were shown in the intervention group. Necrotising enterocolitis decreased from 8.8% to 3.8% when comparing the pre- and post-FICare periods(NS).

CONCLUSIONS

This first report on FICare impact on a wider vulnerable neonatal population confirms the positive effects on breastfeeding, nosocomial infection, and points towards increased parental empowerment beyond the neonatal period.

EP169 / #501

E-Poster Viewing - Neonatology AS02-10. Family-centred care

Antenatal counselling in prematurity: parent and practitioner perspectives'

C. Murphy^{1,2*}, D. Henderson¹, M. Theubo¹, R. O'Toole², M. Boyle^{1,2}, N. Mccallion^{1,2}

¹Rotunda Hospital, Neonatology, Dublin, Ireland

²Royal College of Surgeons in Ireland, Paediatrics, Dublin, Ireland

BACKGROUND AND AIM

In the setting of preterm birth, antenatal counselling (ANC) is provided to parents by neonatologists. The content of ANC and training doctors receive may vary. Studies suggest clinicians underestimate survival and overestimate disability. We aimed to understand parental and healthcare provider's perception of ANC and the information they each deem important.

METHODS

An anonymous cross-sectional survey was carried out at a tertiary maternity unit (8,500 deliveries/year). Parents of preterm infants (23-33 weeks gestation) and neonatal healthcare practitioners (HCP) who provide ANC were invited to participate.

RESULTS

Survey responses were obtained from 23 parents and 22 HCPs. 14 (61%) parents received ANC but 40% reported receiving too little information. 14 (61%) would have liked to visit NICU before delivery. 10 (43%) parents searched Google for information. All wanted their partners present for ANC and 22

(96%) wanted additional written information. No HCP had received formal ANC training; 16 (73%) learned by shadowing their seniors. More experienced HCPs had greater confidence providing ANC to extremely preterm infants ($p=0.01$). For survival and neuro-disability outcomes, several local and international data sources were used, although many did not give exact figures (12-31%). 20 (91%) HCPs would avail of ANC training, if provided. Parents and practitioners rated the importance of survival, disability and breast feeding information similarly. However, parents rated practical information (infant clothing, visiting policies and breast milk alternatives) more highly than HCPs.

CONCLUSIONS

Written information should accompany the verbal ANC consult and practitioners should receive training in ANC, informed by current neonatal outcome data and parental perspectives.

EP170 / #1523

E-Poster Viewing - Neonatology AS02-10. Family-centred care

Outcomes of infants born to irish travellers

N. O'Hanrahan*, T. Condon, E. Molloy

Coombe Women and Infants Hospital, Neonatology, Dublin, Ireland

BACKGROUND AND AIM

Irish travellers are a traditionally nomadic ethnic minority group with significant populations in Ireland and the UK. Infant mortality in Irish travellers is four times higher than the general Irish population. This study aims to review outcomes of liveborn infants of Irish Travellers born in a tertiary maternity hospital.

METHODS

Over a 6-month period, demographics of Irish Traveller mothers and their infants in a tertiary neonatal unit were compared to overall hospital reporting figures.

RESULTS

Records of 64 infants born to 61 mothers were reviewed. Mean maternal age 24.7 (range 18-42) years. Smoking during pregnancy was common 40.9% (n=25). Mean gestational age was 38 weeks 4 days (range 32+6 to 41+4) and mean birth weight 3171(range 1300g-4260g)g. 9 babies (14%) were admitted to the neonatal unit. Only one infant received breast milk. There were two infant deaths (2.9%)- both due to a major congenital anomaly.

CONCLUSIONS

Irish traveller mothers were younger (24.5 vs 31.6 years) and more likely to smoke (40.9% vs 8%) when compared with the general population. Traveller infants were more likely to be admitted to the neonatal unit (14% vs 11.7%) and initiation of breastfeeding was extremely low (1.5% vs 65.5%). Infant mortality was high in this cohort in keeping with previously reported mortality rates for Irish Traveller infants.

EP171 / #1305

E-Poster Viewing - Neonatology AS02-10. Family-centred care

Evaluation of an asynchronous video diary service to support family involvement in neonatal care

S. Kirolos¹, L. Sutcliffe¹, M. Giatsi Clausen², C. Abernethy³,
S. Shanmugalingam⁴, N. Bauwens⁵, J. Orme⁶, K. Thomson⁷,
R. Grattan⁷, N. Patel^{1*}

¹Royal Hospital for Children, Neonatology, Glasgow, United Kingdom

²Queen Margaret University, Edinburgh, School of Health Sciences, Edinburgh, United Kingdom

³Princess Royal Maternity Hospital, Neonatology, Glasgow, United Kingdom

⁴Barnet Hospital, Neonatal Intensive Care, London, United Kingdom

⁵Aberdeen Maternity Hospital, Neonatology, Aberdeen, United Kingdom

⁶Simpson Centre for Reproductive Health, Royal Infirmary of Edinburgh, Neonatology, Edinburgh, United Kingdom

⁷Forth Valley Royal Hospital, Neonatology, Larbert, United Kingdom

BACKGROUND AND AIM

Models of Family Integrated Care (FiCare) empowering parents as primary caregivers are associated with improved outcomes for patients, families and service providers. Innovative FiCare solutions are required to minimise separation and involve parents when they cannot be physically present. This study evaluated the impact on family and staff experience of a cloud-based, asynchronous video messaging service to share short recorded care videos with patient families.

METHODS

Multi-centre survey evaluation of patient families and staff in six UK neonatal units, July - November 2019. Neonatal staff recorded short care videos (1-3 minutes) using tablet devices and shared securely with parents using the vCreate Neonatal Video Diary Service. Pre- and post- implementation

evaluation items included parental stress, breast milk expression, emotional closeness and staff workload.

RESULTS

In post-implementation surveys (n=42), 38 families (90%) perceived a benefit of the service, with positive impacts on anxiety, sleep, family involvement and relationships with staff, Figure 1. Qualitative responses indicated enhanced emotional closeness, involvement in care, and breast-milk feeding. Staff (n=77) indicated that the service was easy to use, and had minimal impact on workload. Fifty-five (71%) indicated a positive effect of the service on relationships with families. The video service has been used in >180 international clinical settings to share over 500,000 videos with patient families.

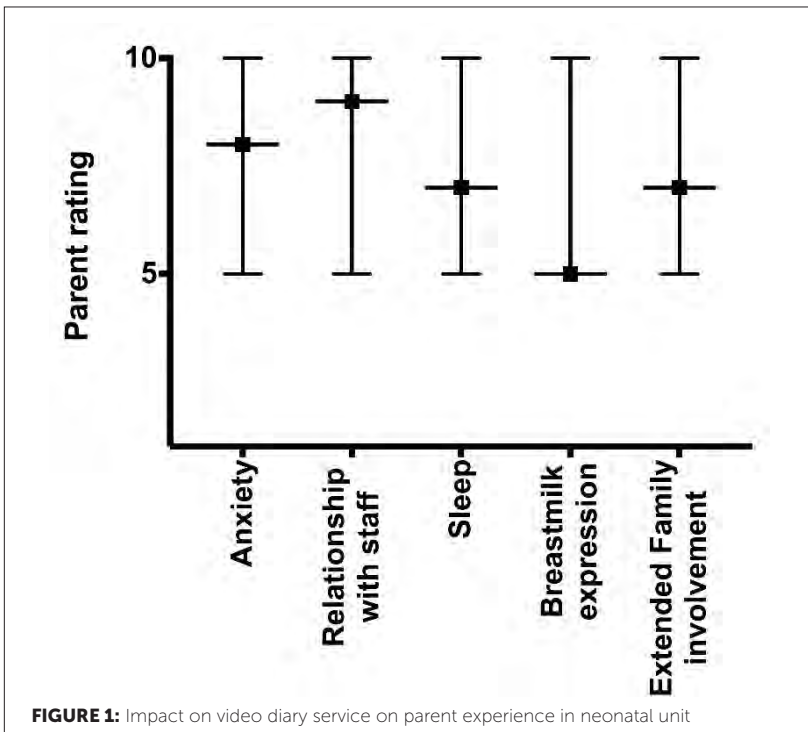

CONCLUSIONS

Neontatal video messaging services improves parental experience, emotional closeness, and builds supportive relationships with staff, supporting FICare and mitigating separation when parents cannot be present.

EP172 / #634**E-Poster Viewing - Neonatology AS02-10. Family-centred care****Getting a grip in the middle of chaos: preparing for preterm parenthood during a high-risk pregnancy – parental experiences and needs****K. Ruhe^{1*}, A. Van Den Hoogen², T. Bröring - Starre³, J. Wielenga¹, M. Weissenbruch¹**¹Amsterdam University Medical Centers, Neonatology, Amsterdam, Netherlands²University Medical Centre Utrecht - Wilhelmina Children's Hospital, Neonatology, Utrecht, Netherlands³Amsterdam University Medical Centers, Child Psychiatry and Psychosocial Care, Amsterdam, Netherlands**BACKGROUND AND AIM**

Admitting an infant to a neonatal intensive care unit (NICU) is stressful for parents. A great source of stress is the loss of their desired parental role. This study explores parents' experiences and needs during a high-risk pregnancy in preparation for their role as parents of a preterm infant.

METHODS

An exploratory qualitative study was conducted among parents with a preterm infant admitted to two level-III NICUs in the Netherlands. A thematic analysis was performed.

RESULTS

Nineteen interviews were conducted with parents of preterm infants (26–34 weeks gestational age). 'Getting a grip in the middle of chaos' was identified

as the central theme. 'Coping with potential preterm parenthood' emerged as a theme in the high-risk pregnancy phase. The emphasis was on strategies to handle the stress of an impending role as a preterm-infant parent. This theme contains four coping mechanisms as subthemes used over time: 'avoidance', 'counterbalancing', 'self-protection', and 'readiness'. The theme 'envisioning the NICU' emerged when parents experienced the NICU and reminisced on what they would have needed during pre-admission. The subthemes 'preterm care journey' and opportunities for involvement fostering 'parental empowerment' emerged from this phase. See Figure 1.

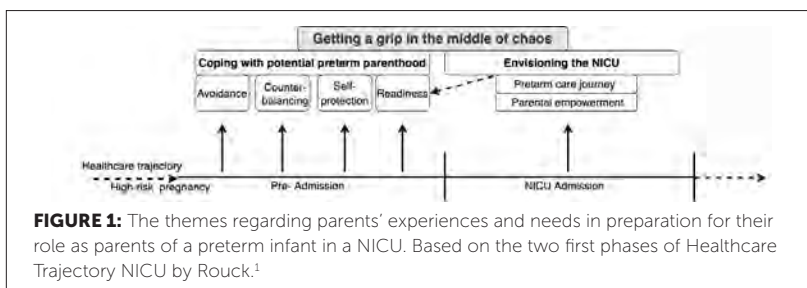

CONCLUSIONS

The timing and content of information about a parental role in the NICU should be tailored to the individual expectant parent. Moreover, providing a vision of the NICU, including parents' active participation in care, can empower and enable parents to get a grip in the middle of chaos.

1. de Rouck S, Leys M. Information behaviour of parents of children admitted to a neonatal intensive care unit: Constructing a conceptual framework. *Health (Irvine Calif)*. 2011;15(1):54–77.

EP173 / #853**E-Poster Viewing - Neonatology AS02-10. Family-centred care****A pilot study of family integrated care (ficare) in critically ill term and preterm infants in the nicu: ficare plus**

N. Sehr Ansari^{1*}, A. Colucci², X. Ye², L. Franck³, C. Tomlinson¹, K. O'Brien⁴

¹The Hospital for Sick Children, Neonatology, Toronto, Canada

²Mount Sinai Hospital, Pediatrics, Toronto, Canada

³University of California, Family Health Care, Toronto, Canada

⁴Mount Sinai Hospital, Neonatology, Toronto, Canada

BACKGROUND AND AIM

Family integrated care is associated with improved developmental outcomes and decreased parent mental health risks in stable infants. However, not much is known about its application in critically ill infants who are more likely to have adverse outcomes. The aim was to assess safety and feasibility of implementation of family integrated care in critically ill infants in the first few weeks of life.

METHODS

In a prospective cohort study at two tertiary care NICU's, 41 critically ill infants [median age 8 days (IQR:5-19)] were enrolled: 17 in observational group receiving standard care and 24 in intervention (FICare-plus) group. Resources were developed for staff and parents to support earlier engagement in infant care. Outcomes were assessed using standardized questionnaires at 4 time points: enrolment, day 21, pre-discharge, and post-discharge. The t-test or Wilcoxon Rank-Sum test were used to compare continuous variables, while Chi-square or Fisher exact test used for categorical variables.

RESULTS

Baseline maternal and infant characteristics were similar in both groups. No significant differences were observed between groups in mortality, major morbidity and duration of invasive ventilation. Total anxiety scores among parents were similar at enrolment between the two groups [83.1 (67-94) vs 77.3 (66-86); p-value 0.4]. However, the scores prior to discharge were lower in FICare-plus group [78 (71-90) vs 63 (52-74.5)]; p-value 0.02).

CONCLUSIONS

This pilot study shows that it is feasible and safe to implement FICare-plus in critically ill infants. Future research is needed to assess if this care model results in improved long-term outcomes for infants and families.

EP174 / #2059**E-Poster Viewing - Neonatology AS02-10. Family-centred care****Implementation of family-centered developmental care in the nicu: what are the obstacles to parental participation?****C. Young*, A. Vuckovic, A. Le Brun, J. Mortiaux**

Hôpital des enfants Reine Fabiola, Neonatal Intensive Care Unit, Bruxelles, Belgium

BACKGROUND AND AIM

Parental participation during the NICU stay is essential for the neurodevelopment of preterm infants. However, parenting in the NICU is challenging. The aim of this study was to characterize parental participation and identify predictors of parental presence and holding in the NICU.

METHODS

This was a single-center, retrospective study including 65 infants born before 37 weeks' gestation and admitted to a level IV NICU between July 2018 and August 2019. Socio-demographics, perinatal data, parental visits and holding duration were collected.

RESULTS

Parents visited their child at a median frequency of 5 (IQR =4–6) days per week. The median duration of daily skin-to-skin contact was 29 (IQR =19–41) minutes in mothers, while it was negligible for fathers ($P < .0001$). Infants born before 28 weeks' gestation were less visited and had their first skin-to-skin contact later than more mature infants ($P < .001$). In infants born before 32

weeks' gestation, the duration of skin-to-skin contact increased gradually until 33 weeks' postmenstrual age but decreased thereafter as the consequence of increased arm holding. Predictors of low maternal participation was the presence of siblings ($P = .0002$), neonatal comorbidities ($P = .0008$), and lack of income ($P = .0002$), accounting for 48% of the variance in maternal presence.

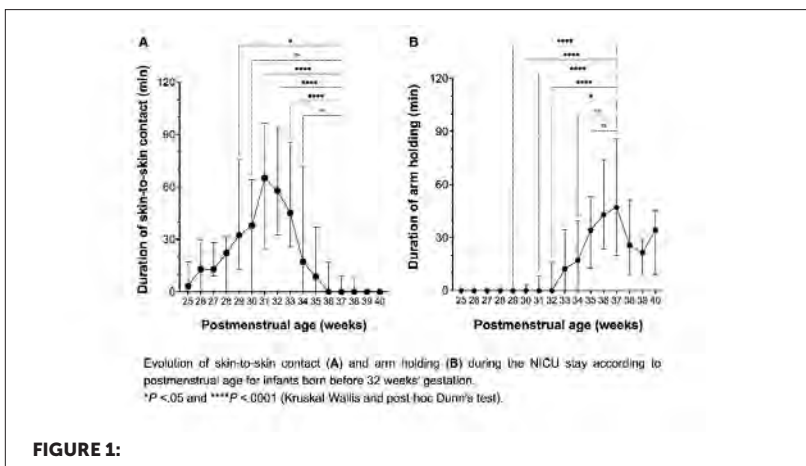

CONCLUSIONS

Socio-demographic and medical factors contribute, at least in part, to parental presence and holding of preterm infants in the NICU. This study also highlights the importance of including fathers, supporting families with siblings, and encouraging skin-to-skin contact until the end of the NICU stay.

EP175 / #790**E-Poster Viewing - Neonatology AS02-11.
Gastroenterology & hepatology****Diazoxide-induced worsening liver injury in a neonate with liver impairment****A. Mohammad Khuzaini^{1,2}, H. Abdul Halim^{1,3*}, V.J. Yap²**¹*Universiti Sains Islam Malaysia, Paediatric Department, Nilai, Malaysia*²*Hospital Ampang, Paediatric Department, Ampang, Malaysia*³*Hospital Ampang, Paediatric Department, Ampang, Malaysia***BACKGROUND AND AIM**

Diazoxide is commonly used to treat neonatal hypoglycaemia when first-line treatment fails and works by inhibiting insulin secretion.

METHODS

We report a case of a female infant born full-term with a birth weight of 3 kilograms who developed refractory hypoglycaemia from 1 hour of life. Diazoxide was started at day 9 of life due to persistent hypoglycaemia. Her initial alanine transaminase (ALT) level was 199 with mildly deranged total serum bilirubin levels. Aspartate transaminase (AST) and gamma glutamyl transferase (GGT) levels were not measured at this point. Albumin level was normal. Subsequently, patient developed worsening jaundice and liver enzymes after initiation of diazoxide. Highest ALT and AST levels were 527 and 937 respectively at day 10 of therapy. Thus, it was discontinued, and the liver enzymes consequently rapidly improved to baseline levels.

RESULTS

Liver impairment has not been described as a side effect of diazoxide. A case report by Tas et al. (2015) described worsening liver enzymes in a patient with hypoalbuminaemia.

CONCLUSIONS

It was hypothesised that as diazoxide binds to albumin, the hypoalbuminaemia resulted in higher free diazoxide in the circulation. Furthermore, the primary metabolism pathway for diazoxide involves oxidation and conjugation in the liver. Thus, in a patient with liver impairment, metabolism of the drug may be inadequate. Both hypotheses result in drug toxicity. However, the pathophysiology of these processes are yet to be explored.

EP176 / #1632**E-Poster Viewing - Neonatology AS02-11.
Gastroenterology & hepatology****Association between abnormal antenatal doppler
and gastrointestinal outcomes in preterm infants.****M. Annunziata^{1*}, M. Brunetti², A.N. Della Gatta³, G. Pilu⁴,
L. Corvaglia⁴, S. Martini⁴**¹University of Bologna, Specialty School of Pediatrics, Bologna, Italy²University of Bologna, Medical School, Bologna, Italy³IRCCS AOU Bologna, Obstetric Unit, Bologna, Italy⁴University of Bologna, Department of Medical and Surgical Sciences, Bologna, Italy**BACKGROUND AND AIM**

Antenatal Doppler impairment is associated with fetal hypoxia and hypoperfusion and may induce a blood flow diversion towards the brain at the expenses of gut circulation, possibly predisposing to gastrointestinal complications. We aimed to compare gastrointestinal outcomes between preterm infants with different degrees of antenatal Doppler impairment.

METHODS

Infants born between 2010-2021 with a GA <32 weeks and/or a birth weight <1500g were included. Infants with major congenital abnormalities, deceased or transferred to other hospitals before achieving the study outcomes were excluded. Based on antenatal Doppler characteristics, the study infants were split into the following groups: normal, absent or reversed end-diastolic flow in the umbilical artery (AREDF-UA) and in the ductus venosus (AREDF-UA+DV). The following outcomes were compared between the 3 groups: time to reach full enteral feeds (FEF, 150 ml/kg/day), duration of parenteral nutrition, signs or symptoms of feeding intolerance requiring feeding withholding >24h, necrotizing enterocolitis (Bell's stage $\geq 2a$), spontaneous intestinal perforation (SIP).

RESULTS

Out of 531 infants included, 90 (16.9%) had AREDF-UA and 22 (4.1%) AREDF-UA+DV. Comparisons of neonatal characteristics and outcomes between the study groups are shown in Figure 1. Compared to controls, AREDF-DV infants achieved FEF significantly later, required parenteral nutritional support for significantly longer periods and had a significantly higher SIP prevalence. The prevalence of feeding intolerance significantly increased for increasing severity of Doppler abnormalities. These results were confirmed even after adjustment for GA.

*Figure 1. Comparison of clinical characteristics and gastrointestinal outcomes between infants with different antenatal Doppler features. Results of Bonferroni post-hoc test are also highlighted (*p<0.05; ^p<0.01). Abbreviations: AREDF, absent or reversed end diastolic flow; UA, umbilical artery; DV, ductus venosus; IQR, interquartile range; FEF, full enteral feeding.*

	AREDF, UA (n=90)	AREDF, UA+DV (n=22)	Normal Doppler (n=419)	P-value
Clinical characteristics				
Gestational age, median (IQR), weeks	31 (29.14-32.78)**	29.2 (28.4-30.3)*	30.1 (27.9-31.2)*	0.001
Birth weight, median (IQR), g	1103 (869-1358)*	952 (680-1203)*	1315 (1020-1486)**	<0.001
Antenatal steroids (corticosteroids), n (%)	80 (88.9)	14 (66.7)	405 (73)	0.002
Male sex, n (%)	47 (52.2)	10 (45.5)	220 (52.5)	0.812
Small for gestational age, n (%)	46 (53.3)	9 (40.9)	56 (13.4)	<0.001
Mixed/formula feeds during hospital stay, n (%)	71 (79.8)	15 (68.2)	328 (78.5)	0.466
Gastrointestinal outcomes				
Parenteral nutrition duration, median (IQR), days	19 (13-27)	26 (19-47)*	17 (11-30)*	0.011
Time to achieve FEF, median (IQR), days	22 (16-31)	25 (20-48)*	20 (14-31)*	0.029
Feeding intolerance, n (%)	35 (38.9)	14 (63.6)	114 (27.2)	<0.001
Necrotizing enterocolitis, n (%)	4 (4.4)	2 (9.1)	10 (2.4)	0.117
Spontaneous intestinal perforation	0 (0)	3 (13.3)	6 (1.4)	<0.001

CONCLUSIONS

Abnormal antenatal Doppler and, in particular, the presence of AREDF-UA+DV, increases the risk of adverse gastrointestinal outcomes in very pre-term neonates.

EP177 / #1050**E-Poster Viewing - Neonatology AS02-11.
Gastroenterology & hepatology****Increase of necrotizing enterocolitis over a decade: a swedish population-based cohort study of extremely low gestational age infants****P. Challis^{1*}, L. Björklund², A. Elfvin³, M. Norman⁴, E. Normann⁵, M. Domellof¹, T. Abrahamsson⁶**¹Umea University, Department of Clinical Sciences, Pediatric Unit, Umea, Sweden²Lunds University, Paediatrics, Neonatology, Lund, Sweden³University of Gothenburg, Department of Pediatrics, Göteborg, Sweden⁴Division of Pediatrics, Department of Clinical Science, Intervention, and Technology, Stockholm, Sweden⁵Uppsala University, Women's and Children's Health, Uppsala, Sweden⁶Linköping University, Department of Biomedical and Clinical Sciences, Linköping, Sweden**BACKGROUND AND AIM**

The Extremely Preterm Infant Study in Sweden (EXPRESS) was conducted 2004-2007, and EXPRESS2 ten years later (2014-2016). Both cohorts include all infants born in Sweden below GA 27w. It has previously been published that the proportion of NEC was significantly higher in the later cohort (Norman, Jama, 2019). The NEC proportion was the only severe neonatal morbidity that showed an increase over time. This study investigates the factors behind the increase in NEC incidence between EXPRESS and EXPRESS2.

METHODS

The EXPRESS cohort included 600 infants surviving 24h, and EXPRESS2 included 846 infants. Data were collected prospectively, and NEC data were later validated against hospital records. NEC was defined as Bell score \geq II. NEC diagnosis was validated for both cohorts.

RESULTS

After validation, the previously observed difference in NEC incidence between EXPRESS and EXPRESS2 remained (27/600[4.5%] vs (72/846[8.5%]), $p=0.003$. Infants born at GA 24-26w showed no significant difference in death or NEC ratio between cohorts (98/517[19.0%] vs (114/651[17.5%]), $p=0.52$. There was no increase in odds for death or NEC between cohorts (aOR=0.98; 95%CI:0.75-1.27). The ratio of Early-onset NEC, ≤ 7 d of life, (14/587[2.4%] vs (20/794[2.5%]), $p=0.87$, showed no difference between cohorts. Late-onset, >7 d of life, was higher in EXPRESS2 (12/585[2.1%] vs 52/826[6.3%]), $p<0.001$, whereas there was no difference in the combined outcome of death or late-onset NEC (110/585[18.8%] vs 175/826[21.2%]), $p=0.27$.

CONCLUSIONS

The increase in NEC incidence between the EXPRESS and the EXPRESS 2 study was explained by an increased survival rate of infants born below 24 gestational weeks.

EP178 / #918**E-Poster Viewing - Neonatology AS02-11.
Gastroenterology & hepatology****The relationship between gut microbiome and feeding tolerance in preterm infants**

C.-C. Chen*, Y.-C. Hsu, Y.-H. Lin, M.-C. Lin, T.-M. Wang, C.-T. Hsu

Taichung Veterans General Hospital, Children's Medical Center, Department of Neonatology, Taichung, Taiwan

BACKGROUND AND AIM

The developmental Origins of Health and Disease (DoHaD), the programming phenomenon since the early fetal life, is a well-accepted theory nowadays. One of the key elements is the gut microbiota. The gut microbe assemblages of preterm infants have been reported to be different from that of healthy term infants. However, the patterns of ecosystem development and inter-individual differences in preterm infants remain studying. This study investigated the relationship between gut microbiota and feeding condition in the hospitalized preterm infants.

METHODS

This prospective study included 15 preterm neonates born at 27-35 weeks of gestational age between January 2021 and May 2021. The perinatal demographic characteristics were gathered. Feeding intolerance was defined as enteral feeding amount less than 100 ml/kg/day at age of 14 days old. The stool samples were collected weekly in the first month. Six of 15 participants were in the feeding intolerance group. All the gut microbiota were analyzed by 16S rRNA gene sequences.

RESULTS

We collected 48 samples from enrolled patients. All the participants were fed with breast milk since the first day of life and none was diagnosed with necrotizing enterocolitis. Separate clusters were demonstrated by principal coordinates analysis and non-metric multidimensional scaling plot between these two groups. This was in line with analysis of similarity (ANOSIM) result. ANOVA, Kruskal-Wallis test, and linear discriminant effect size analysis (LEFSe) all revealed significant differences between feeding tolerance and intolerance groups. The gut microbiota in the feeding intolerance group enriched with pathogenic bacteria such as Proteobacteria, Paenibacillaceae and Flavobacteriaceae. Duration of antibiotic use had significant impact on the development of gut microbiota.

CONCLUSIONS

Duration of antibiotics use might influence the microbiota development. Gut microbiota might be associated with preterm infants' feeding tolerance.

EP179 / #1079**E-Poster Viewing - Neonatology AS02-11.
Gastroenterology & hepatology****Mild controlled hypothermia is effective for nec treatment in preterm infants less than 27 weeks of gestational age.**

P. Morais¹, T. Lages², E. Orlandin², A. Junior², T. Bastos¹, B. Cavasin¹, K. Barszcz¹, D. Aragon¹, C. Ferreira², W. Goncalves-Ferri^{1*}

¹USP Ribeirao Preto, Neonatology, Ribeirao Preto, Brazil

²USP Ribeirao Preto, Neonatology, Ribeirao preto, Brazil

BACKGROUND AND AIM

Necrotizing enterocolitis (NEC) has been treated with mild controlled hypothermia in our neonatal units. However, its effectiveness in extremely preterm infants is unclear. This study aimed to evaluate hypothermic treatment in infants with a GA less than or equal to 27 weeks diagnosed with moderate and severe NEC.

METHODS

Clinical trial (non-randomized, historical controls). Preterm infant's gestational age ≤ 27 weeks with NEC moderate and severe (modified Bell criteria II/III). Control group: conventional treatment (antibiotics and fasting/ January 2015 - May 2018); Hypothermia group (conventional treatment and hypothermia for 48 hours after diagnosis, target temperature as $35^{\circ}\text{C} \pm 0.5^{\circ}\text{C}$ - June 2018- January 2022). We assess unfavorable outcomes related to NEC and the clinical evolution after the treatment. Fischer's exact test was used.

RESULTS

Twenty-eight patients; 9 conventional treatments, 19 hypothermia. Control group: Average weight 847g (SD231.2g), GA 175.8 days (SD9.1), NSOFA 5.8 (SD3.5), and age at diagnosis 18 days (SD17.47). Hypothermia group: 751g (SD 132.3g); 180.0days (SD8.0), 2.5 (SD 2.1) and 22 days (SD20.46), respectively. The hypothermia decrease the NEC surgery ($p<0.01$), perforation bowel ($p<0.01$), short bowel ($p=0.03$) and death ($p=0.02$). (Table 1) The gastrointestinal clinical evolution was better in the hypothermic group; enteral diet reintroduction were lower ($p=0.02$), normal clinical parameters were faster ($p=0.02$); parenteral nutrition length didn't present difference; HRadj: 0,43(0,17;1,09). Adverse effects were not noted.

Table 1: Outcomes related with NEC moderate and severe according to study group:

Outcomes	Control (n=9)	Hypothermia (n=19)	p-value
Days to enteral diet reintroduction	26.2 (\pm 22.11)	13.4 (\pm 5.2)	0.02
Clinical parameters of NEC length	24.6 (\pm 12.48)	10.8 (\pm 6.37)	0.01
Time for normal abdominal examination*	17 (\pm 4.8)	6.6 (\pm 4.94)	0.02
Perforation (%)	8 (88.8)	0 (0)	$p<0,01$
Laparotomy(%)	9 (100)	0(0)	$p<0,01$
Death(%)	3 (33.3)	0(0)	$p=0.02$
Short bowel(%)	3(33.3)	1(5.2)	$p=0.03$

CONCLUSIONS

Mild controlled hypothermia is effective for extremely preterm infants with NEC moderate and severe, associated with decreased NEC surgery, short bowel, and death, without adverse effects.

EP180 / #1742**E-Poster Viewing - Neonatology AS02-11.
Gastroenterology & hepatology****Mild controlled hypothermia to treatment of nec
moderate and severe in vlbw infants: neotherm
project**

**P. Morais, T. Iwashita Lages, E. Orlandin, A. Junior, T. Bastos,
W. Goncalves-Ferri*, C. Ferreira, D. Aragon**

Ribeirão Preto Medical School– University of São Paulo, Neonatology,
Ribeirao Preto, Brazil

BACKGROUND AND AIM

We performed (2015–2018) a quality improvement project using hypothermia as compassionate use to treat NEC, demonstrated favorable outcomes. Since 2018, we have been developing the NEOTHERM project, a prospective project applying hypothermia to preterm infants with NEC.

METHODS

Clinical trial (non-randomized, historical controls). Preterm infant's gestational age ≤ 27 weeks with NEC moderate and severe (modified Bell criteria II/III). Control group: conventional treatment (antibiotics and fasting/ Jan 2015 - May 2018); Hypothermia group (conventional treatment and hypothermia for 48 hours after diagnosis, target temperature as $35 \pm 0.5^\circ\text{C}$ / Jun 2018 - Jan 2022). We assess outcomes related to NEC. Relative risks were estimated and adjusted for chronological age at diagnosis and NSOFA.

RESULTS

Seventy-three patients > 27 weeks; 13 conventional treatments, 60 hypothermia. Control group: Average weight 1039g (SD215g), GA 201.6 days (SD215), NSOFA 3.7 (SD2.7), age at diagnosis 13 days (SD7.5). Hypothermia group: 1345g (SD 650.8g); 218.2 days (SD18.4), 2.6 (SD 3.7), 14.6 days (SD13.7), respectively. The gastric residual was shorter in the hypothermia group ($p=0.02$) and the parenteral nutrition length was lower (26.6 vs 74.08 HRadj 0.39 (0.2;077)). The enteral diet reintroduction was more straightforward for the hypothermia group, but without statistical significance. The control group showed a higher risk of occurrence regarding perforation, NEC surgery, short bowel, and death (Table 1). We did not note adverse effects.

Table: Outcomes related with NEC moderate and severe according the hypothermic treatment.

Outcomes	Control (n=13/%)	Hypothermia (n=60/%)	Adjusted relative Risk CI:95%	
Perforation	9 (69.2)	6 (10)	6.92 (2.98-16.06)	7.23 (3.16-16.5)
Laparotomy	9 (69.2)	10(16.6)	4.08 (2.09-7.99)	4.09 (2.09-8.0)
Death	4(30.7)	3(5.0)	6.15 (1.56-24.25)	6.11 (1.52-24.5)
Short bowel	3(23)	1(1.6)	13.38 (1.51-118.62)	11.66 (1.2-114.6)

*adjusted for NSOFA and chronological age at NEC

CONCLUSIONS

As older patients, VLBW infants with NEC moderate and severe who underwent mild controlled hypothermia had better outcomes when compared to patients who received only conventional therapy. Mild controlled hypothermia should be considered for NEC treatment.

EP181 / #1812**E-Poster Viewing - Neonatology AS02-11.
Gastroenterology & hepatology****The effects of frenotomy on breastfeeding symptoms, infant feeding and gastrointestinal health****R. Hill***

MGH Institute of Health Professions, School of Nursing, Boston, United States of America

BACKGROUND AND AIM

The relationship between maternal symptoms and problematic infant feeding in the context of tongue-tie is unknown. In addition, the effects of frenotomy on infant feeding and gastrointestinal dysfunction remains controversial, with insufficient evidence on the relationship between tongue-tie and disorders of the gastrointestinal tract. In a sample of infants with tongue-tie undergoing frenotomy and their mothers, the aims of this study were to: (1) describe changes in maternal symptoms (2) evaluate the relationships between maternal symptoms and symptoms of problematic feeding, and (3) compare symptoms of gastrointestinal (GI) distress and gastroesophageal reflux (GER) pre- and post-frenotomy.

METHODS

Breastfeeding mothers completed a maternal symptom checklist and the 36-item Gastrointestinal and Gastroesophageal Reflux (GIGER) Scale for Infants and Toddlers pre-frenotomy and two weeks post-frenotomy. Linear regression determined the effect of infant age and tongue-tie severity on GIGER scores. Logistic regression was used to explore changes in reflux strategies and parental perception of reflux symptoms pre- and post-frenotomy.

Poisson regression was used to determine if there were significant changes in maternal symptoms pre- to post-frenotomy.

RESULTS

Maternal symptoms and GI and GER symptoms were significantly less following frenotomy, with younger infants and those with more severe tongue-tie showing greatest improvements.

CONCLUSIONS

This is the first study to use the GIGER Scale to compare symptomology before and after tongue-tie correction. Total and subscale scores on the GIGER were significantly lower post- frenotomy, with significant improvement in maternal symptoms at the two week follow-up. Maternal symptoms, feeding problems and GI/GER symptoms persisting post-frenotomy warrant further evaluation.

EP182 / #982

E-Poster Viewing - Neonatology AS02-11. Gastroenterology & hepatology

Neonatal morbidities and feeding tolerance outcomes in very preterm infants, before and after introduction of probiotics supplementation

A. Mitha¹, S. Krut², S. Bjurman³, A. Rakow⁴, S. Johansson^{5*}

¹CHU Lille, Department of Emergency Medicine, Pediatric and Neonatal Intensive Care Transport Unit, Lille, France

²Karolinska University Hospital, Dept of Neonatology, Stockholm, Sweden

³Södersjukhuset, Sachs Children and Youth Hospital, Stockholm, Sweden

⁴Karolinska Institutet, Department of Woman and Child Health, Solna, Sweden

⁵Karolinska Institutet, Dept of Medicine Solna / Clinical Epidemiology Division T2, Stockholm, Sweden

BACKGROUND AND AIM

Given that probiotics reduce the risk of necrotizing enterocolitis (NEC), the European Society for Paediatric Gastroenterology, Hepatology and Nutrition recently published a Position Paper supporting its use. Thereafter, the NICUs in Stockholm/Sweden implemented probiotics as standard of care for very preterm infants. We hypothesized that probiotics supplementation would improve feeding tolerance and reduce risks of neonatal morbidities.

METHODS

Observational retrospective cohort study including very preterm infants (28+0 – 31+6 weeks) born in Stockholm 2019-2021, before and after implementation of probiotics supplementation. Primary composite outcome of death, infection and NEC. Secondary outcomes: duration of parental nutrition; time to full enteral feeding; abdominal x-ray; number of days on antibiotics; and breast milk feeding at discharge (exclusive and partial).

RESULTS

Among 348 very preterm infants, 209 received no probiotics and 139 received probiotics, with similar perinatal characteristics. As compared with no probiotics supplementation, rates and adjusted relative risks of infants received probiotics supplementation were for the composite outcome (death, infection and NEC) 4.3 % versus 10.5%, 0.41 [0.17 to 0.98]; duration of parenteral nutrition 7.0 days versus 8.2 days, -1.40 [-2.72 to -0.07], time to full enteral feeding 6.8 days versus 7.4 days, -0.73 [-1.39 to -0.07], abdominal x-ray 17.9% versus 28.2%, 0.64 [0.42 to 0.97]; number of days on antibiotics 5.8 versus 7.5, -1.97 [-3.52 to -0.41]; and breast milk feeding at discharge 80.0% versus 70.0%, 1.11 [1.00 to 1.24].

CONCLUSIONS

Very preterm infants benefit from probiotics supplementation by reduced risks of neonatal morbidities and improved feeding tolerance.

EP183 / #1171**E-Poster Viewing - Neonatology AS02-11.
Gastroenterology & hepatology****Fetal-neonatal exposure to antibiotics and necrotizing enterocolitis, a systematic review and meta-analysis****D. Klerk^{1*}, L. Van Avezaath¹, J. Hulscher², E. Kooi¹**

¹University Medical Center Groningen, University of Groningen, Department of Neonatology, Beatrix Children's Hospital, Groningen, Netherlands

²University Medical Center Groningen, University of Groningen, Groningen, Department of Pediatric Surgery, Groningen, Netherlands

BACKGROUND AND AIM

Fetal and neonatal exposure to antibiotics may contribute to the development of necrotizing enterocolitis (NEC) in preterm infants. This systematic review and meta-analysis aims to investigate the association between maternal antibiotics (MAB) and/or prolongation of empirical antibiotics (PEAB) after birth with the risk of developing NEC in preterm infants.

METHODS

We included RCTs and observational studies from MEDLINE and EMBASE, published between 1990 and June 2021. Inclusion criteria were a population consisting of preterm or VLWB infants, exposure was defined as MAB in the final trimester and/or PEAB. Two reviewers independently examined the extracted data and assessed the quality of included studies using GRADE.

RESULTS

Three cohort studies (total n=4676), compared final trimester MAB with no antibiotics. MAB was associated with a lower NEC incidence with an unadjusted pooled effect size of OR 0.57 (95% CI: 0.35, 0.93). Twelve studies demonstrated that PEAB was associated with an increased risk of NEC. For ten cohort studies (n=20388) the unadjusted pooled effect was OR 2.72 (95% CI: 1.65, 4.47), for two case-control studies (n=725) the unadjusted OR was 2.31 (95% CI: 0.94, 3.68). Moderate to substantial heterogeneity was observed but decreased in studies of high quality, with a larger sample size or after exclusion of the one study with a NEC incidence of 34.6%.

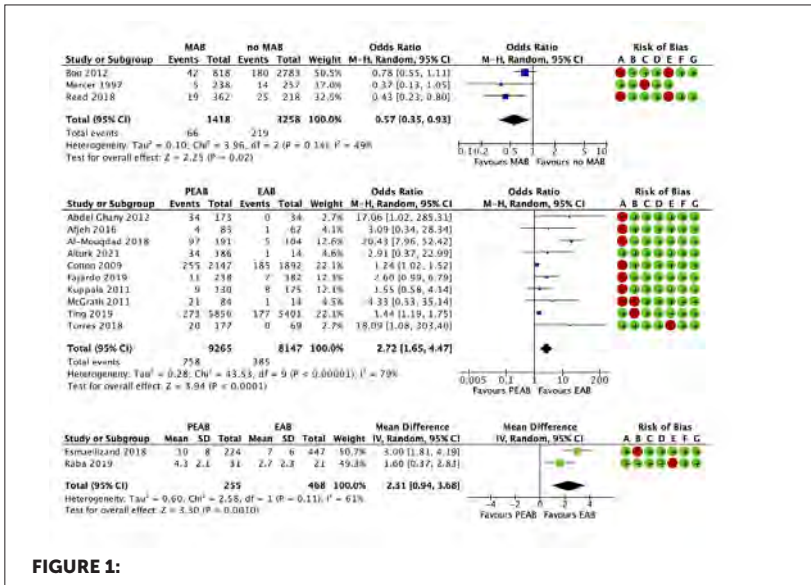

FIGURE 1:

CONCLUSIONS

Evidence suggests an association between MAB and two-fold decreased risk of NEC and an association between PEAB and two-fold increased risk of NEC. High quality RCTs are needed to address whether these associations are causal.

EP184 / #1465**E-Poster Viewing - Neonatology AS02-11.
Gastroenterology & hepatology****Performance of splanchnic nirs oximetry
monitoring in the very low birth weight preterm
infants****Z. Kozłowska^{1*}, Z. Owsiańska¹, I. Miechowicz², T. Szczapa³**¹Poznan University of Medical Sciences, Department of Neonatology, Poznan, Poland²Poznan University of Medical Sciences, Department of Computer Science and Statistics, Poznan, Poland³Poznan University of Medical Sciences, Department of Newborns' Infectious Diseases, Poznań, Poland**BACKGROUND AND AIM**

Near-infrared spectroscopy (NIRS) is a well-established method for monitoring cerebral oxygenation, but its suitability for monitoring splanchnic oxygenation remains uncertain. We evaluated the impact of weight, maturity and equipment on the splanchnic NIRS signal in the very low birthweight infants.

METHODS

Enterally fed preterm infants with birthweight <1500g were enrolled. Recordings of cerebral and splanchnic oxygenation were performed. We compared: 1) Medtronic INVOS 5100 Cerebral/Somatic Oximeter with neonatal, somatic and universal sensors; 2) Masimo O3 Regional Oximetry with pediatric sensor. Cerebral sensor was placed in the frontal area, splanchnic sensor in the pubic area. We simultaneously monitored cerebral and splanchnic oxygenation with different configurations of listed sensors for 60 minutes.

RESULTS

57 newborns were enrolled to the study. We found significantly higher mean percent of time with no signal from splachnic location comparing to the cerebral site (14,70% vs 1,15%, $p=0,000$). Longer mean time with lack of signal was found in patients with weight $<1500\text{g}$ vs $\geq 1500\text{g}$ (23% vs 4%, $p=0,014$) and GA <32 weeks vs ≥ 32 weeks (21,44% vs 3,14%, $p=0,007$) during splachnic monitoring. Spearman's rank correlation ($R_s=-0,356$, $p=0,007$) showed inverse correlation between weight and time without signal from splachnic sensor. Differences in the percentage of time without reading from splachnic site were found between sensors: somatic, Invos 5100 vs pediatric, Masimo in patients with weight $>1500\text{g}$ (0,23% vs 12,66%, $p=0,001$) and GA ≥ 32 weeks (0,00% vs 9,32%, $p=0,001$).

CONCLUSIONS

Splachnic NIRS monitoring may be less reliable then cerebral oximetry in the very low birthweight preterm infants.

EP185 / #2697**E-Poster Viewing - Neonatology AS02-11.
Gastroenterology & hepatology****The role of serum epidermal growth factor in the development of neonatal jaundice**

O. Mazur*, A. Konoplitska, T. Chekotun, I. Kyslova,
N. Chornopyshchuk

National Pirogov Memorial Medical University, Pediatric Department #1,
Vinnytsya, Ukraine

BACKGROUND AND AIM

Epidermal growth factor (EGF) is important for the normal development of the intestine, as well as for recovery from damage to the mucosal lining of the gastrointestinal tract. EGF is found in large quantities in many fluids that bathe the gastrointestinal tract of the fetus and newborn, in saliva, as well as in the mother's breast milk. Its main function is to stimulate the development of the baby's gastrointestinal tract by increasing the proliferation and differentiation of epithelial cells. However, there is evidence that EGF can also be the cause of jaundice in newborns. It is not known exactly what effect EGF has in the development of jaundice in newborns. The aim of this study was to investigate whether there is a relationship between serum EGF levels with implications for the development of neonatal jaundice.

METHODS

40 term newborns with neonatal jaundice enrolled into this study and 20 non-jaundice newborns formed a control group. The average duration of jaundice - 14.8 ± 0.8 days. The level of total bilirubin in blood serum - 286.1 ± 10.2 $\mu\text{mol} / \text{l}$.

RESULTS

The level of blood EGF in newborns with jaundice - 506.9 ± 45.4 ng/ml, which significantly exceeded the value of EGF of non-jaundice newborns - 201.5 ± 23.8 ng/ml, ($p < 0.05$). There was a negative relationship between serum total bilirubin levels and blood EGF levels in the study group ($r_{xy} = -0,6$, $p < 0,05$).

CONCLUSIONS

In newborns with jaundice, the concentration of serum EGF was 2.5 times higher, as a result, the proliferation of the intestinal mucosa is significantly increased and the excretion of bilirubin is significantly reduced.

EP186 / #1150**E-Poster Viewing - Neonatology AS02-11.
Gastroenterology & hepatology****Plasma biochemical and lipid panel analysis of neonatal rats exposed to phytosterols in lipid emulsions****N. Memon^{1,2*}, C. Lee³, A. Herdt³, E. Eckman³**¹Goryeb Children's Hospital, Pediatrics, Morristown, United States of America²MidAtlantic Neonatology Associates, Neonatology, Morristown, United States of America³Biomedical Research Institute of NJ, Research, Morristown, United States of America**BACKGROUND AND AIM**

Traditional lipid emulsions are vegetable-oil based, and contain high concentrations of plant cholesterol, known as phytosterols (PS). Limited studies have shown that PS may contribute to parenteral nutrition-associated liver disease. Using a novel phytosterolemia rat model, we studied the isolated effects of PS exposure that mimics PS exposure with short-term parenteral nutrition use. Our objective was to characterize alterations in biochemical and blood cell count profiles in pups exposed to PS.

METHODS

β -sitosterol, campesterol, and stigmasterol were dissolved in 2-hydroxypropyl- β -cyclodextrin (vehicle) to create a PS solution. Sprague-Dawley rat pups received daily injections of PS solution from P0-P13 at doses approximating PS content in 2 g/kg/d (n=7) or 4 g/kg/d (n=5) Intralipid. Vehicle exposed pups (n=12) served as controls. Plasma CBC, hepatic function tests, and lipid levels were analyzed in subsets of rats by IDEXX BioAnalytics. Total bile acid (BA) analysis was repeated using a fluorimetric BA assay (Sigma Aldrich). Results were compared by unpaired t-test or Mann Whitney U test.

RESULTS

Blood analysis showed no differences in hepatic function tests, lipid levels, and CBC; but detected a 40% increase in plasma BA in pups receiving PS solution vs. vehicle (Fig 1a). Repeat BA analysis showed a similar, but statistically insignificant, 32% increase in BA levels in a larger group of PS exposed pups compared to vehicle (Fig 1b).

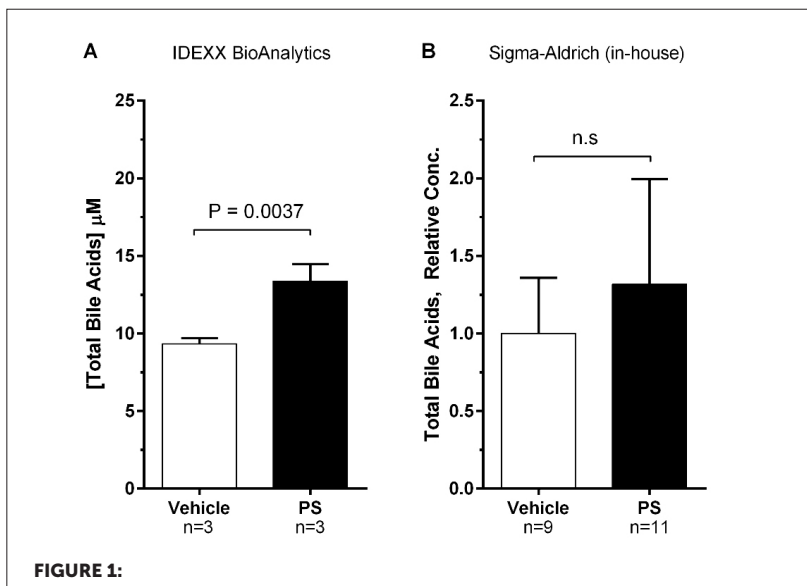

FIGURE 1:

CONCLUSIONS

Our results suggest that short-term exposure of PS does not result in direct hyperbilirubinemia or other changes in hepatic function tests. The increase in BA concentrations in PS exposed pups is intriguing and warrants further investigation.

EP187 / #2329**E-Poster Viewing - Neonatology AS02-11.
Gastroenterology & hepatology****Comparison of the first meconium microbiota: is it related to maternal lcpufa?****E. Ogundipe^{1*}, E. Demertzi²**¹Chelsea & Westminster Hospital/Imperial College London, Neonatal, London, United Kingdom²Kingston General Hospital, Microbiology, London, United Kingdom**BACKGROUND AND AIM**

Factors that influence gut microbiota development in newborn infants' first stools could be critical regulatory determinants of first gut microflora has been linked to inflammatory disorders throughout the life spectrum. Omega n-6 and n-3 series long chain polyunsaturated fatty acids (LCPUFAs) in pregnancy are such probable influencing factors explored as to whether they influence newborn gut microbiota development.

METHODS

"First-pass" meconium microbiota from infants born to women enrolled in a double blinded RCT of LCPUFA supplementation in pregnancy were analysed using culture and semiquantitative genus-specific real time polymerase chain reaction (DNA-PCR) techniques. Findings were correlated to maternal lipid profiles.

RESULTS

LCPUFA profiles highly correlated with "good bacteria" e.g. bifidobacteria ($p=0.020$). By contrast, a deplete maternal LCPUFA blood lipid profile correlated with "bad bacteria" e.g. Enterobacteriaceae ($p<0.0001$) and coagulase

negative staphylococcus species; ($p=0.001$) in the newborn meconium stool at birth.

CONCLUSIONS

Pregnant maternal lipid profile differentially correlate to newborn stool microbiota at birth. LCPUFAs are important in newborn gut microbiota development that could determine early life health and even later neurodevelopmental outcomes

EP188 / #539**E-Poster Viewing - Neonatology AS02-11.
Gastroenterology & hepatology****Impact of neonatologist's performed bedside ultrasound on early diagnosis and management of necrotizing enterocolitis: a before-after controlled study**

J. Rodriguez-Fanjul^{1*}, S. Terroba Seara², C. Sorribes¹, D. Fernandez², A. Pou², S. Fuentes², I. Oulego-Erroz³

¹Hospital Germans Trias i Pujol, Pediatric Intensive Care Unit, Badalona, Spain

²Complejo Asistencial Universitario de León, Neonatal Intensive Care Unit., Leon, Spain

³Complejo Asistencial Universitario de León, Pediatric Intensive Care Unit., Leon, Spain

BACKGROUND AND AIM

Ultrasound is a valuable tool in the diagnosis of necrotizing enterocolitis (NEC). However, it is mainly used as a complement to conventional radiography which remains considered the primary imaging modality in NEC. The aim of the present study was to assess whether bedside ultrasound (BUS) improves early diagnosis of necrotizing enterocolitis (NEC)

METHODS

Design: Before and after controlled study. Setting: Two neonatal intensive care units. Patients: Infants below 37 weeks of gestational age with suspected NEC. Interventions: The intervention group received BUS as first imaging modality and treatment was guided by BUS findings. The retrospective control group received radiography as first imaging modality and was managed conventionally. Main outcomes and measures: The main outcome was NEC confirmation at the time of initial imaging. Secondary outcomes included radiological progression of NEC, laboratory data, treatment requirements, surgical NEC and NEC-related death

RESULTS

Thirty-five episodes of suspected NEC with 14 (40%) confirmed NEC cases and 49 episodes of suspected NEC with 22 (44.9%) confirmed NEC cases were included in the intervention and control group respectively. In the intervention group 14 of 14 (100%) NEC cases were confirmed at initial evaluation compared to 10 of 22 (45.4%) in the control group ($p=0.001$). Infants managed with BUS developed thrombocytopenia and coagulopathy less frequently, progressed less frequently to radiological Bell's stage >II and required less days of bowel rest and parenteral nutrition compared to infants in the control group ($p<0.05$). Rates of surgery [4 of 14 (28.6%) vs 8 of 22 (36.7%); $p=0.727$] and NEC related death [0 of 14 (0%) vs 5 of 22 (22.7%); $p=0.133$] were not different.

CONCLUSIONS

The use of BUS as first imaging modality resulted in an earlier diagnosis and less clinical severity of NEC compared to abdominal radiography

EP189 / #1362**E-Poster Viewing - Neonatology AS02-11.
Gastroenterology & hepatology****Vitamin d deficiency in newborns with prolonged jaundice****O. Ozen¹, S. Yurttutan^{2*}, M. Ozkars³, C. Acipayam⁴, S. Kırık⁵,
M. Kılınc⁶, F. Başturk¹**¹*KSU Medical Faculty, Pediatrics, Kahramanmaraş, Turkey*²*KSU Tıp, Pediatrics, Kahramanmaraş, Turkey*³*KSU Medical Faculty, Allerji-İmmunoloji, İstanbul, Turkey*⁴*KSU Medical Faculty, Pediatric Hematology/oncology, Kahramanmaraş, Turkey*⁵*Firat University Medical Faculty, Pediatric Neurology, Kahramanmaraş, Turkey*⁶*KSU Medical Faculty, Biochemistry, Kahramanmaraş, Turkey***BACKGROUND AND AIM**

Objective: In this study, it was aimed to reveal the relationship between vitamin D level and bilirubin levels and the effect of vitamin D levels on protracted jaundice in term newborn babies who have prolonged jaundice and no other disease that may be effective in the etiology

METHODS**MATERIALS AND METHODS**

In the study, 60 infants with a serum total bilirubin value above 5 mg/dL after 37 weeks of age and above, who applied to Our Unit, neonatal outpatient clinic and pediatric health and diseases polyclinic, and as the control group, from postnatal 14 days with the same demographic characteristics then healthy babies were taken. Postnatal age, birth weight, weight at first admis-

sion, gender, whether they took vitamin D prophylaxis and diet of all cases were recorded. Obtained results were compared statistically

RESULTS

Findings: In our study, there was no statistically significant difference when the demographic data of the patient group and the control group were compared, postnatal age, gender, birth weight, weight at the time of examination, vitamin D prophylaxis intake, feeding styles and delivery types ($p>0.05$). When the vitamin D levels of the patients were compared between the two groups, the 25(OH) vitamin D level was found to be statistically significantly lower in those with prolonged jaundice ($p<0.001$).

CONCLUSIONS

In our study; Infants with prolonged jaundice had significantly lower Vitamin D levels. As a result, vitamin D levels should be kept in mind when evaluating newborn babies presenting with prolonged jaundice.

EP190 / #2333**E-Poster Viewing - Neonatology AS02-12.
Nutrition****Randomized controlled trial of early
docosahexaenoic acid and arachidonic acid
enteral supplementation in very preterm infants**

P. Alvarez Garcia^{1*}, D. Ramiro Cortijo¹, M.T. Montes², B. Moreno-Sanz², A. Esteban Romero¹, M. Ybarra¹, M. Cordeiro¹, E. Valverde³, J. Fontecha⁴, R. Gibson⁵, M. Saenz De Pipaon²

¹Hospital Universitario La Paz, Neonatology, Madrid, Spain

²La Paz University Hospital, Neonatology, Madrid, Spain

³La Paz University Hospital, Madrid (Spain), Neonatology Department, Madrid, Spain

⁴CSIC, Csic, Madrid, Spain

⁵South Australian Health and Medical Research Institute, South Australian Health An Medical Research Institute, Adelaide, Australia

BACKGROUND AND AIM

To evaluate changes in blood long-chain polyunsaturated fatty acids (LCPUFA) and oxylipins concentrations in very preterm infants from birth to 36 weeks PMA after providing a concentrated emulsified LCPUFA supplement at two different concentrations.

METHODS

This prospective, randomized trial, assigned infants to receive a supplement (1) 40:80 (40 mg/kg/day docosahexaenoic acid [DHA] and 80 mg/kg/day arachidonic acid [ARA]; or (2) 60:120 (60 mg/kg/day DHA and 120 mg/kg/day ARA). Infants received supplement daily from birth until 36 weeks PMA or discharge, whichever came first. Whole blood LCPUFA levels were measured in plasma and erythrocytes at baseline, 21 days, and 36 weeks PMA

RESULTS

Infants were of similar gestational age (40:80, 202 [IQR, 192 to 213]; 60:120, 209 [192 to 215]) between groups. At 36 WPA, the change in plasma ARA (mol%) from baseline differed significantly between groups (40:80, n = 9; 0.1 [IQR, -0.7 to 0.7]; 60:120, n = 8; 1.8 [IQR, 0.9 to 3.3]; P = .002 between groups). Whole blood levels of 4-HDHA and 14-HDHA (pg/mL) were higher at 36 weeks PMA in 60:120 group compared to 40:80 group. Change in whole blood 5-, 8-, 9-, 11-, 15-HETEs, 8,9-EET and 18-HEPE (pg/mL) from baseline also differed significantly among groups

CONCLUSIONS

Our results show that ARA levels are modulated by intake. Supplementation at higher doses, 60:120, increased levels of ARA and DHA and ARA derived oxylipins compared to lower doses, 40:80. The effect may be due to increased CYP450 enzymatic activity. Differences were appreciated in DHA metabolites without a significant increase in plasma DHA.

EP191 / #1588**E-Poster Viewing - Neonatology AS02-12.
Nutrition****Hormone content in preterm human milk:
influence of maternal characteristics and impact
on infant growth**

**C. Balcells-Esponera^{1*}, I. Cubells-Serra², C. Borràs-Novell³,
M. López-Abad⁴, A. Basseda-Puig⁵, M. Izquierdo Renau⁶, A. Herranz
Barbero³, I. Iglesias Platas⁶**

¹Hospital Sant Joan de Déu, Neonatology, Esplugues de Llobregat, Spain

²Hospital General Universitari de Castelló, Neonatology, Castelló de la Plana, Spain

³Hospital Clínic de Barcelona, Neonatology, Barcelona, Spain

⁴Fundació Sant Joan de Déu, Neonatology, Esplugues de Llobregat, Spain

⁵University of Barcelona, Faculty of Medicine, Barcelona, Spain

⁶Hospital Sant Joan de Déu, Neonatology, Esplugues de Llobregat, Spain

BACKGROUND AND AIM

Postnatal growth of very preterm infants (VPI) may play a role in developmental programming that can impact adiposity in later life. Adipokines in mother's milk may affect postnatal growth of VPI. We aimed to describe hormone composition in human milk of VPI according to maternal characteristics and to analyse their effect on postnatal growth.

METHODS

We included mother-infant pairs of neonates born ≤ 32 weeks of gestation exclusively breastfed at 4 weeks of life. At this time, mothers collected a representative milk sample of the 24-hour production. Skimmed milk was analysed for insulin, leptin, adiponectin and milk fat globule epidermal growth factor 8 (MFG-E8) with commercial ELISA kits. Clinical data was collected from questionnaires and clinical records.

RESULTS

Milk from 120 mothers had the following mean hormones concentrations: leptin 496.7pg/mL (SD 403.5), insulin 23.3mU/L (SD 26.1), adiponectin 24.9ng/mL (SD 8.0) and MFG-E8 14.0µg/mL (SD 6.0). We found a positive correlation insulin-leptin ($r=0.496$, $p<0.0001$), insulin-MFG-E8 ($r=0.569$, $p<0.0001$) and MFG-E8-adiponectin ($r=0.244$, $p=0.037$). Insulin ($r=0.357$, $p=0.002$) and leptin ($r=0.786$, $p<0.0001$) correlated with BMI and mothers with gestational diabetes had higher levels of adiponectin (24.7 ± 7.9 vs 30.7 ± 6.5 ng/mL, $p=0.042$). Insulin correlated negatively with gestational age ($r=-0.410$, $p<0.0001$). We found a negative correlation between adiponectin and fall in length-for-age ZS (LAZ) at 28 days of life ($r=-0.227$, $p=0.032$).

CONCLUSIONS

Adipokines are found in preterm milk at 28 days of lactation. Insulin and leptin concentrations are related to maternal adiposity. Adiponectin concentration was related to fall in LAZ at 28 days of lactation.

EP192 / #1211**E-Poster Viewing - Neonatology AS02-12.
Nutrition****Neonatal hyperglycaemia in extremely preterm infants: a single service experience in nottingham england****L. Beckham*, D. Batra, M. Haggag**

Nottingham University Hospitals NHS Trust, Neonatal Medicine, Nottingham, United Kingdom

BACKGROUND AND AIM

There is no UK national consensus for the treatment of neonatal hyperglycaemia, nor standardised management at Nottingham's tertiary neonatal centre. The level of hyperglycaemia causing harm produces ongoing debate, with >20mmol/l suggested as 'uncontrolled hyperglycaemia' and most harmful. Definitions of neonatal hyperglycaemia [6.9-8.3mmol/l] and treatment thresholds [most commonly two consecutive values >12mmol/l] vary across units and studies. Management options include glucose load reduction, insulin administration, or both. Aims: -Identify incidence of hyperglycaemia, 'uncontrolled hyperglycaemia' and insulin-related hypoglycaemia in neonates <30 weeks gestational age (WGA) at Queens Medical Centre (QMC) Nottingham University Hospitals NHS Trust UK. -Understand current practice to develop a standardised guideline.

METHODS

Retrospective review of neonatal database and case notes for infants ≤ 29 WGA admitted to QMC, August 2020-2021. Exclusions: infants transferred out in first week, transferred in after day 2 or died day 1.

RESULTS

48 neonates included. Data analysed in two subgroups:

TABLE 1:

	All infants	22-25WGA	26-29WGA
Incidence glucose >8mmol/l (%)	98	100	97
Incidence glucose >12mmol/l twice (%)	81	100	73
Incidence 'uncontrolled hyperglycaemia' (%)	50	87	33
Median highest glucose (mmol/l)	19.6	27	17.5
Median length of hyperglycaemia (days)	10	19	6.5
Incidence hypoglycaemia (%)	19	40	14
Incidence PN glucose load reduced (%)	44	67	30

Insulin sliding scale adjusted 238 times during 319 insulin days.

CONCLUSIONS

Differences between ≤ 25 WGA and ≥ 26 WGA suggest 22-25WGA infants may benefit from modified management strategies, with increasing relevance as more peri-viable neonates receive intensive care. Next steps for quality improvement: -Introduce guideline with specific ≤ 25 WGA management
-Ongoing data-collection and analysis

EP193 / #2144

E-Poster Viewing - Neonatology AS02-12. Nutrition

Post discharge fortifier improves breastfeeding rates for preterm infants

H. Blair*, A. Davidson, A. Ajiboye

Edinburgh Royal Infirmary, Simpsons Centre For Reproductive Health, Edinburgh, United Kingdom

BACKGROUND AND AIM

Breastmilk (BM) is the preferred milk for preterm infants. To ensure growth, additional nutrition is provided by fortifier which is traditionally stopped before discharge. Infants discharged at earlier gestations are at higher risk of growth failure if fed exclusive BM/Breastfeeding (EBM/EBF), often leading to formula supplementation which erodes maternal confidence. The aim of this intervention is to support longer term EBM/EBF by supplementing with small, fortified BM volumes for EBF preterm infants.

METHODS

EBF/EBM fed infants born $<32/40$ +/- <1500 g BW continued with fortifier post discharge with dietetic/nursing support. The fortifier was given as 1 sachet/5ml BM via syringe/spoon (Booster group) before BFs. Retrospective data was also collated on babies of similar gestations on EBM/EBF for comparison (Pre-Booster group). Weight and head circumferences (HC) data with associated change in z-scores were calculated alongside milk type at specific time intervals.

RESULTS

14 babies were discharged on EBM/EBF with boosters and compared to data of 36 babies in the pre-booster group. Infants supplemented with boosters were more likely to be breastfed exclusively at 2 and 4m CGA. Weight gain was slower in the booster group as was OFC growth.

CONCLUSIONS

Improved BF rates in the booster group were demonstrated at all time intervals up to 4m CGA. Significant evidence supports breastmilk improving neurodevelopmental outcome. Better understanding is needed of what optimal weight gain is for breastfed preterm infants. Providing boosters for EBF infants needs a more tailored approach than the 4–6/day that is commonly suggested in the UK.

EP194 / #1122

E-Poster Viewing - Neonatology AS02-12. Nutrition

Reducing the time of colostrum administration to babies on nicu through a qi project

E. Brazier*, C.-L. Chadwick, A. Lakshmanan, C. Proctor, S. Latchford, J. Bradshaw

University Hospitals Coventry and Warwickshire, Neonates, Coventry, United Kingdom

BACKGROUND AND AIM

BAPM recommends that infants receive colostrum within the first 6 hours of life. Before the QI group was set up babies <28weeks gestation were not receiving colostrum until >24hrs of life. This was the 4th PDSA cycle over a two year period. The aim is to reduce the time infants on NICU receive colostrum to less than six hours after birth as per BAPM standards.

METHODS

Originally spot audits of the notes on NICU but since April 2021 data has been collected for all babies admitted to the unit. Information was collected from breastfeeding packs, Bedside charts and Badger. Staff and parental survey at the end of the cycle to see where education should be targeted and ideas for improvement.

RESULTS

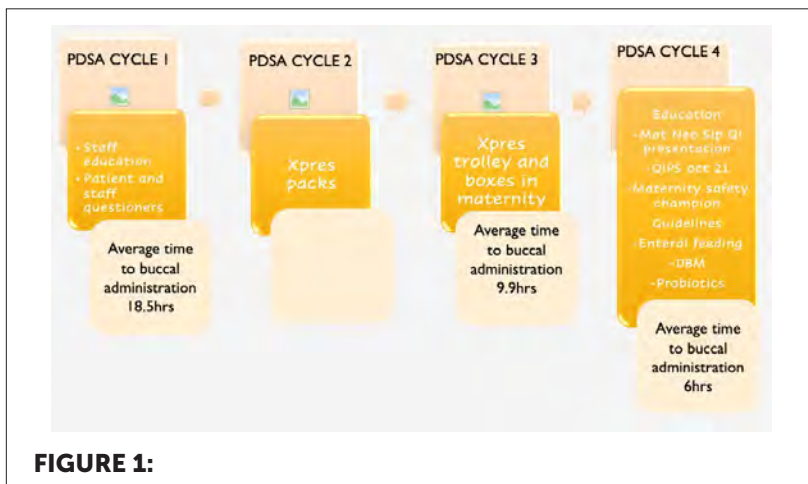

FIGURE 1:

Average time to receive colostrum has been reduced from 18.5hrs to 6hrs (Image 1.) In January 2022 100% of babies went home receiving breastmilk whose feeding preference was breastmilk at birth and compared to 81% in April 2021. The survey revealed the number of staff aware of the Buccal colostrum policy remained the same at 77% compared to the previous survey but 100% of respondents felt that a sick baby should still receive buccal colostrum compared to 80% previously. The top three barriers to getting colostrum early reported by staff were maternal health, staffing levels, and support.

CONCLUSIONS

In conclusion the unit has improved the time babies receive colostrum after birth. Areas for improvement for the next cycle include education of neonatal and maternity staff and embedding discussions regarding colostrum into antenatal counselling

EP195 / #2416

E-Poster Viewing - Neonatology AS02-12. Nutrition

Microbial effects of supplemented prebiotics, probiotics and synbiotics after caesarean section or exposure to antibiotics in the first week of life: a systematic review

N. Carpay^{1*}, K. Kamphorst¹, T. De Meij², J.G. Daams³, A. Vlieger⁴, R. Van Elburg¹

¹Amsterdam UMC location University of Amsterdam, Pediatrics, Amsterdam, Netherlands

²Amsterdam UMC location Vrije Universiteit Amsterdam, Pediatric Gastroenterology, Amsterdam, Netherlands

³Amsterdam UMC location University of Amsterdam, Medical Library, Amsterdam, Netherlands

⁴St. Antonius Hospital, Pediatrics, Nieuwegein, Netherlands

BACKGROUND AND AIM

Disruption of the developing microbiome by Caesarean birth or exposure to antibiotics in the first week of life can have long-term health consequences that potentially can be restored by nutritional supplements. This systematic review aimed to summarise the evidence regarding the effects of prebiotics, probiotics and synbiotics on the intestinal microbiome of term infants born by Caesarean section or exposed to antibiotics in the first week of life.

METHODS

We performed a systematic search in Medline and Embase from inception to August 2021. Two researchers independently performed title and abstract screening (n=11,248), full-text screening (n=48) and critical appraisal.

RESULTS

Eleven randomised controlled trials (RCTs) investigating Caesarean born infants and one RCT studying infants exposed to antibiotics in the first week of life were included. The number of trial participants ranged from 11 to 193. Especially up to 4 weeks of age, significant increases in the supplemented bacterial species (*Bifidobacterium* and *Lactobacillus*) after probiotic (n=8) or synbiotic (n=3) supplementation were reported as well as a decrease in *Enterobacteriaceae*. Furthermore, bacterial species diversity was increased in two studies. At the phylum level, Actinobacteria (n=2), Proteobacteria (n=1) and Firmicutes (n=1) increased after probiotic supplementation. Two studies administered a prebiotic supplement; one study reported a significant increase in *Enterobacteriaceae* and *Bifidobacteria* and the other found no significant microbiome changes.

CONCLUSIONS

Prebiotic, probiotic and synbiotic supplements show promising results in restoring dysbiosis after Caesarean section. However, given the variety in study products and procedures, it is too early to conclude which products should be advocated in clinical settings.

EP196 / #2295

E-Poster Viewing - Neonatology AS02-12. Nutrition

Clinical effects of supplemented prebiotics, probiotics and synbiotics after caesarean section or exposure to antibiotics in the first week of life: a systematic review

N. Carpay^{1*}, K. Kamphorst¹, T. De Meij², J.G. Daams³, A. Vlieger⁴, R. Van Elburg¹

¹Amsterdam UMC location University of Amsterdam, Pediatrics, Amsterdam, Netherlands

²Amsterdam UMC location Vrije Universiteit Amsterdam, Pediatric Gastroenterology, Amsterdam, Netherlands

³Amsterdam UMC location University of Amsterdam, Medical Library, Amsterdam, Netherlands

⁴St. Antonius Hospital, Pediatrics, Nieuwegein, Netherlands

BACKGROUND AND AIM

Caesarean section and antibiotics disrupt the developing gastrointestinal microbiome with long-term health effects. The aim of this systematic review was to summarise the effects of probiotics, prebiotics or symbiotics on health outcomes of term infants born by Caesarean section or exposed to antibiotics in the first week of life.

METHODS

We performed a systematic search in Medline and Embase from inception to August 2021. Title and abstract screening (n=11,248), full text screening (n=48) and quality assessment were independently performed by two researchers.

RESULTS

Six RCTs studying Caesarean born infants were included. The number of participants in each study ranged from 32 to 193. Four studies administered a probiotic, one a synbiotic, and one study investigated a prebiotic and synbiotic. Several significant effects were reported after follow-up between 10 days and 13 years: a decrease in atopic diseases (n=2), higher immune response to tetanus and polio vaccinations (n=2), lower response to influenza vaccination (n=1), fewer infectious diseases (n=2), and less infantile colic (n=1), although results were inconsistent. Prebiotics, probiotics and synbiotics showed significant and non-significant differences, with none of the three standing out. No studies investigating supplementation after antibiotic exposure in the first week of life were found.

CONCLUSIONS

Supplementation of Caesarean-born infants with probiotics, prebiotics or synbiotics resulted in a few significant improvements in various health outcomes. Due to the variety in studied products and the paucity of studies, to date no recommendations can be done on how to influence the gut microbiome to prevent the detrimental health effects after Caesarean section or antibiotic exposure.

EP197 / #1755

E-Poster Viewing - Neonatology AS02-12. Nutrition

Assessment of body composition in preterm infants during hospital

L. Lücke¹, N. Rochow¹, K. Knab², S. Schäfer², J. Zimmermann²,
A. Szakacs-Fusch², C. Fusch^{2*}

¹Paracelsus Medical University, Department of Pediatrics, Nuremberg, Germany

²Paracelsus Medical University, Dept. of Pediatrics, Pediatrics, Nuremberg, Germany

BACKGROUND AND AIM

Air-displacement plethysmography(ADP) is common method to measure body composition(BC) in neonates. Bioelectric Impedance (BIA) is also available for neonates. Aim1)to analyze the workload for weekly measurement of BCT

²)to assess the applicability of ADP in infants in different age groups

³)to compare BC with current reference curves, 4)to compare BC measured with BIA and ADP.

METHODS

This QI project was conducted (Jan to Sept 2021) with weekly ADP(PeaPod®) of clinically stable infants without respiratory support. In a subgroup, BIA(BioScan touch i8-nano) from the first week of life were analyzed daily and weekly thereafter. Individual trajectories for fat mass(FM%), fat mass(FM), and fat-free mass(FFM).

RESULTS

386 tests available from 168 infants. ADP testing was at significantly later weeks of life in infants<28weeks compared with infants>32weeks(Fig.1).

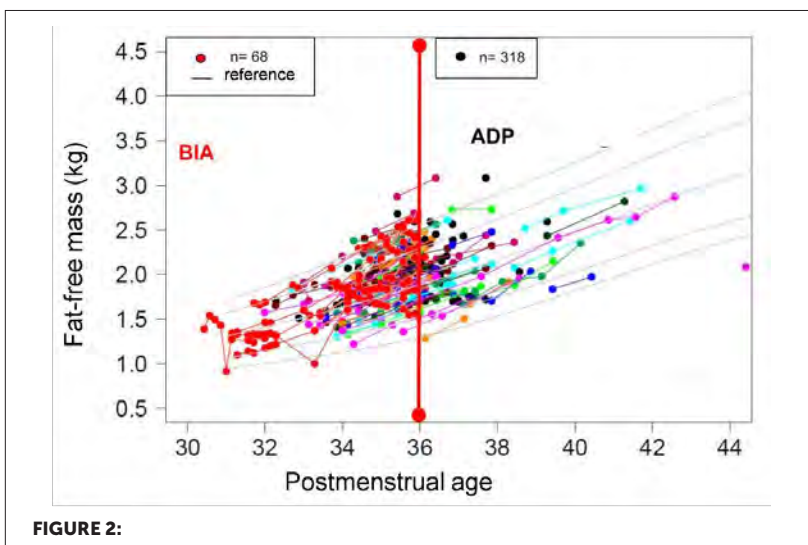
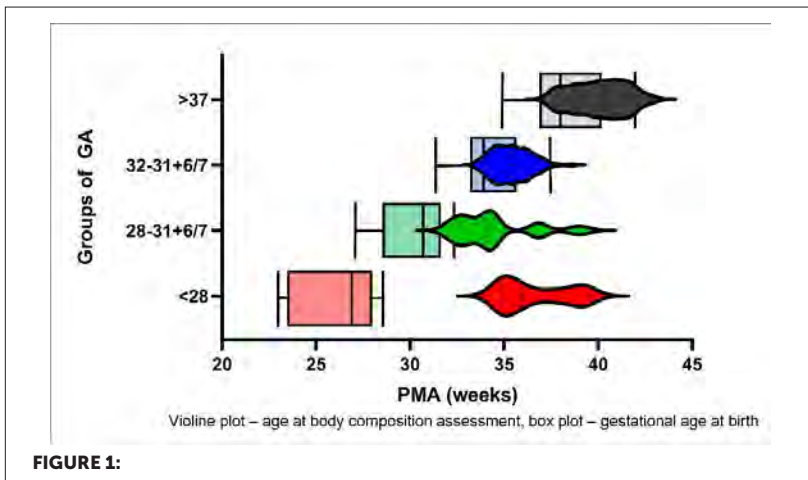

Time required for ADP was 7min, 11(7-15) ADP measurements resulted in a workload of 77(49-105)min for each of two operators. BIA took 3min with one study nurse. Individual FM and FFM trajectories measured with the ADP were

parallel to reference curves. The simultaneous BIA and ADP measurements showed differences (FM:14±70g, FM%:5±3%, FFM:11±70g)(Fig. 2). BIA had smaller 95%CI of FM%(10-11%) compared to ADP(11.5-13.5%).

CONCLUSIONS

ADP and BIA have been successfully integrated into routine clinical practice with reasonable workload. The later availability of ADP during NICU stay limits narrows window for nutritional interventions. Parallel BC trajectories to reference percentiles indicate that our cohort studied had a similar growth to the reference cohort. The BIA asked potential BC measurements over the entire hospital stay. The validity of BC measurements needs further validation.

EP198 / #713**E-Poster Viewing - Neonatology AS02-12.
Nutrition****Vitamin d intake during the first year of life in preterm infants on early solid foods: a secondary analysis of a prospective, randomized intervention study**

M. Gsöllpointner^{1*}, F. Eibensteiner², M. Thanhaeuser², B. Jilma¹, R. Ristl³, A. Berger², N. Haiden¹

¹Medical University of Vienna, Department of Clinical Pharmacology, Vienna, Austria

²Medical University of Vienna, Department of Pediatrics and Adolescent Medicine, Comprehensive Center For Pediatrics, Vienna, Austria

³Medical University of Vienna, Center For Medical Statistics, Informatics and Intelligent Systems, Vienna, Austria

BACKGROUND AND AIM

Preterm infants are at higher risk of developing vitamin D deficiency. Thus, this study aims to investigate vitamin D intake during the complementary feeding (CF) period in very low birth weight (VLBW) infants.

METHODS

This is a secondary outcome analysis of a randomized, intervention trial in VLBW infants. Infants were randomized to an early or late CF group (introduction between 10th-12th or 16th-18th week corrected for term). In addition to formula or breastfeeding, infants were fed a standardized age-dependent step-up CF concept. Vitamin D intake was assessed using monthly 3-day dietary records from 3 until 12 months (M3-M12) corrected for term. Infants received 650 IU/d vitamin D supplementation until one year corrected age. Vitamin D intake was compared with mixed-effects models accounting for possible correlations between siblings and other covariates (e.g. sex).

RESULTS

Fig 1+2: Estimated marginal mean and standard error of the linear mixed-effects models, * $p < 0.01$. Due to a low number of breastfed infants in M9-M12 no p-value calculation was conducted for these timepoints.

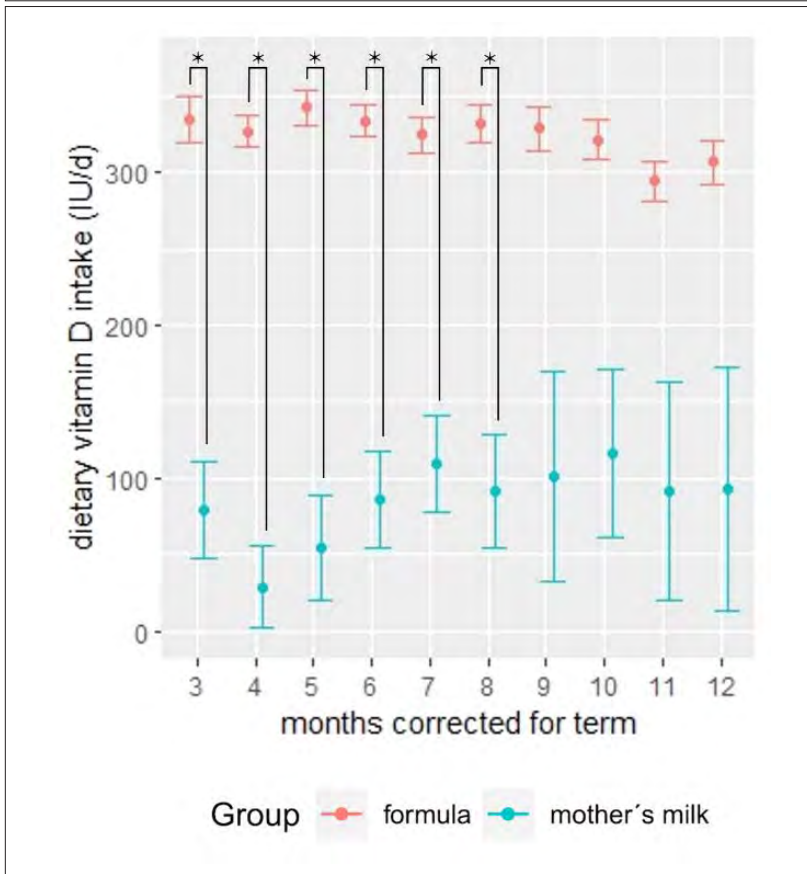

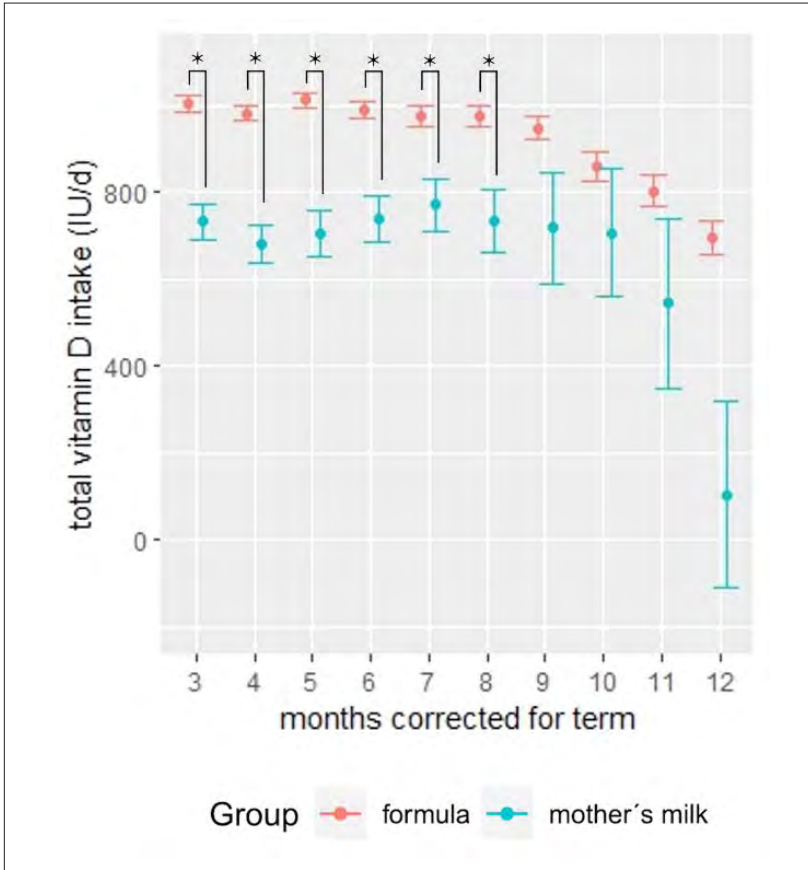

Dietary records could be assessed in 80% (71/89) of infants assigned to the early and 72% (63/88) to the late group. There was no significant difference in mean dietary vitamin D intake between groups. However, breastfed infants had significantly lower mean dietary vitamin D intakes in M3-M8. Moreover mean total vitamin D intake (dietary + supplemental intake) was significantly lower in breastfed infants and ESPGHAN recommendations (800-1000IE/d) were not met throughout the first year of life.

CONCLUSIONS

Dietary and total vitamin D intakes were significantly different between breast-fed and formula-fed infants. Thus, higher vitamin D supplementation in breast fed infants should be considered during the first year of life.

EP199 / #1991

E-Poster Viewing - Neonatology AS02-12. Nutrition

Macronutrients in human milk before and after six months of lactation

K. Holte^{1*}, E. Nygaard¹, C. Ramstad¹, C. Lie¹, A. Grøvslien², K. Størdal³

¹Østfold Hospital Trust, Department of Paediatrics and Adolescence Medicine, Grålum, Norway

²Oslo University Hospital, Department of Paediatrics and Adolescence Medicine, Oslo, Norway

³University of Oslo, Institute of Clinical Medicine, Oslo, Norway

BACKGROUND AND AIM

It has been debated whether the content of macronutrients and energy in human milk decreases, leading to milk bank practices of not accepting donor milk after six months of lactation. We aimed to study longitudinally the quality of donor milk during the first year after delivery.

METHODS

Milk donors at Østfold Hospital Trust and Oslo University Hospital were included. Each mother was asked to provide milk expressed in the morning and evening on the same day once a month during the first year of lactation. Milk analyses were performed twice per sample. We used paired t-tests to compare mean content of macronutrients and energy before and after six months of lactation.

RESULTS

Analyzing milk from 35 mothers, we found an increase in energy content after compared to before six months of lactation, especially in evening milk (figure). Mean concentration of proteins (0.87 vs 0.91 g/100 ml, P=0.18) and

lipids (4.7 vs 5.2 g/100 ml, $P=0.03$) increased, while carbohydrates were reduced (8.3 vs 8.1 g/100ml, $P=0.09$). The changes were more profound in evening milk. Analyzing this separately, we found a significant increase in lipids (5.1 vs 5.7 g/100ml, $P=0.03$) and reduction in carbohydrates (8.3 vs 8.1 g/100ml), $P=0.02$).

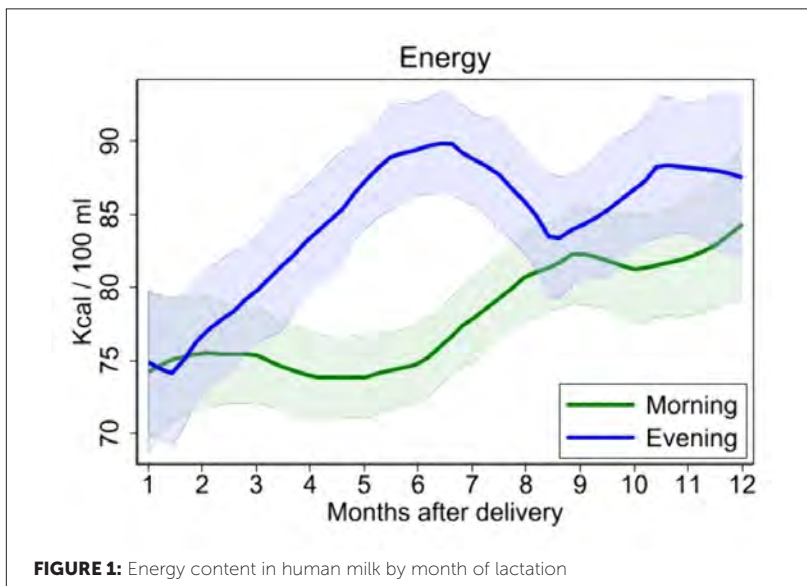

CONCLUSIONS

The nutritious value of human milk increased rather than decreased after six month of lactation. Milk expressed 7-12 months after delivery should be fully usable as donor milk.

EP200 / #1180**E-Poster Viewing - Neonatology AS02-12.
Nutrition****The influence of nutrition on white matter
development in preterm infants: a scoping review**

**E. Janson^{1,2*}, P. Van Beek³, J. Dudink^{1,2}, R. Van Elburg^{4,5},
M. Willemse⁶, L. Hortensius^{1,2}, C. De Theije^{1,7}, N. Van Der Aa^{1,2},
M. Benders^{1,2}**

¹University Medical Center Utrecht, Brain Center, Utrecht, Netherlands

²University Medical Center Utrecht, Wilhelmina Children's Hospital, Department of Neonatology, Utrecht, Netherlands

³Máxima Medical Centre, Department of Neonatology, Veldhoven, Netherlands

⁴Amsterdam University Medical Centers, Department of Pediatrics, Amsterdam, Netherlands

⁵Wilhelmina Children's Hospital, University Medical Center Utrecht, Department of Neonatology, Utrecht, Netherlands

⁶Utrecht University, Faculty of Medicine, Utrecht, Netherlands

⁷University Medical Center Utrecht, Wilhelmina Children's Hospital, Department For Developmental Origins of Disease, Utrecht, Netherlands

BACKGROUND AND AIM

Diffuse white matter (WM) injury is the most common type of brain injury in preterm infants associated with adverse neurodevelopmental outcome (NDO). There are no treatments for WM injury, but optimal nutrition during early preterm life may positively influence WM development. The primary aim of this scoping review was to summarize current literature on the influence of early postnatal nutrition on WM development in preterm infants.

METHODS

Searches were performed in PubMed, EMBASE, and COCHRANE up to October 22nd, 2021. The methodology manual from the Joanna Briggs Institute for scoping reviews was used.

RESULTS

10,651 records were screened, resulting in 31 included studies that were divided into five categories: Macronutrient and energy intake, breast milk intake, parenteral feeding duration, fatty acid supplementation, and glutamine supplementation. Positive associations between macronutrient, energy, and breast milk intake and WM development were often found, especially when fed enterally and in amounts according to recommendations. Negative associations were found between longer parenteral feeding duration and WM development, although likely confounded by illness. Results on fatty acid and glutamine supplementation remained inconclusive. Breast milk intake was often positively associated with NDO, but results remained inconclusive for other nutritional categories. Significant associations were most often detected at the microstructural level using diffusion MRI.

CONCLUSIONS

Optimizing nutrition during early preterm life may positively influence WM development and subsequent NDO in preterm infants, but more studies are needed using quantitative neuroimaging techniques and interventional designs controlling for confounders.

EP201 / #1324

E-Poster Viewing - Neonatology AS02-12. Nutrition

Bovine colostrum fortification of human milk affects bowel habits in preterm infants (forticolos study)

S. Kappel^{1,2*}, P. Sangild^{1,2,3}, A. Ahnfeldt², V. Jóhannsdóttir³, L. Soernsen³, L. Bak⁴, C. Friborg¹, S. Möller^{5,6}, G. Zachariassen^{3,6}, L. Aunsholt^{1,2}

¹Copenhagen University Hospital, Rigshospitalet, Department of Intensive Care For Infants and Toddlers, Copenhagen, Denmark

²University of Copenhagen, Comparative Pediatrics and Nutrition, Frederiksberg, Denmark

³Odense University Hospital, Hans Christian andersen Childrens Hospital, Odense, Denmark

⁴Aarhus University Hospital, Denmark, Department of Neonatology, Skejby, Denmark

⁵Odense University Hospital, Denmark, Open Patient Data Explorative Network (open), odense, Denmark

⁶University of Southern Denmark, Department of Clinical Research, Odense C, Denmark

BACKGROUND AND AIM

Human milk does not meet the nutritional needs to support the optimal growth of very preterm infants during the first weeks of life. Nutrient fortifiers are therefore added to human milk, though processed formula-based products are suspected to affect gut dysmotility. This study aimed to investigate if a fortifier based on intact bovine colostrum (BC) improves bowel habits (defined by parameters such as stool frequency, consistency, and volume) and feeding intolerance in otherwise healthy preterm infants compared with a conventional fortifier (CF)

METHODS

In an unblinded, randomized pilot study, 242 preterm infants (26-31 weeks of gestation) were randomized to receive BC (BC, Biofiber Damino) or CF

(FM85 PreNAN, Nestlé) as a fortifier. Stools (Amsterdam Stool Scale), bowel restlessness (e.g. Grunting and face redness), abdominal appearance, volume and frequency of gastric residuals were recorded at each meal, until 35 weeks post-menstrual age.

RESULTS

In 202 of 242 infants, data were available. As intake of protein from fortifiers increased, stools became harder in both groups ($p < 0.01$) though less in BC infants ($p < 0.05$). The incidence of bowel gas restlessness increased with laxative treatments and days of fortification in both groups ($p < 0.01$), but laxatives were prescribed later in BC infants ($p < 0.01$). With advancing age, stomach appearance scores improved, but more in BC infants ($p < 0.01$).

CONCLUSIONS

A minimally processed, bioactive milk product like BC, induced similar or slightly improved bowel habits in preterm infants.

EP202 / #2163

E-Poster Viewing - Neonatology AS02-12. Nutrition

Microbiological screening in pasteurized donor human milk.

M. Lithoxopoulou*, A. Karagkiozi, C. Tsakalidis, E. Drogouti, G. Mitsiakos, I. Chatzioannidis, E. Diamanti

Aristotle University of Thessaloniki

2nd Neonatology Clinic -nicu, Thessaloniki, Greece

BACKGROUND AND AIM

Preterm infants manage better with Human Milk (HM) nourish which was derived by expression by breast pumps or manually. Donors were instructed to clean hands and breasts before pumping and put HM into sterile storage plastic bags and transport to milk bank, frozen, and preserved. Frozen HM were got bacteriological testing to ensure absence of bacterial growth before and after Holder pasteurization.

METHODS

Milk samples were melted and cultured during two years period from 2019 to 2021. Identification of specific bacteria like coagulase-negative Staphylococcus, Staphylococcus aureus, Enterococcus, Gram-negative microbes was conducted. Quantitative colony counts were checked in positive culture.

RESULTS

Samples from 124 HM were cultured. Twenty-nine (23,4%) were sterile and 95 (76,6%) grew at least one organism. Thirteen (13/95) grew two or more

organisms. Frequently detected microorganisms were *Staphylococcus epidermidis*, (88, 9%). Nineteen mothers wanted to continue donating, retrained and 9/19 were acceptable. All samples after holder pasteurization were sterile.

Bacteria	No of samples
<i>Enterococcus faecalis</i>	5
<i>Corynobact durum</i>	3
<i>Enterobacter cloacae</i>	3
<i>Entrobacter hormaehei</i>	2
<i>Pseudomonas aeruginosa</i>	2
<i>Staphyl. aureus</i>	1
<i>Acinetobacter ursingii & baumani</i>	2
<i>Pseudomonas fragi & putida</i>	2
<i>Serratia marcescens</i>	2
<i>E. coli</i>	2
<i>Klebsiella pneumoniae & oxytoca</i>	2

FIGURE 1: Most common Bacteria Contaminating Donor Human Milk Before Holder Pasteurization

CONCLUSIONS

Bacteria contaminate HM from donors. Most samples grew coagulase-negative *Staphylococcus*. Fewer samples were contaminated with other pathogenic organisms. Holder pasteurization was effective technique which eliminate bacteria. Most women followed advice on hygiene, proper pumping and storage of milk before transporting it to HM Bank.

EP203 / #2659**E-Poster Viewing - Neonatology AS02-12.
Nutrition****Effect of nutritional support and energy-protein balance on growth indices and outcome in premature infants****I. Lygerou^{1*}, S. Ilia², E. Hatzidaki³, M. Miliaraki⁴, G. Briassoulis¹**

¹School of Medicine, University of Crete, Postgraduate Program "emergency and Intensive Care of Children, Adolescents and Young Adults", Heraklion, Greece

²School of Medicine, University of Crete, Picu, University Hospital, Heraklion, Greece

³School of Medicine, University of Crete, Department of Neonatology, Heraklion, Greece

⁴University Hospital of Heraklion, Picu, Heraklion, Greece

BACKGROUND AND AIM

To document the nutritional support of preterm neonates admitted to an academic NICU and to calculate the energy and protein balance and study the impact on growth and outcome. Furthermore, to examine the adherence of the currently used protocols with the recently published guidelines.

METHODS

Data were collected retrospectively from medical records of premature neonates between December 2020 and May 2021. Demographics, clinical information and nutritional care were recorded. Neonates were classified based on gestational age and birth weight. Percentiles and z-scores were assigned using standard curves.

RESULTS

We included 90 neonates (boys 58.9%, late preterms 54.4%). Length of stay differed significantly between GA groups and was independently associated with the age of birth (Beta-0.89, $p=0.047$). Full enteral feeding was achieved later in the very preterm and extremely preterm groups (7.4 and 13 days, $p=0.001$). Daily caloric intake increased significantly from 87Kcal/kg/d (day 3) to 121Kcal/kg/d (days 7 and 14), providing positive energy balance in all neonates >28weeks. Daily protein intake increased significantly from 2.3g/kg/d (day 3) to 2.8g/kg/d (days 7 and 14) ($p<0.001$). Protein balance was negative on day 7 for all preterm groups >28weeks GA, and remained negative on day 14 only for late preterms. Upon discharge, subgroup 28-34GA demonstrated positive z-score change for weight, length, and head circumference(HC), while late subgroup demonstrated negative z-score change.

CONCLUSIONS

All preterm groups, except late-preterm, achieved a positive energy-protein balance and positive weight, height, and HC z-scores on day 14. Initiation and rapid advancement of enteral feeds in preterm neonates are feasible and safe.

EP204 / #2181**E-Poster Viewing - Neonatology AS02-12.
Nutrition****The impact of a multidisciplinary post-discharge infant nutrition clinic on breastfeeding rates and growth trajectories in premature and low birth weight infants.****H. Resvick^{1*}, B. Hartman², O. Dasilva³, J. Madill²**¹Western University, Health and Rehabilitation Sciences, Health Promotion, London, Canada²Brescia University College/Western University, School of Food and Nutritional Sciences, London, Canada³London Health Sciences Center, Neonatology, London, Canada**BACKGROUND AND AIM**

The benefits of breastfeeding are more pronounced in premature and low birth weight (P/LBW) infants. The Post-Discharge Infant Nutrition Clinic (PDINC) at London Health Sciences Centre (LHSC) began offering feeding support in 2012. This unique clinic relies on a multidisciplinary team whose goal is to provide feeding support thereby improving growth and health outcomes in high-risk infants. The aim of this study is to determine if enrollment in the PDINC has improved breastfeeding rates and growth in P/LBW infants.

METHODS

Retrospective clinic data was collected for 150 P/LBW infants and was analysed to assess breastfeeding rates and infant growth.

RESULTS

Mean gestational age at birth was 34 weeks with 44% (66) being male. On average patients made 5 visits to the clinic over 110 days. Half of all infants seen at the first visit were also seen at the fifth visit. By the 5th visit (55 weeks corrected age) 52% were exclusively breastfeeding while 37% were still receiving breastmilk daily. Over the course of clinic involvement, the mean daily weight gain, increase in head circumference and head circumference z-scores for males and females was 19.96 vs 21.81 grams, 1.0 vs 0.9 cm and -0.13 vs 0.12 respectively.

CONCLUSIONS

PDINC support was shown to have a positive impact on breastfeeding rates at 6 months with 89% of infants receiving at least some breastmilk compared to the national Canadian average of 57% for infants. Clinic support had a positive growth trajectory for both males and females with mean z-scores around the 50% percentile.

EP205 / #1688**E-Poster Viewing - Neonatology AS02-12.
Nutrition****Fortification with freeze-dried breast milk in
preterm infants ≥ 31 weeks of gestation – growth
and safety**

N. Rochow*, I. Prothmann, K. Knab, S. Schäfer, J. Zimmermann,
A. Szakacs-Fusch, C. Fusch

Paracelsus Medical University, Dept. of Pediatrics, Pediatrics, Nuremberg,
Germany

BACKGROUND AND AIM

Cow's milk protein used in most fortifiers increases the risk of necrotizing enterocolitis. A fortifier made from BM could reduce risks. Freeze-dried BM powder is available. It increases protein and energy intake but could add excess calories due to high fat content (desirable extra intake at 1.4 g protein/100mL: 1.0g fat, 2.0g carbs, actual intake 4g fat, 6g carbs), suggesting its use more for mature PT. This study aims to evaluate safety and to compare growth with a historical match-pair group.

METHODS

Observational study (PT ≥ 31 weeks), intervention group (IG): BM fortified with 4.8g/100ml lyophilized BM (AS50-Ammeva, Werder). Vitamins and Ca-glycerophosphate were supplemented. Growth, body composition (PeaPod), clinical chemistry, feeding tolerance and macronutrients of BM (MIRIS, Sweden) were analyzed. The control group (CG) received standard fortification (FMS, Nutricia, Germany) and had matching criteria: birth weight ± 100 g, GA ± 1 wk.

RESULTS

64 PT, patient characteristics and outcome parameters were not different between groups (Fig.1). In IG, PT received a nutritional intake of 157 ± 8 ml/kg/d, 14.0 ± 0.9 g/kg/d carbs, 3.3 ± 0.4 g/kg/d protein, 7.4 ± 1.1 g/kg/d fat, and 136 ± 12 kcal/kg/d energy. Urea was 21 ± 12 mg/dl, triglycerides 105 ± 36 mg/dl, blood glucose 86 ± 19 mg/dl. At 36 weeks (PMA), fat mass was 290 ± 110 g ($12 \pm 3\%$) and fat-free mass 2050 ± 240 g. No significant differences for feeding tolerance, growth and discharge weight between groups (Fig.2).

	Intervention (n=32)	Control (n=32)
Birth		
Gestational age (weeks)	32.8 ± 1.0	33.0 ± 1.2
Birth weight (g)	1900 ± 380	1840 ± 370
Length (cm)	43.3 ± 2.6	43 ± 3.0
Head circumference (cm)	30.5 ± 1.5	30.6 ± 1.3
Birth weight percentile	48 ± 28	44 ± 23
Enteral nutrition		
Enteral intake 120 mL/kg/d (DOL)	5.0 ± 1.3	5.2 ± 1.5
Start fortifier (DOL)	6.8 ± 1.8	6.8 ± 2.7
Discharge		
Length of stay (days)	27 ± 7	27 ± 10
Postmenstrual age (weeks)	36.5 ± 0.9	36.6 ± 1.2
Weight (g)	2500 ± 380	2490 ± 360
Weight percentile	30 ± 24	26 ± 18
Length (cm)	46.5 ± 2.5	47.1 ± 2.3
Head circumference (cm)	32.5 ± 1.4	32.5 ± 1.5

FIGURE 1:

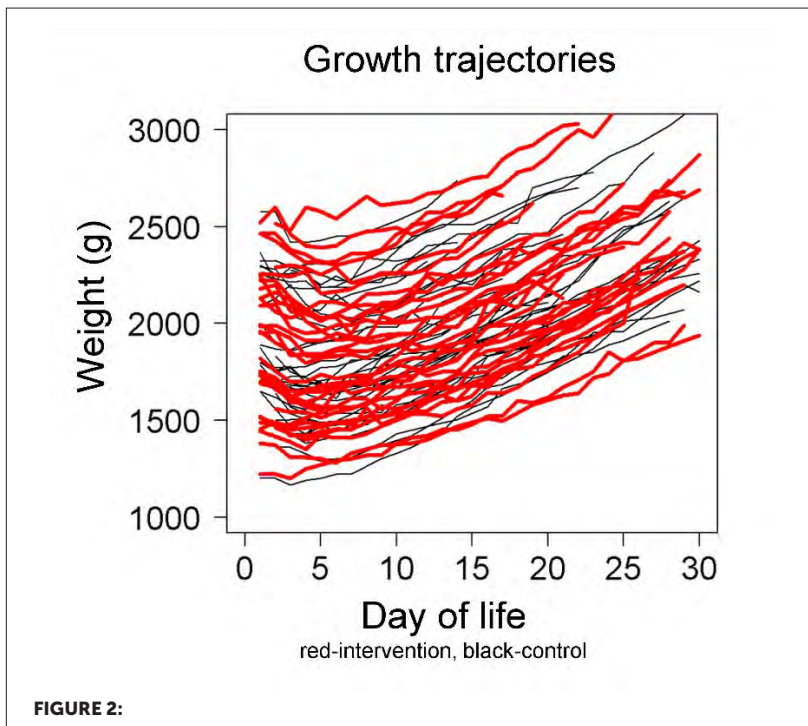

CONCLUSIONS

Fortification with freeze-dried BM is well tolerated by PT ≥ 31 weeks and growth is similar to cow's milk-based fortifiers. To better meet the nutritional requirements of PT (<1.5kg), higher macronutrient intake and protein to energy ratio are required. Multicenter studies are needed to validate the results.

EP206 / #1735

E-Poster Viewing - Neonatology AS02-12. Nutrition

Protein metabolism in preterm and term infants using a ^{15}N -tracer and the nitrogen balance method: a pilot-study

S. Beck¹, C. Fusch¹, J. Däbritz², G. Fusch³, N. Forghani⁴, B. Salewski⁵, K. Wutzke⁵, N. Rochow^{1*}

¹Paracelsus Medical University, Dept. of Pediatrics, Pediatrics, Nuremberg, Germany

²University Medicine, Pediatrics, Greifswald, Germany

³McMaster Children's Hospital, McMaster University, Hamilton Health Sciences, Division of Neonatology, Department of Pediatrics, Hamilton, Canada

⁴McMaster Children's Hospital, McMaster University, Hamilton Health Sciences, Division of Neonatology, Department of Pediatrics, Hamilton, Germany

⁵University Medicine, Pediatrics, Rostock, Germany

BACKGROUND AND AIM

Maximizing utilization of amino acids (AA) supports accrual of fat-free mass in preterm infants. AA oxidation and urea formation should be low. Optimizing macronutrient composition, protein-to-energy, and carbs-to-fat-ratio are required. Kinetics of urinary N-excretion using ^{15}N -labeled-AA after enteral ingestion can measure protein turnover and urea production. This study aims to establish a tracer method for NICU.

METHODS

Observational study, stable growing newborns were enrolled at McMaster Children's Hospital. Nitrogen kinetics was measured using a single oral application (3.3mg/kg) of ^{15}N -98atom%-labeled AA mixture. Urine was collected in 2-to-4hr intervals over 36hr. Urinary- ^{15}N , urea, and creatinine were measured. Using an established three-compartment model, nitrogen balance, protein turnover and net protein gain were calculated.

RESULTS

Eighteen male infants were enrolled (GA:25-39weeks, birth weight:720-2770g). No adverse events were reported during the study. Individual variation of urea, creatinine, and urine volumewas high making spot urine samples not reliably measure protein accretion. Cumulative urinary excretion from tracer varied between 4-14%. Urinary¹⁵N-kinetic curves plateaued at 36 hrs(Fig 1).

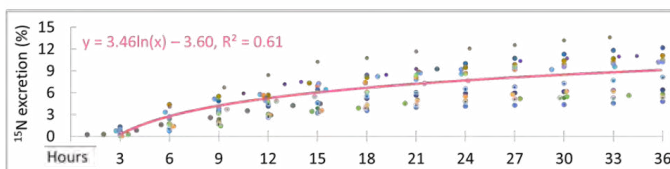

FIGURE 1:

N-balance and tracer method yielded similar slopes of regression lines. A linear relation was observed between N-retention and protein intake from 1.3 to 5.5 g/kg/d. X-axis zero intercept was at 1.0g protein kg/d which compares with previous studies(Fig 2).

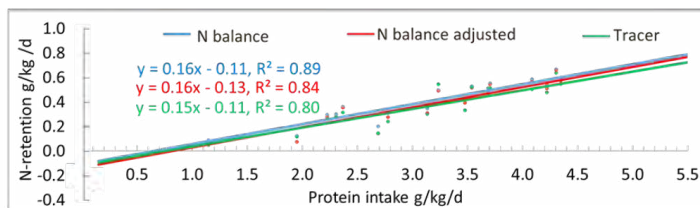

FIGURE 2:

CONCLUSIONS

The ¹⁵N-Tracer method is a safe tool to analyze protein turnover. The high correlation between tracer kinetic and balance method data indicates the

reliability of the ^{15}N -Tracer method. In future studies, protein synthesis should be studied using ^{15}N -Tracer technique to identify optimal macronutrient composition for preterm.

EP207 / #1212**E-Poster Viewing - Neonatology AS02-12.
Nutrition****Effect of pasteurization on different fatty acids in human milk - a prospective observational study from a developing country****A. Ahuja, D. Sikriwal*, R. Mallaiah**

Fortis La Femme, Neonatology, New Delhi, India

BACKGROUND AND AIM

In hospitals and Human milk banks worldwide, human milk is subjected to heat treatment to reduce risk of transmission of various viral and bacterial infections, especially when banked human milk is fed to preterm infants. However, the effect of pasteurization on fatty acids in human milk has not been studied extensively.

METHODS

This prospective observational study investigated the fatty acid composition of breastmilk of mothers from urban population residing in India. The study protocol was approved by the institutional ethics committee. After due consent, milk from mothers of newborn babies (both Term and Preterm babies) admitted to NICU was taken, after post-natal age Day 5 of babies to avoid analysis of colostrum. Sample after collection from each mother, was sent to the lab for analysis of fatty acids. This donor milk was then pasteurized and sample from the same milk was taken again and sent for analysis of fatty acids. Quantitative analysis for levels of 13 fatty acids was done for all the samples, both pre and post pasteurization. A comparative Analysis was then undertaken to determine whether the difference in fatty acid levels pre and post pasteurization was statistically significant.

RESULTS

The independent t-test was used to determine differences in lipid content in human breastmilk pre and post pasteurization. The difference in breast milk lipid content did not statistically differ after pasteurization for any of the 13 fatty acids studied.

CONCLUSIONS

The contents of fatty acids in human milk remain unaltered even after pasteurization.

EP208 / #946**E-Poster Viewing - Neonatology AS02-12.
Nutrition****Calcium and phosphate supplementation for very preterm infants fed two different type of fortifiers****M. Simonsen^{1,2*}, S. Søndergaard^{3,4}, L. Aunsholt^{3,4}, P. Sangild^{2,3,4}, G. Zachariassen^{1,2}**¹*Odense University Hospital, Hans Christian andersen Childrens Hospital, Odense, Denmark*²*University of Southern Denmark, Department of Clinical Research, Odense, Denmark*³*University of Copenhagen, Section of Comparative Paediatrics and Nutrition, Frederiksberg, Denmark*⁴*Copenhagen University Hospital Rigshospitalet, Department of Neonatology, Copenhagen, Denmark***BACKGROUND AND AIM**

In the FORTICOLOS trial (NCT03537365), powdered bovine colostrum (BC) was tested as a new fortifier added to mothers' milk and compared to a conventional fortifier (CF: PreNan FM85) in infants <32 weeks. The BC-product contains less calcium and phosphate, requiring further mineral supplementation to avoid deficiencies that could increase the risk of metabolic bone disease. We aimed to evaluate if early plasma-phosphate and -calcium levels during intervention in BC-infants were similar to CF-infants, as well as the maximum supplementary doses needed in the groups according to recommendations.

METHODS

Retrospective evaluation of plasma-phosphate and -calcium levels prior to and at day 7 and 14 after start of intervention. Subsequently, maximum doses required for dietary supplementation of oral phosphate and calcium were obtained from patient records.

RESULTS

232 infants were included. Plasma-phosphate levels were similar between the groups ($p=0.37$), however, BC-infants required more supplemental phosphate (1.75 mmol P/day (1.09:2.42) vs. 1.01 mmol P/day (0.82:1.19), $p=0.02$) compared to CF-infants. Plasma-calcium levels were lower in the BC-group prior to intervention ($p=0.04$) but were similar at day 7 and 14 of intervention compared to the CF-group. Nevertheless, infants in the BC-group required higher supplemental doses of calcium compared to infants in the CF-group, although not statistically significant (2.35 mmol Ca/day (1.61:3.09) vs. 1.4 mmol Ca/day (-0.22:3.08), $p=0.06$).

CONCLUSIONS

Fortification with BC presupposes higher doses of supplemental phosphate and calcium, requiring additional guidelines for supplementation of these minerals. We proceed with analyses on infant-characteristics and other laboratory findings possibly associated with our results..

EP209 / #1128**E-Poster Viewing - Neonatology AS02-12.
Nutrition****Does it matter how to feed (drip or intermittent) for splanchnic oxygenation in intrauterine growth retarded preterm infants? A prospective randomized study**

O. Surmeli Onay^{1*}, M. Tatal¹, T.D. Sarılar¹, A. Cakil Saglik¹, M. Bilgin², O. Aydemir¹, A.N. Tekin¹, M. Velipasaoglu³, H.M. Tanır³

¹Eskisehir Osmangazi University, Faculty of Medicine, Department of Pediatrics, Division of Neonatology, Eskisehir, Turkey

²Eskisehir Osmangazi University,, Faculty of Medicine, Department of Biostatistics,, Eskisehir, Turkey

³Eskisehir Osmangazi University Faculty of Medicine, Department of Obstetrics and Gynaecology,, Eskisehir, Turkey

BACKGROUND AND AIM

The purpose of this study was to evaluate the impact of drip versus intermittent feeding on splanchnic oxygenation in preterm infants with intrauterine growth retardation.

METHODS

A single-center, prospective, randomized, observational cohort study with 51 infants was conducted. The infants were randomly assigned to one of two feeding modality: Drip (3-hour continuous) or Intermittent (bolus in 10 minutes). Continuous regional splanchnic saturation (rSO₂S) monitoring was carried out during the first week of life, simultaneously together with continuous oxygen arterial saturation (SpO₂) monitoring, and the infants' fractional oxygen extractions (FOE) were calculated. These parameters were evaluated as means on a daily basis for the first week of life, as well as before and after feeding on the seventh day.

RESULTS

The Drip (26 infants) and Intermittent (25 infants) groups were similar in demographic and clinical characteristics, as well as the prevalence of feeding intolerance and necrotizing enterocolitis (Table 1). During the first week of life, there was no difference in daily mean rSO_2S and FOE values between the Drip and Intermittent groups, whereas unfed infants had mostly lower rSO_2S values (Figure 1). Preprandial and postprandial rSO_2S values remained stable in both groups. During the whole week, except for the first two days, infants with umbilical catheters had significantly lower rSO_2S values than infants without (Figure 2). rSO_2S values were strongly correlated to gestational age and birth weight ($p < 0.01$).

Table 1. Prenatal, Natal and Postnatal Demographic and Clinical Characteristics of the Drip and Intermittent Groups.

Demographic and Clinical Characteristics	DRIP GROUP n=26	INTERMITTENT GROUP n=25	p
Gender (M/F), n (%)	14/12 (53.8/46.2)	9/16 (36/64)	0.31
Gestational age (wk)**	32 (28-33)	32 (30-34.5)	0.28
Birth weight (g)*	1245±404 (515-2035)	1377±414 (580-2065)	0.15
Maternal hypertensive disorders, n (%)	14 (53.8)	10 (40)	0.47
Maternal diabetes mellitus, n (%)	4 (15.4)	2 (8)	0.66
Prenatal steroid, n (%)	11 (44)	15 (60)	0.39
SGA, n (%)	16 (61.5)	9 (36)	0.12
Type of delivery (V/CS), n (%)	0/26 (0/100)	2/23 (8/92)	0.23
Apgar score (5th minute)**	9 (8-9)	8 (8-9)	0.68
Respiratory distress syndrome, n (%)	13 (50)	10 (40)	0.66
Patent ductus arteriosus, n (%)	9 (34.6)	9 (36)	1.00
Intraventricular hemorrhage, n (%)	1 (3.8)	4 (16)	0.19
Bronchopulmonary dysplasia, n (%)	6 (23.1)	7 (28)	0.93
Feeding intolerance, n (%)	9 (34.6)	9 (36)	1.00
Necrotizing enterocolitis (? Stage II), n (%)	1 (3.8)	1 (4)	0.75
Placement of umbilical vein catheter, n (%)	19 (73.1)	15 (60)	0.48
Duration of mechanical ventilation (invasive/noninvasive) (day)**	7 (2-21.75)	4 (2-32)	0.76
Duration of oxygen support (day) **	17.5 (10-29)	12 (5-28)	0.22
Duration of hospitalization (day)**	38.5 (25-68)	43 (27-59)	0.85
Mortality, n (%)	1 (3.8)	0 (0)	1.00

Mean±SD (Min-Max) ** Median (Q1-Q3) SGA: small for gestational age; V: vaginal; CS: Cesarean section

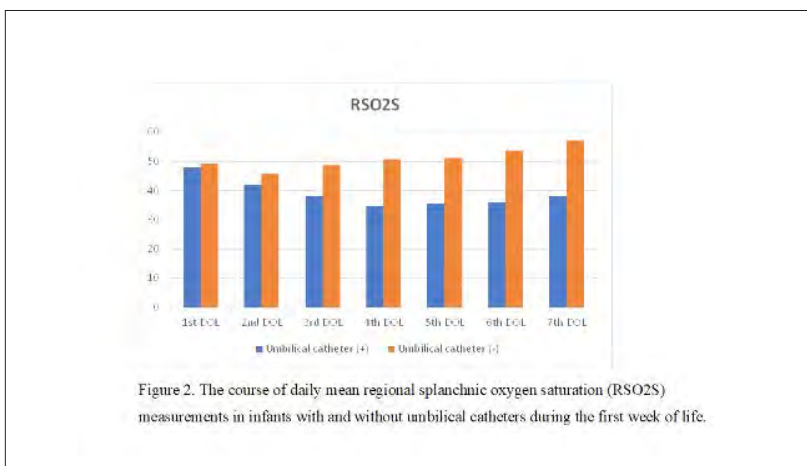
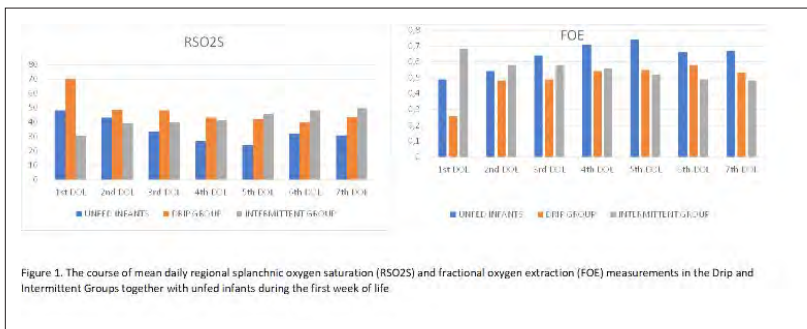

CONCLUSIONS

The key factor in splanchnic oxygenation seems to be feed, not the feeding modality. The umbilical vein catheter had a negative impact on splanchnic oxygenation.

EP210 / #2322

E-Poster Viewing - Neonatology AS02-12. Nutrition

Maternal tacrolimus use and breast feeding: fight or flight?

D. Tuncel, A. Çoban, N. Yeğın, E. Kirit, G. Tosun, L. Bilgin, B. Yaşaa*, Z. Ince

Istanbul University Medical Faculty, Neonatology, Istanbul, Turkey

BACKGROUND AND AIM

Since the pregnancy rates increase in women with solid organ transplantation, the possible adverse effects of maternal medications on the fetus became the main question. This study aimed to evaluate the tacrolimus levels of newborn infants born to mothers with solid organ transplantation and its adverse effects.

METHODS

This retrospective study included a total of 23 neonates born to mothers having tacrolimus treatment during pregnancy. Tacrolimus levels were measured immediately after birth and at following days.

RESULTS

There was no significant difference in terms of tacrolimus levels in breast or formula fed infants. The mean serum tacrolimus levels of babies at birth was 4.60 ng/dL. There was no significant difference between the drug levels of mothers at birth. Even if the infant was exclusively breast fed, serum tacrolimus levels were similar to infants fed by formula.

CONCLUSIONS

Although the data is limited, considering the benefits of breast milk, mothers using tacrolimus after solid organ transplantation should be advised to breastfeed by close monitoring of drug levels and side effects in the infant.

EP211 / #1971

E-Poster Viewing - Neonatology AS02-13. Global health

Congenital nasal pyriform aperture stenosis: a rare cause of neonatal respiratory distress

M. Meneses^{1*}, M. Dias¹, J. Santos¹, S. Peixoto²

¹Hospital Pedro Hispano, Pediatrics, Matosinhos, Portugal

²Hospital Pedro Hispano, Neonatology, Matosinhos, Portugal

BACKGROUND AND AIM

Congenital nasal pyriform aperture stenosis (CNPAS) is a rare clinical entity that causes airway obstruction in the neonate as a result of the narrowing of the nasal pyriform aperture. Its incidence is not accurately known. Therefore, it's often overlooked as a cause of respiratory distress in neonates. Early prompt recognition and timely management are necessary to relieve respiratory distress and to create good outcomes in these patients.

METHODS

This paper reports a case of an isolated CNPAS in which conservative measures were applied with a long-term success.

RESULTS

A full-term male newborn, the first child of nonconsanguineous parents, was admitted to the intensive neonatal unit at 16 hours of life presenting feeding difficulty and respiratory distress. He had mandibular retrognathia and noisy breathing with mouth-breathing. There was marked nasal obstruction and it wasn't possible to pass a nasal tube through both nostrils. After examination by an otolaryngologist, a CT scan was performed, which revealed typical

findings that led to the diagnosis of CNPAS. Airway measures were started and since there was a clinical improvement, the child was discharged after 7 days. Nowadays, the patient is eleven months old and has no clinical sign that justifies regular follow-up.

CONCLUSIONS

CNPAS is an unusual case of neonatal nasal obstruction. It may occur as an isolated congenital defect or in combination with other abnormalities. A CT scan is needed to confirm the diagnosis. Airway measures are the first-line treatment. In all cases, short and long follow-ups should be done carefully by a multidisciplinary team.

EP212 / #648

E-Poster Viewing - Neonatology AS02-13. Global health

Antenatal corticosteroids for special populations of women at risk of imminent preterm birth: a systematic review and meta-analysis

K. Saito^{1*}, E. Nishimura², T. Swa³, F. Namba⁴, J. Cao⁵, J. Ramson⁵, T. Lavin⁶, E. Ota², J.P. Vogel⁵

¹Saitama medical hospital, Pediatrics Department, Kawagoe, Saitama, Japan

²St. Luke's International University, Global Health Nursing, Tokyo, Japan

³Osaka University Graduate School of Medicine, Medicine, Osaka, Japan

⁴Saitama medical hospital, Pediatrics Department, Kawagoe, Japan

⁵Burnet Institute, Maternal, Child and Adolescent Health Program, Melbourne, Australia

⁶World Health Organization, Sexual and Reproductive Health and Research, Geneva, Switzerland

BACKGROUND AND AIM

Antenatal corticosteroid (ACS) use for women with certain pregnancy conditions is controversial, and the lack of evidence-based consensus has been a barrier to effective clinical management. We aimed to synthesize available evidence on ACS effectiveness among women at risk of imminent preterm birth with pregestational/gestational diabetes, elective caesarean section (CS) in the late preterm period, chorioamnionitis, or fetal growth restriction (FGR).

METHODS

A systemic search of MEDLINE, EMBASE, CINAHL, Cochrane Library, Web of Science, Global Index Medicus was conducted for all comparative randomized or non-randomized interventional studies in the four subpopulations. Two reviewers determined eligibility, extracted data, and assessed quality. Odds ratios (ORs) with 95% confidence intervals were determined for review outcomes.

RESULTS

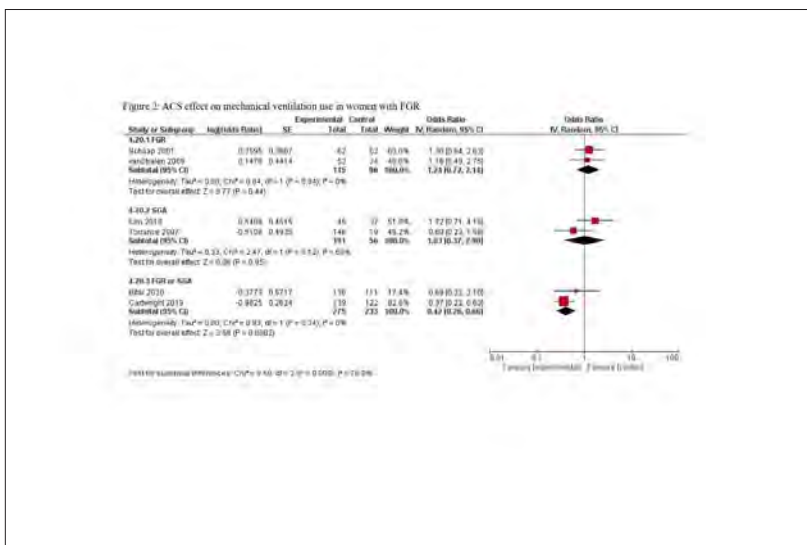
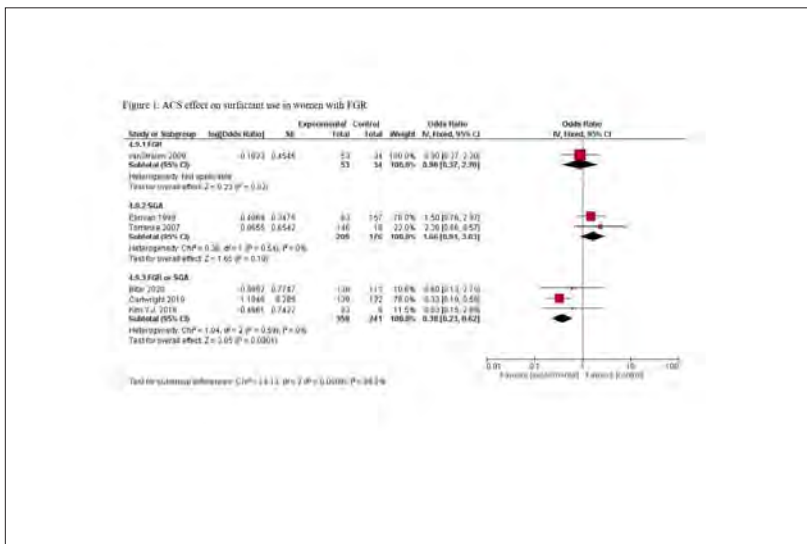

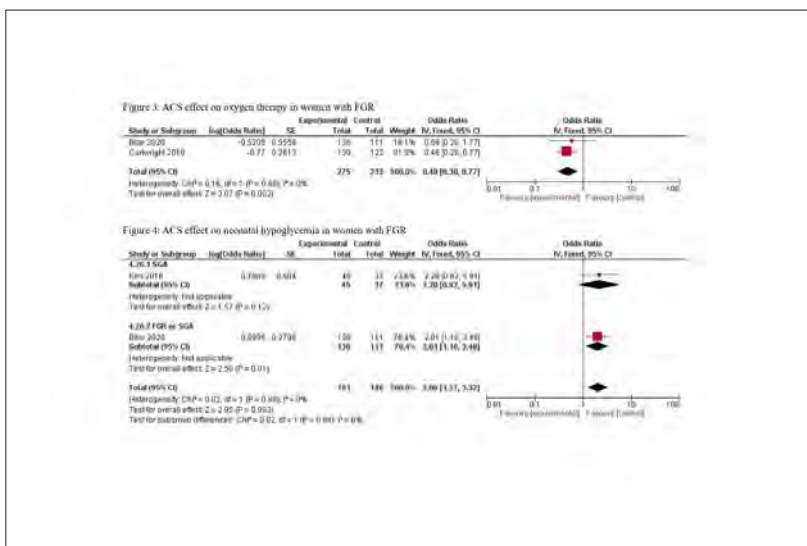

All included articles were observational studies. Among babies of women with diabetes, there were limited data, though the odds of NICU admission is increased (LOW certainty). Evidence is inconclusive for women undergoing elective CS. ACS was associated with a reduction in odds of neonatal mortality (LOW), severe intraventricular haemorrhage (IVH) (LOW), and IVH (LOW) in babies of women with histological chorioamnionitis. Among babies of women with clinical chorioamnionitis, there was a reduction in IVH odds (LOW). Among babies of women with FGR, ACS reduces surfactant use (MODERATE), mechanical ventilation (MODERATE), and oxygen therapy (MODERATE), but increases hypoglycemia (MODERATE).

CONCLUSIONS

Evidence on ACS is lacking for women with diabetes and women undergoing elective CS. It might have benefits in women with chorioamnionitis. ACS is probably beneficial in FGR, though it can increase neonatal hypoglycemia. Well-designed studies with adequate follow-up are required.

EP213 / #857**E-Poster Viewing - Neonatology AS02-13. Global health****Evaluation of low-cost warming mattress to aid in thermoregulation of newborns in low-resource settings**

T. Boles¹, S. Sosa Saenz^{1*}, M. Heenan¹, C. Samuel¹, P. Mtenthaonga², R. Mjumira², M. Valle², R. Johnston¹, J. Bailey¹, K. Payea³, V. Meka³, R. Miros³, Z. Oden¹, R. Richards-Kortum¹, Q. Dube², K. Kawaza²

¹Rice University, Rice360 Institute For Global Health Technologies, Houston, United States of America

²Kamuzu University of Health Sciences, Paediatrics and Child Health, Blantyre, Malawi, 33rd Stone Design, Engineering, San Rafael, United States of America

BACKGROUND AND AIM

Neonatal hypothermia (<36.5°C) is a prevalent and significant mortality risk in resource-constrained NICUs. We designed the Celsi Warmer, consisting of a gel mattress atop a heating element with a reusable temperature sensor and belt. Unlike existing warming mattresses, Celsi Warmer provides appropriate heat based on infant temperature. This study evaluates the safety and efficacy of the warmer.

METHODS

Thirteen hypothermic neonates at Queen Elizabeth Central Hospital in Blantyre, Malawi, were enrolled and placed on the mattress for thermal support. Temperature readings from Celsi Warmer and a reference patient monitor were continuously recorded. The study was approved by the Rice University IRB and the National Health Science Research Committee in Malawi.

RESULTS

Eleven of thirteen participants reached normothermia. Two participants were warming but discontinued study participation before reaching normothermia due to medical conditions unrelated to the intervention. Participant temperatures increased from an average initial temperature of $35.4 \pm 0.7^\circ\text{C}$ to $36.7 \pm 0.2^\circ\text{C}$. Participants warmed to normothermia ($36.5\text{--}37.5^\circ\text{C}$) in an average of 3.1 ± 1.7 hours at an average rate of $0.5 \pm 0.3^\circ\text{C}$ per hour. Representative participant temperature over time is shown in Figure 1.

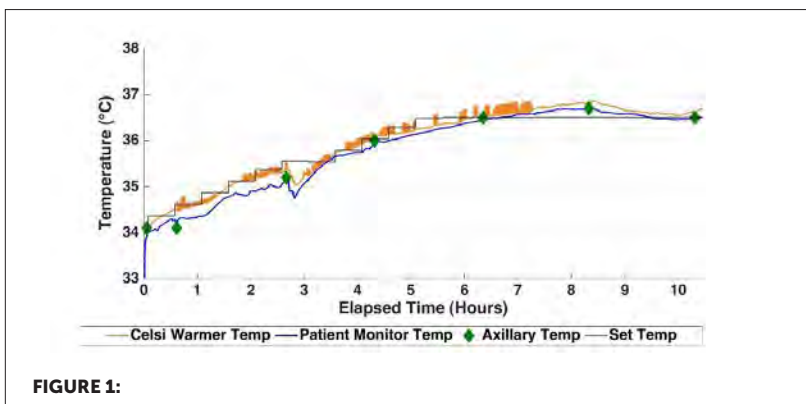

CONCLUSIONS

Celsi Warmer is safe and effective in supporting neonatal thermoregulation. Larger studies are planned to validate the use of Celsi Warmer as a standard of care for NICUs in low-resource settings. This work was supported by the John D. and Catherine T. MacArthur Foundation, the Bill & Melinda Gates Foundation, ELMA Philanthropies, The Children's Investment Fund Foundation UK, The Lemelson Foundation, and the Ting Tsung and Wei Fong Chao Foundation under agreements to Rice University.

EP214 / #2631

E-Poster Viewing - Neonatology AS02-13. Global health

Utilising advancements in online technology to provide remote resuscitation training in developing countries

K. Wilson^{1*}, J. Kajjimu², S. Kapur³

¹Royal Belfast Hospital for Sick Children, Picu, Belfast, United Kingdom

²Mbarara University of Science and Technology, Medicine, Mbarara, Uganda

³Royal Belfast Hospital for Sick Children, Paediatrics, Belfast, United Kingdom

BACKGROUND AND AIM

During the pandemic, medical educators have been developing skills in delivering teaching through online platforms, including traditionally 'hands on' teaching such as resuscitation. We utilised the advancements in technology and understanding gained from existing research to deliver a teaching programme on neonatal life support (NLS) to medical students in Uganda.

METHODS

Using the 'meetings' platform to host our teaching, we commenced with a brief didactic session on neonatal transition, thermodynamics and discussion of the NLS Algorithms. Videos were utilised to demonstrate how to provide resuscitation in both a fully resourced hospital setting and in a low resource or community setting. Scenarios were used to consolidate the learning and help students develop confidence in their decision making. Further group discussion of cultural considerations allowed students to explore how they would navigate local customs around childbirth.

RESULTS

A survey of medical students who had availed of the online paediatric teaching programme demonstrated that all students believed it was 'extremely valuable' to them. They felt that international teaching was relevant to them and would benefit their clinical practice. Reliable internet connection was highlighted as the biggest barrier to accessing this teaching.

CONCLUSIONS

The pandemic has accelerated the development of innovative approaches to traditional learning. Through the utilisation of these advancements, we have demonstrated the feasibility of providing resuscitation training to students in developing countries. Multimodal teaching helped to develop critical thinking and decision making skills, increasing their confidence and competence in a variety of settings.

EP215 / #2433

E-Poster Viewing - Neonatology AS02-13. Global health

Teenage mothers and their newborns - a romanian study

G. Zaharie^{1*}, M. Hasmasanu¹, A. Tutu¹, I. Rotar², I. Taranu³,
G. Nemeti², D. Muresan², C. Lucaciu¹, F. Zaharie⁴, A. Canpean¹,
M. Matyas¹

¹UMF Iuliu Hatieganu, Neonatology, Cluj Napoca, Romania

²University of Medicine and Pharmacy Iuliu Hatieganu Cluj, Mother and Child, Cluj Napoca, Romania

³UMF Iuliu Hatieganu, Biostatistics, Cluj Napoca, Romania

⁴University of Medicine and Pharmacy Iuliu Hatieganu, Student, Cluj Napoca, Romania

BACKGROUND AND AIM

A quarter of world's women were child brides. Teen pregnancy implications are intricate: from obstetric part to maternal health and to social consequences. The aim of the study is to evaluate the incidence of teenage mothers in dynamics over 6 years:2016-2021, analysis of their pregnancies and their newborns.

METHODS

It is an observational study, done in a III-rd level unit, Cluj, Romania. We evaluate the incidence of teenage mother, the demographics parameters, gestational age (GA), birth weight (BW)and ponderal Index (IP)of the newborn. Also, we evaluated the type of delivery and Apgar score (AS). Statistical analysis was done with the IBM SPSS V25 program.

RESULTS

The incidence of teenage mothers was 0,25%(2016); 2,26%(2017); 1,45%(2018); 0,435%(2019); 0,404%(2020); 0,202%(2021). Mother's age/year was: 14,8 ± 1,93 - 16 ± 1,16 - 15,84 ± 0,94 - 15,72 ± 0,54 - 15,12 ± 0,02 - 14,75 ± 0,05 years old. The mean decrease in Covid period. The GA was without significant differences 36,8 ± 3,34 weeks (2016) - 36,48 ± 2,58(2018)- 38,75 ± 1,05(2021) over this period. We observed significant differences only for PI (ponderal index) (2.21 vs 2.37) between the newborn delivered from very early pregnancies versus early pregnancies(p=0,006). No differences for AS at 1min or BW. In our study, mothers were from more from rural environment with unfollow pregnancies and without occupation.

CONCLUSIONS

The incidence of early and very early pregnancies decreased in the period 2016-2021. The newborns were late preterm or early terms infants. Ponderal Index of the newborn was significant lower in very early pregnancies.

EP216 / #1364

E-Poster Viewing - Neonatology AS02-14. Haematology, transfusion therapy & oncology

Development and validation of a smartphone-based screening tool for neonatal jaundice

**A. Aune^{1*}, G. Vartdal², L. Gierman², G.D. Jimenez¹, H. Bergseng³,
E. Darj¹**

¹NTNU, Mh/ism, Trondheim, Norway

²Picterus AS, Rød, Trondheim, Norway

³St. Olav Hospital, Pediatrics, Trondheim, Norway

BACKGROUND AND AIM

Neonatal jaundice (NNJ) is an important cause of newborn morbidity and mortality, and results in more than 100.000 deaths annually. Most cases occur in Sub-Saharan Africa and South-East Asia. In addition, early discharge from hospitals after delivery has raised concerns regarding follow-up of NNJ. Early detection is a key factor in improving current state, but there is a lack of accurate, available, and affordable tools.

METHODS

We used an iterative approach and developed a smartphone-based system to detect NNJ. Work along different axis were performed in parallel, including technical development, clinical testing and data collection, usability testing, and work for regulatory requirements. For each iteration of the system new features were added and improved. The final version was tested in a validation study on healthy, term born newborns aging 1 to 15 days.

RESULTS

We developed a system containing a smartphone app, a color calibration card, and a server. Three iterations of the system were developed, and documentation on the final version was submitted for conformity assessment after Medical Device Regulations (MDR) for CE mark. CE mark was obtained October 2022. 200 infants were included in the validation study, and bilirubin estimates were highly correlated to blood levels ($r=0.84$). The system had a high sensitivity to detect severe jaundice (97%) and maintained a high specificity (64%).

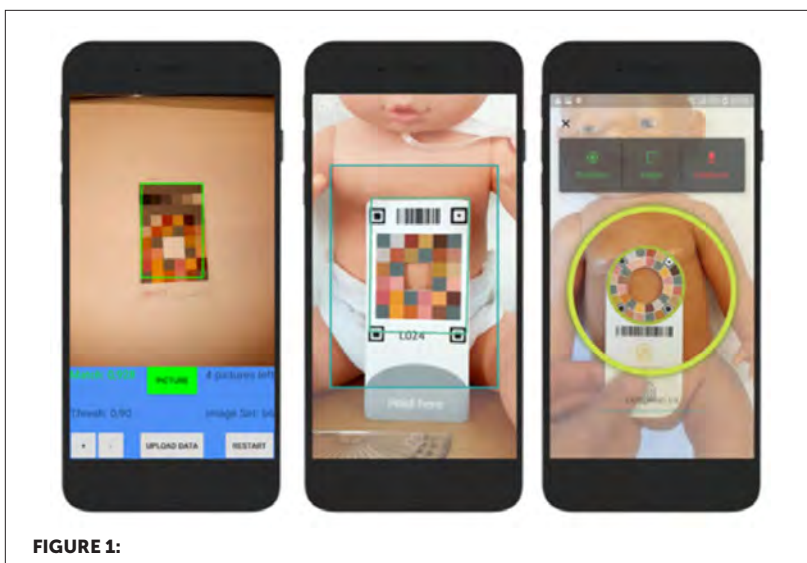

CONCLUSIONS

A smartphone-based system shows large potential for use in screening of NNJ. An iterative approach allows work along different axes in parallel and can rapidly give improved version of novel tools.

EP217 / #1715**E-Poster Viewing - Neonatology AS02-14.
Haematology, transfusion therapy & oncology****Infantile pyknocytosis as cause of hemolytic anemia: a case report****E. Moliner Calderon¹, L. Català Altarriba^{1*}, J. Thió Casals¹,
M.J. García Borau¹, I. Badell Serra², A. Remacha Sevilla³**¹Hospital de la Santa Creu i Sant Pau, Neonatology, Pediatrics Department, Barcelona, Spain²Hospital de la Santa Creu i Sant Pau, Pediatric Hematology, Hematopoietic Transplant Unit, Barcelona, Spain³Hospital de la Santa Creu i Sant Pau, Hematology, Barcelona, Spain**BACKGROUND AND AIM**

The structural membrane defects of erythrocyte are a heterogeneous group of diseases which appears during childhood with hemolytic anemia and jaundice. Infantile pyknocytosis (IP) is in this group of diseases. This is a little-known disease that can occur in the newborn. We report a case of neonatal hemolysis due to IP.

METHODS

Case report

RESULTS

Full term newborn was admitted for jaundice in the range of exchange transfusion. Hematologic study showed severe hemolysis with significant alteration of erythrocyte morphology (acanthocytosis and spherocytosis) and positive erythrocyte osmotic fragility test. The different studies did not show enzymatic or structural congenital red cell defects. Other genetic diseases and congenital viral and bacterial infections with hematologic involvement

were also excluded. Up to one month of life the patient had moderate to severe anemia (hemoglobin: 6.4 g/L) and subsequently remained stable with a decrease in peripheral blood piknocytes. That evolution predicts a resolution of the disease.

CONCLUSIONS

IP occurs in 9% of newborns who develop severe neonatal hemolytic anemia. The diagnosis of this entity is made after exclusion of other diseases that cause hemolysis and after examination of erythrocyte morphology in peripheral blood (irregular, small and spiculated red blood cells). Sometimes treatment with blood products is needed, although in most cases it resolves spontaneously at around 4-6 months of age.

EP218 / #2023**E-Poster Viewing - Neonatology AS02-14.
Haematology, transfusion therapy & oncology****Congenital kaposiform hemangioendothelioma of the leg: report of a rare case of fatal vascular tumor.****C.M. Celini^{1*}, C.J.M. Celini², M. De Mattos², W. Goncalves-Ferri³, F.P. Martins Celini³**¹University of Ribeirão Preto, UNAERP, Department of Pediatrics, Ribeirão Preto, Brazil²University Center Barão de Mauá, Department of Pediatrics, Ribeirão Preto, Brazil³Ribeirão Preto School of Medicine, University of São Paulo, Brazil, Department of Pediatrics, Ribeirão Preto, Brazil**BACKGROUND AND AIM**

Kaposiform Hemangioendothelioma(KH) is a rare vascular neoplasm, locally aggressive and without metastatic power¹

^{2,3}. In 70% of cases it is associated with Kasabach Merritt Syndrome(KMS), characterized by consumption coagulopathy, thrombocytopenia, risk of hemorrhage and death⁴. Treatments include correction of anemia and thrombocytopenia, enoxaparin, salicylic acid, steroids, chemotherapy, interferon, irradiation, embolization and excision⁵. The objective of this study was to present a rare and fatal case of congenital HK associated with KMS, in which early diagnosis and treatments are essential for more favorable outcomes.

METHODS

Retrospective review of medical records in a university hospital in 2022.

RESULTS

Patient with 36 weeks and 6 days of gestational age, male, weighing 4040grams and presenting significant edema in the right lower limb, was

born by cesarean section, Apgar 3 and 7(Figure 1). The newborn evolved with severe respiratory distress requiring tracheal intubation, vasoactive drugs, transfusion of blood products and vitamin K due to change in coagulogram and gastric bleeding. On the 2nd day, after the result of the magnetic nuclear angioresonance compatible with HK(Figure 2), Vincristine(0.05mg/kg/week) was started. Echocardiogram identified cardiac chamber dilation, right ventricular systolic dysfunction and pulmonary hypertension. The neonate evolved with refractory hemodynamic shock, renal failure, tumor lysis syndrome and death on the 3rd day of life.

CONCLUSIONS

Congenital HK associated with KMS is a serious condition in which early recognition and initiation of treatment leads to lower morbidity and mortality. However, the severe clinical condition of the newborn, with cardiorespiratory and renal failure, associated with tumor lysis syndrome, contributed to the fulminant outcome.

EP219 / #1863**E-Poster Viewing - Neonatology AS02-14.
Haematology, transfusion therapy & oncology****Dat positive neonates: developing a guideline and parent information leaflet in a level 2 local neonatal unit****J. Cookson^{1*}, R. Mistry¹, A. Mcmillan², K. Jamieson³**¹Whittington Hospital, General Paediatrics and Neonates, London, United Kingdom²Whittington Hospital, Haematology, NF, United Kingdom³Whittington Hospital, Neonates, NF, United Kingdom**BACKGROUND AND AIM**

The direct antiglobulin test (DAT) detects the presence of immunoglobulin, complement or both bound to red blood cell membranes. However, the test is not specific for haemolysis, and a positive DAT alone does not indicate clinically significant haemolysis. No local guideline on how to manage babies with a positive DAT existed, resulting in variable approaches and potential safety implications. Adequate safety netting for parents of babies with haemolysis is essential. Aims: 1. Audit current departmental practice against national and regional guidelines 2. Standardise practice by developing a safe and acceptable guideline 3. Promote patient safety by providing parent education and information

METHODS

Retrospective review of investigation results and management of all babies with positive DAT over 2-month period. Development of a departmental guideline and parent information leaflet with input from relevant stakeholders including haematology and neonatal teams.

RESULTS

49 DAT-positive babies. 84% had bilirubin level checked. 61% had FBC checked. 39% had blood film checked. 20% needed phototherapy for jaundice of which 50% had haemolysis due to ABO incompatibility, and 50% were due to non-haemolytic causes. 24% of babies were followed up with significant variability in practice. 33% of babies followed up were prescribed folic acid.

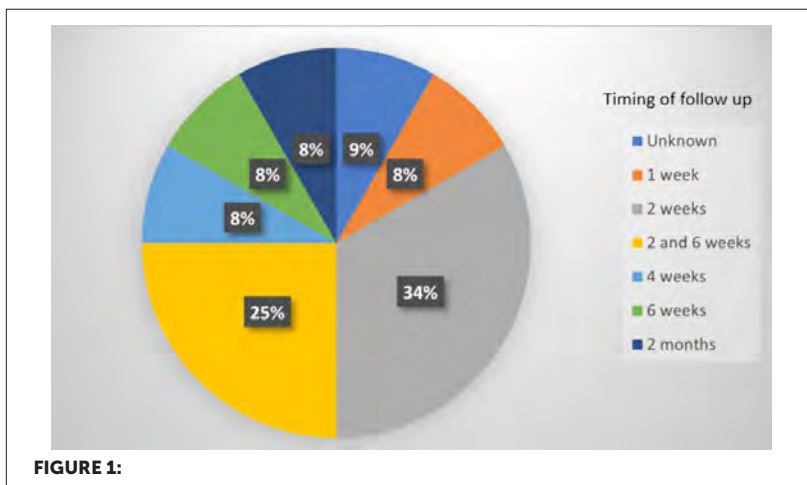

CONCLUSIONS

We demonstrated wide variability in how positive DAT results were investigated and followed up. This demonstrated a need for a guideline and parent-information leaflet, which has been developed along a traffic light system via an MDT approach with haematology colleagues. Further audit cycles are planned to review ongoing practice against the new guideline.

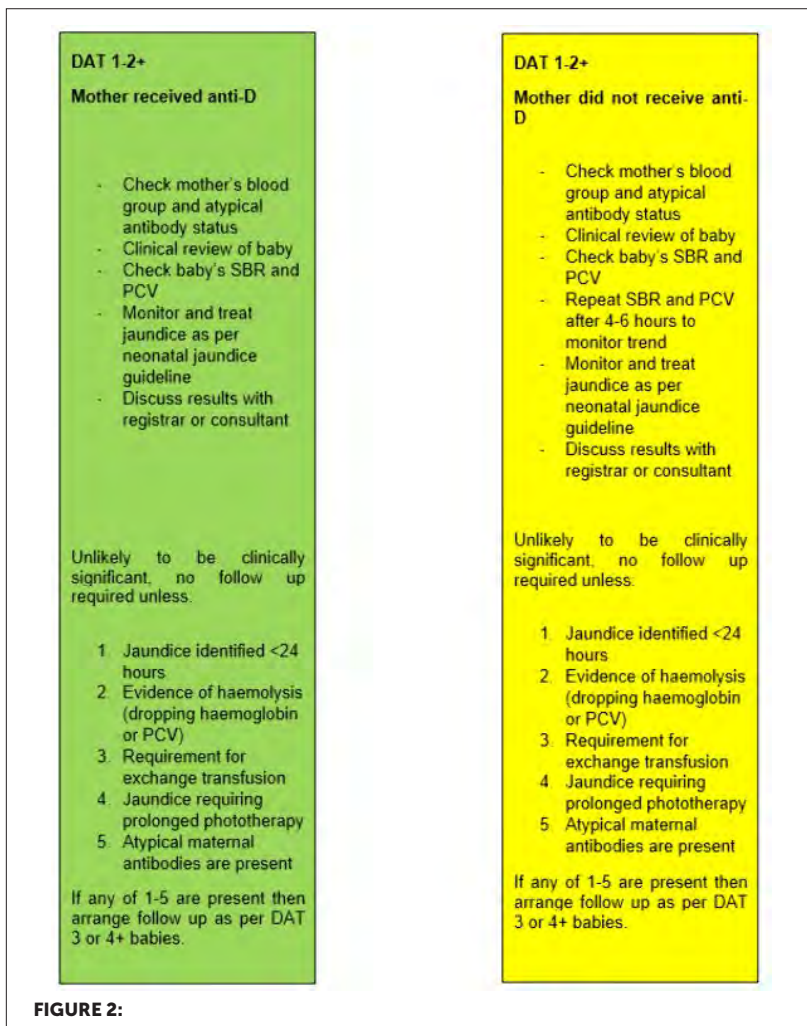
**FIGURE 2:**

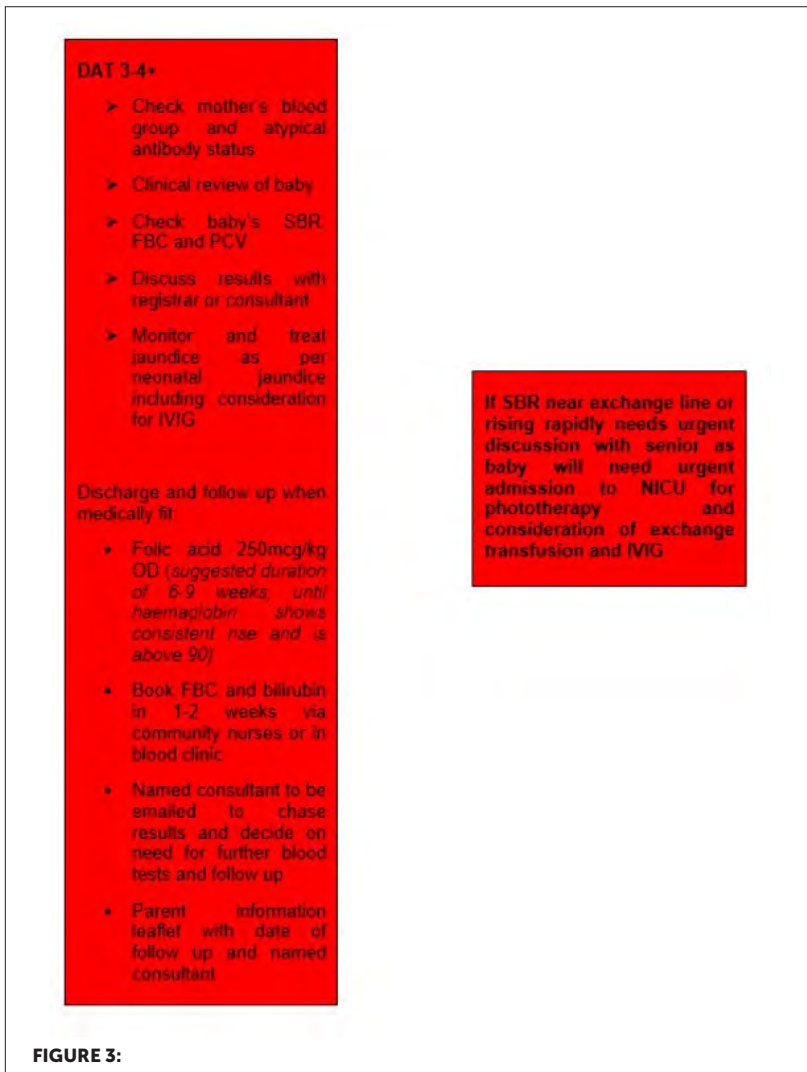

EP220 / #1326**E-Poster Viewing - Neonatology AS02-14.
Haematology, transfusion therapy & oncology****Central catheter-associated thrombosis in neonates**

A. Cuartero*, N. Torre, M. Sardà, D. De Luis, C. Figaró, G. Vallès, M. Domingo

Consorci Sanitari Parc Taulí, Pediatrics, Sabadell, Spain

BACKGROUND AND AIM

Central catheter-associated thrombosis (CC-T) is rare in neonates. However, they are more vulnerable to it. Due to high risk of complications, treatment is controversial. The aim is to analyse the incidence of CC-T in hospitalised neonates.

METHODS

Retrospective descriptive study of CC-T in a tertiary care hospital (Jan17-March22). Demographic and clinical data were compiled.

RESULTS

There were 17 CC-T out of 193 neonates and 276 central catheters (CC). The median gestational age was 32.1 weeks (p25-75 28.4-37.3) and birth weight was 1846gr (p25-75 1185-2405). 11 (64.7%) were admitted for prematurity and 6 (35.3%) for hypoxic-ischemic encephalopathy. The incidence of CC-T was 6%. The catheters involved were umbilical catheter (total 15; 13 venous and 2 arterial) and central venous catheter (2). The median number of days with CC was 3 days (p25-75 2-4). 15 patients (88.2%) were asymptomatic, in relation to umbilical catheter and the diagnosis was due to ultrasound screening

after removing it. The 2 (11.8%) symptomatic presented limb oedema related to central venous catheter. 2 patients (11.8%) received treatment with low molecular weight heparin without complications: asymptomatic left portal vein thrombosis with complete obstruction of blood flow and a distal deep femoral vein thrombosis with significant limb involvement.

CONCLUSIONS

Our CC-T in neonates is rare, it is usually asymptomatic. It can be associated with any kind of central catheter. Indications for treatment should always be individualised, especially in prematures due to the high risk of cerebral haemorrhage.

EP221 / #2330**E-Poster Viewing - Neonatology AS02-14.
Haematology, transfusion therapy & oncology****Identification of perinatal anaemia by umbilical
cord blood gas analysis****Y. King^{1*}, D. Jayasinghe²**¹University of Nottingham, Medical School, Nottingham, United Kingdom²Nottingham University Hospitals NHS Trust, Neonatal Services, Nottingham, United Kingdom**BACKGROUND AND AIM**

Perinatal anaemia is associated with increased neonatal mortality, white-matter injury on MRI, and neurodevelopmental delay. Practices for neonatal blood transfusion are varied and inconsistent across the world. The variation in methods for identifying perinatal anaemia may contribute to this. A local audit was carried out to compare umbilical cord haemoglobin values measured using blood gas analyser (Radiometer ABL90) with laboratory-tested venous haemoglobin.

METHODS

All neonates born at Nottingham University Hospitals NHS Trust from 1st January 2020- 27th February 2022 with a cord haemoglobin of less than 120g/l were included. Demographic information, neonatal blood test results, and outcomes of the infants were collected from hospital records. A Bland-Altman plot was created of the agreement between the two methods.

RESULTS

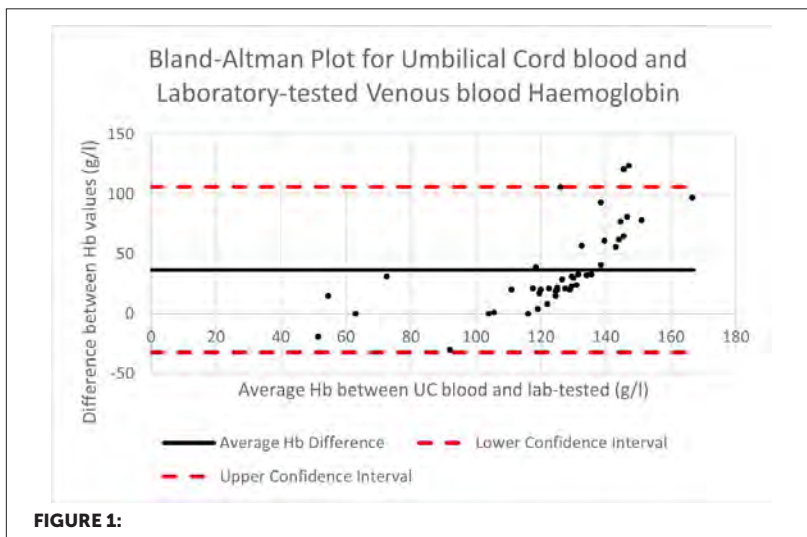

Overall, 56 babies were identified as anaemic by the cord haemoglobin (median 113g/l, range 47-119g/l), of whom 8 were confirmed as anaemic (median 88g/l, range 42-116g/l) by laboratory haemoglobin (median age at testing 1h7m, range 52m-17h30m). 7 of the 8 anaemic neonates received blood transfusions, with the 8th dying before transfusion could happen. The average difference between laboratory haemoglobin and blood gas analyser was 37g/l (95% CI[-32,106]).

CONCLUSIONS

Cord haemoglobin measured by blood gas analyser is an early identifier of neonatal anaemia and has a poor agreement. Thus, it may be useful in identifying neonates that need monitoring and further testing but cannot alone be used to diagnose neonatal anaemia.

EP222 / #942**E-Poster Viewing - Neonatology AS02-14.
Haematology, transfusion therapy & oncology****Not all red blood cells are equal -endogenous erythrocytes with high load of haemoglobin are lost during first 14 postnatal days after extremely preterm birth.****S.M. Larsson^{1,2*}, T. Ulinder³, A. Rakow⁴, M. Vanpee⁴, K. Sävman⁵, I. Hansen Pupp³, A. Hellström⁶, D. Ley³, O. andersson³**¹Halland Hospital, Department of Clinical Chemistry, Halmstad, Sweden²Lund University, Department of Clinical Sciences, Pediatrics, Lund, Sweden³Lund University, Skåne University Hospital, Department of Clinical Sciences, Pediatrics, Lund, Sweden⁴Karolinska Institutet and Karolinska University Hospital, Department of Women's and Children's Health, Stockholm, Sweden⁵University of Gothenburg, Institute For Clinical Sciences, Department of Pediatrics, Sahlgrenska Academy, Gothenburg, Sweden⁶University of Gothenburg, The Sahlgrenska Centre For Pediatric Ophthalmology Research, Department of Clinical Neuroscience, Institute of Neuroscience and Physiology, Sahlgrenska Academy, Gothenburg, Sweden**BACKGROUND AND AIM**

Loss of endogenous blood cell populations following extremely preterm birth may be causal in development of several morbidities. The proportion of erythrocytes with a very high haemoglobin content (>49 pg) can be estimated by the HYPER-He parameter. Whilst very low levels are found in adult blood (0.7-1.3%), the proportions of these red blood cells in neonates remain to be described. The aim of this observational study was to describe neonatal HYPER-He after extremely preterm birth.

METHODS

The study was part of an ongoing prospective RCT investigating reduction of blood sample volumes in neonatal intensive care. Data from Swedish infants born week 22+0 to 26+6 were collected March 2020 to October 2021. HYPER-He was measured using Sysmex XN at birth (cord blood) and thereafter, to avoid any extra blood loss, in blood from clinical sampling until postnatal day 14. The relationship between HYPER-He and postnatal age was tested using Spearman correlation.

RESULTS

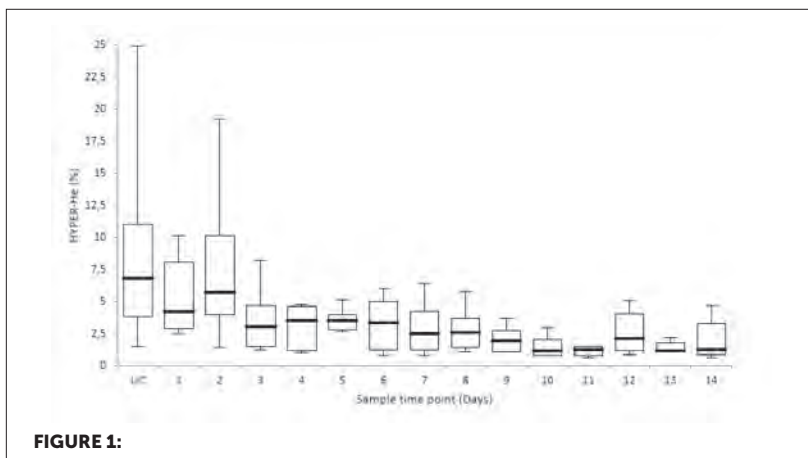

A total of 123 measurements from 33 neonates were analysed. At birth, HYPER-He showed large inter-individual variation ranging from 1.5% to 24.9% (median 6.8%). Overall, there was a strong inverse association between HYPER-He and postnatal age, Spearman's rho -0.58 (-0.69 to -0.45), $p < 0.01$.

CONCLUSIONS

HYPER-He is a biomarker with considerable inter-individual variation and a rapid decrease after birth, potentially describing transition between foetal and infant erythropoiesis. Results need verification by different measurement techniques. Further studies are required to investigate cell characteristics and potential associations with anaemia, transfusions, neonatal morbidity and sampling-related blood loss.

EP223 / #1821

E-Poster Viewing - Neonatology AS02-14. Haematology, transfusion therapy & oncology

Absence of foetal haemoglobin due to bone marrow suppression secondary to anti-kell alloimmunisation: a case report

R. Morales Painamil^{1*}, M. Teresa-Palacio², A. Argudo³, M. Alsina Casanova², J. Gonzalez De Aledo-Castillo³

¹Hospital Sant Joan de Deu, Pediatrics, Barcelona, Spain

²Hospital Clinic Maternitat, Neonatology, Barcelona, Spain

³Hospital Clinic, Inborns Errors of Metabolism-ibc Section. Biochemistry and Molecular Genetics Department, Barcelona, Spain

BACKGROUND AND AIM

Anti-Kell alloimmunisation is a potentially severe minor blood group type incompatibility, not only as a cause of haemolytic disease of the foetus and newborn (HDFN), but also due to the destruction of red blood cell (RBC) precursors and mature forms in the bone marrow with the subsequent hyporegenerative anaemia. In severe cases and when the foetus shows signs of anaemia, an intrauterine transfusion (IUT) may be necessary. When this treatment is repeated, it can also contribute to the suppression of erythropoiesis, with further worsening of anaemia.

METHODS

We report the case of a newborn who required four intrauterine transfusions (IUTs), but also an additional packed RBC transfusion at the age one month of life due to late onset anaemia. The identification of an adult haemoglobin profile with a complete absence of foetal haemoglobin (HbF) in the patient's newborn screening samples at 2 and 10 days of life warned us of a possible risk of late onset anaemia that would require treatment.

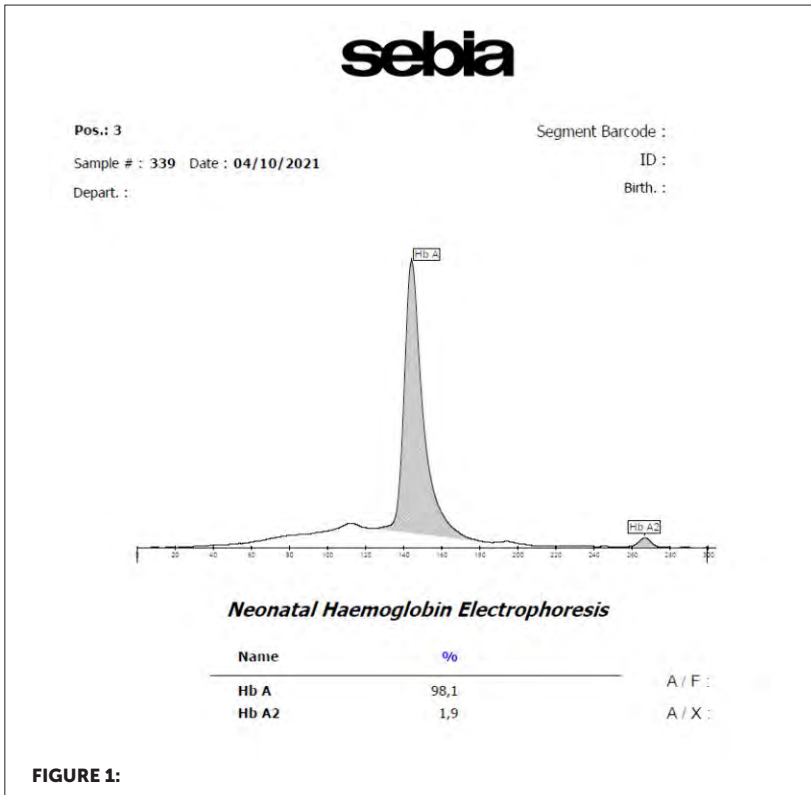

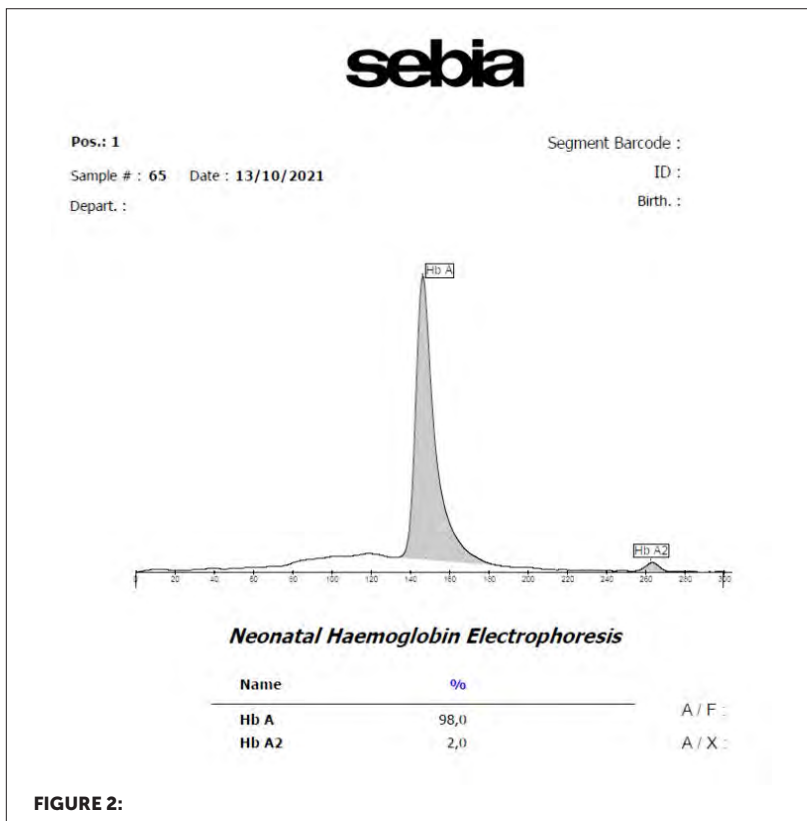

RESULTS

The newborn was successfully treated with a packed RBC transfusion, oral iron and folic acid supplements, and subcutaneous recombinant human erythropoietin (rhEPO) with a gradual recovery of the hyporegenerative anaemia. A blood sample taken at 4 months of life showed the expected haemoglobin profile for that age with a HbF percentage of 17.7%.

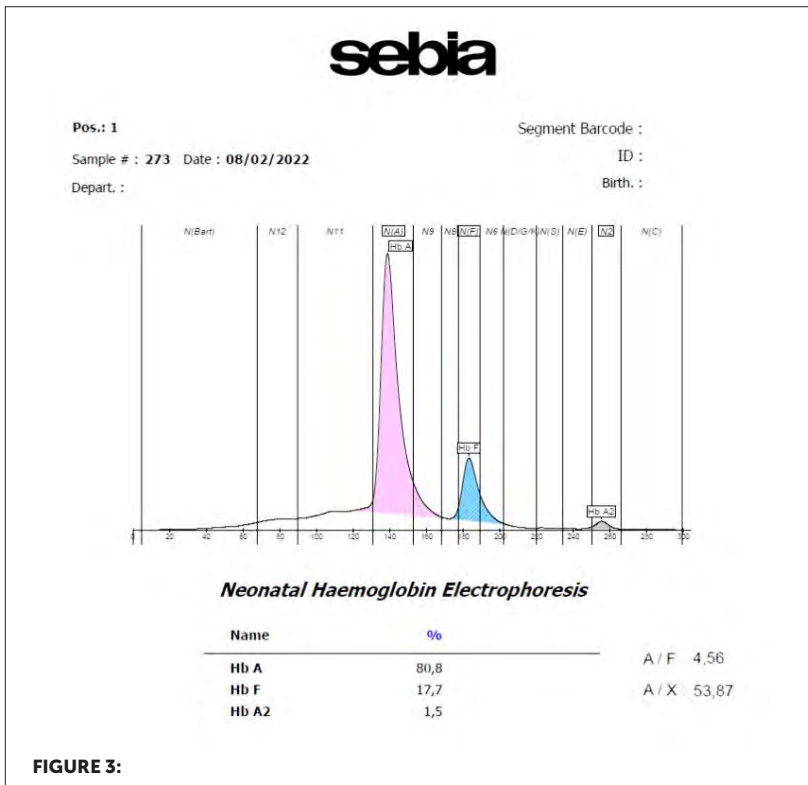

CONCLUSIONS

Through this case, we want to address the importance of close follow-up of these patients both antenatal and postnatally, as well as the usefulness of haemoglobin profile screening as a tool for anaemia assessment.

EP224 / #868

E-Poster Viewing - Neonatology AS02-14. Haematology, transfusion therapy & oncology

Cord blood bilirubin albumin ratio as an early predictor of neonatal hyperbilirubinemia

S. Pandit*

Government Multi Specialty Hospital Sector 16 Chandigarh India, Pediatrics Department, Chandigarh, India

BACKGROUND AND AIM

Neonatal hyperbilirubinemia is the most usual abnormal physical examination finding seen during the early postnatal life in both term and preterm neonates. Primary objective was to determine cut of value of cord blood bilirubin albumin ratio as an early predictor of significant hyperbilirubinemia in neonates of gestational age ≥ 35 weeks.

METHODS

Prospective, observational cohort study was conducted on 90 consecutive singleton newborns with gestation ≥ 35 weeks and birth weight > 1.5 kg in Neonatal unit of Department of Pediatrics at Government Multi-Speciality Hospital, Sector 16, Chandigarh. Newborns were divided into group 1 (significant hyperbilirubinemia) and group 2 (no significant hyperbilirubinemia). Cord blood bilirubin and albumin were estimated and their ratio was calculated.

RESULTS

The mean value of cord blood bilirubin was higher (2.50 ± 0.41 mg/dl) in group 1 than (1.83 ± 0.35 mg/dl) group 2 (P value = 0.0001) and a level ≥ 2.165 mg/dl was determined as a cut off point. The mean value of Cord blood bilirubin

albumin ratio was higher (0.69 ± 0.13) in group1 than (0.52 ± 0.10) group 2(P value=0.0001) and a value of ≥ 0.605 was determined as a cut off point.

CONCLUSIONS

Umbilical cord blood bilirubin and bilirubin albumin ratio both are good predictors of significant neonatal hyperbilirubinemia but cord blood bilirubin is slightly better predictor than bilirubin albumin ratio.

EP225 / #906

E-Poster Viewing - Neonatology AS02-14. Haematology, transfusion therapy & oncology

Survey of practices on the use of iron and erythropoietin in preterm infants in europe

**N. Reibel^{1*}, A. Scrivens², L. Heeger³, E. Lopriore⁴, H. New⁵,
S. Stanworth^{6,7,8}, C.C. Roehr^{9,10}, E. Deschmann¹¹, K. Fijnvandraat¹²,
H. Van Der Staij³, N. Houben³, S. Fustolo-Gunnink^{3,4}, C. Dame¹**

¹Charité Universitätsmedizin Berlin, Department of Neonatology, Berlin, Germany

²Oxford University Hospitals NHS Foundation Trust, John Radcliffe Hospital, Department of Neonatology, Oxford, United Kingdom

³Sanquin Blood Supply Foundation, Center For Clinical Transfusion Research, Amsterdam, Netherlands

⁴Leiden University Medical Center, Department of Neonatology, Leiden, Netherlands

⁵NHS Blood and Transplant, Imperial College, Department of Haematology, London, United Kingdom

⁶National Health Service (NHS) Blood and Transplant, Transfusion Medicine, Bristol, United Kingdom

⁷Oxford University Hospitals NHS Foundation Trust, Department of Haematology, Oxford, United Kingdom

⁸Biomedical Research Centre (BRC) Haematology Theme, University of Oxford,, Radcliffe Department of Medicine, Oxford, United Kingdom

⁹Nuffield Department of Population Health, University of Oxford, National Perinatal Epidemiology Uni, Oxford, United Kingdom

¹⁰Southmead Hospital, North Bristol Trust, Newborn Services, Bristol, United Kingdom

¹¹Karolinska Institutet, Department of Neonatology, Stockholm, Sweden

¹²Amsterdam University Medical Center, Pediatrics, Amsterdam, Netherlands

BACKGROUND AND AIM

Preterm infants are at high risk of anemia. Iron and recombinant human erythropoietin (rhEPO) may be administered to prevent and treat this anemia of prematurity, but the optimal management is not known nor whether use varies between European centers. The aim of this Neonatal Transfusion Network (NTN) survey was to describe practices on iron and rhEPO administration practices in Europe.

METHODS

From October to December 2020, we conducted an online survey of 597 neonatal intensive care units (NICUs) in 18 European countries treating pre-term infants with a gestational age (GA) < 32 weeks.

RESULTS

The survey was completed by 343 NICUs (response rate 57%). Routine supplementation of iron is reported by 98% of participating NICUs. Among them 74% give iron in all infants born at < 32 weeks gestational age (GA). Most NICUs initiate iron supplementation by two weeks of life and stop after six or twelve months. 22% of participating NICUs reported routine use of rhEpo, mostly in infants with GA < 32, and another 7 % reported its use in individual cases. RhEPO was mostly administered subcutaneously. The dose of rhEPO varies widely within individual countries.

CONCLUSIONS

Iron is routinely administered in Europe for preterm infants, with differences in duration and cessation of treatment. RhEPO is routinely used in one-fifth of participating NICUs, but the indications, timing of initiation and dose vary widely across Europe and within each country.

EP226 / #1123

E-Poster Viewing - Neonatology AS02-14. Haematology, transfusion therapy & oncology

Neonatal outcome of transient abnormal myelopoiesis in a quaternary centre: a 6-year experience.

E. Seager*, S. Hannam, M. Chalia

Great Ormond Street Hospital, Nicu, Greater London, United Kingdom

BACKGROUND AND AIM

Background: Ten to fifteen per-cent of infants with trisomy 21 develop transient abnormal myelopoiesis (TAM) in the neonatal period. This is a foetal haematopoiesis disorder associated with trisomy 21 and acquired mutations in the GATA1 gene. Whilst many cases are self-limiting, some require chemotherapy and intensive care with overall mortality rates up to 20%. (Batnagar et al., 2016) Aim: To identify contributing factors that determine mortality in this patient group.

METHODS

This was a single centre, review of neonatal TAM cases requiring admission to intensive care from 2016 to 2022. All infants within the greater London region potentially requiring chemotherapy were admitted to the unit. Data were collected from electronic patient records, laboratory, and genetic results. Chi-square analysis was employed to analyse clinical and laboratory variables in relation to outcome.

RESULTS

Twenty neonates were identified. Thirteen neonates (65%) had a raised white cell count (>50) on admission and 80% ($n=16$) received chemotherapy; 4 required a second round of chemotherapy. The mortality rate in the cohort was 30% ($n=6$). The statistically significant factors associated to adverse outcome were mechanical ventilation (p 0.01), evidence of pulmonary hypertension on Echo (p 0.05), inhaled nitric oxide (p 0.02), inotropic support (p 0.02), presence of effusion(s) (p 0.05), and chemotherapy in the first week of life (p 0.05).

CONCLUSIONS

A high mortality rate was identified in neonates with trisomy 21 and TAM requiring intensive care. The risk factors strongly associated with adverse outcome should be considered in the clinical management, prognosis, and parental counselling.

EP227 / #2339

E-Poster Viewing - Neonatology AS02-14. Haematology, transfusion therapy & oncology

Delayed cord clamping at an extended time did not increase risk of hyperbilirubinemia.

M. Wilander^{1*}, O. andersson², J. Svedenkrans³

¹Lund University, Department of Clinical Sciences, Pediatrics, Lund, Sweden

²Lund University, Skåne University Hospital, Department of Clinical Sciences, Pediatrics, Lund, Sweden

³Lund University, Department of Clinical Sciences, Lund, Sweden

BACKGROUND AND AIM

Delayed cord clamping (CC) for 1-3 minutes is associated with improved outcome for term neonates, but there are still some concerns about side effects. Hyperbilirubinemia and risk of phototherapy are considered to be associated with delayed CC. The optimal time of cord clamping is yet to be decided. We aimed to describe time to cord clamping and associations with hyperbilirubinemia.

METHODS

Observational, single-center study based on data from medical records. Singleton neonates, born vaginally at $\geq 35+0$ weeks gestational age (GA) were included. Data included time to CC and transcutaneous bilirubin levels. Bilirubin values were categorized into risk groups according to a previously published algorithm. Primary outcome was the association between umbilical CC time and high-risk level of hyperbilirubinemia. We used descriptive statistics as appropriate to the distribution of variables. Adjusted analyses were performed using logistic regression.

RESULTS

We analysed 571 neonates, GA mean(SD) 39.9(1.3) weeks. CC was performed at a median(IQR) time of 6(5-8) minutes and mean(SD) bilirubin level was 151(77) $\mu\text{mol/L}$ registered at a median(IQR) of 50.5 (36.7 - 69.0) hours. Phototherapy was initiated in 17(3.0%) of the neonates and 135(23.9%) neonates were in the high-risk zone of needing phototherapy. When adjusted for gestational age and instrumental delivery, time to CC did not affect the risk of being categorized into bilirubin high-risk zone, OR (CI) = 1.00(0.94-1.06)

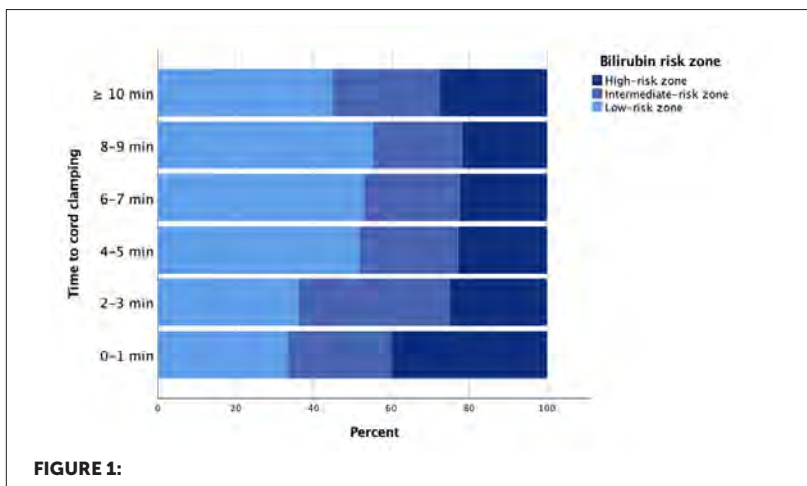

CONCLUSIONS

We conclude that there was no correlation between cord clamping time and high-risk level of hyperbilirubinemia. Our findings indicate that delayed cord clamping for an extended time does not increase risk for hyperbilirubinemia.

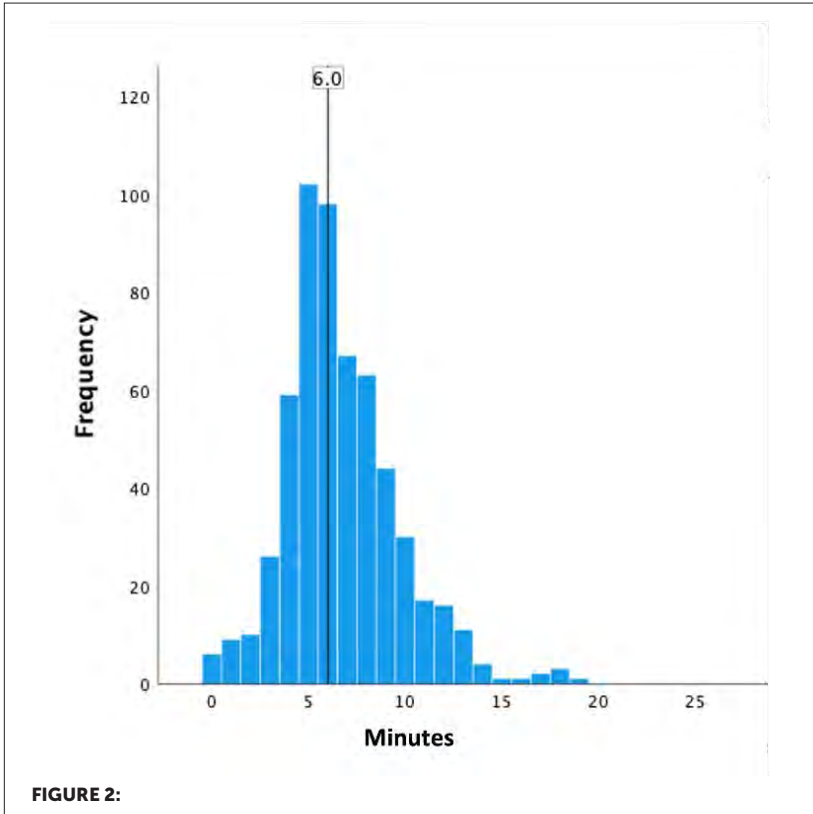

EP228 / #2337**E-Poster Viewing - Neonatology AS02-14.
Haematology, transfusion therapy & oncology****Normal percentiles of coagulation parameters in preterm infants****B. Yaşa*, E. Kirit, Z. Ince, G. Tosun, N. Yeğın, L. Bilgin, A. Çoban**

Istanbul University Medical Faculty, Neonatology, Istanbul, Turkey

BACKGROUND AND AIM**BACKGROUND AND AIMS**

The coagulation system matures as the gestational age increases. Preterm infants tend to have intraventricular hemorrhage and coagulation parameters frequently monitored. Data on the interpretation of normal values of coagulation parameters is limited. This study aimed to define normal percentile values of coagulation parameters in preterm infants below 32 weeks of gestational age.

METHODS

Material-Method: In this retrospective study, medical records of last 10 years were reviewed. The prothrombin time (PT), activated partial thromboplastin time (aPTT) and international normalized ratio (INR) values measured before the administration of vitamin K were recorded. Preterm infants who had major bleeding were excluded. The percentiles of PT, aPTT and INR were evaluated.

RESULTS

A total of 420 infants were included. The median gestational age was 29 (22–32) weeks, and median birth weight was 1150 (395–2790) grams. The percentile values of PT, aPTT and INR according to gestational age are shown in Table.

TABLE 1:

	3 rd	10 th	25 th	50 th	75 th	90 th	97 th
Gestational age (week)							
22-24	13.0/35.2/1.09	14.1/36.6/1.21	15.8/42.6/1.50	17.7/57.5/1.79	19.4/83.4/1.89	27.1/94.2/2.15	27.9/126.9/2.25
25-26	13.0/32.3/1.08	14.5/34.6/1.22	15.8/43.0/1.33	17.9/54.0/1.53	20.8/59.0/1.83	27.4/68.0/2.09	33.6/82.2/2.71
27-28	12.5/25.7/1.01	13.7/32.0/1.18	15.6/38.7/1.36	17.6/50.1/1.51	19.7/63.0/1.69	25.3/77.7/1.99	29.4/101.9/2.58
29-30	12.2/25.8/1.10	14.0/31.2/1.25	15.1/39.3/1.34	17.2/44.8/1.49	19.8/56.4/1.68	23.7/70.7/1.99	28.9/96.4/2.54
31-32	12.0/26.9/1.05	13.2/32.7/1.17	14.5/37.7/1.27	16.2/42.2/1.42	19.8/52.5/1.73	23.4/61.8/1.96	28.1/78.8/2.49

CONCLUSIONS

There are few studies showing the normal distribution of coagulation parameters in the neonatal period, particularly in preterm infants. Knowledge about the normal distributions would allow to evaluate the bleeding tendency of infants and would also reduce the unnecessary treatment.

EP229 / #2449**E-Poster Viewing - Neonatology AS02-15.
Infectious diseases****Neonatal pertussis. Do corticosteroids help? Case report****M. Al-Beltaji^{1*}, E. Hantash²**¹Tanta University, Faculty of Medicine, Pediatrics, Tanta, Egypt²Arryan Hospital, Dr. Suliman Al Habib Medical Group, Neonatal Intensive Care Unit., Riyadh, Saudi Arabia**BACKGROUND AND AIM**

We described a describe a newborn baby with pertussis and its response to treatment.

METHODS**FIGURE 1:**

A 24-day-old female neonate presented with a cough for two weeks. Local examination showed scattered chest crepitations and PaO_2 of 88-95% by pulse oximetry on room air. The respiratory viral panel was negative for all the tested viruses and unremarkable chest x-ray (Table 1 and Figure 1). She was kept on free flow O_2 , intravenous fluids, nothing per mouth, vancomycin, and cefotaxime. Unfortunately, after 3 days she deteriorated with marked leucocytosis, lymphocytosis, and high CRP.

RESULTS



FIGURE 2:

Her cough became episodic and whoop-like. Chest x-ray showed right upper and lower zone opacification (Figure 2), with a positive pharyngeal swab for *Bordetella Pertussis* PCR test. We started CPAP and azithromycin 10 mg/Kg, once daily for 5 days. On the 7th day, she had more distress; so we started a trial of intravenous methylprednisolone course, 4 mg, twice daily for a period of 10 days with close monitoring of her clinical condition and WBC count. Her clinical condition started to improve gradually over the next few days with a gradual reduction in leucocytic and lymphocytic count (Table 1). She

was gradually weaned from respiratory support, shifted to HFNC on day 11, and weaned from respiratory support on day 18.

CONCLUSIONS

Pertussis should be considered in newborn babies presented with protracted cough or apnea. Azithromycin should be started early. In severe cases, a trial of corticosteroids therapy may help before using ECMO or exchange transfusion.

EP230 / #2091

E-Poster Viewing - Neonatology AS02-15. Infectious diseases

Hypoxic-ischemic encephalopathy during rsv infection in a late preterm infant

T. Barsan Kaya^{1*}, M. Tatal¹, O. Surmeli Onay², O. Aydemir¹, A.N. Tekin²

¹Eskişehir Osmangazi University, Neonatology, Eskişehir, Turkey

²Eskişehir Osmangazi University, Faculty of Medicine, Department of Pediatrics, Division of Neonatology, Eskişehir, Turkey

BACKGROUND AND AIM

Introduction: Risk factors for high mortality and prolonged morbidity after Respiratory syncytial virus infection include premature birth, bronchopulmonary dysplasia, congenital heart disease, and Down syndrome. However, some previously healthy, children who are infected with RSV also require hospitalization and even experience severe sequelae or death.

METHODS

The patient was 32 day-old twin girl who was born at 35 gestation weeks, 2700 g. Apgar score was 8 and 9 at 1 and 5 minutes respectively. She was discharged from the hospital 7 days later without any complications. She presented to the emergency department with two-day history of progressive worsening poor feeding and hypoactivity. Upon admission, examination revealed lethargy, dehydration, and recurrent apnea. Serum chemistries were blood pH 7.18, pCO₂ 78.2, BE -5, and hyponatremia. Acute phase reactants were high. The CSF analysis for cells, glucose, and protein was normal. Due to worsening clinical features, including frequent apnoeic episodes, she was intubated within hours. PCRs of the nasopharyngeal swab test were positive for RSV. On the 5th day of admission, she experienced two episodes of focal tonic convulsion without fever.

RESULTS

Diffuse hypodense area was determined on cranial computed tomography scan. Magnetic resonance imaging of the brain showed diffusely abnormal cerebral cortical/subcortical diffusion restriction which may be a secondary hypoxic-ischemic injury (Figure 1).

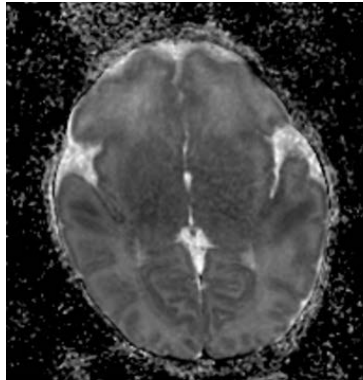

FIGURE 1:

CONCLUSIONS

The late preterm infants showed a higher risk of hospitalization for RSV-induced infection similar to that seen in very preterm infants. This case is presented because RSV infection caused hypoxic ischemic sequelae although there was no additional risk factor in our patient.

EP231 / #1297

E-Poster Viewing - Neonatology AS02-15. Infectious diseases

Role of enteroviruses in the etiology of neonatal meningitis

J. Becerra Hervás^{1*}, E. Moliner Calderon¹, N. Rabella², E. Turon-Viñas³, J. Figueras-Aloy⁴, S. Boronat-Guerrero⁵

¹Hospital de la Santa Creu i Sant Pau, Neonatology, Pediatrics Department, Barcelona, Spain

²Hospital de la Santa Creu i Sant Pau, Section of Virology, Microbiology Department, Barcelona, Spain

³Hospital Sant Pau., Paediatric Intensive Care, Barcelona, Spain

⁴Hospital Clínic i Provincial de Barcelona, Neonatology, Barcelona, Spain

⁵Hospital Sant Pau., Paediatric, Barcelona, Spain

BACKGROUND AND AIM

Neonatal meningitis is one of the potentially most serious pathologies in this period of life. Most of newborns admitted during the first month of life with suspected bacterial meningitis are diagnosed with infections caused by enteroviruses. The aim of this study is to illustrate the importance of the EV as the main pathogens in neonatal meningitis.

METHODS

Retrospective cohort study.

RESULTS

A total of 91 newborns with meningitis and gestational age (GA) greater than 34 weeks were included. EV meningitis was more common than bacterial meningitis in the newborns studied with a percentage of 78% and 22% respectively. The newborns with EV infection presented less maternal pathology

and usually were healthy newborns with higher GA ($p < 0.001$). In half of the cases a family epidemic history was present ($p < 0.001$). Fever was the most constant manifestation (96%) in newborns with EVM. CSF characteristics showed significant differences in pleocytosis and protein concentration ($p < 0.001$). Antibiotherapy was given to 51.4% of patients with EV infection. The detection of EV in CSF samples by RT-PCR showed a high sensitivity and a high PPV in the diagnosis of EV Meningitis. The most frequently implicated EV types were E11.

CONCLUSIONS

In the diagnosis of newborns with suspected sepsis and meningitis is imperative to study the presence of EV due to the high prevalence of these infection.

EP232 / #2356

E-Poster Viewing - Neonatology AS02-15. Infectious diseases

Congenital sepsis complicated by cerebral sinovenous thrombosis

L. Blaga^{1*}, O. Fufezan², M. Hasmasanu¹, M. Matyas¹, G. Zaharie¹

¹University of Medicine and Pharmacy, Neonatology, Cluj-Napoca, Romania

²Emergency Children Hospital, Radiology, Cluj-Napoca, Romania

BACKGROUND AND AIM

Sinovenous thrombosis is a severe condition that generates late neurological sequelae in most of the survivors. 50% of all pediatric sinovenous thromboses are reported in the neonatal period and 50% of the survivors develop late neurological anomalies. The severity of the lesions depends on the location and extension of the thrombus. The incidence varies between 1 and 12 cases in 100.000 newborns; it is hard to evaluate due to the lack of specificity of the clinical features. It is determined by maternal, fetal or neonatal factors. When associated with cerebral hemorrhage, it coexists with protein C and antithrombin deficit. Cerebral ultrasound exam reveals absent or diminished blood flow within the affected sinus and associated lesions: intraventricular hemorrhages, white matter injuries in preterm infants, unilateral thalamic hemorrhage. The diagnosis is confirmed by MRI venography. The aim of this paper is to review ultrasound images and treatment possibilities of sinovenous thrombosis.

METHODS

We present the case of a term newborn male infant, from an unmonitored pregnancy, with congenital sepsis, with unilateral seizures on day of life 7. Cerebral sonography revealed fronto-parietal hemorrhagic infarction, right parietal and right thalamic focal hemorrhages, extended thrombosis of the

superior sagittal sinus, right transverse and sigmoid sinus, subarachnoid hemorrhage. Anticoagulation treatment with Clexane was administered.

RESULTS

Sonographic monitoring revealed patent sinuses, a porencephalic cyst, small cystic lesions in the periventricular white matter. The area of bleeding did not expand under our treatment.

CONCLUSIONS

Anticoagulant treatment stopped the spread of thrombosis. Cerebral sonography is a useful tool for monitoring treatment complications.

EP233 / #2374

E-Poster Viewing - Neonatology AS02-15. Infectious diseases

Necrotising enterocolitis: an overview of potential biomarkers and inflammatory responses

**M. Faizan¹, E. Molloy², A. Yeo¹, A. McMahon¹, I. Khalid¹, E. Roche³,
A. Branagan^{4*}, E. Isweisi⁵, G. Semova³, M. Fadel¹, P. Gavigan¹, S. O' Neill¹**

¹Trinity College Dublin, Paediatrics, School of Medicine, Dublin, Ireland

²Trinity College Dublin, Discipline of Paediatrics, School of Medicine, Dublin, Ireland

³Trinity College Dublin, the University of Dublin, School of Medicine, Dublin, Ireland

⁴Coombe Women & Infants University Hospital, Neonatology, Dublin, Ireland

⁵Prof of Paediatrics, Trinity College Dublin, Dublin, Ireland

BACKGROUND AND AIM

Necrotising enterocolitis (NEC) is an acute inflammatory condition of the gut, commonly affecting preterm neonates. The nonspecific clinical signs followed by rapid progression into fulminant disease, lack of biomarkers of early NEC makes this condition notoriously difficult to diagnose. This systematic review aims to identify potential biomarkers associated with the initial stages of NEC.

METHODS

Following the PRISMA guidelines, a systematic review search was conducted out of PubMed, Cochrane, and Embase pertaining to the studies reporting data on the diagnostic accuracy of biomarkers for NEC, available until September 2021. After preliminary search, we extracted our findings for screening. Once the most relevant studies were selected for inclusion, their data was extracted for analysis.

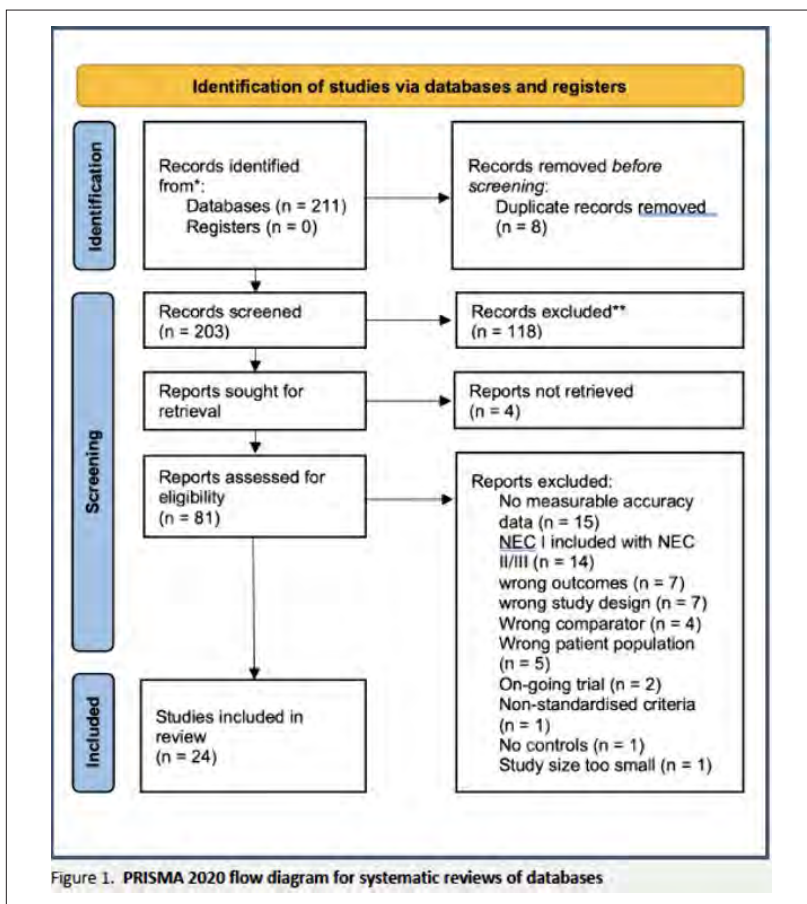

RESULTS

For identifying NEC Bell's stage \geq II, we found high sensitivity and specificity for faecal calprotectin, serum calprotectin, a panel consisting of urine proteins CST3, PEDF, and RET4, and maternal human milk oligosaccharide disialyllacto-N-tetraose (DSNLT) when sampled prior to or around the initial diagnosis

of NEC. IL-33 demonstrated high accuracy when sampled ≥ 3 days post-initial diagnosis. For differentiating between NEC Bell's stage II and stage III, only urinary intestinal fatty acid binding protein (I-FABPu) demonstrated high sensitivity and specificity when sampled around the time of initial diagnosis.

Biomarker	Sample	Reference	Study Design	Study Population	Target Population	Target Condition	Timing of Sampling	Cut-Off Value	AUC Value	Sensitivity (%)	Specificity (%)
Calprotectin (Stool/MS)	Stool	Baerentzen et al. (2019)	Case Control	n=55: 27 NEC, 28 Controls	NEC Stage II vs III	n=25: 14 Stage II vs 11 Stage III	at least 2 symptoms and 1-70 µg/g	0.833	0.93	100	89
	MS	Wang et al. (2017)	Prospective Cohort	n=102: 52 NEC, 50 Controls	NEC Stage II vs III	52 patients with NEC group	before clinical presentation of NEC	0.75 µg/g	0.70	95	88
Calprotectin (Blood)	Blood	Tseng et al. (2012)	Retrospective	n=102: 52 NEC, 50 Controls	NEC Stage II vs III	52 patients with NEC group	at least 2 symptoms and 1-70 µg/g	0.833	0.93	100	89
	MS	Wang et al. (2017)	Prospective Cohort	n=102: 52 NEC, 50 Controls	NEC Stage II vs III	52 patients with NEC group	before clinical presentation of NEC	0.75 µg/g	0.70	95	88
CST3, PEDF, and RET4	Urine	Schmidt et al. (2016)	Multi-Center	n=102: 52 NEC, 50 Controls	NEC Stage II vs III	52 patients with NEC group	at least 2 symptoms and 1-70 µg/g	0.833	0.93	100	89
	Blood	Tseng et al. (2012)	Retrospective	n=102: 52 NEC, 50 Controls	NEC Stage II vs III	52 patients with NEC group	at least 2 symptoms and 1-70 µg/g	0.833	0.93	100	89
IL-33	Blood	Li et al. (2018)	Prospective Cohort	n=102: 52 NEC, 50 Controls	NEC Stage II vs III	52 patients with NEC group	at least 2 symptoms and 1-70 µg/g	0.833	0.93	100	89
	MS	Wang et al. (2017)	Prospective Cohort	n=102: 52 NEC, 50 Controls	NEC Stage II vs III	52 patients with NEC group	before clinical presentation of NEC	0.75 µg/g	0.70	95	88
I-FABPu	Urine	Wang et al. (2017)	Prospective Cohort	n=102: 52 NEC, 50 Controls	NEC Stage II vs III	52 patients with NEC group	at least 2 symptoms and 1-70 µg/g	0.833	0.93	100	89
	Blood	Li et al. (2018)	Prospective Cohort	n=102: 52 NEC, 50 Controls	NEC Stage II vs III	52 patients with NEC group	at least 2 symptoms and 1-70 µg/g	0.833	0.93	100	89
CA, gestational age, W/BW	Urine	Wang et al. (2017)	Prospective Cohort	n=102: 52 NEC, 50 Controls	NEC Stage II vs III	52 patients with NEC group	at least 2 symptoms and 1-70 µg/g	0.833	0.93	100	89
	Blood	Li et al. (2018)	Prospective Cohort	n=102: 52 NEC, 50 Controls	NEC Stage II vs III	52 patients with NEC group	at least 2 symptoms and 1-70 µg/g	0.833	0.93	100	89

CONCLUSIONS

Calprotectin, urinary CST3, PEDF, and RET4, and maternal DSNLT demonstrate usefulness in the initial diagnosis of NEC, while IL-33 may be used for diagnostic confirmation in the follow-up and I-FABPu in the early differentiation of Bell's stage II NEC from stage III. A combined biomarker panel approach can be relevant for future diagnosis.

EP234 / #1213**E-Poster Viewing - Neonatology AS02-15.
Infectious diseases****Incidence, presentation and outcomes of
postnatal cmv infection in preterm neonates****A. Butt^{1*}, D. Batra²**¹University of Nottingham, School of Medicine, Nottingham, United Kingdom²Nottingham University Hospitals NHS Trust, Neonatal Medicine, Nottingham, United Kingdom**BACKGROUND AND AIM**

Postnatal cytomegalovirus (pCMV) can cause severe infection in premature infants; however, very few studies have reported the incidence and clinical features. We aimed to calculate incidence of symptomatic pCMV in preterm neonates and describe its clinical presentation and outcomes including bronchopulmonary dysplasia (BPD) at 36 weeks corrected gestational age (CGA) and 2-year developmental outcomes at our centre.

METHODS

A retrospective cohort study examined data from 2014-2021 from infants within Nottingham University Hospitals NHS Trust. The study included infants born <37 weeks gestational age (GA) who had a positive CMV polymerase chain reaction test <44 weeks CGA, with exclusion of congenital cases. Medical notes and laboratory data were reviewed. Infants treated with antivirals were compared to those managed conservatively.

RESULTS

34 infants were identified, giving an incidence of 5.99 symptomatic pCMV cases per 1000 preterm live births. The median GA was 26.3 weeks (IQR 25.1

-29.3), and median birth weight was 825g (IQR 680 - 1106g). The most common clinical presentations were jaundice, thrombocytopenia, and apnoea/bradycardia. 97% were treated with antibiotics before diagnosis. BPD at 36 weeks CGA occurred in 79.4% of cases while 12.5% of the 16 followed-up infants had moderate-severe developmental delays at 2-years. Treated infants had higher mortality ($p=0.037$) and periventricular leukomalacia ($p=0.048$) than those managed conservatively.

CONCLUSIONS

Symptomatic pCMV has an incidence of 5.99 per 1000 preterm live births and is associated with high incidence of BPD. It should be considered as a differential of bacterial sepsis in previously well preterm babies.

EP235 / #1413**E-Poster Viewing - Neonatology AS02-15.
Infectious diseases****Impact of a clinical observation-based algorithm
for early-onset neonatal sepsis screening in a
third-level hospital**

A. Carmona*, M. Arola, P. Gonzalez, P. Ventura, D. Esteban, R. Porta,
G. Ginovart

Hospital Germans Trias i Pujol, Pediatrics, Badalona, Spain

BACKGROUND AND AIM

The Neonatal sepsis calculator (NSC) has been validated to safely assess the risk of early-onset neonatal sepsis (EOS), avoiding medical interventions in healthy term and late-preterm newborns with infection risk factors (IRF). Since January 2021, a new algorithm based on clinical observation and the NSC has been implemented in our hospital, the impact of which we aim to assess in this study

METHODS

Single-center, observational, retrospective study, including healthy newborns ≥ 35 weeks, with any IRF, admitted in the Maternity ward between January 2020 and December 2021. Two periods were compared: the year before (2020, Period1, P1) and after (2021, Period2, P2) the implementation of the new EOS screening algorithm. Main outcome: number of blood tests obtained for blood culture and blood cell count. Secondary outcome: incidence of EOS

RESULTS

125 infants were included in P1 and 172 in P2. No significant differences were observed in baseline characteristics between both groups. Considering IRF, there was higher maternal colonization by *Streptococcus Agalactiae* in P2 (35,4%vs18,4%, $p=0,03$). No significant differences were observed among other IRF (rupture of membranes >18 hours, maternal intrapartum fever, suspected or confirmed triple I) or in the use of intrapartum antibiotics. Blood tests were performed in 96,8% patients in P1 and 11,6 % in P2 ($p<0,001$). No increased incidence of EOS was registered (0,55/1000 in P1 and 0/1000 in P2)

CONCLUSIONS

The implementation of an observation-based algorithm has resulted in a significant reduction in the number of blood tests performed without missing any EOS cases

EP236 / #1952**E-Poster Viewing - Neonatology AS02-15.
Infectious diseases****Early molecular markers of ventilator-associated pneumonia in bronchoalveolar lavage in preterm infants**

M. Cernada^{1*}, A. Pinilla-Gonzalez¹, I. Lara-Cantón¹, L. Torrejón-Rodríguez¹, A. Parra-Llorca¹, M. Aguar¹, J. Kuligowski¹, M. Vento²

¹La Fe University and Polytechnic Hospital, Neonatology, Valencia, Spain

²University and Polytechnic Hospital La Fe, Division of Neonatology, Valencia, Spain

BACKGROUND AND AIM

Ventilator-associated pneumonia (VAP) constitutes one of the most serious nosocomial infections. Our aim was to evaluate the reliability of cytokines and oxidative stress/inflammation biomarkers in bronchoalveolar lavage fluid (BALF) and tracheal aspirates (TA) as early diagnostic markers of VAP in preterm infants.

METHODS

Concentration of 16 cytokines (*E-Selectin*, *G-CSF*, *ICAM-1*, *IFN- α* , *IFN- γ* , *MCP-1*, *MIP- α* , *TNF- α* , *IL-1 α* , *IL-4*, *IL-6*, *IL-8*, *IL-10*, *IL-12p70*, *IL-13* and *IL-17A*) and eight oxidative stress/inflammation biomarkers (*cystine*, *GSH*, *GSSG*, *Met*, *SAM* ³*Cl-Tyr*

³*NO₂-Tyr*, and *GSA*) was determined in BALF and TA in preterm infants with suspected VAP. Two cohorts of patients were enrolled: the first one to select biomarker candidates and the second one for validation.

RESULTS

In the first batch of 13 patients, values of IL-17A and TNF- α in BALF were significantly higher in patients with VAP. In the second batch of 15 patients, values of IL-10, IL-6 and TNF- α in BALF were higher in VAP patients. TNF- α AUC in both cohorts was 0.86 with a sensitivity of 0.83 and a specificity of 0.88. No cytokine in TA showed to be predictive of VAP. A statistically significant increase in the VAP group was found for concentrations of glutathione sulfonamide (GSA) in BALF and TA.

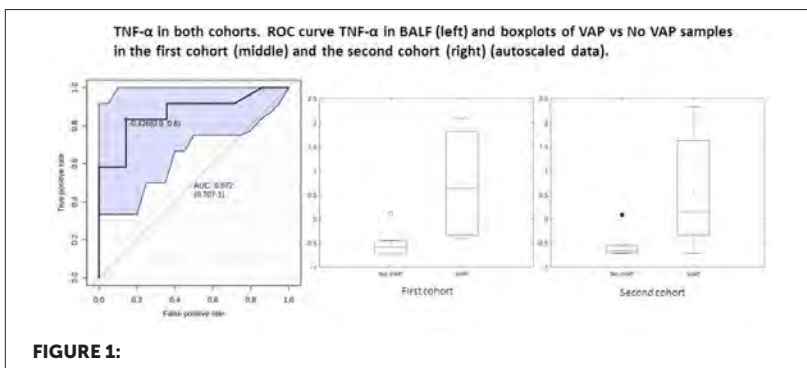

CONCLUSIONS

TNF- α in BALF has shown to be an accurate diagnostic marker of VAP in preterm infants. GSA obtained from BALF and TA discriminates between VAP and controls.

EP237 / #1285**E-Poster Viewing - Neonatology AS02-15.
Infectious diseases****Does a sepsis risk calculator for early onset neonatal sepsis reduce antibiotics without compromising safety? A retrospective audit at uk tertiary neonatal centre**

N. Davis*, N. Imolya, P. Kigozi

Nottingham University Hospitals NHS trust, Neonatal Department, Nottingham, United Kingdom

BACKGROUND AND AIM

Background:- Ongoing concern remains regarding unnecessary antibiotic treatment in infants with risk factors for early onset sepsis (EOS). The Kaiser Permanente sepsis risk calculator (KP-SRC) has reduced amount of antibiotics given for EOS. Aim:- To review antibiotic use and potential impact of implementing KP-SRC or modified versions as used in Wales and East of England for well term infants with maternal risk factors for EOS treated as per UK NICE guidelines

METHODS

Method

- Data was collected retrospectively for term infants born at Nottingham University Hospitals in 2020 requiring EOS empirical treatment as per NICE for maternal risk factors only. KP-SRC and modified KP-SRC were applied retrospectively with incidence rates of 0.5, 1 and 2/1000. Impact on antibiotic use alongside risk of missed or delayed diagnosis of EOS was assessed.

RESULTS

- 253 infants required treatment for suspected EOS for maternal risk factors with no clinical concerns throughout admission. No culture positive EOS were identified. Figure 1 shows the potential antibiotic reduction

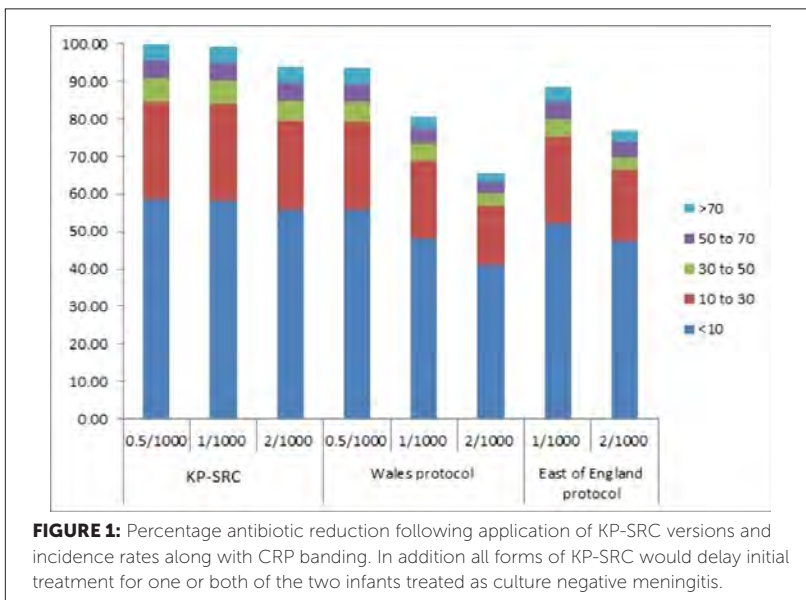

CONCLUSIONS

Conclusion

- Retrospective application of KP-SRC and its modified versions show a marked reduction in antibiotic use. However, concerns remain over its safety locally including missing or delays in treating sepsis or meningitis. Future work is planned on prospective implementation of the calculator after an infrastructure for enhanced observation is present.

EP238 / #1962

E-Poster Viewing - Neonatology AS02-15. Infectious diseases

The use of presepsin (p-sep) versus pct and crp: a new inflammatory marker in neonatology

C. Gammeri^{1*}, M.C. Gauci², G. Di Cataldo², F. Gambilonghi²,
C. Mattia², M. Marletta², M.C. Caracciolo², P. Betta²

¹University of Catania, Department of Pediatrics, Catania (sicilia), Italy

²University of Catania, Pediatrics, Catania, Italy

BACKGROUND AND AIM

Presepsin (P-SEP) has been shown to be an excellent inflammatory marker for sepsis in numerous studies conducted around the world, but not in neonatology. The objective of our study is to evaluate the diagnostic value and prognostic use of P-SEP compared to PCT and CRP in sepsis.

METHODS

The study was conducted at the NICU from August 2021 to April 2022. We enrolled ten children underwent to abdominal surgery and we compared the values of P-SEP, CRP and PCT after the execution of the surgery, at three days, at five days and after suspension of antibiotic therapy.

RESULTS

On the first day after surgery, mean of CRP were 44.49; mean of P-SEP were 1383.37; mean of PCT were 21.53. On the third day, mean of CRP were 53.57; mean of P-SEP were 1773.70; mean of PCT were 23.71. On the fifth day, mean of CRP were 67.69; mean of P-SEP were 1615.78; mean of PCT were 3.77. After suspension of the antibiotic, mean of CRP were 3.74; mean of P-SEP

were 599.00; mean of PCT were 0.16. We correlated the values of PCT, P-SEP and CRP on day 1 ($p = 0.001$), day 3 ($p = 0.001$), day 5 ($p = 0.001$) and after the suspension of antibiotic therapy ($p = 0.001$), highly significant results.

CONCLUSIONS

The our study shows a highly significant correlation between CRP, PCT and P-SEP. P-SEP could therefore be considered a promising marker as an index of infectivity as well as the other two for onset of neonatal sepsis.

EP239 / #1091**E-Poster Viewing - Neonatology AS02-15.
Infectious diseases****Evaluation of sepsis awareness in neonatal UNITS****S. Meylan¹, N. Asper², J. Regina¹, L. Griess³, F. Rosa-Mangeret⁴,
M. Stocker⁵, M. Schuler-Barazzoni³, E. Giannoni^{3*}**

¹Lausanne University Hospital and University of Lausanne, Infectious Diseases Service, Department of Medicine, Lausanne, Switzerland

²University of Bern, School of Medicine, Bern, Switzerland

³Lausanne University Hospital and University of Lausanne, Department Mother-woman-child, Clinic of Neonatology, Lausanne, Switzerland

⁴Geneva University Hospitals and Geneva University, Neonatology and Paediatric Intensive Care Unit, Geneva, Switzerland

⁵Children's Hospital Lucerne, Department of Pediatrics, Lucerne, Switzerland

BACKGROUND AND AIM

Sepsis is a leading cause of neonatal morbidity and mortality. Educational interventions reinforcing sepsis awareness and guidelines adherence improved patient outcomes in adult medicine. Evaluating the perceptions and knowledge gaps of nurses and physicians working in neonatal units is an important step towards development of specific educational programs.

METHODS

We conducted a survey on nurses and physicians working in seven tertiary care neonatal units in Switzerland to assess their understanding of sepsis epidemiology, definitions, recognition, initial evaluation and management tailored to their profession.

RESULTS

The survey was completed by 405 nurses (79%) and 108 physicians (21%). Neonatal sepsis was defined by 44% nurses and 43% physicians as an infection with associated systemic inflammatory response syndrome (SIRS), by 27% nurses and 7% of physicians as an infection with hemodynamic instability, by 15% nurses and 23% physicians as an infection with bacteraemia, and by 14% nurses and 27% physicians as an infection with associated organ dysfunction. Asked whether sepsis is an emergency, 78% and 20% of nurses and 94% and 6% of physicians fully agreed or agreed. Nurses and physicians estimated mortality of neonatal sepsis at 30% (IQR 15-51) and 22% (IQR 10-35), and mortality of septic shock at 40% (IQR 20-67) and 47% (IQR 30-61).

CONCLUSIONS

Our survey shows that SIRS-based definition of sepsis is predominant amongst staff working in Swiss neonatal units, irrespective of their profession. They understand the urgent nature of sepsis care, though they overestimate sepsis mortality based on current epidemiologic data, leaving room for continuing education.

EP240 / #1286

E-Poster Viewing - Neonatology AS02-15. Infectious diseases

Visualisation of the transmission of microbial particles in the neonatal intensive care UNIT

J. Groucutt^{1,2*}, M. Nash²

¹Birmingham Women's and Children's Hospital, Neonatal Unit, Birmingham, United Kingdom

²Birmingham Women's and Children's Hospital, Neonatology, Birmingham, United Kingdom

BACKGROUND AND AIM

Neonates in intensive care are vulnerable to colonisation and invasive infections from multi-resistant gram-negative bacteria. In 2021 our neonatal unit (NNU) fell victim to an ESBL-Klebsiella outbreak. An outbreak control plan was formulated that included education; hand-hygiene and cleaning auditing; cohorting infants; mass screening infants and environment; and reduction of equipment in clinical areas. Our NNU has an active multidisciplinary simulation programme. Simulation is an effective educational tool to increase competence of healthcare providers. We wanted to use simulation to highlight the ease of transmission of particles from a colonised infant.

METHODS

The simulation involved a preterm 28week infant corrected to 35weeks gestation with numerous desaturation episodes. The baby was known to be colonised with pseudomonas. A 'monitored' low fidelity manikin was placed in a cot in an isolation room. Candidates were unaware that the manikin was covered with ultraviolet powder. The manikin had numerous desaturation and bradycardic episodes necessitating airway and breathing support; clinical assessment and septic screen. The spread of powder was assessed afterwards with a black-light.

RESULTS



FIGURE 1:



FIGURE 2:

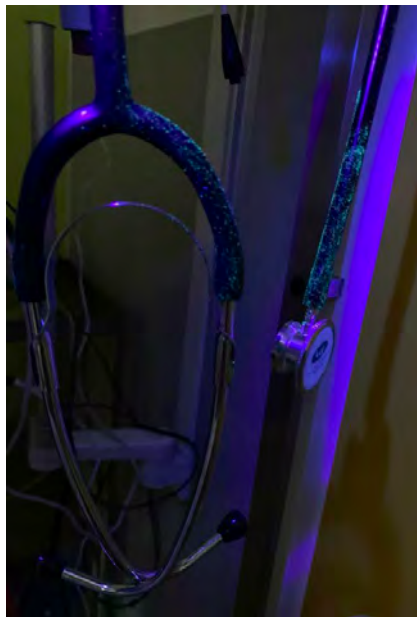

FIGURE 3:

The simulation lasted just 8minutes. There were exemplary unprompted infection-prevention measures with appropriate handwashing and personal protective equipment. Despite this the powder spread to staff facemasks, stethoscope, resuscitation equipment, patient trolley and monitor.

CONCLUSIONS

This demonstrated the ease of transmission of particles to other surfaces despite adherence to infection prevention policies. Most striking was the transmission to candidates' facemasks which are not routinely changed, and could be a potential risk of carriage of microbes to other infants.

EP241 / #1104**E-Poster Viewing - Neonatology AS02-15.
Infectious diseases****Nosocomial infections in neonatal care: a scoping review of the surveillance case definitions used for blood stream and central-line associated infections**

**I. Heijting¹, L. Van Lissum², S. Jansen³, M. Overbeek², V. Bekker³,
A. Tostmann⁴, J. Hopman⁵, W. De Boode², M. Hogeveen^{2*}**

¹Radboud University Nijmegen Medical Center, Paediatrics, Nijmegen, Netherlands

²Radboud University Nijmegen Medical Center, Neonatology, Nijmegen, Netherlands

³Leiden university medical center, Paediatrics, Leiden, Netherlands

⁴Radboud University Nijmegen Medical Center, Microbiology, Nijmegen, Netherlands

⁵Radboud University Nijmegen Medical Center, Quality and Safety, Nijmegen, Netherlands

BACKGROUND AND AIM

Neonatal nosocomial infections (NNI) are an important cause of morbidity and mortality. Therefore it is critical to monitor NNI. Universal definitions of NNI would enable comparison of NNI risk between centers and after interventions. This review provides an overview of surveillance case definitions (SCD), methods and outcome measures for NNI.

METHODS

A scoping review was performed on NNI and the results with regards to BSI/CLABSI are presented. Full text screening was performed on n=1,150 of 16,067 articles; n=122 were included (n=87 BSI, n=23 CLABSI, n=12 both).

RESULTS

The majority of BSI articles use their own SCD (69%); the majority of CLABSI articles use a CDC based case definition (63%). Most common criteria in both SCDs are: positive blood culture (BSI 95%; CLABSI 100%), clinical signs (BSI 73%; CLABSI 80%) and laboratory results (BSI 52%; CLABSI 31%). In 86% of CLABSI definitions, a central line had to be in place at or within 48 h before the onset of symptoms. Surveillance method was not reported in 66% of articles; 32% reported a manual and 2% a semi-automatic surveillance method. Outcome measure for BSI was mainly expressed as an absolute number (92%) and/or as a percentage of the study population (54%); CLABSI was predominantly expressed as the number of CLABSI episodes per 1000 line days (74%).

CONCLUSIONS

CLABSI was more uniformly defined than BSI, but wide variation in surveillance case definitions, surveillance methods and outcome measures for both neonatal BSI and CLABSI was found. A consensus protocol on surveillance definitions and a core outcome set are necessary.

EP242 / #1124**E-Poster Viewing - Neonatology AS02-15.
Infectious diseases****Markers of inflammatory response in infants with
intrauterine infection from mothers with
identified torch infection**

**O. Horlenko*, Y. Chuhran, L. Prylypko, G. Kossey, O. Pushkarenko,
N. Sochka, M. Peresta, L. Pushkash, K. Voronych**

Uzhhorod National University, Pediatrics With Pediatrics Infections, Uzhhorod,
Ukraine

BACKGROUND AND AIM

Background: Intrauterin Infection (IUI) leads to various disorders, including organ defects, the development of severe infectious inflammation.

The aim: To investigate the status of inflammatory response markers in infant organism with identified IUI born to mothers diagnosed with TORCH infection.

METHODS

The study group included: infants diagnosed with IUI (n = 40), born to mothers with the diagnosis of TORCH infection and a control group (n = 25). The average weight of newborns was 1877.69 ± 981.78 g. Gestational age: 32.25 ± 5.15 weeks. Cytokine profile, γ -IFN, TNF- α , PgE2, Neopterin, Procalcitonin were studied.

RESULTS

The values of the parameters of the Cytokine profile (IL-1, IL-6, IL-8, IL-10) varied in reference values, but with significant differences with the values of the control group, which were 1,2;4;10; 6 times, respectively. The levels of

inflammatory mediators (γ -IFN Procalcitonin, Neopterin, TNF- α Pg E2) differed significantly from the data of the control group of infants and exceeded the upper limit of the reference values by 1,3; 3; 25; 4 times, respectively.

CONCLUSIONS

According to the correlation analysis, there are positive correlations: IL 1 and Procalcitonin ($r = 0.33$); IL 6 and IL10 ($r = 0.44$); IL 10 and ProstaglandinE2 ($r = 0.44$); Neopterin and ProstaglandinE2 ($r = 0.39$), which indicates synergism in the performance of biologically active processes. Negative correlations were observed: IL 1 and infants Gestational age($r = -0.36$); IL 6 and IL 8 ($r = -0.34$); γ -IFN and TNF- α ($r = -0.43$). which indicates the diversity in the inflammatory response

EP243 / #1332**E-Poster Viewing - Neonatology AS02-15.
Infectious diseases****Development and validation of a prediction model based on machine learning for early recognition of culture-proven sepsis in newborns in low- and middle-income countries**

**D. Kainth^{1*}, A. Gupta², A. Sachdeva¹, R. Agarwal¹, M. Kapoor³,
T. Sethi², J. Sankar¹**

¹All India Institute of Medical Sciences, Pediatrics, New Delhi, India

²Indrapastha Institute of Information Technology, Centre of Computational Biology, New Delhi, India

³Indian Statistical Unit, Economics and Planning Unit, New Delhi, India

BACKGROUND AND AIM

The prediction scores from high-income countries have limited applicability for early identification of neonatal sepsis in low- and middle-income countries (LMIC). We aimed to develop a prediction model using machine learning (ML) to detect culture-positive sepsis.

METHODS

We first developed an ML model using data from a prospective study in four level-3 hospitals in India and utilizing two approaches for feature selection - clinical and Least Absolute Shrinkage and Selection Operator (LASSO). The final variables were selected to achieve a target sensitivity of 90%. Six ML algorithms were evaluated, and the best classifier was chosen based on sensitivity, specificity, and positive and negative predictive values (PPV and NPV), with culture-positive sepsis being the 'reference standard.' The model was then validated in an ambispective cohort from a different period.

RESULTS

of the 4903 neonates with suspected sepsis, 946 had 'culture-positive sepsis' while 2761 had 'no sepsis.' The clinical and LASSO approach identified a set of 22 and 25 maternal/neonatal and care-related variables, respectively, with the top three variables being birth weight, age at suspicion, and maternal age. LASSO performed the best with the Ensemble ML algorithm (89.6% sensitivity and 42.7% specificity). of the 528 neonates in the validation cohort, 104 had culture-positive sepsis, while 164 had no sepsis. The model achieved 90.4% sensitivity, 50% specificity, 53.4% PPV, and 89.1% NPV. It correctly classified 43 asymptomatic neonates (16%) with perinatal risk factors as 'no sepsis.'

CONCLUSIONS

A prediction model using ML techniques had high sensitivity and reasonable specificity for recognizing neonatal sepsis in LMICs.

EP244 / #1701**E-Poster Viewing - Neonatology AS02-15.
Infectious diseases****Highly sensitive cardiac troponin t is significantly increased in preterm infants with early onset sepsis and hypotension****Z. Stranak^{1,2}, P. Korček^{1,2*}**¹Charles University, Third Faculty of Medicine, Prague, Czech Republic²Institute for the Care of Mother and Child, Neonatology, Prague, Czech Republic**BACKGROUND AND AIM**

Early onset sepsis (EOS) is life-threatening event in premature infants often accompanied by myocardial dysfunction and hypotension. We aimed to test the hypothesis that the highly sensitive cardiac Troponin T (hs-cTnT) might be a fast and reliable biomarker of EOS in preterm newborns where myocardial dysfunction and hypotension are presented.

METHODS

Prospective, case-control study was conducted in Level III Unit. The hs-cTnT levels were measured in infants ≤ 32 weeks of gestation up to 2 hours after delivery using electro-chemiluminescence immunoassay. Clinical data were obtained from hospital database and medical records.

RESULTS

Out of 421 eligible cases 268 infants were enrolled in this study (median birth weight 1070 grams, 780-1330 IQR, median gestational age 29 weeks, 26-30 IQR). The median hs-cTnT level was 121 ng/L (IQR = 74-183). Median hs-cTnT levels correlated significantly with EOS (178 vs 100 ng/L, $p < .0001$)

and hypotension (176 vs 100 ng/L, $p < .0001$). The receiver operating characteristics curve for detection of EOS and hypotension through hs-cTnT values had area under the curve of 0.78 (95% CI=0.65-0.79, $p < .0001$) and 0.78 (95% CI=0.72-0.84, $p < .0001$) respectively.

CONCLUSIONS

Our study revealed significant correlation among hs-cTnT levels, EOS and hypotension in preterm infants 2 hours after delivery. Elevated hs-cTnT level may be a useful biomarker of EOS and hypotension in the early neonatal period.

EP245 / #1412**E-Poster Viewing - Neonatology AS02-15.
Infectious diseases****Risk factors for *s. Aureus* colonization among hospitalized infants in NICU.**

M. Lithoxopoulou*, **E. Papacharalampous**, **E. Drogouti**,
I. Chatziioannidis, **G. Mitsiakos**, **C. Tsakalidis**, **E. Diamanti**

Aristotle University of Thessaloniki

2nd Neonatology Clinic -nicu, Thessaloniki, Greece

BACKGROUND AND AIM

A cause of infection in neonatal intensive care units (NICUs) is methicillin-resistant *Staphylococcus aureus* (MRSA). Colonization with MRSA is a risk of infection and serve as a pool for MRSA. Most studies focus on MRSA outbreaks and surveillance programmes. To recognize risk factors for MRSA colonization among hospitalized infants in NICU.

METHODS

Cohort study in a NICU, hospitalized neonates joined study, with 1 nasal screening swab positive for *S aureus*. Data from July 2019 to December 2021. Screening for *S aureus* colonization was performed until discharge.

RESULTS

Comprehensively, 967 neonates entered (554 [57.3%] males, 165[17.2%] with birthweight <1500 g; 355 [36.7%] preterm; 846 [87.5%] singletons; 554 [57.3%] via cesarean section). Overall, 92 infants (9,5%) were colonized by *S aureus* during their hospitalization. Median time to first identification was 19,5 (interquartile range, 3-148) days. Median length of stay was 20,7 (range, 7-180)

days. Incidence of *S aureus* infection was 0,52% (5 of 967). Low birth weight (<1500 g [odds ratio, 2,98; 95%CI, 1.9-4.7; $p < .0001$]) and longer hospital stay (odds ratio, 2.31; 95%CI, 1.005-5.3; $p < .04$) were associated with colonization. A total of 69 of 92 (75%) cases isolates MRSA. None of isolates was resistant to vancomycin. Nasal carriage was associated with *S aureus* infection (odds ratio, 3.64; 95%CI, 1.3 - 10.2; $p = .014$).

CONCLUSIONS

Risk factors for *S aureus* colonization include low birth weight, younger gestational age, and length of hospitalization. Results suggest that colonization is a relevant risk factor for *S aureus* infection in a NICU.

EP246 / #2668**E-Poster Viewing - Neonatology AS02-15.
Infectious diseases****Maternal and neonatal outcomes of sars-cov-2
infection: a comparative study from brazil****J. Meneses*, C. De Lima, J. Alves, L. Carvalho**

Instituto de Medicina Integral Prof Fernando Figueira, Neonatology, Recife, Brazil

BACKGROUND AND AIM

Pregnant women are more vulnerable to SARS-Cov-2 infection, with increasing risk of adverse perinatal outcomes, however the majority of neonates from mothers with Covid-19 are not infected or asymptomatic. This needs to be clarified since it relies on the different perceptions of the risk of transmission from maternal to neonate, relevance of early maternal-child bonding, and the risk-to-benefit ratio of breastfeeding. The objective was evaluate maternal and neonatal outcomes of pregnant women with and without SARS-CoV-2 infection

METHODS

Observational cohort study of mothers with and without SARS-CoV-2 infection and their newborns. Maternal and neonatal clinical characteristics and outcomes were compared

RESULTS

335 pregnant women were admitted and 166 tested positive for SARS-Cov-2 with 169 neonates, while 169 women tested negative with 171 neonates. A significantly higher rate of admission to the intensive care unit as well as a

higher rate of preterm birth was found among mothers in the infected group when compared to non infected($p < 0.05$). The majority of the neonates in each group roomed in with their mothers, while 33% and 30% were admitted to the NICU for reasons other than SARS-CoV 2 infection. Except for a higher number of preterm infants from infected mothers, neonatal outcomes were similar between infected and non-infected pregnancies

CONCLUSIONS

SARS-CoV-2 infection during pregnancy was associated with higher maternal intensive care admission and higher rate of preterm birth. Most of the newborns from SARS-CoV-2 infected mothers were able to room in and breastfeed. Their neonatal outcomes were similar as those from non infected mothers.

EP247 / #2751**E-Poster Viewing - Neonatology AS02-15.
Infectious diseases****Severe maternal covid 19 affects maternal-infant bonding and breastfeeding****J. Meneses*, C. Oliveira, M. Ferraz**

Instituto de Medicina Integral Prof Fernando Figueira, Neonatology, Recife, Brazil

BACKGROUND AND AIM

Severe Covid- 19 infection in pregnancy is associated with adverse perinatal outcomes and affects negatively in maternal–infant bonding as well as breastfeeding. We aim to describe maternal and infants outcomes from a group of Covid 19 infected pregnant women and evaluate breastfeeding of their infants at discharge

METHODS

We collected maternal and neonatal outcomes from women with severe covid 19 in the ICU and their newborns until discharge

RESULTS

of the 30 women in the ICU with covid 19, 25(83%) tested positive for SARS-Cov 2 and 17% tested negative, but considered infected based on their clinical and laboratory findings. All had indication for cesarean delivery because of severe maternal clinical status. Two thirds of the women received mechanical ventilation. Maternal mortality was 6/30 (20%). All infants were preterm with a mean gestational age of 31.1 ± 3.2 weeks and birthweight of 1790 ± 320 , transferred to the NICU and 28 (87%) needed respiratory support. Only

2 infants were tested positive for SARS-CoV-2. of the 32 infants,27(84%) were discharged, however 16(59%) with their mothers and (11)41% with their families, due to mother's death or mother still hospitalized. Only 6/27 (22%) infants were breastfeeding at time of discharge.

CONCLUSIONS

Severe Covid 19 infection in pregnancy results in a high maternal mortality as well as high rates of preterm birth. Many infants are discharged home without their mothers. The short and long term effects in maternal - infant bonding as well as the very low rates of breastfeeding in this vulnerable population needs to be assessed

EP248 / #1226**E-Poster Viewing - Neonatology AS02-15.
Infectious diseases****Long-term neurodevelopmental outcomes of
neonatal sepsis: a systematic review**

**M. Salman¹, E. Molloy^{2*}, J. Meehan¹, E. Roche³, G. Semova³,
A. Cadden¹, L. Alazawi¹, S. Ram¹, A. Silver¹, R. O'Farrell Tyler¹,
S. Almajed¹, D. Doran¹, L. Byrne¹, A. Branagan⁴, E. Isweisi²**

¹Trinity College Dublin, School of Medicine, Dublin, Ireland

²Prof of Paediatrics, Trinity College Dublin, Dublin, Ireland

³Trinity College Dublin, the University of Dublin, School of Medicine, Dublin, Ireland

⁴Coombe Women & Infants University Hospital, Neonatology, Dublin, Ireland

BACKGROUND AND AIM

Neonatal sepsis is a proven cause worldwide of infant mortality and morbidity. This systematic review aims to determine the long-term neurodevelopmental outcomes of neonates with sepsis, or sepsis-like illness.

METHODS

A systematic search of three databases, PubMed, Embase and Medline, was carried out to analyse 8 relevant papers. The Inclusion criteria included original studies, studies published in English, studies that include neonates with sepsis/ sepsis like syndrome as a presentation with febrile illness with an atypical pathogen such as the parechovirus, studies which looked at longer term neurodevelopmental outcomes (over 18 months).

RESULTS

of the 2264 participants involved in the eight studies, 941 neonates were identified as having diagnosed sepsis or sepsis-like illnesses. The collected data

was obtained over 36 years, from 1994 to 2021. Adverse neurodevelopmental outcomes spanned the main developmental domains of gross motor, vision or hearing and social and behavioural development with cerebral palsy being reported in two studies. The 8 studies found greater motor and hand-eye coordination difficulties, greater emotional behavioural problems such as anxiety and depression, increased risk of cerebral palsy in both gram positive and coagulase negative staphylococci sepsis patients, decreased corpus callosum length at three months corrected age and diminished corpus callosum growth in infants who had a systemic infection.

CONCLUSIONS

This review showed that neonates surviving sepsis have a higher risk of developing long term neurodevelopmental deficits, especially gross motor deficits. Evidence is however limited by differences in study design, lack of long-term follow up and varied definitions of sepsis.

EP249 / #983**E-Poster Viewing - Neonatology AS02-15.
Infectious diseases****Abscessification of a cephalohematoma as a cause
of persistent fever in a newborn****J. Salazar Quiroz*, M. Ramon Jiménez, J. Thió Casals, B. Suriñach-
Ayats, J. Becerra Hervás, E. Moliner Calderon**

Hospital de la Santa Creu i Sant Pau, Neonatology. Pediatrics Department,
Barcelona, Spain

BACKGROUND AND AIM

We report a case of *Escherichia coli* infection of a cephalohematoma in a male full-term 5 days of life newborn delivered by vacuum extraction.

METHODS

Case report

RESULTS

During an admission for phototherapy treatment, we observed a fever spike with an increase of acute phase reactants. At that time, a neonatal infection protocol was carried out and empiric antibiotic therapy with ampicillin and gentamicin was started. Given the persistence of fever, with an increase in the size of the cephalohematoma (Figure 1 and 2) and worsening of analytical parameters, we decided to perform a cranial scan which showed significant blood collection with suspected abscess (Figure 3).



FIGURE 1:



FIGURE 2:

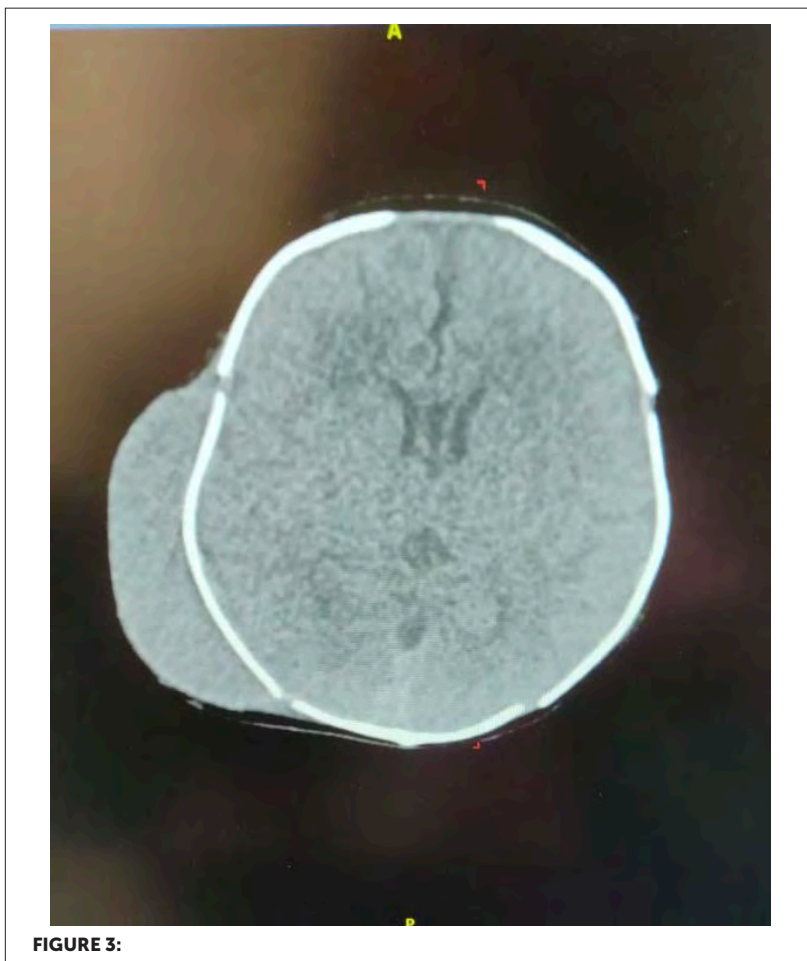

CONCLUSIONS

Given that, we decided to change antibiotic therapy to meropenem and drainage by Neurosurgery. *Escherichia coli* resistant to ampicillin and sensitive

to carbapenems and aminoglycosides grow in the culture of the drained fluid. We complete 15 days of intravenous treatment after drainage and 4 more weeks orally with ciprofloxacin. We observed good evolution with complete resolution of the infection. Cephalohematomas are common among newborns, but infection is a rare but serious complication of cephalohematomas. *Escherichia coli* is the most common pathogen for infected cephalohematomas. Complications include sepsis, meningitis and osteomyelitis.

EP250 / #1423

E-Poster Viewing - Neonatology AS02-15. Infectious diseases

Factors associated with mortality of neonatal sepsis

R. Wilar, S. Gunawan, J. Rompis, S. Rondonuwu, M. Sulistio*

Sam Ratulangi University, Prof. Dr. R. D. Kandou Hospital, Department of Pediatrics, Manado, Indonesia

BACKGROUND AND AIM

The study about mortality risk factors of neonatal sepsis in developing countries were limited. We aimed to know the mortality risk factors of neonatal sepsis in Manado, Indonesia.

METHODS

We conducted a retrospective study that included 365 neonates hospitalized in the Neonatal Intensive Care Unit in Prof. Dr. R. D. Kandou Hospital from January 2016 to December 2018. Data were compiled from medical records. Outcomes were divided into survived or death.

RESULTS

Hypothermia (OR= 5.05, $p < 0.05$, CI 95%), tachypnea (OR= 4.36, $p < 0.05$, CI 95%), leukopenia (OR= 0.49, $p < 0.05$, CI 95%), thrombocytopenia (OR= 0.58, $p < 0.05$, CI 95%), and sclerema (OR= 33.12, $p < 0.05$, CI 95%) significantly associated with mortality of neonatal sepsis. Otherwise, hyperthermia, tachycardia, prolonged CRT, hypoglycemia, seizure, leukocytosis, low birth weight, and high C-reactive protein didn't reach significant association with neonatal sepsis mortality.

CONCLUSIONS

The mortality risk factor of neonatal sepsis were hypothermia, tachypnea, leukopenia, thrombocytopenia, and sclerema. Sclerema neonatorum is the worst mortality risk factors. Further prospective research is needed.

EP251 / #1110

E-Poster Viewing - Neonatology AS02-15. Infectious diseases

Oral care by mother's own milk or sterile water in very-low-birthweight infants until oral feeding: a randomized TRIAL

A. Thatrimontrichai^{1*}, K. Singkhamanan², P. Thongsuksai³

¹Prince of Songkla University, Pediatrics, Songkhla, Thailand

²Prince of Songkla University, Biomedical Sciences and Biomedical Engineering, Songkhla, Thailand

³Prince of Songkla University, Pathology, Songkhla, Thailand

BACKGROUND AND AIM

Oropharyngeal colostrum may have clinical benefits in very-low-birthweight (VLBW) infants. Published data on the effects of oral care by mother's own milk (MOM) for longer periods, i.e., beyond the short duration of colostrum care, in VLBW infants are limited.

METHODS

In this open and pragmatic trial, infants with birthweight of <1500 g and gestational age of <32 weeks were randomly assigned within 48 hours after delivery to MOM or sterile water (SW) groups until they achieved independent oral feeding. Primary outcome was a composite of mortality or severe infection at discharge. Secondary outcomes were pneumonia, clinical sepsis, retinopathy of prematurity, and bronchopulmonary dysplasia.

RESULTS

After a 2-year period, 63 neonates (median gestational age, 29 weeks; median birthweight, 1010 g) underwent randomization. The MOM (n = 30) and SW

(n = 33) groups had similar primary outcomes (17% vs 27%; risk difference [RD] -0.11, 95% confidence interval [CI] -0.31 to 0.10; adjusted risk ratios [RR] 0.80; 95% CI 0.15 to 3.94). Neonates in the MOM group had a significantly lower rate of clinical sepsis than those in the SW group (47% vs 76%; RD -0.29, 95% CI -0.49 to -0.05; adjusted RR 0.20, 95% CI 0.03 to 0.95). There was no significant difference between the MOM and SW groups in terms of the incidence of pneumonia, retinopathy of prematurity, and bronchopulmonary dysplasia.

CONCLUSIONS

Longer duration of oral care by MOM until oral feeding can reduce the clinical sepsis in neonates, but more clinical trials in the future are warranted.

EP252 / #314

E-Poster Viewing - Neonatology AS02-15. Infectious diseases

Prophylactic fluconazole protocol in very low birth weight infants for invasive candidiasis prevention in a south american neonatal intensive care UNIT.

D. Valenzuela-Stutman^{1*}, A. Maccioni Romero², P. Astudillo Paredes³

¹*Pontificia Universidad Catolica de Chile, Pediatrics, Santiago, Chile*

²*Complejo Asistencial Dr. Sotero del Rio, Neonatología, Santiago, Chile*

³*Pontificia Universidad Catolica de Chile, Molecular Virology Laboratory, Santiago, Chile*

BACKGROUND AND AIM

Advances in neonatal care have improved very-low-birth-weight infants (VLBWI) survival. Invasive candidiasis (IC) is the third cause of late-onset sepsis in these patients, associated with high morbidity and mortality. Prophylactic Fluconazole prescription has been proposed in NICUs with a high incidence of IC. The aim of this study was to evaluate the effect of the implementation of a protocol of prophylactic fluconazole for VLBWI in a NICU with a 7.8% incidence of invasive candidiasis (16.6% in extremely low birth weight infants [ELBWI]).

METHODS

Interventional pre-post cohort study that compared 2 years with and without fluconazole prophylaxis protocol (January 2016-December 2018 and July 2019-August 2021) in a tertiary NICU. Fluconazole was administered to all ELBWI and VLBWI with risk factors and positive carrier cultures (3 mg/kg every 72 hours for 4-6 weeks). Liver function tests were performed weekly.

RESULTS

126 patients were recruited in the intervention cohort and 228 for the non-intervened group. There was no significant difference in risk factors for IC. The VLBWI IC incidence decreased from 7.8% to 2.4% (OR:0.3, $p=0.05$) and in ELBWI there was a decrease from 16 cases to 2 (OR:0.1, $p=0.04$) with prophylactic fluconazole use. There was no significant difference in mortality or weekly liver function tests.

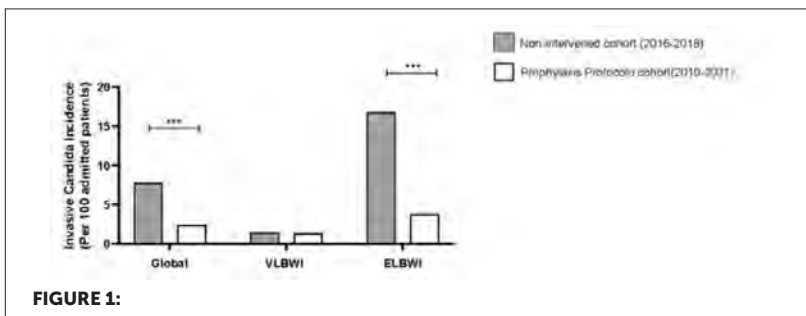

FIGURE 1:

CONCLUSIONS

Prophylactic fluconazole is safe and effective in VLBWI and ELBWI in NICU to prevent invasive candidiasis.

EP253 / #1677

E-Poster Viewing - Neonatology AS02-15. Infectious diseases

Clinical significance of environmental factors for the course of neonatal sepsis

O. Vlasova^{1*}, K. Vlasova², O. Koloskova¹

¹Bukovinian State Medical University, Pediatrics and Children's Infectious Diseases, Chernivtsi, Ukraine

²Bukovinian State Medical University, Medical Biology and Genetics, Chernivtsi, Ukraine

BACKGROUND AND AIM

The working hypothesis of the study was the assumption that, given the non-threshold impact of ecopollutants on the human body, long-term residence of newborns' parents in places of chronic exposure to adverse environmental factors of low intensity may be complicate the course of neonatal sepsis

METHODS

.Based on the assessment of the environmental situation, we proposed an environmental risk ratio (ERR) as a group- forming feature of a comprehensive assessment of the long-term burden on the newborns' parents body of anthropogenic pollution of air, water and soil, which for the first clinical group (main) was ≥ 2.0 , indicating adverse environmental situation, and for the second group (comparison) was less than 2.0.

RESULTS

Statistically significant differences found in the assessment of respiratory disorders in newborns according to the Downes scale, also indicated a more severe clinical condition of the main group. Thus, $52.3 \pm 4.2\%$ of newborns

in the main group and only $23.6 \pm 3.9\%$ of children in the comparison group had more than 4 points in the Dovnes scale assessment ($P < 0.05$). Hardware mechanical ventilation at birth was performed in every third child ($33.6 \pm 3.9\%$) of the main group and in $19.3 \pm 3.6\%$ of observations ($P < 0.05$) in the comparison group.

CONCLUSIONS

The neonates with sepsis have organ dysfunction, the frequency of which prevailed in the group of patients whose parents lived permanently in places of adverse environmental factors of low intensity.

EP254 / #2402

E-Poster Viewing - Neonatology AS02-15. Infectious diseases

“Severe and unusual sars-cov-2 infection in a one month old newborn as primary manifestation of congenital central hypoventilation syndrome.”

C. Descloux¹, S. Waldvogel^{1*}, P.-A. Crisinel², T. Ferry³, A. Truttmann⁴

¹Centre Hospitalier Univesitaire Vaudois, Paediatrics / Neonatology, Lausanne, Switzerland

²Centre Hospitalier Univesitaire Vaudois, Paediatric Infectiology, Lausanne, Switzerland

³Centre Hospitalier Univesitaire Vaudois, Pediatric Intensive Care Unit, Lausanne, Switzerland

⁴University Center Hospital and University of Lausanne, Department of Women Mother Child, Lausanne, Switzerland

BACKGROUND AND AIM

Newborns often develop a more severe SARS-Cov-2 infection with predominant respiratory symptoms but hyperthermia, gastro-intestinal (GI) and neurological symptoms are also described. Up to 30% of infected newborns need respiratory support and around 40% require intensive care. We present the case of a 1-month old female late preterm with a severe SARS-CoV-2 infection, finally diagnosed with a Congenital Central Hypoventilation Syndrome (CCHS) during hospitalization.

METHODS

Clinical case report.

RESULTS

Our patient presented with 1 day of rhinitis, irritability, poor oral intake and diarrhea in the context of a SARS-CoV-2 infection of her parents. After 24h

she was intubated due to repetitive central apneas with a severe respiratory acidosis ($\text{CO}_2 > 150 \text{ mmHg}$, pH 6.99). Chest X-ray showed diffuse bilateral infiltrations and the PCR of respiratory secretions showed SARS-CoV-2 (Omicron variant). Her condition rapidly deteriorated and high dose corticosteroids were started after 7 days. There were three multifactorial failures of extubation (poor respiratory drive, extensive pulmonary inflammation). She was finally extubated after 48 days and at the time of the submission (day 80) still needed non-invasive ventilation at night because of hypopnea/hypercapnia. Genetical investigations showed a mutation of the PHOXB2 gene associated with CCHS.

CONCLUSIONS

Until now no mortality has been reported in neonatal SARS-Cov-2 infections. However, it is associated with a high morbidity and its long-term effects are still unknown. Due to its very small incidence interdisciplinary discussions, comparison therapeutic strategies with those used in adults and older children and case reports are essential to improve the management of this rare but severe complication.

EP255 / #822

E-Poster Viewing - Neonatology AS02-16. Metabolic disease

Analysis of acylcarnitine profile in newborns based on the results of expanded neonatal screening

T. Holota^{1*}, T. Znamenska¹, O. Vorobiova¹, V. Kryvosheieva²

¹Institute of Pediatrics, Obstetrics and Gynecology named after academician O. M. Lukyanova National Academy of Medical Sciences of Ukraine, Neonatology, Kiev, Ukraine

²Donetsk National Medical University, Pediatrics, Neonatologist and children's Infections, Kramatorsk, Ukraine

BACKGROUND AND AIM

For newborns, fatty acid oxidation is essential in the early postnatal period. The physiological limitation of nutrient intake in the first days of life is associated with the mobilization of glycogen and fat. Acylcarnitine profiling by electro-spray ionization tandem mass spectrometry is a potent tool for diagnosing and screening disorders of fatty acid oxidation and organic acids.

METHODS

Acylcarnitine concentrations were measured in dried blood spots by electro-spray tandem mass spectrometry.

RESULTS

A retrospective analysis of the data registry for newborn screening has been conducted at the State Institution "Institute of Pediatrics, Obstetrics, and Gynecology named after academician O. M. Lukyanova of the NAMS of Ukraine". Data on metabolite concentrations in dried blood spots at the time

of screening was obtained from 500 newborns. We detected elevated ratio acylcarnitines C18:1/C16 (cutoff 1.28), C18:2/C16 (cutoff 0,26), and C14:1/C16 (cutoff 0.03) via tandem mass spectrometry. In addition, we noted that in newborns who underwent perinatal asphyxia, abnormalities in the acylcarnitine profile were registered. There is also a relationship between the weight of newborns and carnitine concentration.

CONCLUSIONS

The level of acylcarnitine in full-term infants increases after birth, while free carnitine remains virtually unchanged. The concentration of carnitine in full-term infants is directly proportional to birth weight. Mild acidosis and hypoxia lead to the accumulation of long-chain acylcarnitines, which can be used as an indicator of perinatal asphyxia. Limiting the ability to oxidize fatty acids may have potential pathophysiological significance during the first days of life, especially in conditions with higher energy needs, eg. sepsis.

EP256 / #2206

E-Poster Viewing - Neonatology AS02-16. Metabolic disease

Incidence and risk factors of late-onset hypoglycemia in extremely preterm infants

R. Neumann*, L. Canova, S. Schulzke

University Children's Hospital Basel UKBB, Neonatology, Basel, Switzerland

BACKGROUND AND AIM

The incidence of late-onset hypoglycemia in extremely preterm is unknown. We aimed to determine the incidence and identify risk factors of late-onset hypoglycemia in extremely preterm and/or extremely low birth weight infants.

METHODS

In a retrospective single center cohort study all infants with a gestational age < 28 weeks and/or a birth weight < 1000 g admitted to our unit from January 2013 to December 2019 were included. Late-onset hypoglycemia was defined as any blood glucose level < 2.6 mmol/L occurring in infants from day 8 of life who were on full enteral nutrition.

RESULTS

Forty-one out of 211 included infants (19.4%) had episodes of late-onset hypoglycemia. The first episode occurred at a median (IQR) post-menstrual age of 33.7 weeks (3.6 weeks). Episodes of early hypo- and hyperglycemia in the first week of life occurred more frequently in infants with subsequent late-onset hypoglycemia vs. those without (23/41 (49%) vs. 60/170 (35%), $p=0.014$ and 28/41 (68%) vs. 68/170 (40%), $p=0.001$, respectively). Multivariable logistic regression analysis revealed an association of birth weight z-score, mater-

nal arterial hypertension and gestational age with late-onset hypoglycemia ($p < 0.001$).

CONCLUSIONS

The considerable risk of late-onset hypoglycemia in small preterm infants predominantly depends on the degree of prematurity and intrauterine growth. Due to convenience sampling, the true incidence of late-onset hypoglycemia in this population is probably underestimated. Systematic glucose monitoring of infants at risk is warranted beyond the first week of life even if they are clinically stable and on full enteral nutrition.

EP257 / #1176

E-Poster Viewing - Neonatology AS02-16. Metabolic disease

Longterm metabolic risk and senescence in adults born very preterm

A. Perez^{1*}, M. Heine², K. Thiele³, A. Wieczorek³, N. Felber³, S. Thoma¹,
P. Arck³, J. Heeren²

¹University Medical Center Hamburg-Eppendorf, Division Neonatology and Pediatric Intensive Care, Hamburg, Germany

²University Medical Center Hamburg-Eppendorf, Center For Experimental Medicine, Institute of Biochemistry and Molecular Cell Biology, Hamburg, Germany

³University Medical Center Hamburg-Eppendorf, Center For Obstetrics and Pediatrics, Department of Obstetrics and Fetal Medicine, Hamburg, Germany

BACKGROUND AND AIM

Preterm infants have an increased long-term risk for hyperlipoproteinemia, obesity, insulin resistance and type 2 diabetes. The decrease in brown adipose tissue (BAT) during aging correlates with the occurrence of these metabolic changes. BAT can be detected after defined cold exposure at specific anatomical sites in healthy adults. Our aim was to investigate the thermogenic activity of brown adipose tissue in Adults Born Preterm (ABP) with respect to a premature loss of BAT activity. In addition, telomere length in peripheral blood cells was determined as a superordinate senescence biomarker.

METHODS

Thirty-two ABP (BW < 1500 g, GA < 32 weeks) aged 20-44 years were compared with matched term-born controls. BAT activation was induced by a standardized 2-h cold exposure (cooling vest). The change in tissue temperature in the area of BAT depots (supraclavicular) were measured by thermography (FLIR infrared thermal imaging camera). Blood plasma lipid profiles were determined by LC-MS/MS (liquid chromatography-tandem mass spec-

trometry) before and after cold exposure. Telomere length was measured by qPCR quantification.

RESULTS

After cold activation, the temperature at the BAT depots decreases more in ABP than in controls ($p = 0.01$), indirectly indicating a reduced mass or activity of BAT in ABP. In ABP, temperature decrease after cold activation correlates with higher body mass ($p = 0.007$). Lipid profile and telomere length data from peripheral blood subpopulations are currently being analyzed.

CONCLUSIONS

In ABP, premature aging of various organ systems is discussed. One possible metabolic mechanism is the lower BAT activity in ABP, which could explain their increased metabolic risk.

EP258 / #1185

E-Poster Viewing - Neonatology AS02-16. Metabolic disease

When osteogenesis imperfecta meets osteopenia of prematurity

B. Sousa^{1*}, L. Delgado¹, D. Valente-Silva², A. Bandeira³, B. Sampaio¹

¹Hospital Senhora da Oliveira, Pediatrics Department, Guimarães, Portugal

²Centro Hospitalar Universitário de São João, Pediatrics Department, Porto, Portugal

³Centro Materno Infantil do Norte, Centro Hospitalar Universitário do Porto, Metabolic Disease Department, Porto, Portugal

BACKGROUND AND AIM

Osteogenesis Imperfecta (OI) is a rare genetic disorder characterized by primary bone dysplasia, low bone mass and increased bone fragility. This group of mutations affects quantitative and/or qualitative collagen type 1 production. We present the case of an infant with both diagnosis of OI and prematurity osteopenia (PO) which consists in a significant decrease of bone matrix mineral content.

METHODS

Not applicable

RESULTS

This patient prenatal surveillance showed no analytical or ultrasound abnormality until placental abruption at 26 weeks gestation from a mother with Van der Hoeve's syndrome. The premature newborn was admitted to Neonatal Intensive Care Unit. His clinical course was remarkably complicated by multisystemic comorbidities and intercurrences. At 62 days of life, after being noticed discomfort, swelling and tenderness on the left leg, a radiography

revealed a non-displaced fracture of the femoral shaft. Subsequently, biochemical study formerly unchanged, now displayed elevated alkaline phosphatase serum levels, hypophosphatemia and also elevated PTH, suggestive of PO. Accordingly, started oral calcium and phosphate supplement. Further phosphocalcium metabolism evaluations likewise showed inconstant evolutions with difficult management. Posteriorly, new distal radius fracture motivated a full body imaging. Severe skull osteopenia, multiple fractures including clavicle and ribs beside dentinogenesis anomalies were found. These findings increased suspicion for OI afterwards confirmed by genetic testing with heterozygotic pathogenic mutation described in OI type I.

CONCLUSIONS

Simultaneous OI and PO is poorly described in literature and clinical management appears to be a challenge. The impact of these bone conditions on clinical features, long course outcome remains unknown.

EP259 / #1039**E-Poster Viewing - Neonatology AS02-17.
Nephrology****Postnatal serum creatinine patterns in neonates undergoing therapeutic hypothermia for neonatal encephalopathy compared to a reference dataset in near-term CASES****E. Keles Gulnerman^{1*}, P. Wintermark², F. Groenendaal³, N. Borloo⁴, A. Smits⁵, A. Laenen⁶, D. Mekahli⁷, P. Annaert⁸, S. Şahin⁹, M.Y. Oncel¹⁰, V.Y. Chock¹¹, D. Armangil¹², E. Koc¹, M.R. Battin¹³, A. Frymoyer¹⁴, K. Allegaert^{4,8,15,16,17,18}**¹Gazi University Hospital Ankara, Neonatology, Ankara, Turkey²McGill University/Montreal Children's Hospital, Division of Newborn Medicine, Montreal, Canada³University Medical Center Utrecht, Neonatology, Utrecht, Netherlands⁴University Hospitals Leuven, Neonatal Intensive Care Unit, Leuven, Belgium⁵KU Leuven, Department of Development and Regeneration, Leuven, Belgium⁶Leuven Biostatistics and Statistical Bioinformatics Center, Bioinformatics, Leuven, Belgium⁷University Hospitals of Leuven, Pediatric Nephrology, Leuven, Belgium⁸KU Leuven, Department of Pharmaceutical and Pharmacological Sciences, Leuven, Belgium⁹Izmir Demokrasi University, Faculty of Medicine, Neonatology, Izmir, Turkey¹⁰Izmir Katip Çelebi University, Neonatology, Izmir, Turkey¹¹Stanford University School of Medicine, Neonatal and Developmental Medicine, Palo Alto, United States of America¹²Koru Hospital, Neonatal Intensive Care Unit, Ankara, Turkey¹³University of Auckland, Neonatology, Auckland, New Zealand¹⁴Stanford University School of Medicine, Pediatrics - Neonatal and Developmental Medicine, Palo Alto, United States of America¹⁵KU Leuven, Department of Development and Regeneration, and Pharmaceutical and Pharmacological Sciences, Leuven, Belgium¹⁶Erasmus MC, Department of Clinical Pharmacy, Rotterdam, Netherlands¹⁷KU Leuven, Department of Development and Regeneration, and Pharmaceutical and Pharmacological Sciences, Leuven, Belgium¹⁸UZ Leuven, Department of Development and Regeneration, Leuven, Belgium

BACKGROUND AND AIM

There is extensive variability in renal function in neonates with neonatal encephalopathy undergoing therapeutic hypothermia. Acute Kidney Injury definitions with categorical approaches may insufficiently well capture this. Centile serum creatinine on postnatal age could provide more information. We, therefore, compiled serum creatinine trends, explored serum creatinine variability (centiles) and its covariates (postnatal age, acute kidney injury, survival, gestational age, birth weight) in therapeutic hypothermia-treated cases, and compared these patterns to (near)term reference neonates.

METHODS

Based on seven therapeutic hypothermia-treated cohorts and one control cohort (ref Krzyzanski et al., AAPS J 2021), repeated measurement linear models were applied to capture trends, modeling serum creatinine on postnatal age, birth weight or gestational age, using heterogeneous autoregressive residual covariance structure and maximum likelihood methods.

RESULTS

The pooled dataset contained 1136 therapeutic hypothermia-treated cases and 4724 serum creatinine observations to generate centiles (10th-25th-50th-75th-90th-95th) over postnatal age (day 1-3 hypothermia, day 4 rewarming, 5-10 normothermia). In treated cases, the incidence of acute kidney injury was 132/1136 (11.6%), mortality 193/1136 (17%). Neonates with acute kidney injury had higher mortality (37.2 to 14.3%, $p < 0.001$), and trends in median creatinine over postnatal age were significantly different comparing survivors to non-survivors ($p < 0.01$) or between cases with or without acute kidney injury ($p < 0.001$). In therapeutic hypothermia-treated cases, postnatal age and gestational age or birth weight explained serum creatinine variability. Trends over postnatal age were significantly different between therapeutic hypothermia cases and controls (801 neonates, 2779 serum creatinine observations).

CONCLUSIONS

Serum creatinine patterns and centiles in therapeutic hypothermia-treated cases were described and compared to controls. Such patterns enable clinicians to better assess renal function and tailor pharmacotherapy, fluids, or kidney supportive therapies in individual therapeutic hypothermia-treated cases.

EP260 / #1652**E-Poster Viewing - Neonatology AS02-17.
Nephrology****Atypical hemolytic uremic syndrome as cause of renal failure in a preterm: case report**

B. Martínez Estradé^{1*}, M. Ramon Jiménez¹, M.J. García Borau¹, J. Salazar Quiroz¹, E. Moliner Calderon¹, G.M. Fraga-Rodríguez²

¹Hospital de la Santa Creu i Sant Pau, Neonatology, Pediatrics Department, Barcelona, Spain

²Hospital Sant Pau., Nephrology Paediatric., Barcelona, Spain

BACKGROUND AND AIM

Atypical hemolytic uremic syndrome (HUS) is caused by dysregulation of the alternative pathway of the complement system, leading to endothelial damage and systemic thrombotic microangiopathy. It corresponds to 5% of HUS in infancy and is uncommon in the neonatal period.

METHODS

Case report

RESULTS

We report a 32 weeks old preterm admitted for hypoxic-ischemic disease and hypovolemic shock after umbilical bleeding. During first weeks of life he presented progressive anemia of 4.8 g/dL associated with low platelet count (77000/mm³) and progressive renal failure (AKI2). Renovesical ultrasound was performed without significant findings. Bacterial and viral microbiological studies were negative. Study of inborn errors of metabolism was performed with normal result. With clinical suspicion of HUS we made complement study showing activation of C5b-9 in the endothelial membrane. Eculizumab was

initiated after vaccination and antibiotic prophylaxis were started. Genetic study of molecular alternative complement pathway was negative. After initiation of treatment, stabilization of renal function was observed with no further worsening. Currently, he is 8 months old and continues with the same treatment. Renal function remains stable without requiring renal replacement therapy and without failure to thrive.

CONCLUSIONS

Atypical HUS is a severe disease with poor prognosis that progresses to chronic renal failure without adequate treatment. The treatment of choice in pediatrics is Eculizumab, a monoclonal antibody that inhibits the terminal fraction of complement and blocks the membrane attack complex. Is a rare disease in the newborn and its diagnosis should be considered to avoid severe renal damage.

EP261 / #2041

E-Poster Viewing - Neonatology AS02-17. Nephrology

Acute kidney injury in preterm and intrauterine growth restricted newborns: what's the best criteria for diagnosis?

A. Celebi¹, O. Aydemir¹, D. Gunes¹, H. Ozen², T. Barsan Kaya¹,
A. Kavaz Tufan³, O. Surmeli Onay^{1*}, A.N. Tekin¹

¹Eskisehir Osmangazi University, Faculty of Medicine, Department of Pediatrics, Division of Neonatology, Eskisehir, Turkey

²Eskisehir Osmangazi University, Faculty of Medicine, Department of Biostatistics, Eskisehir, Turkey

³Eskisehir Osmangazi University, Faculty of Medicine, Department of Pediatrics, Division of Pediatric Nephrology, Eskisehir, Turkey

BACKGROUND AND AIM

Preterm infants are vulnerable to acute kidney injury (AKI) due to incomplete nephrogenesis, comorbid illnesses, and exposure to nephrotoxic agents. The hemodynamic redistribution that occurs in intrauterine growth restriction (IUGR) caused by placental insufficiency affects renal perfusion.

METHODS

A prospective cohort study was conducted to assess the incidence and risk factors of AKI using urine output and serum creatinine/glomerular filtration rate based diagnostic criteria in IUGR and appropriate for gestational age (AGA) preterm infants.

RESULTS

We enrolled 119 preterm infants with a mean gestational age (GA) of 30^{+6}_{-3} weeks and a birth weight of 1486 ± 520 g. The incidence of AKI was similar in IUGR and AGA preterms (26.8% and 30%, respectively) and highest in the

smallest babies(table1). Neonatal RIFLE was the most sensitive criteria in the diagnosis of AKI especially for mild kidney damage (figure1, table2). Low GA, intubation at birth, low APGAR, respiratory distress syndrome, patent ductus arteriosus, pulmonary and intraventricular haemorrhage, multiple inotropes, invasive ventilation, and sepsis increased risk of AKI(table3). Hemodynamic redistribution on prenatal ultrasonography was twice as common in IUGR infants suffering AKI but not statistically significant. In multivariate logistic regression analysis, low GA and late sepsis were identified as independent risk factors for AKI(table4). Mechanical ventilation duration and hospitalizations were longer, and bronchopulmonary dysplasia and mortality rates were higher in newborns with AKI.

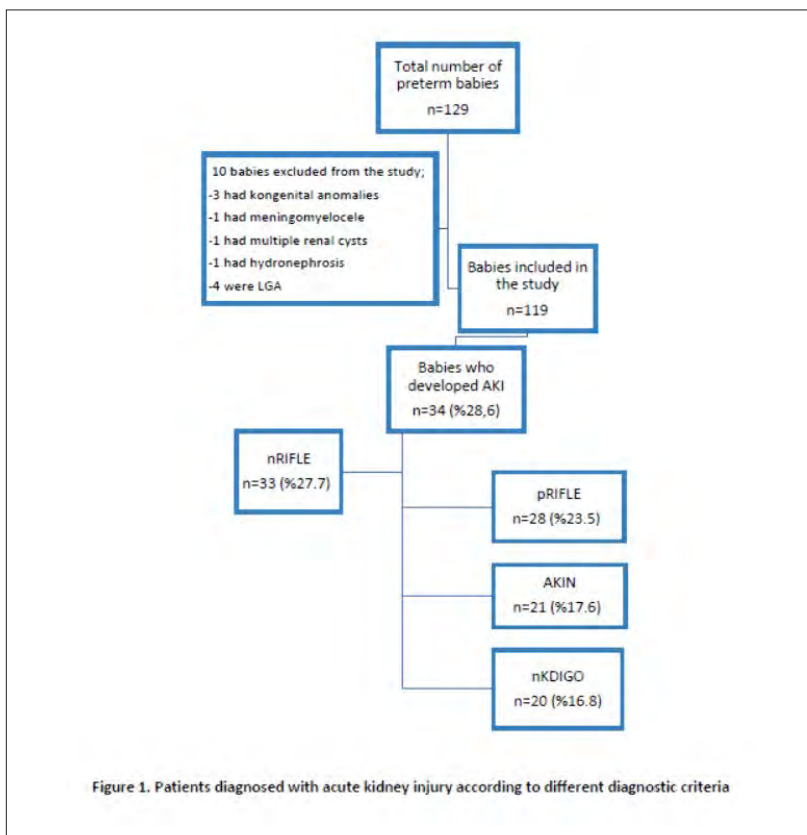

Table 1. Frequency of AKI based on gestational age and birth weight

	AKI (n=34)	No AKI (n=85)	p
Gestational week (week)*	28 ^{cd} (26 ^{bc} -31 ^{ab})	32(29 ^{cd} -34 ^{ab})	<0.001 ^a
34-36 (late preterm)**	4 (13.3)	26 (86.6)	<0.001 ^b
32-33 (moderate preterm)**	1 (5)	19 (95)	
26-31 (very preterm)**	26 (40)	39 (60)	
<26 (extremely preterm)**	3 (75)	1 (25)	
Birth weight (g)*	1090 (800-1400)	1550 (1265-1910)	<0.001 ^a
>2500**	1 (25)	4 (75)	0.002 ^f
1500-2499 (LBW)**	7 (14)	43 (86)	
1499-1000 (VLBW)**	12 (30.7)	27 (69.3)	
<1000 (ELBW)**	14 (56)	11 (44)	

*Median (Q1-Q3), **Number (Percent). ^aMann Whitney analysis. ^bPearson Chi-Square analysis a (yates) continuity correction

Table 2. Acute kidney injury stages in infants with multiple attacks

	1 AKI (n=34)	2 AKI (n=10)	3 AKI (n=1)
AKIN*	21 (61.7)	8 (80)	1 (100)
Stage 1*	15 (71.4)	6 (75)	1 (100)
Stage 2*	5 (23.8)	1 (25)	0
Stage 3*	1 (4.7)	1 (25)	0
nKDIGO*	20 (58.8)	8 (80)	1 (100)
Stage 1*	14 (70)	6 (75)	1 (100)
Stage 2*	5 (23.8)	1 (25)	0
Stage 3*	1 (4.7)	1 (25)	0
pRIFLE*	28 (82.3)	8 (80)	1 (100)
Risk*	22 (78.5)	6 (75)	1 (100)
Injury*	5 (17.8)	1 (25)	0
Failure*	1 (3.5)	1 (25)	0
nRIFLE*	33 (97)	10 (100)	1 (100)
Risk*	24 (70.7)	7 (70)	1 (100)
Injury*	8 (24.2)	1 (10)	0
Failure*	1 (3.1)	2 (20)	0

*Number (percent)

Table 3. Univariate logistic regression analysis of risk factors for acute kidney injury

	Odds ratio	95% confidence interval	p
Gestational age (week)	0.95	0.928-0.972	<0.001
Birth weight (g)	0.998	0.997-0.999	<0.001
5-minute APGAR score	0.47	0.324-0.683	<0.001
Intubation at birth	5.611	2.376-13.254	<0.001
Respiratory distress syndrome	5.008	1.881-13.331	0.001
Pathological weight loss (>%15)	5.857	1.373-24.989	0.017
Hemodynamically significant PDA	3.666	1.596-8.419	0.002
Inotrope/vasopressor use			
1	1.52	0.354-6.530	0.573
2 or more	6.080	1.415-26.120	0.015
Bleeding (IVH-pulmonary)	4.937	1.596-15.277	0.006
Invasive ventilation	5.25	2.059-13.387	0.001
Umbilical venous catheter	3.429	1.347-8.725	0.01
Late sepsis	6.303	2.587-15.360	<0.001

Table 4. Investigation of acute kidney injury risk factors by multivariate logistic regression analysis

	Odds ratio	95% confidence interval	p
Gestational week (week)	0,755	0,634-0,898	0,002
Late sepsis	3,164	1,177-8,505	0,02

CONCLUSIONS

Acute kidney injury, a common condition in preterm neonates, is associated with increased morbidity and mortality. Neonatal RIFLE is the criteria of choice in AKI diagnosis since it allows for earlier identification of at-risk neonates.

EP262 / #1697**E-Poster Viewing - Neonatology AS02-17.
Nephrology****Incidence and outcome of neonatal acute kidney injury (aki) based on modified kidney disease improving global outcomes (kdigo) criteria****O. Trampleasure^{1*}, C. Longley¹, N. Liow¹, R. Ayling², M. Sinha³,
A. Sinha^{1,4}**¹Royal London Hospital, Neonatal Medicine, London, United Kingdom²Royal London Hospital, Clinical Biochemistry, London, United Kingdom³St Thomas' Hospital, Paediatric Nephrology, London, United Kingdom⁴Queen Mary University of London, Blizard Institute, London, United Kingdom**BACKGROUND AND AIM**

Neonatal AKI, as defined by KDIGO criteria is common worldwide. However, despite its prevalence, there is a paucity of data about the incidence and outcomes of babies diagnosed with AKI from the UK. Aims: To review the demographics and outcomes of babies diagnosed with AKI

METHODS

A retrospective review was performed of all babies admitted to a London tertiary neonatal unit with at least 3 serial creatinine measurements between January-December 2019. Creatinine levels for infants were combined with demographic data from Badgernet. KDIGO criteria was used to define AKI and its severity. Data was analysed using SPSS 28.

RESULTS

73 out of 348 infants (21%) were identified to have any stage of AKI with 51% born at <28 weeks GA affected (Table). Female gender was more likely to be diagnosed with AKI (M vs F 18.1% vs 24.8%). of those with AKI, 58% (42/73) were diagnosed within 1 week of age (Early AKI). A higher proportion of those with AKI died (AKI 15/73 (20.5%) vs Non-AKI 10/275 (3.6%), $p < 0.001$).

TABLE 1:

Incidence of AKI and outcomes by Gestational Age category

	Term infants (n=145)	33-36 weeks (n=73)	28-32 weeks (n=62)	<28 weeks (n=68)
AKI any stage n(%)	17 (11.7)	8 (11.0)	13(21.0)	35(51.5)
AKI stage 2 or 3 n(%)	8 (5.5)	4(5.5)	2 (3.3)	12(17.6)
Early AKI(n)	12	3	9	18

CONCLUSIONS

Our data shows slightly lower rates of AKI but higher proportion with early AKI in comparison with previous epidemiological study (AWAKEN) looking at AKI in newborn infants. The development of AKI was associated with increased mortality.

EP263 / #1206

E-Poster Viewing - Neonatology AS02-18. Neurology

Hyperpolarized ^{13}C magnetic resonance imaging after neonatal hypoxia-ischemia and therapeutic hypothermia; a newborn piglet MODEL

T.C.K. andelius^{1*}, L. Hansen¹, R. Pinnerup¹, H. andersen¹, E. Hansen², N. Bøgh², H. Hagberg³, E. Rocha-Ferreira³, K. Kyng¹, C. Laustsen², T. Henriksen¹

¹Aarhus University Hospital, Department of Pediatrics, Aarhus N, Denmark

²Aarhus University Hospital, The Mr Research Centre, Aarhus, Denmark

³Inst of Clinical Sciences, Sahlgrenska Academy, University of Gothenburg, Centre of Perinatal Medicine & Health, Gothenburg, Sweden

BACKGROUND AND AIM

Biomarkers of brain injury are needed for accurate prognosis and early evaluation of neuroprotective interventions in newborns with hypoxic ischemic encephalopathy (HIE). Hyperpolarized ^{13}C MRI is a novel method to quantify metabolism in vivo with unprecedented resolution. We have previously shown that ^{13}C MRI can quantify changes in cerebral metabolic phenotype in the acute phase after a hypoxic-ischemic (HI) insult in piglets. In this study we aimed to apply ^{13}C MRI to investigate the metabolic phenotype in piglets subjected to a standardised HI insult and treated with therapeutic hypothermia (TH) compared to supportive care only.

METHODS

16 piglets were anesthetised, subjected to a HI insult, and randomized to treatment with TH (n = 8) or supportive care only (n = 8). Imaging was performed approximately 44 hours after the insult in a 3T MR scanner followed by acquisition of cerebral tissue for histological analysis. For ^{13}C studies,

[1-¹³C] pyruvate was hyperpolarized in a clinical polarizer. Following intravenous injection (6 mL of 125 mM isotonic pyruvate solution), rapid interleaved spectroscopic images were acquired using a spectral-spatial spiral imaging sequence. Metabolism of pyruvate to its metabolic products lactate, bicarbonate, and alanine will be reported as the accumulated signal of each metabolite proportional to the sum of all three metabolites. The ¹³C MRI metabolic patterns will be compared to conventional ¹H MRI/MRS data and cell death measured through TUNEL staining on histological samples.

RESULTS

are pending.

CONCLUSIONS

Experiments was finished in March of 2022. ¹³C MRI data analysis will be performed in May and results will be presented at EAPS conference in October.

EP264 / #1524

E-Poster Viewing - Neonatology AS02-18. Neurology

Early predictors of long-term outcome in perinatal arterial ischemic stroke (pais): a meta-analysis and systematic review.

L.M. Baak^{1*}, N. Van Der Aa¹, A. Verhagen¹, J. Dudink¹, C. Nijboer², M. Benders¹, N. Wagenaar¹

¹University Medical Center Utrecht, Wilhelmina Children's Hospital, Department of Neonatology, Utrecht, Netherlands

²University Medical Center Utrecht Brain Center and Wilhelmina Children's Hospital, Utrecht University, Department For Developmental Origins of Disease, Utrecht, Netherlands

BACKGROUND AND AIM

Perinatal arterial ischemic stroke (PAIS) occurs in 1 in ~5000 live births and often has lifelong neurodevelopmental consequences. We aimed to systematically assess the value of diagnostic procedures regularly performed in neonates with PAIS within four months after birth for long-term outcome prediction.

METHODS

We carried out a systematic literature search using PubMed and Embase. We included term born infants with PAIS that underwent a diagnostic procedure within four months of age, and with a reported outcome parameter >12 months of age. Two reviewers independently included studies, and performed risk of bias analysis using the Checklist for Case Series developed by the Joanna Briggs Institute.

RESULTS

We included 39 articles reporting on 1254 infants with PAIS, whereof 1118 (89%) infants had a completed neurodevelopmental long-term follow-up with a median of 4.2 years. Most studies described MRI characteristics (n=28). A meta-analysis was performed for motor outcome including 22 studies. The best diagnostic procedures in prediction of cerebral palsy were qualitative and quantitative assessment of the corticospinal tracts on diffusion tensor, diffusion-weighted, and conventional MR imaging during the neonatal period, and at three months of age. Few studies reported a high predictive value of early clinical motor assessments for cerebral palsy. Bedside neuromonitoring such as aEEG and NIRS signals might provide valuable information on long-term cognitive functioning, although validation is needed.

CONCLUSIONS

Corticospinal tract assessment on early MRI is the best predictor for long-term motor outcome after PAIS. For cognition, post-neonatal epilepsy, language, and behavioral problems, parameters with high predictive value could not be identified.

EP265 / #2424

E-Poster Viewing - Neonatology AS02-18. Neurology

Cerebral flow in infants with congenital heart disease; monitoring with us-doppler during admission

A. Batista^{1*}, A. Rivas², D. Cañizo², J. Sanchez-De-Toledo³,
M. Camprubí²

¹Hospitalet General de l'Hospitalet, Neonatology, L'Hospitalet de Llobregat, Spain

²Hospital Sant Joan de Déu, Neonatology, Esplugues de Llobregat, Spain

³Hospital Sant Joan de Déu Barcelona, Department of Pediatric Cardiology, Esplugues de Llobregat, Spain

BACKGROUND AND AIM

Newborns with congenital heart disease (CHD) are at risk of neurological injury and impaired neurodevelopment during infancy. Hemodynamic instability, chronic hypoxia and the need of a mayor heart surgery during first weeks of life, may lead to alterations in cerebral perfusion. Brain ultrasonography and Doppler study of the anterior cerebral artery (ACA) is a common tool to evaluate newborn brain lesions and neurologic prognostic. The aim of this study is to describe de the Pulsatility index (PI) and Resistance index (RI) of the ACA of newborns with CHD at the birth, and in different moments around surgery

METHODS

Prospective observational study of infants with a CHD admitted at a Pediatric Tertiary Care Hospital from 2017 to 2020. Cerebral ultrasounds realized during admission have been reviewed. Observations have been registered and analyzed with Stata

RESULTS

211 cerebral ultrasounds of 72 infants with CHD admitted at our hospital from 2017 to 2020 were reviewed. We present results in these two tables:

TABLE 1:

PI of ACA in CHD infants (CI 95%)	Non-Cyanotic CHD		Cyanotic CHD		P
	Low Pulmonar Flow	High Pulmonar Flow	Low Pulmonar Flow	High Pulmonar Flow	
Birth	1.61 2.33-0.90	1.70 2.81-0.59	1.70 2.45-0.95	2.09 2.76-1.42	0.21
PreSurgery	1.46 2.17-0.75	1.60 2.56-0.63	1.80 2.77-0.83	1.85 2.53-1.18	0.06
PostSurgery	1.69 2.30-1.08	1.45 2.61-0.28	1.78 3.08-0.49	1.86 3.20-0.53	0.44
Discharge	1.62 2.50-0.74	1.76 2.76-0.75	1.75 2.93-0.57	1.78 2.93-0.62	0.85

TABLE 2:

RI of ACA in CHD infants (CI 95%)	Non-Cyanotic CHD		Cyanotic CHD		P
	Low Pulmonar Flow	High Pulmonar Flow	Low Pulmonar Flow	High Pulmonar Flow	
Birth	0.77 0.96-0.62	0.80 0.96-0.63	0.76 0.90-0.61	0.88 0.96-0.79	0.07
PreSurgery	0.73 0.91-0.56	0.78 0.94-0.62	0.79 0.99-0.58	0.84 0.97-0.70	0.02
PostSurgery	0.78 0.93-0.64	0.70 0.99-0.41	0.79 1.01-0.56	0.77 0.96-0.58	0.29
Discharge	0.76 0.92-0.61	0.80 1.03-0.56	0.79 1.02-0.55	0.76 0.96-0.57	0.84

CONCLUSIONS

In our population of infants with CHD, parameters of cerebral flow are increased respect those described in the literature in healthy newborns. Infants with cyanotic congenital heart disease with increased pulmonary blood flow, present PI and RI higher than other babies with CHD at birth and around cardiac surgery. More studies are needed to investigate the relationship between alterations in cerebral flow of newborns with CHD and neurologic development of these infants

EP266 / #1851**E-Poster Viewing - Neonatology AS02-18.
Neurology****Magnetic resonance imaging findings in gunn rat model of preterm hyperbilirubinemia****C. Tokat¹, N. Rickman¹, M. Janampalli¹, S. Vatolin¹, C. Flask²,
B. Erokwu², C. Bearer^{1*}**¹Case Western Reserve University, Pediatrics, Cleveland, United States of America²Case Western Reserve University, Radiology, Cleveland, United States of America**BACKGROUND AND AIM**

Bilirubin is produced by the breakdown of hemoglobin and is normally catabolized and excreted. Accumulation of bilirubin can become neurotoxic, as is often the case in premature infants. The homozygous Gunn rat (jj) lacks uridine diphosphate glucuronosyltransferase 1A, the enzyme needed to biotransform bilirubin and can be made acutely hyperbilirubinemic by injection of sulfadimethoxine. This drug displaces bilirubin from albumin and thus increases free bilirubin. The objective of this study was to determine if changes in the cerebellum could be seen on Magnetic Resonance Imaging of adult animals made hyperbilirubinemic on a postnatal day 5 (P5).

METHODS

Gunn rat pups were further randomly assigned to be injected intraperitoneally with either sulfadimethoxine (sulfa) (200 mg/kg) or an equivalent volume of saline on a P5. A 7T Bruker Biospec scanner with a 30cm bore and 400 mT/m magnetic field gradients and a 35mm ID mouse volume coil for signal detection were used to acquire T2-weighted images in vivo P37. Region of Interest analysis was performed in the cerebellum, and cerebellar volumes were measured via Paravision 5.1 software.

RESULTS

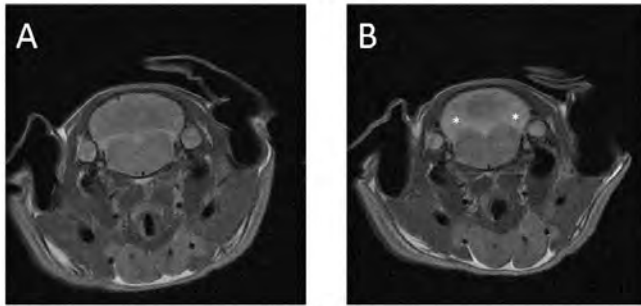

Fig.1. T2-weighted cerebellar cross section

A) jj-sal rat cerebellum image on day P37 **B) jj-sulfa** rat cerebellum image on day P37

* Areas with increased intensity.

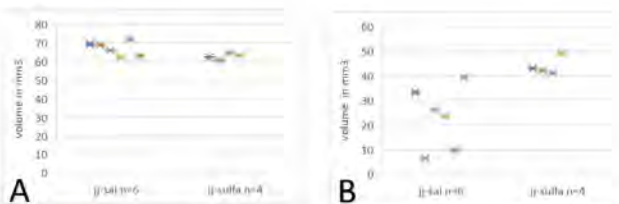

Fig.2. Sulfamethoxine treatment of jj rats at P5 decreases cerebellum volume and causes increased hyperintensity areas in cerebellum.

A) Cerebellum volume (Middle cerebellar peduncle) in mm³. Statistics: jj-sal n=6 and jj-sulfa n=4 ps 0.05;

B) Hyperintensity area volumes in cerebellum in mm³. Statistics: jj-sal n=6 and jj-sulfa n=4 p ≤ 0.01

Cerebellar volume analysis showed significant decreases in jj-sulfa animals compared to jj-saline. jj-sulfa rats exhibit significant white matter changes as increased intensity in the middle cerebellar peduncle (MCP). Hyperintensity areas are predominantly localized peripherally in MCP.

CONCLUSIONS

An acute change in bilirubin toxicity affects the cerebellum volume in the later period of life. Additionally, acute bilirubin encephalopathy in preterms results in white matter changes in the cerebellum, which is reported in patients with Crigler Najjar syndrome.

EP267 / #1692

E-Poster Viewing - Neonatology AS02-18. Neurology

Cranial ultrasound findings in small for gestational infants at TERM

D. Gallo, L. Marconi, I. Bresesti*, A. Bossi, M. Agosti

Asst Sette Laghi, F. Del Ponte" Hospital, Division of Neonatology, Varese, Italy

BACKGROUND AND AIM

Small for gestational age (SGA) infants have increased risk of perinatal morbidity and neurological complications. However, the prevalence of brain lesions among SGA term neonates has not been investigated yet. We aimed to evaluate the rate of cerebral abnormalities in this population and the relationship with perinatal factors.

METHODS

This was a single-center study carried out at a level 3 neonatal unit. A consecutive series of 237 SGA infants and 557 adequate for gestational age (AGA) neonates were enrolled. All underwent a cranial ultrasound scan (cUS) between the 2^d and 3^d day of life.

RESULTS

Severe cUS anomalies including GMH-IVH (germinal matrix haemorrhage – intraventricular haemorrhage) were significantly increased in SGA compared to AGA infants (3.8% vs 1.2%, $p=0.01$). Prevalence of mild anomalies was similar in the two groups and included: plexus cysts (5% vs 3.4%), subependymal cysts (SEC) (2.1% vs 1.2%), lenticulostriate vasculopathy (LSV) (1.5% vs 0.7%) and increased periventricular echogenicity (PHE) (1.5% vs 0.9%). All SGA infants

were tested for CMV infection with urine PCR, that resulted positive in 1% of cases; none of which had SEC or LSV. No significant correlation was found between obstetric characteristics or adverse neonatal outcomes and the occurrence of severe cUS anomalies.

CONCLUSIONS

SGA infants had increased incidence of severe anomalies at cUS but neonatal outcomes were overall good. Abnormal cUS findings did not correlate with perinatal risk factors.

EP268 / #1377

E-Poster Viewing - Neonatology AS02-18. Neurology

Mri based reference values for 2d quantitative brain measurements in a cohort of extremely preterm infants

J. Buchmayer^{1*}, G. Kasprian², K. Klebermass-Schrehof¹, A. Berger¹, K. Goeral¹

¹Medical University of Vienna, Comprehensive Center For Pediatrics, Department of Pediatrics and Adolescent Medicine, Division of Neonatology, Pediatric Intensive Care and Neuropediatrics, Wien, Austria

²Medical University of Vienna, Department of Radiology, Vienna, Austria

BACKGROUND AND AIM

Cerebral magnetic resonance imaging (cMRI) has become an important diagnostic tool for neonatal patients. Through the application of volumetric techniques, infants at risk for developmental impairment might be identified earlier leading to improved outcome prediction and later neurodevelopment. The aim of this study was to create reference values with simple brain metrics, for a contemporary cohort of infants born extremely preterm at a high-volume level IV perinatal center in Austria.

METHODS

Routine cMRI are performed in infants born before 28 weeks gestational age (wGA) at term-equivalent age. All cMRI, done during 11/2017 and 11/2021, with an age-appropriate and unremarkable report were considered. The following parameters were analyzed: cerebral and bone biparietal width (cBPW, bBPW), interhemispheric distance (IHD), transverse cerebellar diameter (TCD) and fronto-occipital diameter (FOD) (figure 1). Reference values were created.

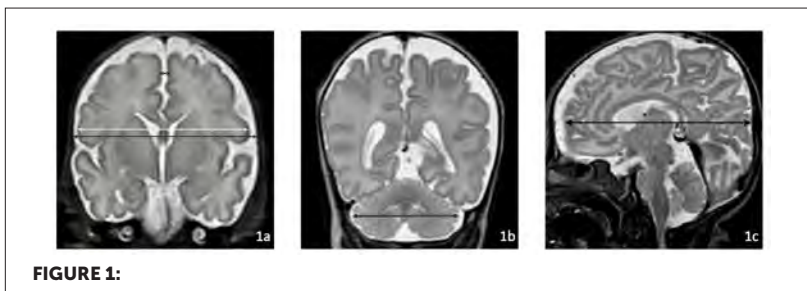

RESULTS

The study cohort consisted of 112 preterm neonates, with a median gestational age of 25.9 (IQR 24.3-26.8) weeks and a median birth weight of 748 (IQR 625-896) grams. cMRI examinations were separated into five groups: 37 wGA (n=51), 38 wGA (n=27), 39 wGA (n=18), 40 wGA (n=9), 41/42 wGA (n=7). Mean values are presented in table 1.

TABLE 1:

Measurements	Week 37	Week 38	Week 39	Week 40	Week 41/42
cBPW	71.4 ± 3.3	73.4 ± 3.5	72.9 ± 4.4	77.4 ± 3.8	79.6 ± 4.1
bBPW	76.6 ± 3.4	78.5 ± 3.8	78.0 ± 5.1	82.8 ± 5.0	84.5 ± 5.0
IHD	3.9 ± 1.3	4.6 ± 1.7	4.0 ± 1.6	4.6 ± 2.2	3.3 ± 1.4
TCD	48.1 ± 4.2	49.2 ± 2.3	48.9 ± 1.9	51.0 ± 4.9	52.3 ± 2.7
FOD	95.7 ± 5.4	96.8 ± 5.1	96.4 ± 7.3	99.2 ± 6.7	100.8 ± 5.3

CONCLUSIONS

We present reference values for basic 2D cMRI measurements at term-equivalent age. In contrast to pre-existing literature, this is the first study to our

knowledge, where a large cohort of extremely preterm infants was studied. Altogether, these measurements are easy feasible and with an increasing use of cMRI in extremely preterm infants, these reference values might help clinicians to identify impaired brain growth.

EP269 / #1927**E-Poster Viewing - Neonatology AS02-18.
Neurology****Retrospective cohort study of infants with hypoxic-ischaemic encephalopathy admitted to christchurch nicu and the correlation of hie changes on early and late mri brain SCANS****M. Buckingham^{1*}, B. Dixon¹, S. Harris², N. Austin^{1,2}**¹Canterbury District Health Board, Child Health, Neonatology, Christchurch, New Zealand²University of Otago Christchurch, Department of Pediatrics, Christchurch, New Zealand**BACKGROUND AND AIM**

In New Zealand HIE has an incidence of 1.2/1000 births and is one of the most common causes of neonatal death and long term neurodisability. Brain MRI has been found to be useful to predict neurological outcome and recent literature has suggested that early and late scan results show a good correlation in patterns of injury. We aimed to audit our local HIE cases to review results of MRI and correlation with neurological examination and outcome.

METHODS

We identified 58 HIE cases born at ≥ 35 weeks gestation admitted between 2016 and 2019. Brain MRI results from 20 infants were classified into 5 distinct patterns of severity and results from early and late scans compared with neurological status and outcome to look for correlation with patterns of injury.

RESULTS

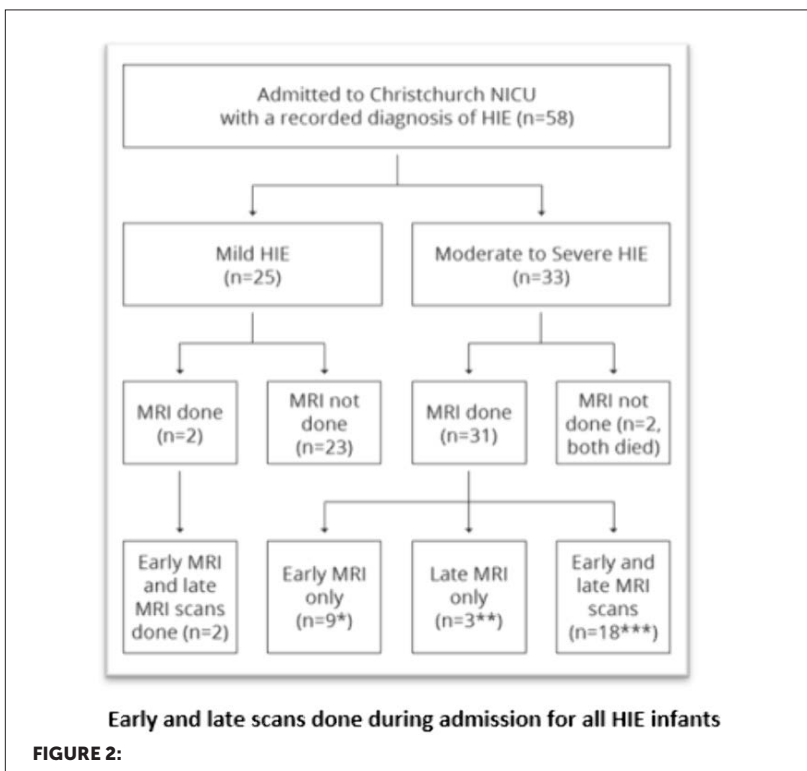
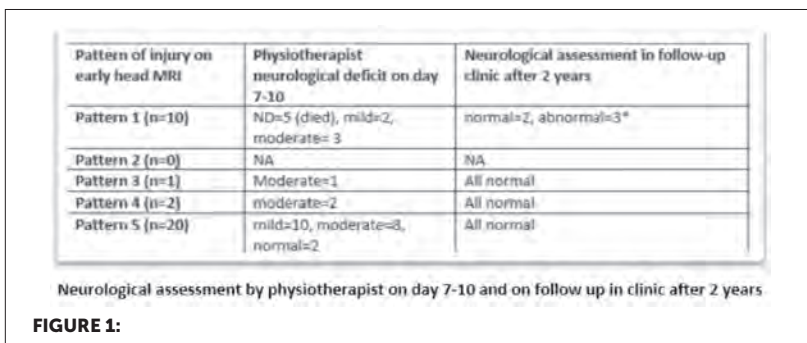

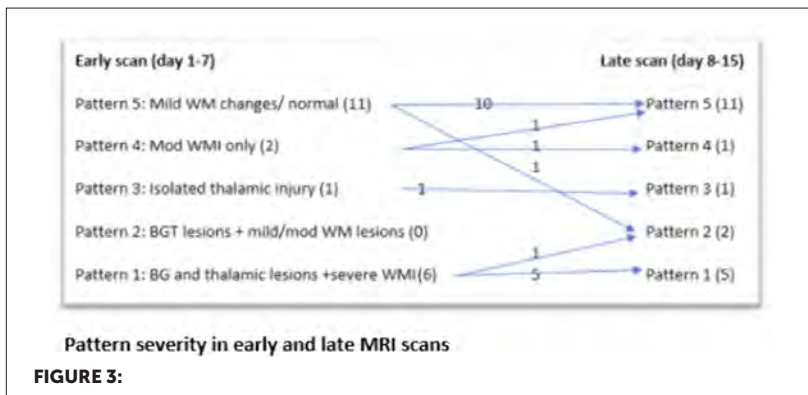

There was good congruity for severity grading between early and late scans. One early MRI head scan with normal or mild patterns showed moderate to severe changes at D8-15 and two further scans showed improvement. All infants who died following MRI showed the most severe pattern of injury. 60% of survivors with a similar pattern had an abnormal neurological examination after two years.

CONCLUSIONS

Results can vary from early and late scans thus highlighting the importance of repeating a scan after D8. An early scan is useful in more severe patterns of injury leading to a poor prognosis and can help redirect care when appropriate. Neurological assessment on day 7-10 may be too early to correlate well with the injury pattern seen on MRI scan.

EP270 / #1555

E-Poster Viewing - Neonatology AS02-18. Neurology

Nb with hie treated with hypothermia: analytical observation in a cohort of a nicu of buenos aires's city and determinants of death and/or brain injury

M.E. Campo^{1*}, M. Valera², J. Tavošnanska², M.L. Failla², L. Roldan², G. Saa², M. Toma², R. Cimbaro Canella²

¹Hospital Fernandez, Buenos Aires, Buenos Aires, Argentina

²Hospital Fernández, Buenos Aires, Buenos Aires, Argentina

BACKGROUND AND AIM

Birth asphyxia in newborns (NB) continues to be a serious condition that causes significant mortality and long-term neurological sequelae, despite treatment with therapeutic hypothermia (TH). OBJECTIVES: analyze the existence of an association of perinatal risk factors as determinants of adverse outcomes, considering those as brain injury in Magnetic Resonance Imaging of the Central Nervous System (CNS MRI) and/or death, in a cohort of NB with hypoxic encephalopathy (HIE) who were admitted to TH in a NICU of Buenos Aires'City

METHODS

Retrospective observational cohort study in NB \geq 36 weeks, admitted to a NICU between 2011 and 2021, with moderate-severe HIE treated with HT. Maternal, birth, and postnatal characteristics were compared between NB with adverse outcomes and those without. Quantitative variables were analysed by the Student's t test or the Mann-Whitney U test and the Chi 2 or Fisher test for the Qualitative variables. The existence of an association between perinatal factors and adverse outcomes was evaluated using bivariate logistic regression. A multivariate regression (Wald's test) was performed, which

included in the control the variables whose significance was $p < 0.1$ (considered confounding). A value of $p < 0.05$ was statistically significant.

RESULTS

114 newborns with HIE were treated with HT; 52% presented pathological CNS MRI and 12% died. The severity of encephalopathy (severe, $p = 0.027$) and abnormal brain function monitor (CFM) ($p = 0.024$) were significantly associated with increased risk of death and/or brain injury.

CONCLUSIONS

In asphyxiated NB treated with HT, the initial severity of encephalopathy and CFM alteration were significantly associated with the risk of death and/or brain injury.

EP271 / #1613

E-Poster Viewing - Neonatology AS02-18. Neurology

Association between intraventricular hemorrhage severity and antenatal, perinatal and postnatal clinical factors in preterm infants.

J. Cangemi^{1*}, S. Galletti², V. Paoletti³, L. Corvaglia², S. Martini²

¹University of Bologna, Specialty School of Pediatrics, Bologna, Italy

²University of Bologna, Department of Medical and Surgical Sciences, Bologna, Italy

³IRCCS AOU Bologna, Neonatal Intensive Care Unit, Bologna, Italy

BACKGROUND AND AIM

Intraventricular haemorrhage (IVH) is a major cause of disability among preterm neonates. We compared clinical features between preterm infants with mild and moderate-severe IVH to evaluate possible associations with IVH severity.

METHODS

Infants <32 weeks' gestation born between 2015-2022 who developed IVH during the first week of life were included. IVH cases were classified as mild (grade 1-2) or moderate-severe (grade III with or without periventricular haemorrhagic infarction). The following clinical characteristics were compared between mild and moderate-severe IVH: GA, BW, delivery mode, antenatal steroids, Apgar¹⁻⁵, CRIB-II score, age at IVH onset. The following data during the first week of life were also retrieved and compared: total sodium bicarbonate (mEq/kg) administered for metabolic acidosis correction; lowest platelet count and highest serum Na levels; prevalence of a haemodynamically significant PDA (hsPDA); pharmacological hsPDA closure and drug used; need for dopamine or dobutamine treatment; need for invasive ventilation.

RESULTS

Out of 23 infants included, 11 (48%) developed mild IVH and 12 (52%) moderate-severe IVH (52%). The latter group had significantly lower Apgar⁵ ($p=0.043$) and platelet levels ($p < 0.001$). The need for dopamine treatment was also significantly higher in the moderate-severe IVH group ($p=0.027$). No significant difference was noted for the other clinical variables (Fig.1).

Figure 1. Comparison of antenatal, perinatal and postnatal clinical characteristics between infants with mild and moderate-severe intraventricular haemorrhage (IVH).

Clinical characteristics	Mild IVH (n=11)	Moderate-severe IVH (n=12)	P-value
Gestational age, median (IQR), weeks	25.3 (24.8-25.7)	25.3 (24.9-25.9)	0.833
Birth weight, median (IQR), g	707 (620-784)	770 (680-869)	0.608
Apgar at 1', median (IQR)	5 (4-7)	3 (2-6)	0.152
Apgar at 5', median (IQR)	9 (7-9)	7 (5-8)	0.043
C-section, n (%)	5 (45.5)	6 (50)	1.000
Antenatal steroids (complete course), n (%)	7 (63.6)	4 (33.3)	0.220
Chorioamnionitis, n (%)	2 (18.2)	2 (16.7)	1.000
Base excess at umbilical blood gas, n (%)	-9.3 (-10;-5.1)	-13 (-20.9;-8.1)	0.104
CRIB-II score, median (IQR)	8 (4-12)	10 (8-14)	0.211
Age at IVH onset, median (IQR), hours	34 (13-96)	41 (18-53)	0.928
<i>Within the first week</i>			
Total NaHCO ₃ , median (IQR), mEq/kg	6.6 (1.9-9.7)	9.6 (5.9-13.5)	0.151
Max serum Na, median (IQR), mmol/L	146 (142-148)	146.5 (144.5-148)	0.740
Min platelet count, median (IQR), 10 ⁹ /L	190 (138-242)	1000 (51.5-123.5)	<0.001
hsPDA, n (%)	10 (91)	12 (100)	0.478
Pharmacological hsPDA closure, n (%)			
Ibuprofen	4 (40)	6 (50)	
Paracetamol	5 (50)	3 (25)	0.421
Both	1 (10)	3 (25)	
Invasive ventilation, n (%)	9 (81.8)	12 (100)	0.217
Dopamine treatment, n (%)	5 (45.5)	11 (91.7)	0.027
Dobutamine treatment, n (%)	8 (72.7)	12 (100)	0.093

Abbreviations: IQR, interquartile range; hsPDA, haemodynamically significant patent ductus arteriosus.

CONCLUSIONS

A lower Apgar⁵ is associated with an increased risk of moderate-severe IVH. Increased dopamine requirements may reflect the greater haemodynamic instability associated with severe bleedings, while reduced platelets may

accompany IVH progression to more severe grades. Larger studies are needed to confirm these preliminary data.

EP272 / #2275**E-Poster Viewing - Neonatology AS02-18.
Neurology****Application of an ultrasonographic brain maturation score for preterm infants****N. Carreras^{1*}, M. Velilla¹, A. García-Alix², C. Skilhan³, A. Alarcon^{1,4}, T. Agut^{1,2}**¹Hospital San Joan de Déu, Institut de Recerca Sant Joan de Déu, Neonatology, Barcelona, Spain²Fundación Nene, Neonatology, Madrid, Spain³Rio Grande do Sul University, Physiotherapy, Porto Alegre, Brazil⁴University of Barcelona, Pediatrics, Barcelona, Spain**BACKGROUND AND AIM**

Up to 50% of preterm infants will show impaired neurodevelopmental outcomes, often without evidence of brain damage. A dysmaturation process has been hypothesized as a possible pathological underlying substrate in this population. Cerebral ultrasound (CUS) may allow to follow brain maturation of preterm infants sequentially and in a safe, cost-effective manner, according to normalized neonatal data. Our aim is to validate a qualitative ultrasonographic score developed for obtaining normalized data on brain maturation, by assessing its correlation with gestational age in a cohort of newborns.

METHODS

Singletons between 23 and 42 weeks of gestational age (GA) without brain lesions or evidence of growth restriction, born in two tertiary hospitals (2019-2020), were eligible. A CUS exam was performed within the 3rd postnatal day, including standard coronal and sagittal planes and videos. A qualitative score (figure 1) based on cerebral sulcal development was applied blindly to clinical

data, for photos and videos separately. The score includes the evaluation of sylvian fissure, cingulate sulcus, pericentral, temporal and frontal regions.











Example	Cingulate sulcus. C3	Description	Points
		Absent	0
		Barely visible indentation	1
		Clear triangular indentation	2
		I-shape	3
		Doubling	4

Figure 1. Score system for assessing the development of the cingulate sulcus (rest of the score system not shown)

RESULTS

Forty-five patients were included. Total score punctuation of videos for each patient and its correlation with GA are shown in figure 2. The score applied to videos showed a similar correlation index than when applied to photos ($r=0.964$ $p<0.01$ vs. $r=0.961$; $p<0.01$).

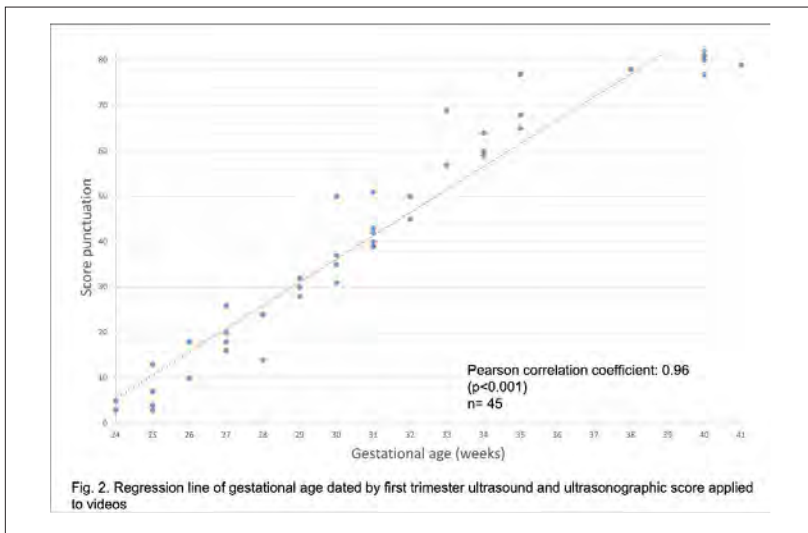

CONCLUSIONS

The ultrasonographic score proposed shows a strong correlation with the GA in a population of preterm and term newborns. Its application in sequential ultrasound exams in preterm babies from birth to term equivalent age may be useful for assessing their maturation process.

EP273 / #1259

E-Poster Viewing - Neonatology AS02-18. Neurology

Serum alanine alteration in perinatal asphyxia and neonatal hypoxic-ischaemic encephalopathy

D. Clifford^{1,2*}, D. O'Boyle³, A. Garvey⁴, E. Dempsey², S. Costelloe⁵, J. Bierau⁶, G. Boylan⁷, B. Walsh², D. Murray⁴

¹Cork University Hospital, Department of Paediatrics and Child Health, Cork, Ireland

²Cork University Maternity Hospital, Neonatal Department, Cork, Ireland

³University College Cork, Infant Research Centre, Cork, Ireland

⁴Cork University Hospital, Department of Paediatrics and Child Health, Cork, Ireland

⁵Cork University Hospital, Department of Clinical Biochemistry, Cork, Ireland

⁶Maastricht University Medical Centre, Department of Clinical Genetics, Maastricht, Netherlands

⁷University College Cork, Department of Paediatrics & Child Health, Cork, Ireland

BACKGROUND AND AIM

HIE is a leading cause of neuro-disability, affecting 1-8/1000 live full-term births. Early, accurate diagnosis can be difficult. Alanine has been identified as a potentially useful marker in predicting HIE. There are no published studies on normal cord blood alanine levels. We report alanine levels in healthy controls and those with HIE at birth and in the immediate postnatal period.

METHODS

Prospective study of alanine in cord blood of term infants with perinatal asphyxia (PA), including those who progressed to clinical encephalopathy (HIE) were recruited at birth, with matched healthy controls. A separate cohort of term infants was recruited to quantify postnatal alanine, during the first 12 hours of life. Alanine concentration was quantified in mmol/L using UPLC-MS/MS.

RESULTS

There was a significant difference in cord blood alanine concentrations; median 438mmol/L (360-516) controls, 509(452-543) PA, 515(460-611) HIE, $P<0.001$. Across grades of HIE the difference was significant: mild 497mmol/L (439-590), moderate 545(465-598), severe 733(556-808) ($P=0.015$). The reference interval derived was 213-675mmol/L. Postnatally, levels were highest in the first 3 hours and decreased by 6-12 hours. Mean (SD) mmol/L alanine was 686.7 (261.6, $n=17$) in the first 3 hours of life, 648 (265.3, $n=6$) at 4-6 hours and 540 (108.6, $n=4$) at 6-12 hours.

CONCLUSIONS

Alanine levels are elevated in cord blood of infants with HIE, increase with grade of HIE, and remain elevated for 6 hours after delivery. We report reference intervals for cord alanine concentrations in healthy term neonates. Alanine levels may aid in the clinical decision to initiate neuroprotective therapies.

EP274 / #2390

E-Poster Viewing - Neonatology AS02-18. Neurology

« Characterization of cell death after periventricular hemorrhagic infarction in premature human neonates »

C. Descloux^{1*}, V. Ginet², J.-P. Puyal², C. Gengler³, A. Truttmann¹

¹Centre Hospitalier Univesitaire Vaudois, Paediatrics / Neonatology, Lausanne, Switzerland

²Université de Lausanne, Département Des Neurosciences Fondamentales, Lausanne, Switzerland

³University Hospital Lausanne (CHUV), Institute of Pathology, Lausanne, Switzerland

BACKGROUND AND AIM

Periventricular Hemorrhagic Infarction (PVHI, 5-10% of very preterm VPT newborns) is the most severe form of intraventricular hemorrhage with parenchymal involvement. To date no study has systematically investigated the different types of cell death and which cell type it affects in this context.

METHODS

Human brain tissues were obtained from 17 VPT <28 gestationnal weeks (approved by local ethical committee), selected retrospectively from death reports of our Clinic of Neonatology (2005-2015). Cases with PVHI (ultra-sonographic/pathological diagnosis, n=9) were compared to controls without significant brain injuries according to the autopsy reports (n=8). Babies with cerebral malformations and known genetic anomalies were excluded. Stainings were performed with cell type and cell death markers.

RESULTS

Mean gestational age at birth of 26 GW, no difference in survival time. No significant difference in overall cell density or cortical thickness. No difference in global intensity of oligodendrocyte and neuronal markers. Significant increase in *cleaved-caspase-3* in the cortex and periventricular white matter in PVHI, and *GFAP* (astrogliosis) in the hippocampus (CA1) and periventricular/subcortical white matter. No difference in *pMLKL* (necroptosis).

CONCLUSIONS

Despite PVHI does not affect the neuronal and oligodendrocytic density, apoptosis and a strong astrogliosis occurs in the overall brain of VPT with PVHI compared to controls, confirming the few existing studies. We are now using markers of autophagy (LC3, Cath-D), since enhanced autophagy could be involved in neuronal death, of inflammation (Iba1, CD68) and ferroptosis (ferritin, GPX4), including new cases and performing co-labelling analysis of cell death and cell type markers.

EP275 / #2006

E-Poster Viewing - Neonatology AS02-18. Neurology

Predictive measures of head ultrasound (hus) performance in the evaluation of subgaleal hemorrhage in neonates

S. Eventov Friedman*, H. Azzam, I. Erlichman

Hadassah Medical Center, Hebrew University, Neonatology, Jerusalem, Israel

BACKGROUND AND AIM

Neonatal subgaleal hemorrhage (SGH) is a rare but potentially life-threatening event. HUS is routinely performed in all SGH cases in our center. We analyzed predictive measures of HUS findings and outcome among neonates with SGH and identified risk factors for cases with poor outcome in different SGH severity stages.

METHODS

A retrospective study including neonates born between the years 2010-2019 and had SGH. HUS results, maternal and pre and post-natal variables categorized according to outcome severity were reviewed. Predictive measures of HUS and outcome were calculated.

RESULTS

Analysis was conducted on 346 cases. All neonates with SGH were born via vacuum extraction. HUS was performed in 232 cases regardless of the severity stage of SGH. 61 cases (18%) had poor outcome. of them 49 had HUS, only 9 of them had pathological HUS findings except of the SGH. The sensitivity, specificity, positive and negative predictive values of HUS findings and poor

outcome were 18%, 99%, 80%, and 82%, respectively. Apgar scores below 5 and 7, at 1 and 5 min., respectively, and the need for resuscitation in the delivery room were the most predictive factors of poor outcome ($P<0.05$), as well as reduction in hematocrit level and moderate to severe SGH in physical examination.

CONCLUSIONS

Most SGH cases are mild and HUS findings in these cases do not predict outcome or contribute to the clinical course. HUS remains an important tool in the rare cases of complicated SGH. Accordingly, we suggest that only neonates with clinically moderate-severe SGH should have HUS examination after birth.

EP276 / #1246

E-Poster Viewing - Neonatology AS02-18. Neurology

Surgical drainage in preterm newborns with peri-intraventricular hemorrhage

C. Folques^{1*}, N. Faria², R. Moinho³, C. Pinto³, L. Carvalho³

¹Centro Hospitalar e Universitário de Coimbra, Hospital Pediátrico, Coimbra, Portugal

²Universidade de Coimbra, Faculdade De Medicina, Coimbra, Portugal

³Centro Hospitalar e Universitário de Coimbra, Hospital Pediátrico, Serviço De Cuidados Intensivos, Coimbra, Portugal

BACKGROUND AND AIM

Peri-intraventricular hemorrhage (PIVH) is a common cause of morbidity and mortality among preterm neonates, especially at gestational ages below 29 weeks. Commonly, PIVH leads to posthemorrhagic hydrocephalus (PHH). Despite the recommended treatment being neurosurgical, it is associated with non-negligible risks. This study aimed to assess the evolution of newborns with PIVH who had undergone surgical drainage.

METHODS

A retrospective exploratory study, including preterm newborns (24 to 32 weeks) admitted during the neonatal period to a Pediatric Intensive Care Unit of a tertiary hospital, which is one referral center for neonatal surgery and neurosurgery, with the clinical diagnosis of PIVH (classified according to Papile criteria), for 20 years (2001-2020).

RESULTS

Thirty-six newborns were included, with a median maximum PIHV grade of 3. Each newborn underwent one or more neurosurgical interventions, with

a median of 3 (minimum 1, maximum 6). A total of 100 interventions were performed, the most used being ventriculoperitoneal shunt (VPS, N=42), followed by Ommaya reservoir (N=32) and external ventricular drain (N=19). There were 8 cases of meningitis (22%), and its occurrence was higher in newborns submitted to a greater number of techniques ($p<0.001$). Five (14%) newborns died, 4 (11%) due to complications of prematurity unrelated to the neurosurgical procedures and 1 (3%) from progressive PHH refractory to multiple neurosurgical interventions. At 12 months of chronological age, 27 (75%) newborns had a VPS.

CONCLUSIONS

PIVH remains an important comorbidity in premature newborns, with a significant number of invasive procedures and associated complications.

EP277 / #1862

E-Poster Viewing - Neonatology AS02-18. Neurology

Neonatal hypertonia: an uncommon CASE

C. Fraga^{1*}, C. Viveiros², S. Soares¹, S. Duarte-Costa¹, A. Azevedo²

¹Unidade Local de Saúde de Matosinhos, EPE, Serviço De Pediatria, Matosinhos, Portugal

²Unidade Local de Saúde de Matosinhos, EPE, Unidade De Neonatologia, Matosinhos, Portugal

BACKGROUND AND AIM

The stiff posture in ventral suspension and the exaggerated startle are reasons of concern in the neonatal period. Authors intend to alert to a rare cause of neonatal hypertonia that can lead to sudden death during hypertonic episodes. So timely diagnosis can prevent such an outcome.

METHODS

Authors describe a clinical case of a term newborn on day 2 of life, with generalized hypertonia and episodes of hypoxemia initially treated as a neonatal seizure.

RESULTS

After the transfer to a Neonatal Intensive Care Unit (NICU) of a level II hospital in Northern Portugal, an exaggerated Startle reaction to unexpected stimuli was observed, with prolonged hypertonia of the limbs, resistance to habituation and no change of consciousness. Infectious, structural causes and epileptogenic phenomena were ruled out. The diagnosis, initially clinical (D12 of life), of hyperekplexia was made, later confirmed with genetic results as hereditary subtype type 1. Currently, the infant is seven months old, has adequate psychomotor development and episodes of hypertonia are controlled by clonazepam.

CONCLUSIONS

Hyperekplexia is characterized by an exaggerated startle response that can present in the 3rd trimester of pregnancy or at birth. Its diagnosis is clinical, but the early onset of hypertonia episodes directs the investigation towards the screening of acute acquired causes. Oral clonazepam is an effective therapy besides behavioral and rescue (Vigevano maneuver) interventions for hereditary cases. Long-term prognosis is good.

EP278 / #661

E-Poster Viewing - Neonatology AS02-18. Neurology

Asphyxia associated metabolite biomarker investigation (aambi) study: short-term clinical outcomes and at the age of 22 to 42 months

A. Franz^{1*}, H. Yapicioglu-Yildizdas², E. Taskin³, A. Yaman⁴, Y. Celik⁵, H. Simsek², S. Hamitoglu⁶, N. Aydinol⁷, E. Keles Gulnerman⁸, M. Keller⁹, M. Benders¹⁰, K. Annink¹¹, F. Groenendaal¹⁰, L. Hellström-Westas¹², O. Saugstad¹³, N. Marlow¹⁴, H.-P. Deigner¹⁵, M. Kohl¹⁶, R. Meyer¹⁷, A. Plum¹⁷, C. Steins-Rang¹⁷, G. Weiss¹⁷, P. Bartmann¹⁸

¹University Hospital Tübingen, Center For Pediatric Clinical Studies, Tübingen, Germany

²Cukurova University Hospital, Neonatoloji, Adana, Turkey

³Firat University Hospital, Neonatoloji, Elazig, Turkey

⁴Özel Güngören Hastanesi Istanbul, Neonatoloji, Güngören - Istanbul, Turkey

⁵Mersin University School of Medicine, Department of Neonatal Intensive Care Unit, Mersin, Turkey

⁶Cukurova University Hospital Adana, Neonatoloji, Adana, Turkey

⁷Özel Güngören Hastanesi, Neonatoloji, Güngören-Istanbul, Turkey

⁸Gazi University Hospital Ankara, Neonatology, Ankara, Turkey

⁹Kinderklinik Dritter Orden, Neonatologie, Passau, Germany

¹⁰University Medical Center Utrecht, Neonatology, Utrecht, Netherlands

¹¹Wilhelmina Children's Hospital, Neonatology, Utrecht, Netherlands

¹²Women's and Children's Health, Uppsala University, Neonatology, Stockholm, Sweden

¹³University of Oslo, Pediatric Research, Oslo, Norway

¹⁴UCL, Institute For Women's Health, London, United Kingdom

¹⁵Hochschule Furtwangen, Institute of Precision Medicine, Villingen-Schwenning, Germany

¹⁶Hochschule Furtwangen, Institute of Precision Medicine, Villingen-Schwenningen, Germany

¹⁷InfanDx AG,., Köln, Germany

¹⁸Universitätsklinikum Bonn, Eltern-kind-zentrum (elki), Bonn, Germany

BACKGROUND AND AIM

Perinatal hypoxic-ischemic encephalopathy (HIE) can be treated by neuro-protective interventions (NPI) like therapeutic hypothermia (TH). Neonates at risk cannot be reliably identified based on clinical parameters only. AAMBI

aims to define a set of metabolomic biomarkers best suited to close this diagnostic gap.

METHODS

Prospective observational study: Group 1: 65 infants meeting criteria indicating TH; Group 2: 38 infants with suspected perinatal brain injury (mild HIE) but not undergoing TH; Group 3: 52 Infants with $\text{pH} \geq 7.25$ and adaptation disorder requiring postnatal surveillance. Neonatal clinical outcome was based on results of central cMRI and aEEG assessments and highest Thompson Scores (TS) within the first 7 hours. Outcome classification at 22-42 months based on neurological assessment, Bayley-Test and Ages-and-Stages-Questionnaire.

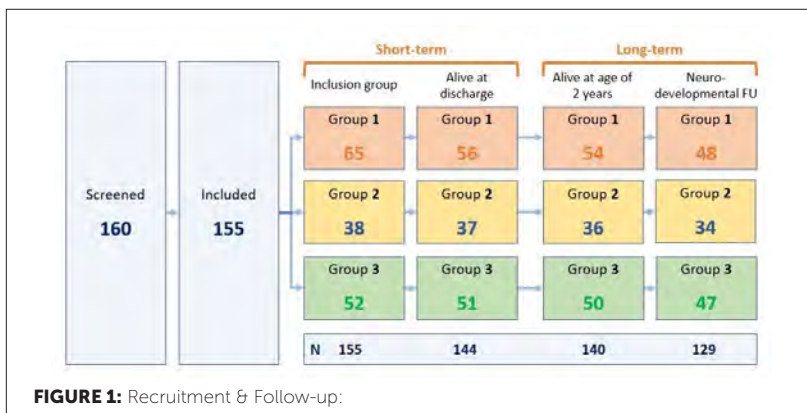

RESULTS

Fig.2 presents a comparison of short-term and long-term clinical outcome. Fig.3 displays the distribution of highest TS values in the first 7 hours after birth.

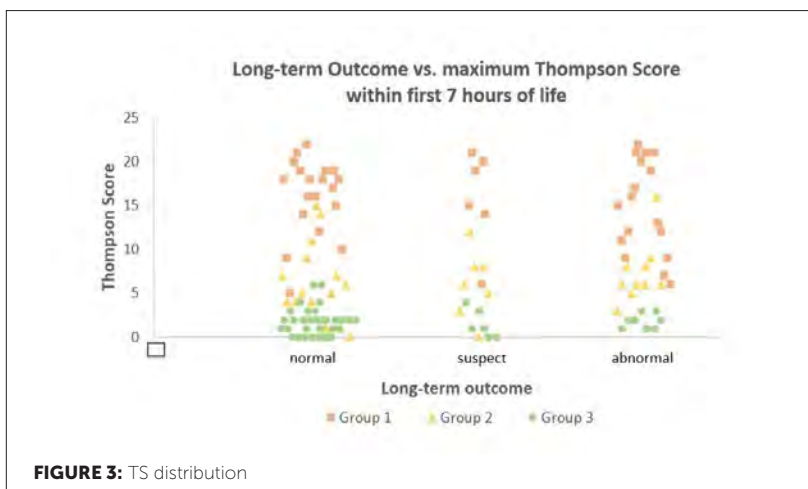
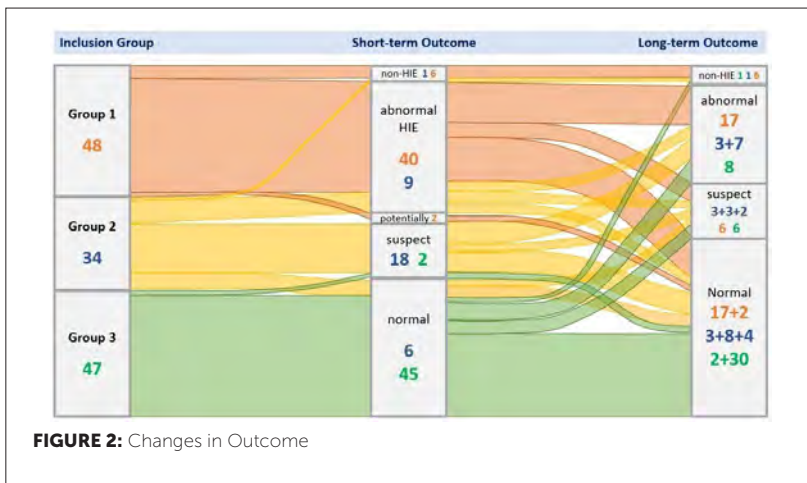

CONCLUSIONS

For all 3 patient groups, typical inclusion criteria for TH do not enable a reliable prognosis of the developmental status at 22-42 months. Maximum TS values in the first 7 hours were not significantly associated with long-term outcome. This study shows that other diagnostic parameters like metabolomic biomarkers are urgently needed to improve the classical diagnostic tools for HIE. Blood samples obtained during this study are now subjected to metabolomic analyses. Funding: State of North Rhine-Westphalia (No.: 005-1505-0002), German Federal Ministry for Education and Research (No. 13GW0297A) and InfanDx AG.

EP279 / #2003

E-Poster Viewing - Neonatology AS02-18. Neurology

Monitoring of seizures in newborns in a tertiary centre

A. Kage^{1*}, D. Wertheim², I. Lancoma-Malcolm¹, C. Francia¹, D. Shah¹

¹Royal London Hospital, Neonatology, London, United Kingdom

²Kingston University, Faculty of Science, Engineering and Computing, Kingston-Upon-Thames, United Kingdom

BACKGROUND AND AIM

Background The neonatal period is vulnerable for developing seizures, particularly in the first two days to the first week after birth. Incidence of seizures in infants born at term is 1-3 per 1000 live births with a higher incidence noted in preterm infants. **Aims** To describe demographics, clinical presentation, diagnoses and MRI brain findings in a cohort of neonates with or at risk of seizures needing cerebral function monitoring (CFM) admitted to a single tertiary centre.

METHODS

Preterm or term infants who were monitored for seizures with CFM at the Royal London Hospital, by treating clinicians, were recruited into a prospective multidisciplinary observational study after obtaining consent from parents between May 2021 and April 2022. The study was approved by the local research ethics committee. CFM recordings were interpreted by two experienced neonatologists, MR images were reported by neuroradiologists.

RESULTS

38 neonates received CFM monitoring of whom 29 were recruited into the study. Median (range) gestation and birthweight were 39 (29+2, 40+5) weeks

and 3115 (1364, 4410) grams. Apgar scores at 10 minutes were 0 for 5/29. 19/29 (65%) were suspected to have clinical seizures by treating clinicians, 13 of whom had electrographic seizures noted on amplitude-integrated EEG (aEEG). Median (range) day of onset of seizures was 1 (0-69). At discharge, 21/29 were on oral feeds, 4 had nasogastric feeds and 4 died before discharge. 16/25 had normal neurological examinations.

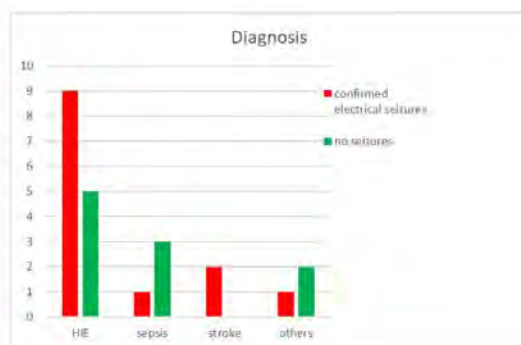
**FIGURE 1****FIGURE 2**

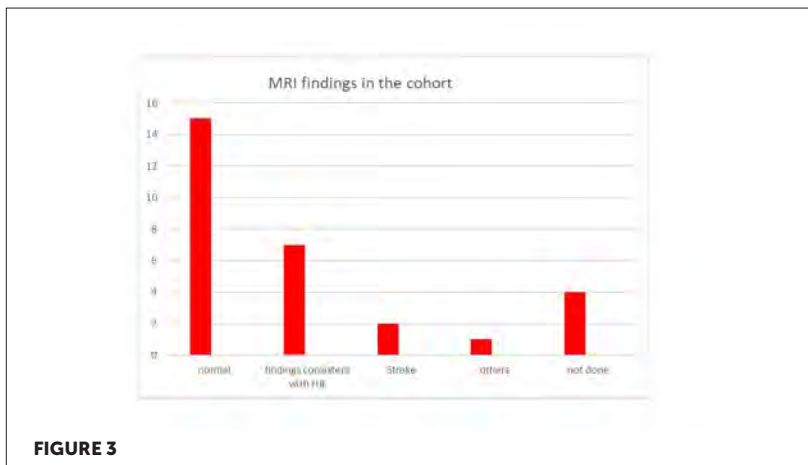
**FIGURE 3**

CONCLUSIONS

Seizures are a common and important problem in newborns. Commonest aetiology in this cohort was HIE.

EP280 / #2045**E-Poster Viewing - Neonatology AS02-18.
Neurology****Risk of therapeutic hypothermia in infants with
suspect birth asphyxia****I. Lagerström^{1*}, D. Daugeliene², J. Bolk¹, S. Cnattingius¹, B. Skiöld³,
M. Altman¹, S. Johansson¹**¹Karolinska Institutet, Division of Clinical Epidemiology, Department of Medicine Solna, Stockholm, Sweden²Sachs' Children and Youth Hospital, -, Stockholm, Sweden³Karolinska Institutet, Department of Women's and Children's Health, Stockholm, Sweden**BACKGROUND AND AIM**

Initiation of therapeutic hypothermia (TH) after birth asphyxia is based on assessment of markers of birth asphyxia and neurological symptoms, so-called A- and B-criteria. Studies on how A-criteria are associated with development of hypoxic ischemic encephalopathy (HIE) and initiation of TH are scarce. Our aim was to investigate associations between A-criteria and risk of TH, a proxy for moderate/severe HIE.

METHODS

Population-based cohort study including 1351 live born term singleton infants with A-criteria (Apgar score ≤ 5 at 10 minutes, need of resuscitation at birth, pH < 7.0 , or base deficit ≥ 16 mmol/L in umbilical cord blood). The data was electronically extracted from medical charts and linked to the Swedish Neonatal Quality Register and National Patient Register. The main outcome measure was the risk of TH presented as adjusted odds ratios with 95% confidence intervals, adjusted for the other A-criteria, infant sex, gestational age, birth weight for gestational age, mode of delivery, maternal age, parity and body mass index.

RESULTS

TH was administered to 89 (6.6%) of the infants. Low Apgar score and need of resuscitation were associated with TH, with adjusted odds ratios (95% CI) of 10.7 (5.10-22.5) and 8.43 (3.34-21.3). Low pH <7.0 was not significantly associated with an increased risk (adjusted odds ratio 1.96 [95% CI 0.99-3.87]). No infant had a base deficit ≥ 16 mmol/L as the only fulfilled A-criterion.

CONCLUSIONS

Low Apgar score and need for resuscitation were associated with increased risk of TH, but low pH was not. This information could be valuable when evaluating infants after birth asphyxia.

EP281 / #1633**E-Poster Viewing - Neonatology AS02-18.
Neurology****Clinical prediction models and predictors for death or adverse neurodevelopmental outcome in term newborns with hypoxic ischemic encephalopathy: a systematic review and evidence MAP.**

J. Langeslag^{1,2*}, K. Berendse², J.G. Daams³, M. Leeflang⁴, W. Onland², A. Van Kaam^{1,2}, T. De Haan²

¹Amsterdam UMC, Amsterdam Reproduction & Development Research Institute, Amsterdam, Netherlands

²Amsterdam UMC location University of Amsterdam, Neonatology, Amsterdam, Netherlands

³Amsterdam UMC location University of Amsterdam, Medical Library, Amsterdam, Netherlands

⁴Amsterdam UMC location University of Amsterdam, Clinical Epidemiology, Amsterdam, Netherlands

BACKGROUND AND AIM

Although many prognostic parameters have been studied, an internationally accepted, validated prognostic model to predict the clinical outcome of asphyxiated infants suffering from hypoxic-ischemic encephalopathy is currently lacking. The aim of this study is to identify, appraise and summarize available clinical prediction models, and provide an overview of all investigated predictors for the outcome death or neurodevelopmental impairment in this population.

METHODS

A systematic literature search was performed in Medline and Embase. Two reviewers independently included eligible studies and extracted data. The quality was assessed using PROBAST for prediction model studies and QUIPS for predictor studies. An evidence map was created for all predictors identified.

RESULTS

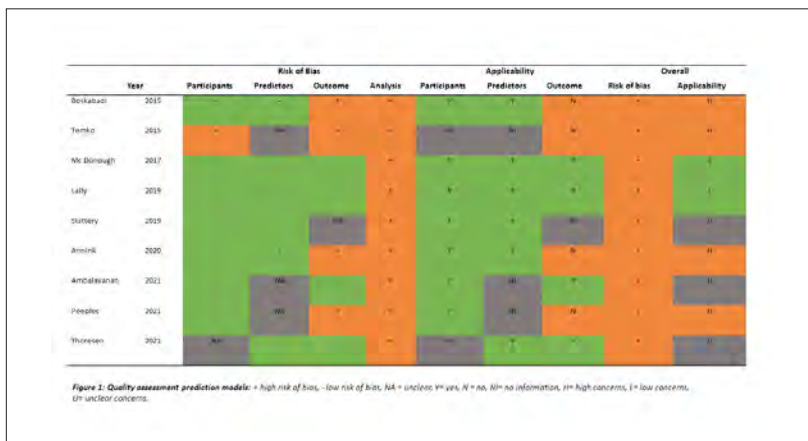

A total of 9 prediction models were included. These models were very heterogeneous in number of predictors assessed, methods of model derivation, and primary outcomes. All studies had a high risk of bias following the PROBAST assessment. Only one study performed an internal validation and none had an external validation. A total of 105 predictor studies were included investigating various predictors as MRI, EEG and aEEG. An evidence map of these studies showed that investigated predictors, timing of predictors, primary outcomes and results were very heterogeneous. Furthermore, the quality of those studies varied greatly.

CONCLUSIONS

Given the low methodological quality of the currently published clinical prediction models implementation into clinical practice is not yet possible. Therefore is an urgent need to develop a prediction model which complies with the PROBAST guideline. The evidence map may guide the inclusion of predictors in such a model.

EP282 / #2378**E-Poster Viewing - Neonatology AS02-18.
Neurology****Systematic review and meta-analysis of preclinical studies on mesenchymal stem cell therapy in perinatal arterial ischemic stroke****V. Lehnerer^{1*}, A. Badura¹, O. Romantsik², R. Guzman^{3,4}, S. Wellmann¹, M. Bruschetti²**

¹University Children's Hospital Regensburg (KUNO), Hospital St. Hedwig of the Order of St. John, Department of Neonatology, Regensburg, Germany

²Paediatrics, Lund University, Skane University Hospital, Lund, Sweden, Department of Clinical Sciences Lund, Lund, Sweden

³University Hospital Basel, 4031 Basel, Switzerland, Department of Neurosurgery, Basel, Switzerland

⁴University of Basel, 4056 Basel, Switzerland, Faculty of Medicine, Basel, Switzerland

BACKGROUND AND AIM

Perinatal arterial ischemic stroke (PAIS) is a serious neurologic disorder leading to long-term complications of surviving infants. Mesenchymal stem cells (MSCs) have emerged as novel therapeutic agents with promising results in experimental studies of PAIS. This systematic review aims to determine the efficacy and safety of MSCs for the treatment of PAIS in preclinical studies.

METHODS

were published in a preregistered protocol (CRD42021239642). Functional outcome was set as primary endpoint assessed e.g. by cylinder rearing or water maze test. All published controlled studies on MSCs in animals until postnatal 14 with PAIS were included. Literature search was performed with no restrictions for language or publication date.

RESULTS

20 studies met inclusion criteria (14 in rats, 6 in mice). All were performed in term-born animals, sex was reported only in 10 studies. PAIS was obtained by either occlusion followed by hypoxia (n=14), artery occlusion only (n=5) or with reperfusion after 30 min (n=1). MSCs were most frequently delivered via intracerebral injection (n=9), three days after induction of PAIS (n=8), at a dose of 5×10^4 to 5×10^6 cells with the most common source being bone marrow (n=9). In meta-analysis MSC treatment is superior to control treatment in regard to functional outcome ($p < 0.01$).

CONCLUSIONS

MSCs improve sensorimotor and cognitive performance in PAIS-injured neonatal animals. However, quality of the evidence is low due to high or unclear risk of bias in most domains of the SYRCLE's risk of bias tool and imprecision of the estimates.

EP283 / #2598**E-Poster Viewing - Neonatology AS02-18.
Neurology****Association between socioeconomic status, brain growth and 5 years neurodevelopmental outcomes of extremely preterm infants**

**R. Lima^{1*}, J. Lopez¹, M. Tataranno¹, C. Koopman-Esseboom¹,
H. Swanenburg De Veye², F. Lammertink¹, F. Groenendaal¹, N. Van
Der Aa¹, J. Dudink¹, M. Benders¹**

¹UMC Utrecht, Neonatology, Utrecht, Netherlands

²UMC Utrecht, Psychology, Utrecht, Netherlands

BACKGROUND AND AIM

Socioeconomic status (SES) contributes to alterations in brain development and disparities in neurodevelopmental outcomes of preterm infants. However, the exact role of SES and the possible association with brain growth and long-term neurodevelopmental outcome has not been investigated yet. Thus, this study aims to relate maternal (MATED) and paternal (PATED) educational level to brain growth during NICU stay, and to behavioural and cognitive outcomes at five years of age in extremely premature born infants.

METHODS

102 extremely preterm infants (born <28 weeks of gestation) admitted to the Wilhelmina Children's Hospital in Utrecht, were included. Brain growth of various tissues was quantified using ~30 and 40 weeks postmenstrual age MRI scans. Cognitive and behavioural outcome was assessed using standardised tests (WPPSI-III-NL; CBCL). Multivariable regression analyses were performed and adjusted for several neonatal variables.

RESULTS

Brain growth from 30 to 40 weeks of gestational age was positively associated with two highly educated parents (WM: $B = 590.95$, $p = 0.03$; CGM: $B = 502.23$, $p = 0.04$). However, there were no significant associations with the growth of the cerebellum and the amygdala. A significant association was found between MATED ($p = 0.02$) and cognitive score. Lower PATED was associated with more internalizing ($p = 0.04$) and externalizing ($p = 0.02$) behavioural problems.

CONCLUSIONS

Our findings suggest that MATED and PATED may play a role in the development of early and long-term neurodevelopment impairment in extremely premature infants. This may highlight the need to reinforce early interventions in high risk patients to reduce the impact of socioeconomic disparities.

EP284 / #859**E-Poster Viewing - Neonatology AS02-18.
Neurology****Endothelial progenitor cell administration promotes neurovascular unit development in growth restricted and appropriately grown fetal LAMBS**

A. Bell¹, T. Yawno¹, A. Watt², I. Dudink¹, A. Sutherland², Y. Pham², S. Miller¹, A. Malhotra^{3*}

¹Monash University, Obstetrics and Gynaecology, Clayton, Australia

²Hudson Institute of Medical Research, Trc, Clayton, Australia

³Monash University, Paediatrics, Clayton, Australia

BACKGROUND AND AIM

Fetal growth restriction (FGR) is associated with alterations at the neurovascular unit (NVU). Endothelial progenitor cells (EPCs) are a type of stem cells capable of stimulating neovascularisation, with their exogenous administration potentially offering a therapeutic strategy to protect the developing NVU in FGR and other types of perinatal brain injury. Aims: To investigate the impact of EPC administration on the development of neurovascular unit in growth restricted and appropriately grown fetal lambs.

METHODS

This investigation compared four groups of lambs: a) untreated appropriate for gestational age (AGA) (n=7), b) untreated FGR (n=5), c) AGA with EPCs (n=6), d) FGR with EPCs (n=6). Single umbilical artery ligation (SUAL) was performed on fetal sheep at 88-days (0.6 gestation), inducing FGR, with AGA fetuses instrumented but not ligated. Human umbilical cord blood-derived EPCs were administered intravenously at 113-days gestation. Fetuses were euthanised at 127-days, with brain tissue collected and immunohistochemistry analysis

conducted to investigate vascular density and morphology (laminin), VEGF expression, vascular remodelling (MMP-9), barrier and metabolic function (GLUT1), vascular astrocyte (laminin/GFAP) and pericyte (desmin/

RESULTS

SUAL resulted in reduced fetal body weight ($p=0.002$) and increased brain:body weight ratio ($p=0.003$) in the lambs. EPC administration was associated with increased overall vascular density throughout the brain (e.g. subcortical white matter (sCWM) $p=0.0001$), primarily due to increased vessel size (sCWM $p=0.02$). EPC administration was also associated with increases in VEGF expression (sCWM $p=0.0007$) and vascular astrocyte coverage (sCWM $p=0.01$). Changes associated with EPC administration occurred across both experimental groups, with no significant changes specific to FGR.

CONCLUSIONS

Intravenous EPC administration to fetal lambs promoted widespread increased cerebral vascular density, likely due to increasing vessel size. EPC administration was also associated with protective effects on various NVU components.

EP285 / #863**E-Poster Viewing - Neonatology AS02-18.
Neurology****Systemic postnatal corticosteroids and mri
measurements of corpus callosum and cerebellum
in extremely preterm infants****C. Han-Menz¹, G. Whiteley², R. Evans², A. Malhotra^{1*}**¹Monash University, Paediatrics, Clayton, Australia²Monash Health, Diagnostic Imaging, Clayton, Australia**BACKGROUND AND AIM**

Postnatal systemic corticosteroid use in preterm infants has been associated with reduction in brain growth and adverse long-term neurological deficits, though information on their specific impact on corpus callosum and cerebellar growth using magnetic resonance imaging (MRI) is limited. Aim: To investigate the impact of postnatal systemic corticosteroids on corpus callosum and cerebellar measurements on MRI brain scans done at term equivalent age.

METHODS

Single centre retrospective cohort study including extremely preterm infants (born < 26 weeks gestation) who had MRI brain scans at term equivalent age. Corpus callosum and cerebellar measurements were measured by two radiologists working independently and blinded to steroid use. Comparative analyses between exposed (to steroid) and non-exposed groups were conducted.

RESULTS

Eighty three extremely preterm infants (mean(SD) 24.9(0.9) weeks gestation, 721(156) g birth weight) were included; thirty eight with postnatal corticosteroid exposure and forty five without exposure. Postnatal corticosteroid administration (vs. no-exposure) resulted in a decreased length of corpus callosum (LCC) (mean(SEM) 36.82(0.49) vs. 39.29(0.47) mm, $p=0.0005$), and LCC:biparietal diameter (mean(SEM) 0.4807 (0.0082) vs. 0.5037 (0.0007), $p=0.0293$). These remained significant after adjusting for gestational age differences. There were no statistically significant changes in cerebellar measurements (vermis height and transcerebellar diameter).

CONCLUSIONS

Postnatal systemic corticosteroid use in extremely preterm infants was associated with reduction of corpus callosum measurements on MRI brain scans done at term equivalent age.

EP286 / #1592**E-Poster Viewing - Neonatology AS02-18.
Neurology****Evaluation of the therapeutic potential of msc treatment in a combined model of hyperoxia-mediated developmental brain and lung injury****S. Obst^{1*}, J. Herz¹, M. Möbius², M. Rudiger², U. Felderhoff-Müser¹, I. Bendix¹**

¹University Hospital Essen, Department of Paediatrics I, Neonatology and Experimental Perinatal Neurosciences, Essen, Germany

²Technische Universität Dresden, Department For Neonatology and Pediatric Intensive Care, Clinic For Pediatric and Adolescence Medicine, Faculty of Medicine, Dresden, Germany

BACKGROUND AND AIM

11% of all newborns worldwide are born preterm. Despite increasing survival rate, the risk for chronic lung disease like Bronchopulmonary dysplasia (BPD) and encephalopathy of prematurity (EoP) remain high. The extra-uterine foetus is very susceptible to high oxygen exposure, leading to developmental injury especially the immature brain and lung. Currently there are no therapies available. Mesenchymal stem cells (MSC) seem to be promising but their therapeutic effect to ameliorate hyperoxia-mediated brain and lung injury remain unknown.

METHODS

To establish a hyperoxia model suitable to assess both affected organs, neonatal Wistar rats are exposed to 80% oxygen for 7 days. To assess the structural damage hematoxylin-eosin staining in lungs and immunohistochemical analysis for myelin basic protein in brains were performed. Changes in gene or protein expression for myelin in the brain and structural markers like alpha smooth muscle actin and periostin in the lung were investigated with qPCR

and Western Blot analysis. Cytokine expression and growth factors were analysed with qPCR.

RESULTS

obtained so far revealed a distinct white matter injury in the brain and associated morphological changes in the lung.

CONCLUSIONS

Lung and brain injury shown in the preliminary results are characteristic for EoP and BPD. Future analysis will focus on effects of MSC treatment on vascularization in both organs using light sheet microscopy. In addition, behaviour analyses will be performed to investigate the motor-cognitive function in 6 week and 6 month old rats.

EP287 / #1263**E-Poster Viewing - Neonatology AS02-18.
Neurology****Anterior cerebral artery resistive index measurement and early cerebral nirs recording in very premature infants: is there an association?****M. Akin, F. Sarı, B. Ceran, D. Bozkaya, E. Okman*, E. Dizdar**

Ankara City Hospital, Neonatology, Ankara, Turkey

BACKGROUND AND AIM

The prediction of adverse conditions in the preterm neonatal brain might be improved by cerebral monitoring using combined measures of cerebral function, including oxygenation and blood flow parameters.

METHODS

This prospective cohort study enrolled very preterm infants, <32 weeks of gestational age, admitted to a tertiary neonatal intensive care unit. Cerebral saturation(Csat) levels were continuously monitored using NIRS for 72h after birth. Anterior cerebral artery resistive index(ACA-RI) measurements were obtained on the first, third, and seventh days of life by using transcranial Doppler ultrasound. The relationship of ACA-RI and Csat measurements with each other and with intraventricular hemorrhage(IVH) and early mortality were compared.

RESULTS

A total of 96 preterm infants with Csat and ACA RI measurements were analyzed. Age at birth was 28.3 ± 1.9 weeks and birth weight was 1090 ± 305 g. The mean Csat of the infants was $77.1 \pm 8.2\%$ during the first 72h of life. Mean

ACA RI values were 0.76 ± 0.10 , 0.75 ± 0.08 , and 0.77 ± 0.08 on the first, third, and seventh days of life, respectively. There was no significant association between ACA RI and Csat levels. RI on the first day of life was significantly higher in infants delivered by the cesarian section than in those delivered vaginally (0.77 vs 0.69 ; $p=0.017$). ACA RI values measured on the first day of infants who died in the early period were significantly higher (0.83 vs 0.76 ; $p<0.001$).

CONCLUSIONS

There was no association between ACA RI and Csat in the early period of life. ACA RI values on the first postnatal day might be significant for predicting early mortality in very preterm infants.

EP288 / #1636

E-Poster Viewing - Neonatology AS02-18. Neurology

L1cam mutation with varying imaging features: a case series

S. O’Riordan^{1*}, D. O’Sullivan², F. Maloney³, N. Mcsweeney^{1,2}

¹Cork University Hospital, Department of Paediatrics & Child Health, Cork, Ireland

²University College Cork, Department of Paediatrics & Child Health, Cork, Ireland

³Cork University Hospital, Department of Radiology, Cork, Ireland

BACKGROUND AND AIM

We describe two cases of L1CAM mutation. Pathogenic mutations of the L1CAM gene/ L1 syndrome cause a spectrum of disorders including X-Linked hydrocephalus with stenosis of aqueduct of Sylvius (HSAS). Classic features are severe intellectual disability, adducted thumbs and spasticity.

METHODS

Case Series.

RESULTS

Case 1: This infant presented with ventriculomegaly at the 20 week anatomy scan confirmed on subsequent fetal MRI. Elective C-Section was performed at 37 weeks. MRI Day of life (DOL)² showed severe dilatation of the lateral ventricles, cobblestone lissencephaly, stenosis of the cerebral aqueduct, cerebellar hypoplasia and brainstem kinking at the mesencephalic pontine junction. Tri-exome sequencing confirmed a hemizygous pathogenic variant of the L1CAM gene. VP shunt insertion occurred on DOL 7. He has adducted thumbs and axial hypotonia, but is making developmental progress to date.

Case 2: This infant presented with ventriculomegaly at 32 weeks and was delivered by planned C-Section at 34+2 weeks. MRI Brain DOL 1 showed aqueduct of Sylvius stenosis with extensive supratentorial hydrocephalus with thin residual mantle of cortical tissue. The cerebellum was hypoplastic. He had a VP shunt inserted DOL 8. He has adducted thumbs and axial hypotonia. Tri-exome result confirmed again confirmed L1CAM mutation.

CONCLUSIONS

Our two cases illustrate the spectrum of radiological abnormalities in L1 syndrome and the clinical sign of adducted thumbs. L1CAM encodes for a membrane glycoprotein mediating cell-to-cell adhesion at the cell surface which plays roles in neuronal migration, axonal growth, and in the development of the ventricular system and cerebellum.

EP289 / #902**E-Poster Viewing - Neonatology AS02-18.
Neurology****Neonatal and 3-month cranial mri in relation to neurodevelopment in hypoxic-ischemic encephalopathy**

C. Parmentier^{1*}, M. Lequin², T. Alderliesten¹, N. Van Der Aa¹, J. Dudink¹, M. Benders¹, J. Harteman¹, C. Koopman-Esseboom¹, L. De Vries¹, F. Groenendaal¹

¹University Medical Center Utrecht, Neonatology, Utrecht, Netherlands

²University Medical Center Utrecht, Radiology, Utrecht, Netherlands

BACKGROUND AND AIM

To determine the value of magnetic resonance imaging (MRI) at 3 months to assess injury evolution and predict outcome in infants with perinatal asphyxia and hypoxic-ischemic encephalopathy (HIE) with neonatal MRI abnormalities.

METHODS

Retrospective single-center study including 55 infants with HIE (n=22 cooled) with repeat MRI at 2-4 months after birth to assess evolution of neonatal MRI lesions. Neonatal MRI was analyzed using a validated score. Three-month MRI was assessed using one- and two-dimensional measurements and a new qualitative score (including white matter (WM), gray matter (GM), and cerebellum subscores), and related to 18-24 months' outcome. Adverse outcomes included cerebral palsy, neurodevelopmental delay, hearing/visual impairment, and epilepsy.

RESULTS

Basal ganglia/thalami (BGT) injury on neonatal MRI generally evolved into BGT atrophy with gliosis, and WM/watershed injury evolved into WM/cortical atrophy on 3-month MRI. The normal outcome group (n=33) had a larger cerebral width and BGT area, and smaller lateral ventricle dimensions on 3-month MRI. They showed more increase in cerebral width and BGT area between neonatal and 3-month MRI. The GM score for neonatal and 3-month MRI were both independently associated with adverse outcomes: the 3-month GM score had higher specificity (1.000 versus 0.909) and lower sensitivity (0.591 versus 0.727) than neonatal MRI.

CONCLUSIONS

Qualitative and quantitative GM abnormalities on 3-month brain MRI in infants with HIE and neonatal MRI abnormalities are associated with outcome, indicating usefulness for early treatment evaluation in neuroprotective trials. However, the superiority of repeat 3-month MRI compared to neonatal MRI alone in clinical practice is debatable, warranting further research.

EP290 / #2352**E-Poster Viewing - Neonatology AS02-18.
Neurology****Temporal evolution of electrographic seizures in neonates with hypoxic-ischaemic encephalopathy during and after therapeutic hypothermia treatment****A. Pavel^{1,2*}, V. Livingstone^{1,2}, S. Mathieson^{1,2}, E. Dempsey^{1,2},
D. Murray^{1,2}, G. Boylan^{1,2}**¹University College Cork, Department of Paediatrics and Child Health, Cork, Ireland²University College Cork, Infant Research Centre, Cork, Ireland**BACKGROUND AND AIM**

Despite therapeutic hypothermia (TH) seizures are common in newborns with Hypoxic-Ischaemic Encephalopathy (HIE). Our aim was to describe the temporal evolution of electrographic seizures in infants during and after TH.

METHODS

Secondary analysis of a European cohort of infants with moderate-severe HIE, with prolonged continuous-electroencephalography (EEG) monitoring. Seizures were annotated and seizure burden (SB) characteristics described: total SB (TSB), SB during and after end of TH, maximum seizure burden (MSB), status epilepticus (SE), seizure period. Abnormal outcome at 2-years of age was defined as >1 SD delay on standardised testing, cerebral palsy, epilepsy, or death.

RESULTS

Out of 181 infants with moderate-severe HIE, 91(50%) infants had seizures. 66/91 infants received TH and had EEG monitoring for at least 8hours after the end of TH (Table1). 44(67%) infants had seizures during TH only (TH-group) and 22(33%) infants had seizures after cooling ended, during and after rewarming (RW-group). Majority (97%) of infants with seizures after TH had seizures during TH also. Only two infants had new onset seizures during rewarming. TSB was significantly higher in RW-group (median(IQR) 166.5(54.2-274.8)minutes) versus TH-group (65.8(22.1-99.9)minutes), p-value=0.003. (Table2) Outcome was available for 46(70%) infants: 63% infants had abnormal outcome in the RW-group versus 23% in TH-group; significantly more infants died in the RW-group compared to TH-group; 44% versus 2%, p-value=0.001.

Table 1. Demographics

		TH-group (median (IQR)) ^k		RW-group (median (IQR)) ^k	
	n*	n=44	n*	n=22	
Place of birth, inborn in recruiting hospital		26 (59.1%)		8 (36.4%)	
Gestational age, weeks		40.3 (39.5-41.2)		39.7 (39.0-40.5)	
Mode of delivery, urgent delivery		26 (59.1%)		15 (68.2%)	
Birth weight, g		3585 (3139-3996)		3384 (3020-3693)	
Sex, male		22 (50%)		16 (72.7)	
Apgar score 1 minute	42	1 (0-2)		0 (0-1)	
Apgar score 5 minute	42	3 (1-4)		3 (0-4)	
Apgar score 10 minute	38	5 (3-6)	21	4 (1-6)	
Assisted ventilation at 10 minutes		34 (77.3%)		20 (31.8%)	
Cord pH	36	7.01 (6.81-7.21)	18	7.00 (6.80-7.15)	
Age at start of cooling, hours		2 (1-3)		2 (1-6)	
Duration of cooling, hours		72 (72-72)		72 (71-72)	
Age at start of rewarming, hours		75 (73-76)		73 (73-78)	
Age at start of EEG monitoring, hours		4.3 (2.9-10.4)		7.1 (4.2-11.9)	
EEG monitoring duration, hours		94.0 (86.3-103.0)		104.5 (89.9-137.3)	
HIE severity					
Moderate		30 (68.2%)		7 (31.8%)	
Severe		14 (31.8%)		15 (68.2%)	
Abnormal outcome	30	10 (22.7%)	16	10 (62.5%)	
Death	30	1 (2.3)	16	7 (43.8%)	

TH-group, therapeutic hypothermia group; RW-group, rewarming group; *complete data for the variable unless otherwise stated; ^kmedian (IQR) unless otherwise stated; EEG, electroencephalogram.

Table 2. Seizure group comparison

	TH-group (median (IQR)) ^a n=44	RW-group (median (IQR)) ^a n=22	p value
Seizure period, hours	11.6 (3.1-27.4)	67.9 (35.0-86.0)	<0.001
TSB, minutes	65.8 (22.1-99.9)	166.5 (54.2-274.8)	0.003
Seizure burden until end of cooling, minutes	65.8 (22.1-99.9)	154.3 (33.1-197.0)	0.023
Seizure burden during rewarming and after, minutes		43.7 (16.6-72.2)	
Total number of seizures	12 (5-36)	93 (24-133)	<0.001
Number of seizures before end of cooling	12 (5-35)	57 (14-91)	0.002
Number of seizures during and after rewarming		22.5 (7.5-52.2)	
MSB, minutes	22.1 (12.0-36.0)	23.3 (14.0-33.3)	0.663
Hours after birth MSB was reached, hours	19.0 (13.0-28.0)	45.0 (26.2-80.0)	<0.001
Status epilepticus, yes	14 (31.8%)	8 (36.4%)	0.712
Age at first seizure, hours	13.7 (9.2-18.3)	19.6 (14.5-50.0)	0.002
Median seizure duration, seconds	128 (79-460)	77 (62-119)	0.011
Any antiseizure treatment, yes	39 (88.6%)	20 (90.9%)	1

TH-group, therapeutic hypothermia group; RW-group, rewarming group; ^amedian (IQR) unless otherwise stated; TSB, total seizure burden; MSB, maximum seizure burden.

CONCLUSIONS

Electrographic seizures persist beyond TH treatment in one third of infants with HIE, particularly those with severe HIE and high seizure burdens during TH and are a poor prognostic sign. This also has implications for the duration of EEG monitoring.

EP291 / #2361

E-Poster Viewing - Neonatology AS02-18. Neurology

The characteristics of neonatal seizures in moderate and severe hypoxic-ischaemic encephalopathy

A. Pavel^{1,2*}, J. O'Toole^{1,2}, S. Mathieson^{1,2}, V. Livingstone^{1,2},
E. Dempsey^{1,2}, D. Murray^{1,2}, G. Boylan^{1,2}

¹University College Cork, Department of Paediatrics and Child Health, Cork, Ireland

²University College Cork, Infant Research Centre, Cork, Ireland

BACKGROUND AND AIM

Seizures in newborns with Hypoxic-Ischaemic Encephalopathy(HIE) are variable in length(duration), onset and spread(cerebral cortex involvement) and intensity(power). Our aim was to correlate neonatal seizure characteristics with HIE severity.

METHODS

Secondary analysis of seizures in infants with moderate-severe HIE, recruited to two European multi-centre cohort studies. Infants with continuous-electroencephalography(EEG) monitoring had seizures annotated by expert neurophysiologists. HIE grade was established collating clinical, EEG and MRI information. Classical summary measures of seizures were calculated: seizure period, total seizure burden(TSB), seizure number, median seizure duration, maximum hourly seizure burden(MSB), status epilepticus. Novel quantitative seizure power analysis was performed: total and mean seizure power, minimum and maximum EEG-channel power.

RESULTS

Over 2649 seizures from 64 infants were analysed: 38(59.4%) moderate and 26(40.6%) severe HIE; 52 infants received therapeutic hypothermia (28 infants with moderate and 24 with severe HIE). 41% of seizures originated over central-posterior regions and secondary generalisation was common (87%). Compared to moderate HIE, infants with severe HIE had significantly more seizures (median:43 vs 11), higher seizure period (median:33.2 vs 13.3 hours) and TSB (median:121.8 vs 61.2 minutes). However, seizures in severe HIE had significantly lower power, even after adjusting for hypothermia status (Table).

TABLE 1:

	Moderate HIE group n=37	Severe HIE group n=26	OR (95% CI)	p value
	[median (IQR)]	[median (IQR)]		
Seizure period (hours)	13.3 (3.3-28.4)	33.2 (15.2-69.5)	8.081 (2.078-31.419)	0.003
TSB (minutes)	61.2 (22.4-81.6)	121.8 (66.7-280.2)	6.218 (1.705-22.670)	0.006
TSB/Seizure period (minutes/hour)	4.9 (1.9-8.8)	3.4 (2.2-8.4)	0.557 (0.195-1.588)	0.273
Number of seizures	11 (4-32)	43 (21-103)	11.011 (2.872-42.211)	<0.001
Median seizure duration (seconds)	119.2 (87.3-456.8)	101.2 (70.2-130.2)	0.278 (0.075-1.024)	0.054
MSB (minutes/hour)	17.0 (12.4-29.1)	28.6 (16.4-39.6)	3.272 (0.725-14.771)	0.123
Age when MSB was reached (hours)	18.5 (12.7-36.5)	28.0 (19.7-55.0)	8.184 (1.300-51.522)	0.025
Status epilepticus (yes), n(%)	9 (23.7)	12 (46.2)	2.762 (0.943-8.086)	0.064
First seizure duration (seconds)	190.5 (80.0-685.5)	69.0 (40.7-254.0)	0.376 (0.141-1.006)	0.052
Age at first seizure (hours)	15.0 (8.9-27.8)	17.6 (13.9-25.6)	1.688 (0.361-7.901)	0.506
Quantitative seizure power analysis*				
Total seizure power per infant (μV^2)	1407 (629-6480)	1952 (945-6959)	1.620 (0.666-3.941)	0.287
Mean seizure power per infant (μV^2)	143 (96-243)	58 (27-113)	0.051 (0.008-0.314)	0.001
Total seizure power per minute (μV^2 /minute)	36 (17-74)	27 (8-60)	0.298 (0.093-0.956)	0.042
Total seizure power/Seizure period (μV^2 /hour)	263 (86-464)	83 (37-177)	0.223 (0.075-0.661)	0.007
Minimum power channel (μV^2)	18 (8-32)	2 (1-4)	0.010 (0.001-0.089)	<0.001
Maximum power channel (μV^2)	1196 (447-2991)	660 (325-2189)	0.589 (0.236-1.471)	0.257

HIE, Hypoxic-Ischaemic Encephalopathy; Seizure period, time (hours) from start of first seizure to end of last seizure; TSB, Total Seizure Burden; MSB, Maximum Hourly Seizure Burden; Status Epilepticus, seizure burden of minimum 30 minutes within one hour; Total seizure power per baby: average power channel per seizure, then sum all power seizure per baby; Mean seizure power per baby: average power channel per seizure, then average power seizure per baby; Seizure power per minute: total seizure power per baby/TSB; Minimum power channel: the channel with lowest power from every seizure averaged per seizures; Maximum power channel: the channel with highest power from every seizure averaged per seizures.

*All quantitative features were log₁₀ transformed for logistic regression analysis. For the transformed variables the odds ratio represents the change in odds for a one-standard deviation increase in the log variable.

CONCLUSIONS

Although infants with severe HIE had overall higher seizure burden (frequent seizures, higher TSB, longer seizure period), our power analysis has shown that these seizures were less intense, possibly reflecting the severity of the primary injury. This may have implications for seizure identification as low power seizures are harder to detect, especially using aEEG monitoring.

EP292 / #1578**E-Poster Viewing - Neonatology AS02-18.
Neurology****Correlation between heart rate variability and severity of brain injury measured by intracerebral glycerol in a newborn piglet model of hypoxic-ischemic encephalopathy**

M. Pedersen^{1*}, T.C.K. andelius¹, H. andersen¹, M. andersen¹, N. Bøgh², C. Omann³, K. Kyng¹, T. Brink Henriken¹

¹Aarhus University Hospital, Department of Pediatrics, Aarhus N, Denmark

²Aarhus University Hospital, The Mr Research Centre, Aarhus, Denmark

³Aarhus University Hospital, Department of Cardiothoracic and Vascular Surgery, Aarhus N, Denmark

BACKGROUND AND AIM

Heart rate variability (HRV) is proposed as a novel biomarker of severity of brain injury in hypoxic-ischemic encephalopathy (HIE). The ability to predict the severity of brain injury from HRV remains uncertain. Intracerebral glycerol has been used as a direct measure of severity of brain injury in traumatic brain injury and in experimental studies of HIE. The aim of this study was to investigate whether HRV is associated with severity of hypoxic-ischemic brain injury measured by intracerebral glycerol in a newborn piglet model.

METHODS

Fourteen newborn piglets were anaesthetized and subjected to a global, standardized hypoxic-ischemic insult. One hour after end-hypoxia, the animals were randomized to therapeutic hypothermia or normothermia and observed for another 24h. Glycerol measured by intracerebral microdialysis catheters at 24h was used as the measure of severity of brain injury. Electrocardiography was recorded continuously and the HRV measure stand-

ard deviation of R-R intervals (SDNN) at 24h was calculated as 1h average of successive 5-minute epochs.

RESULTS

Preliminary analysis showed a significant correlation (r -0.6, 95% CI -0.9; -0.1) between SDNN and intracerebral glycerol at 24h. Stratification by therapeutic hypothermia and normothermia revealed a compatible correlation in both strata. Results of HRV measures at different time points and correlations with amplitude-integrated electroencephalography score will be presented at the conference.

CONCLUSIONS

Preliminary results showed low SDNN was associated with high intracerebral glycerol at 24h as a marker of severity of brain injury following hypoxia and ischemia.

EP293 / #2399**E-Poster Viewing - Neonatology AS02-18.
Neurology****Sonif.Ai: empowering the medical professional
with fast and accurate interpretation of neonatal
EEG****S. Gomez-Quintana¹, F. O'Sullivan¹, A. Factor², E. Popovici^{1*},
A. Temko¹**¹University College Cork, Electrical and Electronic Engineering, Cork, Ireland²University College Cork, Anatomy and Neuroscience, Cork, Ireland**BACKGROUND AND AIM**

Continuous neonatal EEG monitoring and interpretation requires extensive clinical expertise, which is not available 24/7. We present a solution which allows accurate interpretation of neonatal EEG by non-trained clinical personnel. This aims to reduce the latency and improve the detectability of abnormal neurological events, such as seizures, in under-resourced environments.

METHODS

Decisions that are made by artificial intelligence are not always explainable. A solution is developed to combine AI algorithms with a human-centric EEG interpretation method. Neonatal EEG is converted to sound using an AI-driven attention mechanism. Using this method perceptual characteristics of seizure events such as EEG frequency evolution in time can be heard, and an hour of multichannel EEG can be intuitively analysed in five seconds of audio, with minimal training. A survey has been conducted among targeted end-users on a publicly available dataset of neonatal EEG from 79 newborns.

RESULTS

The survey attracted 23 clinicians who answered all audio questions without accessing EEG. Sensitivity of 0.89 and Specificity of 0.78 were obtained for detection of seizure presence. This is on par with the level of interobserver agreement of 3 neurophysiologists who annotated the data, while outperforming the accuracy of AI alone and comparing favourably with the aEEG accuracy reported for the same task.

CONCLUSIONS

Sonif.AI shows a great potential to simplify the task of detecting patients suffering from seizures while providing an extra layer of explainability to AI algorithms. Implementation on low-power embedded systems allows for maximum flexibility in terms of the point of care settings.

EP294 / #701**E-Poster Viewing - Neonatology AS02-18.
Neurology****Quality of life of preterm infants with intra-ventricular haemorrhages at a 10-year follow up: an observational STUDY**

A. Rela^{1*}, S. Jary², C. Lea³, P. Blair², W. Hollingsworth⁴, A. Whitelaw², K. Luyt², D. Odd¹

¹Cardiff University, Population Health, Cardiff, United Kingdom

²University of Bristol, Bristol Medical School, Bristol, United Kingdom

³Royal Cornwall Hospital, Paediatrics, Truro, United Kingdom

⁴University of Bristol, Population Health Sciences, Bristol, United Kingdom

BACKGROUND AND AIM

Post-haemorrhagic ventricular dilation (PHVD) is commonly seen in extremely preterm babies, carries significant morbidity, and may cause neonatal mortality. There is a lack of literature on the subsequent health-related quality of life (HRQoL) in childhood; making decisions around neonatal care difficult; especially around issues of withholding or withdrawing care. The aim is to assess the quality of life of preterm babies with IVH at 10 years of age using two validated questionnaires.

METHODS

Children with PHVD were assessed as part of the 10-year follow up of the DRIFT trial. The HRQoL outcome was measured using parentally reported EQ-5D-5L and HUI-3 questionnaires. Both questionnaires produce a summary score anchored at 1 (best health) and 0 (equivalent to death).

RESULTS

A total of 51 infants had HRQoL data. The median scores were 0.65 (IQR 0.36 to 0.84) for the EQ-5D-5L and 0.52 (IQR (0.22 to 0.87) for the HUI-3. The most severe problems from the EQ-5D were reported on the pain and anxiety domains, while the HUI-3 reported worst measures for hearing and emotional problems. In the multivariable analysis, infants with grade 4 (vs grade 3) IVH's had lower scores, and those who received DRIFT, higher scores, for both measures.

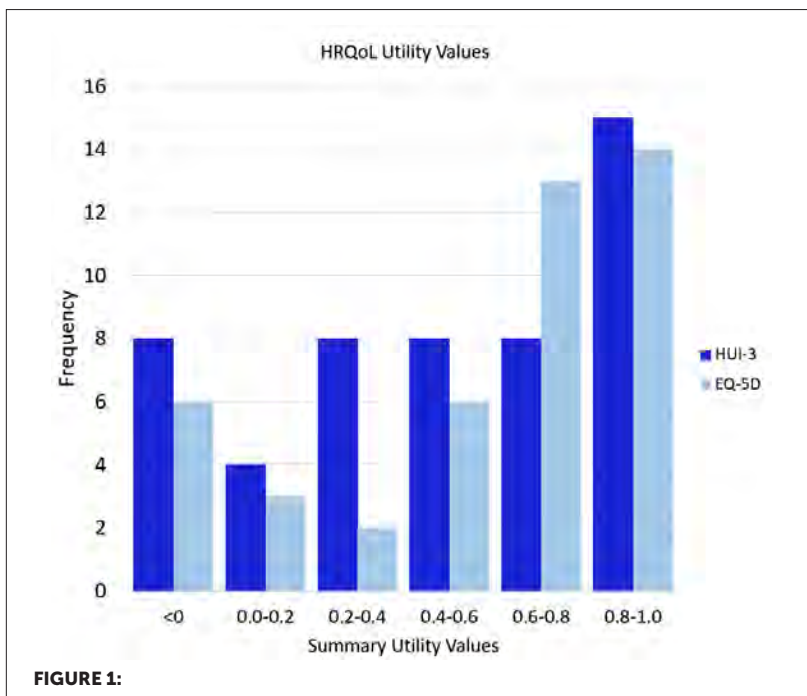

CONCLUSIONS

Children who survive to 10 years of age after PHVD have HRQoL scores around 0.6; similar to children with ASD. Specific domains appear to be more impacted than others (e.g. pain and emotional problems) and higher IVH grade was predictive of poorer HRQoL. DRIFT therapy may increase HRQoL.

EP295 / #1447**E-Poster Viewing - Neonatology AS02-18.
Neurology****Early brain growth in very low birth weight infants related to term-equivalent magnetic resonance imaging**

E. Ruiz-González^{1,2*}, M. Lubián-Gutiérrez^{1,3}, N. Jiménez-Luque^{1,4}, A. Segado Arenas^{1,2}, S. Lubián-López^{1,2}, I. Benavente-Fernández^{1,2,5}

¹Biomedical Research and Innovation Institute of Cádiz (INiBICA), Research Unit, Puerta Del Mar University, Cádiz, Spain

²Puerta del Mar University Hospital, Division of Neonatology, Department of Paediatrics, Cádiz, Spain

³Puerta del Mar University Hospital, Division of Neurology, Department of Pediatrics, Cádiz, Spain

⁴University of Cádiz, Psychology, Cádiz, Spain

⁵University of Cádiz, Area of Paediatrics, Department of Child and Mother Health and Radiology, Medical School, Cádiz, Spain

BACKGROUND AND AIM

Preterm develop smaller total and regional brain volumes compared to term newborns. Our aim is to study early brain growth related to perinatal factors in very low birth weight infants (VLBWI).

METHODS

We studied pre- and perinatal conditions, comorbidities during NICU admission and socioeconomic status in a cohort of VLBWI. Manual segmentation of total brain volume (TBV) was performed in weekly 3D-ultrasonographies. We studied the pattern of brain growth related to their term magnetic resonance image (MRI).

RESULTS

We included 138 VLBWI: 120 (87%) with normal term-MRI and 18 (13%) with abnormal term-MRI. Accounting for repeated measures and time, we found TBV in those with normal term-MRI was related to GA, being small for gestational age (SGA), sex, and duration of parenteral nutrition (TPN) while in those with abnormal MRI findings it was related to GA, TPN, and comorbidities. TBV growth rate differed in those with normal term-MRI and those with abnormal term-MRI ($16.94 (\pm 2.29)$ vs. $14.35 (\pm 1.27)$ cm^3/week ; $P=0.0001$). We found a slowing of brain growth rate in those with ≥ 3 comorbidities, with a mean difference of $9.23 \text{ cm}^3/\text{sem}$ ($P=0.014$) after 32 weeks PMA that increases to $13.87 \text{ cm}^3/\text{sem}$ ($P=0.030$) after 37 weeks PMA.

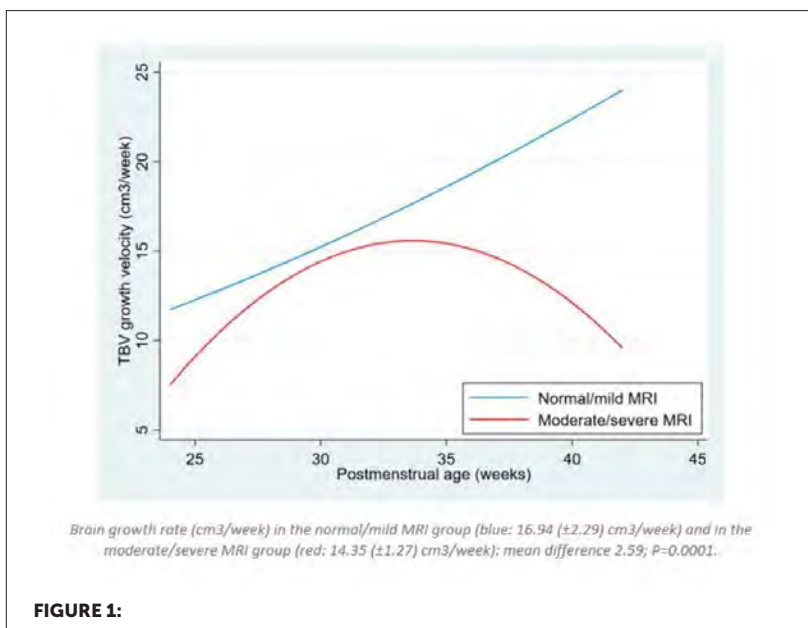

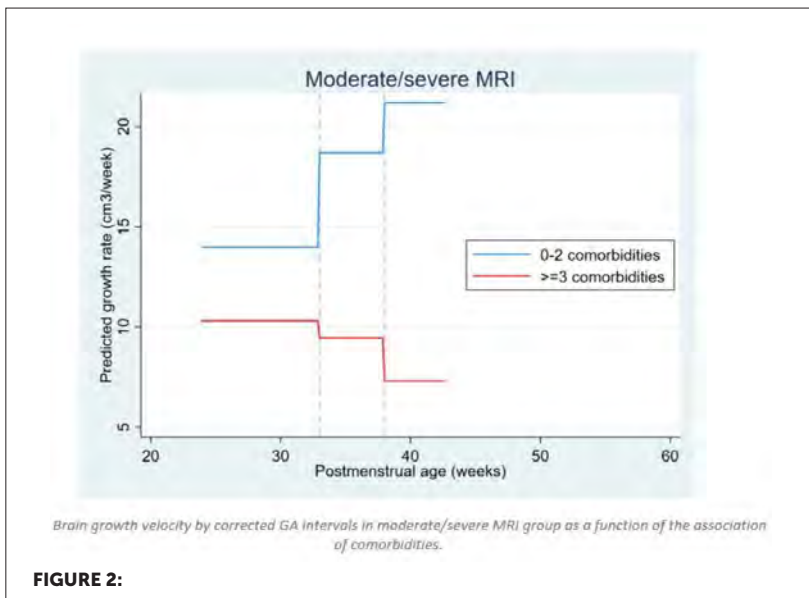

CONCLUSIONS

Brain growth pattern in preterm infants with normal term-MRI is related to GA, being SGA, sex and TPN duration. This pattern changes in the presence of comorbidities with a slower growth rate. We suggest early monitoring of TBV could be useful to detect deviated patterns of brain growth.

EP296 / #1242

E-Poster Viewing - Neonatology AS02-18. Neurology

Cerebral mri and mrs in newborn piglets with and without seizures in a lipopolysaccharide-sensitized hypoxic cardiac arrest MODEL

**K.V. Seiersen^{1*}, H. andersen¹, M. andersen¹, T.C.K. andelius¹,
M. Pedersen¹, B. Løfgren², S. Ringgaard³, K. Kyng¹, T. Henriksen¹**

¹Aarhus University Hospital, Paediatrics and Adolescent Medicine, Aarhus, Denmark

²Randers Regional Hospital, Department of Medicine, Aarhus, Denmark

³Aarhus University, Mr Research Center, Aarhus, Denmark

BACKGROUND AND AIM

Seizures in relation to neonatal hypoxic-ischemic brain injury have been associated with poor neurological outcome. However, the potential underlying pathology is poorly understood. We aim to study the impact of post cardiac arrest (CA) seizures on magnetic resonance imaging (MRI) and spectroscopy (MRS) outcomes in a newborn piglet model of lipopolysaccharide (LPS) sensitized CA.

METHODS

In newborn piglets, systemic inflammation was induced by infusion of the bacterial endotoxin LPS under general anesthesia. After four hours of LPS infusion, CA was induced by endotracheal tube clamping. The piglets were randomized to either resuscitation with epinephrine or placebo. Seizures were detected clinically and/or by amplitude integrated electroencephalography during the observational period. Several MRI and MRS parameters were assessed after 14 hours, including perfusion evaluated by arterial spin labelling.

RESULTS

30 piglets were included and randomized, of which 1 died during resuscitation, and 7 died prior to MRI and MRS. No difference in seizure frequency by epinephrine (+/-) was detected (6/14 piglets resuscitated with epinephrine: 7/15 piglets with placebo). When compared to piglets without seizure, piglets with seizures had increased cerebral perfusion; epinephrine: 162 (77) vs 44 (9) ml/min/100g, $p = 0.02$, Placebo: 192 (78) vs 51 (6) ml/min/100 g, $p = 0.02$. We found no statistically significant differences in any of the other MRI/MRS outcomes.

CONCLUSIONS

At 14 hours after CA, perfusion was increased in piglets with post-CA seizures. Seizures may result in increased perfusion due to altered cerebral metabolism, which in turn may contribute to poor neurological outcome.

EP297 / #1551

E-Poster Viewing - Neonatology AS02-18. Neurology

Establishment of a double-hit model of maternal inflammation and postnatal hyperoxia to investigate the therapeutic potential of mesenchymal stem CELLS

M. Serdar*, M. Gallert, K. Kempe, M. Rizazad, J. Herz, U. Felderhoff-Müser, I. Bendix

University Hospital Essen, Department of Pediatrics I, Neonatology and Experimental Perinatal Neurosciences, Essen, Germany

BACKGROUND AND AIM

Premature born infants represent the biggest patient cohort in pediatrics and the main risk for premature birth is related to maternal inflammation. Premature born infants are highly susceptible to different environmental factors, such as high oxygen concentration and inflammation. As demonstrated previously, hyperoxia as well as inflammation induces perinatal brain injury mostly affecting white matter structures. Up to now, effective therapies are missing. Mesenchymal stem cells (MSCs) appear promising due to their described neuro-protective effects.

METHODS

We first establish a combination model of prenatal inflammation and postnatal hyperoxia. At E20 pregnant Wistar-rat-dams received a single injection of 100 µg/kg LPS (lipopolysaccharide) or NaCl i.p. (intraperitoneal). Pups were kept under hyperoxia (80% O₂) or room-air from P3 to P5. The differentiation capacity of oligodendrocytes was assessed by MBP-protein and APC/CC1 at P11 via immunohistochemistry (IHC) and western blotting (WB). To check how

MSCs affect specifically oligodendrocytes after a hyperoxic event, we used primary oligodendrocyte precursor cells (pOLN). Following hyperoxia for 8 h, pOLN were co-cultured at day 3 in vitro with naïve or hypoxic pre-conditioned MSCs for 48h. The degeneration, proliferation and differentiation capacity of pOLNs were analyzed by Olig2, TUNEL, PCNA and MBP stain.

RESULTS

The combination of maternal inflammation and postnatal hyperoxia revealed a significant reduction of MBP expression by IHC and WB in vivo. Hyperoxia-induced degeneration and reduced proliferation of pOLNs were ameliorated following MSC co-cultures.

CONCLUSIONS

With this newly establishment double-hit model, we will assess the therapeutic effect of MSCs focusing on long-term studies of motor-cognitive development.

EP298 / #1537

E-Poster Viewing - Neonatology AS02-18. Neurology

Adverse impact of short term whole body vibration, as experienced during neonatal ambulance transport, on the developing brain: a mechanism for injury?

L. Shipley*, I. Bloor, D. Sharkey

University of Nottingham, Centre For Perinatal Research, School of Medicine, Nottingham, United Kingdom

BACKGROUND AND AIM

Preterm ambulance transfer in early life exposes infants to whole body vibration (WBV) in excess of safe adult levels and is associated with intraventricular haemorrhage (IVH). Animal models of chronic (many weeks) WBV demonstrate neuronal inflammation, apoptosis and worse neurodevelopmental outcomes. We aimed to evaluate the effects of a single, short WBV exposure, as experienced during typical neonatal ambulance transportation, on the developing brain using a novel rodent model.

METHODS

Thirty postnatal day 4 and day 21 rats (equivalent to 25 week and post-term human neuronal development stages respectively) were randomly divided into control (C) and vibration (V) groups. V groups were exposed to 2m/s² WBV for 90 minutes. Animals were euthanised after 24 hours post exposure. Cortical brain tissue was obtained for quantitative RT-PCR to analyse mRNA gene expression of inflammatory and apoptotic pathways. Data were analysed using Mann-Whitney. The study was compliant with the UK Animal Act 1986.

RESULTS

Day 4 V group showed significantly increased expression of genes involved in inflammation (IL-6, TNF α and TLR4), endoplasmic reticulum stress (GRP78, ATF6, NF κ B-1) and cell death pathways (CHOP, Caspase 3). In contrast, day 21 V rodents had no increase in mRNA within any pathway (Figure).

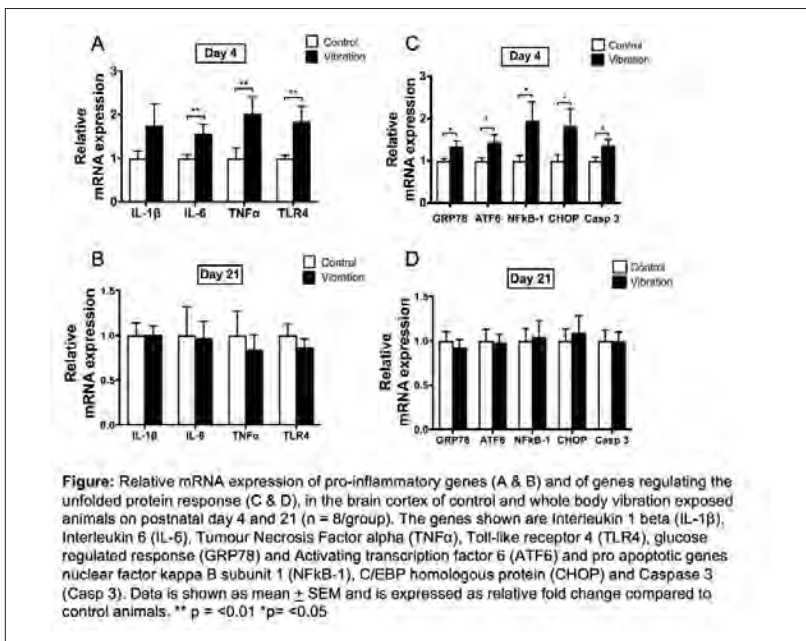

CONCLUSIONS

A single, short-term WBV exposure, as experienced during neonatal transportation, is associated with neuronal injury via activation of neuroinflammatory and apoptotic pathways in the more immature rodent. This mechanism of injury could partly explain the worse neurodevelopmental outcomes for transported preterm infants even in the absence of significant IVH.

EP299 / #2558

E-Poster Viewing - Neonatology AS02-18. Neurology

Intraventricular hemorrhage in full-term newborns with different etiologies: case series

T. Sljivancanin Jakovljevic^{1*}, Z. Mikovic², S. Mihailovic¹, J. Martic³,
J. Kojovic³, T. Lazic Mitrovic¹

¹Obstetrics and Gynecology Clinic Narodni Front, Neonatology, Belgrade, Serbia

²Obstetrics and Gynecology Clinic Narodni Front, High-risk Pregnancy, Belgrade, Serbia

³Mother and Child Health Care Institute of Serbia "Dr Vukan Cupic", Neonatology, Belgrade, Serbia

BACKGROUND AND AIM

Intraventricular hemorrhage (IVH) in term newborns is a very rare finding, usually with a different source of bleeding in comparison to preterm newborns.

METHODS

Four vaginally delivered male newborns with an Apgar score of 10 at 5 minutes were observed.

RESULTS

Observation: The first case was from an uncomplicated pregnancy. Fever was recorded on the fourth day of life. Ultrasound (US) of the central nervous system (CNS) revealed IVH right grade (gr) III and left gr I. Meningitis was diagnosed. The second case was from a pregnancy complicated with chronic hypertension, gestational diabetes mellitus (DMG) type A1 and green amniotic fluid. CRP elevation and convulsions were registered on the fourth/fifth day of life. Further investigations revealed thrombosis of the deep cerebral, Galen and thalamostriate veins, along with hemorrhage in the left thalamus,

lateral ventricles and their plexuses. The third case was from an IVF pregnancy complicated with thrombophilia, DMG class A1 and hypothyroidism. Due to the right parietal cephalhematoma, a CNS ultrasound was performed revealing IVH right gr I and left gr IV. The fourth case was diagnosed with a single umbilical artery in utero. At birth, respiratory distress, hypotonia, caput succedaneum, facial suffusion and intolerance of enteral intake were noticed. Convulsions were detected. CNS ultrasound revealed IVH left gr I and right gr II/III and bilateral hypoxic ischemic encephalopathy.

CONCLUSIONS

Although an accidental finding, IVH in term newborns could be a very serious condition leading to neurodevelopmental delay, which emphasizes the need to always keep in mind its occurrence.

EP300 / #1086

E-Poster Viewing - Neonatology AS02-18. Neurology

The influence of late prematurity on the encephalopathy exam of infants with HIE

Z. Vesoulis*, A. Kodidhi, M. Riley

Washington University in St. Louis, Pediatrics, St. Louis, United States of America

BACKGROUND AND AIM

The modified Sarnat score is used to identify moderate-severe encephalopathy in infants >36 weeks gestational age (GA). Late preterm infants are frequently screened for encephalopathy and undergo therapeutic hypothermia (TH). There is concern that neurodevelopmental differences of preterm infants may independently influence the exam. Our aim was to examine differences in modified Sarnat score components between late preterm and term infants with HIE.

METHODS

Infants with moderate-severe HIE who underwent TH between 01/2019-12/2021 were identified. At-risk infants undergo Sarnat scoring up to 6 hours after birth or until TH treatment is started. Perinatal and outcome characteristics were extracted along with component scores of the worst exam (coded normal=0, mild=1, moderate=2, severe=3). The total Sarnat score is the sum of the worst score of the autonomic components and the six state/neuromuscular/reflex components. Infants were grouped as late preterm (34-36 weeks GA) and term (>36 weeks GA). Variables were compared using the Mann-Whitney U-test or Fisher's Exact test, where appropriate, and considered significant where $p < 0.05$.

RESULTS

136 infants were identified, 35 of whom were late preterm. Late preterm infants had lower mean GA and birthweight, higher 10-minute Apgar scores, and greater LOS.

Table 1. Demographic and outcome characteristics

	Preterm (n=35)	Term (n=101)	P value
Gestational age, mean (SD), weeks	35.43 (0.7)	38.47 (1.2)	<0.01
BW, mean (SD), grams	2723 (568)	3237 (591)	<0.01
Female sex, n (%)	14 (40%)	31 (31%)	0.41
Apgar 5-min, median (IQR)	5 (3.5-6.5)	4 (3-7)	0.48
Apgar 10-min, median (IQR)	7 (5-7)	5 (4-7)	0.04
pH, mean (SD)	7.02 (0.12)	7.02 (0.15)	0.64
Seizures, n (%)	5 (14%)	25 (25%)	0.24
Died, n (%)	0 (0)	5 (5%)	0.32
LOS, median (range)	21 (15.3-29)	13 (9-18)	<0.01

Footnotes: BW=birthweight; IQR=interquartile range; LOS=length of stay

There were no statistically significant differences in component or total scores between the groups.

Table 2. Sarnat score components

	Preterm (n=35)	Term (n=101)	P value
Level of consciousness, median (IQR)	2 (1-2)	2 (1-2)	0.27
Spontaneous activity score, median (IQR)	2 (2-2)	2 (2-2)	0.48
Tone score, median (IQR)	2 (2-2)	2 (2-2)	0.22
Posture score, median (IQR)	1 (1-1)	1 (0-1)	0.35
Suck score, median (IQR)	2 (1-2)	2 (1-2)	0.86
Moro score, median (IQR)	3 (2-3)	2 (2-3)	0.13
Autonomic function			
Pupil score, median (IQR)	0 (0-1)	0 (0-1)	0.49
HR score, median (IQR)	1 (0-1)	0 (0-1)	0.69
Respiration score, median (IQR)	0 (0-1)	0 (0-1)	0.28
Total score, median (IQR)	12 (10-13)	11 (9-12)	0.14

Footnotes: Components scored where 0=none, 1=mild, 2=moderate, 3=severe.

The distribution of Moro subcomponent and total scores demonstrated modestly higher values for late preterm infants.

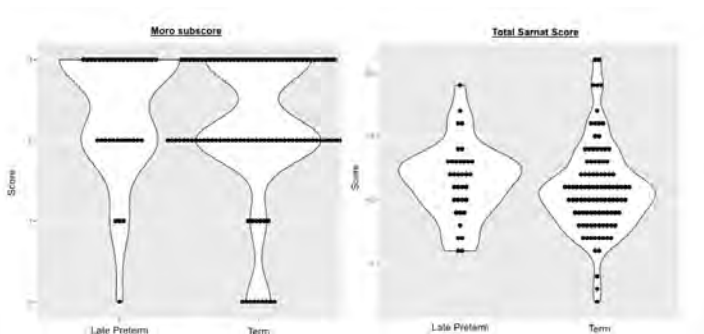

FIGURE 1;

CONCLUSIONS

Although late prematurity is associated with increased LOS and modestly worse Moro reflex impairment, there are no statistically or clinically-significant differences in Sarnat exam scores between late preterm and term infants.

EP301 / #1181**E-Poster Viewing - Neonatology AS02-18.
Neurology****Impaired cerebral vasomotion in the setting of increased cerebral oxygen extraction****Z. Vesoulis*, H. Whitehead, D. Swofford, S. Liao**

Washington University in St. Louis, Pediatrics, St. Louis, United States of America

BACKGROUND AND AIM

Vasomotion is the spontaneous, low-frequency, rhythmic contraction of arteries which facilitates tissue oxygen delivery. Little is known about the relationship between vasomotion and cerebral oxygenation/extraction in preterm infants. Our objective was to identify the relationship between changes in cerebral oxygenation and loss of cerebral/systemic vasomotion in preterm infants.

METHODS

Preterm infants <32 weeks with umbilical arterial lines underwent cerebral NIRS (StO_2), mean arterial blood pressure (MABP), and pulse oximetry (SpO_2) monitoring for 72h after birth. Each recording was divided into 10-min non-overlapping windows. Mean cerebral saturation (StO_2) and fractional tissue oxygen extraction (FTOE, defined as $SpO_2 - StO_2 / SpO_2$) were calculated for each window. Vasomotion strength in systemic blood flow (MABP) and cerebral blood flow (StO_2) were calculated using Welch's power spectral density method in the frequency band 30-150 mHz for each window. Strength of association was evaluated using standard linear fitting.

RESULTS

45,187 ten-minute windows were captured from 96 infants with a mean GA of 25.3 weeks, BW of 810g; 29% had IVH, and 16% died.

Table 1. Sample descriptive statistics

	Included patients n=96
Gestational age, mean (SD), weeks	25.3 (1.2)
Birthweight, mean (SD), grams	810 (201)
Female sex, n (%)	40 (42%)
Antenatal steroids, n (%)	
None	17 (18%)
Partial	23 (24%)
Complete	56 (58%)
Histologic chorioamnionitis, n (%)	35 (36%)
Apgar score, median (range)	
1-minute	3 (0-8)
5-minutes	6 (1-9)
CRIB-II score, median (range)	11.5 (6-19)
Died, n (%)	15 (16%)
Inotropic support ^a	31 (33%)
Any IVH, n (%)	28 (29%)
Grade 3/4 IVH, n (%)	9 (9%)

Footnote ^a defined as receiving dopamine, dobutamine, epinephrine, norepinephrine

Systemic vasomotion (low-frequency oscillation in MABP) had no relationship with cerebral saturation ($R^2 = -0.06$) or FTOE ($R^2 = 0.10$). In contrast, a strong relationship was noted between cerebral vasomotion and cerebral saturation ($R^2 = 0.99$) and cerebral FTOE ($R^2 = -0.93$).

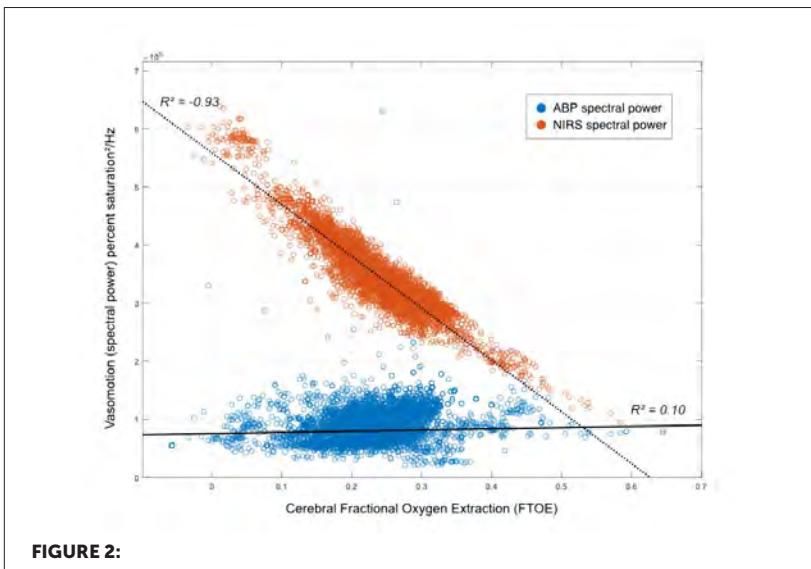
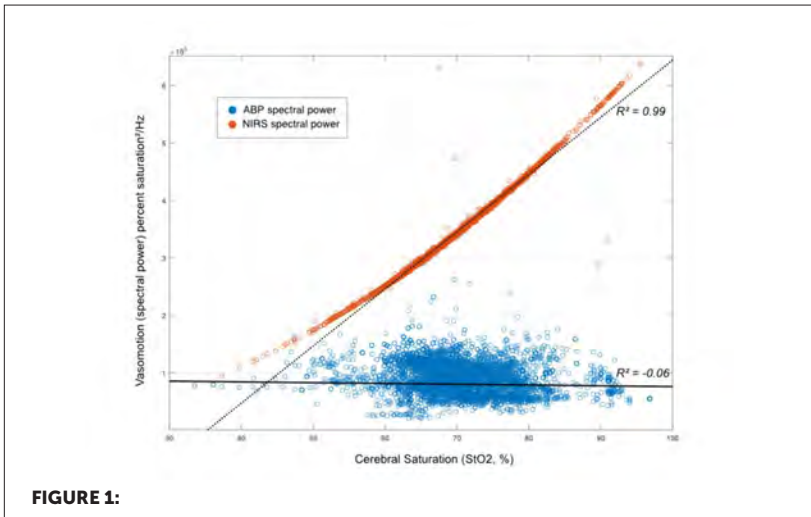

CONCLUSIONS

As cerebral saturations dropped and FTOE increased, there was a marked reduction in cerebral vasomotion while systemic vasomotion remained unchanged, suggesting a localized relationship between CNS vasomotion and cerebral oxygenation. Further research is needed to identify methods for altering vasomotion to improve cerebral blood flow and decrease risk of brain injury.

EP302 / #797**E-Poster Viewing - Neonatology AS02-18.
Neurology****Intra-hospital transportation of extremely preterm infants, incidence of intraventricular haemorrhages and neurodevelopmental impairment at 24 months corrected AGE****N. Wadström^{1*}, V. Árnadóttir¹, M. Breindahl², B. Hallberg³, B. Skiöld⁴**¹Karolinska University Hospital, Neonatology, Stockholm, Sweden²Rigshospitalet, Neonatal and Pediatric Intensive Care, Copenhagen, Denmark³Karolinska Institute, Clintec, Stockholm, Sweden⁴Karolinska University Hospital, Neonatology and Women's and Children's Health, Karolinska Institute, Stockholm, Sweden**BACKGROUND AND AIM**

Karolinska University Hospital reopened in 2016, the Neonatal- and Delivery units were separated by 900-meters. We aimed to evaluate mortality, incidence of IVH and neurodevelopmental outcome in infants exposed to this intra-hospital transfer.

METHODS

Infants born <27 weeks of gestation during 24 months after the move were compared with a control group born during the 24 previous months. Cranial ultrasounds were graded according to a modified Papile classification (I-IV). Neurodevelopmental data at 24 months corrected age (CA) were obtained from the Swedish Neonatal Quality Register and consisted of Bayley-III cognition, language, motoric function; autism screening, behavioral observation, incidence of cerebral palsy, visual and hearing impairment.

RESULTS

The transported group (n=116) and the control group (n=149) were similar regarding gestational age, sex, mode of delivery, multiple pregnancies, APGAR ($P > .05$ for all). Birthweight was higher in transported infants (mean $701\text{g} \pm 153$, range 370-1160 vs $659\text{g} \pm 147$, range 275-1022), $P < .05$). Mortality did not differ between groups; 35% (40/116) in transported compared to 26% (38/149) in controls. The incidence of IVH was similar; transported 37% (41/109) vs controls 47% (60/127) and no differences in severity of IVH or bilaterality were found. Neurodevelopmental impairment did not differ significantly at 24 months CA ($P > .05$).

CONCLUSIONS

The studied intra-hospital transfer of extremely preterm infants did not result in differences in mortality, incidence of IVH or increased rates of neurodevelopmental impairment at 24 months CA, compared with controls.

EP303 / #2401

E-Poster Viewing - Neonatology AS02-18. Neurology

Physiological recording parameter changes associated with seizures in newborns

A. Kage¹, D. Wertheim^{2*}, I. Lancoma-Malcolm¹, C. Francia¹, D. Shah¹

¹Royal London Hospital, Neonatology, London, United Kingdom

²Kingston University, Faculty of Science, Engineering and Computing, Kingston-upon-Thames, United Kingdom

BACKGROUND AND AIM

Background Heart rate and respiratory rate changes have been observed associated with seizures in preterm infants (Shah et al. 2010). The aim of this study was to investigate whether EEG seizures in term newborn babies can be associated with heart rate or blood oxygen saturation level changes.

METHODS

Neonatal EEGs and physiological measurements were monitored where clinically indicated using Olympic Brainz Monitor (OBM) monitors (Natus Medical Incorporated) and synchronised with collection of standard physiological measurements using iCollect software (GE Healthcare) connected to GE Carescape monitors (GE Healthcare). Data were analysed using Excel (Microsoft Corporation) and software we developed in MATLAB (The MathWorks Inc, USA).

RESULTS

Data were collected from four term infants who had seizures on EEG monitoring. The median (range) gestation of the babies was 39 (37 to 40) weeks

gestation and birth weight was 3330 (2980 to 3480)g. We observed that some seizures on EEG were associated with increase in heart rate and/or decrease in SpO₂ (Figure 1)

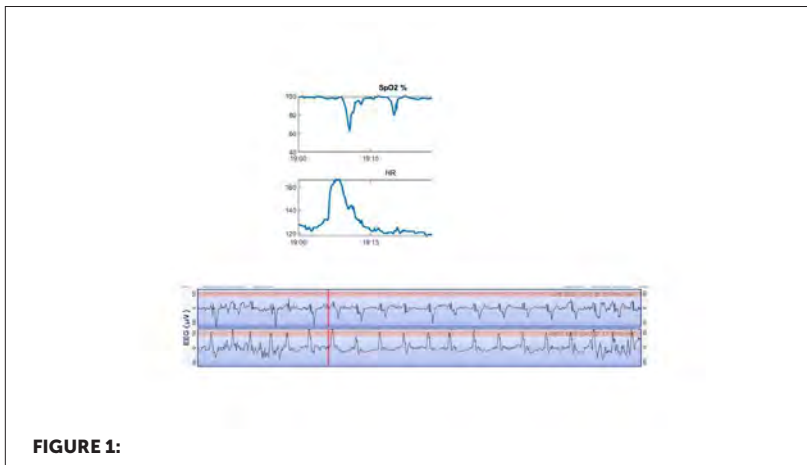

CONCLUSIONS

We have developed a system that allows comparison of EEG data with physiological data collected as part of standard neonatal intensive care. We observed that some seizures seen on EEG monitoring can be associated with changes in heart rate and / or SpO₂.

EP304 / #898

E-Poster Viewing - Neonatology AS02-19. Organisation & safety

Retinopathy of prematurity and risk factors

M. Ahmed^{1*}, R. Eltahir¹, S. Javed¹, N. Mansoor¹, T. Mansoor¹,
K. Bhavra², T. Reynolds³

¹University Hospitals of Derby and Burton NHS Foundation Trust, Paediatrics, Burton Upon Trent, United Kingdom

²University of Nottingham, Medical School, Nottingham, United Kingdom

³University Hospitals of Derby and Burton NHS Foundation Trust, Clinical Chemistry, Burton Upon Trent, United Kingdom

BACKGROUND AND AIM

Retinopathy of Prematurity (ROP) is a condition confined to the premature retina. Hence, it is more commonly associated with extreme prematurity and low birth weight. Over the years, various risk factors have been explored to establish statistical correlation to help produce screening protocols to identify preterm infants most at risk of developing this condition. The aim of our study was to evaluate risk factors, which may potentially lead to ROP.

METHODS

The United Kingdom National neonatal computer system database (Badgernet) was searched for all babies born at Queen's Hospital Burton using the eligibility criteria of gestational age of <32 weeks and/or birth weight <1501grams over a period of five years (Jan 2016 to Dec 2020).

RESULTS

207 fulfilled the inclusion criteria, 8 of them were later excluded due to death. Out of 199 babies studied, 17 developed ROP. The following risk factors

displayed a statistically significant relationship with ROP positive patients: hypoxia, chronic lung disease, intra-ventricular haemorrhage, thrombocytopenia, anaemia, late onset sepsis, hypotension, patent ductus arteriosus, use of total parenteral nutrition, gestation less than 28 weeks and birthweight less than 1kg. Oxygen duration was significantly longer in ROP positive patients ($p < 0.0001$). Similarly, both birthweight and gestational age were significantly lower in ROP positive patients ($p < 0.0001$).

CONCLUSIONS

Our study confirms a strong correlation between ROP and prematurity/low birth weight. This study also adds useful information with statistically significant correlation with certain other important conditions/parameters that co-exist in these premature infants.

EP305 / #1390

E-Poster Viewing - Neonatology AS02-19. Organisation & safety

Excellence reporting in a neonatal intensive care unit during covid-19 ERA

S. Wyton*, F. Terry, C. Perez Fernandez, A. Singh, H. Wood

Birmingham Women's and Children's NHS Foundation Trust, Neonatal Intensive Care Unit, TG, United Kingdom

BACKGROUND AND AIM

The Learning from Excellence (LFE) initiative was successfully implemented at Birmingham Women's and Children's Hospital Neonatal Intensive Care Unit (NICU) in 2016, aiming to identify and learn from peer-reported episodes of excellence. Staff report 'excellent episodes' via the IR 2 (Incident Report 2) form on trust intranet. In addition to individual feedback, themes of good practice are also disseminated to the wider teams via governance meetings and weekly newsletter. Our aim was to study the staff engagement with the LFE process and 'excellence' themes, in the challenging Covid-19 era.

METHODS

LFE reports were collected from April 2020 to March 2022, from the Trust Governance Database. The data was analysed, and themes of excellence were identified.

RESULTS

363 LFE episodes were reported during the study period. They were reported by a wide range of professionals including nurses, midwife, and nurse practitioners (282), doctors (69), allied health professionals (10) and others (2).

There was greater engagement with the LFE process in the Covid-19 era than previously reported LFE episodes of 120 in 2 years (April 2018- March 2020). While the positive feedback was spread across the multi-professional team, the most LFE reports had named 'individual nurses' followed by 'teams'. The themes of LFE are detailed in Table 1.

TABLE 1:

Themes	Number
Family centred care	86
Communication	39
Professionalism/Leadership	34
Managing / helping busy workload	33
Team management of sick neonate	29
Quality Improvement	26
Individual management sick neonate	25
Team wellbeing / Support	25
Infection Control / Equipment	21
Documentation	20
Redirection of Care/ Bereavement	13
Covid related	6
Emergency situation (non-neonatal)	3
Covering staff shortage/Sickness	3

CONCLUSIONS

Despite the Covid-19 related challenges, the increased LFE reporting positively reinforces the excellent work being done by multi-professional teams in a busy NICU. The identified themes highlighted broad areas of excellence, while caring for babies, families and teams.

EP306 / #1424

E-Poster Viewing - Neonatology AS02-20. Palliative care

Review of potential for neonatal organ and tissue donation

R. Chase^{1*}, A. Morris², C. Williams², A. Singh¹

¹Birmingham Women's and Children's NHS Foundation Trust, Neonatal Intensive Care Unit, Birmingham, United Kingdom

²NHS Blood and Transplant, Nhsbt, Birmingham, United Kingdom

BACKGROUND AND AIM

More families and staff are seeking information on Organ Donation (OD) in Neonatal intensive care units (NICU), as an option during the 'End of life care' process. This retrospective study aimed to evaluate the number of 'potential donors' as referrals to the Specialist Nurses for Organ Donation (SNOD) for OD/ tissue donation (TD) screening over a 7-year period.

METHODS

Badgernet database was used to screen all neonatal deaths from 2015-2021 in our NICU, to identify potential organ and/or tissue donors.

RESULTS

There were 64 term / corrected term (37/40) deaths of the 282 neonatal deaths over the study period. The diagnosis included Hypoxic Ischemic Encephalopathy (12), congenital diaphragmatic hernia (14), sepsis (2), congenital cardiac disease (15), renal conditions (7), congenital abnormalities (6) and others (10). All deaths were by 'circulatory criteria'. There were 4 hospice deaths and 1 home palliation. 50 babies were ventilated at time of

reorientation of care / death. There was no clear documentation to accurately identify controlled deaths, for considering OD process. TD could have been explored in all deaths. OD referral was made to the SNOD in one case but was deemed un-suitable.

CONCLUSIONS

There was potential in the study cohort for SNOD referral for OD screening. While the potential for OD and TD is limited in neonates, an on-going education drive should lead to timely referrals by neonatal staff to SNODs, as part of end-of-life care process. The gift of life, if possible, will help the families with the grieving process.

EP307 / #2463**E-Poster Viewing - Neonatology AS02-20.
Palliative care****Withdrawal or withholding of life sustaining
treatment in extremely preterm neonates****I. Galloway^{1*}, C.C. Roehr², R. Bhatia^{1,3}, K. Tan^{1,3}**¹Monash University, Department of Paediatrics, Melbourne, Australia²Nuffield Department of Population Health, University of Oxford, National Perinatal Epidemiology Uni, Oxford, United Kingdom³Monash Children's Hospital, Monash Newborn, Melbourne, Australia**BACKGROUND AND AIM**

Outcomes in extremely preterm (EPT) infants vary substantially between and within countries. Little is known about how variations in end-of-life practices for EPT neonates affect outcomes. We aimed to investigate the role of withdrawal or withholding of life sustaining treatment (WWLST) on infant mortality.

METHODS

This single-centre, 6-year retrospective study examined infants <27 weeks' gestation admitted to Monash Children's Hospital (MCH) from 2015 to 2020. Data previously collected for ANZNN were combined with electronic medical records, death certificates and mortality records. Mortality was assessed to discharge. In-hospital morbidity included Grade III/IV IVH, PVL, NEC, SIP, early or late sepsis, BPD or Stage IV ROP. Summary statistics, logistic regression and survival analyses were performed.

RESULTS

of 278 infants studied, 15.1% died and 85.3% had at least one in-hospital morbidity. The primary reason for WWLST was to prevent expected poor

long-term outcomes. *Figure 1* is a flow-diagram indicating the WWLST practices at MMC. Discussions about WWLST occurred in half of our high-risk infants. WWLST preceded death for 83% infants who died. Infants about whom WWLST discussions occurred were 95.1 times more likely to die than those without discussions. Seven of ten infants who did not undergo WWLST after WWLST discussions survived. They had mostly similar characteristics to the rest of our cohort

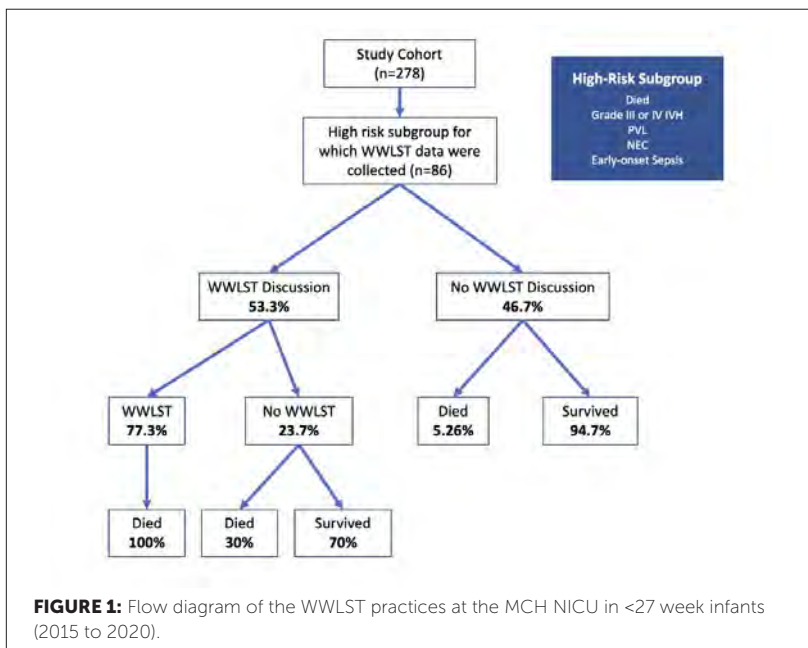

CONCLUSIONS

Our findings indicate the significance of WWLST in EPT infants' mortality at MCH. Future research should focus on comparing WWLST practices between NICUs.

EP308 / #726

E-Poster Viewing - Neonatology AS02-21. Pharmacology & therapeutics

The complex purine metabolism in asphyxiated allopurinol-treated neonates: an albino observation

K. Allegaert^{1,2*}, W. Chu³, T. Dorlo³, A. Huitema^{3,4,5}

¹KU Leuven, Department of Development and Regeneration, and Pharmaceutical and Pharmacological Sciences, Leuven, Belgium

²Erasmus MC, Department of Clinical Pharmacy, Rotterdam, Netherlands

³Netherlands Cancer Institute, Amsterdam,; Department of Pharmacy and Pharmacology, Amsterdam, Netherlands

⁴Princess Máxima Center for Pediatric Oncology, Department of Pharmacology, Utrecht, Netherlands

⁵UMC Utrecht, Department of Clinical Pharmacy, Utrecht, Netherlands

BACKGROUND AND AIM

The ALBINO study investigates the add-on effect of allopurinol to hypothermia (TH) for hypoxic-ischemic encephalopathy (HIE) neonates.¹ Previously, we developed a pharmacokinetics-pharmacodynamics (PK-PD) model of allopurinol, oxypurinol, hypoxanthine, xanthine, and uric acid.² With additional data from the ALBINO mannitol cases, we described the purine bases metabolism in HIE neonates.

METHODS

ALBINO study neonates who received allopurinol (verum) or mannitol (placebo) were included. An extension of our previous population PKPD model was provided using NONMEM, with a fixed PK model.² Purine bases degradation via xanthine oxidoreductase (XOR) was described by hypoxanthine to xanthine to uric acid turnover, including salvage of hypoxanthine to purine nucleotide. The initial hypoxanthine, xanthine and uric acid levels were a combination of endogenous turnover and high disease-related amounts. The effect of allopurinol and oxypurinol (combined) on XOR inhibition was described by a E_{\max} function.

RESULTS

Based on 21 'allopurinol' and 17 'mannitol' neonates, hypoxanthine to xanthine clearance and hypoxanthine salvaging was 0.21 and 0.54 1/h, xanthine to uric acid clearance and uric acid elimination 2.67 and 0.03 1/h. Baseline hypoxanthine and xanthine production was 0.53 and 0.22 mg/L*h, reduced with 0.4%/h due to precursor exhaustion. Initial disease-related level of hypoxanthine and xanthine were 1.5-2.1-fold higher in moderate/severe HIE. Half-maximal XOR inhibition was achieved with a combined allopurinol and oxypurinol concentration of 0.68 mg/L. This is below all observed concentrations, suggesting quasi full XOR inhibition.

CONCLUSIONS

This model describes the complex purine metabolism in asphyxiated allopurinol-treated neonates. ¹Maiwald et al. 2019; ²Chu et al. 2021

EP309 / #979**E-Poster Viewing - Neonatology AS02-21.
Pharmacology & therapeutics****Analysis of drug information of prescribed
medicines and potential drug incompatibles in
neonatal intensive care UNIT****P. Ari^{1*}, E. Arun Özer², M. Arun³**¹Ege University, Faculty of Pharmacy, İzmir, Turkey²Tinaztepe University, School of Medicine, Department of Pediatrics, İzmir, Turkey³Ege University, Faculty of Pharmacy, Department of Clinical Pharmacy, İzmir, Turkey**BACKGROUND AND AIM**

The number of drugs per patient is high in neonatal intensive care units. Intravenous drug administration is commonly used in these units. The purpose of this study was to assess drug information on a drug product summary and drug incompatibility in a newborn critical care unit.

METHODS

This retrospective cross-sectional study was conducted in the NICU unit of Tinaztepe University, School of Medicine hospital. Prescription orders were collected from the electronic health record system of the hospital. Updated summary of drug product documents of prescribed medications which were approved by the Republic of Turkey Ministry of Health was analyzed for information about therapeutic especially use on neonates. All concurrently administered intravenous infusions were analyzed and classified with Trissel's 2 IV compatibility tool in the available Lexi database. Statistical analyses were performed with SPSS 25.

RESULTS

The common admission diagnoses were related to respiratory disorders. About one-half of summary of drug product documents was the lack of information specifically for neonates. The medications were primarily administered intravenously (about 50%), followed by oral and topical administration. Most prescribed intravenous medicines for neonates were antibiotics. We did not detect any major drug incompatibilities however about 20 percent of drug pairs do not have information about incompatibility.

CONCLUSIONS

The results of this study suggested that pharmacy services in NICU should focus on provide reliable drug information for clinicians. Further prospective studies are needed to assess drug information needs and detect actual drug incompatibilities.

EP310 / #765**E-Poster Viewing - Neonatology AS02-21.
Pharmacology & therapeutics****Evaluation of drug utilization in neonatal
intensive care unit in turkey****A. Arı^{1*}, E. Arun Özer², M. Arun³**¹Ege University, Faculty of Pharmacy, İzmir, Turkey²Tinaztepe University, School of Medicine, Department of Pediatrics, İzmir, Turkey³Ege University, Faculty of Pharmacy, Department of Clinical Pharmacy, İzmir, Turkey**BACKGROUND AND AIM**

Effective medication use plays important role in neonates. However, drug therapies are complex in neonates with vulnerability due to developmental immaturity. Neonatal intensive care unit (NICU) patients also have a high drug burden. The purpose of this study was to investigate at drug use in a NICU in Turkey and to examine the possible relationship between gestational age, length of stay with prescribed medicine count.

METHODS

This retrospective cross-sectional study was conducted in the NICU unit of Tinaztepe University, School of Medicine hospital. Clinical data were retrieved from the electronic health record system of the hospital. All prescribed medicine is classified according to the third level of the ATC system. Drug-drug interactions (DDI) were analyzed and classified with the Lexi database. Statistical analysis was carried out using SPSS 25.

RESULTS

The average number of prescribed medicines per patient was 5.5. The most prescribed drugs belonged to anti-infectives for systemic use, and alimentary tract and metabolism drugs. The number of prescribed drugs negatively correlated with gestational age and birth weight. There was a positive correlation between the number of drugs and length of stay. Our analysis revealed most DDIs were associated with antibiotics. There was no link between the quantity of drugs used and the number of caesarean sections.

CONCLUSIONS

Clinical pharmacy services in NICU are still not implemented in Turkey. Further multi-center prospective studies in NICU about drug utilization will help to identify risk factors for drug related problems and the the role of clinical pharmacy.

EP311 / #1958

E-Poster Viewing - Neonatology AS02-21. Pharmacology & therapeutics

Perinatal risk factors for hearing LOSS

K. Chant*, N. Marlow

University College London, Institute For Women's Health, London, United Kingdom

BACKGROUND AND AIM

Hearing loss is ten times higher in preterm infants than those born at term. Putative causes of hearing impairment include genetic susceptibility, sepsis, hypoxia, hyperbilirubinaemia, noise and drug-induced ototoxicity. We have previously suggested that coincidence of risk factors may be critical. We aimed to identify the timeline of concomitant risk factors for hearing loss across the neonatal period.

METHODS

We included 57 children with hearing loss, born below 32 weeks of gestation, and 180 normal hearing matched controls. Saliva samples were collected from all children to screen for the mitochondrial mutation, m.1555A>G. Data were abstracted from clinical records for overall risk factors on a daily basis for the first 14 days and then weekly until discharge from neonatal services.

RESULTS

Children with hearing loss were more likely to have lower birthweight, prolonged ventilation, oxygen therapy, acidosis, intraventricular haemorrhage and necrotising enterocolitis than the control group. Administration of gentamicin, vancomycin, furosemide, inotrope and steroid were also more fre-

quent in the index group. The mitochondrial mutation m.1555A>G was not found among the index group. The cumulative risk of hearing loss following the coincident administration of ototoxic medication in the presence of haemodynamic instability increased with each additional day of occurrence in the first 14 days (OR 1.28 (95%CI 1.14-1.44)).

CONCLUSIONS

Acquired hearing loss in preterm children may be due to be a cumulative effect of coincident neonatal risk factors. Reduced perfusion/renal elimination may increase circulating drug levels leading to accumulation in the inner ear, subsequently causing ototoxicity.

EP312 / #2771**E-Poster Viewing - Neonatology AS02-21.
Pharmacology & therapeutics****Prospective validation of the paracetamol dosage regimen in extremely low birth weight neonates following major abdominal surgery****H. Cihlářová¹, R. Janča², K. Allegaert³, P. Pokorna^{4*}**¹Charles University, Department of Pediatrics and Hereditary Disorders, Prague, Czech Republic²Department of Circuit Theory, Faculty of Electrical Engineering, Czech Technical University, Prague, Czech Republic, Department of Circuit Theory, Faculty of Electrical Engineering, Czech Technical University, Prague, Czech Republic, Prague, Czech Republic³KU Leuven, Department of Development and Regeneration, and Pharmaceutical and Pharmacological Sciences, Leuven, Belgium⁴Charles University, Department of Pediatrics and Inherited Metabolic Disorders, Prague, Czech Republic**BACKGROUND AND AIM**

Background: Intravenous paracetamol added to morphine reduces post-operative morphine consumption in (near) term neonates, while limited data are available in extremely low birth weight (ELBW) neonates. **Aims:** The study aimed to assess the effects of rescue intravenous paracetamol on postoperative pain management (≤ 48 hours postoperatively) in relation to both analgesic efficacy (validated pain assessment, drug consumption, adequate rescue medication) and safety (hypotension and bradycardia) as part of a standardized pain management approach in a single neonatal intensive care unit (NICU) during pre-implementation and prospective validation during the post implementation period.

METHODS

METHODS

According to the results of the retrospective period, age appropriate analgesic dosage pre/perioperatively (dose reduction of opioids, concomitant paracetamol administration using a loading dose of 20 mg/kg) after induction procedures (education, good clinical practice and implementation of updated standards in pain management in the NICU) is evaluated prospectively (a single center study).

RESULTS

RESULTS

All neonates received continuous opioids (sufentanil or morphine), and also intravenous paracetamol over 48 hours, the non-paracetamol group was characterized by oversedation (COMFORTneo <9), a higher incidence of severe hypotension, and younger postnatal age ($p < 0.05$). Expected results of postimplementation period are to achieve adequate analgesia and to reduce opiate consumption and its side effects in severely ill ELBW neonates.

CONCLUSIONS

CONCLUSIONS

Our study focused on postoperative pain management including implementation tools in ELBW neonates and showed that intravenous paracetamol seems to be safe. Prospective validation of dosage regimens of analgesic drugs is needed to achieve efficacy goals and optimal multimodal pain profile in this population.

EP313 / #2375

E-Poster Viewing - Neonatology AS02-21. Pharmacology & therapeutics

Ino use in the very preterm ships cohort was related with mortality and neurodevelopmental impairments

V. Siljehav^{1*}, A. Gudmundsdottir¹, J. Tjerkaski¹, A. Aubert², M. Cuttini³, C. Koopman-Esseboom⁴, J. Zeitlin⁵, U. Aden¹

¹Karolinska Institutet, Department of Women's and Children's Health, Stockholm, Sweden

²Université Paris Cité, Inserm, INRAE, Centre For Research In Epidemiology and Statistics (cress), Paris, France

³Bambino Gesù Children's Hospital, IRCCS, Clinical Care and Management Innovation Research Area, Roma, Italy

⁴University Medical Center Utrecht, Neonatology, Utrecht, Netherlands

⁵INSERM UMR 1153, Obstetrical, Perinatal and Pediatric Epidemiology Research Team (Epopé), Center for Epidemiology and Statistics Sorbonne Paris Cité, DHU Risks in pregnancy, Paris Descartes University, Paris, France, Paris, Paris, France

BACKGROUND AND AIM

Background: Pulmonary hypertension of the very preterm infant and subsequent refractory hypoxia is a growing challenge in the NICU. Inhaled nitric oxide (iNO) is not registered for use in preterm infants, but may be used as a rescue treatment. **Aims:** To determine the effects of iNO in the very preterm population on short term and long term outcomes up to 5 years

METHODS

The SHIPS cohort consisted of all births between 22+0 and 31+6 weeks of gestation in 19 regions across 11 European countries 2011-2012. Since iNO was not randomly prescribed, we used 1-to-3 propensity score matching to reduce the imbalance of measured covariates.

RESULTS

Among 7268 very preterm born infants in the study sample, we identified 292 (4.0%) who were exposed to iNO. The iNO treated infants had higher mortality rate compared to matched controls (odds ratio [OR] 2.1 (95% CI 1.5-2.9). Subgroup analysis of infants further showed increased mortality for infants with several perinatal risk factors when subjected to iNO; pPROM OR 1.8 (95% CI 1.1-2.9), cesarean section OR 2.5 (95% CI 1.9-3.6), intrapartal infection OR 2.2 (95% CI 1.2-4.4), gestational age <28 OR 1.67 (95% CI 1.1-2.5) and ≥ 28 OR 5.1 (95% CI 2.5-10.5). Follow-up at 5 years showed that risk for neurodevelopmental impairments was higher in iNO exposed preterm born infants; hearing impairment OR 2.4 (95% CI >1.0-5.4), speech delay OR 1.92 (95% CI 1.0-3.8) and vision impairment OR 1.8 (95% CI 1.1-3.1).

CONCLUSIONS

Treatment with iNO is associated with increased one year mortality and neurodevelopmental impairment.

EP314 / #2278**E-Poster Viewing - Neonatology AS02-21.
Pharmacology & therapeutics****Need for improved management of iatrogenic withdrawal from analgosedatives in nicu patients with congenital diaphragmatic hernia: a retrospective analysis****E. De Saeger¹, A. Debeer², A. Smits^{2*}**

¹Department of Pediatrics, University Hospitals Leuven, Faculty of Medicine, KU Leuven, Leuven, Belgium

²Neonatal Intensive Care Unit, University Hospitals Leuven, Department of Development and Regeneration KU Leuven, Leuven, Be, Belgium

BACKGROUND AND AIM

Iatrogenic withdrawal syndrome (IWS) is an avoidable complication of inadequate pain and discomfort management. Uniform analgosedative weaning guidelines in neonates are lacking. IWS assessment tools are available, but often randomly applied. We hypothesize large variability in analgosedative management and IWS covariates in a single university NICU.

METHODS

Analgosedative practices during hospitalization (January 1st 2015–December 31st 2020, NICU Leuven, Belgium) of neonates with congenital diaphragmatic hernia (CDH) were retrospectively described. Clinical characteristics, administered analgosedatives, pain (Leuven Neonatal Pain Score) and withdrawal scores (Sophia Observation withdrawal Symptoms scale, SOS) were collected and analysed using descriptive statistics. Subgroup analysis was performed for antenatally assessed CDH severity, IWS presence, survival and sex. Analgosedative dosing and IWS covariates between subgroups were

explored using Mann-Whitney U, Chi² or Kruskal-Wallis tests. SOS score ≥ 4 implies IWS presence.

RESULTS

Forty-two CDH cases were included. A non-systematic use of SOS scores was observed. Neonates with SOS scores ≥ 4 (N=18, 42.9%) needed significantly longer invasive and non-invasive respiratory support ($p=0.000025$ and $p=0.031918$ respectively), more days to achieve full enteral feeding ($p=0.000022$), and higher clonidine doses ($p<0.000001$). Large variability in median analgesedative dosing was found within and across subgroups. A declining trend in median SOS scores over time was observed, stabilizing from postnatal age five weeks.

CONCLUSIONS

Presence of IWS is associated with increased morbidity in CDH patients. SOS scores decreased over time, stabilizing from postnatal age five weeks. Absence of IWS scoring routines limits proper IWS assessment. Consequently, future protocolized implementation is mandatory to improve IWS management.

EP315 / #2209

E-Poster Viewing - Neonatology AS02-21. Pharmacology & therapeutics

Liver transplantation, pregnancy and births

V. Schoenfeld -Silva¹, G. Hida², F.J. Ropero Pelaez³, G. Rodrigues Taniguchi⁴, S. Taniguchi^{5*}

¹Regional Hospital of Cotia, Intensive Care Unit, Sao Paulo, Brazil

²Albert Einstein Hospital, Big Data Analytics- Artificial Intelligence, Sao Paulo, Brazil

³Universidade Federal do ABC, Center of Mathematics, Computation and Cognition, Santo andre, Brazil

⁴Icoaraci Public Health Service, Emergency Care Unit, Belem, Brazil

⁵University of São Paulo, Pharmacology, São Paulo, Brazil

BACKGROUND AND AIM

Immunosuppressive therapy in patients submitted to liver transplantation is a limiting factor for pregnancy This study investigates the use of tacrolimus and pregnancy outcomes in Liver Transplantation recipients admitted in a private hospital in São Paulo/Brazil

METHODS

This retrospective study investigated 60 women of reproductive age submitted to liver transplantation, in a period of 7 years. These patients' minimum Model of end-stage liver disease (MELD) value was 15, and mean age of 34,8± 1,2 years old.

RESULTS

From the 60 patients analyzed, Death related to graft rejection (28 patients), No pregnancy (27 patients), conceptions (05 patients) were observed. Maternal renal impairment was observed in 24,4% of Non-pregnant women compared

to 12,5% pregnant patients. Liver dysfunction in Non-pregnant (20,9%) and 12,5% pregnant patients were observed Urinary infection in Non-pregnant 1,2% compared to 25% in pregnant patients. Pregnancy outcomes were 4 preterm births (gestational age at delivery 20 to 31 weeks) and one neonatal death. The dosage of tacrolimus was 1mg /kg/day before the conception, during the pregnancy and in the postpartum period. Mycophenolic acid 12 mg /kg/day (1 patient) or azathioprine 12 mg /kg/day (1 patient) were also associated to tacrolimus

CONCLUSIONS

Optimization between of the immunosuppressant drug therapy (drugs and dosage) and post-transplant complications such as kidney dysfunction and the transplanted liver condition itself, is essential for positive pregnancy outcomes

EP316 / #1503

E-Poster Viewing - Neonatology AS02-22. Primary care

Congenital dacryocystocele: a case report

S. Branco^{1*}, I. Pais-Cunha², I. Vivas¹, J. Oliveira³, I. Mazedo¹,
A.L. Santos¹

¹Centro Hospitalar Póvoa de Varzim e Vila do Conde, Pediatrics and Neonatology, Póvoa de Varzim, Portugal

²Centro Hospitalar Universitário de São João, Pediatrics, Porto, Portugal

³Centro Materno Infantil do Norte, Pediatrics, Porto, Portugal

BACKGROUND AND AIM

Congenital dacryocystocele (CD) is a rare disorder with an estimated incidence of 0,016-2,76%. This condition is caused by obstruction of the nasolacrimal drainage system and presents at birth with a bluish cystic mass near the medial canthal angle of the affected eye. It is more frequent in females and the bilateral involvement is reported in up to 25% of the cases.

METHODS

A 37-year-old primigravida presented an uneventful pregnancy until a detailed prenatal ultrasonography, at the 33th-week of gestation, revealed a bilateral hypoechogenic cystic lesion located inferiormedially to the right/left orbits, without internal blood flow on Doppler ultrasound. These findings were consistent with bilateral CD.

RESULTS

At 35 weeks of gestation, the pregnant woman experienced a preterm premature rupture of membranes and a cesarean section was performed because of breech presentation. A female infant was born, weighing 2840g with

Apgar score of 10/10 at 1 and 5 minutes. The physical examination yielded a bluish mass inferomedial to the right/left orbits. An ophthalmologist referral was made. No respiratory difficulty was perceived and 2 days after birth the cysts drastically decreased in size spontaneously. At the 4th day of life, the infant developed an acute dacryocystitis of the left eye that was treated with intravenous antibiotic (cefotaxime) and awaits a surgical intervention.



FIGURE 1:



FIGURE 2:



FIGURE 3:

CONCLUSIONS

Detection of CD through prenatal ultrasound has been reported in literature, however, only a few cases were bilateral. The majority resolves spontaneously in utero or after birth. If persistent, the follow-up is important to exclude respiratory compromise, dacryocystitis or periorbital cellulitis.

EP317 / #1582**E-Poster Viewing - Neonatology AS02-22. Primary care****Congenital arhinia: a rare CASE****K. Mekki¹, N. Kolsi¹, N. Hamida¹, S. Kacem^{2*}, A. Gargouri¹**¹*hedi chaker, Neonatology, SFAX, Tunisia*²*hedi chaker, Pediatric Surgery, SFAX, Tunisia***BACKGROUND AND AIM**

Congenital arhinia is an extremely rare malformation which causes severe airway obstruction and poor feeding in the affected neonate. Aim: Description of a case of congenital arhinia

METHODS

we report the case of a congenital arhinia in a newborn

RESULTS

A full-term female was born via a caesarean delivery with 3600 g body weight and height 50 cm. The child was normocephalic, with a head circumference of 36 cm. During the third trimester, there was polyhydramnios and there had been antenatal concern regarding a flat facial profile on ultrasound findings. Family history revealed interrelative marriage and there was no family history of any congenital malformation and no history of any drug intake during pregnancy. At birth, the baby showed complete absence of nasal bones, low set ears, hypertelorism and micrognathism. Ophthalmological findings showed absent nasolacrimal ducts. Owing to severe respiratory difficulty and cyanosis during oral feeding, he was discharged on oro-gastric tube feeding. A CT scan performed in emergency confirmed the absence of nasal cavities and

a cerebral MRI performed under general anesthesia revealed agenesis of the olfactory bulbs and congenital stenosis of the Magnum foramen.



FIGURE 1:

CONCLUSIONS

In arhinia cases, facial anomalies and other concomitant distant anomalies may be present. The main purpose of the first treatment is to provide a safe airway and nutrition. The patients may adapt well for the upper airway obstruction in the early period and surgical correction should be planned.

EP318 / #1323

E-Poster Viewing - Neonatology AS02-22. Primary care

Growth and developmental outcome of twin preterm infants according to the chorionicity and weight discordancy

S. Lim^{1*}, S.H. Shin^{2,3}, S. Park^{2,3}, H.J. Yang¹, Y.H. Jung^{1,2}, C.W. Choi^{1,2}, E.-K. Kim^{2,3}, H.-S. Kim^{2,3}

¹Seoul National University Bundang Hospital, Pediatrics, Seoul, Korea, Republic of

²Seoul National University College of medicine, Pediatrics, Seoul, Korea, Republic of

³Seoul National University Children's Hospital, Pediatrics, Seoul, Korea, Republic of

BACKGROUND AND AIM

In this study, we aimed to investigate the impact of chorionicity and weight discrepancy on the neonatal and long-term outcomes of very preterm infants.

METHODS

Medical records of twin infants who were both born alive and born at <32 weeks of gestation between 2014 and 2019 were retrospectively reviewed. The study population was categorized as monochorionic (MC) Twin and dichorionic (DC) twin. A difference of 20% or more was defined as weight discordance at birth. Neonatal outcomes and neurodevelopmental outcomes at corrected age (CA) 18-24 months were compared among study groups. Multiple logistic regression analysis was conducted to investigate whether MC twin, weight discordance, and small/large among co-twin were associated with neonatal and long-term outcomes.

RESULTS

DC twin had higher incidence of bronchopulmonary dysplasia than MC twin (26.3% vs. 11.9%, $p=0.033$). In the multivariate analysis, smaller baby among co-twin (adjusted OR 3.94, 95% CI 1.33-11.66) and weight discordance (%) (aOR 1.04, 1.00-1.07) were associated with moderate to severe BPD. Smaller baby among co-twin (aOR 3.33, 95% CI 1.033-10.74) and weight discordance (%) (aOR 1.04, 1.00-1.07) were also associated with neurodevelopmental impairment at CA 18-24 months. In the subgroup of discordant twin (>20%), differences in z-scores of weight and height persisted until CA 24 months in DC twin, except at CA 18 months, while those differences disappeared after discharge in MC twin.

CONCLUSIONS

Chorionicity could be important determinant in growth of co-twin, whereas discordance in weight at birth was associated with development of twins of GA <32 weeks.

EP319 / #2250**E-Poster Viewing - Neonatology AS02-22. Primary care****Ocular hemorrhages in neonates with metabolic/mixed acidosis****S. Ünal^{1*}, C. Kara², N. Demirel³, S. Petriçli², S. Kavurt¹, E. Uzlu¹, M. Durukan-Tosun¹, A.Y. Bas³**

¹University of Health Sciences, Etilik Zubeyde Hanım Maternity Teaching and Research Hospital, Neonatology/pediatrics, Ankara, Turkey

²University of Health Sciences, Etilik Zubeyde Hanım Maternity Teaching and Research Hospital, Ankara, Turkey, Ophtalmology, ankara, Turkey

³Ankara Yıldırım Beyazıt University, Department of Pediatrics, Division of Neonatology, ankara, Turkey

BACKGROUND AND AIM

Ocular hemorrhages (OH) may cause visual disturbances and incidence varies as %18-39 in newborns. Precipitated/instrumental delivery and perinatal asphyxia were pre-defined risk factors. Acidosis can interfere coagulation and disrupt pressure of ocular capillaries, and put infants with moderate acidosis with or without hypoxic-ischemic encephalopathy at risk for OH. We aimed to evaluate the OH in neonates with fetal acidosis.

METHODS

Neonates >34 weeks are included if pH < 7.10 and BE < -12 mmol/l within the first hour. Ophtalmologic examinations for retinal (RH), vitreous and anterior chamber (hyphema) hemorrhage were done within third day. RH were staged according to Egge classification. Clinical characteristics of newborns were analysed (SPSS V15).

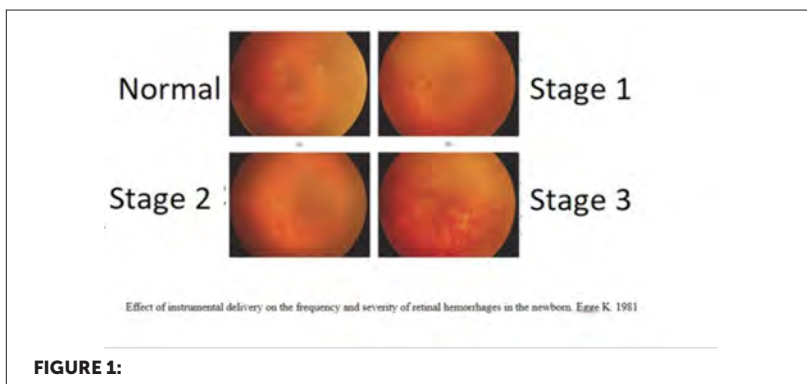

RESULTS

62 neonates (38 ± 2.3 weeks, 2971 ± 612 gr) were included. pH: 6.91 ± 0.16 , BE: -17.2 ± 5.3 mmol/l. OH was found in 22 (36.7%) neonates (hyphema n=2, vitreous n=2, RH n=21). 38 eyes with RH were staged [Stage3; n=15(39.5%), Stage2;n=11 (%28.9), Stage1:n=12 (%31.6)]. Vaginal delivery [OR:4.9 %95CI (1.4 - 17.8)] and intubation at delivery room [OR:8.8 %95CI (1.9 - 41.7)] were found to increase the risk of RH.

TABLE 1:

Clinical characteristics	Ocular Hemorrhage n=22	Normal n=40	p
Birth weight; grams	3040 (2535 - 3600)	2872 (2540 - 3325)	0.635
Gestational age; weeks	39 (37.0-41.0)	38 (37.5-40.0)	0.238
Primiparity; n (%)	7 (32)	14 (35)	0.967
AGA; n (%)	17 (77)	34 (85)	0.665
Male gender; n (%)	17 (77)	25 (62)	0.365
5 min Apgar < 7; n (%)	10 (45)	27 (67)	0.091
Vaginal delivery; n (%)	12 (55)	8 (20)	0.005
Intubation in delivery room; n (%)	10 (46)	8 (20)	0.035
Exitus; n (%)	1 (0.5)	1 (0.3)	1.000

Data presented as median (IQR) or n(%)
Mann Whitney U test, Chi-square test

CONCLUSIONS

RH was detected in approximately 1/3 of neonates with early acidosis when examined at third day. We found that neonates with acidosis presented with mostly stage 3 RH in contrast to previous studies mentioning mild RH in otherwise healthy neonates. While increase of RH in vaginally delivered infants is similar to previous studies, intubation as a risk factor is new to the literature. Our findings highlight the importance of retinal examination in neonates with acidosis in the presence of intubation during resuscitation.

EP320 / #1547**E-Poster Viewing - Neonatology AS02-23.
Psychiatry & mental health****Machine learning to identify autism risk in infancy: a study in the danish national birth cohort.****D. O'Boyle^{1*}, A. Noone², L. Gallagher³, T. Brink Henriken^{4,5},
A. Khashan¹, B. Hammer Bech⁶, J. English⁷**¹University College Cork, Infant Research Centre, Cork, Ireland²University College Cork, Anatomy and Neuroscience, Cork, Ireland³Trinity College Dublin, Trinity Institute of Neuroscience, Dublin, Ireland⁴Aarhus University Hospital, Department of Paediatrics (intensive Care Neonatology), Aarhus, Denmark⁵Clinical Institute, Aarhus University, Perinatal Research Unit, Aarhus, Denmark⁶Aarhus University, Dept. of Public Health, Aarhus, Denmark⁷INFANT Research Centre, University College Cork, Anatomy and Neuroscience, Cork, Ireland**BACKGROUND AND AIM**

Given the mounting evidence for the role of maternal health and prenatal exposures in the development of autism, we investigated if data routinely collected during pregnancy could aid the development of a clinical prediction model for the detection of autism risk in infancy.

METHODS

We studied maternal health records and prenatal interview data from 76,441 mothers within the Danish National Birth Cohort. We identified 492 mothers-child pairs diagnosed with autism and randomly selected 492 mother-child neurotypical controls. For prediction-modelling 75 variables from maternal medical records and prenatal interviews scheduled at 12 and 30 weeks gestation, and 6 months after birth. Machine learning feature selection (Random forest node impurity, LASSO regularisation), classification, and cross

validation techniques were employed to create machine learning models for prediction of autism outcome.

RESULTS

The top performing model for the prediction of autism resulted in an AUROC of 0.68 (95% CI: 0.62 – 0.74), which identified number of previous spontaneous abortions, maternal Body Mass Index (BMI), maternal history of mental disorders, maternal smoking, and financial burdens as the strongest prenatal and lifestyle predictors of autism outcome. A similar predictive score was observed for both the male only (AUC = 0.67, 95% CI: 0.60 – 0.74) and the top performing model for female only analysis achieved an AUROC = 0.70 (95% CI: 0.57 – 0.83).

CONCLUSIONS

Maternal health record and interview data alone are insufficient for prediction of autism outcome, and additional blood-based biomarker measurements will likely be needed create a clinically useful diagnostic aid for the early detection of autism.

EP321 / #2714**E-Poster Viewing - Neonatology AS02-24. Public health & social paediatrics****Prevention and control of childhood tuberculosis: recent findings on parental perceived-knowledge, attitudinal-trend and practice level from south-western bangladesh using a mixed method STUDY**

K. Anwar^{1*}, A. Kabir², N. Yasmin³, M. Hassan⁴, F. Anne⁵, N. Keya⁶, D.M. Khan⁷, T. Biswas⁸, A. Asad⁹, M. Tanzil¹⁰

¹Ad-din Women's Medical College and Hospital (AWMCH), Head, Medical Research Unit, Dhaka, Bangladesh

²Ad-din Women's Medical College and Hospital (AWMCH), Head, Dept. of Pediatrics, Dhaka, Bangladesh

³Ad-din Women's Medical College and Hospital (AWMCH), Director General (hosp & Nursing) and Head, Dept. of Comm Medicine, Awmc, Dhaka., Dhaka, Bangladesh

⁴Ad-din Women's Medical College and Hospital (AWMCH), Vice Principal & Assoc. Prof. Dept. of Peds., Dhaka, Bangladesh

⁵Research officer, icddr,b, Health System & Popul Sc Div., Dhaka, Bangladesh

⁶Ad-din Women's Medical College & Hosp (AWMCH), Research officer (r & d), Medical Research Unit, Awmc, Dhaka, Bangladesh

⁷Ad-din Women's Medical College & Hosp (AWMCH), Asst. Prof. Pediatrics, Dhaka, Bangladesh

⁸ZH Sikder Women's Medical College, Lecturer, Dept. of Community Medicine, Dhaka, Bangladesh

⁹University of Dhaka, Isrt, Dhaka, Bangladesh

¹⁰Ad-din Women's Medical College & Hosp (AWMCH), Research officer (r & P), Medical Research Unit, Awmc, Dhaka, Bangladesh

BACKGROUND AND AIM

Since community-based research on childhood tuberculosis (CTB) is scarcely conducted in Bangladesh, we conducted this KAP (knowledge, attitude and practice) door-to-door survey on CTB in 18 rural-villages of Khulna (relatively ignored and less-focused).

METHODS

Utilizing a hybrid-designed method we conducted this KAP-survey among **434** parents to assess their **knowledge-score**, **attitudinal-trend** and **practice-level** on the prevention/control of CTB, **Quantitively**, potentials of CTB control-dynamics were measured among domiciliary-health-care service (HCW) providers to strengthen DOTS **qualitatively (KII-method: Priori-Code list/Matrix)**.

RESULTS

Most respondents were young-females (90%) from lower/mid socio-economic status being more literate (34%) than men (26%). Poverty, distant-located health-care-centres, poor-household-income remained causes of non-compliance in health-care-seeking-behaviour. Mean knowledge-score was 2.94 ± 0.8 : ~59% had low, 35% good and 10.5% adequate. Respondent's attitude: Likert-scale on CTB-prevention/control were positive in 77%. To answer if CTB is curable: 47% said sometime, 30% always; 23% thinks CTB be prevented by 'avoiding CTB-patient-contact, 23% avoiding open-coughing or spitting-off/discard sputum safely, while 45% had no idea. **Our observation** yielded kitchen (dry-smoke fuel) in >80% households attached to child's living/bed that may cause/aggravate CTB. of all KII involving community-based HCWs, Pediatricians/Administrators, revealed CTB could be latent/underdiagnosed so actual CTB-prevalence may be more than actual-reporting. It became difficult to detect C/TB due to parental misunderstanding on proper diagnosis and care.

CONCLUSIONS

Our findings will **further** assist the **policy makers** towards a better/robust **strategic planning** of CTB-prevention &/or control. Our data will **add prudent values** in **further strengthening** of **preventive strategies, treatment planning** and **control measures** against CTB.

EP322 / #2064**E-Poster Viewing - Neonatology AS02-24. Public health & social paediatrics****Maternal follow-up duration during pregnancy impact on prognosis of vlbw infants****B. Barzilay^{1*}, Y. Labes², T. Smolkin³**¹Mayanei Hayeshua, Neonatology, Bnei Brak, Israel²Bar Ilan University, Medicine, Zefat, Israel³Poria Medical Center, Neonatology, Poria, Israel**BACKGROUND AND AIM**

Prenatal care includes detecting and treating infections in a timely manner, identification of genetic abnormalities, growth disorders caused by placental insufficiency, amniotic fluid amounts and thus intervene appropriately. Consequently, perinatal complications can be prevented, such as Very Low Birth Weight (VLBW), premature birth, hypoxia and acidosis. Prenatal care that started until week 13 of pregnancy defined as proper, while one which started after week 13 or later defined as inadequate. This study deals with the question of how the different prenatal care periods affect the morbidity, complications and mortality incidences among VLBW premature infants.

METHODS

A cross section, retrospective observational study which will be based on existing medical information of mothers with proper and inadequate prenatal care and their VLBW infants born between the years 1997 to 2017 at "Shamir Assaf Harofe" medical center.

RESULTS

1390 VLBW were included in our study. 1204 who had adequate pregnancy follow-up and 186 who didn't. After analyzing the research variables among VLBW neonates who underwent proper and inadequate prenatal care, a significant difference between the two groups was not found.

--	--

CONCLUSIONS

Based on the current research, initiating prenatal care before 13 weeks of gestational age does not reduce the incidence of neonatal morbidity and mortality among VLBW neonates.

EP323 / #2030**E-Poster Viewing - Neonatology AS02-24. Public health & social paediatrics****Parent-reported quality of life in nicu graduates in the first year after birth: a prospective cohort STUDY**

P. Heuvink¹, N. Van Dokkum¹, H. Bouma¹, K. Kraft^{1*}, A. Bos¹, P. Krabbe²

¹Beatrix Children's Hospital, University Medical Center Groningen, University of Groningen, Division of Neonatology, Department of Pediatrics, Groningen, Netherlands

²University Medical Center Groningen, University of Groningen, Department of Epidemiology, Groningen, Netherlands

BACKGROUND AND AIM

After admission to a Neonatal Intensive Care Unit (NICU), Health-Related Quality of Life (HRQoL) problems may occur. Gaining more insight into what parents experience as problematic can be a first step in the direction of interventions to improve infant HRQoL. This study aimed to assess a parental perspective on HRQoL in NICU graduates during their first year after birth, using a newly developed survey app.

METHODS

We performed a prospective cohort study that included NICU graduates from all gestational ages. The 7 domains in the survey app to assess HRQoL were 'Sleeping', 'Feeding', 'Breathing', 'Stooling/poo', 'Mood', 'Skin' and 'Interaction'. We assessed which domains were most problematic and whether there were differences between gestational age groups during the first year after birth.

RESULTS

The survey app was completed 219 times by 108 unique parents. The mean scores for the domains varied greatly between domains and over time (**Figure 1**). The three most problematic domains according to parents were 'Feeding', 'Sleeping' and 'Interaction'. For 'Interaction', reported problems decreased significantly over time. The trajectory of extremely preterm children significantly differed from other gestational ages for the domains 'Breathing', 'Sleeping', and 'Skin'.

Table 1. Reported frequency of a problem in the total sample

	NICU (n=44)	3mo (n=70)	6mo (n=35)	9mo (n=33)	12mo (n=37)	p-value
Feeding	19 (43%)	27 (39%)	5 (14%)	6 (18%)	12 (32%)	0.046
Breathing	18 (41%)	7 (10%)	5 (14%)	4 (12%)	7 (19%)	0.052
Sleeping	12 (27%)	16 (23%)	12 (34%)	14 (42%)	11 (30%)	0.233
Stooling/poo	11 (25%)	27 (39%)	9 (26%)	8 (24%)	8 (22%)	0.264
Skin	18 (41%)	7 (10%)	7 (20%)	6 (18%)	6 (16%)	0.071
Interaction	38 (86%)	37 (53%)	10 (29%)	8 (24%)	7 (19%)	<0.001
Mood	4 (9%)	9 (13%)	2 (6%)	5 (15%)	6 (16%)	0.359

NICU = Neonatal Intensive Care Unit; 3mo = 3 months (corrected) age; 6mo = 6 months (corrected) age; 9mo = 9 months (corrected) age; 12mo = 12 months (corrected) age

CONCLUSIONS

Parents of NICU graduates reported most problems for the domains 'Feeding', 'Sleeping' and 'Interaction' during the first year after birth. Future studies examining which characteristics of these domains were experienced as problematic, may form the basis for new interventions.

EP324 / #1218**E-Poster Viewing - Neonatology AS02-24. Public health & social paediatrics****Examining the age at diagnosis of developmental dysplasia of the hips for patients not identified up by the uk's current screening programme****J. Wright^{1*}, A. Hurley¹, R. Toone¹, L. Deriu²**¹Leeds general infirmary, Neonatal Medicine, Leeds, United Kingdom²Leeds general infirmary, Orthopaedics, Leeds, United Kingdom**BACKGROUND AND AIM**

Developmental dysplasia of the hip (DDH) is a condition which may require surgery if diagnosed beyond 6 months of age. Many countries utilise a universal screening programme to diagnose cases early. In the UK a selective programme is used however patients still present outside of the screening programme. We set out to examine the pattern of age at diagnosis of patients diagnosed outside of the UKs screening programme.

METHODS

We retrospectively reviewed the electronic records of patients seen in the DDH clinic of a single tertiary referral hospital over a 3-year period (July 2018 – July 2021). Those diagnosed through the Newborn and Infant Physical Examination were labelled as screening diagnosed (SD) and those identified outside of this were labelled as non-screening diagnosed (NSD).

RESULTS

Those in the NSD group were more likely to be diagnosed at a later age (mean age 477 days) compared to those in the SD group (mean age 50 days). of

those diagnosed outside the screening programme, 22% were diagnosed before 6 months of age, 25% at 6-12 months, 24% at 12-18 months, 8% at 18-24 months, 7% at 24-30 months, 5% at 30-36 months, 2% at 36-42 months, 5% at 42-48 months, and 2% beyond 48 months of age.

CONCLUSIONS

Infants diagnosed outside of screening were diagnosed much later than those diagnosed through screening. The majority still present within the first 18 months of life, likely because within this time the child's gait develops. However, a significant proportion present outside of when a child would be expected to start walking.

EP325 / #1073**E-Poster Viewing - Neonatology AS02-25.
Pulmonology****Lung ultrasound signs of extubation failure in extremely preterm infants with evolving bronchopulmonary dysplasia****A. Alonso-Ojembarrena^{1*}, L. Rodeño-Fernández², V. Aldecoa-Bilbao³, R. Gregorio-Hernández⁴, A. Concheiro-Guisán⁵, J. Rodriguez-Fanjul⁶**¹*Puerta del Mar University Hospital, Neonatology, Cádiz, Spain*²*Basurto University Hospital, Neonatal Intensive Care Unit, Bilbao, Spain*³*Hospital Clínic Barcelona. BCNatal - Barcelona Center for Maternal-Fetal and Neonatal Medicine, Neonatology Department, Barcelona, Spain*⁴*Gregorio Marañón University Hospital, Neonatal Intensive Care Unit, Madrid, Spain*⁵*Alvaro Cunqueiro Hospital, Neonatal Intensive Care Unit, Vigo, Spain*⁶*Hospital Germans Trias i Pujol, Pediatric Intensive Care Unit, Badalona, Spain***BACKGROUND AND AIM**

Lung ultrasound (LU) is a useful tool to predict extubation failure in respiratory distress syndrome, however, no study has been performed in preterm infants with evolving bronchopulmonary dysplasia.

METHODS

We included infants born before 30 weeks and older than 7 days of life, with LU 24h before (pre-LU) and/or after (post-LU) an extubation attempt in six different NICUs. We created two groups according to extubation success at any time. We compared LU score, the existence, and number of consolidations and calculated the predictive ability of LU for extubation failure using three logistic: model 1 (gestational age, birth weight and preextubation respiratory severity score), model 2 (pre-LU score, existence, and number of consolidations in pre-LU) and model 3 (combination of 1 and 2).

RESULTS

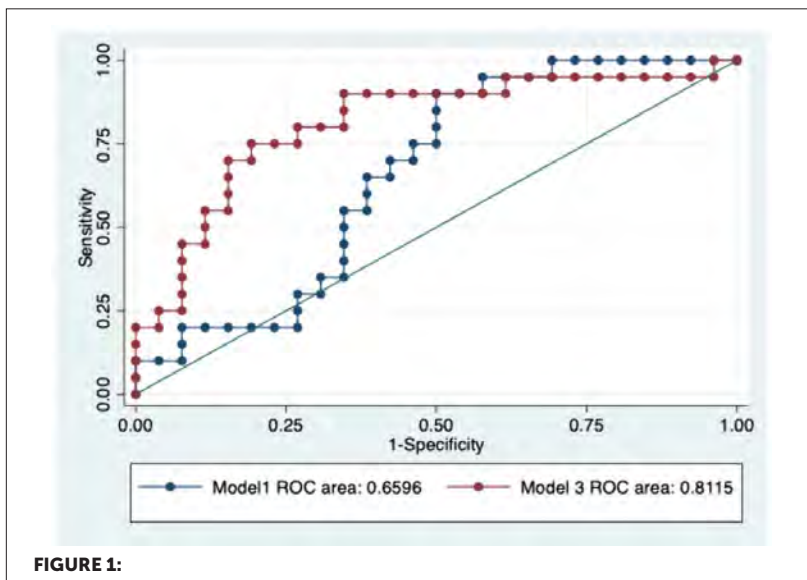

53 pre-LU in 48 patients and 36 post-LU in 29 patients were reviewed. Pre-LU scores were lower in patients with extubation success (12 (10-16) versus 15 (14-16), $p=0.01$), as well as number of consolidations in pre-LU ($p=0.04$). There were no differences in any of LU signs in post-LU. Model 3 had the highest diagnostic accuracy to predict extubation failure: pseudo- R^2 0.22, AUC 0.81 (CI95% 0.67-0.94), $p=0.03$ compared to model 1.

CONCLUSIONS

In infants born before 30 weeks and older than 7 days of age in their extubation attempt, pre-LU scores are higher in those with extubation failure, as well as the number of consolidations in pre-LU. Post-LU is not useful to predict extubation failure. To include pre-LU signs can increase the prediction of extubation failure in these patients.

EP326 / #1741**E-Poster Viewing - Neonatology AS02-25.
Pulmonology****Evaluation of nih calculator to corticosteroid use for avoid bronchopulmonary dysplasia to very low birth weight infants in a lmics.**

T. Bastos^{1*}, T. Iwashita Lages¹, P. Morais¹, E. Orlandin¹, A. Junior¹, F. Celini¹, D. Aragon², C. Calixto¹, C. Ferreira¹, W. Goncalves-Ferri¹

¹Ribeirão Preto Medical School– University of São Paulo, Neonatology, Ribeirao Preto, Brazil

²USP Ribeirao Preto, Neonatology, Ribeirao Preto, Brazil

BACKGROUND AND AIM

Pos-natal corticosteroids can be useful to avoid bronchopulmonary dysplasia. This study aims to evaluate the impact of the N.I.H. (National Institute Healthy) calculator to indicate it's use in Low Middle-Income Countries (L.M.I.C.s).

METHODS

Retrospective cohort. VLBW born at a Brazilian Public NICU (2019 / 2020). The calculator was applied at 14 days of life. If the patient presented a 60% risk of BPD moderate, severe, or death, steroids were indicated. We used dexamethasone intravenous for nine days (decreasing doses from 0.15 mg to 0.05 mg). Two groups were analyzed according to the steroid's indication. We evaluated the steroids use rate and outcomes.

RESULTS

247 preterm. 24 received steroids, according to the calculator (9.7%). Steroids group, the G.A. was 184.3(SD12.2), birthweight 834.8(SD243.2), and hospital stay 105.8 days(SD62.06); No-steroids group, the characteristics were,

respectively, 203days(SD21.7), 1058.2(SD315) and 43.5(SD37.3), with significant difference (p -value <0.01). Surfactant use was associated with protection to steroids indication ($p<0.01$). BPD (oxygen at 36 weeks) occurrence in steroids group was 55% against 16%. Death was 18.8% in the steroids group versus 32.7%. Steroid use didn't increase bowel perforation, leukomalacia or intraventricular hemorrhage; 25% need domiciliary oxygen in the steroids group versus 31.8%. We couldn't verify the statistical protection of steroids in this conditions.

CONCLUSIONS

The corticosteroids didn't affect incidence of death or BPD. However, the patients who met the medication criteria were those with severe comorbidities, even though they presented a lower death rate and domiciliary oxygen need. The steroids used on NICUs at L.M.I.C.s should be investigated and appropriate calculators developed, allowing improvement in neonatal outcomes.

EP327 / #764**E-Poster Viewing - Neonatology AS02-25.
Pulmonology****Bpd an emerging pandemic in neonatal medicine
- learning from a london neonatal network**

**R. Bhatt^{1*}, H. Clark¹, K. Babla¹, G. Kendall¹, L. Dyet¹, S. Hines¹,
I. Mawson¹, A. Taune¹, L. Casanueva², J. Hodges²,
S. Shanmugalingam³, S. D'Souza⁴, C. Singh⁵, J. Meek¹**

¹University College London Hospital, Neonatology, London, United Kingdom

²Royal Brompton Hospital, Long Term Ventilation/picu, London, United Kingdom

³Barnet Hospital, Neonatal Intensive Care, London, United Kingdom

⁴Whittington NHS Trust, Neonatal Intensive Care, London, United Kingdom

⁵North Middlesex hospital, Neonatal Intensive Care, London, United Kingdom

BACKGROUND AND AIM

Bronchopulmonary Dysplasia (BPD) is the commonest complication of prematurity and severe BPD poses challenges to neonatologists. Affected infants stay in hospital for prolonged periods, and there is little evidence to guide their long-term care. This study aimed to identify these challenges and implement interventions to improve care and outcomes for these infants in a London neonatal network.

METHODS

Quality improvement methodologies were applied with an initial analysis of the needs of the local neonatal network in managing complex respiratory patients. A weekly neonatal respiratory multidisciplinary meeting was implemented to present infants and discuss their management and the challenges associated with their care.

RESULTS

Implementation of a multidisciplinary network has allowed preterm infants with challenging respiratory disease and need for ongoing specialist respiratory input to be consistently identified and assessed before term equivalent age. By pooling specialist knowledge, we improved the journey of these infants across the network. There has been greater consistency in respiratory management, increased awareness and assessment of secondary pulmonary hypertension, planned respiratory weaning strategies, emphasis on nutrition and growth, focus on development and earlier involvement of long-term ventilation teams. Parents were updated after each meeting and reassured that teams in their local units were aware of their baby.

CONCLUSIONS

Due to the increased survival of extremely preterm infants, there is a need to identify babies with severe BPD early using improved risk stratification based on their birth history and early respiratory course. In this way, we can share expertise, focus on research questions, and tailor management to optimise lung health.

EP328 / #1955**E-Poster Viewing - Neonatology AS02-25.
Pulmonology****Implementation of point of care lung ultrasound
at a tertiary neonatal UNIT****S. Chellen*, R. Masters, P. Saha, S. Mulla**

East Kent University Hospitals (EKHUFT), William Harvey Hospital, Department of Neonatology, Ashford, Kent, United Kingdom

BACKGROUND AND AIM

Lung ultrasound (LUS) relies on the interpretation of artefacts that are produced when ultrasound waves pass through lung tissue. LUS is quick to perform, easy to learn, reduces the exposure to X-rays and has the added benefit of potential cost savings. The European Society of Paediatric and Neonatal Intensive Care (ESPNIC) have created evidence-based guidelines recommending the use of LUS to aid in the diagnosis of Transient Tachypnoea of the Newborn (TTN)/ Respiratory Distress Syndrome (RDS)/ Pneumonia and Pneumothorax. To develop and implement a LUS teaching and training package for neonatal doctors.

METHODS

Neonatal Registrars and Consultants attended a LUS course. They gained proficiency by performing regular scans with additional guidance from a Paediatric Radiologist. A local LUS protocol was created with multidisciplinary input from a Paediatric Radiologist, Neonatal Consultants, and the Neonatal Respiratory Lead. A unit specific LUS teaching and training package was then developed to train junior doctors. This comprised of face-to-face teaching, supervision and review of scans and completion of a logbook.

RESULTS

More than 50% of neonatal doctors were trained within 3 months to perform LUS independently and could identify the above-mentioned lung pathologies.

CONCLUSIONS

LUS is a valuable tool for diagnosing neonatal pathologies. As this is a relatively 'new' skill, training must be provided to ensure adequate competency amongst those who use it. We have found that using a structured training approach it has been relatively simple to upskill our team in LUS.

EP329 / #861**E-Poster Viewing - Neonatology AS02-25.
Pulmonology****Epidemiological characteristics, clinical course,
and outcomes of neonates with pneumothorax in
the united states****R. Turkson¹, M. Boateng², D. Webster³, G. Kodua⁴, K. Danso^{5*},
N. Parmar⁶, H. Doshi⁷, P. Bhatt⁸, K. Donda⁹, F. Dapaah-Siakwan¹⁰**¹Unaffiliated, Unaffiliated, Lowell, United States of America²Unaffiliated, Unaffiliated, Worcester, United States of America³University of Ghana Medical Center, Intensive Care Unit, Accra, Ghana⁴Quinnipiac University, Biomedical Science, Hamden, United States of America⁵Cape Coast Teaching Hospital, Pediatrics, Cape Coast, Ghana⁶East Tennessee Children's Hospital, Pediatrics, Knoxville, United States of America⁷Children's Hospital of Southwest Florida, Pediatrics/neonatology, Fort Myers, United States of America⁸United Hospital Center, Pediatrics, Bridgeport, United States of America⁹University of South florida, Pediatrics/neonatology, Tampa, United States of America¹⁰Valley Children's Hospital, Neonatal Intensive Care Unit, Madera, United States of America**BACKGROUND AND AIM**

Pneumothorax is a significant cause of morbidity in newborns. Previous studies on neonatal pneumothorax had small sample sizes or were from small geographic regions, thus limiting the generalizability of their findings. We aimed to describe the epidemiology, clinical course, and short-term outcomes of neonates ≥ 35 weeks gestation age (GA) in the United States.

METHODS

This was a population-based, retrospective cross-sectional analysis of newborn hospitalizations with GA ≥ 35 weeks within the National Inpatient Sample from 2016-2019. ICD-10 codes were used to identify hospitalizations with

pneumothorax. The outcome variables were demographic characteristics, hospital course, mortality, and resource use. The Chi-square test and Mann-Whitney U tests were used to compare newborn hospitalizations with and without pneumothorax. P-value <0.05 was considered significant.

RESULTS

Among 15.3 million newborns, 47,320 (3 per 1,000) had pneumothorax. Of those with pneumothorax: 69.1% male, 62.4% White, 75.2% term, 37.3% Caesarean delivery, and 81.4% in teaching hospitals. Compared to those without pneumothorax, newborns with pneumothorax were more likely to have sepsis (11.8% vs 0.8%, $P<0.001$), pneumonia (5.7% vs 0.2%, $P<0.001$), and meconium aspiration (8.3% vs 0.2%, $P<0.001$) and more likely to receive any mechanical ventilation (20.8% vs 0.8%, $P<0.001$), and invasive mechanical ventilation >96 hours (6.7% vs 0.1%, $P<0.001$). Chest tube was placed in 20.7% with pneumothorax. Mortality was higher (1.5% vs 0.1%, $P<0.001$) as was hospital cost and length of stay (5 vs 2 days, $P<0.001$).

CONCLUSIONS

Pneumothorax appears to increase in-hospital mortality and resource utilization in newborns. Identification of risk factors can help reduce the burden of pneumothorax and potentially improve outcomes.

EP330 / #721**E-Poster Viewing - Neonatology AS02-25.
Pulmonology****Type, frequency, and timing of surgical interventions in preterm infants with bronchopulmonary dysplasia in the united states****K. Danso^{1*}, G. Kodua², R. Turkson³, M. Boateng⁴, M. Osei-Bonsu⁵, H. Doshi⁶, N. Parmar⁷, P. Bhatt⁸, K. Donda⁹, F. Dapaah-Siakwan¹⁰**¹Cape Coast Teaching Hospital, Pediatrics, Cape Coast, Ghana²Quinnipiac University, Biomedical Science, Hamden, United States of America³Unaffiliated, Unaffiliated, Lowell, United States of America⁴Unaffiliated, Unaffiliated, Worcester, United States of America⁵Unaffiliated, Unaffiliated, Lawrenceville, United States of America⁶Children's Hospital of Southwest Florida, Pediatrics/neonatology, Fort Myers, United States of America⁷East Tennessee Children's Hospital, Pediatrics, Knoxville, United States of America⁸United Hospital Center, Pediatrics, Bridgeport, United States of America⁹University of South florida, Pediatrics/neonatology, Tampa, United States of America¹⁰Valley Children's Hospital, Neonatal Intensive Care Unit, Madera, United States of America**BACKGROUND AND AIM**

Preterm infants with bronchopulmonary dysplasia (BPD) often undergo invasive procedures as part of BPD management or other complications of prematurity. However, the scope of these surgical interventions has not been comprehensively studied. We aimed to describe the types, frequency, and timing of surgical procedures in preterm hospitalizations with BPD in the United States.

METHODS

This was a retrospective, cross-sectional analysis of the 2018 National Inpatient Sample for preterm infants ≤ 30 weeks gestational age with BPD. Descriptive

statistics were used to describe the type, frequency, and timing of surgical procedures such as tracheostomy, patent ductus arteriosus (PDA) ligation, G-tube placement, cardiac catheterization, laparotomy, and others.

RESULTS

A total of 8,095 had BPD. The characteristics of the study population are shown in Table 1. A total of 1,735 (21.4%) had 2,410 procedures performed and 6,360 (78.6%) had no procedure performed. The majority (n=1,270; 73.2%) of the 1,735 had only one procedure performed. The type, frequency, and timing (hospitalization day) of these procedures are described in Table 2. The commonest procedures were G-tube placement (9.2%) and PDA ligation (8.1%). In-hospital mortality among those with >3 procedures (1.7% of the study cohort) had a mortality rate of 14.3%, 4.5 times the overall mortality rate of 3.2% (Table 3).

Table 1. Baseline characteristics of the study population

	BPD N =8,095	Proportion, %
GA		
≤24 weeks	1805	22.3
25-26 weeks	2490	30.8
27-28 weeks	2475	30.6
29-30 weeks	1325	16.4
Sex		
Female	4350	53.7
Male	3745	46.3
Race		
White	3170	42.4
Blacks	2135	28.6
Hispanics	1310	17.5
Others	860	11.5
Primary Payer		
Medicaid (Public insurance)	4840	59.8
Private	2880	35.6
Other	370	4.6
Census region		
Northeast	1275	15.8
Midwest	2080	25.7
South	3430	42.4
West	1310	16.2
Hospital		
Non-teaching	335	4.1
Teaching	7760	95.9

Table 2. Type, frequency, and timing of surgical interventions in 8,095 preterm hospitalizations with bronchopulmonary dysplasia in 2018

	Number	Proportion (%)	Median age in days at procedure
Tracheostomy	205	2.5	128
Bronchoscopy	180	2.2	93
PDA ligation	655	8.1	28
G-tube	745	9.2	134
Cardiac catheterization	10	0.1	14*
Laparotomy	55	0.7	65
Hernia repair	310	3.8	107
VP shunt/external ventricular drain	65	0.8	88
ROP surgery	185	2.3	95
	2410		

Table 3. The relationship between the number of surgical procedures and the mortality in preterm hospitalizations with BPD

Number of procedures	N	Proportion, %	Mortality, %
No procedure	6,360	78.6	2.8
1	1,270	15.7	4
2	305	3.8	4.9
3	20	0.2	0
>3	140	1.7	14.3
	8,095		3.2

CONCLUSIONS

About 21% of hospitalizations with BPD had at least one surgical procedure performed before discharge. Mortality was higher among those who had >3 surgical procedures. The nexus of anesthesia and the complications of prematurity requiring surgical interventions and their timing need further exploration to optimize outcomes for these infants.

EP331 / #1205**E-Poster Viewing - Neonatology AS02-25.
Pulmonology****Unplanned extubations in a tertiary neonatal intensive care unit (nicu) – incidence and causes**

P. De Silva*, R. Javed, H. Gowda

University Hospitals Birmingham NHS Trust, Neonatal Intensive Care Unit, Bordesley Green East, United Kingdom

BACKGROUND AND AIM

Mechanically ventilated neonates are prone to unplanned extubation causing cardiorespiratory deterioration, and repeated reintubation may lead to airway trauma. Compared with data from PICUs, unplanned extubation in neonates occur 2-3 times more frequently. Studies have shown a variation in the rate of unplanned extubation in NICU from 1.14 to 5.3 per 100 ventilation days. Reasons for this increased incidence include longer duration of intubation, shorter neonatal tracheal length, less routine use of sedation, use of uncuffed endotracheal tubes and the method of fixation. The aim of this study is to find out the incidence, and reasons for unplanned extubation in our NICU.

METHODS

Retrospective data was collected from Badger (Electronic patient records) for all patients requiring endotracheal intubation and ventilation over a 24 month period (September 2019 to August 2021). Neonates with unplanned extubations were identified and causes explored.

RESULTS

336 babies were admitted that needed intubation and ventilation during the study period. The rate of unplanned extubation was 15.57% (n=57) with an incidence of 2.37 per 100 ventilation days. 55% were <28 weeks, 28% were 29-37 weeks and 17% were >38 weeks gestation at birth. Most common reason for unplanned extubation were handling of babies for examinations or procedures. Reintubation was required in 63.1% of babies.

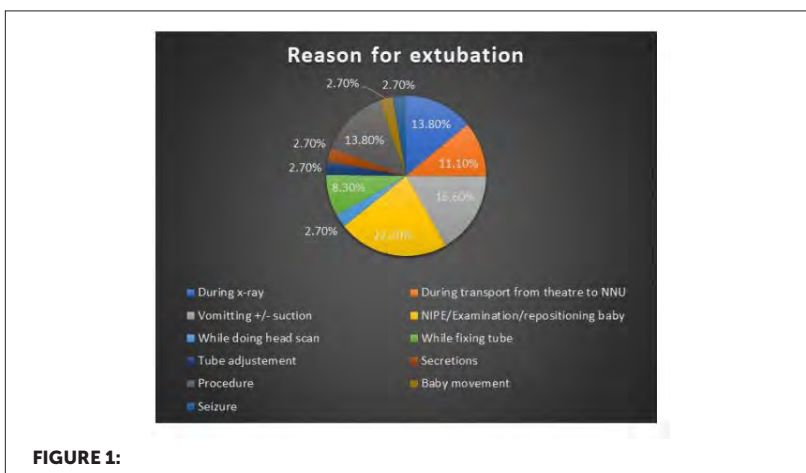

CONCLUSIONS

The incidence of unplanned extubation in our NICU was within the range reported in literature. It can be further reduced by staff education and implementing standards of care during procedures and examinations.

EP332 / #1984**E-Poster Viewing - Neonatology AS02-25.
Pulmonology****Optimising oxygenation of preterm infants during
respiratory support by fine-tuning automatic
titration of oxygen****H. Salverda¹, S. Cramer¹, C. Schmeits¹, J. Van Der Plas¹, A. Te Pas²,
J. Dekker^{1*}**¹Leiden University Medical Center, Neonatology, Leiden, Netherlands²Leiden University Medical Centre, Neonatology, Leiden, Netherlands**BACKGROUND AND AIM**

Automated oxygen control can reduce hypoxia and hyperoxia associated with significant morbidity and mortality, by aiming to maintain SpO₂ within a set target range (TR). A TR entailing slightly higher SpO₂ values may correspond to a less steep part of the oxygen-haemoglobin dissociation curve. We hypothesize that this in turn leads to higher stability of SpO₂, with less time spent under the TR.

METHODS

A randomised cross-over study was performed in preterm infants born <30 weeks of gestation, receiving respiratory support. Oxygen was automatically titrated by the OxyGenie controller (SLE6000 ventilator) to a TR of 91%-95% (TR_{low}) and 92%-96% (TR_{high}) for 24 hours each, in random sequence. Outcomes included frequency and duration of hypoxic (SpO₂<80%) and hyperoxic (SpO₂>96%) episodes. Data are in median and presented as TR_{high} vs. TR_{low}, p-value.

RESULTS

20/27 infants have been studied, of gestational age $27^{0/7}$ ($25^{2/7}$ - $28^{1/7}$) weeks and postnatal age 18 (12-23) days. Hypoxic episodes were less frequent in the higher TR (TR_{high} 2.8/hour vs. TR_{low} 3.7/hour, $p=0.04$), but the duration was not significantly different (5.1s vs. 5.2s, $p=0.60$). Neither was time in SpO_2 91%-96% (80% vs. 81%, $p=0.15$). Hyperoxic episodes were more frequent in the higher TR (7.4/hour vs. 3.7/hour, $p=0.003$) but the duration was not significantly different (4.5s vs. 4.5s, $p=0.82$).

CONCLUSIONS

Targeting a higher TR during automated oxygen titration by OxyGenie led to less frequent hypoxic episodes albeit at the cost of more frequent hyperoxic episodes. The duration of hypoxic and hyperoxic episodes were not significantly different.

EP333 / #1961**E-Poster Viewing - Neonatology AS02-25.
Pulmonology****Respiratory outcomes following less invasive surfactant administration in late preterm infants: a comparative STUDY****G. Di Cataldo^{1*}, C. Gammeri², M.C. Gauci³, F. Gambilonghi³,
C. Mattia³, M.A. Conversano³, A. Saporito³, P. Betta³**¹University of Catania, Department of Pediatrics, Catania, Italy²University of Catania, Department of Pediatrics, Catania (sicilia), Italy³University of Catania, Pediatrics, Catania, Italy**BACKGROUND AND AIM**

Late preterm infants (LPIs) represent about 74% of all preterm births. The purpose of this study was to evaluate the effectiveness of less invasive surfactant administration (LISA) in late preterm infants for the management of respiratory distress.

METHODS

The present comparative study was conducted at the Neonatal Intensive Care Unit of the University of Catania between January 2019 and December 2022. Preterm infants, born between 34 and 37 weeks of gestation and affected by respiratory distress, were assessed for eligibility. Patients were divided into two groups: Group 1, 25 infants treated with LISA; Group 2, 25 control infants. The primary outcome was the change in FiO₂ parameters following LISA in Group 1. Duration of non-invasive respiratory support and duration of hospital stay were considered as secondary outcomes.

RESULTS

In group 1, mean FiO₂ significantly improved from 41.5% to 25.5% following LISA ($p < 0.001$). Mean duration of non-invasive respiratory support was lower in Group 1, being 49 hours and 74 hours in Group 1 and Group 2, respectively. Mean length of hospital stay was 15 days and 24 days in group 1 and group 2, respectively.

CONCLUSIONS

Nowadays, there is no guideline on surfactant use in late preterm infants. Our findings showed that LISA was effective in reducing FiO₂, allowing a shorter need for non-invasive respiratory support and a faster recovery compared with untreated controls. Further studies are needed to corroborate our results and to understand which are the most appropriate LISA protocols in late preterm infants.

EP334 / #1445**E-Poster Viewing - Neonatology AS02-25.
Pulmonology****Impact of time point of extracorporeal membrane oxygenation on mortality and morbidity in congenital diaphragmatic hernia****F. Dittgen*, C. Wegele, N. Rafat, T. Schaible, A. Perez Ortiz**

University Hospital Mannheim, Neonatology, Mannheim, Germany

BACKGROUND AND AIM

While the inclusion criteria for initiating ECMO have been described in detail by the CDH Study Group, there is no data available on the influence of the time point, when ECMO was initiated, on the morbidity and mortality in CDH patients. We hypothesized that an early initiation of ECMO after birth is associated with a beneficial outcome in severe forms of CDH.

METHODS

In this retrospective cohort study all neonates with congenital diaphragmatic hernia admitted to our institution between 2010 and 2020 undergoing ECMO treatment were included. The study population was divided into the four following groups depending on the time point of ECMO initiation: 1) < 12 hours after birth (n=143)

2) between 12-24 hours after birth (n=31)

3) between 24-120 hours after birth (n=48) and 4) > 120 hours after birth (n=14). Pre-, peri- and postnatal clinical parameter were collected, and mortality and morbidity were compared between the groups.

RESULTS

The mortality rate in the first (34%) and fourth group (43%) was high and in the second (23%) and third group (12%) rather low. The morbidity, did not differ significantly, only patients receiving ECMO >120 hours after birth had an increased rate of severe CLD.

CONCLUSIONS

Our data, although not randomized and limited due to small study groups, suggest that very early need for ECMO and ECMO initiation >120 hours after birth is associated with increased mortality. Therefore, implementation of ECMO support within the first 12 to 120 hours might improve clinical outcome in congenital diaphragmatic hernia.

EP335 / #422**E-Poster Viewing - Neonatology AS02-25.
Pulmonology****Does 'less invasive surfactant administration' technique reduce the need for mechanical ventilation without increasing adverse events in preterm neonates with respiratory distress syndrome?****M. Docksey^{1,2*}, L. Bradley², L. Green², P. Satodia^{1,2}**¹University of Warwick, Warwick Medical School, Coventry, United Kingdom²University Hospital Coventry & Warwickshire NHS Trust, Nicu, Coventry, United Kingdom**BACKGROUND AND AIM**

Premature neonates are at risk of developing respiratory distress syndrome (RDS) due to lack of surfactant production. Traditional treatment involves administering surfactant via endotracheal intubation and mechanical ventilation (MV). This may lead to barotrauma and bronchopulmonary dysplasia (BPD). Less Invasive Surfactant Administration (LISA) can reduce the need for MV and BPD risk. However, neonatal units in the UK have variable practice and lack of standardisation of RDS treatment guideline. The aim was to assess if LISA reduces the need for MV and associated adverse events compared to traditional methods.

METHODS

We retrospectively assessed medical records of preterm infants aged 24-34 weeks with RDS who were treated with surfactant via LISA from 2018-2022 or via endotracheal tube from 2014-2018.

RESULTS

Records of 75 LISA patients and 58 non-LISA patients ('INSURE' and/or surfactant via endotracheal tube) were analysed (mean gestational age (weeks) 29.81 ± 2.1 and 29.43 ± 2.6 , mean birthweight (g) 1382.68 ± 400.97 1391.38 ± 444.35 , 41.3% and 44.8% female in LISA and non-LISA, respectively). Chi-square results found LISA successfully reduced the need for MV <72h of life compared to non-LISA patients (10.7% vs 84.5%, $p < 0.01$) and Mann-Whitney U results revealed significantly shorter durations on MV ($p < 0.001$). No significant differences were found in adverse events between groups.

CONCLUSIONS

We recommend LISA treatment for surfactant delivery in RDS compared to endotracheal intubation as it reduces need for MV without increasing morbidity and mortality. UK neonatal units are encouraged to increase training in the LISA technique and standardise the guideline.

EP336 / #2005**E-Poster Viewing - Neonatology AS02-25.
Pulmonology****Trends in ventilation modes and their impact on the incidence of bronchopulmonary dysplasia (bpd) in very low birth weight (vlbw) infants****S. Eventov Friedman^{1*}, T. Adler Heltovsky², A. Gileles-Hillel³, I. Erlichman¹**¹Hadassah Medical Center, Hebrew University, Neonatology, Jerusalem, Israel²Faculty of Medicine, Hebrew University, Neonatology, Jerusalem, Israel³Hadassah Medical Center, Hebrew University, Pediatric Pulmonology, Jerusalem, Israel**BACKGROUND AND AIM**

Invasive ventilation can injure immature lungs. Therefore, less invasive forms of ventilation have evolved. It is unclear whether changes in ventilation practices have been associated with improvements in respiratory outcomes. We aimed to examine trends of respiratory support modes in preterm neonates over the last decade and their impact on BPD.

METHODS

A retrospective cohort of VLBW infants hospitalized during two periods, 2012-13 and 2018-19. Data on the duration of invasive (IV) and non-invasive (NIV) ventilation were collected. The primary outcome was BPD severity at 36 weeks corrected age.

RESULTS

We enrolled 481 infants. Between the two time periods, the prevalence of IV and NIV increased significantly (32.9% to 46.7%, $P < 0.002$; 43.6% to 71.6%,

$P < 0.001$, respectively). The average duration of IV did not increase, whereas that of NIV increased by 52%, (9.24 to 14.08 days, $P < 0.016$). The total duration of respiratory support remained unchanged (median 14 and 12.5 days in the early and late period, respectively). Overall, the prevalence of moderate-severe BPD at 36 weeks' corrected age remained unchanged 10.7% and 13.5% in the early and late periods, respectively, and found similar in gestational age subgroups: 40% in infants born at less than 28 weeks of gestation and 7.5% in those born at above 28 weeks.

CONCLUSIONS

The increasing utilization of NIV in the last decade was not accompanied by a reduction in IV in VLBW infants. The higher rate of ventilation of any kind was not accompanied by a higher prevalence of moderate-severe BPD.

EP337 / #2046**E-Poster Viewing - Neonatology AS02-25.
Pulmonology****Refining the oxyhemoglobin dissociation curve
for clinical oxygen management in premature
infants****N. Gangaram-Panday^{1*}, W. Van Weteringen¹, S. Willemsen²,
D. Rizopoulos², A. Tintu³, I. Reiss¹**¹Erasmus MC Sophia Children's Hospital, University Medical Center Rotterdam, Department of Pediatrics, Division of Neonatology, Rotterdam, Netherlands²Erasmus MC University Medical Center Rotterdam, Biostatistics, Rotterdam, Netherlands³Erasmus MC, University Medical Center Rotterdam, Department of Clinical Chemistry, Rotterdam, Netherlands**BACKGROUND AND AIM**

Oxygen management in preterm infants strongly depends on continuous monitoring of the oxygen saturation with pulse oximetry (SpO₂). Unfortunately, due to the oxyhaemoglobin dissociation curve a single SpO₂ value can correspond to a wide range of arterial partial pressure of oxygen (PaO₂) values, which remains the one of the best indicators of tissue oxygenation. This study aimed to create a model-based estimation of PaO₂ from SpO₂ levels in premature neonates.

METHODS

This retrospective study included children aged 0 to 18 years, admitted from June 2007 to June 2017 at Erasmus MC Sophia Children's Hospital. Generalised additive models (GAM) were fitted to determine the nonlinear relation between the oxygen pressure and oxygen saturation, including the covariates acidity, carbon dioxide, haemoglobin, and postnatal age. Data was randomly assigned to a train and test dataset. To validate the prediction

model in the neonatal population, a paired dataset of SpO₂ and arterial blood gas values between June 2017 and June 2019 was included.

RESULTS

A total of 7,044 patients with 126,256 blood gas samples were included for analyses. The GAM had an R-squared value of 0.86 with a root mean squared error of 0.17 and a mean squared error of 0.03. The PaO₂ levels estimated from SpO₂, showed an accuracy (bias (95% limits of agreement)) of 0.2 (-2.4 to 2.8) kPa with a Pearson's correlation coefficient of $r = 0.85$ ($n = 468$).

CONCLUSIONS

A new model-based method is presented for oxygen management in premature infants, which accurately estimates PaO₂ values from clinical SpO₂ measurements.

EP338 / #1839**E-Poster Viewing - Neonatology AS02-25.
Pulmonology****Keep the chin up: evidence-based standardised care pathway for infants with pierre robin sequence (PRS)****D. Goel^{1,2,3*}, S. Rao^{1,2}, A. Wilson^{1,3}, A. O'Donnell^{1,3}**¹*The University of Western Australia, Division of Paediatric Medicine, Nedlands, Australia*²*Perth Children's Hospital, Neonatology, Nedlands, Australia*³*Perth Children's Hospital, Respiratory and Sleep Medicine, Nedlands, Australia***BACKGROUND AND AIM**

Management of upper airway obstruction in neonates with Pierre Robin Sequence (PRS) is often challenging due to difficulties in grading the severity of disease, difficulties obtaining early polysomnography (PSG) and variable practices with no widely accepted standard protocol. We aimed to develop and implement a standardised care pathway for infants with PRS.

METHODS

Total of 190 publications were identified of which 21 were read in detail. Majority were review articles or retrospective studies. Consultation was obtained from the Complex Airway Team (multidisciplinary team of neonatologist, paediatric sleep specialist, otolaryngologist, plastic surgeon, clinical nurse specialist and speech pathologist), geneticists, audiologists, the consumer group "PRS Australia" and paediatric sleep specialist across Australia and NewZealand. Final recommendations were based on consensus and quality of the evidence.

RESULTS

We developed a pathway outlining sequential intervention to manage OSA based on functional assessment by PSG (7-14 day of life) and structural assessment by flexible nasal endoscopy "FNE" (0-7 day of life). Conduct of bedside PSG in NICU instead of sleep lab enables innovative, timely, patient-centred and cost-effective service delivery. We standardised reporting of glossoptosis (Yellon classification), laryngomalacia (Olney et.al) and airway (Seattle DISE scoring) on FNE. Early multidisciplinary involvement, structured assessment of comorbidities such as feeding, synchronous airway lesions or associated genetic syndromes, discharge planning with clearly defined multidisciplinary follow-up are also considered.

CONCLUSIONS

This project is likely first in Australia to standardise care pathway for infants with PRS encompassing collaborative, innovative and structured care delivery principles. Its creation process provides foundation for future clinical and research collaboration.

EP339 / #1666

E-Poster Viewing - Neonatology AS02-25. Pulmonology

Lisa versus insure – implementing a new procedure

S.S. Hedegaard^{1*}, R. Kristensen², C.K. Schmidt³, N. Breindahl⁴,
E. Bay³, A. Lando³, C. Heiring³, E. Malchau Carlsen³, L. Aunsholt³

¹Gødstrup Hospital, Neonatology, Herning, Denmark

²Copenhagen University Hospital, Rigshospitalet, Cardiothoracic Surgery, Copenhagen, Denmark

³Copenhagen University Hospital, Rigshospitalet, Department of Intensive Care For Infants and Toddlers, Copenhagen, Denmark

⁴Rigshospitalet, Department of Neonatal and Pediatric Intensive Care, Copenhagen, Denmark

BACKGROUND AND AIM

Surfactant is an evidence-based treatment of respiratory distress syndrome in premature infants. A newer method of administering surfactant, LISA (less-invasive-surfactant-administration), introduced in 2017, aims to reduce lung injury and is primarily used for infants born <28 weeks of gestation. LISA was shown to be superior to INSURE (intubation-surfactant-extubation), however recent evidence indicates that the clinical potential is overestimated. Our aim was to compare the need for mechanical ventilation within the first 72 hours after birth, and the need for repeated dose surfactant between LISA and INSURE.

METHODS

We conducted a retrospective study of all immature infants receiving surfactant from 2013-2021 in a level IV NICU at Rigshospitalet, Denmark. Infants receiving surfactant were eligible for inclusion. Infants exposed to LISA were matched 1:1 with INSURE according to inspired oxygen and gestational age.

RESULTS

A total of 639 immature infants were admitted at the NICU. of these, 387 received surfactant within the first 72 hours after birth (50 LISA, 85 INSURE, 252 via mechanical ventilation). All 50 infants receiving LISA were matched 1:1 with INSURE. Gestational age, pre-procedural O₂-saturation and birth-weight were equally comparable. The need for mechanical ventilation within 72 hours was equal in the LISA vs. INSURE group (18 (58%) vs. 13 (42%), $p = 0.28$). The need for a repeated dose of surfactant was higher in the LISA group vs. INSURE (15 (30%) vs. 5 (10%), $p < 0.01$).

CONCLUSIONS

Surfactant applied by LISA predisposes to repeated surfactant treatment with subsequent need for positive pressure ventilation and supposed increased risk of lung injury.

EP340 / #1486**E-Poster Viewing - Neonatology AS02-25.
Pulmonology****Breathing synchronous changes in cervical
bioimpedance in preterm infants**

**M.-L. Herrmann^{1*}, H. Nahrstaedt², M. Mandl³, T. Reicherzer⁴,
C. Frank⁴, A. Flemmer⁴, M. Klemme⁴, U. Thome¹, W. Braun⁵,
B. Ackermann¹**

¹Universitätsklinikum Leipzig, Neonatology, Leipzig, Germany

²Hasomed GmbH, Embedded Development, Magdeburg, Germany

³Ludwig-Maximilians-Universität München, Institut Für Medizinische Informationsverarbeitung
Biometrie Und Epidemiologie (ibe), München, Germany

⁴Dr. von Hauner Children's Hospital of LMU Klinikum, Neonatology, Munich, Germany

⁵Fritz Stephan GmbH, Forschung Und Entwicklung, Gackebach, Germany

BACKGROUND AND AIM

Upper airway muscles are involved in stabilizing airways during spontaneous breathing. We hypothesized that breathing synchronous changes in cervical bioimpedance (cBI) might be detectable in preterm infants.

METHODS

A prospective observational study was performed on preterm infants with non-invasive ventilatory support. Breathing was examined by Graseby capsule and respiratory inductance plethysmography (RIP), and quiet breathing without limb or facial movements was verified by reviewing a video recording. We measured cBI at a sampling rate of 4 kHz and compared cBI to abdominal wall movements breath by breath during spontaneous breathing. We calculated synchronicity and delays between cBI, Graseby capsule, and RIP. Time lags were corrected for known technical delays.

RESULTS

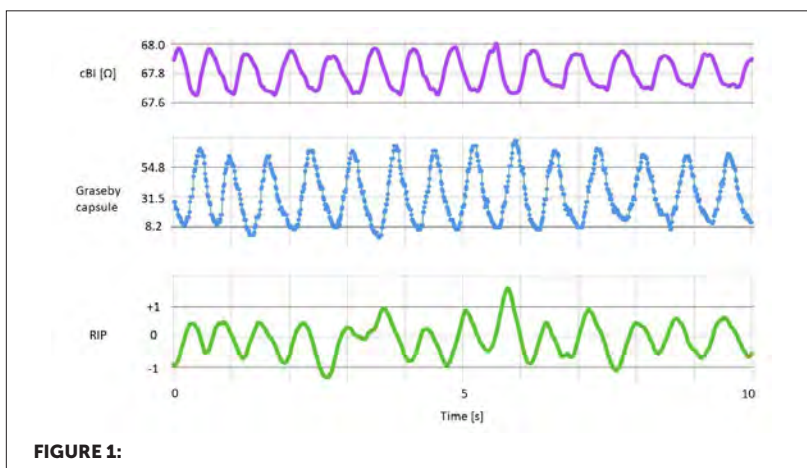

We examined 6 preterm infants (3 female, 3 male) with a gestational age of 26 weeks (23+0–27+5), a birth weight of 788g (445–990g), and a median age at the examination of 33d (12–68d). Mean raw value of cBI was $69.57 \pm 9.11 \Omega$. A total of 4833sec of quiet spontaneous breathing were analyzed. We detected 7070 breaths in cBI and 6867 in abdominal wall movement signals. Zero-crossings of normalized cBI data occurred in median 55 (-33–137) msec before Graseby capsule signals and 85 (18–150) msec before RIP signals. A typical example of cBI, Graseby signal, and RIP is shown in fig. 1.

CONCLUSIONS

The higher detection rate of breaths in cBI compared to our reference signals might indicate a high sensitivity. Cervical bioimpedance changes synchronously to abdominal movement in spontaneously breathing preterms. Monitoring cBI might be beneficial in non-invasively supported infants.

EP341 / #860

E-Poster Viewing - Neonatology AS02-25. Pulmonology

Identification of risk factors for severe bronchopulmonary dysplasia in extremely premature infants: a scoping review

M. Ito^{1*}, F. Namba², S. Kato³, M. Saito⁴, N. Miyahara², E. Ota⁵, H. Nakanishi⁶

¹Akita University Graduate School of Medicine, Department of Pediatrics, Akita city, Japan

²Saitama medical hospital, Pediatrics Department, Kawagoe, Japan

³Nagoya City University Graduate School of Medical Sciences, Department of Pediatrics and Neonatology, Nagoya city, Japan

⁴University of Tsukuba, Department of Child Health, Tsukuba, Japan

⁵St. Luke's International University, Global Health Nursing, Tokyo, Japan

⁶Kitasato University Hospital, Department of Pediatrics, Sagami, Japan

BACKGROUND AND AIM

The remarkable improvement in the long-term prognosis of extremely premature infants (<28 weeks) has led to an increase in the number of cases of bronchopulmonary dysplasia (BPD). Therefore, identifying its risk factors in the early period of life followed by exploring better prophylactics and treatment strategies are important. The objectives of our scoping review are to screen available evidence, identify perinatal risk factors involved in the development and severity of BPD, and devise a novel disease classification system that can predict long-term prognosis.

METHODS

Eligibility criteria are as follows: articles published from 2016 to 2021; studies conducted in developed countries; articles written in English (PubMed) or Japanese (Ichushi); randomized controlled trials, prospective/retrospective cohort studies, or case-control studies. We screened the titles and abstracts

of studies identified by independent reviewers using the population-concept-context framework.

RESULTS

of the initial 3,015 articles identified, 34 studies were included. Prenatal risk factors associated with the development or severity of BPD included males (4 studies positively associated/4 studies that evaluated risk factors), twins (2/2), premature rupture of membranes (2/2), chorioamnionitis (3/3), maternal hypertensive disorders (2/3), lower gestational age (4/4), and lower birth weight (2/3). Similarly, postnatal factors associated with the development or severity of BPD included positive airway pressure on day 0 or 1 (2/2), respiratory distress syndrome (3/4), need for management of patent ductus arteriosus (3/4).

CONCLUSIONS

Our scoping review identified various prenatal and postnatal factors related to BPD. We need to keep track of whether these risk factors are important.

EP342 / #1635**E-Poster Viewing - Neonatology AS02-25.
Pulmonology****Electrical impedance tomography based
evaluation of the aeration of the lungs of
newborns born naturally and through the section
cesarea****A. Janulionis*, E. Viršilas, A. Valiulis, A. Liubsys**

Vilnius University Medical Faculty, Clinic of Children's Diseases, Institute of Clinical Medicine, Vilnius, Lithuania

BACKGROUND AND AIM

Electrical impedance tomography (EIT) is non-invasive, radiation free real time lung monitoring tool used for the evaluation of lung function and uniformity of ventilation. We aimed to evaluate the aeration of lungs using this tool during the early postnatal adaptation period of term newborns born naturally and during caesarean section.

METHODS

52 spontaneously breathing term newborns enrolled in our case control study. 20 neonates were born naturally and 32 after caesarean section. Three EIT data recordings were performed: within the first 30 min., 60 min and 90 min after the birth.

RESULTS

No statistically significant differences in lung aeration were found between neonates born naturally and via CPO within the first 30 min after the birth.

First changes associated with minimal or no ventilation were found in the dependent lung regions more exposed to gravity. The post-CPO neonates had more “silent areas” in the dependent lung regions 60 min after the birth than those born naturally. The potential of the lungs to expand was statistically significant at 30 min and 60 min after the birth. The results did not show a statistically significant shift in the ventilation center between the study groups.

CONCLUSIONS

Differences in lung aeration of term naturally born or post-CPO neonates appeared gradually and became significant one hour after the birth. Poorer aeration in the dependent lung regions and in both lungs together was observed in the post-CPO group. The EIT is an appropriate method for the assessment of pulmonary aeration of neonates in the period of early post-natal adaptation.

EP343 / #1573**E-Poster Viewing - Neonatology AS02-25.
Pulmonology****Preterm infants spontaneous ventilation
feasibility and ventilatory repercussions the
during high-frequency oscillatory ventilation.**

A. Junior*, A. Bernardes, T. Iwashita Lages, E. Orlandin, T. Bastos,
P. De Morais, W. Goncalves-Ferri

Ribeirão Preto Medical School– University of São Paulo, Neonatology,
Ribeirao Preto, Brazil

BACKGROUND AND AIM

Is unclear if preterm infants can overcome the ventilatory work on high-frequency ventilation (HFOV). This study aimed to analyze the feasibility and repercussions of spontaneous ventilation of preterm infants during HFOV.

METHODS

Observational study. Were selected patients on HFOV. Subjects remained unhandled. Data from the ventilator (VN 600 Drager, German) was collected for one-hour. We monitored the respiratory patterns and the vital parameters. Sighs were considered a VTHF increase above the baseline concomitantly with a reduction in oscillation amplitude when the patient was ventilated at guaranteed volume and increased VTHF and DCO₂ when oscillation amplitude was fixed.

RESULTS

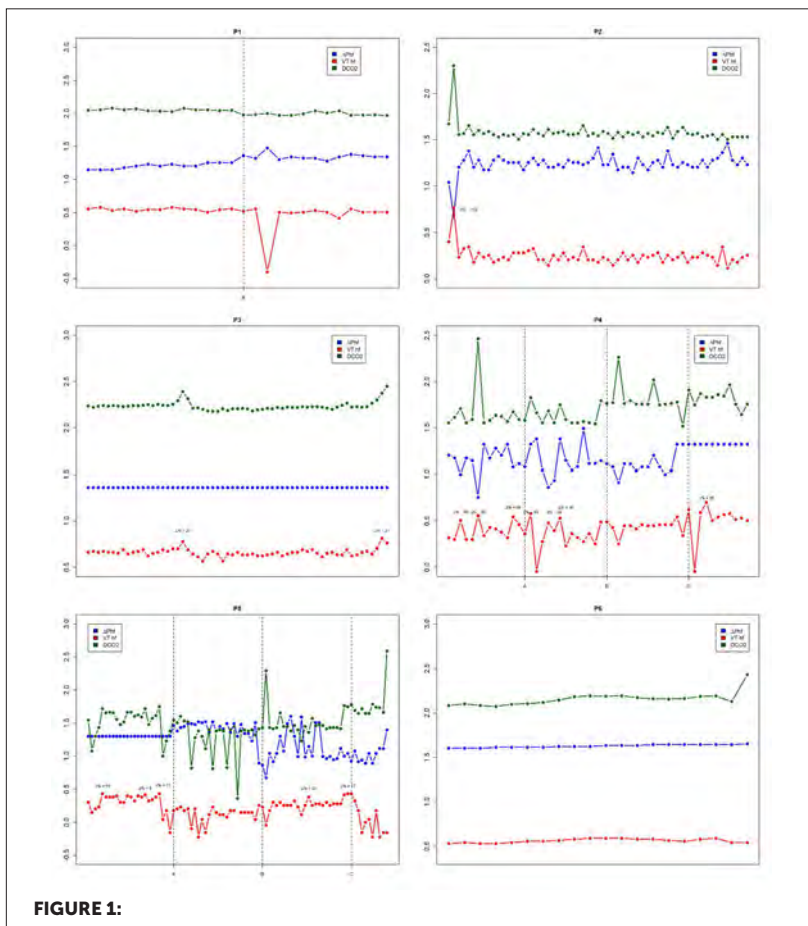

We performed 13 observations (1 hour each) on six different patients. Gestational age between 25 – 35 weeks and birthweight 675- 1500 g. The BSA was 3. Infants present effective spontaneous sighs, leading to VThf and DCO2 increase, consequently decreasing oscillatory amplitude. The increased volume was between 8%- 132% above the baseline. Patient 6 was deeply sedated,

and we didn't note sighs; the other patients presented adequate COMFORT scale; thus, effective spontaneous ventilation was observed. Patient 3 was the older infant (35 weeks), and we couldn't note meaningful sighs, indicating an individual behavior seems independent of gestational age. We noted spontaneous sighs on HFOV + VG and HFOV with fixed amplitude. (Figure 1)

CONCLUSIONS

We demonstrated that preterm patients could present effective spontaneous ventilation in the HFVO ventilator through sighs supporting the possibility that patients can be extubated from HFOV. Therefore, excessive sedation should be avoided.

EP344 / #799

E-Poster Viewing - Neonatology AS02-25. Pulmonology

Brain oxygenation and bioelectrical function in newborns receiving aerosolized lucinactant (aerosurf)

L. Karpinski^{1*}, K. Szczepanska², P. Niedbalski³, I. Miechowicz⁴,
H. Slawska², J. Mocha³, J. Mazela⁵, S. Simonson⁶

¹Poznan University of Medical Sciences, II Department of Neonatology, Poznan, Poland

²Medical University of Silesia, Department of Neonatology, Bytom, Poland

³Elmiko Biosignals, Research and Development, Warszawa, Poland

⁴Poznan University of Medical Sciences, Department of Computer Science and Statistics, Poznan, Poland

⁵Poznan University of Medical Sciences, Department of Neonatology, Poznan, Poland

⁶Windtree Therapeutics, Research and Development, Warrington, United States of America

BACKGROUND AND AIM

Recent years has brought new modes of surfactant replacement therapy (SRT). The only truly non-invasive method of surfactant dosing is aerosolization. Aerosurf is drug device combination of nCPAP and aerosolized lucinactant (KL4 surfactant). Standard surfactant instillation has been shown to be accompanied with suppression of brain bioelectrical function, drop in saturation and heart function. The aim of the study was to compare brain bioelectrical function, saturation and heart rate measured with pulseoxymetry and brain oxygenation obtained with near infrared spectroscopy (NIRS) before, during and after treatment with Aerosurf.

METHODS

Preterm infants were randomly and blindly included into Aerosurf study (03-CL-1702) in two level III NICUs in Poznan and Bytom. During aerosolization of lucinactant following parameters had been monitored: amplitude integrated

electroencephalography (iCFM Elmiko Biosignals), cerebral oxygenation with NIRS and pulsoximetry (iCFM, NONIN). Each patient was monitored for 10 minutes before and after procedure. Monitoring was also used during each aerosol instillation, which lasted at least 50 minutes. For statistical analysis Mauchley test and variance analysis for related data has been used.

RESULTS

There were 5 patients included in the study. Mean birthweight 1412g \pm 463g (SD), mean gestational age 30 wks \pm 2 wks (SD). 13 Aerosurf procedures had been analysed. There were no significant differences in mean aEEG voltage, heart rate, pulsoximetry and cerebral oxygenation before, during and after procedure. Results presented in Graph 1 and 2.

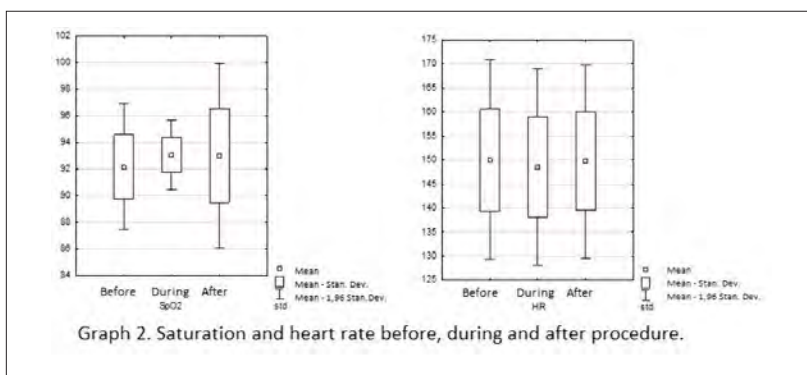
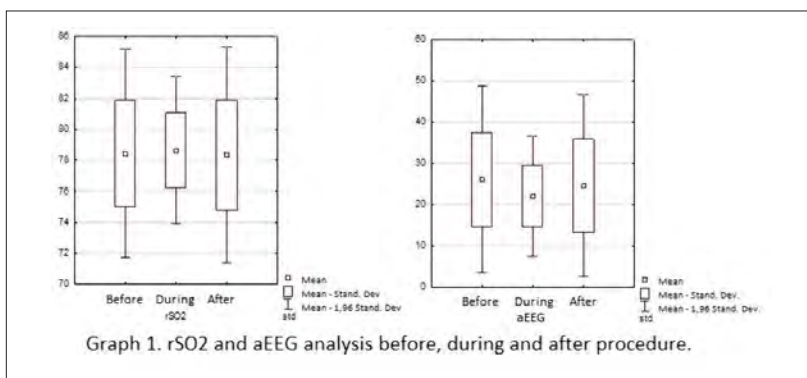

CONCLUSIONS

Aerosurf treatment is not correlated with any side effects affecting central nervous system expressed by low EEG voltage and brain oxygenation deviations.

EP345 / #1327**E-Poster Viewing - Neonatology AS02-25.
Pulmonology****The effect of incompletely administered antenatal corticosteroids on neonatal pulmonary outcomes in late preterm infants****H. Kim*, C.W. Choi**

Seoul National University Bundang hospital, Pediatrics, Seongnam, Korea, Republic of

BACKGROUND AND AIM

Recent obstetric guideline recommends an administration of antenatal corticosteroid in pregnant women at risk of delivering infants between 34 and 36 weeks gestational age. But only a few of them received a complete course of ACS for practical reasons. We examined the effect of incompletely administered antenatal corticosteroid on the neonatal pulmonary outcomes in late preterm infants.

METHODS

Late preterm infants (34⁺⁰-36⁺⁶ weeks gestational age) born in Seoul National University Bundang Hospital from January 2019 to June 2020 were retrospectively enrolled. Multiplets except twins, major congenital anomalies, death or transfer to other hospitals were exclusion criteria. An incomplete administration of antenatal corticosteroid was defined as when the first or second dose of betamethasone was administered within 24 hours before delivery. The rates of neonatal pulmonary morbidities including respiratory distress syndrome and transient tachypnea of the newborn, assisted ventilation including invasive mechanical ventilation, nasal continuous positive airway pressure and high-flow nasal cannula, and admission to neonatal intensive

care unit were compared between late preterm infants given incomplete antenatal corticosteroid and their peers who not given antenatal corticosteroid.

RESULTS

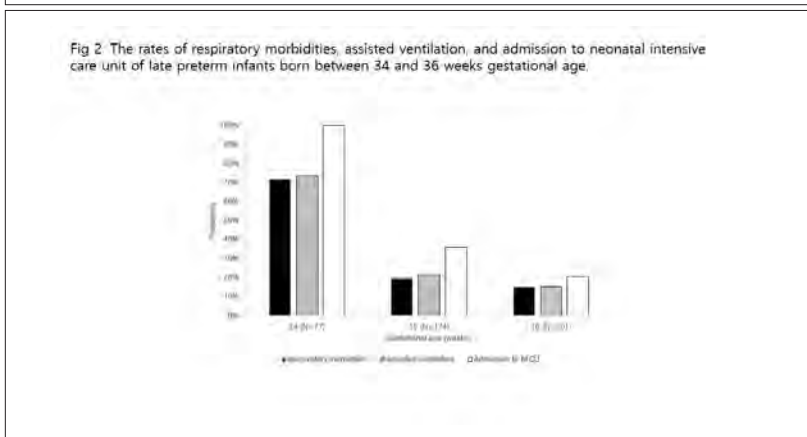
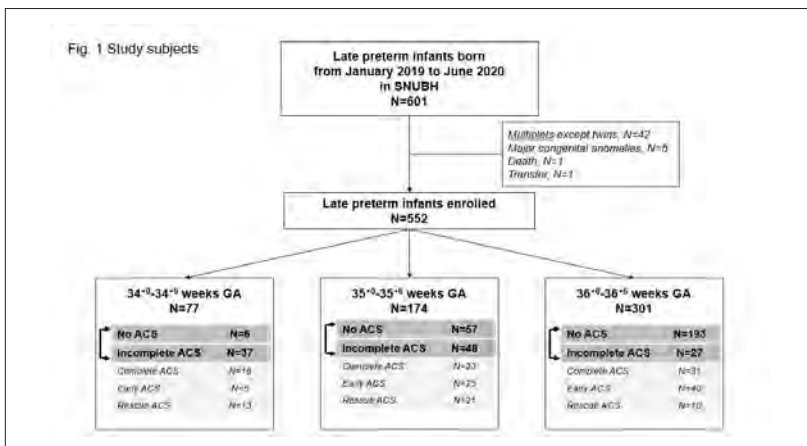

A total of 368 infants met inclusion criteria. After adjusting for baseline maternal and neonatal characteristics, there were no significant differences in the rate of neonatal pulmonary morbidities, assisted ventilation, or admission to

neonatal intensive care unit between late preterm infants given incomplete antenatal corticosteroid and their peers not given antenatal corticosteroid.

CONCLUSIONS

In this single center retrospective cohort study, incompletely administered antenatal corticosteroid did not significantly alter neonatal pulmonary outcomes in late preterm infants.

EP346 / #2428

E-Poster Viewing - Neonatology AS02-25. Pulmonology

The clinical effects of high frequency oscillatory ventilation in the treatment of neonatal severe distress.

A. Borgi¹, K. Ben Cheikh¹, A. Louati^{1*}, A. Ayari¹, A. Hajji¹, C. Haj Hssine¹, K. Menif¹, A. Bouziri², N. Ben Jaballah¹

¹Tunis El Manar University - Peadiatric Children Hospital, Peadiatric Intensive Care Unit, Nabeul, Tunisia

²Tunis El Manar University - Peadiatric Children Hospital, Peadiatric Intensive Care Unit, Tunis, Tunisia

BACKGROUND AND AIM

Neonatal respiratory distress is the main reason for hospitalization in neonatal and pediatric intensive care unit. High frequency oscillation ventilation (HFOV) represents a ventilatory mode of last resort. The aim of this study was to precise the clinical characteristics and outcomes of neonates ventilated with HFOV.

METHODS

This is a retrospective descriptive study conducted in a PICU of Children's Hospital of Tunis over a period of 4 years (2018-2021) including all neonates hospitalized for severe respiratory distress and requiring HFOV.

RESULTS

Sixty-two neonates were included, with a median age at admission of 10 hours [2; 60]. The sex ratio was 1.95. Prematurity was noted in 33.9% of cases. The neonatal respiratory distress was secondary to neonatal distress syndrome

in 24.2% of cases, transient tachypnea in 21% of cases, meconium aspiration syndrome in 17.7%, pneumothorax in 17.7%, and infectious alveolitis in 8% of cases. High pulmonary hypertension was recorded in 93.5% of patients. HFOV was performed after a median duration of conventional mechanical ventilation of 10 hours. The main indication was hypoxemia with high requirements of oxygen ($FiO_2 > 60\%$). HFOV was complicated by pneumothorax in 11.3% of cases, and hemodynamic disorders in 3.2%. The median duration of HFOV was 4 days. Mortality rate was 5%

CONCLUSIONS

HFOV is a safe and effective treatment option when conventional ventilation failed. It can effectively improve lung ventilation and oxygenation function.

EP347 / #986

E-Poster Viewing - Neonatology AS02-25. Pulmonology

Postnatal col4a1 expression in the developing human LUNG

L. Markasz^{1*}, H. Mobini-Far², R. Sindelar¹

¹Department of Women's and Children's Health, Uppsala University, Uppsala, Sweden, Uppsala, Sweden

²Department of Pathology, Uppsala University Hospital, Uppsala, Sweden, Uppsala, Sweden

BACKGROUND AND AIM

Collagen IV (COL4A1) in the basement membrane is an important component during lung development, as suggested from animal models where COL4A1 has been shown to regulate alveolarization and angiogenesis. Less is known about its role in human lung development. Our aim was to study COL4A1 expression in preterm infants with different lung maturational and clinical features.

METHODS

COL4A1 expression in 115 lung samples from newborn infants (21-41 weeks' gestational age; 0-228 days' postnatal age [PNA]) was studied by immunohistochemistry combined with digital image analysis. Cluster analysis was performed to find subgroups according to immunohistologic and clinical data.

RESULTS

Patients were automatically categorized into 4 Groups depending on their COL4A1 expression. Group 1-4 did not differ in clinical parameters. Expression of COL4A1 was mainly extracellular in Group 1, low in Group 2, intracellular

in Group 3, and both extra- and intracellular in Group 4 (Figure 1 and 2). Intracellular/extracellular ratio of COL4A1 expression related to PNA showed a distinctive postnatal maturational pattern on days 1-7, where intracellular expression of COL4A1 was overrepresented in extremely preterm infants (Group C and D, Figure 3).

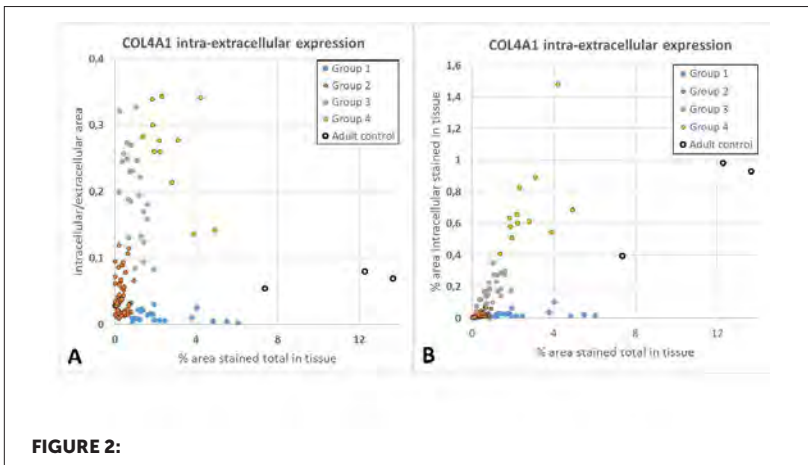
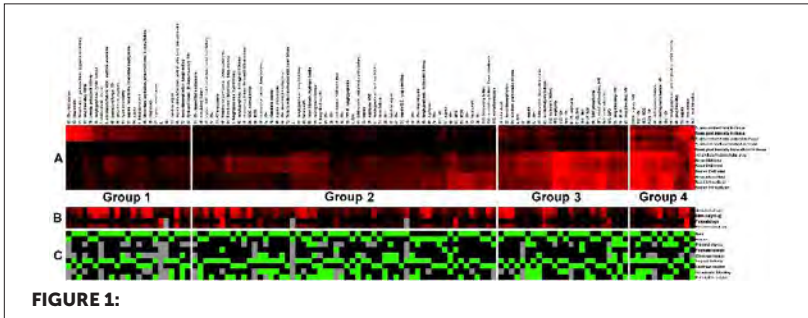

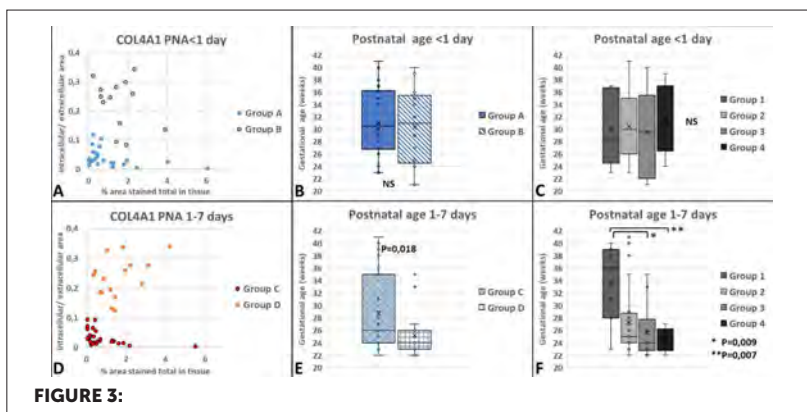

CONCLUSIONS

COL4A1 expression seems to be dynamic during the postnatal life due to rapid remodeling of the basement membrane. Intracellular accumulation of COL4A1 in the lungs of extremely premature infants occurs more frequently between 1–7 postnatal days than during the first 24 hours. In view of the lung arrest described in extremely preterm infants, the pathological and/or developmental role of postnatally increased COL4A1 needs further investigations.

EP348 / #1020**E-Poster Viewing - Neonatology AS02-25.
Pulmonology****High flow nasal cannula versus ncpap, feeding tolerance in preterm infants: a secondary analysis of the nippn STUDY**

Y. Minamitani^{1*}, R. Hayashi¹, S. Oka¹, A. Uchiyama², M. Wada³, K. Okazaki⁴, M. Kondo⁴, N. Nagano⁵, Y. Soeno⁶, H. Maruyama⁷, Y. Ito⁷, F. Namba¹

¹Saitama Medical Center, Saitama Medical University, Department of Pediatrics, Kawagoe, Saitama, Japan

²Tokai University School of Medicine, Pediatrics, Kanagawa, Japan

³Tokyo Women's Medical University, Department of Neonatology, Maternal and Perinatal Center, Tokyo, Japan

⁴Tokyo Metropolitan Children's Medical Center, Division of Neonatology, Tokyo, Japan

⁵Nihon University School of Medicine, Department of Pediatrics and Child Health, Tokyo, Japan

⁶Nagaoka Red Cross Hospital, Department of Neonatology, Niigata, Japan

⁷National Center for Child Health and Development, Division of Neonatology, Center For Maternal-fetal, Neonatal and Reproductive Medicine, Tokyo, Japan

BACKGROUND AND AIM

Preterm infants often require mechanical ventilation. High-flow nasal cannula (HFNC), nasal continuous positive airway pressure (NCPAP), or noninvasive positive-pressure ventilation (NIPPV) are often selected as post-extubation respiratory therapy. HFNC is generally considered to have fewer enteral feeding problems than NCPAP/NIPPV, but there are few reports about the superiority of HFNC in feeding tolerance.

METHODS

This retrospective study included preterm infants randomly assigned to HFNC or NCPAP/NIPPV after extubation from April 2015 to September 2018 (NIPPV study). Clinical data were collected from medical records.

RESULTS

In total 266, 113 infants were allocated to the HFNC group and 153 to the NCPAP/NIPPV group. There was no difference between the HFNC and NCPAP/NIPPV group in corrected gestational age when the infant attains full feeding (160 mL/kg/day). However, compared with the NCPAP/NIPPV group, the HFNC group showed earlier corrected gestational age when the infant starts oral feeding (35.3 [34.9-36.0] vs 35.7 [35.0-36.7] wk, $p=0.02$), the earlier end date of tube feeding (37.0 [36.4-38.1] vs 37.7 [36.4-39.7] wk, $p<0.01$), and earlier date when the infant reaches oral full feeding (37.4 [36.6-38.3] vs 38.3 [36.6-39.9] wk, $p<0.01$). In addition, the body weight at 36 weeks of corrected age in the HFNC group was significantly heavier than that in the NCPAP/NIPPV group (1942 ± 359 vs 1838 ± 395 g, $p=0.03$).

CONCLUSIONS

HFNC may be associated with early nutritional establishment and weight gain compared with the NCPAP/NIPPV.

EP349 / #2159**E-Poster Viewing - Neonatology AS02-25.
Pulmonology****Evidence-based use of diuretics in
bronchopulmonary dysplasia: a systematic review**

**E. Ó Briain¹, E. Molloy^{1,2,3,4*}, J. Meehan^{1,5,6}, A. Branagan^{1,6,7},
D. Mockler⁸, G. Fitzgerald⁹, G. Semova^{1,5,10}, E. Isweisi^{1,5,6}, E. Roche^{1,5,10},
A. O'Byrne¹, L. Alomairi¹, J. Dowling¹, L. Mulkerrin¹, L. Coyle¹,
J. Kiernan¹, J. Lynch¹**

¹Trinity College Dublin, Discipline of Paediatrics, School of Medicine, Dublin, Ireland

²Coombe Women and Infants University Hospital, Neonatology, Dublin, Ireland

³Children's Health Ireland at Tallaght, Neonatology, Dublin, Ireland

⁴Children's Health Ireland at Crumlin, Neonatology, Dublin, Ireland

⁵Tallaght, Children's Health Ireland At Tallaght, Dublin, Ireland

⁶Trinity College Dublin, Trinity Research In Childhood Centre, Dublin, Ireland

⁷Coombe Women & Infants University Hospital, Neonatology, Dublin, Ireland

⁸St. James' Hospital, John Stearne Medical Library, Dublin, Ireland

⁹Trinity College Dublin, Library of Trinity College Dublin, Dublin, Ireland

¹⁰Trinity Research in Childhood Centre, Trinity College Dublin, Dublin, Ireland

BACKGROUND AND AIM

Bronchopulmonary dysplasia (BPD) is a respiratory complication associated with neonatal prematurity. While diuretics are used in the treatment of BPD, their use is controversial owing to a lack of evidence supporting their efficacy and so there is variance in use between institutions. The aim of this review was to summarise the evidence of clinical trials studying diuretic use in BPD.

METHODS

A systematic review of the Excerpta Medica database (EMBASE), Medline, Web of Science, and cumulative index to nursing and allied health literature (CINAHL) library databases was conducted in accordance with the preferred

reporting items for systematic reviews and meta-analyses (PRISMA) guidelines. Covidence was used to screen the results and to aid in data extraction.

RESULTS

of the 430 records identified on database screening, 13 were included for analysis.

TABLE 1:

Number of Studies	Intervention
3	Spironolactone+Chlorothiazide
2	Spironolactone+Hydrochlorothiazide
8	Furosemide

All studies analysed the effect of the drugs on dynamic pulmonary compliance and pulmonary resistance; therefore, these were used as comparative tools in our review.

CONCLUSIONS

The efficacy of diuretics for the treatment of bronchopulmonary dysplasia remains uncertain. Applying the Population, Intervention, Comparison, Outcome (PICO) approach suggests that the focused question cannot be answered using high-level evidence, because few randomised controlled trials (RCTs) were identified. Good quality, large prospective studies may lead to firmer conclusions, although the limited numbers of eligible patients make such studies difficult to perform. We conclude that further research is needed in this area, predominantly focusing on RCTs evaluating the safety and efficacy of diuretics in this population.

EP350 / #2542**E-Poster Viewing - Neonatology AS02-25.
Pulmonology****Congenital nasal pyriform aperture stenosis(cnpas) – a rare cause of respiratory distress in neonates and its implications.****V. Mundeshi^{1*}, N. Chinchankar², A. Sharma³**¹NHS Lothian, Paediatrics, Edinburgh, United Kingdom²NHS Lothian, Paediatric Critical Care, Edinburgh, United Kingdom³NHS Lothian, Ent, Edinburgh, United Kingdom**BACKGROUND AND AIM**

Respiratory distress is a common presentation in neonates with anatomical airway anomalies and presents early in life due to being obligate nasal breathers. Here we present a case of respiratory distress due to Congenital Nasal Pyriform Aperture Stenosis, a rare finding which has diagnostic implications.

METHODS

Term baby presented on day 1 of life with a cyanotic episode and increased work of breathing. Initially managed as suspected sepsis; however, there was difficulty passing the nasogastric tube, work of breathing transiently improved with airway repositioning. Initial ENT examination suggested possibility of deviated nasal septum. The baby persisted to have respiratory distress and obstructive upper airway noises. CT scan of Facial / Nasal Bones showed narrowing of pyriform aperture (3-4mm) and presence of Central Megaincisor. Baby underwent investigations to rule out associated anomalies. Balloon dilatation of nasal aperture was done on day 7, subsequently weaned off respiratory support and discharged with feeding support.

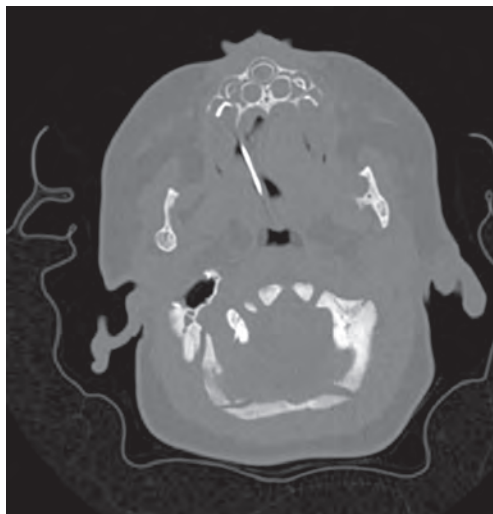

FIGURE 1:

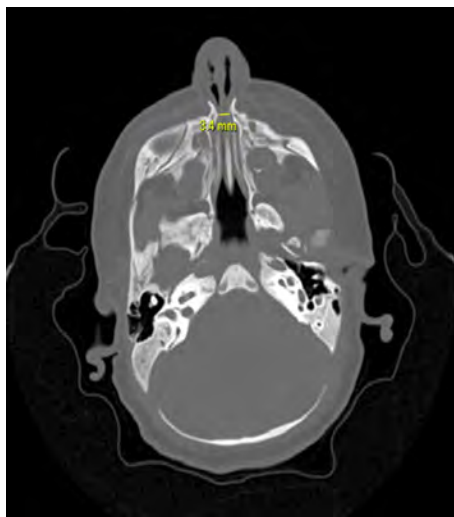

FIGURE 2:

CT

**FIGURE 3:**

D

RESULTS

CNAPS is a rare cause of respiratory distress and an entity called Solitary Median Maxillary Central Incisor (SMMCI) commonly seen with CNAPS, a malformation with defects of midline structures including nasal bones, Pituitary, Holoprosencephaly, Ocular Coloboma or Chromosomal abnormalities.

CONCLUSIONS

Upper airway anomalies are one of the causes of neonatal respiratory distress and differential diagnosis commonly includes choanal atresia when there is difficulty to pass the NG tube. CNAPS should be considered and investigated early. A diagnosis of CNAPS should prompt to look for SMMCI, as it is associated with serious anomalies and warrants multidisciplinary management, and may have poor outcomes.

EP351 / #975**E-Poster Viewing - Neonatology AS02-25.
Pulmonology****Diaphragm electrical activity during weaning of
nasal high flow therapy in preterm infants****R. Naples^{1*}, A. Fenton¹, M. Brodrie², S. Harigopal¹, C. O'Brien²**¹Newcastle upon Tyne Hospitals Trust, Neonatology, Newcastle upon Tyne, United Kingdom²Newcastle upon Tyne Hospitals, Paediatric Respiratory Medicine, Newcastle upon Tyne, United Kingdom**BACKGROUND AND AIM**

Weaning high flow (HF) in preterm infants is largely a trial-and-error process. Electrical activity of the diaphragm (Edi) is an objective measure of respiratory muscle effort that may be useful to guide weaning. This study aimed to determine how Edi changes when weaning nasal HF therapy in preterm infants according to a standardised protocol.

METHODS

Preterm infants born at <32 weeks gestation receiving nasal HF as part of routine clinical care were recruited. HF was weaned according to set clinical criteria. Edi was measured using a modified gastric feeding tube serially at four time-points from baseline (pre-wean) to 24- hours post-weaning. Minimum Edi during expiration, maximum Edi during inspiration and amplitude of the Edi signal (Edi delta) were measured. Clinical parameters (heart rate, respiratory rate, and oxygen requirement) were also recorded.

RESULTS

Forty preterm infants (median gestational age 26.4wk [IQR 25.0-27.3]) were recruited. Data from 156 weaning steps were analysed, 91% of which were successful. Edi did not change significantly from baseline during flow rate reduction steps, but increased significantly when discontinuing HF (median increase in Edi delta immediately post-discontinuation 1.68 μ V [IQR 0.5-3.8]) and at 24-hours 1.86 μ V [IQR 0-4.9]). No significant difference in Edi was observed between successful and unsuccessful steps.

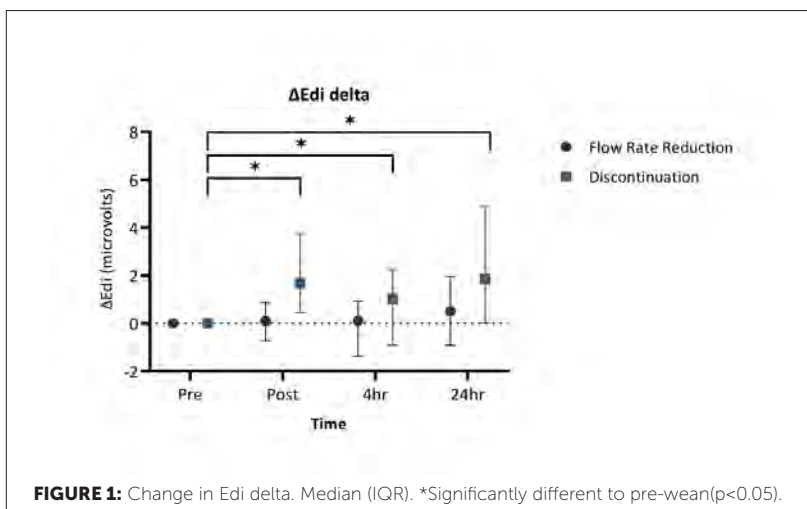

CONCLUSIONS

A protocolised approach to weaning has a high probability of success. Edi does not change with reducing HF rate, but significantly increases with discontinuation of HF from 2L/min. This data is useful in refining HF weaning protocols in preterm infants.

EP352 / #1724**E-Poster Viewing - Neonatology AS02-25.
Pulmonology****Diaphragmatic ultrasound to assess dysfunction during mechanical ventilation (mv) in newborns**

S. Nobile*, N. Salce, A. Sbordone, M.L. Patti, A. Perri, S. Fattore, M. Tana, L. Giordano, G. Prontera, G. Vento

Fondazione Policlinico Universitario "A. Gemelli" IRCCS, Department of Woman, Child and Public Health, Rome, Italy

BACKGROUND AND AIM

There is lack of studies about ventilator-induced diaphragmatic dysfunction in newborns. We aimed to assess 1) changes in diaphragmatic contractility and thickness during MV; 2) associations with diaphragmatic atrophy (DA, thickness reduction >10%); 3) relationship between DA and extubation failure.

METHODS

Prospective study with diaphragmatic ultrasound (Figure 1): linear transducer longitudinally applied on right mid-axillary line (diaphragm apposition zone). Measurements: diaphragm thickness at end-inspiration (TDI) and end-expiration (TDE). Daily measurements while intubated, then 1/day for the first 3 days after extubation. Inclusion criteria: newborns on MV for ≥ 2 days; informed consent. Exclusion criteria: major malformations; need for palliative care. Statistical tests: descriptive statistics, Wilcoxon signed rank test, univariate analysis.

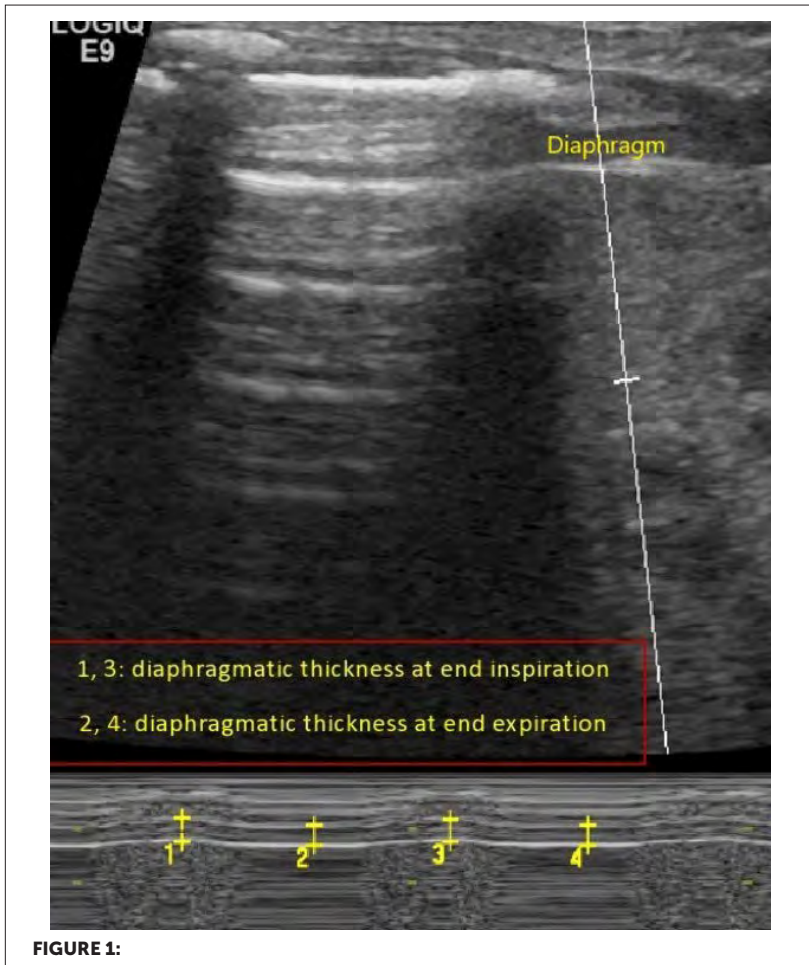

RESULTS

Fifteen patients enrolled: mean GA 28^{4/7} weeks ($\pm 4^{1/7}$); 18 MV cycles (median 9 days, IQR 3-22). TDE on the 1st MV day 0.118 cm (IQR 0.094-0.165), on the

last MV day 0.104 cm (IQR 0.083-0.120), $p=0.06$. DA in 10/15 infants (66.7%), early during MV (median: 2nd MV day– IQR 1-3 days). DA associated with gestational age: 27^{1/7} weeks ($\pm 2^{4/7}$) versus 31^{5/7} ($\pm 5^{3/7}$) in infants without DA. Infants with DA versus those without received more surfactant [2 (2-3.5) vs 0 (0-1) doses, $p=0.012$], were kept NPO for more time [18 (6-36) vs 3 (3-3) days, $p=0.05$], were diagnosed more frequently with bronchopulmonary dysplasia [62% vs 0, $p=0.024$]. DA was more frequent in infants with extubation failure (5/5 vs 5/10 with extubation success, $p=0.036$).

CONCLUSIONS

DA, associated with extubation failure, is a significant problem in preterm infants on MV.

EP353 / #1120

E-Poster Viewing - Neonatology AS02-25. Pulmonology

Systemic inflammatory indices as predictors of lung maturation in preterm infants born before 32 weeks of gestation

M. Akin, B. Ceran, E. Okman*, F. Sari, E. Dizdar

Ankara City Hospital, Neonatology, Ankara, Turkey

BACKGROUND AND AIM

Increased inflammation in the perinatal period reduces respiratory distress syndrome (RDS) in premature infants. In our study, we aimed to determine the systemic inflammatory indices as predictors of lung maturation in preterm infants born before 32 weeks of gestation.

METHODS

The study was conducted in a tertiary-level neonatal intensive care unit between September 2019 and December 2021. <32 weeks infants were divided into two groups according to the diagnosis of RDS. Systemic inflammatory indices include systemic immune-inflammation index (SII), pan-immune-inflammation value (PIV), systemic inflammation response index (SIRI), Monocyte-to-lymphocyte ratio (MLR), neutrophil-to-lymphocyte ratio (NLR), platelet-to-lymphocyte ratio (PLR) were calculated for each infant at birth.

RESULTS

The study included 359 infants, of whom 207 had RDS and 152 did not have RDS. Median gestational ages (GA) were 27 (25-29) and 30 (29-31) weeks, and median birth weights (BW) were 850 (660-1360), 1750 (1090-1600) g

in the RDS and control groups, respectively. Infants in the RDS group had significantly lower BW and GA. Antenatal steroid use was similar between groups. Infants in the RDS group had significantly lower SII, PIV, SIRI, MLR, and NLR values ($p = 0.001$) when compared with the control group. Cutoff values having a good ability to predict RDS for SII, SIRI and PIV were 239, 0.44, and 78. SII level ≥ 239 decreased the risk of RDS as revealed by multivariate analyses ($p=0.001$).

CONCLUSIONS

Inflammation in the perinatal period reduces the frequency of RDS in premature infants. SII might be used as an independent factor in determining RDS risk.

EP354 / #1080

E-Poster Viewing - Neonatology AS02-25. Pulmonology

Positive end-expiratory pressure effects in infants on non-invasive ventilation monitored by electrical tomography impedance are not associated with fraction of inspired oxygen and respiratory distress.

E. Orlandin^{1*}, T. Iwashita Lages¹, A. Junior¹, P. Morais¹, T. Bastos¹, F. Celini¹, M. Nakamura², M. Amato³, W. Goncalves-Ferri¹

¹Ribeirão Preto Medical School– University of São Paulo, Neonatology, Ribeirao Preto, Brazil

²Universidade de São Paulo (Laboratório de investigações Médicas 09), Departamento De Pneumologia, Sao Paulo, Brazil

³University of São Paulo, Cardiopulmonary, Sao Paulo, Brazil

BACKGROUND AND AIM

The success of non-invasive ventilation is associated with optimal positive end-expiratory pressure (PEEP). However, the ideal level of PEEP is still unknown in preterm infants. We hypothesized that FiO_2 and respiratory distress are insufficient to determine an optimal PEEP for preterm infants on VNI. The present study applied electrical impedance tomography (EIT) to evaluate the effect of increasing PEEP on the distribution of pulmonary ventilation in premature and correlated with FiO_2 and respiratory distress.

METHODS

A prospective observational study. Preterms above 750g on CPAP, hemodynamic stable. Patients were monitored through EIT (Enlight1800, Timpel, Brazil). PEEP defined by assistant clinicians, supine position without changes in the last four hours, aspirated one hour before. Patients were submitted

to a gradual increase and posterior decrease in PEEP (1 or 2cm every 30 minutes), until 11cmH₂O. Were collected vital signs, pain assessment (NIPS), respiratory distress (BSA), and EIT data.

RESULTS

Three preterms were observed. Results showed individual responses to PEEP changes. Ventilatory distribution worsens in one patient with higher EELZ. The others probably presented an inadequate lung recruitment, as the response to higher PEEP was adequate, leading to a better EELZ final (see Figure 1). The FiO₂ and BSA remained unchanged. There was no hemodynamic instability.

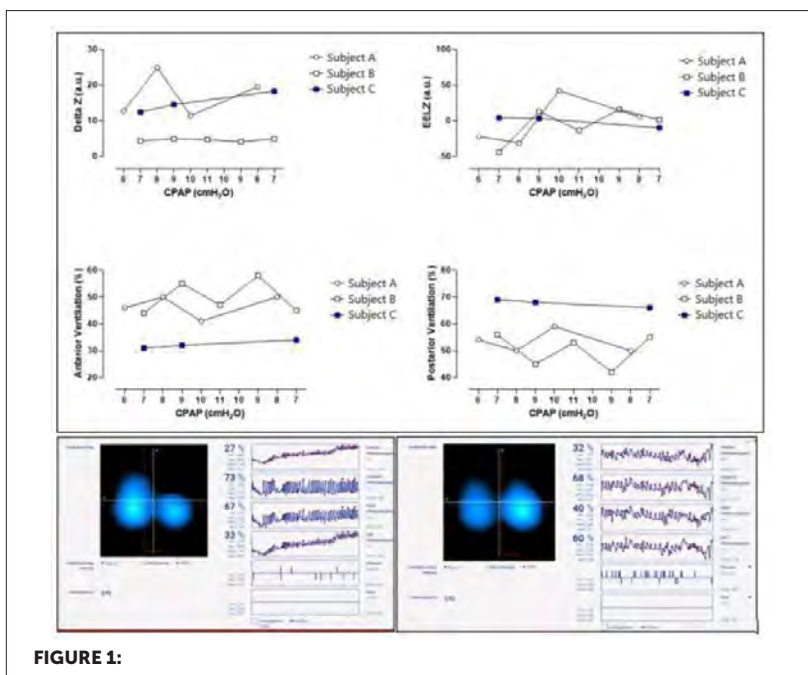

CONCLUSIONS

The results suggested heterogeneity of regional pulmonary ventilation response with different PEEP levels. Bedside usual parameters to adjust optimal PEEP, FiO₂ and BSA, are not correlated with modifications on pulmonary distribution ventilation, suggesting the necessity of an individualized approach and the use of complementary tools such as impedance tomography to achieve optimal PEEP.

EP355 / #1004**E-Poster Viewing - Neonatology AS02-25.
Pulmonology****Continuous oxygen saturation index
measurements as early predictor of outcomes in
congenital diaphragmatic hernia****D. Oudshoorn^{1*}, M. Vermeulen¹, R. Knol¹, A. Te Pas², S. Cochius-Den Otter³, M. Schnater³, I. Reiss¹, P. Dekoninck⁴**

¹Erasmus MC Sophia Children's Hospital, University Medical Center Rotterdam, Department of Pediatrics, Division of Neonatology, Rotterdam, Netherlands

²Leiden University Medical Center, Pediatrics, Leiden, Netherlands

³Erasmus MC Sophia Children's Hospital, Intensive Care and Department of Pediatric Surgery, Rotterdam, Netherlands

⁴Erasmus MC Sophia Children's Hospital, Department of Obstetrics and Gynecology, Rotterdam, Netherlands

BACKGROUND AND AIM

To improve individualized treatment of infants with a congenital diaphragmatic hernia (CDH), early identification of infants at risk for a complicated postnatal course is needed. We evaluated the oxygen saturation index (OSI), a ratio that continuously reflects the infant's respiratory status, as an early predictor of clinical deterioration.

METHODS

A single-center retrospective cohort study in infants with isolated CDH between June 2017-July 2021, with continuous OSI measurements collected in the first 24 hours after birth. Outcomes of interest were pulmonary hypertension, extracorporeal membrane oxygenation (ECMO) therapy, and mortality before discharge. We evaluated the predictive values of the highest OSI value and of mean OSI values in the first 24 hours.

RESULTS

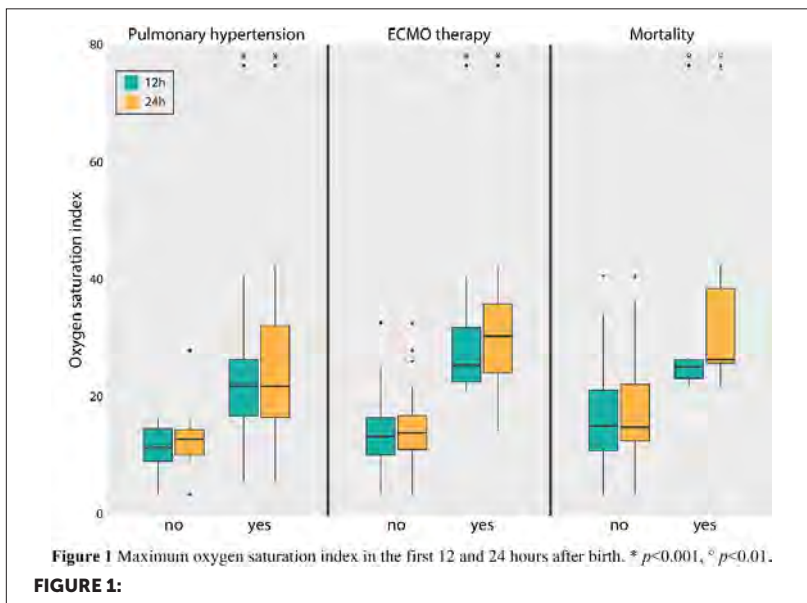

In 42 infants with 49,473 OSI measurements, the median OSI was 5.0 [interquartile range 3.1-10.6]. 27 infants developed pulmonary hypertension, 14 infants required ECMO therapy, and six infants died. Maximum OSI values in the first 12 or 24 hours were associated with pulmonary hypertension, ECMO therapy, and mortality (Figure 1). Mean OSI values had an acceptable discriminative ability for pulmonary hypertension and an excellent discriminative ability for ECMO therapy and mortality. A mean OSI ≥ 15 in the first hour predicted the occurrence of pulmonary hypertension (sensitivity 56%; specificity 100%) and the need for ECMO therapy (sensitivity 80%; specificity 89%). A mean OSI ≥ 17 in the first hour predicted a high risk of mortality (sensitivity 100%; specificity 91%).

CONCLUSIONS

Continuous OSI evaluation is a promising modality to identify infants at highest risk for clinical deterioration already in the first hours after birth.

EP356 / #1111

E-Poster Viewing - Neonatology AS02-25. Pulmonology

The effect of clinical chorioamnionitis on respiratory effort in premature infants at birth: a retrospective case-control STUDY

T. Panneflek^{1*}, K. Kuypers¹, G. Polglase², S. Hooper², T. Van Den Akker³, A. Te Pas¹

¹Leiden University Medical Centre, Neonatology, Leiden, Netherlands

²Hudson Institute of Medical Research, The Ritchie Centre, Clayton, Australia

³Leiden University Medical Centre, Obstetrics, Leiden, Netherlands

BACKGROUND AND AIM

Inflammation induced by chorioamnionitis could adversely affect respiration of infants. Therefore, we examined the effect of clinical chorioamnionitis (CCA) on respiratory effort in premature infants at birth.

METHODS

Suspected Triple I infants (CCA infants) born <30 weeks' gestation were matched to unaffected controls based on gestational age (± 6 days), birth weight (± 300 g), antenatal corticosteroids, sex and general anaesthesia. The primary outcome was respiratory effort expressed as minute volume (MV) of spontaneous respiration. We also assessed tidal volume (Vt), respiratory rate (RR), and apnoea in the first 5 minutes and additional physiological parameters in the first 10 minutes after start of respiratory support.

RESULTS

92 infants were included (n=46 CCA infants vs. n=46 controls; median (IQR) gestational age 26^{+4} (25^{+0} - 27^{+6}) vs. 26^{+6} (25^{+1} - 28^{+3}) weeks). MV and Vt were significantly lower, while RR was similar in CCA infants compared to controls (MV: 43 (17-93) vs. 70 (31-119) mL/kg/min, $p=0.043$; Vt: 2.1 (1.0-3.1) vs. 2.7 (2.1-4.3) mL/kg/breath, $p=0.004$; RR: 21 (15-32) vs. 25 (17-33), $p=0.996$). A higher incidence of apnoea (5 (2-6) vs. 2 (1-4), $p=0.002$) and a longer total duration of apnoea (90 (21-139) vs. 35 (12-98) s, $p=0.025$) were evident in CCA infants. CCA infants took significantly longer to reach an oxygen saturation $>80\%$ (3:37 (2:10-4:29) vs 2:25 (1:06-3:52) min, $p=0.016$), despite receiving more oxygen (mean (\pm SD) 63 ± 17 vs. $56\pm 19\%$, $p=0.015$).

CONCLUSIONS

Clinical chorioamnionitis inhibited respiratory effort and oxygenation in pre-mature infants at birth.

EP357 / #1567

E-Poster Viewing - Neonatology AS02-25. Pulmonology

Chronic lung disease following neonatal extracorporeal membrane oxygenation. A single center experience.

A. Perez Ortiz*, A. Glauner, F. Dittgen, T. Doniga, N. Rafat, T. Schaible

University Hospital Mannheim, Neonatology, Mannheim, Germany

BACKGROUND AND AIM

The application of ECMO has improved survival of neonates with severe respiratory failure but carries also a higher risk of long-term morbidity. Among neonatal ECMO survivors, long-term pulmonary sequelae are well described. Whereas obstructive pattern with bronchospasm, asthma, decreased exercise tolerance are the most common conditions within the respiratory morbidity; development of chronic lung disease (CLD) may be an early marker for future pulmonary morbidity. The aim of this study was to assess the incidence and severity of CLD in neonates after ECMO in patients treated in our institution, distinguished by primary underlying condition. Furthermore, we aimed to identify perinatal characteristics associated with the development of CLD.

METHODS

A retrospective observational study in a neonatal ECMO centre was conducted. All neonates who received support with ECMO in our institution between January 2019 and October 2021 were included and their pulmonary outcome was investigated.

RESULTS

A total of 91 patients were included in this study. 76% ECMO survivors developed chronic lung disease (CLD). Patients with CLD had lower birth weight, were younger at initiation of ECMO and required longer ECMO runs. Patients with congenital diaphragmatic hernia (CDH) developed CLD more often than infants with other underlying disease. 25% ECMO survivors developed severe CLD.

CONCLUSIONS

The incidence of CLD after neonatal ECMO is clinically relevant. Risk factors for its development include CDH as underlying condition, the necessity of an early initiation of ECMO and the need of ECMO over 7 days.

EP358 / #885

E-Poster Viewing - Neonatology AS02-25. Pulmonology

Quantitative lung ultrasound detects real-time changes in total and regional lung volume in the preterm LAMB

A. Sett^{1,2}, K. Kenna¹, G. Foo², R. Sutton¹, E. Perkins¹, M. Sourial¹, S. Rogerson^{2*}, B. Manley², P. Davis², P. Pereira-Fantini¹, D. Tingay¹

¹Murdoch Children's Research Institute, Neonatal Research, Parkville, Australia

²The Royal Women's Hospital, Newborn Research Centre, Parkville, Australia

BACKGROUND AND AIM

Background Current lung ultrasound (LUS) scoring systems incompletely discriminate small changes in lung volume. This may be overcome with grey-scale analysis using computer assisted quantitative lung ultrasound (Q-LUS). Aim To investigate the ability of Q-LUS measurements of mean greyscale (Q-LUS_{MGV}) to detect changes in total and regional lung volume, opening and closing pressures and pulmonary hysteresis.

METHODS

Preterm lambs (n=40) underwent LUS of the right dependent (n=20) and non-dependent (n=20) lung during in-vivo static pressure-volume (PV) curve mapping using a super syringe as a gold standard measurement of lung volume. Regional lung volume was measured with electrical impedance tomography. Q-LUS_{MGV} of the pleural region was measured by two investigators blinded to the experiment and its relationship between lung volumes was calculated.

RESULTS

Dependent $Q-LUS_{M_{GV}}$ moderately correlated with total lung volume ($r=0.6$, $p<0.0001$, 95% CI 0.51-0.67, Figure 1) and fairly with right whole ($r=0.39$, $p<0.0001$, 0.27-0.49), central ($r=0.38$, $p<0.0001$, 0.27-0.48), ventral ($r=0.41$, $p<0.0001$, 0.31-0.51) and dorsal regional lung volumes ($r=0.32$, $p<0.0001$, 0.21-0.43). Non-dependent $Q-LUS_{M_{GV}}$ moderately correlated with total lung volume ($r=0.57$, $p<0.0001$, 0.48-0.65, Figure 1) and right whole ($r=0.43$, $p<0.001$, 0.32-0.52), central ($r=0.46$, $p<0.0001$, 0.35-0.55), ventral ($r=0.36$, $p<0.0001$, 0.25-0.47) and dorsal regional lung volumes ($r=0.36$, $p<0.0001$, 0.25-0.47). Sonographic hysteresis occurred 39/40 lambs. Greatest change in $Q-LUS_{M_{GV}}$ occurred at opening and closing pressures.

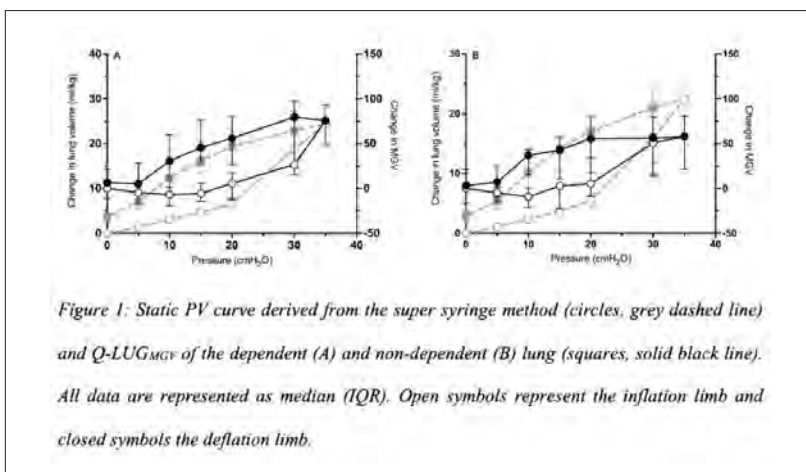

CONCLUSIONS

$Q-LUS$ detected changes in total and regional lung volume, opening and closing pressures and pulmonary hysteresis. $Q-LUS$ may enhance conventional LUS in discriminating real-time changes in lung volume at the bedside.

EP359 / #916

E-Poster Viewing - Neonatology AS02-25. Pulmonology

Diagnostic challenges in neonatal respiratory distress – *abca3* mutation as a cause of inherited surfactant deficiency.

J. Rogulska^{1,2*}, K. Wróblewska - Seniuk¹, R. Śmigiel³, J. Szydłowski⁴, T. Szczapa¹

¹Poznan University of Medical Sciences, Ii Department of Neonatology, Poznań, Poland

²Poznan University of Medical Sciences, Doctoral School, Poznan, Poland

³Wroclaw Medical University, Department of Pediatrics, Department of Family and Paediatric Nursing, Wrocław, Poland

⁴Poznan University of Medical Sciences, Department of Otolaryngology, Head and Neck Surgery and Laryngological Oncology, Poznan, Poland

BACKGROUND AND AIM

Surfactant is a complex of phospholipids and proteins produced in type II pneumocytes. Its deficiency frequently occurs in preterm infants leading to respiratory distress syndrome. Congenital surfactant deficiency due to mutations in SFTPC, SFTPB, NKX2-1, or ABCA3 genes involved in the surfactant metabolism may cause a similar presentation of severe respiratory distress syndrome with lethal respiratory failure in full-term newborns. ABCA3 encodes an ATP-binding cassette, which is responsible for transporting phospholipids into lamellar bodies in type II pneumocytes.

METHODS

We present a case of a male late-preterm newborn with inherited surfactant deficiency. We discuss the diagnostic challenges and the management options. Since the baby's condition has not improved despite aggressive

treatment, there was a suspicion of congenital surfactant defect, and the new generation sequencing was used.

RESULTS

We identified the likely pathogenic c.604G>A variant in one allele and splice region/intron variant c.4036-3C>G of uncertain significance in the second allele of ABCA3. These variants were observed in trans configuration. The first variant has already been described in a patient with congenital surfactant deficiency. The other one was not defined yet. However, it can disturb RNA splicing resulting in the loss of exons or the inclusion of introns and an altered protein-coding sequence.

CONCLUSIONS

ABCA3 variants in both alleles may result in loss of function of the ABCA3 protein causing significant surfactant deficiency with severe respiratory failure. We want to raise awareness about congenital surfactant deficiency as a rare cause of respiratory distress in term newborns.

EP360 / #635

E-Poster Viewing - Neonatology AS02-25. Pulmonology

Diaphragm activity measured with standard cardiorespiratory monitoring electrodes

A. Scholten^{1,2*}, R. Van Leuteren^{1,2}, F. De Jongh^{2,3}, A. Van Kaam^{1,2}, G.J. Hutten^{1,2}

¹Amsterdam UMC, Amsterdam Reproduction & Development Research Institute, Amsterdam, Netherlands

²Amsterdam UMC location University of Amsterdam, Neonatology, Amsterdam, Netherlands

³University of Twente, Faculty of Science and Technology, Enschede, Netherlands

BACKGROUND AND AIM

Current cardiorespiratory monitoring in neonates with ECG and chest impedance (CI) has important limitations. Adding transcutaneous electromyography of the diaphragm (dEMG) may provide better cardiorespiratory monitoring, but requires three additional electrodes at a different location. We aimed to measure dEMG and ECG/CI simultaneously using only three electrodes positioned at the dEMG location.

METHODS

Fifteen stable infants (median post-menstrual age 30.1 weeks) on nasal CPAP were included. ECG and CI were measured for ± 30 minutes at the standard location. Then, the electrodes were repositioned to the dEMG location and data was recorded for 30 min per ECG-lead (Figure 1). Breathing related changes in airway pressure were measured as reference for respiratory rate (RR). Main outcomes were: agreement in RR based on dEMG per lead and airway pressure, the discrepancy in measured RR between airway pressure and CI at the two electrode locations, and the ability to measure ECG at the dEMG location.

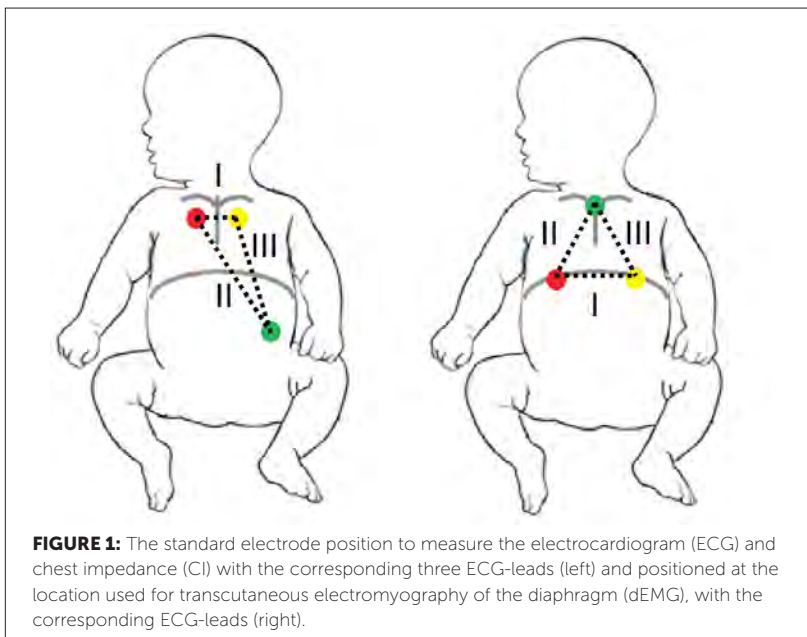

RESULTS

The mean RR difference and limits of agreement for lead I, II and III were 0.80 [-9.0 to 10.6], 0.44 [-10.0 to 10.9] and -0.19 [-9.51 to 9.13] breaths/min, respectively. These limits corresponded to intraclass correlation coefficients of 0.85 (0.81-0.89), 0.83 (0.78-0.87) and 0.85 (0.79-0.89), respectively. No significant RR discrepancy at the two locations was observed ($p=0.20$) and the ECG could be measured at the alternative position.

CONCLUSIONS

This study shows that measuring dEMG with standard monitoring electrodes on the diaphragm is feasible in infants, while still reliably measuring ECG/CI.

EP361 / #687

E-Poster Viewing - Neonatology AS02-25. Pulmonology

Non-inferiority study on the performance of a wireless, non-adhesive belt for cardiorespiratory monitoring in neonates

A. Scholten^{1,2*}, Z. Zhan³, H. Niemarkt⁴, M. Vervoorn⁴, R. Van Leuteren^{1,2}, F. De Jongh^{2,5}, A. Van Kaam^{1,2}, E. Van Den Heuvel³, G.J. Hutten^{1,2}

¹Amsterdam UMC, Amsterdam Reproduction & Development Research Institute, Amsterdam, Netherlands

²Amsterdam UMC location University of Amsterdam, Neonatology, Amsterdam, Netherlands

³Eindhoven University of Technology, Mathematics and Computer Science, Eindhoven, Netherlands

⁴Máxima Medical Center, Neonatology, Veldhoven, Netherlands

⁵University of Twente, Science and Technology, Enschede, Netherlands

BACKGROUND AND AIM

Cardiorespiratory monitoring in neonates is performed with adhesive wired electrodes to measure ECG and chest impedance (CI). These electrodes can hinder caregiving and potentially cause skin damage. A non-adhesive wireless belt (Bambi® belt) has been developed for cardiorespiratory monitoring based on diaphragm activity. We aim to demonstrate non-inferior heart rate (HR) and respiratory rate (RR) monitoring with the belt compared to ECG/CI.

METHODS

Thirty-nine neonates were simultaneously monitored with the belt and ECG/CI for 24 hours. The percentage reliable HR/RR-data was determined. HR-monitoring performance of the belt was assessed with 95% limits-of-agreement (LoA) and cardiac event detection (tachycardia/bradycardia). RR-monitoring was assessed by the 95% LoA of the RR-trend. Prespecified

margins were used to assess non-inferiority (Table 1). **Table 1-Prespecified margins**

TABLE 1:

	<i>Margins</i>
<i>Reliable HR-data</i>	90%
<i>Reliable RR-data</i>	70%
<i>LoA of HR differences</i>	+/- 8 bpm
<i>Sensitivity and PPV of brady-/tachycardia detection</i>	90%
<i>LoA of RR-trend differences</i>	+/- 15 breaths/min

PPV: positive predictive value.

RESULTS

HR- and RR-data were reliable in 96.4% (standard error (SE)=0.4%) and 96.0% (SE=0.4%) of time, respectively. The mean HR difference between the belt and ECG was 0.03 bpm (SE=0.02) (LoA [-5,5]bpm). Sensitivity and positive predictive value (PPV) for cardiac event detection were 95.8% (SE=0.8%) and 94.9% (SE=1.0%), respectively. The mean RR-trend difference was 3.7 breaths/min (SE=0.8) (LoA [-11,19]breaths/min). The belt's HR-monitoring was non-inferior to the ECG (p-values<0.001), but evidence lacks to support non-inferior RR-monitoring (p-value>0.05).

CONCLUSIONS

The non-adhesive, wireless belt showed non-inferior HR-monitoring, but current evidence cannot support non-inferior RR-monitoring. This might be explained by the different techniques to measure respiration.

EP362 / #1254

E-Poster Viewing - Neonatology AS02-25. Pulmonology

Utilization and effects of non-synchronized biphasic nasal cpap in preterm neonates below 29 weeks of gestation

L. Mileder, J. Schmid, F. Reiterer, B.C. Schwabberger*, B. Urlesberger

Medical University of Graz, Division of Neonatology, Department of Paediatrics and Adolescent Medicine, Graz, Austria

BACKGROUND AND AIM

Biphasic continuous positive airway pressure (CPAP) is primarily used in preterm neonates to treat respiratory distress syndrome, to prevent apnoea, and after extubation. However, indications and utilization differ between centres and we, therefore, investigated these aspects as well as effects of biphasic nasal CPAP.

METHODS

We included preterm neonates below 29 weeks of gestation, who were born in 2016 at the Division of Neonatology, Medical University of Graz, Austria, and required biphasic nasal CPAP, in this retrospective analysis (ethics committee number 29-421 ex 16/17). Main outcome measures were duration and frequency of non-invasive respiratory support. Data are presented as relative numbers [%] or as median (minimum-maximum).

RESULTS

Twenty-eight (m:f=17:11, gestational age 25.7 weeks [23.3-28.9]) of 32 preterm neonates (87.5%) were treated with biphasic CPAP for a median of three times

(1-12; duration 469h [13.5-1256.0]). Main indications were after extubation (50.0%), recurrent apnoea (20.3%), high FiO_2 (10.9%), and respiratory acidosis (6.3%). CPAP failure occurred in four of 28 preterm neonates (14.3%) within 72h after initiation. After excluding those neonates who failed biphasic CPAP, the FiO_2 was significantly lower at the end of therapy in comparison to the initial FiO_2 (0.25 [0.21-0.60] versus 0.23 [0.21-0.70], $p=0.009$). pCO_2 did not differ between the initial values and those before discontinuation of biphasic CPAP (50.2mmHg [22-78.2] versus 50.2mmHg [29.0-80.6], $p=0.902$).

CONCLUSIONS

Biphasic nasal CPAP was used regularly, repeatedly and primarily after extubation. Given the relatively low rate of CPAP failure, biphasic nasal CPAP seems to be effective even in extremely preterm neonates.

EP363 / #873

E-Poster Viewing - Neonatology AS02-25. Pulmonology

Relative humidity during high frequency oscillatory ventilation compared to intermittent positive pressure ventilation in extremely preterm neonates: an in-vitro and in-vivo observational STUDY

**M. Tauzin^{1*}, F. Decobert¹, C. Jung², X. Durrmeyer¹, C. Treussart¹,
L. Caeymaex¹, C. Danan¹**

¹Hôpital Intercommunal de Créteil, Neonatal Intensive Care Unit, CRETEIL, France

²CHI Créteil, Clinical Research Center, Créteil, France

BACKGROUND AND AIM

Inappropriate humidification of inspired gas during mechanical ventilation can impair lung development in extremely low birth weight (ELBW) infants. Humidification depends on multiple factors such as heater-humidifier devices, type of ventilation or environmental factors. Few studies exist on inspired gas humidification in ELBW and especially during high frequency oscillatory ventilation (HFOV). Our objective was to compare humidity during HFOV versus intermittent positive pressure ventilation (IPPV), in vitro and in vivo.

METHODS

In vitro and in vivo studies used the same ventilator during HFOV and IPPV. The bench-test study used a neonatal test lung and 2 heater-humidifiers with their specific circuits; the in vivo study prospectively included preterm infants born below 28 weeks of gestation.

RESULTS

On bench-test, mean (SD) relative humidity was significantly lower during HFOV compared to IPPV (79.4 (8.1) versus 89.0 (6.2) %, $p = 0.004$). Whatever the ventilatory mode, mean (SD) relative humidity was different between the 2 heater-humidifiers (89.6 (6.7) versus 78.7 (6.8) %). In vivo study included 10 neonates (mean (SD) gestational age: 25.7 (0.9) weeks, mean (SD) birth weight: 624.4 (96.1) g). Relative humidity during HFOV was significantly lower than during IPPV (mean (SD) 74.6 (5.7) versus 83.0 (6.7) %, $p = 0.004$).

CONCLUSIONS

Relative humidity was significantly lower during HFOV as compared to IPPV, both in vitro and in vivo. The type of heater-humidifier also has an influence on humidification. More systematic measure of humidity and improvement of humidification of inspired gas, especially during HFOV, should be considered to optimize lung protective strategies in ELBW infants.

EP364 / #1988

E-Poster Viewing - Neonatology AS02-25. Pulmonology

Effects of two rates of mechanical dorsal stimuli on the respiratory drive, pain scale and sleep architecture in healthy preterm: pilot study.

P. Toso*, M. Faunes, M. Alvarez, A. Toso, A. Gonzalez, S. Campbell

Pontificia Universidad Católica de Chile/Escuela de Medicina, Neonatology, Santiago, Chile

BACKGROUND AND AIM

Mechanical stimulation could be useful to treat apneas of prematurity, however its impacts are not well known. To compare vital signs, pain scale and aEEG sleep-wake cycle, basal and between two rates of mechanical stimuli in preterm.

METHODS

Cross over pilot study on 10 preterm (GA 28-33 weeks) without respiratory support. A surgical glove connected to a mechanical ventilator was placed under patients back on supine. A 2-hour baseline period was followed by two 2-hours random periods with glove inflation at 20 and 40 rate per minute (rpm), respectively. Babies were continuously monitored. Respiratory rate (RR), heart rate (HR), oxygen saturations (Sats), respiratory synchronicity (RS), Neonatal-Infant Pain Scale (NIPS) and presence of sleep-wake cycle (SWC) by aEEG were evaluated and saved every 10 minutes. NCT04584814.

RESULTS

RR mean decreases in a range of 19-50% of the basal period, instead of Sats mean increases until 2-7% during interventions ($p < 0,0001$). 18% (0-77) of the time, the respiratory drive synchronizes with the mechanical stimuli, without differences between 20 or 40 rpm. 94% of the record, babies seem relaxed and quiet (NIPS score ≤ 2). 9/10 patients don't alter the basal SWC on aEEG during the stimulation protocol.

CONCLUSIONS

Mechanical dorsal stimuli interferes the respiratory drive of these healthy preterm. Main findings are a marked decrease of the basal RR, increase of oxygen saturation and some synchronization with the external stimuli. On the other hand, this stimulation don't cause discomfort or altered sleep structure. Next steps should correlate this with respiratory volumes measures.

EP365 / #757

E-Poster Viewing - Neonatology AS02-25. Pulmonology

Fetal haemoglobin during the postnatal period of infants born preterm

**E. Williams^{1*}, N. Bednarczuk², O. Kaltsogianni¹, T. Dassios¹,
A. Greenough¹**

¹King's College London, Department of Women and Children's Health, London, United Kingdom

²King's College Hospital, Neonatal Intensive Care Unit, London, United Kingdom

BACKGROUND AND AIM

Postnatally, low levels of fetal haemoglobin (HbF) have been associated with bronchopulmonary dysplasia (BPD) and retinopathy of prematurity (ROP). Variations and trends in postnatal levels of HbF in infants born extremely prematurely have not been reported. The aim was to describe patterns in fetal haemoglobin (HbF) after birth in prematurely born infants.

METHODS

Observational study of infants born less than 30 weeks of gestational age who were admitted to a tertiary neonatal intensive care unit between 2019-2021. Routine blood gas analysis was undertaken as per clinical need. Values of HbF were presented as a fraction of total haemoglobin and mean HbF levels per postnatal age were reported.

RESULTS

One hundred and three infants were included and a total of 4,631 blood gases were analysed. The infants had a median (range) gestational age of 27.4 (22.4 – 29.9) weeks and a birthweight of 865 (395 – 1710) grams. The

median HbF value over the first 150 postnatal days was 23.5 (16.0 – 81.5) %, with all infants exhibiting a temporal decline in the first month. Those born at less than 24 weeks had the steepest initial decline and demonstrated a second peak in HbF at 120 days [figure 1].

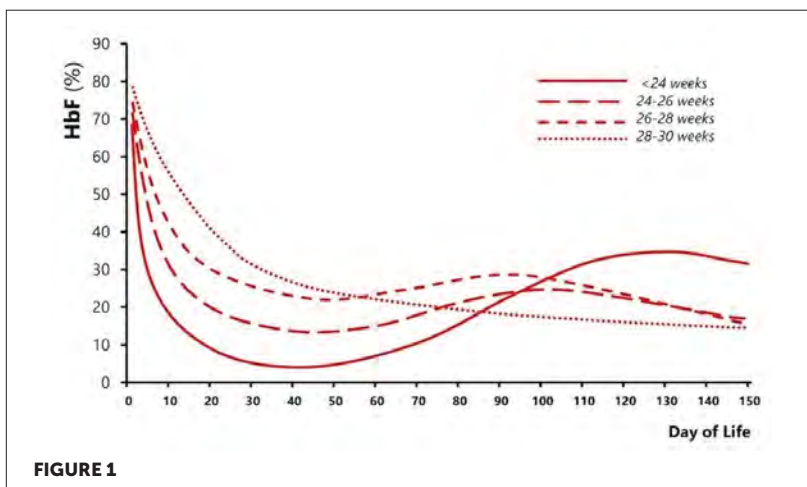

CONCLUSIONS

Fetal haemoglobin levels in preterm infants follow a downward trajectory postnatally. Those born at less than 24 weeks of gestation exhibited the greatest initial decline, with a subsequent second peak in the relative HbF levels reflecting the ongoing postnatal production of HbF after initial suppression and dilution of HbF by transfused adult haemoglobin (HbA).

EP366 / #644

E-Poster Viewing - Neonatology AS02-25. Pulmonology

Morbidities associated with pulmonary circulation and adverse respiratory outcomes in very-low-birthweight infants affected by pulmonary hypoplasia

Y. Seo, M.-Y. Oh, S. Kim, M.S. Kim, S.K. Yum*

Catholic University of Korea, Pediatrics, Seoul, Korea, Republic of

BACKGROUND AND AIM

We aimed to evaluate whether the two factors regarding pulmonary circulation [early pulmonary hypertension (PHTN) and prolonged ductal shunt flow] would contribute to respiratory outcomes in preterm infants depending on pulmonary hypoplasia.

METHODS

Electronic medical records of preterm very-low-birthweight infants during the study period were reviewed. The included infants were divided depending on the presence of presumed pulmonary hypoplasia (PPH). Baseline neonatal and maternal characteristics, respiratory morbidities, and information concerning PHTN and hemodynamically significant patent ductus arteriosus (hsPDA) treatment were compared between the groups. A multivariable logistic regression analysis was performed to assess the association of PPH and early PHTN/delayed hsPDA closure (>21 days after birth) with neonatal outcomes.

RESULTS

A total of 379 infants (295 in the no-PPH vs 84 in the PPH group) were included. Based on multivariable logistic regression analysis, early PHTN increased the odds for neonatal death and composite outcomes. Delayed hsPDA closure increased the odds for adverse respiratory outcome and composite outcome, while decreasing the odds for neonatal death. Based on subanalyses, early PHTN increased the odds for neonatal death for PPH infants (OR=9.981, 95%CI=1.334-74.647). In the no-PPH infants early PHTN increased the odds for neonatal death (OR=11.575, 95%CI=2.988-44.833), while delayed hsPDA closure showed contrary effect. Delayed hsPDA closure in no-PPH infants increased the odds for composite outcome (OR=3.320, 95%CI=1.048-10.515).

CONCLUSIONS

Delayed PDA closure adversely impacts composite outcome in no-PPH infants but the same does not apply to PPH infants.. Early PHTN seems to be the main circulatory factor affecting neonatal mortality regardless of PPH.

EP367 / #2719

E-Poster Viewing - Neonatology AS02-25. Pulmonology

Burden of disease after discharge from the neonatal intensive care unit and hypoxic challenge test failure in infants with bronchopulmonary disease

C. Zaat^{1*}, L. Duijts¹, T. Karamass¹, S. Ballink¹, I. Reiss², M. Pijnenburg²

¹Erasmus MC Sophia Children's Hospital, University Medical Center Rotterdam, Department of Pediatrics, Division of Respiratory Medicine An Allergology, The Generation R Study Group, Rotterdam, Netherlands

²Erasmus MC Sophia Children's Hospital, University Medical Center Rotterdam, Department of Pediatrics, Division of Neonatology, Rotterdam, Netherlands

BACKGROUND AND AIM

Hypoxic challenge test findings could be used as a proxy for pulmonary reserve or the ability for cardiorespiratory compensation for hypoxic conditions in infants with bronchopulmonary dysplasia (BPD). Whether disease burden in the first 6 months after discharge from the neonatal intensive care unit (NICU) affects hypoxic challenge test findings is unclear. To examine the association of disease burden in the first 6 months after discharge from the NICU with hypoxic challenge test findings in infants with BPD.

METHODS

This study among 64 children with moderate-severe BPD was embedded in a hospital-based prospective cohort study. Data on disease burden (hospital admissions, antibiotic courses, contacts with the specialist) at the corrected ages of 3 and 6 months was obtained from medical electronic patient files or standardized e-health care questionnaires. The hypoxic challenge test

was performed according to the European Respiratory Society guideline. Multivariate logistic regression analyses were applied.

RESULTS

Infants with hospital admissions and antibiotic courses for respiratory symptoms had a reduced but non-significant risk of a hypoxic challenge test failure (OR (95% CI): 0.73 (0.22, 2.40) and 0.47 (0.12, 1.90)), while those having contact with a specialist had an increased but non-significant risk of a hypoxic challenge test failure (2.50 (0.68, 9.13)).

CONCLUSIONS

Disease burden in the first 6 months after discharge from the NICU tended to be associated with altered hypoxic challenge test findings in infants with BPD. Further large-scale studies are needed to explore the true valuable use of the hypoxic challenge test.

EP368 / #1065

E-Poster Viewing - Neonatology AS02-26. Quality improvement

Maintaining normothermia in preterm infants following stabilisation with an intact umbilical cord - a quality improvement project (qip) in a uk neonatal intensive care UNIT.

N. Aikman*, E. Coombe, D. Edwards, L. Levingston, M. Mok, D. Prasad, K. Purnell, E. Hoyle, J. Hurst

Liverpool Women's Hospital, Neonatal Unit, Liverpool, United Kingdom

BACKGROUND AND AIM

Hypothermia (<36.5°C) is an independent risk factor for morbidity and mortality in preterm babies. It can potentiate hypoglycaemia, jaundice and respiratory distress.

The aim of this QIP was to identify barriers to achieving normothermia (36.5-37.5°C) and implement changes to sustain improved thermoregulation.

METHODS

Prospective tracking between January 2019 and March 2022 for all admissions from delivery <32 weeks' gestation. This was expanded to 32-36 week infants from November 2021. A series of Plan, Do, Study, Act (PDSA) cycles were performed, aiming to improve thermoregulation at delivery. Interventions included recruitment of medical and nursing workforce champions, policy modification, lesson of the week, newsletters, increased staff training and targeted feedback. Clinical interventions included the use of hats, plastic bags, exothermic mattresses, Lifestart trolleys and continuing radiant heat on transfer.

RESULTS

Below 32 weeks: (See Figure 1) 64.2% (43/67) normothermic in 2019, improving to 74.0% (97/131) in 2020, 74.8% (92/123) in 2021 and 84.2% (16/19) January-March 2022. Sustained improvement in hypothermia (<36.5°C) rates from 23.9% to 5.3%, with reduction in infants <36°C from 7.5% to 0%.

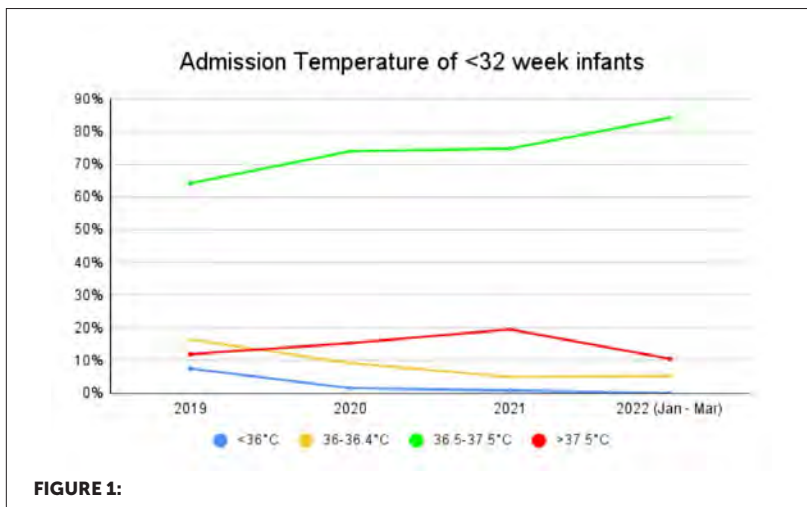

32 - 36 weeks: November 2021-March 2022: 80% (60/75) normothermic on admission, 12% hypothermic, 6.7% hyperthermic.

CONCLUSIONS

Using a quality improvement approach is an effective method of changing clinical practice to improve outcomes. We have successfully demonstrated improved thermoregulation with significantly reduced rates of hypothermia. Further PDSA cycles have addressed the challenges of hyperthermia resulting from thermoregulatory interventions, with improvement demonstrated following flowchart policy modification and publicity. ACKNOWLEDGEMENTS Thanks to all previous members of the thermoregulation QIP through its iterations.

EP369 / #876

E-Poster Viewing - Neonatology AS02-26. Quality improvement

Antenatal counselling for preterm deliveries less than thirty-four weeks gestational age: a quality improvement initiative aimed at improving the delivery of information given to parents.

I. Anwunah*, O. Olaore, N. Singh

University Hospitals Coventry and Warwickshire NHS Trust, Neonatal Unit, Coventry, United Kingdom

BACKGROUND AND AIM

BACKGROUND BAPM recommends parental involvement in making decisions about their baby's care. It is the healthcare professional's responsibility to provide consistent information to parents that will allow them to understand and engage meaningfully in decision-making. We fail to counsel many women expected to deliver <34 weeks, leaving them anxious and uninformed about short term complications and long term outcomes. AIM For 8 out of 10 women at risk of pre-term birth < 34 weeks to receive antenatal counselling "ANC" before the 2nd dose of steroids (within 12 hours from the 1st dose) with a plan documented on K2 electronic record.

METHODS

Key drivers for change were identified through process mapping, fishbone cause and effect analysis and driver diagram creation. Change ideas were then implemented in a plan-do-study-act cycle by an team of inter-professionals coming together.

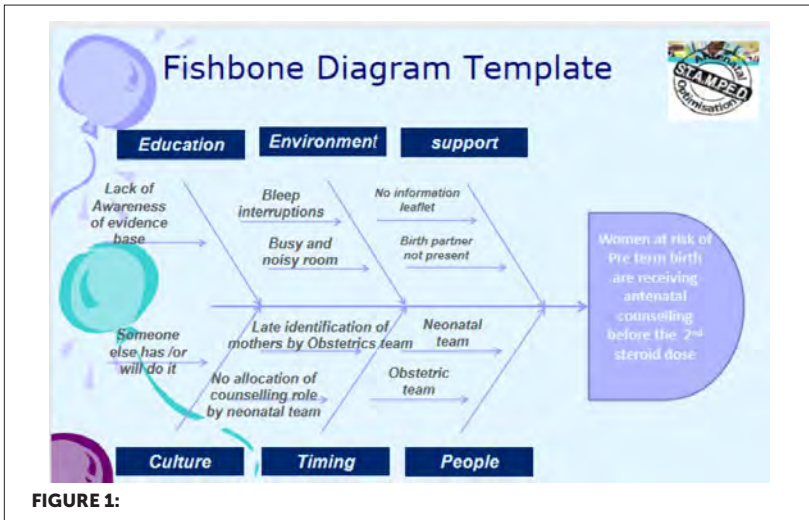

FIGURE 1:

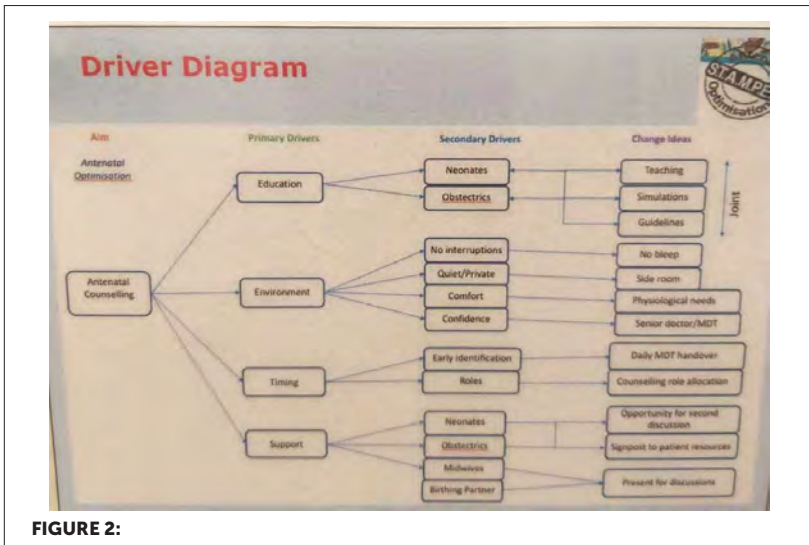

FIGURE 2:

PDSAs – summary table

PDSA Test #	PLAN	Do	STUDY	ACT
1	Assess current knowledge and practise of the neonatal team towards antenatal counselling	A survey of juniors doctors and ANNP on their experience of counselling and knowledge of key information	Survey showed variation in both knowledge and practise	Aim to bridge the gap with education
2	To enhance the knowledge, attitude and practice of the neonatal team towards providing high quality antenatal counselling	Organise teaching on antenatal counselling and follow up with simulation sessions for practise	Feedback on teaching showed it gave confidence to more junior doctors to Provide comprehensive and detailed antenatal counselling and agree on a plan with parents	Share pocket reminders of key information to share during counselling.
3	Create awareness of goal to provide ANC before 2nd steroid dose / 12 hours of arrival to unit for IUT.	Present QIP project at local meeting and on what's app.	More colleagues say they understand the goals of the project	Regularly feedback to the team on how well we are providing timely counselling via what's app and notice board.

FIGURE 3:

RESULTS

Feedback from teaching and simulation sessions organised to enhance knowledge and practice showed it gave confidence to more junior doctors to provide detailed ANC and agree on a plan with parents. Creation of awareness of goal to provide ANC before 2nd dose of steroids/ 12 hours of arrival to unit if intrauterine transfer. More colleagues were aware of this time line and acting towards it. Preliminary survey shows the use of the antenatal counselling cribsheets by junior doctors.

CONCLUSIONS

To maintain and sustain changes, it should be targeted towards system change, involve the stakeholders who can influence system changes. Following this recipe has led to meaningful improvements in quality of antenatal care and parental decision making.

EP370 / #2652**E-Poster Viewing - Neonatology AS02-26. Quality improvement****Developing an automatic artifact correction approach based on empirical mode decomposition (emd) for near-infrared spectroscopy (nirs) signals among pre-term infants****E. Arasteh^{1*}, J. Dudink¹, T. Alderliesten²**¹UMCU-WKZ, Neonatology, Utrecht, Netherlands²University Medical Center Utrecht, Neonatology, Utrecht, Netherlands**BACKGROUND AND AIM**

Motion is an ever-lasting challenge for feasible analysis of any neuro-monitoring technique and can lead to mistakes in signal processing of the recorded signals. Unfortunately, researchers cannot easily ignore all segments of brain data (suspicious of being contaminated by motion artifact) due to loss of probable informative details. This also holds in neonatology, where early birth brain signal is hard to capture and we need fast interpretation of this data to determine further appropriate operations. Although using ground truth sources like accelerometer can help to distinguish real data from artifact, but is not always applicable due to infants' medical situation and related time consuming analysis. In this regard, we need devising algorithms and protocols that can correct artifacts on the bedside in a short time.

METHODS

In this paper, regarding multivariable metric of comparison, we use EMD method to rise variable dimensionality of NIRS signal. Through this, we show

that aggregation of different Intrinsic mode functions (IMF) can lead to better hemodynamic response (HR) estimation and higher carrier to noise (CNR).

RESULTS

We prove that highly corrupted pre-term infants NIRS data due to rapid and constant motions can be improved HR response and CNR at least by 20 % and 15 %, respectively.

CONCLUSIONS

As a result, the idea of increasing dimensionality of NIRS data to overcome the fast and slow motion artifacts seems plausible and verified by encouraging results. As the next step, we should go through testing our idea on a new data set as a validation group.

EP371 / #1204**E-Poster Viewing - Neonatology AS02-26. Quality improvement****Consensus on training and assessment of less invasive surfactant administration competence: an international delphi survey****N. Breindahl^{1,2}, M. Tolsgaard², C.C. Roehr^{3,4}, T. Szczapa⁵, L. Gagliardi⁶, M. Vento⁷, R. Støen^{8,9}, K. Bohlin¹⁰, A. Van Kaam¹¹, D. Klotz¹², X. Durrmeyer¹³, T. Han¹⁴, A. Katheria¹⁵, P. Dargaville¹⁶, T. Brink Henriken^{17,18}, L. Aunsholt^{19*}**¹Rigshospitalet, Department of Neonatal and Pediatric Intensive Care, Copenhagen, Denmark²Copenhagen University Hospital, Copenhagen Academy For Medical Education and Simulation (cames), Cop, Denmark³Nuffield Department of Population Health, University of Oxford, National Perinatal Epidemiology Uni, Oxford, United Kingdom⁴Southmead Hospital, North Bristol Trust, Newborn Services, Bristol, United Kingdom⁵Poznan University of Medical Sciences, Department of Neonatology, Neonatal Biophysical Monitoring and Cardiopulmonary Therapies Research Unit, Poznań, Poland⁶Ospedale Versilia, Division of Neonatology and Pediatrics, Viareggio, Azienda USL Toscana Nord Ovest, Pisa, Italy⁷University and Polytechnic Hospital La Fe, Division of Neonatology, Valencia, Spain⁸St. Olav's University Hospital, Department of Neonatology, Trondheim, Norway⁹Norwegian University of Science and Technology, Department of Clinical and Molecular Medicine, Trondheim, Norway¹⁰Stockholm University Hospital, Karolinska University Hospital, Stockholm, Sweden¹¹Emma Children's Hospital Amsterdam UMC, University of Amsterdam, Division of Neonatology, Amsterdam, Netherlands¹²University of Freiburg, Faculty of Medicine, University of Freiburg, Center For Pediatrics, Division of Neonatology and Pediatric Intensive Care Medicine, Medical Center, Freiburg, Germany¹³Department of Neonatal Intensive Care and Neonatology, Centre Hospitalier Intercommunal De Créteil, Créteil, France¹⁴Peking University Third Hospital, Department of Pediatrics, Beijing, China¹⁵Sharp Mary Birch Hospital for Women & Newborns, Neonatal Research Institute, San Diego, United States of America¹⁶Royal Hobart Hospital, Department of Paediatrics, Hobart, Australia¹⁷Aarhus University Hospital, Department of Paediatrics (intensive Care Neonatology), Aarhus, Denmark¹⁸Clinical Institute, Aarhus University, Perinatal Research Unit, Aarhus, Denmark

¹⁹Copenhagen University Hospital, Rigshospitalet, Department of Intensive Care For Infants and Toddlers, Copenhagen, Denmark

BACKGROUND AND AIM

Due to variation in procedural and training methods, a consensus is needed on the training and competence needs for Less Invasive Surfactant Administration (LISA). The aim of the study is to obtain international consensus on the items to be included in 1) a LISA training curriculum and 2) a LISA assessment tool to evaluate operator competence.

METHODS

From February to June 2022, we are conducting an international needs-assessment survey using the Delphi technique to gather consensus from experts performing LISA. In the first round a brainstorming phase was conducted to identify all potential items to be included in a LISA curriculum and assessment tool. In the second round, experts will rate the importance of each item and items to be included will be determined by consensus. In the third round, all experts will be asked to approve or reject the final LISA curriculum and assessment tool.

RESULTS

From 14 countries 153 experts participated in the first round. For the LISA curriculum and the assessment tool, 159 and 83 unique items were suggested and further condensed to 44 and 22 items by the steering committee. Data from rounds 2 and 3 will be collected from April 2022 to June 2022.

CONCLUSIONS

This Delphi study will generate a consensus-based LISA curriculum and assessment tool to aid the mastery of the procedure among LISA operators. The final expert-approved curriculum and assessment tool will be presented at EAPS 2022.

EP372 / #909**E-Poster Viewing - Neonatology AS02-26. Quality improvement****Development and evaluation of an evidence-based intervention protocol for the prevention of hypothermia of the preterm infants in delivery room and after admission to NICU****S.M. Cheng***

Prince of Wales Hospital, Department of Paediatrics, Shatin, Hong Kong PRC

BACKGROUND AND AIM

Neonatal hypothermia is the leading cause of neonatal morbidity and mortality, especially in preterm infants. An evidence-based intervention protocol applicable to local context was developed to prevent hypothermia of preterm infants. The aims of the project were to develop, implement and evaluate the protocol on prevention of hypothermia of the preterm infants in the delivery room and after admission to the NICU.

METHODS

The Iowa Model-Revised was adopted as the theoretical framework to guide the project process. The thermal care intervention protocol (including use of temperature controlled thermal blanket, occlusive wrap and polyethylene cap) was developed after an extensive review of evidence. Staff were educated to facilitate the dissemination and implementation of the protocol. The project utilized a retrospective-prospective study design for comparison of baseline data from a pre-thermal care protocol implementation cohort with data from a post-thermal care protocol period. The primary outcome was admission temperature after admission to NICU.

RESULTS

A total of 56 preterm neonates (30 in the pre-implementation group and 26 in the post-implementation group) <32 weeks gestational age was recruited. Baseline characteristics such as gestational age, birth weight of infants was similar in the 2 groups. Admission temperature in the NICU was higher in the intervention group but could not achieve statistical significance [36.4 °C (0.57) vs 36.1°C (0.51) p=0.13].

CONCLUSIONS

Though the result was not reached the statistically significant, the project showed improvement in preventing the hypothermia for the preterm infants by using the thermal care protocol, in addition to staff training and followed the protocol strictly.

EP373 / #2135**E-Poster Viewing - Neonatology AS02-26. Quality improvement****Diagnostics and treatment approach in premature neonates below 30th week of gestation. A comparison study between two neonatal centers in rijeka and prishtina****Z. Demiri^{1*}, L. Kryeziu², U. Zeka³, I. Bilić Čače⁴**¹University of Rijeka, Faculty of Medicine, Rijeka, Croatia²University Clinical Center Prishtina, Department of Neonatology, Prishtina, Kosovo³University of Sussex, Department of Economics, Brighton, United Kingdom⁴Clinical Hospital Centre Rijeka, Department of Pediatrics, Rijeka, Croatia**BACKGROUND AND AIM**

As treatment and diagnostic methods towards extreme premature birth have developed over the past decades, an increase in morbidity for the survivors has been detected. The aim of this study is to evaluate if different treatment and diagnostic methods exist between two neonatal units and if any specific approach could have significance on the general outcome.

METHODS

Infants delivered at a gestational age <30 weeks were retrospectively studied. Both descriptive and inferential statistics were used to analyze a sample of 59 babies, 29 born in Rijeka(Croatia, 2400 births/year) and 30 in Prishtina (Kosovo, 10000 births/year). Data were collected from birth to discharge.

RESULTS

Using ordinary least squares, we tested the hypothesis that infants treated in Rijeka are more likely to have shorter hospitalization, due to more advanced methods, than those treated in Prishtina. Other factors affecting hospitalization, such as the types of treatment, were also analyzed. Gender, birth weight, gestational age, Apgar score, continuous positive air pressure (CPAP) and mechanical ventilation were used as control variables. The results suggest that receiving treatment in Kosovo increases hospitalization by 4 days, albeit at statistically insignificant levels. Birth weight, alternatively, affects hospitalization at statistically significant levels, the median in Rijeka being 900gr, whereas 1250gr, in Prishtina.

CONCLUSIONS

The significant distinction between birth weight median of the survived infants can be attributed to the different treatment methods used in the two centers. Forthrightly related to birth weight, hospitalization duration was reduced by 4 days for every additional 100 grams, on average.

EP374 / #2346**E-Poster Viewing - Neonatology AS02-26. Quality improvement****Consequences of implementations of nutritional care bundle in infants born before 32 gestational WEEKS****E. Stoltz Sjöström¹, I. Zamir², J. Dušek^{3*}**¹Umeå University, Department of Food, Nutrition and Culinary Science, Umeå, Sweden²Umeå University, Department of Clinical Sciences, Pediatrics, Umeå, Sweden³University of South Bohemia, Faculty of Health and Social Sciences, České Budějovice, Czech Republic**BACKGROUND AND AIM**

Preterm infants are at risk of malnutrition, growth failure, and neonatal morbidity. This study aimed to evaluate how implementation of a nutritional care bundle affected growth and morbidity in very preterm infants.

METHODS

This before-and-after study compared 87 very preterm infants (<32 gestational weeks) born 2018 (BG) with 75 infants born 2020 (AG), all treated at the same neonatal intensive care unit in the Czech Republic. A nutritional care bundle was implemented during 2019, comprising daily calculation of fluids using an online software, targeted fortification of breastmilk, and use of a standard concentrated parenteral solution. Anthropometric data was registered once weekly using the Fenton growth curve and perinatal data was prospectively registered for both groups.

RESULTS

There were no differences in baseline characteristics between the groups. During postnatal days 1-14, parenteral fluid intake was significantly lower in the AG compared to the BG and conversely, enteral fluid intake was significantly higher in the AG. Weight z-scores decreased significantly less from birth to 36 weeks in the AG (-0.8 [IQR -1.3 to -0.5]) compared to the BG (-1.5 [IQR -2.0 to -1.2]) and head circumference z-scores decreased significantly less in the AG (-0.8 ± 0.9) compared to the BG (-1.6 ± 1.1). A decrease in the rate of treated patent ductus arteriosus was noted in the AG ($P < 0.001$).

CONCLUSIONS

Individual daily calculation of fluids, use of concentrated parenteral solution and targeted fortification of enteral nutrition enhance postnatal growth and reduce the incidence of patent ductus arteriosus in very preterm infants.

EP375 / #2578**E-Poster Viewing - Neonatology AS02-26. Quality improvement****Improving preterm cranial ultrasound surveillance in a local neonatal intensive care unit. A single centre quality improvement project****G. Elley*, K. Jamieson**

Whittington Health NHS Trust, Neonatal Department, London, United Kingdom

BACKGROUND AND AIM

The National Neonatal Audit programme (NNAP) highlighted preterm brain injury as a key outcome measure, with promotion of national online registry recording (Badger). Adherence to evidence based cranial ultrasound sonography (CrUSS) surveillance schedules and early recognition/diagnosis of intracranial events can support interventions to optimise neurodevelopmental outcome. While junior doctors often perform CrUSS, scans can be difficult to interpret- senior support can help identify and interpret anomalies. We aimed to: - Improve adherence to recommended CrUSS surveillance schedule. - Improve documentation (local notes and Badger). - Ensure timely senior review. - Improve junior confidence/competence in performing/interpreting scans.

METHODS

- 1) Retrospective data collection of CrUSS findings/documentation for infants born <33 weeks' gestation over 14 months. Implementation of novel bespoke CrUSS documentation proforma (*figure 1*) with re-audit hereafter.
- 2) Anonymous questionnaire of junior doctors to assess confidence and education/support available.

Cranial Ultrasound Surveillance Chart
It is recommended for babies born <33 weeks to have scans on day 1; 3; 14; 21; and after 36/40 cGA. The need for further scans will be dependent on findings.

Whittington Health
 NHS Trust

Gestation at Birth:			Consultant Review <small>(date/time/name/ any change to findings)</small>
<u>Date/Time:</u>	<u>cGA:</u> <u>Scan Indication:</u>	<u>Age (days):</u>	
Report <small>Comment on anatomy, presence/absence of ICH, ventricular anomalies +/- VCs, periventricular</small>			Normal / Abnormal scan <u>Suggested timing of next scan:</u>
Name: _____ Documented on badger? _____ Designation: _____ Y / N			
<u>Date/Time:</u>	<u>cGA:</u> <u>Scan Indication:</u>	<u>Age (days):</u>	Consultant Review <small>(date/time/name/ any change to findings)</small>
Report			
Name: _____ Documented on badger? _____ Designation: _____ Y / N			Normal / Abnormal scan <u>Suggested timing of next scan:</u>

FIGURE 1:

RESULTS

Total scans = 121: 84 (69%) routine surveillance, no documentation of indication in 52% of others. - 41 (56%) adhered to recommended timing. - 33 (27%) documented on Badger. - 67 (80%) had senior review- 17% revealed new/different interpretation. Only 58% had clear follow up plan. Data collection following proforma implementation is ongoing at time of submission, but preliminary results show significant improvement. Questionnaire results (figure 2).



CONCLUSIONS

CrUSS remains a key diagnostic tool in neonates. Introduction of a bespoke CrUSS proforma can improve CrUSS surveillance, documentation, interpretation and follow up. It can also help promote senior support and education for juniors. Further research to create national CrUSS surveillance recommendations and promote training could be beneficial.

EP376 / #2070

E-Poster Viewing - Neonatology AS02-26. Quality improvement

Developing virtual education across a neonatal network: therapies in action

E. Foulerton*, S. Clarke, K. Parnell

Birmingham Women's and Children's NHS Foundation Trust, West Midlands Neonatal Operational Delivery Network, Birmingham, United Kingdom

BACKGROUND AND AIM

The Neonatal Critical Care Review recommendations highlight Allied Health Professionals (AHPs) as pivotal in embedding developmentally sensitive care. West Midlands Neonatal Network AHPs have delivered staff education across the region. There was an urgent need to change delivery methods following COVID19 restrictions with the aim to maintain high-quality teaching with specific learning objectives, improve accessibility and use knowledge scores to inform change.

METHODS

The Therapies in Action (TiA) course was developed with remote delivery of structured content over 3 months. The Software was identified to support online delivery, both live and recordings, manage registration and host resources. Outcome measures included accessibility, quality of education (knowledge scores), participant feedback (questionnaire) and PDSA cycles were used to inform change.

RESULTS

Access increased from 7 contacts per month (average) in 2019 compared to 97 and 99 contacts per month (average) in 2020/early 2021 respectively. Average percentage increase in knowledge scores was 27.7% and 26.1% in 2020/21 respectively (figure 1). 75% (2020) and 74 % (2021) of responders said they would change practice based on their learning. Feedback was overwhelmingly positive but the registration process was reported as challenging during PDSA cycle 1(Figure 2). This was adapted.

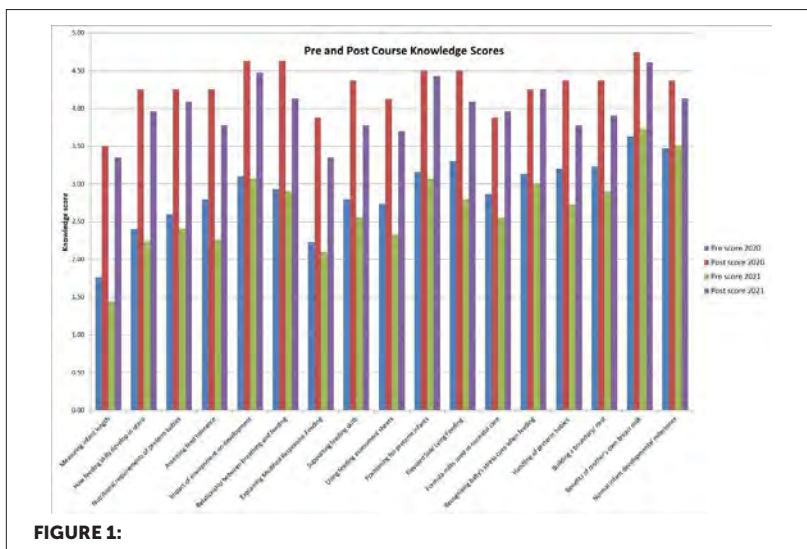
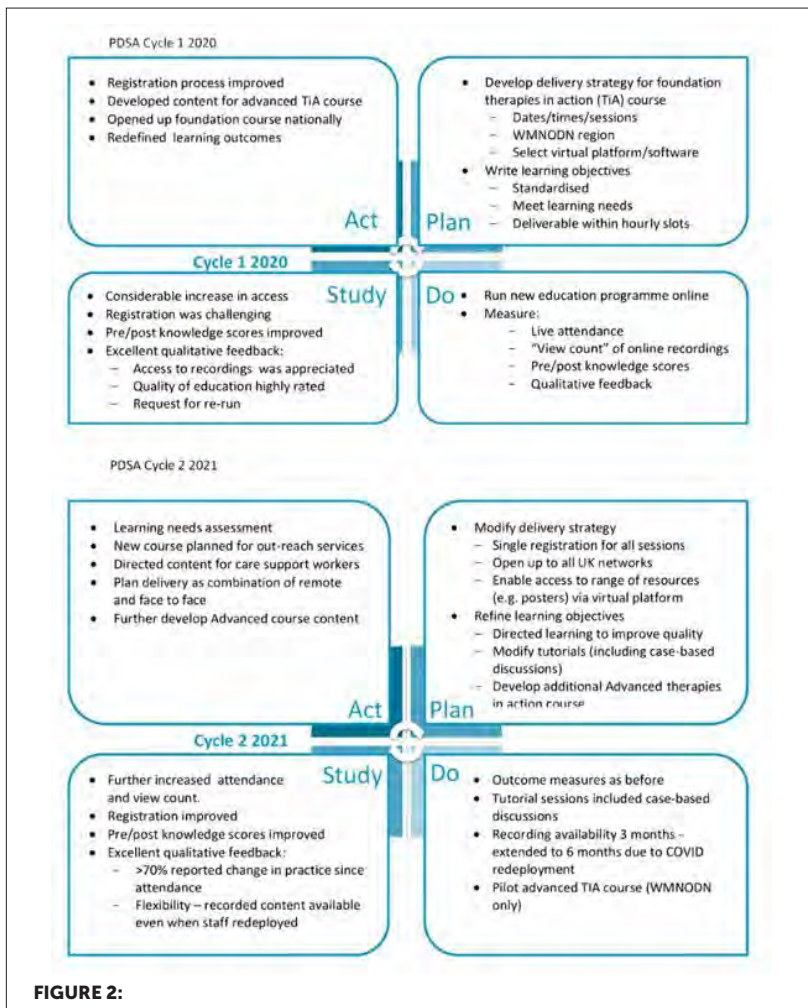

FIGURE 1:

CONCLUSIONS

Successful implementation of TiA course demonstrated by huge increase in contacts per month was driven by necessity for change, with associated appetite for online learning. Future challenges include sustaining interest and avoiding remote learning fatigue. Further iterations include a hybrid model; combining remote and face to face teaching.



EP377 / #999**E-Poster Viewing - Neonatology AS02-26. Quality improvement****Reducing unplanned extubation in neonatal intensive CARE****C. Granger^{1*}, R. Naples^{1,2}, R. Tinnion^{1,2}**

¹Newcastle upon Tyne Hospitals NHS Trust, Newcastle Neonatal Services, Newcastle, United Kingdom

²Newcastle upon Tyne Hospitals Trust, Neonatology, Newcastle upon Tyne, United Kingdom

BACKGROUND AND AIM

Background Unplanned extubation (UE) is associated with significant complications in the neonate: events can rapidly lead to include cardiovascular instability and a requirement for re-intubation is associated with significant morbidity and mortality. Factors that contribute to UE events include incorrect use of endotracheal tube fixation devices, and unintentional disturbance during procedures and handling within NICU. Aims We set a target of 1 event per 100 ventilator days, as has been benchmarked in many NICUs across the country.

METHODS

To first identify the scale of the problem we undertook six months prospective data collection of all unplanned events, with an audit form completed contemporaneously as a "hot debrief" with the team on shift, and a datix filled in.

RESULTS

Initial findings showed that the majority of our unplanned extubations occur in our smallest babies with smallest endotracheal tubes. Two thirds of infants

who had an UE were re-intubated in the following 24 hours, and on one occasion an infant required cardiac compressions and adrenaline. Following this prospective audit, we have implemented an education package increasing staff awareness of the problem with visual aids, together with mandating two person handling for infants <30 weeks gestation and/or <1kg in weight. With these changes, we have increased the visibility of UE as a concern within NICU. In the five months since implementing a package of change, we have shown a 10% reduction in unplanned extubation.

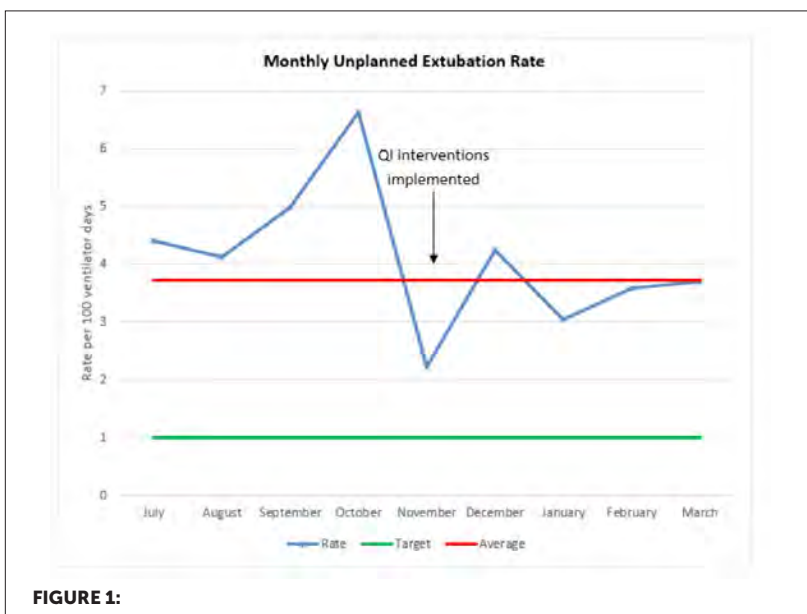

CONCLUSIONS

Work is ongoing, but we have shown with commitment, education and regular review, sustained reduction in harm can be achieved.

EP378 / #409**E-Poster Viewing - Neonatology AS02-26. Quality improvement****Projected application of the sepsis risk calculator versus screening for early onset sepsis based on national guidelines for the polish population: a cost analysis****J. Seliga-Siwecka, J. Ulan-Drozdowska, A. Zwijacz, B. Grochowski***

Medical University of Warsaw, Department of Neonatology and Neonatal Intensive Care, Warsaw, Poland

BACKGROUND AND AIM

The sepsis risk calculator (SRC) is a novel tool to aid antibiotic stewardship in newborns that has been created from a case-control study of blood culture-proven early onset sepsis (EOS). Despite multiple reports on the use of SRC, no data on the implementation and effect on financial costs associated with healthcare in a central European setting have been published. Thus, we compare the costs of using Polish Neonatal Society Guidelines (PNSG) with the Kaiser Permanente SRC for addressing the risk of EOS.

METHODS

A retrospective single center study was conducted in a level III university teaching hospital in Warsaw, Poland for 24 months (2017–2018). We collected maternal intrapartum risk factors and newborn parameters for each infant >34 weeks. Newborns were treated based on PNSG. To determine the sepsis risk and recommendations, we applied SRC on each patient retrospectively, in alignment with the timing of clinical assessment based on PNSG.

RESULTS

of the 6183 infants, 38.9% were started on antibiotics as per PNSG compared with 16.5% projected by SRC. Out of 543 blood samples only three were positive for bacteria. No sepsis-related deaths were registered. Almost 25% saving of actual costs per patient could be achieved by decreasing hospital stay cost by 23% and antibiotic cost by nearly 5%.

CONCLUSIONS

Implementing the SRC in clinical practice safely and effectively reduces the length and cost of hospital stay in newborns at risk of early onset sepsis.

EP379 / #2102

E-Poster Viewing - Neonatology AS02-26. Quality improvement

Video-reflection of acute neonatal interventions

V. Heesters^{1*}, H. Van Zanten¹, V. Heijstek¹, S. Jansen², D. Van Valkenburg³, A. Te Pas¹, R. Witlox¹

¹Leiden University Medical Centre, Neonatology, Leiden, Netherlands

²Leiden university medical center, Paediatrics, Leiden, Netherlands

³Leiden University Medical Center, Quality and Patient Safety, Leiden, Netherlands

BACKGROUND AND AIM

In the NICU of the Leiden University Medical Center, video recordings are used to visualize clinical care in an objective way and to reflect on interventions performed by caregivers during neonatal resuscitation. Recently, video-reflection was expanded to other acute interventions. The aim of this study is to describe the process, success factors and preconditions of this implementation.

METHODS

An action-research study was performed using Plan-Do-Study-Act cycles, interviews, observations and questionnaires. Interventions, such as sterile line insertion, intubation and resuscitation were recorded. Video-reflection sessions were held in a multidisciplinary setting at the NICU.

RESULTS

To ensure successful implementation of video-reflection, use of adequate equipment is essential for the quality of recordings. Full transparency in the way videos are recorded and stored helps to obtain trust from caregivers. Thorough preparation of the reflection sessions and a dedicated chair created

a safe learning environment. Caregivers who recorded and reviewed their own videos activated and encouraged the rest of the team to do the same. A structured evaluation of the reflection sessions was set up which enabled the lessons learned from reflection to be used to drive change, e.g. develop education programs, adjust protocols and improve use of medical equipment.



CONCLUSIONS

Success factors and preconditions were identified and can be used for an implementation guideline of video-reflection of acute interventions in a neonatal unit.

EP380 / #1174**E-Poster Viewing - Neonatology AS02-26. Quality improvement****A quality improvement project aim to produced sustained reduction case numbers of esbl colonisation by improving infection control practices in the neonatal UNIT****I. Hunt^{1*}, S. Shehabi¹, C. Hiatt¹, N. Tsonchev¹, N. Singh²**¹University Hospital Coventry and Warwickshire NHS Trust, Neonates, Coventry, United Kingdom²University Hospitals Coventry and Warwickshire NHS Trust, Neonatal Unit, Coventry, United Kingdom**BACKGROUND AND AIM**

An outbreak of ESBL colonisation on our neonatal unit highlighted the need to review infection control practices. We aimed to produce an infection control bundle which would standardise practices, reducing ESBL cases

METHODS

Our multiprofessional team identified areas of improvement using QI tools and introduced these across 3 concurrent PDSA cycles targeting: neonatal bathing, LocSSIP (Local Safety Standards for Invasive procedures) and bed space management/unit education/infection control management. A fourth PDSA cycle was completed after 12 months as the improvement produced by the first 3 cycles were not sustained. This re-audited bathing compliance, LocSIPP compliance while re-educating and engaging staff through teaching, training and daily ward huddles. We also monitored blood culture numbers during this period.

RESULTS

During the initial PDSA cycles bathing compliance increased from 10% to 88% following implementation of our changes. LocSIPP forms were present in 92.5% but only complete 38.8% of the time. This resulted in 100 days ESBL free on the neonatal unit however this was not sustained. The re-audit of bathing compliance showed an improvement over 4 months from 20-35% compliance to 60-80% compliance which led to a further period of 108 days ESBL free. LocSIPP forms were present 96% of the time but only complete 65% of the time and blood culture positives remained similar throughout this period

CONCLUSIONS

Improvement in case numbers of ESBL colonisation were reproducible by re-establishing standards of bathing on the unit and should be sustainable by keeping standards high. Further improvements in LocSSIP compliance may help reduce blood culture positives.

EP381 / #655

E-Poster Viewing - Neonatology AS02-26. Quality improvement

Neonatal super 60 project

K. Ibrahim*, S. Mulla

East Kent University Hospitals (EKHUFT), William Harvey Hospital, Nicu, Ashford, Kent, United Kingdom

BACKGROUND AND AIM

Studies have shown marked reduction in hypothermia, hypoglycemia, intraventricular hemorrhage (IVH), bronchopulmonary dysplasia (BPD), and retinopathy of prematurity (ROP) if the standard of the first hour of care is effectively followed on neonatal admission especially when applied to preterm infant. Aims: To achieve all aspects of initial care and interventions in preterm neonates, in the first sixty minutes of post-natal life including:

- Neonatal delivery room transition/resuscitation (including temperature maintenance, DCC etc.)
- Transportation to NICU (maintaining thermal chain and respiratory support)
- Admission of the baby to the Neonatal Unit (coordinated and focused care)
- Post admission care and stabilization (Prioritization and team working)

METHODS

A prospective study using data collected through designed proforma, audit sheet and documentation system (Badger net). First audit covered the period between January to March 2021 then the 2nd audit involved the 3 months between July and September 2021.

RESULTS

The initial audit showed only 56% achievement in all domains of care in the first hour of care. Areas of improvement were recognised and a further awareness and training was conducted. This led to significant improvement which was reflected in the re-audit demonstrating an increase by >30% in the successful attainment of all aspects of golden hour.

CONCLUSIONS

Further teaching sessions, posters, fliers and auditing to be made to increase the awareness about the Super 60 project in both nursing and medical staff, in order to achieve the previously mentioned target of providing the best possible care for sick infants during their 60 minutes of admission in NICU.

EP382 / #2282**E-Poster Viewing - Neonatology AS02-26. Quality improvement****Introduction of delivery room glucogel to reduce rates of admission hypoglycaemia in preterm neonates****A. Shaw, C. Jackson***

Leeds Teaching Hospitals NHS Trust, Leeds Centre For Newborn Care, Leeds, United Kingdom

BACKGROUND AND AIM

Admission hypoglycaemia is common in preterm infants and may impact on neurodevelopmental outcome. In a pre-intervention sample, 60% preterm infants <34/40 were hypoglycaemic on arrival to the neonatal unit (blood glucose <2.6mmol/l). The aim of this project was to reduce admission hypoglycaemia by introducing the routine use of buccal dextrose gel at preterm deliveries.

METHODS

We introduced a dose of buccal 40% glucogel and incorporated this into our stabilisation of the newborn protocol. The dose was based on an estimated birthweight. We engaged medical and nursing staff through micro-teachings, visual aids and simulation exercises. It became evident that a second dose was warranted and this was updated in our protocol.

RESULTS

We have shown that it is feasible to introduce this change within our neonatal unit. We have seen a modest reduction in admission hypoglycaemia. In

infants receiving 2 doses of glucogel, admission hypoglycaemia was almost exclusively seen in infants with other significant comorbidity (IUGR, maternal diabetes). We have not observed any significant complications.

CONCLUSIONS

We have demonstrated this intervention to be feasible in our unit with 80% eligible babies receiving at least one dose of glucogel. Our initial challenges centred around administration difficulty, particularly for intubated babies. We overcame this by better education and training of staff. We also experienced rebound hypoglycaemia and increased from a single dose to two doses of glucogel. We are currently aiming to develop staff education further to better achieve full compliance with the double dosing intervention and demonstrate lower rates of hypoglycaemia in the coming months.

EP383 / #1266

E-Poster Viewing - Neonatology AS02-26. Quality improvement

An audit on neonatal jaundice management at a specialist maternity hospital

C.Y. Lai*, M. Cawsey

Birmingham Women's Hospital, Neonatology, Birmingham, United Kingdom

BACKGROUND AND AIM

Management of neonatal jaundice in the UK is governed by guidelines from the National Institute of Health and Care Excellence (NICE). The primary objective of this prospective audit is to determine the rate of compliance to NICE guidelines.

METHODS

Inclusion criteria: 1) All babies on postnatal wards, transitional care and special care unit who had their bilirubin levels measured 2) All babies on intensive care or high dependency for whom jaundice was their main reason of admission were also included. The electronic patient records of all babies born between 18/12/2020 and 3/1/2021 were prospectively screened. If they met the inclusion criteria, their electronic records were studied to identify audited variables.

RESULTS

61 babies were included. 100% of babies had bilirubin levels measured within the NICE-specified time frame. NICE guidelines suggest that transcutaneous bilirubinometer be used for babies above GA 35/40 and >24 hours old. of the 10 babies with jaundice within the first 24 hours of life, 50% had bilirubin

bin levels measured transcutaneously, though serum bilirubin should have been taken. Fourteen babies required phototherapy; of these, 5 (36%) had bilirubin measured 4-6 hours after initiating phototherapy (Figure 1). Whilst on phototherapy, 62% of bilirubin measurement intervals were within the recommended 6-12 hourly intervals (Figure 2). Once off phototherapy, 43% of babies had rebound bilirubin levels measured 12-18 hours after stopping phototherapy.

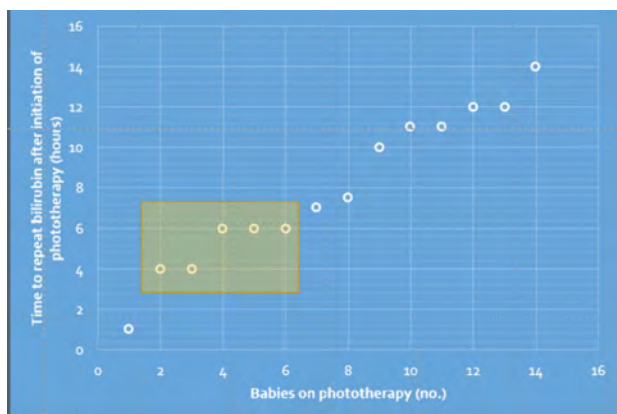
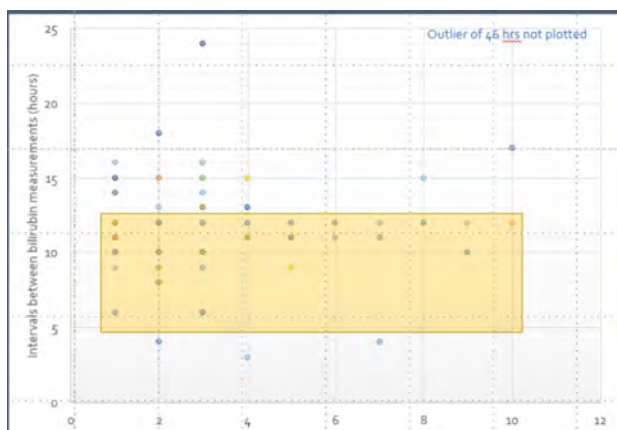
**FIGURE 1:****FIGURE 2:**

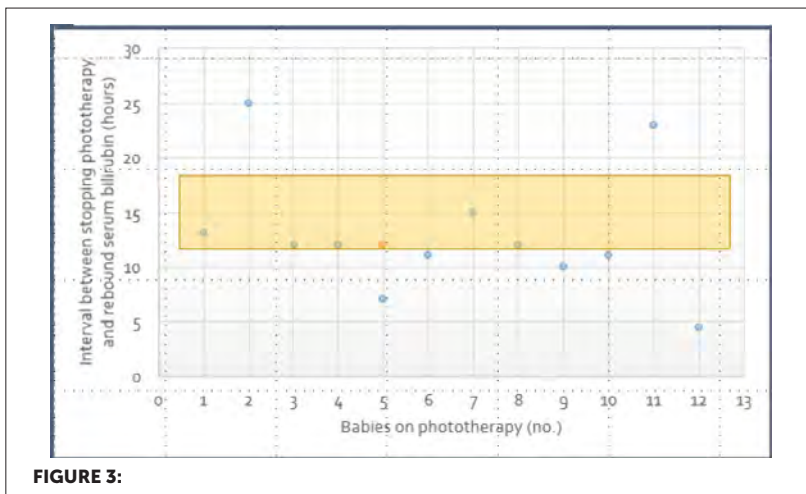

CONCLUSIONS

Jaundice management at our hospital has improved significantly since the widespread introduction of transcutaneous bilirubinometers on the post-natal ward. Areas of discussion include management of babies less than 24 hours old.

EP384 / #2335

E-Poster Viewing - Neonatology AS02-26. Quality improvement

Predictors of compliance to neurodevelopmental follow after preterm birth: a 10-year observational cohort STUDY

A. Le Brun^{1*}, A. Thiriar¹, M. Kennes², P. Clément², A. Vuckovic¹

¹Queen Fabiola Children's University Hospital, Université libre de Bruxelles, Neonatal Intensive Care Unit, Bruxelles, Belgium

²Queen Fabiola Children's University Hospital, Université libre de Bruxelles, Pediatric Neurology, Bruxelles, Belgium

BACKGROUND AND AIM

Very preterm/very-low-birth weight infants are at risk of impaired neurodevelopment. Therefore, follow-up programs are essential to provide healthcare support on the long term. Compliance to follow-up can be challenging even in countries where costs are covered by national health insurance. To improve quality of care, this study aimed at evaluating predictors of compliance to neurodevelopmental follow-up.

METHODS

This retrospective, single-center study included 295 very preterm/very-low-birth weight infants, born between January 2010 and December 2019, and routinely scheduled for a multidisciplinary follow-up at 12- and 24-months' corrected age. Medical and socio-demographic characteristics of infants with complete assessment were compared with data of those with low/non-compliance to follow-up.

RESULTS

Complete follow-up including neurobehavioral, auditive and visual assessments was achieved in 206 (70%) infants. Follow-up rates remained stable overtime. of the remaining 89 (30%) infants with moderate or no compliance, 32 (11%) did not attend any scheduled appointment, 52 (17.6%) underwent only one neurobehavioral assessment, and 5 (1.7%) did not have any hearing and/or ophthalmological exam. Following multiple logistic regression, independent predictors of compliance were maternal age (OR, 1.065; 95% CI 1.008–1.108; $P = .024$), gravidic hypertension (OR, 2.820; 95% CI 1.140–8.115; $P = .036$), and lack of income (OR, 0.406; 95% CI 0.227–0.724; $P = .023$).

CONCLUSIONS

Good overall compliance to neurodevelopmental follow-up was obtained in this cohort of very preterm infants. Attention must be drawn to infants born to young mothers with low income, who are at higher risk of attrition.

EP385 / #1232

E-Poster Viewing - Neonatology AS02-26. Quality improvement

Reducing preterm mortality & brain injury: the periprem (perinatal excellence to reduce injury in premature birth) care pathway

H. Mcbain¹, S. Tuvey¹, A. Glover-Williams², N. Menzies³, S. Hedge¹, S. Bates⁴, A. Smith-Collins⁵, K. Luyt^{5*}

¹South West Academic Health Science Network, South West Academic Health Science Network, Exeter, United Kingdom

²UHBW, Nicu, Bristol, United Kingdom

³West of England AHSN, Quality Improvement, Bristol, United Kingdom

⁴Great Western Hospitals NHS Foundation Trust, Paediatrics, Swindon, United Kingdom

⁵University of Bristol, Bristol Medical School, Bristol, United Kingdom

BACKGROUND AND AIM

In England, NHS policy aims to reduce neonatal mortality and brain injury by 50% by 2025. In 2020, the PERIPrem project was launched in the South-West (SW) of England. PERIPrem is a perinatal care bundle of 11 interventions associated with significant reductions in preterm mortality and brain injury implemented using Quality Improvement (QI) methodology. This evaluation aimed to understand the impact of PERIPrem and the implementation process.



METHODS

Adherence to the bundle was analysed for 693 babies born between 2020 and 2021 across 12 perinatal centres and compared to 2019. Regional Vermont Oxford Network data was used to analyse mortality and severe brain injury. To evaluate implementation and develop recommendations for future spread, questionnaires were completed, alongside qualitative interviews.

RESULTS

Between 2019-21 there was a 23% increase in proportion of interventions received by mother-baby dyads. Delivery of all 11 interventions improved (range 8%-63%), with statistically significant improvements in 8 interventions. A 34% reduction in severe brain injury ($p=0.02$) and a 22% reduction in mortality ($p=0.15$) was noted between 2014-2019 and 2020. There was also a statistically significant improvement in team function and communication. Interviewees described capability, motivation and opportunity acting as barriers and enablers to implementing the bundle.

TABLE 1:

ELEMENT	DESCRIPTION	OPTIMAL TIMING	EVIDENCE BASE
Place of birth	Babies <37.0 weeks gestation (<28.0 weeks for babies of <800g who are born in a tertiary unit)	Nil	Especially pre-term babies born in a non tertiary unit are 2.4 times more likely to develop severe brain injury and 1.2 times more likely to die when transported, if not compared to controls (Helenius et al., 2015)
Antenatal steroids	Mothers who give birth at <34 weeks gestation receive at least one dose of antenatal steroids	2 doses 12-24hrs apart, >24hrs and <7days prior to birth	Reduces the risk of neonatal death by 31%, NEC by 54% and grade 3-4 ROP by 46% (Roberts et al., 2017)
Magnesium sulphate	Mothers who give birth at <30 weeks gestation receive antenatal magnesium sulphate	>4hrs and <24hrs prior to birth	Reduces the risk of severe palsy by 32% (Dove et al., 2009)
Intrapartum antibiotics	Mothers who are in active labour at any point prior to delivery receive intrapartum antibiotics	At least 4hrs prior to birth	Reduces risk of neonatal GBS sepsis in GBS colonised women by 86% (Farine et al., 2013)
Optimal cord management	Babies born at <34 weeks gestation have their cord clamped	At or after one minute of birth	Reduces mortality by 32% compared to early cord clamping (Doherty et al., 2018)
Thermoregulation	Babies born at <34 weeks gestation have a normothermic temperature (36.5-37.5°C)	Within 1hr of admission to the neonatal unit	28% increase in mortality per 1°C decrease in body temperature (Japrook et al., 2007)
Ventilation	Babies born at <34 weeks gestation who are in need of respiratory support are given volume targeted ventilation in combination with pressure limited ventilation as the primary mode of respiratory support	At birth	Moderate hypothermia associated with higher odds of IVH (OR 1.31) and death (OR 1.3) compared to a normothermic temperature (Miller et al., 2014)
Caffeine	Babies born at <30 weeks gestation and/or <1500g receive caffeine therapy	With in first 74hrs of life	Reduces death or BPD by 27% and IVH (Grade 3-4) by 47% compared to RLV modes (Korenzberg et al., 2017)
Early breast milk	Babies born at <34 weeks gestation receive 17 M BM	With in first 6hrs of life	The odds of death or BPD decrease by 19% and the odds of PDA decrease by 26% (Lodha et al., 2013). The odds of significant neurodevelopmental impairment decrease by 32% when caffeine is received within 2 days of birth (Lodha et al., 2015)
Multi strain probiotics	Babies born at <32 weeks gestation and/or <1500g are started on multi strain probiotic	With in first 24hrs of life	Reduces the risk of NEC by 38% compared to formula (Milibelli et al., 2020)
Prophylactic hydrocortisone	Babies born at <26 weeks gestation are started on hydrocortisone	With in first 74hrs of life	The odds of death are 44% less and the odds of developing NEC are between 45-69% less when receiving probiotics compared to a placebo (Morgan et al., 2020)
			The odds of survival without BPD significantly increase by 15% and the odds of death are pre discharge reduce by 38% (Shaffer et al., 2019)

CONCLUSIONS

Using a cohesive and coordinated QI approach, perinatal teams across the SW were able to successfully implement an 11-intervention perinatal care bundle and reduce rates of preterm mortality and severe brain injury. This was achieved through improvements in perinatal team culture, teamwork, knowledge and skills, having strong leadership and access to the right evidence-based resources.

EP386 / #2156**E-Poster Viewing - Neonatology AS02-26. Quality improvement****Implementing multiple parallel changes on a nicu: the experience of the rosie preterm bundle**

C. Macdougall*, T. Austin, S. Hoodbhoy, R. Chaudhary, J. Arthur

Cambridge University Hospitals NHS Foundation Trust, Neonatal Intensive Care Unit, Cambridge, United Kingdom

BACKGROUND AND AIM

Implementing change in healthcare settings is challenging. In the drive to improve outcomes for preterm infants, there are several evidence-based interventions which have either not been adopted or are provided inconsistently. Introducing changes to practice in series is time consuming and risks staff becoming disengaged. Our aim was to develop and rapidly implement a care bundle comprising evidence-based interventions for babies less than 32 weeks' gestation in the perinatal period designed to reduce mortality and morbidity. Our aim was for 85% appropriate interventions to be delivered to eligible babies.

METHODS

Driver diagrams and process mapping were used to establish the interventions to be included in the bundle. Data was collected from the electronic patient record on which interventions were received between Jan 2021 and December 2021. Staff engagement was maintained through newsletters, e-learning modules, weekly team meetings and an information board.

RESULTS

121 eligible babies were identified in 2021. Some interventions were not appropriate for all babies (fig 1). Figure 1. Implementation rates for individual elements of the Rosie Preterm Bundle

TABLE 1:

Bundle Element	Number of eligible babies	Number of babies receiving intervention (%)
Place of birth	36	29 (80.6%)
Antenatal corticosteroids	91	69 (75.8%)
Magnesium sulphate	72	63 (87.5%)
Delayed cord clamping*	90	47 (52.2%)
Prophylactic hydrocortisone**	19	17 (89.5%)
Normothermia*	91	62 (68.1%)
Caffeine	121	115 (95.0%)
Early PN*	94	83 (88.3%)
Early colostrum*	121	36 (29.8%)
Probiotics**	67	43 (64.2%)
All elements	802	564 (70.3%)

* Existing interventions with updated approach
 ** New interventions

CONCLUSIONS

Care bundles are an effective way to standardise care to optimise outcomes. Incorporating multiple new interventions as a care bundle has the advantage of introducing change rapidly. Interventions based on simple procedures (e.g. drug administration) performed better than more complex interventions dependent on human factors. Nevertheless, we have demonstrated that it is possible to introduce many changes in clinical practice, while maintaining staff engagement. Ongoing data collection will be required to demonstrate sustainability and ultimately improved outcomes.

EP387 / #841**E-Poster Viewing - Neonatology AS02-26. Quality improvement****Improving and sustaining time to antibiotic administration for neonates at risk of early onset neonatal infection (eons) using quality improvement methodology****M. Carpenter¹, M. Scott², P. Nath^{3*}, N. Singh²**¹Coventry University, Health & Life Sciences, FB, United Kingdom²University Hospitals Coventry and Warwickshire NHS Trust, Neonatal Unit, Coventry, United Kingdom³UHCW, Nicu, Coventry, United Kingdom**BACKGROUND AND AIM**

NICE guideline (NG195) recommends for neonates at risk of EONS, antibiotics should be administered within 60 minutes of the decision to treat. Aims: To identify barriers to meeting 60 minutes to antibiotics target. To implement interventions to meet 60 minutes antibiotic target. To reduce antibiotic administration time by 10% with each QI cycle.

METHODS

A multi-disciplinary QI team was formed. Barriers and interventions were identified using QI tools including process mapping, fishbone analysis, human factors, Pareto chart and driver diagram (Figure 1 and 2). Data collection and change implementation using Plan- Do- Study – Act (PDSA) cycles. CYCLE 1 Interventions: An educational package was delivered and posters displayed in clinical areas. All equipment required placed into a sepsis trolley. CYCLE 2 Barriers: Incomplete documentation. Lack of early identification of at risk babies. Intervention: Sepsis screening tool designed to accurately capture times and identification of babies early.

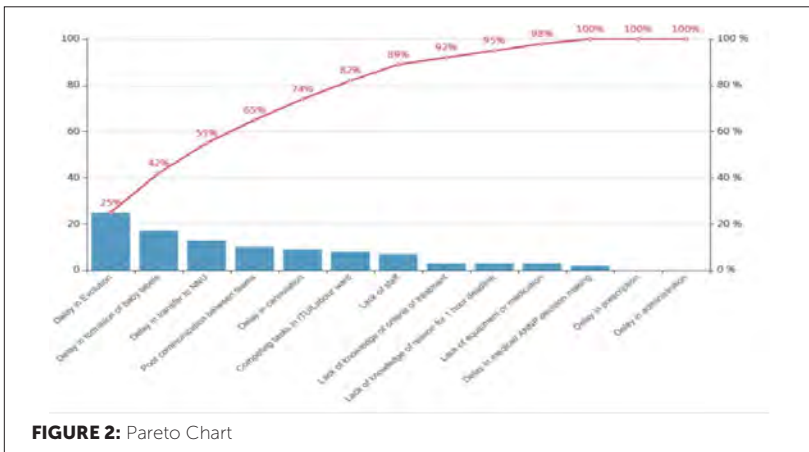
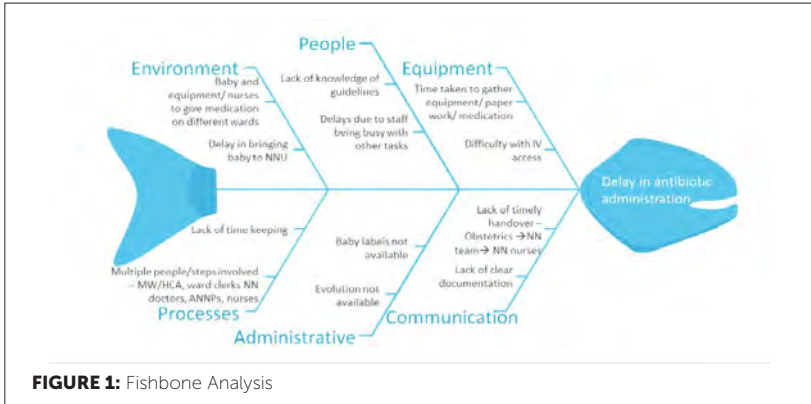

RESULTS

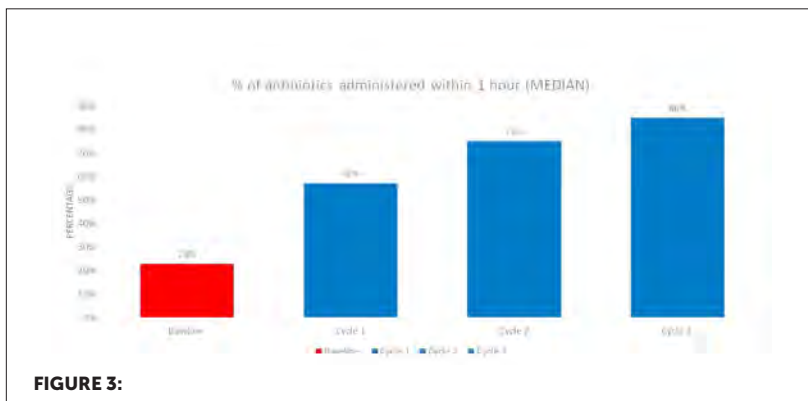

FIGURE 3:

On average, 60 patients were prescribed antibiotics per month. The graph summarises the results following each PDSA cycle. Administration time has improved from an average 90 minutes to 42.5 minutes. The median percent of infants now receiving antibiotics within 60 minutes has increased from 23% to 55% to 73% to 86%

CONCLUSIONS

Time of antibiotic administration has significantly improved and the majority of infants now receive antibiotics within 60 minutes of the decision to treat. Analysis and identification of barriers using QI tools has allowed for targeted interventions to streamline processes, engage stakeholders and have produced sustainable changes.

EP388 / #1669

E-Poster Viewing - Neonatology AS02-26. Quality improvement

Pushing the boundaries of quality improvement on the neonatal UNIT

S. Williamson, A. Pearce*, N. Singh

University Hospital Coventry & Warwickshire, Neonatology, Coventry, United Kingdom

BACKGROUND AND AIM

Quality improvement (QI) projects improve outcomes in neonatology but implementing sustainable change is often difficult, hindered by rotational staffing and small-scale projects. This leads to poor engagement, organisational buy-in and a lack of resources to enact change. Our aim was to introduce a multi-faceted, inter-professional QI initiative on our neonatal intensive care unit.

METHODS

Local stakeholders were approached to explore barriers to change. Priority areas of improvement were identified by reviewing local and national data. Toolkits were designed to support the design, implementation, and monitoring of individual projects.

RESULTS

Since September 2020, 7 QI groups have been established: STAMPED – antenatal optimisation Opticlamp – delayed cord clamping and thermoregulation XPRES – neonatal nutrition Project PEEP – reducing bronchopulmonary dysplasia Bug Busters – infection control KP NUTS – neonatal infection The

HI-5s – streamlining process in NIPE clinic Each group identified their SMART aims and drivers and implemented their change ideas through multiple Plan, Do, Study Act (PDSA) cycles. Groups were encouraged to provide weekly updates, highlighted at morning safety huddles, and to share progress and learning at local, national, and international meetings, to ensure sustainable change. In an attempt to reduce bronchopulmonary dysplasia, Project PEEP introduced delivery room CPAP circuits in March 2021. Delivery room intubations have decreased by an average of 9% since 2020 and 20% since 2019.

CONCLUSIONS

By empowering staff at all levels to contribute their skills and ideas to bring about change, this has led to a change in culture, increased enthusiasm and inter-professional involvement enabling sustainable change.

EP389 / #1761

E-Poster Viewing - Neonatology AS02-26. Quality improvement

Project peep: a respiratory quality improvement project.

L. Bradley, A. Pearce*, M. Wasif, N. Singh

University Hospital Coventry & Warwickshire, Neonatology, Coventry, United Kingdom

BACKGROUND AND AIM

A QI team of interdisciplinary individuals was established on our neonatal unit. Our aim was to reduce incidence of BPD through implementation of an evolving respiratory care bundle.

METHODS

Key drivers for change were identified through process mapping, fish-bone cause and effect analysis and driver diagram creation. Change ideas were implemented in consecutive plan-do-study-act cycles (PDSA) from 2019-ongoing. Cycle 1: Education to start to change culture in a safe and effective way. Cycle 2: Implementation of LISA technique including education of theory and training in the skill. Cycle 3: Sourcing nasal delivery room CPAP and formulation of a clinical algorithm for application at all preterm deliveries <32 weeks GA. A video tutorial was developed and the team cascaded learning of the algorithm and the use of the DRCPAP circuit. Cycle 4: Training in use of video-laryngoscopy (VL) to increase user confidence and success in LISA. Preterm ventilation guideline written including interventions implemented. Cycle 5: Staff surveys conducted to investigate opinions on postnatal steroids for BP. Audit of previous and current postnatal steroid use and subsequent development of day 7 checklist for considering late postnatal steroid use.

RESULTS

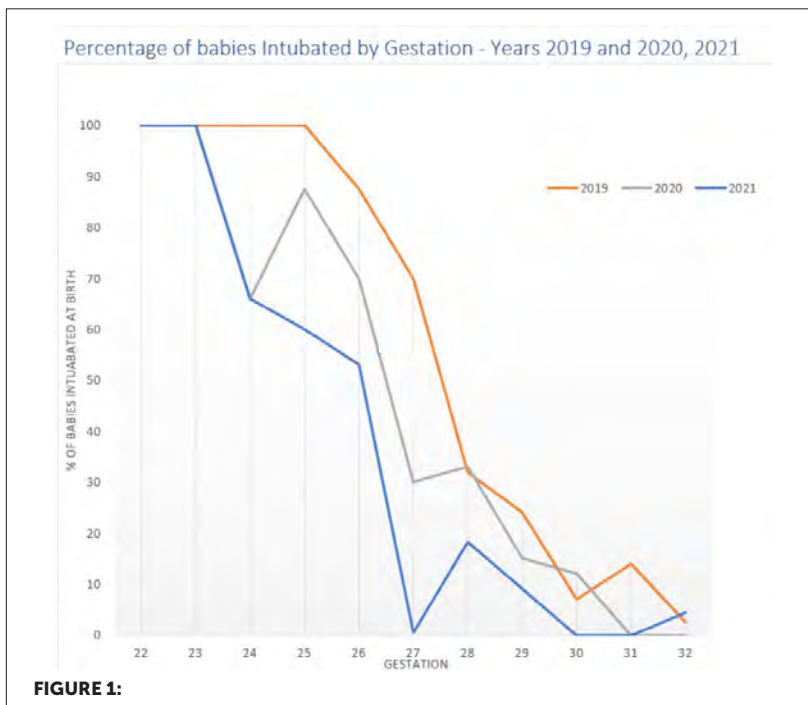

Intubations reduced by 9% since 2020 and 20% since 2019. BPD rates have fallen in <32 GA from 48% to 38% since initiation. 68/78 (87%) of <32 GA were immediately started on delivery room CPAP in the 2021.

CONCLUSIONS

Introduction of a preterm respiratory care bundle has resulted in a decrease in the number of babies intubated at birth, potentially positively influencing the rate of BPD.

EP390 / #1284

E-Poster Viewing - Neonatology AS02-26. Quality improvement

Development of a web-based oxygenation viewer for preterm neonates at the NICU

J. Poppe*, R. Smorenburg, T. Goos, H.R. Taal, I. Reiss, S. Simons

Erasmus MC Sophia Children's Hospital, University Medical Center Rotterdam, Department of Pediatrics, Division of Neonatology, Rotterdam, Netherlands

BACKGROUND AND AIM

Most data of extensively monitored preterm neonates admitted to the NICU are not used in detail and crucial patterns can be missed due to the snapshot bedside presentation. Fluctuations in the oxygen saturation (SpO_2) and fraction of inspired oxygen (FiO_2) are associated with adverse outcomes and therefore essential to monitor closely. This study aimed to develop a web-based customized viewer with trend data on the respiration and oxygenation status to support clinical decision making.

METHODS

Data measured by pulse oximeters and ventilators were synchronized and stored to enable real-time trend visualization in a web-based viewer. The viewer was developed based on interviews with neonatologists. A preliminary version was evaluated during daily clinical rounds. The respiratory status of neonates (gestational age <32 weeks) with respiratory support at the NICU was first assessed as is standard during clinical care, followed by an assessment with the assistance of the viewer.

RESULTS

The web-based viewer included data on the SpO_2 , FiO_2 , SpO_2/FiO_2 ratio, and area $<80\%$ SpO_2 curve during a variable time interval. The distribution of SpO_2 values was also visualized as a histogram. In 65% of the evaluated neonates ($n=86$) the level of hypoxia was assessed differently with the viewer. In 75% of the patients the viewer was judged to have added value in supporting clinical decisions.



FIGURE 1:

CONCLUSIONS

A web-based customized viewer was developed presenting trend data on the respiration and oxygenation status of neonates at the NICU. More clear and objective information could support clinicians in tailoring treatment strategies.

Ep391 / #1090

E-Poster Viewing - Neonatology AS02-26. Quality improvement

Prediction of severe retinopathy of prematurity using physiological data in preterm neonates

J. Poppe^{1*}, S. Fitzgibbon², H.R. Taal¹, S. Loudon³, A. Tjiam³, C.C. Roehr^{4,5}, I. Reiss¹, S. Simons¹, C. Hartley⁶

¹Erasmus MC Sophia Children's Hospital, University Medical Center Rotterdam, Department of Pediatrics, Division of Neonatology, Rotterdam, Netherlands

²Wellcome Centre for Integrative Neuroimaging, FMRIB, University of Oxford, Nuffield Department of Clinical Neurosciences, Oxford, United Kingdom

³Erasmus MC, University Medical Center Rotterdam, Department of Ophthalmology, Rotterdam, Netherlands

⁴Southmead Hospital, North Bristol Trust, Newborn Services, Bristol, United Kingdom

⁵Nuffield Department of Population Health, University of Oxford, National Perinatal Epidemiology Unit, Oxford, United Kingdom

⁶University of Oxford, Department of Paediatrics, Oxford, United Kingdom

BACKGROUND AND AIM

Early identification of retinopathy of prematurity (ROP) is essential to provide optimal treatment. Risk stratification of patients could be useful to identify both those infants in need of extra screening and conversely avoid unnecessary screening examinations. The aim of this study was to examine the ability of routinely monitored physiological data during the first 30 days after birth to predict preterm infants with and without severe ROP.

METHODS

In this observational study, preterm infants with a gestational age <32 weeks and birth weight <1500 grams who were screened for ROP at the Erasmus MC NICU between 2016 and 2020 were eligible for inclusion. Non-parametric cluster analyses were performed to identify time periods with significant

differences between neonates with and without severe (required laser treatment) ROP development. Tree-based classification models were trained and independently tested on continuous physiological data and baseline demographics.

RESULTS

In total, 208 preterm neonates were included in the analysis of whom 30 (14%) neonates required laser treatment. Significant differences occurred in the level of hypoxia and hyperoxia, oxygen requirement and skewness of the heart rate in the first month after birth. The best model had a balanced accuracy of 0.81 (0.72-0.87), a sensitivity of 0.73 (0.64-0.81), and a specificity of 0.88 (0.80-0.93) and included the SpO_2/FiO_2 ratio and baseline demographics.

CONCLUSIONS

Physiological monitor data from preterm neonates during the first 30 days after birth can already predict later development of severe ROP. These data provide the opportunity for tailored treatment strategies during NICU admission.

Ep392 / #2083

E-Poster Viewing - Neonatology AS02-26. Quality improvement

Feasibility of the web-based training and certification of clinical staff for the randomised clinical trial safeboosc-III

M. Rasmussen*, M. Lühr Hansen, G. Greisen

Rigshospitalet, Copenhagen University Hospital, Department of Neonatology, Copenhagen E, Denmark

BACKGROUND AND AIM

SafeBoosC-III is a pragmatic, multinational randomised clinical trial evaluating the effects of treatment guided by cerebral oximetry monitoring in extremely preterm infants. In total, 1601 infants were randomised across 70 centres in Asia, Europe, and North America. To heighten the quality of trial data and patient care, we developed a multilingual web-based training program, to train trial staff members and test their competencies, efficiently and consistently.

METHODS

All modules consisted of initial learning material followed by a case-based quiz, with elaborate responses to correct as well as to wrong answers (integrated learning and testing). The modules were available in eight languages and hosted on an online platform. All nurses and physicians on the GCP-lists of participating centres were invited. The training program included five modules: Introduction; Near-infrared-spectroscopy; Treatment guideline; Cerebral ultrasound; and Good Clinical Practice. Certification was obtained by completing modules, relevant for staff category. To motivate training, investigators from participating centres, continuously received reports of local certification rates.

RESULTS

A total of 926 out of 2100 staff members obtained certification. Six months after start of randomisation, the mean certification rate per centre for doctors and nurses was 47% and 35%, respectively (figure1). Among staff members who completed the evaluation module, 83% found the overall quality of the training program to be good/very good. Furthermore, 94% agreed/strongly agreed that it was relevant to clinical practice.

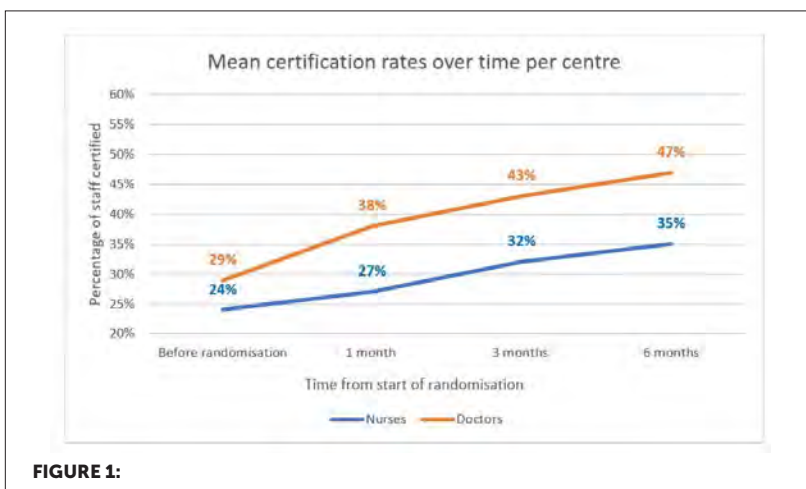

CONCLUSIONS

Despite differences in clinical practice across participating centres, language barriers and a low budget, our web-based training and certification program proved feasible in an international trial setting.

EP393 / #2314

E-Poster Viewing - Neonatology AS02-26. Quality improvement

Ankyloglossia: a new medical subject

L. Ruiz-Guzman^{1*}, L. López-García², E. Ciriza-Barea³,
M.D.M. Ruiz-Calderón⁴, M. García-Howard⁵

¹Institut Catala Salut, Cap 17 Setembre, El Prat de Llobregat, Spain

²Facultad de Medicina. Universidad Navarra, Departamento De Preventiva Ysalud Publica, Urb. Ardoi. ZizurMayor, Spain

³Salud Navarra, Cs Ansoain, Berriozar, Spain

⁴Gava Salut Familiar, Lactancia Materna, Gavà, Spain

⁵Servicio Navarro de Salud, Hospital Universitario De Navarra, Pamplona, Spain

BACKGROUND AND AIM

Ankyloglossia generates problems and its management is controversial. In breastfeeding produces: pain, cracks, mastitis, poor weight gain and unwanted early weaning. It affects maternal physical-emotional health. These disorders are solved with frenectomy. Their presence may go unnoticed. Training on ankyloglossia is necessary, especially for pediatricians caring for mothers and babies. Health professionals were trained and the changes observed were assessed. Objectives: Make visible the importance of training in ankyloglossia for professionals who work with the mother-child dyad.

METHODS

Face-to-face course in ankyloglossia with the program: Definition, History, Incidence and prevalence, Consequences, Ankyloglossia and lactation, Difficulties in older children and adults, Clinical presentation and diagnosis of ankyloglossia in new-borns. Rehabilitation treatment. Considerations, 2 recent cases, Colloquium. Pre and post-training tests were performed. This is a descriptive study of the results.

RESULTS

184 health professionals attended the two-day-course. 145 responded the pre-test and 77 the post. 26% were pediatricians. All participants performed examination of the mouth, only 60% used a test for it. 11% performed frenectomy. The increase in knowledge after the training is high and 88% found it useful for their subsequent work.

CONCLUSIONS

Training in ankyloglossia is necessary. Few professionals are trained to assess ankyloglossia, but much less to solve them. The few professionals who carry out frenotomies diagnose twice as much as those who refer them to another professional.

EP394 / #2611

E-Poster Viewing - Neonatology AS02-26. Quality improvement

Virtual bedside teaching of neonatal interventions and subsequent quality improvement utilizing video recordings

H. Schwarz*, K. Bibl, L. Kumer, J. Leutgeb, P. Steinbauer, T. Werther, K. Klebermass-Schrehof, A. Berger, M. Wagner

Division of Neonatology, Pediatric Intensive Care and Neuropediatrics, Comprehensive Center for Pediatrics, Medical University of Vienna, Vienna, Austria, Pediatrics, Vienna, Austria

BACKGROUND AND AIM

Eye-tracking glasses and room view cameras enable learners to observe interventions in a NICU closely while being present in another room in real-time or any other time during a structured video debriefing. These recordings can also be used to assess, discuss, and adjust local adherence to guidelines. The aim of this research project is to determine the experience and feasibility of using video recordings, reviewing the adherence to the implemented standard operating procedures (SOPs) and introduce regular video debriefings for quality improvement. Further, feasibility of each video recording system will be compared.

METHODS

Healthcare providers of the NICU at the Medical University of Vienna will be either wearing eye-tracking glasses (Tobii 3 mobile glasses, Tobii AB, Danderyd, Sweden) and/or a GoPro (GoPro, San Mateo, CA, USA) while performing neonatal interventions. After the intervention, the proceduralist will fill in a questionnaire about the feasibility and subjective experience. Furthermore, two investigators will review the recordings and develop SOPs

for each intervention and will evaluate the recordings with a specific score before and after implementation of SOPs.

RESULTS

Until now, 72 patients were included, the mean gestational age was 31+1 (*IQR* 27+1-37+0). Recordings including 22 intubations, 14 delivery room managements, two surfactant administrations, five central-line insertions, six lumbar punctures, four chest drain insertions and one Ommaya reservoir puncture were conducted. Within a year, regular video debriefings could have been established.

CONCLUSIONS

Video recording is a simple and easy-to-use tool to enhance educational training and create SOPs. This contributes substantially to the improvement of patient safety.

EP395 / #1849

E-Poster Viewing - Neonatology AS02-26. Quality improvement

What's wrong, baby? An acoustic analysis of cry triggers in newborns

C. Onu¹, S. Latremouille^{1,2}, A. Paul¹, W. Basfar³, A. Ali³, E. Senechal^{2*}, D. Precup⁴, G. Sant'Anna^{2,3}

¹Ubenwa Health, Research & Development, Montréal, Canada

²McGill University, Department of Experimental Medicine, Montreal, Canada

³McGill University Health Centre, Montreal Children's Hospital, Montréal, Canada

⁴McGill University, Computer Science, Montréal, Canada

BACKGROUND AND AIM

Background: Newborn cry is an involuntary reflex used to communicate needs. However, differentiation of cry triggers is subjective. Understanding newborn cry via acoustic analysis could guide classification of a variety of conditions and improve care from parents and healthcare workers. **Objective:** To describe the acoustic characteristics of cries originating from various triggers in healthy term newborns.

METHODS

At least one cry was recorded from healthy term newborns (³36wks gestational age) for 30sec-3min using a smartphone and an in-house developed study application during a neurological examination performed the day of discharge. Researchers annotated the primary reason for cry: spontaneous (i.e. undressing), discomfort (i.e. soiled diaper), hunger, or startling from Moro reflex test. Recordings passed through an AI-based algorithm to remove noise, isolate cry, and identify single cry units (CU; one voiced expiration) (Figure1). Acoustic features were extracted using an automated algorithm to obtain pitch, CU duration, and pause between CUs. Acoustic features were compared between cry triggers using the Kruskal-Wallis test.

METHODS

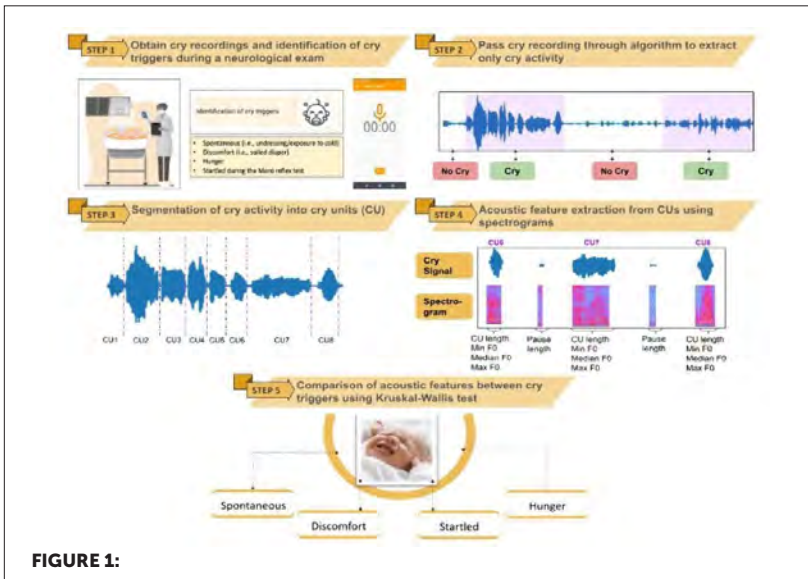

RESULTS

RESULTS

N=105 newborns (**Table 1**), were recruited, and 166 recordings were analyzed. Recordings had median 28 [20–41 IQR] CUs extracted. Number of annotated CUs per type of trigger are specified in **Table 2**. Despite overlap, all 5 acoustic features differed significantly between cry triggers (**Table 2**). Consistent differences were noted between discomfort and hunger cries (**Table 2**)

Table 1. Patient demographics

	All newborns (n=105)
Neonatal Data	
Gestational age (weeks)	39.1 [38.6 - 40.0] (n=104)
Birth weight (g)	3,350 [3,110 - 3,690]
Sex (male)	51/104 (49%)
Inborn delivery	105/105 (100%)
Maternal Characteristics	
Age (years)	34 [30 - 37] (n=103)
Gravida	2 [1 - 3] (n=104)
Parity	2 [1 - 2] (n=93)
Ethnicity	
White	55/96 (57%)
Hispanic	4/96 (4%)
Asian	18/96 (19%)
Black	10/96 (10%)
Other	9/96 (9%)
Perinatal Data	
Abnormal cardiotocography	17/105 (16%)
Shoulder dystocia	1/99 (1%)
Mode of delivery	
Vaginal	54/103 (52%)
Vaginal with instrumentation	6/103 (6%)
C-section	43/103 (42%)
5min APGAR score	9 [9 - 9] (n=102)
Resuscitation required*	5/104 (5%)
Cord Blood Gas	
pH	7.28 [7.23 - 7.33] (n=104)
PCO ₂ (mmHg)	50.6 [42.0 - 60.0] (n=101)
HCO ₃ (mmol/L)	22.5 [21.1 - 24.2] (n=101)
Base Excess (mmol/L)	-2.8 [-4.4 - -1.7] (n=102)
Neurological Evaluation	
Normal Samat stage at discharge	105/105 (100%)

Legend: Values are reported as median [IQR] or n/N (%). *Resuscitation includes the use of positive pressure ventilation within 10min of life, and/or continuous need for assisted ventilation at 10min of life.

Table 2. Summary of acoustic analysis results for cry triggers.

	Spontaneous (n=1776)	Discomfort (n=831)	Hunger (n=518)	Startle (n=746)	p-value
Median Pitch (Hz)	432 [380 - 505] ^{##}	426 [361 - 478] ^{##}	447 [397 - 525]	442 [381 - 512]	<0.001
Minimum Pitch (Hz)	344 [272 - 420] [#]	320 [219 - 394] ^{##}	348 [293 - 428] [§]	339 [274 - 407]	<0.001
Maximum Pitch (Hz)	498 [432 - 686] [#]	495 [437 - 598] [#]	542 [444 - 813]	508 [441 - 705]	<0.001
Cry Unit Length (s)	0.57 [0.23 - 1.00] [#]	0.68 [0.26 - 1.08] ^{##}	0.56 [0.22 - 0.93]	0.59 [0.24 - 0.95]	<0.001
Pause Length (s)	0.19 [0.06 - 0.39] ^{##}	0.14 [0.05 - 0.43] [#]	0.10 [0.05 - 0.28]	0.12 [0.05 - 0.31]	<0.001

Legend: Values presented as median [IQR]. Sample sizes are for cry units. P-values obtained from the Kruskal-Wallis test, with Tukey-Kramer's post-hoc comparison results: [#] p<0.05 vs. Discomfort, ^{##} p<0.05 vs. Hunger, and [§] p<0.05 vs. Startle.

CONCLUSIONS

Conclusion

Acoustic analysis is a potentially useful tool for parents or healthcare workers to differentiate between newborn cry triggers. This preliminary data will help in the study of neonatal to assess pathological conditions.

EP396 / #1946

E-Poster Viewing - Neonatology AS02-26. Quality improvement

Wireless monitoring devices in hospitalized children: a scoping review

E. Senechal^{1*}, E. Jeanne¹, L. Tao², R. Kearney³, W. Shalish^{1,2}, G. Sant'Anna^{1,2}

¹McGill University, Department of Experimental Medicine, Montreal, Canada

²McGill University Health Centre, Montreal Children's Hospital, Montréal, Canada

³McGill University, Biological and Biomedical Engineering, Montréal, Canada

BACKGROUND AND AIM

Introduction: In hospitalized children, especially those in intensive care, vital signs and other physiological signals are continuously observed using sensors connected to bedside monitors via wires. The presence of wires is cumbersome, limits patient's mobility, hinders the parents' ability to interact with their children, and practice of Kangaroo Care. Wireless technology has improved, and several novel sensors have been introduced in pediatric care. **Objective:** To provide a structured overview of existing wireless monitoring technologies for hospitalized children.

METHODS

METHODS

A systematic search of the literature published after 2010 was conducted by a librarian in Medline, Embase, Scielo, Cochrane, and Web of Science. Two investigators independently reviewed articles to determine eligibility for inclusion. Information on study type, setting, participants number, reference sensor, vital signs monitored, duration of monitoring, type of wireless

information transfer, and outcomes of the wireless devices was extracted. A descriptive analysis was applied.

RESULTS

RESULTS

of the 1131 studies identified, 34 met eligibility criteria (Figure 1). Most articles were prospective observational studies (91%). Over half (68%) of all articles were published between 2019 and 2021 and 25 (74%) included a sample size of ≤ 50 (Figure 2). Twenty-four (71%) studies included the use of a reference sensor. Detailed results are presented in Table 1.

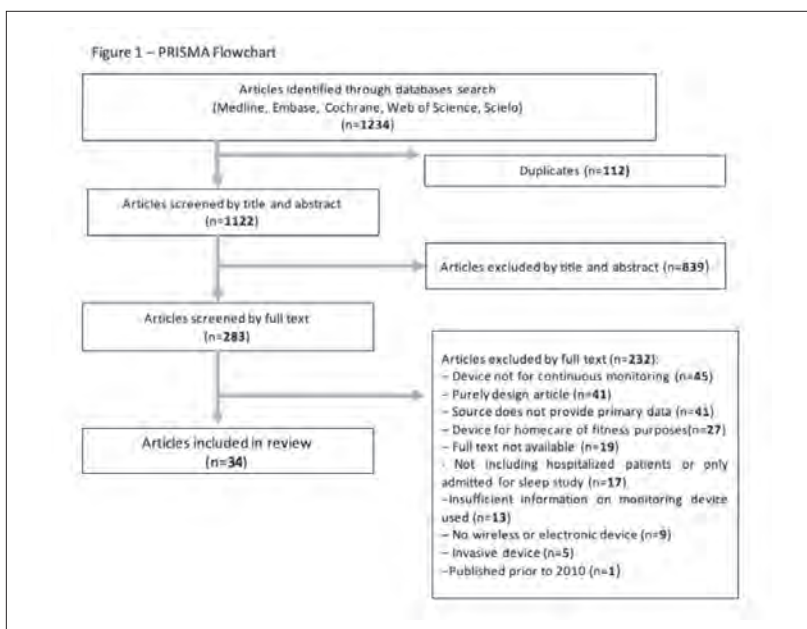

Figure 2 – Number of Participants in Study



Table 1 – Descriptive Analysis of Included Studies

Included articles	n=34
Study Site*:	n (%)
NICU	14 (41)
Pediatric Ward	13 (38)
PICU	5 (15)
Hospital (other/unspecified)	4 (12)
Age of Participants*:	n (%)
Infant (< 1 year)	21 (62)
Toddler to Early Childhood (≥ 1 to 5 years)	28 (82)
Middle Childhood (> 5 to 10 years)	18 (53)
Adolescence (>10 to <18 years)	18 (53)
Duration of Monitoring*:	n (%)
<1 hour	10 (29)
1– 8 hours	4 (12)
> 8 -24 hours	7 (21)
> 24 hours	5 (15)
Overnight (unspecified hours)	3 (9)
N/A	5 (15)
Number of Vital Signs Monitored by Device:	n (%)
0	9 (26)
1	11 (32)
2	7 (21)
3	4 (12)
4	3 (9)
Type of Vital Signs Recorded by Device*:	n (%)
Heart Rate	20 (59)
Oxygenation Saturation	12 (35)
Temperature	11 (32)
Respiratory Rate	6 (18)
Type of Wireless Information Transfer:	n (%)
Bluetooth	14 (41)
Not Specified	13 (38)
No Wireless Information Transfer	4 (12)
Wi-Fi	3 (9)
Outcomes Reported:	n (%)
Validity	28 (82)
Feasibility	15 (44)
Clinical	9 (26)

***Legend:** Data are presented as n (%). In certain cases, more than one study site, or age category was included in study thus each category included was counted

CONCLUSIONS

Conclusion

Research on the use of wireless monitoring for hospitalized children has been increasing in recent years. However, studies were often limited by a small sample size, lack of a reference sensor, short duration, single focus on validity, and lack of on information wireless data transfer.

EP397 / #712

E-Poster Viewing - Neonatology AS02-26. Quality improvement

First attempt neonatal intubation success rates are low: a 2 year single centre retrospective review

H. Turner*, V. Monnelly

Royal Infirmary of Edinburgh, Neonatal Unit, Edinburgh, United Kingdom

BACKGROUND AND AIM

Acquiring and maintaining competence in neonatal intubation is increasingly challenging, largely due to declining opportunities. The UK paediatric training curriculum has recently changed to reflect this, thus neonatal intubation is no longer a mandatory procedure for all junior trainees. Nevertheless, intubation remains essential for some infants and intubation safety must be prioritised. This retrospective review aimed to document current intubation practices, including first attempt success rates, in a single NICU in the UK to facilitate planning of intubation safety QI work.

METHODS

Infants born between 1st January 2019 and 31st December 2020 who underwent intubation in the hospital were included. Data was extracted manually from electronic patient records and analysed in Excel.

RESULTS

188 infants underwent 298 intubation procedures. 25% of infants required intubation on multiple separate occasions. 33% were extremely preterm (Figure 1) and 35% weighed <1000g at the time of the procedure (Figure 2). The first clinician attempting intubation was most often tier 2 (Figure 3). First attempt success rate was 49% and was higher with increasing clinician seniority, for procedures occurring in NICU rather than the delivery room,

and when pre-medication was used. >3 attempts were required in 9% of procedures.

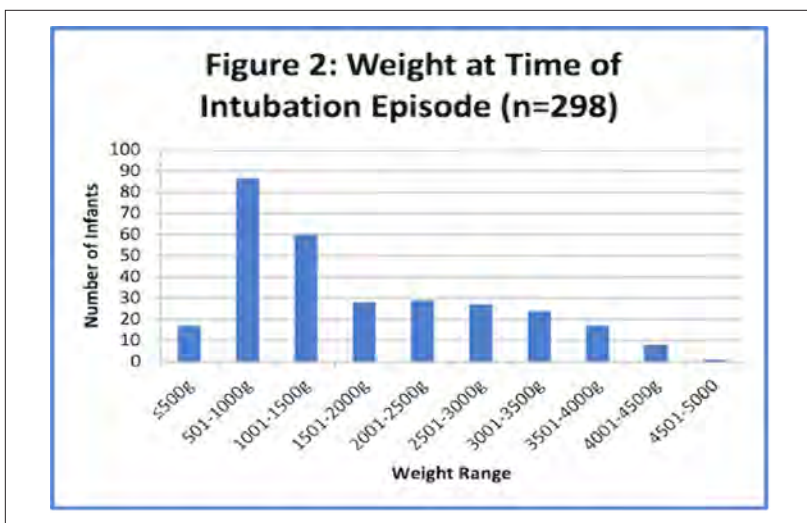
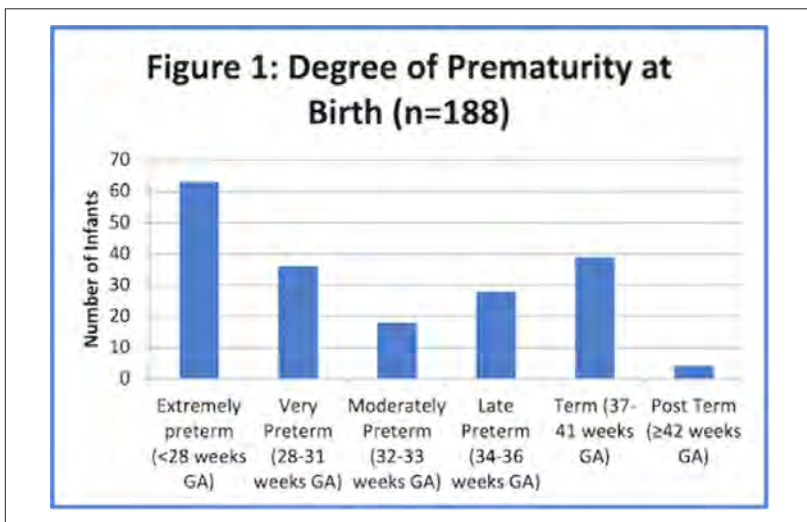

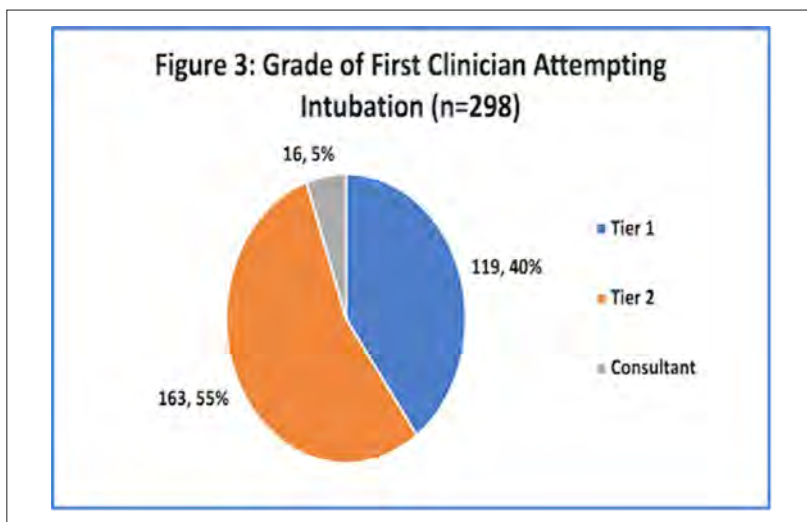

CONCLUSIONS

Our review demonstrated that fewer than half of intubations were successful on first attempt and has influenced our intubation safety QI priorities, focusing on: appropriate patient selection for teaching, introducing a videolaryngoscope and developing an escalation pathway. These data demonstrate difficulties faced by junior clinicians in achieving proficiency in neonatal intubation, therefore supporting the recent UK curriculum change.

EP398 / #767**E-Poster Viewing - Neonatology AS02-26. Quality improvement****Successful quality improvement project to introduce intact cord stabilisation in preterm infants of less than 32 weeks gestation – a uk nicu experience**

N. Veeraraghavan*, S. Kiani, V. Ponnusamy

Ashford and St Peter's Hospital NHS Foundation Trust, Neonatal Intensive Care Unit, Chertsey, United Kingdom

BACKGROUND AND AIM

Deferred cord clamping (DCC) for a minimum duration of 60 seconds in preterm infants has been shown to significantly reduce mortality. Optimal cord management is one of the UK's current National Neonatal Audit Program measures. In 2019, we introduced a QIP to implement DCC for 3 minutes along with stabilisation of preterm infants to establish intact cord stabilisation (ICS) as the best practice.

METHODS

Retrospective analysis of electronic database and resuscitation sheet of preterm infants < 32 weeks delivered locally, over a two-year period from September 2019 to August 2021.

RESULTS

In total 167 neonates were studied, of which 61% (102) were males. The mean gestational age was 27+3 weeks (IQR:25+2 – 29+5) and mean birth weight was 967 grams (IQR:664-1187). The baseline data is shown in image 1. Overall, the percentage of DCC increased from 57% to 84% in two years,

which is twice the national average of 41.8%. The mean duration of DCC was 133 seconds (IQR:90-180) with ICS achieved in 48% of the babies. The graph in image 1 shows the rate of DCC as per the duration. Reasons for immediate cord clamping were babies born in poor condition, short cord, placenta delivered along with baby, placenta previa with active bleeding, baby delivered prior to arrival of neonatal team, and equipment issues.

Table1: Demographic data of the study population

	Gestational age, weeks	Birth weight, grams	DCC duration, seconds	Cord clamped after establishing breathing (%)
Sep 2019-Feb 2020	26+4 (22+0-31+6)	842 (451-1894)	120 (60-240)	42
Mar 2020-Aug 2020	27+2 (23+0-31+6)	932 (491-2073)	137 (60-240)	60
Sep 2020-Feb 2021	28+4 (24+0-31+6)	1019 (456-1744)	105 (60-267)	41
Mar 2021-Aug 2021	27+3 (22+0-31+6)	898 (303-1860)	180 (60-240)	51

All data are median (range) unless specified

Figure 1: Run chart illustrating percentage of DCC according to the duration

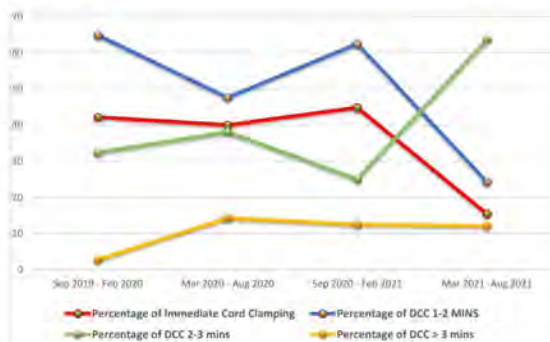

CONCLUSIONS

It is feasible to stabilise babies with intact cord while providing DCC to all pre-term infants. With a successful QIP to introduce effective team working and communication, better DCC rate could be achieved for all preterm infants.

EP399 / #1075**E-Poster Viewing - Neonatology AS02-26. Quality improvement****The hi 5s: an inter professional quality improvement initiative using lean methodology to improve staff experience on post natal ward and nipe clinic**

T. Eyo, M. Wasif*, L. Pilcher, N. Singh, P. Nath

University Hospitals Coventry and Warwickshire, Neonatal Unit, Coventry, United Kingdom

BACKGROUND AND AIM

Post-natal wards (PNW) are busy and can be difficult to provide timely and effective care. Junior doctors often dread covering this shift and midwifery staff can find care coordination challenging which may affect morale. Our aim was improved staff experience on PNW and new-born infant physical examination (NIPE) clinic.

METHODS

Fishbone cause and effect analysis helped identify causes of anxiety related to PNW shifts. Driver diagram highlighted drivers for change and change ideas. (Fig. 1) Lean methodology, 5S process was used to: Sort reviews, Set in order NIPE clinic via a non-urgent jobs book with goal of reducing interruptions and last-minute tasks, Shine at timely discharges, Standardise process via use of 'NIPE survival booklet' and help of team of support staff (NIPE champions) Sustain the process via education and sharing PDSA outcome.

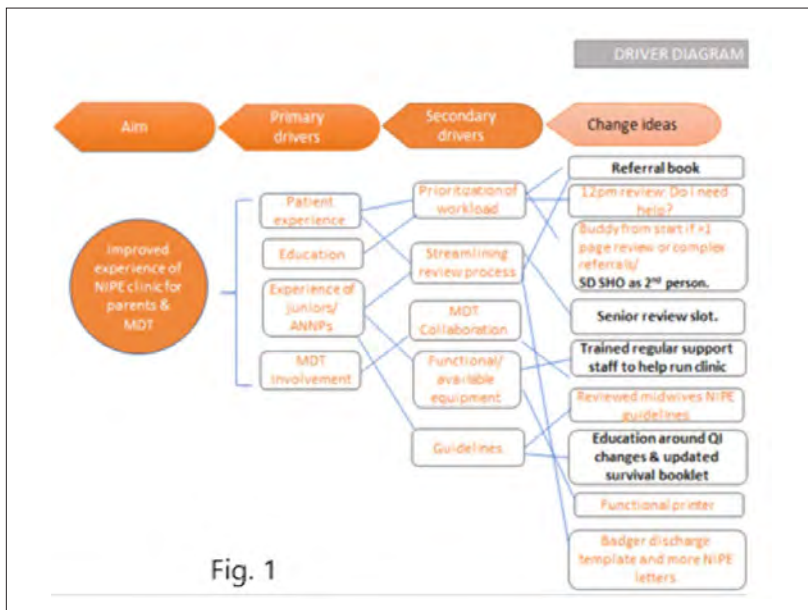
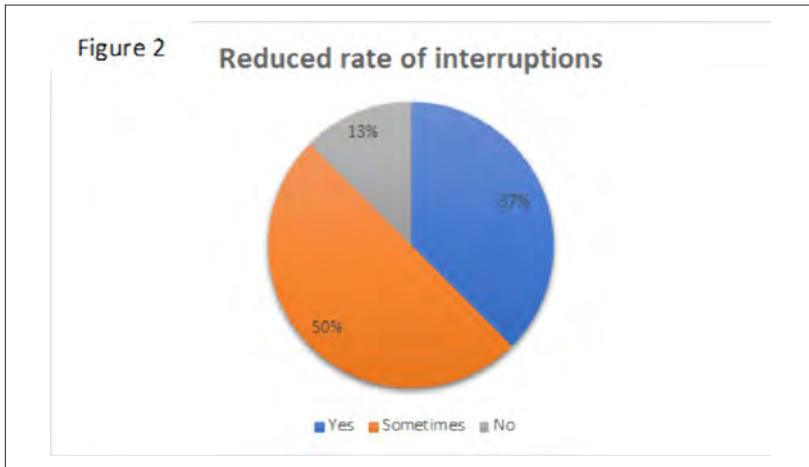

Fig. 1

RESULTS

3 cycles. Surveys included tier 1 junior doctors and Advanced nurse practitioners. Cycle 1: Revealed 60% of responders having anxiety levels of 5 or more (out of 10) prior to shift and a common theme of frequent interruptions, heavy workload, and late finish (12 respondents). Cycle 2: A survey post non-urgent jobs book introduction (8 responses) showed decline in interruptions for 87.5% of respondents albeit with inconsistent effect (Fig. 2). Cycle 3: Following incorporation of survival booklet at induction, a survey showed 60% found it beneficial and 80% continued to find the jobs book useful (5 responses).



CONCLUSIONS

The QI has led to improved PNW experience and better interdisciplinary teamwork to achieve change. Next focus is update of the booklet.

EP400 / #1188

E-Poster Viewing - Neonatology AS02-26. Quality improvement

Reducing unplanned neonatal extubations; a quality improvement initiative

A. Young*, E. Hassanin, L. Miall, A. Fane De Salis, I. Ibrahim, J. Peniston, T. Kinkad

Leeds Teaching Hospitals NHS Trust, Centre For Newborn Care, Leeds, United Kingdom

BACKGROUND AND AIM

Reported rates of unplanned extubation (UE) vary between 0.14 to 5.3 per 100 ventilator days. Neonates are at particular risk, due to difficulty securing endotracheal tube (ETTs), routine use of uncuffed tubes and use of only light sedation. We aimed to reduce the rate of UE in our own Level 3 Unit by 50% over 12 months.

METHODS

Episodes of UE, and their reasons, were recorded between May 2021 and February 2022. During this period, a bundle of interventions was implemented. These included mandating “flagging” the ETT adjacent to the fixator, embedding a “push test” into daily ward round checks, introducing new equipment to mitigate risk to the smallest babies and during kangaroo care, and encouraging reporting all UEs via a simple QR code. Multimedia and safety huddles were utilised to raise awareness and engage stakeholders.

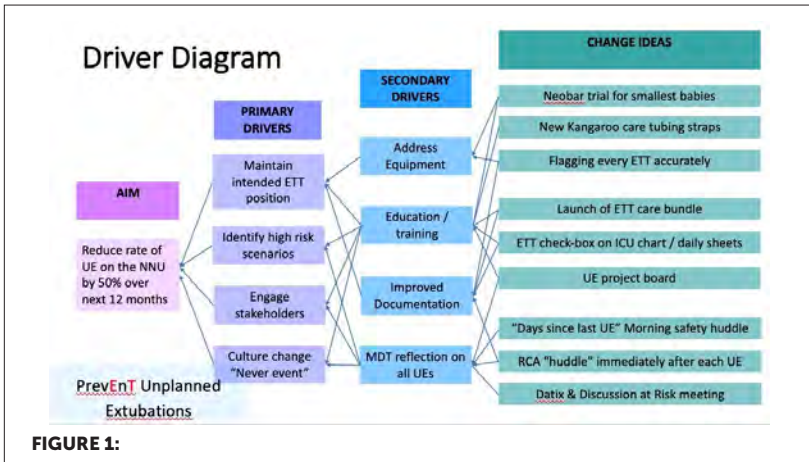

RESULTS

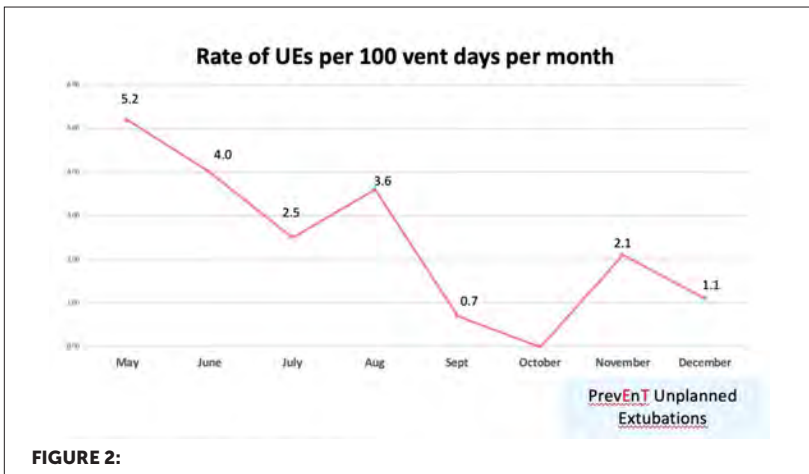

The UE rate fell from 5.2 to 1.1 per 100 ventilator days during the study period. The number of ventilator days ranged between 117 and 192 per month. No

correlation was seen between rates of UE and number of ventilator days or time of day. A third of all UEs were attributed to “slipped” ETTs, which were reduced from 33% to 12% over the study period. “Blocked” ETTs were implicated in 25% of all UEs.

CONCLUSIONS

Rates of UE can be successfully reduced using a package of care comprising a number of simple, reproducible measures. Encouraging consistent, contemporaneous reflection when episodes occur can successfully engender culture change, whereby UEs become viewed as “Never” events.

EP401 / #636**E-Poster Viewing - Neonatology AS02-27.
Resuscitation & transport****Initiating resuscitation with 100% oxygen & titration achieved a heart rate of 100 & preductal saturation of 80% faster in an asphyxiated preterm ovine MODEL**

**M. Bawa^{1*}, S. Gugino¹, J. Helman¹, N. Bradley¹, L. Nielsen¹,
A. Prasath¹, J. Nair¹, S. Lakshminrusimha², M. Rawat¹,
P. Chandrasekharan¹**

¹Jacobs School of Medicine and Biomedical Sciences at the University at Buffalo, Pediatrics/ neonatology, Buffalo, United States of America

²University of California Davis, University of California Davis Children's Hospital, Davis, United States of America

BACKGROUND AND AIM

In bradycardic preterm neonates who do not require chest compressions (CC), failure to achieve HR ≥ 100 bpm & peripheral saturation (SpO₂) $\geq 80\%$ by 5 min increased mortality 18 times. We wanted to evaluate the effect of initiating positive pressure ventilation (PPV) with 30% O₂ (OX30), 60% O₂ (OX60) or 100% O₂ (OX100) on a) primary outcome of HR ≥ 100 bpm & SpO₂ $\geq 80\%$ by 5 min b) time to achieve primary outcome, gas exchange, hemodynamics, oxygen delivery to brain & oxidative injury.

METHODS

Preterm lambs asphyxiated by umbilical cord occlusion to achieve HR < 100 bpm. PPV was initiated with OX30, OX60 or OX100 and titrated based on preductal SpO₂. Data was collected for the first ten min.

RESULTS

Time to achieve primary outcome in OX100 (6 ± 2 min) was significantly lower ($p=0.042$) compared to OX30 (10 ± 3 min). Preductal SpO_2 was significantly higher with OX100 compared to OX30 (fig1B). O_2 concentration in OX100 was significantly lower than OX30 (fig1C). Arterial oxygenation (PaO_2) and peak pulmonary blood flow (PBF) were lowest in the OX30 group (fig1D, 2A). There was no difference in left carotid blood flow (fig2B). O_2 delivery to brain (fig3A) and oxidized to reduced glutathione ratio (fig3B) were not different.

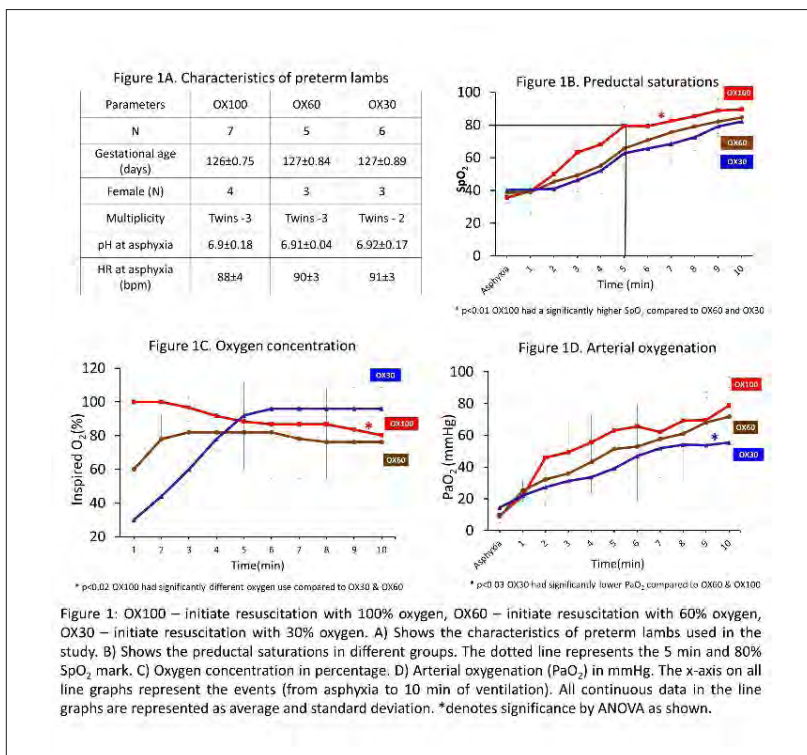

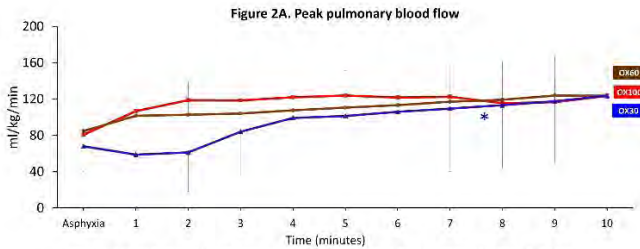

* $p < 0.012$ OX30 had significantly lower peak pulmonary blood flow compared to OX60 & OX100

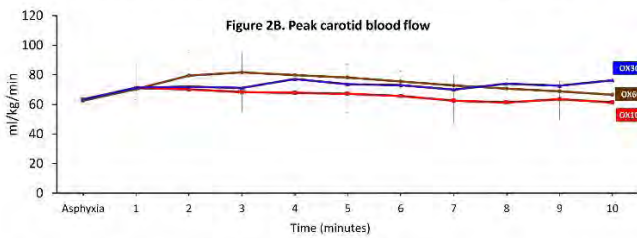
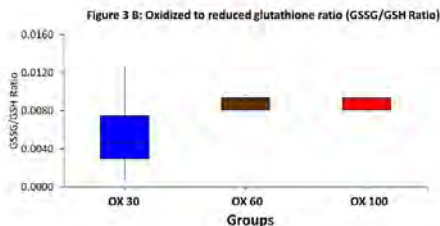
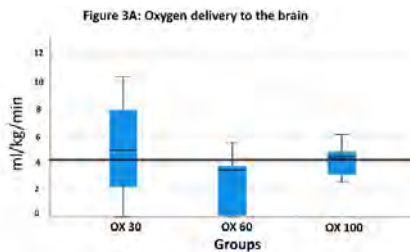

Figure 2: OX100 – initiate resuscitation with 100% oxygen, OX60 – initiate resuscitation with 60% oxygen, OX30 – initiate resuscitation with 30% oxygen. A) Shows the peak pulmonary blood flow. B) Shows the peak carotid blood flow. The x-axis on all line graphs represent the events (from asphyxia to 10 min of ventilation) unless otherwise specified. All continuous data in the line & bar graphs are represented as average and standard deviation. *denotes significance by ANOVA as shown .



CONCLUSIONS

In our study, an initial supplemental O₂ of 100%, decreased the duration to achieve a combined target HR \geq 100 bpm & SpO₂ \geq 80% compared to 30%. Although 100% O₂ reduced the time to achieve the primary outcome, more translational studies are required to understand the pulmonary and cerebral oxidative stress secondary to higher oxygen exposure in the background of asphyxia.

EP402 / #2430**E-Poster Viewing - Neonatology AS02-27.
Resuscitation & transport****Randomized trial of 21%, 50% and 100% inspired oxygen during chest compressions in neonatal resuscitation**

C. Blanco^{1*}, M. Bawa¹, A. Prasath¹, A. Mari¹, S. Gugino¹, J. Helman¹, N. Bradley¹, J. Nair¹, S. Lakshminrusimha², P. Chandrasekharan¹, M. Rawat¹

¹Jacobs School of Medicine and Biomedical Sciences at the University at Buffalo, Pediatrics/neonatology, Buffalo, United States of America

²University of California Davis, University of California Davis Children's Hospital, Davis, United States of America

BACKGROUND AND AIM

Neonatal Resuscitation Program (NRP) guidelines currently recommend use of 100% oxygen during chest compressions (CC) in neonatal resuscitation; but the evidence behind this is insufficient. This study aims to evaluate whether an intermediate level of inspired oxygen (~50%) during CC will increase the incidence and hasten return of spontaneous circulation (ROSC) and result in optimal cerebral oxygen delivery in an ovine model of perinatal asphyxia.

METHODS

This blinded study used 12 near-term fetal lambs randomized into 3 groups prior to asphyxiation: 21%, 50% and 100%. Two minutes after cardiac arrest, positive pressure ventilation (PPV) with 21% O₂ was initiated per NRP guidelines, followed by CC 30 seconds after PPV onset. Inspired O₂ was either continued at 21% (n=4) or increased to either 50% (n=4) or 100% (n=4). The lambs were monitored for evidence of ROSC and were ventilated for 20 minutes after ROSC. Oxygenation, ventilation and hemodynamics were continuously monitored throughout the study.

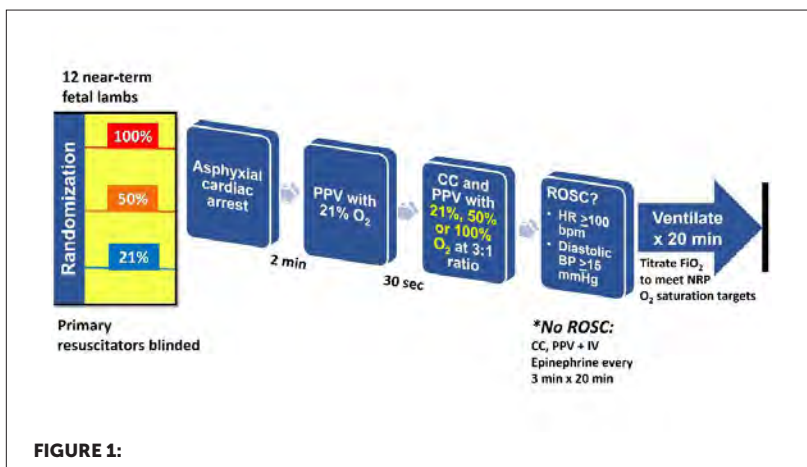

RESULTS

The incidence and time to ROSC were not significantly different among the 3 groups. Mean carotid blood flow was higher in the 50% group after ROSC compared with the 21% and 100% groups. The same was true for cerebral oxygen delivery ($p < 0.05$). However, the 50% group had the lowest total oxygen exposure among the 3 groups throughout the post-ROSC period.

Table 1. Baseline characteristics prior to asphyxia

	21% O ₂ (n = 4)	50% O ₂ (n = 4)	100% O ₂ (n = 4)
Male	2 (50%)	2 (50%)	3 (75%)
Gestational age, days (Term = 142-145 days)	139.5 ± 0.6	139.3 ± 0.5	139.5 ± 1
Birth weight, kg	4.5 ± 1.7	3.7 ± 1.2	4.5 ± 0.7
Multiple gestation, n (%)	1 twin + 1 triplet (50%)	3 twins (75%)	3 twins (75%)

Table 2. Return of spontaneous circulation parameters

	Inspired O ₂ Concentration During Chest Compression			P value
	21% O ₂ (n = 4)	50% O ₂ (n = 4)	100% O ₂ (n = 4)	
ROSC, n (%)	3 (75%)	4 (100%)	2 (50%)	0.2692
Time to ROSC, Mean (Range)	4 min 59 s (2 min 52 s to 6 min 19 s)	5 min 1 s (2 min 44 s to 6 min 53 s)	6 min 19 s (4 min 26 s to 8 min 11 s)	0.6666

Definition of abbreviations: ROSC (return of spontaneous circulation), min = minute; s = seconds

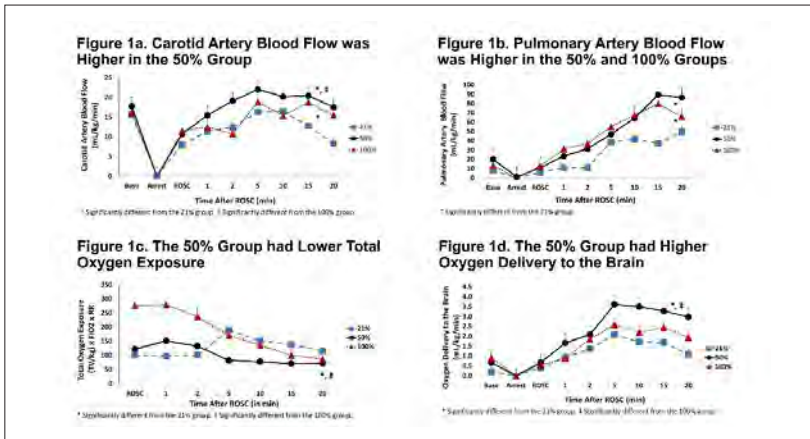

CONCLUSIONS

Use of 50% inspired oxygen during chest compressions for cardiac arrest yielded similar ROSC rates, higher mean carotid blood flow, higher cerebral oxygen delivery, yet lower total oxygen exposure after ROSC, compared to 21% and 100% oxygen.

EP403 / #1250

E-Poster Viewing - Neonatology AS02-27. Resuscitation & transport

Difficult airway simulation in neonates: a systematic review

S. Sotirakos¹, S. Bocchinfuso¹, R. Tobin¹, C. Pearson¹, C. Mckenna¹,
A. Hakim¹, E. Visser¹, C. O'Hare¹, E. Isweisi^{1,2,3}, G. Semova^{1,2,3},
J. Meehan^{1,2,3}, E. Roche^{1,2,3}, A. Branagan^{1,3,4*}, D. Mockler⁵,
E. Molloy^{1,3,6,7,8}

¹Trinity College Dublin, Discipline of Paediatrics, School of Medicine, Dublin, Ireland

²Tallaght, Children's Health Ireland At Tallaght, Dublin, Ireland

³Trinity College Dublin, Trinity Research In Childhood Centre, Dublin, Ireland

⁴Coombe Women and Infants University Hospital, Neonatology, Dublin, Ireland

⁵St. James' Hospital, John Stearne Medical Library, Dublin, Ireland

⁶Children's Health Ireland at Tallaght, Neonatology, Dublin, Ireland

⁷Coombe Women and Infants Hospital, Neonatology, Dublin, Ireland

⁸Children's Health Ireland at Crumlin, Neonatology, Dublin, Ireland

BACKGROUND AND AIM

Neonatal airway management success rates are declining, indicating a need for alternate methods of training and skills maintenance. We aimed to evaluate current methods of teaching difficult airway management techniques with an emphasis on the effectiveness of simulation.

METHODS

A systematic review of literature pertaining to training techniques and modalities of managing difficult neonatal airways was performed following the PRISMA guidelines. Inclusion and exclusion criteria were set using the Population, Intervention, Comparison and Outcomes (PICO) tool.

RESULTS

The search yielded a total of 268 studies. 35 papers met the inclusion criteria, of these 27 related to topics around the approach to training in neonatal airway management, 18 of the papers pertained to the efficacy of devices in managing difficult airways in neonates. Efficacy of training was measured in various ways from information and skill retention, to confidence and self-efficacy scores. Studies that focused on airway devices generally concentrated on the comparison of devices for visualising airways and their effect on time to intubation (TTI). Participants in the selected studies varied across medical professions.

CONCLUSIONS

Simulation may be an effective way to increase trainee confidence and improve long-term retention, especially with recurrent training sessions. However, current simulation training methods lack uniformity. The use of direct laryngoscope (DL) and video laryngoscope (VL) for neonatal airway management remains to be an ongoing debate. Future technological developments should be integrated into an evolving airway management training scheme to optimize future simulation training sessions.

EP404 / #1400

E-Poster Viewing - Neonatology AS02-27. Resuscitation & transport

Cardiopulmonary resuscitation of an extremely low birth weight infant using high-frequency oscillation ventilation

J. Buchmayer^{1*}, L. Wisgrill¹, M. Schneider¹, T. Werther¹, K. Goeral¹, A. Berger¹, G. Schmölzer², M. Wagner¹

¹Medical University of Vienna, Comprehensive Center For Pediatrics, Department of Pediatrics and Adolescent Medicine, Division of Neonatology, Pediatric Intensive Care and Neuropediatrics, Wien, Austria

²Royal Alexandra Hospital, Centre For The Studies of Asphyxia and Resuscitation, Neonatal Research Unit, Edmonton, Canada

BACKGROUND AND AIM

We present a novel approach of asynchronous ventilation during neonatal cardiopulmonary resuscitation (CPR), using high-frequency oscillation ventilation (HFOV). This case report highlights the controversial topic of coordination of ventilation and chest compression, with current neonatal resuscitation guidelines recommending a coordinated 3:1 compression:ventilation ratio during CPR, versus constant and asynchronous ventilation with continuous and uninterrupted chest compressions.

METHODS

Our patient, a female infant born at 30 weeks gestational age, weighing 970 grams, appeared floppy and apneic following birth in the amniotic sac.

RESULTS

Lungs were unfolded and white-out in an x-ray done during resuscitation (figure 1). The aim was to open lungs effectively using HFOV, instead of positive pressure ventilation, which was used unsuccessfully until the 7th minute of life. Heart rate continuously remained below 60/minute after 15 minutes after birth and chest compressions with asynchronous HFOV were started. It was possible to stabilize the patient after 15 minutes of CPR and lung recruitment with HFOV, following return of spontaneous circulation.

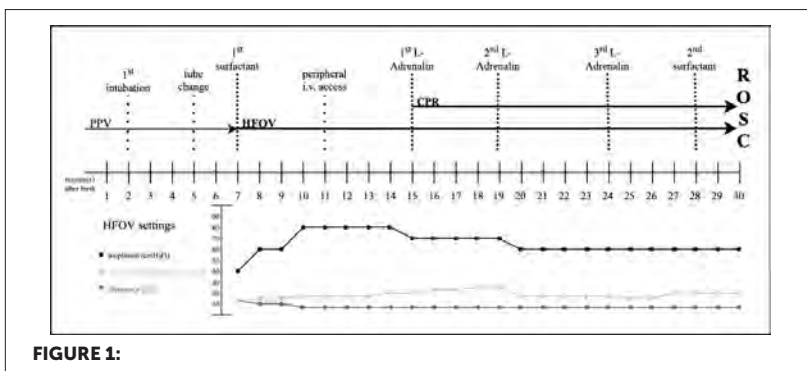

FIGURE 1:

CONCLUSIONS

The presented case describes a rescue approach of asynchronous ventilation during neonatal resuscitation using HFOV as the primary ventilation mode resulting in ROSC. It highlights the importance of adequate lung inflation during CPR and enables HFOV as an alternative option to achieve this.

EP405 / #1968

E-Poster Viewing - Neonatology AS02-27. Resuscitation & transport

Inter-hospital transfers: the reality of a level ii hospital

S. Duarte Costa^{1*}, C. Fraga^{1,2}, A. Azevedo³, A. Portela³

¹Hospital Pedro Hispano, Serviço De Pediatria, Porto, Portugal

²Hospital Pedro Hispano, Pediatria, Porto, Portugal

³Hospital Pedro Hispano, Unidade De Neonatologia, Porto, Portugal

BACKGROUND AND AIM

A neonatal transfer between hospitals must be well considered, given the well documented inherent risk in these transports. A detailed description of the patient's clinical status, the complementary exams already carried out as well as the therapy instituted allows the destination hospital to be prepared. This study aimed to identify which neonates needed to be transferred from a level II hospital into a level III hospital.

METHODS

Retrospective analysis of all neonates who needed specific exams or therapies transferred from a Portuguese neonatal intensive care unit (NICU) level II hospital between the last 5 years was made. A descriptive statistical analysis was performed using SPSS® and statistical significance was set at $p < 0,05$.

RESULTS

of a total of 884 neonates admitted in NICU, 43 needed to be transferred (4.9%). The mean gestational age was 30 weeks, 61.1% resulting from an urgent/emergent cesarean section. Mean birth weight was 1370g and 43.2% required

resuscitation at birth. The more frequent transfer days were Thursday and Friday(21%each day). The main reasons were surgical(32.6%) - necrotizing enterocolitis(n=5), intestinal occlusion(n=3) and anorectal malformations(n=2); due to hypoxic-ischemic encephalopathy(n=8) and pulmonary hypertension(n=3) for hypothermia and oxide nitric, respectively. Most were transferred at 2.5 days of life and 1.5 days of diagnosis. 16.3% returned to our unit only for maintenance of care and 16.3% died.

CONCLUSIONS

Not all hospitals have different tests, therapies and specialties. Therefore, it is extremely important to quickly recognize patients who need specialized care so that inter-hospital transfer takes place safely and quickly.

EP406 / #1308

E-Poster Viewing - Neonatology AS02-27. Resuscitation & transport

Design of a checklist for teaching and assessment of neonatal endotracheal intubation for pediatric residents

M. Escalante*, P. Hayler

Pontificia Universidad Católica de Chile, Neonatología, Santiago, Chile

BACKGROUND AND AIM

Neonatal endotracheal intubation (NEI) is a procedure that occurs frequently in life-threatening situations. Repeated execution of a procedure is a fundamental element in the acquisition of motor skills. However, during their training, pediatric residents have a low exposure to neonatal intubation. The Neonatal Resuscitation Program (NRP) makes recommendations for conducting intubation in the context of resuscitation, but does not establish steps to achieve proficiency. The aim of this study is to develop a specific assessment checklist for the teaching of neonatal endotracheal intubation in simulated settings.

METHODS

A checklist was developed by the structured consensus Delphi process for teaching NEI in simulated settings. Expert panel was formed by 15 neonatologists in contact with pediatric residents. The recommendations of NRP were taken as an initial guide. The surveys were focused on identifying the fundamental steps that must be taught to achieve intubation.

RESULTS

Four rounds of surveys with Delphi methodology were conducted remotely by email, obtaining a total of 15 responses in the first two rounds (100%), 13 responses in the third (87%) and 14 responses in the fourth (93%). The final assessment checklist has 14 main elements. The experts also suggested adding elements that were absent from the PRN recommendations.

Neonatal Endotracheal Intubation checklist steps	
<input type="checkbox"/>	1. Mentions the equipment and devices necessary to perform endotracheal intubation.
	2. Determines the indication for endotracheal intubation.
	3. Wears sterile gloves to perform the procedure.
	4. Selects the correct type and size of laryngoscopy blade.
	5. Selects the appropriate endotracheal tube size.
	6. Successfully performs some ventilation with PPV device.
	7. Properly positions the newborn.
	8. Manipulates the laryngoscope correctly.
	9. Performs a laryngoscopy correctly.
	10. Identifies anatomical structures during laryngoscopy.
	11. Inserts the endotracheal tube correctly.
	12. Provides positive pressure ventilations through the endotracheal tube.
	13. Corroborates the correct position of the endotracheal tube.
	14. Determines the appropriate depth of the endotracheal tube.

FIGURE 1:

CONCLUSIONS

The expert consensus was able to define the critical points for the teaching of neonatal intubation in pediatric residents. The experts suggested modifications in the different rounds, allowing the construction of a specific tool for the teaching and assessment of the procedure and its future implementation in a simulated environment.

EP407 / #597

E-Poster Viewing - Neonatology AS02-27. Resuscitation & transport

A randomised, crossover study of standard laryngoscope and two videolaryngoscopes (acutronic infant view & c-mac) for endotracheal intubation of newborn mannequins

L. Geraghty^{1*}, G. Gambacorta², L. Smiles¹, C. O'Donnell¹

¹National Maternity Hospital, Neonatology, Dublin, Ireland

²Children's Hospital V. Buzzi, University of Milan, Neonatology, Milan, Italy

BACKGROUND AND AIM

When intubating babies, standard laryngoscopes (SL) are used to look directly into the mouth (direct laryngoscopy), whereas videolaryngoscopes (VL) display the view obtained on a screen (indirect laryngoscopy). Trainees performing direct laryngoscopy with an Acutronic VL have greater first attempt success rate when a mentor views the screen and trainees acquire competence more quickly with C-MAC VL than SL. We compared the performance of intubators using 3 devices in two mannequins.

METHODS

Crossover study – each participant used SL (Heine, Germany), Acutronic Infant View (Acutronic, Switzerland) and C-MAC (Karl Storz, Germany) to intubate a preterm (Premie Hal, Gaumard) and term (Newborn Anne, Laerdal) mannequin in random order. We recorded success at first attempt to intubate and the duration of attempts.

RESULTS

Twenty-four (6 senior, 18 trainee) doctors and 1 advanced nurse practitioner participated. Success at first attempt and duration of successful attempts were similar for the SL and C-MAC for both mannequins. The success rate was lower and duration of attempts longer with the Acutronic VL in the term mannequin.

TABLE 1:

	Standard		Acutronic		C-MAC	
	Term	Preterm	Term	Preterm	Term	Preterm
Successful first attempt, n (%)	22 (88)	21 (84)	14 (56)	24 (96)	24 (96)	23 (92)
Median (IQR) duration of successful first attempt, sec	18 (11, 19)	28 (17, 34)	52 (20, 74)	20 (13, 23)	23 (13, 25)	22 (17, 28)

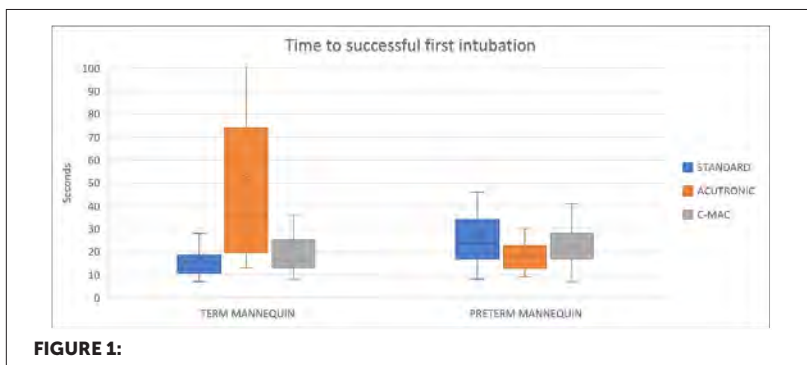

CONCLUSIONS

Participants performed similarly using direct or indirect laryngoscopy with the C-MAC when intubating mannequins. Direct laryngoscopy and C-MAC for intubation of newborns merit comparison in a randomised trial.

EP408 / #1600

E-Poster Viewing - Neonatology AS02-27. Resuscitation & transport

Simulating preterm birth in the community

J. Groucutt^{1*}, D. Aguirre², S. Henry³, L. Williamson⁴, D. Wright⁴,
A. Joynes⁵, C. Perez Fernandez¹

¹Birmingham Women's and Children's Hospital, Neonatal Unit, Birmingham, United Kingdom

²University Hospitals Birmingham, Neonatal Unit, Birmingham, United Kingdom

³West Midlands Ambulance Service, Maternity Lead, Brierley Hill, United Kingdom

⁴Birmingham Women's and Children's Hospital, Maternity, Birmingham, United Kingdom

⁵West Midlands Ambulance Service, Education, Brierley Hill, United Kingdom

BACKGROUND AND AIM

Childbirth can be unpredictable in its timing and clinical course. Unplanned pre-hospital births can occur, including premature births. In these cases, every minute matters in order to reduce morbidity and mortality. In 2020-1 webinars were delivered to West Midlands Ambulance Service (WMAS) to improve their knowledge and expertise when attending preterm births. This encompassed training on basic Neonatal Life Support skills and a focus on thermoregulation. A heated mattress is also now carried routinely by WMAS. There was overwhelming positive feedback so the education was expanded. Our aim was to show the clinical management of a marginal preterm infant in the community focussing on simple interventions known to improved outcomes such as delayed cord clamping and optimal thermal care.

METHODS

The simulation involved a low-risk term pregnant woman who went in to preterm labour and quickly delivered at 35 weeks. The paramedics attended as the baby delivered. It established regular respirations with simple airway manoeuvres. They used a heated gel mattress to maintain the baby's tem-

perature and allowed delayed cord clamping and then conveyed the mother and infant to hospital for assessment.

RESULTS

The simulation was recorded and is now being used to deliver training to West Midlands Ambulance Service. The paramedics who attended stated how much it had increased their confidence in managing a preterm delivery and consolidated their learning from the previous webinar.



FIGURE 1:

CONCLUSIONS

We expect that with increased staff training and confidence, the incidence of babies admitted with hypothermia following an unexpected birth in the community will reduce thus reducing mortality.

EP409 / #1627**E-Poster Viewing - Neonatology AS02-27.
Resuscitation & transport****Simulating obstetric and neonatal emergencies in
the community****J. Groucutt^{1*}, D. Aguirre², S. Henry³, A. Joynes⁴, L. Williamson⁵,
D. Wright⁵, C. Perez Fernandez¹**¹Birmingham Women's and Children's Hospital, Neonatal Unit, Birmingham, United Kingdom²University Hospitals Birmingham, Neonatal Unit, Birmingham, United Kingdom³West Midlands Ambulance Service, Maternity Lead, Brierley Hill, United Kingdom⁴West Midlands Ambulance Service, Education, Brierley Hill, United Kingdom⁵Birmingham Women's and Children's Hospital, Maternity, Birmingham, United Kingdom**BACKGROUND AND AIM**

Childbirth can be unpredictable in its timing and clinical course. Low risk pregnant women can choose to deliver their infants at home yet obstetric emergencies can occur and infants are born in poor condition. In these cases every minute matters in order to reduce morbidity and mortality. Expertise and resources are also limited in the community; midwives and paramedic crews must work synergistically to achieve the best outcomes. Our aim was not only to show best clinical management of a combined neonatal and obstetric emergency but also explore multidisciplinary team working, communication and human factors of these complex situations.

METHODS

The simulation involved a low-risk term pregnant woman who has chosen to have a home birth. In attendance were a community midwife and maternity assistant. The baby was born in poor condition floppy, pale with no respiratory effort and bradycardic. Neonatal life support was given. Handover was given to the paramedics and the child conveyed to neonatal unit. The scenario

then unfolded with mother also having a postpartum haemorrhage requiring resuscitation and a second paramedic crew and transfer.

RESULTS

The simulation was recorded and is now being used to deliver training to West Midlands Ambulance Service. The community midwife, midwifery assistant and paramedics who attended stated how much it had increased their confidence in managing a dual emergency; and affirmed their roles and responsibilities in such cases.



FIGURE 1:



FIGURE 2:

CONCLUSIONS

We expect that with increased staff education and confidence that the outcomes of babies born in the community in unexpectedly poor conditions will improve.

EP410 / #1911**E-Poster Viewing - Neonatology AS02-27.
Resuscitation & transport****Ultrasonography of the vocal cords in preterm infants during neonatal transition at birth; an observational STUDY**

V. Heesters*, R. Visser, K. Kuypers, S. Van Groningen, R. Witlox, A. Te Pas

Leiden University Medical Centre, Neonatology, Leiden, Netherlands

BACKGROUND AND AIM

Recently, it was demonstrated in a preterm rabbit model that during apnea the larynx is closed immediately after birth, which can completely negate the effect of noninvasive ventilation of the lung. The aim of this study is to visualize the position and movement of the vocal cords during non-invasive respiratory support of preterm infants after birth.

METHODS

In an observational study vocal cords were visualized with ultrasonography and respiratory function monitoring was simultaneously recorded during stabilization at birth and at one hour after birth. We aim to include twenty infants.

RESULTS

So far 8/20 infants were included (mean GA 28+1). The position of the vocal cords varied between open, closed and vibrating. In 2/8 patient there were periods of apneas and during apnea in 100% of the time vocal cords were closed. During positive-pressure ventilation (PPV), some air is pushed through the vocal cords, but the arytenoid cartilage remains in the middle.

CONCLUSIONS

Study is still ongoing but the preliminary results confirm experimental findings. During apnea the larynx is closed and negating the effect of ventilation.

EP411 / #2097**E-Poster Viewing - Neonatology AS02-27.
Resuscitation & transport****The effect of first and subsequent mask applications on breathing and heart rate in preterm infants at BIRTH****K. Kuypers¹, A. Hopman^{1*}, S. Cramer¹, R. Visser¹, S. Hooper², A. Te Pas¹**¹Leiden University Medical Centre, Neonatology, Leiden, Netherlands²Hudson Institute of Medical Research, The Ritchie Centre, Melbourne, Australia**BACKGROUND AND AIM**

Application of a face mask may provoke the trigeminocardiac reflex, leading to apnoea and bradycardia. We evaluated the effect of first and subsequent mask applications on breathing and heart rate in preterm infants.

METHODS

Resuscitation videos and respiratory function monitor data of preterm infants <30 weeks gestation recorded between 2018-2020 were reviewed. Breathing and heart rate before and after first and subsequent mask applications were analysed.

RESULTS

In total, 111 infants were included with 413 mask applications. In 254/413 (61.5%) applications there was breathing prior to application. In 67/254 (29.9%) applications, an apnoea was observed after the application. Apnoea occurred significantly more often after first than subsequent applications (first: 32/67 (47.8%) vs subsequent: 44/187 (23.5%), $p < 0.001$). In most infants apnoea after

mask application was accompanied by bradycardia (first: 8/11 (72.7%) and subsequent: 22/33 (67%)). In a logistic regression model, the occurrence of apnoea after subsequent mask application was inversely associated with breathing rate (OR= 0.853 (0.757-0.962), $p = 0.010$) and heart rate (OR= 0.940 (0.908-0.972), $P < 0.001$) prior to mask application.

CONCLUSIONS

Applying a face mask during neonatal stabilisation is associated with apnoea and bradycardia. Apnoea occurs more often after first compared to subsequent mask applications in preterm infants. In addition, apnoea following subsequent mask applications was dependent on breathing- and heart rate prior to mask application.

EP412 / #2179**E-Poster Viewing - Neonatology AS02-27.
Resuscitation & transport****A study of usability in a telemedicine system for neonatal transport and resuscitation education using wearable devices in JAPAN****K. Iwanaga***

Kyoto University Hospital, Pediatrics, Kyoto, Japan

BACKGROUND AND AIM

In Japan, we have been using ICT network to construct medical care support and educational systems by video communication and medical image information sharing using wearable devices. In 2022, the medical cooperation system for the sick newborn transport was constructed and the operation was started, by connecting the obstetric clinic in the Kyoto city with the doctor-car and the perinatal center by the network. We study the usability of a telemedicine system for neonatal transport and resuscitation education using a wearable device.

METHODS

In Kyoto city, the network consisted of Kyoto University Hospital and nearby perinatal-medical-institutions. The devices used for communication were mobile phones and smart-glasses, which were placed in each medical institution and doctor-car. The operation is carried out by the physician of Kyoto-University-Hospital which is the tertiary medical institution for the medical support request from the other institution. Then, we judge the appropriateness of the transport according to the severity of the sickness. At the same time, an appropriate destination is selected and the preparation for transport is promptly made.

RESULTS

Due to the internet condition during the transport, a temporary delay in video-image was observed, but there was no communication delay in communication between the devices deployed in each hospital. The transport staff was able to provide real-time clinical information to the hub hospital by using the web camera.

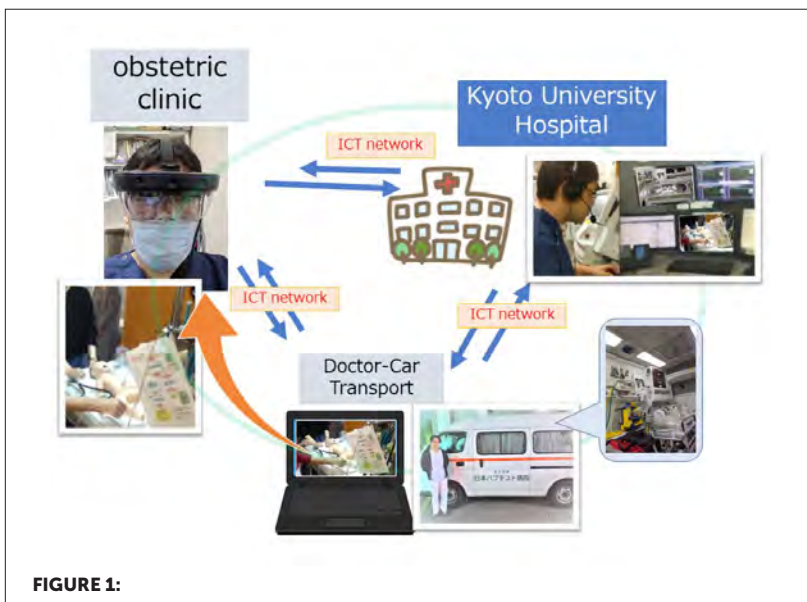

CONCLUSIONS

This system is expected to enable rapid medical provision of severely ill newborn. Also, this system enables more information sharing as compared to methods such as requesting transport by telephone.

EP413 / #846**E-Poster Viewing - Neonatology AS02-27.
Resuscitation & transport****Effective thermoregulation during non-invasive stabilisation with intact cord in extreme preterm infants of < 32 weeks - experience of a uk neonatal UNIT****S. Kiani*, N. Veeraraghavan, V. Ponnusamy**

Ashford and St Peter's Hospital NHS Foundation Trust, Neonatal Intensive Care Unit, Chertsey, United Kingdom

BACKGROUND AND AIM

Deferred cord clamping (DCC) for at least 60 seconds has been shown to reduce mortality. We introduced a QIP to implement continuous temperature monitoring alongside intact cord stabilisation and delivery room cuddle (DRC) to provide the best start for extreme preterm infants.

METHODS

Retrospective analysis of electronic database and resuscitation sheet of pre-term infants <32 weeks from September 2019 to August 2021. We used NeoHELP bag and transwarmer on the LifeStart during DCC with continuous temperature monitoring on Draeger.

RESULTS

of the 167 neonates studied, 61% (102) were male. Table 1 shows their details in six monthly cohorts. Overall, the percentage of normal admission temperature increased from 78 % to 95%. of all the babies with abnormal temperature, 70% had hyperthermia versus 30% with hypothermia.

TABLE 1: Baseline characteristics of neonates and their stabilisation in delivery unit

	Sep 2019- Feb 2020	March- August 2020	Sep 2020- Feb 2021	March-Sep 2021
Gestational age	26+4(22+0-31+6)	27+2(23+0-31+6)	28+4(24+0-31+6)	27+3(22+0-31+6)
Birth weight, g	842(451-1894)	932(491-2073)	1019(456-1744)	898(303-1860)
DCC duration, seconds	120(60-240)	137(60-240)	105(60-267)	180(60-240)
DRC achieved, %	60%	69%	60%	64%
Dextrogel given, %	44%	89%	90%	85%
Age at NICU admission, minutes	24 (14-73)	27(12-43)	27(15-59)	28(15-53)
Age at 1 st temperature, minutes	29(14-74)	37(12-129)	42(15-93)	37(16-59)
Admission temperature, °C	36.9(36.3-38.9)	37(36.6-38)	36.8(35.8-37.8)	36.9(36.4-38.2)
Normal temperature, %	78%	86%	69%	95%

Data are all median (range) unless specified otherwise

CONCLUSIONS

It is feasible to maintain normothermia during intact cord stabilisation and DRC in extreme preterm infants. This was achieved through a successful QIP implementing clear guidance, team working and improved documentation.

EP414 / #2261

E-Poster Viewing - Neonatology AS02-27. Resuscitation & transport

Synchronized noninvasive ventilation in neonatal transport- scottie

F. Kreuzer¹, M. Mandl², W. Braun³, M. Haller⁴, J. Schwindt⁴,
W. Becker⁵, A. Flemmer¹, M. Klemme^{1*}

¹Dr. von Hauner Children's Hospital of LMU Klinikum, Neonatology, Munich, Germany

²Ludwig-Maximilians-Universität München, Institut Für Medizinische Informationsverarbeitung Biometrie Und Epidemiologie (ibe), München, Germany

³Fritz Stephan GmbH, Forschung Und Entwicklung, Gackebach, Germany

⁴SIMCharacters GMBH, Simcharacters, Vienna, Austria

⁵ASB Rettungsdienst GmbH, Notfallrettung-intensivtransport-krankentransport, Munich, Germany

BACKGROUND AND AIM

Noninvasive Ventilation (NIV) is a common ventilation strategy in neonatal transport. In clinical studies *synchronized* noninvasive ventilation (sNIV) has been shown to be superior to non-synchronized noninvasive ventilation. This study was performed to evaluate whether sNIV is feasible during neonatal transport.

METHODS

The simulation dummy Paul® (SIMCharacters GmbH, Vienna, Austria), simulates the abdominal breathing movements of a 28 weeks preterm infant. Breathing movements were sensed by a Graseby-Capsule, taped to the dummy's abdominal wall, and detected by a ventilator (EVE®, Fritz Stephan GmbH, Gackebach, Germany). The Graseby signal triggered an inspiratory support through the ventilator. During transport, signals from Paul® and Eve® were recorded simultaneously. To verify the usability of the Graseby-Capsule as a trigger device on transport, signals were recorded during standardized vehicle

maneuvers (breaking, acceleration, circular driving) and synchronization rate (abdominal signal: Graseby-signals [%]) was determined.

RESULTS

As preliminary results we evaluated 59 minutes and 24 seconds of different driving maneuvers. In addition ten min of the data were collected while the ambulance vehicle was parked. In the parked vehicle synchronization rate was 100%. During the driving maneuvers the synchronization rate varied from 96% (circular driving clockwise) to 100% (acceleration from 0 km/h to 40 km/h).

CONCLUSIONS

Our results demonstrate for the first time that sNIV is feasible during ground-based neonatal transport. The Graseby-signal is only slightly influenced by driving maneuvers. The high rate of synchronization might be idealized by the regular breathing efforts of the dummy and the missing restlessness of real patients.

EP415 / #2310

E-Poster Viewing - Neonatology AS02-27. Resuscitation & transport

Knowledge of neonatal delivery room management among health care professionals at different levels of referral in poland

U. Szuwarska¹, A. Kornacka^{2*}, I. Miechowicz³, J. Mazela¹, T. Szczapa²

¹Poznan University of Medical Sciences, Department of Neonatology, Poznan, Poland

²Poznan University of Medical Sciences, II Department of Neonatology, Poznan, Poland

³Poznan University of Medical Sciences, Department of Computer Science and Statistics, Poznan, Poland

BACKGROUND AND AIM

Approximately 10% of newborns require resuscitation at birth. The knowledge of neonatal delivery room management according to European Resuscitation Council (ERC) is essential to improve short and long-term outcomes. The aim of the study was to assess the knowledge of current Newborn Life Support (NLS) guidelines among personnel at different levels of neonatal care.

METHODS

The study was carried out using a questionnaire designed for the study purposes. The survey consisted of 18 questions (including latest changes in the 2021 guidelines) regarding delivery room management of full-term and preterm neonates.

RESULTS

The study involved 479 respondents working at different levels of care (1st n=117
2nd n=135

^{3rd} n=214). Medical staff working at tertiary perinatal centers demonstrated higher scores as compared with level II (median 13 (min. 4 max. 18) vs 12 points (min. 4 max. 17); $p = 0.018$) and level I (median 13 (min. 4 max. 18) vs 12 (min. 6 max. 17) points; $p = 0.017$) hospitals. The Significant differences between the scores of midwives and nurses versus physicians were also observed (Fig.1). Knowledge regarding the latest 2021 changes was similar in all groups.

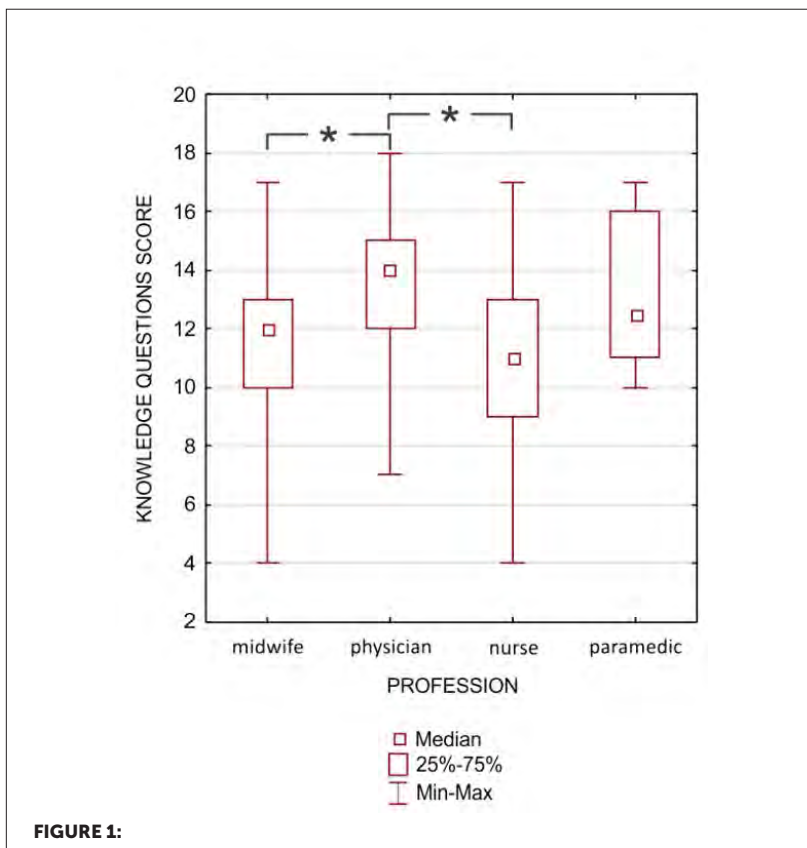

CONCLUSIONS

Presented results suggest the need for optimization of education in neonatal resuscitation of medical personnel in Polish centers, especially among midwives and nurses.

EP416 / #499**E-Poster Viewing - Neonatology AS02-27.
Resuscitation & transport****Prospective observational study and european-wide survey on the second golden hour of life - the time between delivery room care and admission to the NICU****H. Küster^{1*}, G. Bauerschmitz², F. Hartmann³**¹University Medicine Göttingen, Neonatology, Göttingen, Germany²University Medicine Göttingen, Gynecology and Obstetrics, Göttingen, Germany³Charite, Klinik Für Anästhesiologie Mit Schwerpunkt Operative Intensivmedizin, Berlin, Germany**BACKGROUND AND AIM**

Quality of delivery room care has significant impact on outcome of preterm infants. Therefore, this critical phase is called "First Golden Hour of Life". While this time-period has many guidelines, there are almost none for the "Second Golden Hour of Life", the time between delivery room care and completion of admission to the NICU. Aim of this study was to characterize processes during this time-period.

METHODS

To answer predefined questions, 1. a prospective observational study was done on 40 consecutive VLBW preterms born by C-section; 2. an online survey was sent to 279 neonatologists in 21 European countries on a theoretical preterm of 27 weeks and 800g on nCPAP.

RESULTS

In the observational study, transfer-time was significantly shorter for infants transported in a transport incubator compared to a mobile incubator. The time of disconnection from the ventilator was unphysiologic long and ten times longer in infants with nCPAP compared to those intubated. The survey showed major differences in type and order specific measures are used. This concerned type of transport, involvement of parents, temperature management, ventilation, presence and qualification of staff. Only 36% of NICUs don't interrupt ventilation. In 46%, parents can touch their infant before transport, in 18% hold it, in 10% practice kangaroo care.

CONCLUSIONS

This first study of the management between delivery room care and completion of admission to the NICU shows high variability of the duration of this transfer and the procedures taken within. International standards for this time-period should be established as they may improve quality of care.

EP417 / #985

E-Poster Viewing - Neonatology AS02-27. Resuscitation & transport

Neonatal airway skills and equipment; a national irish survey

C. Ni Chathasaigh^{1,2*}, E. O'Curraín^{1,2,3,4}, A. Curley^{1,2}

¹The National Maternity Hospital, Holles St, Department of Neonatology, Dublin, Ireland

²University College Dublin, School of Medicine, Dublin, Ireland

³Children's Health Ireland at Temple St, Department of Neonatology, Dublin, Ireland

⁴National Neonatal Transport Programme, Department of Neonatology, Dublin, Ireland

BACKGROUND AND AIM

Neonatal airway skills are difficult to master and may impede effective resuscitation. Facemask leak and unsuccessful intubation attempts are common. A wide variety of new neonatal facemasks, facemask training devices and laryngoscopes are now available, however their use may require specific training. We aimed to describe neonatal airway skills training and equipment in Irish neonatal centres.

METHODS

Survey of Irish neonatal intensive care units and special care nurseries disseminated in October 2021.

RESULTS

Data were obtained from all 19 (100%) centres. 11 different face masks are in use; 4 round and 7 anatomical. Video laryngoscopes (VL's) are available in 15 (79%) centres and in use at 14 (74%) centres. 2 (11%) centres use their VL as first-line equipment for intubating. Three different VL's are in use; Acutrionic (InfantView) at 9 (60%) centres, C-MAC (Karl Storz) at 3 (20%) centres and

McGrath MAC (MedTronic) at 3 (20%) centres. of the 15 centres,14 (93%) have a single VL, while 1 (7%) centre has two C-MAC VLs. Manikin based learning is conducted at 16 (84%) centres while 14 (74%) organise simulation-based scenarios. All but one centre has an intubatable manikin. No centre provided dedicated or objective airway skills training.

CONCLUSIONS

Videolaryngoscopy has been embraced by Irish neonatal units. There are 11 different face masks in use nationally. Learning to use them all effectively may present a challenge for trainees. Examination of the feasibility and efficacy of face mask ventilation training interventions using objective, evidenced-based training tools may be justified.

EP418 / #1047**E-Poster Viewing - Neonatology AS02-27.
Resuscitation & transport****Does cerebral tissue oxygenation vary in neonates retrieved by road and air? A prospective between subject analysis using near infrared spectroscopy (nirs) in western australia.**

**M. O'Dea^{1,2,3*}, M. Saito-Benz^{1,4}, G. Tremblay^{1,5}, R. Trawber⁶,
S. Resnick⁷, J. Tan¹, J. Davis^{1,8}**

¹Newborn Emergency Transport Service Western Australia, c/o Perth Children's Hospital, Neonatology, Perth, Australia

²Coombe Women and Infants University Hospital, Neonatology, Dublin, Ireland

³Children's Health Ireland, Crumlin, Neonatology, Dublin, Ireland

⁴University of Otago, Department of Paediatrics and Child Health, Wellington, New Zealand

⁵CHU de Québec-Université Laval, Department of Neonatology, Quebec City, Canada

⁶Fiona Stanley Hospital, Neonatology, Perth, Australia

⁷King Edward Memorial Hospital, Neonatology, Perth, Australia

⁸University of Western Australia, Medical School, Perth, Australia

BACKGROUND AND AIM

Sick newborns in rural Western Australia (WA) may require air transport for tertiary care. Travelling at altitude may impact oxygenation. The study aim was to compare cerebral oxygenation in newborns using NIRS during air and road transport.

METHODS

Infants referred for retrieval were consented for NIRS monitoring and transported by air and road (Air group) or road alone (Road group). Cerebral oxygenation (crSO₂) and fractional tissue extraction (cFTOE) were compared between air and road phases in the Air group and between the 1st and 3rd jour-

ney quarters in the Road group. Demographic, arterial saturation (SpO₂), respiratory support and haemoglobin (Hb) data were also compared. Data was analysed by within-subject paired t-tests.

RESULTS

There were 24 infants in Air and 31 in the Road groups; the median (interquartile range) gestations and weights were similar [39⁺¹(31 – 41⁺³) vs. 40⁺¹(35⁺³–43) wk; 3.3 (1.8 – 4.95) vs 3.2 (2.2 – 4.2) Kg]. There was no difference in SpO₂, respiratory support or Hb. The Air group had lower mean (SD) crSO₂ when at maximum altitude compared to the road (75.3 (6.2) vs 77.9 (6.2), p=<0.0001). The mean (SD) cFTOE (0.18 (0.07) vs. 0.21 (0.07), p<0.001) was greater when in the air. In the Road group, there were no differences in the crSO₂ or cFTOE between the 1st and 3rd journey quarters.

CONCLUSIONS

In this small prospective observational study, infants had lower crSO₂ and greater cFTOE while travelling by air compared to road. Further examination in a larger cohort of term and preterm infants is warranted.

EP419 / #856**E-Poster Viewing - Neonatology AS02-27.
Resuscitation & transport****Should we wait to initiate chest compressions if a newborn is born with no heartbeat?**

A. Prasath*, S. Gugino, J. Helman, N. Bradley, L. Nielsen, M. Bawa, C. Blanco, A. Torrealba, B. Mathew, M. Rawat, P. Chandrasekharan

Neonatology, Jacobs school of Medicine, University at Buffalo,, Buffalo, NY, United States., Neonatology, Buffalo, United States of America

BACKGROUND AND AIM

Chest compressions (CC) are recommended by current Neonatal resuscitation guidelines when newborns are born with a heart rate(HR) < 60 after obtaining a definitive airway i.e., endotracheal tube(ETT) or Laryngeal mask airway(LMA). When newborns are born with asystole there is delay in initiating chest compressions during attempts to place an airway. Aim was to evaluate the effect of immediate CC and face mask Positive Pressure Ventilation (FM-PPV) in a complete cardiac arrest ovine model on I) timing and rates of return of spontaneous circulation(ROSC), II) gas exchange and hemodynamics, compared to delayed initiation of CC (after 2 min) in an ovine neonatal model of asphyxia.

METHODS

Lambs were randomized to resuscitation by current guidelines or initiating chest compressions early with simultaneous FM-PPV after inducing cardiac arrest post cord occlusion. Rate and time to establish ROSC, ventilation, oxygenation and hemodynamic parameters were collected until ROSC or 20 mins and post ROSC at regular intervals.

RESULTS

11 lambs were randomized to controls (N=6) and study (N=5) (Fig 1a). Time to achieve ROSC was faster in the study group (Fig 1a & 1b) (Fig 1a & 1c). The pH, arterial carbon dioxide levels, and arterial oxygen were similar (Fig 2c). Peak carotid blood flow (PCF) was significantly higher during resuscitation in the study compared to controls (Fig 3a), while the Pulmonary blood flow (PBF) was not different (Fig 3b)

Table/Figure 1A – Characteristics

Parameters	Control	Experimental
N	6	5
Gestational age (days)	139±0.40	139±0.44
Birth weight (kg)	3.36±1.11	3.60±1.18
Sex (N)	M-0, F-6	M-3, F-2
Multiplicity	Twin - 3	Twin - 4
ROSC (N)	4/6	4/5
Time to ROSC (min)	7.39±1.49	4.85±1.20*
Lambs requiring a dose of Epinephrine (N)	6	3

* p-0.039 by t-test. ROSC - return of spontaneous circulation

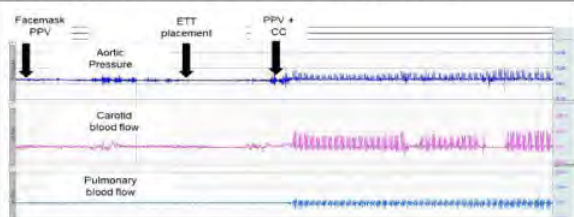

Figure 1B: Controls - Shows a BIOPAC snapshot of pressure and blood flows in a complete cardiac arrest model for the first 5 min. During facemask positive pressure ventilation (PPV), endotracheal tube (ETT) placement there are no blood flows. Post ETT placement, blood flows and pressure changes are seen when chest compressions (CC) are initiated in a coordinated fashion with PPV.

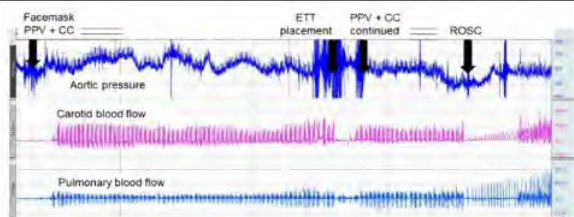
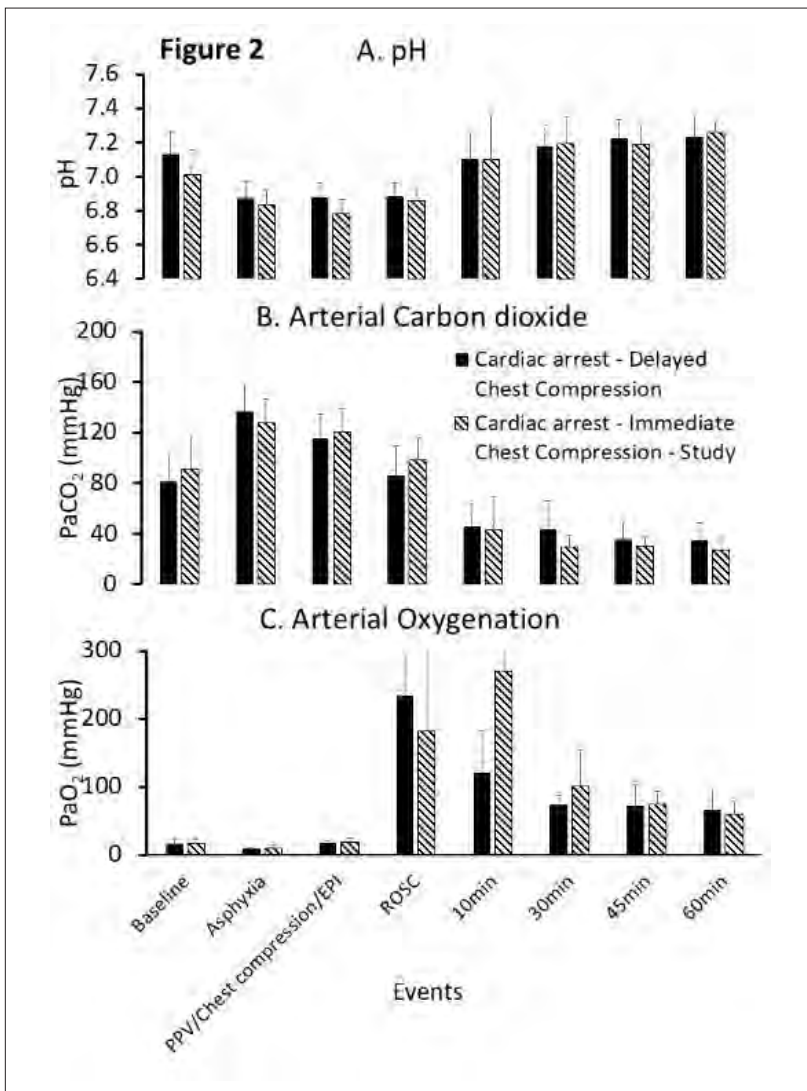
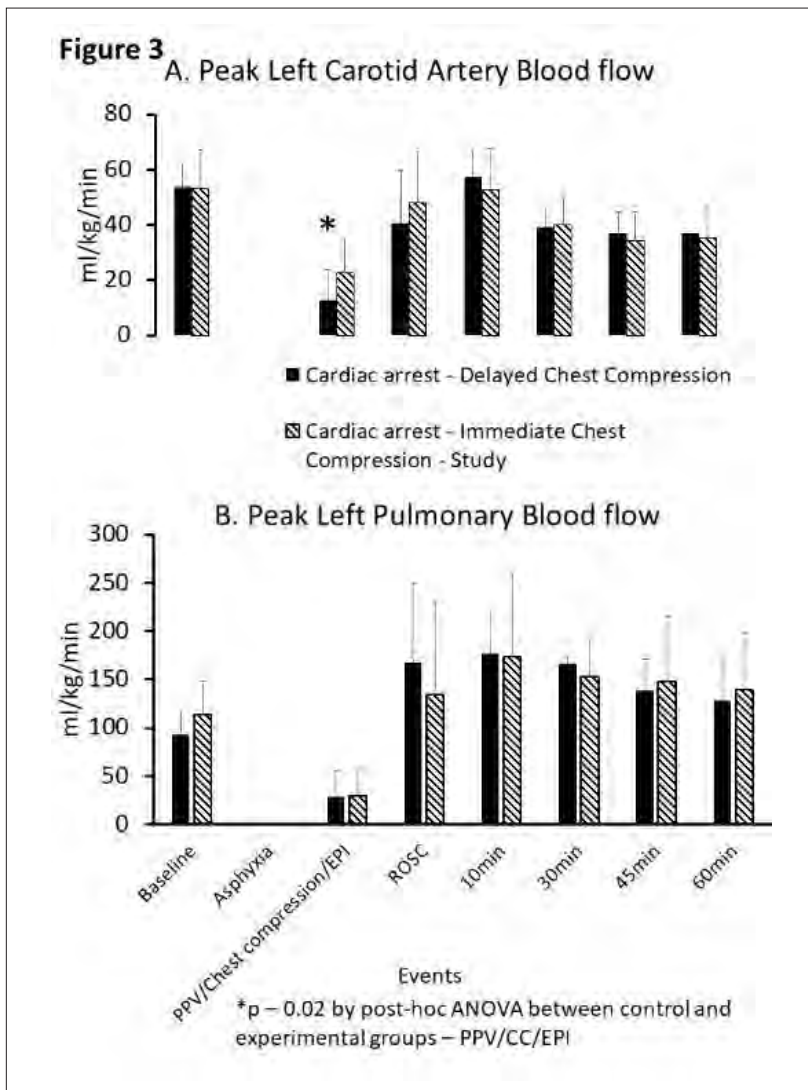

Figure 1C: Study - Shows a BIOPAC snapshot of pressure and blood flows in a complete cardiac arrest model for the first 4 min. Facemask positive pressure ventilation (PPV) and chest compressions (CC) were initiated at the start of resuscitation, endotracheal tube (ETT) placement at 2 min. Post ETT placement, PPV & CC were continued until return of spontaneous circulation (ROSC).





CONCLUSIONS

Initiation of resuscitation with CC and FM-PPV, while preparing and placing an ETT lead to faster ROSC & improved PCF during resuscitation in a ovine cardiac arrest model

EP420 / #1261

E-Poster Viewing - Neonatology AS02-27. Resuscitation & transport

Role of the electrocardiogram in neonatal resuscitation: report of two CASES

M. Ramon Jiménez*, M.J. García Borau, E. López Bernal, J. Becerra Hervás, J. Salazar Quiroz, E. Moliner Calderon

Hospital de la Santa Creu i Sant Pau, Neonatology. Pediatrics Department, Barcelona, Spain

BACKGROUND AND AIM

Traditionally, auscultation has been the preferred method of heart rate monitoring during neonatal resuscitation. However, sometimes auscultation significantly underestimates the true heart rate. Latest guidelines have suggested the possibility of using the electroencephalogram as the standard method due to its rapid detection of heart rate and its ease of use. In addition, the electrocardiogram is the only method that allows diagnosing a shockable rhythm. Below we present two cases of resuscitation in the delivery room where electrocardiogram was key to recovery.

METHODS

Case report

RESULTS

Case 1 30-week-old male preterm infant delivered by emergency cesarean section due to placental abruption. He needs positive pressure ventilation, intubation and chest compressions. He receives 4 intravenous adrenaline, as well as a volume load and desperate transfusion. Cardiothoracic ultrasound

is performed to rule out effusions or air leaks, observing ineffective cardiac contractility. He is monitored with an electrocardiogram that shows pulseless ventricular tachycardia. It presents a good response to defibrillation, recovering sinus rhythm. Apgar 0/0/0//2. Due to the important brain lesions and the poor prognosis, we made adequacy of therapeutic effort at 24 hours of life. Case 2 Term newborn with dystocia. He needs positive pressure ventilation, intubation and chest compressions. He receives 3 doses of intravenous adrenaline. After the third dose, ventricular fibrillation is observed on the electrocardiogram. Recovers sinus rhythm after defibrillation. Apgar 0/0/0/2. He received therapeutic hypothermia with good evolution and mild sequelae.

CONCLUSIONS

In our limited experience, cardiac monitoring with electrocardiogram can be key in the recovery of some newborns.

EP421 / #1464

E-Poster Viewing - Neonatology AS02-27. Resuscitation & transport

Abdominal compression to raise diastolic blood pressure during resuscitation of asystolic newborn LAMBS

C. Roberts^{1*}, C. Hwang², D. Blank³, S. Badurdeen², K. Crossley², M. Kluckow⁴, A. Gill⁵, E. Camm², R. Galinsky², Y. Brian², S. Hooper², G. Polglase²

¹Monash University, Department of Paediatrics, Clayton, Australia

²Hudson Institute of Medical Research, The Ritchie Centre, Clayton, Australia

³Monash Children's Hospital, Monash Newborn, Clayton, Australia

⁴University of Sydney, Northern Clinical School, Sydney, Australia

⁵University of Western Australia, Paediatrics, Perth, Australia

BACKGROUND AND AIM

Return of spontaneous circulation (ROSC) during neonatal resuscitation is believed to be dependent upon increasing diastolic blood pressure (BP). Applying abdominal compression (AC) during chest compressions could raise diastolic BP, enhancing the likelihood of ROSC. We assessed the physiological effects of AC during resuscitation of asphyxiated newborn lambs.

METHODS

Anaesthetised near-term lambs (mean 140 days, term=148) were delivered and asphyxiated until asystolic. Resuscitation was commenced according to neonatal guidelines, with lambs randomised to four groups: intravenous (IV) epinephrine 0.02mg/kg, IV saline placebo, IV epinephrine + AC, IV saline placebo + AC. IV epinephrine lambs could receive up to 4 doses at 3-minute intervals; placebo lambs could receive three doses then up to two 'rescue' epinephrine doses. Lambs achieving ROSC were ventilated for 60 minutes then euthanised. Micro-haemorrhages were assessed in fixed brain tissue. Data were compared using two-way ANOVA, or t-test, as appropriate.

RESULTS

AC increased mean intra-abdominal and intra-pleural pressure by 16 and 8 mmHg respectively. Mean physiological data during chest compressions are shown in Figure 1. Figure 2 shows diastolic blood pressure over time. ROSC rate, and time to ROSC, were similar with or without AC. Most physiological parameters after ROSC were similar in all groups. Micro-haemorrhage was increased in AC lambs versus non-AC lambs (Figure 3).

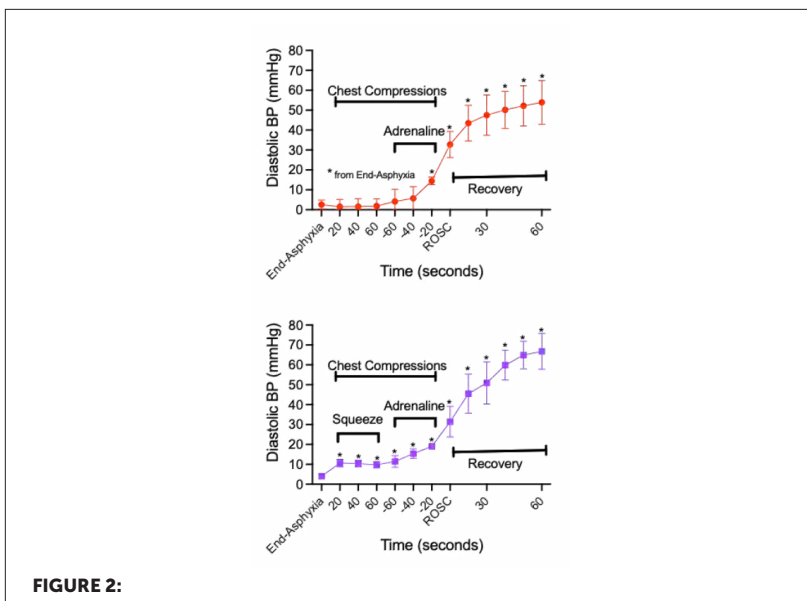
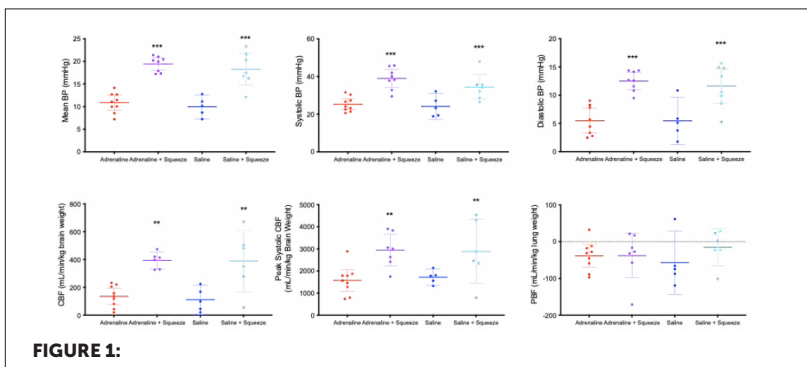

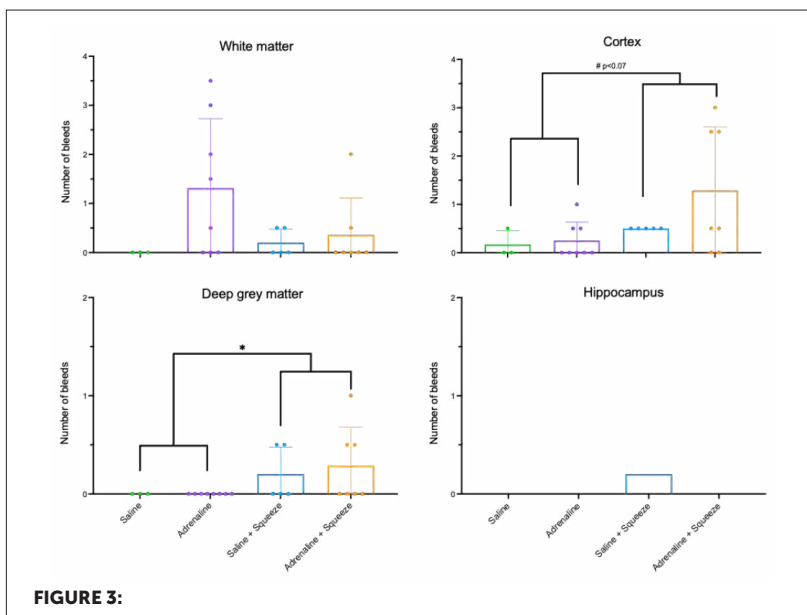

CONCLUSIONS

AC effectively increased diastolic BP during chest compressions in asphyxiated newborn lambs, but failed to reduce time to achieve ROSC, or increase rate of ROSC. AC may result in greater risk of cerebral micro-haemorrhage.

EP422 / #1066

E-Poster Viewing - Neonatology AS02-27. Resuscitation & transport

Newborn life support: risk factors for advanced resuscitation

M. Sousa Dias^{1*}, M. Meneses¹, M. Araújo², B. Neves², A. Azevedo³,
C. Ferraz³, S. Peixoto³

¹Hospital Pedro Hispano, Pediatrics, Matosinhos, Portugal

²Hospital Pedro Hispano, Obstetrics and Gynaecology, Matosinhos, Portugal

³Hospital Pedro Hispano, Neonatology, Matosinhos, Portugal

BACKGROUND AND AIM

Transition to extrauterine life involves significant physiological changes for every newborn. Although most neonates begin breathing on their own, about 10% require assistance at birth and approximately 1% need advanced resuscitation. This study aimed to identify antepartum, intrapartum and newborn factors associated with the need for neonatal advanced resuscitation.

METHODS

Cross-sectional study conducted on neonates born in a Portuguese level 2 hospital, from January/2018 to December/2020. A descriptive and inferential statistical analysis was performed using SPSS®27.0.1 and statistical significance was set at $p < 0.05$.

RESULTS

of 4604 included neonates, 97% received routine care and 3% ($n=143$) required extrauterine transitional support, of which 19% ($n=27$) consisted in advanced measures, such as intubation, chest compressions and/or vaso-

active drugs. In the group of term and near-term newborns ($n=102$), factors significantly associated to neonatal resuscitation were intrapartum bleeding ($p=0.002$), prolapsed cord ($p=0.002$) and need for urgent or emergent c-section ($p<0.001$). For moderately preterm infants ($n=26$), we found significant correlation for corioamnionitis ($p=0.043$), intrapartum bleeding ($p=0.043$), vacuum-assisted delivery ($p=0.043$), emergent c-section ($p=0.011$) and low birth weight ($p=0,031$). In extreme preterm newborns ($n=15$), need for urgent or emergent c-section ($p=0.003$) and extreme low birth weight ($p=0.038$) were the variables significantly correlated to advanced reanimation.

CONCLUSIONS

Anticipation and preparation are the first and most important steps in delivering effective neonatal resuscitation, essential for the best outcomes. With this study, the authors intend to show which risk factors should be considered, promoting the ability to predict the need for advanced resuscitation. These results support the findings of previous studies.

EP423 / #2173**E-Poster Viewing - Neonatology AS02-27.
Resuscitation & transport****Introduction of servo-controlled cooling during neonatal retrieval for infants with hypoxic ischaemic encephalopathy: new zealand experience****F. Steiner^{1*}, S. Cody¹, M. Berry^{1,2}, M. Saito-Benz^{1,2}**¹Wellington Regional Hospital, Neonatal Intensive Care Unit, Wellington, New Zealand²University of Otago, Wellington, Department of Paediatrics and Child Health, Wellington, New Zealand**BACKGROUND AND AIM**

Moderate therapeutic hypothermia (TH) of 33-34°C initiated by 6hrs of life reduces adverse neurodevelopmental outcomes for infants with hypoxic ischaemic encephalopathy (HIE). Retrieval from peripheral hospitals to tertiary NICUs can delay time to TH and risks excessive hypothermia and its complications. The use of servo-controlled cooling systems during retrieval can increase the efficacy and safety of TH during transport. This retrospective audit aims to assess whether introduction of Tecotherm Neo servo-controlled cooling system by Wellington NeTS (Neonatal Transport Service) in 2018 has improved the efficacy and safety of TH during transport.

METHODS

We identified 86 neonates retrieved for moderate TH using NeTS and electronic admission databases between January 2019-2022. Patient data was collected from medical records and transport documentation, and compared with a previously studied cohort from our centre.

RESULTS

Overall, 66/86 (76.7%) achieved moderate TH within 6hrs of life since introduction of Tecotherm Neo, compared to 35/58 (60.3%) in our previous cohort ($p=0.03$). There was no significant difference in rates of overcooling ($T<33^{\circ}\text{C}$) or its complications between the two groups. In the current cohort we identified under or sub-optimal utilization of Tecotherm Neo in 56/86 (65.1%). Commonly reported reasons included incompatibility with AeroNOx on the transport incubator, and challenges to providing continuous power supply during long-distance multi-modality retrieval.

CONCLUSIONS

Introduction of Tecotherm Neo resulted in more outborn neonates achieving TH within 6hrs, optimising the neuroprotective effect. Further investigation is required to identify and overcome barriers to its use so as to maximise potential benefits.

EP424 / #1654**E-Poster Viewing - Neonatology AS02-27.
Resuscitation & transport****A population-based 27-year study of neonatal air transport in north norway.****L.N. Trulsen^{1*}, N. Songstad², C. Klingenberg^{2,3}**¹Lene Nymo Trulsen, Department of Pediatrics and Adolescence Medicine, TROMSØ, Norway²University Hospital of North Norway, Department of Pediatrics and Adolescence Medicine, Tromsø, Norway³UiT-The Arctic University of Norway, Tromsø, Paediatric Research Group, Faculty of Health Sciences, Tromsø, Norway**BACKGROUND AND AIM**

Regionalized centralization of risk pregnancies is essential, but a well-organized postnatal transport service is equally important. This study audits the activity of the neonatal air transport team at the University Hospital of North Norway (UNN), covering a large area in the Arctic region of Norway.

METHODS

Medical data from all neonatal air transports between year 1994-2020 were recorded prospectively. Body temperature, blood glucose and blood gas within 3-6 hours after arrival were assessed from medical charts. To assess temporal changes, we compared data between 1994-2007 (Period 1) and 2008-2020 (Period 2).

RESULTS

A total of 787 transports were included: 588 (75%) referrals to the tertiary neonatal unit at UNN and 199 (25%) transfers to national surgical centers. Main reasons for referrals were respiratory conditions (22%), prematurity (18%),

suspected sepsis (17%) and perinatal asphyxia (16%). Main reasons for transfers were congenital heart defects (50%) and other congenital anomalies (30%). A total of 179/787 (23%) infants received mechanical ventilation during transport. Comparing first and second period, proportions transported due to prematurity (20.5% vs. 10.7%) and congenital heart defects (23.6% vs. 13.2%) decreased significantly ($P < 0.001$). Overall rates of hypoglycemia, hypothermia and hypo-hypercapnia were 5%, 10% and 23%, respectively. Rates of hypoglycemia on arrival was significantly lower in Period 2 ($P < 0.001$).

CONCLUSIONS

Decreasing rates of transport due to prematurity and congenital heart defects is probably secondary to improved regional perinatal care. Rates of hypoglycemia and hypothermia were acceptable, but improvements in CO₂ control is warranted.

EP425 / #1350**E-Poster Viewing - Neonatology AS02-27.
Resuscitation & transport****Transport risk index of physiologic stability: a validation for swedish conditions a validation for swedish conditions****J. Van Den Berg*, J. Van Den Berg, S. Håkansson***Dep of Clinical Science, Pediatrics, Umeå, Sweden***BACKGROUND AND AIM**

There are several instruments for assessing mortality risk or severity of illness in NICU settings, including laboratory tests, and/or a prolonged period of data collection which make them less suitable for neonatal transport. Specific instruments for neonatal transports are available but many require invasive procedures. The transport risk index of physiologic stability (TRIPS) including four noninvasive physiological variables, seems to be a more generalized scoring system for both emergency and planned transports with easily obtained noninvasive variables to evaluate the infant and the transport team. TRIPS have been modified into TRIPS II and to California-TRIPS. The aim is to validate and to compare TRIPS, TRIPS II and California-TRIPS in a Swedish setting.

METHODS

Retrospective analyses of 350 emergency retrieval transports in Northern Sweden. Background data, mortality rate, mode and duration of transport were recorded. Infants were scored according to TRIPS.

RESULTS

TRIPS and California-TRIPS scores decreased after transport between 37% and 53% depending on gestational age. Mortality rate within 7-days after transport was 2,3%. ROC curves showed 0.8, 0.77, 0.76, 0.8 and 0.78 for TRIPS score before/after transport, California-TRIPS score before/after transport, and TRIPS II respectively. Goodness of fit were not significant indicating that there is no difference between observed and expected 7-day mortality.

CONCLUSIONS

TRIPS, California-TRIPS and TRIPS were equal in performance, but could not be validated against mortality. Additional data and/or more noninvasive variables might increase the performance of TRIPS and California-TRIPS.

EP426 / #582**E-Poster Viewing - Neonatology AS02-28.
Sedation & analgesia****Reducing procedural pain in the neonatal
intensive care UNIT****L. Harrison****Oxford University Hospitals, Department of Paediatrics, Oxford, United Kingdom***BACKGROUND AND AIM**

Neonates may experience over 200 painful procedures during their first 14 days of life. Neonates are hypersensitive to pain and poorly treated pain may lead to life threatening and long-term physiological effects. Non-pharmacological and pharmacological treatments are beneficial in alleviating pain. This study aimed to establish the number of painful procedures undergone by neonates, in a tertiary NICU, in the first 5 days of life and identify ways to reduce procedures and procedural pain without compromising patient care.

METHODS

All the inborn neonates in the ICU and HDU nurseries on the day of data collection, who were more than 5 days old, were included. Records were reviewed retrospectively to ascertain the number and type of painful procedures undertaken.

RESULTS

18 neonates were included (born between 23+5 and 40+1 weeks gestation). The average number of procedures in the first 5 days of life was 24.4 (range: 14 to 48), approximately 4.9 per day. The most common procedures were

blood tests, cannulation and insertion of central venous lines. Many babies had multiple sets of blood tests performed within a few hours of each other.

CONCLUSIONS

Neonates undergo significant painful procedures and these can be reduced while maintaining the highest standards of medical care. Recommendations include combining blood tests, using cannula/line insertion and indwelling lines for blood tests and consultant-led, MDT planning of daily bloods. Where procedures cannot be avoided, reducing procedural pain should be a priority, primarily using non-pharmacological methods, e.g. sucrose, kangaroo care, non-nutritive sucking and swaddling.

EP427 / #838**E-Poster Viewing - Neonatology AS02-28.
Sedation & analgesia****Prospective pharmacoepidemiologic study of
analgesic, sedative, anesthetic, and paralytic
prescriptions in 30 french nicus from 2014 to
2020****M. Tauzin^{1*}, B. Gouyon², D. Hirt³, R. Carbajal⁴, J.-B. Gouyon², A.-
C. Brunet⁵, M. Ortala⁵, S. Goro⁶, C. Jung⁶, X. Durrmeyer¹**¹Hôpital Intercommunal de Créteil, Neonatal Intensive Care Unit, CRETEIL, France²Université de la Réunion, Centre D'études Périnatales De L'océan Indien (cepoi, Ea7388), Saint Pierre, France³Hopital Cochin - APHP, Pharmacology Department, PARIS, France⁴Assistance Publique-Hôpitaux de Paris, Hôpital Armand Trousseau- Sorbonne Université, Pediatric Emergency Department, PARIS, France⁵Kaduceo, Kaduceo, Toulouse, France⁶CHI Créteil, Clinical Research Center, Créteil, France**BACKGROUND AND AIM**

No consensus exists about the doses of analgesics, sedatives, anesthetics, and paralytics used in critically ill neonates. Large-scale, detailed pharmacoepidemiologic studies of prescription practices are a prerequisite to future research. This study aimed to describe the detailed prescriptions of these drug classes in neonates hospitalized in NICUs and to compare prescriptions by gestational age.

METHODS

We included all neonates requiring intensive care in 30 French level III units from 2014 through 2020 with a computerized prescription for an analgesic, sedative, anesthetic, or paralytic agent. We described frequencies of pre-

scription, methods of administration, concomitant drug prescriptions, and dosing regimen and compared them by gestational age.

RESULTS

Among 65 555 neonates, 29 340 (44.8%) were prescribed at least one analgesic (opioids in 17.8%), sedative (9.8%), anesthetic (8.5%), and/or paralytic agent (1%). Among preterm neonates born before 28 weeks, 3771/4283 (88.0%) were prescribed at least one of these agents. In most neonates opioids and sedatives were prescribed as continuous infusion, whereas anesthetics were prescribed as single doses. Opioids, sedatives and paralytics were mostly prescribed with another agent. Doses varied significantly by gestational age, which was inversely correlated to the frequency, cumulative dose, and duration of prescriptions. Differences in initial or maintenance doses by gestational age were statistically very significant, but clinically limited.

CONCLUSIONS

44.8% of neonates were prescribed at least one analgesic, sedative, anesthetic, or paralytic agent during their NICU hospitalization, often in association. Frequencies of prescription and doses varied by gestational age. Dose-finding studies to determine individualized dosing regimens appear necessary.

EP428 / #1721**E-Poster Viewing - Neonatology AS02-29. Surgery & anaesthesia****Urethrocutaneous fistula repair after distal hypospadias surgery****N. Ben Saad^{1*}, M. Belhaj Mansour², H. Ben Ameer³, N. Ben Kraiem², H. Zitouni³, M. Ben Dhaou², R. Mhiri⁴**¹Hopital Hedi Chaker sfax, Pediatric Surgery, Sfax, Tunisia²Hopital Hadi Chaker Sfax, Pediatric Surgery, Sfax, Tunisia³Hopital Hadi Chaker Sfax, Pediatric Surgery, Sfax, Tunisia⁴Faculty of Medicine of Sfax, University of Sfax, Sfax, Tunisia, Pediatric Surgery, Sfax, Tunisia**BACKGROUND AND AIM**

Urethrocutaneous fistula (UCF) after distal hypospadias repair remains a frustrating problem for pediatric surgeon. Furthermore, with the improvement in suture materials and surgical techniques, such complications are increasingly unacceptable. The occurrence of UCF precludes a goal of hypospadias surgery, in an early one-stage repair of the defect. The aim of the present study was to compare different surgical technique on the recurrence rate of UCF.

METHODS

From January 2000 to December 2016, 290 boys with distal hypospadias were referred to our hospital. Only 85 who developed fistula were considered in the present study.

RESULTS

The fistula site was predominantly at the anterior penile level (54.9%) and it was punctiform on 53.1% of the cases. The most used surgical technique was WEISE (42.3%) then MATHTEU (29.6%). The success rate of the WEISE

technique was 78.2% compared to 52.3% for the MATHIEU technique. The difference was statistically significant for the both repairs.

CONCLUSIONS

The present results suggest that although this may be far from an optimal technique for repairing UCF, that the WEISE method provides a good success rate for penile fistula after distal hypospadias.

EP429 / #1923**E-Poster Viewing - Neonatology AS02-29. Surgery & anaesthesia****Neonatal gastric perforation and non-invasive mechanical ventilation**

E. Domingo Lagman^{1,2*}, M. Alsina Casanova^{1,2}, I. De Haro Jorge³, C. Carrasco Carrasco², M. Teresa Palacio¹

¹Hospital Clinic Maternitat, Neonatology, Barcelona, Spain

²Hospital Sant Joan de Déu, Neonatology, Barcelona, Spain

³Hospital Sant Joan de Déu, Pediatric Surgery, Barcelona, Spain

BACKGROUND AND AIM

Neonatal gastric perforation (NGP) is a rare and life-threatening complication. Non-invasive mechanical ventilation (NIMV) strategies could lead to iatrogenic NGP. We have recently introduced advanced ventilators in our neonatal intensive care units (NICUs) that provide leak compensation and high pressures in NIMV mode with the aim of improving lung recruitment and reducing the need for endotracheal intubation. At the same time, we have observed an increase in the number of NGP cases. The aim of this study is to raise awareness of the risk of NGP associated to NIMV.

METHODS

Retrospective review of neonates with NGP admitted to the NICUs of two tertiary referral hospitals between January 2019 and July 2021. Infants with gastrointestinal congenital abnormalities were excluded. Data regarding prenatal and neonatal conditions and clinical features prior to perforation were recorded.

RESULTS

Twenty-four infants presented gastrointestinal perforation, seven of them gastric (29%). All patients were extremely preterm infants (EPI) and were in NIMV mode with leak compensation ventilators at the time of perforation. The median positive inspiratory pressure (PIP) was 14 cmH₂O (13-15) and the median inspiratory flow rate was 15.5 L/min (10.5-19). The median pCO₂ prior to perforation was 41.1 mmHg (36.2-46.0).

CONCLUSIONS

NGP could be related to the use of high PIP and high inspiratory flow when NIMV mode is used with leak compensating ventilators. Although NGPs associated to NIMV are unusual, we consider important to be aware of this association and appropriately adapt respiratory support to minimize the risk of this complication.

EP430 / #953

E-Poster Viewing - Neonatology AS02-29. Surgery & anaesthesia

Defa6 and guca2a as tissue markers in necrotizing enterocolitis

A. Hoffsten^{1*}, H. Engstrand Lilja^{1,2}, H. Mobini-Far³, R. Sindelar^{1,4}, L. Markasz^{1,4}

¹Department of Women's and Children's Health, Uppsala University, Uppsala, Sweden, Uppsala, Sweden

²Section of Pediatric Surgery, Uppsala University Children's Hospital, Uppsala, Sweden, Uppsala, Sweden

³Department of Pathology, Uppsala University Hospital, Uppsala, Sweden, Uppsala, Sweden

⁴Neonatal Intensive Care Unit, Uppsala University Children's Hospital, Uppsala, Sweden

BACKGROUND AND AIM

Previous studies have suggested that Paneth cells might be involved in NEC development. Defensin alpha 6 (DEFA6) and Guanylate cyclase activator 2A (GUCA2A) are selective protein markers of Paneth cells. The objective was to explore expression of DEFA6 and GUCA2A in intestinal tissue samples from newborn infants with and without NEC.

METHODS

Tissue samples were collected from viable intestine from 70 infants, 43 of which underwent bowel resection due to NEC (NEC-group) and 27 where operated due to another condition (Controls). Three adult samples were used as positive controls. In each tissue sample, expression of DEFA6 and GUCA2A was immunohistochemically stained. Semi-automated digital image analysis was performed to determine tissue protein expression. Clinical data and protein expression were compared between the NEC-group and the Controls.

RESULTS

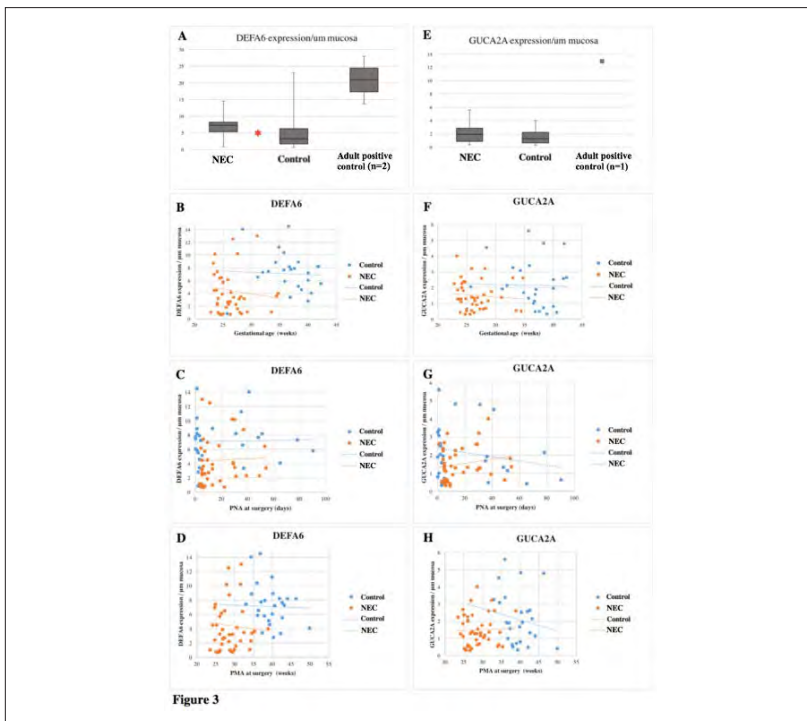
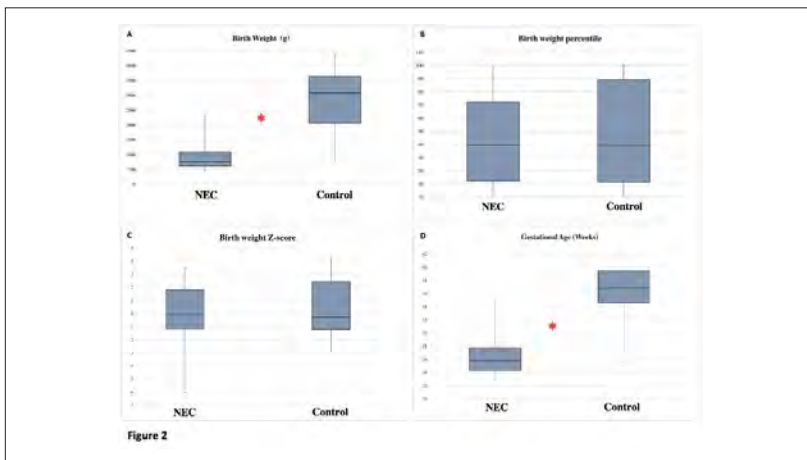

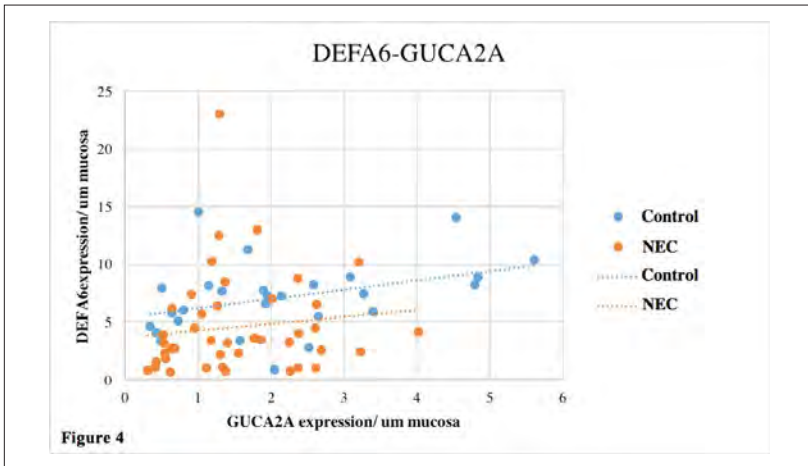

The NEC-group had a lower gestational age (median 25.9 weeks) compared to the controls (median 34.9 weeks) ($p < 0.001$). DEFA6-expression was lower in the NEC-group ($p = 0.006$), and low DEFA6 correlated with risk for developing NEC in the logistic regression ($p = 0.018$). The correlation was present independently of gestational age and birth weight. GUCA2A-expression did not differ between the two groups and had no maturational correlation.

CONCLUSIONS

Paneth cells seem to play a role in NEC development. The finding of intact GUCA2A-expression independent of maturation together with diminished expression of DEFA6, indicates that NEC-patients have well defined Paneth cells but with dysfunctional defensin activity.

EP431 / #1036

E-Poster Viewing - Neonatology AS02-29. Surgery & anaesthesia

Effect of covid-19 pandemic on investigation and treatment of neonates with bilious vomiting

R. Jones*, M. Chalia, S. Hannam

Great Ormond Street Hospital for Children, Neonatal Intensive Care Unit, London, United Kingdom

BACKGROUND AND AIM

Background: Bilious vomiting in a term neonate can indicate a time critical surgical pathology. Up to 25% of referrals have a surgical diagnosis, with up to 8% having a diagnosis of malrotation and/or volvulus. Aim: To review current practice, incidence of surgical diagnosis in neonates referred for bilious vomiting and investigate the effect of the COVID-19 pandemic.

METHODS

This was a service evaluation over a 27-month period including the era of the COVID-19 pandemic (2019 –2021) compared to a previous 21-month study period (2015-2016). Data was collected from the electronic patient records.

RESULTS

One-hundred neonates were admitted between 2019 to 2021. The median gestational age was 39 weeks (IQR 36-40). Sixty-eight per-cent were admitted within 4 hours of referral and 85% (n=85) underwent a contrast study. Eighteen per-cent (n=18) had a surgical diagnosis and 8% (n=8) had malrotation and/or volvulus. The median time from contrast to theatre was 278 minutes. In the pre-COVID period, 93 neonates were admitted with 88% being admitted within 4 hours of referral and 15% being diagnosed with malrotation

and/or volvulus. The median time from contrast to surgery was shorter by 2 hours. The main identified reason for this delay was waiting for a negative COVID test prior to contrast.

CONCLUSIONS

The incidence of malrotation and/or volvulus within this cohort is comparable to the one in the literature. During the COVID-19 pandemic, the timings of referral to admission, admission to contrast and contrast to theatre were prolonged, but no adverse incidents or deaths were noted.

EP432 / #1546

E-Poster Viewing - Neonatology AS02-29. Surgery & anaesthesia

Primary segmental volvulus in newborns

S. Kacem^{1*}, S. Ammar¹, E. Krichen¹, M. Hbaieb¹, K. Mekki², H. Zitouni¹, R. Mhiri³

¹Hedi Chaker Hospital, Pediatric Surgery, Sfax, Tunisia

²Hedi Chaker Hospital, Pediatric, Sfax, Tunisia

³Hedi Chaker Hospital, Pediatric Surgery, Sfax, Tunisia

BACKGROUND AND AIM

Most cases of volvulus in the children, including the newborns, involve the midgut and are secondary to malrotation. Primary segmental volvulus (PSV) is rare. It's early diagnosis and managements are a challenge. We present 3 cases of PSV in newborns and describe management.

METHODS

Retrospective study of charts of patients with PSV operated between 2018 and 2021 in our department of pediatric surgery.

RESULTS

Three cases were identified aged respectively 5 days, 7 days and one month with a sex ratio equal to 2. The clinical presentation was sepsis with occlusive syndrome in the 3 patients with a duration of symptom development ranging from 1 to 5 days. The volvulus was due to a congenital bridge in one case, a persistence of the omphalo-mesenteric canal in one case and volvulus of the loops upstream a grelic atresia. The site of the intraoperative VS was ileal in the 3 patients. The surgical treatment consisted of an immediate intestinal resection and anastomosis for the 3 patients treating at the same time the

small bowel atresia in one case, releasing the bridle in one case, and carrying off the Meckel's diverticulum in one case,. The postoperative course was marked by the survival of the 3 newborns with an average follow-up of 1.5 year.

CONCLUSIONS

The exact preoperative diagnosis of VS as well as its etiology remains difficult. The resection anastomosis of the volvulated loops often necrotic at the time of surgery is frequently necessary. The prognosis could be improved by early diagnosis and management.

EP433 / #1058

E-Poster Viewing - Neonatology AS02-29. Surgery & anaesthesia

Challenges in the assessment of scrotal swelling and discolouration in neonates

S. Kutty*, N. Kottarakou, S. Quinn, J. Kutty

South West Acute Hospital, Paediatrics, Enniskillen, United Kingdom

BACKGROUND AND AIM

Scrotal swelling and discolouration in a neonate pose unique challenges in diagnosis and management. Testicular torsion identified within the first month of life is referred as neonatal testicular torsion (NTT) with a reported incidence of 6.1/100,000 live births. Bilateral torsion is an even rarer event, which can present with unilateral signs and can lead to testicular atrophy.

METHODS

We present two cases of bilateral NTT diagnosed within the first 24 hours of life in the postnatal unit of our institution over a period of three months.

RESULTS

Case 1: A male infant was born at 39⁺⁵ weeks of gestation via forceps delivery due to non-reassuring CTG. At 20 hours of life, there was scrotal discolouration with firm, non-tender and non transilluminant right testis. On the upper pole of left scrotum, there was a small dark spot. He had emergency bilateral scrotal exploration and both testes were salvaged. Case 2: This infant was born by ventouse delivery at term and presented at 12 hours of age similarly with scrotal discolouration, firm enlarged, non-tender left testis and a small right testis. He had left orchidectomy with fixation on the right side.

CONCLUSIONS

The presentation and outcome of NTT is fraught with controversies, with many considering prenatal and postnatal torsion as two different entities. Any scrotal or inguinal discolouration or swelling warrants timely attention. Even though there are still some controversies regarding the timing of intervention, we highlight importance of urgent surgical exploration. Appropriate parental counselling is crucial to emphasize the low salvage rate even after emergent surgical intervention.

EP434 / #2324

E-Poster Viewing - Neonatology AS02-29. Surgery & anaesthesia

Modes of ventilation in intubated preterm infants: a systematic review

R. Coomey^{1,2}, L. Alabbasi^{1,2}, C. Lim^{1,2}, J. Rice^{1,2}, A. Dass^{1,2},
A. Fairhurst^{1,2}, S. Marsh^{1,2}, N. Tuite^{1,2}, E. Isweisi^{1,2,3}, G. Semova^{1,2,3},
A. Branagan^{1,2,4}, D. Mockler⁵, J. Meehan^{1,2,3}, E. Roche^{1,2,3},
E. Molloy^{1,2,3,4,6*}

¹Trinity College Dublin, Discipline of Paediatrics, School of Medicine, Dublin, Ireland

²Trinity College Dublin, Trinity Research In Childhood Centre (tricc), Dublin, Ireland

³Tallaght, Children's Health Ireland At Tallaght, Dublin, Ireland

⁴Coombe Women and Infants Hospital, Neonatology, Dublin, Ireland

⁵St. James' Hospital, John Stearne Medical Library, Dublin, Ireland

⁶Children's Health Ireland at Crumlin, Neonatology, Dublin, Ireland

BACKGROUND AND AIM

Invasive ventilation continues to be a necessity for preterm infants with respiratory distress syndrome. However, ventilation is associated with significant complications, including bronchopulmonary dysplasia and neurodevelopmental issues. In addition, it is unclear whether some ventilator settings are superior to others with regard to morbidity and mortality outcomes in preterm infants. The study aims to compare and assess the short- and long-term outcomes of the different modes of invasive ventilation in preterm infants.

METHODS

Following the Preferred Reporting Items for Systematic Review and Meta-analysis (PRISMA), a systematic review of Embase, Web of Science and Medline was performed.

RESULTS

A total of 1407 studies from the search results were imported into Covidence. of these, 138 were assessed as part of the full screening stage. A total of 6 papers met the final inclusion criteria. Included studies investigated Volume-based Ventilation, Pressure-based Ventilation, Synchronised Intermittent Mandatory Ventilation (SIMV), and High-frequency Ventilation (HFV). of these, statistically significant positive evidence was shown from the three studies involving Pressure Support Ventilation (PSV) with Volume-Guarantee (VG).

CONCLUSIONS

There was no definitive mode of ventilation found to be superior across all outcomes and birthweights. Overall, PSV with VG was shown to have significant benefits in short- and long-term outcomes. However, these findings mainly support the need for additional trials to provide high quality evidence to guide clinical practice.

EP435 / #2555

E-Poster Viewing - Neonatology AS02-29. Surgery & anaesthesia

Midgut volvulus and possible association with *nphs1* mutation: case report

J. Salazar Quiroz^{1*}, E. Moliner Calderon¹, G.M. Fraga-Rodríguez², M.J. García Borau¹, B. Martínez Estradé¹, S. Boronat³

¹Hospital de la Santa Creu i Sant Pau, Neonatology, Pediatrics Department, Barcelona, Spain

²Hospital Sant Pau., Nephrology Paediatric., Barcelona, Spain

³Hospital Sant Pau., Paediatric, Barcelona, Spain

BACKGROUND AND AIM

Congenital nephrotic syndrome (CNS) is characterized by massive proteinuria, hypoalbuminemia and edema that usually manifest in utero or during the first 3 months of life. Most cases are caused by genetic defects in podocytes; *NPHS1* which encodes nephrin is the most common. Here we present an infant with CNS and multiple episodes of abdominal sepsis with associated intestinal malrotation (IM).

METHODS

At 33+5 weeks gestation, premature rupture of membranes occurred and labor was triggered. Female was born with a weight of 1990 g and Apgar 7/9. She developed abdominal distension, vomits and arterial hypotension at 12 hours of life. Complementary examinations ruled out primary digestive pathology. Antibiotic therapy was started (ampicillin, gentamicin and metronidazole). At 48 hours of life she presented generalized edema with hypoalbuminaemia and massive proteinuria. The CNS was diagnosed by exome sequencing. She presented 3 episodes of sepsis due to gram-negative germs. The clinical course was complicated at 6 weeks of life with an

intestinal volvulus secondary to IM type II C. Surgery was performed with extensive ileal resection.

RESULTS

Clinical manifestation of IM in newborns is bilious vomiting with or without abdominal distention. A delay in diagnosis and treatment may result in a extensive small bowel necrosis. The association between CNS and IM has only been described in cases of Pearson syndrome with mutations of the laminin-2 gene.

CONCLUSIONS

In conclusion, this is the first report describing the association between Finnish CNS and IM. Although a causal relationship cannot be established.

EP436 / #2182

E-Poster Viewing - Neonatology AS02-29. Surgery & anaesthesia

The use of laryngeal mask airway reduces postoperative ventilatory need in preterm infants undergoing rop laser treatment

S. Trinh^{1*}, G. Tovishazi², L. Bogner¹, L. Kátai¹, E. Maka³, V. Balog¹, M. Szabó¹, Á. Jermendy¹, B. Hauser²

¹Semmelweis University, 1st Department of Paediatrics, Budapest, Hungary

²Semmelweis University, Department of Anesthesiology and Intensive Therapy, Budapest, Hungary

³Semmelweis University, Department of Ophthalmology, Budapest, Hungary

BACKGROUND AND AIM

There is no protocol for anesthetic care of infants with retinopathy of prematurity undergoing laser photocoagulation. Patients can undergo sedation, topical anesthesia, or general anesthesia with endotracheal intubation. Most patients undergoing laser photocoagulation have a history of difficulties with weaning from mechanical ventilation, thus reintubation has a high risk for postoperative invasive ventilation. However, there is evidence that laryngeal mask airway may provide a safe alternative. Our objective was to assess the need for postoperative invasive ventilation in preterm infants undergoing general anesthesia for retinopathy of prematurity laser photocoagulation with laryngeal mask airway versus endotracheal intubation.

METHODS

In this retrospective cohort study premature infants undergoing laser photocoagulation between 2014-2021 at the 1st Department of Pediatrics, Semmelweis University, Budapest were enrolled. Patients were allocated to Group laryngeal mask airway (n=224) and Group endotracheal intubation (n=47) at the beginning of general anesthesia. The choice of airway man-

agement was at the discretion of the anesthesiologist. Some cases required conversion from laryngeal mask airway to endotracheal intubation during anesthesia. Outcome was defined as need for postoperative invasive ventilation. Data is given in median [IQR], data analysis was carried out with nonparametric tests and logistic regression with a $p < 0.05$.

RESULTS

Please see attached tables below.

CLINICAL DATA			
Variables	Group laryngeal mask airway	Group endotracheal tube	p
Gestational age at birth (weeks)	26 [25;28]	25 [24, 26]	0.001
Birth weight (g)	810 [700; 990]	640 [538; 850]	<0.001
Age at laser photocoagulation (weeks)	37 [35; 39]	35 [33; 36]	<0.001
Body weight at laser photocoagulation (g)	2110 [1800; 2780]	1375 [1235;1600]	<0.001
Invasive ventilation before laser photocoagulation (days)	11 [2; 25]	29 [16; 39.5]	<0.001
Length of general anesthesia for laser photocoagulation (min)	85 [70; 110]	138 [105; 160]	<0.001
Length of laser photocoagulation (min)	55.5 [42; 75]	90 [70; 115]	<0.001

FIGURE 1:

POST- LASER PHOTOCOAGULATION CLINICAL CHARACTERISTICS			
Variables	Group laryngeal mask airway	Group endotracheal tube	p
Post- laser photocoagulation observational time (days)	2 [2; 3]	3.5 [2; 18]	<0.001
Distribution of ventilatory support			
Non-invasive (HFNC, CPAP/BIPAP) ventilation	10% (24)	23% (11)	NS
Invasive ventilation	6% (14)	60% (28)	NS
Duration of post- laser photocoagulation invasive ventilation (days)	0 [0; 0.438]	1.5 [1; 5.25]	<0.001

FIGURE 2:

FACTORS INFLUENCING THE NEED FOR POST- LASER PHOTOCOAGULATION VENTILATORY SUPPORT				
Variables	Unadjusted odds ratios		Adjusted odds ratios	
	OR	(95% CI)	aOR	(95% CI)
Gestational age	0.62	0.49-0.76	0.76	0.50-1.11
Previous mechanical ventilation (days)	1.07	1.05-1.10	1.07	1.03-1.13
Bodyweight at laser photocoagulation (in 100 g)	0.72	0.65-0.80	0.74	0.63-0.84
Length of general anesthesia (h)	1.03	1.02-1.04	1.02	1.01-1.03
Airway management (laryngeal mask airway vs endotracheal intubation)	33.38	15.25-78.24	4.80	1.67-14.50
Major comorbidity	2.65	1.90-3.78	2.02	1.16-3.68

OR=odds ratios, aOR=adjusted odds ratio, CI=confidence interval

FIGURE 3:

CONCLUSIONS

Data suggests that with the use of laryngeal mask airway the need for post-operative ventilatory support can be reduced, independently from previous mechanical ventilation and body weight. Laryngeal mask airway can increase patient safety in infants at anesthesiologists' discretion.

EP437 / #1372**E-Poster Viewing - Neonatology AS02-29. Surgery & anaesthesia****Comparing age at diagnosis and the need for surgical intervention in infants with developmental dysplasia of the HIPS****J. Wright*, A. Hurley, R. Toone, L. Deriu***Leeds General Infirmary, Neonatal Medicine, Leeds, United Kingdom***BACKGROUND AND AIM**

Developmental dysplasia of the hips (DDH) is a condition which, if left untreated, can lead to difficulty walking and early arthritis. Diagnosis at a later age is felt to increase the need for surgical intervention, instead of the use of a Pavlik harness. The age after which surgical intervention is likely to be required has been quoted at 6 months in UK guidance. We set out to compare the age at diagnosis and definitive treatment of infants with DDH.

METHODS

We retrospectively reviewed the electronic records of patients born during a one-year period who were seen in the DDH clinic of a single tertiary referral hospital. The age at diagnosis was calculated based on the date of referral to clinic or the date of imaging if this was not available.

RESULTS

We identified 72 usable records. For those diagnosed under 30 days of age, 0% required surgical intervention; of those diagnosed between 31-60 days, 10% required surgery; of those diagnosed between 61-90 days, 15% required surgery; of those diagnosed between 91-120 days, 20% required surgery; and

of those diagnosed beyond 120 days 90% required surgical intervention with the remainder felt unlikely to benefit from any intervention.

CONCLUSIONS

These findings show an expected increase in the need for surgical intervention with age of diagnosis, however they suggest that treatment with a Pavlik harness is much less effective beyond the age of approximately 4 months (used to successfully treat 90% of case before 4 months and 0% of cases after) as opposed to the currently accepted 6 months.

EP438 / #2289**E-Poster Viewing - Neonatology AS02-30.
Translational research****Brainstem auditory evoked response
abnormalities in a rodent model of preterm infant
hyperbilirubinemia**

**M. Janampalli¹, I. Held², N. Rickman¹, S. Vatolin¹, K. Alagramam²,
C. Bearer^{1*}**

¹Case Western Reserve University, Pediatrics, Cleveland, United States of America

²Case Western Reserve University, Otolaryngology, Cleveland, United States of America

BACKGROUND AND AIM

Brainstem auditory evoked response (BAER) is a clinically informative test to evaluate bilirubin neurotoxicity in the neonatal intensive care unit. Homozygous Gunn rats(*jj*) acutely increase free bilirubin following administration of sulfadimethoxine (SDMX). Our prior results show that SDMX given on postnatal day (P) 5 (24 – 28-week human equivalent) results in cerebellar-mediated behavior perturbation and decreased cerebellar weights on P30, in *jj* but not heterozygous animals (*Nj*). We hypothesize that SDMX given to *jj* rat pups on P5 alters hearing as measured by BAER.

METHODS

On P5, *Nj* and *jj* Gunn rats were injected with 200 mg/kg SDMX or saline (n=6 per group). BAER recordings were obtained on P17-20. Apparatus from Intelligent Hearing System (Miami, FL) was used to record BAERs.

RESULTS

Mean peak 1 latencies at 80 dB SPL for *Nj* saline, *Nj* SDMX, *jj* Saline, and *jj* SDMX were 1.415 ± 0.04 , 1.44 ± 0.05 , 1.41 ± 0.07 , and 1.54 ± 0.1 milliseconds (msec), respectively. There was a significant delay in peak 1 latency in the *jj* SDMX

group in comparison to *Nj* SDMX ($p=0.036$) and *jj* saline ($p=0.045$) when tested using a two-tailed paired t-test. There were no significant differences in BAER thresholds between groups ($p>0.05$, two-tailed paired t-test) indicating no overt hearing loss originating from the sensory hair cells of the cochlea at P17-P20.

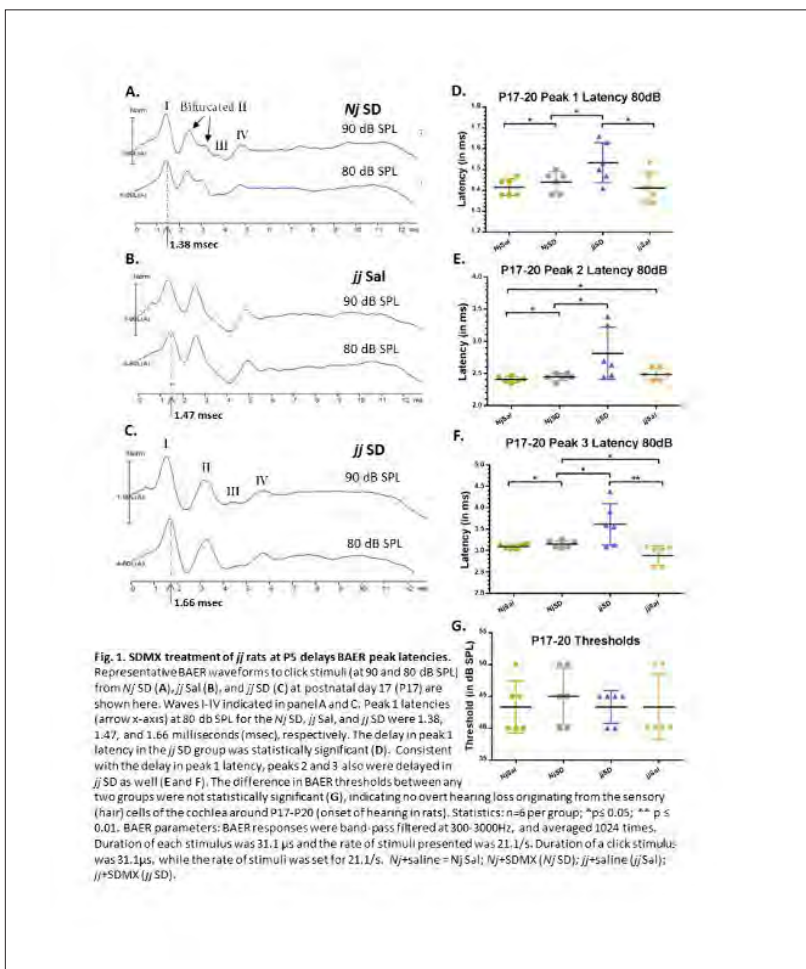

CONCLUSIONS

The induction of acute elevation in free bilirubin on P5 results in changes in the BAER. This model may be used in future studies to determine effective interventions to preserve hearing in preterm infants.

EP439 / #847

E-Poster Viewing - Neonatology AS02-30. Translational research

Laryngeal chemoreflexes and cardiorespiratory events under non-invasive nasal respiratory support in preterm LAMBS

B.F. Elsedawi*, N. Samson, C. Nadeau, A. Charrette, A. Lehoux, É. Fortin-Pellerin, J.-P. Praud

Université de Sherbrooke, Departments of Physiology and Pediatrics, Sherbrooke, Canada

BACKGROUND AND AIM

Serious acute cardiorespiratory events can be triggered in preterm infants during laryngeal chemoreflexes (LCRs) following laryngopharyngeal refluxes; such events, if repeated, may have long-term consequences. We have previously shown that nasal continuous positive airway pressure (nCPAP) markedly blunts these cardiorespiratory events (Boudaa N, 2013). Aims: We aimed to compare the effect of nCPAP and high-flow nasal cannula (HFNC) on the cardiorespiratory events induced during LCRs.

METHODS

Eleven preterm lambs born 14 days before full term were instrumented to record respiration, ECG, oxygenation and states of alertness. LCRs were induced during non-rapid eye movement sleep by injecting 0.5 mL HCl (pH 2) just above the larynx in the randomly ordered following conditions: nCPAP 6 cmH₂O, HFNC 7 L/min, and no respiratory support.

RESULTS

Both nCPAP and HFNC significantly increased minimal heart rate compared to control during LCRs; blunting of the cardiac inhibition appeared somewhat more important with nCPAP. Respiration inhibition was not significantly affected by nCPAP or HFNC ($p = 0.1$).

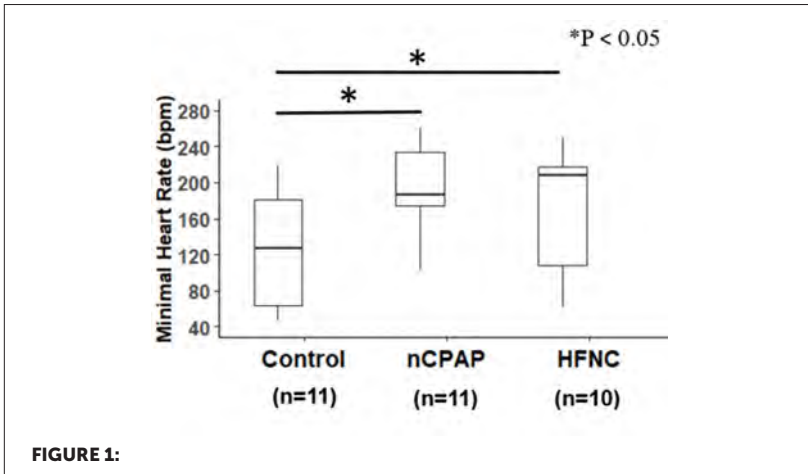

FIGURE 1:

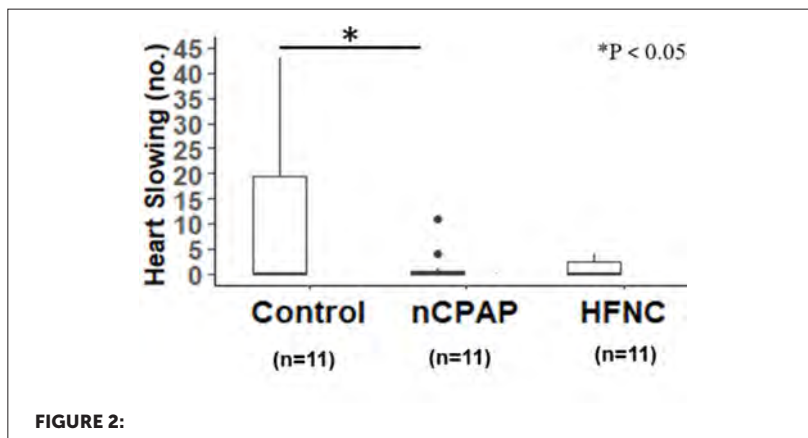
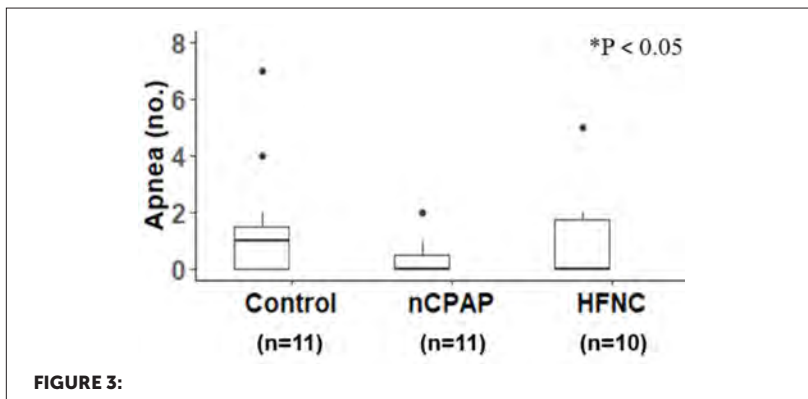

FIGURE 2:



CONCLUSIONS

Nasal respiratory support reduces the cardiac inhibition observed during LCRs. The mechanisms are unclear and may involve stimulation of the polymodal upper airway receptors.

EP440 / #1386**E-Poster Viewing - Neonatology AS02-30.
Translational research****Exit procedure simulation through an umbilical
cord cannulation SETUP****J. Heyer^{1*}, C. Hoyos-Banchón², F. Schubert¹, R. Sommer¹,
T. Orlikowsky², U. Steinseifer¹, S. Jansen¹, M. Schoberer²**

¹Institute for Applied Medical Technology, RWTH Aachen University, Cardiovascular Engineering, Aachen, Germany

²Paediatric and Adolescent Medicine, University Clinic RWTH Aachen, Section of Neonatology and Paediatric Intensive Care Medicine, Aachen, Germany

BACKGROUND AND AIM

The intubation and mechanical ventilation of premature and term born neonates cause severe and partially permanent damage to the lung (bronchopulmonary dysplasia). Relocating the oxygenation of the blood to an extracorporeal membrane oxygenator (ECMO) would allow to preserve the developing organ. ECMO treatment would ideally happen via the umbilical vessels mimicking the in-utero situation. Developing cannulae and cannulation techniques for this application is difficult since non-perfused navel vessels become spastic, and using perfused umbilical arteries or veins of healthy subjects in vivo is unethical. Within our project, we aim to reperfuse donated umbilical vessels with placental blood to create a test environment for the development of appropriate devices and techniques.

METHODS

Here we report our first experience with a newly designed test stand that simulates the perfused umbilical cord within an exit procedure. The main goal is to reperfuse the vessels of donated umbilical cord offcuts to reestablish physiological pressure and flow within the vessels. In a first step, vessels are probed, and the vasospasm is antagonized using papaverine. This permits

mid-bore cannulation of all vessels from both ends of the offcut. Cannulae are sealed, and the umbilical vessels are reperfused using a centrifugal pump.

RESULTS

We report test results for the tightness of the sealing and maximum flow and compliance and flow resistance of the vessels from n= 23 umbilical cords. The setup allows the insertion of full-bore pediatric ECMO cannulae into the reperfused umbilical vessels.

CONCLUSIONS

This new test environment opens new perspectives for future testing, cannula development, and cannulation training.

EP441 / #2422**E-Poster Viewing - Neonatology AS02-30.
Translational research****Rapid exome sequencing as a first-tier test in neonates with suspected genetic disorder: results of a prospective multicenter clinical utility study in the netherlands**

A. Marouane^{1*}, R. Olde Keizer¹, M. Kerstjens², C. Deden¹, K. Lichtenbelt³, T. Jonckers⁴, M. Vervoorn⁵, M. Vreeburg¹, L. Henneman⁶, L. De Vries⁷, R. Sinke¹, R. Pfundt¹, S. Stevens¹, P. andriessen⁸, R. Lingen⁹, M. Nelen¹, H. Scheffer¹, D. Stemkens¹⁰, C. Oosterwijk¹⁰, H. Kristian³, P. Amstel³, W. Zelst¹, G. Frederix³, L. Vissers¹, W. De Boode¹¹

¹Radboud University Medical Center, Human Genetics, Nijmegen, Netherlands

²University Medical Center Groningen, Human Genetics, Groningen, Netherlands

³University Medical Center Utrecht, Human Genetics, Utrecht, Netherlands

⁴Maxima Medical Center, Human Genetics, Veldhoven, Netherlands

⁵Maxima Medical Center, Neonatology, Veldhoven, Netherlands

⁶VU University Medical Center Amsterdam, Human Genetics, Amsterdam, Netherlands

⁷University Medical Center Utrecht, Neonatology, Utrecht, Netherlands

⁸Radboud University Medical Center, Neonatology, Nijmegen, Netherlands

⁹Isala, Neonatology, Zwolle, Netherlands

¹⁰University Medical Center Utrecht, National Patient Alliance For Rare and Genetic Disorders, Utrecht, Netherlands

¹¹Radboud University Nijmegen Medical Center, Neonatology, Nijmegen, Netherlands

BACKGROUND AND AIM

The introduction of rapid exome sequencing (rES) for critically ill neonates admitted to the neonatal intensive care unit has made it possible to impact clinical decision making. Unbiased prospective studies to quantify the impact of rES over routine genetic testing are however scarce. We here performed a clinical utility study to compare rES to conventional genetic diagnostic workup for critically ill neonates with suspected genetic disorders.

METHODS

In a prospective multicenter study involving five Dutch NICUs, we performed rES in parallel to routine genetic testing for 60 neonates with a suspected genetic disorder, and monitored diagnostic yield and the time-to-diagnosis. To assess the economic impact of rES, healthcare resource use was collected for all neonates. Questionnaires and Visual Analogue Scale (VAS) scores were obtained from parents and referring physicians to gain insight into their perspectives of rES.

RESULTS

rES detected significantly more conclusive genetic diagnoses than routine genetic testing (20% vs. 10%, respectively, $P < 0.05$), in a significantly shorter time-to-diagnosis (15 days (95% CI 10-20) vs. 59 days (95% CI 22-99)). Moreover, rES resulted in genetic diagnostic cost-savings of 1.5%. Parents showed preference towards rES over routine genetic testing, and referring physicians reported clinical benefits for the rES trajectory

CONCLUSIONS

Our findings demonstrate the clinical utility of rES for critically ill neonates based on increased diagnostic yield, shorter time-to-diagnosis and net healthcare savings. Together with the positive user experience, our observations warrant the widespread implementation of rES as first-tier genetic test in critically ill neonates with disorders of suspected genetic origin

EP442 / #604**E-Poster Viewing - Neonatology AS02-30.
Translational research****Association of dti findings between term and 13 years in very preterm infants - a prospective cohort STUDY****S. Setänen¹, H. Merisaari^{2*}, V. Saunavaara³, L. Haataja⁴, L. Lehtonen⁵, K. Lahti⁶, P. Ngum⁷, R. Parkkola²**¹University of Turku and Turku University Hospital, Pediatric Neurology and Pediatrics, Turku, Finland²University of Turku, Department of Radiology, Turku, Finland³Turku University Hospital, Department of Medical Physics, Turku, Finland⁴University of Helsinki, Department of Pediatric Neurology, Helsinki, Finland⁵University of Turku, Department of Pediatrics, Turku, Finland⁶Turku University Hospital, Department of Adolescent Psychiatry, Turku, Finland⁷Turku University Hospital, Turku Brain Injury Center, Turku, Finland**BACKGROUND AND AIM**

Very preterm birth increases risk for major brain pathologies. We aimed to study the association between diffusion tensor imaging (DTI) findings at term and 13 years in very preterm infants with and without major brain pathology in structural magnetic resonance imaging (MRI) at term.

METHODS

Very preterm infants (gestational age <32 weeks/birth weight \leq 1500 grams) born in 2004-2006 in Turku University Hospital, Finland, underwent brain MRI including DTI both at term and 13 years. A neonatal atlas was used for automatic region of interest (ROI) definitions. 17 ROIs were analyzed. Fractional anisotropy (FA) and Mean diffusivity (MD) values were extracted from the DTI scalar maps in ROI analysis. The correlation between DTI values at term and 13 years was analyzed. Comparisons in the DTI values at both ages

were performed between infants with and without major brain pathologies in structural MRI at term age.

RESULTS

At term, 6/24 included (25.0%) very preterm infants had major pathologies in structural brain MRI. There were no statistically significant differences (FDR corrected $p \geq 0.05$) in DTI values between infants with and without major brain pathologies in MRI at term. Two of the ROIs correlated between term age and 13 years (FDR corrected $p < 0.05$) in FA.

CONCLUSIONS

DTI may provide useful additional information along with structural MRI about brain development in very preterm infants at term and still at 13 years.

EP443 / #938**E-Poster Viewing - Neonatology AS02-30.
Translational research****Umbilical cord blood-derived stem cell collection
is feasible for autologous therapy in extremely
preterm infants****L. Zhou^{1,2,3*}, C. Mcdonald¹, T. Yawno^{1,2,4}, G. Jenkin^{1,4}, S. Miller^{1,4},
A. Malhotra^{2,3}**¹The Ritchie Centre, Hudson Institute of Medical Research, Monash University, Melbourne, Australia²Monash University, Paediatrics, Clayton, Australia³Monash Children's Hospital, Monash Newborn, Melbourne, Australia⁴Monash University, Obstetrics and Gynaecology, Clayton, Australia**BACKGROUND AND AIM**

Umbilical cord blood (UCB)-derived stem cells have shown promise as treatment for neonatal brain injury in pre-clinical models and early-phase clinical trials, but while UCB collection for term infants is established, there are limited data for preterm infants. We aimed to assess feasibility of UCB-derived cell collection for autologous use in extremely preterm infants, a population with a high incidence of brain injury.

METHODS

In a prospective study at a tertiary hospital in Melbourne, Australia, UCB was collected from infants born at <28 weeks and processed to obtain total nucleated cell counts, and cell viability via fluorescence-activated cell sorting. Feasibility was pre-defined as adequate for cryopreservation (>9 mLs UCB collected) and >25x10⁶ total nucleated cells/kg retrieved.

RESULTS

Twenty-seven infants (14 male, 13 female) were included in the study. Sixteen (59%) were delivered via caesarean section, 22 (81%) received delayed cord clamping, 10 (37%) were multiple births. Mean (SD) gestational age and birth weight was 25 (1.3) weeks and 772 (232) grams respectively. Mean (SD) UCB volume was 16.8 (8.4) mL/kg, and mean (SD) total nucleated cell count was 104 (89) $\times 10^6$ /kg. Mean (SD) cell viability was 92 (7.4) %. Feasibility for cell cryopreservation and for cell counts was achieved in 18 (66%) and 19 (70%) of infants respectively.

CONCLUSIONS

UCB-derived stem cell collection adequate for autologous use was achievable in two thirds of extremely preterm infants. Recruitment to demonstrate safety of UCB cell administration in extremely premature infants (The CORD-SaFe study ACTRN12619001637134) is ongoing, with 7 extremely premature infants receiving autologous infusion to date.

EP444 / #2178**E-Poster Viewing - Nursing AS03-01. Adolescence & transition****Investigation of the relationship between body mass index and sleep quality of adolescents****A. Ekim^{1*}, Z. Akozlu²**¹*Istanbul Arel University, Nursing, Istanbul, Turkey*²*Maltepe University, Nursing, Istanbul, Turkey***BACKGROUND AND AIM**

Sleep quality has significant implications for children's future health, as it has been identified as a risk factor for many poor health outcomes. In this study, it was aimed to examine the relationship between body mass index (BMI) and sleep quality of adolescents.

METHODS

This study is of descriptive and cross-sectional study design. The sample of the study consisted of 966 high school students aged 14-18. Participant information form, Pittsburg Sleep Quality Index (PSQI), BMI, was used as data collection tool. Children's anthropometric measurements were and their BMI values were calculated.

RESULTS

The mean age of the adolescents participating in the study was 15.9 ± 1.0 . PSQI mean total score was 8.17 ± 2.22 . Sleep quality was good for 50% of the participants, bad for 30%, and very bad for 10%. It was observed that there was a significant difference between the hours of sleeping on weekdays ($t=4.965$; $p=0.000$), sleeping on weekends ($t=3.527$; $p=0.001$) and waking

up on weekdays ($t=-2.596$; $p=0.01$) and PSQI. Their mean body mass index was 22.0 ± 3.16 and no significance was found between PSQI and BMI categories of adolescents ($p>0.05$).

CONCLUSIONS

The results of this study demonstrate the importance of considering life-long sleep quality from childhood to adulthood in reducing the risks of poor health outcomes.

EP445 / #2176

E-Poster Viewing - Nursing AS03-02. Allergy & immunology

Use of cam in childhood asthma: a sistematik review

A. Ekim^{1*}, N. Sisman²

¹Istanbul Arel University, Nursing, Istanbul, Turkey

²Marmara University, Nursing, Istanbul, Turkey

BACKGROUND AND AIM

The purpose of the present study was to conduct a systematic review in order to identify CAM modalities and use for childhood asthma.

METHODS

PubMed, Cochrane Library, Embase, Google Scholar, Cumulative Index to Nursing and Allied Health Literature, ProQuest Central and SCOPUS databases were searched. Peer-reviewed journals published between 2000 and March 2021 were included. The search terms used were complementary and alternative medicine, complementary therapies, complementary medicine, alternative medicine and those terms were combined with the words "child" and "asthma. Items for Systematic Reviews and Meta-Analysis (PRISMA) methodology was utilized to realize systematic review of study.

RESULTS

Twenty-one studies were analyzed for review. The frequency of CAM use varied between 13% to 89%. The most common CAM method was biologically based therapies (85.7%). Among biologically based therapies, the most common one was multivitamins (47.6%) and others were herbs (57.1%) such

as garlic, echinacea, lemon, ginger and natural foods (42.8%) such as quail eggs, honey, probiotics respectively. Mind-based therapies were the second common methods and the frequency of their use ranged between 43.0%-81.7%. Among the most common mind-based therapies prayer was the most frequent (between 37% - 62.3%) and others were relaxation techniques, deep breathing and meditation respectively.

CONCLUSIONS

The results of the study suggested that CAM was used as combined with traditional medicine to control symptoms. Potential interaction with other drugs of CAM modalities indicated that it is high time to question CAM use in clinical follow-ups.

EP446 / #2376**E-Poster Viewing - Nursing AS03-03.
Cardiovascular & haemodynamics****Pressure ulcer prediction in pediatric patients: a machine learning MODAL****E. Ardahan Akgul^{1*}, I. Kaya², H. Yıldırım Sarı¹, S. Özbodur Yıldırım³, O.N. Sariosmanoglu³**¹Katip Celebi University, Department of Pediatric Nursing, Izmir, Turkey²Izmir Katip Celebi University, Department of Biomedical Engineering, Izmir, Turkey³Dr. Behcet Uz Pediatric Diseases and Surgery Training and Research Hospital, Pediatric Cardiovascular Surgery Intensive Care Unit, Izmir, Turkey**BACKGROUND AND AIM**

Pressure ulcers are important health problems that are expensive to treat and require comprehensive care. They increase the likelihood of death and illness and negatively affect the quality of life by causing pain and suffering to the patient. Therefore, it is necessary to prevent the development of pressure ulcers so that the child's comfort does not deteriorate. Gradually human-based clinical decision rule-based algorithms will be replaced with deep learning-based artificial intelligence systems for higher performance, higher repeatability, less dependency on the previous data, and cost-effective advantages, such as health care. This study aims to early predict the pressure ulcer incidence using machine learning modelling and to determine the independent variables.

METHODS

Electronic data records of children who have been hospitalized in the pediatric cardiovascular surgery intensive care unit have been collected retrospectively. Machine learning algorithms such as Artificial Neural Network algorithm were used adopted for modelling and prediction analysis in the SPSS Modeler 18.

RESULTS

The variables that most affected the occurrence of pressure ulcers in children were determined as Braden Q scale score, follow-up time on a mechanical ventilator, lactate dehydrogenase and the partial pressure of oxygen in arterial blood level on the day of surgery, and APACHE 2 score. The algorithm used has given satisfactory results in predicting the occurrence of pressure ulcers in children.

CONCLUSIONS

It is expected that this evidence-based prediction model, coupled with clinical indicators, will increase the early prediction of the occurrence of pressure ulcers in pediatric patients and thus improve the quality of nursing care and outcomes for children before the pressure ulcers develop

EP447 / #2439**E-Poster Viewing - Nursing AS03-03.
Cardiovascular & haemodynamics****Quality-of-life in adolescents with sickle cell
disease in urban ghana: a cross-sectional study.****J. Armah, A. Diji*, J. Dompim, C. Ahoto, H. Budu, C. Poku, E. Boateng***Kwame Nkrumah University of Science and Technology, Department of Nursing, Kumasi, Ghana***BACKGROUND AND AIM**

Impact of Sickle Cell Disease (SCD) on patients is wide-ranging, thus, reducing the quality of life (QoL) of patients and their families to resulting in a high financial drain for the patients and relatives, health systems and the nation. SCD is related to limitations in different aspects of health-related QoL, particularly emotional, physical, social, and school aspects. Determining the QoL of patients with SCD and assess the correlation between socio-demographic characteristics and their quality of life.

METHODS

A cross-sectional study involving 324 adolescents (aged 12–18 years) were selected randomly from Sickle Cell Clinic at the Teaching Hospital in Kumasi, Ghana. The Short Form (SF-36) questionnaire measured areas of physical functioning, role limitations, energy, emotional well-being, social functioning, pain, and general health. Data analysis involved mean, standard deviation, independent sample t-test; and Pearson Product Moment Correlation

RESULTS

Overall, the quality of life was high (Mean = 506.90, SD = 120.918) though with respect to physical functioning it was low (Mean = 55.04, SD = 26.625).

Females reported better quality of life ($M = 516.60$, $SD = 117.12$) than males ($M = 500.43$, $SD = 123.83$). There was a statistically significant negative correlation between age and all domains of quality of life except the energy domain.

CONCLUSIONS

Adolescents with SCD in Ghana were reported to have above average QoL. An all-encompassing, caregiver and adolescent-focused care method with strong emotional support should be established to support SCD patients throughout the period of adolescence.

EP448 / #1329**E-Poster Viewing - Nursing AS03-05. Dermatology****Effect of topical propolis on burn healing in experimental burn MODEL****E. Ardahan Akgul^{1*}, F. Yardimci², D. Demir³, F. Soylu⁴**¹*Katip Celebi University, Department of Pediatric Nursing, Izmir, Turkey*²*Ege University, Department of Pediatric Nursing, Izmir, Turkey*³*Ege University, Faculty of Medicine, Izmir, Turkey*⁴*Ege University, Laboratory Animals Application and Research Center, Izmir, Turkey***BACKGROUND AND AIM**

Pediatric burn is the most common cause of accident-related mortality after motor vehicle accidents and drownings. This study aims to compare and evaluate the effects of 1% silver sulfadiazine, 0.2% nitrofurazone, propolis vehicle and 10% water-soluble and 15% water-soluble propolis on wound healing in the partial-thickness burn wound histopathologically.

METHODS

This randomised controlled clinical trial was conducted in a Laboratory Animals Application and Research Center between September 1-28, 2020. Rats were randomly divided into six groups (control-silver sulfadiazine-nitrofurazone-propolis vehicle-10% water-soluble propolis-15% water-soluble propolis). Rats were anaesthetized before the burn induction. Four contact burns were created and the wound area was measured and recorded and the tissue sample was taken from the wound area and a histopathological examination was performed. ARRIVE Guideline was used in this research.

RESULTS

In the study, the width of the wound areas of rats treated with 15% water-soluble propolis was found to be significantly smaller on the 7th, 14th and 21st days compared to the control group and propolis vehicle group. In histopathological examinations, on the 14th day of the study, a difference in favour of propolis was determined between the groups in terms of fibroblast proliferation, collagenization, fibrosis and mononuclear cells.

CONCLUSIONS

Applying water-soluble propolis to the burn wound of rats seems to have a positive effect on wound healing. To prove the effectiveness of water-soluble propolis on pediatric burn wound healing, it is recommended to repeat the study in larger samples and to investigate whether similar results can be obtained.

EP449 / #521**E-Poster Viewing - Nursing AS03-06.
Development****Interprofessional undergraduate education: a
foundational necessity. Are we ready?****R. Acal Jimenez****Mount Sinai Kravis Children's Hospital, Pediatrics, New York, United States of America***BACKGROUND AND AIM**

The American Association of Colleges of Nursing requires interprofessional communication and collaboration skills as one of the primary components for accrediting undergraduate nursing programs. Similarly, we have witnessed an increase in the number of medical schools requiring IPE competencies.

METHODS

A literature review for existing research on interprofessional education was conducted on both the benefits of IPE as well as examples of its implementation on undergraduate programs. Additionally, we researched related topics such as interprofessional collaboration and teamwork in order to provide background and support to the main subject.

RESULTS

The road to a full integration within our academic institutions has been far from positive. Several studies highlighted how undergraduate and graduate students felt unprepared to communicate effectively with other health professionals. Lack of understanding of roles may lead to conflicts within teams and may have negative effects on patient care. It is reported that at least 20% of residents have serious conflicts with other staff members. Medical and

allied health students may pass their courses and programs and may enter their practical careers with certain perceptions or understandings of other professions that may or may not be accurate.

CONCLUSIONS

Establishing curricula that targets undergraduate students from the different disciplines that contribute to the plan of care for our patients will promote a sense of teamwork and culture of safety. A recent study noted that institutional structures challenge the degree to which this [IPE] can actually be realized. We propose that further research concentrates in looking into understanding the origins of these challenges.

EP450 / #2386**E-Poster Viewing - Nursing AS03-06.
Development****Motor developmental interventions in preterm infants during nicu stay – what do we KNOW?****A. Badura*, S. Wellmann**

University Children`s Hospital Regensburg (KUNO), Hospital St. Hedwig of the Order of St. John, Department of Neonatology, Regensburg, Germany

BACKGROUND AND AIM

Infants born preterm are at risk for neurodevelopmental impairments. Several studies report positive effects of various motor developmental interventions and recommend an early start. In 2016, Hughes et al. (PMID 27638931) analyzed motor developmental interventions and concluded that interventions with specific motor components are most effective. Since then, no review has addressed these specific interventions and it is unclear which motor developmental interventions are evidence based and which underlying frameworks support them especially during NICU stay. To systematically review and discuss state of science on motor developmental interventions involving the whole body during NICU stay of preterm infants from a theoretical and contextual point of view.

METHODS

The research included motor developmental interventional studies published between 2015 and 2022 in MEDLINE (PubMed) database involving preterm infants hospitalized in the intensive care unit. We used snowball referencing to identify relevant studies.

RESULTS

Seven different intervention programs were identified. They all initiated or provided motor developmental therapy during hospitalization, were small in size, including feasibility and pilot trials, and one case study. The most common content were exercises for improving posture. Half of the interventions were family-centered in terms of parent-administered exercises and educational elements. Only four studies described an in-depth theoretical framework.

CONCLUSIONS

Overall there is high variety of concepts and theoretical frameworks for early motor developmental interventions in preterm infants. Yet, based on the published data, it is unclear which interventions have a significant effect for infants and parents. Further data in the context of conceptual approaches are needed.

EP451 / #1118

E-Poster Viewing - Nursing AS03-06. Development

My hospital friend wheely

C. Dyekjær^{1*}, B. Hviid¹, L. Skovholm¹, C.S. Jensen^{1,2}

¹Aarhus University Hospital, Department of Paediatrics and Adolescent Medicine, Aarhus N, Denmark

²Aarhus University Hospital, Research Center For Emergency Medicine, Aarhus N, Denmark

BACKGROUND AND AIM

Paediatric nurses often find that children aged 0-4 years are particularly challenging to support because it is difficult to explain procedures associated with anxiety and pain. We aimed to develop a tool to support this age group in coping during pain full procedures.

METHODS

We launched games introducing "my hospital friend Wheely". The games are played on a tablet attached to a stand on wheels. Around the tablet and at the stand we placed frames to give the child the impression that "Wheely" was a dinosaur. The games use the technologies Augmented Reality and Computer Vision. These technologies enable the child to play the game without having to touch the screen. Our pilot study included 21 children aged six months to five years. The children underwent procedures such as blood sampling, catheter removal, or introduction of anesthesia. Data collection was made by field observations, using the pain score tool FLACC (Face, Legs, Activity, Cry, Consolability), questionnaires and narratives

RESULTS

Our pilot study showed that "Wheely" was easy to use. 16 out of 21 children who tried "Wheely" were distracted or partially distracted. Several factors were

significant whether the distraction was successful. The procedure should take place in a quiet environment, and it was important that parents and health professionals acted calmly and supportively.

CONCLUSIONS

Most children were distracted when they were playing with “Wheely”. The health professionals reported that “Wheely” was easy to use and contributed to support the youngest children to cope with painful procedures.

EP452 / #899**E-Poster Viewing - Nursing AS03-06.
Development****Development of a method for evaluating
emotional responses by skin temperature****T. Ikeda^{1*}, H. Odawara², S. Ajisaka³, S. Miyamoto⁴, K. Kamata¹**¹*Setsunan University, Faculty of Nursing, Osaka, Japan*²*Osaka Metropolitan University, Graduate School of Human Life and Ecology, Osaka, Japan*³*Osaka Metropolitan University College of Technology, College of Technology, Osaka, Japan*⁴*Setsunan University, Department of Architecture, Osaka, Japan***BACKGROUND AND AIM**

Focusing on the fact that emotional responses can be ascertained by measuring skin temperature, the validity of the evaluation method will be examined using a contact-type sensor and a non-contact-type thermography.

METHODS

The subjects were eight university students. Skin temperature was measured in a constant temperature and humidity room using a contact-type temperature sensor and a non-contact-type thermography. The measurement sites were the forehead and the tip of the nose. Pink noise was played as a sound stimulus for 10 minutes. After that, the subjects were instructed to spend 20 minutes wearing an eye mask and earplugs. Pearson's correlation coefficient was calculated by subtracting the nasal tip temperature from the forehead temperature measured by a temperature sensor and a non-contact thermography. The larger the temperature difference between the forehead and nasal tip, the more significant the sympathetic nervous system.

RESULTS

The correlation coefficients of the temperature difference between the forehead and nasal tip of 8 subjects ranged from 0.25 to 0.91 and were statistically significant. There was a mixture of subjects in which the temperature difference between the forehead and the tip of the nose increased due to the sound stimulation, subjects in which the temperature difference increased after the sound stimulation ended, and subjects in which it did not change.

CONCLUSIONS

The results of skin temperature measurements using contact sensors and non-contact thermography showed a correlation. This suggests the possibility that non-contact temperature measurement can be used to understand emotional responses.

EP453 / #771

E-Poster Viewing - Nursing AS03-06. Development

Application and benefits of basal stimulation® in newborns and infants with atypical development

P. Potmesilova¹, M. Potmesil^{2*}

¹Palacky University Olomouc, Department of Christian Education, Olomouc, Czech Republic

²Palacky University Olomouc; Faculty of education, Special Education, Olomouc, Czech Republic

BACKGROUND AND AIM

Basal stimulation (BS) is understood as a rehabilitation concept that supports the sensory functions, communication, and physical abilities of newborns and infants that do not show typical signs after birth. The concept of BS is based on the assumption that the ability to receive stimuli as sensations is possible in any case. The subject of the research was the analysis of available scientific texts following the Joanna Brigs Institute recommendations.

METHODS

A research question was set for the research: "What effect does Basal Stimulation have on the cognitive-behavioral functions or temperament of a preterm or disabled infant?" The following sources were searched: PsycINFO, MEDLINE, PsycArticles, ERIC, Wiley Online Library, ProQuest Scopus, WOS, JSTOR, Google Scholar, and MedNar.

RESULTS

The authors of all selected 10 texts describe the possibilities of applying BS as accessible and effective support and rehabilitation method in the target

group of atypical newborns. BS is a therapy that supports the development of cognitive functions and manifestations of the child's temperament.

CONCLUSIONS

The study brings an important conclusion, the authors prove that – the concept of Basal stimulation can be considered an effective rehabilitation intervention in high-risk pediatric patients

EP454 / #1628**E-Poster Viewing - Nursing AS03-10. Family-centred care****Parents experiences of childhood functional constipation****G. Flanckegård^{1*}, E. Mörelius², P. Rytterström¹**

¹Linköping University, Department of Health, Medicine and Caring Sciences, Division of Nursing Sciences and Reproductive Health, Norrköping, Sweden

²Edith Cowan University, School of Nursing and Midwifery, Joondalup, Australia

BACKGROUND AND AIM

Background: Childhood functional constipation (FC) is a common but serious condition, often ongoing for long periods of time. Treatment regimens include education with life-style adjustments and pharmacological interventions. The knowledge about treatment impact on family life is low. Therefore, there is a need to explore the daily experiences of parents living with a child with functional constipation. Aim: To explore parental experiences of childhood functional constipation

METHODS

Parents of children with functional constipation were interviewed. A phenomenological design with a Reflective Lifeworld Research approach (RLR) was used. The RLR approach describes phenomena as they are experienced and focuses on the narratives of the informants. No dominant theoretical pretext coloured the interviews or analysis.

RESULTS

Making your child to go and take care of their bowels is the central part of everyday life for parents. Demanding treatment situations induces guilt in parents with feelings of abuse. Social life is affected. The impact on everyday life increases with a longer duration of symptoms and disrupts family life. Parents struggle every day for help and understanding from the society as well as within the healthcare system.

CONCLUSIONS

Conclusion

Childhood functional constipation is a great challenge for parents and have a considerable impact on daily living. Understanding aspects beyond the pharmacological treatment might increase healthcare professional's knowledge about the condition and it's challenges. Help and support for parenting a child with FC should be a priority and might hinder some of the common relapses and enable the best parental homecare for children with FC.

EP455 / #2200

E-Poster Viewing - Nursing AS03-10. Family-centred care

“A constant vigilance. Parents’ experiences of being hospitalized in a pediatric ward with their chronically ill child”

M. Jensen¹, C.S. Jensen^{2*}, S. Angel³

¹Aarhus University Hospital, The Department of Paediatrics and Adolescent Medicine, Aarhus N, Denmark

²Aarhus University Hospital, Department of Paediatrics and Adolescent Medicine, Aarhus N, Denmark

³Aarhus University, Department of Public Health- Department of Science In Nursing, Aarhus, Denmark

BACKGROUND AND AIM

Background: Research shows that parents hospitalized with their child are met with high expectations from staff. During the hospitalization, parents act as the child’s primary caregiver and are left with a great deal of responsibility for both care and observations. Especially parents of children with chronic diseases experience a lack of mental surplus when hospitalized with their child. Aim: To explore and describe the experiences of parents hospitalized with their child with a chronic disease in a pediatric ward.

METHODS

Data collection and analysis were inspired by the hermeneutical phenomenological methodology of Max van Manen. Four phenomenological interviews with parents were conducted during their hospitalization and formed the empirical basis of the study.

RESULTS

The parents experienced a need for constantly keeping an eye on the child, being persistent and enduring the situation. Together this places a burden on the parents. Four essential themes emerged from the data analysis: 1) When parents are admitted with their child, everything takes place on the child's terms

2) Parents feel responsible for the safety and security of their child

3) Parents are constantly alert and 4) Parents must find the strength to put reason and necessity before emotions.

CONCLUSIONS

Parents are in a vulnerable position when hospitalized with their child. Moreover, they do not feel seen, heard or understood by staff. This study contributes to increase awareness of the experiences of parents when they are hospitalized with their child.

EP456 / #1313**E-Poster Viewing - Nursing AS03-10. Family-centred care****Educational intervention combined with brief motivational interview to promote self-efficacy for breastfeeding: randomized clinical TRIAL**

K. Lima*, J. Sousa, R. Lima, F. Vasconcelos, L. Brito, R. Melo, L. Barbosa

Federal University of Ceara, Nursing, Fortaleza, Brazil

BACKGROUND AND AIM

Breastfeeding promotes numerous benefits for both mother and baby, but it can become a challenging practice. Therefore, it is necessary educational strategies that promote self-efficacy to breastfeed. This study aimed to evaluate the effectiveness of a flipchart combined with a brief motivational interview in promoting self-efficacy to breastfeed.

METHODS

Randomized clinical trial carried out in the Rooming-in of a Reference Maternity Hospital in Brazil, with 152 postpartum women, 76 in each group, control group(CG) and intervention group(IG). The intervention consisted of the application of a flipchart containing information to promote self-efficacy to breastfeed combined with the brief motivational interview technique. The control group received the usual maternity care. Before the intervention, the Brazilian version Breastfeeding Self-Efficacy Scale Short Form (BSES-SF) was applied. After 120 days, the scale was applied again by phone to measure breastfeeding self-efficacy scores. The differences between the groups were compared by the student's T test. Approval from a Research Ethics Committee was obtained.

RESULTS

Before the intervention, mothers in the IG had self-efficacy scores of 51.01 points, while those in the CG had scores of 57.36. The intervention was applied in the IG and the mothers in the CG received the usual care. After 120 days, the CG self-efficacy scores were 63.5, while the IG participants had scores of 68.9. There was a statistically significant difference in the CG and IG 120 days after the intervention ($p < 0.0001$).

CONCLUSIONS

Intervention with the flipchart associated with brief motivational interviewing was effective in increasing breastfeeding self-efficacy scores.

EP457 / #518

E-Poster Viewing - Nursing AS03-10. Family-centred care

Family room – satisfaction with care after caesarean section

K. Paulauskaitė^{1,2*}, A. Vaškelytė², V. Grigaliūnienė²

¹Hospital of Lithuanian University of Health Sciences Kauno Klinikos, Department of Obstetrics and Gynaecology, Kaunas, Lithuania

²Lithuanian University of Health Sciences, Department of Nursing, Kaunas, Lithuania

BACKGROUND AND AIM

To ensure quality maternal care, early skin-to-skin contact is important and recommended not only after natural childbirth, but also after caesarean section (CS). Family-centred care model was developed, focusing on the installation of a family room (FR) after CS. The aim: To analyse the significance of family room after caesarean section.

METHODS

The research was conducted at the hospital of Lithuanian University of Health Sciences Kauno Klinikos. Research inventory was used to assess satisfaction with the services of care, including the environment, care provided by the staff and provided information, and breastfeeding success. The study involved 140 participants: (65 – FR and 75 – Intensive care unit (ICU)).

RESULTS

Assessing the overall satisfaction with the 10-point system, it was found that women who stayed in FR after birth, assessed their satisfaction with 9.82 ± 0.4 points, who stayed in ICU - with 8.76 ± 1.3 points ($p < 0.001$). Women from

FR were statistically significantly more often satisfied with the cosiness of the room (FR-100%; ICU- 84%), a comfortable bed (FR-98.5%; ICU - 70,7%), the opportunity to be with a newborn's father (FR-93.8%; ICU-24%), also with pain control performed by anaesthesia nurses (FR-98.5%; ICU-85,3%), the assistance of a midwife while breastfeeding (FR-100%; ICU-85,3%) and receiving all answers to the questions in a detailed and comprehensible manner (FR-98.5%; ICU-90.7%), compared with ICU ($p<0.05$). Women who stayed in ICU, had statistically significantly more often breastfeeding-related problems (ICU-58.7%; FR-10,8%), compared with women from FR ($p<0.05$).

CONCLUSIONS

Women who stayed in family room were more satisfied with the services of care, the satisfaction was determined by the possibility of keeping a newborn skin-to-skin, privacy of the family and the possibility of early breastfeeding, these women were less likely to have breastfeeding problems after the surgery.

EP458 / #2517**E-Poster Viewing - Nursing AS03-12. Nutrition****The challenges of teenage mothers in breastfeeding****E. Akansalinkum****Manyia Government Hospital, Midwife, Kumasi, Ghana***BACKGROUND AND AIM**

The challenges of breastfeeding among young mothers in Ghana has become an increasingly concern among parents and health workers. A descriptive research design was used to investigate the challenges of breastfeeding among teenage mothers in the Wiamose community in Ghana and explore the strategies adopted by nursing in relation to breastfeeding

METHODS

The target population of the study comprise of young mothers who have involved themselves in breastfeeding, totaling one hundred and four (104). Since a sample was desired, a sample size of forty-two (42) was selected to represent the population. In this study both primary and secondary data were used as method of data collection. This study used data collection tools which involve questionnaire. As a descriptive survey, statistical tools such as the statistical package for social scientist (SPSS).

RESULTS

The finding suggest in order for young / teenage mothers to breastfeed their babies, mothers require to get positive messages about proper breastfeeding from friends and family members

CONCLUSIONS

This research revealed a good number of the subjects sampled to be very interested in after birth medical care in Ghana. There have been progress and the responded are optimistic that the government and health workers still have to give opportunity to women in the society. I will therefore, recommend women to acknowledge and support themselves whiles finding time to educate the men rather than advocating for gender equality. Policies makers should allow some community members create awareness of teenage mothers to help reduced the stigma against teenage mothers.

EP459 / #866**E-Poster Viewing - Nursing AS03-14.
Haematology, transfusion therapy & oncology****Understanding the perceptions and experiences
of children undergoing chemotherapy and their
caregivers.****T.G. Melesse^{1,2*}, J.P.C. Chau¹, M.A. Yimer³**

¹The Chinese University of Hong Kong, The Nethersole School of Nursing, Hong Kong, Hong Kong PRC

²Debre Markos University, Department of Paediatrics and Child Health Nursing, Debre Markos, Ethiopia

³University of Gondar, Paediatric Haematology-oncology Unit, Department of Paediatrics, Gondar, Ethiopia

BACKGROUND AND AIM

The course of childhood cancer places a significant burden on children and their caregivers. Children receiving chemotherapy experience considerable collateral suffering and psychological impacts in addition to the illness itself. Caregivers also encounter substantial distress and are secondary victims when witnessing their children's suffering amid other psychosocial and economic problems. Thus, this study aimed to explore the perceptions and experiences of Ethiopian children with haematological malignancy undergoing chemotherapy and their caregivers.

METHODS

The study employed a qualitative descriptive study design and took place in the paediatric haematology-oncology unit of the University of Gondar specialised hospital. In-depth face-to-face interviews were conducted among children with haematological malignancies receiving chemotherapy and their caregivers using a maximum variation sampling technique. The interviews

were audio-recorded, transcribed verbatim, and analysed using content analysis.

RESULTS

Data saturation was reached after conducting 15 interviews with children with haematological malignancies receiving chemotherapy and 20 interviews with their caregivers. Six themes emerged: 1) attitude towards the diagnosis and its treatment

2) physical illness and drug side-effects

3) economic impact, 4) psychosocial problems, 5) children and caregiver needs, and 6) coping strategies. The results indicate an urgent need for the improvement of care of children and their caregivers during cancer care.

CONCLUSIONS

Children with haematological malignancies receiving chemotherapy and their caregivers had substantial unmet health care and economic needs. The findings highlight that essential improvements are required in the care of children with haematological malignancies during chemotherapy and their caregivers.

EP460 / #1914**E-Poster Viewing - Nursing AS03-19. Organisation & safety****The challenges of confidentiality: the experiences of young people, and their parents, admitted to children's WARDS****C.S. Jensen^{1,2*}, M. Eg³**¹Aarhus University Hospital, Department of Paediatrics and Adolescents, Aarhus N, Denmark²Aarhus University Hospital, Research Center For Emergency Medicine, Aarhus N, Denmark³Viborg Regional Hospital, Paediatrics and Adolescents, Viborg, Denmark**BACKGROUND AND AIM**

Healthcare professionals play a vital role in safeguarding patient confidentiality. However, evidence shows that breaches in confidentiality are common in hospitals for various reasons related to the environment and staff professionalism. The situation can be complicated further in paediatric care because of the age range of patients and their associated needs and rights regarding information sharing, confidentiality and consent. The aim of the study was to explore the views and experiences of young people admitted to hospital, and their parents, regarding the effects of confidentiality breaches.

METHODS

A descriptive questionnaire-based survey conducted in 2018 in two regional hospitals in Denmark over two weeks. A total of 214 surveys were completed by parents and other caregivers ($n=173$) and by young people ($n=41$).

RESULTS

Parents and young people overheard healthcare professionals discussing care, including information about named patients, test results, personal disclosures and comments or opinions about personalities or treatment plans.

CONCLUSIONS

The study highlights the challenges of preserving confidentiality in in-patient children's units. Situations in which confidentiality breaches were reported appear to be influenced physical environment, such as ward design, and professional attitudes including staff behaviour and attention to discretion and privacy.

EP461 / #1730**E-Poster Viewing - Nursing AS03-19. Organisation & safety****Paediatric intensive care (picu) health care professionals' views on medication interruptions and their management****S. Owen^{1,2*}, J. Menzies³, S. Pontefract⁴**

¹Birmingham Children's Hospital, Paediatric Intensive Care Unit Research, Birmingham, United Kingdom

²Birmingham Health Partners, College of Medical and Dental Sciences, Birmingham, United Kingdom

³Birmingham Children's Hospital, Paediatric Intensive Care Unit, Birmingham, United Kingdom

⁴University of Birmingham, Clinical Pharmacy and Therapeutics, Birmingham, United Kingdom

BACKGROUND AND AIM

Interruptions during the medication process are a key cause of medication errors. A UK PICU audit(2017) identified interruptions in 81% of medication episodes. However, there is a paucity of research exploring Health Care Professionals (HCP) perspectives on interruptions and management. Aim: To explore PICU staff views on interruptions and their management.

METHODS

A survey was developed and disseminated via email to all PICU HCP (n=408) working in a 31bedded UK PICU, with promotion and reminders via a private staff Facebook group. Questions included Likert scales, with the opportunity for free text. The work was registered and approved with University and local NHS governance.

RESULTS

49 responses (12% response rate) were received from Nurses (84% of all responses), Doctors, Health Care Assistants, Pharmacists and 'others'. 90% (n=44) of participants strongly agreed that medication safety research was important. 92% (n=45) recognised interruptions were a significant issue in practice, with 71% (n=35) recognising they had knowingly interrupted. There was variation about when it was acceptable to interrupt (Figure 1). 24% (n=12) felt it was never appropriate, commenting about the frustrations interruptions cause staff. The locally developed phrase "I'm sorry I'm preparing medication. Unless it is an emergency, I will speak to you when I have finished", was felt by 86% (n=42) to be an appropriate blocking strategy.

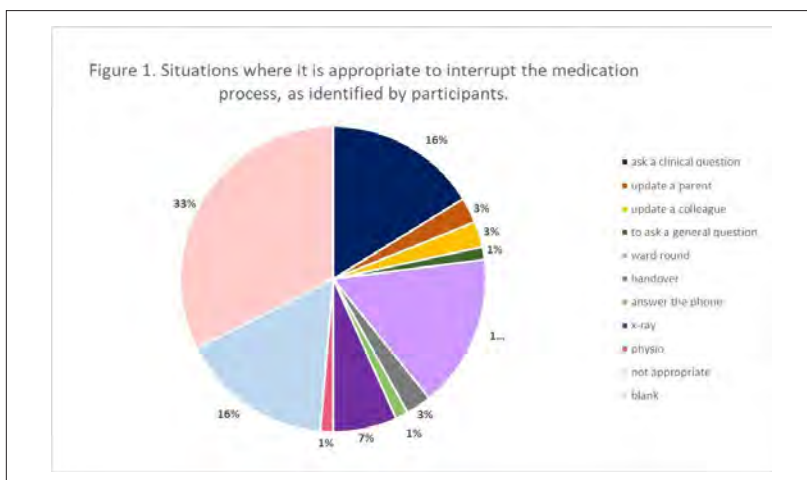

CONCLUSIONS

PICU HCP perceived medication interruptions to be a significant problem. A locally developed strategy was viewed as acceptable; however there was a lack of consensus amongst HCP about when it was appropriate. Further work is required to standardise and embed best practice.

EP462 / #1383**E-Poster Viewing - Nursing AS03-20. Palliative care****A good death, dying on the WARD****W. Leeuwenburgh-Pronk****Emma Children's hospital, Amsterdam UMC, General Paediatrics, H7-274, Amsterdam, Netherlands***BACKGROUND AND AIM**

The Emma Children's hospital multidisciplinary palliative care team provides palliative care both at home and in a university hospital setting. Through case reports we show the procedure from moral counselling to advanced care planning on a general pediatrics ward. We aim to show how this multidisciplinary team consisting of nurses, pediatricians, intensive care doctors, psychologists, social workers provide palliative care in the hospital setting. We provide practical tips for both nurses and doctors involved in palliative care. We show how compassionate care delivered by non-health care workers such as movie makers and professional photographers is implemented in a palliative setting.

METHODS

case reports, parent interviews

RESULTS

State of the art palliative care in the context of a general pediatrics ward in a university hospital. Granting a child's last wish by facilitating a trip outside the hospital provided by a special ambulance, professional movie of a family with a dying child, professional photography of the patient and his/her family members.

CONCLUSIONS

State of the art palliative care requires both excellent team work and outside the box thinking when it comes to granting last wishes and creating memorable memories.

EP463 / #870**E-Poster Viewing - Nursing AS03-22. Primary care****Insomnia symptoms and quality of life in preschool children with severe caries****C. Angelhoff^{1*}, T. Faresjö², A.L. Sundell³**

¹Linköping University, Crown Princess Victoria's Child and Youth Hospital, and Department of Biomedical and Clinical Sciences, Linköping, Sweden

²Linköping University, Department of Health, Medicine and Caring Sciences, Community Medicine, Linköping, Sweden

³Jönköping University, Department of Pediatric Dentistry, Institute For Postgraduate Dental Education, Jönköping, Sweden

BACKGROUND AND AIM

Caries is the most common preventable chronic disease worldwide, causing discomfort and pain, that could lead to stress, insomnia symptoms and poor quality of life. This study aimed to investigate hair cortisol concentration, insomnia symptoms, and health-related quality of life in preschool children with severe caries and to compare these factors with children without clinical signs of caries.

METHODS

Fifteen children with severe caries and 35 controls without clinical signs of caries, aged 3-5 years, were included in the study. Interpreters were used to include families with language difficulties. Dental examination was performed and hair samples for cortisol were taken. The parents completed a health declaration for the child, the Pediatric Insomnia Severity Index, KIDSCREEN-27, and the Child Oral Health-Related Quality-of-Life questionnaire.

RESULTS

Children with severe caries had more insomnia symptoms and poorer oral health-related quality of life than children without clinical signs of caries. We also found that the higher the caries frequency, the more insomnia symptoms as well as poorer oral health-related quality of life. No statistically significant differences were found between the groups in hair cortisol concentration or KIDSCREEN-27.

CONCLUSIONS

Caries in children is correlated with insomnia symptoms and poor oral health-related quality of life. Health care staff who meets the family in health care services must not forget to ask about the child's oral health when examining the child. Anamnesis at the dentist should include children's sleep as insomnia related to caries may lead to several physical, mental, and social problems.

EP464 / #1027**E-Poster Viewing - Nursing AS03-23. Psychiatry & mental health****Parents' experiences and expectations after a child's suicide attempt****V. Grigaliūnienė*, I. Kliūzienė, A. Vaškelytė***Lithuanian University of Health Sciences, Department of Nursing, Kaunas, Lithuania***BACKGROUND AND AIM**

Suicide is a significant issue in Lithuania. Single person's suicide attempt affects 10 to 20 people. Child's suicide attempt impact to relatives is revealed by parents' experiences and expectations. Objective of the study is to reveal parents' experiences and expectations after child's suicide attempt.

METHODS

A qualitative research method and semi-structured interview were used. The study involved 7 parents of children treated at psychiatric clinic after a suicide attempt. Data was coded, divided into subtopics and topics, and interpreted.

RESULTS

Parents' experiences have revealed that child's suicide attempt affects both physical and emotional health. Such an issue affects personal life of parents and other loved ones. The study revealed that parents' expectations relate to both aspects of child and family support. Parents stated lack of child psychological help, as well as help the child return to the educational institution. Professionals in educational institutions are not able to recognize and help with child experience of psychological crisis. The analysis showed lack of parents' psychological help. Shortage of financial support for treatment after

hospitalisation and the fact that parents often must give up work to ensure higher quality childcare. Parents hope for change of stigmatized public attitude towards the person who has attempted suicide and his/her relatives.

CONCLUSIONS

Parents undergo psychological and physical experiences after child suicide attempt. Child's suicide attempt affects parents' personal life. Parents' expectations are focused on the availability and quality of health care services, financial support, public attitude and the readiness of professionals working in educational institutions to provide assistance.

EP465 / #872**E-Poster Viewing - Nursing AS03-23. Psychiatry & mental health****Cognitive-behavioural intervention to improve psychological wellbeing and quality of life among children with haematological malignancies receiving chemotherapy: study protocol for randomised controlled trial.****T.G. Melesse^{1,2*}, J.P.C. Chau¹**

¹*The Chinese University of Hong Kong, The Nethersole School of Nursing, Hong Kong, Hong Kong PRC*

²*Debre Markos University, Department of Paediatrics and Child Health Nursing, Debre Markos, Ethiopia*

BACKGROUND AND AIM

Anxiety and depression are frequently reported among children with cancer. Evidence shows that cognitive-behavioural interventions may help reduce anxiety and depression in paediatric oncology. However, to our knowledge, there is no published study on the impact of cognitive-behavioural interventions on these aspects of functioning in Ethiopia. Thus, this study aims to evaluate the effects of a cognitive-behavioural intervention on anxiety, depression and quality of life among Ethiopian children with haematological malignancies receiving chemotherapy.

METHODS

An assessor blinded, parallel-group, pre-test and post-test randomised controlled trial will be conducted among 80 children (aged 8-18 years) with haematological malignancies receiving chemotherapy. The experimental group will receive five weekly sessions (30-35 minutes each) of a face-to-face cog-

nitive-behavioural intervention containing an introduction to cognitive-behavioural intervention; identifying and challenging maladaptive thoughts and behaviour; behavioural activation; practising deep breathing exercises; reassessing goals or treatment plans, and encouraging participants to maintain changes. The control group will receive usual care. The outcomes will be measured at baseline, post-intervention, and one month after the intervention using the Revised Child Anxiety and Depression Scale and Paediatric Quality of Life Inventory Generic Core Score 4.0.

RESULTS

The results from this study will provide evidence to support the integration of culturally effective cognitive-behavioural intervention strategies into paediatric oncology practice and thus, contribute to the literature and help improve the care of children with haematological malignancies receiving chemotherapy.

CONCLUSIONS

If the intervention proves to be effective and acceptable, it will provide evidence to include a cognitive-behavioural intervention as a standard of care in paediatric oncology.

EP466 / #800**E-Poster Viewing - Nursing AS03-23. Psychiatry & mental health****Intimate partner violence: impact on maternal mental health and neonatal well being.****G. Sashidharan****University Hospitals Coventry and Warwickshire, Neonatal, Coventry, United Kingdom***BACKGROUND AND AIM**

There is published evidence that intimate partner violence is significantly related to adverse maternal and neonatal outcomes 2.5 times risk of preterm delivery and low birth weight; higher levels of depression, anxiety and phobias, miscarriage and late prenatal care. Aim is to enhance the well-being of the neonate and family, by spreading awareness about domestic violence and encourage appropriate actions.

METHODS

Poster displayed throughout the maternity and neonatal unit catalysing heightened awareness of intimate partner violence and encouragement to seek appropriate timely help and support with the contact information highlighted. Regular teaching session for multi-disciplinary teams on how to screen and identify victims for intimate partner violence and sign post for appropriate support.

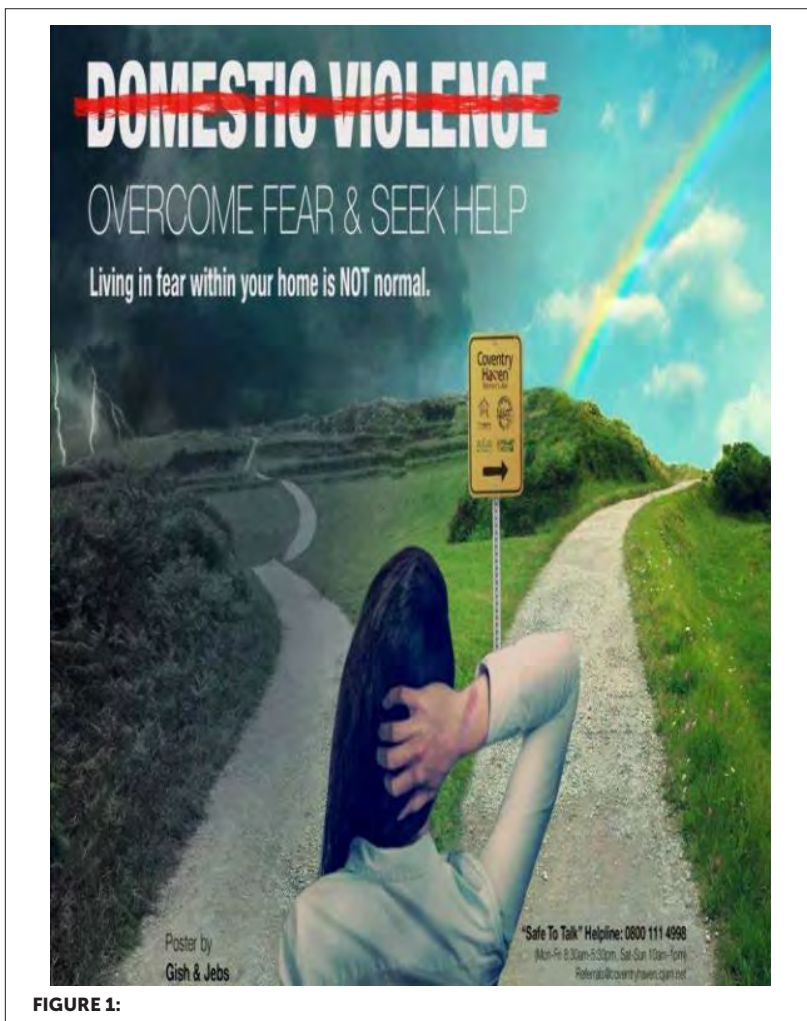

RESULTS

Poster has increased awareness regarding impact of intimate partner violence. It has also assisted as an ice-breaker with few colleagues able to seek help. Safeguarding concern regarding intimate partner violence gets discussed routinely as a part of the booking process for antenatal mothers. In addition health care professionals have also benefited from the resources available to sign post victims to the right organisation. The poster was one of the top three entries at the trust safeguarding awareness event.

CONCLUSIONS

When families subject to violence receive appropriate and timely help, it safeguards healthy outcome for the neonate and family. Health professionals now have a better understanding of the impacts of intimate partner violence and are equipped with the knowledge of right resources to guide the victims to relevant help.

EP467 / #549

E-Poster Viewing - Nursing AS03-24. Public health & social paediatrics

Relationship between the presence of inter-municipal cooperation to provide daycare services for children with mild illness and geographic, financial, and demographic factors

A. Ehara*

Hiroshima International University, Department of Health Services Management, Higashihiroshima, Japan

BACKGROUND AND AIM

In Japan, more than 30% of infants attend general nursery schools during the day. However, these facilities do not accept children that are unwell, even those with mild symptoms such as low-grade fever. Although nurseries for children with mild illness are being developed, these facilities have mainly been established in urban areas, with few located in small municipalities. Some small municipalities work with neighboring municipalities with these facilities to secure access to daycare for children with mild illness for their residents. This study analyzed associations between the presence of inter-municipal cooperation and the geographical, financial, and demographic factors of municipalities depending on such cooperation.

METHODS

Applying a logistic model, the association between the presence of inter-municipal cooperation to provide daycare for children with mild illness and the geographical, financial, and demographic factors of municipalities without nurseries for children with mild illness was investigated.

RESULTS

The reciprocal of the distance to the nearest municipality with such nurseries was positively correlated with the presence of cooperation between municipalities ($P < 0.001$). The capacity of general nursery schools for healthy children had a negative association ($P = 0.010$) with the presence of inter-municipal cooperation. However, the financial indicators of municipalities without nurseries for children with mild illness did not show a significant association with the presence of inter-municipal cooperation.

Table. Geographic, financial, and demographic factors and the presence of inter-municipal cooperation

	Parameter	B (Estimate)	SD	P
Reciprocal of distance* (/km)	a1	10.898	1.417	<0.001
Financial capability indicator	a2	-0.200	0.427	0.639
Ordinary balance ratio (%)	a3	-0.013	0.016	0.421
Capacity of general nursery schools for healthy children ($\times 100$)	a4	-0.042	0.016	0.010
Region				
01 Hokkaido	a5	-1.166	0.595	0.050
02 Tohoku	a6	0.531	0.367	0.148
03 Kanto	Reference			
04 Chubu	a7	1.522	0.326	<0.001
05 Kinki	a8	0.686	0.384	0.074
06 Chugoku	a9	2.853	0.457	<0.001
07 Shikoku	a10	0.841	0.455	0.064
08 Kyushu and Okinawa	a11	1.232	0.340	<0.001
Constant	b	-1.480	1.493	0.321

CONCLUSIONS

Proximity to the nearest municipality with such nurseries had a strong association with the presence of inter-municipal cooperation, albeit with regional differences. However, financial indicators were not related to the presence of cooperation.

EP468 / #1858**E-Poster Viewing - Nursing AS03-26. Quality improvement****Bladder temperature as control temperature in neonates undergoing targeted temperature management: a case report****E. Buccione*, D. Scarponcini Fornaro, S. Palombaro, M. Colonna, D. Gil Mendez, V. Palumbo, L. Di Pietro, S. Di Valerio***Asl Pescara, Neonatal Intensive Care Unit, Pescara, Italy***BACKGROUND AND AIM**

Neonatal Encephalopathy is a condition of disturbed neurologic function in the first days of life in neonates born over 35 weeks of gestation. This condition is associated with a high risk of death or neurodevelopmental morbidity. Targeted Temperature Management (TTM) is a useful way to manage mitigating neurologic sequelae. Several studies defined the positive effects of TTM, but few published studies focused on the best and less invasive site to assess the temperature of neonates during TTM. The aim of the study is to describe the reliability of bladder temperature.

METHODS

A Case Report was performed. A comparison between bladder and rectal temperatures was performed using BD™ Arctic-Sun™5000-Temperature-Management-System wich recorder temperatures each minute.

RESULTS

A total of 4642 records of rectal temperature and 4520 for the bladder one were collected. The rectal average temperature was $34.08\text{ }^{\circ}\text{C} \pm .43$ while for

the bladder site the average was $34.02\text{ }^{\circ}\text{C} \pm .40$ ($P < 0.01$). During cooling phase averages were $33.99\text{ }^{\circ}\text{C} \pm .24$ and $33.94\text{ }^{\circ}\text{C} \pm .25$ for rectal and bladder respectively. In re-warming average temperatures were $35.25\text{ }^{\circ}\text{C} \pm .72$ for rectal and $34.97 \pm .70$ for bladder one. Seems that delta between sites' temperature was not influenced by hourly patient's urine output ($F = .092$, $p = .762$).

CONCLUSIONS

At date isn't clear which temperature's site is better. Bladder temperature seems to have a good reliability and not to be inferior to other sites currently used. A bladder catheter could: reduce devices and related infectious risks; ensure better stabilization reduce treatment's downtime.

EP469 / #1359**E-Poster Viewing - Nursing AS03-26. Quality improvement****Evaluation of an interprofessional simulation education module on preventing and managing neonatal extravasation injuries****J.P.C. Chau^{1*}, S.H.S. Lo¹, V.W.Y. Lee²**

¹The Chinese University of Hong Kong, The Nethersole School of Nursing, Hong Kong, Hong Kong PRC

²The Chinese University of Hong Kong, Centre For Learning Enhancement and Research, Hong Kong, Hong Kong PRC

BACKGROUND AND AIM

Extravasation injuries are largely preventable. An interprofessional simulation module on preventing and managing neonatal extravasation injuries was developed. The module was produced by a team of advanced practice nurses and pharmacists. The learning outcomes include critically examining nurses' actions that contribute to problems associated with the administration of vesicant drugs or solutions and identifying the best practices in preventing and managing newborn babies with peripheral extravasation or fluid extravasation of central venous catheters.

METHODS

All final year nursing students enrolled in a pre-registration nursing programme were invited to attend a 3-hour interactive learning session led by two facilitators. Pre-readings were given to students a week before the session to prepare for the learning activities. Students were encouraged to review the 21 Panopto videos posted on the blackboard after the session. User satisfaction was assessed two weeks post-intervention.

RESULTS

Thirty students completed the 26-item user satisfaction questionnaire. All items had a mean score of over 4.1 (out of 5). The majority of students found the learning resources interesting and useful. Students commented that they learnt more effectively using the learning resources and that the critical thinking exercises helped them better understand real clinical situations. They expressed more confidence in anticipating possible complications associated with high-risk intravenous fluid and medications.

CONCLUSIONS

A better understanding of students' preferred learning methods is essential to help drive a contextual change toward learner-centred education. Acknowledgement This study is supported by the Teaching Development and Language Enhancement Grant, The Chinese University of Hong Kong.

EP470 / #1138

E-Poster Viewing - Nursing AS03-30. Translational research

Computer vision based neonatal behavior stage detection and classification

Á. Nagy^{1,2}, I. Jánoki^{1*}, Á. Zarándy¹, P. Földesy¹, J. Varga³, M. Szabó³

¹Pázmány Péter Catholic University, Faculty of Information Technology and Bionics, Budapest, Hungary

²Institute for Computer Science and Control (SZTAKI), Computational Optical Sensing and Processing Laboratory, Budapest, Hungary

³Semmelweis University, Department of Obstetrics and Gynecology (division of Neonatology Ist Department of Pediatrics), Budapest, Hungary

BACKGROUND AND AIM

Prevalence of sleep disorder in the pediatric population exceeds 30%, in neurodevelopmental disorders 80%, which may worsen further development (Hoban, 2010). Therefore, development-friendly care is very popular and required nowadays. The presented project focuses on classifying the behavior stage of preterm and newborn infants in a neonatal intensive care unit using a novel, camera-based solution utilizing deep neural networks.

TABLE 1:

Demographic properties of the population of participants										
Subject	1	2	3	4	5	6	7	8	9	10
Recording time (hours)	96.7	5.5	39.4	27.4	51	105.5	50.1	36.4	56	38.2
Gender	F	M	M	F	F	M	F	F	F	M
Gestational age (weeks)	32	32+3	31+4	35+4	39	32	33	38+6	24+2	33+4
Birth weight (g)	2020	1840	1850	1870	3150	2120	2080	2840	760	2100
Postnatal age (days)	4	4	10	8	4	7	2	7	11	1
Actual weight (g)	1900	1850	1680	1820	2905	2040	1960	3150	750	-
Length (cm)	46	44	-	45	57	45	44	48	46	45
Head circumference (cm)	32	29.5	-	32	34	30	32	33	22	-
Respiratory support	no	no	no	no	no	no	no	yes	yes	no
Any drugs	no	no	no	no	yes	no	no	yes	yes	yes
Fitzpatrick scale	2	3	2	2	2	2	2	2	2	2

METHODS

The observed and evaluated periods were recorded at the Neonatal Intensive Care Units of the Dept. of Obstetrics and Gynecology, Semmelweis University, Budapest, Hungary. The behavioral stage labeling was done in accordance with "Practical Skills for Family Centred Developmental Care" (Warren et al, 2012). We provide a novel method for classification of the newborn's behavioral phases. Video-based actigraphy by optical flow on different ROIs and other features (like respiration) provide a set of one-dimensional features that are dynamically interpreted by an LSTM-stack.

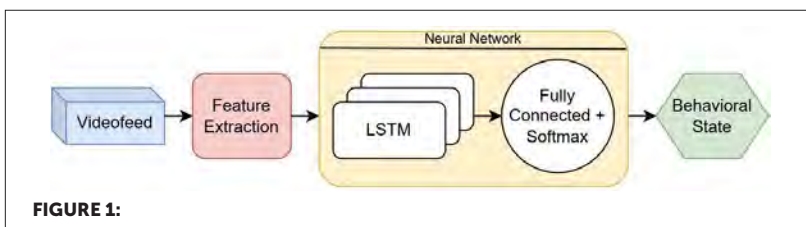

RESULTS

Utilizing the Top-Level Classification Block from Nagy et al, 2019 we first classify empty incubator and caring cases with a sensitivity of 97.9% and specificity of 97.5%. On the rest of the database, the accuracy of the automatic identification of different behavioral phases (quiet sleep, active sleep, drowsy, quiet awake, active awake) is being compared to human decisions and labeling.

CONCLUSIONS

The solution helps the medical staff to optimize the timing of nursing procedures, examinations, and treatments and to minimize stress on the infants.

EP471 / #1602

E-Poster Viewing - Paediatrics AS04-01. Adolescence & transition

Chronic pain experience among adolescents in saudi arabia: “pain is affecting my LIFE”

F. Alsaggaf^{1*}, I. Coyne²

¹Trinity College Dublin, King AbdulAziz University, School of Nursing and Midwifery, School of Nursing, Dublin, Ireland

²Trinity College Dublin, School of Nursing and Midwifery, Dublin, Ireland

BACKGROUND AND AIM

Background: Chronic pain is a health problem that can affect children and adolescents' quality of life. Aim: This paper aims at the adolescents' experience of chronic pain since there is a dearth of pediatric pain research in Saudi Arabia.

METHODS

Multiple case study design was used following Yin's (2018) approach. Purposeful and theoretical samplings were used to recruit adolescents (12 to 18 years old) who had experienced chronic pain and their parents. Data was collected through face-to-face or telephone interviews and were analyzed using 1) constant comparative analysis and

2) cross-case analysis.

RESULTS

Adolescents' experiences of chronic pain were classified into three themes, 1) experiencing chronic pain 2) impact of pain on daily life and

³) chronic pain management. Adolescents' pain was mainly caused by a chronic condition, where musculoskeletal/joint pain, abdominal pain, and headache/migraine were the most prevalent pains. All adolescents explained the impacts of chronic pain on daily life considering the aspects of physical, psychological, and social functioning. Most of the adolescents described the everyday strategies used to manage their pain.

CONCLUSIONS

Pediatric chronic pain is a significant health issue that impacts the daily life of adolescents in Saudi Arabia. Nevertheless, adolescents appeared to use a variety of pain management strategies, so that they could continue with their daily life activities.

EP472 / #807

E-Poster Viewing - Paediatrics AS04-01. Adolescence & transition

Pediatric sapho syndrome – case series of a tertiary UNIT

M. Bastos Gomes^{1*}, I. Cardoso², A.L. Carvalho³, I. Pinto⁴, F. Aguiar⁵, M. Rodrigues⁵, I. Brito⁵

¹Unidade Local de Saúde do Alto Minho, Pediatric Department, Viana do Castelo, Portugal

²Centro Hospitalar de Vila Nova de Gaia/Espinho, Pediatric Department, Vila Nova de Gaia, Portugal

³Hospital de Braga, Pediatric Department, Braga, Portugal

⁴Centro Hospitalar de Trás-os-Montes e Alto Douro, Physical Medicine and Rehabilitation Department, Vila Real, Portugal

⁵Centro Hospitalar Universitário de São João, Pediatric and Young Adult Rheumatology Unit, Porto, Portugal

BACKGROUND AND AIM

SAPHO syndrome (synovitis, acne, pustulosis, hyperostosis, and osteitis), is a rare inflammatory disorder of bone, joints, and skin.

METHODS

The authors present 3 pediatric cases identified in a tertiary care hospital.

RESULTS

A 14-year-old boy was receiving doxycycline for severe nodulocystic acne and presented with left hip pain. On examination, positive sacroiliac joint (SIJ) maneuvers. Studies showed normal blood count, C-reactive protein (CRP) 44.8mg/l; magnetic resonance imaging (MRI) revealed bone marrow edema foci of femoral neck and peri-SIJ, hypointense on T1 and contrast enhanced. SAPHO was diagnosed; indomethacin was successfully added. A 17-year-

old boy with psoriasis presented with mild left upper limb pain, and later anterior chest and left thumb pain, worse at night; no other complaints. On examination he presented swollen painful first left interphalangeal joint, and painful sternoclavicular and manubrium pressure. Workup revealed normal blood count, erythrocyte sedimentation rate (ESR) 17mm/h, CRP 11.4mg/l. MRI demonstrated manubrium-sternal and right clavicle bone marrow edema. Bone-scan was also compatible with SAPHO. He received acetaminophen, with partial response. Step-up to methotrexate and adalimumab was required, with remission. A previously healthy 15-year-old boy was referred due to left hip pain. On examination: positive SIJ maneuvers, exuberant untreated acne on face and trunk. Studies showed normal blood count, ESR 64mm/h and CRP 17.4mg/L. He received NSAIDs and isotretinoin, with progressive improvement.

CONCLUSIONS

The diagnosis of SAPHO syndrome can be difficult, given its heterogeneous clinical features and a diagnosis of exclusion. A high level of suspicion is required, especially in childhood. Early treatment is crucial to improve outcomes.

EP473 / #851

E-Poster Viewing - Paediatrics AS04-01. Adolescence & transition

Nothing about us without us. The voice of paediatric cancer patients and survivors in portugal

T. Sousa, T. Costa*, J. Silvestre

Acreditar, Central Region, Coimbra, Portugal

BACKGROUND AND AIM

Two thirds of the survivors of paediatric cancer, in Portugal, suffer long term effects, one third of these are severe and have a significant impact on their lives. Acreditar has accompanied these patients and survivors for 27 years. Objective: show the importance of involvement of paediatric cancer patients and survivors in the fight for their rights and their quality-of-life improvement.

METHODS

We put patients, survivors, and their families at the centre of problem solving and identification of their needs. Indeed, we held national survivors' meetings to share experiences and created working groups on the daily challenges of survival.

RESULTS

13 young people benefited from psychological support; a long-felt need. School support benefited 52 young people and 24 scholarships were awarded. 89 young people were involved in the working groups where it was held: a) 20 empowerment actions: 150 young people took part; b) Preparation of a white paper on survivorship follow-up; c) Advocacy campaign with the

objective of implementing the right to be forgotten in Portugal: Law Nº 75/2021 of 18 November; d) 71 carers took part in well-being and clarification activities; e) 19 awareness actions; f) Production of a game about paediatric oncology for young people.

CONCLUSIONS

The number of paediatric cancer survivors is increasing and improving their quality of life is essential. Human resources must be allocated to ensure a multidisciplinary and personalized accompaniment. We advocate for the improvement of the transition from paediatric to adult services and for awareness of financial discrimination of survivors in Europe.

EP474 / #1186

E-Poster Viewing - Paediatrics AS04-01. Adolescence & transition

Adolescence and sexually transmitted infections: a silence topic.

B. De andrade*, A. Feio, J. Faria, A. Santos, A. Pereira, P. Fonseca

Centro Hospitalar do Médio Ave, Paediatrics, Vila Nova de Famalicão, Portugal

BACKGROUND AND AIM

Adolescence is usually related to risk-taking behaviours (including sexual behaviours). Sexually transmitted infections due to *Chlamydia trachomatis* (CT) and *Neisseria Gonorrhoea* (NG) have been growing worldwide. There is limited data in adolescents.

METHODS

Retrospective study between January 2017 and January 2022 of laboratory screening for CT and NG (occasional urine sample PCR) ordered in emergency department (ED) and adolescence outpatient consultation (AOC) of a public hospital.

RESULTS

This study included 120 urine samples, with 14 positive results, 10 for CT, 2 for NG and 4 for both infections, corresponding to 12 adolescents (2 reinfections). The prevalence was 11.7%, 92% female, mean age was 15 years. Mean age of onset of sexual activity was 15 years, 67% had conflicting family backgrounds, abusive relationships and scholar absenteeism. of those, 60% were diagnosed in ED and had urinary symptoms. Pregnancy tests were performed, all negative, serologies were also negative. HPV test was positive

in one female. Three reported not using any contraceptive, 58% reported multiple partners (two or more). 50% reported to have tobacco and alcohol abuse and 41% actively consumed cannabinoids. All adolescents with CT infections were treated with azithromycin and NG were treated with azithromycin and ceftriaxone. All cases were followed-up in AOC.

CONCLUSIONS

The frequency of both infections was high; the majority had several risk behaviours and unfavourable social context. The prevalence is in line with global studies, reinforcing the necessity of CT and NG annual screening, effective prevention, and treatment strategies in all sexually active adolescents.

EP475 / #2074

E-Poster Viewing - Paediatrics AS04-01. Adolescence & transition

When being obese and pre-adolescent is a problem

D. Henriques Pinto^{1*}, R. Ramos², M. Santos³

¹Centro Hospitalar Entre Douro e Vouga, Pediatrics, Santa Maria da Feira, Portugal

²Centro Hospitalar Vila Nova de Gaia/Espinho, Orthopedics Department, Unidade 2, Vila Nova de Gaia, Portugal

³Centro Hospitalar Vila Nova de Gaia/Espinho, Pediatric Orthopedics Department, Unidade 2, Vila Nova de Gaia, Portugal

BACKGROUND AND AIM

Childhood and adolescent obesity is increasing worldwide and is associated with an increase in numerous diseases, such as musculoskeletal disorders.

METHODS

Here we present a clinical case of slipped capital femoral epiphysis (SCFE), which is the most common hip disorder in pre-adolescent and adolescent children, but it is not routinely encountered and diagnosis is often delayed.

RESULTS

Clinical case: Nine years old girl with obesity and subclinical hypothyroidism, presented to the emergency department with pain in the right thigh, with inability to bear weight and associated lameness. These complaints had been present for the last month but with recent deterioration. There was no fever, recent infection or traumatic history. On objective examination she presented with pain when mobilizing the right thigh that worsened with rotations and flexion of the hip. Bilateral hip radiography was performed and showed slip-

page of the proximal femoral epiphysis in relation to the neck. These findings are in keeping with SCFE. The patient was treated with in-situ fixation and prophylactic fixation of the contralateral hip, with progressive improvement.

CONCLUSIONS

Slipped capital femoral epiphysis should be a key component of the differential diagnosis of every non-traumatic limp of the adolescent. The frog-leg lateral projection sets the diagnosis of SCFE in the vast majority of cases (irrelevant of slip severity) and should always be requested by the health professional in order to diagnose the non-traumatic pathology of limping adolescent.

EP476 / #1559**E-Poster Viewing - Paediatrics AS04-01.
Adolescence & transition****Assessment of stress level among adolescents of class 12th science, commerce, and arts streams in 6 higher secondary schools of anand, gujarat, INDIA****B. Mungala^{1*}, C. Contractor², H. Parmar³, R. Amrutiya³, D. Sharma³, U.S. Singh³**¹SMT NHL Municipal Medical College, Pediatrics, Ahmedabad, India²B J Medical College, Internal Medicine, Ahmedabad, India³Pramukhswami Medical College, Community Medicine, Karamsad, India**BACKGROUND AND AIM**

Students face a wide variety of stresses like academic, parental, peer pressure, socioeconomic status, and many others. Stress is seen as a negative, cognitive, emotional, behavioral, and physiological process that occurs, as a person attempts to deal with stressors. The study aims to identify and assess the level of stress among 12th standard students.

METHODS

A Cross-Sectional study was done in six higher secondary schools among 303 students from each stream [Science, Arts, and Commerce] by considering gender equality. Educational Stress Scale for Adolescents (ESSA), Patient Health Questionnaire 9 (PHQ 9), and Rosenberg Self-Esteem Scale (RSE) questionnaires were used to assess stress among students.

RESULTS

Analysis was done by using SPSS 15.0 software. 45.2%, 25.0%, and 29.8% were under high stress respectively from Science, Arts, and Commerce stream. There is a strong association between perceived stress and students' academic performance among students of the Science stream. Based on PHQ-9 for assessment of depression, 38.0% of students showed minimal depressive symptoms, 21.5% showed major depression with mild severity, 4.3% of students had major depression with moderate severity, 0.7% had major depression with severe severity. Whereas 21 students of the Arts stream perceived high stress, 76.2% living in urban areas (Cronbach's alpha=0.774 and 0.734 for ESSA and RSE respectively).

CONCLUSIONS

Students of the Science stream perceived the most stress; reasons are pressure from study, worry about grades, workload, and despondency. As the stress level increases, there is an increase in depressive symptoms as well as a decrease in self-esteem seen.

EP477 / #2639**E-Poster Viewing - Paediatrics AS04-01.
Adolescence & transition****Socio demographic determinants of measures of
cognitive function of early adolescent students in
abuja, nigeria****V. Nwatah^{1*}, P. Ahmed¹, L. Audu², S. Okolo³**¹National Hospital Abuja, Department of Pediatrics, Abuja, Nigeria²Barau Dikko Teaching Hospital, Kaduna State University, Department of Pediatrics, Kaduna, Nigeria³Jos University Teaching Hospital, University of Jos, Department of Pediatrics, Jos, Nigeria**BACKGROUND AND AIM**

The brain during early adolescence undergoes enhanced changes with radical reorganisation of the neuronal network while complex interplay exists between environment and genetics that influences the outcome of intellectual capability. We therefore aimed to evaluate the relationship between socio-demographic variables and measures of cognitive function of early adolescents.

METHODS

The study was a descriptive cross-sectional study of early adolescent aged 10 to 14 years. Ravens Standard Progressive Matrices (RSPM) was used to assess the intelligence quotient and academic performance was assessed by obtaining the average of all the subjects' scores in the last three terms that made up an academic year. A confidence interval of 95% was assumed and a p-value of < 0.05 was considered statistically significant.

RESULTS

The overall mean (SD) age of the study population was 11.1years (± 1.3) with male to female ratio of 1:1. Female sex was associated with better academic performance with p-value of 0.004. The students with optimal IQ performance were more likely (61.7%) to perform above average than those with sub-optimal IQ performance (28.6%). As mother's age increased, the likelihood of having optimal IQ performance increased 1.04 times (OR = 1.04; 95CI = 1.01 to 1.07). Student in private schools were three times more likely to have optimal IQ performance than those from public schools (OR = 2.79; 95CI = 1.65 to 4.71).

CONCLUSIONS

The present study demonstrated that students' IQ performance and gender were associated with above-average academic performance. The predictors of optimal IQ performance found in this study were students' age, maternal age and school type.

EP478 / #1070

E-Poster Viewing - Paediatrics AS04-01. Adolescence & transition

Team project: consensus recommendations for transition from pediatric to adult medicine in patients with metabolic bone diseases

G. Pintos-Morell^{1*}, S. Chocron-Benzaquen², P. Arango-Sancho³, R. Bou-Torrent⁴, A. Barreda-Bonis⁵, Y. Olmedilla-Ishishi⁶, B. Soler-López⁷, C. Gómez-Alonso⁸, E. Casado-Burgos⁹

¹University Hospital Vall d'Hebron, Hereditary Metabolic Disorders, Barcelona, Spain

²University Hospital Vall d'Hebron, Pediatric Nephrology, Barcelona, Spain

³Hospital Sant Joan de Déu, Pediatric Nephrology, Barcelona, Spain

⁴Hospital Sant Joan de Déu, Pediatric Rheumatology, Barcelona, Spain

⁵Hospital Universitario La Paz, Pediatric Endocrinology, Madrid, Spain

⁶Kyowa Kirin Farmacéutica, S.L., Medical Manager, Madrid, Spain

⁷E-C-BIO, Estudios Científicos, Directora Médica, Madrid, Spain

⁸Hospital Universitario Central de Asturias, Metabolismo Óseo Y Mineral, Oviedo, Spain

⁹Hospital Universitari Parc Taulí, Servei De Reumatologia, Sabadell, Spain

BACKGROUND AND AIM

Currently, there are no clearly defined transition models for patients with rare metabolic bone diseases (MBD), such as hypophosphatemic rickets. The objective of the TEAM project was to assess how the Spanish units manage the transition of patients with MBD, and to elaborate consensus recommendations for a transition program for pediatric patients to adulthood.

METHODS

A group of experts in pediatric and adult MBD developed the project, which was completed in the following phases: Systematic literature review, identification of critical points during the transition period, production of a questionnaire afterward distributed through the related scientific societies, according

to the following sections: a) justification of the transition program and time of initiation, b) model and transition plan, c) information, d) documentation and education, and elaboration of consensus recommendations. The project was authorized by a local Ethics Committee.

RESULTS

86 physicians belonging to 53 Spanish centers and 8 scientific societies participated. Consensus was reached on 45 of the 48 questions, except for two statements about the adequacy and feasibility to start the transition program at 12 years of age, and one on the feasibility of the preferred transition model in each respective environment. The main barriers to the transition process were the lack of resources and coordination between the Pediatric and Adult departments. Finally, an algorithm was designed to facilitate the transition process.

CONCLUSIONS

The TEAM project provides a global view of the status of transition in Spain, with practical recommendations for the implementation of the Pediatric to Adult Medicine transition in patients with MBD.

EP479 / #1609

E-Poster Viewing - Paediatrics AS04-01. Adolescence & transition

A rare cause of primary amenorrhea in adolescence – case report

A. Rodrigues*, L. Torres, I. González, R. Oliveira

Unidade Local de Saúde da Guarda, Pediatrics, Guarda, Portugal

BACKGROUND AND AIM

Primary amenorrhea occurs when there is an absence of menses at age 15 with secondary sexual characters or at age 13 without any secondary sexual character. Amenorrhea is result of one or more dysfunctional organs such as the hypothalamus, pituitary, ovaries, uterus or vagina.

METHODS

clinical case

RESULTS

A fifteen-year-old adolescent was referred from allergology (asthma/rhinitis follow-up) to pediatric evaluation because of primary amenorrhea. In pediatric evaluation, it was found that her mother's menarche occurred at age 15 and no other particularities were detected in her clinical history. The objective examination revealed an overweight adolescent with a weight inside 50-85 percentile, a height in 15 percentile and no other changes. As such, extensive analytical study and abdominal ultrasound were requested. Two months later, the analysis was completely normal and ultrasound described: "slightly globose ovaries with some cystic structures; few intercepted segments of the rudimentary uterine area, to be compared with pelvic magnetic resonance

imaging for correct locoregional uterine characterization". Thus, pelvic resonance imaging and a gynecology evaluation was requested. One month later, the resonance imaging described: "unidentified uterus. Ovaries of normal characteristics." So, primary amenorrhea was caused by a nonexistent uterus. Her karyotype was 46,XX and endocrinology evaluation was requested.

CONCLUSIONS

In this adolescent, the diagnosis of Rokitansky-Mayer-Hauser Syndrome was possible through resonance imaging. This exam is essential not only for the diagnosis but also for the exclusion of malformations, like nephro-urological, which are often associated. This case shows the importance of a complete medical history regardless of the reason for the specialized consultation.

EP480 / #657

E-Poster Viewing - Paediatrics AS04-02. Allergy & immunology

The use of different brands of adrenaline auto-injector among caregivers of children with food allergies: a cross – sectional descriptive STUDY

C. Cronin^{1*}, C. Okelly², H. Keohane¹, L. Flores Villarta², J. Trujillo Wurttele^{1,2,3}

¹University College Cork, Department of Paediatrics and Child Health, Cork, Ireland

²Cork University Hospital, Paediatrics, Cork, Ireland

³Cork University Hospital, Infant Research Centre, Cork, Ireland

BACKGROUND AND AIM

The aim of this study is to explore the usage of different brands of adrenaline auto-injector among caregivers of children with food allergy in Ireland.

METHODS

This is a cross-sectional descriptive study that will be conducted in the Cork University Hospital (CUH). Caregivers of children with food allergies for which an AAI has been prescribed will complete an online questionnaire. They will then demonstrate how they would use the AAI their child carries and assessed via video call.

RESULTS

75.5% of caregivers carried an Epipen®, while 16.6% carried Jext® and 7.9% carried Anapen®. No caregiver carried Emerade®. 48.3% of those surveyed had switched between brands of AAI at least once. 62.2% of those who had switched brands of AAI did not receive training in the administration of the

new AAI. 72.1% (44) of caregivers preferred Epipen®. 76.19% were unable to show how to successfully administer the AAI. Chi-squared analysis did not show a significant difference between the success rates of the different brands of AAI ($p = 0.4$).

CONCLUSIONS

Switching brands is a common occurrence with almost half of those surveyed having switched brands at least once. This is the first study in Ireland to assess the administration of different brands of AAI in parents of children with allergies. This study illustrates the importance of training caregivers in all available brands of AAI, as it has been shown that AAI administration performance decreases after switching brands. Further study should explore educational interventions for AAI use and the effects of AAI brand switching.

EP481 / #1942

E-Poster Viewing - Paediatrics AS04-02. Allergy & immunology

Insulin resistance in children with asthma

V. Cvejaska Cholakovska*

University Children's Hospital, Pulmonology and Allergology, Skopje, North Macedonia

BACKGROUND AND AIM

Obesity increases the risk of asthma and asthma severity and is a well-known risk factor for insulin resistance. The aim of the study was to evaluate insulin resistance with the homeostasis model assessment-insulin resistance (HOMA-IR) index in children with asthma, and to correlate with parameters of obesity – body mass index (BMI), waist circumferences (WC), waist to hips ratio (WHR).

METHODS

Prospective study with 112 children aged 7-17 years was performed at the University Children's Clinic, Skopje, N Macedonia. The patients were divided in three groups, the overweight group - 41 overweight children, the asthma group - 38 children with asthma and normal BMI, and the overweight + asthma group - 33 overweight children with asthma. BMI was calculated according to the standard formula. For abdominal obesity assessment, WC was measured and then WHR was calculated. HOMA-IR indices was calculated using standard formulas.

RESULTS

There is no significant association between the groups and the age differences ($p=0,46$), sex ($p=0,71$), premature birth ($p=0,71$), and breast feeding ($p=0,53$). Levels of BMI, WC, WHR, HOMA-IR were significantly higher in overweight

group ($p < 0,001$) as well as overweight with asthma group compared to asthma ($p < 0,05$) with no significant differences between them. After adjustment with sex and age, a significant positive strong correlation was observed between insulinemia and BMI in overweight ($r = 0,384$) and asthma group ($r = 0,603$). Significant strong correlations were found between HOMA-IR with BMI in asthma group ($p = 0,0001$).

CONCLUSIONS

Overweight has been shown to be a major driver of metabolic changes, hyperinsulinemia, insulin resistance in children with asthma.

EP482 / #498

E-Poster Viewing - Paediatrics AS04-02. Allergy & immunology

Optimising administration of nasal corticosteroids

T. De Vries^{1*}, C. Rollema², E. Van Roon²

¹Medical Centre Leeuwarden, Paediatrics, Leeuwarden, Netherlands

²Medical Centre Leeuwarden, Clinical Pharmacy and Pharmacology, Leeuwarden, Netherlands

BACKGROUND AND AIM

Worldwide, about 8% of all children suffer from allergic rhinitis. Although nasal corticosteroids (NCs) are helpful, many patients report reduced effectivity or side effects. We therefore wanted to know if patients administer NC correctly and what the quality of knowledge was about NC administration of three sources (health care workers (HCWs), patient information leaflets (PILs) and instructional videos on the internet (IVI)).

METHODS

First, we made a distinction between all and essential steps for administration of NC sprays (1). Secondly, we analysed the quality of the administration technique performed by patients, by HCWs and in IVI. (1

2

3) Thirdly, we studied the instruction steps in PILs, available in the UK. (4)

RESULTS

Four out of 64 patients (6%) performed all administration steps correctly, and seven patients (11%) the essential ones. of 75 HCWs, none performed all steps correctly; 27 HCWs (36%) showed the essential steps. None of the 33 IVI studied showed administration correctly, five IVI (15%) displayed over

75% of the steps correctly. The PILs varied in advices, none described all steps correctly.

CONCLUSIONS

Only few patients administer their NC spray correctly. This might be negatively influenced by the absence of clear and uniform instructions. Improvement is necessary. In our country, we published the correct administration technique of NC sprays on the website of the Lung Alliance Netherlands, an organisation that develops standardized protocols for correct use of inhalers. (5) Furthermore, we made an age-adjusted instruction video. (6) This work was mainly performed by Corine Rollema. 1 Rollema C. *J Asthma Allergy*. 2019;12:91-94. 2 de Boer M. *BMJ Open*. 2020;10(8):e037660. 3 Peters-Geven MM. *JMIR Med Educ*. 2020;6(2):e23668. 4 Rollema C. *BMJ Open*. 2019;9(1):e026710. 5 Lung Alliance Netherlands. Inhaler use - Corticosteroid nasal spray. <https://inhalatorgebruik.nl/nl/home>. 2022. URL: https://inhalatorgebruik.nl/contents/uploads/gebruiksaanwijzingen/123_1.patientenkaart-corticosteroid-neusspray-def.pdf 6 Ter Laak S. *Allergol Immunopathol*. 2020;48(5):465-468.

EP483 / #1917

E-Poster Viewing - Paediatrics AS04-02. Allergy & immunology

Frequent anaphylaxis treated with omalizumab in a patient with nsaid-exacerbated respiratory disease.

A. Devolder-Nicolau^{1*}, D. Encarnación², J. Casas², B. Suriñach-Ayats³, L. Armendáriz Lacasa⁴, G. Garcia Del Cerro⁵, S. Boronat-Guerrero⁶

¹Hospital de la Santa Creu i Sant Pau, Pediatric Nephrology, Barcelona, Spain

²Hospital de la Santa Creu i Sant Pau, Pediatrics, Barcelona, Spain

³Hospital de la Santa Creu i Sant Pau, Neonatology. Pediatrics Department, Barcelona, Spain

⁴Hospital de la Santa Creu i Sant Pau, Paediatrics Department, Barcelona, Spain

⁵Hospital de Sant Pau, Department of Paediatrics, Barcelona, Spain

⁶Hospital Sant Pau., Paediatric, Barcelona, Spain

BACKGROUND AND AIM

NSAID-exacerbated respiratory disease (NERD) refers to the combination of asthma, chronic rhinosinusitis, nasal polyposis and acute respiratory tract reactions to ingestion of aspirin/NSAIDs. The pathophysiology is not fully understood. There appears to be a dysregulation of arachidonic acid metabolism resulting in an imbalance between proinflammatory and anti-inflammatory mediators. The first manifestation is rhinitis, typically in the third decade. Asthma tends to appear 2 years later, followed by nasal polyposis and NSAID-reactions 4 years later. These reactions are dose related, ranging from mild (nasal congestion) to severe anaphylactic-like cases. Treatment with monoclonal anti-IgE antibodies (Omalizumab) has shown to reduce the use of relief medication, being unclear the mechanism as the disease is not IgE-mediated.

METHODS

Case report.

RESULTS

We report the case of a 17-year-old male with NERD, frequent anaphylaxis and pseudoallergic reactions requiring corticosteroid treatment. Between ages 13-17 he presented several anaphylactic episodes confirmed by tryptase levels, associated with fish, paracetamol, IBP or metamizole ingestions, requiring ICU admission twice due to acute respiratory failure. He also presented frequent pseudoallergic reactions after NSAIDs intake, covering from rhinitis to abdominal pain. Total IgE was elevated with negative NSAID, paracetamol, pneumoallergens or food specific IgE. Other immune or hematological diseases were ruled out. Omalizumab was started due to severe asthma and steroid-dependence to control allergic reactions. Since then he hasn't presented any clinical exacerbations or allergic reactions, allowing the steroid-treatment to be stopped.

CONCLUSIONS

Every asthmatic patient with rhinitis/nasal polyposis and frequent clinical exacerbations should undergo a detailed clinical history to explore the presence of intolerance to NSAIDs.

EP484 / #1933

E-Poster Viewing - Paediatrics AS04-02. Allergy & immunology

Microbiota and potential asthma markers: a case control study in a sample of egyptian children

E. Abdelhamid¹, A.S. El Refay¹, A.A. Elkhatib^{1*}, S. El Nagar², L. Sherif¹, N. Mehanna³

¹National Research Centre, Child Health, Cairo, Egypt

²El Azhar University, Pediatric, Cairo, Egypt

³National Research Centre, Food and Dairy Microbiology, Cairo, Egypt

BACKGROUND AND AIM

It is well known that allergy development is linked to alteration in microbiome and cytokines levels. Colonization of children gut by wide array of microbes and bacteria is associated with systemic and mucosal immune responses as well as allergy development. Investigating the role of gut microbiota and serum cytokines clarifies the pathophysiology of the disease and enhance development of management plan. This study aimed to assess fecal microbiota in asthmatic children, and correlate it with serum CXCL8 and P38 as potential asthma severity markers.

METHODS

Study was conducted on 56 asthmatic children aged 2-8 years, and 20 non asthmatic children of matched age and sex as a control group. Fresh stool samples were obtained from enrolled children for analysis of gut microbiota through DNA extraction and Real time PCR, using species-specific primers, serum IL8 and P38MAPK levels were estimated by ELISA.

RESULTS

Study showed higher level of Bifidobacterium and lower level of Lactobacillus in asthmatic compared to non-asthmatic children, current results showed significant difference between asthmatic and non-asthmatic subgroups regarding IL 8 serum level. Study reported significant negative correlation between presence of asthma and serum markers CXCL8 and P38MAPK while significant positive correlation between presence of asthma and Bifidobacterium Log.

CONCLUSIONS

the association between IL8 level, P38 and microbiome suggesting a link between gut bacteria and inflammatory status. Moreover, elevated IL8, and P38 level increase symptoms severity. The alteration of microbiome level associated with elevated markers level suggesting the protective role of gut microbiome in asthma control.

EP485 / #1463

E-Poster Viewing - Paediatrics AS04-02. Allergy & immunology

Un unusual case of macrophage activation syndrome

L. Gianolio^{1*}, A. Sala¹, A. Mari¹, F. Zunica², V. Giudici², V. Fabiano¹, G.V. Zuccotti¹

¹University of Milan - Vittore Buzzi Children's Hospital, Department of Pediatrics, Milan, Italy

²Vittore Buzzi Children's Hospital, Department of Pediatrics, Milan, Italy

BACKGROUND AND AIM

Macrophage activation syndrome (MAS) is usually defined as a potentially life-threatening complication of rheumatic disorders, most commonly systemic juvenile idiopathic arthritis. However, due to its clinical heterogeneity, an early diagnosis remains challenging, although fundamental for a successful treatment. Our aim is to describe a case of MAS with undefined etiology at the moment.

METHODS

Clinical case description.

RESULTS

N.K., an 8-year-old female, arrived to our attention for a 5-month history of right eyelid oedema and a new-onset migrant rash. At medical evaluation appeared feverish; previous pathological and familiar history was unremarkable. An intravenous antibiotic therapy with ceftriaxone was started without effects on fever trend; at the 10th day of hospitalization a diffuse petechial rash was noticed. Blood tests revealed worsening PCR, ferritin and triglycer-

ides values associated with significantly abnormal liver function and coagulation profile; blood-count revealed mild anemia and thrombocytopenia. Infectivological investigations excluded acute infections and immune-rheumatological analysis revealed mild positivity of antinuclear antibodies. Chest X-ray, abdomen and cardiac ultrasounds resulted normal. Considering clinical and laboratory hints suggestive of MAS diagnosis, intravenous high-dosage corticosteroids were started, and then switched to immunoglobulin with transient success; a dramatic response was obtained only after the administration of the IL-1 inhibitor, anakinra. Genetic analysis for primary hemophagocytic lymphohistiocytosis was performed and resulted negative.

CONCLUSIONS

Although classically associated with rheumatological disorders, our case highlights that a MAS diagnosis should be considered also in patients without clear or suspected signs of rheumatological conditions. In fact, an early recognition remains the cornerstone of therapeutic success.

EP486 / #1629

E-Poster Viewing - Paediatrics AS04-02. Allergy & immunology

A 5-year retrospective study of children hospitalized with food allergy in a secondary hospital of central greece

D. Grammenou^{1*}, E. Valavani^{1,2}, E.-I. Vourli¹, I. Tassiou¹,
A. Anastasiou-Katsiardani¹

¹General Hospital of Volos Achillopouleio, Pediatrics, Volos, Greece

²University of Edinburgh, Usher Institute, Edinburgh, United Kingdom

BACKGROUND AND AIM

Background: Food allergies are adverse immunologic responses to foods and can be IgE or non-IgE mediated. Worldwide, food allergy prevalence ranges from 1–10%. Clinical manifestations include gastrointestinal, cardiovascular, respiratory, cutaneous and ocular symptoms and signs. Aims: The presentation of patients' characteristics and food allergy treatment.

METHODS

We analyzed data from patients hospitalized due to food allergies from January 2017 to December 2021.

RESULTS

Thirty patients were included in the study (mean age:4 years, 70% male) with a diagnosis of anaphylaxis(73%) or urticaria(27%). Seventy-one percent had a past medical history of atopy and 4% had past hospitalizations due to food allergy. Eggs, nuts and fish were the most common causes reported, with a frequency of 20%, 37% and 7% respectively. Among patients diagnosed with

anaphylaxis, 59% were presented with cutaneous and respiratory manifestations and 41% with cutaneous and gastrointestinal manifestations. Half of the patients diagnosed with urticaria received medication with antihistamines and corticosteroids. Patients diagnosed with anaphylaxis received intramuscular epinephrine, corticosteroids, antihistamines and a combination of all of them with a frequency of 41%, 77%, 91% and 32% respectively. One of the patients was deceased. Eighty-three percent of the patients were subsequently referred to a pediatric allergist.

CONCLUSIONS

The majority of the patients admitted to our department due to food allergy were diagnosed with anaphylaxis, but epinephrine was only administered to a fraction of them. Therefore, pediatricians should be alert to immediately identify the symptoms and signs of anaphylaxis, so that the right treatment is administered at the right time.

EP487 / #2435

E-Poster Viewing - Paediatrics AS04-02. Allergy & immunology

Digeorge syndrome: clinical and immunological features

M. Ouederni¹, T. Lamouchi^{2*}, S. Rekaya¹, I. Ben Fraj¹, M. Said¹,
R. Kouki³, M. Bejaoui¹, F. Mellouli¹, M. Ben Khaled¹

¹University Tunis ElManar, Faculty of Medicine, TUNIS, Tunisia

²Bone Marrow Transplant Center, Pediatrics, Tunis, Tunisia

³Centre National De Greffe De Moelle Osseuse, Pediatrics, Tunis, Tunisia

BACKGROUND AND AIM

DiGeorge Syndrome (DGS) is a primary immunodeficiency disease caused by a 22q11.2 deletion and characterized by various degrees of T-cell deficiency. The triad of features on presentation: conotruncal cardiac anomalies, hypoplastic thymus, and hypocalcaemia support the diagnosis. The aim of our study is to describe the clinical and immunological features of the syndrome.

METHODS

Medical records of seven patients with DiGeorge Syndrome were retrospectively reviewed. The diagnosis was made on the presence of 22q11.2 deletion for all patients.

RESULTS

RESULTS

The study included 6 males and 1 female with DGS. Patients were diagnosed at the medium age of 9 months (1-18). Clinical features were mild facial

dysmorphism (n=4), seizures (n=2), cyanosis (n=1), stridor (n=1), pulmonary infections (n=2), cutaneous infections (n=1) and congenital heart defect (n=3). Three patients had hypocalcemia. The thymus was not seen on all patients' chest X-rays. A low T-cell number was found in three patients associated with an inverted CD4/CD8 ratio. B-lymphocyte counts were normal. Mitogen-induced proliferative responses of lymphocytes were low for all patients. No autoimmune manifestations were seen. At the last follow-up, two patients are alive, aged 9 months and 14 months respectively. They are infection-free with resolved hypocalcemia. Five patients died from infectious diseases.

CONCLUSIONS

CONCLUSION

Di George syndrome is the third primary immunodeficiency in the world but rare in our country. Prognosis depends on the severity of the immune deficiency and associated complications such as hypocalcemia and heart disease.

EP488 / #1937

E-Poster Viewing - Paediatrics AS04-02. Allergy & immunology

Allergy to cow's milk proteins: search for ige specific to cow's milk special case of a polyallergic infant.

S. Mamouzi^{1*}, F.Z. Souid¹, D. Dahlouk²

¹Central Army Hospital of Algeria, Immunology Department, Algiers, Algeria

²Central Army Hospital of Algeria, Pediatric Department, Algiers, Algeria

BACKGROUND AND AIM

Cow's milk protein allergy (CMPA) is defined by an immunological reaction to one or more milk proteins. It is responsible for a variety of symptoms, involving the skin, the digestive tract and sometimes the respiratory tract. Our objective is to respond to requests for exploration of IgE-mediated CMPA, in the event of discrepancy with the results of the Prick Test.

METHODS

Mediwiss AlleisaScreen is an immunoblot based on an immunological reaction thus quantitatively determining the disposition of allergen-specific IgE in human serum.

RESULTS

On a cohort of 88 children aged between 1 and 3 years, 26 were positive CMPA: F2 and Casein.

Among them, an infant had in addition a positivity for alpha-lactalbumins, beta-lactoglobulins.

At the age of 1 year he presents a refusal of food, and a persistent cough.

The 2-year follow-up found positive specific IgE to mites, shrimp, egg white and egg yolk.

CONCLUSIONS

CMPA has a good prognosis with recovery before the age of 10 for the majority.

However, they are at risk of developing other allergic manifestations, food, respiratory, rhinitis. The monitoring of specific IgE concentrations over time is essential to allow the reintroduction of milk.

EP489 / #2426

E-Poster Viewing - Paediatrics AS04-02. Allergy & immunology

An unconventional approach of tubulointerstitial nephritis and uveitis – case report

R.-G. Miulescu^{1*}, A. Dinulescu², D. Păcurar³, A. Voicu⁴, F. Şandru⁵, G. Ion²

¹University of Medicine and Pharmacy "Carol Davila", Pharmacology, Bucharest, Romania

²"Grigore Alexandrescu" Emergency Hospital for Children, Paediatrics, Bucharest, Romania

³Paediatrics, "Grigore Alexandrescu" Emergency Hospital for Children, Bucharest, Romania, Paediatrics, Bucharest, Romania

⁴SCUC "Grigore Alexandrescu" Hospital, Pediatric, Bucharest, Romania

⁵University of Medicine and Pharmacy "Carol Davila", Bucharest, Romania, Dermatology, Bucharest, Romania

BACKGROUND AND AIM

Tubulointerstitial nephritis and uveitis (TINU) represents a non-granulomatous ocular inflammatory syndrome, with renal impairment and it is yet underdiagnosed. Usually, ocular inflammation and renal function respond to corticosteroids or immune modulation, but the rate of recurrences is high. In this paper, we focused on the mechanism of the disease, and the possible cross-reactions between gliadin (and different food allergens) and tissue antigens.

METHODS

We present a case of a 11-year-old male, who was diagnosed with TINU. The patient received conventional therapy, but the acute episodes persisted. So, we reconsidered the mechanism of the disease, thinking what else can we do for a chronic nephropathy of unspecified etiology, which has not improved on treatment. The suspicion of immunological damage is maintained, especially due to the association with uveitis.

RESULTS

New theories about inflammatory diseases in children are based on different food allergies, as mentioned before. So, we performed an type III Ig G food allergies test and we excluded the foods involved from the diet. After 3 months, the proteinuria and hematuria improved and uveitis disappeared.

CONCLUSIONS

Virtually, any leaky gut trigger can initiate an immune conflict. What type of hypersensitivity or what organ is involved depends on the genetics of the patient. The path of recovery is the same of that of disease, but in reverse. Healing means helping the immune system do what it needs to do according to the information in the DNAd.

EP490 / #1543

E-Poster Viewing - Paediatrics AS04-02. Allergy & immunology

Not always atopic dermatitis

J. Oliveira^{1*}, I. Vivas², D. Pinto^{1,3}, F. Teixeira^{1,3}, A.R. Araújo^{1,3}

¹Centro Materno Infantil do Norte, Centro Hospitalar Universitário do Porto, Pediatrics, Porto, Portugal

²Centro Hospitalar Póvoa de Varzim e Vila do Conde - Portugal, Pediatrics and Neonatology, Póvoa de Varzim, Portugal

³Centro Materno Infantil do Norte, Centro Hospitalar Universitário do Porto, Pediatric Allergology, Porto, Portugal

BACKGROUND AND AIM

Atopic dermatitis (AD) is a highly prevalent skin condition affecting almost 20% of children worldwide. The diagnosis is mostly clinical based on the morphology of the skin lesions. This diagnosis is therefore dependent on the practitioner knowledge and it is always fundamental to remember the differential diagnosis when facing a patient with lesions that might mimic AD.

METHODS

We present 2 cases of children that were referred to a paediatric allergologist consultation with the suspected diagnosis of AD that was refractory to treatment.

RESULTS

The first case is a 2 months infant that, since the first month of age, had diffuse scaling skin lesions with the presence of vesicopustules on the palms and soles. When further investigated it was noted that an uncle with whom he had contact was diagnosed with scabies and after starting 5% permethrin cream the infant presented a significant improvement of the skin lesions. The

second case is a 11-year-old boy that presented with symmetrically distributed pruritic lesions with significant impact on the quality of life. The skin biopsy confirmed the diagnosis of prurigo nodularis. This patient was initially treated with topical and systemic medication and is currently under treatment with dupilumab with near complete remission of the disease.



FIGURE 1:



FIGURE 2:



FIGURE 3:

CONCLUSIONS

These 2 cases are important to recall the importance of a thorough physical examination and that even though the diagnosis of AD is clinical it is important to remember the differential diagnosis when patients do not improve with treatment or present with atypical manifestations.

EP491 / #2165

E-Poster Viewing - Paediatrics AS04-02. Allergy & immunology

Severity scoring of atopic dermatitis (scorad index) and bronchial hyperreactivity in children

A.C. Pantazi^{1,2*}, T. Chisnoiu^{1,2}, C. Mihai^{1,2}, A. Balasa^{1,2}, L. Mihai^{1,2},
C.E. Frecus^{1,2}, A. Ungureanu¹, V. Cuzic^{1,2}, A.D. Pinzaru^{1,2}

¹Ovidius University of Constanta, Faculty of Medicine, Constanta, Romania

²Constanta Clinical Emergency Hospital, Pediatrics Department, Constanta, Romania

BACKGROUND AND AIM

Atopic dermatitis (AD), allergies and bronchial hyperreactivity are frequent pathologies in pediatric activity. Using severity score for atopic dermatitis (SCORAD index) we can anticipate the evolution of respiratory episodes.

METHODS

During a five-year period (January 2016 - January 2021) 156 patients diagnosed with AD were admitted to the Pediatrics Department of Constanta Clinical Emergency Hospital for bronchial hyperreactivity and included in our study. SCORAD index at presentation, total and specific Immunoglobulin E and eosinophil count were included as definitory elements of atopy as well as the atopic family history. Chronic diseases and malformations were the main exclusion criteria.

RESULTS

The mean age at admission was 2.3 ± 2.7 years and 68% were male. According to SCORAD index three groups were established: Group I (59,3%) with severe clinical manifestations, Group II (25,1%) with moderate clinical manifestations

and Group III (15,6%) with mild symptoms. Group I presented severe symptoms (polypnea, tachycardia, irritability, fever, dehydration, abdominal pain) compared with other groups. The hospitalization period was higher in Group I (36 hours) compared with other groups. Immunoglobulin E mean value for Group I was 352 IU/ml, for Group II 123 IU/ml and for Group III 86 IU/ml. A significant correlation was established ($p=0.002$) between eosinophil count and SCORAD index. In all groups, SCORAD index significantly decreased after the respiratory episode.

CONCLUSIONS

Using the SCORAD index the evolution of a respiratory episode could be anticipated and treated to prevent atopic events. Correlating SCORAD index, Immunoglobulin E and eosinophils values we can appreciate the clinical evolution of a respiratory episode in patients with bronchial hyperreactivity.

EP492 / #707**E-Poster Viewing - Paediatrics AS04-02. Allergy & immunology****Paediatric immunological screening for children with medical complexity****S. Ricci*, L. Lodi, M. Calamini, G.M. Poggi, C. Azzari***Meyer Children's Hospital, Pediatric Immunology, Firenze, Italy***BACKGROUND AND AIM**

Children with medical complexity(CMC) have chronic pathological condition(>12 months)that affects more than one organ or just one organ, but which nonetheless determines the need for high-level specialist care and often admission to a tertiary centre.The complex chronicity of these children is also strongly aggravated by the high number of infections, both community and nosocomial, which are a major cause of morbidity and mortality.The increased susceptibility of these patients to frequent and severe infections is commonly attributed to the presence of devices, swallowing deficits, structural abnormalities of the upper respiratory tract,neuromuscular problems, malnutrition or frequent hospitalizations. However, the presence of genomic or chromosomal defects or causative monogenic mutations may explain underlying immune defect associated with a syndromic clinical picture.This study aims to characterize the immunological characteristics of CMCs followed at the Meyer Children's Hospital in Florence.

METHODS

This is a retrospective observational cross-sectional study in which paediatric patients defined as CMC followed at the Meyer Children's Hospital in Florence from June 2016 to June 2020 were included in the study.

RESULTS

123 children were included in the present work. We identified 22 cases (17.9%) characterized by complex immunodeficiency, 77.3% presented both humoral and cellular defects (CID) and 22.7% presented common variable immunodeficiency (CVID) phenotype. Among these, 72.7% required prophylactic therapy: immunoglobulin replacement therapy (18.1%), antibiotic prophylaxis (18.1%), or both of the above (18.1%). All patients, if necessary, received individualized vaccination schedule.

CONCLUSIONS

This study demonstrates that CMC may have underlying immune deficits that are often misrecognised and therefore should need paediatric immunological assessment throughout their follow-up, being able to benefit from personalised follow-up.

EP493 / #2243**E-Poster Viewing - Paediatrics AS04-02. Allergy & immunology****Acceptance, safety and tolerability of neocate® syneo® in cmpa infants: egypt experience**

S. Shaaban^{1*}, A. Hamdy¹, M. Amin², H. Hussein³, A. Emil⁴, O. El-Asheer⁵, A. Mahfouz⁶, S. Gad⁷, T. Barakat², S. Tawfik⁸, M. Abozekri⁴, G. Bebars⁹

¹Ain Shams University, Department of Pediatrics, Cairo, Egypt

²Mansoura University, Department of Pediatrics, Mansoura, Egypt

³Zagazig University, Department of Pediatrics, Zagazig, Egypt

⁴Cairo University, Department of Pediatrics, Cairo, Egypt

⁵Assiut University, Department of Pediatrics, Assiut, Egypt

⁶Alexandria University, Department of Pediatrics, Alexandria, Egypt

⁷Suez Canal University, Department of Pediatrics, Ismailia, Egypt

⁸Military Medical Academy, Department of Pediatrics, Cairo, Egypt

⁹Minya University, Department of Pediatrics, Minya, Egypt

BACKGROUND AND AIM

Cow's milk protein allergy (CMPA) is one of the most prevalent immune-mediated food allergies in early life. Neocate® SYNEO® is a hypoallergenic formula for infants up to 12 months of age. An early experience programme gathered insights into its tolerability, completeness of the preparation information and the overall clinical experience.

METHODS

Insights were gathered using two questionnaires and case studies conducted over six months in 34 CMPA patients.

RESULTS

Patients transitioned to Neocate® SYNEO® over 1-7 days and regular follow-ups showed marked improvements in gastrointestinal symptoms, skin manifestations, weight gain and tolerance to foods like eggs, fish, fruits, vegetables, and nuts. Hematochezia persisted in some patients. Change in stool colour was observed in 53% of patients, softer stools in 32%, and diarrhoea in 26%. The formula was associated with the successful reintroduction of antigenic proteins that patients were previously sensitised to. About 97% of parents were able to correctly follow the preparation guidelines. Healthcare providers recommended a gradual transition to Neocate® SYNEO® upon diagnosis of CMPA and the use of room temperature/tepid water for preparation since higher temperatures may destroy the probiotics.

CONCLUSIONS

Neocate® SYNEO® can benefit CMPA patients not responding to hydrolysed or other amino acid-based formulas. It contains prebiotics and probiotics and is nutritionally complete. An improvement in symptoms with subsequent improvement in sleep quality and immunity were reported after the transition to Neocate® SYNEO®. Palatability was comparable with other hydrolysed or amino acid-based formulas, but with better acceptance. Clinical trials evaluating gut microbiota, gastrointestinal symptoms, and long-term outcomes are warranted.

EP494 / #1243**E-Poster Viewing - Paediatrics AS04-02. Allergy & immunology****The collapsed infant – a rare cause: food protein-induced enterocolitis syndrome (fpies)****S. Sheridan*, N. Jameel, A.M. Murphy***University Hospital Limerick, Paediatrics, Co Limerick, Ireland***BACKGROUND AND AIM**

Food protein-induced enterocolitis syndrome (FPIES) is a non-IgE mediated food allergy. It's presentation is variable from vomiting and diarrhoea to severe metabolic derangement and shock. Our aim is to report the case of an infant who presented in a collapsed state due to FPIES.

METHODS

We describe the clinical presentation, results of haematological, metabolic and radiological investigations, management and outcome of our patient to date.

RESULTS

A 4 week old term male infant presented to the emergency department resuscitation area with hypovolaemic shock on a background of diarrhoea and vomiting from birth and two days of lethargy and poor feeding. He is the firstborn child of healthy Libyan parents, with an unremarkable perinatal history. He was severely acidotic (pH 6.8) with hyperchloraemia (141mmol/L), hypernatraemia (150mmol/L) and raised inflammatory markers. He was initially treated for sepsis. Subsequent investigations revealed methaemoglobinaemia (24%) and hyperammonaemia (118 μ mol/L). He was transferred to PICU and

managed with intravenous methylene blue and exchange transfusion until his methaemoglobin levels normalised. His amino acid and acylcarnitine profile reflected a malnourished child with low amino acids and ketosis. Further metabolic and radiological investigations were normal. A diagnosis of FPIES was made and he was commenced on extensively hydrolysed formula. Currently, age 6 months, he is developmentally normal and thriving. He will need an in-hospital cow's milk protein trial in the future.

CONCLUSIONS

The commonest causes of collapse in an infant include sepsis, cardiovascular, metabolic and surgical pathology. We suggest that the diagnosis of FPIES also be considered after other diagnoses are excluded.

EP495 / #2768**E-Poster Viewing - Paediatrics AS04-02. Allergy & immunology****Role of booster dose in a x-linked agammaglobulinemia adolescent sars-cov-2 infected**

M. Stracuzzi^{1*}, C. Vanetti², M. Clerici³, G.V. Zuccotti⁴, D. Trabattoni², V. Giacomet¹

¹università degli studi di milano, Pediatric Infectious Disease, Milano, Italy

²Chair of Immunology, Department of Biomedical and Clinical Sciences, Università Degli Studi Di Milano, Milan, Italy, Milano, Italy

³Chair of Immunology, Department of Pathophysiology and Transplantation, Università Degli Studi Di Milano, Milan, Italy, Milano, Italy

⁴University of Milan - Vittore Buzzi Children's Hospital, Department of Pediatrics, Milan, Italy

BACKGROUND AND AIM

A very limited amount of data is present in literature on SARS-CoV-2 infection in X-Linked Agammaglobulinemia (XLA) patients. Moreover, it remains unclear the role of vaccination against SARS-CoV-2 in these subjects.

METHODS

We investigated immune response of a mild symptomatic SARS-CoV-2 strain BA.2 (B.1.1.529.2) infected XLA 12 years old male, vaccinated with booster dose during acute infection (AI) and after one month post COVID-19 diagnosis (PI).

RESULTS

B cell compartment was compromised (CD19+ 0,004*10³/mL, 0,2%). No NTA was found against Omicron. No significant differences in CD4+ and

CD8+ T effector memory (CD4+/CCR7-/CD45RA-, CD8+/CCR7-/CD45RA-) and central memory (CD4+/CCR7+/CD45RA-, CD8+/CCR7+/CD45RA-) lymphocytes were observed in unstimulated compared to SARS-CoV-2-specific cells at AI. In contrast with these data, SARS-CoV-2-specific IFN γ -producing CD8+ T lymphocyte were increased compared to the unstimulated condition. We treated our patient with Xevudy (Sotrovimab) monoclonal antibodies. According to the monoclonal antibodies infusion, at PI high level of NTA was found against Omicron (1:60) variants. A moderate increment of SARS-CoV-2-specific IFN γ -producing CD8+ T lymphocyte and degranulating CTL were detected when compared to the unstimulated condition. Notably, a robust increment in CD4+ and CD8+ central memory T lymphocytes was detected at PI compared to AI.

CONCLUSIONS

Due to the lack of the NTA in AI and the observation that virus-specific memory T cell was only seen at PI, we conclude that the booster dose of COVID-19 vaccine was unable to trigger a relevant immunological protection in this patient. The absence of BTK have a role in mitigate symptoms by impairing IL-6 production.

EP496 / #561**E-Poster Viewing - Paediatrics AS04-02. Allergy & immunology****Rupatadine treatment in childhood allergic rhinitis****T. Tansavatdi*, B. Dardaranonda***Faculty of Medicine, Burapha university, Department of Pediatrics, Chonburi, Thailand***BACKGROUND AND AIM**

Allergic rhinitis is a common allergic disease and has higher prevalence every year. Treatment included drugs that inhibit mediators from allergic inflammation. Rupatadine is anti-histamine and anti-PAF that several studies in children aged ≥ 12 years and adult showed the efficacy equal or better than other anti-histamine drugs. Studies in children aged < 12 years showed the efficacy and safety for treatment but did not compare with other anti-histamine drugs. Objective: To study the efficacy of Rupatadine compared with Cetirizine for treatment of Allergic Rhinitis in children aged 6-11 years.

METHODS

Study in 24 allergic rhinitis patients aged 6-11 years attended at Allergy clinic, Burapha university hospital, Faculty of Medicine, Burapha university that divided into 2 groups by random sampling. Group 1 received Rupatadine 5 mg. OD and group 2 received Cetirizine 5 mg. OD for 2 weeks. Symptoms score, nasal airway resistant and peak inspiratory flow rate were recorded before and after received the medicine 2 weeks.

RESULTS

There were 10 patients received Rupatadine and 14 patients received Cetirizine. After finish the 2 weeks of medicine, patients had better Symptom score, NAR, PNIF in both groups but only symptom score had statistical difference. To compare the improvement of Symptom score, NAR, PNIF between the two groups founded that the Rupatadine group had better Symptom score and PNIF improvement but statistics not difference.

CONCLUSIONS

Rupatadine had tendency of better efficacy in Symptom score and PNIF than Cetirizine. Further study in larger samples needed for the conclusion.

EP497 / #2319**E-Poster Viewing - Paediatrics AS04-02. Allergy & immunology****A common drug, with an uncommon clinical manifestation****D. Valente-Silva^{1*}, L. Leite De Almeida², A. Maia³, S. Jacob¹**¹*Centro Hospitalar Universitário de São João, Pediatrics Department, Porto, Portugal*²*Centro Hospitalar Universitário de São João, Pediatrics, Porto, Portugal*³*Centro Hospitalar e Universitário São João, Department of Pediatrics, Porto, Portugal***BACKGROUND AND AIM**

Drug hypersensitivity reactions (DHR) include allergic, exaggerated pharmacologic reactions to medications that result from an enhanced immunologic or inflammatory response. They are responsible for 6-10% of all adverse reactions to drugs. Nonsteroidal anti-inflammatory drugs (NSAIDs) are a widely used class of drugs. However, the prevalence of DHR in general population is still unknown.

METHODS

A 12-year-old male, with no previous medical history, was referred to our hospital due to four episodes of sudden vesiculobullous rash of tegument with bullous detachment of the epidermis and mucous membranes (conjunctival, oral). They all occurred after self-limited fever periods, and in all episodes he was given paracetamol and ibuprofen. No other symptoms were present.

RESULTS

An etiological investigation was carried out, and the main infectious and autoimmune causes were excluded. Drug allergy was considered, but oral food

challenge to paracetamol was negative. Then, a lymphocyte transformation test to ibuprofen was performed, which was positive.

CONCLUSIONS

The present case report describes an exuberant vesiculobullous rash of the tegument and mucous membranes as a hypersensitivity reaction to ibuprofen. Stevens-Johnson Syndrome (SJS) and toxic epidermal necrolysis (TEN) are life-threatening, bullous cutaneous diseases. They are characterized by epidermal necrosis and extensive detachment of the epidermis, due to immune-mediated reactions to drugs. This rare case report addresses the fact that severe hypersensitivity reactions can occur with Ibuprofen, which can be potentially dangerous. It is thus important for the clinicians to be alert to such severe hypersensitivity reactions, even with drugs which are deemed to be safe.

EP498 / #924**E-Poster Viewing - Paediatrics AS04-03.
Cardiovascular & haemodynamics****Improvement in maximal oxygen consumption
after a physical exercise program in child
survivors of acute lymphoblastic leukemia
undergoing chemotherapy**

**R. Álvarez Pérez^{1*}, J. Manchola-González², J.R. Serra-Grima³,
I. Badell Serra⁴**

¹Hospital de la Santa Creu i Sant Pau, Pediatric Cardiology, Barcelona, Spain

²Universitat Internacional de Catalunya, Physiotherapy, Barcelona, Spain

³Hospital de la Santa Creu I Sant Pau, Cardiology, Barcelona, Spain

⁴Hospital de la Santa Creu I Sant Pau, Pediatric Hematology. Hematopoietic Transplant Unit, Barcelona, Spain

BACKGROUND AND AIM

Acute lymphoblastic leukaemia (ALL) is one of the most common cancer in children. The standard treatment and the disease itself may impair cardiac function with a decrease of patients' physical fitness. The objective of this study was to evaluate the positive effect of exercise on physical fitness after a home-exercise programme in children diagnosed with ALL.

METHODS

A assessor-blinded, randomised controlled trial was conducted at the Sant Pau Hospital (Department of Pediatrics) at Barcelona (Spain). Patients survivors of ALL included were between 7 and 17 years. They had completed their chemotherapy treatment and were in complete remission for a minimum of 1 year. Patients with structural or functional cardiac abnormality were excluded. Twenty-four patients were assigned to usual care or to a home-exercise program. Peak oxygen uptake, minute ventilation, output of carbon

dioxide, respiratory exchange ratio, peak heart rate, maximal load, VO₂ at anaerobic threshold, pulse oxygen, heart rate at anaerobic threshold, left ventricular ejection fraction, mitral E-wave velocity, mitral A-wave velocity, E/A ratio, tissue Doppler of the lateral and septal mitral and tricuspid annulus and Tei index were measured at baseline and over 16 weeks of intervention.

RESULTS

Adjusted mixed linear models revealed a significant group-time interaction + 6.7 (95% CI = 0.6–12.8 ml/kg/min; η^2 partial = 0.046, $P = 0.035$) for VO₂peak.

CONCLUSIONS

The home-exercise programme resulted in significant changes in VO₂peak. This study show that exercise is a key tool for patients diagnosed of ALL to recover their physical fitness after medical treatment, facilitating the resumption of their daily activities.

EP499 / #1017**E-Poster Viewing - Paediatrics AS04-03.
Cardiovascular & haemodynamics****Arterial stiffness indices, pulse wave velocity and central pulse pressure, are able to discriminate obese and non-obese children**

**J. Bittencourt*, G. Scheinbein, G.K. Gonçalves,
M.G. Rodrigues-Machado**

Faculdade Ciências Médicas de Minas Gerais, Post-graduate Program In Health Sciences, Belo Horizonte, Brazil

BACKGROUND AND AIM

Premature vascular aging is one of the complications of obesity. Aim: To verify whether arterial stiffness indices are able to discriminate obese children from non-obese children.

METHODS

Arterial stiffness indices were non-invasively assessed by the Mobil-O-Graph, which incorporates the ARCSolver method capable of reconstructing the central or aortic pulse wave, from the brachial oscillometric pressure by applying a transfer function. The indices evaluated were pulse wave velocity (PWV), central systolic blood pressure (SBPc) and central pulse pressure (PPc).

RESULTS

The sample consisted of 78 eutrophic children (8.1 ± 1.96 years) and 58 obese children (9.0 ± 1.87 years). The groups were similar in terms of sex and age ($p=0.400$ and $p=0.060$, respectively). PWV, PPc and SBPc were significantly higher in the group of obese children (4.40 ± 0.26 m/sec; 31.41 ± 4.83 mmHg

and 95.51 ± 7.75 mmHg, respectively) when compared with the control group (4.19 ± 0.27 m/sec; 30.00 ± 5.30 mmHg and 88.29 ± 7.04 mmHg, respectively). ROC curve analysis showed AUC: 0.729 (95%CI: 0.645– 0.813), sensitivity: 0.931, specificity: 0.590 and cutoff: 4.09 m/sec for PWV and AUC: 0.744 (95%CI: 0.661 – 0.827), sensitivity: 0.931, specificity: 0.551 and cutoff: 86.17 mmHg for SBPc. ROC curve for PPc did not show good discriminatory capacity between the two groups.

CONCLUSIONS

Obese children presented premature aging of the arterial system, evaluated by the main arterial stiffness indices. Cutoff points of PWV > 4.09 m/s and SBPc > 86.17 mmHg were associated with a higher risk of obesity. These results show that the simple, fast and non-invasive measurement of arterial stiffness, adds prognostic information on cardiovascular risk beyond the increase of body mass index.

EP500 / #389**E-Poster Viewing - Paediatrics AS04-03.
Cardiovascular & haemodynamics****Familial pseudo-recessive long qt syndrome: a
three-generation tunisian pedigree****N. Bouayed Abdelmoula^{1*}, B. Abdelmoula²**¹Medical University of Sfax, Genomics of Signalopathies At The Service of Medicine, Sfax, Tunisia²Medical University of Sfax, Genomics of Signalopathies At The Service of Medicine, SFAX, Tunisia**BACKGROUND AND AIM**

Congenital long QT syndrome (LQTS) is a familial cardiac channelopathy characterized by ventricular arrhythmias associated with syncope, seizure or sudden death. Despite the 16 associated genes and the many molecular forms (LQTS1 to LQTS16), 20% to 25% of LQTS remain genetically elusive and heterogeneous phenotypes remain challenging. Here, we report a 3-generation pedigree of a LQTS Tunisian consanguineous family.

METHODS

A consanguineous couple was referred to our genetic counselling to genetically explore congenital LQTS in all offspring. Clinical and family history for over three generations was taken.

RESULTS

The index case was a 6-month-old girl who had a post-term delivery with oligohydramnios complication and C-section. LQTS electric diagnosis was confirmed at 3 months, for her as well as her 3 and 5 year-old sisters. In the large family, a LQTS recessive form appeared in only consanguineous unions. The last generation included 3 children with recurrent syncopal episodes and

seizures. In the second generation, there was no history of diagnosed LQTS except a case of a sudden death in a 30-year-old man.

CONCLUSIONS

LQTS is the most common cause of arrhythmic death in children and causes 8-10% of unexplained fetal end. Oligohydramnios may be a significant marker to predict abnormal heart tracings in post-term pregnancies and accurate family history is important to establish transmission patterns. The reported family seems to have a pseudo-recessive pattern of LQTS transmission considering the frequent consanguinity. Prenatal diagnosis and anticipatory postnatal care improve the outcome of LQTS in children and predict risk of sudden cardiac death in familial pedigrees.

EP501 / #391

E-Poster Viewing - Paediatrics AS04-03. Cardiovascular & haemodynamics

Genetics of familial left ventricular noncompaction cardiomyopathy in sfax, tunisia

N. Bouayed Abdelmoula^{1*}, B. Abdelmoula²

¹Medical University of Sfax, Genomics of Signalopathies At The Service of Medicine, Sfax, Tunisia

²Medical University of Sfax, Genomics of Signalopathies At The Service of Medicine, SFAX, Tunisia

BACKGROUND AND AIM

Left ventricular noncompaction cardiomyopathy (LVNC) is a genetic cardiac disease characterized by the presence of pronounced intertrabecular spaces into the left ventricle chamber leading to a distinct "non-compacted" layer in the myocardium. LVNC familial forms may be isolated or syndromic and are related to heterozygous genetic mutations. Here, we reported 2 Tunisian familial pedigrees of LVNC.

METHODS

This study included 2 families of LVNC patients. A clinical genetic assessment as well as cytogenetic exploration were performed for all patients.

RESULTS

Two families harbouring a syndromic form of LVNC were recorded. Septal defects, patent ductus arteriosus, and Ebstein's anomaly were the most prevalent congenital heart defects in these patients. In the first family, the index case, born from a first degree consanguineous family, presented a syndromic LVNC with pseudo-Down dysmorphic features and other congenital malformations. Her sibling presented short stature, retinal dystrophy, nystagmus,

sluggish, severely decreased visual acuity and photophobia. Moderate mental retardation and ataxia were noted in the case index, her sister and brother. In the second family, the index case and his sibling born from healthy distant consanguineous parents presented LVNC associated with arrhythmia/conduction disorders with paroxysmal ventricular fibrillation and a marfanoid habitus. Left ventricular noncompaction with sudden death among his siblings as well as other familial cases of sudden death were recorded.

CONCLUSIONS

LVNC is a genetically heterogeneous congenital disorder that can occur in association with other cardiac or noncardiac anomalies. Children with LVNC often have an increased familial prevalence, associated facial dysmorphism, and increased concurrence of congenital arrhythmias.

EP502 / #1330**E-Poster Viewing - Paediatrics AS04-03.
Cardiovascular & haemodynamics****Assesstment of cardiac function in pediatric
oncological patients undergoing chemotherapy
treatment**

**E. Aurensanz¹, P. Cassanello^{1*}, P. Garcia-Canadilla², S. Cesar¹,
M. Gorostegui³, J. Sanchez-De-Toledo¹**

¹Hospital Sant Joan de Déu Barcelona, Department of Pediatric Cardiology, Esplugues de Llobregat, Spain

²Institut de Recerca Sant Joan de Déu, Cardiovascular Diseases and Child Development, Esplugues de Llobregat, Spain

³Hospital Sant Joan de Déu, Department of Pediatric Oncology, Esplugues de Llobregat, Spain

BACKGROUND AND AIM

Advances in oncological therapies have significantly improved patients' outcomes; However associated toxicities remain a challenge. The aim of this study is to analyse early chemotherapy-induced cardiac dysfunction in pediatric oncological patients.

METHODS

Prospective study including pediatric patients treated with chemotherapy in our institution from 2019-2022. Systolic and diastolic function was assessed by echocardiography upon initial diagnosis (T1) and after completing chemotherapy (T2), Cardiac parameters included: "Mitral E/A, E'/A', E/E'", pulmonary vein (S/D), maximal left atrial volume indexed to body surface area (LAVi) and left ventricular ejection fraction (LVEF). Cardiac function parameters were correlated with proBNP and troponin values.

RESULTS

41 patients were included, age 8 ± 5.48 years, 56.1% males, 37% had solid tumors, 63% hematologic. Follow-up 6.3 ± 1.7 months.

TABLE 1:

	T1	T2	p-value
LAVi (ml/m ²)	17.9 ± 3.6	16.6 ± 3.3	0.080
E/A	2.1 ± 0.9	3.6 ± 1.7	<0.001
E/E'	6.8 ± 3.1	0.9 ± 0.9	<0.001
LVEF (%)	70 ± 5.9	68 ± 4.6	0.026
S/D	1.1 ± 0.2	1.1 ± 0.3	0,410
proBNP (ng/L)	360 ± 123	226 ± 65.4	0.041
Troponin (ng/ml)	0.004 ± 0.005	0.018 ± 0.4	0.60
Systolic blood pressure (BP) SD	0.8 ± 1.1	0.2 ± 0.8	0.004
Diastolic BP SD	1.6 ± 0.9	1.2 ± 0.8	0.052

CONCLUSIONS

Our study showed preserved systodiastolic function of the left ventricle in pediatric oncological patients receiving chemotherapy. Further studies encompassing larger oncological pediatric cohorts should focus on describing mid and long term cardiovascular risk factors.

EP503 / #1957**E-Poster Viewing - Paediatrics AS04-03.
Cardiovascular & haemodynamics****The chiari network: an embryonic remnant causing intermintent hypoxemia in a 2-months old infant.**

P. Cassanello^{1*}, B. Moscoso², J. Carretero¹, F. Zuccarino³, S. Congiu², J. Mayol², J.M. Caffarena-Calvar²

¹Hospital Sant Joan de Déu Barcelona, Department of Pediatric Cardiology, Esplugues de Llobregat, Spain

²Hospital Sant Joan de Déu Barcelona, Department of Pediatric Cardiovascular Surgery, Esplugues de Llobregat, Spain

³Hospital Sant Joan de Déu Barcelona, Department of Radiology, Esplugues de Llobregat, Spain

BACKGROUND AND AIM

Chiari's network (CN) is a filamentous web-like structure that results from embryological persistence of the right valve of the sinus venosus and septum spurium. Its prevalence ranges from 1.5-3% in postpartum and 0.3-9.5% with the use of transthoracic echocardiography. CN is usually of no-clinical significance, often found incidentally during diagnostic imaging studies or surgical interventions. However, previous literature has reported an increased prevalence of patent foramen ovale, atrial septal aneurysm, risk for arrhythmias, infective endocarditis, thromboembolic disease and catheters entrapment upon percutaneous interventions

METHODS

We present the case of a 2 months-old female with no previous relevant medical history, presenting with intermittent cyanosis episodes with spontaneous remission and no other clinical findings. The echocardiography and

Cardiac Computed Tomography (figure 1) revealed a prominent obstructive CN causing intermittent right to left shunt through a 5mm atrial septal defect.



RESULTS

Upon these findings, surgical repair was indicated. Under cardiac arrest the right atrium was opened longitudinally revealing a large 2cm slightly perforated CN (Figure 2). The network was resected and the ASD closed without postoperative complications and adequate follow-up.



FIGURE 2:

CONCLUSIONS

CN is a meshwork of thread-like strands due to incomplete reabsorption of the right valve of the sinus venosus and septum spurium. CN is often clinically insignificant however previous literature has reported its association with other congenital anomalies and higher risk for thromboembolic disease, endocarditis and arrhythmias among others. Surgical repair in symptomatic CN cases is a definitive and a low-risk intervention

EP504 / #1462**E-Poster Viewing - Paediatrics AS04-03.
Cardiovascular & haemodynamics****Left atrial function in pediatric oncological patients before and after completing chemotherapy.****P. Cassanello^{1*}, E. Aurensanz¹, P. Garcia-Canadilla², S. Cesar¹,
M. Gorostegui³, J. Sanchez-De-Toledo¹**

¹Hospital Sant Joan de Déu Barcelona, Department of Pediatric Cardiology, Esplugues de Llobregat, Spain

²Institut de Recerca Sant Joan de Déu, Cardiovascular Diseases and Child Development, Esplugues de Llobregat, Spain

³Hospital Sant Joan de Déu, Department of Pediatric Oncology, Esplugues de Llobregat, Spain

BACKGROUND AND AIM

Left atrium (LA) modulates left ventricular filling and cardiovascular performance, functioning as reservoir and conduit for pulmonary venous return and as booster pump increasing ventricular filling during ventricular diastole. Previous studies have described LA contribution to cardiovascular disease. We aimed to explore LA remodeling in pediatric patients before initiation of chemotherapy and after treatment.

METHODS

Prospective study including pediatric patients treated with chemotherapy in our institution from 2019-2022. LA phasic function was assessed using volumetric analysis (reservoir function, conduit function and booster pump) and functional related atrial ejection fraction as total (tEF), passive (pEF) and active (aEF). LA peak strain was assessed timed to the P-wave (LA total longitudinal, positive and negative).

RESULTS

41 patients were included. Mean age 8 ± 5.48 years, 56.1% males. 37% had solid tumors, 63% hematologic. Follow-up 6.3 ± 1.7 months.

TABLE 1:

	T1	T2	p-value
Reservoir function (ml/m ²)	17.9 \pm 3.6	16.6 \pm 3.3	0.080
Conduit function (ml/m ²)	6.4 \pm 5.5	6.7 \pm 2.5	0.035
Booster pump (ml/m ²)	9.2 \pm 3.2	8.1 \pm 3.8	0.050
tEF (%)	73.4 \pm 33.4	69.6 \pm 28.6	<0.001
pEF (%)	47.3 \pm 12.4	57.2 \pm 18.9	0.090
aEF (%)	29.9 \pm 17.5	29.8 \pm 19.7	0.490
Peak total strain (%)	41.9 \pm 5.2	37.8 \pm 6.4	0.010
Peak positive strain (%)	37.2 \pm 7.1	33.1 \pm 8.3	0.036
Peak negative strain %	-7.8 \pm 5.9	-6.8 \pm 5.5	0.313
proBNP (ng/L)	360 \pm 123	226 \pm 65.4	0.041
Heart rate	92.9 \pm 32.8	86.1 \pm 22.7	0.275

CONCLUSIONS

Assessment of LA volumes showed decreasing TEF and lower LA total strain peak time (related with reservoir function) and positive peak (related with conduit function) when comparing pre and post-chemotherapy. Further studies including larger series of patients are needed to elucidate the role of LA function in early onset diastolic dysfunction.

EP505 / #1986

E-Poster Viewing - Paediatrics AS04-03. Cardiovascular & haemodynamics

Assessment of growth failure in children with congenital heart disease

T. Chisnoiu^{1,2*}, A. Balasa^{2,3}, A.C. Pantazi^{2,4}, C. Mihai^{1,2}

¹Constanta Clinical Emergency Hospital, Pediatric Department, Romania, Pediatric, Constanta, Romania

²Ovidius University of Constanta, Faculty of Medicine, Constanta, Romania

³Constanta Clinical Emergency Hospital, Pediatrics Department, Constanta, Romania

⁴Faculty of Medicine, Ovidius University, Pediatric, Constanta, Romania

BACKGROUND AND AIM

Because congenital heart disease is the third leading cause of congenital disease and also the leading cause of infant mortality in the first year of life, it is necessary to determine the implications it may have on somatic development and quality of life. Therefore, the study aims to identify issues such as: - the degree of growth and development impairment by analyzing anthropometric indices - establishing the incidence and distribution according to sex, age, environment of origin, birth weight - assessing the growth deficit by using graphs that use percentiles

METHODS

We conducted a retrospective study between 01.01.2020-01.01.2021 at the Emergency County Clinical Hospital, analyzing the evolution and impact on the development and growth of 55 patients who were diagnosed with congenital heart defects. I used the growth curves from the Center for Disease Control (CDC).

RESULTS

Congenital non-cyanotic heart disease are much more common (85%) than congenital cyanotic heart disease (15%). The most common congenital heart defects encountered are atrial septal defect, ventricular septal defect and Fallot tetralogy. This affects the development of the subjects by the lack of necessary investigations during pregnancy for the early diagnosis and treatment of these diseases. Out of the total of 55 subjects studied, 24 are below the 5th percentiles, 23 are between the 5-50th percentiles and only 8 subjects are between the 50-90th percentiles.

CONCLUSIONS

Regarding the evolution of the patients on the growth charts, the weight gain was not being in accordance with the ideal increase of the age.

EP506 / #1695**E-Poster Viewing - Paediatrics AS04-03.
Cardiovascular & haemodynamics****The efficiency of combining target therapy with bosentan and sildenafil in children with pulmonary arterial hypertension****I. Palii, P. Daniela*, I. Rodoman, S. Sciuca***State University of Medicine and Pharmacy "Nicolae Testemitanu", Paediatrics, Chisinau, Moldova***BACKGROUND AND AIM**

To analyse the treatment with Bosentan and Sildenafil in 7 patients with PAH secondary to cardiac congenital shunts and to confirm the improvement of efficiency criteria.

METHODS

Patients with PAH moderate and severe, FC II and III-IV NYHA/ROSS, inoperable for the moment ($PVRI > 6-9 \text{ UWood} \times \text{m}^2$), without use of medication with action on the pulmonary pressure. FC WHO/NYHA, O₂ saturation, 6-min walk test, mean pulmonary artery pressure, cardiac index, pulmonary vascular resistance- are evaluated at the beginning, after 3, 6 and 12 months.

RESULTS

6MWT at the beginning $m-335,71 \text{ m} \pm 81,46$ after 3 months $m-347,52 \pm 83,4-$ ($p=0,005$), after 6 months $-360 \pm 80,40-$ ($p < 0,0001$), and after 1 year $m-379,2 \pm 83,98$ meters, ($p < 0,0001$). The capacity at 6MWT raised with $m-97,85 \pm 26,90$ steps. Initial Mean PAP: $m-83 \pm 12,16$, after 3 months $m-66,28 \pm 7,1-$ ($p=0,003$), after 6 months $m-62,85 \pm 13,15-$ ($p=0,007$) and at 12 months $m-55,14 \pm 11,09$ mm/Hg- ($p=0,002$). Initial cardiac index: $m-4,1$

$\pm 0,99$, after 3 months $m-3,54 \pm 0,76$ - ($p=0,041$), after 6 months $m-3,06 \pm 0,65$ - ($p=0,006$) and after 1 year $m-3,12 \pm 0,60$ - ($p=0,004$). Oxygen saturation at the beginning $m-93,42 \pm 1,71$, after 3 months $m-95 \pm 1,63$ - ($p=0,002$), after 6 months $m-95,85 \pm 1,06$ - ($p=0,001$) and after 1 year $m-96,28 \pm 0,75$ - ($p=0,001$). The PVR at the beginning the $m- 6,5 \pm 0,56$ and after 12 months $m-3,80 \pm 0,2$, it decreased with $2,7 \pm 0,21$ $UW \cdot m^2$ ($p < 0,001$).

CONCLUSIONS

This preliminary study reveals how Bosentan and Sildenafil considerably improve the results of efficiency criteria. This treatment is of choice in PAH secondary to congenital shunts and it improves 6MWT results, oxygen saturation, mean PAP and cardiac index, and decreases PVR.

EP507 / #2418**E-Poster Viewing - Paediatrics AS04-03.
Cardiovascular & haemodynamics****Sickle cell disease among children in Ghana:
recounting the experiences of caregivers**

**J. Armah, A. Diji*, J. Dompim, S. Baffour, H. Budu, C. Poku,
E. Boateng, D. ofori**

Kwame Nkrumah University of Science and Technology, Department of Nursing, Kumasi, Ghana

BACKGROUND AND AIM

Sickle cell disease (SCD) is one of the commonest life-threatening diseases that cut all geographical boundaries with Ghana being no exception. Due to the severe and deteriorating health effects SCD has on children, they require close and constant monitoring by caregivers of these children. This demanding nature of caring for children with SCD places increased responsibilities and stress on these caregivers. To explore the experiences of caregivers of children with SCD and how they have managed their experiences in order to give the best of care.

METHODS

Fourteen parents of children with SCD were purposively sampled at the Government Hospital in the Western region of Ghana. They were individually engaged in face-to-face interviews; which were audiotaped, transcribed, and analysed using inductive thematic analysis.

RESULTS

Participants were mothers of children aged between 6months and 17 years. Three themes were generated in the study. Community and societal stressors

explored the participants' experiences with societal institutions. Interpersonal relationship challenges explored the numerous relational challenges that influenced their ability to manage and cope with SCD. Personal issues described emotional struggles caregivers faced in coping with their responsibilities.

CONCLUSIONS

The findings of this study enhance the understanding of 'what it is like' to be the parent of a child with SCD and a better understanding of the often-overwhelming demands on these parents is critical in establishing supportive relationships with them when working together in the best interest of their children.

EP508 / #2031**E-Poster Viewing - Paediatrics AS04-03.
Cardiovascular & haemodynamics****Appearances deceive. A rare cause of right
ventricular outflow tract obstruction.****A. Greco^{1*}, P. Cassanello¹, F. Zuccarino², S. Planas³, B. Moscoso⁴,
S. Congiu⁴, J. Mayol⁴, J.M. Caffarena-Calvar⁴, J. Carretero¹**

¹Hospital Sant Joan de Déu Barcelona, Department of Pediatric Cardiology, Esplugues de Llobregat, Spain

²Hospital Sant Joan de Déu Barcelona, Department of Radiology, Esplugues de Llobregat, Spain

³Hospital Sant Joan de Déu Barcelona, Pediatric Pathology, Esplugues de Llobregat, Spain

⁴Hospital Sant Joan de Déu Barcelona, Department of Pediatric Cardiovascular Surgery, Esplugues de Llobregat, Spain

BACKGROUND AND AIM

A 12-year-old boy from Kenya was referred to our center, through an international charity organization for evaluation of severe dyspnea and asthenia. Echocardiography demonstrated an hypertrophic and dilated right ventricle (RV) with severe subpulmonary stenosis (gradient 150mmHg) leading to an initial diagnosis of severe subpulmonary stenosis. Infectious and autoimmune markers were inconclusive. Upon these findings, surgical treatment was planned.

METHODS

Surgery revealed severe pericardial thickening with foci of calcification and fibrotic bands on the A/V groove extending to the pulmonary annulus (Figure 1).

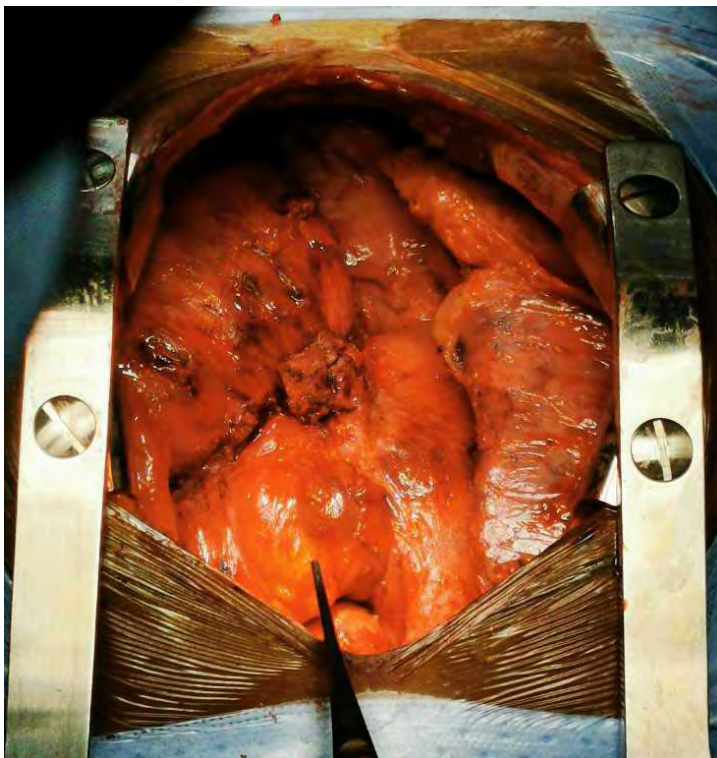
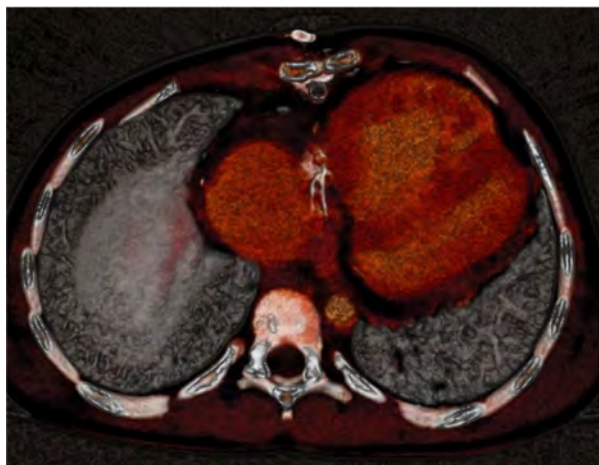
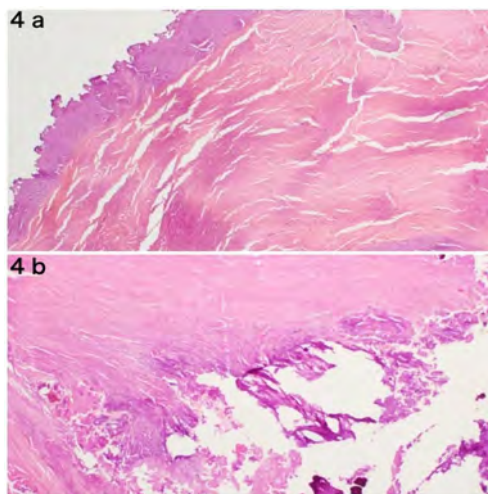

FIGURE 1:

Partial pericardiectomy was performed resulting in RV mean pressure decrease (45mmHg). Thoracic Computed Tomography showed calcific constrictive pericarditis (CP) at the level of the A/V groove with inversion of the IV septum (Figure 2).

**FIGURE 2:**

Ten days later, percutaneous pulmonary angioplasty was performed reducing RV mean pressure to 25mmHg. Histopathological examination showed non-specific pericardial thickening and fibrosis with dystrophic calcifications (Figure 3).

**FIGURE 3:**

RESULTS

Although CP is rare in children it should be considered in the differential diagnosis of RV outflow tract obstruction. CP is usually diffuse; however, localised forms can mimic other cardiac conditions such as valvular stenosis. Pericardiectomy is the only definitive and potentially curative treatment.

CONCLUSIONS

CP causes progressively impaired diastolic filling of the heart with associated symptoms of heart failure due to loss of pericardial compliance. Tuberculosis is still the most prevalent cause of CP in developing countries, particularly in paediatric population, however in the chronic stage the findings may be non-specific, and the etiology cannot always be established.

EP509 / #2268**E-Poster Viewing - Paediatrics AS04-03.
Cardiovascular & haemodynamics****Look beyond the brain: case report of an
intracardiac rhabdomyoma in an infant with early
onset epilepsy**

**A.M. Jurca^{1*}, C.-C. Olteanu¹, C. Bulescu², A. Barsan², M. Goicea²,
B. Ciocea³, O. Lazar⁴, M. Chira⁵**

¹Grigore Alexandrescu Emergency Hospital for Children, Pediatric Cardiology, Bucharest, Romania

²Grigore Alexandrescu Emergency Hospital for Children, Cardiovascular Surgery, Bucharest, Romania

³Grigore Alexandrescu Emergency Hospital for Children, Neurology, Bucharest, Romania

⁴Life Memorial Hospital, Intensive Care Unit, bucharest, Romania

⁵Heart Institute, Cardiovascular Surgery, Cluj, Romania

BACKGROUND AND AIM

Cardiac rhabdomyomas are the most frequent cardiac tumors in infants and often associated with tuberous sclerosis. The aim of this clinical case report is to emphasize the importance of cardiac screening in infants with early epilepsy onset.

METHODS

A case of a 6-month-old male infant was documented. Digital and physical archives were used. Admitted for acute onset of seizures 7 days prior. No familial or birth-related complication history. Clinical examination: three achromatic skin patches and grade IV systolic murmur. EEG: multiple high voltage waves and spikes. ECG: premature atrial complexes. Echocardiography: severe subvalvular aortic stenosis due to an intracavitary mass of 9 millimeters in the left ventricle outflow tract, with septal origin, which determined a pressure gradient of 100 mmHg, concentric left ventricle hypertrophy, and an intraparietal mass of 11 millimeters in the right atrium. Due to the

life-threatening status, surgery was rapidly performed, with excision of the two aforementioned masses.

RESULTS

Histopathological examination of the tumors revealed rhabdomyomas. The patient is now stable hemodynamically, with no pressure gradient in the left ventricle outflow tract, and successful antiepileptic treatment was instated, achieving control of the seizures. Therefore tuberous sclerosis was thought to be a possible concomitant disease with both epilepsy and cardiac rhabdomyomas.

CONCLUSIONS

Although one may be attempted to treat seizures alone in an infant with early onset of epilepsy, one must also thoroughly examine such patients, with emphasis on cardiologic examination. Cardiac rhabdomyoma should be screened for whenever necessary in early epilepsy onset patients since it may cause unstable cardiovascular parameters.

EP510 / #1924**E-Poster Viewing - Paediatrics AS04-03.
Cardiovascular & haemodynamics****Health self-evaluation using questionnaire in
paediatric patients with primary
hypercholesterolemia****Y.-E. Kulchytska, T. Marushko, T. Kurilina*, O. German***Shupyk National Healthcare University of Ukraine, Department of Paediatrics No2, Kyiv, Ukraine***BACKGROUND AND AIM**

The aim of our study was to determine the self-rated quality of life in paediatric patients with primary hypercholesterolaemia compared with their healthy peers, and to confirm our hypothesis that our patients may consider themselves to be fully healthy, subsequently compromising diet and therapy.

METHODS

Using the KINDL-R for assessing health-related quality of life, we surveyed 13 our patients with primary hypercholesterolemia who are being treated at the All-Ukrainian Children's Dyslipidaemia Centre in Kyiv. We ran the regression analysis of our data in SAS OnDemand for Academics.

RESULTS

According to the questionnaire data, the average Quality of Life Score in our patients was 65.73, while the same score for healthy peers was 67.50). However, the statistical analysis showed that the regression significance was low (F value 0.41, Pr > F 0.5509). Thus, the life-quality scores in our paediatric patients with primary hypercholesterolaemia differed.

CONCLUSIONS

Our paediatric patients with primary hypercholesterolaemia showed a fairly unbiased assessment of their quality of life and well-being on self-assessment. In spite of this, some patients have low to medium therapy compliance.

EP511 / #1489**E-Poster Viewing - Paediatrics AS04-03.
Cardiovascular & haemodynamics****Usefulness and accuracy of the smartwatch in the diagnosis of cardiac arrhythmias in children****J. Martins^{1*}, S. Laranjo², P. Silva Cunha³, F. Morgado³**¹Hospital dos Lusíadas Lisboa, Cardiology Department, Pediatric Cardiology Unit, Lisboa, Portugal²Hospital dos Lusíadas Lisboa, Cardiology Department, Pediatric Cardiology Unit, Lisboa, Portugal³Hospital dos Lusíadas Lisboa, Cardiology Department, Lisboa, Portugal**BACKGROUND AND AIM**

The diagnosis of cardiac arrhythmias in children is challenging when they are self-limited sporadic events that have normal baseline ECG. Holter monitors and variants are cumbersome devices that have a limited usage time which therefore provides normal results if the child did not experience arrhythmia during the usage time. Optical sensors on wearable devices can detect cardiac arrhythmias in adults. We present two cases that report the usefulness and accuracy of a smartwatch in the diagnosis of cardiac arrhythmias in children.

METHODS

We present two cases of children, aged 12 and 14 years old, referred to the Pediatric Cardiology clinic with a history of paroxysmal palpitations, light-headedness, and shortness of breath. The baseline ECGs were normal, as were the 24h-long Holter monitoring, during which both patients remained asymptomatic. A smartwatch (Apple Watch®) was therefore suggested.

RESULTS

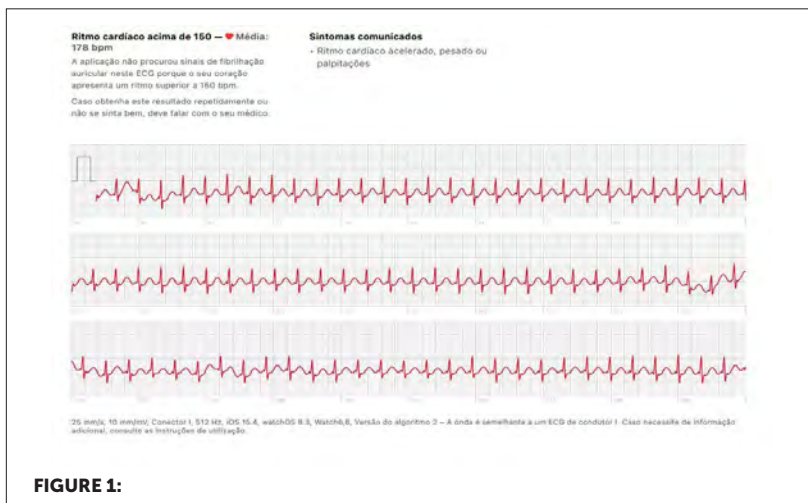

FIGURE 1:

After three weeks, both patients had episodes of palpitations. The smartwatch recording showed a high-quality ECG tracing that allowed for the diagnosis of paroxysmal supraventricular tachycardia, with a heart rate between 180 and 220 beats per minute. Betablocker (atenolol) was prescribed in both cases. The two patients were later submitted to an electrophysiological study that confirmed a reentrant auriculo-ventricular node tachycardia, followed by successful radiofrequency ablation.

CONCLUSIONS

In our two cases, the Apple Watch proved an easy, fun, and accurate means of diagnosing cardiac arrhythmia in children. Further studies should assess the accuracy and cost impact of these wearable devices in Pediatric Cardiology.

EP512 / #1227**E-Poster Viewing - Paediatrics AS04-03.
Cardiovascular & haemodynamics****Wide qrs complex tachycardia camouflaging wpw syndrome: a case report of a healthy soccer player without previous ecg recordings****M. Mihalec*, D. Bartoniček, D. Šarić, D. Dilber***University Hospital Center Zagreb, Pediatric Cardiology, zagreb, Croatia***BACKGROUND AND AIM**

Introduction: Wolf-Parkinson-White (WPW) preexcitation syndrome represents a presence of an accessory conduction pathway leading from atria to the ventricles. Seldom, the current can move rapidly through this pathway and back through AV node, causing a wide QRS tachycardia, a life-threatening condition.

METHODS

Healthy 15-year-old soccer player presented to our emergency department due to complaints of chest pain during the training, along with vomiting and generally feeling sick.

RESULTS

Case report: Healthy 15-year-old soccer player presented to our emergency department due to complaints of chest pain during the training, along with vomiting and generally feeling sick. He was hemodynamically stable at the initial presentation, with normal blood pressure, but with tachycardia of up to 160/min. The ECG recording showed a tachycardia with wide, irregular, polymorphic QRS complex. He was immediately admitted to our pediatric

ICU, where synchronised cardioversion with 1 J/kg of energy was performed, leading to restoration of a normal sinus rhythm. Afterwards, the repeated ECG revealed a delta wave, which aroused suspicion of malignant accessory pathway capable of rapid signal conduction from atria to ventricles. Therefore, electrophysiology study and radiofrequent ablation was performed the next day, leaving no signs of WPW in ECG. Finally, the patient had normal 24h ECG recordings, with no subsequent arrhythmogenic events.

CONCLUSIONS

Discussion

WPW preexcitation is an important cause of tachycardia in children, which can be easily prevented by early ECG performed especially in those playing sport. Possible lethal tachycardia is rare but can be prevented by timely electrophysiological study and ablation therapy.

EP513 / #1396**E-Poster Viewing - Paediatrics AS04-03.
Cardiovascular & haemodynamics****Is pulmonary hypertension a risk factor for poor outcomes in bronchiolitis?**

M.L. Rossi^{1*}, M.C. Escobar-Diaz¹, S. Hadley², P. Randanne¹, I. Jordan³, J. Sanchez-De-Toledo¹

¹Hospital Sant Joan de Déu Barcelona, Department of Pediatric Cardiology, Esplugues de Llobregat, Spain

²Boston Children's Hospital, Department of Pediatrics, Boston, United States of America

³Hospital Sant Joan de Deu, Pediatric Intensive Care Unit, Esplugues de Llobregat, Spain

BACKGROUND AND AIM

Pulmonary hypertension (PH) has been reported as a crucial factor in the pathophysiology of severe bronchiolitis. The aim of this study was to assess PH and right ventricle (RV) function in patients with bronchiolitis and to analyze their correlation with clinical outcomes.

METHODS

This prospective cohort study included infants less than 12 months of age hospitalized with bronchiolitis. The cohort was divided in mild and severe cases based on the need for positive pressure respiratory support (PPRS). PH was considered when one of the following: RV acceleration/ejection time ratio (AT/ET) ≤ 0.3 , RV isovolumic relaxation time (IVRT) > 40 msec, eccentricity index (EI) ≥ 1.1 .

RESULTS

One hundred eighty-one patients were included. Median age was 2[1- 4] months. 73(40%) required PPRS, presenting increased NT-proBNP values

compared to mild cases ($p=0.007$) and worse RV systolic function measured with TAPSE ($p<0.001$). Ninety-six (53%) patients had at least one parameter of PH, 52 mild and 44 severe cases ($p=0.09$). Only 23(12%) cases had more than one parameter, 15 mild and 8 severe cases ($p=0.56$). Sixty-six(36%) patients had altered AT/ET, with no difference between mild and severe groups ($p=0.67$). There was no difference for diastolic or systolic EI or altered IVRT. There was no correlation between AT/ET and TAPSE, NT proBNP or HLOS.

CONCLUSIONS

In our cohort patients with severe bronchiolitis had poorer RV systolic function but, interestingly, PH was not clearly evident. Although 36% of patients had an $AT/ET \leq 0.3$, this finding was not reinforced with other echocardiographic parameters of PH or associated to worse RV function or adverse clinical outcomes.

TABLE 1:

Variable	PPRS n= 73 Median [IQR]	NC, HFNC, None n=108 Median [IQR]	p value
<i>Pulmonary pressure assessment</i>			
AT/ET	0.32 [0.26-0.34]	0.31[0.27-0.38]	0.18
AT/ET < 0.3	24/60	29/88	0.38
RV IVRT	20 [17.5-40]	30 [17.5-35]	0.87
RV IVRT > 40 msec	6/54	8/89	0.68
LV EI systolic	1.06 [1-1.14]	1.06 [1-1.13]	0.67
LV EI diastolic	1.05 [1-1.09]	1.04 [1-1.06]	0.23
LV EI ≥ 1.1	20/65	30/95	0.91
One altered parameter	44/68	52/101	0.09
Two altered parameters	8/68	15/101	0.56
TAPSE (mm)	11 [9.7-13]	13 [11-14]	<0.001
NT-proBNP (pg/ml)	1615[763-3716]	510[243-1269]	0.007

PPRS: positive pressure respiratory support, IQR: interquartile range. AT: acceleration time, ET: ejection time, RV: right ventricle, IVRT: isovolumic relaxation time, LV: left ventricle, EI: eccentricity index, TAPSE: tricuspid annulus systolic excursion.

EP514 / #1641**E-Poster Viewing - Paediatrics AS04-03.
Cardiovascular & haemodynamics****Intermittent claudication in an adolescent:
suspected antiphospholipid syndrome. An open
case for differential diagnosis**

**J. Serralabós-Ferré^{1*}, G. Garcia Del Cerro¹, J.M. Valle-T-Figueras¹,
M. Espinet-Pedrol¹, J.M. Romero², R. Tejedor², E. Bramon², N. Vilalta
Seto³, S. Boronat¹**

¹Hospital de Sant Pau, Department of Paediatrics, Barcelona, Spain

²Hospital de Sant Pau, Department of Angiology and Vascular Surgery, Barcelona, Spain

³Hospital de Sant Pau, Unit of Haemostasy and Thrombosis, Barcelona, Spain

BACKGROUND AND AIM

Intermittent claudication is very uncommon in children, and it can be a symptom of peripheral arterial disease. We present the case of a child experiencing a 4-months right leg pain that appears after walking 300 meters.

METHODS

Case report

RESULTS

A 15-year-old previously healthy male is referred to the emergency department by his paediatrician due a 4-month history of right calf pain when walking over 300 meters which was relieved with rest. Femoral pulses were palpable, while popliteal and distal pulses were absent. There was no difference in colour, temperature, size or capillary refill time between both legs. A sonogram showed apparent occupation of the right popliteal artery, with apparent revascularization of the posterior tibial artery. Basic blood test, ECG

and echocardiography were normal. An angioTC and dynamic MRI showed the same lesions and didn't show signs of popliteal artery entrapment syndrome or adventitial cystic disease. Thrombophilia screening showed elevated anti-protein S antibodies (>p90), therefore we are considering antiphospholipid syndrome as diagnosis, awaiting retesting 12 weeks after the episode to demonstrate persistence, as well as homocysteine and lipid profile. The patient received heparin treatment at anticoagulant doses and is being considered for surgery.

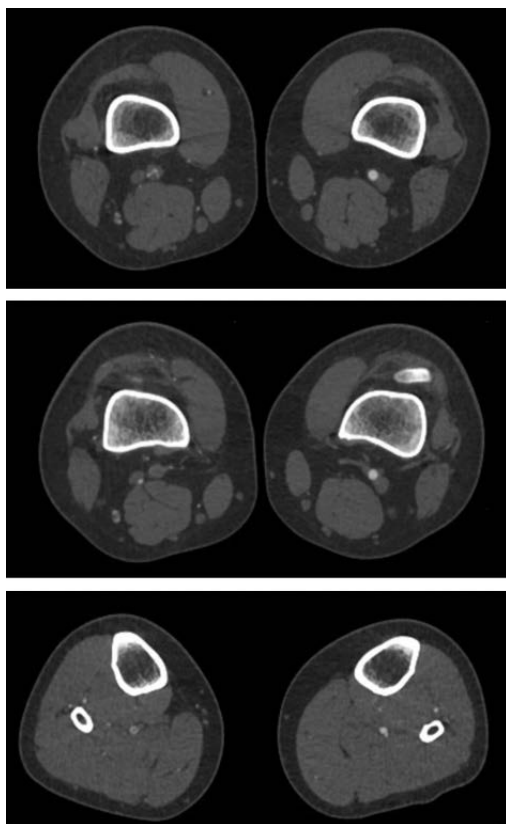

FIGURE 1:



FIGURE 2:

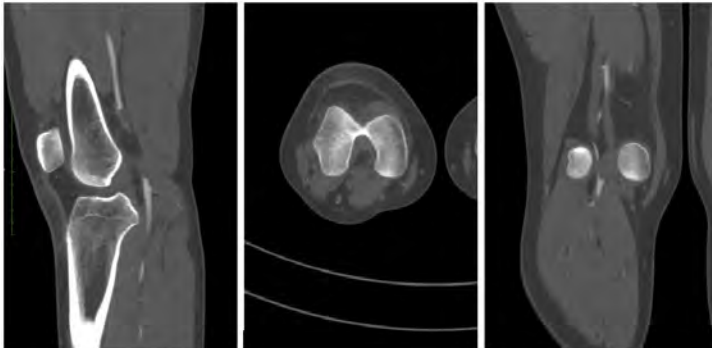

FIGURE 3:

CONCLUSIONS

Acute limb ischemia is a serious and uncommon condition in paediatrics that can present with intermittent claudication in adolescents. It can be caused by a number of conditions, including paediatric antiphospholipid syndrome, a rare entity that increases the risk of arterial and venous thrombosis.

EP515 / #874**E-Poster Viewing - Paediatrics AS04-03.
Cardiovascular & haemodynamics****Aberrant central venous catheter (cvc) courses
and undiagnosed congenital heart disease (chd):
role of point of care ultrasound (pocus) and chd
screening.****J. Shah^{1*}, B. Bhojnagarwala²**¹Hillingdon Hospital, Paediatrics, Hillingdon, United Kingdom²Medway NHS Foundation Trust, Neonatology, Kent, United Kingdom**BACKGROUND AND AIM**

POCUS has been increasingly used in neonatal medicine with compelling evidence of increased safety and accuracy¹, and reduction of x-ray exposure to confirm CVC positioning². We reviewed 2 children with very difficult access where 3 CVCs were almost or completely removed due to anatomical variants.

METHODS

X-ray, POCUS and CHD screening echocardiography were performed to investigate aberrant course of CVC's. (Figure 1)

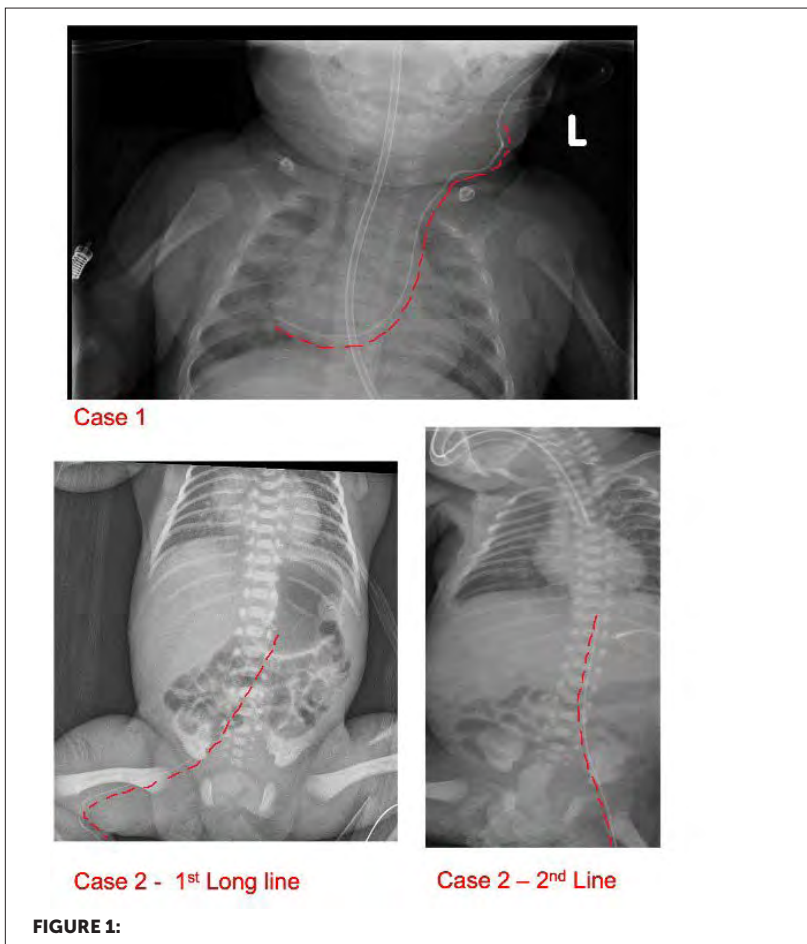

Case 1: Peripheral long line inserted via scalp vein in neonate: Abnormal course taken via the left side of heart and entering the cardio chamber. Case 2: Long line in infant (via right saphenous vein): Found to be crossing the midline and therefore removed. Repeat attempt, (via left saphenous vein): Found on the left side until the diaphragm and was also removed.

RESULTS

Case 1: Echocardiogram displayed bilateral Superior Vena Cava's (SVC's) with left SVC draining into coronary sinus, explaining X-Ray findings. (Dilated coronary sinus usually first clue). CVC was withdrawn so tip was in the left SVC. In this case preventing unnecessary withdrawal. Case 2: Echocardiography showed an interrupted infrahepatic Inferior Vena Cava with azygos continuation and left atrial isomerism. Both CVCs were removed unnecessarily which could have been prevented with POCUS at time of insertion.

CONCLUSIONS

These cases highlights that when unexplained aberrant line courses are noted on imaging further assessment like screening echocardiography may be beneficial and prevent unnecessary removal of well-placed CVC's and aid diagnosis of unsuspected CHD. References: 1. Wilson, S, Simplified POCUS protocol to confirm CVC placement. 2. Jain, A, Use of targeted neonatal echocardiography.

EP516 / #2619

E-Poster Viewing - Paediatrics AS04-03. Cardiovascular & haemodynamics

Association between cardiometabolic factors and ejection fraction in healthy obese children

M. Tankoska*

University Children's Hospital Skopje, Department of Endocrinology and Genetics, Skopje, North Macedonia

BACKGROUND AND AIM

Obesity is a global healthcare problem that has markedly increased in children. It predisposes individuals to greater future morbidity and mortality, with specific increase in susceptibility to cardiovascular diseases. To understand the relationship between glucose and insulin levels of obese healthy children and the cardiac-based measured of left ventricular ejection fraction(LVEF).

METHODS

62 children were referred to the University Pediatric Clinic due to obesity concerns. Structured interview, and children's weight, height and waist circumference, as well as measurement of the systolic and diastolic blood pressure were performed. The oral glucose tolerance test (OGTT) was performed where insulin and glucose levels were collected. Fasting glucose levels higher than 120 mg/dL (6.7 mmol/L) or 200 mg/dL (11 mmol/L) at 2 hours after the OGTT were indicative of diabetes. The LVEF was acquired and classified as normal EF ($\geq 55\%$), slightly reduced (41%–55%), moderately reduced (31%–40%), and markedly reduced ($\leq 30\%$).

RESULTS

The average LVEF was 68.4% (without LVEF below the 55% cut-off). Higher LVEF was associated with the greater waist circumference ($r=0.279$, $p=0.035$), greater LDL-C ($r=-0.421$, $p=0.041$) and greater insulin levels measured at baseline ($r=0.366$, $p=0.02$) and post-OGTT ($r=0.344$, $p=0.028$). These findings were driven only by the female population, where the LVEF was significantly associated with the post-OGTT insulin levels ($r=0.684$, $p=0.003$; surviving Benjamini-Hochberg correction).

CONCLUSIONS

Insulin levels in healthy obese children are associated with the EF, as measured by Doppler ultrasound. Insulin-induced increase in myocardial contractility in prediabetic obese children may lead to early myocardial exhaustion and future development of cardiac comorbidities.

EP517 / #1439

E-Poster Viewing - Paediatrics AS04-03. Cardiovascular & haemodynamics

The need for scrutiny in paediatric dilated cardiomyopathies: why the differential diagnosis should extend beyond the acute phase.

D. Toader^{1*}, D. Lazar¹, O. Racz¹, A. Borlean¹, B. Lucian², G. Tita¹, S. Cainap³

¹Clinical Emergency Hospital of Children, Second Department of Pediatrics, Cluj-Napoca, Romania

²Emergency Regional Hospital 'Constantin Opris', Department of Pediatrics, Baia Mare, Romania

³University of Medicine and Pharmacy 'Iuliu Hatieganu', Department of Pediatrics, Cluj-Napoca, Romania

BACKGROUND AND AIM

Dilated cardiomyopathy, the most common type of cardiomyopathy in the paediatric population, carries a high morbidity and mortality risk, with many patients requiring advanced heart failure therapies. The majority of cases are of idiopathic origin, while the rest can be brought about by myocarditis, ischaemia, genetic mutations, toxin exposure, nutritional deficiencies or connective tissue diseases.

METHODS

We present the case of a 4-month-old infant who was referred to our centre for the investigation of a systolic murmur.

RESULTS

About one month before, the patient presented an episode of bronchiolitis, with important respiratory distress. In our service, the physical exam revealed

above average weight, wheezing, mild respiratory distress, systolic murmur grade 2/6 and mild splenomegaly. The cardiac echography detected dilated cardiomyopathy with severe systolic dysfunction. Laboratory investigations showed elevated troponins and NT-proBNP and positive IgM antibodies for Cytomegalovirus and Coxsackie. Viral myocarditis was suspected to be the cause of the heart dysfunction. However, at the 6 month follow-up, the patient associated vertical nystagmus, head bobbing and right torticollis. Neurologic causes were excluded, while the ophthalmologic consult revealed rod and cone cell dysfunction. The triad of persistent above average weight, dilated cardiomyopathy and rod and cone cell dysfunction raised the suspicion of Alstrom syndrome. The genetic test confirmed the diagnosis.

CONCLUSIONS

This case report means to emphasise the need for a high index of suspicion when evaluating for the cause of dilated cardiomyopathies in children. Although rare, genetic causes such as Alstrom syndrome, should always be a part of the differential diagnosis, especially in infants.

EP518 / #2417

E-Poster Viewing - Paediatrics AS04-03. Cardiovascular & haemodynamics

Early detection of cardiovascular risk factors in children.

V. Urbanová*, K. Rücklová

University Hospital Vinohrady and Third Faculty of Medicine, Charles University, Clinic Children and Adolescents, Prague, Czech Republic

BACKGROUND AND AIM

The Czech Republic is one of the countries with the highest risk of cardiovascular disease in Europe. Atherosclerosis has been demonstrated in childhood. A number of risk factors (RF) have a cumulative negative effect, therefore early intervention from childhood is very important. Affectable RF include, in particular, unhealthy lifestyles with lack of exercise and excessive calorie intake, obesity, hypertension, diabetes mellitus, dyslipidemia and psychosocial stress. Another important RF is familial hypercholesterolemia (FH), which occurs in the population with a high prevalence of 1: 250. Although there is effective statin therapy, currently available for children aged 8-10, FH remains undiagnosed and often untreated in our population. Non-traditional RF include hyperhomocysteinemia, the presence of antiphospholipid and other autoantibodies, thrombophilic and pro-inflammatory conditions.

METHODS

Patients after acute coronary syndrome (ACS) over the age of fifty are invited with their children. The examination includes a detailed history, physical examination, blood examination (lipidogram, glycemia, HbA1c, homocysteine, inflammatory parameters, coagulation tests, antiphospholipid autoantibodies, molecular genetic analysis of many genes for FH) and carotid ultrasound and for detection of atherosclerotic plaques.

RESULTS

Already available data show that significant RF for early ACS requiring intervention in children was detected (hypercholesterolemia, hypertension). Incidence of RF in czech population is similar to that in other populations.

CONCLUSIONS

RF for premature coronary syndromes in czech population do not differ from other populations significantly. A significant number of children of patients with premature coronary syndrome has a preventable risk factor, the establishment of preventive cardiology centers for children makes sense. Familial hypercholesterolemia and hypertension are underdiagnosed and untreated in czech population.

EP519 / #2604

E-Poster Viewing - Paediatrics AS04-03. Cardiovascular & haemodynamics

Transfer of a patient or a surgeon? Pilot project: transfer of the surgeon from the reference center to the hospital without on-site pediatric cardiac surgery.

**K. Polak¹, A.P. Fariña Ruíz², F. Portela Torron³, R. Bellot Fernández³,
C. Rubio Iglesias², S. Rusu⁴, M. Rivero Falero¹, S. Romero Ramírez¹,
B. Reyes Milan¹, I. Vidal Gil^{1*}**

¹HUNSC, Pediatrics, Santa Cruz De Tenerife, Spain

²HUNSC, Cardiology, Santa Cruz De Tenerife, Spain

³Complejo Hospitalario Universitario Insular - Materno Infantil, Pediatric Cardiac Surgery, Las Palmas de Gran Canaria, Spain

⁴Hospital Universitario Nuestra Señora de Candelaria, Pediatric Surgery, Santa Cruz de Tenerife, Spain

BACKGROUND AND AIM

Patent ductus arteriosus (PDA) is a frequent pathology needing surgical intervention in the neonatal period, with the majority of patients premature and in critical medical state. The journey to a regional specialist centre, could impact negatively the general status of such children. For some cardiac procedures such as closing the PDA, it was proposed that the surgical team makes the journey.

METHODS

We review the medical notes and outcome of the patients requiring PDA ligation in neonatal period for whom the surgical cardiac team came to our center. The trial started in January 2019 and is ongoing.

RESULTS

Three neonatal prematures had their PDA ligation in the unit by visiting surgical team. Two males born at 27 (1084 grams) and 25 weeks (850 grams) and a female born at 25 weeks (855 grams). All had medical failed treatment for the PDA. The boys had otherwise normal cardiac structure, and the girl had a right aortic arch. They underwent open closure of the PDA in the neonatal unit on day 18 of life, 26 and 31 respectively. Both boys are currently discharged at home with a good evolution post-operatively at 9 and 11 month respectively. They have good cardiac function. The girl had an exitus at 50 days of life for unrelated cases.

CONCLUSIONS

PDA ligation in neonatal units by visiting specialist team is feasible and reduces the risks of transport for instable prematures and is more accommodating for the family that has the care of their baby in one hospital.

EP520 / #723

E-Poster Viewing - Paediatrics AS04-03. Cardiovascular & haemodynamics

Trends in cardiac arrhythmias among pediatric hospitalizations with cannabis use in the united states, 2009-2019

D. Webster^{1*}, G. Kodua², K. Danso³, S. Mensah⁴, N. Parmar⁵,
K. Donda⁶, P. Bhatt⁷, F. Dapaah-Siakwan⁸

¹University of Ghana Medical Center, Intensive Care Unit, Accra, Ghana

²Quinnipiac University, Biomedical Science, Hamden, United States of America

³Cape Coast Teaching Hospital, Pediatrics, Cape Coast, Ghana

⁴Tarkwa Municipal Hospital, Medicine, Tarkwa, Ghana

⁵East Tennessee Children's Hospital, Pediatrics, Knoxville, United States of America

⁶University of South Florida, Pediatrics/neonatology, Tampa, United States of America

⁷United Hospital Center, Pediatrics, Bridgeport, United States of America

⁸Valley Children's Hospital, Neonatal Intensive Care Unit, Madera, United States of America

BACKGROUND AND AIM

A few studies suggest an increase in cannabis use (CU) among hospitalized children. Cannabis use can cause cardiovascular complications such as arrhythmias, but these have not been studied in the pediatric population. We aimed to examine the trends in the prevalence of cardiac arrhythmias (CA) in pediatric adolescent hospitalizations with CU in the United States (US) from 2009-2019.

METHODS

This was a repeated cross-sectional analysis of pediatric hospitalizations aged 11-20 years within the Kids Inpatient Database (2009, 2012, 2016, and 2019). ICD-9 and ICD-10 codes were used to identify hospitalizations with CU and CA. The outcomes of interest were the trends in the prevalence of CA among pediatric adolescent hospitalizations and the type of CA. The Chi-square test for trends was used to analyze trends. P-value <0.05 was considered significant.

RESULTS

Out of 5.57 million hospitalizations aged 11-20 years, 292,816 were associated with CU (prevalence of 52.5 per 1,000). The characteristics of the study population are shown in Table 1. Those with CA were more likely to experience mortality (3.1% vs 0.1%, $P < 0.001$). The prevalence of CA among hospitalizations with CU was 0.64% and it increased from 0.41% in 2009 to 0.79% in 2019. The most frequent arrhythmias were tachyarrhythmia (0.33%), bradyarrhythmia (0.33%), bundle branch block (0.22%), and supraventricular tachycardia (0.12%) [Table 2].

Table 1. Baseline demographic characteristics and bivariate comparison of pediatric adolescent hospitalizations accompanied by cannabis use with and without cardiac arrhythmias

	Hospitalizations with Cannabis Use, N = 292,816		P-value
	No Arrhythmia, N = 290,944 (%)	Arrhythmia, N = 1,872 (%)	
Sex			<0.001
Male	52.0	70.7	
Female	48.0	29.3	
Age			<.0001
11-13 years	2.2	0.4	
14-16 years	22.2	13.7	
17-21 years	75.7	85.8	
Race/Ethnicity			0.006
White	59.0	55.8	
Black	23.4	26.4	
Hispanic	14.7	15.8	
American Indian/Alaska native	1.4	1.1	
Other	1.5	1.0	
Household income quartile			0.01
1st (lowest)	47.6	45.4	
2nd	39.3	40.8	
3rd	8.0	9.5	
4th (highest)	5.1	4.3	
Insurance			0.01
Medicaid/Medicare (Public)	47.6	45.4	
Private	39.3	40.8	
Self-pay	8.0	9.5	
Others	5.1	4.3	
Hospital region			<0.0001
Northeast	19.6	18.2	
Midwest	30.0	26.2	
South	31.2	32.8	
West	19.2	22.8	

Table 2. Types of cardiac arrhythmias in pediatric hospitalizations with cannabis use

Type of Arrhythmia	Proportion of Pediatric Hospitalizations with Cannabis Use (%)
Any Arrhythmia	0.64
Tachyarrhythmia	0.33
Supraventricular tachycardia	0.12
Atrial fibrillation	0.1
Atrial flutter	0.02
Ventricular tachycardia	0.09
Ventricular fibrillation	0.03
Bradyarrhythmia	0.33
Heart Block (any)	0.12
First degree	0.06
Second degree	0.04
Complete	0.02
Bundle branch block	0.22
Left	0.02
Right	0.14
Other BBB	0.07

CONCLUSIONS

Cardiac arrhythmias may be associated with increased CU in children in the US. While further studies are needed to confirm and establish a causal relationship between cannabis use and CA, adolescents presenting with cardiac arrhythmias should be screened for CU.

EP521 / #2012

E-Poster Viewing - Paediatrics AS04-03. Cardiovascular & haemodynamics

Flecainide - an intravenous alternative to amiodarone for refractory paediatric supraventricular reentry tachycardia?

M.-C. Zammit^{1*}, J. Swain¹, V. Grech¹, R. Farrugia²

¹Mater Dei Hospital, Paediatrics, Msida, Malta

²Mater Dei Hospital, Department of Child and Adolescent Health, Msida, Malta

BACKGROUND AND AIM

Supraventricular tachycardia (SVT) is the commonest arrhythmia in children. Adenosine is the recommended first line treatment for chemical cardioversion, followed by amiodarone for refractory cases. This study analysed treatment in Malta for refractory paediatric SVT.

METHODS

This was a retrospective study involving children <16 years presenting with SVT to the emergency department over the 10-year period 2009-2018. Patients were identified by electronic discharge diagnoses. Mann-Whitney U test was used for significance.

RESULTS

Twenty nine episodes of SVT (27 patients) were identified; median age 5.3 years. None had congenital heart disease or previous cardiac surgery. ECG showed AVNRT in 11; AVRT in 9; undetermined type in 9. SVT resolved spontaneously or with vagal manoeuvres in 6. Adenosine was the first line treatment in 22/23 patients and was ineffective in 10 (45%). A median of 3 adenosine

doses were administered overall, with no significant difference between the 2 groups ($p = 0.29$). All 10 patients then responded to one dose of intravenous flecainide 2mg/kg. Median time to return to sinus rhythm from presentation was significantly longer for patients receiving flecainide (23.5 versus 6 minutes; $p = 0.004$). No patients needed electrical cardioversion.

CONCLUSIONS

Intravenous flecainide is an effective second line treatment for all children with refractory SVT in this cohort of patients in the emergency setting.

EP522 / #900

E-Poster Viewing - Paediatrics AS04-04. Covid-19

Evaluation of parents' experience of remote consultations since covid-19 pandemic

M. Ahmed^{1*}, R. Ogunleye²

¹University Hospitals of Derby and Burton NHS Foundation Trust, Paediatrics, Burton Upon Trent, United Kingdom

²Queen's Medical Centre, University of Nottingham Medical School, Nottingham, United Kingdom

BACKGROUND AND AIM

Remote consultation is a form of telemedicine, and its selective use has been in existence in various forms and shapes for the last few decades. Remote consultations were used widely in the United Kingdom (UK) during the Covid-19 pandemic to reduce the risk hospitals and healthcare settings posed to transmission of the virus. We explored the experiences of parents of paediatric patients at Queen's Hospital Burton (QHB), who had remote consultations during the pandemic, to determine how successfully the service was provided.

METHODS

This was a qualitative study involving semi-structured interviews of parents of paediatric patients at QHB, UK. During the interview, three key themes explaining experience or signifying areas of improvement for the delivery of remote consultations emerged. The themes were, technology concerns, service concerns and doubt.

RESULTS

All parents expressed satisfaction with the service and the preference for video consultations over telephone was also made clear. Some drawbacks

were noted about the service and all respondents made it clear that they do not view remote consultations as a permanent substitution for face-to-face consultations.

CONCLUSIONS

Overall, majority of the parents denoted mainly positive experiences with remote consultations. The findings of this study therefore conclude that the delivery of remote consultations by clinicians at QHB was sufficient and supports the continued use of remote consultations for paediatric outpatients at this hospital in the future.

EP523 / #1493

E-Poster Viewing - Paediatrics AS04-04. Covid-19

Parental knowledge, attitude and willingness to vaccinate their children against covid-19 infection in nigeria.

A. Ajose^{1*}, C. Akinde², A. Ilo³, Y. Shittu², A. Robert⁴, T. Durojaiye⁵

¹Lagos University Teaching Hospital, Obstetrics and Gynaecology, Lagos, Nigeria

²The Neo Child Initiative, Founder, Lagos, Nigeria

³Asokoro District Hospital, Department of Surgery, Abuja, Nigeria

⁴Lagos University Teaching Hospital, Department of Community Health, Lagos, Nigeria

⁵The Neo Child Initiative, Research Associate, Lagos, Nigeria

BACKGROUND AND AIM

Attitude of parents and caregivers towards COVID-19 vaccination plays a significant role in the success of herd immunity. Our study aimed to evaluate the knowledge, attitude, and willingness of Nigerian parents to vaccinate their children against COVID-19 and identify factors that influence vaccine acceptance.

METHODS

An online cross-sectional survey using non-random convenience sampling method was done in Nigeria. We used univariate and bivariate logistic analysis to explore factors that affect willingness to vaccinate their children for the COVID-19.

RESULTS

A total of 500 parents and caregivers participated in this survey, with the majority being females and aged between 31-40(63.6% and 34.6% respectively). A total of 265(53.0%) and 266(53.2%) respondents had good knowl-

edge and attitude towards COVID-19 vaccination respectively. Less than half of the surveyed parents (48.4%) were willing to vaccinate their children against COVID-19. Factors associated with willingness to vaccinate children against COVID-19 included age greater than 40 years, male gender, residing in Southern Nigeria, having good knowledge, knowing an infected person or a vaccinated person, feeling self or child is at risk of contracting COVID-19 infection, willingness to vaccinate self against COVID-19 and good attitude. Significant predictors of willingness to vaccinate child include age greater than 40 years (AOR: 2.558,95%CI: 1.136-5.761), willingness to vaccinate self (AOR: 1016.808,95%CI:128.505-8045.595) and good attitude (AOR: 6.214,95%CI:2.831-13.638).

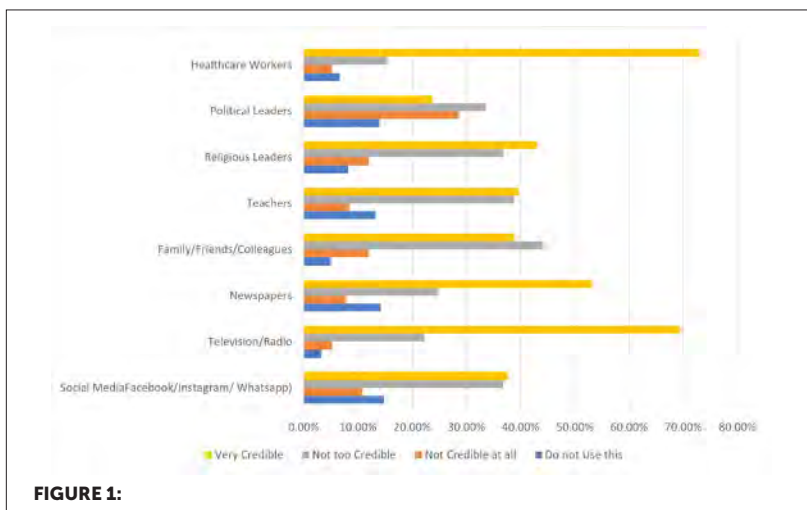

CONCLUSIONS

Parental willingness to vaccinate their children against COVID-19 in Nigeria is low. The information from this survey will help relevant authorities develop health promotion programs geared towards ensuring optimal uptake of the COVID-19 vaccine in children once implemented.

EP524 / #1061**E-Poster Viewing - Paediatrics AS04-04. Covid-19****Evolution of emotional and behavioral symptoms during the 2020-2021 school year in the context of the covid-19 pandemic**

A. Gatell¹, E. Alcover^{2*}, J. Balaguer³, T. Pérez-Porcuna⁴, E. Fortea⁵, D. Rodà⁶, P. Álvarez⁷, O. Salvadó²

¹Equip Pediatria Territorial Alt Penedés-Garraf, Paediatrics, Vilafranca del Penedés, Spain

²Pediatricia dels Pirineus. ICS, Paediatrics, Tremp, Spain

³CAP St Ildefons, Paediatrics, Cornellà de Llobregat, Spain

⁴CAP Valldoreix. APFA Mútua de Terrassa, Paediatrics, Terrassa, Spain

⁵CAP Montilivi, Paediatrics, Girona, Spain

⁶SAP Baix Llobregat Nord, Paediatrics, Barcelona, Spain

⁷Pediatricia dels Pirineus, ABS Alta Ribagorça, Paediatrics, Pont de Suert, Spain

BACKGROUND AND AIM

In previous epidemic situations, there has been an impact on mental health. There are few follow-up studies in the pediatric population to assess the evolution of the emotional and behavioral symptomatology throughout the first covid-19 completely pandemic school year. We aim to describe the most important emotional symptoms and behavioral disorders during the 2020-21 academic year.

METHODS

Longitudinal and prospective study of a cohort of children between 5 and 14 years in Catalonia between September 2020 and August 2021. Participants were randomly selected and accompanied by the primary care pediatrician. Data were collected through an online survey through the RedCap platform at the beginning of the course and at the end of each term (4 cuts).

RESULTS

35 pediatricians participated and 369 patients were recruited (final sample of 321 patients). Main symptoms were problematic screen use, nervousness, sadness and irritability. Symptoms worsened at the end of the 1st and 2nd terms, and improved at the end of the course. No COVID-19-related variables were associated with more symptoms. The perception of a good family environment and a lower level of health concern were related to fewer symptoms.

CONCLUSIONS

Emotional and behavioral symptoms worsened in the 1st and 2nd terms, but improved at the end of the school year. Families with a perceived good environment and who were less concerned about their health reported fewer symptoms. Aspects directly related to COVID-19 were not correlated with more emotional or behavioral symptoms.

EP525 / #1068**E-Poster Viewing - Paediatrics AS04-04. Covid-19****Use of the sdq questionnaire to assess child and adolescent mental health during the 2020-2021 school year in the context of the covid-19 pandemic**

E. Alcover^{1*}, A. Gatell², J. Balaguer³, T. Pérez-Porcuna⁴, O. Salvadó⁵, P. Álvarez⁶, D. Rodà⁷, E. Fortea⁸

¹*Pediatría dels Pirineus. ICS, Paediatrics, Tremp, Spain*

²*Equip Pediatría Territorial Alt Penedés-Garraf, Paediatrics, Vilafranca del Penedés, Spain*

³*CAP St Ildefons, Paediatrics, Cornellà de Llobregat, Spain*

⁴*CAP Valldoreix. APFA Mútua de Terrassa, Paediatrics, Terrassa, Spain*

⁵*Institut Català de la Salut, Cap Llibertat Reus, Reus, Spain*

⁶*Pediatría dels Pirineus, ABS Alta Ribagorça, Paediatrics, Pont de Suert, Spain*

⁷*SAP Baix Llobregat Nord, Paediatrics, Barcelona, Spain*

⁸*CAP Montilivi, Paediatrics, Girona, Spain*

BACKGROUND AND AIM

In 2019, 7.5% of Catalan children were at risk of presenting psychopathology. There are few longitudinal studies that evaluate effects on mental health in this covid-19 pandemic. The Strengths and Difficulties Questionnaire (SDQ) is a validated tool to assess the risk of child psychopathology. Our objective was to evaluate the mental health of a pediatric population cohort throughout the 2020-21 academic year.

METHODS

Longitudinal and prospective study of a cohort of randomly selected children aged 5 - 14 years in Catalonia between September 2020 and August 2021. Risk of psychopathology was assessed with the SDQ. Data were collected through an online survey through the RedCap platform at the beginning of the course and at the end of each term (4 cuts).

RESULTS

At the beginning of the school year, 9.8% of the patients were probable cases of psychopathology. This risk went progressively down till 6.2% at the end of the year. The level of health concern of the children as well as previous mental health diagnoses were related to presenting psychopathology, while a good family environment was related at all times with a lower risk. No COVID-19 related variables were associated with altered SDQ outcomes.

CONCLUSIONS

Throughout the 2020-2021 school year, the percentage of children with a probability of presenting psychopathology went down from 9,8% to 6.2%. Children with a previous diagnosis of mental health problems and with a perception of a bad family environment had worse SDQ values, while variables directly related to COVID-19 had no influence.

EP526 / #675**E-Poster Viewing - Paediatrics AS04-04. Covid-19****The impact of the covid-19 pandemic on the most common diagnoses in pediatric surgery**

M. Bašković*, A. Čizmić, M. Bastić, B. Župančić, M. Žganjer,
L. Zaninović

Children's Hospital Zagreb, Department of Pediatric Surgery, Zagreb, Croatia

BACKGROUND AND AIM

In our study, we were interested in whether the pandemic has caused a statistically significant decrease in the number of examinations of children in the emergency department according to the most common diagnoses in pediatric surgery and whether there was a decrease in the number of emergency surgeries.

METHODS

The analysis included 15 months of the pre-coronavirus disease-19 period and 15 months of the coronavirus disease-19 period. The primary outcome of the study was to determine the cumulative number of all examinations and then to determine the number of examinations according to the most common diagnoses and, consequently, to determine whether there was a statistically significant decrease. The secondary outcome was to determine the cumulative number of all operations and then to determine the number of the most common emergency operations and, consequently, to see if there was a statistically significant decrease.

RESULTS

In the 15 months of the pre- coronavirus disease-19 period, a total of 33 646 children were examined in the emergency department, while in the coronavirus disease-19 period, 26 831 were examined ($p=0.010$). Although a decrease was recorded in all categories, a statistically significant decrease was recorded for diagnoses of abdominal pain ($p=0.007$) and lower extremity injuries ($p=0.014$). The total number of operations, due to strict measures and reduction of the elective program, decreased statistically significantly in the coronavirus disease-19 period ($p<0.0001$). The number of most common emergency operations did not decrease statistically significantly.

CONCLUSIONS

This study represents the first longer, 15-month experience of a pandemic in the only and largest children's hospital in Croatia. There is no doubt that coronavirus disease-19 had the effect of reducing the number of examinations in the emergency department for all the most common diagnoses, but the number of operations did not change significantly.

EP527 / #2284**E-Poster Viewing - Paediatrics AS04-04. Covid-19****Multisystem inflammatory syndrome in children (mis-c) with neurological symptoms, an under recognized presentation at admission: case series from two tertiary health care centers****I. Camelo^{1*}, G. Ntolkeras², E. Peacock-Chambers², J. Patel³**¹Augusta University, Pediatric Infectious Diseases, Augusta, United States of America²University of Massachusetts/Baystate Children's Hospital, Pediatrics, Springfield, United States of America³Augusta University/Children's Hospital of Georgia, Rheumatology, Augusta, United States of America**BACKGROUND AND AIM**

MIS-C is a rare complication seen in children previously diagnosed with COVID-19 infection. Neurologic manifestations in the setting of MIS-C with other concomitant symptoms can be difficult to detect by clinicians or describe especially by younger children, with potential under recognition at the time of admission.

METHODS

Retrospective chart review of 64 patients admitted from April 2020 to December 2021 with MIS-C diagnosis to two Pediatric Tertiary Care Centers and new-onset neurological symptoms at presentation. Clinical manifestations, neurological exams and magnetic resonance imaging (MRI) findings were collected and analyzed.

RESULTS

of the 64 children admitted with MIS-C diagnosis, 5 had multiple neurological complaints (7.8%). Symptoms included difficulty finding words, being confused, disoriented, unable to remember details, difficulty following commands, numbness and tingling of hands and/or feet, pain with ocular movements, neck pain, headaches, photophobia, phonophobia, unilateral weakness, and gait disturbances. of those with neurological symptoms, 3 had abnormal findings on neurologic examination at admission. One had normal neurological exam on admission but later developed seizures, a subsequent MRI exam showed evidence of multifocal leptomeningitis. Three had neurological symptoms and abnormal neurological exam but normal MRI findings. Gastrointestinal symptoms were most commonly associated.

CONCLUSIONS

In children with neurological symptoms, abnormal neurological exams were predominant. Even with symptoms and abnormal exam, the majority had normal MRI images. Neurological symptoms vary greatly in severity and include central and peripheral nervous system involvement. One child with subtle neurological symptoms later had seizures and abnormal MRI findings. Neurological symptoms in MIS-C can be subtle and be under recognized.

EP528 / #2410**E-Poster Viewing - Paediatrics AS04-04. Covid-19****A retrospective cohort analysis of the clinical course of sars-cov-2-positive infants****R. Mansfield¹, O. Oremakinde², N. Khambati¹, S.D. Sia², T. Campion-Smith^{2*}**¹University of Oxford, Paediatrics, Oxford, United Kingdom²Royal Berkshire Hospital, Paediatrics, Reading, United Kingdom**BACKGROUND AND AIM**

Deciding which febrile infants <3 months should undergo a full septic screen (including blood, lumbar and urine cultures) and commence intravenous antibiotics can be challenging, particularly in the context of known SARS-CoV-2 infection. We aimed to understand better the natural history of COVID-19 in <3-month-olds, and to assess our Unit's current practice in order to inform local guidelines.

METHODS

A retrospective cohort analysis of all SARS-CoV-2 positive <3-month-old infants admitted to the paediatric ward (March 2020-2022) at Royal Berkshire Hospital, UK (n=56), registered as a Quality Improvement Project (N5077). Data gathered from electronic medical records included clinical presentation, investigations and outcomes.

RESULTS

The most common reason for presentation was suspected or actual fever (75%), followed by poor feeding (54%). 20% had respiratory distress at presentation, while 56% initially had signs of poor perfusion. The mean WBC was 9.12 and CRP was 5.63. There were no positive pathogenic blood cultures

(n=46), nor lumbar puncture cultures (n=24), but there were three clinically-significant positive urine cultures (31 performed). 75% received IV antibiotics, 20% required fluid resuscitation, and one patient required supplemental oxygen. No infant was transferred for higher-level care.

CONCLUSIONS

This is the first dataset to describe the presentation, investigations and management of SARS-CoV-2-positive <3-month-old infants. Limitations include the retrospective design and the unknown influence of changing SARS-CoV-2 variants. Overall, we observe a good prognosis for SARS-CoV-2-positive infants, with little severe respiratory involvement. We advocate for continuing to test for other infections in these infants, since 10% of those tested had a urinary tract co-infection.

EP529 / #2756**E-Poster Viewing - Paediatrics AS04-04. Covid-19****New diagnostic perspectives in paediatric patients with hydroelectrolytic disorders due to covid-19****D. Ciortea^{1*}, M. Ursu², R. Cebuc³, R. Goroftei¹, A. Nechita¹, M. Matei⁴**¹*Dunarea de Jos" University, Faculty of Medicine and Pharmacy, Clinic Medical, Galati, Romania*²*Dunarea de Jos" University, Faculty of medicine, Școala doctorală de Științe biomedicale, Dsmf, Galati, Romania*³*INSMC Bucharest, Paediatrics, Bucharest, Romania*⁴*Dunarea de Jos" University, Faculty of Medicine and Pharmacy, Dental Medicine, Galati, Romania***BACKGROUND AND AIM**

The recent pandemics forced us to develop new investigation and treatment solutions for paediatric patients with moderate and severe forms of SARS-CoV2 infections. One of the most well-known aspects is represented by the pro inflammatory cytokines release, which is recently associated with the direct effects of the pathogen agent itself, fever, pain, hypovolemia, dehydration, and psychological stress. All these mechanisms are being intricated and conducting to a direct damage of the magnocellular neurones in the hypothalamic nuclei responsible for arginine-vasopressin (AVP) synthesis and release, and therefore the high blood viscosity is present in COVID-19 patients, resulting in microcirculatory disfunction and hydroelectrolytic imbalances.

METHODS

After performing a retrospective study based on statistical analysis of data obtain from our recent medical experience with paediatric patients, we revealed that an important percentage of the medium and severe forms of COVID-19 patients were associated with dehydration, polyuria and hydroelectrolytic imbalances.

RESULTS

Hyponatremia was directed correlated with severe form of acute SARS CoV2 infection in young children and adolescents, which may be explained due to inappropriate secretion of AVP, in these patients.

CONCLUSIONS

One of the main conclusions is represented by the fact that hyponatremia may be a used as a predictive marker of severity outcome in children admitted for COVID-19. As a future perspective we propose to use the copeptin dosing as part of the assessment of paediatric patients with severe forms of COVID-19, due to the high sensitivity and specificity of this biomarker, especially in children presenting with homeostatic disturbances.

EP530 / #1221

E-Poster Viewing - Paediatrics AS04-04. Covid-19

Digestive disease at the covid patients in a tertiary-level hospital

A. Dinulescu^{1*}, A. Păsărică², E. Smădeanu³, C. Becheanu⁴

¹Grigore Alexandrescu Emergency Hospital for Children, Paediatrics, Bucharest, Romania

²Grigore Alexandrescu Emergency Hospital for Children, Paediatrics, Bucharest, Romania

³Grigore Alexandrescu Emergency Hospital for Children, Paediatrics II, Bucharest, Romania

⁴Grigore Alexandrescu Emergency Hospital for Children, Paediatrics II, Bucharest, Romania

BACKGROUND AND AIM

The infection with the SARS CoV-2 predominantly causes respiratory disease, but many studies had shown an increased incidence of digestive symptoms in children. The Department Paediatrics II of the "Grigore Alexandrescu" Emergency Hospital for Children, Bucharest was transformed from November 2021 to March 2022 in a COVID-19 department for children. We aimed to analyze the profile of digestive symptoms of the COVID-19 disease in children admitted in this period of time in the aforementioned department.

METHODS

We performed a prospective study over the course of 4 months which comprised 110 patients with COVID-19 and digestive symptoms. SPSS ver 26 was used for the analysis.

RESULTS

of 379 COVID-19 positive patients, 126 (33,24%) presented digestive symptoms. The mean age at inclusion was $31,95 \pm 54,34$ months with 73 of them being infants (57,93%). The mean day at the presentation was $2,24 \pm 2,45$ days and the hospitalization period $4,89 \pm 4,46$ days. There was no correlation

between the age and the days of disease at the presentation ($p=0.227$) or the hospitalization period ($p=0.160$). The predominant symptoms were the following: diarrhea 81 (64,28%), emesis 75 (59,52%) and abdominal pain 34 (26,98%). 49 (38,88%) had elevated inflammatory markers ($CRP>0,5$ mg/dl). High inflammatory markers at the presentation was less present in infants ($p=0,001$). 64 (50,79%) had modified WBC count at the presentation.

CONCLUSIONS

The digestive symptoms were mild and non-specific and the day of presentation was around 2 days and the hospitalization period around 5 days. Elevated inflammatory markers at the presentation was least common in infants.

EP531 / #1224

E-Poster Viewing - Paediatrics AS04-04. Covid-19

A group of paediatric covid 19 patients analyzed by AGE

A. Dinulescu^{1*}, A. Păsărică², E. Smădeanu³, C. Becheanu⁴

¹Grigore Alexandrescu* Emergency Hospital for Children, Paediatrics, Bucharest, Romania

²Grigore Alexandrescu* Emergency Hospital for Children, Paediatrics, Bucharest, Romania

³Grigore Alexandrescu* Emergency Hospital for Children, Paediatrics II, Bucharest, Romania

⁴Grigore Alexandrescu* Emergency Hospital for Children, Paediatrics II, Bucharest, Romania

BACKGROUND AND AIM

Although at the beginning of the COVID-19 pandemic SARS-CoV 2 infection was rare in children, along the way represented a health issue to this category as well. This paper will analyze by age the SARS-CoV 2 positive paediatric patients admitted in November 2021-March 2022.

METHODS

From the aforementioned period, a group of 370 COVID-19 children was divided by age in 2 subgroups: infants and above one year of age. The groups were analyzed using SPSS ver 26.

RESULTS

The mean age at the presentation was $23,67 \pm 42,25$ months. 228 (61,16%) of them were infants. The most frequent symptom was fever. 204 (89,47%) of infants and 131 (92,25%) children above one year old had fever. There was no statistical significance between the type of disease by age, respiratory or digestive ($p=0,311$). The infants presented early at the hospital ($p=0,007$). Inflammatory markers were high (CRP>0,5 mg/dl) at 139 (37,56%) patients and 173 (46,75%) of them had modified WBC count. Infants had less often high

CRP at the presentation ($p < 0.001$). There were no statistical significance between WBC count by age ($p = 0,392$). The hospitalization period for these two groups was not statistically different ($p = 0,276$).

CONCLUSIONS

Fever was the most frequent manifestation in both groups. Early hospital arrival was present in infants and infants had less often high CRP at the presentation to the hospital. The type of disease, respiratory or digestive was not influenced by age.

EP532 / #1296**E-Poster Viewing - Paediatrics AS04-04. Covid-19****Comparison of covid-19 and rsv infection courses in children under 36 months hospitalized in paediatric department in fall and winter season 2021/2022****A. Fedorczak^{1*}, N. Zielińska¹, P. Nosek², K. Mikołajczyk², J. Lisiak², K. Zeman²**¹Medical University of Lodz, Department of Paediatrics, Nephrology and Immunology, Lodz, Poland²Polish Mother's Memorial Hospital Research Institute, Department of Paediatrics, Immunology and Nephrology, Lodz, Poland**BACKGROUND AND AIM**

The SARS-CoV-2 virus spreads easily and causes Coronavirus disease 2019 (COVID-19), which may manifest as severe respiratory illnesses. Respiratory syncytial virus (RSV) causes respiratory tract infections in infants and young children, many of whom require hospitalization. The study aimed to determine the differences between COVID-19 and RSV infections in young children hospitalized in the paediatric department.

METHODS

This retrospective study included 52 children with COVID-19 and 43 children with RSV infection younger than 36 months hospitalized in a paediatric department between September 2021 and March 2022. Clinical and laboratory findings, methods of treatment, and hospitalization length were compared.

RESULTS

In RSV group significantly higher rates of cough (93,2% vs 38,5%), rhinitis (83,7% vs 50%), dyspnoea (83,7% vs 21,1%), crackles (69,8% vs 5,8%) and wheezes (72,1% vs 9,6%) were observed. COVID-19 group had significantly higher rates of fever (80,8% vs 37,2%) and seizures (13,5% vs 0%). Patients with RSV infection had significantly higher rates of bronchodilator therapy (88,37 % vs 5,77 %), oxygen therapy (48,8% vs 7,7%) and required longer hospitalization (8 vs 3 days). In admission the majority of patients from both groups (RSV 86% and COVID-19 98,1%) were not treated with antibiotics, but because of clinical deterioration and suspected or proven bacterial coinfections, antibiotics were administered significantly more frequently in RSV group (30,2% vs 9,6%).

CONCLUSIONS

RSV infection in infants and small children had a more severe course than COVID-19 infection. RSV infection was associated with a longer hospitalization period and required more elaborate treatment.

EP533 / #2630**E-Poster Viewing - Paediatrics AS04-04. Covid-19****Profile of patients with pims – ts with medium term follow up- a tertiary care hospital experience with in the UK****K. Goyal^{1*}, P. Kukreja², S. Neshat²**¹University Hospitals of Leicester, Leicester Royal Infirmary, Paediatrics, Leicester, United Kingdom²University Hospitals of Leicester, Paediatrics Intensive Care, Leicester, United Kingdom**BACKGROUND AND AIM**

- Surge of novel paediatric inflammatory multisystem syndrome temporally associated with SARS-CoV-2 (PIMS-TS) first reported in April 2020 Objectives
- To gather clinico-biochemical information of patients with PIMS-TS presenting to University Hospital of Leicester
- To evaluate our management practice against available guidance
- To evaluate medium term follow up

METHODS

Prospective, single centre, observational study from April 2020 to March 2021 All admissions meeting RCPCH PIMS-TS case definition Clinical, biochemical and echocardiographic presentation Treatment as per National Consensus Follow-up post discharge - 6 weeks at general paediatric clinics, 6 weeks and 6 months in patients with predominant cardiac involvement

RESULTS

Total Patients (n)=24

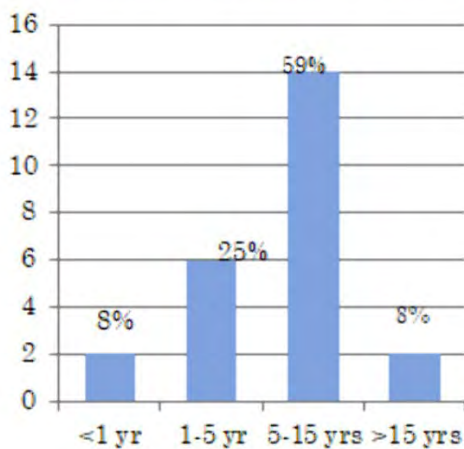
GRAPH 1: DEMOGRAPHICS - AGE

- Range – 6 months- 17 years
- Maximum no. of patients – 5-15 years

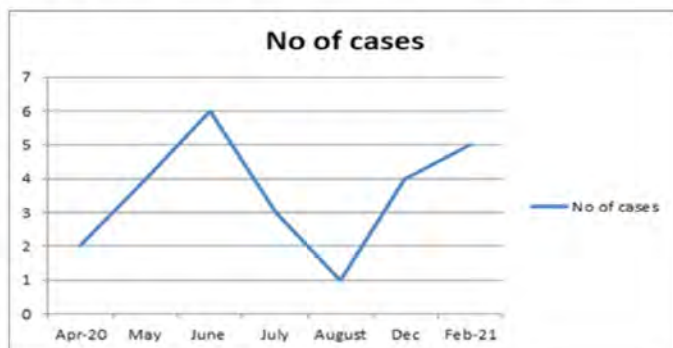
GRAPH 2: DISTRIBUTION OF CASES OVER TIME

Presentation: fever- all, 80% with abdominal symptoms

TABLE 1: CLINICO-BIOCHEMICAL PARAMETERS

Parameter (mean)	No shock (n=11)	Shock (n=13)	p value (<0.05)
Clinical:			
Age described as mean (SD)	4.1 (2.9)	9 (5.3)	0.009 ←
CICU /HDU stay (days)	4	5.1	0.51
Hospital stay (days)	5.42	9.89	0.0321 ←
Blood counts:			
WBC	15.1	18.15	0.394
Lymphopenia	2.251	0.955	0.033 ←
Neutrophils	11.139	14.11	0.389
Thrombocytosis	518.67	372.46	0.151
Thrombocytopenia	303.89	125.11	0.0024 ←
Biochemical indicators			
Highest Pro-BNP	8776.5	15989.77	0.140
Highest Troponin I	189.97	1381.45	0.131
Low Albumin	36.25	25.2	0.0004 ←
ALT	26.33	100.38	0.0321 ←
High Fibrinogen	6.4	6.023	0.56
High D-dimer	7.745	7.956	0.934
Urea	3.758	10.27	0.0067 ←
Creatinine	28.33	95.92	0.0385 ←

Initial ECHO findings	
Echo findings	No. of Patients involved
Pericardial effusion	10
Impaired systolic function	5
Dilated coronary arteries	2
No major echo findings	7
Total echo performed	24

PIMS-TS and COVID-19 status – Is there potential association?			
PIMS_TS Patients (n=24)	Covid-19 PCR	COVID-19 Ab	COVID-19 PCR+Ab
postive	4 (16%)	10(40%)	4 (16%)
negative	20(84%)	4(20%)	-
not available	-	10(40%)	-

Treatment- Supportive, IV antibiotics, steroids, IVIG All patients improved and discharged from hospital

CONCLUSIONS

No case fatality noted Follow up at 6 weeks and 6 months-no medium term complications and no residual cardiac dysfunction Statistically significant parameters in patients with shock. Older age group (median 9 years), longer hospital stay, lymphopenia, thrombocytopenia, low albumin, Raised ALT, deranged KFT. Such parameters may be scrutinise to triage and attend cases in future. No consistent Antibody testing for those patients who are COVID PCR negative at admission

EP534 / #1200**E-Poster Viewing - Paediatrics AS04-04. Covid-19****“Tout doux”: providing french-speaking canadians families with adequate tools and resources on vaccination for their children in the context of a pandemic.**

S. Loemba, M.-J. Dore-Bergeron, P. Laforce, J. Paquette, A. Lacroix, M.-F. Langlet, B. Grou*, E. D. Trottier

CHU Sainte-Justine, Tout Doux, Montreal, Canada

BACKGROUND AND AIM

With the ongoing COVID-19 pandemic, distribution of vaccination resources and tools is becoming more important than ever to help protect the population. Resources for procedural pain and distress management are not as abundant and diverse for French-speaking users. Through their partnership with the organization Solutions for Kids in Pain (SKIP), the institutional quality improvement (QI) initiative “Tout doux”, from CHU Sainte Justine, aims at further improving access resources for all pediatric French-speaking patients and healthcare providers on pain and distress prevention and management related to procedures, including vaccination.

METHODS

In summer 2021, “Tout doux”, a QI institutional initiative aiming at reducing pain and distress during medical procedures, developed a web page with French-written resources for parents and healthcare providers. With frequent demands for getting access to more resources and tools on vaccination, “Tout doux” decided to produce and promote through social media specific, concise and accessible tools dedicated to this procedure.

RESULTS

This included an infographic handout as well as two educational videos in French intended to patients and families. These newly developed tools were conceived to help families and patients be better prepared on how to manage and prevent the procedural pain and distress that may occur prior and during vaccination. Moreover, an e-learning module was created to help healthcare providers improve their practice of pain and distress management during vaccination.

CONCLUSIONS

The next step will be to ensure their optimal diffusion and dissemination through the ongoing vaccination campaign. It is likely that "Tout doux" will develop an effective knowledge transmission strategy.

EP535 / #1189**E-Poster Viewing - Paediatrics AS04-04. Covid-19****Antibodies against sars-cov-2. Does the children covid-19 burden of disease reflect the reality of their seroprevalence?****V. Matias¹, M. Gutierrez^{1*}, I. Sanz², M.D. Calvo³, A. Cubillo¹, B. Pacho¹, J. Sanchez², C. Montero³, J.M. Eiros²**¹Hospital Clinico Universitario de Valladolid, Department of Paediatrics, Valladolid, Spain²National Influenza Center of Valladolid, Vigilancia Virologica, Valladolid, Spain³Hospital Clinico Universitario de Valladolid, Department of Clinical Analysis, Valladolid, Spain**BACKGROUND AND AIM**

In children, COVID-19 usually courses mildly or asymptotically, frequently not being tested. This may underestimate its relevance and its role in the transmission of the virus. Our study aims to demonstrate whether the low burden of COVID-19 disease detected in children represents the prevalence of antibodies (Abs).

METHODS

A seroepidemiological randomized survey was carried out during 2021 in a group of children <15 years that come to the "Hospital Clínico Universitario de Valladolid, Spain" for other reasons different to SARS-CoV-2 infection. We obtained a serum sample to verify the existence and quantify the SARS-CoV-2 IgG Abs (in Arbitrary units/ μ l [AU/ μ l]) against S1, RBD and N antigens using Luminex technology. We recruited 121 children; 10.7% between 2-4 years, 24.8% between 5-9 years and 64.5% between 10-14 years.

RESULTS

A total of 64 children (52.9%) showed detectable Abs against SARS-CoV-2: 30.8% in the 2-4-years, 56.7% in the 5-9-years and 55.1% in the 10-14-years (Figure 1). The amount of Abs increased with age but without significant differences (Student-T, $p > 0.05$) (Figure 2).

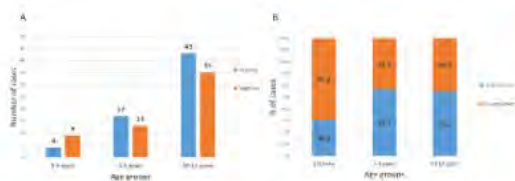

Figure 1 Number of cases (A) and percentage (B) of positives detected by age group in children.

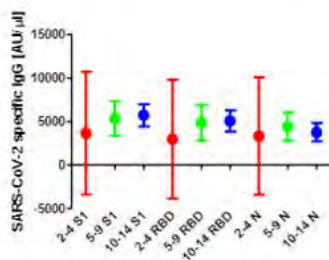

Figure 2 Abs values (mean and CI95%) against S1, RBD and N antigens of SARS-CoV-2 in children 2-4 years, 5-9 years and 10-14 years. AU, Arbitrary units.

CONCLUSIONS

The SARS-CoV-2 seroprevalence of recruited children ranged 50% and suffered a slightly increase with the age. The intensity of Abs production was similar in all age groups. The incidence data of COVID-19 in children published to date show a lower incidence of the disease than we detect using indirect methods (Abs). With these data, we believe that the impact of COVID-19 in children is being underestimated.

EP536 / #2212**E-Poster Viewing - Paediatrics AS04-04. Covid-19****The association between vitamin d levels and the clinical severity of covid-19 among ukrainian children****T. Harashchenko^{1*}, Y. Antypkin¹, T. Umanets¹, V. Lapshyn¹,
T. Kaminska², S. Stryzhak³**

¹SI «Institute of Pediatrics, Obstetrics and Gynecology named after Academician O.M. Lukyanova, National Academy of Medical Sciences of Ukraine», Respiratory Diseases and Respiratory Allergy In Children, Kyiv, Ukraine

²Kyiv City Children's Clinical Hospital of Infectious Diseases #12, Pediatric Infectious Diseases, Kyiv, Ukraine

³SI «Institute of Pediatrics, Obstetrics and Gynecology named after Academician O.M. Lukyanova, National Academy of Medical Sciences of Ukraine», Laboratory of Cytology, Endocrinology and Biochemistry, Kyiv, Ukraine

BACKGROUND AND AIM

Previous studies demonstrated that the deficiency of vitamin D affects the severity of COVID-19 and other viral respiratory infections in children. The aim of study was to determine the association between vitamin D deficiency and severity of COVID-19 in children from Ukraine.

METHODS

The study included 125 children aged 6 to 18 years, boys - 71 (56,8%), girls - 54 (43,2%), after laboratory-confirmed Covid-19 during the period between March and May 2021. Patients were divided into two groups: hospitalized children (n=68) with moderate/severe course of disease, outpatients (n=57) with mild. No significant difference was found between the groups in age and sex. Serum vitamin D levels were measured for all children.

RESULTS

Vitamin D deficiency (<20 ng/mL) among hospitalized children observed in 34 cases (50%), compared with 5 outpatient children (8,7%) (OR (95% CI) = 8.613 (2.707), <0,001). Vitamin D insufficiency (<30 ng/mL) had 19 hospitalized patients (27%), versus 10 outpatient (17,5%). The normal level note in 15 (22,1%), versus 17 (29,8%). Patients with low vitamin D levels were older than the patients with normal vitamin D levels (12.6 ± 4.4 vs. 7.2 ± 1.8 years, $P = 0.016$). Among the hospitalized patients 19 children (79,1%) with severe course of COVID-19 and 5 (100,0%) from intensive care unit had vitamin D deficiency.

CONCLUSIONS

Our study confirmed the association between vitamin D deficiency and the severity of COVID-19 in pediatric patients, suggesting an important potential role for this vitamin in the prevention or treatment of viral respiratory infections, including COVID-19.

EP537 / #895**E-Poster Viewing - Paediatrics AS04-04. Covid-19****Post covid cerebellar ataxia. A case series****S. Kalyanshettar***

BLDE (Deemed to be University) Sri B M Patil Medical college Vijayapura, Pediatrics, VIJAYAPUR, India

BACKGROUND AND AIM

The pandemic of COVID19 has multisystemic effects. It affects both the central and peripheral nervous systems. The SARS-CoV-2 virus enters brain by hematogenous route or olfactory system. ACE receptors present on endothelial cells of cerebral vessels are a possible route for entry. CNS effects range from mild features like headache, lethargy and confusion to severe manifestations like encephalopathy, encephalitis, myelitis, stroke, seizures, GB syndrome, cerebellar ataxia. four cases of post covid Cerebellar ataxia are presented.

METHODS

Its a case series. Four patients of Post covid cerebellar ataxia of varying severity are described

RESULTS

TABLE 1:

Clinical features	case 1	case 2	case 3	case4
Age	4 year	11 year	6 year	5 year
Sex	Male	Male	Male	Female
Presenting complaints	Swaying	Swaying Leg pains	Mild Swaying slurred speech	Unable to sit swaying
Cerebellar signs	Positive	Positive	Positive	Positive
Meningeal signs	Absent	Absent	Absent	Absent
Lab Parameters	Normal RT-PCR negative Covid Ig G Strongly positive	Normal RT-PCR negative Covid Ig G Strongly positive	Normal RT-PCR negative Covid Ig G Strongly positive	Normal RT-PCR negative Covid Ig G Strongly positive
Covid 19 vaccine	Not given	Not given	Not given	Not given
Treatment	Supportive Methylprednisolone	Supportive Methylprednisolone	Supportive Dexamethasone	Supportive
Improvement	2 weeks	10 days	10 days	10 days

CONCLUSIONS

Covid 19 disease can have CNS manifestations. Cerebellar ataxia may be seen in children secondary to covid 19. The primary infection might be asymptomatic in most of the patients A high index of suspicion is required to diagnose early. Steroids and supportive treatment are effective in such patients. No sequelae were observed in these patients

EP538 / #2778**E-Poster Viewing - Paediatrics AS04-04. Covid-19****Impact of the covid-19 pandemic on a pediatric emergency department**

L. Leite De Almeida^{1*}, I. Pais-Cunha¹, D. Valente-Silva¹, S. Gerales Paulino¹, A. Assunção¹, D. Rabiço-Costa¹, A. Reis-Melo², M. Tavares², R. Rocha¹

¹Centro Hospitalar Universitário de São João, Pediatrics, Porto, Portugal

²Centro Hospitalar e Universitário São João, Infectious Diseases/immunodeficiencies Unit, Department of Pediatrics, Porto, Portugal

BACKGROUND AND AIM

The impact of Covid19 pandemic on pediatric emergency department (PED) visits is not yet fully characterized. We aimed to analyze the changes in PED visits in a portuguese tertiary care hospital during the two years of pandemic.

METHODS

A retrospective cohort study was conducted. A pandemic period (March/2020 to February/2022) was compared to the prepandemic year (March/2019 to February/2020). The number of visits and its variations, triage code, discharge mode and SarsCov2 testing were analyzed.

RESULTS

During the first and second pandemic years, 40340 and 72020 visits to the PED were registered, compared to 76646 visits in the prepandemic period. This represents a reduction of 47.4% and 6.0%, respectively. The month with a sharper reduction was February/2021 (-70.1%, during the third wave and second lockdown), followed by April-May (first lockdown) and December/2020. On the contrary, between July-November/2021 (fourth/fifth wave) the visits

increased comparing to the homologous prepandemic period (peak of 19.6% increase in October). The proportion of different triage levels was similar in the three years. However, the percentage of hospitalizations was higher in the first year of pandemic (3.8% vs. 2.9%, $p < 0.001$). A total of 36830 SarsCov2 tests were performed, 61.1% during the second year of pandemic. During the first year, 35.5% of the patients were tested, 4.9% of them positive vs. 31.3% and 6.6% during the second year.

CONCLUSIONS

The continuous study of the impact of the different phases of the pandemic on health services is essential, as it may provide guidance when planning resources for future similar situations.

EP539 / #660**E-Poster Viewing - Paediatrics AS04-04. Covid-19****Multi-system inflammatory syndromes (mis-c) secondary to covid and/or dengue in paediatric population in guadeloupe****S. Balaguette¹, C. Caderoly¹, L. Kovacic¹, A. Mallard^{1*}, B. Muanza¹, P. Desprez¹, J. Helene-Pelage², E. Janky³**¹CHU de Guadeloupe, Paediatrics, Pointe-à-Pitre, France²Universite Des Antilles Et De La Guyane, Medicine General, Pointe-à-Pitre, France³CHU de Guadeloupe, Gynecology and Obstetrics, Pointe-à-Pitre, France**BACKGROUND AND AIM**

The COVID-19 outbreak has resulted in pediatric Multi-System Inflammatory Syndromes (MIS-C) that are similar to Kawasaki diseases (KD). Dengue has also been associated to a MIS-C such as a KD. The main objectives of this study were to determine the incidence, characteristics and the course of care of these MIS-C.

METHODS

The study is multi-centered, observational, descriptive, and retrospective, including all children under 15 years and 3 months who were admitted to the pediatric departments of the Centre Hospitalier Universitaire de la Guadeloupe (CHUG) and the Centre Hospitalier de Basse-Terre (CHBT) for a Covid 19 and/or Dengue infection from February 1st, 2020 to February 1st, 2021, with a clinical-biological and radiological situation compatible with MIS-C and/or KD.

RESULTS

Eight patients were included in this study. The incidence rate of MIS-C was estimated at 10.8 per 100,000 children under 15 years of age. The sex ratio M/F was 1.5. All patients suffered from gastrointestinal, mucous and skin signs. Sixty-three percent of patients had a cardiac ultrasound that highlighted decreased left ventricular ejection fraction. Two-thirds of them had coronary dilatation without aneurysm, 80% had myocarditis, and 2/3 had pericardial effusion. Half of all of the patients, was hospitalized in intensive care unit, 25% of them had hemodynamic failure. Among the half of the children who received an immunoglobulin treatment. No death was reported.

CONCLUSIONS

MIS-C can follow infection with Covid 19 or Dengue among the children.

EP540 / #1565**E-Poster Viewing - Paediatrics AS04-04. Covid-19****Malnutrition in paediatric patients with primary dyslipidaemia due to dietary compliance****Y. Marushko^{1*}, T. Marushko², Y.-E. Kulchytska²**¹*O.O. Bohomolets Medical University, Kiev, Ukraine, Department of Pediatrics of Postgraduate Education, Kyiv, Ukraine*²*Shupyk National Healthcare University of Ukraine, Department of Paediatrics No2, Kyiv, Ukraine***BACKGROUND AND AIM**

The aim of our study was to determine the effect of the CHILD-1 and CHILD-2 diets on the nutritional profile of paediatric patients with primary dyslipidaemia compared with their healthy peers and to identify possible deviations from the required daily nutrient intake.

METHODS

Using the FFQ: Food Frequency Questionnaire, we surveyed 13 our patients with congenital hypercholesterolemia who are being treated at the All-Ukrainian Children's Dyslipidaemia Centre in Kyiv.

RESULTS

92.3% of patients had a marked protein deficiency. At the same time, cholesterol intake was below 300 mg/day in all respondents. Patients with dyslipidaemia were also found to be moderately to severely deficient in vitamins A, B and D, as well as micronutrients such as potassium, magnesium and iron. No correlation with gender was found.

CONCLUSIONS

Paediatric patients induced to follow the CHILD-1 and CHILD-2 diets suffer from the protein deficiency and of certain vitamin groups according to our FFQ data ($r = 0.98$, $p < 0.05$). Prompt medical intervention and dietary patient education can help to avoid malnutrition in these patients.

EP541 / #2257**E-Poster Viewing - Paediatrics AS04-04. Covid-19****Neurological complications with sars cov-2 infection in pediatric patients****S. Mdimegh*, S. Ghorbel, A. Tej, N. Soyah, R. Kebaili, M. Abdelbari, H. Ben Belgacem, S. Tilouche, J. Bouguila, L. Boughamoura**

Farhat Hached Hospital, Pediatric, Sousse, Tunisia

BACKGROUND AND AIM

Since the onset of the COVID-19 pandemic, neurological manifestations of this virus have been observed with both acute infection or as a following phenomena. We aim in this review to describe neurological impact of Covid-19 as to help clarify clinical management and highlight lines of investigation.

METHODS

Data was collected from January 2021 to march 2022. We studied clinical characteristics, laboratory tests, radiological data and outcome of pediatric cases with SARS-CoV-2 infection complicated with neurological manifestations.

RESULTS

We report the cases of 5 children referred in the Intensive Care Unit, classified into: one case with acute SARS COV 2 infection (positive RT-PCR testing), while the others had previous infection testified with positive serological antibodies. Three of them were diagnosed with Acute Disseminated Encephalomyelitis–Like Disease (ADEM), one with Guillain-Barré Syndrome (GBS) and the other with meningoencephalitis. They were 4 boys and a girl, aged between 2 months and 7 years with no medical past history. Gait and speech disorders, visual disturbances, headaches and seizures were the main

first symptoms. Brain magnetic resonance imaging revealed diffuse FLAIR hyperintensity in basal ganglia, cerebellar peduncles and brain stem in patients with ADEM; however, it showed radicular damage in the patient with GBS. Four of our patients received immunomodulatory treatments consisting in steroids and IV immunoglobulins. The outcome was fatal in one case.

CONCLUSIONS

COVID-19 can lead to serious neurological complications. Increased awareness of its potential involvement and further investigation of its physiopathology will be necessary to understand and, ultimately, mitigate the neurological damage associated with SARS-CoV-2 infection.

EP542 / #347**E-Poster Viewing - Paediatrics AS04-04. Covid-19****Corticosteroid use in a child with covid-19 induced acute respiratory distress syndrome: a case report****F. Mirghani Ahmed Ali^{1*}, A. Masai², M. Hassan¹**¹Hamad Medical Corporation, Pediatrics, Doha, Qatar²Hacettepe University, Public Health, Ankara, Turkey**BACKGROUND AND AIM**

To describe a case of corticosteroid treatment in a 3-year-old child with severe COVID-19 and outcomes.

METHODS

We report a case of acute respiratory distress syndrome (ARDS) secondary to COVID-19 in a 3-year-old child and her treatment with dexamethasone. The child was brought to Hamad General Hospital with a fever (39 °C), runny nose, and a cough. The child tested positive for COVID-19. We did a chest radiograph that showed patchy consolidation in the right lower zone in the pericardiac region. After 72 hours of admission, she began to have tachypnea with desaturation up to 90 % that improved with oxygen support. She showed signs of sepsis, with a maximal CRP of 23.1 mg/L (normal 0.02-14.4). She had lymphopenia of 1.3×10^9 cells per L (normal 2.5-10.0). Her serum interleukin-6 (IL-6) concentration was 41.0 pg/mL. Her serum ferritin and D-dimer levels were 263 ng/ mL (normal 7-140) and 0.63 mg/ ML (normal 0.4-2.27). She was started on intravenous dexamethasone 0.15mg/kg (1.845 mg) and observed over 72 hours. She showed significant improvement.

RESULTS

Severe respiratory distress secondary to COVID-19 in children is rare. There is no current definitive data regarding the dose and duration of corticosteroids therapy for children with severe COVID-19. Our patient presented with COVID-19 induced ARDS. She responded to intravenous dexamethasone 0.15mg/kg (1.845 mg).

CONCLUSIONS

COVID-19 induced ARDS occurs more in adults. However, it is rare in children under five years. Children with ARDS secondary to COVID-19, requiring mechanical ventilation and oxygenation respond to dexamethasone.

EP543 / #1392**E-Poster Viewing - Paediatrics AS04-04. Covid-19****Retrospective-epidemiological study of children with mis-c, in a secondary hospital of central greece (12th/2020-12th/2021)****I. Tassiou, V. Mouratoglou*, M. Kopanou, A. Anastasiou-Katsiardani**

General Hospital of Volos, "Achillopouleio", Pediatrics, VOLOS, Greece

BACKGROUND AND AIM

Background: In Greece, more than 100 cases of children with multisystemic inflammatory syndrome (MIS-C), a serious condition with multiple organ involvement, have been reported so far. Aims: The annual recording of pediatric cases, and the detailed presentation of the clinical-laboratory findings, in order to sensitize the pediatricians so that they can suspect the appearance of MIS-C, after Covid-19 infection, in children.

METHODS

Material-Method: For this purpose, we gathered data from the electronic files of patients who were hospitalized in the Pediatric Clinic or were examined in the Pediatric Emergency Department from 12th/2020-12th/2021.

RESULTS

Six patients had clinical and laboratory findings compatible with MIS-C, 5 of which had positive antibodies (IgG-SARS-COV-2). 67% were male (mean age: 9.5 years). The main symptom was high fever (mean temperature: 39.8°C), followed by abdominal pain (67%), vomiting and diarrhea (50%). Signs included spotted rash (67%), inflamed throat, lymphadenitis and abdominal pain (50%), ophthalmia (17%), tachycardia (83.5%) and hypotension (33.5%).

From the laboratory tests all of them had increased CRP, D-DIMERS and fibrinogen, 67% had polymorphonucleosis while 1 had leukocytosis. 33.5% had thrombocytopenia and 50% had increased troponin. 5/6 had an initial normal cardiac examination. One child required immediate transfer to a tertiary hospital, while the others were sent within 48 hours after meeting the criteria for MIS-C.

CONCLUSIONS

Although children and adolescents have a low risk of serious disease from SARS-CoV-2, the pediatrician should be suspicious of and quickly recognize possible MIS-C symptoms so that the patient can have a prompt diagnosis, a proper treatment and finally the best prognosis.

EP544 / #547**E-Poster Viewing - Paediatrics AS04-04. Covid-19****Childcare teacher functioning over the 2-year course of the covid-19 pandemic.****R. Natale^{1*}, S. Messiah², Y. Agosto³, M. Ma³**¹University of Miami School of Medicine, Pediatrics, Ft Lauderdale, United States of America²University of Texas, Public Health, Houston, United States of America³University of Miami School of Medicine, Pediatrics, Miami, United States of America**BACKGROUND AND AIM**

Childcare centers (CCs) are essential businesses that provide care to children > 5 years old to support parent employment. Many CCs have been negatively impacted by the COVID-19 pandemic, but little is known about the psychosocial implications among teachers.

METHODS

A COVID-19 Risk-and-Resiliency survey (to determine psychosocial impacts and coping strategies) was electronically administered (in English, Spanish, Creole) in March, 2022 to CCs teachers (n=95) who work in predominantly low resource CCs. A second sample of CC teachers (n=81) completed the survey December 2021-January 2022. Teacher work environment was also assessed via the Healthy Environment Survey (HERS). Linear regression analysis examined the association between teacher psychosocial impacts and the CC work environment.

RESULTS

Both teacher samples were predominantly Hispanic/Latina (71%, 90%, respectively). The March 2020 sample reported high prevalence of anxiety (72.6%), sleep disturbance (52.7%) and sadness/depression (39.6%). 53% reported

needing support with CC social mitigation strategies while 68% reported that telehealth was a helpful learning platform. Results of the 2021-22 sample showed many of the original challenges reported in 2020 remained prevalent; 46% reported anxiety and 22% reported ongoing challenges with CC social mitigation strategies. Among the 2021-22 cohort, the higher levels of COVID related the stress, the more disorganized the classroom environment.

CONCLUSIONS

The negative impacts of COVID-19 on CCs teachers were sustained over 2 years and translated to disorganized CC classrooms. These findings are especially concerning given the essential, yet vulnerable population.

EP545 / #342**E-Poster Viewing - Paediatrics AS04-04. Covid-19****Incidental finding of ground glass appearance in ct chest in a symptomatic infant with covid-19 disease: unusual case report**

M. Odeh*, F. Al-Khori, A. Khalil, M. Hassan

Hamad Medical Corporation, Pediatrics, Doha, Qatar

BACKGROUND AND AIM

Covid-19 infections' course is still under studies especially among children. However Infantile age are usually asymptomatic or with mild symptoms so chest CT are rarely performed.

We are presenting 3-month old child who were completely asymptomatic with incidental finding of CT chest finding of COVID19 infection.

METHODS

Child of 3-month old due to recurrent vomiting for investigations, multiple labs and imaging test done and all were negative covid19 PCR done for imaging purposes a week apart and both were negative. On week 3-of admission patient partially improved so allowed to leave out on pass.

After 2-days mother describe a tactile fever when she came from home, sepsis work up done and was negative.

Abdomen CT performed and show incidental finding of ground glass appearance in the lower part of lung bilaterally(image-1).

Covid-19 PRC test done in response the CT finding, it was positive with CT value 19, patient still asymptomatic.

Patient then referred for Covid-19 center, discharged later for outpatient follow up.

RESULTS

Chest CT scan is rarely done for pediatric COVID-19 diseases. However, when performed it can have multiple finding with ground glass appearance as the commonest for severe presentation.

In our case patient was completely asymptomatic but still develop ground glass appearance in lower part of his lungs..



FIGURE 1:

TABLE 1:

	3 weeks after admission	2 weeks after admission	1 st day of admission
WBCs		8.4	13.3
HB		11.6	12.2
platelets		457	545
RBCs		4.3	4.5
Neutrophils		10.8	1.6
Lymphocytes		6.9	10.9
CRP			0.3
COVID-19 PCR	positive	negative	negative
COVID-19 CT	19		

CONCLUSIONS

Lung Ground glass appearance is pathognomonic in COVID-19 disease however it shouldn't be reflected as sequence of severe infection or attributed to COVID-19 complications alone without clinical presentation as it might present also in Asymptomatic children.

EP546 / #2601

E-Poster Viewing - Paediatrics AS04-04. Covid-19

Henoch schönlein purpura – is it a mild condition?

L.-M. Olăroiu^{1*}, R. Iorga¹, R.-G. Miulescu¹, D. Păcurar^{1,2},
M. Pavelescu^{1,2}, I. Dijmărescu^{1,2}

¹"Grigore Alexandrescu" Emergency Children's Hospital, Paediatrics, Bucharest, Romania

²"Carol Davila" University of Medicine and Pharmacy, Paediatrics, Bucharest, Romania

BACKGROUND AND AIM

Henoch-Schönlein purpura (HSP) is the most common childhood vasculitis, with deposition of immunoglobulin A (IgA) complexes in the small vessel walls. We aimed to identify possible correlations among patient's history, severity of the manifestations and laboratory tests, including a possible link to SARS-CoV2 infection.

METHODS

We performed a retrospective study over two years, which included HSP patients admitted to the Pediatrics Department. We collected history data, signs and symptoms and laboratory tests.

RESULTS

We enrolled 20 patients, sex ratio M/F = 1.5, mean age 10 years. A history of upper respiratory tract infection in the prior month was noted in 10% of cases, COVID19 was reported in the previous 3 months in 20% of cases. Out of the study group, 20% were presenting an upper respiratory tract infection at the time of HSP diagnosis. Associated with the characteristic skin lesions, arthritis (75%), gastro-intestinal (45%) and renal involvement (75%) were recorded. High levels of IgA were identified in 30% of cases, high inflammatory markers in 60%. In respect to the renal involvement, 60% of patients had proteinuria,

40% had microscopic hematuria, all with normal creatinine. Three patients (15%) presented relapses, all with previous chronic conditions (inflammatory bowel disease, chronic multifocal osteomyelitis, and epilepsy on Depakine).

CONCLUSIONS

For HSP etiology remains unknown, but in our cohort 20% were related to COVID-19. Even though renal involvement is not considered to be frequent, we report proteinuria and hematuria in a significant number of children. Also, high inflammatory markers are frequently found in HSP.

EP547 / #1541

E-Poster Viewing - Paediatrics AS04-04. Covid-19

Covid-19 in children from northeastern brazil: demographic and clinical profile

S. Florencio¹, B. Oliveira^{2*}, F.E. Lima², E.A. Brito², E.S. Melo³,
L. Barbosa⁴, M.G. Fontenele², M. Diógenes⁵, M.W. Ventura², G. Lima²,
M. Araujo⁶, A.P. Queiroz⁷

¹Federal University of Ceara, Nursing Department, Fortaleza, Brazil

²Federal University of Ceará, Department of Nursing, Fortaleza, Brazil

³University for the International Integration of Afro-Brazilian Lusophony, Institute of Health Sciences, Redenção, Brazil

⁴Federal University of Ceara, Nursing, FORTALEZA, Brazil

⁵Federal University of Ceará, Department of Nursing, Fortaleza, Brazil

⁶Federal University of the São Francisco Valley, Medicine Department, Petrolina, Brazil

⁷Federal University of Ceara, Department of Nursing, Fortaleza, Brazil

BACKGROUND AND AIM

The complications caused by COVID-19 in children are relatively less severe when compared to other age groups. However, some children have severe forms of the disease requiring hospitalization. Therefore, the objective was to verify the demographic and clinical characteristics of children diagnosed with COVID-19 in Northeastern Brazil.

METHODS

A cross-sectional study was carried out based on notifications of suspected cases of COVID-19 in Northeastern Brazil. The sample was composed of 59,701 confirmed cases of the disease in children aged 0 to 9, from March 2020 to January 2021. The data collection took place on the Brazilian Ministry of Health's platform on Influenza Syndrome Notifications (SIVEP Influenza). Descriptive statistics were used in the analysis.

RESULTS

There was a predominance of males (50.7%) and people from the countryside (82.9%). The mean age was 4.2 years. The State of Bahia had the highest prevalence of confirmed diagnoses (26.9%), followed by Ceará (18.4%), Piauí (13.4%), Maranhão (11.5%), Pernambuco (10.3%), Paraíba (9.4%), Alagoas (4.4%), Sergipe (3.1%), and Rio Grande do Norte (2.6%). The most common symptoms were fever (45.1%), cough (38.4%), and sore throat (20.2%), and the most common pre-existing morbidities were respiratory diseases (1.4%). Most cases evolved to cure (84.4%), but there was one record of death (0.2%).

CONCLUSIONS

The clinical manifestations of the disease were mild; however, one child has died. We thank the Coordination for the Improvement of Higher Education Personnel (CAPES Brazil) and the National Council for Scientific and Technological Development (CNPq Brazil, Process no. 402170/2020-2).

EP548 / #1568

E-Poster Viewing - Paediatrics AS04-04. Covid-19

Covid-19 pandemic: changes in children's school routine

M. Diógenes¹, B. Oliveira^{2*}, F.E. Lima², G. Lima², S. Florencio³,
M.G. Fontenele², M.W. Ventura², A.P. Queiroz⁴, I. Silva Junior⁵

¹Federal University of Ceará, Department of Nursing, Fortaleza, Brazil

²Federal University of Ceará, Department of Nursing, Fortaleza, Brazil

³Federal University of Ceara, Nursing Department, Fortaleza, Brazil

⁴Federal University of Ceara, Department of Nursing, Fortaleza, Brazil

⁵University Center of the Faculty of Medicine of ABC, Medicine Department, Santo andre, Brazil

BACKGROUND AND AIM

The COVID-19 pandemic caused sudden changes in the lives of millions of children and their guardians worldwide, including the establishment of a new school routine¹. Therefore, the objective was to identify the changes caused by the COVID-19 pandemic in children's school routine in the State of Ceará, Brazil.

METHODS

A cross-sectional study was carried out with 149 children aged between five months and five years living in the State of Ceará, Brazil. Data collection was carried out remotely with the children's guardians, from September/2021 to March/2022, through a Google Forms questionnaire.

RESULTS

The sample of children was predominantly female (n=75; 50.3%), with a mean age of 28.3±14.5 months, and residing in the capital (n=93; 62.4%). In the school routine, 71 children (47.7%) were studying under the following

conditions: they had started their studies before the pandemic (57.7%), had remote classes (78.9%), had changes in their school routine (73, 2%), did not have a specific place at home to attend classes (54.9%), were supervised by the parent in charge during class (74.6%), and have had a worsening in school performance (35.7%). of the 149 children, 71 (47.7%) have had behavioral changes, such as irritability (40.3%), stress (31.5%), anxiety (17.4%), and difficulty concentrating (16.1%).

CONCLUSIONS

The COVID-19 pandemic affected children's study routine, interfered with their school performance, and caused behavioral changes. We thank the Coordination for the Improvement of Higher Education Personnel (CAPES Brazil) and the National Council for Scientific and Technological Development (CNPq Brazil, Process no. 402170/2020-2).

EP549 / #1604

E-Poster Viewing - Paediatrics AS04-04. Covid-19

The respiratory symptomatology associated with covid-19 disease in paediatric patients

S. Pasarica^{1*}, A. Dinulescu², C. Becheanu¹, E. Smădeanu³

¹Grigore Alexandrescu* Emergency Hospital for Children, Paediatrics li, Bucharest, Romania

²Grigore Alexandrescu* Emergency Hospital for Children, Paediatrics, Bucharest, Romania

³Grigore Alexandrescu* Emergency Hospital for Children, Paediatrics li, Bucharest, Romania

BACKGROUND AND AIM

SARS CoV-2 virus represents a health issue with a heterogenous impact in the respiratory tract. This study aims to analyze the profile of paediatric patients with respiratory symptomatology, admitted in our clinic.

METHODS

We conducted a retrospective study, between November 2021 – February 2022, which included 260 patients diagnosed with COVID-19 associated with respiratory symptoms. Microsoft Excel and SPSS ver 26 were used for the analysis.

RESULTS

of the 260 patients, 117 are girls (45%) and 143 boys (55%). The mean age was 19.12 months (0-192). The severity of the disease: 59.61% upper respiratory tract infection, 27.3% pneumonia, 8.84% asymptomatics, 4.23% acute respiratory failure. Most patients presented at the E.R. one day after the onset of the disease (31.92%) with the most frequent first symptom of the disease, fever, that occurred in 178 patients (68.46%). Clinic, 235 patients presented fever (90.38%), 184 rhinorrhoea/nasal obstruction (70.76%), 155 cough (59.61%), 31 dyspnea (11.92%), 26 acute respiratory distress syndrome (10%) and 24 of

this patients had altered general condition (9.23%). The mean length of hospitalization was 3.76 days (0-27). Paraclinical, 103 patients had leukocytosis (6.92%) and 103 leukopenia (39.61%). Inflammatory syndrome was observed in 93 patients (35.76%). Lung radiography was normal for 128 patients (49.23%), 80 had interstitial pneumonia (30.76%), 14 unilateral pneumonia (5.38%) and 8 bilateral pneumonia (3.07%). There was no statistical significance between the high CRP and modified radiography ($p=0,094$).

CONCLUSIONS

Although the respiratory symptoms associated with COVID-19 disease have great variability, we observed that, for children, predominant forms are mild/moderate, with favorable evolution.

EP550 / #1875

E-Poster Viewing - Paediatrics AS04-04. Covid-19

Risk factors for disease severity and mortality of children with covid-19: a study at a vietnamese children's hospital

N. Phung*

University of Medicine and Pharmacy at Ho Chi Minh city, Pediatric Department, Ho Chi Minh, Viet Nam

BACKGROUND AND AIM

To find out risk factors for disease severity and mortality of pediatric COVID-19 in a terminal center in the fourth wave of COVID-19 in Vietnam

METHODS

This retrospective cohort study was performed at Children's Hospital 1 (CH1) from July 25 to December 31, 2021. All children with COVID-19 confirmed by a positive Realtime PCR SARS-CoV-2 result and treated at COVID-19 department for at least 72 hours were included

RESULTS

555 children with COVID-19 confirmed by positive RT-PCR and treated at our center for more than 72 hours. Median age was 22.3 months (3.2–88.6), 55.1% were male. The rate of mild, moderate and severe/critical cases was 73.7%, 9.0% and 17.3%, respectively. 192 children (34.6%) had underlying diseases. Underlying disease, dyspnea and CRP were 2 independent factors related to severe illness, with OR of 3.1 (95%CI: 1.75 – 5.5, $p < 0.001$), 75.5 (95%CI: 26.2 – 217.7, $p < 0.001$) and 1.008 (95%CI: 1.001 - 1.014, $p = 0.024$), respectively. 20.2% of patients in our study needed respiratory support, including 22

invasive mechanical ventilation cases. 18 cases (3.2%) died because of severe comorbidities, poor response to treatment. Through multivariable logistic regression analysis, we found that elevated WBC count and CRP were 2 independent factors related to mortality, with OR of 1.14 (95%CI: 1.01 – 1.28, $p = 0.031$) and 1.01 (95%CI: 1.001 – 1.02, $p = 0.032$), respectively.

CONCLUSIONS

All of death cases had severe comorbidities. Elevated WBC count, CRP in underlying disease were independent factors related to severity and mortality

EP551 / #447**E-Poster Viewing - Paediatrics AS04-04. Covid-19****Acute alcohol intoxication in dutch adolescents before, during, and after the first covid-19 lockdown****L. Pigeaud***

Erasmus University Rotterdam, Erasmus School of Health Policy & Management, Rotterdam, Netherlands

BACKGROUND AND AIM

The association between acute alcohol intoxication among adolescents and the COVID-19 lockdown has been studied previously in Trieste, Italy. They recommended that emergency services should be prepared for a potential peak of alcohol intoxication-related emergencies among adolescents as a result of the COVID-19 lockdown. Therefore, this study investigated the influence of the COVID-19 pandemic on the prevalence of acute alcohol intoxication among adolescents in the Netherlands.

METHODS

To determine both the prevalence and characteristics of adolescents admitted for acute alcohol intoxication in 2019-2020, a retrospective cohort study was conducted. All adolescents <18 years of age admitted for acute alcohol intoxication in the 12 participating hospitals in the Netherlands in 2019-2020 were included. Adolescents were divided in periods before, during, and subsequent to the first COVID-19 lockdown and the beginning of the second lockdown, in comparison with the same periods in 2019.

RESULTS

The prevalence of acute alcohol intoxication among adolescents decreased by 70% during the first lockdown (March 16-May 31, 2020) compared with the period before lockdown (January 1-March 15, 2020). Between the first lockdown phase and the reopening period (June 1-October 14, 2020), the prevalence significantly increased.

CONCLUSIONS

This study demonstrates that COVID-19 lockdown led to a decrease in acute alcohol intoxication among adolescents. This decrease is multifactorial, including the closure of bars/restaurants, sport clubs, schools and increased parental supervision due to obligatory working from home of parents. Based on the findings, this specific population requires close monitoring, especially in the reopening phases.

EP552 / #346

E-Poster Viewing - Paediatrics AS04-04. Covid-19

A pediatric case of covid-19 multisystem inflammatory syndrome with neuropsychiatric symptoms

K. Plėšnytė- Čapkauskienė^{1*}, L. Kilaitė², B. Paškevič², B. Lukšaitė¹, J. Radzevičienė¹

¹Vilnius university hospital Santaros Klinikos, Child Development Center, Vilnius, Lithuania

²Vilnius university hospital Santaros Klinikos, Paediatrics Centre, Vilnius, Lithuania

BACKGROUND AND AIM

In our report, we present a case of PIMS with exposed psychotic symptoms.

METHODS

To present and discuss a case of a patient with neuropsychiatric symptoms following the COVID-19 infection with Paediatric Inflammatory Multisystem Syndrome (PIMS) as a complication.

RESULTS

6 years old patient was diagnosed with PIMS based on the following findings: positive SARS-CoV-2 IgG antibodies, anamnesis includes patient's mother diagnosed with COVID19 one month earlier; fever; dysfunction of multiple organ systems; hallucinations, partially positive Babinski sign, bad coordination; splenomegaly, worsening thrombocytopenia; cardiac repolarization abnormalities; one episode of abdominal pain with emesis. The MRI performed during the first hospitalization exhibited abnormalities compatible with PIMS. The subsequent test during the second hospitalization showed improved dynamics. After the treatment of IVG (2mg/kg), steroids and aspirin

(75g/day, p/os) the patient improved and was discharged. After a month she was readmitted with persistent auditory and visual hallucinations and sleep disorders. After presenting a more detailed family anamnesis with impact towards differential diagnosis the patient was hospitalized at the children psychiatric department. 6 months later the detailed psychiatric examination showed absence of symptoms. The patient had been overseen by a children's cardiologist. No cardiovascular pathology was detected at the time of examination.

9 months later the patient started primary school with good adaptation.

CONCLUSIONS

In our case, 6 months later the detailed psychiatric examination showed absence of symptoms. Pediatric patients with PIMS can pose a major challenge in differentiating the main cause of the symptoms.

EP553 / #755

E-Poster Viewing - Paediatrics AS04-04. Covid-19

Cutaneous reaction to covid-19 vaccine

A. Rebelo*, R. Cunha, L. Sá, T. Oliveira, J. Lorenzo

Centro Hospitalar Entre Douro e Vouga, Pediatrics, Santa Maria da Feira, Portugal

BACKGROUND AND AIM

Atopic dermatitis (AD) is a chronic, pruritic, inflammatory skin disease that occurs most frequently in children. Various mechanisms are involved in its pathogenesis including epidermal barrier dysfunction and environmental triggers of inflammation. COVID-19 vaccines may induce numerous cutaneous complications related to COVID-19 vaccination.

METHODS

Authors report the case of a 15-year-old adolescent girl, with an unmedicated mild atopic dermatitis.

RESULTS

She presented to the Emergency Department due to a recent-onset itchy rash on her face with 1-month evolution. She reported that the rash appeared a day after her first dose of Pfizer-BioNTech COVID-19 vaccine and worsened after the second dose. On physical exam, she presented pruritic, red, scaly lesions involving the face, cheilitis and eyelid eczema (Figures 1 and 2). She was discharged home medicated with a topical corticosteroid and emollient. At one-month follow-up consultation she was fully recovered (Figure 3).



Figure 1



Figure 2

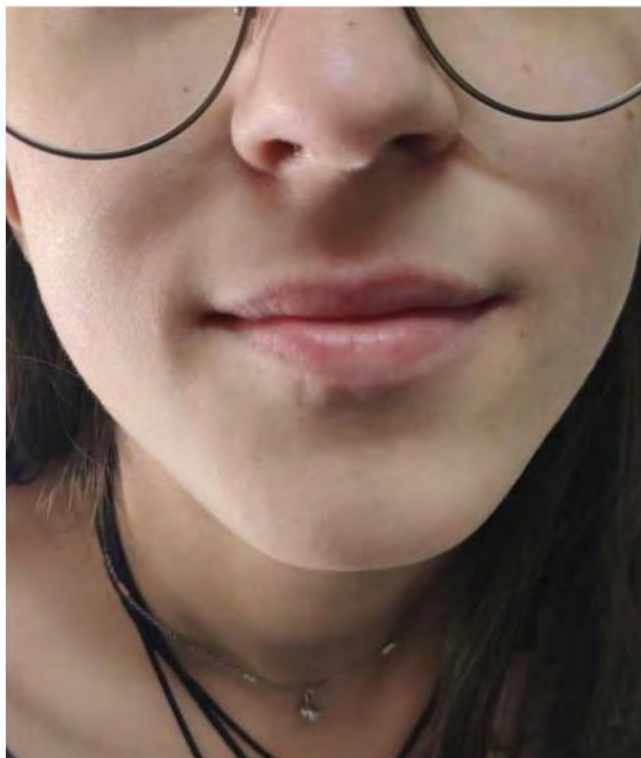

Figure 3

CONCLUSIONS

As COVID-19 vaccination has started worldwide to control this pandemic, health authorities recommended universal vaccination for adolescents aged 12-15 years old. COVID-19 vaccines may evoke numerous cutaneous adverse drug reaction, either de novo or a flare of pre-existing dermatosis. Patients with atopic dermatitis are not at increased risk for allergic reactions to COVID-19 vaccination. However, as seen in this case, vaccination may result in short-

term eczema exacerbation due to general immune stimulation. Usually, there are no contraindications to vaccination in pediatric population with allergic diseases such as atopic dermatitis. In the case of an acute flare, patients may be vigorously treated, and vaccination should not be delayed.

EP554 / #1564

E-Poster Viewing - Paediatrics AS04-04. Covid-19

Death of children with severe acute respiratory syndrome by covid-19 in brazil

I. Silva Junior^{1*}, A.P. Queiroz², B. Oliveira³, M. Diógenes⁴,
S. Florencio³, L. Figueiredo⁵, N.L. Albuquerque⁶, P. Oliveira²,
J. Pereira⁴, F.E. Lima³

¹University Center of the Faculty of Medicine of ABC, Medicine Department, Santo andre, Brazil

²Federal University of Ceara, Department of Nursing, Fortaleza, Brazil

³Federal University of Ceará, Department of Nursing, Fortaleza, Brazil

⁴Federal University of Ceará, Department of Nursing, Fortaleza, Brazil

⁵Assis Chateaubriand Maternity School, Medicine Department, Fortaleza, Brazil

⁶University of the International Integration of Brazilian Lusophony, Health Department, Redenção, Brazil

BACKGROUND AND AIM

In April 2022, Brazil reached the mark of 30 million cases and 660,312 deaths from COVID-19 in the pediatric population¹. Deaths reached 1,400 in the first two years of the pandemic². The objective is to describe the clinical profile of children who died from Severe Acute Respiratory Syndrome (SARS) by COVID-19 in Brazil.

METHODS

A descriptive, cross-sectional study was carried out using public data from Brazil's SARS Database (Sivep-Gripe, in Portuguese). The sample consisted of 276 children aged 0 to 9 years, who died from SARS by COVID-19, from January to March 2022. Descriptive statistics were used for the analysis.

RESULTS

Pediatric deaths from COVID-19 occurred in all regions of Brazil with the following incidences: Southeast (34.1%), Northeast (30.8%), North (12.8%), Midwest (11.6%), and South (10.7%). There was a predominance of males (56.2%) aged under one year (46.4%). The most common symptoms were fever (75.2%), cough (56.6%), dyspnea (75.7%), and oxygen saturation < 95% (75.9%). Pre-existing comorbidities included neurological diseases (45.6%), heart disease (35.3%), Down syndrome (19.8%), lung disease (14.3%) and immunodepressive diseases (13.8%). Most children were hospitalized (93.6%), required admission to an intensive care unit (69.3%), and needed ventilatory support (84%), mostly invasive (65.8%).

CONCLUSIONS

There was a high incidence of deaths among children under one year old. Respiratory symptoms were the most frequent, requiring ventilatory support. Acknowledgments: We thank the Coordination for the Improvement of Higher Education Personnel (CAPES Brazil) and the National Council for Scientific and Technological Development (CNPq, process no. 402170/2020-2).

EP555 / #1076**E-Poster Viewing - Paediatrics AS04-04. Covid-19****Clinical characteristics of brazilian children diagnosed with severe acute respiratory syndrome by covid-19 after two years of pandemic****I. Silva Junior^{1*}, A.P. Queiroz², B. Oliveira³, N.L. Albuquerque⁴, L. Figueiredo⁵, P. Oliveira⁶, M. Diógenes⁷, J. Pereira⁷, S. Florencio⁸, F.E. Lima⁷**¹University Center of the Faculty of Medicine of ABC, Medicine Department, Santo andre, Brazil²Federal University of Ceara, Department of Nursing, Fortaleza, Brazil³Federal University of Ceará, Department of Nursing, Fortaleza, Brazil⁴University of the International Integration of Brazilian Lusophony, Health Department, Redenção, Brazil⁵Assis Chateaubriand Maternity School, Medicine Department, Fortaleza, Brazil⁶Federal University of Ceará, Nursing Department, Fortaleza, Brazil⁷Federal University of Ceará, Nursing Department, Fortaleza, Brazil⁸Federal University of Ceara, Nursing Department, Fortaleza, Brazil**BACKGROUND AND AIM**

COVID-19 is an acute respiratory disease that can be asymptomatic or present various mild or severe symptoms, requiring hospitalization and admission to intensive care units¹. The objective is to describe the clinical characteristics of children diagnosed with Severe Acute Respiratory Syndrome (SARS) by COVID-19 in Brazil.

METHODS

A descriptive, cross-sectional study was carried out using public data from Brazil's SARS Database. The sample consisted of 5,995 children aged 0 to 9 years, with Severe Acute Respiratory Syndrome by COVID-19, from January to March 2022. Descriptive statistics were used for the analysis.

RESULTS

The sample was predominantly male (56.7%) and aged < 1 year (42.1%). The most common symptoms were fever (75.2%), cough (73.9%), dyspnea (52.1%), and respiratory distress (53, 9%). Most children were hospitalized (98.9%), of which 23.5% required intensive care. Risk factors were reported in 26.1% of the cases. Neurological diseases (34.7%) stood out. Most of the cases progressed to cure (91.4%), 5.4% died from the disease, and information on the progression of 3.2% of the cases have still did not been filled in the system. Only 3% of reported pediatric cases with COVID-19 have received at least one dose of the COVID-19 vaccine.

CONCLUSIONS

COVID-19 has a health-disease process that varies in its clinical course in pediatric patients. In this context, it's important to carry out more studies to understand the process of illness in different populations. We thank the Coordination for the Improvement of Higher Education Personnel and the National Council for Scientific and Technological Development, process no. 402170/2020-2).

EP556 / #1528**E-Poster Viewing - Paediatrics AS04-04. Covid-19****Hospitalization of Brazilian children diagnosed with severe acute respiratory syndrome by covid-19****I. Silva Junior^{1*}, A.P. Queiroz², B. Oliveira³, M. Diógenes⁴, S. Florencio⁴, L. Figueiredo⁵, N.L. Albuquerque⁶, P. Oliveira², J. Pereira⁴, F.E. Lima⁴**¹University Center of the Faculty of Medicine of ABC, Medicine Department, Santo andre, Brazil²Federal University of Ceará, Nursing Department, Fortaleza, Brazil³Federal University of Ceará, Department of Nursing, Fortaleza, Brazil⁴Federal University of Ceará, Nursing Department, Fortaleza, Brazil⁵Assis Chateaubriand Maternity School, Medicine Department, Fortaleza, Brazil⁶University for the International Integration of Afro-Brazilian Lusophony, Health Department, Redenção, Brazil**BACKGROUND AND AIM**

COVID-19 is an acute respiratory disease that can be severe, leading patients to hospitalization. The objective is to describe the characteristics of Brazilian children hospitalized with the Severe Acute Respiratory Syndrome (SARS) by COVID-19.

METHODS

A descriptive, cross-sectional study was carried out using public data from Brazil's SARS Database (Sivep-Gripe, in Portuguese). The sample consisted of 5,804 children aged 0 to 9 years, with SARS by COVID-19, hospitalized from January to March 2022.

RESULTS

Most hospitalizations (65.8%) occurred within the first three days of symptoms onset; 42.1% were children aged < 1 year. Hospitalizations occurred in wards (74.1%) and intensive care units (ICU) (25.9%). ICU admissions lasted from 1 to 63 days, with an average of 7.13 days, with a predominance of 7 days (71%). Ventilatory support was used in 49% of the children (9.3% invasive and 39.7% non-invasive). Imaging exams were performed including X-ray (57.2%) and tomography (8.7%). PCR diagnostic tests, antigen, or serological testing were performed in 99.9% of the cases. Hospitalizations progressed to cure (91.9%) or death (5.1%). Registers concerning the remaining cases have not yet been filled out in the system.

CONCLUSIONS

Hospitalized children with SARS by COVID-19 presented different levels of severity, were admitted to general wards and ICUs, had a prolonged hospital stay, and needed ventilatory support. Acknowledgments: We thank the Coordination for the Improvement of Higher Education Personnel (CAPES Brazil) and the National Council for Scientific and Technological Development (CNPq, process no. 402170/2020-2).

EP557 / #1576

E-Poster Viewing - Paediatrics AS04-04. Covid-19

The diagnostic struggles of mis-c: confounding factors or real concerns?

D. Toader^{1*}, A. Mititelu¹, R. Babici², M. Vintan³, A. andrei⁴, S. Cainap⁵

¹Clinical Emergency Hospital of Children, Second Department of Pediatrics, Cluj-Napoca, Romania

²Clinical Emergency Hospital of Children, Department of Pediatric Intensive Care, Cluj-Napoca, Romania

³Clinical Emergency Hospital of Children, Department of Pediatric Neurology, Cluj-Napoca, Romania

⁴Clinical Emergency Hospital of Children, Department of Radiology, Cluj-Napoca, Romania

⁵University of Medicine and Pharmacy 'Iuliu Hatieganu', Department of Pediatrics, Cluj-Napoca, Romania

BACKGROUND AND AIM

In the spring of 2020, reports of a mysterious syndrome similar to toxic shock syndrome and Kawasaki disease appeared, that seemed to be timely associated with SARS-CoV2 infection in children. The condition was termed Multisystem Inflammatory Syndrome in Children (MIS-C) and was defined broadly as a post-viral myocarditis and inflammatory vasculopathy.

METHODS

We present the case of a previously healthy 1 year old boy who was brought to our service after 5 days of fever, with bilateral non-purulent conjunctivitis, sore throat, strawberry tongue, adenopathies, polymorphous rash on the trunk and erythema of the palms and soles.

RESULTS

Laboratory investigations revealed markedly increased inflammatory markers, D-dimers, IL-6 levels, with positive IgG antibodies for SARS-CoV2. The case

was interpreted as MIS-C according to the WHO criteria and the patient was started on IGIV, with apparent improvement of symptoms. However, after the first week, the patient associated oculogyric crises, dysphagia, ataxia and right hemiparesis. The MRI was non-specific, while the CSF was suggestive of viral encephalitis. There was a slight positivity of the serous Herpes IgM antibodies, but with negative multiplex PCR of the CSF. Viral encephalitis was suspected and Dexamethasone and Acyclovir were administered, with slow resolution of neurological symptoms over the next months.

CONCLUSIONS

Whether the neurologic manifestations were symptoms of MIS-C (with false-positive Herpes serology from IGIV treatment) or an overlapped acute herpetic encephalitis, it was cautious to consider them both as real possibilities and treat them accordingly. While gaining experience with a new disease, precaution should always be exerted.

EP558 / #2754

E-Poster Viewing - Paediatrics AS04-04. Covid-19

Newly diagnosed type i diabetes and covid-19 pandemic

M. Ursu^{1*}, D. Ciortea², M. Arbune³, A. Nechita², M. Matei⁴, C. Dodul⁵

¹"Dunarea de Jos" University, Faculty of Medicine and Pharmacy, Dsmf, Galati, Romania

²"Dunarea de Jos" University, Faculty of Medicine and Pharmacy, Clinic Medical, Galati, Romania

³"Dunarea de Jos" University, Faculty of Medicine and Pharmacy, Clinic Medical, Galati, Romania

⁴"Dunarea de Jos" University, Faculty of Medicine and Pharmacy, Dental Medicine, Galati, Romania

⁵"Dunarea de Jos" University, Faculty of Medicine an Pharmacy, Doctoral School, Galati, Romania

BACKGROUND AND AIM

2020-beginning of COVID-19 Pandemic, SARS-COV2 is changing, spreading new variants with different infectivity and virulence. It was considered a respiratory disease, the systemic involvement and viral pathogenesis is proved more daily, possibly a trigger for new cases of diabetes. The aim of this study is to analyze these cases in "St.Ioan" Hospital from Galati, Romania.

METHODS

A retrospective pediatric population-based incidence study was performed, analysing medical reports, cases were stratified in age category: 0-5,5-10,10-15,15-18 years; sex: male, female; stages of COVID-19 pandemic: pre-pandemic I-year 2018 and II-year 2019, pandemic III-year 2020, IV-year 2021 and V- January-April 2022 the OMICRON variant of the virus. Clinical symptoms presented were especially polyuria, polydipsia and severe ketoacidosis.

RESULTS

46 new type I diabetes were notified, annually they fluctuated from 5 to 16, with unusual pick up in 2020. The incidence during pandemic was almost

double, with increased hospitalization rate. The weighting was between 23 and 60 %, the biggest in 2020. In 2022 almost half of them were new cases. From age groups prevailed 5-10 and 10-14 years; distribution based on sex shows equal affect, but the number of girls were bigger in 2020 and 2022.

CONCLUSIONS

Year-2020 had the highest incidence, age group 5-10 the most affected and there is no correlation for the sex category. The main symptoms, hyperosmolar polyuria and secondary polydipsia are usually ignored and therefore the diagnosis sometimes delayed. Although the data for 2022 are incomplete we can expect a boom in the number of cases at the end of this year.

EP559 / #1203

E-Poster Viewing - Paediatrics AS04-04. Covid-19

Prevalence of sars-co-v-2 antibodies in asymptomatic children with unexplained symptoms

G. Venckutė^{1*}, L. Jankauskaitė², G. Laucaitytė², K. Ganzijeva³,
E. Hansted³, A. Šnipaitienė³, R. Kėvalas³

¹LHUS Kaunas Clinics, Pediatrics, Kaunas, Lithuania

²Lithuanian University of Health Sciences, Pediatrics, Kaunas, Lithuania

³LUHS Kaunas Clinics, Pediatrics, Kaunas, Lithuania

BACKGROUND AND AIM

Since COVID pandemics, ~50% of children can have asymptomatic infection. However, they tend to have post-covid symptoms. Due to unexplained symptom origin (without confirmed COVID), they are referred to different paediatric specialists. Aim: to analyse SARS-CoV-2 antibody levels in children referred to our University Hospital ambulatory care with unexplained symptoms to clarify percentage of asymptomatic covid cases and related post-covid symptoms.

METHODS

Prospective study was conducted including children up to age of 18y without previous SARS-CoV-2 infection, were not breastfed, nor vaccinated against SARS-CoV-2. Parents were asked to fill-in the questionnaire about symptoms within one year before referral.

RESULTS

In total, 124 children were included into the study, 47.5 were female. Median age was 8.6y. 63.7% had different chronic diseases, e.g., asthma or arthritis and

56.4 were allergic. 41% noted that they have had symptoms of acute infection within one year, 24% of family members tested positive for SARS-CoV-2. 24.2% of children had antibodies against SARS-CoV-2 (Ab+). No correlation between positive test of family member and Ab+ child was found. No significant difference was observed between Ab+ versus Ab- within age groups, with or without chronic diseases. There were 57 children with unexplained symptoms and 26% of those children had Ab+. Most of those symptoms were respiratory (dyspnoea, cough), followed by neurological symptoms (insomnia, tiredness).

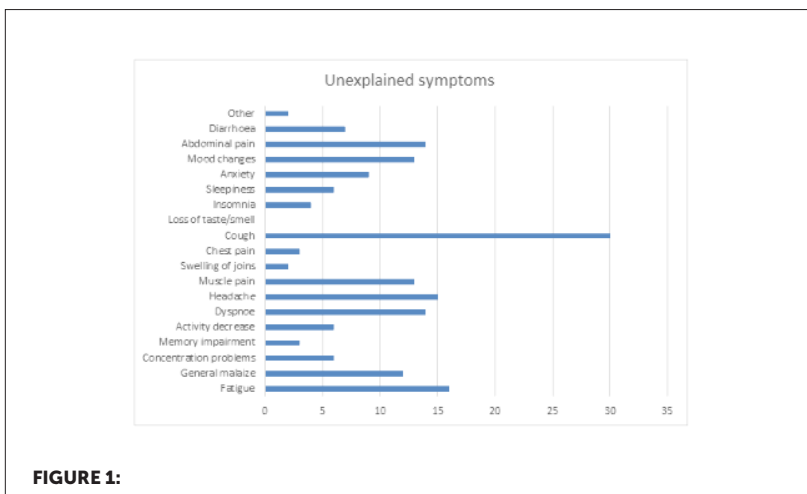

CONCLUSIONS

We did find 24% of the children Ab+ and those were children defined as never ill with COVID. Majority of unexplained symptoms within the Ab+ group were respiratory and/or neurological.

EP560 / #1421

E-Poster Viewing - Paediatrics AS04-04. Covid-19

The impact of covid-19 lockdown on children with recurrent wheezing and asthma in SPAIN

M. Rázquin Arias¹, Z. Daoud Pérez², P. Ventura^{3*}, A. Díaz Conradi⁴

¹HM Nens Hospital, Pediatric Pneumology, Barcelona, Spain

²Emirates Speciality Hospital Dubai, Pediatric Department, Dubai, United Arab Emirates

³Hospital Germans Trias i Pujol, Pediatrics, Badalona, Spain

⁴HM Nens Hospital, Pediatric Department, Barcelona, Spain

BACKGROUND AND AIM

The rapid spread of a novel human coronavirus SARS-CoV-2, led to drastic measures worldwide. Most countries were forced to declare the national lockdown. We studied the effect of lockdown measures on the level of asthma control and maintenance treatment in children with recurrent wheezing and asthma during the first wave of COVID-19 in Spain.

METHODS

we analyzed children with recurrent wheezing and asthma before and after the implementation of the national lockdown, considering pre-existing respiratory disorders, step treatment and level of asthma control before/after lockdown, COVID history and laboratory testing (including IgG SARS-CoV-2).

RESULTS

475 asthmatic and preschool wheezers (60.6% males) were enrolled, mean age 5.6 years. No differences were found in asthma treatment comparing both periods, since 81.7% maintained the same treatment ($p=0.103$). According to a validated questionnaire 87.7% remained well controlled during confinement. Nearly a third of children (34.9%) needed reliever treatment. IgG SARS-CoV-2

was performed in 233 children (49.1%) of whom 17 (7.3%) tested positive. Seven patients positive to IgG SARS-CoV-2 were assisted in the emergency department and two required hospital admission.

CONCLUSIONS

We observed that most of the children with recurrent wheezing and asthma remained well controlled from their underlying disease and did not modify greatly their maintenance treatments during the COVID-19 lockdown in Spain. We also observed that those children that tested positive to IgG SARS-CoV-2 showed significant increase in pediatric hospital admissions and attendances to urgent care settings.

EP561 / #2358

E-Poster Viewing - Paediatrics AS04-04. Covid-19

Children's mental health and covid-19

Z. Yazdanpanahi*, M. Hajfoghaha, N. Nasabeh

Shiraz University of Medical Sciences, Nursing and Midwifery School, Shiraz, Iran

BACKGROUND AND AIM

Background: Covid-19 affected whole family life, especially children that are the most vulnerable group in any society. Therefore their needs should be considered during any pandemic.

METHODS

Search keywords in PubMed, Google Scholar, and Medline database.

RESULTS

Result

Covid-19 affect the mental and physical aspect of the people involved. However, children are more affected, especially in their mental health. Children cannot express their feeling and emotions. Research shows that home quarantine impacts children's feelings of fear, hostility, decreased vitality, lack of security, inefficiency, skepticism, and passivity. The outbreak of coronavirus has limited children's play and happiness. Studies showed that children are generally affected in terms of age: in preschool, in the form of fear of being alone, loss of caregivers, speech problems such as stuttering, and loss of urinary control. and also, anorexia, eating and sleep disorders, nightmares, increased mood swings, grumbling, and more attachment to parents, the latter two are more common; At school age, mood swings, nagging, constant complaining, boredom, coping and dependence on par-

ents, anorexia nervosa, sleep disorders, physical symptoms, loss of interest in play, interaction with peers, Indicates learning and focus; In children 11 to 18 years old in the form of irritability, mood swings, impatience, restlessness, risky behaviors, Internet dependence, and cyberspace.

CONCLUSIONS

Conclusion

Children are vulnerable groups and quarantines affected their mental health. Considering children's psychological aspects is necessary and parents should be educated to detect and manage their problems.

EP562 / #1095

E-Poster Viewing - Paediatrics AS04-05. Dermatology

Johnson's stevens syndrome induced by carbamazepine: a case report

D. Belamri*, N. Boutalbi, L. Boustil, H. Sehab, N. Bouchair

CHU Annaba - Clinique Sainte Thérèse, Service De Pédiatrie, Annaba, Algeria

BACKGROUND AND AIM

Stevens-Johnson Syndrome or 'erosive ectodermatosis Pluriorificial' is a severe skin reaction to certain drugs. The diagnosis is purely clinical, associating painful involvement of the mucous membranes in the foreground and cutaneous involvement of erythematous papules with predominantly diffuse bubbles in the palmoplantar region.

METHODS

The authors present a literature review of Stevens's Johnson Syndrome and report a commented medical observation of an 8-year-old boy.

RESULTS

Our patient is an eight-year-old child with Depakine for epilepsy. We started treatment with carbamazepine because of the increased frequency of seizures. Three weeks later, dysphagia and skin extended eruption appeared. Clinical examination noticed: purpuric macules widespread in the abdomen, chest, and lower limbs, bubbles in the palmoplantar region, and a loose skin estimated at 10% of body surface area. bilatéral purulent conjunctivitis, erosion of the inner side of the bulkhead internostril, swollen lips covered with black crusts with erosions on the tongue and jugal mucous, scrotal bubble.

Biological investigation shows cytolysis liver, leukopenia, VS accelerated, and CRP+. The clinical aspect is evocative of Johnsons Stevens Syndrome, and the treatment was: stop the molecules, venous catheter, fluid and electrolyte intake, antiseptic for cleaning the lesions, and eye care. The evolution was favorable except for the pigmented spots. (after five years)

CONCLUSIONS

Carbamazepine is a drug with a high risk of Stevens-Johnson Syndrome; its introduction at the outset high dose and/or its association with Valproic acid seems to increase this risk.

EP563 / #2271

E-Poster Viewing - Paediatrics AS04-05. Dermatology

Re-activation of alopecia areata in a 12-year-old following pfizer- biontech covid 19 vaccination

K. Grounds, G. Cura*

NHS, Dermatology, Swansea, United Kingdom

BACKGROUND AND AIM

A 12-year-old with previous history of alopecia areata presented with new sudden onset hair loss 7 days after receiving the 1st Pfizer- BioNtech Covid 19 vaccination. This case highlights a potential association between 1st dose of SARS- Cov – 2 vaccination and reactivation of alopecia areata in a paediatric patient.

METHODS

A 12-year-old female presented to dermatology with new onset hair loss to her upper and lower occiput areas. She describes gradual loss of hair in a 7-day period following the SARS- Cov- 2 vaccination in December 2021. She has a background history of alopecia areata from the age of 9 years old where she developed a solitary patch of alopecia to her frontal scalp.

RESULTS

She is now applying topical Dermovate ointment to the affected areas daily with good response and evidence of hair regrowth.

CONCLUSIONS

The timing of this case however strongly suggests a potential connection between the administration of 1st dose of Pfizer-BioNtech Covid-19 vaccination and the onset of alopecia areata. A strong link between certain vaccines and autoimmune conditions has been established only in a few cases. (1) where Covid vaccine related AA onset or recurrence may be related to IFN -I mediated immune response to viral antigens. (2) Understanding this relationship will ultimately improve patient outcomes in view of clinical and psychological well-being. (3) Further research is therefore required to defiantly evaluate the association between covid-19 and development/ re-activation of alopecia areata especially in the paediatric population.

EP564 / #2444

E-Poster Viewing - Paediatrics AS04-05. Dermatology

Epidermolysis bullosa - a family metter

O.-E. Frasinariu^{1*}, M. Cozorici², I. Vasiliu³, V. Sreanga⁴, L. Trandafir⁴

¹University of Medicine and Pharmacy Grigore T. Popa Iasi, Mother and Child Department, Iasi, Romania

²Saint Mary Children Hospital, Pediatrics 3, Iasi, Romania

³University of Medicine and Pharmacy Grigore T. Popa Iasi, Pediatrics 3, Iasi, Romania

⁴University of Medicine and Pharmacy Grigore T. Popa Iasi, Mother and Child, Iasi, Romania

BACKGROUND AND AIM

Epidermolysis bullosa (EB), often referred to as the butterfly disease, is a group of rare genetic conditions characterized by skin that is delicate and fragile as butterfly wings. The skin blisters in response to friction, minor injury, or trauma.

METHODS

We present the case of a 3 years old boy, with Congenital bullous epidermolysis, dysmorphic form that referred to us for weight loss in the last 2 weeks.

RESULTS

Clinical exam showed disseminated post-bullous plaques covered by generalized sero-hematic secretions all over the body, erosive, ulcerated, painful lesions, covered with bloody crusts at the level of the mouth and of the buccal commissure, hypoplasia and anonychias of the fingernails and toenails. Biological test showed a severe anemia (hemoglobin 6 g/dl). Microbiological examination of open culture purulent collection showed the presence of *Staphylococcus aureus*. He needed erythrocyte mass transfusion. and also,

antibio-therapy for his extensive lesions. He referred to us for second transfusion some days, because of due to insensitive skin loss.

CONCLUSIONS

It is a case with severe lesions, with rapid progression, from a family with history of epidermolysis, in which the parents didn't follow the genetic counsel. While there has been significant progress in classifying the disease – identifying genes and proteins involved – there have been few advances in the treatment of the disease. The care of the EB patient focuses on management of symptoms, protecting the skin, and preventing complications.

EP565 / #1509

E-Poster Viewing - Paediatrics AS04-05. Dermatology

Genotype, phenotype correlation of incontinentia pigmenti; a case report

N. Jameel*, S. Sheridan, B. Finn, A.M. Murphy

University Hospital Limerick, Pediatrics, Limerick, Ireland

BACKGROUND AND AIM

Incontinentia pigmenti (IP), also known as Bloch Sulzberger syndrome, is a genetic ectodermal dysplasia affecting the skin, hair, teeth, microvasculature, and central nervous system. Progressive skin changes occur in four stages, the first of which appear in early infancy or can be present at birth. It is a hereditary, X-linked dominant disorder, with high penetrance and variable expressivity caused by changes (mutations) in the IKBKG gene. Aim: To report a case of IP in a 2-month-old infant with unremarkable family or personal history.

METHODS

We describe the clinical presentation, examinations findings, results of hematological & genetic investigation, photographs, radiological & skin biopsy findings, treatment, and outcome in our patient.

RESULTS

Our patient is 2nd child to a healthy non consanguineous Caucasian parents who presented to A&E at 6 days of age with vesicular crusted linear plaque on the lower limbs extending from left buttock to ankle with circular crust of scalp. She was diagnosed by our dermatologist with IP which was later confirmed by genetic test showing mutation in IKBKG gene and skin biopsy.

Her ophthalmological findings were also consistent of the diagnosis, however she has normal visual development and good fixing and following. She had a normal MRI and cardiology assessment. She continues to achieve all her developmental milestones and we are closely monitoring her with regular follow-up.

CONCLUSIONS

Long-term and close cooperation between dermatologists, pediatricians, neurologists, genetic counselors, and even dentists is crucial for better understanding of IP and prediction of the occurrence of the potential anomalies later in life.

EP566 / #2396

E-Poster Viewing - Paediatrics AS04-05. Dermatology

Parry romberg syndrome: a pediatric case report

I. Mazeda^{1*}, S. Alves², S. Ramos¹, C. Zilhão²

¹*Centro Hospitalar Póvoa de Varzim e Vila do Conde, Porto, Portugal, Department of Pediatrics, Póvoa do varzim, Portugal*

²*Centro Materno Infantil do Norte, Department of Pediatrics, Porto, Portugal*

BACKGROUND AND AIM

Parry-Romberg syndrome (PRS) is a form of linear scleroderma of the face and head. It is an acquired and progressive disorder, of unknown etiology, characterized by facial atrophy that may involve the dermis, subcutaneous tissues, muscles and bone, with mild or absent involvement of superficial skin. Timely diagnosis and treatment can prevent disease progression.

METHODS

Report based on clinical records and authorized photos.

RESULTS

A healthy 10-year-old girl presented to the pediatrics outpatient clinic for facial asymmetry evaluation. By the age of 5 years, parents noticed a reddish stain on the lower left eyelid, sequentially diagnosed as dermatitis and rosacea. Over the years, the lesion became progressively hyperpigmented and slightly depressed, and a gradual change in her facial features was observed, with emphasis on the left nasal wing deformity. Extracutaneous manifestations were never mentioned. Diagnosis of PRS was based on clinical examination. CT scan revealed mild facial asymmetry with left deviation of the nasal pyramid. MRI of the brain was normal. Laboratory investigations, including

autoantibodies, were unremarkable. Multidisciplinary evaluation in a tertiary center was carried on (pediatric rheumatologist, dermatologist and ENT), and methotrexate, topical calcitriol and tacrolimus started. During the first year of treatment, she reported slight lesion improvement, with no progression.



FIGURE 1:



FIGURE 2:



FIGURE 3:

CONCLUSIONS

This case shows the classical features of this rare entity, but also the diagnostic delay in early phases. Timely diagnosis and treatment allow a better prognosis and halt disease progression.

EP567 / #552**E-Poster Viewing - Paediatrics AS04-05.
Dermatology****Amyopathic juvenile dermatomyositis with
widespread calcinosis at disease onset: a case
report****M.Ç. Menteşe^{1*}, S. Şahin², A. Günalp², F. Haşlak², M. Yildiz²,
A. Adroviç², K. Barut², Ö. Kasapçopur²**¹MALTEPE UNIVERSITY FACULTY OF MEDICINE, Department of Pediatrics, ISTANBUL, Turkey²ISTANBUL UNIVERSITY CERRAHPAŞA, Department of Pediatric Rheumatology, ISTANBUL, Turkey**BACKGROUND AND AIM**

Amyopathic juvenile dermatomyositis (AJDM) is a rare form of juvenile dermatomyositis (JDM) occurs in approximately 1% of the myositis cases in which patients develop skin rashes without muscle weakness. Herein we present a 15 year-old patient with a diagnosis of AJDM.

METHODS

A 15 year-old male patient is referred to our outpatient clinic with a history of erythematous rashes on face, upper eyelids, hands and feet which were present for about a year. He had no complaints of weakness, myalgia or arthralgia. As AJDM is considered in differential diagnosis, laboratory tests and radiographic studies are performed for final diagnosis.

RESULTS

On physical examination there were malar rashes and bilateral heliothropic rashes on his upper eyelids (Figure 1A-B). Proximal and distal muscle strength of limbs were normal and no muscle tenderness was noted. Subcutaneous

plaques and nodules were palpable both on the upper and lower limbs which probably was developed as a result of calcium deposition. Laboratory tests including complete blood count and muscle enzymes resulted within normal range. Myositis-specific autoantibodies were negative. Radiographic studies showed widespread calcinosis of the muscle tissue all over the body (Figure C-E)

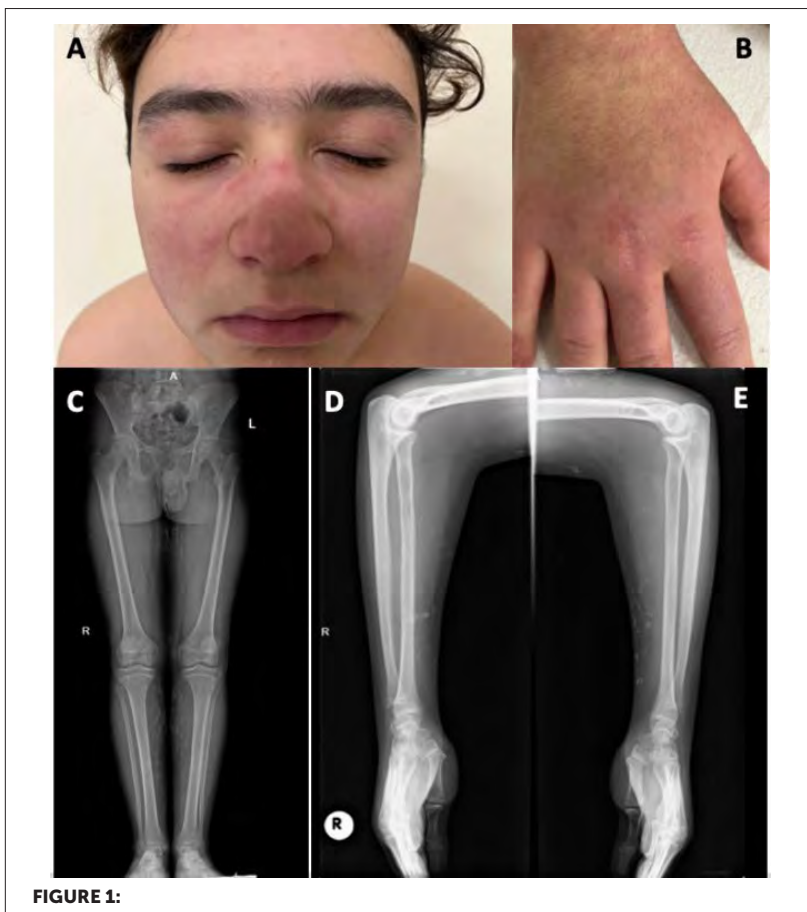

CONCLUSIONS

AJDM is a rare condition among children. As the initial presentation is the classic rash of JDM in the absence of clinically muscle involvement, it's very important to make the differential diagnosis carefully. Although the disorder is rare, early recognition and treatment are important ways to decrease the morbidity of systemic complications like calsinosis.

EP568 / #1853

E-Poster Viewing - Paediatrics AS04-05. Dermatology

Segmental achromic nevus – an uncommon clinical TYPE

C. Morais^{1*}, S. Catarino¹, A. Nogueira², A. Maia¹

¹Centro Hospitalar e Universitário São João, Department of Pediatrics, Porto, Portugal

²Centro Hospitalar e Universitário São João, Department of Dermatology and Venereology, Porto, Portugal

BACKGROUND AND AIM

Introduction: Achromic nevus (AN) is a hypopigmented skin disorder which fulfills Coupe's criteria: seen at birth or at least before three years of age; non-progression; no change in texture or sensation; no hyperpigmented borders. AN can be classified into two clinical types: isolated nevus (solitary, oval or round lesion) and segmental nevus (unilateral lesion that spans the lines of Blaschko). AN seems to be a form of pigmentary mosaicism, with functional defects of melanocytes and morphologic abnormalities of melanosomes.

METHODS

Case description: A previously healthy three-month-old female was referred by a private physician to General Pediatrics for a localized hypomelanosis noticed at two months of age, apparently without pruritus or other symptoms. Physical examination revealed multiple hypopigmented areas at the right hemithorax that had dorsal extension and crossed the midline. The lesion had serrated borders, spanned the lines of Blaschko and had no changes in texture or sensation.



FIGURE 1:

RESULTS

Clinical Hypothesis/Diagnostic Pathways: Diagnosis of AN was suspected since it fulfilled Coupe's criteria. The patient was observed by an experienced dermatologist, validating this hypothesis. Mosaic chromosomal abnormalities were excluded by karyotyping. At reevaluation (at six and 12 months), AN maintained its characteristics and the patient was discharged.

CONCLUSIONS

Conclusion/Discussion

AN is a differential diagnosis of hypomelanosis of the skin, often under-reported (prevalence 0.4-3%). The authors decided to highlight this case because segmental type of AN is less frequent (40%). Recognition of this disorder allows to reassure parents on the benignity of the condition. Treatment is mainly for aesthetics.

EP569 / #2665**E-Poster Viewing - Paediatrics AS04-05.
Dermatology****Severe skin damage in a patient with ulcerative colitis: two diseases or ONE?****L.-M. Olăroiu^{1*}, R. Iorga¹, I. Dijmărescu^{1,2}, G. Brînză¹, D. P. curar^{1,2}**¹"Grigore Alexandrescu" Emergency Children's Hospital, Paediatrics, Bucharest, Romania²"Carol Davila" University of Medicine and Pharmacy, Paediatrics, Bucharest, Romania**BACKGROUND AND AIM**

Henoch-Schönlein purpura (HSP), also known as immunoglobulin A (IgA) vasculitis, affects small vessels by deposition of IgA immune complexes. It is characterized by palpable purpura together with joint, digestive and renal involvement in varying degrees, and it is mostly diagnosed in children. Extraintestinal manifestations presenting as skin lesions have also been reported in patients with inflammatory bowel disease (IBD).

METHODS

We present the diagnosis and outcome of a patient known with ulcerative colitis and subsequently diagnosed with HSP.

RESULTS

We present the case of a 10-year-old boy diagnosed with ulcerative colitis 3 years prior, currently not treated, who was admitted to our Pediatrics Department with abdominal pain, loss of appetite, bloody diarrhea and one-day onset severe ulcerative palpable purpura involving both upper and lower extremities and the abdomen. He also associated renal (proteinuria and hematuria) and joint involvement. Laboratory tests showed normal hemoglobin,

high inflammatory markers, high IgA, normal gamma globulins and high fecal calprotectin. Urine studies displayed hematuria and mild proteinuria. The parents refused to approve performing a colonoscopy with biopsies. Given the severity of the symptoms (skin lesions, abdominal pain and bloody diarrhea), corticosteroids were administered with favorable outcome. Although the initial clinical diagnosis was HSP with gastrointestinal and renal involvement, the patient's history and evolution raise the question whether extraintestinal expression of IBD would have been a more accurate diagnosis.

CONCLUSIONS

This case supports the theory that known patients with an immune-mediated disease can develop a severe form of HSP and require appropriate treatment and follow-up.

EP570 / #372**E-Poster Viewing - Paediatrics AS04-05.
Dermatology****Multiple malherben's calcifying epitheliomas****A.E.C. Silva*, A. Azevedo, S. Miranda, C. Silva, S. Martins, S.C. Silva**

Santa Luzia - Ulsam, Pediatria, Viana Do Castelo, Portugal

BACKGROUND AND AIM

Pilomatricoma, also named Malherben's calcifying epithelioma, is a benign skin tumor that originates from the outer sheath of the hair follicle cells. Usually presents with an asymptomatic, solitary, firm, subcutaneous nodule with bluish-red discoloration of the overlying skin, occurring mostly in the head, neck, or extremities. Imaging can be used to rule out vascular or lymphatic malignancies, ultrasound being the most requested method

METHODS

No methods Clinical case

RESULTS

Regarding the clinical history, patients are usually asymptomatic but can report some pain or itching. When examined, pressing one edge of the lesion causes the opposite edge to protrude from the skin like a 'teeter-totter'. Also, stretching of the skin over the tumor demonstrates the 'tent sign' with multiple facets and angles. [1,2,4] Definitive diagnosis is performed by biopsy, merely. [5] As to treatment, surgical excision is the treatment of choice as spontaneous regression of pilomatrixomas has never been observed. Pilomatrixomas that are likely to undergo malignant transformation have a higher degree of cellular pleomorphism, high mitotic rate and atypia, central necrosis, and

more extensive infiltration into the skin, soft tissue, and blood and lymphatic vessels.]



FIGURE 1:



FIGURE 2:

Figure 1 and 2 - protuberant, non-tender, fluctuating, cystic mass with bluish discoloration on the medial aspect of the right arm



FIGURE 3: Nodule like lesion, with "whitish" coloration on the left preauricular region

CONCLUSIONS

Conclusion

Complete surgical excision with clear margins is almost always curative and serves as diagnostic confirmation. In the case of multiple pilomatrixomas, the presence of familial or associated conditions should be considered.

EP571 / #1081

E-Poster Viewing - Paediatrics AS04-06. Development

Down syndrome: a monocentric STUDY

B. Abdelmoula^{1*}, N. Bouayed Abdelmoula²

¹Medical University of Sfax, Genomics of Signalopathies At The Service of Medicine, SFAX, Tunisia

²Medical University of Sfax, Genomics of Signalopathies At The Service of Medicine, Sfax, Tunisia

BACKGROUND AND AIM

Down syndrome or trisomy 21 is a multi-systemic cytogenetic disorder described by John Langdon Down in 1866 and associated with chromosome 21 by Dr. Jerome Lejeune in Paris 100 years later. Characteristic facial features are key to this syndrome clinical diagnosis. Here, we report both clinical and cytogenetic features of a North African cohort who benefited from genetic counselling and cytogenetic analysis.

METHODS

We retrospectively analyzed epidemiological and clinical data of trisomic children who attended our genetic counselling between 2007 and 2009. Cytogenetic analysis was also carried out using conventional methods and RHG banding. At least 20 metaphases and 3 karyotypes were analyzed for each patient.

RESULTS

We identified 23 trisomy 21 cases including 36.36% males and 63.64% females. The mean age was 6 months among newborns and infants (n=20: 87%) and 6,3 years among preschoolers and school-aged children (n=3: 13%). All trisomic children suffered from constant clinical conditions with typical facial dysmorphism, intellectual impairment and neurological features, growth

retardation and developmental disabilities. Congenital heart malformations were present in 17,4% of cases. 91.3% of the karyotypes identified a free trisomy 21 (47,XX,+21 / 47,XY,+21) whereas 8.7% of the karyotypes identified an additional chromosome 21 as the consequence of a maternal Robertsonian translocation: 46,XX,+21t(21;21)(q10;q10).

CONCLUSIONS

All children with trisomy 21 dysmorphic features should benefit from cytogenetic diagnosis. Parents should be aware of the clinical features variability and the possible congenital malformations that can affect their trisomic offspring such as congenital heart disease to appropriately manage their children's condition and prevent it in future offspring.

EP572 / #2146

E-Poster Viewing - Paediatrics AS04-06. Development

Hematometra due to hymenal atresia

**M. Anastasakis*, I. Galonaki, C. Doitsidis, M. Mitroudi, C. Panteli,
I. Patoulis**

G.H.G.Gennimatas, Paediatric Surgery, Thessaloniki, Greece

BACKGROUND AND AIM

Hematometra is a condition involving retention of menstrual blood and occurs in 0.014-0.1% of females.

METHODS

It is most commonly caused by an imperforate hymen. Presentation of hematometra at the neonatal period includes hydrocolpos, hydrometrocolpos or mucocolpos, while post menarche blood is gradually accumulated in the vagina (hematocolpos), in the uterus (hematometra), in the fallopian tubes (hematosalpinx) or even in the peritoneal cavity (hemoperitoneum). Early diagnosis is feasible either by prenatal testing or by clinical examination of female neonates by pediatric surgeons. This study presents the cases of hematometra in three girls of 12, 13 and 14 years, who were managed by a single surgical team, at our department, in the last five years. The first two girls presented with acute urinary retention, while the third had long lasting back pain. On abdominal examination, fullness at hypogastrium and on vaginal inspection a bulging imperforate hymen were noted. A pelvic mass was felt on bimanual palpation. Diagnosis was confirmed by ultrasound. Under general anesthesia, a hymenotomy and drainage of vaginal canal were performed. To conclude, post menarche diagnosis poses the risk of complications, such as endometriosis or pelvic adhesions, that may cause infertility.

RESULTS

Vaginal inspection should be a part of clinical examination in all prepubertal girls with secondary sex characteristics, but without menarche, who experience urinary symptoms, constipation or back, pelvic or perineal pain.

CONCLUSIONS

We hereby present three rare cases of hematometra due to hymenal atresia, for enriching the known literature.

EP573 / #1094

E-Poster Viewing - Paediatrics AS04-06. Development

Developing a blended-learning training for childcare professionals to screen, refer and provide trauma-sensitive care for children exposed to domestic violence

J. Blom^{1*}, E. Bisagno¹, Z. Linde-Ozola^{2,3}, D. Morva⁴, M. Rozsa⁴, D. Bou Mosleh⁵, A. Kandate³, N. Laszlo⁴, G.L. De Fazio⁶, A. Cadamuro¹, D. Varga-Sabján⁴, D. Wuyts⁵, S. Dierickx^{5,7}

¹University of Modena and Reggio Emilia

²Department of Biomedical, Metabolic and Neural Sciences, Modena, Italy

²University of Latvia, Department of Anthropology, Riga, Latvia

³Centrs Dardedze, Prevention Center, Riga, Latvia

⁴Pressley Ridge, Hungary Foundation, Budapest, Hungary

⁵University Colleges Leuven-Limburg, Resilient People, Heverlee, Belgium

⁶University of Modena and Reggio Emilia, Department of Law, Modena, Italy

⁷Psychology and educational sciences, Clinical Psychology, Leuven, Belgium

BACKGROUND AND AIM

Children aged 0-3 are particularly vulnerable to the unpredictable stress of domestic violence. Young children slip through the net because they are unable to communicate their suffering. Childcare professionals are essential frontline professionals, as they have the opportunity to monitor children and families on a daily basis and can offer a safe environment to them. However, childcare professionals often miss the non-verbal signal of children at risk, feel incompetent to react or lack tools or procedures.

METHODS

This project is an initiative by four European organisations that work with the stakeholders of their countries: Belgium, Hungary, Latvia, and Italy. In Stage 1, focus groups and desk research were executed. In Stage 2, we organised living lab sessions to co-create (a) a tool to systematically detect signs of domestic violence among children and to adequately refer their families; and (b) a trauma-sensitive protocol that provides professionals with tools to enhance the resilience of children, caregivers and colleagues. The tool and protocol are integrated during Stage 3 in a training with virtual application to educate childcare professionals in screening, referral and providing trauma-sensitive care.

RESULTS

We found that most childcare professionals appeal to their gut feeling and experience to screen, refer and work trauma-sensitive when they are concerned for children being exposed to domestic violence. The stakeholders express a need for a durable and low-threshold solution to implement screening, referral and trauma-sensitive care in childcare organisations.

CONCLUSIONS

A pilot with 120 professionals will be executed to evaluate the training between May and October 2022.

EP574 / #1743

E-Poster Viewing - Paediatrics AS04-06. Development

Stepping up - a regional simulation education programme designed to support and enhance the skills of level 1 trainees in 'stepping up' to middle grade.

**S. Cromie^{1*}, S. Kapur¹, N. Kirk¹, J. Johnston¹, R. Mcbay-Doherty¹,
C. Lafferty¹, D. Mclaughlin¹, J. Wallace¹, N. McMahan¹, J. Richardson²**

¹Royal Belfast Hospital for Sick Children, Paediatrics, Belfast, United Kingdom

²Royal Belfast Hospital for Sick Children, Paediatric Intensive Care, Belfast, United Kingdom

BACKGROUND AND AIM

This education programme was initially created during the Covid 19 pandemic and delivered on a virtual platform with limited opportunity for interaction. The course has developed incorporating some didactic style teaching alongside simulation education scenarios. We aim to create a safe environment promoting learning amongst participants focusing on management, team working and non-technical skills required to practice at middle grade level.

METHODS

A faculty of senior trainees supported by the Northern Ireland Medical and Dental Training Agency (NIMDTA) School of Paediatrics created simulation scenarios incorporating non-technical and management skills. Facilitators adapted sessions ensuring effective transition from online delivery to a face-to-face course whilst adhering to current social distancing guidelines. A variety of simulation methods were used to maintain motivation and focus of participants and emphasising the pre-brief and creating a feeling of safety optimised participants' learning.

RESULTS

Feedback demonstrated that creating a relaxed and informal atmosphere established a safe environment for participants to learn. Simulation of scenarios which are concerning for trainees allowed them to feel more prepared for 'stepping up' to middle grade. Inclusion of management skills such as telephoning the consultant out of hours was noted to be particularly useful by participants.

CONCLUSIONS

Transformation of this course from virtual delivery to in-person simulation education has been welcomed by participants and been effective in addressing their concerns and making them feel more prepared for stepping up to a middle grade role. Creation of a course manual incorporating the simulation scenarios will ensure this programme remains an integral part of the regional teaching program.

EP575 / #1280**E-Poster Viewing - Paediatrics AS04-06.
Development****Global psychomotor developmental delay: a rare etiology****I. Eiras*, L. Abelha, I. Magalhães, S.C. Ferraz, S. Miranda, C. Silva,
F. Martins, D. Rocha**

Unidade Local Saude Alto Minho, Pediatrics, Viana do Castelo, Portugal

BACKGROUND AND AIM

The Global Psychomotor Developmental Delay (GPDD) is characterized by significant delay (≥ 2 standard deviations) in normalized age-appropriated tests in children under 5 years, in two or more domains of development.

METHODS

-Description-of-case-report-

RESULTS

Male child, referred to developmental consultation due to motor and language delay associated with deficits in social interaction, at age of 3. Physical examination showed no changes. He was oriented to otolaryngology and ophthalmology, and performed visual and auditory screening, both normal. An Autism Diagnostic Interview (ADI-R) was carried out and an Autism Diagnostic Observation Schedule (ADOS) was applied, both not compatible with the diagnosis of autism spectrum disorder. He was signaled to the local early intervention team and started speech and occupational therapy. At 60 months, a formal developmental assessment was performed using Griffith Mental Development Scale, which revealed an overall quotient of 58% (for

an average of 100). Etiological investigation was carried out with metabolic study and study of the FMR1 gene (X-fragile), which didn't reveal alterations. CGH array was performed, having detected an interstitial loss in heterozygosity in 4q28.1, involving exons 12 and 14 of the protein coding SPATA5 gene, probably pathogenic.

CONCLUSIONS

Interstitial loss in heterozygosity in 4q28.1, involving exons 12 and 14 of the protein coding gene SPATA5, is a rare disease that frequently occurs with GPDD, epilepsy, and sensorineural deafness. Although this diagnosis was only established two years after the first appointment, its absence didn't delay the start of intervention, which, in the event of a GPDD, should be as early as possible.

EP576 / #1660

E-Poster Viewing - Paediatrics AS04-06. Development

Superman syndrome

S.C. Ferraz*, I. Magalhães, L. Abelha, I. Eiras, S. Miranda, M. Costa

Unidade Local de Saúde do Alto Minho, Paediatrics, Viana do Castelo, Portugal

BACKGROUND AND AIM

XXX syndrome is caused by the presence of an extra chromosome y and it's a rare disease that affects only males. They can manifest intellectual disability, behavioral problems, tall stature among other features.

METHODS

We report an 11-year old boy with a height above the 99th percentile followed on neurodevelopmental consultation for ADHD and learning disabilities. He has a full-scale IQ test inferior to 70 and significant problems in adaptative functioning. On physical examination we notice a very tall boy, with facial dysmorphism, calcaneus valgus bilaterally with excessive pronation, positive Babinski sign and clonus on the left foot, and normal plantar reflex on the right foot. He had tandem gait and standing in one leg difficulties.

RESULTS

Etiologic evaluation was carried out by performing blood work that revealed a normal FMRI gene and an array-CGH with 47, XXX.

CONCLUSIONS

This boy was diagnosed with XXY/Jacob/Superman syndrome which is associated with tall stature, macrocephaly, facial dysmorphism, speech delay, ADHD, spectrum autistic disorder, developmental delay, impaired adaptive function, and a high risk for social and emotional problems. This syndrome is also associated with infertility. This diagnosis allows a better clinical follow-up of the patient, providing adequate genetic counselling to this family.

EP577 / #2042

E-Poster Viewing - Paediatrics AS04-06. Development

Down syndrome: characterization of the children followed in the development consultation of our hospital

D. Henriques Pinto*, A. Rebelo, S.S. S. Rodrigues, M. Azevedo, V. Monteiro

Centro Hospitalar Entre Douro e Vouga, Pediatrics, Santa Maria da Feira, Portugal

BACKGROUND AND AIM

Down syndrome (DS) is one of the most common chromosomal disorder and is a cause of developmental delay. It is also associated with congenital malformations and specific medical conditions. The aim of this study was to characterize the cases of DS in our hospital, aiming to alert to the most common problems.

METHODS

The authors characterized the cohort of children attending Development consultation in Centro Hospitalar entre Douro e Vouga between 1999 and 2022.

RESULTS

We have already seen in our consultation 71 children with DS but only 22 maintain follow up at this time. 52% of them were female and in 10 cases was made prenatal diagnosis. In the last decade, the average number of births was 0.7/year, with no births in majority of the years. The growth of

prenatal screening has reduced significantly the number of babies being born per year with DS. The average maternal age was 32.4 years. Cardiac (59%), ophthalmologic (46,5%) and otorhinolaryngological (40,8%) pathologies were the most frequent comorbidities. Recurrent lower airway infections (28,5%), endocrinological (28%) and orthopedic (28%) pathology were also prevalent. Global developmental delay/intellectual developmental disorder was present in all of them, although with a variable spectrum of severity. Most of them were followed up in Early Intervention and in Physical Medicine Rehabilitation hospital consultation.

CONCLUSIONS

The follow-up of this children involves multidisciplinary assessment and intervention. It is important that the care is standardized so that complications are not missed, enhancing their maximum development and improving their quality of life.

EP578 / #2232**E-Poster Viewing - Paediatrics AS04-06.
Development****Regional brain gray matter concentration
correlates to neurobehavior in very preterm
children and adolescent****E. Fischi-Gomez^{1,2}, V. Siffredi^{1,3,4}, M.C. Liverani¹, C. Borradori Tolsa¹,
R. Hà-Vinh Leuchter¹, P. Hüppi^{1*}**

¹Geneva University Hospital, Division of Development and Growth, Department of Paediatrics, Gynaecology and Obstetrics, Geneva, Switzerland

²Ecole Polytechnique Federale de Lausanne, Signal Processing Laboratory 5, Lausanne, Switzerland

³Ecole Polytechnique Fédérale de Lausanne, Institute of Bioengineering, Center For Neuroprosthetics, Lausanne, Switzerland

⁴Faculty of Medicine, University of Geneva, Department of Radiology and Medical Informatics, Geneva, Switzerland

BACKGROUND AND AIM

Preterm birth is associated with increased risk for executive and socio-emotional difficulties as well as cortical and subcortical gray matter (GM) alteration from birth to adolescence. The present study aims to unravel developmental changes in GM concentration in very preterm from childhood to adolescence and to relate these changes to executive and socio-emotional outcomes.

METHODS

Neuropsychological tests and parent-questionnaires targeting executive and socio-emotional abilities and high-resolution T1-weighted MRI (MPRAGE, 0.9mm isotropic) were collected for 105 subjects (Table1).

TABLE 1:

POPULATION N=105	GENDER	GA (weeks)	BW (g)	AGE SCAN (months)
PRETERM (PT) (N=65)	33F/32M	29.5 (1.75) [25.71-31.85]	1287.5 (274) [5101-990]	120.7 (26.7) [6.08-14.41]
CONTROLS (N=40)	17F/23M	39.7 (1.5) [35.85-42.43]	3414.5 (409.5) [2620-4110]	124.5 (926.4) [10.08-14.24]

Data is presented as mean (standard deviation) and range for continuous variables and count for categoric variables

Brain tissues and cortical regions were segmented using Freesurfer. GM concentration was computed over the MPRAGE and projected to the pial surface, averaging the GM concentration sampled at three cortical locations: pial, middle and outer surface. Cortical folding patterns were aligned using a nonlinear registration minimizing cortical geometry mismatch. Group-wise differences in cortical GM were inferred using a general linear model (with age at baseline and gender as regressors and FDR-correction). Linear mixed model was used to assess the correlation between altered GM concentration and neurobehavioral scores.

RESULTS

Fig1 shows significant alterations in GM concentration (blue: Controls > PT, red: PT > Controls).

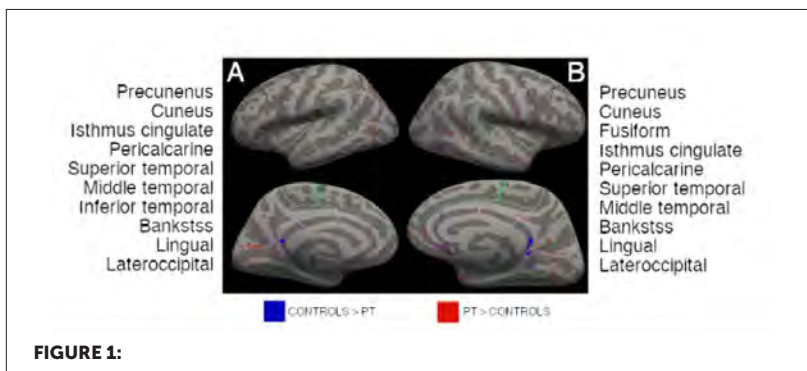

Correlations with neuropsychological tests are displayed in Fig2

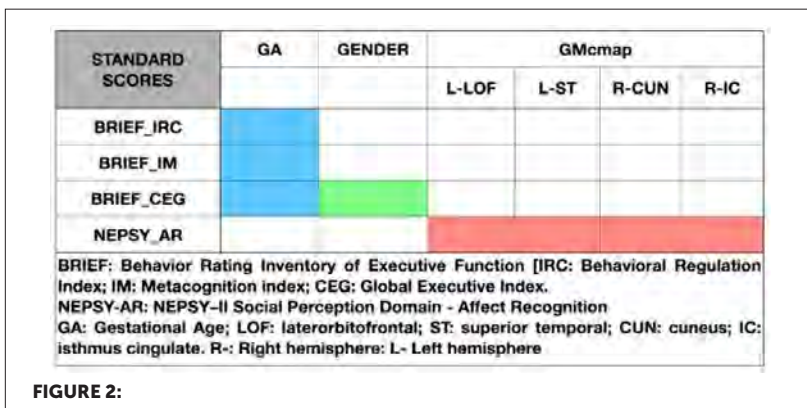

CONCLUSIONS

Our findings show alterations in GM characteristics after preterm birth across development. Associations between altered GM concentration and affect recognition abilities were found in several cortical regions, including prefrontal and cingulate regions known to be involved in affect recognition. Further work combining high resolution quantitative MRI and diffusion MRI is needed to corroborate these results.

EP579 / #883**E-Poster Viewing - Paediatrics AS04-06.
Development****Exploring relationships between motor skills performance and self-care abilities in young children with ASD****Y.R. Jin*, L.-Y. Lin**

National Cheng Kung University, Department of Occupational Therapy, Tainan, Taiwan

BACKGROUND AND AIM

Motor skills difficulties are one of challenges in children with autism spectrum disorder (ASD). Motor abilities are important to developmental profiles and occupational performance such as self-care activities. However, less research has focused on motor and self-care abilities of young children with ASD. This study aimed to explore the relationship between motor skills performance and self-care abilities in young children with ASD.

METHODS

Seventeen children with ASD between the ages of four and six years (mean = 5.02, SD = 6.27) were recruited. The Movement Assessment Battery for Children: Second Edition (MABC-2) and Assessment of Motor and Process Skills (AMPS) were administered.

RESULTS

Children with ASD demonstrated risks of motor difficulties in aiming and catching (mean = 6.12, SD = 2.98), and balance (mean = 5.00, SD = 2.24) domains and total score (mean = 5.12, SD = 2.60). For self-care abilities, low

levels of process skills were found (mean=.75 logits, SD =.73). Motor skills performance showed a significantly relationship with self-care motor ($r = .58$, $p = .014$) and process ($r = .63$, $p = .007$) skills.

CONCLUSIONS

Risks of motor difficulties in aiming and catching and balance domains and poor process skills in self-care abilities were found in young children with ASD. Main motor impairments include poor eye-hand coordination, bilateral coordination and motor control problems. Additionally, motor skills had a significantly strong relationship with self-care abilities in young children with ASD. Motor abilities may play an important role in children's occupational performance in self-care activities.

EP580 / #1630

E-Poster Viewing - Paediatrics AS04-06. Development

Developmental outcomes of low birth infants

M. Kherkheulidze^{1*}, N. Khavlashvili¹, E. Kandelaki², D. Abelashvili¹

¹State medical University, Pediatrics, Tbilisi, Georgia

²State Medical University, Pediatrics, Tbilisi, Georgia

BACKGROUND AND AIM

Aim of the study was assessment of growth and developmental outcome in low birth weight (LBW -1500-2000g) infants based on need of resuscitation during neonatal period.

METHODS

Case control study included 138 children, divided in 3 groups: I group - 38 LBW infants with history of resuscitation in neonatal period due to different problems, II group - 36 LBW without resuscitation, III - control group 42 patients with normal birth weight and uncomplicated history. Assessment of health history and examination), growth (WHO charts) and development (Bayley Scales) was conducted at corrected age of 18+3 months. Statistical analyses were based on SPSS 17.

RESULTS

Assessment shows that infants of I and II group have more ARVI during first years of life and more hospitalization than control group. The p-value is >0,5 comparing I and II group, but $p < 0,05$ if we compare the both group of LBW with control group of infants. Growth assessment does not show significant difference in child's height and HC, while the percentage of children with underweight was more evident in I and II group than in control. Assessment of the gross motor and cognitive scores does not show significant difference

between study and control groups, while the language developmental scores in first and second group were significantly lower than in control ($P < 0.0001$), but there was no difference between I and II groups.

CONCLUSIONS

LBW increases risk for neurodevelopmental impairments that is important to identify and start early intervention to improve the outcomes.

EP581 / #2757**E-Poster Viewing - Paediatrics AS04-06.
Development****Developmental problems in children with atopic dermatitis****E. Kandelaki, M. Kherkheulidze*, N. Khavlashvili**

State Medical Univeristy, Pediatrics, Tbilisi, Georgia

BACKGROUND AND AIM

Link between atopic dermatitis and emotional and behavioral dysfunction is more or less well recognized. Children with a chronic health condition have long been considered at excess risk for psychosocial morbidity. **The aim** of the study was assessment of incidence of atopic dermatitis in children of 4-5 years with developmental and behavioral problems.

METHODS

The cross sectional study was conducted. Children with developmental and behavioral problems according to medical records and aged 4-5 years were recruited consecutively in 2016-2019 years. PEDS:DM and Parents Illustrated Checklist was used for assessment. 327 children with delays were enrolled in study.

RESULTS

Significant amount of children with D&B problems and symptoms are developing AD. Children with language delay were more frequently developing AD symptoms than children with behavioral problems. In both cases everyday activities, sleep and recreational activities were affected and there more affected than in children with D&B problems and symptoms with AD comparable to

children without AD..Date represents that boys are more likely to develop AD than girls. Both boys and girls were similarly affected by QL problems in case of AD and D&B problems and symptoms.

CONCLUSIONS

Chronic diseases and development and behavior of children in further dilemma for researchers. Our study gives us further impulse for more deep insight in factors affecting children with delays and behavioral problems and prospective studies on group with D&B problem and symptoms and AD.

EP582 / #2437**E-Poster Viewing - Paediatrics AS04-06.
Development****Multi-disciplinary management of rett syndrome:
an audit of compliance with consensus guidelines****R. Mccarthy^{1*}, S. Mccormack¹, D. Mcdonald²**¹CHI @ Tallaght University Hospital, Paediatrics, Dublin, Ireland²Children's Health Ireland at Tallaght, Paediatrics, Dublin, Ireland**BACKGROUND AND AIM**

Background Rett syndrome is a rare genetic neurological disorder that results in severe cognitive impairment and developmental regression with associated motor dysfunction, the management of which requires a multidisciplinary approach due to its complex nature. **Aims** Our aim was to compare our clinical practice against pre-established guidelines that outline how best to care for these children. *Fu et al*⁽¹⁾ published a comprehensive breakdown of the management of Rett syndrome, and will serve as a standard for us to audit our own multi-disciplinary management.

METHODS

Methods Patients were identified through departmental records. We then retrospectively examined their medical documents to establish their overall management to date and compared this to the published standards.

RESULTS

Results We identified 6 patients in our cohort with a confirmed Rett syndrome diagnosis. We developed multiple categories to evaluate whether we were meeting international standards on care. Areas that scored well included

MDT involvement (100%), developmental checkups (100%), clear medication documentation (100%), and appropriate community care (100%). Some areas which scored poorly included clear documentation of original genetic results (33%), regular tanner staging (33%), and audiology assessments (16%).

CONCLUSIONS

Conclusions While we appear to be meeting several of our goals for the holistic management of these children, there are some areas requiring closer attention. Closer alignment with standards may be achieved by using a checklist or simplified local guideline. This study further highlights that the care of these children is extremely complex, requiring a great deal of multidisciplinary collaboration to ensure an anticipatory approach to optimizing clinical care.

EP583 / #1657**E-Poster Viewing - Paediatrics AS04-06.
Development****Dog ownership and childhood development****S. Abdelhafeez¹, C. Loh¹, K. Cahill¹, N. Crawley¹, S. Murray¹,
R. Huijsdens¹, S. Alam-Shoushtari¹, N. Essa¹, E. Isweisi^{1,2,3},
G. Semova^{1,2,3}, A. Branagan^{1,3,4}, J. Meehan^{1,2,3}, E. Roche^{1,2,3},
E. Molloy^{1,2,3,5*}**¹Trinity College Dublin, Discipline of Paediatrics, School of Medicine, Dublin, Ireland²Tallaght, Children's Health Ireland At Tallaght, Dublin, Ireland³Trinity College Dublin, Trinity Research In Childhood Centre, Dublin, Ireland⁴Coombe Women & Infants University Hospital, Neonatology, Dublin, Ireland⁵Children's Health Ireland at Crumlin, Neonatology, Dublin, Ireland**BACKGROUND AND AIM**

Childhood development focuses on the impact of human-human interaction, whilst the literature surrounding child-animal interaction centre on the impact of pet ownership on neurodivergent individuals. This paper seeks to address the gaps in current literature regarding the impact of dog ownership on positive childhood developmental outcomes.

METHODS

This systematic review was conducted utilising the PRISMA guidelines. Embase, PubMed and Web of Science were searched using key terms: 'dog', 'dog ownership', 'child', 'children', 'development', 'social', 'gross motor', 'fine motor', 'vision', 'hearing' and 'language'. 2867 articles were returned of which 13 were selected for extraction.

RESULTS

Pet ownership among children had positive effects on early childhood development, social and emotional development, child-dog attachment, language and communication development, and mental health and physical outcomes. Decreased developmental delay and fewer problems with peers by facilitating social engagement were reported. Children with higher levels of attachment demonstrated increased socio-emotional development and confidence. The effect of dog ownership also improved the development of language and speech.

CONCLUSIONS

Dog ownership was associated with improved development in childhood. Further understanding to quantify and expand on the influence of dog ownership on reaching and accelerating child developmental milestones would be valuable.

EP584 / #1868**E-Poster Viewing - Paediatrics AS04-06.
Development****Ank2 variant in a child with autism spectrum disorder and epilepsy****C. Morais^{1*}, R. Quental², L. Lourenço³, M. Guardiano³, C. Silva³, M. Leão²**¹*Centro Hospitalar e Universitário São João, Department of Pediatrics, Porto, Portugal*²*Centro Hospitalar e Universitário São João, Department of Medical Genetics, Porto, Portugal*³*Centro Hospitalar e Universitário São João, Pediatric Neurodevelopment Unit, Department of Pediatrics, Porto, Portugal***BACKGROUND AND AIM**

Background: In patients with autism spectrum disorder where clinical history, physical examination, array comparative genomic hybridization and molecular genetic testing for fragile X syndrome are inconclusive, the next step on etiological assessment is usually a whole exome sequencing trio or clinical exome sequencing.

METHODS

Case description: We report the case of a female with personal history of epilepsy, that was referred to the Pediatric Neurodevelopment department at two years old, because she was unable to achieve the language developmental milestones. She presented difficulties on establishing eye contact, following instructions or responding consistently to her name. Her mother reported an obsession with water and keyboards. She displayed some peculiar facial features including a large mouth with widely spaced teeth. Head growth evaluation was normal and neurological examination was unremarkable aside from toe walking.

RESULTS

Diagnostic pathways: Additional evaluation included an array CGH and Angelman Syndrome methylation analysis which were normal. A clinical exome sequencing was performed and a heterozygous variant of uncertain significance was identified in the ANK2 gene: c.3412C>T p. (Arg1138Ter). The genetic variant was searched in her parents and was negative in both, suggesting a *de novo* variant.

CONCLUSIONS

CONCLUSIONS

Recent studies of next-generation sequencing have shown that ANK2 seems to be an important candidate gene for autism spectrum disorder and there have been reports correlating *de novo* ANK2 variants with autism spectrum disorder and neurological phenotypes (including seizures). Additional research is required to better understand the association between ANK2 and autism spectrum disorder, as well as its implications on phenotypic spectrum.

EP585 / #2701**E-Poster Viewing - Paediatrics AS04-06.
Development****Sylver-russel syndrome – recurrent
hypoglycemia: the diagnostic KEY****B. Mota*, C. Silva, C. Costa, L. Lourenço, T. Campos, E. Rodrigues**

Centro Hospitalar de São João, Pediatric Department, Porto, Portugal

BACKGROUND AND AIM

Russell-Silver syndrome (RSS) is a rare disease characterized by short stature and, besides other phenotypic features, is also associated with development impairment, including autistic traits. May also develop recurrent episodes of hypoglycemia.

METHODS

A 3 year old boy, with short stature and poor weight gain and history of Intrauterine growth restriction, had language delay at 18 months and interaction and feeding difficulties and hand flapping noted at the age of 3. Griffiths scale showed a slight developmental delay and ADOS-2 score compatible with autism spectrum disorder (ASD.) Array CGH and X-fragile detection were negative. Brain MRI and electroencephalogram were normal. By the age of 5 he was admitted to the ER with a severe episode of hypoglycemia (47 mg/dL), in the context of excessive sleepiness after one day of excessive physical activity and poor feeding. In the subsequent evaluation, daily hypoglycemia were detected. Metabolic evaluation, including during a fasting test were normal. Clonidine stimulation test, IGF-1, thyroid hormones, insulin levels, and C-peptid after a fasting test were normal.

RESULTS

Genetic testing confirmed an alteration in gene KCNQ10T1, associated with RSS. Hypoglycemia avoidance was first attempted with starch but it wasn't enough and a histamine H₁ antagonist for appetite stimulation was tried unsuccessfully and he now maintains starch and dextrinomaltose daily.

CONCLUSIONS

RSS' diagnose is based on unspecific findings and remains difficult. We highlight that children with RSS are at higher risk for fasting hypoglycemia based on multiple factors and the presence of ASD aggravates the feeding difficulties, making it harder to avoid the hypoglycemia.

EP586 / #1599**E-Poster Viewing - Paediatrics AS04-06.
Development****Trigonocephaly associated with genetic syndrome
- craniosynostosis 4 (crs4)****M. Pereira^{1*}, D. Baptista¹, M. Rocha², C. Sá³**¹Hospital de Braga, Paediatrics, Braga, Portugal²Hospital de Braga, Genetics, Braga, Portugal³Hospital de Braga, Neonatal Intensive Care Unit, Braga, Portugal**BACKGROUND AND AIM**

Craniosynostosis can be found in isolation or as part of a genetic syndrome. Recently, an association with ERF (ETS2 Repressor Factor) gene was described - CRS4. This is characterized by synostosis of one or more cranial sutures, facial dysmorphism (prominent forehead, hypertelorism and exorbitism), Chiari-1 malformation, language delay and behavioral and learning problems. Some patients also have midface hypoplasia, retrognathia and digital shortening. It is an autosomal dominant syndrome, with 50% risk of transmitting the disease to the offspring.

METHODS

Not applied.

RESULTS

Case presentation: Male newborn with mild macrocephaly and facial dysmorphism (prominent forehead and exophthalmos). Family history of benign macrocephaly. At 4-months-old was noted prominent metopic suture with trigonocephaly, hypertelorism, exorbitism, low-set ears with posterior rota-

tion, bulbous nasal tip/hypoplastic nostrils and mild syndactyly of second and third toes. Cranial ultrasound showed "enlargement of subarachnoid space in a probable context of benign macrocephaly". 3D head tomography confirmed "early fusion of metopic suture, with trigonocephaly and subarachnoid enlargement, in relation to benign macrocephaly". No indication for neurosurgery treatment. Normal karyotype, heterozygous mutation in ERF gene (c.652C>T;p.(Arg218*)), detected by craniosynostosis NGS panel. On follow-up with mild global and language delay.

CONCLUSIONS

The diagnose of this rare syndrome is essential for a multidisciplinary follow-up and early intervention, when indicated. This families should also receive genetic counseling. Given the great variability of the clinical presentation, its identification will allow us to better understand the phenotypic spectrum and natural history of the disease.

EP587 / #599**E-Poster Viewing - Paediatrics AS04-06.
Development****Spatiotemporal evolution of infants' foot pressure during learning of standing****E. Pourreza^{1*}, B.C. Cengiz¹, N.B. Yaradanakul¹, A. Duyan Çamurdan², G. Bora Taş², M. Zinnuroğlu², S. Gürses¹**¹Middle East Technical University, Engineering Sciences-biomechanics, Ankara, Turkey²Gazi University Hospital, Internal Medicine, Ankara, Turkey**BACKGROUND AND AIM**

This study explores the developmental changes in active usage of contact surface and pressure distribution beneath infants' feet during learning of upright posture at quiet stance.

METHODS

The longitudinal study started with 44 healthy infants (1st-trimester, T1:12.5th months) continued every three months (T2,T3) during routine appointments in the pediatrics clinic. Each trial included an infant standing on a pressure-pad for 15-sec at T1, and 25-sec at T2, T3. Each of left and right foot were divided into three regions: Fore (FL,FR), Mid (ML,MR), and Hind (HL,HR). We performed frequency domain analyses on center of pressure at anteroposterior direction (CoP_x) and pressure signals, where mean-squared pressure at each region was estimated from the total area under frequency spectrum (Figure 3).

RESULTS

We used Two-Way ANOVA, with $p=0.05$. Significant results of Centroidal Frequency (CFREQ) and cut-off frequency covering 90% of total power

[90%PF] are provided below. Further, females had greater CFREQ of CoP_x in MR.

TABLE 1:

CoP _x		FL	FR	ML	MR	HL	HR
T1	CFREQ[Hz]				2.03±0.23 ^b		1.93±0.23 ^b
	90%PF[Hz]	2.96±1.55 ^{a,b}	2.36±0.75 ^b		2.03±0.72 ^b	1.68±0.63 ^{a,b}	1.81±0.56 ^b
T2	CFREQ				2.03±0.34 ^c		1.93±0.38 ^c
	90%PF	1.68±1.03				1.16±0.63	1.38±0.61 ^c
T3	CFREQ				1.77±0.20		1.61±0.16
	90%PF	1.36±0.62	1.41±0.81		1.17±0.55	1.00±.48	0.92±0.35
Pressure		FL	FR	ML	MR	HL	HR
T1	CFREQ				2.27±0.20 ^b		1.99±0.17 ^b
	90%PF	1.86±0.48 ^b	1.93±0.59 ^{a,b}	2.36±1.00 ^{a,b}	2.73±0.98 ^{a,b}	1.71±0.50 ^{a,b}	1.80±0.59 ^b
T2	CFREQ	2.01±0.36 ^c					
	90%PF		1.44±0.49	1.66±0.77	1.53±0.57	1.28±0.51	
T3	CFREQ	1.78±0.17			1.93±0.22		1.77±0.16
	90%PF	1.16±0.49	1.35±0.47	1.23±0.52	1.33±0.63	1.00±0.35	1.09±0.49

a. T1-T2 b. T1-T3 c. T2-T3

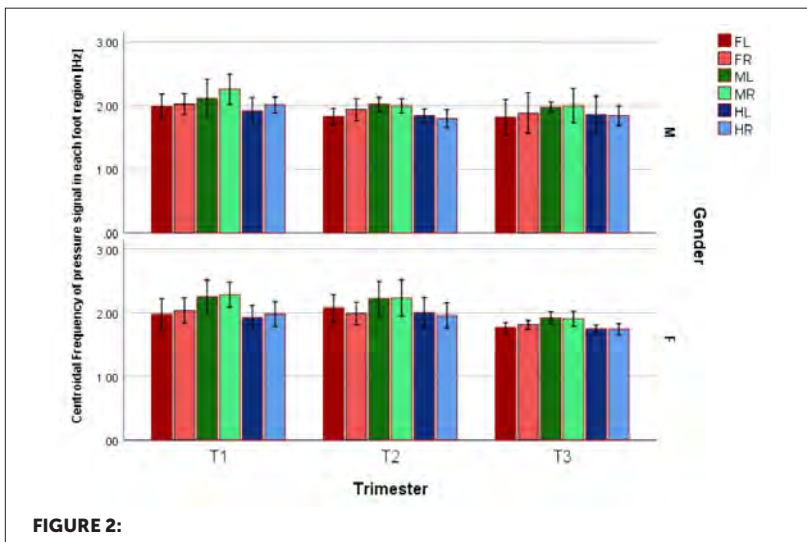
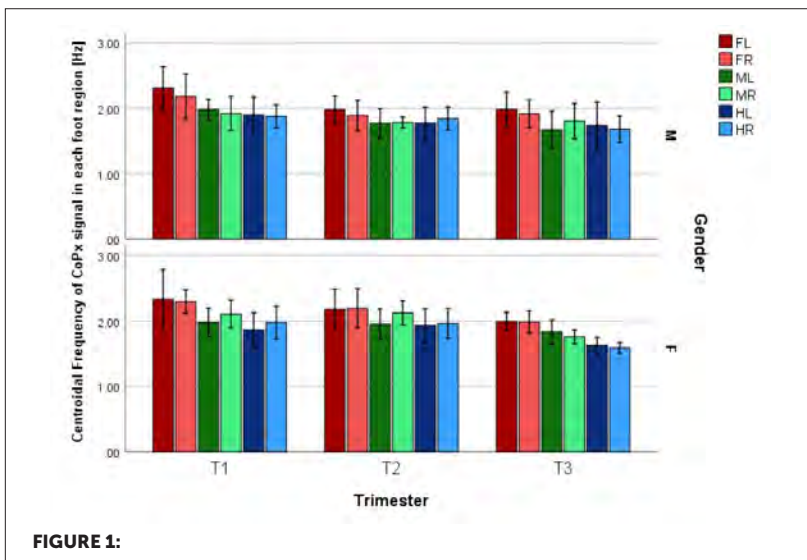

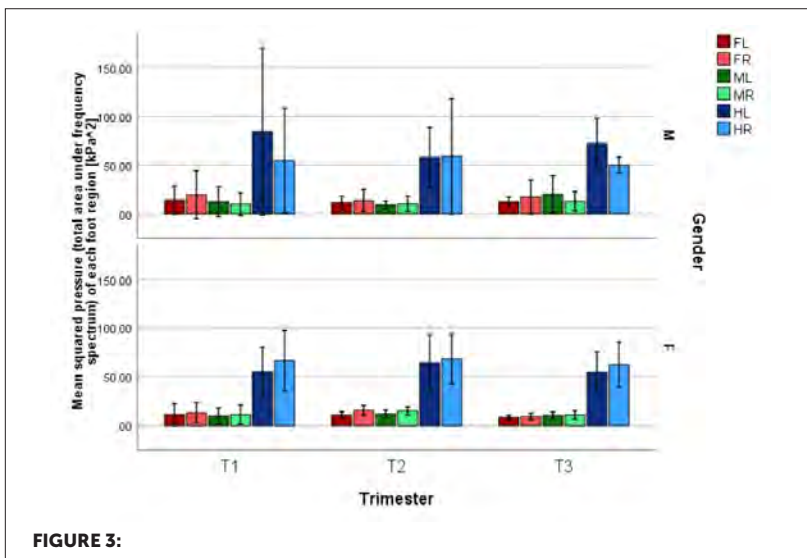

FIGURE 3:

CONCLUSIONS

We observed substantial spectral shifts to lower frequencies throughout the developmental stages. However, mean-squared pressure beneath each region was invariant.

EP588 / #1298

E-Poster Viewing - Paediatrics AS04-06. Development

Glass syndrome

M. Ribeiro^{1*}, M. Nogueira¹, A.R. Soares², S. Costa¹

¹Hospital de Braga, Serviço De Pediatria, Braga, Portugal

²Centro Materno Infantil do Norte, Genética Médica, Porto, Portugal

BACKGROUND AND AIM

SATB2-associated syndrome (Glass syndrome) is a neurogenetic multisystem disorder characterized by developmental delay (with severe speech delay), behavioural problems and dysmorphic features, mainly craniofacial anomalies. Genetic testing is mandatory to confirm the diagnosis. The most common features can be described using the acronym SATB2: speech anomalies, abnormalities of the palate, teeth anomalies, behavioural issues and onset before the age of 2.

METHODS

Our work will be presented as a single case report.

RESULTS

A 3-year-old male was referred to the hospital due to global developmental delay. He presented with absent speech, aggressive outbursts, difficulties in establishing eye contact and stereotyped behaviour. Physical examination showed an elongated face, downslanting palpebral fissures, depressed nasal bridge and diastemata. A clinical diagnosis of autism spectrum disorder was made and evaluation for potential underlying abnormalities was performed. Brain magnetic resonance imaging was normal. Auditory brainstem and steady-state responses revealed a bilateral sensorineural hearing loss. Clinical

exome sequencing revealed a *de novo* pathogenic variant in SATB2 gene location c.1285C>T(p.Arg429*). The diagnosis of Glass syndrome was made, and genetic counselling was given to the family.

CONCLUSIONS

The SATB2 gene is important for brain and skeletal development. Global developmental delay is usually the initial presentation of the syndrome. Due to multiple phenotypic manifestations and the lack of specific laboratory tests (other than genetic testing) it is possibly an underdiagnosed condition. Nonpharmacological treatment should be first-line treatment whenever possible. With the increasing progress of medical genetics, the multidisciplinary management of these patients is of utmost importance.

EP589 / #1665**E-Poster Viewing - Paediatrics AS04-06.
Development****Developmental delay in an institutionalized child
– case report****A. Rodrigues*, L. Torres, L. Salicio**

Unidade Local de Saúde da Guarda, Pediatrics, Guarda, Portugal

BACKGROUND AND AIM

Developmental delay in children can be caused by several etiologies. In a developmental pediatrics consultation follow-up a full clinical history thorough objective examination and complementary exams are fundamental for a successful diagnosis.

METHODS

clinical case

RESULTS

A five-year-old child was referred from primary care to developmental evaluation because of developmental delay. In developmental evaluation, it was found that he had microcephaly, dysmorphia and was institutionalized due to dysfunctional family. He presented several verbal and non-verbal cognition problems and was integrated in speech therapy, National Early Attention System and psychological evaluation with WISC Scale implementation. Over the years, the developmental follow-up revealed an analytical study, a cranioencephalic resonance and an electroencephalogram that were normal. Thus, an intellectual disability perturbation was diagnosed without a known etiology. At age 12, he began struggling with feeding difficulties and apathy.

Simultaneously, a neurological examination showed a myotonic phenomenon of the fingers. Besides that, the institution informed that his father had an unexplained congenital myopathy. Thus, genetic and neurological evaluation were requested. The genetic study found out a pathogenic expansion of the DMPK gene and Steinert Myotonic Dystrophy was diagnosed. As such, ophthalmology and pneumology evaluation were performed without problems identified. Currently, he is 14 years old and maintains developmental follow-up and neuromuscular consultation. He is autonomous although he needs help in fine motor tasks.

CONCLUSIONS

A multidisciplinary team is fundamental in diagnosing and treating such children. An institutionalized child is susceptible to a delayed diagnosis due to the difficulties in identifying associated problems and lack of awareness regarding family history.

EP590 / #548

E-Poster Viewing - Paediatrics AS04-06. Development

Learning disabilities - a retrospective STUDY

E. Sousa^{1*}, M.A. Passas², H. Santos², J.B. Silva², T. Pena², A.C. Maia²,
C. Madureira²

¹Centro Hospitalar do Tâmega e Sousa, Department of Pediatrics, Penafiel, Portugal

²Centro Hospitalar Vila Nova de Gaia/Espinho, Department of Pediatrics, Vila Nova de Gaia, Portugal

BACKGROUND AND AIM

Learning Disabilities (LD) are a common problem in the pediatric age and a frequent reason for referral to Development Pediatrics Consultation. LD can have several underlying etiologies, intrinsic or extrinsic to the child. Our aim was to characterize the children and adolescents referred for learning disabilities.

METHODS

A retrospective and observational analysis of patients first observed at Developmental Consultation for LD in 2019 was performed.

RESULTS

In 2019, 115 children and adolescents with LD were observed. The median referral age was 8 years (IQR: 7-9 years), 55% were male and 19% had at least one retention. Most children (89%) had previously attended preschool, and concerns about neurodevelopment and learning skills were already present in 44%. The follow-up was maintained in 106 patients. The most frequent diagnosis was attention deficit hyperactivity disorder (n=66), followed by intellectual disability (n=46), specific learning disorder (n=24) and developmental language disorder (n=12); 42% of patients presented more than one disorder

simultaneously. Socioeconomic/emotional problems were considered LD's cause in 6%. Pharmacological treatment was required in 27% of patients, 40% needed therapies (speech, occupational and physiotherapy), and 58% benefited from measures to support learning and inclusion in schools.

CONCLUSIONS

Early referral is essential to allow early intervention and to prevent school failure and related socio-emotional problems. In our sample, many cases should have been referred sooner as signs of LD were already present during preschool attendance and some patients already had one retention at the first appointment. Most children had one or more neurodevelopmental disorders needing treatment or intervention.

EP591 / #1713**E-Poster Viewing - Paediatrics AS04-06.
Development****Impact on mental health of children with asd,
adhd, slds and their families in greece due to covid
19 pandemic social isolation.****E. Tsekoura***

Asklepieion General Hospital, Pediatric, Voula, Greece

BACKGROUND AND AIM

COVID-19 pandemic came unexpectedly in the beginning of 2020. Greece put in place two periods of lockdown to control COVID-19 pandemic. Under the new circumstances everybody was placed at a high-risk position for mental health issues but children with neurodevelopmental disorders and their families were even more vulnerable. Aim. The purpose of the study was to investigate how parents in Greece of children with ASD, Asperger's syndrome, ADHD of inattentive-hyperactive type and SLDs perceived changes in the core symptoms of their child's neurodevelopmental disorder regarding alterations in frequency and intensity during the second COVID-19 quarantine in Greece, compared to before and if they experienced any increased feelings of emotional distress.

METHODS

This is a descriptive analysis survey. A self-compiled survey questionnaire consisted of 40 items was constructed and given anonymously to participants. Data compared between the five dyads of children/parents with neurodevelopmental disorders.

RESULTS

A total of 75 parents that visited researcher's office between 20 of September and 9 October 2021 participated in the study. Parents of children with neurodevelopmental disorders didn't perceive any significant changes in the core symptoms of their children's disease during COVID-19 quarantine in Greece. Parents didn't experience any significantly increased emotional distress.

CONCLUSIONS

Preschool age and discontinuation of physical activity was significantly associated with children's symptom deterioration. Changes in parents' work status and increased time spent with their children were significantly associated with improved perception of their children's core symptoms.

EP592 / #2162

E-Poster Viewing - Paediatrics AS04-06. Development

Kinesio taping effectiveness of treatment juvenile idiopathic scoliosis

T. Waldheim^{1*}, O. Rybalko²

¹Karol Marcinkowski University of Medical Sciences, Dermatology, Pediatrician, Stomatology, Poznan, Poland

²Medical center, Pediatrician, Kiev, Ukraine

BACKGROUND AND AIM

Nowadays children with juvenile idiopathic scoliosis (JIS) have higher mortality and morbidity in comparison to those with general population. Untreated JIS may cause severe cardiorespiratory compromise. Objectives: To evaluate kinesio taping role in treatment of JIS and find the factors associated with successful recovering.

METHODS

Retrospective comparative therapeutic clinical study in Medical center evaluating the results of kinesio taping for juvenile idiopathic scoliosis (JIS) during 12 months. 40 children with JIS treated by kinesio taping and followed up until their skeletal maturity.

RESULTS

27(67,5%) boys and 13 (32,5%) girls with JIS were analyzed. The average age at referral and initiation of kinesio taping was $8.3 \pm 0,7$ and $10.3 \pm 0,7$ years, respectively. Average curve magnitude at time of taping was 10 to 15 degrees. Length of taping 6 months with follow-up discontinuation of 6 months. 29

(72,5%) were successfully managed after kinesio taping. None of the patients had surgery of any kind during the juvenile phase.

CONCLUSIONS

Kinesio tapingin of JIS is successful and is better than the natural history.

EP593 / #1929**E-Poster Viewing - Paediatrics AS04-06.
Development****Home-based sensory stimulation program
improves developments of preterm infants in
southwest china: a randomized controlled TRIAL****W. Zheng^{1*}, R. Chotipanvithayakul²**¹The 2nd Affiliated Hospital of Kunming Medical University, Pediatric Department, Kunming, China²Prince of Songkla University, Epidemiology, Hat Yai, Thailand**BACKGROUND AND AIM**

Preterm infants are prone to growth and developmental delay. Sensory stimulation may benefit developmental outcomes for this special group. This study aims to determine whether home-based integrated sensory stimulation improves preterm infants' development.

METHODS

A randomized, parallel trial was conducted from November 2018 to January 2020 at three tertiary hospitals in Kunming, China. Preterm infants were eligible if gestational ages were from 28 weeks to 36 weeks based on ultrasound results when discharged from neonatal wards. Social-emotional development was assessed with the Ages and Stages Questionnaires. Temperament was assessed with the Infant Behavior Questionnaire-Revised, and anthropometry including weight, length, head circumference was measured at corrected ages of 1³, and 6 months.

RESULTS

Two hundred preterm infants were randomly allocated to the intervention group (n=98) and the standard care group (n=102). Demographic and clinical characteristics were similar between the intervention and the standard care groups. At 1- and 3-month corrected age, there was no significant difference between the two groups in terms of infant neurodevelopment and temperament. At 6 months, significant disparities were found in social-emotional development scale (mean difference -0.29, [95% CI -0.58 – <-0.001], p=0.01), length of the infants (mean difference 0.70, [95% CI <0.001 – 1.4], p=0.03), distress to limitation (p=0.04), and sadness (p=0.03). A mixed model revealed that the intervention positively affected social-emotional development, length, distress to limitation, and sadness for preterm infants.

CONCLUSIONS

Integrated sensory stimulation has benefits on social-emotional development, temperament, and length for preterm infants. This program provides a feasible method to promote social-emotional development for preterm infants.

EP594 / #2421**E-Poster Viewing - Paediatrics AS04-07.
Endocrinology & diabetes****Impact of covid-19 pandemic lockdown on the incidence of central precocious puberty in female children in Jordan****A. Alassaf*, S. Aqeilan, H. Fataftah, R. Odeh**

University of Jordan, Pediatrics, Amman, Jordan

BACKGROUND AND AIM

Few recent studies had reported increased incidence of central precocious puberty (CPP), during the recent COVID-19 pandemic, with proposed various theories, including alteration in levels of neurotransmitters and decreased serum melatonin concentrations probably due to disturbed sleep and increased use of digital devices. We aim to study the effect of the pandemic on incidence of CPP in female children in Jordan.

METHODS

This is a retrospective chart review for female children who presented with CPP to the pediatric endocrine clinic at our hospital. We had compared the clinical characteristics, hormonal profile and radiological findings between patients who were divided into two groups: patients presented after the start of the COVID-19 pandemic in Jordan, between May 2020 and May 2021, and patients presented during the preceding year.

RESULTS

Thirty three (57.1 %) and 24 (42.9 %) patients presented with CPP during and prior to the COVID-19 pandemic respectively, p-value = 0.00. There

was no significant difference in age at presentation for patients in the 2 groups, p -value = 0.35. There was no significant difference in hormonal levels between the 2 groups except for estradiol level which was higher in patients who presented during the pandemic, p -value = 0.03. Brain and pituitary MRI had significantly higher odds of being abnormal in patients presented during the pandemic (OR=0.13, p -value = 0.03).

CONCLUSIONS

The pandemic lockdown had affected the number of diagnosed cases of CPP, making it important to study further the risk factors contributing to this finding

EP595 / #2014

E-Poster Viewing - Paediatrics AS04-07. Endocrinology & diabetes

Van wyk-grumbach syndrome: an early and unusual presentation

M. Arham^{1*}, H. Sattar², M. Arish³

¹Rawalpindi Medical Univeristy, Research, Rawalpindi, Pakistan

²Rawalpindi Medical University, Paediatrics, Rawalpindi, Pakistan

³Rawalpindi Medical University, Medical Student, Rawalpindi, Pakistan

BACKGROUND AND AIM

Long standing juvenile hypothyroidism can lead to a rare manifestation known as Van Wyk-Grumbach syndrome characterized by high levels of thyroid stimulating hormone, uni- or bilateral ovarian cysts, isosexual precocity and a delayed bone age.

METHODS

CASE: A 2 year 9 month old girl presented with complaint of two episodes of vaginal bleeding 4 months apart, each lasting for about 2-4 days. Her cognitive and motor development was delayed. On examination she was pale, had coarse facies, dry coarse skin, apathetic look, protuberant abdomen with umbilical hernia. There was absence of thelarche, adrenarche and other secondary sexual characteristics. Laboratory investigations revealed a normocytic normochromic anemia, raised TSH (42 mIU/ml; ref. 0.17-4.0), decreased free T4 (1.4 pmol/L; ref. 11.5-23.0), elevated estradiol (85 pg/ml; ref. 6.0-27.0), mildly raised FSH (9.6 mIU/ml; ref. 1.0-4.2) and normal level of LH. Her bone age was delayed for age. Pelvic ultrasonography revealed bilateral cystic ovaries enlarged for age. Treatment with levothyroxine resulted in resolution of symptoms, rapid height gain and improvement in cognitive function. Ovarian cysts disappeared at 3 month follow-up.

RESULTS

DISCUSSION

Considering published reports, this is the youngest presentation of Van Wyk-Grumbach syndrome and also with an unusual presentation of isolated menarche without thelarche. According to literature most cases present after 7 years of age with combined features of menarche and thelarche.

CONCLUSIONS

Van Wyk-Grumbach syndrome can present at a very early age and with isolated menarche. High clinical suspicion and early diagnosis can avoid unnecessary surgical intervention in children with this syndrome.

EP596 / #2016**E-Poster Viewing - Paediatrics AS04-07.
Endocrinology & diabetes****Self-prescribed topical steroid application at routine diaper change leading to iatrogenic cushing syndrome in an infant: a case report from a developing country****H. Sattar¹, M. Arham^{2*}, M. Arish³**¹Rawalpindi Medical University, Paediatrics, Rawalpindi, Pakistan²Rawalpindi Medical University, Research, Rawalpindi, Pakistan³Rawalpindi Medical University, Medical Student, Rawalpindi, Pakistan**BACKGROUND AND AIM**

Iatrogenic Cushing syndrome is caused by exogenous glucocorticoid use, with oral and parenteral administration routes being most frequently responsible. Excessive topical steroid application can rarely lead to this syndrome in children and even more rarely in infants.

METHODS

CASE: A 3 month old female child presented with complaint of facial swelling for 3 weeks and a history of self-prescribed topical clobetasol ointment application at routine diaper change by her mother as a prophylactic measure against diaper dermatitis. On examination the female child had moon facies, hypertrichosis, facial plethora and thinning of skin. Laboratory investigations revealed decreased serum cortisol (1.2 µg/dL; ref. 6.2-19.4) and ACTH level (3.6 pg/ml; ref. 7.2-63.3). The mother was advised to immediately stop the topical steroid application and an oral hydrocortisone therapy was initiated at 12 mg/m²/day in 3 divided doses. After 3 months of therapy, symptom resolution began and ACTH increased to 11.2 pg/ml. Exogenous hydrocortisone therapy was then tapered and eventually stopped.

RESULTS

DISCUSSION

Some rare reports of iatrogenic Cushing syndrome in children due to self-prescribed overuse of topical steroid ointment for diaper dermatitis have been reported in developing countries. This is because of over-the-counter availability of topical steroidal agents and lack of adequate parental knowledge in low-middle income countries. Imposing strict regulations on over-the-counter dispensing of topical steroid ointments and increasing parental awareness regarding the proper use of such preparations can prevent further cases of this rare complication.

CONCLUSIONS

Unregulated overuse of potent topical steroid preparations in infants can lead to iatrogenic Cushing syndrome.

EP597 / #2249**E-Poster Viewing - Paediatrics AS04-07.
Endocrinology & diabetes****A systemically well 10-year-old boy with
persistent cervical lymphadenopathy for the last
twelve months. Infection or something to worry?****A. Barmpakou^{1*}, S.-Z. Siska¹, K. Kakleas¹, A. Santou¹, I. Orfanou¹,
C. Kanaka-Gantenbein²**¹*Aghia Sophia Children's Hospital, First Department of Pediatrics, Athens, Greece*²*Division of Metabolism, Endocrinology, and Diabetes, First Department of Pediatrics of Medical School of Athens, National and Kapodistrian University, "Aghia Sophia" Children's Hospital, Athens, ATHENS, Greece***BACKGROUND AND AIM**

Papillary thyroid carcinoma is the commonest type of thyroid cancer in childhood. Although rare, if diagnosed early and treated appropriately, has good prognosis.

METHODS

A ten-year-old boy, previously fit and well, was referred by a primary care pediatrician with one-year history of painless, firm, left cervical lymphadenopathy for further investigation. No systemic symptoms were present during that period. At 6 months from the initial detection, an ultrasound of the cervix had been performed that showed multiple fluctuant lymph nodes possibly of reactive/inflammatory etiology, with normal thyroid gland. Blood tests were normal. Nevertheless, the size of the palpable mass was fluctuating, and especially within the last two months prior to the referral had started to gradually increase in size.

RESULTS

On admission, the boy was clinically well, without systemic symptomatology. The inflammatory markers were not increased (ESR: 5 CRP < 1 mg/l WBC: $6,490 \times 10^3/\mu\text{l}$). An ultrasound of the cervix showed a hypoechogenic solid lesion with relatively regular margins and microcalcifications, approximately 2.44 x 1.93 cm, in the left thyroid lobe, as well as a lymph node block at the same side of the above lesion, posing the suspicion of malignancy either of thyroid or parathyroid glands. A fine needle aspiration (FNA) was performed and revealed cytological findings compatible with secondary location of papillary thyroid carcinoma. The thyroid function tests were within normal range. A multidisciplinary team approach was adopted and the patient was transferred to ENT ward for excision of the lesion, whereas post-operative management was guided by the endocrinology team.

CONCLUSIONS

Cervical lymphadenopathy is a common presentation in pediatrics and in the majority of cases has infectious/inflammatory etiology. However, it is of utmost importance to keep in mind other possible differential diagnoses that require involvement of other specialties.

EP598 / #527**E-Poster Viewing - Paediatrics AS04-07.
Endocrinology & diabetes****Alstrom syndrome (alms) with early vision and hearing affection**

**A. Beqiri Jashari^{1*}, A. Janchevska¹, F. Doksimovski², I. Ahmeti³,
B. Teov⁴, H. Nestorov⁵, N. Laban⁶, E. Sukarova-Stefanovska⁷,
Z. Gucev¹, D. Plasevska-Karanfilska⁸**

¹University Clinic for Pediatrics, Endocrinology and Diabetes, Skopje, North Macedonia

²Institute of Respiratory Diseases in Children Kozle, Icu, Skopje, North Macedonia

³Clinic of Endocrinology, Diabetes and Metabolic Disorders, Endocrinology, Skopje, North Macedonia

⁴University Clinic for Pediatrics, Hematology and Oncology, Skopje, North Macedonia

⁵Institute of Respiratory Diseases in Children Kozle, Asthma, Skopje, North Macedonia

⁶Clinic of Endocrinology, Diabetes and Metabolic Disorders, Cabinet For Ophtalmology, Skopje, North Macedonia

⁷University Clinic for Pediatrics, Molecular Diagnostics, Skopje, North Macedonia

⁸Macedonian Academy of Sciences and Arts, Research Center For Genetic Engineering and Biotechnology "georgi D. Efremov", skopje, North Macedonia

BACKGROUND AND AIM

Alstrom syndrome (ALMS) is a progressive cone-rod dystrophy, sensorineural hearing loss, childhood obesity, and type 2 diabetes mellitus.

METHODS

A 13 year old child manifested early signs of impaired hearing and vision. Central vision was first affected, followed by the peripheral one. In addition, his weight started increasing after the age of two years, to reach 78 kg at the height of 157 cm (BMI 31.64). No polydactyly was present. His mental development was normal, in spite of his hearing and vision impairments. There was acantosis nigricans on the neck. ECG and cardiac ultrasound were normal. At the age of 12 years his testicles are 12 ml and pubertal status

is P2 A2. oGTT revealed impaired glucose tolerance, with elevated insulin concentrations 121uIU/mL(reference range 2,00-29,1 uIU/mL). Renal function was unaffected, liver functions were normal. Uric acid and lipids were within normal plasma concentrations.

RESULTS

Trio whole-exome sequencing was carried out, and pathogenicity assessment of candidate variants was done by in silico analysis according to ACMG criteria. Trio whole-exome sequencing revealed compound heterozygous ALMA1 gene alterations (c.4156dup (p.Thr1386AsnfsTer15) of the proband and carrier status in the parents.

CONCLUSIONS

The absence of mental retardation and polydactyly differentiates Alstrom and Bardet-Biedle syndrome.

EP599 / #528**E-Poster Viewing - Paediatrics AS04-07.
Endocrinology & diabetes****Gnatodiaphyseal dysplasia without jaw lesions in two generations**

**F. Doksimovski¹, H. Nestorov², A. Beqiri-Jashari^{3*}, V. Tasic⁴,
D. Plasevska-Karanfilska⁵, B. Teov⁶, Z. Gucev³, M. Gorgievska⁷,
A. Janchevska³**

¹*Institute of Respiratory Diseases in Children Kozle, Icu, Skopje, North Macedonia*

²*Institute of Respiratory Diseases in Children Kozle, Asthma, Skopje, North Macedonia*

³*University Clinic for Pediatrics, Endocrinology and Diabetes, Skopje, North Macedonia*

⁴*University Clinic for Pediatrics, Nephrology, Skopje, North Macedonia*

⁵*Macedonian Academy of Sciences and Arts, Research Center For Genetic Engineering and Biotechnology "georgi D. Efremov", skopje, North Macedonia*

⁶*University Clinic for Pediatrics, Hematology and Oncology, Skopje, North Macedonia*

⁷*Macedonian Academy of Sciences and Arts, Research Center For Genetic Engineering and Biotechnology "georgi D. Efremov", Skopje, North Macedonia*

BACKGROUND AND AIM

Gnatodiaphyseal dysplasia (GDD) skeletal dysplasia is manifested by diaphyseal sclerosis of long bones, bone fragility, bowing of tubular bones and cementoosseous lesions of the jawbones.

METHODS

A 5-year-old boy was referred for bowing of the legs. There were no fractures of any bones and no jaw lesions replaced the tooth-bearing segments of the maxilla and mandible. His acid-base status was normal as creatinine, urea, calcium, phosphorus and alkaline phosphatase. Trio whole-exome sequencing was carried out, and pathogenicity assessment of candidate variants was done by in silico analysis according to ACMG criteria.

RESULTS

Trio whole-exome sequencing revealed compound heterozygous ANO5 gene alterations (c.1520delT p.(Phe507SerfsTer6) of the proband and carrier status in the mother and his brother. The alteration results in frameshift effect where the exchange of phenylalanine with serine on the position 507 terminates the protein after 6 amino-acids. Homozygous or double heterozygous variants of ANO5 gene alterations result in autosomal recessive muscular dystrophy, while dominant variants of ANO5 gene variants result in GDD. Both the mother and the brother did not display jaw lesions, while the bowing of the extremities was mild.

CONCLUSIONS

The phenotype of GDD in those patients was mild. Follow up should give more information on jaw and long bones eventual alterations.

EP600 / #2660

E-Poster Viewing - Paediatrics AS04-07. Endocrinology & diabetes

Mody: a rare mutation

S. Branco^{1*}, I. Mazedo², B. Vieira¹, I. Vivas¹, E. Coelho¹

¹Centro Hospitalar Póvoa de Varzim e Vila do Conde, Pediatrics and Neonatology, Póvoa de Varzim, Portugal

²Centro Hospitalar Póvoa de Varzim e Vila do Conde - Portugal, Pediatrics and Neonatology, Póvoa de Varzim, Portugal

BACKGROUND AND AIM

MODY (Maturity-Onset Diabetes of the Young) represents a heterogeneous group of monogenic diabetes, with autosomal dominant transmission.

METHODS

It is underdiagnosed, with a frequency of 2-5% among patients with diabetes.

RESULTS

A 8-year-old boy, with nocturnal enuresis medicated with desmopressin, was referred to the Pediatric Diabetes Consultation for suspected diabetes in the routine tests (fasting blood glucose 121mg/dL, HbA1c 6.5%). The child was asymptomatic and the physical examination was normal. The child presented a body mass index at the 50th percentile and a normal blood pressure. The initial study performed revealed: fasting blood glucose 114mg/dL, HbA1c 6.4%, insulin 2.83uIU/mL (lower limit of normal), C-peptide 0.63ng/mL (decreased) and negative islet cell/GAD 65/insulin antibodies. The urine test strip detected traces of ketone bodies, with no other changes. The glycemic profile was controlled. During the 3 years of follow-up, blood glucose values remained slightly elevated, mean HbA1c was 6.5%, autoimmunity markers

were negative and insulin/C-peptide normal. After the glycemic control of the parents, it was found that the father also had asymptomatic hyperglycemia. The investigation of MODY was performed and the molecular study detected the c.757G>C p.(Val253Leu) variant in heterozygosity in the GCK gene, confirming the diagnosis. Currently, the child remains asymptomatic, with no need for pharmacological intervention.

CONCLUSIONS

This case illustrates the need for a high index of suspicion for the diagnosis of MODY. We found the c.757G>Cp. (Val253Leu) variant in the GCK gene, which has been described in the literature in only three cases of a family with MODY.

EP601 / #2667

E-Poster Viewing - Paediatrics AS04-07. Endocrinology & diabetes

A rare thyroid disorder

S. Branco^{1*}, I. Vivas², B. Vieira¹, I. Mazedo¹, E. Coelho¹

¹Centro Hospitalar Póvoa de Varzim e Vila do Conde, Pediatrics and Neonatology, Póvoa de Varzim, Portugal

²Centro Hospitalar Póvoa de Varzim e Vila do Conde - Portugal, Pediatrics and Neonatology, Póvoa de Varzim, Portugal

BACKGROUND AND AIM

Assessment of thyroid function and measurement of anti-thyroid antibodies are mandatory in any child diagnosed with type 1 diabetes mellitus (T1DM) to exclude thyroid autoimmune disease (AD).

METHODS

We report a clinical case with negative thyroid AD screening, but through which another pathology was diagnosed.

RESULTS

A 9-year-old boy with a history of T1DM diagnosed at age 7 and Attention Deficit Hyperactivity Disorder. During follow-up at the Pediatric Diabetes Consultation, persistently elevated levels of thyroid hormones (FT3 and FT4) were detected, with a normal TSH value and negative anti-peroxidase, anti-thyroglobulin and anti-TSH receptor antibodies. The child was always asymptomatic and presented a normal physical examination. A thyroid ultrasound was performed, with no changes. In addition, there was a normal TSH alpha subunit measurement (<0.1) and its relationship with TSH ($2,950 \mu\text{UI}/\text{mL}$) <1 , more compatible with thyroid hormone resistance syndrome

than central hyperthyroidism (pituitary adenoma). Thus, pituitary magnetic resonance imaging was postponed and a genetic study was carried out to sequence the THRB (Thyroid Hormone Receptor Beta) gene, which revealed the presence of the c.728G>Ap. (Ala243Gln) variant in heterozygosity, confirming the hypothesis of thyroid hormone resistance syndrome. The child was adopted, without contact with the biological family. Given the adequate weight and height evolution and the absence of symptoms, pharmacological treatment was not initiated, with only periodic surveillance.

CONCLUSIONS

Thyroid hormone resistance syndrome is a rare condition, that occurs mainly due to mutations in THRB. Treatment is symptomatic and should not aim to normalize thyroid hormone levels.

EP602 / #1025**E-Poster Viewing - Paediatrics AS04-07.
Endocrinology & diabetes****Acceptance of a pre-clinic visit intervention to engage and empower adolescents with type 1 diabetes mellitus in clinic encounters with doctors**

I. Coyne^{1*}, J. Surdey¹, B. Sleath², M. Hughes¹, M. Murphy¹, S. Raferty¹, S. Pembroke¹, S. Rogerson¹, V. Burke¹, M. Brenner³, D. Cody⁴, C. Hilliard⁵, E. Roche⁶

¹Trinity College Dublin, School of Nursing and Midwifery, Dublin, Ireland

²University of North Carolina, Division of Pharmaceutical Outcomes and Policy UNC Eshelman School of Pharmacy, Chapel Hill, United States of America

³UCD College of Health Sciences, Ucd School of Nursing, Midwifery and Health Systems, Dublin, Ireland

⁴Children's Health Ireland, Tallaght, Department of Endocrinology and Diabetes, Dublin, Ireland

⁵Children's Health Ireland, Crumlin, Department of Diabetes and Endocrinology, Dublin, Ireland

⁶Trinity College Dublin, the University of Dublin, School of Medicine, Dublin, Ireland

BACKGROUND AND AIM

We conducted a pilot randomised control trial of an intervention (co-designed educational video and question prompt list (QPL)) to improve adolescents' engagement and provider education during paediatric diabetes visits (PACE study). This paper reports on the acceptance of the two-part intervention from adolescents and parents' perspectives.

METHODS

Ninety-nine adolescents ages 11 to 17 with type 1 diabetes attending two clinics were enrolled. The intervention group adolescents completed a QPL and watched an educational video with their parents before meeting their doctors at three clinic appointments. They completed a short evaluation on

the intervention and data were analysed with SPSS (v 27). Ethical approval was obtained.

RESULTS

of the 49 adolescents in the intervention group, 96% said adolescents should complete the QPL before visits, 80% recommended adolescents should watch the video before visits, and younger or more recently diagnosed adolescents found the video more useful. All parents recommended adolescents should complete the QPL before visits and 96% recommended adolescents should watch the video before visits. Over the three clinic visits, there was a decrease in the number of questions ticked. Reasons given included knowing the answers already, they had asked them previously or they had some questions of their own.

CONCLUSIONS

Participants provided very positive feedback about the intervention which may be due to the fact that the intervention was co-designed with adolescents and parents. Providers could consider providing adolescents with the QPL and the video during clinic wait time to promote adolescents' confidence and active engagement in clinic encounters.

EP603 / #2147**E-Poster Viewing - Paediatrics AS04-07.
Endocrinology & diabetes****Noonan syndrome-like disorder in a 1-year-old
BOY**

**A. Janchevska^{1*}, V. Tasic¹, V. Jovanovska¹, S. Antonievska¹,
O. Jordanova¹, Z. Gucev¹, D. Plashevska-Karanfilska²**

¹University Children's Hospital, Medical Faculty, Skopje, North Macedonia

²Research Center for Genetic Engineering and Biotechnology „Georgi D. Efremov“, Masa, Skopje, North Macedonia

BACKGROUND AND AIM

Noonan syndrome-like is a developmental disorder with heterogenic phenotype (macrocephaly, dysmorphic facial features, congenital heart disease, motor delay etc). Most patients carry heterozygous mutations in the *CBL* gene, with an increased risk of malignancies, particularly juvenile myelomonocytic leukemia.

METHODS

A 1-year-old boy, born in term with intrauterine growth retardation (birth weight -5.18 SDS and birth length -0.38 SDS), has dysmorphic facial features, dolichocephaly and microcephaly (-3.5 SDS), short neck, delayed motor development, height (-0.6 SDS) and weight (-1.3 SDS), for his age and sex. The diagnostic assessment included a clinical examination, biochemical and hormonal investigations, followed by the imaging studies and cytogenetic and molecular analyses.

RESULTS

The evaluation has shown normal values of serum biochemical and hormonal analyses. The abdominal ultrasound was uneventful, but the cardiac echo sonography revealed mitral valve insufficiency and an uncompact left ventricular wall with normal motion. There are no signs of hematologic malignancy. Karyotype was normal male, 46, XY. An array comparative genomic hybridization did not show any deletion or duplication. The targeted resequencing analysis revealed a heterozygous pathogenic variant, c.1675C>T, p. (Arg559Ter) in the *CBL* gene. Unfortunately, our patient is an orphan living with foster carers and the evaluation of his ancestors is unavailable.

CONCLUSIONS

Herein we present a child with a very rare Noonan syndrome-like disorder without malignancy, clinically and molecularly confirmed. The adequate diagnostic assessment and monitoring in these patients are not only necessary for the therapeutic approach, but also lifesaving.

EP604 / #2238**E-Poster Viewing - Paediatrics AS04-07.
Endocrinology & diabetes****A 13-year-old boy with klinefelter syndrome and hashimoto thyroiditis**

**M. Torkovska¹, S. Antonievska¹, B. Teov¹, A. Beqiri-Jashari¹,
F. Doksimovski², H. Nestorov², O. Jordanova¹, V. Tasic¹, Z. Gucev¹,
A. Janchevska^{1*}**

¹University Children's Hospital, Medical Faculty, Skopje, North Macedonia

²Institute of Respiratory Diseases in Children Kozle, Medical Faculty, Skopje, North Macedonia

BACKGROUND AND AIM

The Klinefelter syndrome (KS), with a karyotype 47 XXY, is the most frequent sex chromosome disorder among males. Only less than 10% of patients are diagnosed in childhood. An infertility is the most common abnormality in KS patients, but various comorbidities as metabolic syndrome, thyroid, neurocognitive, and other disorders are detected also. They have an increased risk of particular cancers and autoimmune diseases. Hashimoto thyroiditis have 5.4 to 10% of children with KS.

METHODS

A 13-year-old boy had a thin body with eunuchoid appearance, height (1.44 SDS), weight (0.13 SDS) and BMI z score (-2.28), bilateral gynecomastia, B2, pubarche P 2/3, adrenarche A2, penis length 8cm and small testicles 5ml and 6ml, respectively. He is an average student in the 8th grade. The diagnostic assessment included a clinical examination, hormonal, and cytogenetic investigations.

RESULTS

The evaluation has shown FSH (1.75 mIU/ml), LH (3.17 mIU/ml) and testosterone concentrations (300.65 ng/dl) within normal range. The serum thyroxine value (5.45 µg/dl) was in the lower limit of the normal range, but TSH (8.8 uIU/ml) and thyroid peroxidase antibodies, TPOab, (43.11 IU/ml) were elevated. The heart ultrasound was uneventful. Karyotype was male, 47, XXY. In the next months the boy developed overt hypothyroidism and started the replacement treatment.

CONCLUSIONS

Herein we present a teenager with a Klinefelter syndrome associated with hypothyroidism and Hashimoto thyroiditis. The adequate diagnostic assessment and monitoring of these patients are essential for the therapeutic approach.

EP605 / #2432

E-Poster Viewing - Paediatrics AS04-07. Endocrinology & diabetes

A clinical case of galactorrhea in a female adolescent

L. Leite De Almeida^{1*}, M.M. Resende², P. Gomes Pereira³, M. Martins³, L. Santos³

¹Centro Hospitalar Universitário de São João, Pediatrics, Porto, Portugal

²Centro Hospitalar do Baixo Vouga, Pediatrics, Aveiro, Portugal

³Centro Hospitalar de Baixo Vouga, Pediatrics, Aveiro, Portugal

BACKGROUND AND AIM

Antipsychotics are being increasingly prescribed for adolescents. Galactorrhea is a well-known side effect of risperidone in adults. However, this adverse reaction has been rarely described in the pediatric population and is usually associated with hyperprolactinemia.

METHODS

We present a clinical case of a 14-year-old postpubertal female, referred to our hospital due to unilateral galactorrhea.

RESULTS

The patient had a four-month history of motor and phonic tics, and a personal and familiar history of psychotic symptoms. It was prescribed risperidone 0.5mg per day and soon after initiating it, she developed a whitish left nipple discharge. Her birth, developmental and remaining medical history were unremarkable. Physical examination was normal and pubertal development consistent with Tanner stage V. The menstruation was regular. No visual

disturbance or symptoms suggestive of raised intracranial pressure were reported. Laboratory investigations were within normal limits, including complete blood count, acute phase reactants, routine biochemical tests, prolactin serum levels (19.4ng/mL, reference range 2.8-29ng/mL), follicle-stimulating, luteinizing and thyroid stimulating hormones, free thyroxine, estradiol, testosterone and B-hCG. Moreover, mammary ultrasonography was normal. Risperidone was assumed as a possible cause and discontinued, with a total resolution of the symptoms.

CONCLUSIONS

Screening for galactorrhea in adolescents taking antipsychotic medications is important. As described, this symptom can be present despite normal values of prolactin. Cessation or changing of the therapeutic should be considered in these cases.

EP606 / #1645**E-Poster Viewing - Paediatrics AS04-07.
Endocrinology & diabetes****Early onset pediatric systemic lupus erythematosus: case report.**

C.I. López Aldunate*, M. Mass-Lindenbaum, G. Reveco Pérez,
H. Villalón Urrutia

Universidad de los andes, Pediatrics Department, Santiago, Chile

BACKGROUND AND AIM

Systemic lupus erythematosus (SLE) is a chronic autoimmune disease. Childhood onset is present in 20% Average debuting age is 11.5 - 12.6 years. The most common manifestations are hematologic, cutaneous, musculo-skeletal, renal and fever. The earlier the onset, the greater probabilities of misdiagnosing SLE. Objective: Present a case of very early onset pediatric SLE

METHODS

School age 10.1 year old female patient with previously diagnosed hypothyroidism, who complains of bilateral ankle pain during last 2-months. Orthopedic surgeon finds petechiae and refers to hematology, where mother reports recurrent epistaxis. Patient is referred to dermatology and finally to emergency room for a complete blood count that reports platelets count 2.000/mm³, white blood cells 4290/mm³ and red count 29.8% (Hb: 9.9 g/dL). Patient is admitted in Paediatric ward and oncohematologic causes of pancytopenia were ruled out. Serology resulted positive for SLE. She was put on treatment with Methylprednisolone 1mg/kg/day with an excellent clinical and hematological outcome. She was discharged with oral treatment.

RESULTS

Most common manifestations of SLE are blood, cutaneous and musculoskeletal, all of which our patient presented. With her not being within the mean of onset age, SLE was not considered as a first diagnosis.

CONCLUSIONS

When facing a clinical case with hematological manifestations associated with other symptoms, SLE should be taken into consideration as a diagnosis in a pediatric patient, even at ages below the average age of onset.

EP607 / #382**E-Poster Viewing - Paediatrics AS04-07.
Endocrinology & diabetes****Height-estimated basal creatinine in diagnosing acute kidney injury in children with type 1 diabetes mellitus ONSET**

P. Marzuillo^{1*}, G. Rivetti², A. Di Sessa², M. De Lucia², P.L. Palma², E. Miraglia Del Giudice², C. Polito², S. Guarino²

¹Università degli Studi della Campania Luigi Vanvitelli, Department of Woman, Child and of General and Specialized Surgery., Naples, Italy

²Università degli Studi della Campania Luigi Vanvitelli, Department of Woman, Child and of General and Specialized Surgery, Naples, Italy

BACKGROUND AND AIM

At type 1 diabetes mellitus onset (T1DM), acute kidney injury (AKI) is very common. To diagnose AKI, the availability of a basal serum creatinine (bSCr) is pivotal. However, in most of the hospitalized children a bSCr is unknown. We aimed testing if the bSCr estimated on the basis of height (ebSCr) could be a reliable surrogate for AKI diagnosis compared with the measured bSCr (mbSCr).

METHODS

We considered as mbSCr, the creatinine measured 14days after T1DM onset while $ebSCr(mg/dL) = (k * height[cm]) / 120mL/min/1.73m^2$, where $k=0.55$ for children and adolescent girls, and $k=0.7$ for adolescent boys. AKI was defined as serum creatinine values >1.5 times the basal creatinine. Kappa statistics and percentage of agreement in AKI classification by ebSCr-AKI versus mbSCr-AKI definition methods were calculated. Bland-Altman plots were used to show the agreement between the creatinine ratio (highest/basal creatinine) calculated with mbSCr and ebSCr. 163patients with T1DM onset were included.

RESULTS

On the basis of mbSCr, 66/163 (40.5%) presented AKI while, on the basis of ebSCr, 50/163 (30.7%) accomplished AKI definition. ebSCr showed good correlation with mbSCr both at Spearman test ($\rho=0.67$; $p<0.001$) and regression analysis ($r=0.68$; $p<0.001$). At the Bland–Altman plots, the bias of the highest/basal creatinine ratio calculated on the basis of the mbSCr compared to ebSCr was minimal (bias=-0.08mg/dL; 95% limits of agreement=-0.23/0.39). AKI determined using ebSCr showed 90% agreement with AKI using mbSCr ($\kappa=0.66$; $p<0.001$).

CONCLUSIONS

In conclusion, when mbSCr is unknown in patients with T1DM onset, the ebSCr calculated on the basis of height could be a valid alternative to orientate clinicians toward AKI diagnosis.

EP608 / #2230**E-Poster Viewing - Paediatrics AS04-07.
Endocrinology & diabetes****Infant with disorders of sex development (dsd):
initial approach and evaluation**

**M. Nikolaou^{1*}, M. Binou¹, S. Bampalitsa¹, E. Kollia², I.-A. Vasilakis¹,
M. Dolianiti¹, C. Kanaka-Gantenbein¹**

¹*Division of Metabolism, Endocrinology, and Diabetes, First Department of Pediatrics of Medical School of Athens, National and Kapodistrian University, "Aghia Sophia" Childrens' Hospital, Athens, ATHENS, Greece*

²*Division of Metabolism, Endocrinology, and Diabetes, First Department of Pediatrics of Medical School of Athens, National and Kapodistrian University, "Aghia Sophia" Childrens' Hospital, Athens, ATHENS, Greece*

BACKGROUND AND AIM

Disorders of sex development (DSD) are rare congenital conditions in which a newborn presents with atypical external genitalia. Many factors are involved in the differentiation of the sex organs, however the underlying etiology remains often unknown. Aim of our study is to raise awareness of pediatricians to the approach and management of a newborn with DSD.

METHODS

A 4-day-old baby was born full term with normal delivery. Based on a level II ultrasound scan, a female was expected. Clinical examination showed a bifid scrotum with a palpable structure in the right side. The phallus was measured 2.7cm long with perineal hypospadias, while no vaginal entrance could be seen.

RESULTS

Endocrine, urological surgical and genetic evaluation was performed. Electrolyte disturbances and hypoglycemia were ruled out. Abdominal ultrasound scan showed a right testicle, the presence of a structure resembling an epididymis, an atrophic testicle in the left inguinal canal and normal adrenal glands. Blood test showed AMH 145pmol / L (mp <33 pmol/L), TESTO 292ng / dL (20-64ng / dL), inhibin 206.7ng / L (<30ng / L). Cytogenetic test revealed mosaicism 45, X (77%) / 46, XY (23%) and the presence of SRY gene. Parents were informed and involved in the MDT meeting for gender assignment resulted in a declaration of "male".

CONCLUSIONS

The management of a newborn with atypical external genitalia is a rare issue that requires urgent multidisciplinary intervention. Early correct diagnosis is a key factor for optimizing quality of life. The gender is always decided by a team of experts in collaboration with parents.

EP609 / #1960**E-Poster Viewing - Paediatrics AS04-07.
Endocrinology & diabetes****Grave's disease following hashimoto thyroiditis****F.Z. Souid***

central hospital of the army, Pharmacy, algiers, Algeria

BACKGROUND AND AIM

Hashimoto's thyroiditis (HT) and Graves' diseases (GD) are auto-immune diseases. They have different phenotypes and are generally believed to share a number of common etiological factors but the mechanisms leading to their dichotomy are unknown. An unusual outcome of HT is the conversion to GD. A mechanism that might be hypothesized to account for the change from HT to GD is the alteration in the biological activity of TSH receptor Abs from predominantly thyroid-blocking antibodies during the hypothyroid phase to thyroid-stimulating antibodies when GD manifests itself.

METHODS

The FT4 and TSH evaluated by immunoenzymatic methods Antimicrosomial antibody and Trab by luminex

RESULTS

A 10-year-old boy, B W, was seen for the first time in 2015 for enlargement of thyroid gland with clinical euthyroidism. The result of thyroid function was FT4=10.4pg /ml (in the low normal range), TSHs=6.84 μ UL/ml, and antibody anti microsomal titer was very high 4889 UI/ml and the cervical ultrasound showed an hypoechogen aspect. He was followed every 6 months and the thyroid function was normal. In September 2021, he presented clinical

hyperthyroidism, the FT4= 22.24 pg/ml, TSH <0.001, anti microsomal antibody > 1000 UI and Trab raised at 4.09. The cervical ultrasound showed a diffuse hypervascularisation and a hyperfixation in scintigraphy confirming Grave disease. He is treated with carbimazol and the last thyroid function is in normal range.

CONCLUSIONS

This case report illustrates a rare evolution of hashimotothyroiditis to Grave's disease but the mechanism leading to this state remains unclear.

EP610 / #1461**E-Poster Viewing - Paediatrics AS04-07.
Endocrinology & diabetes****Research progress on the relationship between
vitamin d deficiency and central precocious
puberty****X. Liu, J. Wang*, Z. Li**

China-Japan Friendship Hospital, Pediatrics, Beijing, China

BACKGROUND AND AIM

Central precocious puberty refers to a series of common children's endocrine diseases with precocious manifestations, such as premature activation of hypothalamic pituitary gonadal axis, early release of gonadotropin releasing hormone (GnRH) from hypothalamus, activation of pituitary secretion of gonadotropin, and promotion of sex hormone secretion, gonadal development, internal and external genital development and secondary sexual characteristics. It is found that vitamin D deficiency is common in CPP girls. Studies have shown that vitamin D deficiency is a risk factor for CPP, but its mechanism is not clear. This paper reviews the correlation between vitamin D deficiency and CPP and its possible mechanism

METHODS

We searched the following 6 electronic databases: PubMed, China Biomedical Literature Database (CBM), China National Knowledge Infrastructure (CNKI), China Science and Technology Periodicals Database (VIP) and Wanfang Database (Wanfang Database). square data).

RESULTS

Many studies have shown that vitamin D deficiency is related to CPP in children

CONCLUSIONS

Many studies have shown that vitamin D deficiency is related to CPP in children, and its mechanism may be related to sunshine time, obesity, action on hypothalamic pituitary gonadal axis, insulin-like growth factor 1, vitamin D receptor and receptor gene polymorphism. The overall effect of vitamin D combined with gonadotropin-releasing hormone analogues in the treatment of CPP is significant. In order to provide some theoretical basis for researchers.

EP611 / #1736

E-Poster Viewing - Paediatrics AS04-08. Epidemiology

Epidemiological analysis of zika virus cases in children and adolescents in brazil

C. Augusto De Lima^{1*}, S. Silva Sabino², S. Silva Sabino², S. Silva Sabino³, M. De Lima Alves³, E. Gonçalves Silva³, D. Alves Da Costa Canella⁴, E. Fellipe Capini De Almeida Tavares⁵, M. Evelyn Da Silva², O. Augusto Freire Campos², T. Calegari²

¹UFU, Faculty of Medicine, Uberlândia, Brazil

²UFU, Faculty of Medicine, Uberlândia, Brazil

³UNIPAC, Health Department, Uberlândia, Brazil

⁴Universidade Federal da Grande Dourados, Faculty of Medicine, Uberlândia, Brazil

⁵EMESCAM, Faculty of Medicine, Uberlândia, Brazil

BACKGROUND AND AIM

This project aims to report and analyze the reported cases of Zika during the years 2016 – 2020 in children and adolescents.

METHODS

The analyzed data were collected from the notification database of the Brazilian Ministry of Health - DATASUS, with only notifications from 2016 onwards.

RESULTS

The data show a control in the number of cases after 2017 with a drop from 71,397 cases in 2016 to 10,069 cases in 2017 and maintaining this plateau in the other years. The cure rate reaches 65,121 (63.4%) patients, but 37,340 (36.3%) were reported blank or ignored, a high rate of underreporting of the

evolution of cases in pediatric patients. Individuals aged 0-4 years (n = 27,194; 26.4%) have the second highest rate of infection compared to groups 5-9 years (n = 19,366; 18.8%), 10-14 years (n = 22,294; 21.7%), 15-19 years (n = 33,828; 32.9%).

CONCLUSIONS

There is progress in the control of the disease, however, there is a need to improve the follow-up of patients. The worrying data is found in the age group of 0-4 years (second most affected group) because the immune system is maturing with limitations in innate and adaptive immunological mechanisms, so more severe forms of the disease and irreversible complications can develop, especially, at the neural level.

EP612 / #2068**E-Poster Viewing - Paediatrics AS04-08.
Epidemiology****Spatial distributions of common childhood illnesses, healthcare utilisation and associated factors in ethiopia: evidence from 2016 ethiopian demographic and health survey****A. Deghebo^{1*}, Y. Okwaraji², Z. Tigabu³, L.Å. Persson⁴, K. Gelaye⁵**

¹Ethiopian Public Health Institute, Health System and Reproductive Health Research Directorate, ADDIS ABABA, Ethiopia

²London School of Hygiene and Tropical Medicine,, Department of Infectious Disease Epidemiology, London, United Kingdom

³University of Gondar, Department of Paediatrics and Child Health, School of Medicine, College of Medicine and Health Sciences, Gondar, Ethiopia

⁴London School of Hygiene and Tropical Medicine,, Department of Infectious Disease Epidemiology, London, Ethiopia

⁵University of Gondar, Department of Epidemiology and Biostatistics, Institute of Public Health, College of Medicine and Health Sciences, Gondar, Ethiopia

BACKGROUND AND AIM

This study aimed to assess the geographical distribution and associated factors for common childhood illnesses and service utilisation across Ethiopia using the 2016 Demographic and Health Survey.

METHODS

A total of 10,641 under-five children were included in this analysis. Data on common illnesses during the last two weeks and healthcare utilisation were linked to Global Positioning System information of their local area. We applied a spatial autocorrelation to determine the spatial clustering of the prevalence of childhood illnesses and healthcare utilisation. Ordinary Least Square analysis was done to assess the association between selected

explanatory variables and sick child healthservices utilisation. Getis-Ord-Gi* was used to determine the hot and cold spot clusters. Interpolation-kriging was done to predict sick child healthcare utilisation in areas where study samples were not drawn.

RESULTS

Overall, 23%(95CI:21,25) of children under-five had some illness during the last two weeks before the survey. of these, 38%(95%CI:34,41) sought care from an appropriate provider. Illnesses and service utilisation were not randomly distributed across the country (Moran's-Index 0.111, Z-score 6.22, $P<0.001$, and Moran's-Index=0.0804, Z-score 4.498, $P<0.001$). Wealth and distance to healthfacilities were associated with service utilisation. Childhood illnesses was higher in the North, while service utilisation was on a low level in the Eastern, South-western, and the Northern parts of the country.

CONCLUSIONS

There was a geographic clustering of common childhood illnesses and healthservice utilisation when the child was sick. Areas with low service utilisation for childhood illnesses need priority, including actions to counteract barriers such as poverty and long distances to services.

EP613 / #1370**E-Poster Viewing - Paediatrics AS04-08.
Epidemiology****Molecular analysis of cc11 isolates from invasive meningococcal disease from the czech republic, 1993–2020****M. Honskus*, P. Křížová**

The National Institute of Public Health, Centre For Epidemiology and Microbiology, Prague, Czech Republic

BACKGROUND AND AIM

In 1993, a hypervirulent meningococcal clone (*Neisseria meningitidis* C, cc11) emerged in the Czech Republic, causing a sharp rise in the morbidity and mortality of invasive meningococcal disease. We present analysis of WGS data for cc11 isolates from the Czech Republic.

METHODS

Whole genome sequencing of 92 cc11 isolates was performed on the Illumina MiSeq. The data were processed using the Velvet de novo assembler, and the Genome comparator tool was used to generate a distance matrix. A phylogenetic tree was constructed in SplitsTree4.

RESULTS

Cc11 is composed by isolates of three serogroups (C, B, and W) and form two major lineages on the phylogenetic tree. The first lineage is represented by isolates of serogroups C and B, and these serogroups do not form the respective discrete subpopulations. From the second lineage, a subpopulation of serogroup W isolates rapidly diverges, and this lineage is further constituted

exclusively by serogroup C isolates. While isolates of the first main lineage were primarily recovered in 1993-2006, all isolates of the second main cc11 lineage originate from 2014-2020 and form two genetically distinct subpopulations, defined by the respective dominant phenotypes: C: P1.5,2:F3-3:ST-11 (cc11); rST-2328; BAST-3 and C: P1.5,2:F3-3:ST-11 (cc11); rST-51365; BAST-8.

CONCLUSIONS

Isolates of *N.meningitidis* C, cc11, recovered in the Czech Republic in 2014-2020 form a distinct lineage that is highly distant from the lineage of earlier cc11 isolates. In addition, two separate subpopulations have been described within this new lineage. Acknowledgements Supported by Ministry of Health of the Czech Republic, grant no. NV19-09-00319. All rights reserved.

EP614 / #443**E-Poster Viewing - Paediatrics AS04-08.
Epidemiology****Clinical, behavioural, and environmental factors associated with yellow fever, dengue, chikungunya, and west nile virus exposure in children in teso sub county, western kenya.**

M. Inziani^{1*}, F. Adung'O², E. Obimbo², F. Onyango², S. Inoue³, K. Morita³, M. Mwau¹

¹Kenya Medical Research Institute, Centre For Virus Research, NAIROBI, Kenya

²University of Nairobi, College of Health Sciences, School of Medicine, Department of Paediatrics, Nairobi, Kenya

³Nagasaki University Institute of Tropical Medicine, Department of Virology, Nagasaki, Japan

BACKGROUND AND AIM

Arboviruses like Yellow fever (YFV), Dengue (DENV), Chikungunya (CHIKV), and West Nile virus (WNV) are emerging and re-emerging on the African continent, with several outbreaks reported in Kenya. Despite this, data on the associated risk factors in Kenyan children is scarce. We describe the clinical, behavioural, and environmental factors associated with exposure to YFV, DENV, CHIKV, and WNV among children 1-12 years in Teso Sub County, Western Kenya.

METHODS

In a hospital-based survey, data were collected from eligible children, serum drawn and tested for IgA/IgM/IgG serocomplex antibodies by an indirect ELISA. Data were analysed using STATA Ver. 14.

RESULTS

About 28% of the participants had arbovirus antibodies. Clinical: Overall arbovirus exposure was associated with a rash; WNV with a rash, a past rash, hepatomegaly, gastrointestinal (GIT) and central nervous systems (CNS) complaints. CHIKV was associated with CNS complaints, incomplete vaccination; and YFV with pallor. Behavioural: Overall arbovirus and WNV exposure was associated with storing water in open containers; WNV with lack of vaccination and having no bed net; CHIKV with other mosquito control measures (insecticides, bush clearing), and storing water in closed containers; while overall arboviruses, WNV and CHIKV were all associated with having non-insecticide treated bed nets and, outdoor activities after school, Environmental: DENV exposure was associated with iron sheets roof; WNV with urban residence; and CHIKV with grass-thatched roof, and keeping cows, goats and sheep; while overall arboviruses, WNV and CHIKV were all associated with mosquito bites occurring inside the house, and water bodies, and vegetation near the home.

CONCLUSIONS

Clinical, behavioural and environmental factors are associated with arbovirus exposure in children.

EP615 / #1393**E-Poster Viewing - Paediatrics AS04-08.
Epidemiology****Detailed molecular characterization of neisseria meningitidis isolates by whole genome sequencing (wgs), czech republic, 2010–2019****P. Křížová*, M. Honskus**

The National Institute of Public Health, Centre For Epidemiology and Microbiology, Prague, Czech Republic

BACKGROUND AND AIM

Presentation of the first results of the analysis of *Neisseria meningitidis* isolates from invasive meningococcal disease and from clinically and/or epidemiologically linked cases from 2010–2019. Whole genome sequencing (WGS) was used for the study.

METHODS

The study set included 59 isolates of *N. meningitidis* from 2010–2019. WGS was used for detailed molecular characterization, covering not only basic genes but also ribosomal and capsular genes, antibiotic resistance gene *penA*, and outer membrane protein gene *porA*.

RESULTS

WGS analysis of *N. meningitidis* isolates resulted in a detailed molecular characterization. In a large part of the genes analysed, new mutated allelic variants were found. They were submitted to the PubMLST database and subsequently annotated by the curator. All 59 study isolates were assigned to BAST types, characterized by a unique combination of allelic variants of *N. meningitidis*

B vaccine (MenB vaccine) antigen genes. Overall, 32 different BAST types were identified, and 10 isolates either carried an unknown combination of BAST loci or a new allelic variant in some of the BAST loci. Furthermore, the MenDeVAR index, which provides information on the functional effect of MenB vaccines on a given isolate, was determined.

CONCLUSIONS

The results obtained add to the body of knowledge of the transmission of invasive and non-invasive strains of *N. meningitidis* in the population. The WGS analysis provided detailed data on the coverage of these strains by new MenB vaccines. Acknowledgements: Supported by Ministry of Health of the Czech Republic, grant no. NV19-09-00319. All rights reserved.

EP616 / #1098**E-Poster Viewing - Paediatrics AS04-08.
Epidemiology****Questionnaire based survey for the detection of gaps of paediatric tuberculosis knowledge among physicians and medical students**

M. andrejeva¹, G. Megelinskiene^{2*}, A. Valiulis³, J. Korabliovienė⁴, A. Valiulis¹

¹Vilnius university, Faculty of Medicine, Vilnius, Lithuania

²Vilnius university, Faculty of Medicine, Institute of Health Sciences, Vilnius, Lithuania

³Vilnius university, Faculty of Medicine, Department of Rehabilitation, Physical and Sports Medicine, Institute of Health Sciences, Vilnius, Lithuania

⁴Ministry of Health of the Republic of Lithuania, Health Promotion Division, Vilnius, Lithuania

BACKGROUND AND AIM

The COVID-19 pandemic has reversed years of progress made in the fight to end TB. For the first time in over a decade, TB death rate is increased (WHO, 2022). Objective. To evaluate theoretical and practical knowledge on pediatric TB as basic tool for the disease control as well as to find main gaps of under- and postgraduate education.

METHODS

Anonymous online questionnaire was used. The data was processed by SPSS 22.0 program.

RESULTS

About 50% physicians and medical students and 35.7% resident doctors reported insufficient knowledge on topic of TB. 32% of medical students

reported that the main sources of knowledge about TB are Internet sources. 82.6% of respondents reported that practical illustrations of theoretical knowledge on pediatric TB provided by their academic institutions was poor and fragmentary. Only 9.3% of students based on the experience of other EU countries supported the idea to stop or to postpone BCG vaccination till 3 or 6 months of age. BCG vaccination coverage in Lithuania is declining. In 2021, compared to the previous year, the coverage of BCG decreased by 2.48% and was 93.31%.

CONCLUSIONS

Knowledge on the topic of pediatric TB is lacking in all the analyzed groups. It is clear evidence of clinical case-based TB training in both undergraduate and postgraduate training settings. Biggest educational gap was found at undergraduate training level, therefore, TB teaching at academic institutions should be re-evaluated and updated.

EP617 / #2564**E-Poster Viewing - Paediatrics AS04-08.
Epidemiology****A case of acute rheumatic fever in a 14 year old
GIRL****E. Neziri^{1*}, L. Sadedini¹, M. Kapllanaj², S. Demiraj³, M. Kurti⁴**¹Mother Teresa Hospital Center, Albania, Pediatric Emergency Department, tirana, Albania²Mother Teresa Hospital Center, Albania, Pediatric Onco-hematology Department, tirana, Albania³Mother Teresa Hospital Center, Albania, Hygea Hospital Albania, tirana, Albania⁴Mother Teresa Hospital Center, Albania, Pediatric Resident, tirana, Albania**BACKGROUND AND AIM**

A 14 year old girl was brought to the emergency department with the history of sore throat since 2 weeks, pain first in the left knee joint for 10 days and then in the right shoulder for 5 days, palpitation and fever for 4 days. Her mother refers that the girl used to have repeated attack of sore throat caused by tonsillopharyngitis which has always been seeking medical treatment. At the age of 6 years old she was diagnosed with acute rheumatic fever. After recovery she started prophylaxis with Benzathine Penicillin G IM q3 weeks 1.2 million units until April 2018. From 2018 to November 2021 no Prophylaxis Examination: The girl was pallor. Inflamed tonsils with presence of pus was noted. Holosystolic murmur at the apex. Pain, swelling, redness and limitation of movements in the left knee joint. Laboratory findings: Wbc 20×10^3 , neutrophili, Hb 8.9mg/dl Throat swab: Gr.A β -hemolytic streptococci (GAS) Blood culture: Sterile ECG: P-R interval is prolonged. Echocardiogram: Mild mitral regurgitation and moderate left atrium dilatation LA X-ray: No significant findings Treatment: strict bed rest. Eradication of Streptococcal Infection with benzathine penicillin G IM 1.2 million units single injection. Relief Symptoms with aspirin 75-100mg/kg/daily in 4 divided doses for 10 weeks and prednisolone 2mg/kg/daily in 2 divided doses for 3 weeks, followed by secondary prevention with benzathine penicillin G IM q3 weeks 1.2 million units.

METHODS

Case presentation

RESULTS

case presentation

CONCLUSIONS

Overdiagnosis of ARF can lead to an unnecessary treatment over time and underdiagnosis can lead to further attack of ARF with heart damage. There is different susceptibility among children with streptococcal infection to develop ARF. Duration of Prophylaxis depends on the number of attacks of ARF and heart involvement.

EP618 / #2752**E-Poster Viewing - Paediatrics AS04-08.
Epidemiology****Orofacial clefts and ocular anomalies: 30 years of
experience of a multidisciplinary group in a
tertiary hospital in portugal****I. Pais-Cunha^{1,2*}, L. Leite De Almeida³, T. Magalhães⁴, A. Maia⁵**¹*Centro Hospitalar Universitário de São João, Porto, Portugal, Pediatrics, Porto, Portugal*²*275737357, Department of Gynaecology-obstetrics and Pediatrics, Chusj, Porto, Portugal*³*Centro Hospitalar Universitário de São João, Pediatrics, Porto, Portugal*⁴*275737357, Pediatrics, Porto, Portugal*⁵*Faculty of Medicine of the University of Porto, Department of Gynaecology-obstetrics and Pediatrics, Porto, Portugal***BACKGROUND AND AIM**

Orofacial clefts (OFC) are the most common types of birth defects, arising in about 1.7/1000 newborns. The etiology may be multifactorial, genetic or teratogenic and are presented alone, associated with malformations or integrating several syndromes. Few studies have focused on the presence of ocular defects in patients with OFC. The aim of this study was to describe ocular anomalies in these patients.

METHODS

Retrospective study of patients that attend Cleft Lip and Palate multidisciplinary group at a tertiary hospital from January 1992 until June 2022. OFC were classified according *Spina* classification: cleft lip (CL), cleft lip and palate (CLP), isolated cleft palate (CP) and atypical clefts (AC).

RESULTS

There were 690 patients with OFC, 129 (19%) with ocular anomalies. Among this group, 57% were female and 40% had family history of OFC. CP was present in 61%; CLP in 27%; CL in 9% and AC in 2%. The most frequent ocular findings were refractive errors (72%), eyelid defects (45%) and strabismus (31%). Other relevant anomalies included coloboma (14%), microphthalmia (12%) and hypertelorism (11%). The majority (72%) had an associated syndrome, most frequently the Pierre Robin syndrome (n=26). Other systems were affected in 65 patients with cranioencephalic anomalies and 55 with cardiovascular defects.

CONCLUSIONS

In patients with OFC, as in the general population, refractive errors are very frequent. This population also has a significant prevalence of other important ocular anomalies which can occur without other malformations. It is essential to screen all children with OFC for ocular defects in order to make an early diagnosis and manage these patients effectively.

EP619 / #1900

E-Poster Viewing - Paediatrics AS04-08. Epidemiology

A study on factors influencing vaccine hesitancy in albania

L. Qatipi*

ABC Health Foundation, Health Center, Tirana, Albania

BACKGROUND AND AIM

BACKGROUND In Albania, childhood immunization rates have dropped in recent years from 94% in 2008-2009 to 75% in 2017-2018 according to Albania Demographic and Health Survey. The **"Vaccine hesitancy" phenomenon** is becoming a concern in Albania and is highly contributing to the decrease in immunization rates. **AIMS** Our study aims to discover: 1. Reasons why parents delay/refuse vaccination of their children 0-5 years old, 2. Find similarities of concerns between parents who vaccinate their children and parents who delay/refuse vaccination, and 3. Identify and evaluate the prime factors that influence parents' decisions on childhood vaccination.

METHODS

METHODS Our study is cross-sectional. Anonymous confidential questionnaires were given to 1748 random parents in 18 public and private health centers across Albania. After collecting the data, we analyzed it with Machine Learning Classification algorithms: Chi2, Decision Tree, Random Forest, ExtraTree Classifier.

RESULTS

RESULTS Our statistical analysis concluded that 87% of parents choose to immunize their children on time. After analyzing the data, we found 8 statistically significant concerns and factors (Chi2 $p < 0.05$, Accuracy=95.82%, Specificity=0.976, Sensitivity=0.857) that influenced parents' decisions: Autism concern, State vaccines effectiveness, Age, Education level, "Don't trust vaccines overall", Concern on Vaccines safety, Religious reasons, and Employment in Medical Field.

CONCLUSIONS

The Institute of Public Health and children's health care providers should provide parents with educational handouts with the latest information on the quality, effectiveness, and safety of each state vaccine. The implementation of European Vaccine Action Plan 2015 – 2020 actions will address vaccination concerns and ultimately increase the immunization rate in Albania.

EP620 / #806**E-Poster Viewing - Paediatrics AS04-08.
Epidemiology****Genes encoding enterotoxins m, n, o, u detections in isolates of staphylococcus aureus collected from the paraguayan paediatric population in the year 2017**

F. Rodríguez Acosta*, C. Salinas, P. Acuña, S. Franco, G. Florentín, R. Guillén

Instituto de Investigaciones en Ciencias de la Salud-UNA, Dpto. De Microbiología, San Lorenzo, Paraguay

BACKGROUND AND AIM

The ability of *S. aureus* to infect humans and cause a wide range of infections so efficiently is a consequence of the many variant virulence factors that it can produce. Superantigens (SAGs) make up a group and include staphylococcal enterotoxins (SE). This study aimed to detect genes encoding SE M, N, O, and U in isolates of *S. aureus* that caused infections in Paraguayan children in 2017.

METHODS

Observational, descriptive, and cross-sectional study, with a non-probabilistic sampling of consecutive cases. The detection of genes encoding the SEM, SEN, SEO, and SEU was performed by PCR.

RESULTS

181 *S. aureus* isolates causing skin, and soft tissue infections (SSTI, n=140, 77%) were collected; most of them, 50% (n=90), came from children under

six years of age. At least one gene encoding enterotoxin was detected in 96% (174/181) of isolates, and 24% (44/181) carried the entire M, N, O, U group of enterotoxins. In addition, an association between methicillin resistance and *seo* and *seu* gene carriage was observed ($p \leq 0.05$, Fisher's exact test). Figure: Heat Map and dendrogram according to the carriage of genes encoding SE M, N, O, and U in *S. aureus* isolates. A purple box represents the presence of these genes in the isolates, and the light blue box represents the absence. Ward's algorithm with Euclidean distance metric was used to group the isolates according to the profile of virulence factors they carry, providing a solid separation in the dendrogram.

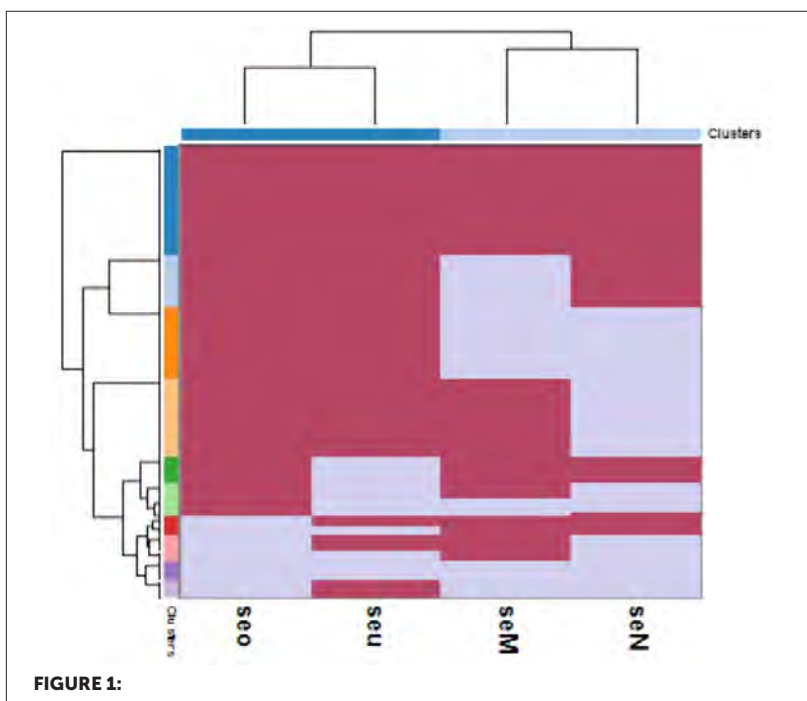

CONCLUSIONS

Through this study, the molecular detection of the genes encoding enterotoxins M, N, O, and U was achieved with a high prevalence in isolates of *S. aureus* collected from infectious in children who attended the main care centers in Paraguay.

EP621 / #1997

E-Poster Viewing - Paediatrics AS04-09. Ethics & law

Respecting the child's legal voice: has the best interests test incorporated an element of substituted judgment in medical decision-making?

T. Hubble*

De Montfort University, Law School, Leicester, United Kingdom

BACKGROUND AND AIM

In medical decision-making, it is trite law that decisions must be made in the best interests of the child. Yet, there is ambiguity in the term 'best interests'. How can we determine what is best for a particular child? The aim of this research was to interrogate the English judiciary's modern approach to paediatric best interests assessments.

METHODS

English statutes, case law, and legal commentary were critically appraised. Cases involving children competent to make their own medical decisions were excluded.

RESULTS

The best interests assessment aims to promote the child's welfare as the primary focus of medical decisions. It is, however, extremely challenging to apply the test to an inherently subjective matter: the best interests of a child with unique idiosyncrasies and individual sociocultural background.

This research found evidence that substituted judgment has been covertly applied in paediatric medical case law. This test attempts to evaluate what decision the child would have made, had they been competent to do so. Whilst entirely artificial, it is the only way to ensure the child (and their evolving worldview) is at the centre of all medical decisions.

CONCLUSIONS

Substituted judgement is a necessary component of best interests assessments. It prevents the responsible adult from clouding evaluation of the child's welfare with their own subjective beliefs. This research provides evidence that the English judiciary are already incorporating substituted judgment into their best interests assessments. To ensure the law and medicine remain coordinated in their approach to paediatric medical decisions, this must be properly communicated to clinicians.

EP622 / #399

E-Poster Viewing - Paediatrics AS04-09. Ethics & law

Through different eyes, a paradigm shift regarding treatment of trisomy 18

W. Leeuwenburgh-Pronk*

Emma Children's hospital, Amsterdam UMC, General Paediatrics, H7-274, Amsterdam, Netherlands

BACKGROUND AND AIM

We present a case of trisomy 18 with the shift from non-intervention at birth towards active treatment throughout the first year of life. We aim to create a better understanding of the quality of life for children with trisomy 18 as a justification for active treatment.

METHODS

case report and review of the literature with emphasis on narrative ethics, the zone of parental discretion, interview with the parents of a child with trisomy 18.

RESULTS

Family empowerment through online peer support by international patient organization, the influence of social media (youtube and facebook), trisomy 18 perceived as an identity instead of a syndrome.

CONCLUSIONS

A paradigm shift towards active treatment of patients with trisomy 18.

EP623 / #1356

E-Poster Viewing - Paediatrics AS04-10. Family-centred care

Factors that influence a clinician's decision to support the initiation of invasive long-term ventilation for a young child: a factorial survey

M. Quirke¹, D. Alexander¹, J. Greene¹, C. Walsh², M. Brenner^{1*}

¹University College Dublin, School of Nursing, Midwifery and Health Systems, Dublin, Ireland

²University of Limerick, Department of Mathematics and Statistics, Limerick, Ireland

BACKGROUND AND AIM

The decision to initiate invasive long-term ventilation (I-LTV) for a young child with complex and integrated care needs (CICN) is a multifaceted one, yet few studies examine the influences on a clinician's decision to support this pathway of care. Using Bronchopulmonary Dysplasia (BPD) and Spinal Muscular Atrophy (SMA) type 1 as case examples, this study aims to identify the main determinants that influence this decision.

METHODS

We conducted a vignette-based online factorial survey with clinicians, distributed internationally via eight professional organisations. Participants anonymously completed two sections: eight factorial vignettes; demographic questions. We obtained host institution ethical approval. Analysis utilised multilevel logistic regression modelling.

RESULTS

277 respondents completed 1038 'young child' (12/24months) vignettes (60% female; mean age= 45.6 years; SD=10.3; years' experience working

with children with CICN: 15.9 years; SD=9.3). Controlling for other factors, clinicians were significantly more likely to support initiation for children with a diagnosis of BPD, than for those with SMA type 1. Parental agreement with the decision, presence of a good family network and proximity to a tertiary centre were also predictors of a clinician's likelihood to support treatment initiation.

CONCLUSIONS

A child's diagnosis is central in the decision whether to initiate I-LTV, considered in line with available evidence regarding prognosis and treatment options. Aside from clinical considerations, family support and capacity are key in a clinician's decision to support initiation. This was the first study we know of to use a factorial survey in the critical care setting and is a useful approach for examining decision-making on sensitive topics.

EP624 / #1003

E-Poster Viewing - Paediatrics AS04-10. Family-centred care

The mourning of a lifetime doesn't fit into five DAYS

T. Sousa, T. Costa*

Acreditar, Central Region, Coimbra, Portugal

BACKGROUND AND AIM

Despite the survival rate of paediatric cancer approaching 80% in Portugal, each year about 80 patients lose their lives. The death of a child is one of the most traumatic experiences according to Acreditar's understanding, having accompanied these families for over 27 years. To correct the injustice of the law that granted these parents a mourning period of 5 days leave, we launched a petition for the purpose of increasing this period from 5 to 20 days, regardless of the age or cause of death.

METHODS

The campaign to inform and create awareness for parental mourning implied:

- a) Legal counsel - comparison of European policies / adaptation to 20 days;
- b) Consultancy - research on parental mourning: academic works, social listening and interviews of specialists and grieving parents;
- c) Prominent public figures as first signatories;
- d) Awareness through a film with mourning parents;
- e) Site with a petition, scientific and witness information;
- f) Media distribution.

RESULTS

The petition was delivered to Parliament in October 2021 with 83.508 signatures; universal parliamentary consensus; Law N^o. 1/2022 made changes to the Work Code increasing the mourning period from 5 to 20 consecutive days, including the right to receive psychological accompaniment.

CONCLUSIONS

The recognition of the role of Acreditar allowed for the subject to be brought to public discussion. The need to establish, as a general rule, 20 days for parental mourning in other EU jurisdictions.

EP625 / #2265

E-Poster Viewing - Paediatrics AS04-10. Family-centred care

Parents' process of recognition and response to clinical deterioration of their children with medical complexity at home: a grounded theory

C. Genna^{1*}, K.R. Thekkan¹, C. Geremia², M. Di Furia², A. Campana², I. Dall'Oglio¹, E. Tiozzo¹, O. Gawronski¹

¹Bambino Gesù Children's Hospital IRCCS, Nursing and Allied Health Professional Development, Continuing Education and Research Unit, Medical Directorate, Rome, Italy

²Bambino Gesù Children's Hospital IRCCS, Department of Emergency, Acceptance and General Pediatrics, Rome, Italy

BACKGROUND AND AIM

Children with Medical Complexity (CMC) are characterized by chronic conditions associated with frailty and functional limitations and high use of technology and resources. Their medical complexity often leads to the onset of complications. Parent's targeted care ensures timely recognition and response to clinical deterioration at home, thus avoiding serious sequelae, inappropriate hospitalizations and improving quality of life. Evidence on parents' management of clinical deterioration of CMC at home is limited. The aim is to explore the process of recognition and response to clinical deterioration of CMC at home by their parents.

METHODS

Qualitative study using Grounded Theory. Seven online focus groups with CMC' parents and healthcare providers (HCPs). The interviews were transcribed verbatim and coded, using a constant comparative iterative method.

RESULTS

Five macro-categories were identified: 1) Awareness of unique and shared characteristics; 2) Parents' care maintenance and management; 3) Parents' care monitoring; 4) Parents' response to clinical deterioration; and 5) The relationship with HCPs. "Seeking the Shift of Agency from HCPs to CMC's parent", was identified as the foundation of the Process of Recognition and Response of Parents To Deterioration (PRE-PARE-D) theory.

CONCLUSIONS

The role of parents is evolving into active care leaders, by developing care management competences and negotiating care with HCPs. The shift of agency from HCPs to parents requires counselling pathways to promote the development of parent's self-efficacy and empowerment in care of their CMC. Home care delivery for CMC should aim at sustaining this partnership between HCPs and parents of CMC.

EP626 / #844

E-Poster Viewing - Paediatrics AS04-10. Family-centred care

Fever phobia – where are we NOW

C. Gomes Pereira^{1*}, S. Nogueira Machado¹, R. Lages Pereira²,
A. Rebelo¹, M. Salgado¹

¹Hospital Senhora da Oliveira, Pediatrics Department, Guimarães, Portugal

²Hospital de Braga, Pediatrics Department, Braga, Portugal

BACKGROUND AND AIM

Fever is a common complaint in the ED. Despite frequently benign, it's still cause for anxiety for caregivers. This study aimed to characterize parents' knowledge and attitudes towards fever.

METHODS

A cross sectional and descriptive survey was conducted by applying a questionnaire to pediatric patients' caregivers that attended consultation from April to August 2021. Questions regarding sociodemographic data, knowledge about fever, interventions used to reduce it, and beliefs were included. Descriptive analysis was performed.

RESULTS

A total of 1014 questionnaires were included. The thermometer was used by 97,7% caregivers to measure fever, with armpit being the preferred location (80,9%). Around 87% wrongly defined fever. About 11,8% don't offer anti-pyretics before resorting to health care mostly because of fear of masking the disease (47,7%). About 91% undress the child in thermal ascent and 49% uses sponging with cold water to decrease temperature. Caregivers search for help mainly in the primary care (66,2%). The physician was the preferred

source of information (75,8%). Seizures (83,4%) were appointed as the main complication, 10,3% referred death as a possible effect of fever. Teething was appointed as causing fever by 78%, 54,8% consider fever to be harmful for children's health, 67% believe temperature will go up indefinitely if not treated and 85,2% believed that temperature should always decrease to normal values after antipyretic.

CONCLUSIONS

Fever phobia is still a reality, with wrong beliefs and misconceptions about the consequences and treatment. It's important to inform parents about this subject to improve the management of fever and reduce caregivers' anxiety.

EP627 / #716

E-Poster Viewing - Paediatrics AS04-10. Family-centred care

Parents' knowledge about sudden infant death syndrome

C. Gomes Pereira^{1,2*}, B. De Sousa¹, A. Fernandes²

¹Hospital Senhora da Oliveira, Pediatrics Department, Guimarães, Portugal

²Hospital Senhora da Oliveira, Neonatology Unit, Guimarães, Portugal

BACKGROUND AND AIM

Sudden infant death syndrome (SIDS) is characterized by an unexplained death during the sleep period in the first year of life in a previously healthy infant and behavioral measures have been shown to decrease its incidence. The aim of this study was to characterize parents' knowledge about SIDS and preventive measures.

METHODS

A cross sectional and descriptive survey was conducted by applying a questionnaire to caregivers with infant children that attended pediatric consultation from October to December 2021. Questions regarding sociodemographic data and compliance with SIDS preventive measures were included.

RESULTS

A total of 168 questionnaires were included, with a median age of infants of 2 months (min. 15 days, max 11 months). The majority of the responders were female (94,6%). Around 81% claimed to be aware of SIDS. 85% reported having breastfed or being currently breastfeeding their baby. Lateral decubitus was the sleeping position chosen by 12%, and 3% admitted to laying the baby

in ventral decubitus position. Around 11% slept at least part of the night in a shared bed with their parents or other child. 24.4% used a pillow to sleep, of which 56,4% didn't have a medical prescription to use one. 12% covered their child with some kind of object to sleep. Around 7% of mothers smoked during pregnancy and 34,5% currently lived with smokers.

CONCLUSIONS

Despite multiple awareness campaigns on this topic, caregivers continue to make major mistakes when it comes to SIDS prevention. It is important that health professionals continue to insist on educating parents and caregivers.

EP628 / #1763

E-Poster Viewing - Paediatrics AS04-10. Family-centred care

Tout doux: an institutional initiative to reduce pain and distress management related to procedures

S. Loemba, M.-J. Dore-Bergeron, P. Laforce, J. Paquette, A. Lacroix, M.-F. Langlet, E. Trempe, K. Gatuso, B. Grou*, E. D. Trottier

CHU Sainte-Justine, Tout Doux, Montreal, Canada

BACKGROUND AND AIM

Pain and distress management related to procedures needs to be a priority for hospital treating children. A project emerged from this priority and is now an institutional policy at the CHU Sainte-Justine tertiary care pediatric hospital in Montreal, Canada. The project called *Tout doux* is supported by the institution and the Foundation to improve procedural pain management. The aim of this project is to assist the healthcare providers (HCP) in reducing children's procedural pain and distress.

METHODS

Since its launching event in June 2021, a multidisciplinary team composed of nurses, doctors, professionals and patient partners are working together to improve accessibility to resources, increase education, facilitate process and outcomes for procedural pain. Eight work teams have been created in a structured plan to address specifically the deployment of the projects, audits, training tools, proper diffusion of the project, outreach and networking.

RESULTS

A deployment is currently ongoing in many departments with the help of the project's nurse champion (NC). Each department deployment involved pre and post audits. Training through formal presentations and e-learning modules for all HCP, and support of the project by a NC to guide the HCP in their practice, consolidate knowledge, and change the unit's care culture. To this day, 500 HCP have been trained using formal training or e-learning from hematology-oncology, collection center, outpatient pediatric, plastic, orthopedics and ENT clinics, surgical wards and emergency department.

CONCLUSIONS

The next step for this QI initiative will be to ensure its optimal dissemination through the organisation and further assess the long-term outcome on patients.

EP629 / #2047

E-Poster Viewing - Paediatrics AS04-10. Family-centred care

Role of virtual mdt in managing paediatric safeguarding

R. Gupta*

luton and dunstable university hospital, Paediatrics, Milton Keynes, United Kingdom

BACKGROUND AND AIM

15 month old toddler presented with bucket handle type wrist fracture. Radiologist and orthopaedic team concerned about non accidental injury (NAI) given type of fracture.

METHODS

Virtual MDT was arranged within an hour to investigate possible NAI concerns. A multi-professional team including the paediatric consultant, paediatric registrar, radiologist, orthopaedic registrar, orthopaedic consultant on call and paediatric orthopaedic consultant were able to meet virtually on Microsoft teams -a secure internet connection. At the end of the meeting, MDT team arrived at a decision to repeat X-ray as query was raised about the fracture since the child was heavily clothed. The repeat X-ray did not show fracture. This was followed by orthopaedic review that indicated there was no localised tenderness or restriction of wrist movements, thereby ruling out fracture clinically. Hence child protection (CP) medical was not required. Parent was reassured and child was discharged home with no further follow up.

RESULTS

Swift and appropriate action as a result of virtual MDT helped in expediting the decision-making process and allowed child to be discharged home averting hospital stay and the family were not subjected to unnecessary mental stress of a CP medical. NHS resources and expert professional time was used judiciously.

CONCLUSIONS

Establishing a standard of procedure in the local trust for optimal use of a secured internet platform that can bring about a much desired and essential evolution in family centric care especially in safeguarding cases that require multi-disciplinary involvement.

EP630 / #2286

E-Poster Viewing - Paediatrics AS04-10. Family-centred care

Missing opportunities in outpatient clinic and paediatric emergency department to discuss about childhood obesity

M. Ezzati, O. Ozieh*, F. Yousif, A. Abdelgadir, M. Higgins-Abrago

Homerton University Hospital, Paediatric, London, United Kingdom

BACKGROUND AND AIM

Childhood obesity is a public health matter. Besides their clinical role, paediatricians have also the role to take any opportunity to prevent ill health and obesity and promote wellbeing as part of their everyday practice. This retrospective study explores the missed opportunities to discuss about childhood obesity when young patients and their families presenting to emergency department or outpatient clinics for other primary medical problems.

METHODS

Data were collected from medical notes and clinic letters of patients who presented to general paediatric clinic and emergency department at a district hospital over the course of 1 week in 2021. Weight, height and BMI of total of 120 patients between 1-16 years old were plotted. BMI above the 91st centile was considered as overweight and above 98th centile was considered as very overweight (clinically obese). Information about any discussion around young person's weight and advice about healthy life style and increased activity were given to young patient and their families/carers were extracted from medical notes.

RESULTS

In outpatient clinic, 24 patients were very overweight (obese) and 3 overweight. In emergency department, 6 were very overweight and 2 overweight. Only 50% (12 patients) of obese patients in outpatient clinics had discussions around their weight and healthy life style, There was no documentation about healthy lifestyle advice and concerns around patients weight in emergency department and in overweight children.

CONCLUSIONS

This study highlights despite routine weight and height measurements in OPD, the opportunity to measure BMI and recognise obesity is missed in more than 50% of cases. More awareness is needed among professionals.

EP631 / #2029

E-Poster Viewing - Paediatrics AS04-10. Family-centred care

Early onset of psychological support for families of children with complex needs.

R. Martin¹, E. Di Mauro¹, M. Dell'Anna², C. Trapani², M. Parpagnoli^{2*}

¹Meyer Children Hospital, Psychology, FIRENZE, Italy

²Meyer Children Hospital, Complex Care Unit, FIRENZE, Italy

BACKGROUND AND AIM

Management of complex care needs child entails important health needs. It is more often the family that has the task of satisfying these needs. Sometimes also takes charge of the provision of real medical care. The family may experience a lack of infrastructure for home and community care, inadequate training for home care. High stress of parents is likely to increase their defensive barriers and, as a result, they respond less to psychological support. We present the project of anticipating the intake of psychological assistance of the family from the neonatal moment.

METHODS

This work respects the local ethical guidelines. Parents will interview to request feedback on the psychological care provided.

RESULTS

Our project plans to anticipate the psychological management of the family of complex care needs baby from the time of hospitalization in the neonatal intensive care. The family was followed from psychologists with frequent and regular interviews. We have been seeing how the advance of psychologi-

cal management improves the subsequent relationships with the operators and supports the parent-child relationship. Care givers have seen a greater confidence of the parents towards them. This project can help families feel supported in the practical management of the child.

CONCLUSIONS

Care of child with complex needs should be early. The family must be helped psychologically from the beginning. Our experience indicates that immediate start of psychologically monitoring improves the family psychological state. We plan to submit satisfaction questionnaires to families to improve the service and assess the differences with a later start of psychological counseling.

EP632 / #1684

E-Poster Viewing - Paediatrics AS04-10. Family-centred care

Self medication in children less than 5 years of AGE

P. Patel^{1*}, S. Nimbalkar¹, J. Ganjiwale², T. Manavalan³

¹Pramukhswami Medical College, Pediatrics, Anand, India

²Pramukhswami Medical College, Public Health, Anand, India

³Pramukhswami Medical College, Pharmacy, Anand, India

BACKGROUND AND AIM

Self-medication in children less than 5 years of age Introduction This study focuses mainly on asking parents whether they self-medicated their child or not and if they did further questions were asked to assess their knowledge regarding this practice and their focus on child's health.

METHODS

Parents of children less than 5 years of age visiting pediatric OPD at Shree Krishna hospital were approached and after consent, basic demographic and personal details along with knowledge regarding dosage and expiry date of drugs was asked. Parents were also asked if their child recovered or became worse after self-medication.

RESULTS

Total 299 parents participated in this study. Prevalence for self-medication usage is as follows - 72.57 % didn't use self-medication, 27.43% used self-medication. For those who self-medicated their child for Fever- 20.73%, Cough- 32.93%, Fever and Cough- 26.83%, fever cough and diarrhea – 10.97%, fever

and diarrhea – 4.88%, diarrhea-1.22%, diarrhea and abdominal pain-1.22%, 1.22 % for fever cough and abdominal pain. In rural area 71.02% didn't use self-medication while 62.35% did, for urban 28.98% didn't use and 37.65% used self-medication. Awareness regarding expiry dates- 7.7% unaware and 92.3% aware, for people using self-medication 2.4% is unaware and 97.6% aware, for people who didn't use self-medication 90.19% is aware and 9.81% unaware.

CONCLUSIONS

Conclusion Parents who used previously prescribed drugs mostly revisit doctor for consultation but also seems to advice using same method of self-medication to peer parents and tend to think that their way of self-medicating is a safe choice.

EP633 / #963

E-Poster Viewing - Paediatrics AS04-10. Family-centred care

Parents' experiences and perspectives of their child's sleep quality during hospitalization

C.-J. Van Der Perk^{1*}, P. Burger¹, R. Gemke¹, J. Maaskant^{1,2}

¹Amsterdam UMC location University of Amsterdam, Pediatrics, Amsterdam, Netherlands

²Amsterdam UMC location University of Amsterdam, Data Science and Epidemiology, Amsterdam, Netherlands

BACKGROUND AND AIM

Sleep is an essential daily requirement for the development and maintenance of physical and psychological health. Hospitalized children are at risk for sleep disturbances caused by disease-related, psychological, social, and environmental factors. Few studies have researched the sleep quality in hospitalized children. The aim of this study was to explore experiences and opinions of parents on the quality of sleep of their child.

METHODS

We used a descriptive explorative qualitative design with semi-structured interviews. Parents were purposefully chosen to participate in the study. Interviews were audio recorded and transcribed verbatim. Thematic analysis involved initial coding, deriving categories from codes, and identifying main themes. To achieve transparency and consistency regarding the process, study data and the interpretations, consensus meetings were organized with three researchers. MAXQDA software was used. All data were analyzed and reported anonymously.

RESULTS

Twelve parents of eleven children admitted on a general pediatric ward, participated in the study between October 2021 and April 2022. Three preliminary themes were found: disruption of sleep occurs often and any time of the day, parents are the main advocates in ensuring their child's sleep, and lack of focus on the child in coordination of care. For example, one parent said: "...there are also moments when she just falls asleep and the doctors come to check on her. of course you can't control that, because it depends on when they have time."

CONCLUSIONS

Parents together with healthcare professionals can make a distinctive difference in facilitating the hospitalized child's sleep quality.

EP634 / #1561

E-Poster Viewing - Paediatrics AS04-10. Family-centred care

Childhood obesity and healthy lifestyle change: a global perspective from new zealand

C. Wild^{1*}, N. Rawiri², E. Willing³, P. Hofman², Y. anderson⁴

¹University of Oxford, Primary Care Health Sciences, Oxford, United Kingdom

²University of Auckland, Liggins Institute, Auckland, New Zealand

³University of Otago, Kōhatu – Centre For Hauora Maori, Dunrdin, New Zealand

⁴Curtin University, Faculty of Health Sciences, Perth, Australia

BACKGROUND AND AIM

Family-based multidisciplinary interventions are recommended best practice by the World Health Organization for addressing paediatric obesity. However, engagement in intervention programmes is challenging and inequities by ethnicity and socioeconomic deprivation are persistent. This study aimed to understand family experiences of accessing care for childhood obesity, identify barriers and facilitators of engagement in a healthy lifestyle programme (Whanau Pakari) and highlight challenges for successful multidisciplinary intervention moving forward.

METHODS

A multi-methods approach underpinned by Kaupapa Maori theory principles was undertaken. Past participants of Whanau Pakari were surveyed to determine factors that served as barriers or facilitators of engagement. Sixty-four in-depth interviews were conducted with past participants and their families, with varying levels of attendance, including non-service users (declined input after referral). Data were analysed using thematic analysis.

RESULTS

The context of complex family lives and socioeconomic deprivation, social norms of body weight and previous experiences of healthcare impact engagement at the service level and produce inequities. Compassionate, respectful care can partially mitigate negative experiences and facilitate further engagement. The health system itself presents further barriers to access, and the obesogenic environment is substantially hindering intervention efforts.

CONCLUSIONS

The Whanau Pakari programme has achieved improvements on multiple outcome measures, begun to address health equity, and has outperformed past conventional models of lifestyle-focused care in terms of reach and initial engagement. However, a coordinated approach between intervention and prevention is needed to enhance the success of multidisciplinary interventions and improve outcomes for childhood obesity globally.

EP635 / #580

E-Poster Viewing - Paediatrics AS04-10. Family-centred care

Factors associated with favoring parental presence during cardiopulmonary resuscitation among doctors involved in the emergency care of children in a tertiary hospital in GHANA

S. Zakariah^{1*}, A. Afrane¹, T. Beattie²

¹*Korle bu Teaching Hospital, Department of Child Health, Accra, Ghana*

²*University of Edinburgh, Paediatric Emergency Medicine, Edinburgh, United Kingdom*

BACKGROUND AND AIM

In the past, parents were asked to leave the room whenever their child required cardiopulmonary resuscitation (CPR). Although many parents would want to be present, some doctors have concerns about parental presence during CPR (PPDCPR). Recently there has been a trend towards favouring PPDCPR. Little is known about the practice of PPDCPR in Ghana, and the factors associated with favouring PPDCPR. An understanding of these factors is important to facilitate change. Aim: To determine the factors associated with favouring PPDCPR among doctors involved in the emergency care of children in Ghana

METHODS

In this cross-sectional study, doctors working in a Tertiary Hospital were sent an online questionnaire. Associations were examined between favoring PPDCPR and variables such as previous experience of consequences of PPDCPR and demographic variables.

RESULTS

The response rate was 129/164 (78%). Despite PPDCPR not being offered routinely, most doctors (83/129[64.3%]) were in favour of PPDCPR. Being a parent, prior positive experience and not experiencing a negative consequence of PPDCPR were significantly associated with favouring PPDCPR (Table 1) Table 1: Factors associated with favouring PPDCPR

TABLE 1:

Factor	p-value
Sex	0.318
Being a parent	0.028
Number of years since graduation from medical school	0.311
Professional Grade	0.058
Previous experience of positive consequence	0.000
Not experiencing a negative consequence	0.002

CONCLUSIONS

Past experiences of PPDCPR among doctors affect the probability of favouring the practice. Further studies need to be conducted in a larger, more diverse cohort to confirm these findings and investigate interventions that may lead to an improved experience and PPDCPR being offered routinely.

EP636 / #1992

E-Poster Viewing - Paediatrics AS04-11. Gastroenterology & hepatology

Tranexamic acid for upper gastrointestinal bleeding - systematic review and meta-analysis

I. Abdelgadir^{1*}, E. Twum-Barimah², M. Gordon³, E. Langholz⁴,
L. Gluud⁵, G. Aali³, A. Akobeng⁶

¹Sidra Medicine, Paediatric Emergency, Doha, Qatar

²Department of Pediatrics and Child Health, Barts Health NHS Trust, Pediatrics, London, United Kingdom

³School of Medicine, University of Central Lancashire, Pediatrics, Preston, United Kingdom

⁴University Hospital, Hellerup, Gastroenterology, Gentofte, Denmark

⁵Copenhagen University Hospital Hvidovre, Gastroenterology, Hvidovre, Denmark

⁶Sidra Medicine, Gastroenterology, Doha, Qatar

BACKGROUND AND AIM

Background Upper gastrointestinal bleeding (UGIB) is a common medical emergency and is associated with high mortality. Tranexamic acid may reduce haemorrhage through its antifibrinolytic effects. **Objectives** To assess the effects of tranexamic acid versus no intervention, placebo, or other treatment modalities UGIB.

METHODS

Search methods We searched the following electronic databases: Cochrane Central Register of Controlled Trials, MEDLINE, Embase, Science Citation Index, from inception to September 2021. **Selection criteria** We included only randomised controlled trials (RCTs) **Data collection and analysis** We used the standard methodological procedures of The Cochrane. The primary outcome was all-cause mortality. Secondary outcomes included: re-bleeding, the need for blood transfusion, the need for surgical interventions and the occurrence of adverse events.

RESULTS

Main results We included 15 RCTs (n= 13,072). of these, 14 trials were included in meta-analyses that compared tranexamic acid to other treatment, placebo, or no other treatment (n=12,939). Tranexamic acid group reported less mortality (RR 0.71, 95% CI 0.54 to 0.93; studies = 13; participants = 12,939; low-certainty evidence, $I^2=22\%$). Re-bleeding was not different between the two groups (RR 0.80, 95% CI 0.58 to 1.01; studies = 12, participants = 2265; low-certainty evidence, $I^2 = 43\%$). The need for blood transfusion, surgical intervention, the frequency of thromboembolic phenomenon and the development of thrombophlebitis was not different between the two groups.

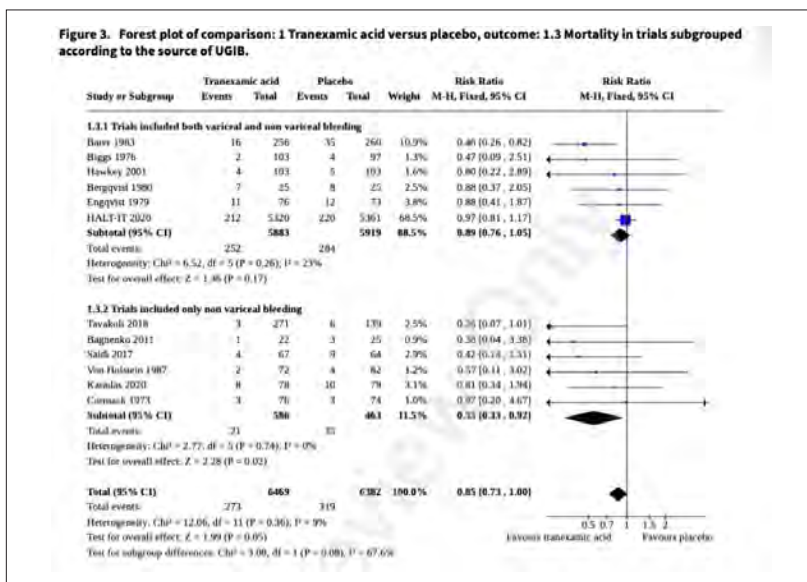

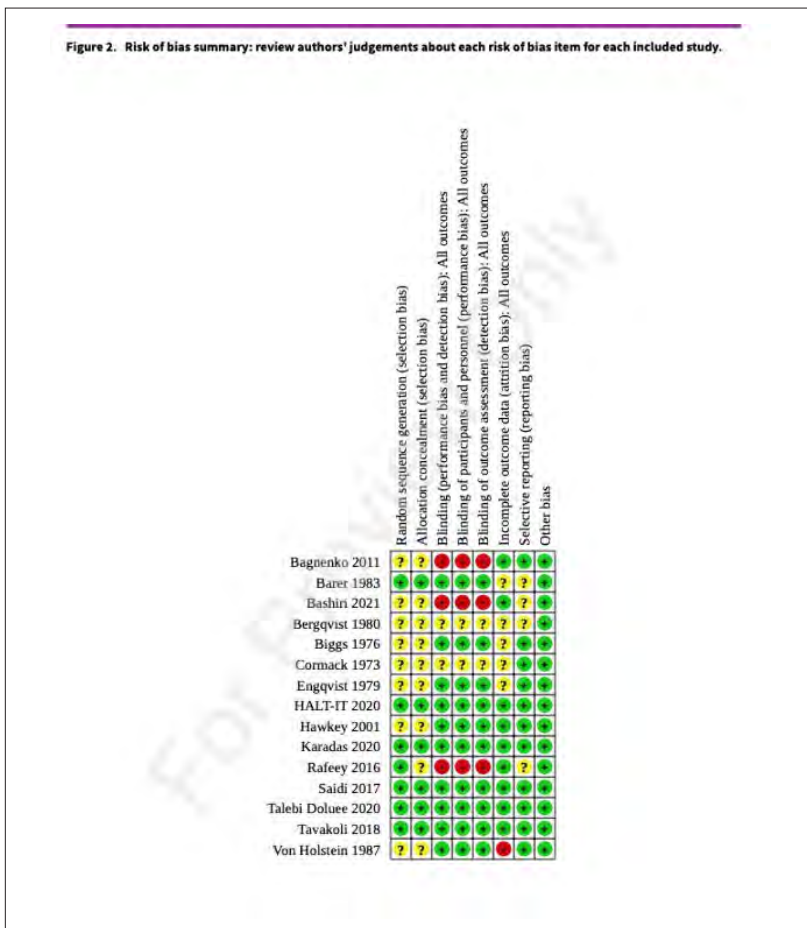

CONCLUSIONS

conclusions Tranexamic acid might have a beneficial effect on mortality. No evidence of differences was noted when re-bleeding, the need for

surgical intervention, the need for blood transfusion, and adverse events were assessed.

EP637 / #2321

E-Poster Viewing - Paediatrics AS04-11. Gastroenterology & hepatology

Bilocular cystic ileal duplication: case report

**M. Anastasakis*, I. Galonaki, C. Doitsidis, M. Mitroudi, C. Panteli,
I. Patoulis**

G.H.G.Gennimatas, Paediatric Surgery, Thessaloniki, Greece

BACKGROUND AND AIM

The aim of this study is to present two rare entities: a) a bilocular cystic intestinal duplication and b) the occurrence of bleeding from the duplication due to lesions associated with chronic hemorrhagic enteritis rather than ectopic gastric mucosa.

METHODS

A 13-year-old male was hospitalized in the Department of Pediatrics for severe lower GI hemorrhage. During neonatal life, the boy had been hospitalized in the Intensive Care Neonatal Unit for necrotizing enterocolitis treated by peritoneal drainage (drains entered into iliac fossae bilaterally). Imaging and scintigraphic exams failed to identify the cause of the current GI hemorrhage. After a second episode of bleeding, pediatricians asked for a pediatric surgical consult and we decided to proceed to an urgent exploratory laparotomy. A diverticular lesion of considerable size and with a wide base was identified 30 cm proximal to ileocecal valve at the antimesenteric intestinal surface. The lateral wall of the lesion was adhered to the sigmoid colon while its upper surface was adhered to the lateral abdominal wall. Our attempt to mobilize the small bowel from the sigmoid colon revealed the absence of muscular layers in both the small and large bowel walls for length of 1.5 cm. Segmental intestinal resection including the duplication was performed followed by an end to end anastomosis in two layers.

RESULTS

In our case, the bleeding cause was the chronic active hemorrhagic enteritis at the wall of the cystic duplication, according to the histological study of the specimen.

CONCLUSIONS

We present a rare case to enlighten the literature.

EP638 / #1882

E-Poster Viewing - Paediatrics AS04-11. Gastroenterology & hepatology

The role of vitamin d supplementation in children with inflammatory bowel diseases

O. Belei^{1*}, L. Olariu², T. Marcovici², I. Enatescu³, O. Marginean¹

¹Victor Babes^{*} University of Medicine and Pharmacy, First Pediatric Clinic, Disturbances of Growth and Development On Children Research Center, Timisoara, Romania

²Victor Babes^{*} University of Medicine and Pharmacy, First Pediatric Clinic, Timisoara, Romania

³Victor Babes^{*} University of Medicine and Pharmacy, Xii Th Department, Neonatology, Timisoara, Romania

BACKGROUND AND AIM

There are only a few pediatric studies regarding the potential benefit of vitamin D supplementation on the clinical course of inflammatory bowel diseases (IBD) in children. Objectives: To investigate the relationship between vitamin D intake and disease activity after 2 different dose regimen administration in children with IBD and hypovitaminosis D.

METHODS

This study included 38 patients aged 8-18 years old, with quiescent IBD, following maintaining treatment and having 25OH vitamin D (25OHD) serum level below 30 ng/ml at baseline. The patients were randomized in 2 lots. The first group received supplementation with 800 IU vitamin D/day and the second group received 2000 IU daily for a period of 6 months.

RESULTS

25OHD mean serum level was significantly higher after 3 months in the second lot receiving 2000 IU Vitamin D/day as compared to the first lot receiving

800 IU/day ($p < 0,001$). The same statistically significant difference regarding 25OHD serum level was observed after 6 months between the study lots. There was no difference between the proportion of cases that relapsed in the first lot compared to the second lot after 3 months of follow up. After 6 months, there were significantly lower cases that relapsed in the first lot of study (49%) compared to the percent of cases in activity from the second lot of study (13%), $p < 0,001$.

CONCLUSIONS

Supplementation with vitamin D in children with IBD significantly prevented relapses at 6 months after higher dose administration - 2000 IU daily compared to 800 IU/day.

EP639 / #2392

E-Poster Viewing - Paediatrics AS04-11. Gastroenterology & hepatology

Changes of the pro-inflammatory cytokines in children with inflammatory bowel disease

S. Bojadzieva^{1*}, A. Sofijanovska², O. Jordanovska³, S. Jancevska⁴

¹University Children Hospital-Skopje, Medical Faculty Skopje, Gastroenterology, Department of Pediatrics, Skopje, North Macedonia

²University Children Hospital-Skopje, Intensive Care Unit, Skopje, North Macedonia

³University Children Hospital-Skopje, Clinical Biochemistry (hematology, biochemistry Immunology, Allergology), Skopje, North Macedonia

⁴University Gynecology and Obstetrics, Medical Faculty, Skopje, Neonatology, Skopje, North Macedonia

BACKGROUND AND AIMS

Introduction: Inflammatory bowel disease (IBD), including ulcerative colitis (UC) and Crohn's disease (CD) are idiopathic chronic diseases of the gastrointestinal tract. The pathogenesis and etiology of UC and CD is still unknown, but the abundant research indicates simultaneous influence of the immunological, external factors, genetic, and an imbalance between proinflammatory and antiinflammatory cytokines. Cytokines with proinflammatory function which have main role in pathogenesis of disease are: Interleukin 1 (IL-1), Tumor necrosis factor alpha (TNF- α), IL-6, IL-8, IL-12. The cytokines play a central role in the modulation of the intestinal immune defense. The aim of our study was to examine pro-inflammatory cytokines in children with IBD, their changes and correlation with phenotypic characteristics and activity of the disease.

METHODS

We have examined 48 children with IBD, (26 with CD and 22 with UC). Cytokines were determined with the ELISA (Enzyme-linked immunosorbent

assay) method. Diagnosis was confirmed after the realisation of all diagnostic protocols.

RESULTS

The TNF- α , IL-1 and IL-6 values were increased in patients with CD and severe forms of disease. Correlation has been found between the phenotypic characteristics and the cytokines profile through increased TNF- α and IL-6 values in patients with CD with disease of terminal ileum, fistulas, stenosis, and severe forms of IBD.

CONCLUSIONS

Pro-inflammatory cytokines, especially the key cytokine TNF- α are very important in determining the disease activity.

EP640 / #2244

E-Poster Viewing - Paediatrics AS04-11. Gastroenterology & hepatology

A rare presentation of h.Pylori infection in children

F. Dhillip*

Leeds Teaching Hospitals, Paediatrics, Leeds, United Kingdom

BACKGROUND AND AIM

A rare presentation of H.pylori infection in children Background 11 year old girl admitted with a 2 year history of mild abdominal pain and intermittent vomiting which started at the same time she commenced menarche. This was associated with worsening pain and vomiting which is post prandial, for over last 6 months. Few episodes reported as 'coffee-ground' with no frank haematemesis and was non-bilious. 10 kg weight loss was reported due to reduced eating because of pain. She was opening bowels regularly and has had some constipation intermittently since starting Iron supplements 2 years ago. At presentation her bowels were not opened for 3 days and had severe abdominal pain and vomiting. No history of blood or mucous in stools. Endoscopy -Stomach - mucosal nodularity. **CLO test positive.**

Gastric antrum and body-type mucosa: Antrum predominant, moderately severe pan-gastritis with focal activity and plentiful Helicobacter pylori. Pylorus: - Duodenal mucosa showed severe erosive active chronic duodenitis. D1 - pylorus - inflamed, oedematous and superficial ulceration in duodenal bulb. D2 - normal. Histology: D1: Non-specific mild active chronic inflammation. Pylorus: HP-associated moderate/severe chronic gastritis with activity

Diagnosis: Gastric outlet obstruction secondary to H.Pylori infection

Gastric outlet obstruction is a very rare presentation in children with H.pylori infection. Recent literature shows gastric outlet obstruction in children is commonly caused by peptic ulcer disease before the introduction of PPI's and H2 receptor antagonists. Most of the cases with GOO in the literature were H.pylori negative. Although there are few cases seen in adults.

METHODS

Not relevant

RESULTS

Not relevant

CONCLUSIONS

Not relevant

EP641 / #2625

E-Poster Viewing - Paediatrics AS04-11. Gastroenterology & hepatology

Crohn's disease and primary adrenal insufficiency – could there be a connection?

R. Iorga¹, I. Dijmărescu^{1,2*}, L.-M. Olăroiu¹, D. P. curar^{1,2}

¹"Grigore Alexandrescu" Emergency Children's Hospital, Paediatrics, Bucharest, Romania

²"Carol Davila" University of Medicine and Pharmacy, Paediatrics, Bucharest, Romania

BACKGROUND AND AIM

Inflammatory bowel disease's (IBD) prevalence is increasing, Crohn's disease (CD) prevailing in children. According to several studies, patients with IBD have a higher risk of associating other autoimmune diseases.

METHODS

We report the case of an adolescent with primary adrenal insufficiency (PAI) who was diagnosed with CD. This rare association was further complicated by acute appendicitis.

RESULTS

A 15-year-old male with PAI diagnosed 13 years prior, under treatment with hydrocortisone, was admitted with fever, vomiting, diarrhea (4 stools/day) and abdominal pain. Laboratory tests revealed microcytic hypochromic anemia, high inflammatory markers, hypoalbuminemia and high fecal calprotectin. Enteral infections were excluded. A multidisciplinary approach was crucial to adjust the hydrocortisone dosage for stress management. We proceeded to perform a colonoscopy and during the bowel preparation the patient started having bloody stools. Macroscopic findings were suggestive for CD

(lesions of the terminal ileum, aphthous erosions, cobblestone aspect) and histopathological examination confirmed the diagnosis. Magnetic resonance enterography showed an ileal sinus tract towards a mesenteric inflammatory mass, which proved to be appendicitis. Exploratory laparoscopy, viscerolysis and appendectomy were required. The patient was started on exclusive enteral nutrition with favorable outcome.

CONCLUSIONS

In literature, little is known about the correlation of PAI and CD and this rare case might be the subject for further studies. Furthermore, these pathologies can determine complications that require a solid differential diagnosis for the correct treatment.

EP642 / #1996

E-Poster Viewing - Paediatrics AS04-11. Gastroenterology & hepatology

Crohn's colitis in a 10 year old BOY

**M. Dimitrovska-Ivanova^{1*}, A. Kostovski², B. Sonja², L. Jovceski³,
N. Jordanova Cepreganova⁴, E. Josifoska⁵, E. Simonovska²,
A. Murtezani²**

¹Clinical Hospital Shtip, University Goce Delcev Shtip, Department of Pediatrics, Shtip, North Macedonia

²University Clinic for Pediatric disease Skopje, Gastroenterology/hepatology, Skopje, North Macedonia

³University Clinic for Pediatric Surgery, Pediatric Surgery, Skopje, North Macedonia

⁴Public Health Organization Zdravstven dom Dr Pance Karagozov, Preventive Pediatrics, Stip, North Macedonia

⁵JZU General Hospital with extended activity Prilep, Pediatrics, Prilep, North Macedonia

BACKGROUND AND AIM

Crohn's disease is a chronic, granulomatous, inflammatory bowel disease which can affect the entire gastrointestinal tract and extraintestinal organs but it is most commonly located in the terminal ileum. Rarely occurs in children under 10 years of age. This is a rare case of Crohn's colitis in a young boy.

METHODS

10 year old boy presented with liquid stools in the past 4 months, perianal abscess and fistula treated surgically. At admission with liquid stools, abdominal pain and pale skin. On examination: wide anal opening with purulent secretion, a site of a previous fistulous opening was seen, anal sphincter with lost tone. Blood tests: ESR=71/min, Hgb=102 g/l, Hct=31,9%, Wbc=12,5x10⁹/l, CRP=28,7mg/l, Serum Iron=4umol/l, Vitamin D=20ng/ml. Immunological tests were realized-ASCA IgA=313IE/ml, fecal calprotectin >2285,70mg/kg. Esophagogastroduodenoscopy:The antral gastric mucosa is discretely hyperemic. Colonoscopy:The terminal ileal mucosa is diffusely inflamed, numerous

ulcers are seen, the mucosa of the valvular region, cecum, and colon ascendens, also markedly inflamed, with numerous aphthous erosions and irregular ulcers with fibrin exudates. Mucosa of the rectum, sigma, colon descendens and transferum with rare aphthous erosions in several places.

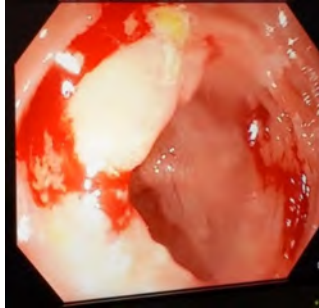

FIGURE 1:

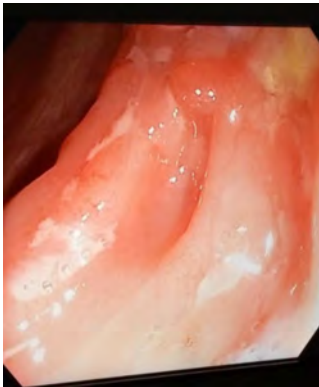

FIGURE 2:



FIGURE 3:

RESULTS

Colon biopsy with pathohistological findings in support of Crohn's disease. The child was prescribed Prednisone 2x20 mg, Mesalazine 3x500 mg, Omeprazole 1x20 mg, Vitamin D 1x1000 mg. Due to the frequent stools, the dose of mesalazine was increased 3x1 g and Azathioprine was introduced.

CONCLUSIONS

Crohn's disease is rare in childhood, especially as Crohn's colitis and should be considered in children with chronic diarrhea and perianal changes such as fistula and abscess.

EP643 / #854**E-Poster Viewing - Paediatrics AS04-11.
Gastroenterology & hepatology****Recurrent vomiting and autism spectrum disorder****S.C. Ferraz^{1*}, I. Magalhães¹, A. Costa Azevedo¹, M. Costa¹,
H. Antunes², I. Martinho¹**¹Unidade Local de Saúde do Alto Minho, Paediatrics, Viana do Castelo, Portugal²Hospital de Braga, Paediatrics, Braga, Portugal**BACKGROUND AND AIM**

Children with autism spectrum disorder (ASD) frequently have tactile and oral defensiveness that can lead to food selectivity in type and texture. Paediatric onset eosinophilic esophagitis can present with a variety of clinical symptoms including feeding disorders or food selectivity, vomiting, abdominal pain, dysphagia, and food impaction.

METHODS

We report a case of a 5-year old male with a diagnosis of ASD associated with food selectivity, allergic rhinitis, and egg allergy who came to the hospital four times a year for nausea and persistent vomiting, without fever, abdominal pain, or diarrhea. These episodes happened around one time per month, in the morning.

RESULTS

Blood analysis was performed in these episodes with normal ionogram, renal function, and metabolic study. It was performed an upper endoscopy and the histopathological exam revealed findings compatible with eosinophilic esophagitis. He started treatment with complete resolution of these episodes.

CONCLUSIONS

This case supports that feeding disorders in children with ASDs aren't always behavioral and organic causes should be investigated. This case highlights that eosinophilic esophagitis can present only with recurrent vomiting.

EP644 / #2427**E-Poster Viewing - Paediatrics AS04-11.
Gastroenterology & hepatology****Sars cov 2 - a possible cause of primary biliary
colangitis in a 2 month old BABY?****O.-E. Frasinariu^{1*}, I. Miron¹, I. Ciongradi², M. Panzaru¹, E. Cojocaru³,
L. Trandafir¹**¹University of Medicine and Pharmacy Grigore T. Popa Iasi, Mother and Child, Iasi, Romania²University of Medicine and Pharmacy Grigore T. Popa Iasi, Departament of Surgery II, Iasi, Romania³University of Medicine and Pharmacy Grigore T. Popa Iasi, Department of Morphofunctional Sciences I, Iasi, Romania**BACKGROUND AND AIM**

Primary biliary cholangitis is a chronic disease in which the bile ducts in your liver are slowly destroyed.

METHODS

We present the case of a baby girl, one month old, that addressed to our unit for a neonatal thrombocytopenia and severe anemia.

RESULTS

After receiving erythrocyte mass transfusion, in 24 hours, she developed a intense jaundice, with increased hepatic transaminase. We suspected a hemolytic anemia, but all the diagnosis tests were negative. Moreover, the fraction of bilirubin increased was direct bilirubin. After that we suspected a biliary system pathology. We performed cholangio-MRI, without modification on the biliary system. Based on the elevated transaminase and jaundice, we investigate the causes of hepatitis, from infections disease to metabolic disease, all negative. We performed also a hepatic biopsy, that showed an

aspect of immune cholangitis. The patient tested negative for anti-nuclear and anti-mitochondrial autoantibodies, anti-smooth muscle, anti-liver kidney microsome and anti-neutrophil cytoplasmic antibodies. Also, we had an extensive genetic panel without any gene modification. We evaluated also the profile of Sars Cov 2 antibodies, high elevated in the infant compared with her mom. Anamnestic, we find that in the third week after birth, the child had some cold. Based on all these negative tests and the aspect of immune cholangitis, we started Prednison treatment, with decrease of the bilirubin and transaminase levels and amelioration of jaundice.

CONCLUSIONS

We supposed that we can be in front of a primary biliary cholangitis induces by SARS-CoV2. However, the relationship between primary biliary cholangitis (PBC) and SARS-CoV-2 remains unknown.

EP645 / #880**E-Poster Viewing - Paediatrics AS04-11.
Gastroenterology & hepatology****Association of early childhood constipation and risk of autism spectrum disorder in taiwan: real-world evidence from a nationwide population-based cohort study.****Y.F. Lee^{1*}, M.C. Wu², S.K. Ma³**¹Children's Medical Center, Taichung Veterans General Hospital, Neonatology, Taichung, Taiwan²Children's Medical Center, Taichung Veterans General Hospital, Gastroenterology, Taichung, Taiwan³Chung Shan Medical University, Taichung, Taiwan, Dentistry, Taichung, Taiwan**BACKGROUND AND AIM**

Autism spectrum disorder (ASD) is a neurodevelopmental problem which affects mostly since childhood. Mounting evidence reveals that imbalanced gut microbiota contributes to autism via the gut-brain axis. Constipation can lead to alteration of the gut microbiota. The clinical impact of constipation on ASD has not been researched. Therefore, we aim to assess whether early childhood constipation influence the risk of developing ASD by a nationwide population-based cohort study.

METHODS

We identified 12,935 constipated children with age less than 3 years from National Health Insurance Research Database (NHIRD) in Taiwan between 1997 and 2013. Propensity score matching of age, gender, and underlying comorbidities is administered to make the ratio 1:1. Furthermore, chi-squared

tests, t-tests, absolute standardized differences, Kaplan-Meier analysis, log-rank test, and Cox proportional hazard model are applied in this study.

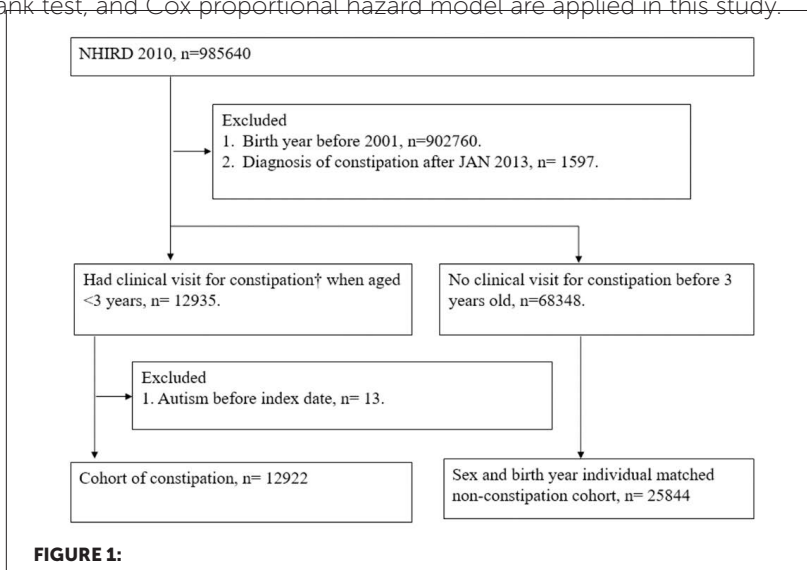

RESULTS

The incidence of ASD was 12.36 per 100,000 person-months in the constipation group, which was higher than the rate of 7.84 per 100,000 person-months observed in the non-constipation controls. Constipated children presented with a significantly higher risk of autism when compared to the non-constipation group (crude relative risk = 1.458, 95% CI = 1.116-1.904; adjusted hazard ratio = 1.445, 95% CI=1.095-1.907). Moreover, constipated children with subgroups of receiving more laxative prescriptions, male, constipation during infancy, and atopic dermatitis have significantly higher risks of ASD when compared to the non-constipation group.

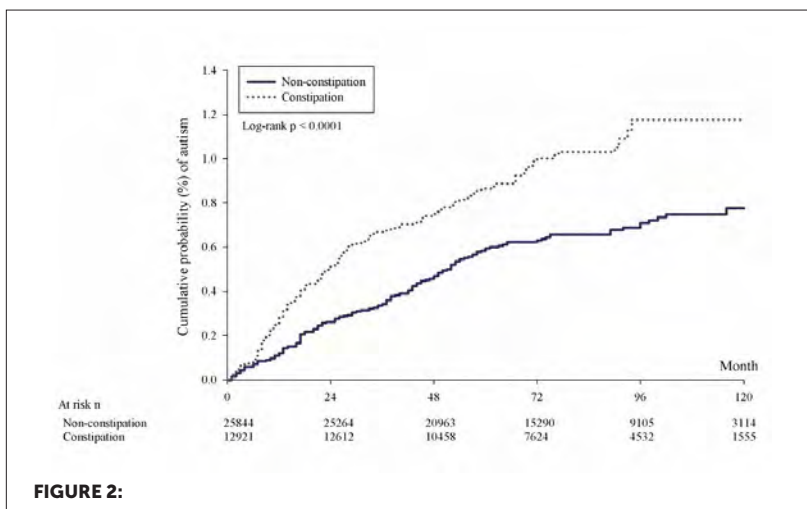

FIGURE 2:

TABLE 1:

Incidence of autism in study groups					
	Person-months	New autism case	Incidence rate*(95% C.I.)	Crude Relative risk (95% C.I.)	Adjusted HR (95% C.I.)
Followed from index date					
Non-constipation (n=25844)	2026818	159	7.84 (6.72-9.16)	Reference	Reference
Constipation (n=12922)	1011294	125	12.36 (10.37-14.73)	1.458 (1.116-1.904)	1.445 (1.095-1.907)
Subgroup of constipation					
Without laxatives at baseline (n=4813)	389812	37	9.49 (6.88-13.10)	1.110 (0.733-1.682)	1.075 (0.705-1.639)
Laxatives for 1-2 prescription (n=6553)	505838	65	12.85 (10.08-16.38)	1.528 (1.099-2.123)	1.533 (1.094-2.149)
Laxatives for ≥ 3 prescription (n=1556)	115644	23	19.89 (13.22-29.93)	2.300 (1.387-3.815)	2.396 (1.430-4.016)

* Incidence rate, per 100,000 person-months

CONCLUSIONS

Early childhood constipation have significant greater risk of ASD. Clinicians should pay attention to the coming ASD in constipated children. Further research is warranted to investigate the possible pathophysiological mechanisms of this association.

EP646 / #2434

E-Poster Viewing - Paediatrics AS04-11. Gastroenterology & hepatology

Wilson disease in children: a serie of 7 CASES

**I. Mallassi*, M. Tifha, S. Nour, F. Majdoub, S. Mabrouk, J. Chemli,
S. Abroug**

university hospital center SAHLOUL, Pediatric, Sousse, Tunisia

BACKGROUND AND AIM

wilson disease (WD) is a rare recessively inherited disorder of copper metabolism. It has a wide spectrum of clinical manifestations. In childhood and adolescents, hepatic manifestations are predominant while neurological and psychiatric symptoms are rare. Here we report seven cases of wilson's disease seen in sahloul pediatric department.

METHODS

clinical and laboratory data are collected from observations of 7 children with WD.

RESULTS

the average of age was 11yearsold. there was 4boys and 3girls. Six children were issued from consanguineous marriage. three patients were refered because of abnormal liver function. jaundice noted inthree cases, an oedematous syndrome found in two cases, hemorrhagic syndrome present in five cases and hepatomegaly noted in six cases. Two patients consulted for neurological and psychiatric symptoms. In one case, the discovery of hepatic cytolysis was incidental. Biologically, four patients had hepato-cellular failure at the beginning. haemolytic anaemia was discovered in 5cases. the biologic

data showed a decreased ceruloplasminemia in three cases and high level of urinary copper excretion more than 75microg/24h before Trolovol use and more than 1000microg/24 hours after Trolovol challenge. five patients had keyser fleischer rings. Only three had portal hypertension signs on abdominal ultrasound. Upper gastrointestinal fibroscopy was done for five children and revealed esophageal varices in three cases. Genetic analysis, done for two patients, confirmed the diagnosis and detected a mutation in ATP7B gene. Treatment was based on Trolovol, however, the evolution was fatal in 2 cases who consulted at the cirrhosis stage.

CONCLUSIONS

Prognosis of Wilson's disease depends on early treatment, early diagnosis through family screening is important.

EP647 / #2051

E-Poster Viewing - Paediatrics AS04-11. Gastroenterology & hepatology

A single centre study on fat free mass in a teenage population with cystic fibrosis: what really affects IT?

M.R. Mitakidou^{1*}, T. Dassios^{2,3}, A. Dhawan^{4,5}, N. Papalexopoulou⁶, A. Gupta⁷, A. Greenough^{1,8,9}

¹King's College London, Department of Women and Children's Health, School of Life Course Sciences, Faculty of Life Sciences and Medicine, London, United Kingdom

²King's College London, Department of Women and Children's Health, London, United Kingdom

³King's College Hospital NHS Foundation Trust, Neonatal Intensive Care Centre, London, United Kingdom

⁴King's College Hospital, Pediatric Liver, GI & Nutrition Centre and Mowat Labs, London, United Kingdom

⁵King's College London, Institute of Liver Studies, London, United Kingdom

⁶King's College London, Women and Children's Health, Faculty of Life Sciences and Medicine, London, United Kingdom

⁷King's College Hospital NHS Foundation Trust, Pediatric Respiratory Medicine, London, United Kingdom

⁸King's College London, Mrc & Asthma Uk Centre In Allergic Mechanisms of Asthma, London, United Kingdom

⁹NIHR Biomedical Research Centre, Guy's and St Thomas' Nhs Foundation Trust and King's College London, London, United Kingdom

BACKGROUND AND AIM

Cystic fibrosis (CF) predominantly affects the respiratory tract but is also characterized by nutritional impairment, decrease in skeletal muscularity and reduction in fat free mass. Our aim was to determine the clinical and anthropometric characteristics that would be linked with fat free mass impairment in adolescents with CF, which has not been thoroughly addressed.

METHODS

A Secondary Analysis of a tertiary center (King's College Hospital, London, UK) study cohort aiming to further investigate the measurement of: fat free mass index (FFMI) using bioelectrical impedance, lung function using spirometry, the number of shuttles as a measure of exercise tolerance and the reported physical activity in 28 children and young people with CF with a median (interquartile range - IQR) age of 15(13-17)years. CF-related liver disease was diagnosed by abnormal liver enzymes and/or ultrasonography.

RESULTS

The FFMI correlation with age ($\rho=0.568$, $p=0.002$), number of shuttles ($\rho=0.691$, $p<0.001$) and reported hours of activity per day ($\rho=0.426$, $p=0.024$) was statistically significant. The median (IQR) FFMI was significantly higher in male [15.1 (13.1 – 18.6) kg/m^2] compared to female teenagers [12.7 (11.6 – 14.1) kg/m^2 , $p=0.008$] while the median (IQR) FFMI was significantly lower in the 10 (36%) participants with liver disease [11.9 (11.5 – 13.4) kg/m^2] compared to the FFMI in the remaining 18 participants without liver disease [14.4 (12.5 – 15.9) kg/m^2 , $p=0.027$].

CONCLUSIONS

In conclusion, age and growth are significant determinants of fat free mass, with physical activity playing a beneficial role and CF-related liver disease having negative effects on fat free mass in teenagers with CF.

EP648 / #1157

E-Poster Viewing - Paediatrics AS04-11. Gastroenterology & hepatology

Insights on indicators for gut health for infants and toddlers (0-36 months) from an electronic survey among various healthcare professionals in seven countries

I. Zakharova¹, A. Darma², B. Hegar³, R.T. Ng⁴, S.Y. Chong⁵, E. Toro-Monjaraz⁶, M. Hasosah⁷, M. Cetinkaya⁸, C.M. Chow⁹, L. Muhandi^{10*}, U. Kudla¹¹, D. Delsing¹¹, L.N. West¹¹, K. Huysentruyt¹², Y. Vandenplas¹²

¹Russian Medical Academy of Continuing Postgraduate Education, Pediatrics, Moscow, Russian Federation

²Universitas Airlangga, Department of Pediatrics, Surabaya, Indonesia

³Universitas Indonesia, Department of Pediatrics, Jakarta, Indonesia

⁴University of Malaya, Department of Pediatrics, Kuala Lumpur, Malaysia

⁵Pantai Hospital, Department of Pediatrics, Ipoh, Malaysia

⁶Unit of Physiology and Gastrointestinal Motility, National Institute of Pediatrics, Gastroenterology and Nutrition Department, Mexico City, Mexico

⁷King Saud Bin Abdulaziz University for Health Sciences, National Guard Hospital, Department of Pediatrics, Jeddah, Saudi Arabia

⁸Health Sciences University, Basaksehir Cam and Sakura City Hospital, Department of Neonatology, Istanbul, Turkey

⁹Virtus Medical Group, Pediatrics, Hong Kong, Hong Kong PRC

¹⁰FrieslandCampina AMEA, Medical Affairs, Singapore, Singapore

¹¹FrieslandCampina, R&D, Amersfoort, Netherlands

¹²Vrije Universiteit Brussel (VUB), UZ Brussel, KidZ Health Castle, Pediatrics, Brussels, Belgium

BACKGROUND AND AIM

A healthy gut is important, especially during early childhood. It seems there are no standard indicators used to assess the condition. One question on gut health indicators (GHIs) for infants and one for toddlers were part of an e-survey among healthcare professionals (HCPs) on the diagnosis and management of constipation among 0-36 months old children.

METHODS

Results of seven participating countries (Russia (67%), Indonesia (11%), Malaysia (6%), Mexico (6%), The Kingdom of Saudi Arabia (KSA) (3%), Turkey (3%), Hong Kong (2.3%)) are presented. Ethics approval was obtained in each country. A chi-square test was used to assess differences in frequencies of responses; a p-value <0.05 was considered significant.

RESULTS

Two thousand one hundred sixty-six participating respondents were further classified into three continents (Asia (29%), Europe (70%) and Others (11%)). Most of them were paediatricians (82%), followed by paediatric gastroenterologists (8%) and general practitioners (6%). The top three preferred GHIs for infants and toddlers were similar. They were an absence of Gastrointestinal (GI) symptoms, effective digestion/absorption as indicated by normal growth, and status of well-being (Figure 1). The absence of GI-related infection was the least preferred indicator. For infants, there was a significant difference between preferred GHIs by continent ($p < 0.01$) in which the indicator "Stool Frequency and Consistency" was part of the top three lists in Asia and not for others.

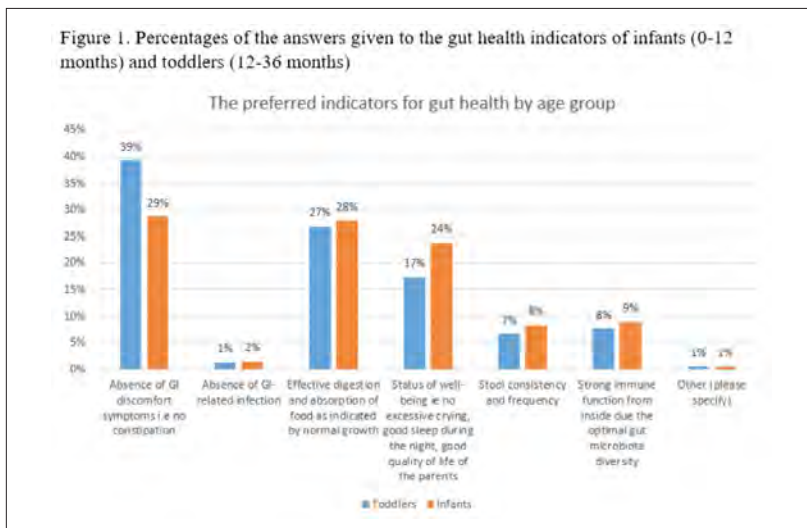

Figure 2. Percentages of the answers given to the gut health indicators of infants (0-12 months) and toddlers (12-36 months) by continents



CONCLUSIONS

In conclusion, HCPs in seven countries reported having similar top two indicators for infants and toddlers. However, the third indicator was different among respondents in Asia vs the rest of the world.

EP649 / #1706**E-Poster Viewing - Paediatrics AS04-11.
Gastroenterology & hepatology****Fulminant liver failure in a teenager secondary to an intentional mixed drug overdose, requiring a liver transplant.****J. Ndzo***

University Hospitals Derby NHS Trust, Paediatrics, Nottingham, United Kingdom

BACKGROUND AND AIM

This case aims to describe treatment dilemmas in a teenager who presented to our Accident and Emergency Unit 14 hours following an intentional mixed drug overdose of mainly iron and paracetamol. Within 24 hours of the overdose, she had developed established liver failure and was eventually transferred to a liver centre where she had an urgent liver transplant.

METHODS

A 14-year old teenager presented to our A&E unit 14 hours following a mixed drug overdose. Overall, the medicines she had ingested included Codeine 1.3mg/kg, 316mg/kg of Paracetamol, 79mg/kg of Elemental iron 79mg/kg, 64mg/kg of Ibuprofen 1mg/kg of Cetirizine, and an uncertain amount of Methylphenidate.

RESULTS

Her Initial management included Acetylcysteine and fluid hydration. There was some reluctance by the poisons specialists to start Desferrioxamine (DFO), which was eventually started 19 hours post ingestion. By 28 hours

post ingestion, her liver function and clotting tests had become markedly deranged. A decision was made to transfer her to a liver failure unit where she received a liver transplant 5 days after her demise. She has since made good recovery.

CONCLUSIONS

Fulminant liver failure following IDO needing a liver transplant is uncommon in children. There are few reported paediatric cases worldwide. The combination of iron and paracetamol are concerning but iron toxicity alone is potentially fatal, especially with a delayed presentation. Renal replacement therapy and plasmapheresis may change the outcome but are not readily available, so early initiation of DFO should be considered, as well as early referral to specialist centers.

EP650 / #2028

E-Poster Viewing - Paediatrics AS04-11. Gastroenterology & hepatology

Ct imaging evaluation of hepatoblastoma: pre and post neoadjuvant chemotherapy and correlation with clinical and pathological findings.

K. Nigam^{1*}, V. Patil²

¹TATA MEMORIAL HOSPITAL, Radio Diagnosis, MUMBAI, India

²Tata Memorial Hospital, Radiodiagnosis, Mumbai, India

BACKGROUND AND AIM

1. Study the post chemotherapy imaging response of hepatoblastoma in AFP responders and non-responders and attempt to identify radiological criterias for response (other than RECIST 1.1). 2. Correlate the CT imaging response with baseline imaging.

METHODS

Setting: A retrospective study between 2014 and 2020 was performed.

Participants: The patients fulfilling the given criteria:

- Diagnosis of hepatoblastoma based on histopathology or compatible imaging findings with raised AFP and patients should have undergone neoadjuvant chemotherapy.

STATISTICAL METHODS

Categorical data was summarized by counts and continuous data was summarized by mean (sd) or median (IQR) based on the distribution of data. 150 cases were screened, out of which, only 46 patients were included in the study.

RESULTS

There was a significant association between AFP responder and radiological responder, based on RECIST with odds ratio for this association being 9.6. Various annotation factors in AFP responders like PRETEXT stage/ change in PRETEXT stage, or annotation factors show no statistically significant association with AFP responders and P value for these factors were > 0.05 . There was no correlation seen with age and gender of patient in AFP responders. The distant metastases showed statistically significant association with AFP non-responders. The distance of tumor from bifurcation of portal vein and from confluence of hepatic veins with IVC was studied in AFP responders which also did not show any statistically significant margin regression.

CONCLUSIONS

PRETEXT system is extremely important in hepatoblastoma management, however change in POST TEXT staging is not a predictor of response and RECIST is the radiological criteria for response

EP651 / #1041

E-Poster Viewing - Paediatrics AS04-11. Gastroenterology & hepatology

Case report of ongoing cmv infection at the time of kasai portoenterostomy

N. Nikchevska^{1*}, R. Simeonov²

¹Acibadem Sistina Hospital, Pediatrics, Skopje, North Macedonia

²Acibadem Sistina Hospital, Pediatric Surgery, Skopje, North Macedonia

BACKGROUND AND AIM

Biliary Atresia (BA) is a condition that presents in infancy with cholestasis leading to progressive sclerosing inflammation and hepatic fibrosis. Kasai portoenterostomy (KPE) is the only choice for a definitive therapy, restoring bile flow in 30%-80%. However, complications often occur. An ongoing Cytomegalovirus (CMV) infection at the time of KPE has worse prognosis, slower clearance of jaundice and increased mortality.

METHODS

KPE was performed at 2 months. First two days post operatively were stable, with improvement in the bile flow, normally colored stools, no infection. 3rd day infant rapidly jaundiced, had fever 38C and raised inflammatory markers, alcoholic stools and dark urine, high direct bilirubin 158 umol/L, AST 971, ALT 217, GGT 328, and positive CMV IgM titer of 5.46 COI. Postoperative treatment consisted of antibiotics, ursodeoxycholic acid, moderate doses of corticosteroids. Considering the liver was damaged, and with knowledge that bile duct injury in BA is a consequence of an aberrant immune response, we treated the infant with Immunoglobulins, dosage 400 IU per kilo..

RESULTS

After therapy infection was controlled, stool color normalized and cholestasis reduced with no side effects. At 3 months follow up bilirubin 11.5 $\mu\text{mol/L}$, AST 85, ALT 113, GGT 919 U/L and APRI index of 0,437, normal weight gain and development.

CONCLUSIONS

Ongoing CMV infection results in diminished clinical response to KPE. Intravenous Immunoglobulin treatment of CMV infection at the time of KPE, results in lower bilirubin levels, hepatic improvement and clearance of jaundice. Immunoglobulin therapy appeared to improve the outcome and are acceptable and safe.

EP652 / #1272**E-Poster Viewing - Paediatrics AS04-11.
Gastroenterology & hepatology****Cholestatic jaundice and epstein-barr virus
infection in children****A. Oyegunle*, N. Kottarakou, J. Kutty**

South West Acute Hospital, Paediatrics, Enniskillen, United Kingdom

BACKGROUND AND AIM

Epstein-Barr infections in childhood are usually asymptomatic and self-limiting. Clinical presentation in older adolescents can be with fever, cervical adenopathy, tonsillar exudates, palatal petechiae and hepatosplenomegaly. Mild hepatitis with transient elevation of serum transaminases less than five times upper limit of normal can occur. Fulminant liver failure is a very rare occurrence. In contrast to hepatotropic viruses, EBV does not infect hepatocytes or biliary canaliculi. The pathogenesis of cholestatic hepatitis in EBV illness therefore remains unclear. Some studies attribute this to lipid peroxidation and free radical production. Presentation with cholestatic jaundice is rare and is reported in less than 5% of cases in paediatric population.

METHODS

We retrospectively evaluated clinical course of two eleven-years-old children who had similar history of sore throat and right sided neck swelling. Both of them developed jaundice. The girl had mild hepatomegaly and the boy had persistent right sided abdominal pain.

RESULTS

Investigations revealed raised transaminases less than five times upper limit of normal, evidence of cholestasis and reactive EBV IgM and quantitative PCR for both. Monospot was positive for the girl, but negative for the boy. Both of them developed pruritus with normalisation of symptoms and transaminases within 4-6 weeks. Hepatitis A, B, C and E serology was negative

CONCLUSIONS

Clinical presentation with jaundice and biochemical evidence of cholestasis is a rare occurrence in children with EBV infection. It is however necessary to adequately differentiate this from other aetiologies of hepatitis. Even in the absence of typical infectious mononuclear clinical features, primary EBV infection should be part of the differential diagnosis of cholestatic hepatitis.

EP653 / #2355**E-Poster Viewing - Paediatrics AS04-11.
Gastroenterology & hepatology****Composition of gut microbiota in overweight children in the first 3 years of LIFE**

A.C. Pantazi^{1,2*}, A. Balasa^{1,2}, T. Chisnoiu^{1,2}, C. Mihai^{1,2}, C.E. Frecus^{1,2}, L. Mihaj^{1,2}, V. Cuzic^{1,2}, A.K. Mustafa¹, S. Castelo Da Graça¹, B. Plaka¹, A.D. Pinzaru², A. Ungureanu¹

¹Ovidius University of Constanta, Faculty of Medicine, Constanta, Romania

²Constanta Clinical Emergency Hospital, Department of Pediatrics, Constanta, Romania

BACKGROUND AND AIM

Recent evidence suggests that gut microbiota determines a long-term impact on health, including chronic diseases and obesity. Dysbiosis is a public health concern due to pathogenesis of overweight and diet influence on gut microbiota.

METHODS

During a period of two years (January 2020 - January 2022) fifty-seven children under three years old performed height and weight measurements. Stool samples analysis of microbiota composition was performed. The aim of the study was to analyse composition of gut microbiota in overweight children during the first three years of life.

RESULTS

Acidifying (protective) germs such as Bacteroides species (1×10^8 CFU/g), Bifidobacterium species ($< 1 \times 10^8$ CFU/g), Lactobacillus species ($< 1 \times 10^5$ CFU/g) and Enterococcus species ($< 1 \times 10^4$ CFU/g) were found to have

lower abundance in overweight children. Moreover, overweight children were observed to present a high level of *Candida* species (*Candida albicans* and *Candida krusei* 4×10^5 CFU/g) and proteolytic germs such as *Escherichia coli* (6×10^9 CFU/g), *Klebsiella* species (2×10^9 CFU/g), *Enterobacter* species (3×10^5 CFU/g) and *Clostridium* species (4×10^5 CFU/g). Flora index suggested an intermediate dysbiosis (median value 6) and it was observed an elevated stool pH value (6.0).

CONCLUSIONS

Diversity of gut microbiota in overweight children is characterized by low levels of acidifying germs and high abundance of proteolytic germs from Enterobacteriaceae family. Increased detection of putrefactive germs indicated a disturbance of the microbial initial colonization. Elevated stool pH value corresponds to this flora profile. Probiotic measures are recommended to develop and stabilise a healthy microbiological milieu.

EP654 / #1878**E-Poster Viewing - Paediatrics AS04-11.
Gastroenterology & hepatology****Pediatric-onset chronic liver disease and adult care transition - a 45 patients' cohort STUDY****J. Pereira-Nunes^{1,2*}, S.C. Teixeira^{2,3}, G. Reis^{2,4}, N. Gaspar^{2,5},
C. Espinheira^{2,6}, E. Trindade^{2,6}**¹Universidade do Porto, Faculty of Medicine, Porto, Portugal²Centro Hospitalar Universitário de São João, Department of Pediatrics, Porto, Portugal³Centro Hospitalar de Trás-os-Montes e Alto Douro, Department of Pediatrics, Vila Real, Portugal⁴Unidade Local de Saúde do Baixo Alentejo, Department of Pediatrics, Beja, Portugal⁵Centro Hospitalar Médio Tejo, Department of Pediatrics, Tomar, Portugal⁶Centro Hospitalar Universitário de São João, Pediatric Gastroenterology Unit, Department of Pediatrics, Porto, Portugal**BACKGROUND AND AIM**

Few studies evaluated the transition of pediatric-onset chronic liver disease patients to adult care. When available, they focused on liver transplanted patients'. Herein we describe our pediatric to adult care transition experience.

METHODS

Single-center retrospective observational study of pediatric-onset liver disease patients followed up from January/1991 to December/2021. A p-value of 0.05 or less was considered statistically significant.

RESULTS

Eighty-one patients were identified. Thirty-six did not transition: 29 due to age, 6 due to death and 1 due to emigration. of the remaining 45 patients, 24 were male. Median age at diagnosis and transition was 9.5 [0-17.0] and

18 [16-20.0] years old, respectively. Most frequent diagnoses were: autoimmune hepatitis (8/45), infectious hepatitis (7/45), primary sclerosing cholangitis (6/45), Wilson's disease (5/45) and alpha-1 antitrypsin deficiency (4/45). Thirteen underwent liver transplantation before transition. Median pediatric and adult follow-up time was 107.0 [1.0-223.0] and 23.5 [0-162.0] months, respectively. Mean interval between appointments and attendance during pediatric *versus* adult follow-up were not statistically different ($p=0.265$ and $p=0.878$, respectively). Therapeutic adjustments were performed in 48.6% of cases in the first 3 adult appointments. Six transitioned patients were no longer followed up in adult care: 4 due to sustained virological response and 2 due to emigration.

CONCLUSIONS

Our study reflects childhood liver disease heterogeneous etiology. Mean interval between appointments and attendance during pediatric *versus* adult follow-up were not different. We highlight our low dropout rate, although follow-up time is still short. We suggest future prospective and multicenter studies to better assess the quality of the transition of these patients.

EP655 / #2364**E-Poster Viewing - Paediatrics AS04-11.
Gastroenterology & hepatology****Oral ondansetron in the pediatric emergency department - friend or FOE?**

P. Sousa*, S. Correia-De-Oliveira, C. Gomes Pereira, H. Ferreira, A. Lopes, M. Salgado

Hospital Senhora da Oliveira - Guimarães, Department of Pediatrics, Guimarães, Portugal

BACKGROUND AND AIM

Vomiting is a frequent symptom in the pediatric emergency department (ED). We aimed to assess the impact of oral ondansetron (OND-PO) use in our ED.

METHODS

Observational retrospective study of pediatric patients presenting with vomiting in our ED. Two groups were compared: G1 (presenting in 2010, before OND-PO was available) and G2 (presenting in 2019 and treated with OND-PO). Each group included the first 50 children from each trimester. Comparisons are according to chi-squared and Fisher's Exact tests for categorical variables, and Mann-Whitney test for continuous non-parametric variables. Statistical significance was established at 0.05.

RESULTS

Sex and age distribution, duration of vomiting and dehydration severity were similar among groups. Most common diagnoses were gastritis/gastroenteritis in both groups. No children received a serious alternative diagnosis in either group. Need for intravenous fluids (28,0% vs 8,5%, $p < 0,001$) and hospital

admissions (12,5% vs 1,0%, $p < 0,001$) were significantly lower in G2, whereas ED length of stay was higher [median 141 (80-283) vs 188 (144-243) minutes, $p < 0,001$]. There were no significant differences in overall ED readmission rates or readmission specifically due to diarrhea. We found no evidence of readmissions for prolonged QT interval.

CONCLUSIONS

The use of OND-PO in our ED increased ED length of stay but reduced the need for intravenous fluids and hospital admissions. We found no evidence of increased adverse effects or masking of serious diagnosis. These results are consistent with literature and further support the use of OND-PO as the preferred antiemetic in the pediatric ED.

EP656 / #1926**E-Poster Viewing - Paediatrics AS04-11.
Gastroenterology & hepatology****Progress in the study of health-related quality of life (HRQOL) for functional abdominal pain in children****Y. Wang¹, J. Wang^{2*}**

¹Beijing University of Chinese Medicine, China-japan Friendship Hospital Clinical Medicine Department, Beijing, China

²China-Japan Friendship Hospital, Department of Pediatrics, Beijing, China

BACKGROUND AND AIM

As the biopsychosocial model of medicine continues to improve, there is an increasing focus on multidimensional assessment tools for functional abdominal pain (FAP) in children. Several scales can be used to assess FAP in children, but most of them are single-dimensional. However, there's still a multidimensional scale named the Health-Related Quality of Life (HRQOL) scale, a comprehensive health assessment in terms of physical, psychological, and social adjustment to the new medical model. Most of the HRQOL scales that can be used for children with functional abdominal pain are universal scales, and there is a lack of research on specific scales.

METHODS

In this review, we comprehensively searched databases including National Knowledge Infrastructure (CNKI), Weipu Information Chinese Periodical Service Platform (VIP), Wanfang Data Knowledge Service Platform (Wanfang Data), PubMed, and Cochrane Library from inception to March 2022 to find out the tools that can be used in children with functional abdominal pain. Some tools that can be used to evaluate children with functional abdominal pain or maybe in the future can be used to evaluate children with functional

abdominal pain are included. The following search terms were used: functional abdominal pain, health-related quality of life or HRQOL, and scales or questionnaire or estimating tools.

RESULTS

The HRQOL scale can reflect the influence of functional abdominal pain on a child's physical, emotional, social, and learning abilities, among other things.

CONCLUSIONS

Developing a particular HRQOL scale for children with FAP will be important in assessing HRQOL, disease severity and clinical outcome in children with FAP.

EP657 / #2264**E-Poster Viewing - Paediatrics AS04-12. Nutrition****Evaluation of acceptance, safety and tolerability of aptamil advance®: early experience in the united arab emirates, qatar, oman, kuwait, and bahrain****M. Al-Beltagi^{1*}, H. Abutalib², K. Elmanaie³, M. Kaushal⁴,
M. Abdellatif⁵, S. Tomaraei⁶, A. Surka⁷, A. Shabaan⁸, A. Silva⁵, M. Ali⁹**

¹University Medical Center, King Abdulla Medical City, Arabian Gulf University, Department of Pediatrics, Manama, Bahrain

²Primary Health Care Corporation, Department of Pediatrics, Doha, Qatar

³Al Salam International Hospital, Department of Pediatrics, Kuwait, Kuwait

⁴Emirates Speciality Hospital, Department of Pediatrics, Dubai, United Arab Emirates

⁵Starcare Hospital, Department of Pediatrics, Muscat, Oman

⁶NMC Hospital, Department of Pediatrics, Dubai, United Arab Emirates

⁷Al Hilal Hospital, Department of Pediatrics, Manama, Bahrain

⁸Mowasat Hospital, Department of Pediatrics, Salmiya, Kuwait

⁹Queen Medical Center, Department of Pediatrics, Doha, Qatar

BACKGROUND AND AIM

APTAMIL Advance® is an instant milk formula containing prebiotics, postbiotics, and lipids (omega-6 arachidonic acid and omega-3 docosahexaenoic acid) and supports immunity development. The early experience programme aimed to evaluate the acceptance, safety and tolerability among babies/infants during the transition to APTAMIL Advance®.

METHODS

Insights were gathered using two questionnaires and case studies conducted over a period of six months in 153 babies/infants from five gulf countries. The first questionnaire evaluated the acceptance and experience during the

transition to APTAMIL Advance® and the second questionnaire evaluated its safety and tolerability during and after the transition.

RESULTS

Most babies/infants (75%) transitioned to APTAMIL Advance® within 24-48 hours with no changes in drinking habits. It was well-tolerated and well-accepted by the babies/infants according to 91% of the parents, 97% reported that their babies/infants felt well after consumption and that they would recommend it to others, and 99% reported that their babies/infants liked the taste and digested APTAMIL Advance® easily. Babies consumed larger portions after a week of transition to APTAMIL Advance®, and most parents reported softer but normal stool consistency during the transition. Overall, there were marked improvements in gastrointestinal symptoms, skin manifestations, weight gain, respiratory tract infections, excessive crying, and sleep quality. Most parents (59%) found the formula easy to prepare.

CONCLUSIONS

Overall, APTAMIL Advance® was well-tolerated and well-accepted by babies and had excellent palatability and parent satisfaction. This advantage can benefit babies who do not respond to alternative formulas. Further evaluation of gut microbiota, gastrointestinal symptoms, and long-term outcomes are warranted.

EP658 / #1941**E-Poster Viewing - Paediatrics AS04-12. Nutrition****Serum albumin and prealbumin levels in relation with bone metabolism markers in prepubertal children**

J. Ambroszkiewicz^{1*}, J. Gajewska¹, W. Klemarczyk², G. Rowicka², M. Chetchowska¹

¹Institute of Mother and Child, Department of Screening Tests and Metabolic Diagnostics, Warsaw, Poland

²Institute of Mother and Child, Department of Nutrition, Warsaw, Poland

BACKGROUND AND AIM

Vegetarian diet is becoming increasingly popular in developed countries. Parents, who follow a vegetarian diet, often decide to introduce it to their children. The aim of the study was to evaluate serum albumin and prealbumin and bone metabolism markers levels in children on different type of diets.

METHODS

The study included 45 prepubertal children: 25 children on a lacto-ovo-vegetarian diet and 20 on an omnivorous diet. Concentrations of bone metabolism markers (25-hydroxyvitamin D, parathormone, bone alkaline phosphatase – BALP, C-terminal telopeptide of collagen type I – CTX, bone alkaline phosphatase – BALP, insulin-like growth factor-1 – IGF-1) and levels of albumin and prealbumin were determined using immunoenzymatic methods.

RESULTS

There were no significant differences in the anthropometric parameters in both studied groups. Serum levels of albumin (53.8 ± 9.5 ng/ml vs. 63.2 ± 8.8

mg/ml, $p=0.002$) and prealbumin (232.9 ± 46.8 vs. 257.8 ± 29.4 $\mu\text{g/ml}$, $p=0.041$) were significantly lower in children on a vegetarian diet compared with those on a traditional diet. We observed higher serum CTX concentration (1.832 ± 0.391 vs. 1.665 ± 0.431 ng/ml, $p<0.05$) and BALP activity (115.3 ± 25.2 vs. 95.6 ± 26.0 U/L, $p<0.05$) in vegetarians than in omnivores. However, levels of 25-hydroxyvitamin D, PTH and IGF-I did not significantly differ in both groups of children. Additionally, we found inverse correlations between albumin/prealbumin levels and parathormone, CTX and BALP.

CONCLUSIONS

Children following a vegetarian diet had lower serum albumin and prealbumin levels and a trend towards increased bone turnover than omnivores. The observed correlations between albumin/prealbumin concentrations and bone metabolism markers are indicative of the link between diet, nutritional status and bone metabolism.

EP659 / #2066

E-Poster Viewing - Paediatrics AS04-12. Nutrition

Study on eating habits of children and adolescents before and during the covid 19 pandemic

D.T. Anton Paduraru*, A.S. Bocec, A.E. Coman

“Grigore T.Popa” University of Medicine and Pharmacy, Mother and Child Medicine, IASI, Romania

BACKGROUND AND AIM

The COVID-19 lockdown could cause significant changes in everyday life of children and adolescents. The aim was to evaluate the effects of the COVID-19 lockdown on eating habits of children and adolescents (3-18 years old).

METHODS

An online survey (COV-EAT) was carried out among the parents of 64 children during March-April 2022.

RESULTS

Most children consumed fast food only 1-3 times a month (57.81% vs. 59.37%) in both periods studied. The percentage of children who consumed fruit daily was the same (over 60%), but in the pandemic the number of those who consumed 2-4 fruits/day increased. 12.50% consumed daily 1 glass of fresh fruit juice, the situation remaining in a pandemic. Over 50% consumed vegetables and greens daily in both periods. The same goes for dairy consumption, but the majority (68.75%) consumed only one serving per day. The majority of patients (43.75%) consumed poultry meat 3-4 times / week, more than they consumed red meat or fish. Consumption of pasta, potatoes and rice remained at similar percentages. In both periods, 34.37% consumed

commercial sweets 3-4 times / week. 14.06% consumed salty snacks before the pandemic compared to 18.75% in the pandemic.

CONCLUSIONS

CONCLUSIONS

In this study, the COVID-19 lockdown did not cause negative changes in nutrition habits, but nutritional education is necessary to improve the knowledge of children and their parents. We intend to continue the study on a larger group of respondents.

EP660 / #1751**E-Poster Viewing - Paediatrics AS04-12. Nutrition****Association between infectious disease and hygiene practice with stunting in children aged 6-24 months****A. Aswin^{1*}, A. Aswin², A. Safitri¹**¹Bontang Utara 1, Primary Health Care Center, Bontang, Indonesia²Mulawarman University, Faculty of Medicine, Samarinda, Indonesia**BACKGROUND AND AIM**

Stunting remains the most common malnutrition problem in children. Indonesia is currently ranked fifth among countries with the highest burden of stunted children. Identifying the risk factors of stunting including infectious disease and hygiene practice is a fundamental step for intervention.

METHODS

This study aimed to evaluate the incidence of stunting in terms of the history of infectious disease in the past two weeks and hygiene practice in Bontang Utara 1 Primary Health Care Center, Bontang, East Kalimantan, Indonesia. This study was an observational analytic study with a case-control design carried out in March 2022. Sampling was done with the purposive sampling technique. This study involved 70 children aged 6-24 months (35 cases and 35 control samples). The instrument used was in the form of a questionnaire regarding the data of respondents and parents. The statistical analysis used the Chi-square test followed by the analysis of odds ratio (OR) with 95% CI.

RESULTS

The results showed that the fever in the past two weeks was significantly associated with stunting ($p < 0.05$, OR = 3.85). But there was no significant association between diarrhea in the past two weeks, acute respiratory tract infection in the past two weeks, and hygiene practice with stunting ($p > 0.05$).

CONCLUSIONS

It can be concluded that there is a significant relationship between fever in the past two weeks with the incidence of stunting in children aged 6-24 months.

EP661 / #2438**E-Poster Viewing - Paediatrics AS04-12. Nutrition****Examining the association between pediatric binge eating disorder and high ultra-processed foods consumption****M. Balhara***

Broward College, N/a, Davie, United States of America

BACKGROUND AND AIM

Current guidelines for treating binge eating disorders recommend increasing food choices and eating at regular intervals but disregard ultra-processed food (UPF) intake, despite UPF now making 67% of adolescent diet. No other study has analyzed the association between UPF and eating disorders specifically in adolescents and this area is understudied.

METHODS

The study enrolled 375 participants aged 14-19 years in Florida, US. UPF intake was assessed using Processed Intake Evaluation (PIE) score (scale 0-100) averaged for different ultra-processed foods (1) before COVID-19, (2) during COVID-19 restrictions, and (3) now after easing COVID-19 restrictions.

RESULTS

The mean participant age was 15.6 ± 1.3 years with 38% ($n=142$) with binge eating disorder. The study found UPF was higher among participants with binge eating disorder (46.2 vs. 41.7, $p<0.01$). Next, we divided UPF based on glycemic impact. Low-glycemic UPF did not vary (59.8 vs. 57.1, $p=NS$) but High-glycemic UPF was higher among patients with binge eating disorder (41.8 vs. 36.5, $p<0.01$). Next, we studied if the COVID-19 pandemic affects

UPF in participants. The UPF declined by -10.9 from the start of the COVID-19 pandemic in participants with binge eating disorder vs. -6.8 in participants without binge eating disorder.

CONCLUSIONS

This study identifies a significant association between ultra-processed food intake and binge eating disorder and warrants further research to examine this association and treatment implications in pediatric binge eating. Additionally, the marked decline in ultra-processed food intake seen with the COVID-19 in this study has significant implications for pediatric eating disorders and should be an area for expanded research.

EP662 / #1121**E-Poster Viewing - Paediatrics AS04-12. Nutrition****Impact of infant formulas with age-adapted or static protein concentrations compared to breast milk on urinary metabolite profile at age 1 and 3 months**

**S. Bartova^{1*}, M.P. Giner¹, F.-P. Martin², S. Moco¹, N.P. Hays³,
F. Gambin^{4,5}, L. Fernández^{4,6}, S. Marco^{4,6}, J.-P. Godin¹, J.-C. Picaud⁷**

¹Nestlé Research, Nestlé Institute of Food Safety and Analytical Sciences, Lausanne, Switzerland

²Nestlé Research, Nestlé Institute of Health Sciences, Lausanne, Switzerland

³Nestlé Product Technology Center, Nutrition, Vevey, Switzerland

⁴Institute for Bioengineering of Catalonia, Signal and Information Processing For Sensing Systems, Barcelona, Spain

⁵Institut Hospital del Mar d'Investigacions Mèdiques, Applied Metabolomics Research Group, Barcelona, Spain

⁶University of Barcelona, Department of Electronics and Biomedical Engineering, Barcelona, Spain

⁷Hôpital de la Croix Rousse, Hospices Civils De Lyon, Lyon, France

BACKGROUND AND AIM

Adapting the protein content of infant formulas to be closer to the dynamic composition of human milk may reduce possible metabolic differences between breastfed and formula-fed infants. We aimed to assess growth/metabolic endpoints (reported previously) and the urinary metabolome (secondary objective) in healthy term infants fed with a staged (age-adapted) formula regimen or standard starter formula in comparison with breastfed infants.

METHODS

Urinary metabolome was measured at age 1mo and 3mo using nuclear magnetic resonance in infants randomized to receive either Control (CTRL; standard starter formula with 1.85g protein/100kcal from enrollment [age \leq 7d] until 3mo; n=26) or Experimental (EXPL; new formula with 2.5g pro-

tein/100kcal from enrollment until age 1mo followed by CTRL formula until 3mo; n=25) formula interventions. Breastfed infants (BF; n=17) served as a reference group. Multivariate and univariate analysis was used to compare groups.

RESULTS

At 1mo, the EXPL regimen resulted in significantly higher urinary levels of essential amino acids (leucine, threonine, and lysine) and microbiota-related metabolites (phenylacetylglutamine, 4-hydroxyphenylacetate, indoxyl sulfate, and hippurate) as compared to BF. From these specific metabolites, only phenylacetylglutamine and 4-hydroxyphenylacetate were significantly increased in CTRL versus BF infants at 1mo. All these metabolic changes observed for the two formula groups were transient, since only phenylacetylglutamine remained significantly higher in both groups compared to BF at 3mo.

CONCLUSIONS

Urinary metabolome of infants at age 1mo is influenced by differences in formula protein concentration but this influence is mostly transient. The effect of these metabolite differences on short- and longer-term health requires further evaluation.

EP663 / #949**E-Poster Viewing - Paediatrics AS04-12. Nutrition Knowledge, attitudes, and practices of women on exclusive breastfeeding (eb) in annaba (algeria)****D. Belamri*, D. Djighader, N. Boutalbi, N. Bouchair**

CHU Annaba - Clinique Sainte Thérèse, Service De Pédiatrie, Annaba, Algeria

BACKGROUND AND AIM

Exclusive breastfeeding (EB) is the natural, most suitable way to feed a child. Its superiority over industrial substitutes is summed up in the slogan "breast is best." Annaba, one of the two largest cities in eastern Algeria, has no data on this subject; this is why we make this study.

METHODS

Evaluate the knowledge, attitudes, and practices of mothers towards the EB of their children (6-24 months) in the municipality of Annaba. Identify the frequency and the factors influencing the practice of EB.

RESULTS

The authors report the results of a descriptive study of 1 month with 164 couples (mother, infants) at the maternal and child prevention services. The rate of EB during the first six months of life is 29.9%. At birth, this rate was 50.6% and then gradually decreased to reach 29.9% at six months. The lack of information during pregnancy (59%) and after childbirth (68%) would explain this drop. Causes of early weaning or non-EB were: insufficient lactation (32%) followed by a return to work (17.7%). Vaginal delivery and multiparity are significantly correlated with the adoption of EB. The same correlation is noted between EB and the high socioeconomic level of the mothers ($p=910$

-3). The benefits of EB on child health were the first argument presented by mothers in favor of this type of breastfeeding (45%)

CONCLUSIONS

EB is a cultural practice placed in the history of our society. It is a right that must be protected and encouraged by informing and supporting these women with scrupulous respect for their choice

EP664 / #2468**E-Poster Viewing - Paediatrics AS04-12. Nutrition****Prevalence of dyslipidemia in children with type 1 diabetes mellitus**

R. Ben Rabeh*, N. Toulgui, N. Missaoui, S. Yahyaoui, O. Bouyahya, S. Mazigh, S. Boukthir

University of Tunis EL MANAR, Faculty of medicine of Tunis, Bechir Hamza Children's Hospital of Tunis, Pediatric Department C, Tunis, Tunisia

BACKGROUND AND AIM

The association between type 1 diabetes and dyslipidemia increases the risk of cardiovascular disease in adulthood. The prevalence of dyslipidemia in type 1 diabetic children is unknown in Tunisia. The aim of our study was to assess the prevalence of dyslipidemia in children with type 1 diabetes and to identify the risk factors for its occurrence.

METHODS

It was a cross-sectional, prospective study including patients followed for type 1 diabetes. Dyslipidemia was defined by the guidelines of the "National Cholesterol Education Program" based on data from the "National Heart Lung and Blood Institute" from 2012. Multivariate regression analysis was performed to identify risk factors for dyslipidemia.

RESULTS

We included 172 type 1 diabetic patients aged between eight and 18 years, 68% were adolescents. The nutritional status was normal in 74% of cases. No patient was obese. Sedentarity was present in 40.1%. Glycemic control was good, moderate, and poor in 11.1%, 20.9% and 68% of cases, respectively.

The prevalence of dyslipidemia in children with type 1 diabetes was 27.3%. The main lipid abnormalities found were: isolated hypertriglyceridemia (49%), hypertriglyceridemia and hypercholesterolemia (13%), isolated hypercholesterolemia (11%). Previous borderline anomalies of the lipid test (ORaj=6.08 [1.00–46.50]), waist circumference / waist ratio ≥ 0.5 (ORaj=2.16 [1.00–10.49]), and poor glycemetic control (ORaj=5.80 [1.00–58.78]) were risk factors of dyslipidemia in type 1 diabetic patients.

CONCLUSIONS

Dyslipidemia concerned 27.3% of our type 1 diabetic patients. This proves the importance of systematic screening of dyslipidemia and early management of risk factors in order to prevent complications of diabetes in adulthood and decrease cardiovascular risk.

EP665 / #758**E-Poster Viewing - Paediatrics AS04-12. Nutrition****Nutritional status and dietary intake of school-age children and early adolescents: systematic review in a developing country and lessons for the global perspective****D.S. Khan^{1*}, J. Das¹, Z. Lassi², Z. Bhutta³**¹Aga Khan University, Department of Pediatrics, Karachi, Pakistan²University of Adelaide, Robinson Research Institute, Adelaide, Australia³The Hospital for Sick Children, Toronto, Chair In Global Child Health and Policy At The Centre For Global Child Health, Toronto, Canada**BACKGROUND AND AIM**

Background: The prevalence of double burden of malnutrition (DBM) is high in low- and middle-income countries (LMICs). Data on malnutrition trends is robust for children <5 years of age, however the data for school-going children and adolescents aged 5–15 years is scarce. Objective: This systematic review presents pooled prevalence of nutritional status and dietary intake habits amongst children aged 5–15 years in Pakistan, an LMIC, and provides a perspective for broader global nutrition in this age group.

METHODS

An electronic search of databases, grey literature and archives of local scientific journals was run. Studies meeting the eligibility criteria were included and a pooled proportional analysis on relevant data was performed.

RESULTS

A total of 51 studies including 62,148 children of 5–15 years met the inclusion criteria, of which 30 studies reported on anthropometric indices alone, eight on dietary intake patterns while 13 reported both. The pooled proportional analysis showed that the proportion of underweight to be 25.1%(95%CI:17.3–33.7%); stunting 23%(95%CI:11.8–36.7%); wasting 24%(95%CI:15.2–34%); thinness 12.5%(95%CI:9.4–16.1%); overweight 11.4%(95%CI:7.2–16.3%); and obesity 6.9%(95%CI:3–12%). A high intake of carbohydrates, soft drinks, and sweets/chocolates; and a low intake of protein-rich foods, fruits, and vegetables, compared to the recommended daily allowance (RDA), was reported.

CONCLUSIONS

The limited data suggests presence of DBM amongst children aged 5–15 years and identifies dietary intake patterns to not meet the RDA. This review highlights the gaps and the need for larger, well-designed studies for this age group. Similar studies in other LMICs are also needed so that appropriate actions can be deliberated.

EP666 / #2105**E-Poster Viewing - Paediatrics AS04-12. Nutrition****A national survey of dietetic support, tube feeding and breastfeeding advice for infants with single ventricle cardiac physiology****C. Kidd^{1*}, L. Marino², B. Rothman¹, G. O'Connor¹**¹Great Ormond St Hospital, Department of Nutrition and Dietetics, JH, United Kingdom²Southampton Children's Hospital, Paediatric Intensive Care Unit, YD, United Kingdom**BACKGROUND AND AIM**

Infants with single ventricles often experience poor feeding and growth, particularly during the interstage period (between first and second surgeries). Poor interstage growth is associated with increased morbidity and mortality. Some healthcare professionals perceive breastfeeding is unsafe during this time, due to potential dehydration increasing risk of shunt occlusion. There is no published breastfeeding guidance for this group. Parents report feeling excluded from feeding choices, especially breastfeeding. This survey aimed to assess breastfeeding advice for infants with single ventricles.

METHODS

A national, cross-sectional survey investigating breastfeeding advice was distributed to all paediatric surgical cardiac centres in England. The survey investigated: feeding route, dietetic support, frequency of anthropometric measurements and breastfeeding advice.

RESULTS

All centres responded (n=10/10) caring for ~115 infants/ annum. Interstage infants are discharged home from 90% of centres (n=9/10). Weights are

taken daily in 50% of centres (n=5/10), bi-weekly in 10% (n=1/10) or weekly in 20% (n=2/10). There is a 'blanket' referral to dietetics in 90% of centres (n=9/10); the remaining 10% (1/10) refers as required. All centres allow oral feeding (breast/ bottle). Partial/ exclusive breastfeeding is encouraged in 80% of centres (n=8/10) and partial in a further 10% (n=1/10). Breastfeeding is not permitted in 10% (n=1/10). Patients are discharged with an NG if required in 78% of centres (n=7/9), are all discharged with an NG in situ in 11% (n=1/9) or discharged only without an NG in situ in 11% (1/9). No centres reported dehydration concerns.

CONCLUSIONS

This highlights disparity in breastfeeding practices for infants with single ventricles across England.

EP667 / #1152**E-Poster Viewing - Paediatrics AS04-12. Nutrition****Breastfeeding education: medical students knowledge and confidence**

M. Kinoshita^{1,2*}, E. Khoo³, M. Nezafat⁴, A. Branagan^{5,6}, K. Allen⁷, S. Young⁷, G. Avalos⁴, A. Dumitrescu³, J. Costa⁷, G. Kearney⁷, E. Molloy^{1,8,9}, S. Brennan⁴, N. Mccallion^{2,10}, A. Doolan^{1,2}

¹Coombe Women and Infants University Hospital, Neonatology, Dublin, Ireland

²Royal College of Surgeons Ireland, Department of Paediatrics, Dublin, Ireland

³University College Cork, Paediatrics, Cork, Ireland

⁴National University of Ireland, Galway, Paediatrics, Galway, Ireland

⁵Coombe Women & Infants University Hospital, Neonatology, Dublin, Ireland

⁶Trinity College Dublin, Discipline of Paediatrics, School of Medicine, Dublin, Ireland

⁷Queen's University Belfast, Centre For Medical Education, Belfast, United Kingdom

⁸Prof of Paediatrics, Trinity College Dublin, Dublin, Ireland

⁹Trinity College Dublin, School of Medicine, Discipline of Paediatrics, Dublin, Ireland

¹⁰Rotunda Hospital, Neonatology, Dublin, Ireland

BACKGROUND AND AIM

Ireland consistently has the lowest breastfeeding initiation and duration rates in Europe with only modest improvements over the past decade. Breastfeeding information should be consistent and evidence based yet, qualitative studies have described parental experience of receiving contradictory information from healthcare professionals. Knowledge and skills to support breastfeeding are included in the Irish National Paediatric Undergraduate Medical Curriculum. This aim was to assess medical student knowledge, attitudes and confidence in providing breastfeeding support and the type of education provided.

METHODS

This cross-sectional anonymous online survey of medical students was performed across four Irish Universities. Medical students over 18 years of age and in clinical placements (final and penultimate years of education) were eligible.

RESULTS

225 students completed the survey. 70% of respondents were female with mean age of 24 years. 75% received lectures and 32% had clinical interactions involving breastfeeding (Figure 1). Over 80% of students correctly identified benefits of breastmilk while 21% and 25% incorrectly identified mastitis and maternal medications as contraindications to breastfeeding (Figure 2). Only 15% of students felt confident about indications for supplementing with formula or medication use in breastfeeding. Students who had clinical interactions were more likely to feel confident providing advice and support (24% vs 11%, $p=0.001$). 92% of students ($n=207$) requested additional breastfeeding education, most commonly in the form of clinical interactions (60%).

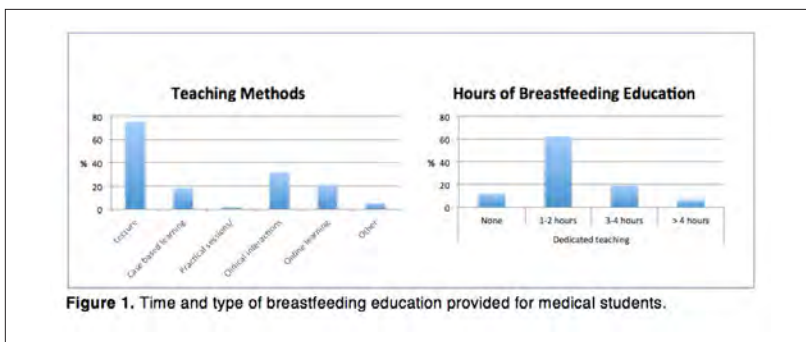
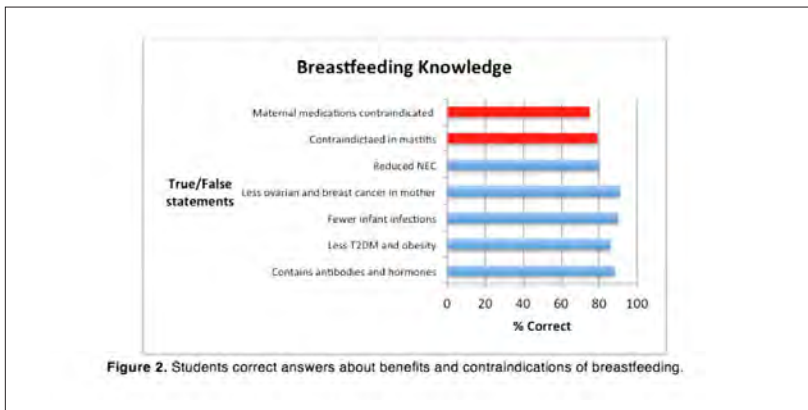

Figure 1. Time and type of breastfeeding education provided for medical students.



CONCLUSIONS

Medical students recognize the benefits of breastfeeding but confidence in common clinical scenarios is low. Clinical interactions improved confidence, highlighting the importance of clinical exposure to integrate theoretical knowledge into practical skills.

EP668 / #2210

E-Poster Viewing - Paediatrics AS04-12. Nutrition

Gut microbiome responses to two different complementary feeding regimens in healthy infants: secondary results from a single-blind, randomized, controlled TRIAL

C. Le Roy^{1*}, N.P. Hays², C. Monnard¹, J. Korbinian Vogt³, P. Myers², A. Eklund³, J. Ramos-Nieves¹, E. Estorninos⁴

¹Nestlé Research, Nestlé Institute of Health Sciences, Lausanne, Switzerland

²Nestlé Product Technology Center, Nutrition, Vevey, Switzerland

³Clinical Microbiomics, Integrative Systems Biology, København Ø, Denmark

⁴Asian Hospital and Medical Center, Asian Hospital and Medical Center, Muntinlupa City, Philippines

BACKGROUND AND AIM

The infant microbiome is developing rapidly during the weaning period and is highly impacted by extrinsic factors including diet. The maturation process of this ecosystem has been linked to long-term health outcomes. Here we explored the effects of two complementary feeding regimens differing in carbohydrate and protein profile fed from age 6 to 12mo on gut microbiome maturation.

METHODS

Infants ($n=102$; 44% girls) aged 24.3 ± 0.5 weeks (~ 5.6 mo) who had not started complementary feeding were randomized to EXPL (lower-protein follow-up formula [FuF] containing 100% lactose plus infant cereal [IC] containing whole grain wheat flour and pulses) or CTRL (standard-protein FuF containing 70% lactose plus IC containing wheat flour). FuFs (*ad libitum*) and ICs (≥ 1 serving/day) were fed until age 12mo; parents could introduce other complementary foods as desired. The main endpoint was glycemic/metabolic response. As a secondary endpoint, fecal samples were collected at age 6 (baseline), 7.5,

9 and 12mo for gut microbiome profiling through whole shotgun metagenomic sequencing.

RESULTS

We observed a consistently lower diversification of the gut microbiome in the EXPL group compared to CTRL at all time points ($P < 0.01$) together with a greater relative abundance of *Bifidobacterium* genus at all follow-up visits.

CONCLUSIONS

Lower-protein follow-up formula with 100% lactose complemented with infant cereal (containing whole grain and pulses) promoted a more breast-fed-like change in gut microbiome diversity and composition when compared to standard follow-up formula and infant cereal.

EP669 / #829

E-Poster Viewing - Paediatrics AS04-12. Nutrition

Safe and alternative new complementary feeding method: baby-led introduction to solids (bliss)

M. Lozano-Casanova*, L. Collado, A. Gutierrez-Hervas, C. Grainger, M.A. AVECILLA, I. Sospedra

University of Alicante, Nursing Department, Faculty of Health Science, Alicante, Spain

BACKGROUND AND AIM

Baby-Led Weaning (BLW) is considered one of the most appropriate methods to start complementary feeding (CF). However, both parents and healthcare professionals doubt its use, as they suspect that it could increase the risk of iron deficiency, choking, and growth faltering. Because of that, a new CF method called Baby-Led Introduction to SolidS (BLISS) has emerged. BLISS method seems to give parents specific information regarding what food should be given at each meal to their child plus provides recipes and cooking recommendations in order to solve the above-mentioned risks. The aim of this work seeks to verify whether the modifications proposed in BLISS solve the existing problems in BLW, and if it continues to provide benefits over the traditional spoon-feeding approach.

METHODS

A systematic review has been carried out including randomized clinical trials (RCT) in which BLISS was compared with the traditional spoon-feeding approach.

RESULTS

After the review was performed, 9 Papers were selected. Children who follow BLISS do not suffer a higher incidence of choking, low iron intake, or growth faltering compared to the others. Comparing BLW with BLISS, it was observed that, by adding the proposed modifications, children consumed more iron and suffered less choking following BLISS than following BLW.

CONCLUSIONS

Our results suggest that BLISS is a safe method to initiate CF but it would be appropriate to conduct more RCT investigating it as few studies have been conducted to date and in a few different settings.

EP670 / #2057

E-Poster Viewing - Paediatrics AS04-12. Nutrition

Correlation between hypocalcemia and skeletal disorders in the late preterm children

O. Rybalko*, T. Waldheim

Karol Marcinkowski University of Medical Sciences, Pediatrician, Krakow, Poland

BACKGROUND AND AIM

Late preterm Infants (LPIs 34 - 36 weeks GA) account for approximately 84% of preterm births. There is lack of information about LPIs' long-term outcomes and predictors of skeletal problems, which consist 40% of their population. The aim of our study was to evaluate the correlation between the blood calcium levels and skeletal disorders of LPIs in 3 years old.

METHODS

The calcium level was measured in LPIs which mother had dental and skeletal problems and demonstrated a level of calcium less 2,25 mmol/l. Their mother had vitamin D3 and mineral supplementation during pregnancy. The study included 100 LPIs with level calcium less 1,72 mmol/l in neonatal screening. The calcium samples database was conducted on «G3000 Premier» in 1 month of life. The follow up for skeletal spheres in children was detected during 3 years. Spearman's rank correlation coefficient was used for correlations.

RESULTS

The study population consist of 63% males. All children had low level of blood calcium during first month of their life, however their mothers received vitamin D3 and calcium supplementation. Different level of dental decay (36%)

and enamel hypoplasia (20%) at 3 years correlated with mean calcium level around 1.3 ± 0.7 mmol/L, in 56% preterm children ($r=0.7$; $p=0.001$). Scoliosis (14%), kyphosis (10%) and hip dysplasia(20%) at the age of 3 years correlates with the calcium level in first months of 1.5 ± 0.7 mmol/L in 44% preterm children ($r=0.6$; $p=0.001$).

CONCLUSIONS

According to our study results continuous low level of blood calcium influence on skeletal development in future.

EP671 / #2740

E-Poster Viewing - Paediatrics AS04-12. Nutrition

10 years dairy-check: results of a long-term study on the sugar content of dairy products

J. Bhardwaj, Msc.¹, U.L.M.D.M. Schätzer^{1*}, N. Moser, Bsc.¹,
P.U.P.D.D.F. Hoppichler²

¹Special Institute for Preventive Cardiology and Nutrition - SIPCAN, -, Elsbethen/Salzburg, Austria

²Hospital of the Brothers of St. John of God Salzburg, Department of Internal Medicine, Salzburg, Austria

BACKGROUND AND AIM

As important providers of nutrients, dairy products are valuable components of a balanced diet, whereby preference should be given to products which meet nutritional recommendations. However, the high sugar content of many dairy products affords scrutiny of their health-promoting effects. The dairy-check was created as an orientation guide for healthier product choices and as a method for sugar reduction in order to prevent diet-related diseases.

METHODS

Since 2012, an annual survey of the entire range of dairy products in supermarkets has been carried out throughout Austria. In 2022, 937 dairy products were analyzed in regard to their content of sugar, fat and sweeteners and presented in a comparable way. In order to meet the current orientation criteria, a dairy product may contain a maximum of 11.5 g of sugar and 4.2 g of fat per 100 ml or 100 g and no sweeteners.

RESULTS

The average sugar content of dairy products decreased by 18.7% since 2012 and is currently 11.46 g per 100 ml/g. The percentage of products containing

sweeteners decreased from 15.2 to 6.9% over the same time period. The proportion of products that meet the criteria increased from 16.0 to 43.1%.

CONCLUSIONS

Clear orientation criteria and the comparability of products offer consumers support for a healthier product selection. The changes achieved by the dairy-check may contribute to the prevention of diet-related diseases in the long term.

EP672 / #2745

E-Poster Viewing - Paediatrics AS04-12. Nutrition

The association between stress and the consumption of sweet beverages in adolescents during the pandemic

P.B. Preissler, Msc.¹, U.L.M.D.M. Schätzer^{2*}, J. Bhardwaj, Msc.², P.U.P.D.D.F. Hoppichler³

¹University of Vienna, Department For Nutritional Sciences, Wien, Austria

²Special Institute for Preventive Cardiology and Nutrition - SIPCAN, -, Elsbethen/Salzburg, Austria

³Hospital of the Brothers of St. John of God Salzburg, Department of Internal Medicine, Salzburg, Austria

BACKGROUND AND AIM

Stress is an inevitable part of everyday life. However, severe or chronic stress can negatively impact health and behavior. Previous data showed that stress is associated with the consumption of palatable, high-energy foods. Based on these findings, associations between the perception of stress and the consumption of sweet beverages among adolescents during the COVID-19 pandemic were examined.

METHODS

By means of a questionnaire, Viennese grammar school students were asked about their stress perception and beverage consumption in the past month. Additionally, selected control variables, which could be associated with the intake of sweet beverages, were collected. Furthermore, the perceived influence of the pandemic on general stress level and average consumption of sweet beverages was determined.

RESULTS

In total 430 students (female: 52.1%; mean age: 16.3 years) were included in the study. 27.7% of the participants reported an increased consumption of sweet beverages and 69.3% felt an increased stress level due to the pandemic. In addition to gender and frequency of consumption of nutritionally unfavorable foods, the interaction of stress perception and restrained eating behavior proved to be a significant predictor for the daily intake of sweet beverages. A significant main effect of stress could be determined for the daily intake of caffeinated sweet beverages.

CONCLUSIONS

The observed positive association between the potentially pandemic-related stress perception and the intake of sweet beverages is particularly considerable with regards to possible health effects of high and long-term consumption of these beverages and highlights the need for effective stress management, especially in adolescents with restrained eating behavior.

EP673 / #1376

E-Poster Viewing - Paediatrics AS04-12. Nutrition

Investigation of regional variation of hmo levels in mature MILK

B. Soyilmaz^{1*}, I. Vassallo², E. Pakalynte¹, A. Ibáñez Navarro¹, A. Lau¹

¹DSM, Human Nutrition & Health, Hørsholm, Denmark

²DSM, Nutrition Innovation Center, Kaiseraugst, Switzerland

BACKGROUND AND AIM

Human milk oligosaccharides (HMOs) are the third largest solid component of human milk with important functions for the neonate. HMO profiles have been shown to vary by genetic and non-genetic factors such as geography. Characterizing HMO levels have applications in informing suitable levels for testing beneficial outcomes in infants. The objective of this work was to identify and compare median levels of HMOs reported from mothers in Europe and Asia.

METHODS

Data from literature reporting medians of individual HMOs were gathered between March 2019 and March 2022. Country information as well as other defining study characteristics such as sample size, secretor status and lactation period were extracted. Weighted medians of medians of ten HMOs were calculated and applied a non-parametric test for comparison between regions.

RESULTS

Three publications from Asia and from eight to nine publications from Europe reported median levels of individual HMOs. To ensure a sufficient sample size of milk donors, summary statistics from only mature milk were opted

for further analysis. Median (g/L) levels of 2'-FL and 3'-SL were significantly lower in Asia ($p < 0.05$) while differences in the medians of other HMOs were not statistically significant in mature milk.

CONCLUSIONS

Emerging analysis shows that 2'-FL and 3'-SL levels may be lower in the milk of Asian mothers. The results of this work could provide basis for elucidating regional variation and informing regionally relevant intervention levels for evaluating beneficial outcomes of individual HMOs in infants and children. Further studies should be performed to validate regional differences.

EP674 / #904

E-Poster Viewing - Paediatrics AS04-12. Nutrition

Breastfeeding counselors networking program (bcnp) as a social & behaviour change communication (sbcc) intervention to improve breastfeeding rate in malaysia

H.A. Tajuddin*

Monash University Malaysia, Pediatric, JOHOR BAHRU, Malaysia

BACKGROUND AND AIM

In Malaysia, exclusive breastfeeding rate was 47.1% (NHMS III in 2016) and this is still below 50% although it is increasing every year. The 2025 targets of the Ministry of Health for National Plan of Action for Nutrition of Malaysia 2016 - 2025 are 70% of babies being exclusively breastfed within the first 6 month of life. Therefore, BCNP is one of the model of Social & Behaviour Change Communication (SBCC) intervention to improve breastfeeding rate. A post intervention survey showed that exclusive breastfeeding rate was 68.1% has been achieved.

METHODS

This post intervention survey divided into 2 groups of cohort who answered the questionnaires that are lactation counselors (n=58) and mothers (clients) (n=72) group. The survey questionnaires is to determine the counselors perception on BCNP. Another questionnaires given to 72 mothers was done by phone calls, and they were the clients from 1st January until 31st December 2019.

RESULTS

The result showed that post BCNP intervention (home visit counseling), the rate of exclusive breastfeeding significantly higher than current Malaysian statistics. Among mothers who answered, 68.1 % of them were successfully breastfeed their infants. Result of the questionnaires thier perception on BCNP service showed that 70 % of them feel satisfied with the service.

CONCLUSIONS

The BCNP is the model of SBCC intervention and post intervention surveys showed that both cohort satisfied with the home visit counseling session. It is a successful program to increase exclusive breastfeeding rate in Malaysia through this effective networking.

EP675 / #2766

E-Poster Viewing - Paediatrics AS04-12. Nutrition

Comparison of the impact of bariatric surgery performed at pediatric age versus young adults

M. Von Hafe^{1*}, M. Borges-Canha¹, J. Chaves¹, J. Neves², S. Corujeira³, A. Varela², J. Preto⁴, P. Freitas², D. Carvalho⁵

¹Faculdade de Medicina da Universidade do Porto, 1. departamento De Cirurgia E Fisiologia, Porto, Portugal

²Centro Hospitalar Universitário de São João, Serviço De Endocrinologia, Diabetes E Metabolismo, Porto, Portugal

³Centro Hospitalar Universitário de São João, Pediatrics, Porto, Portugal

⁴Centro Hospitalar Universitário São João, Serviço De Cirurgia, Porto, Portugal

⁵Faculdade de Medicina da Universidade do Porto, Instituto De Investigação E Inovação Em Saúde (i3s), Porto, Portugal

BACKGROUND AND AIM

Obesity is a complex multifactorial disease which prevalence is rising. The time of exposure to the inflammation involved in this pathology seems to be an important risk factor for the development of other comorbidities. Bariatric surgery improves the adipotoxic environment. Aim: To compare the impact of bariatric surgery on pediatric age and young adults.

METHODS

Observational retrospective cohort study in patients with morbid obesity that underwent bariatric surgery in our center, comparing pediatric patients and young adults from 19 to 22-year-old.

RESULTS

In the pediatric group (n=12), the average age was 17.2 ± 1.2 years and 75.0% were female; in the adult group (n=35), the average age was 20.6 ± 1.5 years

and 74.3% were female. The BMI in the pediatric group was 48.0 ± 5.1 kg/m² and 46.2 ± 5.6 kg/m² in the adult group ($p=0.31$). All the pediatric patients were submitted to sleeve gastrectomy, while 34.2% of the adult group underwent sleeve gastrectomy and the remaining gastric bypass. After one year, the decrease of body fat percentage was $12.7\% \pm 10.9$ in the pediatric group vs $16.1\% \pm 8.4$ in the adult group, ($p=0.55$). BMI also decreased similarly in both groups ($p=0.59$). Prediabetes remission rate was similar between groups (50.0 vs 87.5%, $p=0.24$). In both groups there was a decrease of HbA1c levels ($0.1 \pm 0.2\%$ in the pediatric group versus $0.2 \pm 0.2\%$, $p=0.16$). The remission of dyslipidemia (83.3 vs 64.3%, $p=0.39$), and hypertension (60.0 vs 80.0%, $p=0.41$) was similar in both groups.

CONCLUSIONS

The bariatric surgery outcomes in pediatric patients were comparable to adults. Performing bariatric surgery in the pediatric age may be beneficial.

EP676 / #2010

E-Poster Viewing - Paediatrics AS04-12. Nutrition

Early aggressive enteral feeding advancement on premature infants at 30-34 weeks in CHINA

Q. Zhang¹, X. Wan^{1*}, P.-Y. Cheung², F. Lin¹, H. Huang¹, Y. Deng¹

¹Hongkong university-shenzhen hospital, Paediatrics Department, shenzhen, China

²University of Alberta, Departments of Pediatrics & Pharmacology, Alberta, Canada

BACKGROUND AND AIM

To study the effects of early aggressive and conventional enteral feeding tolerance and safety on premature infants at 30-34 weeks.

METHODS

A total of 160 premature infants at 30-34 weeks who were hospitalized and treated in the neonatal intensive care unit between Jan. 2018 and Jun. 2020 were enrolled. According to the enteral feeding patterns they were divided into the aggressive enteral feeding group (initial enteral feeding within 4 hours after birth, and increased progressively at 25-30 ml/kg each day) and the conventional feeding group (initial enteral feeding within 24 hours after birth, and increased progressively at 10-15 ml/kg each day). A retrospective analysis was performed to collect the clinical data of the two groups. They were compared in terms of general information, treatment process, and complication while hospitalized.

RESULTS

No NEC occurred in both groups. and there were no significant differences in feeding intolerance between the two groups ($P>0.05$). Compared with the conventional feeding group, the aggressive enteral feeding group had reached the full enteral feeding time significantly earlier ($P<0.001$), significantly shorter durations of intravenous infusion ($P<0.001$), and a significantly lower

rate of UVC and PICC ($P<0.05$). There were no significant differences in hospital stays and time to recovery birth weight between the two groups ($P>0.05$).

Table 1 Baseline Demographic, Perinatal, and Neonatal Variables

	cohort 1 (n=76)	cohort 2 (n=84)	<i>P Value</i>
Gestational age, ($\bar{x}\pm s$, wk)	32.2 \pm 1.2	32.5 \pm 1.1	0.168
Sex, No. (%)			0.319
male	43 (56.6)	54 (64.3)	
female	33 (43.4)	30 (35.7)	
Twin, No. (%)	34 (44.7)	30 (35.7)	0.270
Caesarean section, No. (%)	59 (77.6)	56 (66.7)	0.123
antenatal corticosteroids, No. (%)	74 (97.4)	78 (95.1)	0.455
PROM > 18h, No. (%)	18 (24.3)	19 (22.6)	0.801
Birth weight, ($\bar{x}\pm s$, g)	1746.79 \pm 3	1800.99 \pm 343.3	0.327
Apgar at 1 min, ($\bar{x}\pm s$)	9 (8-9)	9 (8-9)	0.647
Apgar at 5 min, ($\bar{x}\pm s$)	10 (9-10)	10 (9-10)	0.850
SGA (>P3, <P10), No. (%)	8 (10.5)	5 (6.0)	0.290
NRDS, No. (%)	21(27.6)	18(21.4)	0.361
PS treatment, No. (%)	7 (9.2)	8 (9.5)	0.946
noninvasive assisted ventilation, No. (%)	61(80.2)	58 (69.0)	0.105

PROM (Premature rupture of membranes), SGA (small for gestational age), NRDS (Neonatal respiratory distress syndrome), PS (Pulmonary surfactant)

Table 2. Outcome of the Study Patients

	cohort 1 (n=76)	cohort 2 (n=84)	<i>P Value</i>
UVC placement, No. (%)	31 (40.8)	16 (19.0)	0.003
PICC placement, No. (%)	22 (28.9)	4 (4.8)	<0.001
HOL enteral feeding started ($\bar{x}\pm s$, h)	12.5 \pm 4.2	2.1 \pm 0.1	<0.001
DOL parenteral lipid supply, ($\bar{x}\pm s$, d)	7.3 \pm 0.3	4.5 \pm 0.2	<0.001
DOL full enteral feeding reached, ($\bar{x}\pm s$, d)	9.2 \pm 0.7	5.8 \pm 0.6	<0.001
DOL gastric tube indwelling, ($\bar{x}\pm s$, d)	20.8 \pm 1.6	16.9 \pm 1.3	0.044
DOL regained to birth weight ($\bar{x}\pm s$, d)	9.4 \pm 3.3	9.1 \pm 3.7	0.643
length of hospital stay, ($\bar{x}\pm s$, d)	27.3 \pm 13.	24.8 \pm 11.89	0.221
Feeding intolerance, No. (%)	8(10.5)	11(13.1)	0.334
BPD, No. (%)	3 (3.9)	3 (3.6)	0.901
IVH, No. (%)	1 (1.3)	1 (1.2)	0.971

DOL (days of life), HOL (hours of life), UVC (Umbilical vein catheterization), PICC (peripherally inserted central catheter), BPD (bronchopulmonary dysplasia), IVH (intraventricular hemorrhage)

CONCLUSIONS

Early aggressive enteral feeding on premature infants at 30-34 weeks is beneficial to shorten the time of parenteral nutrition, reduce the rate of UVC and PICC, and does not increase the risk of feeding intolerance and neonatal necrotizing enterocolitis.

EP677 / #1527**E-Poster Viewing - Paediatrics AS04-13. Global health****Correlation between chest x ray (cxr) and point of care ultrasound (pocus) findings in children diagnosed with rsv infection by nasopharyngeal rt-pcr: the zambia experience****I. Camelo^{1*}, R. Pieciak², I. Castro-Aragon³, B. Setty³, H. Chang³, M. Betke⁴, L. Etter⁵, J. Li², R. Thompson⁶, C. Gill²**¹Augusta University, Pediatric Infectious Diseases, Augusta, United States of America²Boston University, Global Health Department, Boston, United States of America³Boston Medical Center, Radiology, Boston, United States of America⁴Boston university, Artificial Intelligence, Boston, United States of America⁵Boston university, Global Health, Boston, United States of America⁶Worcester Polytechnic institute, Artificial Intelligence, Worcester, United States of America**BACKGROUND AND AIM**

Respiratory syncytial virus (RSV) pneumonia is a leading cause of infant mortality worldwide. RSV infection in resource-limited settings is usually diagnosed by CXR. POCUS is an alternative, non-radiating, easy to implement imaging modality in these settings. We compared CXR and POCUS imaging findings in children diagnosed with RSV using reverse transcriptase polymerase chain reaction (PCR) on nasopharyngeal (NP) samples.

METHODS

200 children ages 1-59 months with WHO-defined severe/very severe pneumonia were enrolled from the Emergency Department at University Teaching Hospital in Lusaka, Zambia. Demographic, clinical information, NP samples, a CXR and 12 lung POCUS images per patient were included. All CXR and POCUS images were adjudicated by two radiologists independently. They

were masked to correspondence between CXR, POCUS images and PCR status. Images were categorized as end point consolidation, no consolidation or normal on both, CXR and POCUS.

RESULTS

20% of cases tested RSV+ by PCR (44/200; 22%). The median age RSV+ participants, 7 months (IQR: 3-13). Median (IQR) respiratory rate: 53 (40-60). Median (IQR) SpO₂ on room air: 91 (90-94). (%) of cases with SpO₂ <95: 33 (75%). 32 patients had abnormal findings on POCUS on the left side, only 26 demonstrated abnormal findings on CXR on the same side. On the right side, 42 patients had abnormal findings, only 31 showed abnormal findings on CXR.

CONCLUSIONS

POCUS proved to be a reliable imaging alternative compared to CXR to diagnose RSV in limited resource settings. More abnormal findings were seen on POCUS than on CXR for children diagnosed with RSV by RT-PCR.

EP678 / #2069**E-Poster Viewing - Paediatrics AS04-13. Global health****Glutathione status in young women with polycystic ovary syndrome****M. Chetchowska^{1*}, J. Jurczewska², J. Gajewska¹, D. Szostak-Węgierek², E. Rudnicka³, M. Ołtarzewski¹, J. Ambroszkiewicz¹**

¹*Institute of Mother and Child, Department of Screening Tests and Metabolic Diagnostics, Warsaw, Poland*

²*Medical University of Warsaw, Department of Clinical Dietetics, Faculty of Health Sciences, Warsaw, Poland*

³*Medical University of Warsaw, Department of Gynecological Endocrinology, Warsaw, Poland*

BACKGROUND AND AIM

Metabolic disorders present in women with polycystic ovary syndrome (PCOS) may result in increased oxidative stress and associated risk of obesity and reproductive failure. Glutathione plays a key role in maintaining a physiological balance between prooxidants and antioxidants in human body. Therefore, the aim of this study was to assess the glutathione status in patients with PCOS.

METHODS

The study was conducted among 45 young women with PCOS, diagnosed according to the Rotterdam criteria, who were divided into two groups: with normal body mass index (BMI) and $BMI \geq 25 \text{ kg/m}^2$. Serum concentrations of reduced glutathione (GSH), oxidized glutathione (GSSG), glutathione peroxidase (Gpx-3) and glutathione reductase (GR) were assessed using immunoenzymatic ELISA assay. The GSH/GSSG ratio (R), which is considered an index of the cell's redox, was calculated.

RESULTS

Women with $\text{BMI} \geq 25 \text{ kg/m}^2$ had significantly higher levels of GSSG (6.3 ± 1.3 vs $3.3 \pm 0.9 \text{ } \mu\text{mol/L}$; $p < 0.001$) and lower levels of GR (245.9 ± 51.2 vs $289.4 \pm 73.6 \text{ pg/mL}$; $p < 0.05$) compared to women with normal BMI. The levels of GSH and GPx-3 were similar in both study groups, however the R-index was significantly lower in the group of women with abnormal body weight (3.4 vs 1.8 ; $p < 0.001$). There was a positive correlation between serum GSSG levels and BMI ($r = 0.481$, $p < 0.05$).

CONCLUSIONS

Overweight women with PCOS have increased oxidative stress when compared with their lean counterparts. The use of parameters such as GSH and GSSG, and the determination of the R factor may be useful to assess the oxidative-antioxidant balance and thus the predisposition to free radical complications in patients with PCOS.

EP679 / #2425**E-Poster Viewing - Paediatrics AS04-13. Global health****Breastfeeding preparedness during humanitarian emergencies. A review of online resources available for the population****A. Tarantino¹, P. Amadio², E. Chapin³, G. Salvatori², I. Dall'Oglio^{4*}**

¹San Giovanni Calibita Fatebenefratelli Hospital, Isola Tiberina, Department of Obstetrics and Gynecology, Rome, Italy

²Bambino Gesù Children's Hospital, IRCCS, Department of Medical and Surgical Neonatology, Rome, Italy

³Italian National Committee for UNICEF, Baby-friendly Initiatives, Rome, Italy

⁴Bambino Gesù Children's Hospital, IRCCS, Professional Development, Continuing Education and Research Service, Rome, Italy

BACKGROUND AND AIM

Breastfeeding in humanitarian emergencies has become very topical even in highly developed countries. There is extensive evidence about the implications of breastfeeding for mothers and babies during humanitarian emergencies. The Covid-19 pandemic has taught us important lessons about the need to effectively address breastfeeding preparedness. The aim of this review was to identify online resources materials available to the population regarding preparedness on breastfeeding during humanitarian emergency situations.

METHODS

A systematic review of online resources available on the Web was conducted regarding the preparedness of the population on breastfeeding during humanitarian emergencies. To this end, the Google search engine was used using keywords in English and Italian.

RESULTS

Out of 44 documents (n = 33 in English and n=11 in Italian), 3 documents in English and none in Italian met the purposes of this study. Eleven contents have resulted. Regarding breastfeeding preparedness and Covid-19 infection, a total of 13 documents were found, of which 5 in Italian and 8 in English.

CONCLUSIONS

The contents of the documents all underlined the importance of family preparedness in emergency situations with particular attention to breastfeeding. However, in general the present study highlighted a paucity of information for the general population regarding breastfeeding preparedness during humanitarian emergencies and the need for more information on breastfeeding for mothers and families. Instead, more documents were available regarding breastfeeding preparedness and Covid-19, because governmental and non-governmental bodies had disseminated information regarding good practices for the protection, promotion, and support of breastfeeding through their websites to reach out to the population.

EP680 / #2440**E-Poster Viewing - Paediatrics AS04-13. Global health****Breastfeeding and humanitarian emergency contents to ensure population's preparedness: a survey on childbirth preparation courses****A. Tarantino¹, E. Chapin², P. Amadio³, G. Salvatori³, I. Dall'Oglio^{4*}**

¹San Giovanni Calibita Fatebenefratelli Hospital, Isola Tiberina, Department of Obstetrics and Gynecology, Rome, Italy

²Italian National Committee for UNICEF, Baby-friendly Initiatives, Rome, Italy

³Bambino Gesù Children's Hospital, IRCCS, Department of Medical and Surgical Neonatology, Rome, Italy

⁴Ospedale Pediatrico Bambino Gesù, Nursing and Allied Health Professional Development, Continuing Education and Research Unit, Medical Directorate, Rome, Italy

BACKGROUND AND AIM

Breastfeeding during humanitarian emergencies is an urgent issue even in highly developed countries and the ongoing Covid-19 emergency has shown us how the unpredictability of certain events can endanger entire countries. The aim of the survey was to explore the contents of breastfeeding during humanitarian emergencies, proposed in childbirth preparation courses in the Lazio Region, during the Covid-19 emergency, the method adopted to attend these courses.

METHODS

From July 2020 to February 2021 a mixed response questionnaire was administered in Birth Centres, Maternity Homes, and Family Counselling Services of the Lazio Region, regarding breastfeeding in emergencies and the Covid-19 emergency proposed during childbirth preparation courses.

RESULTS

of the responding services, 43 (74%) offered childbirth preparation courses. of these, 15 (35%) included breastfeeding in humanitarian emergencies and agreed on encouraging breastfeeding in humanitarian emergencies, importance of breastfeeding, on the possibility of recovering a decrease in milk production and increasing supply of breast milk and the risks of using milk replacers in poor sanitary conditions. Following lockdown, all the services provided information about the safety of breastfeeding during the Covid-19 pandemic and hygienic rules to avoid contagion.

CONCLUSIONS

Breastfeeding in humanitarian emergencies is not frequently included in childbirth preparation courses, although these courses are recognized as the right place where to disseminate this information. However, the Covid-19 emergency triggered a significant response by the providers of childbirth preparation courses, which highlighted the importance of protecting, promoting and supporting breastfeeding and what to do despite Covid-19.

EP681 / #2266**E-Poster Viewing - Paediatrics AS04-13. Global health****Training on breastfeeding protection, promotion and support in humanitarian emergencies, a pilot observational study among humanitarian organizations****F. Marchetti^{1,2}, P. Amadio³, A. Giusti², G. Salvatori³, I. Dall'Oglio^{4*}**¹University of Rome "Tor Vergata", Department of Biomedicine and Prevention, Rome, Italy²Italian National Institute of Health, National Center For Disease Prevention, Rome, Italy³Bambino Gesù Children's Hospital, IRCCS, Department of Medical and Surgical Neonatology, Rome, Italy⁴Bambino Gesù Children's Hospital, IRCCS, Professional Development, Continuing Education and Research Service, Rome, Italy**BACKGROUND AND AIM**

During humanitarian emergencies, breastfeeding (BF) safeguards health and saves lives, and international recommendations[1] underline the importance of structured interventions to protect, promote and support it. Training personnel of humanitarian organizations (HOs) about BF during emergencies is vital. In literature was described a lack of evidence about interventions effectiveness[2]. In this study we explored how training about protection, promotion, and support of BF in humanitarian emergencies is provided to personnel of HOs in Italy.

METHODS

An observational pilot study was conducted involving the main Italian HOs operating in emergency contexts. A self-administered online semi-structured questionnaire was developed and administered between July-October 2018,

to assess how BF training was provided to HO personnel, and respondents' attitudes about the importance of BF training in emergencies.

RESULTS

Twenty-one HOs were included with a 66.7% (n=14) response rate. of these, 11 (78.6%) employed health care professionals. Specific training on BF in emergencies was provided only by one HO (7.14%). General training about BF in Low Income Countries was provided by another HO (7.14%). No BF training was provided by the other HOs (n=11;78.6%). Although all respondents recognized the importance of BF during humanitarian emergencies, not everyone agreed it was crucial for training.

CONCLUSIONS

Training about BF protection, promotion and support during humanitarian emergencies of HO personnel was lacking in Italian HOs, and should be enhanced using existing programs and tools, even online. This study could be extended internationally to explore how training on BF during humanitarian emergencies is provided and raise HOs' awareness about its importance. [1] IFECOREGroup(2017).www.enonline.net/operationalguidance-v3-2017 [2] Dall'Oglioli.(JHumLact2020)

EP682 / #2213**E-Poster Viewing - Paediatrics AS04-13. Global health****Kabuki syndrome**

I. Eiras*, L. Abelha, A.I. Sequeira, A. Rego, B. Sousa, C. Dias, I. Soro, D. Rocha

Unidade Local de Saúde do Alto Minho- Hospital Santa Luzia, Pediatrics, Viana do Castelo, Portugal

BACKGROUND AND AIM

Kabuki syndrome is a rare clinical condition, associated with polymalformative syndrome, facial dysmorphism, poor height-weight evolution and intellectual deficit.

METHODS

-Description-of-case-report-

RESULTS

Newborn, female, 33 weeks premature with intrauterine growth restriction and flowmetry alteration. Perimembranous ventricular septal defect suspected on fetal ultrasound. Unchanged serologies. No relevant family history. Completed a course of prenatal corticosteroid. At birth she cried vigorously and weighed 1690g. Due to suspected dysmorphic facies, low implantation of auricles and retrognathism, karyotype was requested, which was normal. Evaluation by ophthalmology, for apparent absent visual contact, detected bilateral hyperpigmented peripapillary halo, suggestive of optic nerve hypoplasia. Cerebral magnetic resonance was performed, which excluded septo-optic dysplasia. Postnatal echocardiogram was normal. At 3 months, she

was referred to genetic consultation due to suspected polymalformative syndrome. A reno-vesical ultrasound was performed, with apparent excretory duplication on the left, and complemented study with MAG-3, showing asymmetric differential renal function. Follow-up in ophthalmology, with bilateral strabismus, repeated blepharitis, and exclusion of optic nerve hypoplasia with normal visual acuity. Due to global delay in psychomotor development, she began physical and speech therapy and was referred to a local early intervention team. At 10 months, due to phenotype suggestive of Kabuki Syndrome, sequencing of KMT2D and KDM6A genes was requested, and a heterozygous variant was detected in KMT2D gene.

CONCLUSIONS

Absence of etiological clarification shouldn't delay the start of intervention, which should be as early as possible. Advances in genetic studies have made possible establishing an etiological diagnosis in children with dysmorphic syndromes, screening for associated comorbidities and counsel genetically.

EP683 / #1442**E-Poster Viewing - Paediatrics AS04-13. Global health****Repercussions of the nutritional status of zinc in children and adolescents with down syndrome.**

C. Delambert¹, I. Santos¹, B. Moreira¹, A.M. Pereira¹, P. Sauretti¹, L. Carvalho², C. Fonseca^{1*}

¹São Paulo State University (Unesp); Botucatu Medical School, Pediatrics, Botucatu, Brazil

²São Paulo State University (Unesp); Botucatu Medical School, Biostatistics, Botucatu, Brazil

BACKGROUND AND AIM

Zinc is one of the micronutrients involved in the processes of cell differentiation, height growth, neurological development and immune defense, and its deficiency can lead to damage in children with Down Syndrome (DS). This study aimed to evaluate the nutritional status of zinc in children and adolescents with DS and its effects on growth and thyroid function, and to verify the response to supplementation of this micronutrient, proposing an assistance protocol for these.

METHODS

A case-control clinical and a clinical trial study, 2020-2021, in an outpatient service of a University Hospital, with a convenience sample. Case Group: children and adolescents with DS, paired by sex and age with the control group, without the syndrome (1:1). Study steps: Anthropometric assessment and classification, laboratory analysis of TSH and free T4, erythrocyte and serum zinc dosages, and IGF-1, in addition to assessment of dietary zinc intake; administration of zinc sulfate heptahydrate for 6 months and reassessment of initial parameters.

RESULTS

Six (37.5%) patients had an increase greater than or equal to 0.5 in stature z-score at the time of inclusion in the study post-supplementation. There was an improvement in the thyroid profile in 6.2% of the patients, with a reduction in TSH and implementation in free T4. The variations in TSH, free T4, height, IGF-1, serum zinc and erythrocytes were not significant.

CONCLUSIONS

Children and adolescents with DS presented better adequacy of the nutritional status of zinc than the control group; the zinc supplementation observed opens expectations about changes in height/age of those with DS.

EP684 / #1477**E-Poster Viewing - Paediatrics AS04-13. Global health****Early motor and thyroid intervention improves motor function in children with down syndrome.**

M. Couto¹, J. Oliveira¹, C. Delambert¹, L.C. Antunes¹, J. Corrente², A. Prearo¹, T. Goldberg¹, C. Fonseca^{1*}

¹São Paulo State University (Unesp); Botucatu Medical School, Pediatrics, Botucatu, Brazil

²São Paulo State University (Unesp); Botucatu Medical School, Research office, Botucatu, Brazil

BACKGROUND AND AIM

The early diagnosis of thyroid disorders is beneficial to the physical, psychomotor and intellectual development of children with Down Syndrome (DS). This study aimed to assess the gross motor function of children and adolescents with DS and its relationship with factors capable of influencing its development.

METHODS

Cross-sectional study with data collection through questionnaire and clinical assessment of gross motor function using the GMFM-88 motor scale, 2018 to 2020, at the Genetic Pediatrics, Botucatu, Brazil. A sample of 50 children with DS were included, aged between 5 months and 15 years. The Pearson's correlation coefficient was applied (p -value <0.50).

RESULTS

Child's age ($p <0.001$), age at start of motor stimulation ($p = 0.0029$) and hypothyroidism treatment ($p = 0.0464$) were associated with better scores on the GMFM-88. Motor function was positively correlated ($p = 0.029$) with age

at start of motor stimulation, age at diagnostic suspicion and confirmation of DS ($p = 0.0314$ and $p = 0.01257$, respectively), number of weekly stimulation consultations in the first year of life ($p = 0.0222$). Age at start of treatment with levothyroxine was associated with number of weekly consultations in the first year of life for motor stimulation ($p = 0.0351$), length of hospitalization at birth ($p = 0.0391$) and best GMFM-88 score ($p = 0.0464$).

CONCLUSIONS

The diagnostic suspicion and confirmation of DS favored the start of motor stimulation in the first year of life and positively influenced the gross motor function of these children and adolescents, as well as the timely treatment of hypothyroidism.

EP685 / #1498**E-Poster Viewing - Paediatrics AS04-13. Global health****Comprehensive health care for children and adolescents with congenital (non-genetic) diseases: the experience of an assistance service.****C. Fonseca^{1*}, C. Delambert¹, L. Carvalho², A.M. Pereira¹, E. Cyrino¹**¹São Paulo State University (Unesp); Botucatu Medical School, Pediatrics, Botucatu, Brazil²São Paulo State University (Unesp); Botucatu Medical School, Biostatistics, Botucatu, Brazil**BACKGROUND AND AIM**

Congenital disorders are a major concern to public health as they cause high morbidity and mortality for the affected population. Evaluation is a relevant and necessary step in health care, always with the aim at improving the quality of services in the Unified Health System (SUS). The objective was to characterize and evaluate the magnitude of the Genetic Pediatrics service for assistance, considering Comprehensive Health Care as the primary purpose of the Service.

METHODS

All children and adolescents attended in the Genetic Pediatrics- HCFMB outpatient clinics were included, 2012-2019. Data were collected through the Management Report of records from the patients' Electronic Health Record: patients, number of medical visits, age and municipality of origin, medical visits in health care specialties, additional tests, main diagnosis identified at the medical visit - according to the International Classification of Diseases code (ICD-10). Descriptive analysis and chi-square test were used.

RESULTS

Children started follow-up in the first year of life. The most of children were included until three years old (52,7%). Improved records of ICD-10 diagnoses, was identified DS as the most frequent congenital disorder with significant attendance due to mental and behavioral disorders such as Autism. Several medical and non-medical specialties were used for therapeutic and diagnostic support. The karyotype exam was the most requested exam (29%).

CONCLUSIONS

The Genetic Pediatrics service was able to provide comprehensive care to children and adolescents with congenital disorders, coordinating multiprofessional activities and including most children in the first years of life.

EP686 / #672**E-Poster Viewing - Paediatrics AS04-13. Global health****A review of paediatric early warning scores in low- and middle-income countries****N. Kemps*, H. Moll, J. Zachariasse**

Erasmus Medical Center - Sophia Children's Hospital, General Pediatrics, Rotterdam, Netherlands

BACKGROUND AND AIM

Early assessment, prioritization of children and efficient allocation of resources are crucial for optimal health outcomes of children attending acute care settings. Paediatric Early Warning Scores (PEWS) are simple scoring systems based on vital signs that could play an important role, particularly in low- and middle income countries (LMICs). This study aims to review the existing evidence.

METHODS

To identify studies on development, implementation and/or validation of PEWS in LMICs a literature search was conducted on PubMed till December 2021, using search terms related to "Early Warning Score", "Child" and "LMICs". Study characteristics were described, including details of the setting, PEWS characteristics, and the used outcomes.

RESULTS

Thirteen studies, using nine PEWS, were identified. Twelve studies were conducted in tertiary care or large referral hospitals, and one study was conducted in a rural setting. Four PEWS were developed in LMICs and five were origi-

nally developed in high-income countries, of which two were modified for LMICs. Eight PEWS were based on expert opinion, and one was developed using statistical analyses. Outcome measures most frequently used were mortality (n=5) and ICU admission (n=3). No outcome measures reflecting intermediate or low urgency were studied, that may contribute assigning patients to specific levels of care.

CONCLUSIONS

Research on PEWS in LMICs is mainly performed in tertiary care hospitals. The majority PEWS studied are based on expert opinion, aimed at predicting the high urgency outcomes such as mortality and ICU admission. For application as a prioritization tool, future research should focus on a more comprehensive definition of urgency.

EP687 / #1088

E-Poster Viewing - Paediatrics AS04-13. Global health

Is childhood resilience associated with early childhood factors?

B. Koshy^{1*}, M. Srinivasan², S. Gopalakrishnan¹, V.R. Mohan³, R. Scharf⁴, S. John⁵, R. Beulah¹, J. Muliylil², G. Kang³

¹Christian Medical College, Developmental Paediatrics, Vellore, India

²Christian Medical College, Wellcome Research Unit, Vellore, India

³Christian Medical College, Community Health, Vellore, India

⁴University of Virginia Children's Hospital, Global Health, Virginia, United States of America

⁵Christian Medical College, Lcecu, Vellore, India

BACKGROUND AND AIM

Background: Resilience can be defined as the ability to overcome adversity and can help to improve quality of life and longevity.

METHODS

METHODS

The current analysis evaluates childhood resilience at 9 years of age and its associations with concurrent cognition and early childhood factors, using longitudinal follow-up of a community-based birth cohort in Vellore, south India. Resilience was assessed using the Child and Youth Resilience measure and cognition utilizing the Malin's Intelligence Scale for Indian Children. Early childhood variables included stunting, maternal depression scores, home environment scores and socio-economic status (SES) at 2 years of age. Statistical evaluation included bivariate analysis with multi-variable regression for each resilience domain and the total resilience score.

RESULTS

RESULTS

Out of 251 new-borns recruited into the MAL-ED birth cohort, 205 (81.7%) children were available for the 9-year follow-up. Individual resilience domain was associated with verbal cognition scores at 9 years of age (0.07, $p=0.019$) and total home environment scores (0.16, $p = 0.027$) at 2 years of age, when adjusted for stunting, maternal depression, and SES. The total resilience score was associated only with concurrent verbal intelligence (0.08, $p = 0.026$) after adjustment with early childhood factors. Analysis of individual home environment factors showed that daily stimulation was associated with the individual domain of resilience.

CONCLUSIONS

Follow up of an Indian birth cohort showed that in addition to concurrent cognitive abilities, childhood resilience was related to early childhood stimulating home environment. Promoting optimal stimulating home environments in low-resource settings to nurture early childhood development is essential.

EP688 / #2633**E-Poster Viewing - Paediatrics AS04-13. Global health****Recurrent choking: parental anxiety or vascular anomaly?**

J.A. Neto^{1*}, A. Lemos¹, M. Garcia², M. Madureira³, J. Laranjeiro⁴, J. Spratley⁵, A. Maia⁶

¹Centro Hospitalar S João, Pediatrics, Porto, Portugal

²Centro Hospitalar Universitário de São João, Pediatric Surgery, Porto, Portugal

³Centro Hospitalar Universitário S João, Radiology, Porto, Portugal

⁴Hospital Privado de Alfena, Otorhinolaryngology, Porto, Portugal

⁵Centro Hospitalar Universitário S João, Otorhinolaryngology, Porto, Portugal

⁶Centro Hospitalar e Universitário São João, Department of Pediatrics, Porto, Portugal

BACKGROUND AND AIM

Choking episodes are frequent in infants and their multiple diagnostic hypotheses range from physiological to potentially fatal. It is imperative to recognize the potentially fatal causes for timely treatment and to identify the physiological causes to reassure parents about their benignity.

METHODS

Case Report of an infant referred to the Paediatrics Consultation for multiple episodes of choking and apnea since the first month of life and dysphagia for pasty and solid textures since starting food diversification.

RESULTS

The five-month-old male infant resorted to health care multiple times for episodes of choking, with soup and not completely liquid porridge, associated with respiratory difficulty in the supine position. The nasofibroscope showed

mild laryngomalacia and a vascular anomaly suggestive of vinous swelling in the proximal esophagus, causing a slight decrease in the esophageal lumen. The cervical Angio-MRI identified a four millimeters nodule in the location, suggesting a vascular malformation, most probably venous. After a multidisciplinary discussion between Paediatrics, Paediatric Surgery, Radiology and Otorhinolaryngology, it was decided to keep clinical surveillance, without surgical or endoscopic intervention, due to the expected very slow growth of these vascular malformations in childhood. Currently, he has sporadic episodes of choking, mainly with thick textures. He is thriving properly and did not require any intervention to remove the lesion.

CONCLUSIONS

Although rare, vascular anomalies can cause common symptoms in infants. It is important to recognize the ones that require urgent treatment and those that should be kept under surveillance. The diagnostic and therapeutic approach should involve a multidisciplinary assessment of these patients.

EP689 / #338

E-Poster Viewing - Paediatrics AS04-13. Global health

Acid-base disorders in children with acute vomiting

B. Pitekova^{1*}, S. Szoradova², S. Tarnokova², L. Podracka², J. Stanik²

¹Comenius University Faculty of Medicine and National Institute of Children's Diseases, Department of Pediatric Urology, Bratislava, Slovak Republic

²Comenius University Faculty of Medicine and National Institute of Children's Diseases, Department of Paediatrics, Bratislava, Slovak Republic

BACKGROUND AND AIM

Vomiting is presented as a major cause of metabolic alkalosis in children and adolescents by textbooks and recent review articles. The main aim of our study was to determine the prevalence of acid-base disorder in our study group of vomiting paediatric patients.

METHODS

We conducted a retrospective study 351 children due to acute vomiting while focusing on metabolic alkalosis. Children with diarrhea, pyloric stenosis or underlying chronic conditions were excluded. Blood gases were analyzed using standardized methods.

RESULTS

From overall 351 patients, 40.6% (CI 35.6-45.8%) developed metabolic acidosis, 39.3% (CI 34.3-44.5%) had normal pH, and 20.2% (CI 16.4-24.7%) had alkalosis. In the alkalosis group, 9.1% from all children in the study (CI 6.5-12.6%) had respiratory alkalosis, 9.4% (CI 6.8-12.9%) had respiratory alkalosis with BE < -3 mmol/l, and 1.7% (CI 0.8-3.7) had mild alkalosis (pH<7.48) with normal

BE and pCO₂ values. No individuals with metabolic alkalosis were reported (CI 0-1.1%). In our study, metabolic acidosis was the most common disorder of the acid-base balance in children. Children have less effective gluconeogenesis and without food intake are prone to earlier lipolysis, ketogenesis and metabolic acidosis (ketoacidosis) compared to adults. This assumption is supported by the finding of low BE (-13.04 ± 2.66 mmol/l) and high anion gap (22.57 ± 4.13 mmol/l) in the group of children with metabolic acidosis.

CONCLUSIONS

Metabolic alkalosis seems to be a rare condition in children with acute vomiting, which contradicts traditional learning.

EP690 / #2744

E-Poster Viewing - Paediatrics AS04-13. Global health

Lead, vitamin "d" and hemoglobin in children living in west georgia

N. Shavlakadze^{1*}, I. Pkhakadze², T. Dolaberidze³

¹Akaki Tsereteli State University, Medical Faculty, Kutaisi, Georgia

²ATSU, Medical Faculty, Kutaisi, Georgia

³Medical Clinic "XXI Saukune", Pediatrician, Kutaisi, Georgia

BACKGROUND AND AIM

Research conducted in recent years has determined that more than a billion of the world's citizens are vitamin D deficient, and several hundred million have excess lead and hemoglobin deficiency. It is also known how important these three parameters are for the child's health. We studied the lead, vitamin "D" and hemoglobin in the bodies of children living in W.Georgia.

METHODS

We conducted a multi-indicator study that was ongoing for the last 4 years. The blood samples of 281 children (aged 1-11y.) who came to the clinic for various reasons were examined. The inclusion of children in the study was based on the principle of random selection, and blood samples for lead content was measured by ICP MS, vitamin "D" and hemoglobin were determined by immunoenzymatic and colorimetric methods.

RESULTS

The research found that 69% of the examined children had lead >5 µg/dL, >10 µg/dL - 41%, >20 µg/dL only 5%. 58%, of children had vitamin D < 30 ng/

ml, 17% < 20 ng/ml, only 7% < 10 ng/ml. Among the same children 14% had low hemoglobin < 10•0 g/dl. An increase in lead and a decrease in vitamin D levels of siblings in the family were confirmed. It was observed that the vast majority of children with musculoskeletal, nervous and immune system problems were characterized by vitamin D deficiency and high lead levels.

CONCLUSIONS

Georgian children actually has high lead prevalence and vitamin D deficiency. These parameters are aggravated by age. Finding and determining their causes is an urgent task of our healthcare system.

EP691 / #2323**E-Poster Viewing - Paediatrics AS04-13. Global health****Antibiotic prescription in children by paediatricians and family doctors****S.C. Teixeira^{1*}, Â. Martins², J.A. Paiva³, P. Poeta⁴**¹*Centro Hospitalar de Trás-os-Montes e Alto Douro, Paediatrics Department, Vila Real, Portugal*²*University of Trás-os-Montes and Alto Douro, Zoothechnics Department, Animal and Veterinary Research Centre (cecav), Vila Real, Portugal*³*Centro Hospitalar Universitário São João, Intensive Medicine Department, Porto, Portugal*⁴*University of Trás-os-Montes and Alto Douro, Veterinary Sciences Department, Vila Real, Portugal***BACKGROUND AND AIM**

Paediatricians and Family Doctors (FD) play an important part in antibiotic resistance development, as they are the major medical specialties providing medical care to children. This study aims to compare both specialties concerning antibiotic prescription.

METHODS

An anonymous online questionnaire was answered between 18.06.2021 and 31.01.2022. Study participants were Portuguese physicians recruited using social media. Descriptive and statistical analysis was made using JMP 13 (SAS).

RESULTS

A total of 427 questionnaires were submitted, 156 by paediatricians and 223 by FD. Both paediatricians and FD groups claimed amoxicillin was the most frequent antibiotic they prescribed in paediatric age (90.4% versus 83.0% respectively), with higher percentage for physicians ≤ 10 of clinical practice (94.9% versus 88.7% respectively). 69.9% of paediatricians and 57.8% of FD

showed remarkable knowledge regarding Portuguese antibiotic prescription guidelines. From those, 72.9% in the FD group and 55.0% in the paediatricians group had ≤ 10 years of clinical practice. Both paediatricians and FD admitted they had already prescribed an antibiotic having doubts regarding the existence of infection (60.3% versus 67.7%, respectively) or because they felt pressured by parents (18.6% versus 33.2%, respectively).

CONCLUSIONS

Globally paediatricians seem to have more knowledge of antibiotic guidelines than FD, but this difference seems to attenuate if FD have less years of clinical practice. A high percentage of physicians in both groups claimed having prescribed antibiotic with doubts about the existence of infection and a fair amount have felt pressured for antibiotic prescription. Further education of physicians and parents may impact positively.

EP692 / #1049**E-Poster Viewing - Paediatrics AS04-13. Global health****A pediatric early warning score to recognize serious illness in a lower middle-income country****N. Kemps¹, S. Unger², E. Ledger³, H. Mark⁴, H. Moll⁵, J. Zachariasse^{5*}**¹Erasmus MC- Sophia Children's hospital, General Paediatrics, Rotterdam, Netherlands²University of Edinburgh, Department of Child Life and Health, Edinburgh, United Kingdom³Bristol Royal Hospital for Children, Department of Paediatric Accident and Emergency, Bristol, United Kingdom⁴Wilton Park, N/a, West Sussex, United Kingdom⁵Erasmus Medical Center - Sophia Children's Hospital, General Pediatrics, Rotterdam, Netherlands**BACKGROUND AND AIM**

Early recognition of children at risk of serious illness is essential in preventing morbidity and mortality, particularly in low- and middle-income countries (LMICs). This study aimed to assess the performance of the Emergency Department- Paediatric Early Warning Score (ED-PEWS) for prioritization of children in a LMIC.

METHODS

This observational study is based on previously collected clinical data from a rural primary care clinic in Kiang West, The Gambia. We included all children <16 years attending between 2010 and 2014. ED-PEWS performance was assessed by the area under the curve (AUC), sensitivity and specificity with pre-defined cut-offs for high (PEWS ≥ 15) and low risk (PEWS <6), and analyses in prespecified subgroups. The outcome measure was a composite marker of urgency consisting of admission, referral, need for intravenous medication or death on the day of presentation.

RESULTS

We included 41,917 children (median age 4.2 years) of whom 2,044 (4.9%) were of high urgency. The ED-PEWS had an AUC of 0.67 (95%CI 0.65-0.68). The high risk cut-off had a sensitivity of 0.83 and specificity of 0.34. For the low risk cut-off the sensitivity and specificity were 0.16 and 0.97 respectively. Performance was better in children younger than five, and children with infectious symptoms.

CONCLUSIONS

The ED-PEWS has a moderate performance for the recognition of seriously ill children in this rural setting in a LMIC. Broader validation in LMICs is needed to assess its performance across different settings and determine how the score can be approved for application in clinical practice.

EP693 / #1718**E-Poster Viewing - Paediatrics AS04-13. Global health****Body image perceptions and self-esteem among a moroccan group of adolescents****R. Zakaria*, H. Amor, A. Baali**

Laboratory of Pharmacology, Neurobiology, Anthropobiology and Environment, Faculty of Science Semlalia, University of Cadi Ayyad, Biology, Marrakesh, Morocco

BACKGROUND AND AIM

Adolescents are a vulnerable group to the body dissatisfaction that causes unhealthy attitudes and behaviors. The aim of the study was to assess body dissatisfaction and self-esteem, to evaluate the association between these two parameters with gender, age, physical activity and weight status among a group of Moroccan adolescents.

METHODS

This cross-sectional survey comprised of a sample of 487 adolescents. Stunkard's figure rating scale was used to assess perceptions of current and ideal body image and body dissatisfaction. Rosenberg self-esteem scale was used to assess self-esteem.

RESULTS

Body dissatisfaction was prevalent in 61.0% of the adolescents, of whom 38.2% wanted to gain weight and 22.8% wanted to lose weight. This dissatisfaction was strongly associated with weight status in both girls and boys; the adolescent was more dissatisfied, the more his weight status was lower or higher

and wants to gain and lose body weight, respectively. As for self-esteem, the average score calculated for the whole was (31.5). Results showed that body dissatisfaction was strongly associated with weight status in both girls and boys. As for the self-esteem, it was related to the adolescent's gender, physical activity and body dissatisfaction.

CONCLUSIONS

it is interesting to act on different components that could improve global self-esteem such as the satisfaction of one's appearance and to correct the wrong concepts of body image.

EP694 / #2648**E-Poster Viewing - Paediatrics AS04-14.
Haematology, transfusion therapy & oncology****Covid-19 a cause of abnormal clotting in children****M. Amir*, M. Aye, M. Borumand**

Milton keynes univeristy hospital, Paediatrics, MK, United Kingdom

BACKGROUND AND AIM

In children, Lupus autoantibodies (LA) are generally transient secondary to viral infections with no long-term complications. However, it can rarely lead to a stroke. Whereas, in adults, LA is commonly associated with systemic lupus erythematosus (SLE) and other autoimmune disorders. Moreover, many studies have shown association between LA and thrombotic events in COVID-19 patients.

METHODS

This is a retrospective electronic case review of a 5-year-old child. The girl presented to the paediatric assessment unit (PAU) with recurrent epistaxis. She was pale, lethargic, and had bruises on the shins. She contracted COVID-19 two months earlier. The examination was unremarkable with no lymphadenopathy. Furthermore, there was no medical history of bleeding disorder, associated family history, or use of regular medications. On admission, standard investigations were performed including vital signs, viral studies, full blood count (FBC), and coagulation studies.

RESULTS

The results for vital signs, viral studies and FBC were unremarkable. However, there was prolonged prothrombin (15.3) and aPTT (65). Subsequent aPTT

mixing studies were 56.6 seconds indicating the presence of circulating anti-coagulant, which was confirmed by further studies revealing positive lupus antibodies. Hence, elucidating the diagnosis of Transient LA secondary to viral illness. The antibodies were negative after 3 months.

CONCLUSIONS

In the otherwise healthy patient, transient LA secondary to viral illness do not usually require extensive medication and exhibit negative antibodies results within 3 months. We believe these findings can be beneficial to the medical community as the relationship between COVID-19 and lupus anticoagulant has not been extensively studied.

EP695 / #405**E-Poster Viewing - Paediatrics AS04-14.
Haematology, transfusion therapy & oncology****Congenital factor vii deficiency presenting with
isolated recurrent hematuria: a case report****S. Ansari^{1*}, M. Shampour¹, S. Ghazavi²**¹*Iran University, Hematology, Tehran, Iran*²*Azad University, Pharmacy, Tehran, Iran***BACKGROUND AND AIM**

Factor VII deficiency is a rare congenital coagulopathy disorder. In most cases, this disorder is diagnosed in childhood. Common symptoms of congenital factor VII deficiency are different and consist of cutaneous, mucosal hemorrhage, gastrointestinal bleeding, and joint bleeding. CNS hemorrhage is a fatal and severe complication of congenital factor VII deficiency. The incidence of gross hematuria is a rare symptom of factor VII deficiency. Isolated presentation of hematuria is rarer and usually is accompanied by bleeding in other sites.

METHODS

The patient reported here is a 6-month-old girl who was diagnosed with congenital Factor VII deficiency following episodes of isolated gross hematuria.

RESULTS

We decided to report this case to demonstrate if there is no other organic cause in the investigation of a child with recurrent hematuria, we should also consider a coagulation factors deficiency.

CONCLUSIONS

Since isolated hematuria is a rare symptom in the coagulation factors deficiency, the coagulation tests may be of less interest.

EP696 / #836**E-Poster Viewing - Paediatrics AS04-14.
Haematology, transfusion therapy & oncology****A five year look-back of bacterial species
intermittently detected in cord blood UNITS****H. Barreto Henriksson^{1,2*}, A. Hellström³, A. Nilsson³, S. Frändberg¹**

¹Sahlgrenska Universitetssjukhuset, Department of Clinical Immunology and Transfusion Medicine,, Mölndal, Sweden

²Region Västra Götaland, Sahlgrenska University Hospital, Sahlgrenska University Hospital, Gothenburg, Sweden, Department of Research, Development, Education and Innovation,, Molndal, Sweden

³The Sahlgrenska Centre for Pediatric Ophthalmology Research Sahlgrenska Academy, University of Gothenburg, Gothenburg, Sweden., Department of Clinical Neuroscience, Institute of Neuroscience and Physiology, Gothenburg, Sweden

BACKGROUND AND AIM

Cord blood banking plays an important role in clinical practice in world health care systems. Quality-controlled collection procedures that minimize the risk of contamination of umbilical cord blood units (UCBUs) have been implemented at the National Swedish Cord Blood Bank (NS-CBB), Gothenburg Sweden. The NS-CBB quality goal is less than 5% of UCBUs discarded due to positive cultures. Recently, cord blood has also been suggested as a source for erythrocytes for transfusion into neonates. This study aimed to investigate bacterial species in positive cultures from UCBUs collected between years 2016-2020 at NS-CBB.

METHODS

Retrospective registry study of positive bacterial cultures in data from NS-CBB. Processed UCBUs were controlled for sterility with the BacTAlert aerobic and anaerobic culture systems (BioMerieux, Marcy-L'Étoile, France). 2x3 mL samples were cultured for ten days with standard protocols.

RESULTS

Sixteen different bacterial species were detected in processed UCBUs (n=728) over the five years of collection. All cultivable bacteria were known species of the skin and gut microbiota. The major groups of detected bacteria were coagulase-negative Staphylococcus, Bifidobacterium and group B Streptococcus. The percentage of positive sterile controls in processed UCBUs varied from 7.1 to 1.4 % during the investigated period.

CONCLUSIONS

The percentage of UCBUs with positive cultures varied between years with a major improvement for 2020, probably to improved collection routines. These results show that it's possible to produce sterile high-quality UCBUs for patient-safe care and maintenance of professional cord blood banking.

EP697 / #2252**E-Poster Viewing - Paediatrics AS04-14.
Haematology, transfusion therapy & oncology****Prevalence of endocrine complications in
transfusion-dependent thalassemia**

H. Ben Belgacem*, A. Ben Taieb, M. Ben Guedria, N. Soyah,
M. Abdelbari, S. Ghorbel, R. Kebaili, A. Tej, J. Bouguila, S. Tilouche,
L. Boughamoura

Farhat Hached University Hospital, Pediatrics Departments, Sousse, Tunisia

BACKGROUND AND AIM

Frequent blood transfusions lead to iron overload. In spite of improvements in iron chelation therapy, a significant number of transfusion-dependent thalassemia (TDT) children still develop endocrine complications. The aim of this study is to evaluate the prevalence of various endocrine complications in children with major beta-thalassemia receiving a regular transfusion and iron chelation therapy

METHODS

A retrospective review of 28 children with TDT treated in the pediatrics department of Farhat Hached hospital Sousse Tunisia was conducted. Demographic data, iron chelation therapy, serum vitamin D level, serum ferritin, liver iron concentration from T2*MRI results, and endocrine complications were retrieved from medical records of patients

RESULTS

The mean age of patients was 9.5 years (2 years – 16 years), with an equal sex distribution. The mean serum ferritin level was 3414.16 µg/l. 39% of children

with TDT suffered from at least one endocrine complication. Among the TDT patients with endocrine complications, 54, 5% have one endocrinopathy, 45,5% with two types of endocrinopathies. Hypogonadism (26, 6%) was the commonest endocrine complication, followed by short stature (21%), and hypoparathyroidism (6.6%) with low vitamin D levels in all patients. Hypothyroidism (3,3%) and diabetes mellitus (3,3%) were infrequent complications. No patient had hypocortisolism. In our study, the mean serum ferritin level and liver iron concentration were higher among patients with endocrine complications.

CONCLUSIONS

Endocrinopathy leads to significant morbidities among patients with TDT. Therefore, regular monitoring and early detection with an intensification of chelation therapy are essential to improve the quality of life and psychological outcome of these patients.

EP698 / #2635**E-Poster Viewing - Paediatrics AS04-14.
Haematology, transfusion therapy & oncology****Giant hepatic hamartoma in a 2-year-old child: a case report****F. Caino De Oliveira^{1*}, R. Oliveira Faxina¹, N.B. De Alcantara Ferreira Garrido², P. Rute Moutinho¹, W. Brunow De Carvalho²**¹*Santa Catarina Hospital, Picu, Sao Pauli, Brazil*²*Santa Catarina Hospital, Picu, São Paulo, Brazil***BACKGROUND AND AIM**

Hepatic hamartoma is a rare and benign liver tumour that arises from the mesenchyme of the portal triad.

METHODS

The purpose of this work is to report a case of mesenchymal hepatic hamartoma in a 2-year-old child.

RESULTS

2 years and 7 months child, male he looks for assistance in the children's emergency room with complaint of fever for 4 days, soiled feces with the presence of mucus, no previous history or previous surgery; physical examination had distended abdomen, diagnostic hypothesis of acute diarrhea and requested ultrasonography, laboratory exams and rapid adenovirus and rotavirus. reevaluation on image examination found liver of usual topography, presenting heterogeneous mass in the right lobe, measuring 12.5 x 10.0 x 6.4 cm in longer axes, with predominantly solid isoecogenic content to the hepatic parenchyma with hypoeogenic areas. Cystics, and absence of flow

on color doppler examination; pediatric surgery called for evaluation, two days after hospitalization; surgical approach performed 7 days after hospitalization with right hepatic lobectomy; identification of a well delimited tumor in the right hepatic lobe; as shown in anatomopathological (figure 1 and 2); discharged for the ward on 10 day of hospitalization.

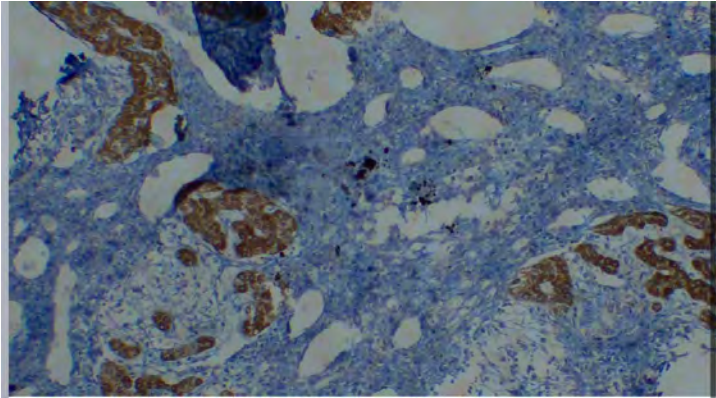

FIGURE 1:

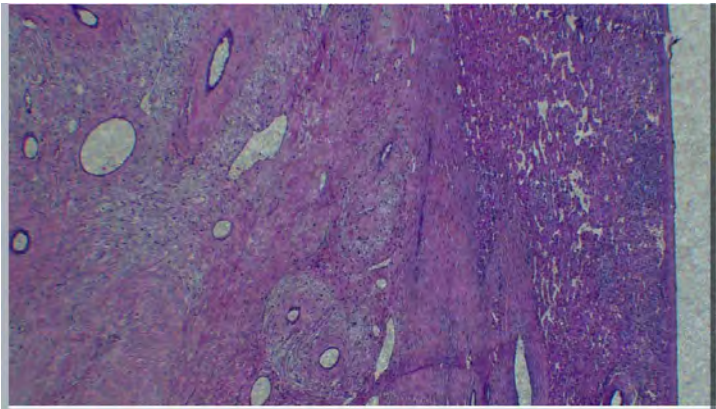

FIGURE 2:

CONCLUSIONS

In 80% of the cases they present before two years of age and the preference for male sex, as in the case in question; mostly the tumor does not cause symptoms and is diagnosed by accident in imaging exams, such as ultrasonography.³ Most patients have abdominal mass in the upper right quadrant, painless, with hepatomegaly with surgical treatment as reported.

EP699 / #2225

E-Poster Viewing - Paediatrics AS04-14. Haematology, transfusion therapy & oncology

Iron deficiency-a risk factor for febrile seizures in children

**T. Chisnoiu^{1,2*}, A.C. Pantazi¹, A. Balasa¹, L. Mihai¹, C.E. Frecus³,
C. Mihai^{1,3}**

¹Constanta Clinical Emergency Hospital, Pediatric Department, Romania, Pediatric, Constanta, Romania

²Ovidius University of Constanta, Faculty of Medicine, Constanta, Romania

³Constanta Clinical Emergency Hospital, Pediatric Department, Romania, Faculty of Medicine, Constanta, Romania

BACKGROUND AND AIM

Febrile seizures are the seizures of the infant or young child that occur due to a physical aggression - the sudden increase in internal temperature - on the CNS of the infant and young child.

METHODS

This paper is a retrospective study from 2019-2020 from the Pediatric Department of the County Emergency Hospital Constanța. The study group includes a number of 55 patients diagnosed with iron deficiency anemia and febrile seizures, selected from a number of 687 patients diagnosed with anemia.

RESULTS

of the 687 patients diagnosed with anemia, 55 were cases of iron deficiency anemia with febrile seizures, accounting for 8% of all patients diagnosed with anemia. The percentage distribution of patients by sex is almost equal, so 28

are male (51%) and 27 are female (49%). Regarding the incidence of cases depending on the type of seizure and the age of the patient, the highest incidence of cases with simple seizure was in patients aged 1-2 years, and in cases of complex seizure in patients up to one year. The ferritin value was analyzed by age categories, 0-12 months, 13-36 months and 37-60 months. Ferritin values below the normal minimum were found in all patients studied, regardless of age.

CONCLUSIONS

It is important that children with febrile seizures be evaluated for iron deficiency anemia, so that complications and the costs of caring for these patients can be prevented.

EP700 / #1010

E-Poster Viewing - Paediatrics AS04-14. Haematology, transfusion therapy & oncology

The importance of partnerships between patient associations and healthcare professionals in achieving the best levels of healthcare

T. Sousa, T. Costa*

Acreditar, Central Region, Coimbra, Portugal

BACKGROUND AND AIM

In Portugal, approximately 400 new cases of paediatric cancer are diagnosed each year.

Demonstration of the importance of partnerships to achieve early diagnoses, minimization of the illness's impact, investigation, and creation of the best treatments.

METHODS

Following the 2019 paediatric oncological conference, the need to provide human resources to ROPP - Portuguese Paediatric Oncological Register - and for oncological research was determined. The last register, incomplete, is from 2018.

Without this register it's not possible to characterise the incidence and epidemiology of the paediatric and youth oncological population; the illness's evolution and sequels; treatments; investigation and clinical trials. At issue is the definition of adequate public policies in this field and the quality of life of survivors.

Collaboration in the national awareness campaign on retinoblastoma is vital to bring about early diagnoses and minimise the impact of the illness and the treatments on the child/youth with cancer. This results in the tracking of the

red reflex by the paediatricians and general practitioners in all consultations for infants up to the age of 5 years.

Working in partnership with doctors and researchers, integrating the patient / carer in the clinical investigation. The integration of Acreditar as representative of the parents' associations on the board of ALLTogether represents the importance of inter-institutional involvement.

RESULTS

Human resources were allocated to ROPP; we reinforced the importance of early diagnosis for retinoblastoma e we started the participation of patients' associations in the investigation groups.

CONCLUSIONS

The partnership between institutions results in better, customized, and more innovative healthcare for the patient.

EP701 / #1930

E-Poster Viewing - Paediatrics AS04-14. Haematology, transfusion therapy & oncology

Iodine deficiency as a risk factor of malignant blood diseases in children

**O. Dorosh^{1,2,3,4*}, I. Tsymbalyuk-Voloshyn³, O. Vorobel³, A. Stepanyuk³,
O. Kozlova^{1,3}, K. Bodak³, L. Dubey¹, M. Troyanovsky⁵**

¹Danylo Halytsky Lviv National Medical University, Lviv, Ukraine, of Pediatrics and Neonatology Fpge, Danylo Halytsky Lviv National Medical University, Lviv, Ukraine, Lviv, Ukraine

²Western Ukrainian Specialized Pediatric Medical Centre; Danylo Halytsky Lviv National Medical University: Lviv, UA, Department of Hematology and Intensive Chemotherapy; Paediatrics and Neonatology Department of Fpge, Lviv, Ukraine

³Western Ukrainian Specialized Pediatric Medical Centre, Department of Hematology and Intensive Chemotherapy, Lviv, Ukraine

⁴Danylo Halytsky Lviv National Medical University, Lviv, Ukraine, Department of Pediatrics N2, Lviv, Ukraine

⁵Municipal Children's Clinical Hospital, Lviv, Pediatric Anesthesiologist, Department of Resuscitation and Intensive Care, Lviv, Ukraine

BACKGROUND AND AIM

The role of iodine as an anticarcinogenic agent is just beginning to be widely appreciated.

METHODS

The aim of our study is to identify a link between iodine deficiency and the development of hematological malignancies in children. We screened iodine status in 36 children with oncohematological diseases and 32 healthy. Children were tested for iodine in the urine, ultrasound of thyroid glands were done.

RESULTS

The group of patients aged 1.5 to 17 years. Acute lymphoblastic leukemia was diagnosed in 29 children, acute myeloblastic leukemia - 5, juvenile myelomonocytic leukemia - 1, Hodgkin's lymphoma - 1. The concentration of iodine in urine was reduced in 30 patients (83.3%), and normal in 16.7%. The group of healthy children aged 2 to 18 years. In 16 children (48.5%) normal levels of iodine in the urine were found, in 15 (45.5%) reduced, in 1 (3%) significantly reduced and in 2 (6%) elevated. The concentration of iodine in the urine of children with oncohematological diseases was significantly lower than in healthy ($p = 0.008$). The most common pathology (69.2%) detected during sonographic examination of thyroid gland in the group of children with blood malignancies were colloidal inclusions. Increased thyroid volume was found in 53.8% of patients and changed thyroid echostructure with the appearance of hypoechoic zones and the formation of nodules confirmed in 46.2%.

CONCLUSIONS

Iodine deficiency among children with oncohematological pathology is more common than in healthy children. An early marker of iodine deficiency is the appearance of colloidal inclusions in the tissue of thyroid gland.

EP702 / #1972

E-Poster Viewing - Paediatrics AS04-14. Haematology, transfusion therapy & oncology

Myofibroma, a rare benign TUMOR

A. Fraga^{1*}, S. Miranda², C. Sousa³, A. Maia³, Í. Maia³

¹Centro Hospitalar de Leiria, EPE, Department of Pediatrics, Leiria, Portugal

²Hospital de Braga, EPE, Department of Pediatrics, Braga, Portugal

³Instituto Português de Oncologia do Porto Francisco Gentil, EPE, Department of Pediatrics, Porto, Portugal

BACKGROUND AND AIM

Myofibroma is a rare benign mesenchymal neoplasm with few documented cases described. Despite being asymptomatic and usually manifesting as a solitary lesion, it has the potential to impact internal organs and bones (intraosseous myofibromas) through the body. The exact etiology is unknown, but a familial pattern of inheritance is suggested. Due to its characteristics, it can be misdiagnosed as other osteolytic, spindle-cell lesion since it can be misleading clinically and radiologically, depending on biopsy and immunohistochemistry for diagnosis. With this report, the authors aim to increase awareness to this diagnosis.

METHODS

Case report.

RESULTS

Patient M.S., six years-old, female, referred to an Oncology service due to a hard two centimeter right temporal tumefaction with evolution of five weeks, without pain or constitutional symptoms, with suspicion of Langerhans Cell Histiocytosis. An incisional biopsy was performed, and results showed

a myofibroma. Further evaluation was performed for other lesions, with no visceral or generalized involvement. The treatment consisted of excision of the tumor in the temporal squama by a neurosurgeon. It was decided to maintain vigilance for the risk of infantile myofibromatosis. The patient has two years of follow-up without signs of recurrence and a normal physical exam. She has no familial history of myofibroma.

CONCLUSIONS

Myofibroma is a rare benign soft tissue tumor with survival greater the 80%, but with an unpredictable behavior sometimes. As it can be a differential diagnosis to malignant lesions, it is important to know how to identify and treat a myofibroma, despite reports of spontaneous regression.

EP703 / #1974

E-Poster Viewing - Paediatrics AS04-14. Haematology, transfusion therapy & oncology

Fibrolamellar hepatocellular carcinoma – a five-year surveillance case report

A. Fraga^{1*}, S. Silva², F. Leite², A. Maia², Í. Maia²

¹*Centro Hospitalar de Leiria, EPE, Department of Pediatrics, Leiria, Portugal*

²*Instituto Português de Oncologia do Porto Francisco Gentil, EPE, Department of Pediatrics, Porto, Portugal*

BACKGROUND AND AIM

Fibrolamellar hepatocellular carcinoma (FL-HCC) is rare (incidence: 0.02/100 000 cases), with scarce literature, without a clear uniform approach to diagnosis and management, affecting adolescent and young adults without underlying liver diagnosis. Metastatic disease at diagnosis has a prognosis inferior to 10%-20% five-year overall survival. FL-HCC generally presents with an abdominal mass and signs of mass effect, rarely with paraneoplastic display. Cure is only achievable with complete surgical resection (exceptional); chemotherapy response rates are low (20%-30%). The authors aim to increase awareness to this diagnosis.

METHODS

Case report.

RESULTS

A 12-year-old male patient presenting with unexplained bilateral gynecomastia for five-months, which further investigation detected a bulky hypervascularized solid nodular formation in the right lobe of the liver, was referred to an

Oncology Center. A histological diagnosis of FL-HCC was made. Radiologically showed a globose liver of about 20 centimeters and regional lymph node metastases. He started chemotherapy (SIOPEL 4) and was submitted to an hepatectomy five months after with a post-surgery staging pTNM: T2 N1 IVL; AJCC: stage IVA. Fifteen-months after treatment, he had a relapse with pulmonary metastasis. He started second-line treatment with sorafenib, but one year later had progression of the hepatic lesions. A third-line was initiated with regorafenib. The patient has 5 years of follow-up, is autonomous, goes to school, and has only occasional abdominal pain.

CONCLUSIONS

FL-HCC are very rare, diagnosed often late, and require multidisciplinary care. Palliative care is also important and can improve quality of life in these patients.

EP704 / #1975

E-Poster Viewing - Paediatrics AS04-14. Haematology, transfusion therapy & oncology

When the kidney is a cannonball to the LUNGS

A. Fraga^{1*}, S. Silva², A. Maia², F. Leite², Í. Maia²

¹Centro Hospitalar de Leiria, EPE, Department of Pediatrics, Leiria, Portugal

²Instituto Português de Oncologia do Porto Francisco Gentil, EPE, Department of Pediatrics, Porto, Portugal

BACKGROUND AND AIM

Wilms' tumor is one of the most common malignant neoplasms in children, affecting 1 in 10.000 children, with 90% occurring before the age of seven. Management consists of nephrectomy, chemotherapy, and, if eligible, radiotherapy. The blastemal Wilms' tumor type is considered a high-risk pathological finding, requiring intensified chemotherapy, linked to an adverse outcome with aggressiveness and relative chemotherapy-resistance. The relapses with metastases occurred mainly on the first year after diagnosis, being the lungs the principal site for Wilms' tumor metastases. The recommended follow-up of Wilms' tumor are 5 years of surveillance and consists in chest and abdominal imaging.

METHODS

Case report.

RESULTS

A 6-year-old female presented blastemal-type Wilms tumor, stage II, high risk. She was submitted to a unilateral nephrectomy and chemotherapy with complete response. A year after end-of treatment a follow-up chest radiography showed bilateral lung metastasis in a cannonball pattern. The patient only

complaints at that time were anorexia and asthenia. She started second-line chemotherapy with partial response; so we changed to third-line chemotherapy (palliative) achieving a relative good control of the disease for one year. After this period she was submitted to pulmonary radiotherapy. Despite efforts, she passed away 22 months after relapse.

CONCLUSIONS

Recurrence of Wilms' tumor is associated with significant mortality, so, continuous follow-up care is key for detection of relapse and second malignancies. Cannonball lesions are classical metastatic lesions and clinicians must be aware of this occurrence. This report shows that even in this case, time with quality of life is possible.

EP705 / #1056

E-Poster Viewing - Paediatrics AS04-14. Haematology, transfusion therapy & oncology

Non-spherocytic haemolytic anaemia of unknown cause in a caucasian boy- a clinical report

S. Gamadia^{1*}, M. Aye²

¹University of Buckingham Medical School at Milton Keynes University Hospital, Department of Medicine, Milton Keynes, United Kingdom

²Milton Keynes University Hospital, Paediatrics, Milton Keynes, United Kingdom

BACKGROUND AND AIM

Hereditary Spherocytosis (HS) is a common cause of congenital haemolytic anaemia in Northern European descent populations. Conversely, G6PD Deficiency, another cause of haemolytic anaemia, occurs primarily in Mediterranean and African population groups. This case report aims to provide evidence of atypical causes of haemolytic anaemia, besides HS, in Caucasian population.

METHODS

A retrospective analysis of the patient's electronic records was performed.

RESULTS

A 13-months Caucasian male presented to paediatric assessment unit with acute-onset jaundice. Blood tests showed high bilirubin (119 μ mol/L), anaemia and reticulocytosis. Family history was unremarkable and negative for HS, however both the mother and maternal grandmother had cholecystectomies at age 21/23. Further haemolytic episodes required two blood transfusions. Persistently raised LDH and reticulocytes, indicated some low level of com-

compensated haemolysis. Direct Antiglobulin Test and red cell autoantibodies were negative. Haptoglobin was low. Ultrasound showed no splenomegaly. Although HS was suspected, MCHC was normal prior to transfusion. All haemolytic episodes succeeded infections. Pyruvate Kinase levels returned normal. Later, G6PD enzyme levels confirmed a deficiency (0.6 IU/g). Genetic testing revealed the patient's G6PD gene mutation, and the mother as a carrier. For his ongoing Cow's Milk Protein Intolerance, the patient was prescribed hydrolysed cow's milk, which his mother discovered, contained fava bean extract, thus being the cause of his ongoing haemolysis process.

CONCLUSIONS

While rare, G6PD Deficiency can certainly occur in Caucasian patients and should not be ruled out during initial investigations. Patients must be thoroughly screened for any possible precipitants, via a thorough history-taking and set of investigations.

EP706 / #1597

E-Poster Viewing - Paediatrics AS04-14. Haematology, transfusion therapy & oncology

A 3 year epidemiological retrospective study of hematological malignancies found in hospitalized children in a secondary hospital (central greece 2019-2022)

**I. Tassiou^{1,2}, M. Vroutsi¹, D. Grammenou^{1*}, V. Mouratoglou¹,
A. Anastasiou-Katsiardani¹**

¹General Hospital of Volos, "Achillopouleio", Pediatrics, volos, Greece

²General Hospital of Volos Achillopouleio, Pediatrics, Volos, Greece

BACKGROUND AND AIM

Background: Leukemia is the most common cancer in children and teens, accounting for almost 40% of cases of pediatric cancer which is the second cause of mortality among children older than 1 year of age in our country. Aims: The registration of all the patients with hematological malignancy and the importance of clinical and hematological characteristics the patients had during their diagnosis.

METHODS

We collected data from the electronic files of 7 patients admitted to the pediatric clinic during the above period.

RESULTS

The median age of the patients was 4 years. The most common complaint was fever and persistent fatigue-weakness (43%) followed by pain in the bones and abdominal pain (29%). During clinical examination the patients

had: petechiae and swollen lymph nodes (43%), paleness (29%), enlarged liver or spleen (29%) and recurrent bleeding from the gums (14%). The blood tests revealed pancytopenia in 3 patients, anemia, thrombocytopenia neutropenia with normal WBCs in 2 patients, while 1 patient had severe leucopenia and thrombocytopenia. Only 1 child had normal findings from blood tests but due to recurrent septicemias the blood smear was examined and blasts were found. In 5/7 patients the blood smear had blasts. The biochemical parameters had a mean C-reacted protein of 75mg/dl and LDH 1730U/L. The imaging studies had no specific findings.

CONCLUSIONS

Conclusion

The paraclinical examinations are major contributors to the diagnosis of hematological malignancies. The clinician should always be alerted if the patient has suspicious signs and symptoms.

EP707 / #584

E-Poster Viewing - Paediatrics AS04-14. Haematology, transfusion therapy & oncology

Improving blood transfusion prescribing and reducing blood transfusion risks in paediatric oncology patients

L. Harrison*

Oxford University Hospitals, Department of Paediatrics, Oxford, United Kingdom

BACKGROUND AND AIM

Blood transfusions are common amongst paediatric oncology patients, due to disruption of erythropoiesis caused by the disease or treatment. Red cells are the most commonly prescribed blood product. Evidence for paediatric transfusion practices is limited. However, the risks are well-known and can be life-threatening. The aim of this study was to assess the accuracy of the prescription of red cell transfusions and to reduce transfusion-associated risk in paediatric oncology patients.

METHODS

All paediatric oncology patients at a tertiary centre, prescribed a red cell transfusion between 01/09/2021 and 31/12/2021, were included. Their medical records were retrospectively reviewed to ascertain their pre-transfusion haemoglobin, the dose of red cells prescribed and any documented reason for the transfusion.

RESULTS

65 red cell transfusions were included. 63 (96.92%) had a documented pre-transfusion haemoglobin of $<80\text{g/L}$, consistent with the guidelines. 51 transfusions (78.46%) had the correct dose of red cells prescribed. 39 transfusions (60.00%) had a reason for the transfusion documented.

CONCLUSIONS

There was poor adherence to the guidelines for prescription and documentation. Recommendations included reviewing the guidelines to ensure clarity of the requirements for prescribing. This should include an upper weight limit for prescribing doses in millilitres, above which units should be prescribed, to avoid prescribing more than a standard adult unit. Only 1 unit should be prescribed at a time unless a specific reason is stated (e.g. major haemorrhage). Education of prescribers would then ensure they are aware of the requirements for prescribing and documentation.

EP708 / #1105

E-Poster Viewing - Paediatrics AS04-14. Haematology, transfusion therapy & oncology

Resolution of high risk classification of infantile hemangioma in a newborn child; will close observation play a part in treating these infantile hemangiomas?

Z. Hejji*, M. Hassan

SIDRA medicine, Pediatric, Doha, Qatar

BACKGROUND AND AIM

A 17 months old male boy with right axillary skin lesion initially thought to be congenital nevi. Thereafter, skin lesion was diagnosed as extensive infantile hemangioma. Parents refused treatments at every stage even with extensive ulcerations. This implies that we are still not completely familiar with the categories of infantile hemangioma and how they progress, which make us question the previous cases that could have complete resolution of the hemangioma without using intervention such as propranolol and putting patient at risk of their complications.

METHODS

17 months old boy with right axillary skin lesion found to have high risk infantile hemangioma. Treatment plan of propranolol was refused by parents at every stage. Infantile hemangioma work up including ultrasound head and abdomen at birth, MRI, EKG and Echo were all unremarkable and no signs of internal organ hemangiomas were found.



FIGURE 1:



FIGURE 2:

RESULTS

Overtime, lesions were larger in size and extensive ulcerations were seen, parents refused treatment again. Fortunately, significant regressing were noted. In addition, as a high risk hemangioma, he was a at risk of kasabach-Merritt syndrome, however his blood work up at several occasions were unremarkable and showed no evidence of thrombocytopenia or DIC picture.

CONCLUSIONS

Infantile hemangioma are well known clinical course with limited information regarding the treatment and types. As per hemangioma classification, this patient was under high risk criteria, and usually watchful waiting is not recommended, however, patient showed significant improvement with no interventions.

EP709 / #2603

E-Poster Viewing - Paediatrics AS04-14. Haematology, transfusion therapy & oncology

The indications and use of coagulation screening and clotting tests in paediatric patients

Y. Jeong^{1*}, S. Shahid¹, B. Ribeiro¹, M. Borumand¹, M. Aye²

¹Milton Keynes University Hospital, The University of Buckingham, Milton Keynes, United Kingdom

²Milton Keynes University Hospital, Paediatrics, Milton Keynes, United Kingdom

BACKGROUND AND AIM

The haemostatic system in paediatric patients is different from adults, therefore clotting tests and coagulation screening are not routinely carried out unless directly indicated such as with suspected malignancies or inherited clotting disorders. The tests cause a significant emotional burden on patients and their parents, and a financial strain on the NHS. This study assessed the number and indications of clotting tests and coagulation screens requested in Milton Keynes University Hospital (MKUH).

METHODS

This is a single-centre retrospective study. 114 patients between 2 months to 16 years who had clotting tests requested between January 2022 and April 2022 were enrolled. The indications, number of times the sample was requested, the number of samples requested, the number of patients who had the test once, and the number of samples deemed inadequate were recorded.

RESULTS

Among 114 patients, 207 sample requests were made. 72 patients (63%) had the test once, 43 patients (38%) had multiple sample requests, 59 patients (52%) had at least one sample rejected or deemed inadequate by the laboratory. However, only 62% of patients were found to have a definite indication for clotting tests, with the remaining 38% of patients having insufficient evidence of requiring these samples to be taken.

CONCLUSIONS

The results showed a significant number of requests are made for paediatric patient populations without sufficient indications. The guidelines for requesting samples should be reinforced in MKUH and discussed in multidisciplinary team meetings. A re-audit is due to assess the impact of this study's findings.

EP710 / #2189

E-Poster Viewing - Paediatrics AS04-14. Haematology, transfusion therapy & oncology

A case report of neonatal lymphoblastic leukemia revealed by a macrophage activation syndrome

T. Lamouchi^{1,2*}, M. Ben Khaled²

¹Centre National de Greffe de Moelle Osseuse de Tunis, Pédiatrie, Tunis, Tunisia

²Centre National de Greffe de Moelle Osseuse de Tunis, Pédiatrie, Tunis, Tunisia

BACKGROUND AND AIM

Neonatal leukaemia is a rare entity. It's usually revealed by hepatomegaly, splenomegaly and skin lesions (leukaemia cutis) with hyperleucocytosis, anaemia and thrombocytopenia. Macrophage activation syndrome (MAS) is also a rare entity and it could be challenging diagnosis in infants, once underlying infections are ruled out.

METHODS

Herein we report an unusual case of MAS caused by acute lymphoblastic leukemia in a two months old infant.

RESULTS

The patient was a two months boy when he had his first symptoms. He first presented fever, cutaneous pustules and ulcerations, cholestasis, jaundice and hepatomegaly. He was diagnosed with MAS in the presence of the following criteria: prolonged fever despite antibiotics, cytopenias, elevated blood triglyceride levels, low fibrinogen levels, elevated ferritin blood levels, erythrophagocytosis on bone marrow, elevated lymphocyte CD8+ DR+ count. He had rare lymphoblast in the cerebrospinal fluid. The clinical and

biological findings pleaded for severe MAS and the patient received antibiotics and corticosteroids initially and Etoposide within 48 hours. All infections were ruled out. Bone marrow aspirates cytology first showed: poor cellularity and erythrophagocytosis compatible with MAS. Later, immunophenotyping by flow cytometry allowed diagnosis of T-ALL type III/IV. The absence of blast cells on the bone marrow samples could have been explained either by the MAS or the existence of bone marrow fibrosis. The infant was then switched on T-ALL specific treatment. Sadly, his response to the treatment was poor.

CONCLUSIONS

MAS could be a diagnostic challenge in infants. The underlying condition should be vigorously looked up before concluding to a primary haemophagocytic lymphohistiocytosis.

EP711 / #2447**E-Poster Viewing - Paediatrics AS04-14.
Haematology, transfusion therapy & oncology****Risk factors for developing central-lines associated infections in infants receiving chemotherapy for acute leukemia and bone marrow transplant****T. Lamouchi*, M. Ben Khaled**

Centre National de Greffe de Moelle Osseuse de Tunis, Pédiatrie, Tunis, Tunisia

BACKGROUND AND AIM

Central lines are inevitable in children receiving chemotherapy. Central line associated blood stream infection (CLABSI) is the most common complication with important morbidity. In this study, we investigated the different infections associated to central lines in children aged less than two years and who were admitted for chemotherapy for acute leukemia.

METHODS

It's a descriptive, cross sectional and monocentric study conducted from January 2016 to October 2021. We included all patients aged two years and less who were hospitalized for chemotherapy acute leukemia or bone marrowtransplant and who have had at least one central-line catheter.

RESULTS

The study included 55 infants who had 100 central venous catheter (CVC) for a total of 6886 catheter days. The overall complications incidence was 6.9/1000 catheter days and CLABSI was the most frequent with an incidence

of 5.3/1000 catheter days. Antibiotic-lock therapy has prevented the CVC removal in 38% of patients with CLABSI. The analyzed risk factors were: age<12months, leukemia type, catheter type, parenteral nutrition, gut colonization by resistant bacteria, prior prescription of broad-spectrum antibiotics... In multivariate analysis, severe neutropenia and femoral CVCs were related to a higher incidence of CLABSI. Tunnelled CVCs were associated to a lower rate of CLABSI compared to femoral and ports ($p=0.007$). Femoral CVCs and chemotherapy prior to haematopoietic stem cell transplant were significantly associated to the occurrence of septic shock ($p=0.008$ and $p=0.04$ respectively).

CONCLUSIONS

CVCs are highly associated to infections in infants receiving chemotherapy. Prevention of CLABSI is elementary especially with the emergence of resistant bacteria in these patients.

EP712 / #2455

E-Poster Viewing - Paediatrics AS04-14. Haematology, transfusion therapy & oncology

Hematopoietic stem cell transplantation in omenn syndrome

**M. Ouederni^{1,2}, M. Said³, S. Rekaya³, I. Ben Fraj³, T. Lamouchi^{3*},
Y. Chebbi⁴, S. Frigui^{1,4}, A. Wafa^{2,4}, F. Mellouli¹, M. Ben Khaled¹**

¹Bone Marrow Transplant Center, Pediatrics, TUNIS, Tunisia

²University Tunis ElManar, Faculty of Medicine, Tunis, Tunisia

³Centre National De Greffe De Moelle Osseuse, Pediatrics, Tunis, Tunisia

⁴Bone Marrow Transplant Center, Laboratory of Microbiology, Tunis, Tunisia

BACKGROUND AND AIM

Omenn syndrome (OS) is a rare autosomal recessive disorder characterized by severe combined immunodeficiency. In the absence of hematopoietic stem cell transplantation (HSCT), OS remains a fatal disorder due to increased susceptibility to infections. We report our experience of HSCT in six patients with OS

METHODS

Six children underwent allo-HSCT for OS using myeloablative conditioning regimen (n=3) and reduced toxicity conditioning regimen (n=3). All patients fulfilled clinical criteria of OS.

RESULTS

The mean age at diagnosis was 3.2 months(1-11 months). All of the cases were born to consanguineous parents and had a family history of immune deficiency. Infection was documented in all the patients at diagnosis. Pretransplant manifestations included BCGitis (n=2), pneumonia (n=4), CMV (n=1), failure to

thrive (n=4), ichthyosiform erythroderma (n=4), and infiltration of lymphoid tissues (n=4), hypereosinophilia and/or raised IgE level (n=6) and T and B cell lymphopenia (n=6). The mean age at transplantation was 13 months (3 to 44 months). Only one child was transplanted from a mismatched-related donor. Engraftment was recorded in all cases. Post HSCT complications included grade IV acute GVHD (n=1), Chronic GVHD (n=2) and CMV infection (n=3). Three children died, one with acute CMV pneumonia, one with extensive GVHD, and one with the veno-occlusive disease. Three patients had good engraftment and are alive respectively two, five, and seven years after HSCT.

CONCLUSIONS

OS is a combined immunodeficiency with heterogeneous clinical and immunological phenotype. Evolution is usually fatal outside the HSCT. Despite HSCT from matched related donors, survival was 50%. Early diagnosis and prompt HSCT could improve prognosis.

EP713 / #2610

E-Poster Viewing - Paediatrics AS04-14. Haematology, transfusion therapy & oncology

Megaloblastic anemia and hypogammaglobulinemia in a vegan child. The importance of well-planned DIET

M. Mascaró Ginard*, M. Torrent Español, M. Freixas Bermejo, J. Thió Casals, B. Suriñach Ayats, X. González Rioja, J. Serralabós-Ferré, E. Martínez-Ferrer, M.T. Moina Anguera De Sojo, S. Boronat-Guerrero

Hospital de la Santa Creu i Sant Pau, Pediatrics, Barcelona, Spain

BACKGROUND AND AIM

Megaloblastic anemia due to vitamin B12 deficiency is rare in childhood. Its main etiology is maternal vitamin B12 deficiency in exclusively breast-fed newborns or plant-based diets with inappropriate B12 supplementation. Moreover, malnutrition can affect the humoral immune system mimicking in some cases primary immunodeficiency. Diagnosing these diseases assumes great clinical importance since they respond well to treatment.

METHODS

Case report

RESULTS

We report a twelve-month-old patient who consulted for lower extremity edema and arrest in growth. The infant was following a vegan diet (as well as her mother) and was breastfed since birth, without any kind of supplementation. Laboratory evaluation revealed macrocytic anemia, hypoalbuminemia,

minemia and hypogammaglobulinemia at expense of IgG. Vitamin B12 levels were found to be very low. Upon confirmation of megaloblastic anemia and protein deficiency, vitamin B12 supplementation, seroalbumin intravenous and nutritional supplements were started. This resulted in good reticulocyte response, increase of hemoglobin values, normalization of albumin levels with the disappearance of edemas and improvement of antibody deficiency.

CONCLUSIONS

Vitamin B12 deficiency can cause irreversible neurological damage. For that reason it is important to recognize situations where cobalamin deficiency can be present, such as vegan diets without correct supplementation. Also, a poorly planned diet can lead to a state of malnutrition leading to a secondary immunodeficiency. Once the diagnosis has been done, early supplementation can correct the deficits and thus improve the prognosis. This case emphasizes the need for assuring maternal balanced diet during pregnancy and after birth, as well as the importance of a well-planned diet in childhood.

EP714 / #1183

E-Poster Viewing - Paediatrics AS04-14. Haematology, transfusion therapy & oncology

Deep cervical infantile hemangioma: a dilemma approach

S. Nogueira Machado^{1*}, B. De Sousa¹, C. Gomes Pereira¹, M. Do Bom-Sucesso^{2,3,4,5}, M. Santalha¹

¹Hospital Senhora da Oliveira, Pediatrics Department, Guimarães, Portugal

²Centro Hospitalar Universitário São João (CHUSJ), Pediatric Oncology Department, Porto, Portugal

³Centro Hospitalar Universitário São João (CHUSJ), Anovasc - Interdisciplinary Vascular Anomalies Team, Porto, Portugal

⁴Centro Hospitalar Universitário São João (CHUSJ), Paedcan European Reference Network For Pediatric Oncology, Porto, Portugal

⁵Centro Hospitalar Universitário São João (CHUSJ), Vascern Vasca European Reference Network For Rare Multisystemic Vascular Anomalies, Porto, Portugal

BACKGROUND AND AIM

Infantile hemangiomas (IH) are the most common benign vascular tumors in childhood. Although most cases can be clinically diagnosed, deep lesions can pose diagnostic dilemmas and warrant further investigation.

METHODS

Not applicable

RESULTS

A healthy 3-month-old girl was presented by her parents to the outpatient clinic for a routine consultation. A 4x2cm compressible and non-tender left posterior cervical mass was identified on examination. There was no skin color change or limitation of neck mobility. Physical examination was oth-

erwise unremarkable, except for an infracentimetric cutaneous IH on the scalp. Parents reported that such swelling was not present at the time of birth. Doppler's ultrasound revealed a 4,5x1,9x3,2cm heterogeneous, poorly delimited, highly vascularized mass in the posterior cervical soft tissue. MRI later confirmed the ultrasound findings, revealing a profound larger mass (5,1x4,7x5,5cm) in strict contact with the airway and carotid sheath, determining right deviation of the airway without compromising its caliber. The child was referred to a Vascular Anomaly Multidisciplinary Team and, given the most likely diagnosis of deep subcutaneous IH and the patient's clinical stability, an active non-intervention approach was chosen. Currently, at 7 months, the mass has softened and the child remains stable without treatment.

CONCLUSIONS

A typical clinical history and physical examination are usually sufficient to diagnose an IH. However, deep lesions without overlying skin changes often warrant additional studies to exclude other vascular anomalies or neoplastic lesions and define the best treatment approach. For most IH an expectant observation, rather than a pharmacological/surgical intervention, is recommended, since most regress spontaneously without complications.

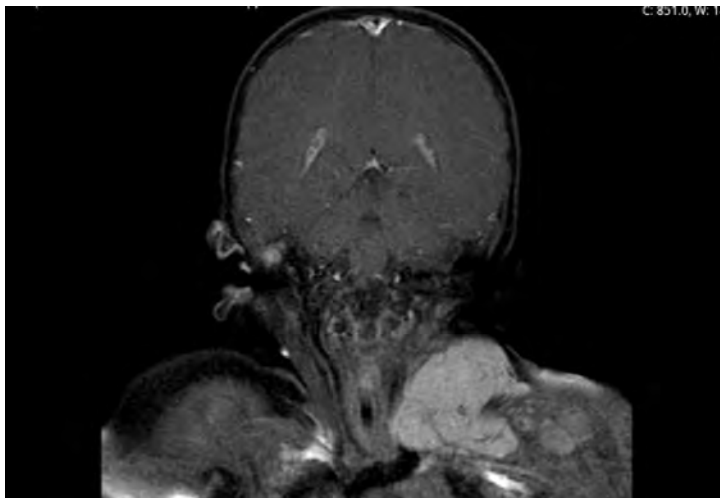

FIGURE 1:

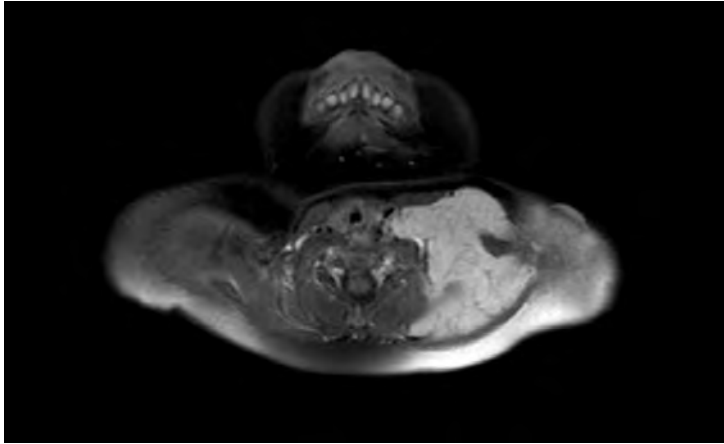

FIGURE 2:

EP715 / #1893**E-Poster Viewing - Paediatrics AS04-14.
Haematology, transfusion therapy & oncology****The impact of health insurance coverage and outcomes among patients diagnosed with burkitt lymphoma in western KENYA****L. Oyuke***

Ampath Oncology Institute, Hemato-oncology, Eldoret, Kenya

BACKGROUND AND AIM

Burkitt lymphoma is a highly aggressive malignancy of mature B-cell non-Hodgkin lymphoma. The outcome of sporadic Burkitt's lymphoma in high-income countries is considered excellent due to long-term survival rates of up to 90% mainly due to prompt diagnosis and treatment. On the contrary, lack of health insurance e.g NHIF in Kenya, Health system delays, late patient referrals and financial constraints lead to late presentation and advanced disease with survival rates of about 30-40 percent. The abstract highlights health insurance importance and establishes a comparison between patient outcomes among patients with NHIF and patients without NHIF.

METHODS

The target population consisted of 131 patients enrolled in the lymphoma program at the Chandaria Cancer Center and Chronic Diseases (CCCDC). The ages of the patients ranged from 0-14 years of age. Comparisons derived on presentation of disease at diagnosis and survival rates among patients with National Hospital Insurance Fund (NHIF) and those without NHIF.

RESULTS

Uninsured patients presented with more advanced disease than insured patients did. Insured patients had better diagnostic opportunities than uninsured. Survival rates were at 1.9:1 for insured patients' verses the uninsured respectively.

CONCLUSIONS

Adverse outcomes of Burkitt lymphoma(BL) patients without health Insurance suggest that health insurance improves access to screening, diagnosis, standard treatment and care. NHIF (National Health Insurance Fund) is the primary provider of healthcare insurance in the country.NHIF enables most Kenyans access to quality, sustainable and affordable health care which contribute to realizing the Universal Health Coverage goal by hastening diagnosis and improving survival rates of lymphoma patients.

EP716 / #1347**E-Poster Viewing - Paediatrics AS04-14.
Haematology, transfusion therapy & oncology****The risk factors for tumor lysis syndrome in
childhood leukemia: a singer-center study from
southern thailand****P. Prasertsan*, T. Chotsampancharoen**

Faculty of Medicine, Prince of Songkla University, Pediatrics, Hatyai, Thailand

BACKGROUND AND AIM

Background: Tumor lysis syndrome (TLS) is a potentially life-threatening condition occurs following intensive chemotherapy in newly diagnosed hematologic malignancy in children. Predictive risk factors of TLS development in children are still heterogenous. Objective: To define the pre-chemotherapy risk factors for TLS development in childhood leukemia in a single tertiary center in Thailand.

METHODS

Method

Children aged less than 15 years old with newly diagnosed acute leukemia and received the first induction chemotherapy at Songklanagarind Hospital during January 2009 to December 2019 were reviewed retrospectively.

RESULTS

51 of 252 patients (20.2%) developed TLS during induction chemotherapy; 60.7% (31/51) were spontaneous TLS and 47% (24/51) developed clinical TLS. Median age at diagnosis was 58 months (interquartile range (IQR) 31, 105.25), 62.7% were male and 73% were diagnosed as acute lymphoblastic

leukemia. After multivariable analysis was performed, factors significantly associated with TLS were peripheral blast cell (adjusted odds ratio (aOR): 1.01, 95%CI:1.00-1.02), serum creatinine level (aOR: 28.9, 95%CI: 5.65-147.9), transaminitis (aOR:4.80, 95%CI: 2.29-10.06), and hepatomegaly (aOR: 7.67, 95%CI: 0.87-67.7). Mortality in the first admission in patients with and without TLS were 21.6% vs. 8.5%, respectively (P = 0.016).

CONCLUSIONS

Conclusion

The tumor lysis syndrome caused significant deaths in childhood leukemia. Identify high risk patient before chemotherapy initiation could improve the outcomes.

EP717 / #1530**E-Poster Viewing - Paediatrics AS04-14.
Haematology, transfusion therapy & oncology****Assessment of knowledge and drug adherence of oral chemotherapy for acute lymphoblastic leukemia****C. Rhaymi^{1*}, A. Chaibi²**¹Children's Hospital of Rabat, Clinical Pharmacy, rabat, Morocco²faculty of medicine and pharmacy of rabat, Clinical Pharmacy, rabat, Morocco**BACKGROUND AND AIM**

Acute lymphoblastic leukemia (ALL) is the most common type of cancer in children and its treatment is based on oral Mercaptopurine(6-MP). Its effectiveness is conditioned by good compliance. The objective is to evaluate the knowledge and adherence of children treated with oral mercaptopurine (6-MP) for Acute lymphoblastic leukemia

METHODS

This is a prospective study carried out over a period of 2 months in the pediatric hemato-oncological center of the hospital. All patients who were on mercaptopurine treatment at home were included. An evaluation questionnaire was used, he appreciates the knowledge, the know-how and the soft skills. The Morisky compliance questionnaire (8 questions) was used to assess medication adherence.

RESULTS

40 patients answered the questionnaire. The average age is 8.4 years. The interviews lasted an average of 10 minutes. 98% of our patients had a compli-

ance problem (60%: low compliance and 38%: average compliance).48% of parents did not wash their hands before and after handling mercaptopurine tablets.90% of the patients took their treatment in the evening but none of them respected the schedule or the interval between taking the tablets and meals. 65% of patients forgot to take the treatment at least once. Finally, there is a link between knowledge and compliance with treatments

CONCLUSIONS

Medication adherence is an important parameter in the management of chronic pathologies. Regular reminders on how to take it are necessary to optimize the effectiveness of the treatment and the safety of its administration.

EP718 / #2316**E-Poster Viewing - Paediatrics AS04-14.
Haematology, transfusion therapy & oncology****Abnormal gait in a child: a clue for a systemic disease****S.C. Teixeira^{1*}, J. Azevedo², J. Carvalho¹**¹*Centro Hospitalar de Trás-os-Montes e Alto Douro, Paediatrics Department, Vila Real, Portugal*²*Centro Hospitalar e Universitário de Coimbra, Clinical Haematology Department, Coimbra, Portugal***BACKGROUND AND AIM**

Shwachman-Diamond Syndrome (SDS) is a rare autosomal recessive disorder, characterized by exocrine pancreatic dysfunction, cytopenias (particularly neutropenia), and in some cases skeletal abnormalities. Clinical manifestations usually present in the first year of life.

METHODS

Case presentation

RESULTS

A three year-old Caucasian girl was observed in a routine checkup. She was the first child of unrelated parents and there was no relevant family history. Weight evolution in P15-50, height in P3-15, descending to <P3 at two years and eight months. There was no history of steatorrhea or recurrent infections. Physical exam was unremarkable except for a positive Galleazi Test, with a left hip abduction limitation, and a slight external rotation of the left feet during gait. A hip x-ray was requested and metaphyseal dysplasia was suspected. Her blood work revealed a raised alanine aminotransferase (67 U/L; N <39 U/L) and aspartate aminotransferase (66 U/L; N <36 U/L), and a low neutro-

phil count ($0.78 \times 10^3 / \mu\text{L}$; N: $1.5-8.5 \times 10^3 / \mu\text{L}$). Based on this findings SDS was suspected and a faecal elastase level and genotyping was requested. Faecal elastase level was very low ($< 15 \text{ ug/g}$; N: $>200 \text{ ug/g}$) and she was found to have pathogenic biallelic variants (c.183_184delTAinsCT; p.Lys62Ter and c.258+2T>C) in SBDS gene, confirming the diagnose of SDS with pancreatic insufficiency. Sweat test is pending. She was referred to a tertiary center for follow-up and management of the disease.

CONCLUSIONS

Orthopedic exam should always be undertaken in routine checkups independent of the child age, as it may offer important information for detection systemic conditions.

EP719 / #2128**E-Poster Viewing - Paediatrics AS04-14.
Haematology, transfusion therapy & oncology****Problems in the diagnosis of hemophagocytic
lymphohistiocytosis in kazakhstan****D. Yeginbergenova^{1*}, A. Zhailaubayeva¹, L. Manzhuova²**¹Scientific Centre of pediatric and Children's Surgery, Oncology/hematology #4, Almaty, Kazakhstan²Scientific Centre of Pediatric and Children's Surgery, Administration, Almaty, Kazakhstan**BACKGROUND AND AIM**

To voice problems in the diagnosis of HLH and suggest solutions.

METHODS

The object of the study was children with an established HLH from 2016 to 2019. A retro- and prospective study of 4 clinical cases was conducted.

RESULTS

Over the past 7 years, 4 cases of HLH have been identified in 3 boys (patient No1, No2, No3) and 1 girl (patient No4). In the family history of patient No1, the first child died of acute leukemia. Genetic analysis was not carried out due to the unavailability of the study at that time, but the diagnosis was not in doubt according to clinical and laboratory data. A genetic study was conducted in patient No2, no mutations were detected. The SH2D1A gene was detected in patient No3, which indicates a genetic diagnosis of X-linked lymphoproliferative syndrome type 1. The family history of patient No4 is burdened by the kinship marriage of the parents. Mutation in the RAB27A gene was detected in both of parents, which leads to the development of type 2

Griscelli syndrome, a characteristic feature of which is HLH. The duration of the diagnostic period averaged 1.5 months.

CONCLUSIONS

None of the patients had suspicions of HLH at the level of regional hospitals, which indicates low alertness of doctors.

Molecular genetic verification of the diagnosis is an important criterion influencing the tactics of therapy. The patients' genetics were performed at a later date, which led to a loss of time. Thus, it is necessary to adjust this stage of diagnosis.

EP720 / #2582**E-Poster Viewing - Paediatrics AS04-15. Infectious diseases****Development of zinc deficiency in children with a course of community-acquired pneumonia****T. Abdul-Rahman*, A.A. Wireko, V. Horbas**

Sumy State University, Medical Institute, SUmy, Ukraine

BACKGROUND AND AIM

Health represents an unconditional value for every child. However, improper nutrition, lack of sleep and unfavorable environmental situation reduces the quality of life contributing to increase in the number of diseases. Zinc (Zn) is the main trace element that regulates activity of the immune system. It also affects the body's resistance, reproduction processes and death of microorganisms, especially during inflammation. The aim is to study the relationship between trace element of Zn content in blood serum and indicators of immune status in children with pneumonia.

METHODS

Blood content among 55 children diagnosed with community-acquired pneumonia in Sumy Children's Clinical Hospital were analyzed.

RESULTS

Indicators of Zn level in children with pneumonia, regardless of age and severity of the disease, were reduced in both acute and convalescence periods of the disease. Correlative analysis showed that the level of Zn in blood serum during the acute period in children with pneumonia had a negative average correlation with the level of blood leukocytes ($r = -0.442$, $p < 0.05$), and

average positive relationship with the number of lymphocytes in peripheral blood ($r=0.452$, $p<0.05$). The levels of leukocytes and lymphocytes had a clear dependence on severity of the course of the disease. Higher levels of leukocytosis corresponded to a significant decrease in the absolute number of lymphocytes and increased severity of condition of the children.

CONCLUSIONS

The impact of impaired Zn metabolism in the body during pneumonia on development of the body's immune response after antigenic stimulation is of significant importance, which is manifested by significant disintegrating changes in immune homeostasis.

EP721 / #2450**E-Poster Viewing - Paediatrics AS04-15. Infectious diseases****Prevalence of *s. Aureus* infection in a chilean pediatric hospital and associated factors, including social determinants****M. Acuña^{1*}, D. Benadof², K. Yohannessen³, Y. Leiva⁴**¹*Hospital de Niños Roberto del Río, Infectious Diseases, Santiago, Chile*²*Hospital de Niños Roberto del Río, Laboratory, Santiago, Chile*³*Universidad de Chile, Escuela De Salud Pública, Santiago, Chile*⁴*Hospital de Niños Roberto del Río, Infection Diseases, Santiago, Chile***BACKGROUND AND AIM**

Staphylococcus aureus is a widespread bacterium among people. The resistance to methicillin (MRSA), which became a problem mainly in hospital environments. Its prevalence in pediatrics is variable in different countries, and in our country there are no studies that describe it, nor the frequency of resistant *S. aureus* methicillin in the community. Objectives: to describe the clinical presentation of *S. aureus* infections in pediatric population, determine their susceptibility to methicillin and associated factors.

METHODS

A descriptive, retrospective study that included episodes of *S. aureus* infections between 2016 and 2019 in pediatric patients seen in Roberto del Río Children's Hospital, Chile. Inclusion criteria: <18 years of age, isolates were obtained from blood samples or sterile fluids or tissue obtained in surgery, isolates obtained from secretions of patients with clinical infections. Laboratory: The identification of *S. aureus* was done with traditional biochemical methods or mass spectrometry. The susceptibility was made by diffusion with Kirby

Bauer disks or MIC by automated method. We will work with descriptive statistics, percentages, and rates, in the Excel program.

RESULTS

On study period were included 895 *S. aureus* infection episodes in 895 children from newborn to 17 years old. 798 (89%) were MSSA, 664 (74%) Chilean. 651 (73%) were treated ambulatory. 245 (27%) of children had at less one foreign parent. Factor related with MRSA infection in children was foreign parent with OR 2,43. No related with outpatients or inpatients.

CONCLUSIONS

S. aureus infections are frequent and MRSA infections were associated to a social determinants, than pediatricians we must know.

EP722 / #2300

E-Poster Viewing - Paediatrics AS04-15. Infectious diseases

Antimicrobial stewardship: is there a role for patients and their carers in a children's hospital

D. Akpeki^{1*}, L. Howlett¹, J. Harbet¹, S. Todd², I. Okike³

¹University of Nottingham, Medicine, RD, United Kingdom

²University Hospitals of Derby and Burton, Patient Experience, NE, United Kingdom

³University Hospitals of Derby and Burton (Derbyshire Children's Hospital), Paediatrics, Derby, United Kingdom

BACKGROUND AND AIM

Antimicrobial stewardship (AMS) is a process used by healthcare professionals to safeguard antibiotics. Parents/carers and young patients generally do not contribute to the process. We embarked on a survey to establish how parents receive AMS related information in an in-patient setting. Additionally, we wanted to ascertain whether parents would accept to contribute to AMS process through focused questions to healthcare professionals.

METHODS

An anonymised online questionnaire developed in collaboration with the patient experience team of the hospital was administered to parents and young patients admitted into a busy children's hospital between 1/11/2021 and 6/4/2022. Ethics approval was not required.

RESULTS

of the 102 parents/carers who completed the survey, 73 (72%) reported that their child was on antibiotics. 56/80(70%) reported that they were informed of the type of infection their child is being treated for. 81% were aware of

tests done prior to starting antibiotics whilst only 62% had received the results of the tests. 32% reported that side effects of antibiotics was discussed with them. 77% felt that they had enough information whilst 76% felt that they were involved in the decision making. 84-89% agreed to five questions we proposed for parents to ask healthcare workers to facilitate AMS and include them in the process.

CONCLUSIONS

There are gaps in the information we give parents as part of AMS. It is possible to engage and empower parents in the process through the questions we have identified. We plan to pilot these questions to determine whether they encourage AMS discussions with parents and young patients.

EP723 / #1772

E-Poster Viewing - Paediatrics AS04-15. Infectious diseases

Children exposed and not infected with hiv in the wilaya of tlemcen: evolutionary aspects

Y. Badla*

Centre Hospitalouniversitaire Tidjani Demerdji, Infectiology, Tlemcen, Algeria

BACKGROUND AND AIM

Introduction: la prévention de la transmission du VIH de la mère à l'enfant s'accompagne de l'émergence d'une population croissante de nourrissons non infectés nés connus sous le nom de nourrissons non infectés exposés au VIH (CHEU) Notre objectif était de décrire l'aspect évolutif de cette population

METHODS

Matériels et méthodes Il s'agit d'une étude prospective descriptive portant sur des enfants exposés non infectés issus de mères séropositives, suivis au service des maladies infectieuses de Tlemcen sur une période comprise entre 2017 et 2022.

RESULTS

Résultats 30 enfants ont été inclus dans l'étude L'âge moyen est de 24 mois +/- 3 mois Le sexe ratio est de 0,57 (11/19), 20% sont nés par césarienne, le poids de naissance était supérieur à 2Kg 500 dans 80% des cas Une chimioprophylaxie a été prescrite dans 100% des cas Tous nos enfants ont fourni un PCR à la naissance Nous avons noté une mortalité de 13,3% Trois décès précoces à l'âge d'un mois: Syndrome de Prune Belly, détresse respiratoire, syndrome de malformation digestif, et un décès tardif à l'âge de 02 ans

pour fièvre inexpliquée On a noté 35% de manifestations hématologiques réversibles

CONCLUSIONS

Conclusion

le praticien doit rester vigilant dans le suivi de ces enfants exposés non infectés par le VIH

EP724 / #2240**E-Poster Viewing - Paediatrics AS04-15. Infectious diseases****2 1/2-month-old male with cough, coryza and inability to extend the right lower limb-an unusual, but important to diagnose condition**

A. Barmpakou*, G. Kolovakis, S.-Z. Siska, K. Kakleas, A. Santou, I. Orfanou

Aghia Sophia Children's Hospital, First Department of Pediatrics, athens, Greece

BACKGROUND AND AIM

Septic arthritis though presents infrequently in infancy, still can be challenging in terms of diagnosis and treatment.

METHODS

A 2 1/2 month-old boy was admitted with inability to extend the right lower limb. Symptoms presented five hours prior to the emergency department attendance. He had cough and coryza for a week and low grade fever (maximum temperature of 37.7°C) five days prior to the presentation. He had normal hip radiograph, but the ultrasound of right hip revealed fluid in the joint.

RESULTS

On admission, the patient was clinically well, with right hip being on flexion, abduction, external rotation, with decreased range of movements and tender on handling. The inflammatory markers were not raised (WBC: 16,470/ μ L, CRP: 13mg/L, ESR: 18). He was started on intravenous cefotaxime and clindamycin. On day four of admission, a repeat ultrasound and an arthro-

centesis were performed. The blood culture revealed methicillin-sensitive *Staphylococcus aureus* (MSSA) and antibiotic therapy was switched to cloxacillin. The synovial fluid microscopy showed raised white cell count with neutrophilia, but there was no bacterial growth. The patient completed 14 days of intravenous antibiotic therapy and during the admission remained clinically very well, afebrile, with progressive improvement of the range of motion of right lower limb. He was discharged with oral co-amoxiclav in order to complete 6 weeks of antibiotic treatment in total. Orthopedic team has reviewed the patient two weeks post-discharge and during the clinical examination the right hip had full range of motion.

CONCLUSIONS

The prompt diagnosis and appropriate management of septic arthritis is of outmost importance, as it can prevent significant complications of the joint involved.

EP725 / #1279

E-Poster Viewing - Paediatrics AS04-15. Infectious diseases

Costal osteomyelitis secondary to bcg in an immunocompetent pediatric patient. Case report

C. Kunze Küllmer¹, C. Werner Ratto¹, V. Burckhardt Bravo¹, T. Barros Vial^{1*}, H. Villalón Urrutia²

¹Universidad de los andes, Pediatrics Department, Las Condes, Chile

²Universidad de los andes, Pediatrics Department, las condes, Chile

BACKGROUND AND AIM

The BCG (Bacillus Calmette-Guerin) vaccine protects against severe forms of tuberculosis. It is the most widely used vaccine worldwide, approximately 80% of neonates receive it. Adverse effects are rare, usually local reactions. Severe events are seen in congenital immunodeficiencies. Osteomyelitis is a late and rare (0.2/1,000,000 NB); it manifests 3-26 months after vaccination. It should be suspected when there is a radiological osteolytic focus in infants.

METHODS

Objective: To present a case of costal osteomyelitis secondary to BCG in an infant and highlight the importance of early management.

RESULTS

Clinical case: Male infant, 17 months. Consulted for increased costal volume and tenderness, with no inflammatory changes X-ray, soft tissue ultrasound, CT, and MRI described osteolytic lesion, increased volume, and abscessation. Bone scintigram shows focus in the seventh rib and left fibula. Severe combined immunodeficiency was ruled out. Surgeons drained, resected,

and repaired the lesion. The content did not show Bacillus Koch, but in bacilloscopy Mycobacterium was (+) and the anatomopathological showed characteristic granulomas. He started treatment with Isoniazid, Rifampicin, and Ethambutol (50 doses) with good outcome.

CONCLUSIONS

Discussion

TBC incidence has increased since 2020, and 63% of patients under 15 did not receive treatment (WHO). Therefore, immunization plans should be reinforced in at-risk populations. An osteolytic lesion in a child under five years requires urgent referral to a specialty.

Conclusion

Adverse reactions to BCG are rare but require a high level of suspicion to avoid the dissemination and sequelae of osteomyelitis. It is essential to rule out immunodeficiencies in severe events after BCG vaccination.

EP726 / #954**E-Poster Viewing - Paediatrics AS04-15. Infectious diseases****Acute diarrhea in infants: a pathology still relevant in algeria****D. Belamri*, N. Boutalbi, L. Boustil, H. Sehab, N. Bouchair**

CHU Annaba - Clinique Sainte Thérèse, Service De Pédiatrie, Annaba, Algeria

BACKGROUND AND AIM

Acute diarrhea (AD) is frequent in pediatrics. It remains one of the main causes of morbidity and mortality in developing countries. Due to its cost and potential seriousness, it remains a real public health problem in Algeria. Study the epidemiological, clinical, and evolutionary aspects of acute diarrhea

METHODS

The authors report the results of a retrospective study of 266 infants hospitalized for acute diarrhea

RESULTS

The hospital frequency of AD is 31.82%. A male predominance was noted with a sex ratio of 1.46. The most affected age group is between 0 and 3 months, with an average of 3 months. A high rate of hospitalization for AD is noticed in the winter period. The majority of children come from an average socio-economic level. More than half of the patients were assisted, children. The average hospital stay is three days. Almost all of our patients were dehydrated (91.35%) 97% of them were assisted, children. Malnutrition is noted in one out of two patients. The germs most often found are salmonellas. The

mortality rate remains high at 21%, 70% of them are assisted, malnourished and dehydrated children

CONCLUSIONS

AD remains a common condition causing a high morbidity and mortality rate. Hence the importance of recommending the promotion of public education on acute diarrhea

EP727 / #2177**E-Poster Viewing - Paediatrics AS04-15. Infectious diseases****Tuberculous lymphadenitis in children: a retrospective study on clinical and therapeutic features****H. Ben Belgacem^{1*}, H. Ajmi², J. Bouguila¹, M. Abdelkafi³, L. Boughamoura¹, S. Abroug²**¹Farhat Hached University Hospital, Pediatrics Departments, Sousse, Tunisia²Sahloul University Hospital, Pediatrics Departments, Sousse, Tunisia³Farhat Hached University Hospital³. ent Department, Sousse, Tunisia**BACKGROUND AND AIM**

Lymph node tuberculosis is the most common extrapulmonary manifestation of tuberculosis that can be difficult to diagnose in the pediatric population. **Aim:** To analyze the epidemiological profile, clinical and therapeutic approaches in children with tuberculous lymphadenitis.

METHODS

A retrospective study from January 2000 to December 2017 including children with lymph node tuberculosis admitted to the pediatric departments of Sousse (Sahloul University Hospital and Farhat Hached University Hospital) and ENT department of Farhat Hached University Hospital Sousse.

RESULTS

Our study interested 118 patients with a mean age of 9.8 years. A family history of tuberculosis was found in 12,7% of patients. Tuberculous lymphadenitis

were most often peripheral (85.6%). Cervical lymph nodes were the most common site of involvement (71,2%). Deep lymph nodes were noted in 17 cases (14,4%). Their common site was intra-abdominal in 10 cases (8,5%). A tuberculin skin test was conducted with 70% positive responses. Diagnostics confirmation was done with an anatomopathology study in most of the patients (73,7%). A bacteriologic exam was performed only in 17,8% of cases. Acid-fast bacilli (AFB) smear was positive in 5 cases and culture in 3 cases. The mean duration of medical treatment was 9,5 months. Clinical response was favorable in most patients at the end of treatment (73,3%). Paradoxical reactions were noted in 10,2%. Recurrence was observed in 8 cases (6,8%).

CONCLUSIONS

Tuberculous lymphadenopathy in children has multiple anatomical and clinical expressions. It should be put in the differential diagnosis in the etiology of lymphadenopathies in different body regions.

EP728 / #2211**E-Poster Viewing - Paediatrics AS04-15. Infectious diseases****Invasive streptococcus pneumoniae infection in secondary hospital: cases on the last 6 years.****E. Berbel Palau^{1*}, A. Moreira², M.T. Sandino Martinez², J.M. Solis Baltodano², R. Rubio Casino³**¹Fundació Hospital Sant Joan de Déu de Martorell, Servei De Pediatria, Martorell, Spain²Hospital de Martorell, Paediatrics, Martorell, Spain³Catlab, Microbiology, Viladecavalls, Spain**BACKGROUND AND AIM**

Invasive *Streptococcus pneumoniae* infection (ISPI) used to be the first cause of invasive infection on children and has decreased due to universal vaccination for *S. pneumoniae* in our area on 2016. Aims Describe epidemiology and clinical characteristics of cases of ISPI from Jan. 2015 till Dic. 2021.

METHODS

Observational retrospective descriptive study between 2015-2021 on <15 years-old (yo) admitted patients who had ISPI. Studied variables: age, sex, diagnostic, treatment.

RESULTS

8 cases of ISPI. 4 girls and 4 boys. 4 cases of pneumonia, 1 bronchiolitis by RSV and *S. pneumoniae*, 2 occult bacteremia and 1 case that presented with meningitis and endocarditis. 75% of the patients were ≤ 3 yo, the rest where 6 and 13yo. Only 3 patients weren't vaccinated (it wasn't included on their calendar at the moment). 2 patients had had 3 doses of vaccine PNC13V and

the rest 2 doses. Serotype of infections from 2019 were: 8, 12F, 16F, 24ABF, 15BC. Not included on the vaccines. Treatment: 4 Amoxicillin clavulanate (1 with antibiotal resistance), 2 amoxicillin, 1 cefuroxime, 1 multiple antibiotics (ceftriaxone, cefotaxime, vancomicine, teicoplanine). The last patient required ICU.

CONCLUSIONS

Even with universal vaccination we keep seeing sporadic cases of IPSI, due to vaccine covering only 13 serotypes. In our hospital, incidence has been stable on the last years, around 0,05% of admitted patients. Our antimicrobial politics should be revised to improve our care as 3 patients were treated with higher spectrum antibiotics when it wasn't needed.

EP729 / #2588**E-Poster Viewing - Paediatrics AS04-15. Infectious diseases****Case report; cancrum oris(noma) and hemiparesis in a young female patient at the yaoundé university teaching hospital****Z. Brian Ngokwe*, N.K. Gimel Stephane, N.N. David Bienvenue, B.M. Charles**

University of Yaoundé I, Oral Surgery, Maxillofacial Surgery and Periodontology, Yaounde, Cameroon

BACKGROUND AND AIM

Noma is an orofacial gangrene and a debilitating disease that mainly occurs in young children living in precarious situations. The presence of underlying pathologies such as HIV/AIDS and malnutrition can increase the likelihood of the advent of Noma.

METHODS

We present the case of a 9-year-old female patient, malnourished upon arrival, who presented with an ulcerating communicating right mandibular soft tissue lesion and a right hemiparesis. The patient was also a PLWH discovered following routine work-ups upon arrival was an ART treatment naïve patient.

RESULTS

She presented with repeated cases of seizures (absence followed by tonic seizures) which prompted us to carry out a CT head scan which revealed hypodense lesion in favour of an ischaemic stroke. This stroke could be as a result of the comorbid interaction. We installed an ART regimen, installed

a feeding formula, an antibiotherapy and carried out a twice daily dressing with a progressive and favourable response.

CONCLUSIONS

We as physicians and the healthcare society in general, have to put every effort to ensure that such easily preventable situations do not repeat in the future.

EP730 / #1615**E-Poster Viewing - Paediatrics AS04-15. Infectious diseases****Severe acute respiratory syndrome coronavirus 2 (sars-cov-2) reinfection in children: a retrospective STUDY**

J. Camarasa De Masdevall*, J. Marcè Igual, L. Herrero, J. Candel Pau, A. Bilbao Garitagoitia, M.N. Lopez Segura

Hospital del Mar, Department of Paediatrics, Barcelona, Spain

BACKGROUND AND AIM

The prevalence of SARS-CoV-2 reinfection was supposed to be rare (<1%), but with immune escape variants it may be increasingly common. As for primary infection, it is likely that reinfection in children do not cause relevant problems. We aimed to evaluate how common was reinfection in our cohort, and if there were differences in severity.

METHODS

Retrospective analysis of children under 17 years old with confirmed SARS-CoV-2 infection, attended at the emergency department between March 2020 and March 2022. Reinfection was defined as a positive RT-PCR or antigen test following confirmation of earlier infection. Demographics, number and mean time between infection episodes, clinical presentation and vaccination status were collected through Catalonia's shared health records.

RESULTS

Reinfection rate was 7.9% (32/405), with a mean age of 8.8 years. Only one reinfected child had comorbidities, requiring immunosuppressants. Most

episodes of reinfection occurred in January 2022. Mean time between episodes was 295 days. The shortest period of reinfection was 42 days, genome sequencing reported first delta variant and later omicron. Only one child had more than one episode of reinfection. She had COVID-19 four times, first reinfection due to alpha variant and second reinfection due to delta. No hospitalizations and long-term complications were found after reinfection.

CONCLUSIONS

Reinfection has increased with the highly transmissible omicron variant. Cases occurring after a short time (<90 days) or experiencing mild or no symptoms can be missed. Although reinfection did not entail higher severity, it is important to monitor new variants for potential complications.

EP731 / #782**E-Poster Viewing - Paediatrics AS04-15. Infectious diseases****Adaption of the modified carolina hpv immunisation attitudes and beliefs scale to measure perceptions of hpv vaccination among female adolescents****J.P.C. Chau*, S.H.S. Lo, L. Butt, K.C. Choi**

The Chinese University of Hong Kong, The Nethersole School of Nursing, Hong Kong, Hong Kong PRC

BACKGROUND AND AIM

The uptake of human papillomavirus (HPV) vaccine among adolescents is influenced by their views and perceptions of the vaccination. This study aimed to translate and validate the Chinese version of the modified Carolina HPV Immunisation Attitudes and Beliefs Scale (CHIAS), a well-established instrument to measure adolescents' views of HPV vaccination.

METHODS

Two hundred and twelve female adolescents were recruited from secondary schools and a cross-sectional descriptive study was carried out. Internal consistency, convergent validity, and construct validity were examined.

RESULTS

Acceptable internal consistency was found, with the Cronbach's alpha of the five domains ranging from 0.60 to 0.89. Evaluated by Pearson's correlation coefficient, negative correlations were found between the domain scores

of “Harms” and “Risk denial” and HPV vaccination intention while positive correlations were found between the domain scores of “Effectiveness” and “Uncertainty” and HPV vaccination intention, thus suggesting acceptable convergent validity. Confirmatory factor analysis indicated that the five-factor structure of the CHIAS-C was an acceptable fit to the data and construct validity was thus established. The participating adolescents generally had positive views toward vaccination and were likely to initiate HPV vaccination if provided with more information.

CONCLUSIONS

The results suggest that the CHIAS-C is a reliable and valid tool to measure adolescents’ perceptions of HPV vaccination. The translated scale may therefore be used to guide the development of educational interventions to improve HPV vaccine acceptability and increase vaccination among Chinese-speaking adolescents. Acknowledgement: This study is supported by the General Research Fund, University Grants Committee, Hong Kong.

EP732 / #1859**E-Poster Viewing - Paediatrics AS04-15. Infectious diseases****Tackling hpv vaccine hesitancy: an exploration of community myths and misconceptions of hpv and hpv vaccination****J.P.C. Chau^{1*}, S.H.S. Lo¹, L. Butt¹, V.W.Y. Lee², G.C.Y. Lui³, A.Y.L. Lau³**

¹The Chinese University of Hong Kong, The Nethersole School of Nursing, Hong Kong, Hong Kong PRC

²The Chinese University of Hong Kong, Centre For Learning Enhancement and Research, Hong Kong, Hong Kong PRC

³The Chinese University of Hong Kong, Department of Medicine & Therapeutics, Hong Kong, Hong Kong PRC

BACKGROUND AND AIM

HPV vaccination efforts have been hampered by vast amounts of misinformation in traditional and social media, leading to significant vaccine hesitancy among parents and adolescents. As people's beliefs are vital in determining their health behaviours, it is important to recognise their concerns and disseminate trustworthy health knowledge. This study aimed to identify myths and misconceptions held about HPV and its vaccination in order to better address community information needs and increase the effectiveness of future HPV vaccination promotion initiatives.

METHODS

A qualitative study with individual semi-structured interviews was carried out. Twenty-six participants including eight mother-daughter dyads, four secondary school teachers, two school principals, three social workers, and one school nurse were interviewed. All interviews were audio-recorded and data was analysed thematically.

RESULTS

Participants' beliefs revealed a variety of misinformation about HPV and the vaccination. Several participants associated HPV with AIDS and HIV, and believed that HPV damages the immune system. There was a low perception of risk as some believed the infection was uncommon. Negative views towards the vaccination were influenced by reports of adverse side effects and the perceived commercialisation of the vaccine. Participants also linked the presence of side effects with a weaker immune system. Moreover, the lack of recommendation by healthcare workers was also cited as a reason for vaccine refusal.

CONCLUSIONS

Myths and misconceptions about HPV and its vaccination are rife. These findings will be instrumental in determining the content of future health education interventions aimed at reducing HPV vaccine hesitancy and addressing any related health concerns.

EP733 / #392**E-Poster Viewing - Paediatrics AS04-15. Infectious diseases****Unusual case of acute viral hepatitis in a 5 year old GIRL****M. Dimitrovska-Ivanova***

Clinical Hospital Shtip, University Goce Delcev Shtip, Department of Pediatrics, Shtip, North Macedonia

BACKGROUND AND AIM

In most of the cases acute viral hepatitis in children is caused by hepatitis virus type A. There are rare cases where other types of hepatitis virus or other viruses such as Epstein Barr Virus (EBV) and Cytomegalovirus (CMV) can cause acute hepatitis. This is an unusual case of acute viral hepatitis in a 5 year old girl caused by concomitant EBV and CMV infection.

METHODS

Five year old girl presented with fever, fatigue, headache, nausea, vomiting, abdominal pain, swelling of upper eyelids and darker urine. On physical examination conscious, pale, febrile (39 C) dehydrated, icteric sclera, pharynx hyperemic, oedema of upper eyelids, pain and hepatosplenomegaly on abdominal palpation. Succusio renalis negative. Blood tests with leukocytosis (Le=28,35 with Ly=72,4%), Hgb=108g/l, CRP=34mg/l, AST=470U/L, ALT=684U/L, GGT=95U/L, Total bilirubin=87.7umol/l, Direct Billirubin=69,8 umol/l. Serological test for hepatitis A, B,C were negative. EBV IgM and CMV IgM were positive. Urine test positive for acetone and bilirubin. Abdominal ultrasound with small hepatosplenomegaly and 70 ml of free liquid in Douglas space.

RESULTS

After appropriate conservative treatment, with gradually decrease of hepatic enzymes and bilirubin values, normalization of urine color, withdrawal of abdominal organomegaly, disappearing of free liquid in Douglas space and improvement of general condition.

CONCLUSIONS

Concomitant infection of EBV and CMV are rare causes of acute hepatitis. In most of the cases it is manifested as noncomplicated infective mononucleosis, but symptomatic hepatitis is rare. We should consider infectious mononucleosis hepatitis in differentiating patients presenting with liver abnormality, fever, pharyngitis and lymphadenopathy.

EP734 / #519

E-Poster Viewing - Paediatrics AS04-15. Infectious diseases

Are children with meningitis receiving the correct CARE?

J.A. Guanzon*, T. Dawson, H. Coakley, J. Ejim, O. Oyewu

Worcestershire Royal Hospital, Paediatrics, Worcester, United Kingdom

BACKGROUND AND AIM

Children with suspected meningitis require urgent evaluation and management, including prompt administration of appropriate antimicrobial therapy. The mortality rate of untreated bacterial meningitis approaches 100 percent. Neurologic sequelae are also common among survivors. In the UK, NICE has developed guidelines for managing children with bacterial meningitis and meningococcal septicaemia (NICE: CG102). Aims To establish whether patients with suspected bacterial meningitis are being investigated and treated appropriately, in accordance with NICE guidelines To identify areas in the management of these patients which require improvement.

METHODS

This was a retrospective design including all patients admitted with meningitis identified from ICD-10 codes between February 2014 and March 2020 aged 29 days to 15 years. The clinical information was obtained from patient notes.

RESULTS

23 patients, aged 30 days to 15 years old were included. 22(96%) had bloods tests including glucose and blood culture, 8(35%) had Blood PCR for N. meningitidis. 19(83%) had lumbar punctures, 15(65%) CSF samples were sent

for viral PCR and 6(26%) samples for meningococcal /pneumococcal PCR. 22(96%) received antibiotics within 4 hours. 22(96%) were commenced on the correct antibiotic for age, but only 12(52%) received the correct duration. 15(65%) received IV fluids and 2(9%) received a 20ml/kg bolus. 17(74%) had clinic follow-up arranged and 16(70%) had a hearing test requested. The majority of patients had been managed according to NICE guidelines.

CONCLUSIONS

Compared to the previous audit (2011-2014), improvements were made in blood meningococcal PCR testing, giving the recommended antibiotics for the correct duration and requesting hearing test.

EP735 / #1648**E-Poster Viewing - Paediatrics AS04-15. Infectious diseases****Relationship of nutritional status to patient's mortality in children's community-acquired pneumonia in dr. Moewardi hospital****A.S. Harjanti^{1*}, I. andarini², S. Nugraha²**¹Universitas Sebelas Maret, Faculty of Medicine, Surakarta, Indonesia²Dr. Moewardi Hospital, Department of Paediatrics, Surakarta, Indonesia**BACKGROUND AND AIM**

Pneumonia, among other infectious diseases, is still one of the biggest cause of mortality in children under age of five years in many developing countries. Risk factors of the disease include malnutrition, comorbidities, and environmental factors. This study intends to understand the relationship of nutritional status with patient's mortality in children community-acquired pneumonia in Dr. Moewardi Hospital.

METHODS

This study is a case-control study using medical records of children diagnosed with community-acquired pneumonia in Dr. Moewardi Hospital from 2017 to 2019. Seventy subjects were divided into two groups, survivors and deceased group, to assess 30-day mortality in children's community-acquired pneumonia. Data analysis was done using Shapiro-Wilk ($n > 50$) and non-parametric Kruskal-Wallis test through SPSS Version 22.

RESULTS

There were 37 subjects in the deceased group and 33 subjects in the surviving group. As of nutritional status, in deceased group, 17 subjects were categorized as underweight, 15 were normal, and 6 were overweight. While in the surviving group, 10 subjects were categorized as underweight, 21 subjects were normal, and 2 subjects were overweight. Correlation test using Kruskal Wallis was performed because the data were not normally distributed. The result showed a statistically difference p-value of 0,012. Other variables being tested including gender, age, and comorbidity showed no statistical difference ($p > 0,05$).

CONCLUSIONS

There was a significant relationship between nutritional status and patient's mortality in children's community-acquired pneumonia in Dr. Moewardi Hospital. Community-acquired pneumonia in children has several risk factors, one of them being discussed here is nutritional status. Understanding these risk factors can help to reduce mortality rate in children's community-acquired pneumonia.

EP736 / #1360**E-Poster Viewing - Paediatrics AS04-15. Infectious diseases****Severe community-acquired methicillin-resistant staphylococcus aureus (ca-mrsa) infection: an increasingly common threat**

**L. Herrero^{1*}, J. Candel¹, J. Camarasa De Masdevall¹, S. Maya¹,
A. Alier², M.N. Lopez Segura¹**

¹Hospital del Mar, Department of Paediatrics, Barcelona, Spain

²Hospital del Mar, Department of Traumatology, Barcelona, Spain

BACKGROUND AND AIM

CA-MRSA can present with severe and rapidly progressive disease, affecting multiple sites. The optimal antibiotic choice for invasive MRSA infection is not well defined. Most guidelines recommend vancomycin, although treatment failure has been reported.

METHODS

Two severe MRSA cases are reported.

RESULTS

A 14-year-old boy presented with fever and pain of right shoulder. MRI showed humeral osteomyelitis with subperiosteal abscess. He was treated with cefazolin and daptomycin and surgical debridement. A whole-body MRI was done due to persistent fever and generalized pain, identifying new foci of osteomyelitis in left fibula and distal femur, abscesses in left buttock and right thigh. Surgical treatment was again needed. Blood culture grew MRSA. He received daptomycin and ceftaroline for three weeks, then ceftaroline

for two weeks, and continued with oral linezolid for five more weeks with clinical resolution. A 16-day-old infant presented with fever of recent onset. Cefotaxime and amikacin were started after unsuccessful lumbar puncture attempt. The following day a painful dorsolumbar erythematous plaque was noted. The mother explained the baby had a lumbosacral pustule 24 hours before admission. Treatment was switched to meropenem, clindamycin and vancomycin. Bullous purple lesions appeared all over her back. Ultrasound and MRI showed cellulitis and non-necrotizing fasciitis. Purulent drainage culture yield MRSA. Vancomycin was administered for two weeks with good outcome.

CONCLUSIONS

MRSA antibiotic coverage should be included in a child with a severe soft tissue or musculoskeletal infection. Whole-body MRI can help to promptly identify the extent of disease and the need for surgical treatment when multiple foci are suspected.

EP737 / #1379**E-Poster Viewing - Paediatrics AS04-15. Infectious diseases****Aerococcus urinae cystitis and bladder diverticulum in a 6 year-old BOY**

L. Herrero^{1*}, J. Camarasa De Masdevall¹, S. Ramis¹, O. Martin Sole², M.N. Lopez Segura¹

¹Hospital del Mar, Department of Paediatrics, Barcelona, Spain

²Hospital Sant Joan de Déu, Department of Paediatric Surgery, Barcelona, Spain

BACKGROUND AND AIM

Aerococcus urinae has been rarely reported as a cause of urinary tract infection in male children, presenting with characteristic fishy smelling urine. Severe infections such as sepsis or endocarditis have also been described.

METHODS

A child with *Aerococcus urinae* infection revealing a bladder diverticulum is presented.

RESULTS

A 6-year-old boy presented to the emergency department due to dysuria, polachyuria and malodorous urine for 8 days. He had two episodes of cystitis the previous year with negative urine culture. The mother explained the smell was so strong that it impregnated all his clothes. He had been attended on the second day of symptoms, but voluntarily left the hospital before knowing urine sediment results. He was afebrile with normal physical exam, except for balanoprepucial adhesions. Urine sediment showed leukocyturia with abundant Gram-positive cocci. He received amoxicillin-clavulanate for 7

days, with resolution of symptoms. Both urine cultures grew 10.000-100.000 colony forming units of *Aerococcus urinae* (table 1). Abdominal ultrasound showed a diverticulum in the left ureterovesical junction 2,8 x 1,4 x 3,5 cm. He is being followed up by the urologist, with no recurrent episodes. Table 1. Antibiotic susceptibility of *Aerococcus urinae* isolate

TABLE 1:

Antimicrobial	Interpretation
Penicillin	Susceptible
Amoxicillin	Susceptible
Cefotaxime	Susceptible
Clindamycin	Susceptible
Vancomycin	Susceptible

CONCLUSIONS

Aerococcus urinae is a Gram-positive coccus, difficult to recognize with conventional methods. Identification has become easier with the introduction matrix-assisted laser desorption/ionization time-of-flight mass spectrometry (MALDI-TOF MS) in laboratories. Imaging of the urinary tract is advised when these bacteria are isolated, as it can reveal underlying genitourinary anomalies.

EP738 / #2160**E-Poster Viewing - Paediatrics AS04-15. Infectious diseases****Pneumococcal bloodstream infection in a tertiary paediatric hospital - a 12 year retrospective descriptive STUDY****M. Hussein^{1*}, S. Suliman¹, N. Wall², A. Prior², C. Purcell³**¹CHI at Tallaght, General Paediatrics, Dublin, Ireland²CHI at Tallaght, Clinical Microbiology, Dublin, Ireland³CHI at Tallaght, Tallaght University Hospital, General Paediatrics, Dublin, Ireland**BACKGROUND AND AIM**

Pneumococcal sepsis is considered the most vaccine-preventable paediatric cause of death. The global mortality rate due to pneumococcal disease in 2015 was 45 deaths (29-56) per 100 thousand children <5 years of age (1). Complications include pneumonia, meningitis, brain abscesses and lung empyema, Mortality is highest with bacteraemia or meningitis. National figures in Ireland suggest that pneumococcal pneumonia is estimated to affect 0.1% of the population every year (2).

METHODS

This retrospective, descriptive study at Children's Health Ireland at Tallaght in Dublin included children under the age of 16 with *Streptococcus pneumoniae* bacteraemia from January 2010-March 2022. Patient data collected included length of stay, admission blood results (C-reactive protein (CRP) and white cell count (WCC)), vaccine history, source of infection, complications and age at presentation.

RESULTS

28 children with *S. pneumoniae* bacteraemia were identified (18 male, 10 female), mean age of 3.7 years. The average hospital stay was six days (range 2-15 days). Admitting bloods including WCC and CRP did not correlate with severity of infection or the duration of treatment required. 15% of patients required high dependency unit admission, the worst observed complication was empyema requiring decortication and pleurectomy.

CONCLUSIONS

The incidence of invasive pneumococcal infection has reduced significantly in 20 years, it is still an important cause of morbidity and mortality in Ireland. Understanding the factors influencing disease severity, promoting early recognition and prompt treatment are key. Increasing antimicrobial resistance makes empiric treatment more challenging. This study highlights the ongoing childhood morbidity associated with this infection, emphasising the importance of vaccination.

EP739 / #1448

E-Poster Viewing - Paediatrics AS04-15. Infectious diseases

Coping with uncertainty

N. Jameel*, A.M. Murphy

University Hospital Limerick, Pediatrics, Limerick, Ireland

BACKGROUND AND AIM

Paediatric multisystem inflammatory syndrome (PIMS) is a newly described disorder occurring in the aftermath of COVID 19 infection, which can cause severe life-threatening symptoms. Some of these can overlap with other vasculitic disorders such as Kawasaki (KD) or toxic shock syndrome. Aim: To report a case of PIMS/Kawasaki in a 2-month-old infant with unremarkable family or personal history.

METHODS

We describe the clinical presentation, examination findings, results of haematological investigation, echocardiogram, treatment, and outcome in our patient.

RESULTS

A three-year-old female presented to our Emergency Department with an 8-day history of fever, irritability, reduced oral intake and vomiting. She had a normal systemic exam, no joint swelling or redness, conjunctivitis, lymphadenopathy, or signs of meningism but was febrile, lethargic, and miserable looking. She was admitted with an impression of Atypical Kawasaki disease or pyelonephritis and started on IV antibiotics. Repeat blood on D3 showed an increase in platelets count to 611. She was commenced on IVIG 2g/kg, high dose aspirin 12.5mg/kg. Blood work up was repeated. She had a headache/

vomiting and fever after the dose of IVIG, so no further dose was given. She was switched to IV methylprednisolone 2mg/kg for 3 days. Initial echo was done on D6 which showed no valvular pathology/ myocarditis or evidence of coronary artery aneurysmal formation. Our Patient improved with these interventions both clinically and biochemically. A repeat echo is scheduled for 6 weeks and one year's time.

CONCLUSIONS

Although they (PIMS & KD) share some clinical similarities, their epidemiology is quite dissimilar. As there is no diagnostic test for either condition, it remains difficult to distinguish between the two. Clinical acumen is key. Early intervention is imperative to prevent and minimize life threatening acute and long-term complications.

EP740 / #2094

E-Poster Viewing - Paediatrics AS04-15. Infectious diseases

Oral azithromycin versus doxycycline in the treatment of children with scrub typhus without complications – a randomised controlled TRIAL

J. John*, K. K, A. Satapathy, S. Sahu, B. Behera, B. Padhy

All India Institute of Medical Sciences, Pediatrics, Bhubaneswar, India

BACKGROUND AND AIM

To compare the efficacy of Azithromycin versus Doxycycline in the treatment of children with uncomplicated scrub typhus in terms of the percentage of children who attained remission of fever after 72 hours of administration of the first dose of the study drug, mean time taken to attain fever defervescence, normalisation of laboratory parameters, resolution of hepatosplenomegaly and lymphadenopathy.

METHODS

Patients admitted with undifferentiated fever in the In-Patient Department (IPD), Department of Paediatrics, All India Institute of Medical Sciences, Bhubaneswar as per the inclusion criteria were randomised and was treated with Azithromycin at 10mg/kg/day in one group and Doxycycline at 4.4mg/kg/day for 5 days in the other group and was assessed based on the primary and secondary objectives. **Design** – Interventional, Open labelled Randomized Controlled Trial

RESULTS

There was no statistically significant difference between the percentage of children who attained remission of fever after 72 hours of administration of Azithromycin (98.2%) and Doxycycline (96.5%) (p-value-0.47) and the average time taken for fever defervescence (Azithromycin – 24.53 hours Doxycycline – 25.82 hours, p-value- 0.36). The odds of attaining fever remission in the Doxycycline group as compared to the Azithromycin group was 1.01 (95 % confidence interval (CI) - (0.60 – 1.71) which was also statistically not significant. There was less incidence of adverse drug events in the Azithromycin group (1.78%) as compared to the Doxycycline group (8.6%) which was statistically significant (p-value-0.02).

CONCLUSIONS

Azithromycin is equally efficacious, in fever defervescence, resolution of clinical signs and laboratory parameters as Doxycycline, is safer and better tolerated

EP741 / #334**E-Poster Viewing - Paediatrics AS04-15. Infectious diseases****Varicella cerebellitis - four-year retrospective study IN****R. Komitova¹, A. Kevorkyan², J. Kalchev^{3*}**¹University Hospital, Infectious Diseases, Plovdiv, Bulgaria²Medical University, Epidemiology and Disaster Medicine, Plovdiv, Bulgaria³Medical University, Microbiology and Immunology, Plovdiv, Bulgaria**BACKGROUND AND AIM**

Varicella is a highly contagious febrile exanthematous disease caused by varicella zoster virus (VZV). It is usually a self-limiting although can cause serious complications. Aim to describe the clinical picture and outcome of children with varicella cerebellitis.

METHODS

Seven children with varicella cerebellitis hospitalized at the University Hospital, Plovdiv, Bulgaria from 2014 to 2019 were studied. Six were diagnosed by a physician. The seventh child had a discreet rash and was not examined, but was exposed to chickenpox at school. Polymerase chain reaction (PCR) was performed to test for VZV in spinal fluid. Serological tests for VZV in blood and magnetic resonance imaging (MRI) were performed when necessary. Follow-up was conducted, including neurological and cognitive evaluation.

RESULTS

In total, seven children, aged three to 11 years were evaluated and four of them were female. All had clinical manifestations of cerebellitis and all but

one typical rash. Two children presented with behavioral changes. They both underwent MRI and pathological findings, consistent with cerebellitis, were found in one child. PCR VZV in spinal fluid was positive in 4 children. Positive serology for VZV confirmed varicella in the child without rash. All patients received intravenous acyclovir and four - dexamethasone. All but the child with MMRI finding recovered uneventfully. Follow-up varied from 6 month to 4 years. The cognitive disturbance persisted in the child with MMR finding.

CONCLUSIONS

Our results have confirmed the benign course of VZV cerebellitis but also found cognitive sequelae. Further studies are needed to reveal the characteristic of these sequelae.

EP742 / #1674

E-Poster Viewing - Paediatrics AS04-15. Infectious diseases

Cases of critical pertussis

M. Kherkheulidze^{1*}, T. Kutubidze¹, G. Bibilashvili², P. Lursmanishvili³

¹State Medical University, Pediatrics, Tbilisi, Georgia

²Pediatric Clinic, Intensive Care, Tbilisi, Georgia

³G. Jvania Pediatric academic Clinic, Emergency Department, Tbilisi, Georgia

BACKGROUND AND AIM

Despite of high coverage of vaccination with hexavalent vaccine in Georgia (98,5 %) there still remains severe cases of pertussis, that needs critical care and has high mortality rate. The aim of our study was to evaluate patient's history with critical pertussis and determine risk factors associated with poor outcomes.

METHODS

Retrospective study was conducted analyzing cases of patients admitted in 2 tertiary pediatric clinics from 1/11/19 to 1/12/20 with diagnosis of pertussis. The study involved the cases with standard case presentation (paroxysmal cough, inspiratory whoop, post tussive emesis, apnea and/or cyanosis) and positive PSR test. Patients demographic and clinical data, duration of illness and date of admission, comorbid factors, lab tests, radiological data and outcome were analyzed.

RESULTS

At all 11 clinical records were analyzed. 4 patients were unimmunized and 4 have only one dose. During admission main presentation was respiratory failure. From 11 patients, mean age 7+ 4 months, 72,7 % (n=8) were on

mechanical ventilation and 45,4% (n=5) need exchange transfusion due to high leucocyte level more than $50 \times 10^9/L$ and 1 patient need ECMO therapy. The mortality rate was 27, 2% (n=3). The study showed that shock, altered mental status, small age and high leucocyte level as well as the delayed blood exchange in patients with high leucocyte level were associated with poor outcome.

CONCLUSIONS

Critical pertussis is more common in early infancy, small age as well as delayed blood exchange, low Glasgow score can be considered as predictor factors for poor outcome.

EP743 / #1234

E-Poster Viewing - Paediatrics AS04-15. Infectious diseases

Herpetic whitlow of big TOE

N. Fundano, S. Kutty*, S. Mujeeb, J. Kutty

South West Acute Hospital, Paediatrics, Enniskillen, United Kingdom

BACKGROUND AND AIM

Herpes simplex virus (HSV) type 1 infection usually involves the oral mucosa, while genital mucosal involvement occurs in type 2 infections. Herpetic whitlow occurs when primary infection spreads to distal phalanx of fingers or thumbs through direct inoculation. Primary herpetic whitlows of the toes are not reported frequently in children with correct diagnoses made in only about 65% of cases. Incision and drainage is contraindicated as it can exacerbate viremia.

METHODS

An 8-month-old previously well female child presented with a 3-day history of redness and spots on her left big toe. She was treated for bacterial infection, although she was afebrile and systemically well. The left big toe was swollen and erythematous with multiple grouped vesicles on the lateral pulp with no evidence of a primary herpetic lesion. The pandemic situation mandated mask wearing of all, but a chance glimpse of mother's face noted a healing 'cold sore', which clinched the clinical diagnosis.

RESULTS

Investigations showed lymphocytosis and neutropaenia with normal infection markers. Viral PCR from a deroofed vesicle was positive for HSV type 1 with Ct

value of 19.36. Culture of the wound swab was negative. The infant had intravenous and oral acyclovir with complete resolution of lesions in three weeks.

CONCLUSIONS

We present this case to remind us that herpetic whitlows of toes are commonly mistaken for paronychia or bacterial infection. In our case, transmission and infection most likely occurred from the herpes lesion on her mother. Correct diagnosis will limit cross infection and will help to counsel the family regarding the risk of recurrence and reinfection.

EP744 / #2040

E-Poster Viewing - Paediatrics AS04-15. Infectious diseases

Adolescent hip pain: a case report

R. Lages Pereira^{1*}, S. Nogueira Machado², L. Macedo², A. Osório³, J. Correia-Pinto³, A. Lobo²

¹Hospital de Braga, Pediatrics Department, Braga, Portugal

²Hospital Senhora da Oliveira, Pediatrics Department, Guimarães, Portugal

³Hospital de Braga, Pediatric Surgery Department, Braga, Portugal

BACKGROUND AND AIM

Inapplicable

METHODS

Inapplicable

RESULTS

An otherwise healthy 14-year-old boy presented to the emergency with a two-day history of left hip pain, walk claudication, fever, anorexia and vomiting. On physical examination he had hip flexion and adduction, pain on palpation of the left sacroiliac joint/gluteal region and with active and passive mobilization of the limb. CRP (276.5mg/L) and ESR (58mm/h) were elevated. Radiography and CT of the hips were reported as unremarkable. Due to suspicion of osteoarticular infection, he was admitted for IV flucloxacillin. Admission blood culture was positive for *Staphylococcus Aureus*. MRI showed a probable abscess of the left iliopsoas/iliac muscles that was later confirmed by CT, measuring 7.4x4.7x2.1cm. Since D4 afebrile and with progressive improvement. Pediatric Surgery was contacted, and a conservative attitude was assumed with laboratory and imaging reassessment. CRP (49.6mg/L)

and ESR (59mm/h) improved but an abscess of the left iliac psoas muscle (7.2x2.7x1.7cm) persisted on the CT. Because of its location, with high risk of lesion of major vessels, a percutaneous or surgical drainage weren't feasible. Conservative management was then maintained and on D24 he kept clinical, laboratory and imagiological improvement (residual collection of 5mm on US). He was discharged with oral flucloxacillin, completing a total of 21 days. After one month, and in the follow up consultations he kept clinically asymptomatic. Immunodeficiencies study was negative.

CONCLUSIONS

This case resembles a rare condition that presents with varied symptoms, leading to delays in diagnosis and management. An accurate history and examination are essential to raise suspicion of iliopsoas abscess.

EP745 / #2025**E-Poster Viewing - Paediatrics AS04-15. Infectious diseases****Clinical features and severity predictors of mycoplasma pneumoniae infection in hospitalised children in hong KONG****S.H.F. Lai*, C.I. Kuok, P.P.K. Ho, W.H. Chan, Y.S. Yau**

Queen Elizabeth Hospital, Department of Paediatrics, Hong Kong, Hong Kong PRC

BACKGROUND AND AIM

Mycoplasma pneumoniae is one of the commonest bacterial causes of community acquired pneumonia in children. This study aimed to evaluate the clinical features of paediatric *Mycoplasma pneumoniae* infection, and to identify factors that associate with poorer prognosis and outcome.

METHODS

A retrospective review was conducted on paediatric patients aged ≤ 18 years old who were admitted to the Department of Paediatrics, Queen Elizabeth Hospital, Hong Kong due to *Mycoplasma pneumoniae* infection between 2018 and 2019. Diagnosis was made with positive *Mycoplasma pneumoniae* PCR from nasopharyngeal swabs.

RESULTS

A total of 142 patients were included in the study. Most patients presented with fever (98%) and cough (99.3%). Majority of patients were diagnosed with pneumonia (86.6%). Other diagnoses included upper respiratory tract infection, acute bronchiolitis and encephalitis. Co-infection with respiratory

viruses was associated with more PICU admission (21.1% vs 3.3%, $p=0.012$), increased use of oxygen therapy (52.6% vs 26.8%, $p=0.023$) and mechanical ventilation (15.8% vs 0.8%, $p=0.008$). Our study also identified that Paediatric Early Warning Signs (PEWS) ≥ 2 on admission (OR 5.93, 95% CI 1.15-30.59), alanine transaminase (ALT) ≥ 35 IU/L (OR 7.2, 95% CI 1.50-34.61) and C-reactive protein ≥ 100 mg/L (OR 14.22, 95% CI 1.99-101.74) increased the risk of PICU admissions.

CONCLUSIONS

Pneumonia was the commonest diagnosis for *Mycoplasma pneumoniae* infection in children. Patient co-infected by respiratory viruses required more oxygen therapy and mechanical ventilation. PEWS ≥ 2 , ALT ≥ 35 IU/L and CRP ≥ 100 mg/L were associated with more PICU admissions.

EP746 / #1860**E-Poster Viewing - Paediatrics AS04-15. Infectious diseases****Parental vaccine hesitancy: translation and validation of scales to measure hpv and hpv vaccination knowledge, beliefs, and attitudes among chinese parents****S.H.S. Lo*, J.P.C. Chau, L. Butt, K.C. Choi**

The Chinese University of Hong Kong, The Nethersole School of Nursing, Hong Kong, Hong Kong PRC

BACKGROUND AND AIM

Parents are key facilitators of childhood human papillomavirus (HPV) vaccination and vaccine initiation is heavily influenced by their knowledge, attitudes, and beliefs about HPV and the vaccination. This study aimed to examine the psychometric properties of the Chinese versions of the Carolina HPV Immunisation Attitudes and Beliefs Scale (CHIAS), HPV Knowledge scale (GK23), and Vaccination Knowledge Scale (VK9).

METHODS

The CHIAS, GK23, and VK9 were translated into Chinese and content validity were established. To assess their psychometric properties, the scales were administered to 195 Chinese parents. Structural validity of CHIAS-C was assessed by confirmatory factor analysis. Internal consistency was assessed by Cronbach's alpha (α) for CHIAS-C, and by Kuder-Richardson 20 for GK23 and VK9.

RESULTS

All scales had acceptable internal consistency, with the CHIAS-C receiving a Cronbach's α ranging from 0.68-0.85 for its four domains, and the GK23 and VK9 receiving a Kuder-Richardson 20 score of 0.88 and 0.75, respectively. Confirmatory factor analysis suggested that the 4-factor structure of the CHIAS-C was a good fit for the data. Although the parents demonstrated basic knowledge and awareness of the benefits of HPV vaccination, concerns regarding vaccine side effects and deficiency in knowledge remained a barrier to vaccination.

CONCLUSIONS

The Chinese versions of the CHIAS, GK23, and VK9, are valid and reliable instruments to evaluate attitudes, beliefs, and knowledge regarding HPV and HPV vaccination. These instruments may inform the design of targeted interventions to address parental vaccine hesitancy. Acknowledgement: This study is supported by the General Research Fund, University Grants Committee, Hong Kong.

EP747 / #2326**E-Poster Viewing - Paediatrics AS04-15. Infectious diseases****Clinical and paraclinical findings in pediatrics with inflammation of the gastrointestinal tract due to enterobius vermicularis infection: a systematic review****J. Mahdavi^{1*}, R. Ghasemikhah²**¹Arak University of Medical Sciences, Students Research Committee, Arak, Iran²Arak University of Medical Sciences, Department of Parasitology and Mycology, School of Medicine, Arak, Iran**BACKGROUND AND AIM**

Enterobius vermicularis (*E. vermicularis*) is one of the most prevalent parasitic helminths which commonly infects pediatrics. Infection with *E. vermicularis* can cause symptoms including perianal itching, insomnia, and irritability. This study evaluates clinical and paraclinical findings in pediatrics with inflammation of the gastrointestinal tract due to enterobiasis as a rare complication of this infection.

METHODS

This study is a systematic review that followed the PRISMA checklist. PubMed, Web of Science, Scopus, ScienceDirect, and Google Scholar were searched using keywords including: "Enterobius vermicularis", "pinworm", "colitis", "enteritis", "gastritis", "esophagitis", "inflammatory bowel disease", and "Crohn's disease", up to 2022. Inclusion criteria consisted of studies describing esophagitis, gastritis, enteritis, and colitis in pediatrics with *E. vermicularis* infection.

RESULTS

A total of 8 studies describing 30 patients were included. Patients with colitis had the most prevalence (24 cases) followed by ileocolitis (2 cases), gastritis, ileitis, jejunal enterocolitis, and esophagogastritis (each one: 1 case). The most prevalent symptoms were abdominal pain, rectal bleeding, diarrhea, and weight loss. In laboratory data, melanic stool and increased WBC count with the highest eosinophilia level of 24% were reported. Colonoscopy revealed discrete proctitis, superficial and stellate ulcerations, erythematous and friable mucosa, purulent discharge, and numerous worms throughout the colon. In addition, ulcers surrounded by inflammatory cell infiltrate, eosinophils as the most common, were found in the biopsy.

CONCLUSIONS

E. vermicularis infection should be one of the differential diagnoses in pediatrics with inflammation of the gastrointestinal tract including esophagitis, gastritis, enteritis, and colitis.

EP748 / #1140**E-Poster Viewing - Paediatrics AS04-15. Infectious diseases****Antibody persistence following primary series with dtwp-ipv-hb-prp~t versus separate dtwp-hb-prp~t and ipv vaccines and response to a booster dose of dtwp-ipv-hb-prp~t in healthy indian toddlers**

S. Mangarule^{1*}, S. Prashanth², A. Kawade³, I.V. Padmavathi⁴, V.N. Tripathi⁵, M.D. Ravi⁶, S. Palkar⁷, R. Singh⁸, R. Shetty⁹, M. Mitra¹⁰, P. Kudyar¹¹, J. Leclercq¹², V.J. Midde¹³, K. Varghese¹⁴, S.R. Kandukuri¹⁵, D. Kukian¹⁵, F. Noriega¹⁶

¹Sanofi, Global Clinical Development, Lyon, France

²Mysore Medical College & Research Institute and Cheluvamba Hospital, Department of Pediatrics, Mysore, India

³Vadu Rural Health Program, King Edward Memorial Hospital Research Centre, Department of Pediatrics, Pune, India

⁴Victoria Government Hospital, Department of Pediatrics, Visakhapatnam, India

⁵Prakhar Hospital Pvt Ltd, Department of Pediatrics, Kanpur, India

⁶JSS Hospital and Medical College, JSS Academy of Higher Education and Research, Department of Pediatrics, Mysore, India

⁷Bharati Vidyapeeth Deemed University Medical College, Department of Pediatrics, Pune, India

⁸Maulana Azad Medical College & Associated Lok Nayak Hospital, Department of Pediatrics, New Delhi, India

⁹Kasturba Medical College, Department of Community Medicine, Manipal, India

¹⁰Institute of Child Health, Department of Pediatrics, Kolkata, India

¹¹Seth GS Medical College and KEM Hospital, Department of Clinical Pharmacology, Mumbai, India

¹²Aixial, Biostatistics, Boulogne-billancourt, France

¹³Sanofi, Global Pharmacovigilance, Hyderabad, India

¹⁴Sanofi, Global Clinical Immunology, Swiftwater, United States of America

¹⁵Sanofi, Clinical Research Department, Hyderabad, India

¹⁶Sanofi, Global Clinical Development, Swiftwater, United States of America

BACKGROUND AND AIM

This study evaluated one booster dose of the hexavalent DTwP-IPV-HB-PRP~T vaccine given alone or co-administered with measles, mumps, and rubella (MMR) vaccine.

METHODS

This Phase III, randomized, open-label study was conducted in India (CTRI/2020/04/024843). Healthy toddlers who had previously completed a DTwP-IPV-HB-PRP~T or separate DTwP-HB-PRP~T and IPV infant primary vaccination series, received a DTwP-IPV-HB-PRP~T booster at 12–24 months of age. MMR vaccine was co-administered concomitantly (n=336) or 28 days after (n=340) the DTwP-IPV-HB-PRP~T booster. All participants were monitored for safety. Immunogenicity was evaluated in randomized subsets.

RESULTS

Pre-booster, 100% of participants demonstrated antibody persistence for anti-T (≥ 0.01 IU/mL), anti-polio 1 and 3 (≥ 8 1/dil), and $\geq 96.9\%$ of participants for anti-D (≥ 0.01 IU/mL), anti-Hib (≥ 0.15 $\mu\text{g/mL}$), anti-HB (≥ 10 mIU/mL), and anti-polio 2 (≥ 8 1/dil). For pertussis antigens, antibody persistence (≥ 2 EU/mL) ranged from 87.4–90.3% (anti-PT), 95.5–99.7% (anti-FIM), 75.5–77.5% (anti-PRN), and 94.7–97.3% (anti-FHA). Post-booster, seroprotection rates based on primary series or MMR vaccine co-administration were 100% for anti-D and anti-T (≥ 0.01 IU/mL), anti-Hib (≥ 0.15 $\mu\text{g/mL}$), and anti-polio 1, 2, and 3 (≥ 8 1/dil), and $\geq 98.2\%$ for anti-Hib (≥ 1.0 $\mu\text{g/mL}$) and anti-HB (≥ 10 mIU/mL, ≥ 100 mIU/mL). For pertussis antigens, booster responses ranged from 72.0–74.6% (anti-PT), 80.1–84.3% (anti-FIM), 77.6–81.5% (anti-PRN), and 79.2–80.6% (anti-FHA). Similar immune responses were observed for anti-measles, anti-mumps, and anti-rubella irrespective of co-administration with DTwP-IPV-HB-PRP~T or 28 days later. No safety concerns were observed.

CONCLUSIONS

This study demonstrated good antibody persistence following DTwP-IPV-HB-PRP~T primary series, and good immunogenicity and safety of booster dose co-administered with MMR vaccine in the second year of life.

EP749 / #1146**E-Poster Viewing - Paediatrics AS04-15. Infectious diseases****Justification of the method of acoustic diagnostics of preschool children with community-acquired pneumonia using the device "trembita-corona"**

Y. Marushko^{1*}, O. Khomych¹, T. Hyshchak¹, G. Shchegel², . Olefir², V. Khomych³, O. Malezhik⁴, L. Popova⁴

¹*O.O. Bohomolets Medical University, Kiev, Ukraine, Department of Pediatrics of Postgraduate Education, Kyiv, Ukraine*

²*National Aviation University, Kyiv, Ukraine, Department of Mechanics, Kyiv, Ukraine*

³*Institute of Neurosurgery named after academician A.P. Romodanov of the National Academy of Medical Sciences of Ukraine, Department of Anesthesiology and Pediatric Intensive Care, Kyiv, Ukraine*

⁴*KNP "Children's Clinical Hospital No. 7 of the Pechersky District of Kyiv", Department of Pediatrics, Kyiv, Ukraine*

BACKGROUND AND AIM

Community-acquired pneumonia (CAP) is an urgent problem in practical medicine and the main cause of morbidity and mortality in the world. Aim: to determine the features of acoustic diagnostics of preschool children with community-acquired pneumonia using the "Trembita-Corona" acoustic monitoring device, to correct and supplement traditional diagnostic methods.

METHODS

We studied 120 children aged 1 month to 6 years, who were treated in the pediatric departments in hospitals. The children were divided into two groups: Group I – 60 patients with CAP, Group II – 60 healthy children. Children from - group underwent a comprehensive examination. All children underwent

research using the “Trembita-Corona” acoustic monitoring device for the diagnosis of respiratory noise and localization of lung lesions. The computerized analysis of breathing sounds was carried out using mathematical methods without involving human factors.

RESULTS

In preschool children, the clinical picture of CAP consisted of pulmonary (respiratory) complaints, symptoms of intoxication and local physical changes. Respiratory lung sounds in the frequency range from 0.1 Hz to 30 kHz were studied in all patients using the “Trembita-Corona” device and the corresponding original software. The frequency ranges have been found experimentally and the prospects for the diagnosis of pneumonia in children with CAP in these ranges that have been proved.

CONCLUSIONS

The “Trembita-Corona” acoustic monitoring device is a new and promising acoustic method for determining the location of a pathological process in the lungs.

EP750 / #973

E-Poster Viewing - Paediatrics AS04-15. Infectious diseases

Experience in the use of a herbal expectorant with *thymus vulgaris* and *hedera helix* in preschool children with acute bronchitis and atopic background

Y. Marushko^{1*}, T. Hyshchak¹, T. Marushko^{2,3}, O. Khomych¹

¹O.O. Bohomolets Medical University, Kiev, Ukraine, Department of Pediatrics of Postgraduate Education, Kyiv, Ukraine

²Shupyk National Medical Academy of Postgraduate Education, Kiev, Ukraine, Department of Pediatrics No2, Kyiv, Ukraine

³Shupyk National Healthcare University of Ukraine, Department of Paediatrics No2, Kyiv, Ukraine

BACKGROUND AND AIM

Acute bronchitis is an urgent problem in pediatrics. Children with allergic background have special requirements for the treatment of acute bronchitis, as treatment should not increase the allergy of the body. Objective: to study the effectiveness and safety of the use of expectorants of plant origin containing *Thymus vulgaris* and *Hedera helix* in children with acute bronchitis and atopic background.

METHODS

The study involved 60 children aged 3-7 years with acute bronchitis with a burdened history of allergic diseases. In the course of treatment, all children received antipyretic drugs as medically indicated and a herbal expectorant with *Thymus vulgaris* and *Hedera helix* in the form of syrup 3 times a day for 10 days.

RESULTS

In the complex treatment with the herbal expectorant *Thymus vulgaris* and *Hedera helix*, the intensity of fever and intoxication syndrome were significantly lower on the 3rd day of inpatient treatment and disappeared on the 5th day in the vast majority of children. Improvement in the secretion of nasal and bronchial secretions was observed on day 3 after the start of therapy. There were no significant changes in serum IgE levels within 10 days of treatment. Thus, at the beginning of therapy it was within 38.3 ± 1.3 kE / l, and after 10 days - 36.8 ± 1.1 kE / l.

CONCLUSIONS

The use of the herbal expectorant with *Thymus vulgaris* and *Hedera helix* in the form of a syrup in children with acute bronchitis and an allergic background showed good efficacy and safety and no allergic complications.

EP751 / #1571

E-Poster Viewing - Paediatrics AS04-15. Infectious diseases

Group b streptococcus late-onset disease and contaminated breast milk – a case report

I. Mazeda^{1*}, B. Vieira², S. Branco¹, J. Pinho³, M.J. Dinis¹, G. Oliveira²

¹Centro Hospitalar Póvoa de Varzim e Vila do Conde, Porto, Portugal, Department of Pediatrics, Póvoa do varzim, Portugal

²Centro Hospitalar da Póvoa de Varzim e Vila do Conde, Department of Pediatrics, Póvoa de Varzim, Portugal

³Centro Hospitalar de Vila Nova de Gaia e Espinho, Department of Pediatrics, Vila Nova de Gaia, Portugal

BACKGROUND AND AIM

Group B streptococcus (GBS) is a significant cause of infection in newborns and infants. Late-onset disease (LOD) occurs less frequently and is related to maternal, hospital or community contact. Tough rare, infection through contaminated breast-milk, should be considered in the presence of late-onset or recurrent GBS disease.

METHODS

We present the case of a one-month-old infant with GBS LOD, in which the source of infection appears to be the breast milk.

RESULTS

A one-month-old male infant was born vaginally at term, following an uneventful pregnancy. Apgar scores were normal. Maternal GBS screening was negative. Membrane rupture occurred 5h before labor and amniotic fluid was clear. At 1 month and 22 days, he is brought to the emergency due to

a 24h-history of increasing irritability, feed refusal and fever. Investigations revealed leukocytosis ($23870/\text{mm}^3$) and elevated C-reactive protein (8.65mg/dL). Cerebrospinal fluid (CSF) analysis was normal. He was started on ampicillin and cefotaxime. Three days after admission, both blood and breast-milk cultures were positive for GBS. CSF culture was negative. Treatment was adjusted: cefotaxime suspended and 10 days of ampicillin were completed. Breastfeeding was discontinued until breast milk culture became sterile, which occurred at 48h of a 10-day course of amoxicillin given to the mother.

CONCLUSIONS

GBS transmission through infected breast milk is not entirely understood. The proposed mechanism suggests the newborn (throat colonization) is GBS source, while the mammary gland is GBS replication site. The authors emphasize that whenever LOD is considered on breastfed infants, breast milk culture should be performed.

EP752 / #1869**E-Poster Viewing - Paediatrics AS04-15. Infectious diseases****Orbital cellulitis in pediatrics – a five-year review****C. Morais^{1*}, R. Curval¹, J. Pereira-Nunes¹, S. Martins², A. Reis-Melo³, C. Faria³, M. Tavares³**¹*Centro Hospitalar e Universitário São João, Department of Pediatrics, Porto, Portugal*²*Centro Hospitalar e Universitário São João, Department of Otorhinolaryngology, Porto, Portugal*³*Centro Hospitalar e Universitário São João, Infectious Diseases/immunodeficiencies Unit, Department of Pediatrics, Porto, Portugal***BACKGROUND AND AIM**

Infection of the skin and other soft tissues, in and surrounding the eye, can occur in the pre-septal (pre-septal cellulitis) or post-septal (orbital cellulitis) regions. Distinction of these entities is fundamental since orbital cellulitis can lead to ocular and/or cerebral complications. We aim to characterize clinical features and treatment of hospitalized pediatric cases of orbital cellulitis in a five-year period.

METHODS

Retrospective study of pediatric patients admitted to a central hospital with orbital cellulitis between April 2014 and March 2019.

RESULTS

A total of 36 cases were included, 23 (63.9%) males. Patients had a mean age of 5.94 ± 4.59 years. Maximum annual number of admissions occurred in 2018: 11 (30.6%) cases, four of which had complications. In 32 (88.9%) patients, sinusitis was the predisposing factor. Imaging findings suggestive of complications were reported in 12 (33.3%) patients, predominantly subperiosteal

abscess. Combined antibiotics were used in 21 (58.3%) patients and systemic corticosteroids in 26 (72.2%). Five (13.9%) children required surgical drainage of abscess and one isolate of *Streptococcus constellatus* (*Streptococcus anginosus* group - SAG) was obtained. In blood cultures, we obtained one isolate of *Streptococcus intermedius*, also from SAG, and another isolate of *Streptococcus pyogenes*. The course was favorable in all cases, except for one patient with subdural empyema and septic thrombosis that required neurosurgical intervention.

CONCLUSIONS

Microbial identification is difficult in orbital cellulitis; we obtained isolates of SAG and *S. pyogenes*, which are on the most frequent pathogens in published data. Analysis of prognostic factors and multidisciplinary collaboration remain essential to therapeutical optimization.

EP753 / #2350

E-Poster Viewing - Paediatrics AS04-15. Infectious diseases

Complicated acute mastoiditis – in search of the etiologic AGENT

B. Mota^{1*}, C. Morais¹, M.D.R. Cunha², D. Simões¹, I. Vivas³, A. Reis-Melo⁴, R. Vaz⁵, S. Rebelo⁶, M. Tavares⁴

¹Centro Hospitalar de São João, Pediatric Department, Porto, Portugal

²Centro Hospitalar de Entre Douro e Vouga, Pediatric Department, Santa Maria da Feira, Portugal

³Centro Hospitalar da Póvoa de Varzim e Vila do Conde, Pediatrics, Póvoa de Varzim, Portugal

⁴Centro Hospitalar e Universitário São João, Infectious Diseases/immunodeficiencies Unit, Department of Pediatrics, Porto, Portugal

⁵Centro Hospitalar de São João, Department of Otorhinolaryngology, Porto, Portugal

⁶Centro Hospitalar de São João, Uag Dos Meios Complementares Diagnósticos E Terapêutica, Porto, Portugal

BACKGROUND AND AIM

Acute mastoiditis (AM) is the most common complication of otitis media in children. The peak incidence is between 2 and 3 years of age and the main pathogens are *Streptococcus pneumoniae* and *S. pyogenes*.

METHODS

Healthy 20-month-old child, vaccinated, observed previously for rhinorrhea and fever for 5 days, diagnosed with viral infection, returned 48 hours later with left retro auricular erythema, displacement of the left ear, edema and cervical erythema, without fever. Blood workout revealed leukocytosis 14,360/uL and C-reactive protein 16.5 mg/L. She was transferred to our hospital and performed a CT-scan: "filling of left mastoid, thickening of surrounding tissues, hypodense cerebellar collection and possible thrombus in the sigmoid sinus." She underwent myringotomy and mastoidectomy with collection of tissue and pus for analysis. Empirically, started ceftriaxone and metronidazole and, in

view of the suspicion of thrombus, anticoagulation. MRI and Angio-MRI were then performed: no abscesses/osteomyelitis. Metronidazole was suspended, but multiple thrombi were confirmed. She favorably completed 4 weeks of ceftriaxone associated with hypocoagulation, which she still maintains.

RESULTS

Bacteriology of the collected pus was negative, but molecular biology techniques on the specimen sent for histopathology allowed the identification of *Streptococcus pneumoniae* (serotype 3).

CONCLUSIONS

In cases of complicated AM, prompt surgical and medical treatment are essential to avoid sequelae, and recognition of etiologic agent enables directing antibiotic treatment. Despite the success in reducing the incidence of invasive disease, the PCV 13 conjugate vaccine does not appear to have reduced the incidence of AM, but further studies are required to assess the impact of this vaccine.

EP754 / #1757

E-Poster Viewing - Paediatrics AS04-15. Infectious diseases

Periorbital edema and severe thrombocytopenia in Epstein-Barr virus infection: two case-reports

M. Novo^{1*}, T. Monteiro¹, E. Schortenschi¹, M. Pereira², M. Amado²

¹Centro Hospitalar Universitário do Algarve, Unidade de Faro, Paediatric, Faro, Portugal

²Centro Hospitalar Universitário do Algarve, Unidade de Portimão, Paediatric, Portimão, Portugal

BACKGROUND AND AIM

The Epstein-Barr virus (EBV) belongs to the Herpesviridae family, the main agent of infectious mononucleosis (IM). Primary infection is most frequent in pediatric age, mainly asymptomatic and <10% evolve clinical infection. The aim is to report two cases of IM, with different clinical presentations.

METHODS

Two cases were selected in the emergency room (ER) from a level III hospital, with subsequent clinical history analysis, laboratory and imaging findings.

RESULTS

Case-report 1: A 2-year-old girl attends to ER with periorbital edema. Laboratory investigation revealed lymphocytosis (59%), atypical lymphocytes (22%) and neutropenia (200/uL). There was no elevation of transaminases. One day later, she had hoarseness and fever and clinical examination shows tonsillar hypertrophy with bilateral exudate and cervical lymphadenopathy. Serology EBNA IgM+/ IgG-. Normalization of the leukocyte formula and clinical resolution in 2 weeks. Case-report 2: A 5-year-old boy with fever, odynophagia and right cervical pain, presented cervical lymphadenopathy, splenomegaly

and petechiae in the armpits, chest, and lower limbs, on medical examination. Analytically, leukocytosis without lymphocytosis, 15% atypical lymphocytes and severe thrombocytopenia (8000/uL). On the second day of hospitalization, the result EBNA IgM+/ IgG - was obtained.

CONCLUSIONS

IM is characterized by the classic triad of fever, tonsillar pharyngitis, and lymphadenopathy. Other manifestations are splenomegaly (50-60%) and periorbital edema which, although less frequent (25-40%) is characteristic. The most common laboratory finding is lymphocytosis (>50%) that was not present in case 2, in other hand presented 15% atypical lymphocytes on peripheral blood smear. Neutropenia and thrombocytopenia, if present, are usually mild-moderate, in both cases the patients had severe cytopenias, requiring clinical and peripheral blood smear surveillance, that proved to be transient.

EP755 / #1337**E-Poster Viewing - Paediatrics AS04-15. Infectious diseases****Covid-19 evaluation in pediatric hematology oncology patients****Y. Ersozlu¹, C. Canpolat², G. Yalcin³, M. Ozen^{4*}**¹*Acibadem University, Pediatric Infectious Disease, Maltepe, Turkey*²*Acibadem University, Pediatric Hematology Oncology, Istanbul, Turkey*³*Acibadem University, Pediatric Health and Diseases, Istanbul, Turkey*⁴*Acibadem University, Pediatric Infectious Disease, Istanbul, Turkey***BACKGROUND AND AIM**

Coronavirus Disease 2019 (COVID-19) is still a current health problem caused by the SARS-CoV-2 virus, which causes significant mortality and morbidity in risky groups. While elderly with concomitant disease have severe symptoms, children usually get over it milder. Malignancy patients raise concerns about COVID-19, as they are immunosuppressed due to both the underlying disease and chemotherapy. Otherwise, some publications suggest that reduced inflammatory process may be 'protective'. Outcomes of patients with hematological malignancies who had COVID-19 were evaluated for this purpose.

METHODS

Patients with positive SARS-CoV-2 PCR test in Pediatric Hematology-Oncology follow-up were screened retrospectively, their demographic and clinical characteristics were recorded.

RESULTS

SARS-CoV-2 PCR positive 21 patients were included in the study. 11 girls and 10 boys. All patients admitted with fever. Their malignancies were ALL(9), brain tumors(9) and Ewing sarcoma, neuroblastoma and spinal tumor. None of the patients needed mechanical ventilation and intensive care follow-up. Chemotherapy regimens were postponed only in minority of patients because none of them developed severe infection. There was zero mortality due to COVID-19.

CONCLUSIONS

When the clinical features of pediatric hematology-oncology patients with follow-up COVID-19 were examined, it was seen the mortality rate was lower than adults, which was consistent with the literature. In a review investigating causes of severe disease in children with SARS-CoV-2 infection, it was found that patients with malignancy had increased mortality rate, while intensive care need was not increased. This was thought to be incidental as these patients had diseases with a high mortality rate.

EP756 / #1624**E-Poster Viewing - Paediatrics AS04-15. Infectious diseases****Characteristics of pediatric hospitalizations for respiratory diseases from march-2020 to march-2022 occurred in a reference teaching hospital, rio de janeiro, brazil**

E. Veiga, Á. Veiga, N. Moliterno, J. Pacheco*, G. Cordeiro, A.C. Dominguez, P. Valente, S. Cordeiro, I. Silva

Faculdade de Medicina de Petrópolis, Paediatrics, Petrópolis, Brazil

BACKGROUND AND AIM

Diseases of respiratory origin are the major cause of pediatric morbidity and mortality in children under 5 years of age since the 20th century, with acute lower respiratory tract infection being the most responsible for hospitalizations in this age group. The world incidence of respiratory diseases in childhood is 95% in children under 5y old and in developing countries, it is estimated that 7-13% of respiratory cases result in hospitalization, and about 1,3% evolve to death. Our objective was to identify characteristics of pediatric hospitalizations for respiratory diseases in general in the period of March 2020-March 2022 to better understand the nosological profile.

METHODS

Cross-sectional, retrospective, descriptive study of respiratory diseases in children between 0 and 14 years old hospitalized in the Pediatrics Sector of the public university hospital, State of Rio de Janeiro, Brazil from 03/2020 to 03/2022. Variables: diagnosis, age, gender, classification of pathologies found by the CID-10, length of stay, outcome.

RESULTS

In total of 1332 hospitalizations, 621(46.6%) were respiratory diseases. Distribution:180/2020; 193/2021; 248/January-March/2022. Male gender: 368(59.2%). Children under 5 years old: 508(81.8%). COVID-19 34 cases(5.4%). Average age: 3 years. Average stay: 6d.

CONCLUSIONS

As we can see, the distribution of respiratory diseases during the study period underwent a change in relation to the historical seasonality that occurs predominantly in the autumn and winter months, with a higher incidence in spring and summer. Prevention measures for SARS-COV-2 were not only effective in reducing transmission, but also reflected in the incidence of other respiratory diseases.

EP757 / #1725**E-Poster Viewing - Paediatrics AS04-15. Infectious diseases****Pediatric hospitalizations for respiratory diseases that occurred in a teaching public hospital, rio de janeiro, brazil, in the last 6 years.**

E. Veiga, Á. Veiga, N. Moliterno, J. Pacheco*, G. Cordeiro, A.C. Dominguez, I. Silva, M. Neves, F. Moliterno

Faculdade de Medicina de Petrópolis, Paediatrics, Petrópolis, Brazil

BACKGROUND AND AIM

Respiratory diseases in childhood have a well-established seasonality in the literature, with a peak occurring in the autumn and winter months. This study evaluates the influence of the COVID-19 pandemic on the seasonality of these diseases in order to identify the prevalence of pediatric respiratory hospitalizations in children in the last 6 years and to describe the seasonal epidemiological behavior of these diseases before, during and after the COVID-19 pandemic. 19.

METHODS

Cross-sectional, retrospective, descriptive study, considering hospitalizations from 0 to 14 years old with respiratory diseases from January/2016 to December/2021 in public hospital, RJ/Brazil. Variables studied: diagnosis, age, gender and length of stay. Respiratory diseases were classified into 9 groups: upper airway infections, asthma/bronchospasm, bronchiolitis, pneumonia, bronchiolitis with pneumonia, associated upper and lower airway infection, COVID-19, respiratory diseases with previous comorbidities and complicated pneumonias.

RESULTS

There were 5504 hospitalizations between 01/01/2016 and 12/31/2021, and 2233 (40.5%) were respiratory causes. Average age: 32 months minimum of 9 days and maximum of 14 years. Average hospital stay: 7 days. A 65.1% decrease in respiratory hospitalizations in 2020 compared to 2019 and a 100% increase in 2021 compared to 2020. There were 34 hospitalizations for COVID-19.

CONCLUSIONS

During the COVID-19 pandemic, there was a drop in pediatric hospitalizations as a result of the preventive measures adopted due to the COVID-19 pandemic. The years before the pandemic showed a historical evolution in terms of known seasonality. A change in this profile can be observed from March 2020. The present study will continue to record future behavior.

EP758 / #1535**E-Poster Viewing - Paediatrics AS04-15. Infectious diseases****Varicela zoster virus infection and immunoglobulin a vasculitis – a rare finding****I. Pais-Cunha^{1*}, I. Vivas², I. Mazedo², S. Branco², M.J. Dinis², G. Nogueira Oliveira²**¹*Centro Hospitalar Universitário de São João, Porto, Portugal, Pediatrics, Porto, Portugal*²*Centro Hospitalar Póvoa de Varzim e Vila do Conde, Porto, Portugal, Department of Pediatrics, Póvoa do varzim, Portugal***BACKGROUND AND AIM**

Immunoglobulin A vasculitis (IgAV) is the most common childhood systemic vasculitis. It is characterized by purpura, arthritis, gastrointestinal and/or renal involvement. Etiology is unknown, but two-thirds have a prior upper respiratory infection. The probable mechanism is immune-complex deposition in response to bacteria or viruses.

METHODS

We report a rare case of varicella zoster virus (VZV) infection and IgAV.

RESULTS

A 3-year-old boy was admitted to our emergency with lower extremities purpura. He refused to ambulate and had tenderness and edema of the ankles, hand and wrists. Four days prior he was diagnosed with Varicella and was being treated with acyclovir. On examination, he was hemodynamically stable and had crusted lesions over the trunk and scalp. Review of other systems was unremarkable. Fever onset occurred on admission. Investigation showed:

erythrocyte sedimentation rate 39mm/h; normal platelet count and coagulation. IgA title, urinalysis and renal function were normal. Antistreptolysine-O, urine and blood cultures were negative. VZV-IgM was positive. He was hospitalized and treated with ibuprofen and acyclovir with clinical improvement. One-week after discharge, he complained of severe abdominal pain and was started on a 30-day prednisolone course with complete symptom resolution. No other complications occurred at 6-month follow-up.



FIGURE 1:



FIGURE 2:



FIGURE 3:

CONCLUSIONS

The occurrence of VZV infection with IgAV is a rare finding and few reports are available. The authors hypothesize that VZV specific viral antigens may be the triggering factor of IgAV. Even though both present with cutaneous involvement, IgAV can severely affect other systems and requires a close follow-up. Nevertheless, as in our case, prognosis is excellent.

EP759 / #1670

E-Poster Viewing - Paediatrics AS04-15. Infectious diseases

Tuberculosis in childhood. Polyserosistis.

E. Paskaleva - Georgieva*

*MBALBB *Sv.Sofia, Childrens Clinic, Sofia, Bulgaria*

BACKGROUND AND AIM

Polyserositis is a reaction of serosis, that occurs in several body cavities, most often as a result of other system diseases: tuberculosis, toxoplasmosis, polyarthritis, lupus, intestinal cavity, and others. How do recognize the true diagnosis?

METHODS

The presentation is a look at this condition with an etiological focus on tuberculosis, illustrated by a clinical case of an 11-year-old girl.

RESULTS

The presented case begins with a high fever and inflammatory activity, abdominal pain, and a history of long-term constipation. Imaging studies present unilateral pleurisy and ascites on the background of changes in the colon, considered a congenital anomaly of the digestive system, and later inflammation of the pericardium. A positive IGRA test and good response after six months of tuberculostatic treatment prove the etiological diagnosis.

CONCLUSIONS

The first case of tuberculous polyserositis was described in 1846. by Van Dean. Long-term observation and research interest do not show both diagnostic and treatment to become more easily. The present case requires consideration of the possibility of tuberculosis infection in any form of effusion in any body cavity.

EP760 / #1249

E-Poster Viewing - Paediatrics AS04-15. Infectious diseases

A perinealsandpaper-like erythematous eruption

M. Pedro*, M. Caldas, T. Magalhães, A.S. Esteireiro, C. Gomes

Centro Hospitalar do Oeste, Unidade Caldas da Rainha, Pediatria, Caldas da Rainha, Portugal

BACKGROUND AND AIM

A previously healthy 5-year-old boy presented to the emergency room with a 4-day history of perioral erythema, penis and testicles' edema and erythema, followed by genital desquamation for the past few hours. There was no history of trauma, fever, odynophagia, abdominal pain or other symptoms. On physical examination, he had a good general condition and was hemodynamically stable. Dryness and cracking of the lips, oropharyngeal hyperemia and strawberry tongue were observed (fig.1). He also had a perineal sandpaper-like rash with desquamation of the genitalia (fig.2). There was no rash on the trunk, underarms, groin or extremities.



FIGURE 1:



FIGURE 2:

METHODS

A negative cutaneous rapid strep test and a positive oropharyngeal rapid strep test were performed.

RESULTS

Scarlet fever was admitted, and a 10 day course of amoxicillin prescribed. After 48 hours the genital erythema was resolved and the desquamation gradually improved. One week later there was symptomatic resolution with complete recovery of the exanthem (fig.3).



FIGURE 3:

CONCLUSIONS

Scarlet fever is a syndrome caused by infection with toxin-producing group A *Streptococcus pyogenes* and primarily affects children between ages of five and fifteen. It occurs in less than 10% of cases of streptococcal tonsillopharyngitis. Usually, the characteristic exanthem is more prominent in flexural and dependent areas, frequently extending to the trunk and extremities. In our case the rash was limited do the perineal area and there were no systemic symptoms. It is important to remember atypical scarlet fever presentations and ruling out other bacteria associated-syndromes, like toxic shock syndrome and staphylococcal scalded skin syndrome.

EP761 / #2654**E-Poster Viewing - Paediatrics AS04-15. Infectious diseases****Data gap analysis and current medical needs to support respiratory syncytial virus (rsv) prevention strategies in italy: input from a panel of experts**

R. Prato^{1*}, F. Fortunato¹, R. Cutrera², S. Esposito³, S. Giuffrida⁴, G.V. Zuccotti⁵, D. Martinelli¹

¹University of Foggia, Hygiene Unit, Policlinico Riuniti Foggia Hospital, Department of Medical and Surgical Sciences, Foggia, Italy

²Bambino Gesù Children's Hospital, IRCCS, Pediatric Pulmonology & Respiratory Intermediate Care Unit, Sleep, and Long Term Ventilation Unit, Academic Department of Pediatrics (dpuo), Roma, Italy

³University Hospital of Parma, Pediatric Clinic, Department of Medicine and Surgery, Parma, Italy

⁴Azienda Sanitaria Provinciale of Reggio Calabria, Department of Prevention, Reggio Calabria, Italy

⁵University of Milan - Vittore Buzzi Children's Hospital, Department of Pediatrics, Milan, Italy

BACKGROUND AND AIM

In Italy, RSV epidemiology has been very stable over the years. The absence of cases during the 2020-2021 season and the numerous cases during the 2021-2022 season are consequences of the non-pharmaceutical measures adopted against Sars-Cov-2. There is a need for systematic structured surveillance together with evidence on factors related to incidence changes. An advisory board workshop was held on 28/04/2022 to provide input on the prevention of medically-attended lower-respiratory tract infection caused by RSV in children.

METHODS

A group of experts in pediatric and public health areas reviewed RSV epidemiology, new prevention perspectives, and future research streams. Experts

contributed to the discussion surrounding current scientific issues in RSV, providing, in an unstructured way, insights on filling data gaps and informing policy recommendations for RSV vaccine and monoclonal antibody (mAb).

RESULTS

RSV infection is largely underestimated depending on the failure to suspect infection or the failure to test for RSV. According to the available literature, 40-50% of RSV bronchiolitis cases are associated with otitis media. Since most RSV infections occur in very young children with no comorbidity, often requiring intensive care, they should receive passive immunization with mAb or through maternal immunization. Vaccination would be convenient for children aged >6 months. Estimates of costs with and without prevention and of vaccination versus mAbs are needed to implement programs.

CONCLUSIONS

Any possible RSV prophylaxis scenario will have to fit into the National Immunization Plan. Strong communication interventions, education of families, and training of healthcare professionals will be crucial.

EP762 / #1295**E-Poster Viewing - Paediatrics AS04-15. Infectious diseases****The particularities of encephalitis and meningoencephalitis in children in batna algeria****N. Righi***

University batna 2 Algeria, Medical School, Batna, Algeria

BACKGROUND AND AIM

Authors: N.Righi*,S.Slimani,* Y A.Mekki,**D.Floret, S.Tbbal* B.Lina** Abstract
Acute encephalitis in children occurs in most cases during a systemic infection, sometimes the neurological damage is the only infection. Objective: Demonstrate the particularity as well as the frequency of encephalitis and meningoencephalitis in children

METHODS

Materials and methods: A longitudinal and exhaustive prospective study (April 1, 2012 to August 31, 2012) focused on patients aged over 28 days with symptoms suggestive of encephalitis meeting the inclusion and exclusion criteria established by SPILF.

RESULTS

of the 141 cases, 38 were children (27%). Median age of 5 (1-9) with a male predominance (sex ratio of 1.37). The onset was more often brutal (81.6%), convulsions 73.7%. Respiratory involvement was noted in 36.8%. Pleiocytosis was found in 81.4%. The etiology was found in 28/38 patients(73.7%). The viral etiology is largely predominant (57.4%) whose confirmed or probable etiologies were represented by (7 EBV, 4 ADV, 3 CMV, 3 Gpe, 2 VZV, 2 ETV, 1

HSV1 Rhino, 1 HHV6 against the bacterial etiology which represented 36.9% with confirmed or probable etiologies (3 Pn, 3 Mg, BGN, 3 Mycoplasma, 3 BK, 2 Chlamydiae, 2 Lyme).

CONCLUSIONS

This study made it possible to highlight in children the etiologies of encephalitis and meningo-encephalitis with their clinical and paraclinical particularities, in the region of eastern Algeria.

EP763 / #1411**E-Poster Viewing - Paediatrics AS04-15. Infectious diseases****Acute disseminated encephalomyelitis and co-infections about a child in batna algeria****N. Righi***

University Batna 2 Algeria, Medical School, Batna, Algeria

BACKGROUND AND AIM

Authors: N.Righi*, L.Rahmoun*, S.Slimani*,YA.Mekki**D.Floret, S.Tbbal* B.Lina** Abstract: Acute disseminated encephalomyelitis (ADEM) is a multifocal inflammatory demyelinating disease mainly involving the white matter of the central nervous system. Objective: Describe for the first time quadri co-infections and encephalomyelitis in children as well as the resulting severity.

METHODS**PATIENT AND METHODS**

A case of exceptional severity and co-infections was identified during research work from April 1, 2012 to August 31, 2015 with a longitudinal and exhaustive prospective study on patients aged over 28 days with symptoms suggestive of encephalitis meeting the criteria inclusion and exclusion criteria (HIV negative), established by SPILF.

RESULTS

; This is the 12-year-old BI patient admitted to the pediatric department on 04/09/2013 for an encephalomyelitis picture marked by the installation of a meningoencephalitic syndrome. A cerebral MRI was performed showing bilateral frontoparietal involvement with multiple demyelinating above and below tentorial and medullary lesions of an infectious appearance, the appearance of which was in favor of acute disseminated encephalomyelitis. The LCS was clear with 02 elements. PCR on LCS negative, PCR Blood isolated an Adenovirus and Parvovirus B19, and PCR on pharyngeal swab isolated a Coronavirus, with IGM lyme on serology. The evolution was marked by the appearance of serious neurological disorders, hence his orientation to the intensive care unit for a total duration of hospitalization of 07 years and 06 months before his death.

CONCLUSIONS

Conclusion

Management of ADEM must be early and multidisciplinary.

EP764 / #1417**E-Poster Viewing - Paediatrics AS04-15. Infectious diseases****An exceptional case of meningoencephalitis due to coinfections by enterovirus and streptococcus pneumoniae in an infant batna algeria****N. Righi***

University batna 2 Algeria, Medical School, Batna, Algeria

BACKGROUND AND AIM

Authors: N.Righi*, S.Katouche*, S.Slimani, D.Hadef,*YA.Mekki**D.Floret, B.Lina** Abstract Infectious meningoencephalitis, a frequent reason for hospitalization in pediatrics. Objective: Demonstrate the possibility of confirmed bacterial and viral co-infection during childhood meningoencephalitis and the resulting severity.

METHODS

Patient and methods A case of exceptional severity and co-infections was identified during research work from April 1, 2012 to August 31, 2015, which had been carried out on patients aged over 28 days with symptoms suggestive of encephalitis meeting the criteria for inclusion and exclusion established by SPILF.

RESULTS

: This is a 7-month-old infant, with no particular pathological history, correctly vaccinated, was admitted to the pediatric department on 04/10/2014 for a sudden onset of meningoencephalitis. The examination objectified diarrhoea, tachycardia, The LCS study found 450 polymorphonuclear elements

with hypoglycorachia and Hyperproteinorachia, the culture isolated streptococcus pneumoniae. PCR on LCS isolated Streptococcus pneumoniae and Enterovirus Biologically, pancetopenia was found, positive CRP at 16.3 mg/l and pro-calcitonin at 10.28 ng/ml, hyponatremia with hypochloremia, hypocalcemia, hypoprotidemia 42g/l and hepatic cytolysis. Cerebral MRI shows an area of ischemia with perilesional edema. The EEG shows spike waves. The evolution was favorable but in favor of epilepsy-type neurological sequelae.

CONCLUSIONS

Conclusion

In the presence of favorable climatic and environmental conditions, co-infection with two neurotropic agents is possible at the cost of a clinical picture of severe meningoencephalitis and residual neurological sequelae.

EP765 / #1196**E-Poster Viewing - Paediatrics AS04-15. Infectious diseases****Immunogenicity and safety of a dtwp-ipv-hb-prp~t vaccine administered with routine pediatric vaccines in healthy infants in thailand**

L. Sanchez^{1*}, S. Rungmaitree², P. Kosalaraksa³, W. Jantarabjenjakul⁴, J. Leclercq⁵, Y. Yaiprayoon⁶, V.J. Midde⁷, K. Varghese⁸, S. Mangarule⁹, F. Noriega¹⁰

¹Sanofi, Global Clinical Development, Taguig, Philippines

²Medicine Siriraj Hospital, Mahidol University, Department of Pediatrics, Bangkok, Thailand

³Srinagarind Hospital, Khon Kaen University, Department of Pediatrics, Khon Kaen, Thailand

⁴Chulalongkorn Hospital, Department of Pediatrics, Bangkok, Thailand

⁵Aixial, Biostatistics, Boulogne-billancourt, France

⁶Sanofi, Global Clinical Study Management, Bangkok, Thailand

⁷Sanofi, Global Pharmacovigilance, Hyderabad, India

⁸Sanofi, Global Clinical Immunology, Swiftwater, United States of America

⁹Sanofi, Global Clinical Development, Lyon, France

¹⁰Sanofi, Global Clinical Development, Swiftwater, United States of America

BACKGROUND AND AIM

This study aimed to demonstrate the non-inferiority of a hexavalent DTwP-IPV-HB-PRP~T vaccine to a licensed antigen-matched DTwP-HB-PRP~T pentavalent vaccine given with bivalent oral polio vaccine (bOPV) and IPV concomitantly.

METHODS

This Phase III, randomized, active-controlled, open-label, multi-center study was conducted in 460 healthy infants and toddlers in Thailand (NCT04429295). Healthy infants who had received a birth dose of BCG vaccine received either the DTwP-IPV-HB-PRP~T or the DTwP-HB-PRP~T vaccine given with bOPV

at 2, 4, and 6 months of age and IPV at 4 months of age. Pneumococcal 13-valent conjugate vaccine was co-administered at 2, 4, and 6 months of age, while the oral rotavirus vaccine was co-administered at 2 and 4 months of age.

RESULTS

Non-inferiority of the DTwP-IPV-HB-PRP~T vaccine versus the DTwP-HB-PRP~T vaccine given with bOPV and IPV was demonstrated as 95% CIs for seroprotection rate differences and adjusted geometric mean concentration ratios were all within pre-defined clinical margins. Seroprotection rate was $\geq 98.6\%$ for anti-D ≥ 0.01 IU/mL, anti-T ≥ 0.01 IU/mL, anti-HB ≥ 10 mIU/mL, anti-PRP ≥ 0.15 $\mu\text{g}/\text{mL}$, and anti-polio 1, 2, and 3 ≥ 8 (1/dil). The vaccine response rate in the DTwP-IPV-HB-PRP~T group was 63.6% for anti-PT and 94.9% for anti-FIM. The safety profiles of DTwP-IPV-HB-PRP~T and DTwP-HB-PRP~T given with bOPV and IPV were similar.

CONCLUSIONS

DTwP-IPV-HB-PRP~T demonstrated non-inferiority to DTwP-HB-PRP~T given with bOPV and IPV following vaccination at 2, 4, and 6 months of age. There were no safety concerns and no evidence of any effect of co-administration with the pneumococcal conjugate and oral rotavirus vaccines.

EP766 / #724**E-Poster Viewing - Paediatrics AS04-15. Infectious diseases****Importance of viral quantitation in children with rhinovirus infections: interference with other respiratory viruses and disease severity**

M.I. Sánchez Códez^{1*}, K. Moyer², I. Benavente-Fernández³, O. Ramilo⁴, A. Mejias⁴

¹Puerta del Mar University Hospital, Division of Pediatric Infectious Diseases, Cadiz, Spain

²Inova Children's Hospital, Division of Pediatric Infectious Diseases, VA, United States of America

³Biomedical Research and Innovation Institute of Cádiz (INiBICA), Research Unit, Cádiz, Spain

⁴Nationwide Children's Hospital, Division of Infectious Diseases, Department of Pediatrics, and Center For Vaccines and Immunity, Columbus, United States of America

BACKGROUND AND AIM

Human rhinoviruses (RVs) are the most common cause of respiratory tract infections. The role of viral loads and co-detection on RV disease severity is not well understood. We sought to define the impact of RV loads, with and without a concomitant viral co-infection, on clinical outcomes.

METHODS

Retrospective cross-sectional study of patients ≤ 21 years old with RV infections (real time PCR) at a referral hospital from 07/2011 to 12/2013. Semiquantitative RV loads were stratified in three groups according to cycle threshold (Ct) values: low (>32 Ct), intermediate (26-32 Ct) and high (<25 Ct) viral load and compared between patients with RV detection and RV co-detection according to disease severity assessed by the need of admission, intensive care, duration of hospitalization and oxygen requirement.

RESULTS

2473 children tested positive for RV. of those, 1899/2473 (76.8%) were symptomatic. RV/Viral coinfections were identified in 24% of patients. RV loads were higher in children with single RV infections, who were also older (14.9 months) vs those with viral coinfections (9.5 months; $p=0.001$). The frequency of viral coinfections was inversely proportional to RV viral loads, with 32%($n=84$) of RV/viral coinfections in children with low; 28%($n=197$) with intermediate, and 19%($n=178$) with high RV loads. Importantly, children with <25 Ct were longer hospitalized (median IQR: 2.4 [1.7-4.5] vs. 2.2[1.4-3.8] days; $p =0.047$) and required ICU care more frequently (303 [32.93%] vs. 202 [28.33%]; $p=0.047$) than those with >32 Ct.

CONCLUSIONS

Patients with higher RV loads were younger and had lower rates of viral co-infections. Higher RV loads were associated with prolonged hospitalization and ICU care.

EP767 / #1797**E-Poster Viewing - Paediatrics AS04-15. Infectious diseases****Case series in a portuguese tertiary level hospital: admissions for pediatric varicella infections****A.E.C. Silva^{1*}, A. Azevedo¹, S. Miranda², C. Silva³, S. Martins²**¹*Santa Luzia - Ulsam, Pediatria, Viana Do Castelo, Portugal*²*Unidade Local de Saúde do Alto Minho, Pediatrics, Viana do Castelo, Portugal*³*ULSAM - Hospital de Santa Luzia, Pediatria, Viana do Castelo, Portugal***BACKGROUND AND AIM**

Introduction: Varicella is a common, usually benign, and self-limited disease in children but can lead to severe complications and hospitalization. The objective of this study is to characterize varicella-related hospitalizations and their corresponding complications.

METHODS**METHODS**

Retrospective and descriptive study of the clinical records of children admitted to the Pediatrics service of the Local Health Unit of Alto Minho (ULSAM) with varicella-zoster virus (VZV) infection between January 1, 2019 and December 31, 2021.

RESULTS

RESULTS

In the time interval evaluated, 20 cases of children diagnosed with varicella-zoster infection were registered in the inpatient service of ULSAM. They were aged between 19 days and 13 years (median 2 years). Cellulitis was the most frequent varicella-associated complication, followed by cerebellitis, toxic shock, and pneumonia. 25% of the children admitted had no complications associated but presented either risk factors for poor outcome and/or severe symptoms as the reason for hospitalization. All children showed a good evolution, without sequelae. The average length of stay in this group was 5 days. As for treatment, 45% of children were treated with acyclovir, of which 2 had already started it before hospitalization. No children were immunized with the varicella-zoster virus vaccine.

CONCLUSIONS

CONCLUSIONS

In this retrospective study, complications occurred more frequently in pre-school-age children, probably due to more favorable conditions for transmission and lack of immunity in this age group. Regarding the complications of varicella-infections, these are in accordance with those described in the literature, with cutaneous complications being the most frequently described.

EP768 / #1035**E-Poster Viewing - Paediatrics AS04-15. Infectious diseases****Mediterranean spotted fever in the spectrum of pediatric fever with rashes****E. Skenderi***

University Hospital Center "Mother Tereza", Tirana, Albania, Pediatrics, Tirana, Albania

BACKGROUND AND AIM

When febrile illnesses develop rash in children, parents are very concerned of a serious disease. Many rashes associated with fever are caused by infectious diseases. Rashes are generally nonspecific and play supportive role in differential diagnosis, but for some diseases the appearance of the rash is essential in making a diagnosis. This case was reported to highlight the role of Mediterranean Spotted Fever in the spectrum of childhood fever with rash.

METHODS

This is a case report.

RESULTS



FIGURE 1:



FIGURE 2:

**FIGURE 3:**

A 4-years old boy admitted at the University Hospital Center "Mother Teresa" of Tirana, Albania on late summer with a history of 5 days high grade fever 38.5°C - 39.5°C , maculopapular rash (appeared on the third day of fever), headache, chills, vomiting, loose stool (5-6 times a day), abdominal pain. On physical examination the child appeared ill, with high fever 39.5°C . Although he was irritated, no stiff neck nor other neurological anomalies were observed. Sclera were slightly injected, pharyngeal injection and cervical lymphadenopathy were observed. A maculopapular rash was spread over the trunk, extremities including palms and soles too, accompanied by slightly swollen hands and feet. On the posterior area of the neck at the hair line border was found a black eschar. Laboratory findings resulted in moderate leukocytosis and moderately involvement of liver and renal function.

CONCLUSIONS

MSF cases are on the increase all over the world. Children suffer from milder forms of the disease, however severe and malignant forms which seriously affect the entire organism have been reported. Because there is no reliable test that can confirm MSF in its early stages, the diagnosis is commonly made on the basis of clinical findings. The course of MSF can be shortened

and complications avoided with appropriate antibiotics, so a high index of suspicion should be maintained while evaluating a child with fever and rash.

EP769 / #410

E-Poster Viewing - Paediatrics AS04-15. Infectious diseases

The paradox of medical therapy in tuberculous lymphadenitis

M. Stracuzzi*, V. Giacomet

università degli studi di milano, Pediatric Infectious Disease, Milano, Italy

BACKGROUND AND AIM

We report a case of a 5-year-old Pakistan male with persistent fever and enlargement of laterocervical lymphnodes on the left side. A positive Mantoux skin test, the DNA amplification by polymerase chain reaction and the culture from fine needle aspiration confirmed the diagnosis of Mycobacterium tuberculosis.

METHODS

He started medical treatment with isoniazid, rimpaficin, pyrazinamide. There was an initial remission of the fever and general conditions, while the characteristics of the affected lymphnodes did not change. After 1 month of therapy, he came back to our observation for increased lateral cervical swelling, redness of the overlying skin and pain, in addition to the reappearance of serotin fever and night sweats. Therapy was then modified by discontinuing the isoniazid, adding ethambutol, prednisone and levofloxacin.

RESULTS

After another month, due to no clinical improvement, a magnetic resonance was performed: marked deformation of the laterocervical region was found with voluminous confluent necrotic-colliquative adenopathies (88x72 mm).

We therefore decided to subject the child to surgery to remove the colliquate laterocervical lymphnodes and to proceed with histological examination, with confirmation of *M. tuberculosis*. A drug resistance was ruled out by antibiogram. He continued therapy with isoniazid, rimpaficin, pyrazinamide and ethambutol. At the 2-month ultrasound examination, only a few immuno-reactive lymphnodes were found, without necrotic-colliquative phenomena. Clinically, the child was in well-being, with excellent therapy compliance and good tolerance.

CONCLUSIONS

Excluding drug resistance and the presence of immunodeficiencies, paradoxical upgrading reaction (PUR) to the medical therapy offer a plausible explanation for this phenomenon.

EP770 / #1306**E-Poster Viewing - Paediatrics AS04-15. Infectious diseases****Respective role of non-pharmaceutical interventions on bronchiolitis outbreaks**

L. Lengart¹, N. Ouldali¹, K. Honeyford¹, Z. Bognar², S. Bressan³, D. Buonsenso⁴, L. Da Dalt³, T. De¹, R. Farrugia¹, I.K. Maconochie¹, H. Moll⁵, R. Oostenbrink⁵, N. Parri⁶, D. Roland⁷, K. Rose¹, E. Akyuz Ozkan¹, F. Angoulvant¹, C. Aupiais¹, C. Barber¹, M. Barrett¹, R. Basmaci¹, S. Castanhinha¹, A. Chiaretti⁴, S. Durnin¹, P. Fitzpatrick¹, L. Fodor¹, B. Gomez¹, S. Greber-Platzer¹, R. Guedj¹, F. Hey¹, L. Jankauskaitė⁸, D. Kohlfuerst¹, I. Mascarenhas¹, A.M. Musolino¹, Z. Pucuka¹, S. Reis¹, A. Rybak¹, P. Salomon¹, M. Schaffert¹, K. Shahar-Nissan¹, M.C. Supino¹, Ö. Tekşam¹, C. Turan¹, R. Velasco⁹, R. Nijman¹⁰, L. Titomanlio^{1*}

¹Robert Debre Hospital, Pediatric Emergency Department, Paris, France

²Heim Pal National Paediatric Institute, Paediatric Emergency, Heim Pal, Hungary

³Ospedale Universitario di Padova, Pediatric Emergency, Padova, Italy

⁴Fondazione Policlinico Universitario A. Gemelli IRCCS, Department of Woman and Child Health and Public Health, Rome, Italy

⁵Erasmus Medical Center - Sophia Children's Hospital, General Pediatrics, Rotterdam, Netherlands

⁶Meyer Hospital, Pediatric Emergency, Florence, Italy

⁷Leicester Royal infirmary, Paediatric Emergency Medicine Leicester Academic (pemla) Group, Emergency Department, Leicester, United Kingdom

⁸Hospital of Lithuanian University of Health Sciences, Coordinating Center For Rare and Undiagnosed Diseases, Kaunas, Lithuania

⁹Hospital Universitario Rio Hortega, Pediatric Emergency, Valladolid, Spain

¹⁰Imperial College London, Section of Paediatric Infectious Diseases, London, United Kingdom

BACKGROUND AND AIM

Bronchiolitis is a major source of morbimortality among young children worldwide. Non-pharmaceutical interventions (NPIs) implemented to reduce the spread of SARS-CoV-2 may have had an important impact on bronchiolitis cases, as well as major societal consequences. Discriminating between their respective impacts would help define optimal public-health strategies. We

aimed to assess the respective impact of each NPI on bronchiolitis outbreaks in 14 European countries.

METHODS

We conducted a quasi-experimental interrupted time-series analysis based on a multinational surveillance system. All children diagnosed with bronchiolitis presenting to the paediatric emergency department of one of the 27 centres from January 2018 to March 2021 were included. We assessed the association between each NPI and change in the bronchiolitis trend over time by seasonally adjusted multivariable quasi-Poisson regression modelling.

RESULTS

In total, 42,916 children were included. We observed an overall cumulative 78% reduction (95%CI [-100;-54], $p < 0.0001$) in bronchiolitis cases following NPI implementation. The decrease varied between countries from -97% (95%CI [-100;-47], $p = 0.0005$) to -36% (95%CI [-79;+07], $p = 0.105$). Full lockdown (IRR 0.21, 95%CI [0.14;0.30], $p < 0.001$), secondary-school closure (IRR 0.33, 95%CI [0.20;0.52], $p < 0.0001$), wearing a mask indoors (IRR 0.49, 95%CI [0.25;0.94], $p = 0.034$), and teleworking (IRR 0.55, 95%CI [0.31;0.97], $p = 0.038$) were independently associated with reducing bronchiolitis.

CONCLUSIONS

Multiple NPIs were associated with reducing bronchiolitis cases. Among them, full lockdown and school closure are not sustainable in the long term due to their societal consequences. Teleworking and facial masking may be important public-health tools to reduce bronchiolitis burden. Further studies are required to explore their long-term impact.

EP771 / #1479**E-Poster Viewing - Paediatrics AS04-15. Infectious diseases****Unusual neck mass in a teenage boy – a case report****I. Vivas^{1*}, S. Branco¹, I. Cunha², J. Oliveira³, G. Oliveira¹, P. Botelho⁴**¹*Centro Hospitalar Póvoa de Varzim e Vila do Conde, Pediatrics, Póvoa de Varzim, Portugal*²*Hospital de São João, Pediatrics, Porto, Portugal*³*Centro Materno Infantil do Norte, Pediatrics, porto, Portugal*⁴*Centro Hospitalar da Póvoa de Varzim e Vila do Conde, General Surgery, Póvoa de Varzim, Portugal***BACKGROUND AND AIM**

Superficial masses of the head and neck are a common finding in childhood and usually benign. However, the broad differential diagnosis includes inflammatory, infectious, congenital, traumatic and even neoplastic etiologies. Some masses cause a lot of concern and unleash extensive investigations.

METHODS

This case report aims to describe an interesting case of cat-scratch disease (CSD).

RESULTS

13-year-old boy referred to the pediatrician with a 2-month history of a left submandibular mass. Besides fatigue, no other symptoms were reported. There was no history of local trauma, surgery or infection. Medical and family histories were unremarkable. He had a domestic cat for years and a feral kitten for 6 months. Examination revealed a tender, firm, fixed, well-circumscribed left submandibular mass measuring 4x3cm and cat-scratches on the arms. He completed a course of amoxicillin/clavulanate with no response.

Complete blood count, liver function, C-reactive protein and chest x-ray were unremarkable. Computed tomography showed a submandibular heterogeneous nodule measuring 3x2.5cm. Fine needle aspiration revealed epithelioid necrotizing granulomas (characteristic of CSD) and was negative both for malignant cells and Mycobacterium tuberculosis. Bartonella henselae IgM and IgG were positive (1/256;1/20) and azytromycin initiated. At 2-month follow-up, lymphadenitis significantly improved (1.5x1cm).



FIGURE 1:

CONCLUSIONS

Despite having some alarming characteristics, the neck mass investigation ultimately revealed a CSD lymphadenitis. Faced with a case of granulomatous lymphadenitis, CSD must be considered for the differential diagnosis and anamnesis about contact should always be asked. To conclude, the authors emphasize the importance of a thorough history and physical examination in establishing an accurate diagnosis and treatment.

EP772 / #696

E-Poster Viewing - Paediatrics AS04-15. Infectious diseases

A tale of two infections in ONE!

S. Waugh*, P. Vallabhaneni

Swansea Bay University Health Board, Paediatrics, Swansea, United Kingdom

BACKGROUND AND AIM

A 23-month-old girl with a background of focal epilepsy presented to the paediatric assessment unit with a 10-day history of pyrexia between 39-41 °C and a new and worsening maculopapular rash. Initial assessment revealed hepatosplenomegaly and a florid erythematous rash, with blood results demonstrating deranged transaminases, coagulation and raised white cells. Initial differentials included hepatitis, carbamazepine-induced rash and hepatomegaly, CMV or EBV infection, haemophagocytic lymphohistiocytosis, leukaemia, and Kawasaki disease. The patient had an extensive work-up and was treated with broad-spectrum antibiotics.

METHODS

A variety of investigations were undertaken to identify the causative agent. Infectious and Inflammatory causes were extensively explored and multiple consultations with experts were held to identify and treat the cause.

RESULTS

Human herpesvirus type 6 DNA (35079 copies per ml) and adenovirus (95 copies per ml) PCR positive, CMV PCR negative, EBV PCR negative, parvovirus negative, throat swab no growth, measles PCR negative, blood culture no

growth, legionella culture not isolated, adenovirus PCR pleural fluid DNA not detected and autoimmune hepatitis screen was negative.

CONCLUSIONS

We report a rare case of dual infection with HHV6 and Adenovirus causing hepatitis in an immunocompetent child. We propose that these infective causes should be screened for commonly in children presenting with acute hepatic picture.

EP773 / #2637

E-Poster Viewing - Paediatrics AS04-15. Infectious diseases

Association between pediatric tuina (massage) and the incidence of acute respiratory tract infections in children at guangdong provincial hospital, southern china: a retrospective cohort STUDY

L. Yin^{1*}, C. Lundborg¹, D. Wu², J. Yang³, H. Alvensson¹, J. Cai², T. Lu², Q. Xie², G. Marrone¹

¹Karolinska Institutete, Global Public Health, Stockholm, Sweden

²Guangdong Provincial Hospital of Chinese Medicine, Program For Outcome Assessment In Chinese Medicine, Guangzhou, China

³Guangdong Provincial Hospital of Chinese Medicine, Pediatrics, Guangzhou, China

BACKGROUND AND AIM

Pediatric *Tuina* (PT) has been utilized as a clinical prevention for children in China, but it is unknown whether this is associated with a decreased ARTI recurrence. This study aimed to determine the effectiveness of PT in preventing recurrent acute respiratory tract infections (ARTIs) in children.

METHODS

This is a retrospective cohort study based on the electronic medical records of children with recurrent ARTIs in 2016. Children were divided into a PT group or a non-PT group, according to whether they had received PT or not in 2016. The primary outcome was the number of ARTI episodes in 2017 and 2018. The secondary outcomes were the number of ARTI leading to outpatient department visits and outpatient antibiotics prescriptions due to

ARTIs in the same time period. Negative binomial regressions were used to detect the association between PT and the outcomes.

RESULTS

A total of 2,303 children were included in the analysis, 94 in the PT group. Children with PT six or more times in 2016 had fewer episodes of ARTIs in 2017 (IRR: 0.59, 95% CI: 0.42-0.84) and 2018 (IRR: 0.58, 95% CI: 0.36-0.94) and fewer outpatient department visits due to ARTIs in 2017 (IRR: 0.56, 95% CI: 0.38-0.83) compared to children who had not received PT in 2016. There was no significant difference in the number of outpatient antibiotic prescriptions between the two groups.

CONCLUSIONS

Having six or more PT within one year is associated with a decrease in recurrent ARTIs in children. Randomized controlled trials are needed for effect evaluation.

EP774 / #2017

E-Poster Viewing - Paediatrics AS04-15. Infectious diseases

Epidemiology of pediatric viral infections during the third covid 19 pandemic WAVE

M. Zantiotou*, A. Kyriakopoulou, S. Karageorgos, T. Pappa, I. Farakla, E. Mpotsa

Aghia Sophia Children's Hospital, National and Kapodistrian University of Athens, First Department of Pediatrics, Athens, Greece

BACKGROUND AND AIM

The implementation of mitigation measures to reduce Sars-CoV-2 transmission influenced the prevalence of common seasonal viruses. The number of hospitalized cases with respiratory and gastrointestinal viral infections was noticeably reduced since RSV, influenza viruses, and adenovirus were almost eliminated. This resulted in increased population susceptibility as children were abruptly exposed to viral pathogens. **Aim:** The aim of the study was to investigate the incidence of infectious diseases and the prevalence of viral agents during the third wave of the COVID-19 pandemic.

METHODS

Observational, retrospective study of patients hospitalized with infectious diseases in the special admission unit for suspected COVID-19 cases of Aghia Sophia Children's Hospital in Athens, from September 2021 to March 2022.

RESULTS

The rate of hospitalization due to respiratory tract and gastrointestinal infections demonstrated an increase of almost 40% compared to the respective

rates of previous COVID-19 eras. RSV appeared in September presenting a peak in November 2021 accounting for up to 41% of all bronchiolitis cases, earlier than expected according to its usual seasonality. Sars-CoV-2 caused an outbreak from late December 2021 to mid-February 2022 accounting for up to 30% of total cases, in accordance with global data, due to the emergence of the Omicron variant. Adenovirus' incidence displayed a slight peak in January, while Influenza reappeared in March 2022 causing 13% and 32% of all respiratory tract infections, respectively.

CONCLUSIONS

The third COVID-19 pandemic wave commenced in September 2021 and is currently ongoing. An outbreak of common viral pediatric infectious diseases reoccurred following irregular seasonal patterns.

EP775 / #1754

E-Poster Viewing - Paediatrics AS04-16. Metabolic disease

Progressive pseudorheumatoid dysplasia – a rare arthropathy of childhood

**A.L. Carvalho^{1*}, M. Bastos Gomes², I. Cardoso³, T. Campos⁴,
E. Rodrigues⁴, M. Rodrigues^{5,6}, I. Brito^{5,6}**

¹Hospital de Braga, Pediatric Department, Braga, Portugal

²Unidade Local de Saúde do Alto Minho, Pediatric Department, Viana do Castelo, Portugal

³Centro Hospitalar de Vila Nova de Gaia/Espinho, Paediatrics Department, Vila Nova de Gaia, Portugal

⁴Centro Hospitalar Universitário São João, Reference Center of Inherited Metabolic Diseases, Porto, Portugal

⁵Centro Hospitalar Universitário de São João, Pediatric and Young Adult Rheumatology Unit, Porto, Portugal

⁶Faculdade de Medicina da Universidade do Porto-FMUP, Rheumatology Department, Porto, Portugal

BACKGROUND AND AIM

Progressive pseudorheumatoid dysplasia (PPRD) is a rare autosomal-recessive arthropathy of childhood, that can be misdiagnosed as juvenile idiopathic arthritis (JIA). It usually presents between ages 3-6 years and affects multiple joints with progressive stiffness and enlargement, in the absence of inflammation.

METHODS

Authors present a case of a 12-year-old girl, Iraqi refugee, born from consanguineous parents, referred due to suspected JIA and Farber disease.

RESULTS





FIGURE 3:

She reported onset around 2-3 years of age with enlarged interphalangeal (IFP) joints of hands and nodules, progressive restricted mobility of all joints, severe scoliosis and gait abnormalities. Normal intelligence. Previous medical care had been sparse and had not received any treatments. Physical examination revealed short stature, no dysmorphic features, a normal voice, severe thoracolumbar kyphoscoliosis, genu varum, lower limb dysmetria and fixed contractures fingers with IFP nodules, without effusion. Painless restricted mobility of all peripheral joints, and cervical limitation. She required a wheelchair. Bone radiographies (Fig.1) also showed periarticular osteopenia, platyspondyly with narrowing of intervertebral disc spaces, enlarged epiphyses, and widened metaphysis. Laboratorial workup revealed normal inflammatory markers, negative RF/ACPA, positive antinuclear antibodies. Abdominal ultrasound was normal. DXA scan showed normal Z-scores. Skeletal dysplasias NGS panel excluded FD and identified a homozygous variant in *CCN6* gene, compatible with progressive pseudorheumatoid dysplasia. The patient received genetic counseling and conservative management with intensive physical rehabilitation. After two years, she presents improvement of stiffness and joint mobility and uses crutches as a walking aid.

CONCLUSIONS

Despite its rarity, diagnosis of PPRD allows adequate management and avoids unnecessary and potentially harmful treatments

EP776 / #1256

E-Poster Viewing - Paediatrics AS04-16. Metabolic disease

Effectiveness of time-limited eye movement desensitization reprocessing therapy for parents of children with a life-limiting illness: a randomized clinical TRIAL

T. Conijn¹, C. De Roos², H. Vreugdenhil³, F. Wijburg¹, E. Van Dijk³, L. Haverman^{3*}

¹Amsterdam UMC, University of Amsterdam, Pediatric Metabolic Diseases, Emma Children's Hospital and Amsterdam Lysosome Center "sphinx", Amsterdam, Netherlands

²Amsterdam UMC, University of Amsterdam, Academic Center For Child and Adolescent Psychiatry, Level, Amsterdam, Netherlands

³Emma Children's Hospital, Department of Child and Adolescent Psychiatry and Psychosocial Care, Amsterdam, Netherlands

BACKGROUND AND AIM

Parents of children with a progressive life limiting illness report high levels of posttraumatic stress disorder (PTSD) symptoms. Effective treatment is highly relevant as stress symptoms in parents impacts the wellbeing of the child. The aim of this study is to evaluate the feasibility and effectiveness of time-limited Eye Movement and Desensitization Reprocessing (EMDR) therapy in reducing PTSD symptoms, comorbid psychological symptoms, distress, and parental stress.

METHODS

Mono-center RCT conducted between February 2020 and April 2021. Fourteen parents (N=7 mothers, N=7 fathers) of mucopolysaccharidosis type III patients reporting PTSD symptoms on a (sub)clinical level were assigned to 4 sessions EMDR (90 minutes each, divided over 2 days) or a wait-list control condition

followed by EMDR. Measurements were conducted at baseline, post-treatment/post-waitlist, and 3-months post-treatment. The primary outcome was PTSD symptom severity (PTSD Check List for DSM-5). Secondary outcomes included comorbid psychological symptoms (Brief Symptom Inventory), distress (Distress Thermometer for Parents) and parenting stress (Parenting Stress Questionnaire). Between-group comparisons pre-to-post treatment (N=7 EMDR vs. N=7 wait-list) and within-group comparisons (EMDR, N=14) from pre-to-post treatment and from pre-treatment to 3-months follow-up were carried out per intent-to-treat linear mixed model analyses.

RESULTS

Compared to wait-list, EMDR resulted in a significant reduction on total PTSD symptom severity ($d=1.78$) and on comorbid psychological symptoms, distress and parenting stress ($d=.63-1.83$). Within-group comparisons showed a significant effect on all outcomes at post-treatment ($d=1.04-2.21$) and at 3-months follow-up ($d=.96-2.30$) compared to baseline.

CONCLUSIONS

Time-limited EMDR reduces PTSD symptoms, psychological comorbidity, parenting distress in parents of children with a progressive, life-limiting illness.

EP777 / #2799

E-Poster Viewing - Paediatrics AS04-16. Metabolic disease

Mitochondrial diseases in latin america, epidemiology and quality of life indicators.

D.L. Juarez-Flores*

lamitocondria.org, Medical, Barcelona, Spain

BACKGROUND AND AIM

Mitochondrial disease (MD) is the leading cause of neurodegenerative disease in children. Clinical manifestations are widely diverse and diagnostic procedures, nor therapeutic approaches are standardized yet. Consequently, quality of life (QoL) is greatly affected not only due to the severity of disease but by the lack integral paediatric care worldwide.

METHODS

Mitochondrial disease (MD) is the leading cause of neurodegenerative disease in children. Clinical manifestations are widely diverse and diagnostic procedures, nor therapeutic approaches are standardized yet. Consequently, quality of life (QoL) is greatly affected not only due to the severity of disease but by the lack integral paediatric care worldwide.

RESULTS

40 questionnaires were eligible to take part in the study. 75% of the participants were children; of which 73% had a confirmed MD (cMD) and 26.7% were in study for a suspected MD (sMD) (n=30, 22 and 18, respectively). In most cases, the diagnosis was established after a year of having symptoms, with international collaboration needed in 36.7% of cases (n=11). On behalf

of clinical manifestations and medical follow-up, the gathered data reported similar results as in worldwide cases.

CONCLUSIONS

As new information is emerging daily, it is increasingly difficult for primary practice physicians to be trained in diagnosis, assessment and treatment of MD. Generation of worldwide clinical databases and the use of artificial intelligence for their analysis may be an efficient, sustainable, and economic way of improving the quality of life of people with MD.

EP778 / #640

E-Poster Viewing - Paediatrics AS04-16. Metabolic disease

The prevalence of hypovitaminosis d in Indonesian children

S. Gunawan, V. Pateda, C. Prayogo*, Y. Arif Putra

RD Kandou General Hospital, Pediatric, Manado, Indonesia

BACKGROUND AND AIM

Background: There are growing reports from tropical countries about vitamin D deficiency (VDD) in children. However, only few data on the prevalence of VDD in Indonesian children.

Objectives: To determine the prevalence of VDD in both normal and sick Indonesian children.

METHODS

We conducted a cross sectional study of 538 infants and children in Manado, Indonesia. The demographic data, clinical conditions, and serum 25-hydroxy vitamin D (25(OH)2D3) levels were collected. Vitamin D level was classified as sufficient if > 20 ng/mL, insufficient 15-20 ng/mL, and deficient <15 ng/mL.

RESULTS

There were 345 healthy children and 193 unhealthy ones. Overall, infants and children with sufficient level of vitamin D were 68.7%, insufficient 17.8%, and deficient 15.5%. Among healthy but obese children (n=120) almost half were hypovitaminosis D (21% deficient, and 28% insufficient).

CONCLUSIONS

In spite of sun rich climate, one third of children have hypovitaminosis D. Hence, the provision of supplement can be one of the solutions to treat vitamin D deficiency.

EP779 / #2725

E-Poster Viewing - Paediatrics AS04-16. Metabolic disease

What an unpleasant smell: a case report of fish odor syndrome.

M.M. Resende^{1*}, L. Leite De Almeida², P. Campos¹, I. Sobreira¹, P. Garcia³

¹Centro Hospitalar do Baixo Vouga, Pediatrics, Aveiro, Portugal

²Centro Hospitalar Universitário de São João, Pediatrics, Porto, Portugal

³Centro Materno Infantil do Norte - Centro Hospitalar Universitário do Porto, Pediatrics, Porto, Portugal

BACKGROUND AND AIM

Trimethylaminuria (fish-odor syndrome) is a rare autosomal recessive inherited disorder characterized by a body odor similar to that of rotting fish. This unpleasant smell is due to an increased excretion of trimethylamine (TMA) in corporal fluids that is caused by a deficiency of flavin-containing monooxygenase-3 (FMO3) enzyme, responsible to convert malodorous TMA into non-odorous N-oxide. This metabolic condition is attributed to mutations and polymorphisms affecting FMO3 gene which can result in a wide phenotypic spectrum.

METHODS

We present a clinical case of a 19-month-old healthy boy, referred to a general pediatrician with an unusual complaint of a fish-like smell from his hands and head. The symptoms started after consumption of some specific fishes, and were resolved with its avoidance.

RESULTS

Genetic variants in heterozygosity of FMO3 gene were found and its combination was reported as responsible for moderate or transitory symptoms. The parents were advised to reintroduce fish but in smaller portions and he had no recurrence of symptoms. Nowadays, he consumes all foods containing choline such as eggs and fish, with no symptoms.

CONCLUSIONS

Fortunately, this case seems to be a transient form. Genetic testing is important to a definitive diagnosis and to a better understanding of genetic variants and disease-associated phenotypes. Trimethylaminuria is not associated with mortality or morbidity, but psychosocial factors can severely interfere with daily functioning and simple measures can improve symptoms and quality of life.

EP780 / #1658

E-Poster Viewing - Paediatrics AS04-16. Metabolic disease

A familial case of leigh disease in an infant – a case report

S. Sheridan*, N. Jameel, A.M. Murphy

University Hospital Limerick, Paediatrics, Co Limerick, Ireland

BACKGROUND AND AIM

Leigh disease, also known as subacute necrotizing encephalomyelopathy, is an early-onset, progressive neurodegenerative disease. It is a genetic condition resulting in failure of the mitochondrial respiratory chain that leads to disability and death in early childhood. Our aim is to present the case of a male infant with this condition.

METHODS

We describe the clinical presentation, results of metabolic, genetic and radiological investigations, management and outcome of our patient to date.

RESULTS

A term infant male was the third child born to healthy consanguineous parents of Pakistani ethnicity, currently living in Ireland in asylum seeker accommodation. He was well postnatally. His family history was significant for a sister who died age 11 months from complications of Leigh disease. At 9 months of age he presented with developmental regression and failure to meet milestones. On examination he was severely hypotonic with no head control. He was found to have a raised serum lactate at 4.8mmol/l with a mild compensated metabolic acidosis. He had a normal echo, chest x-ray,

abdominal ultrasound and ophthalmology exam. His MRI brain findings were consistent with Leigh disease. At 13 months of age he smiles but is unable to sit, roll or support himself when prone. He has significant oral aversion and weighs 8kg (2nd-9th centile for age). Treatment to date includes nasogastric feeding with high energy formula and coenzyme Q10.

CONCLUSIONS

As an inherited condition this diagnosis has significant implications for this family. There is no cure for Leigh disease, which is ultimately fatal. The management is primarily supportive.

EP781 / #780

E-Poster Viewing - Paediatrics AS04-17. Nephrology

Posterior urethral valves: recent advances of management and outcomes

G. Grech*, M. Shoukry

Mater Dei Hospital, Department of Paediatric Surgery, Msida, Malta

BACKGROUND AND AIM

To review management of posterior urethral valves(PUV) in tertiary care center.

METHODS

Retrospective analysis of 17 patients' case notes between 2013-2021.

RESULTS

Age ranges from birth to 3 years (average 3 months). 10 boys presented with antenatal bilateral hydronephrosis, one of which showing the keyhole sign, attributed to improved antenatal ultrasound(USS) techniques. 5 presented with febrile urinary tract infection(UTI) treated conservatively and continued on prophylactic antibiotics. However, one patient presented with incidental bilateral hydronephrosis, and one had raised creatinine whilst in intensive care. Local hospital protocol mandates USS performance within 48hrs post-natally, identifying hydronephrosis in 39%. A micturating cystourethrogram was performed to confirm PUV. 61% have suspicious urethra anatomy, 33% have a trabeculated bladder and 53% have secondary vesicoureteral reflux. All patients underwent neonatal cystoscopy evaluation and valve ablation. Check cystoscopy was advised 3 months later in 88%, however, 64% underwent circumcision. One patient required temporary ureterostomy followed by ureteric

reimplantation and mitrofanoff appendicovesicostomy for clean intermittent catheterization. 24% have associated pelviureteric-junction obstruction requiring pyeloplasty and one complete renal duplex (6%). Parents are involved in management and all patients were followed-up with renal USS performed bi-annually and DMSA at 3 months after presentation, with 35% reported to have abnormal split kidney function. Regular nephrology assessment and prophylaxis antibiotics are advised until potty-training behaviour is achieved. The review reported zero mortality.

CONCLUSIONS

Primary valve ablation is feasible and safe practice for PUV. Early diagnosis and long-term monitoring via multidisciplinary teams are imperative to alleviate the effects of altered bladder compliance.

EP782 / #1581

E-Poster Viewing - Paediatrics AS04-17. Nephrology

The use of ambulatory blood pressure monitoring in pediatrics: a local hospital experience

**I. Magalhães*, S.C. Ferraz, C. Silva, S. Miranda, V. Gonçalves,
I. Maciel, A. Carneiro**

Unidade Local de Saúde do Alto Minho, Pediatrics, Viana do Castelo, Portugal

BACKGROUND AND AIM

Ambulatory blood pressure monitoring (ABPM) is an increasingly recognized method with an important role in hypertension (HTN) diagnosis, evaluation of therapeutic effectiveness, diagnosis of white-coat HTN (WCH) or masked HTN and accessing BP circadian pattern and ambulatory arterial stiffness index (AASI). The objective was to characterize the population performing ABPM tests in the Pediatrics Department and to analyze the results.

METHODS

Review of ABPM tests carried out between May 2019 and December 2021.

RESULTS

Sixty-one ABPM tests of 54 patients (median age 12 years old) were included. The main reasons for testing were obesity, chronic kidney disease (CKD), HTN diagnosis and therapy responsiveness evaluation. HTN was evidenced

in 42,6% of the tests performed, 80,8% of which considered severe. of the patients with office HTN, it was confirmed in 56,3%; 28.1% had WCH and 15,6% had high BP load. Adequate BP control was observed in 7 of the 9 previously medicated patients. In the tests of obese patients, HTN was detected in 51,6% and high BP load in 19,4%. 31,3% of the tests of patients with CKD showed HTN, high BP load was present in 31,3%. 65% of the tests evidenced absence of nocturnal dipping, 48.7% of which without HTN criteria. The average AASI was 0.39 ± 0.13 , being significantly higher in obese patients (0.44 ± 0.13) than in non-obese (0.35 ± 0.12) ($p=0.005$). AASI was also significantly increased in patients with ABPM-diagnosed HTN ($p=0,003$) and non-dippers ($p=0.033$).

CONCLUSIONS

ABPM is essential in HTN diagnosis and classification, as well as in the identification of occult and early alterations, enabling an adequate, timely intervention.

EP783 / #2019

E-Poster Viewing - Paediatrics AS04-17. Nephrology

The anti-c1q antibody as a marker of lupus nephritis in children.

S. Mamouzi*, M. Smara

Military Central Hospital dr Mohamed Seghir Nekkache, Department of Immunology, Algiers, Algeria

BACKGROUND AND AIM

To evaluate the role of anti-C1q antibody in combination with anti-DNA antibodies in detecting the activity of LES disease in children and involvement in renal disease (lupus nephritis).

METHODS

The anti-C1q and anti-DNA were sought in lupus in 20 selected children. Children who have benefited biopsy are those with impaired renal (kidney disturbed balance). The control group consisted of 20 healthy children. According to lupus nephritis (NL) and the SLEDAI score, patients were divided into two groups: Group 1, nine children with NL; group 2, eleven children without NL;

RESULTS

A significant association of the presence of active lupus nephritis and the presence of any of the studied antibody (anti-C1q Ab or anti-dsDNA). None of the children in group 1 had anti-C1q Ab only, all children of the G1 were positive for anti-C1q Ab and anti-DNA. The levels of anti-dsDNA and anti-C1q were significantly higher in LN more active than NL less active. The

sensitivity and specificity of anti-C1q and anti-Ac Ac DNAb for the NL more active detection was 77.0% and 75.0% and 89.0% and 90.0%, respectively, and 83.0 % and 82.5% for both. Both antibodies are positively correlated with the SLEDAI score and proteinuria and a negative correlation with the decline in C3 levels. A high significant positive correlation was detected between anti-C1q Ab and anti-dsDNA Ab.

CONCLUSIONS

Anti-C1q Ab in combination with anti-DNA Ab can serve as markers notreliable and invasive potential of the activity of SLE and renal impairment foravoid unnecessary kidney biopsies.

EP784 / #1693

E-Poster Viewing - Paediatrics AS04-17. Nephrology

An unusual case of hyponatraemic seizure secondary to primary polydipsia

L. Reaney*

University Hospital Waterford, Paediatrics, Waterford, Ireland

BACKGROUND AND AIM

Hyponatraemia secondary to primary polydipsia is an uncommon phenomenon in the paediatric population. In this report we describe a case of hyponatraemic seizure in a previously well child secondary to psychogenic polydipsia.

METHODS

A previously well twenty month old boy was brought in to the emergency department of a regional hospital in status epilepticus. His history was significant for polydipsia and polyuria: he would compulsively drink upwards of 2500ml a day (approximately 220ml/kg/day), and had approximately twenty wet nappies a day. An initial blood gas showed a sodium level of 112 mmol/L. A 3ml/kg bolus of 3% saline was administered, and subsequently repeated. His seizures were concomitantly treated as per local status epilepticus guideline. Serum osmolality was 246mOsm/kg. Urinary sodium was 68mmol/L and urinary osmolality was 158 mOsm/kg. Repeat serum sodium level was 124 mmol/L. He was commenced on normal saline and dextrose fluids. Serial sodium levels showed a steady rise over subsequent hours. After the postictal period, he regained full consciousness and had no further seizure activity.

RESULTS

TABLE 1:

Serial Serum Sodium and Osmolality						
	21/03/2021 15:30	21/03/2021 16:50	1/03/2021 18:10	21/03/2021 23:20	22/03/2021 08:15	23/03/2021 11:58
Sodium (mmol/L)	115	124	127	134	140	139
Serum Osmolality (mOsm/kg)	246				291	

Further investigations including HbA1c, thyroid function, random cortisol, short synacthen test, renin, and aldosterone levels were normal, as was a CT brain and renal ultrasound.

CONCLUSIONS

This case illustrates the potentially life-threatening consequences of excessive water consumption in a paediatric patient. There is need for more public awareness of the significance of the symptoms of polydipsia and polyuria.

EP785 / #1518

E-Poster Viewing - Paediatrics AS04-17. Nephrology

Short stature: when the guilty is not so obvious

C. Silva*, S. Miranda, I. Magalhães, A.E.C. Silva, S.C. Ferraz, F. Martins, A. Carneiro

ULSAM - Hospital de Santa Luzia, Pediatrics, Viana do Castelo, Portugal

BACKGROUND AND AIM

Preterm infants are at greater risk of impaired growth and development. Serial measurements of growth are an important parameter in monitoring the health of children. During the first 2 to 3 years of life, usually happens catch-up growth. Although most causes of short stature in this age group are nonpathologic variants of growth, etiological investigation is necessary, especially when associated with other findings.

METHODS

Clinical approach is described through anamnesis, physical examination, laboratory and imaging studies.

RESULTS

A 35-week preterm girl followed in development specialist was referred to a pediatric endocrinologist at 2 years-old due to the short stature that was accentuated after starting to walk. Otherwise, psychomotor development was adequate, except for the motor area. In addition to short stature, there is prominent frontal bossing, pectus carinatum and lower limb varus. Family history of short stature and bow-legs. Bone age, IGF-1, karyotype, celiac disease antibodies, thyroid, renal and liver function, parathyroid hormone,

25-hydroxyvitamin d, serum calcio, catecholamines and metabolic study were all normal. Serum phosphorus was low and alkaline phosphatase was high. Thereafter was calculated tubular reabsorption of phosphorus and maximal renal tubular threshold for phosphate per glomerular filtration rate and both were low, no other changes in the remaining urinary parameters. On suspicion of hypophosphatemic rickets, a genetic study was performed and showed probably pathogenic variant in the PHEX gene.

CONCLUSIONS

The genetic diagnosis of X-linked hypophosphatemic rickets is extremely important given that it currently has specific treatment with an impact on the prognosis and allow genetic counseling of the patient and family.

EP786 / #1610

E-Poster Viewing - Paediatrics AS04-17. Nephrology

Robot-assisted retrograde intrarenal surgery in children – own experiences.

**M. Szymanek-Szwed*, E. Wajszczuk, K. Załęska-Oracka,
J. Samotyjek, B. Jurkiewicz**

Medical Center of Postgraduate Education, Pediatric Surgery and Pediatric Urology Department, Łomianki, Warsaw, Poland

BACKGROUND AND AIM

In developed countries, the incidence of urolithiasis increases by 6-10% annually, and its prevalence is seen in patients of all ages. It is important to choose a treatment method that allows the complete removal of stone in the least invasive and effective way. The authors perform about 250 minimally invasive procedures in urolithiasis annually in pediatric patients. Aim of the study is to present the advantages of a robot-assisted retrograde intrarenal surgery (RIRS)

METHODS

Since 2021 RIRS procedures have been assisted with an instrument holding surgical robot. 20 robot-assisted operations were performed by April 2022, using a 7.5F flexible ureterorenoscope.

RESULTS

The use of the robot assist did not elongate the time of RIRS procedure. In the control ultrasound, the results were better than in the case of classic RIRS.

CONCLUSIONS

The conclusions should be considered preliminary due to the small size of the study group. Using the robot in RIRS procedure in advanced stone disease is effective and safe for pediatric patients. It allows more precise manipulation in the kidney and a higher stone free rate. It significantly increases the comfort and safety of the surgeon's work and shortens the learning curve.

EP787 / #1603

E-Poster Viewing - Paediatrics AS04-18. Neurology

Spinal muscular atrophy and genetic screening TOOLS

B. Abdelmoula^{1*}, N. Bouayed Abdelmoula²

¹Medical University of Sfax, Genomics of Signalopathies At The Service of Medicine, SFAX, Tunisia

²Medical University of Sfax, Genomics of Signalopathies At The Service of Medicine, Sfax, Tunisia

BACKGROUND AND AIM

Spinal muscular atrophy (SMA) is one of the most common autosomal recessive diseases, affecting approximately 1 in 10 000 live births. SMA is caused by a deficit of the survival of motor neuron protein (SMN), which is encoded by two genes: SMN1 and SMN2 at 5q13. Due to a specific SNP, SMN2 produces a transcript that can not completely prevent neuronal cell death at physiologic gene dosages. Whereas PCR-RFLP analysis can detect the homozygous absence of SMN1 in approximately 95% of patients with clinically typical SMA, carrier testing for SMA is relatively complex and requires quantitative PCR to determine SMN1 copy number. This study reported our SMA genetic testing experience, combined with appropriate genetic counselling and risk assessment of patients and their families.

METHODS

DNA extraction was performed using standard procedures (Phenol-Chloroform method). A PCR technique was developed in our department to amplify SMN1 exon 7 and SMN1 exon 8. Upstream and downstream primers were designed using PCR in silico restriction enzyme digestion with respectively Dral and Ddel was used to detect SMN1 deletions and to differentiate between the highly homologous SMN1 and SMN2 genes.

RESULTS

10 SMA patients and their parents were explored. All patients were positive with apparent homozygous SMN1 exon 7 deletion. Additional exon 8 deletion was detected in 75% of cases. A comprehensive genetic counselling was delivered to the families and molecular prenatal diagnosis was considered for 2 families.

CONCLUSIONS

We concluded that PCR-RFLP of SMN remains an accurate and reproducible method to detect SMA patients with SMN1 deletion.

EP788 / #1007

E-Poster Viewing - Paediatrics AS04-18. Neurology

Genetic diagnosis of intellectual disability

L. Abelha^{1*}, S.C. Ferraz¹, I. Eiras¹, I. Magalhães¹, M. Costa¹, M. Leão²

¹Unidade Local de Saúde do Alto Minho- Hospital Santa Luzia, Pediatrics, Viana do Castelo, Portugal

²Centro Hospitalar Universitário de São João, e.P.e, Genetics, Porto, Portugal

BACKGROUND AND AIM

Phelan-McDermid syndrome, is a rare genetic disorder caused by a deletion of the distal long arm of chromosome 22 or by a variant in the SHANK3 gene. In addition to overgrowth and a group of dysmorphic features, it is characterized by global developmental delay, intellectual impairment, severely delayed speech, neonatal hypotonia and autism or autistic-like behavior.

METHODS

A 13-year-old male had Neurodevelopmental consultations since age 7, for language regression at age 3, intellectual disability, with very poor speech, tendency to isolation and repeated behaviour. He has family history of a brother with ADHD and a deaf uncle. On physical examination, he was in the 99th percentile for height; Long philtrum, retrognathia, kyphoscoliosis, clinodactyly, ligamentous hyperlaxity, hypermobile kneecaps, dynamic flat foot and hyperactive osteotendineous reflexes.



FIGURE 1:

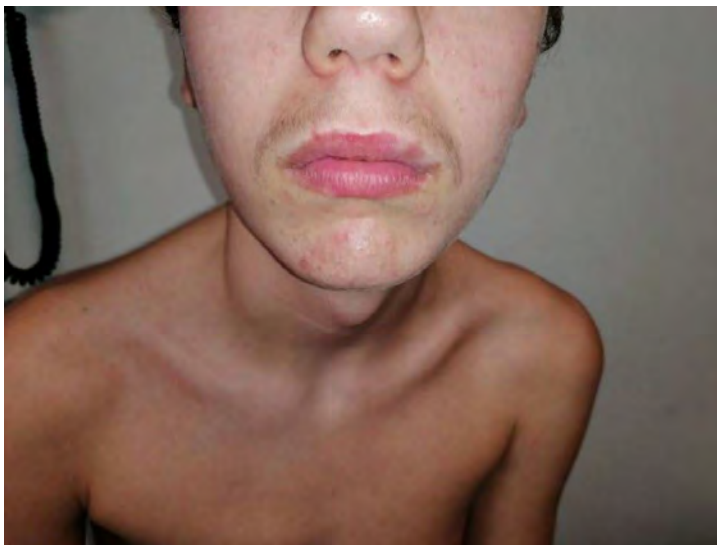

FIGURE 2:



FIGURE 3:

In those pictures we can see: prominent finger pads; cubital deviation of the distal phalanges; clinodactyly of the 5th finger; ligament hyperlaxity. Long philtrum, thick lips, retrognathia and kyphoscoliosis.

RESULTS

In the diagnostic evaluation, the metabolic testing, FMR1 gene testing and the aCGH were normal. The brain MRI was also normal. DNA extraction, followed by PCR, direct sequencing and next generation sequencing: Heterozygosity the variant c.3140C>T (p.(Ser1047Phe)) in the SHANK3 gene.

CONCLUSIONS

Many children diagnosed with autism spectrum disorder or intellectual disability have changes in the shank3 gene, hence the importance of doing a

study in order to give the correct diagnosis and provide adequate genetic counseling to these families

EP789 / #2373**E-Poster Viewing - Paediatrics AS04-18.
Neurology****A different aura – stroke mimic case report****R. Aldeia Da Silva^{1*}, A. Ferreira², C. Magalhães¹, M. Rodrigues¹,
H. Silva¹, C. Ferreira³, C. Garcez³**¹Hospital de Braga, Serviço De Pediatria, Braga, Portugal²Hospital de Braga, Serviço De Neurologia, Braga, Portugal³Hospital de Braga, Unidade De Cuidados Intermédios Pediátricos, Braga, Portugal**BACKGROUND AND AIM**

Hemiplegic migraine (HM) is an uncommon subtype of migraine, characterized by unilateral weakness that accompanies a headache attack. Motor aura occurs with other forms of aura, such as impaired vision, speech or sensation. Based on family history and genetic tests it is possible to differentiate familial from sporadic HM. Aim*: Describe a different clinical presentation of migraine in pediatrics.

METHODS

Fifteen-year-old boy hospitalized for tibial fracture. Two days after surgery, he became febrile and started antibiotics for a suspected surgical complication. One week later, he complained about a headache associated to tingling and right arm weakness. Suddenly, he had a deterioration of consciousness and developed aphasia and right hemiparesis. At that moment, his father revealed that the boy had had previous episodes of headache associated with speech difficulties, with spontaneous remission, and himself had already experienced migraine with arm weakness too.

RESULTS

Computed tomography and magnetic resonance imaging excluded vascular causes. Blood tests revealed decreasing inflammatory markers, blood culture exams and lumbar puncture excluded infectious causes. Electroencephalogram showed a mild encephalopathy. Within 24 hours, he had fully recovered, without headache, fever or neurologic deficits. This case met the International Classification of Headache Disorders criteria for familial HM diagnosis. Genetic testing is underway for a further confirmation.

CONCLUSIONS

HM can have a heterogeneous clinical presentation. Other neurological causes should be excluded and imaging is essential on differential diagnosis. Most cases have a favorable outcome and genetics plays a very important role, especially when there is a positive family history.

EP790 / #2492

E-Poster Viewing - Paediatrics AS04-18. Neurology

Epileptic encephalopathy in children: a glimpse into its black BOX

A. Arafat^{1*}, A. Wageeh²

¹Egypt Healthcare Authority, Pediatrics, Cairo, Egypt

²Egypt Healthcare Authority, Pediatrics, Egypt, Egypt

BACKGROUND AND AIM

Abstract [Introduction] Epilepsy is the most common serious primary disease of the brain. Approximately 10% of people can expect to have at least one epileptic seizure during a normal lifespan, and one-third of these will develop epilepsy. [Objective] The object of this study was to identify potential biomarkers of epilepsy.

METHODS

[Methods] In our study, we report most of the potential biomarkers of epilepsy to date, according to their magnitude in either diagnosis of epilepsy or estimation of the efficacy of antiepileptic treatment through reviewing the significance of each of pathologic High-Frequency Oscillations pHFOs, brain inflammation, Blood-Brain Barrier BBB dysfunction, Traumatic Brain Injury TBI and microRNAs as a potential biomarker of epilepsy.

RESULTS

[Results] Among all pHFOs, fast ripples seem to be more specific for the epileptogenic zone. Activation of the IL 1b system, COX-2, and mTOR are the major inflammatory pathways that many studies have shown their possible contribution to epileptogenesis. As for BBB dysfunction, ICAM 1, VCAM 1, and E-and P selectin studies have shown their close linkage to status epilepticus.

So far miRNA 301a-3p and MiRNA-106b-5p have shown the best diagnostic efficacy for epilepsy with high sensitivity and specificity values.

CONCLUSIONS

[Conclusion] Although current pieces of evidence demonstrate that a definite biomarker of epilepsy is almost impossible, our review helped to get us closer to what might be a biomarker of epilepsy.

EP791 / #1557**E-Poster Viewing - Paediatrics AS04-18.
Neurology****Functional hemihyposomatognosia in infants:
about a CASE****T. Barros Vial^{1*}, B. Pizarro Stanke², C. Werner Ratto², H. Villalón Urrutia³, C. Kunze Küllmer², V. Burckhardt Bravo⁵**¹Universidad de los andes, Pediatrics Department, Las Condes, Chile²Universidad de los andes, Departamento De Pediatría, Santiago, Chile³Universidad de los andes, Pediatrics Department, Santiago, Chile**BACKGROUND AND AIM**

INTRODUCTION Somatognosia is the notion of one's own body and its position in space. This is constructed from external stimuli that are integrated into a body schema. The newborn does not have a full development of the neurological structures, which is developed during the first months of life by the integration of visual, proprioceptive, motor and sensory stimuli. Unilateral preferential vision, as occurs in cases of postural plagiocephaly, can lead to reduced perceptual recognition of one hemibody and, consequently, less differentiation and integration. This can be corrected with motor kinesiotherapy, early initiated. **OBJECTIVE** To alert in the early diagnosis of hemihyposomatognosia through the description of a case.

METHODS

CLINICAL CASE Full term newborn, with exclusive breastfeeding, with no relevant medical history. Consulted at 3 months of age for movements of the right hemibody only and ipsilateral preferential gaze in context of postural plagiocephaly. Left hemibody with preserved tone and strength. Motor kinesiotherapy was started to stimulate left motor skills, with rapid normalization.

RESULTS

RESULTS This condition is frequently associated with postural plagiocephaly. Despite the good functional prognosis, early treatment with motor kinesiotherapy can avoid delays in psychomotor development. It is important to rule out other causes of neurological origin.

CONCLUSIONS

In cases with postural plagiocephaly, the symmetry of the movements must be evaluated to identify this condition early and, thus, initiate timely treatment.

EP792 / #525**E-Poster Viewing - Paediatrics AS04-18.
Neurology****Compound heterozygosity in cerebellar ataxia,
mental retardation, and disequilibrium syndrome
4 (camrq4)****B. Teov¹, Z. Gucev², G. Kungulovski³, Z. Mitrev⁴, A. Janchevska²,
A. Beqiri-Jashari^{2*}, F. Doksimovski⁵**¹University Clinic for Pediatrics, Hematology and Oncology, Skopje, North Macedonia²University Clinic for Pediatrics, Endocrinology and Diabetes, Skopje, North Macedonia³Bio Engineering LLC, Bio Engineering, Skopje, North Macedonia⁴Zan Mitrev Clinic, Zan Mitrev Clinic, Skopje, North Macedonia⁵Institute of Respiratory Diseases in Children Kozle, Iuc, Skopje, North Macedonia**BACKGROUND AND AIM**

Cerebellar ataxia, mental retardation, and disequilibrium syndrome (CAMRQ) is a genetically and clinically heterogeneous disorder with four described subtypes. Autosomal recessive syndrome of cerebellar ataxia, mental retardation, and disequilibrium type 4 (CAMRQ4) is caused by mutations in the *ATP8A2* gene.

METHODS

We report an 8-year-old boy with choreoathetosis, hypotonia, without the ability to keep his head up and profound mental retardation. There was quadrupedal locomotion, as well. MRI of the brain revealed a hypotrophy of the corpus callosum, diffuse white matter reduction, widespread delayed myelination and ventriculomegaly.

RESULTS

Trio whole-exome sequencing revealed compound heterozygosity in the *ATP8A2* gene consisting of a known variant c.1756C>T (p.Arg586*) inherited from the mother and a novel variant c.691_701delCTGATGAAGTT (p.Leu231fs) inherited from the father.

CONCLUSIONS

CAMRQ4 type has been found in about 50 patients. To the best of our knowledge, this is the first reported compound heterozygous patient with CAMRQ4 with these gene variants. The clinical presentation is severe.

EP793 / #2675**E-Poster Viewing - Paediatrics AS04-18.
Neurology****When you get more than you bargained FOR****M. Caldas*, M. Pedro, M. Viegas, C. Mendonça, A.S. Esteireiro**

Centro Hospitalar do Oeste, Pediatrics, Caldas da Rainha, Portugal

BACKGROUND AND AIM

A 2-year-old healthy boy was admitted with a 3-day history of a mild bi-parietal headache. The pain did not interfere with daily activity or sleep and resolved without medication. At the morning of admission, the child had one episode of vomiting and temporary gait imbalance. Physical examination revealed, good general status, no gait imbalance, neurological impairments or fever. However, a headache that interrupted his activity and worsened when he coughed was noticed.

METHODS

The brain CT and MRI revealed a large expansive lesion on the cerebellum, causing compression of the fourth ventricle, supratentorial hydrocephalus and transependymal edema, compatible with pilocytic astrocitoma (Figure 1). Surgical resection of the tumor was performed without complications. The histopathological exam confirmed the diagnosis. One month after surgery the patient was asymptomatic and the MRI showed complete excision of the tumor.

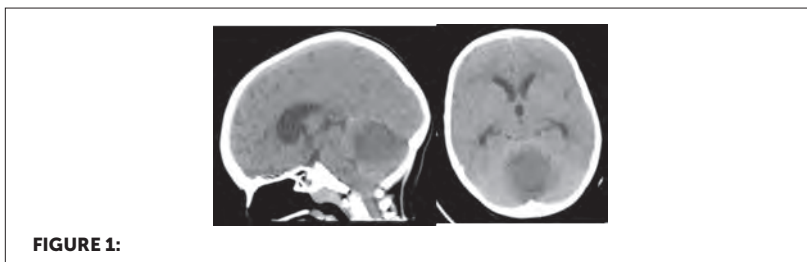

RESULTS

Primary central nervous system tumors are the second most common childhood malignancies, the most frequent solid organ tumor and the leading cause of cancer death in children. Pilocytic astrocytoma is the most predominant brain tumor and has good prognosis. The typical presentation is progressive headache over several months, with matinal persistent vomiting and unsteady gait, mainly in 6-9-year-olds. Although most brain tumors present with headaches, only 3% of headaches are attributed to tumors. Consequently, it is essential to perform a detailed anamnesis and physical examination.

CONCLUSIONS

This case serves as a reminder of the importance of valuing the presence of red flags, even before an atypical presentation with mild symptoms, short evolution and an uncommon age group.

EP794 / #1712**E-Poster Viewing - Paediatrics AS04-18.
Neurology****The importance of a multidisciplinary
genodermatosis committee**

**A. Diaz Gomez^{1*}, E. Roe Crespo², S. Bernal Noguera³, C. Serra Jue³,
A. Pintor Ojeda⁴, S. Luna Marine⁵, R. Esmel Vilomara⁶, E. Tobajas
Torrubiano⁷, M. Torrent Español⁸, M. Gomez Chiari⁹,
G.M. Fraga-Rodríguez¹⁰, H. Iznardo Ruiz², E. Turon-Viñas¹,
S. Boronat-Guerrero¹**

¹Hospital De La Santa Creu I Sant Pau, Neuropediatrics, Barcelona, Spain

²Hospital De La Sant Creu I Sant Pau, Dermatology, Barcelona, Spain

³Hospital De La Santa Creu I Sant Pau, Genetics, Barcelona, Spain

⁴Hospital De La Santa Creu I Sant Pau, Physical Medicine, Barcelona, Spain

⁵Hospital De La Santa Creu I Sant Pau, Ophthalmology, Barcelona, Spain

⁶Hospital De La Santa Creu I Sant Pau, Pediatric Cardiology, Barcelona, Spain

⁷Hospital De La Santa Creu I Sant Pau, Pediatric Psychology, Barcelona, Spain

⁸Hospital De La Santa Creu I Sant Pau, Pediatric Oncology, Barcelona, Spain

⁹Hospital De La Santa Creu I Sant Pau, Radiology, Barcelona, Spain

¹⁰Hospital De La Santa Creu I Sant Pau, Pediatric Nephrology, Barcelona, Spain

BACKGROUND AND AIM

Genodermatosis are rare and multisystemic diseases, so in their management a great number of specialties are involved. The aims of our committee are: to make an early diagnosis and an appropriate interdisciplinary management and treatment of these conditions, the comfort of the families (in only one appointment they can visit all specialists) and to decide by consensus (in diagnostic and treatment aspects). Furthermore, this committee allows us to achieve a higher degree of clinical expertise.

METHODS

In our committee we attended patients from 0 to 18 years. It's formed by different pediatric specialties (dermatology, cardiology, ophthalmology, rehabilitation, oncology, nephrology, radiology, psychology and neurology), a medical geneticist, a molecular geneticist and a genetic counsellor. The pathologies assessed in the committee are: Rasopathies (Neurofibromatosis type 1, Legius Syndrome, Noonan Syndrome and Capillary Malformation-Arteriovenous Malformation Syndrome), Tuberous sclerosis, Incontinentia pigmentii, Sturge-Weber syndrome, Giant congenital nevus and ectodermic dysplasia. The periodicity of the committee is monthly. We visit patients from all our autonomous community (Catalonia) as reference center of this disease.

RESULTS

The Genodermatosis Committee in our hospital takes place since 2013 and we internalized genetic studies in 2018. Since 2018 we have studied 120 patients and we have performed 51 genetic tests (15 Neurofibromatosis type 1, 3 Legius Syndrome, 3 Tuberous sclerosis, 5 Capillary Malformation-Arteriovenous Malformation Syndrome).

CONCLUSIONS

In our experience, this committee allows the patients to have less medical visits and to the professionals to accumulate more expertise. Another positive aspect is that the decisions are consensual and the number of complementary explorations are reduced.

EP795 / #1184**E-Poster Viewing - Paediatrics AS04-18.
Neurology****Fever and headache without infectious CAUSE****M. Espinet Pedrol^{1*}, F. Castillo-Gómez^{1,2}, E. Coca-Fernandez^{2,3},
M. Rodríguez- Martínez², S. Brió-Sanagustin⁴, S. Boronat-Guerrero⁵**¹Hospital de la Santa Creu i Sant Pau, Pediatria, Barcelona, Spain²Hospital Sant Pau., Paediatric Intensive Care, Barcelona, Spain³Hospital de la Santa Creu i de Sant Pau, Paediatric Intensive Care, Barcelona, Spain⁴Hospital Sant Pau, Paediatric, Barcelona, Spain⁵Hospital Sant Pau., Paediatric, Barcelona, Spain**BACKGROUND AND AIM**

Encephalitis is an inflammatory process of the brain parenchyma leading to neurological dysfunction. It can be caused by a primary infection or an auto-immune process triggered by infection OR vaccination. Autoimmune encephalitis is mediated by antibodies against neuronal surface proteins or neurotransmitter receptors. Anti-NMDA receptors encephalitis is the most common cause. We describe the pathology in a case report.

METHODS

Case report

RESULTS

A previously healthy 7 years old boy presented fever, headache and vomiting of several days' duration. The blood test showed mild elevations of acute phase reactants without leukocytosis, cerebrospinal fluid (CSF) with predominantly lymphocytic/monocytic pleocytosis and normal tomography. The treatment was started with Cefotaxime and Acyclovir, as he presented progressive neu-

rological deteriorations requiring intubation. Electroencephalogram was performed, which was normal, and magnetic resonance imaging showed signs of rhomboencephalitis. Virus and bacterial PCR in CSF were negative, nasopharyngeal aspirate virus PCR, stool enterovirus and tuberculin test negative. An antibiotic treatment was withdrawn. Blood and CFS cultures were also negative. With the suspicion of autoimmune encephalitis, therapeutic plasma exchange (TPX) was started. There resolution took 7 sessions of TPX. Subsequently, the patient was reported to be positive for anti-MOG antibodies in CSF.

CONCLUSIONS

Anti-MOG antibodies are associated with range of clinical heterogeneity. It is course may be monophasic or recurrent. Diagnosis is confirmed by demonstration of autoantibodies in serum and/or cerebrospinal fluid. Acute treatment with intravenous methylprednisolone, immunoglobulins or plasma exchange has been shown to be effective. There is little evidence on long-term treatment and subsequent outcome and prognosis.

EP796 / #1964

E-Poster Viewing - Paediatrics AS04-18. Neurology

Focal epilepsies in childhood: clinical aspects, eeg and neuroimaging

M.C. Gauci^{1*}, R. Leonardi¹, C. Gammeri², G. Di Cataldo², M. Ruggieri¹, A.D. Praticò¹

¹University of Catania, Pediatrics, Catania, Italy

²university of catania, Department of Pediatrics, catania (sicilia), Italy

BACKGROUND AND AIM

The main aim of our study is to analyse the clinical aspects, assess the electrophysiological and imaging diagnostic investigations, in order to find an intrinsic correlation between these elements; furthermore, treatment is also evaluated.

METHODS

In this retrospective study, we enrolled 39 patients of our unit and compared them considering several genetic, pre, peri and postnatal risk factors, family history, clinical and instrumental features, treatment.

RESULTS

Gender is not a critical factor for the development of focal epilepsies, such as familiarity and the type of delivery; the age at onset is after the first year of life; pre and postnatal risk factors have contributed to onset of epilepsy, above all genetics, risk of miscarriage, febrile seizure and asphyxia; developmental disabilities it is not a significant condition; the presence of cutaneous anomalies is very significant ($p < 0.0001$). Temporal lobe epilepsy is the most

frequent with a spike-and-wave pattern ($p < 0.005$), it is usually associated with a MRI - ($p = 0.004$). MRI is significant in 43.6%. We have assumed that not all the patients with negative MRI should be non-lesional, since most of them referred to temporal crises, preferred focus for focal cortical dysplasia, often occult lesion. We compared CT, BU, MRI, confirming the superiority of the EEG for sensitivity. The most used drug is valproic acid.

CONCLUSIONS

It would be profitable to have a higher resolution MRI available in order to exactly detect epileptogenic foci and to define the possible etiological cause and, consequentially a neurosurgical cure. Some therapeutic choices need to be reviewed.

EP797 / #1940**E-Poster Viewing - Paediatrics AS04-18.
Neurology****Familial case of *slc6a1*-related disorder with
diverse clinical presentation****N. Gogatishvili^{1,2*}, T. Tkemaladze³, S. Kasradze^{1,2}**¹*Caucasus International University, Department of Neurology, Tbilisi, Georgia*²*Institute of Neurology and Neuropsychology, Department of Epilepsy, Tbilisi, Georgia*³*Tbilisi State Medical University, Department of Molecular and Medical Genetics, Tbilisi, Georgia***BACKGROUND AND AIM**

SLC6A1-related disease is responsible for wide range of neurodevelopmental disorders including mild to severe intellectual disability (ID), epileptic encephalopathy, autism spectrum disorder. Our aim was to characterize different family members carrying *SLC6A1* pathogenic variant and discuss the efficacy of anti seizure drugs.

METHODS

case report of 6 y old boy with severe ID, ASD, epilepsy and ataxia, developmental milestones were delayed, with the ability to walk from 17 months and first words from 5 years. at the age of 2.5 years, developed episodes of recurrent eyelid twitching, accompanied by abrupt loss of muscle control, sudden falls without loss of consciousness, with the frequency of one-two times per week. Such episodes were diagnosed as epileptic seizures only at age of six years. Brain MRI was without any structural abnormalities. Sleep video-EEG demonstrated bilateral synchronous rhythmic slow wave and spike-wave or sharp-slow wave activity in frontal as well as parietal regions, generalized 2.5-3.5 spikes/poly spikes and slow waves discharges, as well as delta activity in the right central-parietal regions were seen. Treatment was started with Valproic acid (VPA).

RESULTS

Since starting of VPA treatment seizures stopped. Whole exome sequencing revealed novel heterozygous frameshift variant Val189Leufs*13 in *SLC6A1* gene. Segregation analysis showed the variant was inherited from the father, who has mild intellectual disability.

CONCLUSIONS

Our case provides further support for the efficacy of VPA in patients with *SLC6A1*-related epilepsy and illustrates diverse phenotypic presentation of the same mutation even in different members of the same family.

EP798 / #2643**E-Poster Viewing - Paediatrics AS04-18.
Neurology****Rare genetic condition mimicking cerebral PALSY**

C. Gomes Pereira*, B. De Sousa, S. Nogueira Machado, S. Soares,
C. Magalhães

Hospital Senhora da Oliveira, Pediatrics Department, Guimarães, Portugal

BACKGROUND AND AIM

Cerebral palsy (CP) is characterised by movement disorders that appear during the first year of life as a manifestation of disrupted brain development. CP is associated with structural brain alterations by environmental factors. However, some genetic conditions present similarly. In the absence of central nervous system insults and of MRI changes compatible with CP, investigation is mandatory. Genetic diagnosis allows for an adequate prognosis and follow-up, as well as genetic counseling.

METHODS

Non applicable.

RESULTS

A 4-month-old infant was referred to neuropaediatric consultation due to hypertonia. She had a history of weak suckling reflex since birth, early neonatal sepsis with no agent identified, neonatal jaundice requiring phototherapy, two urinary tract infections, poor staturoponderal development, microcephaly, and episodes of choking while feeding. In terms of family background she had a cousin with motor and growth development delay. The metabolic study, cranio-encephalic MRI and electroencephalogram previously carried

out were normal. On physical examination, the infant had mild axial hypotonia associated with hypertonia of the limbs, no asymmetries and apparent cognitive delay, compatible with CP. As the MRI and history were not compatible with the diagnosis, a genetic study was requested and revealed a deletion in 3p22.1 involving the CTNNB1 gene.

CONCLUSIONS

CTNNB1 Syndrome is a rare and severe neurodevelopmental disorder caused by disruption of chromosome 3p22.1 of the CTNNB1 gene. The main phenotypic manifestations include global developmental delay, intellectual deficit motor delay, axial hypotonia, visual abnormalities and facial dysmorphisms with microcephaly, which mimic CP. This condition was first described in 2012 and is probably underdiagnosed.

EP799 / #2628**E-Poster Viewing - Paediatrics AS04-18.
Neurology****A rare iatrogenic association of carbamazepine-induced syndrome of inappropriate antidiuretic hormone secretion with an acute symptomatic seizures in pediatric patient with epilepsy.****K. Polak, M. Herrera Llobat*, L. Martín Viota, D. González Barrios, C. Solís Reyes, A.K. Rolo Álvarez, D.D.C. Montesino Delgado, A. Dominguez Coello**

Hospital Universitario Nuestra Señora de Candelaria, Pediatric, Santa Cruz de Tenerife, Spain

BACKGROUND AND AIM

Carbamazepine-induced syndrome of inappropriate antidiuretic hormone secretion (SIADH) is a known adverse effect, yet extremely rare in pediatrics.

METHODS

We report the case of our patient, who presented SIADH secondary to carbamazepine use. Consequently, using the PRISMA protocols, we performed a review of literature published within the last 10 years.

RESULTS

A 10-year-old female diagnosed 5 months prior with epilepsy, well controlled with carbamazepine, presented to the emergency department 2 hours after suffering a 10 minute generalized tonic clonic seizure. During the last 6 hours she was vomiting and had various absense seizures that never occurred

before. The physical examination revealed drowsiness, disorientation and hypotonia. During the observation period the patient presented two more tonic clonic seizures. Laboratory test revealed: severe hyponatremia, low serum osmolality, high urine osmolality and fractional excretion of sodium. The carbamazepine serum level, head CT and ECG resulted normal. Treatment included 3% saline bolus infusion, 24-hours sodium correction, levetiracetam and suspension of carbamazepine, with complete remission of symptoms. The literature review identified 12 articles addressing the syndrome: 6 case reports, 3 reporting 19, 82 and 634 patients respectively and two expert opinions, none of which refer to patients under 18. They revealed high levels of evidence associating carbamazepine with SIADH with age, high dosages, low baseline serum sodium concentrations, polytherapy and female gender as risk factors.

CONCLUSIONS

Due to non specific symptoms and low prevalence in pediatric population, establishing this diagnosis could be challenging. Despite of potentially life-threatening effects, once correctly diagnoses, it is curable with good outcomes.

EP800 / #1053**E-Poster Viewing - Paediatrics AS04-18.
Neurology****Genotype, phenotype correlation of scn2a mutation; a case report****N. Jameel^{1*}, S. Sheridan¹, A.M. Murphy^{1,2}**¹University Hospital Limerick, Pediatrics, Limerick, Ireland²University Hospital Limerick, Pediatrics, limerick, Ireland**BACKGROUND AND AIM**

Background: SCN2A related disorders are a group of epilepsy and neurodevelopmental disorders. Phenotypes include benign familial neonatal-infantile seizures (BFNIS), autism/intellectual disability, infantile spasms progressing to epileptic encephalopathy and severe early-onset epileptic encephalopathy. However, functional aspects remain to be elucidated and there is currently no good mouse model available. Aim: To report a case of SCN2A mutation induced seizure in a 2-month-old infant with unremarkable family or personal history beside maternal history of recurrent miscarriages and multiple attempts of IVF.

METHODS

We describe the clinical presentation, examinations findings, results of hematological, metabolic & genetic investigation, video footage, EEG, radiological findings, treatment, and outcome in our patient.

RESULTS

Our patient is the first child to healthy non consanguineous Caucasian parents and was brought in following an episode of arm flexion/stiffening, unrespon-

siveness, pallor, shallow breathing followed by 45-60 minutes of lethargy. Initial blood work up including ECG was normal with no dysmorphic features. Baby was admitted, later in HDU had two similar events at which stage working diagnosis was migratory epilepsy of infancy and commenced on phenobarbital and Kepra. Investigation including epilepsy panel, metabolic screen, CSF neurotransmitters, microarray and karyotyping was sent. Genetic results later confirmed the diagnosis of SCN2A mutation. Meanwhile he continued to have intermittent focal seizures and eventual seizure control was achieved via Tegretol. At the age of 8 months our patient is developmentally normal and seizure free for over 4 months and we continue to closely monitor him.

CONCLUSIONS

This patient exhibited a novel phenotype for heterozygous SCN2A variants, and the case provides novel insights into the genotype–phenotype correlation for SCN2A variants.

EP801 / #1346**E-Poster Viewing - Paediatrics AS04-18.
Neurology****The curious case of an infant with scalp swelling****O. Kazeem*, V. Wardley, A. Fiaz**

Norfolk and Norwich University Hospitals NHS Foundation Trust, Paediatrics,
Norwich, United Kingdom

BACKGROUND AND AIM

Acquired scalp swellings in infants can pose a diagnostic dilemma because of extensive differential diagnoses.

METHODS

Case report

RESULTS

Our patient is a 12-week-old female infant who presented for evaluation of a painless fluctuant scalp swelling. She was born in good condition via forceps assisted delivery for failure to progress; following an unremarkable pregnancy. Parents confirmed that the swelling, which appeared a few days prior to presentation had remained static after an initial increase in size. They also denied any history of trauma. Examination revealed a fluctuant, ill-defined, 5cm by 3cm free-flowing swelling across suture lines in the posterior occipitoparietal area, sans discoloration, or bruising in an otherwise healthy infant. Follow-up evaluation including an ophthalmologic review and blood work-up was unremarkable. However, a cranial CT scan confirmed subaponeurotic fluid collection (SFC) in the posterior parieto-occipital area. The infant had

spontaneous resolution of the swelling within a few weeks from the time of its onset without any adverse sequelae.

CONCLUSIONS

SFC is characterised by boggy, ill-defined, fluctuant, suture-crossing, and highly mobile swelling. These characteristics, along with later presentation (1-4 months of life) in healthy infants – differentiate SFC from other scalp swellings. Aetiology of SFC is unknown albeit the literature has afforded instrumental delivery as a likely risk factor, as found in our patient. Additionally, conservative management including parental reassurance is recommended. A confident clinical diagnosis will prevent the sequelae of unnecessary investigations and parental distress. Therefore, clinicians' awareness is vital.

EP802 / #2126**E-Poster Viewing - Paediatrics AS04-18.
Neurology****Anti-glycine receptor encephalitis in children: a systematic review****R. Leonardi***, M. Lo Bianco, M.C. Gauci, A.D. Praticò, M. Ruggieri

University of Catania, Pediatrics, Catania, Italy

BACKGROUND AND AIM

Anti-glycine receptor encephalitis is a paediatric autoimmune encephalitis reported only in a few childhood cases. The aim of this study was to recorder the diagnostic features and current treatment options concerning this extremely rare entity.

METHODS

A literature search was carried out to locate all cases of anti-glycine receptor encephalitis in children, using the following search terms: "autoimmune encephalitis in children", "anti-glycine receptor encephalitis" or "Anti-GlyR encephalitis". Systematic review was performed in 13 patients from 6 studies.

RESULTS

The clinical presentation includes limbic encephalitis, brainstem encephalitis, progressive dyskinesia, status epilepticus, epileptic encephalopathy, ADEM and Optic Neuritis. GlyR-Abs could be detected in serum and/or in CSF. Serum GlyR-Abs value at onset are around 1:200, with a progressive reduction in GlyR-Abs titres treatment-related. High CSF GlyR-Abs levels are common and may be associated with pleocytosis, proteinorrachia and oligoclonal bands. Brain MRI is frequently normal (70%), sometimes there are

non-specific abnormalities: hippocampal sclerosis, optic nerve increased T2 signal. About the pathogenic mechanisms, which could include a direct inhibition of GlyR function, the normality in the MRI images and the substantial recovery after immunotherapies in most patients argues against a destructive process and suggests a direct inhibition or internalization of the GlyRs. EEG is abnormal in several patients, usually slowing. I-line therapy includes IV Methylprednisolone, IVIG and PLEX; II-line: Rituximab; Maintenance therapy: oral prednisone, Azathioprine. Immunotherapy is associated with a marked clinical improvement.

CONCLUSIONS

Better knowledge of the ever-expanding spectrum of autoimmune encephalitis in childhood could allow prompt diagnosis and targeted immunotherapy to improve outcome.

EP803 / #1074**E-Poster Viewing - Paediatrics AS04-18.
Neurology****Rapid response to management with vigabatrin in an infant with west's syndrome: case report.**

C.I. López Aldunate*, M. Mass-Lindenbaum, G. Reveco Pérez,
H. Villalón Urrutia

Universidad de los andes, Pediatrics Department, Santiago, Chile

BACKGROUND AND AIM

West's syndrome (WS), usually characterized by the triad: involuntary spasms, electroencephalogram (EEG) hypsarrhythmia, and delayed psychomotor development. It's uncommon, with rates of 1.4 - 4.5 per 1,000 live births. Mortality rate varies between 3 - 33% and neurological sequelae are common. Treatment includes Adreno-corticotropin hormone (ACTH) and Vigabatrin. Mean response is seen 12 - 35 days with Vigabatrin and 7-12 with ACTH. Objective: Report a case of an infant with WS with rapid response to treatment with Vigabatrin.

METHODS

7-month-old male infant with Down's syndrome, who presented recurrent spasms, associated with guttural sounds, rhythmic tongue movements and whose EEG showed hypsarrhythmia. Psychomotor delay was evident. WS was diagnosed and therapy was started with ACTH and Vigabatrin. A quick response, in 2-days, was seen, achieving a complete control of crises. He continued on antiepileptic treatment and discharged to outpatient follow-up.

RESULTS

Despite the refractoriness to treatment reported in the literature (40%), this patient had an unusually rapid clinical response, since no clinical crises were observed from 2nd day onwards being on treatment with vigabatrin, comparing to average reports 12 - 35 days.

CONCLUSIONS

Although it is a rare syndrome, it must be suspected in patients with predisposing factors. Early treatment is a favorable prognostic factor. In this case, an extremely rapid response was achieved, considering the refractoriness and response ranges described in literature.

EP804 / #1656**E-Poster Viewing - Paediatrics AS04-18.
Neurology****Pelvic lipomatosis: case report of a 10-year-old girl with chronic pelvic PAIN**

I. Magalhães*, S.C. Ferraz, C. Silva, A.E.C. Silva, C. Silva, S. Miranda, A. Carneiro

Unidade Local de Saúde do Alto Minho, Pediatrics, Viana do Castelo, Portugal

BACKGROUND AND AIM

Pelvic lipomatosis is a rare benign condition of unknown etiology, associated with deposition of fatty tissue in the pelvis, not delimited by a capsule. Clinical manifestations are caused by the extrinsic compression of the pelvic structures. It is rare in children.

METHODS

We present a case report of a 10-year-old girl with chronic pelvic pain.

RESULTS

The patient presented with vulvar, suprapubic and perianal sting-like pain for three years, with increasing frequency and intensity and several episodes of urinary urgency. Various urine cultures were negative and parasitic therapy was unsuccessful. No relevant past medical history reported. No relevant findings at physical examination. Lumbosacral MRI was normal. Pelvic MRI revealed: "an exuberant lipomatosis of the ischiorectal fossa, which results in a compressive deformation of the rectum and the vagina. This fatty tissue extends to the buttock fat." She was then referred to a Chronic Pain consultation.

CONCLUSIONS

The clinical presentation of pelvic lipomatosis varies, depending on the compressed structures, and the physical examination may be normal. MRI is an accurate method for diagnosis, assessing the involvement of the adjacent structures. Treatment options are limited. Surgical approach is rarely possible. Management of symptoms may be achieved with chronic pain medication or urinary derivation in case of obstruction. Long-term follow-up is required to monitor the symptoms and to prevent renal function decline.

EP805 / #2451**E-Poster Viewing - Paediatrics AS04-18.
Neurology****Anti nmda-r encephalitis in children: a serie of 3
CASES**

**I. Mallassi*, M. Tifha, S. Mdimagh, S. Nouir, F. Majdoub, S. Mabrouk,
J. Chemli, S. Abroug**

university hospital center SAHLOUL, Pediatric, Sousse, Tunisia

BACKGROUND AND AIM

Anti NMDA-R encephalitis is a neurological disorder, due to an autoimmune phenomenon that induce inflammation of the brain's parenchyma. It is the most identifiable autoimmune encephalitis in children. It causes a wide range of symptoms varying in severity. The common clinical manifestations are abnormal mental behavior, seizure, abnormal memory and cognitive function.

METHODS

We report the cases of three children with EAI seen in sahloul pediatric department.

RESULTS

The age of diagnosis was 3; 7 and 9 years. The three children were females with no personal or family history of autoimmune disease. The onset of the signs was subacute 3; 7 and 15 days respectively. the first signs in three cases was psychomotor regression and behaviour disorders with memory troubles, excessive crying, agitation, self-mutilation, and mutism. One patient presented with generalized tonic-clonic seizures. we identified one patient who has ophatalmoplegia. Consciousness was maintained in all three cases.

The infectious origin was eliminated. EEG showed non-specific slowing of brain activity. Brain-MRI showed signal abnormalities in two out of three cases. The diagnosis has been established by the detection of anti NMDA antibodies. Ovarian tumour screening done by pelvic MRI was negative. Two patients respond to intravenous immunoglobulin and steroids, in just one case we used rituximab. the evolution is favourable with a follow-up of 7 months to 1 year.

CONCLUSIONS

NMDAR encephalitis is underdiagnosed in infants and toddlers. Routine biological tests and imaging are non-specific Antibody testing is extremely important for diagnosis of certainty, in order to start the treatment early and provide a better outcomes.

EP806 / #1857**E-Poster Viewing - Paediatrics AS04-18.
Neurology****Paraneoplastic autoimmune encefalitis with anti-hu antibodies, a rare entity in the pediatric population**

E. Martínez-Ferrer^{1*}, E. Turon-Viñas², E. Coca-Fernandez¹, A. Díaz-Gómez¹, M. Mascaró Ginard¹, M.T. Moina Anguera De Sojo¹, J. Serralabós-Ferré¹, S. Boronat-Guerrero¹

¹Hospital de la Santa Creu i Sant Pau, Pediatrics, Barcelona, Spain

²Hospital Sant Pau., Paediatric Intensive Care, Barcelona, Spain

BACKGROUND AND AIM

Paraneoplastic diseases are a group of disorders caused by an abnormal immune system response, usually to an infection or cancer. Anti-Hu antibodies are common among adult population; however, they are rare in children.

METHODS

Case report.

RESULTS

We report a 6-year-old patient who presented with neurological symptoms, including ataxia, oculomotor apraxia, cognitive behavioural disorder and progressive bilateral sensorineural hearing loss. The patient had had a diagnosis of neuroblastoma 4 years before; which was treated with chemotherapy and surgery, actually in remission. The case was initially orientated as an opso-clonus-myoclonus syndrome and treated with immunoglobulins, without improvement. Further tests showed anti-Hu antibodies positivity in plasma and CSF and cerebellar atrophy in MRI. Therefore, she was diagnosed of

encephalitis with anti-Hu antibodies, and treatment with high dose of corticoids was started, with notable improvement of symptoms.

CONCLUSIONS

Paraneoplastic autoimmune encephalitis with anti-Hu antibodies (or ANNA-1) is a rare entity among paediatric population. It is commonly associated to small cell carcinoma of the lung in adults, and, in the paediatric population, to neuroblastoma. Clinical forms of this disease include: sensitive neuropathy, encephalomyelitis, cerebellar degeneration and limbic encephalitis. Oculomotor apraxia is a constant sign in this disease, and directly correlated to positivity of anti-Hu antibodies; that is the reason why it can be used as a sign of the activity of the disorder. When removal of the neoplasm does not control the paraneoplastic syndrome, immunosuppressor treatment is often needed. However, high resistance to treatment has been reported.

EP807 / #1744**E-Poster Viewing - Paediatrics AS04-18.
Neurology****Epidemiology and aetiology of acute ataxia in
paediatric emergencies: 12 years experience in a
third-level hospital****D. Navarro Molina^{1*}, N. Donisanu Peñaranda², A. Extraviz Moreno¹,
A. Ortiz Ortigosa^{2,3}, J. Ramos Fernandez¹**¹Hospital Regional Universitario de Málaga, Department of Pediatrics, Malaga, Spain²Hospital Regional Universitario de Málaga - Hospital Materno Infantil, Paediatrics, Málaga, Spain³Facultad de Medicina, Paediatrics, Málaga, Spain**BACKGROUND AND AIM**

Despite the majority of acute ataxia aetiologies in children are self-limiting conditions, this clinical sign may be underlined severe pathologies, including infections and/or central nervous system neoplasias. The aim of our study is to identify the incidence and describe the most frequent associated symptoms, complementary tests and aetiology of acute ataxia cases in our hospital.

METHODS

We conducted a retrospective observational study including children under 14 years of age, with diagnosis of acute ataxia, who attended our emergency department (ED) between 2010 to 2021. We relied on clinical records for data extraction and analysed it with IBM-SPSS-Statistics (2021 version).

RESULTS

Ninety-nine patients (57 males) with a median (IQR) age of 3 (2-6) years were included. The incidence of acute ataxia was 7.9 cases/100,000 ED/year.

The most frequently diagnostic tests ordered were CT scan (81.8%), blood test (71.7%), lumbar puncture (58.6%) and urine drug screening (55.6%). The most frequent aetiologies were post-infectious cerebellitis (29.3%), vestibular pathologies (18.2%), intoxications (13.1%), viral encephalitis (10.1%), acute disseminated encephalomyelitis (ADEM) (6.1%) and space-occupying brain lesions (SOL) (5.1%). The most frequent associated symptoms were headache (54.5%), vomiting (39.4%) and fever (36.2%). Headache was present in 90% of viral encephalitis and 80% of SOL.

CONCLUSIONS

The observed incidence of acute ataxia was lower than that described in other studies in Europe (10-25 cases/100000 ED/year). There was a higher proportion of viral encephalitis and ADEM. The most frequent cause was post-infectious cerebellitis. Headache combined with acute ataxia may be an association of increased risk of severe pathology that should be considered.

EP808 / #1766**E-Poster Viewing - Paediatrics AS04-18.
Neurology****Clinical utility of a secure, carer recorded, clinical video transfer system for paediatric neurology: a model for asynchronous clinical video.****S. Zuberi¹, E. Ogden^{1*}, M. Hutchison¹, N. Patel², J. Shetty³**¹Royal Hospital for Children, Paediatric Neurosciences, Glasgow, United Kingdom²Royal Hospital for Children, Neonatology, Glasgow, United Kingdom³Royal Hospital for Children & Young People, Paediatric Neurosciences, Edinburgh, United Kingdom**BACKGROUND AND AIM**

An interactive cloud based platform allowing patients and carers to upload smartphone video and linked metadata for neurological diagnosis was designed by paediatric neurologists with a technology partner and established in 21 paediatric centres; the first from 1/5/2020. We describe the clinical utility, health economic and environmental impact of the technology (www.vcreate.tv/neuro).

METHODS

Parent/carers invited to register by clinical team and utilise a password and passcode for access. Videos uploaded with a structured history. Clinician classifies using drop-down menus. Users and clinicians completed online evaluations. Health economists evaluated the system. Distance travelled saved and carbon savings calculated based on postcode to hospital and average family car.

RESULTS

To 06/04/2022, 12,056 paediatric video uploads from 4374 patients. About 600 videos uploaded per month. 405 physician/nurse users registered. Postcode derived deprivation scores indicate equitable use across socio-economic groups. Videos classified as non-epileptic (59%), epileptic (33%), unknown (8%). Seizure types include: focal impaired awareness (23%), generalised tonic clonic (17%) Carers (523) report system easy or very easy to use (88%). Clinicians (297) report video very useful (67%) or useful (25%) for diagnosis and prevented investigations in 44%. Video quality high (88%) or adequate (11%). Cost savings to health service estimated at £550 per patient. A minimum of 680,000km travel and 127 tonnes of CO₂ was saved. Patients avoided a half-day (8%) or full-day (12%) off school and carers avoided half-day (8%) full-day (10%) off work.

CONCLUSIONS

The system facilitates remote care, communication & rapid diagnosis. Investigations are prevented or prioritised with efficiencies in patient pathways and cost saving.

EP809 / #1239**E-Poster Viewing - Paediatrics AS04-18.
Neurology****A mind-blowing ct scan of the HEAD****M. Pedro^{1*}, M. Caldas¹, M. Viegas¹, C. Caetano², B. Marques¹**¹Centro Hospitalar do Oeste, Unidade Caldas da Rainha, Pediatria, Caldas da Rainha, Portugal²ACES Oeste Norte, Usf Tornada, Tornada, Portugal**BACKGROUND AND AIM**

A 3-year-old female, without previous medical history, presented to the paediatric emergency department reporting a 2 week holocranial headache, more intense in the occipital region and worsening in the past three days. She denied pain relief with analgesics and she didn't have any comfortable sleeping position. The night before admission she started persistent vomiting. In addition, in the past 2 weeks, her school teacher noticed an imbalance in gait. On physical examination, she was prostrated and had an easy crying during mobilization; no meningeal signs or apparent changes on neurological examination were noted.

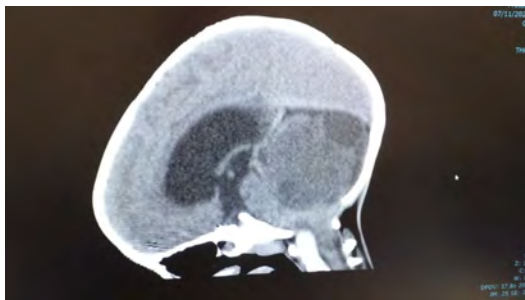
METHODS**FIGURE 1:**

It was performed a CT head scan that showed a large and heterogeneous expansive lesion in the posterior fossa, causing compression of the fourth ventricle and mesencephalic aqueduct in the lower portion, with consequent supratentorial ventriculomegaly and signs of transependymal edema (figure 1).

RESULTS

The diagnosis of brain tumor was admitted and she was transferred to a neurosurgical unit.

CONCLUSIONS

Primary malignant central nervous system (CNS) tumors are the second most common childhood malignancies and are the most common paediatric solid organ tumor. Posterior fossa tumors usually present with nausea, vomiting, headache and abnormal gait and coordination. Furthermore, headache is the most common manifestation of CNS tumors, occurring in one-third of affected children. Advances in neuroimaging, surgical technology, radiotherapy and conventional chemotherapy have improved children's outcomes in various types of brain tumors. However, it is essential to carry out an early diagnosis, paying attention to the warning signs, as demonstrated in this clinical case.

EP810 / #492

E-Poster Viewing - Paediatrics AS04-18. Neurology

The child with acute encephalitis: experience of the last decade

J. Pires*, M. Vila-Real, F. Santos

Centro Hospitalar Vila Nova de Gaia/Espinho, Pediatrics Department, Vila Nova de Gaia, Portugal

BACKGROUND AND AIM

Acute encephalitis is a serious neurological disorder in children associated with considerable morbidity and mortality. The aim of this study was to describe the epidemiology, aetiology, clinical presentation, diagnosis, treatment, and outcome of a series of children with acute encephalitis in Portugal.

METHODS

A descriptive retrospective record review study was conducted in a level II hospital in Portugal during the period from January 2011 to December 2019.

RESULTS

of 19 cases recorded, 56.9% were males. The incidence of encephalitis was 3.4 per 100,000 person/year, and 73.7% of children were ≤ 5 years old. Half (52.6%) of all cases occurred in summer. Infectious and autoimmune encephalitis constituted 36.8% and 31.5% of cases, respectively. Enteroviruses and human-herpes-virus 6 (HHV-6) and 7 (HHV-7) were the most common viral causes (21%). Acute disseminating encephalomyelitis (ADEM) constituted 26.3% of cases. Altered mental status (100%), fever (84.2%), and vomiting (53%) were the most common clinical features. Lumbar puncture, brain CT,

brain MRI, and EEG were utilized for diagnosis in 94.7%, 84.2%, 73.7% and 52.6% of cases, respectively. No mortalities were seen, but long-term complications occurred in 31.6% of cases.

CONCLUSIONS

The aetiologies of encephalitis in this cohort were different from literature, i.e. herpes simplex virus-1 was not the prototype virus and autoimmune encephalitis were more prevalent, with ADEM being the most frequently identified single cause of encephalitis in our study. The introduction of acyclovir became a routine empiric treatment. The incidence and mortality in this study were lower than literature.

EP811 / #400**E-Poster Viewing - Paediatrics AS04-18.
Neurology****Hallucination related to seizure or atypical manifestation of acute polymorphic psychotic episode: a case study of a thirteen-year-old GIRL**

**K. Plėšnytė- Čapkauskienė^{1*}, L. Kilaitė², J. Radzevičienė³,
B. Lukšaitė¹, R. Samaitienė -Aleknienė², R. Praninskienė²**

¹Vilnius university hospital Santaros Klinikos, Child Development Center,, Vilnius, Lithuania

²Vilnius university hospital Santaros Klinikos, Paediatrics Centre, Vilnius, Lithuania

³Vilnius university hospital Santaros Klinikos, Child Development Center, Vilnius, Lithuania

BACKGROUND AND AIM

To review clinical data of pediatric patient with unusual psychiatric manifestation

METHODS

We analyse a case of 13 years old patient against the background of the relevant contemporary literature.

RESULTS

The patient was complaining that all the other people seem “fake” to her, except for herself. She recalled episodes of visual hallucinations. Her case was evaluated as acute polymorphic psychotic disease. Patient’s symptoms can be separated into two groups. The first would involve short paroxysms of several minutes length during which patient would experience cognitive disturbances, become slower, she would not adequately react to conversational stimuli. These improved after the treatment with Aripiprazol. The second group would involve longer (usually less than 20 minutes) intervals

of paroxysms, involving disturbances of visual comprehension (experiencing moving ceiling, flickering walls, morphing own body parts). The latter would not react to the treatment. After discontinuing the medication patient's condition remained stable. Differential diagnostic was supported by ASO (negative titre), Autoimmune encephalitis (AK mosaic not observed), TTH, FT4, ATPO were normal. Consecutive EEG showed generalized epileptiform/paroxysmic activity (against the background of treatment with Aripirazol). Brain MRI – without pathological changes. ECG results after the discontinuation of Aripirazol – without pathological changes. Following the persisting psychotic symptoms the patient continued out-patient treatment with Risperidon.

CONCLUSIONS

Since the majority of symptoms improved after a brief treatment with Diazepam, we suspected an underlying neurological condition. Risperidon was chosen as the safest treatment since it did not involve changes in EEG. Following the treatment with Risperidon patient's condition improved.

EP812 / #596

E-Poster Viewing - Paediatrics AS04-18. Neurology

Huge arachnoid cyst presented with bilateral sixth cranial nerve PALSY

A. Rebelo^{1*}, A.I. Martins², S. Rodrigues³, J. Pereira⁴, S. Aires³

¹Centro Hospitalar Entre Douro e Vouga, Pediatrics, Santa Maria da Feira, Portugal

²Centro Hospitalar e Universitário de Coimbra, Pediatrics, Coimbra, Portugal

³Centro Hospitalar Entre Douro e Vouga, Pediatrics, Porto, Portugal

⁴Centro Hospitalar Universitário de São João CHUSJ e Faculdade de Medicina da Universidade do Porto FMUP, Pediatric Neurosurgeon, Department of Neurosurgery, Porto, Portugal

BACKGROUND AND AIM

Arachnoid cysts (AC), extra-axial cerebrospinal fluid collections of variable brain and spine location, are generally asymptomatic and detected incidentally on imaging.

METHODS

We report a case of a huge arachnoid cyst presented with bilateral sixth cranial nerve palsy.

RESULTS

A previously healthy 8-year-old boy, presented to the Emergency Department (ED), with headache and diplopia for three months. There was no history of recent trauma. The patient was diagnosed with bilateral papilledema, which resulted in his transfer to the ED. On physical examination, abduction of both eyes was deficient consistent with bilateral sixth cranial nerve palsy. Cranial computed tomography (CT) scan revealed large arachnoid cyst with mass effect and a concomitant chronic subdural hygroma on the left, and he was

referred to Paediatric Neurosurgery. Magnetic Resonance Imaging (MRI) of the brain confirmed a left arachnoid cyst in the middle, posterior and anterior cranial fossa measuring 97 x63 x84 mm with mass effect on the left cerebral hemisphere, with displacement of the midline structures (Gallasi type 3 cyst, fig.1-2). Endoscopic fenestration was performed. Control imaging revealed a decrease in the size and mass effect of both the cyst and subdural hygromas. At 2 weeks follow-up external appointment he remains asymptomatic with normal ocular motility.

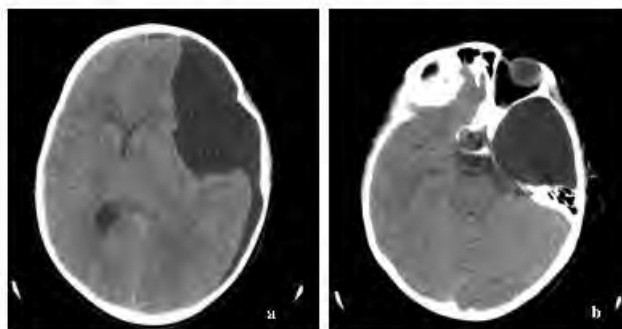

Figure 1 (a,b): Axial CT images of the temporal left arachnoid cyst seen along the frontal and temporal lobe with displacement of the ventricular system and midline structures to the right.

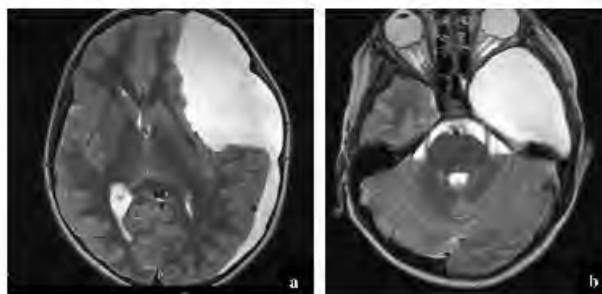

Figure 2 (a,b): Axial T2-weighted MRI images of the huge arachnoid cyst and associated homolateral parietal hygromas (a) protruding to the left preponine cistern and nerves (b).

CONCLUSIONS

If large, arachnoid cysts, can lead to neurovascular structures displacement and increased intracranial pressure. Review of literature confirms that they are a rare cause of acquired sixth nerve palsy in children. Clearly symptomatic AC should be operated. Ophthalmological evaluation is mandatory to early screening of associated complications.

EP813 / #756

E-Poster Viewing - Paediatrics AS04-18. Neurology

Oculogyric crisis

M. Ribeiro^{1,2*}, C. Curto^{1,3}, S. Gama¹, M. Figueiredo¹

¹Centro Hospitalar Médio Ave, Pediatria, Famalicao, Portugal

²Hospital de Braga, Serviço De Pediatria, Braga, Portugal

³Centro Materno Infantil do Norte, Pediatria, Porto, Portugal

BACKGROUND AND AIM

Oculogyric crisis is an acute focal dystonia, that produces a conjugate deviation of the eyes, more frequently upwards. Antipsychotic therapy is the most frequent cause of oculogyric crisis. Due to pharmacokinetics, pharmacodynamics, and dopaminergic receptor density, which is inversely proportional to age, the paediatric population is more susceptible to extrapyramidal symptoms caused by antipsychotics.

METHODS

Our work will be presented as a single case report.

RESULTS

A 17-year-old female teenager, suffering from generalized anxiety disorder, was admitted to the emergency department with complaints of abnormal eye movements, eye pain and worsening anxiety. She was under treatment with escitalopram 10mg/day for 6 months and started aripiprazole 10 mg/day two weeks prior. Neurological examination showed sustained conjugate tonic eye upward deviation, accompanied by blepharospasm. The initial clinical suspicion was oculogyric crisis and started treatment with biperiden 5mg, with slow intravenous administration, and aripiprazole was discontinued. The

patient was kept in hospital under observation and her symptoms resolved completely within 24 hours, with no further episodes in the following months.



CONCLUSIONS

Oculogyric crisis is a rare movement disorder, with a clinical diagnosis, and it requires a focused detailed history and physical examination to find out possible triggers. Exacerbation of psychiatric symptoms may also occur during the crisis. It can occur a few weeks to several months after the initiation of antipsychotics. Even though atypical antipsychotics are safer in terms of extrapyramidal effects, this possibility should always be taken into consideration. It can cause extreme agitation, therefore it needs to be managed at earlier stages, primarily using anticholinergic medication.

EP814 / #2022

E-Poster Viewing - Paediatrics AS04-18. Neurology

Clinical and genetic characteristics of six korean patients with kleefstra syndrome

J.H. Ryu*, S.H. Shin, J.M. Ko, E.-K. Kim, H.-S. Kim

Seoul National University Hospital, Department of Pediatrics, Seoul, Korea, Republic of

BACKGROUND AND AIM

Kleefstra syndrome (OMIM #610253) is a rare genetic disorder characterized by distinctive facial features, developmental delay or intellectual disability, seizure, anomalies of brain, heart or kidney. A heterozygous deletion at chromosome 9q34.3 that includes at least part of EHMT1 (~50%) or a heterozygous intragenic EHMT1 pathogenic variant (~50%), is responsible for Kleefstra syndrome.

METHODS

Six pediatric patients who were genetically confirmed as Kleefstra syndrome were enrolled. Clinical data including gender, age, auxological parameters, congenital dysmorphisms and deformities, family history and results of genetic study were collected.

RESULTS

Microdeletion of 9q34.3 with various degrees was confirmed by CMA(Chromosomal microarray) or aCGH(Microarray-based comparative genomic hybridization) in all patients. All individuals presented with developmental delay and intellectual disability. Five out of six patients showed

anomalies on brain imaging of various findings including corpus callosum dysgenesis, white matter anomalies, ranthke cleft cyst and craniosynostosis. Four patients had seizure requiring anti-epileptic drug treatment. Congenital cardiovascular problem and renal anomaly were identified in 5 out of 6 patients, respectively. Four patients had respiratory problems immediate after birth requiring hospitalization in the neonatal intensive care unit.

TABLE 1:

Clinical features	Patient 1	Patient 2	Patient 3	Patient 4	Patient 5	Patient 6	n = 6
Gender	M	M	F	F	F	F	M:F = 2:4
Gestational age	39+0wks	39+0wks	41+0wks	37+1wks	38+0wks	38+5wks	
Birth weight	2.8kg (10p)	3.92kg (88p)	3.84kg (68p)	2.83kg (47p)	2.67kg (20p)	2.75kg (17p)	
NICU care	+	-	+	+	-	+	4 / 6
Centiles at diagnosis							
Height	-	90-95p	10-25p	50-75p	<3p	50-75p	
Weight	-	75-90p	50-75p	50-75p	5-10p	10-25p	
Head circumference	10-25p	50-75p	10-25p	5-10p	<3p	<3p	
Age at diagnosis	11mo	7yr	1mo	0mo	2yr	6mo	
Diagnostic method	CMA, FISH 9q34.3	aCGH, FISH 9q34.3	aCGH, FISH 9q34.3	aCGH, FISH 9q34.3	aCGH, FISH 9q34.3	aCGH, 9q34.3	
Genetic diagnosis	1.6Mb del (de novo)	0.32Mb del (de novo)	2.955Mb del (trio not done)	microdeletion (trio not done)	0.7Mb del (trio not done)	1.34Mb del (trio not done)	
Facial dysmorphism							
Microcephaly	-	-	-	-	+	+	2 / 6
Hypertelorism	-	-	+	+	+	+	4 / 6
eyebrow dysmorphism	-	+	+	+	-	+	4 / 6
Midface retrusion	-	-	+	+	-	+	3 / 6
Depressed nasal bridge	+	-	+	+	-	+	4 / 6
Short nose	+	-	+	+	-	+	4 / 6
Macroglossia	-	+	+	+	-	-	3 / 6
Characteristic lip morphology	-	-	+	+	-	+	3 / 6
Dental anomaly	-	+	-	-	-	-	1 / 6
Otologic problem							
Ear anomaly	+	-	-	+	-	+	3 / 6
Hearing impairment	+	-	+	+	-	+	4 / 6
Neurologic problem							
Hypotonia	-	+	+	+	+	-	2 / 6
Seizure	-	-	-	+	-	-	4 / 6
Anomalies on brain imaging	+ ^A	-	+ ^B	+ ^C	+ ^D	+ ^E	5 / 6
DD / ID	+	+	+	+	+	+	6 / 6
Dysphagia	-	-	-	+	-	-	2 / 6
Sleep problem	-	-	-	-	-	-	1 / 6
Behavioral problem	-	+	+	-	-	-	2 / 6
Others							
Hirsutism	-	-	+	+	-	+	3 / 6
Cardiovascular anomaly	+ ^F	-	+ ^G	+ ^H	+ ^I	+ ^I	5 / 6
Renal anomaly (including VUR)	+	+	+	-	+	+	5 / 6
Genital anomaly	+	+	+	-	-	-	2 / 6
Extremity anomaly	-	-	+	-	+	-	2 / 6
Ocular problem	-	+	-	+	-	-	3 / 6
Recurrent infections	-	-	-	-	+	-	1 / 6
Tracheomalacia	-	-	-	+	-	-	1 / 6
Umbilical/inguinal hernia	-	+	-	-	-	-	1 / 6
Endocrinologic problem	-	+ ^K	- ^L	-	-	-	2 / 6

CMA: Chromosomal microarray; aCGH: Microarray-based comparative genomic hybridization; DD/ID: developmental delay/intellectual disability; VUR: vesicoureteral reflux; A: dysgenetic corpus callosum with absent splenium; B: diffuse mild atrophy of parenchyme; C: white matter injury; D: prominent peritrigonal area; E: mectopic synostosis; ranthke cleft cyst; F: VSD; ASD; PDA; G: VSD; ASD; PDA; arch hypoplasias; H: VSD; ASD; PDA; PHT; I: ASD; J: ASD; VSD; ventricular septal defect; ASD: atrial septal defect; PDA: patent ductus arteriosus; PHT: pulmonary hypertension; K: precocious puberty; L: congenital hypothyroidism



Figure 1. Facial profiles of patients with Kleeftstra syndrome. (A) Patient 3 at age 0 month, (B) Patient 3 at age 3 years, (C) Patient 4 at age 4 months, (D) Patient 6 at age 13 months.

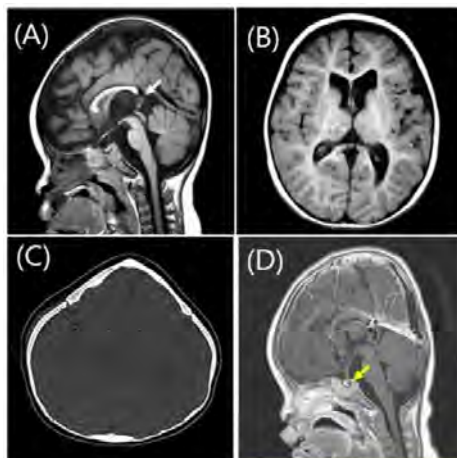

Figure 2. Brain images of patients with Kleeftstra syndrome. (A) dysgenetic corpus callosum with absent splenium in Patient 1 (white arrow), (B) brain atrophy in Patient 3, (C) mectopic synostosis and trigonocephaly in Patient 6, (D) rathke cleft cyst in Patient 6 (yellow arrow)

CONCLUSIONS

Kleefstra syndrome should be suspected in the newborn infant with distinctive facial features and accompanied anomalies in the heart, kidney and brain, as well as various neurologic problems including seizure and hypotonia. Diagnosis of Kleefstra syndrome could be made during neonatal period by simple genetic diagnostic method such as CMA or aCGH.

EP815 / #2158

E-Poster Viewing - Paediatrics AS04-18. Neurology

Erythropoietic protoporphyria, epilepsy and syringomyelia: a case report

L. Sizgoric^{1*}, Z. Gjergja², S. Delin^{3,4}, M. Kovac Sizgoric⁵, Z. Sabol⁶

¹University of Zagreb, School of Medicine, Zagreb, Croatia

²Outpatient Clinic for Sick Children „Dr.Sabol“, Cardiology, Zagreb, Croatia

³Zadar General Hospital, Department of Pediatrics, Zadar, Croatia

⁴University of Zadar, Department of Psychology, Zadar, Croatia

⁵Children`s Hospital Srebrnjak, Department of Neuropediatric and Sleep Disorders Unite, Zagreb, Croatia

⁶Outpatient Clinic for Sick Children „Dr.Sabol“, Department of Neurology, Zagreb, Croatia

BACKGROUND AND AIM

Porphyrias are autosomal dominant inherited or acquired disorders of porphyrin metabolism, which lead to the accumulation of porphyrin or its' precursor compounds in different organs or serum. The basic defect is a reduction in activity of enzyme ferrokelatase that catalyzes the binding of protoporphyrin and iron in the heme which leads to accumulation of protoporphyrin in erythrocytes and serum and its' photosensitivity result in hypersensitivity to sunlight. In addition to skin other organs can be affected - the liver, peripheral (polyneuropathy), and central nervous system (convulsions, somatosensory, cognitive and behavioral deficiency).

METHODS

In this paper we present a young patient with erythropoietic protoporphyria, epilepsy and syringomyelia.

RESULTS

Our female patient was observed from infant period because of repetitive episodes of abdominal colic and seasonal occurrence of skin changes accompanied by the edema of metacarpal joints of unclear etiology. At the age of 8 years and 10 months she developed absence seizures. During neurological examination brain MRI was normal, MRI of the spine showed syringomyelia of cervicothoracic segment. Because of persistent relapses of peripheral cutaneous signs associated with exposure to sunlight and seizures we thought of porphyria.

CONCLUSIONS

A large number of unrecognized and untreated cases indicate the necessity of making early diagnosis of porphyria, as the first important step towards prevention of exacerbations and possible complications. Connections between porphyria and epilepsy, as well as its neurological complications have so far been repeatedly observed and described, but according to the literature available to us, never in association with syringomyelia.

EP816 / #2169

E-Poster Viewing - Paediatrics AS04-18. Neurology

Moyamoya syndrome - a rare complication of neurofibromatosis type 1

L. Sizgoric^{1*}, M. Kovac Sizgoric², J. Stepan Giljevic³, T. Grmoja⁴,
S. Delin^{5,6}, F. Jadrijevic Cvrlije³, G. Krakar⁷

¹University of Zagreb, School of Medicine, Zagreb, Croatia

²Children's Hospital Srebrnjak, Department of Neuropediatric and Sleep Disorders Unite, Zagreb, Croatia

³Children's Hospital Zagreb, Department of Hematology and Oncology, Zagreb, Croatia

⁴Children's Hospital Zagreb, Department of Pediatric Radiology, Zagreb, Croatia

⁵Zadar General Hospital, Department of Pediatrics, Zadar, Croatia

⁶University of Zadar, Department of Psychology, Zadar, Croatia

⁷Outpatient Clinic for Sick Children „Dr.Sabol“, Child Neurology, Zagreb, Croatia

BACKGROUND AND AIM

Neurofibromatosis Type 1 (NF1) is a multisystem disease affecting the skin, central nervous system and bones. Changes in cerebral blood vessels in NF1 vary in degree from stenosis to occlusion, aneurysm, atriovenous fistula to Moyamoya syndrome (MMS), and are estimated at about 2%.

METHODS

We present a young female identical twin with MMS and NF1.

RESULTS

Our patient was born as firstborn identical twin from spontaneous pregnancy. From early infancy, both twins have been observed to have multiple cafe au lait spots whose size and number increase over time, with no other signs

of NF1. The parents had no skin changes. At the age of 18 months, patient refuses food, the examination reveals right-sided hemiparesis. MRI of the brain showed bilateral optic glioma involving the chiasm and optic tract. 13 cycles of chemotherapy were performed according to the LGG 2004 protocol which led to a reduction in tumor mass. The twin sister was also diagnosed with gliomatosis of the optic tract. Linkage analysis identified a haplotype for NF1 inherited from the father. At the age of 5.5 years, as part of the planned neuroradiological diagnostic processing MMS was suspected. DSA determined left-sided occlusion of the cerebral media artery on M1 with MoyaMoya collaterals. After PET-CT with Diamox test to assess cerebral perfusion reserves, surgical treatment was indicated.

CONCLUSIONS

During the monitoring of patients with NF1, it is necessary to follow-up the recommended protocols and thus early identify rare manifestations of the disease in which rapid intervention can prevent serious life-threatening complications.

EP817 / #1132

E-Poster Viewing - Paediatrics AS04-18. Neurology

Primary familial erythromelalgia – a clinical diagnosis

M. Sousa Dias*, M. Meneses, N. Rodrigues

Hospital Pedro Hispano, Pediatrics, Matosinhos, Portugal

BACKGROUND AND AIM

Erythromelalgia is a rare chronic disorder characterized by a triad of intermittently red, hot and painful extremities. It can be classified as primary or secondary, depending on the detection of an underlying cause. There is no cure or universally effective therapies. Due to the impact on quality of life, its early identification is essential. We aim to report a pediatric case of primary erythromelalgia, in which anamnesis and physical examination played a key role in its diagnosis.

METHODS

Previously healthy 19-month-old male child referred to a pediatric appointment for recurrent episodes of erythema, heat, edema and pain in the lower limbs, which endured for about one hour, triggered by defecation or trauma and relieved by immersion of the extremities in cold water. These episodes had been occurring on a monthly matter for seven months. He had no other associated symptoms or signs. There was a family history of similar episodes in the maternal branch, without an established diagnosis. Physical examination was normal. His mother brought photographs that evidenced the complaints (pictures 1 and 2).



FIGURE 1:



FIGURE 2:

RESULTS

Owing to the suspicion of familial erythromelalgia, a targeted genetic study was performed, confirming a mutation in the SCN9A gene.

CONCLUSIONS

Primary erythromelalgia is associated with a mutated gene that encodes an aberrant ion channel responsible for the hyperexcitability of peripheral nociceptors. This mutation can be sporadic or familial, transmitted as an autosomal dominant trait. Diagnosis is clinical and genetically confirmed. Treatment is based on behavioral measures, such as body cooling measures, and pain-modulation pharmacological therapies.

EP818 / #1824**E-Poster Viewing - Paediatrics AS04-19.****Organisation & safety****Phthalate exposure and pediatric asthma: a cross-sectional study in a sample of egyptian children****A.S. El Refay^{1*}, M. Youssef¹, E. Eldin¹, M. Abushady¹, N. El Baroudy², A. Gouda³, W. Nazim³**¹National Research Center Cairo Egypt, Child Health Department, Giza, Egypt²Cairo univeristy, Pediatric, Giza, Egypt³National Research Center, Biochemical Genetics Department (biochemical Genetics), Giza, Egypt**BACKGROUND AND AIM**

Phthalates (diesters of phthalic acid) are widely used as plasticizers and additives in many consumer products. Several phthalates have been recognized as substances of high concern. Exposure to phthalate esters (PAEs) has been associated with childhood asthma, but the relative specific effects of PAEs on childhood asthma were unclear. The aim of this study was to compare the level of urinary phthalate in asthmatic and control children and to investigate the implication of phthalate among other risk factors for the development of asthma.

METHODS

A case control study involved 65 children (50 asthmatic and 50 healthy controls) aged 2–14 years. Asthmatic children were diagnosed according to Global initiative for asthma (GINA) guidelines. Sociodemographic factors were assessed, and urinary levels of phthalate were determined in spot urine samples using high-performance liquid chromatography. Ethical approval from Medical Research Ethics Committee No:16368

RESULTS

Mean urinary Monoethyl levels were significantly higher in asthmatic children than control group (895.2 ng/mL in asthmatic children compared to 60.5ng/mL in control group, p 0.001). Subjects living in houses with oil painted wall were less likely to be asthmatic. Multiple logistic regression analysis for predictors of asthma showed the use of phthalate containing shampoo as a more significant predictor than passive smoking and oil painting.

CONCLUSIONS

Interpretation of our results show that higher levels of urinary phthalate is associated with the diagnosis of asthma in children may indicate the potential risk of phthalate exposure in the precipitation of bronchial asthma. Further research is needed to clear up the proper mechanism explaining this association.

EP819 / #1584

E-Poster Viewing - Paediatrics AS04-19. Organisation & safety

Enterprise-wide innovation initiative to improve pediatric remote patient monitoring outcomes

L. Erickson^{1*}, A. Ricketts¹, J. Marshall², K. Nelson³, P. Churchill⁴,
D. Wolff⁵, R. Steele⁵

¹Children's Mercy Hospital, Remote Health Solutions, Kansas City, United States of America

²Children's Mercy Hospital, Feasibility and Strategic Outcomes, Kansas City, United States of America

³Children's Mercy Hospital, Innovation Center, Kansas City, United States of America

⁴Children's Mercy Hospital, Medical Informatics, Kansas City, United States of America

⁵Children's Mercy Hospital, Strategy and Innovation, Kansas City, United States of America

BACKGROUND AND AIM

Children's High Acuity Monitoring Program (CHAMP®) is a software platform for pediatric remote patient monitoring. It is used with a proactive, personalized, pediatric care model providing a link for communication with a specialized healthcare team to patients and families in their homes. Successful implementation since 2014 includes: adoption at 12 pediatric hospitals and over 870 infants with a survival of 96.5% (down from 20% in 2012). This work led our team to engage leadership to discuss a remote patient monitoring department with new monitoring devices and expanded access to pediatric conditions.

METHODS

Strategic Planning and Innovation facilitated navigation of an enterprise-wide endeavor over an 18-month period. Closed-loop feedback with the administrative, clinical, information systems, and research teams ended with a well-rounded proposal for an innovative strategic initiative.

RESULTS

Remote Health Solutions department was founded in September 2021 with a focus on integration of digital health and mobile applications, hardware, software platforms and wearable sensors to improve the healthcare team's ability to provide personalized, proactive patient care. The team has three active feasibility studies for pediatric monitoring devices, four analyses from the Cardiac CHAMP registry, performs consults on remote monitoring facilitation with care teams, and is expanding CHAMP application use into additional clinical pediatric areas.

CONCLUSIONS

The forward movement of pediatric remote health stands at a precipice of opportunity within the landscape of mobile devices and applications in advancing pediatric medicine and outcomes. This project magnifies opportunities for evidence-based innovative pediatric care models, especially in the midst of the pandemic.

EP820 / #2676**E-Poster Viewing - Paediatrics AS04-19.
Organisation & safety****Changing the paradigm - improving reflective
practice and patient care by learning from
complaints****A. Gite***

Lister Hospital, East and North Herts NHS Trust, Department of Paediatrics, Hertfordshire, United Kingdom

BACKGROUND AND AIM

Historically complaints within the NHS have been viewed as a negative part of the job. They are often complicated time-consuming processes with associated emotional impact for staff involved, limiting the important reflection and learning. We aimed to change the way the department think about and learn from complaints to optimise patient safety and experience.

METHODS

We systematically reviewed all complaints over one-year to the acute paediatrics department focusing on the key themes and the 'parental voice'. Using this data we developed a teaching session for both nursing and medical staff to reflect and learn from the core themes in order to prevent similar mistakes.

RESULTS

-There were 14 complaints to acute paediatrics over the course of one year; 78% of which had arisen within the emergency setting. -100% of complaints related to communication deficiencies, with "poor explanation" and 'feeling dismissed' the most common cited reasons. -Teaching sessions focussing on direct quotations from complaints allowed staff to reflect on the feedback. Overwhelmingly staff felt this was a good way to learn; with 100% saying they benefited from such a session.

CONCLUSIONS

-We advocate focusing on the 5 C's during interactions with patients and families – competence, communication, consent, confidentiality and conduct. -offering a sincere apology to parents and a non-defensive response is a priority for families. -Anecdotally nursing and medical staff find it useful and cathartic to participate in non-judgmental teaching session focusing on complaints. -We advocate reviewing recurrent themes of complaints in order to tailor bespoke teaching sessions.

EP821 / #926

E-Poster Viewing - Paediatrics AS04-19. Organisation & safety

Impact of value-based health care reform on pediatric asthma quality of care and disparities in the U.S

S. Goff^{1*}, P. Lindenauer², A. Ash³, J. Krishnan⁴, E. Decou¹, K. Geissler¹

¹University of Massachusetts, Health Promotion and Policy, Amherst, United States of America

²University of Massachusetts Medical School-Baystate, Health Care Delivery and Population Health, Springfield, United States of America

³University of Massachusetts Medical School - Worcester, Population and Quantitative Health Sciences, Worcester, United States of America

⁴University of Illinois-Chicago, Pulmonary Medicine, Chicago, United States of America

BACKGROUND AND AIM

Asthma, the most common chronic condition of childhood, is a disease of disparities. Value-based care models, (e.g., ACOs), could improve asthma inequities, but little is known about how such models affect pediatric quality of care and outcomes. This study explored variation in utilization and influenza vaccination rates for Medicaid-insured children with asthma to privately insured children in the U.S. prior to launch of a new Medicaid ACO. Medicaid is a government-sponsored insurance for lower-income families. This study is part of a larger mixed-methods study of the effect of Medicaid ACOs on pediatric asthma care.

METHODS

We used administrative claims and pharmacy data from the 2014-2018 Massachusetts All-Payer Claims Data set to compare baseline influenza vaccination and utilization rates for Medicaid-insured and privately-insured

children ages 2-17 years with asthma. Unadjusted results are presented here and risk-adjusted results will be completed by June 2022.

RESULTS

There was a total of 508,721 child-year observations; 58.4% were Medicaid-insured; 67.0% were between ages 5-14; 57.0% were male. Children insured by Medicaid had higher rates of emergency department visits (23.6% vs. 10.2%) and hospitalizations (2.9% vs. 2.1%) that included a diagnosis of asthma and lower influenza vaccination rates (45.9% vs. 53.2%).

CONCLUSIONS

Although inequities in health care access are generally more pronounced in the U.S. than developed countries with national health care plans, disparities in health outcomes exist even in the presences of more equitably distributed healthcare. This study demonstrates variation in income-based insurance plans prior to implementation of a new Medicaid ACO program, suggesting opportunities for the new value-based finance system to improve care and reduce disparities.

EP822 / #1199

E-Poster Viewing - Paediatrics AS04-19. Organisation & safety

Awareness and use of point of care handheld ultrasound devices amongst paediatric trainees.

S. Mahesh^{1*}, P. Satodia^{2,3}, S. Brown⁴, S. Rashid¹

¹University Hospitals Coventry and Warwickshire, Neonatal Unit, Coventry, United Kingdom

²University of Warwick, Warwick Medical School, Coventry, United Kingdom

³University Hospital Coventry & Warwickshire NHS Trust, Nicu, Coventry, United Kingdom

⁴University Hospital Coventry and Warwickshire NHS Trust, Neonatal Unit, Coventry, United Kingdom

BACKGROUND AND AIM

Point of care ultrasound (POCUS) using Handheld ultrasound devices (HHUDs) has been used in the paediatric and emergency settings for the assessment of cardiovascular and respiratory systems, vascular access and intraventricular haemorrhage detection. However, HHUDs are not widely used in the UK and they are not included in the paediatric training curriculum. This study evaluated the awareness and use of POCUS using HHUDs amongst paediatric trainees in the West Midlands, UK.

METHODS

An electronic survey was sent to paediatric trainees within the West Midlands region. Questions covered trainee familiarity with HHUDs, awareness of potential uses and challenges with their implementation.

RESULTS

30 responses were received from trainees between grades ST1 – ST8. 77% percent of trainees had heard of HHUDs and only 15% had seen it being used. None of the trainees had personally used HHUDs whilst 100% of them

declared their interest in receiving training on their use. Trainees mainly thought that HHUDs could be used in Neonatal and paediatric intensive cares, and the emergency department with a couple of trainees suggesting that it could be used on general paediatric wards. The main perceived barriers towards use of HHUDs was training, associated costs and device management (storage, infection control).

CONCLUSIONS

Despite being aware of HHUDs, trainees had not personally used them but were interested in receiving further training. This has potential implications for the paediatric training both locally and nationally. Training and availability of HHUDs is likely to improve patient safety in clinical care.

EP823 / #571**E-Poster Viewing - Paediatrics AS04-19.
Organisation & safety****An audit assessing appropriate breaks for paediatric junior doctors in a dgh to avoid staff fatigue and safeguard patient safety****V. Naguleswaran*, K. Zia, K. Ominu-Evbota**

Mid and South Essex NHS Foundation Trust, Paediatrics, Basildon, United Kingdom

BACKGROUND AND AIM

Junior doctors at a DGH (BTUH) are rostered to work a variety of shifts to provide a 24hour service. Sleep and breaks are fundamental for good health and to optimise patient safety. As per the BMA Junior Doctor Contract and RCPCH, at least 75% of the time doctors should get; at least one 30-minute paid break for a shift >5hours; a second 30-minute break for a shift >9hours; a third 30-minute break for a night shifts of >12 hours. Our aim is to measure the percentage of doctors that are taking adequate rest during their shifts; identify any barriers to doctors taking adequate breaks and recommend changes to optimize breaks.

METHODS

An electronic questionnaire was sent out to all doctors to complete from 1st December 2021 – 12th January 2022.

RESULTS

We had 107 responses. We did not meet the standard of doctors getting the required number of breaks on shift; only 46% of doctors got their entitled

breaks (30% uninterrupted). 87% of doctors got at least one 30minute break; (62% uninterrupted). 69% of doctors didn't get a second break and 71% didn't get a third break on their night shift. Reasons for not taking a break was largely due to workload, emergencies and short staffing.

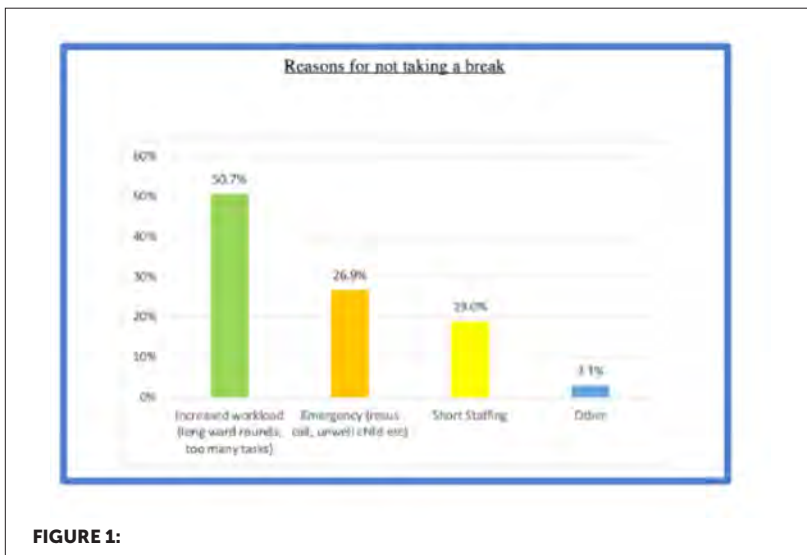

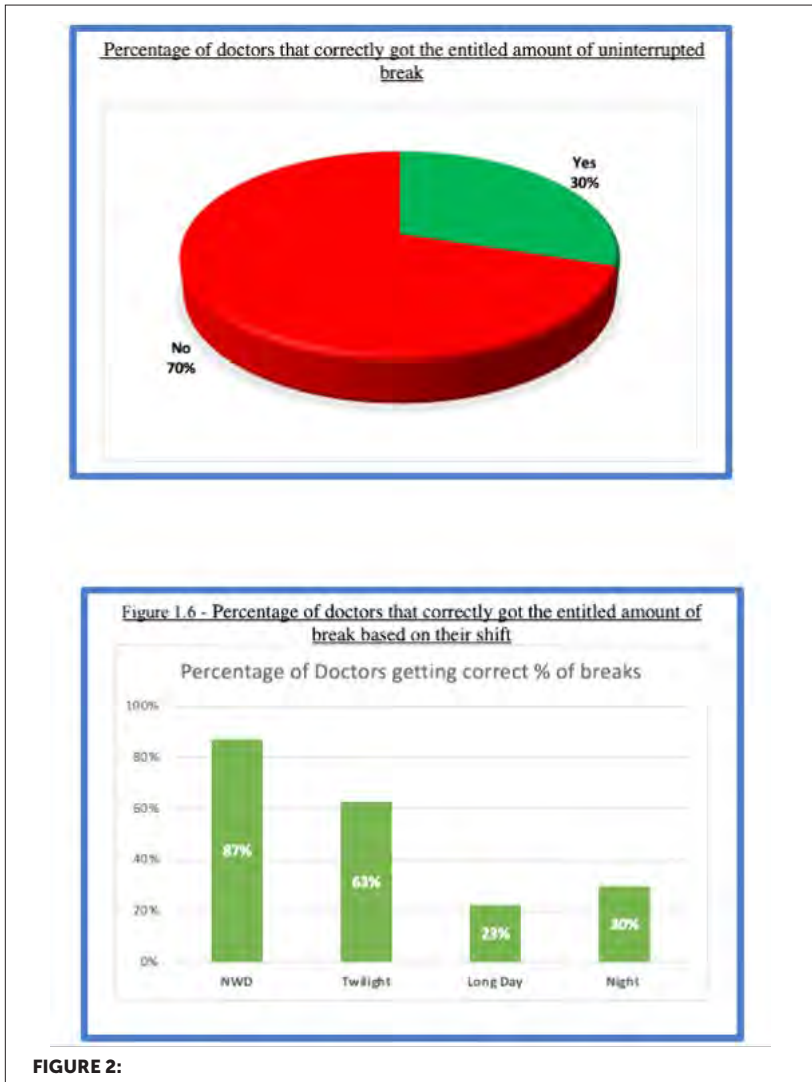

CONCLUSIONS

We did not meet the set standard of junior doctors getting the appropriate amount of breaks on shift. Our action plans include presenting our audit to the MDT; team to cover each other's bleeps to facilitate breaks and to allocate breaks at the start of each shift. We will re-audit in 6months.

EP824 / #1994

E-Poster Viewing - Paediatrics AS04-19. Organisation & safety

New subject on breastfeeding at the university of barcelona

**L. Ruiz-Guzman^{1*}, C. Gonzalez-Rodriguez², I. Marcos-Marcos³,
A. Padro⁴, V. Pleguezuelos-Hernández⁵, P. Giménez-Bonafé⁶**

¹Institut Catala Salut, Cap 17 Setembre, El Prat de Llobregat, Spain

²Gava Salut Familiar, Private Practice, Gava, Spain

³Neixer a Casa, Coordinator, Barcelona, Spain

⁴LACTAPP, Ilcbc, Barcelona, Spain

⁵Banc de Sang i Teixits Edifici Dr. Frederic Duran i Jordà Passeig Taulat, 116 08005 Barcelona, Coordination, Barcelona, Spain

⁶School of Medicine and Health Sciences. Bellvitge Campus, University of Barcelona (UB), Associate Professor, Hospitalet de Llobregat, Spain

BACKGROUND AND AIM

Beastfeeding is important for health. Medical doctors are not specifically trained in this subject. Especific breastfeeding training is not included in the medical curriculum. The new subject we have organized and put into practice aimed to develop in the future health personnel a critical and reflective attitude on this matter, and the ability to communicate with women who want to breastfeed.

METHODS

A two-credit course based on the 20-hour training course from the World Health Organization (WHO) proposed in the fourth year of the Medicine Degree. Teaching staff are Paediatricians, International Breastfeeding Consultants, Midwives and Milk-bank professionals. Tests on the students' general knowledge of breastfeeding before and after the course were done, and the grades obtained by the students were comparatively analyzed.

RESULTS

120 students in the four years were enrolled. Future gynaecologists and obstetricians, paediatricians, surgeons, otolaryngologists and other specialities were interested. The analysis of the grades obtained in the pre and post subject tests showed a highly significant improvement in the grades post-test ($P < 0.0001$) in each of the 4 academic years. The students' surveys showed a high degree of satisfaction and at the same time, the overall ignorance that they had at the beginning of the courses since the topics dealt with had not been previously presented to them.

CONCLUSIONS

After four years of experience with the new subject, the introduction of this new subject has been a success. The training of health professionals on breastfeeding is essential for all in order to attend correctly to breastfeeding mother and child

EP825 / #567**E-Poster Viewing - Paediatrics AS04-19.
Organisation & safety****The use of melatonin among paediatric
population in child and family health centre axe
street****J. Tan***

NELFT, NHS, Community Paediatrics, London, United Kingdom

BACKGROUND AND AIM

Background Sleeping difficulty is a common presentation among paediatric populations with neurodevelopmental problems. Melatonin has become the mainstay of pharmacological treatment for sleep disturbance in children. Aim Detect Number of Melatonin patients Medical Background of Melatonin patients Medication safety

METHODS

Retrieve patient list via appointment administrator. Organising data according to aims of study using excel sheet.

RESULTS

There are 258 patients on Melatonin. Melatonin is prescribed appropriately. The majority of patients prescribed with Melatonin are ASD, ADHD, Learning difficulty, Neurodisability conditions and also rare genetic diseases. There is no adverse side effect noted. All patients have shared care guidelines with GP

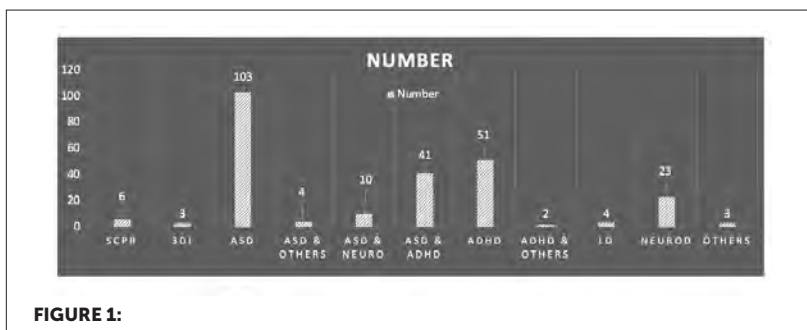

CONCLUSIONS

There are 258 patients on Melatonin. These 258 patients are prescribed appropriately. The majority of patients that are prescribed Melatonin are ASD, ADHD, Learning difficulty, Neurodisability conditions and also rare genetic diseases. There is no adverse side effect noted on all patients. All patients have shared care guidelines, forwarded to GP. Circadin (Melatonin) remains the main melatonin prescribed among the children population. There have been increasing caseloads where GP are unwilling to sign shared care melatonin guidelines/ GP unwilling to continue prescription for the child. Upon reviewing our current guideline, it is noted that it has not been updated since 2012. Our next step is to update our shared care guideline and include a sleeping difficulty guideline for the community services.

EP826 / #2755**E-Poster Viewing - Paediatrics AS04-19.
Organisation & safety****An infant with a 3 day fever and a neck rash - a case report****I. Vivas^{1*}, J. Oliveira², S. Branco³, I. Pais-Cunha⁴, G. Nogueira Oliveira³, I. Mazedo³**¹*Centro Hospitalar da Póvoa de Varzim e Vila do Conde, Pediatrics, Póvoa de Varzim, Portugal*²*Centro Materno Infantil do Norte, Pediatrics, porto, Portugal*³*Centro Hospitalar Póvoa de Varzim e Vila do Conde, Porto, Portugal, Department of Pediatrics, Póvoa do varzim, Portugal*⁴*Centro Hospitalar Universitário de São João, Pediatrics, Porto, Portugal***BACKGROUND AND AIM**

Amber necklaces or bracelets are being used by parents on their infants/ toddlers for many reasons, mostly for relieving teething pain. Nonetheless, currently there is no scientific evidence to support their effectiveness. Moreover, FDA has received reports of death and serious injuries, including strangulation and choking, which brings a major safety concern. Also, the literature shows that amber necklaces can be colonised by commensal germs of the skin, mainly coagulase-negative staphylococci. Although these bacteria are saprophytes, they may become pathogenic in particular conditions.

METHODS

We present the case of a previously healthy 6-month-old girl who presented to ER with a 7 day neck rash and a 3 day fever (T. 102.2°F maximum), without other symptoms. When asked, the mother reported the use of an amber necklace on the last 2 weeks (daily and nocturnal use).

RESULTS

Examination revealed a conglomerate of red macular lesions with honey-colored crusts on the posterior neck compatible with impetigo. The rest of the physical exam was unremarkable. She completed a course of oral flucloxacillin and eviction of the necklace with full resolution of symptoms.



FIGURE 1:

CONCLUSIONS

Despite its popular and frequent use, amber necklaces are shown to be dangerous since they can lead to bacterial skin infections (mostly coagulase-negative staphylococci) as we present in this case of impetigo or even more serious complications like choking/strangulation and that's one of the reasons the American Academy of Pediatrics completely discourages the use of such products.

EP827 / #1935**E-Poster Viewing - Paediatrics AS04-20. Palliative care****A case of an unrecognized fracture in a patient with severe disability****M. Dell'Anna*, A. Tamborino, C. Trapani, L. Facchini, M. Parpagnoli**

Meyer Children Hospital, Complex Care Unit, FIRENZE, Italy

BACKGROUND AND AIM

Multiple factors influenced bone health, such as accelerated calcium excretion, anticonvulsant therapy, joint contractures, immobilization, and malnutrition. The aim of the present case report was to highlight the importance of early diagnosis and treatment of uncommon musculoskeletal complications in children with severe disability.

METHODS

A written informed consent for diagnostic and research purposes was signed by the baby's parents. This work respects the local ethical guidelines. Clinical, hematochemical and radiological data were collected.

RESULTS

A fourteen years girl with epilepsy (seizures with opisthotonus), spastic quadriplegia secondary to perinatal hypoxic brain damage presented with excessive crying and fever. Examination found right knee swelling with tenderness. No traumatic episodes were found. Blood tests showed: C reactive protein 11 mg/dl (0-0.5 mg/dl), procalcitonin 70 ng/ml (< 0.5 ng/ml). Calcium level was low, 7 mg/dl (9.3-10.6 mg/dl), phosphorus and vitamin D levels were normal. Thus, broad-spectrum antibiotics therapy for suspected sepsis were started.

Extremities X-ray revealed a fracture of distal femoral epiphysis with periosteal reaction. Magnetic resonance imaging report inveterate femur fracture, with right knee osteomyelitis. Surgical fixation of fracture and arthrocentesis of the knee were performed. Microbial cultures were collected, but no bacterial growth was detected by bacterial culture. In previous tests, the metabolism of calcium phosphorus was balanced. The patient takes vitamin D. Last DXA: Z SCORE -1,8.

CONCLUSIONS

Spontaneous fractures in children are multifactorial. Severe spasticity, opisthotonus and contractures in this case are probably the major causes. In children with disabilities, it is important to implement active surveillance to prevent complications of unrecognized fractures.

EP828 / #1938**E-Poster Viewing - Paediatrics AS04-20. Palliative care****A multidisciplinary approach to the treatment of residue of perinatal suffering: a case report****M. Dell'Anna*, A. Tamborino, C. Trapani, L. Facchini, M. Parpagnoli**

Meyer Children Hospital, Complex Care Unit, Firenze, Italy

BACKGROUND AND AIM

Using a multidisciplinary approach can be a key factor in initiatives designed to increase the effectiveness of health care services offered to children with residue of perinatal suffering. We present a case of neonatal suffering post-defenestration perinatal maternal trauma; to stress the importance of a multidisciplinary follow up.

METHODS

A written informed consent for diagnostic and research purposes was signed by the baby's parents. This work respects the local ethical guidelines.

RESULTS

A girl born at 38 weeks gestational age after a maternal politrauma due to defenestration. At birth, she was areactive and asystolic; endotracheal intubation and heart massage were performed, epinephrine was given. Therapeutic hypothermia was performed. Critical episodes appeared in the first hours. From the beginning a multidisciplinary approach was used. The family was immediately followed from the psychological point of view with frequent and regular interviews. Electroencephalography recorded isolated paroxysmal anomalies on the

left anterior regions and on the right frontal regions; the brain magnetic resonance imaging documented diffuse restriction including deep portions, suggestive of severe hypoxic damage, spectroscopic examination showed marked reduction of the N-acetyl aspartate/Creatine ratio. Phenobarbital therapy was carried out. For enteral nutrition it was necessary to place nasogastric tube. The girl is currently awaiting percutaneous gastrostomy placement according to surgical indications. Dietetic follow up has improved body mass index and nutritional state.

CONCLUSIONS

Complex care of child with residue of perinatal suffering should be early and comprehensive. Our experience indicates that immediate start (from the neonatal period) of multidisciplinary monitoring improves patient management and family psychological state.

EP829 / #1939**E-Poster Viewing - Paediatrics AS04-20. Palliative care****A persistent cardiac defect in a premature girl with dysmorphic features.****M. Dell'Anna*, A. Tamborino, C. Trapani, L. Facchini, M. Parpagnoli**

Meyer Children Hospital, Complex Care Unit, FIRENZE, Italy

BACKGROUND AND AIM

RASopathies are syndromes deriving from germline mutations in genes that take part in the rat sarcoma/mitogen-activated protein kinases pathway. The aim of the present case report was to highlight the importance of a primary heart disease to diagnose RASopathies in a premature baby.

METHODS

Clinical data were collected by pediatricians. A written informed consent for diagnostic and research purposes was signed by the baby's parents. This work respects the local ethical guidelines. Genomic DNA of the patient and her parents was analysed by a predesigned Haloplex Noonan panel. Other genes involved in RASopathie were added.

RESULTS

In a premature (30+2), very low birth weight, dysmorphic new born to non-consanguineous parents was observed a resistant cardiac hypertrophy. The other sibling was normal. She had triangular facies, hypertelorism, deep set eyes, down slanting palpebral fissures, low set ears, cleft palate. Clinically there was evidence of tachycardia

³/6 ejection systolic murmur. Hemogram, thyroid function tests, renal parameters and ultra sound abdomen were normal. Electrocardiogram showed left atrial enlargement, ventricular hypertrophy. Echocardiogram showed left atrial enlargement, very high left ventricular hypertrophy; intra ventricular gradient 40 mmHg. DNA was analysed by a Next Generation Sequencing panel for RASopathie and a de novo variant (p.Ser257Leu) in RAF1 was found.

CONCLUSIONS

Diagnosis within RASopathies continue to be a clinical challenge in the first months of life, since the greater part of clinical features become manifest later. A high index of suspicion is necessary to recognize these patients. This case is presented because of its association with cardiac defects and prematurity.

EP830 / #1002

E-Poster Viewing - Paediatrics AS04-20. Palliative care

Sunflower course - bringing paediatric end-of-life care teaching to trainees

A. Haddick^{1*}, B. Rafferty², K. Stefkova³, A. Sweeney¹, S. Gosling⁴, D. Gates², N. Thompson³, J. Richardson²

¹Royal Belfast Hospital for Sick Children, Children's Haematology Unit, Belfast, United Kingdom

²Royal Belfast Hospital for Sick Children, Paediatric Intensive Care, Belfast, United Kingdom

³Royal Jubilee Maternity Hospital, Neonatal Intensive Care, Belfast, United Kingdom

⁴Royal Belfast Hospital for Sick Children, Neurology Department, Belfast, United Kingdom

BACKGROUND AND AIM

End-of-life care medicine is practiced in all specialities throughout paediatrics. The importance of delivering effective end of life care to children and their families is paramount. In Northern Ireland trainees get little experience and limited teaching in this field. This project aimed to teach trainees develop the skills they need when delivering end-of-life care.

METHODS

We recruited a team of enthusiastic trainees to develop the course. We researched topics that were pertinent in delivering effective end-of-life care such as communication, advanced care plans, symptom control and psychological needs of patients, families and staff. We included practical issues such as brainstem testing, writing a death certificate and interpreting Coroner reports. Teaching was delivered via lectures, pre-recorded and live simulation scenarios, and videos of parent's perspectives. The teaching was delivered online due to Covid 19 restrictions. The topics were taught by specialists within the field. The course is taught over 3 day to allow for comprehensive teaching. We then sought feedback through questionnaires.

RESULTS

The course proved to be very successful at equipping trainees with the skills needed to deliver effective end-of-life care. Feedback included: 'This course has been incredible!', 'very useful and so much learning from it', 'inspiring teaching session-I learnt so much and hope I can be a better doctor now for patients and their parents in these situations.'

CONCLUSIONS

End-of-life training is essential in trainees to equip them with the skills needed to deliver effective and empathetic care. This course has helped trainees build on their skills, creating a positive impact for patient's and their families.

EP831 / #1210

E-Poster Viewing - Paediatrics AS04-20. Palliative care

Trisomy 18, a clinical case of long survival

T. Magalhães*, M. Pedro, M. Viegas, G. Croca, D. Soares

Centro Hospitalar do Oeste, Pediatria, Caldas da Rainha, Portugal

BACKGROUND AND AIM

Trisomy 18 or Edward's syndrome, the second most common aneuploidy in live born infants, is associated with mortality rates of nearly 90% in the first year and significant morbidity in survivors. Children with trisomy 18 present a high prevalence of severe congenital anomalies, such as, cardiac and neurologic malformation, respiratory complications, genitourinary and skeletal defects and neoplastic disorders. As well, nearly all have difficulty with oral feeding. However, interventions to repair or palliate those life-threatening anomalies are resulting in higher rates of survival beyond the first year of life.

METHODS

A 10-year-old girl with karyotype-confirmed prenatal diagnosis of complete trisomy 18 was evaluated in a routine neurodevelopmental consultation. Limited growth, severe developmental delay with total dependence and frequent respiratory infections were reported in her history. She has dysmorphic facies, cerebellar hypoplasia, dysplastic aortic valve and scoliosis.

RESULTS

At the age of 3, she underwent choanal atresia repair. Owing to feeding difficulties and poor weight progression, a percutaneous endoscopic gastrostomy was performed at the age of 7, which greatly improved growth

and nutritional status. She is currently attending basic education in a special Education Unit, physiotherapy, occupational and speech therapy that slightly improved her abilities. Moreover, she has multidisciplinary follow-up, including Gastroenterology, Cardiology and Neurology.

CONCLUSIONS

The management of Edward's syndrome-associated complications is gaining clinical relevance with the increase of care options and survival. This case highlights the importance of a multidisciplinary approach that should attend to both the medical and psychosocial needs of the patient and family.

EP832 / #1872**E-Poster Viewing - Paediatrics AS04-21.
Pharmacology & therapeutics****Leukotriene-modifying agents and
neuropsychiatric events in clinical paediatric
practice: prevalence, physician awareness and
pharmacovigilance within the irish primary care
setting****M. Feighery*, I. Korotchikova**

University College Cork, School of Medicine, Cork, Ireland

BACKGROUND AND AIM

As of March 2019, the European Medicines Agency (EMA) stated that the issue of neuropsychiatric adverse drug reactions (ADRs) deserves specific attention due to safety concerns and requested alterations in the marketing authorisations of medicinal products containing montelukast. Stemming from this, the aims are as follows: To determine the degree of awareness amongst general practitioners (GPs) in the counties of Cork and Kerry of such a safety warning To estimate which neuropsychiatric side effects are most frequent and whether GPs feel such a safety warning is warranted

METHODS

Design: Cross sectional study **Setting:** Primary care GPs in Cork and Kerry who provide care to children were invited to partake in this study. GPs who are not involved in paediatric care were excluded. Respondents demographic information was analysed. Survey questions examined prescriber awareness, pharmacovigilance reporting, ADRs to montelukast and GP insight.

RESULTS

Surveys were distributed to 310 GPs and 96 returned surveys were analysed. The majority of the responded GPs had between 10-30 years of working experience. Out of the total number of respondents, 63.5% (n= 61) were unaware of the EMA amendment. Forty GPs reported one or more reasons for discontinuation. Nightmares and sleep disturbances were reported by 38 GPs, followed by behavioural issues, including aggression, personality change and irritability.

CONCLUSIONS

This study would appear to support the need for an alteration to the marketing authorisation of montelukast. High quality epidemiological studies are needed to accurately evaluate the level of association of neuropsychiatric ADRs in children receiving montelukast therapy.

EP833 / #452**E-Poster Viewing - Paediatrics AS04-21.
Pharmacology & therapeutics****Efficacy and safety comparison of two brands of triptorelin in treatment of idiopathic central precocious puberty****S. Ghazavi***

Pharmacy, Tehran, Iran

BACKGROUND AND AIM

In treating central precocious puberty, the monthly formulations of GnRH agonists are the main formulations that have been used. Triptorelin is a GnRH agonist and is approved to be used in CPP as a 1-month formulation. This study aimed to compare the efficacy and safety of a subcutaneous formulation of Triptorelin (Variopeptyl) with Diphereline during a double-blinded randomized clinical trial

METHODS

Girls with idiopathic CPP were randomly allocated to Group A (IM injection of Diphereline 3.75 mg, IPSEN, France) and Group B (SC injection of Variopeptyl 3.75 mg, Varian Pharmed, Iran) repeated every 28 days for 3 months. Hormonal changes, also safety and efficacy endpoints were measured at baseline and month 3.

RESULTS

Out of 35 girls with confirmed CPP, 18 cases were assigned to take Diphereline (group A) and 17 cases to take Variopeptyl (group B). Mean level of estradiol had a decrease of 31.7 ± 11 pg /ml (P-value: 0.00) in group A and 27.3 ± 10

pg /ml (P-value: 0.00) in group B. The mean LH level reduced $3/1 \pm 2/3$ IU/L (P-value: 0.00) in group A and 1.6 ± 0.9 IU/L (P-value: 0.00) in group B. No significant side effects were seen. 3 patients in group B had nodules at the injection site and one patient in each group had minimal vaginal bleeding.

CONCLUSIONS

This study demonstrated that the efficacy of Variopeptyl is as same as Diphereline in suppressing the hypothalamic-pituitary-gonadal axis and can be a substitute for Diphereline.

EP834 / #2075**E-Poster Viewing - Paediatrics AS04-21.
Pharmacology & therapeutics****Symptom and clinical staging on acute l-thyroxine poisoning in children****J. Lee^{1*}, W. Jeon², Y. Ko¹**

¹Ajou University School of Medicine, Department of Emergency Medicine, Suwon, Korea, Republic of
²Inje University Ilsan Paik hospital, Department of Emergency Medicine, Ilsan, Korea, Republic of

BACKGROUND AND AIM

To describe the clinical characteristics of L-thyroxine poisoning in children and investigate the clinical course and change of thyroid function test (TFT) according to the stage.

METHODS

We retrospectively reviewed the patients with L-thyroxine poisoning younger than 18 years old during 10 years. Clinical characteristics and TFT were analyzed. We selected patients who underwent TFT more than two times and analyzed the TFT results according to the stage which reflected the pharmacokinetics of T4 and T3 after poisoning. We compared TFT according to the presence of symptoms.

RESULTS

Total 24 cases were analyzed. The median age was 22 months. The median ingested amount of L-thyroxine was 225ug/day (interquartile range, 150-600 ug/day) and massive ingestion (>3mg/d) was not reported. Seven patients (29.2%) showed clinical symptoms. One patient showed delayed symptoms on 4 days after ingestion. There were not significant differences in age,

median amount of ingestion, and initial TFT result between symptomatic and asymptomatic groups. Despite the lack of significance, the median TFT values tended to show dynamic changes in the symptomatic groups. The serial results of TFT were variable and there seemed to be no particular relationship between L-thyroxine dosage and TFT change patterns. However, symptoms or initial TFT abnormalities were observed in three patients who ingested more than 1,000mcg.

CONCLUSIONS

Symptomatic patients were common in L-thyroxine in younger children. Children's response to L-thyroxine was highly variable and may developed in delayed fashion. Young children who consume more than 1000 mcg of L-thyroxin need to be treated and observed carefully.

EP835 / #1089**E-Poster Viewing - Paediatrics AS04-21.
Pharmacology & therapeutics****Paracetamol microfine particle-based suspension
for enhanced stability and precise dosing****G. Sethi^{1*}, P. Kachroo², D. Nair³, M. Cavinato⁴**¹*In Good Hands Specialist Child Care Group, Pediatrics, New Delhi, India*²*GSK Consumer Healthcare, Medical Affairs, Singapore, Singapore*³*GSK Consumer Healthcare, Medical Affairs, Stockholm, Sweden*⁴*GSK Consumer Healthcare, R&D, Nyon, Switzerland***BACKGROUND AND AIM**

Although paracetamol suspension is a commonly used antipyretic and analgesic in children, it is associated with the concern of poor homogeneity. Microfine particle-based suspension is an attractive and promising alternative to solve this concern. This article (a) presents results of a study comparing different paracetamol suspensions and (b) reviews the literature relating to effect of particle size on formulation stability, dosing variations and drug absorption.

METHODS

Newly developed GSK microfine paracetamol suspension (Formulation A) was compared with current GSK marketed suspensions (Formulations B/C) for particle size using the optical microscope (40x). Unpublished benchmark and sensory studies by GSK compared these formulations for stability and perceived texture. Additionally, literature review was performed using Pubmed to identify the effect of particle size on precise dosing, formulation stability and drug absorption.

RESULTS

Compared with current GSK marketed suspensions, the newly developed GSK paracetamol suspension had 'microfine' particle size (refer Figure 1). Studies results showed higher stability, homogeneity, lower sedimentation rate, and smoother texture for formulation A compared with formulations B and C. Reviewed literature confirms that small and microfine particles in suspension contribute to homogeneity, optimal sedimentation rate, re-dispersibility, precise dosing and potential improvement in drug absorption.

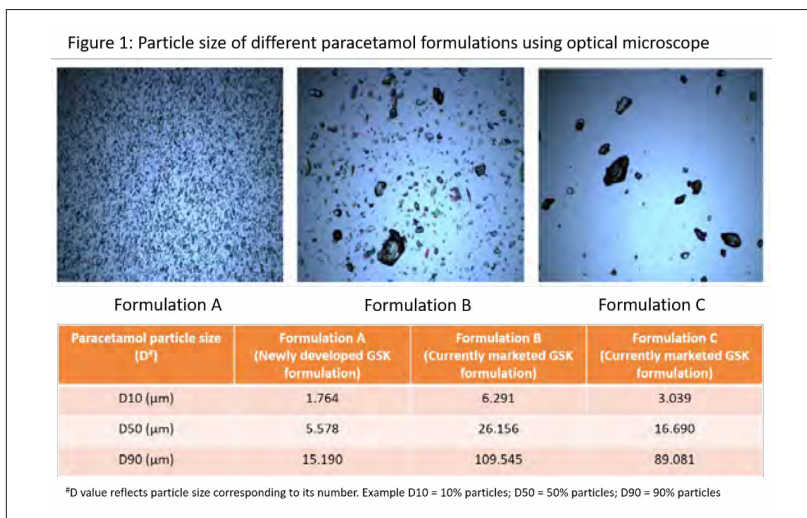

CONCLUSIONS

Smaller particle size is important for homogeneous distribution of the active ingredients in a suspension format. GSK's microfine paracetamol suspension with homogeneous distribution has improved stability, smooth texture and may help to deliver a more precise dose. Further studies can help to confirm the relationship of microfine particle size with drug absorption.

EP836 / #304

E-Poster Viewing - Paediatrics AS04-22. Primary care

The prevalence and types of childhood vaccination administration errors

A. Al Saleh*

King Abdulaziz Medical city, National Guard Health Affairs, Family Medicine and Primary Care, Riyadh, Saudi Arabia

BACKGROUND AND AIM

Background: Vaccination administration errors are preventable events that can affect patients via inadequate immunological protection, injury, increased costs, inconvenience, and reduced confidence in the healthcare delivery system. Amis: To calculate the prevalence of vaccination errors, determine which types of errors are most common, and identify opportunities for prevention.

METHODS

A cross-sectional study was conducted at the National Guard Comprehensive Specialized Clinic in Riyadh, Saudi Arabia. The study population consisted of 2580 children who received routine vaccinations at the Well Baby Clinic. A checklist was used to collect data regarding vaccination administration errors.

RESULTS

The prevalence of vaccination administration errors was 0.57%. The most common vaccination errors were vaccine dosing errors, administration of the wrong vaccine, and incorrect vaccination intervals.

CONCLUSIONS

Vaccine administration errors are uncommon; however, the impact of vaccination errors on the health of individuals and the population can be severe. Prevention strategies to avoid these errors should be considered.

EP837 / #1345

E-Poster Viewing - Paediatrics AS04-22. Primary care

Contactless infant monitoring – a pilot STUDY

M. Angeli^{1*}, P. Vorgia^{2,3}, V. Sakkalis², N. Tzanakis⁴, E. Galanakis¹

¹Heraklion University Hospital, Pediatrics, Heraklion, Greece

²Foundation for Research and Technology-Hellas, Institute of Computer Science, Heraklion, Greece

³Hellenic Mediterranean University, Agri-food and Life Sciences Institute, Heraklion, Greece

⁴Heraklion University Hospital, Respiratory Medicine, Heraklion, Greece

BACKGROUND AND AIM

The development of contactless, infant monitoring devices has been an evolving field of research over the last years. Our goal was to design a non-invasive, user-friendly monitoring system to detect abnormal vital signs and potentially life-threatening conditions such as fever, apnea, arrhythmia, vomiting and seizures to be used at home settings.

METHODS

Study population included hospitalized infants in our pediatric department. The device consisted of a high-definition camera, an infrared temperature sensor, a humidity sensor, ballistocardiogram sensors and a microphone. Aim was to securely monitor cardiac activity, respiratory function, body temperature and record potential epileptic and vomiting episodes.

RESULTS

A total of 13 infants (2 girls, 11 boys) were recruited during an eight-month period. Mean age was four months (minimum age 11 days, maximum age 9 months). Hospital admission was due to febrile infections in 7/13 infants (54%), seizures in 3/13 (23%), bronchiolitis in 2/13 (15%) and vomiting in 1 infant (8%).

During monitor recording fever was documented in one infant, seizures in one infant, vomiting in two infants and oxygen supplementation was required due to bronchiolitis in two infants. Parents reported no discomfort with the use of the device.

CONCLUSIONS

The proposed system appears to be feasible and safe providing promising results for remote infant monitoring in clinical and especially home settings. Further patient recruitment and data analysis is required to examine accuracy and efficacy. Acknowledgements. This study was funded through the Operational Program "Competitiveness, Entrepreneurship and Innovation" under the call RESEARCH – CREATE – INNOVATE (project name: xVLEPSIS, project code: T1EDK-04440).

EP838 / #961**E-Poster Viewing - Paediatrics AS04-22. Primary care****Infant home monitoring – current situation and future perspectives**

M. Angeli^{1*}, G. Rouva¹, P. Vorgia², V. Sakkalis², N. Tzanakis³, E. Galanakis¹

¹Heraklion University Hospital, Paediatrics, Heraklion, Greece

²Foundation for Research and Technology-Hellas, Institute of Computer Science, Heraklion, Greece

³Heraklion University Hospital, Respiratory Medicine, Heraklion, Greece

BACKGROUND AND AIM

Infant home monitoring has recently attracted interest due to increasing need for remote vital signs assessment and prevention of life-threatening conditions such as apnea, seizures, arrhythmia, and SIDS particularly in high-risk infants. Current cable-based devices are quite difficult to use and ineligible for continuous home monitoring due to skin irritation and patient discomfort. Recent studies have introduced practical, non-invasive devices for daily use that measure heart and respiratory rates to detect abnormalities and notify parents and caregivers.

METHODS

A comprehensive literature review was performed to identify articles reporting on the different types of contactless home monitor devices for infants.

RESULTS

Recent approaches for infant home monitoring have included ballistocardiography, imaging photoplethysmography, thermal imaging analysis, and laser doppler vibrometers. The devices consist of a high-definition video camera

to detect visual signals, and microscopic sensors for heart and respiratory signals that are built into socks, buttons, onesies, leg bands, mattresses, and diaper clips. These devices are connected wirelessly with a base station or a smartphone application to monitor vital signs remotely and generate alarms for life-threatening conditions. However, false alarms may lead to significant parental frustration and unnecessary medical visits.

CONCLUSIONS

Contactless devices seem to be the future in infant home monitoring as they provide an infant-friendly method to document vital signs. This field provides a wide spectrum for further research, to optimize monitoring methods and increase accuracy and effectiveness. Acknowledgements. This study was funded through the Operational Program "Competitiveness, Entrepreneurship and Innovation" under the call RESEARCH – CREATE – INNOVATE (project name: xVLEPSIS, project code: T1EDK-04440).

EP839 / #706

E-Poster Viewing - Paediatrics AS04-22. Primary care

Atraumatic splenic rupture as the initial and only manifestation of covid-19

I. Bakalli^{1*}, D. Cela², M. Biqiku¹, E. Celaj¹, E. Kola¹, M. Zguri², I. Gjeta¹, D. Klironomi³

¹UHC "Mother Theresa", Pediatrics, Tirana, Albania

²UHC "Mother Theresa", Radiology, Tirana, Albania

³Medical University of Vienna, Pediatrics, Vienna, Austria

BACKGROUND AND AIM

During the COVID-19 pandemic, the diagnostic uncertainty for children with abdominal pain has increased. Gastrointestinal symptoms, which mimic an acute abdomen, can be the primary manifestation of SARS-CoV-2 infection. On the other side, the abdominal pain in MIS-C can be so severe that patients were misdiagnosed with peritonitis or another surgical abdominal condition in many cases reported in the literature.

METHODS

We report here a child with an atraumatic splenic rupture (ASR) as the initial and only manifestation of COVID-19.

RESULTS

A 13-year-old boy with clinical signs of acute abdomen, left-sided abdominal pain, and hemodynamic instability was admitted to the PICU in critical condition. His parents denied any trauma had occurred. In addition to imaging tests, a nasopharyngeal swab was taken for COVID-19 testing, which was

positive. The thoracic CT scan was normal, whereas the abdominal CT scan revealed hemoperitoneum, splenic rupture, and free fluid in the abdomen.

CONCLUSIONS

The spleen is one of the organs targeted by the SARS-CoV-2 and similarly to other viruses, could cause an atraumatic rupture. Splenic rupture is generally not considered in the differential diagnosis of abdominal pain, in the absence of trauma. Pediatricians should be aware of the possibility of ASR in children with COVID-19. A high index of suspicion for ASR is important not only because the condition is uncommon, but also because a delayed diagnosis and treatment can be life-threatening. This case highlights the importance of multidisciplinary collaboration and the utility of early cross-sectional imaging in determining the underlying condition.

EP840 / #2674**E-Poster Viewing - Paediatrics AS04-22. Primary care****Primary care guidelines and referral pathways - design of a website to assist primary care professionals and improve patient outcome****E.M. Bikou*, M. Michael, A. Gite***East and North Hertfordshire NHS Trust, Paediatric Department, Stevenage, United Kingdom***BACKGROUND AND AIM**

There is consensus that good integration between services in primary and secondary care will enhance service delivery and improve quality of care to children and their families. We decided to design a webpage available to primary health care professionals which will contain information about paediatric primary care pathways. More specifically, the website contains information regarding the management of common paediatric presentations, when to refer to secondary care and how to refer and chase the referrals. The aim of this project is to improve quality of care to children by: a. Reducing referrals to the paediatric emergency department that could be better managed elsewhere (i.e. rapid access clinic) b. Streamlining referrals to the correct paediatric service first time round, therefore reducing the waiting times for outpatient appointments c. Reducing telephone referrals to the on-call team for advice that can be found on the website

METHODS

The first step in designing the website was to create a word document with common paediatric conditions that primary health care professionals come across. These conditions were arranged in alphabetical order (A-Z). Subsequently, we signposted pathways for their management using

local guidelines and highly reviewed paediatric resources such as Healthier Together Website, RCPCH (Royal College of Paediatrics and Child Health) etc.

RESULTS

We are envisioning to gather feedback from the website users and analyse if the number of referrals to AE and outpatient service will be reduced.

CONCLUSIONS

Primary and secondary care should work hand in hand to improve patients' outcome. Our website containing primary care guidelines will serve to that end.

EP841 / #867**E-Poster Viewing - Paediatrics AS04-22. Primary care****Proper hand hygiene practices have a great impact on the reduction of hospital-acquired bloodstream infection among pediatric oncology patients at Indus Hospital Karachi Pakistan****S. Bilal****The Indus hospital karachi, Infection Control, karachi, Pakistan***BACKGROUND AND AIM**

Infections are responsible for almost a quarter of the 2.8 million neonatal mortality globally each year. Low and middle-income states account for more than 95% of sepsis-related newborn mortality. Due to the immune system's suppression, pediatric oncology patients are at a greater risk of infection. The main route of nosocomial infection transmission is through the hands of healthcare personnel. Through a global WHO survey, we wanted to determine the level of hand hygiene implementation and its determinants in healthcare facilities to enhance the reduction of the PLABSI rate. Objective: To determine the educational impact and hand hygiene improvement with the aim of minimizing PLABSI in the oncology department at Indus Hospital

METHODS



METHODS

From January 2019 to December 2021, an observational and interventional study was conducted. A total of 4500 patients and 125 nurses were studied using data from daily surveillance and medical records. Education is provided through videos, booklets, demos, and face-to-face sessions that are based on WHO and CDC guidelines.

RESULTS

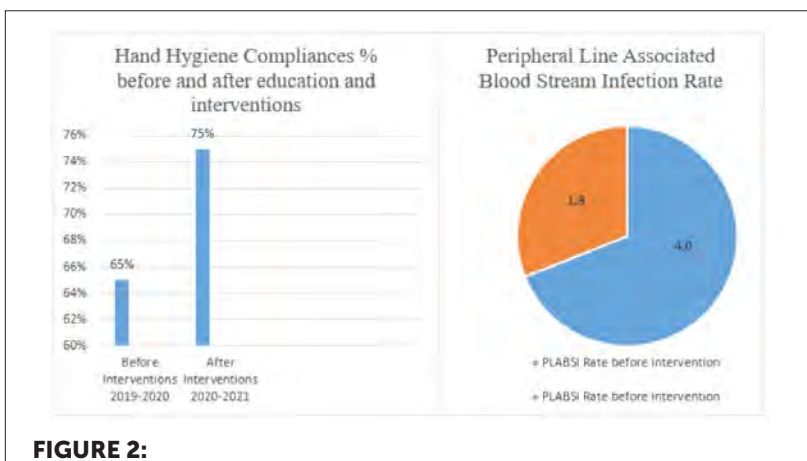

After intervention PLABSI rate was decreased from 4.0/1000 device days to 1.8/1000 and Hand Hygiene compliance was increased from 65% to 75%.

CONCLUSIONS

An intervention designed to educate HCWs about how to prevent bloodstream infections and placement of hand-rub dispensers at the care sites may lead to a reduction in the incidence of bloodstream infections, medical care costs, morbidity, and mortality.

EP842 / #495

E-Poster Viewing - Paediatrics AS04-22. Primary care

Integration of behavioral health care in pediatric primary care settings

S. Goff^{1*}, B. Brooks², M. Dacosta¹, J. Bromberg³, L. Vernacchio⁴, H. Walter⁵

¹University of Massachusetts, Health Promotion and Policy, Amherst, United States of America

²Boston Children's Hospital, Pediatric Physicians' Organization At Children's, Boston, United States of America

³Boston Children's Hospital, Psychiatry and Behavioral Sciences, Boston, United States of America

⁴Boston Children's Primary Care Alliance, Pediatrics, Boston, United States of America

⁵Boston Children's Hospital, Psychiatry and Pediatrics, Boston, United States of America

BACKGROUND AND AIM

In response to chronic unmet behavioral/mental health (BH) care needs, a growing number of U.S. pediatric primary care practices have attempted to integrate BH care into primary care. The Behavioral Health Integration Program (BHIP) is a multi-component program that supports BH integration in a large community-based network of pediatric primary care practices in the state of Massachusetts. This study aimed to understand pediatric primary care providers' perspectives on BH integration and to identify contextual barriers and facilitators to implementing programs such as BHIP.

METHODS

Semi-structured interviews were conducted with pediatricians in a purposive sample of BHIP practices from November 2021-March 2022. Transcripts were analyzed using directed qualitative content analysis. Emerging major themes were identified both deductively and inductively.

RESULTS

27 interviews have been conducted with pediatricians in 20 practices. Major themes identified include: 1) Improved pediatrician self-efficacy for BH care; 2) Increased prioritization of BH in primary care; 3) Improved patient access; 4) Variation in intra-practice screening, treatment, and referral; 5) Importance of relationship with consultants; 6) Structural barriers to BH care (e.g., insurance/reimbursement).

CONCLUSIONS

Programs such as BHIP can provide critical support for integrating BH care into primary care in health systems with limited BH access. Addressing contextual factors such as care variation within practices, quality assurance, psychiatric consultation stability, and insurance coverage may further improve BH care for children in the U.S and other countries seeking to improve pediatric BH care. The COVID-19 pandemic has increased an already large burden of unmet BH need.

EP843 / #2748

E-Poster Viewing - Paediatrics AS04-22. Primary care

Low birth weight and preterm - connection with respiratory illness

E. Kandelaki, N. Khavlashvili, M. Kherkheulidze*

State Medical University, Pediatrics, Tbilisi, Georgia

BACKGROUND AND AIM

This study was carried out to evaluate short-term respiratory morbidity in late preterm infants compared with full term LBW (low birth weight) and full term infants at age of 9 month.

METHODS

Medical records of infants assessed in Child Developmental Center of Iashvili central Hospital, Tbilisi, from 2014-2019. The cases were divided into three groups by their gestational age (GA) and birth weight. 127 late preterm births, 345 term births and 203. We compared late preterm births and term births considered to perinatal characteristics and respiratory morbidities

RESULTS

From 127 late preterm births 187 – 42, 7 % had respiratory tract disease. From 127 term births 90 -15 % had respiratory tract disease at the age of 12 month. Compared with term births, late preterms represented significantly more respiratory diseases and conditions such as upper respiratory tract infections ($P < 0.01$) transient tachypnea of newborn ($P < 0.05$) and pneumonia ($P < 0.01$), wheezing ($P < 0.001$) Full term LBW infants at age of 9 month represented the higher incidence of upper respiratory tract infections than full

term infants ($P < 0.01$) and late preterm infants ($P < 0.05$). Congenital infection was most significant factor affecting respiratory tract later in infancy in this two groups.

CONCLUSIONS

Late preterm infants are more likely to develop respiratory system illnesses than term infants. LBW full term infants are more prone to respiratory diseases than peers born with gestational age appropriate weight. LBW and late preterm infant's morbidity with respiratory system diseases was associated with congenital infections.

EP844 / #1623

E-Poster Viewing - Paediatrics AS04-22. Primary care

Effect of c reactive protein point-of-care testing and family physician education on antibiotic prescribing for children with acute respiratory illnesses in primary care in latvia

Z. Likopa^{1*}, A. Kivite-Urtane², J. Pavare³

¹Children's Clinical University Hospital, Department of Pediatrics, Riga, Latvia

²Institute of Public Health, Riga Stradins University, Department of Public Health and Epidemiology, Riga, Latvia

³Riga Stradins University, Department of Pediatrics, Riga, Latvia

BACKGROUND AND AIM

Although acute respiratory illnesses are mostly viral infections, antibiotics are frequently prescribed by family physicians (FP). The aim of this study is to explore whether the interventions as C reactive protein (CRP) point-of-care tests (POCT) and FP education reduce antibiotic prescribing for children with respiratory infections.

METHODS

Single-arm pre-post intervention study was conducted in Latvia between November 2019 and May 2021. 40 FP from urban and rural practices recorded data on children aged 1 month up to 17 years consulted with acute respiratory infections. After 3 months period FP received CRP POCT and educational course. Antibiotic prescribing rates for upper and lower respiratory infections were compared before and after the interventions.

RESULTS

Overall, 1442 patients were included (n=855 in pre-intervention group; n=587 in post-intervention group, the median age 4.0 years for both groups), from whom the majority were with upper respiratory infections - 78.9% (n=675) in pre-intervention group and 77.3% (n=454) in post-intervention group. For 32.5% (n=278) of patients in pre-intervention group and 32.4% (n=190) patients in post-intervention group antibiotics were prescribed both in urban and rural practices, the difference was not statistically significant ($p=0.95$). Meanwhile, interventions significantly reduced antibiotic prescribing for lower respiratory infections in rural practices - 71.6% (n=48) in pre-intervention group versus 37.8% (n=17) in post-intervention group ($p<0.001$).

CONCLUSIONS

Although results demonstrated that availability of POCT in combination with the educational activity did not reduce the overall antibiotic prescribing for children with acute respiratory infections, these interventions should be considered in rural practices and for children with lower respiratory infections.

EP845 / #1558

E-Poster Viewing - Paediatrics AS04-22. Primary care

Health literacy of parents/caregivers of children accompanied in asthma program

K. Lima*, R. Lima, R. Colares, A. Veras, D. Rocha, T. Távora, L. Barbosa

Federal University of Ceara, Nursing, Fortaleza, Brazil

BACKGROUND AND AIM

Health literacy of parents/caregivers of children with asthma can improve aspects that determine motivation and ability to access, understand and use information to promote and maintain asthma control. The aim of this study was to evaluate the health literacy of parents/caregivers of children with asthma and to associate it with sociodemographic factors.

METHODS

Cross-sectional study, with 157 parents/caregivers of children aged 2 to 12 years followed in an asthma program. Data were collected in three basic health units, located in the northeast of Brazil, based on an interview using the Health Literacy Scale – Brazilian Version (HLS-14) and a form that addressed sociodemographic aspects of the families. Data were analyzed using Student's T test and Pearson's correlation. Approval from a Research Ethics Committee was obtained.

RESULTS

The average of total HLS-14 scores were 35.15, with a total of 89.2% (n = 140) presenting low literacy, in this sample of parents/caregivers of children with asthma. There was a statistically significant association between socio-

demographic factors and scores of the scale in the following variables: living without a partner ($p = 0.005$), family income of up to 1 minimum wage ($p = 0.002$), receiving government benefits ($p = <0.001$).

CONCLUSIONS

Health literacy is a tool that can promote the autonomy and empowerment of parents/caregivers of children with asthma in controlling the disease. Acknowledgements: CNPQ, CAPES, PET.

EP846 / #1575

E-Poster Viewing - Paediatrics AS04-22. Primary care

Educational booklet and brief motivational interview to reduce the occurrence of diarrhea in children under FIVE

K. Lima*, E. Mendes, R. Lima, M. Santos, V. Ruiz, L. Barbosa

Federal University of Ceara, Nursing, Fortaleza, Brazil

BACKGROUND AND AIM

Childhood diarrhea is a preventable disease, but it is a frequent cause of hospitalizations and deaths. Therefore, educational strategies are necessary to avoid this problem. This study aimed to evaluate the effect of an educational booklet combined with a brief motivational interview to reduce the occurrence of diarrhea in children under five.

METHODS

A quasi-experimental study carried out with 61 mothers of children under five followed at a Basic Health Unit in a Brazilian Northeast city. In the Basic Unit, a sociodemographic questionnaire was applied and the educational booklet was combined with a brief motivational interview. After 60 days, the mothers were contacted by telephone to verify the occurrence of diarrhea in the child. The occurrence of the diarrhea outcome before and after 60 days was compared using McNemer's chi-square test in the statistical package R 3.6.3. Approval from a Research Ethics Committee was obtained.

RESULTS

Before the intervention, 55.7% of the participants reported episodes of diarrhea in their children. After 60 days of the booklet's application combined with the brief motivational interview, 2.5% of the participants reported diarrheal episodes. When associating the number of diarrheal events before and after the intervention, there was a statistically significant difference ($p < 0.0001$ / OR 0.074 [95%CI -0.039-0.217]). Thus, receiving the educational intervention reduced the chances of diarrhea episodes.

CONCLUSIONS

The educational intervention with the booklet associated with brief motivational interview helped to reduce episodes of diarrhea among children participating in the study.

EP847 / #1201

E-Poster Viewing - Paediatrics AS04-22. Primary care

Increased number and changed clinical presentation of certain viral infections in children after lockdown caused due to covid-19 pandemic in north macedonia

E. Manoleva Nikolovska*

PHO Polyclinic Manolevi, Paediatric, Skopje, North Macedonia

BACKGROUND AND AIM

The covid-19 pandemic has caused significant changes around the world. Restrictive measures have been taken around the world to prevent the spread of the virus.

In North Macedonia, due to the restrictive measures, children were isolated in their homes with their families, which reduced the number of children with infectious diseases. The most common viral disease that occurred seasonally before the covid-19 pandemic was chickenpox. Hand,foot and mouth disease(HFMD) caused by coxsackievirus was rare and occurred sporadically.

METHODS

To describe the situation with an increasing number of coxsackievirus and varicella-zoster infections and changes in the clinical forms of the disease, we made statistical processing of data for infectious diseases of interest in the period two year before the pandemic and seven months after the reduction of restrictive measures and return of children to kindergartens and schools. The diagnosis of interest according to the International Statistical Classification of Diseases and Related Health Problems (ICD-10) were infectious diseases with code B01 and B33.8.

RESULTS

The results shown that there was a significant increase in the number of children with certain infectious disease. There was an increased number of children with varicella and also, an increased number of children with coxsackievirus infection(HFMD). HFMD has been almost undiagnosed in previous years. Clinical presentation was more intense in both diseases.

CONCLUSIONS

After the reduction of covid-19 measures and the return of children to kindergartens and schools, we faced an increased number of children infected with certain infectious diseases with a more intense form of clinical presentation than before.

EP848 / #738

E-Poster Viewing - Paediatrics AS04-22. Primary care

Diagnostic challenges associated with mononucleosis in young children up to 6 YEARS

E. Manoleva Nikolovska^{1*}, A. Manolev²

¹PHO Polyclinic Manolevi, Paediatric, Skopje, North Macedonia

²PHI Polyclinic Manolevi, Internal Medicine, Skopje, North Macedonia

BACKGROUND AND AIM

Infectious mononucleosis is common viral infection in teenagers and young adults. Symptoms of mononucleosis can often be very similar to other conditions so infection can often go undiagnosed. Diagnosis of mononucleosis is usually based on symptoms and can be confirmed with specific blood tests and other laboratory tests, including white blood cell count and antibody test. Treatment for mononucleosis is symptomatic because is caused by virus.

METHODS

In the period of three years, in our ambulance there were four children age three to six years with moderately severe form of mononucleosis. Physical examination confirmed the presence of enlarged submandibular lymph nodes on both sides in all children. All children had a finding of pharyngitis or tonsillitis with pseudomembranous exudate deposits. Beside the physical examination, in all children were performed laboratory tests. The children were tested for sedimentation, white blood cell count, liver function, mononucleosis antibody test (Paul-Bunnell test), nose and throat swab, antistreptolysin O test (ASO) and C-reactive protein (CRP).

RESULTS

In all children the diagnosis was confirmed by the presence of IgM antibodies to Epstein-Barr virus ((Paul-Bunnell test).

CONCLUSIONS

Infectious mononucleosis is thought to be rare in young children. Usually passes asymptotically or in a mild form of the disease and therefore often goes undiagnosed. Our experience shows that mononucleosis is not so rare in children up to 6 years old.

Every paediatrician should consider mononucleosis as an infectious disease that can often cause illness in children.

Prompt and accurate diagnosis of diseases is the right path to successful treatment of the patients.

EP849 / #2218

E-Poster Viewing - Paediatrics AS04-22. Primary care

Efficacy of live attenuated vaccines after two doses of intravenous immunoglobulin therapy for kawasaki disease

Y. Morikawa^{1*}, H. Sakakibara², M. Miura³

¹Tokyo Metropolitan Children's Medical Center, Clinical Research Support Center, Tokyo, Japan

²Tokyo Metropolitan Children's Medical Center, Department of General Pediatrics, Tokyo, Japan

³Tokyo Metropolitan Children's Medical Center, Cardiology, Tokyo, Japan

BACKGROUND AND AIM

This study aimed to assess the efficacy of live attenuated vaccines (LAV) after two intravenous immunoglobulin (IVIG) treatments for Kawasaki disease (KD) and to explore the appropriate timing of vaccination.

METHODS

The present, prospective, interventional study included KD patients who had no medical history of measles, rubella, varicella, mumps or vaccinations against these diseases and received two IVIG treatments at age six months or older. The subjects received initial vaccination against these diseases at six or nine months after IVIG treatment. If the antibody titers after vaccination were negative, the subjects received a booster vaccination at 12 months after IVIG treatment. The primary outcome was the prevalence of positivity for antibodies after the initial and booster vaccinations.

RESULTS

This study enrolled 11 children, three of whom were vaccinated at six months and eight at nine months after IVIG treatment. One and two subjects who were vaccinated at six months remained negative for measles and rubella antibodies, respectively, but all those vaccinated at nine months were positive. Booster vaccination for measles and rubella led to seroconversion in all. After the initial vaccination, mumps antibody titers remained negative in all, and about 30% were positive for varicella. Booster vaccinations for mumps and varicella resulted in seroconversion in about 80%.

CONCLUSIONS

Six months may be too short an interval after IVIG treatment before administering measles and rubella vaccines whereas nine months may be adequate. The initial mumps and varicella vaccines were ineffective at either time point, but a sero-response was obtainable by administering a booster vaccination.

EP850 / #1169

E-Poster Viewing - Paediatrics AS04-22. Primary care

Hyperphosphatasemia in infancy – what diagnosis?

M. Pereira*, C. Magalhães, C. Patraquim

Hospital de Braga, Paediatrics, Braga, Portugal

BACKGROUND AND AIM

Benign transient hyperphosphatasemia (BTH) of infancy is characterized by a marked elevation of serum alkaline phosphatase (ALP) in children under five years, with spontaneous resolution in weeks or months, in the absence of detectable liver or bone disease.

METHODS

Not applied.

RESULTS

Case presentation: A 10 months old female, previously healthy, was referred from the primary care to our emergency department due to a marked elevation of serum ALP (4584U/L), detected in a study of suspected growth retardation. She was taking prophylactic vitamin D supplementation, without use of other medication. A second laboratory analysis was requested, which confirmed the elevation (5093 U/L). The patient was asymptomatic and had no abnormalities on physical exam. Growth retardation was not confirmed. Renal and liver function were normal. Bone remodelling markers such as calcium, phosphorus and PTH were normal. Abdominal ultrasound had no abnormalities. She was referred for paediatric follow-up and evaluation. A

diagnosis of BTH was considered and laboratory analysis were repeated five months later. ALP decreased to 446U/L. ALP isoenzyme analysis could not be performed.

CONCLUSIONS

BTH is a relatively common condition, that is generally detected incidentally in laboratory examinations requested for other purposes. It should be considered in infants and young children with a serum elevation of ALP in the absence of underlying liver or bone disease. Recognition of this condition avoids unnecessary procedures and concerns.

EP851 / #1277

E-Poster Viewing - Paediatrics AS04-22. Primary care

Delayed diagnosis of severe iron deficiency anaemia in a 14-month-old boy: the collateral effects of covid-19 pandemic

A. Sharma*, A. Shastri

Norfolk and Norwich University Hospital, Paediatrics, Norwich, United Kingdom

BACKGROUND AND AIM

The Covid-19 pandemic has not only posed direct clinical challenges to healthcare systems all around the world, it has also disrupted previously well-established pathways of presentation to the primary health services

METHODS

Case Here we present the case of a 14-month old boy who was seen in our emergency department with breathlessness and reduced oral intake. He had regression of motor and speech milestones for a few months. The parents had sought primary healthcare advice, but in view of the Covid-19 related restrictions, they had not been able to see their primary physician face-to-face.. His haemoglobin level at the time of admission was 1.6 g/dL, which is the lowest we have seen in a child in our Unit. After a thorough clinical examination and investigations in the hospital, he was diagnosed to have severe form of iron deficiency anaemia and anaemia related heart failure. This was a vegetarian family, and the child's intake of cow's milk was extremely high(>2 litres a day on average). This was treated with red blood cell transfusion, iron infusion and diuretics. He made a remarkable recovery. On repeated out-patient consultations including with appropriate dietetic advice, he has remained symptom-free with stable haemoglobin levels in the normal range.

RESULTS

Conclusion Given the severity of anaemia in this child, it is unlikely that the diagnosis would have been delayed if the usual mechanisms of screening in primary care were not disrupted by the pandemic related restrictions.

CONCLUSIONS

Face-to-face consultation in paediatrics is of paramount importance.

EP852 / #1365

E-Poster Viewing - Paediatrics AS04-23. Psychiatry & mental health

Predicting the pathways of adolescents with chronic disease at high-risk for mental health problems: a dynamic network approach mapping digitally collected data to stratify RISK

J. Blom^{1*}, P. Sarti¹, C. Colliva²

¹University of Modena and Reggio Emilia, Department of Biomedical, Metabolic and Neural Sciences, Modena, Italy

²Local Health Unit of Modena, District of Carpi, Carpi, Italy

BACKGROUND AND AIM

Background: Adolescents diagnosed with chronic disease often face mental health related problems which makes it fundamental to recognize the unique path faced by the adolescent patient at the time of diagnosis, during treatment and in the period following the end (if any) of therapy. Within this context adolescents indicate two domains of concern: 1) physical and mood related problems, and 2) the need to be better involved and connected. Purpose: The development of digital data-driven multidisciplinary clinical research protocols combined with innovative network analysis to predict the onset of psychopathology in adolescents with chronic disease in time for efficient therapy.

METHODS

Innovative digital health technologies (DHT) will be used to collect Real-world data via familiar tools: mobile phones, tablets, and other wearables, enabling participation from home, regardless of geographical location. Data will also be collected by self-report questionnaires, ecological momentary assessment (EMA), and disease related parameters.

RESULTS

will demonstrate the compatibility of DHTs with a dynamic dimensional network approach and enrich our predictions related to future risk and efficacy of treatment adolescents with chronic diseases.

CONCLUSIONS

The rationale underlying the use of DHT combined with network analysis is to be flexible, user friendly, and involve the adolescent as primary data source, incorporated in existing infrastructures and analyzed with new predictive models. In this way, we are keeping in line with advancing science while adapting its use to fit the characteristics and trajectories of individual adolescent patients and comply with their need to be engaged in first person in their present and future health.

EP853 / #1133

E-Poster Viewing - Paediatrics AS04-23. Psychiatry & mental health

Internet addiction in adolescents with attention-deficit/hyperactivity disorder: associations with parental depression and anxiety

S. Derin^{1*}, M. Ersin², S.B. Selman³, C. Gercek¹

¹Bezmi Alem Vakıf University, Department of Child and Adolescent Psychiatry, Istanbul, Turkey

²Bezmi Alem Vakıf University, School of Medicine, Istanbul, Turkey

³University of Wisconsin-Madison, Human Development and Family Studies, Madison, United States of America

BACKGROUND AND AIM

The aim of the present study was to explore the associations of adolescents' internet addiction symptoms with depression and anxiety in parents of adolescents with attention deficit/hyperactivity disorder (ADHD).

METHODS

100 participants with ages ranging from 11 to 17 ($M = 13.6$; 27% female), who have a primary diagnosis of ADHD were included in the study. Parental depression and anxiety symptoms, and adolescents' internet addiction symptoms were assessed in parent-child dyads using the Beck Depression (BDI) and Beck Anxiety Inventories (BAI), and Young's Internet Addiction Scale (YIA). A total score of 50 or above is regarded as having significant problems due to internet use. Participants with scores over 50 were then categorized as having high internet addiction symptoms.

RESULTS

After controlling adolescent gender, parental education levels and household income, parents' depressive ($B = 0.09$, $p = 0.00$) and anxiety symptoms ($B = 0.06$, $p = 0.01$) significantly predicted an increased risk for internet addiction symptoms among adolescents with ADHD.

CONCLUSIONS

The high predictive value of depression and anxiety in parents emphasizes its importance as risk factors of internet addiction symptoms in adolescents with attention deficit/hyperactivity disorder.

EP854 / #2186

E-Poster Viewing - Paediatrics AS04-23. Psychiatry & mental health

Utilization of echo (extension of community health outcomes) series to increase pediatric primary care providers' ability to assess and treat behavioral health concerns

S. Fritsch^{1*}, J. Van Cleave², D. Keller²

¹University of Colorado School of Medicine, Psychiatry, Aurora, United States of America

²University of Colorado School of Medicine, Pediatrics, Aurora, United States of America

BACKGROUND AND AIM

Child mental health morbidity has greatly increased over the last decade, and the pediatric mental health workforce is inadequate. Pediatric Mental Health Access programs (PMHCAs) were developed to support early identification and treatment of mild to moderate pediatric behavioral health conditions in the primary care setting. One such program, the Colorado Pediatric Psychiatry Consultation and Access Program, (CoPPCAP) reaches a geographically diverse group of primary care practices in Colorado. CoPPCAP offers education through the Extension for Community Health Outcomes (ECHO) model; a widely-used, virtual, case based-learning modality that involves 6-8 weekly sessions. We will review the process of creating the ECHO series, modifying the series over time, and lessons learned from our evaluation, thus enabling participants to begin planning ECHO series for use in their own practice communities.

METHODS

Over the course of 4 years, 13 ECHO series were developed and deployed, with separate introductory and advanced tracks. Curricula were developed

and modified based on feedback in an iterative fashion. Impact was evaluated using qualitative and quantitative methods.

RESULTS

239 practitioners from throughout Colorado participated in at least one ECHO series. 31% of practitioners were from very rural areas. Quantitative evaluation showed excellent uptake, with 100 % of participants reporting increasing comfort managing mild to moderate behavioral health problems in their primary care practice. Qualitative assessment of the evaluation comments demonstrated positive feedback, specific future topics, and more robust case discussion.

CONCLUSIONS

An ECHO format is a popular and effective educational modality to reach both urban and rural practitioners.

EP855 / #2594

E-Poster Viewing - Paediatrics AS04-23. Psychiatry & mental health

Behavioral treatment of phagophobia in a 6-year-old CHILD

W. Jbilou*, F. Aftahi, Y. Asbai, H. Serhani, G. Benjelloun

Child and Adolescent Psychiatry Service, Abderrahim Lharrouchi Mother and Child Hospital – CHU Ibn Rochd, Clinical Neurosciences and Mental Health Laboratory, Casablanca, Morocco

BACKGROUND AND AIM

6-year-old female patient hospitalized in pediatric surgery for caustic esophageal stenosis due to accidental ingestion of hydrochloric acid requiring esophageal replacement. A child psychiatric opinion was requested following the persistence of postoperative deglutition disorder with a normal etiological assessment. The purpose of our work is to show the diagnostic and therapeutic difficulty of phagophobia and the importance of anesthetic and psychological preparation of the child before invasive procedures.

METHODS

Clinical observation: At the first child psychiatric meeting with the patient H., manifestations of phobic anxiety were present. Also, H. chewed food during meals without swallowing it. She has no particular personal and family history. During the child psychiatric follow-up, these manifestations were linked to the memory of traumatic events that she experienced during the oesogastric fibroscopy. The diagnosis of phobic disorder (phagophobia) was retained. Given the patient's age, treatment was based on behavioral therapy.

RESULTS

Discussion Phagophobia or swallowing phobia is an uncommon phobic disorder listed in the International Classification of Mental Disorders, 11th edition and DSM-5. The most important question before diagnosing this disorder is to determine its psychogenic basis [1] In most cases, the onset of the disorder follows a deglutition accident, which has led to phagophobia being considered a specific form of post-traumatic stress disorder [2] Behavioral therapy for the treatment is more commonly reported in the literature [5,6]

CONCLUSIONS

Phagophobia is considered a specific, non-developmental phobia. Frequently associated with other anxiety disorders in children, it poses a diagnostic problem. This disorder responds favorably to cognitive and behavioral therapies.

EP856 / #2557

E-Poster Viewing - Paediatrics AS04-23. Psychiatry & mental health

Effect of low frequency pulsed electromagnetic field therapy on autistic children, a new potential therapy case reports

O. Kasim Aldaleel^{1*}, S. Ibrahim², A. Saleh²

¹Medway Community Healthcare, Consultant - Paediatrics, Strood, United Kingdom

²Physioheal Clinic, Therapeutics, Birmingham, United Kingdom

BACKGROUND AND AIM

Childhood Autism is a health burden on families and health systems. So far, no clear therapeutic interventions have proven to significantly improve the course of Autism. There is a reasonable evidence to suggest that Autism pathogenesis is a subtle neuro-inflammation. Pulsed Electromagnetic Field Therapy, PEMF, has shown promising potential to improve chronic inflammations. We are presenting two cases' reports showing statistically measurable improvement in autism symptoms in children using PEMF Therapy.

METHODS

Our cases are two children, both males, aged 14 year(Case-1) and 9 year(-Case-2). We identified the severity of their autism symptoms using Autism Spectrum Quotient (AQ), which has a cut-off score of 76 for Autism diagnosis. Each child received low frequency PEMF wave sessions, 3 to 22 Hz, on their parieto-occipital areas. Sessions were 30 minutes each, once a week for seven weeks. The relevant AQ questionnaires were completed by parents, before and eight weeks after starting sessions. Undesirable effects were observed and reported on weekly basis.

RESULTS

No significant undesirable effects or safety concerns have been reported by parents or observed by us during the eight weeks and up to six weeks after end of sessions. Case-1 AQ scores:104, before, and 94 after. Case-2 AQ scores: 82, before, and 74 after. In addition, Case-1 started to intermittently point out when their nappies were soaked (a new gained skill reported by parents).

CONCLUSIONS

PEMF therapy has potential promising effects to improve overall severity of Childhood Autism. Further studies are needed to consolidate these findings and to determine which symptoms are more prone to improvement.

EP857 / #992

E-Poster Viewing - Paediatrics AS04-23. Psychiatry & mental health

Brain mri in young adults with simple congenital heart defects and adhd symptoms

S. Lau-Jensen^{1*}, B. Asschenfeldt², S. Eskildsen³, V. Hjortdal⁴

¹Rigshospitalet, university hospital of copenhagen, Dept. of Cardiothoracic Surgery, Copenhagen, Denmark

²Aarhus University, Dept of Clinical Medicine, Aarhus, Denmark

³Aarhus University, Center of Functionally Integrative Neuroscience, Aarhus, Denmark

⁴Aarhus University, Dept of Clinical Medicine, Aarhus, Denmark

BACKGROUND AND AIM

Patients with congenital heart defect (CHD) have an increased risk of neurodevelopmental difficulties. In this study we investigate the correlation between known ADHD symptoms and a potential organic substrate on brain MRI scans in a group of young adults with simple CHD.

METHODS

Out of 80 patients with ASD or VSD, 17 patients (age=25.1y) had symptoms of ADHD (CAARS-questionnaire). Volumes and microstructural changes were measured from T1-weighted and diffusion kurtosis MRI images using automatic segmentation algorithms and compared to 36 healthy controls (age=25.3y).

RESULTS

The subgroup of ADHD CHD patients had 5.7% lower whole brain volume and lower hippocampal volumes compared to the healthy control group ($p < 0.05$, all values corrected for age and sex). Compared to the nonADHD

CHD patients the patients with ADHD and CHD had lower whole brain volume, a reduction in genu corpus callosum and a changed microstructural pattern in the prefrontal lobes.

CONCLUSIONS

ADHD is more prevalent in young adults with simple CHD and they have lower whole brain volumes and lower hippocampal volumes compared to heart healthy peers and a lower whole brain volume, lower volume of the genu corpus callosum and changed microstructure in the prefrontal cortex compared to nonADHD CHD. Fibers from the prefrontal cortex cross in the genu corpus callosum. This study indicates that there may be an organic cerebral substrate for some of the neurodevelopmental difficulties this patient group encounter.

EP858 / #2201

E-Poster Viewing - Paediatrics AS04-23. Psychiatry & mental health

Autism spectrum disorder and event related potentials

T. Nadiradze*, S. Bakhtadze, N. Khachapuridze

G. Zhvania Academic Clinic of Pediatrics, Tbilisi State Medical University, Department of Paediatric Neurology, Tbilisi, Georgia

BACKGROUND AND AIM

Autism spectrum disorder (ASD) is characterized by persistent impairments in social communication, and restricted, repetitive, and stereotyped patterns of behaviours, interests, or activities. Abnormal development is present during early childhood and we aimed to study Event-related potential (ERP) changes in children with diagnosed ASD. ERP technique can directly record brain neural activity in real time. P300 is a positive ERP component which can measure the neuroelectrophysiological characteristics of human beings and has the potential to discover the pathological mechanism of ASD. Limited reviews show that ASD could be associated with abnormalities during event related potentials study. Accumulating evidence suggests that ASD could be linked to increased latency during P300. However, there is a lack of evidence between correlation of ASD and ERP regarding whether there could be strong correlation. P300 is an objective indicator of brain activity. Our aim was to describe Changes of ERP in children with diagnosed ASD.

METHODS

Study included 39 participants with IAD and 28 controls, all aged 8–17 years. ASD was assessed by the DSM 5, and The ERP was conducted in a sound protected room and oddball paradigm was used to receive P300 response.

RESULTS

Our study shows correlation between increased score of latency in subjects with ASD compared with controls. Study proved that children with severe ASD are more likely to show increased score of latency indicating the troubles while performing cognitive tasks.

CONCLUSIONS

There is lack of studies of ERP changes during ASD, especially in children population and concluding them could be lead for better understanding of ASD.

EP859 / #1260

E-Poster Viewing - Paediatrics AS04-23. Psychiatry & mental health

Impact of the covid19 pandemic in suicide attempts in adolescents

A. Sala De La Concepcion^{1*}, P. Ventura², A. De Francisco Profumo², L. Subirana², M. Giralt Lopez³, I. Francia Guil², M. Mendez Hernandez²

¹Hospital Germans Trias i Pujol, Division of Pediatrics, Badalona, Spain

²Hospital Germans Trias i Pujol, Pediatrics, Badalona, Spain

³Hospital Germans Trias i Pujol, Psychiatry, Badalona, Spain

BACKGROUND AND AIM

Suicide in adolescents is a global public health problem. Specifically in Spain, suicide is the third leading cause of death among children aged 15-19 years old. Recent studies reported a progressive increase in suicide attempts (SA) admitted in Emergency Departments (ED) in other countries. Up so far, there are no studies published about the issue in Spain. The objective of the present work is to analyse the epidemiological trends of SA in adolescents attended in a Spanish Pediatric ED in the last six years. We also intend to elucidate how the Covid-19 pandemic might have acted as a compounding factor.

METHODS

Retrospective study including all children younger than 18 years old admitted after a SA in the ED of a tertiary hospital, from January 2016 to December 2021.

RESULTS

We included 206 patients (84% women), median of 15 years old. During pre-pandemic period (2016 to 2019), SA represented 0,61% of all teenagers attended in our ED; in 2021 they increased significantly to 1,88% (see Table1). When comparing the two periods, pre-pandemic and Covid-19 post-pandemic, there was significantly higher proportion of women admitted and they more often referred history of personal and familiar psychiatric disorders and being treated with psychiatric drugs. On the other hand, there were no differences in the clinical features, therapeutic requirements or severity outcomes (see Table2).

Table 1. Temporal trends of suicide attempts in adolescents (12-18 years old) in the ED of HUGTP in 2016-2021.

Year	Total patients admitted in ED for any reason	Number of suicide attempts	% suicide attempts tentativas de suicidio from total patients admitted
2016	3918	25	0,64
2017	4128	28	0,68
2018	4602	29	0,63
2019	4637	23	0,5
2020	2985	29	0,97
2021	3822	72	1,88
Total	24092	206	
ED = Emergency Department.			
HUGTP = Hospital Universitari Germans Trias i Pujol			

CONCLUSIONS

During Covid-19 pandemics, we observed that the incidence of SA in teenagers attended in ED tripled from the years before. Despite this, only 3,2% of patients identified Covid-19 pandemics situation as a trigger.

Table 2. Description of the suicide attempts in adolescents attended in the ED of HUGTP considering two periods: preCovid19 (January 2016 to February 2020) and postCovid19 (March 2020 to December 2021) (n = 206)

	PreCovid19 (n = 113)	PostCovid19 (n = 93)	P value
Age, years old (median)	15	14,8	0,2
Female	89 (78,8%)	84 (90,3)	0,035
Psychiatric history			
Previous psychiatric disorder	63 (55,8%)	75 (80,6%)	< 0,001
Depression	23 (20,4%)	29 (31,2%)	
Anxiety	16 (14,2%)	33 (35,5%)	
Conduct disorder	8 (7,1%)	7 (7,5%)	
Adjustment disorder	6 (5,3%)	11 (11,8%)	
History of previous self-injury	54 (47,8%)	47 (50,5%)	0,989
Previous psychiatric treatment	44 (39,0%)	51 (54,9%)	0,041
In follow-up by mental health professional	66 (58,4%)	68 (73,1%)	0,079
Family history of psychiatric disorders (first line relatives)	23 (20,5%)	39 (41,9%)	< 0,001
History of drug abuse	25 (39,1%)	20 (27,0%)	0,148
About the current suicide attempt			
Suicide attempt mechanism			
Pharmacological intoxication ^a	100 (88,5%)	69 (74,2%)	
Self-harm with sharp object	16 (14,2%)	24 (25,8%)	
Fall into de void	3 (1,5%)	0 (0%)	
Detergent intake	7 (1,8%)	7 (7,5%)	
Trigger identified by the patient	87 (77,0%)	64 (68,8%)	0,208
Covid-19 identified as trigger		3 (3,2%)	
Patient warns about the suicide attempt	38 (33,6%)	43 (46,2%)	0,005
Time from the suicidal attempt to the arrival in the ED, hours (mean)	6,1	6,6	0,46
Symptomatic			
Neurological	75 (66,4%)	47 (50,5%)	
Gastrointestinal	43 (57,3%)	25 (53,2%)	
Urine drugs test positive	52 (46,0%)	48 (51,6%)	0,484
Psychiatric assessment during the stay in the ED	52 (46,0%)	86 (92,5%)	< 0,001
Previous suicidal ideation	57 (50,4%)	60 (64,5%)	0,125
Suicide attempt criticism made by the patient during the stay in ED	47 (41,6%)	46 (49,5%)	0,001
Emergency room stay, hours (mean)	9	10,2	0,059
Destination after being discharged			
Hospitalization	75 (66,4%)	48 (51,6%)	
Outpatient mental health clinic	22 (19,5%)	34 (36,6%)	
Pharmacological intoxications (n = 169)			
	n = 100	n = 69	
Medicine used			
Benzodiazepines	39 (39,0%)	27 (39,1%)	
Paracetamol	27 (27,0%)	24 (34,8%)	
NSAIDs	24 (24,0%)	18 (26,1%)	
Intoxication with 2 or more medicines	40 (40,0%)	34 (48,0%)	0,276
Dose intake over pharmacological toxic levels	60 (60,0%)	43 (57,3%)	0,466
National Toxicology Information Service having been contacted	35 (34,4%)	19 (27,5%)	0,247
Decontamination techniques applied	53 (53,0%)	36 (52,2%)	0,838
Antidote administered	11 (11,0%)	17 (24,6%)	0,138
Electrocardiogram performed	33 (33,0%)	27 (39,1%)	0,402
^a Combined mechanism in 8 patients (medicine and self-harm)			
ED = Emergency Department			
HUGTP = Hospital Universitari Germans Trias i Pujol			
NSAID = Non steroid antiinflammatory drugs			

EP860 / #2357**E-Poster Viewing - Paediatrics AS04-23.
Psychiatry & mental health****Toxic stress and neurodevelopment-could
symptoms of toxic stress imitate a
neurodevelopmental disorders?****V. Slijepcevic Saftic****Zagreb Child and Youth Protection Center, Neurology, Zagreb, Croatia***BACKGROUND AND AIM**

Objective: The effects of negative environmental factors in childhood result in neuro-biological changes. Exposed to powerful, negative environment, lead to hyperactivation of the neurological, immune and endocrine system. This state is known as a toxic stress.

METHODS

The aim of this study was to estimate preliminary results of a multi-disciplinary clinical assessment of patient came to Child and Youth protection Center, Zagreb, Croatia, in case of adverse childhood experiences, according ACES (Adverse Childhood Experience score) ≥ 4 . From 2015 - 2021 in Child and Youth Protection Center Zagreb we prospectively observed 1954 children with ≥ 4 . We were looking for presence of minor neurological dysfunctions. For those with ACES ≥ 4 , and neurodevelopmental delay, EEG was indicated. We also evaluated symptoms of impulsivity, hyperactivity, and attention deficit.

RESULTS

Neglect, physical and emotional abuse and high conflict divorce are the most important adverse experiences resulting in deviations in neurodevelopment.

Impulsive behaviour, and other form of ADHD “like” variants are significantly more frequent (over 50 %) in children with history of toxic stress. Over 30 % of patients with ACES ≥ 4 showed non-specific changes in EEG. In case of foetal abuse (Neonatal Abstinence Syndrome) 19 percent showed cognitive impairment, over 50 percent symptoms from ADHD spectrum, 33 percent had speech problems, and over 60 percent had learning problems. Child faced with toxic stress are obese in more than 70 percent.

CONCLUSIONS

Early detection of adverse childhood experiences help to start with early interventions in order to prevent short and long term consequences of toxic stress.

EP861 / #1325**E-Poster Viewing - Paediatrics AS04-23.
Psychiatry & mental health****Activity participation and emotion regulation among young children with autism spectrum disorder.****Y.S. Sung^{1*}, L.-Y. Lin^{1,2}**

¹National Cheng Kung University, College of Medicine, Institute of Allied Health Science, Tainan, Taiwan

²National Cheng Kung University, Department of Occupational Therapy, Tainan, Taiwan

BACKGROUND AND AIM

Participation in activities is a critical aspect of autistic children's health. Less participation of autistic children in daily activities was reported in previous studies. Emotion regulation are commonly reported among young autistic children. However, there are no studies about the relationship between emotion regulation and activity participation among young autistic children. The purpose of this study was to investigate the relationships of participation in different activities and emotion regulation in young autistic children.

METHODS

Fifty-six young autistic children between the ages of 33 and 73 months (mean age = 58.58) were recruited. All of the participants were diagnosed with ASD by pediatric psychiatrists and their CARS2 scores were all above 30. The Childhood Autism Rating Scale -2 were assessed by qualified occupational therapists. Assessment of Preschool Children's Participation (APCP) and Emotion regulation checklist (ERC) were reported by their parents. Pearson correlation coefficients were used to analyze the relationship between emotion regulation and activity participation.

RESULTS

Emotion regulation was positively moderately correlated with the diversity of social activities ($r = 0.30$, $p < 0.01$) and diversity ($r = 0.34$, $p < 0.01$) and frequency ($r = 0.33$, $p < 0.01$) of skill development activities in young autistic children. However, emotion regulation was no significantly related to total activity participation.

CONCLUSIONS

The result suggested that good emotion regulation ability was associated with higher diversity of participation in social and skill development activity and the frequency of skill development activities. Based on our findings, the professionals can facilitate activity participation by further treatment of emotion regulation.

EP862 / #2687**E-Poster Viewing - Paediatrics AS04-23.
Psychiatry & mental health****The role of epigenetics and nr3c1 in the development of psychopathology later in life of children and adolescents facing bullying****S. Usmani^{1*}, M. Mehendale², A. Malik³, N. Ashraf⁴**¹Dow University of Health Sciences, Psychiatry, Karachi, Pakistan²Smolensk State Medical University, Psychiatry, Smolensk, Russian Federation³King Edward Medical University, Medicine, Lahore, Pakistan⁴Freeman Health Systems-Ozark Center, Psychiatry, Joplin, United States of America**BACKGROUND AND AIM**

Bullying, ubiquitous social stress, is a strong future predictor of mental health disorders. Stressors during critical periods of brain development can disrupt key epigenetic processes, thereby increasing the vulnerability of psychopathology later in adult life. For example, in adults, DNA methylation in the glucocorticoid receptor gene (NR3C1) is associated with adverse childhood experiences, and this process has been suggested to mediate the development of anxiety disorders. This review explores the association between NR3C1 methylation and psychopathology in bullied children and adolescents.

METHODS

A literature search across several databases was conducted using the keywords "Epigenetics", "Bullying" and "NR3C1". Only three original studies were included in the review.

RESULTS

Internalizing psychopathological symptoms were assessed using the Center for Epidemiologic Studies Depression Scale for Children (CES-DC) and Saliva DNA in a cohort of 1149 adolescents. NR3C1 hypermethylation was significantly associated with a high score for internalizing symptoms in the whole group and having been bullied (OR = 1.89, 95% CI = 1.08–3.32). A study by Mulder et al. was the first study at the epigenome-wide significance level. However, there were no strong associations between DNA methylation and bullying exposure. Similarly, an epigenome-wide analysis of multiple forms of victimization, including bullying across childhood and adolescence, in a longitudinal study by Marzi et al. did not reveal associations with DNA methylation and genes, including the NR3C1 gene.

CONCLUSIONS

More longitudinal studies are needed to address whether NR3C1 methylation mediates the link between social stressors like bullying and psychopathology in children and adolescents.

EP863 / #2784**E-Poster Viewing - Paediatrics AS04-23.
Psychiatry & mental health****Propensity of adolescent substance use disorder
in body dysmorphic disorder****A. Malik¹, S. Usmani^{2*}**¹King Edward Medical University, Medicine, Lahore, Pakistan²Dow University of Health Sciences, Psychiatry, Karachi, Pakistan**BACKGROUND AND AIM**

Body Dysmorphic Disorder (BDD) being a mental illness involves an obsessive focus on a perceived flaw in appearance. Precursors to BDD are dissatisfaction with body weight and image. BDD is traced to adolescents and teens while the window for developing body image dissatisfaction begins earlier in childhood. Most adolescent BDD literature focusses on psychiatric comorbidities of BDD with a slight reference to developing a risk of Substance Use Disorder (SUD). There is a dearth of information showing an association and causation of BDD and substance use disorder (SUD). Hence, we decided to undertake a literature review on BDD in adolescents primarily with a focus to establish a causation with SUD.

METHODS

We searched Pubmed and Google scholar for literature on BDD in adolescents, body dissatisfaction, body image, and SUD, and carried out a critical examination of findings from studies with sound methodology.

RESULTS

BDD is frequent in adolescents as they are vulnerable to body dysmorphia. Teens with BDD are more likely to use drugs. Almost half of the BDD sufferers also have a substance use disorder. This disorder frequently begins in childhood or adolescence, and continues into adulthood. Despite the prevalence of BDD being greater in females, the pressures of body image on adolescent males leads to greater substance use in in male teens and adolescents.

CONCLUSIONS

Practitioners and clinicians often fail to diagnose BDD as a risk factor for SUD. This calls for action by having a high clinical suspicion for BDD and SUD.

EP864 / #2033**E-Poster Viewing - Paediatrics AS04-23.
Psychiatry & mental health****Non-pharmacological treatment modalities for
adhd in children and adolescents: a scoping
review****S. Usmani^{1*}, M. Mehendale², N. Walia³**¹*Dow University of Health Sciences, Psychiatry, Karachi, Pakistan*²*Smolensk State Medical University, Psychiatry, Smolensk, Russian Federation*³*Baylor College of Medicine, Psychiatry, Houston, United States of America***BACKGROUND AND AIM**

Attention-deficit/hyperactivity disorder (ADHD) is the most common childhood neurodevelopmental disorder, affecting about 5% of children worldwide. Alternative treatment modalities have been shown to be efficient in its treatment. In this review, we explore non-pharmacological treatment available for ADHD in children and adolescents.

METHODS

An extensive literature search was conducted using MEDLINE, PubMed, Scopus, and Cochrane databases. Systematic reviews and randomized controlled trials published on or before April 2022 were included in the review.

RESULTS

A virtual reality-based intervention in the pediatric age group had a substantial influence on errors, precision, and perceptual awareness mainly responsible for maintaining attention, rather than impulsive reactions, such as commissions and reaction speed. Exercise, particularly moderate to high-intensity

cardio training, showed a homogeneous nature with significantly effective magnitude, while cognitive training and cognitive behavioral therapy showcased a moderate improvement. The neurofeedback was found to be ubiquitous and to have effect sizes ranging from moderate to high. Furthermore, a double-blind, sham-controlled pilot trial using Trigeminal Nerve Stimulation (TNS) found that employing TNS resulted in higher ARDS-Rating Scales and Clinical Global Improvement Scales with minimal adverse effects. Digital health smartphone apps have not scientifically been proven to be effective.

CONCLUSIONS

Timely management of ADHD in the pediatric population is critical as it poses risk for other mental health disorders and negative outcomes. This review highlights the various integrative approaches available for the treatment of ADHD. Further research is warranted to validate the results and provide evidence-based recommendations to healthcare providers.

EP865 / #2370**E-Poster Viewing - Paediatrics AS04-23.
Psychiatry & mental health****Coppcap: colorado pediatric psychiatry
consultation & access program: data and lessons
learned to DATE****J. Van Cleave^{1*}, D. Keller¹, S. Fritsch²**¹University of Colorado School of Medicine, Pediatrics, Aurora, United States of America²University of Colorado School of Medicine, Psychiatry, Aurora, United States of America**BACKGROUND AND AIM**

Child psychiatry access programs were developed to support pediatric primary care providers assess and treat mental health concerns through peer-to-peer consultation, resource identification, and education. CoPPCAP, the Colorado Pediatric Psychiatry Access Program, began in September 2019. CoPPCAP has enrolled 56 urban and rural practices (~420 providers, > 380,000 covered lives), and provided 1380+ peer-to-peer consultations. CoPPCAP provides resources and education on its website. We sought to evaluate the breadth and reach of this intervention.

METHODS

For each encounter, the encounter record includes: demographics, question being asked, severity rating score, and recommendations. We study monthly website utilization. Descriptive statistics and provider feedback were used to assess impact of the program.

RESULTS

Of the 1380 consults: 11% for 0 – 6 yo, 30% for 7 – 12 yo, 49% for 13 – 18 yo, and 9% for 18 – 25 yo. Patient specific questions are majority of calls at 89%, 10% seeking referral options, and 1% having general questions. Outcomes of the patient related questions include: general medical education 19%, medication change 18%, referral to therapist 12%, and differential diagnosis 11%. Differences emerge in peer-to-peer consultation requests from urban versus rural providers with rural providers more likely to seek consultation for antipsychotic medication use (16.4% vs 7.9%), PTSD (13.6% vs 6.1%), and Psychosis (4.1% vs 1.9%). In March 2022, www.coppcap.org had 1180 visits from 49/50 states. 61 countries have accessed the website.

CONCLUSIONS

CoPPCAP has provided a valuable service to support pediatric primary care providers assess and treat behavioral health concerns in the primary care setting.

EP866 / #1177**E-Poster Viewing - Paediatrics AS04-24. Public health & social paediatrics****Beliefs and practices towards teething symptoms among parents**

S. Bektas^{1*}, A.E. Askin¹, Z. Aktug¹, F.Z. Manap¹, K.N. Ozekinci¹, B. Aktura², M. Basibuyuk³, N. Karabayir⁴

¹Istanbul Medipol University, School of Medicine, Istanbul, Turkey

²Istanbul Medipol University School of Medicine, Department of Family Medicine, Istanbul, Turkey

³Istanbul Medipol University School of Medicine, Department of Pediatrics, Istanbul, Turkey

⁴Istanbul Medipol University School of Medicine, Department of Pediatrics, Department of Social Pediatrics, Istanbul, Turkey

BACKGROUND AND AIM

Parents attribute many symptoms to teething and often use certain medications or methods to relieve these symptoms. The aim of our study is to investigate parents' beliefs and their practices towards teething symptoms.

METHODS

In our cross-sectional study conducted in Istanbul Medipol University Pediatrics outpatient clinic between February 2 and March 1, 2022, a structured questionnaire consisting of 6 questions was applied face-to-face to parents with children aged 6-36 months.

RESULTS

of 408 children included in our study, 234 (57.4%) were male. The mean age was 18.8 months. The most common reason for using any methods was crying/restlessness with a rate of 69.7%. It was determined that crying, red palate/swelling and increased salivation were significantly more common in

boys than in girls. It was determined that an average of 2 methods were used by the parents and the most frequently used method was the teether (60%). In addition, it was stated by 96 (23.5%) of the parents that the teether was the most effective method. It was found that oral analgesics in 31.1% of the cases, palate massage in 30.1%, gels containing local anesthetics in 25.7%, amber necklaces in 22.5%, teething granules in 17.9% and in 15.2% herbal products were used. Only 59 (14.5%) of parents stated not using any method.

CONCLUSIONS

Apart from classical methods, amber necklace or herbal treatments have started to be used frequently during the teething period. Guidance on management of teething by health professionals can help parents manage teething period better.

EP867 / #1985

E-Poster Viewing - Paediatrics AS04-24. Public health & social paediatrics

The relationship between the mother's body mass index and vitamin b12 levels and anthropometric measurements of the newborns

L. Sezen Pehlivan¹, B. Aktura², S. Bektas^{3*}, M. Basibuyuk⁴, N. Karabayir⁵

¹Family Health Center, Family Health Department, Istanbul, Turkey

²Istanbul Medipol University School of Medicine, Department of Family Medicine, Istanbul, Turkey

³Istanbul Medipol University, School of Medicine, Istanbul, Turkey

⁴Istanbul Medipol University School of Medicine, Department of Pediatrics, Istanbul, Turkey

⁵Istanbul Medipol University School of Medicine, Department of Pediatrics, Department of Social Pediatrics, Istanbul, Turkey

BACKGROUND AND AIM

Our purpose is to investigate the relationship between the mother's pre-gestational weight, weight gain and vitB12 levels during pregnancy and the anthropometric measurements of the babies.

METHODS

In this cross-sectional study conducted in Family Health Center in Istanbul, between January 2019 and November 2020, 98 mothers with singleton pregnancies were included. Among the babies, there were 52 girls and 46 boys with no reported history of congenital anomalies and NICU admission. All mothers who were first evaluated at <6 weeks of gestation, were followed up 4 times until delivery and maternal weight was recorded during every visit. Anthropometric measurements of newborns were obtained from the records. VitB12 level <200pg/ml was considered as deficiency.

RESULTS

No significant relationship was found between BMI values of mothers and vitB12 levels ($p > 0.05$). The birth weight of the babies from the group with $BMI > 30$ was significantly higher than the group with $BMI \leq 25$. No significant relationship was found between BMI and gender, birth height and head circumference. While significant correlation was found between the $BMI > 30$ group and height ($p < 0.05$), there was no significant relationship between changes in BMI and vitB12 level, birth weight, height, head circumference. In addition, no significant correlation was observed between maternal vitB12 level and birth weight, height and head circumference. Considering mothers' vitB12 levels, anthropometric measurements of newborns were similar.

CONCLUSIONS

The nutritional status of a woman before and during pregnancy is important for a healthy pregnancy outcome. Pregestational weight, vitB12 and weight gain during pregnancy do not have a significant effect on anthropometric measurements of the babies.

EP868 / #530**E-Poster Viewing - Paediatrics AS04-24. Public health & social paediatrics****Predicting low cognitive ability at age 5 – feature selection using machine learning methods and birth cohort DATA****A. Bowe^{1*}, A. Staines², F. Mccarthy¹, G. Lightbody¹, D. Murray¹**¹INFANT Research Centre, University College Cork, Cork, Ireland²Dublin City University, School of Nursing, Psychotherapy, and Community Health, Dublin, Ireland**BACKGROUND AND AIM**

Early intervention can help address disparities in cognitive development. In this study, we applied the random forest (RF) algorithm to birth-cohort data to train a model to predict low cognitive ability at 5 years of age and to identify the important predictive features.

METHODS

Data was from 1,070 participants in the Irish population-based BASELINE cohort. A RF model was trained to predict an intelligence quotient (IQ) score <90, (corresponding to an IQ <1.5 standard deviations below the cohort mean), at age 5 years using maternal, infant, and sociodemographic features. Feature importance was examined using the mean decrease in Gini impurity and in accuracy. Internal validation was performed using 10-fold cross validation repeated 5 times.

RESULTS

Children with low cognitive ability at age 5 were more likely to be male (65.2% v 34.8%, $p=0.022$), to be from single-parent families (9.1% v 3.1%, $p=0.025$)

and lower socioeconomic backgrounds. The five most important predictive features were the total years of maternal schooling, infant Apgar score at 1 minute, socioeconomic index, maternal BMI, and alcohol consumption in the first trimester. A parsimonious RF model based on 11 features showed excellent predictive ability, with a sensitivity of 0.89 and a specificity of 0.98, providing a foundation suitable for external validation in an unseen cohort.

CONCLUSIONS

Machine learning approaches to large existing datasets can provide accurate feature selection to improve risk prediction. Further validation of this model is required in cohorts representative of the general population. Accurate risk prediction can facilitate targeted screening and intervention.

EP869 / #1517**E-Poster Viewing - Paediatrics AS04-24. Public health & social paediatrics****A national italian survey on social determinants of health and distance learning during the first wave of sars-cov-2.**

E. Candela^{1*}, A. Dondi², J. Lenzi³, S. Sureshkumar⁴, F. Morigi¹, C. Biagi², M. Lanari⁵

¹Specialty School of Pediatrics, Alma Mater Studiorum, University of Bologna, Pediatric Emergency Unit, Scientific Institute For Research and Healthcare (irccs), Sant'Orsola Hospital, Bologna, Italy

²Scientific Institute for Research and Healthcare (IRCCS), Sant'Orsola Hospital, Pediatric Emergency Unit, Bologna, Italy

³University of Bologna, Department of Biomedical and Neuromotor Sciences, Bologna, Italy

⁴Institute of Global Health, University of Geneva, Geneva, Switzerland

⁵IRCCS Azienda ospedaliero-Universitaria di Bologna, Pediatric Emergency Unit, Department of Medical and Surgical Sciences, Via Massarenti, Italy

BACKGROUND AND AIM

To analyze the impact of distance learning (DL) among Italian families during the months of the first wave and the consequent nationwide lockdown owing to the SARS-CoV-2 pandemic, and to study the correlations between social determinants of health (SDH) and this different methodology of education.

METHODS

We have spread a cross-sectional online survey 6 months after the beginning of the pandemic to examine various SDH and parents' attitude towards DL. Our sample population was made of parents of school age children and living in Italy.

RESULTS

Among 3791 respondents, we observed that, when parents lived apart, children were reported to have greater difficulties in concentrating during DL ($p = 0.04$) and parents referred a lower capacity for commitment in support of DL ($p = 0.001$). Non-Italian parents complained more difficulties in supporting children in DL because of a poor knowledge of the language ($p < 0.001$) or lack of an appropriate digital equipment ($p = 0.004$). At the same time, parental level of education appeared as the mostly correlated SDH to perceived impairments in DL, as well as the number of technological devices available for DL increased progressively with the rise of the level of education ($p < 0.001$) or of a better personal perception of the family economic situation.

CONCLUSIONS

The SDH are a fundamental key to understand and analyze every change in children's everyday life. Our national policy must act on the enhancement of SDH in order to provide more equal conditions and a peer access to education.

EP870 / #2767**E-Poster Viewing - Paediatrics AS04-24. Public health & social paediatrics****Taking a sexual history of gender diverse youth: a qualitative study of their needs towards healthcare professionals****C. Casavant*, R. Wahlen***Université de Lausanne, Disa, Lausanne, Switzerland***BACKGROUND AND AIM**

Gender diverse youth (GDY) represent a significant proportion of the population, which is acquiring more visibility due to societal movements. This means that primary care practitioners are more likely to be confronted to these patients and their health issues. However, medical training lacks specific teaching on the management of this vulnerable health population. In this work we wish to address a specific question: how should physicians adapt their sexual anamnesis to GDY to offer open, non-judgmental and supportive care?

METHODS

We have conducted qualitative analysis of role play exercises between 8 GDY aged 18-22 years of age.

RESULTS

The lack of knowledge about the specific needs of GDY is detrimental to their health. This can be seen on several levels: the pressure to meet the doctor's expectations (hetero-normativity, universal trans journey, exclusively penetrative intercourse), risk-taking due to lack of knowledge/ressources (safe sex queer, LBGTQ+ youth targeted on the internet), the isolation of suffering

(dysphoria, passing, depression). This results in a reluctance to consult a healthcare facility, well described in the current literature. Our youth cohort suggested key points to give gender inclusive care, like creating a welcoming and safe environment for the consultation, accepting and validating the patient, using inclusive language and being a resource for GDY.

CONCLUSIONS

Health disparities that GDY face result in restricted access to healthcare which can be detrimental. By conducting gender inclusive care, practitioners may create a better doctor-patient relationship and health outcomes. A clinical vignette of sexual history taking summarises these results and good practice recommendations (WPATH).

EP871 / #1340

E-Poster Viewing - Paediatrics AS04-24. Public health & social paediatrics

Knowledge and experiences of families regarding the use of amber necklaces

M. Dertli^{1*}, E. Ozen², E. Hashimov², E. Onaran², B. Aktura², M. Basibuyuk², N. Karabayir²

¹Istanbul Medipol University, International School of Medicine, Istanbul, Turkey

²Istanbul Medipol University, School of Medicine, Istanbul, Turkey

BACKGROUND AND AIM

Amber necklaces have been used frequently claiming that it reduces the complaints of babies during teething. In this study, the knowledge and experiences of families about amber necklaces were investigated.

METHODS

A questionnaire consisting of 16 questions was applied face-to-face to the parents of a 0-24 month old baby who applied to the Pediatrics outpatient clinic.

RESULTS

In 101 families participated in the study, 44 (43.6%) babies were girls and 57 (56.4%) were boys, with a mean age of 17.9 ± 6.41 (5-24) months. The most common reasons for using amber necklaces were restlessness ($n=72$, 30.4%), itching of the gums ($n=58$, 24.5%) and increased salivation ($n=56$, 23.6%). The time to start use was 5.4 ± 2.63 (1-13) months, and the mean duration of use was 12.5 ± 6.36 (0-23) months. Amber necklace was purchased most frequently with the recommendation of friends/relatives ($n=65$, 64.4%) and

most frequently from the internet (n=51, 50.5%). 83.2% (n=84) of families reported that amber necklaces were beneficial for their babies. A negative correlation was found between the time of starting to use and usefulness ($p < 0.01$). Families corresponding to 36.1% had no knowledge and 72.3% weren't warned about the risks. %2 of the infants experienced suffocation, and 2% had the problem of dispersal of the particles. Amber necklaces (n=28, %27.7) and teething granules (n=17, 16.8%) were the most effective methods.

CONCLUSIONS

It is seen that amber necklaces are most beneficial method in managing teething symptoms. However, families should be informed about the risks by health professionals.

EP872 / #1408**E-Poster Viewing - Paediatrics AS04-24. Public health & social paediatrics****Cost analysis of delivering positive newborn screening results comparing existing practice versus innovative, co-designed strategies from the respond STUDY**

J. Chudleigh¹, F. Fusco^{2*}, P. Holder¹, J. Bonham³, K. Southern⁴, A. Simpson¹, L. Moody⁵, E. Olander⁶, H. Chinnery⁷, F. Ulph⁸, S. Morris²

¹King's College London, Florence Nightingale Faculty of Nursing, Midwifery and Palliative Care, London, United Kingdom

²University of Cambridge, Department of Public Health and Primary Care, Cambridge, United Kingdom

³Sheffield Children's NHS Foundation Trust, Pharmacy, Diagnostics and Genetics, Sheffield, United Kingdom

⁴University of Liverpool, Women's and Children's Health, Liverpool, United Kingdom

⁵Coventry University, Centre For Arts, Memory and Communities, Coventry, United Kingdom

⁶City, University of London, Centre For Maternal and Child Health, London, United Kingdom

⁷St. Mary's University, Faculty of Sports, Health and Applied Science, London, United Kingdom

⁸University of Manchester, Division of Psychology and Mental Health, Manchester, United Kingdom

BACKGROUND AND AIM

Poor or inappropriate communication of positive newborn bloodspot screening (NBS) results to parents can lead to negative sequelae. The ReSPoND study explored costs associated with existing and innovative co-designed strategies to improve communication.

METHODS

Experience-based co-design (EBCD) was used to co-design interventions with parents and HPs to improve communication of positive NBS result to parents. A scenario analysis was used to compare costs of existing commu-

nication pathways with the co-designed interventions by (i) home-visits and (ii) telecommunications.

RESULTS

On average, the existing communication pathways cost £447.08 per infant (range: £237.12 to £628.51). Implementing the new interventions relying on home-visits exclusively would cost on average £521.62 (£312.84 to £646.39) per infant, or £447.19 (£235.79 to £552.03) if implemented via teleconsultations.

CONCLUSIONS

Using the co-designed interventions via telecommunications is unlikely to require additional resources compared with current practice but may improve parental experiences. Acknowledgments This work has been published: Fusco F, Chudleigh J, Holder P, Bonham JR, Southern KW, Simpson A, Moody L, Olander EK, Chinnery H, Morris S. Delivering Positive Newborn Screening Results

Cost Analysis of Existing Practice versus Innovative, Co-Designed Strategies from the ReSPoND Study. *Int J Neonatal Screen*. 2022 Mar 14;8(1):19. doi: 10.3390/ijns8010019 and is being reproduced under licence CC-BY-4.0. This project was funded by the National Institute for Health Research Health Services and Delivery Research (NIHR HS&DR) Programme (project number 16/52/25). The views expressed are those of the authors and not necessarily those of the NIHR or the Department of Health and Social Care.

EP873 / #990

E-Poster Viewing - Paediatrics AS04-24. Public health & social paediatrics

Vitamin d status correlations with il-6 and il-10 levels in pediatric pneumonia

K. Gogberashvili*

Tbilisi State Medical University, Pediatrics, Tbilisi, Georgia

BACKGROUND AND AIM

The aim of present study was to establish correlations between vit D status and systemic cytokines profile in children with community acquired pneumonia (CAP).

METHODS

The prospective study was performed in 41 Children with CAP at age 5 to 15 years hospitalized in Pediatric Academic Clinic between November 2019 to March 2021 (negative SARS-2-CoV). One moment blood concentration of 25-hydroxyvitamin D was determined in every study participant. Interleukin (IL) 6 and 10 were determined twice on first and fifth days of hospital admission in the blood of each patient. Interleukin (IL) 6 and 10 were determined twice on first and fifth days of hospital admission in the blood of each patient. Data were analyzed using computer program SPSS 18 (SPSS INC., CHICAGO, IL, USA). Statistical significance was taken as $p < 0.05$.

RESULTS

Serum levels of IL-6 and IL-10 upon admission were significantly higher in every patient with pneumonia to compare to normal data. IL-6 level in vit D deficient patients were significantly increased, as at admission, as on 5-th day

of hospitalization, but had already normalized with IL-10 level in vit D insufficient and sufficient patients to levels similar to those of healthy individuals on 5 to 7th days of hospitalization. Whereas IL 10 level stayed high in four patients who required intensive care for ARDS.

CONCLUSIONS

Our results show that the systemic cytokines levels and IL6/IL10 ratio are increased in CAP patients. Vit D plasma concentration affects systemic cytokines levels in the blood according the severity of vitamin deficiency.

EP874 / #1148

E-Poster Viewing - Paediatrics AS04-24. Public health & social paediatrics

Process results of a health program for children and adolescents in a rural health district

M.R. Hernández-Soto^{1*}, I. Escalona Labella², J.A. Donaire-Granado³, S. Sicre Alonso², L. Luque-Romero³

¹Districto Sanitario Aljarafe-Sevilla Norte, General Manager, Sevilla, Spain

²Districto Sanitario Aljarafe-Sevilla Norte, Prevention, Promotion and Surveillance of Health Unit, Sevilla, Spain

³Districto Sanitario Aljarafe-Sevilla Norte, Research Unit, Sevilla, Spain

BACKGROUND AND AIM

The andalusian Health Program for Children and youth population (PSIAA) has as its main purpose, the follow-up of the health in children and youngsters in andalusia, based on prevention of diseases and promotion of health activities according to the available evidence. There are two programs included in this strategy: "Creciendo en Salud" for the ages of 3 to 12 yo, and "Forma Joven" for teenagers among 12 to 18 yo. The aim is to describe the results in the process of PSIA in 2021 in the Aljarafe-North Seville District in Seville, Spain.

METHODS

Cross-sectional observational study. Variables: percentage of active centres, number of developed activities, attended population characteristics. Descriptive statistical analysis.

RESULTS

PSIA has been developed in 130 schools of 162 subscribed in the program. The nurses and paediatricians have accomplished a total of 457 activities

in Creciendo en Salud (Growing in Health Program) and in Forma Joven (Young Form Program) 205 individual counselling to 338 youngsters, and 363 group activities on a total amount of 96374 youngsters in the 130 schools subscribed. The activities in Creciendo en Salud offered to teachers were 200, 151 to children and the rest to parents. Most of them were structured as a workshop, in presence 341 and 117 virtual. The activities were based on healthy life styles, autonomy, accessibility and selfcare, emotional education, prevention of drug abuse, safe sexuality and equal relationships.

CONCLUSIONS

PSIA is a health strategy oriented to take promotion of health and prevention of diseases activities to educational centres in a structured program with an important accessibility offered and high acceptance by teachers, parents and pupils.

EP875 / #1415**E-Poster Viewing - Paediatrics AS04-24. Public health & social paediatrics****Parents' views of co-designed interventions to improve communication of positive newborn bloodspot screening results****J. Chudleigh¹, P. Holder^{1*}, J. Bonham², A. Simpson¹, L. Moody³, F. Fusco⁴, S. Morris⁴, E. Olander⁵, H. Chinnery⁶, F. Ulph⁷, K. Southern⁸**

¹King's College London, Florence Nightingale Faculty of Nursing, Midwifery and Palliative Care, London, United Kingdom

²Sheffield Children's NHS Foundation Trust, Pharmacy, Diagnostics and Genetics, Sheffield, United Kingdom

³Coventry University, Centre For Arts, Memory and Communities, Coventry, United Kingdom

⁴University of Cambridge, Department of Public Health and Primary Care, Cambridge, United Kingdom

⁵City, University of London, Centre For Maternal and Child Health, London, United Kingdom

⁶St. Mary's University, Faculty of Sports, Health and Applied Science, London, United Kingdom

⁷University of Manchester, Division of Psychology and Mental Health, Manchester, United Kingdom

⁸University of Liverpool, Women's and Children's Health, Liverpool, United Kingdom

BACKGROUND AND AIM

Communicating positive newborn bloodspot screening (NBS) results to parents can be challenging. Despite guidance, variation exists regarding approaches used. Here we report parents' opinions of co-designed (parents and health professionals) interventions to improve communication practices as part of the ReSPoND study.

METHODS

Twenty parents who had received a positive NBS result for their child (eight had experienced the interventions, twelve had not) were interviewed.

RESULTS

Parents thought the interventions could reduce uncertainty, ensure parity and help pace and tailor information given when communicating a positive NBS result. Parents also suggested the interventions could facilitate communication within and between clinical teams. Parents felt providing information on reliable information sources immediately after receiving their child's positive NBS result could reduce anxiety.

CONCLUSIONS

The co-designed interventions showed promise for improving communication of positive NBS results to parents. Further research is needed to explore their acceptability and feasibility in practice. Acknowledgements Sections of this abstract have been reproduced from Chudleigh J, Holder P, Moody L, Simpson A, Southern K, Morris S, Fusco F, Ulph F, Bryon M, Bonham JR, Olander E. Process evaluation of co-designed interventions to improve communication of positive newborn bloodspot screening results. *BMJ Open*. 2021 Aug 27;11(8):e050773. doi: 10.1136/bmjopen-2021-050773 published under licence CC-BY-4.0. This project was funded by the National Institute for Health Research Health Services and Delivery Research (NIHR HS&DR) Programme (project number 16/52/25). The views expressed are those of the authors and not necessarily those of the NIHR or the Department of Health and Social Care.

EP876 / #2098**E-Poster Viewing - Paediatrics AS04-24. Public health & social paediatrics****The process of child and youth engagement in school health promotion: a scoping review protocol****J. Kontak^{1*}, S. Kirk²**¹Dalhousie University, Faculty of Health and Healthy Populations Institute, Halifax, Canada²Dalhousie University, School of Health and Human Performance and Healthy Populations Institute, BHE, Canada**BACKGROUND AND AIM**

School environments are an essential setting to influence the health and well-being of children and youth. Health Promoting Schools (HPS) is a whole-school approach that strengthens and builds a safe and healthy school environment for students to learn and develop. A core component of HPS is the engagement of students. Despite promising outcomes arising from student participation in school health promotion, there is less known on the process of how they are involved and in what form. This scoping review will map the different components of the student engagement process in school health promotion with specific focus on whole-school approaches.

METHODS

We will follow scoping review guidelines employed by JBI and the Arksey and O'Malley's framework. We will use the Preferred Reporting Items for Systematic Reviews and Meta-Analysis extension for scoping reviews for reporting. The Participant, Concept and Context (PCC) mnemonic will be used to develop eligibility criteria. Databases to be searched include: CINAHL, ERIC, MEDLINE, Scopus, ProQuest Dissertations & Theses Global databases, and Google Scholar. Organizational websites and sources identified by experts

will also be reviewed. Two reviewers will screen the title, abstract and full text of the sourced articles.

RESULTS

Data from included articles will be charted using a charting tool. Descriptive analysis will be conducted for quantitative data, and thematic analysis will be employed for qualitative data. Data will be displayed through tables and narrative descriptions.

CONCLUSIONS

This scoping review aims to understand the process and forms of child and youth engagement in school health promotion.

EP877 / #1131**E-Poster Viewing - Paediatrics AS04-24. Public health & social paediatrics****Is an educational intervention enough to change the habits in young people?**

L. Luque-Romero^{1*}, A. Alonso Bueno², M.T. Jiménez Gómez-Casero³, J.M. Sáenz Lussagnet⁴, M.R. Hernández-Soto⁵, J.A. Donaire-Granado¹

¹D Distrito Sanitario Aljarafe-Sevilla Norte, Research Unit, Sevilla, Spain

²D Distrito Sanitario Aljarafe-Sevilla Norte, Tomares, Sevilla, Spain

³D Distrito Sanitario Aljarafe-Sevilla Norte, Tomares Primary Care Centre, Sevilla, Spain

⁴H Hospital Universitario Juan Ramón Jiménez, Mental Health Unit, Huelva, Spain

⁵D Distrito Sanitario Aljarafe-Sevilla Norte, General Manager, Sevilla, Spain

BACKGROUND AND AIM

To analyse the effectiveness of a short structured educational intervention on the consumption of water pipes.

METHODS

A pre-post study design was carried out among schooled teenagers in the 1st to 4th course in Secondary School. An educational intervention was developed on the subject of consumption of water pipes. Two questionnaires were designed ad-hoc and answered online, before, and 8 months after the educational intervention. A bivariate and descriptive analyse was made to compare the beliefs and the tobacco consumption (water pipes and cigarettes) basal and final taking into account the socio-demographic risks factors and mental wellbeing (SDQ questionnaire)

RESULTS

The baseline sample were 325 pupils, 3.7% of them had consolidated the consumption of cigarettes, 4.9% water pipes, 3.1% electronic cigarettes, 6.8% alcohol and 1.2% cannabis. No statistically significant association was found between consolidated consumption of water pipe and sexual activity. A statistically significant decrease of the wrong beliefs about the consumption of water pipes was found. Among those that had never used tobacco, 1.6 % had had a previous experience with cigarettes and 0.8% with water pipes. The consumption of water pipes is statistically associated to the consumption of cigarettes, electronic cigarettes and alcohol, with emotional disorders, behavioural disorders and hyperactivity.

CONCLUSIONS

This study shows that a structured intervention improves the knowledge about the risks associated to the consumption of water pipes but does not have any impact in the variations of the consumption habits.

EP878 / #1804**E-Poster Viewing - Paediatrics AS04-24. Public health & social paediatrics****Impact of the covid-19 pandemic on child cancer treatment in brazil****A.B. Machado De Almeida^{1*}, N. Oliveira²**¹*Brazilian Association of Lymphoma and Leukemia, Research, São Paulo, Brazil*²*Brazilian Association of Lymphoma and Leukemia, Research, Sao Paulo, Brazil***BACKGROUND AND AIM**

The Covid-19 pandemic demanded the reorganization of health services causing significant interruptions in services aimed at diagnosis, treatment, rehabilitation of patients with other diseases, including cancer patients. The objective of this study is to identify the impact of the pandemic in reducing the treatment of patients diagnosed with childhood cancer in Brazil.

METHODS

Descriptive study based on the Authorizations for High Complexity Procedures (APAC) of chemotherapy and radiotherapy of the Unified Health System (SUS) of patients under 12 years of age between 2019 and 2021.

RESULTS

The treatment of childhood cancer patients underwent changes in 2020 and 2021. There was a significant reduction in radiotherapy procedures, with 38% in 2020 and 32% in 2021. There was also a considerable reduction in the number of patients who underwent treatment in the SUS in the period, for both chemotherapy (3%) and radiotherapy (23%). Pediatric patients were already starting their treatment in the SUS in advanced stages before the pan-

demic and this scenario has worsened in the last two years. Considering only patients with staging information filled in, the percentage of staging III and IV increased from 36% in 2019 to 42% in 2021 for chemotherapy treatment and from 56% in 2019 to 57% in 2021 for radiotherapy.

CONCLUSIONS

The treatment of childhood cancer patients was affected during the years of the pandemic. The increase in patients treated in advanced stages affects the success of treatment, considering that early diagnosis is a crucial factor in achieving a cure for childhood cancer.

EP879 / #665**E-Poster Viewing - Paediatrics AS04-24. Public health & social paediatrics****Anthropometric predictors of systolic and diastolic blood pressure considering intersexual differences in the group of selected schoolchildren****K. Rimarova***

Faculty of Medicine; University of Pavol Jozef Safarik, Department of Public Health and Hygiene, Košice, Slovak Republic

BACKGROUND AND AIMS

The association between anthropometric parameters and blood pressure has been established for adults, but the relationship for children has not been thoroughly studied in Slovakia.

METHODS

Examinations were conducted as a cross-sectional study with 760 schoolchildren (381 boys and 379 girls). The blood pressure evaluation (SBP and DBP) included sphygmomanometer technique (seated 3 times repeated). Anthropometric measurements included: body weight, height, circumference of waist, hip and chest, BMI, WHR (waist-hip ratio), fat skinfolds measurement, triceps skinfold and derivation of body fat percentage.

RESULTS

Pearson correlations revealed highly significant relationship of anthropometric indices on SBP compared to DBP. Correlations of anthropometric parameters with SBP and DPB were more significant for boys compared to

girls. Linear regression analysis confirmed that highest impact on SBP and DBP had Z-score of BMI, followed by weight and height. Z-score of body weight has statistical impact on SBP and DBP in all group and group of boys ($p < 0.001$), lower significance was on DBP of girls ($p < 0.01$). Z-score for BMI and height in DBP has lower statistical significance.

CONCLUSIONS

Linear regression confirmed higher statistical relationship of SBP and DBP in the group of boys compared to girls. SBP correlations and linear regression model of revealed more significant outputs compared to DPB. The results confirmed the fact that we have to consider anthropometric indices in paediatric blood pressure evaluation. Acknowledgement: The work was supported with grant KEGA 010UPJŠ-4/2021 The Ministry of Education, Science, Research and Sport of the Slovak Republic.

EP880 / #2044

E-Poster Viewing - Paediatrics AS04-24. Public health & social paediatrics

Safe ni: introducing practical paediatric safeguarding training in northern ireland

A. Sproule^{1*}, J. Wallace², R. Moore², J. Richardson³, A. Thompson², A. Livingstone⁴

¹RBHSC, Paediatrics, Belfast, United Kingdom

²Royal Belfast Hospital for Sick Children, Paediatrics, Belfast, United Kingdom

³Royal Belfast Hospital for Sick Children, Paediatric Intensive Care, Belfast, United Kingdom

⁴Antrim Area Hospital, Paediatrics, Antrim, United Kingdom

BACKGROUND AND AIM

Safeguarding is a challenging yet inevitable aspect of paediatric care. SafeNI was developed due to low confidence in local senior paediatric trainees in this area. Previously available training was not felt to be sufficient. A blended learning approach was constructed, including an innovative practical course allowing simulation and exploration of safeguarding topics. Our aim was to transform safeguarding training and equip trainees with the skills to confidently manage the practical aspects of child protection.

METHODS

A practical safeguarding teaching session was led by a faculty of safeguarding experts. There were 13 candidates, with small groups for simulation. Two lectures were given with sensitive images involving ano-genital injuries. There were four practical stations: · Simulation of a collapsed infant, to allow assessment of a child presenting acutely with child protection concerns and address these with the parents. · Practicing description and documentation of injuries. · Practicing gaining consent for skeletal surveys. · Safeguarding vignettes to allow discussion and rating of level of concern of cases.

RESULTS

Candidates felt the teaching was relevant, and the delivery kept them interested. Qualitative feedback included "Excellent simulation", "very informative" and "interactive and fun". Candidates stated "no one ever does it" and "never been covered before", highlighting gaps in previous education. Improvements recommended included "more scenarios".

CONCLUSIONS

This successful inaugural practical safeguarding session was positively received by all candidates. They felt it addressed a gap in their learning, in an interactive and informative way. The course is being finessed based on feedback. Acknowledgements Drs Daphne Primrose, Julie-Ann Maney, Philip Ross

EP881 / #1719**E-Poster Viewing - Paediatrics AS04-24. Public health & social paediatrics****Changes in young athletes' exercise, diet quality and sleep routine during covid -19 pandemic****F. Giannisi¹, S. Totska², I. Toulia^{3*}, S. Tsotoulidis⁴**¹Kassandria Primary Health Centre, Pediatric, Kassandria, Greece²Toumpa Primary Health Centre, Pediatric, Thessaloniki, Greece³Kassandria Primary Health Centre, Pediatric, KASSANDRIA, Greece⁴Kassandria Primary Health Centre, Internal Medicine, Kassandria, Greece**BACKGROUND AND AIM**

Public health measures that were imposed globally to restrict spreading of severe acute respiratory syndrome coronavirus 2, caused sudden and major changes in children and adolescents' daily routine. Aim of this study was to investigate the impact of COVID-19 pandemic on young athletes' exercise and screen time, meal and sleep routine.

METHODS

An online survey was conducted by means of a questionnaire which was completed by athletes (aged 12-18) from various cities in Greece, during a strict 3-month lockdown (January 2021- April 2021).

RESULTS

A total of 518 children completed the questionnaire (248 boys) whose mean age was 15.3 ± 1.56 years. Most of them were involved in team sports (84.2%) and the majority of them practiced for more than 3 years (79.6%). Mean training time was 4.83 ± 1.57 hours/week before pandemic which was reduced significantly by 1 hour during lockdown (3.82 ± 2.34 hours/week spent on

leisure activities, $p=0.001$). Regarding screen time other than tele-education, the percentage of children exceeding the recommended 2-hour limit, increased from 35% to 79.3% ($p < 0.001$). Diet quality, recorded on a scale from 1 to 5, worsened during lockdown (3.76 ± 0.75 vs 3.5 ± 0.87 , $p < 0.001$), whilst mean sleep time increased significantly (7.76 ± 1.079 vs 8.2 ± 1.65 , $p < 0.001$).

CONCLUSIONS

This study revealed the negative impact of Covid-19 pandemic restrictions on children and adolescents' everyday routine causing deviation from recommended guidelines.

EP882 / #827**E-Poster Viewing - Paediatrics AS04-24. Public health & social paediatrics****Paediatric inclusion health: providing equitable healthcare for children experiencing social adversity****A. Walsh^{1*}, R. Clarke², E. Molloy³, C. Ní Cheallaigh⁴, C. Hensey²**¹Children's Health Ireland at Temple Street, General Paediatrics, Dublin, Ireland²Children's Health Ireland at Temple Street, General Paediatrics, Dublin, Ireland³Prof of Paediatrics, Trinity College Dublin, Dublin, Ireland⁴Trinity College Dublin, Clinical Medicine, Dublin, Ireland**BACKGROUND AND AIM**

Paediatric Inclusion Health (PIH) is model of healthcare delivery for children that addresses inequitable access to necessary services. Adverse social determinants of health (SDH) contribute to higher rates of illness and increased barriers accessing healthcare. Our hospital began a PIH service to facilitate equitable access and better understand SDH in clinical practice.

METHODS

Need for PIH was determined by identification of adverse SDH including insecure housing, precarious primary care, disadvantaged ethnic minorities, or vulnerable migration status. Healthcare encounters were optimised with outreach clinics, pathways focused on specific population needs (e.g. migrant, Roma), and community representative involvement in service planning. Supports included interpreter phone-call confirmation of attendance, and facilitated phlebotomy and radiology services.

RESULTS

Over 15 months, 125 children were referred to the service, the majority from the following cohorts: homeless children (68.8%, n=86), Irish Travellers (14.4%, n=18), Roma (31.2%, n=39) and vulnerable migrants (28.0%, n=35). High rates of homelessness (72%, n=90), low complete vaccinations (26.4%, n=33), need for interpreters (49.6%, n=62) and insecure access to primary care (35.2%, n=44) were noted. Attendance at first appointment was 76.8% (n=96). 8% (n=10) cancelled due to illness. of those who did not attend, 52.6% (n=10) attended a rescheduled appointment. Initiatives developed include: streamlined healthcare for migrant children, integrated dental care pathways and opportunistic vaccination.

CONCLUSIONS

A PIH service for children experiencing social deprivation enabled us to better understand individual and population needs. Tailored interventions to enable equitable access has developed methods that facilitate attendance and promote health in the most marginalised children in our society.

EP883 / #1728**E-Poster Viewing - Paediatrics AS04-24. Public health & social paediatrics****Identified health needs of roma children through outreach paediatric services****A. Walsh^{1*}, R. Clarke², E. Molloy³, C. Ní Cheallaigh⁴, C. Hensey²**¹Children's Health Ireland at Temple Street, General Paediatrics, Dublin, Ireland²Children's Health Ireland at Temple Street, General Paediatrics, Dublin, Ireland³Prof of Paediatrics, Trinity College Dublin, Dublin, Ireland⁴Trinity College Dublin, Clinical Medicine, Dublin, Ireland**BACKGROUND AND AIM**

In Ireland, little is known about the health of children from the Roma community with no population health data available. An estimated 5000 Roma live in Ireland. Factors influencing Roma health include low education and health literacy levels, social exclusion, cultural differences, historical trauma and financial constraints. Effective healthcare provision is hindered by these factors and lack of equitable access to necessary services.

METHODS

An outreach clinic for children at risk of social exclusion provided a unique opportunity to engage Roma children and to better understand their specific health care needs and social determinants of health (SDH). The service was developed in partnership with existing Roma health and community services. Interpreters were utilised to verbally communicate appointment details and transport was arranged by hospital services when needed.

RESULTS

Over 17 months 49 Roma children were referred for general Paediatric assessment. 81.6% 89.8% (n=44) were homeless, 85.7% (n=42) had no formal access to primary care. 93.9% (n=46) required interpreters. Only 16.3% (n=8) were fully vaccinated. Anaemia, vitamin D deficiency, dental disease and poor growth and nutrition were commonly identified issues. 61.2% (n=30) required hospital follow-up, with many significant pathologies identified.

CONCLUSIONS

Roma children referred to the clinic experienced marked social adversity and had extremely limited access to primary healthcare. Services have developed as a result to promote healthcare access such as Roma cultural ambassadors attending outreach clinics, streamlined dental care pathways and opportunistic vaccination. Future planning includes specialised clinics with community liaison and a role in health promotion supporting primary care initiatives.

EP884 / #1194**E-Poster Viewing - Paediatrics AS04-25.
Pulmonology****Management of croup among italian pediatricians:
a national survey****G. Toschi Vespasiani¹, L. Pierantoni², G. Stera¹, L. andreozi^{2*},
C. Totaro¹, M. Lanari²**¹Alma Mater Studiorum of Bologna, Specialty School of Paediatrics, Bologna, Italy²IRCCS Azienda Ospedaliero-Universitaria di Bologna, Paediatric Emergency Unit, Bologna, Italy**BACKGROUND AND AIM**

Adherence to recommendations in croup management is reported to be low. Aim of our survey was to investigate croup management among Italian pediatricians, both Hospital Pediatricians (HP) and Primary Care Pediatricians (PCP).

METHODS

Italian pediatricians were invited to participate and questioned separately using an online questionnaire (Qualtrics®) between February and May 2021.

RESULTS

1,849 pediatricians were invited; 694 completed the questionnaire (323 HP; 326 PCP, response rate: 58% and 26%, respectively). Westley Croup Score (WCS) is used to assess croup severity only by 23.5% of HP and 4.0% of PCP, although most (HP 75.3%; PCP 57.3%) of them declare to have a different approach according to severity. Inhaled corticosteroids (ICS) are often prescribed for mild croup (HP 75.8%; PCP 75.1%), while oral corticosteroids (OCS) prescription are uncommon (HP 8.1%; PCP 6.2%). A combination of ICS and

OCS is preferred (HP 40.0%; PCP 56.8%) for moderate croup. Nebulized epinephrine is commonly used in severe croup (81.5%) especially by HP (HP 95.3%; PCP 67.6%; $p < 0.001$). Budesonide and Betamethasone were the most commonly used ICS and OCS, respectively. Dexamethasone was preferred by PHP ($p < 0.001$).

CONCLUSIONS

Data showed a poor adherence to recommendations. WCS is little known and applied, resulting in a low adherence to recommendations. Moreover, ICS are preferred over OCS. National guidelines are needed to guide Italian pediatricians through the proper croup management.

EP885 / #678**E-Poster Viewing - Paediatrics AS04-25.
Pulmonology****Diagnostic performance of multiplex pcr
pneumonia panel and its role in pediatric
pneumonia management****A. Angelova^{1*}, I. Paskaleva², R. Komitova^{3,4,5}, M. Atanasova¹, K. Ketev⁶,
G. Lengeova¹, J. Kalchev⁷, T. Dimcheva⁸, M. Murdjeva⁷**¹Medical University of Plovdiv., Microbiology and Immunology, Plovdiv, Bulgaria²University Hospital, Pediatrics and Medical Genetics., Plovdiv, Bulgaria³Medical University, Infectious Diseases, Plovdiv, Bulgaria⁴University Hospital, Infectious Diseases, Plovdiv, Bulgaria⁵Medical University of Plovdiv., Infectious Diseases, Plovdiv, Bulgaria⁶Medical University, Medical Simulation Training Center At Research Institute, Plovdiv, Bulgaria⁷Medical University of Plovdiv., Microbiology and Immunology, Plovdiv, Bulgaria⁸Medical University of Plovdiv., Medical Informatics, Biostatistics, and E-learning., Plovdiv, Bulgaria**BACKGROUND AND AIM**

Conventional microbiological methods for lower respiratory tract infections are currently too slow and insensitive to guide early antibiotic treatment. Syndrome-specific diagnostic panels have the potential to determine the etiology more rapidly. We aimed to evaluate the multiplex PCR (mPCR) BioFire FilmArray Pneumonia panel plus (BFPP) in establishing a fast microbiological diagnosis and better antimicrobial treatment in pediatric pneumonia

METHODS

Tracheal aspirate, sputum, bronchoalveolar lavage and pleural fluid samples from 36 children with severe pneumonia were analyzed in parallel by traditional culture methods and BFPP. The panel's diagnostic performance was compared to respiratory specimen cultures as the reference standard test.

RESULTS

Although insignificantly ($p=0.090$), the panel increased microbiological yield from 18 positive results out of 36 samples in the microbiological culture to 26/36 in mPCR. Twenty-four children required mechanical ventilation, and 62,5 % of them died during hospitalization. Coinfections (both viral-bacterial and multiple bacterial pathogens) were identified in 44,4.% of cases. After re-evaluation of the empirical antimicrobial therapy, a potential to change it adequately according to mPCR results was found in 21 out of 36 (58,3%) patients. In six patients, a pathogen not covered by current therapy was detected, requiring antibiotic escalation. In the other 15 patients, antimicrobials could have been de-escalated

CONCLUSIONS

The mPCR panel testing in the diagnostic work-up of pediatric pneumonia increased the chance for precise and fast microbiological diagnosis and could aid in improving antibacterial therapy.

EP886 / #2640**E-Poster Viewing - Paediatrics AS04-25.
Pulmonology****Necrotizing pneumonia. Review of the cases in a
third-level hospital.**

L. Armendáriz Lacasa*, F. Castillo-Gómez, G. Garcia Del Cerro,
F. Thorndike, M. Freixas Bermejo, S. Boronat-Guerrero

Hospital de la Santa Creu i Sant Pau, Paediatrics Department, Barcelona, Spain

BACKGROUND AND AIM

Necrotizing pneumonia is the most serious complication of community-acquired pneumonia. It is characterized by the loss of the architecture of the lung parenchyma and cavitated lesions. Although rare in children, an increased incidence has been detected. The objective of this study is to describe the epidemiology, clinical features, microbiology, management and prognosis of paediatric patients diagnosed with necrotizing pneumonia in a tertiary care hospital.

METHODS

Retrospective observational study, in patients <18 years old, diagnosed with necrotizing pneumonia from January 2009 to April 2019.

RESULTS

18 patients with a mean age of 5 years (1.5-15 years) were diagnosed with necrotizing. Most of them were male 73% (13) and all but one had updated vaccination schedule. In all cases, a blood culture was obtained, with little yield (77% negative – 14) and a study of pleural fluid was performed. The most frequently identified germ in the pleural fluid was *S. pyogenes*.

TABLE 1:

Pleural fluid microbiology	Cases	%
Negativo	11	50
<i>S. pyogenes</i>	7	31.8
<i>S. pneumoniae</i>	4	18.1

All received early intravenous antibiotic therapy.

TABLE 2:

Other treatments	Cases	%
Pleural drainage	22	95.6
Fibrinolysis	12	52.1
Thoracoscopy	11	47.8
Thoracotomy + Decortication	3	13

The majority presented healing without sequelae.

TABLE 3:

Complications	Cases	%
Bronchopleural fistula	3	13
Pneumatocele	3	13
Exitus	1	4.3

CONCLUSIONS

Necrotizing pneumonia, although rare, has high morbidity that predominates in preschool ages. Due to early antibiotic therapy, the yield of microbiological cultures is usually low. Its prompt diagnosis and correct treatment are the key for a better prognosis, with sequelae being rare.

EP887 / #2341

E-Poster Viewing - Paediatrics AS04-25. Pulmonology

High flow nasal cannula therapy in infants with severe bronchiolitis

H. Ben Belgacem*, S. Tilouche, M. Barkallah, N. Soyah, M. Abdelbari, S. Ghorbel, R. Kebaili, A. Tej, J. Bouguila, L. Boughamoura

Farhat Hached University Hospital, Pediatrics Departments, Sousse, Tunisia

BACKGROUND AND AIM

High-flow nasal cannula oxygen therapy (HFNC) is a technique for noninvasive ventilation commonly used in pediatric intensive care units for acute bronchiolitis. **Objectives:** To evaluate the interest in using HFNC in the pediatric intensive care unit for infants with severe bronchiolitis.

METHODS

A retrospective and comparative study was conducted in the intensive care unit of the pediatric department of Farhat Hached hospital to compare two periods: P0 (before the introduction of HFNC) from 2013 to 2015 P1 (after its introduction: from 2015 to 2017 We compared clinical characteristics, gasometric data, and duration of oxygenation and hospitalization in the two groups.

RESULTS

We included 179 patients (92 in P0 VS 87 in P1). Respiratory status was more severe in the HFNC group. Respiratory acidosis was more present in patients in P1 ($p < 10^{-3}$). For patients in P1, the pH increased by 0.03 ($p = 0.01$), and capnia decreased by 5 mmHg ($p < 10^{-3}$) after 4 to 6 hours. In P1, only 8% of

infants admitted to the intensive care unit for bronchiolitis were intubated, compared to 20.7% in P0 ($p=0.01$). A significant reduction in the total duration of hospitalization and the intensive care unit stay were noted between P0 and P1. Oxygen therapy was shortened by 3 days in the HFNC group ($p<10^{-3}$). The complication rate went from 35% in P0 to 14.9% in P1 ($p<10^{-3}$). The mortality rate decreased significantly from 13% in P0 to 3.4% in P1.

CONCLUSIONS

HFNC therapy seems to be an advantageous therapeutic option in the early treatment of infants with severe bronchiolitis.

EP888 / #869

E-Poster Viewing - Paediatrics AS04-25. Pulmonology

Does a nurse-led weaning protocol with a spontaneous breathing trial in critically ill children lead to a shorter duration of ventilation? A multi-center STUDY

A. Duyndam^{1*}, M. De Neef², R.J. Houmes¹, J. Smit¹, R. Klein-Blommert², M. Van Gestel², R. Pheil³, M. Ijland³, J. Van Rosmalen¹, J. Van Woensel², J. Lemson³, D. Tibboel¹, M. Van Dijk¹, E. Ista¹

¹Erasmus MC Sophia Rotterdam, Picu, Rotterdam, Netherlands

²Emma Children's Hospital Amsterdam UMC, location University of Amsterdam, Picu, Amsterdam, Netherlands

³Radboudumc-Amalia Children's Hospital, Picu, Nijmegen, Netherlands

BACKGROUND AND AIM

To determine the effects of a nurse-led weaning protocol on duration of ventilation (DOV) in mechanically ventilated children.

METHODS

Design: A multi-center pre-post study in which DOV was compared between usual care and nurse-led weaning including a spontaneous breathing trial. Setting: Three Pediatric Intensive Care Units in the Netherlands Main outcome measures: Primary outcome: DOV. Secondary outcomes: length of stay, reintubation rate and protocol compliance.

RESULTS

One hundred and nineteen children (median age 1.7 months [IQR 0.5-7.8]) received usual care and 157 (median age 2.0 months [IQR 0.0-10.8]; $p=0.14$) received nurse-led weaning. The median DOV for usual care was 116.0 hours (IQR 81.8-169.0), and for protocolized weaning 122.0 hours (IQR 85.0-163.5). Multivariate analysis showed no significant difference in DOV between the pretest and posttest periods ($p=0.79$). Estimated difference in DOV was -0.02 (IQR -0.14 - 0.11) for nurse-led weaning. Study site, gender, age, admission indication and PRISM were not significantly associated with a reduction of DOV. In a univariate analysis, there was no significant difference in median length of stay between the pretest and posttest periods; 8.1 [IQR 5.7-14.1] days for usual care versus 9.9 [IQR 6.6-15.0]; $p=0.43$ days for protocolised weaning. The reintubation rate was not significantly different between groups (5.7% vs. 8.2%; $p=0.602$). The rate of compliance with protocolised weaning was 77.7%.

CONCLUSIONS

We found a non-significant shorter duration of ventilation for nurse-led weaning compared to usual care in an observational multi-center setting in critically ill children ventilated longer than 48 hours.

EP889 / #2273

E-Poster Viewing - Paediatrics AS04-25. Pulmonology

Recurrent spontaneous pneumothorax: typical biotope and idiopathic etiology

J. Faria^{1*}, A. Feio², B. andrade², F. Rocha², D. Ferreira²

¹Centro Hospitalar do Médio Ave, Paediatrics, Vila Nova de Famalicão, Portugal

²Centro Hospitalar do Médio Ave, Pediatrics, Braga, Portugal

BACKGROUND AND AIM

Spontaneous pneumothorax (SP) occurs in the absence of identified trauma. Primary SP usually observe in adolescents without underlying lung pathology. In contrast, secondary SP occurs in pre-existing lung conditions such as asthma, Marfan Syndrome or cystic fibrosis.

METHODS

We present a 15-year-old, previously healthy boy hospitalized due to left side pneumothorax that ultimately resolved after pleural drainage and 6-day oxygen therapy. He was recommended to avoid abrupt movements, coughing, sneezing and contact sports. One year later, he presented with a second left-side SP episode. After pleural drainage, he was referred to the thoracic surgery department for an apex resection and pleurodesis. At the age of 17, he had a third episode of SP, but in the right lung. The boy was treated with active, passive drainage and oxygen therapy, followed by subsequent apex resection and pleurodesis. The thoracic CT revealed no bules, cystic lesions, or other pathological findings. The α 1-antitrypsin level, lung function test and the other laboratory data were normal.

RESULTS

Few studies in the literature describe the risk factors for recurrent primary SP; hence, it is difficult to predict. However, some studies have been carried out to assess the risk of primary SP recurrence after surgical intervention at first presentation. The vast majority concluded that the recurrence rate after the surgical intervention was higher. of note, some cases demonstrate that surgery at first presentation of SP appears to predict the occurrence of SP on the contralateral lung.

CONCLUSIONS

In conclusion, in children, pleurodesis and pleural resection should be postponed.

EP890 / #1432

E-Poster Viewing - Paediatrics AS04-25. Pulmonology

Management of wheezing in children aged >1 year at the paediatric emergency department

M. Galea*, C. Schembri, R. Farrugia

Mater Dei Hospital, Department of Child and Adolescent Health, Msida, Malta

BACKGROUND AND AIM

Asthma is a common medical emergency, with one in three children having at least one wheezing episode prior to three years of age. International guidelines recommend salbutamol (via inhaled route for mild/moderate exacerbations or nebulised for severe episodes) and systemic steroids as first-line treatment. The aim of this audit is to evaluate the current first line management of wheezing in children at the paediatric emergency department (PED).

METHODS

This is a retrospective observational study involving all children aged over one year of age presenting to PED at Mater Dei Hospital with wheezing exacerbation during February and March 2022. Asthma severity was graded as mild/moderate, severe or life-threatening as per SIGN 158 British guideline on the management of asthma. Data regarding salbutamol delivery route, administration of systemic steroids and time at presentation and at treatment administration were collected from patient records. T-test was used for significance.

RESULTS

A total of 71 children were included; mean age 3.1 years. of these, 52.1% (37/71) had a mild/moderate wheezing exacerbation. The median time to salbutamol administration was 20 minutes (Interquartile range [IQR] 5, 65), with no significant time difference for mild/moderate or severe exacerbations (p 0.16). Only 2 children (5.4%) with mild-moderate exacerbations were administered inhaled salbutamol as first-line treatment. Steroids were prescribed for 59/71 children at a median time interval of 40 minutes (IQR 15, 94) following presentation.

CONCLUSIONS

This audit shows that prompt treatment is being administered to children presenting with wheezing exacerbations. However, nebulised salbutamol is preferred over inhaled salbutamol for mild/moderate exacerbations.

EP891 / #1006

E-Poster Viewing - Paediatrics AS04-25. Pulmonology

Pre-pandemic and pandemic patterns of respiratory diseases referred to pediatric emergency: experience from lithuanian university of health sciences hospital

L. Jankauskaitė^{1*}, U. Kubiliūtė², L. Štendelytė², E. Gelšvartaitė²

¹Lithuanian University of Health Sciences, Pediatrics, Kaunas, Lithuania

²Lithuanian University of Health Sciences, Medical Academy, Kaunas, Lithuania

BACKGROUND AND AIM

Due to different protection methods (face masks, social distancing etc.) following SARS-CoV-1 pandemics, many countries reported decrease in respiratory tract infections (RTI). Thus, we aimed to investigate pre-pandemic and pandemic pediatric RTI cases referred to our University Hospital pediatric emergency (PED).

METHODS

Retrospective analysis from electronic record data system was conducted including children aged 0-18 years from 2018 1st of January to 2021 31st of December. We collected following working diagnosis: upper viral, bacterial respiratory tract diseases (URTI) (tonsillitis, adenoiditis, nasopharyngitis, pharyngitis, laryngitis); lower respiratory diseases (LRTI) (tracheitis, bronchitis, tracheobronchitis, bronchiolitis, asthma, pneumonia), and influenza. Data were analyzed according to year and/or age group. Statistical analysis was done using SPSS 27.0; $p < 0.05$ was considered significant.

RESULTS

In total, 17620 cases of RTI were included, 45% were female. Clear decrease in URTI and LRTI was observed starting from 2020 March (first lock-down in Lithuania) (URTI:3740/2018y→4201/2019y→2091/2020y→3522/2021y; LRTI:969/2018y→1054/2019y→533/2020y→944/2021y). Biggest drop was seen in flu cases, with clear decrease since 2020 March (122→212→131→0). In total, 1-12y children comprised majority of URTI (92%) and LRTI (86%). We observed an increase of URTI in 2021 in 1-5y age group (68%(from total)/2018y→69%/2019y→75%/2020y→81%/2021y). Same patterns were observed in LRTI. We noted significant increase in 2021 in bronchiolitis (52/2018y→47/2019y→26/2020y→80/2021y), laryngitis (253/2018y→315/2019y→83/2020y→666/2021y) and bronchitis (306/2018y→295/2019y→155/2020y→423/2021y).

CONCLUSIONS

Our analysis revealed clear patterns of drop of RTI during pandemics and significant increase in 2021y of such viral diseases as bronchiolitis and laryngitis, and bronchitis. This contributes to other worldwide data and shows a clear post-pandemic shift of some of the viral diseases.

EP892 / #1101

E-Poster Viewing - Paediatrics AS04-25. Pulmonology

Impact of covid-19 pandemic on indoor air pollution in primary schools and risk of pollution related effects on child health

I. Juskiene^{1*}, N. Prokopciuk^{1,2}, A. Valiulis^{1,3}

¹Vilnius University Faculty of Medicine, Clinic of Children's Diseases, Institute of Clinical Medicine, Vilnius, Lithuania

²Vilnius University Faculty of Medicine, Institute of Biomedical Sciences, Vilnius, Lithuania

³Vilnius University Faculty of Medicine, Department of Public Health, Institute of Health Sciences, Vilnius, Lithuania

BACKGROUND AND AIM

According to recent studies indoor air pollutants, especially in the size range of 0.3–1 µm can play a major role for the development of asthma in younger school age children (Juskiene I, 2022). Objective. We compared indoor air pollution in the classrooms of 11 primary schools of Vilnius during the pre-COVID (2017-2018 year of education) and COVID (2020-2021) periods.

METHODS

Optical Particle Sizer (OPS, TSI model 3330) of particle number (PNC) and mass concentrations (PMC) (size range of 0.3-10 µm) was used. During the COVID pandemic the measurements of indoor air pollution were measured in autumn and spring only, because in winter time the primary schools were closed due to quarantine.

RESULTS

In autumn of 2017 the mean PNC (0.3-1.0 μm) in 11 schools was 55 ± 40 particles/ cm^3 , while in spring of 2018 it was 41 ± 24 particles/ cm^3 . The mean PNC (COVID period) in autumn of 2020 was 89 ± 57 particles/ cm^3 , while in spring of 2021 it dropped down to 21 ± 11 particles/ cm^3 . If we consider the entire year of education, we found that the mean PNC (0.3-1.0 μm) in all 11 schools (pre-COVID period) was 55 ± 35 particles/ cm^3 and in COVID period it reached 57 ± 25 particles/ cm^3 . The mean total PNC (0.3-10 μm) in the same schools (pre-COVID and COVID periods) was 57 ± 36 and 59 ± 25 particles/ cm^3 respectively. Same trend was found during the evaluation of PMC.

CONCLUSIONS

We concluded that during the COVID pandemic annual indoor air pollution in schools in contrast to outdoor air pollution did not diminish keeping high risk of pollution related effects on child health.

EP893 / #1663

E-Poster Viewing - Paediatrics AS04-25. Pulmonology

Foreign body aspiration in children in tunisia

S. Mdimegh^{1*}, J. Bouguila¹, M. Ben Guedria¹, R. Kbaili¹, A. Tej¹,
N. Soyah¹, S. Ghorbel¹, M. Abdelbari¹, H. Belgacem¹, M. Abdelkafi²,
S. Tilouche¹, L. Boughamoura¹

¹Farhat Hached Hospital, Pediatric, Sousse, Tunisia

²Farhat Hached Hospital, Ent, Sousse, Tunisia

BACKGROUND AND AIM

Accidental Foreign Body Aspiration (FBA) in children is one of the most common causes of domestic accidents in children under five years old. The aim of our study is to report cases of FBA and to present the difficulties related to their management

METHODS

We conducted a retrospective study over a period of five years (January 2017- December 2021). We studied the epidemiological aspects, age, and gender, elapsed time until being referred to the hospital, presenting symptoms, radiological exams; type and location of aspirated FB

RESULTS

The study included 40 patients, Children aged one to three years represented 80% of the patients, with an average age of two years and six months. A clear male predominance was noted: 29 were boys (73%) and 11 girls (28%). Main symptoms motivating the consultation were: Cough (93%), cyanosis (43%) and dyspnea (58%). Most of the children (50%) were admitted within 48 hours after aspiration, while 7 (18%) had a history of FBA between 6 days

and 6 months before. Rigid bronchoscopy was performed on the majority of patients (93%). The average delay to perform bronchoscopy was 70 hours since admission, with an average of 18 days from the onset of symptoms. The right bronchus was the most frequent location of FB detection and FB of organic origin were the most common in our study (68%) dominated by dried vegetables (53%).

CONCLUSIONS

FBA remains one of the frequent accidental pathologies in children under three years and any suspicion must imperatively be supported by radiological or bronchoscopic confirmation to avoid delay in management.

EP894 / #1033

E-Poster Viewing - Paediatrics AS04-25. Pulmonology

Evaluating the impact of covid-19 on respiratory infections and presentations in a district general hospital

S. Patel*, P. Vallabhaneni

Swansea Bay University Health Board, Paediatrics, Swansea, United Kingdom

BACKGROUND AND AIM

To quantify and evaluate the impact of the SARS-CoV-2 pandemic on hospital admissions and paediatric respiratory infections in a large district general hospital located in Swansea, Wales.

METHODS

A retrospective cohort study evaluating data for hospital attendance to the paediatric assessment unit and admission to in-patient wards. Data was collected for children aged under 16 years who were diagnosed with common respiratory paediatric infections (exacerbation of asthma, bronchiolitis, chest infection, pneumonia, viral-induced wheeze). The number of children diagnosed with respiratory infections from March 2020 to February 2021 (COVID year), was compared with the 4 preceding pre-COVID years (March 2016 – February 2020)

RESULTS

There were 596 admissions with diagnosed respiratory infections from March 2020 to February 2021 compared to an annual average of 2385 (range 2557-2223) from pre-COVID years. There was an average 75% reduction in all

respiratory infections in the COVID year compared with the average during pre-COVID years: bronchiolitis (-85%), chest infection (-78%), pneumonia (-77%), viral-induced wheeze (-74%) and asthma (-60%).

CONCLUSIONS

The SARS-CoV-2 pandemic has caused a stark decline in the incidence of paediatric respiratory infections diagnosed in hospitals in Swansea. This can be attributed to many social changes adopted during the pandemic, including but not limited to school closures, isolation, and travel restrictions. Our experience is similar to reports from across the world. As restrictions begin to ease it would be interesting to monitor the trends of respiratory infections.

EP895 / #2164

E-Poster Viewing - Paediatrics AS04-25. Pulmonology

Incidence of alpha-1 antitrypsin pi*s and pi*z alleles in the lithuanian cohort of wheezing children

E. Poluzioroviene^{1*}, J. Chorostowska-Wynimko², A. Valiulis^{1,3}

¹Vilnius University Faculty of Medicine, Institute of Clinical Medicine, Vilnius, Lithuania

²National Institute of Tuberculosis and Lung Diseases, Department of Genetics and Clinical Immunology, Warsaw, Poland

³Vilnius University Faculty of Medicine, Department of Public Health, Institute of Health Sciences, Vilnius, Lithuania

BACKGROUND AND AIM

It was earlier reported the importance of alpha-1 antitrypsin deficiency SS, SZ, and ZZ phenotypes for chronic obstructive pulmonary disease (COPD). We aimed to evaluate the frequency of Pi*S and Pi*Z allele among the Lithuanian cohort of preschool wheezers.

METHODS

133 wheezing children under 72 months of age were enrolled. Alpha-1 antitrypsin (AAT) serum concentration was measured by nephelometry, Pi phenotype was identified by real-time PCR. The Pi*S and Pi*Z alleles were identified by isoelectrofocusing. We compared the frequency of Pi*S and Pi*Z in our cohort with earlier reported data on the frequencies of the same alleles in COPD patients from the Central-Eastern European AAT Network and non-disease specific epidemiological studies done in Lithuania (Chorostowska-Wynimko J, 2013; Serapinas D, 2009).

RESULTS

Mean age of wheezers was 23.99 ± 16.82 months with the predominant male gender - 89 (66,9%) cases. Pi*S was found in 3 (2.26%), and Pi*Z in 9 (6.77%) patients. Rare mutations were identified in 3 (2.26%) cases. The frequency of Pi*S and Pi*Z alleles among wheezing children was 11,3 (95% CI: 4,8- 17,8) and 45,1 (95% CI: 32,2-58), respectively. It is close to the frequency of these alleles among COPD patients - 15,8 (95% CI: 6,92-24,6) and 46,1 (95% CI: 31,1-60,9), respectively. Pi*Z allele was statistically significant more common if compare with data from non-disease specific epidemiological studies - 45,1 (95% CI: 32,2-58) vs 13,6 (95% CI: 10,7-17,4).

CONCLUSIONS

We concluded that some wheezing phenotypes in early childhood can be the target for the future investigation of the origin and first manifestation of COPD.

EP896 / #1168

E-Poster Viewing - Paediatrics AS04-25. Pulmonology

Treatment and outcome of chylothorax in children: 20-year experience of a single institute

**K. Ruangnapa*, W. Anuntaseree, K. Saelim, P. Prasertsan,
M. Puwanant, S. Dissaneevate**

Faculty of Medicine, Prince of Songkla University, Pediatrics, Hatyai, Thailand

BACKGROUND AND AIM

Chylothorax is an uncommon cause of pleural effusion in children. This study aims to determine the characteristics, treatment strategies, and outcomes of chylothorax in children from a single institute.

METHODS

The 65 episodes of chylothorax in patients aged 0-15 years who were diagnosed and received treatment in Songklanagarind Hospital between January 2001 and December 2020 were analyzed.

RESULTS

of the 65 episodes, 80% were postoperative chylothorax, which mostly were related to cardiac surgery, and 10% occurred bilaterally. The most common treatment strategy used was nutritional modification (64.6%). Octreotide was used as adjunctive therapy in 33.8% cases. Most cases of chylothorax were successfully treated by conservative treatment, while 10.7% (7/65) required surgical therapy. Young children aged <1 year were more likely to require mechanical ventilation and develop ventilator-associated pneumonia and

catheter-related complications. The factors associated with death or prolonged hospitalization were non-postoperative chylothorax, fasting of more than 14 days, having intercostal drainage (ICD)-related complications, and ventilator-associate pneumonia.

CONCLUSIONS

The most common type of chylothorax among children occurred postoperatively. Most case (89.2%) of chylothorax cases were successfully treated conservatively, using dietary modification and octreotide therapy. Young children age <1 year have a higher rate of complications during treatment of chylothorax.

EP897 / #645

E-Poster Viewing - Paediatrics AS04-25. Pulmonology

Diaphragm eventration; a rare cause of respiratory distress in infants

B.B. Yilmaz*

Nevşehir, Nevşehir State Hospital, Nevşehir, Turkey

BACKGROUND AND AIM

CASE: 8-month-old girl, was born at full term with cephalic presentation and weighed 3000 gr. The mother knew of no respiratory symptoms, but since the age of 3 months the girl had suffered from anorexia and vomiting and normal development was retarded. At the time of examination her weight was a normal 7.5 kg. On examination, patient had a respiratory rate of 55/min. Chest examination revealed decreased movements on left infra-mammary, infra-axillary, and infrascapular areas. Tactile vocal fremitus was decreased and note was impaired on the left infrascapular area. Breath sounds were decreased in the left infra-axillary and infrascapular areas. Extensive crepitations were heard throughout the left lung field. Chest X-ray showed raised dome of left diaphragm and mediastinal shift to the right side. In the case also the left eventration of the diaphragm was successfully treated with plication

CONCLUSION: Eventration of the diaphragm can present with recurrent respiratory tract infections in infants, and a differential diagnosis of eventration should be kept in mind.

METHODS

Eventration of the diaphragm (ED) is a relatively rare condition.

RESULTS

CONCLUSION: Eventration of the diaphragm can present with recurrent respiratory tract infections in infants, and a differential diagnosis of eventration should be kept in mind.

CONCLUSIONS

CONCLUSION: Eventration of the diaphragm can present with recurrent respiratory tract infections in infants, and a differential diagnosis of eventration should be kept in mind.

EP898 / #896

E-Poster Viewing - Paediatrics AS04-26. Quality improvement

Improving clinical documentation: introduction of electronic health records in paediatrics

M. Ahmed*, J. Koh

University Hospitals of Derby and Burton NHS Foundation Trust, Paediatrics, Burton Upon Trent, United Kingdom

BACKGROUND AND AIM

Medical records are crucial facet of a patient's journey, providing clinician with a permanent record of the patient's illness and ongoing medical care. In many hospitals, patient medical records are written on paper which are liable to misinterpretation due to illegibility and misplacement. This can affect the patient's medical care and has medico-legal implications. Electronic patient records (EPR) have been introduced to replace patient's paper notes with the aim of providing a reliable record-keeping system. It is perceived that EPR improve the quality and efficiency of patient care. We aimed to improve and standardise clinical documentation of paediatric admissions and ward round notes by developing electronic proforma for initial paediatric clerking, ward rounds and patient reviews.

METHODS

The paediatric department at Queen's Hospital Burton uses a mix of paper notes and computerised medical records. Clinicians primarily use paper notes for admission clerking, ward rounds, ward reviews and outpatient clinic consultations. Laboratory tests, imaging results and prescription requests are executed via the EPR system. Documentation by nurses is also carried out electronically.

RESULTS

This quality improvement project improved clinical documentation on the paediatric wards and enhanced patient record-keeping, boosted clinical information sharing and streamlined patient journey. We undertook a staff survey to investigate the opinion before and after implementing the electronic health record. Doctors, nurses and healthcare support workers overwhelmingly supported the quality, usefulness, completeness of specified fields and practicality of the electronic records.

CONCLUSIONS

This project completely fulfilled various generic multidisciplinary record keeping audit tool standards endorsed by the Royal College of Physicians.

EP899 / #1230

E-Poster Viewing - Paediatrics AS04-26. Quality improvement

Point-of-care ultrasound scanning in paediatric post-graduate training: a survey of practice and trainee perspectives

S. Brown^{1,2*}

¹University of Birmingham, College of Medical and Dental Sciences, Birmingham, United Kingdom

²University Hospital Coventry and Warwickshire NHS Trust, Neonatal Unit, Coventry, United Kingdom

BACKGROUND AND AIM

Point-of-care ultrasound (POCUS) is being increasingly used as an adjunct to bedside clinical care. Emerging evidence shows a role for it across paediatric subspecialties. This study aims to address the experience of paediatric trainees with POCUS and what their views are on its value to paediatric post-graduate training.

METHODS

A web-based survey invite was disseminated to all 315 paediatric post-graduate doctors in training in the West Midlands region (UK) between July-August 2021.

RESULTS

Sixty responses were received (response rate 19%). Exposure to the different forms ranged from higher (98% for cranial ultrasound, 75% for echocardiography) to lower (40% for vascular access, but only 25% for lung, 17% for abdominal and 10% for soft tissue ultrasound). Self-reported confidence in skills was compared between cranial ultrasound scans and echocardiography,

on the whole being higher for cranial ultrasounds. Echocardiography was felt less relevant to training (excluding those with subspecialty interests), cranial ultrasound skills were deemed relevant by most trainees, and there was a skew towards greater perceived relevance for vascular access ultrasound. There was limited exposure to lung, abdominal and soft-tissue POCUS, with trainees feeling these had only limited, specific application, depending on paediatric subspecialty. Advantages to POCUS training were seen as increased knowledge, confidence and patient care. Barriers were equipment, supervision and training availability, as well as time/resource costs.

CONCLUSIONS

These findings show there is scope to improve POCUS training in paediatrics, although this needs to be targeted to those who would benefit most in their career pathways.

EP900 / #1163

E-Poster Viewing - Paediatrics AS04-26. Quality improvement

Audit of referrals to specialist developmental CLINIC

S. Cavallari*, A. Khan

Cork University Hospital, Department of Paediatrics, Cork, Ireland

BACKGROUND AND AIM

The importance of early intervention in children with developmental delay is well established (1). Across Ireland as of February 2022, there are over 600 children awaiting outpatient appointments for developmental paediatric clinics, of whom one third have been waiting greater than 18 months (2). Wait times are allocated on the basis of information provided in referral letters. Robust referral information is crucial to accurately triage patients. The aim is to audit referrals to paediatric developmental clinic in Cork University Hospital.

METHODS

Referrals to developmental clinic between 2018 and 2021 were identified. A randomly selected sample was analysed. Data was collected on an anonymised audit form and compared against the criteria of Irish College of General Practitioner's national standards.

RESULTS

Approximately 220 referrals were made to developmental clinic between 2018 and 2021. Forty seven were randomly selected; 29 male, 18 female. The age ranged from 7 months-12 years, with a median age of 6 and a half years. Most referrals received from GPs (55%), Area Medical officers (19%),

and Consultants (17%). All referrals included referral reason, however 68% described symptoms, and 61.7% included an examination. The majority of referrals were due to motor, and speech & language delay with 19 referrals each. Multiple referrals related to more than one domain.

CONCLUSIONS

Referrals to developmental clinics are received from a range of disciplines. While all included reasons for referral, no other area of standard referral information was provided consistently. Poor compliance to standardised referral forms could affect efficacy of referral triage. (1) *Infants Young Child*. 2011 January 1; 24(1): 6–28. doi:10.1097/IYC.0b013e3182002cfe. (2) <https://www.ntpf.ie/home/pdf//2022/02/nationalnumbers/out-patient/National02.pdf>

EP901 / #923

E-Poster Viewing - Paediatrics AS04-26. Quality improvement

Barriers and facilitators to pediatric fluoride varnish application in primary care medical offices in the united states: a qualitative STUDY

S. Goff^{1*}, E. Decou¹, K. Wallace¹, C. Gilson¹, A. Kranz²

¹University of Massachusetts, Health Promotion and Policy, Amherst, United States of America

²RAND Corporation, Health Policy Research, Washington DC, United States of America

BACKGROUND AND AIM

Dental caries is one of the most prevalent preventable non-communicable diseases among children in developed and developing countries worldwide. Dental caries causes substantial morbidity, yet delivery of pediatric preventive oral health services, including application of fluoride varnish (FV), varies widely in the European Union and United States. This qualitative study identified barriers and facilitators to FV application at multiple levels (policy, organizational, provider, patient/family) in primary care medical settings in the US.

METHODS

Semi-structured interviews are currently being conducted with a purposive sample of pediatric primary care and family medicine practices and are expected to be completed by June 1, 2022. Interview transcripts are being analyzed using thematic analysis and the constant comparative method. Emerging major themes and subthemes are being identified both deductively and inductively.

RESULTS

Eleven interviews have been conducted to date. Emerging themes include: 1) Positive impact of state and national policy on FV application in medical

settings, including coverage by private and public medical insurers; 2) Role of practice leadership in facilitating application; 3) Effectiveness of automated systems; 4) Desire for integration of dental and primary care systems; 5) Variation in provider awareness of national guideline content; and 6) Potential for value-based care payment systems to promote FV application.

CONCLUSIONS

FV is a low-cost, low-risk effective intervention for preventing dental caries in children <6 years of age. This study suggests important policy and organizational levers that may be applied across different policy and practice contexts to increase FV application rates for young children.

EP902 / #666

E-Poster Viewing - Paediatrics AS04-26. Quality improvement

Dreams of emma children's hospital

L. Haverman*, C.-J. Van Der Perk, B. Geven, L. Teela, M. Meulekom, M.A.J. Luijten, K. Fijnvandraat, J. Maaskant

Amsterdam University Medical Center, Pediatrics, Amsterdam, Netherlands

BACKGROUND AND AIM

Transforming healthcare services is necessary to react effectively to rapidly changing surroundings. Transition to a learning healthcare organization is believed to be sustainable in the twenty-first century, as it is characterized by the alignment of science, informatics, incentives and culture, with best practices and participation of stakeholders. In the Emma Children's Hospital, we started this transition by mobilizing the 'wisdom of the crowd'.

METHODS

We invited all healthcare professionals employed by Emma Children's Hospital to share their dreams on future pediatric care, without restrictions on the content or mode of expression, but limited to one page. The dreams were analyzed by six researchers and supervised by two senior researchers, all experienced in qualitative research. The thematic analysis involved initial coding, emerging codes into categories, and identification of main themes. Consensus meetings were organized to achieve transparency and consistency regarding the process, study data and the interpretations. MAXQDA software was used. All data were analyzed and reported anonymously.

RESULTS

From 94 dreams, nine themes emerged: (1) child and family centered care, (2) psychosocial care, (3) continuity of care, (4) interprofessional collaboration, (5) research and innovation, (6) smooth work processes, (7) education and personal development, (8) ecological sustainability, and (9) appreciation and collegiality. Three themes were overarching: (a) inclusivity, (b) digitalization and (c) transitional care. We also identified underlying emotions: positively (e.g. compassion, creativity) and negatively (e.g. doubts, suspicion).

CONCLUSIONS

We derivated themes that will guide us toward a learning children's hospital by using the 'wisdom of the crowd'.

EP903 / #1236

E-Poster Viewing - Paediatrics AS04-26. Quality improvement

A national standardized set of pediatric generic pros and proms for pediatric medical specialist care in the netherlands:. A consensus based co-creation approach

L. Haverman^{1*}, K. Dulfer², M. Oude Voshaar³, R. Kalf³, A. Beurskens⁴

¹Emma Children's Hospital, Department of Child and Adolescent Psychiatry and Psychosocial Care, Amsterdam, Netherlands

²Erasmus Medical Center, Sophia Children's Hospital, Intensive Care Unit, Department of Pediatrics and Pediatric Surgery, Rotterdam, Netherlands

³National Health Care Institute (Zorginstituut Nederland), Department Care, Diemen, Netherlands

⁴Maastricht University, School Caphri, Department Family Medicine, Maastricht, Netherlands

BACKGROUND AND AIM

Using pediatric patient-reported outcome (measures) (PRO(M)s) in daily clinical practice is increasingly recognized. However, implementing PRO initiatives is hampered by e.g. the existence of many different PROMs. We aimed, initiated by the Dutch Ministry of Health (VWS), to develop a consensus based standard set of generic pediatric PROs and PROMs in medical specialist care.

METHODS

VWS appointed a national working group consisting of mandated representatives of all relevant umbrella organizations involved in Dutch pediatric medical specialty care together with PROM experts and patients. A structured, consensus driven co-creation approach including literature review, online expert meetings, feedback from patient/umbrella organizations, was used based on the 'PROM-cycle' methodology (van der Wees et al.) and guided by

the principles that it should be possible to obtain feasible, valid and reliable domain scores for all PROs.

RESULTS

will be shown during the conference. The group will try to agree on a core set of generic PROs across different levels of health: e.g. symptoms, functioning and mental health and quality of life. For each PRO a limited number of generic PROMs is endorsed. The core set can be supplemented with disease-specific PROs and PROMs if needed.

CONCLUSIONS

Future Implementation of this national pediatric generic set of PROs and PROMs will improve PROM use across medical specialty care. This method can be used in other settings or regions.

EP904 / #1664

E-Poster Viewing - Paediatrics AS04-26. Quality improvement

Novel pubertal weight and bmi references aligned for the individual variation in the timing of pubertal GROWTH

A. Holmgren^{1,2*}, A. Niklasson³, L. Gelander³, A. Nierop^{4,5},
K. Albertsson-Wikland⁵

¹Gothenburg University, Paediatrics, Gothenburg, Sweden

²Halmstad hospital, Paediatrics, Halmstad, Sweden

³University of Gothenburg, Paediatrics, Gothenburg, Sweden

⁴Multivariate Analysis of Research Data, Muvara, Leiderdorp, Netherlands

⁵University of Gothenburg, Physiology/endocrinology, Gothenburg, Sweden

BACKGROUND AND AIM

Despite the broad individual variation of pubertal maturation, references traditionally describe growth in relation to just chronological age and not biological age. Hence, growth references for the adolescent period have been of limited usefulness for monitoring individual growth and for research. To fill this gap, we aimed to develop novel pubertal weight and BMI references for the adolescent years.

METHODS

To model QEPS-weight, 3595 subjects (1779 girls) from GrowUp1974Gothenburg and GrowUp1990Gothenburg were used. The QEPS-height-model was transformed to a corresponding QEPS-weight-model; thereafter, QEPS-weight was modified by an individual weight-height-factor (WHF). The QEPS-height and weight models were used to define a corresponding QEPS-BMI model. QEPS-BMI was modified by the same WHF. Longitudinal measurements from GrowUp1990Gothenburg were used to create weight references aligned for height at pubertal onset, defined as 5% of the specific pubertal growth (AgeP5). GrowUp1974Gothenburg subgroups based on pubertal timing, stature at

pubertal onset, and childhood body composition were assessed using the novel references.

RESULTS

References (median, SDS) for total weight/BMI (QEPS-functions), weight/BMI specific to puberty (P-function), and weight/BMI gain in the absence of specific pubertal growth (basic weight, QES-functions), allowing alignment of individual growth based on age at pubertal onset. For both sexes, basic weight/BMI was greater for tall, and high-BMI subgroups. The P-function-related weight/BMI was greater in short children (Figure 1).

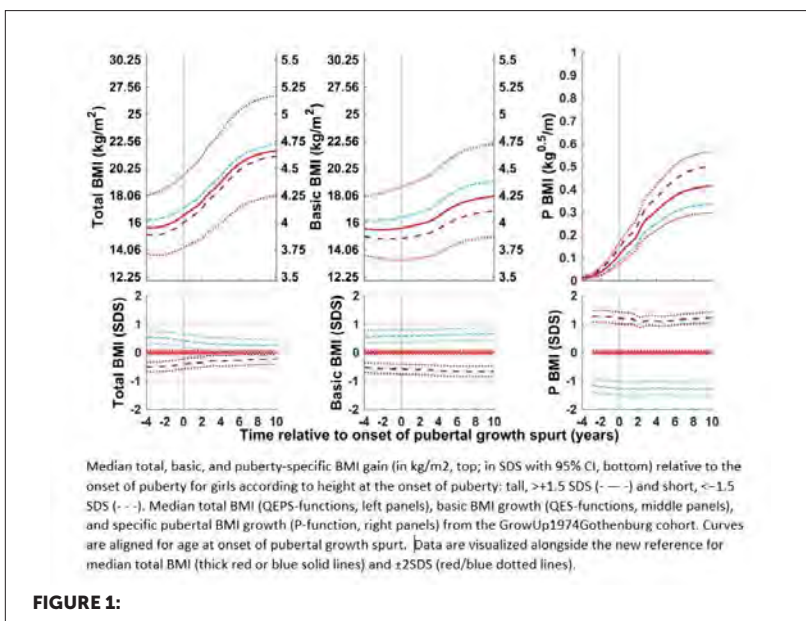

CONCLUSIONS

Novel pubertal weight/BMI references consider individual variations in pubertal timing. The references will improve growth monitoring, especially for children with overweight/obesity or underweight and serve as valuable research tools.

EP905 / #1458

E-Poster Viewing - Paediatrics AS04-26. Quality improvement

Damage control surgery pathway: a strengths-based quality improvement project

A. Jones^{1*}, M. Tajik², J. Martin³, E. Freeman⁴, J. Banks⁴, A. Mckeown³, A. Philpott⁵, R. Cole⁶, M. Nash⁷, C. Muhaso⁵, S. Arul⁸

¹Birmingham Women's and Children's Hospital, Picu, Birmingham, United Kingdom

²Birmingham Women's and Children's Hospital, Anesthetics, Birmingham, United Kingdom

³Birmingham Children's Hospital, Picu, Birmingham, United Kingdom

⁴Birmingham Children's Hospital, Theatre, Birmingham, United Kingdom

⁵Birmingham Womens' and Children's Hospital, Nts, Birmingham, United Kingdom

⁶Birmingham Women's and Children's Hospital, Blood Bank, Birmingham, United Kingdom

⁷Birmingham Women's and Children's Hospital, Neonatology, Birmingham, United Kingdom

⁸Birmingham Women's and Children's Hospital, Surgery, Birmingham, United Kingdom

BACKGROUND AND AIM

Damage Control Surgery (DCS) is a novel surgical approach for management of necrotising enterocolitis (NEC). Undertaken on PICU, it aims to swiftly remove necrotic bowel and stop deterioration. Challenges include: complex pathway from referring centres via the transport team to PICU and a diverse team rapidly convened in high-stake conditions. Appreciative Inquiry (AI) is a strengths-based, action research methodology that investigates successful work. We aimed to optimise processes by surfacing 'work as done' perspectives and generate improvement ideas.

METHODS

Semi-structured focus groups were held with 8 teams across the DCS pathway (n=100 staff): transport/PICU consultants, PICU nurses, ODPs, anaesthetists, technical team, ANPs, surgeons, team leaders. Answers were thematically analysed.

RESULTS

TABLE 1:

Questions	Themed responses	
How do you feel about DCS?	80% negative: 20% neutral/positive	
What are the specific challenges? 7 themes, all shared by $\geq 50\%$ of teams	Unknown team Unclear pathway Impact on unit Out of control Behaviours Parental care Time pressure	7 teams 6 5 5 5 4 4
What happens when DCS goes well? What are your 3 DCS wishes? 8 themes, 7 shared by $\geq 50\%$ of teams	Communication Pathway clarity Respectful behaviour Decisiveness Appreciation of roles Appropriate bedspace, floor plan Appropriate skill/ resource Blood available	8 teams 7 6 6 4 4 4 3

Improvement ideas: expedited cross-match, trauma-call whiteboard; pre-pre-scribing; scrub team grab-bag, standardised bloodpack

CONCLUSIONS

Strengths-based questions highlight shared challenges and aspirations enabling generation of a constructive improvement plan. Positive stakeholder engagement should be integral to the design and implementation of complex pathways.

EP906 / #2129

E-Poster Viewing - Paediatrics AS04-26. Quality improvement

Implementation of a departmental greatix SYSTEM

E. Kennard*

Whittington Hospital, Paediatrics, London, United Kingdom

BACKGROUND AND AIM

In healthcare we often lack formal structure enabling learning from good behaviours. 'GREATix' is a learning from excellence initiative that facilitates nominations of everyday excellence. Our aim was to implement a departmental 'GREATix' programme, designed to improve staff morale and performance through the promotion of excellence, using the concept of 'nudge theory.'

METHODS

We set up a structured Paediatric and Neonatal 'GREATix' programme with any staff member able to nominate any other colleague. Nominees received a personalised certificate to use for their portfolio or appraisal. A monthly summary of the key themes and lessons learnt was emailed to the whole team. Three people each month were additionally nominated for trust 'Staff Excellence Awards' (those that sent and received the most nominations, and one outstanding person based on what they had been nominated for). We collected data from questionnaires prior to the initiative being implemented and after a 6-month period about people's perceptions of the initiative and how the system was being used.

RESULTS

Over 6-months 152 nominations were made for staff over multiple departments. The number of people that had ever sent or received a 'Staff Excellence Award' or 'GREATix' increased from 8% to 80% and 26% to 76%, respectively. Feedback was overwhelmingly positive with comments such as "I think this is a really fab initiative that helps people to keep going."

CONCLUSIONS

A positive reporting system can lead to increased staff morale and shared learning of excellent practice. We have demonstrated that the GREATix system is a feasible way of implementing this.

EP907 / #996

E-Poster Viewing - Paediatrics AS04-26. Quality improvement

Anti-microbial but pro-learning: the impact of paediatric antimicrobial stewardship meetings on patient care and team development

L. Pickard¹, N. Kerdegari^{2*}, T. Busari¹, C. Curtis³

¹King's College Hospital NHS Foundation Trust, Paediatrics, London, United Kingdom

²King's College London, Undergraduate Medicine, London, United Kingdom

³King's College Hospital NHS Foundation Trust, Microbiology, London, United Kingdom

BACKGROUND AND AIM

Paediatric Antimicrobial Stewardship (AMS) is known to reduce the side effects of antimicrobials, reduce 'bug-drug' mismatches, improve dosing errors and reduce length of stay. We are a large central London teaching hospital: we commenced weekly AMS meetings to discuss the general paediatric patients' antimicrobial and infection needs.

METHODS

Weekly AMS meetings were attended by a Consultant Microbiologist, Consultant Paediatrician, Trainee Doctors, a Pharmacist, and an outside observer who collected information on: whether a pharmacological intervention was made and what; whether non-pharmacological advice or a teaching point was generated; any iterative improvements to the format. Structured interviews were carried out with 6 doctors and thematic analysis completed.

RESULTS

From 14/1/22, 21 patients were discussed across 5 meetings. 9/21 discussions resulted in a pharmacological change for that patient: most common was stopping an agent (6/9). 14/21 resulted in non-pharmacological advice, most commonly a teaching point for the team. Thematic analysis demonstrated positives: learning regarding samples, culture times, unusual antimicrobial agents, planning ahead, rationalisation of drugs and the value of pharmacy presence. Improvements needed: clearer communication/documentation, early identification of cases to discuss. Observer observations supported the value of a Pharmacist present for smooth running and rapid medication changes.

CONCLUSIONS

This pilot suggests positive patient care impact since AMS meetings resulted changes to antimicrobials for half of those cases discussed, crucially for stewardship this was most commonly rationalisation, and 2/3 of cases discussed generated advice/team learning. The team valued these meetings and suggested practical improvements for the format.

EP908 / #2602

E-Poster Viewing - Paediatrics AS04-26. Quality improvement

The root of the problem: paediatric dentistry in northern ireland, a multidisciplinary team approach

R. Magee*, D. Magee

NIMDTA, Paediatrics, Belfast, United Kingdom

BACKGROUND AND AIM

Dental procedures are one of the leading causes for the use of general anaesthetics in the paediatric population. This study aimed to review paediatric elective dental procedures requiring a general anaesthetic, to determine the reasons and to identify possible preventative intervention strategies.

METHODS

The data collected was from the Royal School of Dentistry Belfast. Data prior to and post 2020 was used to avoid the impact of COVID. The review included appointment letters and procedure notes. The past medical and medication histories for the patients were also reviewed.

RESULTS

See tables

Table 1: Patient numbers related to general anaesthetic and dental caries

Year	No. of Patients	No. requiring GA	Primary Diagnosis of Dental Caries	No. with dental caries requiring GA	% patients with primary diagnosis of dental caries requiring GA
2019	81	67	50	37	74%
2021	99	98	58	57	98%

GA: general anaesthetic

Table 2: Medical Conditions
(21% of Patients)

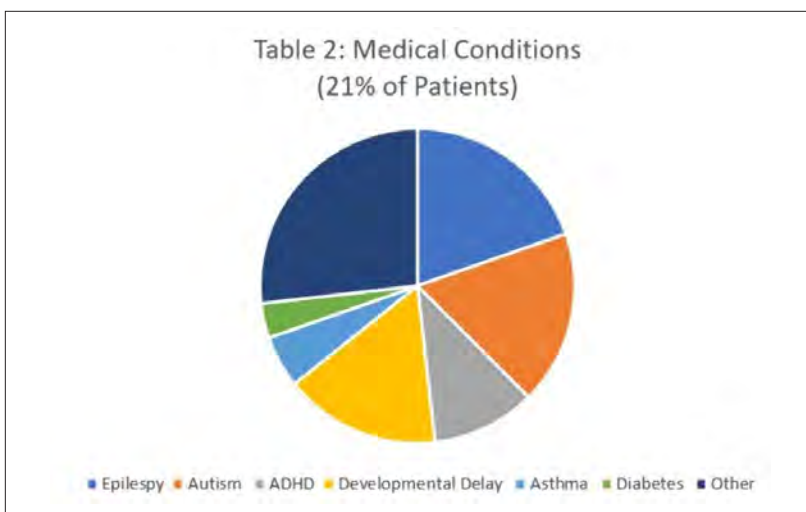

CONCLUSIONS

The vast majority of patients requiring GA did not have an underlying health concern contributing to their dental caries and this mirrored the widely accepted view that dental caries are a result of life style behaviours. 'Dental neglect' is acknowledged by the British Dental Association as a key factor impacting specifically on paediatric oral health. **Outcome and moving forward** Defining an effective preventative strategy is the next step. All paediatric

practitioners should be alert to dental neglect and should reference it in the patient's routine baseline health assessment. General Practice also has a unique opportunity to highlight and refer dental neglect. Education and effective communication of information are the key for parents and patients to embrace good oral health routines. Effective presentations targeting pupils in schools is an aspect of outreach that has not been fully developed. The use of doctors and dentists to deliver the 'neglect' message could increase its impact.

EP909 / #2304

E-Poster Viewing - Paediatrics AS04-26. Quality improvement

Improve your paediatric trial through multi-disciplinary expert advice of conect4children

F. Mahler^{1*}, K. Cheng², I. Lutsar³, B. Nafria⁴, S. Breitenstein⁵, G. Vassal⁶, J. Claverol⁴, N. Noel Palacio⁴, R. Portman⁷, G. Pope⁸, M. Bakker⁹, T. Van Der Geest¹, C. 4C Expert Group Leads¹, M. Turner¹⁰, S. De Wildt¹

¹Radboudumc, Farmtox, Nijmegen, Netherlands

²Johnson and Johnson, Child Health Innovation Leadership Department (child), High Wycombe, United Kingdom

³University of Tartu/Tartu Ulikool, Institute of Translational Medicine, TARTU, Estonia

⁴Sant Joan de Déu Children's Hospital, Patient Engagement In Research, Esplugues de Llobregat, Spain

⁵Bayer AG, Pediatric Development, Wuppertal, Germany

⁶Institut Gustave Roussy, Pediatric Oncology, Villejuif, France

⁷Novartis Pharmaceuticals Corporation, Pediatric Clinical Development, East Hannover, United States of America

⁸Novartis Pharma AG, Legal Global Pharmaceuticals Development, Medical Affairs & Litigation, Basel, Switzerland

⁹Radboudumc, Technology Transfer office, Nijmegen, Netherlands

¹⁰University of Liverpool, Institute of Lifecourse and Medical Sciences, Liverpool, United Kingdom

BACKGROUND AND AIM

Children have the right to new and improved medicines. conect4children (c4c) aims to promote innovative trial design to optimise paediatric development plans while including the voice of young patients and their families.

METHODS

A network of Experts, divided into Expert Groups, was set-up. In parallel a Patient Experts database was formed to involve patients and representatives

to give their expert opinion of the paediatric clinical studies. Advice is given according to the following process: (1) Sponsors contact c4c (2) scoping interview is held (3) formation of ad-hoc Strategic Feasibility Advice Group (5) advice meeting is held (6) advice report is provided. To continuously improve this process, feedback from Experts and requestors on the service was collected.

RESULTS

24 clinical and innovative methodology Expert Groups, consisting of >300 diverse Experts were established. The patient experts database includes 4 subgroups. To date, (April 2022) 33 advice requests were received from academia and industry and 25 have been completed. Clinical, methodology and Patient Experts participated in several of these requests. Sponsors appreciated the diversity of the Expert Groups as well as the quality of the advice which contributed to shaping the paediatric development strategy. Experts and patients and caregivers were satisfied with the advice process.

CONCLUSIONS

c4c has shown a successful proof of concept for a European multidisciplinary advice service for paediatric drug development, tailored to industry and academia. This service presents a new framework for innovative and feasible paediatric trials.

EP910 / #994

E-Poster Viewing - Paediatrics AS04-26. Quality improvement

Managing complex chronic conditions in children through the lens of icf-cy: a pilot STUDY

M. Tofani¹, M. Mustari^{1*}, D. Di Lallo², M. Salata³, L. Cantonetti⁴, M. Raponi², E. Tiozzo¹

¹Bambino Gesù Children Hospital IRCCS, Professional Development, continuous Education and Research Service, Rome, Italy

²Bambino Gesù Children Hospital IRCCS, Health Directorate, Rome, Italy

³Bambino Gesù Children Hospital IRCCS, Center For Pediatric Palliative Care, Rome, Italy

⁴Bambino Gesù Children Hospital, Department of Intensive Neurorehabilitation and Robotics, Rome, Italy

BACKGROUND AND AIM

Complex Chronic Conditions (CCCs) requires long-term health care, recurrent hospitalizations and, in many cases, the use of technology for life maintenance. Management of CCCs requires multidisciplinary and multifaced approach. The aim of this pilot study is to describe and analyze the feasibility of a model for managing children with CCCs using the International Classification of Functioning, Disability and Health: Children and Youth version (ICF-CY).

METHODS

Medical records of children previously hospitalized at the Bambino Gesù Children's Hospital were analyzed according to the inclusion criteria (CCCs, 9 hospitalizations between 2018 and 2020 or 1 for a duration above 60 days, diseases or procedures that need Integrated Home Care, age between 5 to 21). A preliminary phase consisting in second-level coding for Body Function and Structures domains were applied in a convenience sample. Next in collaboration with family, teachers and the whole health team a semi-structured

interview will be performed for investigating activity and participation, as well as contextual factors.

RESULTS

11 children were included in the pilot study. Two allied healthcare professionals selected specific codes and cross-checked their evaluation in order to investigate reliability of ICF-CY. The average time for coding ICF-CY was 30 minutes. Activity and Participation and Environmental Factors were age dependent. Two case studies will be discussed.

CONCLUSIONS

The ICF-CY for children with CCCs showed promising feasibility to investigate the management of children according to the bio-psycho-social model of health. In the next phase, we standardize coding and understand the actual applicability in the current clinical practice of a children's hospital.

EP911 / #928**E-Poster Viewing - Paediatrics AS04-26. Quality improvement****“Spending a penny but keeping it clean”: reducing the rate of contaminated non-invasive urine samples in the paediatric department****J. O’Gorman^{1*}, J. Clarke¹, M. Robinson²**¹Altnagelvin Area Hospital, Paediatrics, Londonderry, United Kingdom²Altnagelvin Area Hospital, Microbiology, Londonderry, United Kingdom**BACKGROUND AND AIM**

When investigating for a urinary tract infection (UTI) contaminated samples can delay diagnosis, and lead to inappropriate antibiotic prescribing and unnecessary follow-up. Our aim was to reduce the contamination rate of non-invasive urine samples in the paediatric department by 50% over a 6 month period.

METHODS

Data was collected weekly using a laboratory database search. Primary outcome measure was the number of contaminated non-invasive urine samples per PDSA cycle as a percentage of total non-invasive urine samples. Change ideas aimed at reducing the contamination rate were introduced: 1. Staff & parent focus groups 2. Introduction of a parent information leaflet 3. Trial of the “Quick-Wee” method 4. Staff education session and use of infographic 5. New method for urine pad use

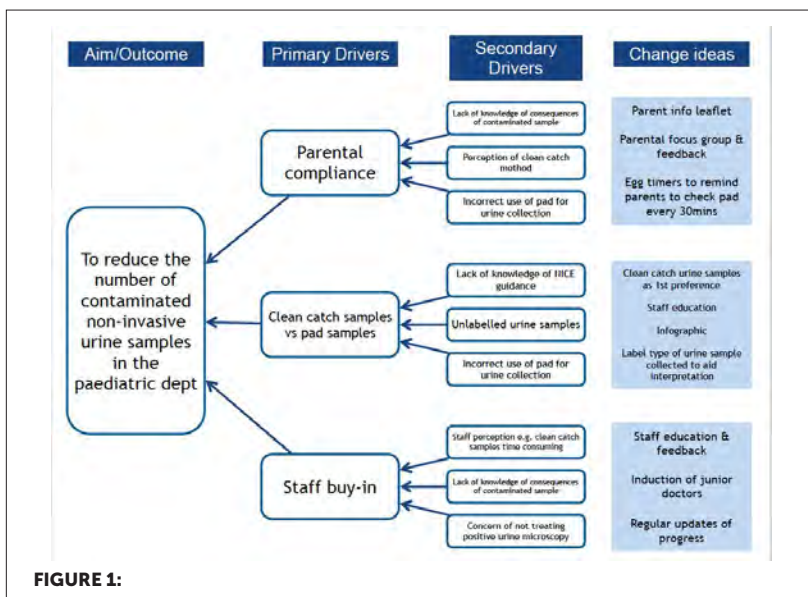

RESULTS

Our baseline contamination rate was 42.8-47%. We demonstrated sustained improvement, achieving our target by PDSA cycle 3. Shift in consecutive data points below the median indicated non-random variation. The contamination rate in subsequent cycles remained below the median, however there is a tendency towards increasing contamination rate

CONCLUSIONS

We used multiple small tests of change and engaged front line users to achieve our goal. Continuous improvement takes time and sustained effort - the increasing contamination rate in PDSA cycles 4 and 5 correlates with the project lead no longer working in the department. The project has been handed over, and there are change cycles planned to further optimise the use

of urine pad samples when used as second preference, as well as expansion of these improvement methods to the emergency department.

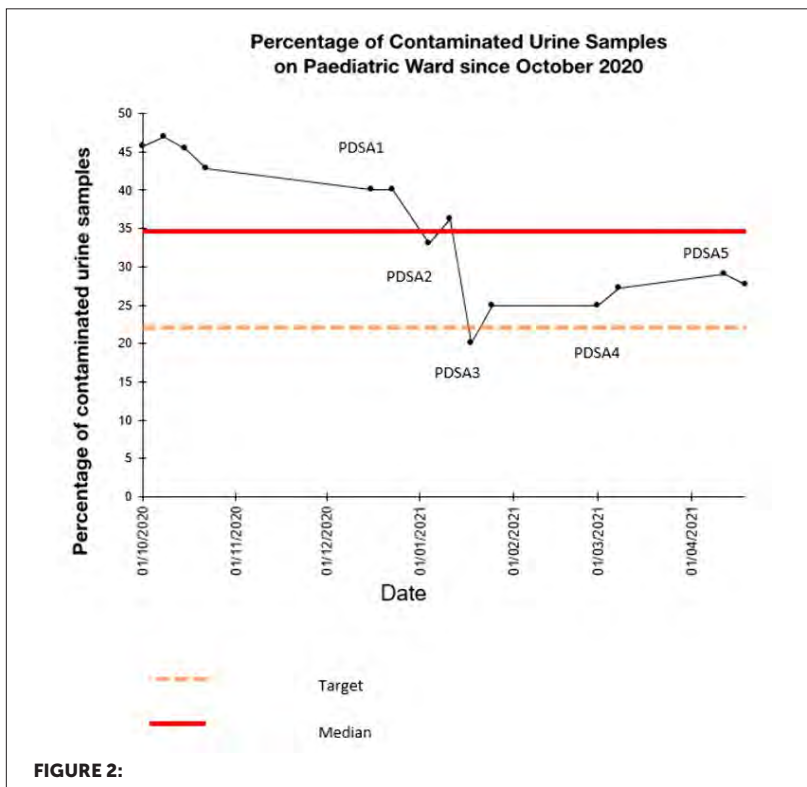

EP912 / #693

E-Poster Viewing - Paediatrics AS04-26. Quality improvement

Teaching in the DARK

S. Patel*, K. Gurnett, P. Vallabhaneni

Swansea Bay University Health Board, Paediatrics, Swansea, United Kingdom

BACKGROUND AND AIM

COVID19 pandemic forced educational institutions to transition from in-person to online teaching, utilising programs such as Zoom and Teams. As a result, tutors and students had to adapt quickly to these digital platforms. We undertook a study to evaluate medical student's attitudes and practices toward online teaching.

METHODS

A cross-sectional study of Swansea University medical students was conducted using a 14-part online questionnaire. This contained multiple-choice questions, 3-point Likert scales and free text comment box options. The survey was distributed to all year groups.

RESULTS

92(n=380) responses were received. 67.4% preferred in-person teaching ($p=0.416$). It was viewed as more engaging (77.2%) and rated highly for overall satisfaction (75%). Students felt they were more likely to skip (57%) or become distracted in online sessions (83%). However, students indicated that smaller groups would improve their engagement (83.7%) with online teaching. 62% felt there was no benefit to turning their cameras on and did not feel it improved engagement.

CONCLUSIONS

Online teaching has been adopted more than ever in delivering medical education. Our study shows that students have a preference for face to face teaching. This aligns with some of the evidence published, but some studies show benefits with online medical education. The positive aspects of online teaching could be utilised by educators to design content that will aid engagement. Educators have to also prepare for planning HYFLEX teaching sessions. We hope to share some ways of doing it.

EP914 / #731

E-Poster Viewing - Paediatrics AS04-26. Quality improvement

Education needs in diagnosing rare diseases in pediatrics: a clinician SURVEY

S.C. Rohani-Montez^{1*}, J. Bomberger²

¹*Medscape Education Global, Medscape Education Global, London, United Kingdom*

²*Medscape Education, Medscape Education, New York, United States of America*

BACKGROUND AND AIM

With approximately 70% of the ~7,000 known rare diseases presenting exclusively in childhood, pediatricians are in a unique position to identify these patients. However, there continues to be a significant delay in diagnosis across rare diseases.

METHODS

A 14-question online survey to assess rare disease knowledge, experience, and educational needs was emailed to US and EU Medscape member physicians. It launched on March 31, 2021 and closed on August 2, 2021.

RESULTS

A total of 927 physicians across 16 different specialties participated in the survey. of those, 55 were pediatricians from the EU or US. A majority, 77% of pediatricians considered rare diseases much rarer compared with standard definitions in the EU (5 per 10,000) or US (<200,000). and 70% said they never or only rarely (every 6 months to 1 year) see rare disease patients. Although 85%, have been involved in a rare disease diagnosis, only 9% were 'mostly confident' in making such a diagnosis and none 'very confident'. Compared

with US pediatricians, those in the EU more often experienced barriers in their knowledge of signs and symptoms that should trigger a suspicion of rare diseases and knowing where to refer the patient; and less often found sufficient time to investigate properly as a barrier. Pediatricians noted a preference for a comprehensive online learning platform with case-based, text-based, and short-format education, given by world renowned clinicians.

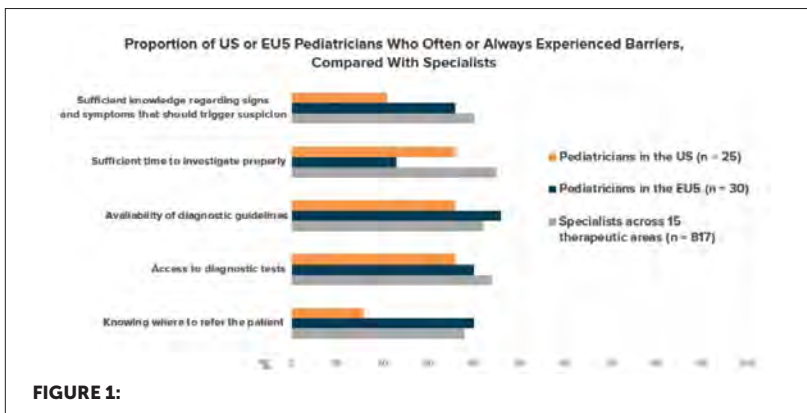

CONCLUSIONS

This educational research study identifies gaps in diagnosing rare diseases and supports the need to develop education for pediatricians on recognizing rare diseases earlier.

EP915 / #2054

E-Poster Viewing - Paediatrics AS04-26. Quality improvement

Return visits (rvs) to the paediatric emergency department (ped) within 72hours

K. Tan^{1*}, J. Wong², J. Badron¹, J.H. Lee¹, S. Ganapathy¹

¹KK Women's and Children's Hospital, Department of Emergency Medicine, Singapore, Singapore

²KK Women's and Children's Hospital, Data Analytics and Data Science In Quality Improvement, Singapore, Singapore

BACKGROUND AND AIM

Return visits (RVs) to the paediatric emergency department (PED) may contribute to strained healthcare resources. The COVID-19 pandemic has also changed healthcare utilisation. We aimed to determine the rate and characterise factors influencing RVs and admission upon RV; and to examine the impact of the COVID-19 pandemic on these variables.

METHODS

We conducted a retrospective cohort study of all visits to our tertiary PED amongst patients aged ≤ 16 years from 1/1/2018–31/12/2021. 1/1/2018–31/1/2020 was designated "pre-COVID-19" and 1/2/2020–31/12/2021 was designated "during COVID-19". RVs were defined as reattendance within 72 hours of initial visit.

RESULTS

511,497 visits were made during the study period, 331,670 (64.8%) pre-COVID-19 and 179,827 (35.2%) during COVID-19. 20,737 patients (4.1%) reattended. Children were more likely to reattend if they were <3years old, febrile or tachycardiac at triage during the initial visit, or were served medication during the initial visit. Children who underwent blood/urinary investigations or radiological studies during the initial visit were less likely to reattend. 9051 children (43.6%) were admitted on RV, 55.7% of whom were aged <3years. The RV rate dropped from 4.3% pre-COVID-19 to 3.5% during COVID-19, corresponding to reduced RVs of children in higher acuity triage categories. Admission rates on RV in both periods were comparable (43.5% vs. 43.9%).

CONCLUSIONS

We identified clinical characteristics associated with RVs and admission on reattendance. Although we noted a reduction in RVs during the pandemic, patients did not appear to be more unwell, with comparable admission rates on RV between both epochs. Our results may guide efforts to reduce RVs in PEDs.

EP916 / #2641

E-Poster Viewing - Paediatrics AS04-26. Quality improvement

Streamlining case loads in specialist school- north east LONDON

J. Tan^{1*}, M. Raji², M. Tanwar², A. O Grady³

¹NHS- NELFT- Child and Family Health Centre, Paediatrics, London, United Kingdom

²Nelft NHS Child and Family Health Centre, Paediatrics, London, United Kingdom

³NHS- NELFT- Child and Family Health Centre, Paediatrics Administrative, London, United Kingdom

BACKGROUND AND AIM

Background: There are over 300 caseloads in Specialist School (Trinity School Dagenham). They consists of complex medical background and neurodevelopmental concerns Aim: Caseload review and recapture patients requiring care Update diagnosis of the patient according to diagnosis Improve the paediatric service to see in timely manner

METHODS

Caseloads were reviewed on network database since December 2021 till June 2022. Caseloads were streamlined according to clinic pathway (Cerebral Palsy, Syndrome, ASD, ADHD, Epilepsy, Neurodevelopmental delay Clinic) in excel sheet. Caseloads were reviewed and captured patients requiring medical attention and patients that can be discharged Nursing school team work closely with school and educate staff around medical needs of child. Appointment team increased appointments slot according to clinic pathway. Numbers of clinic per month increased from 4-6 to meet the caseloads numbers. Appointments are offered based on last seen date and clinical needs.

RESULTS

Between December 2021 and March 2022, over 100 discharges made. There are 166 on our caseloads. As per graph below, after clinical case review and additional clinics, numbers of waitlist reduced significantly. Currently we have 36 on the waitlist which equivalent to 2 months of waitlist.

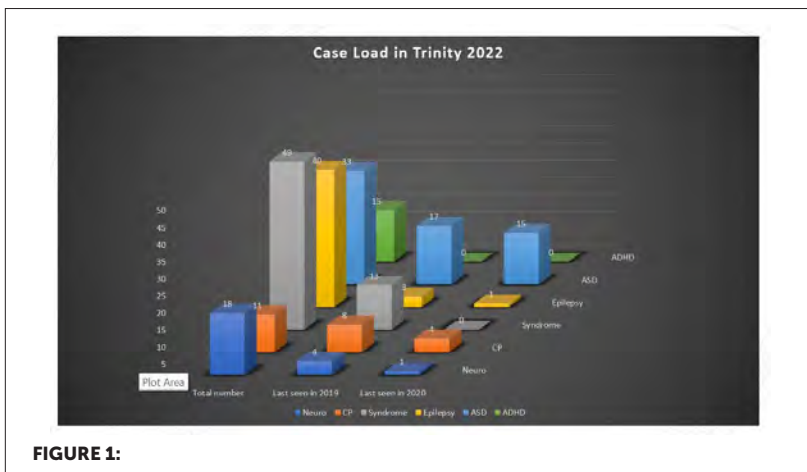

CONCLUSIONS

Challenges are overcome by working as a team with clinical and non clinical staff. Education and understanding of the health system helps non clinical staff to collaborate. This study is only the beginning of our quality improvement project and the vision is to aim of integrated health care system among clinical and non clinical staff to provide patients centred care.

EP917 / #453

E-Poster Viewing - Paediatrics AS04-26. Quality improvement

Biobanking and consenting to research: a qualitative thematic analysis of young people's perspectives

F. Van Der Velden^{1,2*}, L. Gills³, J. Broadey⁴, L. Hayes⁵, E. Roberts⁶, J. Courtney³, J. Ball³, M. Emonts^{1,2}, E. Lim^{2,5,6}

¹Newcastle University, Translational and Clinical Research Institute, Newcastle upon Tyne, United Kingdom

²Great North Children's Hospital - Royal Victoria Infirmary, Paediatric Immunology, Infectious Diseases and Allergy, Newcastle upon Tyne, United Kingdom

³Great North Children's Hospital, Young Person's Advisory Group North England, Newcastle upon Tyne, United Kingdom

⁴Great North Children's Hospital, The Great North Youth Forum, Newcastle upon Tyne, United Kingdom

⁵Newcastle University, Population Health Sciences Institute, Newcastle upon Tyne, United Kingdom

⁶Great North Children's Hospital, General Paediatrics, Newcastle upon Tyne, United Kingdom

BACKGROUND AND AIM

Biobanking samples and consent are common practice in paediatric research. We aimed to gain insight into children and young people's (CYP) knowledge and perspectives around current biobanking and consent practices, to improve our own consent procedures.

METHODS

In co-production with CYP We designed a survey, collecting CYP demographic data, views on biobanking, and consent using three scenarios: 1) prospective consent

2) deferred consent, and 3) recontact and assent. The survey was disseminated via Young Person's Advisory Group North England and participating CYP's secondary schools. Data were analysed utilising a qualitative thematic approach by three independent reviewers, and common themes identified. Data triangulation occurred independently by a 4th reviewer.

RESULTS

102 CYP completed the survey. Most were between 16-18 years (63.7%, n=65) and female (66.7%, n=68). 72.3% had no prior knowledge of biobanking (n=73). Prospective consent acceptability for biobanking was high (91.2%, n=93); main themes 'altruism' and 'potential benefits outweigh individual risks', and 'increased complication risk'. Deferred consent acceptability was lower (84.3%, n= 86), common themes: 'altruism', 'body integrity', and 'sample frugality'. 76.5% preferred to re consent when mature enough to give assent (n=78). 79.2% wanted to be informed if their biobanked sample is reused (n=80).

CONCLUSIONS

Prospective and deferred consent acceptability for biobanking is high among CYP. 'Altruism', 'frugality' and 'body integrity' are important themes. Clear communication and justification are paramount. CYP with capacity should be part of the consenting procedure, whenever possible. Acknowledgements This project received funding under the European Union's Horizon2020 Research and Innovation programme, under grant agreement number 848196.

EP918 / #1720

E-Poster Viewing - Paediatrics AS04-26. Quality improvement

Use of natural language processing for quality assessment of electronic health records of patients under 36 months with fever without source in the emergency department.

L. Subirana¹, P. Ventura^{2*}, L. Sumoy³

¹Hospital Germans Trias i Pujol, Pediatric Emergency Department, Badalona, Spain

²Hospital Germans Trias i Pujol, Pediatrics, Badalona, Spain

³Germans Trias i Pujol Research Institute, Bioinformatics, Badalona, Spain

BACKGROUND AND AIM

Natural Language Processing (NLP) is an informatics discipline that performs computational analysis of large amounts of free text. Our aim is to apply a NLP tool called text mining (TM) to describe quality metrics of Electronic Health Records (EHR) of patients under 36 months visited in the Pediatric Emergency Department (ED) for fever without source (FWS).

METHODS

EHR are selected from January 2010 to December 2021. 30 diagnoses that may match FWS definitions are selected. TM is carried out using the open software "R" using specific packages for data import; for TM and for exploratory data analysis. Descriptive data and quality metrics are analyzed.

RESULTS

35024 EHR are analyzed. 27918 (79,7%) match FWS definitions of which 15167 (54,3%) correspond to males. 1588 (5,7%) EHR are from children under

3 months and 26330 (94,3%) between 3-36 months. In 16211 (58,1%) cases complementary examinations were performed, specifically 3311 (11,9%) blood cultures. 570 cases (2,0%) were admitted. The median number of words used to describe the anamnesis is 40 (p25-75: 28-54). In 25143 (90,1%) EHR the fever value was recorded; in 7964 (28,5%) the anatomical site where it was measured and in 20544 (73,6%) the fever evolution time. In 6115 (21,9%) cases, the epidemiological context was recorded, and in 1413 (89,0%) cases under 3 months, the perinatal history was recorded.

CONCLUSIONS

Despite not having standardized quality metrics it can be stated that the studied EHR have enough quality although there is significant room for improvement. We have verified the enormous potential offered by the new bioinformatic techniques in pediatric research.

EP919 / #1837

E-Poster Viewing - Paediatrics AS04-26. Quality improvement

Onsite dispensing improved winter pressures in a tertiary children's hospital during the covid pandemic

D. Ward*, S. Mooney

RBHSC, Pharmacy office, Belfast, United Kingdom

BACKGROUND AND AIM

The prolonged time taken for discharge prescriptions to be dispensed for patients in the Children's Hospital has been a long-standing issue. It causes delays in patient discharges which has knock-on effect on patient flow in the hospital; leading to children waiting in the emergency department for longer; impacting their care and impairing the function of the emergency department. In September 2021 to try and alleviate some of these pressures a temporary dispensing room was established

METHODS

A temporary dispensing room was set up where a child's prescription could be dispensed. Prescriptions were logged onto the prescription tracking system and tracked. Results were collated encompassing the number of items to be dispensed together with the time taken for dispensing and data was compared to that from the previous winter.

RESULTS

TABLE 1: comparison between average number of items per prescription together with average dispensing time.

	Sept 2020 – Feb 2021	Sept 2021- Feb 2022	Percentage Time Reduction
Total number of prescriptions	1525	1068	
Average number of items per prescription	2.71	1.77	
Average dispensing time of prescription (min)	135.11	11.36	91.59%

TABLE 2: T test significance for time taken for prescription dispensing. CI 95% used. T Stat of 28.68 shows statistical significance in onsite dispensing.

	Time taken to dispense
T Stat with 95% CI	28.68
T with 95% CI	1.96
ρ value	<.001

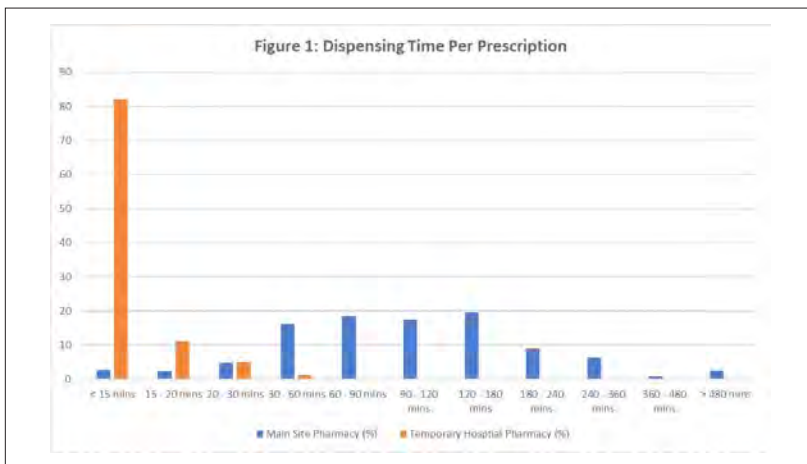

CONCLUSIONS

A hospital dispensary situated onsite run by the paediatric pharmacy team resulted in a statistically significantly decreased time for dispensing prescriptions.

EP920 / #2151

E-Poster Viewing - Paediatrics AS04-27. Resuscitation & transport

Status epilepticus - a 2 year review of children referred to the yorkshire critical care transport network (embrace)

L. Riddick^{1*}, S. Hancock¹, S. Davies²

¹Sheffield Childrens Hospital Trust, Embrace Transport Network, Barnley, United Kingdom

²Alderhey Childrens Hospital, Picu, Liverpool, United Kingdom

BACKGROUND AND AIM

Background: Status epilepticus is a condition that affects 20 per 100.000 children in the UK per year and carries a significant morbidity¹. Embrace Transport Service is often contacted for advice and transfer of these patients requiring critical care support. **Aim:** Review cases of paediatric status epilepticus in Yorkshire that involved the Embrace Transport Service either for transfer or advice, from September 2018- September 2020. The objectives will assess the following: 1. Adherence to current APLS guidelines 2. Which patients are extubated locally 3. The predictors of those requiring transfer to PICU 4. The barriers to local extubation and management

METHODS

Paper records of patients that were referred to Embrace for advice or transfer with status epilepticus under the age of 16 from 2018-2020 were accessed and reviewed. An audit undertaken in 2017 was used for comparison.

RESULTS

124 events were identified. 67% (84) of patients followed the APLS algorithm. 47 patients underwent extubation in their local centre with a 77% success rate. 33% of patients not extubated met criteria to do so, however staffing and the amount of anti-epileptic medication required acted as barriers. of the five main variables, there were no significant predictors for patients requiring transfer to PICU. There was a significant reduction of cases from February to September 2020.

CONCLUSIONS

Overall, there was a reduction in patients requiring transfer, and the majority of those transferred did not require long PICU stays. We also feel that COVID had an impact on the number of cases, which may warrant further analysis and re-audit.

EP921 / #2453**E-Poster Viewing - Paediatrics AS04-27.
Resuscitation & transport****Development and whole hospital evaluation of an end-to-end real-time situation awareness solution for in-patient deterioration for children in hospital: the detect STUDY****G. Sefton^{1*}, E. Carrol², B. Carter³, S. Lane⁴, F. Mehta⁵, C. Eyton-Chong⁶, C. Lambert⁷, S. Siner⁸, D. Jones⁸, L. Evans⁸**¹Alder Hey Children's Nhs Foundation Trust, Picu, Liverpool, United Kingdom²University of Liverpool, Institute of Infection, Veterinary and Ecological Sciences Liverpool, Liverpool, United Kingdom³Edge Hill University, Department of Nursing, Lancashire, United Kingdom⁴University of Liverpool, Medical Statistics, Liverpool, United Kingdom⁵Alder Hey Children's Nhs Foundation Trust, General Paediatrics, Liverpool, United Kingdom⁶Alder Hey Children's Nhs Foundation Trust, Hdu, Liverpool, United Kingdom⁷University of Liverpool, Detect Study, Liverpool, United Kingdom⁸Alder Hey Children's Nhs Foundation Trust, Clinical Research Business Unit, Liverpool, United Kingdom**BACKGROUND AND AIM**

Smart technology to provide real-time situation awareness about evolving in-patient deterioration in adults, have been used for more than fifteen years. development of similar technology for use in children was hampered by the cost and complexity of developing evidence-based age-specific risk models. Having established proof-of-concept of a paediatric prototype, this whole hospital mixed-method study evaluated the clinical effectiveness, cost effectiveness and clinical utility of this intervention.

METHODS

Bespoke development of the intervention used the careflow vitals and connect platforms (SYSTEM C), incorporating the alder hey age-specific paediatric early warning score (PEWS) and modified nice pro-active screening for signs of sepsis. deployment on apple devices occurred across ten wards (240 beds). Automated alerts were configured for high pews, critical pews or new sepsis concerns. compliance with a chain of deterioration prevention was tracked. quality improvement methodology supported the implementation.

RESULTS

rapid whole hospital culture change occurred. technology use was mandated for the ward teams and compliance was easier to attain in the established workforce. Sustaining change was more challenging with junior medical staff due to rotational posts. Critical effectiveness was established with a 29% reduction in emergency transfers to critical care, with 29% reduction in children affected, and optimisation of critical care productivity.

CONCLUSIONS

The system effectiveness of the end-to-end deterioration solution relies on high levels of compliance from nursing and medical teams, and a pro-active approach to care. real-time data provided enhanced team situational awareness but to deliver sustained improvements to clinical care, ongoing senior clinical oversight and endorsement is required.

EP922 / #877**E-Poster Viewing - Paediatrics AS04-28. Sedation & analgesia****Safety and efficacy of pediatric sedation protocol for painless diagnostic examination in a pediatric emergency room of a single tertiary hospital****S.R. Kim*, J. Park***Asan Medical Center, University of Ulsan College of Medicine, Pediatrics, Seoul, Korea, Republic of***BACKGROUND AND AIM**

Pediatric patients undergoing diagnostic tests in the pediatric emergency department are frequently sedated. Although efforts are made to prevent adverse events, no sedation protocol has specified the optimal regimen, dosage, and interval of medication to prevent adverse events. This study analyzed the safety and efficiency of sedation protocol sequentially administering multiple low-dose sedatives for painless diagnostic tests in the pediatric emergency department of a single tertiary medical center.

METHODS

The medical records of patients aged <18 years who visited the pediatric emergency department of Seoul Asan Medical Center between January and December 2019 for diagnostic testing were retrospectively reviewed. Sedation protocols consisted of 50 and 25 mg/kg chloral hydrate, 0.1 and 0.1 mg/kg midazolam, and 1 and 0.5–1 mg/kg ketamine, administered sequentially at intervals of 30, 20, 10, 10, and 10 min, respectively. Continuous monitoring of depth of sedation and adverse events (AEs) were conducted by dedicated ED physician throughout the whole sedation process.

RESULTS

of the 289 included patients, 20 (6.9%) experienced AEs, none was serious, and nine (3.1%) failed to reach the optimal depth of sedation required to complete the test. The regimen ($P=0.622$), dosage ($P=0.777$), and usage of chloral hydrate ($P=0.544$) of the sedatives were unrelated to the occurrence of AEs when sedation was performed according to protocol.

CONCLUSIONS

The sedation protocol used in the study, involving sequential administration of low dose sedatives with continuous monitoring by a dedicated physician, yielded an AE rate less to that of a single sedative agent in pediatric patients undergoing painless diagnostic testing. Moreover, this protocol resulted in a high rate of sufficient depth of sedation, indicating that it is safe and efficient for painless diagnostic testing. However, further large-scaled prospective study using suitable control is needed to generalize and quote the protocol.

EP923 / #2606**E-Poster Viewing - Paediatrics AS04-28. Sedation & analgesia****Serious adverse events in pediatric procedural sedation before and after the implementation of a pre-sedation checklist****S. Librov^{1*}, I. Shavit^{2,3}**¹*Technion-institute of Technology, Rappaport Faculty of Medicine, haifa, Israel*²*Technion-institute of Technology, 1. rappaport Faculty of Medicine, haifa, Israel*³*Hadassah Medical Center, Pediatrics, Jerusalem, Israel***BACKGROUND AND AIM**

Emergency Department (ED) procedural sedation is considered by the Joint Commission on Accreditation of Healthcare Organizations as a high-risk procedure. A pre-sedation checklist is a set of items checked before any procedural sedation. We evaluated the impact of a pre-sedation checklist on the rate of serious adverse events (SAE) in a pediatric ED.

METHODS

We conducted a retrospective study comparing the rates of adverse events requiring intervention in children treated with the combination of ketamine and propofol before and after the implementation of a pre-sedation checklist. The outcome measures for the study were the rates of suspected aspiration, laryngospasm, apnea, oxygen saturation $\leq 90\%$, and unplanned hospital admission due to sedation.

RESULTS

The before-and-after cohorts included 1,349 and 1,846 patients, respectively. The two groups were similar with regard to age, sex, length and type of procedure, and the level of physicians' training. A total of 183/1349 (13.5%) and 420/1846 (22.7%) SAE were recorded during the before-checklist and after-checklist periods, respectively ($p < 0.0001$). The rates of suspected aspiration, laryngospasm, apnea, and oxygen saturation $\leq 90\%$ at the before-checklist and after-checklist periods were (5/1349 and 3/1846); $p = 0.29$, (9/1349 and 30/1846); $p < 0.05$, (48/1349 and 77/1846); $p = 0.37$, and (123/1349 and 312/1846); $p < 0.0001$, respectively. All the SAE were successfully managed, and no patient required hospitalization.

CONCLUSIONS

In this large cohort of children who underwent deep sedation, the rates of SAE increased after checklist implementation. Study findings failed to show a benefit from the implementation of a pre-sedation checklist in this pediatric ED.

EP924 / #1023**E-Poster Viewing - Paediatrics AS04-29. Surgery & anaesthesia****Congenital elbow venous malformation: a rare presentation in a previously healthy CHILD****S. Ali^{1*}, M. Hassan²**¹Hamad Medical Corporation, Medical Education, Doha, Qatar²Hamad Medical Corporation, General Pediatrics, Doha, Qatar**BACKGROUND AND AIM**

Peripheral Vascular Malformations comprise a spectrum of lesions that can be benign or limb- or life-threatening. Low- or slow-flow malformations consist of venous and/or lymphatic vessels are rare disorders that differ in symptomatology and prognosis depending on their location and extension.

METHODS

We case report a rare occurrence of a congenital low flow venous malformation in an otherwise healthy 2 years male child of the left elbow joint.

RESULTS

The child had a large bluish-greenish skin lesion over the left elbow (Figures 1,2) associated with similar relatively smaller lesions on the left side of face adjacent to the lateral canthus of the right eye, the right flank area in proximity to the iliac crest and on the right posterior thigh. There was a notable maternal history of similar lesion in the same elbow (Figure 3). His complete blood count including platelets count, blood chemistry profile and coagulation profile were all normal. There were typical venous malformation ultrasonography and magnetic resonance features confirmed the diagnosis

of elbow slow-flow venous malformations with phleboliths, subcutaneous as well as intramuscular components.

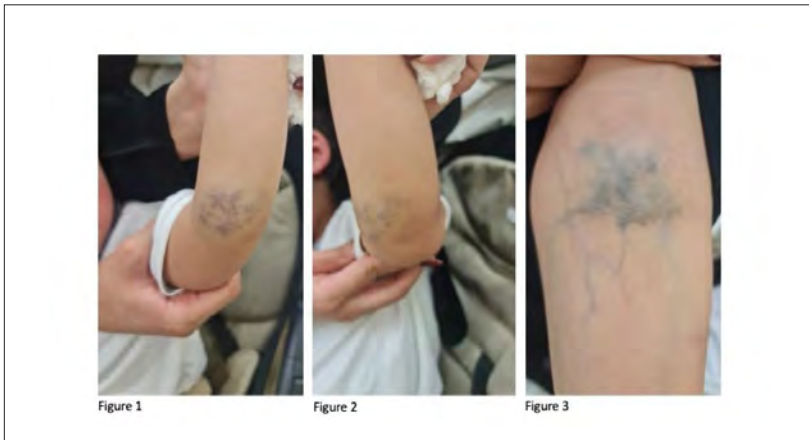

CONCLUSIONS

The case highlights the importance of early recognition of venous malformations in early screening during well child visits and signifies the role of multidisciplinary team approach for optimal patient outcome.

EP925 / #2541**E-Poster Viewing - Paediatrics AS04-29. Surgery & anaesthesia****A characteristic finding for diagnosing idiopathic scrotal edema. Description of 2 CASES.**

M. Anastasakis*, I. Galonaki, C. Doitsidis, M. Mitroudi, C. Panteli, I. Patoulis

G.H.G.Gennimatas, Paediatric Surgery, Thessaloniki, Greece

BACKGROUND AND AIM

Idiopathic edema is a self-limited disease of unknown etiology characterized by inflammation of the scrotum and dartos, but not extending to the underlying layers or to the scrotal structures.

METHODS

There are 2 boys, aged 7 years. The 1st presented to the emergency department with redness and edema of the scrotum extending to the base of the penis, dating from 2 days. The redness started from the anterior surface of the right hemiscrotum and gradually expanded. Objective examination revealed no surgical pathology of the endoscrotal structures. This was followed by an ultrasound scan that showed homogeneity of the testicular parenchyma and a color-flow Doppler that showed the Fountain sign. The 2nd was presented to the emergency department with acute urticaria. After admission, he was treated with intravenous hydrocortisone. There was a recession of the rash and on the 5th day he developed edema and thickening of the scrotum, especially on the left. The pediatric surgical examination did not observe surgical pathology of the intrascrotal structures. Ultrasound of the scrotum revealed normal blood supply, thickening of the scrotum wall, especially of the left, with hyperemia forming the Fountain sign.

RESULTS

Conservative treatment was then followed for patients who improved gradually over the next three days.

CONCLUSIONS

A combination of thorough clinical examination along with the findings of the color-flow Doppler examination, and in particular of the fountain sign, idiopathic edema is documented, and the need for emergency surgical investigation of the scrotum due to diagnostic uncertainty is limited.

EP926 / #673**E-Poster Viewing - Paediatrics AS04-29. Surgery & anaesthesia****Do we treat undescended testes on TIME!?****M. Bašković^{1*}, L. Zaninović¹, I. Sansović², A.M. Meašić², A. Katušić Bojanac³, D. Ježek⁴**¹Children's Hospital Zagreb, Department of Pediatric Surgery, Zagreb, Croatia²Children's Hospital Zagreb, Department of Medical Genetics and Reproductive Health, Zagreb, Croatia³University of Zagreb, School of Medicine, Department of Biology, Zagreb, Croatia⁴University of Zagreb, School of Medicine, Department of Histology and Embryology, Zagreb, Croatia**BACKGROUND AND AIM**

Undescended testes are the most common anomaly of the male genitourinary tract. The guidelines suggest that orchidopexy in congenitally undescended testes should be performed between 6 and 18 months of age, while in acquired undescended testes orchidopexy should be performed before puberty. Delay in treatment increases the risk of cancer and infertility. The main aim of this study was to determine whether we meet international standards in the treatment of undescended testes.

METHODS

The study included all boys who underwent orchidopexy either due to congenital or acquired undescended testes in 2019. For each group, laterality, location, associated anomalies, premature birth and in how many cases ultrasound was applied, were determined. Also, for each group, the types of surgery, the number of necessary reoperations and in how many cases atrophy occurred, were determined. Finally, the age of referral, the age of clinical examination, and the age of orchidopexy were determined.

RESULTS

During this period, 198 patients with 263 undescended testes underwent orchidopexy. The median time of orchidopexy for the congenital group was 30 months while for the acquired group was 99 months. In the congenital group up to 18 months of age, orchidopexy was performed in 16 (16%) boys, while in the acquired group up to 13 years of age, orchidopexy was performed in 95 (96.94%) boys.

CONCLUSIONS

Given the well-known risks of late treatment of undescended testes, orchidopexy needs to be done much earlier. Also, it will certainly be necessary to conduct extensive education and public health intervention for pediatricians and family physicians in order to move the time of referral to an earlier age.

EP927 / #1634**E-Poster Viewing - Paediatrics AS04-29. Surgery & anaesthesia****A large mediastinal lipoblastoma: a rare cause of acute respiratory compromise**

H. Ben Ameer*, H. Zitouni, S. Ammar, E. Krichen, M. Ben Dhaou, R. Mhiri

Hedi Chaker Hospital of Sfax, Pediatric Surgery, Sfax, Tunisia

BACKGROUND AND AIM

Lipoblastoma tumors are rare benign mesenchymal tumors arising from the embryonic fat tissue. Typically, it is seen in the extremities and the trunk of male children less than 3 years old. Head, neck, retroperitoneum, and mediastinum locations are uncommon.

METHODS

We report a case of an infant with a posterior mediastinal lipoblastoma triggering an unexpected life-threatening emergency.

RESULTS

A healthy 16-month-old male infant developed a productive cough with stridor 1 day before visiting our hospital. In the pediatric emergency department, dyspnea with obvious subcostal retraction and an SpO₂ level of 92% were observed. Physical examination showed stridor and wheezing. The infant was administered oxygen through a cannula to maintain saturation. He was explored by a chest X-ray which showed a 6-cm-diameter lesion on the right lung apex. We completed our exploration by a computed tomography (CT) scan which revealed a 5cm heterogeneous mass without calcification in the

right mediastinum. The mass displaced the trachea as well as the esophagus to the left side. A complete surgical excision of the mass was achieved through a lateral thoracotomy. The mass was white in appearance, encapsulated, and lobulated in shape. The histopathologic examination proved that the mass was a lipoblastoma.

CONCLUSIONS

We emphasize that this rare mediastinal tumor should be included in the differential diagnosis of infants having a mediastinal. Complete surgical excision with at least 2 years of follow-up is the preferred therapy.

EP928 / #1659**E-Poster Viewing - Paediatrics AS04-29. Surgery & anaesthesia****Management of pediatric gastrointestinal neoplasms****H. Ben Ameer^{1*}, H. Zitouni¹, M. Hbaieb¹, A. Chaabouni², M. Ben Dhaou¹, S. Boujelben², R. Mhiri¹**¹Hedi Chaker Hospital of Sfax, Pediatric Surgery, Sfax, Tunisia²Habib Bourguiba Hospital of Sfax, General Surgery, Sfax, Tunisia**BACKGROUND AND AIM**

The primary Gastrointestinal malignancies, in contrast to adults, are exceedingly rare in children. They constituted only about 1% of pediatric cancers. This study presents our experience in the management of the more common malignant tumors of the Gastrointestinal tract in the pediatric population.

METHODS

This is a retrospective study of patients treated for gastrointestinal neoplasms at the department of pediatric surgery and general surgery in Sfax between January 1994 and January 2022. Patients included were aged less than 18 years old.

RESULTS

There were 10 patients with malignant gastrointestinal tumor identified over 28 years' time frame. The average age of the children was 11.9 years-old. Female patients represented 80% of cases. All our patients had a history of abdominal pain and were explored by abdominal Ultrasound. Six children had an appendicular tumor with four of them had a neuroendocrine neoplasm

and two had a mucinous neoplasm. Simple appendectomy was efficient in all cases. No one had a hemicolectomy. Colonic carcinoma was identified in two patients, without having diffuse disease. The remaining malignant tumors identified included Hodgkin's lymphoma in two children. Only lymphoma patients received an adjuvant chemotherapy. One patient with colonic adenocarcinoma was died secondary to primary brain tumor.

CONCLUSIONS

Despite the rarity of primary Gastrointestinal malignancies, early detection is still important because of their relatively more advanced clinical stage and poorer outcomes than benign tumors.

EP929 / #1253**E-Poster Viewing - Paediatrics AS04-29. Surgery & anaesthesia****Urinary tract infection following surgical management of vesicoureteral reflux in children**

H. Ben Ameer^{1*}, M. Hbaieb^{1,2}, H. Zitouni^{1,3}, E. Krichen^{1,2}, M. Ben Dhaou^{1,2,3}, R. Mhiri^{1,2}

¹Hedi Chaker Hospital of Sfax, Pediatric Surgery, Sfax, Tunisia

²Faculty of medicine of Sfax, University of Sfax, Sfax, Tunisia, Pediatric Surgery, Sfax, Tunisia

³Faculty of medicine of Sfax, University of Sfax, Sfax, Tunisia, Department of Pediatric Surgery, Sfax, Tunisia

BACKGROUND AND AIM

The incidence of symptomatic urinary tract infection following vesico-ureteral-reflux (VUR) resolution is unclear. We determined the factors relating to development of urinary tract infection (UTI) after surgical reflux correction.

METHODS

A retrospective study was performed of all children operated for primary VUR from January 2009 to January 2020 in the Pediatric Surgery Department of Hedi Chaker Hospital of Sfax. Patient's demographic and clinical outcomes were abstracted from the medical record. Risk factors for postoperative UTI, including female gender, preoperative VUR grade, recurrent UTI, bladder dysfunction, nephropathy and persistent vesicoureteral reflux after surgery, were analyzed.

RESULTS

We had a total of 140 children. There were 77% female and 23% male. 68% operated for bilateral VUR and 22.8% treated by endoscopic injection. UTI

occurred in 95% of patients before surgery, and was febrile in 80%. Mean follow-up of our patients was 2.4 years. Postoperatively UTI developed in 20 cases (14.3%) of which 7 were febrile. Three of them showed recurrent VUR. of assessed risk factors only female gender ($p=0.01$), preoperative recurrent UTI ($p=0.03$) and bladder dysfunction ($p=0.001$) were independent predictors of postoperative UTI.

CONCLUSIONS

Patients with recurrent urinary tract infections and bladder dysfunction pre-operatively are at increased risk for urinary tract infection after VUR surgical treatment.

EP930 / #1550**E-Poster Viewing - Paediatrics AS04-29. Surgery & anaesthesia****Variations in timing of elective orchidopexy****N. Ben Kraiem^{1*}, H. Zitouni², H. Ben Ameer³, M. Hbaieb², C. Rahma³, S. Ammar², M. Ben Dhaou⁴, R. Mhiri⁵**¹Faculty of medicine of Sfax, Pediatric Surgical Department, sfax, Tunisia²Hedi Chaker Hospital, Pediatric Surgery, sfax, Tunisia³HEDI CHAKER HOSPITAL, UNIVERSITY OF SFAX, Department of Pediatric Surgery, Sfax, Tunisia⁴Faculty of medicine of Sfax, University of Sfax, Sfax, Tunisia, Department of Pediatric Surgery, Sfax, Tunisia⁵Faculty of medicine of Sfax, University of Sfax, Sfax, Tunisia, Pediatric Surgery, Sfax, Tunisia**BACKGROUND AND AIM**

Strong evidence suggests that in order to prevent irreversible testicular damage, surgical correction for undescended testis (UDT) should be performed between 12-18months of age. We compared the age of patients with UDT at the time of surgery between two different periods.

METHODS

A retrospective study included 611 cases of cryptorchid patients who undergone orchidopexy in two different periods (2011-2013 and 2017-2019) in the pediatric surgical department of Hedi Chaker Hospital of Sfax.

RESULTS

253 cases operated in the first period (2011-2013: Group1) and 358 in the second period (2017-2019: Group2). The right side of UDT was in 295 cases, the left side in 248 cases and the bilateral side in 68 cases. The Mean age at presentation was 4,3 years in group 1 and 3,8 years in group 2 with non-sig-

nificant difference ($P>0,05$). The infants were addressed by a pediatric-clinician, boys aged of 5 to 6 years old by a scholar-clinician and the others at prepubertal age by a general-practitioner. The mean timing of operation after presentation was 3 months. We had 37,5% from group1 and 39,1% from group2 managed on their first 2 years of life with non-significant difference ($P>0,05$).

CONCLUSIONS

The timing of surgical treatment of UDT in our department did not identified a significant amelioration during the observed periods. It is necessary to provide additional information for pediatricians and parents about the current guidelines on cryptorchidism and consequences of the late treatment.

EP931 / #1750**E-Poster Viewing - Paediatrics AS04-29. Surgery & anaesthesia****Predictive factor of operability of the pyeloureteral obstruction in children**

N. Ben Saad*, M. Belhaj Mansour, H. Ben Ameer, R. Dghaies, M. Ben Dhaou, R. Mhiri

hopital hedi chaker sfax, Pediatric Surgery, sfax, Tunisia

BACKGROUND AND AIM

Primary standard clinical assessments do not predict surgical intervention in patients with an upper tract hydronephrosis. The aim of this study is to identify predictive factors of operability of the pyeloureteral obstruction (PUO) in children.

METHODS

We conducted a retrospective study of 56 children managed for PUO between January 2014 and June 2018 in the department of pediatric surgery of Sfax. Two groups of patients: 1 concerned the operated children and 2 concerned patients undergoing surveillance.

RESULTS

There were 23 patients in the first group and 33 patients in the second. The mean age was 20 months for the first group versus 18 months for the second. Prenatal diagnosis was present among 14 patients in the first group versus 15 patients in the second. Severe antenatal hydronephrosis (SAH) was detected in 12 patients for the first group and 2 patients for the second. Anteroposterior diameter (APD) of the renal pelvis in the postnatal ultrasound was >20mm in

19 cases of the first group and 10 cases of the second. Thinning of the cortex was noted in 12 patients in the first group and 10 patients of the second. Relative renal function (RRF) on renography was $< 40\%$ in 10 cases of the first group versus 2 patients of the second. There was significant difference between the two groups according to SHA ($p=0.001$), APD of the renal pelvis $> 20\text{ mm}$ ($p=0.001$), thinning of the cortex ($p=0.0001$) and RRF on renography $< 40\%$ ($p=0.001$).

CONCLUSIONS

SAH, APD of the renal pelvis $> 20\text{ mm}$, thinning of the cortex and RRF on renography $< 40\%$ are predictive factors of operability of the PUO in children.

EP932 / #1756**E-Poster Viewing - Paediatrics AS04-29. Surgery & anaesthesia****Treatment of anterior hypospadias: comparison of different surgical techniques (about 276 CASES)**

N. Ben Saad*, M. Belhaj Mansour, H. Ben Ameer, R. Dghaies, M. Ben Dhaou, R. Mhiri

hopital hedi chaker sfax, Pediatric Surgery, sfax, Tunisia

BACKGROUND AND AIM

Hypospadias is a congenital malformation resulting from an incomplete development of the anterior urethra with ectopic involvement of the urethral meatus on the ventral side of the penis. Surgical techniques are variable. The purpose of our study is to compare the different surgical techniques according to the anatomical shape of the hypospadias.

METHODS

Our series included 276 cases of anterior hypospadias collected at the pediatric surgery department of Sfax over a period of 16 years (2000 and 2016). We studied the different surgical techniques used according to the anatomical form of the anterior hypospadias (balanic, balanopreputial, anterior penile).

RESULTS

For the Balanic variety, 26 cases out of 47 (21,3%) were operated according to the DUPLAY technique with a success rate of 56%. The minimal approach according to NASRALLAH technique was practiced in 21 cases (44.7%) with a success rate of 90.5% ($p = 0.017$). For the balanopreputial form, 34 out of 138 cases were operated by the MATHIEU technique (24%) with a success

rate of 76.5%. 104 cases (75%) were operated by the DUPLAY technique with a success rate of 68.7% ($p = 0.61$) For the anterior penile variety, 21 cases were operated according to the technique of MATHIEU (21.4%) with a success rate of 76.2%, 70 cases were operated according to the DUPLAY technique (71.4%) with a success rate of 47.1% ($p = 0.029$).

CONCLUSIONS

The treatment of the anterior hypospadias still a challenge for the surgeon concerning the choice of the most appropriate surgical technique.

EP933 / #1064

E-Poster Viewing - Paediatrics AS04-29. Surgery & anaesthesia

Uncovering the PENIS

M. Caldas*, M. Pedro, M. Viegas, T. Magalhães, A. Bicho

Centro Hospitalar do Oeste, Pediatria, Caldas da Rainha, Portugal

BACKGROUND AND AIM

Buried penis is a rare and probably underdiagnosed entity in which a penis of normal size appears to be smaller due to concealment within the pubic tissue. It is important to differentiate from a true micropenis, as these two entities have distinct etiologies, diagnostic approaches and treatments. The diagnosis of buried penis is clinical and is characterized by partially visible or completely invisible penis that can be associated with voiding complications, difficulty with penetration and recurrent urinary tract infections or balanitis. Surgical correction is the gold-standard treatment, however there is no consensus on patient eligibility, timing of the surgery and surgical technique.

METHODS

A 12-month-old healthy boy presented with exuberant ballooning of the prepuce during micturition, requiring manual expression of urine. Upon physical examination, the penis was not visible, with only the glands covered by prepuce protruding. A regular sized penis could be exposed by applying finger pressure on opposite sides of the shaft base and retracting the prepuce. The patient did not have phimosis or any other findings.



FIGURE 1:



FIGURE 2:

RESULTS

The clinical presentation was compatible with the diagnosis of buried penis with megaprepuce and the patient was referred to a Pediatric Surgery consultation. Corrective surgery was performed 9 months later, no postoperative complications were observed and the procedure had excellent cosmetic and functional results.

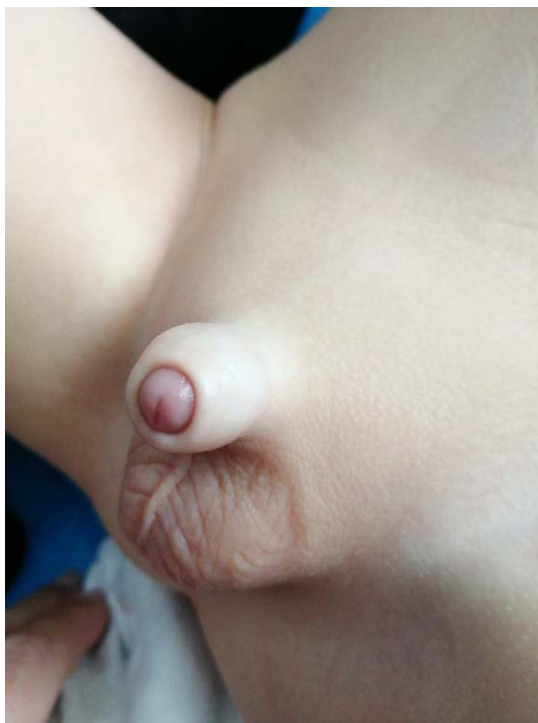

FIGURE 3:

CONCLUSIONS

This case serves as a reminder of the importance of keeping the diagnose of buried penis in mind in order to avoid unnecessary workup.

EP934 / #662**E-Poster Viewing - Paediatrics AS04-29. Surgery & anaesthesia****The use of telemedicine for early discharge after appendectomy in children**

J. Ceradini^{1*}, I. Aloï², S. Frediani², A. Accinni², C. Brusco¹, A. Inserra², M. Raponi¹

¹Bambino Gesù Children's Hospital, Medical Direction, rome, Italy

²Bambino Gesù Children's Hospital, Departement of Surgery, Rome, Italy

BACKGROUND AND AIM

Early discharge after appendectomy surgery in children reduces hospital costs and it is appreciated by families. The aim of our study is to test the cost-effectiveness and safety of the protected early discharge pathways of children treated with appendectomy after appendicitis.

METHODS

in 2022 we introduced a protocol that integrated protected post-discharge examination (including blood test, ultrasound and other radiologic exams) and telemedicine visits. We enrolled patients treated in the first trimester of the 2022 and compared them with a homogenous population of children treated in 2019 for the same diagnosis and procedure (icd9 severity level APR drg). We surveyed hospital readmissions and adverse events reported, and interviewed the families of the enrolled patients. The differences in terms of mean hospital stay, were compared using T student's test.

RESULTS

in the first trimester of 2022, 12 patients were enrolled in the protocol. The mean of length of stay compared in the two periods were significantly different (9.09 days in 2019 vs 6.33 days in 2022, $p = 0.032$) There were no readmissions or adverse events reported in 2022 so far. Families interviewed reported being satisfied or very satisfied with the path.

TABLE 1:

drg	description	n 2019	mean dd 2019	n 2022	mean dd 2022
165	appen- dectomy w com- plicated principal diag w/o cc	133	6,03 ds 2.4	13	9,05 ds 4,3

CONCLUSIONS

The adoption of telemedicine tools and protected laboratory test was well received by parents, it was safe and allowed to save 2,76 days of hospitalization with a cost reduction of 1300E per patient.

EP935 / #1650**E-Poster Viewing - Paediatrics AS04-29. Surgery & anaesthesia****Complications in laparoscopic appendicectomy in children - a national paediatric study in MALTA****G. Degiorgio^{1*}, M. Shoukry²**¹*Mater Dei Hospital Malta, Paediatric Surgery, L-Imnsida, Malta*²*Mater Dei Hospital, Department of Paediatric Surgery, Msida, Malta***BACKGROUND AND AIM**

Laparoscopic appendicectomy (LA) is recognised as the standard in managing acute paediatric appendicitis (APA) as supported by numerous meta-analyses. Few articles have however studied its complications. This national study presents all complications (immediate, early and late) encountered when treating APA with LA.

METHODS

Retrospective cohort study of 70 out of 98 cases which underwent LA between October 2017 and March 2022 whose case notes were available for the study. Patients' demographics, duration of hospital stay, peri-operative complications, incidental findings and management were noted.

RESULTS

Age ranged from 4-15 years. M:F ratio 1.8. None were converted to open. 22 cases of perforated appendicitis. Hospital stay range 1-17 days (median=4, interquartile range 2-7).

TABLE 1:

Complications: Incidence and Management

INTRA-OPERATIVE	INCIDENCE (%)	MANAGEMENT
Laparoscopic working port bleeding	2 (2.86)	1 deep stitch & 1 balloon compression
Omental haematoma	1 (1.43)	Clipped
Omental infarction	1 (1.43)	Conservative
Mesoappendix haematoma	1 (1.43)	Clipped
POST-OPERATIVE		
Umbilical wound stitch sinus	3 (4.29)	2 conservative & 1 excised
Umbilical surgical site infection	3 (4.29)	Antibiotics
Intra-abdominal collections	3 (4.29)	2 Antibiotics & 1 with US-guided drainage
Longstanding abdominal pain	2 (2.86)	Conservative
Skin Reaction to skin glue	1 (1.43)	Hydrocortisone
Allergy to antibiotics	1 (1.43)	Conservative
Umbilical port seroma	1 (1.43)	Conservative
Lower respiratory tract infection	1 (1.43)	Antibiotics

Diagnoses separate from appendicitis; parasitic infection (n=3), enlarged ovarian functional cyst (n=2) and perforated Meckel's diverticulum (n=1).

CONCLUSIONS

LA is widely accepted in paediatric surgical centres for APA. Suitable management strategies are essential to minimise burden on health authorities and reduce LA-related patient distress.

EP936 / #2591

E-Poster Viewing - Paediatrics AS04-29. Surgery & anaesthesia

Feminized génitoplastie: experience of pediatric urology department oran, algeria

B. Hammou*, R. Rebiha, H. Fatema, H. Hafida, H. Faycel, M. Nouria

Medical School of Oran, Pediatric Urology, Oran, Algeria

BACKGROUND AND AIM

The anomalies of the sexual differentiation, group of very different situations, the decision and the management is particularly complex, for the sex assignment, the technique of the genitoplasty and the timing. The care of these children will be done only after discussion of a multidisciplinary team. our work we have put forward laparoscopy and urinary endoscopy in the diagnosis and choice of genitoplasty

METHODS

descriptive study of a series of 51 children presenting DSD a data sheet include the analysis of the data of the interrogation, clinical and paraclinical, according phenotype, sex declared, the karyotype, the degree of virilization is according classification of Prader, the length of the urogenital sinus at the endoscopy.

RESULTS

the average age is 24 months, 76% of patients are declared boy, 22% girl, 2% not declared. 72% of patients referred for abnormalities of the external genital organs. 67% with a male phenotype. 51% 46XY, 41% 46XX. 8% karyotype mosaic. Laparoscopy was indicated in 30 patients, the presence of mullerian ducts in 46.7%. Urinary endoscopy was performed in 47 patients an average length

of the urethra of 1.73cm,a urogenital sinus average length of 2.93 cm.The diagnosis: congenital hyperplasia of the adrenal represents 41% of patients.

CONCLUSIONS

The understanding and support of DSD has evolved considerably in recent years and has been better identified since the Chicago Conference and the many international meetings that followed. Disorder of Sexual Development (DSD), requires the intervention of a qualified multi-disciplinary team to make a proper care.

EP937 / #2592

E-Poster Viewing - Paediatrics AS04-29. Surgery & anaesthesia

What is to be done, how to proceed with PMDS?

B. Hammou*, H. Hafida, H. Fatema

Medical School of Oran, Pediatric Urology, Oran, Algeria

BACKGROUND AND AIM

Disorders of sex development (DSD) affecting 1 birth in 10,000. Current management is very heterogeneous due to the small volume of patients on this subject. The series reported are short, often retrospective, and non-consensual support.

METHODS

the management of DSD patients admitted to the pediatric urology department since October 2015 until July 2018. Paraclinical characteristics of the patients are recorded. All the patients included in the study underwent an ultrasound and laparoscopic exploration. The surgical management of Mullerian duct is done with laparoscopy procedure

RESULTS

31 one patients, were identified from October 2015 to July 2018, The ultrasound and laparoscopy were successfully identified Mullerian duct in 5 cases (17%), in 16 cases (51%) they confirm the absence of Mullerian duct, in 10 cases there was a difference between the ultrasound and the laparoscopy, the ultrasound haven't identify the Mullerian duct in 10 cases (32%), and streak gonads was not detected against the diagnostic laparoscopy is an excellent tool which allowed us all the identified mixed type or it was necessary to do a biopsy as reported by Yu and al.

CONCLUSIONS

all the clinical situation mentioned above, means that the surgeon must be familiar with the diagnosis of PMDS. laparoscopy provide diagnosis of PMDS syndrome, and management without disturb blood supply of the testes, and the vas.

EP938 / #2593

E-Poster Viewing - Paediatrics AS04-29. Surgery & anaesthesia

Inguinal hernia;open surgery vs laparoscopy

B. Hammou*, G. Laya, H. Fatema, R. Rebiha, M. Nouria, H. Faycel

Medical School of Oran, Pediatric Urology, Oran, Algeria

BACKGROUND AND AIM

surgeons have wrestled with the question regarding the contralateral inguinal region in an infant or child with a known unilateral inguinal hernia. A number of publications have advocated bilateral hernia repair, unilateral hernia repair with observation of the contralateral region or laparoscopic evaluation of the contralateral region. Laparoscopic hernia repair LS is an effective and increasingly popular alternative to open herniotomy OS.

METHODS

In a prospective study 20 children underwent either LS or OS 20 for PIH. complications, postoperative pain, postoperative stay, cosmesis, and the size of testis were recorded and compared. Patients were followed up for an average of 6 months.

RESULTS

-operative time longer in LS for unilateral but shorter in bilateral -The difference in pain perception between LS and OS was insignificant. -Immediate postoperative recovery (<3 hr) was delayed in a greater proportion of children undergoing LS but duration of hospital stay was similar. -scrotal edema was observed in 2 cases following OS, -testicular atrophy significant in OS. -iatrogenic testicular malposition significant in open surgery -vas deferent injury

CONCLUSIONS

application of the laparoscopic technique to hernia repair seems warranted to improve the sensitivity of diagnosis, the protection of vas, vessel, and sliding hernia sac content, and the placement using magnified vision of sac closing sutures laparoscopy may be particularly advantageous for the diagnosis and the treatment of both direct inguinal and femoral hernias

EP939 / #1487

E-Poster Viewing - Paediatrics AS04-29. Surgery & anaesthesia

Newborns enterostomies: characteristics and outcomes

S. Kacem^{1*}, S. Ammar¹, S. Sallemi¹, K. Mekki², N. Ben Hmida³,
H. Zitouni¹, R. Mhiri⁴

¹Hedi Chaker Hospital, Pediatric Surgery, sfax, Tunisia

²Hedi Chaker Hospital, Pediatric, sfax, Tunisia

³Hedi Chaker Hospital, Neonatology, sfax, Tunisia

⁴Hedi Chaker Hospital, Pediatric Surgery, Sfax, Tunisia

BACKGROUND AND AIM

Neonates may present intestinal conditions such as necrotizing enterocolitis (NEC), Hirschsprung disease (HD), meconium ileus (MI), anorectal malformation (ARM), intestinal perforation (IP), intestinal atresia (IA) and volvulus, which often require enterostomy creation. However, enterostomy may lead to several complications. We aimed to evaluate the occurrence and outcomes of enterostomy in newborns.

METHODS

Charts of neonates, aged less than 30 days and who underwent enterostomy from 2009 to 2020 in our department, were reviewed retrospectively.

RESULTS

Thirty patients were included. Enterostomy was performed for ARM in 14 cases, HD in 8 cases, IP secondary to NEC in 6 cases, IP complicating IA in one case and spontaneous IP in one case. The level of intestinal derivation was the left colon in 15, the right colon in 5 cases, the coecum in 2 cases

and the ileum in 7 cases. Ileostomy was performed for patients with NEC in 4 cases, HD in 2 cases and IA in one case. Patients with ileostomy presented low weight, low body mass index during the follow up-period. Malnutrition occurred in 2 patients with ileostomy and one patient with coecostomy. Five patients died during the postoperative course (4 patients presented severe sepsis secondary to NEC and one patient with ARM had severe prematurity).

CONCLUSIONS

Complications occur in almost all infants with enterostomies. The majority of these complications do not require surgical treatment but a special clinical care and therapeutic monitoring. There seems a trend that neonates with NEC have a higher risk for death than those without NEC.

EP940 / #1661

E-Poster Viewing - Paediatrics AS04-29. Surgery & anaesthesia

Morbidity and mortality factors in anorectal malformations

B.K. Najoua^{1*}, C. Rahma¹, M. Zouari¹, K. Emna², B.D. Mahdi³, R. Mhiri⁴

¹HEDI CHAKER HOSPITAL, FACULTY OF MEDICINE OF SFAX, UNIVERSITY OF SFAX, Department of Pediatric Surgery, Sfax, Tunisia

²HEDI CHAKER HOSPITAL, UNIVERSITY OF SFAX, Department of Pediatric Surgery, Sfax, Tunisia

³Hedi Chaker Hospital, Faculty of Medicine of Sfax, University of Sfax, Department of Pediatric Surgery, Sfax, Tunisia

⁴Hedi Chaker Hospital, Faculty of Medicine of Sfax, University of Sfax, Department of Pediatric Surgery, Sfax, Tunisia

BACKGROUND AND AIM

Anorectal malformations (ARM) are common anomalies observed in pediatric population. We aim to highlight mortality and morbidity factors related to this condition.

METHODS

We retrospectively reviewed the records of all patients which were managed in our department, between 2002 and 2020, for ARM. All demographic, diagnostic and therapeutic data were collected.

RESULTS

A total of 52 children with ARM were included (31 males and 21 females). The diagnosis was delayed (after the neonatal age) in 13.5%. ARM with apparent perineal or vestibular fistula represented 28 of cases (53.8%) and were treated immediately in a single stage with an average age of 3 months. Patients with

recto-urogenital fistula or without fistula (24 cases, 46.1%) underwent in a first step a diverting neonatal colostomy with an average age of 30 hours, followed by anorectoplasty within an average of 6 months. Associated anomalies were present in 12 patients: urogenital (21.1%), cardiovascular (9%), vertebral (7.7%), and gastrointestinal (7.7%), limb abnormalities (3.8 %). A VACTERL syndrome was noted in 4 patients (7.7% of cases). These anomalies have been taken care specifically. At the neonatal age, morbidity and mortality were mainly related to cardiac associated malformations and delayed diagnosis causing bowel obstruction and constipation. In the medium and long terms, morbidity was related to associated anomalies, in addition to colostomy complications, constipation and fecal incontinence.

CONCLUSIONS

Despite advances in surgical techniques and improvement in postoperative care, morbidity related to ARMs remains high due mostly to associated congenital anomalies and delayed diagnosis.

EP941 / #1682

E-Poster Viewing - Paediatrics AS04-29. Surgery & anaesthesia

What could be hidden by small-bowel intussusceptions in children?

B.K. Najoua*, C. Rahma, M. Zouari, N. Ben Saad, M. Ben Dhaou, R. Mhiri

Hedi Chaker Hospital, Faculty of Medicine of Sfax, University of Sfax, Department of Pediatric Surgery, Sfax, Tunisia

BACKGROUND AND AIM

Intussusception is the most common cause of abdominal emergency in children and infants. The majority of cases are ileocolic, while obstructive small-bowel forms are rare in this age. The aim of this work is to present clinical and therapeutical characteristics of isolated small- bowel intussusception in children.

METHODS

We retrospectively reviewed the records of all patients who were operated in our department between 2013 and 2021 for isolated small- bowel intussusception. All epidemiologic, clinical and therapeutic data were collected.

RESULTS

A total of 8 patients were included (2 boys and 6 girls). Mean age was 4 years. In the history of these children, we noted a rheumatoid purpura in one case, sub-cutaneous lipomatosis in one case and transient prior small-bowel intussusceptions in two cases. All patients presented with clinical and radiological signs of acute intestinal obstruction, requiring emergent lapa-

rotomy. Surgical exploration showed ileo-ileal intussusception in 6 cases and jejuno-jejunal one in 2 cases. An underlying pathological lead point was found in 6 cases (75%): Meckel diverticulum (2 cases), intestinal lipoma (1 case), intestinal hematoma (1 case with rheumatoid purpura), intestinal hamartomatous polyps (2 cases, one related to Peutz-Jeghers Syndrome and the other to Bannayan-Riley-Ruvalcaba Syndrome). The treatment consisted on a resection of the pathological intestinal segment in all cases and end-to-end anastomosis, with uneventful postoperative course.

CONCLUSIONS

Clinically significant small bowel-small bowel intussusceptions occur more frequently in older children and are often secondary to pathological lead points or conditions that surgeon should systematically look for and remove.

EP942 / #1700

E-Poster Viewing - Paediatrics AS04-29. Surgery & anaesthesia

Is dietl's crisis an under-reported clinical entity? Case report and review of literature

K. Polak^{1*}, M. Herrera Llobat², I. Vidal Gil², M. Llanas Marco³, S. Rusu²

¹HUNSC, Pediatrics, santa cruz de tenerife, Spain

²Hospital Universitario Nuestra Senora de Candelaria, Pediatric Surgery, Santa Cruz de Tenerife, Spain

³Hospital Universitario Nuestra Senora de Candelaria, Pediatric, Santa Cruz de Tenerife, Spain

BACKGROUND AND AIM

Background: Dietl syndrome is characterised by recurrent abdominal pain accompanied by vomits and altered general status. Non-specific symptoms and normal investigations between episodes can cause a delay in diagnosis and treatment.

METHODS

We report the case of one of our patients that presented with Dietl's crisis. Consequently, using the PRISMA protocols, a literature review addressing the syndrome published in the last 10 years was performed.

RESULTS

A 14-year-old boy presents with multiple episodes of abdominal pain, vomits, fever and high blood pressure that last from 1 to 3 days. Blood and urine laboratory evaluations are within normal. Abdominal ultrasound notes a mild right pelvicalyceal dilatation. The MAG3 renogram demonstrates lower renal function on the right with a flattened without ruling out obstruction. The renal MRI reveals a right polar vessel and consequently underwent a laparo-

scopic pyeloplasty with complete remission of symptoms. The review of the literature identified 13 articles that addressed the syndrome. Nine of them are case reports. The other 4 are reporting each a number of 13, 14, 8 and 150 patients respectively. The underlying surgical conditions consisted of crossing vessels, nephroptosis, ureteral polyp, parapelvic cyst, megaureter. All authors are reporting favourable outcomes after the adequate diagnosis and surgical treatment.

CONCLUSIONS

Conclusion

Establishing the diagnosis of Dietl's crisis could be challenging, and the intermittent nature of the symptoms can make it easily missed. Once correctly diagnosed, it is curable with good outcomes.

EP943 / #1723

E-Poster Viewing - Paediatrics AS04-29. Surgery & anaesthesia

Pelvic ganglioneuroma presents as a nonmedical responding primary enuresis – case REPORT

K. Polak^{1*}, S. Rusu²

¹Hospital Universitario Nuestra Senora de Candelaria, Pediatric, Santa Cruz de Tenerife, Spain

²Hospital Universitario Nuestra Senora de Candelaria, Pediatric Surgery, Santa Cruz de Tenerife, Spain

BACKGROUND AND AIM

Background: Primary nocturnal enuresis is a frequent cause of presentation in paediatric and urology clinics, with the vast majority improving with age or treatment. Ganglioneuroma is a rare neurogenic tumour that could grow gradually with minimal or no symptoms.

METHODS

We reviewed the medical history and imaging of a patient that had an unexpected outcome after presenting with primary nocturnal enuresis.

RESULTS

Case report: A 10 years old boy presents to the nephrology clinic with primary nocturnal enuresis that failed nonpharmacological treatment delivered by primary care. Treatment with desmopressin was started with no improvement of the symptoms. He has no significant medical history, and the clinical examination is within normal. Abdominal ultrasound reveals a pelvic mass with well-defined margins that compresses the urinary bladder. A Magnetic Resonance Imaging scan describes a well-circumscribed mass that displaces the bladder laterally and with radiological findings compatible with gangli-

oneuroma or ganglioneuroblastoma. Tumoral markers are negatives. The mass is removed via a laparoscopic-assisted procedure, and the histology examination confirms the diagnosis of ganglioneuroma. Immediately after the procedure, the enuresis stops, and the child is dry 11 months after the procedure.

CONCLUSIONS

Ganglioneuroma is a rare tumour, and pelvic location is even more exceptional. Compression on other organs is usually the clinical presentation, with the local improvement of symptoms after excision.

EP944 / #2283

E-Poster Viewing - Paediatrics AS04-29. Surgery & anaesthesia

Hydrometrocolpos and hematocolpos: clinical presentation at two extremes of pediatric AGE

S. Soares Cardoso^{1*}, M. Cordoeiro², A. Oliveira¹, S. Reis¹, J. Antunes¹, P. Horta³, A. Pipa², C. Salgado³

¹Centro Hospitalar Tondela-Viseu, Pediatrics Department, Viseu, Portugal

²Centro Hospitalar Tondela-Viseu, Gynecology and Obstetrics Department, Viseu, Portugal

³Centro Hospitalar Tondela-Viseu, Pediatric Surgery, Viseu, Portugal

BACKGROUND AND AIM

The congenital imperforate hymen is a rare external urogenital anomaly that occurs in 1 in 2000 women and may not be detected until puberty. Hydrometrocolpos can present as an antenatal pelvic cystic mass. Hematocolpos is a rare pathology resulting from vaginal blood accumulation in adolescents with imperforate hymen.

METHODS

Cases Presentation: Case 1 describes a female newborn with prenatal diagnosis of a mass posterior to the bladder, with no other relevant background. At birth, presented an imperforate hymen (Fig. 1); pelvic ultrasound a large collection of dense fluid in the hypogastrium, translating hydrometocolpos. Performed a hymenotomy on the second day of life, which was uneventful. At 3 months of age the hymen was patent.



FIGURE 1:

RESULTS

Case 2 describes a 16-year-old female with a complaint of recurrent abdominal pain with one year of evolution, with worsening complaints in the previous week. With no urinary symptoms, no menarche, with telarche at age 12. Physical examination revealed painful abdominal distension in the lower quadrants with imperforate hymen (Fig. 2).

**FIGURE 2:**

An ultrasound was performed that confirmed the diagnosis of hematocolpos. She was submitted to hematocolpos drainage (Fig. 3) and hymenoplasty, with favorable evolution. She was discharged from the gynecology consultation 1 year later, with regular menstrual cycles.

**FIGURE 3:**

CONCLUSIONS

Despite the possibility of prenatal diagnosis of imperforate hymen, with early guidance and resolution, a high level of suspicion is necessary to diagnose hematocolpos in adolescents with abdominal pain, a frequent and often nonspecific complaint. A detailed medical history and physical examination are the key.

EP945 / #2120

E-Poster Viewing - Paediatrics AS04-29. Surgery & anaesthesia

Pediatric tracheotomy in infants: based on 8 years of experience at a pediatric tertiary center in south KOREA

E.-S. Sung*

Pusan National University Yangsan Hospital, Otolaryngology- Head and Neck Surgery, Yangsan, Korea, Republic of

BACKGROUND AND AIM

The reasons for and outcomes of pediatric tracheostomy have changed over the decades. However, outcomes related to cause have not been studied in infants. The aim of this study is to report experiences about outcomes of infants who have undergone tracheostomy.

METHODS

A retrospective chart review was performed on 30 infants (<1 year old) that underwent tracheostomy from December 2008 to December 2016. Variables that could affect the outcomes were analyzed using correlation analysis.

RESULTS

The most common reasons of tracheostomy were ventilation weaning failure (26.7%) and prolonged intubation (23.3%). There were significant differences in duration of tracheostomy between indications ($p=0.003$). The duration of tracheostomy was short in upper airway obstruction (15.2 ± 6.6 months), but relatively long in neurological impairments (47.9 ± 15.3 months). The time of

decannulation was correlated with the duration of tracheostomy($r = 0.528$, $p=0.003$).

CONCLUSIONS

The longer the duration of tracheostomy the slower the time of decannulation. Therefore, efforts are needed to reduce the duration of the tracheostomy to pull the time of successful decannulation in infant. For infants with no specific problems, such as prolonged intubation needs or ventilation weaning failure, periodic laryngeal and tracheal assessment under general anesthesia should be actively considered for decannulation by surgeon.

EP946 / #1385

E-Poster Viewing - Paediatrics AS04-29. Surgery & anaesthesia

Acute urinary retention in a 13-year-old male adolescent; a rare manifestation of acute appendicitis

E. Valavani^{1,2*}, I. Tassiou², S. Makri², A. Anastasiou-Katsiardani²

¹University of Edinburgh, Usher Institute, Edinburgh, United Kingdom

²General Hospital of Volos Achillopouleio, Pediatrics, Volos, Greece

BACKGROUND AND AIM

Acute urinary retention is rare in childhood and a diagnostic dilemma for pediatricians. Prompt identification of its cause is crucial since, in certain cases, delayed treatment may prove life-threatening. The aim of this study is the description of an unusual case of acute appendicitis presenting as urinary retention in a 13-year-old boy.

METHODS

A 13-year-old adolescent, with no past medical and surgical history, was admitted to hospital with acute sharp pain in the lower abdomen and acute urinary retention. During the week, the patient complained of suprapubic pain radiating to his testicles, dysuria, difficulty in starting urination and strangury, progressively deteriorating over the last 48 hours. The family denied any previous history of fever, anorexia, nausea, vomiting, or diarrhea. Laboratory tests revealed leukocytosis (WBC: 17,100/ μ L) with neutrophilia (neutrophils: 75.6%), a high level of C-Reactive Protein (CRP: 89.78mg/L) and normal urinalysis. An initial ultrasound scan of the abdomen showed a dilated bladder containing 780mL of urine which made identification of the appendix difficult. Insertion of a urethral catheter to decompress the bladder alleviated the suprapubic pain, while tenderness of the right lower quadrant persisted. Hence, a new

abdominal ultrasound was conducted, which revealed a dilated appendix (0.86mm outer diameter).

RESULTS

The patient underwent emergency laparotomy, which showed a ruptured appendix with periappendiceal abscess. No postoperative complications were reported.

CONCLUSIONS

Acute appendicitis should always be included in the differential diagnosis of acute urinary retention. Pediatricians should be aware of this challenging presentation of appendicitis, so that diagnosis and treatment are not delayed.

EP947 / #536

E-Poster Viewing - Paediatrics AS04-29. Surgery & anaesthesia

Quality of life and anorectal malformations: a single centre experience.

N. Zampieri*, G. Scirè, F. Camoglio

University of Verona, Woman and Child Hospital, Pediatric Surgical Unit, Surgery, Dentistry Paediatrics and Gynaecology, Verona, Italy

BACKGROUND AND AIM

The treatment and long time clinical results of children with anorectal malformation (ARM) has always been the focus of interest of pediatric surgeons. The aim of this study was to report our experience with a long time follow-up

METHODS

Patients treated between 1999 and 2019 were enrolled. Inclusion and exclusion criteria were created. A validated questionnaire was used to identify long-time quality of life results. inclusion and exclusion criteria were created

RESULTS

48 patients were treated and 28 patients were enrolled for analysis; among these patients more than 35% had at least 1 long time complication, while more than 90% have a good lifestyle. Urinary and fecal continence is achieved by more than 95% using medical devices.

CONCLUSIONS

This study aims to open new aspects and to consider patients with ARM in all aspects of life, from school to sexuality, passing through the fecal and urinary continence; this is essential to improve the skills of all specialists involved in the management of these patients, to implement strategies to enhance postoperative function and especially to increase communication between doctors for an adequate transition to adult life.

EP948 / #1407

E-Poster Viewing - Paediatrics AS04-30.

Translational research

Health care provider perspectives of barriers and facilitators to the transition from pediatric to adult care: a behavioural analysis using the com-b model of behaviour

C. Cassidy^{1*}, J. Kontak², J. Pidduck³, A. Higgins², S. anderson², S. Best³, A. Grant², E. Jeffers², S. Macdonald³, A. Mireault², L. Rowe², R. Walls⁴, J. Curran³

¹Dalhousie University, School of Nursing, Halifax, Canada

²Nova Scotia Health, Maritime Spor Support Unit, Halifax, Canada

³IWK Health, Children's Health Program, Halifax, Canada

⁴Nova Scotia Health, Mental Health and Addictions, Halifax, Canada

BACKGROUND AND AIM

Transition of care can be a complex process that involves multiple providers working together across the pediatric and adult health care system to support youth. The purpose of this study was to identify the barriers and facilitators to the transition of care from the perspective of pediatric and adult health care providers.

METHODS

A qualitative descriptive design was used to conduct semi-structured interviews guided by the COM-B Model of Behaviour. The study took place in the province of Nova Scotia, Canada. Data were first analyzed using directed content analysis, then further examined using inductive thematic analysis to identify barriers and facilitators.

RESULTS

Twenty-six health care providers participated in this study including a mix of adult and pediatric physicians, nurses, and allied health care professionals. We identified a range of interconnected barriers and facilitators across each of the COM-B Model of Behaviour domains such as, degree of formalized training (capability), facilitation and coordination responsibilities (opportunity), collaboration across providers (opportunity), and securing attachment to adult care system (motivation). Findings were categorized by three overarching themes: 1) Knowledge and Skills to Support Transition of Care; 2) Navigation Role for Youth and Caregivers; and 3) System Coordination.

CONCLUSIONS

By using the COM-B Model of Behaviour, we identified key barriers and facilitators that intersect to influence the transition of care process. These findings will be used to inform and adapt initiatives and interventions in Nova Scotia to improve the transition experience and may be transferrable to the pediatric to adult care transition experience in other settings.

EP949 / #2615

E-Poster Viewing - Paediatrics AS04-30. Translational research

Pediatrics biobanks for improving translational and clinical research for children.

P. Mirabelli*

Santobono-Pausilipon Children's Hospital, AORN, Naples, Italy, Uos Biobank and Laboratory Research, Napoli, Italy

BACKGROUND AND AIM

Medical research on children is challenging due to difficulties in study design and conduction (i.e., small study population, limited volumes of biological specimens allowed) as well as in patients and families feeling distrustful towards the trials or study (i.e., high rates of patients withdrew from the trial). In this context, pediatric biobanks have an important role in improving medical research on pediatrics.

METHODS

A review of the literature has been conducted using PubMed and the following terms: Pediatrics Biobank, Pediatrics Research, Children Biobank.

RESULTS

Pediatric biobanks are needed to face the following issues when considering research activities on children: i) define participation of children in biobanking activities by taking into consideration the following issues: assent, re-consent at the age of majority, capacity to consent, and consequences of genetic results on the child and family members; ii) considering the continuing development of children, biobanks should provide appropriate and closely age-

matched normal sample controls; iii) due to the limited amount of tissue and blood samples obtainable from children, biobanks have to provide optimized standard procedures for the storage of biological material; iv) biobanks have to contrast the lack of public awareness on medical research on children by the participation to scientific communication and dissemination initiatives (i.e. European Biotech Week).

CONCLUSIONS

Pediatric biobank activities are challenging, due to the fact that pediatric diseases are almost exclusively rare, low sample volume is available, and important ethical-legal issues are linked to children's research. However, biobanks can tackle these issues thanks to their partnership with international networks (i.e. BBMRI-ERIC) and apply standard procedures for providing high-quality biosamples.

EP950 / #583

E-Poster Viewing - Paediatrics AS04-30. Translational research

Regulatory t cells' stimulation inhibits osteoclastogenesis in gorham-stout disease

D. Vecchio^{1,2*}, M. Rossi², I. Rana³, P.S. Buonuomo³, G. Battafarano², V. De Martino⁴, M. D'Agostini⁵, O. Porzio^{5,6}, C. Cipriani⁴, S. Minisola⁴, R. De Vito⁷, M.V. Gonfiantini³, M. Macchiaiolo³, A. Jenkner⁸, A. Bartuli³, A. Del Fattore²

¹Rare Diseases and Medical Genetics Unit. Bambino Gesù Children's Hospital., Academic Department of Pediatrics, Roma, Italy

²Bone Physiopathology Research Unit. Bambino Gesù Children's Hospital, IRCCS, Genetics and Rare Diseases Research Division, Rome, Italy

³Rare Diseases and Medical Genetics Unit. Bambino Gesù Children's Hospital, IRCCS, Academic Department of Pediatrics, Rome, Italy

⁴Sapienza University, Department of Clinical, Internal, Anaesthesiology and Cardiovascular Sciences, Rome, Italy

⁵Bambino Gesù Children's Hospital, IRCCS, Clinical Laboratory, Rome, Italy

⁶University of Rome Tor Vergata, Department of Experimental Medicine, Rome, Italy

⁷Bambino Gesù Children's Hospital, IRCCS, Department of Histopathology, Rome, Italy

⁸Division of Immunology and Infectious Diseases. Bambino Gesù Children's Hospital, IRCCS, Academic Department of Pediatrics, Rome, Italy

BACKGROUND AND AIM

Gorham-Stout disease (GSD) is a very rare syndrome with excessive osteolysis and angiomatous proliferation. The etiopathogenesis is still unknown. The involvement of immune system in the progressive osteolysis was recently suggested. Our study aimed to evaluate alterations of immune cells in GSD.

METHODS

Serum samples were collected from patients and analyzed by ELISA assays. Flow cytometry analysis of Peripheral Blood Mononuclear Cells (PBMC) and

in vitro study were performed. Gene expression was evaluated by Real-Time RT-PCR analysis.

RESULTS

ELISA assay revealed high levels of IL-6 and a reduction of TGF β in patients' sera. FACS analysis of PBMC showed no alteration of CD19⁺ cells, increase of CD8⁺ cells and reduction of CD4⁺ and Treg cells compared to Healthy Donors (HD). Interestingly, patients' Treg cells maintained the ability to proliferate under aCD3/aCD28 signal and exerted their immunomodulatory activity on Teff cells and inhibitory effects on osteoclastogenesis. To evaluate whether these effects were dependent on cell-cell contact, osteoclasts were treated with conditioned medium from Treg. Real-Time RT-PCR expression analysis revealed that treatment with CM from GSD-Treg induced a downregulation of DC-STAMP, ATP6V0D2, MMP9 and CATHEPSIN K genes compared to CM from HD-Treg. Moreover, CM from GSD-Treg inhibited osteoclastogenesis 7.5-fold more than HD-Treg CM, while no effects were reported on bone resorption. CM from GSD Treg was able to stimulate control osteoblasts as suggested by increased ALP staining.

CONCLUSIONS

These results suggest that stimulation of Treg cells could open the way for the identification of new therapeutic approaches for GSD patients.

Ep951 / #2454

E-Poster Viewing - Paediatrics AS04-31. Trauma & emergency medicine

The use of simulation for training in major incident management in a tertiary paediatric hospital

N. Bee^{1*}, S. Sweeney², D. Kampman¹

¹Royal Hospital for Children Glasgow, Emergency Department, Glasgow, United Kingdom

²Royal Hospital For Children, Glasgow, Ed, Glasgow, United Kingdom

BACKGROUND AND AIM

Major incidents (MI) in paediatric practice are rare but an event we must be prepared for. Hospital wide training can be a challenge whilst maintaining routine service particularly in a busy tertiary paediatric hospital. Primary aim: introduce simulation of major incidents to advance multi-disciplinary and inter-departmental training whilst evaluating our MI plan. Secondary aim: identify changes to our plan that could advance our MI response.

METHODS

We developed a MI simulation requiring involvement from teams with action cards in our MI plan. There were staff on duty and additional staff to ensure no disruption in patient care. An ED Consultant was given the information from an ambulance call declaring the MI. They then proceeded to manage the MI using their action card. The simulation ran for 3 hours including a debrief event with the whole team followed by a debrief with senior decision makers. Participants present at the end of the debrief were asked to complete a questionnaire.

RESULTS

25 responses. Prior to the simulation participants rated their confidence in their role, an average of 7.32 on a likert scale with 44% scoring 8 or above. This increased to a score of 8.36 with 80% scoring 8 or above after the simulation. 80% thought the simulation advanced their non technical skills. 96% would benefit from MI simulation 6-12 monthly. The debrief/questionnaire provided agenda items for the quaterly meeting on how the MI plan should be adapted.

CONCLUSIONS

We have shown that major incident simulation raises staff confidence. We have incorporated this into our simulation schedule.

EP952 / #2629

E-Poster Viewing - Paediatrics AS04-31. Trauma & emergency medicine

Evaluation of activation criteria in paediatric multi-trauma

N. Cohen^{1,2*}, A. Davis¹, G. Test¹, D. Singer–Harel¹, Y. Pasternak¹, S. Beno¹, D. Scolnik¹

¹Division of Pediatric Emergency Medicine, Department of Pediatrics, Hospital for Sick Children, University of Toronto, Pediatric Emergency Department, Toronto, Canada

²Tel Aviv Sourasky Medical Center affiliated to the Sackler Faculty of Medicine, Tel Aviv University, Tel Aviv, Israel, Pediatric Emergency Department, Tel Aviv, Israel

BACKGROUND AND AIM

Trauma is a leading cause of death among children and youth. We aimed to explore the optimal set of trauma activation criteria predicting paediatric patients' need for acute care following multi-trauma, with particular attention to Glasgow Coma Scale (GCS) cut-off value.

METHODS

A retrospective cohort study of paediatric multi-trauma patients aged 0-16 years, performed at a Level 1 paediatric trauma centre. Trauma activation criteria and GCS levels were examined with respect to patients' need for acute care, defined as: direct to operating room disposition, intensive care unit admission, need for acute interventions in the trauma room, or in-hospital death.

RESULTS

We enrolled 436 patients (median age 8.0 years). The following predicted need for acute care: GCS <14 (adjusted odds ratio [aOR] 23.0, 95% confi-

dence interval [CI]: 11.5-45.9, $P < 0.001$), hemodynamic instability: (aOR 3.7, 95% CI: 1.2-8.1, $P = 0.01$), open pneumothorax/flail chest (aOR: 20.0, 95% CI: 4.0-98.7, $P < 0.001$), spinal cord injury (aOR 15.4, 95% CI; 2.4-97.1, $P = 0.003$), blood transfusion at the referring hospital (aOR: 7.7, 95% CI: 1.3-44.2, $P = 0.02$) and GSW to the chest, abdomen, neck or proximal extremities (aOR 11.0, 95% CI; 1.7-70.8, $P = 0.01$). Using these activation criteria would have decreased over- triage by 10.7%, and under-triage by 1.3%.

CONCLUSIONS

Using $GCS < 14$, hemodynamic instability, open pneumothorax/flail chest, spinal cord injury, blood transfusion at the referring hospital, and GSW to the chest, abdomen, neck of proximal extremities, as T1 activation criteria could decrease over- and under-triage rates. Prospective studies are needed to validate the optimal set of activation criteria in paediatric patients.

EP953 / #1979

E-Poster Viewing - Paediatrics AS04-31. Trauma & emergency medicine

Epidemiology and change in pattern of traumatic injuries in children visiting emergency department during covid era in hong kong: a retrospective single-institutional serial cross-sectional STUDY

A.C.H. Fung^{1*}, H.H.T. Wong², W.C. Dai¹, K.K.Y. Wong¹

¹The University of Hong Kong, Department of Surgery, Hong Kong, Hong Kong PRC

²Queen Mary Hospital, Trauma Service, Hong Kong, Hong Kong PRC

BACKGROUND AND AIM

The Coronavirus stay-at-home regulations have been reported to have changed patterns and severity of paediatric trauma, yet data in major Asian cities including Hong Kong is lacking. Current study was conducted to examine the spectrum of paediatric trauma in Hong Kong and to address knowledge gaps in its change in epidemiology during pandemic.

METHODS

This is a retrospective cross-sectional study of trauma patients under 18-year-old, recruited from trauma data base of a tertiary trauma centre in Hong Kong. Demographics and clinical data of injuries (January 2010 to March 2022) were reviewed. Bivariate analysis of injury patterns between periods (pre- and post- COVID-19 pandemic, 1st Feb 2019) was conducted.

RESULTS

Total of 725 children attended Emergency Department (AED) due to trauma during the study period. The overall incidence of paediatric trauma attending

AED was similar before and after COVID-19 social distancing policy (5.8 cases per/month both). There was significant reduction in the number of trauma call activation (8.4% vs 5.7%, $p=0.002$) and road traffic accident (10.6% vs 5.7%, $p=0.009$). However, there were significant increase in injury involving younger patients (<10 years) (85.7% vs 71%, $p= 0.001$), more burns (28% vs 45.7% $p=0.0002$) and more domestic injuries (65.5% vs 85.7%, $p = 0.001$). There was no significant increase in self-harm, assault, or abuse ($p=0.326$).

CONCLUSIONS

The incidence of paediatric trauma remained constant in HK during this pandemic period. However, there was a significant rise in burns and domestic injuries. These findings highlighted important epidemiological changes and injury prevention measures to be taken in future pandemics.

EP954 / #1505

E-Poster Viewing - Paediatrics AS04-31. Trauma & emergency medicine

The importance of a multidisciplinary review in identifying paediatric burns suspicious of inflicted injury.

H. Ironton^{1*}, A. Paessler¹, K. Fowler², K. Patel³

¹Brighton and Sussex Medical School, Medicine, Brighton, United Kingdom

²Queen Victoria Hospital NHS Foundation Trust, Paediatrics, East Grinstead, United Kingdom

³Brighton and Sussex University Hospitals NHS Trust, Royal Alexandra Children's Hospital, Brighton, United Kingdom

BACKGROUND AND AIM

Clinicians should be skilled in identifying burn presentations suspicious of inflicted injury. As trends in burn pattern and mechanism change over time, there is constant demand for up-to-date research describing inflicted burns. The study reviewed characteristics of paediatric burn cases flagged for safeguarding concerns and aimed to identify distinguishing features in cases highly suspicious of inflicted injury.

METHODS

A retrospective review was made of paediatric burns presenting to a single, specialist unit from January 2016-December 2021. A descriptive analysis was undertaken of cases with safeguarding concerns, documented by the unit's multi-disciplinary team.

RESULTS

The unit treated 5022 paediatric burns during the 6-year period, of which 3% had safeguarding concerns (n=165). Case presentations were varied; no single presentation feature was consistently associated with inflicted injury. In cases with safeguarding concerns, contact burns were seen more frequently than scalds (48% v 30%, n=165), whereas in cases without safeguarding concerns this was reversed (39% v 51%, n=4857).

CONCLUSIONS

At this centre, every paediatric burn is objectively reviewed by an experienced, multidisciplinary clinical team. This process appears crucial for the correct identification of those cases requiring further investigation and referral to Children's Social Services. This study focused on burns treated in an out-patient setting and it shows that small burns can also result from inflicted injury. It is likely that a substantial proportion of small burns are not referred to specialist units, and therefore it is paramount that clinicians in the community, as well as the hospital, consider inflicted injury with any paediatric burn presentation.

EP955 / #2632

E-Poster Viewing - Paediatrics AS04-31. Trauma & emergency medicine

Self inflicted extensive subcutaneous emphysema and pneumomediastinum in an adolescent MALE.

N. Keenan*, A. Rahman

Cavan General Hospital, Paediatrics, Cavan, Ireland

BACKGROUND AND AIM

Subcutaneous emphysema is defined as the abnormal presence of gas or air in the subcutaneous tissue. Subcutaneous emphysema can infiltrate into other spaces and result in such conditions as pneumothorax, pneumomediastinum, periperitoneum to name a few. It can occur as a result of medical/surgical procedures, trauma/injury, infection or spontaneous etiologies (1). We report the case of a 13 year old who intentionally introduced air into a healing wound resulting in subcutaneous emphysema and pneumoperitoneum.

METHODS

A 13 year boy presented with abdominal, testicular and neck pain and associated testicular swelling for 1 day. His background was significant ADHD, asthma, previous bowel obstruction requiring laparotomy and a history of deliberate self harm to the old surgical scar site. No cough, fever or recent infections. The patient disclosed that he had inserted a football pump through a healing wound on the old surgical scar and inserted an unquantifiable amount of air into this wound. On examination he was vitally stable. Crepitus was elicited on palpation of his neck, chest wall and abdomen and scrotum. The rest of his examination was unremarkable.

RESULTS

A x-ray (Figure 1) confirmed extensive subcutaneous emphysema and pneumomediastinum. Surgeons advised conservative management. He was reviewed by the Child and Adolescent Mental Health Service and discharged on day three with safety netting and psychiatry outpatient input.

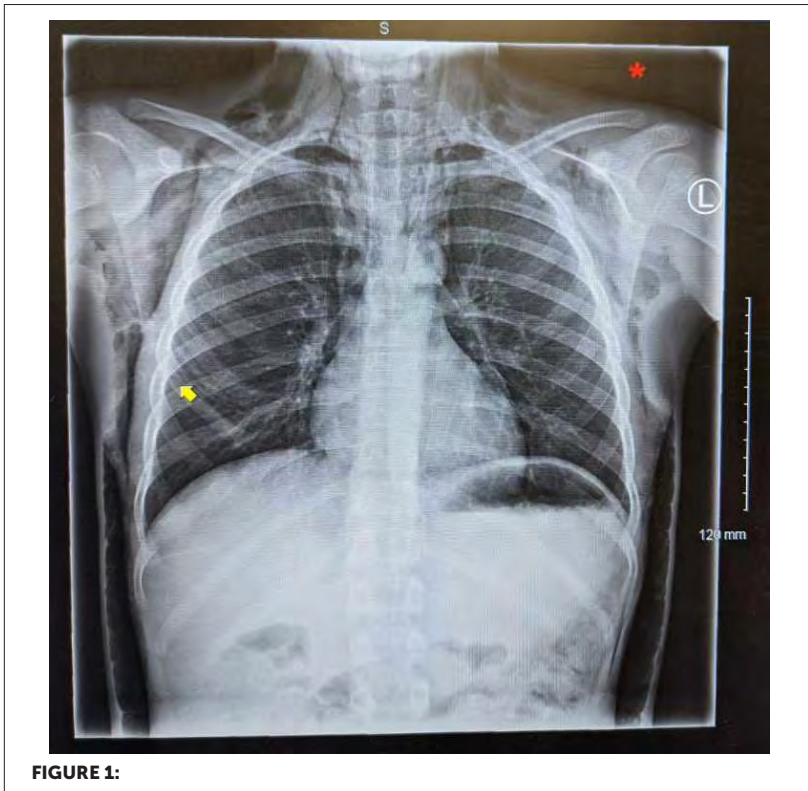

CONCLUSIONS

Subcutaneous emphysema is a rare condition and relatively benign. Air can infiltrate the deep cervical fascia connecting with the mediastinum, leading to pneumomediastinum and so CXR is key in these presentations. 1)Kukuruza K,Aboeed A.Subcutaneous Emphysema. StatPearls; 2022 Jan. <https://www.ncbi.nlm.nih.gov/books/NBK542192/>

EP956 / #2666

E-Poster Viewing - Paediatrics AS04-31. Trauma & emergency medicine

To ed, or not to ed - learning from missed opportunities in the paediatric emergency department

R. Kirk*, C. Chipperfield

Lister Hospital, East and North Herts NHS Trust, Department of Paediatric Emergency Medicine, Hertfordshire, United Kingdom

BACKGROUND AND AIM

During this post-pandemic recovery period, paediatric emergency departments (PED) have seen unprecedented attendances, record waiting-times and increased staff pressure. Our aim was to identify missed opportunities in our District General Hospital PED (UK) to optimise paediatric emergency care.

METHODS

The triage notes of all PED attendances over 24 hours were systematically reviewed. Data analysis was undertaken by the senior PED medical and nursing team alongside primary care colleagues to establish whether the expertise of PED was required. 100% outcome agreement was needed.

RESULTS

-92 patients in 24 hours. Between 5pm–8pm one patient attended every 6.5 minutes, causing a cumulative knock-on effect for evening waiting times. -13% were minor injuries. -53% were minor illnesses with normal observations. -43% were deemed not to require the skills of PED, and could have been managed in another setting (e.g. urgent care centre/pharmacist). -18% required urgent

medical attention from triage. 24% were streamed to a speciality. -12% were unheralded referrals from primary care. The re-attendance rate was 2%.

CONCLUSIONS

-To avoid PED becoming the universal contingency for acute paediatric care, we advocate for improved liaison between primary care and PED. Sharing the challenges to develop initiatives to streamline paediatric referral and care. -To avoid unheralded referrals, improve GP access to PED/paediatric specialist advice via dedicated hotlines. -Improve public health awareness of the non-PED options for minor illnesses. -We advocate for senior paediatric medical and nursing input in PED (dedicated PEM consultants and emergency nurse practitioners) to 'dart' and clinically stream patients.

EP957 / #1895**E-Poster Viewing - Paediatrics AS04-31. Trauma & emergency medicine****Identifying children presenting with burns with associated concerns about lack of supervision or neglect: a single-centre retrospective REVIEW****A. Paessler^{1*}, H. Ironton¹, K. Fowler², K. Patel³**¹Brighton and Sussex Medical School, Medicine, Brighton, United Kingdom²Queen Victoria Hospital NHS Foundation Trust, Paediatrics, East Grinstead, United Kingdom³Brighton and Sussex University Hospitals NHS Trust, Royal Alexandra Children's Hospital, Brighton, United Kingdom**BACKGROUND AND AIM**

Up to 25% of burns in children are estimated to be due to physical abuse or neglect and can have long-lasting physical and psychological effects on a child. However, there is a severe lack of data in this area, particularly in cases as a result of insufficient supervision or neglect.

METHODS

A retrospective database review was conducted of all children who presented with burns to a single specialist burns centre with documented child protection concerns from 2016-2021. The demographics, site, pattern, types of injury and social history were compared between children with and without concern over significant ongoing supervision issues.

RESULTS

3.2% of all presenting children had documented child protection concerns, of which 17.5% were thought to have significant ongoing supervision issues.

These patients were younger, predominantly had contact burns, deeper burns, resembled accidental burns and were more likely to report a mechanism that did not match the injury pattern. The MDT played a key role in identifying these children and identified a further 40.6% of children that had no concerns upon initial presentation to healthcare settings.

CONCLUSIONS

Ongoing supervision issues that lead to burn injuries in children are common and are important to identify. This study identified certain factors that may help in the identification of these children. The role of the MDT is key in paediatric burns patients and is essential for improved child safeguarding and appropriate interventions. Further multi-centre research is needed into this cohort of patients to better understand them.

EP958 / #2651**E-Poster Viewing - Paediatrics AS04-31. Trauma & emergency medicine****Adverse events during sedation for oro-dental trauma in an israeli paediatric emergency department****I. Pasternak^{1*}, L. Bilder¹, S. Librov², Z. Gutmacher¹, I. Shavit¹**¹RAMBAM MEDICAL CENTER, Pediatric Emergency Department, HAIFA, Israel²Technion-institute of technology, Rappaport Faculty of Medicine, haifa, Israel**BACKGROUND AND AIM**

There is a paucity of data regarding the safety of of the sedation for oro-dental trauma in pediatric emergency departments. In the pediatric ED of a tertiary trauma centre in Israel one of two regimens is used: a single dose of intramuscular ketamine or a combination of ketamine and propofol intravenously. The aim of this study was to assess the safety of KP sedation in children undergoing emergency treatment of oro-dental injuries in this ED

METHODS

A single-centre retrospective study was conducted. Data were extracted from the electronic medical records of all ED patients aged 0–18 years who underwent sedation for an oro-dental procedure between 1 January 2019 and 31 December 2020. The primary outcome was sedation adverse events that required intervention. The secondary outcomes were sentinel adverse events reported. Descriptive statistics were used to summarize the data.

RESULTS

During the study period, 66 children were treated with sedation for oro-dental injuries: 17 with intravenous KP, 20 with intramuscular ketamine and 29 with N₂O. No SAERI were observed in patients who were sedated with intramuscular ketamine. Overall, 35% SAERI occurred in patients treated with KP sedation, including one episode of a sentinel adverse event. All the SAERI were successfully managed by the emergency physicians.

CONCLUSIONS

In line with the aforementioned reports, the findings of the current study suggest that caution should be used when young children with oro-dental injuries are treated with KP sedation in the ED. The results also corroborate the findings of a previous study that demonstrated the safety of intramuscular ketamine in paediatric ED patients

EP959 / #2145

E-Poster Viewing - Paediatrics AS04-31. Trauma & emergency medicine

Can we introduce nurse led discharge into the paediatric emergency department for minor head injuries?

L. Riddick*, B. Basu

Bradford Teaching Hospitals Foundation Trust, Paediatric Emergency Medicine, Bradford, United Kingdom

BACKGROUND AND AIM

Background: Paediatric head injuries account for 30% of attendances and often do not require much medical intervention (Aldridge 2020). Many other trusts have looked at discharging minor head injuries that require no further medical intervention other than simple wound closure from triage by a member of the nursing team. Aims: To assess how many children attend the Bradford Paediatric Emergency Department (PED) with a minor injury, and how many of these children can be discharged using the National Institute for Clinical Excellence (NICE) CT head guidelines. This can be used as a screening tool for head injuries by the nurses at triage.

METHODS

We obtained paediatric patient records (aged under 16 years) from Electronic Patient Records (EPR), classified as having a "head injury". We reviewed their notes to see how many would be appropriate for a nurse led discharge. Data was collected over May 2021 and compared to the NICE CT head criteria.

RESULTS

We obtained 230 relevant notes and found that 70% of those attending ED would have been appropriate for nurse led discharge. Additionally, 38% of patients needed simple wound closure. Five patients had significant head injury which were identified by the screening tool. There were no serious head injuries that reattended or was missed by the screening tool

CONCLUSIONS

By introducing a nurse led discharge package at triage we could discharge 70% of minor head injuries safely, reducing waiting times for these and other patients. Using NICE CT head criteria, no major head injuries that required admission, investigation or surgical input were missed.

EP960 / #1675**E-Poster Viewing - Paediatrics AS04-31. Trauma & emergency medicine****Assessment of the pediatric early warning score and the pediatric risk of hospital admission score ii in the pediatric emergency observation ROOM****A. Bilgin, Ö. Tekşam****Hacettepe University, Pediatrics / Pediatric Emergency Medicine, Ankara, Turkey***BACKGROUND AND AIM**

Early recognition of clinical deterioration in children is crucial during pediatric emergency department (PED) visits. However, it is not always easy to identify critical patients or patients who will require hospitalization in a short time. In these circumstances, physicians may need more information to correctly identify the patients who need to be hospitalized and reach the treatment to be given as soon as possible. The objective of this study was to compare the effectiveness of PEWS and PRISA II scores in determining admission to pediatric wards and PICU in patients who are waiting for inpatient beds in observation unit.

METHODS

Patients who admitted to the pediatric emergency department between July 1, 2019 and December 31, 2019 for any reason and who were taken to the pediatric emergency observation room were included in the study.

RESULTS

It was observed that high PEWS and PRISA II scores were associated with hospital and intensive care hospitalization, PEWS ≥ 2 and ≥ 3 , PRISA II scores ≥ 11 and ≥ 16 as the cut-off points.

CONCLUSIONS

PEWS and PRISA II scores can be helpful in the decision of hospitalization of patients and can be used to show admission to ICU. High scores of PEWS and PRISA II should be taken seriously while deciding on hospitalization of patients taken to emergency OUs, but low scores will be insufficient to exclude hospitalization.

EP961 / #1727**E-Poster Viewing - Paediatrics AS04-31. Trauma & emergency medicine****Factors associated with clinically important neuroimaging findings in children presenting to the pediatric emergency department****E. Güngör¹, K. Karli Oguz², G. Halilioglu³, D. Yalnizoglu³, Ö. Tekşam^{1*}**¹Hacettepe University, Pediatrics / Pediatric Emergency Medicine, Ankara, Turkey²Hacettepe University, Radiology, Ankara, Turkey³Hacettepe University, Pediatrics / Pediatric Neurology, Ankara, Turkey**BACKGROUND AND AIM**

Computed tomography (CT) and magnetic resonance imaging (MRI) use have steadily increased in recent years and have become an important patient-evaluation component in the pediatric emergency department (PED). The aim of the present study was to investigate the factors associated with clinically important neuroimaging findings in children presenting with PED.

METHODS

This study included completely healthy children who had brain CT and MRI performed in the PED for any reason between January 1, 2015, and December 31, 2020, without any underlying disease. Trauma patients were excluded from the study. Clinically important neuroimaging finding was defined as any radiological finding that required a decision for hospitalization, for which a medical or surgical treatment plan was made or changed according to the imaging results.

RESULTS

882 patients who underwent neuroimaging were included in our study. 71.1% of the imagings were MRI and 28.9% of them were CT. Only 13.5% of neuroimaging results were found to be clinically significant ($p < 0.05$). Clinically important neuroimaging results were detected in patients with blurred vision, ataxia, focal weakness, and altered level of consciousness in this population.

CONCLUSIONS

Neuroimaging should be performed because of significant increase in clinically important neuroimaging findings among children presenting to the PED with blurred vision, ataxia, focal weakness, and altered level of consciousness. Additional longitudinal studies are needed to investigate whether our data can aid management in the PED setting.

EP962 / #927**E-Poster Viewing - Paediatrics AS04-31. Trauma & emergency medicine****Girls with cognitive impairment are at high risk of ovariectomy for delayed recognition of adnexal torsion****A. Trombetta^{1,2*}, S. Pintaldi², R. Dall'Amico¹, E. Barbi², M. Canton³**¹Azienda Sanitaria Friuli Occidentale, Pordenone, Italy, Pediatrics, Pordenone, Italy²University of Trieste, Pediatrics, Trieste, Italy³University of Trieste, Gynecology and Obstetrics, Trieste, Italy**BACKGROUND AND AIM**

Adnexal torsion is a relatively frequent problem in the Paediatric Emergency Department (PED)¹. The diagnosis is often difficult due to non-specific symptoms and relies mainly on imaging². Little is known about specific risk factors for delayed diagnosis and the possible need for ovariectomy.

METHODS

To investigate this item, we conducted a multicenter retrospective study in the Trieste and Pordenone hospitals. We included adolescents aged between 11 and 18 who received a diagnosis of adnexal torsion in the PED from January 2013 to December 2021.

We collected the following data: demographic characteristics, presence of any cognitive impairment, type of symptoms, time spent from arrival in PED to diagnosis, alteration of any laboratory tests. We compared quantitative variables with the Wilcoxon-Mann-Whitney/Shapiro test and qualitative variables with the chi-square test (significance level at 0.05).

RESULTS

We detected 40 cases of adnexal torsion, of which 36 were enrolled in the study. We found that cognitive impairment was a risk factor for ovarian loss (p-value < 0.001). As expected, the time between symptom onset and diagnosis was related to ovarian loss risk (p-value 0.033); the average time was 26 hours in the ovarian loss group compared to 12 hours in the restituito ad integrum group.

TABLE 1:

Variables	Total N=36	Outcome		p-value
		Ovarian conservatio n N=28	Ovarian loss N=8	
Age (years), mean (SD)	13.9 (2.3)	13.8 (2.4)	14.4 (2.4)	0.502
Cognitive impairment				<0.001
None	32 (88.9)	28 (100)	4 (50.0)	
Yes	4 (11.1)	0	4 (50.0)	
Symptoms, N (%)				0.216
Only pain	24 (66.7)	19 (67.9)	5 (62.5)	
Nausea/vomiting	7 (19.4)	6 (21.4)	1 (12.5)	
Peritonism	2 (5.5)	2 (7.1)	0	
Pain and other symptoms	2 (5.6)	1 (3.6)	1 (12.5)	
Other	1 (2.8)	0	1 (12.5)	
Time of symptoms onset (hours), average (IQR)	16.5 (7- 38)	12 (5.5-37)	26 (21-47)	0.033
Number of clinical assessment (IQR)	2 (1-4)	1.5 (1-3.5)	4 (3-4)	0.051
Pain improvement N (%)				0.618
None	13 (36.1)	10 (37.5)	3 (37.5)	
Yes	23 (63.9)	18 (64.3)	5 (62.5)	
Diagnostic work-up length (hours), average (IQR)	6 (4-12)	6 (4-12)	6.5 (3.5-15)	0.760

CONCLUSIONS

This study demonstrates the high risk of ovarian loss due to ovarian torsion in children with cognitive impairment. Therefore, we advise physicians to be aware of this risk and maintain a high suspicion index in these patients, carefully emphasizing the possible key symptoms (pain, vomiting and peritonism) in peri-puberal girls.

Advantages of publishing in Frontiers



OPEN ACCESS

Articles are free to read for greatest visibility and readership



FAST PUBLICATION

Around 90 days from submission to decision



HIGH QUALITY PEER-REVIEW

Rigorous, collaborative, and constructive peer-review



TRANSPARENT PEER-REVIEW

Editors and reviewers acknowledged by name on published articles

Frontiers

Avenue du Tribunal-Fédéral 34
1005 Lausanne | Switzerland

Visit us: www.frontiersin.org

Contact us: info@frontiersin.org | +41 21 510 17 00



REPRODUCIBILITY OF RESEARCH

Support open data and methods to enhance research reproducibility



DIGITAL PUBLISHING

Articles designed for optimal readership across devices



FOLLOW US

[@frontiersin](https://twitter.com/frontiersin)



IMPACT METRICS

Advanced article metrics track visibility across digital media



EXTENSIVE PROMOTION

Marketing and promotion of impactful research



LOOP RESEARCH NETWORK

Our network increases your article's readership