

$$V_{OUT} = 0.6V * (1 + R1/R2)$$

$$R2 = 1500K$$

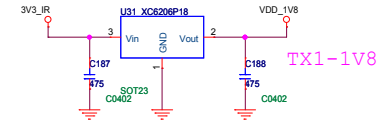

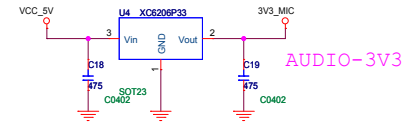
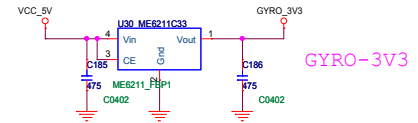
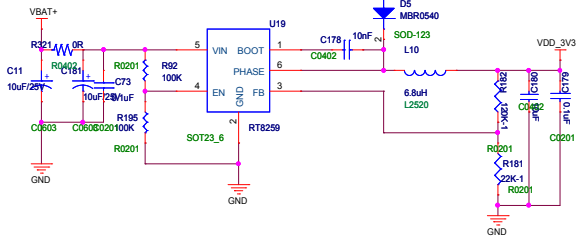
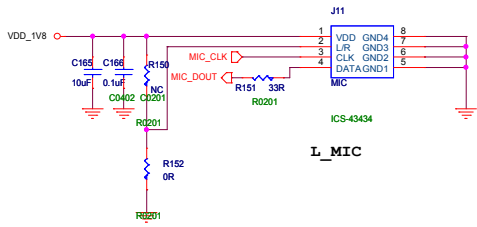
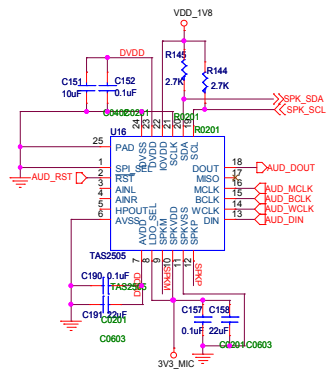

L_MIC

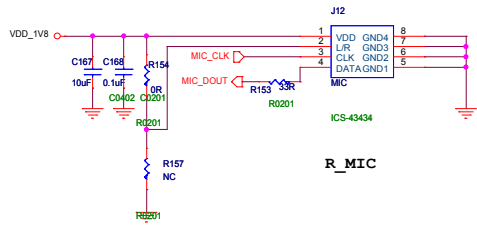

R_MIC