

PRODUCT CATALOG

TRACE • THREATS

SUMMER 2023



**Delivering Security
to the World**



Department for
Transport



DSA Detection[®]

Capabilities & Past Performance

Company Overview

DSA Detection is a leading manufacturer of **DHS-approved trace detection consumables** used in the operation and maintenance of all explosive trace detection (ETD) instruments commercially available. DSA is also a leading manufacturer of **X-ray correct explosive simulants, IED training aids, and test articles** used in training screeners to identify threats and to verify security checkpoint equipment. DSA then combines all its products and expertise into comprehensive and in-depth **training for threat recognition and security equipment operation**, tailored to meet all levels of detection.

Core Competencies

- Largest independent checkpoint supplier
- Critical ETD consumables submitted quarterly to the DHS Transportation Security Laboratory
- Product innovation - QS-B220 Dual-Mode Verification Trap replaces A&B cans
- X-ray correct training aids that provide accurate imaging and trigger threat detection alarms
- Proprietary training methodology for security screening
- Subject-matter experts: Trace, IED design, threat interpretation training
- Highly reliable security checkpoint supply chain
- Worldwide distributors: Canada, Mexico, Australia, Europe, Asia, South America, Africa
- Industry-leading, longest shelf life guarantee on all products

Unique Selection

- ETD consumables for all leading instruments
- Extensive product line of X-ray and metal-detector correct inert IEDs and weapons
- Digital X-ray threat image libraries for equipment certifications and stock library updates
- Custom engineering and manufacturing: ETD products, explosive simulants, X-ray image libraries, etc.
- ETD, X-ray, and metal detector training from industry-vetted experts certified by OEMs

US Federal Government

- The leading supplier of trace consumables during the COVID19 national supply shortage
- General Dynamics logistics supplier of ETD consumables (all US DOS embassies and consulates) from 2007-present
- Northrop Grumman/Peraton Supplier for TSA checkpoint training aids and red teaming
- TSA ILS supplier 2007-present through 3 consecutive contracts with Siemens then Leidos
- 4 consecutive TSA BPA contracts, supplying 465 +/- airports with all ETD consumables
- 1,000 ETD TQC Red Team kits provided to TSA for ETD training and testing
- Defense Logistics Agency (DLA) supplier
- Largest supplier of security divesting screening bins for federal security checkpoints

- FBI 5-year IDIQ contract for up to 3,000+ training aids with options to add over 22,000
- Nearly 4,000 inert IEDs and associated products supplied to the US Army in Afghanistan
- 405 custom inert training kits for the Federal Protective Services
- 2 consecutive contracts for 200+ training kits provided to the USMS at 94 federal courthouses
- DHS-TSL Creative Research & Development Agreement (CRADA) for explosive simulants
- Inert IED/Explosive Simulant Customers - DOD: the Pentagon, Army, Navy, Air Force, Army National Guard, and Navy National Guard, NSWC Indian Head; DOS: multiple embassies and consulates; CIA
- Replica Ordnance Customers: Naval Sea Systems Command, US Air Force
- Threat identification training: US Mint, US embassies, US military, DOS, and secure facilities

US State and Local Government

- 600 Hi-Traction Screening Bins used by California Senate
- Largest supplier of security screening bins sold to state security checkpoints
- Threat identification training: Pennsylvania State Mail Center and Essex County Sheriff's Dept.
- Training kits supplied to Cambridge, MA Police Department EOD (explosive disposal) team

International Governments

- ETD consumables supplied to Canadian (CATSA), UK, European, and other international airports (Key supplier of ETD consumables for all Mexican airports)
- Inert IED devices for the United Nations in Iraq and Somalia
- Hundreds of training aids for Transport Canada (AVSEC Technology) and CATSA
- 30 training kits for Canadian embassies
- Inert ordnance replicas provided to the United Nations and Canadian Armed Forces
- Threat identification training: Moroccan Civil Aviation Authority
- Kits and simulants: HMGCC, DSTL, Port Authority St. Lucia, CAA Bahamas, CAA New Zealand, ANAC Brazil and many airports around the world.

Commercial Companies

- ETD consumables developed for and supplied to instrument manufacturers: Implant Sciences, 908 Devices, Bruker, FLIR, Greyscan
- X-ray threat image projection libraries (TIP) for leading X-ray manufacturers
- Hundreds of training kits provided to domestic and international security companies and cargo companies, such as Delta, AA, Lufthansa, Amazon, and Virgin Cruises.
- Custom solutions developed for national laboratories, research groups, and industry leaders
- X-ray image analysis training: Several major sporting league stadiums and events. (Training aids also provided.)
- X-ray, WTMD, and ETD training at Peacemaker National Training Center in WV
- Partnered with a variety of security consulting companies on government and commercial programs

Cage Code 49BS5 DUNS 609595215 Certified Small Business BAA Compliant

Table of Contents

5 ETD Consumables

- 7 QS-B220
- 14 QS-H150E
- 14 500DT
- 18 Itemiser DX/3/MobileTrace
- 28 400B
- 31 SABRE 4000/5000
- 33 Itemiser 2
- 33 Checkpoint & Cleaning

49 Training Kits

- 51 Inert Advanced Threat Screening Kit
- 51 Inert IED Circuit Boards Kit
- 52 Inert Modular Bomb System Training Kit
- 52 Inert Domestic Terrorism Threat Training Kit
- 53 Inert Mail Threat Kit
- 53 Inert Anti-Terrorism Training Kit
- 54 Inert Threat Screening Kit
- 54 Non-Metallic Edged Weapons Kit
- 55 Inert Air Cargo (CCSP) Threat Kit
- 55 Inert Guns and Knives Threat Kit
- 56 Inert Advanced Weapons Kit
- 56 Inert Explosives Threat Kit
- 57 Inert P.I.E.S. Kit
- 57 Concealed Weapons Kit
- 58 Inert Prohibited Items Kit
- 58 Inert Clothing IED Kit
- 59 Blasting Cap Test Kit
- 59 Metal Detector Test Kit
- 60 3-Gun Test Kit
- 60 Trace Quality Control (TQC) Kit

61 Explosive Simulants & Detonators

- 63 Explosive Simulants
- 83 Inert Detonators

89 Threat Training Aids

TRACE DETECTION CONSUMABLES Product Catalog

SUMMER 2023

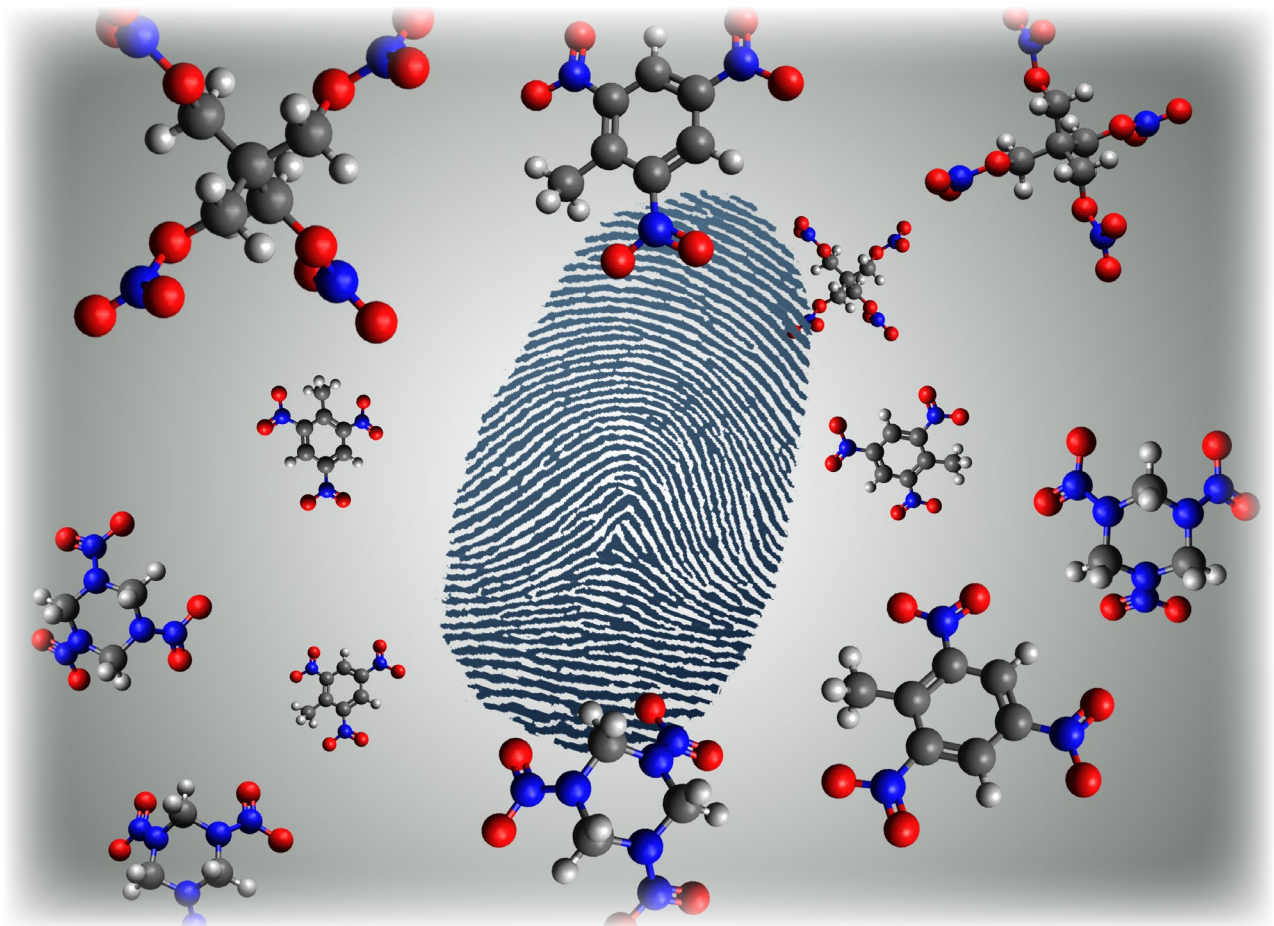

Department for
Transport



Table of Contents

7 Cotton Swabs (100ct)	28 Sintered Filter
7 Bumper Feet	28 Condenser Tube
7 Fan Filter Replacement, 5pk	28 Foam Filter
8 Sieve Canister X-Ring (#019)	29 Behind Bottle Foam Filter
8 Sieve Canister X-Ring (#012)	29 Fan Guard, 4-Prong
8 Thermal Paper Roll, 112 mm	29 Behind Bottle Cover and Filter
9 Verification Sample A - Negative	30 Filter Kit
9 Verification Sample, B - Positive	30 O-ring, Viton (#009)
9 Filter Screen, Sample Pathway	30 O-ring, Viton (#012)
10 Filter Screen, Sample Pathway (5ct)	31 400B Printer Paper, Intl
10 Orifice Filter Replacement Tool	31 Swab Sampler Velcro Hook (10ct)
10 Sieve Canister (4-pack) with Filter	31 Fuse, 0.5A, 125V
11 Sieve Canister (12-pack) with Filters	32 Fuse, 15A, 32V
11 Alcohol Wipes, 1.7x3.5 (100ct)	32 CW/TIC Vapor Verific
11 Calibration Traps, Dual (25ct)	32 Verification Pen
12 B220 Checkpoint Sample Traps (100ct)	33 Membrane Kit
12 B220 Checkpoint Sample Traps (300ct)	33 O-Ring Silicone (#022)
12 Cargo Sample Traps (100ct)	33 Canned Air
13 Cargo Sample Traps (300ct)	34 Standard Bin Cart
13 Dual Mode Verification Trap (25ct)	34 Safety Enclosure Cleaning Cloth
13 Dual Mode Verification Trap (100ct)	34 ETD Mobile Workstation (non-powered)
14 QS-H150E Sieve Canister	35 ETD Mobile Workstation (powered)
14 Condenser Tube Kit with Gaskets	35 ETD Mobile Powered Workstation LiFePO4
14 Thermal Printer Paper	35 Replacement Battery Pack for Mobile Workstation (2 pack)
15 Thermal Printer Paper (pkg of 5)	36 Inverter/Charger 1000w, Mobile Workstation
15 Printer Paper	36 LiFePO4 Battery
15 Printer Ribbon	36 Small, Powder-Free, Nitrile Gloves (4mil)
16 500DT Hand Swab (100ct)	37 Medium, Powder-Free, Nitrile Gloves (4mil)
16 500DT Hand Swabs (200ct)	37 Large, Powder-Free, Nitrile Gloves (4 mil)
16 500DT Sample Swabs (200ct)	37 Extra Large, Powder-Free, Nitrile Gloves (4mil)
17 500DT Sample Swabs (400ct)	38 Standard Screening Bin, Selectee (Red)
17 Sampling Wand Velcro Hook (10ct)	38 Standard Screening Bin
17 Verification Pen	38 Standard Screening Bin w/ Hi-Traction
18 Clearing Dropper	39 X-Ray Marker Kit
18 Sampling Wand Velcro Shaper (10ct)	39 Standard Screening Bin w/ X-Ray Marker
18 Itemiser® DX Starter Consumable Kit	39 Disposable Shoe Covers (50 pair)
19 Calibration Pen	40 Screening Bin Rack
19 Clearing Spray	40 Distilled Water
19 Calibration Traps (25ct)	40 Distilled Water Dropper
20 Calibration Traps (100ct)	41 Large Cotton Gloves
20 N-Mode Dopant, Long Life Positive Ion	41 Small Cotton Gloves
20 N-Mode Dopant, Long Life Positive Ion	41 Isopropyl Alcohol 70%, 16 oz
21 E-Mode Dopant, Negative Ion	42 Isopropyl Alcohol 70%, Gallon (4pk)
21 Sample Filter and Purge Inlet Filter	42 Membrane Stick
21 Fan Filter	42 Privacy Sheet, 2 Ply Tissue, 40" x 48"
22 Fan Guard	43 Privacy Sheet, 2 Ply Tissue, 40" x 72"
22 Fan Filter Kit	43 Plastic Jug Pump
22 Fuse, 250V AC 3.15A	43 Liquid Surface and Hand Sanitizer 16.9oz Spray Bottle
23 Fuse, 15A, 32V 3AG, for DC input	44 Instant Surface and Hand Sanitizer Refill
23 Nozzle Screen Kit	44 Spray Bottle, 16oz
23 O-Ring Silicone (#019)	44 Sample Swabs/Traps Box
24 O-Ring Viton (#008)	45 ASTM F 792-88 Stepped Wedge
24 Thermal Printer Paper	45 Bottle Label Sticker
24 Spare Parts Kit	45 Dryer Material 500g (Molecular Sieve)
25 Itemiser® 3/DX Spare Parts Kit	46 Eye Wash Station, 32 oz
25 Sample Traps (25ct)	46 Eye Wash Station Refill, 32 oz
25 Itemiser Sample Traps (100ct)	46 Leak Test Kit
26 Itemiser Sample Traps (300ct)	47 Saturated Swabs (25ct)
26 Sample Traps (300ct) and Sample Box Kit	47 Swab Sampler Disk (10ct)
26 Verification Pen	47 Saturated Alcohol Wipes
27 Verification Traps (100ct)	48 Alcohol Pads (50ct)
27 Verification Traps (25ct)	48 PTFE Tubing (1/8" ID)
27 Check Sample Vial - Military	48 Silastic Tubing (1/8" ID)

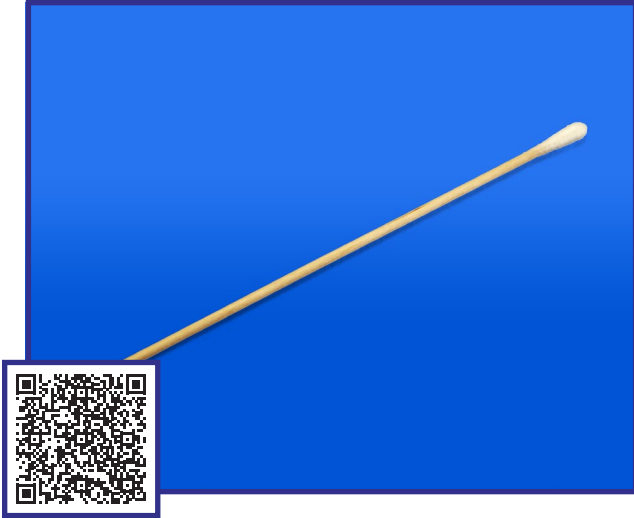

Cotton Swabs (100ct)

SKU: **BCS1020**

Compatible with: *Checkpoint and Cleaning*

Excellent for a range of cleaning purposes. Recommended to be used with Isopropyl Alcohol (70% or greater).

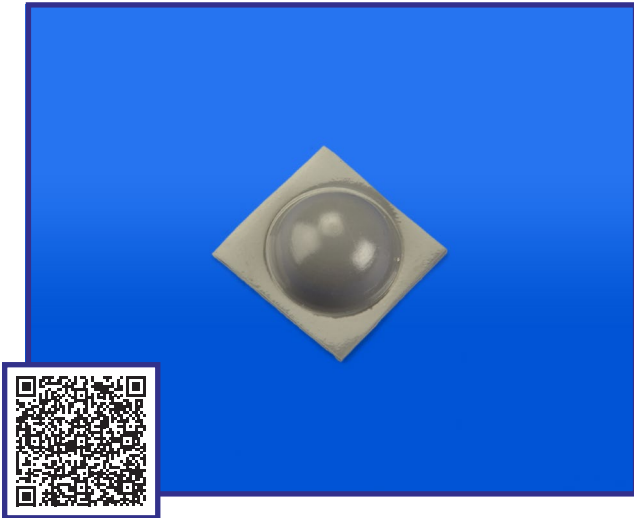

Bumper Feet

SKU: **BF1702**

Compatible with: *Itemiser® 3/DX/4/5X*

Approval: *DHS*

Bumper feet may become worn or detached and require replacement. Bumper feet are made of self-adhering polyurethane material. The instrument uses eight feet in total, four on the bottom and four on the back for setting it down in an upright position.

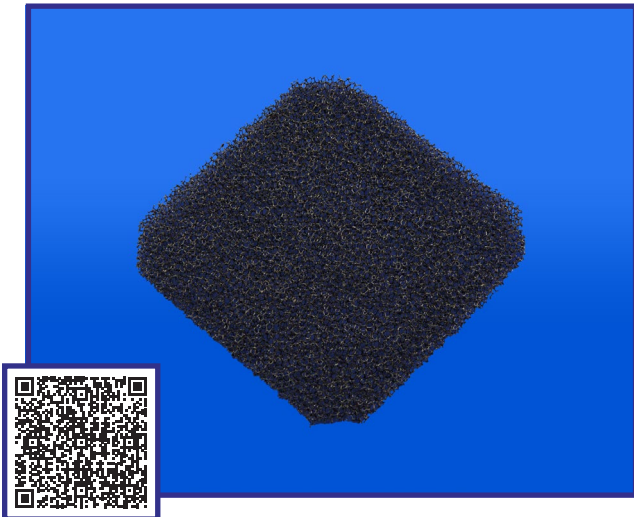

Fan Filter Replacement, 5pk

SKU: **BFF1015**

Compatible with: *QS-B220™*

The fan filter is typically located at the rear of the instrument and is accessible by unsnapping the fan guard. This component filters the cooling air that enters the instrument. Visible dust on the filter is an indication it should be changed immediately.

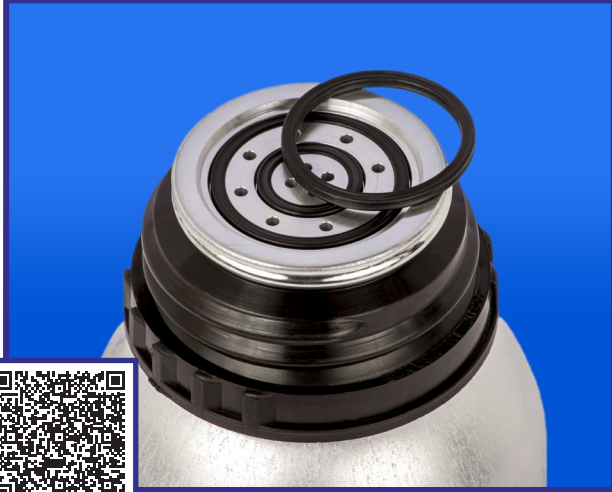

Sieve Canister X-Ring (#019)

SKU: **BOR0180**

Compatible with: QS-B220™

O-rings can occasionally become visually contaminated, damaged or worn and will need to be replaced.



Sieve Canister X-Ring (#012)

SKU: **BOR0181**

Compatible with: QS-B220™

O-rings can occasionally become visually contaminated, damaged or worn and will need to be replaced.

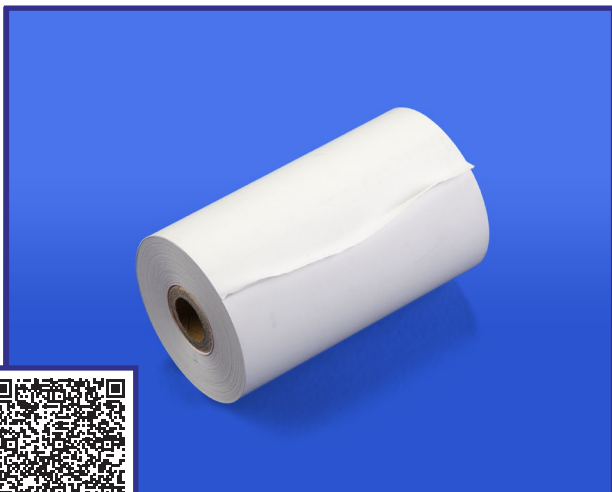

Thermal Paper Roll, 112 mm

SKU: **BPP1010**

Compatible with: QS-B220™

The Thermal Printer Paper Rolls are individually packaged in sealed plastic wrappers for freshness.



Verification Sample A - Negative

SKU: **BSA1030**

Compatible with: QS-B220™

Approval: DHS

The Verification Sample, A-Negative is used to verify that the ETD instrument is properly calibrated. This product is produced under strict laboratory controls. The Verification Sample, A-Negative is packaged in contaminant-free containers and sealed for maximum freshness and longevity. Please store in a cool, dry place, away from direct sunlight. This product should be stored at room temperature. Clean cotton gloves (GL7500) are required when sampling to prevent contaminants interfering with the performance of the instrument.



Verification Sample, B - Positive

SKU: **BSB1035**

Compatible with: QS-B220™

Approval: DHS

The Verification Sample, B-Positive is used to verify that the ETD instrument is properly calibrated. This product is produced under strict laboratory controls. The Verification Sample, B-Positive is packaged in contaminant-free containers and sealed for maximum freshness and longevity. Please store in a cool, dry place, away from direct sunlight. This product should be stored at room temperature. Clean cotton gloves (GL7500) are required when sampling to prevent contaminants interfering with the performance of the instrument.

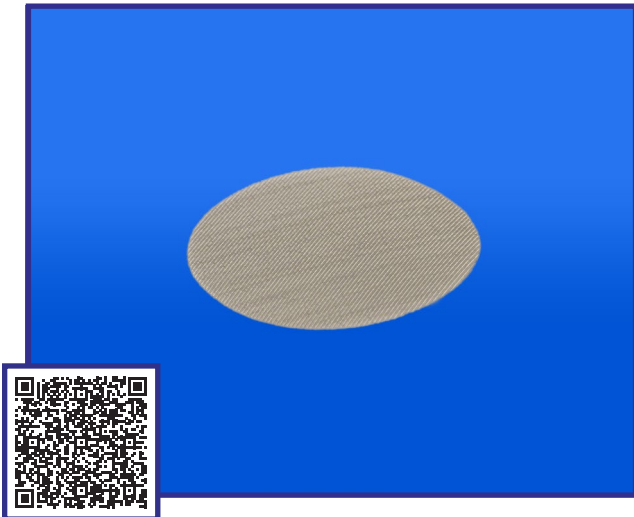

Filter Screen, Sample Pathway

SKU: **BSC0001**

Compatible with: QS-B220™

The filter screen allows target vapors to pass through into the detection system, while blocking out contaminants. During normal use, the filter screen is replaced yearly. In more contaminated environments, the filter screen is replaced as needed.



Filter Screen, Sample Pathway (5ct)

SKU: **BSC0002**

Compatible with: QS-B220™

The filter screen allows target vapors to pass through into the detection system, while blocking out contaminants. During normal use, the filter screen is replaced yearly. In more contaminated environments, the filter screen is replaced as needed.



Orifice Filter Replacement Tool

SKU: **BSC1307**

Compatible with: QS-B220™

Approval: *DHS Accepted*

This tool is used to remove/change the 5-micron filter when doing regular maintenance and changing the four sieve canisters on a QS-B220 instrument.



Sieve Canister (4-pack) with Filter

SKU: **BSC1329**

Compatible with: QS-B220™

Approval: *DHS*

Four canisters and one exterior 5-micron filter are included. The Molecular Sieve Canisters are critical in maintaining proper performance of the QS-B220 instrument and must be replaced periodically. Manufactured in the USA, the QS-B220 Molecular Sieve Canisters have been extensively tested by the DHS Transportation Security Laboratory to ensure they meet or exceed performance standards. Please refer to the instrument manual for installation instructions.



Sieve Canister (12-pack) with Filters

SKU: **BSC1340**

Compatible with: QS-B220™

Approval: DHS

Twelve canisters and three exterior 5-micron filter are included. The Molecular Sieve Canisters are critical in maintaining proper performance of the QS-B220 instrument and must be replaced periodically. Manufactured in the USA, the QS-B220 Molecular Sieve Canisters have been extensively tested by the DHS Transportation Security Laboratory to ensure they meet or exceed performance standards. Please refer to the instrument manual for installation instructions.



Alcohol Wipes, 1.7x3.5 (100ct)

SKU: **BSW1025**

Compatible with: Checkpoint and Cleaning

Approval: DHS Accepted

Pre-saturated with ultra-pure isopropyl alcohol, these well-constructed wipes resist tears. Excellent for general cleaning of instrument surfaces, they work equally well cleaning harder-to-reach areas.



Calibration Traps, Dual (25ct)

SKU: **CT1272P**

Compatible with: QS-B220™

Approval: DHS

Calibration Traps are required for proper operation of the instrument. Calibration Traps are produced under strict laboratory controls and are engineered using the highest quality Teflon®-coated (PTFE) fiberglass material available. Calibration Traps meet the exact standards required for precise calibration of your instrument. Traps are packaged in contaminant-free recyclable trays and sealed for maximum freshness and longevity.



B220 Checkpoint Sample Traps (100ct)

SKU: **ST1267**

Compatible with: QS-B220™

Approval: DHS Checkpoint / Checked Bag Screening

These advanced sample traps are specifically designed for use in a security checkpoint to collect more particles of interest from various surfaces for analysis. Sample traps are produced under strict laboratory controls and packaged in contaminant-free, recyclable trays. Please store in a cool, dry place, away from direct sunlight. Clean cotton (GL7500, GL7501) or Nitrile gloves (CNG2091, CNG2092, CNG2093, CNG2094) are required when handling sample traps to prevent contaminants from interfering with the performance of the instrument.



B220 Checkpoint Sample Traps (300ct)

SKU: **ST1268**

Compatible with: QS-B220™

Approval: DHS Checkpoint / Checked Bag Screening

These advanced sample traps are specifically designed for use in a security checkpoint to collect more particles of interest from various surfaces for analysis. Sample traps are produced under strict laboratory controls and packaged in contaminant-free, recyclable trays. Please store in a cool, dry place, away from direct sunlight. Clean cotton (GL7500, GL7501) or Nitrile gloves (CNG2091, CNG2092, CNG2093, CNG2094) are required when handling sample traps to prevent contaminants from interfering with the performance of the instrument.



OEM Cargo Sample Traps (100ct)

SKU: **ST1269P**

Compatible with: QS-B220™, QS-H150E™

Approval: DHS Cargo Screening

DSA is the original manufacturer and the only approved supplier of the QS-B220 sample trap for cargo screening. Sample traps are designed to harvest particles for analysis by the instrument. Sample traps are produced under strict laboratory controls, and packaged in contaminant free recyclable trays. Sample traps should be stored at room temperature away from direct heat. Clean cotton gloves (GL7500, GL7501) are required when handling sample traps to prevent contaminants interfering with the performance of the instrument.



Cargo Sample Traps (300ct)

SKU: **ST1270**

Compatible with: *QS-B220™, QS-H150E™*

Approval: *DHS Cargo Screening*

DSA is the original manufacturer and the only approved supplier of the QS-B220 sample trap for cargo screening. Sample traps are designed to harvest particles for analysis by the instrument. Sample traps are produced under strict laboratory controls, and packaged in contaminant free recyclable trays. Sample traps should be stored at room temperature away from direct heat. Clean cotton gloves (GL7500, GL7501) are required when handling sample traps to prevent contaminants interfering with the performance of the instrument.



Dual Mode Verification Trap (25ct)

SKU: **VT1272**

Compatible with: *QS-B220™, QS-H150E™*

Approval: *DHS*

Verification is required to verify that the instrument is properly calibrated. These single-use dual mode verification traps eliminate the need for verification A and verification B canisters, resulting in significant cost savings annually. Dual mode verification traps are produced under strict laboratory controls and are engineered using the highest quality Teflon®-coated (PTFE) fiberglass material available. Traps are packaged in contaminant-free recyclable trays and sealed for maximum freshness and longevity. Clean nitrile gloves are required when handling traps.



Dual Mode Verification Trap (100ct)

SKU: **VT1273**

Compatible with: *QS-B220™, QS-H150E™*

Approval: *DHS*

Verification is required to verify that the instrument is properly calibrated. These single-use dual mode verification traps eliminate the need for verification A and verification B canisters, resulting in significant cost savings annually. Dual mode verification traps are produced under strict laboratory controls and are engineered using the highest quality Teflon®-coated (PTFE) fiberglass material available. Traps are packaged in contaminant-free recyclable trays and sealed for maximum freshness and longevity. Clean nitrile gloves are required when handling traps.



QS-H150E Sieve Canister

SKU: **BSC1210**

Compatible with: QS-H150E™

The Molecular Sieve Canisters are critical in maintaining proper performance of the QS-H150E instrument and must be replaced periodically. Please refer to the instrument manual for installation instructions.



Condenser Tube Kit with Gaskets

SKU: **DCK7658**

Compatible with: IONSCAN™ 500DT

Approval: DHS

The condenser tubes are designed to remove contaminants within air lines. They are manufactured to perform equal to or better than the OEM product. For installation, follow instrument manufacturer's procedures.

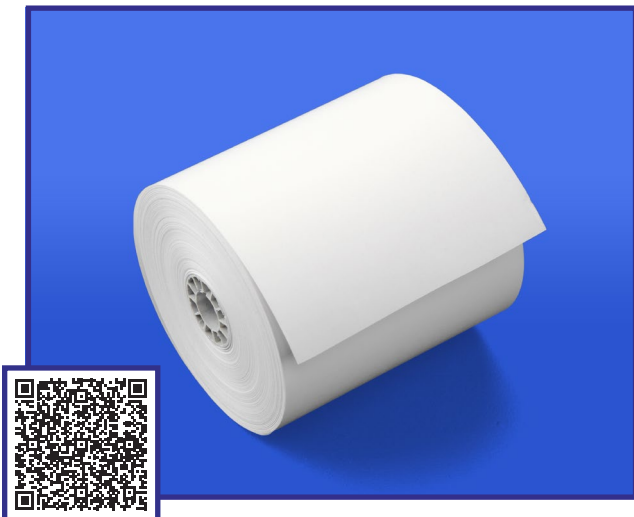

Thermal Printer Paper

SKU: **DPP4145**

Compatible with: IONSCAN™ 500DT

Approval: DHS Accepted

The thermal printer paper rolls are specifically designed for the IONSCAN™ 500DT & 600DT and matches the manufacturer's OEM part number - 6824145.



Thermal Printer Paper (pkg of 5)

SKU: **DPP4146**

Compatible with: *IONSCAN™ 500DT*

Approval: *DHS Accepted*

The thermal printer paper rolls are specifically designed for the IONSCAN™ 500DT & 600DT and matches the manufacturer's OEM part number - 6824145.

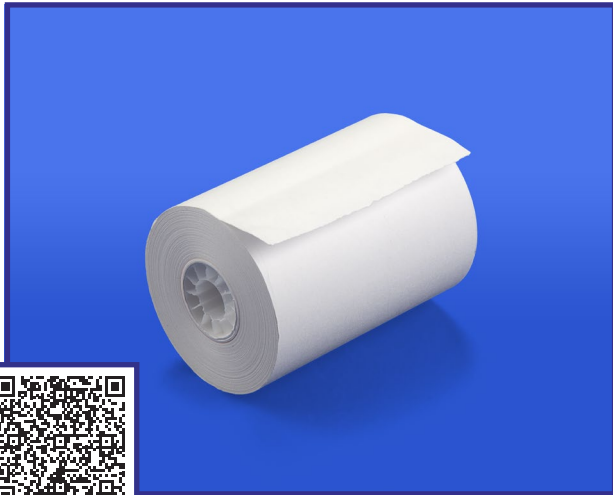

Printer Paper

SKU: **DPP8047**

Compatible with: *IONSCAN™ 500DT*

Approval: *DHS Accepted*

Impact printer paper is specifically designed for the IONSCAN™ 500DT and matches the manufacturer's specifications precisely for printer part number - 1818777.



Printer Ribbon

SKU: **DPR4728**

Compatible with: *IONSCAN™ 500DT*

Approval: *DHS Accepted*

Star Micronics printer cartridge, specified for use on the IONSCAN™ 500DT ETD internal printer (part number - 1818777), matches the ETD manufacturer's specifications precisely.



500DT Hand Swab (100ct)

SKU: **DSW1205P**

Compatible with: *IONSCAN™ 500DT*

Approval: *DHS, STAC*

Hand swabs are designed to sample particles for analysis by an explosive trace detector (ETD). Swabs are packaged in contaminant free recyclable trays and sealed for maximum freshness and longevity. Store in a cool, dry place, away from direct sunlight. Clean cotton gloves (GL7500) are required when handling. Product is also available in quantity 200 (DSW1210P).



500DT Hand Swabs (200ct)

SKU: **DSW1210P**

Compatible with: *IONSCAN™ 500DT*

Approval: *DHS, STAC*

Hand swabs are designed to sample particles for analysis by an explosive trace detector (ETD). Swabs are packaged in contaminant free recyclable trays and sealed for maximum freshness and longevity. Store in a cool, dry place, away from direct sunlight. Clean cotton gloves (GL7500) are required when handling. Product is also available in quantity 100 (DSW1205P).



500DT Sample Swabs (200ct)

SKU: **DSW8055P**

Compatible with: *IONSCAN™ 500DT*

Approval: *DHS, STAC*

Our DSA-approved Sample Swabs are designed to sample particles from various surfaces for analysis by the instrument. DSA's Sample swabs are produced under strict laboratory controls and manufactured using the highest quality Nomex® available. Sample Swabs are packaged in contaminant free recyclable trays and sealed for maximum freshness and longevity. Clean cotton gloves (DSW1210P) are required when handling Sample Swabs. Product is also available in quantity 400 (DSW8066P).



500DT Sample Swabs (400ct)

SKU: **DSW8066P**

Compatible with: *IONSCAN™ 500DT*

Approval: *DHS, STAC*

Our DSA-approved Sample Swabs are designed to sample particles from various surfaces for analysis by the instrument. DSA's Sample Swabs are produced under strict laboratory controls and manufactured using the highest quality Nomex® available. Sample Swabs are packaged in contaminant free recyclable trays and sealed for maximum freshness and longevity. Clean cotton gloves (DSW1210P) are required when handling Sample Swabs. Product is also available in quantity 200 (DSW8055P).



Sampling Wand Velcro Hook (10ct)

SKU: **DVH3347**

Compatible with: *IONSCAN™ 500DT*

Approval: *DHS Accepted*

Located at the end of the sampling wand, the Velcro® pad can wear or become contaminated, and thus requires replacement. The Velcro® has a self-adhesive backing for easy installation.

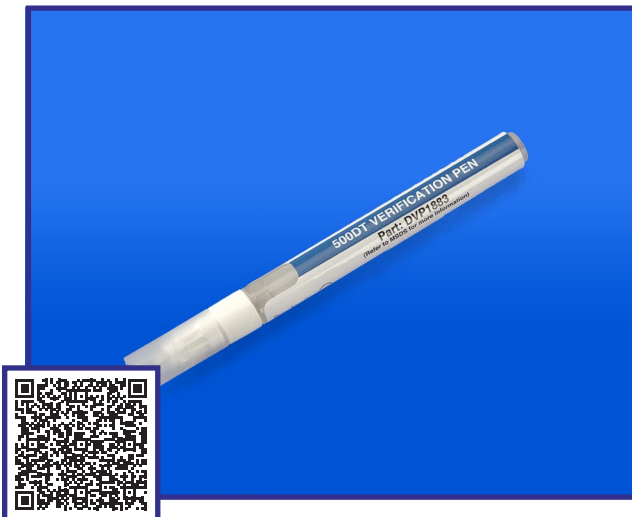

Verification Pen

SKU: **DVP1883**

Compatible with: *IONSCAN™ 500DT*

Approval: *DHS, STAC*

The Verification Pen is produced under strict laboratory controls, and meets the exact standards required for precise verification of the IONSCAN™ 500DT instrument. The Verification Pen should be stored at room temperature away from direct heat. For extended shelf life, DSA Detection recommends the pen be stored in a refrigerator or freezer. Refer to the label for product instructions. Suitable for cargo use only.



Clearing Dropper

SKU: **DWD1004**

Compatible with: *IONSCAN™ 500DT*

Approval: *DHS Accepted*

The Clearing Dropper for the 500DT accelerates clear down time after an alarm. This product is produced under strict laboratory quality controls and dispenses a precise amount of clearing solution.

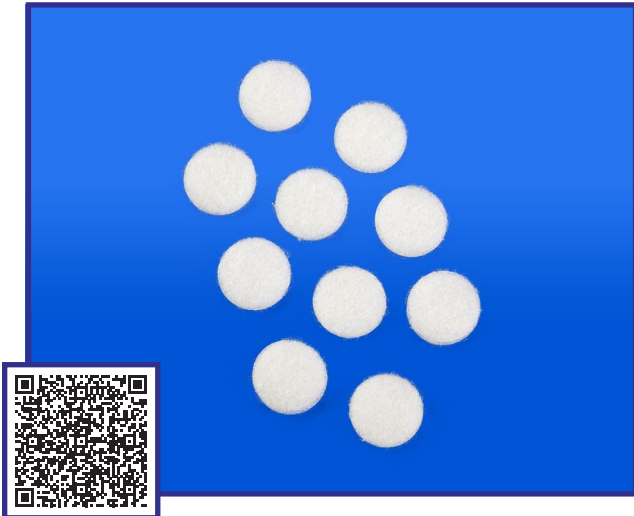

Sampling Wand Velcro Shaper (10ct)

SKU: **DWS8944**

Compatible with: *IONSCAN™ 500DT*

Approval: *DHS Accepted*

The Velcro® pad is located at the end of the wand where the sample swab is placed. It may wear or become contaminated, thus needing to be replaced.



Itemiser® DX Starter Consumable Kit

SKU: **CK1269**

Compatible with: *Itemiser® DX*

Approval: *DHS*

Our Itemiser® DX Starter Consumable Kit includes (1) N-Mode Dopant Long Life Positive Ion, (1) E-Mode Dopant Negative Ion, (1) Sample Traps (100ct), (1) Calibration Traps (100ct), (1) Verification Traps (100ct), (1) Canned Air, (1) Clearing Spray, (2) Thermal Printer Paper

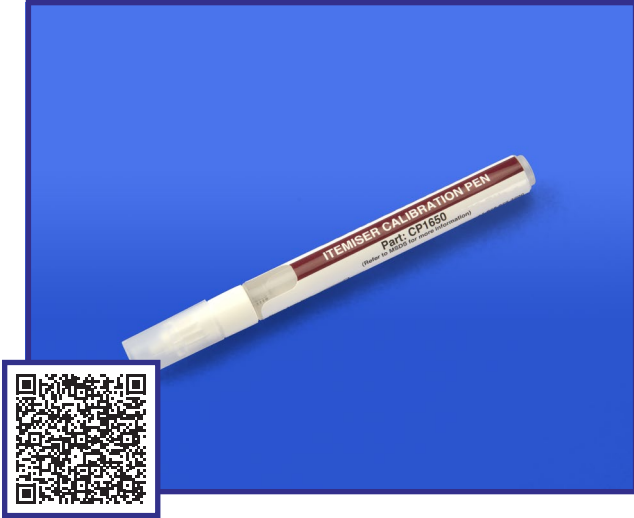

Calibration Pen

SKU: **CP1650**

Compatible with: *Itemiser® 3/DX/4/5X, VaporTracer2®, MobileTrace®*

The Calibration Pen is produced under strict laboratory controls and meets the exact standards required for precise calibration. The Calibration Pen should be stored at room temperature away from direct heat. For extended shelf life, it is recommended the pen be stored in a refrigerator or freezer. Refer to the label for product instructions.



Clearing Spray

SKU: **CS1831**

Compatible with: *Itemiser® DX*

Approval: *DHS Accepted*

Our Clearing Spray - 20mL (0.68 fl oz) for the Itemiser® DX accelerates clear down time after an alarm. This product is produced under strict laboratory quality controls and dispenses a precise amount of clearing solution.



Calibration Traps (25ct)

SKU: **CT1317P**

Compatible with: *Itemiser® 3/DX/4/5X, VaporTracer2®, MobileTrace®*

Approval: *DHS*

Calibration traps are required for proper operation of the instrument. Calibration traps are produced under strict laboratory controls and are engineered using the highest quality Teflon®-coated (PTFE) fiberglass material available. Traps are packaged in contaminant-free recyclable trays and sealed for maximum freshness and longevity. Calibration traps should be stored at room temperature away from direct heat. Clean cotton gloves (GL7500) are required when handling to prevent contaminants from interfering with the performance of the instrument. Calibration traps are single use only.



Calibration Traps (100ct)

SKU: **CT1319P**

Compatible with: *Itemiser® 3/DX/4/5X, VaporTracer2®, MobileTrace®*

Approval: *DHS*

Calibration traps are required for proper operation of the instrument. Calibration traps are produced under strict laboratory controls and are engineered using the highest quality Teflon®-coated (PTFE) fiberglass material available. Traps are packaged in contaminant-free recyclable trays and sealed for maximum freshness and longevity. Calibration traps should be stored at room temperature away from direct heat. Clean cotton gloves (GL7500) are required when handling to prevent contaminants from interfering with the performance of the instrument. Calibration traps are single use only.

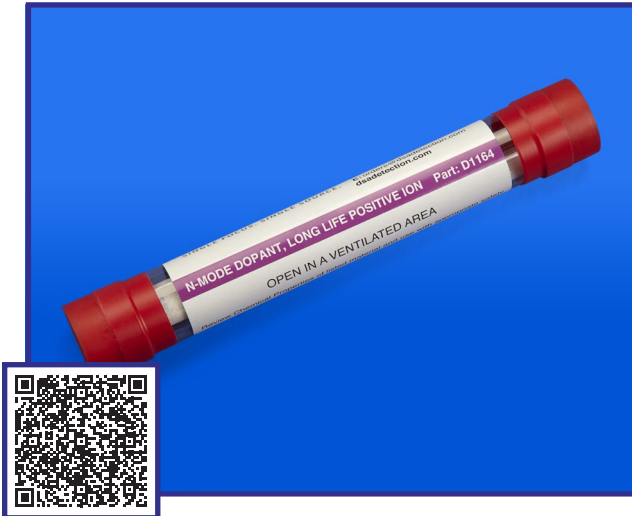

N-Mode Dopant, Long Life Positive Ion

SKU: **D1164**.

Compatible with: *Itemiser® 3/DX/4/5X, VaporTracer2®, MobileTrace®*

VaporTracer2® and MobileTrace® Instruments require this product in combination with Negative Ion E-Mode Dopant (D5810) during dual-mode operation. The Long Life, Positive Ion, N-Mode Dopant contains solid ammonia that is released as a gas during the life of the product. Under typical operating conditions, the product will gradually be depleted over an 11-month period as intended. DSA Detection recommends the dopant be refrigerated or frozen to extend its shelf life.

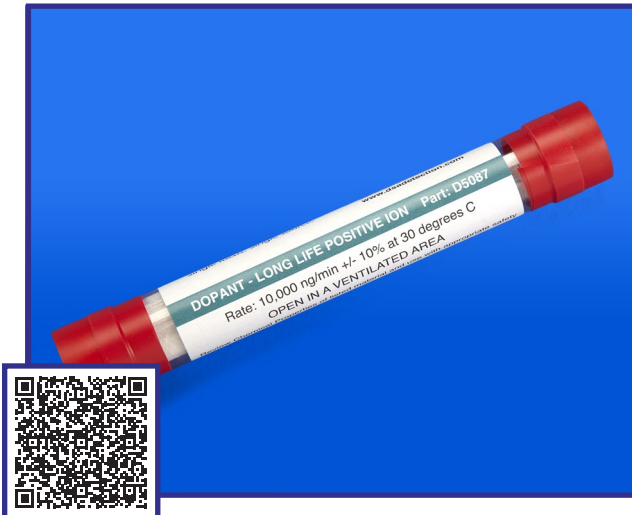

N-Mode Dopant, Long Life Positive Ion

SKU: **D5087**

Compatible with: *Itemiser® 3/DX/4/5X, VaporTracer2®, MobileTrace®*

Approval: *DHS*

The Long Life, Positive Ion, N-Mode Dopant contains solid ammonia that is released as a gas during the life of the product. Under typical operating conditions, this product will gradually deplete over an 11-month period. Our product lasts 30% longer than the OEM product. DSA Detection recommends the dopant be stored in a refrigerator or freezer to extend its shelf life.

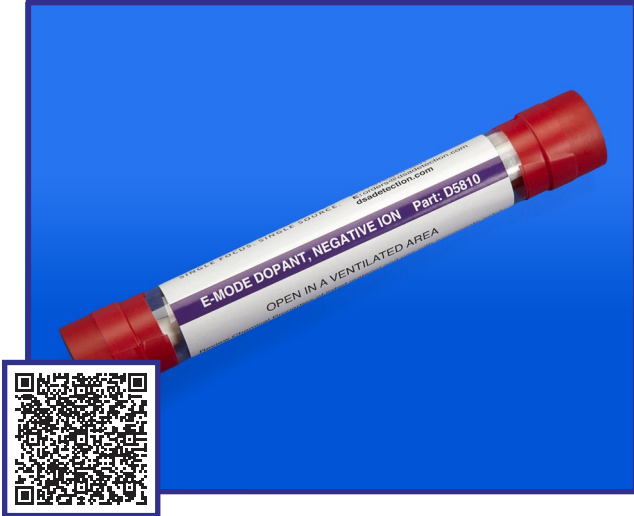

E-Mode Dopant, Negative Ion

SKU: **D5810**

Compatible with: *Itemiser® 3/DX/4/5X*, *VaporTracer2®*, *MobileTrace®*

Approval: *DHS*

VaporTracer2® and MobileTrace® Instruments require this product in combination with D1164 Positive Ion N-Mode Dopant during dual-mode operation. The Negative Ion Dopant contains dichloromethane which, under typical operating conditions, will gradually deplete over a 12-month period. DSA Detection recommends the dopant be stored in a refrigerator or freezer to extend its shelf life.



Sample Filter and Purge Inlet Filter

SKU: **FE3224**

Compatible with: *Itemiser® 3/DX/4/5X*

Approval: *DHS*

The Sample Filter and Purge Inlet Filter is used to remove contaminants within the air lines.

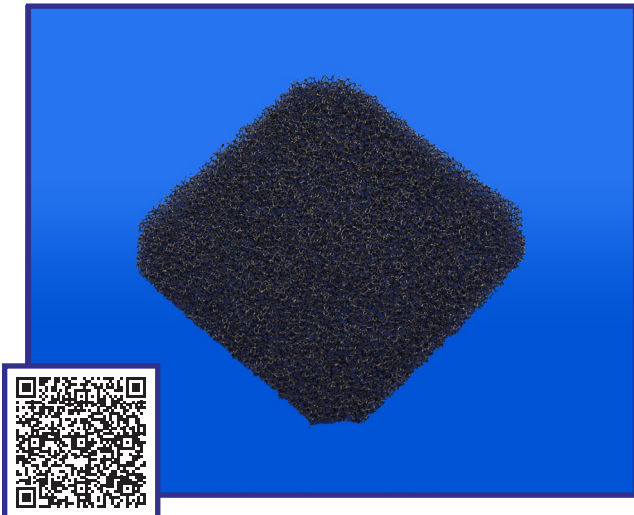

Fan Filter

SKU: **FF3222**

Compatible with: *Itemiser® 3/DX/4/5X*

Approval: *DHS*

The Fan Filter is typically located at the rear of the instrument and is accessible by unsnapping the fan guard. This component filters the cooling air that enters the instrument. Visible dust on the filter is an indication it should be changed immediately.

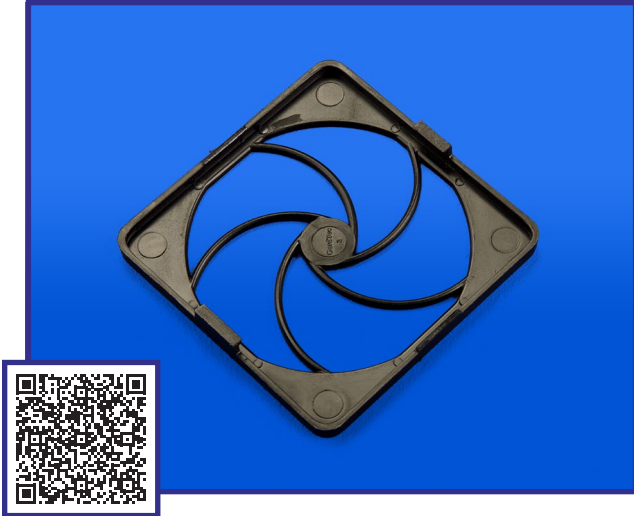

Fan Guard

SKU: **FG7125**

Compatible with: *Itemiser® 3/DX/4/5X*

Approval: *DHS*

The fan guard is a rigid plastic grill that protects the fan and filter elements from damage and serves as a retainer to hold the filter in place. The guard snaps on and off to service the filter. If you need to replace the fan filter, please reference the instrument manufacturer's replacement instructions.

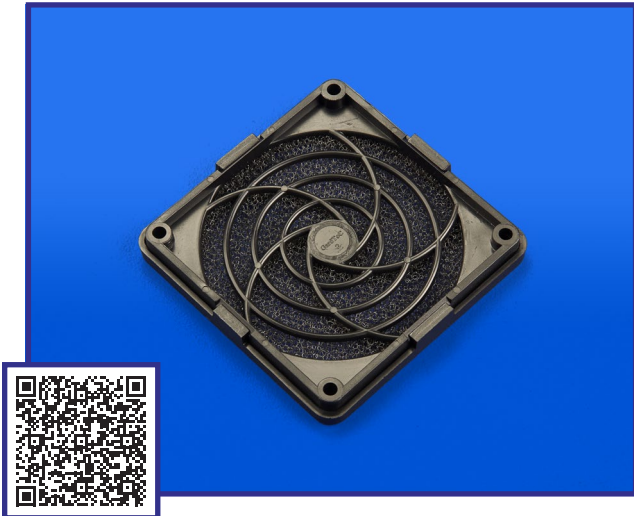

Fan Filter Kit

SKU: **FK3033**

Compatible with: *Itemiser® 3/DX/4/5X*

Approval: *DHS*

Kit Contents: *Itemiser® DX/3 Fan Guard, Itemiser® DX/3 Fan Filter, Fan Guard Backing*

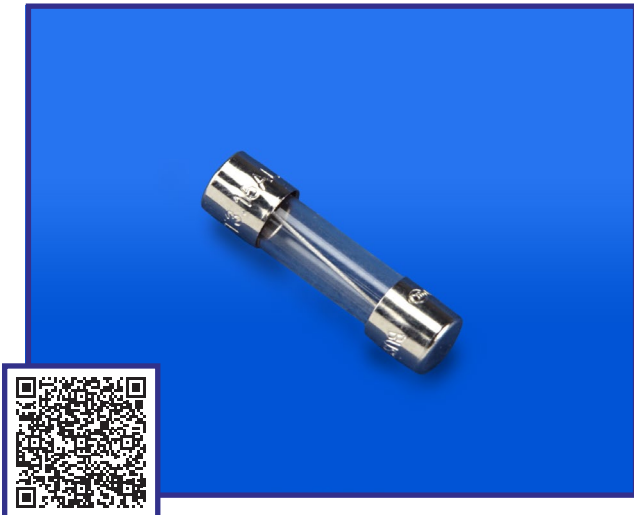

Fuse, 250V AC 3.15A

SKU: **FS2500**

Compatible with: *Itemiser® DX/4/5X, VaporTracer2®*

Approval: *DHS*

Direct replacement for OEM P/N EP002500. 3.15A Type T 5x20mm

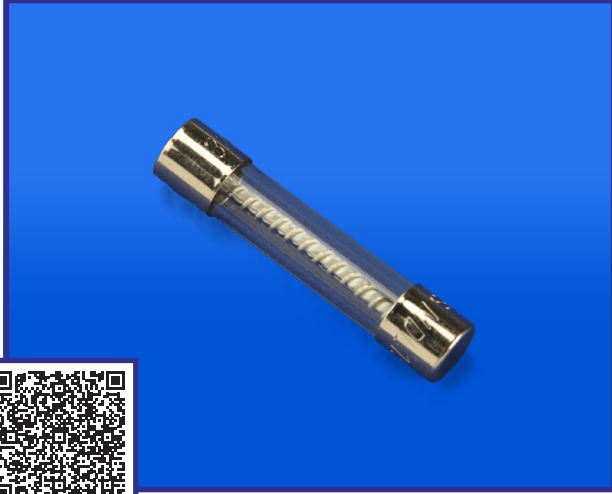

Fuse, 15A, 32V 3AG, for DC input

SKU: **FS2525**

Compatible with: *Itemiser® 3/DX/4/5X*

Approval: *DHS*

Direct replacement for OEM P/N EP002525.



Nozzle Screen Kit

SKU: **NK5282**

Compatible with: *Itemiser® DX*

Approval: *DHS*

The Nozzle Screen Kit contains (6) screens that allow target vapors to pass through into the detection system. The kit also contains a Nozzle Removal Tool. Generally, the Nozzle Screen is replaced during monthly maintenance; but harsh operating environments may require more frequent changing. At a minimum, the Nozzle Screen should be inspected weekly and cotton gloves (Large GL7500, Small GL7501) should be worn while servicing the instrument. For installation, follow instrument manufacturer's procedures.

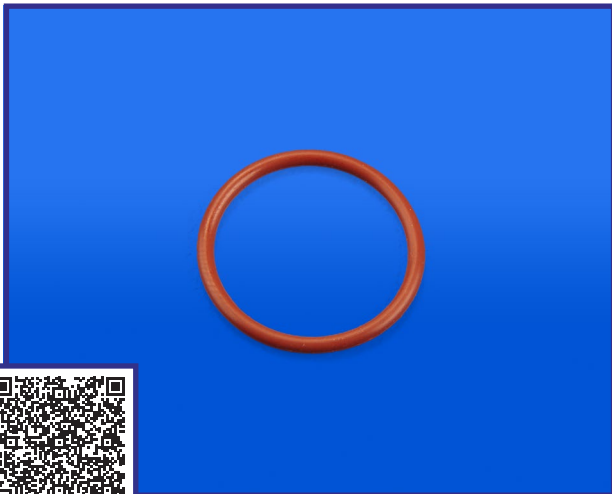

O-Ring Silicone (#019)

SKU: **OR1060**

Compatible with: *Itemiser® 3/DX/4/5X*

Approval: *DHS*

O-rings can occasionally become visually contaminated, damaged or worn and will need to be replaced.



O-Ring Viton (#008)

SKU: **OR1108**

Compatible with: *Itemiser® DX/3/2*

Approval: *DHS*

O-rings can occasionally become visually contaminated, damaged or worn and will need to be replaced.

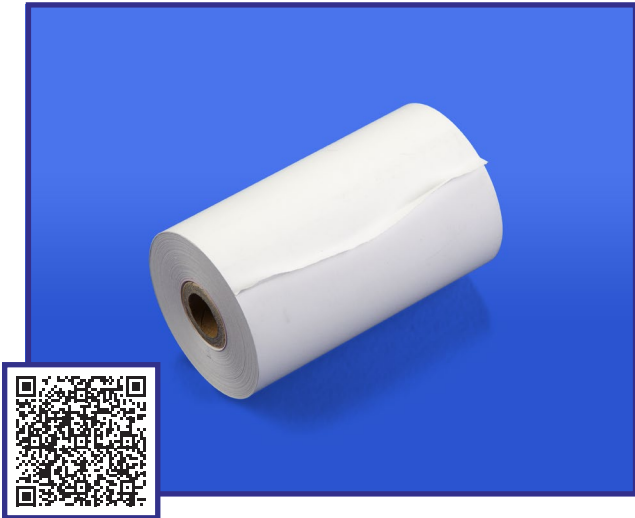

Thermal Printer Paper

SKU: **PP5060**

Compatible with: *Itemiser® DX/3/2*

Approval: *DHS*

The thermal printer paper rolls are individually packaged in sealed plastic wrappers for freshness.



Spare Parts Kit

SKU: **SK5141**

Compatible with: *Itemiser® 3*

This Maintenance Kit contains commonly used parts to keep your instrument in service and avoid downtime. All items are easily replaced in the field. Kit contents include: Fuse 220V AC 3.15A Qty (2), Fuse 15A 32V 3AG For DC Input Qty (1), O-Ring Silicone .8125ID Qty (1), Sample Air Filter Rubber Washer Qty (1), Sintered Filter Qty (1), O-Ring .176ID Qty (2).



Itemiser® 3/DX Spare Parts Kit

SKU: **SK5284**

Compatible with: *Itemiser® DX*

Approval: *DHS*

This spare parts kit contains commonly used parts to keep your instrument in service and avoid downtime. All the items are easily replaced in the field. Kit contents include (4) Bumper Feet, (1) 15A 32V 3AG DC Input Fuse, (2) 220V AC 3.15A Fuses, (1) O-Ring Silicone .8125ID, *(1) O-Ring Silicone .301ID. *This item not sold separately.



Sample Traps (25ct)

SKU: **ST1316P**

Compatible with: *Itemiser® 3/DX/4/5X, VaporTracer2®, MobileTrace®*

Approval: *DHS and DFT*

Sample traps are designed to harvest particles from various surfaces for analysis by the instrument. Sample traps are produced under strict laboratory controls and manufactured using the highest quality Teflon®-coated (PTFE) fiberglass material available. Traps are packaged in contaminant free recyclable trays and sealed for maximum freshness and longevity. Sample traps should be stored at room temperature away from direct heat. Clean cotton gloves (GL7500) are required when handling to prevent contaminants from interfering with the performance of the instrument.



Itemiser Sample Traps (100ct)

SKU: **ST1318P**

Compatible with: *Itemiser® 3/DX/4/5X, VaporTracer2®, MobileTrace®*

Approval: *DHS and DFT*

Sample traps are designed to harvest particles from various surfaces for analysis by the instrument. Sample traps are produced under strict laboratory controls and manufactured using the highest quality Teflon®-coated (PTFE) fiberglass material available. Traps are packaged in contaminant free recyclable trays and sealed for maximum freshness and longevity. Sample traps should be stored at room temperature away from direct heat. Clean cotton gloves (GL7500) are required when handling to prevent contaminants from interfering with the performance of the instrument.



Itemiser Sample Traps (300ct)

SKU: **ST1322P**

Compatible with: *Itemiser® 3/DX/4/5X, VaporTracer2®, MobileTrace®*

Approval: *DHS and DfT*

Sample traps are designed to harvest particles from various surfaces for analysis by the instrument. Sample traps are produced under strict laboratory controls and manufactured using the highest quality Teflon®-coated (PTFE) fiberglass material available. Traps are packaged in contaminant free recyclable trays and sealed for maximum freshness and longevity. Sample traps should be stored at room temperature away from direct heat. Clean cotton gloves (GL7500) are required when handling to prevent contaminants from interfering with the performance of the instrument.



Sample Traps (300ct) and Sample Box Kit

SKU: **STK1322P**

Compatible with: *Itemiser® 3/DX/4/5X, VaporTracer2®, MobileTrace®*

Approval: *DHS and DfT*

Kit Contents include: (1) Sample Swabs/Traps Box, and (1) Sample Traps (300ct) Sample traps are designed to harvest particles for analysis by the instrument. Sample traps are produced under strict laboratory controls. Traps are packaged in contaminant free recyclable trays and sealed for maximum freshness and longevity. Sample traps should be stored at room temperature away from direct heat. Clean cotton gloves (GL7500) are required when handling sample traps to prevent contaminants from interfering with the performance of the instrument.

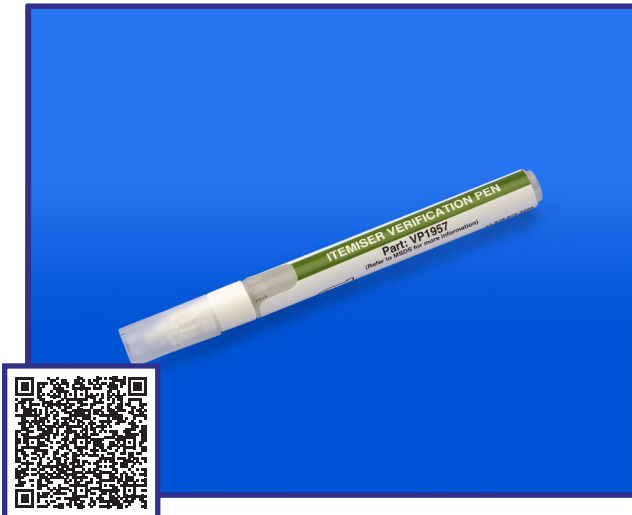

Verification Pen

SKU: **VP1957**

Compatible with: *Itemiser® 3/DX/4/5X, VaporTracer2®, MobileTrace®*

The Verification Pen is produced under strict laboratory controls and meets the exact standards required for precise verification of the instrument. The Verification Pen should be stored at room temperature away from direct heat. For extended shelf life, DSA Detection recommends the pen be stored in a refrigerator or freezer. Refer to the label for product instructions.



Verification Traps (100ct)

SKU: **VT1336P**

Compatible with: *Itemiser® 3/DX/4/5X, VaporTracer2®, MobileTrace®*

Approval: *DHS*

Verification traps are required to verify that the instrument is properly calibrated. Verification traps are produced under strict laboratory controls. Traps are packaged in contaminant-free recyclable trays and sealed for maximum freshness and longevity. Verification traps should be stored at room temperature away from direct heat. Clean cotton gloves (GL7500, GL7501) are required when handling verification traps to prevent contaminants from interfering with the performance of the instrument. Verification traps are single use and should not be reused.



Verification Traps (25ct)

SKU: **VT1337P**

Compatible with: *Itemiser® 3/DX/4/5X, VaporTracer2®, MobileTrace®*

Approval: *DHS*

Verification traps are required to verify that the instrument is properly calibrated. Verification traps are produced under strict laboratory controls. Traps are packaged in contaminant-free recyclable trays and sealed for maximum freshness and longevity. Verification traps should be stored at room temperature away from direct heat. Clean cotton gloves (GL7500, GL7501) are required when handling verification traps to prevent contaminants from interfering with the performance of the instrument. Verification traps are single use and should not be reused.



Check Sample Vial - Military

SKU: **SV1172M**

Compatible with: *MobileTrace®*

Use the check sample vial to verify the instrument's proper calibration and detection capability. Check sample vials should be stored at room temperature away from direct heat.



Sintered Filter

SKU: **SF3001**

Compatible with: *Itemiser® 3/2*

Approval: *DHS*

The sintered filter removes contaminants from the instrument's air supply. Inspect monthly and replace when visibly dirty. For installation, follow instrument manufacturer's procedures.



Condenser Tube

SKU: **SCT5030**

Compatible with: *IONSCAN™ 400B*

Approval: *DHS*

Condenser tubes are designed to remove contaminants within air lines. They are manufactured to perform equal to or better than the OEM product. For installation, follow instrument manufacturer's procedures.

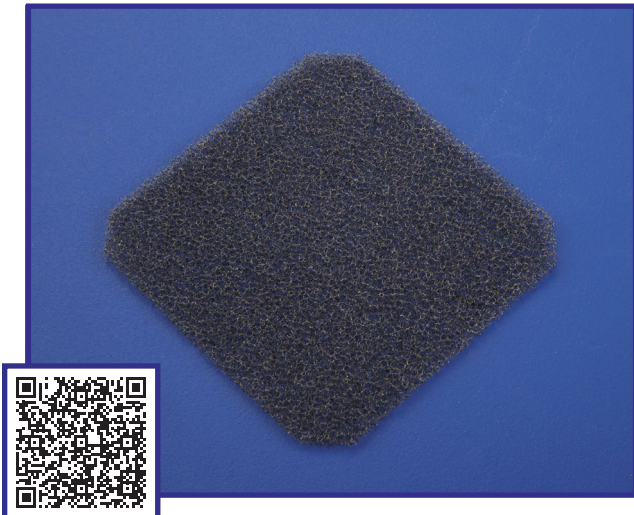

Foam Filter

SKU: **SFF1654**

Compatible with: *IONSCAN™ 400B/500DT*

Approval: *DHS*

The fan filter filters cooling air as it enters the instrument. To access, unsnap the fan guard on the back panel of the instrument. The frequency with which the filter requires changing depends on the operating environment; however visible dust on the filter indicates it should be changed immediately.

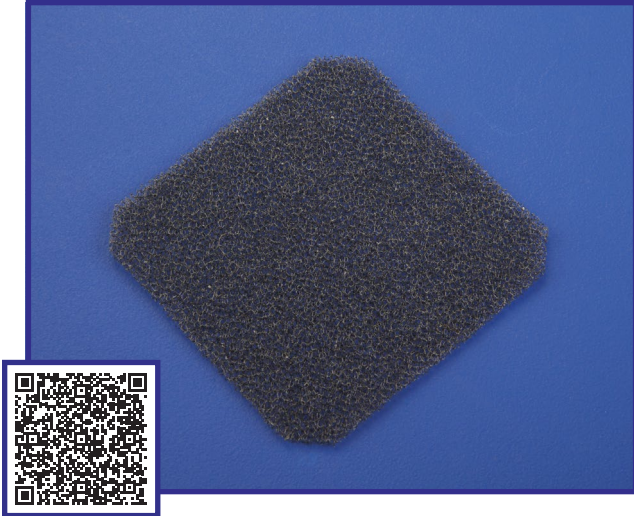

Behind Bottle Foam Filter

SKU: **SFF3222**

Compatible with: *IONSCAN™ 400B*

Approval: *DHS*

The Foam Filter filters the cooling air as it enters the rear of the instrument. The frequency with which the filter requires changing depends on the operating environment; however visible dust on the filter indicates it should be changed immediately.

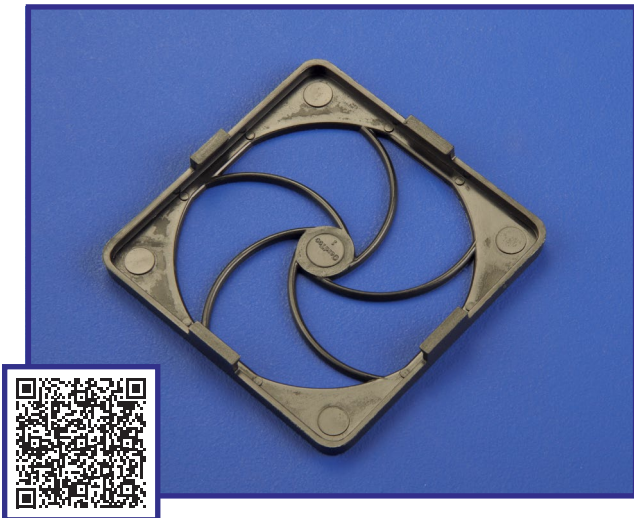

Fan Guard, 4-Prong

SKU: **SFG0280**

Compatible with: *IONSCAN™ 400B*

Approval: *DHS*

The fan guard is a rigid plastic grill that protects the fan and filter elements from damage and serves as a retainer to hold the filter in place. The guard snaps on and off to service the filter.

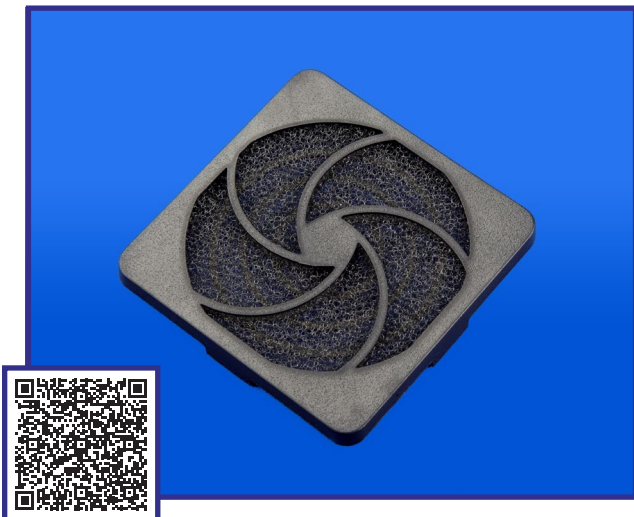

Behind Bottle Cover and Filter

SKU: **SFK0279**

Compatible with: *IONSCAN™ 400B*

Approval: *DHS*

Frequency of changing the filter is dependent on the atmosphere in which the instrument is operating, however when dust becomes visible on the filter, this is an indication it should be changed immediately.

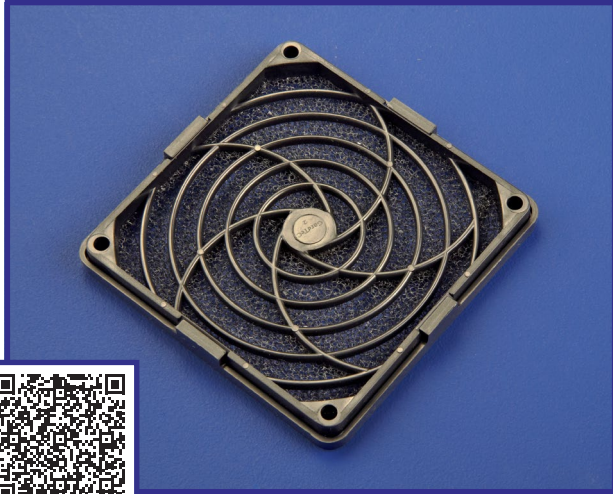

Filter Kit

SKU: **SFK9230**

Compatible with: *IONSCAN™ 400B/500DT*

Approval: *DHS*

The fan filter kit includes front and rear plastic fan guards, and a fan filter. The purpose is to filter the cooling air that enters the rear of the instrument. Frequency of changing the filter is dependent on the atmosphere in which the instrument is operating, however when dust becomes visible on the filter, this is an indication it should be changed immediately.

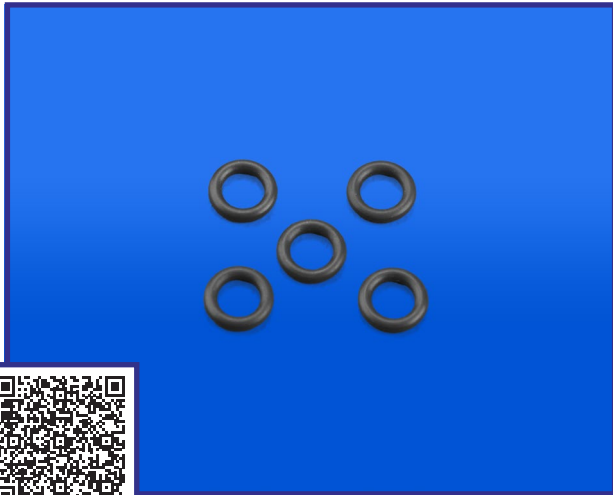

O-ring, Viton (#009)

SKU: **SOR3730**

Compatible with: *IONSCAN™ 400B*

Approval: *DHS Accepted*

O-rings can occasionally become visually contaminated, damaged or worn and will need to be replaced.



O-ring, Viton (#012)

SKU: **SOR5330**

Compatible with: *IONSCAN™ 400B*

Approval: *DHS Accepted*

O-rings can occasionally become visually contaminated, damaged or worn and will need to be replaced.

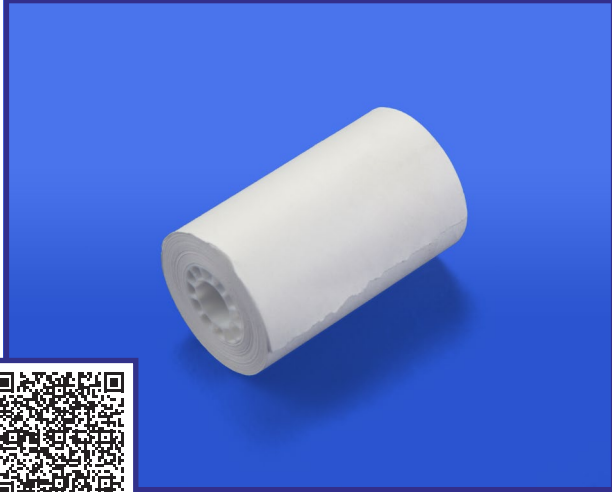

400B Printer Paper, Intl

SKU: **SPP0601**

Compatible with: *IONSCAN™ 400B*

Packaged in sealed wrappers for freshness, this printer paper is specified by the printer manufacturer. Highly recommended to use only original printer manufacturer paper to avoid damage.

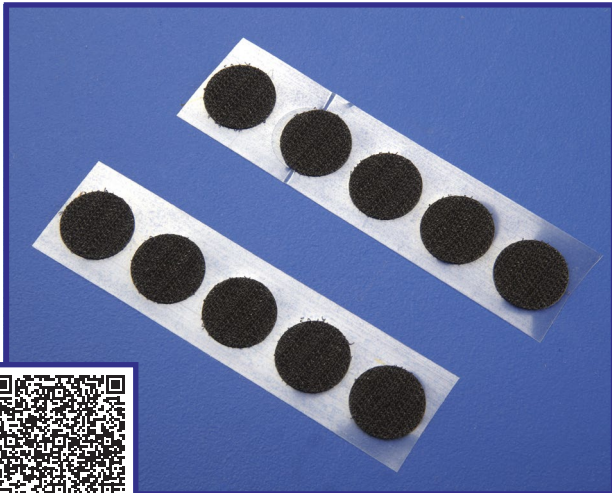

Swab Sampler Velcro Hook (10ct)

SKU: **SVH5038**

Compatible with: *IONSCAN™ 400B*

Approval: *DHS, STAC*

Located at the end of the sampling wand, the Velcro® pad can wear or become contaminated, and thus requires replacement. The Velcro® has a self-adhesive backing for easy installation.



Fuse, 0.5A, 125V

SKU: **AFS0118**

Compatible with: *SABRE™ 4000/5000*

Approval: *DHS*

Direct replacement for OEM P/N 7040118.



Fuse, 15A, 32V

SKU: **AFS0580**

Compatible with: *SABRE™ 4000/5000*

Approval: *DHS*

Direct replacement for OEM P/N 7040580.



CW/TIC Vapor Verific

SKU: **ASV2919**

Compatible with: *SABRE™ 4000/5000*

Approval: *DHS*

For use in CW/TIC vapor mode to verify the instrument is properly calibrated. For use, follow instrument manufacturers procedures. The vapor verific vial should be stored at room temperature away from direct heat.

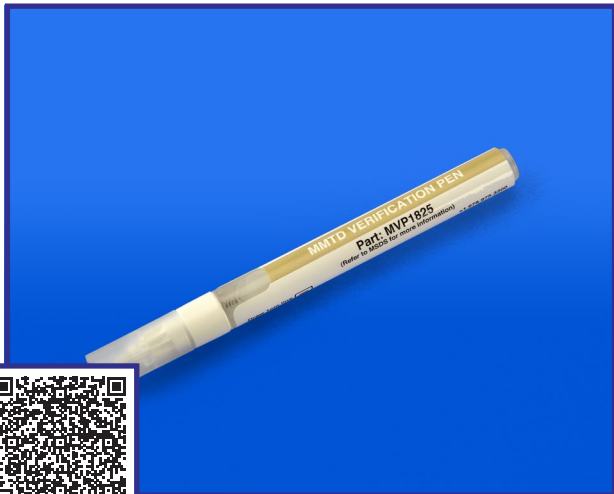

Verification Pen

SKU: **MVP1825**

Compatible with: *SABRE™ 4000/5000*

Approval: *DHS, STAC*

The Verification Pen is produced under strict laboratory controls, and meets the exact standards required for precise verification of the SABRE 4000/5000 and MMTD instrument. The Verification Pen should be stored at room temperature away from direct heat. For extended shelf life, DSA Detection recommends the pen be stored in a refrigerator or freezer. Refer to the label for product instructions.



Membrane Kit

SKU: **MK5007**

Compatible with: *Itemiser® 3/2, VaporTracer2®, MobileTrace®*

Approval: *DHS*

The membrane kit contains five semi-permeable elastomeric membranes that allow target vapors to pass through into the detection system. Generally, the membrane is replaced during monthly maintenance; but harsh operating environments may require more frequent changing of the membrane. At a minimum, the membrane should be inspected weekly and cotton gloves (GL7500) should be worn while servicing the membrane. For installation, follow instrument manufacturer's procedures.



O-Ring Silicone (#022)

SKU: **OR1102**

Compatible with: *Itemiser® 2, VaporTracer2®, MobileTrace®*

Approval: *DHS*

O-rings can occasionally become visually contaminated, damaged or worn and will need to be replaced.



Canned Air

SKU: **CA7503**

Compatible with: *Checkpoint and Cleaning*

Approval: *DHS*

The "Duster" canned air has an air stream of .2 microns to clean critical components and areas of trace instruments. Hold can upright—never inverted, tilted, or shaken—and apply in short bursts several inches from the target area to avoid damage to fragile components. This is OEM recommended, not the flammable and less-pure canned air product available from office supply stores. Please note: Due to supply chain issues, canned air pricing is subject to change at any moment.



Standard Bin Cart

SKU: **CBC4400**

Compatible with: *All*

Approval: *DHS Accepted*

Key Features of our 20 1/2" x 32 1/2" Standard Bin Cart include non-marking casters, 2 pre-drilled permanent bins and hardware, a 250 lb load capacity, and a 50 bin capacity. Some assembly required. Adjustable wrench recommended. For use with DSA's Standard Bin (CSB3349). Also compatible with this product are DSA bins with X-ray markers (CSBX3349) and traction (CSB3351).

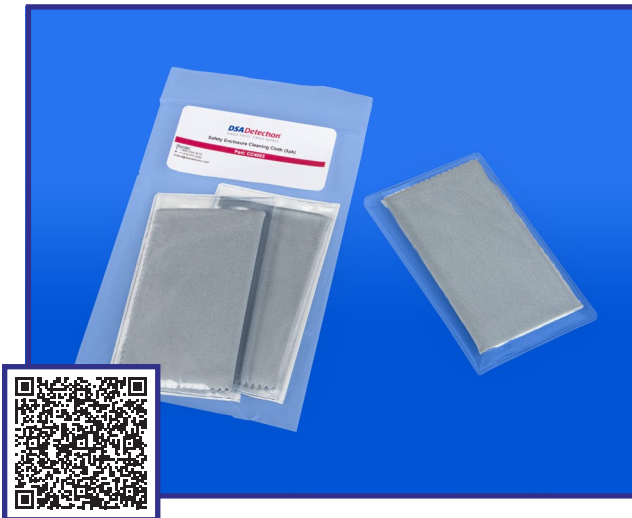

Safety Enclosure Cleaning Cloth

SKU: **CC4003**

Compatible with: *Checkpoint and Cleaning*

Approval: *DHS Accepted*

The Safety Enclosure Cleaning Cloth is used with the liquid scanner to clean the sensitive glass area. Also used with VT or any other instrument that has a glass portion or an LCD screen.

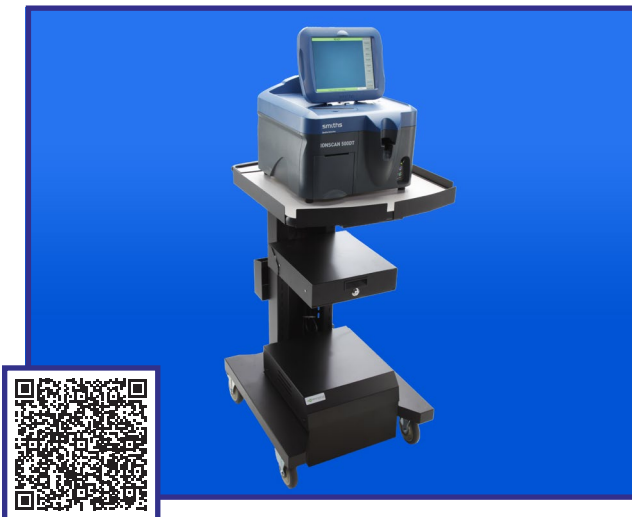

ETD Mobile Workstation (non-powered)

SKU: **CMW3000**

Compatible with: *All*

Approval: *DHS Accepted*

Screen for trace explosives anywhere comfortably with the ETD Mobile Workstation. Made with 13-gauge steel (warranted for five years), the workstation is built sturdy with adjustable handles for ease of rolling the lockable wheels. The ergonomically-designed workstation also features easily adjustable table-height settings and will safely hold all TSA-approved ETDs. Has 3" locking drawer, 1.5" shelf lip, and binder holder. Top Shelf Dimensions: 22" wide x 24" deep. No tools needed. Some assembly required.



ETD Mobile Workstation (powered)

SKU: **CMW4000**

Compatible with: *All*

Approval: *DHS Accepted*

Key Features of our ETD Mobile Powered Workstation include adjustable push handle, locking wheels, 3" tall locking drawer, three sided shelf lip 1.5" high, binder holder, Top Shelf: 22" wide x 24" deep. Battery Specifications include power pack including two (2) fully enclosed 100 Amp hr AGM, deep cycle industrial batteries charged with standard 120V outlet, warranted for 6 months, expected life-cycle is two years with proper use, integrated 15 amp power strip with 6 outlets, eight foot power cord.



ETD Mobile Powered Workstation LiFePO4

SKU: **CMW6000**

Compatible with: *All*

Key Features of our ETD Mobile Powered Workstation include adjustable push handle, locking wheels, 3" tall locking drawer, three sided shelf lip 1.5" high, binder holder, Top Shelf: 22" wide x 24" deep. Battery Specifications include 1 Lithium Iron Phosphate Battery, with a charge time of 7.5 hours. This battery has an 8-10 year lifetime rated for 3,000 power cycles.



Replacement Battery Pack for Mobile Workstation (2 pack)

SKU: **CMWB206**

Compatible with: *All*

Approval: *DHS Accepted*

Battery Kit includes: two fully enclosed 100 Amp hr AGM Deep cycle industrial batteries charged with standard 120V outlet. The battery is warranted for 6 months and has an expected life cycle is two years with proper use.



Inverter/Charger 1000w, Mobile Workstation

SKU: **CMWB235**

Compatible with: *All*

1000W Inverter/Charger for use with the Mobile Workstation.



LiFePO4 Battery

SKU: **CMWB279**

Compatible with: *All*

Approval: *DHS Accepted*

Upgrading to the NEW power source (lithium iron phosphate) has many proven benefits over the previous battery model (sealed lead acid): Only 1 battery required vs. 2, Battery lasts 8-10 years vs. 1-2, Battery weighs 32 lbs vs. 140, Battery lasts 3,000 charge/discharge cycles vs. 300. Other benefits include: Improved worker safety, much easier to move on cart, weighs 100 lbs less than the previous battery model, new smart battery with Bluetooth user interface.

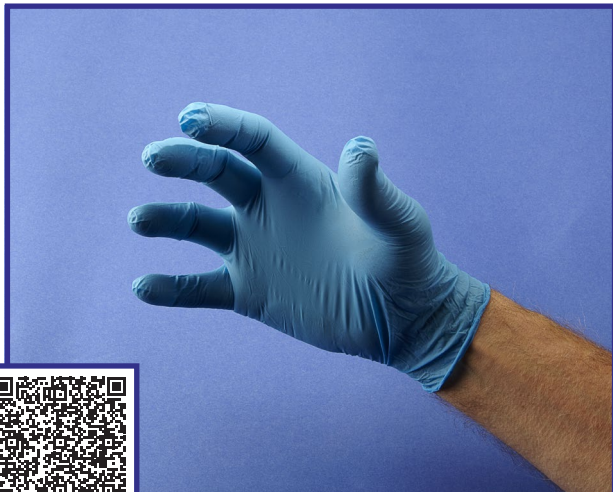

Small, Powder-Free, Nitrile Gloves (4mil)

SKU: **CNG2091**

Compatible with: *Checkpoint and Cleaning*

Wearing disposable gloves while operating or maintaining instruments is extremely important to avoid contamination from the natural oils, dirt, and lotions typically found on hands that can adversely affect the instrument's ability to analyze. Also available in Medium (CNG2092), Large (CNG2093), and Extra Large (CNG2094).



Medium, Powder-Free, Nitrile Gloves (4mil)

SKU: **CNG2092**

Compatible with: *Checkpoint and Cleaning*

Wearing disposable gloves while operating or maintaining instruments is extremely important to avoid contamination from the natural oils, dirt, and lotions typically found on hands that can adversely affect the instrument's ability to analyze. Also available in Small (CNG2091), Large (CNG2093), and Extra Large (CNG2094).



Large, Powder-Free, Nitrile Gloves (4 mil)

SKU: **CNG2093**

Compatible with: *Checkpoint and Cleaning*

Wearing disposable gloves while operating or maintaining instruments is extremely important to avoid contamination from the natural oils, dirt, and lotions typically found on hands that can adversely affect the instrument's ability to analyze. Also available in Small (CNG2091), Medium (CNG2092), and Extra Large (CNG2094).



Extra Large, Powder-Free, Nitrile Gloves (4mil)

SKU: **CNG2094**

Compatible with: *Checkpoint and Cleaning*

Wearing disposable gloves while operating or maintaining instruments is extremely important to avoid contamination from the natural oils, dirt, and lotions typically found on hands that can adversely affect the instrument's ability to analyze. Also available in Small (CNG2091), Medium (CNG2092), and Large (CNG2093).



Standard Screening Bin, Selectee (Red)

SKU: **CSB1529**

Compatible with: *All*

Approval: *DHS Accepted*

Our red screening bin is used primarily as a "selectee identifier" for passengers going through a checkpoint. Dimensions for this bin are 21.5"L x 15.75"W x 5"H. Not compatible with our Bin Cart (CBC4400). The selectee screening bin can be combined with the X-ray marker kit (CSB3500). We also offer bins with X-ray markers (CSBX3349) and traction (CSB3351).



Standard Screening Bin

SKU: **CSB3349**

Compatible with: *All*

Approval: *DHS Accepted*

Our Standard Screening Bin (Dimensions: 20"L x 15"W x 5"H) is the same one used across all airports by the TSA. We always have stock ready to ship. The screening bin is the most durable available and conveniently stacks on our Screening Bin Cart (CBC4400). We also offer bins with X-ray markers (CSBX3349) and traction (CSB3351).

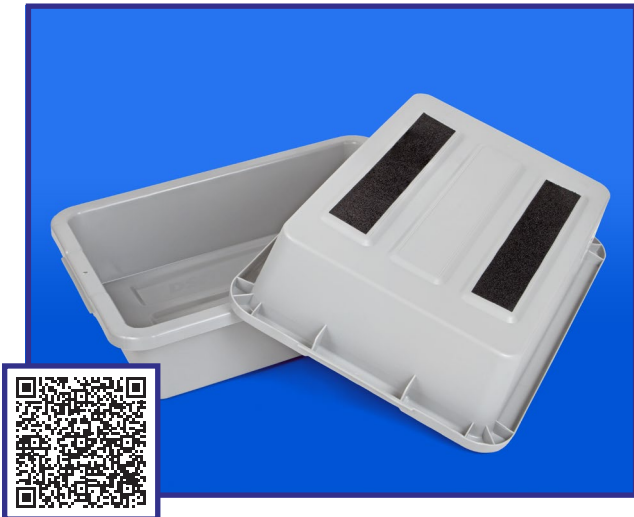

Standard Screening Bin w/ Hi-Traction

SKU: **CSB3351**

Compatible with: *All*

Approval: *DHS Accepted*

DSA's hi-traction bin (20"L x 15"W x 5"H) is able to move lighter items through the lead curtains of the X-ray machine. Traction pads are permanent, durable, non-abrasive and do not affect bin stackability. DSA testing determined that a hi-traction screening bin could carry about 60-70% less weight through the lead curtains of an X-ray machine, when compared to a standard screening bin without traction. Still compatible with the same portable screening bin cart currently used in 465 +/- airports: CBC4400.



X-Ray Marker Kit

SKU: **CSB3500**

Compatible with: *All*

Approval: *DHS*

Now, screeners can easily identify bins for secondary screening by their individual numbers, visible by sight and while positioned in an X-ray system tunnel. X-ray markers are permanent, durable, and do not affect bin stackability. Only compatible with DSA screening bins CSB3349, CSB1529, and CSB3351.



Standard Screening Bin w/ X-Ray Marker

SKU: **CSBX3349**

Compatible with: *All*

Approval: *DHS*

Introducing the first and only DHS/TSA/TSL/TSIF-approved numbered screening bin (20"L x 15"W x 5"H) that is X-ray correct. Now, screeners can easily identify bins for secondary screening by their individual numbers, visible by sight and while positioned in an X-ray system tunnel. X-ray markers are permanent, durable, and do not affect bin stackability! Compatible with screening bin cart used in 465 +/- airports: CBC4400. We also offer x-ray marker kits (CSB3500). Only compatible with DSA screening bins CSB3349 and CSB3351.



Disposable Shoe Covers (50 pair)

SKU: **CSC4600**

Compatible with: *All*

Approval: *DHS Accepted*

One size fits all. Latex and lint free polypropylene shoe covers. These shoe covers are clean-room compliant and have an elastic opening that provides a snug fit around the ankle.

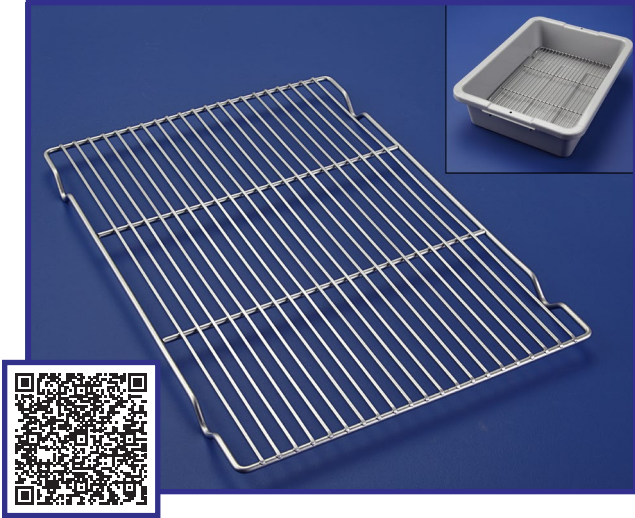

Screening Bin Rack

SKU: **CSR5491**

Compatible with: *All*

Approval: *DHS Accepted*

The chrome-plated metal rack fits neatly inside the bottom of our gray screening bin and is used when screening objects such as funeral urns. We also offer bins with X-ray markers (CSBX3349) and traction (CSB3351).



Distilled Water

SKU: **DW0003**

Compatible with: *All*

Approval: *DHS Accepted*

Distilled water is excellent for a range of uses at checkpoint.



Distilled Water Dropper

SKU: **DWD1005**

Compatible with: *All*

Approval: *DHS Accepted*

The Distilled Water Dropper is for use with test strips. This product is produced under strict laboratory quality controls.



Large Cotton Gloves

SKU: **GL7500**

Compatible with: *Checkpoint and Cleaning*

Approval: *DHS*

Wearing cotton gloves while operating or maintaining the instrument is extremely important to avoid contamination from the natural oils, dirt, and lotions typically found on hands that can adversely affect the instrument's ability to analyze. Made of pure cotton, these gloves absorb perspiration and allow the hands to "breathe" for greater operator comfort while protecting the sample. Frequent changing to fresh gloves is recommended and required after an alarm.



Small Cotton Gloves

SKU: **GL7501**

Compatible with: *Checkpoint and Cleaning*

Approval: *DHS*

Wearing cotton gloves while operating or maintaining the instrument is extremely important to avoid contamination from the natural oils, dirt, and lotions typically found on hands that can adversely affect the instrument's ability to analyze. Made of pure cotton, these gloves absorb perspiration and allow the hands to "breathe" for greater operator comfort while protecting the sample. Frequent changing to fresh gloves is recommended and required after an alarm.



Isopropyl Alcohol 70%, 16 oz

SKU: **IA0002**

Compatible with: *Checkpoint and Cleaning*

Approval: *DHS Accepted*

70% Isopropyl Alcohol. Excellent for a range of cleaning purposes. Use with Cotton Swabs (BCS1020) and Spray Bottle (SB1686)



Isopropyl Alcohol 70%, Gallon (4pk)

SKU: IA2128

Compatible with: *Checkpoint and Cleaning*

Approval: *DHS Accepted*

70% Isopropyl Alcohol. Excellent for a range of cleaning purposes. Perfect for cleaning with cotton swabs and for use with DSA's spray bottle. Sanitizes 99.9% of germs. Sold by the case, 4 gallons per case. Orders over qty. 5 will ship on a pallet. HAZMAT fees and standard delivery without special instructions are included in the price for TSA customers. There is currently no limit on order quantities. Air Shipment (Overnight, 2nd Day, OCONUS) possible. Contact us for a quote.

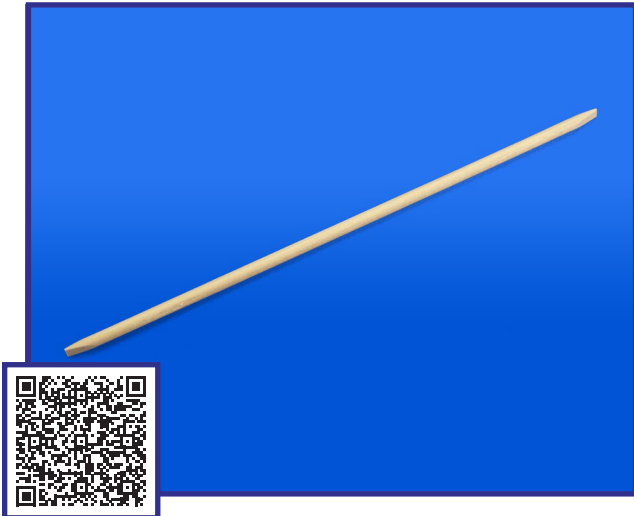

Membrane Stick

SKU: MS5226

Compatible with: *Itemiser® 3/2, VaporTracer2®, MobileTrace®*

Approval: *DHS*

Use the soft membrane stick to remove the membrane or sintered filter while performing maintenance to avoid scratching the detector nozzle during membrane removal.

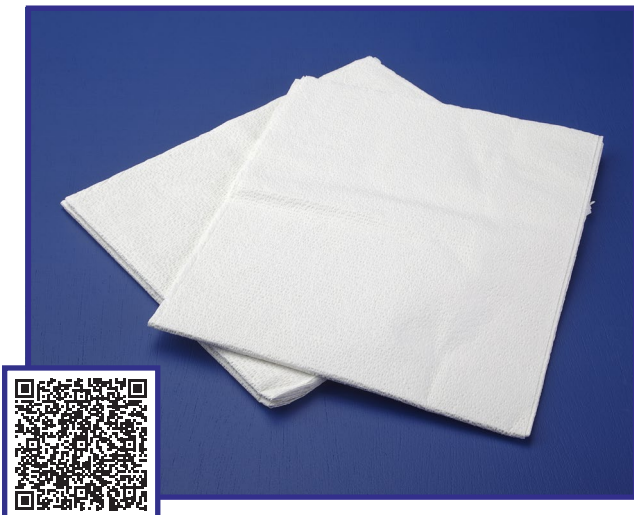

Privacy Sheet, 2 Ply Tissue, 40" x 48"

SKU: PS0001

Compatible with: *All*

Approval: *DHS Accepted*

Use to protect passenger privacy during searches at security checkpoints.



Privacy Sheet, 2 Ply Tissue, 40'' x 72''

SKU: **PS0002**

Compatible with: *All*

Approval: *DHS Accepted*

Use to protect passenger privacy during searches at security checkpoints.



Plastic Jug Pump

SKU: **PU0001**

Compatible with: *All*

For dispensing liquids. Perfect fit for Isopropyl Alcohol (IA128). Fits 1/2 gal. and 1 gal. F-style jugs, utility jugs and square utility jugs. Spout rotates 360°. FDA compliant. Polypropylene with flexible 11" intake tube.



Liquid Surface and Hand Sanitizer 16.9oz Spray Bottle

SKU: **SAN1017**

Compatible with: *Checkpoint and Cleaning*

Approval: *DHS Accepted*

Alcohol Antiseptic Solution (Non-gel), ideal for sanitizing hands and surfaces. This product does not increase false alarm rates on ETD instruments per extensive testing at the DSA Detection laboratory. FDA Approved Formulation – 80% Ethanol. Sanitizes 99.9% of germs. Sold by the case, 16.9oz bottles with sprayers (qty 24 per case). Proudly manufactured in the U.S.A.



Instant Surface and Hand Sanitizer Refill

SKU: **SAN1128**

Compatible with: *Checkpoint and Cleaning*

Approval: *DHS Accepted*

Alcohol Antiseptic Solution (Non-gel), ideal for sanitizing hands and surfaces. This product does not increase false alarm rates on ETD instruments per extensive testing at the DSA Detection laboratory. FDA approved formulation – 80% Ethanol. Sanitizes 99.9% of germs. Sold by the case, 4 gallons per case. Proudly manufactured in the U.S.A. Any order over qty 5 will ship on a pallet. HAZMAT fees and standard delivery without special instructions are included for TSA customers. No limits on quantities.



Spray Bottle, 16oz

SKU: **SB1686**

Compatible with: *Checkpoint and Cleaning*

Approval: *DHS Accepted*

Perfect for use around the checkpoint for cleaning ETD stainless steel tables and cabinets. The Spray Bottle is refillable with Isopropyl Alcohol (IA0002).



Sample Swabs/Traps Box

SKU: **SBX1100**

Compatible with: *All*

Approval: *DHS Accepted*

Our Calibration and Verification Box design properly dispenses the product in a protected way. As a result, the Calibration and Verification Box comes with a sticky pad attached at the bottom to firmly hold it in place. This stability allows the operator to easily retrieve products with one hand. The sticky pad is refreshed with water or IPA. The spring in the hinge closes the lid automatically, providing protection to the calibration/verification traps from contaminants. Packaging material is recyclable.



ASTM F 792-88 Stepped Wedge

SKU: **TSK9288**

Compatible with:

The ASTM-F792-88 Step Wedge is made of ASTM No. 1100 Aluminum or equivalent and is 10" long, consisting of 10 one-inch steps with five copper wires with plastic insulation, and are 22, 24, 26, 28, and 30 AWG (American Wire Gage) in diameter. The ASTM-F792-88 Step Wedge is used to meet the needs for testing sophisticated X-raysystems and was developed to strictly comply with FAA and TSA requirements.



Bottle Label Sticker

SKU: **CBL1920**

Compatible with: *All*

Approval: *DHS Accepted*

Bottled liquids scanner screening systems differentiate liquid explosives from common, benign liquids. BLS units use a variety of technologies including lasers, infrared, and electromagnetic resonance. Current units screen clear and tinted glass and plastic bottles. DSA Detection's sticker label allows the laser to pass through a non-clear or frosted glass. Once the sticker is attached to the surface of the frosted container, the operator aligns it with the laser, and the liquid is evaluated.



Dryer Material 500g (Molecular Sieve)

SKU: **DM5019**

Compatible with: *Itemiser® 2, VaporTracer2®, MobileTrace®*

Approval: *DHS*

The molecular sieve removes moisture and contaminants from the instruments air lines. For installation, follow instrument manufacturer's procedures.

Eye Wash Station, 32 oz

SKU: **EW0001**

Compatible with: *All*

Approval: *DHS Accepted*

Eye Wash stations provide immediate relief after accidents. Packaged for high visibility, each wall unit is designed for easy access for emergency flushing and decontamination of the eyes, face and body. Wall stations mount easily with provided fasteners. Also available are Eye Wash Station Refills (EW0002).



Eye Wash Station Refill, 32 oz

SKU: **EW0002**

Compatible with: *All*

Approval: *DHS Accepted*

This refill consists of two 32 fl. oz. bottles of sterile isotonic eyewash solution. To be used with the EW0001 Eye Wash Station, 32 oz.



Leak Test Kit

SKU: **LT0001**

Compatible with: *All*

The radiation leak test kit is required semiannual to comply with regulations. For detailed instructions, refer to the included wipe test kit instructions and the maintenance/troubleshooting section of your user's manual. Kit contents include cotton swabs, decontamination wipes, leak test instructions, and a fully addressed envelope.





Saturated Swabs (25ct)

SKU: **SS7502**

Compatible with: *Checkpoint and Cleaning*

Approval: *DHS*

Use pre-saturated CHEM SWABS™ for routine cleaning and maintenance of sensitive, hard-to-reach areas, such as the membrane on the detector nozzle, where dust and dirt can reduce instrument sensitivity. Made of urethane foam, these non-abrasive swabs are saturated with alcohol which evaporates quickly and leaves no residue or contamination.

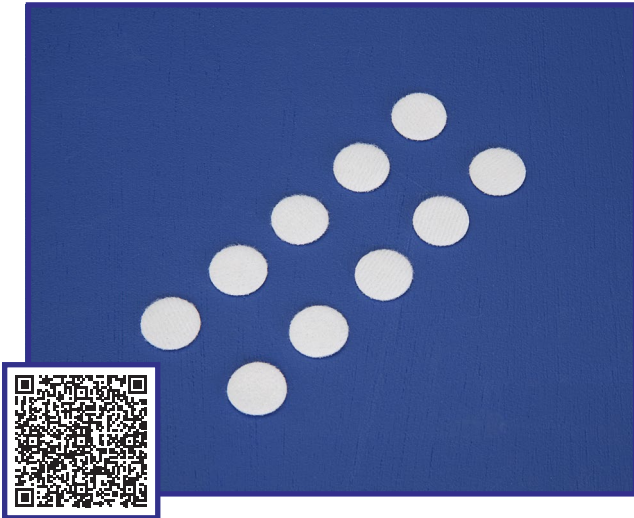

Swab Sampler Disk (10ct)

SKU: **SSD5278**

Compatible with: *IONSCAN™ 400B*

Approval: *DHS*

The Velcro® pad is located at the end of the wand where the sample swab is placed. It may wear or become contaminated, thus needing to be replaced.



Saturated Alcohol Wipes

SKU: **SW7501**

Compatible with:

Approval: *DHS*

Pre-saturated with ultra-pure isopropyl alcohol, these well-constructed wipes resist tears and linting. Excellent for general cleaning of instrument surfaces, they work equally well cleaning hard-to-reach areas. This item may not be shipped by air.



Alcohol Pads (50ct)

SKU: **SW7507**

Compatible with: *Checkpoint and Cleaning*

Approval: *DHS*

Pre-saturated with ultra-pure isopropyl alcohol, these well-constructed wipes resist tears and linting. Excellent for general cleaning of instrument surfaces, they work equally well cleaning hard-to-reach areas.

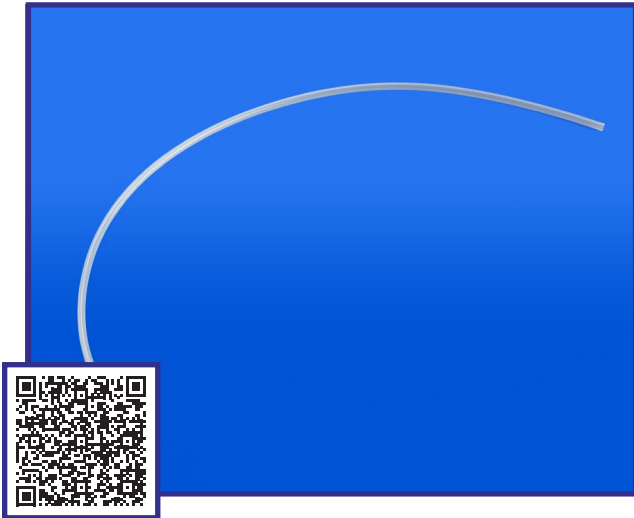

PTFE Tubing (1/8" ID)

SKU: **TU8043**

Compatible with: *All*

Approval: *DHS*

PTFE tubing can occasionally become visually contaminated, damaged or worn and will need to be replaced. Sold by the foot.

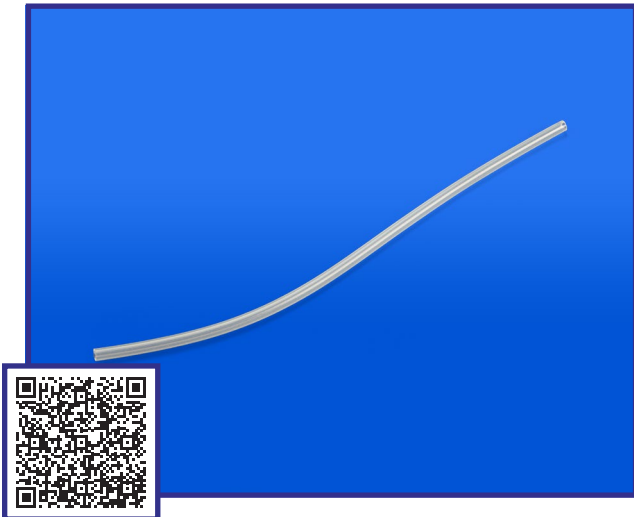

Silastic Tubing (1/8" ID)

SKU: **TU8047**

Compatible with: *Itemiser® 3/DX/4/5X, VaporTracer2®, MobileTrace®*

Approval: *DHS*

Silastic tubing can occasionally become visually contaminated, damaged or worn and will need to be replaced. Sold by the foot.

TRAINING KITS

Product Catalog

SUMMER 2023

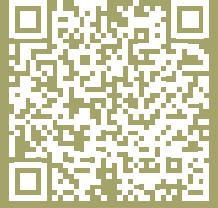

Department for
Transport



Table of Contents

51	Inert Advanced Threat Screening Kit
51	Inert IED Circuit Boards Kit
52	Inert Modular Bomb System Training Kit
52	Inert Domestic Terrorism Threat Training Kit
53	Inert Mail Threat Kit
53	Inert Anti-Terrorism Training Kit
54	Inert Threat Screening Kit
54	Non-Metallic Edged Weapons Kit
55	Inert Air Cargo (CCSP) Threat Kit
55	Inert Guns and Knives Threat Kit
56	Inert Advanced Weapons Kit
56	Inert Explosives Threat Kit
57	Inert P.I.E.S. Kit
57	Concealed Weapons Kit
58	Inert Prohibited Items Kit
58	Inert Clothing IED Kit
59	Blasting Cap Test Kit
59	Metal Detector Test Kit
60	3-Gun Test Kit
60	Trace Quality Control (TQC) Kit

Inert Advanced Threat Screening Kit

SKU: **ASK8000**

Weight: 67 lb (30.4 kg)

Dimensions: 33 in x 21 in x 17 in (83.8 cm x 53.3 cm x 43.2 cm)

The Inert Advanced Threat Screening Kit contains multiple visual and X-ray correct training aids. Each training aid is designed to represent the types of threats likely to be encountered by security staff and X-ray operators, including edged weapons, firearms, ammunition, and IEDs. This kit not only contains complete threat items but also different threat components that may be used to plug and play, allowing screeners to create new threats for training and testing. This kit is based on a series of custom kits built for the United States Marshals Service. It is designed for more experienced personnel and advanced training scenarios. This kit does not contain items from our TSK1000 training kit. The pistol training aids are not considered firearms in the U.S. but should be treated with the same respect as a real gun and may be subject to country-specific import requirements. Each cutting edge and point has been blunted to ensure items are safe for training.



DSA Detection®



INERT ADVANCED THREAT SCREENING KIT

Export Control: EAR99

Inert IED Circuit Boards Kit

SKU: **ICK2000**

Weight: 82 lb (37.2 kg)

Dimensions: 33 in x 21 in x 17 in (83.8 cm x 53.3 cm x 43.2 cm)

The Inert IED Circuit Boards Kit is a one-of-a-kind teaching aid that contains a complete array of IED firing circuits to help familiarize security officers with examples of IED circuitry, switches, and explosive simulants. Each circuit board is X-ray correct, and offers an interactive training aid with a functioning switch circuit. It contains all the necessary P.I.E.S. (Power source, Initiator, Explosive, and Switch) components of an IED. Inside the kit guide, each circuit board is shown in multiple X-ray orientations. This approach allows the trainer to build situational awareness of the ways different threats can look in person and in an X-ray at difficult angles. The explosive simulants in this kit are engineered to have the same density and effective atomic number (Z_{eff}) as the real explosive threats. An ITAR-compliant version of this training kit is also available.



DSA Detection®



INERT IED CIRCUIT BOARDS KIT

Export Control: ITAR

Inert Modular Bomb System Training Kit

SKU: **MBS1000**

Weight: 32 lb (14.5 kg)

Dimensions: 24.8 in x 19.7 in x 11.9 in (63 cm x 50 cm x 30 cm)

The Inert Modular Bomb System Training Kit is DSA's upgraded version of the Transportation Security Administration's (TSA) MBSII X-ray training kit used to train their officers on explosive threat identification. Unique to this kit's design is the use of common travel items paired together as threat/non-threat items. This allows the screener to compare conventional and modified items commonly seen during everyday screening. The kit contains 27 commercial, military, and homemade explosives, as well as 17 different IED circuit components and detonators. Each simulant is engineered to have the same density and effective atomic number (Z_{eff}) as the real explosive and is visually correct to be used in classroom training.



DSA Detection®



INERT MODULAR BOMB SYSTEM (MBSII) TRAINING KIT

Export Control: EAR99

Inert Domestic Terrorism Threat Training Kit

SKU: **MSK1000**

Weight: 70 lb (31.8 kg)

Dimensions: 33 in x 21 in x 17 in (83.8 cm x 53.3 cm x 43.2 cm)

The Inert Domestic Terrorism Threat Training Kit contains many types of threats a security officer may encounter at an entry checkpoint or mail screening facility. Designed in partnership with the United States Marshals Service this kit contains inert guns, knives, explosive simulants, IEDs, and IED firing circuits. The kit gives trainers the ability to build diverse configurations of known and theoretical threats, allowing for a large variety of scenarios to be presented to train and evaluate security officers. Each simulant is engineered to have the same density and effective atomic number (Z_{eff}) as the real explosive and is visually correct for classroom use. The pistol training aids are not considered firearms in the U.S. but should be treated with the same respect as real guns and may be subject to country-specific import requirements. Each cutting edge and point has been blunted to ensure items are safe for training.



DSA Detection®



INERT DOMESTIC TERRORISM THREAT KIT

Export Control: ITAR

DSA Detection®



INERT MAIL THREAT KIT

Export Control: EAR99



Inert Mail Threat Kit

SKU: **MTK3000**

Weight: 54 lb (24.5 kg)

Dimensions: 33 in x 21 in x 17 in (83.8 cm x 53.3 cm x 43.2 cm)

The Inert Mail Threat Kit contains a wide variety of X-ray correct threat packages that could be seen by mail screeners and security officers at corporate and government mail facilities. This kit includes an assortment of parcel sizes and shapes including 6 different size boxes, padded and non-padded envelopes, letter envelopes, and a musical greeting card. The MTK3000 includes many types of "mail bombs" with firing circuits that have been used in actual attacks, as well as nonexplosive threats. The kit also includes two white powder devices, meant to simulate anthrax, ricin, fentanyl, or a hoax. Each device is engineered to have the same density and effective atomic number (Z_{eff}) as the real threat. To assist in classroom training, a picture of the internal components is displayed on the outer packaging of each device with each of the threat (P.I.E.S.) components identified. This helps build image association without compromising the training aid.

DSA Detection®



INERT ANTI-TERRORISM TRAINING KIT

Export Control: ITAR



Inert Anti-Terrorism Training Kit

SKU: **TSK0055**

Weight: 25 lb (11.3 kg)

Dimensions: 23 in x 14 in x 10 in (58.4 cm x 35.6 cm x 25.4 cm)

The Inert Anti-Terrorism Training Aid Kit was designed for mobility without sacrificing training quality. Every threat in this kit was chosen from historic IED events, perceived hazards, threats constructed from common parts, or items stolen from a blasting site. Each training aid is considered a security risk and can be found on the Interagency Security Committee (ISC) standard prohibited items list. This kit is perfect for security checkpoints where mobility and storage are important. The explosive simulants are visually correct and engineered to have the same density and effective atomic number (Z_{eff}) as the real explosive threat. An ITAR-compliant version of this training kit is also available. The pistol training aid is not considered a firearm in the U.S. but should be treated with the same respect as a real gun and may be subject to country-specific import requirements. Each cutting edge and point has been blunted to ensure items are safe for training.

DSA Detection®



INERT THREAT SCREENING KIT

Export Control: ITAR

Inert Threat Screening Kit

SKU: **TSK1000**

Weight: 75 lb (34 kg)

Dimensions: 33 in x 21 in x 17 in (83.8 cm x 53.3 cm x 43.2 cm)

The Inert Threat Screening Kit was specifically designed to address every threat category for training and testing at any security checkpoint. This kit is composed of several different inert weapons, simple firing circuits, and explosive components. Inside the provided carrying case are various types of handguns, knives, grenades, pipe bombs, firing circuits, commercial, military, homemade high and low explosives, and blasting caps. Altogether, this kit includes 70 separate items. The explosive simulants are visually correct and engineered to have the same density and effective atomic number (Z_{eff}) as the real explosive threat. The gun training aids are not considered firearms in the U.S. but should be treated with the same respect as a real gun and may be subject to country-specific import requirements. Each cutting edge and point has been blunted to ensure items are safe for training. An ITAR-compliant version of this training kit is also available.

DSA Detection®



INERT NON-METALLIC EDGED WEAPONS KIT

Export Control: EAR99

Non-Metallic Edged Weapons Kit

SKU: **TSK1055**

Weight: 9 lb (4.1 kg)

Dimensions: 17 in x 14 in x 8 in (43.2 cm x 35.6 cm x 20.3 cm)

The Non-Metallic Edged Weapons Kit was designed to train security officers on detecting knife blades or punctured weapons that are void of any metallic signature. It allows security officers to learn and perfect the optimal screening methods to detect these types of threats. Each edged weapon in the TSK1055 was selected to represent a large variety of blade types, shapes, and materials. These items are X-ray correct to replicate the real threats with which they are associated. Each cutting edge and point has been blunted to ensure items are safe for training.

Inert Air Cargo (CCSP) Threat Kit

SKU: **TSK4000**

Weight: 47 lb (21.3 kg)

Dimensions: 26 in x 20 in x 13 in (66 cm x 50.8 cm x 33 cm)

The Inert Air Cargo (CCSP) Threat Kit was designed with cargo and transportation operations in mind. It was developed in partnership with a major commercial transportation company. This kit exceeds the performance and capabilities of the current TSA/FAA modular bomb kit. The explosive simulants are visually correct and engineered to have the same density and effective atomic number (Z_{eff}) as the real explosive threat. The gun training aids are not considered firearms in the U.S. but should be treated with the same respect as a real gun and may be subject to country-specific import requirements. An ITAR-compliant version of this training kit is also available.



DSA Detection®



INERT AIR CARGO (CCSP) THREAT KIT

Export Control: ITAR

Inert Guns and Knives Threat Kit

SKU: **TSK5000**

Weight: 13 lb (5.9 kg)

Dimensions: 17 in x 14 in x 8 in (43.2 cm x 35.6 cm x 20.3 cm)

The Inert Guns and Knives Threat Kit is the industry standard for training law enforcement and security personnel. It contains a comprehensive set of inert gun and knife replicas that may be encountered at a security checkpoint. Unlike blue plastic weapons, the items in this kit are real weight and construction. These items perfectly match the X-ray and metal detector signatures of real gun and knife threats. The pistols have removable magazines with inert ammunition. Due to the durability and realism of the items in the TSK5000, this kit has also become popular for self-defense and disarming training. Every item in this kit is inert and coated in blue rubber to identify it as safe to handle. The pistols are not considered firearms in the U.S. but should be treated with the same respect as a real gun and may be subject to country-specific import requirements. Each cutting edge and point has been blunted to ensure the items are safe for training.



DSA Detection®



INERT GUNS AND KNIVES THREAT KIT

Export Control: EAR99

DSA Detection®



INERT ADVANCED WEAPONS KIT

Export Control: EAR99

Inert Advanced Weapons Kit

SKU: **TSK5500**

Weight: 13 lb (5.9 kg)

Dimensions: 17 in x 14 in x 8 in (43.2 cm x 35.6 cm x 20.3 cm)

The Inert Advanced Weapons Kit was designed to fill a void in checkpoint security by enhancing the screener's knowledge of disassembled weapons. Screeners are trained to look for complete guns and edged weapons but guns can be broken down be brought through security as individual components and blunt force threats like brass knuckles can be very dangerous. The TSK5500 provides common-caliber ammunition and firearm components which can help screeners identify items that can be reassembled after the security checkpoint. DSA recommends pairing this kit with the Guns and Knives Kit (TSK5000), this ensures the most complete weapon training possible. The weapon simulants are visually correct and engineered to have the same density and effective atomic number (Z_{eff}) as a real threat. None of the items in this kit are firearms in the U.S. but may be subject to country-specific import requirements. All cutting edges and points have been blunted to ensure items are safe for training. Most inert training aids are coated in blue rubber which helps to identify it as safe to handle. Bullets have a missing or spent primer and an inerting hold in the casing.

DSA Detection®



INERT EXPLOSIVES THREAT KIT

Export Control: EAR99

Inert Explosives Threat Kit

SKU: **TSK6000**

Weight: 54 lb (24.5 kg)

Dimensions: 26 in x 20 in x 13 in (66 cm x 50.8 cm x 33 cm)

The Inert Explosives Threat Kit provides a large assortment of inert explosive and IED simulants. This kit is best used to train screeners on the vast difference explosives can have in size, shape, texture, and feel. The TSK6000 is complete with 35 different examples of military explosives, commercial explosives, and homemade explosives found all over the world. Each explosive simulant is visually correct and engineered to have the same density and effective atomic number (Z_{eff}) as the real explosive threat. Perfect for classroom and checkpoint training, this kit allows screeners to evaluate what an explosive can look and feel like. This helps build image association of explosive texture and X-ray characteristics.

DSA Detection®



INERT P.I.E.S. KIT

Export Control: EAR99



Inert P.I.E.S. Kit

SKU: **TSK6500**

Weight: 54.2 lb (24.6 kg)

Dimensions: 26 in x 20 in x 13 in (66 cm x 50.8 cm x 33 cm)

The Inert P.I.E.S. Kit allows for thousands of IED component combinations for use in screening and training environments. P.I.E.S. (Power source, Initiator, Explosive, and Switch) is a popular security mnemonic for IED components in a screening environment. Built on the foundation of the popular Inert Explosive Kit (TSK6000), the TSK6500 includes ten different X-ray correct assemblies and 32 different X-ray correct explosive simulants. Each assembly consists of various switch configurations, blasting caps, and batteries (power sources) that can mix and match with each explosive simulant. Most of the switches are recognizable as common, everyday items, such as timers and cell phones. This kit is often used to train screeners on the vast difference explosives can have in size, shape, texture, and feel. Each explosive simulant and assembly is visually correct and engineered to have the same density and effective atomic number (Z_{eff}) as the real explosive threat. Perfect for classroom and checkpoint training, this kit allows screeners to evaluate the ways IED components can look and feel, and function. This helps build image association of explosive texture and X-ray characteristics.

DSA Detection®



INERT CONCEALED WEAPONS KIT

Export Control: EAR99



Concealed Weapons Kit

SKU: **TSK7500**

Weight: 9 lb (4.1 kg)

Dimensions: 17 in x 14 in x 8 in (43.2 cm x 35.6 cm x 20.3 cm)

The Concealed Weapons Kit was assembled from threats that are commercially available and designed specifically to disguise a weapon. Every item in this kit was selected to represent a different concealment method. This kit is designed to train security officers on the detection of concealed-edged weapons and other threats. Each training device is visually correct and engineered to have the same density and effective atomic number (Z_{eff}) as a real concealed weapon. These items are also correct for training and testing in metal detectors. Each cutting edge and point has been blunted to ensure items are safe for training.

DSA Detection®



Inert Prohibited Items Kit

SKU: **TSK8500**

Weight: 38 lb (17.2 kg)

Dimensions: 26 in x 20 in x 13 in (66 cm x 50.8 cm x 33 cm)

The Inert Prohibited Items Kit was designed in partnership with a leading U.S. cruise company. Each item was selected from their prohibited items list to ensure their security staff could properly screen for concealed narcotics, weapons, and ammunition. Each concealed device was replicated from examples found during passenger screening. Several devices can conceal either inert powder drugs, pills, or marijuana simulants. There are no inert explosives in this kit. This may (country-dependent) decrease some of the transportation requirements when moving this kit from port to port. Each simulant is visually correct and engineered to have the same density and effective atomic number (Z_{eff}) as the real threat. The pistol training aids are not considered firearms in the U.S. but should be treated with the same respect as real guns and may be subject to country-specific import requirements. Each cutting edge and point has been blunted to ensure items are safe for training.

INERT PROHIBITED ITEMS KIT

Export Control: EAR99

DSA Detection®



Inert Clothing IED Kit

SKU: **TSK9540**

Weight: 59 lb (26.8 kg)

Dimensions: 33 in x 21 in x 17 in (83.8 cm x 53.3 cm x 43.2 cm)

The Inert Clothing IED Kit was developed to assist screeners to understand and recognize modified or altered clothing and braces. Each of the ten different devices has been identified from historic IED attacks or perceived threats. Every training aid contains all the necessary P.I.E.S. (Power source, Initiator, Explosive, and Switch) components of an IED. The X-ray correct explosive simulant is engineered to have the same density and effective atomic number (Z_{eff}) as the real explosive threat. Because of the discrete modifications made to the original article of clothing, this kit can be used to conduct penetration testing and help evaluate security protocols.

INERT CLOTHING IED KIT

Export Control: EAR99

DSA Detection®



Blasting Cap Test Kit

SKU: **OTK0010**

Weight: 12 oz (340 g)

Dimensions: 7.5 in x 4.8 in x 2.2 in (19.1 cm x 12.1 cm x 5.7 cm)

The Blasting Cap Test Kit contains various blasting caps and initiation devices, providing accurate examples of commercial, military, and improvised (homemade) versions. Some of the blasting caps are electronically shunted, while others do not have electrical continuity—helpful when incorporating blasting caps into functioning IED circuitry. Also included in the kit are two modified electric blasting caps, complete with LED indicators that illuminate when functioning. Both the electric and non-electric blasting caps in this kit are completely inert and accurate when viewed in person or on an X-ray/CT scanner. All DSA blasting caps are made with industry-standard, 24AWG wire when possible. Other wire gauges are available by request. Each simulated explosive initiator in this kit is density, Z_{eff} , and X-ray/CT correct to replicate the real threats with which they are associated.

BLASTING CAP TEST KIT

Export Control: EAR99

DSA Detection®



Metal Detector Test Kit

SKU: **TSK7000**

Weight: 3 lb (1.4 kg)

Dimensions: 8 in x 10 in x 3 in (20.3 cm x 25.4 cm x 7.6 cm)

The Metal Detector Test Kit was designed to maintain and improve the security of federal buildings, courthouses, correctional facilities, and public buildings, as well as any other secure facility. These test objects allow you to configure a walk-through or hand-held metal detector, test new metal detectors, and train your security staff. They will allow you to determine a security setting that will detect the most dangerous metallic threats. The TSK7000 complies with NIJ Standard 0601.02 “Metal Detectors for use in Concealed Weapon and Contraband Detection using an NAA 22 disassembled gun standard”, which was the result of extensive consultation with law enforcement and correction communities. These training aids are not considered firearms in the U.S. but should be treated with the same respect as a real gun and may be subject to country-specific import requirements. Each cutting edge and point has been blunted to ensure items are safe for training.

METAL DETECTOR TEST KIT

Export Control: EAR99

DSA Detection®



3-GUN TEST KIT

Export Control: EAR99



3-Gun Test Kit

SKU: **TSK7100**

Weight: 12 lb (5.4 kg)

Dimensions: 11 in x 13 in x 3 in (27.9 cm x 33 cm x 7.6 cm)

The 3-Gun Test Kit is designed to maintain and improve the security of federal buildings, courthouses, correctional facilities, and public buildings, as well as any other secure facility. Inside the case are three test objects labeled as NA-22/TKC0052 (NAA-.22 revolver), DA/TKC0138 (Derringer Model 95), and BR/TKC0511 (similar to the Beretta Jetfire 950 or FIE Titan .25). These test objects allow for the configuration and testing of any metal detector, allowing you to determine a machine setting that will detect your most dangerous metallic threat. Each test piece is cast in durable resin to minimize any safety concerns when conducting covert testing. This kit is particularly effective for testing operator alertness and training new operators. The TSK7100 complies with NIJ Standard-0601.01 "Walk-Through Metal Detectors for Use in Concealed Weapon and Contraband Detection". There are no bullets included in this kit. It is considered a training or test piece and as such is not labeled as "INERT".

DSA Detection®



TRACE QUALITY CONTROL KIT

Export Control: EAR99



Trace Quality Control (TQC) Kit

SKU: **TSK9552**

Weight: 2 lb (907.2 g)

Dimensions: 8 in x 10 in x 3 in (20.3 cm x 25.4 cm x 7.6 cm)

The Trace Quality Control (TQC) Kit allows users to perform Red Team penetration testing using real explosive materials without the hazards and restrictions of bulk explosives. The 3 unique samples of clay-like material each contain a small amount of real explosive material added (RDX, PETN, and TNT). This small amount of explosive material is easily detectable with today's ETDs but is perfectly safe to ship, carries no handling restrictions, and is even non-flammable.

EXPLOSIVE SIMULANTS & DETONATORS

Product Catalog

SUMMER 2023



Department for
Transport



Table of Contents

63 Inert DetPak Binary Explosive Simulant	78 Inert Detonation Cord (Smooth, Synthetic Sheath) 6 ft
63 Inert Trojan Cast Booster (.75 lb)	78 Inert Military TNT (.5 lb)
63 Inert Soviet Dynamite	79 Inert Military TNT (1 lb)
64 Inert Sweaty Dynamite	79 Inert Sheet Explosive (1.5 lb)
64 Inert Yellow Dynamite	79 Inert PLX Liquid Explosive (34 oz)
64 Inert Nitro Dynamite	80 Inert RDX (1 lb)
65 Inert Ammonium Dynamite	80 Inert Bulk RDX (3 lb)
65 Inert Extra Gelatin (E.G.) Dynamite	80 Inert ETN Simulant (1 lb)
65 Inert Commercial Pull Friction Igniter, Cardboard	81 Inert PETN (1 lb)
66 Inert Cast TNT (.75 lb)	81 Inert Smokeless Powder (1 lb)
66 Inert Flake TNT (1 lb)	81 Inert Binary Exploding Target Simulant (1 lb)
66 Inert Bulk Flake TNT (2.5 lb)	82 Inert Black Powder (1 lb)
67 Inert ANFO (1 lb)	82 Inert Hobby Fuse (36 in)
67 Inert Blasting Emulsion (.75 lb)	82 Inert Thermite (1 lb)
67 Inert Nitromethane (34 oz)	83 Inert LED Commercial Electrical Blasting Cap
68 Inert Potassium Perchlorate (1 lb)	83 Inert Electric Blasting Cap (Shunted)
68 Inert Bulk Potassium Perchlorate (4.5 lb)	83 Inert Electric Blasting Cap (25 ct)
68 Inert Poor Man's C4 (1 lb)	84 Inert Electric Blasting Cap (50 ct)
69 Inert Bulk Poor Man's C4 (4.5 lb)	84 Inert Commercial Blasting Cap
69 Inert Ammonium Nitrate (AN) (1 lb)	84 Inert Commercial Fuse Head Blasting Cap
69 Inert ANAL (1 lb)	85 Inert Improvised Light Bulb Detonator
70 Inert Hydrous HMTD (1 lb)	85 Inert Improvised Blasting Cap
70 Inert Bulk HMTD (3 lb)	85 Inert Cardboard Blasting Cap
70 Inert TATP (1 lb)	86 Inert M81 Fuse Igniter
71 Inert Liquid Peroxide (34 oz)	86 Inert M81 Fuse Igniter With Shock Tube
71 Inert Potassium Chlorate (1 lb)	86 Inert M81 Fuse Igniter With Time Fuse
71 Inert Demolition Charge, M112 C4 Simulant	87 Inert Non-Electrical Blasting Cap
72 Inert Bulk C4 Simulant (5 lb)	87 Inert Non-Electrical Blasting Cap w/ Time Fuse
72 Inert M112 Block (C4)	87 Inert LED Military Electrical Blasting Cap
72 Inert Plastic Explosive Simulant (1 lb)	88 Inert Military Electrical Blasting Cap
73 Inert Bulk Semtex H Simulant (5 lb)	88 Inert Electric Match / Squib
73 Inert Semtex H Simulant	
73 Inert Semtex H Simulant, Patty (1 lb)	
74 Inert Bulk 1A Simulant (5 lb)	
74 Inert Semtex 1A Simulant	
74 Inert Bulk Semtex 10 Simulant (5 lb)	
75 Inert Semtex 10 Simulant	
75 Inert P.E.4, Long (.75 lb)	
75 Inert P.E.4, Short (.5 lb)	
76 Inert Flake Pentolite (1 lb)	
76 Inert Military M1 Dynamite	
76 Inert M118 (Flex-X) Charge Simulant	
77 Inert Time Fuse (72 in)	
77 Inert Detonation Cord (72 in)	
77 Inert Bulk Detonation Cord (Braided Cloth Sheath)	
78 Inert Bulk Detonation Cord (Synthetic Smooth Sheath)	



Export Control #: EAR99

Inert DetPak Binary Explosive Simulant

SKU: TSK0108

Weight: 6.4 oz (181 g)

Dimensions: 8.1 in x 2.4 in x 2.4 in (20.5 cm x 6 cm x 6 cm)

This training aid simulates a binary liquid blasting explosive (TEXPAK). The explosive simulant is visually correct and engineered to have the same density and effective atomic number (Z_{eff}) as the real explosive threat. This simulant can also be purchased in custom/bulk quantities or packaging.

Technology: mmWave, Portable X-Ray, Backscatter, Computed Tomography (CT), Single and Multiple X-Ray Generator Systems

Physical Form: Liquid
Field of Use: Commercial



Export Control #: EAR99

Inert Trojan Cast Booster (.75 lb)

SKU: TSK1500

Weight: 12 oz (340 g)

Dimensions: 4.8 in x 2.1 in x 2.1 in (12.3 cm x 5.4 cm x 5.4 cm)

This training aid simulates a cast explosive booster. The explosive simulant is visually correct and engineered to have the same density and effective atomic number (Z_{eff}) as the real explosive threat. It has a through hole for easy insertion of detonating cord or a blasting cap.

Technology: mmWave, Portable X-Ray, Backscatter, Computed Tomography (CT), Single and Multiple X-Ray Generator Systems

Physical Form: Cast Solid
Field of Use: Commercial



Export Control #: EAR99

Inert Soviet Dynamite

SKU: TSK1600

Weight: 8.6 oz (247 g)

Dimensions: 8.6 in x 1.5 in x 1.5 in (21.9 cm x 3.7 cm x 3.7 cm)

This training aid simulates Soviet dynamite. The explosive simulant is visually correct and engineered to have the same density and effective atomic number (Z_{eff}) as the real explosive threat.

Technology: mmWave, Portable X-Ray, Backscatter, Computed Tomography (CT), Single and Multiple X-Ray Generator Systems

Physical Form: Solid
Field of Use: Commercial



Export Control #: EAR99

Inert Sweaty Dynamite

SKU: TSK1601

Weight: 9.9 oz (282 g)

Dimensions: 8.7 in x 1.6 in x 1.6 in (22 cm x 4 cm x 4 cm)

As improperly stored dynamite ages, it can exude nitroglycerin, which crystallizes and makes the movement of the explosive very dangerous. Being able to recognize this hazard is important for first responders, law enforcement, and military personnel. This training aid simulates sweaty dynamite. The explosive simulant is visually correct and engineered to have the same density and effective atomic number (Z_{eff}) as the real explosive threat.

Technology: mmWave, Portable X-Ray, Backscatter, Computed Tomography (CT), Single and Multiple X-Ray Generator Systems

Physical Form: Solid
Field of Use: Commercial



Export Control #: EAR99

Inert Yellow Dynamite

SKU: TSK1605

Weight: 2.4 oz (68 g)

Dimensions: 8.7 in x 1.3 in x 1.3 in (22 cm x 3.4 cm x 3.4 cm)

The Inert Yellow Dynamite is designed to be high quality and durable. This training aid is not X-ray correct and will not generate the proper alarm in a material discrimination X-ray system. The TSK1605 is more cost-effective than our X-ray correct dynamites and is great for hands-on use and field training. This simulant is filled with sawdust and is waxed to be weather resistant, similar to the way dynamite was originally made. DSA's Inert Yellow Dynamite is used by national bomb squad training facilities for disruptor training and is biodegradable for easy range cleanup. This item can also be purchased as a case of 88.

Technology: mmWave, Portable X-Ray

Physical Form: Solid
Field of Use: Commercial



Export Control #: EAR99

Inert Nitro Dynamite

SKU: TSK1700

Weight: 9.9 oz (282 g)

Dimensions: 8.7 in x 1.5 in x 1.5 in (22 cm x 3.7 cm x 3.7 cm)

This training aid simulates nitroglycerin (nitro) dynamite. The explosive simulant is visually correct and engineered to have the same density and effective atomic number (Z_{eff}) as the real explosive threat.

Technology: mmWave, Portable X-Ray, Backscatter, Computed Tomography (CT), Single and Multiple X-Ray Generator Systems

Physical Form: Solid
Field of Use: Commercial



Export Control #: EAR99

Inert Ammonium Dynamite

SKU: TSK1900

Weight: 9.6 oz (273 g)

Dimensions: 8.7 in x 1.5 in x 1.5 in (22 cm x 3.7 cm x 3.7 cm)

This training aid simulates ammonium dynamite. The explosive simulant is visually correct and engineered to have the same density and effective atomic number (Z_{eff}) as the real explosive threat.

Technology: mmWave, Portable X-Ray, Backscatter, Computed Tomography (CT), Single and Multiple X-Ray Generator Systems

Physical Form: Solid
Field of Use: Commercial



Export Control #: EAR99

Inert Extra Gelatin (E.G.) Dynamite

SKU: TSK2000

Weight: 10.4 oz (294 g)

Dimensions: 8.7 in x 1.5 in x 1.5 in (22 cm x 3.7 cm x 3.7 cm)

This training aid simulates E.G. dynamite. The explosive simulant is visually correct and engineered to have the same density and effective atomic number (Z_{eff}) as the real explosive threat.

Technology: mmWave, Portable X-Ray, Backscatter, Computed Tomography (CT), Single and Multiple X-Ray Generator Systems

Physical Form: Solid
Field of Use: Commercial



Export Control #: EAR99

Inert Commercial Pull Friction Igniter, Cardboard

SKU: TSK2323

Weight: 0.3 oz (8 g)

Dimensions: 4.5 in x 0.4 in x 0.4 in (11.5 cm x 1 cm x 1 cm)

The Inert Cardboard Pull Friction Igniter is an inert version of the commercial igniter used to light safety, cannon, and hobby fuses. This training aid is visually correct and engineered to have the same density and effective atomic number (Z_{eff}) as a fuse ignitor.

Technology: mmWave, Portable X-Ray, Backscatter, Computed Tomography (CT), Single and Multiple X-Ray Generator Systems

Physical Form: Other
Field of Use: Commercial



Export Control #: EAR99

Inert Cast TNT (.75 lb)

SKU: **TSK4200**

Weight: 12.8 oz (365 g)

Dimensions: 5.7 in x 2.8 in x 1.4 in (14.5 cm x 7 cm x 3.5 cm)

This training aid simulates cast TNT explosives. The explosive simulant is visually correct and engineered to have the same density and effective atomic number (Z_{eff}) as the real explosive threat. This simulant can also be purchased in custom/bulk quantities or packaging.

Technology: mmWave, Portable X-Ray, Backscatter, Computed Tomography (CT), Single and Multiple X-Ray Generator Systems

Physical Form: Cast Solid
Field of Use: Commercial



Export Control #: EAR99

Inert Flake TNT (1 lb)

SKU: **TSK8000**

Weight: 1 lb (465 g)

Dimensions: 7.7 in x 5.7 in x 2.2 in (19.5 cm x 14.5 cm x 5.5 cm)

This training aid simulates flake TNT explosives. The explosive simulant is visually correct and engineered to have the same density and effective atomic number (Z_{eff}) as the real explosive threat. This simulant can also be purchased in custom/bulk quantities or packaging.

Technology: mmWave, Portable X-Ray, Backscatter, Computed Tomography (CT), Single and Multiple X-Ray Generator Systems

Physical Form: Cast Solid
Field of Use: Commercial



Export Control #: EAR99

Inert Bulk Flake TNT (2.5 lb)

SKU: **TSK8000B**

Weight: 2.5 lb (1.1 kg)

Dimensions: 7.2 in x 4.9 in x 4.9 in (18.4 cm x 12.5 cm x 12.5 cm)

This training aid simulates bulk flake TNT and is available in larger quantities for custom builds. The explosive simulant is visually correct and engineered to have the same density and effective atomic number (Z_{eff}) as the real explosive threat.

Technology: mmWave, Portable X-Ray, Backscatter, Computed Tomography (CT), Single and Multiple X-Ray Generator Systems

Physical Form: Cast Solid
Field of Use: Commercial



Export Control #: EAR99

Inert ANFO (1 lb)

SKU: TSK8020

Weight: 1 lb (462 g)

Dimensions: 7.7 in x 5.5 in x 1.4 in (19.5 cm x 14 cm x 3.5 cm)

This training aid simulates ammonium nitrate and fuel oil mixture (ANFO) explosives. The explosive simulant is visually correct and engineered to have the same density and effective atomic number (Z_{eff}) as the real explosive threat. This simulant can also be purchased in custom/bulk quantities or packaging.

Technology: mmWave, Portable X-Ray, Backscatter, Computed Tomography (CT), Single and Multiple X-Ray Generator Systems

Physical Form: Prilled
Field of Use: Commercial



Export Control #: EAR99

Inert Blasting Emulsion (.75 lb)

SKU: TSK8050

Weight: 12.5 oz (354 g)

Dimensions: 8.9 in x 1.8 in x 1.8 in (22.5 cm x 4.5 cm x 4.5 cm)

This training aid simulates blasting emulsion explosives. The explosive simulant is visually correct and engineered to have the same density and effective atomic number (Z_{eff}) as the real explosive threat. This simulant can also be purchased in custom/bulk quantities or packaging.

Technology: mmWave, Portable X-Ray, Backscatter, Computed Tomography (CT), Single and Multiple X-Ray Generator Systems

Physical Form: Emulsion/Gel
Field of Use: Commercial



Export Control #: EAR99

Inert Nitromethane (34 oz)

SKU: TSK9080

Weight: 2.7 lb (1.2 kg)

Dimensions: 9.6 in x 3.1 in x 3.1 in (24.4 cm x 8 cm x 8 cm)

This training aid simulates nitromethane. The explosive simulant is visually correct and engineered to have the same density and effective atomic number (Z_{eff}) as the real explosive threat.

Technology: mmWave, Portable X-Ray, Backscatter, Computed Tomography (CT), Single and Multiple X-Ray Generator Systems

Physical Form: Liquid
Field of Use: Commercial



Export Control #: EAR99

Inert Potassium Perchlorate (1 lb)

SKU: TSK1205

Weight: 1 lb (463 g)

Dimensions: 7.2 in x 4.9 in x 4.9 in (18.4 cm x 12.5 cm x 12.5 cm)

This training aid simulates potassium perchlorate. The explosive simulant is visually correct and engineered to have the same density and effective atomic number (Z_{eff}) as the real explosive threat. This simulant can also be purchased in custom/bulk quantities or packaging. Unlike most explosives, chlorate explosives display green in most material discrimination X-ray systems.

Technology: mmWave, Portable X-Ray, Backscatter, Computed Tomography (CT), Single and Multiple X-Ray Generator Systems

Physical Form: Powder
Field of Use: HME



Export Control #: EAR99

Inert Bulk Potassium Perchlorate (4.5 lb)

SKU: TSK1205B

Weight: 4.5 lb (2.00 kg)

Dimensions: 7.2 in x 4.9 in x 4.9 in (18.4 cm x 12.5 cm x 12.5 cm)

This training aid simulates bulk potassium perchlorate and is available in larger quantities for custom builds. The explosive simulant is visually correct and engineered to have the same density and effective atomic number (Z_{eff}) as the real explosive threat. Unlike most explosives, chlorate explosives display green in most material discrimination X-ray systems.

Technology: mmWave, Portable X-Ray, Backscatter, Computed Tomography (CT), Single and Multiple X-Ray Generator Systems

Physical Form: Powder
Field of Use: HME



Export Control #: EAR99

Inert Poor Man's C4 (1 lb)

SKU: TSK1210

Weight: 1 lb (460 g)

Dimensions: 7.9 in x 4.7 in x 1 in (20 cm x 12 cm x 2.5 cm)

This training aid simulates Poor Man's C4. The explosive simulant is visually correct and engineered to have the same density and effective atomic number (Z_{eff}) as the real explosive threat. This simulant can also be purchased in custom/bulk quantities or packaging. Unlike most explosives, chlorate explosives display green in most material discrimination X-ray systems.

Technology: mmWave, Portable X-Ray, Backscatter, Computed Tomography (CT), Single and Multiple X-Ray Generator Systems

Physical Form: Other
Field of Use: HME



Export Control #: EAR99

Inert Bulk Poor Man's C4 (4.5 lb)

SKU: TSK1212

Weight: 4.7 lb (2.1 kg)

Dimensions: 7.2 in x 4.9 in x 4.9 in (18.4 cm x 12.5 cm x 12.5 cm)

This training aid simulates bulk "poor man's C4" and is available in larger quantities for custom builds. The explosive simulant is visually correct and engineered to have the same density and effective atomic number (Z_{eff}) as the real explosive threat. Unlike most explosives, chlorate explosives display green in most material discrimination X-ray systems.

Technology: mmWave, Portable X-Ray, Backscatter, Computed Tomography (CT), Single and Multiple X-Ray Generator Systems

Physical Form: Other
Field of Use: HME



Export Control #: EAR99

Inert Ammonium Nitrate (AN) (1 lb)

SKU: TSK8010

Weight: 1 lb (467 g)

Dimensions: 7.7 in x 5.1 in x 1.8 in (19.5 cm x 13 cm x 4.5 cm)

This training aid simulates ammonium nitrate (AN) explosives. The explosive simulant is visually correct and engineered to have the same density and effective atomic number (Z_{eff}) as the real explosive threat. This simulant can also be purchased in custom/bulk quantities or packaging.

Technology: mmWave, Portable X-Ray, Backscatter, Computed Tomography (CT), Single and Multiple X-Ray Generator Systems

Physical Form: Prilled
Field of Use: HME



Export Control #: EAR99

Inert ANAL (1 lb)

SKU: TSK8085

Weight: 1 lb (465 g)

Dimensions: 7.8 in x 5.5 in x 1.4 in (19.7 cm x 14 cm x 3.5 cm)

This training aid simulates ANAL (ammonium nitrate and aluminum powder). The explosive simulant is visually correct and engineered to have the same density and effective atomic number (Z_{eff}) as the real explosive threat. This simulant can also be purchased in custom/bulk quantities or packaging.

Technology: mmWave, Portable X-Ray, Backscatter, Computed Tomography (CT), Single and Multiple X-Ray Generator Systems

Physical Form: Powder
Field of Use: HME

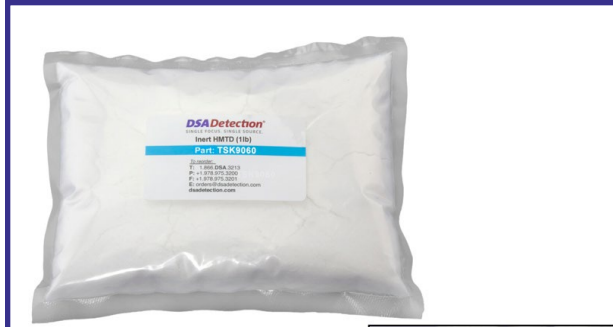

Inert Hydrous HMTD (1 lb)

SKU: TSK9060

Weight: 1 lb (473 g)

Dimensions: 7.7 in x 5.9 in x 1 in (19.5 cm x 15 cm x 2.5 cm)

This training aid simulates hydrous (damp) HMTD. It is designed to replicate HMTD that has not been completely cured during the manufacturing process. The TSK9060 simulates explosives that were discovered during a foiled European terror plot. The explosive simulant is visually correct and engineered to have the same density and effective atomic number (Z_{eff}) as the real explosive threat. This simulant can also be purchased in custom/bulk quantities or packaging.



Export Control #: EAR99

Technology: mmWave, Portable X-Ray, Backscatter, Computed Tomography (CT), Single and Multiple X-Ray Generator Systems

Physical Form: Other
Field of Use: HME



Inert Bulk HMTD (3 lb)

SKU: TSK9060B

Weight: 3.2 lb (1.5 kg)

Dimensions: 7.2 in x 4.9 in x 4.9 in (18.4 cm x 12.5 cm x 12.5 cm)

This training aid simulates bulk hydrous HMTD and is available in larger quantities for custom builds. The explosive simulant is visually correct and engineered to have the same density and effective atomic number (Z_{eff}) as the real explosive threat.



Export Control #: EAR99

Technology: mmWave, Portable X-Ray, Backscatter, Computed Tomography (CT), Single and Multiple X-Ray Generator Systems

Physical Form: Other
Field of Use: HME



Inert TATP (1 lb)

SKU: TSK9070

Weight: 1 lb (465 g)

Dimensions: 7.7 in x 7.1 in x 1.8 in (19.5 cm x 18 cm x 4.5 cm)

This training aid simulates TATP. The explosive simulant is visually correct and engineered to have the same density and effective atomic number (Z_{eff}) as the real explosive threat. This simulant can also be purchased in custom/bulk quantities or packaging.



Export Control #: EAR99

Technology: mmWave, Portable X-Ray, Backscatter, Computed Tomography (CT), Single and Multiple X-Ray Generator Systems

Physical Form: Powder
Field of Use: HME



Export Control #: EAR99

Inert Liquid Peroxide (34 oz)

SKU: TSK9090

Weight: 2.9 lb (1.3 kg)

Dimensions: 9.6 in x 3.1 in x 3.1 in (24.4 cm x 8 cm x 8 cm)

This training aid simulates liquid peroxide. The explosive simulant is visually correct and engineered to have the same density and effective atomic number (Z_{eff}) as the real explosive threat.

Technology: mmWave, Portable X-Ray, Backscatter, Computed Tomography (CT), Single and Multiple X-Ray Generator Systems

Physical Form: Liquid
Field of Use: HME



Export Control #: EAR99

Inert Potassium Chlorate (1 lb)

SKU: TSK9576

Weight: 1 lb (462 g)

Dimensions: 7.7 in x 5.1 in x 1 in (19.5 cm x 13 cm x 2.5 cm)

This training aid simulates potassium chlorate. The explosive simulant is visually correct and engineered to have the same density and effective atomic number (Z_{eff}) as the real explosive threat. This simulant can also be purchased in custom/bulk quantities or packaging. Unlike most explosives, chlorate explosives display green in most material discrimination X-ray systems.

Technology: mmWave, Portable X-Ray, Backscatter, Computed Tomography (CT), Single and Multiple X-Ray Generator Systems

Physical Form: Powder
Field of Use: HME



Export Control #: EAR99

Inert Demolition Charge, M112 C4 Simulant

SKU: EODMNP30

Weight: 1.3 lb (600 g)

Dimensions: 11.8 in x 2.4 in x 1.6 in (30 cm x 6 cm x 4 cm)

This training aid is designed to be durable for field training and identical to a C4, M112 1.25 lb explosive charge, including double stick tape. This M112 simulant is not made of clay and will not dry out. It is not X-ray correct but may still generate an alarm in some X-ray systems.

Technology: mmWave, Portable X-Ray, Backscatter, Computed Tomography (CT), Single and Multiple X-Ray Generator Systems

Physical Form: Plastic Explosive
Field of Use: Military



Export Control #: EAR99

Inert Bulk C4 Simulant (5 lb)

SKU: EPE1-A-02268-0

Weight: 5.1 lb (2.3 kg)

Dimensions: 4.7 in x 4.7 in x 7.1 in (12 cm x 12 cm x 18 cm)

This training aid is the most realistic C4 simulant available. This explosive simulant is visually correct and is engineered to have the same density and effective atomic number (Z_{eff}) as the real explosive. Additionally, this updated simulant feels identical to the real explosive material when handled, it is perfect for complicated IED builds. It will not dry out or go bad when removed from its packaging. This simulant is available in bulk quantities and in custom packaging.

Technology: mmWave, Portable X-Ray, Backscatter, Computed Tomography (CT), Single and Multiple X-Ray Generator Systems

Physical Form: Plastic Explosive
Field of Use: Military



Export Control #: EAR99

Inert M112 Block (C4)

SKU: EPE1-B-00567-0

Weight: 1.3 lb (598 g)

Dimensions: 12 in x 2.2 in x 1 in (30.5 cm x 5.5 cm x 2.5 cm)

This training aid is the most realistic M112 Block simulant available. This C4 simulant is visually correct and is engineered to have the same density and effective atomic number (Z_{eff}) as the real explosive. Additionally, this updated simulant feels identical to the real explosive material when handled, it is perfect for complicated IED builds. It will not dry out or go bad when removed from its packaging. This simulant is available in bulk quantities and in custom packaging.

Technology: mmWave, Portable X-Ray, Backscatter, Computed Tomography (CT), Single and Multiple X-Ray Generator Systems

Physical Form: Plastic Explosive
Field of Use: Military



Export Control #: EAR99

Inert Plastic Explosive Simulant (1 lb)

SKU: EPE1-C-00454-0

Weight: 1.1 lb (480 g)

Dimensions: 5.9 in x 5.9 in x 0.8 in (15 cm x 15 cm x 2 cm)

This training aid is made from the most realistic C4 simulant available. It is visually correct and is engineered to have the same density and effective atomic number (Z_{eff}) as the real explosive. Additionally, this updated simulant feels identical to the real explosive material when handled, it is perfect for complicated IED builds. It will not dry out or go bad when removed from its packaging. This simulant is available in bulk quantities and in custom packaging.

Technology: mmWave, Portable X-Ray, Backscatter, Computed Tomography (CT), Single and Multiple X-Ray Generator Systems

Physical Form: Plastic Explosive
Field of Use: Military



Export Control #: EAR99

Inert Bulk Semtex H Simulant (5 lb)

SKU: EPE2-A-02268-0

Weight: 5.1 lb (2.3 kg)

Dimensions: 4.7 in x 4.7 in x 7.1 in (12 cm x 12 cm x 18 cm)

This training aid is the most realistic Semtex H simulant available. This explosive simulant is visually correct and is engineered to have the same density and effective atomic number (Z_{eff}) as the real explosive. Additionally, this updated simulant feels identical to the real explosive material when handled, it is perfect for complicated IED builds. It will not dry out or go bad when removed from its packaging. This simulant is available in bulk quantities and in custom packaging.

Technology: mmWave, Portable X-Ray, Backscatter, Computed Tomography (CT), Single and Multiple X-Ray Generator Systems

Physical Form: Plastic Explosive
Field of Use: Military



Export Control #: EAR99

Inert Semtex H Simulant

SKU: EPE2-B-00500-0

Weight: 1.1 lb (512 g)

Dimensions: 5.7 in x 2.8 in x 2 in (14.5 cm x 7 cm x 5 cm)

This training aid is the most realistic Semtex H simulant available. It is visually correct and is engineered to have the same density and effective atomic number (Z_{eff}) as the real explosive. Additionally, this updated simulant feels identical to the real explosive material when handled, it is perfect for complicated IED builds. It will not dry out or go bad when removed from its packaging. This simulant is available in bulk quantities and in custom packaging.

Technology: mmWave, Portable X-Ray, Backscatter, Computed Tomography (CT), Single and Multiple X-Ray Generator Systems

Physical Form: Plastic Explosive
Field of Use: Military



Export Control #: EAR99

Inert Semtex H Simulant, Patty (1 lb)

SKU: EPE2-C-00454-0

Weight: 1.1 lb (480 g)

Dimensions: 5.9 in x 5.9 in x 0.8 in (15 cm x 15 cm x 2 cm)

This training aid is made from the most realistic Semtex H simulant available. It is visually correct and is engineered to have the same density and effective atomic number (Z_{eff}) as the real explosive. Additionally, this updated simulant feels identical to the real explosive material when handled, it is perfect for complicated IED builds. It will not dry out or go bad when removed from its packaging. This simulant is available in bulk quantities and in custom packaging.

Technology: mmWave, Portable X-Ray, Backscatter, Computed Tomography (CT), Single and Multiple X-Ray Generator Systems

Physical Form: Plastic Explosive
Field of Use: Military



Export Control #: EAR99

Inert Bulk 1A Simulant (5 lb)

SKU: EPE3-A-02268-0

Weight: 5.1 lb (2.3 kg)

Dimensions: 4.7 in x 4.7 in x 7.1 in (12 cm x 12 cm x 18 cm)

This training aid is the most realistic Semtex 1A simulant available. This explosive simulant is visually correct and is engineered to have the same density and effective atomic number (Z_{eff}) as the real explosive. Additionally, this updated simulant feels identical to the real explosive material when handled, it is perfect for complicated IED builds. It will not dry out or go bad when removed from its packaging. This simulant is available in bulk quantities and in custom packaging.

Technology: mmWave, Portable X-Ray, Backscatter, Computed Tomography (CT), Single and Multiple X-Ray Generator Systems

Physical Form: Plastic Explosive
Field of Use: Military



Export Control #: EAR99

Inert Semtex 1A Simulant

SKU: EPE3-B-00500-0

Weight: 1.1 lb (515 g)

Dimensions: 5.7 in x 2.8 in x 2 in (14.5 cm x 7 cm x 5 cm)

This training aid is the most realistic Semtex 1A simulant available. It is visually correct and is engineered to have the same density and effective atomic number (Z_{eff}) as the real explosive. Additionally, this updated simulant feels identical to the real explosive material when handled, it is perfect for complicated IED builds. It will not dry out or go bad when removed from its packaging. This simulant is available in bulk quantities and in custom packaging.

Technology: mmWave, Portable X-Ray, Backscatter, Computed Tomography (CT), Single and Multiple X-Ray Generator Systems

Physical Form: Plastic Explosive
Field of Use: Military



Export Control #: EAR99

Inert Bulk Semtex 10 Simulant (5 lb)

SKU: EPE4-A-02268-0

Weight: 5.1 lb (2.3 kg)

Dimensions: 4.7 in x 4.7 in x 7.1 in (12 cm x 12 cm x 18 cm)

This training aid is the most realistic Semtex 10 simulant available. This explosive simulant is visually correct and is engineered to have the same density and effective atomic number (Z_{eff}) as the real explosive. Additionally, this updated simulant feels identical to the real explosive material when handled, it is perfect for complicated IED builds. It will not dry out or go bad when removed from its packaging. This simulant is available in bulk quantities and in custom packaging.

Technology: mmWave, Portable X-Ray, Backscatter, Computed Tomography (CT), Single and Multiple X-Ray Generator Systems

Physical Form: Plastic Explosive
Field of Use: Military



Export Control #: EAR99

Inert Semtex 10 Simulant

SKU: EPE4-B-00500-0

Weight: 1.1 lb (515 g)

Dimensions: 5.7 in x 2.8 in x 2 in (14.5 cm x 7 cm x 5 cm)

This training aid is the most realistic Semtex 10 simulant available. It is visually correct and is engineered to have the same density and effective atomic number (Z_{eff}) as the real explosive. Additionally, this updated simulant feels identical to the real explosive material when handled, it is perfect for complicated IED builds. It will not dry out or go bad when removed from its packaging. This simulant is available in bulk quantities and in custom packaging.

Technology: mmWave, Portable X-Ray, Backscatter, Computed Tomography (CT), Single and Multiple X-Ray Generator Systems

Physical Form: Plastic Explosive
Field of Use: Military



Export Control #: EAR99

Inert P.E.4, Long (.75 lb)

SKU: TSK1300

Weight: 10.7 oz (303 g)

Dimensions: 8.6 in x 1.6 in x 1.6 in (21.8 cm x 4 cm x 4 cm)

This training aid simulates P.E.4. The explosive simulant is visually correct and engineered to have the same density and effective atomic number (Z_{eff}) as the real explosive threat.

Technology: mmWave, Portable X-Ray, Backscatter, Computed Tomography (CT), Single and Multiple X-Ray Generator Systems

Physical Form: Plastic Explosive
Field of Use: Military



Export Control #: EAR99

Inert P.E.4, Short (.5 lb)

SKU: TSK1400

Weight: 7.5 oz (211 g)

Dimensions: 5.2 in x 1.8 in x 1.8 in (13.2 cm x 4.5 cm x 4.5 cm)

This training aid simulates P.E.4. The explosive simulant is visually correct and engineered to have the same density and effective atomic number (Z_{eff}) as the real explosive threat.

Technology: mmWave, Portable X-Ray, Backscatter, Computed Tomography (CT), Single and Multiple X-Ray Generator Systems

Physical Form: Plastic Explosive
Field of Use: Military



Export Control #: EAR99

Inert Flake Pentolite (1 lb)

SKU: TSK1495

Weight: 1 lb (458 g)

Dimensions: 7.7 in x 6.2 in x 2 in (19.5 cm x 15.8 cm x 5 cm)

This training aid simulates flake pentolite. The explosive simulant is visually correct and engineered to have the same density and effective atomic number (Z_{eff}) as the real explosive threat.

Technology: mmWave, Portable X-Ray, Backscatter, Computed Tomography (CT), Single and Multiple X-Ray Generator Systems

Physical Form: Cast Solid
Field of Use: Military



Export Control #: EAR99

Inert Military M1 Dynamite

SKU: TSK1800

Weight: 9.3 oz (261 g)

Dimensions: 8.7 in x 1.5 in x 1.5 in (22 cm x 3.7 cm x 3.7 cm)

This training aid simulates military M1 dynamite. The explosive simulant is visually correct and engineered to have the same density and effective atomic number (Z_{eff}) as the real explosive threat.

Technology: mmWave, Portable X-Ray, Backscatter, Computed Tomography (CT), Single and Multiple X-Ray Generator Systems

Physical Form: Solid
Field of Use: Military



Export Control #: EAR99

Inert M118 (Flex-X) Charge Simulant

SKU: TSK2250

Weight: 2.4 lb (1.1 kg)

Dimensions: 14 in x 3.5 in x 1.4 in (35.5 cm x 9 cm x 3.5 cm)

This training aid simulates an M118 (Flex-X) demolition charge. The explosive simulant is visually correct and engineered to have the same density and effective atomic number (Z_{eff}) as the real explosive threat. It consists of four sheet explosives, each with breachers tape.

Technology: mmWave, Portable X-Ray, Backscatter, Computed Tomography (CT), Single and Multiple X-Ray Generator Systems

Physical Form: Plastic Explosive
Field of Use: Military



Export Control #: EAR99

Inert Time Fuse (72 in)

SKU: TSK3500

Weight: 1.3 oz (36 g)

Dimensions: 6.5 in x 6.2 in x 0.2 in (16.6 cm x 15.7 cm x 0.5 cm)

This training aid simulates military time fuse. The pyrotechnic simulant is visually correct and engineered to have the same density and effective atomic number (Z_{eff}) as the real fuse. This simulant can also be purchased in custom/bulk quantities or packaging.

Technology: mmWave, Portable X-Ray, Backscatter, Computed Tomography (CT), Single and Multiple X-Ray Generator Systems

Physical Form: Other
Field of Use: Military



Export Control #: EAR99

Inert Detonation Cord (72 in)

SKU: TSK4100

Weight: 1.4 oz (40 g)

Dimensions: 6.7 in x 6.7 in x 0.2 in (17 cm x 17 cm x 0.5 cm)

This training aid simulates blasting detonation (Det) cord. The explosive simulant is visually correct and engineered to have the same density and effective atomic number (Z_{eff}) as the real explosive threat. This simulant can also be purchased in custom/bulk quantities.

Technology: mmWave, Portable X-Ray, Backscatter, Computed Tomography (CT), Single and Multiple X-Ray Generator Systems

Physical Form: Other
Field of Use: Military



Export Control #: EAR99

Inert Bulk Detonation Cord (Braided Cloth Sheath)

SKU: TSK4110

This training aid simulates blasting detonation (Det) cord. The explosive simulant is visually correct and engineered to have the same density and effective atomic number (Z_{eff}) as the real explosive threat. This simulant can also be purchased in custom/bulk quantities or packaging and is sold by the foot.

Technology: mmWave, Portable X-Ray, Backscatter, Computed Tomography (CT), Single and Multiple X-Ray Generator Systems

Physical Form: Other
Field of Use: Military

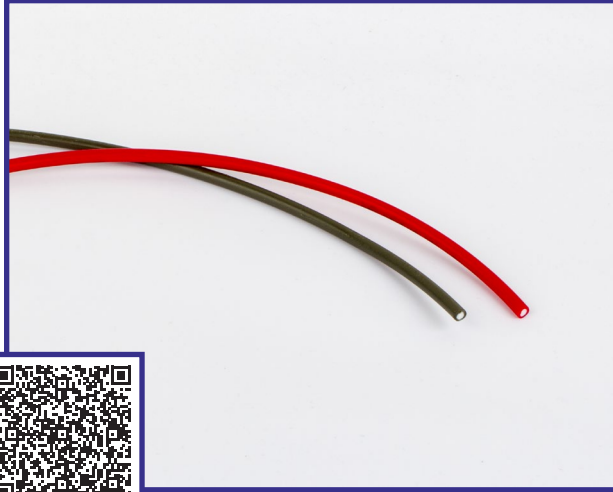

Export Control #: EAR99

Inert Bulk Detonation Cord (Synthetic Smooth Sheath)

SKU: **TSK4120**

This training aid simulates military detonation (Det) cord. The explosive simulant is visually correct and engineered to have the same density and effective atomic number (Z_{eff}) as the real explosive threat. This simulant can also be purchased in custom/bulk quantities or packaging and is sold by the foot.

Technology: mmWave, Portable X-Ray, Backscatter, Computed Tomography (CT), Single and Multiple X-Ray Generator Systems

Physical Form: Other
Field of Use: Military



Export Control #: EAR99

Inert Detonation Cord (Smooth, Synthetic Sheath) 6 ft

SKU: **TSK4121**

Weight: 1.8 oz (50 g)

Dimensions: 6.9 in x 6.9 in x 0.3 in (17.5 cm x 17.5 cm x 0.8 cm)

This training aid simulates military detonation (Det) cord. The explosive simulant is visually correct and engineered to have the same density and effective atomic number (Z_{eff}) as the real explosive threat. This simulant can also be purchased in custom/bulk quantities.

Technology: mmWave, Portable X-Ray, Backscatter, Computed Tomography (CT), Single and Multiple X-Ray Generator Systems

Physical Form: Other
Field of Use: Military



Export Control #: EAR99

Inert Military TNT (.5 lb)

SKU: **TSK4201**

Weight: 8.6 oz (247 g)

Dimensions: 3.8 in x 1.8 in x 1.8 in (9.6 cm x 4.6 cm x 4.6 cm)

This training aid simulates military TNT explosives. The explosive simulant is visually correct and engineered to have the same density and effective atomic number (Z_{eff}) as the real explosive threat. This simulant can also be purchased in custom/bulk quantities or packaging.

Technology: mmWave, Portable X-Ray, Backscatter, Computed Tomography (CT), Single and Multiple X-Ray Generator Systems

Physical Form: Cast Solid
Field of Use: Military



Export Control #: EAR99

Inert Military TNT (1 lb)

SKU: TSK4202

Weight: 1.1 lb (484 g)

Dimensions: 7.3 in x 1.8 in x 1.8 in (18.5 cm x 4.6 cm x 4.6 cm)

This training aid simulates military TNT explosives. The explosive simulant is visually correct and engineered to have the same density and effective atomic number (Z_{eff}) as the real explosive threat. This simulant can also be purchased in custom/bulk quantities or packaging.

Technology: mmWave, Portable X-Ray, Backscatter, Computed Tomography (CT), Single and Multiple X-Ray Generator Systems

Physical Form: Cast Solid
Field of Use: Military



Export Control #: EAR99

Inert Sheet Explosive (1.5 lb)

SKU: TSK8040

Weight: 1.5 lb (680 g)

Dimensions: 12.4 in x 10.4 in x 0.4 in (31.5 cm x 26.5 cm x 1 cm)

This training aid simulates C-7 Detasheet explosives. The explosive simulant is visually correct and engineered to have the same density and effective atomic number (Z_{eff}) as the real explosive threat. This simulant can also be purchased in custom thickness or bulk quantities/packaging.

Technology: mmWave, Portable X-Ray, Backscatter, Computed Tomography (CT), Single and Multiple X-Ray Generator Systems

Physical Form: Plastic Explosive
Field of Use: Military



Export Control #: EAR99

Inert PLX Liquid Explosive (34 oz)

SKU: TSK9085

Weight: 2.6 lb (1.2 kg)

Dimensions: 9.6 in x 3.1 in x 3.1 in (24.4 cm x 8 cm x 8 cm)

This training aid simulates Picatinny Liquid Explosive (PLX). The explosive simulant is visually correct and engineered to have the same density and effective atomic number (Z_{eff}) as the real explosive threat.

Technology: mmWave, Portable X-Ray, Backscatter, Computed Tomography (CT), Single and Multiple X-Ray Generator Systems

Physical Form: Liquid
Field of Use: Military



Export Control #: EAR99

Inert RDX (1 lb)

SKU: **TSK9095**

Weight: 1 lb (467 g)

Dimensions: 7.5 in x 4.7 in x 1.4 in (19 cm x 12 cm x 3.5 cm)

This training aid simulates RDX. The explosive simulant is visually correct and engineered to have the same density and effective atomic number (Z_{eff}) as the real explosive threat. This simulant can also be purchased in custom/bulk quantities or packaging.

Technology: mmWave, Portable X-Ray, Backscatter, Computed Tomography (CT), Single and Multiple X-Ray Generator Systems

Physical Form: Powder
Field of Use: Military



Export Control #: EAR99

Inert Bulk RDX (3 lb)

SKU: **TSK9095B**

Weight: 3 lb (1.4 kg)

Dimensions: 7.2 in x 4.9 in x 4.9 in (18.4 cm x 12.5 cm x 12.5 cm)

This training aid simulates bulk RDX and is available in larger quantities for custom builds. The explosive simulant is visually correct and engineered to have the same density and effective atomic number (Z_{eff}) as the real explosive threat.

Technology: mmWave, Portable X-Ray, Backscatter, Computed Tomography (CT), Single and Multiple X-Ray Generator Systems

Physical Form: Powder
Field of Use: Military



Export Control #: EAR99

Inert ETN Simulant (1 lb)

SKU: **TSK9096**

Weight: 1 lb (454 g)

Dimensions: 9.6 in x 3.1 in x 3.1 in (24.4 cm x 8 cm x 8 cm)

This training aid simulates ETN. The explosive simulant is visually correct and engineered to have the same density and effective atomic number (Z_{eff}) as the real explosive threat. This simulant can also be purchased in custom/bulk quantities or packaging.

Technology: mmWave, Portable X-Ray, Backscatter, Computed Tomography (CT), Single and Multiple X-Ray Generator Systems

Physical Form: Powder
Field of Use: Military



Inert PETN (1 lb)

SKU: **TSK9099**

Weight: 1 lb (464 g)

Dimensions: 7.5 in x 5.5 in x 1 in (19 cm x 14 cm x 2.5 cm)

This training aid simulates PETN. The explosive simulant is visually correct and engineered to have the same density and effective atomic number (Z_{eff}) as the real explosive threat. This simulant can also be purchased in custom/bulk quantities or packaging.

Technology: mmWave, Portable X-Ray, Backscatter, Computed Tomography (CT), Single and Multiple X-Ray Generator Systems

Physical Form: Powder
Field of Use: Military

Export Control #: EAR99



Inert Smokeless Powder (1 lb)

SKU: **TSK3300**

Weight: 1.1 lb (512 g)

Dimensions: 6.5 in x 3.2 in x 3.2 in (16.4 cm x 8.1 cm x 8.1 cm)

This training aid simulates smokeless powder. The explosive simulant is visually correct and engineered to have the same density and effective atomic number (Z_{eff}) as the real explosive threat. This simulant can also be purchased in custom/bulk quantities or packaging.

Technology: mmWave, Portable X-Ray, Backscatter, Computed Tomography (CT), Single and Multiple X-Ray Generator Systems

Physical Form: Powder
Field of Use: Pyrotechnic

Export Control #: EAR99



Inert Binary Exploding Target Simulant (1 lb)

SKU: **TSK3350**

Weight: 1.1 lb (510 g)

Dimensions: 6.5 in x 3.2 in x 3.2 in (16.4 cm x 8.1 cm x 8.1 cm)

This training aid simulates a binary exploding target (Tannerite). The explosive simulant is visually correct and engineered to have the same density and effective atomic number (Z_{eff}) as the real explosive threat. This simulant can also be purchased in custom/bulk quantities or packaging.

Technology: mmWave, Portable X-Ray, Backscatter, Computed Tomography (CT), Single and Multiple X-Ray Generator Systems

Physical Form: Prilled
Field of Use: Pyrotechnic

Export Control #: EAR99



Export Control #: EAR99

Inert Black Powder (1 lb)

SKU: **TSK3400**

Weight: 1.1 lb (510 g)

Dimensions: 6.5 in x 3.2 in x 3.2 in (16.4 cm x 8.1 cm x 8.1 cm)

This training aid simulates black powder. The explosive simulant is visually correct and engineered to have the same density and effective atomic number (Z_{eff}) as the real explosive threat. This simulant can also be purchased in custom/bulk quantities or packaging.

Technology: mmWave, Portable X-Ray, Backscatter, Computed Tomography (CT), Single and Multiple X-Ray Generator Systems

Physical Form: Powder
Field of Use: Pyrotechnic



Export Control #: EAR99

Inert Hobby Fuse (36 in)

SKU: **TSK3600**

Weight: 0.5 oz (13 g)

Dimensions: 4.1 in x 4.4 in x 0.2 in (10.4 cm x 11.3 cm x 0.5 cm)

This training aid simulates hobby or cannon time fuse. The pyrotechnic simulant is visually correct and engineered to have the same density and effective atomic number (Z_{eff}) as the real fuse. This simulant can also be purchased in custom/bulk quantities or packaging.

Technology: mmWave, Portable X-Ray, Backscatter, Computed Tomography (CT), Single and Multiple X-Ray Generator Systems

Physical Form: Other
Field of Use: Pyrotechnic



Export Control #: EAR99

Inert Thermite (1 lb)

SKU: **TSK8060**

Weight: 1 lb (463 g)

Dimensions: 7.9 in x 4.7 in x 1 in (20 cm x 12 cm x 2.5 cm)

This training aid simulates thermite. This pyrotechnic simulant is visually correct and engineered to have the same density and effective atomic number (Z_{eff}) as real thermite. This simulant can also be purchased in custom/bulk quantities or packaging. Unlike most explosives, thermite displays blue in most material discrimination X-ray systems.

Technology: mmWave, Portable X-Ray, Backscatter, Computed Tomography (CT), Single and Multiple X-Ray Generator Systems

Physical Form: Powder
Field of Use: Pyrotechnic

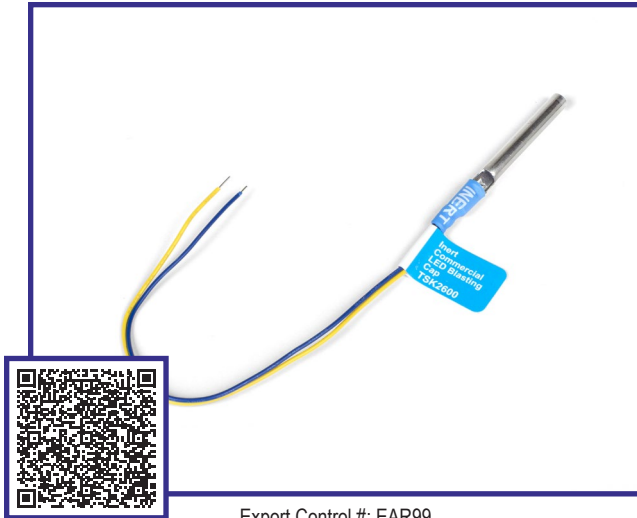

Inert LED Commercial Electrical Blasting Cap

SKU: TSK2600

Weight: 1 oz (25 g)

Dimensions: 6 in x 0.6 in x 0.7 in (15.2 cm x 1.6 cm x 1.9 cm)

The LED commercial electrical blasting cap simulates a functioned IED circuit by illuminating an LED light. This X-ray correct, inert commercial detonator is an electrically initiated blasting cap. This cap accurately simulates the bridge wire, lead azide/lead styphnate, and main charge (RDX/PETN) in most X-ray systems. This blasting cap simulant is visually correct and engineered to have the same density and effective atomic number (Z_{eff}) as the real explosive threat. It does not have electrical continuity or an "inerting hole".

Technology: mmWave, Portable X-Ray, Backscatter, Computed Tomography (CT), Single and Multiple X-Ray Generator Systems

Physical Form: Other
Field of Use: Commercial

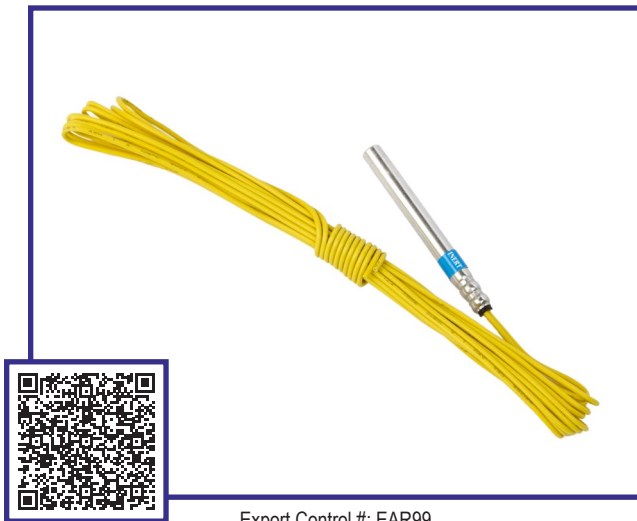

Inert Electric Blasting Cap (Shunted)

SKU: TSK2602

Weight: 0.8 oz (21 g)

Dimensions: 6.1 in x 0.8 in x 0.6 in (15.5 cm x 2 cm x 1.5 cm)

This X-ray correct, inert commercial detonator is an electrically initiated blasting cap. This cap accurately simulates the bridge wire, lead azide/lead styphnate, and main charge (RDX/PETN) in most X-ray systems. This blasting cap simulant is visually correct and engineered to have the same density and effective atomic number (Z_{eff}) as the real explosive threat. This cap shows electrical continuity. It does not have an "inerting hole". This simulant is also sold in bulk quantities of 25 or 50.

Technology: mmWave, Portable X-Ray, Backscatter, Computed Tomography (CT), Single and Multiple X-Ray Generator Systems

Physical Form: Other
Field of Use: Commercial



Inert Electric Blasting Cap (25 ct)

SKU: TSK2605

Weight: 1.2 lb (554 g)

Dimensions: 6.5 in x 5.5 in x 2.4 in (16.5 cm x 14 cm x 6 cm)

This X-ray correct, inert commercial detonator is an electrically initiated blasting cap. This cap accurately simulates the bridge wire, lead azide/lead styphnate, and main charge (RDX/PETN) in most X-ray systems. This blasting cap simulant is visually correct and engineered to have the same density and effective atomic number (Z_{eff}) as the real explosive threat. This cap shows electrical continuity. It does not have an "inerting hole". This simulant is also sold by itself or in bulk quantities of 50.

Technology: mmWave, Portable X-Ray, Backscatter, Computed Tomography (CT), Single and Multiple X-Ray Generator Systems

Physical Form: Other
Field of Use: Commercial



Export Control #: EAR99

Inert Electric Blasting Cap (50 ct)

SKU: TSK2606

Weight: 2.4 lb (1.1 kg)

Dimensions: 7.9 in x 5.5 in x 2.4 in (20 cm x 14 cm x 6 cm)

This X-ray correct, inert commercial detonator is an electrically initiated blasting cap. This cap accurately simulates the bridge wire, lead azide/lead styphnate, and main charge (RDX/PETN) in most X-ray systems. This blasting cap simulant is visually correct and engineered to have the same density and effective atomic number (Z_{eff}) as the real explosive threat. This cap shows electrical continuity. It does not have an "inerting hole". This simulant is also sold by itself or in bulk quantities of 25.

Technology: mmWave, Portable X-Ray, Backscatter, Computed Tomography (CT), Single and Multiple X-Ray Generator Systems

Physical Form: Other
Field of Use: Commercial



Export Control #: EAR99

Inert Commercial Blasting Cap

SKU: TSK2800

Weight: 0.8 oz (23 g)

Dimensions: 6 in x 0.6 in x 0.5 in (15.2 cm x 1.5 cm x 1.2 cm)

This X-ray correct, inert commercial detonator is an electrically initiated blasting cap. This cap accurately simulates the bridge wire, lead azide/lead styphnate, and main charge (RDX/PETN) in most X-ray systems. This blasting cap simulant is visually correct and engineered to have the same density and effective atomic number (Z_{eff}) as the real explosive threat. It does not have electrical continuity or an "inerting hole".

Technology: mmWave, Portable X-Ray, Backscatter, Computed Tomography (CT), Single and Multiple X-Ray Generator Systems

Physical Form: Other
Field of Use: Commercial



Export Control #: EAR99

Inert Commercial Fuse Head Blasting Cap

SKU: TSK2820

Weight: 0.6 oz (18 g)

Dimensions: 6.1 in x 0.6 in x 0.4 in (15.5 cm x 1.5 cm x 1 cm)

This X-ray correct, inert commercial detonator is an electrically initiated blasting cap. This cap accurately simulates the fuse head, primary explosives, and main charge in most X-ray systems. This blasting cap simulant is visually correct and engineered to have the same density and effective atomic number (Z_{eff}) as the real explosive threat. This cap shows electrical continuity. It does not have an "inerting hole".

Technology: Backscatter, Computed Tomography (CT), Single and Multiple X-Ray Generator Systems

Physical Form: Other
Field of Use: Commercial



Export Control #: EAR99

Inert Improved Light Bulb Detonator

SKU: TSK0192

Weight: 0.3 oz (7 g)

Dimensions: 6.5 in x 0.4 in x 0.4 in (16.6 cm x 0.9 cm x 0.9 cm)

This X-ray correct, inert improved light bulb detonator is an electrically initiated blasting cap that is very similar to what is being used by terrorists overseas. The initiator part of the detonator comes from a string of decorative lights, reinforcing how simple, everyday objects can easily be transformed into IED components. This blasting cap simulant is visually correct and engineered to have the same density and effective atomic number (Z_{eff}) as the real explosive threat. This cap shows electrical continuity. It does not have an "inerting hole".

Technology: mmWave, Portable X-Ray, Backscatter, Computed Tomography (CT), Single and Multiple X-Ray Generator Systems

Physical Form: Other
Field of Use: HME



Export Control #: EAR99

Inert Improved Blasting Cap

SKU: TSK3000

Weight: 1 oz (27 g)

Dimensions: 6 in x 0.8 in x 0.6 in (15.2 cm x 2 cm x 1.5 cm)

This X-ray correct, inert improved copper tube detonator is an electrically initiated blasting cap. This cap accurately simulates the ignition, primary explosive, and main charge in most X-ray systems. This blasting cap simulant is visually correct and engineered to have the same density and effective atomic number (Z_{eff}) as the real explosive threat. It does not have electrical continuity or an "inerting hole".

Technology: mmWave, Portable X-Ray, Backscatter, Computed Tomography (CT), Single and Multiple X-Ray Generator Systems

Physical Form: Other
Field of Use: HME



Export Control #: EAR99

Inert Cardboard Blasting Cap

SKU: TSK4700

Weight: 0.6 oz (19 g)

Dimensions: 8.5 in x 0.4 in x 0.4 in (21.5 cm x 1 cm x 1 cm)

This X-ray correct, inert, improvised detonator is an electrically initiated blasting cap. This cap accurately simulates the fuse head, primary explosives, and main charge in most X-ray systems. This blasting cap simulant is visually correct and engineered to have the same density and effective atomic number (Z_{eff}) as the real explosive threat. This cap shows electrical continuity. It does not have an "inerting hole".

Technology: mmWave, Portable X-Ray, Backscatter, Computed Tomography (CT), Single and Multiple X-Ray Generator Systems

Physical Form: Other
Field of Use: HME



Export Control #: ITAR

Inert M81 Fuse Igniter

SKU: TSK0033

Weight: 1.1 oz (34 g)

Dimensions: 6.3 in x 0.8 in x 0.8 in (16 cm x 2 cm x 2 cm)

The inert M81 igniter replicates a military igniter used with a time fuse or shocktube (NONEL/MDI). This training aid is engineered to have the same density and effective atomic number (Z_{eff}) as a fuse igniter. This item is ITAR restricted and requires special licensing for most international sales. An ITAR-compliant version of this training aid is also available.

Technology: mmWave, Portable X-Ray, Backscatter, Computed Tomography (CT), Single and Multiple X-Ray Generator Systems

Physical Form: Other
Field of Use: Military



Export Control #: ITAR

Inert M81 Fuse Igniter With Shock Tube

SKU: TSK1105

Weight: 2.4 oz (70 g)

Dimensions: 9.8 in x 5.9 in x 1.2 in (25 cm x 15 cm x 3 cm)

This training aid simulates an X-ray correct firing circuit designed to function using a military M81 igniter and shock tube (NONEL/MDI). Once paired with one of our patented explosive simulants, this assembly completes all the necessary components of a non-electrically initiated IED. The TSK1105 can also be used for hands-on demolition training. This flexibility allows for more training and testing opportunities. Each component is visually correct and engineered to have the same density and effective atomic number (Z_{eff}) as a real firing assembly. An ITAR-compliant version of this training aid is also available.

Technology: mmWave, Portable X-Ray, Backscatter, Computed Tomography (CT), Single and Multiple X-Ray Generator Systems

Physical Form: Other
Field of Use: Military



Export Control #: ITAR

Inert M81 Fuse Igniter With Time Fuse

SKU: TSK1106

Weight: 1.9 oz (55 g)

Dimensions: 5.9 in x 3.9 in x 1.2 in (15 cm x 10 cm x 3 cm)

This training aid simulates an X-ray correct firing circuit designed to function using a military M81 igniter and a time delay fuse. Once paired with one of our patented explosive simulants, this assembly completes all the necessary components of a non-electrically initiated IED. The TSK1106 can also be used for hands-on demolition training. This flexibility allows for more training and testing opportunities. Each component is visually correct and engineered to have the same density and effective atomic number (Z_{eff}) as a real firing assembly. An ITAR-compliant version of this training aid is also available.

Technology: mmWave, Portable X-Ray, Backscatter, Computed Tomography (CT), Single and Multiple X-Ray Generator Systems

Physical Form: Other
Field of Use: Military



Export Control #: EAR99

Inert Non-Electrical Blasting Cap

SKU: TSK2500

Weight: 0.2 oz (3 g)

Dimensions: 2.2 in x 0.2 in x 0.2 in (5.7 cm x 0.6 cm x 0.6 cm)

This X-ray correct, inert military M7 detonator is a non-electrically initiated blasting cap. This blasting cap simulant is visually correct and engineered to have the same density and effective atomic number (Z_{eff}) as the real explosive threat. This cap accurately simulates the lead azide/lead styphnate, and the main charge (RDX/PETN) in most X-ray systems. It does not have electrical continuity or an "inerting hole".

Technology: mmWave, Portable X-Ray, Backscatter, Computed Tomography (CT), Single and Multiple X-Ray Generator Systems

Physical Form: Other
Field of Use: Military

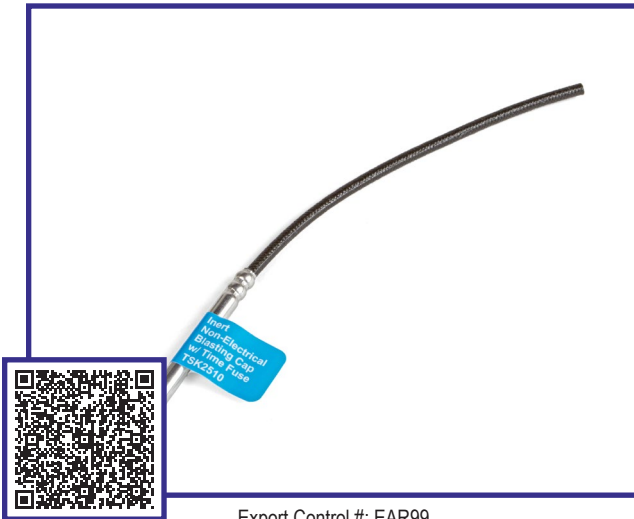

Export Control #: EAR99

Inert Non-Electrical Blasting Cap w/ Time Fuse

SKU: TSK2510

Weight: 0.2 oz (6 g)

Dimensions: 7.3 in x 0.2 in x 0.2 in (18.5 cm x 0.6 cm x 0.6 cm)

This X-ray correct, inert military M7 detonator is a non-electrically initiated blasting cap crimped on 6 in of time fuse. This blasting cap simulant is visually correct and engineered to have the same density and effective atomic number (Z_{eff}) as the real explosive threat. This cap accurately simulates the lead azide/lead styphnate, and main charge (RDX/PETN) in most X-ray systems. It does not have electrical continuity or an "inerting hole".

Technology: mmWave, Portable X-Ray, Backscatter, Computed Tomography (CT), Single and Multiple X-Ray Generator Systems

Physical Form: Other
Field of Use: Military



Export Control #: EAR99

Inert LED Military Electrical Blasting Cap

SKU: TSK2700

Weight: 1 oz (26 g)

Dimensions: 6 in x 0.6 in x 0.6 in (15.2 cm x 1.6 cm x 1.4 cm)

The LED military electrical blasting cap simulates a functioned IED circuit by illuminating an LED light. This X-ray correct, inert military detonator is an electrically initiated blasting cap. This cap accurately simulates the bridge wire, lead azide/lead styphnate, and main charge (RDX/PETN) in most X-ray systems. This blasting cap simulant is visually correct and engineered to have the same density and effective atomic number (Z_{eff}) as the real explosive threat. It does not have electrical continuity or an "inerting hole".

Technology: mmWave, Portable X-Ray, Backscatter, Computed Tomography (CT), Single and Multiple X-Ray Generator Systems

Physical Form: Other
Field of Use: Military



Export Control #: EAR99

Inert Military Electrical Blasting Cap

SKU: TSK2900

Weight: 1 oz (26 g)

Dimensions: 4.9 in x 0.7 in x 0.7 in (12.5 cm x 1.7 cm x 1.7 cm)

This X-ray correct, inert military M6 detonator is an electrically initiated blasting cap. This cap accurately simulates the bridge wire, lead azide/lead styphnate, and main charge (RDX/PETN) in most X-ray systems. This blasting cap simulant is visually correct and engineered to have the same density and effective atomic number (Z_{eff}) as the real explosive threat. This cap shows electrical continuity. It does not have an "inerting hole".

Technology: mmWave, Portable X-Ray, Backscatter, Computed Tomography (CT), Single and Multiple X-Ray Generator Systems

Physical Form: Other
Field of Use: Military



Export Control #: EAR99

Inert Electric Match / Squib

SKU: TSK4800

Weight: 0.6 oz (16 g)

Dimensions: 6.3 in x 0.8 in x 0.6 in (16 cm x 2 cm x 1.5 cm)

This X-ray correct, inert squib/E-match is electrically initiated and similar to a blasting cap. These are commercially available and easily modified to initiate explosives. This X-ray correct, inert improvised detonator is an electrically initiated blasting cap. This cap accurately simulates the fuse head, primary explosives, and main charge in most X-ray systems. This initiator simulant is visually correct and engineered to have the same density and effective atomic number (Z_{eff}) as the real pyrotechnic threat. This E-match shows electrical continuity. It does not have an "inerting hole".

Technology: mmWave, Portable X-Ray, Backscatter, Computed Tomography (CT), Single and Multiple X-Ray Generator Systems

Physical Form: Other
Field of Use: Pyrotechnic

THREAT TRAINING AIDS

Product Catalog

SUMMER 2023

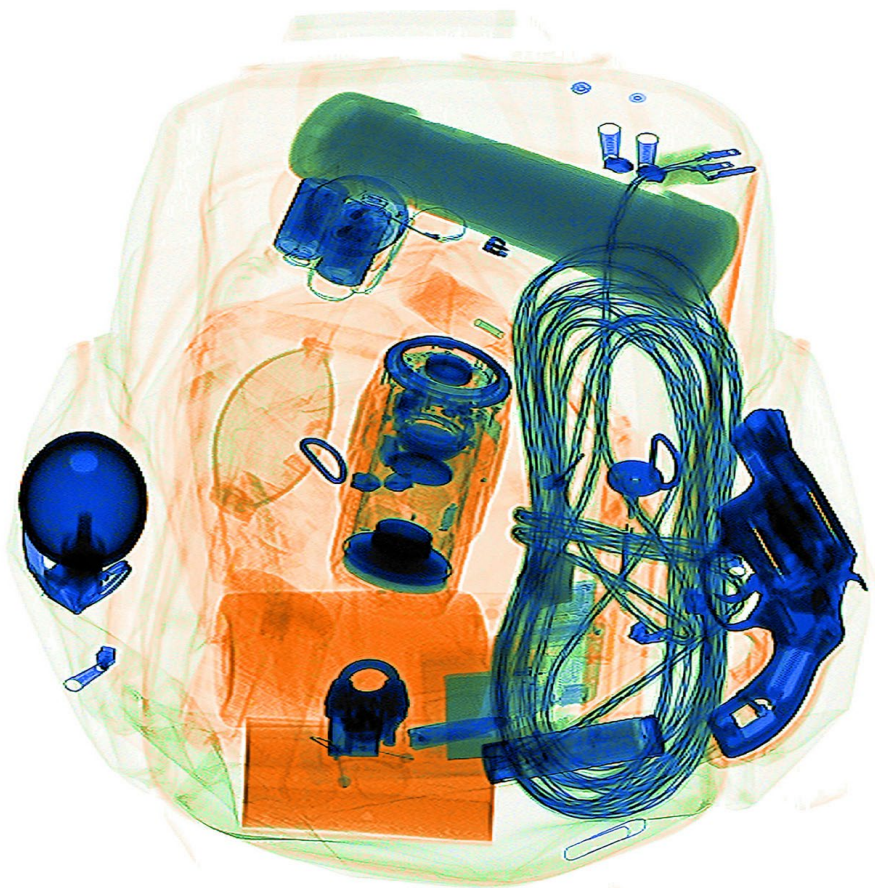
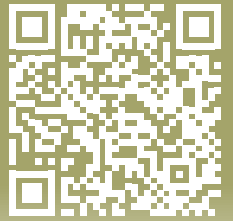

Department for
Transport



Table of Contents

91	Improvised C-cell Battery Pack	111	Inert Sandal Shoe IED	131	Inert 9mm Bullets
91	Inert Pressure Pad Switch	111	Inert Belt IED	132	Inert Box of 9 mm Ammunition (50 rounds)
91	Inert Mousetrap Switch	112	Inert Knee Brace IED	132	Inert Metal Pipe IED, Large
92	Inert Clothespin Switch	112	Inert Hand Brace IED	132	Inert Metal Pipe IED, Small
92	Inert Wireless Doorbell	112	Inert Printer Cartridge IED	133	Inert PVC Pipe IED, Large
92	Inert Vibration Anti-Movement Switch	113	Inert Electric Screwdriver IED	133	Inert PVC Pipe IED, Small
93	Inert Magnetic Reed Switch	113	Inert Baseball Hat IED	133	Inert 5.56 Bullets
93	Inert RCIED Cell Phone	113	Inert Picnic Cooler IED	134	Inert Sub-compact Pistol, Semiautomatic
93	Inert RCIED Radio	114	Inert Light Jacket IED	134	Inert Pistol Magazine with Bullets (Dipped)
94	Inert Passive Infrared (PIR) Motion Sensor	114	Inert Heavy Jacket IED	134	Inert Rifle Magazine with Bullets (Dipped)
94	Inert Homemade Pressure Switch	114	Inert Paperback Book IED	135	Inert 3D-Printed Replica Firearm
94	Inert Micro Switch (Pressure/Pressure Release)	115	Inert Hardcover Book IED	135	Inert Compact Revolver, Double Action
95	Inert Digital Timer	115	Inert Coffee Mug IED	135	Inert Derringer Pistol
95	Inert Ball Tilt Switch	115	Inert Neck Pillow IED	136	Inert NAA .22 Revolver, Assembled
95	Inert Electronic Time Delay (hours)	116	Inert Backpack / Pressure Cooker IED	136	Inert NAA .22 Revolver, Disassembled
96	Inert Mechanical Time Delay (hours)	116	Inert Backpack / 2 Metal Pipes IED	136	Inert 380 Bullets
96	Inert Mechanical Time Delay (minutes)	116	Inert Flashlight IED	137	Lead Sheet 8" x 4" x 1/16"
96	Inert Homemade Vibration Switch	117	Inert Small Toolbox IED	137	Fragmentation Sleeve
97	Inert Mechanical Altimeter Switch	117	Inert Toothpaste Concealed Explosive Simulant	137	Inert Compact Pistol, Semiautomatic
97	Inert Electric Temperature Switch	117	Inert Handbag IED	138	Inert Cell Phone Stun Gun
97	Inert Mechanical Temperature Switch	118	Inert Foot Powder Bottle IED	138	Inert Pepper Spray
98	Inert Mercury Tilt Switch	118	Inert Pressure Cooker IED	138	Inert 6 Point Throwing Star
98	Inert Light Sensitive Photocell	118	Inert Lunch Box IED	139	Inert Brass Knuckles
98	Inert Wire Loop Switch	119	Inert Workout Belt IED (with Fragmentation)	139	Inert AR-15 Bolt
99	Inert Non-Electrical Firing Display	119	Inert Workout Belt IED	139	Inert AR-15 Bolt Carrier Group
99	Inert Micro Switch Pressure Release	119	Inert Cell Phone Concealed IED	140	Inert AR-15 Firing Pin
99	Inert Mousetrap Pull Switch	120	Inert Laptop IED (CD Drive Concealment)	140	Inert Pistol Slide Group
100	Inert Small Envelope, Razors	120	Inert Laptop IED (Hard Drive Concealment)	140	Inert Pistol Frame
100	Inert Small Envelope, White Powder	120	Inert Bluetooth Speaker IED	141	X-Ray Interpretation Reference Guide
100	Inert Metal Pipe IED with Photocell	121	Inert Headphone IED	141	Explosives Poster
101	Inert Wire Loop Switch	121	Inert Flat Safety Box Cutter	141	Pipe Bombs with X-Ray Poster
101	Inert Clothespin Pull Switch	121	Inert Empty Rifle Magazine (Dipped)	142	Mail Threat with X-Ray Poster
101	Inert Wire Loop with Lead Sheet	122	Inert Empty Pistol Magazine (Dipped)	142	Guns and Knives X-Ray Poster
102	Inert Chemical IED	122	Inert Ceramic Folding Knife	142	Grenades Poster
102	Inert Anti Probe	122	Inert Vape Pen	143	Concealed IED Poster
102	Inert Barometric Pressure Switch	123	Inert Vaporizer	143	P.I.E.S. Threat Identification Poster
103	Musical Greeting Card Normal and Inert IED	123	Inert Marijuana Simulant	143	Explosives X-Ray Texture Poster
103	Inert Express Envelope, White Powder	123	Inert Methadone Tablets (1000ct)	144	Ammunition Identification Poster
103	Inert RCIED Cell Phone Trigger Assembly	124	Inert Concealed Pringles Can (Marijuana and Cocaine)	144	Detonators and Blasting Caps Poster
104	Inert Electronic Time Delay (Hours) Assembly	124	Inert Concealed Soda Can (Marijuana and Cocaine)	144	Suspicious Mail Identification Poster
104	Inert Electronic Time Delay (Minutes) Assembly	124	Inert Concealed Shoe (Cocaine)	145	Threat Backpack X-Ray Poster
104	Inert 555 Timer Circuit Board Assembly	125	Inert Concealed Stuffed Animal (Methadone Tablets)	145	FN SCAR® X-Ray Poster
105	Inert PIR Motion Sensor Light Assembly	125	Inert Cocaine HCl Simulant	145	AR-15 Rifle X-Ray Poster
105	Inert Soda Can IED	125	Inert RG-42 Grenade	146	Afghan Pressure Cooker IED Poster
105	Inert Suicide Switch Assembly	126	Inert MK-2 Frag Grenade	146	Chlorate Frag IED X-Ray Poster
106	Inert Hostage Switch Assembly	126	Inert M26 Grenade	146	Springfield XD-40 Pistol X-Ray Poster
106	Inert Mechanical Time Delay Assembly	126	Inert M26 Grenade	147	Inert IED Training Display Board
106	Inert Micro Switch Assembly	126	Inert M7A3 Riot CS Grenade		
107	Inert Vibration Sensor Assembly	127	Inert M67 Frag Grenade		
107	Inert Laptop IED (Screen Concealment)	127	Inert F1 Frag Grenade		
107	Inert Stuffed Animal IED	127	Inert RGD-5 Grenade		
108	Inert Tablet IED	128	Inert .25 Caliber Bullets		
108	Inert Child's Toy IED	128	Inert AN-M14 Incendiary Grenade		
108	Inert Smartphone RCIED (Sheet)	128	Inert Mini Snap Blade Knife		
109	Inert Boom Box IED	129	Multi-Blade Metal Folding Knife (2.6 in)		
109	Inert Computer Bag IED	129	Inert Folding Knife (3 in)		
109	Inert Small Suitcase IED	129	Inert Folding Knife (2 in)		
110	Inert Duffle Bag IED	130	Inert Folding Knife (1 in)		
110	Inert Drone IED	130	Inert Lexan Knife (11 in)		
110	Inert Tennis Shoe IED	130	Inert Ceramic Paring Knife (3 in)		
111	Inert Hiking Boot IED	131	Inert Razor Blade		
		131	Inert 12ga Shotgun Shells		



Improved C-cell Battery Pack

SKU: **TSK0022**

Weight: 8 oz (227 g)

Dimensions: 1.5 in x 1.5 in x 7 in (3.8 cm x 3.8 cm x 17.8 cm)

Similar to what is used in Afghanistan, this improved C-cell battery pack provides classroom and X-ray training on an uncommon threat component. This device matches the density and Z_{eff} of the actual item.

Export Control: EAR99

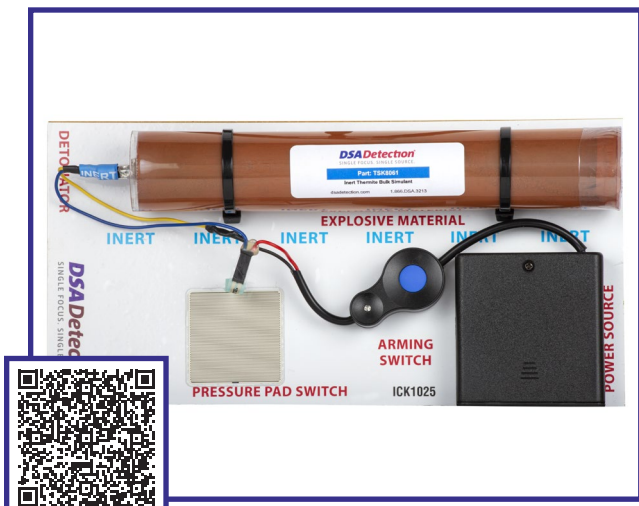

Inert Pressure Pad Switch

SKU: **ICK1025**

Weight: 1.9 lb (850 g)

Dimensions: 10 in x 5 in x 2 in (25.5 cm x 12.7 cm x 5.1 cm)

The X-ray correct, inert pressure pad firing circuit will function via pressure. The circuit board contains all of the necessary components of an improvised explosive device (IED). The circuit is fully functional and will demonstrate that the firing switch has been activated by illuminating the LED in the blasting cap. The circuit board contains an X-ray correct battery, wire, switch, detonator, and inert pyrotechnic simulant. Powered by four AA batteries, this IED circuit would be activated by applying pressure to the pressure pad switch. The X-ray correct thermite pyrotechnic simulant is engineered to have the same density and effective atomic number (Z_{eff}) as the real explosive threat. Unlike most explosives, thermite displays blue in most material discrimination X-ray systems.

Export Control: EAR99

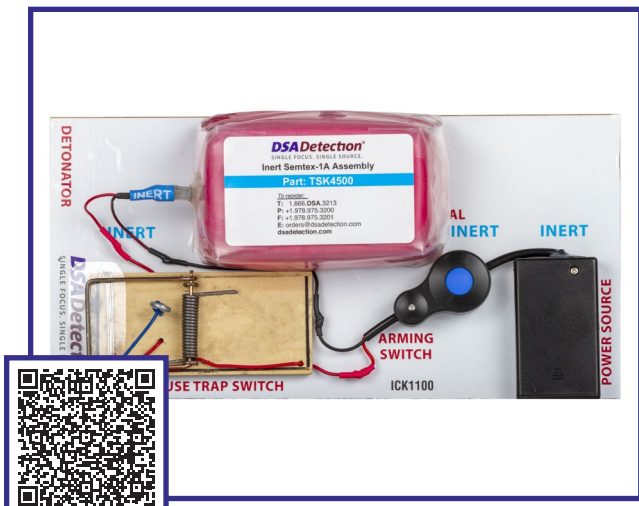

Inert Mousetrap Switch

SKU: **ICK1100**

Weight: 1.8 lb (810 g)

Dimensions: 10 in x 5 in x 2.6 in (25.5 cm x 12.7 cm x 6.6 cm)

The X-ray correct, inert mousetrap firing circuit will function via pressure release or pull. The circuit board contains all of the necessary components of an improvised explosive device (IED). The circuit is fully functional and will demonstrate that the firing switch has been activated by illuminating the LED in the blasting cap. The circuit board contains an X-ray correct battery, wire, switch, detonator, and inert explosive. Powered by two AA batteries, this IED circuit would be activated by the modified mousetrap switch. The mousetrap switch can be activated when pressure is removed from the bail, or the insulator is removed. The X-ray correct Semtex 1A simulant is engineered to have the same density and effective atomic number (Z_{eff}) as the real explosive threat.

Export Control: EAR99

Inert Clothespin Switch

SKU: **ICK1150**

Weight: 1.7 lb (761 g)

Dimensions: 10 in x 5 in x 2.4 in (25.5 cm x 12.7 cm x 6 cm)

The X-ray correct, inert, clothespin switch firing circuit will function via pressure, pressure release, or pull. The circuit board contains all of the necessary components of an improvised explosive device (IED). The circuit is fully functional and will demonstrate that the firing switch has been activated by illuminating the LED in the blasting cap. The circuit board contains an X-ray correct battery, wire, switch, detonator, and inert explosive. Powered by two AAA batteries, this IED circuit would be activated by the modified clothespin switch. The clothespin switch can be activated when either side makes contact (pressure or pressure release) or the insulator is removed. The X-ray correct nitroglycerin dynamite simulant is engineered to have the same density and effective atomic number (Z_{eff}) as the real explosive threat.

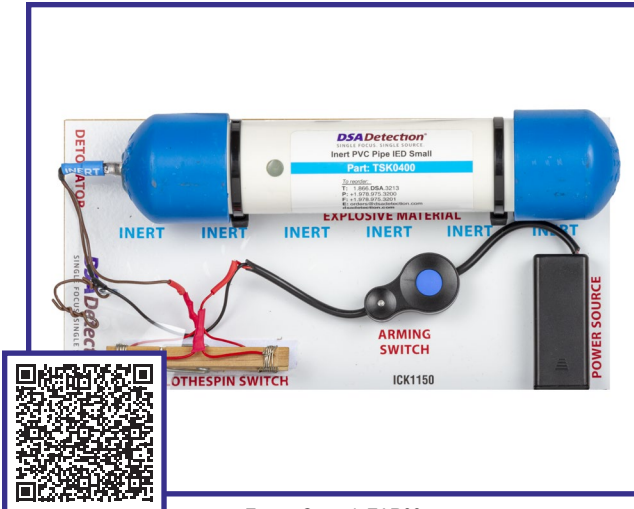

Export Control: EAR99

Inert Wireless Doorbell

SKU: **ICK2200**

Weight: 1.7 lb (782 g)

Dimensions: 10 in x 5 in x 2 in (25.5 cm x 12.7 cm x 5 cm)

The X-ray correct, inert, wireless doorbell firing circuit contains all of the necessary components of an improvised explosive device (IED). The circuit is fully functional and will demonstrate that the firing switch has been activated by emitting an audible tone or illuminating the LED in the blasting cap. The circuit board contains an X-ray correct battery, wire, switch, detonator, and inert explosive. Powered by two AA batteries inside of the wireless doorbell, this IED circuit would be activated when the remote doorbell button is pressed. The X-ray correct PETN simulant is engineered to have the same density and effective atomic number (Z_{eff}) as the real explosive threat.



Export Control: EAR99

Inert Vibration Anti-Movement Switch

SKU: **ICK2250**

Weight: 2 lb (915 g)

Dimensions: 10 in x 5 in x 2.6 in (25.5 cm x 12.7 cm x 6.5 cm)

The X-ray correct, inert, vibration anti-movement switch firing circuit contains all of the necessary components of an improvised explosive device (IED). The circuit is fully functional and will demonstrate that the firing switch has been activated by emitting an audible tone or illuminating the LED in the blasting cap. The circuit board contains an X-ray correct battery, wire, switch, detonator, and inert explosive. Powered by four AAA batteries, this IED circuit would be activated by movement or vibration via the commercial anti-vibration switch. The military TNT explosive simulant is engineered to have the same density and effective atomic number (Z_{eff}) as the real explosive threat.

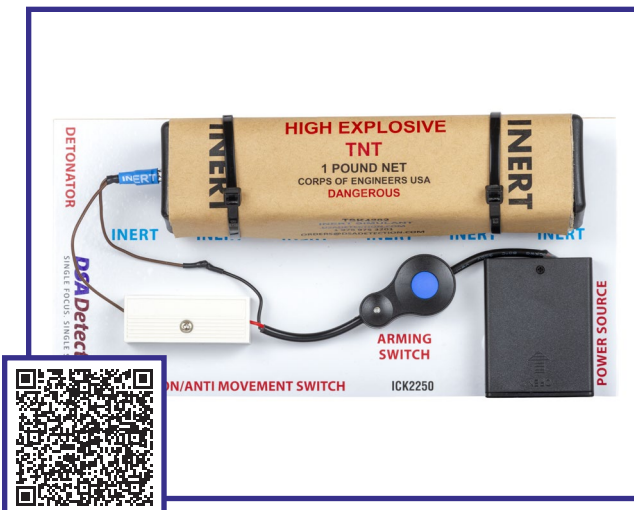

Export Control: EAR99

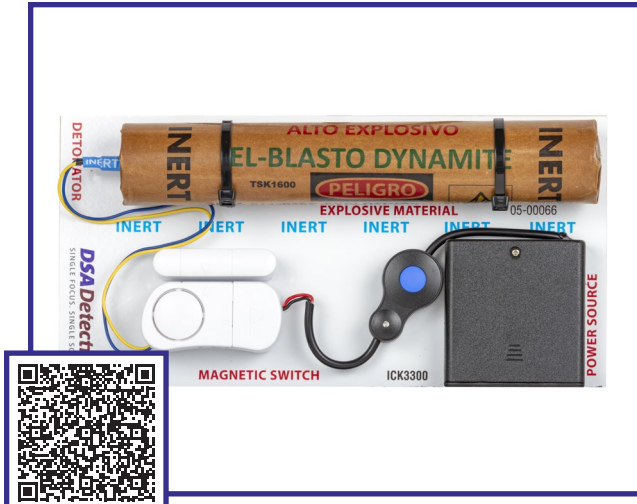

Export Control: EAR99

Inert Magnetic Reed Switch

SKU: **ICK3300**

Weight: 1.6 lb (719 g)

Dimensions: 10 in x 5 in x 2.1 in (25.5 cm x 12.7 cm x 5.4 cm)

The X-ray correct, inert, magnetic-reed switch firing circuit contains all of the necessary components of an improvised explosive device (IED). The circuit is fully functional and will demonstrate that the firing switch has been activated by emitting an audible tone or illuminating the LED in the blasting cap. The circuit board contains an X-ray correct battery, wire, switch, detonator, and inert explosive. Powered by four AAA batteries, this IED circuit would be activated when the second part of the magnetic reed switch is removed. The dynamite simulant is engineered to have the same density and effective atomic number (Z_{eff}) as the real explosive threat.



Export Control: EAR99

Inert RCIED Cell Phone

SKU: **ICK3350**

Weight: 1.7 lb (777 g)

Dimensions: 10 in x 5 in x 2 in (25.5 cm x 12.7 cm x 5.1 cm)

The X-ray correct, inert, RCIED cell phone firing circuit contains all of the necessary components of an improvised explosive device (IED). The circuit board contains an X-ray correct battery, wire, switch, detonator, and inert explosive. Powered by a 9V battery, this IED circuit would be activated remotely by calling the cell phone. It is designed to simulate a "remote-controlled IED" (RCIED). The AN (ammonium nitrate) simulant is engineered to have the same density and effective atomic number (Z_{eff}) as the real explosive threat.



Export Control: EAR99

Inert RCIED Radio

SKU: **ICK4400**

Weight: 1.6 lb (709 g)

Dimensions: 10 in x 5 in x 2 in (25.4 cm x 12.7 cm x 5 cm)

The X-ray correct, inert, RCIED radio firing circuit contains all of the necessary components of an improvised explosive device (IED). The circuit is fully functional and will demonstrate that the firing switch has been activated by illuminating the LED in the blasting cap. The circuit board contains an X-ray correct battery, wire, switch, detonator, and inert explosive. Powered by the walkie-talkie's internal AAA batteries, this IED circuit would be remotely activated by sending a signal from one walkie-talkie to the other. It is designed to simulate a "remote-controlled IED" (RCIED). The TATP simulant is engineered to have the same density and effective atomic number (Z_{eff}) as the real explosive threat.



Export Control: EAR99

Inert Passive Infrared (PIR) Motion Sensor

SKU: **ICK5500**

Weight: 1.8 lb (827 g)

Dimensions: 10 in x 5 in x 2.2 in (25.5 cm x 12.7 cm x 5.6 cm)

The X-ray correct, inert, passive infrared (PIR) motion-sensor firing circuit contains all of the necessary components of an improvised explosive device (IED). The circuit is fully functional and will demonstrate that the firing switch has been activated by illuminating the LED in the blasting cap. The circuit board contains an X-ray correct battery, wire, switch, detonator, and inert explosive. Powered by four AA batteries, this IED circuit would be activated when the PIR senses movement. The blasting emulsion explosive simulant is engineered to have the same density and effective atomic number (Z_{eff}) as the real explosive threat.

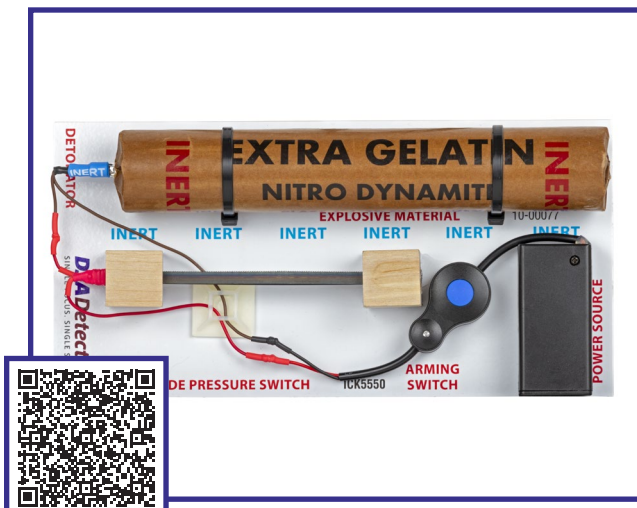

Export Control: EAR99

Inert Homemade Pressure Switch

SKU: **ICK5550**

Weight: 1.6 lb (730 g)

Dimensions: 10 in x 5 in x 2 in (25.5 cm x 12.7 cm x 5.1 cm)

The X-ray correct, inert, homemade pressure switch firing circuit contains all of the necessary components of an improvised explosive device (IED). The circuit is fully functional and will demonstrate that the firing switch has been activated by illuminating the LED in the blasting cap. The circuit board contains an X-ray correct battery, wire, switch, detonator, and inert explosive. Powered by a 9-volt battery, this IED circuit would be activated when the two saw blades press together. The E.G. dynamite simulant is engineered to have the same density and effective atomic number (Z_{eff}) as the real explosive threat.



Export Control: EAR99

Inert Micro Switch (Pressure/Pressure Release)

SKU: **ICK6600**

Weight: 1.9 lb (876 g)

Dimensions: 10 in x 5 in x 2 in (25.5 cm x 12.7 cm x 5 cm)

The X-ray correct, inert, micro-switch (pressure/pressure release) firing circuit contains all of the necessary components of an improvised explosive device (IED). The circuit is fully functional and will demonstrate that the firing switch has been activated by illuminating the LED in the blasting cap. The circuit board contains an X-ray correct battery, wire, switch, detonator, and inert explosive. Powered by a 9-volt battery, this IED circuit would be activated by pressure applied to or released from the micro switch. The military M1 dynamite simulant is engineered to have the same density and effective atomic number (Z_{eff}) as the real explosive threat.



Export Control: EAR99

Inert Digital Timer

SKU: **ICK6650**

Weight: 2 lb (904 g)

Dimensions: 10 in x 5 in x 2.8 in (25.5 cm x 12.7 cm x 7 cm)

The X-ray correct, inert, digital timer firing circuit contains all of the necessary components of an improvised explosive device (IED). The circuit is fully functional and will demonstrate that the firing switch has been activated by emitting an audible tone or illuminating the LED in the blasting cap. The circuit board contains an X-ray correct battery, wire, switch, detonator, and inert explosive. Powered by a 9-volt battery, this IED circuit would be activated when the digital timer counts down to zero. The cast booster simulant is engineered to have the same density and effective atomic number (Z_{eff}) as the real explosive threat.

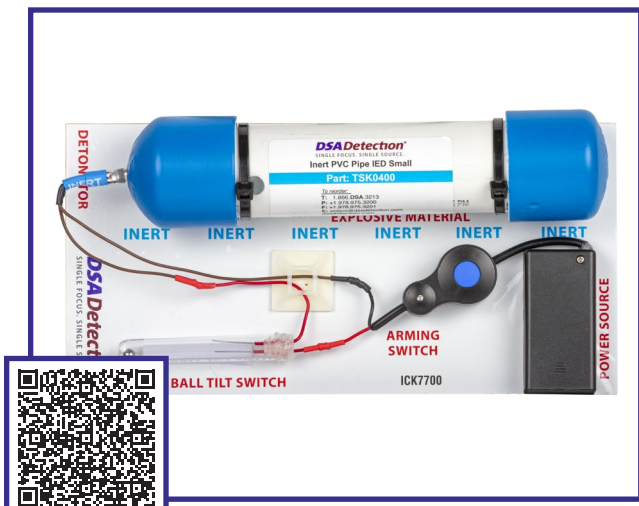

Export Control: EAR99

Inert Ball Tilt Switch

SKU: **ICK7700**

Weight: 2.2 lb (994 g)

Dimensions: 10 in x 5 in x 2.5 in (25.5 cm x 12.7 cm x 6.4 cm)

The X-ray correct, inert, ball-tilt switch firing circuit contains all of the necessary components of an improvised explosive device (IED). The circuit is fully functional and will demonstrate that the firing switch has been activated by illuminating the LED in the blasting cap. The circuit board contains an X-ray correct battery, wire, switch, detonator, and inert explosive. Powered by two AA batteries, this IED circuit would be activated when the improvised ball in the tilt switch comes in contact with the two wire leads. The pipe bomb is a PVC pipe with inert black powder. The X-ray correct black powder simulant is engineered to have the same density and effective atomic number (Z_{eff}) as the real explosive threat.



Export Control: EAR99

Inert Electronic Time Delay (hours)

SKU: **ICK7750**

Weight: 2.1 lb (936 g)

Dimensions: 10 in x 5 in x 3 in (25.4 cm x 12.7 cm x 7.6 cm)

The X-ray correct, inert, electronic time delay firing circuit contains all of the necessary components of an improvised explosive device (IED). The circuit is fully functional and will demonstrate that the firing switch has been activated by emitting an audible tone or illuminating the LED in the blasting cap. The circuit board contains an X-ray correct battery, wire, switch, detonator, and inert explosive. Powered by two AA batteries, this IED circuit would be activated by a digital time alarm circuit. The P.E.4 simulant is engineered to have the same density and effective atomic number (Z_{eff}) as the real explosive threat.

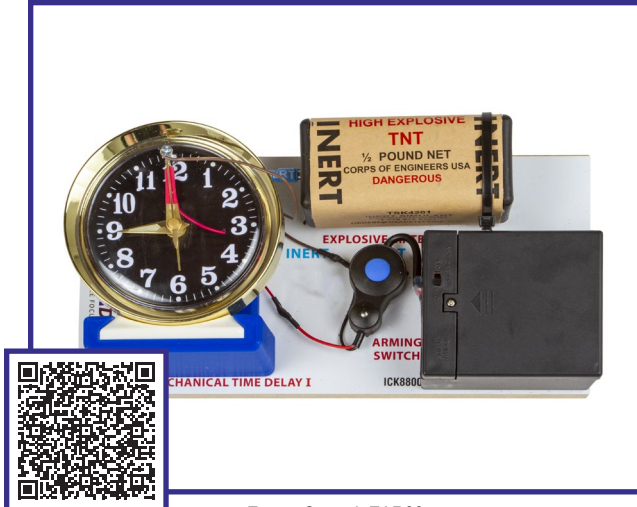

Export Control: EAR99

Inert Mechanical Time Delay (hours)

SKU: **ICK8800**

Weight: 2.6 lb (1.2 kg)

Dimensions: 10 in x 5 in x 3 in (25.5 cm x 12.7 cm x 7.6 cm)

The X-ray correct, inert, mechanical time delay firing circuit contains all of the necessary components of an improvised explosive device (IED). The circuit is fully functional and will demonstrate that the firing switch has been activated by illuminating the LED in the blasting cap. The circuit board contains an X-ray correct battery, wire, switch, detonator, and inert explosive. Powered by two D batteries, this IED circuit would be activated by a mechanical time alarm circuit. The military TNT simulant is engineered to have the same density and effective atomic number (Z_{eff}) as the real explosive threat.



Export Control: EAR99

Inert Mechanical Time Delay (minutes)

SKU: **ICK8850**

Weight: 2.3 lb (1 kg)

Dimensions: 10 in x 5 in x 2 in (25.5 cm x 12.7 cm x 5.1 cm)

The X-ray correct, inert, mechanical time delay firing circuit contains all of the necessary components of an improvised explosive device (IED). The circuit is fully functional and will demonstrate that the firing switch has been activated by illuminating the LED in the blasting cap. The circuit board contains an X-ray correct battery, wire, switch, detonator, and inert explosive. Powered by two D batteries, this IED circuit would be activated by a mechanical countdown time circuit. The Semtex 10 simulant is engineered to have the same density and effective atomic number (Z_{eff}) as the real explosive threat.

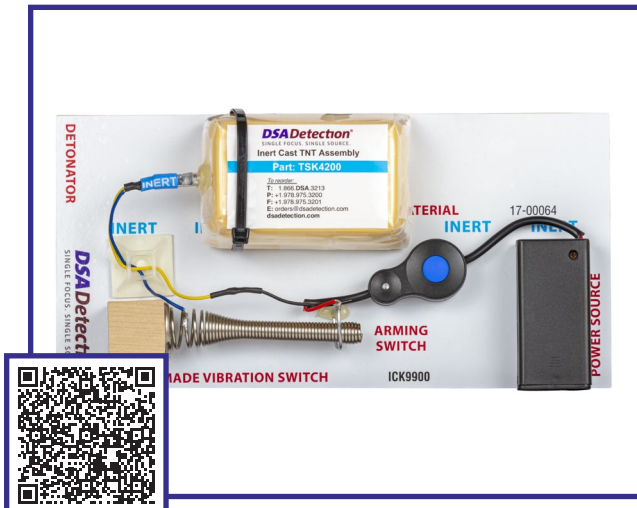

Export Control: EAR99

Inert Homemade Vibration Switch

SKU: **ICK9900**

Weight: 1.5 lb (680 g)

Dimensions: 10 in x 5 in x 3 in (25.4 cm x 12.7 cm x 7.6 cm)

The X-ray correct, inert, homemade vibration switch firing circuit contains all of the necessary components of an improvised explosive device (IED). The circuit is fully functional and will demonstrate that the firing switch has been activated by illuminating the LED in the blasting cap. The circuit board contains an X-ray correct battery, wire, switch, detonator, and inert explosive. Powered by a 9V battery, this IED circuit would be activated when the doorstop spring makes contact with the wire loop. The cast TNT simulant is engineered to have the same density and effective atomic number (Z_{eff}) as the real explosive threat.



Export Control: EAR99

Inert Mechanical Altimeter Switch

SKU: **ICK9905**

Weight: 1.9 lb (850 g)

Dimensions: 10 in x 5 in x 2.4 in (25.5 cm x 12.7 cm x 6 cm)

The X-ray correct, inert mechanical altimeter switch contains all of the necessary components of an improvised explosive device (IED). The circuit board contains an X-ray correct battery, wire, switch, detonator, and inert explosive. Powered by two C batteries, this IED circuit would be activated by rotating the bezel on the altimeter to the desired elevation. Once the elevation is reached, the altimeter needle will complete the circuit. The X-ray correct ANFO (ammonium nitrate-fuel oil) simulant is engineered to have the same density and effective atomic number (Z_{eff}) as the real explosive threat.



Export Control: EAR99

Inert Electric Temperature Switch

SKU: **ICK9915**

Weight: 2.1 lb (949 g)

Dimensions: 10 in x 5 in x 2.5 in (25.5 cm x 12.7 cm x 6.3 cm)

The X-ray correct, inert, electric temperature switch firing circuit contains all of the necessary components of an improvised explosive device (IED). The circuit is fully functional and will demonstrate that the firing switch has been activated by emitting an audible tone or illuminating the LED in the blasting cap. The circuit board contains an X-ray correct battery, wire, switch, detonator, and inert explosive. Powered by two C batteries, this IED circuit would be activated when the electrical temperature sensor alarms due to a temperature difference. The Semtex H simulant is engineered to have the same density and effective atomic number (Z_{eff}) as the real explosive threat.



Export Control: EAR99

Inert Mechanical Temperature Switch

SKU: **ICK9920**

Weight: 3 lb (1.4 kg)

Dimensions: 10 in x 5 in x 2.4 in (25.5 cm x 12.7 cm x 6 cm)

The X-ray correct, inert, mechanical temperature switch firing circuit contains all of the necessary components of an improvised explosive device (IED). The circuit is fully functional and will demonstrate that the firing switch has been activated by illuminating the LED in the blasting cap. The circuit board contains an X-ray correct battery, wire, switch, detonator, and inert explosive. Powered by four AAA batteries, this IED circuit would be activated when the mechanical thermometer arm makes contact with the circuit. The pipe bomb is a steel pipe with inert black powder. The X-ray correct black powder simulant is engineered to have the same density and effective atomic number (Z_{eff}) as the real explosive threat.

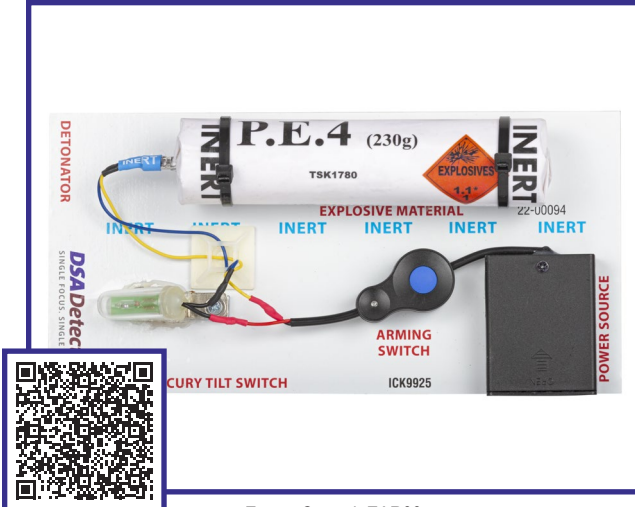

Export Control: EAR99

Inert Mercury Tilt Switch

SKU: **ICK9925**

Weight: 1.5 lb (683 g)

Dimensions: 10 in x 5 in x 2 in (25.5 cm x 12.7 cm x 5.1 cm)

The X-ray correct, inert, mercury tilt-switch firing circuit contains all of the necessary components of an improvised explosive device (IED). The circuit is fully functional and will demonstrate that the firing switch has been activated by illuminating the LED in the blasting cap. The circuit board contains an X-ray correct battery, wire, switch, detonator, and inert explosive. Powered by four AAA batteries, this IED circuit would be activated when the mercury makes contact with the two wire leads. The P.E.4 simulant is engineered to have the same density and effective atomic number (Z_{eff}) as the real explosive threat.



Export Control: EAR99

Inert Light Sensitive Photocell

SKU: **ICK9930**

Weight: 2 lb (907 g)

Dimensions: 10 in x 5 in x 2 in (25.5 cm x 12.7 cm x 5 cm)

The X-ray correct, inert, light-sensitive photocell firing circuit contains all of the necessary components of an improvised explosive device (IED). The circuit is fully functional and will demonstrate that the firing switch has been activated by illuminating the LED in the blasting cap. The circuit board contains an X-ray correct battery, wire, switch, detonator, and inert explosive. Powered by a 9V battery, this IED circuit would be activated when the container holding the photodiode is opened. When the diode is exposed to light, it completes the circuit. The M112 C4 simulant is engineered to have the same density and effective atomic number (Z_{eff}) as the real explosive threat.

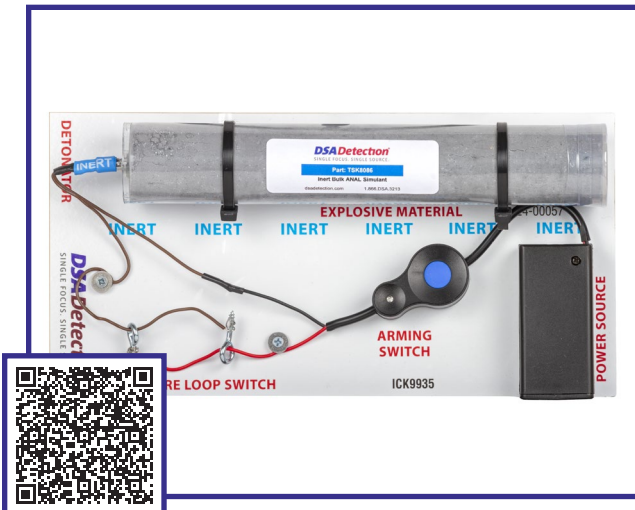

Export Control: EAR99

Inert Wire Loop Switch

SKU: **ICK9935**

Weight: 1.8 lb (819 g)

Dimensions: 10 in x 5 in x 2.2 in (25.5 cm x 12.7 cm x 5.6 cm)

The X-ray correct, inert, wire loop switch firing circuit contains all of the necessary components of an improvised explosive device (IED). The circuit is fully functional and will demonstrate that the firing switch has been activated by illuminating the LED in the blasting cap. The circuit board contains an X-ray correct battery, wire, switch, detonator, and inert explosive. Powered by a 9V battery, this IED circuit would be activated when the two eye screw loops are pulled and come into contact with each other, completing the circuit. The ANAL (ammonium nitrate-aluminum) explosive simulant is engineered to have the same density and effective atomic number (Z_{eff}) as the real explosive threat.

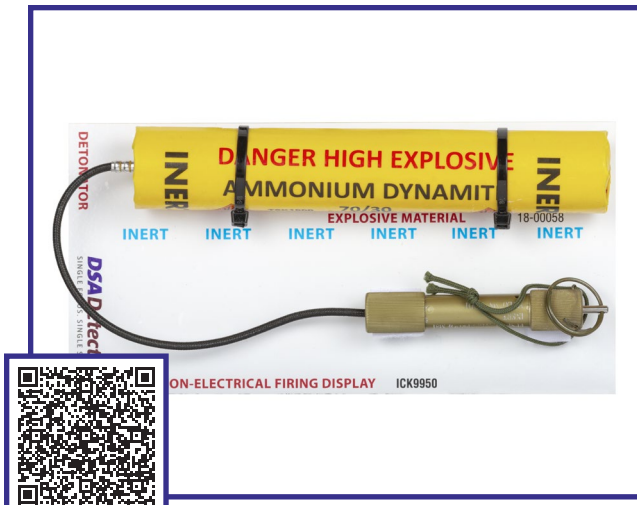

Export Control: ITAR

Inert Non-Electrical Firing Display

SKU: **ICK9950**

Weight: 1.4 lb (636 g)

Dimensions: 10 in x 5 in x 2 in (25.5 cm x 12.7 cm x 5 cm)

The X-ray correct, inert non-electrical firing display contains all of the necessary components of a non-electrically initiated explosive device. This board contains the basic configuration of a non-electrical firing system, utilizing a military-style pull igniter, time fuse, and a non-electrical blasting cap. The display simulates an explosive device that is activated by an M81 fuse igniter. The ammonium dynamite simulant is engineered to have the same density and effective atomic number (Z_{eff}) as the real explosive threat. This item is ITAR restricted and requires special licensing for most international sales. An ITAR-compliant version of this training aid is also available.



Export Control: EAR99

Inert Micro Switch Pressure Release

SKU: **MTK1101**

Weight: 1.40 lb (614 g)

Dimensions: 9.3 in x 9.3 in x 5.6 in (23.5 cm x 23.5 cm x 14.1 cm)

This simulated mail threat is an X-ray correct package bomb with a pressure-release switch. It contains all the necessary P.I.E.S. (Power source, Initiator, Explosive, and Switch) components of an IED. The dynamite explosive simulant is engineered to have the same density and effective atomic number (Z_{eff}) as the real explosive threat. To assist in classroom training, a picture of the internal components is displayed on the outer packaging with each of the P.I.E.S. components identified. This helps build image association without compromising the training aid.

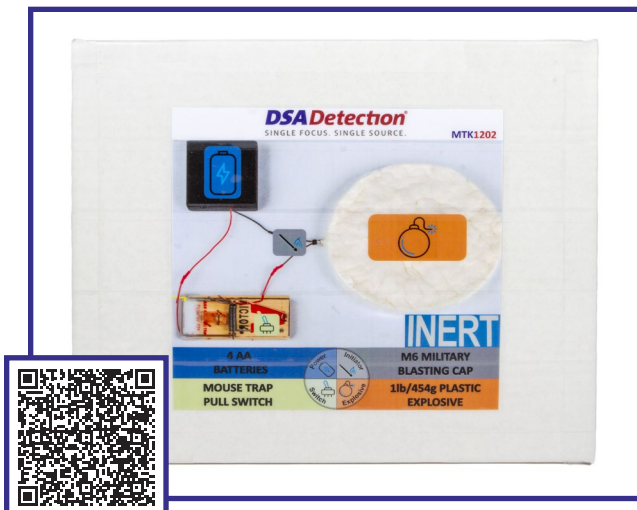

Export Control: EAR99

Inert Mousetrap Pull Switch

SKU: **MTK1202**

Weight: 2.1 lb (957 g)

Dimensions: 13 in x 11.1 in x 2.5 in (32.9 cm x 28.2 cm x 6.3 cm)

This simulated mail threat is an X-ray correct package bomb with an improvised pull switch. It contains all the necessary P.I.E.S. (Power source, Initiator, Explosive, and Switch) components of an IED. The plastic explosive simulant is engineered to have the same density and effective atomic number (Z_{eff}) as the real explosive threat. To assist in classroom training, a picture of the internal components is displayed on the outer packaging with each of the P.I.E.S. components identified. This helps build image association without compromising the training aid.



Export Control: EAR99

Inert Small Envelope, Razors

SKU: **MTK1303**

Weight: 2.6 oz (73 g)

Dimensions: 9.6 in x 4.1 in x 0 in (24.4 cm x 10.3 cm x 0.1 cm)

This simulated mail threat is an X-ray correct, non-explosive, sharps threat. This type of device has been historically used as a letter device against judicial officials. The blades in this device have been dulled for safety. To assist in classroom training, a picture of the internal components is displayed on the outer packaging. This helps build image association without compromising the training aid.



Export Control: EAR99

Inert Small Envelope, White Powder

SKU: **MTK1404**

Weight: 12.2 oz (344 g)

Dimensions: 9.6 in x 4.1 in x 0 in (24.4 cm x 10.3 cm x 0.1 cm)

This simulated mail threat is an X-ray correct, non-explosive, white powder threat. This type of device has been historically used as a letter device against politicians and in hoax incidents. The powder in this device is inert and nontoxic. The envelope is sealed to prevent contamination in training.



Export Control: EAR99

Inert Metal Pipe IED with Photocell

SKU: **MTK1505**

Weight: 4.5 lb (2 kg)

Dimensions: 15.6 in x 11.4 in x 3.1 in (39.6 cm x 29 cm x 8 cm)

This simulated mail threat is an X-ray correct package bomb with a light-sensitive switch. It contains all the necessary P.I.E.S. (Power source, Initiator, Explosive, and Switch) components of an IED. The metal pipe bomb simulant is engineered to have the same density and effective atomic number (Z_{eff}) as the real explosive threat. To assist in classroom training, a picture of the internal components is displayed on the outer packaging with each of the P.I.E.S. components identified. This helps build image association without compromising the training aid.



Export Control: EAR99

Inert Wire Loop Switch

SKU: **MTK1707**

Weight: 1.00 lb (477 g)

Dimensions: 14.8 in x 10.6 in x 0.7 in (37.5 cm x 26.9 cm x 1.7 cm)

This simulated mail threat is an X-ray correct package bomb with a loop switch. It contains all the necessary P.I.E.S. (Power source, Initiator, Explosive, and Switch) components of an IED. The Detasheet simulant is engineered to have the same density and effective atomic number (Z_{eff}) as the real explosive threat. To assist in classroom training, a picture of the internal components is displayed on the outer packaging with each of the P.I.E.S. components identified. This helps build image association without compromising the training aid.



Export Control: EAR99

Inert Clothespin Pull Switch

SKU: **MTK1808**

Weight: 2 lb (912 g)

Dimensions: 13.4 in x 3.1 in x 3.1 in (34 cm x 8 cm x 8 cm)

This simulated mail threat is an X-ray correct package bomb with an improvised pull switch. It contains all the necessary P.I.E.S. (Power source, Initiator, Explosive, and Switch) components of an IED. The PVC pipe bomb simulant is engineered to have the same density and effective atomic number (Z_{eff}) as the real explosive threat. To assist in classroom training, a picture of the internal components is displayed on the outer packaging with each of the P.I.E.S. components identified. This helps build image association without compromising the training aid.



Export Control: EAR99

Inert Wire Loop with Lead Sheet

SKU: **MTK1909**

Weight: 15 oz (425 g)

Dimensions: 12.5 in x 9.5 in x 1 in (31.8 cm x 24.1 cm x 2.5 cm)

This simulated mail threat is an X-ray correct package bomb with an improvised loop switch. It contains all the necessary P.I.E.S. (Power source, Initiator, Explosive, and Switch) components of an IED. The Det cord simulant is engineered to have the same density and effective atomic number (Z_{eff}) as the real explosive threat. Portions of the device are shielded from X-ray examination with a lead sheet. To assist in classroom training, a picture of the internal components is displayed on the outer packaging with each of the P.I.E.S. components identified. This helps build image association without compromising the training aid.

Inert Chemical IED

SKU: **MTK2000**

Weight: 4.4 lb (2 kg)

Dimensions: 13.6 in x 11.4 in x 3.1 in (34.6 cm x 29 cm x 8 cm)

This simulated mail threat is an X-ray correct chemical bomb with a pressure release switch. It contains all the necessary P.I.E.S. (Power source, Initiator, Explosive, and Switch) components of an IED, with the blasting cap acting as a bursting charge in place of conventional explosives. The inert blasting cap is engineered to have the same density and effective atomic number (Z_{eff}) as the real explosive threat. This training aid is designed to simulate a binary chemical device, where once functioned, the two chemicals would mix and create a noxious substance. The simulated chemicals in this device are inert and nontoxic. To assist in classroom training, a picture of the internal components is displayed on the outer packaging with each of the P.I.E.S. components identified. This helps build image association without compromising the training aid.



Export Control: EAR99

Inert Anti Probe

SKU: **MTK2101**

Weight: 2.2 lb (1 kg)

Dimensions: 9.4 in x 9.4 in x 5.5 in (24 cm x 24 cm x 14 cm)

This simulated mail threat is an X-ray correct package bomb with an anti-open switch. It contains all the necessary P.I.E.S. (Power source, Initiator, Explosive, and Switch) components of an IED. The PVC pipe bomb simulant is engineered to have the same density and effective atomic number (Z_{eff}) as the real explosive threat. This type of switch is commonly referred to as a foil or anti-penetration switch. It uses kitchen cooking foil to create contacts on the exterior of the box. A knife would close the circuit and function the device. To assist in classroom training, a picture of the internal components is displayed on the outer packaging with each of the P.I.E.S. components identified. This helps build image association without compromising the training aid.



Export Control: EAR99

Inert Barometric Pressure Switch

SKU: **MTK2202**

Weight: 2.1 lb (962 g)

Dimensions: 13 in x 11.1 in x 2.5 in (32.9 cm x 28.2 cm x 6.3 cm)

This simulated mail threat is an X-ray correct package bomb with an improvised barometric pressure (altitude) switch. It contains all the necessary P.I.E.S. (Power source, Initiator, Explosive, and Switch) components of an IED. The Semtex H simulant is engineered to have the same density and effective atomic number (Z_{eff}) as the real explosive threat. To assist in classroom training, a picture of the internal components is displayed on the outer packaging with each of the P.I.E.S. components identified. This helps build image association without compromising the training aid.



Export Control: EAR99



Export Control: EAR99

Musical Greeting Card Normal and Inert IED

SKU: **MTK2303**

Weight: 10.2 oz (289 g) Dimensions: 8.7 in x 5.9 in x 0.4 in (22.1 cm x 15 cm x 1.1 cm)

This simulated mail threat is an X-ray correct letter bomb with a modified pull switch. It contains all the necessary P.I.E.S. (Power source, Initiator, Explosive, and Switch) components of an IED. The Detasheet simulant is engineered to have the same density and effective atomic number (Z_{eff}) as the real explosive threat. Due to the complexity and popularity of musical greeting cards, an unmodified (original) card is included with this device. To assist in classroom training, a picture of the internal components is displayed on the outer packaging with each of the P.I.E.S. components identified. This helps build image association without compromising the training aid.



Export Control: EAR99

Inert Express Envelope, White Powder

SKU: **MTK2505**

Weight: 4.3 oz (123 g) Dimensions: 12.4 in x 9.6 in x 0.2 in (31.4 cm x 24.3 cm x 0.5 cm)

This simulated mail threat is an X-ray correct, non-explosive, white powder threat. This type of device has been historically used as a letter device against politicians and in hoax incidents. The powder in this device is inert and nontoxic. This simulant is sealed inside the envelope to prevent contamination in training.



Export Control: EAR99

Inert RCIED Cell Phone Trigger Assembly

SKU: **TSK0800**

Weight: 8.5 oz (242 g) Dimensions: 5.9 in x 3.3 in x 1.2 in (15 cm x 8.5 cm x 3 cm)

This training aid simulates an X-ray correct firing circuit designed to function using a cell phone or remote-controlled IED (ECIED) circuit. Once paired with our patented explosive simulant, this assembly completes all the necessary P.I.E.S. (Power source, Initiator, Explosive, and Switch) components of an IED. This flexibility allows for more training and testing opportunities. Each component is visually correct and engineered to have the same density and effective atomic number (Z_{eff}) as a real firing assembly.



Export Control: EAR99

Inert Electronic Time Delay (Hours) Assembly

SKU: **TSK0900**

Weight: 7.7 oz (217 g)

Dimensions: 4.9 in x 3.5 in x 2.6 in (12.4 cm x 9 cm x 6.5 cm)

This training aid simulates an X-ray correct firing circuit designed to function using an alarm clock timer circuit. Once paired with our patented explosive simulant, this assembly completes all the necessary P.I.E.S. (Power source, Initiator, Explosive, and Switch) components of an IED. This flexibility allows for more training and testing opportunities. Each component is visually correct and engineered to have the same density and effective atomic number (Z_{eff}) as a real firing assembly.

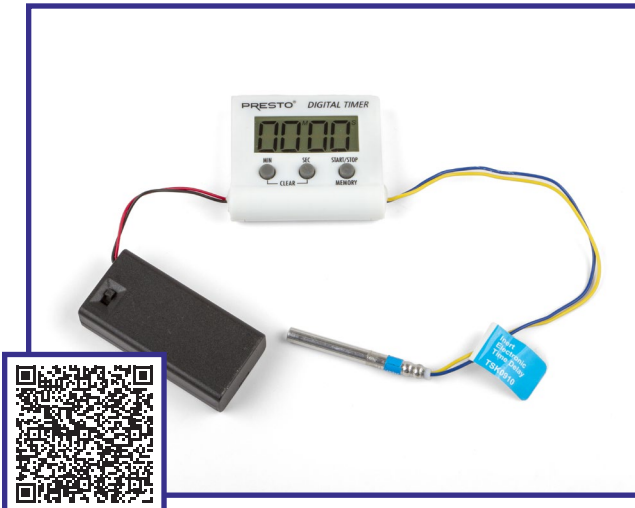

Export Control: EAR99

Inert Electronic Time Delay (Minutes) Assembly

SKU: **TSK0910**

Weight: 4 oz (114 g)

Dimensions: 3.7 in x 2.3 in x 1.6 in (9.5 cm x 5.8 cm x 4 cm)

This training aid simulates an X-ray correct firing circuit designed to function using a kitchen timer circuit. Once paired with our patented explosive simulant, this assembly completes all the necessary P.I.E.S. (Power source, Initiator, Explosive, and Switch) components of an IED. This flexibility allows for more training and testing opportunities. Each component is visually correct and engineered to have the same density and effective atomic number (Z_{eff}) as a real firing assembly.

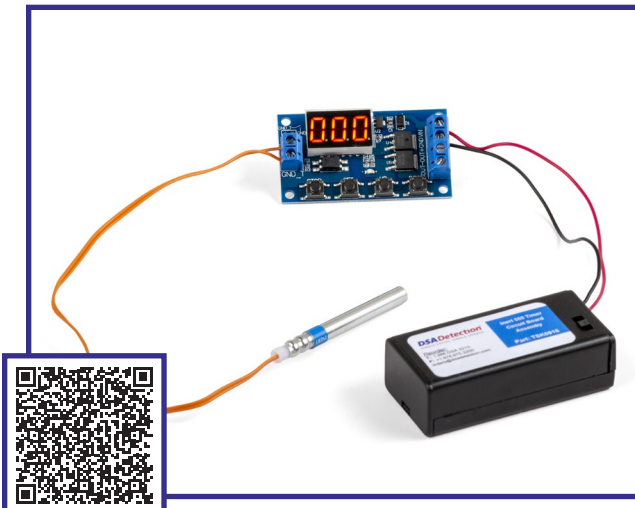

Export Control: EAR99

Inert 555 Timer Circuit Board Assembly

SKU: **TSK0918**

Weight: 3 oz (88 g)

Dimensions: 8.5 in x 4 in x 3.8 in (21.6 cm x 10.2 cm x 9.7 cm)

This training aid simulates an X-ray correct firing circuit designed to function using a 555 timer (Hollywood timer) circuit. Once paired with our patented explosive simulant, this assembly completes all the necessary P.I.E.S. (Power source, Initiator, Explosive, and Switch) components of an IED. This flexibility allows for more training and testing opportunities. Each component is visually correct and engineered to have the same density and effective atomic number (Z_{eff}) as a real firing assembly.



Export Control: EAR99

Inert PIR Motion Sensor Light Assembly

SKU: TSK1100

Weight: 7 oz (198 g)

Dimensions: 4.8 in x 3.1 in x 3.1 in (12.3 cm x 8 cm x 8 cm)

This training aid simulates an X-ray correct firing circuit designed to function using a passive infrared (PIR) motion sensor. Once paired with our patented explosive simulant, this assembly completes all the necessary P.I.E.S. (Power source, Initiator, Explosive, and Switch) components of an IED. This flexibility allows for more training and testing opportunities. Each component is visually correct and engineered to have the same density and effective atomic number (Z_{eff}) as a real firing assembly.



Export Control: EAR99

Inert Soda Can IED

SKU: TSK1103

Weight: 13 oz (368 g)

Dimensions: 5.9 in x 2.6 in x 2.6 in (15 cm x 6.5 cm x 6.5 cm)

The inert soda can IED contains an X-ray correct C4 explosive filler initiated by 1 ft of time fuse inserted into a non-electrical detonator. This IED contains an initiator, explosive, and switch (time fuse). Each component is visually correct and engineered to have the same density and effective atomic number (Z_{eff}) as a real firing assembly.

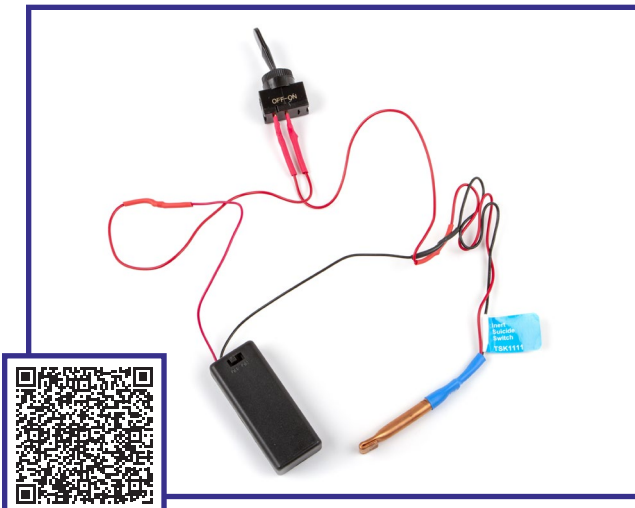

Export Control: EAR99

Inert Suicide Switch Assembly

SKU: TSK1111

Weight: 2.1 oz (60 g)

Dimensions: 3.9 in x 1.5 in x 1.8 in (10 cm x 3.8 cm x 4.5 cm)

This training aid simulates an X-ray correct firing circuit designed to function when the trigger switch is pressed. Once paired with our patented explosive simulant, this assembly completes all the necessary P.I.E.S. (Power source, Initiator, Explosive, and Switch) components of an IED. This flexibility allows for more training and testing opportunities. Each component is visually correct and engineered to have the same density and effective atomic number (Z_{eff}) as a real firing assembly.

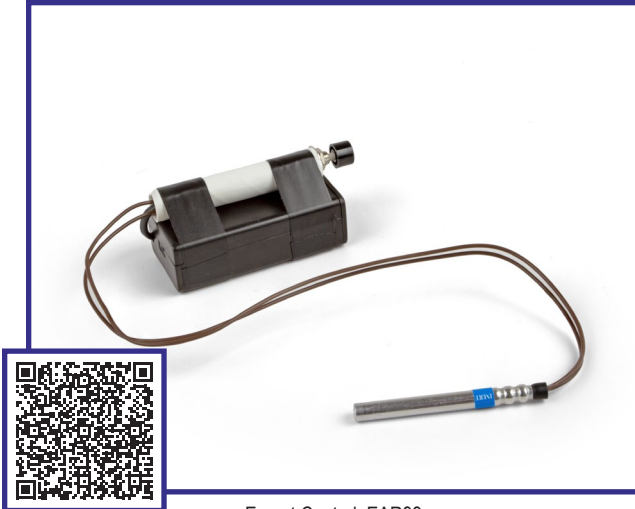

Export Control: EAR99

Inert Hostage Switch Assembly

SKU: **TSK1122**

Weight: 2.1 oz (60 g)

Dimensions: 3.7 in x 1.4 in x 1.4 in (9.4 cm x 3.5 cm x 3.5 cm)

This training aid simulates an X-ray correct firing circuit designed to function when the dead-man switch is released. Once paired with our patented explosive simulant, this assembly completes all the necessary P.I.E.S. (Power source, Initiator, Explosive, and Switch) components of an IED. This flexibility allows for more training and testing opportunities. Each component is visually correct and engineered to have the same density and effective atomic number (Z_{eff}) as a real firing assembly.

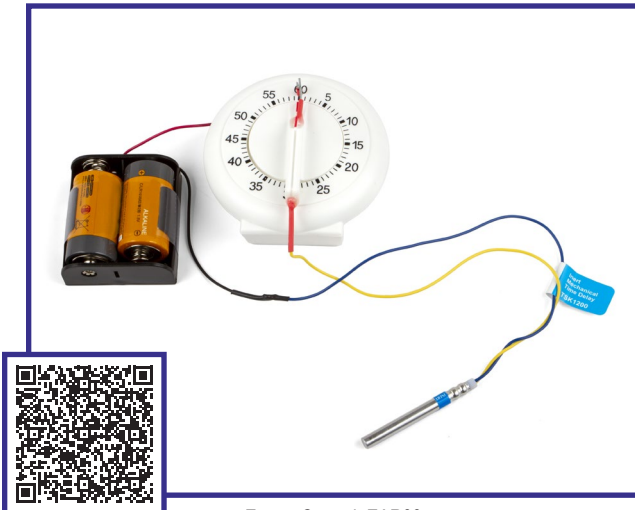

Export Control: EAR99

Inert Mechanical Time Delay Assembly

SKU: **TSK1200**

Weight: 8.2 oz (232 g)

Dimensions: 3.7 in x 2.6 in x 2.8 in (9.5 cm x 6.5 cm x 7 cm)

This training aid simulates an X-ray correct firing circuit designed to function using a time delay circuit. Once paired with one of our patented explosive simulants, this assembly completes all the necessary P.I.E.S. (Power source, Initiator, Explosive, and Switch) components of an IED. This flexibility allows for more training and testing opportunities. Each component is visually correct and engineered to have the same density and effective atomic number (Z_{eff}) as a real firing assembly.

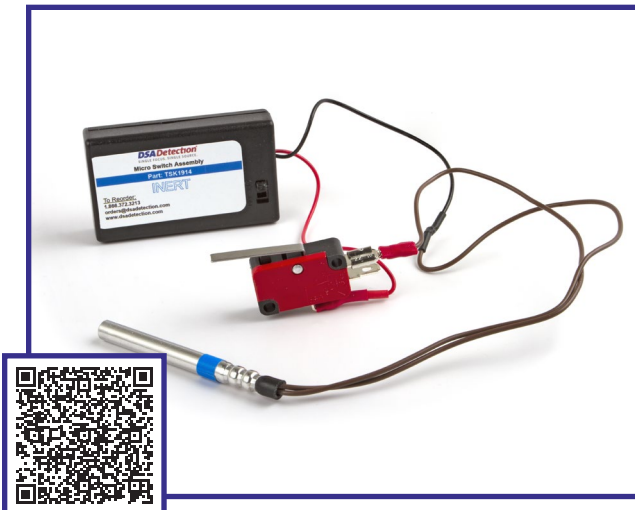

Export Control: EAR99

Inert Micro Switch Assembly

SKU: **TSK1914**

Weight: 2.4 oz (68 g)

Dimensions: 3.7 in x 1.6 in x 1.4 in (9.5 cm x 4 cm x 3.5 cm)

This training aid simulates an X-ray correct firing circuit designed to function using pressure or pressure release. Once paired with one of our patented explosive simulants, this assembly completes all the necessary P.I.E.S. (Power source, Initiator, Explosive, and Switch) components of an IED. This flexibility allows for more training and testing opportunities. Each component is visually correct and engineered to have the same density and effective atomic number (Z_{eff}) as a real firing assembly.



Export Control: EAR99

Inert Vibration Sensor Assembly

SKU: **TSK2400**

Weight: 4 oz (115 g)

Dimensions: 4.1 in x 2 in x 1.8 in (10.5 cm x 5 cm x 4.5 cm)

This training aid simulates an X-ray correct firing circuit designed to function using a vibration or movement. Once paired with one of our patented explosive simulants, this assembly completes all the necessary P.I.E.S. (Power source, Initiator, Explosive, and Switch) components of an IED. This flexibility allows for more training and testing opportunities. Each component is visually correct and engineered to have the same density and effective atomic number (Z_{eff}) as a real firing assembly.



Export Control: EAR99

Inert Laptop IED (Screen Concealment)

SKU: **CED0001**

This training aid simulates an X-ray correct IED concealed in the screen of a laptop computer. It contains all the necessary P.I.E.S. (Power source, Initiator, Explosive, and Switch) components of an IED. The X-ray correct explosive simulant is Detasheet and is engineered to have the same density and effective atomic number (Z_{eff}) as the real explosive threat.



Export Control: EAR99

Inert Stuffed Animal IED

SKU: **CED0003**

This training aid simulates an X-ray correct IED concealed in a plush toy. It is nonelectric and uses time fuse to initiate the device. The X-ray correct explosive simulant is 6ft of Det cord and is engineered to have the same density and effective atomic number (Z_{eff}) as the real explosive threat.



Export Control: EAR99

Inert Tablet IED

SKU: **CED0004**

This training aid simulates an X-ray correct IED concealed in a tablet or e-reader. It contains all the necessary P.I.E.S. (Power source, Initiator, Explosive, and Switch) components of an IED. The X-ray correct explosive simulant is Detasheet and is engineered to have the same density and effective atomic number (Z_{eff}) as the real explosive threat.



Export Control: EAR99

Inert Child's Toy IED

SKU: **CED0005**

This training aid simulates an X-ray correct IED concealed in a child's electronic toy. It contains all the necessary P.I.E.S. (Power source, Initiator, Explosive, and Switch) components of an IED. The X-ray correct explosive simulant is ANFO (ammonium nitrate-fuel oil) and is engineered to have the same density and effective atomic number (Z_{eff}) as the real explosive threat.



Export Control: EAR99

Inert Smartphone RCIED (Sheet)

SKU: **CED0006**

This training aid simulates an X-ray correct IED concealed in a smartphone case. It contains all the necessary P.I.E.S. (Power source, Initiator, Explosive, and Switch) components of an IED. The X-ray correct explosive simulant is Detasheet and is engineered to have the same density and effective atomic number (Z_{eff}) as the real explosive threat.



Export Control: EAR99

Inert Boom Box IED

SKU: **CED0012**

This training aid simulates an X-ray correct IED concealed in a boom-box radio. It contains all the necessary P.I.E.S. (Power source, Initiator, Explosive, and Switch) components of an IED. The X-ray correct explosive simulant is C4 and is engineered to have the same density and effective atomic number (Z_{eff}) as the real explosive threat.



Export Control: EAR99

Inert Computer Bag IED

SKU: **CED0013**

This training aid simulates an X-ray correct IED concealed in a computer bag or backpack. It contains all the necessary P.I.E.S. (Power source, Initiator, Explosive, and Switch) components of an IED. The X-ray correct explosive simulant is P.E.4 and is engineered to have the same density and effective atomic number (Z_{eff}) as the real explosive threat.



Export Control: EAR99

Inert Small Suitcase IED

SKU: **CED0016**

This training aid simulates an X-ray correct IED concealed in a carry-on suitcase. It contains all the necessary P.I.E.S. (Power source, Initiator, Explosive, and Switch) components of an IED. The X-ray correct explosive simulant is ANFO (ammonium nitrate-fuel oil) and is engineered to have the same density and effective atomic number (Z_{eff}) as the real explosive threat.



Export Control: EAR99

Inert Duffle Bag IED

SKU: **CED0017**

This training aid simulates an X-ray correct IED concealed in a duffel or gym-style bag. It contains all the necessary P.I.E.S. (Power source, Initiator, Explosive, and Switch) components of an IED. The X-ray correct explosive simulant is Semtex H and is engineered to have the same density and effective atomic number (Z_{eff}) as the real explosive threat.



Export Control: EAR99

Inert Drone IED

SKU: **CED0018**

This training aid simulates an X-ray correct IED concealed in a drone. This device cannot fly and is only meant to conceal the device. It contains all the necessary P.I.E.S. (Power source, Initiator, Explosive, and Switch) components of an IED. The X-ray correct explosive simulant is C4 and is engineered to have the same density and effective atomic number (Z_{eff}) as the real explosive threat.



Export Control: EAR99

Inert Tennis Shoe IED

SKU: **CED0019**

This training aid simulates an X-ray correct IED concealed in a pair of athletic shoes. It contains all the necessary P.I.E.S. (Power source, Initiator, Explosive, and Switch) components of an IED. The X-ray correct explosive simulant is Semtex H and is engineered to have the same density and effective atomic number (Z_{eff}) as the real explosive threat.



Export Control: EAR99

Inert Hiking Boot IED

SKU: **CED0020**

This training aid simulates an X-ray correct IED concealed in a pair of hiking boots. It contains all the necessary P.I.E.S. (Power source, Initiator, Explosive, and Switch) components of an IED. The X-ray correct explosive simulant is PETN and is engineered to have the same density and effective atomic number (Z_{eff}) as the real explosive threat.



Export Control: EAR99

Inert Sandal Shoe IED

SKU: **CED0021**

This training aid simulates an X-ray correct IED concealed in a pair of thong sandals or flip-flops. It contains all the necessary P.I.E.S. (Power source, Initiator, Explosive, and Switch) components of an IED. The X-ray correct explosive simulant is Detasheet and is engineered to have the same density and effective atomic number (Z_{eff}) as the real explosive threat.



Export Control: EAR99

Inert Belt IED

SKU: **CED0022**

This training aid simulates an X-ray correct IED concealed in a belt. It contains all the necessary P.I.E.S. (Power source, Initiator, Explosive, and Switch) components of an IED. The X-ray correct explosive simulant is Detasheet and is engineered to have the same density and effective atomic number (Z_{eff}) as the real explosive threat.

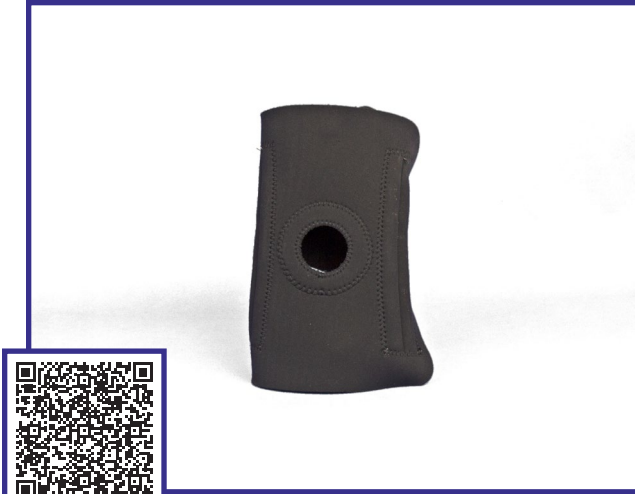

Export Control: EAR99

Inert Knee Brace IED

SKU: **CED0024**

This training aid simulates an X-ray correct IED concealed in an elastic brace. It contains all the necessary P.I.E.S. (Power source, Initiator, Explosive, and Switch) components of an IED. The X-ray correct explosive simulant is 12ft of Det cord and is engineered to have the same density and effective atomic number (Z_{eff}) as the real explosive threat.



Export Control: EAR99

Inert Hand Brace IED

SKU: **CED0025**

This training aid simulates an X-ray correct IED concealed in an elastic brace. It contains all the necessary P.I.E.S. (Power source, Initiator, Explosive, and Switch) components of an IED. The X-ray correct explosive simulant is about 100g of HMTD and is engineered to have the same density and effective atomic number (Z_{eff}) as the real explosive threat.



Export Control: EAR99

Inert Printer Cartridge IED

SKU: **CED0028**

This training aid simulates an X-ray correct IED concealed in a printer toner cartridge. It contains all the necessary P.I.E.S. (Power source, Initiator, Explosive, and Switch) components of an IED. The X-ray correct explosive simulant is PETN and is engineered to have the same density and effective atomic number (Z_{eff}) as the real explosive threat.



Export Control: EAR99

Inert Electric Screwdriver IED

SKU: **CED0030**

This training aid simulates an X-ray correct IED concealed in an electric screwdriver power tool. It contains all the necessary P.I.E.S. (Power source, Initiator, Explosive, and Switch) components of an IED. The X-ray correct explosive simulant is PETN and is engineered to have the same density and effective atomic number (Z_{eff}) as the real explosive threat.



Export Control: EAR99

Inert Baseball Hat IED

SKU: **CED0035**

This training aid simulates an X-ray correct IED concealed in a baseball-style hat or cap. It contains all the necessary P.I.E.S. (Power source, Initiator, Explosive, and Switch) components of an IED. The X-ray correct explosive simulant is Detasheet and is engineered to have the same density and effective atomic number (Z_{eff}) as the real explosive threat.



Export Control: EAR99

Inert Picnic Cooler IED

SKU: **CED0036**

This training aid simulates an X-ray correct IED concealed in a hard-sided, insulated cooler or thermos. It contains all the necessary P.I.E.S. (Power source, Initiator, Explosive, and Switch) components of an IED. The X-ray correct explosive simulant is Semtex H and is engineered to have the same density and effective atomic number (Z_{eff}) as the real explosive threat.



Export Control: EAR99

Inert Light Jacket IED

SKU: **CED0037**

This training aid simulates an X-ray correct IED concealed in a lightweight jacket. It contains all the necessary P.I.E.S. (Power source, Initiator, Explosive, and Switch) components of an IED. The X-ray correct explosive simulant is Detasheet and is engineered to have the same density and effective atomic number (Z_{eff}) as the real explosive threat.



Export Control: EAR99

Inert Heavy Jacket IED

SKU: **CED0038**

This training aid simulates an X-ray correct IED concealed in a heavyweight jacket. It contains all the necessary P.I.E.S. (Power source, Initiator, Explosive, and Switch) components of an IED. The X-ray correct explosive simulant is TATP and is engineered to have the same density and effective atomic number (Z_{eff}) as the real explosive threat.

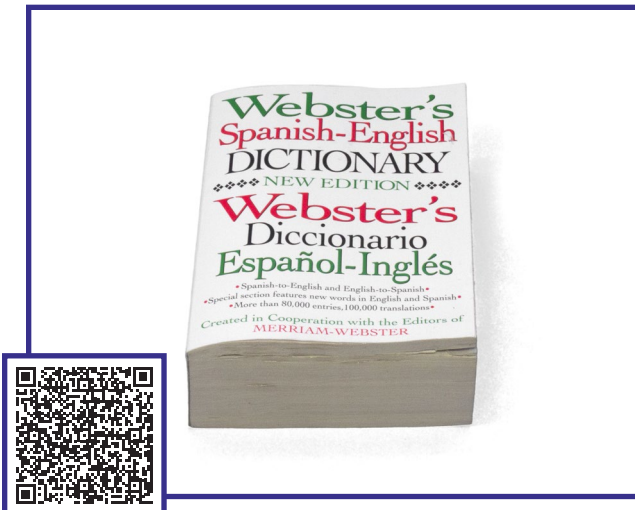

Export Control: EAR99

Inert Paperback Book IED

SKU: **CED0041**

This training aid simulates an X-ray correct IED concealed in a hollowed-out book. It contains all the necessary P.I.E.S. (Power source, Initiator, Explosive, and Switch) components of an IED. The X-ray correct explosive simulant is cast TNT and is engineered to have the same density and effective atomic number (Z_{eff}) as the real explosive threat.



Export Control: EAR99

Inert Hardcover Book IED

SKU: **CED0042**

This training aid simulates an X-ray correct IED concealed in a hollowed-out book. It contains all the necessary P.I.E.S. (Power source, Initiator, Explosive, and Switch) components of an IED. The X-ray correct explosive simulant consists of four CO2 cartridges filled with inert explosives that are engineered to have the same density and effective atomic number (Z_{eff}) as the real explosive threat.



Export Control: EAR99

Inert Coffee Mug IED

SKU: **CED0047**

This training aid simulates an X-ray correct IED concealed in an insulated travel mug. It contains all the necessary P.I.E.S. (Power source, Initiator, Explosive, and Switch) components of an IED. The X-ray correct explosive simulant is HMTD and is engineered to have the same density and effective atomic number (Z_{eff}) as the real explosive threat.



Export Control: EAR99

Inert Neck Pillow IED

SKU: **CED0048**

This training aid simulates an X-ray correct IED concealed in a travel pillow. It contains all the necessary P.I.E.S. (Power source, Initiator, Explosive, and Switch) components of an IED. The X-ray correct explosive simulant is C4 and is engineered to have the same density and effective atomic number (Z_{eff}) as the real explosive threat.



Export Control: EAR99

Inert Backpack / Pressure Cooker IED

SKU: **CED0050**

This training aid simulates an X-ray correct IED constructed from a pressure cooker concealed in a backpack. It is designed to closely replicate historical IED attacks. It contains all the necessary P.I.E.S. (Power source, Initiator, Explosive, and Switch) components of an IED. The X-ray correct explosive simulant is black powder and is engineered to have the same density and effective atomic number (Z_{eff}) as the real explosive threat.



Export Control: EAR99

Inert Backpack / 2 Metal Pipes IED

SKU: **CED0051**

This training aid simulates an X-ray correct IED pipe bombs concealed in a backpack. It is designed to closely replicate historical IED attacks. It contains all the necessary P.I.E.S. (Power source, Initiator, Explosive, and Switch) components of an IED. The X-ray correct explosive simulant is black powder inside of modified steel pipes and is engineered to have the same density and effective atomic number (Z_{eff}) as the real explosive threat.



Export Control: EAR99

Inert Flashlight IED

SKU: **CED0053**

This training aid simulates an X-ray correct IED concealed in a flashlight. It contains all the necessary P.I.E.S. (Power source, Initiator, Explosive, and Switch) components of an IED. The X-ray correct explosive simulant is dynamite and is engineered to have the same density and effective atomic number (Z_{eff}) as the real explosive threat.



Export Control: EAR99

Inert Small Toolbox IED

SKU: **CED0064**

This training aid simulates an X-ray correct IED concealed in a small toolbox or case. It contains all the necessary P.I.E.S. (Power source, Initiator, Explosive, and Switch) components of an IED. The X-ray correct explosive simulant is P.E.4 and is engineered to have the same density and effective atomic number (Z_{eff}) as the real explosive threat.



Export Control: EAR99

Inert Toothpaste Tube Concealed Explosive Simulant

SKU: **CED0065**

This training aid simulates a concealed explosive inside a tube of toothpaste. It does not contain any other components of an IED. The X-ray correct explosive simulant is PETN and is engineered to have the same density and effective atomic number (Z_{eff}) as the real explosive threat.



Export Control: EAR99

Inert Handbag IED

SKU: **CED0066**

This training aid simulates an X-ray correct IED concealed in a purse, clutch, or handbag. It contains all the necessary P.I.E.S. (Power source, Initiator, Explosive, and Switch) components of an IED. The X-ray correct explosive simulant is dynamite and is engineered to have the same density and effective atomic number (Z_{eff}) as the real explosive threat.



Export Control: EAR99

Inert Foot Powder Bottle IED

SKU: **CED0073**

This training aid simulates an X-ray correct IED concealed in a bottle of foot powder. It contains all the necessary P.I.E.S. (Power source, Initiator, Explosive, and Switch) components of an IED. The X-ray correct explosive simulant is a blasting emulsion and is engineered to have the same density and effective atomic number (Z_{eff}) as the real explosive threat.



Export Control: EAR99

Inert Pressure Cooker IED

SKU: **CED0076**

This training aid simulates an X-ray correct IED concealed in a pressure cooker. It contains all the necessary P.I.E.S. (Power source, Initiator, Explosive, and Switch) components of an IED. The X-ray correct explosive simulant is smokeless powder and is engineered to have the same density and effective atomic number (Z_{eff}) as the real explosive threat.



Export Control: EAR99

Inert Lunch Box IED

SKU: **CED0077**

This training aid simulates an X-ray correct IED concealed in a soft sided, insulated lunch box. It contains all the necessary P.I.E.S. (Power source, Initiator, Explosive, and Switch) components of an IED. The X-ray correct explosive simulant is Semtex H and is engineered to have the same density and effective atomic number (Z_{eff}) as the real explosive threat.



Export Control: EAR99

Inert Workout Compression Belt IED (with Fragmentation)

SKU: **CED0078**

This training aid simulates an X-ray correct IED compression or workout belt intended to be worn on the body and concealed under normal clothing. Complete with steel ball bearing fragmentation, this device is designed to closely replicate historical IED attacks. It contains all the necessary P.I.E.S. (Power source, Initiator, Explosive, and Switch) components of an IED. The X-ray correct explosive simulant is TATP connected with Det cord and is engineered to have the same density and effective atomic number (Z_{eff}) as the real explosive threat.



Export Control: EAR99

Inert Workout Compression Belt IED

SKU: **CED0079**

This training aid simulates an X-ray correct IED compression or workout belt intended to be worn on the body and concealed under normal clothing. This device is designed to closely replicate historical IED attacks. It contains all the necessary P.I.E.S. (Power source, Initiator, Explosive, and Switch) components of an IED. The X-ray correct explosive simulant is Detasheet and is engineered to have the same density and effective atomic number (Z_{eff}) as the real explosive threat.



Export Control: EAR99

Inert Cell Phone Concealed IED

SKU: **CED0081**

This training aid simulates an X-ray correct IED concealed in a dummy or display cell phone that is devoid of internal electronic circuitry. It contains all the necessary P.I.E.S. (Power source, Initiator, Explosive, and Switch) components of an IED. The X-ray correct explosive simulant is RDX and is engineered to have the same density and effective atomic number (Z_{eff}) as the real explosive threat.



Export Control: EAR99

Inert Laptop IED (CD Drive Concealment)

SKU: **CED0098**

This training aid simulates an X-ray correct IED concealed in the CD drive of a laptop computer. It contains all the necessary P.I.E.S. (Power source, Initiator, Explosive, and Switch) components of an IED. The X-ray correct explosive simulant is Detasheet and is engineered to have the same density and effective atomic number (Z_{eff}) as the real explosive threat.



Export Control: EAR99

Inert Laptop IED (Hard Drive Concealment)

SKU: **CED0099**

This training aid simulates an X-ray correct IED concealed in the hard drive of a laptop computer. It contains all the necessary P.I.E.S. (Power source, Initiator, Explosive, and Switch) components of an IED. The X-ray correct explosive simulant is Detasheet and is engineered to have the same density and effective atomic number (Z_{eff}) as the real explosive threat.



Export Control: EAR99

Inert Bluetooth Speaker IED

SKU: **CED0132**

This training aid simulates an X-ray correct IED concealed in a Bluetooth portable speaker. It contains all the necessary P.I.E.S. (Power source, Initiator, Explosive, and Switch) components of an IED. The X-ray correct explosive simulant is Semtex 10 and is engineered to have the same density and effective atomic number (Z_{eff}) as the real explosive threat.



Export Control: EAR99

Inert Headphone IED

SKU: **CED0134**

This training aid simulates an X-ray correct IED concealed in portable, over-the-ear headphones. It contains all the necessary P.I.E.S. (Power source, Initiator, Explosive, and Switch) components of an IED. The X-ray correct explosive simulant is Detasheet and is engineered to have the same density and effective atomic number (Z_{eff}) as the real explosive threat.

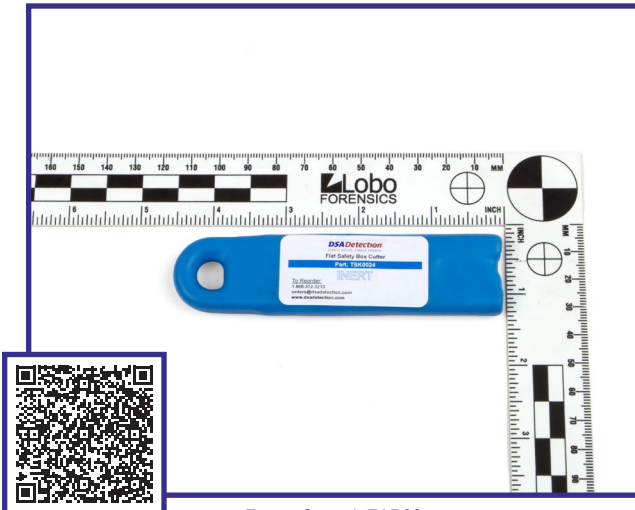

Export Control: EAR99

Inert Flat Safety Box Cutter

SKU: **TSK0024**

Weight: 1.4 oz (40 g)

Dimensions: 4.4 in x 1 in x 0.4 in (11.3 cm x 2.5 cm x 1 cm)

This X-Ray correct training aid simulates a knife which may be encountered at a facility. The metallic mass of each knife simulant perfectly matches that of the real threat with which it is associated. As with real knives, it may or may not alarm in a walk-through metal detector depending on the type of knife threats being simulated and the sensitivity settings of the unit. The cutting edge has been blunted and dulled for safety. This training aid is inert and coated in blue rubber to identify it as safe to handle.



Export Control: EAR99

Inert Empty Rifle Magazine (Dipped)

SKU: **TSK0066**

Weight: 6.4 oz (180 g)

Dimensions: 4.9 in x 2.6 in x 1 in (12.5 cm x 6.5 cm x 2.5 cm)

This inert magazine is designed to accurately simulate an empty rifle magazine. This threat is engineered to have the same density and effective atomic number (Z_{eff}) as a real unloaded magazine. This training aid is inert and coated in blue rubber to identify it as safe to handle. A loaded magazine version is also available.



Export Control: EAR99

Inert Empty Pistol Magazine (Dipped)

SKU: **TSK0067**

Weight: 1.1 oz (33.8 g) Dimensions: 3.3 in x 1.5 in x 0.6 in (8.5 cm x 3.80 cm x 1.6 cm)

This inert magazine is designed to accurately simulate an empty pistol magazine. This threat is engineered to have the same density and effective atomic number (Z_{eff}) as a real unloaded magazine. This training aid is inert and coated in blue rubber to identify it as safe to handle. A loaded magazine version is also available.



Export Control: EAR99

Inert Ceramic Folding Knife

SKU: **TSK0110**

Weight: 1.1 oz (30 g) Dimensions: 4.7 in x 1.2 in x 0.8 in (12 cm x 3 cm x 2 cm)

This training aid simulates an X-ray correct ceramic knife. It is engineered to have the same density and effective atomic number (Z_{eff}) as a ceramic knife. This device will display like a metal blade in the X-ray but will not elicit a metal detector alarm. The cutting edge has been blunted and dulled for safety. This training aid is inert and coated in blue rubber to identify it as safe to handle.



Export Control: EAR99

Inert Vape Pen

SKU: **TSK2860**

Weight: 1.6 oz (45 g) Dimensions: 6.3 in x 0.8 in x 0.8 in (16 cm x 2 cm x 2 cm)

This X-ray correct, inert vape pen helps to properly train security staff how to identify a popular vaporizer contraband in an X-ray machine.



Export Control: EAR99

Inert Vaporizer

SKU: TSK2865

Weight: 2.4 oz (68 g)

Dimensions: 3.9 in x 1.6 in x 1.2 in (10 cm x 4 cm x 3 cm)

This X-ray correct, inert vaporizer helps to properly train security staff how to identify a popular vaporizer contraband in an X-ray machine.



Export Control: EAR99

Inert Marijuana Simulant

SKU: TSK0002

Weight: 1 lb (454 g)

Dimensions: 5.9 in x 6.7 in x 2 in (15 cm x 17 cm x 5 cm)

Narcotics detection is an important part of checkpoint screening. Most ETD and X-ray systems are capable of detecting narcotics in some form when properly equipped and programmed. Marijuana has become legal in some areas but is considered a prohibited item in almost all screening areas. This inert simulant has a similar odor to real marijuana but contains none of the active ingredients like THC or other cannabinoids. It is engineered to have the same density and effective atomic number (Z_{eff}) as marijuana. Custom packaging or quantity can be ordered through our Customer service department



Export Control: EAR99

Inert Methadone Tablets (1000ct)

SKU: TSK0003

Weight: 13.3 oz (375 g)

Dimensions: 5.5 in x 5.1 in x 2 in (14 cm x 13 cm x 5 cm)

Narcotics detection is an important part of checkpoint screening. Most ETD and X-ray systems are capable of detecting narcotics in some form when properly equipped and programmed. This inert narcotic simulant represents methadone tablets and is engineered to have the same density and effective atomic number (Z_{eff}) as many abused pharmaceuticals. Custom packaging or quantity can be ordered through our Customer service department.



Export Control: EAR99

Inert Concealed Pringles Can (Marijuana and Cocaine)

SKU: **TSK0064**

Weight: 13.8 oz (390 g) Dimensions: 9.1 in x 3.1 in x 3.1 in (23 cm x 8 cm x 8 cm)

Concealed narcotics is a problem encountered more often than concealed weapons or explosive threats. For example, passengers may attempt to travel with drugs when moving between areas where marijuana is legal and areas where it is not. Screeners must be able to recognize modified containers or anomalies in commercial items that indicate concealment or nefarious activity. The Inert Concealed Pringles Can includes both inert Marijuana and Cocaine simulants which fit inside a modified can. This allows screeners to train with different inert narcotics. These simulants are visually correct and engineered to have the same density and effective atomic number (Z_{eff}) as a real threat.



Export Control: EAR99

Inert Concealed Soda Can (Marijuana and Cocaine)

SKU: **TSK0065**

Weight: 9 oz (255 g) Dimensions: 4.7 in x 2.8 in x 2.8 in (12 cm x 7 cm x 7 cm)

Concealed narcotics is a problem encountered more often than concealed weapons or explosive threats. For example, passengers may attempt to travel with drugs when moving between areas where marijuana is legal and areas where it is not. Screeners must be able to recognize modified containers or anomalies in commercial items that indicate concealment or nefarious activity. The Inert Concealed Soda Can includes both inert Marijuana and Cocaine simulants which fit inside a modified can. This allows screeners to train with different inert narcotics. These simulants are visually correct and engineered to have the same density and effective atomic number (Z_{eff}) as a real threat.



Export Control: EAR99

Inert Concealed Shoe (Cocaine)

SKU: **TSK0078**

Concealed narcotics is a problem encountered more often than concealed weapons or explosive threats. For example, passengers may attempt to travel with drugs. Screeners must be able to recognize modified containers or anomalies in commercial items that indicate concealment or nefarious activity. The Inert Concealed Shoe features about 25 grams of Cocaine simulant built into the sole of a shoe. Only one shoe has been modified, allowing screeners to compare the pair of shoes. This training aid is visually correct and engineered to have the same density and effective atomic number (Z_{eff}) as a real threat.



Export Control: EAR99

Inert Concealed Stuffed Animal (Methadone Tablets)

SKU: **TSK0079**

Concealed narcotics is a problem encountered more often than concealed weapons or explosive threats. For example, passengers may attempt to travel with drugs. Screeners must be able to recognize modified containers or anomalies in commercial items that indicate concealment or nefarious activity. The Inert Concealed Stuffed Animal includes about 1,000 methadone pills concealed inside a child's plush toy. This training aid is visually correct and engineered to have the same density and effective atomic number (Z_{eff}) as a real threat.



Export Control: EAR99

Inert Cocaine HCl Simulant

SKU: **TSK9300**

Weight: 1 lb (454 g)

Dimensions: 6.7 in x 5.9 in x 2 in (17 cm x 15 cm x 5 cm)

Narcotics detection is an important part of checkpoint screening. Most ETD and X-ray systems are capable of detecting narcotics in some form when properly equipped and programmed. Cocaine or Coke can come in many forms. Drug purity can affect how this narcotic appears in an X-ray. This simulant is designed to simulate the density and effective atomic number (Z_{eff}) of one of the most common forms of Cocaine, Cocaine Hydrochloride. Custom packaging or quantity can be ordered through our Customer service department.



Export Control: EAR99

Inert RG-42 Grenade

SKU: **TSK0004**

Weight: 10.6 oz (298 g)

Dimensions: 4.9 in x 2.8 in x 2.2 in (12.5 cm x 7 cm x 5.5 cm)

This inert soviet hand grenade replica is designed to accurately simulate a hand grenade threat when scanned in an X-ray. This training aid is colored blue to identify it as safe to handle. The fuse has been modified to meet EAR regulations. Components controlled under ITAR have been removed.



Export Control: ITAR

Inert MK-2 Frag Grenade

SKU: **TSK0005**

Weight: 1.1 lb (506 g)

Dimensions: 4.5 in x 2.8 in x 2.8 in (11.5 cm x 7 cm x 7 cm)

This inert U.S. hand grenade replica is designed to accurately simulate a hand grenade threat when scanned in an X-ray or when conducting a physical search. This replica is engineered to have the same density and effective atomic number (Z_{eff}) as a real grenade. This training aid is inert and coated in blue rubber to identify it as safe to handle. This item is ITAR restricted and requires special licensing for most international sales.



Export Control: ITAR

Inert M26 Grenade

SKU: **TSK0006**

Weight: 1.1 lb (519 g)

Dimensions: 4.3 in x 2.8 in x 2.8 in (11 cm x 7 cm x 7 cm)

This inert U.S. hand grenade replica is designed to accurately simulate a hand grenade threat when scanned in an X-ray or when conducting a physical search. This replica is engineered to have the same density and effective atomic number (Z_{eff}) as a real grenade. This training aid is inert and coated in blue rubber to identify it as safe to handle. This item is ITAR restricted and requires special licensing for most international sales.



Export Control: EAR99

Inert M7A3 Riot CS Grenade

SKU: **TSK0007**

Weight: 1.3 lb (599 g)

Dimensions: 6 in x 2.5 in x 2.5 in (15.2 cm x 6.4 cm x 6.4 cm)

This inert U.S. hand grenade replica is designed to accurately simulate a hand grenade threat when scanned in an X-ray or when conducting a physical search. This replica is engineered to have the same density and effective atomic number (Z_{eff}) as a real grenade. This training aid is inert and coated in blue rubber to identify it as safe to handle. This item is BIS Controlled and requires a commerce license for most international sales.



Export Control: ITAR

Inert M67 Frag Grenade

SKU: TSK0008

Weight: 15 oz (427 g)

Dimensions: 3.9 in x 3 in x 3 in (9.8 cm x 7.6 cm x 7.6 cm)

This inert U.S. hand grenade replica is designed to accurately simulate a hand grenade threat when scanned in an X-ray or when conducting a physical search. This replica is engineered to have the same density and effective atomic number (Z_{eff}) as a real grenade. This training aid is inert and coated in blue rubber to identify it as safe to handle. This item is ITAR restricted and requires special licensing for most international sales.



Export Control: EAR99

Inert F1 Frag Grenade

SKU: TSK0009

Weight: 8.3 oz (237 g)

Dimensions: 5.2 in x 2.3 in x 2.3 in (13.1 cm x 5.9 cm x 5.9 cm)

This inert soviet hand grenade replica is designed to accurately simulate a hand grenade threat when scanned in an X-ray. This training aid is colored blue to identify it as safe to handle. The fuse has been modified to meet EAR regulations. Components controlled under ITAR have been removed.



Export Control: EAR99

Inert RGD-5 Grenade

SKU: TSK0010

Weight: 10.4 oz (295 g)

Dimensions: 4.7 in x 2.4 in x 2.4 in (12 cm x 6 cm x 6 cm)

This inert soviet hand grenade replica is designed to accurately simulate a hand grenade threat when scanned in an X-ray. This training aid is colored blue to identify it as safe to handle. The fuse has been modified to meet EAR regulations. Components controlled under ITAR have been removed.



Export Control: EAR99

Inert .25 Caliber Bullets

SKU: **TSK0012**

Weight: 0.2 oz (4.8 g)

Dimensions: 0.9 in x 0.3 in x 0.3 in (2.20 cm x 0.8 cm x 0.8 cm)

These inert bullets are X-ray/CT correct and designed to represent standard target ammunition. Each of the five rounds is engineered to have the same density, effective atomic number (Z_{eff}), and weight as the real version. The primer has been expended or removed and the gunpowder removed. Each bullet is inert, identified with a hole drilled through the casing. This training aid is not considered to be ammunition in the U.S. but should be treated with the same respect as a projectile and may be subject to country-specific import requirements.



Export Control: EAR99

Inert AN-M14 Incendiary Grenade

SKU: **TSK0013**

Weight: 1.60 lb (748 g)

Dimensions: 6 in x 2.5 in x 2.5 in (15.2 cm x 6.4 cm x 6.4 cm)

This inert U.S. hand grenade replica is designed to accurately simulate a hand grenade threat when scanned in an X-ray or when conducting a physical search. This replica is engineered to have the same density and effective atomic number (Z_{eff}) as a real grenade. This training aid is inert and coated in blue rubber to identify it as safe to handle. This item is BIS Controlled and requires a commerce license for most international sales.

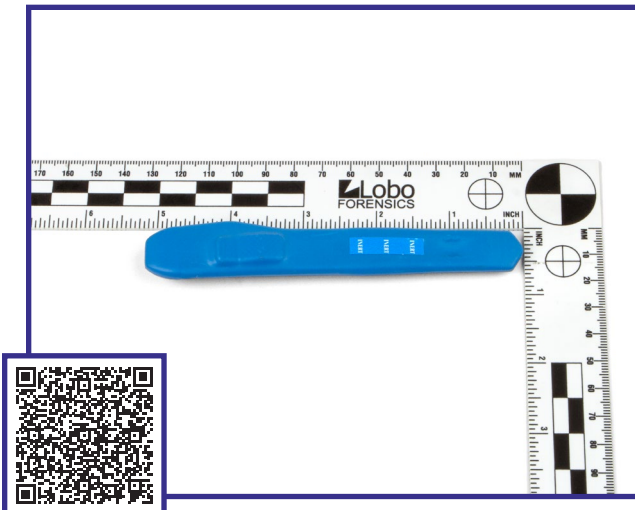

Export Control: EAR99

Inert Mini Snap Blade Knife

SKU: **TSK0014**

Weight: 0.6 oz (17 g)

Dimensions: 5.5 in x 1.2 in x 0.8 in (14 cm x 3 cm x 2 cm)

This X-Ray correct training aid simulates a knife which may be encountered at a facility. The metallic mass of each knife simulant perfectly matches that of the real threat with which it is associated. As with real knives, it may or may not alarm in a walk-through metal detector depending on the type of knife threats being simulated and the sensitivity settings of the unit. The cutting edge has been blunted and dulled for safety. This training aid is inert and coated in blue rubber to identify it as safe to handle.



Export Control: EAR99

Multi-Blade Metal Folding Knife (2.6 in)

SKU: **TSK0015**

Weight: 3.5 oz (100 g)

Dimensions: 3.5 in x 1.2 in x 0.8 in (9 cm x 3 cm x 2 cm)

This X-Ray correct training aid simulates a knife which may be encountered at a facility. The metallic mass of each knife simulant perfectly matches that of the real threat with which it is associated. As with real knives, it may or may not alarm in a walk-through metal detector depending on the type of knife threats being simulated and the sensitivity settings of the unit. The cutting edge has been blunted and dulled for safety. This training aid is inert and coated in blue rubber to identify it as safe to handle.



Export Control: EAR99

Inert Folding Knife (3 in)

SKU: **TSK0016**

Weight: 2.2 oz (63 g)

Dimensions: 4.3 in x 1.6 in x 0.8 in (11 cm x 4 cm x 2 cm)

This X-Ray correct training aid simulates a knife which may be encountered at a facility. The metallic mass of each knife simulant perfectly matches that of the real threat with which it is associated. As with real knives, it may or may not alarm in a walk-through metal detector depending on the type of knife threats being simulated and the sensitivity settings of the unit. The cutting edge has been blunted and dulled for safety. This training aid is inert and coated in blue rubber to identify it as safe to handle.



Export Control: EAR99

Inert Folding Knife (2 in)

SKU: **TSK0017**

Weight: 1.4 oz (42 g)

Dimensions: 3.5 in x 1.2 in x 0.8 in (9 cm x 3 cm x 2 cm)

This X-Ray correct training aid simulates a knife which may be encountered at a facility. The metallic mass of each knife simulant perfectly matches that of the real threat with which it is associated. As with real knives, it may or may not alarm in a walk-through metal detector depending on the type of knife threats being simulated and the sensitivity settings of the unit. The cutting edge has been blunted and dulled for safety. This training aid is inert and coated in blue rubber to identify it as safe to handle.



Export Control: EAR99

Inert Folding Knife (1 in)

SKU: **TSK0018**

Weight: 0.6 oz (18 g)

Dimensions: 2.8 in x 1.2 in x 0.4 in (7 cm x 3 cm x 1 cm)

This X-Ray correct training aid simulates a knife which may be encountered at a facility. The metallic mass of each knife simulant perfectly matches that of the real threat with which it is associated. As with real knives, it may or may not alarm in a walk-through metal detector depending on the type of knife threats being simulated and the sensitivity settings of the unit. The cutting edge has been blunted and dulled for safety. This training aid is inert and coated in blue rubber to identify it as safe to handle.



Export Control: EAR99

Inert Lexan Knife (11 in)

SKU: **TSK0019**

Weight: 1.9 oz (55 g)

Dimensions: 11.4 in x 1.5 in x 0.8 in (29 cm x 3.8 cm x 2 cm)

This training aid simulates an X-ray correct Lexan (plastic) cake knife. It is engineered to have the same density and effective atomic number (Z_{eff}) as a Lexan knife. This device will be difficult to identify in an X-ray and will not elicit a metal detector alarm. The cutting edge has been blunted and dulled for safety. This training aid is inert and coated in blue rubber to identify it as safe to handle.



Export Control: EAR99

Inert Ceramic Paring Knife (3 in)

SKU: **TSK0020**

Weight: 1.8 oz (50 g)

Dimensions: 7.5 in x 1.1 in x 0.8 in (19 cm x 2.8 cm x 2 cm)

This training aid simulates an X-ray correct ceramic paring knife. It is engineered to have the same density and effective atomic number (Z_{eff}) as a ceramic knife. This device will display like a metal blade in the X-ray but will not elicit a metal detector alarm. The cutting edge has been blunted and dulled for safety. This training aid is inert and coated in blue rubber to identify it as safe to handle.

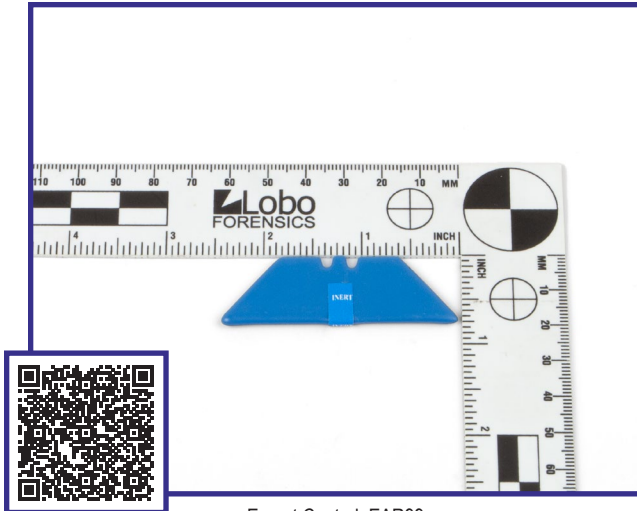

Export Control: EAR99

Inert Razor Blade

SKU: **TSK0034**

Weight: 0.2 oz (6 g)

Dimensions: 2.4 in x 0.8 in x 0.2 in (6 cm x 2 cm x 0.4 cm)

This X-Ray correct training aid simulates a utility razor blade. The metallic mass of each blade simulant perfectly matches that of the real threat with which it is associated. As with real knives, it may or may not alarm in a walk-through metal detector depending on the type of knife threats being simulated and the sensitivity settings of the unit. The cutting edge has been blunted and dulled for safety. This training aid is inert and coated in blue rubber to identify it as safe to handle.



Export Control: EAR99

Inert 12ga Shotgun Shells

SKU: **TSK0059**

Weight: 1.6 oz (43.5 g)

Dimensions: 2.4 in x 0.9 in x 0.8 in (6 cm x 2.20 cm x 2 cm)

These inert shotgun shells are X-ray/CT correct and designed to represent standard birdshot hunting shells. The holder contains five rounds engineered to have the same density, effective atomic number (Z_{eff}), and weight as the real version. Each shell is inert, identified with a "dummy" label. This training aid is not considered to be ammunition in the U.S. but should be treated with the same respect as a projectile and may be subject to country-specific import requirements.



Export Control: EAR99

Inert 9mm Bullets

SKU: **TSK0098**

Weight: 0.5 oz (11.4 g)

Dimensions: 0.7 in x 0.4 in x 0.4 in (1.80 cm x 1 cm x 1 cm)

These inert bullets are X-ray/CT correct and designed to represent standard target ammunition. Each of the five rounds is engineered to have the same density, effective atomic number (Z_{eff}), and weight as the real version. The primer has been expended or removed and the gunpowder removed. Each bullet is inert, identified with a hole drilled through the casing. This training aid is not considered to be ammunition in the U.S. but should be treated with the same respect as a projectile and may be subject to country-specific import requirements.



Export Control: EAR99

Inert Box of 9 mm Ammunition (50 rounds)

SKU: **TSK0099**

Weight: 1.4 lb (635 g)

Dimensions: 4.8 in x 3 in x 1.4 in (12.3 cm x 7.5 cm x 3.6 cm)

This box of inert ammunition contains fifty (50) 9mm inert bullets. These inert bullets are X-ray/CT correct and designed to represent standard target ammunition. Each round is engineered to have the same density, effective atomic number (Z_{eff}), and weight as the real version. The primer has been expended or removed and the gunpowder removed. Each bullet is inert, identified with a hole drilled through the casing. This training aid is not considered to be ammunition in the U.S. but should be treated with the same respect as a projectile and may be subject to country-specific import requirements.



Export Control: EAR99

Inert Metal Pipe IED, Large

SKU: **TSK0100**

Weight: 2.6 lb (1.2 kg)

Dimensions: 7.8 in x 2.6 in x 2.6 in (19.7 cm x 6.5 cm x 6.5 cm)

This inert, X-ray correct large metal pipe accurately simulates one of the most often used IED components in the world today, the "pipe bomb". It is engineered to have the same density and effective atomic number (Z_{eff}) as an actual pipe bomb. It is filled with inert smokeless powder, and the hole in the end cap can be used to insert various blasting caps or initiators (sold separately) for unlimited hands-on training scenarios. To prevent the loss of explosive simulant, there is a paper seal in the end cap. This training aid is inert and the caps are coated in blue rubber to identify it as safe to handle. There is also an "inerting hole" on the side that is sealed with glue.



Export Control: EAR99

Inert Metal Pipe IED, Small

SKU: **TSK0200**

Weight: 1.7 lb (777 g)

Dimensions: 9.4 in x 1.9 in x 1.9 in (24 cm x 4.8 cm x 4.8 cm)

This inert, X-ray correct small metal pipe accurately simulates one of the most often used IED components in the world today, the "pipe bomb". It is engineered to have the same density and effective atomic number (Z_{eff}) as an actual pipe bomb. It is filled with inert smokeless powder, and the hole in the end cap can be used to insert various blasting caps or initiators (sold separately) for unlimited hands-on training scenarios. To prevent the loss of explosive simulant, there is a paper seal in the end cap. This training aid is inert, and the caps are coated in blue rubber to identify it as safe to handle. There is also an "inerting hole" on the side that is sealed with glue.



Export Control: EAR99

Inert PVC Pipe IED, Large

SKU: **TSK0300**

Weight: 1.3 lb (582 g)

Dimensions: 9.8 in x 2.8 in x 2.8 in (25 cm x 7 cm x 7 cm)

This inert, X-ray correct large PVC pipe accurately simulates one of the most often used IED components in the world today, the “pipe bomb”. It is engineered to have the same density and effective atomic number (Z_{eff}) as an actual pipe bomb. It is filled with inert smokeless powder, and the hole in the end cap can be used to insert various blasting caps or initiators (sold separately) for unlimited hands-on training scenarios. To prevent the loss of explosive simulant, there is a paper seal in the end cap. This training aid is inert and the caps are coated in blue rubber to identify it as safe to handle. There is also an “inerting hole” on the side that is sealed with glue.



Export Control: EAR99

Inert PVC Pipe IED, Small

SKU: **TSK0400**

Weight: 11 oz (315 g)

Dimensions: 9.1 in x 2 in x 2 in (23.2 cm x 5.1 cm x 5.1 cm)

This inert, X-ray correct small PVC pipe accurately simulates one of the most often used IED components in the world today, the “pipe bomb”. It is engineered to have the same density and effective atomic number (Z_{eff}) as an actual pipe bomb. It is filled with inert smokeless powder, and the hole in the end cap can be used to insert various blasting caps or initiators (sold separately) for unlimited hands-on training scenarios. To prevent the loss of explosive simulant, there is a paper seal in the end cap. This training aid is inert and the caps are coated in blue rubber to identify it as safe to handle. There is also an “inerting hole” on the side that is sealed with glue.



Export Control: EAR99

Inert 5.56 Bullets

SKU: **TSK0556**

Weight: 0.3 oz (10.5 g)

Dimensions: 2.2 in x 0.4 in x 0.4 in (5.6 cm x 1 cm x 1 cm)

These inert bullets are X-ray/CT correct and designed to represent standard target ammunition. Each of the five rounds is engineered to have the same density, effective atomic number (Z_{eff}), and weight as the real version. Each bullet is inert, identified with a hole drilled through the casing. This training aid is not considered to be ammunition in the U.S. but should be treated with the same respect as a projectile and may be subject to country-specific import requirements.



Export Control: EAR99

Inert Sub-compact Pistol, Semiautomatic

SKU: **TSK0600**

Weight: 1.2 lb (548 g)

Dimensions: 5.9 in x 4.1 in x 0.9 in (15.1 cm x 10.5 cm x 2.4 cm)

This firearm training aid is X-ray correct and is designed to accurately represent a sub-compact sized pistol. It is engineered to have the same density, effective atomic number (Z_{eff}), and weight as an actual sub-compact pistol. This item contains the correct metallic mass to generate an alarm in both hand-held and walk-through metal detectors. Five inert bullets are included in a removable magazine to allow for more training opportunities. This training aid is inert and is coated in blue rubber to identify it as safe to handle. This training aid is not considered a firearm in the U.S. but should be treated with the same respect as a real gun and may be subject to country-specific import requirements.



Export Control: EAR99

Inert Pistol Magazine with Bullets (Dipped)

SKU: **TSK0604**

Weight: 2.1 oz (58.2 g)

Dimensions: 3.3 in x 1.5 in x 0.6 in (8.5 cm x 3.80 cm x 1.6 cm)

This inert magazine is designed to accurately simulate a pistol magazine loaded with 5 bullets. This threat is engineered to have the same density and effective atomic number (Z_{eff}) as a real loaded magazine. This training aid is inert and coated in blue rubber to identify it as safe to handle. Each bullet inside the magazine is inert, identified with a hole drilled through the casing. The primer has been expended or removed and the gunpowder removed. This training aid is not considered to be ammunition in the U.S. but should be treated with the same respect as a projectile and may be subject to country-specific import requirements. An empty magazine version is also available.



Export Control: EAR99

Inert Rifle Magazine with Bullets (Dipped)

SKU: **TSK0607**

Weight: 10.1 oz (285 g)

Dimensions: 4.9 in x 2.6 in x 1 in (12.5 cm x 6.5 cm x 2.5 cm)

This inert magazine is designed to accurately simulate a rifle magazine loaded with 10 bullets. This threat is engineered to have the same density and effective atomic number (Z_{eff}) as a real loaded magazine. This training aid is inert and coated in blue rubber to identify it as safe to handle. Each bullet inside the magazine is inert, identified with a hole drilled through the casing. The primer has been expended or removed and the gunpowder removed. This training aid is not considered to be ammunition in the U.S. but should be treated with the same respect as a projectile and may be subject to country-specific import requirements. An empty magazine version is also available.



Export Control: EAR99

Inert 3D-Printed Replica Firearm

SKU: TSK0610

Weight: 10.6 oz (301 g) **Dimensions:** 8.5 in x 6.3 in x 1.8 in (21.5 cm x 16 cm x 4.5 cm)

The Inert 3D-Printed Replica Firearm is an exact match to the one most commonly printed worldwide and accurately represents the screening limitations associated with this new type of threat. This 3D-printed replica contains an inert bullet and aluminum firing pin, as well as a removable steel cube that provides threat-accurate responses on walk-through and hand-held metal detectors. This has been designed to allow for complete disassembly to allow for more training opportunities. DSA engineered this print file to prevent misuse of any of this replica's components. This item is printed in blue plastic and is engineered to have the same density and effective atomic number (Z_{eff}) as a 3D-printed weapon. This training aid is not considered a firearm in the U.S. but should be treated with the same respect as a real gun and may be subject to country-specific import requirements.



Export Control: EAR99

Inert Compact Revolver, Double Action

SKU: TSK0650

Weight: 1.3 lb (576 g) **Dimensions:** 6.5 in x 4.7 in x 1.3 in (16.5 cm x 12 cm x 3.2 cm)

This firearm training aid is X-ray correct and is designed to accurately represent a compact-sized revolver. It is engineered to have the same density, effective atomic number (Z_{eff}), and weight as an actual compact revolver. This item contains the correct metallic mass to generate an alarm in both hand-held and walk-through metal detectors. This training aid is inert and is coated in blue rubber to identify it as safe to handle. This training aid is not considered a firearm in the U.S. but should be treated with the same respect as a real gun and may be subject to country-specific import requirements.



Export Control: EAR99

Inert Derringer Pistol

SKU: TSK0670

Weight: 12 oz (340 g) **Dimensions:** 4.8 in x 3.5 in x 1 in (12.1 cm x 8.9 cm x 2.5 cm)

This firearm training aid is X-ray correct and is designed to accurately represent a pocket pistol. It is engineered to have the same density, effective atomic number (Z_{eff}), and weight as an actual pocket pistol. This item contains the correct metallic mass to generate an alarm in both hand-held and walk-through metal detectors. This training aid is inert and is coated in blue rubber to identify it as safe to handle. This training aid is not considered a firearm in the U.S. but it should be treated with the same respect as a real gun and may be subject to country-specific import requirements.



Export Control: EAR99

Inert NAA .22 Revolver, Assembled

SKU: **TSK0680**

Weight: 5 oz (141 g)

Dimensions: 4.1 in x 2.4 in x 1 in (10.5 cm x 6 cm x 2.5 cm)

The North American Arms (NAA) compact revolver is designed to be used for hand-held (HHMD) and walk-through (WTMD) testing and calibration. The TSK0680 complies with NIJ Standard 0601.02. This item is engineered to have the same density, effective atomic number (Z_{eff}), and weight as an actual NAA mini revolver. It contains the correct metallic mass to generate an alarm in both hand-held and walk-through metal detectors. This training aid is factory inert and is coated in blue rubber to identify it as safe to handle. This training aid is not considered a firearm in the U.S. but should be treated with the same respect as a real gun and may be subject to country-specific import requirements.



Export Control: EAR99

Inert NAA .22 Revolver, Disassembled

SKU: **TSK0690**

Weight: 3.8 oz (108 g)

Dimensions: 4.1 in x 2.4 in x 1 in (10.5 cm x 6 cm x 2.5 cm)

The North American Arms (NAA) compact revolver frame is designed to be used for hand-held (HHMD) and walk-through (WTMD) testing and calibration. The TSK0690 complies with NIJ Standard 0601.02. This item is engineered to have the same density, effective atomic number (Z_{eff}), and weight as an actual NAA mini revolver frame. It contains the correct metallic mass to generate an alarm in both hand-held and walk-through metal detectors. This training aid is factory inert and is coated in blue rubber to identify it as safe to handle. This training aid is not considered a firearm in the U.S. but should be treated with the same respect as a real gun and may be subject to country-specific import requirements.



Export Control: EAR99

Inert 380 Bullets

SKU: **TSK0695**

Weight: 0.3 oz (10 g)

Dimensions: 1 in x 0.4 in x 0.4 in (2.5 cm x 1.00 cm x 1.00 cm)

These inert bullets are X-ray/CT correct and designed to represent standard target ammunition. Each of the five rounds is engineered to have the same density, effective atomic number (Z_{eff}), and weight as the real version. The primer has been expended or removed and the gunpowder removed. Each bullet is inert, identified with a hole drilled through the casing. This training aid is not considered to be ammunition in the U.S. but should be treated with the same respect as a projectile and may be subject to country-specific import requirements.



Export Control: EAR99

Lead Sheet 8'' x 4'' x 1/16''

SKU: **TSK3100**

Weight: 1.4 lb (655 g)

Dimensions: 8.6 in x 4.5 in x 0.5 in (21.8 cm x 11.5 cm x 1.3 cm)

Lead is used to simulate any variety of high-density objects. The resulting image should prompt further inspection. This product contains heavy metals and should not be removed from its outer packaging.



Export Control: EAR99

Fragmentation Sleeve

SKU: **TSK3200**

Weight: 3.4 oz (97 g)

Dimensions: 12 in x 2 in x 0.6 in (30.5 cm x 5.1 cm x 1.5 cm)

Fragmentation (frag) can be added to any explosive device to increase its lethality. This frag sleeve consists of a metal nail matrix that can be added to any explosive simulant. This training aid simulates a visually and X-ray correct metal fragmentation.



Export Control: EAR99

Inert Compact Pistol, Semiautomatic

SKU: **TSK3700**

Weight: 2.1 lb (943 g)

Dimensions: 7.3 in x 5.3 in x 1.6 in (18.5 cm x 13.5 cm x 4 cm)

This firearm training aid is X-ray correct and is designed to accurately represent a compact-sized pistol. It is engineered to have the same density, effective atomic number (Z_{eff}), and weight as an actual compact pistol. This item contains the correct metallic mass to generate an alarm in both hand-held and walk-through metal detectors. Five inert bullets are included in a removable magazine to allow for more training opportunities. This training aid is inert and is coated in blue rubber to identify it as safe to handle. This training aid is not considered a firearm in the U.S. but it should be treated with the same respect as a real gun and may be subject to country-specific import requirements.



Export Control: EAR99

Inert Cell Phone Stun Gun

SKU: **TSK3800**

Weight: 3 oz (87 g)

Dimensions: 5.5 in x 2.6 in x 0.4 in (13.9 cm x 6.7 cm x 1 cm)

This inert training aid simulates a stun gun disguised as a modern cell phone. This item is visually correct and engineered to have the same density and effective atomic number (Z_{eff}) as a real stun gun.



Export Control: EAR99

Inert Pepper Spray

SKU: **TSK3900**

Weight: 1 oz (27 g)

Dimensions: 3.3 in x 1 in x 0.9 in (8.3 cm x 2.5 cm x 2.4 cm)

This inert training aid simulates an easily concealed can of pepper spray (MACE). This item is visually correct and engineered to have the same density and effective atomic number (Z_{eff}) as a real can of pepper spray. It is factory inert and filled with a nontoxic liquid.

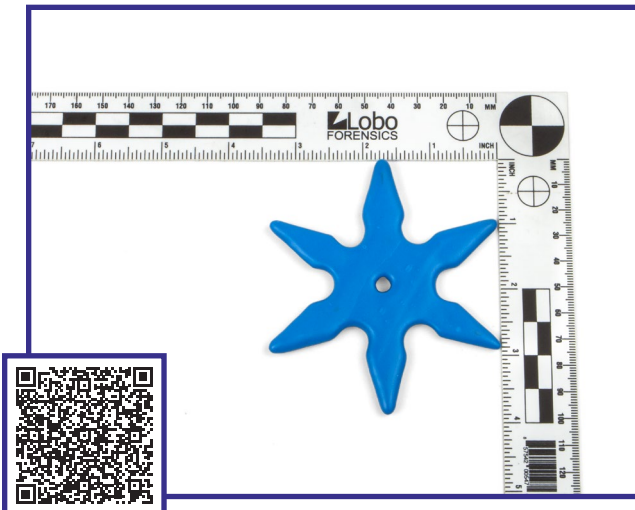

Export Control: EAR99

Inert 6 Point Throwing Star

SKU: **TSK5510**

Weight: 2.2 oz (65 g)

Dimensions: 3.9 in x 3.9 in x 0.3 in (9.8 cm x 9.8 cm x 0.60 cm)

Surprisingly, throwing stars and knives are often discovered during checkpoint screening. This X-ray/CT correct throwing star's six blunted and dulled points are coated in a blue rubber, visually identifying the item as safe to handle. It is engineered to have the same density, effective atomic number (Z_{eff}), and weight as the real version. As possible with real knives, this inert throwing star may or may not alarm in a walk-through metal detector, depending on the sensitivity settings of the unit.



Export Control: EAR99

Inert Brass Knuckles

SKU: **TSK5511**

Weight: 7.2 oz (203.2 g) Dimensions: 4.7 in x 2.9 in x 0.7 in (12 cm x 7.40 cm x 1.7 cm)

Brass knuckles are illegal in many states and countries, making the ability to detect them that much more important. These inert brass knuckles are X-ray/CT correct. Each finger hole has been filled before this inert training aid is coated in blue rubber, which helps to identify it as safe to handle. It is engineered to have the same density, effective atomic number (Z_{eff}), and weight as the real version. Brass knuckles are not always made of brass. Depending on sensitivity and detection settings, this training aid may not alarm in a walk-through or hand-held metal detector. This training aid may be subject to country-specific import requirements.

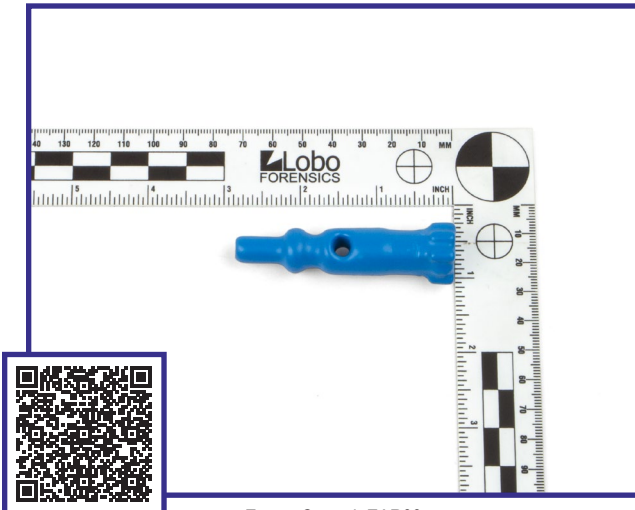

Export Control: EAR99

Inert AR-15 Bolt

SKU: **TSK5512**

Weight: 1.6 oz (47.5 g) Dimensions: 2.9 in x 0.9 in x 0.9 in (7.20 cm x 2.20 cm x 2.20 cm)

This inert firearm component training aid is X-ray/CT correct and is designed to accurately represent an AR-15 rifle bolt. It is engineered to have the same density, effective atomic number (Z_{eff}), and weight as an actual AR-15 bolt. This item contains the correct metallic mass to generate an alarm in both hand-held and walk-through metal detectors. This training aid is inert and is coated in blue rubber to identify it as safe to handle. This training aid is considered a gun part in the U.S. and may be subject to country-specific import requirements.



Export Control: EAR99

Inert AR-15 Bolt Carrier Group

SKU: **TSK5513**

Weight: 12.3 oz (347.7 g) Dimensions: 7.7 in x 1 in x 1.4 in (19.5 cm x 2.5 cm x 3.5 cm)

This inert firearm component training aid is X-ray/CT correct and is designed to accurately represent an AR-15 rifle bolt carrier group. It is engineered to have the same density, effective atomic number (Z_{eff}), and weight as an actual AR-15 bolt carrier group. This item contains the correct metallic mass to generate an alarm in both hand-held and walk-through metal detectors. This training aid is inert and is coated in blue rubber to identify it as safe to handle. It is considered a gun part in the U.S. and may be subject to country-specific import requirements.

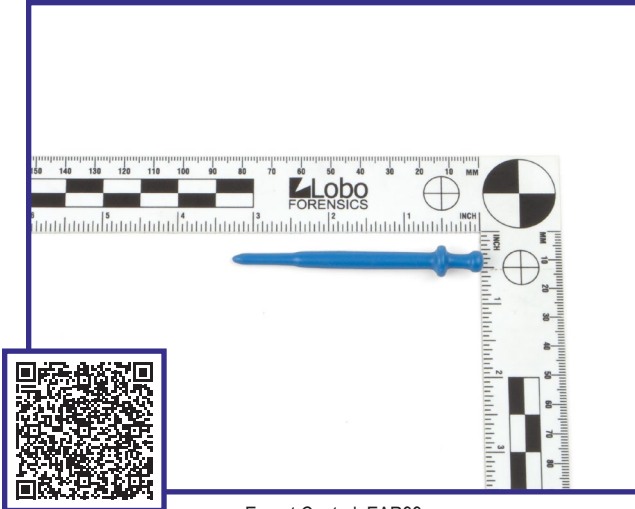

Export Control: EAR99

Inert AR-15 Firing Pin

SKU: **TSK5514**

Weight: 0.3 oz (9.2 g)

Dimensions: 3.3 in x 0.5 in x 0.5 in (8.5 cm x 1.20 cm x 1.20 cm)

This inert firearm component training aid is X-ray/CT correct and is designed to accurately represent an AR-15 rifle firing pin. It is engineered to have the same density, effective atomic number (Z_{eff}), and weight as an actual AR-15 firing pin. This item contains the correct metallic mass to generate an alarm in both hand-held and walk-through metal detectors. To identify it as inert and safe to handle, this training aid is coated in a blue rubber. This is considered a gun part in the U.S. and may be subject to country-specific import requirements.



Export Control: EAR99

Inert Pistol Slide Group

SKU: **TSK5515**

Weight: 1.1 lb (480 g)

Dimensions: 6.9 in x 1.2 in x 1.3 in (17.5 cm x 3 cm x 3.20 cm)

This inert firearm component training aid is X-ray/CT correct and is designed to accurately represent a pistol slide group, including a barrel (4 inch), spring, slide, and internal components. It is engineered to have the same density, effective atomic number (Z_{eff}), and weight as an actual compact pistol upper. This item contains the correct metallic mass to generate an alarm in both hand-held and walk-through metal detectors. To identify it as inert and safe to handle, this training aid is coated in a blue rubber. These are considered gun parts in the U.S. and may be subject to country-specific import requirements.



Export Control: EAR99

Inert Pistol Frame

SKU: **TSK5516**

Weight: 5.3 oz (150 g)

Dimensions: 7.3 in x 4.5 in x 1.4 in (18.5 cm x 11.5 cm x 3.5 cm)

This inert firearm component training aid is X-ray/CT correct and is designed to accurately represent a polymer pistol frame. It is engineered to have the same density, effective atomic number (Z_{eff}), and weight as an actual compact pistol lower. To identify it as inert and safe to handle, this training aid is coated in a blue rubber. This is considered a gun part in the U.S. and may be subject to country-specific import requirements.



Export Control: EAR99

X-Ray Interpretation Reference Guide

SKU: **CBT1129**

Weight: 3.80 lb (1.7 kg)

Dimensions: 11.8 in x 11.4 in x 3.1 in (30 cm x 29 cm x 8 cm)

This guide is designed to assist the student with X-ray interpretation. It includes the identification of various Improvised Explosive Device (IED) components, such as batteries, initiators, explosives, and switches. It also includes the identification of prohibited items, such as knives, guns, cameras, cell phones, and liquids. This guide contains over 200 X-ray images of many different threat types an X-ray operator can encounter at a checkpoint. All the images are X-ray correct and are true depictions of threat items. The guidebook is broken down into 7 categories: Knives and Edged Weapons, Guns and Firearms, Tasers and Mace, Explosives, IEDs, IED components, and Concealed IEDs.



Export Control: EAR99

Explosives Poster

SKU: **EPS1003**

Weight: 3.5 oz (100 g)

Dimensions: 24 in x 36 in (61 cm x 91.4 cm)

This poster displays many different types of commercial explosives manufactured by Dyno Nobel. The poster will help your staff familiarize themselves with what these explosives look like. Our posters are printed with fade-resistant UV ink on a durable, 13 oz. vinyl, tarp-like material. Four grommets and a welded hem provide added strength and durability, ensuring it will hold up to years of training in even an unforgiving environment.



Export Control: EAR99

Pipe Bombs with X-Ray Poster

SKU: **EPS1006**

Weight: 3.5 oz (100 g)

Dimensions: 24 in x 36 in (61 cm x 91.4 cm)

This poster displays many different types of pipe bombs that could potentially be encountered at a checkpoint. The poster also includes an X-ray image of each pipe bomb to allow security staff to familiarize themselves with this type of threat. Our posters are printed with fade-resistant UV ink on a durable, 13 oz. vinyl, tarp-like material. Four grommets and a welded hem provide added strength and durability, ensuring it will hold up to years of training in even an unforgiving environment.

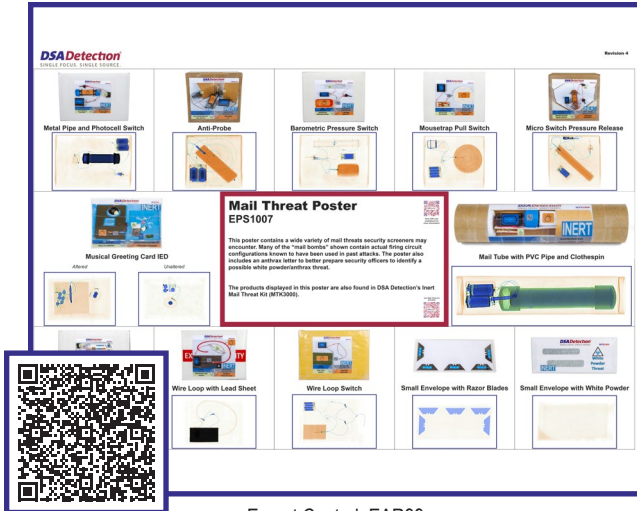

Export Control: EAR99

Mail Threat with X-Ray Poster

SKU: **EPS1007**

Weight: 3.5 oz (100 g)

Dimensions: 24 in x 36 in (61 cm x 91.4 cm)

This poster displays many different types of mail threats that could potentially be encountered at a checkpoint. The poster also includes an X-ray image of each device to allow security staff to familiarize themselves with this type of threat. Our posters are printed with fade-resistant UV ink on a durable, 13 oz. vinyl, tarp-like material. Four grommets and a welded hem provide added strength and durability, ensuring it will hold up to years of training in even an unforgiving environment.



Export Control: EAR99

Guns and Knives X-Ray Poster

SKU: **EPS1008**

Weight: 3.5 oz (100 g)

Dimensions: 24 in x 36 in (61 cm x 91.4 cm)

This poster displays many different types of firearms and ammunition that could potentially be encountered at a checkpoint. The poster also includes an X-ray image of each weapon to allow security staff to familiarize themselves with this type of threat. Our posters are printed with fade-resistant UV ink on a durable, 13 oz. vinyl, tarp-like material. Four grommets and a welded hem provide added strength and durability, ensuring it will hold up to years of training in even an unforgiving environment.

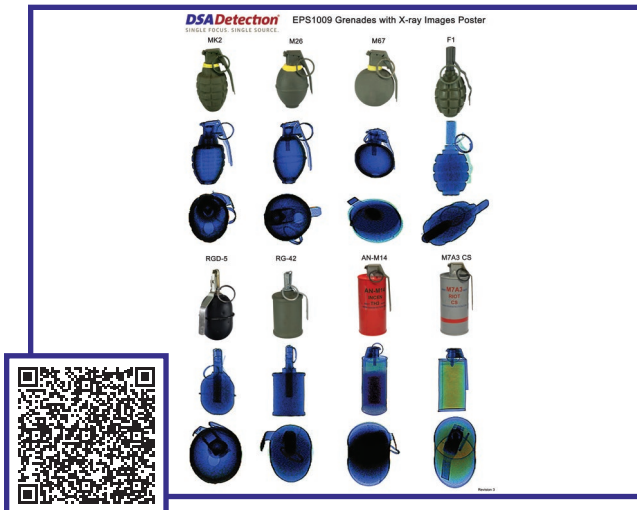

Export Control: EAR99

Grenades Poster

SKU: **EPS1009**

Weight: 3.5 oz (100 g)

Dimensions: 24 in x 36 in (61 cm x 91.4 cm)

This poster displays many different types of hand grenades. The poster also includes an X-ray correct image of each grenade to allow security staff to familiarize themselves with this type of threat. Our posters are printed with fade-resistant UV ink on a durable, 13 oz. vinyl, tarp-like material. Four grommets and a welded hem provide added strength and durability, ensuring it will hold up to years of training in even an unforgiving environment.

Concealed IED Poster

SKU: **EPS1010**

Weight: 3.5 oz (100 g)

Dimensions: 24 in x 36 in (61 cm x 91.4 cm)

This poster displays many different types of IEDs concealed in common, everyday items that could potentially be encountered at a checkpoint. The poster also includes an X-ray image of each concealed IED. The poster will help your staff familiarize themselves with what these threats look like in an X-ray. Our posters are printed with fade-resistant UV ink on a durable, 13 oz. vinyl, tarp-like material. Four grommets and a welded hem provide added strength and durability, ensuring it will hold up to years of training in even an unforgiving environment.



Export Control: EAR99

P.I.E.S. Threat Identification Poster

SKU: **EPS1011**

Weight: 3.5 oz (100 g)

Dimensions: 24 in x 36 in (61 cm x 91.4 cm)

This poster displays different identifying characteristics of an IED, including the Power source, Initiator, Explosive, and Switch. The poster also includes X-ray images of each component. Our posters are printed with fade-resistant UV ink on a durable, 13 oz. vinyl, tarp-like material. Four grommets and a welded hem provide added strength and durability, ensuring it will hold up to years of training in even an unforgiving environment.



Export Control: EAR99

Explosives X-Ray Texture Poster

SKU: **EPS1012**

Weight: 3.5 oz (100 g)

Dimensions: 24 in x 36 in (61 cm x 91.4 cm)

This poster displays the X-ray textures of many different types of explosives. This poster will help your staff familiarize themselves with the appearance of these explosives. Our posters are printed with fade-resistant UV ink on a durable, 13 oz. vinyl, tarp-like material. Four grommets and a welded hem provide added strength and durability, ensuring it will hold up to years of training in even an unforgiving environment.

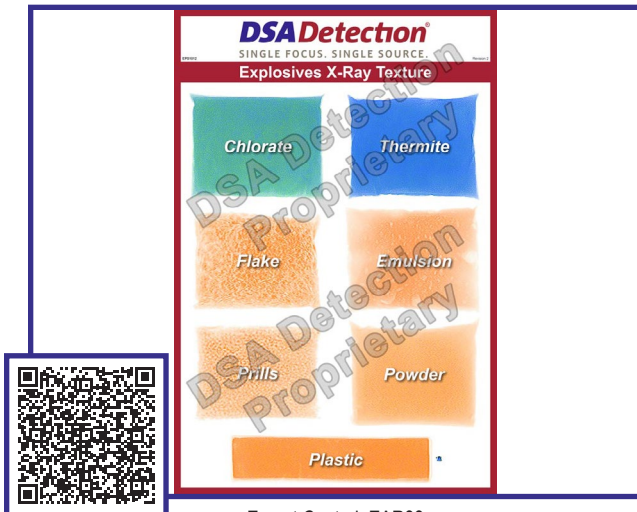

Export Control: EAR99



Export Control: EAR99

Ammunition Identification Poster

SKU: **EPS1013**

Weight: 3.5 oz (100 g)

Dimensions: 24 in x 36 in (61 cm x 91.4 cm)

This poster displays different types of ammunition ranging from .17 caliber rimfire to 30mm armor-piercing rounds. Our posters are printed with fade-resistant UV ink on a durable, 13 oz. vinyl, tarp-like material. Four grommets and a welded hem provide added strength and durability, ensuring it will hold up to years of training in even an unforgiving environment.

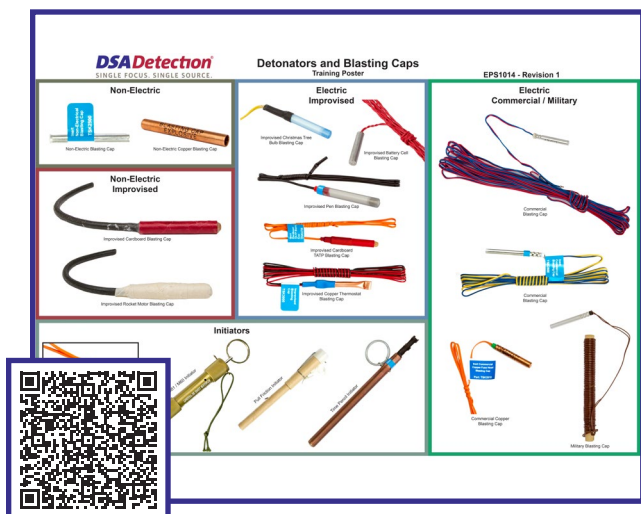

Export Control: EAR99

Detonators and Blasting Caps Poster

SKU: **EPS1014**

Weight: 3.5 oz (100 g)

Dimensions: 24 in x 36 in (61 cm x 91.4 cm)

This poster displays different types of detonators, blasting caps, and initiators. Examples range from military and commercial versions to homemade or improvised detonators. Our posters are printed with fade-resistant UV ink on a durable, 13 oz. vinyl, tarp-like material. Four grommets and a welded hem provide added strength and durability, ensuring it will hold up to years of training in even an unforgiving environment.



Export Control: EAR99

Suspicious Mail Identification Poster

SKU: **EPS1016**

Weight: 3.5 oz (100 g)

Dimensions: 24 in x 36 in (61 cm x 91.4 cm)

This poster displays different identifying characteristics of various mail threats. It was recreated from the popular USPS Suspicious Mail Poster. Our posters are printed with fade-resistant UV ink on a durable, 13 oz. vinyl, tarp-like material. Four grommets and a welded hem provide added strength and durability, ensuring it will hold up to years of training in even an unforgiving environment.



Export Control: EAR99

Threat Backpack X-Ray Poster

SKU: **EPS1017**

Weight: 3.5 oz (100 g)

Dimensions: 24 in x 36 in (61 cm x 91.4 cm)

This poster displays several threats that could potentially be encountered at a checkpoint. This poster will help your staff familiarize themselves with the appearance of these real-world threats. Our posters are printed with fade-resistant UV ink on a durable, 13 oz. vinyl, tarp-like material. Four grommets and a welded hem provide added strength and durability, ensuring it will hold up to years of training in even an unforgiving environment.



Export Control: EAR99

FN SCAR® X-Ray Poster

SKU: **EPS1018**

Weight: 3.5 oz (100 g)

Dimensions: 24 in x 36 in (61 cm x 91.4 cm)

This poster displays a colored (material discrimination) X-ray of an FN SCAR® 17 rifle. The FN SCAR is a common rifle that could be encountered at a checkpoint assembled or disassembled. FN SCAR is a registered trademark of FN America LLC. Our posters are printed with fade-resistant UV ink on a durable, 13 oz. vinyl, tarp-like material. Four grommets and a welded hem provide added strength and durability, ensuring it will hold up to years of training in even an unforgiving environment.



Export Control: EAR99

AR-15 Rifle X-Ray Poster

SKU: **EPS1019**

Weight: 3.5 oz (100 g)

Dimensions: 24 in x 36 in (61 cm x 91.4 cm)

This poster displays pictures and X-rays of a disassembled AR-15 and its components. The AR-15 is a very common rifle that could be encountered at a checkpoint assembled or disassembled. Our posters are printed with fade-resistant UV ink on a durable, 13 oz. vinyl, tarp-like material. Four grommets and a welded hem provide added strength and durability, ensuring it will hold up to years of training in even an unforgiving environment.



Export Control: EAR99

Afghan Pressure Cooker IED Poster

SKU: **EPS1020**

Weight: 3.5 oz (100 g)

Dimensions: 24 in x 36 in (61 cm x 91.4 cm)

This poster displays a black and white X-ray of an Afghan pressure cooker IED. Our posters are printed with fade-resistant UV ink on a durable, 13 oz. vinyl, tarp-like material. Four grommets and a welded hem provide added strength and durability, ensuring it will hold up to years of training in even an unforgiving environment.

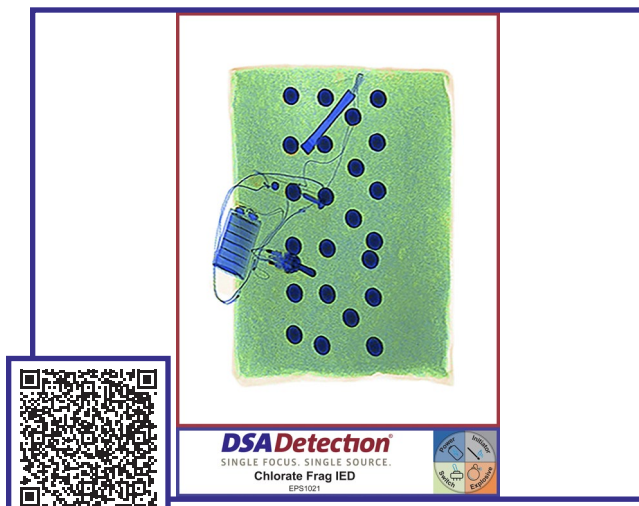

Export Control: EAR99

Chlorate Frag IED X-Ray Poster

SKU: **EPS1021**

Weight: 3.5 oz (100 g)

Dimensions: 24 in x 36 in (61 cm x 91.4 cm)

This poster displays a colored X-ray of a chlorate frag IED. Unlike most explosives, chlorate explosives display green in most material discrimination X-ray systems. Our posters are printed with fade-resistant UV ink on a durable, 13 oz. vinyl, tarp-like material. Four grommets and a welded hem provide added strength and durability, ensuring it will hold up to years of training in even an unforgiving environment.



Export Control: EAR99

Springfield XD-40 Pistol X-Ray Poster

SKU: **EPS1022**

Weight: 3.5 oz (100 g)

Dimensions: 24 in x 36 in (61 cm x 91.4 cm)

This poster displays pictures and X-rays of a disassembled Springfield XD®-40 and its components. This pistol size is very common and may be encountered at a checkpoint assembled or disassembled. XD is a registered trademark of Springfield Armory. Our posters are printed with fade-resistant UV ink on a durable, 13 oz. vinyl, tarp-like material. Four grommets and a welded hem provide added strength and durability, ensuring it will hold up to years of training in even an unforgiving environment.

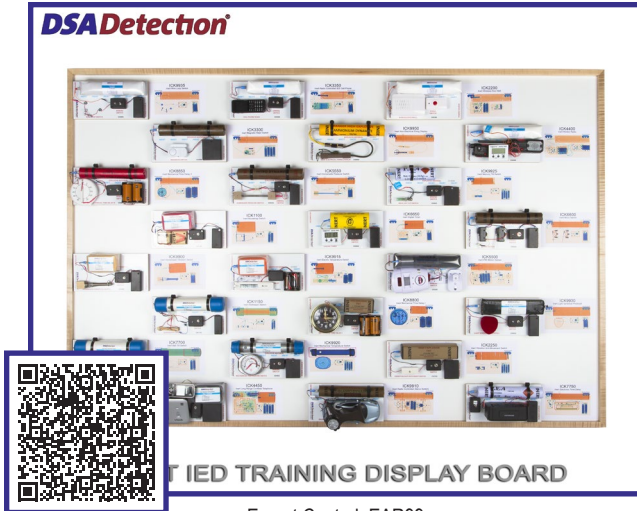

Inert IED Training Display Board

SKU: **TSK1062**

Weight: 135 lb (61.2 kg)

Dimensions: 72 in x 48 in x 5 in (183 cm x 122 cm x 12.7 cm)

The training display board features 24 inert circuit board training aids that represent a wide variety of blasting caps, explosive materials, switches, and power sources. Each inert circuit is configured to mimic a real circuit that could be detonated. The boards are removable from the main display and can be run through an X-ray. All of the IED components are exactly X-ray correct, including the explosive simulants. Weighing 135 pounds and measuring 4ft by 6ft, this display board can only ship via special freight arrangement. Each circuit board on this display is also available as an individual product or as part of a kit complete with a carrying case.



DSA Detection Training

Education should be provided only by the most knowledgeable instructors, encompassing a variety of teaching methods to provide informative content. DSA's checkpoint security instructors are relied upon to provide the right training to homeland security's best terrorism defense officers. Simply stated, DSA's training breaks down how the screening technology detects threats, coupled with clearly-explained operational knowledge of checkpoint screening best practices. DSA's instructors possess equipment manufacturer certifications and decades of security screening experience.

DSA Detection's subject matter experts will teach anywhere in the world or host courses at the DSA Detection training center near Boston, Massachusetts. Training sessions begin with checkpoint facility surveys and instrument assessments. Class sizes are limited to small sessions to allow for effective teacher-student ratios. Students will learn using DSA's accurate replications of threats and obtain first-hand experience identifying them in scenarios of varying difficulties. Our trainers will demonstrate the technical attributes of every type of threat and provide equipment setting recommendations tailored to any facility's prohibited items.

DSA Detection offers several courses designed to train security officers in a variety of fields, and can design a customized course to suit your requirements.

Visit dsadetection.com/dsa-training.html to see our course list or for more information.

Feel free to contact DSA Detection with any questions about our training program.



**120 Water Street; Suite 211
North Andover, Massachusetts, 01845
Phone: 978.975.3200
www.dsadetection.com**

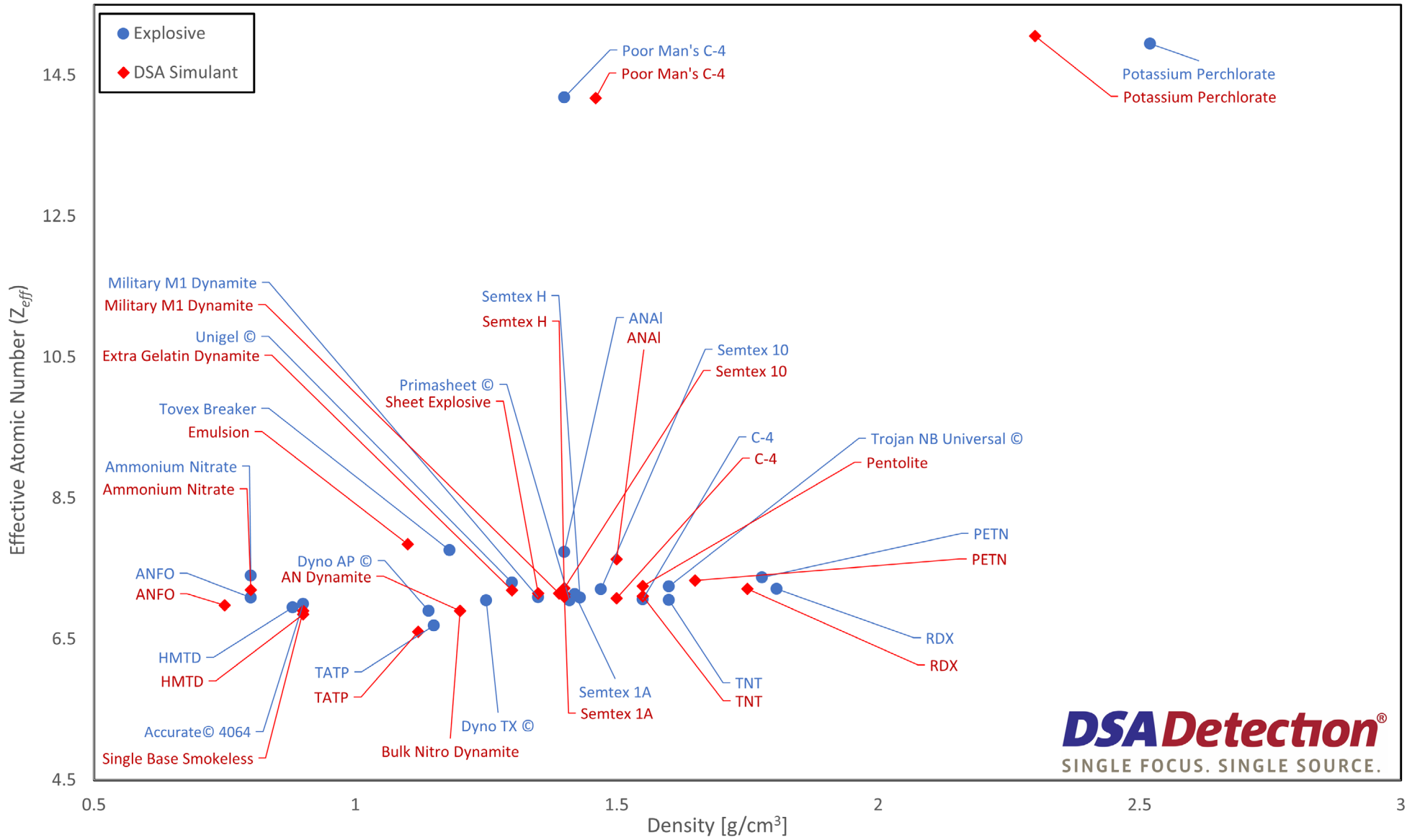

DSA Detection[®]
SINGLE FOCUS. SINGLE SOURCE.