



Tarifa de Precios 2019 Tabela de Preços 2019





Novedades 2019 Novidades 2019

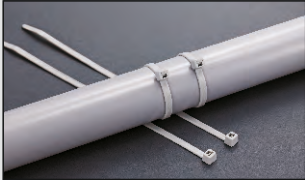

Bridas y Tacos Grises

¡Nos lo habíais pedido... y aquí lo traemos! Bridas y Tacos en color gris, con las mismas propiedades que nuestras fijaciones estándar. La tonalidad de Gris (RAL 7035) las hace perfectas para fijar el típico tubo rígido gris (RAL7035) usado en las instalaciones eléctricas industriales. ¡Pide Muestras GRATIS a nuestro Equipo Comercial!

Abraçadeiras e Tacos de fixação cinzentos

Abraçadeiras e Tacos em cor cinzenta, com as mesmas propriedades que nossas fixações standard. A tonalidade de Cinza (RAL 7035) torna-as perfeitas para fixar o típico tubo rígido cinzento (RAL 7035) usado nas instalações elétricas industriais. Peça já amostras GRÁTIS á nossa Equipa Comercial!

Pág. 6 y 8



Bases para Bridas con Máquina de Clavar Serie KR10CL

Si usas máquina de clavar en tus instalaciones eléctricas, ahora te damos la solución, usa nuestras bases KR10CL «... y solucionado». Dos colores Negro y Gris (RAL7035) y para bridas de ancho max de 10mm. Compatible con la gran mayoría de pistolas del mercado.

Bases para Fixar com perno de aço Série KR10CL

Se usa bases para fixar com perno de aço nas suas instalações elétricas, agora damos-lhe a solução: use nossas bases KR10CL «... e resolvido». Disponível em duas cores - Preto e Cinzento (RAL7035) - e para abraçadeiras de largura máx de 10mm. Compatível com a grande maioria de pistolas do mercado.

Pág. 8

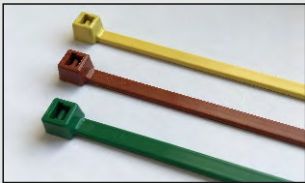

Bridas Detectables de Colores

Las necesidades de la Industria Alimentaria y Farmacéutica crecen día tras día. Por ello, os presentamos nuestras Bridas Detectables, ahora en colores amarillo, rojo y verde. En dimensiones 390 x 4,6 y con la misma calidad de nuestros productos detectables.

Abraçadeiras de cor detetáveis

As necessidades da Indústria Alimentar e Farmacêutica crescem dia após dia. Por isso, apresentamos-lhe nossas Abraçadeiras Detetáveis, agora nas cores amarela, vermelha e verde. Nas dimensões 390 x 4,6 e com a mesma qualidade de nossos produtos detetáveis.

Pág. 9



Capuchones Termorretráctiles

Los Capuchones Termorretráctiles, son generalmente utilizados para el sellado de los finales de cables. Aplicación típica para evitar el deterior de estos cables en el transporte y/o hasta el momento de su uso. Su alto grado de contracción disminuye el número de medidas a usar.

Capacetes Termorretrácteis

Os Capacetes Termorretrácteis, são geralmente utilizados para selagem das extremidades dos cabos. Aplicação típica para evitar a deterioração desses cabos no transporte e/ou até o momento de seu uso. O seu alto grau de contração permite cobrir mais diâmetros com menos medidas.

Pág. 13



Formas Termorretráctiles

Formas Termorretráctiles son el producto ideal para el aislamiento y la protección en derivaciones de cables tanto en interior como exterior. Estas formas permiten ahorrar tiempo, aislar y facilitar la bifurcación del cable principal a cables individuales.

Formas Termorretrácteis

Formas Termorretrácteis são o produto ideal para o isolamento e a proteção nas derivações de cabos tanto no interior como exterior. Estas formas permitem poupar tempo, isolar e facilitar a bifurcação do cabo principal a cabos individuais.

Pág. 14



Servicio de Impresión PrintShop

¿Necesitas imprimir Etiquetas, Placas o Termo para tus Instalaciones? ¿No funciona tu impresora? ¿Te has quedado sin consumibles? Indicanos qué necesitas imprimir y recibe tus impresiones en tiempo exprés gracias a nuestro Servicio PrintShop.

Serviço de Impressão PrintShop

Necessita imprimir Etiquetas, Placas ou Termo para as suas Instalações? A sua impressora não funciona? Ficou sem consumíveis? Indique-nos que necessita imprimir e receba as suas impressões em tempo "express" graças ao nosso Serviço PrintShop.

Pág. 33, 34



Novedades



1 Bridas y Sistemas de Fijación Abraçadeiras e Sistemas de Fixação 5 - 11

1.1. Bridas y Sistemas de Fijación Abraçadeiras e Sistemas de Fixação	5
1.2. Bases y Clips de Fijación Bases e Clips de Fixação	8
1.3. Productos para Industria Alimentaria Produtos para Indústria Alimentar	9
1.4. Familia Q-Tie Familia Q-Tie	11



2 Aislamiento Isolamento 12 - 14

2.1. Tubos Termorretráctiles Tubos Termorretrácteis	12
2.2. Manguitos Mangas	13
2.3. Manguitos Elásticos (No Termorretráctiles) Mangas Elásticas Não Termorretrácteis	14
2.4. Herramientas Ferramentas	14



3 Sistemas de Protección para Cables Sistemas de Proteção de Cabos 15 - 21

3.1. Tubo Corrugado y Racores Tubo Corrugado e Bucins	15
3.2. Organizadores de Cables Organizador de Cabos	15
3.3. Fundas Fitas e Mangas	16
3.4. Pasamuros y Perfiles Passa Fios e Perfis	16
3.5. Canales Ranurados y Accesorios Calha com Rasgos e Acessórios	18
3.6. Canales de Instalación y Accesorios Calhas de Instalação e Acessórios	19



4 Componentes para la Instalación Componentes para Instalação 22 - 24

4.1. Cinta Aislante Fita Isolante	22
4.2. Cintas Técnicas No Aislantes Fitas Técnicas Não Isolantes	22
4.3. Conectores Ligadores	22
4.4. Protectores de Focos Proteção de Focos	23
4.5. Lubricante para Guía de Cables Lubrificante para Guia de Cabos	23
4.6. RELICON: Empalmes en Resina y Gel RELICON: Juntas em Resina e Gel	24



5 Sistemas de Identificación Sistemas de identificação 25 - 34

5.1. Tubos y Placas de Impresión Tubos e Placas de Impressão	25
5.2. Señalizadores Marcadores de Cabo	27
5.3. Etiquetas Etiquetas	30
5.4. Sistema de Impresión en Acero Inoxidable Sistema de Impressão de Aço Inoxidável	32
5.5. Impresoras y Accesorios Impressoras e Acessórios	32
5.6. Servicio de Impresión Personalizado PrintShop Serviço de Impressão Personalizado Printshop	34



6 Sistemas de Banda Ancha Sistemas de Banda Larga 35 - 40

6.1. Bandejas Cassetes	35
6.2. Cajas de Empalme Caixas de Juntas	35
6.3. Cajas de Fibra Caixas de Fibra	40



7 HellerBRICO HellerBRICO 41 - 45



8 Condiciones Generales de Venta Condições Gerais de Venda 46

Fijaciones: Guía de Materiales
 Fixações: Guia de Materiais

Muy / Muito Alta
 Temperatura



Alta
 Temperatura



Temperatura
 Moderada

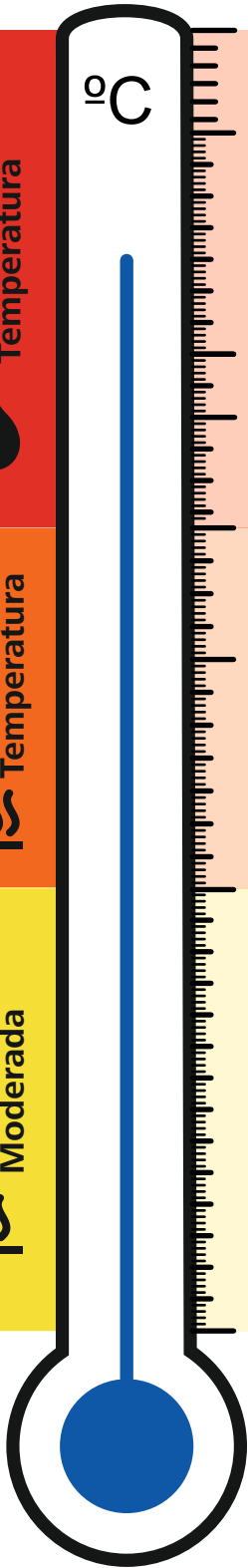

Material	Temperatura (°C)	Propiedades
SS	-80°C a +538°C	Acero Inoxidable, Abrasión, Alta Resistencia Rayos UV, Detección Magnética, Resiste Químicos, Resiste Alta Tensión, Resistente Condiciones Atmosféricas
PEEK	-55°C a +240°C	Abrasión, Alta Resistencia Rayos UV, Resiste Radiaciones, Resiste muy Bajas Temperaturas, Flotabilidad, Resistente Alto Impacto, Resistente al Fuego, Resiste muy Altas Temperaturas
E/TFE	-80°C a +170°C	Resiste muy Bajas Temperaturas, Flotabilidad, Resistente Alto Impacto, Resistente al Fuego, Resiste muy Altas Temperaturas
PA4.6	-40°C a +150°C	Flotabilidad, Resistente Alto Impacto
PP	-40°C a +115°C	Resiste muy Bajas Temperaturas, Flotabilidad, Resistente Alto Impacto
PP MC (Metal Content)	-40°C a +115°C	Detección Magnética
PA66HS	-40°C a +105°C	Flotabilidad, Resistente Alto Impacto
PA66HIRHS	-40°C a +105°C	Flotabilidad, Resistente Alto Impacto, Resiste muy Altas Temperaturas
PA66	-40°C a +85°C	Flotabilidad
PA66 W	-40°C a +85°C	Alta Resistencia Rayos UV, Resistente Condiciones Atmosféricas, Flotabilidad
PA66 VO	-40°C a +85°C	Resiste Químicos, Flotabilidad
PA66 HIR	-40°C a +85°C	Resistente Alto Impacto, Flotabilidad
PA66MC (Metal Content)	-40°C a +85°C	Detección Magnética
PA11	-40°C a +85°C	Resistente Alto Impacto, Resiste muy Bajas Temperaturas, Flotabilidad, Resistente al Fuego, Resiste muy Altas Temperaturas

Legenda / Legenda



Acero Inoxidable
 Aço Inoxidável



Abrasión
 Abrasão



Alta Resistencia Rayos UV
 Alta Resistência a Raios UV



Detección Magnética
 Deteção Magnética



Resiste Químicos
 Resistente a Químicos



Resiste Alta Tensión
 Resistente a Alta Tensão



Resistente Condiciones Atmosféricas
 Resistente às Condições Atmosféricas



Resistente Radiaciones
 Resistente a Radiações



Bioplástico
 Bioplástico



Resiste muy Bajas Temperaturas
 Resistente a Baixa Temperatura



Flotabilidad
 Flutuabilidade



Resistente Alto Impacto
 Resistente ao Impacto



Resistente al Fuego
 Resistente ao Fogo



Resiste muy Altas Temperaturas
 Resistente a Alta Temperatura

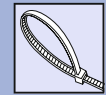

1.1. Bridas y Sistemas de Fijación / Abraçadeiras e Sistemas de Fixação

Bridas Estándar / Abraçadeiras Standard

TIPO	L	W	Caja / Caixa (Uds.)	Bolsa (Uds.)	Ref Herram. Ref Ferram.	Código		€/ 100 Uds.
						Natural	Negro / Preto	
T18S	83	2,3	50.000	1.000	1 - 4, 9 - 10	111-02809	-	1,31
T18R	100	2,5	32.000	100	1 - 4, 9 - 10	111-01919	111-01910	1,48
T18I	145	2,5	25.000	100	1 - 4, 9 - 10	111-02319	Tipo "W"	3,74
T18L	205	2,5	20.000	100	1 - 4, 9 - 10	111-02119	111-02110	3,83
T25L	240	2,8	12.000	100	1 - 4, 9 - 10	111-02519	Tipo "W"	5,88
T30R	150	3,5	12.000	100	1 - 4, 9 - 10	111-03219	111-03210	3,44
T30L	190	3,5	12.000	100	1 - 4, 9 - 10	111-03419	111-03410	4,73
T30LL	290	3,5	7.000	100	1 - 4, 9 - 10	111-03529	111-03500	7,31
T40R	175	4	10.000	100	1 - 5, 9 - 10	111-03819	111-03970	5,01
T50S	150	4,6	8.000	100	1 - 5, 9 - 10	111-05819	111-05810	4,88
T50R	200	4,6	6.000	100	1 - 5, 9 - 10	111-05013	111-05000	4,70
T50M	245	4,6	6.000	100	1 - 5, 9 - 10	111-06201	Tipo "W"	5,87
LK2A	270	4,6	6.000	100	1 - 5, 9 - 10	111-60119	111-60110	8,43
	270	4,6	6.000	100	1 - 5, 9 - 10	111-01203-01	111-01204-01	8,43
T50I	300	4,6	5.000	100	1 - 5, 9 - 10	111-05219	111-05210	9,37
T50L	390	4,6	4.000	100	1 - 5, 9 - 10	111-05409	111-05400	9,95
T80R	210	4,7	7.000	100	1 - 5, 9 - 10	111-05019	111-08010	4,46
T80I	300	4,7	5.000	100	1 - 5, 9 - 10	111-08229	111-08250	8,57
T80L	390	4,7	4.000	100	1 - 5, 9 - 10	111-05419	111-00388	8,93
T120S	225	7,6	2.000	50	2, 6 - 8, 11 - 12	111-12829	Tipo "W"	27,68
T120I	300	7,6	2.000	100	2, 6 - 8, 11 - 12	111-12219	Tipo "W"	16,98
T150R	365	7,6	2.000	100	2, 6 - 8, 11 - 12	111-14819	111-15050	16,65
T120R (E)	380	7,6	2.000	100	2, 6 - 8, 11 - 12	111-12019	111-12010	17,81
T120M	460	7,6	1.500	100	2, 6 - 8, 11 - 12	111-12619	111-12610	34,46
T120XM	600	7,6	500	50	2, 6 - 8, 11 - 12	111-12704	111-12701	40,57
T120L	760	7,6	1.000	50	2, 6 - 8, 11 - 12	111-12429	Tipo "W"	46,70
T150M	530	8,9	1.000	25	2, 6 - 8, 11 - 12	111-15619	Tipo "W"	73,28
T150XL	1095	8,9	500	25	2, 6 - 8, 11 - 12	111-15519	Tipo "W"	108,09
LK5	535	13,2	600	50	2, 6 - 8, 11 - 12	111-60519	111-60510	66,51

Material: PA6.6 UL94V2 (-40°C a +85°C). Color / Cor: ●●

Bridas Estándar para Uso Externo "W" / Abraçadeiras Standard para Uso no Exterior "W"

TIPO	L	W	Caja / Caixa (Uds.)	Bolsa (Uds.)	Ref Herram. Ref Ferram.	Color / Cor	Código	€/ 100 Uds.
T18RW	100	2,5	32.000	100	1 - 4, 9 - 10	Negro / Preto	111-01960	1,62
T18IW	140	2,5	25.000	100	1 - 4, 9 - 10	Negro / Preto	111-02360	4,28
T18LW	205	2,5	20.000	100	1 - 4, 9 - 10	Negro / Preto	111-02160	4,28
T25LW	240	2,8	12.000	100	1 - 4, 9 - 10	Negro / Preto	111-02560	5,59
T30RW	150	3,5	12.000	100	1 - 4, 9 - 10	Negro / Preto	111-03260	3,87
T30LW	190	3,5	8.000	100	1 - 4, 9 - 10	Negro / Preto	111-03460	5,31
T30LLW	290	3,5	7.000	100	1 - 4, 9 - 10	Negro / Preto	111-03570	8,18
T40RW	175	4	10.000	100	1 - 5, 9 - 10	Negro / Preto	111-03860	4,78
T50SW	150	4,6	8.000	100	1 - 5, 9 - 10	Negro / Preto	111-05860	5,58
T50RW	200	4,6	6.000	100	1 - 5, 9 - 10	Negro / Preto	111-04889	5,16
T50MW	250	4,6	6.000	100	1 - 5, 9 - 10	Negro / Preto	111-06206	6,54
T50IW	300	4,6	5.000	100	1 - 5, 9 - 10	Negro / Preto	111-01258	9,65
T80RW	205	4,7	7.000	100	1 - 5, 9 - 10	Negro / Preto	111-05060	5,11
T80IW	300	4,7	5.000	100	1 - 5, 9 - 10	Negro / Preto	111-08290	9,80
T80LW	385	4,7	4.000	100	1 - 5, 9 - 10	Negro / Preto	111-05460	10,48
T120SW	225	7,6	2.000	50	2, 6 - 8, 11 - 12	Negro / Preto	111-12830	31,32
T120IW	300	7,6	2.000	100	2, 6 - 8, 11 - 12	Negro / Preto	111-12230	23,09
T150RW	365	7,6	2.000	100	2, 6 - 8, 11 - 12	Negro / Preto	111-14860	19,04
T120RW	390	7,6	2.000	100	2, 6 - 8, 11 - 12	Negro / Preto	111-12060	20,25
T120MW	460	7,6	1.500	100	2, 6 - 8, 11 - 12	Negro / Preto	111-12660	39,38
T120LW	760	7,6	1.000	50	2, 6 - 8, 11 - 12	Negro / Preto	111-12430	47,37
T150MW	530	8,9	1.000	25	2, 6 - 8, 11 - 12	Negro / Preto	111-15660	75,73
LK5W	535	13,2	600	50	2, 6 - 8, 11 - 12	Negro / Preto	111-60560	75,99

Material: PA6.6 UL94V2 (-40°C a +85°C). Color / Cor: ●

También fabricamos en muchos otros Materiales / Também fabricamos noutros materiais

Material	Características
HS	PA6.6 Alta temperatura (-40°C a +105°C)
HR	PA4.6 Alta Temperatura (-40°C a +145°C)
VO	PA6.6 Temp (-40°C a +85°C) UL94 V0
TZ	E/TFE Temp (-80°C a +150°C) Autoextinguible V0 Color Azul / Autoextinguível V0 Cor Azul

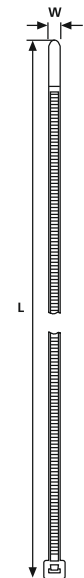
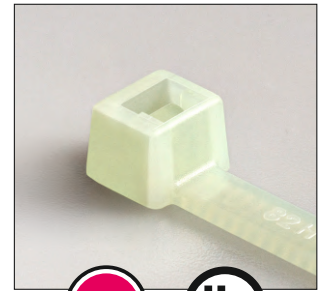

ASTM D6779





Bridas Grises / Abraçadeiras Cor Cinzenta

TIPO	L	W	Caja / Caixa (Uds.)	Bolsa (Uds.)	Ref Herram. Ref Ferram.	Gris / Cinzenta Claro	€/ 100 Uds.
T30R GY	150	3,5	12.000	100	1 - 4, 9 - 10	RAL7035	3,74
T50R GY	200	4,6	6.000	100	1 - 5, 9 - 10	RAL7035	5,90
LK2A GY	270	4,6	6.000	100	1 - 5, 9 - 10	RAL7035	8,93

Material: PA6.6 UL94V2 (-40°C a +85°C). Color / Cor: ● En stock próximamente / Em breve em stock



Bridas Dentado Exterior / Abraçadeiras Dentado Exterior

TIPO	L	W	Caja / Caixa (Uds.)	Bolsa (Uds.)	Ref Herram.	Color / Cor	Código	€/ 100 Uds.
T18ROS	100	2,5	20.000	500	1 - 4, 9 - 10	Negro / Preto	118-04701	3,03
T30ROS	148	3,4	10.000	100	1 - 4, 9 - 10	Negro / Preto	118-04800	5,44
T30LOS	200	3,4	10.000	100	1 - 4, 9 - 10	Negro / Preto	118-04900	6,75
T50SOS	150	4,6	7.000	100	1 - 5, 9 - 10	Negro / Preto	118-05850	7,50
T50ROS	200	4,6	6.000	500	1 - 5, 9 - 10	Negro / Preto	118-05040	7,98
T50LOS	384	4,6	4.000	100	1 - 5, 9 - 10	Negro / Preto	118-05900	13,09
T120ROS	385	7,6	2.000	100	2, 6 - 8, 11 - 12	Negro / Preto	118-00066	28,62

Material: PA6.6. HS Alta Temperatura (-40°C a + 105°C). Color / Cor: ●



Bridas Recuperables SpeedyTie / Abraçadeiras Recuperáveis SpeedyTie

TIPO	L	W	Caja / Caixa (Uds.)	Pack (Uds.)	Ref Herram.	Color / Cor	Código	€/ Pack
RTT750HR YE	750	13	200	25	No	Amarillo / Amarelo	115-00000	29,59
SPEEDYTIE X 2	750	13	60	2	No	Amarillo / Amarelo	914-60149	3,54

Material: PA6.6 UL94V2 (-40°C a +85°C). Color / Cor: ●

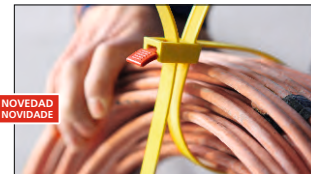

Bridas Recuperables Estándar LR55R / Abraçadeiras Recuperáveis Standard LR55R

TIPO	L	W	Caja / Caixa (Packs.)	Pack (Uds.)	Ref Herram.	Color / Cor	Código	€/ Pack
LR55R	195	4,7	12	25	No	Negro / Preto	914-60130	4,71
LR55R	195	4,7	12	25	No	Natural	914-60135	4,71

Material: PA6.6 UL94V2 (-40°C a +85°C). Color / Cor: ●○

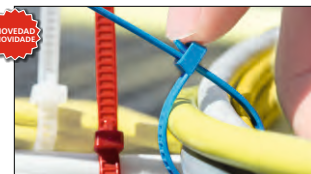

Bridas Textiles / Abraçadeiras Têxteis

TIPO	L	W	Caja / Caixa (Packs)	Pack (Uds.)	Ref Herram. Ref Ferram.	Color / Cor	Código	€/ Pack
TEXTIE S BK	150	12,5	150	10	No / Não	Negro / Preto	130-00012	8,26
TEXTIE M BK	200	12,5	150	10	No / Não	Negro / Preto	130-00013*	9,78
TEXTIE L BK	330	12,5	200	10	No / Não	Negro / Preto	130-00019	11,28
TEXTIE 5M BK	5.000	12,5	120	1 (1x5 Mtrs)	No / Não	Negro / Preto	130-00020	12,78
TEXTIE 25M BK	25.000	12,5	25	1 (1x25 Mtrs)	No / Não	Negro / Preto	130-00022	66,08
TEXTIE 6XC	200	12,5	60	6	No / Não	6 Colores / Cores	914-60140	6,30

Material: PA6.6 UL94V2, Polipropileno (-40°C a +85°C). Color / Cor: ● *Otros colores disponibles / *Outras cores disponíveis: ●●●●○



Bridas de Fijación a Perfil / Abraçadeiras de Fixação a Perfis

TIPO	Brida/Abra. LxW (mm)	Para Esp. (mm)	Caja / Caixa (Uds.)	Bolsa (Uds.)	Ref Herram. Ref Ferram.	Composición Composição	Código	€/ 100 Uds.
T80REC4A	200 x 4,6	1-3	4.000	500	1 - 5, 9 - 10	2 Piezas / Peças	914-90520	31,00
T80REC4B	200 x 4,6	1-3	4.000	500	1 - 5, 9 - 10	2 Piezas / Peças	914-90521	31,00
T80REC5A	200 x 4,6	1-3	3.000	500	1 - 5, 9 - 10	2 Piezas / Peças	914-90525	31,00
T80REC5B	200 x 4,6	1-3	3.000	500	1 - 5, 9 - 10	2 Piezas / Peças	914-90526	31,00

Material: PA6.6. HS Alta Temperatura (-40°C a + 105°C) * Material: PA6.6 W. Color / Cor: ●



Bridas de Panel / Abraçadeiras de Painel

TIPO	Brida/Abra. LxW (mm)	Agujero Furo (mm)	Caja / Caixa (Uds.)	Bolsa (Uds.)	Ref Herram.	Composición Composição	Negro / Preto	€/ 100 Uds.
T18RSF - NA	100 x 2,5	4,6 - 4,8	6.000	100	1 - 4, 9 - 10	1 Ud. (Flecha)	111-85519	8,52
T50SSL5 - NA	135 x 4,6	6,1 - 6,5	7.000	1000	1 - 4, 9 - 10	1 Ud. (Flecha)	111-85339	7,29
T50RFT6 - BK	200 x 4,6	6,4 - 7,1	3.000	500	1 - 5, 9 - 10	2 Uds. (Abeto)	150-77941	10,55
T50RFT8 - BK	200 x 4,6	7,7 - 8,0	4.000	500	1 - 5, 9 - 10	2 Uds. (Abeto)	111-85880	34,95

Material: PA6.6. HS Alta Temperatura (-40°C a + 105°C). Color / Cor: ●○





Bridas ROBUSTO Bio-Material - Abraçadeiras ROBUSTO Bio-Material

TIPO	L	W	Caja / Caixa (Uds.)	Bolsa (Uds.)	Código	€/ 100 Uds.
LPH942	180	9	2.400	100	112-00011	26,89
LPH962	260	9	1.600	100	112-00012	39,47
LPH992	355	9	800	100	112-00013	57,05

Material: PA11 (-40°C a +85°C). Color / Cor: ●



Bridas para Parques Infantiles Serie PE400 / Abraçadeiras para Parques Infantís Série PE400

TIPO	L x W		Caja / Caixa (Uds.)		Bolsa (Uds.)	Código. Herram. Código Ferram.		€/ 100 Uds.
PE400	400 x 9		1.500		100	EVO9 / MK-10 <small>Ver debajo/ Veja abaixo</small>		30,90
Negro Preto	Marrón Castanho	Verde Verde	Azul	Violeta	Rosa	Rojo Vermelho	Naranja Laranja	Amarillo Amarelo
112-00018	112-00019	112-18100	112-18101	112-00021	112-00020	112-18102	112-18105	112-18103

Material: PA66 UL94V2 (-40 °C a +85 °C). Posibilidad en color Natural / Possibilidade em cor natural ●●●●●●●●●●
Ref. Herram./ Ferram: EVO9 / MK-10



Bridas Metálicas Serie MBT / Abraçadeiras Metálicas Série MBT

TIPO (316 / 304)	L x W (mm)	Caja / Caixa (Uds.)	Bolsa (Uds.)	Ref.Herr. Ref.Ferram.	Cod.Mat: SS316	Cod.Mat: SS304	SS316 €/ 100 Uds.	SS314 €/ 100 Uds.
MBT5S / MBT5SS	127 x 4,6	5.000	100	15 - 16	111-93059	111-93058	88,50	75,00
MBT8S / MBT8SS	201 x 4,6	4.000	100	15 - 16	111-93089	111-93088	108,00	80,50
MBT14S / MBT14SS	362 x 4,6	4.000	100	15 - 16	111-93149	111-93148	125,00	94,00
MBT20S / MBT20SS	521 x 4,6	2.000	100	15 - 16	111-93209	111-93208	165,50	129,00
MBT27S / MBT27SS	681 x 4,6	2.000	100	15 - 16	111-93279	111-93278	190,50	139,50
MBT33S / MBT33SS	838 x 4,6	1.000	100	15 - 16	111-93339	111-93338	243,50	185,00
MBT8H / MBT8HS	201 x 7,9	2.000	50	15 - 16	111-94089	111-94088	125,50	119,00
MBT14H / MBT14HS	362 x 7,9	2.000	50	15 - 16	111-94149	111-94148	185,00	150,00
MBT20H / MBT20HS	521 x 7,9	2.000	50	15 - 16	111-94209	111-94208	277,00	164,50
MBT27H / MBT27HS	681 x 7,9	1.000	50	15 - 16	111-94279	111-94278	287,00	195,00
MBT33H / MBT33HS	838 x 7,9	1.000	50	15 - 16	111-94339	111-94338	310,00	246,50
MBT14XH / MBT14XHS	362 x 12,3	1.000	50	15 - 16	111-95149	111-95148	270,00	205,00
MBT20XH / MBT20XHS	521 x 12,3	1.000	50	15 - 16	111-95209	111-95208	340,00	295,00

Material: Acero Inoxidable / Aço inoxidável SS304-SS316 (-80 °C a +538 °C). Color / Cor: ● Otras dimensiones disp./ Outras dimensões disp.

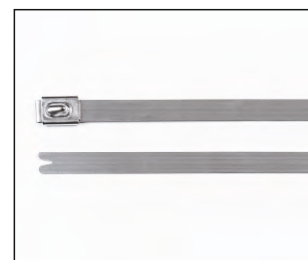

Acero / Aço 316



IEC60092

Bridas Metálicas Recubiertas Serie MBT-FC / Abraçadeiras Metálicas Revestidas Série MBT-FC

TIPO	L	W	Caja / Caixa (Uds.)	Bolsa (Uds.)	Ref.Herr. Ref.Ferram.	Material	Código	€/ 100 Uds.
MBT5SFC	127	4,6	5.000	100	15 - 16	SS316 + SP	111-00288	119,88
MBT8SFC	201	4,6	4.000	100	15 - 16	SS316 + SP	111-00289	139,82
MBT14SFC	362	4,6	4.000	100	15 - 16	SS316 + SP	111-00290	169,00
MBT20SFC	521	4,6	2.000	100	15 - 16	SS316 + SP	111-00291	225,30
MBT27SFC	681	4,6	1.000	100	15 - 16	SS316 + SP	111-00292	245,14
MBT33SFC	838	4,6	1.000	100	15 - 16	SS316 + SP	111-00293	278,05
MBT8HFC	201	7,9	2.000	50	15 - 16	SS316 + SP	111-00294	174,41
MBT14HFC	362	7,9	2.000	50	15 - 16	SS316 + SP	111-00295	230,28
MBT20HFC	521	7,9	1.000	50	15 - 16	SS316 + SP	111-00296	269,00
MBT27HFC	681	7,9	1.000	50	15 - 16	SS316 + SP	111-00297	299,00
MBT33HFC	838	7,9	1.000	50	15 - 16	SS316 + SP	111-00298	338,73
MBT14XHFC	362	12,3	1.000	50	15 - 16	SS316 + SP	111-00299	291,90
MBT20XHFC	521	12,3	1.000	50	15 - 16	SS316 + SP	111-00300	378,09

Material: Acero Inoxidable / Aço inoxidável SS316 (-80 °C a +538 °C). Color / Cor: ● Otras dimensiones disp./ Outras dimensões disp.



Herramientas Manuales para Bridas / Ferramentas Manuais para Abraçadeiras

TIPO	Ref.Herr. Ref.Ferram.	Para Brida / Abraçadeira ancho / larg. (mm)	Uso Tipo	Caja / Caixa	Código	€/ Ud.
MK 20	1	2,5-4,6	Manual	1	110-20006	30,13
MK 21	2	4,6-7,6	Manual	1	110-21016	44,75
MK 3SP	3	2,5-4,8	Manual	1	110-03500	294,32
EVO7	4	2,5-4,8	Manual	1	110-70129	460,00
MK 7HT	5	2,5-4,8	Manual	1	110-07000	525,55
EVO9	7	4,8-13	Manual	1	110-80002	680,00
EVO9HT	8	4,8-13	Manual	1	110-80017	695,00
MK3PNSP2	9	2,5-4,8	Neumática / Pneumática	1	110-03400	1.716,00
MK7PN	10	2,5-4,8	Neumática / Pneumática	1	110-07100	1.716,00
MK9P L	11	4,6-13,5	Neumática / Pneumática	1	110-09100	5.688,00
MK9P U	12	4,6-13,5	Neumática / Pneumática	1	110-09110	5.775,00
KST-STG200	15	Serie MBT	Manual	1	110-09950	430,00
MK 9SST	16	Serie MBT	Manual	1	110-95000	1.125,00



Consultar modelo:
MS90387-1, SAE-AS90387



1.2. Bases y Clips de Fijación / Bases e Clips de Fixação

Bases Adhesivas Serie MB / Bases Adesivas Série MB

TIPO	L	W	Caja / Caixa (Uds.)	Bolsa (Uds.)	Código		€/ 100 Uds.
					Natural	Negro / Preto	
MB3A	19	19	12.000	100	914-60220	914-60304	14,38
MB4A	28	28	5.000	100	914-60221	914-60305	24,71

Material: PA6.6 UL94V2 (-40°C a +85°C). Color / Cor: ●○

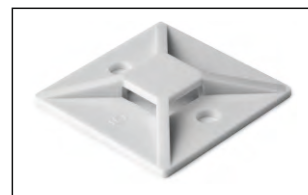

Bases Flexibles con Adhesivo Especial FlexTack / Bases Flexíveis com Adesivo Especial FlexTack

TIPO	L	W	Caja / Caixa (Packs.)	Pack (Uds.)	Código		€/ Pack
					Natural	Negro / Preto	
FMB4APT-I/10	28	28	12	10	914-60302	914-60300	13,44

Material: PA6.6 HS UL94V2 (-40°C a +105°C). Color / Cor: ●○



Bases con Adhesivo Especial SolidTack / Bases com Adesivo Especial SolidTack

TIPO	L	W	Caja / Caixa (Uds.)	Bolsa (Uds.)	Negro / Preto	Blanco / Branco	€/ 100 Uds.
MB4APT-I	28	28	5.000	100	151-01559	151-01560	83,72
MB5APT-I	38	38	2.400	100	151-01561	-	132,33

Material: PA6.6 UL94V2 (-40°C a +85°C). Color / Cor: ●○



Tacos para Brida Serie LOK / Suporte para Abraçadeiras Série LOK

TIPO	L	Taladro / Furo (mm)	Caja / Caixa (Uds.)	Bolsa (Uds.)	Color / Cor	Código	€/ 100 Uds.
TBR-6	34	6,0	5.000	100	Negro / Preto	914-60216	5,66
TBR-8	40	8,0	5.000	100	Negro / Preto	914-60218	5,66
LOK01	44	8,0	5.000	100	Negro / Preto	151-80110*	10,69
LOK01B	30	6,0	6.000	100	Negro / Preto	151-80500	10,69
LOK02	21	5,1	6.000	100	Negro / Preto	151-80210	11,26
TBR-6 GY	34	6,0	5.000	100	Gris / Cinzento Claro	914-60217	5,66
TBR-8 GY	40	8,0	5.000	100	Gris / Cinzento Claro	914-60219	5,66

Material: PA6.6 UL94V2 (-40°C a +85°C) / *PA6HIR (-40°C a +80°C). Color / Cor: ●● Gris/Cinzento RAL7035



Bases para Atornillar / Bases Aparafusáveis

TIPO	L x W	Taladro / Furo (mm)	Caja / Caixa (Uds.)	Bolsa (Uds.)	Color / Cor	Código	€/ 100 Uds.
LKC	25 x 17	5,5	6.000	100	Natural	151-27019	20,25
LKCSF1	40 x 19	6,0	2.000	100	Natural	151-27219	22,69
KR6G5	18 x 12	4,5	3.000	100	Natural	151-24619	14,45
KR8G5	25 x 14,5	6,5	2.000	100	Natural	151-24819	20,01
CL8	27,3 x 12,5	6,5	2.000	100	Natural	151-02258	11,03

Material: PA6.6 UL94V2 (-40°C a +85°C). Color / Cor: ○



Bases para Máquina de Clavo / Bases para fixar com perno de aço

TIPO	L x W	Para Brida / Abraçad. ancho / larg. (mm)	Caja/Caixa (Uds.)	Bolsa (Uds.)	Color / Cor	Código	€/ 100 Uds.
KR10CL-BK	22,5 x 15	10 mm max	2.400	100	Negro/Preto	914-60306	9,90
KR10CL-GY	22,5 x 15	10 mm max	2.400	100	Gris/Cinzento	914-60307	9,90

Material: PA6 UL94V2 (-40°C a +80°C). Color / Cor RAL7035: ●●

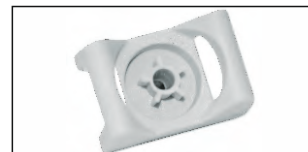

Bases para Atornillar Serie H-P* / Bases Aparafusáveis Série H-P*

TIPO	Ø Apli. (mm)	Taladro Furo (mm)	Caja / Caixa (Uds.)	Bolsa (Uds.)	Código		€/ 100 Uds.
					Negro / Preto	Natural	
H1P	3,2	4,2	6.000 / 15.000	100 / 1.000	211-60000	211-60019	3,27 / 4,13
H2P	5,0	4,2	6.000 / 10.000	100 / 1.000	211-60001	211-60029	3,09 / 3,38

Material: PA6.6 UL94V2 (-40°C a +85°C) *Diferente Embalaje y precio según Color / Embalagem e preço varia por Cor. Color / Cor: ●○
Otras medidas disponibles / Outras medidas disponíveis.



Abrazaderas Ratchet P-Clamp* / Abraçadeiras Ratchet P-Clamp*

TIPO	Ø Apli. Min/Max(mm)	Taladro Furo (mm)	Variante Ángulo / Ângulos	Bolsa (Uds.)	Color / Cor	Código	€/ 100 Uds.
RCA90SM6	6,2 - 13,7	6	90° corto / curto	300	Negro/Preto	151-01643	286,64
RCB90LM8	12,7 - 19,5	8	90° largo / comprido	200	Negro/Preto	151-01460	253,65
RCD90LM8	36 - 51	8	90° largo / comprido	140	Negro/Preto	151-01521	340,21
RCTT			Acc.Tensión / Tensão	100	Negro/Preto	151-01529	55,65

Material: PA66HIRHSUV UL94HB (-40°C a +105°C). Color / Cor: ●
Otras medidas y ángulos disponibles / Outras medidas e ângulos disponíveis.





1.3. Productos para Industria Alimentaria / Produtos para Indústria Alimentar



Bridas Detectables / Abraçadeiras Detectáveis

TIPO	L	W	Caja / Caixa (Uds.)	Bolsa (Uds.)	Ref Herram. Ref Ferram.	Color / Cor	Código	€/ 100 Uds.
MCT18R	100	2,5	25.000	100	1 - 4, 9 -10	Azul	111-01225	9,00
MCT30R	150	3,5	10.000	100	1 - 4, 9 -10	Azul	111-00829	9,81
MCT50R	200	4,6	6.000	100	1 - 5, 9 - 10	Azul	111-00830	13,50
MCTRELK2M (Recuperable / Recuperável)	250	4,6	4.000	100	1 - 5, 9 - 10	Azul	111-00937	21,16
MCT50L	390	4,6	4.000	100	1 - 5, 9 - 10	Azul	111-00831	27,66
MCT120R	380	7,6	2.000	100	2, 6 - 8, 11 - 12	Azul	111-01136	42,36

Material: PA6.6MP / UL94 HB (-40°C a +85°C). Color / Cor: ●



Bridas Detectables en Colores / Abraçadeiras Detetáveis em Cores

TIPO	L x W (mm)	Caja / Caixa (Uds.)	Bolsa (Uds.)	Ref Herram. Ref Ferram.	Color / Cor	Código	€/ 100 Uds.
MCT50L	390 x 4,6	4.000	100	1 - 5, 9 - 10	Amarillo / Amarelo	111-01168	53,70
MCT50L	390 x 4,6	4.000	100	1 - 5, 9 - 10	Rojo / Vermelho	111-01167	53,70
MCT50L	390 x 4,6	4.000	100	1 - 5, 9 - 10	Verde	111-01169	53,70

Material: PA6.6MP + / UL94 HB (-40°C a +85°C). Colores / Cores: ●●●

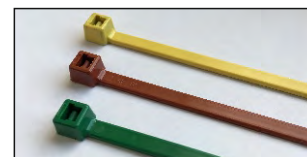

Bridas Detectables en Polipropileno / Abraçadeiras Detetáveis em Polipropileno

TIPO	L	W	Caja / Caixa (Uds.)	Bolsa (Uds.)	Ref Herram. Ref Ferram.	Color / Cor	Código	€/ 100 Uds.
MCTPP18R	100	2,5	25.000	100	1 - 4, 9 -10	Azul	111-01664	12,22
MCTPP30R	150	3,5	10.000	100	1 - 4, 9 -10	Azul	111-01665	15,00
MCTPP50R	200	4,6	6.000	100	1 - 5, 9 - 10	Azul	111-01666	18,06
MCTPP50L	390	4,6	4.000	100	1 - 5, 9 - 10	Azul	111-01667	31,67
MCTPP120R	380	7,6	2.000	100	2, 6 - 8, 11 - 12	Azul	111-01668	41,56

Material: PMP / UL94 HB (-40°C a +115°C). Color / Cor: ●

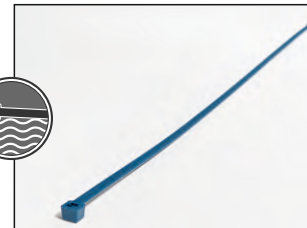

Bridas Metálicas Serie MBT SS316 / Abraçadeiras Metálicas Série MBT SS316

TIPO	L	W	Caja / Caixa (Uds.)	Bolsa (Uds.)	Ref Herram. Ref Ferram.	Código	€/ 100 Uds.
MBT5S	127	4,6	5.000	100	15 - 16	111-93059	88,50
MBT8S	201	4,6	4.000	100	15 - 16	111-93089	108,00
MBT14S	362	4,6	4.000	100	15 - 16	111-93149	125,00
MBT20S	561	4,6	2.000	100	15 - 16	111-93209	165,50

Material: Acero Inoxidable SS316 / Aço inoxidável SS316 (-80 °C a +538 °C). Color / Cor: ●

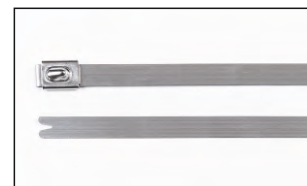

Bases para Atornillar Detectables / Bases Detetáveis Aparafusáveis

TIPO	L	W	Caja / Caixa (Uds.)	Bolsa (Uds.)	"W" Brida / Abra.	Color / Cor	Código	€/ 100 Uds.
MCMB3	19	19	18.000	100	MCT18 / 30	Azul	151-01169	65,27
MCMB4	28	28	5.000	100	MCT50	Azul	151-01170	69,72
MCKR6G5	17,8	11,8	10.000	100	"W" Brida/Abra < 6,4	Azul	151-00950	49,50
MCKR8G5-5	24,8	14,3	2.000	100	"W" Brida/Abra < 8,3	Azul	151-01020	69,50

Material: PA6.6MP / UL94 HB (-40°C a +85°C) * PA6.6MP+ / UL94 HB (-40°C a +85°C). Color / Cor: ●



Funda Helicoidal Detectable / Fita Helicoidal Detetável

TIPO	Ø Int. (mm) nominal	Apli. Ø Min (mm)	Apli. Ø Max. (mm)	Rollo / Rolo Emb (Mts.)	Color / Cor	Código	€/ 100 Mts.
SBPEMC1.5	1,5	1,6	8,0	30	Azul	161-46000	98,65
SBPEMC4	4,0	5,0	20,0	30	Azul	161-46100	174,05
SBPEMC9	9,0	10,0	100,0	30	Azul	161-46200	287,45
SBPEMC16	16,0	20,0	150,0	30	Azul	161-46300	456,05

Material: PEMP / UL94 HB (-60°C a +80°C). Color / Cor: ●



HACCP

Hazard Analysis Critical Control Points

La directiva HACCP (Análisis del Punto de Control de Riesgo), es el método de identificar y eliminar potenciales peligros en la producción o manipulación de alimentos. O HACCP é o sistema internacionalmente aceite e documentado pelo Codex Alimentarius, que define os requisitos para o controlo eficaz da segurança alimentar



Helawrap Organizador de Cables Detectable / Helawrap Organizador de Cabos Detetável

TIPO	Ø Int. (mm) nominal	Apli. Ø Max (mm)	Caja (Rollos) Caixa (Rollos)	Rollo / Rolo Emb (Mts.)	Color / Cor	Código	€/ 100 Mts.
HWPPMC8	8,0	9,0	1 + Herr./ Ferr.	25	Azul	161-66000	353,85
HWPPMC16	16,0	16,0	1 + Herr./ Ferr.	25	Azul	161-66100	462,65
HWPPMC20	20,0	21,0	1 + Herr./ Ferr.	25	Azul	161-66200	695,60
HWPPMC25	25,0	27,0	1 + Herr./ Ferr.	25	Azul	161-66300	809,75
HWPPMC30	30,0	32,0	1 + Herr./ Ferr.	25	Azul	161-66400	1.137,80

Material: PPMP / UL94 HB (-60°C a +100°C). Color / Cor: ●



Tubo Plástico para Industria Alimentaria / Tubo Plástico para Industria Alimentar

TIPO	Ø Exterior (mm)	Ø Interior (mm)	Material	Color / Cor	Rollo / Rolo	Código	€/ Mt
PSRSC16	17,8	12,0	PVC	Gris / Cinzento	30	166-40302	5,45
PSRSC20	21,1	16,0	PVC	Gris / Cinzento	30	166-40303	5,67
PSRSC25	26,4	21,0	PVC	Gris / Cinzento	30	166-40304	7,26
PSRSC32	33,1	26,5	PVC	Gris / Cinzento	30	166-40305	9,32
PSRSC40	41,8	35,4	PVC	Gris / Cinzento	30	166-40306	11,17
PSRSC50	47,9	40,0	PVC	Gris / Cinzento	30	166-40307	13,48
PSRSC63	59,7	51,3	PVC	Gris / Cinzento	30	166-40308	19,48

Material: PVC IP68 (-5°C a +70 °C). Color / Cor: ●



Racores para Ind. Alimentaria IP69K / Bucins para Ind. Alimentar IP69K

TIPO	Para Tubo	Rosca	Material*	Color / Cor	Emb. (Uds)	Código	€/ Ud
PSRSC16-FMCFSS-M16	PSRSC16	M16	AC SS316	Metal	1	166-41601	50,65
PSRSC20-FMCFSS-M20	PSRSC20	M20	AC SS316	Metal	1	166-41602	61,37
PSRSC25-FMCFSS-M25	PSRSC25	M25	AC SS316	Metal	1	166-41603	82,66
PSRSC32-FMCFSS-M32	PSRSC32	M32	AC SS316	Metal	1	166-41604	119,52
PSRSC40-FMCFSS-M40	PSRSC40	M40	AC SS316	Metal	1	166-41605	150,3
PSRSC63-FMCFSS-M63	PSRSC63	M63	AC SS316	Metal	1	166-41607	275,44

Material: Acero Inoxidable / Aço inoxidável SS316, NPB, PA6 (-50 °C a +135 °C). Color / Cor: ●



Placas de Identificación Detectables / Placas Identificação Detetáveis

TIPO	L	W	Uds. x Rollo / Rolo	Caja / Caixa (Nº Rollos / Rolos)	Código	€/ Rollo / Rolo
TTAGMC11BEX65S	65,0	11,0	190	5	556-26500	113,80
TTAGMC11BEX100S	100,0	11,0	120	5	556-26501	113,80
TTAGMC15BEX65S	65,0	15,0	190	4	556-26502	127,50
TTAGMC15BEX100S	100,0	15,0	120	4	556-26503	127,50

Material: POX, MET(-40°C a +85°C). Color / Cor: ●



printshop Servicio de Impresión
Serviço de Impressão

Placas Impresas de Acero Inoxidable / Placas Impressas Aço Inoxidável

TIPO	L	W	Placas x Pack	Código	€/ 100 Unidades
MBML10X45 Printed	45,0	10,0	1.000	544-80101-00	185,00
MBML10X90 Printed	90,0	10,0	500	544-80102-00	211,00
MBML20X45 Printed	45,0	20,0	1.000	544-80201-00	256,00
MBML20X90 Printed	90,0	20,0	500	544-80202-00	295,00

Material: Acero Inoxidable / Aço inoxidável SS316 (-80 °C a +538 °C)

* Placas de Identificación - Servicio de Impresión ya incluido / Placas de identificação -Serviço de impressão incluido. Color / Cor: ●



printshop Servicio de Impresión
Serviço de Impressão

HACCP

Hazard Analysis Critical Control Points

La directiva HACCP (Análisis del Punto de Control de Riesgo), es el método de identificar y eliminar potenciales peligros en la producción o manipulación de alimentos. O HACCP é o sistema internacionalmente aceite e documentado pelo Codex Alimentarius, que define os requisitos para o controlo eficaz da segurança alimentar.



1.4. Familia Q-Tie / Família Q-Tie

Bridas con Cabezal Abierto Q-Tie / Abraçadeiras com a cabeça aberta Q-Tie

TIPO	L	W	Caja / Caixa (Uds.)	Bolsa (Uds.)	Ref Herram. Ref Ferram.	Código		€/ 100 Uds.
						Natural	Negro / Preto	
Q18R	105	2,6	16.000	100	1 - 4, 9 - 10	109-00001	109-00030	1,72
Q18I	155	2,6	25.000	100	1 - 4, 9 - 10	109-00004	109-00033	2,69
Q18L	195	2,6	25.000	100	1 - 4, 9 - 10	109-00007	109-00036	3,41
Q30R	160	3,6	12.000	100	1 - 5, 9 - 10	109-00010	109-00039	3,35
Q30L	200	3,6	10.000	100	1 - 5, 9 - 10	109-00012	109-00041	4,20
Q30LR	250	3,6	8.000	100	1 - 5, 9 - 10	109-00014	109-00043	4,78
Q50R	210	4,7	6.000	100	1 - 5, 9 - 10	109-00018	109-00047	5,10
Q50I	290	4,7	5.000	100	1 - 5, 9 - 10	109-00020	109-00049	7,65
Q50L	410	4,7	4.000	100	1 - 5, 9 - 10	109-00022	109-00051	13,00
Q120I	300	7,7	2.000	100	2, 6 - 8, 11 - 12	109-00024	109-00053	18,50
Q120R	420	7,7	1.500	100	2, 6 - 8, 11 - 12	109-00026	109-00055	22,44
Q120M	520	7,7	1.500	100	2, 6 - 8, 11 - 12	109-00028	109-00057	27,94

Material: PA6.6 UL94V2 (-40°C a +85°C). Color / Cor: ●○



Bridas Q-Tie en Colores / Abraçadeiras Q-Tie em Cores

TIPO	L x W (mm)	Caja/Caixa a (Uds.)	Bolsa (Uds.)	Ref Herram. Ref Ferram.	Azul	Verde	Rojo / Verm.	Ama.	€/100 Uds.
Q18I	155 x 2,6	25.000	100	1 - 4, 9 - 10	109-00152	109-00153	109-00154	109-00155	3,28
Q18L	195 x 2,6	25.000	100	1 - 4, 9 - 10	109-00157	109-00158	109-00159	109-00160	3,69
Q30R	160 x 3,6	12.000	100	1 - 5, 9 - 10	109-00162	109-00163	109-00164	109-00165	3,46
Q30L	200 x 3,6	10.000	100	1 - 5, 9 - 10	109-00167	109-00168	109-00169	109-00170	5,10
Q30LR	250 x 3,6	8.000	100	1 - 5, 9 - 10	109-00172	109-00173	109-00174	109-00175	5,67
Q50R	210 x 4,7	6.000	100	1 - 5, 9 - 10	109-00182	109-00183	109-00184	109-00185	7,14
Q50I	290 x 4,7	5.000	100	1 - 5, 9 - 10	109-00187	109-00188	109-00189	109-00190	9,65
Q50L	410 x 4,7	4.000	100	1 - 5, 9 - 10	109-00192	109-00193	109-00194	109-00195	15,11
Q120I	300 x 7,7	2.000	100	2, 6 - 8, 11 - 12	109-00197	109-00198	109-00199	109-00200	21,64
Q120R	420 x 7,7	1.500	100	2, 6 - 8, 11 - 12	109-00202	109-00203	109-00204	109-00205	26,91
Q120M	520 x 7,7	1.500	100	2, 6 - 8, 11 - 12	109-00207	109-00208	109-00209	109-00210	30,99

Material: PA6.6 UL94V2 (-40°C a +85°C). Color / Cor: ●●●●

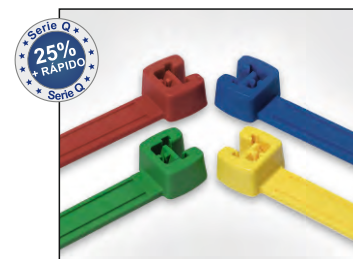

Bases Adhesivas Serie QM(A) / Bases Adesivas Serie QM(A)

TIPO	L x W (mm)	Para Brida Ancho Para Abraç. Larg.	Caja / Caixa (Uds.)	Bolsa (Uds.)	Código		€/ 100 Uds.
					Natural	Negro / Preto	
QM20A	20 x 20	4,0 max.	12.000	100	151-10904	151-10914	23,22
QM30A	30 x 30	5,1 max.	5.000	100	151-10905	151-10915	28,31
QM40A	40 x 40	8,4 max.	1.000	100	151-10906	151-10916	63,05

Material: PA6.6 UL94V2 (-40°C a +85°C). Color / Cor: ●○



Bases Atornillables CTQM / Bases Aparafusáveis Série CTQM

TIPO	L x W x H (mm)	Para Brida Ancho Para Abraç. Larg.	Caja / Caixa (Uds.)	Bolsa (Uds.)	Código		€/ 100 Uds.
					Natural	Negro / Preto	
CTQM5 *	21 x 9,5 x 6,5	5,0 max.	3.000	100	151-10920	151-10930	21,28

Material: PA6.6 UL94V2 (-40°C a +85°C) *Tal. / paraf. 4,5mm. Color / Cor: ●○



Placas de Señalización / Placas de identificação

TIPO	L x W x H (mm)	Para Brida Ancho Para Abraç. Larg.	Caja / Caixa (Uds.)	Bolsa (Uds.)	Color / Cor	Código	€/ 100 Uds.
QT7016R	100 - 70 x 18	4,7	1.000	100	Blanco / Branco	151-10950	88,15
QT7040R	100 - 70 x 42	4,7	800	100	Blanco / Branco	151-10951	90,05
QT7040S	100 - 70 x 42	3,6	800	100	Blanco / Branco	151-10952	69,75
QT10065R	135 - 100 x 67	4,7	400	100	Blanco / Branco	151-10953	2,50

Material: PA6.6 UL94V2 (-40°C a +85°C). Color / Cor: ●



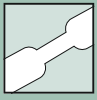

2.1. Tubos Termorretráctiles / Tubos Termorretrácteis

ShrinKit 321 Tubos Termorretráctiles en Trocitos / Tubos Termorretrácteis Cortados

Tipo	Contrac.	Ø Aplic.	Caja / Caixa (Nº Kits)	Uds x Kit	Color / Cor	Código	€/ Kit
ShrinKit 321 Basic	3:1	1,5 a/até 16	1	220	Negro / Preto	380-03001	40,24
ShrinKit 321 Universal	3:1	1,5 a/até 20	1	775	Surtido / Sortido	380-03002	148,08
ShrinKit 321-A (Adhesivo)	3:1	1,5 a/até 20	1	385	Transp + Negro/Preto	380-03003	153,53
ShrinKit 321-A Basic	3:1	1,5 a/até 10	1	130	Transp + Negro/Preto	380-03004	53,54
ShrinKit 321 Universal Basic	3:1	1,5 a/até 16	1	177	Surtido / Sortido	380-03005	55,52

Material: Poliolefina PO-X VDE 0530 (-55 °C a +135 °C; con/com adh.: -55°C a +110°C)



Tubos Termorretráctiles 2:1 en Tiras de 1 Metro / Tubos Termorretrácteis 2:1 em Tiras de 1 Metro

TIPO	Ø Expandido	Ø Contraído Retraído	Caja / Caixa (Tiras)	Tiras (Mts)	Color / Cor	Código	€/ Mt.
TCN20-1,2/0,6-BK	1,2	0,6	30	1	Negro / Preto	300-73550	0,55
TCN20-1,6/0,8-BK	1,6	0,8	30	1	Negro / Preto	300-73551	0,55
TCN20-2,4/1,2-BK	2,4	1,2	30	1	Negro / Preto	300-73552	0,60
TCN20-3,2/1,6-BK	3,2	1,6	30	1	Negro / Preto	300-73556	0,60
TCN20-4,8/2,4-BK	4,8	2,4	24	1	Negro / Preto	300-73560	0,60
TCN20-6,4/3,2-BK	6,4	3,2	24	1	Negro / Preto	300-73564	0,69
TCN20-9,5/4,8-BK	9,5	4,8	20	1	Negro / Preto	300-73568	0,99
TCN20-12,7/6,4-BK	12,7	6,4	16	1	Negro / Preto	300-73572	1,15
TCN20-19,1/9,5-BK	19,1	9,5	10	1	Negro / Preto	300-73576	1,67
TCN20-25,4/12,7-BK	25,4	12,7	5	1	Negro / Preto	300-73580	2,46
TCN20-38,1/19,1-BK	38,1	19,1	6	1	Negro / Preto	300-73584	4,07
TCN20-50,8/25,4-BK	50,8	25,4	6	1	Negro / Preto	300-73588	5,04
TCN20-76,0/38,0-BK	76,0	38,0	3	1	Negro / Preto	300-73592	10,01
TCN20-101,6/50,8-BK	101,6	50,8	2	1	Negro / Preto	300-73596	13,02

Material: Poliolefina UL224 (-55 °C a +125 °C). Color / Cor: ●

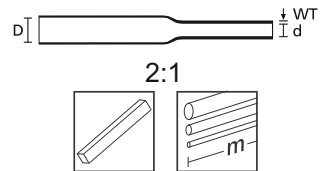

Tubos Termorretráctiles 2:1 en Tiras de 1 Metro / Tubos Termorretrácteis 2:1 em Tiras de 1 Metro

TIPO	Ø Expand.	Ø Cont. Retraído	Caja / Caixa (Tiras)	Tiras (Mts)	Blanco Blanco	Azul	Rojo Vermelho	Transp.*	€/ Mt.
TCN20-2,4/1,2	2,4	1,2	30	1	300-73555	300-73554	300-73553	313-80000	0,63
TCN20-3,2/1,6	3,2	1,6	30	1	300-73559	300-73558	300-73557	313-80001	0,63
TCN20-4,8/2,4	4,8	2,4	24	1	300-73563	300-73562	300-73561	313-80002	0,63
TCN20-6,4/3,2	6,4	3,2	24	1	300-73567	300-73566	300-73565	313-80003	0,72
TCN20-9,5/4,8	9,5	4,8	20	1	300-73571	300-73570	300-73569	313-80004	1,04
TCN20-12,7/6,4	12,7	6,4	16	1	300-73575	300-73574	300-73573	313-80005	1,21
TCN20-19,1/9,5	19,1	9,5	10	1	300-73579	300-73578	300-73577	313-80006	1,75
TCN20-25,4/12,7	25,4	12,7	5	1	300-73583	300-73582	300-73581	313-80007	2,59
TCN20-38,1/19,1	38,1	19,1	6	1	300-73587	300-73586	300-73585	313-80008	4,32
TCN20-50,8/25,4	50,8	25,4	6	1	300-73591	300-73590	300-73589	313-80009	5,46
TCN20-76,0/38,0	76,0	38,0	3	1	300-73595	300-73594	300-73593	313-80010	10,51
TCN20-101,6/50,8	101,6	50,8	2	1	300-73599	300-73598	300-73597	313-80011	13,86

Material: Poliolefina UL224 (-55 °C a +125 °C). Color / Cor: ● ● ● ● ● ● ● ● ● ● * Tipo Color / Cor Transparente: TCN24 UL224 (-55°C a +125°C)
Otros colores bajo consulta / Outras cores sob consulta ● ● ● ● ● ● ● ● ● ●

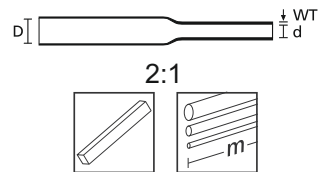
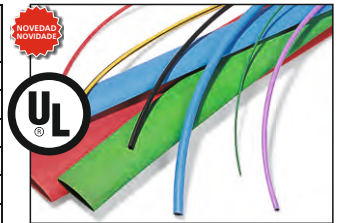

Tubos Termorretráctiles 2:1 en Tiras de 1 Metro / Tubos Termorretrácteis 2:1 em Tiras de 1 Metro

TIPO	Ø Expandido	Ø Contraído Retraído	Caja / Caixa (Tiras)	Tiras (Mts)	Tierra / Terra	€/ Mt.
TFN21-2,4/1,2-GNYE	2,4	1,2	30	1	309-60119	0,77
TFN21-3,2/1,6-GNYE	3,2	1,6	30	1	309-60127	0,77
TFN21-4,8/2,4-GNYE	4,8	2,4	24	1	309-60138	0,84
TFN21-6,4/3,2-GNYE	6,4	3,2	24	1	309-60149	1,04
TFN21-9,5/4,8-GNYE	9,5	4,8	20	1	309-60158	1,23
TFN21-12,7/6,4-GNYE	12,7	6,4	16	1	309-60168	1,47
TFN21-19,1/9,5-GNYE	19,1	9,5	10	1	309-60179	2,49
TFN21-25,4/12,7-GNYE	25,4	12,7	5	1	309-60187	3,17

Material: Poliolefina UL224 (-55 °C a +135 °C). Color / Cor: ● Otros colores bajo consulta / Outras cores sob consulta
Otras medidas bajo consulta (38,1 – 50,8 – 76,2 y 101,6) / Outras dimensões sob consulta (38,1 – 50,8 – 76,2 y 101,6)

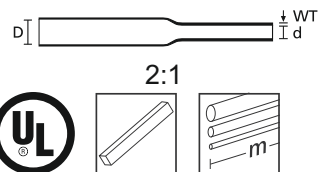



Minicajas 2:1 Pared Fina* / Minicaixas 2:1 Parede Fina*

TIPO	Ø Expandido	Ø Contraído Retraído	Caja / Caixa (Nº Packs)	Pack (Mts.)	Color / Cor	Código	€/ Pack
HIS 12	1,2	0,6	5	10	Negro / Preto	300-30120	14,95
HIS 16	1,6	0,8	5	10	Negro / Preto	300-30160	14,95
HIS 24	2,4	1,2	5	10	Negro / Preto	300-30240	14,95
HIS 32	3,2	1,6	5	10	Negro / Preto	300-30320	14,95
HIS 48	4,8	2,4	5	10	Negro / Preto	300-30480	14,95
HIS 64	6,4	3,2	5	5	Negro / Preto	300-30640	14,95
HIS 95	9,5	4,8	5	5	Negro / Preto	300-30950	14,95
HIS 127	12,7	6,4	5	5	Negro / Preto	300-31270	14,95
HIS 190	19,0	9,5	5	5	Negro / Preto	300-31900	16,16
HIS 254	25,4	12,7	5	5	Negro / Preto	300-32540	20,20

Material: Poliolefina UL224 (-55 °C a +125 °C). Color / Cor: ● Otros Colores / Outros Cores: ●●● (PVP +5%); Tierra / Terra ●●● (PVP +15%).
Otros colores / Outras cores CONSULTAR. * Disponible versión contracción 3:1 / Disponível versão contração 3:1

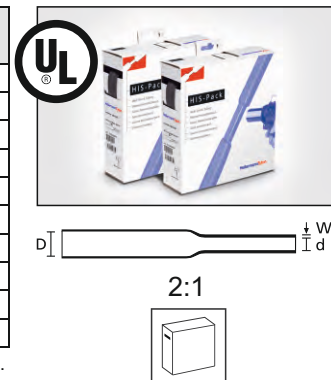

Tubos Termorretráctiles 2:1 Pared Fina / Tubos Termorretrácteis 2:1 Parede Fina

TIPO	Ø Expandido	Ø Contraído Retraído	Caja (Rollos) Caixa (Rolos)	Rollo / Rolo (Mts.)	Color / Cor	Código	€/ 100 Mts.
TCN20 12	1,2	0,6	1	300	Negro / Preto	300-73010	49,85
TCN20 16	1,6	0,8	1	300	Negro / Preto	300-73020	49,85
TCN20 24X	2,4	0,8	1	300	Negro / Preto	300-73130	54,83
TCN20 32	3,2	1,6	1	300	Negro / Preto	300-73040	54,83
TCN20 48	4,8	2,4	1	300	Negro / Preto	300-73050	54,83
TCN20 64	6,4	3,2	1	300	Negro / Preto	300-73060	62,31
TCN20 95	9,5	4,8	1	100	Negro / Preto	300-73070	89,73
TCN20 127	12,7	6,4	1	100	Negro / Preto	300-73080	104,68
TCN20 191	19,0	9,5	1	60	Negro / Preto	300-73090	152,04
TCN20 254	25,4	12,7	1	60	Negro / Preto	300-73100	224,32
TCN20 381	38,1	19,0	1	30	Negro / Preto	300-73110	294,11
TCN20 508	50,8	25,4	1	30	Negro / Preto	300-73120	403,77

Material: Poliolefina UL224 (-55 °C a +125 °C). Color / Cor: ● / Posibilidad / Possibilidade 3:1 Familia TCN20-X

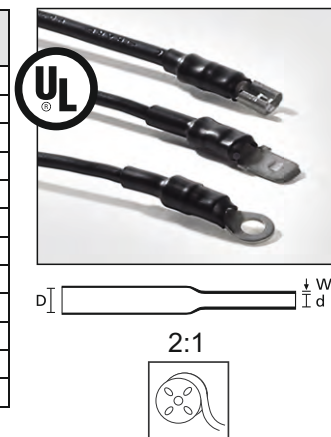

Tubos Termo 3-4:1 Pared Media con Adhesivo / Tubos Termo 3-4:1 Parede Média com Adesivo

TIPO	Ø Expandido	Ø Contraído Retraído	Caja / Caixa (Nº Barras)	Color / Cor	Código	€/ Barra (1 Mt)
MA47 8/2	8,0	2,0	240	Negro / Preto	323-20080	3,03
MA47 12/3	12,0	3,0	120	Negro / Preto	323-20120	4,41
MA47 19/6	19,0	6,0	40	Negro / Preto	323-20190	5,94
MA47 30/8	30,0	8,0	20	Negro / Preto	323-20300	7,20
MA47 40/12	40,0	12,0	15	Negro / Preto	323-20400	8,89
MA47 50/16	50,0	16,0	8	Negro / Preto	323-20500	11,94
MA47 63/19	63,0	19,0	6	Negro / Preto	323-20630	14,13
MA47 75/22	75,0	22,0	5	Negro / Preto	323-20750	15,26
MA47 95/30	95,0	30,0	4	Negro / Preto	323-20950	17,58
MA47 115/34	115,0	34,0	3	Negro / Preto	323-21150	26,21
MA47 140/42	140,0	42,0	3	Negro / Preto	323-21400	42,06

Material: Poliolefina Libre de Halógenos / Livre de Halogéneos (-55 °C a +125 °C). Color / Cor: ●

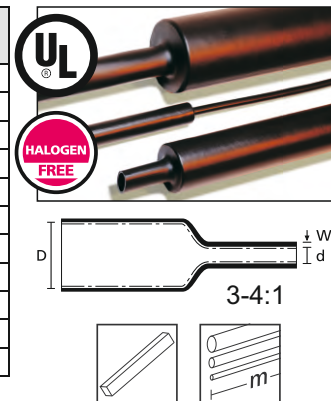

2.2. Manguitos / Mangas

Manguitos Abiertos Termorretráctiles / Mangas Abertas Termorretrácteis

Tipo	Ø Aplic.	Esp. Nominal (mm)	Largo / Comp. (mm)	Emb. (Uds.)	Color / Cor	Código	€/ Ud.
RMS 43-10, 500	15 - 35	2,30	500	5	Negro / Preto	450-20001	18,74
RMS 52-15, 500	20 - 45	2,30	500	5	Negro / Preto	450-20011	18,74
RMS 76-22, 500	28 - 65	2,50	500	5	Negro / Preto	450-20021	25,81
RMS 100-30, 500	35 - 85	2,54	500	5	Negro / Preto	450-20030	29,59

Material: Poliolefina Libre de Halógenos / Livre de Halogéneos (-40 °C a +120 °C). Color / Cor: ●
Otras dimensiones disponibles / Outras dimensões disponíveis



Capuchones / Capacetes Termorretrácteis

Tipo	Ø Aplic.	Esp. Nominal (mm)	Largo / Comp. (mm)	Emb. (Uds.)	Color / Cor	Código	€/ Ud.
1612-1-B5W2	4 - 8	2,60	40	1.000	Negro / Preto	416-12046	0,72
1613-1-B8W	6,5 - 16	2,80	55	1.000	Negro / Preto	416-13060	1,11
1614-1 B8W2	16 - 32	3,30	75	300	Negro / Preto	416-14047	2,31
1615-1 B8W2	26 - 51	3,8	132	100	Negro / Preto	416-15035	4,04

Material: Poliolefina (-55 °C a +80 °C). Color / Cor: ●





Formas Termoretráctiles / Formas Termorretrácteis

Tipo	Salidas Saídas	Ø Principal Max-Min	Ø Salidas / Saídas Max-Min (mm)	Emb. (Uds.)	Color / Cor	Código	€/ Ud.
218-2-B8W	2	49-22,9	20-7,6	50	Negro / Preto	402-18051	10,91
342-1-B8W2	3	110-35	40-17,5	25	Negro / Preto	403-42006	17,25
442-1-B8WM250	4	28-9,0	9,0-1,8	50	Negro / Preto	404-42022	8,25

Material: Poliolefina (-55 °C a +80 °C). Color / Cor: ●

NOVEDAD
NOVIDADE



2.3. Manguitos Elásticos (No Termoretráctiles) / Mangas Elásticas NãoTermorretrácteis

Manguitos de Neopreno / Mangas de Neoprene

TIPO	Ø Aplic. (mm)	Largo / Comp. (mm)	Cajas / Caixas (Uds.)	Bolsa (Uds.)	Color / Cor	Código	€/ 100 Uds.
H12x20BK	1,5 - 2,0	20	40.000	1.000	Negro / Preto	600-02498	2,88
H15x20BK	1,75 - 3,5	20	60.000	1.000	Negro / Preto	600-02929	3,08
H25x25BK	2,5 - 4,0	25	15.000	1.000	Negro / Preto	600-02934	5,25
H30x25BK	3,0 - 6,0	25	15.000	500	Negro / Preto	600-02938	6,57
H40x30BK	4,0 - 8,0	30	5.000	500	Negro / Preto	600-02947	6,87
H50x25BK	5,0 - 9,0	25	10.000	500	Negro / Preto	600-02949	6,97
H75x30BK	7,5 - 13,0	30	4.000	200	Negro / Preto	600-02198	13,33
TH100x35BK	10,0 - 20,0	35	2.000	200	Negro / Preto	600-02493	38,27
TH120x50BK	12,0 - 23,0	50	1.500	100	Negro / Preto	600-02495	53,34
TH140x50BK	14,0 - 25,0	50	1.000	100	Negro / Preto	600-02496	55,81
TH170x50BK	17,0 - 28,0	50	1.000	100	Negro / Preto	600-02497	72,41

Material: Cloropreno UL94 HB (-65 °C a +95 °C - Intermitente +120 °C). Color / Cor: ●
Otros colores disponibles bajo consulta / Outras cores disponíveis sob pedido



2.4. Herramientas / Ferramentas

Herramientas para Termoretráctiles / Ferramentas para Termorretrácteis

Tipo	Tipo Herram. / Ferram.	Tipo	Para Tubo Termo	Caja / Caixa (Uds.)	Código	€/ Ud.
E4500H	Pistola Portátil a Gas / Gás	Manual	HIS / TCN / TF / MA	1	391-90002	247,45
445	Carga / Botija para E4500H	Manual	-	12	391-90101	10,80



Herramientas para Manguitos Elásticos / Ferramentas para Mangas Elásticas

Tipo	Ø Max.	Tipo	Manguito Manga	Caja / Caixa (Uds.)	Código	€/ Ud.
NA - 0/1	10,5	Manual	H12 - H15	1	621-10001	145,86
NA - 1K/3	11,0	Manual	H25 - H50	1	621-10103	145,86
NA - 4/5	15,5	Manual	H75 - TH100	1	621-10405	187,20
NA - 8/10	25,5	Manual	TH120 - TH170	1	621-10810	187,20
KIT D	11,5	Manual	H12 - H75	1	621-80005	176,17
Hellerrine 250ml	-	Lubricante / Lubrificante	Serie H y TH	10	625-00250	10,23

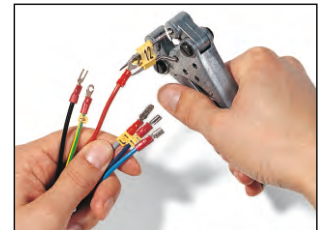

HellermannTyton
www.HellermannTyton.es

Formas Termoretráctiles Formas Termorretrácteis

Conoce el Catálogo - Conheça o Catálogo.

www.HellermannTyton.es





3.1. Tubo Corrugado y Racores / Tubo Corrugado e Bucins

Tubo Corrugado HelaGuard PA6 Light

TIPO	Ø Int. (mm)	Ø Ext. (mm)	Rollo / Rolo Emb. (Mts.)	Código		€/ Mt.
				Negro / Preto	Gris / Cinzento	
HG-LW10	6,5	10,0	50	166-11200	166-11216	0,96
HG-LW11	8,4	11,5	50	166-11201	166-11217	0,96
HG-LW13	10,0	13,0	50	166-11202	166-11218	1,04
HG-LW16	12,0	15,8	50	166-11203	166-11219	1,18
HG-LW21	16,9	21,2	50	166-11204	166-11212	1,60
HG-LW28	23,0	28,5	50	166-11205	166-11213	2,73
HG-LW34	28,3	34,5	50	166-11206	166-11214	3,90
HG-LW42	35,7	42,5	25	166-11207	166-11215	4,18
HG-LW54	47,4	54,5	25	166-11208	166-11220	7,49

Material: Poliamida 6 Libre de Halógenos / Livre de Halogêneos IP66 (-40 °C a +120 °C). Color / Cor: ●●



Racores Rectos Poliamida IP66 / Bucins em Poliamida IP66

TIPO	Para Tubo	MT o / ou PG	Emb. (Uds.)	Código		€/ Ud.
				Negro / Preto	Gris / Cinzento	
HG10-S-M12	HG-LW10	M 12	10	166-21000	166-21060	1,77
HG13-S-M12	HG-LW13	M 12	10	166-21022	166-21061	1,84
HG16-S-M16	HG-LW16	M 16	10	166-21002	166-21053	1,96
HG21-S-M20	HG-LW21	M 20	10	166-21004	166-21045	1,71
HG28-S-M25	HG-LW28	M 25	10	166-21005	166-21046	2,86
HG34-S-M32	HG-LW34	M 32	10	166-21006	166-21056	3,71
HG42-S-M40	HG-LW42	M 40	2	166-21007	166-21057	7,44
HG54-S-M50	HG-LW54	M 50	2	166-21008	166-21059	10,02
HG10-S-PG7	HG-LW10	PG 7	10	166-21010	166-21063	1,77
HG13-S-PG9	HG-LW13	PG 9	10	166-21011	166-21047	1,81
HG16-S-PG11	HG-LW16	PG 11	10	166-21012	166-21054	1,96
HG21-S-PG16	HG-LW21	PG 16	10	166-21014	166-21048	2,00
HG28-S-PG21	HG-LW28	PG 21	10	166-21015	166-21049	3,15
HG34-S-PG29	HG-LW34	PG 29	10	166-21016	166-21050	3,71
HG42-S-PG36	HG-LW42	PG 36	2	166-21017	166-21051	7,44
HG54-S-PG48	HG-LW54	PG 48	2	166-21018	166-21069	10,02

Material: PA6 Libre de Halógenos / Livre de Halogêneos IP66 (-40 °C a +120 °C). Racores IP68 disponibles / Bucins IP68 disponíveis. Color / Cor: ●●
Racores con rosca métrica, se incluye la tuerca / Bucins com rosca métrica, a porca está incluída.



3.2. Organizadores de Cables / Organizador de Cabos

HelaWrap Organizador de Cables / HelaWrap Organizador do Cabos

TIPO	Pared Parede (mm)	Ø Max. (mm)	Caja (Rollos) Caixa (Rolos)	Rollo / Rolo Emb. (Mts.)	Color / Cor	Código	€/ Mt.
HWPP8 BK	0,75	9	1	25	Negro / Preto	161-64101	1,88
HWPP16 BK	0,85	16	1	25	Negro / Preto	161-64201	2,32
HWPP20 BK	0,95	21	1	25	Negro / Preto	161-64301	2,81
HWPP25 BK	1,05	27	1	25	Negro / Preto	161-64401	3,27
HWPP30 BK	1,30	32	1	25	Negro / Preto	161-64501	3,81
HWPP40 BK	1,40	40	1	15	Negro / Preto	161-64601	8,71

TIPO	Pared Parede (mm)	Ø Max. (mm)	Caja / Caixa (Nº Packs)	Pack (Mts.)	Color / Cor	Código	€/ Pack
HWPP16/2 BK	0,85	15	15	2	Negro / Preto	914-64204	8,73
HWPP16/2 GY	0,85	15	15	2	Gris / Cinzento Claro	914-64205	8,73
HWPP16/2 SR	0,85	15	15	2	Plata / Prata	914-64206	8,73
HWPP25/2 BK	1,05	25	10	2	Negro / Preto	914-64404	11,50
HWPP25/2 GY	1,05	25	10	2	Gris / Cinzento Claro	914-64405	11,50
HWPP25/2 SR	1,05	25	10	2	Plata / Prata	914-64406	11,50

Material: Polipropileno UL94 HB (-60 °C a +110 °C - Intermitente +140 °C). Color / Cor: ●●●
Todos los formatos incluyen su herramienta de aplicación / Todos os formatos incluem a sua ferramenta de aplicação.



Accesorios HelaWrap / Acessórios HelaWrap

TIPO	Pack Incluye Inlui	Caja / Caixa (Nº Packs)	Helawrap Tipo	Color / Cor	Código	€/ Pack
CLIP+BASE2	3 Bases + 3 Clips	50 packs	16	Negro / Preto	914-64200	3,91
CLIP+BASE3	3 Bases + 3 Clips	50 packs	25	Negro / Preto	914-64400	4,25

TIPO	Descripción Descrição	Caja (Uds.) Caixa (Uds.)	Emb. (Uds.)	Color / Cor	Código	€/ 100 Uds.
HWBASEA	Base con / com Ad.	1.000	50	Negro / Preto	161-64012	73,17



Material: Poliamida 6.6 - UL94 HB (-40 °C a +105 °C). Color / Cor: ●



3.3. Fundas / Fitas e Mangas

Fundas / Fitas e Mangas

TIPO	Ø Int. (mm)	Ø Ext. (mm)	Caja (Rollo) Caixa (Rolos)	Rollo / Rolo Emb. (Mts.)	Código Blanco / Branco	Código Negro / Preto	Código Transparente	€/ 100 Mts.
FHP1B	1,5	3	20	50	914-40005	914-40007	914-40010	28,38
FHP2B	4,0	6	20	25	914-40022	914-40015	914-40032	33,67
FHP3B	8,0	10	10	25	914-40067	914-40065	914-40066	92,28
FHP4B	9,0	12	10	20	914-40095	914-40085	914-40094	157,95

Material: Polietileno. Color / Cor: ○ ● ●

Todas las medidas son nominales y sujetas a modificaciones técnicas / Todas as medidas são Nominais e sujeitas a modificações técnicas



Funda Trenzada Helagaine / Manga Expansível Helagaine

TIPO	Ø Min. (mm)	Ø Max. (mm)	Caja (Rollo) Caixa (Rolos)	Rollo / Rolo Emb. (Mts.)	Código	€/ 100 Mts.
HEGP 04 BK	2	7	5	200	170-10400	37,48
HEGP 08 BK	5	12	5	100	170-10800	68,27
HEGP 10 BK	7	15	5	100	170-11000	85,44
HEGP 12 BK	8	17	5	100	170-11200	103,18
HEGP 20 BK	14	26	5	50	170-12000	173,70
HEGP 25 BK	18	34	5	50	170-12500	217,68
HEGP 40 BK	30	50	5	50	170-14000	360,19

Material: PET UL94V2, FMVSS-302 (-50 °C a +150 °C, intermitente +220 °C). Color / Cor: ● Posib. / Possib.: PA666, PA66V0. Posib. / Possib.: ●

Todas las medidas son nominales y sujetas a modificaciones técnicas / Todas as medidas são Nominais e sujeitas a modificações técnicas



Funda Autocerrable / Manga Autocerrável

TIPO	Ø Min. (mm)	Ø Max. (mm)	Caja (Nº Rollo) Caixa (Nº Rolos)	Rollo / Rolo Emb. (Mts.)	Código	€/ Mt.
Twist-In 05	4	5	2	150	170-01000	2,22
Twist-In 08	5	8	2	100	170-01001	2,87
Twist-In 13	10	13	2	50	170-01002	4,74
Twist-In 19	16	19	2	25	170-01004	6,09
Twist-In 25	19	25	2	25	170-01005	8,70
Twist-In 29	25	29	2	15	170-01006	9,42
Twist-In 32	29	32	2	15	170-01007	10,23
Twist-In 38	32	38	2	15	170-01008	12,50
Twist-In FR 50	38	50	2	15	170-01109	29,89

Material: PET autoextinguible (-70 °C a +125 °C). Color / Cor: ●

Todas las medidas son nominales y sujetas a modificaciones técnicas / Todas as medidas são Nominais e sujeitas a modificações técnicas



3.4. Pasamuros y Perfiles / Passa Fios e Perfis

Pasamuros / Passa Fios

TIPO	Ø Interno	Ø Externo	Cajas / Caixas (Uds.)	Bolsa (Uds.)	Código	€/ 100 Uds.
HV 1101	12,0	25,5	5.000	500	633-01010	15,18
HV 1203	10,0	17,5	12.000	1.000	633-02030	7,80
HV 1207	6,0	14,0	30.000	1.000	633-02070	7,08
HV 1208	8,0	14,0	24.000	1.000	633-02080	5,79
HV 1209	4,0	11,0	30.000	1.000	633-02090	4,88
HV 1210	6,0	15,0	12.000	1.000	633-02100	10,42
HV 1212	4,0	9,0	2.000	2.000	633-02120	3,91

Material: PVC-FR UL94 V0 (-30 °C a +60 °C). Color / Cor: ● ● Otras Dimensiones Disponibles / Outras dimensões disponíveis



Perfiles / Perfis

TIPO	Esp. Chapa	W int.	H	Rollo / Rolo (Mts.)	Código	€/ Rollo / Rolo
G51PA	0,4 - 1,3	1,5	4,3	25	251-10109	26,79
G51PB	1,3 - 2,1	2,4	4,3	25	251-10209	26,79
G51PC	2,1 - 3,3	3,5	4,3	25	251-10309	31,79
G51PD	3,3 - 4,8	5,1	6,2	25	251-10409	33,89
Con Adhesivo / Com Adesivo						€/ Mt.
THA-012	1,2	1,2	4,8	20	251-06100	1,32
THA-016	1,6	1,6	5,2	20	251-06102	1,40
THA-024	2,3	2,3	5,2	20	251-06104	1,46

Material: PE / PE+Adh UL94 HB (-30 °C a +80 °C / -20°C a +50°C). Color / Cor: NAT. Otras Dimensiones Disponibles / Outras dimensões disponíveis.

Todas las medidas son nominales y sujetas a modificaciones técnicas / Todas as medidas são Nominais e sujeitas a modificações técnicas



Soluciones para Cuadros Eléctricos - Soluções para Quadros Elétricos

Soluciones de Fijación, Aislamiento, Protección e Identificación de Cables en Cuadros Eléctricos.
- Soluções de Fixação, Isolamento, Proteção e Identificação de Cabos em Quadros Elétricos.
¡Pide tu Catálogo! - Peça já o seu catálogo!

[HellermannTyton.es/cuadros-electricos](https://hellermanntyton.es/cuadros-electricos)

MADE FOR REAL 



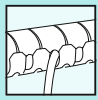

3.5. Canales Ranurados y Accesorios / Calha com Rasgos e Acessórios



HelaDuct Canal Ranurado / HelaDuct Calha com Rasgos

TIPO	B x A (mm)	Caja / Caixa (Mts.)	Código	€/ Mt.
HTWD-PN-25X40	25 x 40	72	184-10068	3,90
HTWD-PN-25X60	25 x 60	48	184-10138	5,47
HTWD-PN-25X80	25 x 80	48	184-10198	6,64
HTWD-PN-40X40	40 x 40	40	184-10078	5,35
HTWD-PN-40X60	40 x 60	36	184-10148	6,73
HTWD-PN-40X80	40 x 80	32	184-10208	8,23
HTWD-PN-40X100	40 x 100	16	184-10258	10,59
HTWD-PN-60X40	60 x 40	24	184-10088	6,60
HTWD-PN-60X60	60 x 60	24	184-10158	7,81
HTWD-PN-60X80	60 x 80	24	184-10218	9,72
HTWD-PN-60X100	60 x 100	8	184-10268	12,92
HTWD-PN-80X40	80 x 40	24	184-10098	8,30
HTWD-PN-80X60	80 x 60	24	184-10168	9,51
HTWD-PN-80X80	80 x 80	24	184-10228	11,71
HTWD-PN-80X100	80 x 100	8	184-10329	15,30
HTWD-PN-100X40	100 x 40	16	184-10108	10,59
HTWD-PN-100X60	100 x 60	16	184-10178	11,42
HTWD-PN-100X80	100 x 80	16	184-10238	13,71
HTWD-PN-100X100	100 x 100	8	184-10278	17,94
HTWD-PN-120X60	120 x 60	16	184-10188	13,58
HTWD-PN-120X80	120 x 80	16	184-10248	15,53

Paso estrecho 4-6 mm / Rasgo estreito 4-6 mm. Color / Cor: Gris / Cinzento (RAL 7030) ● - UL Registrado

Material: PVC M1 - UL Registrado. Disponible también / Disponível também: Paso Ancho / Rasgo largo (5/7,5 mm); Serie HTWD-PW. Medidas DIN; Serie HTWD-PD. En color Azul Paso ancho / Em cor Azul com Rasgo largo; Serie HTWD-PWB

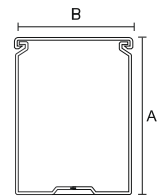
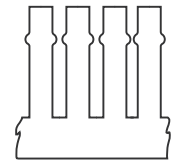
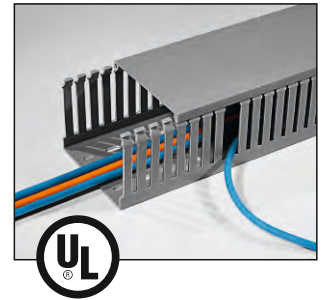

Tapas Canal Ranurado / Tampas Calha com Rasgos

TIPO	para Canal / para Calha B (mm)	Caja / Caixa (Mts.)	Código	€/ Mt.
HTWD-PCOVM-25	25	50	181-30208	1,92
HTWD-PCOVM-40	40	50	181-30308	2,41
HTWD-PCOVM-60	60	50	181-30408	3,06
HTWD-PCOVM-80	80	50	181-30508	3,43
HTWD-PCOVM-100	100	40	181-30608	4,22
HTWD-PCOVM-120	120	40	181-30708	5,09
HTWD-PCOVM-150	150	40	181-30808	7,47

Color / Cor: Gris / Cinza (RAL7030) ● Material: PVC M1 - UL registrado

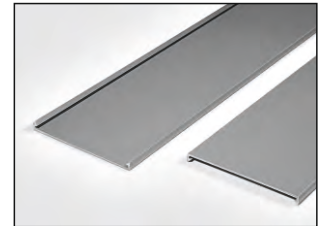

Retenedores de Cable HelaDuct-BWR / Retentores de Cabos HelaDuct-BWR

TIPO	Long./ Compr.(L)	Altura (H)	Anchura / Largura (W)	Caja / Caixa (Nº Piezas/Peças)	Código	€/ Ud.
HTWD-BWR-40X80	34	75	20	20	181-50480	1,69
HTWD-BWR-40X40	35	36	20	40	181-50440	1,27
HTWD-BWR-40X60	35	56	20	40	181-50460	1,50
HTWD-BWR-60X60	54	55	20	20	181-50660	1,74
HTWD-BWR-60X80	54	75	20	20	181-50680	1,93
HTWD-BWR-60X100	54	95	20	20	181-50690	1,93
HTWD-BWR-60X40	55	35	20	40	181-50640	1,50
HTWD-BWR-80X60	74	55	20	10	181-50860	2,40
HTWD-BWR-80X80	74	74	20	10	181-50880	2,54
HTWD-BWR-80X100	74	94	20	30	181-50890	2,54
HTWD-BWR-100X100	93	94	20	5	181-51090	3,90
HTWD-BWR-100X60	94	55	20	10	181-51060	2,82
HTWD-BWR-100X80	94	75	20	10	181-51080	2,82
HTWD-BWR-120X80	113	74	20	10	181-51280	3,67
HTWD-BWR-120X60	114	54	20	10	181-51260	3,06

Color/Cor: Negro / Preto (RAL7030) ● - UL94HB Material: PC/ABS



Retenedores de Cable HelaDuct-BWR / Retentores de Cabos HelaDuct-BWR

TIPO	Para Canal Ranurado / Para Calha com Rasgos	Anchura./ Largura. (W)	Caja / Caixa (Nº Piezas / Peças)	Código	€/ Ud.
HTWD-NFWR	HTWD-PN	14	100	181-10020	23,71

Color/Cor: Negro / Preto (RAL7030) ● - UL94HB Material: ABS

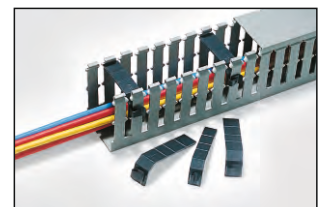



Canal Libre de Halógenos / Canal Livre de Halogéneo

TIPO	B x A (mm)	Caja / Caixa (Mts.)	Código	€/ Mt.
HTWD-HF-25X25	25 x 25	50	183-22525	9,28
HTWD-HF-25x40	25 x 40	48	183-22540	9,43
HTWD-HF-25X60	25 x 60	60	183-25060	12,39
HTWD-HF-25X80	25 x 80	20	183-22580	15,83
HTWD-HF-40X25	40 x 25	48	183-24025	11,13
HTWD-HF-40X40	40 x 40	50	183-24040	12,30
HTWD-HF-40X60	40 x 60	40	183-24060	14,84
HTWD-HF-40X80	40 x 80	20	183-24080	17,70
HTWD-HF-60X40	60 x 40	40	183-26040	15,00
HTWD-HF-60X60	60 x 60	24	183-26060	17,80
HTWD-HF-60X80	60 x 80	20	183-26080	20,10
HTWD-HF-60X100	60 x 100	16	183-26010	31,30
HTWD-HF-80X40	80 x 40	30	183-28040	20,17
HTWD-HF-80X60	80 x 60	24	183-28060	21,80
HTWD-HF-80X80	80 x 80	12	183-28080	24,00
HTWD-HF-80X100	80 x 100	16	183-28010	34,66
HTDW-HF-100X40	100 x 40	20	183-22040	23,53
HTWD-HF-100X60	100 x 60	16	183-21060	29,88
HTWD-HF-100X80	100 x 80	12	183-21080	29,00
HTWD-HF-100X100	100 x 100	12	183-21010	39,20
HTWD-HF-120X60	120 x 60	12	183-21260	30,40
HTDW-HF-120X80	120 x 80	16	183-21280	33,10

Paso estrecho 4-6 mm / Rasgo estreito 4-6 mm - Color / Cor: Gris /Cinza (RAL70305)

Material: PC/ABS - UL94V0 Registrado



EN 45545-2

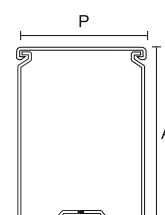
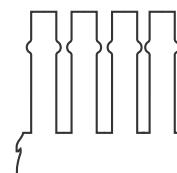

Herramientas y Accesorios / Ferramentas e Acessórios

TIPO	Desc.	Emb. Cantidad / Emb. Quantidade	Código	€/ Ud.
Cortadora 4F	Herram. / Ferram.	1	914-01036	230,83
Cuchilla 4F	Repuesto/Lâmina	1	914-01038	38,04
FIXO RT4	Para Ductafix R4	4	914-06500	79,54
FIXO RT6	Para Ductafix R6	4	914-06501	78,59
DUCTAFIX R4	Ø 4	1.000 (4 x 250)	914-06502	5,36€/ 100
DUCTAFIX R6	Ø 6	500 (2 x 250)	914-06511	8,04€/ 100



3.6. Canales de Instalación y Accesorios / Calhas de Instalação e Acessórios

Microcanal «Tapa Bisagra» con Base Adhesiva TMR / Micro-Calhas com Base Adesiva TMR

TIPO	B x A (mm)	Caja / Caixa (Mts.)	Código	€/ Mt.
TMR 12X7 W0	12 x 7	162	914-00369	1,97
TMR 12X12 W0	12 x 12	90	914-00308	2,34
TMR 16X12 W0	16 x 12	70	914-00312	2,95

Color/Cor: Blanco /Branco W0 (RAL9010) ○ Posib. Blanco / Branco W (RAL9001) ○

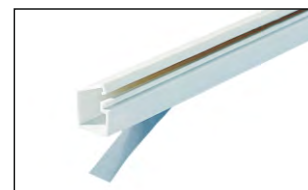

MiniCanal TMC / Mini-Calhas TMC

TIPO	B x A (mm)	Caja / Caixa (Mts.)	Código	€/ Mt.
TMC 22/1X10 W0	22 x 10	106	914-00317	1,68
TMC 22/2X10 W0	22 x 10	106	914-00316	1,97
TMC 30/1X10 W0	30 x 10	80	914-00311	2,17
TMC 30/2X10 W0	30 x 10	80	914-00309	2,41
TMC 40/2X10 W0	40 x 10	64	914-00301	4,43
TMC 15/1X17 W0	15 x 17	96	914-00303	1,97
TMC 25/1X17 W0	25 x 17	60	914-00304	3,22
TMC 40/1x17 W0	40 x 17	64	914-00351	4,60
TMC 40/2X17 W0	40 x 17	64	914-00305	4,79
TMC 60/3X17 W0	60 x 17	48	914-00306	7,20
TMC 50/1X20 W0	50 x 20	48	914-00313	4,97
TMC 50/2X20 W0	50 x 20	48	914-00314	5,68
TMC 50/3X20 W0	50 x 20	48	914-00315	7,20

Color/Cor: Blanco / Branco W0 (RAL9010) ○ Posib. Blanco / Branco W (RAL9001) ○





Accesorios para MiniCanal TMC / Acessórios para Mini-Calhas TMC

Medida							
TIPO	22 x 10	30 x 10	40 x 10	15 x 17	25 x 17	40 x 17	50 x 20
Código	914-00396	914-00397	914-00398	914-00403	914-00404	914-00406	914-00656
Emb. Cant.	40 (4x10)	40 (4x10)	20 (2x10)	40 (4x10)	20 (2x10)	20 (2x10)	20 (2x10)
AEM €/ Ud.	1,05	1,37	2,16	1,11	1,74	1,56	1,76
Código	914-00386	914-00387	914-00388	914-00390	914-00391	914-00395	914-00655
Emb. Cant.	40 (4x10)	40 (4x10)	20 (2x10)	40 (4x10)	40 (4x10)	20 (2x10)	20 (2x10)
AIM €/ Ud.	1,05	1,37	2,16	1,11	1,74	1,56	1,76
Código	914-00407	914-00408	914-00409	914-00414	914-00415	914-00425	914-00654
Emb. Cant.	40 (4x10)	40 (4x10)	20 (2x10)	40 (4x10)	40 (4x10)	20 (2x10)	20 (2x10)
APM €/ Ud.	1,05	1,37	2,16	1,11	1,74	1,56	1,76
Código	914-00594	914-00595	914-00596	914-00590	914-00591	914-00597	914-00653
Emb. Cant.	20 (2x10)	40 (4x10)	40 (4x10)	20 (2x10)	20 (2x10)	40 (4x10)	20 (2x10)
GM €/ Ud.	1,03	1,31	2,02	1,07	1,16	1,47	1,65
Código	914-00525	914-00527	914-00528	914-00535	914-00536	914-00541	914-00652
Emb. Cant.	40 (4x10)	20 (2x10)	20 (2x10)	20 (2x10)	20 (2x10)	20 (2x10)	20 (2x10)
IM €/ Ud.	1,10	1,42	2,25	1,16	1,23	1,65	1,84
Código	914-00580	914-00581	914-00582	914-00577	914-00578	914-00579	914-00651
Emb. Cant.	20 (2x10)	40 (4x10)	40 (4x10)	40 (4x10)	20 (2x10)	20 (2x10)	20 (2x10)
LM €/ Ud.	1,07	1,31	1,07	1,07	1,16	1,47	1,65

Color/Cor: Blanco / Branco W0 (RAL9010) ○ Posib. Blanco / Branco W (RAL9001) ○

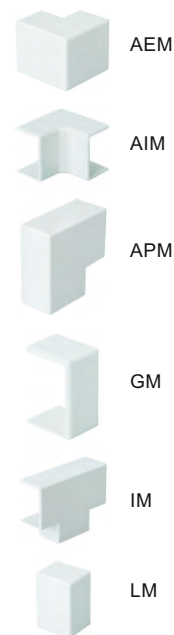

Canal de Instalación TA-EN / Calha de Instalação - Base Não Perfurada TA-EN

TIPO	B x A (mm)	Caja / Caixa (Mts.)	Código	€/ Mt.
TA-EN 25X30 W0	25 x 30	80	914-00323	4,31
TA-EN 40X40 W0	40 x 40	48	914-00324	7,56
TA-EN 60X40 W0	60 x 40	24	914-00325	7,67
TA-EN 80X40 W0	80 x 40	24	914-00320	11,28
TA-EN 100X40W0	100 x 40	16	914-00329	14,42
TA-EN 120X40W0	120 x 40	16	914-00330	17,92
TA-EN 60X60 W0	60 x 60	24	914-00319	9,22
TA-EN 80X60 W0	80 x 60	16	914-00326	13,74
TA-EN 100X60W0	100 x 60	16	914-00327	15,16
TA-EN 120X60W0	120 x 60	16	914-00328	15,84
TA-EN 150X60W0	150 x 60	12	914-00331	28,65
TA-EN 200X60W0	200 x 60	8	914-00322	34,33
TA-EN 100X80W0	100 x 80	16	914-00360	16,89
TA-EN 120X80W0	120 x 80	16	914-00359	17,70
TA-EN 150X80W0	150 x 80	12	914-00358	35,59
TA-EN 200X80W0	200 x 80	8	914-00357	50,20

Color/Cor: Blanco / Branco W0 (RAL9010) ○ Posib. Blanco / Branco W (RAL9001) ○

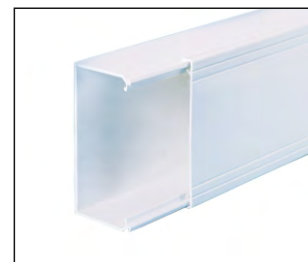

Ángulo Exterior Variable NEAV / Angulo Exterior Variável NEAV

TIPO	B x A (mm)	Emb. Cant. / Quant. (Uds.)	Código	€/ Ud.
NEAV 25X30 W0	25 x 30	20 (20x1)	914-01705	1,84
NEAV 40X40 W0	40 x 40	10 (10x1)	914-01706	4,32
NEAV 60X40 W0	60 x 40	10 (10x1)	914-01707	5,11
NEAV 80X40 W0	80 x 40	10 (10x1)	914-01708	5,55
NEAV 100X40 W0	100 x 40	10 (10x1)	914-01709	5,92
NEAV 120X40 W0	120 x 40	10 (10x1)	914-01710	6,86
NEAV 60X60 W0	60 x 60	10 (10x1)	914-01711	6,68
NEAV 80X60 W0	80 x 60	10 (10x1)	914-01712	7,21
NEAV 100X60 W0	100 x 60	10 (10x1)	914-01713	7,78
NEAV 120X60 W0	120 x 60	10 (10x1)	914-01714	8,04
NEAV 150X60 W0	150 x 60	5 (5x1)	914-01715	11,41
NEAV 200X60 W0	200 x 60	4 (4x1)	914-01716	18,50
NEAV 100X80 W0	100 x 80	4 (4x1)	914-01717	12,12
NEAV 120X80 W0	120 x 80	4 (4x1)	914-01718	14,42
NEAV 150X80 W0	150 x 80	5 (5x1)	914-01719	20,09
NEAV 200X80 W0	200 x 80	4 (4x1)	914-01720	20,24

Color/Cor: Blanco / Branco W0 (RAL9010) ○ Posib. Blanco / Branco W (RAL9001) ○





Ángulo Interior Variable NIAV / Angulo Interior Variável NIAV

TIPO	B x A (mm)	Emb. Cant. / Quant. (Uds.)	Código	€/ Ud.
NIAV 25X30 W0	25 x 30	20 (20x1)	914-01721	1,84
NIAV 40X40 W0	40 x 40	10 (10x1)	914-01722	4,32
NIAV 60x40 W0	60 x 40	10 (10x1)	914-01723	5,11
NIAV 80x40 W0	80 x 40	10 (10x1)	914-01724	5,55
NIAV 100x40 W0	100 x 40	10 (10x1)	914-01725	5,92
NIAV 120x40 W0	120 x 40	10 (10x1)	914-01726	6,86
NIAV 60x60 W0	60 x 60	10 (10x1)	914-01727	6,68
NIAV 80x60 W0	80 x 60	10 (10x1)	914-01728	7,21
NIAV 100x60 W0	100 x 60	10 (10x1)	914-01729	7,78
NIAV 120x60 W0	120 x 60	10 (10x1)	914-01730	8,04
NIAV 150x60 W0	150 x 60	5 (5x1)	914-01731	11,41
NIAV 200x60 W0	200 x 60	4 (4x1)	914-01732	18,50
NIAV 100x80 W0	100 x 80	4 (4x1)	914-01733	12,12
NIAV 120x80 W0	120 x 80	4 (4x1)	914-01734	14,42
NIAV 150x80 W0	150 x 80	5 (5x1)	914-01735	20,09
NIAV 200x80 W0	200 x 80	4 (4x1)	914-01736	20,24

Color/Cor: Blanco / Branco W0 (RAL9010) ○ Posib. Blanco / Branco W (RAL9001) ○



Ángulo Plano NPAN

TIPO	B x A (mm)	Emb. Cant. / Quant. (Uds.)	Código	€/ Ud.
NPAN 25X30 W0	25 x 30	20 (4x5)	914-01737	3,56
NPAN 40X40 W0	40 x 40	10 (2x5)	914-01738	6,45
NPAN 60X40 W0	60 x 40	10 (5x2)	914-01739	10,98
NPAN 80X40 W0	80 x 40	10 (5x2)	914-01740	11,28
NPAN 100X40 W0	100 x 40	10 (10x1)	914-01741	11,64
NPAN 120X40 W0	120 x 40	10 (10x1)	914-01742	13,01
NPAN 60X60 W0	60 x 60	10 (5x2)	914-01743	11,49
NPAN 80X60 W0	80 x 60	10 (5x2)	914-01744	12,50
NPAN 100X60 W0	100 x 60	10 (10x1)	914-01745	13,72
NPAN 120X60 W0	120 x 60	10 (10x1)	914-01746	14,29
NPAN 150X60 W0	150 x 60	4 (4x1)	914-01747	31,40
NPAN 200X60 W0	200 x 60	4 (4x1)	914-01748	39,83
NPAN 100X80 W0	100 x 80	4 (4x1)	914-01749	16,84
NPAN 120X80 W0	120 x 80	4 (4x1)	914-01750	19,32
NPAN 150X80 W0	150 x 80	4 (4x1)	914-01751	33,62
NPAN 200X80 W0	200 x 80	4 (4x1)	914-01752	45,09

Color/Cor: Blanco / Branco W0 (RAL9010) ○ Posib. Blanco / Branco W (RAL9001) ○



Derivación NTAN / Derivação NTAN

TIPO	B x A (mm)	Emb. Cant. / Quant. (Uds.)	Código	€/ Ud.
NTAN 25X30 W0	25 x 30	20 (4x5)	914-01753	1,91
NTAN 40X40 W0	40 x 40	10 (2x5)	914-01754	3,84
NTAN 60X40 W0	60 x 40	10 (5x2)	914-01755	3,84
NTAN 80X40 W0	80 x 40	10 (5x2)	914-01756	3,96
NTAN 100X40 W0	100 x 40	10 (10x1)	914-01757	5,12
NTAN 120X40 W0	120 x 40	10 (10x1)	914-01758	6,32
NTAN 60X60 W0	60 x 60	10 (5x2)	914-01759	5,51
NTAN 80X60 W0	80 x 60	10 (5x2)	914-01760	5,78
NTAN 100X60 W0	100 x 60	10 (10x1)	914-01761	5,78
NTAN 120X60 W0	120 x 60	10 (10x1)	914-01762	6,42
NTAN 150X60 W0	150 x 60	4 (4x1)	914-01763	19,06
NTAN 200X60 W0	200 x 60	4 (4x1)	914-01764	61,22
NTAN 100X80 W0	100 x 80	4 (4x1)	914-01765	14,80
NTAN 120X80 W0	120 x 80	4 (4x1)	914-01766	15,98
NTAN 150X80 W0	150 x 80	4 (4x1)	914-01767	59,80
NTAN 200X80 W0	200 x 80	4 (4x1)	914-01768	62,27

Color/Cor: Blanco / Branco W0 (RAL9010) ○ Posib. Blanco / Branco W (RAL9001) ○

Tapa Final LAN / Topo Final LAN

TIPO	B x A (mm)	Emb. Cant. / Quant. (Uds.)	Código	€/ Ud.
LAN 25X30 W0	25 x 30	20 (4x5)	914-00867	2,42
LAN 40X40 W0	40 x 40	20 (4x5)	914-00868	2,56
LAN 60x40 W0	60 x 40	20 (10x2)	914-00869	2,61
LAN 60x60 W0	60 x 60	10 (5x2)	914-00870	2,84
LAN 80x40 W0	80 x 40	20 (10x2)	914-00871	2,84
LAN 80x60 W0	80 x 60	10 (5x2)	914-00872	3,25
LAN 100x40 W0	100 x 40	10 (5x2)	914-00873	2,93
LAN 100x60 W0	100 x 60	10 (5x2)	914-00874	3,31
LAN 100x80 W0	100 x 80	10 (5x2)	914-00875	3,68
LAN 120x40 W0	120 x 40	10 (5x2)	914-00876	3,07
LAN 120x60 W0	120 x 60	10 (5x2)	914-00877	3,57
LAN 120x80 W0	120 x 80	10 (5x2)	914-00878	4,55
LAN 150x60 W0	150 x 60	5 (5x1)	914-00879	3,72
LAN 150x80 W0	150 x 80	5 (5x1)	914-00880	5,07
LAN 200x60 W0	200 x 60	5 (5x1)	914-00881	5,53
LAN 200x80 W0	200 x 80	5 (5x1)	914-00882	6,42

Color/Cor: Blanco / Branco W0 (RAL9010) ○ Posib. Blanco / Branco W (RAL9001) ○

Unión GAN / União GAN

TIPO	B (mm)	Embalaje Cantidad / Embalagem Quantidade (Uds.)	Código	€/ Ud.
GAN 25 W0	25	20 (4x5)	914-00883	1,37
GAN 40 W0	40	10 (2x5)	914-00884	1,71
GAN 60 W0	60	10 (2x5)	914-00885	1,87
GAN 80 W0	80	10 (2x5)	914-00886	2,01
GAN 100 W0	100	20 (4x5)	914-00887	2,16
GAN 120 W0	120	10 (2x5)	914-00888	2,32
GAN 150 W0	150	10 (2x5)	914-00889	2,47
GAN 200 W0	200	10 (2x5)	914-00890	2,62

Color/Cor: Blanco/Branco W0 (RAL9010) ○ Posib. Blanco / Branco W (RAL9001) ○





4.1. Cinta Aislante / Fita Isolante

Cinta Aislante de PVC / Fita Isolante de PVC (Esp.: 0,15mm)

TIPO	L (Mtrs) x W (mm)	Caja / Caixa (Uds.)	Color / Cor	Código	€/ Ud. (Rollo/Rolo)
HTAPE-FLEX15-15x10 BU	10 x 15	100	Azul	710-00100	0,57
HTAPE-FLEX15-15x10 RD		100	Rojo / Vermelho	710-00101	0,57
HTAPE-FLEX15-15x10 YE		100	Amarillo / Amarelo	710-00102	0,57
HTAPE-FLEX15-15x10 GN		100	Verde	710-00103	0,57
HTAPE-FLEX15-15x10 BK		100	Negro / Preto	710-00104	0,57
HTAPE-FLEX15-15x10 WH		100	Blanco / Branco	710-00105	0,57
HTAPE-FLEX15-15x10 GN-YE		100	Tierra / Terra (Am/Ver)	710-00106	0,63
HTAPE-FLEX15-15x10 BN		100	Marrón / Castanho	710-00107	0,57
HTAPE-FLEX15-15x10 GY		100	Gris / Cinzento	710-00108	0,57
HTAPE-FLEX15-15x10 VT		100	Violeta	710-00109	0,57
HTAPE-FLEX15-15x10 OG	100	Naranja / Laranja	710-00110	0,57	
HTAPE-FLEX15-19x20 BU	20 x 19	100	Azul	710-00151	1,13
HTAPE-FLEX15-19x20 RD		100	Rojo / Vermelho	710-00152	1,13
HTAPE-FLEX15-19x20 YE		100	Amarillo / Amarelo	710-00153	1,13
HTAPE-FLEX15-19x20 GN		100	Verde	710-00154	1,13
HTAPE-FLEX15-19x20 BK		100	Negro / Preto	710-00155	1,13
HTAPE-FLEX15-19x20 WH		100	Blanco / Branco	710-00156	1,13
HTAPE-FLEX15-19x20 GN-YE		100	Tierra / Terra (Am/Ver)	710-00157	1,24
HTAPE-FLEX15-19x20 BN		100	Marrón / Castanho	710-00158	1,13
HTAPE-FLEX15-19x20 GY		100	Gris / Cinzento	710-00159	1,13
HTAPE-FLEX15-19x20 VT		100	Violeta	710-00160	1,13

Material: PVC (-10°C a +90°C). Color / Cor: ●●●●●●●●●●

Cinta Aislante de PVC / Fita Isolante de PVC (Esp.: 0,15mm)

TIPO	L (Mtrs) x W (mm)	Caja / Caixa (Nº Packs.)	Pack (Nº Rollos / Rolos)	Código	€/ Pack
HTAPE-FLEX15- MIX-15x10	10 x 15	10	10	710-00146	6,10

Material: PVC (-10°C a +90°C). Color / Cor: ●●●●●●●●●●

HTAPE-FLEX15- MIX-15x10 incluye todos los colores / HTAPE-FLEX15- MIX-15x10 inclui todas as cores.

Cinta Aislante Premium / Fita Isolante Premium (Esp.: 0,18mm)

TIPO	L (Mtrs) x W (mm)	Caja / Caixa (Uds.)	Color / Cor	Código	€/ Ud. (Rollo / Rolo)
HTAPE-FLEX1000+19x20 BK	20 x 19	80	Negro / Preto	710-10602	4,47

Material: PVC (-18°C a +105°C). Color / Cor: ● Posib. / Possib.: ●●●●●●●●●●

Otras Posib. / Outras Possib (L x W): 6x19, 33x19 y/e 33x50.

Cinta Power Auto-amalgamante / Fita Power Auto-Vulcanizadora (Esp.: 0,76mm)

TIPO	L (Mtrs) x W (mm)	Caja / Caixa (Uds.)	Color / Cor	Código	€/ Ud. (Rollo / Rolo)
HTAPE-POWER810 9,1 BK*	9,1 x 19	42	Negro / Preto	711-10401	11,05
HTAPE-POWER820 9,1 BK	9,1 x 19	42	Negro / Preto	711-10402	11,05

Material: EPR (hasta / até +90°C). Color / Cor: ● *Con papel soporte / Com papel de suporte.

4.2. Cintas Técnicas No Aislantes / Fitas Técnicas Não Isolantes

Cinta Multiusos / Fita Multiusos (No aislante / Não Isolante: 0,15mm)

TIPO	L (Mtrs) x W (mm)	Caja / Caixa (Uds.)	Color / Cor	Código	€/ Ud. (Rollo / Rolo)
HTAPE-ALLROUND1500	46 x 50	24	Gris / Cinzento	710-01000	9,95

Material: PVC. Color / Cor: ●

4.3. Conectores / Ligadores

Conectores Reconectables HCR* / Ligadores Reutilizáveis HCR*

TIPO	Sección / Secção (mm²)	Nº Polos	Emb. (Uds.)	Caja / Caixas (Uds.)	Código	€/ 100 Uds.
HCR-2	0,2 - 2,5	2	100	2.000	148-90043	37,98
HCR-3		3	75	1.500	148-90044	49,23
HCR-5		5	50	1.000	148-90045	69,05

Material: PC UL94 V0 (-30°C a +85°C). Color / Cor: ⊗

*Para Cables Rígidos, Semi-Rígidos y Flexibles / *Para Cabos, Rígidos, Semi-Rígidos e Flexíveis

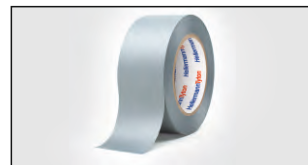
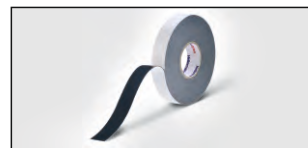



Conector sin Tornillos HelaCon Plus Mini* / Ligador Rápido HelaCon Plus Mini*

TIPO	Sección / Secção (mm ²)	Nº Polos	Color / Cor	Caja / Caixas (Uds.)	Emb. (Uds.)	Código	€/ 100 Uds.
HCPM-2	0,5 - 2,5	2	Amarillo / Amarelo	9.450	150	148-90036	14,44
HCPM-3		3	Naranja / Laranja	6.300	100	148-90037	16,99
HCPM-4		4	Transparente	6.300	100	148-90038	19,53
HCPM-5		5	Azul	4.725	75	148-90039	24,07
HCPM-6		6	Violeta	3.150	50	148-90040	34,53
HCPM-8		8	Gris / Cinzento	3.150	50	148-90041	42,75

Material: PC UL94 V0 (-30°C a +85°C). Color / Cor: ●●●●●●●●

*Para Cables Rígidos y Semi-Rígidos / *Para Cabos Rígidos e Semi-Rígidos



Conector sin Tornillos HelaCon LUX* / Ligador Rápido HelaCon LUX*

TIPO	Sección Secção (mm ²)	Nº Polos	Color / Cor	Caja / Caixas (Uds.)	Emb. (Uds.)	Código	€/ 100 Uds.
HECL-1/1	0,5 (0,75) - 2,5	1 - 1	Gris / Cinzento	4.100	100	148-90022	23,64
HECL-2/1	0,5 (0,75) - 2,5	2 - 1	Blanco / Branco	4.100	100	148-90023	26,01

Material: PA66 UL94 V0 (-5°C a +100°C). Color / Cor: ●○

*Para Cables: Principal Rígido y Salida Rígido-Semi-Rígido-Flexible *Para Cabos: Principal Rígido e Saída Rígido-Semi-Rígido-Flexível.



Conector Lineal Fijo IP68 / Conector Linear Estanque IP68

TIPO	Sección Secção (mm ²)	Color / Cor	Nº Polos	Caja / Caixas (Uds.)	Código	€/ Ud.
CTH391	Hasta / até 2,5	Negro / Preto	4	50	914-60224	11,03
CTH391+G			4	50	914-60226	15,44

Material: PA66GF+PBT+TPE / NB+ZS (-40°C a +125°C). Color / Cor: ●



Conector Lineal IP68 / Conector Linear Estanque IP68

TIPO	Sección Secção (mm ²)	Color / Cor	Nº Polos	Caja / Caixas (Uds.)	Código	€/ Ud.
CTH387	Hasta / até 1,5	Negro / Preto	4	50	914-60225	22,06
CTH387+G			4	50	914-60227	26,75

Material: PA66GF+PBT+TPE / NB+ZS (-40°C a +125°C). Color / Cor: ●



Caja de Conexión IP67 / Caixa de Derivação IP67

TIPO	Sección / Secção (mm ²)	Color / Cor	Nº Polos	Caja / Caixas (Uds.)	Código	€/ Ud.
CTH200	Hasta / até 2,5	Negro / Preto	3	25	914-60222	20,70

Material: PA66GF+PBT+TPE / NB+ZS (-40°C a +125°C). Color / Cor: ●



4.4. Protectores de Focos / Proteção de Focos

Protector de Focos / Proteção de Focos - Viviendas / Habitação

TIPO	Ø Fijación / Fijação min-max	Altura (mm)	Caja / Caixas (Uds.)	Emb. (Uds.)	Código	€/ Ud.
SpotClip-II BK	62 - 90	107	50	10	148-00098	5,58

Material: PA66GF (-20°C a +120°C). Color / Cor: ● Para Focos Halógenos y LED / Para focos de halogéneo e LED.

Otras variantes disponibles / Outras variantes disponíveis.



Protector de Focos / Proteção de Focos - Industrial

TIPO	Ø Fijación / Fijação min-max	L x W (mm)	Caja / Caixas (Uds.)	Emb. (Uds.)	Código	€/ Ud.
SpotClip-Plate 600 BK	75 - 314	592 x 592	10	1	148-00117	33,15

Material: PA66HS (-40°C a +105°C). Color / Cor: ● - Para Placas de Escayola / Gesso 600x600.

Otras variantes disponibles / Outras variantes disponíveis. Accesorios Disponibles / Acessórios disponíveis sob consulta.



4.5. Lubricante para Guía de Cables / Lubrificante de Guia de Cabos

CableScout + Lubricante / CableScout + Lubrificante

TIPO	Para	Caja / Caixas (Uds.)	Embalaje / Embalagem (Lts.)	Código	€/ Ud.
CS - CPL	Guías de Cables / Cabos	8	1	897-90031	13,25





4.6. RELICON: Empalmes en Resina y Gel / RELICON: Juntas em Resina e Gel

RELICON Empalmes de Resina Rectos (Sin Conectores) / RELICON Caixas de Junção em Resina (Sem Ligadores)

TIPO	Secc. Hasta / Até Min / Max (mm ²)	Cable/Cabo Ø Princ.	L x M (mm)	Color Cor	Bolsa (Uds.)	Caja/Caixa (Uds.)	Código	€/ Ud.
i-0 / SF	3x1,5 - 5x2,5	7 - 16	182 x 25	Transp.	1	10	435-12019	24,79
i-1 / SF *	3x1,5 - 4x10 - 5x6	8 - 24	190 x 36	Transp.	1	10	435-12000	25,59
i-1.5 / SF	3x1,5 - 4x16 - 5x10	8 - 24	215 x 39	Transp.	1	10	435-12001	30,25
i-2 / SF *	5x1,5 - 4x25 - 5x16	14 - 30	276 x 49	Transp.	1	10	435-12002	36,64
i-3 / SF *	5x10 - 4x50 - 5x35	23 - 35	360 x 54	Transp.	1	10	435-12003	66,70

Material: Resina: PUR33 (-25 °C a +120 °C). Temp. Alm. (+4 °C a +40 °C). Vida: 48 meses. Color / Cor: ●
Otras medidas y bifurcaciones disponibles / Outras medidas e bifurcações disponíveis. *Posibilidad con conectores / Possibilidade com ligadores



Empalmes Rectos Flexibles (sin conectores) / Caixas de Junção Rectas Flexíveis (Sem Ligadores)

F-11/SF	4 x 1,5 - 5 x 4	11 - 16	L375 x Ø31	BK	1	1	435-00200	213,10
F-12/SF	4 x 4 - 5 x 6	17 - 20	L375 x Ø34	BK	1	1	435-00201	231,33

Material: Resina: PUR44 (-25 °C a +120 °C). Temp. Alm. (+4 °C a +40 °C). Vida: 24 meses. Color / Cor: ○



RELICON Empalmes Aislados en Gel (Con Conector) / RELICON Caixas de Junção em Gel (Com Ligadores)

TIPO	Secc. Hasta / Até Min / Max (mm ²)	Cable/Cabo Ø Princ.	LxWxH (mm)	Color Cor	Bolsa (Uds.)	Caja/Caixa (Uds.)	Código	€/ Ud.
Relifix V150	1x10-1x50/1x2,5-1x6	9 - 16	86x47x27	Verde	1	10	435-00651	18,27
Relifix V31.5	3x0,5 - 3x2,5	9 - 16	86x47x27	Verde	1	10	435-00650	18,27
Relifix V56	3x1,5 - 5x6	9 - 20	146x55x35	Verde	1	10	435-00654	33,85

Material: PP+SI (-20°C a +90°C). Vida: Sin Límite / Vida Sem limite. Color / Cor: ●



RELICON Empalmes de Gel Rectos (con conector) / RELICON Juntas Isoladas em Gel Reto (Com Ligadores)

TIPO	Secc. Hasta / Até Min / Max (mm)	Cable/Cabo Ø Princ.	L x M (mm)	Color Cor	Bolsa (Uds.)	Caja/Caixa (Uds.)	Código	€/ Ud.
Reliseal V56	3 x 2,5	5 x 6	190 x 60	Verde	1	1	435-01660	36,05
Reliseal V510	3 x 4,0	5 x 10	235 x 69	Verde	1	1	435-01661	67,95
Reliseal V525	3 x 10,0	5 x 25	310 x 88	Verde	1	1	435-01662	96,56

Material: PP + SI (-20 °C a +90 °C). Vida: Sin Límite / Vida: Sem Limite. IP68 hasta / até 10 m. Color / Cor: ●



RELICON Toallitas de Limpieza / RELICON Toalhetes de Limpeza

TIPO	Medidas	Color / Cor	Cubo / Balde (Nº Toallitas Toalhetes)	Código	€/ Cubo/Balde
Reliclean 70	27 x 31	Natural	72	435-01601	32,50

Material: Tejido desengrasante antibacterial, biodegradable y secado rápido / Tecido desengordurante de limpeza antibacteriana e de secagem rápida.



RELICON by
HellermannTyton

Empalmes de Cables

Caixas de Junção de Cabos

Empalmes de Resina y Gel.
Conoce el Catálogo RELICON.

Caixas de Junção de Cabos em Resina e Gel.
Coheça o Catálogo RELICON.

www.HellermannTyton.es



5.1. Tubos y Placas de Impresión / Tubos e Placas de Impressão

Tubo Termorretráctil 2:1 para TIP's / Tubo Termorretráctil 2:1 para TIP's

TIPO	Ø Expandido (mm)	Ø Contraído Retraído (mm)	Caja / Caixa (Mts./m)	Caja (Rollos x Mts.) Caixa (Rolos x m)	Código	€ Caja / Caixa
TLFX-2-1-24-YE	2,4	1,2	144	8 x 18	554-51001	255,55
TLFX-2-1-32-YE	3,2	1,6	126	7 x 18	554-51101	247,61
TLFX-2-1-48-YE	4,8	2,4	108	6 x 18	554-51201	234,01
TLFX-2-1-64-YE	6,4	3,2	90	5 x 18	554-51301	189,51
TLFX-2-1-95-YE	9,5	4,8	72	4 x 18	554-51401	201,24
TLFX-2-1-127-YE	12,7	6,4	54	3 x 18	554-51501	217,81
TLFX-2-1-190-YE	19,0	9,5	30	2 x 15	554-51601	160,27
TLFX-2-1-254-YE	25,4	12,7	30	2 x 15	554-51701	229,50
TLFX-2-1-381-YE	38,1	19,1	13	1 x 13	554-51801	171,11
TLFX-2-1-508-YE	50,8	25,4	10	1 x 10	554-50901	82,18

Material: PO-X (-55°C a +135°C). Color / Cor: ● Cinta de Impresión Recomendada / Fita de Impressão Recomendada: TTDTHOUT.
Otros Colores Disponibles / Outras cores disponíveis: ○



printshop Servicio de Impresión
Serviço de Impressão

Tubo Termorretráctil 3:1 para TIP's / Tubo Termorretráctil 3:1 para TIP's

TIPO	Ø Expandido (mm)	Ø Contraído Retraído (mm)	Caja / Caixa (Mts./m)	Caja (Rollos x Mts.) Caixa (Rolos x m)	Código	€ Caja / Caixa
TULT-3-1-3/1-YE	3,0	1,0	176	8 x 22	553-40350	669,65
TULT-3-1-4,8/1,6-YE	4,8	1,6	110	5 x 22	553-40450	501,72
TULT-3-1-6/2-YE	6,0	2,0	110	5 x 22	553-40650	513,29
TULT-3-1-9/3-YE	9,0	3,0	72	4 x 18	553-40950	406,52
TULT-3-1-12/4-YE	12,0	4,0	54	3 x 18	553-41250	341,96
TULT-3-1-18/6-YE	18,0	6,0	26	2 x 13	55341850	242,96
TULT-3-1-24/8-YE	24,0	8,0	26	2 x 13	55342450	384,43
TULT-3-1-39/13-YE	39,0	13,0	10	1 X 10	553-43950	225,36

Material: PO-X (-55°C a +135°C). Color / Cor: ● Otros Colores Disponibles / Outras cores disponíveis: ○ ● ● ●
Cinta de Impresión Recomendada / Fita de Impressão Recomendada: TTDTHOUT.



UL224

printshop Servicio de Impresión
Serviço de Impressão

Tubo Termorretráctil 3:1 para TIP's Formato en Banda / Tubo Termorretráctil 3:1 para TIP's Formato em Banda

TIPO	Ø Expand. (mm)	Ø Contraído Retraído (mm)	Marcadores por Línea / Linha	Nº Marcadores Rollo / Rolo	Código	€ Rollo / Rolo
TULT2.4-0.8DS-1x50YE	2,4	0,8	1 x 50 mm	1.000	553-71001	319,42
TULT2.4-0.8DS-2x25YE	2,4	0,8	2 x 25 mm	2.000	553-71003	319,42
TULT2.4-0.8DS-3x16YE	2,4	0,8	3 x 16 mm	3.000	553-71005	319,42
TULT3-1DS-1x50YE	3,0	1,0	1 x 50 mm	1.000	553-71007	336,38
TULT3-1DS-2x25YE	3,0	1,0	2 x 25 mm	2.000	553-71009	336,38
TULT3-1DS-3x16YE	3,0	1,0	3 x 16 mm	3.000	553-71011	336,38
TULT4.8-1.6DS-1x50YE	4,8	1,6	1 x 50 mm	1.000	553-71013	365,99
TULT4.8-1.6DS-2x25YE	4,8	1,6	2 x 25 mm	2.000	553-71015	365,99
TULT4.8-1.6DS-3x16YE	4,8	1,6	3 x 16 mm	3.000	553-71017	365,99
TULT6-2DS-1x50YE	6,0	2,0	1 x 50 mm	1.000	553-71019	433,17
TULT6-2DS-2x25YE	6,0	2,0	2 x 25 mm	2.000	553-71021	433,17
TULT6-2DS-3x16YE	6,0	2,0	3 x 16 mm	3.000	553-71023	433,17
TULT9-3DS-1x50YE	9,0	3,0	1 x 50 mm	500	553-71025	297,99
TULT9-3DS-2x25YE	9,0	3,0	2 x 25 mm	1.000	553-71027	297,99
TULT9-3DS-3x16YE	9,0	3,0	3 x 16 mm	1.500	553-71029	297,99
TULT12-4DS-1x50YE	12,0	4,0	1 x 50 mm	500	553-71031	399,97
TULT12-4DS-2x25YE	12,0	4,0	2 x 25 mm	1.000	553-71033	399,97
TULT12-4DS-3x16YE	12,0	4,0	3 x 16 mm	1.500	553-71035	399,97
TULT18-6DS-1x50YE	18,0	6,0	1 x 50 mm	500	553-71037	524,31
TULT18-6DS-2x25YE	18,0	6,0	2 x 25 mm	1.000	553-71039	524,31
TULT18-6DS-3x16YE	18,0	6,0	3 x 16 mm	1.500	553-71041	524,31
TULT24-8DS-1x50YE	24,0	8,0	1 x 50 mm	250	553-71043	355,07
TULT24-8DS-2x25YE	24,0	8,0	2 x 25 mm	500	553-71045	355,07
TULT24-8DS-3x16YE	24,0	8,0	3 x 16 mm	750	553-71047	355,07
TULT39-13DS-1x50YE	39,0	13,0	1 x 50 mm	250	553-71049	600,56
TULT39-13DS-2x25YE	39,0	13,0	2 x 25 mm	500	553-71051	600,56
TULT39-13DS-3x16YE	39,0	13,0	3 x 16 mm	750	553-71053	600,56

Material: PO-X (-55°C a +135°C). Color / Cor: ● Otros Colores Disponibles / Outras cores disponíveis: ○
Cinta de Impresión Recomendada / Fita de Impressão Recomendada: TTDTHOUT



UL224

printshop Servicio de Impresión
Serviço de Impressão



Placas de Señalización / Placas de Sinalização para TIP's

TIPO	Largo / Compr. (mm)	Ancho / Largura (mm)	Uds. Rollo / Rolo	Código		€ Rollo Rolo
				Amarillo / Amarelo	Blanco / Branco	
TIPTAG-HF-11X65	11	65	190	556-20064	556-20069	90,30
TIPTAG-HF-15X65	15	65	190	556-21064	556-21069	103,33
TIPTAG-HF-11X100	11	100	120	556-20074	556-20079	90,30
TIPTAG-HF-15X100	15	100	120	556-21074	556-21079	103,33

Material: PO (-40°C a +90°C). Colores / Cores: ○ ● Cinta de Impresión Recomendada / Fita de Impressão Recomendada: TTDTHOUT



printshop Servicio de Impresión
Serviço de Impressão

TipTag PU - UV Estabilizada / TipTag PU - Estabilizado UV

TIPO	Largo / Comprimento (mm)	Ancho / Largura (mm)	Rollo / Rolo (Nº Pcs / Peças)	Código	€ Rollo / Rolo
TTAGPU11X65WH	11,0	65,0	190	556-25012	168,12
TTAGPU11X65YE	11,0	65,0	190	556-25019	168,12
TTAGPU15X65WH	15,0	65,0	190	556-25007	169,60
TTAGPU15X65YE	15,0	65,0	190	556-25011	169,60
TTAGPU11X100WH	11,0	100,0	125	556-25021	151,33
TTAGPU11X100YE	11,0	100,0	125	556-25020	151,33
TTAGPU15X100WH	15,0	100,0	125	556-25006	169,60
TTAGPU15X100YE	15,0	100,0	125	556-25010	169,60

Material: PUR DS UL94 V0 (-65°C a +120°C). Colores / Cores: ● ○ Cinta de Impresión Recomendada / Fita de Impressão Recomendada: TTRC+



printshop Servicio de Impresión
Serviço de Impressão

Placas de Identificación Formato en Banda / Placas de Identificação Formato em Banda

TIPO	Área de Impresión / Impressão (mm)	Larg. Máx. de Abraç. (mm) / Nº de Agujeros / Furos	Uds. Rollo / Rolo	Código	€ Rollo / Rolo
TAGUL10X51-4WH	10 x 33	4,7 / 4	2.000	556-82000	1.113,89
TAGUL10X51-4YE	10 x 33	4,7 / 4	2.000	556-82001	1.113,89
TAGUL20x51-4WH	12 x 51	4,7 / 4	1.000	556-82005	816,63
TAGUL20x51-4YE	12 x 51	4,7 / 4	1.000	556-82004	816,63
TAGUL20x51-6WH	12 x 51	4,7 / 6	1.000	556-82002	816,63
TAGUL20x51-6YE	12 x 51	4,7 / 6	1.000	556-82003	816,63

Material: PO-X (-55°C a +135°C). Color / Cor: ● ○ Cinta de Impresión Recomendada / Fita de Impressão Recomendada: TTDTHOUT



UL224

printshop Servicio de Impresión
Serviço de Impressão

Placas de Señalización / Placas de Sinalização

TIPO	L (mm)	W (mm)	Caja / Caixa (Uds.)	Bolsa (Uds.)	Código	€/ 100 Uds.
AT1 NA (Natural)	63,0	4,7	20.000	100	151-41119	8,47
AT1 BK (Negro / Preto)	63,0	4,7	20.000	100	151-41110	8,47
AT2 NA (Natural)	63,0	9,0	15.000	100	151-41219	8,71
AT2 BK (Negro / Preto)	63,0	9,0	15.000	100	151-41210	8,71
AT3 NA (Natural)	100,0	9,0	12.000	100	151-41319	9,16
AT3 BK (Negro / Preto)	100,0	9,0	12.000	100	151-41310	9,16
IT1 NA NA (Natural)	44,0	19,0	20.000	100	151-42119	17,92
IMP2.5 WH (Blanco / Branco)	63,5	19,3	100	100	151-42259	24,16
IMP2.5W1.75 WH (Blanco / Branco)	63,5	44,0	100	100	151-42269	30,20

Material: PA66 UL94 V2 (-40°C a +85°C). Color / Cor: ○ ●



Bridas de Señalización / Abraçadeiras de Sinalização

TIPO	Apli Ø Min. (mm)	Apli Ø Max. (mm)	Larg / Comp. (L)	Anch. / Larg. (W)	Caja / Caixa (Uds.)	Bolsa (Uds.)	Código	€ 100 Uds.
IT18R (Natural)	6,0	22,0	100	2	10.000	100	111-81821	8,20
IT18FL (Natural)	1,5	19,0	110	3	10.000	100	111-81919	15,84
IT50R (Natural)	9,5	44,5	210	5	5.000	100	111-85019	18,88
IT50L (Natural)	19,0	100,0	390	5	5.000	100	111-85319	49,43
IT50RD (Natural)	10,0	44,0	205	5	1.000	100	111-85219	44,82
IT50RT (Natural)	10,0	44,0	205	5	1.000	100	111-85119	55,62

Material: PA66 UL94 V2 (-40°C a +85°C). Color / Cor: ○



printshop Servicio de Impresión
Serviço de Impressão

Soluciones RFID

Soluções RFID



Conoce el Catálogo
Conheça o Catálogo

www.HellermannTyton.es



5.2. Señalizadores / Marcadores de Cabo

Señalizadores Helagrip / Marcadores Helagrip

TIPO	Larg. / Comp. (mm)	Ø Min / Max (mm)	Caja / Caixa (Nº Rollos / Rolos)	Señalizadores x Rollo / Marcadores x Rolo	Código	€/ 100 Uds.
HGDC 1-3	3,5	1,0 - 3,0	5	1.000	Ver Tabla / Tabela	1,65
HGDC 2-5	3,5	2,0 - 5,0	5	1.000	Ver Tabla / Tabela	1,65
HGDC 4-9	5,0	4,0 - 9,0	4	250	Ver Tabla / Tabela	2,32

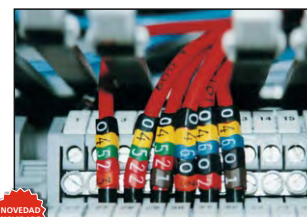

NOVEDAD / NOVIDADE

PHG1-3X11	11,0	1,0 - 3,0	4	250	523-00109	5,54
PHG2-5X18	18,0	2,0 - 5,0	4	150	523-00226	5,54
PHG4-8X25	25,0	4,0 - 9,0	4	50	523-00411	9,30

Señalizador / Marcador	Código TIPO HGDC 1-3	Código TIPO HGDC 2-5	Código TIPO HGDC 4-9
A	515-01014	515-02014	515-03014
B	515-01024	515-02024	515-03024
C	515-01034	515-02034	515-03034
D	515-01044	515-02044	515-03044
E	515-01054	515-02054	515-03054
F	515-01064	515-02064	515-03064
G	515-01074	515-02074	515-03074
H	515-01084	515-02084	515-03084
I	515-01094	515-02094	515-03094
J	515-01104	515-02104	515-03104
K	515-01114	515-02114	515-03114
L	515-01124	515-02124	515-03124
M	515-01134	515-02134	515-03134
N	515-01144	515-02144	515-03144
O	515-01154	515-02154	515-03154
P	515-01164	515-02164	515-03164
Q	515-01174	515-02174	515-03174
R	515-01184	515-02184	515-03184
S	515-01194	515-02194	515-03194
T	515-01204	515-02204	515-03204
U	515-01214	515-02214	515-03214
V	515-01224	515-02224	515-03224
W	515-01234	515-02234	515-03234
X	515-01244	515-02244	515-03244
Y	515-01254	515-02254	515-03254
Z	515-01264	515-02264	515-03264
+	515-01704	515-02704	515-03704
-	515-01714	515-02714	515-03714
~	-	515-03969	515-03970
=	515-01764	515-01831	-
/	515-01724	515-02724	515-03724
⊥	515-01734	515-02734	515-01947
.	515-01804	515-02715	515-01946
SIN IMP.	523-00109	523-00223	523-00407
0	515-01604	515-02604	515-03604
1	515-01614	515-02614	515-03614
2	515-01624	515-02624	515-03624
3	515-01634	515-02634	515-03634
4	515-01644	515-02644	515-03644
5	515-01654	515-02654	515-03654
6	515-01664	515-02664	515-03664
7	515-01674	515-02674	515-03674
8	515-01684	515-02684	515-03684
9	515-01694	515-02694	515-03694
0	515-01600	515-02600	515-03600
1	515-01611	515-02611	515-03611
2	515-01622	515-02622	515-03622
3	515-01633	515-02633	515-03633
4	515-01644	515-02644	515-03644
5	515-01655	515-02655	515-03655
6	515-01666	515-02666	515-03666
7	515-01677	515-02677	515-03677
8	515-01688	515-02688	515-03688
9	515-01699	515-02699	515-03699

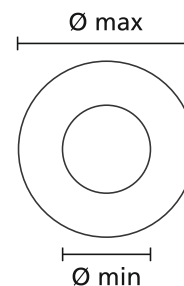

Material: PVC UL94 V0 (-65°C a +105°C). Colores / Cores: ●●●●●●●●○



Señalizadores Ovalgrip / Marcadores Ovalgrip

TIPO	Larg. / Comp. (mm)	Ø Min / Max (mm)	Caja / Caixa (Nº Rollos / Rolos)	Señalizadores x Rollo Marcadores x Rolo	Código	€/ 100 Uds.
HODS 50	4,0	1,7 - 3,6	5	1.000	Ver Tabla / Tabela	2,25
HODS 85	4,5	1,8 - 6,3	4	1.000	Ver Tabla / Tabela	2,25



Señalizador / Marcador	Código TIPO HODS50	Código TIPO HODS85
A	531-15014	531-07935
B	531-15024	531-07936
C	531-15034	531-07937
D	531-15044	531-07938
E	531-15054	531-07939
F	531-15064	531-07940
G	531-15074	531-07941
H	531-15084	531-07942
I	531-15094	531-07943
J	531-15104	531-07944
K	531-15114	531-07945
L	531-15124	531-07946
M	531-15134	531-07947
N	531-15144	531-07948
O	531-15154	531-07949
P	531-15164	531-07950
Q	531-15174	531-07951
R	531-15184	531-07952
S	531-15194	531-07953
T	531-15204	531-07954
U	531-15214	531-07955
V	531-15224	531-07956
W	531-15234	531-07957
X	531-15244	531-07958
Y	531-15254	531-07959
Z	531-15264	531-07960
+	531-00451	531-07924
-	531-00452	531-07923
/	531-00175	531-07961
⊥	531-00176	531-00386
.	531-00174	531-00384
0	531-15274	531-07925
1	531-15284	531-07926
2	531-15294	531-07927
3	531-15304	531-07928
4	531-15314	531-07732
5	531-15324	531-07930
6	531-15334	531-07931
7	531-15344	531-07932
8	531-15354	531-07933
9	531-15364	531-07934
0	531-15365	531-07728
1	531-15366	531-07729
2	531-15367	531-07730
3	531-15368	531-07731
4	531-15314	531-07732
5	531-15370	531-07733
6	531-15371	531-07734
7	531-15372	531-07735
8	531-15373	531-07736
9	531-15374	531-07737

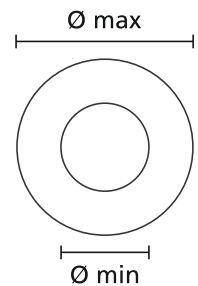
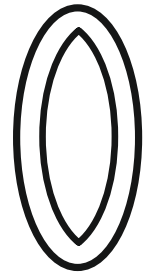
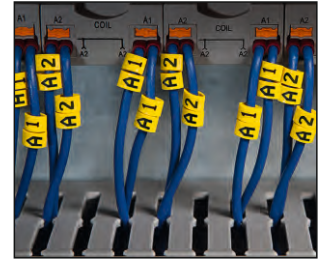

Material: PVC UL94 V0 (-65°C a +105°C). Colores / Cores: ●●●●●●●●●○

Señalizadores WIC Tipo Clip / Marcadores de Encaixe WIC

TIPO	Ø Min / Max (mm)	Sección / Secção (mm2)	Señalizadores x Caja Marcadores x Caixa	Código	€/ 100 Uds.
WIC 0	0,8 - 2,20	0,15 - 0,75	1.000 (5 Placas x 200)	Ver Tabla / Tabela	3,66
WIC 1	2,0 - 2,8	0,5 - 1,5	1.000 (5 Placas x 200)	Ver Tabla / Tabela	3,66
WIC 2	2,8 - 3,8	1,5 - 2,5	1.000 (5 Placas x 200)	Ver Tabla / Tabela	3,66
WIC 3	4,3 - 5,3	4,0 - 6,0	500 (5 Placas x 100)	Ver Tabla / Tabela	5,76
Herramienta / Ferramenta	Para WIC		Caja / Caixa (Uds.)	Código	€ / Ud.
WICTOOL - Para WIC 1/2/3			5	561-00001	6,17
WICA-ACT-BK			100	561-06000	30,13 (100ud)
WICA-AC10-25			100	561-06001	33,39 (100ud)

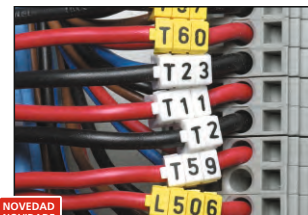

NOVEDAD
NOVEDAD
NOVEDAD
NOVEDAD



WICA-ACT-BK



WICA-AC10-25

Señalizador / Marcador	Código TIPO WIC0	Código TIPO WIC1	Código TIPO WIC2	Código TIPO WIC3
A	561-00014	561-01014	561-02014	561-03014
B	561-00024	561-01024	561-02024	561-03024
C	561-00034	561-01034	561-02034	561-03034
D	561-00044	561-01044	561-02044	561-03044
E	561-00054	561-01054	561-02054	561-03054
F	561-00064	561-01064	561-02064	561-03064
G	561-00074	561-01074	561-02074	561-03074
H	561-00084	561-01084	561-02084	561-03084
I	561-00094	561-01094	561-02094	561-03094
J	561-00104	561-01104	561-02104	561-03104
K	561-00114	561-01114	561-02114	561-03114
L	561-00124	561-01124	561-02124	561-03124
M	561-00134	561-01134	561-02134	561-03134
N	561-00144	561-01144	561-02144	561-03144
O	561-00154	561-01154	561-02154	561-03154
P	561-00164	561-01164	561-02164	561-03164
Q	561-00174	561-01174	561-02174	561-03174
R	561-00184	561-01184	561-02184	561-03184
S	561-00194	561-01194	561-02194	561-03194
T	561-00204	561-01204	561-02204	561-03204
U	561-00214	561-01214	561-02214	561-03214
V	561-00224	561-01224	561-02224	561-03224
W	561-00234	561-01234	561-02234	561-03234
X	561-00244	561-01244	561-02244	561-03244
Y	561-00254	561-01254	561-02254	561-03254
Z	561-00264	561-01264	561-02264	561-03264
+	561-00704	561-01704	561-02704	561-03704
-	561-00714	561-01714	561-02714	561-03714
/	561-00724	561-01724	561-02724	561-03724
⊥	561-00734	561-01734	561-02734	561-03734
.	561-00744	561-01744	561-02744	561-03744
0	561-00604	561-01604	561-02604	561-03604
1	561-00614	561-01614	561-02614	561-03614
2	561-00624	561-01624	561-02624	561-03624
3	561-00634	561-01634	561-02634	561-03634
4	561-00644	561-01644	561-02644	561-03644
5	561-00654	561-01654	561-02654	561-03654
6	561-00664	561-01664	561-02664	561-03664
7	561-00674	561-01674	561-02674	561-03674
8	561-00684	561-01684	561-02684	561-03684
9	561-00694	561-01694	561-02694	561-03694
0-9	561-00101	561-01101	561-02101	561-03101
AELNRST+ ⊥	561-00994	561-01994	561-02994	561-03994
BCUVWPDFIM	561-00005	561-01002	561-02002	561-03002
GHYZQJKXL	561-00003	561-01003	561-02003	561-03003
0	561-00600	561-01600	561-02600	561-03600
1	561-00611	561-01611	561-02611	561-03611
2	561-00622	561-01622	561-02622	561-03622
3	561-00633	561-01633	561-02633	561-03633
4	561-00644	561-01644	561-02644	561-03644
5	561-00655	561-01655	561-02655	561-03655
6	561-00666	561-01666	561-02666	561-03666
7	561-00677	561-01677	561-02677	561-03677
8	561-00688	561-01688	561-02688	561-03688
9	561-00699	561-01699	561-02699	561-03699
CC 0-9*	561-00100	561-01100	561-02100	561-03100

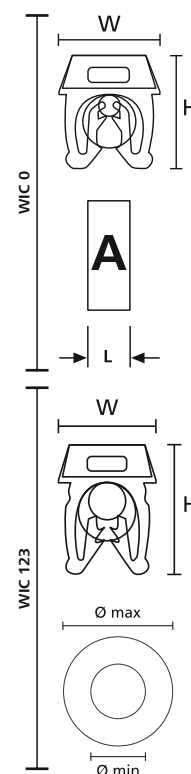

Material: PA66 UL94 V2 (-40°C a +85°C). Colores / Cores: ●●●●●●●●●● *CC: Código de Color (Números) / CC: Código de Cor (Números).

5.3. Etiquetas / Etiquetas

Etiquetas Helatag para Impresora Transferencia Térmica (Con Película)

Etiquetas Helatag para Impresora Transferência Térmica (Com Película)

TIPO	Apli. Ø	Apli. Ø	Ancho (W)	Alt. (H)	Alt. (H2)	Etiqu. x Pack	Código	€/Pack
	Min.	Max.						
TAG51TD3-1209-WHCL	1,4	3,0	25,4	8,80	19,05	5.000	596-12091	127,13
TAG26TD6-1209-WHCL	1,5	3,0	12,7	9,52	19,05	10.000	596-12096	140,58
TAG36TD7-1209-WHCL	2,0	4,7	12,7	9,00	23,80	10.000	596-12097	368,33
TAG2TD6-1209-WHCL	3,5	7,6	12,7	12,70	36,50	5.000	596-61209	85,77
TAG22TD3-1209-WHCL	3,5	7,6	25,4	12,70	36,50	2.500	596-32091	62,37
TAG24TD1-1209-WHCL	3,5	7,6	50,8	12,70	36,50	1.000	596-12094	83,66
TAG23TD5-1209-WHCL	4,5	10,0	19,1	12,70	44,50	5.000	596-12095	454,55
TAG25TD3-1209-WHCL	4,5	10,0	25,4	12,70	44,50	2.500	596-51209	349,65
TAG9TD3-1209-WHCL	5,5	12,1	25,4	19,05	57,10	2.500	596-91209	78,93
TAG10TD2-1209-WHCL	5,5	12,1	49,5	19,05	57,10	1.000	596-12090	399,39
TAG91TD1-1209-WHCL	8,0	16,0	70,0	35,00	85,00	500	596-41209	120,24
TAG1TD2-1209-WHCL	8,5	18,2	48,2	19,05	79,20	1.000	596-21209	189,95
TAG3TD3-1209-WHCL	10,0	22,2	25,4	25,40	95,25	1.000	596-31209	57,42
TAG6TD1-1209-WHCL	10,0	22,2	50,8	25,40	95,25	500	596-11209	58,37
TAG107TD3-1209-WHCL	12,0	37,5	25,4	31,75	149,86	1.000	596-01209	170,10
TAG38TD3-1209-WHCL	20,8	47,5	25,4	38,10	187,20	1.000	596-12098	319,41
TAG07TD1-1209-WHCL	20,8	47,5	50,8	25,40	187,20	250	596-71209	77,72

Material: PVC 1209 (-20°C a +80°C). Color / Cor: ○ Film Transparente / Filme Transparente.

Cinta de Impresión Recomendada / Fita de Impressão Recomendada: TT932OUT

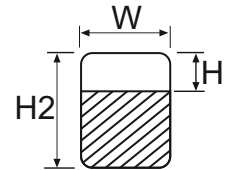

Servicio de Impresión
Serviço de Impressão

Etiquetas Helatag para Impresora Láser / Laser (Con Película / Com Película)

TIPO	Apli. Ø	Apli. Ø	Ancho (W)	Alt. (H)	Alt. (H2)	Hojas/Folhas (Pack)	Código	Etiqu. x Pack	€/Pack
	Ø	Max.							
TAG26LA4-1104-WHCL	1,5	3,0	12,7	9,50	19,10	180	594-11041	5.000	179,31
TAG130LA4-1104-WHCL	2,4	4,8	12,7	9,00	24,00	165	594-21104	5.000	194,50
TAG49LA4-1104-WHCL	2,6	5,3	25,4	8,80	25,40	70	594-11042	2.500	224,84
TAG131LA4-1104-WHCL	3,8	7,6	12,7	12,70	36,50	105	594-31104	2.500	153,21
TAG132LA4-1104-WHCL	3,8	7,6	20,3	12,70	36,50	63	594-41104	2.500	208,01
TAG02LA4-1104-WHCL	3,8	7,6	25,4	12,70	36,50	49	594-01104	2.450	326,06
TAG133LA4-1104-WHCL	5,1	10,1	19,1	12,70	44,50	60	594-51104	2.500	260,52
TAG134LA4-1104-WHCL	5,1	10,1	25,4	12,70	44,50	42	594-61104	1.000	142,69
TAG09LA4-1104-WHCL	5,8	11,6	25,4	19,05	55,50	35	594-11104	1.000	180,95
TAG135LA4-1104-WHCL	6,7	13,5	48,5	12,70	55,50	20	594-71104	500	159,09
TAG137LA4-1104-WHCL	7,1	14,3	31,8	22,86	67,70	24	594-91104	1.000	260,63
TAG136LA4-1104-WHCL	7,7	15,5	25,4	19,05	67,70	28	594-81104	1.000	209,75
TAG145LA4-1104-WHCL	11,1	22,3	25,4	25,40	95,30	21	594-11040	1.000	297,90
TAG138LA4-1105-WHCL	11,8	23,6	38,1	19,05	93,13	15	594-13876	500	212,82
TAG139LA4-1105-WHCL	18,2	36,4	38,1	25,40	139,70	10	594-13976	500	291,39

Material: PET 1104 (-40°C a +150°C). Color / Cor: ○ Film Transparente / Filme Transparente.

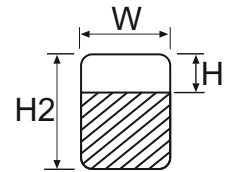
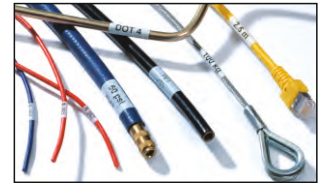

Etiquetas Manuales Rite On / Etiquetas Manuais Rite On

TIPO	Ancho (W)	Alt. (H)	Alt. (H2)	Ø Aplicac. (mm)	Ø Aplicac. (mm)	Código	Etiqu. x Pack	€/Pack
SPRO200-1401-WH (Pack Inicio)	19,1	12,7	50,8	6,1 - 12,1		550-14010	150	29,97
RO201-1401-WH (Dispensador)	12,7	12,7	38,1	4,0 - 8,1		550-14011	200	23,36
RO202-1401-WH (Dispensador)	19,1	12,7	50,8	6,1 - 12,1		550-14012	150	23,36
RO203-1401-WH (Dispensador)	19,1	25,4	76,2	9,1 - 18,2		550-14013	100	23,36
RO201REF-1401-WH (Pack Recambio/Substituição)	12,7	12,7	38,1	4,0 - 8,1		550-14014	200	13,63
RO202REF-1401-WH (Pack Recambio / Substituição)	19,1	12,7	50,8	6,1 - 12,1		550-11401	150	14,11
RO203REF-1401-WH (Pack Recambio / Substituição)	19,1	25,4	76,2	9,1 - 18,2		550-71401	100	14,57

Material: Vinilo / Vinil 1401 (-40°C a +80°C). Color / Cor: ○



Pack Inicio 550-14010

Rotulador Indeleble / Marcador Indelével

TIPO	Color / Cor	Pack (N° Uds)	Código	€/Pack
T82S-RD Rotulador Indeleble / Marcador Indelével	Rojo / Vermelho	2	550-50822	11,19
T82S-BK Rotulador Indeleble / Marcador Indelével	Negro / Preto	2	500-50820	11,19

Rotuladores / Marcadores: ●●



Portaetiquetas de Identificación Helafix / Porta Etiquetas Helafix

TIPO	Largo / Comp. (L)	Ancho / Larg. (H)	Etiqueta Adecuada / Adequada	Pack (Uds.)	Código	€/Pack
HC 06-17	17,5	7,0		50	525-07173	13,27
HC 06-35	35,0	7,0		50	525-07353	14,55
HC 09-17	17,5	10,0	HFX9-17P	50	525-10173	13,91
HC 09-35	35,0	10,0	HFX9-35P	50	525-10353	14,94
HC 09-52	52,0	10,0	HFX9-52P	50	525-10523	16,42
HC 12-17	17,5	13,0		50	525-13173	13,78
HC 12-35	35,0	13,0	HFX12-35P	50	525-13353	15,19
HC 12-52	52,0	13,0	HFX12-52P	50	525-13523	16,88
HC 12-70	70,0	13,0		50	525-13703	18,29
HC 18-35	35,0	19,0		50	525-19353	18,29
HC 18-52	52,0	19,0		50	525-19523	20,48
HC 18-70	70,0	19,0		50	525-19703	20,93
HC 24-52	52,0	25,0		50	525-25523	23,96
HC 24-70	70,0	25,0		50	525-25703	26,92
HCR 06	25 mts	7,0		25 Mts.	525-07003	51,06
HCR 09	25 mts	10,0	HFX9	25 Mts.	525-10003	58,41
HCR 12	25 mts	13,0	HFX12	25 Mts.	525-13003	62,72
HCR 18	25 mts	19,0		25 Mts.	525-19003	81,71
HCR 24	25 mts	25,0		25 Mts.	525-25003	108,05

Material: PEUV (-60°C a +65°C). Color / Cor: ○

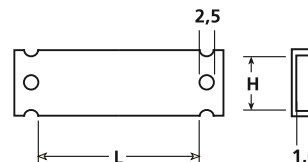

Etiquetas Helafix para Impresora Láser / Etiquetas Helafix para Impresora Laser

TIPO	H	W	Pack (Uds.)	Código	€/Pack
HFX9-17P-SP-YEWH	17,5	9,5	6.380	526-01014	432,07
HFX9-35P-SP-YEWH	35,0	9,5	2.900	526-01514	585,33
HFX12-35P-SP-YEWH	35,0	12,5	2.200	526-01714	557,70
HFX9-52P-SP-YEWH	52,5	9,0	2.480	526-02014	606,92
HFX12-52P-SP-YEWH	52,5	12,0	1.840	526-02214	591,25
HFX12-105P-SP-YEWH	105,0	12,5	880	526-02514	538,32
HFX24-105P-SP-YEWH	105,0	25,0	440	526-03014	615,12
HFX48-105P-SP-YEWH	105,0	50,0	200	526-04014	437,87
HFX12-210P-SP-YEWH	210,0	12,5	440	526-05014	486,42
HFX24-210P-SP-YEWH	210,0	25,0	220	526-05514	636,19
HFX48-210P-SP-YEWH	210,0	50,0	100	526-06014	437,87

Material: SP (-70°C a +125°C). Color / Cor: ○●

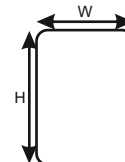

Etiquetas de Panel Impresora de Transferencia Térmica / Etiquetas para Panel Impresora Transferência Térmica

TIPO	W (mm)	H (mm)	Uds. Rollo / Rolo	Código (Tipo 1220)		€/Rollo / Rolo
				Blanco / Branco	Plata / Prata	
TAG13-07TDK1	13,0	7,0	1.000	596-00560	596-00573	162,70
TAG22-22TDK1	22,0	22,0	1.000	596-00561	596-00574	290,26
TAG27-08-TDK1	27,0	8,0	1.000	596-00562	596-00575	216,91
TAG27-12,5TDK1	27,0	12,5	1.000	596-00558	596-00576	276,44
TAG27-15TDK1	27,0	15,0	1.000	596-00563	596-00577	249,76
TAG27-18TDK1	27,0	18,0	1.000	596-00564	596-00578	283,14
TAG27-27TDK1	27,0	27,0	1.000	596-00565	596-00579	602,00
TAG35-18TDK1	35,0	18,0	1.000	596-00566	596-00580	559,28
TAG45-15TDK1	45,0	15,0	1.000	596-00567	596-00581	591,44
TAG45-25TDK1	45,0	25,0	1.000	596-00568	596-00582	728,76
TAG60-30TDK1	60,0	30,0	500	596-00569	596-00583	485,11
TAG90-45TDK1	90,0	45,0	500	596-00570	596-00584	901,71
TAG100-30TDK1	100,0	30,0	250	596-00571	596-00585	354,52
TAG100-70TDK1	100,0	70,0	250	596-00572	596-00586	723,81

Material: PET (-40°C a +90°C). Color / Cor: ○● Cinta de Impresión Recomendada / Fita de Impressão Recomendada: TT122OUT o /ou TT822OUT



printshop Servicio de Impresión Serviço de Impressão

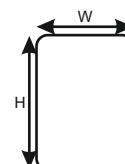

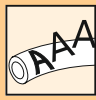

Etiquetas Helatag para Impresora de Transferencia Térmica (Sin Película)

Etiquetas Helatag para Impressora Transferência Térmica (Sem Película)

TIPO	W (mm)	H (mm)	Etiquetas x Pack	Código	€/Pack
TAG71TD6-1203-SR	12,7	11,1	15.000	596-71120	348,84
TAG15TD3-1203-SR	25,4	12,7	7.500	596-51203	323,21
TAG27TD2-1203-SR	38,1	19,1	2.500	596-71203	275,93
TAG67TD2-1203-SR	38,1	31,8	1.000	596-67120	222,09
TAG73TD1-1203-SR	50,8	25,4	2.000	596-73120	362,01
TAG66TD1-1203-SR	50,8	36,5	1.000	596-66120	260,96
TAG68TD1-1203-SR	63,5	25,4	2.000	596-68120	287,37
TAG63TD1-1203-SR	63,5	38,1	1.000	596-63120	270,14
TAG76TD1-1203-SR	63,5	50,8	500	596-76120	235,31
TAG62TD1-1203-SR	76,2	50,8	500	596-21203	253,80
TAG64TD1-1203-SR	88,9	36,5	1.000	596-64120	347,88
TAG97TD1-1203-SR	101,6	74,0	500	596-97120	296,53
TAG98TD1-1203-SR	101,6	160,0	250	596-98120	382,73

Material: PET 1203 (-40°C a +120°C). Color / Cor: ○ ● Cinta de Impresión Recomendada / Fita de Impresão Recomendada: TT8220UT



printshop Servicio de Impresión
Serviço de Impresão

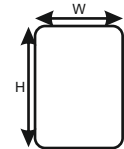

5.4. Sistema de Impresión en Acero Inoxidable / Sistema de Impresão de Aço Inoxidável

Impresora / Impressora

TIPO	Código	€/Ud.
M-BOSS Compact	544-20000	Consulta
M-BOSS Compact C/ Organizador	544-21000	Consulta

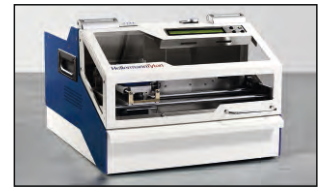

Placas Sin Impresión / Placas Sem Impresão

TIPO	W (mm)	L (mm)	Señalizadores x Pack Marcadores x Pack	Código	€/100 Uds.
MBML10X45	10,0	45,0	1.000	544-80101	73,01
MBML10X90	10,0	90,0	500	544-80102	83,80
MBML20X45	20,0	45,0	1.000	544-80201	100,04
MBML20X90	20,0	90,0	500	544-80202	133,57



Placas Impresas / Placas impressas

TIPO	W (mm)	L (mm)	Código	€/100 Uds.
MBML10X45 Printed	10,0	45,0	544-80101-00	185,00
MBML10X90 Printed	10,0	90,0	544-80102-00	211,00
MBML20X45 Printed	20,0	45,0	544-80201-00	256,00
MBML20X90 Printed	20,0	90,0	544-80202-00	295,00



Material: SS316 (+8°C a +538°C). Color / Cor: ●

printshop Servicio de Impresión
Serviço de Impresão

5.5. Impresoras y Accesorios / Impressoras e Acessórios

Sistema de Impresión TIP's / Sistema de Impresão TIP's

TIPO	Descripción Descrição	Tipo	Caja/Caixa (Uds.)	Código	€/Ud.
TT431	Impresora / Impressora	Termo. 300 dpi	1	556-00400	2.223,00
TT431	Porta rollos/rolos externo	Accesorio / Acessório TT431	1	556-00454	406,00
P431	Perforador / Perfurador	Accesorio / Acessório TT431	1	556-00456	1.797,00
TT4030	Impresora / Impressora	Termo. 300 dpi	1	556-04037	Sob. Consulta
P4030	Perforador / Perfurador	Accesorio / Acessório TT4030	1	556-04051	Sob. Consulta
TrakMark DS	Impresora / Impressora	Termo. 2 x 300 dpi	1	556-05000	Sob. Consulta
P4000	Perforador / Perfurador	Accesorio/Acessório TrackMarck DS	1	556-04024	Sob. Consulta
TAG PRINT PRO 3.0 EMEA		Software Etiquetas	-	556-00051	858,00



NOVEDAD
NOVIDADE

Cintas de Impresión TIP's / Fitas de Impressão TIP's

TIPO	Material	Dimensión / Dimensão	Caja / Caixa (Uds.)	Código	€/ Ud.
TT122OUT 60mm	1220 / 1221	60mm x 300m.	1	556-00060	51,29
TT122OUT 110mm	1220 / 1221	110mm x 300m.	1	556-00061	88,61
TT822OUT 60mm	1220 / 1221	60mm x 300m.	1	556-00111	51,66
TT822OUT 110mm	1220 / 1221	110mm x 300m.	1	556-00101	88,61
TTDTHOUT40	TLFX/ TULT/ TIPTAG/ TAGUL/ TULT DS	40mm x 300m.	1	556-00139	125,81
TTDTHOUT60	TLFX/ TULT/ TIPTAG/ TAGUL/ TULT DS	60mm x 300m.	1	556-00140	188,47
TTDTHOUT100	TLFX/ TULT/ TIPTAG/ TAGUL/ TULT DS	100mm x 300m.	1	556-00141	313,20
TTRC+ 30mm	TIPTAG PU	30mm x 300m.	1	556-00114	123,87
TTRC+ 60mm	TIPTAG PU	60mm x 300m.	1	556-00115	247,54
TTRC+ 100mm	TIPTAG PU	100mm x 300m.	1	556-00103	360,33
TT932DOUT 35mm	1209	35mm x 300m	1	556-00124	12,92
TT932DOUT 85mm	1209	85mm x 300m	1	556-00117	39,29
TT932DOUT 110mm	1209	110mm x 300m.	1	556-00118	105,63

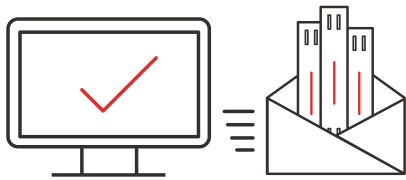
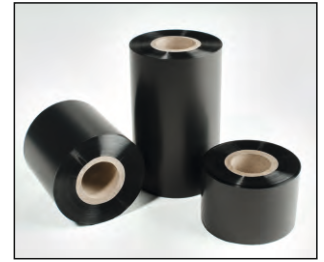

printshop

by HellermannTyton

¿Necesitas marcar tus Cables y Cuadros?
Necessita de identificar os seus cabos o quadros?

La solución es / A solução é.. printshop

by HellermannTyton

NUEVO! NOVO!



1. Llámanos al (+34) 91 661 23 58

1. Ligue-nos para (+351) 221 202 335



2. Elige producto

2. Escolha produto



3. Recíbelo impreso en 24-48 H.

3. Receba impreso em 24-48 H.





6.1. Bandejas / Cassetes

Bandejas / Cassetes

TIPO	Número máx. Empalmes / Fusões	Bolsa (Uds.)	Código	€
Bandejas del Sistema de Gestión Integrada / Bandejas do Sistema de Gestão Integrada				€/ Pack
Bandeja de 4 Fibras SC TRAY-SC-IR-12	4	12	857-40244	25,45
Bandeja de 12 Fibras SC TRAY-SC-B-IR-2x3A-12	12	12	857-40335	33,85
Bandeja de 24 Fibras SE TRAY-BK-SE-IR-RB/3A-O6PK	24	6	857-40342	24,03
Bandeja de 24 Fibras SE TRAY-SE-IR-2x3A-06	24	6	857-40257	15,85
Kit Hellapon				€/ Ud.
Bandeja Hellapon Small TRAY-HS-3A-01	12	2	857-40278	7,96
Bandeja Hellapon Medium Style C TRAY-HMC-3A-01	24	2	857-40353	4,84
Kit Hellafos				€/ Ud.
Bandeja Hellafos (124082)	24	50	857-20002	4,30
ACC3266 - Kit 50 Tapas, Etiquetas y Gomas	-	1	857-40026	110,43



6.2. Cajas de Empalme / Caixas de Juntas

Cajas de Empalme de Fibra Óptica FST / Caixas de Juntas de Fibra Optica FST

TIPO	Número Entradas	Número Máx. Empalmes / Fusões	Bolsa (Uds.)	Código	€/ Ud.
FST3705 - KIT - Hellapon Small (2 bandejas)	4	24 - 48	1	857-00182	161,10
FSTTB - AX _____ **	13	12 - 24 - 36	1	-	** Sob. Consulta
FSTTB - AX _____ **	4	12 - 24 - 36	1	-	** Sob. Consulta

**Dependiendo de la composición / Dependendo da composição.

Accesorios / Acessórios					
ACC1037 - Soporte Pared / Suporte Parede		-	1	857-40000	18,82

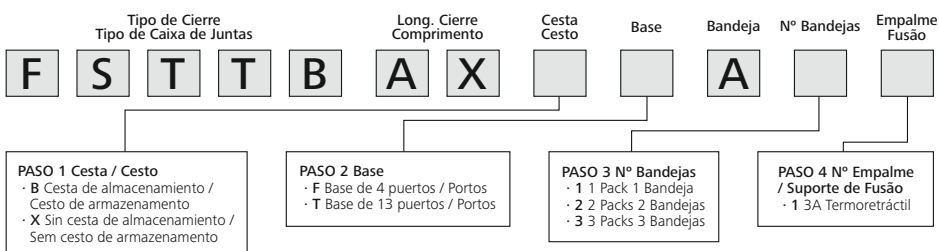

Puerto / Porto	Nº Puertos / Portos	Cable / Cabo (mm)	
		Cablelok	Termoretráctil
LM	1	2 x 4 - 15,0	2 x 8,0 - 22,0
B	2 or 3	4,8 - 16,5	6,0 - 19,0
R	10	1,7 - 9,5	-

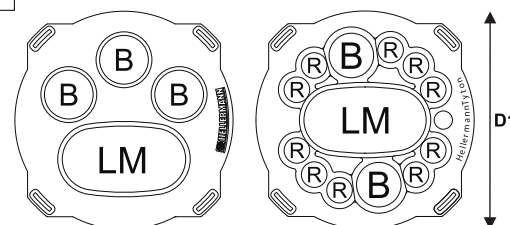



Cajas de Empalme de Fibra Óptica FRBU / Caixas de Juntas de Fibra Óptica FRBU

TIPO	Número Entradas	Número Máx. Empalmes / Fusões	Bolsa (Uds.)	Código	€/ Ud.
FRBU1314 - KIT Hellapon Medium (4 bandejas)	9	48 - 96	1	857-00104	270,17
FRBU1315 - KIT Hellapon Medium (6 bandejas)	9	72 - 144	1	857-00105	274,15
FRBTB-AX _____ COVER A	9 o 11	72 - 144	1	**	Sob. Consulta
FRBTB-AB _____ COVER B	9 o 11	72 - 144	1	**	Sob. Consulta

**Dependiendo de la composición / Dependendo da composição

Accesorios / Acessórios					
ACC1037 - Soporte Pared / Suporte Parede	-	-	1	857-40000	18,82

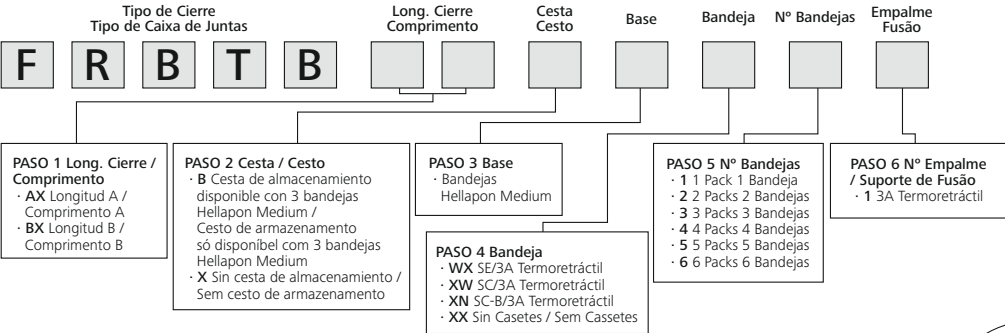

Puerto / Porto	Nº Puertos / Portos	Cable / Cabo (mm)	
		Cablelok	Termoretráctil
L	1	2 x 5,5 - 20,0	2 x 12,0 - 24,0
LM	1	2 x 4,0 - 15,0	2 x 8,0 - 22,0
B	2 or 4	4,8 - 16,5	6,0 - 19,0
R	4 or 8	1,7 - 9,5	4,0 - 11,0

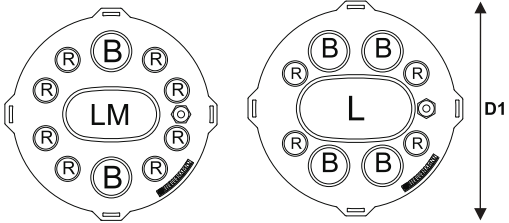

Cajas de Empalme FDNIR 16 e 59 Port. Con Gestión Integrada / Caixas de Juntas FDNIR 16 e 59 Port. Gestão Integrada

TIPO / COMPOSICIÓN	Número Entradas	Número Máx. Empalmes / Fusões	Bolsa (Uds.)	Código	€/ Ud.
FDNIR-AX _____ COVER A	16 o 57	144	1	-	Sob. Consulta
FDNIR-AB _____ COVER AB	16 o 57	288	1	-	Sob. Consulta
FDNIR-BX _____ COVER BX	16 o 57	576	1	-	Sob. Consulta
FDNIR-CX _____ COVER CX	16 o 57	864	1	-	Sob. Consulta

**Dependiendo de la composición / Dependendo da composição

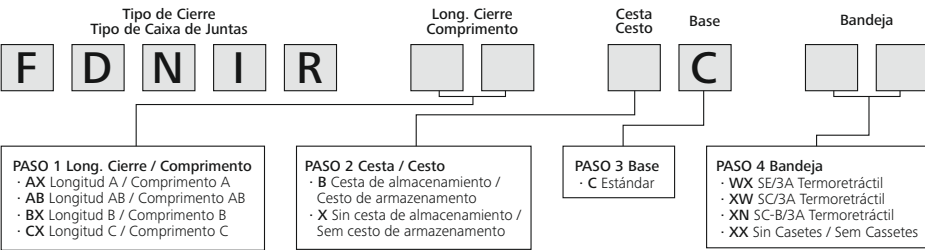

Puertos / Portos		Cable / Cabo (mm)	
59	16	Cablelok	Termoretráctil
1	1	2 x 5,5 - 20,0	2 x 12,0 - 24,0
2	2	15,5 - 29,0	12,0 - 35,0
4	9	5,0 - 20,0	12,0 - 26,0
2	4	4,8 - 16,5	6,0 - 19,0
52	-	1,7 - 9,5	-

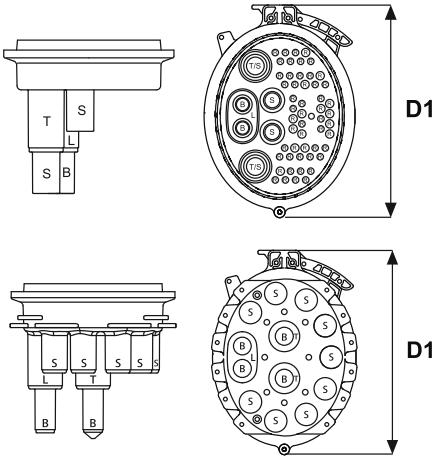



Cajas de Empalme UFC Con Gestión Integrada / Caixas de Juntas UFC Com gestão integrada

TIPO	Número Entradas	Número Máx. Empalmes / Fusões	Bolsa (Uds.)	Código	€/ Ud.
UFCIR-BX _____ COVER B	26	288 a 576	1	-	Sob. Consulta
UFCIR-BC _____ COVER BC	26	432 a 864	1	-	Sob. Consulta
UFCIR-CX _____ COVER-C	26	720 a 1440	1	-	Sob. Consulta

**Dependiendo de la composición / Dependendo da composição.

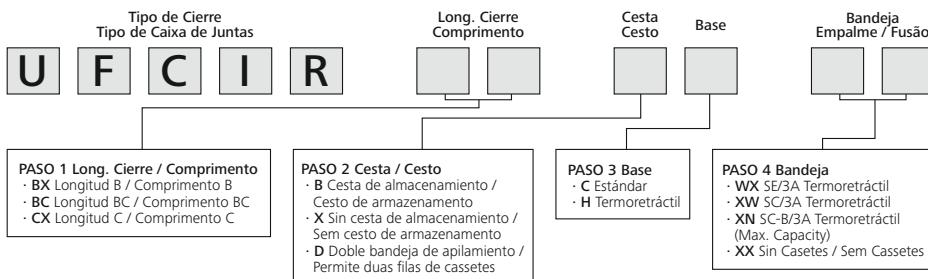

Puerto / Porto	Nº Puertos / Portos	Cable / Cabo (mm)	
		Cablelok	Termorretráctil
L	1	2 x 5,5 - 20,0	2 x 12,0 - 24,0
LM	1	2 x 4,0 - 15,0	2 x 8,0 - 22,0
T	2	15,5 - 29,0	12,0 - 35,0
S	10	5,0 - 20,0	12,0 - 26,0
B	16	4,8 - 16,5	6,0 - 19,0

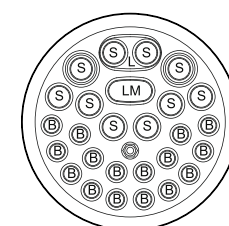
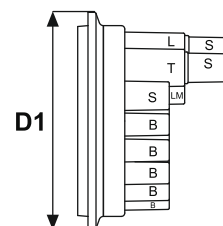

Cajas de Empalme FML Con Gestión Integrada / Caixas de Juntas FML Com gestão integrada

TIPO	Número Entradas	Número Máx. Empalmes / Fusões	Bolsa (Uds.)	Código	€/ Ud.
FMLIR-BX _____ COVER-B	9	432	1	-	Sob. Consulta
FMLIR-BC _____ COVER-BC	9	576	1	-	Sob. Consulta
FMLIR-CX _____ COVER-C	9	720	1	-	Sob. Consulta

**Dependiendo de la composición / Dependendo da composição.

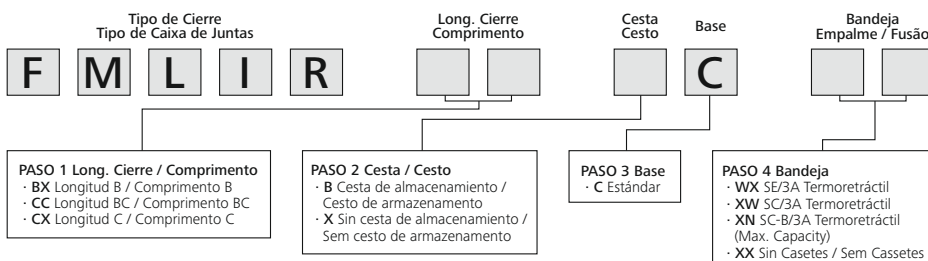

Puerto / Porto	Nº Puertos / Portos	Cable / Cabo (mm)	
		Cablelok	Termorretráctil
L	1	2 x 5,5 - 20,0	2 x 12,0 - 24,0
T	2	15,5 - 29,0	12,0 - 35,0
S	6	5,0 - 20,0	12,0 - 26,0
B	4	4,8 - 16,5	6,0 - 19,0

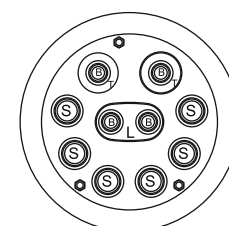
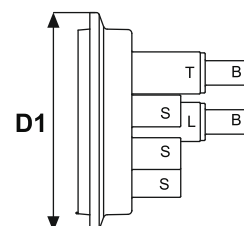



Cajas de Empalme Pre-Conectorizados / Caixas de Juntas Pre-Conectorizadas

TIPO	Número Entradas	Número máx. Empalmes / Fusões	Bolsa (Uds.)	Código	€/ Ud.
FSTCT-13Ports 2 o 8 SC/APC	13	12	1	-	Sob. Consulta
FRBCT-11Ports 24 SC/APC	11	48	1	-	Sob. Consulta
FDNCT-59Ports 24 LC/UPCeAPC / 24 SC/UPCeAPC	59	180	1	-	Sob. Consulta

Adaptadores Duplex. o Simplex dependiendo de la composición / Adaptadores Duplps ou Simples dependendo da composição final.

**Dependiendo de la composición / Dependendo da composição



FDN Connectorised

Puerto / Porto	Nº Puertos/ Portos	Cable / Cabo (mm)	
		Cablelok	Termoretráctil
L	1	2 x 5,5 - 20,0	2 x 12,0 - 24,0
T	2	15,5 - 29,0	12,0 - 35,0
S	4	5,0 - 20,0	12,0 - 26,0
B	2	4,8 - 16,5	6,0 - 19,0
R	52	1,7 - 9,5	-

FRBU Connectorised

Puerto / Porto	Nº Puertos/ Portos	Cable / Cabo (mm)	
		Cablelok	Termoretráctil
LM	1	2 x 4,0 - 15,0	2 x 8,0 - 22,0
B	2 or 3	4,8 - 16,5	6,0 - 19,0
R	10	1,7 - 9,5	-

FST Connectorised

Puerto / Porto	Nº Puertos/ Portos	Cable / Cabo (mm)	
		Cablelok	Termoretráctil
LM	1	2 x 4,0 - 15,0	-
B	2 or 3	4,8 - 16,5	-
R	10	1,7 - 9,5	-

Cablelok

Sistema mecánico de sellado adaptado a su torpedo disponible para todos los puertos
Sistema de selagem mecânica, adaptada à sua caixa de juntas, disponível para todos os portos

TIPO	Puerto Porto	Medida	Bolsa (Uds.)	Código	€/ Pack
CABLELOK - B10 ; B20 ; B30	B	4,8-9,0 ; 8,0-14,0 ; 13,0-16,0	10	-	Sob. Consulta
CABLELOK - R10 ; R20 ; R30 ; R40 ; R50 ; R60 ; R70 ; R80	R	1,7-2,0 ; 3,0-3,8 ; 3,8-4,8 ; 3,8-5,2 ; 5,2-5,8 ; 6,0-8,5 ; 8,0-9,5	10	-	Sob. Consulta
CABLELOK - S10 ; S20 ; S30 ; S40 ; S50	S	5,0-8,5 ; 38,0-12,0 ; 10,0-11,5 ; 12,0-16,0 ; 16,0-20,0	10	-	Sob. Consulta
CABLELOK - T10 ; T20 ; T30 ; T40	T	15,5-22,0 ; 20,5-23,5 ; 23,5-25,5 ; 24,5-29,0	10	-	Sob. Consulta

Códigos Dependiendo de los puertos a utilizar/Códigos Dependende dos portos utilizados

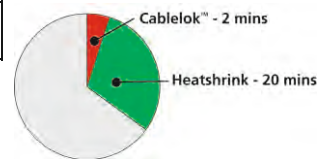



6.3. Cajas de Fibra / Caixas de Fibra

S Series MDU Enclosures

S5 - Cajas solo de fusiones / Armários só para fusões

TIPO	Descripción / Descrição	Código	€/ Ud.
MDU-S5-LLWX	MDU S5 - 216F Splice Only, 18 x SE-IR 3A, Loop Storage Management	857-01494	577,33
MDU-S5-LLXN	MDU S5 - 432F Splice Only, 36 x SC-B 3A, Loop Storage Management	857-01495	655,36

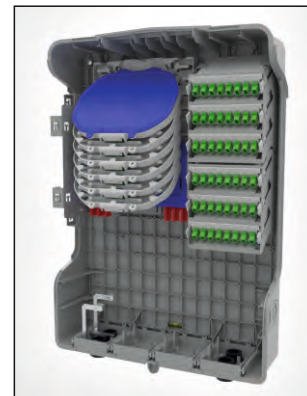

S5 - Cajas Conectorizadas / Armários Conectorizados

TIPO	Descripción / Descrição	Código	€/ Ud.
MDU-S5-BXMX06CS048R48A1	MDU S5 - 6 x LC APC Cassettes, 48 LC APC Pigtailed, 6 x 900µm 3A Trays, Basket	857-01496	1.487,22
MDU-S5-LBMX01CP024B96A1	MDU S5 - 24 LC APC Quad Adaptors, 96 LC APC Pigtailed, 6 x 900µm 3A Trays, Basket, Loop Storage Management	857-01497	1.730,21
MDU-S5-LXMX06CS048R031:8	MDU S5 - 6 x Cassettes 1:8 LC APC Splitter, 6 x 900µm 3A Trays, Loop Storage Management	857-01498	2.106,10
MDU-S5-LBMX02CP024B121:8	MDU S5 - 24 LC APC Quad Adaptors, 12x1:8 LC APC Pigtailed, 6 x 900µm 3A Trays, Basket, Loop Storage Management	857-01499	3.130,52

S3 - Cajas solo de fusiones / Armários só para fusões

TIPO	Descripción / Descrição	Código	€/ Ud.
MDU-S3-XWX	MDU S3 - 48F Splice Only, 4 x SE-IR 3A	857-01481	137,16
MDU-S3-BWX	MDU S3 - 48F Splice Only, 4 x SE-IR 3A, Basket	857-01482	199,93
MDU-S3-XXN	MDU S3 - 96F Splice Only, 8 x SC-B IR 3A	857-01483	150,21
MDU-S3-BXN	MDU S3 - 96F Splice Only, 8 x SC-B IR 3A, Basket	857-01484	212,98
MDU-S3-XWX-CPXX	MDU S3 - 12F Connectorised - o Adaptors or Pigtailed	857-01562	176,70
MDU-S3-BWX-CPXX	MDU S3 - 12F Connectorised - with Basket - No Adaptors or Pigtailed	857-01563	233,61

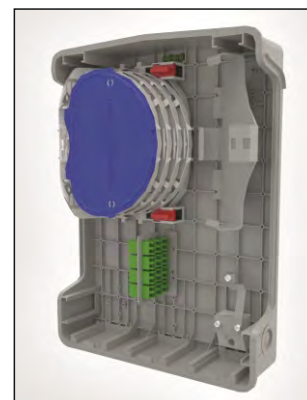

S3 - Cajas Conectorizadas / Armários Conectorizados

TIPO	Descripción / Descrição	Código	€/ Ud.
MDU-S3-XWX-CP06LA1	MDU S3 - 6 x LC DX PC Adaptors, 12 x LC PC Pigtailed, 4 x 3A SE Trays	857-01485	200,81
MDU-S3-BWX-CP06LA1	MDU S3 - 6 x LC DX PC Adaptors, 12 x LC PC Pigtailed, 4 x 3A SE Trays, Basket	857-01486	258,88
MDU-S3-XWX-CP12LA1	MDU S3 - 12 x LC DX APC Adaptors, 24 x LC PC APC Pigtailed, 4 x 3A SE Trays	857-01487	241,51
MDU-S3-BWX-CP12LA1	MDU S3 - 12 x LC DX APC Adaptors, 24 x LC PC APC Pigtailed, 4 x 3A SE Trays, Basket	857-01488	294,67
MDU-S3-XWX-CP06L31:4	MDU S3 - 3 x 1:4 LC APC Splitter, 12 Adaptors, 4 x 3A SE Trays	857-01489	284,18
MDU-S3-BWX-CP06L31:4	Basket	857-01490	346,98

S1 - Cajas de Fibras / Caixa de Fusões

TIPO	Descripción / Descrição	Código	€/ Ud.
MDU-S1-01SC	MDU S1 - 3A Splice Management Tray, SC SX Adaptor and Drop Cable Management Tray, Cable Entry Seal and Clamps (10mm-15mm) Drop Cable Seal.	857-01513	98,56
MDU-S1-01LC	MDU S1 - 3A Splice Management Tray, LC SX Adaptor and Drop Cable Management Tray, Cable Entry Seal and Clamps (10mm-15mm) Drop Cable Seal.	857-01514	98,56
MDU-S1-01SC08SA1	MDU S1 - 3A Splice Management Tray, 8 x SC SX PC Adaptor/Drop Cables, Cables Entry Seal and Clamps (10mm-15mm) Drop Cable Seal.	857-01515	130,35
MDU-S1-01SC08TA1	MDU S1 - 3A Splice Management Tray, 8 x SC SX APC Adaptor/Drop Cables, Cables Entry Seal and Clamps (10mm-15mm) Drop Cable Seal.	857-01516	131,86
MDU-S1-01LC08SA1	MDU S1 - 3A Splice Management Tray, 8 x LC SX PC Adaptor/Drop Cables, Cables Entry Seal and Clamps (10mm-15mm) Drop Cable Seal.	857-01517	171,40
MDU-S1-01LC08RA1	MDU S1 - 3A Splice Management Tray, 8 x LC SX APC Adaptor/Drop Cables, Cables Entry Seal and Clamps (10mm-15mm) Drop Cable Seal.	857-01518	210,53

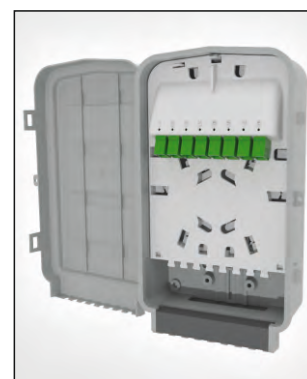



AFN - Cajas de Fibras / Caixa de Fusões

TIPO	Descripción / Descrição	Código	€/ Ud.
AFN-9999LCRXXX1/BK	AFN, BK, CE KIT 7MM, DC KIT 4MM, 24 LX SX APC ADPTS	857-01537	266,91
AFN-9999LCPXXX1/BK	AFN, BK, CE KIT 7MM, DC KIT 4MM, 24 LX SX PC ADPTS	857-01538	266,91
AFN-9999LCRS381/BK	AFN, BK, CE KIT 7MM, DC KIT 4MM, 3X1:8 BE/LC APC ADPTS	857-01541	406,60
AFN-9999LCRS641/BK	AFN, BK, CE KIT 7MM, DC KIT 4MM, 6X1:4 BE/LC APC ADPTS	857-01547	427,37
AFN-9999LCRP241/BK	AFN, BK, CE KIT 7MM, DC KIT 4MM, 24XLC SX APC ADPTS/PTAILS	857-01548	340,98
AFN-9999LCXXX1/BK	AFN, BK, CE KIT 7MM, DC KIT 4MM, 24 LC SX (No Adaptors/No Pigtailes)	857-01561	183,40



AFN - Cajas de Fibras / Caixa de Fusões

TIPO	Descripción / Descrição	Código	€/ Ud.
FFE-01SCXXX1/BK0	Splice Management Tray - 2 x 3A Splice Bridges - SC Simplex Adaptor and Drop Cable Management Tray. Cable Entry Seal and Clamps (10.0mm - 13.0mm) Drop Cable Seal. Wall Mounting Kit (4 x screws, nylon plugs, 2 x O-rings), Pole Mounting Kit (2 x 770mm UV stable cable ties).	857-01169	119,78
FFE-02SCTXXX1/BK	Splice Management Tray - 2 x 3A Splice Bridges - SC Simplex Adaptor and Drop Cable Management Tray. 8 x SC APC Adaptors and Drop Cables, Cable Entry Seal and Clamps (07.0mm - 10.0mm) Drop Cable Seal. Wall Mounting Kit (4 x screws, nylon plugs, 2 x O-rings), Pole Mounting Kit (2 x 770mm UV stable	857-01198	125,82
FFE-02LCAXXX1/BK0	Splice Management Tray - 2 x 3A Splice Bridges - LC Duplex Adaptor and Drop Cable Management Tray. 8 x LC APC Adaptors and Drop Cables, Cable Entry Seal and Clamps (07.0mm - 10.0mm) Drop Cable Seal. Wall Mounting Kit (4 x screws, nylon plugs, 2 x O-rings), Pole Mounting Kit (2 x 770mm UV stable	857-01199	218,17



CCP - Punto de Conexión del Cliente / Ponto de Conexão ao Cliente

TIPO	Descripción / Descrição	Código	€/ Ud.
CCPA-M11XXX/BK-0	CCP Black, Cable Entry Kit 4.6 - 5.6mm, 1 x SC Simplex PC Blue	857-01106	20,08
CCPA-M111SP/BK-0	CCP Black, Cable Entry Kit 4.6 - 5.6mm, 1 x SC Simplex APC Green	857-01107	24,92
CCPA-M111TP/BK-0	CCP Black, Cable Entry Kit 4.6 - 5.6mm, 1 x LC Duplex PC Blue	857-01108	24,92
CCPA-M111LP/BK-0	CCP Black, Cable Entry Kit 4.6 - 5.6mm, 1 x LC Duplex APC Green	857-01109	35,98
CCPA-M111AP/BK-0	Adaptor/2 x LC Duplex APC Pigtail	857-01110	35,98



Ferramienta de Apertura de Puertos / Ferramenta para Abertura de Portos

TIPO	Contenido / Conteúdo	Código	€/ Ud.
SBT R 01	Short Body Port Opening Tool R x 01	857-40432	10,40
SBT B 01	Short Body Port Opening Tool B x 01	857-40433	10,40
SBT S 01	Short Body Port Opening Tool S x 01	857-40434	11,22



Cajas de Conexión Internas / Caixas de Fibra Internas

TIPO	Contenido / Conteúdo	Código	€/ Ud.
FEDEC	Internal fibre distribution enclosure connectorized, unloaded	914-41560	67,50
FDES	Internal fibre distribution splice enclosure	914-41565	22,50
FWOA	Fibre Wall Outlet, Unloaded	914-41570	6,75



FEDEC



FDES



FWOA

MODB Caja de distribución de múltiples operadores / Caixa de distribuição multi-operador

TIPO	Descripción / Descrição	Código	€/ Ud.
MODB	Multi Operator Distribution Box 48FO	914-41610	158





Bridas Estándar Natural y Negro / Abraçadeiras Standard Natural e Preto

TIPO	L	W	Bolsa (Nº Uds.)	Embalaje / Embalagem (Nº Bolsas)	Color / Cor	Código	€/ Bolsa
T18R / 50 NA	100	2,5	50	12	Natural	914-60190	0,75
T18R / 50 BK	100	2,5	50	12	Negro / Preto	914-60191	0,75
T30R / 50 NA	150	3,5	50	12	Natural	914-60192	1,80
T30R / 50 BK	150	3,5	50	12	Negro / Preto	914-60193	1,80
T50R / 50 NA	200	4,6	50	12	Natural	914-60195	2,36
T50R / 50 BK	200	4,6	50	12	Negro / Preto	914-60196	2,36
LK2A / 50 NA	275	4,6	50	12	Natural	914-60199	4,29
LK2A / 50 BK	275	4,6	50	12	Negro / Preto	914-60200	4,29
T120R / 10 NA	390	7,6	10	6	Natural	914-60203	1,94
T120R / 10 BK	390	7,6	10	6	Negro / Preto	914-60204	1,94

Material: PA6.6 UL94V2 (-40°C a +85°C). Colores / Cores: ●○

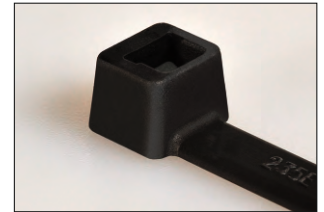

Bridas Estándar Marrón y Verde (Ideal Jardinería) / Abraçadeiras Standard Castanho e Verde (Ideal Jardinagem)

TIPO	L	W	Bolsa (Nº Uds.)	Embalaje / Embalagem (Nº Bolsas)	Color / Cor	Código	€/ Bolsa
T30R / 50 GN	150	3,5	50	12	Verde	914-60194	1,94
T50R / 50 GN	200	4,6	50	12	Verde	914-60197	2,40
T50R / 50 BN	200	4,6	50	12	Marrón / Castanho	914-60198	2,40
LK2A / 50 GN	275	4,6	50	12	Verde	914-60201	4,59
LK2A / 50 BN	275	4,6	50	12	Marrón / Castanho	914-60202	4,59

Material: PA6.6 UL94V2 (-40°C a +85°C). Colores / Cores: ●●

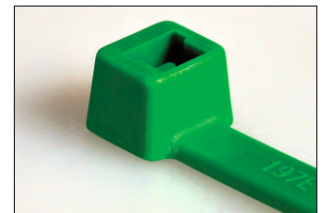

Bridas Recuperables "Speedy Tie" / Abraçadeiras Recuperáveis "Speedy Tie"

TIPO	L	W	Bolsa (Nº Uds.)	Embalaje / Embalagem (Nº Bolsas)	Color / Cor	Código	€/ Bolsa
SpeedyTie / 2	750	13	2	12	Amarillo / Amarelo	914-60149	3,54

Material: PA6.6 UL94V2 (-40°C a +85°C). Color / Cor: ●



Bridas Estándar Recuperables LR55R / Abraçadeiras Standard Recuperáveis LR55R

TIPO	L	W	Bolsa (Nº Uds.)	Embalaje / Embalagem (Nº Bolsas)	Color / Cor	Código	€/ Bolsa
LR55R 25 BK	195	4,7	25	12	Negro / Preto	914-60130	4,71
LR55R 25 NA	195	4,7	25	12	Natural	914-60135	4,71

Material: PA6.6 UL94V2 (-40°C a +85°C). Colores / Cores: ●○



Bridas Textiles Serie TEXTIE / Abraçadeiras Têxteis Série TEXTIE

TIPO	L	W	Bolsa (Nº Uds.)	Embalaje / Embalagem (Nº Bolsas)	Color / Cor	Código	€/ Bolsa
TEXTIE 6XC	200	12,5	6	12	6 Colores / Cores	914-60140	6,30

Material: PA6.6 UL94V2, Polipropileno (-40°C a +85°C). Colores / Cores: ●●●●●●



Bridas Metálicas Serie MBT / Abraçadeiras Metálicas Série MBT

TIPO	L	W	Bolsa (Nº Uds.)	Embalaje / Embalagem (Nº Bolsas)	Material	Código	€/ Bolsa
MBT5SS x 5	127	4,6	5	12	SS304	914-60075	4,20
MBT8SS x 5	201	4,6	5	12	SS304	914-60080	4,60

Material: Acero Inoxidable / Aço inoxidável S304 (-80 °C a +538 °C). Color / Cor: ●



Bases Adhesivas Serie MB / Bases Adesivas Série MB

TIPO	L x W	Brida / Abraçad. (W) Max.	Bolsa (Nº Uds.)	Embalaje / Embalagem (Nº Bolsas)	Negro / Preto	Natural	€/ Bolsa
MB3A / 10	19 x 19	4,0 mm	10	12	914-60211	914-60210	2,08
MB4A / 10	28 x 28	5,4 mm	10	12	914-60213	914-60212	2,65

Material: PA66 UL94 V2 (-40°C a +85°C). Colores / Cores: ●○



Bases Flexibles con Adhesivo Especial FlexTack / Bases Flexíveis com Adesivo Especial FlexTack

TIPO	L	W	Bolsa (Nº Uds.)	Embalaje / Embalagem (Nº Bolsas)	Código		€/ Bolsa
					Natural	Negro / Preto	
FMB4APT-I/10	28	28	10	12	914-60302	914-60300	13,44

Material: PA6.6 HS UL94V2 (-40°C a +105°C). Color / Cor: ●○



Tacos para Brida Serie LOK / Suporte para Abraçadeiras Série LOK

TIPO	L	Taladro / Furo (mm)	Bolsa (Nº Uds.)	Embalaje / Embalagem (Nº Bolsas)	Color / Cor	Código	€/ Bolsa
LOK01	44	8,0 mm	10	12	Negro / Preto	914-60215	1,74

Material: PA6 (-40°C a +80°C). Color / Cor: ●



Taco WPT / Suporte WPT

TIPO	L	Ø Taladro / Furo (mm)	Bolsa (Nº Uds.)	Embalaje / Embalagem (Nº Bolsas)	Color / Cor	Código	€/ Bolsa
WPT230X5BK	230	8	5	12	Negro / Preto	914-60145	2,78

Material: PA6HIR (-40°C a +80°C). Color / Cor: ●

Bridas Atado Doble / Abraçadeiras Atado Duplo

TIPO	LxW	Ø	Caja / Caixa (Packs)	Pack (Uds.)	Color / Cor	Código	€/ Pack
T50RCoupler 25	2x (200x4,6)	2 x 47	10	25	Negro / Preto	156-00276-00	18,05

Material: PA6.6HIRHS UL94V2 (-40°C a +105°C). Color / Cor: ●

Tubos Termoretráctiles 2:1 en Tiras de 120mm / Tubos Termorretrácteis 2:1 em Tiras de 120mm

TIPO	Ø Min / Max	Long. (mm)	Bolsa (Nº Uds.)	Embalaje / Embalagem (Nº Bolsas)	Color / Cor	Código	€/ Bolsa
UNICOLOR 32	3,2 - 1,6	120	10	12	Negro / Preto	914-50405	2,24
UNICOLOR 48	4,8 - 2,4	120	10	12	Negro / Preto	914-50410	2,45
UNICOLOR 64	6,4 - 3,2	120	10	12	Negro / Preto	914-50415	2,65
UNICOLOR 95	9,5 - 4,8	120	10	12	Negro / Preto	914-50420	2,96
SURTIDO 32	3,2 - 1,6	120	10	12	Surtido / Sortido	914-50407	2,24
SURTIDO 48	4,8 - 2,4	120	10	12	Surtido / Sortido	914-50413	2,45
SURTIDO 64	6,4 - 3,2	120	10	12	Surtido / Sortido	914-50418	2,65
SURTIDO 95	9,5 - 4,8	120	10	12	Surtido / Sortido	914-50423	2,96

Material: Poliolefina UL224 (-55 °C a +125 °C). Colores / Cores: ●●●●●

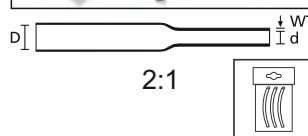
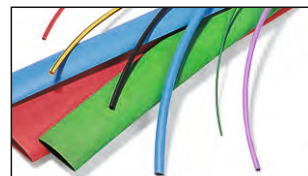
MiniCajas de Tubo Termotráctil 2:1 Pared Fina / MiniCaixas de Tubo Termorretráctil 2:1 Parede Fina

TIPO	Ø Expand.	Ø Contraído Retraído	Caja / Caixa (Mts.)	MiniCaja / MiniCaixa (Mts.)	Color	Código	€/ MiniCaja / MiniCaixa
HIS 12	1,2	0,6	50	10	Negro / Preto	300-30120	14,95
HIS 16	1,6	0,8	50	10	Negro / Preto	300-30160	14,95
HIS 24	2,4	1,2	50	10	Negro / Preto	300-30240	14,95
HIS 32	3,2	1,6	50	10	Negro / Preto	300-30320	14,95
HIS 48	4,8	2,4	50	10	Negro / Preto	300-30480	14,95
HIS 64	6,4	3,2	25	5	Negro / Preto	300-30640	14,95
HIS 95	9,5	4,8	25	5	Negro / Preto	300-30950	14,95
HIS 127	12,7	6,4	25	5	Negro / Preto	300-31270	14,95
HIS 190	19	9,5	25	5	Negro / Preto	300-31900	16,16
HIS 254	25,4	12,7	25	5	Negro / Preto	300-32540	20,20

Material: Poliolefina UL224 (-55 °C a +125 °C). Color / Cor: ●

Otros colores / Outras cores (PVP +5%); Tierra / Terra (PVP +15%). Posibilidad / Possibilidade 3:1.

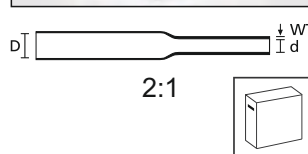
Tubos Termoretráctiles 2:1 en Tiras de 1 Metro / Tubos Termorretrácteis 2:1 em Tiras de 1 Metro

TIPO	Ø Expandido	Ø Contraído Retraído	Caja / Caixa (Nº Tiras)	Tiras (Mts.)	Color	Código	€/ Tira de 1 Mt.
TCN20-1,2/0,6-BK	1,2	0,6	30	1	Negro / Preto	300-73550	0,55
TCN20-1,6/0,8-BK	1,6	0,8	30	1	Negro / Preto	300-73551	0,55
TCN20-2,4/1,2-BK	2,4	1,2	30	1	Negro / Preto	300-73552	0,60
TCN20-3,2/1,6-BK	3,2	1,6	30	1	Negro / Preto	300-73556	0,60
TCN20-4,8/2,4-BK	4,8	2,4	24	1	Negro / Preto	300-73560	0,60
TCN20-6,4/3,2-BK	6,4	3,2	24	1	Negro / Preto	300-73564	0,69
TCN20-9,5/4,8-BK	9,5	4,8	20	1	Negro / Preto	300-73568	0,99
TCN20-12,7/6,4-BK	12,7	6,4	16	1	Negro / Preto	300-73572	1,15
TCN20-19,1/9,5-BK	19,1	9,5	10	1	Negro / Preto	300-73576	1,67
TCN20-25,4/12,7-BK	25,4	12,7	5	1	Negro / Preto	300-73580	2,46
TCN20-38,1/19,1-BK	38,1	19,1	6	1	Negro / Preto	300-73584	4,07
TCN20-50,8/25,4-BK	50,8	25,4	6	1	Negro / Preto	300-73588	5,04
TCN20-76,0/38,0-BK	76	38	3	1	Negro / Preto	300-73592	10,01
TCN20-101,6/50,8-BK	101,6	50,8	2	1	Negro / Preto	300-73596	13,02

Material: Poliolefina UL224 (-55 °C a +125 °C). Color / Cor: ●

Otros colores bajo consulta / Outras cores sobre consulta : ●●●●●



Tubos Termoretráctiles 2:1 en Tiras de 1 Metro / Tubos Termorretrácteis 2:1 em Tiras de 1 Metro

TIPO	Ø Expand.	Ø Contr. Retraído	Caja/Caixa (N° Tiras)	Tiras (Mts.)	Blanco / Branco	Azul	Rojo / Vermelho	Transp.*	€/ Tira 1 Mt.
TCN20-2,4/1,2	2,4	1,2	30	1	300-73555	300-73554	300-73553	313-80000	0,63
TCN20-3,2/1,6	3,2	1,6	30	1	300-73559	300-73558	300-73557	313-80001	0,63
TCN20-4,8/2,4	4,8	2,4	24	1	300-73563	300-73562	300-73561	313-80002	0,63
TCN20-6,4/3,2	6,4	3,2	24	1	300-73567	300-73566	300-73565	313-80003	0,72
TCN20-9,5/4,8	9,5	4,8	20	1	300-73571	300-73570	300-73569	313-80004	1,04
TCN20-12,7/6,4	12,7	6,4	16	1	300-73575	300-73574	300-73573	313-80005	1,21
TCN20-19,1/9,5	19,1	9,5	10	1	300-73579	300-73578	300-73577	313-80006	1,75
TCN20-25,4/12,7	25,4	12,7	5	1	300-73583	300-73582	300-73581	313-80007	2,59
TCN20-38,1/19,1	38,1	19,1	6	1	300-73587	300-73586	300-73585	313-80008	4,32
TCN20-50,8/25,4	50,8	25,4	6	1	300-73591	300-73590	300-73589	313-80009	5,46
TCN20-76,0/38,0	76	38	3	1	300-73595	300-73594	300-73593	313-80010	10,51
TCN20-101,6/50,8	101,6	50,8	2	1	300-73599	300-73598	300-73597	313-80011	13,86

Material: Poliolefina UL224 (-55 °C a +125 °C). Colores / Cores: ●●●●
Otras dimensiones bajo consulta (38,1 - 50,8 - 76,2 - 101,6) / Outras dimensões sob consulta (38,1 - 50,8 - 76,2 - 101,6)

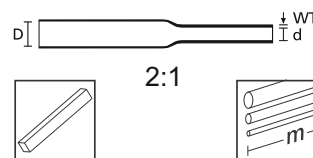

Tubos Termoretráctiles 2:1 en Tiras de 1 Metro / Tubos Termorretrácteis 2:1 em Tiras de 1 Metro

TIPO	Ø Expandido	Ø Contraído Retraído	Caja / Caixa (N° Tiras)	Tiras (Mts)	Tierra / Terra	€/ Mt.
TFN21-2,4/1,2-GNYYE	2,4	1,2	30	1	309-60119	0,77
TFN21-3,2/1,6-GNYYE	3,2	1,6	30	1	309-60127	0,77
TFN21-4,8/2,4-GNYYE	4,8	2,4	24	1	309-60138	0,84
TFN21-6,4/3,2-GNYYE	6,4	3,2	24	1	309-60149	1,04
TFN21-9,5/4,8-GNYYE	9,5	4,8	20	1	309-60158	1,23
TFN21-12,7/6,4-GNYYE	12,7	6,4	16	1	309-60168	1,47
TFN21-19,1/9,5-GNYYE	19,1	9,5	10	1	309-60179	2,49
TFN21-25,4/12,7-GNYYE	25,4	12,7	5	1	309-60187	3,17

Material: Poliolefina UL224 (-55 °C a +135 °C). Color / Cor: ●
Otras medidas bajo consulta (38,1 - 50,8 - 76,2 y 101,6) / Outras dimensões sobre consulta (38,1 - 50,8 - 76,2 y 101,6)

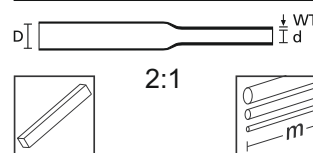

ShrinKit 321 Tubos Termoretráctiles en Trocitos / Tubos Termorretrácteis em pedaços

Tipo	Contrac.	Ø Aplic.	Caja/Caixa (N° Kits)	Uds x Kit	Color / Cor	Código	€/ Kit
ShrinKit 321 Basic	3:1	1,5 a/até 16	1	220	Negro/Preto	380-03001	40,24
ShrinKit 321 Universal	3:1	1,5 a/até 20	1	775	Surtido/Sortido	380-03002	148,08
ShrinKit 321-A (Adhesivo)	3:1	1,5 a/até 20	1	385	Transp + Negro/Preto	380-03003	153,53
ShrinKit 321-A Basic	3:1	1,5 a/até 10	1	130	Transp + Negro/Preto	380-03004	53,54
ShrinKit 321 Universal Basic	3:1	1,5 a/até 16	1	177	Surtido/Sortido	380-03005	55,52

Material: Poliolefina PO-X VDE 0530 (-55 °C a +135 °C; con/com adh.: -55°C a +110°C)



HelaWrap Organizador de Cables / HelaWrap Organizador do Cabos

TIPO	Ø Max. (mm)	Long. (Mts)	Bolsa (N° Uds.)	Embalaje / Embalagem (N° Bolsas)	Color	Código	€/ Bolsa
HWPP16/2 BK	15	2	1pz (2Mts)	15	Negro / Preto	914-64204	8,73
HWPP16/2 GY	15	2	1pz (2Mts)	15	Gris / Cinzento	914-64205	8,73
HWPP16/2 SR	15	2	1pz (2Mts)	15	Plata / Prata	914-64206	8,73
HWPP25/2 BK	25	2	1pz (2Mts)	10	Negro / Preto	914-64404	11,50
HWPP25/2 GY	25	2	1pz (2Mts)	10	Gris / Cinzento	914-64405	11,50
HWPP25/2 SR	25	2	1pz (2Mts)	10	Plata / Prata	914-64406	11,50
3xIAHC2T + 3xHWPBASEA (para HWPP16)			3 Bases + 3 Clips	12	Negro / Preto	914-64200	3,81
3xIAHC3T + 3xHWPBASEA (para HWPP25)			4 Bases + 3 Clips	12	Negro / Preto	914-64400	4,15

Material: Polipropileno UL94 HB (-60 °C a +110 °C - Intermitente +140 °C). Colores / Cores: ●●●●
Material Bases y Clips / Material Bases e Clips: PA66 UL94 V2 (-40°C a +105°C). Color / Cor: ●

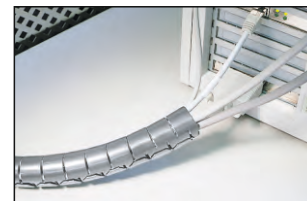

Cinta Aislante de PVC / Fita Isolante de PVC (Esp.: 0,15mm)

TIPO	L (Mts.)	W (mm)	Embal. (N°Uds.)	Color / Cor	Código	€/ Ud
HTAPE-FLEX15-15x10 BU	10	15	100	Azul	710-00100	0,57
HTAPE-FLEX15-15x10 RD	10	15	100	Rojo / Vermelho	710-00101	0,57
HTAPE-FLEX15-15x10 YE	10	15	100	Amarillo / Amarelo	710-00102	0,57
HTAPE-FLEX15-15x10 GN	10	15	100	Verde	710-00103	0,57
HTAPE-FLEX15-15x10 BK	10	15	100	Negro / Preto	710-00104	0,57
HTAPE-FLEX15-15x10 WH	10	15	100	Blanco / Branco	710-00105	0,57
HTAPE-FLEX15-15x10 GN-YE	10	15	100	Tierra/Tierra(Am/Ver)	710-00106	0,63
HTAPE-FLEX15-15x10 BN	10	15	100	Marrón / Castanho	710-00107	0,57
HTAPE-FLEX15-15x10 GY	10	15	100	Gris / Cinzento	710-00108	0,57
HTAPE-FLEX15-15x10 VT	10	15	100	Violeta	710-00109	0,57
HTAPE-FLEX15-15x10 OG	10	15	100	Naranja / Laranja	710-00110	0,57
HTAPE-FLEX15- MIX-15x10	10	15	10 packs	Surtido / Sortido	710-00146	6,10 (1Pack de 10 Uds.)

Material: PVC (-10°C a +90°C). Colores / Cores: ●●●●●●●●●●●●
HTAPE-FLEX15-MIX-15x10 incluye todos los colores / HTAPE-FLEX15-MIX-15x10 inclui todas as cores.



Cinta Multiusos / Fita Multiusos (No Aislante / Não Isolante: 0,15mm)

TIPO	L (Mts.)	W (mm)	Embalaje / Embalagem (Nº Uds.)	Color / Cor	Código	€/ Ud
HTAPE-ALLROUND1500	46	50	24	Gris / Cinzento	710-01000	9,95

Material: PVC(-40°C a +85°C). Color / Cor: ●

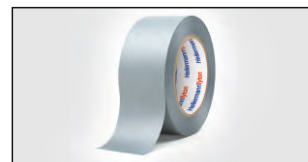
Conectores Reconnectables HCR* / Ligadores Reutilizáveis HCR*

TIPO	Sección / Seção (mm²)	Nº Polos	Bolsa (Nº Uds.)	Embalaje / Embalagem (Nº Bolsas)	Código	€/ Bolsa
HCR-2	0,2 - 2,5	2	5	6	914-60180	2,03
HCR-3		3	5	6	914-60182	3,05
HCR-5		5	5	6	914-60184	4,03

Material: PC UL94 V0 (-30°C a +85°C).

*Para Cables Rígidos, Semi-Rígidos y Flexibles. / *Para Cabos Rígidos, Semi-Rígidos e Flexíveis.

Conectores HelaCon Plus Mini* / Ligadores HelaCon Plus Mini*

TIPO	Sección / Seção (mm²)	Nº Polos	Bolsa (Nº Uds.)	Embalaje / Embalagem (Nº Bolsas)	Código	€/ Bolsa
HECP-2 YW 5	0,5 - 2,5	2	5	6	914-60160	1,83
HECP-3 OR 5		3	5	6	914-60162	1,93
HECP-4 CL 5		4	5	6	914-60164	2,09
HECP-5 BU 5		5	5	6	914-60166	2,31
HECP-6 VT 5		6	5	6	914-60168	1,52
HECP-8 GY 5		8	5	6	914-60170	3,14
SURTIDO HECP		2-3-4-5-6-8	12	6	914-60175	4,03

Material: PC UL94 V0 (-30°C a +85°C).

* Para Cables Rígidos, Semi-Rígidos y Flexibles. / *Para Cabos Rígidos, Semi-Rígidos e Flexíveis.

Conectores HelaCon Lux* / Ligadores HelaCon Lux*

TIPO	Sección / Seção (mm²)	Nº Polos	Bolsa (Nº Uds.)	Embalaje / Embalagem (Nº Bolsas)	Código	€/ Bolsa
SURTIDO HELUX	0,5 (0,75) - 2,5	1-1 y 2-1	3+3	6	914-60178	2,47

Material: PA66 UL94 V2 (-5°C a +100°C). Color / Cor: ●

* Para Cables: Principal Rígido y Salida Rígido-Semi-Rígido-Flexible *Para Cabos: Principal Rígido e Saída Rígido-Semi-Rígido-Flexível.

Regletas Cerámicas / Ligadores Cerâmicos

TIPO	Nº Polos	Taladro / Parafuso (mm)	Caja / Caixa (Nº Packs)	Packs (Uds.)	Color / Cor	Código	€/ Pack
RC2,5-2Px2	2	2,5 mm	10	2	Blanco / Branco	914-60240	3,39
RC2,5-3Px2	3	2,5 mm	10	2	Blanco / Branco	914-60241	4,57
RC2,5-4Px2	4	2,5 mm	10	2	Blanco / Branco	914-60242	6,38
RC4-2Px2	2	4 mm	5	2	Blanco / Branco	914-60243	4,32
RC4-3Px2	3	4 mm	5	2	Blanco / Branco	914-60244	6,13
RC4-4Px2	4	4 mm	5	2	Blanco / Branco	914-60245	8,57

Conector Lineal Fijo IP68 / Conector Linear Estanque IP68

TIPO	Sección / Seção (mm²)	Color / Cor	Nº Polos	Bolsa (Nº Uds.)	Embalaje / Embalagem (Nº Uds)	Código	€/ Bolsa.
CTH391	Hasta / até 2,5	Negro / Preto	4	1	50	914-60224	11,03
CTH391+G			4	1	50	914-60226	15,44

Material: PA66GF+PBT+TPE / NB+ZS (-40°C a +125°C).

Conector Lineal IP68 / Conector Linear Estanque IP68

TIPO	Sección / Seção (mm²)	Color / Cor	Nº Polos	Bolsa (Nº Uds.)	Embalaje / Embalagem (Nº Uds)	Código	€/ Bolsa.
CTH387	Hasta / até 1,5	Negro / Preto	4	1	50	914-60225	22,06
CTH387+G			4	1	50	914-60227	26,75

Material: PA66GF+PBT+TPE / NB+ZS (-40°C a +125°C).

Caja de Conexión IP67 / Caixa de Derivação IP67

TIPO	Sección / Seção (mm²)	Color / Cor	Nº Polos	Bolsa (Nº Uds.)	Embalaje / Embalagem (Nº Bolsas)	Código	€/ Bolsa
CTH200	Hasta / até 2,5	Negro / Preto	3	1	25	914-60222	20,70

Material: PA66GF+PBT+TPE / NB+ZS (-40°C a +125°C).

Lubricante para CableScout / Lubrificante para CableScout

TIPO	Para	Botella / Garrafa (Nº Lts.)	Embalaje / Embalagem (Nº Botellas / Nº Garrafas)	Código	€/ Botella / Garrafa
CS - CPL	Guías de Cables / Guias de Cabos	1	8	897-90031	13,25





RELICON Empalmes Aislados en Gel (Con Conector) / RELICON Juntas Isoladas em Gel (Com Ligadores)

TIPO	Secc. Hasta / Até	Cable / Cabo Ø Princ.	L x M (mm)	Color / Cor	Bolsa (Nº Uds.)	Embal. (Nº Uds.)	Código	€/ Ud.
Relifix V31.5	3 x 0,5 - 3 x 2,5	9 - 16	86 x 47	Verde	1	1	435-00650	18,27

Material: PP + SI (-20 °C a +90 °C). Vida: Sin Límite / Vida: Sem Limite. Color / Cor: ●
Otras medidas y bifurcaciones disponibles / Outras medidas e bifurcações disponíveis



Toallitas de Limpieza RELICON / Toalhetes de Limpeza RELICON

TIPO	Medidas	Color / Cor	Cubo / Balde (Nº Toallitas / Nº Toalhetes)	Embal. (Nº Cubos / Baldes)	Código	€/ Cubo / Balde
Reliclean 70	27 x 31	Natural	72	6	435-01601	32,50

Material: Tejido desengrasante antibacterial, biodegradable y secado rápido / Tecido desengordurante de limpeza antibacteriana e de secagem rápida.



Bridas de Señalización / Abraçadeiras de Sinalização

TIPO	L x W	Placa	Bolsa (Nº Uds.)	Embalaje / Embalagem (Nº Bolsas)	Color / Cor	Código	€/ Bolsa
IT18R / 10	100 x 2,5	25 x 8	10	12	Natural	914-60156	4,59
IT50R / 10	203 x 4,6	28 x 13	10	12	Natural	914-60157	5,27

Material: PA66 UL94 V2 (-40°C a +85°C). Color / Cor:



Señalizadores de Cable WIC Tipo Clip / Marcadores do Cabo de Encaixe WIC

TIPO	Ø Min / Max	Sección / Seção (mm²)	Blister (Nº Uds.)	Embalaje / Embalagem (Nº Blisters)	Color / Cor	Código	€/ Blister
WIC1 0-9 CC / 1	2,0 - 2,8	0,5 - 1,5	200	12	Surtido	914-60151	7,52
WIC2 0-9 CC / 1	2,8 - 3,8	1,5 - 2,5	200	12	Surtido	914-60152	7,52
WIC3 0-9 CC / 1	4,3 - 5,3	4,0 - 6,0	100	12	Surtido	914-60153	5,79

Material: PA66 UL94 V2 (-40°C a +85°C). Colores / Cores: ●●●●●●●●●●

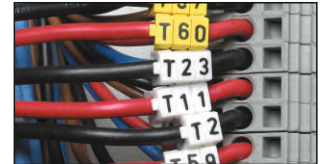

Etiquetas Manuales Rite On / Etiquetas Manuais RiteOn

TIPO	W (mm)	Alt. (H)	Alt. (H2)	Ø Aplicac. (mm) / Ø Aplic. (mm)	Código	Pack (Nº Etiq.)	€/ Pack
SPRO200-1401-WH (Pack Inicio)	19,1	12,7	50,8	6,1 - 12,1	550-14010	150	29,97
RO201-1401-WH (Dispensador)	12,7	12,7	38,1	4,0 - 8,1	550-14011	200	23,36
RO202-1401-WH (Dispensador)	19,1	12,7	50,8	6,1 - 12,1	550-14012	150	23,36
RO203-1401-WH (Dispensador)	19,1	25,4	76,2	9,1 - 18,2	550-14013	100	23,36
RO201REF-1401-WH (Pack Recambio/Substituição)	12,7	12,7	38,1	4,0 - 8,1	550-14014	200	13,63
RO202REF-1401-WH (Pack Recambio / Substituição)	19,1	12,7	50,8	6,1 - 12,1	550-11401	150	14,11
RO203REF-1401-WH (Pack Recambio / Substituição)	19,1	25,4	76,2	9,1 - 18,2	550-71401	100	14,57
T82S-RD Rotulador Indeleble / Marcador Indelével (Pack 2 Uds.)					500-50822	-	11,19
T82S-BK Rotulador Indeleble / Marcador Indelével (Pack 2 Uds.)					500-50820	-	11,19

Material: Vinilo / Vinil 1401 (-40°C a +80°C).



Rosetas / Tomadas de Fibra

TIPO	Descripción / Descrição	Pack (Uds.)	Código	€/ Ud
FWOA	Fibre Wall Outlet, Unloaded	1	914-41570	6,75



Adaptadores / Conectores

TIPO	Descripción / Descrição	Pack (Uds.)	Caja / Caixa (Uds.)	Código	€/ Ud
ADP.SM SC-SC / UPC S	Adaptador SC-SC / UPC Singlemode - Simplex	50	50	914-41110	1,03
ADP.SM SC-SC / UPC D	Adaptador SC-SC / APC Singlemode - Simplex	25	25	914-41112	1,23

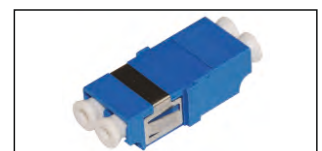

Patchcord Simplex - Singlemode

TIPO	Descripción / Descrição	Long. / Comp.	Pack (Uds.)	Caja/Caixa (Uds.)	Código	€/ Ud
PC-SSCSC9/125-1-YW	Patchcord Simplex SM SC-SC 9/125 2,1mm LSZH Yellow	1 m	1	20	914-41444	9,23
PC-SSCSC/APC9/125-1-YW	Patchcord Simplex SMSC-SC/APC 9/125 2,1mm LSZH Yellow	1 m	1	20	914-41450	21,70

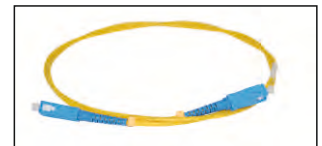



Características de los productos

Las cantidades, características o magnitudes que aparecen en nuestros catálogos o tarifas son orientativas, pudiendo verse modificadas sin previo aviso.

Precios y entregas

Los precios de venta, serán los que se hayan ofertado por escrito o los que aparezcan reflejados en la tarifa en vigor en el momento del suministro. A los precios de venta se les aplicará el IVA vigente en el momento del suministro.

Los precios son para mercancías puestas en nuestros almacenes. Se suministrarán libre de portes los pedidos de importe superior a 300 € netos y cuyo destino sea la Península o las Islas Baleares, siempre y cuando los envíos se realicen por los medios de transporte habituales utilizados por HellermannTyton. En el caso de envíos a las Islas Canarias, estos serán siempre a portes debidos.

No se considerará pedido en firme de entrega todos aquellos pedidos que no superen los 150 €. Las declaraciones de conformidad se deberán solicitar antes de enviar el material.

Devoluciones

No se aceptará ninguna devolución sin la conformidad expresa de HellermannTyton y se remitirán siempre a nuestro almacén a portes pagados.

Las devoluciones por causas no imputables a HellermannTyton y una vez aceptadas conllevarán unos costes 20% del importe facturado al Cliente, en concepto de almacenaje, reacondicionamiento, revisión de los materiales, y costes administrativos.

Materiales especiales

En los casos en que el cliente realice un pedido de productos o materiales que deban ser fabricados ex profeso para atender su petición, HellermannTyton se reserva la opción de pedir el pago del 30% del valor del pedido a la realización del mismo.

En estos casos no se aceptará devolución alguna de productos.

Validez de los precios

Los precios que aparecen en nuestra tarifa son válidos durante la vigencia de la misma, con las siguientes excepciones que podrían motivar su modificación:

-Errores debidos a la impresión.

-Cambios en la paridad del Euro con respecto a la Libra Esterlina (GBP) y al Dólar (USD).

Derecho de propiedad

Los productos suministrados serán de propiedad de Hellermann Tyton hasta que el cobro este realizado, por lo que el cliente se compromete a devolverlo en el caso de no poder hacer frente al vencimiento de las facturas.

Protección de datos de carácter personal

En cumplimiento con lo dispuesto en la legislación de protección de datos de carácter personal, le informamos que sus datos personales, así como todos aquellos que derivan de las relaciones de negocio que usted mantenga con Hellermann Tyton, se incorporarán en un fichero de esta Compañía, cuyo objetivo es facilitar la gestión contable fiscal y administrativa de dichas relaciones.

Por otro lado, mediante la contratación con HellermannTyton, Vd. Estará consintiendo en que todos sus datos puedan ser conservados y tratados para mantenerle informado de nuevos productos y servicios de la compañía. Cualquier modificación que usted sufra en los datos personales que ha facilitado a HellermannTyton, deberá comunicarla a la misma, con la mayor brevedad posible.

HellermannTyton se compromete a respetar y facilitar el ejercicio de los derechos, rectificación, cancelación y oposición dentro de los límites previstos en la legislación de protección de datos.

Responsabilidad

Nuestra responsabilidad civil caduca al año del suministro considerando una instalación y utilización correcta.

Jurisdicción

Con renuncia expresa de su fuero, el cliente se somete a los tribunales de Alcobendas (Madrid), España.

Forma de pago

En ningún caso, la forma de pago puede exceder la normativa expuesta en la nueva ley contra la morosidad 15/2010 de 5 de julio. Los pagos deben de ser realizados el día del vencimiento sin deducciones ni gastos financieros o bancarios. La empresa no está obligada a aceptar cheques o letras de cambio. En caso de demora en el pago de las facturas, la empresa está autorizada a cargar intereses de demora en acuerdo con las Resoluciones de la Dirección General del Tesoro y Política Financiera, por la que se publica el tipo legal de interés de demora aplicable a las operaciones comerciales, publicado en el B.O.E. del Ministerio de Economía y Hacienda. Si se ha realizado una petición de apertura de un concurso de acreedores al comprador o un procedimiento parecido o si la empresa obtiene información de otros hechos, que aminoran esencialmente la solvencia del comprador y el cumplimiento por el comprador debida contraprestación parezca peligrar, tiene la empresa el derecho de exigir para los envíos pendientes pagos por adelantado, negar las entregas pendientes y pedir la devolución de la mercancía entregada.

Características dos produtos

As quantidades, características ou dimensões que aparecem nos nossos catálogos ou tabelas são orientativas, podendo ser modificadas sim pré-aviso.

Preços e entregas

Os preços de venda serão os que constem de proposta escrita ou os que se encontrem na tabela em vigor à data do fornecimento. Aos preços de venda aplicar-se-á o regime de IVA legalmente adequado.

Os preços são considerados para produtos colocados à saída dos nosso armazém. Estarão isentos de portes os pedidos cujo valor líquido seja superior a 300 € e cujo destino seja a Península Ibérica, sempre e quando o envio se realize pelos meios habitualmente utilizados pela HellermannTyton. Envios para outros destinos deverão ser objecto de acordo prévio.

Não serão considerados pedidos de valor líquido inferior a 150 €. As declarações e/ou certificados de conformidade devem solicitar-se antes do envio do material.

Devoluções

Não se aceitará nenhuma devolução sem o consentimento prévio da HellermannTyton e a colocação da mercadoria no nosso armazém é da responsabilidade do cliente.

As devoluções por causas não imputáveis à HellermannTyton, uma vez aceites, serão penalizadas em 20% do valor faturado para cobrir os custos de armazenagem, acondicionamento, revisão dos materiais e custos administrativos.

Materiais especiais

Nos casos em que o cliente realize um pedido de produtos ou materiais que necessitem ser fabricados exclusivamente para o servir, a HellermannTyton reserva-se o direito de pedir o pagamento antecipado de 30% do valor do pedido.

Nestes casos não serão aceites quaisquer devoluções.

Validade dos preços

Os preços que aparecem na nossa tabela são válidos durante a vigência da mesma, com as seguintes exceções que podem motivar a sua modificação:

- Erros de impressão.

- Alteração substancial na paridade do Euro em relação à Libra Esterlina (GBP) e ao Dólar Americano (USD).

Direito de propriedade

Os produtos fornecidos serão propriedade da HellermannTyton até que o seu pagamento esteja realizado, pelo que o cliente se compromete a devolvê-los no caso de não poder efectuar o respectivo pagamento.

Protecção de dados de carácter pessoal

No cumprimento com o disposto na legislação de protecção de dados de carácter pessoal, informámos que os seus dados pessoais, assim como todos aqueles que derivam das relações de negócio que mantenha com a HellermannTyton, serão inseridos num ficheiro desta companhia, cujo objectivo é facilitar a gestão contabilística fiscal e administrativa das ditas relações.

Por outro lado, mediante contratação com a HellermannTyton, consente que todos os seus dados possam ser conservados e tratados para permitir mantê-lo informado de novos produtos e serviços da companhia. Qualquer modificação que ocorra dos dados pessoais que facilitou à HellermannTyton deverá ser-nos comunicada com a maior brevidade possível.

A HellermannTyton compromete-se a respeitar e facilitar o exercício dos direitos de rectificação, cancelamento e oposição dentro dos limites previstos na legislação de protecção de dados.

Responsabilidade

A nossa responsabilidade civil caduca um ano após o fornecimento, considerando uma instalação e utilização correctas.

Jurisdicção

Com renúncia expressa à sua comarca, o cliente submete-se aos tribunais de Alcobendas (Madrid) Espanha.

Forma de pagamento

O prazo de pagamento é acordado entre as partes. Os pagamentos devem ser realizados no dia de vencimento sem encargos de nenhum tipo para a HellermannTyton. A empresa não está obrigada a aceitar cheques ou letras. No caso de atraso no pagamento das facturas, a empresa está autorizada a cobrar juros de mora de 8% ao ano. A HellermannTyton reserva-se o direito de alterar o limite de crédito concedido em função de alterações das circunstâncias que serviram de base à atribuição do mesmo. Esta decisão pode afectar pedidos já existentes.

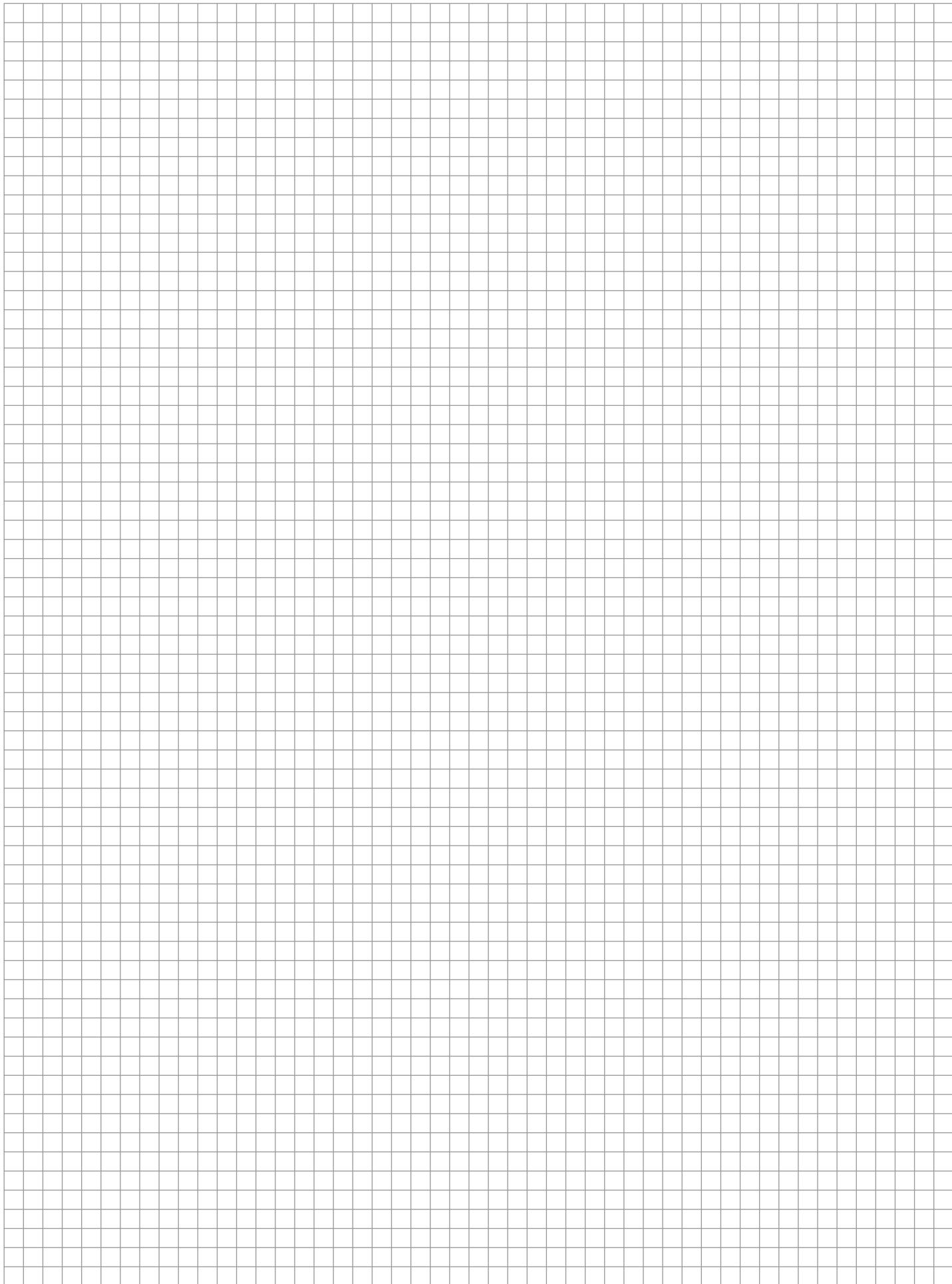

Notas
Anotações

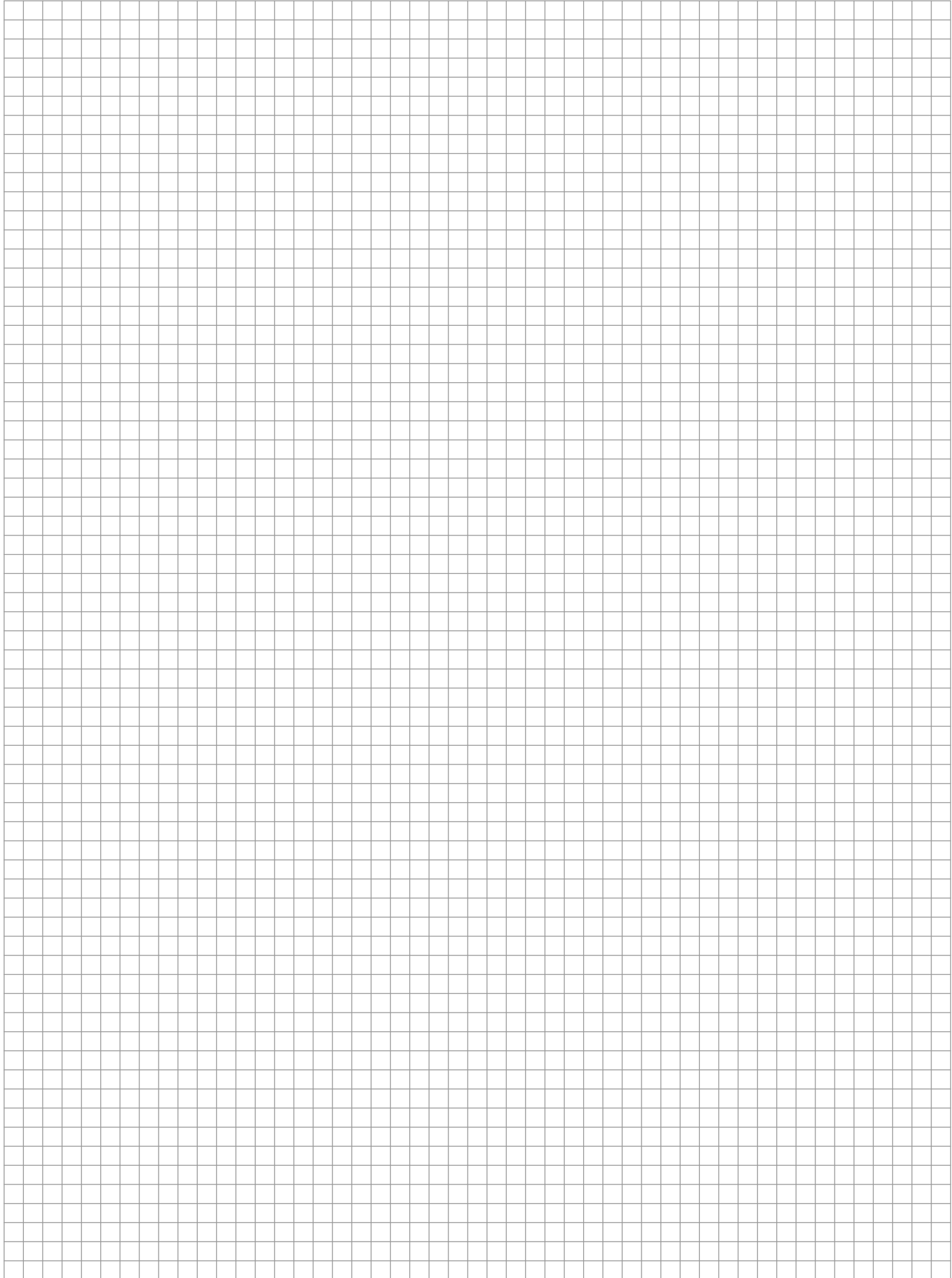



MADE FOR REAL

HellermannTyton

HellermannTyton España / Portugal
Avda. de la Industria 37 2º 2
28108 Alcobendas, Madrid
ES: Tel: +34 91 661 2835
Fax: +34 91 661 2368
PT: Tel.: (+351) 221 202 335
Fax: (+351) 221 202 226
E-Mail: HellermannTyton@HellermannTyton.es
www.HellermannTyton.es