

brother[®]

Advanced User's Guide

MFC-8510DN
MFC-8520DN

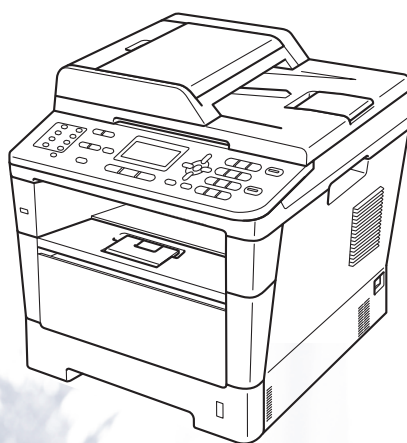

Not all models are available in all countries.

Version 0

UK/IRE

User's Guides and where do I find them?

Which Guide?	What's in it?	Where is it?
Product Safety Guide	Read this Guide first. Please read the Safety Instructions before you set up your machine. See this Guide for trademarks and legal limitations.	Printed / In the box
Quick Setup Guide	Follow the instructions for setting up your machine and installing the drivers and software for the operating system and connection type you are using.	Printed / In the box
Basic User's Guide	Learn the basic Fax, Copy, Scan and Direct Print operations and how to replace consumables. See troubleshooting tips.	Printed / In the box For Czech Republic, Republic of Bulgaria, Republic of Hungary, Republic of Poland, Romania, Slovak Republic : PDF file / Installer CD-ROM / In the box
Advanced User's Guide	Learn more advanced operations: Fax, Copy, security features, printing reports and performing routine maintenance.	PDF file / Installer CD-ROM / In the box
Software User's Guide	Follow these instructions for Printing, Scanning, Network Scanning, Remote Setup, PC-Fax, and using the Brother ControlCenter utility.	PDF file / Installer CD-ROM / In the box
Network User's Guide	This Guide provides useful information about wired and wireless network settings and security settings using the Brother machine. You can also find supported protocol information for your machine and detailed troubleshooting tips.	PDF file / Installer CD-ROM / In the box
Google Cloud Print Guide	This Guide provides details on how to configure your Brother machine to a Google account and use Google Cloud Print services for printing over the Internet from devices using Gmail™ for mobile, GOOGLE DOCS™ for mobile and applications for the Chrome OS.	PDF file / Brother Solutions Center ²
Mobile Print/Scan Guide for Brother iPrint&Scan	This Guide provides useful information about printing JPEG and PDF ¹ files from your mobile device and scanning from your Brother machine to your mobile device when connected on a Wi-Fi network.	PDF file / Brother Solutions Center ²

¹ PDF printing is not supported on Windows® Phone.

² Visit us at <http://solutions.brother.com/>.

Table of Contents

1	General Setup	1
	Memory storage.....	1
	Automatic Daylight Saving Time.....	1
	Ecology features.....	2
	Toner Save	2
	Sleep Time	2
	Deep Sleep mode.....	2
	Quiet mode feature.....	3
	Quiet mode	3
	LCD Contrast.....	3
	Mode Timer.....	4
2	Security features	5
	Secure Function Lock 2.0.....	5
	Setting the password for the administrator	6
	Changing the password for the administrator.....	6
	Setting up the Public user mode.....	7
	Setting up restricted users	7
	Turning Secure Function Lock on/off.....	8
	Switching Users	8
	Setting Lock.....	9
	Setting up the password	10
	Changing your Setting Lock password	10
	Turning Setting Lock on/off.....	11
	Restricting dialling.....	11
	Dial pad restriction	11
	One Touch restriction	12
	Speed Dial restriction	12
	LDAP server restriction.....	12

3	Sending a fax	13
	Additional sending options	13
	Changing a 2-sided fax layout (MFC-8520DN)	13
	Sending faxes using multiple settings	13
	Contrast	14
	Changing Fax Resolution	14
	Additional sending operations	15
	Sending a fax manually	15
	Dual access	15
	Broadcasting	16
	Real Time Transmission	17
	Overseas Mode	18
	Delayed Fax	18
	Delayed batch transmission	19
	Checking and cancelling waiting jobs	19
	Electronic cover page	20
	Destination Display	22
	Polling overview	23
	Polled transmit	23
4	Receiving a fax	25
	Remote Fax Options	25
	Fax Forwarding	25
	Fax Storage	25
	Changing Remote Fax Options	26
	Remote retrieval	27
	Remote fax commands	29
	Additional receiving operations	30
	Printing a reduced incoming fax	30
	Duplex (2-sided) printing for FAX mode	30
	Setting the Fax Receive Stamp	31
	Setting the Print Density	31
	Printing a fax from the memory	31
	Out of Paper Reception	32
	Polling overview	32
	Polling receive	32
	Stop polling	33
5	Dialling and storing numbers	34
	Telephone line services	34
	BT Call Sign (U.K. only)	34
	Additional dialling operations	34
	Combining quick dial numbers	34
	Additional ways to store numbers	35
	Setting up Groups for Broadcasting	35
	Changing Group numbers	39
	Deleting Group numbers	41

6	Printing reports	42
	Fax reports.....	42
	Transmission Verification Report.....	42
	Fax Journal (Activity Report)	42
	Reports	43
	How to print a report.....	43
7	Making copies	44
	Copy settings.....	44
	Stop copying.....	44
	Enlarging or reducing the image copied	44
	Using the Options key	46
	Sorting copies.....	47
	Improving copy quality.....	47
	Adjusting Brightness and Contrast	48
	Making N in 1 copies (page layout)	49
	2 in 1 ID Copy.....	50
	Tray selection	51
	Duplex (2-sided) copying.....	52
	Duplex Copy (long edge flip)	52
	Advanced Duplex Copy (short edge flip)	53
A	Routine maintenance	55
	Cleaning and checking the machine.....	55
	Checking the Page Counters.....	56
	Checking the remaining life of parts	56
	Replacing periodic maintenance parts.....	56
	Packing and shipping the machine	57
B	Options	59
	Optional paper tray (LT-5400)	59
	Memory board.....	59
	SO-DIMM Types	59
	Installing extra memory	60
C	Glossary	62
D	Index	65

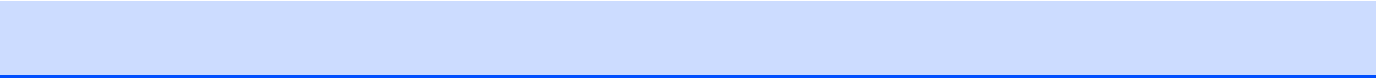

Memory storage

Your menu settings are stored permanently, and in the event of a power failure will *not* be lost. Temporary settings (for example, Contrast, Overseas Mode) *will* be lost. Also, during a power failure the machine will retain the date and time and programmed fax timer jobs (e.g. Delayed Fax) for up to 60 hours. Other fax jobs in the machine's memory will not be lost.

Automatic Daylight Saving Time

You can set the machine to change automatically for Daylight Saving Time. It will set itself forward one hour in the Spring, and back one hour in the Autumn.

- 1 Press **Menu**, **0**, **2**, **2**.
- 2 Press **▲** or **▼** to choose **On** or **Off**. Press **OK**.
- 3 Press **Stop/Exit**.

Ecology features

Toner Save

You can save toner using this feature. When you set Toner Save to *On*, prints appear lighter. The default setting is *Off*.

- 1 Press **Menu, 1, 4, 1**.
- 2 Press **▲** or **▼** to choose *On* or *Off*. Press **OK**.
- 3 Press **Stop/Exit**.



Note

We do not recommend Toner Save for printing Photo or Greyscale images.

Sleep Time

The Sleep mode setting can reduce power consumption. When the machine is in Sleep mode (Power Save mode) it acts as though it is turned off. The machine will wake up and start printing when it receives a print job.

You can choose how long the machine must be idle before it goes into Sleep mode. When the machine receives a fax or a print job, the timer will be reset. The default setting is 3 minutes.

While the machine is in Sleep mode the LCD will show *Sleep*.

- 1 Press **Menu, 1, 4, 2**.
- 2 Enter the length of time (0-90 minutes) the machine is idle before entering Sleep mode. Press **OK**.
- 3 Press **Stop/Exit**.

Deep Sleep mode

If the machine is in Sleep mode and does not receive any jobs for a certain length of time, the machine will go into Deep Sleep mode automatically and the LCD will show *Deep Sleep*. Deep Sleep mode uses less power than Sleep mode. The machine will wake up when it receives a fax or a print job.

Quiet mode feature

Quiet mode

The Quiet mode setting can reduce noise while printing. When Quiet Mode is turned *On*, the print speed becomes slower. The default setting is *Off*.

- 1 Press **Menu**, **1**, **5**.
- 2 Press **▲** or **▼** to choose *On* or *Off*. Press **OK**.
- 3 Press **Stop/Exit**.

LCD Contrast

You can change the contrast to make the LCD look lighter or darker.

- 1 Press **Menu**, **1**, **7**.
- 2 Press **▶** to make the LCD darker. Or, press **◀** to make the LCD lighter. Press **OK**.
- 3 Press **Stop/Exit**.

Mode Timer

The machine has three mode keys on the control panel: **FAX**, **SCAN**, and **COPY**.

You can set how much time the machine takes after the last Copy or Scan operation to return to FAX mode. If you choose *Off*, the machine will stay in the mode you used last.

This setting also sets the time the machine will change from registered user to the Public mode when using Secure Function Lock. (See *Switching Users* >> page 8.)



- 1 Press **Menu**, **1**, **1**.
- 2 Press **▲** or **▼** to choose **0 Sec**, **30 Secs**, **1 Min**, **2 Mins**, **5 Mins** or **Off**. Press **OK**.
- 3 Press **Stop/Exit**.

Secure Function Lock 2.0

Secure Function Lock lets you restrict Public access to the following machine functions:

- Fax Tx
- Fax Rx
- Copy
- Scan ¹
- USB Direct
- Print ²
- Page Limit ³

¹ Scan includes scan jobs sent via Brother iPrint&Scan.

² Print includes print jobs via Google Cloud Print and Brother iPrint&Scan.

³ Page Limit is configured using Web Based Management.

This feature also prevents users from changing the default settings of the machine by limiting access to the user-defined Menu settings.

Before using the security features you must first enter an administrator password.

Access to restricted operations can be enabled by creating a restricted user. Restricted users must enter a password to use the machine.

Make a careful note of your password. If you forget it, you will have to reset the password stored in the machine. For information about how to reset the password call Brother Customer Service.



Note

- Secure Function Lock can be set manually at the control panel, or by using Web Based Management or BRAdmin Professional 3 (Windows[®] only). We recommend using Web Based Management or BRAdmin Professional 3 (Windows[®] only) to configure this feature. (▶▶ Network User's Guide)
- Only administrators can set limitations and make changes for each user.
- When Secure Function Lock is on, you can only use 1.Contrast, 6.Polled TX and 7.Coverpage under 2.Setup Send in the Fax menu.
If Fax Tx is disabled, you cannot use any of the function in the Fax menu.
- Polling Receive is enabled only when both Fax Tx and Fax Rx are enabled.

Setting the password for the administrator

The password you set in these steps is for the administrator. This password is used to set up users and to turn the Secure Function Lock on or off. (See *Setting up restricted users* >> page 7 and *Turning Secure Function Lock on/off* >> page 8.)

- 1 Press **Menu, 1, 8, 1**.
- 2 Enter a four-digit number for the password using numbers 0-9.
Press **OK**.
- 3 Re-enter the password when the LCD shows `Verify:.`
Press **OK**.
- 4 Press **Stop/Exit**.

Changing the password for the administrator

- 1 Press **Menu, 1, 8, 1**.
- 2 Press **▲** or **▼** to choose `Set Password`.
Press **OK**.
- 3 Enter the registered four-digit password.
Press **OK**.
- 4 Enter a four-digit number for the new password.
Press **OK**.
- 5 If the LCD shows `Verify:` re-enter the new password.
Press **OK**.
- 6 Press **Stop/Exit**.

Setting up the Public user mode

Public user mode restricts the functions that are available for Public users. Public users do not need to enter a password to access the features made available through this setting. You can set up one Public user.

- 1 Press **Menu**, **1**, **8**, **1**.
- 2 Press **▲** or **▼** to choose `Setup ID`. Press **OK**.
- 3 Enter the administrator password. Press **OK**.
- 4 Press **▲** or **▼** to choose `Public`. Press **OK**.
- 5 Press **▲** or **▼** to choose `Enable` or `Disable` for `Fax Tx`. Press **OK**.
After you have set `Fax Tx`, repeat this step for `Fax Rx`, `Copy`, `Scan`, `USB Direct` and `Print`. When the LCD shows `Exit`, press **OK**.
- 6 Press **Stop/Exit**.

Setting up restricted users

You can set up users with a password and restrict the functions that are available to them. You can set up more advanced restrictions, such as by page count or PC user login name, through Web Based Management. (►► Network User's Guide) You can set up to 25 restricted users.

- 1 Press **Menu**, **1**, **8**, **1**.
- 2 Press **▲** or **▼** to choose `Setup ID`. Press **OK**.
- 3 Enter the administrator password. Press **OK**.
- 4 Press **▲** or **▼** to choose `UserXX`. Press **OK**.
- 5 Use the numeric keys to enter the user name. (►► Basic User's Guide: *Entering text*) Press **OK**.
- 6 Enter a four-digit password for the user. Press **OK**.
- 7 Press **▲** or **▼** to choose `Enable` or `Disable` for `Fax Tx`. Press **OK**.
After you have set `Fax Tx`, repeat this step for `Fax Rx`, `Copy`, `Scan`, `USB Direct` and `Print`. When the LCD shows `Exit`, press **OK**.
- 8 Repeat steps 4 to 7 for entering each additional user and password.
- 9 Press **Stop/Exit**.



Note

You cannot input the same name for different users.

Turning Secure Function Lock on/off

If you enter the wrong password, the LCD will show `Wrong Password`. Re-enter the correct password.

Turning Secure Function Lock on

- 1 Press **Menu**, **1**, **8**, **1**.
- 2 Press **▲** or **▼** to choose `Lock Off-On`. Press **OK**.
- 3 Enter your four-digit administrator password. Press **OK**.

Turning Secure Function Lock off

- 1 Press **Menu**, **1**, **8**, **1**.
- 2 Press **▲** or **▼** to choose `Lock On-Off`. Press **OK**.
- 3 Enter your four-digit administrator password. Press **OK**.

Switching Users

This setting allows you to switch between registered restricted users or Public mode when Secure Function Lock is turned on.

Changing to the restricted user mode

- 1 Hold down **Shift** and press **Secure Print**.
- 2 Press **▲** or **▼** to choose ID. Press **OK**.
- 3 Enter your four-digit password. Press **OK**.



Note

- If the current ID is restricted for the function you want to use, `Access Denied` will appear on the LCD and then the machine will ask you to confirm your name. If you are allowed to access the function you want to use, press **▲** or **▼** to choose your name and enter your four-digit password.
 - If your User ID has a page limit restriction and you have already reached the maximum number of pages, the LCD will show `Limit Exceeded` when you print data. Contact your administrator to check your Secure Function Lock Settings.
-

Changing to the Public mode

After a restricted user has finished using the machine, it will return to the Public setting within the same time as the Mode Timer setting (**Menu, 1, 1**). (See *Mode Timer* >> page 4.) You can also exit from the restricted user mode by pressing the current Mode key you are in. Then LCD will ask you Go to Public?.

Press **1** to choose 1.Yes.



Note

If the function you want to use is restricted for all users, *Not Available* will appear on the LCD and the machine will go back to the Ready mode, and you cannot access the function you want to use. Contact your administrator to check your Secure Function Lock Settings.

Setting Lock

Setting Lock lets you set a password to stop other people from accidentally changing your machine settings.

Make a careful note of your password. If you forget it, you will have to reset the passwords stored in the machine. Please call your administrator or Brother Customer Service.

While the Setting Lock is *On*, you cannot change the settings without a password. You can only change the following Fax transmission settings that are in the FAX menu (**Menu, 2, 2**).

- Contrast
- Fax Resolution
- Delayed Fax
- Real Time TX
- Polled TX
- Overseas Mode

Machine settings cannot be changed using the **Remote Setup** while Setting Lock is *On*.

Setting up the password

- 1 Press **Menu**, **1**, **8**, **2**.
- 2 Enter a four-digit number for the password using numbers 0-9.
Press **OK**.
- 3 Re-enter your password when the LCD shows *Verify:.*
Press **OK**.
- 4 Press **Stop/Exit**.

Changing your Setting Lock password

- 1 Press **Menu**, **1**, **8**, **2**.
- 2 Press **▲** or **▼** to choose *Set Password*.
Press **OK**.
- 3 Enter your current four-digit password.
Press **OK**.
- 4 Enter a four-digit number for the new password.
Press **OK**.
- 5 Re-enter your new password when the LCD shows *Verify:.*
Press **OK**.
- 6 Press **Stop/Exit**.

Turning Setting Lock on/off

If you enter the wrong password when following the instructions below, the LCD will show `Wrong Password`. Re-enter the correct password.

Turning Setting Lock on

- 1 Press **Menu**, **1**, **8**, **2**.
- 2 Press **▲** or **▼** to choose `On`. Press **OK**.
- 3 Enter your four-digit password. Press **OK**.
- 4 Press **Stop/Exit**.

Turning Setting Lock off

- 1 Press **Menu**, **1**, **8**, **2**.
- 2 Enter your four-digit password. Press **OK** twice.
- 3 Press **Stop/Exit**.

Restricting dialling

This feature is to prevent users from sending a fax or calling a wrong number by mistake. You can set the machine to restrict dialling when you use the dial pad, One Touch, Speed Dial or LDAP search ¹.

If you choose `Off`, the machine does not restrict the dialling method.

If you choose `Enter # twice`, the machine will prompt you to re-enter the number, and then if you re-enter the same number correctly, the machine will start dialling. If you re-enter the wrong number, the LCD will show an error message.

If you choose `On`, the machine will restrict all fax sending and outbound calls for that dialling method.

¹ LDAP is available as a download from the Brother Solutions Center at: <http://solutions.brother.com/>.

Dial pad restriction

- 1 Press **Menu**, **2**, **6**, **1**.
- 2 Press **▲** or **▼** to choose `On`, `Off` or `Enter # twice`. Press **OK**.
- 3 Press **Stop/Exit**.

One Touch restriction

- 1 Press **Menu, 2, 6, 2**.
- 2 Press **▲** or **▼** to choose **On, Off** or **Enter # twice**.
Press **OK**.
- 3 Press **Stop/Exit**.

Speed Dial restriction

- 1 Press **Menu, 2, 6, 3**.
- 2 Press **▲** or **▼** to choose **On, Off** or **Enter # twice**.
Press **OK**.
- 3 Press **Stop/Exit**.

LDAP server restriction

(The LDAP function is available as a download.)

- 1 Press **Menu, 2, 6, 4**.
- 2 Press **▲** or **▼** to choose **On, Off** or **Enter # twice**.
Press **OK**.
- 3 Press **Stop/Exit**.



Note

- The Restricting dialling feature will not work if you use an external handset.
 - The machine cannot restrict dialling when you use the **Redial/Pause** button.
 - If you chose **On** or **Enter # twice**, you cannot use the **Broadcasting** feature and cannot combine quick dial numbers when dialling.
-

Additional sending options

Changing a 2-sided fax layout (MFC-8520DN)

You need to choose the duplex scanning format before you send a 2-sided fax. The format you choose will depend on the layout of your 2-sided document.

- 1 Press **Menu**, **1**, **9**, **3**.
- 2 Do one of the following:
 - If your document is flipped on the Long edge, press **▲** or **▼** to choose Long edge.
Press **OK**.

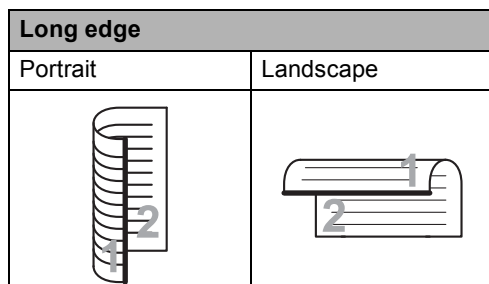

- If your document is flipped on the Short edge, press **▲** or **▼** to choose Short edge.
Press **OK**.

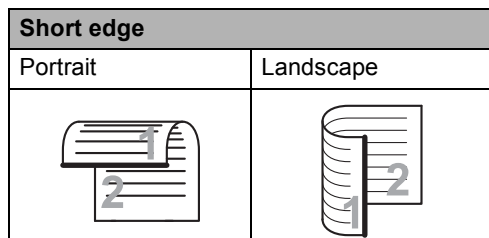

- 3 Press **Stop/Exit**.

Sending faxes using multiple settings

Before you send a fax, you can change any combination of these settings: contrast, resolution, Overseas mode, delayed fax timer, polling transmission, real time transmission or cover page settings.

- 1 Make sure you are in FAX mode . After each setting is accepted, the LCD asks if you want to enter more settings.

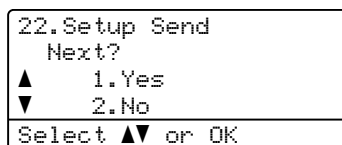

- 2 Do one of the following:
 - To change more settings, press **1**. The LCD returns to the Setup Send menu so you can change another setting.
 - If you have finished changing settings, press **2** and go to the next step for sending your fax.

Contrast

For most documents the default setting of **Auto** will give the best results.

Auto automatically chooses a suitable contrast for your document.

If your document is very light or dark, changing the contrast may improve the quality of the fax.

Use **Dark** to make the faxed document lighter.

Use **Light** to make the faxed document darker.

- 1 Make sure you are in FAX mode .
- 2 Load your document.
- 3 Press **Menu, 2, 2, 1**.
- 4 Press **▲** or **▼** to choose **Auto**, **Light** or **Dark**. Press **OK**.



Note

Even if you choose **Light** or **Dark**, the machine will send the fax using the **Auto** setting if you choose **Photo** as the Fax Resolution.

Changing Fax Resolution

The quality of a fax can be improved by changing the Fax Resolution. Resolution can be changed for the next fax or for all faxes.

To change the default Fax Resolution setting

- 1 Make sure you are in FAX mode .
- 2 Press **Menu, 2, 2, 2**.
- 3 Press **▲** or **▼** to choose **Standard**, **Fine**, **S.Fine** or **Photo**. Press **OK**.



Note

You can choose four different resolution settings.

Standard: Suitable for most typed documents.

Fine: Good for small print and transmits a little slower than **Standard** resolution.

S.Fine: Good for small print or artwork and transmits slower than **Fine** resolution.

Photo: Use when the document has varying shades of gray or is a photograph. This has the slowest transmission time.

Additional sending operations

Sending a fax manually

Manual transmission

Manual transmission lets you hear the dialling, ringing and fax-receiving tones while sending a fax.

- 1 Make sure you are in FAX mode .
- 2 Load your document.
- 3 Pick up the handset of an external telephone and listen for a dial tone.
- 4 Dial the fax number using the external telephone.
- 5 When you hear the fax tone, press **Start**.
 - If you are using the scanner glass, press **1** to send a fax.
- 6 Replace the handset of the external telephone.

Dual access

You can dial a number and start scanning the fax into memory—even when the machine is sending from memory, receiving faxes or printing PC data. The LCD will show the new job number.

The number of pages you can scan into the memory will vary depending on the data that is printed on them.



Note

If you get an *Out of Memory* message while scanning the first page of a fax, press **Stop/Exit** to cancel scanning. If you get an *Out of Memory* message while scanning a subsequent page, you can press **Start** to send the pages scanned so far, or press **Stop/Exit** to cancel the operation.

Broadcasting

Broadcasting lets you send the same fax message to more than one fax number. You can include Groups, One Touch, Speed Dial numbers and up to 50 manually dialed numbers in the same broadcast.

You can broadcast to 366 different numbers. This will depend on how many Groups, access codes or credit card numbers you have saved, and on how many delayed or stored faxes are in the memory.

Before you begin the broadcast

One Touch and Speed Dial numbers must be stored in the machine's memory before they can be used in a broadcast. (►► Basic User's Guide: *Storing One Touch Dial numbers* and *Storing Speed Dial numbers*)

Group numbers must also be stored in the machine's memory before they can be used in a broadcast. Group numbers include many previously stored One Touch Dial and Speed Dial numbers for easier dialling. (See *Setting up Groups for Broadcasting* ►► page 35.)

How to broadcast a fax



Note

Use (Address Book) to help you choose numbers easily.

- 1 Make sure you are in FAX mode .
- 2 Load your document.
- 3 Enter a number.
Press **OK**.
You can use either a One Touch, a Speed Dial, a Group number, or a number manually entered using the dial pad. (►► Basic User's Guide: *How to dial*)
- 4 Repeat step 3 until you have entered all the fax numbers you want to broadcast to.
- 5 Press **Start**.

After the broadcast is finished the machine will print a broadcast report to let you know the results.



Note

The scan profile of the One Touch, Speed Dial or Group number you chose first will be applied to the broadcast.

Cancelling a Broadcast in progress

While broadcasting you can cancel the fax currently being sent or the whole broadcast job.

- 1 Press **Menu, 2, 7**.
The LCD will display the Broadcast job number followed by the fax number or name being dialled (for example, #001 0123456789) and the broadcast job number (for example, Broadcast#001).

```
27.Remaining Jobs
▲ #001 0123456789
▼ Broadcast#001
-----
Select ▲▼ or OK
```

- 2 Press **▲** or **▼** to choose one of the following:
 - Choose the fax number being dialled, and press **OK**.
 - Choose the broadcast job number, and press **OK**.

```
27.Remaining Jobs
Broadcast#001
▲ 1.Clear
▼ 2.Exit
-----
Select ▲▼ or OK
```

- 3 Press **1** to cancel the fax number or Broadcast job number you chose in step 2, or press **2** to exit without cancelling.
If you chose to only cancel the fax currently being sent in step 2, the LCD will ask you if you want to cancel the broadcast job. Press **1** to clear the whole broadcast job or **2** to exit.
- 4 Press **Stop/Exit**.

Real Time Transmission

When you are sending a fax, the machine will scan the documents into the memory before sending it. Then, as soon as the telephone line is free, the machine will start dialling and sending.

Sometimes, you may want to send an important document immediately, without waiting for memory transmission. You can set **Real Time TX** to **On** for all documents or **Next Fax:On** for the next fax only.



Note

- If the memory is full and you are sending a fax from the ADF, the machine will send the document in real time (even if Real Time TX is set to Off). If the memory is full, faxes from the scanner glass cannot be sent until you clear some of the memory.
- In Real Time Transmission, the automatic redial feature does not work when using the scanner glass.

Sending in real time for all faxes

- 1 Make sure you are in FAX mode .
- 2 Press **Menu, 2, 2, 5**.
- 3 Press **▲** or **▼** to choose **On**. Press **OK**.

Sending in real time for the next fax only

- 1 Make sure you are in FAX mode .
- 2 Press **Menu, 2, 2, 5**.
- 3 Press **▲** or **▼** to choose `Next Fax:On`. Press **OK**.

Not sending in real time for the next fax only

- 1 Make sure you are in FAX mode .
- 2 Press **Menu, 2, 2, 5**.
- 3 Press **▲** or **▼** to choose `Next Fax:Off`. Press **OK**.

Overseas Mode

If you are having difficulty sending a fax overseas due to a bad connection, then turning on Overseas Mode may help.

This is a temporary setting, and will only be active for your next fax.

- 1 Make sure you are in FAX mode .
- 2 Load your document.
- 3 Press **Menu, 2, 2, 8**.
- 4 Press **▲** or **▼** to choose `On` or `Off`. Press **OK**.

Delayed Fax

You can store up to 50 faxes in the memory to be sent within a twenty-four hour period.

- 1 Make sure you are in FAX mode .
- 2 Load your document.
- 3 Press **Menu, 2, 2, 3**.
- 4 Enter the time you want the fax to be sent in 24-hour clock format. Press **OK**.



Note

The number of pages you can scan into the memory depends on the amount of data printed on each page.

Delayed batch transmission

Before sending the delayed faxes, your machine will help you economize by sorting all the faxes in the memory by destination and scheduled time.

All delayed faxes that are scheduled to be sent at the same time to the same fax number will be sent as one fax to save transmission time.

- 1 Make sure you are in FAX mode .
- 2 Press **Menu, 2, 2, 4**.
- 3 Press **▲** or **▼** to choose **On** or **Off**. Press **OK**.
- 4 Press **Stop/Exit**.

Checking and cancelling waiting jobs

Check which jobs are still waiting in the memory to be sent. If there are no jobs, the LCD will show **No Jobs Waiting**. You can cancel a fax job that is stored and waiting in the memory.

- 1 Press **Menu, 2, 7**.
The number of jobs still to be sent will be displayed.
- 2 Press **▲** or **▼** to scroll through the waiting jobs, and then choose the job you want to cancel.
Press **OK**.
- 3 Do one of the following:
 - Press **1** to cancel the waiting job.
 - Press **2** to exit without cancelling the job.
- 4 When you have finished, press **Stop/Exit**.

Electronic cover page

This feature will *not* work unless you have programmed your Station ID. (►► Quick Setup Guide)

You can automatically send a cover page with every fax. Your cover page includes your Station ID, a comment, and the name stored in the One Touch or Speed Dial memory.

By choosing `Next Fax:On` you can also display the number of pages on the cover page.

You can choose one of the following preset comments.

1. `Comment Off`
2. `Please Call`
3. `Urgent`
4. `Confidential`

Instead of using one of the preset comments, you can enter two personal messages of your own, up to 27 characters long.

(See *Composing your own comments* ►► page 20.)

5. (User Defined)
6. (User Defined)

Composing your own comments

You can set up two comments of your own.

- 1 Make sure you are in FAX mode .
- 2 Press **Menu, 2, 2, 7, 2**.
- 3 Press **▲** or **▼** to choose 5. or 6. to store your own comment.
Press **OK**.
- 4 Enter your own comment using the dial pad. (►► Basic User's Guide: *Entering text*)
Press **OK**.

Send a cover page for the next fax

If you want to send a cover page only for the next fax, your machine will ask you to enter the number of pages you are sending so it can be printed on the cover page.

- 1 Make sure you are in FAX mode .
- 2 Load your document.
- 3 Press **Menu, 2, 2, 7, 1**.
- 4 Press **▲** or **▼** to choose `Next Fax:On` (or `Next Fax:Off`). Press **OK**.
- 5 Press **▲** or **▼** to choose a comment. Press **OK**.
- 6 Enter two digits to show the number of pages you are sending. Press **OK**.
For example, enter **0, 2** for 2 pages or **0, 0** to leave the number of pages blank. If you make a mistake, press **◀** or **Clear** to back up and re-enter the number of pages.

Send a cover page for all faxes

You can set the machine to send a cover page whenever you send a fax.

- 1 Make sure you are in FAX mode .
- 2 Press **Menu, 2, 2, 7, 1**.
- 3 Press **▲** or **▼** to choose `On` (or `Off`). Press **OK**.
- 4 Press **▲** or **▼** to choose a comment. Press **OK**.

Using a printed cover page

If you want to use a printed cover page that you can write on, you can print the sample page and attach it to your fax.

- 1 Make sure you are in FAX mode .
- 2 Press **Menu, 2, 2, 7, 1**.
- 3 Press **▲** or **▼** to choose `Print Sample`. Press **OK**.
- 4 Press **Start**.
- 5 After the machine prints a copy of your cover page, press **Stop/Exit**.

Destination Display

The machine displays the information registered in the address book or the number you dialed to send a fax. You can set the machine to hide the destination information on the LCD.

- 1 Make sure you are in FAX mode .
- 2 Press **Menu**, **2**, **2**, **9**.
- 3 Press **▲** or **▼** to choose **Hidden or Display**.
Press **OK**.
- 4 Press **Stop/Exit**.

Polling overview

Polling lets you set up your machine so other people can receive faxes from you, but they pay for the call. It also lets you call somebody else's fax machine and receive a fax from it, so you pay for the call. The polling feature needs to be set up on both machines for this to work. Not all fax machines support polling.

Polled transmit

Polled transmit lets you set up your machine to wait with a document so another fax machine can call and retrieve it.

Setup for polled transmit

- 1 Make sure you are in FAX mode .
- 2 Load your document.
- 3 Press **Menu**, **2**, **2**, **6**.
- 4 Press **▲** or **▼** to choose *Standard*. Press **OK**.
- 5 Press **2** to choose *2.No* if you do not want to change any more settings when the LCD asks you the following question:

```

22.Setup Send
Next?
▲ 1.Yes
▼ 2.No
Select ▲▼ or OK
  
```

- 6 Press **Start**.

- 7 If you are using the scanner glass, the LCD will prompt you to choose one of the options below:

```

Flatbed Fax:
Next Page?
▲ 1.Yes
▼ 2.No (Send)
Select ▲▼ or OK
  
```

- Press **1** to scan another page. Go to step 8.
- Press **2** or **Start** if you are finished scanning pages.

- 8 Place the next page on the scanner glass, press **OK**. Repeat steps 7 and 8 for each additional page.

The document will be stored in memory and wait to be polled.



Note

The document will be stored and can be retrieved from any other fax machine until you delete the fax from memory.

To delete the fax from memory, press **Menu**, **2**, **7**. (See *Checking and cancelling waiting jobs* ►► page 19.)

Setup for polled transmit with a secure code

Secure polling lets you restrict who can get the documents you set up to be polled. Secure polling only works with Brother fax machines. If another person wants to retrieve a fax from your machine they will have to enter the secure code.

- 1 Make sure you are in FAX mode .
- 2 Load your document.
- 3 Press **Menu**, **2**, **2**, **6**.
- 4 Press **▲** or **▼** to choose *Secure*. Press **OK**.

- 5 Enter a four-digit number.
Press **OK**.
- 6 If you do not want to change any more settings, press **2** to choose **2.No** when the LCD shows you the following question:

```

22.Setup Send
Next?
▲ 1.Yes
▼ 2.No
Select ▲▼ or OK

```

- 7 Press **Start**.
- 8 If you use the scanner glass, the LCD will prompt you to choose one of the options below:

```

Flatbed Fax:
Next Page?
▲ 1.Yes
▼ 2.No (Send)
Select ▲▼ or OK

```

- Press **1** to scan another page.
Go to step 9.
 - Press **2** or **Start** if you are finished scanning pages.
- 9 Place the next page on the scanner glass, press **OK**. Repeat steps 8 and 9 for each additional page. Your machine will automatically send the fax when it is polled.

Remote Fax Options

Remote Fax Options let you receive faxes while you are away from the machine.

You can use *only one* Remote Fax Option at a time.

Fax Forwarding

The Fax Forwarding feature lets you automatically forward your received faxes to another machine. If you choose **Backup Print On**, the machine will also print the fax.

- 1 Press **Menu, 2, 5, 1**.
- 2 Press **▲** or **▼** to choose **Fax Forward**. Press **OK**.
The LCD will ask you to enter the fax number you want your faxes to be forwarded to.
- 3 Enter the forwarding number (up to 20 digits). Press **OK**.
- 4 Press **▲** or **▼** to choose **On** or **Off**. Press **OK**.

```

25.Remote Fax Opt
  Backup Print
▲   Off
▼   On
-----
Select ▲▼ or OK
  
```

- 5 Press **Stop/Exit**.

! Important

If you choose **Backup Print On**, the machine will also print the fax at your machine so you will have a copy. This is a safety feature in case there is a power failure before the fax is forwarded or a problem at the receiving machine.

Fax Storage

The Fax Storage feature lets you store your received faxes in the machine's memory. You can retrieve stored fax messages from a fax machine at another location using the remote retrieval commands. (See *Retrieving fax messages* >> page 28.) Your machine will automatically print a copy of the stored fax.

- 1 Press **Menu, 2, 5, 1**.
- 2 Press **▲** or **▼** to choose **Fax Storage**. Press **OK**.
- 3 Press **Stop/Exit**.

Changing Remote Fax Options

If received faxes are left in your machine's memory when you change to another Remote Fax Option, the LCD will ask you one of the following questions:

```

25.Remote Fax Opt
Erase All Doc?
▲ 1.Yes
▼ 2.No
Select ▲▼ or OK
  
```

or

```

25.Remote Fax Opt
Print All Fax?
▲ 1.Yes
▼ 2.No
Select ▲▼ or OK
  
```

- If you press **1**, faxes in the memory will be erased or printed before the setting changes. If a backup copy has already been printed the faxes will not be printed again.
- If you press **2**, faxes in the memory will not be erased or printed and the setting will be unchanged.

If received faxes are left in the machine's memory when you change to PC Fax Receive from another remote fax option (Fax Forward or Fax Storage), the LCD will ask you the following question:

```

25.Remote Fax Opt
Send Fax to PC?
▲ 1.Yes
▼ 2.No
Select ▲▼ or OK
  
```

- If you press **1**, faxes in the memory will be sent to your PC before the setting changes.
- If you press **2**, faxes in the memory will not be erased or transferred to your PC and the setting will be unchanged.

The LCD will ask you the following question:

```

25.Remote Fax Opt
Backup Print
▲ Off
▼ On
Select ▲▼ or OK
  
```

Press **▲** or **▼** to choose *On* or *Off*.

Press **OK**.

Press **Stop/Exit**.

Important

If you choose Backup Print On, the machine will also print the fax at your machine so you will have a copy. This is a safety feature in case there is a power failure before the fax is forwarded or a problem at the receiving machine.

Turning off Remote Fax Options

- 1 Press **Menu**, **2**, **5**, **1**.
- 2 Press **▲** or **▼** to choose *Off*. Press **OK**.



Note

The LCD will give you options if there are received faxes still in your machine's memory. (See *Changing Remote Fax Options* >> page 26.)

- 3 Press **Stop/Exit**.

Remote retrieval

The remote retrieval feature lets you retrieve your stored fax messages when you are not at the machine. You can call your machine from any touch tone phone or fax machine, then use the Remote Access Code to retrieve your messages.

Setting a Remote Access Code

The Remote Access Code feature lets you access the remote retrieval features when you are away from your machine. Before you use the remote access and retrieval features, you have to set up your own code. The default code is an inactive code: --*.

- 1 Press **Menu**, **2**, **5**, **2**.

```
25.Remote Fax Opt
 2.Remote Access

Access Code:---*
Enter & OK Key
```

- 2 Enter a three-digit code using the numbers **0** – **9**, ***** or **#**. Press **OK**.
- 3 Press **Stop/Exit**.



Note

DO NOT use the same code used for your Remote Activation code (***51**) or Remote Deactivation code (**#51**). (►► Basic User's Guide: *Using Remote Codes*)

You can change your code at any time. If you want to make your code inactive, press **Clear** and then **OK** in 2 to restore the default setting --*.

Using your Remote Access Code

- 1 Dial your fax number from a telephone or another fax machine using touch tone.
- 2 When your machine answers, immediately enter your Remote Access Code.
- 3 The machine signals if it has received messages:
 - *No beeps*
No messages received.
 - *1 long beep*
Fax message received.
- 4 The machine gives two short beeps to tell you to enter a command. (See *Remote fax commands* ►► page 29.) The machine will hang up if you wait longer than 30 seconds before entering a command. If you enter an invalid command the machine will beep three times.
- 5 Press **90** to reset the machine when you have finished.
- 6 Replace the handset.



Note

If your machine is set to **Manual** mode, you can still access the remote retrieval features. Dial the fax number as usual and let the machine ring. After 100 seconds you will hear a long beep to tell you to enter the remote access code. You will then have 30 seconds to enter the code.

Retrieving fax messages

- 1 Dial your fax number from a telephone or another fax machine using touch tone.
- 2 When your machine answers, immediately enter your Remote Access Code (3 digits followed by *). If you hear one long beep, you have messages.
- 3 When you hear two short beeps, use the dial pad to press **9 6 2**.
- 4 Wait for a long beep, and then use the dial pad to enter the number of the remote fax machine where you want your fax messages sent, followed by **##** (up to 20 digits).
- 5 Replace the handset after you hear your machine beep. Your machine will call the remote machine, which will then print your fax messages.



Note

You can insert a pause in a fax number by using the # key.

Changing the Fax Forwarding number

You can change the default setting of your fax forwarding number from another telephone or fax machine using touch tone.

- 1 Dial your fax number from a telephone or another fax machine using touch tone.
- 2 When your machine answers, enter your Remote Access Code (3 digits followed by *). If you hear one long beep, you have messages.
- 3 When you hear two short beeps, use the dial pad to press **9 5 4**.
- 4 Wait for a long beep, and then use the dial pad to enter the new number of the remote fax machine where you want your fax messages forwarded followed by **##** (up to 20 digits).
- 5 Press **9 0** to reset the machine when you have finished.
- 6 Replace the handset after you hear your machine beep.



Note

You can insert a pause in a fax number by using the # key.

Remote fax commands

Follow the commands below to access features when you are away from the machine. When you call the machine and enter your Remote Access Code (3 digits followed by *), the system will give two short beeps and you must enter a remote command.

Remote commands		Operation details
95	Change the fax forwarding or fax storage settings	
	1 OFF	You can choose <code>OFF</code> after you have retrieved or erased all your messages.
	2 Fax Forwarding	One long beep means the change is accepted. If you hear three short beeps, you cannot change the setting because the conditions have not been met (for example, registering a fax forwarding number). You can register your fax forwarding number by entering 4. (See <i>Changing the Fax Forwarding number</i> >> page 28.) Once you have registered the number, fax forwarding will work.
	4 Fax Forwarding number	
6 Fax Storage		
96	Retrieve a fax	
	2 Retrieve all faxes	Enter the number of a remote fax machine to receive stored fax messages. (See <i>Retrieving fax messages</i> >> page 28.)
	3 Erase faxes from the memory	If you hear one long beep, fax messages have been erased from the memory.
97	Check the receiving status	
	1 Fax	You can check whether your machine has received any faxes. If yes, you will hear one long beep. If no, you will hear three short beeps.
98	Change the Receive Mode	
	1 External TAD	If you hear one long beep, your change has been accepted.
	2 Fax/Tel	
	3 Fax Only	
90	Exit	Press 9 0 to exit remote retrieval. Wait for the long beep, then replace the handset.

Additional receiving operations

Printing a reduced incoming fax

If you choose **On**, the machine automatically reduces each page of an incoming fax to fit on one page of A4, Letter, Legal or Folio size paper.

The machine calculates the reduction ratio by using the page size of the fax and your Paper Size setting (**Menu, 1, 2, 2**) and Tray Use for Fax setting (**Menu, 1, 6, 2**).

- 1 Make sure you are in FAX mode .
- 2 Press **Menu, 2, 1, 5**.
- 3 Press **▲** or **▼** to choose **On** or **Off**. Press **OK**.
- 4 Press **Stop/Exit**.

Duplex (2-sided) printing for FAX mode

Your machine can automatically print received faxes onto both sides of the paper when Duplex is set to **On**.

You can use A4 size paper for this function (60 to 105 g/m²).

- 1 Make sure you are in FAX mode .
- 2 Press **Menu, 2, 1, 9**.
- 3 Press **▲** or **▼** to choose **On** (or **Off**). Press **OK**.
- 4 Press **Stop/Exit**.



Note

When Duplex is turned on incoming faxes will automatically be reduced to fit the size of paper in the paper tray.

Setting the Fax Receive Stamp

You can set the machine to print the received date and time in the top centre of each received fax page.

- 1 Make sure you are in FAX mode .
- 2 Press **Menu, 2, 1, 8**.
- 3 Press **▲** or **▼** to choose **On** or **Off**. Press **OK**.
- 4 Press **Stop/Exit**.



Note

- The received time and date will not appear when using Internet Fax.
- Make sure you have set the current date and time in the machine. (▶▶ Quick Setup Guide)

Setting the Print Density

You can adjust the Print Density setting to make your printed pages darker or lighter.

- 1 Make sure you are in FAX mode .
- 2 Press **Menu, 2, 1, 6**.
- 3 Press **▶** to make the print darker. Or, press **◀** to make the print lighter. Press **OK**.
- 4 Press **Stop/Exit**.

Printing a fax from the memory

If you are using the Fax Storage feature (**Menu, 2, 5, 1**), you can still print a fax from the memory when you are at your machine. (See *Fax Storage* ▶▶ page 25.)

- 1 Press **Menu, 2, 5, 3**.
- 2 Press **Start**.
- 3 Press **Stop/Exit**.

Out of Paper Reception

As soon as the paper tray becomes empty during fax reception, the LCD shows **No Paper**. Put some paper in the paper tray. (►► *Basic User's Guide: Loading paper and print media*)

The machine will carry on receiving the fax, with the remaining pages being stored in the memory, if enough memory is available.

Incoming faxes will continue to be stored in the memory until the memory becomes full or paper is loaded in the paper tray. When the memory is full the machine will stop automatically answering calls. To print the faxes, put fresh paper in the tray.

Polling overview

Polling lets you set up your machine so other people can receive faxes from you, but they pay for the call. It also lets you call somebody else's fax machine and receive a fax from it, so you pay for the call. The polling feature needs to be set up on both machines for this to work. Not all fax machines support polling.

Polling receive

Polling receive lets you call another fax machine to receive a fax.

- 1 Make sure you are in FAX mode .
 - 2 Press **Menu, 2, 1, 7**.
- ```

21.Setup Receive
 7.Polling RX
▲ Standard
▼ Secure
Select ▲▼ or OK

```
- 3 Press **▲** or **▼** to choose **Standard**. Press **OK**.
  - 4 Enter the fax number you are polling. Press **Start**.

### Secure polling

Secure polling lets you restrict who can get the documents you set up to be polled. Secure polling only works with Brother fax machines. If you want to get a fax from a secured Brother machine you have to enter the secure code.

- 1 Make sure you are in FAX mode .
- 2 Press **Menu, 2, 1, 7**.
- 3 Press **▲** or **▼** to choose **Secure**. Press **OK**.
- 4 Enter a four-digit secure code. Press **OK**.  
This is the security code of the fax machine you are polling.

- 5 Enter the fax number you are polling.
- 6 Press **Start**.

### Delayed polling

Delayed polling lets you set the machine to begin polling receive at a later time. You can only set up *one* delayed polling operation.

- 1 Make sure you are in FAX mode .
- 2 Press **Menu, 2, 1, 7**.
- 3 Press **▲** or **▼** to choose *Timer*. Press **OK**.
- 4 Enter the time (in 24-hour clock format) you want to begin polling. Press **OK**.
- 5 Enter the fax number you are polling. Press **Start**.  
The machine makes the polling call at the time you entered.

### Sequential polling

Sequential polling lets you request documents from several fax machines in one operation.

- 1 Make sure you are in FAX mode .
- 2 Press **Menu, 2, 1, 7**.
- 3 Press **▲** or **▼** to choose *Standard*, *Secure* or *Timer*. Press **OK**.
- 4 Choose one of the options below.
  - If you choose *Standard* go to step 5.
  - If you choose *Secure*, enter a four-digit number, press **OK**, go to step 5.
  - If you chose *Timer*, enter the time (in 24-hours format) you want to begin polling and press **OK**, go to step 5.

- 5 Specify the destination fax machines you want to poll by using One Touch, Speed Dial, Search, a Group or the dial pad. You must press **OK** between each location.

- 6 Press **Start**.

### Stop polling

To cancel the polling process, press **Stop/Exit** while the machine is dialling.

To cancel all sequential polling receive jobs, press **Menu, 2, 7**. (See *Checking and cancelling waiting jobs* >> page 19.)

# 5

## Dialling and storing numbers

### Telephone line services

#### BT Call Sign (U.K. only)

---

The BT Call Sign subscriber service is a way to have a separate number for your machine, it allows you to have at least two separate telephone numbers on one phone line. Each phone number has its own distinctive ringing pattern.

You can set up your machine so that it only responds to the second number.

When you set the BT Call Sign feature to ON, the receive mode is set to *Manual* automatically. *Manual* mode will not respond to incoming telephone calls, since the number you use for telephone calls will use the normal ring pattern. If you turn the feature off, your receive mode will remain on *Manual*.

#### To enable the machine to work with BT Call Sign

This feature will only work with your external phone.

- 1 Press **Menu**, **2**, **0**, **2**.  
The screen displays the current setting.
- 2 Press **▲** or **▼** to choose *On* or *Off*.  
Press **OK**.
- 3 Press **Stop/Exit**.

### Additional dialling operations

#### Combining quick dial numbers

---

You can combine more than one quick dial number when you dial. This feature may be useful if you need to dial an access code for a cheaper rate from another long distance carrier.

For example, you might have stored '01632' in Speed Dial #003 and '960555' in Speed Dial #002. You can use them both to dial '01632-960555' if you press the following keys:

Press  (**Address Book**) twice, **003**.

Press  (**Address Book**) twice, **002** and **Start**.

Numbers can be added manually by entering them on the dial pad:

Press  (**Address Book**) twice, **003**, **960556** (on the dial pad), and **Start**.

This would dial '01632-960556'. You can also add a pause by pressing the **Redial/Pause** key.



## Additional ways to store numbers

### Setting up Groups for Broadcasting

If you often want to send the same fax message to many fax numbers you can set up a Group.

Groups are stored on a One Touch key or a Speed Dial number. Each Group uses up a One Touch key or a Speed Dial location. You can then send the fax message to all the numbers stored in a Group just by pressing a One Touch key or entering a Speed Dial number, and then pressing **Start**.

Before you can add numbers to a Group, you need to store them as One Touch or Speed Dial numbers. You can set up to 20 small Groups, or you can assign up to 315 numbers to one large Group.

If you have downloaded and installed the IFAX and E-mail options, see *If you have downloaded the IFAX and E-mail options* >> page 37.

- 1 Press **Menu**, **2**, **3**, **3**.

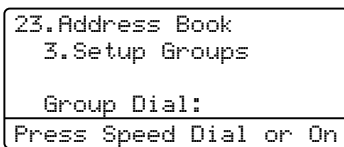

- 2 Choose the One Touch key or Speed Dial location where you want to store the Group.

- Press a One Touch key.
  - Press  (**Address Book**) and then enter the three-digit Speed Dial location.
- Press **OK**.

- 3 Use the dial pad to enter a Group number (01 to 20). Press **OK**.

- 4 To add One Touch or Speed Dial numbers follow the instructions below:
  - For One Touch numbers, press the One Touch keys one after the other.
  - For Speed Dial numbers, press  (**Address Book**) and then enter the three-digit Speed Dial location.

The LCD will display your chosen One Touch numbers with a \* and Speed Dial numbers with a # (for example \*006, #009).

- 5 Press **OK** when you have finished adding numbers.
- 6 Do one of the following:
  - Enter the name using the dial pad (up to 15 characters).
    - (>> Basic User's Guide: *Entering text*)
 Press **OK**.
  - Press **OK** to store the Group without a name.
- 7 If you want to save a fax resolution along with the number, choose one of the options below:
  - To store the fax resolution, press **▲** or **▼** to select *Std*, *Fine*, *S.Fine* or *Photo*. Press **OK**.
  - Press **OK** if you do not want to change the default resolution.

- 8 Do one of the following:
  - To store another Group for broadcasting, go to step 2.
  - To finish storing Groups for broadcasting, press **Stop/Exit**.

## Options for Setting Up Groups

The following chart shows the additional options for setting up Group numbers when IFAX and E-mail options are installed on the machine. When you store numbers, the LCD instructs you to choose from the options shown in the following steps.

| Step 1<br>Enter Group Location | Step 2<br>Enter Group Number | Step 3<br>Select Registration Type <sup>1</sup> | Step 4<br>Add Stored One Touch and Speed Dial Numbers to the Group | Step 5<br>Enter Group Name | Step 6<br>Select Resolution            | Step 7<br>Select File type |
|--------------------------------|------------------------------|-------------------------------------------------|--------------------------------------------------------------------|----------------------------|----------------------------------------|----------------------------|
| One Touch or Speed Dial        | (1 to 20)                    | Fax/IFAX                                        | Faxnumber, Tel Number or E-mail Address                            | (Name)                     | Std, Fine, S.Fine <sup>2</sup> , Photo | -                          |
|                                |                              | Email Color PDF                                 | E-mail Address                                                     |                            | 100dpi, 200dpi, 300dpi, 600dpi, Auto   | PDF, PDF/A, SPDF, SiPDF    |
|                                |                              | Email Color JPG                                 |                                                                    |                            | 100dpi, 200dpi, 300dpi, 600dpi, Auto   | -                          |
|                                |                              | Email Color XPS                                 |                                                                    |                            | 100dpi, 200dpi, 300dpi, 600dpi, Auto   | -                          |
|                                |                              | Email Gray PDF                                  |                                                                    |                            | 100dpi, 200dpi, 300dpi, Auto           | PDF, PDF/A, SPDF, SiPDF    |
|                                |                              | Email Gray JPG                                  |                                                                    |                            | 100dpi, 200dpi, 300dpi, Auto           | -                          |
|                                |                              | Email Gray XPS                                  |                                                                    |                            | 100dpi, 200dpi, 300dpi, Auto           | -                          |
|                                |                              | Email B&W PDF                                   |                                                                    |                            | 300dpi, 200dpi, 200x100dpi             | PDF, PDF/A, SPDF, SiPDF    |
|                                |                              | Email B&W TIFF                                  |                                                                    |                            | 300dpi, 200dpi, 200x100dpi             | -                          |

<sup>1</sup> The IFAX and E-mail Registration Type options are available if you have installed the IFAX and E-mail options on your machine. You can add the IFAX and E-mail options by downloading them from the Brother Solutions Center at: <http://solutions.brother.com/>.

<sup>2</sup> S.Fine does not appear if you add an E-mail address in Step 4.



### Note

- PDF/A is a PDF file format intended for long-term archiving. This format contains all the necessary information for reproducing the document after long-term storage.
- SPDF (Secure PDF) is a PDF file format that has been password-protected.
- SiPDF (Signed PDF) is a PDF file format that helps prevent data tampering and the impersonation of an author by including a digital certificate within the document. If you choose SiPDF, you must install a certificate on your machine using Web Based Management. Choose **Signed PDF** from **Administrator** in Web Based Management. (How to install a certificate ►► *Network User's Guide*)

## If you have downloaded the IFAX and E-mail options

If you have installed the IFAX and E-mail options to your machine, use this procedure to set up Groups.

- 1 Press **Menu**, **2**, **3**, **3**.

```

23.Address Book
 3.Setup Groups

Group Dial:
Press Speed Dial or On

```

- 2 Choose the One Touch key or Speed Dial location where you want to store the Group.

- Press a One Touch key.
- Press  (**Address Book**) and then enter the three-digit Speed Dial location.

Press **OK**.

- 3 Use the dial pad to enter a Group number (01 to 20). Press **OK**.

- 4 Press **▲** or **▼** to select one of the following:

```

Fax/IFAX
Email Color PDF
Email Color JPG
Email Color XPS
Email Gray PDF
Email Gray JPG
Email Gray XPS
Email B&W PDF
Email B&W TIFF

```

Press **OK**.

- 5 To add One Touch or Speed Dial numbers follow the instructions below:
- For One Touch numbers, press the One Touch keys one after the other.
  - For Speed Dial numbers, press  (**Address Book**) and then enter the three-digit Speed Dial location.

The LCD will display your chosen One Touch numbers with a \* and Speed Dial numbers with a # (for example \*006, #009).



### Note

When you include email addresses, the Group can only contain email addresses and no numbers.

- 6 Press **OK** when you have finished adding numbers.
- 7 Do one of the following:
- Enter the Group name using the dial pad (up to 15 characters).  
(>> Basic User's Guide: *Entering text*)  
Press **OK**.
  - Press **OK** to store the Group without a name.

- 8 To choose the fax/scan resolution for the Group number, go to the appropriate next step as shown in the following table

| Option selected in step 4 | Go to step |
|---------------------------|------------|
| Fax/IFAX                  | 9          |
| Email Color PDF           | 10         |
| Email Color JPG           |            |
| Email Color XPS           |            |
| Email Gray PDF            | 11         |
| Email Gray JPG            |            |
| Email Gray XPS            |            |
| Email B&W PDF             | 12         |
| Email B&W TIFF            |            |

- 9 Press ▲ or ▼ to select Std, Fine, S.Fine<sup>1</sup> or Photo. Press **OK** and go to step 14.
- <sup>1</sup> S.Fine is available if the Group includes only fax numbers.
- 10 Press ▲ or ▼ to select 100dpi, 200dpi, 300dpi, 600dpi or Auto. Press **OK**.
- If you chose Email Color PDF, go to step 13.
  - If you chose Email Color JPG or Email Color XPS, go to step 14.
- 11 Press ▲ or ▼ to select 100dpi, 200dpi, 300dpi or Auto. Press **OK**.
- If you chose Email Gray PDF, go to step 13.
  - If you chose Email Gray JPG or Email Gray XPS, go to step 14.

- 12 Press ▲ or ▼ to select 300dpi, 200dpi or 200x100dpi. Press **OK**.
- If you chose Email B&W PDF, go to step 13.
  - If you chose Email B&W TIFF, go to step 14.
- 13 Press ▲ or ▼ to select the PDF type from PDF, PDF/A, SPDF (Secure PDF) or SiPDF (Signed PDF) that will be used to send to your PC. Press **OK**.



### Note

If you choose SPDF (Secure PDF), the machine will ask you to enter a four-digit password using the numbers 0-9 before it starts scanning.

- 14 Press **Stop/Exit**.



### Note

- When you do a broadcast and you have saved a scan profile along with the number or E-mail address, the scan profile of the One-Touch, Speed-Dial or Group number you chose *first* will be applied to the broadcast.
- For details about the file format, see the Software User's Guide.
- If you have selected Fax/IFAX in step 4 and added One-Touch or Speed-Dial numbers that are stored as 'IFAX', you cannot select S.Fine.

## Changing Group numbers

You can change a Group number that has already been stored. The LCD will show the name or number, and if the Group has been set to a fax forwarding number, it will display a message.

If you have downloaded and installed the IFAX and E-mail options, see *If you downloaded IFAX and E-mail options* >> page 39.

- 1 Press **Menu**, **2**, **3**, **3**.

```
23.Address Book
 3.Setup Groups

Group Dial:
Press Speed Dial or On
```

- 2 Choose the One Touch key or Speed Dial number where the Group is stored. Do one of the following:

- Press the One Touch key.
- Press  (**Address Book**) and enter the three-digit Speed Dial number.

Press **OK**.

### Note

If the Group number you are trying to change has been set to a fax forwarding number, the LCD will ask you if you want to change the name or number.

- 3 Do one of the following:
- To change the stored Group information, press **1**. Go to step 4.
  - To exit without making a change, press **Stop/Exit**.

```
23.Address Book
G01:*001*002#001
▲ 1.Change
▼ 2.Clear
Select ▲▼ or OK
```

- 4 Add or delete One Touch or Speed Dial numbers by following the instructions below:

- To add One Touch numbers, press ◀ or ▶ to position the cursor just after the last number. Then press the One Touch key of the number you want to add.
- To add Speed Dial numbers, press ◀ or ▶ to position the cursor just after the last number. Then press  (**Address Book**) and then enter the three-digit Speed Dial location of the number you want to add.
- To delete One Touch or Speed Dial numbers, press ◀ or ▶ to position the cursor under the number you want to delete, and then press **Clear**.

Press **OK**.

- 5 Edit the Group name by the following instruction.

- To edit the name, press ◀ or ▶ to position the cursor under the character you want to change. Then press **Clear** to delete it, and enter the correct character using the dial pad.

When you are finished editing, press **OK**.

- 6 If you want to change the fax resolution along with the number, press ▲ or ▼ to choose the resolution you want. Press **OK**.

- 7 Press **Stop/Exit**.

### If you downloaded IFAX and E-mail options

If you have installed the IFAX and E-mail options to your machine, use this procedure to change Group numbers.

- 1 Press **Menu**, **2**, **3**, **3**.

```

23.Address Book
 3.Setup Groups

Group Dial:
Press Speed Dial or On

```

- 2 Choose the One Touch key or Speed Dial number where the Group is stored. Do one of the following:

- Press the One Touch key.
- Press  (**Address Book**) and enter the three-digit Speed Dial number.

Press **OK**.



### Note

If the Group number you are trying to change has been set to a fax forwarding number, the LCD will ask you if you want to change the name or number.

- 3 Do one of the following:
- To change the stored Group information, press **1**. Go to step 4.
  - To exit without making a change, press **Stop/Exit**.

```

23.Address Book
 G01:*001*002#001
▲ 1.Change
▼ 2.Clear
Select ▲▼ or OK

```

- 4 Press **▲** or **▼** to select one of the following:

```

Fax/IFAX
Email Color PDF
Email Color JPG
Email Color XPS
Email Gray PDF
Email Gray JPG
Email Gray XPS
Email B&W PDF
Email B&W TIFF

```

Press **OK**.

- 5 Add or delete One Touch or Speed Dial numbers by following the instructions below:

- To add One Touch numbers, press **◀** or **▶** to position the cursor just after the last number. Then press the One Touch key of the number you want to add.
- To add Speed Dial numbers, press **◀** or **▶** to position the cursor just after the last number. Then press  (**Address Book**) and then enter the three-digit Speed Dial location of the number you want to add.
- To delete One Touch or Speed Dial numbers, press **◀** or **▶** to position the cursor under the number you want to delete, and then press **Clear**.

Press **OK**.

- 6 Edit the Group name by the following instruction.
- To edit the name, press **◀** or **▶** to position the cursor under the character you want to change. Then press **Clear** to delete it, and enter the correct character using the dial pad.

When you are finished editing, press **OK**.

- 7 If you want to change the fax resolution for the Group, press **▲** or **▼** to choose the resolution you want.

Press **OK**.

For details, follow the directions beginning with step 8 in *Options for Setting Up Groups*. (See *Options for Setting Up Groups* ►► page 36.)

- 8 Press **Stop/Exit**.

## Deleting Group numbers

You can delete a Group number that has already been stored. The LCD will show the name or number, and if the Group has been set to a fax forwarding number, it will display a message.

- 1 Press **Menu, 2, 3, 3**.

```
23.Address Book
 3.Setup Groups

Group Dial:
Press Speed Dial or On
```

- 2 Choose the One Touch key or Speed Dial number where the Group is stored. Do one of the following:
  - Press the One Touch key.
  - Press  (**Address Book**) and enter the three-digit Speed Dial number. Press **OK**.



### Note

If the Group number you are trying to delete has been set to a fax forwarding number, the LCD will ask you if you want to delete the name or number.

- 3 To delete the Group, press **2**.

```
23.Address Book
G01:*001*002#001
▲ 1.Change
▼ 2.Clear
Select ▲▼ or OK
```

- 4 Do one of the following:
  - To delete the Group, press **1**.
  - To exit without deleting the Group, press **2**.

```
23.Address Book
Erase This Data?
▲ 1.Yes
▼ 2.No
Select ▲▼ or OK
```

- 5 Press **Stop/Exit**.

# 6

## Printing reports

### Fax reports

Some fax reports (Transmission Verification and Fax Journal) can be printed automatically and manually.

#### Transmission Verification Report

You can use the Transmission Verification Report as proof that you sent a fax.

(>> Basic User's Guide: *Transmission Verification Report*)

#### Fax Journal (Activity Report)

You can set the machine to print a journal at specific intervals (every 50 faxes, 6, 12 or 24 hours, 2 or 7 days). If you set the interval to *Off*, you can still print the report by following the steps in *How to print a report* >> page 43. The factory setting is *Every 50 Faxes*.

- 1 Press **Menu**, **2**, **4**, **2**.
- 2 Press **▲** or **▼** to choose an interval. Press **OK**.  
If you choose *Every 50 Faxes*, go to step 5.  
If you choose *Every 7 Days*, go to step 4.
  - 6, 12, 24 hours, 2 or 7 days  
The machine will print the report at the chosen time and then erase all jobs from its memory. If the machine's memory becomes full with 200 jobs before the time you chose has passed, the machine will print the Journal early and then erase all jobs from the memory. If you want an extra report before it is due to print, you can print it without erasing the jobs from the memory.
  - **Every 50 Faxes**  
The machine will print the Journal when the machine has stored 50 jobs.
- 3 Enter the time to start printing in 24-hour format. Press **OK**.
- 4 If you chose *Every 7 Days* in step 2, press **▲** or **▼** to choose the first day of the 7-day countdown and enter the time to start printing (see step 3). Press **OK**.
- 5 Press **Stop/Exit**.



# Reports

The following reports are available:

- 1 **XMIT Verify**  
Displays the Transmission Verification Report for your last outgoing 200 faxes and prints the last report.
- 2 **Tel Index List**  
Prints a list of names and numbers stored in the One Touch and Speed Dial memory in numerical or alphabetical order.
- 3 **Fax Journal**  
Prints a list of information about your last 200 incoming and outgoing faxes. (TX: transmit.) (RX: receive.)
- 4 **User Settings**  
Prints a list of your current settings.
- 5 **Network Config**  
Lists your network settings.
- 6 **Drum Dot Print**  
Prints the drum dot check sheet for troubleshooting a dotted print problem.

## How to print a report

- 1 Press **Menu**, **6**.
- 2 Press **▲** or **▼** to choose the report you want to print.  
Press **OK**.
- 3 Do one of the following:
  - If you chose **XMIT Verify**, press **▲** or **▼** to choose **View on LCD or Print Report**.  
Press **OK**.
  - If you chose **Tel Index List**, press **▲** or **▼** to choose **Numeric or Alphabetic**.  
Press **OK**.
  - For other reports, press **OK**.  
Go to step 4.
- 4 Press **Start**.
- 5 Press **Stop/Exit**.

# 7

## Making copies

### Copy settings

When you want to quickly change the copy settings for the next copy, use the temporary **COPY** keys. You can change multiple settings in any combination.

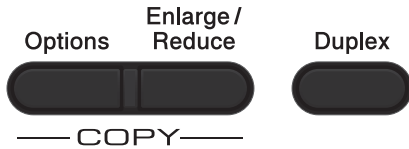

The machine returns to its default settings one minute after copying, unless you have set the Mode Timer to 30 seconds or less. (See *Mode Timer* >> page 4.)

To change a setting, press **COPY** and then press ▲ or ▼ and ◀ or ▶ to scroll through the COPY settings. When the setting you want is highlighted, press **OK**.

When you have finished changing the settings, press **Start** to begin printing.

### Stop copying

To stop copying, press **Stop/Exit**.

### Enlarging or reducing the image copied

You can choose the following enlargement or reduction ratios:

|              |                               |
|--------------|-------------------------------|
| Press<br>    | <b>100%*</b>                  |
|              | 97% LTR→A4                    |
|              | 94% A4→LTR                    |
|              | 91% Full Page                 |
|              | 85% LTR→EXE                   |
|              | 83% LGL→A4                    |
|              | 78% LGL→LTR                   |
|              | 70% A4→A5                     |
|              | 50%                           |
|              | Custom (25-400%) <sup>1</sup> |
|              | Auto <sup>2</sup>             |
|              | 200%                          |
| 141% A5→A4   |                               |
| 104% EXE→LTR |                               |

\* The factory setting is shown in Bold with an asterisk.

<sup>1</sup> Custom (25-400%) allows you to enter a ratio from 25% to 400%.

<sup>2</sup> Auto sets the machine to calculate the reduction ratio that best fits the size of paper. Auto is only available when using the ADF.

To enlarge or reduce the next copy follow the instructions below:

- 1 Make sure you are in COPY mode .
- 2 Load your document.
- 3 Use the dial pad to enter the number of copies (up to 99).
- 4 Press **Enlarge/Reduce**, then press ▶.

- 5 Do one of the following:
- Press ▲ or ▼ to choose the enlargement or reduction ratio you want.  
Press **OK**.
  - Press ▲ or ▼ to choose Custom (25-400%).  
Press **OK**.  
Use the dial pad to enter an enlargement or reduction ratio from 25% to 400%. (For example, press **5** and **3** to enter 53%.)  
Press **OK**.

- 6 Press **Start**.

**Note**

---

Page Layout Options 2 in 1 (P), 2 in 1 (L), 2 in 1 (ID), 4 in 1 (P) and 4 in 1 (L) are *not* available with Enlarge/Reduce.

---

## Using the Options key

Use the **Options** key to quickly set the following copy settings temporarily for the next copy.

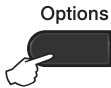
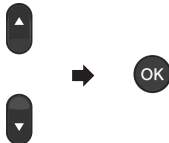
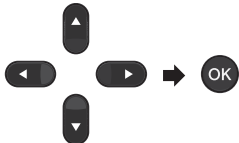
| Press                                                                                      | Menu selections                                                                                                  | Options                                                                                                                                                              | Page |
|--------------------------------------------------------------------------------------------|------------------------------------------------------------------------------------------------------------------|----------------------------------------------------------------------------------------------------------------------------------------------------------------------|------|
| Press<br> | Press ▲ or ▼, then press OK<br> | Press ▲, ▼, ◀ or ▶, then press OK<br>                                              |      |
|                                                                                            | Stack/Sort                                                                                                       | <b>Stack*</b><br>Sort                                                                                                                                                | 47   |
|                                                                                            | Quality                                                                                                          | <b>Auto*</b><br>Text<br>Photo<br>Graph                                                                                                                               | 47   |
|                                                                                            | Brightness                                                                                                       | -■□□□+<br>-□■□□+<br>-□□■□+*<br>-□□□■+<br>-□□□■+                                                                                                                      | 48   |
|                                                                                            | Contrast                                                                                                         | -■□□□+<br>-□■□□+<br>-□□■□+*<br>-□□□■+<br>-□□□■+                                                                                                                      | 48   |
|                                                                                            | Page Layout                                                                                                      | <b>Off (1 in 1)*</b><br>2 in 1 (P)<br>2 in 1 (L)<br>2 in 1 (ID)<br>4 in 1 (P)<br>4 in 1 (L)                                                                          | 49   |
|                                                                                            | Tray Select                                                                                                      | <b>MP&gt;T1*</b> or <b>M&gt;T1&gt;T2*</b> <sup>1</sup><br>T1>MP or T1>T2>M <sup>1</sup><br>#1 (XXX) <sup>2</sup><br>#2 (XXX) <sup>1 2</sup><br>MP (XXX) <sup>2</sup> | 51   |

The factory settings are shown in Bold with an asterisk.

<sup>1</sup> T2 and #2 appear only if the optional lower tray is installed.

<sup>2</sup> XXX is the paper size you set in **Menu, 1, 2, 2**.

## Sorting copies

You can sort multiple copies. Pages will be stacked in the order 1 2 3, 1 2 3, 1 2 3, and so on.

- 1 Make sure you are in COPY mode .
- 2 Load your document.
- 3 Use the dial pad to enter the number of copies (up to 99).
- 4 Press **Options**. Press ▲ or ▼ to choose *Stack/Sort*. Press **OK**.
- 5 Press ▲ or ▼ to choose *Sort*. Press **OK**.
- 6 Press **Start** to scan the page. If you placed the document in the ADF, the machine scans the pages and starts printing.

**If you are using the scanner glass, go to step 7.**

- 7 After the machine scans the page, press **1** to scan the next page.

```
Flatbed Copy:
Next Page?
▲ 1.Yes
▼ 2.No
Select ▲▼ or OK
```

- 8 Put the next page on the scanner glass. Press **OK**. Repeat steps 7 and 8 for each page of the document.
- 9 After all the pages have been scanned, press **2** in step 7 to finish.

## Improving copy quality

You can choose from a range of quality settings. The default setting is *Auto*.

- **Auto**  
Auto is the recommended mode for ordinary printouts. Suitable for documents that contain both text and photographs.
- **Text**  
Suitable for documents containing mainly text.
- **Photo**  
Better copy quality for photographs.
- **Graph**  
Suitable for copying receipts.

To temporarily change the quality setting, follow the steps below:

- 1 Make sure you are in COPY mode .
- 2 Load your document.
- 3 Use the dial pad to enter the number of copies (up to 99).
- 4 Press **Options**. Press ▲ or ▼ to choose *Quality*. Press **OK**.
- 5 Press ◀ or ▶ to choose *Auto*, *Text*, *Photo* or *Graph*. Press **OK**.
- 6 Press **Start**.

To change the *default* setting, follow the steps below:

- 1 Press **Menu**, **3**, **1**.
- 2 Press ▲ or ▼ to choose the copy quality. Press **OK**.
- 3 Press **Stop/Exit**.

## Adjusting Brightness and Contrast

### Brightness

Adjust the copy brightness to make copies darker or lighter.

- To *temporarily* change the copy brightness setting, follow the steps below:

- 1 Make sure you are in COPY mode .
- 2 Load your document.
- 3 Use the dial pad to enter the number of copies (up to 99).
- 4 Press **Options**.  
Press ▲ or ▼ to choose *Brightness*.  
Press **OK**.
- 5 Press ► to make a lighter copy or press ◀ to make a darker copy.  
Press **OK**.

- 6 Press **Start**.

- To change the *default* setting, follow the steps below:

- 1 Press **Menu, 3, 2**.
- 2 Press ► to make a lighter copy or press ◀ to make a darker copy.  
Press **OK**.
- 3 Press **Stop/Exit**.

### Contrast

Adjust the contrast to help an image look sharper and more vivid.

- To *temporarily* change the copy contrast setting, follow the steps below:

- 1 Make sure you are in COPY mode .
- 2 Load your document.
- 3 Use the dial pad to enter the number of copies (up to 99).
- 4 Press **Options**.  
Press ▲ or ▼ to choose *Contrast*.  
Press **OK**.
- 5 Press ◀ to decrease the contrast or press ► to increase the contrast.  
Press **OK**.

- 6 Press **Start**.

- To change the *default* setting, follow the steps below:

- 1 Press **Menu, 3, 3**.
- 2 Press ◀ to decrease the contrast or press ► to increase the contrast.  
Press **OK**.
- 3 Press **Stop/Exit**.

## Making N in 1 copies (page layout)

You can reduce the amount of paper used when copying by using the N in 1 copy feature. This allows you to copy two or four pages onto one page. If you want to copy both sides of an ID card onto one page, see *2 in 1 ID Copy* >> page 50.

### ! Important

- Please make sure the paper size is set to Letter, A4, Legal or Folio.
- (P) means Portrait and (L) means Landscape.
- You cannot use the Enlarge/Reduce setting with the N in 1 feature.

- 1 Make sure you are in COPY mode .
  - 2 Load your document.
  - 3 Use the dial pad to enter the number of copies (up to 99).
  - 4 Press **Options**. Press **▲** or **▼** to choose Page Layout. Press **OK**.
  - 5 Press **▲** or **▼** to choose Off (1 in 1), 2 in 1 (P), 2 in 1 (L), 2 in 1 (ID)<sup>1</sup>, 4 in 1 (P) or 4 in 1 (L). Press **OK**.
- <sup>1</sup> For details about 2 in 1 (ID), see *2 in 1 ID Copy* >> page 50.
- 6 Press **Start** to scan the page. If you placed the document in the ADF, the machine scans the pages and starts printing.

If you are using the scanner glass, go to step 7.

- 7 After the machine scans the page, press **1** to scan the next page.

```
Flatbed Copy:
Next Page?
▲ 1.Yes
▼ 2.No
Select ▲▼ or OK
```

- 8 Put the next page on the scanner glass. Press **OK**. Repeat steps 7 and 8 for each page of the layout.
- 9 After all the pages have been scanned, press **2** in step 7 to finish.

### If you are copying from the ADF:

Insert your document *face up* in the direction shown below:

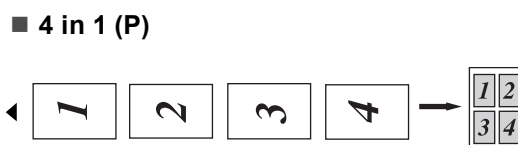
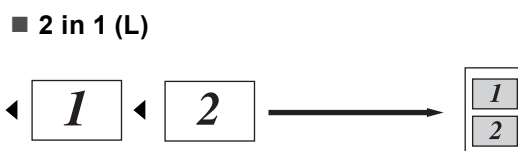

## If you are copying from the scanner glass:

Place your document *face down* in the direction shown below:

### ■ 2 in 1 (P)



### ■ 2 in 1 (L)

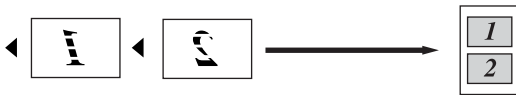

### ■ 4 in 1 (P)



### ■ 4 in 1 (L)



## 2 in 1 ID Copy

You can copy both sides of your identification card onto one page, keeping the original card size.



### Note

You can copy an identification card to the extent permitted under applicable laws.

(►► Product Safety Guide: *Unlawful use of copying equipment (MFC and DCP only)*)

- 1 Press  (**COPY**).
- 2 Place your identification card *face down* at the left corner of the scanner glass.

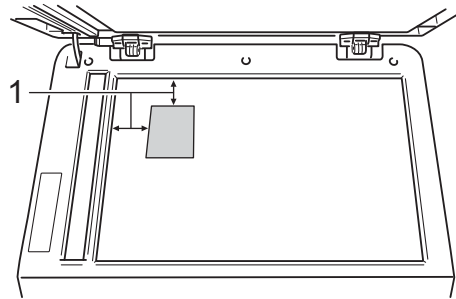

### 1 4 mm or greater (top, left)

- Even if a document is placed on the ADF, the machine scans the data from the scanner glass when in this mode.

- 3 Enter the number of copies you want.
- 4 Press **Options**. Press ▲ or ▼ to choose **Page Layout**. Press **OK**.
- 5 Press ▲ or ▼ to choose **2 in 1 (ID)**. Press **OK**.



- 6 Press **Start**.  
After the machine scans the first side of the card, the LCD will display the following instruction.

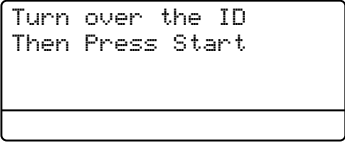

Turn over the ID  
Then Press Start

- 7 Turn over your identification card and place it at the left side of the scanner glass.
- 8 Press **Start**. The machine scans the other side of the card and prints the page.



### Note

When 2 in 1 ID Copy is chosen, the machine sets the quality to **Photo** and the contrast to +2 (-□□□□■+).

## Tray selection

You can change the Tray Use only for the next copy.

- 1 Make sure you are in COPY mode .
- 2 Load your document.
- 3 Use the dial pad to enter the number of copies (up to 99).
- 4 Press **Options**. Press **▲** or **▼** to choose **Tray Select**. Press **OK**.
- 5 Press **◀** or **▶** to choose the MP>T1, M>T1>T2<sup>1</sup>, T1>MP, T1>T2>M<sup>1</sup>, #1 (XXX)<sup>2</sup>, #2 (XXX)<sup>1 2</sup> or MP (XXX)<sup>2</sup>.
  - <sup>1</sup> T2 and #2 appears only if the optional lower tray is installed.
  - <sup>2</sup> XXX is the paper size you set in **Menu, 1, 2, 2**.
- 6 Press **OK**.
- 7 Press **Start**.



### Note

To change the default setting for Tray Select, >> Basic User's Guide: *Tray Use in COPY mode*.

## Duplex (2-sided) copying

If you want to use the automatic duplex copy feature, load your document in the ADF.

If you get an Out of Memory message while you are making duplex copies, try installing extra memory. (See *Installing extra memory* >> page 60.)

### Duplex Copy (long edge flip)

#### MFC-8510DN

##### ■ 1 sided → 2 sided L

Portrait

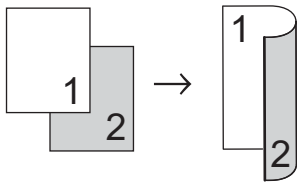

Landscape

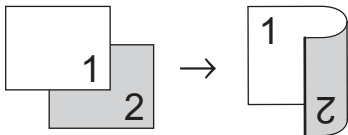

- 1 Make sure you are in COPY mode .
- 2 Load your document.
- 3 Enter the number of copies (up to 99) using the dial pad.
- 4 Press **Duplex** and ▲ or ▼ to select 1sided→2sided L. Press **OK**.
- 5 Press **Start** to copy the document.

#### MFC-8520DN

Portrait

##### ■ 1 sided → 2 sided

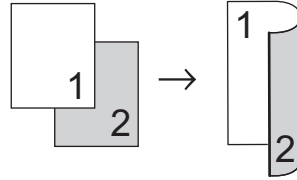

##### ■ 2 sided → 2 sided

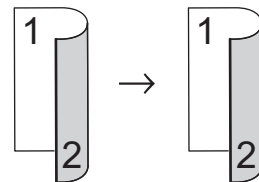

##### ■ 2 sided → 1 sided

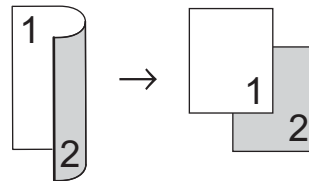

Landscape

##### ■ 1 sided → 2 sided

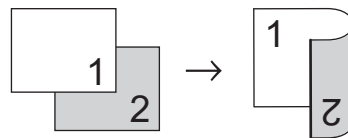

##### ■ 2 sided → 2 sided

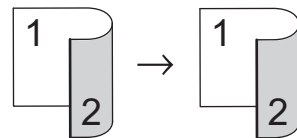

##### ■ 2 sided → 1 sided

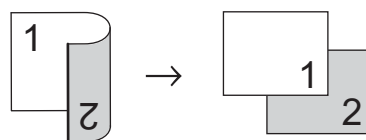

- 1 Make sure you are in COPY mode .
- 2 Load your document.
- 3 Enter the number of copies (up to 99) using the dial pad.
- 4 Press **Duplex** and ▲ or ▼ to select 1sided → 2sided, 2sided → 2sided or 2sided → 1sided. Press **OK**.
- 5 Press **Start** to copy the document.

## Advanced Duplex Copy (short edge flip)

### MFC-8510DN

#### ■ 1 sided – 2 sided S

Portrait

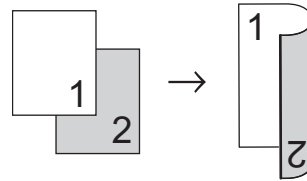

Landscape

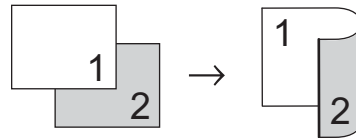

- 1 Make sure you are in COPY mode .
- 2 Load your document.
- 3 Enter the number of copies (up to 99) using the dial pad.
- 4 Press **Duplex** and ▲ or ▼ to select 1sided→2sided S. Press **OK**.
- 5 Press **Start** to copy the document.

**MFC-8520DN**

Portrait

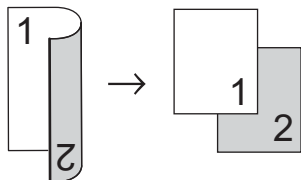
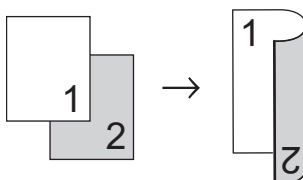
■ **Advanced 2 sided → 1 sided**■ **Advanced 1 sided → 2 sided**

Landscape

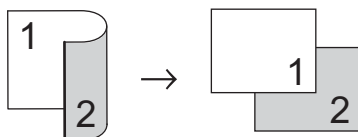
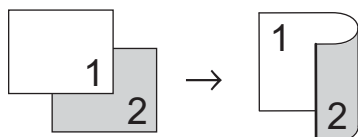
■ **Advanced 2 sided → 1 sided**■ **Advanced 1 sided → 2 sided**

- 1 Make sure you are in COPY mode .
- 2 Load your document.
- 3 Enter the number of copies (up to 99) using the dial pad.
- 4 Press **Duplex** and ▲ or ▼ to select **Advanced**. Press **OK**.
- 5 Press ▲ or ▼ to select **2sided → 1sided** or **1sided → 2sided**. Press **OK**.

- 6 Press **Start** to copy the document.

# A

## Routine maintenance

### Cleaning and checking the machine

Clean the outside and inside of the machine regularly with a dry, lint-free cloth. When you replace the toner cartridge or the drum unit, make sure that you clean the inside of the machine. If printed pages are stained with toner, clean the inside of the machine with a dry, lint-free cloth.

#### WARNING



- DO NOT put a toner cartridge or a toner cartridge and drum unit assembly into a fire. It could explode, resulting in injuries.
- DO NOT use flammable substances, any type of spray, or an organic solvent/liquid containing alcohol or ammonia to clean the inside or outside of the machine. Doing so could cause a fire or electrical shock. Instead, use only a dry, lint-free cloth.

(>> Product Safety Guide: *General precautions*)



#### Important

Use neutral detergents. Cleaning with volatile liquids such as thinner or benzene will damage the surface of the machine.

## Checking the Page Counters

You can see the machine's Page Counters for copies, printed pages, reports, lists and faxes or a summary total.

- 1 Press **Menu**, **8**, **2**.
- 2 Press **▲** or **▼** to see Total, Fax/List, Copy or Print.
- 3 Press **Stop/Exit**.

## Checking the remaining life of parts

You can see the machine's parts life on the LCD.

- 1 Press **Menu**, **8**, **3**.

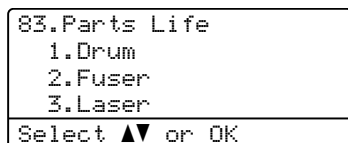

```
83. Parts Life
 1. Drum
 2. Fuser
 3. Laser
Select ▲▼ or OK
```

- 2 Press **▲** or **▼** to choose 1. Drum, 2. Fuser, 3. Laser, 4. PF Kit MP, 5. PF Kit 1 or 6. PF Kit 2<sup>1</sup>. Press **OK**.
- 3 Press **Stop/Exit**.

<sup>1</sup> If the optional lower tray is installed.



### Note

The life check will be accurate only if you have reset the part counter when you installed a new part. It will not be accurate if that part's life counter was reset during the life of the used part.

The remaining life of the toner cartridge is listed on the User Settings report. (See *How to print a report* ►► page 43.)

## Replacing periodic maintenance parts

The periodic maintenance parts will need to be replaced regularly to maintain the print quality. The parts listed below will have to be replaced after printing approximately 50,000 pages<sup>1</sup> for PF Kit MP and 100,000 pages<sup>1</sup> for PF Kit 1, PF Kit 2<sup>2</sup>, Fuser and Laser. Please call Brother Customer Service or your Brother dealer when the following messages appear on the LCD.

| LCD message                            | Description                                                |
|----------------------------------------|------------------------------------------------------------|
| Replace Parts<br>Fuser Unit            | Replace the fuser unit.                                    |
| Replace Parts<br>Laser Unit            | Replace the laser unit.                                    |
| Replace Parts<br>PF Kit 1              | Replace the paper feeding kit for the paper tray.          |
| Replace Parts<br>PF Kit 2 <sup>2</sup> | Replace the paper feeding kit for the lower tray (option). |
| Replace Parts<br>PF Kit MP             | Replace the paper feeding kit for the multi-purpose tray.  |

<sup>1</sup> A4 or Letter size single-sided pages.

<sup>2</sup> If the optional lower tray is installed.

## Packing and shipping the machine

### **⚠ WARNING**

This machine is heavy and weighs more than 15.8 kg. Be careful not to pinch your fingers when you put the machine down.

If you use a Lower Tray, DO NOT carry the machine with the Lower Tray as you may be injured or cause damage to the machine because it is not attached to the Lower Tray.



### **Note**

If for any reason you must ship your machine, carefully repack the machine in the original packaging to avoid any damage during transit. The machine should be adequately insured with the carrier.

- 1 Turn off the machine. Leave the machine turned off for at least 10 minutes to cool down.
- 2 Disconnect all the cables, and then unplug the power cord from the electrical socket.

- 3 Put the packing material (1) into the carton.

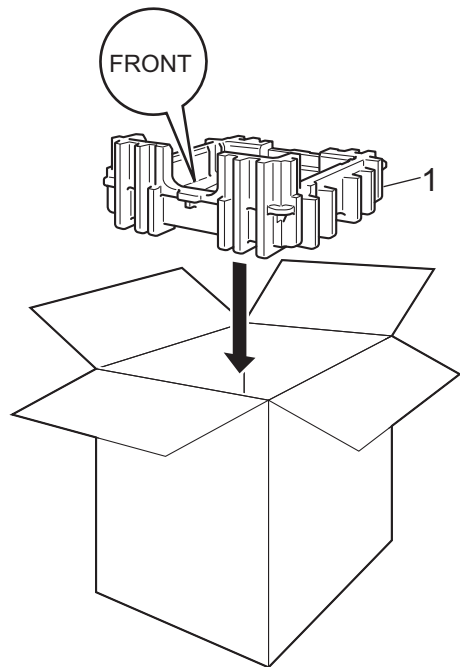

- 4 Wrap the machine in a plastic bag, then put it on the bottom packing material (1).

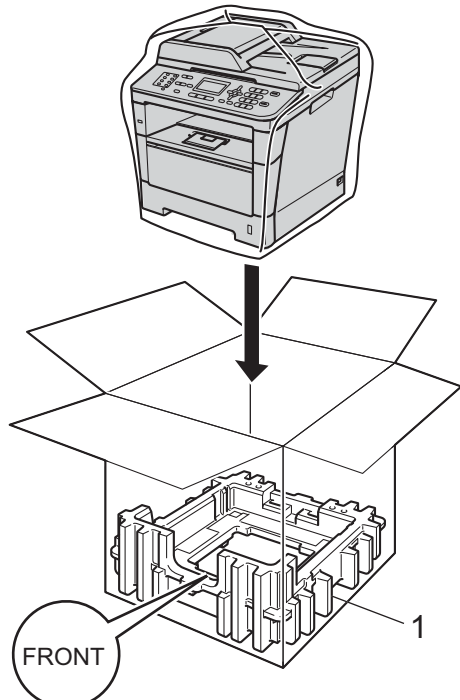

- 5 Put the two packing material pieces (1) into the carton matching the right of the machine to the “RIGHT” mark on one of the packing material pieces, and the left of the machine to the “LEFT” mark on the other packing material piece. Put the AC power cord and printed materials in the original carton as shown in the illustration.

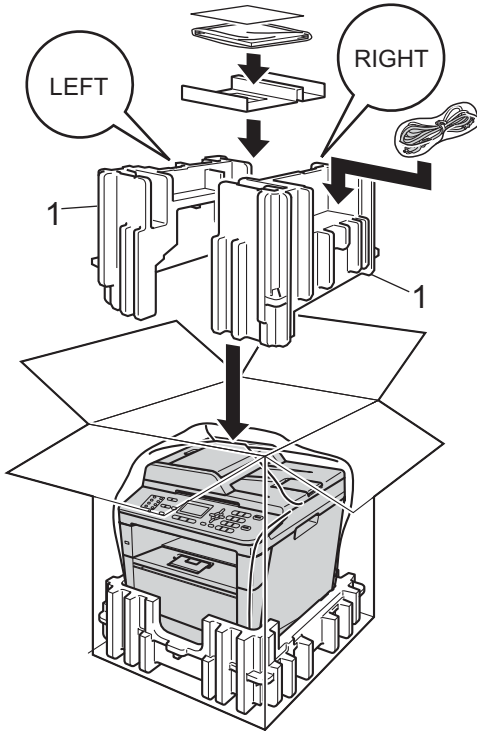

- 6 Close the carton and tape it shut.

- 7 <If you have a Lower Tray>  
Repack the lower tray as shown in the illustration.

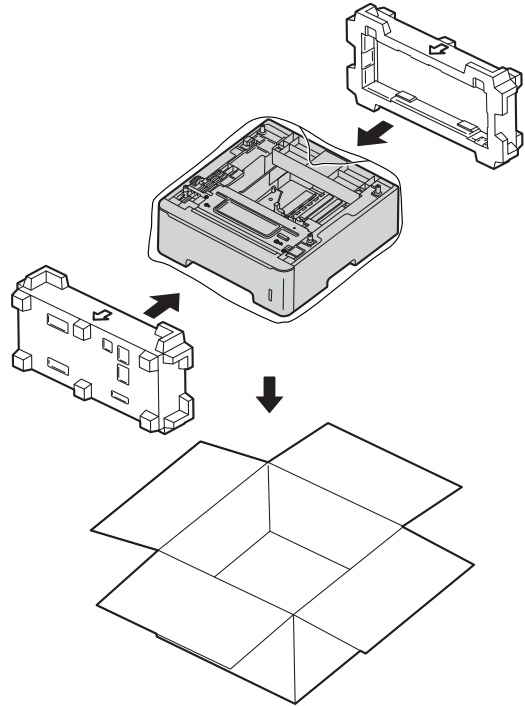



## Optional paper tray (LT-5400)

An optional lower tray can be installed on MFC-8510DN and MFC-8520DN, and it can hold up to 500 sheets of 80 g/m<sup>2</sup> paper.

When an optional tray is installed, the machine can hold up to 800 sheets of plain paper.

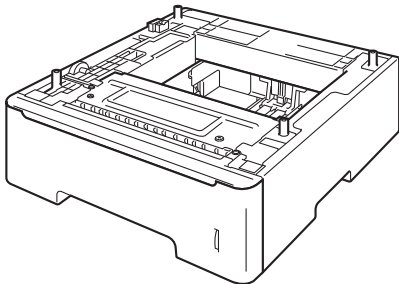

For setup, see the Instructions that we have supplied with the lower tray unit.

### **! WARNING**

If you use a Lower Tray, DO NOT carry the machine with the Lower Tray as you may be injured or cause damage to the machine because it is not attached to the Lower Tray.

## Memory board

MFC-8520DN has 128 MB of standard memory, and MFC-8510DN has 64 MB. Both models have one slot for optional memory expansion. You can increase the memory up to maximum of 384 MB for MFC-8520DN and 320 MB for MFC-8510DN by installing one SO-DIMM (Small Outline Dual In-line Memory Module).

### SO-DIMM Types

You can install the following SO-DIMMs:

- 256 MB Kingston KTH-LJ2015/256
- 256 MB Transcend TS256MHP423A



#### Note

- For more information, visit the Kingston Technology website at <http://www.kingston.com/>.
- For more information, visit the Transcend website at <http://www.transcend.com.tw/>.

In general, the SO-DIMM must have the following specifications:

|                 |                                |
|-----------------|--------------------------------|
| Type            | 144-pin and 16-bit output      |
| CAS latency     | 4                              |
| Clock frequency | 267 MHz (533 Mb/S/Pin) or more |
| Capacity        | 256 MB                         |
| Height          | 30.0 mm                        |
| DRAM type       | DDR2 SDRAM                     |



#### Note

- There might be some SO-DIMMs that will not work with the machine.
- For more information, call the dealer you bought the machine from or Brother Customer Service.

## Installing extra memory

- 1 Turn off the machine's power switch. Unplug the telephone line cord.
- 2 Disconnect the interface cable from the machine, and then unplug the power cord from the electrical socket.



### Note

Be sure to turn off the machine's power switch before you install or remove the SO-DIMM.

- 3 Remove the plastic (1) and then metal (2) SO-DIMM covers.

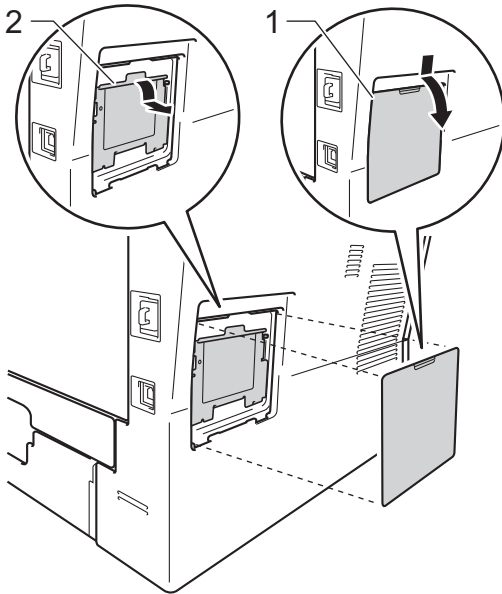

- 4 Unpack the SO-DIMM and hold it by its edges.

### Important

To prevent damage to the machine from static electricity, DO NOT touch the memory chips or the board surface.

- 5 Hold the SO-DIMM by the edges and align the notches in the SO-DIMM with the protrusions in the slot. Insert the SO-DIMM diagonally (1), then tilt it toward the interface board until it clicks into place (2).

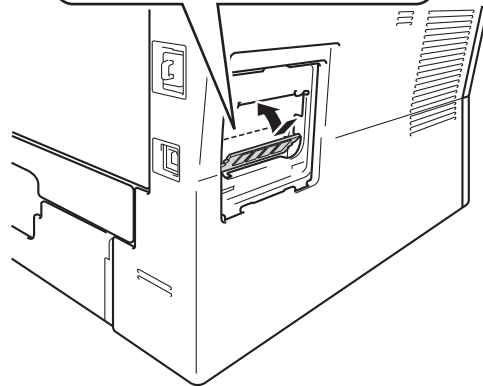
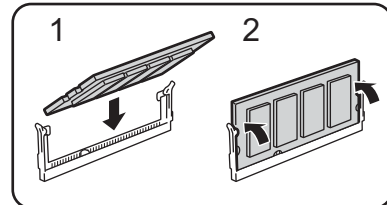

- 6 Put the metal (2) and then the plastic (1) SO-DIMM covers back on.

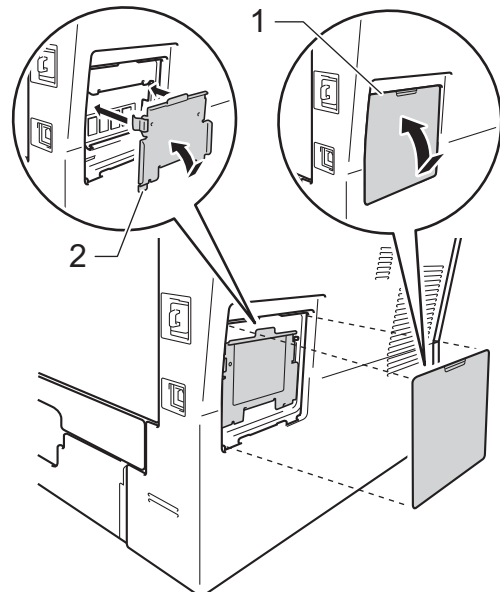

- 7 Plug the machine's power cord back into the electrical socket first, and then connect the interface cable.
- 8 Plug in the telephone line cord. Turn on the machine's power switch.

**Note**

To make sure that you have installed the SO-DIMM correctly, you can print the User Setting List that shows the current RAM SIZE. (See *How to print a report* >> page 43.)

# C

## Glossary

This is a comprehensive list of features and terms that appear in Brother manuals. Availability of these features depends on the model you purchased.

### **ADF (automatic document feeder)**

The document can be placed in the ADF and scanned one page at a time automatically.

### **Auto Reduction**

Reduces the size of incoming faxes.

### **Automatic fax transmission**

Sending a fax without picking up the handset of the external telephone.

### **Automatic Redial**

A feature that enables your machine to redial the last fax number after five minutes if the fax did not go through because the line was busy.

### **Backup Print**

Your machine prints a copy of every fax that is received and stored in memory. This is a safety feature so you will not lose messages during a power failure.

### **Batch Transmission**

As a cost saving feature, all delayed faxes to the same fax number will be sent as one transmission.

### **Beeper Volume**

Volume setting for the beep when you press a key or make an error.

### **Broadcasting**

The ability to send the same fax message to more than one location.

### **BT Call Sign**

A subscriber service purchased from the telephone company in the U.K. that gives you another phone number on an existing phone line. The Brother machine uses the new number to simulate a dedicated fax line.

### **Cancel Job**

Cancels a programmed print job and clears it from the machine's memory.

### **CNG tones**

The special tones (beeps) sent by fax machines during automatic transmission to tell the receiving machine that a fax machine is calling.

### **Coding method**

Method of coding the information contained in the document. All fax machines must use a minimum standard of Modified Huffman (MH). Your machine is capable of greater compression methods, Modified Read (MR), Modified Modified Read (MMR) and JBIG, if the receiving machine has the same capability.

### **Communication error (or Comm. Error)**

An error during fax sending or receiving, usually caused by line noise or static.

### **Compatibility group**

The ability of one fax unit to communicate with another. Compatibility is assured between ITU-T Groups.

### **Contrast**

Setting to compensate for dark or light documents, by making faxes or copies of dark documents lighter and light documents darker.

### **Delayed Fax**

Sends your fax at a specified later time that day.

### **Dual Access**

Your machine can scan outgoing faxes or scheduled jobs into memory at the same time it is sending a fax or receiving or printing an incoming fax.

**ECM (Error Correction Mode)**

Detects errors during fax transmission and resends the pages of the fax that had an error.

**Extension telephone**

A telephone on the fax number that is plugged into a separate wall socket.

**External phone**

A TAD (telephone answering device) or telephone that is connected to your machine.

**F/T Ring Time**

The length of time that the Brother machine fast double-rings (when the Receive Mode setting is Fax/Tel) to notify you to pick up a voice call that it answered.

**Fax Detect**

Enables your machine to respond to CNG tones if you interrupt a fax call by answering it.

**Fax Forwarding**

Sends a fax received into the memory to another pre-programmed fax number.

**Fax Journal**

Lists information about the last 200 incoming and outgoing faxes. TX means Transmit. RX means Receive.

**Fax Storage**

You can store faxes in the memory.

**Fax tones**

The signals sent by sending and receiving fax machines while communicating information.

**Fax/Tel**

You can receive faxes and telephone calls. Do not use this mode if you are using a telephone answering device (TAD).

**Fine resolution**

Resolution is 203 × 196 dpi. It is used for small print and graphs.

**Greyscale**

The shades of grey available for copying and faxing photographs.

**Group number**

A combination of One Touch and Speed Dial numbers that are stored on a One Touch key or in a Speed Dial location for Broadcasting.

**Journal Period**

The pre-programmed time period between automatically printed Fax Journal Reports. You can print the Fax Journal on demand without interrupting the cycle.

**LCD (liquid crystal display)**

The display screen on the machine that shows interactive messages during On-Screen Programming and shows the date and time when the machine is idle.

**Manual fax**

When you lift the handset of your external telephone so you can hear the receiving fax machine answer before you press **Start** to begin transmission.

**Menu mode**

Programming mode for changing your machine's settings.

**OCR (optical character recognition)**

Nuance™ PaperPort™ 12SE or Presto! PageManager software application converts an image of text to text you can edit.

**One Touch**

Keys on the machine's control panel where you can store numbers for easy dialling. You can store a second number on each key if you press **Shift** and the One Touch key together.

**Out of Paper Reception**

Receives faxes into the machine's memory when the machine is out of paper.

## Overseas Mode

Makes temporary changes to the fax tones to accommodate noise and static on overseas telephone lines.

## Pause

Allows you to place a 2.8 second delay in the dialling sequence while you are dialling using the dial pad or while you are storing One Touch and Speed Dial numbers. Press **Redial/Pause** as many times as needed for longer pauses.

## Polling

The process of a fax machine calling another fax machine to retrieve waiting fax messages.

## Pulse

A form of rotary dialling on a telephone line.

## Real Time Transmission

When memory is full, you can send faxes in real time.

## Remaining Jobs

You can check which programmed fax jobs are waiting in the memory and cancel the jobs individually.

## Remote Access Code

Your own four-digit code (– – –\*) that allows you to call and access your machine from a remote location.

## Remote Activation code

Press this code (\* 5 1) when you answer a fax call on an extension or external telephone.

## Remote Retrieval Access

The ability to access your machine remotely from a touch tone telephone.

## Resolution

The number of vertical and horizontal lines per inch.

## Ring Delay

The number of rings before the machine answers in Fax Only and Fax/Tel modes.

## Ring Volume

Volume setting for the machine's ring.

## Scanning

The process of sending an electronic image of a paper document into your computer.

## Search

An electronic, alphabetical listing of stored One Touch, Speed Dial and Group numbers.

## Speed Dial

A pre-programmed number for easy dialling.

## Station ID

The stored information that appears on the top of faxed pages. It includes the sender's name and fax number.

## TAD (telephone answering device)

You can connect an external TAD to your machine.

## Tel Index List

A listing of names and numbers stored in One Touch and Speed Dial memory, in numerical order.

## Temporary settings

You can choose certain options for each fax transmission and copy without changing the default settings.

## Tone

A form of dialling on the telephone line used for Touch Tone telephones.

## Transmission

The process of sending faxes over the telephone lines from your machine to the receiving fax machine.

## User Settings List

A printed report that shows the current settings of the machine.

## Xmit Report (Transmission Verification Report)

A listing for each transmission, that shows its date, time and number.

# D

# Index

## A

Apple Macintosh  
See Software User's Guide.

## B

Broadcasting ..... 16  
cancelling ..... 17  
setting up Groups for ..... 35

## C

Cancelling  
broadcast in process ..... 17  
fax jobs in memory ..... 19  
fax storage ..... 25  
jobs awaiting redial ..... 19  
remote fax options ..... 26

ControlCenter2 (for Macintosh)  
See Software User's Guide.

ControlCenter4 (for Windows®)  
See Software User's Guide.

Copy  
2 in 1 ID Copy ..... 50  
contrast ..... 48  
Duplex key ..... 52, 53  
Enlarge/Reduce key ..... 44  
keys ..... 44  
N in 1 (page layout) ..... 49  
Options key ..... 46  
quality ..... 47  
sort ..... 47  
temporary settings ..... 44  
using ADF ..... 47  
using scanner glass ..... 47, 49

Cover page ..... 20  
custom comments ..... 20  
for all faxes ..... 21  
for next fax only ..... 21  
printed form ..... 21

## D

Daylight Saving Time ..... 1  
Deep Sleep mode ..... 2  
Delayed batch transmission ..... 19  
Dialling  
Groups (broadcasting) ..... 16  
restricting dialling ..... 11  
Drum unit  
checking (remaining life) ..... 56  
Dual access ..... 15  
Duplex copy ..... 52

## E

Enlarge/Reduce key ..... 44

## F

Fax codes  
changing ..... 27  
remote access code ..... 27

Fax forwarding  
changing remotely ..... 28, 29  
programming a number ..... 25  
Fax storage ..... 25  
printing from memory ..... 31  
turning off ..... 26  
turning on ..... 25

Fax, stand-alone  
receiving  
fax forwarding ..... 29  
fax receive stamp ..... 31  
into memory (fax storage) ..... 25  
polling receive ..... 32  
reducing to fit on paper ..... 30  
retrieving from a remote site ..... 28, 29  
sending ..... 13  
broadcasting ..... 16  
cancelling from memory ..... 19  
contrast ..... 14  
delayed batch ..... 19  
delayed fax ..... 18  
destination display ..... 22  
from memory (dual access) ..... 15  
manual ..... 15  
overseas ..... 18  
polled transmit ..... 23  
real time transmission ..... 17  
resolution ..... 14

D

## G

---

Groups for broadcasting .....35

## L

---

LCD (liquid crystal display)  
contrast .....3

## M

---

Machine information  
checking remaining life of parts .....56  
page counts .....56  
Macintosh  
See Software User's Guide.  
Maintenance, routine .....55  
checking the remaining life of parts .....56  
Manual  
transmission .....15  
Memory  
adding DIMM (option) .....59  
installing .....60  
storage .....1

## N

---

N in 1 (page layout) .....49  
Network  
faxing  
See Software User's Guide.  
printing  
See Network User's Guide.  
scanning  
See Software User's Guide.  
Nuance™ PaperPort™ 12SE  
See Software User's Guide and Help in the  
PaperPort™ 12SE application to access  
How-to-Guides.

## P

---

Page layout (N in 1) .....49  
PC-Fax  
See Software User's Guide.  
Polling  
polled transmit .....23  
polling receive .....32  
Power failure .....1

Presto! PageManager  
See Software User's Guide. See also Help  
in the Presto! PageManager application.

Print  
fax from memory ..... 31  
reports ..... 43  
Printing  
See Software User's Guide.

## Q

---

Quality  
copying ..... 46, 47  
Quick dial  
broadcasting ..... 16  
using Groups ..... 16  
Group dial  
setting up Groups for broadcasting ... 35  
Quiet mode ..... 3

## R

---

Reducing  
copies ..... 44  
incoming faxes ..... 30  
Remote retrieval ..... 27  
access code ..... 27  
commands ..... 29  
getting your faxes ..... 28  
Remote setup  
See Software User's Guide.  
Reports ..... 42, 43  
Drum Dot Print ..... 43  
Fax Journal ..... 42, 43  
journal period ..... 42  
how to print ..... 43  
Network Configuration ..... 43  
Tel Index List ..... 43  
Transmission Verification ..... 42  
User Settings ..... 43  
WLAN Report ..... 43  
Resolution  
fax (standard, fine, superfine, photo) .... 14  
setting for next fax ..... 14  
Resolution key ..... 14  
Restricted users ..... 7



## S

---

### Scanning

See Software User's Guide.

### Security

|                              |    |
|------------------------------|----|
| restricting dialling .....   | 11 |
| Secure function lock         |    |
| administrator password ..... | 6  |
| Public user mode .....       | 7  |
| restricted users .....       | 7  |
| Setting lock .....           | 9  |
| Sleep mode .....             | 2  |
| Sort .....                   | 47 |

## T

---

|                               |    |
|-------------------------------|----|
| Temporary copy settings ..... | 44 |
| Toner Save .....              | 2  |

## W

---

### Windows®

See Software User's Guide.

### Wireless Network

See Quick Setup Guide and Network User's Guide.

# brother®

**Visit us on the World Wide Web**  
**<http://www.brother.com/>**

These machines are approved for use in the country of purchase only. Local Brother companies or their dealers will only support machines purchased in their own countries.