



EVAPORATORS



VOL
1

PRICE LIST

**EFFECTIVE DATE:
01 OCT 2021**

SUPERCEDES:
TLP-C-2021-2

Bulletin TLP-C-2021-3-1-AEE

Part # 1090747-1-AEE



Prices are F.O.B. shipping point. Freight is allowed via lowest common carrier to nearest freight station in Canada and U.S.A. (except to Alaska or Hawaii) on shipments of \$4800 NET or more.

Shipments of less than \$4800 NET are F.O.B. shipping point and are not freight allowed.

Prices, weights and specifications subject to change without notice.

Terms: Net 30 days.

Subject to Terms and Conditions of Sale / General Warranty / Claims Procedures



**INCLUDES MODELS FOR DOE & NRCAN
AWEF-EXEMPT APPLICATIONS**

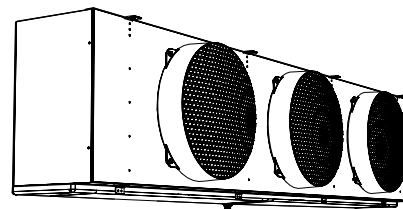
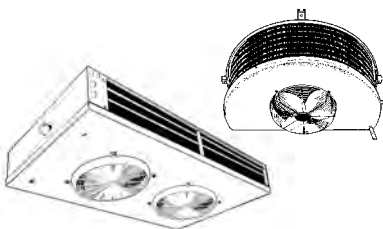
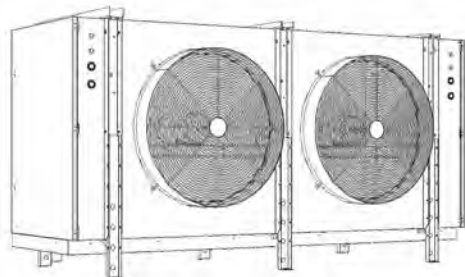

Contents

T - Line, Half Round Evaporators.....	2
TTL - Line, Two-Way Evaporators.....	3 - 4
TTM - Line, Two-Way Evaporators.....	5 - 6
TLV - Line, Low Velocity Evaporators.....	7 - 9
TPLP - Line, Pre-Assembled Low Profile Evaporators.....	10 - 14
TLP - Line, Low Profile Evaporators.....	15 - 20
TMP - Line, Medium Profile Evaporators.....	21 - 30
TEP - Line, Extended Profile Evaporators.....	31 - 41
THP - Line, High Profile Evaporators.....	42 - 49
Optional Evaporator Accessories.....	50 - 54
Thermosaver System.....	55
Lead-Lag Control Panel.....	55
Product Support Resources.....	BACK



2021 Refrigeration Products Price List

TLP-C-2020-3 - EFFECTIVE DATE: 01 OCT 2021 - SUPERCEDES: TLP-C-2020-2



T-LINE, HALF ROUND EVAPORATORS

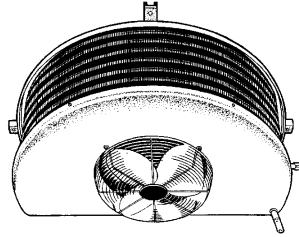

web: www.t-rp.com/truc
email: evaps@t-rp.com
call: 1-844-893-3222 x520

NOMENCLATURE

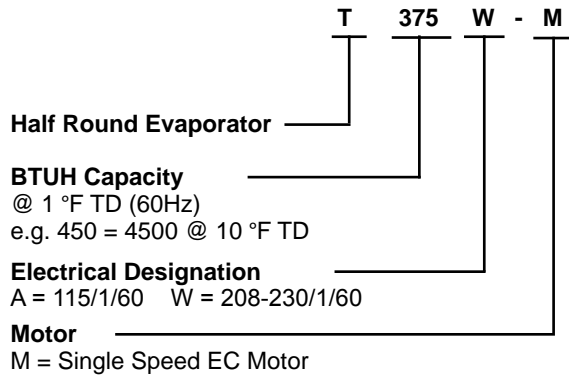

FEATURES

- Compatible with Low GWP Refrigerants
- Direct backwall location and minimum height provides maximum usable storage space.
- Textured heavy gauge aluminum cabinet - lightweight, doesn't show scratches.
- Rigid, slotted channel hangers simplify installation.
- Hinged drain pan for ease of cleaning and service.
- Full collar aluminum plate fins on expanded seamless copper tubes ensure optimum heat transfer efficiency.
- Fan motors are inherently protected
- Standard EC motors

MEDIUM TEMP - AIR DEFROST - 115 Volt

EC MOTORS			WEIGHT	
MODEL	VOLTAGE	\$	lbs.	kg
T375A-M	115/1/60	2689	72	32.7
T485A-M	115/1/60	3135	76	34.5
T595A-M	115/1/60	3293	98	44.5
T775A-M	115/1/60	3565	104	47.3
T905A-M	115/1/60	4407	108	49.1
T1025A-M	115/1/60	4811	114	51.8
T1305A-M	115/1/60	5596	124	56.4
T2050A-M	115/1/60	7885	187	85.0

MEDIUM TEMP - AIR DEFROST - 208-230 Volt

EC MOTORS			WEIGHT	
MODEL	VOLTAGE	\$	lbs.	kg
T775W-M	208-230/1/60	3565	104	47.3
T905W-M	208-230/1/60	4407	108	49.1
T1025W-M	208-230/1/60	4811	114	51.8
T1305W-M	208-230/1/60	5596	124	56.4
T2050W-M	208-230/1/60	7885	187	85.0



2021 Refrigeration Products Price List

TLP-C-2020-3 - EFFECTIVE DATE: 01 OCT 2021 - SUPERCEDES: TLP-C-2020-2



TTL-LINE, TWO WAY EVAPORATORS

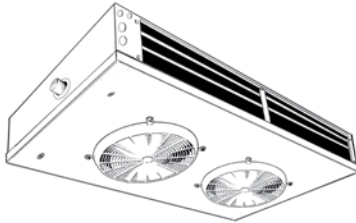

web: www.t-rp.com/ttl
email: evaps@t-rp.com
call: 1-844-893-3222 x520

NOMENCLATURE

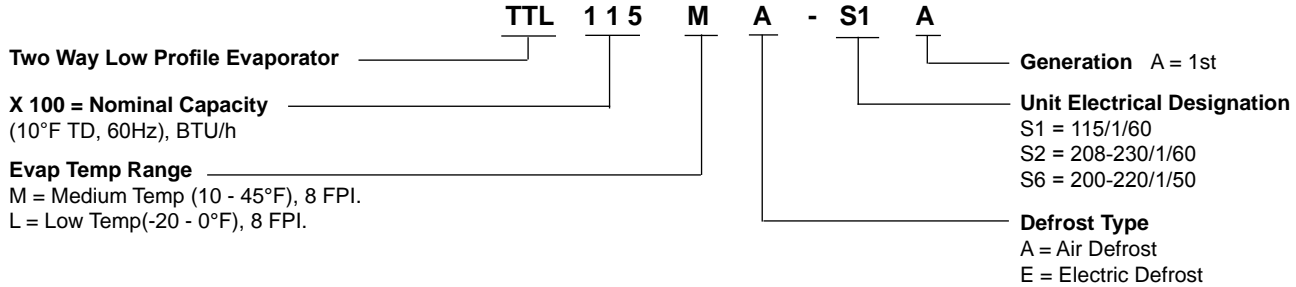

STANDARD FEATURES

- Compatible with Low GWP Refrigerants
- Low height compact size maximizes usable storage space
- Dual refrigeration coils and two-way air distribution reduces air velocities to minimize product dehydration
- Air enters through fan and discharges two ways out of each coil side
- Rugged heavy duty motor mount reduces vibration and noise
- Electric defrost models include factory installed defrost termination and fan delay thermostat
- NSF approved “flush to ceiling mount”
- Internally enhanced tube

AVAILABLE OPTIONS

- Additional options available, please contact factory

MEDIUM TEMP - AIR DEFROST

MODEL	SHADED POLE MOTORS		WEIGHT	
	VOLTAGE	\$	lbs.	kg
TTL010MA-S1A	115/1/60	796	12	5
TTL010MA-S2A	208-230/1/60	835	12	5
TTL010MA-S6A	200-220/1/50	835	12	5
TTL015MA-S1A	115/1/60	838	13	6
TTL015MA-S2A	208-230/1/60	896	13	6
TTL015MA-S6A	200-220/1/50	896	13	6
TTL020MA-S1A	115/1/60	974	14	6
TTL020MA-S2A	208-230/1/60	1041	14	6
TTL020MA-S6A	200-220/1/50	1041	14	6
TTL025MA-S1A	115/1/60	1198	15	7
TTL025MA-S2A	208-230/1/60	1276	15	7
TTL025MA-S6A	200-220/1/50	1276	15	7
TTL032MA-S1A	115/1/60	1387	19	9
TTL032MA-S2A	208-230/1/60	1479	19	9
TTL032MA-S6A	200-220/1/50	1479	19	9
TTL038MA-S1A	115/1/60	1551	20	9
TTL038MA-S2A	208-230/1/60	1658	20	9
TTL038MA-S6A	200-220/1/50	1658	20	9
TTL060MA-S1A	115/1/60	1968	38	17
TTL060MA-S2A	208-230/1/60	2123	38	17
TTL060MA-S6A	200-220/1/50	2123	38	17
TTL077MA-S1A	115/1/60	2397	40	18
TTL077MA-S2A	208-230/1/60	2588	40	18
TTL077MA-S6A	200-220/1/50	2588	40	18
TTL115MA-S1A	115/1/60	2994	60	27
TTL115MA-S2A	208-230/1/60	3192	60	27
TTL115MA-S6A	200-220/1/50	3192	60	27



2021 Refrigeration Products Price List

TLP-C-2020-3 - EFFECTIVE DATE: 01 OCT 2021 - SUPERCEDES: TLP-C-2020-2



TTL-LINE, TWO WAY EVAPORATORS (cont'd)

MEDIUM TEMP - ELECTRIC DEFROST

SHADED POLE MOTORS			WEIGHT	
MODEL	VOLTAGE	\$	lbs.	kg
TTL010ME-S1A	115/1/60	1229	11.6	5.3
TTL010ME-S2A	208-230/1/60	1308	11.6	5.3
TTL010ME-S6A	200-220/1/50	1308	11.6	5.3
TTL015ME-S1A	115/1/60	1312	12.6	5.7
TTL015ME-S2A	208-230/1/60	1403	12.6	5.7
TTL015ME-S6A	200-220/1/50	1403	12.6	5.7
TTL020ME-S1A	115/1/60	1547	13.7	6.2
TTL020ME-S2A	208-230/1/60	1629	13.7	6.2
TTL020ME-S6A	200-220/1/50	1629	13.7	6.2
TTL025ME-S1A	115/1/60	1902	14.7	6.7
TTL025ME-S2A	208-230/1/60	1996	14.7	6.7
TTL025ME-S6A	200-220/1/50	1996	14.7	6.7
TTL032ME-S1A	115/1/60	2206	18.9	8.6
TTL032ME-S2A	208-230/1/60	2315	18.9	8.6
TTL032ME-S6A	200-220/1/50	2315	18.9	8.6
TTL038ME-S1A	115/1/60	2429	20	9.1
TTL038ME-S2A	208-230/1/60	2595	20	9.1
TTL038ME-S6A	200-220/1/50	2595	20	9.1
TTL060ME-S1A	115/1/60	3265	37.8	17.2
TTL060ME-S2A	208-230/1/60	3298	37.8	17.2
TTL060ME-S6A	200-220/1/50	3298	37.8	17.2
TTL077ME-S1A	115/1/60	3723	39.9	18.1
TTL077ME-S2A	208-230/1/60	3760	39.9	18.1
TTL077ME-S6A	200-220/1/50	3760	39.9	18.1
TTL115ME-S1A	115/1/60	4529	59.9	27.2
TTL115ME-S2A	208-230/1/60	4575	59.9	27.2
TTL115ME-S6A	200-220/1/50	4575	59.9	27.2

LOW TEMP - ELECTRIC DEFROST

SHADED POLE MOTORS			WEIGHT	
MODEL	VOLTAGE	\$	lbs.	kg
TTL009LE-S1A	115/1/60	859	11.6	5.3
TTL009LE-S2A	208-230/1/60	902	11.6	5.3
TTL009LE-S6A	200-220/1/50	902	11.6	5.3
TTL013LE-S1A	115/1/60	905	12.6	5.7
TTL013LE-S2A	208-230/1/60	968	12.6	5.7
TTL013LE-S6A	200-220/1/50	968	12.6	5.7
TTL017LE-S1A	115/1/60	1052	13.7	6.2
TTL017LE-S2A	208-230/1/60	1124	13.7	6.2
TTL017LE-S6A	200-220/1/50	1124	13.7	6.2
TTL021LE-S1A	115/1/60	1293	14.7	6.7
TTL021LE-S2A	208-230/1/60	1378	14.7	6.7
TTL021LE-S6A	200-220/1/50	1378	14.7	6.7
TTL028LE-S1A	115/1/60	1498	18.9	8.6
TTL028LE-S2A	208-230/1/60	1597	18.9	8.6
TTL028LE-S6A	200-220/1/50	1597	18.9	8.6
TTL033LE-S1A	115/1/60	1676	20	9.1
TTL033LE-S2A	208-230/1/60	1790	20	9.1
TTL033LE-S6A	200-220/1/50	1790	20	9.1
TTL052LE-S1A	115/1/60	2125	37.8	17.2
TTL052LE-S2A	208-230/1/60	2292	37.8	17.2
TTL052LE-S6A	200-220/1/50	2292	37.8	17.2
TTL066LE-S1A	115/1/60	2589	39.9	18.1
TTL066LE-S2A	208-230/1/60	2795	39.9	18.1
TTL066LE-S6A	200-220/1/50	2795	39.9	18.1
TTL099LE-S1A	115/1/60	3234	59.9	27.2
TTL099LE-S2A	208-230/1/60	3447	59.9	27.2
TTL099LE-S6A	200-220/1/50	3447	59.9	27.2



2021 Refrigeration Products Price List

TLP-C-2020-3 - EFFECTIVE DATE: 01 OCT 2021 - SUPERCEDES: TLP-C-2020-2



TTM-LINE, TWO WAY EVAPORATORS

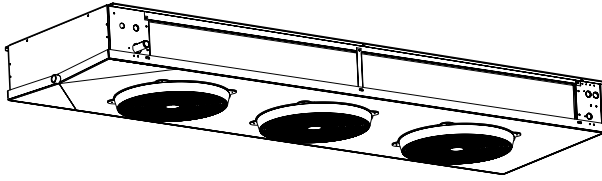

web: www.t-rp.com/ttm
email: evaps@t-rp.com
call: 1-844-893-3222 x520



see page 49 for details

NOMENCLATURE

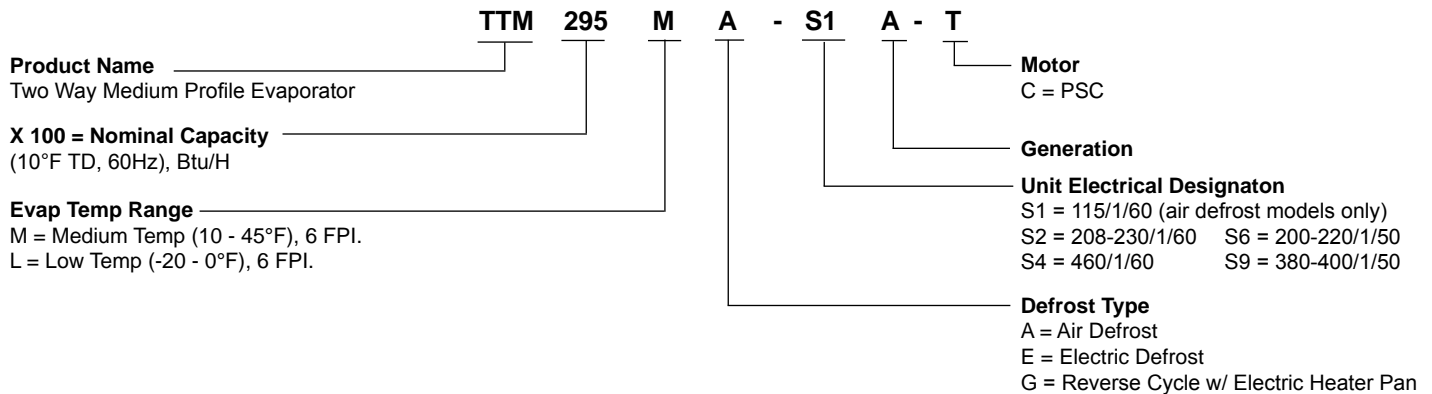

STANDARD FEATURES

- Compatible with Low GWP Refrigerants
- Heavy gauge textured aluminum cabinet construction resists scratches/corrosion and minimizes weight for shipment, installation and service.
- Capacity up to 29,500 BTUH nominal @ 10F TD.
- Dual refrigeration coils with two-way air distribution reduces air velocities to minimize product dehydration.
- Air enters through fan and discharges two ways out of each coil side.
- Low height compact size usable storage space.
- Internally enhanced tube.
- Attractive and durable high - density polyethylene fan guards.
- Standard PSC motors
- Hinged drain pan provides convenient access for cleaning.
- Terminal board allows for easy electrical connections.
- Reduced operating charge with 3/8" OD tubing

AVAILABLE OPTIONS

- Factory mounted solenoid valve, TXV and Thermostat on air and electric defrost models.
- **ESP+ Intuitive Evaporator Control Technology.**
- Corrosion protection: alternate fin materials and coatings
- Additional options available, please consult factory.



2021 Refrigeration Products Price List

TLP-C-2020-3 - EFFECTIVE DATE: 01 OCT 2021 - SUPERCEDES: TLP-C-2020-2



TTM-LINE, TWO WAY EVAPORATORS (cont'd)

MEDIUM TEMP - AIR DEFROST

PSC MOTORS			WEIGHT	
MODEL	VOLTAGE	\$	lbs.	kg
TTM115MA-S1A-C	115/1/60	3197	110	50.0
TTM115MA-S2A-C	208-230/1/60	3433	110	50.0
TTM115MA-S4A-C	460/1/60	3948	110	50.0
TTM115MA-S6A-C	200-220/1/50	3433	110	50.0
TTM115MA-S9A-C	380-400/1/50	3948	110	50.0
TTM139MA-S1A-C	115/1/60	3696	116	52.7
TTM139MA-S2A-C	208-230/1/60	3922	116	52.7
TTM139MA-S4A-C	460/1/60	4511	116	52.7
TTM139MA-S6A-C	200-220/1/50	3922	116	52.7
TTM139MA-S9A-C	380-400/1/50	4511	116	52.7
TTM172MA-S1A-C	115/1/60	4591	150	68.2
TTM172MA-S2A-C	208-230/1/60	4854	150	68.2
TTM172MA-S4A-C	460/1/60	5582	150	68.2
TTM172MA-S6A-C	200-220/1/50	4854	150	68.2
TTM172MA-S9A-C	380-400/1/50	5582	150	68.2
TTM208MA-S1A-C	115/1/60	5154	157	71.4
TTM208MA-S2A-C	208-230/1/60	5425	157	71.4
TTM208MA-S4A-C	460/1/60	6239	157	71.4
TTM208MA-S6A-C	200-220/1/50	5425	157	71.4
TTM208MA-S9A-C	380-400/1/50	6239	157	71.4
TTM236MA-S1A-C	115/1/60	5755	164	74.5
TTM236MA-S2A-C	208-230/1/60	6042	164	74.5
TTM236MA-S4A-C	460/1/60	6948	164	74.5
TTM236MA-S6A-C	200-220/1/50	6042	164	74.5
TTM236MA-S9A-C	380-400/1/50	6948	164	74.5
TTM260MA-S1A-C	115/1/60	6272	191	86.8
TTM260MA-S2A-C	208-230/1/60	6569	191	86.8
TTM260MA-S4A-C	460/1/60	7555	191	86.8
TTM260MA-S6A-C	200-220/1/50	6569	191	86.8
TTM260MA-S9A-C	380-400/1/50	7555	191	86.8
TTM295MA-S1A-C	115/1/60	7116	198	90.0
TTM295MA-S2A-C	208-230/1/60	7454	198	90.0
TTM295MA-S4A-C	460/1/60	8572	198	90.0
TTM295MA-S6A-C	200-220/1/50	7454	198	90.0
TTM295MA-S9A-C	380-400/1/50	8572	198	90.0

MEDIUM TEMP - HOT GAS DEFROST

PSC MOTORS			WEIGHT	
MODEL	VOLTAGE	\$	lbs.	kg
TTM115MG-S2A-C	208-230/1/60	4326	110	50.0
TTM115MG-S6A-C	200-220/1/50	4326	110	50.0
TTM139MG-S2A-C	208-230/1/60	5000	116	52.7
TTM139MG-S6A-C	200-220/1/50	5000	116	52.7
TTM172MG-S2A-C	208-230/1/60	6211	150	68.2
TTM172MG-S6A-C	200-220/1/50	6211	150	68.2
TTM208MG-S2A-C	208-230/1/60	6973	157	71.4
TTM208MG-S6A-C	200-220/1/50	6973	157	71.4
TTM236MG-S2A-C	208-230/1/60	7787	164	74.5
TTM236MG-S6A-C	200-220/1/50	7787	164	74.5
TTM260MG-S2A-C	208-230/1/60	8485	191	86.8
TTM260MG-S6A-C	200-220/1/50	8485	191	86.8
TTM295MG-S2A-C	208-230/1/60	9628	198	90.0
TTM295MG-S6A-C	200-220/1/50	9628	198	90.0

LOW TEMP - ELECTRIC DEFROST

PSC MOTORS			WEIGHT	
MODEL	VOLTAGE	\$	lbs.	kg
TTM105LE-S2A-C	208-230/1/60	4721	110	50.0
TTM105LE-S6A-C	200-220/1/50	4721	110	50.0
TTM124LE-S2A-C	208-230/1/60	4915	116	52.7
TTM124LE-S6A-C	200-220/1/50	4915	116	52.7
TTM153LE-S2A-C	208-230/1/60	5710	150	68.2
TTM153LE-S6A-C	200-220/1/50	5710	150	68.2
TTM188LE-S2A-C	208-230/1/60	6333	157	71.4
TTM188LE-S6A-C	200-220/1/50	6333	157	71.4
TTM210LE-S2A-C	208-230/1/60	7760	164	74.5
TTM210LE-S6A-C	200-220/1/50	7760	164	74.5
TTM235LE-S2A-C	208-230/1/60	8683	191	86.8
TTM235LE-S6A-C	200-220/1/50	8683	191	86.8
TTM265LE-S2A-C	208-230/1/60	9792	198	90.0
TTM265LE-S6A-C	200-220/1/50	9792	198	90.0

MEDIUM TEMP - ELECTRIC DEFROST

PSC MOTORS			WEIGHT	
MODEL	VOLTAGE	\$	lbs.	kg
TTM115ME-S2A-C	208-230/1/60	4721	110	50.0
TTM115ME-S6A-C	200-220/1/50	4721	110	50.0
TTM139ME-S2A-C	208-230/1/60	4915	116	52.7
TTM139ME-S6A-C	200-220/1/50	4915	116	52.7
TTM172ME-S2A-C	208-230/1/60	5710	150	68.2
TTM172ME-S6A-C	200-220/1/50	5710	150	68.2
TTM208ME-S2A-C	208-230/1/60	6333	157	71.4
TTM208ME-S6A-C	200-220/1/50	6333	157	71.4
TTM236ME-S2A-C	208-230/1/60	7760	164	74.5
TTM236ME-S6A-C	200-220/1/50	7760	164	74.5
TTM260ME-S2A-C	208-230/1/60	8683	191	86.8
TTM260ME-S6A-C	200-220/1/50	8683	191	86.8
TTM295ME-S2A-C	208-230/1/60	9792	198	90.0
TTM295ME-S6A-C	200-220/1/50	9792	198	90.0



2021 Refrigeration Products Price List

TLP-C-2020-3 - EFFECTIVE DATE: 01 OCT 2021 - SUPERCEDES: TLP-C-2020-2



TLV-LINE, LOW VELOCITY EVAPORATORS

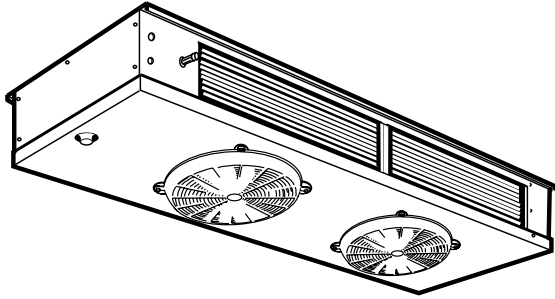

web: www.t-rp.com/tlv
email: evaps@t-rp.com
call: 1-844-893-3222 x520



see page 49 for details

NOMENCLATURE

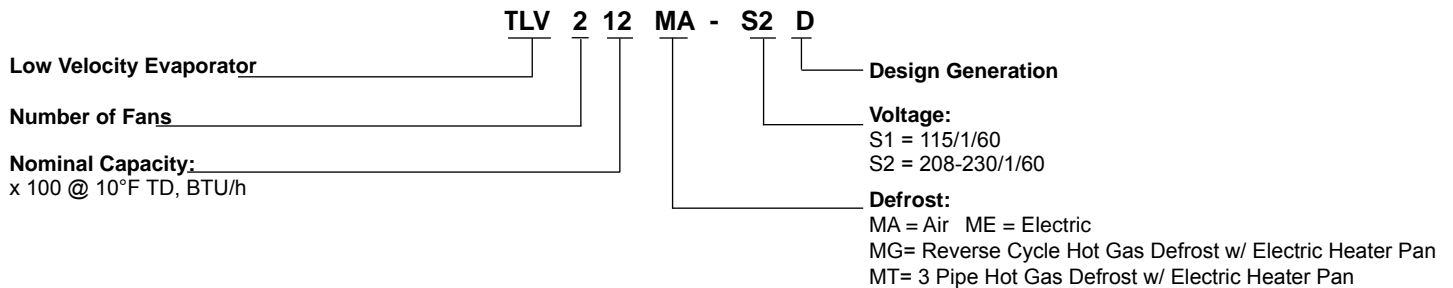

STANDARD FEATURES

- EC motors with patented SmartSpeed® Technology.
- Compatible with Low GWP Refrigerants
- Heavy gauge textured aluminum cabinet construction resists scratches/corrosion and minimizes weight for shipment, installation and service.
- Specially designed for quiet operation - ideal for prep. rooms.
- Dual refrigeration coils with two-way air distribution reduces air velocities to minimize product dehydration.
- Reduced operating charge with 3/8" OD tubing
- Spacious end compartment allows for easy component installation.
- Attractive and durable high-density polypropylene fan guards.
- Hinged drain pan provides convenient access for cleaning.
- Terminal board allows for easy electrical connections.
- Internally enhanced tube

AVAILABLE OPTIONS

- **ESP+ Intuitive Evaporator Control Technology.**
- Hot gas loop pan with hot gas defrost models
- Factory installed expansion valve, solenoid valve and room thermostat
- Painted cabinet
- Corrosion protection: alternate fin materials and coatings
- **PSC Motors (115, 230 + 460V) - suitable or AWEF-Exempted applications - contact factory**
- Additional options available, please contact factory



2021 Refrigeration Products Price List

TLP-C-2020-3 - EFFECTIVE DATE: 01 OCT 2021 - SUPERCEDES: TLP-C-2020-2



TLV-LINE, LOW VELOCITY EVAPORATORS (cont'd)

MEDIUM TEMP - AIR DEFROST

MODEL	PSC MOTORS VOLTAGE	\$	WEIGHT	
			lbs.	kg
TLV106MA-S1D-C	115/1/60	3679	90	41
TLV106MA-S2D-C	208-230/1/60	4091	90	41
TLV106MA-S4D-C	460/1/60	4704	90	41
TLV109MA-S1D-C	115/1/60	4240	105	48
TLV109MA-S2D-C	208-230/1/60	4490	105	48
TLV109MA-S4D-C	460/1/60	5163	105	48
TLV212MA-S1D-C	115/1/60	5055	139	63
TLV212MA-S2D-C	208-230/1/60	5352	139	63
TLV212MA-S4D-C	460/1/60	6155	139	63
TLV217MA-S1D-C	115/1/60	6056	158	72
TLV217MA-S2D-C	208-230/1/60	6419	158	72
TLV217MA-S4D-C	460/1/60	7382	158	72
TLV325MA-S1D-C	115/1/60	7710	235	107
TLV325MA-S2D-C	208-230/1/60	8164	235	107
TLV325MA-S4D-C	460/1/60	9389	235	107
TLV331MA-S1D-C	115/1/60	8854	257	117
TLV331MA-S2D-C	208-230/1/60	9383	257	117
TLV331MA-S4D-C	460/1/60	10791	257	117
TLV437MA-S1D-C	115/1/60	9947	270	123
TLV437MA-S2D-C	208-230/1/60	10535	270	123
TLV437MA-S4D-C	460/1/60	12116	270	123
TLV441MA-S1D-C	115/1/60	11405	280	127
TLV441MA-S2D-C	208-230/1/60	12085	280	127
TLV441MA-S4D-C	460/1/60	13898	280	127
TLV546MA-S1D-C	115/1/60	12496	290	132
TLV546MA-S2D-C	208-230/1/60	13234	290	132
TLV546MA-S4D-C	460/1/60	15219	290	132



2021 Refrigeration Products Price List

TLP-C-2020-3 - EFFECTIVE DATE: 01 OCT 2021 - SUPERCEDES: TLP-C-2020-2



TLV-LINE, LOW VELOCITY EVAPORATORS (cont'd)

MEDIUM TEMP - ELECTRIC DEFROST

PSC MOTORS			WEIGHT	
MODEL	VOLTAGE	\$	lbs.	kg
TLV106ME-S1D-C	115/1/60	3679	90	41
TLV106ME-S2D-C	208-230/1/60	4091	90	41
TLV109ME-S1D-C	115/1/60	4240	105	48
TLV109ME-S2D-C	208-230/1/60	4490	105	48
TLV212ME-S2D-C	208-230/1/60	5352	139	63
TLV217ME-S2D-C	208-230/1/60	6419	158	72
TLV325ME-S2D-C	208-230/1/60	8164	235	107
TLV331ME-S2D-C	208-230/1/60	9383	257	117
TLV437ME-S2D-C	208-230/1/60	10535	270	123
TLV441ME-S2D-C	208-230/1/60	12085	280	127
TLV546ME-S2D-C	208-230/1/60	13234	290	132

MEDIUM TEMP - HOT GAS DEFROST

^ Insert appropriate code for hot gas defrost type

PSC MOTORS			WEIGHT	
MODEL	VOLTAGE	\$	lbs.	kg
TLV106M^S1D-C	115/1/60	3679	90	41
TLV106M^S2D-C	208-230/1/60	4091	90	41
TLV109M^S1D-C	115/1/60	4240	105	48
TLV109M^S2D-C	208-230/1/60	4490	105	48
TLV212M^S1D-C	115/1/60	5055	139	63
TLV212M^S2D-C	208-230/1/60	5352	139	63
TLV217M^S1D-C	115/1/60	6056	158	72
TLV217M^S2D-C	208-230/1/60	6419	158	72
TLV325M^S1D-C	115/1/60	7710	235	107
TLV325M^S2D-C	208-230/1/60	8164	235	107
TLV331M^S1D-C	115/1/60	8854	257	117
TLV331M^S2D-C	208-230/1/60	9383	257	117
TLV437M^S1D-C	115/1/60	9947	270	123
TLV437M^S2D-C	208-230/1/60	10535	270	123
TLV441M^S1D-C	115/1/60	11405	280	127
TLV441M^S2D-C	208-230/1/60	12085	280	127
TLV546M^S1D-C	115/1/60	12496	290	132
TLV546M^S2D-C	208-230/1/60	13234	290	132



2021 Refrigeration Products Price List

TLP-C-2020-3 - EFFECTIVE DATE: 01 OCT 2021 - SUPERCEDES: TLP-C-2020-2



TPLP-LINE, PRE-ASSEMBLED LOW PROFILE EVAPORATORS

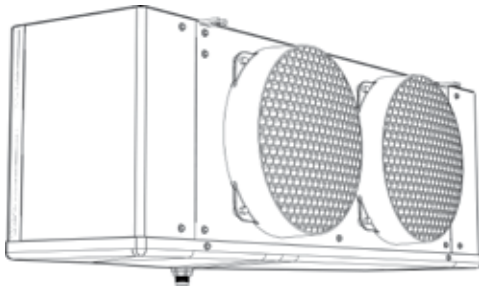

web: www.t-rp.com/tplp
email: evaps@t-rp.com
call: 1-844-893-3222 x520



NOMENCLATURE

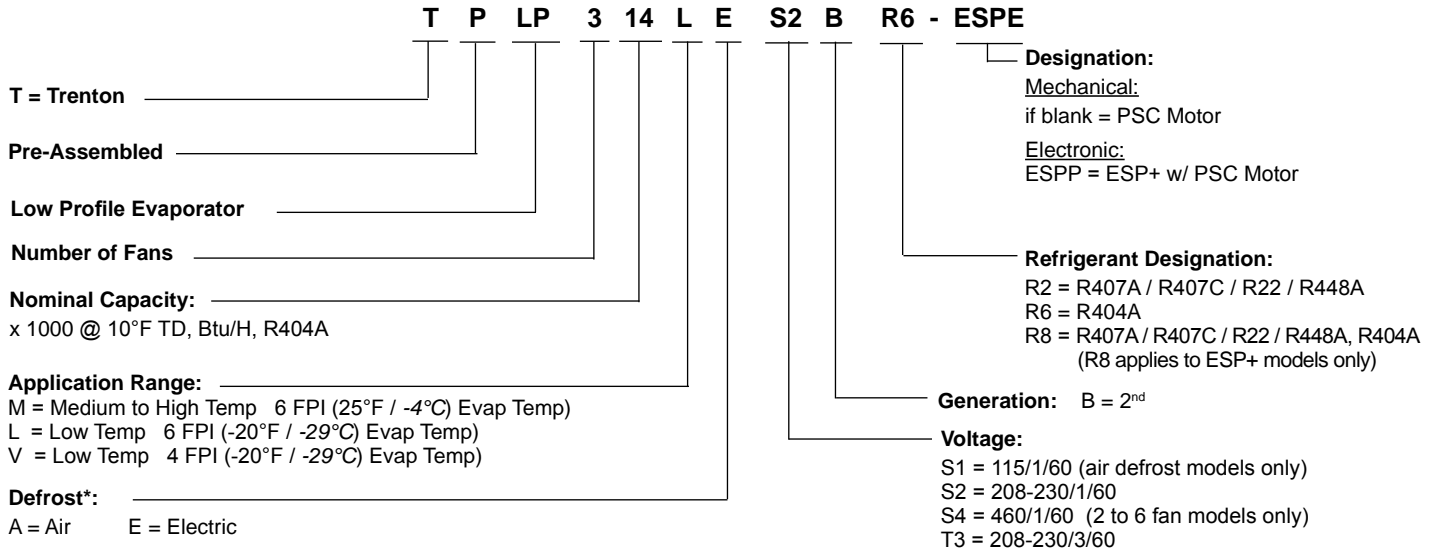

STANDARD FEATURES (ALL MODELS)

- Compatible with Low GWP Refrigerants
- High efficiency and high strength fan guard
- Front access
- Internally enhanced tubing
- Convenient mounting brackets
- Ample electrical and header compartments
- Positive slope, hinged drain pan
- Centrally located, universal drain connection
- Large 3/4" ID (3/4" MPT) drain hole
- Schrader valve on suction header, located outside of cabinet

ESP+ (R8) MODELS

Include factory installed:

- ESP+ Adaptive Defrost Control
- ESP+ Remote Display
- EEV Electronic Expansion Valve
- Solenoid Valve

ELECTRO-MECHANICAL (R2 and R6) MODELS

Include factory installed:

- TX Valve
- Solenoid Valve
- Thermostat



2021 Refrigeration Products Price List

TLP-C-2020-3 - EFFECTIVE DATE: 01 OCT 2021 - SUPERCEDES: TLP-C-2020-2



TPLP-LINE, PRE-ASSEMBLED LOW PROFILE EVAPORATORS (cont'd)

MEDIUM TEMP - AIR DEFROST

R404A R507

PSC MOTORS			WEIGHT	
MODEL	VOLTAGE	\$	lbs.	kg
TPLP104MAS1BR6	115/1/60	2329	45	20
TPLP104MAS2BR6	208-230/1/60	2433	45	20
TPLP106MAS1BR6	115/1/60	2426	47	21
TPLP106MAS2BR6	208-230/1/60	2448	47	21
TPLP107MAS1BR6	115/1/60	2665	49	22
TPLP107MAS2BR6	208-230/1/60	2791	49	22
TPLP209MAS1BR6	115/1/60	3193	70	32
TPLP209MAS2BR6	208-230/1/60	3228	70	32
TPLP209MAS4BR6	460/1/60	3559	70	32
TPLP211MAS1BR6	115/1/60	3363	74	33
TPLP211MAS2BR6	208-230/1/60	3401	74	33
TPLP211MAS4BR6	460/1/60	3757	74	33
TPLP214MAS1BR6	115/1/60	4016	78	35
TPLP214MAS2BR6	208-230/1/60	4058	78	35
TPLP214MAS4BR6	460/1/60	4513	78	35
TPLP317MAS1BR6	115/1/60	4871	101	46
TPLP317MAS2BR6	208-230/1/60	4923	101	46
TPLP317MAS4BR6	460/1/60	5508	101	46
TPLP320MAS1BR6	115/1/60	5321	107	48
TPLP320MAS2BR6	208-230/1/60	5662	107	48
TPLP320MAS4BR6	460/1/60	6358	107	48
TPLP423MAS1BR6	115/1/60	5842	117	53
TPLP423MAS2BR6	208-230/1/60	6227	117	53
TPLP423MAS4BR6	460/1/60	7007	117	53
TPLP426MAS1BR6	115/1/60	6364	135	61
TPLP426MAS2BR6	208-230/1/60	6791	135	61
TPLP426MAS4BR6	460/1/60	7656	135	61
TPLP532MAS1BR6	115/1/60	7508	163	74
TPLP532MAS2BR6	208-230/1/60	7992	163	74
TPLP532MAS4BR6	460/1/60	8975	163	74
TPLP639MAS1BR6	115/1/60	8539	192	87
TPLP639MAS2BR6	208-230/1/60	8985	192	87
TPLP639MAS4BR6	460/1/60	10116	192	87

MEDIUM TEMP - ELECTRIC DEFROST

R404A

PSC MOTORS			WEIGHT	
MODEL	VOLTAGE	\$	lbs.	kg
TPLP104MES2BR6	208-230/1/60	3174	49	22
TPLP104MET3BR6	208-230/3/60	3246	49	22
TPLP106MES2BR6	208-230/1/60	3445	51	23
TPLP106MET3BR6	208-230/3/60	3603	51	23
TPLP107MES2BR6	208-230/1/60	3751	53	24
TPLP107MET3BR6	208-230/3/60	3937	53	24
TPLP209MES2BR6	208-230/1/60	4058	76	35
TPLP209MES4BR6	460/1/60	4614	76	35
TPLP209MET3BR6	208-230/3/60	4272	76	35
TPLP211MES2BR6	208-230/1/60	4285	80	36
TPLP211MES4BR6	460/1/60	4898	80	36
TPLP211MET3BR6	208-230/3/60	4555	80	36
TPLP214MES2BR6	208-230/1/60	5102	84	38
TPLP214MES4BR6	460/1/60	5883	84	38
TPLP214MET3BR6	208-230/3/60	5371	84	38
TPLP317MES2BR6	208-230/1/60	5789	109	50
TPLP317MES4BR6	460/1/60	6594	109	50
TPLP317MET3BR6	208-230/3/60	6078	109	50
TPLP320MES2BR6	208-230/1/60	6458	115	52
TPLP320MES4BR6	460/1/60	7412	115	52
TPLP320MET3BR6	208-230/3/60	6725	115	52
TPLP423MES2BR6	208-230/1/60	7175	127	58
TPLP423MES4BR6	460/1/60	8208	127	58
TPLP423MET3BR6	208-230/3/60	7526	127	58
TPLP426MES2BR6	208-230/1/60	7950	145	66
TPLP426MES4BR6	460/1/60	9074	145	66
TPLP426MET3BR6	208-230/3/60	8219	145	66
TPLP532MES2BR6	208-230/1/60	10456	176	80
TPLP532MES4BR6	460/1/60	11891	176	80
TPLP532MET3BR6	208-230/3/60	10868	176	80
TPLP639MES2BR6	208-230/1/60	11169	207	94
TPLP639MES4BR6	460/1/60	12720	207	94
TPLP639MET3BR6	208-230/3/60	11613	207	94

MEDIUM TEMP - AIR DEFROST

R407A R407C R22 R448A

PSC MOTORS			WEIGHT	
MODEL	VOLTAGE	\$	lbs.	kg
TPLP104MAS1BR2	115/1/60	2329	45	20
TPLP104MAS2BR2	208-230/1/60	2433	45	20
TPLP106MAS1BR2	115/1/60	2426	47	21
TPLP106MAS2BR2	208-230/1/60	2448	47	21
TPLP107MAS1BR2	115/1/60	2665	49	22
TPLP107MAS2BR2	208-230/1/60	2791	49	22
TPLP209MAS1BR2	115/1/60	3193	70	32
TPLP209MAS2BR2	208-230/1/60	3228	70	32
TPLP209MAS4BR2	460/1/60	3559	70	32
TPLP211MAS1BR2	115/1/60	3363	74	33
TPLP211MAS2BR2	208-230/1/60	3401	74	33
TPLP211MAS4BR2	460/1/60	3757	74	33
TPLP214MAS1BR2	115/1/60	4016	78	35
TPLP214MAS2BR2	208-230/1/60	4058	78	35
TPLP214MAS4BR2	460/1/60	4513	78	35
TPLP317MAS1BR2	115/1/60	4871	101	46
TPLP317MAS2BR2	208-230/1/60	4923	101	46
TPLP317MAS4BR2	460/1/60	5508	101	46
TPLP320MAS1BR2	115/1/60	5321	107	48
TPLP320MAS2BR2	208-230/1/60	5662	107	48
TPLP320MAS4BR2	460/1/60	6358	107	48
TPLP423MAS1BR2	115/1/60	5842	117	53
TPLP423MAS2BR2	208-230/1/60	6227	117	53
TPLP423MAS4BR2	460/1/60	7007	117	53
TPLP426MAS1BR2	115/1/60	6364	135	61
TPLP426MAS2BR2	208-230/1/60	6791	135	61
TPLP426MAS4BR2	460/1/60	7656	135	61
TPLP532MAS1BR2	115/1/60	7508	163	74
TPLP532MAS2BR2	208-230/1/60	7992	163	74
TPLP532MAS4BR2	460/1/60	8975	163	74
TPLP639MAS1BR2	115/1/60	8539	192	87
TPLP639MAS2BR2	208-230/1/60	8985	192	87
TPLP639MAS4BR2	460/1/60	10116	192	87

MEDIUM TEMP - ELECTRIC DEFROST

R407A R407C R22 R448A

PSC MOTORS			WEIGHT	
MODEL	VOLTAGE	\$	lbs.	kg
TPLP104MES2BR2	208-230/1/60	3174	49	22
TPLP104MET3BR2	208-230/3/60	3246	49	22
TPLP106MES2BR2	208-230/1/60	3445	51	23
TPLP106MET3BR2	208-230/3/60	3603	51	23
TPLP107MES2BR2	208-230/1/60	3751	53	24
TPLP107MET3BR2	208-230/3/60	3937	53	24
TPLP209MES2BR2	208-230/1/60	4058	76	35
TPLP209MES4BR2	460/1/60	4614	76	35
TPLP209MET3BR2	208-230/3/60	4272	76	35
TPLP211MES2BR2	208-230/1/60	4285	80	36
TPLP211MES4BR2	460/1/60	4898	80	36
TPLP211MET3BR2	208-230/3/60	4555	80	36
TPLP214MES2BR2	208-230/1/60	5102	84	38
TPLP214MES4BR2	460/1/60	5883	84	38
TPLP214MET3BR2	208-230/3/60	5371	84	38
TPLP317MES2BR2	208-230/1/60	5789	109	50
TPLP317MES4BR2	460/1/60	6594	109	50
TPLP317MET3BR2	208-230/3/60	6078	109	50
TPLP320MES2BR2	208-230/1/60	6458	115	52
TPLP320MES4BR2	460/1/60	7412	115	52
TPLP320MET3BR2	208-230/3/60	6725	115	52
TPLP423MES2BR2	208-230/1/60	7175	127	58
TPLP423MES4BR2	460/1/60	8208	127	58
TPLP423MET3BR2	208-230/3/60	7526	127	58
TPLP426MES2BR2	208-230/1/60	7950	145	66
TPLP426MES4BR2	460/1/60	9074	145	66
TPLP426MET3BR2	208-230/3/60	8219	145	66
TPLP532MES2BR2	208-230/1/60	10456	176	80
TPLP532MES4BR2	460/1/60	11891	176	80
TPLP532MET3BR2	208-230/3/60	10868	176	80
TPLP639MES2BR2	208-230/1/60	11169	207	94
TPLP639MES4BR2	460/1/60	12720	207	94
TPLP639MET3BR2	208-230/3/60	11613	207	94



2021 Refrigeration Products Price List

TLP-C-2020-3 - EFFECTIVE DATE: 01 OCT 2021 - SUPERCEDES: TLP-C-2020-2



TPLP-LINE, PRE-ASSEMBLED LOW PROFILE EVAPORATORS (cont'd)

LOW TEMP 6 FPI - ELECTRIC DEFROST R404A

PSC MOTORS			WEIGHT	
MODEL	VOLTAGE	\$	lbs.	kg
TPLP104LES2BR6	208-230/1/60	3174	49	22
TPLP104LET3BR6	208-230/3/60	3246	49	22
TPLP105LES2BR6	208-230/1/60	3445	51	23
TPLP105LET3BR6	208-230/3/60	3603	51	23
TPLP106LES2BR6	208-230/1/60	3751	53	24
TPLP106LET3BR6	208-230/3/60	3937	53	24
TPLP207LES2BR6	208-230/1/60	4058	76	35
TPLP207LES4BR6	460/1/60	4614	76	35
TPLP207LET3BR6	208-230/3/60	4272	76	35
TPLP209LES2BR6	208-230/1/60	4285	80	36
TPLP209LES4BR6	460/1/60	4898	80	36
TPLP209LET3BR6	208-230/3/60	4555	80	36
TPLP211LES2BR6	208-230/1/60	5102	84	38
TPLP211LES4BR6	460/1/60	5883	84	38
TPLP211LET3BR6	208-230/3/60	5371	84	38
TPLP314LES2BR6	208-230/1/60	5789	109	50
TPLP314LES4BR6	460/1/60	6594	109	50
TPLP314LET3BR6	208-230/3/60	6078	109	50
TPLP317LES2BR6	208-230/1/60	6458	115	52
TPLP317LES4BR6	460/1/60	7412	115	52
TPLP317LET3BR6	208-230/3/60	6725	115	52
TPLP419LES2BR6	208-230/1/60	7175	127	58
TPLP419LES4BR6	460/1/60	8208	127	58
TPLP419LET3BR6	208-230/3/60	7526	127	58
TPLP422LES2BR6	208-230/1/60	7950	145	66
TPLP422LES4BR6	460/1/60	9074	145	66
TPLP422LET3BR6	208-230/3/60	8219	145	66
TPLP527LES2BR6	208-230/1/60	10456	176	80
TPLP527LES4BR6	460/1/60	11891	176	80
TPLP527LET3BR6	208-230/3/60	10868	176	80
TPLP631LES2BR6	208-230/1/60	11169	207	94
TPLP631LES4BR6	460/1/60	12720	207	94
TPLP631LET3BR6	208-230/3/60	11613	207	94

LOW TEMP 4 FPI - ELECTRIC DEFROST R404A

PSC MOTORS			WEIGHT	
MODEL	VOLTAGE	\$	lbs.	kg
TPLP103VES2BR6	208-230/1/60	2438	49	22
TPLP103VET3BR6	208-230/3/60	2524	49	22
TPLP104VES2BR6	208-230/1/60	2977	51	23
TPLP104VET3BR6	208-230/3/60	3095	51	23
TPLP105VES2BR6	208-230/1/60	3591	53	24
TPLP105VET3BR6	208-230/3/60	3729	53	24
TPLP206VES2BR6	208-230/1/60	4206	76	35
TPLP206VES4BR6	460/1/60	4533	76	35
TPLP206VET3BR6	208-230/3/60	4362	76	35
TPLP208VES2BR6	208-230/1/60	4488	80	36
TPLP208VES4BR6	460/1/60	4776	80	36
TPLP208VET3BR6	208-230/3/60	4604	80	36
TPLP209VES2BR6	208-230/1/60	5058	84	38
TPLP209VES4BR6	460/1/60	5841	84	38
TPLP209VET3BR6	208-230/3/60	5326	84	38
TPLP312VES2BR6	208-230/1/60	5704	109	50
TPLP312VES4BR6	460/1/60	6574	109	50
TPLP312VET3BR6	208-230/3/60	5916	109	50
TPLP315VES2BR6	208-230/1/60	6349	115	52
TPLP315VES4BR6	460/1/60	7306	115	52
TPLP315VET3BR6	208-230/3/60	6624	115	52
TPLP416VES2BR6	208-230/1/60	7771	127	58
TPLP416VES4BR6	460/1/60	8897	127	58
TPLP416VET3BR6	208-230/3/60	8041	127	58
TPLP419VES2BR6	208-230/1/60	8641	145	66
TPLP419VES4BR6	460/1/60	9953	145	66
TPLP419VET3BR6	208-230/3/60	8924	145	66
TPLP523VES2BR6	208-230/1/60	10268	176	80
TPLP523VES4BR6	460/1/60	11635	176	80
TPLP523VET3BR6	208-230/3/60	10608	176	80
TPLP627VES2BR6	208-230/1/60	11177	207	94
TPLP627VES4BR6	460/1/60	12685	207	94
TPLP627VET3BR6	208-230/3/60	11551	207	94

LOW TEMP 6 FPI - ELECTRIC DEFROST R407A R407C R448A

PSC MOTORS			WEIGHT	
MODEL	VOLTAGE	\$	lbs.	kg
TPLP104LES2BR2	208-230/1/60	3174	49	22
TPLP104LET3BR2	208-230/3/60	3246	49	22
TPLP105LES2BR2	208-230/1/60	3445	51	23
TPLP105LET3BR2	208-230/3/60	3603	51	23
TPLP106LES2BR2	208-230/1/60	3751	53	24
TPLP106LET3BR2	208-230/3/60	3937	53	24
TPLP207LES2BR2	208-230/1/60	4058	76	35
TPLP207LES4BR2	460/1/60	4614	76	35
TPLP207LET3BR2	208-230/3/60	4272	76	35
TPLP209LES2BR2	208-230/1/60	4285	80	36
TPLP209LES4BR2	460/1/60	4898	80	36
TPLP209LET3BR2	208-230/3/60	4555	80	36
TPLP211LES2BR2	208-230/1/60	5102	84	38
TPLP211LES4BR2	460/1/60	5883	84	38
TPLP211LET3BR2	208-230/3/60	5371	84	38
TPLP314LES2BR2	208-230/1/60	5789	109	50
TPLP314LES4BR2	460/1/60	6594	109	50
TPLP314LET3BR2	208-230/3/60	6078	109	50
TPLP317LES2BR2	208-230/1/60	6458	115	52
TPLP317LES4BR2	460/1/60	7412	115	52
TPLP317LET3BR2	208-230/3/60	6725	115	52
TPLP419LES2BR2	208-230/1/60	7175	127	58
TPLP419LES4BR2	460/1/60	8208	127	58
TPLP419LET3BR2	208-230/3/60	7526	127	58
TPLP422LES2BR2	208-230/1/60	7950	145	66
TPLP422LES4BR2	460/1/60	9074	145	66
TPLP422LET3BR2	208-230/3/60	8219	145	66
TPLP527LES2BR2	208-230/1/60	10456	176	80
TPLP527LES4BR2	460/1/60	11891	176	80
TPLP527LET3BR2	208-230/3/60	10868	176	80
TPLP631LES2BR2	208-230/1/60	11169	207	94
TPLP631LES4BR2	460/1/60	12720	207	94
TPLP631LET3BR2	208-230/3/60	11613	207	94

LOW TEMP 4 FPI - ELECTRIC DEFROST R407A R407C R448A

PSC MOTORS			WEIGHT	
MODEL	VOLTAGE	\$	lbs.	kg
TPLP103VES2BR2	208-230/1/60	2438	49	22
TPLP103VET3BR2	208-230/3/60	2524	49	22
TPLP104VES2BR2	208-230/1/60	2977	51	23
TPLP104VET3BR2	208-230/3/60	3095	51	23
TPLP105VES2BR2	208-230/1/60	3591	53	24
TPLP105VET3BR2	208-230/3/60	3729	53	24
TPLP206VES2BR2	208-230/1/60	4206	76	35
TPLP206VES4BR2	460/1/60	4533	76	35
TPLP206VET3BR2	208-230/3/60	4362	76	35
TPLP208VES2BR2	208-230/1/60	4488	80	36
TPLP208VES4BR2	460/1/60	4776	80	36
TPLP208VET3BR2	208-230/3/60	4604	80	36
TPLP209VES2BR2	208-230/1/60	5058	84	38
TPLP209VES4BR2	460/1/60	5841	84	38
TPLP209VET3BR2	208-230/3/60	5326	84	38
TPLP312VES2BR2	208-230/1/60	5704	109	50
TPLP312VES4BR2	460/1/60	6574	109	50
TPLP312VET3BR2	208-230/3/60	5916	109	50
TPLP315VES2BR2	208-230/1/60	6349	115	52
TPLP315VES4BR2	460/1/60	7306	115	52
TPLP315VET3BR2	208-230/3/60	6624	115	52
TPLP416VES2BR2	208-230/1/60	7771	127	58
TPLP416VES4BR2	460/1/60	8897	127	58
TPLP416VET3BR2	208-230/3/60	8041	127	58
TPLP419VES2BR2	208-230/1/60	8641	145	66
TPLP419VES4BR2	460/1/60	9953	145	66
TPLP419VET3BR2	208-230/3/60	8924	145	66
TPLP523VES2BR2	208-230/1/60	10268	176	80
TPLP523VES4BR2	460/1/60	11635	176	80
TPLP523VET3BR2	208-230/3/60	10608	176	80
TPLP627VES2BR2	208-230/1/60	11177	207	94
TPLP627VES4BR2	460/1/60	12685	207	94
TPLP627VET3BR2	208-230/3/60	11551	207	94



2021 Refrigeration Products Price List

TLP-C-2020-3 - EFFECTIVE DATE: 01 OCT 2021 - SUPERCEDES: TLP-C-2020-2



TPLP-LINE w/ESP INTUITIVE EVAPORATOR CONTROL TECHNOLOGY

MEDIUM TEMP - AIR DEFROST R404A R507

PSC MOTORS			WEIGHT	
MODEL	VOLTAGE	\$	lbs.	kg
TPLP104MAS1BR8-ESPP	115/1/60	3287	45	20
TPLP104MAS2BR8-ESPP	208-230/1/60	3391	45	20
TPLP106MAS1BR8-ESPP	115/1/60	3384	47	21
TPLP106MAS2BR8-ESPP	208-230/1/60	3406	47	21
TPLP107MAS1BR8-ESPP	115/1/60	3624	49	22
TPLP107MAS2BR8-ESPP	208-230/1/60	3749	49	22
TPLP209MAS1BR8-ESPP	115/1/60	4151	70	32
TPLP209MAS2BR8-ESPP	208-230/1/60	4186	70	32
TPLP211MAS1BR8-ESPP	115/1/60	4322	74	33
TPLP211MAS2BR8-ESPP	208-230/1/60	4359	74	33
TPLP214MAS1BR8-ESPP	115/1/60	4974	78	35
TPLP214MAS2BR8-ESPP	208-230/1/60	5016	78	35
TPLP317MAS1BR8-ESPP	115/1/60	5829	101	46
TPLP317MAS2BR8-ESPP	208-230/1/60	5881	101	46
TPLP320MAS1BR8-ESPP	115/1/60	6279	107	48
TPLP320MAS2BR8-ESPP	208-230/1/60	6620	107	48
TPLP423MAS1BR8-ESPP	115/1/60	6801	117	53
TPLP423MAS2BR8-ESPP	208-230/1/60	7185	117	53
TPLP426MAS1BR8-ESPP	115/1/60	7322	135	61
TPLP426MAS2BR8-ESPP	208-230/1/60	7749	135	61
TPLP532MAS1BR8-ESPP	115/1/60	8048	163	74
TPLP532MAS2BR8-ESPP	208-230/1/60	8531	163	74
TPLP639MAS1BR8-ESPP	115/1/60	9078	192	87
TPLP639MAS2BR8-ESPP	208-230/1/60	9524	192	87

MEDIUM TEMP - ELECTRIC DEFROST R404A

PSC MOTORS			WEIGHT	
MODEL	VOLTAGE	\$	lbs.	kg
TPLP104MES2BR8-ESPP	208-230/1/60	4132	49	22
TPLP106MES2BR8-ESPP	208-230/1/60	4403	51	23
TPLP107MES2BR8-ESPP	208-230/1/60	4709	53	24
TPLP209MES2BR8-ESPP	208-230/1/60	5016	76	35
TPLP211MES2BR8-ESPP	208-230/1/60	5243	80	36
TPLP214MES2BR8-ESPP	208-230/1/60	6060	84	38
TPLP317MES2BR8-ESPP	208-230/1/60	6748	109	50
TPLP320MES2BR8-ESPP	208-230/1/60	7417	115	52
TPLP423MES2BR8-ESPP	208-230/1/60	8133	127	58
TPLP426MES2BR8-ESPP	208-230/1/60	8908	145	66
TPLP532MES2BR8-ESPP	208-230/1/60	10995	176	80
TPLP639MES2BR8-ESPP	208-230/1/60	11709	207	94



2021 Refrigeration Products Price List

TLP-C-2020-3 - EFFECTIVE DATE: 01 OCT 2021 - SUPERCEDES: TLP-C-2020-2



TPLP-LINE w/ESP INTUITIVE EVAPORATOR CONTROL TECHNOLOGY

LOW TEMP 6 FPI - ELECTRIC DEFROST R404A

PSC MOTORS			WEIGHT	
MODEL	VOLTAGE	\$	lbs.	kg
TPLP104LES2BR8-ESPP	208-230/1/60	4132	49	22
TPLP105LES2BR8-ESPP	208-230/1/60	4403	51	23
TPLP106LES2BR8-ESPP	208-230/1/60	4709	53	24
TPLP207LES2BR8-ESPP	208-230/1/60	5016	76	35
TPLP209LES2BR8-ESPP	208-230/1/60	5243	80	36
TPLP211LES2BR8-ESPP	208-230/1/60	6060	84	38
TPLP314LES2BR8-ESPP	208-230/1/60	6748	109	50
TPLP317LES2BR8-ESPP	208-230/1/60	7417	115	52
TPLP419LES2BR8-ESPP	208-230/1/60	8133	127	58
TPLP422LES2BR8-ESPP	208-230/1/60	8908	145	66
TPLP527LES2BR8-ESPP	208-230/1/60	10995	176	80
TPLP631LES2BR8-ESPP	208-230/1/60	11709	207	94

LOW TEMP 4 FPI - ELECTRIC DEFROST R404A

PSC MOTORS			WEIGHT	
MODEL	VOLTAGE	\$	lbs.	kg
TPLP103VES2BR8-ESPP	208-230/1/60	3396	49	22
TPLP104VES2BR8-ESPP	208-230/1/60	3935	51	23
TPLP105VES2BR8-ESPP	208-230/1/60	4550	53	24
TPLP206VES2BR8-ESPP	208-230/1/60	5164	76	35
TPLP208VES2BR8-ESPP	208-230/1/60	5446	80	36
TPLP209VES2BR8-ESPP	208-230/1/60	6016	84	38
TPLP312VES2BR8-ESPP	208-230/1/60	6662	109	50
TPLP315VES2BR8-ESPP	208-230/1/60	7307	115	52
TPLP416VES2BR8-ESPP	208-230/1/60	8730	127	58
TPLP419VES2BR8-ESPP	208-230/1/60	9599	145	66
TPLP523VES2BR8-ESPP	208-230/1/60	10807	176	80
TPLP627VES2BR8-ESPP	208-230/1/60	11717	207	94



2021 Refrigeration Products Price List

TLP-C-2020-3 - EFFECTIVE DATE: 01 OCT 2021 - SUPERCEDES: TLP-C-2020-2



TLP-LINE, LOW PROFILE EVAPORATORS

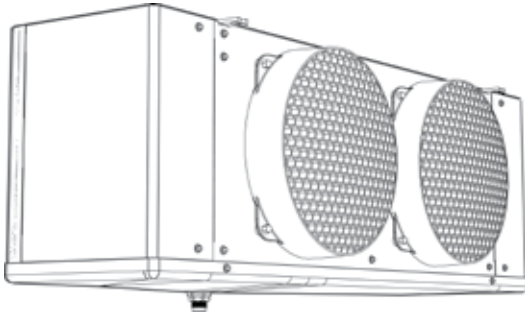

web: www.t-rp.com/tlp
email: evaps@t-rp.com
call: 1-844-893-3222 x520



see page 49 for details

NOMENCLATURE

TLP 3 17 L E - S2 B T

Low Profile Evaporator

Number of Fans

Nominal Capacity:
x 1000 @ 10°F TD, Btu/H, R404A

Application Range:
M = Medium to High Temp 6 FPI (10°F to 45°F (-12°C to 7°C) Evap Temp)
L = Low Temp 6 FPI (-40°F to 0°F (-40°C to -17°C) Evap Temp)
V = Low Temp 4 FPI (-40°F to 0°F (-40°C to -17°C) Evap Temp)
W = Fluid Air Cooler (with water or glycol)

Motor:
Blank = PSC

Generation: B = 2nd

Voltage:
S1 = 115/1/60 (air defrost & hot gas models only)
S2 = 208-230/1/60
S4 = 460/1/60
T3 = 208-230/3/60

Defrost*:
A = Air E = Electric
T = 3 Pipe Hot Gas w/ Electric Heater Pan
or Warm Fluid w/ Electric Heater Pan for Fluid Air Coolers
H = 3 Pipe Hot Gas w/ Hot Gas Loop Pan (optional)
G = Reverse Cycle w/ Electric Heater Pan
R = Reverse Cycle w/ Hot Gas Loop Pan (optional)
* T, H, G, R, available on 2 to 6 fan models only

STANDARD FEATURES

- Compatible with Low GWP Refrigerants
- High efficiency and high strength fan guard
- Front access
- Internally enhanced tubing
- Convenient mounting brackets
- Ample electrical and header compartments
- PSC Motors
- Liquid line solenoid valve wire harness factory installed
- Schrader valve on suction header
- Positive slope, hinged drain pan
- Central drain connections (approximate)
- Universal drain fitting
- Large 3/4" ID (3/4" MPT) drain hole
- Factory installed distributor nozzle

AVAILABLE OPTIONS

- ESP+ Intuitive Evaporator Control Technology.
- Hot gas loop pan with hot gas defrost models
- Factory installed expansion valve, solenoid valve and room thermostat
- Wire fan guard
- Corrosion protection: alternate fin materials and coatings
- Additional options available, please contact factory



2021 Refrigeration Products Price List

TLP-C-2020-3 - EFFECTIVE DATE: 01 OCT 2021 - SUPERCEDES: TLP-C-2020-2



TLP-LINE, LOW PROFILE EVAPORATORS (cont'd)

MEDIUM TEMP - AIR DEFROST

PSC MOTORS			WEIGHT	
MODEL	VOLTAGE	\$	lbs.	kg
TLP104MA-S1B	115/1/60	1307	45	20
TLP104MA-S2B	208-230/1/60	1412	45	20
TLP104MA-S6B	200-220/1/50	1412	45	20
TLP106MA-S1B	115/1/60	1404	47	21
TLP106MA-S2B	208-230/1/60	1426	47	21
TLP106MA-S6B	200-220/1/50	1426	47	21
TLP107MA-S1B	115/1/60	1644	49	22
TLP107MA-S2B	208-230/1/60	1770	49	22
TLP107MA-S6B	200-220/1/50	1770	49	22
TLP209MA-S1B	115/1/60	2108	70	32
TLP209MA-S2B	208-230/1/60	2140	70	32
TLP209MA-S4B	460/1/60	2473	70	32
TLP209MA-S6B	200-220/1/50	2140	70	32
TLP209MA-S9B	380-400/1/50	2473	70	32
TLP211MA-S1B	115/1/60	2415	74	33
TLP211MA-S2B	208-230/1/60	2448	74	33
TLP211MA-S4B	460/1/60	2774	74	33
TLP211MA-S6B	200-220/1/50	2448	74	33
TLP211MA-S9B	380-400/1/50	2774	74	33
TLP214MA-S1B	115/1/60	3025	78	35
TLP214MA-S2B	208-230/1/60	3067	78	35
TLP214MA-S4B	460/1/60	3584	78	35
TLP214MA-S6B	200-220/1/50	3067	78	35
TLP214MA-S9B	380-400/1/50	3584	78	35
TLP317MA-S1B	115/1/60	3563	101	46
TLP317MA-S2B	208-230/1/60	3612	101	46
TLP317MA-S4B	460/1/60	4086	101	46
TLP317MA-S6B	200-220/1/50	3612	101	46
TLP317MA-S9B	380-400/1/50	4086	101	46
TLP320MA-S1B	115/1/60	4178	107	48
TLP320MA-S2B	208-230/1/60	4508	107	48
TLP320MA-S4B	460/1/60	5175	107	48
TLP320MA-S6B	200-220/1/50	4508	107	48
TLP320MA-S9B	380-400/1/50	5175	107	48
TLP423MA-S1B	115/1/60	4804	117	53
TLP423MA-S2B	208-230/1/60	5185	117	53
TLP423MA-S4B	460/1/60	5951	117	53
TLP423MA-S6B	200-220/1/50	5185	117	53
TLP423MA-S9B	380-400/1/50	5951	117	53
TLP426MA-S1B	115/1/60	5398	135	61
TLP426MA-S2B	208-230/1/60	5829	135	61
TLP426MA-S4B	460/1/60	6692	135	61
TLP426MA-S6B	200-220/1/50	5829	135	61
TLP426MA-S9B	380-400/1/50	6692	135	61
TLP532MA-S1B	115/1/60	6162	163	74
TLP532MA-S2B	208-230/1/60	6655	163	74
TLP532MA-S4B	460/1/60	7697	163	74
TLP532MA-S6B	200-220/1/50	6655	163	74
TLP532MA-S9B	380-400/1/50	7697	163	74
TLP639MA-S1B	115/1/60	7182	192	87
TLP639MA-S2B	208-230/1/60	7633	192	87
TLP639MA-S4B	460/1/60	8673	192	87
TLP639MA-S6B	200-220/1/50	7633	192	87
TLP639MA-S9B	380-400/1/50	8673	192	87

MEDIUM TEMP - ELECTRIC DEFROST

PSC MOTORS			WEIGHT	
MODEL	VOLTAGE	\$	lbs.	kg
TLP104ME-S2B	208-230/1/60	2066	49	22
TLP104ME-S6B	200-220/1/50	2066	49	22
TLP104ME-T3B	208-230/3/60	2179	49	22
TLP104ME-T7B	200-220/3/50	2179	49	22
TLP106ME-S2B	208-230/1/60	2447	51	23
TLP106ME-S6B	200-220/1/50	2447	51	23
TLP106ME-T3B	208-230/3/60	2607	51	23
TLP106ME-T7B	200-220/3/50	2607	51	23
TLP107ME-S2B	208-230/1/60	2528	53	24
TLP107ME-S6B	200-220/1/50	2528	53	24
TLP107ME-T3B	208-230/3/60	2764	53	24
TLP107ME-T7B	200-220/3/50	2764	53	24
TLP209ME-S2B	208-230/1/60	3026	76	35
TLP209ME-S4B	460/1/60	3583	76	35
TLP209ME-S6B	200-220/1/50	3026	76	35
TLP209ME-S9B	380-400/1/50	3583	76	35
TLP209ME-T3B	208-230/3/60	3241	76	35
TLP209ME-T7B	200-220/3/50	3241	76	35
TLP211ME-S2B	208-230/1/60	3298	80	36
TLP211ME-S4B	460/1/60	3916	80	36
TLP211ME-S6B	200-220/1/50	3298	80	36
TLP211ME-S9B	380-400/1/50	3916	80	36
TLP211ME-T3B	208-230/3/60	3571	80	36
TLP211ME-T7B	200-220/3/50	3571	80	36
TLP214ME-S2B	208-230/1/60	3950	84	38
TLP214ME-S4B	460/1/60	4691	84	38
TLP214ME-S6B	200-220/1/50	3950	84	38
TLP214ME-S9B	380-400/1/50	4691	84	38
TLP214ME-T3B	208-230/3/60	4277	84	38
TLP214ME-T7B	200-220/3/50	4277	84	38
TLP317ME-S2B	208-230/1/60	4819	109	50
TLP317ME-S4B	460/1/60	5629	109	50
TLP317ME-S6B	200-220/1/50	4819	109	50
TLP317ME-S9B	380-400/1/50	5629	109	50
TLP317ME-T3B	208-230/3/60	5111	109	50
TLP317ME-T7B	200-220/3/50	5111	109	50
TLP320ME-S2B	208-230/1/60	5691	115	52
TLP320ME-S4B	460/1/60	6689	115	52
TLP320ME-S6B	200-220/1/50	5691	115	52
TLP320ME-S9B	380-400/1/50	6689	115	52
TLP320ME-T3B	208-230/3/60	5971	115	52
TLP320ME-T7B	200-220/3/50	5971	115	52
TLP423ME-S2B	208-230/1/60	6367	127	58
TLP423ME-S4B	460/1/60	7435	127	58
TLP423ME-S6B	200-220/1/50	6367	127	58
TLP423ME-S9B	380-400/1/50	7435	127	58
TLP423ME-T3B	208-230/3/60	6728	127	58
TLP423ME-T7B	200-220/3/50	6728	127	58
TLP426ME-S2B	208-230/1/60	7393	145	66
TLP426ME-S4B	460/1/60	8593	145	66
TLP426ME-S6B	200-220/1/50	7393	145	66
TLP426ME-S9B	380-400/1/50	8593	145	66
TLP426ME-T3B	208-230/3/60	7681	145	66
TLP426ME-T7B	200-220/3/50	7681	145	66
TLP532ME-S2B	208-230/1/60	8705	176	80
TLP532ME-S4B	460/1/60	10150	176	80
TLP532ME-S6B	200-220/1/50	8705	176	80
TLP532ME-S9B	380-400/1/50	10150	176	80
TLP532ME-T3B	208-230/3/60	9007	176	80
TLP532ME-T7B	200-220/3/50	9007	176	80
TLP639ME-S2B	208-230/1/60	9683	207	94
TLP639ME-S4B	460/1/60	11226	207	94
TLP639ME-S6B	200-220/1/50	9683	207	94
TLP639ME-S9B	380-400/1/50	11226	207	94
TLP639ME-T3B	208-230/3/60	10124	207	94
TLP639ME-T7B	200-220/3/50	10124	207	94



2021 Refrigeration Products Price List

TLP-C-2020-3 - EFFECTIVE DATE: 01 OCT 2021 - SUPERCEDES: TLP-C-2020-2



TLP-LINE, LOW PROFILE EVAPORATORS (cont'd)

MEDIUM TEMP - HOT GAS DEFROST

^ Insert appropriate code for hot gas defrost type

PSC MOTORS			WEI^HT	
MODEL	VOLTAGE	\$	lbs.	kg
TLP209M^S1B	115/1/60	3086	70	32
TLP209M^S2B	208-230/1/60	3306	70	32
TLP209M^S4B	460/1/60	3655	70	32
TLP209M^S6B	200-220/1/50	3306	70	32
TLP209M^S9B	380-400/1/50	3655	70	32
TLP211M^S1B	115/1/60	3485	74	33
TLP211M^S2B	208-230/1/60	3763	74	33
TLP211M^S4B	460/1/60	4116	74	33
TLP211M^S6B	200-220/1/50	3763	74	33
TLP211M^S9B	380-400/1/50	4116	74	33
TLP214M^S1B	115/1/60	3961	78	35
TLP214M^S2B	208-230/1/60	4277	78	35
TLP214M^S4B	460/1/60	4679	78	35
TLP214M^S6B	200-220/1/50	4277	78	35
TLP214M^S9B	380-400/1/50	4679	78	35
TLP317M^S1B	115/1/60	4867	101	46
TLP317M^S2B	208-230/1/60	5078	101	46
TLP317M^S4B	460/1/60	5606	101	46
TLP317M^S6B	200-220/1/50	5078	101	46
TLP317M^S9B	380-400/1/50	5606	101	46
TLP320M^S1B	115/1/60	5371	107	48
TLP320M^S2B	208-230/1/60	5799	107	48
TLP320M^S4B	460/1/60	6533	107	48
TLP320M^S6B	200-220/1/50	5799	107	48
TLP320M^S9B	380-400/1/50	6533	107	48
TLP423M^S1B	115/1/60	6064	117	53
TLP423M^S2B	208-230/1/60	6619	117	53
TLP423M^S4B	460/1/60	7331	117	53
TLP423M^S6B	200-220/1/50	6619	117	53
TLP423M^S9B	380-400/1/50	7331	117	53
TLP426M^S1B	115/1/60	6799	135	61
TLP426M^S2B	208-230/1/60	7343	135	61
TLP426M^S4B	460/1/60	8228	135	61
TLP426M^S6B	200-220/1/50	7343	135	61
TLP426M^S9B	380-400/1/50	8228	135	61
TLP532M^S1B	115/1/60	8050	163	74
TLP532M^S2B	208-230/1/60	8816	163	74
TLP532M^S4B	460/1/60	9985	163	74
TLP532M^S6B	200-220/1/50	8816	163	74
TLP532M^S9B	380-400/1/50	9985	163	74
TLP639M^S1B	115/1/60	9041	192	87
TLP639M^S2B	208-230/1/60	9927	192	87
TLP639M^S4B	460/1/60	11053	192	87
TLP639M^S6B	200-220/1/50	9927	192	87
TLP639M^S9B	380-400/1/50	11053	192	87

LOW TEMP 6 FPI - ELECTRIC DEFROST

PSC MOTORS			WEIGHT	
MODEL	VOLTAGE	\$	lbs.	kg
TLP104LE-S2B	208-230/1/60	2056	49	22
TLP104LE-S6B	200-220/1/50	2056	49	22
TLP104LE-T3B	208-230/3/60	2169	49	22
TLP104LE-T7B	200-220/3/50	2169	49	22
TLP105LE-S2B	208-230/1/60	2436	51	23
TLP105LE-S6B	200-220/1/50	2436	51	23
TLP105LE-T3B	208-230/3/60	2595	51	23
TLP105LE-T7B	200-220/3/50	2595	51	23
TLP106LE-S2B	208-230/1/60	2528	53	24
TLP106LE-S6B	200-220/1/50	2528	53	24
TLP106LE-T3B	208-230/3/60	2764	53	24
TLP106LE-T7B	200-220/3/50	2764	53	24
TLP207LE-S2B	208-230/1/60	2891	76	35
TLP207LE-S4B	460/1/60	3423	76	35
TLP207LE-S6B	200-220/1/50	2891	76	35
TLP207LE-S9B	380-400/1/50	3423	76	35
TLP207LE-T3B	208-230/3/60	3161	76	35
TLP207LE-T7B	200-220/3/50	3161	76	35
TLP209LE-S2B	208-230/1/60	3263	80	36
TLP209LE-S4B	460/1/60	3875	80	36
TLP209LE-S6B	200-220/1/50	3263	80	36
TLP209LE-S9B	380-400/1/50	3875	80	36
TLP209LE-T3B	208-230/3/60	3533	80	36
TLP209LE-T7B	200-220/3/50	3533	80	36
TLP211LE-S2B	208-230/1/60	3969	84	38
TLP211LE-S4B	460/1/60	4713	84	38
TLP211LE-S6B	200-220/1/50	3969	84	38
TLP211LE-S9B	380-400/1/50	4713	84	38
TLP211LE-T3B	208-230/3/60	4298	84	38
TLP211LE-T7B	200-220/3/50	4298	84	38
TLP314LE-S2B	208-230/1/60	4768	109	50
TLP314LE-S4B	460/1/60	5570	109	50
TLP314LE-S6B	200-220/1/50	4768	109	50
TLP314LE-S9B	380-400/1/50	5570	109	50
TLP314LE-T3B	208-230/3/60	5057	109	50
TLP314LE-T7B	200-220/3/50	5057	109	50
TLP317LE-S2B	208-230/1/60	5437	115	52
TLP317LE-S4B	460/1/60	6390	115	52
TLP317LE-S6B	200-220/1/50	5437	115	52
TLP317LE-S9B	380-400/1/50	6390	115	52
TLP317LE-T3B	208-230/3/60	5704	115	52
TLP317LE-T7B	200-220/3/50	5704	115	52
TLP419LE-S2B	208-230/1/60	6398	127	58
TLP419LE-S4B	460/1/60	7470	127	58
TLP419LE-S6B	200-220/1/50	6398	127	58
TLP419LE-S9B	380-400/1/50	7470	127	58
TLP419LE-T3B	208-230/3/60	6760	127	58
TLP419LE-T7B	200-220/3/50	6760	127	58
TLP422LE-S2B	208-230/1/60	7428	145	66
TLP422LE-S4B	460/1/60	8634	145	66
TLP422LE-S6B	200-220/1/50	7428	145	66
TLP422LE-S9B	380-400/1/50	8634	145	66
TLP422LE-T3B	208-230/3/60	7717	145	66
TLP422LE-T7B	200-220/3/50	7717	145	66
TLP527LE-S2B	208-230/1/60	8746	176	80
TLP527LE-S4B	460/1/60	10199	176	80
TLP527LE-S6B	200-220/1/50	8746	176	80
TLP527LE-S9B	380-400/1/50	10199	176	80
TLP527LE-T3B	208-230/3/60	9050	176	80
TLP527LE-T7B	200-220/3/50	9050	176	80
TLP631LE-S2B	208-230/1/60	9729	207	94
TLP631LE-S4B	460/1/60	11280	207	94
TLP631LE-S6B	200-220/1/50	9729	207	94
TLP631LE-S9B	380-400/1/50	11280	207	94
TLP631LE-T3B	208-230/3/60	10172	207	94
TLP631LE-T7B	200-220/3/50	10172	207	94



2021 Refrigeration Products Price List

TLP-C-2020-3 - EFFECTIVE DATE: 01 OCT 2021 - SUPERCEDES: TLP-C-2020-2



TLP-LINE, LOW PROFILE EVAPORATORS (cont'd)

LOW TEMP 4 FPI - ELECTRIC DEFROST

PSC MOTORS			WEIGHT	
MODEL	VOLTAGE	\$	lbs.	kg
TLP103VE-S2B	208-230/1/60	1416	49	22
TLP103VE-S6B	200-220/1/50	1416	49	22
TLP103VE-T3B	208-230/3/60	1502	49	22
TLP103VE-T7B	200-220/3/50	1502	49	22
TLP104VE-S2B	208-230/1/60	1955	51	23
TLP104VE-S6B	200-220/1/50	1955	51	23
TLP104VE-T3B	208-230/3/60	2073	51	23
TLP104VE-T7B	200-220/3/50	2073	51	23
TLP105VE-S2B	208-230/1/60	2336	53	24
TLP105VE-S6B	200-220/1/50	2336	53	24
TLP105VE-T3B	208-230/3/60	2478	53	24
TLP105VE-T7B	200-220/3/50	2478	53	24
TLP206VE-S2B	208-230/1/60	3028	76	35
TLP206VE-S4B	460/1/60	3339	76	35
TLP206VE-S6B	200-220/1/50	3028	76	35
TLP206VE-S9B	380-400/1/50	3339	76	35
TLP206VE-T3B	208-230/3/60	3178	76	35
TLP206VE-T7B	200-220/3/50	3178	76	35
TLP208VE-S2B	208-230/1/60	3416	80	36
TLP208VE-S4B	460/1/60	3698	80	36
TLP208VE-S6B	200-220/1/50	3416	80	36
TLP208VE-S9B	380-400/1/50	3698	80	36
TLP208VE-T3B	208-230/3/60	3530	80	36
TLP208VE-T7B	200-220/3/50	3530	80	36
TLP209VE-S2B	208-230/1/60	3662	84	38
TLP209VE-S4B	460/1/60	4372	84	38
TLP209VE-S6B	200-220/1/50	3662	84	38
TLP209VE-S9B	380-400/1/50	4372	84	38
TLP209VE-T3B	208-230/3/60	3905	84	38
TLP209VE-T7B	200-220/3/50	3905	84	38
TLP312VE-S2B	208-230/1/60	4656	109	50
TLP312VE-S4B	460/1/60	5491	109	50
TLP312VE-S6B	200-220/1/50	4656	109	50
TLP312VE-S9B	380-400/1/50	5491	109	50
TLP312VE-T3B	208-230/3/60	4894	109	50
TLP312VE-T7B	200-220/3/50	4894	109	50
TLP315VE-S2B	208-230/1/60	5839	115	52
TLP315VE-S4B	460/1/60	6812	115	52
TLP315VE-S6B	200-220/1/50	5839	115	52
TLP315VE-S9B	380-400/1/50	6812	115	52
TLP315VE-T3B	208-230/3/60	6071	115	52
TLP315VE-T7B	200-220/3/50	6071	115	52
TLP416VE-S2B	208-230/1/60	6292	127	58
TLP416VE-S4B	460/1/60	7341	127	58
TLP416VE-S6B	200-220/1/50	6292	127	58
TLP416VE-S9B	380-400/1/50	7341	127	58
TLP416VE-T3B	208-230/3/60	6543	127	58
TLP416VE-T7B	200-220/3/50	6543	127	58
TLP419VE-S2B	208-230/1/60	7171	145	66
TLP419VE-S4B	460/1/60	8405	145	66
TLP419VE-S6B	200-220/1/50	7171	145	66
TLP419VE-S9B	380-400/1/50	8405	145	66
TLP419VE-T3B	208-230/3/60	7437	145	66
TLP419VE-T7B	200-220/3/50	7437	145	66
TLP523VE-S2B	208-230/1/60	8643	176	80
TLP523VE-S4B	460/1/60	9982	176	80
TLP523VE-S6B	200-220/1/50	8643	176	80
TLP523VE-S9B	380-400/1/50	9982	176	80
TLP523VE-T3B	208-230/3/60	8975	176	80
TLP523VE-T7B	200-220/3/50	8975	176	80
TLP627VE-S2B	208-230/1/60	9737	207	94
TLP627VE-S4B	460/1/60	11244	207	94
TLP627VE-S6B	200-220/1/50	9737	207	94
TLP627VE-S9B	380-400/1/50	11244	207	94
TLP627VE-T3B	208-230/3/60	10111	207	94
TLP627VE-T7B	200-220/3/50	10111	207	94

LOW TEMP 6 FPI- HOT GAS DEFROST

^ Insert appropriate code for hot gas defrost type

PSC MOTORS			WEIGHT	
MODEL	VOLTAGE	\$	lbs.	kg
TLP207L^S1B	115/1/60	3101	70	32
TLP207L^S2B	208-230/1/60	3322	70	32
TLP207L^S4B	460/1/60	3672	70	32
TLP207L^S6B	200-220/1/50	3322	70	32
TLP207L^S9B	380-400/1/50	3672	70	32
TLP209L^S1B	115/1/60	3502	74	33
TLP209L^S2B	208-230/1/60	3781	74	33
TLP209L^S4B	460/1/60	4136	74	33
TLP209L^S6B	200-220/1/50	3781	74	33
TLP209L^S9B	380-400/1/50	4136	74	33
TLP211L^S1B	115/1/60	3980	78	35
TLP211L^S2B	208-230/1/60	4298	78	35
TLP211L^S4B	460/1/60	4701	78	35
TLP211L^S6B	200-220/1/50	4298	78	35
TLP211L^S9B	380-400/1/50	4701	78	35
TLP314L^S1B	115/1/60	4891	101	46
TLP314L^S2B	208-230/1/60	5102	101	46
TLP314L^S4B	460/1/60	5633	101	46
TLP314L^S6B	200-220/1/50	5102	101	46
TLP314L^S9B	380-400/1/50	5633	101	46
TLP317L^S1B	115/1/60	5396	107	48
TLP317L^S2B	208-230/1/60	5827	107	48
TLP317L^S4B	460/1/60	6564	107	48
TLP317L^S6B	200-220/1/50	5827	107	48
TLP317L^S9B	380-400/1/50	6564	107	48
TLP419L^S1B	115/1/60	6092	117	53
TLP419L^S2B	208-230/1/60	6650	117	53
TLP419L^S4B	460/1/60	7366	117	53
TLP419L^S6B	200-220/1/50	6650	117	53
TLP419L^S9B	380-400/1/50	7366	117	53
TLP422L^S1B	115/1/60	6832	135	61
TLP422L^S2B	208-230/1/60	7378	135	61
TLP422L^S4B	460/1/60	8267	135	61
TLP422L^S6B	200-220/1/50	7378	135	61
TLP422L^S9B	380-400/1/50	8267	135	61
TLP527L^S1B	115/1/60	8088	163	74
TLP527L^S2B	208-230/1/60	8858	163	74
TLP527L^S4B	460/1/60	10032	163	74
TLP527L^S6B	200-220/1/50	8858	163	74
TLP527L^S9B	380-400/1/50	10032	163	74
TLP631L^S1B	115/1/60	9085	192	87
TLP631L^S2B	208-230/1/60	9974	192	87
TLP631L^S4B	460/1/60	11106	192	87
TLP631L^S6B	200-220/1/50	9974	192	87
TLP631L^S9B	380-400/1/50	11106	192	87



2021 Refrigeration Products Price List

TLP-C-2020-3 - EFFECTIVE DATE: 01 OCT 2021 - SUPERCEDES: TLP-C-2020-2



TLP-LINE, LOW PROFILE EVAPORATORS (cont'd)

LOW TEMP 4 FPI - HOT GAS DEFROST

^ Insert appropriate code for hot gas defrost type

PSC MOTORS			WEIGHT	
MODEL	VOLTAGE	\$	lbs.	kg
TLP206V^S1B	115/1/60	3145	70	32
TLP206V^S2B	208-230/1/60	3241	70	32
TLP206V^S4B	460/1/60	3490	70	32
TLP206V^S6B	200-220/1/50	3241	70	32
TLP206V^S9B	380-400/1/50	3490	70	32
TLP208V^S1B	115/1/60	3486	74	33
TLP208V^S2B	208-230/1/60	3602	74	33
TLP208V^S4B	460/1/60	3859	74	33
TLP208V^S6B	200-220/1/50	3602	74	33
TLP208V^S9B	380-400/1/50	3859	74	33
TLP209V^S1B	115/1/60	3670	78	35
TLP209V^S2B	208-230/1/60	3963	78	35
TLP209V^S4B	460/1/60	4333	78	35
TLP209V^S6B	200-220/1/50	3963	78	35
TLP209V^S9B	380-400/1/50	4333	78	35
TLP312V^S1B	115/1/60	4430	101	46
TLP312V^S2B	208-230/1/60	4780	101	46
TLP312V^S4B	460/1/60	5235	101	46
TLP312V^S6B	200-220/1/50	4780	101	46
TLP312V^S9B	380-400/1/50	5235	101	46

Continues at top of next column >>>

LOW TEMP 4 FPI - HOT GAS DEFROST (cont'd)

^ Insert appropriate code for hot gas defrost type

PSC MOTORS			WEIGHT	
MODEL	VOLTAGE	\$	lbs.	kg
TLP315V^S1B	115/1/60	5569	107	48
TLP315V^S2B	208-230/1/60	6009	107	48
TLP315V^S4B	460/1/60	6591	107	48
TLP315V^S6B	200-220/1/50	6009	107	48
TLP315V^S9B	380-400/1/50	6591	107	48
TLP416V^S1B	115/1/60	5940	117	53
TLP416V^S2B	208-230/1/60	6409	117	53
TLP416V^S4B	460/1/60	7030	117	53
TLP416V^S6B	200-220/1/50	6409	117	53
TLP416V^S9B	380-400/1/50	7030	117	53
TLP419V^S1B	115/1/60	6699	135	61
TLP419V^S2B	208-230/1/60	7231	135	61
TLP419V^S4B	460/1/60	7952	135	61
TLP419V^S6B	200-220/1/50	7231	135	61
TLP419V^S9B	380-400/1/50	7952	135	61
TLP523V^S1B	115/1/60	8344	163	74
TLP523V^S2B	208-230/1/60	9038	163	74
TLP523V^S4B	460/1/60	9812	163	74
TLP523V^S6B	200-220/1/50	9038	163	74
TLP523V^S9B	380-400/1/50	9812	163	74
TLP627V^S1B	115/1/60	9501	192	87
TLP627V^S2B	208-230/1/60	10292	192	87
TLP627V^S4B	460/1/60	11172	192	87
TLP627V^S6B	200-220/1/50	10292	192	87
TLP627V^S9B	380-400/1/50	11172	192	87

NOTES:

- ELECTRIC DRAIN PAN IS A STANDARD FEATURE ON ALL HOT GAS DEFROST LOW PROFILE EVAPORATORS
- HOT GAS LOOP IN DRAIN PAN IS A **NO CHARGE** OPTION
- REFER TO PRODUCT CATALOG ON EXTENT OF STANDARD FACTORY PIPING. OPTIONAL HOT GAS KITS ARE AVAILABLE - SEE NEXT PAGE
- FOR APPROX. SHIPPING WEIGHTS FOR HOT GAS LOOP IN DRAIN PAN MODELS, REFER TO INSTALLATION MANUAL

TLP-LINE, LOW PROFILE EVAPORATORS - WATER / GLYCOL COILS

MODEL	VOLTAGE	LIST	Shipping Weight	
			lbs.	Kgs
TLP104WA-S1B	115/1/60	2273	46.5	21
TLP106WA-S1B	115/1/60	2693	46.5	21
TLP107WA-S1B	115/1/60	2781	46.5	21
TLP209WA-S1B	115/1/60	3394	69.5	32
TLP211WA-S1B	115/1/60	3833	69.5	32
TLP214WA-S1B	115/1/60	4357	69.5	32
TLP317WA-S1B	115/1/60	5354	100.5	46
TLP320WA-S1B	115/1/60	5908	100.5	46
TLP423WA-S1B	115/1/60	6670	134.5	61
TLP426WA-S1B	115/1/60	7479	134.5	61
TLP532WA-S1B	115/1/60	8855	163	74
TLP639WA-S1B	115/1/60	9946	192	87
TLP104WA-S2B	208-230/1/60	2273	46.5	21
TLP106WA-S2B	208-230/1/60	2693	46.5	21
TLP107WA-S2B	208-230/1/60	2781	46.5	21
TLP209WA-S2B	208-230/1/60	3394	69.5	32
TLP211WA-S2B	208-230/1/60	3833	69.5	32
TLP214WA-S2B	208-230/1/60	4357	69.5	32

MODEL	VOLTAGE	LIST	Shipping Weight	
			lbs.	Kgs
TLP317WA-S2B	208-230/1/60	5354	100.5	46
TLP320WA-S2B	208-230/1/60	5908	100.5	46
TLP423WA-S2B	208-230/1/60	6670	134.5	61
TLP426WA-S2B	208-230/1/60	7479	134.5	61
TLP532WA-S2B	208-230/1/60	8855	163	74
TLP639WA-S2B	208-230/1/60	9946	192	87
TLP104WA-S4B	460/1/60	2273	46.5	21
TLP106WA-S4B	460/1/60	2693	46.5	21
TLP107WA-S4B	460/1/60	2781	46.5	21
TLP209WA-S4B	460/1/60	3394	69.5	32
TLP211WA-S4B	460/1/60	3833	69.5	32
TLP214WA-S4B	460/1/60	4357	69.5	32
TLP317WA-S4B	460/1/60	5354	100.5	46
TLP320WA-S4B	460/1/60	5908	100.5	46
TLP423WA-S4B	460/1/60	6670	134.5	61
TLP426WA-S4B	460/1/60	7479	134.5	61
TLP532WA-S4B	460/1/60	8855	163	74
TLP639WA-S4B	460/1/60	9946	192	87



2021 Refrigeration Products Price List

TLP-C-2020-3 - EFFECTIVE DATE: 01 OCT 2021 - SUPERCEDES: TLP-C-2020-2



TLP-LINE, LOW PROFILE EVAPORATORS (cont'd) OPTIONAL HOT GAS KITS

FOR 3-PIPE UNITS WITH ELECTRIC DRAIN PAN HEATER

OPT1-T: TXV + BYPASS CHECK VALVE KIT

INCLUDES QTY. ONE BYPASS CHECK VALVE + TXV
FACTORY INSTALLED

MODEL			LIST
ME	LE	VE	
TLP209	TLP207	TLP206	658
TLP211	TLP209	TLP208	
TLP214	TLP211	TLP209	
		TLP312	681
TLP317	TLP314	TLP315	
TLP320	TLP317	TLP416	
		TLP419	686
	TLP419		
	TLP422		
TLP532	TLP527	TLP523	
TLP629	TLP631	TLP627	

FOR 3-PIPE UNITS WITH HOT GAS LOOP

OPT1-H: TXV + BYPASS CHECK VALVE KIT

INCLUDES QTY. ONE TXV, BYPASS CHECK VALVE AND
PIPING FROM DRAIN LOOP TO CHECKVALVE

MODEL			LIST
ME	LE	VE	
TLP209	TLP207	TLP206	792
TLP211	TLP209	TLP208	
TLP214	TLP211	TLP209	
		TLP312	815
TLP317	TLP314	TLP315	
TLP320	TLP317	TLP416	
		TLP419	855
	TLP419		
	TLP422		
TLP532	TLP527	TLP523	
TLP629	TLP631	TLP627	

FOR REVERSE CYCLE UNITS WITH ELECTRIC DRAIN PAN HEATER

OPT1-G: TXV + BYPASS CHECK VALVE KIT

INCLUDES QTY. ONE TXV, BYPASS CHECK VALVE
AND BYPASS PIPING

MODEL			LIST
ME	LE	VE	
TLP209	TLP207	TLP206	687
TLP211	TLP209	TLP208	
TLP214	TLP211	TLP209	
		TLP312	715
TLP317	TLP314	TLP315	
TLP320	TLP317	TLP416	
		TLP419	715
	TLP419		
	TLP422		
TLP532	TLP527	TLP523	
TLP629	TLP631	TLP627	

FOR REVERSE CYCLE UNITS WITH HOT GAS LOOP

OPT1-R: TXV + BYPASS CHECK VALVE KIT

INCLUDES QTY. ONE TXV, BYPASS CHECK VALVE AND BYPASS PIPING
PIPING FROM DRAIN LOOP TO CHECKVALVE

OPT2-R: DRAIN PAN LOOP CHECK VALVE AND SUCTION LINE CHECK VALVE KIT

INCLUDES QTY. ONE DRAIN PAN CHECK VALVE, QTY. ONE
SUCTION LINE CHECK VALVE AND CONNECTED PIPING

MODEL			TXV KYPASS CHECK VALVE KIT	DRAIN PAN + SUCT. LINE CHECK VALVE KIT
ME	LE	VE		
TLP209	TLP207	TLP206	709	1640
TLP211	TLP209	TLP208		
TLP214	TLP211	TLP209		
		TLP312	735	1720
TLP317	TLP314	TLP315		
TLP320	TLP317	TLP416		
		TLP419	735	1784
	TLP419			
	TLP422			
TLP532	TLP527	TLP523		
TLP629	TLP631	TLP627		



2021 Refrigeration Products Price List

TLP-C-2020-3 - EFFECTIVE DATE: 01 OCT 2021 - SUPERCEDES: TLP-C-2020-2



TMP-LINE, MEDIUM PROFILE EVAPORATORS

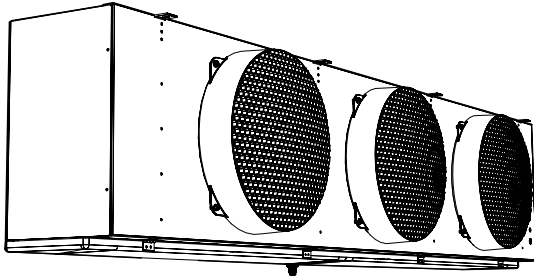

web: www.t-rp.com/tmp
email: evaps@t-rp.com
call: 1-844-893-3222 x520

SMARTSPEED™

FAN MOTOR TECHNOLOGY

AVAILABLE WITH OPTIONAL EC MOTORS

ESP+

see page 49 for details

NOMENCLATURE

TMP 3 48 L E - T5 A - T

Medium Profile Evaporator

Number of Fans

Nominal Capacity:

x 1000 @ 10°F TD, Btu/H

Application Range:

M = Medium to High Temp 6 FPI (10°F to 35°F Evap Temp) *

L = Low Temp 6 FPI (-40°F to 0°F Evap Temp)

V = Low Temp 4 FPI (-40°F to 0°F Evap Temp)

W = Fluid Air Cooler (with water or glycol)

* except "488M", which is 8 FPI

Motor:

C = PSC Motors

T = SmartSpeed ECM

V = Variable Speed EC Motors (Requires a Controller)

Generation: A = 1st

Voltage:

S2 = 208-230/1/60

S4 = 460/1/60

S5 = 575/1/60

T3 = 208-230/3/60

T4 = 460/3/60

T5 = 575/3/60

Defrost:

A = Air

E = Electric

T = 3 Pipe Hot Gas w/ Electric Heater Pan

or Warm Fluid w/ Electric Heater Pan for Fluid Air Coolers

H = 3 Pipe Hot Gas w/ Hot Gas Loop Pan

G = Reverse Cycle w/ Electric Heater Pan

R = Reverse Cycle w/ Hot Gas Loop Pan

STANDARD FEATURES

- Compatible with Low GWP Refrigerants
- Totally enclosed high efficiency PSC motors
- High efficiency and high strength fan guard
- Hinged access panels
- Internally enhanced tubing
- Ample electrical and header compartments
- Adjustable Fan Delay on medium temp. Electric Defrost units
- Liquid line solenoid valve wire harness factory installed
- Schrader valve on suction header
- Positive slope, hinged drain pan
- Central drain connections (approximate)
- Universal drain fitting
- Large 3/4" ID (3/4" MPT) drain hole
- Factory installed distributor nozzle

AVAILABLE OPTIONS

- EC motors with patented SmartSpeed® Technology.
- **ESP+ Intuitive Evaporator Control Technology.**
- Hot gas loop pan with hot gas defrost models
- 230/460V Variable Speed EC Motors
- Factory installed expansion valve, solenoid valve and room thermostat
- Corrosion protection: alternate fin materials and coatings
- Additional options available, please contact factory
- Wire fan guard



2021 Refrigeration Products Price List

TLP-C-2020-3 - EFFECTIVE DATE: 01 OCT 2021 - SUPERCEDES: TLP-C-2020-2



TMP-LINE, MEDIUM PROFILE EVAPORATORS (cont'd)

MEDIUM TEMP - AIR DEFROST

PSC MOTORS			WEIGHT		EC MOTORS - SMARTSPEED™		EC MOTORS - VARIABLE SPEED	
MODEL	VOLTAGE	\$	lbs.	kg	MODEL	\$	MODEL	\$
TMP118MA-S2A-C	208-230/1/60	4924	154	70	TMP118MA-S2A-T	5250	TMP118MA-S2A-V	5299
TMP118MA-S4A-C	460/1/60	5129	154	70			TMP118MA-S4A-V	5879
TMP118MA-S5A-C	575/1/60	5231	154	70				
TMP118MA-S6A-C	200-220/1/50	4924	154	70	TMP118MA-S6A-T	5250	TMP118MA-S6A-V	5299
TMP118MA-S9A-C	380-400/1/50	5129	154	70			TMP118MA-S9A-V	5879
TMP122MA-S2A-C	208-230/1/60	5733	161	73	TMP122MA-S2A-T	6059	TMP122MA-S2A-V	6108
TMP122MA-S4A-C	460/1/60	5972	161	73			TMP122MA-S4A-V	6721
TMP122MA-S5A-C	575/1/60	6091	161	73				
TMP122MA-S6A-C	200-220/1/50	5733	161	73	TMP122MA-S6A-T	6059	TMP122MA-S6A-V	6108
TMP122MA-S9A-C	380-400/1/50	5972	161	73			TMP122MA-S9A-V	6721
TMP228MA-S2A-C	208-230/1/60	7722	224	102	TMP228MA-S2A-T	8375	TMP228MA-S2A-V	8472
TMP228MA-S4A-C	460/1/60	8044	224	102			TMP228MA-S4A-V	9544
TMP228MA-S5A-C	575/1/60	8205	224	102				
TMP228MA-S6A-C	200-220/1/50	7722	224	102	TMP228MA-S6A-T	8375	TMP228MA-S6A-V	8472
TMP228MA-S9A-C	380-400/1/50	8044	224	102			TMP228MA-S9A-V	9544
TMP236MA-S2A-C	208-230/1/60	10117	240	109	TMP236MA-S2A-T	10769	TMP236MA-S2A-V	10866
TMP236MA-S4A-C	460/1/60	10538	240	109			TMP236MA-S4A-V	12038
TMP236MA-S5A-C	575/1/60	10749	240	109				
TMP236MA-S6A-C	200-220/1/50	10117	240	109	TMP236MA-S6A-T	10769	TMP236MA-S6A-V	10866
TMP236MA-S9A-C	380-400/1/50	10538	240	109			TMP236MA-S9A-V	12038
TMP245MA-S2A-C	208-230/1/60	11957	254	116	TMP245MA-S2A-T	12610	TMP245MA-S2A-V	12707
TMP245MA-S4A-C	460/1/60	12535	254	116			TMP245MA-S4A-V	14034
TMP245MA-S5A-C	575/1/60	12786	254	116				
TMP245MA-S6A-C	200-220/1/50	11957	254	116	TMP245MA-S6A-T	12610	TMP245MA-S6A-V	12707
TMP245MA-S9A-C	380-400/1/50	12535	254	116			TMP245MA-S9A-V	14034
TMP355MA-S2A-C	208-230/1/60	13920	326	148	TMP355MA-S2A-T	14899	TMP355MA-S2A-V	15045
TMP355MA-S4A-C	460/1/60	14690	326	148			TMP355MA-S4A-V	16939
TMP355MA-S5A-C	575/1/60	14985	326	148				
TMP355MA-S6A-C	200-220/1/50	13920	326	148	TMP355MA-S6A-T	14899	TMP355MA-S6A-V	15045
TMP355MA-S9A-C	380-400/1/50	14690	326	148			TMP355MA-S9A-V	16939
TMP368MA-S2A-C	208-230/1/60	14776	349	159	TMP368MA-S2A-T	15755	TMP368MA-S2A-V	15901
TMP368MA-S4A-C	460/1/60	15546	349	159			TMP368MA-S4A-V	17795
TMP368MA-S5A-C	575/1/60	15855	349	159				
TMP368MA-S6A-C	200-220/1/50	14776	349	159	TMP368MA-S6A-T	15755	TMP368MA-S6A-V	15901
TMP368MA-S9A-C	380-400/1/50	15546	349	159			TMP368MA-S9A-V	17795
TMP480MA-S2A-C	208-230/1/60	16756	414	188	TMP480MA-S2A-T	18061	TMP480MA-S2A-V	18255
TMP480MA-S4A-C	460/1/60	17719	414	188			TMP480MA-S4A-V	20718
TMP480MA-S5A-C	575/1/60	18072	414	188				
TMP480MA-S6A-C	200-220/1/50	16756	414	188	TMP480MA-S6A-T	18061	TMP480MA-S6A-V	18255
TMP480MA-S9A-C	380-400/1/50	17719	414	188			TMP480MA-S9A-V	20718
TMP488MA-S2A-C	208-230/1/60	17895	433	197	TMP488MA-S2A-T	19200	TMP488MA-S2A-V	19395
TMP488MA-S4A-C	460/1/60	18641	433	197			TMP488MA-S4A-V	21640
TMP488MA-S5A-C	575/1/60	19013	433	197				
TMP488MA-S6A-C	200-220/1/50	17895	433	197	TMP488MA-S6A-T	19200	TMP488MA-S6A-V	19395
TMP488MA-S9A-C	380-400/1/50	18641	433	197			TMP488MA-S9A-V	21640

• OPTIONAL WIRE FAN GUARD - \$171 LIST / FAN SECTION



2021 Refrigeration Products Price List

TLP-C-2020-3 - EFFECTIVE DATE: 01 OCT 2021 - SUPERCEDES: TLP-C-2020-2



TMP-LINE, MEDIUM PROFILE EVAPORATORS (cont'd)

MEDIUM TEMP - ELECTRIC DEFROST

PSC MOTORS			WEIGHT		EC MOTORS - SMARTSPEED		EC MOTORS - VARIABLE SPEED	
MODEL	VOLTAGE	\$	lbs.	kg	MODEL	\$	MODEL	\$
TMP118ME-S2A-C	208-230/1/60	6076	163	74	TMP118ME-S2A-T	6402	TMP118ME-S2A-V	6451
TMP118ME-S4A-C	460/1/60	6383	163	74			TMP118ME-S4A-V	7133
TMP118ME-S5A-C	575/1/60	6509	163	74				
TMP118ME-S6A-C	200-220/1/50	6076	163	74	TMP118ME-S6A-T	6402	TMP118ME-S6A-V	6451
TMP118ME-S9A-C	380-400/1/50	6383	163	74			TMP118ME-S9A-V	7133
TMP118ME-T3A-C	208-230/3/60	6076	163	74	TMP118ME-T3A-T	6402	TMP118ME-T3A-V	6451
TMP118ME-T4A-C	460/3/60	6383	163	74			TMP118ME-T4A-V	7133
TMP118ME-T5A-C	575/3/60	6509	163	74				
TMP118ME-T7A-C	200-220/3/50	6076	163	74	TMP118ME-T7A-T	6402	TMP118ME-T7A-V	6451
TMP118ME-T9A-C	380-400/3/50	6383	163	74			TMP118ME-T9A-V	7133
TMP122ME-S2A-C	208-230/1/60	7300	171	78	TMP122ME-S2A-T	7627	TMP122ME-S2A-V	7675
TMP122ME-S4A-C	460/1/60	7842	171	78			TMP122ME-S4A-V	8592
TMP122ME-S5A-C	575/1/60	7999	171	78				
TMP122ME-S6A-C	200-220/1/50	7300	171	78	TMP122ME-S6A-T	7627	TMP122ME-S6A-V	7675
TMP122ME-S9A-C	380-400/1/50	7842	171	78			TMP122ME-S9A-V	8592
TMP122ME-T3A-C	208-230/3/60	7300	171	78	TMP122ME-T3A-T	7627	TMP122ME-T3A-V	7675
TMP122ME-T4A-C	460/3/60	7842	171	78			TMP122ME-T4A-V	8592
TMP122ME-T5A-C	575/3/60	7999	171	78				
TMP122ME-T7A-C	200-220/3/50	7300	171	78	TMP122ME-T7A-T	7627	TMP122ME-T7A-V	7675
TMP122ME-T9A-C	380-400/3/50	7842	171	78			TMP122ME-T9A-V	8592
TMP228ME-S2A-C	208-230/1/60	9630	241	109	TMP228ME-S2A-T	10283	TMP228ME-S2A-V	10380
TMP228ME-S4A-C	460/1/60	10155	241	109			TMP228ME-S4A-V	11654
TMP228ME-S5A-C	575/1/60	10359	241	109				
TMP228ME-S6A-C	200-220/1/50	9630	241	109	TMP228ME-S6A-T	10283	TMP228ME-S6A-V	10380
TMP228ME-S9A-C	380-400/1/50	10155	241	109			TMP228ME-S9A-V	11654
TMP228ME-T3A-C	208-230/3/60	9630	241	109	TMP228ME-T3A-T	10283	TMP228ME-T3A-V	10380
TMP228ME-T4A-C	460/3/60	10155	241	109			TMP228ME-T4A-V	11654
TMP228ME-T5A-C	575/3/60	10359	241	109				
TMP228ME-T7A-C	200-220/3/50	9630	241	109	TMP228ME-T7A-T	10283	TMP228ME-T7A-V	10380
TMP228ME-T9A-C	380-400/3/50	10155	241	109			TMP228ME-T9A-V	11654
TMP236ME-S2A-C	208-230/1/60	10837	257	117	TMP236ME-S2A-T	11490	TMP236ME-S2A-V	11587
TMP236ME-S4A-C	460/1/60	11651	257	117			TMP236ME-S4A-V	13150
TMP236ME-S5A-C	575/1/60	11885	257	117				
TMP236ME-S6A-C	200-220/1/50	10837	257	117	TMP236ME-S6A-T	11490	TMP236ME-S6A-V	11587
TMP236ME-S9A-C	380-400/1/50	11651	257	117			TMP236ME-S9A-V	13150
TMP236ME-T3A-C	208-230/3/60	10837	257	117	TMP236ME-T3A-T	11490	TMP236ME-T3A-V	11587
TMP236ME-T4A-C	460/3/60	11651	257	117			TMP236ME-T4A-V	13150
TMP236ME-T5A-C	575/3/60	11885	257	117				
TMP236ME-T7A-C	200-220/3/50	10837	257	117	TMP236ME-T7A-T	11490	TMP236ME-T7A-V	11587
TMP236ME-T9A-C	380-400/3/50	11651	257	117			TMP236ME-T9A-V	13150
TMP245ME-S2A-C	208-230/1/60	13344	270	123	TMP245ME-S2A-T	13997	TMP245ME-S2A-V	14094
TMP245ME-S4A-C	460/1/60	14162	270	123			TMP245ME-S4A-V	15662
TMP245ME-S5A-C	575/1/60	14446	270	123				
TMP245ME-S6A-C	200-220/1/50	13344	270	123	TMP245ME-S6A-T	13997	TMP245ME-S6A-V	14094
TMP245ME-S9A-C	380-400/1/50	14162	270	123			TMP245ME-S9A-V	15662
TMP245ME-T3A-C	208-230/3/60	13344	270	123	TMP245ME-T3A-T	13997	TMP245ME-T3A-V	14094
TMP245ME-T4A-C	460/3/60	14162	270	123			TMP245ME-T4A-V	15662
TMP245ME-T5A-C	575/3/60	14446	270	123				
TMP245ME-T7A-C	200-220/3/50	13344	270	123	TMP245ME-T7A-T	13997	TMP245ME-T7A-V	14094
TMP245ME-T9A-C	380-400/3/50	14162	270	123			TMP245ME-T9A-V	15662
TMP355ME-S2A-C	208-230/1/60	15121	349	159	TMP355ME-S2A-T	16100	TMP355ME-S2A-V	16245
TMP355ME-S4A-C	460/1/60	16124	349	159			TMP355ME-S4A-V	18373
TMP355ME-S5A-C	575/1/60	16446	349	159				
TMP355ME-S6A-C	200-220/1/50	15121	349	159	TMP355ME-S6A-T	16100	TMP355ME-S6A-V	16245
TMP355ME-S9A-C	380-400/1/50	16124	349	159			TMP355ME-S9A-V	18373
TMP355ME-T3A-C	208-230/3/60	15121	349	159	TMP355ME-T3A-T	16100	TMP355ME-T3A-V	16245
TMP355ME-T4A-C	460/3/60	16124	349	159			TMP355ME-T4A-V	18373
TMP355ME-T5A-C	575/3/60	16446	349	159				
TMP355ME-T7A-C	200-220/3/50	15121	349	159	TMP355ME-T7A-T	16100	TMP355ME-T7A-V	16245
TMP355ME-T9A-C	380-400/3/50	16124	349	159			TMP355ME-T9A-V	18373

Continues on next page >>>

NOTE: Fixed defrost termination is a standard feature. Optional adjustable defrost termination available.



2021 Refrigeration Products Price List

TLP-C-2020-3 - EFFECTIVE DATE: 01 OCT 2021 - SUPERCEDES: TLP-C-2020-2



TMP-LINE, MEDIUM PROFILE EVAPORATORS (cont'd)

MEDIUM TEMP - ELECTRIC DEFROST (cont'd)

PSC MOTORS			WEIGHT		EC MOTORS - SMARTSPEED™		EC MOTORS - VARIABLE SPEED	
MODEL	VOLTAGE	\$	lbs.	kg	MODEL	\$	MODEL	\$
TMP368ME-S2A-C	208-230/1/60	16759	372	169	TMP368ME-S2A-T	17738	TMP368ME-S2A-V	17883
TMP368ME-S4A-C	460/1/60	18059	372	169			TMP368ME-S4A-V	20308
TMP368ME-S5A-C	575/1/60	18420	372	169				
TMP368ME-S6A-C	200-220/1/50	16759	372	169	TMP368ME-S6A-T	17738	TMP368ME-S6A-V	17883
TMP368ME-S9A-C	380-400/1/50	18059	372	169			TMP368ME-S9A-V	20308
TMP368ME-T3A-C	208-230/3/60	16759	372	169	TMP368ME-T3A-T	17738	TMP368ME-T3A-V	17883
TMP368ME-T4A-C	460/3/60	18059	372	169			TMP368ME-T4A-V	20308
TMP368ME-T5A-C	575/3/60	18420	372	169				
TMP368ME-T7A-C	200-220/3/50	16759	372	169	TMP368ME-T7A-T	17738	TMP368ME-T7A-V	17883
TMP368ME-T9A-C	380-400/3/50	18059	372	169			TMP368ME-T9A-V	20308
TMP480ME-S2A-C	208-230/1/60	21370	441	200	TMP480ME-S2A-T	22675	TMP480ME-S2A-V	22869
TMP480ME-S4A-C	460/1/60	21500	441	200			TMP480ME-S4A-V	24499
TMP480ME-S5A-C	575/1/60	21709	441	200				
TMP480ME-S6A-C	200-220/1/50	21370	441	200	TMP480ME-S6A-T	22675	TMP480ME-S6A-V	22869
TMP480ME-S9A-C	380-400/1/50	21500	441	200			TMP480ME-S9A-V	24499
TMP480ME-T3A-C	208-230/3/60	21370	441	200	TMP480ME-T3A-T	22675	TMP480ME-T3A-V	22869
TMP480ME-T4A-C	460/3/60	21500	441	200			TMP480ME-T4A-V	24499
TMP480ME-T5A-C	575/3/60	21709	441	200				
TMP480ME-T7A-C	200-220/3/50	21370	441	200	TMP480ME-T7A-T	22675	TMP480ME-T7A-V	22869
TMP480ME-T9A-C	380-400/3/50	21500	441	200			TMP480ME-T9A-V	24499
TMP488ME-S2A-C	208-230/1/60	23507	460	209	TMP488ME-S2A-T	24812	TMP488ME-S2A-V	25006
TMP488ME-S4A-C	460/1/60	23650	460	209			TMP488ME-S4A-V	26649
TMP488ME-S5A-C	575/1/60	23880	460	209				
TMP488ME-S6A-C	200-220/1/50	23507	460	209	TMP488ME-S6A-T	24812	TMP488ME-S6A-V	25006
TMP488ME-S9A-C	380-400/1/50	23650	460	209			TMP488ME-S9A-V	26649
TMP488ME-T3A-C	208-230/3/60	23507	460	209	TMP488ME-T3A-T	24812	TMP488ME-T3A-V	25006
TMP488ME-T4A-C	460/3/60	23650	460	209			TMP488ME-T4A-V	26649
TMP488ME-T5A-C	575/3/60	23880	460	209				
TMP488ME-T7A-C	200-220/3/50	23507	460	209	TMP488ME-T7A-T	24812	TMP488ME-T7A-V	25006
TMP488ME-T9A-C	380-400/3/50	23650	460	209			TMP488ME-T9A-V	26649

MEDIUM TEMP - HOT GAS DEFROST

^ Insert appropriate code for hot gas defrost type

PSC MOTORS			WEIGHT		EC MOTORS - SMARTSPEED™		EC MOTORS - VARIABLE SPEED	
MODEL	VOLTAGE	\$	lbs.	kg	MODEL	\$	MODEL	\$
TMP118M^S2A-C	208-230/1/60	5684	156	71	TMP118M^S2A-T	6011	TMP118M^S2A-V	6059
TMP118M^S4A-C	460/1/60	6142	156	71			TMP118M^S4A-V	6892
TMP118M^S5A-C	575/1/60	6265	156	71				
TMP118M^S6A-C	200-220/1/50	5684	156	71	TMP118M^S6A-T	6011	TMP118M^S6A-V	6059
TMP118M^S9A-C	380-400/1/50	6142	156	71			TMP118M^S9A-V	6892
TMP122M^S2A-C	208-230/1/60	6888	164	75	TMP122M^S2A-T	7214	TMP122M^S2A-V	7263
TMP122M^S4A-C	460/1/60	7443	164	75			TMP122M^S4A-V	8193
TMP122M^S5A-C	575/1/60	7592	164	75				
TMP122M^S6A-C	200-220/1/50	6888	164	75	TMP122M^S6A-T	7214	TMP122M^S6A-V	7263
TMP122M^S9A-C	380-400/1/50	7443	164	75			TMP122M^S9A-V	8193
TMP228M^S2A-C	208-230/1/60	9088	228	104	TMP228M^S2A-T	9740	TMP228M^S2A-V	9837
TMP228M^S4A-C	460/1/60	9619	228	104			TMP228M^S4A-V	11118
TMP228M^S5A-C	575/1/60	9811	228	104				
TMP228M^S6A-C	200-220/1/50	9088	228	104	TMP228M^S6A-T	9740	TMP228M^S6A-V	9837
TMP228M^S9A-C	380-400/1/50	9619	228	104			TMP228M^S9A-V	11118
TMP236M^S2A-C	208-230/1/60	10222	244	111	TMP236M^S2A-T	10875	TMP236M^S2A-V	10972
TMP236M^S4A-C	460/1/60	11055	244	111			TMP236M^S4A-V	12554
TMP236M^S5A-C	575/1/60	11277	244	111				
TMP236M^S6A-C	200-220/1/50	10222	244	111	TMP236M^S6A-T	10875	TMP236M^S6A-V	10972
TMP236M^S9A-C	380-400/1/50	11055	244	111			TMP236M^S9A-V	12554
TMP245M^S2A-C	208-230/1/60	12591	258	117	TMP245M^S2A-T	13243	TMP245M^S2A-V	13340
TMP245M^S4A-C	460/1/60	13445	258	117			TMP245M^S4A-V	14945
TMP245M^S5A-C	575/1/60	13714	258	117				
TMP245M^S6A-C	200-220/1/50	12591	258	117	TMP245M^S6A-T	13243	TMP245M^S6A-V	13340
TMP245M^S9A-C	380-400/1/50	13445	258	117			TMP245M^S9A-V	14945

Continues on next page >>>



2021 Refrigeration Products Price List

TLP-C-2020-3 - EFFECTIVE DATE: 01 OCT 2021 - SUPERCEDES: TLP-C-2020-2



TMP-LINE, MEDIUM PROFILE EVAPORATORS (cont'd)

MEDIUM TEMP - HOT GAS DEFROST (cont'd)

^ Insert appropriate code for hot gas defrost type

PSC MOTORS			WEIGHT		EC MOTORS - SMARTSPEED		EC MOTORS - VARIABLE SPEED	
MODEL	VOLTAGE	\$	lbs.	kg	MODEL	\$	MODEL	\$
TMP355M^S2A-C	208-230/1/60	14265	332	151	TMP355M^S2A-T	15244	TMP355M^S2A-V	15390
TMP355M^S4A-C	460/1/60	15288	332	151			TMP355M^S4A-V	17537
TMP355M^S5A-C	575/1/60	15594	332	151				
TMP355M^S6A-C	200-220/1/50	14265	332	151	TMP355M^S6A-T	15244	TMP355M^S6A-V	15390
TMP355M^S9A-C	380-400/1/50	15288	332	151			TMP355M^S9A-V	17537
TMP368M^S2A-C	208-230/1/60	15977	355	161	TMP368M^S2A-T	16956	TMP368M^S2A-V	17102
TMP368M^S4A-C	460/1/60	17123	355	161			TMP368M^S4A-V	19372
TMP368M^S5A-C	575/1/60	17466	355	161				
TMP368M^S6A-C	200-220/1/50	15977	355	161	TMP368M^S6A-T	16956	TMP368M^S6A-V	17102
TMP368M^S9A-C	380-400/1/50	17123	355	161			TMP368M^S9A-V	19372
TMP480M^S2A-C	208-230/1/60	20459	421	191	TMP480M^S2A-T	21764	TMP480M^S2A-V	21958
TMP480M^S4A-C	460/1/60	20840	421	191			TMP480M^S4A-V	23839
TMP480M^S5A-C	575/1/60	21257	421	191				
TMP480M^S6A-C	200-220/1/50	20459	421	191	TMP480M^S6A-T	21764	TMP480M^S6A-V	21958
TMP480M^S9A-C	380-400/1/50	20840	421	191			TMP480M^S9A-V	23839
TMP488M^S2A-C	208-230/1/60	22505	440	200	TMP488M^S2A-T	23810	TMP488M^S2A-V	24004
TMP488M^S4A-C	460/1/60	22924	440	200			TMP488M^S4A-V	25923
TMP488M^S5A-C	575/1/60	23382	440	200				
TMP488M^S6A-C	200-220/1/50	22505	440	200	TMP488M^S6A-T	23810	TMP488M^S6A-V	24004
TMP488M^S9A-C	380-400/1/50	22924	440	200			TMP488M^S9A-V	25923

LOW TEMP 6 FPI - ELECTRIC DEFROST

PSC MOTORS			WEIGHT		EC MOTORS - SMARTSPEED		EC MOTORS - VARIABLE SPEED	
MODEL	VOLTAGE	\$	lbs.	kg	MODEL	\$	MODEL	\$
TMP116LE-S2A-C	208-230/1/60	6047	164	75	TMP116LE-S2A-T	6373	TMP116LE-S2A-V	6422
TMP116LE-S4A-C	460/1/60	6352	164	75			TMP116LE-S4A-V	7102
TMP116LE-S5A-C	575/1/60	6478	164	75				
TMP116LE-S6A-C	200-220/1/50	6047	164	75	TMP116LE-S6A-T	6373	TMP116LE-S6A-V	6422
TMP116LE-S9A-C	380-400/1/50	6352	164	75			TMP116LE-S9A-V	7102
TMP116LE-T3A-C	208-230/3/60	6047	164	75	TMP116LE-T3A-T	6373	TMP116LE-T3A-V	6422
TMP116LE-T4A-C	460/3/60	6352	164	75			TMP116LE-T4A-V	7102
TMP116LE-T5A-C	575/3/60	6478	164	75				
TMP116LE-T7A-C	200-220/3/50	6047	164	75	TMP116LE-T7A-T	6373	TMP116LE-T7A-V	6422
TMP116LE-T9A-C	380-400/3/50	6352	164	75			TMP116LE-T9A-V	7102
TMP119LE-S2A-C	208-230/1/60	7224	171	78	TMP119LE-S2A-T	7550	TMP119LE-S2A-V	7599
TMP119LE-S4A-C	460/1/60	7760	171	78			TMP119LE-S4A-V	8510
TMP119LE-S5A-C	575/1/60	7914	171	78				
TMP119LE-S6A-C	200-220/1/50	7224	171	78	TMP119LE-S6A-T	7550	TMP119LE-S6A-V	7599
TMP119LE-S9A-C	380-400/1/50	7760	171	78			TMP119LE-S9A-V	8510
TMP119LE-T3A-C	208-230/3/60	7224	171	78	TMP119LE-T3A-T	7550	TMP119LE-T3A-V	7599
TMP119LE-T4A-C	460/3/60	7760	171	78			TMP119LE-T4A-V	8510
TMP119LE-T5A-C	575/3/60	7914	171	78				
TMP119LE-T7A-C	200-220/3/50	7224	171	78	TMP119LE-T7A-T	7550	TMP119LE-T7A-V	7599
TMP119LE-T9A-C	380-400/3/50	7760	171	78			TMP119LE-T9A-V	8510
TMP225LE-S2A-C	208-230/1/60	9676	243	110	TMP225LE-S2A-T	10329	TMP225LE-S2A-V	10426
TMP225LE-S4A-C	460/1/60	10203	243	110			TMP225LE-S4A-V	11703
TMP225LE-S5A-C	575/1/60	10408	243	110				
TMP225LE-S6A-C	200-220/1/50	9676	243	110	TMP225LE-S6A-T	10329	TMP225LE-S6A-V	10426
TMP225LE-S9A-C	380-400/1/50	10203	243	110			TMP225LE-S9A-V	11703
TMP225LE-T3A-C	208-230/3/60	9676	243	110	TMP225LE-T3A-T	10329	TMP225LE-T3A-V	10426
TMP225LE-T4A-C	460/3/60	10203	243	110			TMP225LE-T4A-V	11703
TMP225LE-T5A-C	575/3/60	10408	243	110				
TMP225LE-T7A-C	200-220/3/50	9676	243	110	TMP225LE-T7A-T	10329	TMP225LE-T7A-V	10426
TMP225LE-T9A-C	380-400/3/50	10203	243	110			TMP225LE-T9A-V	11703

Continues on next page >>>

NOTES:

- Fixed defrost termination is a standard feature. Optional adjustable defrost termination available.
- Electric heater in drain pan is standard. OPTIONAL HOT GAS LOOP IN DRAIN PAN:
1 FAN = \$553, 2 FAN = \$671, 3 FAN = \$806, 4 FAN = \$948
- For approx. shipping weights for hot gas loop in drain pan models, refer to installation bulletin T30-TMP-PDI
- All hot gas evaps include TXV bypass check valve shipped loose.



2021 Refrigeration Products Price List

TLP-C-2020-3 - EFFECTIVE DATE: 01 OCT 2021 - SUPERCEDES: TLP-C-2020-2



TMP-LINE, MEDIUM PROFILE EVAPORATORS (cont'd)

LOW TEMP 6 FPI - ELECTRIC DEFROST (cont'd)

PSC MOTORS			WEIGHT		EC MOTORS - SMARTSPEED™		EC MOTORS - VARIABLE SPEED	
MODEL	VOLTAGE	\$	lbs.	kg	MODEL	\$	MODEL	\$
TMP232LE-S2A-C	208-230/1/60	10710	257	117	TMP232LE-S2A-T	11362	TMP232LE-S2A-V	11459
TMP232LE-S4A-C	460/1/60	11515	257	117			TMP232LE-S4A-V	13014
TMP232LE-S5A-C	575/1/60	11746	257	117				
TMP232LE-S6A-C	200-220/1/50	10710	257	117	TMP232LE-S6A-T	11362	TMP232LE-S6A-V	11459
TMP232LE-S9A-C	380-400/1/50	11515	257	117			TMP232LE-S9A-V	13014
TMP232LE-T3A-C	208-230/3/60	10710	257	117	TMP232LE-T3A-T	11362	TMP232LE-T3A-V	11459
TMP232LE-T4A-C	460/3/60	11515	257	117			TMP232LE-T4A-V	13014
TMP232LE-T5A-C	575/3/60	11746	257	117				
TMP232LE-T7A-C	200-220/3/50	10710	257	117	TMP232LE-T7A-T	11362	TMP232LE-T7A-V	11459
TMP232LE-T9A-C	380-400/3/50	11515	257	117			TMP232LE-T9A-V	13014
TMP240LE-S2A-C	208-230/1/60	13138	273	124	TMP240LE-S2A-T	13791	TMP240LE-S2A-V	13888
TMP240LE-S4A-C	460/1/60	13944	273	124			TMP240LE-S4A-V	15444
TMP240LE-S5A-C	575/1/60	14224	273	124				
TMP240LE-S6A-C	200-220/1/50	13138	273	124	TMP240LE-S6A-T	13791	TMP240LE-S6A-V	13888
TMP240LE-S9A-C	380-400/1/50	13944	273	124			TMP240LE-S9A-V	15444
TMP240LE-T3A-C	208-230/3/60	13138	273	124	TMP240LE-T3A-T	13791	TMP240LE-T3A-V	13888
TMP240LE-T4A-C	460/3/60	13944	273	124			TMP240LE-T4A-V	15444
TMP240LE-T5A-C	575/3/60	14224	273	124				
TMP240LE-T7A-C	200-220/3/50	13138	273	124	TMP240LE-T7A-T	13791	TMP240LE-T7A-V	13888
TMP240LE-T9A-C	380-400/3/50	13944	273	124			TMP240LE-T9A-V	15444
TMP348LE-S2A-C	208-230/1/60	14291	352	160	TMP348LE-S2A-T	15270	TMP348LE-S2A-V	15416
TMP348LE-S4A-C	460/1/60	15367	352	160			TMP348LE-S4A-V	17616
TMP348LE-S5A-C	575/1/60	15678	352	160				
TMP348LE-S6A-C	200-220/1/50	14291	352	160	TMP348LE-S6A-T	15270	TMP348LE-S6A-V	15416
TMP348LE-S9A-C	380-400/1/50	15367	352	160			TMP348LE-S9A-V	17616
TMP348LE-T3A-C	208-230/3/60	14291	352	160	TMP348LE-T3A-T	15270	TMP348LE-T3A-V	15416
TMP348LE-T4A-C	460/3/60	15367	352	160			TMP348LE-T4A-V	17616
TMP348LE-T5A-C	575/3/60	15678	352	160				
TMP348LE-T7A-C	200-220/3/50	14291	352	160	TMP348LE-T7A-T	15270	TMP348LE-T7A-V	15416
TMP348LE-T9A-C	380-400/3/50	15367	352	160			TMP348LE-T9A-V	17616
TMP356LE-S2A-C	208-230/1/60	16211	377	171	TMP356LE-S2A-T	17190	TMP356LE-S2A-V	17336
TMP356LE-S4A-C	460/1/60	17287	377	171			TMP356LE-S4A-V	19536
TMP356LE-S5A-C	575/1/60	17631	377	171				
TMP356LE-S6A-C	200-220/1/50	16211	377	171	TMP356LE-S6A-T	17190	TMP356LE-S6A-V	17336
TMP356LE-S9A-C	380-400/1/50	17287	377	171			TMP356LE-S9A-V	19536
TMP356LE-T3A-C	208-230/3/60	16211	377	171	TMP356LE-T3A-T	17190	TMP356LE-T3A-V	17336
TMP356LE-T4A-C	460/3/60	17287	377	171			TMP356LE-T4A-V	19536
TMP356LE-T5A-C	575/3/60	17631	377	171				
TMP356LE-T7A-C	200-220/3/50	16211	377	171	TMP356LE-T7A-T	17190	TMP356LE-T7A-V	17336
TMP356LE-T9A-C	380-400/3/50	17287	377	171			TMP356LE-T9A-V	19536
TMP471LE-S2A-C	208-230/1/60	21268	443	201	TMP471LE-S2A-T	22573	TMP471LE-S2A-V	22768
TMP471LE-S4A-C	460/1/60	21398	443	201			TMP471LE-S4A-V	24397
TMP471LE-S5A-C	575/1/60	21606	443	201				
TMP471LE-S6A-C	200-220/1/50	21268	443	201	TMP471LE-S6A-T	22573	TMP471LE-S6A-V	22768
TMP471LE-S9A-C	380-400/1/50	21398	443	201			TMP471LE-S9A-V	24397
TMP471LE-T3A-C	208-230/3/60	21268	443	201	TMP471LE-T3A-T	22573	TMP471LE-T3A-V	22768
TMP471LE-T4A-C	460/3/60	21398	443	201			TMP471LE-T4A-V	24397
TMP471LE-T5A-C	575/3/60	21606	443	201				
TMP471LE-T7A-C	200-220/3/50	21268	443	201	TMP471LE-T7A-T	22573	TMP471LE-T7A-V	22768
TMP471LE-T9A-C	380-400/3/50	21398	443	201			TMP471LE-T9A-V	24397



2021 Refrigeration Products Price List

TLP-C-2020-3 - EFFECTIVE DATE: 01 OCT 2021 - SUPERCEDES: TLP-C-2020-2



TMP-LINE, MEDIUM PROFILE EVAPORATORS (cont'd)

LOW TEMP 4 FPI - ELECTRIC DEFROST

PSC MOTORS			WEIGHT		EC MOTORS - SMARTSPEED		EC MOTORS - VARIABLE SPEED	
MODEL	VOLTAGE	\$	lbs.	kg	MODEL	\$	MODEL	\$
TMP113VE-S2A-C	208-230/1/60	5907	160	73	TMP113VE-S2A-T	6233	TMP113VE-S2A-V	6282
TMP113VE-S4A-C	460/1/60	6244	160	73			TMP113VE-S4A-V	6994
TMP113VE-S5A-C	575/1/60	6369	160	73				
TMP113VE-S6A-C	200-220/1/50	5907	160	73	TMP113VE-S6A-T	6233	TMP113VE-S6A-V	6282
TMP113VE-S9A-C	380-400/1/50	6244	160	73			TMP113VE-S9A-V	6994
TMP113VE-T3A-C	208-230/3/60	5907	160	73	TMP113VE-T3A-T	6233	TMP113VE-T3A-V	6282
TMP113VE-T4A-C	460/3/60	6244	160	73			TMP113VE-T4A-V	6994
TMP113VE-T5A-C	575/3/60	6369	160	73				
TMP113VE-T7A-C	200-220/3/50	5907	160	73	TMP113VE-T7A-T	6233	TMP113VE-T7A-V	6282
TMP113VE-T9A-C	380-400/3/50	6244	160	73			TMP113VE-T9A-V	6994
TMP117VE-S2A-C	208-230/1/60	6505	166	76	TMP117VE-S2A-T	6831	TMP117VE-S2A-V	6880
TMP117VE-S4A-C	460/1/60	7043	166	76			TMP117VE-S4A-V	7793
TMP117VE-S5A-C	575/1/60	7181	166	76				
TMP117VE-S6A-C	200-220/1/50	6505	166	76	TMP117VE-S6A-T	6831	TMP117VE-S6A-V	6880
TMP117VE-S9A-C	380-400/1/50	7043	166	76			TMP117VE-S9A-V	7793
TMP117VE-T3A-C	208-230/3/60	6505	166	76	TMP117VE-T3A-T	6831	TMP117VE-T3A-V	6880
TMP117VE-T4A-C	460/3/60	7043	166	76			TMP117VE-T4A-V	7793
TMP117VE-T5A-C	575/3/60	7181	166	76				
TMP117VE-T7A-C	200-220/3/50	6505	166	76	TMP117VE-T7A-T	6831	TMP117VE-T7A-V	6880
TMP117VE-T9A-C	380-400/3/50	7043	166	76			TMP117VE-T9A-V	7793
TMP222VE-S2A-C	208-230/1/60	8919	238	108	TMP222VE-S2A-T	9572	TMP222VE-S2A-V	9669
TMP222VE-S4A-C	460/1/60	9460	238	108			TMP222VE-S4A-V	10959
TMP222VE-S5A-C	575/1/60	9649	238	108				
TMP222VE-S6A-C	200-220/1/50	8919	238	108	TMP222VE-S6A-T	9572	TMP222VE-S6A-V	9669
TMP222VE-S9A-C	380-400/1/50	9460	238	108			TMP222VE-S9A-V	10959
TMP222VE-T3A-C	208-230/3/60	8919	238	108	TMP222VE-T3A-T	9572	TMP222VE-T3A-V	9669
TMP222VE-T4A-C	460/3/60	9460	238	108			TMP222VE-T4A-V	10959
TMP222VE-T5A-C	575/3/60	9649	238	108				
TMP222VE-T7A-C	200-220/3/50	8919	238	108	TMP222VE-T7A-T	9572	TMP222VE-T7A-V	9669
TMP222VE-T9A-C	380-400/3/50	9460	238	108			TMP222VE-T9A-V	10959
TMP228VE-S2A-C	208-230/1/60	10722	250	114	TMP228VE-S2A-T	11375	TMP228VE-S2A-V	11472
TMP228VE-S4A-C	460/1/60	11439	250	114			TMP228VE-S4A-V	12938
TMP228VE-S5A-C	575/1/60	11666	250	114				
TMP228VE-S6A-C	200-220/1/50	10722	250	114	TMP228VE-S6A-T	11375	TMP228VE-S6A-V	11472
TMP228VE-S9A-C	380-400/1/50	11439	250	114			TMP228VE-S9A-V	12938
TMP228VE-T3A-C	208-230/3/60	10722	250	114	TMP228VE-T3A-T	11375	TMP228VE-T3A-V	11472
TMP228VE-T4A-C	460/3/60	11439	250	114			TMP228VE-T4A-V	12938
TMP228VE-T5A-C	575/3/60	11666	250	114				
TMP228VE-T7A-C	200-220/3/50	10722	250	114	TMP228VE-T7A-T	11375	TMP228VE-T7A-V	11472
TMP228VE-T9A-C	380-400/3/50	11439	250	114			TMP228VE-T9A-V	12938
TMP234VE-S2A-C	208-230/1/60	12612	263	120	TMP234VE-S2A-T	13264	TMP234VE-S2A-V	13361
TMP234VE-S4A-C	460/1/60	13421	263	120			TMP234VE-S4A-V	14921
TMP234VE-S5A-C	575/1/60	13689	263	120				
TMP234VE-S6A-C	200-220/1/50	12612	263	120	TMP234VE-S6A-T	13264	TMP234VE-S6A-V	13361
TMP234VE-S9A-C	380-400/1/50	13421	263	120			TMP234VE-S9A-V	14921
TMP234VE-T3A-C	208-230/3/60	12612	263	120	TMP234VE-T3A-T	13264	TMP234VE-T3A-V	13361
TMP234VE-T4A-C	460/3/60	13421	263	120			TMP234VE-T4A-V	14921
TMP234VE-T5A-C	575/3/60	13689	263	120				
TMP234VE-T7A-C	200-220/3/50	12612	263	120	TMP234VE-T7A-T	13264	TMP234VE-T7A-V	13361
TMP234VE-T9A-C	380-400/3/50	13421	263	120			TMP234VE-T9A-V	14921
TMP339VE-S2A-C	208-230/1/60	13720	346	157	TMP339VE-S2A-T	14699	TMP339VE-S2A-V	14845
TMP339VE-S4A-C	460/1/60	14795	346	157			TMP339VE-S4A-V	17044
TMP339VE-S5A-C	575/1/60	15091	346	157				
TMP339VE-S6A-C	200-220/1/50	13720	346	157	TMP339VE-S6A-T	14699	TMP339VE-S6A-V	14845
TMP339VE-S9A-C	380-400/1/50	14795	346	157			TMP339VE-S9A-V	17044
TMP339VE-T3A-C	208-230/3/60	13720	346	157	TMP339VE-T3A-T	14699	TMP339VE-T3A-V	14845
TMP339VE-T4A-C	460/3/60	14795	346	157			TMP339VE-T4A-V	17044
TMP339VE-T5A-C	575/3/60	15091	346	157				
TMP339VE-T7A-C	200-220/3/50	13720	346	157	TMP339VE-T7A-T	14699	TMP339VE-T7A-V	14845
TMP339VE-T9A-C	380-400/3/50	14795	346	157			TMP339VE-T9A-V	17044

Continues on next page >>>



2021 Refrigeration Products Price List

TLP-C-2020-3 - EFFECTIVE DATE: 01 OCT 2021 - SUPERCEDES: TLP-C-2020-2



TMP-LINE, MEDIUM PROFILE EVAPORATORS (cont'd)

LOW TEMP 4 FPI - ELECTRIC DEFROST (cont'd)

PSC MOTORS			WEIGHT		EC MOTORS - SMARTSPEED		EC MOTORS - VARIABLE SPEED	
MODEL	VOLTAGE	\$	lbs.	kg	MODEL	\$	MODEL	\$
TMP350VE-S2A-C	208-230/1/60	15526	362	165	TMP350VE-S2A-T	16505	TMP350VE-S2A-V	16650
TMP350VE-S4A-C	460/1/60	16599	362	165			TMP350VE-S4A-V	18849
TMP350VE-S5A-C	575/1/60	16931	362	165				
TMP350VE-S6A-C	200-220/1/50	15526	362	165	TMP350VE-S6A-T	16505	TMP350VE-S6A-V	16650
TMP350VE-S9A-C	380-400/1/50	16599	362	165			TMP350VE-S9A-V	18849
TMP350VE-T3A-C	208-230/3/60	15526	362	165	TMP350VE-T3A-T	16505	TMP350VE-T3A-V	16650
TMP350VE-T4A-C	460/3/60	16599	362	165			TMP350VE-T4A-V	18849
TMP350VE-T5A-C	575/3/60	16931	362	165				
TMP350VE-T7A-C	200-220/3/50	15526	362	165	TMP350VE-T7A-T	16505	TMP350VE-T7A-V	16650
TMP350VE-T9A-C	380-400/3/50	16599	362	165			TMP350VE-T9A-V	18849
TMP459VE-S2A-C	208-230/1/60	16725	425	193	TMP459VE-S2A-T	18031	TMP459VE-S2A-V	18225
TMP459VE-S4A-C	460/1/60	18070	425	193			TMP459VE-S4A-V	21069
TMP459VE-S5A-C	575/1/60	18429	425	193				
TMP459VE-S6A-C	200-220/1/50	16725	425	193	TMP459VE-S6A-T	18031	TMP459VE-S6A-V	18225
TMP459VE-S9A-C	380-400/1/50	18070	425	193			TMP459VE-S9A-V	21069
TMP459VE-T3A-C	208-230/3/60	16725	425	193	TMP459VE-T3A-T	18031	TMP459VE-T3A-V	18225
TMP459VE-T4A-C	460/3/60	18070	425	193			TMP459VE-T4A-V	21069
TMP459VE-T5A-C	575/3/60	18429	425	193				
TMP459VE-T7A-C	200-220/3/50	16725	425	193	TMP459VE-T7A-T	18031	TMP459VE-T7A-V	18225
TMP459VE-T9A-C	380-400/3/50	18070	425	193			TMP459VE-T9A-V	21069

LOW TEMP 6 FPI - HOT GAS DEFROST

^ Insert appropriate code for hot gas defrost type

PSC MOTORS			WEIGHT		EC MOTORS - SMARTSPEED		EC MOTORS - VARIABLE SPEED	
MODEL	VOLTAGE	\$	lbs.	kg	MODEL	\$	MODEL	\$
TMP116L^S2A-C	208-230/1/60	5684	157	71	TMP116L^S2A-T	6011	TMP116L^S2A-V	6059
TMP116L^S4A-C	460/1/60	6142	157	71			TMP116L^S4A-V	6892
TMP116L^S5A-C	575/1/60	6265	157	71				
TMP116L^S6A-C	200-220/1/50	5684	157	71	TMP116L^S6A-T	6011	TMP116L^S6A-V	6059
TMP116L^S9A-C	380-400/1/50	6142	157	71			TMP116L^S9A-V	6892
TMP119L^S2A-C	208-230/1/60	6817	164	75	TMP119L^S2A-T	7143	TMP119L^S2A-V	7192
TMP119L^S4A-C	460/1/60	7366	164	75			TMP119L^S4A-V	8116
TMP119L^S5A-C	575/1/60	7513	164	75				
TMP119L^S6A-C	200-220/1/50	6817	164	75	TMP119L^S6A-T	7143	TMP119L^S6A-V	7192
TMP119L^S9A-C	380-400/1/50	7366	164	75			TMP119L^S9A-V	8116
TMP225L^S2A-C	208-230/1/60	9352	230	105	TMP225L^S2A-T	10005	TMP225L^S2A-V	10102
TMP225L^S4A-C	460/1/60	9901	230	105			TMP225L^S4A-V	11400
TMP225L^S5A-C	575/1/60	10098	230	105				
TMP225L^S6A-C	200-220/1/50	9352	230	105	TMP225L^S6A-T	10005	TMP225L^S6A-V	10102
TMP225L^S9A-C	380-400/1/50	9901	230	105			TMP225L^S9A-V	11400
TMP232L^S2A-C	208-230/1/60	10102	245	112	TMP232L^S2A-T	10755	TMP232L^S2A-V	10852
TMP232L^S4A-C	460/1/60	10926	245	112			TMP232L^S4A-V	12426
TMP232L^S5A-C	575/1/60	11145	245	112				
TMP232L^S6A-C	200-220/1/50	10102	245	112	TMP232L^S6A-T	10755	TMP232L^S6A-V	10852
TMP232L^S9A-C	380-400/1/50	10926	245	112			TMP232L^S9A-V	12426
TMP240L^S2A-C	208-230/1/60	12397	261	119	TMP240L^S2A-T	13050	TMP240L^S2A-V	13147
TMP240L^S4A-C	460/1/60	13236	261	119			TMP240L^S4A-V	14736
TMP240L^S5A-C	575/1/60	13502	261	119				
TMP240L^S6A-C	200-220/1/50	12397	261	119	TMP240L^S6A-T	13050	TMP240L^S6A-V	13147
TMP240L^S9A-C	380-400/1/50	13236	261	119			TMP240L^S9A-V	14736
TMP348L^S2A-C	208-230/1/60	13487	335	152	TMP348L^S2A-T	14466	TMP348L^S2A-V	14612
TMP348L^S4A-C	460/1/60	14580	335	152			TMP348L^S4A-V	16830
TMP348L^S5A-C	575/1/60	14874	335	152				
TMP348L^S6A-C	200-220/1/50	13487	335	152	TMP348L^S6A-T	14466	TMP348L^S6A-V	14612
TMP348L^S9A-C	380-400/1/50	14580	335	152			TMP348L^S9A-V	16830
TMP356L^S2A-C	208-230/1/60	15293	360	164	TMP356L^S2A-T	16272	TMP356L^S2A-V	16417
TMP356L^S4A-C	460/1/60	16390	360	164			TMP356L^S4A-V	18640
TMP356L^S5A-C	575/1/60	16719	360	164				
TMP356L^S6A-C	200-220/1/50	15293	360	164	TMP356L^S6A-T	16272	TMP356L^S6A-V	16417
TMP356L^S9A-C	380-400/1/50	16390	360	164			TMP356L^S9A-V	18640

Continues on next page >>>



2021 Refrigeration Products Price List

TLP-C-2020-3 - EFFECTIVE DATE: 01 OCT 2021 - SUPERCEDES: TLP-C-2020-2



TMP-LINE, MEDIUM PROFILE EVAPORATORS (cont'd)

LOW TEMP 6 FPI - HOT GAS DEFROST (cont'd)

^ Insert appropriate code for hot gas defrost type

PSC MOTORS			WEIGHT		EC MOTORS - SMARTSPEED™		EC MOTORS - VARIABLE SPEED	
MODEL	VOLTAGE	\$	lbs.	kg	MODEL	\$	MODEL	\$
TMP471L [^] -S2A-C	208-230/1/60	20459	423	192	TMP471L [^] -S2A-T	21764	TMP471L [^] -S2A-V	21958
TMP471L [^] -S4A-C	460/1/60	20840	423	192			TMP471L [^] -S4A-V	23839
TMP471L [^] -S5A-C	575/1/60	21257	423	192				
TMP471L [^] -S6A-C	200-220/1/50	20459	423	192	TMP471L [^] -S6A-T	21764	TMP471L [^] -S6A-V	21958
TMP471L [^] -S9A-C	380-400/1/50	20840	423	192			TMP471L [^] -S9A-V	23839

LOW TEMP 4 FPI - HOT GAS DEFROST

^ Insert appropriate code for hot gas defrost type

PSC MOTORS			WEIGHT		EC MOTORS - SMARTSPEED™		EC MOTORS - VARIABLE SPEED	
MODEL	VOLTAGE	\$	lbs.	kg	MODEL	\$	MODEL	\$
TMP113V [^] -S2A-C	208-230/1/60	5288	153	70	TMP113VH-S2A-T	5589	TMP113VH-S2A-V	5638
TMP113V [^] -S4A-C	460/1/60	5724	153	70			TMP113VH-S4A-V	6447
TMP113V [^] -S5A-C	575/1/60	5839	153	70				
TMP113V [^] -S6A-C	200-220/1/50	5288	153	70	TMP113VH-S6A-T	5589	TMP113VH-S6A-V	5638
TMP113V [^] -S9A-C	380-400/1/50	5724	153	70			TMP113VH-S9A-V	6447
TMP117V [^] -S2A-C	208-230/1/60	6742	160	73	TMP117VH-S2A-T	7036	TMP117VH-S2A-V	7085
TMP117V [^] -S4A-C	460/1/60	7298	160	73			TMP117VH-S4A-V	8013
TMP117V [^] -S5A-C	575/1/60	7444	160	73				
TMP117V [^] -S6A-C	200-220/1/50	6742	160	73	TMP117VH-S6A-T	7036	TMP117VH-S6A-V	7085
TMP117V [^] -S9A-C	380-400/1/50	7298	160	73			TMP117VH-S9A-V	8013
TMP222V [^] -S2A-C	208-230/1/60	9209	226	103	TMP222VH-S2A-T	9818	TMP222VH-S2A-V	9915
TMP222V [^] -S4A-C	460/1/60	9769	226	103			TMP222VH-S4A-V	11222
TMP222V [^] -S5A-C	575/1/60	9965	226	103				
TMP222V [^] -S6A-C	200-220/1/50	9209	226	103	TMP222VH-S6A-T	9818	TMP222VH-S6A-V	9915
TMP222V [^] -S9A-C	380-400/1/50	9769	226	103			TMP222VH-S9A-V	11222
TMP228V [^] -S2A-C	208-230/1/60	10102	238	108	TMP228VH-S2A-T	11387	TMP228VH-S2A-V	11484
TMP228V [^] -S4A-C	460/1/60	10926	238	108			TMP228VH-S4A-V	13066
TMP228V [^] -S5A-C	575/1/60	11145	238	108				
TMP228V [^] -S6A-C	200-220/1/50	10102	238	108	TMP228VH-S6A-T	11387	TMP228VH-S6A-V	11484
TMP228V [^] -S9A-C	380-400/1/50	10926	238	108			TMP228VH-S9A-V	13066
TMP234V [^] -S2A-C	208-230/1/60	12262	252	114	TMP234VH-S2A-T	12857	TMP234VH-S2A-V	12954
TMP234V [^] -S4A-C	460/1/60	13127	252	114			TMP234VH-S4A-V	14564
TMP234V [^] -S5A-C	575/1/60	13388	252	114				
TMP234V [^] -S6A-C	200-220/1/50	12262	252	114	TMP234VH-S6A-T	12857	TMP234VH-S6A-V	12954
TMP234V [^] -S9A-C	380-400/1/50	13127	252	114			TMP234VH-S9A-V	14564
TMP339V [^] -S2A-C	208-230/1/60	13487	329	150	TMP339VH-S2A-T	14424	TMP339VH-S2A-V	14569
TMP339V [^] -S4A-C	460/1/60	14580	329	150			TMP339VH-S4A-V	16825
TMP339V [^] -S5A-C	575/1/60	14874	329	150				
TMP339V [^] -S6A-C	200-220/1/50	13487	329	150	TMP339VH-S6A-T	14424	TMP339VH-S6A-V	14569
TMP339V [^] -S9A-C	380-400/1/50	14580	329	150			TMP339VH-S9A-V	16825
TMP350V [^] -S2A-C	208-230/1/60	15293	346	157	TMP350VH-S2A-T	16872	TMP350VH-S2A-V	17018
TMP350V [^] -S4A-C	460/1/60	16390	346	157			TMP350VH-S4A-V	18970
TMP350V [^] -S5A-C	575/1/60	16719	346	157				
TMP350V [^] -S6A-C	200-220/1/50	15293	346	157	TMP350VH-S6A-T	16872	TMP350VH-S6A-V	17018
TMP350V [^] -S9A-C	380-400/1/50	16390	346	157			TMP350VH-S9A-V	18970
TMP459V [^] -S2A-C	208-230/1/60	17900	406	185	TMP459VH-S2A-T	19206	TMP459VH-S2A-V	19400
TMP459V [^] -S4A-C	460/1/60	18477	406	185			TMP459VH-S4A-V	21476
TMP459V [^] -S5A-C	575/1/60	18846	406	185				
TMP459V [^] -S6A-C	200-220/1/50	17900	406	185	TMP459VH-S6A-T	19206	TMP459VH-S6A-V	19400
TMP459V [^] -S9A-C	380-400/1/50	18477	406	185			TMP459VH-S9A-V	21476

NOTES:

- Fixed defrost termination is a standard feature. Optional adjustable defrost termination available.
- Electric heater in drain pan is standard. OPTIONAL HOT GAS LOOP IN DRAIN PAN:
1 FAN = \$553, 2 FAN = \$671, 3 FAN = \$806, 4 FAN = \$948
- For approx. shipping weights for hot gas loop in drain pan models, refer to installation bulletin T30-TMP-PDI
- All hot gas evaps include TXV bypass check valve shipped loose.



2021 Refrigeration Products Price List

TLP-C-2020-3 - EFFECTIVE DATE: 01 OCT 2021 - SUPERCEDES: TLP-C-2020-2



TMP-LINE, MEDIUM PROFILE EVAPORATORS (cont'd) OPTIONAL HOT GAS KITS

FOR 3-PIPE UNITS WITH ELECTRIC DRAIN PAN HEATER

OPT1-T: TXV + BYPASS CHECK VALVE KIT

INCLUDES QTY. ONE BYPASS CHECK VALVE
+ TXV FACTORY INSTALLED

MODEL	LIST
1 FAN UNITS	970
2 FAN UNITS	1244
3 FAN UNITS	1359
4 FAN UNITS	1455

FOR REVERSE CYCLE UNITS WITH ELECTRIC DRAIN PAN HEATER

OPT1-G: TXV + BYPASS CHECK VALVE KIT

INCLUDES QTY. ONE TXV, BYPASS CHECK VALVE
AND BYPASS PIPING

MODEL	LIST
1 FAN UNITS	1021
2 FAN UNITS	1310
3 FAN UNITS	1431
4 FAN UNITS	1532

FOR 3-PIPE UNITS WITH HOT GAS LOOP

OPT1-H: TXV + BYPASS CHECK VALVE KIT

INCLUDES QTY. ONE TXV, BYPASS CHECK VALVE AND
PIPING FROM DRAIN LOOP TO CHECKVALVE

MODEL	LIST
1 FAN UNITS	1104
2 FAN UNITS	1378
3 FAN UNITS	1528
4 FAN UNITS	1623

Kit does not include Hot Gas Loop option price.

FOR REVERSE CYCLE UNITS WITH HOT GAS LOOP

OPT1-R: TXV + BYPASS CHECK VALVE KIT

INCLUDES QTY. ONE TXV, BYPASS CHECK VALVE AND BYPASS PIPING
PIPING FROM DRAIN LOOP TO CHECKVALVE

OPT2-R: DRAIN PAN LOOP CHECK VALVE AND SUCTION LINE CHECK VALVE KIT

INCLUDES QTY. ONE DRAIN PAN CHECK VALVE, QTY. ONE
SUCTION LINE CHECK VALVE AND CONNECTED PIPING

MODEL	TXV BY-PASS CHECK VALVE KIT	DRAIN PAN + SUCTION LINE CHECK VALVE KIT
1 FAN UNITS	1021	2721
2 FAN UNITS	1310	2989
3 FAN UNITS	1431	3085
4 FAN UNITS	1532	3215

Kit does not include Hot Gas Loop option price.



2021 Refrigeration Products Price List

TLP-C-2020-3 - EFFECTIVE DATE: 01 OCT 2021 - SUPERCEDES: TLP-C-2020-2



TEP-LINE, EXTENDED PROFILE EVAPORATORS

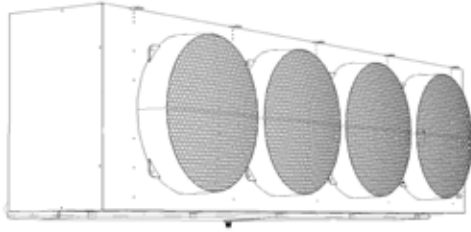

web: www.t-rp.com/tep
email: evaps@t-rp.com
call: 1-844-893-3222 x520

SMARTSPEED™
FAN MOTOR TECHNOLOGY

AVAILABLE WITH OPTIONAL EC MOTORS

ESP+

see page 49 for details

NOMENCLATURE

TEP 115 M A - S2 A - T

Extended Profile Evaporator

Nominal Capacity:

x 1000 @ 10°F TD, Btu/H (R404A)

Application Range:

H = High Temp 7 FPI (25°F + Evap Temp)

M = Medium Temp 6 FPI (10°F to 35°F Evap Temp)

L = Low Temp 6 FPI (-40°F to 0°F Evap Temp)

V = Low Temp 4 FPI (-40°F to 0°F Evap Temp)

W = Fluid Air Cooler (with water or glycol)

Motor:

C = PSC Motors

T = SmartSpeed ECM

V = Variable Speed EC Motors (Requires a Controller)

Generation: A = 1st

Voltage:

S2 = 208-230/1/60

S4 = 460/1/60

S5 = 575/1/60

T3 = 208-230/3/60

T4 = 460/3/60

T5 = 575/3/60

Defrost:

A = Air

E = Electric

T = 3 Pipe Hot Gas w/ Electric Heater Pan

or Warm Fluid w/ Electric Heater Pan for Fluid Air Coolers

H = 3 Pipe Hot Gas w/ Hot Gas Loop Pan

G = Reverse Cycle w/ Electric Heater Pan

R = Reverse Cycle w/ Hot Gas Loop Pan

STANDARD FEATURES

- Compatible with Low GWP Refrigerants
- Totally enclosed high efficiency PSC motors
- High efficiency and high strength fan guard
- Hinged access panels
- Internally enhanced tubing
- Ample electrical and header compartments
- Adjustable Fan Delay on Electric Defrost units
- Liquid line solenoid valve wire harness factory installed
- Schrader valve on suction header
- Positive slope, hinged drain pan
- Central drain connections (approximate)
- Universal drain fitting
- Large 3/4" ID (3/4" MPT) drain hole
- Factory installed distributor nozzle

AVAILABLE OPTIONS

- EC motors with patented SmartSpeed® Technology.
- **ESP+ Intuitive Evaporator Control Technology.**
- Hot gas loop pan with hot gas defrost models
- 230/460V Variable Speed EC Motors
- Wire fan guard
- Factory installed expansion valve (TXV + EEV), solenoid valve and room thermostat
- Corrosion protection: alternate fin material and coatings
- Additional options available, please contact factory



2021 Refrigeration Products Price List

TLP-C-2020-3 - EFFECTIVE DATE: 01 OCT 2021 - SUPERCEDES: TLP-C-2020-2



TEP-LINE, EXTENDED PROFILE EVAPORATORS (cont'd)

HIGH TEMP - AIR DEFROST

PSC MOTORS			WEIGHT		EC MOTORS - SMARTSPEED		EC MOTORS - VARIABLE SPEED	
MODEL	VOLTAGE	\$	lbs.	kg	MODEL	\$	MODEL	\$
TEP028HA-S2A-C	208-230/1/60	9357	200	91	TEP028HA-S2A-T	9884	TEP028HA-S2A-V	9984
TEP028HA-S4A-C	460/1/60	9918	200	91			TEP028HA-S4A-V	10952
TEP028HA-S5A-C	575/1/60	10105	200	91				
TEP028HA-S6A-C	200-220/1/50	9357	200	91	TEP028HA-S6A-T	9884	TEP028HA-S6A-V	9984
TEP028HA-S9A-C	380-400/1/50	9918	200	91			TEP028HA-S9A-V	10952
TEP033HA-S2A-C	208-230/1/60	9782	210	95	TEP033HA-S2A-T	10310	TEP033HA-S2A-V	10409
TEP033HA-S4A-C	460/1/60	10369	210	95			TEP033HA-S4A-V	11403
TEP033HA-S5A-C	575/1/60	10565	210	95				
TEP033HA-S6A-C	200-220/1/50	9782	210	95	TEP033HA-S6A-T	10310	TEP033HA-S6A-V	10409
TEP033HA-S9A-C	380-400/1/50	10369	210	95			TEP033HA-S9A-V	11403
TEP043HA-S2A-C	208-230/1/60	12074	290	132	TEP043HA-S2A-T	13129	TEP043HA-S2A-V	13328
TEP043HA-S4A-C	460/1/60	12798	290	132			TEP043HA-S4A-V	14867
TEP043HA-S5A-C	575/1/60	13040	290	132				
TEP043HA-S6A-C	200-220/1/50	12074	290	132	TEP043HA-S6A-T	13129	TEP043HA-S6A-V	13328
TEP043HA-S9A-C	380-400/1/50	12798	290	132			TEP043HA-S9A-V	14867
TEP056HA-S2A-C	208-230/1/60	13196	310	141	TEP056HA-S2A-T	14251	TEP056HA-S2A-V	14450
TEP056HA-S4A-C	460/1/60	13988	310	141			TEP056HA-S4A-V	16056
TEP056HA-S5A-C	575/1/60	14252	310	141				
TEP056HA-S6A-C	200-220/1/50	13196	310	141	TEP056HA-S6A-T	14251	TEP056HA-S6A-V	14450
TEP056HA-S9A-C	380-400/1/50	13988	310	141			TEP056HA-S9A-V	16056
TEP065HA-S2A-C	208-230/1/60	14050	330	150	TEP065HA-S2A-T	15105	TEP065HA-S2A-V	15304
TEP065HA-S4A-C	460/1/60	14893	330	150			TEP065HA-S4A-V	16962
TEP065HA-S5A-C	575/1/60	15174	330	150				
TEP065HA-S6A-C	200-220/1/50	14050	330	150	TEP065HA-S6A-T	15105	TEP065HA-S6A-V	15304
TEP065HA-S9A-C	380-400/1/50	14893	330	150			TEP065HA-S9A-V	16962
TEP084HA-S2A-C	208-230/1/60	17924	425	193	TEP084HA-S2A-T	19507	TEP084HA-S2A-V	19806
TEP084HA-T3A-C	208-230/3/60	17924	425	193				
TEP084HA-S4A-C	460/1/60	19000	425	193			TEP084HA-S4A-V	22103
TEP084HA-S5A-C	575/1/60	19358	425	193				
TEP084HA-S6A-C	200-220/1/50	17924	425	193	TEP084HA-S6A-T	19507	TEP084HA-S6A-V	19806
TEP084HA-S9A-C	380-400/1/50	19000	425	193			TEP084HA-S9A-V	22103
TEP098HA-S2A-C	208-230/1/60	21045	455	207	TEP098HA-S2A-T	22628	TEP098HA-S2A-V	22926
TEP098HA-T3A-C	208-230/3/60	21045	455	207				
TEP098HA-S4A-C	460/1/60	22307	455	207			TEP098HA-S4A-V	25410
TEP098HA-S5A-C	575/1/60	22728	455	207				
TEP098HA-S6A-C	200-220/1/50	21045	455	207	TEP098HA-S6A-T	22628	TEP098HA-S6A-V	22926
TEP098HA-S9A-C	380-400/1/50	22307	455	207			TEP098HA-S9A-V	25410
TEP124HA-S2A-C	208-230/1/60	22945	565	257	TEP124HA-S2A-T	25055	TEP124HA-S2A-V	25453
TEP124HA-T3A-C	208-230/3/60	22945	565	257				
TEP124HA-S4A-C	460/1/60	24321	565	257			TEP124HA-S4A-V	28458
TEP124HA-S5A-C	575/1/60	24780	565	257				
TEP124HA-S6A-C	200-220/1/50	22945	565	257	TEP124HA-S6A-T	25055	TEP124HA-S6A-V	25453
TEP124HA-S9A-C	380-400/1/50	24321	565	257			TEP124HA-S9A-V	28458



2021 Refrigeration Products Price List

TLP-C-2020-3 - EFFECTIVE DATE: 01 OCT 2021 - SUPERCEDES: TLP-C-2020-2



TEP-LINE, EXTENDED PROFILE EVAPORATORS (cont'd)

MEDIUM TEMP - AIR DEFROST

PSC MOTORS			WEIGHT		EC MOTORS - SMARTSPEED™		EC MOTORS - VARIABLE SPEED	
MODEL	VOLTAGE	\$	lbs.	kg	MODEL	\$	MODEL	\$
TEP026MA-S2A-C	208-230/1/60	8911	210	95	TEP026MA-S2A-T	9439	TEP026MA-S2A-V	9538
TEP026MA-S4A-C	460/1/60	9446	210	95			TEP026MA-S4A-V	10480
TEP026MA-S5A-C	575/1/60	9624	210	95				
TEP026MA-S6A-C	200-220/1/50	8911	210	95	TEP026MA-S6A-T	9439	TEP026MA-S6A-V	9538
TEP026MA-S9A-C	380-400/1/50	9446	210	95			TEP026MA-S9A-V	10480
TEP031MA-S2A-C	208-230/1/60	9316	220	100	TEP031MA-S2A-T	9844	TEP031MA-S2A-V	9943
TEP031MA-S4A-C	460/1/60	9875	220	100			TEP031MA-S4A-V	10909
TEP031MA-S5A-C	575/1/60	10061	220	100				
TEP031MA-S6A-C	200-220/1/50	9316	220	100	TEP031MA-S6A-T	9844	TEP031MA-S6A-V	9943
TEP031MA-S9A-C	380-400/1/50	9875	220	100			TEP031MA-S9A-V	10909
TEP038MA-S2A-C	208-230/1/60	11499	315	143	TEP038MA-S2A-T	12554	TEP038MA-S2A-V	12753
TEP038MA-S4A-C	460/1/60	12189	315	143			TEP038MA-S4A-V	14257
TEP038MA-S5A-C	575/1/60	12419	315	143				
TEP038MA-S6A-C	200-220/1/50	11499	315	143	TEP038MA-S6A-T	12554	TEP038MA-S6A-V	12753
TEP038MA-S9A-C	380-400/1/50	12189	315	143			TEP038MA-S9A-V	14257
TEP052MA-S2A-C	208-230/1/60	12568	335	152	TEP052MA-S2A-T	13623	TEP052MA-S2A-V	13822
TEP052MA-S4A-C	460/1/60	13322	335	152			TEP052MA-S4A-V	15390
TEP052MA-S5A-C	575/1/60	13573	335	152				
TEP052MA-S6A-C	200-220/1/50	12568	335	152	TEP052MA-S6A-T	13623	TEP052MA-S6A-V	13822
TEP052MA-S9A-C	380-400/1/50	13322	335	152			TEP052MA-S9A-V	15390
TEP062MA-S2A-C	208-230/1/60	14050	350	159	TEP062MA-S2A-T	15105	TEP062MA-S2A-V	15304
TEP062MA-S4A-C	460/1/60	14893	350	159			TEP062MA-S4A-V	16962
TEP062MA-S5A-C	575/1/60	15174	350	159				
TEP062MA-S6A-C	200-220/1/50	14050	350	159	TEP062MA-S6A-T	15105	TEP062MA-S6A-V	15304
TEP062MA-S9A-C	380-400/1/50	14893	350	159			TEP062MA-S9A-V	16962
TEP079MA-S2A-C	208-230/1/60	17071	455	207	TEP079MA-S2A-T	18654	TEP079MA-S2A-V	18952
TEP079MA-T3A-C	208-230/3/60	17071	455	207				
TEP079MA-S4A-C	460/1/60	18095	455	207			TEP079MA-S4A-V	21198
TEP079MA-S5A-C	575/1/60	18436	455	207				
TEP079MA-S6A-C	200-220/1/50	17071	455	207	TEP079MA-S6A-T	18654	TEP079MA-S6A-V	18952
TEP079MA-S9A-C	380-400/1/50	18095	455	207			TEP079MA-S9A-V	21198
TEP093MA-S2A-C	208-230/1/60	20043	485	220	TEP093MA-S2A-T	21626	TEP093MA-S2A-V	21924
TEP093MA-T3A-C	208-230/3/60	20043	485	220				
TEP093MA-S4A-C	460/1/60	21245	485	220			TEP093MA-S4A-V	24348
TEP093MA-S5A-C	575/1/60	21646	485	220				
TEP093MA-S6A-C	200-220/1/50	20043	485	220	TEP093MA-S6A-T	21626	TEP093MA-S6A-V	21924
TEP093MA-S9A-C	380-400/1/50	21245	485	220			TEP093MA-S9A-V	24348
TEP115MA-S2A-C	208-230/1/60	21852	600	273	TEP115MA-S2A-T	23963	TEP115MA-S2A-V	24360
TEP115MA-T3A-C	208-230/3/60	21852	600	273				
TEP115MA-S4A-C	460/1/60	23163	600	273			TEP115MA-S4A-V	27300
TEP115MA-S5A-C	575/1/60	23600	600	273				
TEP115MA-S6A-C	200-220/1/50	21852	600	273	TEP115MA-S6A-T	23963	TEP115MA-S6A-V	24360
TEP115MA-S9A-C	380-400/1/50	23163	600	273			TEP115MA-S9A-V	27300



2021 Refrigeration Products Price List

TLP-C-2020-3 - EFFECTIVE DATE: 01 OCT 2021 - SUPERCEDES: TLP-C-2020-2



TEP-LINE, EXTENDED PROFILE EVAPORATORS (cont'd)

MEDIUM TEMP - ELECTRIC DEFROST

PSC MOTORS			WEIGHT		EC MOTORS - SMARTSPEED		EC MOTORS - VARIABLE SPEED	
MODEL	VOLTAGE	\$	lbs.	kg	MODEL	\$	MODEL	\$
TEP026ME-S2A-C	208-230/1/60	10159	210	95	TEP026ME-S2A-T	10687	TEP026ME-S2A-V	10786
TEP026ME-S4A-C	460/1/60	10769	210	95			TEP026ME-S4A-V	11803
TEP026ME-S5A-C	575/1/60	10972	210	95				
TEP026ME-S6A-C	200-220/1/50	10159	210	95	TEP026ME-S6A-T	10687	TEP026ME-S6A-V	10786
TEP026ME-S9A-C	380-400/1/50	10769	210	95			TEP026ME-S9A-V	11803
TEP026ME-T3A-C	208-230/3/60	10159	210	95	TEP026ME-T3A-T	10687	TEP026ME-T3A-V	10786
TEP026ME-T4A-C	460/3/60	10769	210	95			TEP026ME-T4A-V	11803
TEP026ME-T5A-C	575/3/60	10972	210	95				
TEP026ME-T7A-C	200-220/3/50	10159	210	95	TEP026ME-T7A-T	10687	TEP026ME-T7A-V	10786
TEP026ME-T9A-C	380-400/3/50	10769	210	95			TEP026ME-T9A-V	11803
TEP031ME-S2A-C	208-230/1/60	11127	220	100	TEP031ME-S2A-T	11654	TEP031ME-S2A-V	11754
TEP031ME-S4A-C	460/1/60	11794	220	100			TEP031ME-S4A-V	12829
TEP031ME-S5A-C	575/1/60	12017	220	100				
TEP031ME-S6A-C	200-220/1/50	11127	220	100	TEP031ME-S6A-T	11654	TEP031ME-S6A-V	11754
TEP031ME-S9A-C	380-400/1/50	11794	220	100			TEP031ME-S9A-V	12829
TEP031ME-T3A-C	208-230/3/60	11127	220	100	TEP031ME-T3A-T	11654	TEP031ME-T3A-V	11754
TEP031ME-T4A-C	460/3/60	11794	220	100			TEP031ME-T4A-V	12829
TEP031ME-T5A-C	575/3/60	12017	220	100				
TEP031ME-T7A-C	200-220/3/50	11127	220	100	TEP031ME-T7A-T	11654	TEP031ME-T7A-V	11754
TEP031ME-T9A-C	380-400/3/50	11794	220	100			TEP031ME-T9A-V	12829
TEP038ME-S2A-C	208-230/1/60	12852	315	143	TEP038ME-S2A-T	13907	TEP038ME-S2A-V	14106
TEP038ME-S4A-C	460/1/60	13623	315	143			TEP038ME-S4A-V	15691
TEP038ME-S5A-C	575/1/60	13880	315	143				
TEP038ME-S6A-C	200-220/1/50	12852	315	143	TEP038ME-S6A-T	13907	TEP038ME-S6A-V	14106
TEP038ME-S9A-C	380-400/1/50	13623	315	143			TEP038ME-S9A-V	15691
TEP038ME-T3A-C	208-230/3/60	12852	315	143	TEP038ME-T3A-T	13907	TEP038ME-T3A-V	14106
TEP038ME-T4A-C	460/3/60	13623	315	143			TEP038ME-T4A-V	15691
TEP038ME-T5A-C	575/3/60	13880	315	143				
TEP038ME-T7A-C	200-220/3/50	12852	315	143	TEP038ME-T7A-T	13907	TEP038ME-T7A-V	14106
TEP038ME-T9A-C	380-400/3/50	13623	315	143			TEP038ME-T9A-V	15691
TEP052ME-S2A-C	208-230/1/60	14705	335	152	TEP052ME-S2A-T	15760	TEP052ME-S2A-V	15959
TEP052ME-S4A-C	460/1/60	15587	335	152			TEP052ME-S4A-V	17656
TEP052ME-S5A-C	575/1/60	15882	335	152				
TEP052ME-S6A-C	200-220/1/50	14705	335	152	TEP052ME-S6A-T	15760	TEP052ME-S6A-V	15959
TEP052ME-S9A-C	380-400/1/50	15587	335	152			TEP052ME-S9A-V	17656
TEP052ME-T3A-C	208-230/3/60	14705	335	152	TEP052ME-T3A-T	15760	TEP052ME-T3A-V	15959
TEP052ME-T4A-C	460/3/60	15587	335	152			TEP052ME-T4A-V	17656
TEP052ME-T5A-C	575/3/60	15882	335	152				
TEP052ME-T7A-C	200-220/3/50	14705	335	152	TEP052ME-T7A-T	15760	TEP052ME-T7A-V	15959
TEP052ME-T9A-C	380-400/3/50	15587	335	152			TEP052ME-T9A-V	17656
TEP062ME-S2A-C	208-230/1/60	16826	350	159	TEP062ME-S2A-T	17881	TEP062ME-S2A-V	18080
TEP062ME-S4A-C	460/1/60	17836	350	159			TEP062ME-S4A-V	19904
TEP062ME-S5A-C	575/1/60	18172	350	159				
TEP062ME-S6A-C	200-220/1/50	16826	350	159	TEP062ME-S6A-T	17881	TEP062ME-S6A-V	18080
TEP062ME-S9A-C	380-400/1/50	17836	350	159			TEP062ME-S9A-V	19904
TEP062ME-T3A-C	208-230/3/60	16826	350	159	TEP062ME-T3A-T	17881	TEP062ME-T3A-V	18080
TEP062ME-T4A-C	460/3/60	17836	350	159			TEP062ME-T4A-V	19904
TEP062ME-T5A-C	575/3/60	18172	350	159				
TEP062ME-T7A-C	200-220/3/50	16826	350	159	TEP062ME-T7A-T	17881	TEP062ME-T7A-V	18080
TEP062ME-T9A-C	380-400/3/50	17836	350	159			TEP062ME-T9A-V	19904
TEP079ME-S2A-C	208-230/1/60	22016	455	207	TEP079ME-S2A-T	23598	TEP079ME-S2A-V	23897
TEP079ME-S4A-C	460/1/60	23336	455	207			TEP079ME-S4A-V	26439
TEP079ME-S5A-C	575/1/60	23777	455	207				
TEP079ME-S6A-C	200-220/1/50	22016	455	207	TEP079ME-S6A-T	23598	TEP079ME-S6A-V	23897
TEP079ME-S9A-C	380-400/1/50	23336	455	207			TEP079ME-S9A-V	26439
TEP079ME-T3A-C	208-230/3/60	22016	455	207	TEP079ME-T3A-T	23598	TEP079ME-T3A-V	23897
TEP079ME-T4A-C	460/3/60	23336	455	207			TEP079ME-T4A-V	26439
TEP079ME-T5A-C	575/3/60	23777	455	207				
TEP079ME-T7A-C	200-220/3/50	22016	455	207	TEP079ME-T7A-T	23598	TEP079ME-T7A-V	23897
TEP079ME-T9A-C	380-400/3/50	23336	455	207			TEP079ME-T9A-V	26439

Continues on next page >>>



2021 Refrigeration Products Price List

TLP-C-2020-3 - EFFECTIVE DATE: 01 OCT 2021 - SUPERCEDES: TLP-C-2020-2



TEP-LINE, EXTENDED PROFILE EVAPORATORS (cont'd)

MEDIUM TEMP - ELECTRIC DEFROST (cont'd)

PSC MOTORS			WEIGHT		EC MOTORS - SMARTSPEED		EC MOTORS - VARIABLE SPEED	
MODEL	VOLTAGE	\$	lbs.	kg	MODEL	\$	MODEL	\$
TEP093ME-S2A-C	208-230/1/60	26748	485	220	TEP093ME-S2A-T	28331	TEP093ME-S2A-V	28629
TEP093ME-S4A-C	460/1/60	28353	485	220			TEP093ME-S4A-V	31456
TEP093ME-S5A-C	575/1/60	28888	485	220				
TEP093ME-S6A-C	200-220/1/50	26748	485	220	TEP093ME-S6A-T	28331	TEP093ME-S6A-V	28629
TEP093ME-S9A-C	380-400/1/50	28353	485	220			TEP093ME-S9A-V	31456
TEP093ME-T3A-C	208-230/3/60	26748	485	220	TEP093ME-T3A-T	28331	TEP093ME-T3A-V	28629
TEP093ME-T4A-C	460/3/60	28353	485	220			TEP093ME-T4A-V	31456
TEP093ME-T5A-C	575/3/60	28888	485	220				
TEP093ME-T7A-C	200-220/3/50	26748	485	220	TEP093ME-T7A-T	28331	TEP093ME-T7A-V	28629
TEP093ME-T9A-C	380-400/3/50	28353	485	220			TEP093ME-T9A-V	31456
TEP115ME-S2A-C	208-230/1/60	29738	600	273	TEP115ME-S2A-T	31849	TEP115ME-S2A-V	32247
TEP115ME-S4A-C	460/1/60	31523	600	273			TEP115ME-S4A-V	35660
TEP115ME-S5A-C	575/1/60	32117	600	273				
TEP115ME-S6A-C	200-220/1/50	29738	600	273	TEP115ME-S6A-T	31849	TEP115ME-S6A-V	32247
TEP115ME-S9A-C	380-400/1/50	31523	600	273			TEP115ME-S9A-V	35660
TEP115ME-T3A-C	208-230/3/60	29738	600	273	TEP115ME-T3A-T	31849	TEP115ME-T3A-V	32247
TEP115ME-T4A-C	460/3/60	31523	600	273			TEP115ME-T4A-V	35660
TEP115ME-T5A-C	575/3/60	32117	600	273				
TEP115ME-T7A-C	200-220/3/50	29738	600	273	TEP115ME-T7A-T	31849	TEP115ME-T7A-V	32247
TEP115ME-T9A-C	380-400/3/50	31523	600	273			TEP115ME-T9A-V	35660

LOW TEMP 6 FPI - ELECTRIC DEFROST

PSC MOTORS			WEIGHT		EC MOTORS - SMARTSPEED		EC MOTORS - VARIABLE SPEED	
MODEL	VOLTAGE	\$	lbs.	kg	MODEL	\$	MODEL	\$
TEP023LE-S2A-C	208-230/1/60	10159	215	98	TEP023LE-S2A-T	10687	TEP023LE-S2A-V	10786
TEP023LE-S4A-C	460/1/60	10769	215	98			TEP023LE-S4A-V	11803
TEP023LE-S5A-C	575/1/60	10972	215	98				
TEP023LE-S6A-C	200-220/1/50	10159	215	98	TEP023LE-S6A-T	10687	TEP023LE-S6A-V	10786
TEP023LE-S9A-C	380-400/1/50	10769	215	98			TEP023LE-S9A-V	11803
TEP023LE-T3A-C	208-230/3/60	10159	215	98	TEP023LE-T3A-T	10687	TEP023LE-T3A-V	10786
TEP023LE-T4A-C	460/3/60	10769	215	98			TEP023LE-T4A-V	11803
TEP023LE-T5A-C	575/3/60	10972	215	98				
TEP023LE-T7A-C	200-220/3/50	10159	215	98	TEP023LE-T7A-T	10687	TEP023LE-T7A-V	10786
TEP023LE-T9A-C	380-400/3/50	10769	215	98			TEP023LE-T9A-V	11803
TEP028LE-S2A-C	208-230/1/60	11127	220	100	TEP028LE-S2A-T	11654	TEP028LE-S2A-V	11754
TEP028LE-S4A-C	460/1/60	11794	220	100			TEP028LE-S4A-V	12829
TEP028LE-S5A-C	575/1/60	12017	220	100				
TEP028LE-S6A-C	200-220/1/50	11127	220	100	TEP028LE-S6A-T	11654	TEP028LE-S6A-V	11754
TEP028LE-S9A-C	380-400/1/50	11794	220	100			TEP028LE-S9A-V	12829
TEP028LE-T3A-C	208-230/3/60	11127	220	100	TEP028LE-T3A-T	11654	TEP028LE-T3A-V	11754
TEP028LE-T4A-C	460/3/60	11794	220	100			TEP028LE-T4A-V	12829
TEP028LE-T5A-C	575/3/60	12017	220	100				
TEP028LE-T7A-C	200-220/3/50	11127	220	100	TEP028LE-T7A-T	11654	TEP028LE-T7A-V	11754
TEP028LE-T9A-C	380-400/3/50	11794	220	100			TEP028LE-T9A-V	12829
TEP035LE-S2A-C	208-230/1/60	12852	315	143	TEP035LE-S2A-T	13907	TEP035LE-S2A-V	14106
TEP035LE-S4A-C	460/1/60	13623	315	143			TEP035LE-S4A-V	15691
TEP035LE-S5A-C	575/1/60	13880	315	143				
TEP035LE-S6A-C	200-220/1/50	12852	315	143	TEP035LE-S6A-T	13907	TEP035LE-S6A-V	14106
TEP035LE-S9A-C	380-400/1/50	13623	315	143			TEP035LE-S9A-V	15691
TEP035LE-T3A-C	208-230/3/60	11900	315	143	TEP035LE-T3A-T	12877	TEP035LE-T3A-V	13061
TEP035LE-T4A-C	460/3/60	12614	315	143			TEP035LE-T4A-V	14529
TEP035LE-T5A-C	575/3/60	12852	315	143				
TEP035LE-T7A-C	200-220/3/50	11900	315	143	TEP035LE-T7A-T	12877	TEP035LE-T7A-V	13061
TEP035LE-T9A-C	380-400/3/50	12614	315	143			TEP035LE-T9A-V	14529

Continues on next page >>>



2021 Refrigeration Products Price List

TLP-C-2020-3 - EFFECTIVE DATE: 01 OCT 2021 - SUPERCEDES: TLP-C-2020-2



TEP-LINE, EXTENDED PROFILE EVAPORATORS (cont'd)

LOW TEMP 6 FPI - ELECTRIC DEFROST (cont'd)

PSC MOTORS			WEIGHT		EC MOTORS - SMARTSPEED [®]		EC MOTORS - VARIABLE SPEED	
MODEL	VOLTAGE	\$	lbs.	kg	MODEL	\$	MODEL	\$
TEP047LE-S2A-C	208-230/1/60	14705	335	152	TEP047LE-S2A-T	15760	TEP047LE-S2A-V	15959
TEP047LE-S4A-C	460/1/60	15587	335	152			TEP047LE-S4A-V	17656
TEP047LE-S5A-C	575/1/60	15882	335	152				
TEP047LE-S6A-C	200-220/1/50	14705	335	152	TEP047LE-S6A-T	15760	TEP047LE-S6A-V	15959
TEP047LE-S9A-C	380-400/1/50	15587	335	152			TEP047LE-S9A-V	17656
TEP047LE-T3A-C	208-230/3/60	14705	335	152	TEP047LE-T3A-T	15760	TEP047LE-T3A-V	15959
TEP047LE-T4A-C	460/3/60	15587	335	152			TEP047LE-T4A-V	17656
TEP047LE-T5A-C	575/3/60	15882	335	152				
TEP047LE-T7A-C	200-220/3/50	14705	335	152	TEP047LE-T7A-T	15760	TEP047LE-T7A-V	15959
TEP047LE-T9A-C	380-400/3/50	15587	335	152			TEP047LE-T9A-V	17656
TEP056LE-S2A-C	208-230/1/60	16826	355	161	TEP056LE-S2A-T	17881	TEP056LE-S2A-V	18080
TEP056LE-S4A-C	460/1/60	17836	355	161			TEP056LE-S4A-V	19904
TEP056LE-S5A-C	575/1/60	18172	355	161				
TEP056LE-S6A-C	200-220/1/50	16826	355	161	TEP056LE-S6A-T	17881	TEP056LE-S6A-V	18080
TEP056LE-S9A-C	380-400/1/50	17836	355	161			TEP056LE-S9A-V	19904
TEP056LE-T3A-C	208-230/3/60	16826	355	161	TEP056LE-T3A-T	17881	TEP056LE-T3A-V	18080
TEP056LE-T4A-C	460/3/60	17836	355	161			TEP056LE-T4A-V	19904
TEP056LE-T5A-C	575/3/60	18172	355	161				
TEP056LE-T7A-C	200-220/3/50	16826	355	161	TEP056LE-T7A-T	17881	TEP056LE-T7A-V	18080
TEP056LE-T9A-C	380-400/3/50	17836	355	161			TEP056LE-T9A-V	19904
TEP070LE-S2A-C	208-230/1/60	22016	460	209	TEP070LE-S2A-T	23598	TEP070LE-S2A-V	23897
TEP070LE-S4A-C	460/1/60	23336	460	209			TEP070LE-S4A-V	26439
TEP070LE-S5A-C	575/1/60	23777	460	209				
TEP070LE-S6A-C	200-220/1/50	22016	460	209	TEP070LE-S6A-T	23598	TEP070LE-S6A-V	23897
TEP070LE-S9A-C	380-400/1/50	23336	460	209			TEP070LE-S9A-V	26439
TEP070LE-T3A-C	208-230/3/60	22016	460	209	TEP070LE-T3A-T	23598	TEP070LE-T3A-V	23897
TEP070LE-T4A-C	460/3/60	23336	460	209			TEP070LE-T4A-V	26439
TEP070LE-T5A-C	575/3/60	23777	460	209				
TEP070LE-T7A-C	200-220/3/50	22016	460	209	TEP070LE-T7A-T	23598	TEP070LE-T7A-V	23897
TEP070LE-T9A-C	380-400/3/50	23336	460	209			TEP070LE-T9A-V	26439
TEP084LE-S2A-C	208-230/1/60	26748	490	223	TEP084LE-S2A-T	28331	TEP084LE-S2A-V	28629
TEP084LE-S4A-C	460/1/60	28353	490	223			TEP084LE-S4A-V	31456
TEP084LE-S5A-C	575/1/60	28888	490	223				
TEP084LE-S6A-C	200-220/1/50	26748	490	223	TEP084LE-S6A-T	28331	TEP084LE-S6A-V	28629
TEP084LE-S9A-C	380-400/1/50	28353	490	223			TEP084LE-S9A-V	31456
TEP084LE-T3A-C	208-230/3/60	26748	490	223	TEP084LE-T3A-T	28331	TEP084LE-T3A-V	28629
TEP084LE-T4A-C	460/3/60	28353	490	223			TEP084LE-T4A-V	31456
TEP084LE-T5A-C	575/3/60	28888	490	223				
TEP084LE-T7A-C	200-220/3/50	26748	490	223	TEP084LE-T7A-T	28331	TEP084LE-T7A-V	28629
TEP084LE-T9A-C	380-400/3/50	28353	490	223			TEP084LE-T9A-V	31456
TEP100LE-S2A-C	208-230/1/60	29738	575	261	TEP100LE-S2A-T	31849	TEP100LE-S2A-V	32247
TEP100LE-S4A-C	460/1/60	31523	575	261			TEP100LE-S4A-V	35660
TEP100LE-S5A-C	575/1/60	32117	575	261				
TEP100LE-S6A-C	200-220/1/50	29738	575	261	TEP100LE-S6A-T	31849	TEP100LE-S6A-V	32247
TEP100LE-S9A-C	380-400/1/50	31523	575	261			TEP100LE-S9A-V	35660
TEP100LE-T3A-C	208-230/3/60	29738	575	261	TEP100LE-T3A-T	31849	TEP100LE-T3A-V	32247
TEP100LE-T4A-C	460/3/60	31523	575	261			TEP100LE-T4A-V	35660
TEP100LE-T5A-C	575/3/60	32117	575	261				
TEP100LE-T7A-C	200-220/3/50	29738	575	261	TEP100LE-T7A-T	31849	TEP100LE-T7A-V	32247
TEP100LE-T9A-C	380-400/3/50	31523	575	261			TEP100LE-T9A-V	35660



2021 Refrigeration Products Price List

TLP-C-2020-3 - EFFECTIVE DATE: 01 OCT 2021 - SUPERCEDES: TLP-C-2020-2



TEP-LINE, EXTENDED PROFILE EVAPORATORS (cont'd)

LOW TEMP 4 FPI - ELECTRIC DEFROST

PSC MOTORS			WEIGHT		EC MOTORS - SMARTSPEED		EC MOTORS - VARIABLE SPEED	
MODEL	VOLTAGE	\$	lbs.	kg	MODEL	\$	MODEL	\$
TEP020VE-S2A-C	208-230/1/60	10702	210	95	TEP020VE-S2A-T	11230	TEP020VE-S2A-V	11329
TEP020VE-S4A-C	460/1/60	11344	210	95			TEP020VE-S4A-V	12379
TEP020VE-S5A-C	575/1/60	11558	210	95				
TEP020VE-S6A-C	200-220/1/50	10702	210	95	TEP020VE-S6A-T	11230	TEP020VE-S6A-V	11329
TEP020VE-S9A-C	380-400/1/50	11344	210	95			TEP020VE-S9A-V	12379
TEP020VE-T3A-C	208-230/3/60	10702	210	95	TEP020VE-T3A-T	11230	TEP020VE-T3A-V	11329
TEP020VE-T4A-C	460/3/60	11344	210	95			TEP020VE-T4A-V	12379
TEP020VE-T5A-C	575/3/60	11558	210	95				
TEP020VE-T7A-C	200-220/3/50	10702	210	95	TEP020VE-T7A-T	11230	TEP020VE-T7A-V	11329
TEP020VE-T9A-C	380-400/3/50	11344	210	95			TEP020VE-T9A-V	12379
TEP024VE-S2A-C	208-230/1/60	11795	215	98	TEP024VE-S2A-T	12322	TEP024VE-S2A-V	12422
TEP024VE-S4A-C	460/1/60	12502	215	98			TEP024VE-S4A-V	13537
TEP024VE-S5A-C	575/1/60	12738	215	98				
TEP024VE-S6A-C	200-220/1/50	11795	215	98	TEP024VE-S6A-T	12322	TEP024VE-S6A-V	12422
TEP024VE-S9A-C	380-400/1/50	12502	215	98			TEP024VE-S9A-V	13537
TEP024VE-T3A-C	208-230/3/60	11795	215	98	TEP024VE-T3A-T	12322	TEP024VE-T3A-V	12422
TEP024VE-T4A-C	460/3/60	12502	215	98			TEP024VE-T4A-V	13537
TEP024VE-T5A-C	575/3/60	12738	215	98				
TEP024VE-T7A-C	200-220/3/50	11795	215	98	TEP024VE-T7A-T	12322	TEP024VE-T7A-V	12422
TEP024VE-T9A-C	380-400/3/50	12502	215	98			TEP024VE-T9A-V	13537
TEP030VE-S2A-C	208-230/1/60	12611	310	141	TEP030VE-S2A-T	13667	TEP030VE-S2A-V	13866
TEP030VE-S4A-C	460/1/60	13368	310	141			TEP030VE-S4A-V	15437
TEP030VE-S5A-C	575/1/60	13620	310	141				
TEP030VE-S6A-C	200-220/1/50	12611	310	141	TEP030VE-S6A-T	13667	TEP030VE-S6A-V	13866
TEP030VE-S9A-C	380-400/1/50	13368	310	141			TEP030VE-S9A-V	15437
TEP030VE-T3A-C	208-230/3/60	12611	310	141	TEP030VE-T3A-T	13667	TEP030VE-T3A-V	13866
TEP030VE-T4A-C	460/3/60	13368	310	141			TEP030VE-T4A-V	15437
TEP030VE-T5A-C	575/3/60	13620	310	141				
TEP030VE-T7A-C	200-220/3/50	12611	310	141	TEP030VE-T7A-T	13667	TEP030VE-T7A-V	13866
TEP030VE-T9A-C	380-400/3/50	13368	310	141			TEP030VE-T9A-V	15437
TEP040VE-S2A-C	208-230/1/60	13701	325	148	TEP040VE-S2A-T	14756	TEP040VE-S2A-V	14955
TEP040VE-S4A-C	460/1/60	14523	325	148			TEP040VE-S4A-V	16592
TEP040VE-S5A-C	575/1/60	14797	325	148				
TEP040VE-S6A-C	200-220/1/50	13701	325	148	TEP040VE-S6A-T	14756	TEP040VE-S6A-V	14955
TEP040VE-S9A-C	380-400/1/50	14523	325	148			TEP040VE-S9A-V	16592
TEP040VE-T3A-C	208-230/3/60	13701	325	148	TEP040VE-T3A-T	14756	TEP040VE-T3A-V	14955
TEP040VE-T4A-C	460/3/60	14523	325	148			TEP040VE-T4A-V	16592
TEP040VE-T5A-C	575/3/60	14797	325	148				
TEP040VE-T7A-C	200-220/3/50	13701	325	148	TEP040VE-T7A-T	14756	TEP040VE-T7A-V	14955
TEP040VE-T9A-C	380-400/3/50	14523	325	148			TEP040VE-T9A-V	16592
TEP048VE-S2A-C	208-230/1/60	16676	340	155	TEP048VE-S2A-T	17731	TEP048VE-S2A-V	17930
TEP048VE-S4A-C	460/1/60	17677	340	155			TEP048VE-S4A-V	19745
TEP048VE-S5A-C	575/1/60	18010	340	155				
TEP048VE-S6A-C	200-220/1/50	16676	340	155	TEP048VE-S6A-T	17731	TEP048VE-S6A-V	17930
TEP048VE-S9A-C	380-400/1/50	17677	340	155			TEP048VE-S9A-V	19745
TEP048VE-T3A-C	208-230/3/60	16676	340	155	TEP048VE-T3A-T	17731	TEP048VE-T3A-V	17930
TEP048VE-T4A-C	460/3/60	17677	340	155			TEP048VE-T4A-V	19745
TEP048VE-T5A-C	575/3/60	18010	340	155				
TEP048VE-T7A-C	200-220/3/50	16676	340	155	TEP048VE-T7A-T	17731	TEP048VE-T7A-V	17930
TEP048VE-T9A-C	380-400/3/50	17677	340	155			TEP048VE-T9A-V	19745

Continues on next page >>>



2021 Refrigeration Products Price List

TLP-C-2020-3 - EFFECTIVE DATE: 01 OCT 2021 - SUPERCEDES: TLP-C-2020-2



TEP-LINE, EXTENDED PROFILE EVAPORATORS (cont'd)

LOW TEMP 4 FPI - ELECTRIC DEFROST (cont'd)

PSC MOTORS			WEIGHT		EC MOTORS - SMARTSPEED		EC MOTORS - VARIABLE SPEED	
MODEL	VOLTAGE	\$	lbs.	kg	MODEL	\$	MODEL	\$
TEP060VE-S2A-C	208-230/1/60	20142	450	205	TEP060VE-S2A-T	21724	TEP060VE-S2A-V	22023
TEP060VE-S4A-C	460/1/60	21350	450	205			TEP060VE-S4A-V	24453
TEP060VE-S5A-C	575/1/60	21753	450	205				
TEP060VE-S6A-C	200-220/1/50	20142	450	205	TEP060VE-S6A-T	21724	TEP060VE-S6A-V	22023
TEP060VE-S9A-C	380-400/1/50	21350	450	205			TEP060VE-S9A-V	24453
TEP060VE-T3A-C	208-230/3/60	20142	450	205	TEP060VE-T3A-T	21724	TEP060VE-T3A-V	22023
TEP060VE-T4A-C	460/3/60	21350	450	205			TEP060VE-T4A-V	24453
TEP060VE-T5A-C	575/3/60	21753	450	205				
TEP060VE-T7A-C	200-220/3/50	20142	450	205	TEP060VE-T7A-T	21724	TEP060VE-T7A-V	22023
TEP060VE-T9A-C	380-400/3/50	21350	450	205			TEP060VE-T9A-V	24453
TEP072VE-S2A-C	208-230/1/60	22016	470	214	TEP072VE-S2A-T	23598	TEP072VE-S2A-V	23897
TEP072VE-S4A-C	460/1/60	23336	470	214			TEP072VE-S4A-V	26439
TEP072VE-S5A-C	575/1/60	23777	470	214				
TEP072VE-S6A-C	200-220/1/50	22016	470	214	TEP072VE-S6A-T	23598	TEP072VE-S6A-V	23897
TEP072VE-S9A-C	380-400/1/50	23336	470	214			TEP072VE-S9A-V	26439
TEP072VE-T3A-C	208-230/3/60	22016	470	214	TEP072VE-T3A-T	23598	TEP072VE-T3A-V	23897
TEP072VE-T4A-C	460/3/60	23336	470	214			TEP072VE-T4A-V	26439
TEP072VE-T5A-C	575/3/60	23777	470	214				
TEP072VE-T7A-C	200-220/3/50	22016	470	214	TEP072VE-T7A-T	23598	TEP072VE-T7A-V	23897
TEP072VE-T9A-C	380-400/3/50	23336	470	214			TEP072VE-T9A-V	26439
TEP088VE-S2A-C	208-230/1/60	29407	555	252	TEP088VE-S2A-T	31518	TEP088VE-S2A-V	31915
TEP088VE-S4A-C	460/1/60	31172	555	252			TEP088VE-S4A-V	35309
TEP088VE-S5A-C	575/1/60	31760	555	252				
TEP088VE-S6A-C	200-220/1/50	29407	555	252	TEP088VE-S6A-T	31518	TEP088VE-S6A-V	31915
TEP088VE-S9A-C	380-400/1/50	31172	555	252			TEP088VE-S9A-V	35309
TEP088VE-T3A-C	208-230/3/60	29407	555	252	TEP088VE-T3A-T	31518	TEP088VE-T3A-V	31915
TEP088VE-T4A-C	460/3/60	31172	555	252			TEP088VE-T4A-V	35309
TEP088VE-T5A-C	575/3/60	31760	555	252				
TEP088VE-T7A-C	200-220/3/50	29407	555	252	TEP088VE-T7A-T	31518	TEP088VE-T7A-V	31915
TEP088VE-T9A-C	380-400/3/50	31172	555	252			TEP088VE-T9A-V	35309



2021 Refrigeration Products Price List

TLP-C-2020-3 - EFFECTIVE DATE: 01 OCT 2021 - SUPERCEDES: TLP-C-2020-2



TEP-LINE, EXTENDED PROFILE EVAPORATORS (cont'd)

MEDIUM TEMP - HOT GAS DEFROST

^ Insert appropriate code for hot gas defrost type

PSC MOTORS			WEIGHT		EC MOTORS - SMARTSPEED		EC MOTORS - VARIABLE SPEED	
MODEL	VOLTAGE	\$	lbs.	kg	MODEL	\$	MODEL	\$
TEP026M^S2A-C	208-230/1/60	10159	205	93	TEP026M^S2A-T	10687	TEP026M^S2A-V	10786
TEP026M^S4A-C	460/1/60	10769	205	93			TEP026M^S4A-V	11803
TEP026M^S5A-C	575/1/60	10972	205	93				
TEP026M^S6A-C	200-220/1/50	10159	205	93	TEP026M^S6A-T	10687	TEP026M^S6A-V	10786
TEP026M^S9A-C	380-400/1/50	10769	205	93			TEP026M^S9A-V	11803
TEP031M^S2A-C	208-230/1/60	11127	215	98	TEP031M^S2A-T	11654	TEP031M^S2A-V	11754
TEP031M^S4A-C	460/1/60	11794	215	98			TEP031M^S4A-V	12829
TEP031M^S5A-C	575/1/60	12017	215	98				
TEP031M^S6A-C	200-220/1/50	11127	215	98	TEP031M^S6A-T	11654	TEP031M^S6A-V	11754
TEP031M^S9A-C	380-400/1/50	11794	215	98			TEP031M^S9A-V	12829
TEP038M^S2A-C	208-230/1/60	12852	295	134	TEP038M^S2A-T	13907	TEP038M^S2A-V	14106
TEP038M^S4A-C	460/1/60	13623	295	134			TEP038M^S4A-V	15691
TEP038M^S5A-C	575/1/60	13880	295	134				
TEP038M^S6A-C	200-220/1/50	12852	295	134	TEP038M^S6A-T	13907	TEP038M^S6A-V	14106
TEP038M^S9A-C	380-400/1/50	13623	295	134			TEP038M^S9A-V	15691
TEP052M^S2A-C	208-230/1/60	14705	315	143	TEP052M^S2A-T	15760	TEP052M^S2A-V	15959
TEP052M^S4A-C	460/1/60	15587	315	143			TEP052M^S4A-V	17656
TEP052M^S5A-C	575/1/60	15882	315	143				
TEP052M^S6A-C	200-220/1/50	14705	315	143	TEP052M^S6A-T	15760	TEP052M^S6A-V	15959
TEP052M^S9A-C	380-400/1/50	15587	315	143			TEP052M^S9A-V	17656
TEP062M^S2A-C	208-230/1/60	16826	335	152	TEP062M^S2A-T	17881	TEP062M^S2A-V	18080
TEP062M^S4A-C	460/1/60	17836	335	152			TEP062M^S4A-V	19904
TEP062M^S5A-C	575/1/60	18172	335	152				
TEP062M^S6A-C	200-220/1/50	16826	335	152	TEP062M^S6A-T	17881	TEP062M^S6A-V	18080
TEP062M^S9A-C	380-400/1/50	17836	335	152			TEP062M^S9A-V	19904
TEP079M^S2A-C	208-230/1/60	22016	430	195	TEP079M^S2A-T	23598	TEP079M^S2A-V	23897
TEP079M^S4A-C	460/1/60	23336	430	195			TEP079M^S4A-V	26439
TEP079M^S5A-C	575/1/60	23777	430	195				
TEP079M^S6A-C	200-220/1/50	22016	430	195	TEP079M^S6A-T	23598	TEP079M^S6A-V	23897
TEP079M^S9A-C	380-400/1/50	23336	430	195			TEP079M^S9A-V	26439
TEP093M^S2A-C	208-230/1/60	26748	460	209	TEP093M^S2A-T	28331	TEP093M^S2A-V	28629
TEP093M^S4A-C	460/1/60	28353	460	209			TEP093M^S4A-V	31456
TEP093M^S5A-C	575/1/60	28888	460	209				
TEP093M^S6A-C	200-220/1/50	26748	460	209	TEP093M^S6A-T	28331	TEP093M^S6A-V	28629
TEP093M^S9A-C	380-400/1/50	28353	460	209			TEP093M^S9A-V	31456
TEP115M^S2A-C	208-230/1/60	29738	545	248	TEP115M^S2A-T	31849	TEP115M^S2A-V	32247
TEP115M^S4A-C	460/1/60	31523	545	248			TEP115M^S4A-V	35660
TEP115M^S5A-C	575/1/60	32117	545	248				
TEP115M^S6A-C	200-220/1/50	29738	545	248	TEP115M^S6A-T	31849	TEP115M^S6A-V	32247
TEP115M^S9A-C	380-400/1/50	31523	545	248			TEP115M^S9A-V	35660

NOTES:

- Fixed defrost termination is a standard feature. Optional adjustable defrost termination available.
- Electric heater in drain pan is standard. OPTIONAL HOT GAS LOOP IN DRAIN PAN:
1 FAN = \$553, 2 FAN = \$671, 3 FAN = \$806, 4 FAN = \$948
- For approx. shipping weights for hot gas loop in drain pan models, refer to installation bulletin T30-TEP-PDI
- All hot gas evaps include TXV bypass check valve shipped loose.



2021 Refrigeration Products Price List

TLP-C-2020-3 - EFFECTIVE DATE: 01 OCT 2021 - SUPERCEDES: TLP-C-2020-2



TEP-LINE, EXTENDED PROFILE EVAPORATORS (cont'd)

LOW TEMP 6 FPI - HOT GAS DEFROST

^ Insert appropriate code for hot gas defrost type

PSC MOTORS			WEIGHT		EC MOTORS - SMARTSPEED		EC MOTORS - VARIABLE SPEED	
MODEL	VOLTAGE	\$	lbs.	kg	MODEL	\$	MODEL	\$
TEP023L^S2A-C	208-230/1/60	10159	205	93	TEP023L^S2A-T	10687	TEP023L^S2A-V	10786
TEP023L^S4A-C	460/1/60	10769	205	93			TEP023L^S4A-V	11803
TEP023L^S5A-C	575/1/60	10972	205	93				
TEP023L^S6A-C	200-220/1/50	10159	205	93	TEP023L^S6A-T	10687	TEP023L^S6A-V	10786
TEP023L^S9A-C	380-400/1/50	10769	205	93			TEP023L^S9A-V	11803
TEP028L^S2A-C	208-230/1/60	11127	215	98	TEP028L^S2A-T	11654	TEP028L^S2A-V	11754
TEP028L^S4A-C	460/1/60	11794	215	98			TEP028L^S4A-V	12829
TEP028L^S5A-C	575/1/60	12017	215	98				
TEP028L^S6A-C	200-220/1/50	11127	215	98	TEP028L^S6A-T	11654	TEP028L^S6A-V	11754
TEP028L^S9A-C	380-400/1/50	11794	215	98			TEP028L^S9A-V	12829
TEP035L^S2A-C	208-230/1/60	12852	300	136	TEP035L^S2A-T	13907	TEP035L^S2A-V	14106
TEP035L^S4A-C	460/1/60	13623	300	136			TEP035L^S4A-V	15691
TEP035L^S5A-C	575/1/60	13880	300	136				
TEP035L^S6A-C	200-220/1/50	12852	300	136	TEP035L^S6A-T	13907	TEP035L^S6A-V	14106
TEP035L^S9A-C	380-400/1/50	13623	300	136			TEP035L^S9A-V	15691
TEP047L^S2A-C	208-230/1/60	14705	320	145	TEP047L^S2A-T	15760	TEP047L^S2A-V	15959
TEP047L^S4A-C	460/1/60	15587	320	145			TEP047L^S4A-V	17656
TEP047L^S5A-C	575/1/60	15882	320	145				
TEP047L^S6A-C	200-220/1/50	14705	320	145	TEP047L^S6A-T	15760	TEP047L^S6A-V	15959
TEP047L^S9A-C	380-400/1/50	15587	320	145			TEP047L^S9A-V	17656
TEP056L^S2A-C	208-230/1/60	16826	340	155	TEP056L^S2A-T	17881	TEP056L^S2A-V	18080
TEP056L^S4A-C	460/1/60	17836	340	155			TEP056L^S4A-V	19904
TEP056L^S5A-C	575/1/60	18172	340	155				
TEP056L^S6A-C	200-220/1/50	16826	340	155	TEP056L^S6A-T	17881	TEP056L^S6A-V	18080
TEP056L^S9A-C	380-400/1/50	17836	340	155			TEP056L^S9A-V	19904
TEP070L^S2A-C	208-230/1/60	22016	435	198	TEP070L^S2A-T	23598	TEP070L^S2A-V	23897
TEP070L^S4A-C	460/1/60	23336	435	198			TEP070L^S4A-V	26439
TEP070L^S5A-C	575/1/60	23777	435	198				
TEP070L^S6A-C	200-220/1/50	22016	435	198	TEP070L^S6A-T	23598	TEP070L^S6A-V	23897
TEP070L^S9A-C	380-400/1/50	23336	435	198			TEP070L^S9A-V	26439
TEP084L^S2A-C	208-230/1/60	26748	470	214	TEP084L^S2A-T	28331	TEP084L^S2A-V	28629
TEP084L^S4A-C	460/1/60	28353	470	214			TEP084L^S4A-V	31456
TEP084L^S5A-C	575/1/60	28888	470	214				
TEP084L^S6A-C	200-220/1/50	26748	470	214	TEP084L^S6A-T	28331	TEP084L^S6A-V	28629
TEP084L^S9A-C	380-400/1/50	28353	470	214			TEP084L^S9A-V	31456
TEP100L^S2A-C	208-230/1/60	29738	550	250	TEP100L^S2A-T	31849	TEP100L^S2A-V	32247
TEP100L^S4A-C	460/1/60	31523	550	250			TEP100L^S4A-V	35660
TEP100L^S5A-C	575/1/60	32117	550	250				
TEP100L^S6A-C	200-220/1/50	29738	550	250	TEP100L^S6A-T	31849	TEP100L^S6A-V	32247
TEP100L^S9A-C	380-400/1/50	31523	550	250			TEP100L^S9A-V	35660

NOTES:

- Fixed defrost termination is a standard feature. Optional adjustable defrost termination available.
- Electric heater in drain pan is standard. OPTIONAL HOT GAS LOOP IN DRAIN PAN:
1 FAN = \$553, 2 FAN = \$671, 3 FAN = \$806, 4 FAN = \$948
- For approx. shipping weights for hot gas loop in drain pan models, refer to installation bulletin T30-TEP-PDI
- All hot gas evaps include TXV bypass check valve shipped loose.



2021 Refrigeration Products Price List

TLP-C-2020-3 - EFFECTIVE DATE: 01 OCT 2021 - SUPERCEDES: TLP-C-2020-2



TEP-LINE, EXTENDED PROFILE EVAPORATORS (cont'd)

LOW TEMP 4 FPI - HOT GAS DEFROST

^ Insert appropriate code for hot gas defrost type

PSC MOTORS			WEIGHT		EC MOTORS - SMARTSPEED™		EC MOTORS - VARIABLE SPEED	
MODEL	VOLTAGE	\$	lbs.	kg	MODEL	\$	MODEL	\$
TEP020V^S2A-C	208-230/1/60	10702	200	91	TEP020V^S2A-T	11230	TEP020V^S2A-V	11329
TEP020V^S4A-C	460/1/60	11344	200	91			TEP020V^S4A-V	12379
TEP020V^S5A-C	575/1/60	11558	200	91				
TEP020V^S6A-C	200-220/1/50	10702	200	91	TEP020V^S6A-T	11230	TEP020V^S6A-V	11329
TEP020V^S9A-C	380-400/1/50	11344	200	91			TEP020V^S9A-V	12379
TEP024V^S2A-C	208-230/1/60	11795	210	95	TEP024V^S2A-T	12322	TEP024V^S2A-V	12422
TEP024V^S4A-C	460/1/60	12502	210	95			TEP024V^S4A-V	13537
TEP024V^S5A-C	575/1/60	12738	210	95				
TEP024V^S6A-C	200-220/1/50	11795	210	95	TEP024V^S6A-T	12322	TEP024V^S6A-V	12422
TEP024V^S9A-C	380-400/1/50	12502	210	95			TEP024V^S9A-V	13537
TEP030V^S2A-C	208-230/1/60	12611	395	180	TEP030VH^S2A-T	13667	TEP030V^S2A-V	13866
TEP030V^S4A-C	460/1/60	13368	395	180			TEP030V^S4A-V	15437
TEP030V^S5A-C	575/1/60	13620	395	180				
TEP030V^S6A-C	200-220/1/50	12611	395	180	TEP030V^S2A-T	13667	TEP030V^S6A-V	13866
TEP030V^S9A-C	380-400/1/50	13368	395	180			TEP030V^S9A-V	15437
TEP040V^S2A-C	208-230/1/60	13701	310	141	TEP040V^S2A-T	14756	TEP040V^S2A-V	14955
TEP040V^S4A-C	460/1/60	14523	310	141			TEP040V^S4A-V	16592
TEP040V^S5A-C	575/1/60	14797	310	141				
TEP040V^S6A-C	200-220/1/50	13701	310	141	TEP040V^S6A-T	14756	TEP040V^S6A-V	14955
TEP040V^S9A-C	380-400/1/50	14523	310	141			TEP040V^S9A-V	16592
TEP048V^S2A-C	208-230/1/60	16676	330	150	TEP048V^S2A-T	17731	TEP048V^S2A-V	17930
TEP048V^S4A-C	460/1/60	17677	330	150			TEP048V^S4A-V	19745
TEP048V^S5A-C	575/1/60	18010	330	150				
TEP048V^S6A-C	200-220/1/50	16676	330	150	TEP048V^S6A-T	17731	TEP048V^S6A-V	17930
TEP048V^S9A-C	380-400/1/50	17677	330	150			TEP048V^S9A-V	19745
TEP060V^S2A-C	208-230/1/60	20142	430	195	TEP060V^S2A-T	21724	TEP060V^S2A-V	22023
TEP060V^S4A-C	460/1/60	21350	430	195			TEP060V^S4A-V	24453
TEP060V^S5A-C	575/1/60	21753	430	195				
TEP060V^S6A-C	200-220/1/50	20142	430	195	TEP060V^S6A-T	21724	TEP060V^S6A-V	22023
TEP060V^S9A-C	380-400/1/50	21350	430	195			TEP060V^S9A-V	24453
TEP072V^S2A-C	208-230/1/60	22016	450	205	TEP072V^S2A-T	23598	TEP072V^S2A-V	23897
TEP072V^S4A-C	460/1/60	23336	450	205			TEP072V^S4A-V	26439
TEP072V^S5A-C	575/1/60	23777	450	205				
TEP072V^S6A-C	200-220/1/50	22016	450	205	TEP072V^S6A-T	23598	TEP072V^S6A-V	23897
TEP072V^S9A-C	380-400/1/50	23336	450	205			TEP072V^S9A-V	26439
TEP088V^S2A-C	208-230/1/60	29407	530	241	TEP088V^S2A-T	31518	TEP088V^S2A-V	31915
TEP088V^S4A-C	460/1/60	31172	530	241			TEP088V^S4A-V	35309
TEP088V^S5A-C	575/1/60	31760	530	241				
TEP088V^S6A-C	200-220/1/50	29407	530	241	TEP088V^S6A-T	31518	TEP088V^S6A-V	31915
TEP088V^S9A-C	380-400/1/50	31172	530	241			TEP088V^S9A-V	35309

NOTES:

- Fixed defrost termination is a standard feature. Optional adjustable defrost termination available.
- Electric heater in drain pan is standard. OPTIONAL HOT GAS LOOP IN DRAIN PAN:
1 FAN = \$553, 2 FAN = \$671, 3 FAN = \$806, 4 FAN = \$948
- For approx. shipping weights for hot gas loop in drain pan models, refer to installation bulletin T30-TEP-PDI
- All hot gas evaps include TXV bypass check valve shipped loose.



2021 Refrigeration Products Price List

TLP-C-2020-3 - EFFECTIVE DATE: 01 OCT 2021 - SUPERCEDES: TLP-C-2020-2



THP-LINE, HIGH PROFILE EVAPORATORS

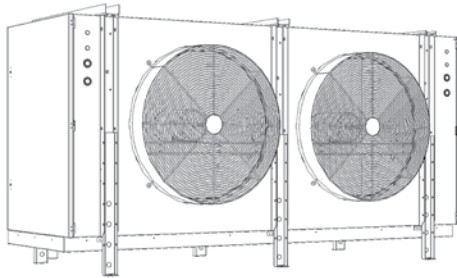

web: www.t-rp.com/thp
email: evaps@t-rp.com
call: 1-844-893-3222 x520



see page 49 for details

NOMENCLATURE

THP 216 L E - T5 A - S B

High Profile Evaporator

Nominal Capacity x 1000
(standard motor/fan blade)

Application Range

H = Hi / Medium Temp 7 FPI (0°F to 35°F Evap Temp)

M = Medium Temp 6 FPI (0°F to 35°F Evap Temp)

P = Medium Temp 4 FPI (0°F to 35°F Evap Temp)

L = Low Temp 6 FPI (-5°F to -40°F Evap Temp)

V = Low Temp 4 FPI (-5°F to -40°F Evap Temp)

Defrost

E = Electric

Throw Boosters:

N = None

B = Booster

Motor Option:

S = Standard

T = Totally Enclosed

M = EC Motor - Motor Only

V = High Velocity†

† Not available on above
+15°F Evap. Temp. models

Generation

A = 1st

Voltage:

T3 = 208-230/3/60*

T4 = 460/3/60

T5 = 575/3/60

T7 = 200-220/3/50

T9 = 380-400/3/50

* Not available on all models

STANDARD FEATURES

- Compatible with Low GWP Refrigerants
- Heavy gauge textured aluminum cabinet with galvanized steel hangers, support channels and end plates
- Hinged access panels with removable hinge pins and captive fasteners.
- Rugged heavy-gauge galvanized steel rail motor mount / support
- Stackable design
- Adjustable defrost termination thermostat
- Heater safety thermostat (on models with heaters)
- Drain pan heaters (standard on hot gas models)
- Fixed fan delay thermostat (all low temperature models)
- Adjustable fan delay thermostat (all medium temperature models)
- Schrader fitting and external equalizer line
- Factory installed solenoid valve wire harness
- Unit shipped upright for convenient handling and quick installation.

AVAILABLE OPTIONS

- Factory mounted TX valve, solenoid valve and thermostat
- Throw boosters
- Insulated drain pan
- 3 HP 1750 RPM motor with cast aluminum fan blade ideal for blast applications
- Hot gas drain pan loop (Hot gas models) fan blade ideal for blast applications
- **ESP+ Intuitive Evaporator Control Technology** (see page 49)
- EC motors available in two speed or variable speed (Title 24) operation, or controls by others
- Totally Enclosed motors
- Optional fin spacing
- Optional fin materials
- Optional coil coating



2021 Refrigeration Products Price List

TLP-C-2020-3 - EFFECTIVE DATE: 01 OCT 2021 - SUPERCEDES: TLP-C-2020-2



THP-LINE, HIGH PROFILE EVAPORATORS (cont'd)

HIGH TEMP - AIR DEFROST

ODP MOTORS			WEIGHT		TEFC MOTORS		EC MOTORS - VARIABLE SPEED	
MODEL	VOLTAGE	\$	lbs.	kg	MODEL	\$	MODEL	\$
THP073HA-T3A-SN	208-230/3/60	18950	660	300	THP073HA-T3A-TN	19512	THP073HA-T3A-MN	23440
THP073HA-T4A-SN	460/3/60	18950	660	300	THP073HA-T4A-TN	19512	THP073HA-T4A-MN	23440
THP073HA-T5A-SN	575/3/60	19329	660	300	THP073HA-T5A-TN	19891		
THP073HA-T7A-SN	200-220/3/50	18950	660	300	THP073HA-T7A-TN	19512	THP073HA-T7A-MN	23440
THP073HA-T9A-SN	380-400/3/50	18950	660	300	THP073HA-T9A-TN	19512	THP073HA-T9A-MN	23440
THP086HA-T3A-SN	208-230/3/60	21089	700	318	THP086HA-T3A-TN	21652	THP086HA-T3A-MN	25580
THP086HA-T4A-SN	460/3/60	21089	700	318	THP086HA-T4A-TN	21652	THP086HA-T4A-MN	25580
THP086HA-T5A-SN	575/3/60	21511	700	318	THP086HA-T5A-TN	22073		
THP086HA-T7A-SN	200-220/3/50	21089	700	318	THP086HA-T7A-TN	21652	THP086HA-T7A-MN	25580
THP086HA-T9A-SN	380-400/3/50	21089	700	318	THP086HA-T9A-TN	21652	THP086HA-T9A-MN	25580
THP113HA-T3A-SN	208-230/3/60	23470	790	359	THP113HA-T3A-TN	24032	THP113HA-T3A-MN	27960
THP113HA-T4A-SN	460/3/60	23470	790	359	THP113HA-T4A-TN	24032	THP113HA-T4A-MN	27960
THP113HA-T5A-SN	575/3/60	23939	790	359	THP113HA-T5A-TN	24502		
THP113HA-T7A-SN	200-220/3/50	23470	790	359	THP113HA-T7A-TN	24032	THP113HA-T7A-MN	27960
THP113HA-T9A-SN	380-400/3/50	23470	790	359	THP113HA-T9A-TN	24032	THP113HA-T9A-MN	27960
THP130HA-T3A-SN	208-230/3/60	28736	1010	459	THP130HA-T3A-TN	29580	THP130HA-T3A-MN	35472
THP130HA-T4A-SN	460/3/60	28736	1010	459	THP130HA-T4A-TN	29580	THP130HA-T4A-MN	35472
THP130HA-T5A-SN	575/3/60	29312	1010	459	THP130HA-T5A-TN	30155		
THP130HA-T7A-SN	200-220/3/50	28736	1010	459	THP130HA-T7A-TN	29580	THP130HA-T7A-MN	35472
THP130HA-T9A-SN	380-400/3/50	28736	1010	459	THP130HA-T9A-TN	29580	THP130HA-T9A-MN	35472
THP154HA-T3A-SN	208-230/3/60	30857	1080	491	THP154HA-T3A-TN	31701	THP154HA-T3A-MN	37593
THP154HA-T4A-SN	460/3/60	30857	1080	491	THP154HA-T4A-TN	31701	THP154HA-T4A-MN	37593
THP154HA-T5A-SN	575/3/60	31474	1080	491	THP154HA-T5A-TN	32318		
THP154HA-T7A-SN	200-220/3/50	30857	1080	491	THP154HA-T7A-TN	31701	THP154HA-T7A-MN	37593
THP154HA-T9A-SN	380-400/3/50	30857	1080	491	THP154HA-T9A-TN	31701	THP154HA-T9A-MN	37593
THP170HA-T3A-SN	208-230/3/60	33509	1140	518	THP170HA-T3A-TN	34352	THP170HA-T3A-MN	40245
THP170HA-T4A-SN	460/3/60	33509	1140	518	THP170HA-T4A-TN	34352	THP170HA-T4A-MN	40245
THP170HA-T5A-SN	575/3/60	34179	1140	518	THP170HA-T5A-TN	35023		
THP170HA-T7A-SN	200-220/3/50	33509	1140	518	THP170HA-T7A-TN	34352	THP170HA-T7A-MN	40245
THP170HA-T9A-SN	380-400/3/50	33509	1140	518	THP170HA-T9A-TN	34352	THP170HA-T9A-MN	40245
THP189HA-T3A-SN	208-230/3/60	37198	1220	555	THP189HA-T3A-TN	38042	THP189HA-T3A-MN	43934
THP189HA-T4A-SN	460/3/60	37198	1220	555	THP189HA-T4A-TN	38042	THP189HA-T4A-MN	43934
THP189HA-T5A-SN	575/3/60	37943	1220	555	THP189HA-T5A-TN	38786		
THP189HA-T7A-SN	200-220/3/50	37198	1220	555	THP189HA-T7A-TN	38042	THP189HA-T7A-MN	43934
THP189HA-T9A-SN	380-400/3/50	37198	1220	555	THP189HA-T9A-TN	38042	THP189HA-T9A-MN	43934
THP233HA-T3A-SN	208-230/3/60	42869	1500	682	THP233HA-T3A-TN	43993	THP233HA-T3A-MN	51850
THP233HA-T4A-SN	460/3/60	42869	1500	682	THP233HA-T4A-TN	43993	THP233HA-T4A-MN	51850
THP233HA-T5A-SN	575/3/60	43726	1500	682	THP233HA-T5A-TN	44850		
THP233HA-T7A-SN	200-220/3/50	42869	1500	682	THP233HA-T7A-TN	43993	THP233HA-T7A-MN	51850
THP233HA-T9A-SN	380-400/3/50	42869	1500	682	THP233HA-T9A-TN	43993	THP233HA-T9A-MN	51850
THP252HA-T3A-SN	208-230/3/60	45574	1600	727	THP252HA-T3A-TN	46699	THP252HA-T3A-MN	54555
THP252HA-T4A-SN	460/3/60	45574	1600	727	THP252HA-T4A-TN	46699	THP252HA-T4A-MN	54555
THP252HA-T5A-SN	575/3/60	46485	1600	727	THP252HA-T5A-TN	47610		
THP252HA-T7A-SN	200-220/3/50	45574	1600	727	THP252HA-T7A-TN	46699	THP252HA-T7A-MN	54555
THP252HA-T9A-SN	380-400/3/50	45574	1600	727	THP252HA-T9A-TN	46699	THP252HA-T9A-MN	54555
THP278HA-T3A-SN	208-230/3/60	48812	1810	823	THP278HA-T3A-TN	49937	THP278HA-T3A-MN	57794
THP278HA-T4A-SN	460/3/60	48812	1810	823	THP278HA-T4A-TN	49937	THP278HA-T4A-MN	57794
THP278HA-T5A-SN	575/3/60	49789	1810	823	THP278HA-T5A-TN	50913		
THP278HA-T7A-SN	200-220/3/50	48812	1810	823	THP278HA-T7A-TN	49937	THP278HA-T7A-MN	57794
THP278HA-T9A-SN	380-400/3/50	48812	1810	823	THP278HA-T9A-TN	49937	THP278HA-T9A-MN	57794



2021 Refrigeration Products Price List

TLP-C-2020-3 - EFFECTIVE DATE: 01 OCT 2021 - SUPERCEDES: TLP-C-2020-2



THP-LINE, HIGH PROFILE EVAPORATORS (cont'd)

MEDIUM TEMP - ELECTRIC DEFROST

ODP MOTORS			WEIGHT		TEFC MOTORS		EC MOTORS - VARIABLE SPEED	
MODEL	VOLTAGE	\$	lbs.	kg	MODEL	\$	MODEL	\$
THP068ME-T3A-SN	208-230/3/60	18805	650	295	THP068ME-T3A-VN	21453	THP068ME-T3A-MN	23296
THP068ME-T4A-SN	460/3/60	18805	650	295	THP068ME-T4A-VN	21453	THP068ME-T4A-MN	23296
THP068ME-T5A-SN	575/3/60	19181	650	295	THP068ME-T5A-VN	21829		
THP068ME-T7A-SN	200-220/3/50	18805	650	295	THP068ME-T7A-VN	21453	THP068ME-T7A-MN	23296
THP068ME-T9A-SN	380-400/3/50	18805	650	295	THP068ME-T9A-VN	21453	THP068ME-T9A-MN	23296
THP081ME-T3A-SN	208-230/3/60	24929	690	314	THP081ME-T3A-VN	27577	THP081ME-T3A-MN	29419
THP081ME-T4A-SN	460/3/60	24929	690	314	THP081ME-T4A-VN	27577	THP081ME-T4A-MN	29419
THP081ME-T5A-SN	575/3/60	25426	690	314	THP081ME-T5A-VN	28074		
THP081ME-T7A-SN	200-220/3/50	24929	690	314	THP081ME-T7A-VN	27577	THP081ME-T7A-MN	29419
THP081ME-T9A-SN	380-400/3/50	24929	690	314	THP081ME-T9A-VN	27577	THP081ME-T9A-MN	29419
THP092ME-T3A-SN	208-230/3/60	28062	730	332	THP092ME-T3A-VN	30710	THP092ME-T3A-MN	32553
THP092ME-T4A-SN	460/3/60	28062	730	332	THP092ME-T4A-VN	30710	THP092ME-T4A-MN	32553
THP092ME-T5A-SN	575/3/60	28623	730	332	THP092ME-T5A-VN	31271		
THP092ME-T7A-SN	200-220/3/50	28062	730	332	THP092ME-T7A-VN	30710	THP092ME-T7A-MN	32553
THP092ME-T9A-SN	380-400/3/50	28062	730	332	THP092ME-T9A-VN	30710	THP092ME-T9A-MN	32553
THP108ME-T3A-SN	208-230/3/60	29109	770	350	THP108ME-T3A-VN	31757	THP108ME-T3A-MN	33600
THP108ME-T4A-SN	460/3/60	29109	770	350	THP108ME-T4A-VN	31757	THP108ME-T4A-MN	33600
THP108ME-T5A-SN	575/3/60	29691	770	350	THP108ME-T5A-VN	32339		
THP108ME-T7A-SN	200-220/3/50	29109	770	350	THP108ME-T7A-VN	31757	THP108ME-T7A-MN	33600
THP108ME-T9A-SN	380-400/3/50	29109	770	350	THP108ME-T9A-VN	31757	THP108ME-T9A-MN	33600
THP123ME-T3A-SN	208-230/3/60	33931	990	450	THP123ME-T3A-VN	37903	THP123ME-T3A-MN	40667
THP123ME-T4A-SN	460/3/60	33931	990	450	THP123ME-T4A-VN	37903	THP123ME-T4A-MN	40667
THP123ME-T5A-SN	575/3/60	34609	990	450	THP123ME-T5A-VN	38581		
THP123ME-T7A-SN	200-220/3/50	33931	990	450	THP123ME-T7A-VN	37903	THP123ME-T7A-MN	40667
THP123ME-T9A-SN	380-400/3/50	33931	990	450	THP123ME-T9A-VN	37903	THP123ME-T9A-MN	40667
THP135ME-T3A-SN	208-230/3/60	36600	1050	477	THP135ME-T3A-VN	40572	THP135ME-T3A-MN	43336
THP135ME-T4A-SN	460/3/60	36600	1050	477	THP135ME-T4A-VN	40572	THP135ME-T4A-MN	43336
THP135ME-T5A-SN	575/3/60	37331	1050	477	THP135ME-T5A-VN	41303		
THP135ME-T7A-SN	200-220/3/50	36600	1050	477	THP135ME-T7A-VN	40572	THP135ME-T7A-MN	43336
THP135ME-T9A-SN	380-400/3/50	36600	1050	477	THP135ME-T9A-VN	40572	THP135ME-T9A-MN	43336
THP162ME-T3A-SN	208-230/3/60	39267	1110	505	THP162ME-T3A-VN	43239	THP162ME-T3A-MN	46003
THP162ME-T4A-SN	460/3/60	39267	1110	505	THP162ME-T4A-VN	43239	THP162ME-T4A-MN	46003
THP162ME-T5A-SN	575/3/60	40052	1110	505	THP162ME-T5A-VN	44024		
THP162ME-T7A-SN	200-220/3/50	39267	1110	505	THP162ME-T7A-VN	43239	THP162ME-T7A-MN	46003
THP162ME-T9A-SN	380-400/3/50	39267	1110	505	THP162ME-T9A-VN	43239	THP162ME-T9A-MN	46003
THP181ME-T3A-SN	208-230/3/60	47831	1200	545	THP181ME-T3A-VN	51803	THP181ME-T3A-MN	54567
THP181ME-T4A-SN	460/3/60	47831	1200	545	THP181ME-T4A-VN	51803	THP181ME-T4A-MN	54567
THP181ME-T5A-SN	575/3/60	48786	1200	545	THP181ME-T5A-VN	52758		
THP181ME-T7A-SN	200-220/3/50	47831	1200	545	THP181ME-T7A-VN	51803	THP181ME-T7A-MN	54567
THP181ME-T9A-SN	380-400/3/50	47831	1200	545	THP181ME-T9A-VN	51803	THP181ME-T9A-MN	54567
THP221ME-T3A-SN	208-230/3/60	56323	1470	668	THP221ME-T3A-VN	61618	THP221ME-T3A-MN	65304
THP221ME-T4A-SN	460/3/60	56323	1470	668	THP221ME-T4A-VN	61618	THP221ME-T4A-MN	65304
THP221ME-T5A-SN	575/3/60	57449	1470	668	THP221ME-T5A-VN	62745		
THP221ME-T9A-SN	380-400/3/50	56323	1470	668	THP221ME-T9A-VN	61618	THP221ME-T9A-MN	65304
THP243ME-T3A-SN	208-230/3/60	60436	1570	714	THP243ME-T3A-VN	65732	THP243ME-T3A-MN	69417
THP243ME-T4A-SN	460/3/60	60436	1570	714	THP243ME-T4A-VN	65732	THP243ME-T4A-MN	69417
THP243ME-T5A-SN	575/3/60	61645	1570	714	THP243ME-T5A-VN	66940		
THP243ME-T9A-SN	380-400/3/50	60436	1570	714	THP243ME-T9A-VN	65732	THP243ME-T9A-MN	69417
THP271ME-T4A-SN	460/3/60	63035	1770	805	THP271ME-T4A-VN	68331	THP271ME-T4A-MN	72016
THP271ME-T5A-SN	575/3/60	64296	1770	805	THP271ME-T5A-VN	69592		
THP271ME-T9A-SN	380-400/3/50	63035	1770	805	THP271ME-T9A-VN	68331	THP271ME-T9A-MN	72016

OPTIONS:

- Adjustable defrost termination / fan delay is a standard feature - included in list price.
- THROW BOOSTER \$463 LIST PER FAN SECTION (derate capacity by 0.92 & CFM by 0.85)



2021 Refrigeration Products Price List

TLP-C-2020-3 - EFFECTIVE DATE: 01 OCT 2021 - SUPERCEDES: TLP-C-2020-2



THP-LINE, HIGH PROFILE EVAPORATORS (cont'd)

MEDIUM TEMP 6 FPI- HOT GAS DEFROST

^ Insert appropriate code for hot gas defrost type

ODP MOTORS			WEIGHT		TEFC MOTORS		EC MOTORS - VARIABLE SPEED	
MODEL	VOLTAGE	\$	lbs.	kg	MODEL	\$	MODEL	\$
THP068M^T3A-SN	208-230/3/60	18398	650	295	THP068M^T3A-TN	18960	THP068M^T3A-MN	27379
THP068M^T4A-SN	460/3/60	18398	650	295	THP068M^T4A-TN	18960	THP068M^T4A-MN	27379
THP068M^T5A-SN	575/3/60	18766	650	295	THP068M^T5A-TN	19328		
THP068M^T7A-SN	200-220/3/50	18398	650	295	THP068M^T7A-TN	18960	THP068M^T7A-MN	27379
THP068M^T9A-SN	380-400/3/50	18398	650	295	THP068M^T9A-TN	18960	THP068M^T9A-MN	27379
THP081M^T3A-SN	208-230/3/60	23725	690	314	THP081M^T3A-TN	24287	THP081M^T3A-MN	32706
THP081M^T4A-SN	460/3/60	23725	690	314	THP081M^T4A-TN	24287	THP081M^T4A-MN	32706
THP081M^T5A-SN	575/3/60	24199	690	314	THP081M^T5A-TN	24762		
THP081M^T7A-SN	200-220/3/50	23725	690	314	THP081M^T7A-TN	24287	THP081M^T7A-MN	32706
THP081M^T9A-SN	380-400/3/50	23725	690	314	THP081M^T9A-TN	24287	THP081M^T9A-MN	32706
THP092M^T3A-SN	208-230/3/60	27477	730	332	THP092M^T3A-TN	28039	THP092M^T3A-MN	36458
THP092M^T4A-SN	460/3/60	27477	730	332	THP092M^T4A-TN	28039	THP092M^T4A-MN	36458
THP092M^T5A-SN	575/3/60	28026	730	332	THP092M^T5A-TN	28589		
THP092M^T7A-SN	200-220/3/50	27477	730	332	THP092M^T7A-TN	28039	THP092M^T7A-MN	36458
THP092M^T9A-SN	380-400/3/50	27477	730	332	THP092M^T9A-TN	28039	THP092M^T9A-MN	31967
THP108M^T3A-SN	208-230/3/60	28790	770	350	THP108M^T3A-TN	29352	THP108M^T3A-MN	33281
THP108M^T4A-SN	460/3/60	28790	770	350	THP108M^T4A-TN	29352	THP108M^T4A-MN	33281
THP108M^T5A-SN	575/3/60	29366	770	350	THP108M^T5A-TN	29928		
THP108M^T7A-SN	200-220/3/50	28790	770	350	THP108M^T7A-TN	29352	THP108M^T7A-MN	33281
THP108M^T9A-SN	380-400/3/50	28790	770	350	THP108M^T9A-TN	29352	THP108M^T9A-MN	33281
THP123M^T3A-SN	208-230/3/60	32230	990	450	THP123M^T3A-TN	33073	THP123M^T3A-MN	36720
THP123M^T4A-SN	460/3/60	32230	990	450	THP123M^T4A-TN	33073	THP123M^T4A-MN	36720
THP123M^T5A-SN	575/3/60	32874	990	450	THP123M^T5A-TN	33718		
THP123M^T7A-SN	200-220/3/50	32230	990	450	THP123M^T7A-TN	33073	THP123M^T7A-MN	36720
THP123M^T9A-SN	380-400/3/50	32230	990	450	THP123M^T9A-TN	33073	THP123M^T9A-MN	36720
THP135M^T3A-SN	208-230/3/60	35327	1050	477	THP135M^T3A-TN	36171	THP135M^T3A-MN	39818
THP135M^T4A-SN	460/3/60	35327	1050	477	THP135M^T4A-TN	36171	THP135M^T4A-MN	39818
THP135M^T5A-SN	575/3/60	36034	1050	477	THP135M^T5A-TN	36877		
THP135M^T7A-SN	200-220/3/50	35327	1050	477	THP135M^T7A-TN	36171	THP135M^T7A-MN	39818
THP135M^T9A-SN	380-400/3/50	35327	1050	477	THP135M^T9A-TN	36171	THP135M^T9A-MN	39818
THP162M^T3A-SN	208-230/3/60	38423	1110	505	THP162M^T3A-TN	39267	THP162M^T3A-MN	42914
THP162M^T4A-SN	460/3/60	38423	1110	505	THP162M^T4A-TN	39267	THP162M^T4A-MN	42914
THP162M^T5A-SN	575/3/60	39192	1110	505	THP162M^T5A-TN	40036		
THP162M^T7A-SN	200-220/3/50	38423	1110	505	THP162M^T7A-TN	39267	THP162M^T7A-MN	42914
THP162M^T9A-SN	380-400/3/50	38423	1110	505	THP162M^T9A-TN	39267	THP162M^T9A-MN	42914
THP181M^T3A-SN	208-230/3/60	44524	1200	545	THP181M^T3A-TN	45367	THP181M^T3A-MN	49015
THP181M^T4A-SN	460/3/60	44524	1200	545	THP181M^T4A-TN	45367	THP181M^T4A-MN	49015
THP181M^T5A-SN	575/3/60	45415	1200	545	THP181M^T5A-TN	46259		
THP181M^T7A-SN	200-220/3/50	44524	1200	545	THP181M^T7A-TN	45367	THP181M^T7A-MN	49015
THP181M^T9A-SN	380-400/3/50	44524	1200	545	THP181M^T9A-TN	45367	THP181M^T9A-MN	51260
THP221M^T3A-SN	208-230/3/60	53936	1470	668	THP221M^T3A-TN	55061	THP221M^T3A-MN	60672
THP221M^T4A-SN	460/3/60	53936	1470	668	THP221M^T4A-TN	55061	THP221M^T4A-MN	60672
THP221M^T5A-SN	575/3/60	55016	1470	668	THP221M^T5A-TN	56140		
THP221M^T7A-SN	200-220/3/50	53936	1470	668	THP221M^T7A-TN	55061	THP221M^T7A-MN	60672
THP221M^T9A-SN	380-400/3/50	53936	1470	668	THP221M^T9A-TN	55061	THP221M^T9A-MN	60672
THP243M^T3A-SN	208-230/3/60	58166	1570	714	THP243M^T3A-TN	59290	THP243M^T3A-MN	64902
THP243M^T4A-SN	460/3/60	58166	1570	714	THP243M^T4A-TN	59290	THP243M^T4A-MN	64902
THP243M^T5A-SN	575/3/60	59329	1570	714	THP243M^T5A-TN	60453		
THP243M^T7A-SN	200-220/3/50	58166	1570	714	THP243M^T7A-TN	59290	THP243M^T7A-MN	64902
THP243M^T9A-SN	380-400/3/50	58166	1570	714	THP243M^T9A-TN	59290	THP243M^T9A-MN	64902
THP271M^T3A-SN	208-230/3/60	61568	1770	805	THP271M^T3A-TN	62692	THP271M^T3A-MN	68304
THP271M^T4A-SN	460/3/60	61568	1770	805	THP271M^T4A-TN	62692	THP271M^T4A-MN	68304
THP271M^T5A-SN	575/3/60	62799	1770	805	THP271M^T5A-TN	63924		
THP271M^T7A-SN	200-220/3/50	61568	1770	805	THP271M^T7A-TN	62692	THP271M^T7A-MN	68304
THP271M^T9A-SN	380-400/3/50	61568	1770	805	THP271M^T9A-TN	62692	THP271M^T9A-MN	68304

HOT GAS DEFROST OPTIONS:

- Adjustable defrost termination / fan delay is a standard feature - included in list price.
- Electric drain pan heater w/ factory mounted check valve, distributor side port is standard.
- LIST ADD \$322 PER FAN SECTION FOR HOT GAS LOOP
- LIST ADD FOR REVERSE CYCLE KITS ON HOT GAS UNITS:(NOT AVAILABLE ON 4 FAN MODELS) (INCLUDES 2 CHECK VALVES & SUCTION PIPING ASSEMBLY-KITS DO NOT INCLUDE HOT GAS LOOP PRICE): - 2 FAN MODELS: LIST \$4666 - 3 FAN MODELS: LIST \$5408



2021 Refrigeration Products Price List

TLP-C-2020-3 - EFFECTIVE DATE: 01 OCT 2021 - SUPERCEDES: TLP-C-2020-2



THP-LINE, HIGH PROFILE EVAPORATORS (cont'd)

LOW TEMP 6 FPI- ELECTRIC DEFROST

ODP MOTORS			WEIGHT		TEFC MOTORS		EC MOTORS - VARIABLE SPEED	
MODEL	VOLTAGE	\$	lbs.	kg	MODEL	\$	MODEL	\$
THP065LE-T3A-SN	208-230/3/60	23507	650	295	THP065LE-T3A-VN	26155	THP065LE-T3A-MN	27997
THP065LE-T4A-SN	460/3/60	23507	650	295	THP065LE-T4A-VN	26155	THP065LE-T4A-MN	27997
THP065LE-T5A-SN	575/3/60	23977	650	295	THP065LE-T5A-VN	26625		
THP065LE-T7A-SN	200-220/3/50	23507	650	295	THP065LE-T7A-VN	26155	THP065LE-T7A-MN	27997
THP065LE-T9A-SN	380-400/3/50	23507	650	295	THP065LE-T9A-VN	26155	THP065LE-T9A-MN	27997
THP078LE-T3A-SN	208-230/3/60	27420	690	314	THP078LE-T3A-VN	30068	THP078LE-T3A-MN	31911
THP078LE-T4A-SN	460/3/60	27420	690	314	THP078LE-T4A-VN	30068	THP078LE-T4A-MN	31911
THP078LE-T5A-SN	575/3/60	27969	690	314	THP078LE-T5A-VN	30617		
THP078LE-T7A-SN	200-220/3/50	27420	690	314	THP078LE-T7A-VN	30068	THP078LE-T7A-MN	31911
THP078LE-T9A-SN	380-400/3/50	27420	690	314	THP078LE-T9A-VN	30068	THP078LE-T9A-MN	31911
THP089LE-T3A-SN	208-230/3/60	30868	730	332	THP089LE-T3A-VN	33516	THP089LE-T3A-MN	35359
THP089LE-T4A-SN	460/3/60	30868	730	332	THP089LE-T4A-VN	33516	THP089LE-T4A-MN	35359
THP089LE-T5A-SN	575/3/60	31486	730	332	THP089LE-T5A-VN	34134		
THP089LE-T7A-SN	200-220/3/50	30868	730	332	THP089LE-T7A-VN	33516	THP089LE-T7A-MN	35359
THP089LE-T9A-SN	380-400/3/50	30868	730	332	THP089LE-T9A-VN	33516	THP089LE-T9A-MN	35359
THP094LE-T3A-SN	208-230/3/60	32020	770	350	THP094LE-T3A-VN	34668	THP094LE-T3A-MN	36510
THP094LE-T4A-SN	460/3/60	32020	770	350	THP094LE-T4A-VN	34668	THP094LE-T4A-MN	36510
THP094LE-T5A-SN	575/3/60	32660	770	350	THP094LE-T5A-VN	35308		
THP094LE-T7A-SN	200-220/3/50	32020	770	350	THP094LE-T7A-VN	34668	THP094LE-T7A-MN	36510
THP094LE-T9A-SN	380-400/3/50	32020	770	350	THP094LE-T9A-VN	34668	THP094LE-T9A-MN	36510
THP118LE-T3A-SN	208-230/3/60	33931	990	450	THP118LE-T3A-VN	37903	THP118LE-T3A-MN	40667
THP118LE-T4A-SN	460/3/60	33931	990	450	THP118LE-T4A-VN	37903	THP118LE-T4A-MN	40667
THP118LE-T5A-SN	575/3/60	34609	990	450	THP118LE-T5A-VN	38581		
THP118LE-T7A-SN	200-220/3/50	33931	990	450	THP118LE-T7A-VN	37903	THP118LE-T7A-MN	40667
THP118LE-T9A-SN	380-400/3/50	33931	990	450	THP118LE-T9A-VN	37903	THP118LE-T9A-MN	40667
THP134LE-T3A-SN	208-230/3/60	36806	1050	477	THP134LE-T3A-VN	40778	THP134LE-T3A-MN	43542
THP134LE-T4A-SN	460/3/60	36806	1050	477	THP134LE-T4A-VN	40778	THP134LE-T4A-MN	43542
THP134LE-T5A-SN	575/3/60	37542	1050	477	THP134LE-T5A-VN	41514		
THP134LE-T7A-SN	200-220/3/50	36806	1050	477	THP134LE-T7A-VN	40778	THP134LE-T7A-MN	43542
THP134LE-T9A-SN	380-400/3/50	36806	1050	477	THP134LE-T9A-VN	40778	THP134LE-T9A-MN	43542
THP143LE-T3A-SN	208-230/3/60	39267	1110	505	THP143LE-T3A-VN	43239	THP143LE-T3A-MN	46003
THP143LE-T4A-SN	460/3/60	39267	1110	505	THP143LE-T4A-VN	43239	THP143LE-T4A-MN	46003
THP143LE-T5A-SN	575/3/60	40052	1110	505	THP143LE-T5A-VN	44024		
THP143LE-T7A-SN	200-220/3/50	39267	1110	505	THP143LE-T7A-VN	43239	THP143LE-T7A-MN	46003
THP143LE-T9A-SN	380-400/3/50	39267	1110	505	THP143LE-T9A-VN	43239	THP143LE-T9A-MN	46003
THP161LE-T3A-SN	208-230/3/60	47831	1200	545	THP161LE-T3A-VN	51803	THP161LE-T3A-MN	54567
THP161LE-T4A-SN	460/3/60	47831	1200	545	THP161LE-T4A-VN	51803	THP161LE-T4A-MN	54567
THP161LE-T5A-SN	575/3/60	48786	1200	545	THP161LE-T5A-VN	52758		
THP161LE-T7A-SN	200-220/3/50	47831	1200	545	THP161LE-T7A-VN	51803	THP161LE-T7A-MN	54567
THP161LE-T9A-SN	380-400/3/50	47831	1200	545	THP161LE-T9A-VN	51803	THP161LE-T9A-MN	54567
THP175LE-T3A-SN	208-230/3/60	51105	1370	623	THP175LE-T3A-VN	56401	THP175LE-T3A-MN	60087
THP175LE-T4A-SN	460/3/60	51105	1370	623	THP175LE-T4A-VN	56401	THP175LE-T4A-MN	60087
THP175LE-T5A-SN	575/3/60	52127	1370	623	THP175LE-T5A-VN	57423		
THP175LE-T7A-SN	200-220/3/50	51105	1370	623	THP175LE-T7A-VN	56401	THP175LE-T7A-MN	60087
THP175LE-T9A-SN	380-400/3/50	51105	1370	623	THP175LE-T9A-VN	56401	THP175LE-T9A-MN	60087
THP198LE-T3A-SN	208-230/3/60	56323	1470	668	THP198LE-T3A-VN	61618	THP198LE-T3A-MN	65304
THP198LE-T4A-SN	460/3/60	56323	1470	668	THP198LE-T4A-VN	61618	THP198LE-T4A-MN	65304
THP198LE-T5A-SN	575/3/60	57449	1470	668	THP198LE-T5A-VN	62745		
THP198LE-T9A-SN	380-400/3/50	56323	1470	668	THP198LE-T9A-VN	61618	THP198LE-T9A-MN	65304
THP216LE-T3A-SN	208-230/3/60	60436	1570	714	THP216LE-T3A-VN	65732	THP216LE-T3A-MN	69417
THP216LE-T4A-SN	460/3/60	60436	1570	714	THP216LE-T4A-VN	65732	THP216LE-T4A-MN	69417
THP216LE-T5A-SN	575/3/60	61645	1570	714	THP216LE-T5A-VN	66940		
THP216LE-T9A-SN	380-400/3/50	60436	1570	714	THP216LE-T9A-VN	65732	THP216LE-T9A-MN	69417
THP228LE-T4A-SN	460/3/60	63035	1770	805	THP228LE-T4A-VN	68331	THP228LE-T4A-MN	72016
THP228LE-T5A-SN	575/3/60	64296	1770	805	THP228LE-T5A-VN	69592		
THP228LE-T9A-SN	380-400/3/50	63035	1770	805	THP228LE-T9A-VN	68331	THP228LE-T9A-MN	72016



2021 Refrigeration Products Price List

TLP-C-2020-3 - EFFECTIVE DATE: 01 OCT 2021 - SUPERCEDES: TLP-C-2020-2



THP-LINE, HIGH PROFILE EVAPORATORS (cont'd)

LOW TEMP 4 FPI- ELECTRIC DEFROST

ODP MOTORS			WEIGHT		TEFC MOTORS		EC MOTORS - VARIABLE SPEED	
MODEL	VOLTAGE	\$	lbs.	kg	MODEL	\$	MODEL	\$
THP055VE-T3A-SN	208-230/3/60	21029	640	291	THP055VE-T3A-VN	23677	THP055VE-T3A-MN	25520
THP055VE-T4A-SN	460/3/60	21029	640	291	THP055VE-T4A-VN	23677	THP055VE-T4A-MN	25520
THP055VE-T5A-SN	575/3/60	21450	640	291	THP055VE-T5A-VN	24098		
THP055VE-T7A-SN	200-220/3/50	21029	640	291	THP055VE-T7A-VN	23677	THP055VE-T7A-MN	25520
THP055VE-T9A-SN	380-400/3/50	21029	640	291	THP055VE-T9A-VN	23677	THP055VE-T9A-MN	25520
THP066VE-T3A-SN	208-230/3/60	23363	670	305	THP066VE-T3A-VN	26011	THP066VE-T3A-MN	27854
THP066VE-T4A-SN	460/3/60	23363	670	305	THP066VE-T4A-VN	26011	THP066VE-T4A-MN	27854
THP066VE-T5A-SN	575/3/60	23831	670	305	THP066VE-T5A-VN	26479		
THP066VE-T7A-SN	200-220/3/50	23363	670	305	THP066VE-T7A-VN	26011	THP066VE-T7A-MN	27854
THP066VE-T9A-SN	380-400/3/50	23363	670	305	THP066VE-T9A-VN	26011	THP066VE-T9A-MN	27854
THP076VE-T3A-SN	208-230/3/60	28256	700	318	THP076VE-T3A-VN	30904	THP076VE-T3A-MN	32747
THP076VE-T4A-SN	460/3/60	28256	700	318	THP076VE-T4A-VN	30904	THP076VE-T4A-MN	32747
THP076VE-T5A-SN	575/3/60	28821	700	318	THP076VE-T5A-VN	31469		
THP076VE-T7A-SN	200-220/3/50	28256	700	318	THP076VE-T7A-VN	30904	THP076VE-T7A-MN	32747
THP076VE-T9A-SN	380-400/3/50	28256	700	318	THP076VE-T9A-VN	30904	THP076VE-T9A-MN	32747
THP087VE-T3A-SN	208-230/3/60	32157	740	336	THP087VE-T3A-VN	34805	THP087VE-T3A-MN	36648
THP087VE-T4A-SN	460/3/60	32157	740	336	THP087VE-T4A-VN	34805	THP087VE-T4A-MN	36648
THP087VE-T5A-SN	575/3/60	32800	740	336	THP087VE-T5A-VN	35448		
THP087VE-T7A-SN	200-220/3/50	32157	740	336	THP087VE-T7A-VN	34805	THP087VE-T7A-MN	36648
THP087VE-T9A-SN	380-400/3/50	32157	740	336	THP087VE-T9A-VN	34805	THP087VE-T9A-MN	36648
THP100VE-T3A-SN	208-230/3/60	32995	960	436	THP100VE-T3A-VN	36967	THP100VE-T3A-MN	39731
THP100VE-T4A-SN	460/3/60	32995	960	436	THP100VE-T4A-VN	36967	THP100VE-T4A-MN	39731
THP100VE-T5A-SN	575/3/60	33656	960	436	THP100VE-T5A-VN	37628		
THP100VE-T7A-SN	200-220/3/50	32995	960	436	THP100VE-T7A-VN	36967	THP100VE-T7A-MN	39731
THP100VE-T9A-SN	380-400/3/50	32995	960	436	THP100VE-T9A-VN	36967	THP100VE-T9A-MN	39731
THP114VE-T3A-SN	208-230/3/60	35563	1010	459	THP114VE-T3A-VN	39535	THP114VE-T3A-MN	42299
THP114VE-T4A-SN	460/3/60	35563	1010	459	THP114VE-T4A-VN	39535	THP114VE-T4A-MN	42299
THP114VE-T5A-SN	575/3/60	36274	1010	459	THP114VE-T5A-VN	40246		
THP114VE-T7A-SN	200-220/3/50	35563	1010	459	THP114VE-T7A-VN	39535	THP114VE-T7A-MN	42299
THP114VE-T9A-SN	380-400/3/50	35563	1010	459	THP114VE-T9A-VN	39535	THP114VE-T9A-MN	42299
THP127VE-T3A-SN	208-230/3/60	38672	1060	482	THP127VE-T3A-VN	42644	THP127VE-T3A-MN	45408
THP127VE-T4A-SN	460/3/60	38672	1060	482	THP127VE-T4A-VN	42644	THP127VE-T4A-MN	45408
THP127VE-T5A-SN	575/3/60	39446	1060	482	THP127VE-T5A-VN	43418		
THP127VE-T7A-SN	200-220/3/50	38672	1060	482	THP127VE-T7A-VN	42644	THP127VE-T7A-MN	45408
THP127VE-T9A-SN	380-400/3/50	38672	1060	482	THP127VE-T9A-VN	42644	THP127VE-T9A-MN	45408
THP145VE-T3A-SN	208-230/3/60	47003	1150	523	THP145VE-T3A-VN	50975	THP145VE-T3A-MN	53739
THP145VE-T4A-SN	460/3/60	47003	1150	523	THP145VE-T4A-VN	50975	THP145VE-T4A-MN	53739
THP145VE-T5A-SN	575/3/60	47942	1150	523	THP145VE-T5A-VN	51914		
THP145VE-T7A-SN	200-220/3/50	47003	1150	523	THP145VE-T7A-VN	50975	THP145VE-T7A-MN	53739
THP145VE-T9A-SN	380-400/3/50	47003	1150	523	THP145VE-T9A-VN	50975	THP145VE-T9A-MN	53739
THP172VE-T3A-SN	208-230/3/60	53519	1420	645	THP172VE-T3A-VN	58815	THP172VE-T3A-MN	62501
THP172VE-T4A-SN	460/3/60	53519	1420	645	THP172VE-T4A-VN	58815	THP172VE-T4A-MN	62501
THP172VE-T5A-SN	575/3/60	54591	1420	645	THP172VE-T5A-VN	59886		
THP172VE-T9A-SN	380-400/3/50	53519	1420	645	THP172VE-T9A-VN	58815	THP172VE-T9A-MN	62501
THP187VE-T3A-SN	208-230/3/60	56769	1510	686	THP187VE-T3A-VN	62065	THP187VE-T3A-MN	65750
THP187VE-T4A-SN	460/3/60	56769	1510	686	THP187VE-T4A-VN	62065	THP187VE-T4A-MN	65750
THP187VE-T5A-SN	575/3/60	57904	1510	686	THP187VE-T5A-VN	63200		
THP187VE-T9A-SN	380-400/3/50	56769	1510	686	THP187VE-T9A-VN	62065	THP187VE-T9A-MN	65750
THP217VE-T4A-SN	460/3/60	66406	1680	764	THP217VE-T4A-VN	71701	THP217VE-T4A-MN	75387
THP217VE-T5A-SN	575/3/60	67734	1680	764	THP217VE-T5A-VN	73030		
THP217VE-T9A-SN	380-400/3/50	66406	1680	764	THP217VE-T9A-VN	71701	THP217VE-T9A-MN	75387



2021 Refrigeration Products Price List

TLP-C-2020-3 - EFFECTIVE DATE: 01 OCT 2021 - SUPERCEDES: TLP-C-2020-2



THP-LINE, HIGH PROFILE EVAPORATORS (cont'd)

LOW TEMP 6 FPI- HOT GAS DEFROST

^ Insert appropriate code for hot gas defrost type

ODP MOTORS			WEIGHT		TEFC MOTORS		EC MOTORS - VARIABLE SPEED	
MODEL	VOLTAGE	\$	lbs.	kg	MODEL	\$	MODEL	\$
THP065L#-T3A-SN	208-230/3/60	18398	650	295	THP065L#-T3A-TN	18960	THP065L#-T3A-MN	27379
THP065L#-T4A-SN	460/3/60	18398	650	295	THP065L#-T4A-TN	18960	THP065L#-T4A-MN	27379
THP065L#-T5A-SN	575/3/60	18766	650	295	THP065L#-T5A-TN	19328		
THP065L#-T7A-SN	200-220/3/50	18398	650	295	THP065L#-T7A-TN	18960	THP065L#-T7A-MN	27379
THP065L#-T9A-SN	380-400/3/50	18398	650	295	THP065L#-T9A-TN	18960	THP065L#-T9A-MN	27379
THP078L#-T3A-SN	208-230/3/60	23725	690	314	THP078L#-T3A-TN	24287	THP078L#-T3A-MN	32706
THP078L#-T4A-SN	460/3/60	23725	690	314	THP078L#-T4A-TN	24287	THP078L#-T4A-MN	32706
THP078L#-T5A-SN	575/3/60	24199	690	314	THP078L#-T5A-TN	24762		
THP078L#-T7A-SN	200-220/3/50	23725	690	314	THP078L#-T7A-TN	24287	THP078L#-T7A-MN	32706
THP078L#-T9A-SN	380-400/3/50	23725	690	314	THP078L#-T9A-TN	24287	THP078L#-T9A-MN	32706
THP089L#-T3A-SN	208-230/3/60	27477	730	332	THP089L#-T3A-TN	28039	THP089L#-T3A-MN	36458
THP089L#-T4A-SN	460/3/60	27477	730	332	THP089L#-T4A-TN	28039	THP089L#-T4A-MN	36458
THP089L#-T5A-SN	575/3/60	28026	730	332	THP089L#-T5A-TN	28589		
THP089L#-T7A-SN	200-220/3/50	27477	730	332	THP089L#-T7A-TN	28039	THP089L#-T7A-MN	36458
THP089L#-T9A-SN	380-400/3/50	27477	730	332	THP089L#-T9A-TN	28039	THP089L#-T9A-MN	36458
THP094L#-T3A-SN	208-230/3/60	28790	770	350	THP094L#-T3A-TN	29352	THP094L#-T3A-MN	33281
THP094L#-T4A-SN	460/3/60	28790	770	350	THP094L#-T4A-TN	29352	THP094L#-T4A-MN	33281
THP094L#-T5A-SN	575/3/60	29366	770	350	THP094L#-T5A-TN	29928		
THP094L#-T7A-SN	200-220/3/50	28790	770	350	THP094L#-T7A-TN	29352	THP094L#-T7A-MN	33281
THP094L#-T9A-SN	380-400/3/50	28790	770	350	THP094L#-T9A-TN	29352	THP094L#-T9A-MN	33281
THP118L#-T3A-SN	208-230/3/60	32230	990	450	THP118L#-T3A-TN	33073	THP118L#-T3A-MN	36720
THP118L#-T4A-SN	460/3/60	32230	990	450	THP118L#-T4A-TN	33073	THP118L#-T4A-MN	36720
THP118L#-T5A-SN	575/3/60	32874	990	450	THP118L#-T5A-TN	33718		
THP118L#-T7A-SN	200-220/3/50	32230	990	450	THP118L#-T7A-TN	33073	THP118L#-T7A-MN	36720
THP118L#-T9A-SN	380-400/3/50	32230	990	450	THP118L#-T9A-TN	33073	THP118L#-T9A-MN	36720
THP134L#-T3A-SN	208-230/3/60	36305	1050	477	THP134L#-T3A-TN	37149	THP134L#-T3A-MN	40796
THP134L#-T4A-SN	460/3/60	36305	1050	477	THP134L#-T4A-TN	37149	THP134L#-T4A-MN	40796
THP134L#-T5A-SN	575/3/60	37032	1050	477	THP134L#-T5A-TN	37875		
THP134L#-T7A-SN	200-220/3/50	36305	1050	477	THP134L#-T7A-TN	37149	THP134L#-T7A-MN	40796
THP134L#-T9A-SN	380-400/3/50	36305	1050	477	THP134L#-T9A-TN	37149	THP134L#-T9A-MN	40796
THP143L#-T3A-SN	208-230/3/60	38423	1110	505	THP143L#-T3A-TN	39267	THP143L#-T3A-MN	42914
THP143L#-T4A-SN	460/3/60	38423	1110	505	THP143L#-T4A-TN	39267	THP143L#-T4A-MN	42914
THP143L#-T5A-SN	575/3/60	39192	1110	505	THP143L#-T5A-TN	40036		
THP143L#-T7A-SN	200-220/3/50	38423	1110	505	THP143L#-T7A-TN	39267	THP143L#-T7A-MN	42914
THP143L#-T9A-SN	380-400/3/50	38423	1110	505	THP143L#-T9A-TN	39267	THP143L#-T9A-MN	42914
THP161L#-T3A-SN	208-230/3/60	44524	1200	545	THP161L#-T3A-TN	45367	THP161L#-T3A-MN	49015
THP161L#-T4A-SN	460/3/60	44524	1200	545	THP161L#-T4A-TN	45367	THP161L#-T4A-MN	49015
THP161L#-T5A-SN	575/3/60	45415	1200	545	THP161L#-T5A-TN	46259		
THP161L#-T7A-SN	200-220/3/50	44524	1200	545	THP161L#-T7A-TN	45367	THP161L#-T7A-MN	49015
THP161L#-T9A-SN	380-400/3/50	44524	1200	545	THP161L#-T9A-TN	45367	THP161L#-T9A-MN	49015
THP175L#-T3A-SN	208-230/3/60	48194	1370	623	THP175L#-T3A-TN	49319	THP175L#-T3A-MN	54930
THP175L#-T4A-SN	460/3/60	48194	1370	623	THP175L#-T4A-TN	49319	THP175L#-T4A-MN	54930
THP175L#-T5A-SN	575/3/60	49157	1370	623	THP175L#-T5A-TN	50282		
THP175L#-T7A-SN	200-220/3/50	48194	1370	623	THP175L#-T7A-TN	49319	THP175L#-T7A-MN	54930
THP175L#-T9A-SN	380-400/3/50	48194	1370	623	THP175L#-T9A-TN	49319	THP175L#-T9A-MN	54930
THP198L#-T3A-SN	208-230/3/60	53936	1470	668	THP198L#-T3A-TN	55061	THP198L#-T3A-MN	60672
THP198L#-T4A-SN	460/3/60	53936	1470	668	THP198L#-T4A-TN	55061	THP198L#-T4A-MN	60672
THP198L#-T5A-SN	575/3/60	55016	1470	668	THP198L#-T5A-TN	56140		
THP198L#-T7A-SN	200-220/3/50	53936	1470	668	THP198L#-T7A-TN	55061	THP198L#-T7A-MN	60672
THP198L#-T9A-SN	380-400/3/50	53936	1470	668	THP198L#-T9A-TN	55061	THP198L#-T9A-MN	60672
THP216L#-T3A-SN	208-230/3/60	58166	1570	714	THP216L#-T3A-TN	59290	THP216L#-T3A-MN	64902
THP216L#-T4A-SN	460/3/60	58166	1570	714	THP216L#-T4A-TN	59290	THP216L#-T4A-MN	64902
THP216L#-T5A-SN	575/3/60	59329	1570	714	THP216L#-T5A-TN	60453		
THP216L#-T7A-SN	200-220/3/50	58166	1570	714	THP216L#-T7A-TN	59290	THP216L#-T7A-MN	64902
THP216L#-T9A-SN	380-400/3/50	58166	1570	714	THP216L#-T9A-TN	59290	THP216L#-T9A-MN	64902
THP228L#-T3A-SN	208-230/3/60	61568	1770	805	THP228L#-T3A-TN	62692	THP228L#-T3A-MN	68304
THP228L#-T4A-SN	460/3/60	61568	1770	805	THP228L#-T4A-TN	62692	THP228L#-T4A-MN	68304
THP228L#-T5A-SN	575/3/60	62799	1770	805	THP228L#-T5A-TN	63924		
THP228L#-T7A-SN	200-220/3/50	61568	1770	805	THP228L#-T7A-TN	62692	THP228L#-T7A-MN	68304
THP228L#-T9A-SN	380-400/3/50	61568	1770	805	THP228L#-T9A-TN	62692	THP228L#-T9A-MN	68304



2021 Refrigeration Products Price List

TLP-C-2020-3 - EFFECTIVE DATE: 01 OCT 2021 - SUPERCEDES: TLP-C-2020-2



THP-LINE, HIGH PROFILE EVAPORATORS (cont'd)

LOW TEMP 4 FPI- HOT GAS DEFROST

^ Insert appropriate code for hot gas defrost type

ODP MOTORS			WEIGHT		TEFC MOTORS		EC MOTORS - VARIABLE SPEED	
MODEL	VOLTAGE	\$	lbs.	kg	MODEL	\$	MODEL	\$
THP055V#-T3A-SN	208-230/3/60	17620	640	291	THP055V#-T3A-TN	18182	THP055V#-T3A-MN	26601
THP055V#-T4A-SN	460/3/60	17620	640	291	THP055V#-T4A-TN	18182	THP055V#-T4A-MN	26601
THP055V#-T5A-SN	575/3/60	17971	640	291	THP055V#-T5A-TN	18533		
THP055V#-T7A-SN	200-220/3/50	17620	640	291	THP055V#-T7A-TN	18182	THP055V#-T7A-MN	26601
THP055V#-T9A-SN	380-400/3/50	17620	640	291	THP055V#-T9A-TN	18182	THP055V#-T9A-MN	26601
THP066V#-T3A-SN	208-230/3/60	20145	670	305	THP066V#-T3A-TN	20707	THP066V#-T3A-MN	29126
THP066V#-T4A-SN	460/3/60	20145	670	305	THP066V#-T4A-TN	20707	THP066V#-T4A-MN	29126
THP066V#-T5A-SN	575/3/60	20549	670	305	THP066V#-T5A-TN	21111		
THP066V#-T7A-SN	200-220/3/50	20145	670	305	THP066V#-T7A-TN	20707	THP066V#-T7A-MN	29126
THP066V#-T9A-SN	380-400/3/50	20145	670	305	THP066V#-T9A-TN	20707	THP066V#-T9A-MN	29126
THP076V#-T3A-SN	208-230/3/60	24566	700	318	THP076V#-T3A-TN	25128	THP076V#-T3A-MN	33547
THP076V#-T4A-SN	460/3/60	24566	700	318	THP076V#-T4A-TN	25128	THP076V#-T4A-MN	33547
THP076V#-T5A-SN	575/3/60	25056	700	318	THP076V#-T5A-TN	25619		
THP076V#-T7A-SN	200-220/3/50	24566	700	318	THP076V#-T7A-TN	25128	THP076V#-T7A-MN	33547
THP076V#-T9A-SN	380-400/3/50	24566	700	318	THP076V#-T9A-TN	25128	THP076V#-T9A-MN	29056
THP087V#-T3A-SN	208-230/3/60	28903	740	336	THP087V#-T3A-TN	29465	THP087V#-T3A-MN	33394
THP087V#-T4A-SN	460/3/60	28903	740	336	THP087V#-T4A-TN	29465	THP087V#-T4A-MN	33394
THP087V#-T5A-SN	575/3/60	29480	740	336	THP087V#-T5A-TN	30043		
THP087V#-T7A-SN	200-220/3/50	28903	740	336	THP087V#-T7A-TN	29465	THP087V#-T7A-MN	33394
THP087V#-T9A-SN	380-400/3/50	28903	740	336	THP087V#-T9A-TN	29465	THP087V#-T9A-MN	33394
THP100V#-T3A-SN	208-230/3/60	32199	960	436	THP100V#-T3A-TN	33042	THP100V#-T3A-MN	36689
THP100V#-T4A-SN	460/3/60	32199	960	436	THP100V#-T4A-TN	33042	THP100V#-T4A-MN	36689
THP100V#-T5A-SN	575/3/60	32843	960	436	THP100V#-T5A-TN	33686		
THP100V#-T7A-SN	200-220/3/50	32199	960	436	THP100V#-T7A-TN	33042	THP100V#-T7A-MN	36689
THP100V#-T9A-SN	380-400/3/50	32199	960	436	THP100V#-T9A-TN	33042	THP100V#-T9A-MN	36689
THP114V#-T3A-SN	208-230/3/60	35226	1010	459	THP114V#-T3A-TN	36069	THP114V#-T3A-MN	39717
THP114V#-T4A-SN	460/3/60	35226	1010	459	THP114V#-T4A-TN	36069	THP114V#-T4A-MN	39717
THP114V#-T5A-SN	575/3/60	35931	1010	459	THP114V#-T5A-TN	36774		
THP114V#-T7A-SN	200-220/3/50	35226	1010	459	THP114V#-T7A-TN	36069	THP114V#-T7A-MN	39717
THP114V#-T9A-SN	380-400/3/50	35226	1010	459	THP114V#-T9A-TN	36069	THP114V#-T9A-MN	39717
THP127V#-T3A-SN	208-230/3/60	38854	1060	482	THP127V#-T3A-TN	39697	THP127V#-T3A-MN	43344
THP127V#-T4A-SN	460/3/60	38854	1060	482	THP127V#-T4A-TN	39697	THP127V#-T4A-MN	43344
THP127V#-T5A-SN	575/3/60	39630	1060	482	THP127V#-T5A-TN	40474		
THP127V#-T7A-SN	200-220/3/50	38854	1060	482	THP127V#-T7A-TN	39697	THP127V#-T7A-MN	43344
THP127V#-T9A-SN	380-400/3/50	38854	1060	482	THP127V#-T9A-TN	39697	THP127V#-T9A-MN	43344
THP145V#-T3A-SN	208-230/3/60	46477	1150	523	THP145V#-T3A-TN	47320	THP145V#-T3A-MN	50967
THP145V#-T4A-SN	460/3/60	46477	1150	523	THP145V#-T4A-TN	47320	THP145V#-T4A-MN	50967
THP145V#-T5A-SN	575/3/60	47407	1150	523	THP145V#-T5A-TN	48251		
THP145V#-T7A-SN	200-220/3/50	46477	1150	523	THP145V#-T7A-TN	47320	THP145V#-T7A-MN	50967
THP145V#-T9A-SN	380-400/3/50	46477	1150	523	THP145V#-T9A-TN	47320	THP145V#-T9A-MN	53213
THP172V#-T3A-SN	208-230/3/60	53029	1420	645	THP172V#-T3A-TN	54153	THP172V#-T3A-MN	59765
THP172V#-T4A-SN	460/3/60	53029	1420	645	THP172V#-T4A-TN	54153	THP172V#-T4A-MN	59765
THP172V#-T5A-SN	575/3/60	54090	1420	645	THP172V#-T5A-TN	55215		
THP172V#-T7A-SN	200-220/3/50	53029	1420	645	THP172V#-T7A-TN	54153	THP172V#-T7A-MN	59765
THP172V#-T9A-SN	380-400/3/50	53029	1420	645	THP172V#-T9A-TN	54153	THP172V#-T9A-MN	59765
THP187V#-T3A-SN	208-230/3/60	56244	1510	686	THP187V#-T3A-TN	57369	THP187V#-T3A-MN	62980
THP187V#-T4A-SN	460/3/60	56244	1510	686	THP187V#-T4A-TN	57369	THP187V#-T4A-MN	62980
THP187V#-T5A-SN	575/3/60	57369	1510	686	THP187V#-T5A-TN	58494		
THP187V#-T7A-SN	200-220/3/50	56244	1510	686	THP187V#-T7A-TN	57369	THP187V#-T7A-MN	62980
THP187V#-T9A-SN	380-400/3/50	56244	1510	686	THP187V#-T9A-TN	57369	THP187V#-T9A-MN	62980
THP217V#-T3A-SN	208-230/3/60	63157	1680	764	THP217V#-T3A-TN	64282	THP217V#-T3A-MN	69893
THP217V#-T4A-SN	460/3/60	63157	1680	764	THP217V#-T4A-TN	64282	THP217V#-T4A-MN	69893
THP217V#-T5A-SN	575/3/60	64422	1680	764	THP217V#-T5A-TN	65546		
THP217V#-T7A-SN	200-220/3/50	63157	1680	764	THP217V#-T7A-TN	64282	THP217V#-T7A-MN	69893
THP217V#-T9A-SN	380-400/3/50	63157	1680	764	THP217V#-T9A-TN	64282	THP217V#-T9A-MN	69893



OPTIONAL EVAPORATOR ACCESSORIES

ESP+

INTUITIVE EVAPORATOR CONTROL TECHNOLOGY

- Adaptive control for air and electric defrost models
- Provides enhanced system performance, energy savings and improved product integrity
- Includes: Adaptive Control Board, Electronic Expansion Valve, Liquid Line Solenoid and On-Board Display

NOW AVAILABLE AS AN OPTION ON MOST OF OUR EXTENSIVE LINE OF EVAPORATORS

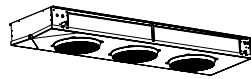

**TTM-LINE TWO-WAY
MEDIUM PROFILE**

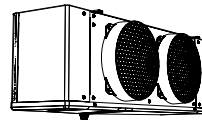

**TPLP / TLP-LINE
LOW PROFILE**

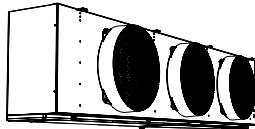

**TMP-LINE
MEDIUM PROFILE**

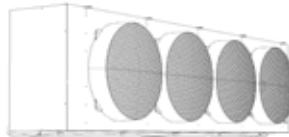

**TEP-LINE
EXTENDED PROFILE**

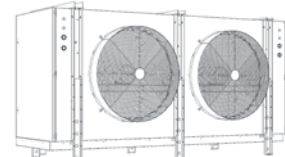

**THP-LINE
HIGH PROFILE**

LIST PRICE ADDER *

MODEL		ADD-ON LIST PRICE *
TTM	all	1981
TPLP / TLP	all	1981
TMP	all	2827
TEP	all	4248
THP	2-fan and 3-fan (small)	4563
	3+fan (large)	6451

**visit www.t-rp.com/esp
for product information, manuals, FAQ, videos and more!**



web: www.t-rp.com/esp
email: evaps@t-rp.com
call: 1-844-893-3222 x520



2021 Refrigeration Products Price List

TLP-C-2020-3 - EFFECTIVE DATE: 01 OCT 2021 - SUPERCEDES: TLP-C-2020-2



OPTIONAL EVAPORATOR ACCESSORIES

MODEL	SOLVLV & COIL	TXV	PRE-ASSEMBLED EVAP		
			W/ TXV	* KE2 EVAP EFFICIENCY +TXV	* KE2 EVAP EFFICIENCY +EEV
TLV 1-4 fan	297	421	1022	3241	4617
TLV 5 fan	340	421	1065	3285	4659
TTM	297	421	1022	3241	4617
TLP 1-5 Fan	297	421	1022	3241	4617
TLP 6 Fan	340	421	1065	3285	4659
TMP - 1 Fan Models	297	571	1173	3392	4927
TMP - 2 Fan Models	297	571	1173	3392	4927
TMP - 3 Fan Models	464	771	1540	3759	5642
TMP - 4 Fan Models	593	1121	2020	4239	6735
TEP - 1 Fan Models	571	1024	1901	3392	4927
TEP - 2 Fan Models	571	1024	1901	3392	4927
TEP - 3 Fan Models	712	1218	2235	3759	5642
TEP - 4 Fan Models	712	1218	2235	4239	6735
THP055, 059	571	1024	1901	4120	6192
THP066, 072	571	1024	1901	4120	6192
THP065, 068	571	1024	1901	4120	6192
THP076, 083	571	1024	1901	4120	6192
THP078, 081, 087, 091	571	1024	1901	4120	6192
THP100, 109	712	1218	2235	4454	6817
THP073, 089, 092	571	1024	1901	4120	6192
THP114, 122	712	1218	2235	4454	6817
THP086, 094, 108	571	1024	1901	4120	6192
THP118, 123, 137	712	1218	2235	4454	6817
THP113, 130, 150	712	1218	2235	4454	6817
THP134, 135	712	1218	2235	4454	6817
THP127, 145, 154, 164	712	1218	2235	4454	6817
THP143, 162	712	1218	2235	4454	6817
THP172, 200	712	1218	2235	4454	6817
THP170, 175, 187, 222	798	1337	2440	4659	7199
THP161, 181, 189	712	1218	2235	4454	6817
THP198, 221, 233	798	1337	2440	4659	7199
THP217, 256	798	1337	2440	4659	7199
THP216, 243	798	1337	2440	4659	7199
THP252	798	1337	2440	4659	7199
THP228, 271	798	1337	2440	4659	7199
THP287	798	1337	2440	4659	7199

PRE-ASSEMBLED EVAPORATOR ACCESSORIES

- All pre-assembled remote evaporators are shipped with a factory mounted expansion valve, liquid line solenoid and thermostat.
- A 115 volt coil is supplied with a 115 volt evaporator, all other evaporators are shipped with a 230 volt coil

KE2 THERM ACCESSORIES- Factory Installed Sensors (Not available on all models)

DESCRIPTION	PRICE
KE2TEMP + DEFROST (Air Defrost)	911
KE2TEMP ADAPTIVE (Demand Electric Defrost)	1096

Controllers may be shipped loose or factory installed depending on evaporator model

KE2 THERM ACCESSORIES

PART NUMBER	DESCRIPTION	PRICE
1049507	KE2 ROUTER	1240
1049612	KE2 8 PORT SWITCH	547
1049508	50' ETHERNET CABLE	135
1049509	50A CONTACTOR KIT	5054

* KE2 Therm Demand Defrost Pre Assembled Packages:

- Demand Defrost with TXV package includes TXV, solenoid valve and coil, KE2 Controller and 3 KE2 temperature sensors (1x RA, 2x Coil temp)
- Demand Defrost with EEV package includes EEV, solenoid valve and coil, KE2 Controller, 4 KE2 temperature sensors (1x RA, 2x Suction Line temp) and 1 KE2 pressure transducer
- Demand Defrost Controller is Shipped Loose on TTM & TLV
- † Sensors for EEV are ordered separately as the sensor MFR must match the controller. As a result they are priced separately and MUST be added to the EEV option



2021 Refrigeration Products Price List

TLP-C-2020-3 - EFFECTIVE DATE: 01 OCT 2021 - SUPERCEDES: TLP-C-2020-2



OPTIONAL EVAPORATOR ACCESSORIES (cont'd)

ROOM THERMOSTATS

PART NUMBER	DESCRIPTION	PRICE
1096563	MECHANICAL JOHNSON A19ABC-97C - FACTORY INSTALLED	374
	MECHANICAL JOHNSON A19ABC-97C - SHIPPED LOOSE	176
1077861	ELECTRONIC JOHNSON A421ABC-1 - FACTORY INSTALLED	524
	ELECTRONIC JOHNSON A421ABC-1 - SHIPPED LOOSE	356

DEFROST TERMINATION/ FAN DELAY THERMOSTATS

PART NUMBER	DESCRIPTION	PRICE
1048610	Combination fan delay and defrost termination thermostat. Ranco F25-209-00. Fixed fan delay setting 20 °F, adjustable termination range from 40 °F to 75 °F. 20 F.L.A. @ 240 VAC. - FACTORY INSTALLED	473
1096563	MECHANICAL JOHNSON A19ABC-97C - FACTORY INSTALLED	381

“HXR” LIQUID / SUCTION HEAT EXCHANGERS (SHIPPED LOOSE with EVAP)

PART #	PACKLESS #	BTUH @ +25°F			PRICE
		R22 R448A R407A R407C	R404A	R404A	
1062814	HXR - 25	5,400	4,000	3,000	170
1062815	HXR - 50	9,900	8,500	5,000	185
500317	HXR - 75	14,850	12,000	7,500	228
1062816	HXR - 100	20,250	16,000	10,500	268
500318	HXR - 150	29,700	23,500	15,000	293
1045700	HXR - 250	45,900	38,000	23,000	488
1061195	HXR - 350	64,800	56,000	33,000	538
1062431	HXR - 500	88,200	74,000	45,000	825
1062432	LHXR - 15	130,500	110,000	67,500	1162
1070420	LHXR - 20	173,250	145,000	87,500	1596
1095411	LHXR - 25	220,500	175,000	105,000	1786
1106207	LHXR - 30	254,250	220,000	135,000	1824
1095412	LHXR - 35	292,500	245,000	150,000	1935
1065492	LHXR - 40	344,250	290,000	175,000	2226

Capacities shown are approximate



2021 Refrigeration Products Price List

TLP-C-2020-3 - EFFECTIVE DATE: 01 OCT 2021 - SUPERCEDES: TLP-C-2020-2



OPTIONAL EVAPORATOR ACCESSORIES (cont'd)

OPTIONAL FIN MATERIALS AND COATINGS

MODEL		EVAPORATOR FIN MATERIALS AND COATINGS			PAINTED CABINET	STAINLESS STEEL CABINET
		COPPER	E-COAT	FinKote		
TTL010M	TTL009L	Consult Factory for Pricing	2153	Consult Factory for Pricing	264	706
TTL015M	TTL013L		2153		264	706
TTL020M	TTL017L		2153		264	706
TTL025M	TTL021L		2153		264	706
TTL032M	TTL028L		2153		264	706
TTL038M	TTL033L		2153		264	706
TTL060M	TTL052L		2153		587	944
TTL077M	TTL066L		2153		587	944
TTL115M	TTL099L		2153		782	1080
TTM105	TTM115	Consult Factory for Pricing	2153	Consult Factory for Pricing	1047	2205
TTM124	TTM139		2153		1047	2205
TTM153	TTM172		2153		1391	2868
TTM188	TTM208		2153		1391	2868
TTM210	TTM236		2153		1391	2868
TTM235	TTM260		2153		1655	3386
TTM265	TTM295		2153		1655	3386

COIL COATINGS

Trenton Refrigeration offers various optional coil coatings as service to our customers. As equipment can be exposed to a variety of atmospheric conditions that are beyond Trenton Refrigeration's control, customers need to decide which coating best suits their application needs. All coil coatings are sold and applied by third party suppliers and while these products can extend the life and integrity of the equipment, Trenton Refrigeration cannot recommend, endorse or warrant any of these products. For more information on coil coatings, visit our website at www.t-rp.com/coilcoatings or contact your local Trenton Refrigeration representative for assistance.

Stainless Steel Cabinet Pricing includes exterior cabinet and drain pan. Internal parts that have corrosion availability may have addition cost added. Consult factory for details.

Insulated Drain Pan consists of a second outer drain pan with insulation between the pans.



2021 Refrigeration Products Price List

TLP-C-2020-3 - EFFECTIVE DATE: 01 OCT 2021 - SUPERCEDES: TLP-C-2020-2



OPTIONAL EVAPORATOR ACCESSORIES (cont'd)

OPTIONAL FIN MATERIALS AND COATINGS (cont'd)

MODEL			EVAPORATOR FIN MATERIALS AND COATINGS			PAINTED CABINET	STAINLESS STEEL CABINET	INSULATED DRAIN PAN		
			COPPER	E-COAT	FinKote					
TLP104M	TLP104L	TLP103V	Consult Factory for Pricing	2153	Consult Factory for Pricing	413	1404	129		
TLP106M	TLP105L	TLP104V		2153		413	1404	129		
TLP107M	TLP106L	TLP105V		2153		413	1404	129		
TLP209M	TLP207L	TLP206V		2153		577	1647	174		
TLP211M	TLP209L	TLP208V		2153		577	1647	174		
TLP214M	TLP211L	TLP209V		2153		577	1647	174		
TLP317M	TLP314L	TLP312V		2153		742	1999	218		
TLP320M	TLP317L	TLP315V		2153		742	1999	218		
TLP423M	TLP419L	TLP416V		4236		906	2449	271		
TLP426M	TLP422L	TLP419V		4236		906	2449	271		
TLP532M	TLP527L	TLP523V		4266		1071	2768	291		
TLP639M	TLP631L	TLP627V		4537		1235	3107	336		
TMP118M	TMP116L	TMP113V		Consult Factory for Pricing		4236	Consult Factory for Pricing	982	1977	355
TMP122M	TMP119L	TMP117V				4236		982	1977	355
TMP228M	TMP225L	TMP222V	4369		1493	2683		473		
TMP236M	TMP232L	TMP228V	4470		1493	2683		473		
TMP245M	TMP240L	TMP234V	4633		1493	2683		473		
TMP355M	TMP348L	TMP339V	5896		2003	3331		567		
TMP368M	TMP356L	TMP350V	6133		2003	3331		567		
TMP480M	TMP471L	TMP459V	8641		2273	3575		615		
TMP488M	-	-	8641		2273	3575		615		
TEP026M	TEP023L	TEP020V	Consult Factory for Pricing		4236	Consult Factory for Pricing		1228	2509	355
TEP031M	TEP028L	TEP054V		4236	1228		2509	355		
TEP038M	TEP035L	TEP030V		4718	1358		3385	473		
TEP052M	TEP047L	TEP040V		5076	1358		3385	473		
TEP062M	TEP056L	TEP048V		5304	1358		3385	473		
TEP079M	TEP070L	TEP060V		6780	2504		4164	567		
TEP093M	TEP084L	TEP072V		7111	2504		4164	567		
TEP115M	TEP100L	TEP088V		10145	2842		4469	615		
THP 2 FAN UNITS	Consult Factory for Pricing			3970	7450		991			
THP 3 FAN UNITS	Consult Factory for Pricing			5232	8572	1203				
THP 3+ FAN UNITS	Consult Factory for Pricing			5581	9262	1203				
THP 4 FAN UNITS	Consult Factory for Pricing			6949	9558	1486				

COIL COATINGS

Trenton Refrigeration offers various optional coil coatings as service to our customers. As equipment can be exposed to a variety of atmospheric conditions that are beyond Trenton Refrigeration's control, customers need to decide which coating best suits their application needs. All coil coatings are sold and applied by third party suppliers and while these products can extend the life and integrity of the equipment, Trenton Refrigeration cannot recommend, endorse or warrant any of these products. For more information on coil coatings, visit our website at www.t-rp.com/coilcoatings or contact your local Trenton Refrigeration representative for assistance.

Stainless Steel Cabinet Pricing includes exterior cabinet and drain pan. Internal parts that have corrosion availability may have addition cost added. Consult factory for details.

Insulated Drain Pan consists of a second outer drain pan with insulation between the pans.



THERMOSEVER SYSTEM OPTION PRICE LIST

Note: Refer to the regular Condensing Unit and Evaporator standard price list and add on as listed below:

THERMOSEVER EVAPORATOR

Hot Gas Thermosaver evaporators include the following factory installed components:

- Hot Gas solenoid valve
- Check valve
- Drain pan heater
- Service access Schrader fittings

Hot Gas Thermosaver evaporators require the following components, which are priced separately:

- Liquid line solenoid valve
- TXV
- Includes fan motor contactor for three phase evap. (mounted in condensing unit panel and priced with condensing unit)
- Room thermostat

MODEL		ADD-ON LIST PRICE
TLP	1 & 2 Fan Models	CONSULT FACTORY FOR PRICING
	3 & 4 Fan Models	
	5 & 6 Fan Models	
TMP	1 Fan Models	
	2 Fan Models	
	3 Fan Models	
	4 Fan Models	
TEP	1 Fan Models	
	2 Fan Models	
	3 Fan Models	
	4 Fan Models	
THP	2 Fan Models	
	3 Fan Models	
	4 Fan Models	

NOTE:

For further information, refer to Bulletin T40-THERM-PDI

TLC LEAD LAG CONTROL PANEL

- For use on TWO independent refrigeration systems (one system used for back-up) using pumpdown control mode. (Thermostat wired into liquid line solenoid valve).
- Panel can be mounted at the first condensing unit on indoor installations or be mounted remote inside on a wall when used with outdoor condensing units.
- The panel is designed to operate each system automatically every 24 hours or can be manually set to run either system independently.
- A shipped loose thermostat will bring the lag unit on for auxiliary cooling if the room temperature rises above it's setpoint. Alarm will activate if room temp does not lower within the specified time period.
- Indicator lights show if the system is in auxiliary cooling mode and/or if in alarm. Dry contact (10A 230V) for alarm circuit can be field wired to remote indicator (buzzer).
- The remote control panel can be easily installed and wired by installing a contactor (provided loose) to each system. Each contactor interrupts the power to the defrost clock /thermostat and liquid solenoid circuits which enables the condensing unit to pumpdown and shut down the system.
- The panel is suitable for Air defrost (with or without clock) or Hot gas systems as well as Electric defrost evaporator systems.

Refer to the Product Data & Installation brochure for further information.

MODEL	ELECTRICAL	PRICE	MODEL	ELECTRICAL	PRICE
TLC1-S1A	115/1/60	2285	TLC2-S1A	115/1/60	4571
TLC1-S2A	208-230/1/60		TLC2-S2A	208-230/1/60	
TLC1-S6A	200-220/1/50		TLC2-S6A	200-220/1/50	

NOTE:

- Additional lead-lag control panels available (consult factory for details)
- Lead-lag control panels available for KE2 controllers (consult factory for details)



2021 Refrigeration Products Price List

TLP-C-2021-1-AEE - EFFECTIVE DATE: 01 FEBRUARY 2021 - SUPERCEDES: TLP-2020



PRODUCT SUPPORT RESOURCES



PRODUCT SUPPORT

web: www.t-rp.com/support
email: evaps@t-rp.com
call: 1-844-893-3222 x520



TROUBLESHOOTING

email: troubleshooting@t-rp.com
call: 1-844-893-3222 x529



SERVICE PARTS

web: www.t-rp.com/parts
email: parts@t-rp.com
call: 1-844-893-3222 x504



WARRANTY

web: www.t-rp.com/warranty
email: warranty@t-rp.com
call: 1-844-893-3222 x507



ORDERS

email: orders@t-rp.com
call: 1-844-893-3222 x501



SHIPPING

email: shipping@t-rp.com
call: 1-844-893-3222 x503



Trenton Refrigeration
Brantford, ON • Longview, TX
1-800-463-9517 info@t-rp.com www.t-rp.com

