

Catalog  
IC 12

Edition  
2023

# Electrical Components for the Railway Industry

[siemens.com/railway-components](https://www.siemens.com/railway-components)

## Related catalogs

### Industrial Controls SIRIUS

IC 10

PDF (E86060-K1010-A101-B3-7600)



### SIMATIC

Products for  
Totally Integrated Automation

ST 70

PDF (E86060-K4670-A101-B9-7600)



### Low-Voltage Power Distribution and Electrical Installation Technology

 SENTRON • SIVACON • ALPHA  
Protection, Switching, Measuring and Monitoring  
Devices, Switchboards and Distribution Systems

LV 10

PDF (E86060-K8280-A101-B5-7600)



### SITOP

SITOP  
Power Supply

KT 10.1

E86060-D4001-A510-E0

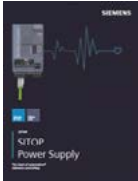

### SITRAIN

Digital Industry Academy

[www.siemens.com/sitrain](http://www.siemens.com/sitrain)

## Miscellaneous

### Industry Mall

Information and Ordering Platform  
on the Internet:
[www.siemens.com/industrymall](http://www.siemens.com/industrymall)

### Siemens TIA Selection Tool

for the selection, configuration and ordering of  
TIA products and devices
[www.siemens.com/tst](http://www.siemens.com/tst)

### Contact

Your personal contact can be found in our  
Contacts Database at:
[www.siemens.com/automation-contact](http://www.siemens.com/automation-contact)

## Trademarks

All product designations may be registered trademarks or product names of Siemens AG or other supplying companies. Third parties using these trademarks or product names for their own purposes may infringe upon the rights of the trademark owners.

Further information about industrial controls:  
[www.siemens.com/sirius](http://www.siemens.com/sirius)

## Technical Support

Expert technical support  
for Industrial controls:

Support Request:  
[www.siemens.com/support-request](http://www.siemens.com/support-request)





# Electrical Components for the Railway Industry



## Catalog IC 12 · 2023

Supersedes:  
Catalog IC 12 · 2019

Refer to the Industry Mall for current updates of  
this catalog:

[www.siemens.com/industrymall](http://www.siemens.com/industrymall)

© Siemens AG 2022



The products and systems described in this catalog are manufactured/distributed under application of a certified quality management system in accordance with EN ISO 9001 (For Certified Registration No., see [www.siemens.com/system-certificates/cp](http://www.siemens.com/system-certificates/cp)). The certificate is recognized by all IQNet countries.

Introduction	1
<b>SIRIUS</b> Industrial Controls	2
<b>SETRON</b> Low-Voltage Power Distribution	3
Fire protection for rolling stock	4
Damper Actuators	5
<b>SIPLUS</b> SIPLUS extreme RAIL	6
SIDOOR	7
Network Components	8
Medium-Voltage Components	9
Surge Arresters for Railway Applications	10
Appendix	11

Large temperature fluctuations, condensation, shock, vibration, electromagnetic interference, and more: Electrical and mechanical components for the railway industry must provide safe and reliable operation even under extreme application conditions at all times. This is why, Siemens leaves nothing to chance when developing these components. Right from the start, sound technology, application and service know-how go hand in hand with the highest quality standards.

As a global technology and innovation leader, we continuously push progress and help our customers overcome challenges e.g. by using the so-called digital twin. This cross-domain digital model integrates all data of a physical asset (product, plant or infrastructure systems) from the early design phase to engineering, commissioning, and service. The digital twin offers real value throughout the entire asset lifecycle, reducing over-engineering as well as improving component reliability with predictive engineering system simulation. It also reduces the costs for design, dimensioning and commissioning and accelerates your engineering and project execution.

We have been your reliable partner in the railway industry for decades. Our comprehensive experience in the fields of rolling stock and infrastructure is directly incorporated in the development of our components as is the knowledge we have gained from close cooperation with international standards committees. Therefore, you can rely on our components' guaranteed compliance with railway-specific requirements and standards.





## Developed, tested and certified in accordance with current standards and directives

Siemens is a founding member of the IRIS Initiative, and consistently implements its requirements.

Our railway components comply with all the relevant standards, for example: DIN, EN, IEC, IEEE, ISO, EAC/GOST and ANSI, as well as the current fire protection standard EN45545.

With our certified components, we actively support the worldwide vehicle approval process.

# Technical Support

One click – and you have all the information you need.



## Industry Online Support – get fast and up-to-date information online

[www.siemens.com/online-support](http://www.siemens.com/online-support)

In Industry Online Support you will find FAQs, manuals, certificates, applications & tools, and much more



## Support Request – the fast track to the experts

[www.siemens.com/support-request](http://www.siemens.com/support-request)

Using the Support Request form in Online Support you can send your query directly to Technical Support.



## Conversion tool – the easy and efficient way to find successor products

[www.siemens.com/conversion-tool](http://www.siemens.com/conversion-tool)

## Any more questions?

Our experts are there to help you with competent technical advice.

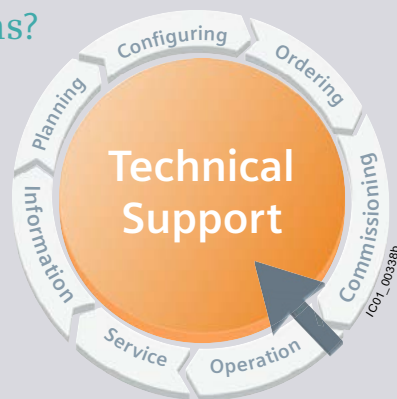

## Competent and fast technical advice regarding:

- Product selection
- Conversion from old to new
- Competitor conversion
- Special versions
- Particular requirements
- Commissioning
- Maintenance

Support Request:  
[www.siemens.com/support-request](http://www.siemens.com/support-request)



## Introduction



1/2	<b>SIRIUS</b>
1/6	<b>SENTRON</b>
1/8	<b>Fire protection</b>
1/10	<b>Damper Actuators</b>
1/11	<b>SIPLUS extreme RAIL</b>
1/12	<b>SIDOOR</b>
1/13	<b>SCALANCE I RUGGEDCOM</b>
1/18	<b>Siemens Propulsion System Network Components</b>
1/20	<b>Medium-Voltage Components</b>
1/21	<b>Surge arresters</b>

## Introduction

1

### Electrical components for the railway industry – SIRIUS

#### Overview

#### **SIRIUS range of electrical components for the railway industry**

Whether for rolling stock or infrastructure applications, we offer a comprehensive portfolio of electrical components for countless applications. One of our portfolio highlights is SIRIUS, the complete range for industrial controls. SIRIUS offers everything required for the switching, protection, or starting of

loads, as well as for their monitoring, control, detection, commanding, signaling, or supply. Our portfolio is rounded out by numerous products specifically developed and tested for the railway industry.

#### SIRIUS 3RV2 motor starter protectors for motor protection



- Spring-loaded or screw-type connection system on the terminals (also ring cable lug connection on request)
- For screw and snap-on mounting on DIN rail
- Short-circuit breaking capacity up to 100 kA
- Trip class 10 (sizes S00-S3)
- Integrated motor protection up to 100 A at +70 °C
- Comprehensive accessories/infeed systems
- Rated current:
  - Up to +60 °C 100 %
  - Up to +70 °C 87 %
- Mechanical service life:
  - 250 to 500 switching cycles

#### SIRIUS 3RT2 motor contactors up to 45 kW



- Spring-loaded or screw-type connection system on the terminals (also ring cable lug connection on request)
- Coil with suppressor diode or varistor circuit
- For screw and snap-on mounting on DIN rail
- Extended operating range: 0.7 – 1.25 x Us
- Communication via IO-Link for stationary applications
- Mounting:
  - Electronic coil: clearance up to ambient temperatures of 70 °C is not required
- Contacts:
  - Electronic coil: Auxiliary switches expandable in the same way as standard contactors

#### SIRIUS 3RT1 motor contactors from 55 to 250 kW



- Screw-type connection system via busbar connection or box terminal
- Optional control via a separate control signal input of 24 to 110 V DC (operating range from 0.7 to 1.25 x Us)
- Can be used at ambient temperatures up to 70 °C
- Contacts:
  - Two NO contacts and two NC contacts as standard
  - Auxiliary switches expandable in the same way as standard contactors



## SIRIUS 3RF solid-state switching devices



- Solid-state switching devices for switching 1- and 3-phase resistive and 3-phase motor loads
- Spring-loaded, screw-type and ring cable lug connection system
- Extremely durable, low-maintenance, rugged, and reliable thanks to long switching service life
- Wear- and noise-free switching, also for noise-sensitive areas
- Expandable functionality through plug-on function modules
- Vibration resistance in accordance with EN 61373 Category 1, Class B

## SIRIUS 3TC DC contactors



- 3TC44 for screw and snap-on mounting on DIN rail
- 3TC48 to 3TC78 for screw mounting
- Solenoid coil fitted with varistor
- Extended operating range: 0.7 – 1.25 x  $U_s$
- Contactors for switching DC voltages up to 1500 V
- Version with series resistor:
  - Mounting clearance up to ambient temperatures of 70 °C is not required
  - Mounting: with size 2 (3TC44) a clearance of 10 mm is required
  - Contacts: auxiliary switches not expandable; two NO contacts and one NC contact as standard



## Introduction

1

### Electrical components for the railway industry – SIRIUS

#### SIRIUS 3RH2 contactor relays



- Spring-loaded and screw-type connection system on all terminals (also ring cable lug connection on request)
- Coil with suppressor diode or varistor circuit
- For screw and snap-on mounting on DIN rail
- Extended operating range: 0.7 to 1.25 x Us
- Electronic coil with very low switch-on and holding power
- With electronic coil:
  - Ambient temperature up to 70 °C
  - Mounting without clearance
  - A 4-pole auxiliary switch block can be mounted
- Standard coil (coupling contactors):
  - Ambient temperature > 60 °C
  - Mounting with a clearance of 10 mm
  - It is not possible to mount an auxiliary switch block

#### SIRIUS 3RH2 latched contactor relays



- Screw-type connection system
- Solenoid coil fitted with varistor
- For screw and snap-on mounting on DIN rail
- Extended operating range: 0.7 – 1.25 x Us
- Electronic coil with very low switch-on and holding power
- With electronic coil:
  - Ambient temperature up to 70 °C
  - Mounting without clearance
  - A 4-pole auxiliary switch block can be mounted

#### SIRIUS 3TH4 contactor relays with 8 and 10 contacts



- Screw-type connection system
- Solenoid coil fitted with varistor
- For screw and snap-on mounting on DIN rail
- Extended operating range: 0.7 – 1.25 x Us
- The contacts are not expandable
- Mounting:
  - At ambient temperatures between 55 °C and 70 °C a clearance of 10 mm is required for side-by-side mounting

#### SIRIUS ACT push buttons and signaling devices



- Modern design and flexible concept:
  - 4 design lines in plastic, shiny metal and matte metal in 22/30 mm
  - Actuators, holders, contact module and LED modules can be ordered individually and combined freely
- Broad product range:
  - State-of-the-art functions, such as ID key-operated switches on RFID basis
  - Customized variants, e.g. special tumbler arrangements, labeling, pre-assembled enclosures
- Communication:
  - Communication-enabled due to optional connection to AS-Interface, IO-Link or PROFINET
- Ruggedness:
  - Degree of protection IP69K is our standard



## Electrical components for the railway industry – SIRIUS

## SIRIUS monitoring relays



- Monitoring relays for electrical parameters, thermistor motor protection, temperature, filling level, speed
- All versions with removable terminals, featuring either spring-loaded or screw-type connection system
- Applicability in all networks thanks to wide voltage range
- Variable adjustability
- 3-phase current monitoring integrated in the main circuit
- Communication via IO-Link for stationary applications

## SIRIUS 3RQ coupling relays



- SIRIUS 3RQ2 coupling relays in robust industrial housing (22.5 mm width) and 3RQ3 coupling relays in slim design (6.2 mm)
- Coupling technology with power, plug-in and coupling relays in accordance with the railway standard
- Coupling links with two-tier design and connections on two levels
- Versions with removable terminals, featuring either spring-loaded or screw-type connection system
- Versions with very slim design of only 6.2 mm (3RQ3)
- Versions with up to 3 changeover contacts in width of only 22.5 mm (3RQ2), also available with hard gold-plated contacts for switching of small currents
- Low power consumption
- Applicability in all networks thanks to wide voltage range
- Version with solid-state compatible outputs (hard gold-plating)

## SIRIUS 3RP2 timing relays



- Electronic timing relays (multifunction) with up to 15 time ranges
- Electronic timing relays with two changeover contacts and positively-driven relay contacts
- Individual or selectable time ranges
- Switch position and voltage indication via LED
- With removable terminals, featuring either spring-loaded or screw-type connection system
- For screw and snap-on mounting on DIN rail
- Electronic timing relays with positively-driven relay contacts:
  - 2 changeover contacts
  - Vibration resistance in accordance with DIN EN 61373 Category 1, Class B
  - Interference immunity in accordance with EN 50121-3-2

## SIRIUS 3SK1 safety relays



- Suitable for all safety applications up to SIL 3/PL e
- Modular hardware configuration
- Simple commissioning using DIP switches and software parameter assignment
- Simple selection thanks to a small number of multifunctional devices
- SIRIUS safety relays can be integrated into systems simply and independently of the automation solution
- More functionality and flexibility through freely configurable safety logic
- Vibration resistance in accordance with DIN EN 61373 Category 1, Class B
- Interference immunity in accordance with EN 50121-3-2 Table 1

## SIRIUS 3SE5 position switches



- Modular device design with easy plug-in connection system
- Four different enclosure versions in plastic and metal
- Optional LED display for all enclosures
- Positive opening of NC contacts
- Area of application up to SIL 3 in accordance with IEC 62061
- High contact reliability, also with 5 V DC/1 mA
- Safety position switches with separate actuator with/without tumbler
- High degree of protection up to IP 66/IP 67
- Extended temperature range: -40 °C to +85 °C
- Versions with increased corrosion protection

## Introduction

1

### Electrical components for the railway industry – SENTRON

#### Overview

##### **SENTRON protection and switching devices**

Tested protection and switching devices from the SENTRON portfolio ensure reliable low-voltage power distribution in infrastructure and railway applications.

The perfectly coordinated components offer outstanding flexibility, convenience, and safety for the railway industry.

#### 5SY4, 5SY5, 5SY7 MCBs



- Optional top or bottom infeed thanks to identical terminals
- Convenient entry thanks to large and easily accessible wiring space
- Rapid manual removal from the busbar assembly
- Vibration- and shock-proof in accordance with DIN EN 61373 and DIN EN 50155 "1B"
- Applicability at ambient temperatures from -40 °C to +70 °C, with max. humidity of 95 %
- Rated switching capacity: 10 kA AC and 1 kA DC
- Vibration resistance:
  - According to IEC 60068-2-6, 50 m/s<sup>2</sup> with 25 to 150 Hz and 60 m/s<sup>2</sup> with 35 Hz (4sec)
  - According to EN 61373 Category 1, Class B
- 5SY5: Usable for DC applications up to 250 volts per pole

#### 5SY17 Circuit Breaker for Equipment



- Circuit Breaker for Equipment offer optimum protection for all applications in AC and DC control circuits in industrial applications and plant engineering.
- They protect solenoid valves, servo motors, signal lamps or even PLC inputs.
- EN 61373, EN 45545-2, UL 1077, IEC 60934

#### 5SL6 COM miniature circuit breakers with communication and measuring function



- The new communication-capable MCB's record measured values and status information and transmit this data wirelessly to higher-level systems.

#### 5ST3 COM Auxiliary switches and fault signal contacts (AS+FC)



- 5ST3 COM Auxiliary switches and fault signal contacts (AS+FC) with Communication and measuring functions

#### 7KN Powercenter 1000



- Wireless radio transmission of measured values and data to the 7KN Powercenter data transceiver
- Parameter assignment, firmware updates and further processing of the data via the 7KN Powercenter 1000 data transceiver



## Electrical components for the railway industry – SENTRON

## 5ST3010 auxiliary switches (AS) for MCBs



- 5ST3 add-on components: can be combined with 5SY MCBs and 5SU1 RCBOs
- Signaling of the miniature circuit breaker's contact position by the auxiliary switch (AS) – released by hand or due to fault
- Auxiliary switch version with test button for testing of the control circuit without switching the miniature circuit breaker
- Rated breaking capacity: 60 A
- Ambient temperatures: -25 °C to +55 °C
- Climate resistance: according to IEC 60068-2-30 28 cycles

## 5SV RCCBs



- Enhanced comfort and safety due to improved design
- Comprehensive uniform accessories for additional functions
- Consistent busbar system concept for all RCCBs with N connection on the right or left
- Easy removal of individual equipment from the linked assembly
- Rated residual current: 30, 300 mA
- Quick and easy replacement thanks to fast manual removal of the RCCBs from the assembly
- Vibration resistance in accordance with DIN EN 61373 Category 1, Class B
- Vibration- and Shocktests according to DIN EN 50155 7391
- Properties for fire protection according to DIN EN 45545-2 7444

## 5SU1 RCBOs



- Clear, visible and controllable connection of the supply line
- Convenient entry thanks to large and easily accessible wiring space
- Peak withstand current (> 1 kA) for safe operation
- Retrofitting of add-on components for miniature circuit breakers on the right side
- Rated residual current: 10, 30, 300 mA, Rated current: 6 to 40 A
- Width: 2 WU
- For all 10 kA versions up to 40 A:
  - Full insulation through integrated, movable terminal covers in the area of conductor entries
  - Replacement time savings thanks to rapid manual removal of the miniature circuit breakers from the assembly when changing the connections
- Vibration resistance in accordance with DIN EN 61373 Category 1, Class B
- Vibration- and Shocktests according to DIN EN 50155 7511
- Properties for fire protection according to DIN EN 45545-2 7512
- Oscillating- and Shock Test Certificate 7209

## Remote controlled mechanisms 5ST30



- The market's most modular system
- Easy selection between manual/off/RC mode
- Easy connection to RCBOs, RCDs, MCBs, and other devices with adapters
- Rated voltages: 12 ... 30/177 ... 270 V AC or 12...48 V DC
- Width: 2 WU
- Applicability at ambient temperatures from -40 °C to +70 °C
- Climate resistance: according to IEC 60068-2-30 28 cycles
- Vibration resistance: according to IEC 60068-2-6. 50 m/s<sup>2</sup> with 10 to 150 Hz

## 3NA3360, 3NA3812 LV HRC fuse links



- Rated breaking capacity 120 kA AC, 25 kA DC
- Rated breaking capacity: 25 kA DC
- Rated current: 2 to 1250 A
- Contact blade: corrosion-free, silver-plated
- Climatic withstand capability: -20 °C up to +50 °C with 95% relative humidity
- Blown-fuse monitoring with 3NX1021 und 3NX1023

## 3NH3030 LV HRC fuse bases and accessories



- Made of ceramic material for screw mounting
- With flat connections, screw
- Size 00, 1, 2, 4

## Introduction

### Fire safety is essential for railway safety

#### Overview



In the event of a fire, a train must be able to reach an appropriate evacuation location to protect people, goods and installations. Automatic fire detection has become an essential aspect of a comprehensive fire safety concept. This is especially the case for train traffic through tunnels and more generally in non-secured areas.

#### **Fire detection for rolling stock**

Whether you are a rolling stock manufacturer or train operator, our fire safety solutions for rolling stock meet all your expectations.

As a rolling stock manufacturer, you want to:

- purchase reliable, turnkey solutions with associated services
- supply and easily integrate products and systems
- use products and systems that completely fulfill current standards

As a train operator, you want to:

- ensure continuous and flexible operation by using high-performance systems
- efficiently manage the availability of your rolling stock
- optimize operating and operational costs
- ensure the highest level of safety for passengers and staff

Backed by our expertise in the field of fire protection, we offer you innovative and lasting solutions for rolling stock like high-speed trains, locomotives, trams and metro lines.

**DSW – Series for rough environmental requirements**

- Solution for rough environmental conditions
- Rail base with external industry standard plug
- Plug & Play solution
- Power supply 24 V DC or 110 V DC
- Alarm and Fault signaling via relay output
- Stand-alone connectivity

**DS1 – Series for standard installation**

- High-end multi criteria spot detector
- Rail base for standard ceiling installation
- Power supply 24 V DC or 110 V DC
- Alarm and Fault signaling via relay output
- 3 parameters selectable
- Stand-alone connectivity

**DS2 – Series for hidden installation and plug&play connectivity**

- High-end multi criteria spot detector
- Rail base with external industry standard plug
- Plug & Play solution
- Power supply 24 V DC or 110 V DC
- Alarm and Fault signaling via relay output
- 3 parameters selectable
- Stand-alone connectivity

**ASD – Series for advanced smoke detection**

- Aspiration smoke detection for railway
- Aspirating smoke detector for high-end fire detection in trains
- Very sensitive and reliable fire detection through differentiation between smoke and deceptive phenomena
- Quick & easy configuration to minimize start-up sequence
- Meets rail specific standards and achieves safety integrity level 2 (SIL2)



## Introduction

1

### Electrical components for the railway industry – Damper actuators

#### Overview

##### **Air Damper actuators with / without spring return functionality for railway vehicles**

Our new damper actuators with DC24 V and DC110 V for use in rail vehicles can be used typically for shut-off and regulation of air volume flows in air conditioning units and air distribution systems.

Typical applications:

- Compact air conditioning units (Driver's cab air-conditioning)
- Roof-top mounted air conditioning units
- Underfloor air conditioning units
- General air distribution

#### Damper actuators with spring return functionality



- GPC... series, for open-close and modulating control
  - Nominal torque 4 Nm
  - Running time 60 s
  - Operating voltage DC 24 V / DC 110 V
  - Connection cables railway specific
  - Emergency function with spring return
  - Position indication
  - Integrated switches for auxiliary functions
  - Degree of protection IP54
  - Printed circuit board with protective coating
- Damper actuators with spring return functionality for difficult operating conditions; they fulfill the main requirements as per:
  - EN 50155 (electronic equipment on rail vehicles)
  - EN 45545 (fire protection of rail vehicles) internal applications
  - EN 61373 (shock and vibration, rail applications)
- These damper actuators are expressly suitable for air conditioning units and air distribution systems for railway vehicles. Typically, used to operate air dampers that must be driven to a defined emergency position in the event of a loss of voltage.
- For damper areas of approx. 0.6 m<sup>2</sup>
- Suitable for use with 2-position, as well as modulating controllers (DC 0/2...10 V)

#### Damper actuators without spring return functionality



- GDD / GDA / GLD / GLA... series, for open-close and modulating control
  - Nominal torque 5 / 8 / 10 Nm
  - Operating voltage DC 24 V / DC 110 V
  - Runtime 30 s / 90 s
  - Rotary angle 0...90°
  - Connection cables railway specific
  - Feedback potentiometer
  - Adjustable auxiliary switches
  - Degree of protection IP54
  - Printed circuit board with protective coating
- Damper actuators without spring return functionality; they fulfill the main requirements as per:
  - EN 50155 (electronic equipment on rail vehicles)
  - EN 45545 (fire protection of rail vehicles) internal applications
  - EN 61373 (shock and vibration, rail applications)
- These damper actuators are expressly suitable for air conditioning units and air distribution systems for railway vehicles. Thanks to a very low sound power level (<28dB(A)), the damper actuators are virtually predestined for use in sleeping cars, couchettes, and passenger coaches.
- For damper areas of approx. 0.8 m<sup>2</sup>
- Suitable for use with 2-position, as well as modulating controllers (DC 0/2...10 V)

## Electrical components for the railway industry – SIPLUS extreme RAIL

## Overview

**SIPLUS extreme RAIL – automation with railway approvals**

Thanks to their extensive approvals and conformity to railway standards, the new SIPLUS extreme RAIL products are the perfect choice for a wide range of rolling stock and trackside applications. Based on SIMATIC industrial controllers, common

features such as integrated system diagnostics and security and safety are already included. Whether simple, complex or distributed - SIPLUS extreme RAIL offers a durable and robust solution for your automation tasks.

## SIPLUS extreme RAIL-Controller



- Basic and advanced controller for use in simple applications such as sanding systems and hygiene cubicles up to complex setups such as HVAC, signaling systems and interlockings
- Compliant to EN 50155, EN 45545 and EN 50124
- Failsafe controller certified for EN 50126, EN 50128, EN 50129 and EN 50159
- Insulation testing for every item
- Conformal Coating
- Temperature classes OT4: -40 °C to +85 °C\* and OT1: -25 °C to +70 °C\* (\* includes +15 K overtemperature for 10 minutes)
- PROFINET, Ethernet, CAN, OPC UA and PROFISAFE communication
- High electromagnetic immunity to interference (EMC) and mechanical resilience (vibration and shock)
- Integrated system diagnostics and security
- 110 V IOs available

## SIPLUS extreme Rail HMI



- HMI Panels for visualization of simple, medium and complex applications
- Compliant to EN 50155, EN 45545 and EN 50124
- Insulation testing for every item
- Conformal Coating
- Temperature class OT1: -25 °C to +70 °C\* (\* includes +15 K overtemperature for 10 minutes)
- PROFINET, Ethernet, CAN, OPC UA and PROFISAFE communication
- High electromagnetic immunity to interference (EMC) and mechanical resilience (vibration and shock)
- Integrated system diagnostics and security
- Horizontal installation

## SIPLUS extreme Rail Distributed I/O



- Distributed I/O controller for medium and complex applications
- Compliant to EN 50155, EN 45545 and EN 50124
- Failsafe controller certified for EN 50126, EN 50128, EN 50129 and EN 50159
- Insulation testing for every item
- Conformal Coating
- Temperature classes OT4: -40 °C to +85 °C\* and OT1: -25 °C to +70 °C\* (\* includes +15 K overtemperature for 10 minutes)
- Seamless integration into the common TIA Portal engineering framework
- PROFINET, Ethernet, CAN, OPC UA and PROFISAFE communication
- High electromagnetic immunity to interference (EMC) and mechanical resilience (vibration and shock)
- Integrated system diagnostics and security

## Introduction

1

### Electrical components for the railway industry – SIDOOR

#### Overview

#### **SIDOOR – Innovative door control systems and now also for metro gap filler control systems**

In the field of railway applications, we offer SIDOOR automatic control system for platform screen doors and gates (PSDs & PSGs), interior train doors and now also for gap fillers.

Safe and convenient operation of the doors or steps is always ensured (friction and energy limitation).

#### Controller for gap filler – SIDOOR ATE530G coated



- Extends a step until 30 kg within 1 s by a maximum of 163 mm against a fixed stop
- Project specific EC motor
- Ice function: A higher extension force can be created within the first 50 mm (parameterizable)
- Variant with additional, transparent protective coating to prevent impairment or damage by moisture and atmospheric pollutants
- Certified according to: DIN EN 50657: 2017 (Basic Integrity)

#### Controllers for platform screen doors – SIDOOR ATE530S COATED and SIDOOR ATE531S

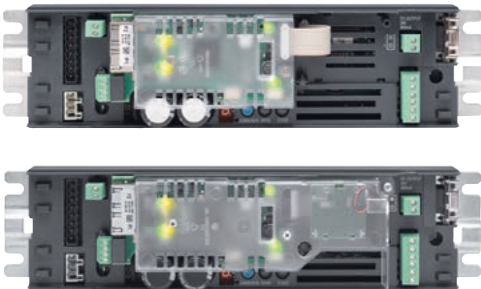

- Less mounting and wiring effort thanks to PROFINET. Furthermore, program changes, software updates and the teach-in drive of all SIDOOR systems can be started from a platform or even from the metro line control center. This substantially reduces commissioning times.
- Seamless integration into the TIA system architecture and expansion of the inputs and outputs for additional actuators and sensors, for example by SIPPLUS ET 200SP RAIL
- Detailed diagnostics and parameter assignment options
- The 5 inputs and 2 outputs can be individually configured
- Freely configurable unlocking sequences
- Certified according to: IEC 62061 (SIL 2 for named functions), EN 60335-1, EN ISO 13849-1, EN 14752 (force and energy)
- Variant with additional, transparent protective coating to prevent impairment or damage by moisture and atmospheric pollutants
  - Corresponds to EN 50155 chapter 12, chapter 9.4
- SIDOOR ATE531S (fig. without lid)
  - additional temperature range extended to +70 °C

#### Motors for platform screen doors and gates– SIDOOR MEG251 and SIDOOR MED280



- Low noise, low heat rise, maintenance-free
- SIDOOR MEG251 left/right:
  - Compact size – EC geared motor for door weights up to 250 kg
  - For retrofit applications (replacement for SIDOOR ATE250S, including SIDOOR MEG250)
- SIDOOR MED280:
  - Gearless EC direct drive for door weights up to 280 kg – provides even higher reliability and energy balance = less wear = long service life
  - Just one motor for different installation orientations = asset minimization

#### Door drive for interior railway doors – SIDOOR ATD400T with SIDOOR MDG180 DIN EN 45545-2 or SIDOOR M3



- Complies with the new fire protection standard for components in rail vehicles according to DIN EN 45545-2 – Hazard Level HL 3
- Certified safety according to DIN EN 14752 (fail-safe limitation of force and energy)
- Extended operating temperature range: -25 °C to +70 °C and for 10 minutes up to +85 °C with reduced track-related speed profile parameters
- SIDOOR MDG180 DIN EN 45545-2 left/right:
  - Compact design – DC geared motor for door weights up to 180 kg
- SIDOOR M3 left/right:
  - better cost position, when extended fire protection standards are not needed
- SIDOOR ATD400T:
  - Including push-to-open and push-to-close function



## Electrical components for the railway industry – SCALANCE | RUGGEDCOM

## Overview

**Communication solutions for railway industry with SCALANCE and RUGGEDCOM**

Siemens offers a wide range of communication products and technologies that are specifically designed to give railway operators all the tools they need for continuously trouble-free railway operation based on current security standards – from the integration of legacy infrastructure to long-haul fiber backbones

and widespread wireless connectivity for mobile and stationary applications. Siemens is active worldwide, and has the knowledge and experience to deliver complete, standardized communication solutions to the railway industry.

**SCALANCE XC-200**

- Meets the railway standard EN 50121-4 (trackside)
- Redundant power supply
- Up to 24 x RJ45 ports 10/100 Mbit/s for mounting in the control cabinet
- Additional versions with optical ports (SC/ST/LC) up to 1 Gbit/s and with conformal coating (XC-200EEC) available
- Slot for optional C-PLUG removable data storage medium for easy device replacement without additional equipment such as a field PG
- Fast mobile network diagnostics by smartphone or tablet via WLAN and NFC (Near Field Communication)

**SCALANCE XP208EEC, XP208PoE EEC, XP216EEC and XP216PoE EEC**

- Meets the railway standards EN 50155 and EN 45545-2 (train- and trackside)
- Managed Switch, high degree of protection (IP 65) for use outside the control cabinet, temperature range -40 °C to +70 °C with coated PCBs (conformal coating), stable metal enclosure
- Flat type for installing in partitions etc., many mounting options
- Clearly highlighted diagnostic area
- Supports PoE ports (IEEE 802.3 at type 2, 30 W per port)
- Variants:
  - XP208EEC: 8-port managed switch
  - XP208PoE EEC: 8-port managed switch, 4 ports with PoE function
  - XP216EEC: 16-port managed switch
  - XP216PoE EEC: 16-port managed switch, 8 ports with PoE function

**SCALANCE XR324-12M TS / XR324-4M PoE TS**

- Meets the railway standards EN 50155, EN 45545-2 and EN 50121-4 (train- and trackside)
- Modular, managed Layer 2 Industrial Ethernet 19" rack switches
- Redundancy functions for highly available ring topologies, tried and tested in industrial applications (MRP/HRP), equipped with additional IT functions, e.g. VLAN, RSTP, MSTP
- Gigabit Ethernet support on all 24 ports
- Ambient temperature -40 °C to +70 °C
- Can be used in harsh environments due to vibration-proof/shock-proof plug-in connection
- Variants:
  - SCALANCE XR324-12 M TS: 12 slots for electrical (RJ45 / M12) and/or optical 2-port media modules (multi-mode or single-mode), which are inserted into the media module slots of the basic unit
  - SCALANCE XR324-4M PoE TS:
    - 16 integrated RJ45 ports, of which 8 are PoE-capable
    - 4 slots for electrical (RJ45 / M12) and/or optical 2-port media modules, which are inserted into the media module slots (multi- or single-mode) of the basic unit

**SCALANCE XM408-8C with Port Extender PE408PoE**

- Meets the railway standard EN 50121-4 (trackside)
- SCALANCE XM408-8C with 8 ports available in total, of which
  - up to 8 x 10/100/1000 Mbit/s are RJ45 ports with retaining collars
  - up to 8 x SFP slots (combo ports), 100 or 1000 Mbit/s of either electric port or SFP slot
- Two port extenders with 8 ports each can be connected to implement a maximum of 24 ports in one switch
- Fast mobile network diagnostics by smartphone or tablet via WLAN and NFC
- High-speed media redundancy through integral redundancy manager even for large networks, for both Gigabit Ethernet and Fast Ethernet
- Opt. activation of the Layer 3 functions in connection with the KEY-PLUG XM-400
- PE408PoE Port Extender for SCALANCE XM-400 managed modular IE switch; extension by 8 x 10/100/1000 Mbit/s RJ45 with up to 8 ports PoE according to IEEE 802.3 at type 2

## Introduction

1

### Electrical components for the railway industry – SCALANCE | RUGGEDCOM

#### SCALANCE MUM856-1



- Meets the railway standards EN 50155, EN 45545 and EN 5012
- 5G/4G/3G router for wireless connection via the mobile radio network – perfect for large bandwidth requirements, e.g. for video transmission, data link for automatic ticket machines, infotainment services, internet on board and telemetry
- Bandwidth up to 1000 Mbit/s downlink and 500 Mbit/s uplink (5G)
- Redundant power supply
- Network management via SNMP
- Integrated firewall and IPsec / OpenVPN
- Ambient temperature -30 °C to +60 °C

#### SCALANCE M876-4 + ANT896-6MH

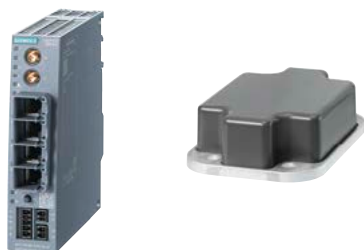

- Meets the railway standards EN 50155 and EN 50121-4
- 4G/3G router for wireless connection via the mobile radio network – perfect for large bandwidth requirements, e.g. for video transmission, data link for automatic ticket machines, infotainment services, internet on board and telemetry
- Bandwidth up to 100 Mbit/s downlink and 50 Mbit/s uplink (4G)
- Redundant power supply
- Managed 4-port switch, network management via SNMP
- Integrated firewall and IPsec/OpenVPN
- Ambient temperature -20 °C to +60 °C
- 2G/3G/4G antenna ANT896-6MH for mounting on the vehicle roof

#### SCALANCE W774-1 M12 EEC and SCALANCE W778-1 M12 EEC



- Meets the railway standards EN 50155 and EN 50121-4
- Industrial Wireless LAN Access Points for installation in control cabinets or for indoor use with IEEE 802.11a/b/g/n support and data transfer rates up to 300 Mbit/s
- Low-profile, compact aluminum enclosure, shock and vibration-proof, for high mechanical requirements, variants in protection class IP30 and IP65
- M12 connections for 10/100 Mbit/s with PoE
- Coated PCBs (conformal coating) and extended temperature range (-30 °C to +70 °C)
- Mounting outside of the cabinet also possible thanks to IP65 protection class (SCALANCE W778-1 M12)
- Additional functions (iFeatures) can be activated optionally with a KEY-PLUG, e.g. iPRP for reliable redundancy with WLAN

#### SCALANCE W1788-2 M12 EEC



- Meets the railway standards EN 50155, EN 45545-4 and EN 50121-4
- Industrial Wireless LAN Access Point for installation in control cabinets or for indoor use with IEEE 802.11ac support with transfer rates up to 1700 Mbit/s
- Rugged aluminum enclosure, shock and vibration-proof, for high mechanical requirements, protection class IP65, coated PCB (conformal coating)
- M12 connection for 10/100/1000 Mbit/s with PoE
- Antenna positioning optimized for 4 x 4 MIMO; no interference between the antennas for direct mounting on the device
- Ambient temperatures: -20 °C to +60 °C
- Additional industrial functions (iFeatures) can be activated optionally via a CLP, e.g. iPRP for reliable redundancy with WLAN

## Electrical components for the railway industry – SCALANCE | RUGGEDCOM

## SCALANCE WAM766-1 EEC



- Meets the railway standards EN 50155, EN 45545-2
- Industrial Wireless LAN Access Point for installation in control cabinets or for indoor use with IEEE 802.11ax support and data transfer rates up to 1,201 Mbit/s
- Rugged aluminum enclosure, shock and vibration-proof, for high mechanical requirements, protection class IP65, conformal coating, e1 approval
- M12 connection for 10/100/1000 Mbit/s with PoE
- Interfaces: 2 x 2:2 MIMO N-Connect antenna connections
- Ambient temperatures: -30 °C to +75 °C
- Additional industrial functions (iFeatures) can be activated optionally via a CLP, e.g. iPRP for reliable redundancy with WLAN

## IWLAN accessories: antennas and cables



- Remote antennas increase the reliability of wireless links by optimizing signal reception and emission
- Use in Industrial Wireless LAN (IWLAN) and WLAN according to IEEE 802.11 at 2.4 GHz and 5 GHz
- The connection cables meet the increased requirements for environmental conditions and fire protection that are required for use in vehicles (including EN 45545-2)

## RUGGEDCOM RS900G / RS900GP



- Meet the railway standard EN 50121-4
- Managed Ethernet switch for reliable operation in critical infrastructure
- Multiple fiber connector types (LC, SC, ST, SFP)
- Long-haul optics allow Gigabit uplinks for distances up to 70 km
- Operating temperature from -40 °C to +85 °C
- Variants:
  - RS900G: Managed Ethernet switch with 10 ports, Gigabit fiber-optic uplinks and 128 bit encryption
  - RS900GP: Managed Ethernet switch with 10 ports, of which 8 are Power-over-Ethernet (PoE) ports and 2 Gigabit uplinks, with 128 bit encryption

## RUGGEDCOM RSG920P



- Meets the railway standards EN 45545-2 and EN50121-4
- High port density to meet the Ethernet requirements along the track
- Compact layer 2 Gigabit switch with 20 Gigabit ports, including 4 PoE ports and 4 SFP slots and I/Os with PoE supply
- SFP ports for greater flexibility and migration in future Ethernet networks
- 19" switch performance features in compact design to save space
- Application and commissioning with USB console and MicroSD firmware/configuration
- RPS1300 power supply suitable for Power-over-Ethernet devices, max. power 140 W

## RUGGEDCOM RSG907R / RSG909R



- Meet the railway standard EN 50121-4
- PRP/HSR coupling functionality to cover all types of redundant network topologies
- 3 x RNA (Redundant Network Access) and coupler Ethernet ports according to IEC 62439-3 (1000BASE-X), plus
  - RSG907R: 4 x SAN (Singly Attached Node) fiber optic ports (LC, 100BASE-FX)
  - RSG909R: 6 x SAN (Singly Attached Node) copper Ethernet (RJ45)
- Power redundancy: Integrated power supply with redundant inputs
  - Universal high voltage range: 88 – 300 VDC or 85 – 264 VA;
  - Universal low voltage power supply range: 10 – 60 VDC



## Introduction

1

## Electrical components for the railway industry – SCALANCE | RUGGEDCOM

## RUGGEDCOM RSG908C / RSG910C



- Meet the railway standards EN 50155 and EN 50121-4
- IEEE 1588 v2 Ordinary & Transparent Clocks
- RUGGEDCOM RSG908C: 4 x 1000BASE-X SFP uplink Ethernet ports and 4 x 100BASE-FX LC fiber optic ports
- RUGGEDCOM RSG910C: 4 x 1000BASE-X SFP uplink Ethernet ports and 6 x 10/100/1000BASE-TX RJ45 copper Ethernet ports

## RUGGEDCOM RST916P / RST916C



- Meet the railway standards EN 50155 and EN 50121-4
- IEEE 1588 v2 Ordinary & Transparent Clocks
- Removable storage medium, CLP, for device configuration back-up
- RUGGEDCOM RST916P: 12 x 10/100/1000BASE-T RJ45 ports, 4 x 1G BASE-X/1000BASE-X SFP+, 10 x 10/100/1000BASE-T IEEE 802.3bt Types 1, 2, and 3 compliant PoE ports (60 W/port)
- RUGGEDCOM RST916C: 12 x 10/100/1000BASE-T RJ45 ports and 4 x 1G/10G BASE-X/1000BASE-X SFP+

## RUGGEDCOM RX1400



- Meet the railway standard EN 50121-4
- Rugged Industrial Ethernet switch and TCP/IP router with LTE and fiber-optic WAN options in compact design
- For safe, cost-effective implementation of extensive communication applications and a high processing performance in harsh industrial environments
- 4 x Fast Ethernet copper ports and 2 x Gigabit SFP slots (Small Form Factor Pluggable)
- Supports multi-mode and single-mode SFPs for distances up to 100 km
- Equipped with GPS input
- Available with or without LTE modem for Europe, North America, the Asia-Pacific Region and Japan
- Operating temperatures from -40 °C to +85 °C; fanless operation
- The RUGGEDCOM VPE1400 provides a virtualized environment to run a guest Linux operating system and third party applications on the RX1400, enabling intelligence at the network edge

## RUGGEDCOM RX1500 / RX1501 / RX1510 / RX1524 / RX1536



- Meet the railway standards EN 50155 and EN 50121-4 (Only RUGGEDCOM RX1524 and RX1536)
- Modular and field-replaceable layer 2 and layer 3 switch and router
- M12 line modules with very wide range of functions (M12/RJ45, Fast Ethernet / Gigabit, etc.)
- ROX II software features with integrated router/firewall / VPN / VRRP/MPLS
- Input voltage: 24 V DC, 48 V DC, 88 to 300 V DC, and 85 to 264 V AC for worldwide operability
- Operating temperature from -40 °C to +85 °C

## RUGGEDCOM RSG2100 / RSG2100P



- Meet the railway standard EN 50121-4
- Modular fully managed Ethernet switch for use in electrically harsh and climatically demanding environments
- Up to 3 Gigabit Ethernet ports and 16 Fast Ethernet ports (copper and /or fiber optic)
- 2-port modules for outstanding flexibility
- Store and forward switching
- Supports many fiber-optic types (multi-mode, single-mode) with diverse connectors (ST, MTRJ, LC, SC, SFP)
- Fully integrated, dual redundant (optional) power supplies
- Variant available with up to 4 ports conforming with IEEE 802.3af (10/100BaseTX)

## Electrical components for the railway industry – SCALANCE | RUGGEDCOM

## RUGGEDCOM RSG2300 / RSG2300P



- Meets the railway standard EN 50121-4
- Fully managed Ethernet rack switch with 32 ports and 4 modular Gigabit uplink ports and 24 Fast Ethernet copper ports
- Optional: up to 4 x 1000LX Gigabit Ethernet ports (copper and/or fiber-optic) and up to 8 x 100FX Fast Ethernet ports (copper and/or fiber-optic)
- Non-blocking, store and forward switching
- Supports many fiber-optic types (multi-mode, single-mode) with diverse connectors (ST, MTRJ, LC, SC, SFP)
- Fully integrated, doubly redundant (optional) power supplies
- Variant available with up to four ports conforming with IEEE 802.3af (10/100BaseTX)

## RUGGEDCOM RST2228 / RST2228P



- Meets the railway standards EN 50155 and EN 50121-4
- 19" Layer 2 rack switch with up to 28 Ports: 4 x 1/10 Gigabit ports (SFP), 24 Gigabit/Fast Ethernet ports (SFP, RJ45, LC)
- Power-over-Ethernet Variant available
- Supports IEEE 8023.at/802.3bt (draft) with max. 60W per port
- Maximum Power budget 500W
- Modular; field-replaceable Ethernet media modules with 4 ports for outstanding flexibility
- Supports IEEE 1588 v2 time synchronization with hardware time stamping and transparent clock
- Non-blocking, store and forward switching
- Integrated dual redundant power supplies

## RUGGEDCOM WIN



- First broadband wireless product portfolio designed for private networks delivering the benefits of 4G technology to critical infrastructure applications in harsh environments
- Provides enhanced security, network simplicity and private network feature set
- Mobile WiMAX compliance based on IEEE 802.16e standard and WiMAX Forum Wave2 (MI-MO) certification
- Lowest frequency use: leverages OFDMA and built-in GPS to enable users to deploy an entire network on a single frequency channel
- Quality of service: separate traffic types over the air and guarantee latency, minimum bandwidth and jitter, according to application needs
- Stand-alone architecture: does not require an entire network infrastructure to be in place, while maintaining the interoperability and technology advances of broadband wireless
- Improved security: built-in features ensure NERC CIP compliance, such as two-factor mutual authentication and AES encryption
- Operating temperature from -40 °C to +75 °C

## Introduction

MoComp – made to move.

### Overview

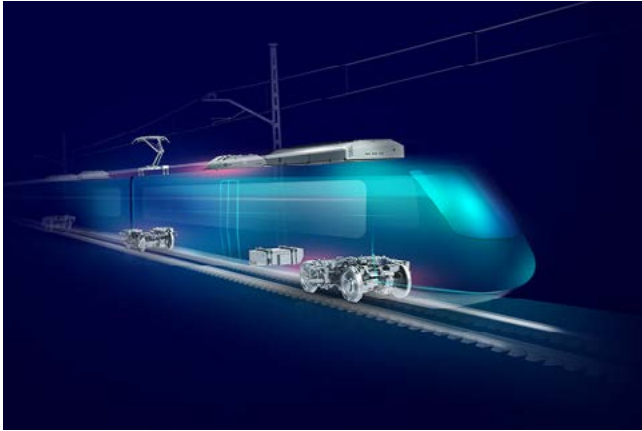

#### **We keep things moving ...**

... in all kinds of weather, year in and year out, around the world, optimized for your vehicle. Components in the MoComp product family make this possible including superior pantographs, auxiliary traction converters, motors, gear units, brake systems, and bogies for all types of rail vehicle.

The products as well as complete propulsion systems are developed, produced, and tested using state-of-the-art methods and technologies. Whether for individual components or an optimized overall system, our focus is always on energy efficiency, weight management, system integration, and reliability. We're your reliable partner with proven expertise, innovations, and competitive technologies.

#### **Railway components that can do more**

With the MoComp product family, you benefit from over 140 years of experience. But our railway components can do even more. They were developed by a vehicle manufacturer – always with your vehicle and its performance in mind – as an individual product or system. In partnership with you, we develop your application to suit your requirements and the needs of your customers.

#### **Your partner for innovation**

Many innovations are developed off the beaten track using the latest technologies and materials and with the help of experience, a pioneering spirit, comprehensive expertise, and good ideas:

- Systems for using alternative energies like batteries or hydrogen
- Space-optimized and extremely aerodynamic pantographs
- Lightweight bogies
- Permanent magnet synchronous machines
- High-speed asynchronous machines with optimized gear units
- Auxiliary and traction converters with the latest IGBT and silicon carbide technology
- Highly efficient closed-loop control
- Digitalization and monitoring
- Highly efficient open-loop control
- Airless brake system

#### **We're there for you – on site and around the world**

As a system supplier, we provide you with the complete powertrain from a single source, from the main switch to the wheel. We're by your side throughout the entire product lifecycle, exactly where you need us! We support you worldwide with Siemens Mobility's extensive manufacturing and service organization for local content, interface-optimized logistics and communication processes, and guaranteed services. You benefit from high energy efficiency and perfect vehicle performance as well as optimized service intervals for low lifecycle costs.

#### **Spotlight**

One special highlight is our development of the airless, electrohydraulic brake system, whose control system is fully integrated in the drive control. As a result, your vehicle is ready for operation sooner, your compressed air supply can be smaller, weight is lower, and more installation space is available for other components. Headways are also shorter because the brake can release much more quickly and the train requires much less time to get moving after the doors are closed.



Our new airless brake system is the world's first completely electrohydraulic friction brake to be used in rail vehicles (brake by wire).

Find out more about railway components from Siemens Mobility: [www.siemens.com/mocomp](http://www.siemens.com/mocomp)



**MoComp® component family****Pantographs**

- Pantographs in reliable contact with the overhead line for all types of electric rail vehicle.

**Traction converters**

- Traction converters with the best possible efficiency for all standard voltage classes and cooling types for all rail vehicles.

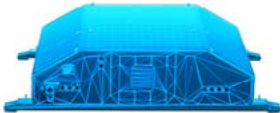
**Auxiliary converters**

- The right power supply for every on-board system converter:  
- a versatile power supply for use in vehicles.

**Bogies**

- Reliable bogies for mass transit and mainline applications:  
- bogies with diagnostic systems.

**Gear units**

- Rail transmissions for all types of vehicle:  
- helical and bevel gear units in single-stage or multi-stage versions as well as special solutions.

**Traction motors**

- More comfortable traveling with our motors:  
- optimal traction performance, low noise, and a high comfort level for passengers.

**Brake systems**

- Innovative Siemens brake systems:  
- an economical solution that has added potential for cross-discipline system optimization

## Introduction

### Medium-Voltage Components

1

#### Overview

##### Vacuum interrupters for medium voltage switching devices



- Extremely safe switching and long service life due to vacuum design
- Many years of manufacturing experience, with more than 5 million interrupters supplied
- Customer-specific development according to OEM customer requirements
- High product variance for different switching applications
- Use in:
  - Medium- and low-voltage switching devices
  - Medium-voltage contactors, circuit breakers, load-break switches and switch disconnectors for railway applications

##### 3AH47 VCB for traction applications



- Rated voltages up to 27.5 kV, frequencies of 16.7 - 60 Hz, Rated current up to 2500 A
- Rated short-circuit breaking current up to 50 kA
- 1-, 2- and 3-pole version
- Vertical pole assembly fixed to operating mechanism via post insulators
- Customer benefits:
  - compact & high mechanically stable design
  - various additional equipment available
  - economical integration
  - competent consultation by our experts

**Overview****Siemens surge arresters for railway applications – reliable, stable and safe overvoltage protection**

Siemens has been designing and manufacturing surge arresters for all kinds of applications since 1925. For more than 80 years we've been manufacturing surge arresters for rail systems. Continuous research and development, the wealth of Siemens know-how, and comprehensive worldwide experience give Siemens surge arresters a leading edge in overvoltage protection. Their uncompromising quality ensures a long service life and the highest reliability in any application.

Siemens surge arresters are an indispensable aid to insulation coordination in electrical power systems. Valuable equipment, such as traction vehicles, is optimally protected against lightning and switching overvoltages. Siemens surge arresters have been designed to meet the requirements of a wide range of common installation environments, from arctic cold to the heat of the desert and the dampness of tropical climates.

All Siemens surge arresters feature a superior sealing system that reliably prevents moisture ingress to ensure the highest possible degree of overvoltage protection and decades of trouble-free service.

**3EB4 surge arrester for railway applications**

- Housing made of glass fiber reinforced plastic (FRP) tube and silicone rubber sheds
- For AC systems up to 25 kV
- For DC systems up to 3 kV
- Train speeds up to 420 km/h
- Short circuit current capability 50 kA
- Tested according to IEC 60099-4 (AC version) and EN 50526-1 (DC version)
- Fire test according to DIN EN 45545-2
- Shock and vibration test according to IEC 61373
- For use on:
  - High-speed trains and intercity trains
  - Commuter and regional trains
  - (Multi-traction) locomotives
  - Urban transportation (light rail, metros and tram cars)

**3EB5 surge arrester for railway applications**

- Cage design™ with directly molded silicone rubber housing
- For AC systems up to 25 kV
- For DC systems up to 3 kV
- Travel speed up to 200 km/h
- Short circuit current capability 65 kA
- Tested according to IEC 60099-4 (AC version) and EN 50526-1 (DC version)
- Fire test according to DIN EN 45545-2
- Shock and vibration test according to IEC 61373
- For use on:
  - Intercity trains
  - Commuter and regional trains
  - (Multi-traction) locomotives
  - Urban transportation (light rail, metros and tram cars)







### 2/3 Power contactors for switching motors

- 2/3 Introduction
- 2/6 General data
- 2/13 SIRIUS 3RT contactors, 3-pole up to 250 kW
- Accessories for SIRIUS 3RT contactors and SIRIUS 3RH2 contactor relays
- 2/52 - General data
- 2/55 - Auxiliary switches, instantaneous
- 2/64 - Link modules
- 2/69 - Connection modules/adapters
- 2/72 - Covers
- 2/73 - Miscellaneous accessories
- Spare parts for SIRIUS 3RT contactors and SIRIUS 3RH2 contactor relays
- 2/74 - Solenoid coils
- 2/75 - Contacts and arc chutes

### 2/76 Contactors for special applications

- 2/76 Introduction
- 2/79 SIRIUS 3RT.4 contactors for weak or non-inductive loads (AC-1), 3-pole up to 2 650 A
- 2/88 SIRIUS 3RT.3 contactors, 4-pole, up to 525 A
- 2/97 SIRIUS 3RT25 contactors, 4-pole, 2 NO + 2 NC
- Containers for railway applications
- 2/101 - SIRIUS 3RT contactors with extended operating range, 3-pole
- 2/109 - SIRIUS 3RH2 contactor relays with extended operating range
- 2/111 - 3TC contactors for switching DC voltage, 2-pole
- 2/113 3TC contactors for switching DC voltage, 1- and 2-pole

### 2/124 Contactor relays

- 2/124 Introduction
- 2/125 SIRIUS 3RH2 contactor relays, 4- and 8-pole
- 2/135 3TH4 contactor relays, 8- and 10-pole
- 2/142 - Accessories for 3TH4 contactor relays

### 2/143 Coupling relays

- 2/143 Introduction
- 2/144 SIRIUS 3RQ1 force-guided coupling relays, fail-safe up to SIL 3 / PL e
- 2/151 SIRIUS 3RQ2 coupling relays with industrial enclosure
- 2/154 SIRIUS 3RQ3 coupling relays, narrow design

### 2/162 Motor starter protectors/circuit breakers

#### SIRIUS 3RV2 motor starter protectors/circuit breakers

- 2/162 Introduction
- 2/163 General data
- 2/177 For motor protection
- 2/185 For motor protection with overload relay function
- 2/187 For starter combinations
- 2/190 For transformer protection
- 2/194 For system protection
- Accessories
- 2/195 - Mountable accessories
- 2/198 - Busbar accessories
- 2/201 - Mounting accessories
- 2/206 3RV29 infeed system

### 2/214 Relays

#### Timing relays

- 2/214 General data
- 2/215 SIRIUS 3RP25 timing relays, 17.5 mm and 22.5 mm
- 2/227 SIRIUS 3RP20 timing relays, 45 mm
- SIRIUS 3RR21, 3RR22 monitoring relays for mounting on 3RT2 contactors
- 2/233 Current and active current monitoring
- SIRIUS 3RR24 monitoring relays for mounting on 3RT2 contactors for IO-Link
- 2/241 Current and active current monitoring
- SIRIUS 3UG5 monitoring relays for stand-alone installation
- 2/248 DC load monitoring
- SIRIUS 3UG45, 3UG46 monitoring relays for stand-alone installation
- 2/253 General data
- 2/255 Line monitoring
- 2/260 Voltage monitoring
- 2/263 Current monitoring
- 2/265 Power factor and active current monitoring
- Residual-current monitoring
- 2/268 - Residual-current monitoring relays
- 2/270 - 3UL23 residual-current transformers
- 2/271 Insulation monitoring
- 2/275 Level monitoring
- 2/278 Speed monitoring
- 2/281 Accessories

**NEW**

Click on this video symbol in the catalog PDF for further product information.







### SIRIUS 3UG48 monitoring relays for stand-alone installation for IO-Link

- 2/282 General data
- 2/285 Line monitoring
- 2/288 Voltage monitoring
- 2/291 Current monitoring
- 2/294 Power factor and active current monitoring
- Residual-current monitoring
- 2/298 - Residual-current monitoring relays
- 2/301 Speed monitoring
- 2/304 Accessories
- SIRIUS 3RS2 temperature monitoring relays
- 2/305 General data
- 2/313 Basic units
- 2/314 Accessories

### **SIRIUS 3SE5 mechanical position switches**

- 2/315 Introduction
- 2/318 General data
- 2/325 Compact design
- 3SE5, open-type design
- 2/327 - Enclosure width 30 mm

### **SIRIUS 3SE5, 3SE2 mechanical safety switches**

- With separate actuator
- 2/328 General data
- With tumbler
- 2/330 General data

### **SIRIUS 3SE5, 3SE2 mechanical safety hinge switches**

- 2/333 General data

### **SIRIUS 3SE5 mechanical position switches for ambient temperatures down to -40 °C**

- Shock and vibration test
- SIRIUS 3SE5 mechanical position switches
- 2/334 - 3SE5, plastic enclosures
- SIRIUS 3SE5 mechanical safety switches with tumbler
- 2/335 - 3SE5, plastic enclosures
- SIRIUS 3SE5 mechanical safety hinge switches
- 2/336 - 3SE5, plastic enclosures
- Shock and vibration test according to railway standard
- SIRIUS 3SE5 mechanical position switches
- 2/337 - 3SE5, plastic enclosures
- 2/340 - 3SE5, metal enclosures
- SIRIUS 3SE5 mechanical safety switches with separate actuator
- 2/345 - 3SE5, plastic enclosures/metal enclosures
- SIRIUS 3SE5 mechanical safety switches with tumbler
- 2/346 - 3SE5, plastic enclosures

### **SIRIUS ACT pushbuttons and indicator lights**

- 2/347 Introduction
- 2/350 General data
- Actuators and indicators, 22 mm, round, plastic, black
- 2/366 Actuating and signaling elements
- Actuators and indicators, flat, 30 mm, metal, matte
- 2/379 Actuating and signaling elements
- Actuators and indicators, customized designs
- 2/383 Special locks
- 2/384 Laser inscriptions
- Holders
- 2/385 Holders without module
- Modules
- 2/386 Contact modules
- 2/389 LED modules
- Enclosures
- 2/392 General data
- 2/393 Empty enclosures
- Accessories
- Labels
- 2/394 - Insert labels
- 2/397 - Label holders for labeling plates
- 2/399 - Labeling plates
- 2/406 - Labeling plates for enclosures
- 2/410 - Labels for laser printers
- 2/411 - Other labels
- 2/414 Protection/access protection
- 2/420 Actuators
- 2/423 Enclosures
- 2/425 Miscellaneous accessories

**NEW**

Click on this video symbol in the catalog PDF for further product information.



# Switching devices – Contactors and contactor assemblies – for switching motors

## Power contactors for switching motors

Introduction

### Overview

#### More information

Homepage, see [www.siemens.com/sirius](http://www.siemens.com/sirius)Industry Mall, see [www.siemens.com/product?3RT\\_3TK\\_3TC](http://www.siemens.com/product?3RT_3TK_3TC)Conversion tool, see [www.siemens.com/conversion-tool](http://www.siemens.com/conversion-tool)TIA Selection Tool Cloud (TST Cloud), see [www.siemens.com/tstcloud/?node=Contactor](http://www.siemens.com/tstcloud/?node=Contactor)Size  
TypeS00  
3RT201S0  
3RT202

#### 3RT20 contactors

Type	3RT2015	3RT2016	3RT2017	3RT2018	3RT2023	3RT2024	3RT2025	3RT2026	3RT2027	3RT2028	
AC, DC operation	(p. 2/43, 2/44, 2/104, 2/105)				(p. 2/45)						
<b>AC-3</b>											
$I_e$ /AC-3/400 V	A	7	9	12	16	9	12	17	25	32	38
400 V	kW	3	4	5.5	7.5	4	5.5	7.5	11	15	18.5
230 V	kW	1.5	2.2	3	4	2.2	3	4	5.5	7.5	11
690 V	kW	4	5.5	5.5	7.5	7.5	7.5	11	11	18.5	18.5
1 000 V	kW	--	--	--	--	--	--	--	--	--	--
<b>AC-4 (at <math>I_a = 6 \times I_e</math>)</b>											
400 V	kW	3	4	4	5.5	4	5.5	7.5	7.5	11	11
400 V (200 000 operating cycles)	kW	1.15	2	2	2.5	2	2.6	3.5	4.4	6	6
<b>AC-1 (40 °C, ≤ 690 V)</b>											
$I_e$	A	18	22	22	22	40	40	40	40	50	50

#### Accessories for contactors

Auxiliary switches	• On front	3RH29		(p. 2/59)	3RH29		(p. 2/59)
	• Lateral	3RH29		(p. 2/61)	3RH29		(p. 2/61)
Function modules	• Direct-on-line starting, star-delta (wye-delta) starting	3RA281. <sup>1)</sup>					
	• IO-Link, AS-Interface	3RA271.-.AA00 <sup>1)</sup>					
Surge suppressors		3RT2916 <sup>1)</sup>			3RT2926 <sup>1)</sup>		

#### 3RU2 and 3RB3 overload relays

3RU thermal overload relays

<sup>1)</sup>

3RB electronic overload relays

<sup>1)</sup>

#### 3RV20 motor starter protectors

Motor starter protectors	3RV2011	0.11 ... 16 A	(p. 2/177)	3RV2021	0.45 ... 40 A	(p. 2/178)
Link modules	3RA1921, 3RA2911			3RA2921		
			(p. 2/203)			(p. 2/203)

#### 3RA23 reversing contactor assemblies

Complete units	Type	<sup>1)</sup>									
400 V	kW	3	4	5.5	7.5	5.5	7.5	11	15	18.5	
Assembly kits, etc.		3RA2913-2AA.				(p. 2/64)					
Function modules		3RA271.-.BA00 <sup>1)</sup>									

#### 3RA24 contactor assemblies for star-delta (wye-delta) starting

Complete units	Type	3RA2415 <sup>1)</sup>	3RA2416 <sup>1)</sup>	3RA2417 <sup>1)</sup>	3RA2423 <sup>1)</sup>	3RA2425 <sup>1)</sup>	3RA2426 <sup>1)</sup>
400 V	kW	5.5	7.5	11	11	15/18.5	22
Assembly kits/wiring modules		3RA2913-2BB.			3RA2923-2BB.		
				(p. 2/65)			(p. 2/65)
Function modules		3RA271.-.CA00 <sup>1)</sup>					

<sup>1)</sup> see Catalog IC 10.



# Switching devices – Contactors and contactor assemblies – for switching motors

## Power contactors for switching motors

### Introduction

2



Size  
Type

**S2**  
3RT203

**S3**  
3RT204

#### 3RT20 contactors

Type	3RT2035	3RT2036	3RT2037	3RT2038	3RT2045	3RT2046	3RT2047
AC, DC operation	(p. 2/46, 2/48)				(p. 2/46, 2/49)		

#### AC-3

$I_e$ /AC-3/400 V	A	41	50	65	80	80	95	110
<b>400 V</b>	<b>kW</b>	<b>18.5</b>	<b>22</b>	<b>30</b>	<b>37</b>	<b>37</b>	<b>45</b>	<b>55</b>
230 V	kW	11	15	18.5	22	22	22	30
690 V	kW	22	22	37	45	55	75	90
1 000 V	kW	--	--	--	--	37	37	37

#### AC-4 (at $I_a = 6 \times I_e$ )

<b>400 V</b>	<b>kW</b>	<b>18.5</b>	<b>22</b>	<b>30</b>	<b>37</b>	<b>37</b>	<b>45</b>	<b>55</b>
400 V (200 000 operating cycles)	kW	11.6	12.6	14.7	15.8	17.9	22	24.3

#### AC-1 (40 °C, ≤ 690 V)

$I_e$	A	60	70	80	90	125	130	130
-------	---	----	----	----	----	-----	-----	-----

#### Accessories for contactors

<b>Auxiliary switches</b>	<ul style="list-style-type: none"> <li>On front</li> <li>Lateral</li> </ul>	3RH29		(p. 2/59)	3RH29		(p. 2/59)
<b>Function modules</b>	<ul style="list-style-type: none"> <li>Direct-on-line starting</li> <li>IO-Link, AS-Interface</li> </ul>	3RA283. <sup>1)</sup>			3RH29		(p. 2/61)
<b>Surge suppressors</b>		3RT2936 <sup>1)</sup>			3RT2936, 3RT2946 <sup>1)</sup>		
<b>Terminal covers</b>		3RT2936-4EA2		(p. 2/72)	3RT2946-4EA2		(p. 2/72)

#### 3RU2 and 3RB overload relays

<b>3RU thermal overload relays</b>	<sup>1)</sup>
<b>3RB electronic overload relays</b>	<sup>1)</sup>

#### 3RV20 motor starter protectors

<b>Motor starter protectors</b>	3RV2031, 3RV2032	9.5 ... 80 A	(p. 2/179)	3RV2041, 3RV2042	28 ... 100 A	(p. 2/180)
<b>Link modules</b>	3RA2931		(p. 2/203)	3RA1941		(p. 2/203)

#### 3RA23 reversing contactor assemblies

Complete units	Type	3RA2335 <sup>1)</sup>	3RA2336 <sup>1)</sup>	3RA2337 <sup>1)</sup>	3RA2338 <sup>1)</sup>	3RA2345 <sup>1)</sup>	3RA2346 <sup>1)</sup>	3RA2347 <sup>1)</sup>
<b>400 V</b>	<b>kW</b>	<b>18.5</b>	<b>22</b>	<b>30</b>	<b>37</b>	<b>37</b>	<b>45</b>	<b>55</b>
<b>Assembly kits/wiring modules</b>		3RA2933-2AA. (p. 2/64)				3RA2943-2AA. (p. 2/64)		
<b>Function modules</b>		3RA271.-.BA00 <sup>1)</sup>						
<b>Mechanical interlocks</b>		3RA2934-2B (p. 2/68)				3RA2934-2B (p. 2/68)		

#### 3RA24 contactor assemblies for star-delta (wye-delta) starting

Complete units	Type	3RA2434 <sup>1)</sup>	3RA2435 <sup>1)</sup>	3RA2436 <sup>1)</sup>	3RA2437 <sup>1)</sup>	3RA2444 <sup>1)</sup>	3RA2445 <sup>1)</sup>	3RA2446 <sup>1)</sup>
<b>400 V</b>	<b>kW</b>	<b>22/30</b>	<b>37</b>	<b>45</b>	<b>55</b>	<b>55</b>	<b>75</b>	<b>90</b>
<b>Assembly kits/wiring modules</b>		3RA2933-2BB./-2C (p. 2/65)				3RA2943-2BB./-2C (p. 2/65)		
<b>Function modules</b>		3RA271.-.CA00 <sup>1)</sup>						

<sup>1)</sup> see Catalog IC 10.

# Switching devices – Contactors and contactor assemblies – for switching motors

## Power contactors for switching motors

## Introduction



Size	<b>S6</b>			<b>S10</b>			<b>S12</b>			
Type	3RT105			3RT1.6			3RT1.7			
<b>3RT10 contactors · 3RT12 vacuum contactors</b>										
Type	<b>3RT1054</b>	<b>3RT1055</b>	<b>3RT1056</b>	<b>3RT1064</b>	<b>3RT1065</b>	<b>3RT1066</b>	<b>3RT1075</b>	<b>3RT1076</b>		
AC, DC operation	(p. 2/50)			(p. 2/50)			(p. 2/50)			
Type	--	--	--	<b>3RT1264<sup>1)</sup></b>	<b>3RT1265<sup>1)</sup></b>	<b>3RT1266<sup>1)</sup></b>	<b>3RT1275<sup>1)</sup></b>	<b>3RT1276<sup>1)</sup></b>		
<b>AC-3</b>										
$I_e$ /AC-3/400 V	A	115	150	185	225	265	300	400	500	
<b>400 V</b>	<b>kW</b>	<b>55</b>	<b>75</b>	<b>90</b>	<b>110</b>	<b>132</b>	<b>160</b>	<b>200</b>	<b>250</b>	
230 V	kW	37	45	55	55	75	90	132	160	
690 V	3RT10/3RT12 kW	110	132	160	200	250	250	400	400/500	
1 000 V	3RT10/3RT12 kW	75	90	90	90/315	132/355	132/400	250/560	250/710	
<b>AC-4 (at <math>I_a = 6 \times I_e</math>)</b>										
<b>400 V</b>	<b>kW</b>	<b>55</b>	<b>75</b>	<b>90</b>	<b>110</b>	<b>132</b>	<b>160</b>	<b>200</b>	<b>250</b>	
400 V	3RT10/3RT12 kW	29	38	45	54/78	66/93	71/112	84/140	98/161	
(200 000 operating cycles)										
<b>AC-1 (40 °C, <math>\leq 690</math> V)</b>										
$I_e$	3RT10/3RT12 A	<b>160</b>	<b>185</b>	<b>215</b>	<b>275/330</b>	<b>330</b>	<b>330</b>	<b>430/610</b>	<b>610</b>	
<b>3RT14 AC-1 contactors</b>										
Type	<b>3RT1456</b>	(p. 2/87)			<b>3RT1466</b>	<b>3RT1467 (p. 2/87)</b>	<b>3RT1476</b>	(p. 2/87)		
$I_e$ /AC-1/40 °C/≤ 690 V	A	<b>275</b>				<b>400</b>	<b>500</b>	<b>690</b>		
<b>Accessories for contactors</b>										
<b>Auxiliary switches</b>	• On front • Lateral	<b>3RH19, 3RT1926</b>			(p. 2/60)					
		<b>3RH19</b>			(p. 2/62, 2/63)					
<b>Surge suppressors</b>		<b>3RT1956-1C<sup>1)</sup></b> (RC element)								
<b>Terminal covers</b>		<b>3RT1956-4EA.</b>			(p. 2/72)			<b>3RT1966-4EA.</b>		
					(p. 2/70)			(p. 2/70)		
<b>Box terminal blocks</b>		<b>3RT1955-4G, 3RT1956-4G</b>			(p. 2/70)					
<b>3RB2 overload relays</b>										
<b>3RB electronic overload relays</b>		<sup>1)</sup>								
<b>3RV10 molded case motor starter protectors</b>										
<b>Molded case motor starter protectors</b>		<b>3RV1063<sup>1)</sup></b> 40 ... 200 A			<b>3RV1073<sup>1)</sup></b> 160 ... 400 A			<b>3RV1083</b> 252 ... 630 A		
<b>Reversing contactor assemblies<sup>1)</sup></b>										
<b>Complete units</b>	Type	--								
<b>400 V</b>	<b>kW</b>	<b>55</b>	<b>75</b>	<b>90</b>	<b>110</b>	<b>132</b>	<b>160</b>	<b>200</b>	<b>250</b>	
<b>Assembly kits/wiring modules</b>		<b>3RA1953-2A</b>			(p. 2/64)			<b>3RA1963-2A</b>		
					(p. 2/64)			<b>3RA1973-2A</b>		
		<b>3RA1954-2A</b>								
		(p. 2/68)								
<b>Contactor assemblies for star-delta (wye-delta) starting<sup>1)</sup></b>										
<b>Complete units</b>	Type	--								
<b>400 V</b>	<b>kW</b>	--								
<b>Assembly kits/wiring modules</b>		<b>3RA1953-2B</b>			(p. 2/66)			<b>3RA1963-2B</b>		
					(p. 2/66)			<b>3RA1973-2B</b>		
		(p. 2/66)								

<sup>1)</sup> see Catalog IC 10.

## Switching devices – Contactors and contactor assemblies – for switching motors

### Power contactors for switching motors

#### General data

#### Overview

##### The SIRIUS family of controls

The SIRIUS modular system with its components for the switching, starting, protection and monitoring of motors and industrial systems stands for the fast, flexible and space-saving construction of control cabinets.

##### 3RT2.1 contactors · Size S00 with mountable accessories

The figure shows the version with screw terminals

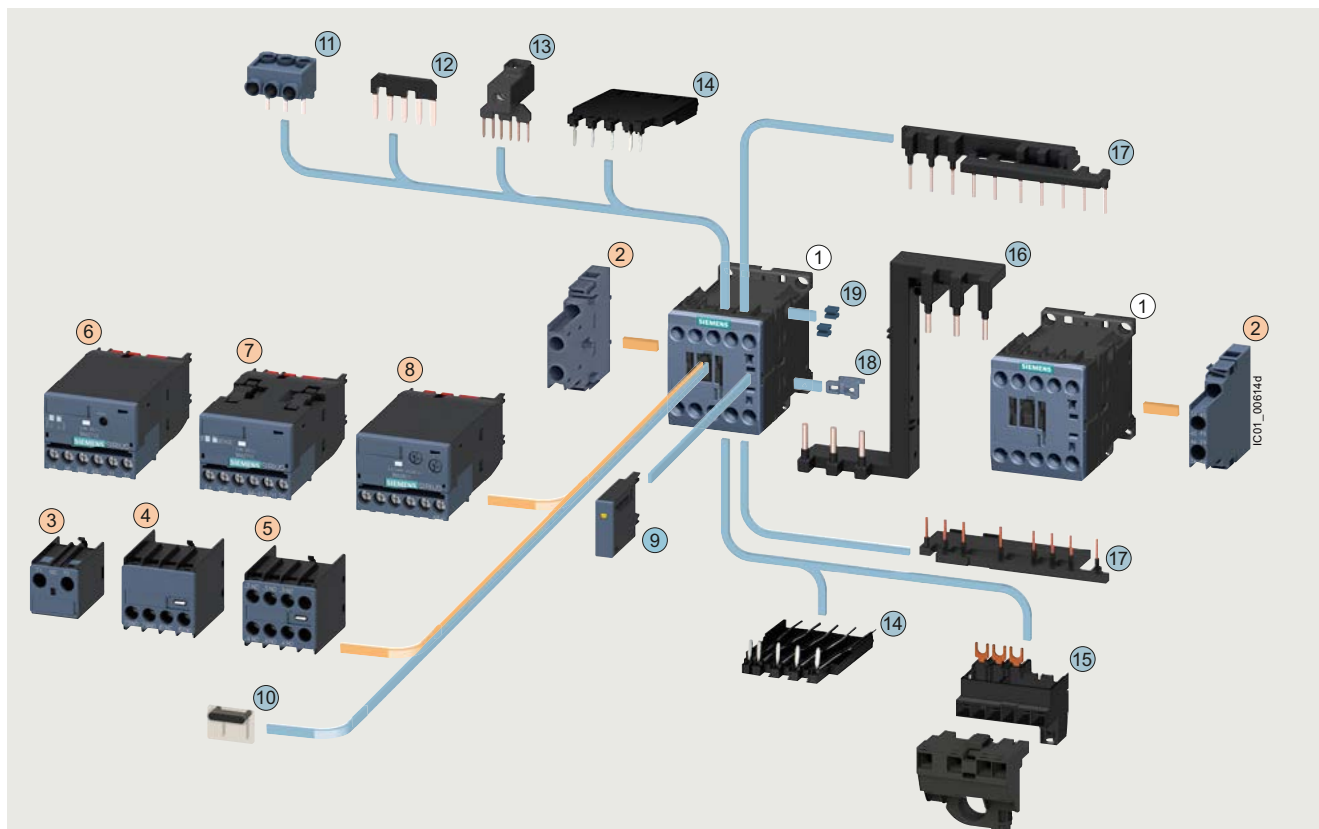

① Contactor, size S00

② 2-pole auxiliary switch, laterally mountable

③ 1-pole auxiliary switch, for snapping onto the front cable entry from the top

④ 2-pole auxiliary switch, for snapping onto the front cable entry from the bottom

⑤ 4-pole auxiliary switch, for snapping onto the front

⑥ 3RA27 function module for AS-Interface

⑦ 3RA27 function module for IO-Link

⑧ 3RA28 function module

⑨ Surge suppressor with/without LED

⑩ Cover, sealable

⑪ 3-phase infeed terminal

⑫ Star jumper, 3-pole, without connecting terminal

⑬ Link for paralleling, 3-pole, with connecting terminal

⑭ Solder pin adapter

⑮ Connection module (adapter and connector) for contactors with screw terminals

⑯ Safety main current connector for two contactors

Assembly kit 3RA2913-2AA1

Consisting of:

⑰ Wiring modules on the top and bottom for connecting the main, auxiliary and control current paths, electrical interlock<sup>1)</sup> included, interruptible (NC contact interlock)

⑱ Mechanical interlocks<sup>2)</sup>

⑲ Two connecting clips for two contactors<sup>2)</sup>

○ For contactors

○ For contactors and coupling contactors

<sup>1)</sup> 3RT201. contactors with one NC contact in the basic unit are required for the electrical interlock. An additional NO contact is required for momentary-contact operation.

<sup>2)</sup> The parts ⑱ and ⑲ can only be ordered together as 3RA2912-2H mechanical connectors.

Accessories and spare parts, see pages 2/52 to 2/75.

# Switching devices – Contactors and contactor assemblies – for switching motors

## Power contactors for switching motors

General data

### 3RT2.2 contactors · Size S0 with mountable accessories

The figure shows the version with screw terminals

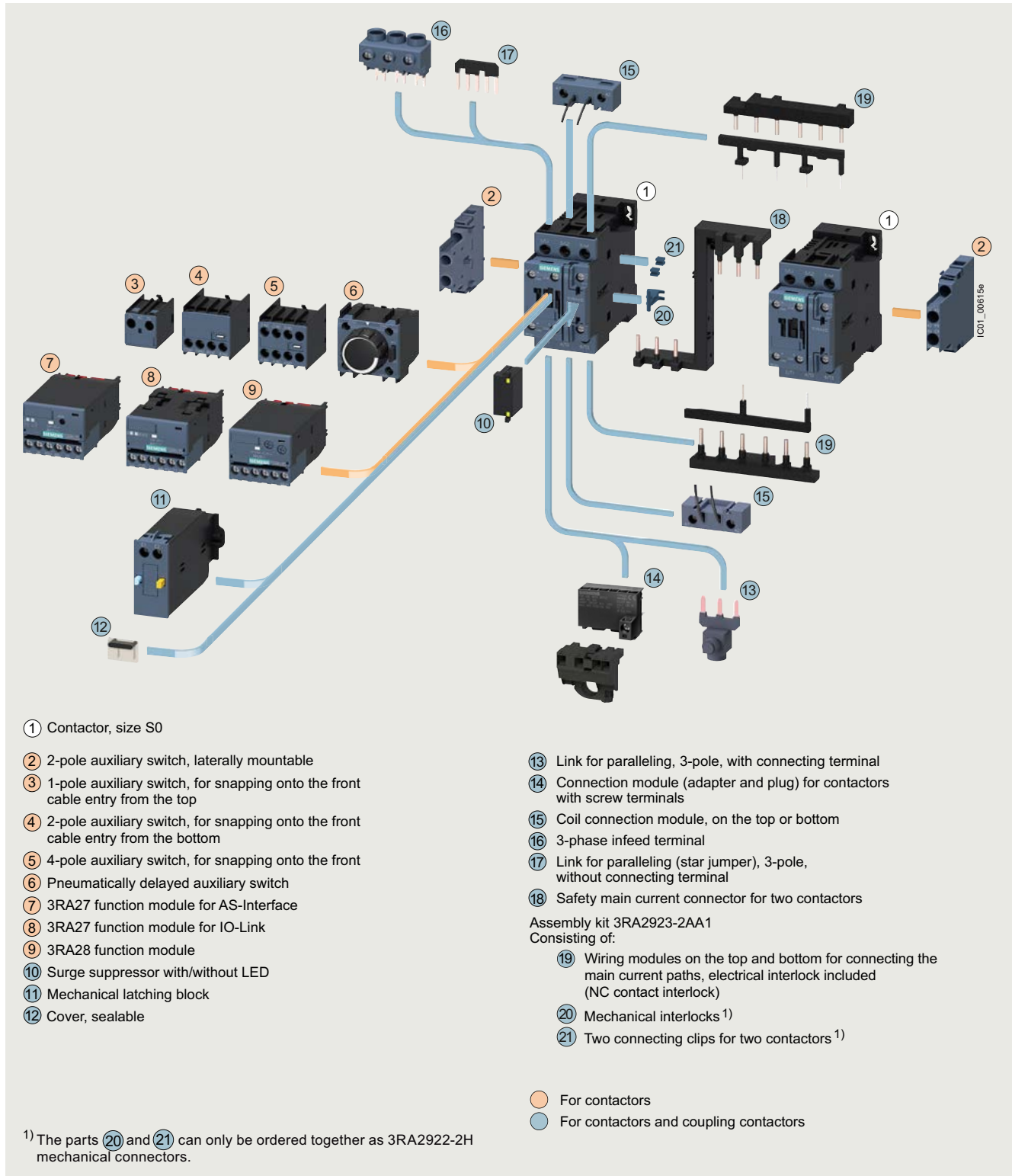

Accessories and spare parts, see pages 2/52 to 2/75.



## Switching devices – Contactors and contactor assemblies – for switching motors

### Power contactors for switching motors

#### General data

#### 3RT2.3 contactors · Size S2 with mountable accessories

The figure shows the version with screw terminals

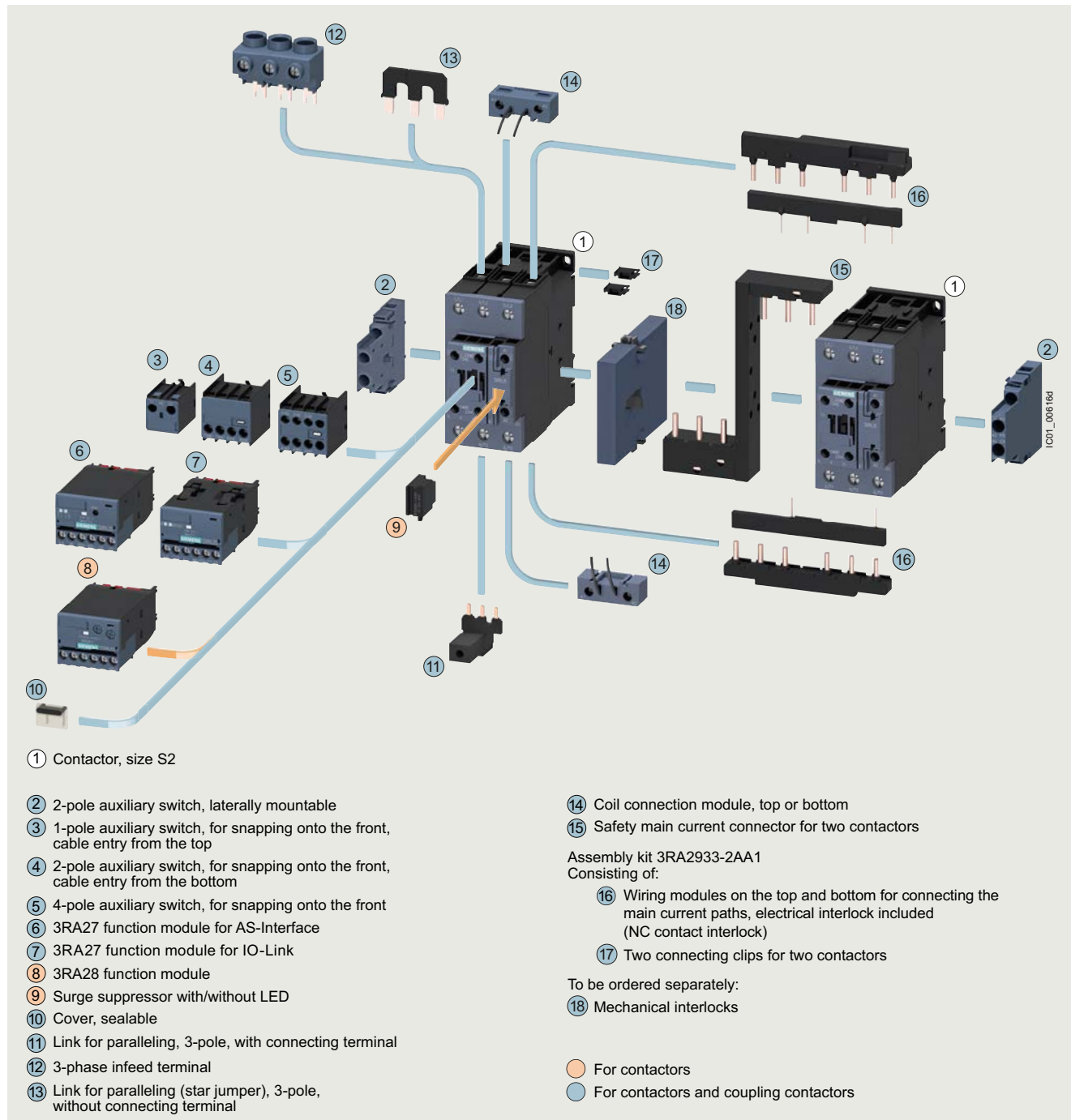

Accessories and spare parts, [see pages 2/52 to 2/75](#).

# Switching devices – Contactors and contactor assemblies – for switching motors

## Power contactors for switching motors

General data

### 3RT2.4 contactors · Size S3 with mountable accessories

The figure shows the version with screw terminals

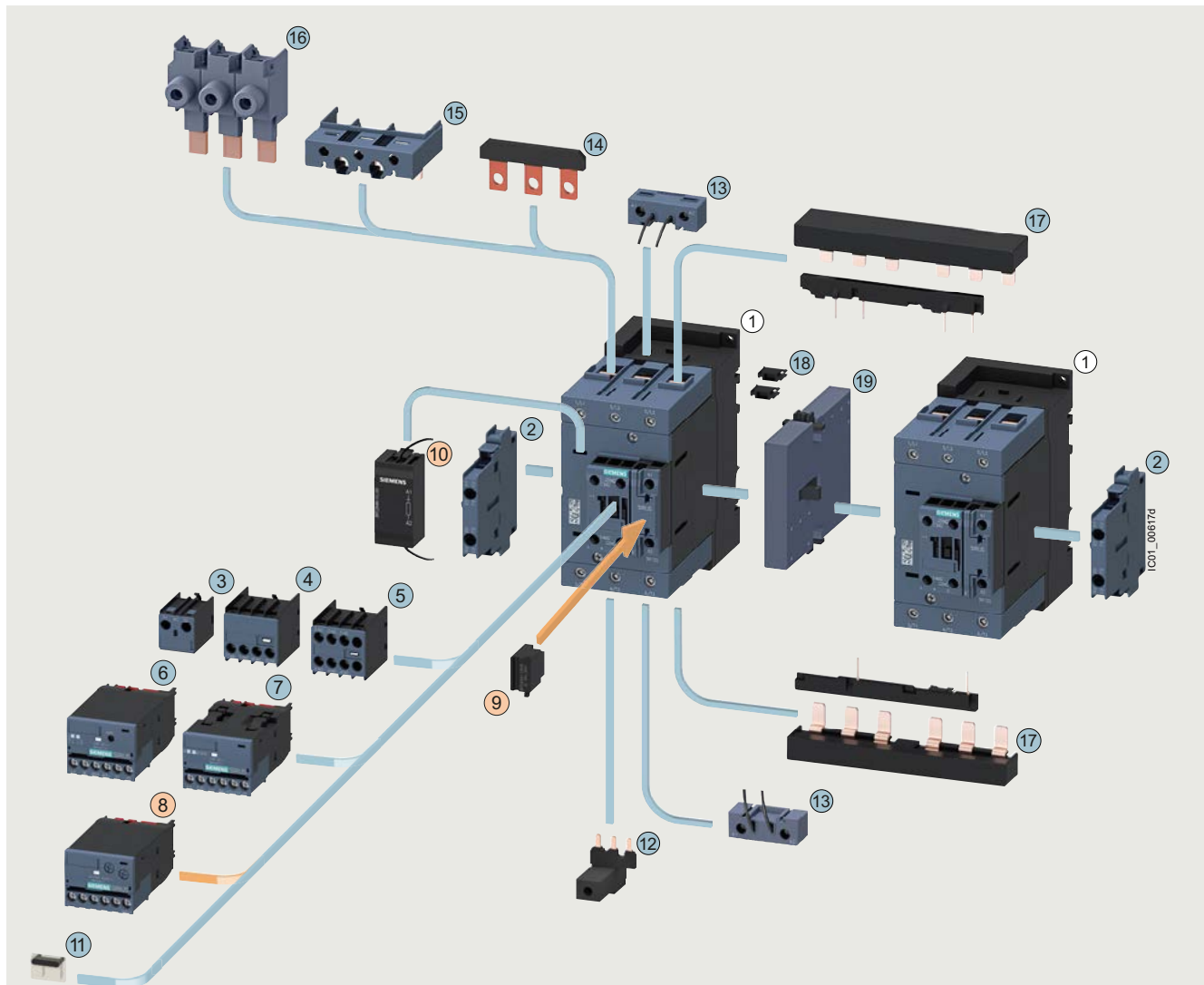

① Contactor, size S3

② 2-pole auxiliary switch block, laterally mountable

③ 1-pole auxiliary switch block, for snapping onto the front, cable entry from the top

④ 2-pole auxiliary switch block, for snapping onto the front, cable entry from the bottom

⑤ 4-pole auxiliary switch block, for snapping onto the front

⑥ 3RA27 function module for AS-Interface

⑦ 3RA27 function module for IO-Link

⑧ 3RA28 function module

⑨ Surge suppressor with/without LED (Varistor, diode assembly), can be plugged in on the front

⑩ Surge suppressor without LED (RC element), can be plugged in on the front in the recesses on the left next to the connection block

⑪ Cover, sealable

⑫ Links for paralleling, 3-pole, with connecting terminal

⑬ Coil connection module, top or bottom

⑭ Links for paralleling (star jumper), 3-pole without connecting terminal

⑮ Auxiliary terminal, 3-pole

⑯ Single-phase infeed terminals (3 units)

Assembly kit 3RA2943-2AA1

Consisting of:

⑰ Wiring modules on the top and bottom for connecting the main, auxiliary and control current paths, electrical interlock<sup>1)</sup> included, interruptible (NC contact interlock)

⑱ Two connectors for two contactors

To be ordered separately:

⑲ Mechanical interlock

<sup>1)</sup> 3RT201. contactors with one NC contact in the basic unit are required for the electrical interlock. An additional NO contact is required for momentary-contact operation.

○ For contactors

● For contactors and coupling contactors

Accessories and spare parts, see pages 2/52 to 2/75.

## Switching devices – Contactors and contactor assemblies – for switching motors

### Power contactors for switching motors

#### General data

#### 3RT105 and 3RT145 contactors - Size S6 with mountable accessories

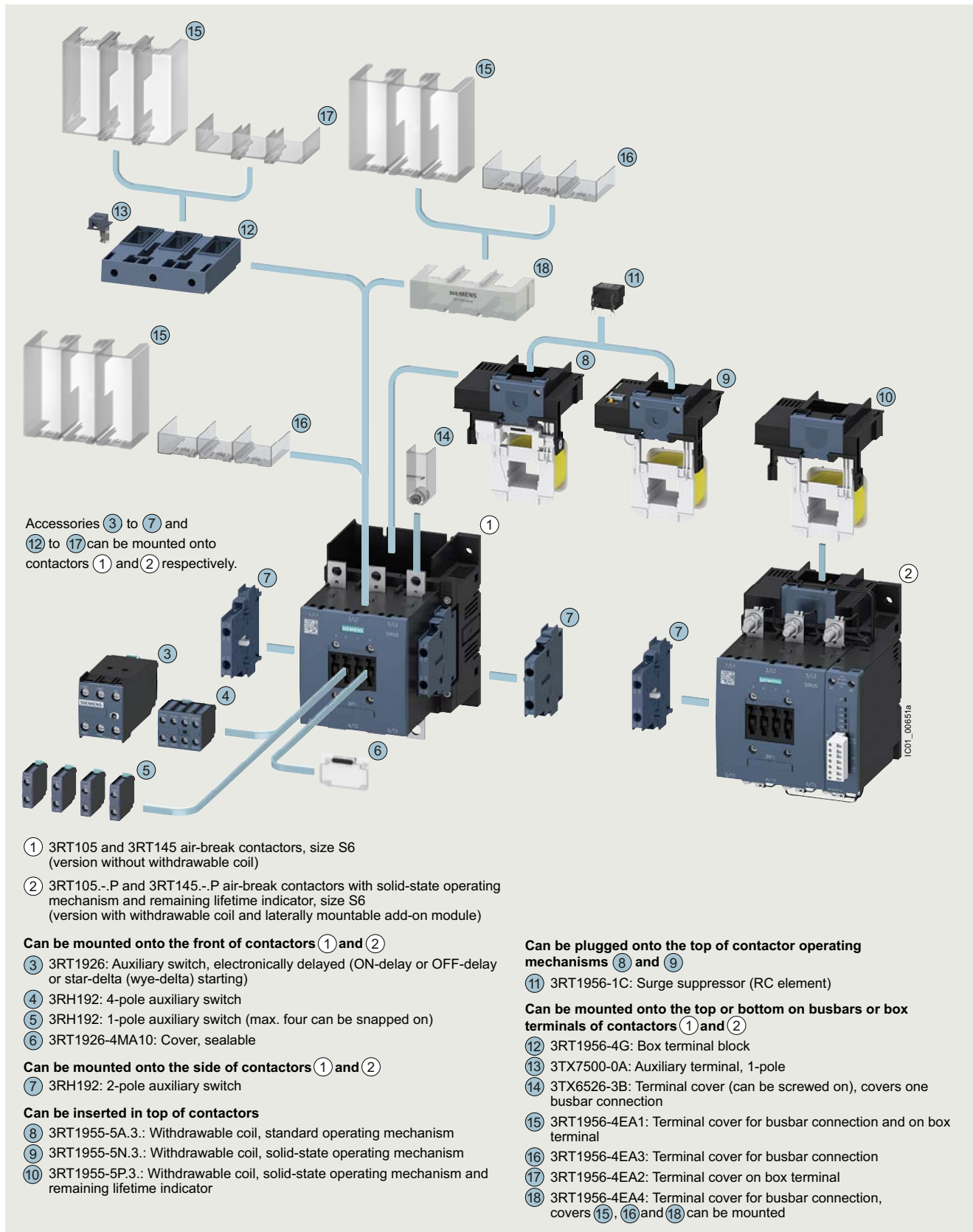

Accessories and spare parts, see pages 2/52 to 2/75.

# Switching devices – Contactors and contactor assemblies – for switching motors

## Power contactors for switching motors

General data

### 3RT106 and 3RT146 contactors · Size S10 with mountable accessories

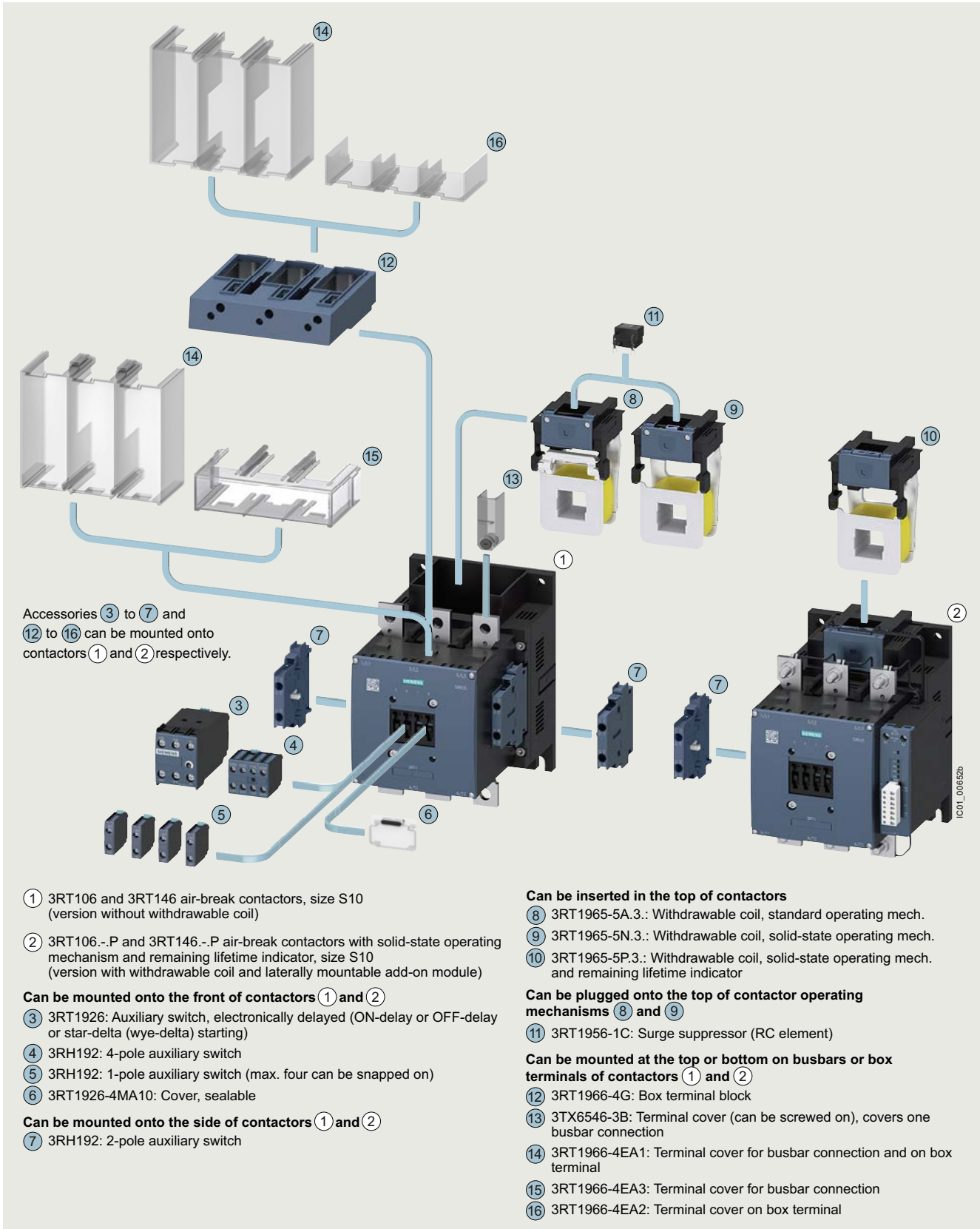

Accessories and spare parts, see pages 2/52 to 2/75.



## Switching devices – Contactors and contactor assemblies – for switching motors

### Power contactors for switching motors

#### General data

#### 3RT107 and 3RT147 contactors · Size S12 with mountable accessories

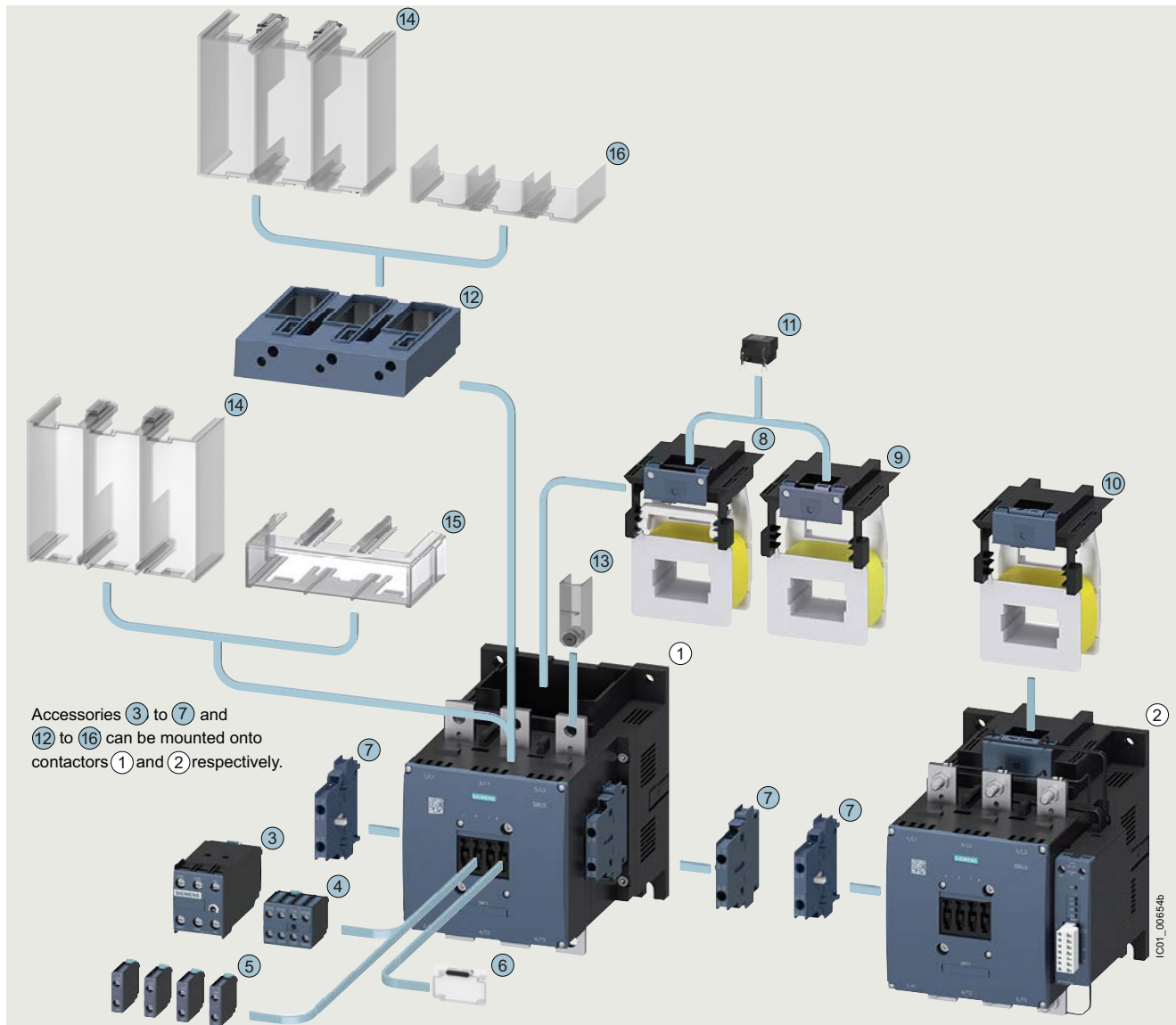

① 3RT107 and 3RT147 air-break contactors, size S12 (version without withdrawable coil)

② 3RT107.-P and 3RT147.-P air-break contactors with solid-state operating mechanism and remaining lifetime indicator, size S12 (version with withdrawable coil and laterally mountable add-on module)

**Can be mounted onto the front of contactors ① and ②**

③ 3RT1926: Auxiliary switch, electronically delayed (ON-delay or OFF-delay or star-delta (wye-delta) starting)

④ 3RH192: 4-pole auxiliary switch

⑤ 3RH192: 1-pole auxiliary switch (max. four can be snapped on)

⑥ 3RT1926-4MA10: Cover, sealable

**Can be mounted onto the side of contactors ① and ②**

⑦ 3RH192: 2-pole auxiliary switch

**Can be inserted in top of contactors**

⑧ 3RT1975-5A.3.: Withdrawable coil, standard operating mech.

⑨ 3RT1975-5N.3.: Withdrawable coil, solid-state operating mech.

⑩ 3RT1975-5P.3.: Withdrawable coil, solid-state operating mech. and remaining lifetime indicator

**Can be plugged onto top of contactor operating mechanisms ⑧ and ⑨**

⑪ 3RT1956-1C: Surge suppressor (RC element)

**Can be mounted at the top or bottom on busbars or box terminals of contactors ① and ②**

⑫ 3RT1966-4G: Box terminal block

⑬ 3TX6546-3B: Terminal cover (can be screwed on), covers one busbar connection

⑭ 3RT1966-4EA1: Terminal cover for busbar connection and on box terminal

⑮ 3RT1966-4EA3: Terminal cover for busbar connection

⑯ 3RT1966-4EA2: Terminal cover on box terminal

Accessories and spare parts, see pages 2/52 to 2/75.

IC01\_00654b

# Switching devices – Contactors and contactor assemblies – for switching motors

## Power contactors for switching motors

SIRIUS 3RT contactors, 3-pole up to 250 kW

### Overview



Contactors with screw terminals: 3RT20 (sizes S00 to S3) and 3RT10 (sizes S6 to S12)

### 3RT power contactors

Our power range:

- Contactors for switching motors:
  - Size S00: 3RT201 up to 7.5 kW
  - Size S0: 3RT202 up to 18.5 kW
  - Size S2: 3RT203 up to 37 kW
  - Size S3: 3RT204 up to 55 kW
  - Sizes S6 to S12: 3RT10 up to 250 kW
- Vacuum contactors for switching motors:
  - Sizes S10 and S12: 3RT12 up to 250 kW
  - Size 14: 3TF6 up to 450 kW

### Standards

IEC 60947-1, IEC 60947-4-1, IEC 60947-5-1 (auxiliary switches)

### Ambient conditions

If the devices are used in ambient conditions which deviate from common industrial conditions (IEC 60721-3-3 "Stationary Use, Weather-Protected"), information must be obtained about possible restrictions with regard to the reliability and endurance of the device and possible protective measures. In this case, contact our Technical Support:

[www.siemens.com/support-request](http://www.siemens.com/support-request).

### Ratings of three-phase motors

The quoted rating (in kW) refers to the output power on the motor shaft (according to the nameplate).

The power rating specifications of the contactors in kW (in accordance with IEC 60947-4-1, Table G) are guide values for 4-pole standard motors at 50 Hz AC and specified voltage (e.g. 400 V). The actual starting and rated data of the motor to be switched must be considered when selecting the units. The motor current, motor protection device and the permissible contactor current according to the utilization category must be aligned with each other.

### Voltage specifications

The specifications for 3-phase systems acc. to IEC 60947-4-1 apply for the following line system configurations:

Voltage data $U_e$ in the catalog	Line system configurations	
	Three-phase Four-wire systems	Three phase Three-wire systems
V	V	V
230	--	230
400	230/400	400
440	260/440	440
500	--	500
690	400/690	690 (from size S3 only)
1 000	--	1 000

-- Not specified

### Contactors in safety-related applications

Contactors are a significant part of safety-related applications. They are generally the actuators that perform the switching operation leading to the safe disconnection of the corresponding application or system.

Contactors with mirror contacts according to IEC 60947-4-1 are generally required for use in safety-related applications. Most of our contactors meet this requirement; a corresponding note can be found in the technical product data sheet.

## Switching devices – Contactors and contactor assemblies – for switching motors

### Power contactors for switching motors

#### SIRIUS 3RT contactors, 3-pole up to 250 kW

##### Contactors with increased tamper protection

Increased tamper protection is ensured either by using our contactor versions with factory-installed, permanently mounted auxiliary switches protected against mechanical external actuation (e.g. 3RT20...-3MA0 or 3RT10...-3PA0 contactors), or by using the 3RT2916-4MA10 or 3RT1926-4MA10 sealable cover as an accessory (see page 2/72).

##### Operating times

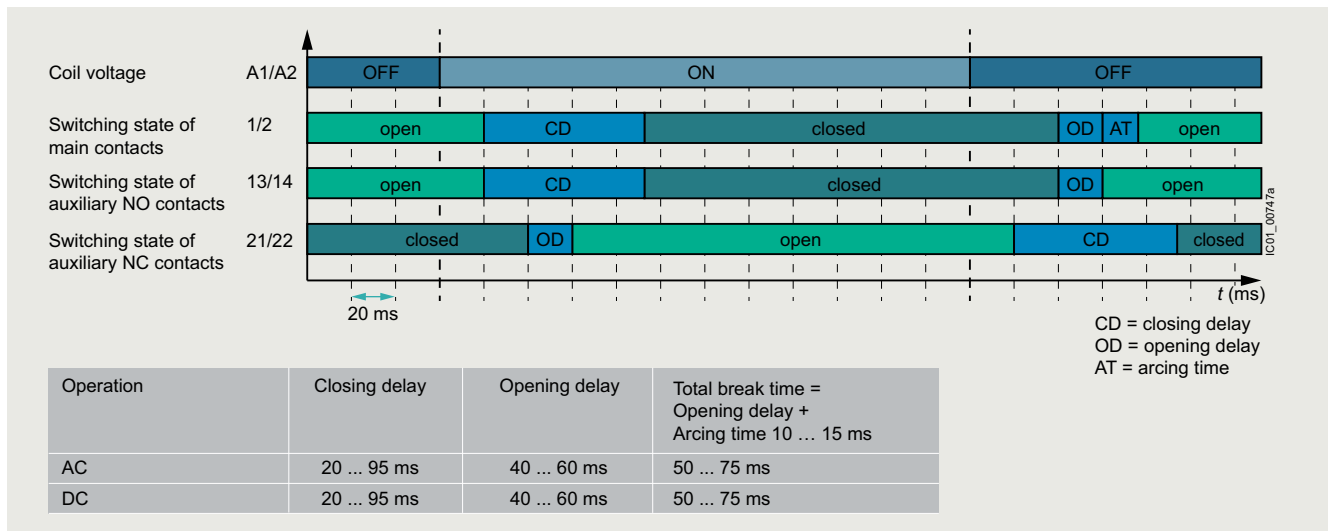

Operating times using the example of contactor 3RT1054-1AB36

##### Main circuit

###### Short-circuit protection

For short-circuit protection of contactors with overload relays or of load feeders, refer to the Configuration Manuals, see "More information" on page 2/18.

###### Surge suppression

Contactors supplied without a coil circuit can be retrofitted with RC elements, varistors, diodes or diode assemblies (combination of diode and Zener diode for short break times) for damping opening surges in the coil.

###### Note:

The break times of the contactor, the opening delay times of the NO contacts and the closing delay times of the NC contacts increase if the contactor coils are attenuated against voltage peaks. Different accessories are available for the contactors (time change with: interference suppression diode 6x to 10x; diode assembly 2x to 6x; suppressor diode +1 to 5 ms; varistor +2 to 5 ms).

For details, see [Equipment Manual](#).

##### Control circuit

###### Connection methods

Screw terminals or spring-loaded terminals

###### Electromagnetic compatibility (EMC)

The contactors fulfill the requirements for environment category A.

###### Note:

When the contactors are used in an **environment with frequency converters**, the configuration notes must be observed, see [Equipment Manual](#).

##### Auxiliary circuit

###### Connection methods

Screw terminals or spring-loaded terminals

###### Contact reliability

If voltages  $\leq 110$  V and currents  $\leq 100$  mA are to be switched, the auxiliary contacts of the 3RT contactors or 3RH contactor relays should be used as they guarantee a high level of contact reliability.

These auxiliary contacts are particularly suitable for solid-state circuits with currents  $\geq 1$  mA at a voltage  $\geq 17$  V.

# Switching devices – Contactors and contactor assemblies – for switching motors

## Power contactors for switching motors

### SIRIUS 3RT contactors, 3-pole up to 250 kW

#### 3RT20 contactors

##### Main circuit

###### Connection methods

- 3RT201 and 3RT202 contactors:  
Screw terminals or spring-loaded terminals;  
spring-loaded terminals with convenient plug-in design for device connectors
- 3RT203 and 3RT204 contactors:  
Screw terminals with box terminal;  
direct connection to the connecting bar is possible with cable lugs for 3RT204 when the box terminal is removed.

###### Short-circuit protection

Short-circuit protection of 3RT20 contactors without overload relays, [see pages 2/23, 2/28, 2/31 and 2/35](#).

For fuseless assembly of motor feeders consisting of 3RV2 motor starter protector and 3RT20 contactor, selection aids are available, [see "SIRIUS 3RA2 load feeders"](#).

###### Motor protection

For protection against overload, 3RU2 thermal overload relays or 3RB3 electronic overload relays can be mounted on the 3RT20 contactors.

###### Plant and application monitoring

For monitoring and measuring in the application, 3RR2 monitoring relays can be mounted on the 3RT20 contactors.

###### Surge suppression

- 3RT201 contactors:  
The surge suppressors are plugged onto the front of the contactors here. Space is provided for them next to a snap-on auxiliary switch.
- 3RT202 and 3RT203 contactors:  
Surge suppressors (varistors, RC elements or diode assemblies) can be plugged into the front of the contactors.
- 3RT204 contactors:  
The varistors and diode combinations are plugged into the front of the contactors. The RC element is plugged into the two recesses on the front of the contactor to the left of the terminal block for the auxiliary switches.

##### Control circuit

###### Contactors with voltage tap-off

The 3RT20 contactors with voltage tap-off are special versions for mounting the SIRIUS 3RA27 function modules for connection to the control system via IO-Link or AS-Interface.

Without a function module, these contactors can be used like the standard versions.

###### Operating mechanism types

3RT20 contactors are available as standard versions with AC or DC operating mechanisms or as versions with a wide-range solid-state operating mechanism and a universal actuating voltage (AC or DC operation possible).

Versions with solid-state operating mechanisms for AC or DC operation with a fail-safe PLC input are also available for the 3RT203 and 3RT204 contactors.

Control takes place via the control supply voltage connection A1 - A2 with varying operating ranges ([see relevant product data sheet](#) for further details).

DC coupling contactors with reduced power consumption are also ideally suited for connection to the controller.

###### Solenoid coils/operating mechanisms

Coil replacement is possible for contactors 3RT202 to 3RT204.

###### NOTICE:

Removal or changing of the operating mechanism is not permitted for 3RT20...S contactors with fail-safe control.

##### Auxiliary circuit

###### Auxiliary contact complement

- 3RT201 contactors: An auxiliary contact is integrated in the basic unit.
- Contactors 3RT202 to 3RT204: The basic units contain two integrated auxiliary contacts (1 NO + 1 NC).

All basic units, with the exception of coupling contactors in sizes S00 and S0, can be expanded using auxiliary switches.

For detailed information about the fitting of auxiliary switches, [see pages 2/55 to 2/58](#).



## Switching devices – Contactors and contactor assemblies – for switching motors

### Power contactors for switching motors

#### SIRIUS 3RT contactors, 3-pole up to 250 kW

##### 3RT10 contactors

###### Main circuit

###### Connection methods

Screw terminals with connecting bars that the cables can be connected to using either cable lugs or flexible or rigid busbars. Alternatively, box terminals are available as accessories.

###### Short-circuit protection

For short-circuit protection of 3RT10 contactors without overload relays, [see page 2/39](#).

###### Motor protection

For protection against overload, 3RB2 electronic overload relays ([see page 2/79 onwards](#)) can be mounted on the 3RT10 contactors.

###### Control circuit

###### Operating mechanism types

The operating mechanisms are powered via a supply voltage with an operating range from 0.8 to 1.1 x  $U_s$ , optionally also controlled depending on the chosen mode of operation. Various rated voltage ranges are available for AC/DC control.

The following control and/or operating mechanism versions are available for contactors 3RT105 to 3RT107:

- 3RT10..-A:  
Standard operating mechanism for AC and DC operation (reduced power consumption when closing and in the closed state)
- Solid-state operating mechanisms  
Overvoltage damping of the operating mechanism coil is already integrated in the electronics for contactors with solid-state operating mechanisms.  
The following versions are available:
  - 3RT10..-N:  
With two operating modes: Direct control or via PLC input (24 V DC)
  - 3RT10..-P:  
Control via PLC input (24 V DC) only, but with additional remaining lifetime indicator (RLT)
  - 3RT10..-S:  
Control via fail-safe PLC input (24 V DC) only, for simplification of safety applications (without mode of operation selection)

###### Solenoid coils/operating mechanisms

The operating mechanisms for 3RT10..-A/-N/-P contactors are removable and can be replaced simply by unlocking and pulling them out.

###### NOTICE:

Removal or changing of the operating mechanism is not permitted for 3RT10..-S contactors with fail-safe control.

###### Surge suppression

Exchangeable operating mechanisms with integrated coil circuit (varistor) are available.

###### Auxiliary circuit

###### Auxiliary contact complement

These contactors are supplied with two laterally mounted auxiliary switches. The fitting of auxiliary switches is possible on the front and on the side.

## Switching devices – Contactors and contactor assemblies – for switching motors

### Power contactors for switching motors

#### SIRIUS 3RT contactors, 3-pole up to 250 kW

#### Contactors for special applications

- SIRIUS 3RT.4 contactors for low or non-inductive loads (AC-1), 3-pole, [see page 2/79 onwards](#)
- SIRIUS 3RT20 and 3RT10 contactors with an extended application range, 3-pole (for railway applications), [see page 2/101 onwards](#)

#### Article No. scheme

Product versions		Article number			
<b>SIRIUS power contactors</b>		<b>3RT2</b> □ □ □ - □ □ □ □ □ - □ □ □ □			
Device type	e.g. 0 = 3-pole motor contactor	□			
Size of the contactor	e.g. 4 = S3	□			
Rating dependent on size	e.g. 5 = 37 kW for S3	□			
Type of electrical connection	e.g. 1 = Screw terminals (main and auxiliary circuits)		□		
Operating range/solenoid coil circuit	e.g. A = AC standard/without coil circuit		□		
Rated control supply voltage	e.g. P0 = 230 V AC, 50 Hz			□ □	
Auxiliary switches	e.g. 0 = for S3: 1 NO + 1 NC integrated				□
Special version					□ □ □ □
Example		<b>3RT2 0 4 5 - 1 A P 0 0</b>			

#### Note:

The Article No. scheme shows an overview of product versions for better understanding of the logic behind the article numbers.

For your orders, please use the article numbers quoted in the selection and ordering data.

# Switching devices – Contactors and contactor assemblies – for switching motors

## Power contactors for switching motors

### SIRIUS 3RT contactors, 3-pole up to 250 kW

#### Technical specifications

##### More information

Technical specifications, see  
<https://support.industry.siemens.com/cs/ww/en/ps/16134/td>  
 FAQs, see  
<https://support.industry.siemens.com/cs/ww/en/ps/16134/faq>

System Manual for modular system, see  
<https://support.industry.siemens.com/cs/ww/en/view/60311318>  
 Equipment Manual, see  
<https://support.industry.siemens.com/cs/ww/en/view/60306557>  
 Application Manual for controls with IE3/IE4 motors, see  
<https://support.industry.siemens.com/cs/ww/en/view/94770820>  
 Configuration Manual for load feeders, see  
<https://support.industry.siemens.com/cs/ww/en/view/39714188>  
 Configuration Manual for UL, see  
<https://support.industry.siemens.com/cs/ww/en/view/53433538>

Type	Contactors			
	3RT2		S3	3RT1
Size	S00 to S2		S3	S6 to S12
<b>Rated data of the auxiliary contacts</b>				
<b>according to IEC 60947-5-1</b>				
Data apply to integrated auxiliary contacts and conventional contacts in the auxiliary switches				
<b>Rated insulation voltage <math>U_i</math></b> (pollution degree 3)	V	690	1 000 (3RT20...-0CC0: 690)	--
• For laterally mountable auxiliary switches	V	690	690	500
• For front auxiliary switches	V	690	690	690
<b>Conventional thermal current <math>I_{th}</math> = rated operational current <math>I_e/AC-12</math></b>	A	10		
<b>AC load</b>				
<b>Rated operational current <math>I_e/AC-15/AC-14</math></b>				
• At rated operational voltage $U_e$	Up to 230 V	A	10 <sup>1)</sup>	6
	400 V	A	3	6
	500 V	A	2	3
	690 V	A	1	2
				1 <sup>2)</sup>
<b>DC load</b>				
<b>Rated operational current <math>I_e/DC-12</math></b>				
• At rated operational voltage $U_e$	24 V	A	10	10
	60 V	A	6	6
	110 V	A	3	3
	125 V	A	2	2
	220 V	A	1	1
	440 V	A	0.3	0.3
	600 V	A	0.15	0.15 <sup>2)</sup>
<b>Rated operational current <math>I_e/DC-13</math></b>				
• At rated operational voltage $U_e$	24 V	A	10 <sup>1)</sup>	10 <sup>3)</sup>
	60 V	A	2	2
	110 V	A	1	1
	125 V	A	0.9	0.9
	220 V	A	0.3	0.3
	440 V	A	0.14	0.14
	600 V	A	0.1	0.15 <sup>2)</sup>
<b>Contact reliability at 17 V, 1 mA</b>	Frequency of contact faults < 10 <sup>-8</sup> i.e. < 1 fault per 100 million operating cycles			
Acc. to IEC 60947-5-4				

1) 3RH22, 3RH29, 3RT2...-...4, 3RT2...-...6:  $I_e = 6$  A at AC-15/AC-14 and DC-13.

2) With laterally mountable auxiliary switches, only the currents for rated operational voltages up to 500 V apply.

3) For laterally mountable auxiliary switches, DC-13/at 24 V: Max. 6 A.

# Switching devices – Contactors and contactor assemblies – for switching motors

## Power contactors for switching motors

### SIRIUS 3RT contactors, 3-pole up to 250 kW

Type  
Size

**3RT contactors**  
**S00 to S12**

#### Electrical endurance of auxiliary contacts

It is assumed that the operating mechanisms are switched randomly, i.e. not synchronized with the phase angle of the supply system.

The electrical endurance is mainly dependent on the breaking current.

#### Sizes S00 to S3

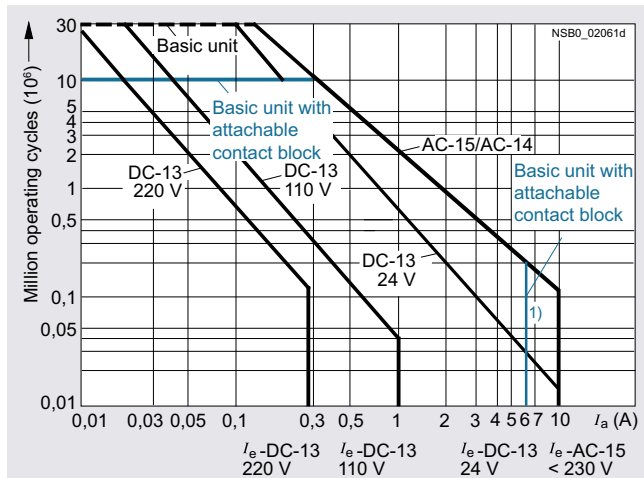

#### Sizes S6 to S12

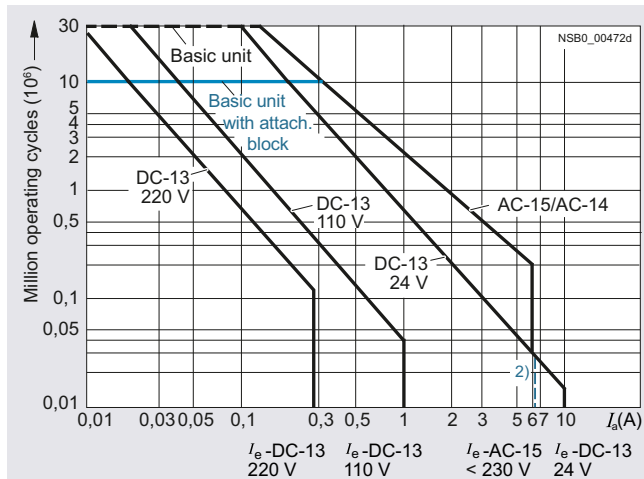

<sup>1)</sup> 3RH22, 3RH29, 3RT2...-...4, 3RT2...-...6:  $I_e = 6$  A at AC-15/AC-14 and DC-13, 3RT2.4:  $I_e = 6$  A at AC-15/AC-14.

<sup>2)</sup> For laterally mountable auxiliary switches, DC-13/at 24 V: Max. 6 A.

<sup>3)</sup> With laterally mountable auxiliary switches, the currents for rated operational voltages up to 500 V apply.



# Switching devices – Contactors and contactor assemblies – for switching motors

## Power contactors for switching motors

### SIRIUS 3RT contactors, 3-pole up to 250 kW

Type **3RT2 contactors**  
Size **S00 and S0**

#### Contact endurance of the main contacts

The characteristic curves show the contact endurance of the contactors when switching low inductive or non-inductive AC loads (AC-1) and motor-driven loads (AC-3) depending on the breaking current and rated operational voltage. It is assumed that the operating mechanisms are switched randomly, i.e. not synchronized with the phase angle of the supply system.

The rated operational current  $I_e$  complies with utilization category AC-4 (breaking 6 times the rated operational current) and is intended for a contact endurance of approximately 200 000 operating cycles.

If a shorter contact endurance is sufficient, the rated operational current  $I_e/AC-4$  can be increased.

If the contacts are used for mixed operation, i.e. normal switching (breaking the rated operational current according to utilization category AC-3) in combination with intermittent inching (breaking of several times the rated operational current according to utilization category AC-4), the contact endurance can be calculated approximately from the following equation:

$$X = \frac{A}{1 + \frac{C}{100} \left( \frac{A}{B} - 1 \right)}$$

Characters in the equation:

- X Contact endurance for mixed operation in operating cycles
- A Contact endurance for normal operation ( $I_a = I_e$ ) in operating cycles
- B Contact endurance for inching ( $I_a = \text{multiple of } I_e$ ) in operating cycles
- C Inching operations as a percentage of total switching operations

#### Size S00

Operating cycles at

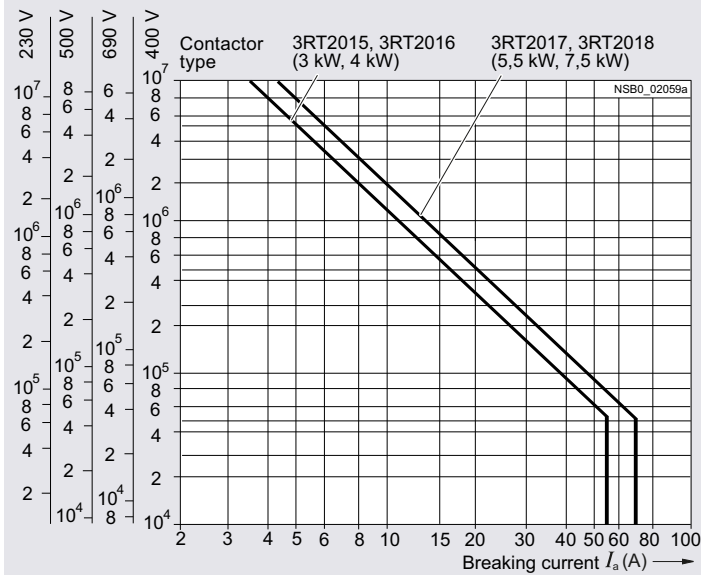

#### Size S0

Operating cycles at

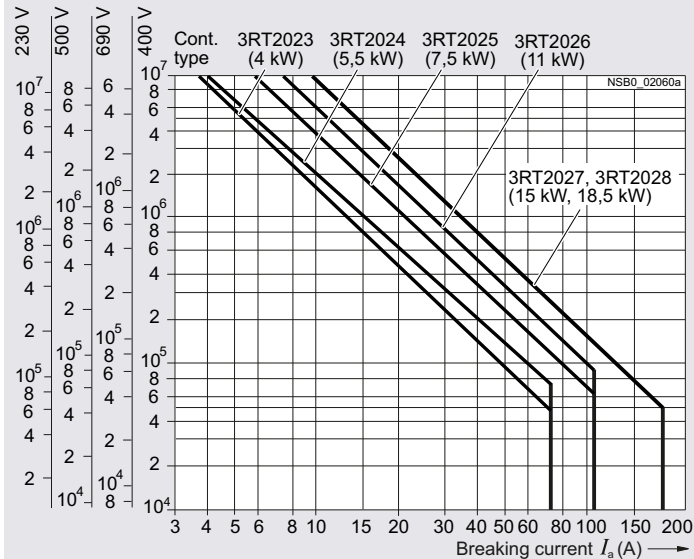

# Switching devices – Contactors and contactor assemblies – for switching motors

## Power contactors for switching motors

### SIRIUS 3RT contactors, 3-pole up to 250 kW

Type **3RT contactors**  
 Size **S2 to S12**

#### Contact endurance of main contacts (continued)

#### Size S2

Operating cycles at

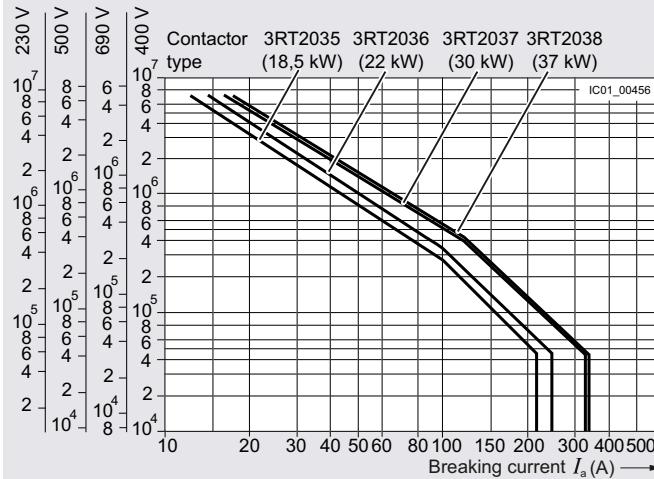

#### Size S3

Operating cycles at

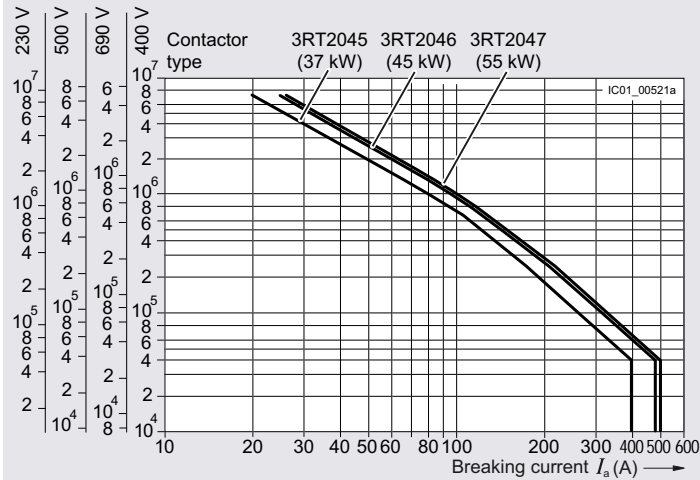

#### Sizes S6 to S12

Operating cycles at

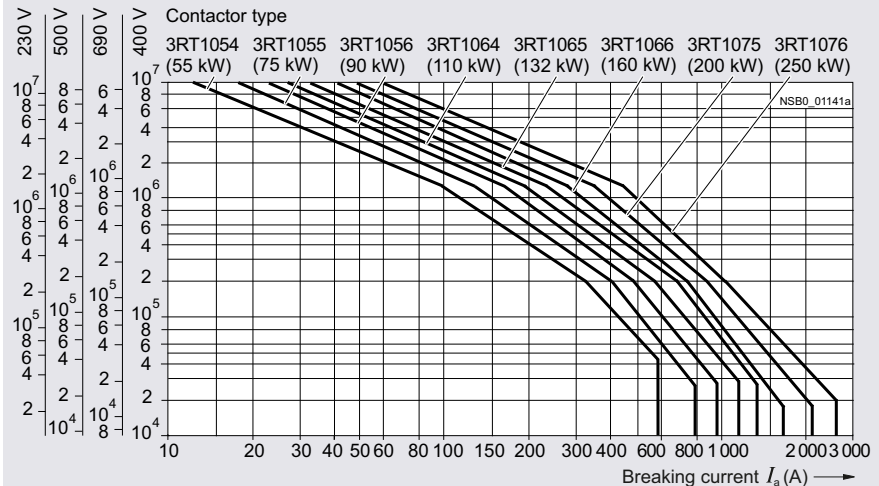



2

# Switching devices – Contactors and contactor assemblies – for switching motors

## Power contactors for switching motors

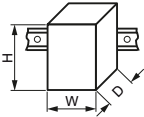
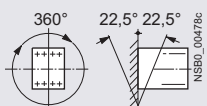
### SIRIUS 3RT contactors, 3-pole up to 250 kW

		Contactors	
		3RT2015, 3RT2016	3RT2017, 3RT2018
		S00	
Type			
Size			
<b>General data</b>			
<b>Dimensions (W x H x D)</b>			
<ul style="list-style-type: none"> <li>Basic unit               <ul style="list-style-type: none"> <li>- Screw terminals</li> <li>- Spring-loaded terminals</li> </ul> </li> <li>Basic unit with mounted auxiliary switch               <ul style="list-style-type: none"> <li>- Screw terminals</li> <li>- Spring-loaded terminals</li> </ul> </li> <li>Basic unit with mounted function module or solid-state time-delay auxiliary switch               <ul style="list-style-type: none"> <li>- Screw terminals</li> <li>- Spring-loaded terminals</li> </ul> </li> </ul>		mm	45 x 58 x 73
		mm	45 x 70 x 73
		mm	45 x 58 x 117
		mm	45 x 70 x 121
		mm	45 x 58 x 147
		mm	45 x 70 x 147
<b>Permissible mounting position</b>			
The contactors are designed for operation on a vertical mounting surface.			
Upright mounting position		 Special version required	
<b>Mechanical service life</b>			
• Basic unit	Operating cycles	30 million	
- With mounted auxiliary switch	Operating cycles	10 million	
- With solid-state compatible auxiliary switch	Operating cycles	5 million	
<b>Electrical endurance</b>			
For contact endurance of the main contacts, see page 2/20.			
<b>Rated insulation voltage <math>U_i</math></b> (pollution degree 3)	V	690	
<b>Rated impulse withstand voltage <math>U_{imp}</math></b>			
• Auxiliary circuit	kV	6	
• Main circuit	kV	6	
<b>Protective separation</b> between the coil and the main contacts acc. to IEC 60947-1, Annex N	V	400	
<b>Mirror contacts</b>			
A mirror contact is an auxiliary NC contact that cannot be closed simultaneously with an NO main contact.			
• 3RT2.1 (removable auxiliary switch)		Yes, this applies to both the basic unit as well as to between the basic unit and the mounted auxiliary switch according to IEC 60947-4-1 Annex F	
• 3RH2919-.NF.. solid-state compatible auxiliary switches		No mirror contact for size S00	
<b>Ambient temperature</b>			
• During operation	°C	-25 ... +60	
• During storage	°C	-55 ... +80	
<b>Degree of protection IP on the front</b> according to IEC 60529		IP20 (screw terminals and spring-loaded terminals)	
<b>Touch protection on the front</b> acc. to IEC 60529		Finger-safe for vertical touching from the front (screw terminals and spring-loaded terminals)	
<b>Shock resistance</b>			
• Rectangular pulse <ul style="list-style-type: none"> <li>- AC operation</li> <li>- DC operation</li> </ul>	g/ms	6.7/5 and 4.2/10	7.3/5 and 4.7/10
	g/ms	6.7/5 and 4.2/10	7.3/5 and 4.7/10
• Sine pulse <ul style="list-style-type: none"> <li>- AC operation</li> <li>- DC operation</li> </ul>	g/ms	10.5/5 and 6.6/10	11.4/5 and 7.3/10
	g/ms	10.5/5 and 6.6/10	11.4/5 and 7.3/10

# Switching devices – Contactors and contactor assemblies – for switching motors

## Power contactors for switching motors

### SIRIUS 3RT contactors, 3-pole up to 250 kW

Type Size		Contactors	
		3RT2015, 3RT2016 S00	3RT2017, 3RT2018
<b>Short-circuit protection</b>			
<b>Main circuit</b>			
• Fuse links, operational class gG: LV HRC, type 3NA; DIAZED, type 5SB; NEOZED, type 5SE according to IEC 60947-4-1			
- Type of coordination "1"	A	35	50
- Type of coordination "2"	A	20	25
- Weld-free (test conditions according to IEC 60947-4-1)	A	10	
• Miniature circuit breaker (up to 230 V) with C characteristic Short-circuit current 1 kA, type of coordination "1"	A	10	
<b>Auxiliary circuit</b>			
Short-circuit test according to IEC 60947-5-1			
• With fuse links, operational class gG: DIAZED, type 5SB; NEOZED, type 5SE with short-circuit current $I_k = 1$ kA	A	10	
• With 230 V miniature circuit breaker, C characteristic with short-circuit current $I_k = 400$ A	A	6	
Short-circuit protection for contactors with overload relays		<a href="#">See Configuration Manual for load feeders</a>	
Short-circuit protection for fuseless load feeders		<a href="#">See 3RA2 load feeders</a>	
<b>Control</b>			
<b>Solenoid coil operating range</b>			
• AC operation	50 Hz 60 Hz	0.8 ... 1.1 x $U_s$ 0.85 ... 1.1 x $U_s$	
• DC operation	Up to 50 °C Up to 60 °C	0.8 ... 1.1 x $U_s$ 0.85 ... 1.1 x $U_s$	
<b>Power consumption of the solenoid coils</b> (for cold coil and 1.0 x $U_s$ )			
• AC operation, 50/60 Hz, standard version			
- Closing	VA	27/24.3	37/33
- P.f.		0.8/0.75	
- Closed	VA	4.2/3.3	5.7/4.4
- P.f.		0.25/0.25	
• AC operation, 50 Hz, for USA/Canada			
- Closing	VA	26.4	36
- P.f. for closing		0.81	0.8
- Closed	VA	4.4	5.9
- P.f. for closed		0.24	
• AC operation, 60 Hz, for USA/Canada			
- Closing	VA	31.7	43
- P.f. for closing		0.81	0.8
- Closed	VA	4.8	6.5
- P.f. for closed		0.25	
• DC operation (closing = closed)	W	4	
<b>Permissible residual current of the electronics</b> (with 0 signal)			
• AC operation		< 3 mA x (230 V/ $U_s$ ) <sup>1)</sup>	< 4 mA x (230 V/ $U_s$ ) <sup>1)</sup>
• DC operation		< 10 mA x (24 V/ $U_s$ ) <sup>1)</sup>	
<b>Operating times within operating range</b>			
Total break time = Opening delay + Arcing time			
• AC operation			
- Closing delay	ms	9 ... 35	
- Opening delay	ms	4 ... 15	
• DC operation			
- Closing delay	ms	30 ... 100	
- Opening delay	ms	7 ... 13	
• Arcing time	ms	10 ... 15	







<sup>1)</sup> The 3RT2916-1GA00 additional load module is recommended for higher residual currents.



## Switching devices – Contactors and contactor assemblies – for switching motors

### Power contactors for switching motors

#### SIRIUS 3RT contactors, 3-pole up to 250 kW

Type	Coupling contactors		
Size	3RT201.-.HB4.	3RT201.-.JB4.	3RT201.-.KB4.
<b>Control</b>			
<b>Solenoid coil operating range</b>	0.7 ... 1.25 x $U_s$		
<b>Power consumption of the solenoid coils</b> (for cold coil) Closing = Closed	At $U_s$ 24 V DC W	2.8	
<b>Permissible residual current</b> of the electronics (with 0 signal)	< 6 mA x (24 V/ $U_s$ )		
<b>Upright mounting position</b>	On request		
<b>Overvoltage configuration of the solenoid coil</b>	No overvoltage damping 	Integrated diode 	Integrated suppressor diode 
<b>Operating times within operating range</b> Total break time = Opening delay + Arcing time			
• DC operation			
- Closing delay	ms	25 ... 130	
- Opening delay	ms	7 ... 20	38 ... 65
• Arcing time	ms	10 ... 15	7 ... 20
<b>Control</b>			
<b>Solenoid coil operating range</b>	0.85 ... 1.85 x $U_s$		
<b>Power consumption of the solenoid coils</b> (for cold coil) Closing = Closed	At $U_s$ 24 V DC W	1.6	
<b>Permissible residual current, upright mounting position</b>	On request		
<b>Overvoltage configuration of the solenoid coil</b>	No overvoltage damping 	Integrated diode 	Integrated suppressor diode 
<b>Operating times within operating range</b> Total break time = Opening delay + Arcing time			
• DC operation			
- Closing delay	ms	25 ... 120	
- Opening delay	ms	5 ... 20	20 ... 80
• Arcing time	ms	10 ... 15	5 ... 20

# Switching devices – Contactors and contactor assemblies – for switching motors

## Power contactors for switching motors

### SIRIUS 3RT contactors, 3-pole up to 250 kW

Type Size	Contactors					
	3RT2015 S00	3RT2016	3RT2017	3RT2018		
<b>Rated data of the main contacts</b>						
<b>Load rating with AC</b>						
<b>Utilization category AC-1</b>						
• Rated operational currents $I_e$	At 40 °C up to 690 V At 60 °C up to 690 V	A A	18 16	22 20		
• Rated power for AC loads <sup>1)</sup> P.f. = 0.95 (at 60 °C)	230 V 400 V 690 V	kW kW kW	6 10.5 18	7.5 13 22		
• Minimum cross-section in the main circuit for max. AC-1 rated value		mm <sup>2</sup>	2.5	4		
<b>Utilization categories AC-2 and AC-3</b>						
• Rated operational currents $I_e$	Up to 400 V 440 V 500 V 690 V	A A A A	7 7 6 4.9	9 9 7.7 6.7	12 11 9.2 8.9	16 14 12.4 8.9
• Rated power for slip-ring or squirrel-cage motors at 50 Hz and 60 Hz	At 230 V 400 V 690 V	kW kW kW	1.5 3 4	2.2 4 5.5	3 5.5	4 7.5 7.5
<b>Thermal load capacity</b>	10 s current	A	56	72	96	128
<b>Power loss per conducting path</b>	At $I_e/AC-3$	W	0.42	0.7	1.24	2.2
<b>Utilization category AC-4 (at <math>I_a = 6 \times I_e</math>)<sup>2)</sup></b>						
• Maximum values						
- Rated operational current $I_e$	Up to 400 V	A	6.5	8.5		11.5
- Rated power for squirrel-cage motors at 50 Hz and 60 Hz	Up to 400 V	kW	3	4		5.5
• The following applies to a contact endurance of about 200 000 operating cycles:						
- Rated operational currents $I_e$	Up to 400 V 690 V	A A	2.6 1.8	4.1 3.3		5.5 4.4
- Rated power for squirrel-cage motors at 50 Hz and 60 Hz	At 230 V 400 V 690 V	kW kW kW	0.67 1.15 1.15	1.1 2 2.5		1.5 2.5 3.5

<sup>1)</sup> Industrial furnaces and electric heaters with resistance heating, etc. (increased power consumption on heating up has been taken into account).

<sup>2)</sup> The data applies to 3RT2516 and 3RT2517 contactors (2 NO + 2 NC) up to a rated operational voltage of 400 V only.

# Switching devices – Contactors and contactor assemblies – for switching motors

## Power contactors for switching motors

### SIRIUS 3RT contactors, 3-pole up to 250 kW



Type Size	Contactors		
	3RT2015 S00	3RT2016 to 3RT2018	
<b>Rated data of the main contacts (continued)</b>			
<b>Load rating with DC</b>			
<b>Utilization category DC-1, (<math>L/R \leq 1</math> ms)</b>			
• Rated operational currents $I_e$ (at 60 °C)			
- 1 conducting path	Up to 24 V A	15	20
	60 V A	15	20
	110 V A	1.5	2.1
	220 V A	0.6	0.8
	440 V A	0.42	0.6
	600 V A	0.42	0.6
- 2 conducting paths in series	Up to 24 V A	15	20
	60 V A	15	20
	110 V A	8.4	12
	220 V A	1.2	1.6
	440 V A	0.6	0.8
	600 V A	0.5	0.7
- 3 conducting paths in series	Up to 24 V A	15	20
	60 V A	15	20
	110 V A	15	20
	220 V A	15	20
	440 V A	0.9	1.3
	600 V A	0.7	1
<b>Utilization category DC-3/DC-5, shunt-wound and series-wound motors (<math>L/R \leq 15</math> ms)</b>			
• Rated operational currents $I_e$ (at 60 °C)			
- 1 conducting path	Up to 24 V A	15	20
	60 V A	0.35	0.5
	110 V A	0.1	0.15
	220 V A	--	
	440 V A	--	
	600 V A	--	
- 2 conducting paths in series	Up to 24 V A	15	20
	60 V A	3.5	5
	110 V A	0.25	0.35
	220 V A	--	
	440 V A	--	
	600 V A	--	
- 3 conducting paths in series	Up to 24 V A	15	20
	60 V A	15	20
	110 V A	15	20
	220 V A	1.2	1.5
	440 V A	0.14	0.2
	600 V A	0.14	0.2
<b>Switching frequency</b>			
<b>Switching frequency <math>z</math> in operating cycles/hour</b>			
Contactors without overload relays			
• No-load switching frequency	AC/DC	1/h	10 000
• Switching frequency $z$ during rated operation (Dependence of the switching frequency $z'$ on operational current $I'$ and operational voltage $U'$ : $z' = z \cdot (I_e/I') \cdot (U_e/U')^{1.5} \cdot 1/h$ )			
- $I_e/AC-1$	At 400 V	1/h	1 000
- $I_e/AC-2$	At 400 V	1/h	750
- $I_e/AC-3$	At 400 V	1/h	750
- $I_e/AC-4$	At 400 V	1/h	250
Contactors with overload relays			
• Mean value		1/h	15

# Switching devices – Contactors and contactor assemblies – for switching motors

## Power contactors for switching motors

### SIRIUS 3RT contactors, 3-pole up to 250 kW

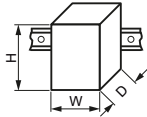
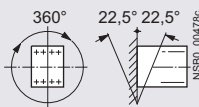
2

Type Size	Contactors	
	3RT2023 to 3RT2025	3RT2026 to 3RT2028
<b>General data</b>		
<b>Dimensions (W x H x D)</b>		
<u>AC operation</u>		
<ul style="list-style-type: none"> <li>Basic unit               <ul style="list-style-type: none"> <li>Screw terminals</li> <li>Spring-loaded terminals</li> </ul> </li> <li>Basic unit with mounted auxiliary switch               <ul style="list-style-type: none"> <li>Screw terminals</li> <li>Spring-loaded terminals</li> </ul> </li> <li>Basic unit with mounted function module or solid-state time-delay auxiliary switch               <ul style="list-style-type: none"> <li>Screw terminals</li> <li>Spring-loaded terminals</li> </ul> </li> </ul>		mm 45 x 85 x 97 mm 45 x 102 x 97
<ul style="list-style-type: none"> <li>Basic unit with mounted auxiliary switch               <ul style="list-style-type: none"> <li>Screw terminals</li> <li>Spring-loaded terminals</li> </ul> </li> <li>Basic unit with mounted function module or solid-state time-delay auxiliary switch               <ul style="list-style-type: none"> <li>Screw terminals</li> <li>Spring-loaded terminals</li> </ul> </li> </ul>	mm 45 x 85 x 141 mm 45 x 102 x 145	
<ul style="list-style-type: none"> <li>Basic unit with mounted function module or solid-state time-delay auxiliary switch               <ul style="list-style-type: none"> <li>Screw terminals</li> <li>Spring-loaded terminals</li> </ul> </li> </ul>	mm 45 x 85 x 171 mm 45 x 102 x 171	
<u>DC operation</u>		
<ul style="list-style-type: none"> <li>Basic unit               <ul style="list-style-type: none"> <li>Screw terminals</li> <li>Spring-loaded terminals</li> </ul> </li> <li>Basic unit with mounted auxiliary switch               <ul style="list-style-type: none"> <li>Screw terminals</li> <li>Spring-loaded terminals</li> </ul> </li> <li>Basic unit with mounted function module or solid-state time-delay auxiliary switch               <ul style="list-style-type: none"> <li>Screw terminals</li> <li>Spring-loaded terminals</li> </ul> </li> </ul>	mm 45 x 85 x 107 mm 45 x 102 x 107	
<ul style="list-style-type: none"> <li>Basic unit with mounted auxiliary switch               <ul style="list-style-type: none"> <li>Screw terminals</li> <li>Spring-loaded terminals</li> </ul> </li> <li>Basic unit with mounted function module or solid-state time-delay auxiliary switch               <ul style="list-style-type: none"> <li>Screw terminals</li> <li>Spring-loaded terminals</li> </ul> </li> </ul>	mm 45 x 85 x 151 mm 45 x 102 x 155	
<ul style="list-style-type: none"> <li>Basic unit with mounted function module or solid-state time-delay auxiliary switch               <ul style="list-style-type: none"> <li>Screw terminals</li> <li>Spring-loaded terminals</li> </ul> </li> </ul>	mm 45 x 85 x 181 mm 45 x 102 x 181	
<b>Permissible mounting position</b>		
The contactors are designed for operation on a vertical mounting surface.		
Upright mounting position		 NSB0_00477a Special version required, also applies for 3RT202.-.K.40 coupling contactors
<b>Mechanical service life</b>		
<ul style="list-style-type: none"> <li>Basic unit and basic unit with mounted auxiliary switch</li> </ul>	Operating cycles	10 million
<ul style="list-style-type: none"> <li>Basic unit with solid-state compatible auxiliary switch</li> </ul>	Operating cycles	5 million
<b>Electrical endurance</b>		
For contact endurance of the main contacts, <a href="#">see page 2/20</a> .		
<b>Rated insulation voltage <math>U_i</math></b> (pollution degree 3)		V 690
<b>Rated impulse withstand voltage <math>U_{imp}</math></b>		
<ul style="list-style-type: none"> <li>Auxiliary circuit</li> </ul>	kV	6
<ul style="list-style-type: none"> <li>Main circuit</li> </ul>	kV	6
<b>Protective separation</b> between the coil and the main contacts (acc. to IEC 60947-1, Annex N)		V 400
<b>Mirror contacts</b>		
A mirror contact is an auxiliary NC contact that cannot be closed simultaneously with an NO main contact.		
<ul style="list-style-type: none"> <li>Integrated auxiliary switches</li> </ul>		Yes, acc. to IEC 60947-4-1, Annex F
<ul style="list-style-type: none"> <li>3RT2.2. (removable auxiliary switch)</li> </ul>		Yes, acc. to IEC 60947-4-1, Annex F
<b>Permissible ambient temperature</b>		
<ul style="list-style-type: none"> <li>During operation</li> </ul>	°C	-25 ... +60
<ul style="list-style-type: none"> <li>During storage</li> </ul>	°C	-55 ... +80
<b>Degree of protection IP on the front</b> according to IEC 60529		IP20 (screw terminals and spring-loaded terminals)
<b>Touch protection on the front</b> acc. to IEC 60529		Finger-safe for vertical touching from the front (screw terminals and spring-loaded terminals)
<b>Shock resistance</b>		
<ul style="list-style-type: none"> <li>Rectangular pulse               <ul style="list-style-type: none"> <li>AC operation</li> <li>DC operation</li> </ul> </li> <li>Sine pulse               <ul style="list-style-type: none"> <li>AC operation</li> <li>DC operation</li> </ul> </li> </ul>	g/ms g/ms g/ms g/ms	7.5/5 and 4.7/10 10/5 and 7.5/10 11.8/5 and 7.4/10 15/5 and 10/10 8.3/5 and 5.3/10 13.5/5 and 8.3/10



# Switching devices – Contactors and contactor assemblies – for switching motors

## Power contactors for switching motors

### SIRIUS 3RT contactors, 3-pole up to 250 kW

Type Size	Contactors			
	3RT2023 to 3RT2025	3RT2026	3RT2027, 3RT2028	
S0				
<b>Short-circuit protection</b>				
<b>Main circuit</b>				
<ul style="list-style-type: none"> <li>Fuse links, operational class gG: LV HRC, type 3NA; DIAZED, type 5SB; NEOZED, type 5SE according to IEC 60947-4-1           <ul style="list-style-type: none"> <li>Type of coordination "1" A 63</li> <li>Type of coordination "2" A 25</li> <li>Weld-free (test conditions acc. to IEC 60947-4-1) A 10</li> </ul> </li> <li>Miniature circuit breaker with C characteristic (short-circuit current 3 kA, type of coordination "1") A 25</li> </ul>				
<b>Auxiliary circuit</b>				
<ul style="list-style-type: none"> <li>Fuse links, operational class gG: DIAZED, type 5SB; NEOZED, type 5SE (weld-free protection at <math>I_k \leq 1</math> kA) A 10</li> <li>230 V miniature circuit breaker, C characteristic (short-circuit current <math>I_k &lt; 400</math> A) A 10</li> </ul>				
Short-circuit protection for contactors with overload relays		See Configuration Manual for load feeders		
Short-circuit protection for fuseless load feeders		See 3RA2 load feeders		

Type Size	Contactors								
	3RT2023 to 3RT2025	3RT2026 to 3RT2028	3RT202..NB3	3RT202..NF3	3RT202..NP3				
S0									
<b>Control</b>									
<b>Type of operating mechanism</b>		AC or DC		AC/DC					
<b>Solenoid coil operating range</b>		AC/DC		0.8 ... 1.1 x $U_s$ <sup>1)</sup>					
<b>Power consumption of the solenoid coils</b> (for cold coil and $1.0 \times U_s$ )									
<ul style="list-style-type: none"> <li>AC operation, 50 Hz, standard version           <ul style="list-style-type: none"> <li>Closing VA 65</li> <li>P.f. 0.82</li> <li>Closed VA 7.6</li> <li>P.f. 0.25</li> </ul> </li> <li>AC operation, 50/60 Hz, standard version           <ul style="list-style-type: none"> <li>Closing VA 68/67</li> <li>P.f. 0.72/0.74</li> <li>Closed VA 7.9/6.5</li> <li>P.f. 0.25/0.28</li> </ul> </li> <li>AC operation, 50 Hz, for USA/Canada           <ul style="list-style-type: none"> <li>Closing VA 65</li> <li>P.f. 0.82</li> <li>Closed VA 7<sup>3)</sup>/7.6</li> <li>P.f. 0.25</li> </ul> </li> <li>AC operation, 60 Hz, for USA/Canada           <ul style="list-style-type: none"> <li>Closing VA 73</li> <li>P.f. 0.76</li> <li>Closed VA 7.2</li> <li>P.f. 0.28</li> </ul> </li> <li>DC operation (closing = closed) W 5.9/5.9</li> </ul>		77	6.6	11.9	12.7				
		9.8	1.9	1.6	3.9				
		0.82	0.98	0.79	0.51				
		81/79	6.6/6.7	11.9/12.0	12.7/14.7				
		10.5/8.5	0.98/0.98	1.6/1.8	3.9/4.3				
		0.82	0.86/0.82	0.79/0.74	0.51/0.56				
		77	--	--	--				
		0.82	--	--	--				
		9.8	--	--	--				
		0.28	--	--	--				
		87	--	--	--				
		9.4	--	--	--				
		--	--	--	--				
		5.9/1.4	10.2/1.3	14.3/1.9					
<b>Permissible residual current of the electronics</b> (with 0 signal)									
<ul style="list-style-type: none"> <li>AC operation mA &lt; 6 mA x (230 V/<math>U_s</math>)</li> <li>DC operation mA &lt; 16 mA x (24 V/<math>U_s</math>)</li> </ul>		< 7 mA x (230 V/ $U_s$ )							
<b>Operating times within operating range</b>									
Total break time = Opening delay + Arcing time									
<ul style="list-style-type: none"> <li>AC operation           <ul style="list-style-type: none"> <li>Closing delay ms 8 ... 40</li> <li>Opening delay ms 4 ... 16</li> </ul> </li> <li>DC operation           <ul style="list-style-type: none"> <li>Closing delay ms 50 ... 170</li> <li>Opening delay ms 15 ... 18</li> </ul> </li> <li>Arcing time ms 10</li> </ul>						50 ... 80	30 ... 50	50 ... 80	30 ... 50

1) Coil operating range

- At 50 Hz: 0.8 to 1.1 x  $U_s$   
- At 60 Hz: 0.85 to 1.1 x  $U_s$ .2) The following applies to  $U_{s,max} = 280$  V: Upper limit = 1.1 x  $U_{s,max}$ .

3) Value applies to 3RT2023 contactor 50 Hz AC.

# Switching devices – Contactors and contactor assemblies – for switching motors

## Power contactors for switching motors

### SIRIUS 3RT contactors, 3-pole up to 250 kW

		<b>Coupling contactors</b>	
Type		<b>3RT202.-KB4.</b>	
Size		<b>S0</b>	
<b>Control</b>			
<b>Solenoid coil operating range</b>		0.7 ... 1.25 x $U_s$	
<b>Power consumption of the solenoid coils</b> (for cold coil) Closing = Closed	At $U_s$ 24 V DC W	4.5	
<b>Permissible residual current</b> of the electronics (with 0 signal)		< 10 mA x ( $24 V/U_s$ )	
<b>Overvoltage configuration of the solenoid coil</b>		Integrated varistor 	
<b>Operating times within operating range</b> Total break time = Opening delay + Arcing time			
• DC operation			
- Closing delay	ms	52 ... 270	
- Opening delay	ms	19 ... 21	
• Arcing time		ms	10

		<b>Contactors</b>					
		<b>3RT2023</b>	<b>3RT2024</b>	<b>3RT2025</b>	<b>3RT2026</b>	<b>3RT2027</b>	<b>3RT2028</b>
Type		<b>S0</b>					
Size		<b>S0</b>					
<b>Rated data of the main contacts</b>							
<b>Load rating with AC</b>							
<b>Utilization category AC-1</b>							
• Rated operational current $I_e$	At 40 °C up to 690 V A	40				50	
	At 60 °C up to 690 V A	35				42	
• Rated power for AC loads <sup>1)</sup> P.f. = 0.95 (at 60 °C)	230 V kW	13.3				15.5	
	400 V kW	23				27.5	
	690 V kW	40				47.5	
• Minimum cross-section in the main circuit for max. AC-1 rated value	mm <sup>2</sup>	10					
<b>Utilization categories AC-2 and AC-3</b>							
• Rated operational currents $I_e$	Up to 400 V A	9	12	17	25	32	38
	440 V A	9	12	17	22	32	35
	500 V A	9	12	17	18	32	
	690 V A	9		13		21	
• Rated power for slip-ring or squirrel-cage motors at 50 Hz and 60 Hz	At 230 V kW	2.2	3	4	5.5	7.5	11
	400 V kW	4	5.5	7.5	11	15	18.5
	690 V kW	7.5		11		18.5	
<b>Thermal load capacity</b>	10 s current A	80	110	150	200	260	304
<b>Power loss per conducting path</b>	At $I_e/AC-3$ W	0.4	0.5	0.9	1.6	2.7	3.8
<b>Utilization category AC-4 (for <math>I_a = 6 \times I_e</math>)</b>							
• Maximum values:							
- Rated operational current $I_e$	Up to 400 V A	8.5	12.5	15.5		22	
- Rated power for squirrel-cage motors at 50 Hz and 60 Hz	At 400 V kW	4	5.5	7.5		11	
• The following applies to a contact endurance of about 200 000 operating cycles:							
- Rated operational currents $I_e$	Up to 400 V A	4.1	5.5	7.7	9	12	
	690 V A	3.3	5.5	7.7	9	12	
- Rated power for squirrel-cage motors at 50 Hz and 60 Hz	At 110 V kW	0.5	0.73	1	1.2	1.6	
	230 V kW	1.1	1.5	2	2.5	3.4	
	400 V kW	2	2.6	3.5	4.4	6	
	690 V kW	2.5	4.6	6	7.7	10.3	

<sup>1)</sup> Industrial furnaces and electric heaters with resistance heating, etc.  
(increased power consumption on heating up has been taken into account).

# Switching devices – Contactors and contactor assemblies – for switching motors

## Power contactors for switching motors

### SIRIUS 3RT contactors, 3-pole up to 250 kW

Type Size	Contactors	
	3RT2023 to 3RT2025	3RT2026 to 3RT2028
<b>Rated data of the main contacts (continued)</b>		
<b>Load rating with DC</b>		
<b>Utilization category DC-1, (<math>L/R \leq 1</math> ms)</b>		
• Rated operational currents $I_e$ (at 60 °C)		
- 1 conducting path	Up to 24 V A	35
	60 V A	20
	110 V A	4.5
	220 V A	1
	440 V A	0.4
	600 V A	0.25
- 2 conducting paths in series	Up to 24 V A	35
	60 V A	35
	110 V A	35
	220 V A	5
	440 V A	1
	600 V A	0.8
- 3 conducting paths in series	Up to 24 V A	35
	60 V A	35
	110 V A	35
	220 V A	35
	440 V A	2.9
	600 V A	1.4
<b>Utilization category DC-3/DC-5, shunt-wound and series-wound motors (<math>L/R \leq 15</math> ms)</b>		
• Rated operational currents $I_e$ (at 60 °C)		
- 1 conducting path	Up to 24 V A	20
	60 V A	5
	110 V A	2.5
	220 V A	1
	440 V A	0.09
	600 V A	0.06
- 2 conducting paths in series	Up to 24 V A	35
	60 V A	35
	110 V A	15
	220 V A	3
	440 V A	0.27
	600 V A	0.16
- 3 conducting paths in series	Up to 24 V A	35
	60 V A	35
	110 V A	35
	220 V A	10
	440 V A	0.6
	600 V A	0.6
<b>Switching frequency</b>		
<b>Switching frequency z</b> in operating cycles/hour		
Contactors without overload relays		
• No-load switching frequency		
	AC 1/h	5 000
	DC 1/h	1 500
	AC/DC 1/h	1 500
• Switching frequency z during rated operation (Dependence of the switching frequency z' on operational current I' and operational voltage U': $z' = z \cdot (I_e/I') \cdot (U_e/U)^{1.5} \cdot 1/h$ )		
- $I_e/AC-1$	At 400 V 1/h	1 000
- $I_e/AC-2$	At 400 V 1/h	1 000
- $I_e/AC-3$	At 400 V 1/h	1 000
- $I_e/AC-4$	At 400 V 1/h	300
Contactors with overload relays		
• Mean value		
	1/h	15

# Switching devices – Contactors and contactor assemblies – for switching motors

## Power contactors for switching motors

### SIRIUS 3RT contactors, 3-pole up to 250 kW

2

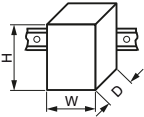
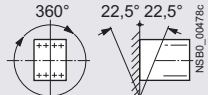
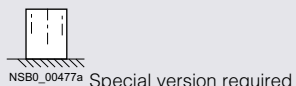
Type Size	Contactors			
	3RT2035	3RT2036	3RT2037	3RT2038
<b>General data</b>				
<b>Dimensions (W x H x D)</b>				
<ul style="list-style-type: none"> <li>Basic unit - Screw/spring-loaded terminals</li> </ul>		mm	55 x 114 x 130	
<ul style="list-style-type: none"> <li>Basic unit with mounted auxiliary switch - Screw terminals - Spring-loaded terminals</li> </ul>		mm	55 x 114 x 174	
<ul style="list-style-type: none"> <li>Basic unit with mounted function module or solid-state time-delay auxiliary switch - Screw/spring-loaded terminals</li> </ul>		mm	55 x 114 x 178	
		mm	55 x 114 x 204	
<b>Permissible mounting position</b>				
The contactors are designed for operation on a vertical mounting surface.				
				
Upright mounting position				
				
<b>Mechanical service life</b>				
<ul style="list-style-type: none"> <li>Basic units and basic units with mounted auxiliary switch</li> </ul>	Operating cycles	10 million (3RT203.-S.30: 5 million)		
<ul style="list-style-type: none"> <li>Basic units with solid-state compatible auxiliary switch</li> </ul>	Operating cycles	5 million		
<b>Electrical endurance</b>				
For contact endurance of the main contacts, see page 2/21.				
<b>Rated insulation voltage <math>U_i</math></b> (pollution degree 3)				
	V	690		
<b>Rated impulse withstand voltage <math>U_{imp}</math></b>				
<ul style="list-style-type: none"> <li>Auxiliary circuit</li> </ul>	kV	6		
<ul style="list-style-type: none"> <li>Main circuit</li> </ul>	kV	6		
<b>Protective separation</b> between the coil and the main contacts (acc. to IEC 60947-1, Annex N)				
	V	400		
<b>Mirror contacts</b>				
A mirror contact is an auxiliary NC contact that cannot be closed simultaneously with an NO main contact.				
<ul style="list-style-type: none"> <li>Integrated auxiliary switches</li> <li>3RT2.3. (removable auxiliary switch)</li> </ul>		Yes, acc. to IEC 60947-4-1, Annex F Yes, acc. to IEC 60947-4-1, Annex F		
<b>Permissible ambient temperature</b>				
<ul style="list-style-type: none"> <li>During operation</li> </ul>	°C	-25 ... +60		
<ul style="list-style-type: none"> <li>During storage</li> </ul>	°C	-55 ... +80		
<b>Degree of protection IP on the front</b> according to IEC 60529				
IP20 (screw terminals and spring-loaded terminals)				
<b>Touch protection on the front</b> acc. to IEC 60529				
Finger-safe for vertical touching from the front (screw terminals and spring-loaded terminals)				
<b>Shock resistance</b>				
<ul style="list-style-type: none"> <li>Rectangular pulse - AC operation - DC operation</li> </ul>	<i>g</i> /ms	11.8/5 and 7.4/10		
	<i>g</i> /ms	7.7/5 and 4.5/10		
<ul style="list-style-type: none"> <li>Sine pulse - AC operation - DC operation</li> </ul>	<i>g</i> /ms	18.5/5 and 11.6/10		
	<i>g</i> /ms	12/5 and 7/10		
<b>Short-circuit protection</b>				
<b>Main circuit</b>				
<ul style="list-style-type: none"> <li>Fuse links, operational class gG: LV HRC, type 3NA; DIAZED, type 5SB; NEOZED, type 5SE according to IEC 60947-4-1</li> </ul>				
- Type of coordination "1"	A	160		250
- Type of coordination "2"	A	80		125
- Weld-free (test conditions acc. to IEC 60947-4-1)	A	16	25	50
160				
<b>Auxiliary circuit</b>				
<ul style="list-style-type: none"> <li>Fuse links, operational class gG: DIAZED, type 5SB; NEOZED, type 5SE (weld-free protection at <math>I_k \leq 1</math> kA)</li> </ul>	A	10		
<ul style="list-style-type: none"> <li>230 V miniature circuit breaker, C characteristic (short-circuit current <math>I_k &lt; 400</math> A)</li> </ul>	A	10		
Short-circuit protection for contactors with overload relays				
See Configuration Manual for load feeders				
Short-circuit protection for fuseless load feeders				
See 3RA2 load feeders				



# Switching devices – Contactors and contactor assemblies – for switching motors

## Power contactors for switching motors

### SIRIUS 3RT contactors, 3-pole up to 250 kW

Type	Contactors			Coupling contactors
	3RT203.-A.../ 3RT203.-C...	3RT203.-N.3.	3RT203.-S.3.	3RT203.-KB4.
Size	S2			
<b>Control</b>				
<b>Type of operating mechanism</b>	AC	AC/DC	DC	
<b>Solenoid coil operating range</b>				
• AC operation <sup>1)</sup>	0.8 ... 1.1 x U <sub>s</sub>	--		
• AC/DC operation <sup>1)</sup>	--	0.8 ... 1.1 x U <sub>s</sub>		
• DC operation	--	--	0.8 ... 1.2 x U <sub>s</sub>	
<b>Power consumption of the solenoid coils</b> (for cold coil and 1.0 x U <sub>s</sub> )				
• AC operation, 50 Hz, standard version				
- Closing	VA	190	--	--
- P.f.		0.72	--	--
- Closed	VA	16	--	--
- P.f.		0.37	--	--
• AC operation, 50/60 Hz, standard version				
- Closing	VA	210/188	--	--
- P.f.		0.69/0.65	--	--
- Closed	VA	17.2/16.5	--	--
- P.f.		0.36/0.39	--	--
• AC operation, 60 Hz, for USA/Canada				
- Closing	VA	212	--	--
- P.f.		0.67	--	--
- Closed	VA	18.5	--	--
- P.f.		0.37	--	--
• AC/DC operation				
- Closing for AC operation	VA	--	40	--
- P.f.		--	0.95	--
- Closed for AC operation	VA	--	2	--
- P.f.		--	0.95	--
- Closing for DC operation	VA	--	23 <sup>2)</sup>	0.7
- Closed for DC operation	VA	--	1	1.6
• DC operation				
- Closing for DC operation	W	--	--	21.5 <sup>3)</sup>
- Closed for DC operation	W	--	--	1
<b>Permissible residual current of the electronics</b> (with 0 signal)				
• AC/DC operation	mA	--	< 20	--
• DC operation	mA	--	--	< 20
<b>Overvoltage configuration of the solenoid coil</b>	--			
	Integrated varistor			
				
<b>PLC control input acc. to IEC 60947-1</b>				
• Solid-state operating mechanism		--	Type 1	--
• Rated voltage	V DC	--	24	--
• Operating range	V DC	--	17 ... 30	--
• Power consumption	mA	--	≤ 30	--
• Recovery time after mains failure, typical	s	--	2	--
<b>Operating times within operating range</b>				
Total break time = Opening delay + Arcing time				
• AC operation				
Closing delay	ms	10 ... 80	35 ... 110	
Opening delay	ms	10 ... 18	30 ... 55	
• DC operation				
Closing delay	ms	--	35 ... 110	35 ... 80
Opening delay	ms	--	30 ... 55	
• Arcing time	ms	10 ... 20		

<sup>1)</sup> Coil operating range  
 - At 50 Hz: 0.8 to 1.1 x U<sub>s</sub>,  
 - At 60 Hz: 0.85 to 1.1 x U<sub>s</sub>.

<sup>2)</sup> In the case of AC/DC coils, increased pickup currents (2.6 A on average) arise during the first 230 ms. For direct control by PLC, we therefore recommend special coupling contactors with reduced power consumption. The connection of one 3RT203.-KB4. coupling contactor is possible per PLC output port with an output current of 2 A, see page 2/46.

<sup>3)</sup> In the case of DC coils, increased pickup currents (2.1 A on average) arise during the first 230 ms.

# Switching devices – Contactors and contactor assemblies – for switching motors

## Power contactors for switching motors

### SIRIUS 3RT contactors, 3-pole up to 250 kW

Type Size	Contactors					
	3RT2035 S2	3RT2036	3RT2037	3RT2038		
<b>Rated data of the main contacts</b>						
<b>Load rating with AC</b>						
<b>Utilization category AC-1</b>						
• Rated operational current $I_e$	At 40 °C up to 690 V At 60 °C up to 690 V	A A	60 55	70 60	80 70	90 80
• Rated power for AC loads <sup>1)</sup> P.f. = 0.95 (at 60 °C)	230 V 400 V 690 V	kW kW kW	23 39 68	26 46 79	30 53 91	34 59 102
• Minimum cross-section in the main circuit for max. AC-1 rated value		mm <sup>2</sup>	16	25		35
<b>Utilization categories AC-2 and AC-3</b>						
• Rated operational currents $I_e$	Up to 400 V 440 V 500 V 690 V	A A A A	41 41 41 24	51 51 51	65 65 65 47	80 80 80 58
• Rated power for slip-ring or squirrel-cage motors at 50 Hz and 60 Hz	At 230 V 400 V 690 V	kW kW kW	11 18.5 22	15 22	18.5 30 37	22 37 45
<b>Thermal load capacity</b>	10 s current	A	400	420	520	640
<b>Power loss per conducting path</b>	At $I_e/AC-3$	W	2.2	4	3.8	5.7
<b>Utilization category AC-4 (for <math>I_a = 6 \times I_e</math>)</b>						
• Maximum values						
- Rated operational current $I_e$	Up to 400 V	A	35	41	55	
- Rated power for squirrel-cage motors at 50 Hz and 60 Hz	At 400 V	kW	18.5	22	30	
• The following applies to a contact endurance of about 200 000 operating cycles:						
- Rated operational currents $I_e$	Up to 400 V 690 V	A A	22 18.5	24 20	28 22	30 24
- Rated power for squirrel-cage motors at 50 Hz and 60 Hz	At 110 V 230 V 400 V 690 V	kW kW kW kW	3.2 6.7 11.6 16.8	3.5 7.3 12.6 18.2	4.1 8.5 14.7 20	4.3 9.1 15.8 21.8

<sup>1)</sup> Industrial furnaces and electric heaters with resistance heating, etc. (increased power consumption on heating up has been taken into account).

# Switching devices – Contactors and contactor assemblies – for switching motors

## Power contactors for switching motors

### SIRIUS 3RT contactors, 3-pole up to 250 kW

Type Size	Contactors			
	3RT2035 S2	3RT2036	3RT2037	3RT2038
<b>Rated data of the main contacts (continued)</b>				
<b>Load rating with DC</b>				
<b>Utilization category DC-1, (<math>L/R \leq 1</math> ms)</b>				
• Rated operational currents $I_e$ (at 60 °C)				
- 1 conducting path	Up to 24 V A	55		
	60 V A	23		
	110 V A	4.5		
	220 V A	1		
	440 V A	0.4		
	600 V A	0.25		
- 2 conducting paths in series	Up to 24 V A	55		
	60 V A	45		
	110 V A	45		
	220 V A	5		
	440 V A	1		
	600 V A	0.8		
- 3 conducting paths in series	Up to 24 V A	55		
	60 V A	55		
	110 V A	55		
	220 V A	45		
	440 V A	2.9		
	600 V A	1.4		
<b>Utilization category DC-3/DC-5, shunt-wound and series-wound motors (<math>L/R \leq 15</math> ms)</b>				
• Rated operational currents $I_e$ (at 60 °C)				
- 1 conducting path	Up to 24 V A	35		
	60 V A	6		
	110 V A	2.5		
	220 V A	1		
	440 V A	0.1		
	600 V A	0.06		
- 2 conducting paths in series	Up to 24 V A	55		
	60 V A	45		
	110 V A	25		
	220 V A	5		
	440 V A	0.27		
	600 V A	0.16		
- 3 conducting paths in series	Up to 24 V A	55		
	60 V A	55		
	110 V A	55		
	220 V A	25		
	440 V A	0.6		
	600 V A	0.35		
<b>Switching frequency</b>				
<b>Switching frequency <math>z</math> in operating cycles/hour</b>				
Contactors without overload relays				
• No-load switching frequency	AC 1/h	5 000		
	DC 1/h	1 500		
	AC/DC 1/h	1 500 (3RT203.-S.30: 1 000)		
• Switching frequency $z$ during rated operation (Dependence of the switching frequency $z'$ on operational current $I'$ and operational voltage $U'$ : $z' = z \cdot (I_e/I') \cdot (U_e/U')^{1.5} \cdot 1/h$ )				
- $I_e/AC-1$ at 400 V	1/h	1 200 (3RT203.-S.30: 1 000)	1 000	800
- $I_e/AC-2$ at 400 V	1/h	750	600	400
- $I_e/AC-3$ at 400 V	1/h	1 000	800	700
- $I_e/AC-4$ at 400 V	1/h	300	250	200
Contactors with overload relays				
• Mean value	1/h	15		

# Switching devices – Contactors and contactor assemblies – for switching motors

## Power contactors for switching motors

### SIRIUS 3RT contactors, 3-pole up to 250 kW

2

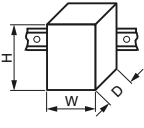
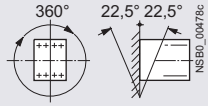
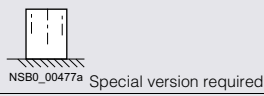
Type	Contactors			
Size	3RT2045	3RT2046	3RT2047	
<b>General data</b>				
<b>Dimensions (W x H x D)</b>				
<ul style="list-style-type: none"> <li>Basic unit               <ul style="list-style-type: none"> <li>Screw/spring-loaded terminals</li> </ul> </li> <li>Basic unit with mounted auxiliary switch               <ul style="list-style-type: none"> <li>Screw terminals</li> <li>Spring-loaded terminals</li> </ul> </li> <li>Basic unit with mounted function module or solid-state time-delay auxiliary switch               <ul style="list-style-type: none"> <li>Screw/spring-loaded terminals</li> </ul> </li> </ul>		mm	70 x 140 x 152	
			mm	70 x 140 x 196
			mm	70 x 140 x 200
			mm	70 x 140 x 226
<b>Permissible mounting position</b>				
The contactors are designed for operation on a vertical mounting surface.				
				
Upright mounting position				
 NSB0_00477a Special version required				
<b>Mechanical service life</b>				
<ul style="list-style-type: none"> <li>Basic units and basic units with mounted auxiliary switch</li> </ul>	Operating cycles		10 million	
<ul style="list-style-type: none"> <li>Basic units with solid-state compatible auxiliary switch</li> </ul>	Operating cycles		5 million	
<b>Electrical endurance</b>				
For contact endurance of the main contacts, see page 2/21.				
<b>Rated insulation voltage <math>U_i</math></b> (pollution degree 3)				
	V		1 000 (3RT20...-.....-OCC0: 690)	
<b>Rated impulse withstand voltage <math>U_{imp}</math></b>				
<ul style="list-style-type: none"> <li>Auxiliary circuit</li> </ul>	kV		6	
<ul style="list-style-type: none"> <li>Main circuit</li> </ul>	kV		8	
<b>Protective separation</b> between the coil and the main contacts (acc. to IEC 60947-1, Annex N)				
	V		690	
<b>Mirror contacts</b>				
A mirror contact is an auxiliary NC contact that cannot be closed simultaneously with an NO main contact.				
<ul style="list-style-type: none"> <li>Integrated auxiliary switches</li> <li>3RT2.4. (removable auxiliary switch)</li> </ul>			Yes, acc. to IEC 60947-4-1, Annex F Yes, acc. to IEC 60947-4-1, Annex F	
<b>Permissible ambient temperature</b>				
<ul style="list-style-type: none"> <li>During operation</li> </ul>	°C		-25 ... +60	
<ul style="list-style-type: none"> <li>During storage</li> </ul>	°C		-55 ... +80	
<b>Degree of protection IP on the front</b> according to IEC 60529				
			IP20 (screw terminals and spring-loaded terminals)	
<b>Touch protection on the front</b> acc. to IEC 60529				
			Finger-safe for vertical touching from the front (screw terminals and spring-loaded terminals)	
<b>Shock resistance</b>				
<ul style="list-style-type: none"> <li>Rectangular pulse               <ul style="list-style-type: none"> <li>AC operation</li> <li>DC operation</li> </ul> </li> <li>Sine pulse               <ul style="list-style-type: none"> <li>AC operation</li> <li>DC operation</li> </ul> </li> </ul>	g/ms g/ms g/ms g/ms		10.3/5 and 6.7/10 6.7/5 and 4.0/10 (3RT204.-.KB40: 6.3/5 and 3.6/10) 16.3/5 and 10.5/10 10.6/5 and 6.3/10 (3RT204.-.KB40: 9.8/5 and 5.6/10)	
<b>Short-circuit protection</b>				
<b>Main circuit</b>				
<ul style="list-style-type: none"> <li>Fuse links, operational class gG: LV HRC, type 3NA; DIAZED, type 5SB; NEOZED, type 5SE according to IEC 60947-4-1               <ul style="list-style-type: none"> <li>Type of coordination "1"</li> <li>Type of coordination "2"</li> <li>Weld-free (test conditions acc. to IEC 60947-4-1)</li> </ul> </li> </ul>	A A A		250 160 On request	
			160	
			200	
<b>Auxiliary circuit</b>				
<ul style="list-style-type: none"> <li>Fuse links, operational class gG: DIAZED, type 5SB; NEOZED, type 5SE (weld-free protection at <math>I_k \leq 1</math> kA)</li> <li>230 V miniature circuit breaker, C characteristic (short-circuit current <math>I_k &lt; 400</math> A)</li> </ul>	A A		10 10	
Short-circuit protection for contactors with overload relays				
See Configuration Manual for load feeders				
Short-circuit protection for fuseless load feeders				
See 3RA2 load feeders				

# Switching devices – Contactors and contactor assemblies – for switching motors

## Power contactors for switching motors

### SIRIUS 3RT contactors, 3-pole up to 250 kW

Type	Contactors			Coupling contactors
	3RT204.-A..., 3RT204.-C...	3RT204.-N.3.	3RT204.-S.3.	3RT204.-KB4.
Size	S3			
<b>Control</b>				
<b>Type of operating mechanism</b>	AC	AC/DC	DC	
<b>Solenoid coil operating range</b>				
• AC operation <sup>1)</sup>	0.8 ... 1.1 x U <sub>s</sub>	--		
• AC/DC operation <sup>1)</sup>	--	0.8 ... 1.1 x U <sub>s</sub>		
• DC operation	--	--	0.8 ... 1.2 x U <sub>s</sub>	
<b>Power consumption of the solenoid coils</b> (for cold coil and 1.0 x U <sub>s</sub> )				
• AC operation, 50 Hz, standard version				
- Closing	VA	296	--	--
- P.f.		0.61	--	--
- Closed	VA	19	--	--
- P.f.		0.38	--	--
• AC operation, 50/60 Hz, standard version				
- Closing	VA	348/296	--	--
- P.f.		0.62/0.55	--	--
- Closed	VA	25/18	--	--
- P.f.		0.35/0.41	--	--
• AC operation, 60 Hz, for USA/Canada				
- Closing	VA	326	--	--
- P.f.		0.62	--	--
- Closed	VA	22	--	--
- P.f.		0.38	--	--
• AC/DC operation				
- Closing for AC operation	VA	--	163	130
- P.f.		--	0.95	--
- Closed for AC operation	VA	--	3.1	2.4
- P.f.		--	0.95	0.7
- Closing for DC operation	VA	--	76 <sup>2)</sup>	130
- Closed for DC operation	VA	--	1.8	--
• DC operation				
- Closing for DC operation	W	--	--	25 <sup>3)</sup>
- Closed for DC operation	W	--	--	0.9
<b>Permissible residual current of the electronics</b> (with 0 signal)				
• AC/DC operation	mA	--	< 20	--
• DC operation	mA	--	--	< 20
<b>Overvoltage configuration of the solenoid coil</b>	--	Integrated varistor 		
<b>PLC control input</b> acc. to IEC 60947-1				
• Solid-state operating mechanism	--	Type 1		--
• Rated voltage	V DC	--	24	--
• Operating range	V DC	--	17 ... 30	--
• Power consumption	mA	--	≤ 30	--
• Recovery time after mains failure, typical	s	--	2	--
<b>Operating times within operating range</b>				
Total break time = Opening delay + Arcing time				
• AC operation				
- Closing delay	ms	13 ... 50	50 ... 70	--
- Opening delay	ms	10 ... 21	38 ... 57	--
• DC operation				
- Closing delay	ms	--	50 ... 70	--
- Opening delay	ms	--	38 ... 57	--
• Arcing time	ms	10 ... 20	--	--

<sup>1)</sup> Coil operating range  
 - At 50 Hz: 0.8 to 1.1 x U<sub>s</sub>  
 - At 60 Hz: 0.85 to 1.1 x U<sub>s</sub>.

<sup>2)</sup> In the case of AC/DC coils, increased pickup currents (6.5 A on average) arise during the first 150 ms. For direct control by PLC, we therefore recommend special coupling contactors with reduced power consumption. The connection of one 3RT204.-KB4. coupling contactor is possible per PLC output port with an output current of 2 A, see page 2/46.

<sup>3)</sup> In the case of DC coils, increased pickup currents (2.1 A on average) arise during the first 150 ms.



# Switching devices – Contactors and contactor assemblies – for switching motors

## Power contactors for switching motors

### SIRIUS 3RT contactors, 3-pole up to 250 kW

Type Size	Contactors		
	3RT2045 S3	3RT2046	3RT2047
<b>Rated data of the main contacts</b>			
<b>Load rating with AC</b>			
<b>Utilization category AC-1</b>			
• Rated operational current $I_e$	At 40 °C up to 690 V A At 60 °C up to 690 V A At 40 °C up to 1 000 V A At 60 °C up to 1 000 V A	125 105 60 50	130 110 70 60
• Rated power for AC loads <sup>1)</sup> P.f. = 0.95 (at 60 °C)	230 V kW 400 V kW 690 V kW	40 69 119	42 72 125
• Minimum cross-section in the main circuit for max. AC-1 rated value	mm <sup>2</sup>	50	
<b>Utilization categories AC-2 and AC-3</b>			
• Rated operational currents $I_e$	Up to 400 V A 500 V A 690 V A 1 000 V A	80 80 58 30	95 95 78 98
• Rated power for slip-ring or squirrel-cage motors at 50 Hz and 60 Hz	At 230 V kW 400 V kW 690 V kW 1 000 V kW	22 37 55 37	30 55 90
<b>Thermal load capacity</b>	10 s current A	760	880
<b>Power loss per conducting path</b>	At $I_e/AC-3$ W	5.3	6.6
<b>Utilization category AC-4 (for <math>I_a = 6 \times I_e</math>)</b>			
• Maximum values			
- Rated operational current $I_e$	Up to 400 V A	66	80
- Rated power for squirrel-cage motors at 50 Hz and 60 Hz	At 400 V kW	37	45
• The following applies to a contact endurance of about 200 000 operating cycles:			
- Rated operational currents $I_e$	Up to 400 V A 690 V A	34 24	42 30
- Rated power for squirrel-cage motors at 50 Hz and 60 Hz	At 110 V kW 230 V kW 400 V kW 690 V kW	4.9 10.4 17.9 21.8	6.1 12 22 27.4
			46 36 6.7 14 24.3 32.9

<sup>1)</sup> Industrial furnaces and electric heaters with resistance heating, etc. (increased power consumption on heating up has been taken into account).

# Switching devices – Contactors and contactor assemblies – for switching motors

## Power contactors for switching motors

### SIRIUS 3RT contactors, 3-pole up to 250 kW

Type Size	Contactors		
	3RT2045 S3	3RT2046	3RT2047
<b>Rated data of the main contacts (continued)</b>			
<b>Load rating with DC</b>			
<b>Utilization category DC-1, (<math>L/R \leq 1</math> ms)</b>			
• Rated operational currents $I_e$ (at 60 °C)			
- 1 conducting path	Up to 24 V A	100	
	60 V A	60	
	110 V A	9	
	220 V A	2	
	440 V A	0.6	
	600 V A	0.4	
- 2 conducting paths in series	Up to 24 V A	100	
	60 V A	100	
	110 V A	100	
	220 V A	10	
	440 V A	1.8	
	600 V A	1.0	
- 3 conducting paths in series	Up to 24 V A	100	
	60 V A	100	
	110 V A	100	
	220 V A	80	
	440 V A	4.5	
	600 V A	2.6	
<b>Utilization category DC-3/DC-5, shunt-wound and series-wound motors (<math>L/R \leq 15</math> ms)</b>			
• Rated operational currents $I_e$ (at 60 °C)			
- 1 conducting path	Up to 24 V A	40	
	60 V A	6	
	110 V A	2.5	
	220 V A	1	
	440 V A	0.15	
	600 V A	0.06	
- 2 conducting paths in series	Up to 24 V A	100	
	60 V A	100	
	110 V A	100	
	220 V A	7	
	440 V A	0.42	
	600 V A	0.16	
- 3 conducting paths in series	Up to 24 V A	100	
	60 V A	100	
	110 V A	100	
	220 V A	35	
	440 V A	0.8	
	600 V A	0.35	
<b>Switching frequency</b>			
<b>Switching frequency z</b> in operating cycles/hour			
Contactors without overload relays			
• No-load switching frequency	AC 1/h	5 000	
	DC 1/h	1 000	
	AC/DC 1/h	1 000	
• Switching frequency z during rated operation (Dependence of the switching frequency z' on operational current I' and operational voltage U': $z' = z \cdot (I_e/I') \cdot (U_e/U)^{1.5} \cdot 1/h$ )			
- $I_e/AC-1$ at 400 V	1/h	900	
- $I_e/AC-2$ at 400 V	1/h	400	350
- $I_e/AC-3$ at 400 V	1/h	1 000	850
- $I_e/AC-4$ at 400 V	1/h	300	250
Contactors with overload relays			
• Mean value	1/h	15	200

# Switching devices – Contactors and contactor assemblies – for switching motors

## Power contactors for switching motors

### SIRIUS 3RT contactors, 3-pole up to 250 kW

Type	Contactors						
	3RT1054	3RT1055, 3RT1056	3RT1064 to 3RT1066	3RT1075	3RT1076		
Size	S6		S10	S12			
<b>General data</b>							
<b>Dimensions (W x H x D)</b>							
<ul style="list-style-type: none"> <li>Basic unit</li> <li>Basic unit with mounted auxiliary switch</li> </ul>			mm	120 x 172 x 170	145 x 210 x 202	160 x 214 x 225	
			mm	120 x 172 x 217	145 x 210 x 251	160 x 214 x 271	
<b>Permissible mounting position</b>							
The contactors are designed for operation on a vertical mounting surface.							
<b>Mechanical service life</b>							
	Operating cycles			10 million			
<b>Electrical endurance</b>							
<b>Rated insulation voltage <math>U_i</math></b> (pollution degree 3)			V	1 000			
<b>Rated impulse withstand voltage <math>U_{imp}</math></b>							
• Auxiliary circuit			kV	6			
• Main circuit			kV	8			
<b>Protective separation</b> between the coil and the main contacts acc. to IEC 60947-1, Annex N			V	690			
<b>Mirror contacts</b>							
A mirror contact is an auxiliary NC contact that cannot be closed simultaneously with an NO main contact.				Yes, acc. to IEC 60947-4-1, Annex F			
<b>Permissible ambient temperature</b>							
• During operation			°C	-25 ... +60			
• During storage			°C	-55 ... +80			
<b>Degree of protection IP on the front</b> according to IEC 60529							
				IP00 (IP20 with box terminal/cover)			
<b>Touch protection on the front</b> acc. to IEC 60529							
				Finger-safe for vertical touching from the front with box terminal/cover			
<b>Shock resistance</b>							
• Rectangular pulse			g/ms	8.5/5 and 4.2/10			
• Sine pulse			g/ms	13.4/5 and 6.5/10			
<b>Electromagnetic compatibility (EMC)</b>							
				See page 2/14			
<b>Short-circuit protection</b>							
<b>Main circuit</b>							
Fuse links, operational class gG: LV HRC, type 3NA; DIAZED, type 5SB; NEOZED, type 5SE according to IEC 60947-4-1							
• Type of coordination "1"			A	355	500	630	
• Type of coordination "2"			A	250	315	400	500
• Weld-free			A	80	160	250	315
<b>Auxiliary circuit</b>							
Short-circuit test							
• With fuse links of operational class gG: DIAZED, type 5SB; NEOZED, type 5SE with short-circuit current $I_k = 1$ kA acc. to IEC 60947-5-1			A	10			
• With miniature circuit breakers with C characteristic with short-circuit current $I_k = 400$ A			A	10			
Short-circuit protection for contactors with overload relays							
				See Configuration Manual for load feeders			

# Switching devices – Contactors and contactor assemblies – for switching motors

## Power contactors for switching motors

### SIRIUS 3RT contactors, 3-pole up to 250 kW

Type Size	Contactors				
	3RT105. S6	3RT106. S10	3RT107. S12		
<b>Control</b>					
<b>Operating range of the solenoid operating mechanism</b>	AC/DC	0.8 x $U_s$ min ... 1.1 x $U_s$ max			
<b>Power consumption of the solenoid operating mechanism</b> (with cold coil and rated range $U_s$ min ... $U_s$ max)					
• Standard operating mechanism (3RT10...-A)					
- AC operation	Closing at $U_s$ min Closing at $U_s$ max Closed at $U_s$ min Closed at $U_s$ max	VA/p.f. VA/p.f. VA/p.f. VA/p.f.	250/0.9 300/0.9 4.8/0.8 5.8/0.8	490/0.9 590/0.9 5.6/0.9 6.7/0.9	700/0.9 830/0.9 7.6/0.9 9.2/0.9
- DC operation	Closing at $U_s$ min Closing at $U_s$ max Closed at $U_s$ min Closed at $U_s$ max	W W W W	300 360 4.3 5.2	540 650 6.1 7.4	770 920 8.5 10
• Solid-state operating mechanism (3RT10...-N/-P/-S)					
- AC operation	Closing at $U_s$ min Closing at $U_s$ max Closed at $U_s$ min Closed at $U_s$ max	VA/p.f. VA/p.f. VA/p.f. VA/p.f.	190/0.8 280/0.8 3.5/0.6 4.8/0.6	400/0.8 530/0.8 5.5/0.5 8.5/0.4	560/0.8 750/0.8 5.6/0.5 9/0.4
- DC operation	Closing at $U_s$ min Closing at $U_s$ max Closed at $U_s$ min Closed at $U_s$ max	W W W W	250 320 2.1 2.8	440 580 2.8 3.4	600 800 3 3.6
<b>PLC control input</b> acc. to IEC 60947-1					
• Solid-state operating mechanism	3RT10...-N/-P 3RT10...-S		Type 2 Type 1		
• Rated voltage		V DC	24		
• Operating range		V DC	17 ... 30		
• Power consumption		mA	≤ 30		
• Recovery time after mains failure, typical (applicable only for fail-safe version 3RT10...-S)		s	2		
<b>Operating times within operating range</b>					
Total break time = Opening delay + Arcing time					
• Standard operating mechanism for AC/DC operation (3RT10...-A)	Closing delay Opening delay	ms ms	20 ... 95 40 ... 60	30 ... 95 40 ... 80	45 ... 100 60 ... 100
• Solid-state operating mechanism for AC/DC operation					
- Actuated via A1/A2 (3RT10...-N/-P)	Closing delay Opening delay	ms ms	95 ... 135 80 ... 90	105 ... 145 80 ... 100	120 ... 150
- Actuated via PLC input (3RT10...-N/-P)	Closing delay Opening delay	ms ms	35 ... 75 80 ... 90	45 ... 80 80 ... 100	60 ... 90
- Actuated via F-PLC input (3RT10...-S)	Closing delay Opening delay	ms ms	60 ... 75 115 ... 130		
• Arcing time		ms	10 ... 20		

# Switching devices – Contactors and contactor assemblies – for switching motors

## Power contactors for switching motors

### SIRIUS 3RT contactors, 3-pole up to 250 kW

Type Size	Contactors							
	3RT1054 S6	3RT1055	3RT1056	3RT1064 S10	3RT1065	3RT1066	3RT1075 S12	3RT1076
<b>Rated data of the main contacts</b>								
<b>Load rating with AC</b>								
<b>Utilization category AC-1</b>								
• Rated operational currents $I_e$								
- At 40 °C up to 690 V	A	160	185	215	275	330	430	610
- At 60 °C up to 690 V	A	140	160	185	250	300	400	550
- At 60 °C up to 1 000 V	A	80	90	100		150	200	
• Rated power for AC loads <sup>1)</sup> with p.f. = 0.95 (at 60 °C)								
- At 230 V	kW	53	60	70	94	113	151	208
- At 400 V	kW	92	105	121	164	197	263	362
- At 500 V	kW	115	131	152	205	246	329	452
- At 690 V	kW	159	181	210	283	340	454	624
- At 1 000 V	kW	131	148	165	164	246	329	
• Minimum cross-section in the main circuit for max. AC-1 rated value	mm <sup>2</sup>	70	95		150	185	300	370
<b>Utilization categories AC-2 and AC-3</b>								
• Rated operational currents $I_e$								
- Up to 500 V	A	115	150	185	225	265	300	400
- At 690 V	A	115	150	170	225	265	280	400
- At 1 000 V	A	53	65		68	95	180	500
• Rated power for slip-ring or squirrel-cage motors at 50 Hz and 60 Hz								
- At 230 V	kW	37	50	61	73	85	97	132
- At 400 V	kW	64	84	104	128	151	171	231
- At 500 V	kW	81	105	132	160	189	215	291
- At 690 V	kW	113	146	167	223	265	280	400
- At 1 000 V	kW	75	90			132	250	453
<b>Thermal load capacity, 10 s current</b>	A	1 100	1 300	1 480	1 800	2 400		3 200
<b>Power loss per main conducting path</b> At $I_e/AC-3/500 V$	W	7	9	13	17	18	22	35
<b>Utilization category AC-4 (for <math>I_a = 6 \times I_e</math>)</b>								
Maximum values:								
• Rated operational current $I_e$								
- Up to 400 V	A	97	132	160	195	230	280	350
• Rated power for squirrel-cage motors at 50 Hz and 60 Hz								
- At 400 V	kW	55	75	90	110	132	160	200
The following applies to a contact endurance of about 200 000 operating cycles:								
• Rated operational currents $I_e$								
- Up to 500 V	A	54	68	81	96	117	125	150
- Up to 690 V	A	48	57	65	85	105	115	135
• Rated power for squirrel-cage motors at 50 Hz and 60 Hz								
- At 230 V	kW	16	20	25	30	37	40	48
- At 400 V	kW	29	38	45	54	66	71	85
- At 500 V	kW	37	47	57	67	82	87	105
- At 690 V	kW	48	55	65	82	102	112	133

<sup>1)</sup> Industrial furnaces and electric heaters with resistance heating, etc.  
(increased power consumption on heating up has been taken into account).



# Switching devices – Contactors and contactor assemblies – for switching motors

## Power contactors for switching motors

### SIRIUS 3RT contactors, 3-pole up to 250 kW

Type Size	Contactors						
	3RT1054 S6	3RT1055, 3RT1056	3RT1064 S10	3RT1065	3RT1066	3RT1075 S12	3RT1076
<b>Rated data of the main contacts (continued)</b>							
<b>Load rating with DC</b>							
<b>Utilization category DC-1, (<math>L/R \leq 1</math> ms)</b>							
• Rated operational currents $I_e$ (at 60 °C)							
- 1 conducting path	Up to 24 V A	160	200	300		400	
	60 V A	160	200	300		330	
	110 V A	18		33			
	220 V A	3.4		3.8			
	440 V A	0.8		0.9			
	600 V A	0.5		0.6			
- 2 conducting paths in series	Up to 24 V A	160	200	300		400	
	60 V A	160	200	300		400	
	110 V A	160	200	300		400	
	220 V A	20		300		400	
	440 V A	3.2		4			
	600 V A	1.6		2			
- 3 conducting paths in series	Up to 24 V A	160	200	300		400	
	60 V A	160	200	300		400	
	110 V A	160	200	300		400	
	220 V A	160	200	300		400	
	440 V A	11.5		11			
	600 V A	4		5.2			
<b>Utilization category DC-3/DC-5, shunt-wound and series-wound motors (<math>L/R \leq 15</math> ms)</b>							
• Rated operational currents $I_e$ (at 60 °C)							
- 1 conducting path	Up to 24 V A	160	200	300		400	
	60 V A	7.5		11			
	110 V A	2.5		3			
	220 V A	0.6					
	440 V A	0.17		0.18			
	600 V A	0.12		0.125			
- 2 conducting paths in series	Up to 24 V A	160	200	300		400	
	60 V A	160	200	300		400	
	110 V A	160	200	300		400	
	220 V A	2.5					
	440 V A	0.65					
	600 V A	0.37					
- 3 conducting paths in series	Up to 24 V A	160	200	300		400	
	60 V A	160	200	300		400	
	110 V A	160	200	300		400	
	220 V A	160	200	300		400	
	440 V A	1.4					
	600 V A	0.75					
<b>Switching frequency</b>							
<b>Switching frequency <math>z</math> in operating cycles/hour</b>							
Contactors without overload relays							
• No-load switching frequency							
- Standard operating mechanism	3RT10...-A	1/h	2 000				
- Solid-state operating mechanism	3RT10...-N/-P	1/h	1 000				
	3RT10...-S	1/h	1 000			500	
• Switching frequency $z$ during rated operation (Dependence of the switching frequency $z'$ on operational current $I'$ and operational voltage $U'$ : $z' = z \cdot (I_e/I') \cdot (U_e/U')^{1.5} \cdot 1/h$ )							
- 3RT10...-A standard operating mechanism and 3RT10...-N/-P solid-state operating mechanism	$I_e/AC-1$ at 400 V	1/h	800		750	800	750
	$I_e/AC-2$ at 400 V	1/h	400	300	250	200	700
	$I_e/AC-3$ at 400 V	1/h	1 000	750	500	200	170
	$I_e/AC-4$ at 400 V	1/h	130			200	420
- 3RT10...-S solid-state operating mechanism	$I_e/AC-1$ at 400 V	1/h	750		500	200	
	$I_e/AC-2$ at 400 V	1/h	400	300	250	200	170
	$I_e/AC-3$ at 400 V	1/h	750		500	200	
	$I_e/AC-4$ at 400 V	1/h	130				
Contactors with mounted overload relay							
• Mean value		1/h	60				

# Switching devices – Contactors and contactor assemblies – for switching motors

## Power contactors for switching motors

IE3/IE4 ready

SIRIUS 3RT contactors, 3-pole up to 250 kW

### Selection and ordering data

#### DC operation for direct control by PLC

- Coupling contactors with adapted power consumption
- Suitable for electronic PLC/F-PLC outputs
- Cannot be expanded with auxiliary switches



3RT201.-2.B4.

Rated data		Auxiliary contacts		Rated control supply voltage $U_s$ DC	Spring-loaded terminals 	Weight
AC-2 and AC-3, $t_u$ : 60 °C	AC-1, $t_u$ : 40 °C	Ident. No.	Version			
Operational current $I_e$ up to	Ratings of three-phase motors at 50 Hz and	Operational current $I_e$ up to			Article No.	
400 V	<b>400 V</b>	690 V	NO	NC		kg
A	kW	A		V		

#### For screw fixing and snap-on mounting on TH 35 standard mounting rail

##### Size S00

(Cannot be expanded with auxiliary switches)

Operating range **0.7 ... 1.25 x  $U_s$** ,power consumption of the solenoid coils **2.8 W** at 24 V

7	<b>3</b>	18	<b>10</b>	1	--	24	<b>3RT2015-2HB41</b>	0.317
			<b>01</b>	--	1	24	<b>3RT2015-2HB42</b>	0.317
9	<b>4</b>	22	<b>10</b>	1	--	24	<b>3RT2016-2HB41</b>	0.300
			<b>01</b>	--	1	24	<b>3RT2016-2HB42</b>	0.315
12	<b>5.5<sup>1)</sup></b>	22	<b>10</b>	1	--	24	<b>3RT2017-2HB41</b>	0.317
			<b>01</b>	--	1	24	<b>3RT2017-2HB42</b>	0.320

Operating range **0.85 ... 1.85 x  $U_s$** ,power consumption of the solenoid coils **1.6 W** at 24 V

7	<b>3</b>	18	<b>10</b>	1	--	24	<b>3RT2015-2MB41-0KT0</b>	0.319
			<b>01</b>	--	1	24	<b>3RT2015-2MB42-0KT0</b>	0.330
9	<b>4</b>	22	<b>10</b>	1	--	24	<b>3RT2016-2MB41-0KT0</b>	0.317
			<b>01</b>	--	1	24	<b>3RT2016-2MB42-0KT0</b>	0.316
12	<b>5.5<sup>1)</sup></b>	22	<b>10</b>	1	--	24	<b>3RT2017-2MB41-0KT0</b>	0.310
			<b>01</b>	--	1	24	<b>3RT2017-2MB42-0KT0</b>	0.317

##### With integrated coil circuit (diode integrated at the factory)<sup>1)</sup>

(Cannot be expanded with auxiliary switches)

Operating range **0.7 ... 1.25 x  $U_s$** ,power consumption of the solenoid coils **2.8 W** at 24 V

7	<b>3</b>	18	<b>10</b>	1	--	24	<b>3RT2015-2JB41</b>	0.315
			<b>01</b>	--	1	24	<b>3RT2015-2JB42</b>	0.316
9	<b>4</b>	22	<b>10</b>	1	--	24	<b>3RT2016-2JB41</b>	0.316
			<b>01</b>	--	1	24	<b>3RT2016-2JB42</b>	0.317
12	<b>5.5<sup>1)</sup></b>	22	<b>10</b>	1	--	24	<b>3RT2017-2JB41</b>	0.316
			<b>01</b>	--	1	24	<b>3RT2017-2JB42</b>	0.316

Operating range **0.85 ... 1.85 x  $U_s$** ,power consumption of the solenoid coils **1.6 W** at 24 V

7	<b>3</b>	18	<b>10</b>	1	--	24	<b>3RT2015-2VB41</b>	0.320
			<b>01</b>	--	1	24	<b>3RT2015-2VB42</b>	0.323
9	<b>4</b>	22	<b>10</b>	1	--	24	<b>3RT2016-2VB41</b>	0.320
			<b>01</b>	--	1	24	<b>3RT2016-2VB42</b>	0.318
12	<b>5.5<sup>1)</sup></b>	22	<b>10</b>	1	--	24	<b>3RT2017-2VB41</b>	0.320
			<b>01</b>	--	1	24	<b>3RT2017-2VB42</b>	0.320

<sup>1)</sup> When using contactors with IE3/IE4 motors, use contactors fitted with varistors instead of diodes. In the case of 5.5 kW coupling contactors of size S00, use 5.5 kW coupling contactors of size S0, see page 2/45.

Accessories and spare parts, see pages 2/52 to 2/75.

# Switching devices – Contactors and contactor assemblies – for switching motors

## Power contactors for switching motors

### SIRIUS 3RT contactors, 3-pole up to 250 kW **IE3/IE4 ready**



#### DC operation for direct control by PLC

- Coupling contactors with adapted power consumption
- Suitable for electronic PLC/F-PLC outputs
- Cannot be expanded with auxiliary switches

2



3RT201.-2.B4.

Rated data		AC-1, $t_{ij}$ : 40 °C	Auxiliary contacts	Rated control supply voltage $U_s$ DC	Spring-loaded terminals 	Weight
AC-2 and AC-3, $t_{ij}$ : 60 °C	Operational current $I_e$ up to	Operational current $I_e$ up to	Ident. No.	Version	Article No.	kg
400 V	Ratings of three-phase motors at 50 Hz and <b>400 V</b> kW	690 V		 		
A		A		NO NC V		

#### For screw fixing and snap-on mounting on TH 35 standard mounting rail

#### Size S00

#### With integrated coil circuit (suppressor diode integrated at the factory)<sup>1)</sup>

(Cannot be expanded with auxiliary switches)

Operating range **0.7 ... 1.25 x  $U_s$** ,

power consumption of the solenoid coils **2.8 W** at 24 V

7	<b>3</b>	18	<b>10</b> <b>01</b>	1 --	-- 1	24 24	<b>3RT2015-2KB41</b> <b>3RT2015-2KB42</b>	0.315 0.318
9	<b>4</b>	22	<b>10</b> <b>01</b>	1 --	-- 1	24 24	<b>3RT2016-2KB41</b> <b>3RT2016-2KB42</b>	0.320 0.316
12	<b>5.5<sup>1)</sup></b>	22	<b>10</b> <b>01</b>	1 --	-- 1	24 24	<b>3RT2017-2KB41</b> <b>3RT2017-2KB42</b>	0.316 0.316
Operating range <b>0.85 ... 1.85 x <math>U_s</math></b> , power consumption of the solenoid coils <b>1.6 W</b> at 24 V								
7	<b>3</b>	18	<b>10</b> <b>01</b>	1 --	-- 1	24 24	<b>3RT2015-2SB41</b> <b>3RT2015-2SB42</b>	0.320 0.317
9	<b>4</b>	22	<b>10</b> <b>01</b>	1 --	-- 1	24 24	<b>3RT2016-2SB41</b> <b>3RT2016-2SB42</b>	0.317 0.320
12	<b>5.5<sup>1)</sup></b>	22	<b>10</b> <b>01</b>	1 --	-- 1	24 24	<b>3RT2017-2SB41</b> <b>3RT2017-2SB42</b>	0.323 0.321

<sup>1)</sup> When using contactors with IE3/IE4 motors, use contactors fitted with varistors instead of diodes. In the case of 5.5 kW coupling contactors of size S00, use 5.5 kW coupling contactors of size S0, see page 2/45. For more information about dimensioning and configuring.

Other voltages on request.

Accessories and spare parts, see pages 2/52 to 2/75.

# Switching devices – Contactors and contactor assemblies – for switching motors

## Power contactors for switching motors

IE3/IE4 ready



SIRIUS 3RT contactors, 3-pole up to 250 kW

### DC operation for direct control by PLC

- Coupling contactors with adapted power consumption
- Suitable for electronic PLC/F-PLC outputs
- Cannot be expanded with auxiliary switches



3RT202.-2KB40

Rated data		Auxiliary contacts	Rated control supply voltage $U_s$	Spring-loaded terminals 	Weight
AC-2 and AC-3, $t_{ij}$ : 60 °C	AC-1, $t_{ij}$ : 40 °C	Ident. No.   Version	DC	Article No.	kg
Operational current $I_e$ up to	Ratings of three-phase motors at 50 Hz and	 			
400 V	<b>400 V</b>		V		
A	<b>kW</b>				

For screw fixing and snap-on mounting on TH 35 standard mounting rail

### Size S0

#### With integrated coil circuit (varistor integrated in electronics at the factory)

(Cannot be expanded with auxiliary switches)

Operating range **0.7 ... 1.25 x  $U_s$** ,  
power consumption of the solenoid coils **4.5 W** at 24 V

9	<b>4</b>	40	<b>11</b>	1	1	24	<b>3RT2023-2KB40</b>	0.635
12	<b>5.5</b>	40	<b>11</b>	1	1	24	<b>3RT2024-2KB40</b>	0.645
17	<b>7.5</b>	40	<b>11</b>	1	1	24	<b>3RT2025-2KB40</b>	0.643
25	<b>11</b>	40	<b>11</b>	1	1	24	<b>3RT2026-2KB40</b>	0.643
32	<b>15</b>	50	<b>11</b>	1	1	24	<b>3RT2027-2KB40</b>	0.650

Other voltages on request.

Accessories and spare parts, [see pages 2/52 to 2/75](#).

## Switching devices – Contactors and contactor assemblies – for switching motors

### Power contactors for switching motors

#### SIRIUS 3RT contactors, 3-pole up to 250 kW **IE3/IE4 ready**

##### DC operation for direct control by PLC **==**



- Coupling contactors with adapted power consumption
- Suitable for electronic PLC/F-PLC outputs with 2 A
- Can be expanded using front or lateral auxiliary switch (1 x left and 1 x right)



3RT203.-3KB40



3RT204.-3KB40

Rated data		Auxiliary contacts	Rated control supply voltage $U_s$	Spring-loaded terminals 	Weight
AC-2 and AC-3, $t_c$ : 60 °C	AC-1, $t_c$ : 40 °C	Ident. No.   Version	DC	Article No.	
Operational $t_{I_e}$ up to	Ratings current of three-phase motors at 50 Hz and	   			
400 V	<b>400 V</b>	NO   NC	V		kg
A	<b>kW</b>				

#### For screw fixing and snap-on mounting on TH 35 standard mounting rail

##### Size S2

###### With integrated coil circuit (varistor integrated in electronics at the factory)

Operating range **0.8 ... 1.2 x  $U_s$** ,  
closing power of the solenoid coils **21.5 W** at 24 V

Rated current	Rated power	Rated voltage	Ident. No.	Version	Rated control supply voltage $U_s$	Article No.	Weight
41	<b>18.5</b>	60	<b>11</b>	1	24	<b>3RT2035-3KB40</b>	1.110
50	<b>22</b>	70	<b>11</b>	1	24	<b>3RT2036-3KB40</b>	1.113
65	<b>30</b>	80	<b>11</b>	1	24	<b>3RT2037-3KB40</b>	1.133
80	<b>37</b>	90	<b>11</b>	1	24	<b>3RT2038-3KB40</b>	1.116

#### For screw fixing and snap-on mounting on TH 35-15 and TH 75-15 standard mounting rails

##### Size S3

###### With integrated coil circuit (varistor integrated in electronics at the factory)

Operating range **0.8 ... 1.2 x  $U_s$** ,  
closing power of the solenoid coils **25 W** at 24 V

Rated current	Rated power	Rated voltage	Ident. No.	Version	Rated control supply voltage $U_s$	Article No.	Weight
80	<b>37</b>	125	<b>11</b>	1	24	<b>3RT2045-3KB40</b>	1.843
95	<b>45</b>	130	<b>11</b>	1	24	<b>3RT2046-3KB40</b>	1.849

Other voltages on request.

Accessories and spare parts, [see pages 2/52 to 2/75](#).



# Switching devices – Contactors and contactor assemblies – for switching motors

## Power contactors for switching motors

IE3/IE4 ready



SIRIUS 3RT contactors, 3-pole up to 250 kW

### AC/DC operation

- Extended operating range of the solenoid coil 0.7 to 1.3 x  $U_s$
- Power consumption reduced from closing to closed



3RT202.-2N.30

Rated data		AC-1, $t_U$ : 40 °C Operational current $I_e$ up to	Auxiliary contacts		Rated control supply voltage $U_s$	Spring-loaded terminals 	Weight
AC-2 and AC-3, $t_U$ : 60 °C	Operational current $I_e$ up to		Ident. No.	Version			
400 V	Ratings of three-phase motors at 50 Hz and <b>400 V</b>	690 V		 		Article No.	kg
A	<b>kW</b>	A		NO NC V			

For screw fixing and snap-on mounting on TH 35 standard mounting rail

### Size S0

With integrated coil circuit (varistor integrated in electronics at the factory)

12	5.5	40	11	1	1	21 ... 28 95 ... 130 200 ... 280	3RT2024-2NB30 3RT2024-2NF30 3RT2024-2NP30	0.608 0.581 0.585
17	7.5	40	11	1	1	21 ... 28 95 ... 130 200 ... 280	3RT2025-2NB30 3RT2025-2NF30 3RT2025-2NP30	0.609 0.583 0.586
25	11	40	11	1	1	21 ... 28 95 ... 130 200 ... 280	3RT2026-2NB30 3RT2026-2NF30 3RT2026-2NP30	0.618 0.582 0.587
32	15	50	11	1	1	21 ... 28 95 ... 130 200 ... 280	3RT2027-2NB30 3RT2027-2NF30 3RT2027-2NP30	0.626 0.590 0.595
38	18.5	50	11	1	1	21 ... 28 95 ... 130 200 ... 280	3RT2028-2NB30 3RT2028-2NF30 3RT2028-2NP30	0.619 0.585 0.594

Other voltages on request.

Accessories and spare parts, see pages 2/52 to 2/75.

## Switching devices – Contactors and contactor assemblies – for switching motors

### Power contactors for switching motors

SIRIUS 3RT contactors, 3-pole up to 250 kW **IE3/IE4 ready**

#### AC/DC operation

- Extended operating range of the solenoid coil 0.8 to 1.1 x  $U_s$
- Power consumption reduced from closing to closed



3RT203.-3N.30

Rated data		Auxiliary contacts	Rated control supply voltage $U_s$	Spring-loaded terminals 	Weight
AC-2 and AC-3, $t_{ij}$ : 60 °C	AC-1, $t_{ij}$ : 40 °C	Ident. No.   Version	50/60 Hz AC or DC	Article No.	
Operational current $I_e$ up to 400 V	Ratings of three-phase motors at 50 Hz and 400 V	NO   NC			kg
A	<b>kW</b>		V		

For screw fixing and snap-on mounting on TH 35 standard mounting rail

#### Size S2

With integrated coil circuit (varistor integrated in electronics at the factory)

Operational current $I_e$ (A)	Power (kW)	Rated voltage (V)	Ident. No.	Version	Rated control supply voltage $U_s$ (V)	Article No.	Weight (kg)
41	18.5	60	11	1	20 ... 33	3RT2035-3NB30	1.112
					83 ... 155	3RT2035-3NF30	1.112
					175 ... 280	3RT2035-3NP30	1.115
50	22	70	11	1	20 ... 33	3RT2036-3NB30	1.100
					83 ... 155	3RT2036-3NF30	1.115
					175 ... 280	3RT2036-3NP30	1.112
65	30	80	11	1	20 ... 33	3RT2037-3NB30	1.130
					83 ... 155	3RT2037-3NF30	1.127
					175 ... 280	3RT2037-3NP30	1.116
80	37	90	11	1	20 ... 33	3RT2038-3NB30	1.114
					83 ... 155	3RT2038-3NF30	1.125
					175 ... 280	3RT2038-3NP30	1.119
					175 ... 280	--	

Other voltages on request.

Accessories and spare parts, [see pages 2/52 to 2/75](#).

# Switching devices – Contactors and contactor assemblies – for switching motors

## Power contactors for switching motors

IE3/IE4 ready

SIRIUS 3RT contactors, 3-pole up to 250 kW

### AC/DC operation

- Extended operating range of the solenoid coil 0.8 to 1.1 x  $U_s$
- Power consumption reduced from closing to closed



3RT204.-3N.30

Rated data AC-2 and AC-3, $t_u$ : 60 °C	AC-1, $t_u$ : 40 °C	Auxiliary contacts	Rated control supply voltage $U_s$	Spring-loaded terminals 	Weight
Operational current $I_e$ up to 400 V	Ratings of three- phase motors at 50 Hz and <b>400 V</b>	Operational current $I_e$ up to 690 V	50/60 Hz AC or DC		
A	<b>kW</b>	A	NO NC V		kg

**For screw fixing and snap-on mounting on TH 35-15 and TH 75-15 standard mounting rails**

### Size S3

With integrated coil circuit (varistor integrated in electronics at the factory)

80	<b>37</b>	125	<b>11</b>	1	1	20 ... 33 83 ... 155 175 ... 280	<b>3RT2045-3NB30</b> <b>3RT2045-3NF30</b> <b>3RT2045-3NP30</b>	1.830 1.815 1.820
95	<b>45</b>	130	<b>11</b>	1	1	20 ... 33 83 ... 155 175 ... 280	<b>3RT2046-3NB30</b> <b>3RT2046-3NF30</b> <b>3RT2046-3NP30</b>	1.834 1.815 1.804
110	<b>55</b>	130	<b>11</b>	1	1	20 ... 33 83 ... 155 175 ... 280	<b>3RT2047-3NB30</b> <b>3RT2047-3NF30</b> <b>3RT2047-3NP30</b>	1.833 1.818 1.818

Other voltages on request.

Accessories and spare parts, see pages 2/52 to 2/75.

## Switching devices – Contactors and contactor assemblies – for switching motors

### Power contactors for switching motors

#### SIRIUS 3RT contactors, 3-pole up to 250 kW **IE3/IE4 ready**

##### AC/DC operation



- Solid-state operating mechanism
  - 3RT10...-N with 24 V DC control signal input
  - 3RT10...-P with 24 V DC control signal input and with remaining lifetime indicator (RLT)
- For screw fixing
- Auxiliary and control conductors: Screw terminals or spring-loaded terminals
- Main conductors: Busbar connections; a connection kit with screws, spring washers and nuts is enclosed.



3RT106.-2N.36



3RT107.-2N.36

Size	Rated data AC-2 and AC-3, $t_{ij}$ : 60 °C Operational current $I_e$ up to	Ratings of three-phase motors at 50 Hz and				AC-1, $t_{ij}$ : 40 °C Operational current $I_e$ up to	Auxiliary contacts, lateral Version  	Rated control supply voltage $U_s$ 50/60 Hz AC or DC V	<b>Spring-loaded terminals</b> 	Weight kg
	500 V A	<b>400 V</b> kW	500 V kW	690 V kW	690 V A	NO NC		Article No.		

##### Solid-state operating mechanism

**With 24 V DC control signal input**  
**e.g. for control by PLC**

**With integrated coil circuit (varistor integrated in electronics at the factory)**

Size	115	55	75	110	160	2	2	96 ... 127 200 ... 277	<b>3RT1054-2NF36</b> <b>3RT1054-2NP36</b>	3.277 3.326
	150	<b>75</b>	90	132	185	2	2	96 ... 127 200 ... 277	<b>3RT1055-2NF36</b> <b>3RT1055-2NP36</b>	3.333 3.350
	185	<b>90</b>	110	160	215	2	2	96 ... 127 200 ... 277	<b>3RT1056-2NF36</b> <b>3RT1056-2NP36</b>	3.353 3.350
<b>S10</b>	225	<b>110</b>	160	200	275	2	2	96 ... 127 200 ... 277	<b>3RT1064-2NF36</b> <b>3RT1064-2NP36</b>	6.610 6.462
	265	<b>132</b>	160	250	330	2	2	96 ... 127 200 ... 277	<b>3RT1065-2NF36</b> <b>3RT1065-2NP36</b>	6.656 6.549
	300	<b>160</b>	200	250	330	2	2	96 ... 127 200 ... 277	<b>3RT1066-2NF36</b> <b>3RT1066-2NP36</b>	6.720 6.599
<b>S12</b>	400	<b>200</b>	250	400	430	2	2	96 ... 127 200 ... 277	<b>3RT1075-2NF36</b> <b>3RT1075-2NP36</b>	10.352 10.095
	500	<b>250</b>	355	400	610	2	2	96 ... 127 200 ... 277	<b>3RT1076-2NF36</b> <b>3RT1076-2NP36</b>	10.501 10.340

Other voltages [according to page 2/51](#) on request.

Accessories and spare parts, [see pages 2/52 to 2/75](#).

# Switching devices – Contactors and contactor assemblies – for switching motors

## Power contactors for switching motors

SIRIUS 3RT contactors, 3-pole up to 250 kW

### Options

**Rated control supply voltages for 3RT10 contactors, possible on request (change of the 10th and 11th digits of the Article No.)**

Delivery time on request

Rated control supply voltage	Contactor type	Rated control supply voltage	Contactor type
	3RT105.-A, 3RT106.-A, 3RT107.-A		3RT105.-N, 3RT106.-N, 3RT107.-N
			3RT105.-P, 3RT105.-S, 3RT106.-P, 3RT106.-S, 3RT107.-P, 3RT107.-S
$U_{s \min}$ to $U_{s \max}$	Sizes S6 to S12	$U_{s \min}$ to $U_{s \max}$	Sizes S6 to S12

#### Sizes S6 to S12

**AC/DC operation (50/60 Hz AC or DC) and operating range  $0.8 \times U_{s \min}$  to  $1.1 \times U_{s \max}$**

##### Standard operating mechanism

23 ... 26 V AC/DC	B3
42 ... 48 V AC/DC	D3
110 ... 127 V AC/DC	F3
200 ... 220 V AC/DC	M3
220 ... 240 V AC/DC	P3
240 ... 277 V AC/DC	U3
380 ... 420 V AC/DC	V3
440 ... 480 V AC/DC	R3
500 ... 550 V AC/DC	S3
575 ... 600 V AC/DC	T3

##### Solid-state operating mechanism

21 ... 27.3 V AC/DC	B3	--
96 ... 127 V AC/DC	F3	F3
200 ... 277 V AC/DC	P3	P3

# Switching devices – Contactors and contactor assemblies – for switching motors

## Power contactors for switching motors

### Accessories for SIRIUS 3RT contactors and SIRIUS 3RH2 contactor relays > General data

#### Overview

Extensive accessories and spare parts are available for SIRIUS 3RT power contactors and SIRIUS 3RH2 contactor relays.

These components are easily fitted to the contactors without the use of any tools according to requirements.

Overview graphics with mountable accessories:

- 3RT2 contactors, [see pages 2/6 to 2/9](#)
- 3RT10, 3RT12 and 3RT14 contactors, [see pages 2/10 to 2/12](#)
- 3RH2 contactor relays, [see page 2/125](#)

#### More information

TIA Selection Tool Cloud (TST Cloud), [see www.siemens.com/tstcloud/?node=Contactor](http://www.siemens.com/tstcloud/?node=Contactor)

Version	For contactors 3RT2, sizes S00 to S3; 3RH2, size S00	3RT105 to 3RT107, 3RT126 and 3RT127, 3RT145 to 3RT147; sizes S6 to S12	Selection and ordering data  Page
<b>Accessories for 3RT contactors and 3RH2 contactor relays</b>			
<b>Auxiliary switches</b>			
<b>Instantaneous</b>	3RH29.1	3RH19.1	<a href="#">2/55 ... 2/63</a>
<b>Delayed</b>			
• Pneumatic time-delay auxiliary switches	3RT2927-2P..1	--	<a href="#">1)</a>
• Solid-state time-delay auxiliary switches	3RA2813, 3RA2814, 3RA2815	3RT1926-2E/-2F/-2G	<a href="#">1)</a>
<b>Surge suppressors</b>			
• Without LED	3RT29.6-1B/-1C/-1D/-1E	3RT1956-1C	<a href="#">1)</a>
• With LED	3RT29.6-1J/-1L/-1M	--	<a href="#">1)</a>
<b>Modules for contactor control</b>			
<b>Coupling links for control by PLC</b>	3RH29.4-.GP11	--	<a href="#">1)</a>
<b>3RA28 function modules</b>			
• For direct on-line starting: ON delay or OFF-delay	3RA2811, 3RA2812, 3RA2831, 3RA2832	--	<a href="#">1)</a>
• For star-delta (weye-delta) starting	3RA2816	--	<a href="#">1)</a>
<b>3RA27 function modules for IO-Link or AS-Interface</b>			
• For direct-on-line, reversing or star-delta (weye-delta) starting	3RA271.-.A/-B/-C	--	<a href="#">1)</a>
<b>Mechanical latching blocks</b>	3RT2926-3A.31	--	<a href="#">1)</a>
<b>OFF-delay devices for contactors with AC/DC and DC operation</b>	3RT2916-2B.01	--	<a href="#">1)</a>
<b>Link modules</b>			
<b>Link modules from motor starter protector to contactor</b>	3RA.9.1	--	<a href="#">2/203</a>
<b>Safety main current connectors for two contactors</b>	3RA29.6-1A	--	<a href="#">2/64</a>
<b>Assembly kits</b>			
• For reversing contactor assemblies	3RA29.3-2AA.	3RA19.3-2A	<a href="#">2/64</a>
• For contactor assemblies for star-delta (weye-delta) starting	3RA29.-.2BB., 3RA29.3-2C	3RA1953-3G, 3RA19.3-2./-3.	<a href="#">2/65, 2/66</a>
<b>Single wiring modules</b>	3RA.9.3-3.A.	3RA19.3-3.	<a href="#">2/67</a>
<b>Star jumpers (links for paralleling), 3-pole</b>	3RT.9.6-4BA3.	3RT19.6-4BA31	<a href="#">2/67</a>
<b>Mechanical interlock kits for two contactors</b>	3RA29.2-2H	--	<a href="#">2/68</a>
<b>Mechanical interlocks for contactor assemblies</b>	3RA2934-2B	3RA1954-2.	<a href="#">2/68</a>
<b>Mechanical connectors for contactor assemblies</b>	3RA29.2-2.	3RA1932-2D	<a href="#">2/68</a>
<b>Connection modules/adapters</b>			
<b>Links for paralleling for main conducting paths</b>	3RT.9.6-4BB.1	--	<a href="#">2/69</a>
<b>1-phase infeed terminals</b>	3RA2943-3L	--	<a href="#">2/70</a>
<b>3-phase infeed terminals</b>	3RA2913-3K, 3RV29.5-5A.	--	<a href="#">2/70</a>
• With increased clearances and creepage distances	3RV2935-5E	--	<a href="#">2/70</a>
<b>3-phase busbars</b>	3RV1915-1AB	--	<a href="#">2/70</a>
<b>Terminal blocks for connecting auxiliary conductors to main terminals</b>			
• Box terminal blocks	3RT2946-4G	3RT19.-.4G	<a href="#">2/70</a>
• Box terminal for auxiliary conductor connection, 1-pole	--	3TX7500-0A	<a href="#">2/70</a>
• Auxiliary terminals, 3-pole	3RT2946-4F	--	<a href="#">2/70</a>
<b>Solder pin adapters for mounting contactors on printed circuit boards</b>	3RT1916-4KA.	--	<a href="#">2/71</a>
<b>Coil connection modules for connections from top or from bottom</b>	3RT2926-4R.1.	--	<a href="#">2/71</a>
<b>Connection module (adapter and plug) for contactors with screw terminals</b>			
• Adapters	3RT19.6-4RD01	--	<a href="#">2/71</a>
• Motor feeder connector	3RT1900-4RE01	--	<a href="#">2/71</a>



# Switching devices – Contactors and contactor assemblies – for switching motors

## Power contactors for switching motors

### Accessories for SIRIUS 3RT contactors and SIRIUS 3RH2 contactor relays > General data

Version	For contactors 3RT2, sizes S00 to S3; 3RH2, size S00	3RT105 to 3RT107, 3RT126 and 3RT127, 3RT145 to 3RT147; sizes S6 to S12	Selection and ordering data  Page
<b>Accessories for 3RT contactors and 3RH2 contactor relays (continued)</b>			
<b>Covers</b>			
<b>Terminal covers</b>	3RT1946-4EA1, 3RT29.6-4EA.	3RT1956-4EA., 3RT1966-4EA., 3TX65.6-3B	<a href="#">2/72</a>
<b>Sealable covers</b>	3RT2916-4MA10	3RT1926-4MA10	<a href="#">2/72</a>
<b>Miscellaneous accessories</b>			
<b>Base plates</b>			
• For reversing contactor assemblies	--	3RT19.2-2A	<a href="#">2/73</a>
• For contactor assemblies for star-delta (wye-delta) starting	3RA29.2-2F	3RA19.2-2.	<a href="#">2/73</a>
<b>Adapters for screw fixing</b>	3RT1926-4P	--	<a href="#">2/73</a>
<b>Connection kit for one complete contactor</b>	--	3RT19...4PA00	<a href="#">2/73</a>
<b>EMC suppression modules</b>	3RT2916-1P . .	--	<a href="#">2/73</a>
<b>Additional load modules</b>	3RT2916-1GA00	--	<sup>1)</sup>
<b>LED modules for displaying contactor operation</b>	3RT2926-1QT00	3RT1926-1QT00	<sup>1)</sup>
<b>Control kit</b>	3RT29.6-4MC00	--	<sup>1)</sup>
<b>Insulation stop for securely holding back the conductor insulation for conductors up to 1 mm<sup>2</sup></b>	3RT2916-4JA02	3RT1916-4JA02	<sup>1)</sup>
<b>Tools for opening spring-loaded terminals</b>	3RA2908-1A	3RA2908-1A	<sup>1)</sup>
<b>Blank labels</b>	3RT2900-1SB.0	3RT2900-1SB.0	<sup>1)</sup>
<b>Spare parts for 3RT2 contactors</b>			
<b>Solenoid coils</b>	3RT29...5...1	--	<sup>1)</sup>
<b>Withdrawable coils</b>	--	3RT19...5....	<a href="#">2/74</a>
<b>Contacts with fixing parts</b>	3RT29...-6.	3RT19...-6.	<a href="#">2/75</a>
<b>Arc chutes</b>	--	3RT19...-7.	<a href="#">2/75</a>

<sup>1)</sup> see Catalog IC 10.

## Switching devices – Contactors and contactor assemblies – for switching motors

### Power contactors for switching motors

#### Accessories for SIRIUS 3RT contactors and SIRIUS 3RH2 contactor relays > General data

##### Auxiliary switches

The auxiliary switches can be designed as force-guided contacts in 3RH contactor relays or also as mirror contacts in the case of 3RT power contactors.

For more information on force-guided operation and mirror contacts, see [Manuals](#) → "More information", page 2/55 onwards.

##### Solid-state time-delay auxiliary switches for mounting on 3RT2 contactors and 3RH2 contactor relays

The 3RA28 solid-state time-delay auxiliary switches which can be mounted on the contactor are designed for applications in the range from 24 to 240 V AC/DC (wide voltage range). Both the electrical and mechanical connection are made by simple snapping on and locking.

The time-delay auxiliary switch is supplied with power directly by two plug-in contacts through the coil terminals of the contactor, in parallel with A./A2.

A protection circuit (varistor) is integrated in each module.

A sealable cover is available to protect against careless adjustment of the set times.

##### Note:

Mounting more auxiliary switches on the contactor is not permitted.

##### Surge suppressors

- Without LED (also for spring-loaded terminals)  
Sizes S00 to S3
- With LED (also for spring-loaded terminals)  
Sizes S00 to S3

All 3RT2 contactors and 3RH2 contactor relays can be retrofitted with RC elements or varistors for damping opening surges in the coil. Diodes or diode assemblies (combination of interference suppression diode and Zener diode for short break times) can also be used.

The surge suppressors are plugged onto the front of size S00 contactors. Space is provided for them next to a snap-on auxiliary switch.

Varistors, RC elements or diode assemblies can be plugged onto the front of size S0 to S3 contactors. Exception: For size S3, the RC element is inserted on the front into the recesses to the left of the connection block.

Coupling contactors are supplied either without overvoltage damping or with a suppressor diode, varistor or diode connected as standard, according to the version.

##### Note:

The break times of the contactor, the opening delay times of the NO contacts and the closing delay times of the NC contacts increase if the contactor coils are attenuated against voltage peaks. Different accessories are available for the contactors (time change with: interference suppression diode 6x to 10x; diode assembly 2x to 6x; suppressor diode +1 to 5 ms; varistor +2 to 5 ms).

For details, see [Equipment Manual](#).

##### Coupling links for control by PLC

- Operation with 24 V DC
- Operating range 17 to 30 V
- Low power consumption of 0.5 W
- An LED indicates the switching state.

The 3RH2924-1GP11 coupling link has an integrated surge suppressor (varistor) for the contactor coil being switched and is mounted on the size S0 contactor coil via a coil connection module.

# Switching devices – Contactors and contactor assemblies – for switching motors

## Power contactors for switching motors

### Accessories for SIRIUS 3RT contactors and SIRIUS 3RH2 contactor relays > Auxiliary switches, instantaneous

#### Overview

#### Auxiliary switch: Terminal designations and identification numbers for auxiliary contacts

##### Terminal designations

The terminal designations are 2-digit, e.g. 13, 14, 21, 22:

- Tens digit: Sequence digit
  - Related terminals have the same sequence digit
- Units digit: Function digit
  - 1-2 for normally closed contacts (NC)
  - 3-4 for normally open contacts (NO)

##### Identification numbers

The identification number indicates the number and type of the auxiliary contacts, e.g. 40, 31, 22, 13:

- 1st digit: number of normally open contacts (NO)
- 2nd digit: number of normally closed contacts (NC)

Examples:









- 31 = 3 NO + 1 NC
- 40 = 4 NO





#### Selection aid for mountable auxiliary switches for power contactors and contactor relays

The auxiliary switches of the 3RH29 series for mounting on the front and side can be used for 3RT2 power contactors as well as for 3RH2 contactor relays.

The possible combinations of basic unit and mounted auxiliary switch can be found in the tables, [see the following pages](#).

Where the columns and lines intersect (blue and green in the example) you will find the identification number for the combination of basic unit (column) and auxiliary switch (line).

Additional auxiliary switch		3-pole contactors		
Article number	Auxiliary contacts	3RT201	3RT201	3RT202 to 3RT204
	Version	<b>S00</b>	<b>S00</b>	<b>S0 to S3</b>
	NO NC	<b>10</b>	<b>01</b>	<b>11</b>
				
				
		2. 3. 4. 5.	5. 6. 7. 8.	3. 4. 5. 6.
		According to EN 50012 <sup>1)</sup>		

Auxiliary switches without NO contact		3RT201	3RT201	3RT202 to 3RT204
3RH2911-□HA01	-- 1 	<b>11</b>	02	<b>12</b>
3RH2911-□HA02	-- 2 	<b>12</b>	03	<b>13</b>
3RH2911-□HA03	-- 3 	<b>13</b>	04	<b>14</b>
3RH2911-□FA04	-- 4 	<b>14</b>	--	--
<b>Auxiliary switch with 1 NO contact</b>				
3RH2911-□HA10	1 -- 	20	11	<b>21</b>

- 1 For screw terminals
- 2 For spring-loaded terminals

<sup>1)</sup> Combinations according to EN 50012, EN 50011 and IEC 60947-5-1 are in **bold print**. All combinations comply with EN 50005.

#### Example 1

Basic unit: 3-pole 3RT2017 motor contactor with 1 NO  
 Required: 1 NO + 4 NC (Ident. No. 14)  
 Result: 3RH2911-.FA04 auxiliary switch

#### Example 2

Basic unit: 3-pole 3RT2023 motor contactor with 1 NO + 1 NC  
 Required: 1 NO + 4 NC (Ident. No. 14)  
 Result: 3RH2911-.HA03 auxiliary switch

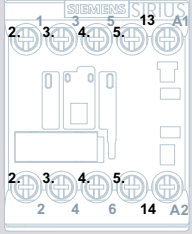
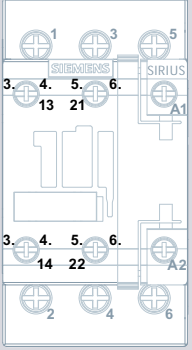
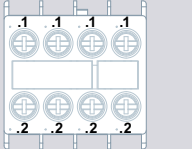
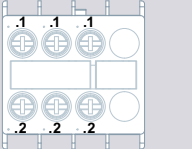
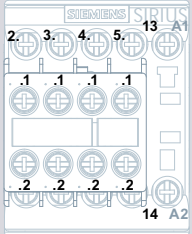
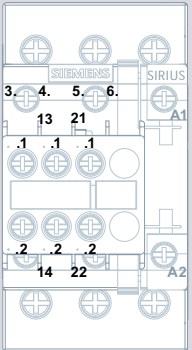
	Example 1	Example 2
Type	3RT20 motor contactor, S00 with 1 NO	3RT20 motor contactor, S00 with 1 NO + 1 NC
Sequence digit	 2. 3. 4. 5.	 3. 4. 5. 6.
Type	Auxiliary switch with 4 NC, H2911-.FA04	Auxiliary switch with 3 NC, 3RH2911-.HA03
Function digit	 1. 1. 1. 1. 2. 2. 2. 2.	 1. 1. 1. 2. 2. 2.
Combination	3RT20 motor contactor, S00 with aux. switch	3RT20 motor contactor, S0 with aux. switch
Terminal designation	 13 21 31 41 51 14 22 32 42 52	 13 21 31 41 51 14 22 32 42 52
Result	<b>Ident. No. 14</b>	<b>Ident. No. 14</b>

# Switching devices – Contactors and contactor assemblies – for switching motors

## Power contactors for switching motors

### Accessories for SIRIUS 3RT contactors and SIRIUS 3RH2 contactor relays > Auxiliary switches, instantaneous

2

Additional auxiliary switches		3-pole contactors			4-pole contactors				Contactor relays		
Article number	Auxiliary contacts Version	S00 3RT201	S0 to S3 3RT202, 3RT203, 3RT204, 3RT244	S00 3RT231	3RT251	S0 to S3 3RT232, 3RT233, 3RT234	3RT252, 3RT253, 3RT254	S00 3RH21, 3RH24			
	NO NC	10	01	11	--	--	11	11	40E	31E	22E
		2. 3. 4. 5.	5. 6. 7. 8.	3. 4. 5. 6.	1. 2. 3. 4.	1. 2. 3. 4.	3. 4. 5. 6.	3. 4. 5. 6.	5. 6. 7. 8.	5. 6. 7. 8.	5. 6. 7. 8.
		According to EN 50005			According to EN 50005				According to EN 50011 <sup>1)</sup>		

#### Auxiliary switches, front (continued)

#### With complete inscription (for contactor relays)<sup>2)</sup>

3RH2911-□GA40	4	--		--	--	--	--	--	--	80E	--	--
3RH2911-□GA31	3	1		--	--	--	--	--	--	71E	--	--
3RH2911-□GA22	2	2		--	--	--	--	--	--	62E	--	--
3RH2911-□GA13	1	3		--	--	--	--	--	--	53E	--	--
3RH2911-□GA04	--	4		--	--	--	--	--	--	44E	--	--

#### Complete inscription

3RH2911-□XA40-0MA0	4	--		50	41	51	40	40	51	51	80E	71X	62X
3RH2911-□XA31-0MA0	3	1		41	32	42	31	31	42	42	71E	62X	53
3RH2911-□XA22-0MA0	2	2		32	23	33	22	22	33	--	62E	53	44X
3RH2911-□XA04-0MA0	--	4		14	--	--	--	--	--	--	44E	--	--

#### Solid-state compatible

3RH2911-□NF02	--	2		12	03	13	02	02	13	--	42	33	24
3RH2911-□NF11	1	1		21	12	22	11	11	22	22	51	42	33
3RH2911-□NF20	2	--		30	21	31	20	20	31	31	60	51	42

<sup>1)</sup> Combinations according to EN 50011 and IEC 60947-5-1 are in **bold** print. All combinations comply with EN 50005.









<sup>2)</sup> For selection and ordering data, see page 2/59.

























# Switching devices – Contactors and contactor assemblies – for switching motors

## Power contactors for switching motors

### Accessories for SIRIUS 3RT contactors and SIRIUS 3RH2 contactor relays > Auxiliary switches, instantaneous

2

Additional auxiliary switches		3-pole contactors			4-pole contactors				Contactor relays		
Article number	Auxiliary contacts Version	S00			S00		S0 to S3		S00		
	NO NC	3RT201			3RT231	3RT251	3RT232, 3RT233, 3RT234	3RT252, 3RT253, 3RT254	3RH21		
		10	01	11	--	--	11	11	40E	31E	22E
											
		2. 3. 4. 5.	5. 6. 7. 8.	3. 4. 5. 6.	1. 2. 3. 4.	1. 2. 3. 4.	3. 4. 5. 6.	3. 4. 5. 6.	5. 6. 7. 8.	5. 6. 7. 8.	5. 6. 7. 8.
		<b>According to EN 50012<sup>1)</sup></b>			<b>According to EN 50012<sup>1)</sup></b>		<b>According to EN 50011<sup>1)</sup></b>				

Lateral auxiliary switches													
For size S00		Left	Right										
3RH2911-□DA02	-- 2 --			<b>12</b>	--	--	02	02	--	--	--	--	--
3RH2911-□DA02 + 3RH2911-□DA02	-- 2 --			14	--	--	--	--	--	--	--	--	--
3RH2911-□DA11	1 1 --			<b>21</b>	--	--	11	11	--	--	--	--	--
3RH2911-□DA11 + 3RH2911-□DA11	1 1			32	--	--	22	22	--	--	--	--	--
3RH2911-□DA20	2 -- --			30	--	--	20	20	--	--	--	--	--
3RH2911-□DA20 + 3RH2911-□DA20	2 --			50	--	--	40	40	--	--	--	--	--
3RH2911-□DA20 + 3RH2911-□DA11	2 -- 1 1			<b>41</b>	--	--	31	31	--	--	--	--	--
3RH2911-□DA20 + 3RH2911-□DA02	2 -- -- 2			<b>32</b>	--	--	22	22	--	--	--	--	--
3RH2911-□DA11 + 3RH2911-□DA02	1 1 -- 2			<b>23</b>	--	--	13	--	--	--	--	--	--
For sizes S0 to S3		Left	Right										
3RH2921-□DA02	-- 2 --			12	03	<b>13</b>	02	02	<b>13</b>	--	--	--	--
3RH2921-□DA02 + 3RH2921-□DA02	-- 2 --			14	--	--	--	--	--	--	--	--	--
3RH2921-□DA11	1 1 --			21	12	<b>22</b>	11	11	<b>22</b>	<b>22</b>	--	--	--
3RH2921-□DA11 + 3RH2921-□DA11	1 1			32	23	33	22	22	--	--	--	--	--
3RH2921-□DA20	2 -- --			30	21	<b>31</b>	20	20	<b>31</b>	<b>31</b>	--	--	--
3RH2921-□DA20 + 3RH2921-□DA20	2 --			50	41	51	40	40	--	--	--	--	--

<sup>1)</sup> Combinations according to EN 50012, EN 50011 and IEC 60947-5-1 are in **bold** print. All combinations comply with EN 50005.

# Switching devices – Contactors and contactor assemblies – for switching motors

## Power contactors for switching motors

### Accessories for SIRIUS 3RT contactors and SIRIUS 3RH2 contactor relays > Auxiliary switches, instantaneous

2

Additional auxiliary switches		3-pole contactors			4-pole contactors				Contactor relays		
Article number	Auxiliary contacts Version	S00 3RT201	S0 to S3 3RT202, 3RT203, 3RT204, 3RT244	S00 3RT231	3RT251	S0 to S3 3RT232, 3RT233, 3RT234	3RT252, 3RT253, 3RT254	S00 3RH21			
	NO NC	<b>10</b>	<b>01</b>	<b>11</b>	--	--	<b>11</b>	<b>11</b>	<b>40E</b>	<b>31E</b>	<b>22E</b>
		2. 3. 4. 5.	5. 6. 7. 8.	3. 4. 5. 6.	1. 2. 3. 4.	1. 2. 3. 4.	3. 4. 5. 6.	3. 4. 5. 6.	5. 6. 7. 8.	5. 6. 7. 8.	5. 6. 7. 8.
		<b>According to EN 50012<sup>1)</sup></b>			<b>According to EN 50012<sup>1)</sup></b>				<b>According to EN 50011<sup>1)</sup></b>		

#### Lateral auxiliary switches (continued)

For sizes S00 to S3		Left	Right										
<b>3RH2921-□DA20</b>	2 --			<b>41</b>	<b>32</b>	<b>42</b>	<b>31</b>	<b>31</b>	--	--	--	--	--
<b>3RH2921-□DA11</b>	1 1												
<b>3RH2921-□DA20</b>	2 --			<b>32</b>	<b>23</b>	<b>33</b>	<b>22</b>	<b>22</b>	--	--	--	--	--
<b>3RH2921-□DA11</b>	1 1												
<b>3RH2921-□DA02</b>	-- 2												
<b>3RH2921-□DA11</b>	1 1			<b>23</b>	<b>14</b>	<b>24</b>	<b>13</b>	--	--	--	--	--	--
<b>3RH2921-□DA02</b>	-- 2												

For contactor relays <sup>2)</sup>		Left									
<b>3RH2921-□DA02</b>	-- 2		--	--	--	--	--	--	<b>42Z</b>	<b>33X</b>	<b>24</b>
<b>3RH2921-□DA11</b>	1 1		--	--	--	--	--	--	<b>51X</b>	<b>42X</b>	<b>33X</b>
<b>3RH2921-□DA20</b>	2 --		--	--	--	--	--	--	<b>60Z</b>	<b>51X</b>	<b>42X</b>

#### Solid-state compatible

For size S00		Left	Right										
<b>3RH2911-2DE11</b>	1 1	--		<b>21</b>	--	--	<b>11</b>	<b>11</b>	--	--	--	--	--
<b>3RH2911-2DE11</b>	1 1			<b>32</b>	--	--	<b>22</b>	<b>22</b>	--	--	--	--	--
<b>3RH2911-2DE11</b>	1 1												

For sizes S00 to S3		Left	Right										
<b>3RH2921-□DE11</b>	1 1	--		<b>21</b>	<b>12</b>	<b>22</b>	<b>11</b>	<b>11</b>	<b>22</b>	<b>22</b>	--	--	--
<b>3RH2921-□DE11</b>	1 1			<b>32</b>	<b>23</b>	<b>33</b>	<b>22</b>	<b>22</b>	--	--	--	--	--
<b>3RH2921-□DE11</b>	1 1												

For contactor relays <sup>2)</sup>		Left									
<b>3RH2921-2DE11</b>	1 1		--	--	--	--	--	--	<b>51X</b>	<b>42X</b>	<b>33X</b>

<sup>1)</sup> Combinations according to EN 50012, EN 50011 and IEC 60947-5-1 are in **bold** print. All combinations comply with EN 50005.

<sup>2)</sup> Without force-guided operation.



# Switching devices – Contactors and contactor assemblies – for switching motors



## Power contactors for switching motors

Accessories for SIRIUS 3RT contactors and SIRIUS 3RH2 contactor relays > Auxiliary switches, instantaneous

### Selection and ordering data



3RH2911-2GA22

For contactor relays <sup>1)</sup>	Contactor relay with auxiliary switch Ident. No.	Auxiliary contacts Version	<b>Spring-loaded terminals</b> 	Weight
Type		 NO  NC	Article No.	kg

### Auxiliary switches for snapping onto the front

#### Size S00

#### Blocks for the assembly of contactor relays with 8 contacts

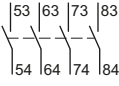
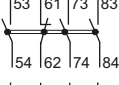
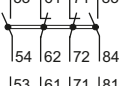
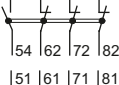
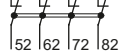
3RH2140, 3RH2440, Ident. No. 40E	80E	4	--		3RH2911-2GA40	0.049
	71E	3	1		3RH2911-2GA31	0.049
	62E	2	2		3RH2911-2GA22	0.064
	53E	1	3		3RH2911-2GA13	0.049
	44E	--	4		3RH2911-2GA04	0.064

<sup>1)</sup> For detailed information on use, see page 2/56.

## Switching devices – Contactors and contactor assemblies – for switching motors

### Power contactors for switching motors

#### Accessories for SIRIUS 3RT contactors and SIRIUS 3RH2 contactor relays > Auxiliary switches, instantaneous

2



3RH2911-2XA22-0MA0

For contactors/ contactor relays <sup>1)</sup>	Auxiliary contacts Version		Spring-loaded terminals	Weight
Type	NO	NC	Article No.	kg

#### Auxiliary switches for snapping onto the front

##### Sizes S00 to S3

3RT2.1, 3RT2.2, 3RT2.3, 3RT2.4, 3RH21, 3RH24	4	--		<b>3RH2911-2XA40-0MA0</b>	0.049
	3	1		<b>3RH2911-2XA31-0MA0</b>	0.049
	2	2		<b>3RH2911-2XA22-0MA0</b>	0.049
	--	4		<b>3RH2911-2XA04-0MA0</b>	0.049

<sup>1)</sup> For detailed information on use, see page 2/56.

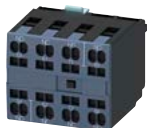

3RH1921-2XA22-0MA0

For contactors	Auxiliary contacts Ident. No.		Version	Spring-loaded terminals	Weight
Type			NO NC NO NC	Article No.	kg

#### Auxiliary switches for snapping onto the front

##### Sizes S6 to S12

	<b>4-pole auxiliary switches</b>							
	• According to EN 50012							
3RT1.5 ... 3RT1.7	<b>22</b>	2	2	--	--		<b>3RH1921-2XA22-0MA0</b>	0.060

# Switching devices – Contactors and contactor assemblies – for switching motors

## Power contactors for switching motors

### Accessories for SIRIUS 3RT contactors and SIRIUS 3RH2 contactor relays > Auxiliary switches, instantaneous



3RH2911-2DA02

For contactors <sup>1)</sup>	Auxiliary contacts Version	<b>Spring-loaded terminals</b>	Weight
------------------------------	-------------------------------	--------------------------------	--------

Type	NO       NC	Article No.	kg
------	-------------	-------------	----

**Laterally mountable auxiliary switches, mounting on the right and/or the left, 2-pole**

			Left	Right			
<b>Size S00</b>							
3RT2.1	--	2			<b>3RH2911-2DA02</b>	0.050	
	1	1				<b>3RH2911-2DA11</b>	0.050
	2	--				<b>3RH2911-2DA20</b>	0.050
<b>3RH21, 3RH24</b>							
3RH21, 3RH24	--	2		--	<b>3RH2921-2DA02</b>	0.051	
	1	1		--		<b>3RH2921-2DA11</b>	0.049
	2	--		--		<b>3RH2921-2DA20</b>	0.050
<b>Sizes S0 to S3</b>							
3RT2.2 <sup>2)</sup> , 3RT2.3 <sup>3)</sup> , 3RT2.4 <sup>3)</sup>	--	2			<b>3RH2921-2DA02</b>	0.051	
	1	1				<b>3RH2921-2DA11</b>	0.049
	2	--				<b>3RH2921-2DA20</b>	0.050

<sup>1)</sup> For detailed information on use, see pages 2/57 and 2/58.

<sup>2)</sup> With 3RT232. and 3RT252. contactors, mountable only on the right.

<sup>3)</sup> 3RH2921-1DA.. lateral auxiliary switches can only be mounted on 3RT26 capacitor contactors of sizes S2 and S3.



## Switching devices – Contactors and contactor assemblies – for switching motors

### Power contactors for switching motors

#### Accessories for SIRIUS 3RT contactors and SIRIUS 3RH2 contactor relays > Auxiliary switches, instantaneous



















3RH1921-2DA11

For contactors	Auxiliary contacts Version	Spring-loaded terminals	Weight
	 NO  NC		
Type		Article No.	kg

Lateral auxiliary switches,  
mounting on right or left,  
2-pole

#### Sizes S6 to S12

		Left	Right			
<b>First auxiliary switch</b>						
• According to EN 50012						
3RT1.5 ... 3RT1.7	1	1			<b>3RH1921-2DA11</b>	0.051
• According to EN 50005						
3RT1.5 ... 3RT1.7	2	--			<b>3RH1921-2EA20</b>	0.050
	1	1			--	
	--	2			<b>3RH1921-2EA02</b>	0.051
<b>Second auxiliary switch</b>						
• According to EN 50012						
3RT1.5 ... 3RT1.7	1	1			<b>3RH1921-2JA11</b>	0.051
• According to EN 50005						
3RT1.5 ... 3RT1.7	2	--			<b>3RH1921-2KA20</b>	0.050
	1	1			--	
	--	2			<b>3RH1921-2KA02</b>	0.051

# Switching devices – Contactors and contactor assemblies – for switching motors

## Power contactors for switching motors

### Accessories for SIRIUS 3RT contactors and SIRIUS 3RH2 contactor relays > Auxiliary switches, instantaneous

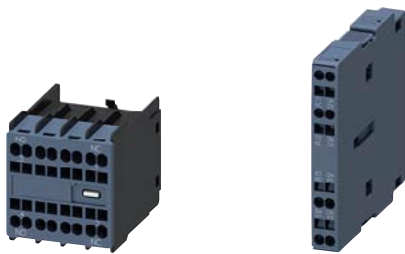

3RH2911-2NF..

3RH1921-2JE11

For contactors/ contactor relays <sup>1)</sup>	Size	Contacts Version	Spring-loaded terminals	Weight
Type		NO     NC	Article No.	kg

#### Solid-state compatible auxiliary switches, 2-pole

- For operation in dusty atmospheres
- For solid-state circuits with rated operational currents  $I_e/AC-14$  and DC-13 from 1 to 300 mA at 3 to 60 V
- Hard gold-plated contacts
- Laterally mountable auxiliary switches and auxiliary switches for snapping onto the front for 3RT2 contactors, sizes S0 to S3, are designed as mirror contacts according to IEC 60947-4-1, Annex F.

#### Auxiliary switches for snapping onto the front

				S00	S0 ... S3		
3RT2.1, 3RT2.2, 3RT2.3, 3RT2.4, 3RH21, 3RH24	<b>S00 ... S3</b>	--	2			<b>3RH2911-2NF02</b>	0.046
		1	1			<b>3RH2911-2NF11</b>	0.047
		2	--			<b>3RH2911-2NF20</b>	0.047

#### Lateral auxiliary switches, mounting on the right and/or the left, acc. to EN 50012

				Auxiliary switches			
3RT2.1	<b>S00</b>	1	1	Left 	Right 	<b>3RH2911-2DE11</b>	0.047
3RH21, 3RH24	<b>S00</b>	1	1		--	<b>3RH2921-2DE11</b>	0.049
3RT2.2, 3RT2.3, 3RT2.4	<b>S0 ... S3</b>	1	1			<b>3RH2921-2DE11</b>	0.049
				First auxiliary switch			
3RT1.5 ... 3RT1.7	<b>S6 ... S12</b>	1	1	Left 	Right 	<b>3RH1921-2DE11</b>	0.050
				Second auxiliary switch			
3RT1.5 ... 3RT1.7	<b>S6 ... S12</b>	1	1	Left 	Right 	<b>3RH1921-2JE11</b>	0.050

<sup>1)</sup> For detailed information on use, see pages 2/56 and 2/58.

# Switching devices – Contactors and contactor assemblies – for switching motors

## Power contactors for switching motors

### Accessories for SIRIUS 3RT contactors and SIRIUS 3RH2 contactor relays > Link modules

#### Selection and ordering data

For contactors Type	Size	Version	Article No.	Weight kg
---------------------	------	---------	-------------	--------------

#### Safety main circuit connectors for two contactors



3RT2.1	<b>S00</b>	For series connection of two contactors	<b>3RA2916-1A</b>	0.051
3RT2.2	<b>S0</b>		<b>3RA2926-1A</b>	0.099
3RT2.3	<b>S2</b>		<b>3RA2936-1A</b>	0.207

For contactors Type	Size	Version	Article No.	Article No.	Weight kg
---------------------	------	---------	-------------	-------------	--------------

#### Assembly kits for reversing contactor assemblies for making 3-pole contactor assemblies



3RA2923-2AA1



3RA2923-2AA2



3RA2933-2AA1



3RA2943-2AA1



3RA2943-2AA2



3RA1953-2A



3RA1963-2A

For contactors Type	Size	Version	Article No.	Article No.	Weight kg
3RT201	<b>S00-S00</b>	The assembly kit contains: Mechanical interlock, two connecting clips for two contactors, wiring modules on the top and bottom • For main, auxiliary and control circuits	<b>3RA2913-2AA1</b>	<b>3RA2913-2AA2</b>	0.075
3RT202	<b>S0-S0</b>	The assembly kit contains: Mechanical interlock, two connecting clips for two contactors, wiring modules on the top and bottom • For main, auxiliary and control circuits <sup>1)</sup> • Only for main circuit <sup>2)</sup>	<b>3RA2923-2AA1</b>	--	0.090
3RT203	<b>S2-S2</b>	The assembly kit contains: Two connectors for two contactors, wiring modules on the top and bottom (The 3RA2934-2B mechanical interlock must be ordered separately, see page 2/68) • For main and auxiliary circuits • Only for main circuit <sup>3)</sup>	<b>3RA2933-2AA1</b>	--	0.159
3RT204	<b>S3-S3</b>	The assembly kit contains: Two connectors for two contactors, wiring modules on the top and bottom (3RA2934-2B mechanical interlock must be ordered separately, see page 2/68) • For main and auxiliary circuits • Only for main circuit <sup>3)</sup>	<b>3RA2943-2AA1</b>	--	0.335
3RT1.5	<b>S6-S6</b>	The assembly kit contains:	<b>3RA1953-2A</b>	<b>3RA1953-2A</b>	1.232
3RT1.6	<b>S10-S10</b>	Wiring modules on the top and bottom	<b>3RA1963-2A</b>	<b>3RA1963-2A</b>	2.400
3RT1.7	<b>S12-S12</b>	Wiring modules on the top and bottom	<b>3RA1973-2A</b>	<b>3RA1973-2A</b>	3.075

<sup>1)</sup> Use of the 3RA2923-2AA1 assembly kit in conjunction with the 3RT202-.....-3MA0 contactors is limited because the auxiliary switches in the basic unit are not allowed to be used on account of the permanently mounted auxiliary switch.

<sup>2)</sup> Version in size S0 with spring-loaded terminals:  
Only the wiring modules for the main circuit are included.  
No connecting clips are included for the auxiliary and control circuit.

<sup>3)</sup> Version in sizes S2 and S3 with spring-loaded terminals in the auxiliary and control circuits: Only the wiring modules for the main circuit are included.  
A cable set is included for the auxiliary circuit.





# Switching devices – Contactors and contactor assemblies – for switching motors

## Power contactors for switching motors

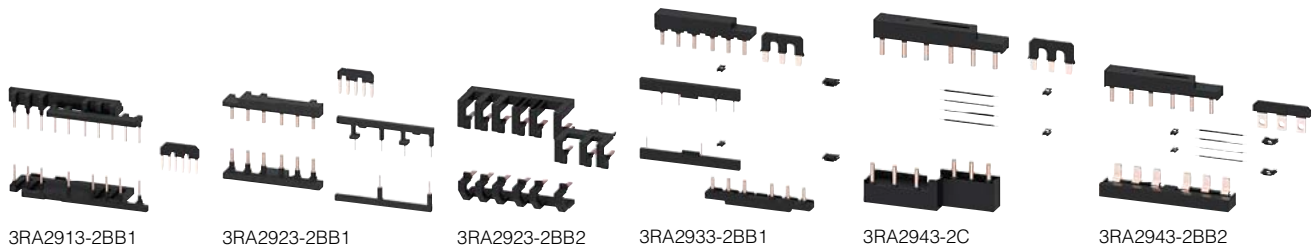
### Accessories for SIRIUS 3RT contactors and SIRIUS 3RH2 contactor relays > Link modules



For con- tactors	Size	Version	Screw terminals 	Spring-loaded terminals 	Weight
Type			Article No.	Article No.	kg
<b>Assembly kits<sup>1)</sup> for contactor assemblies for star-delta (wye-delta) starting for making 3-pole contactor assemblies</b>					
3RT201	<b>S00-S00-S00</b>	The assembly kit contains: Mechanical interlock, four connecting clips for three contactors, a star jumper, wiring modules on the top and bottom • For main, auxiliary and control circuits	<b>3RA2913-2BB1</b>	<b>3RA2913-2BB2</b>	0.084
3RT202	<b>S0-S0-S0</b>	The assembly kit contains: Mechanical interlock, four connecting clips for three contactors, a star jumper, wiring modules on the top and bottom • For main, auxiliary and control circuits • Only for main circuit	<b>3RA2923-2BB1</b> --	-- <b>3RA2923-2BB2</b>	0.099 0.133
3RT202	<b>S0-S0-S0</b>	The assembly kit contains: Mechanical interlock, four connecting clips for three contactors, a star jumper, wiring modules on the top and bottom, 3-phase infeed terminal • For main, auxiliary and control circuits	<b>3RA2924-2BB1</b>	--	0.159
3RT203	<b>S2-S2-S0</b>	The assembly kit <sup>2)</sup> contains: Two connectors for three contactors, an S0 star jumper, a spacer, wiring modules on the top and bottom (S2-S0) for the main circuit, a cable set for the auxiliary circuit, a cable for connecting the A2 coil contact of the line contactor to the A2 coil contact of the delta contactor	<b>3RA2933-2C</b>	<b>3RA2933-2C</b>	0.180
3RT203	<b>S2-S2-S2</b>	The assembly kit <sup>2)</sup> contains: Four connectors for three contactors, an S2 star jumper, a cable for connecting the A2 coil contact of the line contactor to the A2 coil contact of the delta contactor and • Wiring modules on the top and bottom for the main circuit and the auxiliary circuit • Wiring modules on the top and bottom for the main circuit, a cable set for the auxiliary circuit	<b>3RA2933-2BB1</b> --	-- <b>3RA2933-2BB2</b>	0.194 0.180
3RT204	<b>S3-S3-S2</b>	The assembly kit <sup>2)</sup> contains: Two connectors for three contactors, an S2 star jumper, a spacer, wiring modules on the top and bottom (S3-S2) for the main circuit, a cable set for the auxiliary circuit, a cable for connecting the A2 coil contact of the line contactor to the A2 coil contact of the delta contactor	<b>3RA2943-2C</b>	<b>3RA2943-2C</b>	0.260
3RT204	<b>S3-S3-S3</b>	The assembly kit <sup>2)</sup> contains: Four connectors for three contactors, an S3 star jumper, a cable for connecting the A2 coil contact of the line contactor to the A2 coil contact of the delta contactor and • Wiring modules on the top and bottom for the main circuit and the auxiliary circuit • Wiring modules on the top and bottom for the main circuit, a cable set for the auxiliary circuit	<b>3RA2943-2BB1</b> --	-- <b>3RA2943-2BB2</b>	0.315 0.320









<sup>1)</sup> When using the function modules for contactor assemblies for star-delta (wye-delta) starting, the wiring modules for the auxiliary current are not required.

<sup>2)</sup> The 3RA2934-2B mechanical interlock for sizes S2 and S3 must be ordered separately, see page 2/68.

## Switching devices – Contactors and contactor assemblies – for switching motors

### Power contactors for switching motors















#### Accessories for SIRIUS 3RT contactors and SIRIUS 3RH2 contactor relays > Link modules

	For contactors Type	Size	Version	Article No.	Weight kg
<b>Assembly kits for contactor assemblies for star-delta (wye-delta) starting for making 3-pole contactor assemblies</b>					
 3RA1953-3G	3RT1.5, 3RT204	<b>S6-S6-S3</b> For connection with box terminal only	The assembly kit contains: link rails at bottom (a double infeed between the line contactor and the delta contactor is recommended.) The S3 star jumper must be ordered separately, see page 2/67.	<b>3RA1953-3G</b>	0.297
	3RT1.5	<b>S6-S6-S6</b> For connection with box terminal only	--	<b>3RA1953-2B</b>	0.867
 3RA1953-2B	3RT1.5	<b>S6-S6-S6</b> For connection without box terminal	--	<b>3RA1953-2N</b>	0.711
 3RA1953-2N	3RT1.6, 3RT1.5	<b>S10-S10-S6</b> For connection with box terminal only	The S6 star jumper must be ordered separately, see page 2/67.	<b>3RA1963-3E</b>	0.435
 3RA1963-3E	3RT1.6	<b>S10-S10-S10</b> For connection without box terminal	--	<b>3RA1963-2B</b>	1.813
 3RA1963-2B	3RT1.7, 3RT1.6	<b>S12-S12-S10</b> For connection with box terminal only	The S10 star jumper must be ordered separately, see page 2/67.	<b>3RA1973-3E</b>	1.404
 3RA1973-3E	3RT1.7	<b>S12-S12-S12</b> For connection without box terminal	--	<b>3RA1973-2B</b>	2.098
 3RA1973-2B					

# Switching devices – Contactors and contactor assemblies – for switching motors

## Power contactors for switching motors

### Accessories for SIRIUS 3RT contactors and SIRIUS 3RH2 contactor relays > Link modules

For contactors Type	Size	Version	Article No.	Article No.	Weight kg	
<b>Single wiring modules for making 3-pole contactor assemblies</b>						
 3RA2913-3DA1	3RT201	<b>S00-S00</b>	• Top (in-phase) PS = 5 units	<b>Screw terminals</b> 	<b>Spring-loaded terminals</b> 	
			• Bottom (with phase reversal) PS = 5 units	<b>3RA2913-3DA1</b>	<b>3RA2913-3DA2</b>	0.026
 3RA2923-3DA1	3RT202	<b>S0-S0</b>	• Top (in-phase) PS = 5 units	<b>3RA2913-3EA1</b>	<b>3RA2913-3EA2</b>	0.027
			• Bottom (with phase reversal) PS = 5 units	<b>3RA2923-3DA1</b>	<b>3RA2923-3DA2</b>	0.054
 3RA1933-3D	3RT203	<b>S2-S2</b>	• Top (in-phase), contactor clearance 10 mm	<b>3RA2923-3EA1</b>	<b>3RA2923-3EA2</b>	0.044
			• Bottom (with phase reversal), contactor clearance 10 mm	<b>3RA1933-3D</b>	<b>3RA1933-3D</b>	0.079
 3RA1943-3E	3RT204	<b>S3-S3</b>	• Top (in-phase), contactor clearance 10 mm	<b>3RA1933-3E</b>	<b>3RA1933-3E</b>	0.068
			• Bottom (with phase reversal), contactor clearance 10 mm	<b>3RA1943-3D</b>	<b>3RA1943-3D</b>	0.178
 3RA1953-3D	3RT1.5	<b>S6-S6</b>	• Top (in-phase), for connection with box terminal, contactor clearance 10 mm	<b>3RA1943-3E</b>	<b>3RA1943-3E</b>	0.155
			• Top (with phase reversal, for connection without box terminal), contactor clearance 10 mm	<b>3RA1953-3D</b>	<b>3RA1953-3D</b>	0.616
				<b>3RA1953-3P</b>	<b>3RA1953-3P</b>	0.556
<b>Star jumpers (links for paralleling), 3-pole</b>						
 3RT1916-4BA31	3RT201	<b>S00</b>	<b>With through-hole</b> The links for paralleling can be reduced by one pole.	<b>Screw terminals</b> 	<b>Spring-loaded terminals</b> 	
				<b>3RT1916-4BA31</b>	<b>3RT2916-4BA32</b>	0.018
 3RT2926-4BA32	3RT202	<b>S0</b>	Without connecting terminal	<b>3RT1926-4BA31</b>	<b>3RT2926-4BA32</b>	0.032
				<b>3RT203</b>	<b>S2</b>	<b>3RT1936-4BA31</b>
 3RT1936-4BA31	3RT204	<b>S3</b>		<b>3RT1946-4BA31</b>	<b>3RT1946-4BA31</b>	0.028
			<b>3RT1.5</b>	<b>S6</b>	<b>3RT1956-4BA31</b>	<b>3RT1956-4BA31</b>
 3RT1946-4BA31	3RT1.6, 3RT1.7	<b>S10, S12</b>		<b>3RT1966-4BA31</b>	<b>3RT1966-4BA31</b>	0.540
			<b>3RT1956-4BA31</b>			
 3RT1966-4BA31						

\* You can order this quantity or a multiple thereof.

## Switching devices – Contactors and contactor assemblies – for switching motors

### Power contactors for switching motors

#### Accessories for SIRIUS 3RT contactors and SIRIUS 3RH2 contactor relays > Link modules

2

For contactors Type	Size	Version	Article No.	Weight kg
---------------------	------	---------	-------------	-----------

#### Mechanical interlock assembly kits for two contactors for making 3- or 4-pole contactor assemblies

 3RA29.2-2H	3RT201, 3RT231	<b>S00-S00</b>	The interlocking assembly kits can be used without a contactor clearance.	<b>3RA2912-2H</b>	0.001
	3RT202, 3RT232	<b>S0-S0</b>	One assembly kit consists of a mechanical interlock and two connecting clips.	<b>3RA2922-2H</b>	0.001

For contactors Type	Size	Version	Article No.	Weight kg
---------------------	------	---------	-------------	-----------



#### Mechanical interlocks for contactor assemblies

 3RA2934-2B	3RT202, 3RT203, 3RT204	<b>S2-S2-S0, S2-S2-S2, S3-S3-S2, S3-S3-S3</b>	<p>A contactor clearance of 10 mm must be considered when using the following mechanical interlocks.</p> <p><b>Mechanical interlocks</b></p> <p><u>Note:</u> The mechanical interlock for sizes S2 and S3 must be ordered separately.</p>	<b>3RA2934-2B</b>	0.038
---	------------------------	---	---	-------------------	-------

 3RA1954-2G	3RT1.5 with 3RT204 <sup>1)</sup>	<b>S6 (3RT1)-S6 (3RT1)-S3 (3RT2)<sup>1)</sup></b>	<p><b>Adapter in addition to the mechanical interlock</b></p> <p>The mechanical interlock is only possible together with this 3RA1954-2G adapter and the 3RA1954-2A mechanical interlock.</p> <p>Two connectors are included with the adapter, the interlock must be ordered separately.</p>	<b>3RA1954-2G</b>	0.050
--	----------------------------------	---	--	-------------------	-------

 3RA1954-2A	3RT1.5, 3RT1.6, 3RT1.7	<b>S6, S10, S12</b>	<p><b>Mechanical interlocks</b></p> <p>Without auxiliary contacts; contactors in sizes S6, S10 and S12 can be interlocked with each other as required. No adaption of mounting depth is necessary.</p>	<b>3RA1954-2A</b>	0.044
---	------------------------	---------------------	--	-------------------	-------

#### Mechanical connectors for contactor assemblies

 3RA1932-2D			Two connectors are required for each assembly. The contactor clearance must be considered when selecting the connectors.		
	3RT203, 3RT204	<b>S2-S2, S3-S3</b>	<p><b>3-pole version</b></p> <ul style="list-style-type: none"> <li>• Without contactor clearance</li> <li>• With 10 mm contactor clearance</li> </ul>	<b>3RA2932-2C</b>	0.001
	3RT105	<b>S6-S6</b>	<ul style="list-style-type: none"> <li>• With 10 mm contactor clearance (1 unit corresponds to 2 parts for 1 assembly)</li> </ul>	<b>3RA2932-2D</b> <b>3RA1932-2D</b>	0.002 0.003
 3RA2942-2G	3RT233	<b>S2-S2</b>	<p><b>4-pole version</b></p> <ul style="list-style-type: none"> <li>• With 20 mm contactor clearance</li> </ul>	<b>3RA2932-2G</b>	0.003
	3RT234.	<b>S3-S3</b>	<ul style="list-style-type: none"> <li>• With 10 mm contactor clearance</li> </ul>	<b>3RA2942-2G</b>	0.004







<sup>1)</sup> The 3RA1954-2G adapter cannot be used in conjunction with 3RT204...-KB coupling contactors, size S3.

# Switching devices – Contactors and contactor assemblies – for switching motors

## Power contactors for switching motors

Accessories for SIRIUS 3RT contactors and SIRIUS 3RH2 contactor relays > Connection modules/adapters

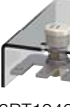
### Selection and ordering data

For contactors	Size	Version	Screw terminals 	Weight
Type			Article No.	kg
<b>Links for paralleling for main conducting paths</b>				
The links for paralleling (insulated) can be reduced by one pole. With connecting terminal				
<b>3-pole</b>				
 3RT1916-4BB31	3RT201	<b>S00</b>	• Max. conductor cross-section: 25 mm <sup>2</sup> , stranded	<b>3RT1916-4BB31</b> 0.017
 3RT2926-4BB31	3RT202	<b>S0</b>	• Max. conductor cross-section: 50 mm <sup>2</sup> , stranded	<b>3RT2926-4BB31</b> 0.043
 3RT1936-4BB31	3RT203	<b>S2</b>	• Max. conductor cross-section: 120 mm <sup>2</sup> , stranded	<b>3RT1936-4BB31</b> 0.140
 3RT1946-4BB31	3RT204, 3RT244	<b>S3</b>	• Max. conductor cross-section: 185 mm <sup>2</sup> , stranded A cover plate is included for touch protection (can only be used when box terminal is removed).	<b>3RT1946-4BB31</b> 0.178
<b>4-pole</b>				
 3RT1916-4BB41	3RT231, 3RT251	<b>S00</b>	• Max. conductor cross-section: 25 mm <sup>2</sup> , stranded	<b>3RT1916-4BB41</b> 0.018

2

## Switching devices – Contactors and contactor assemblies – for switching motors

### Power contactors for switching motors

#### Accessories for SIRIUS 3RT contactors and SIRIUS 3RH2 contactor relays > Connection modules/adapters

	For contactors Type	Size	Version	Article No.	Weight kg
<b>1-phase infeed terminals</b>					
	3RT204, 3RT244, 3RT264	<b>S3</b>	Conductor cross-section: 95 mm <sup>2</sup>	<b>3RA2943-3L</b>	0.105
3RA2943-3L					
<b>3-phase infeed terminals</b>					
	3RT201	<b>S00</b>	Max. conductor cross-section: up to 10 mm <sup>2</sup> , AWG 12 ... 8	<b>3RA2913-3K</b>	0.023
3RA2913-3K					
	3RT202, 3RT262	<b>S0</b>	Max. conductor cross-section: up to 25 mm <sup>2</sup> , AWG 10 ... 2/0	<b>3RV2925-5AB</b>	0.044
3RV2925-5AB					
	3RT203, 3RT263	<b>S2</b>	Max. conductor cross-section: up to 70 mm <sup>2</sup> , AWG 10 ... 2/0	<b>3RV2935-5A</b>	0.181
3RV2935-5A					
<b>3-phase infeed terminals with increased clearances and creepage distances</b>					
	3RT203	<b>S2</b>	Max. conductor cross-section: up to 70 mm <sup>2</sup> , AWG 10 ... 2/0	<b>3RV2935-5E</b>	0.193
3RV2935-5E					
<b>3-phase busbars</b>					
	3RT202	<b>S0</b>	Bridging phase-by-phase of all input terminals of the line contactor (Q11) and delta contactor (Q13)	<b>3RV1915-1AB</b>	0.043
3RV1915-1AB					
<b>Terminal blocks for connecting auxiliary conductors to main terminals</b>					
<b>Box terminal blocks</b>					
For round and ribbon cables (Connectable cross-sections of the contactors for size S3, and for sizes 6 to S12					
	3RT204	<b>S3</b>	• 3-pole, for connection of main contacts, 2.5 to 70 mm <sup>2</sup>	<b>3RT2946-4G</b>	0.124
3RT2946-4G					
	3RT1.5	<b>S6</b>	• Up to 70 mm <sup>2</sup> , as standard on 3RT1054-1 contactor (55 kW) • Up to 120 mm <sup>2</sup>	<b>3RT1955-4G</b> <b>3RT1956-4G</b>	0.240 0.265
3RT1956-4G					
	3RT1.6, 3RT1.7	<b>S10, S12</b>	• Up to 240 mm <sup>2</sup> , with auxiliary conductor connection up to 2.5 mm <sup>2</sup>	<b>3RT1966-4G</b>	0.694
3RT1966-4G					
	3RT1.5	<b>S6</b>	<b>Box terminal for auxiliary conductor connection, 1-pole</b> For connection of auxiliary and control cables (0.5 ... 2.5 mm <sup>2</sup> ) to the main conductor terminals	<b>3TX7500-0A</b>	0.009
3TX7500-0A					
	3RT204	<b>S3</b>	<b>Auxiliary terminals, 3-pole</b> For connection of auxiliary and control cables (0.5 ... 2.5 mm <sup>2</sup> ) to the main conductor terminals	<b>3RT2946-4F</b>	0.032
3RT2946-4F					



# Switching devices – Contactors and contactor assemblies – for switching motors

## Power contactors for switching motors

### Accessories for SIRIUS 3RT contactors and SIRIUS 3RH2 contactor relays > Connection modules/adapters

















For contactors Type	Size	Version	Article No.	Weight kg
<b>Solder pin adapters for mounting contactors on printed circuit boards up to 5.5 kW / 12 A</b>				
	3RT2.1, 3RH21	<b>S00</b>	Assembly kit for soldering contactors with an integrated auxiliary contact onto a printed circuit board <u>Note:</u> For 1 contactor, 1 set is required.	<b>Screw terminals</b>  <b>3RT1916-4KA1</b> 0.030
	3RT2.1, 3RH21	<b>S00</b>	Assembly kit for soldering contactors with 4-pole mounted auxiliary switch onto a printed circuit board <u>Note:</u> For 1 contactor, 1 set is required.	<b>3RT1916-4KA2</b> 0.068
				
				
				
				
3RT1916-4KA2				
<b>Coil connection modules for connections from top or from below</b>				
	3RT2.2, 3RT2.3, 3RT2.4	<b>S0 to S3</b>	<ul style="list-style-type: none"> <li>• Connection from top</li> <li>• Connection from below</li> <li>• Connection diagonally</li> </ul>	<b>3RT2926-4RA11</b> <b>3RT2926-4RB11</b> <b>3RT2926-4RC11</b> 0.027 0.027 0.030
	3RT2.2	<b>S0</b>	<ul style="list-style-type: none"> <li>• Connection from top</li> <li>• Connection from below</li> </ul>	<b>Spring-loaded terminals</b>  <b>3RT2926-4RA12</b> <b>3RT2926-4RB12</b> 0.026 0.025
3RT2926-4RA11				
3RT2926-4RA12				
<b>Connection module (adapter and plug) for contactors with screw terminals</b>				
	3RT201, 3RH2	<b>S00</b>	The connection module comprises an adapter and a motor feeder connector. <b>Adapters</b> Ambient temperature $t_{u\ max.} = 60\ ^\circ\text{C}$	<b>Screw terminals</b>  <b>3RT1916-4RD01</b> 0.032
	3RT202	<b>S0</b>	<ul style="list-style-type: none"> <li>• Rated operational current <math>I_e</math> at AC-3/400 V: 20 A</li> <li>• Rated operational current <math>I_e</math> at AC-3/400 V: 25 A</li> </ul>	<b>3RT1926-4RD01</b> 0.035
	3RT201, 3RT202, 3RH2	<b>S00, S0</b>	<b>Motor feeder connector</b>	<b>3RT1900-4RE01</b> 0.042
3RT1926-4RD01				
3RT1900-4RE01				

# Switching devices – Contactors and contactor assemblies – for switching motors

## Power contactors for switching motors

### Accessories for SIRIUS 3RT contactors and SIRIUS 3RH2 contactor relays > Covers

#### Selection and ordering data

		For contactors	Size	Version	Article No.	Weight
		Type				kg
<b>Terminal covers</b>						
<b>Covers for contactors with screw terminals (box terminals)</b> (2 units required per contactor)						
		3RT203	<b>S2</b>	• For 3-pole contactors	<b>3RT2936-4EA2</b>	0.014
		3RT204, 3RT244	<b>S3</b>		<b>3RT2946-4EA2</b>	0.019
		3RT1.5	<b>S6<sup>1)</sup></b>		<b>3RT1956-4EA2</b>	0.022
		3RT1.6, 3RT1.7	<b>S10<sup>1)</sup>, S12<sup>1)</sup></b>		<b>3RT1966-4EA2</b>	0.038
		3RT233, 3RT253	<b>S2</b>	• For 4-pole contactors (Scope of supply: one 3-pole and two 1-pole terminal covers are supplied)	<b>3RT2936-4EA4</b>	0.027
		3RT234, 3RT254	<b>S3</b>		<b>3RT2946-4EA4</b>	0.035
<b>Covers for contactors with cable lugs and busbar connections</b>						
• For complying with the phase clearances and as touch protection if box terminal is removed (2 units required per contactor)						
		3RT2.4	<b>S3</b>	- Length: 100 mm	<b>3RT1946-4EA1</b>	0.037
		3RT1.5	<b>S6<sup>1)</sup></b>	- Length: 100 mm	<b>3RT1956-4EA1</b>	0.069
		3RT1.6, 3RT1.7	<b>S10<sup>1)</sup>, S12<sup>1)</sup></b>	- Length: 120 mm	<b>3RT1966-4EA1</b>	0.121
		3RT1.5	<b>S6</b>	• For the assembly kits for 3RA1953-.. contactor assemblies for star-delta (wye-delta) starting (see page 2/66) or for the 3RA1953-3. single wiring modules (see page 2/67) - Length: 38 mm	<b>3RT1956-4EA4</b>	0.028
		3RT1.6, 3RT1.7	<b>S10, S12</b>	• For the assembly kits for reversing contactor assemblies and contactor assemblies for star-delta (wye-delta) starting - Length: 42 mm	<b>3RT1966-4EA3</b>	0.080
<b>Terminal covers for busbar connections</b>						
• Cover the three busbar connections, between the contactor and 3RB2 overload relay						
		3RT1.5	<b>S6</b>	- Length: 27 mm	<b>3RT1956-4EA3</b>	0.022
		3RT1.6, 3RT1.7	<b>S10, S12</b>	- Length: 42 mm	<b>3RT1966-4EA3</b>	0.080
		3RT1.5	<b>S6</b>	• Can be screwed on free screw end; covers one busbar connection (1 set = 6 units) - M8	<b>3TX6526-3B</b>	0.174
		3RT1.6, 3RT1.7	<b>S10, S12</b>	- M10	<b>3TX6546-3B</b>	0.278
<b>Sealable covers</b>						
		3RT2.1, 3RT2.2, 3RT2.3, 3RT2.4, 3RH2 <sup>2)</sup>	<b>S00 ... S3</b>	For preventing manual operation (Not suitable for coupling contactors)	<b>3RT2916-4MA10</b>	0.002
		3RT1.5 ... 3RT1.7 <sup>2)</sup>	<b>S6 ... S12</b>		<b>3RT1926-4MA10</b>	0.004

<sup>1)</sup> Also fits on contactors of sizes S6 to S12 with box terminals.







<sup>2)</sup> Exception: Contactors and contactor relays with auxiliary switch mounted on the front.

# Switching devices – Contactors and contactor assemblies – for switching motors

## Power contactors for switching motors

Accessories for SIRIUS 3RT contactors and SIRIUS 3RH2 contactor relays > Miscellaneous accessories

### Selection and ordering data

For contactors Type	Size	Version	Article No.	Weight kg		
<b>Base plates</b>						
<b>For reversing contactor assemblies</b>						
	3RT1.5	<b>S6</b>	For customer assembly of reversing contactor assemblies	<b>3RA1952-2A</b>	1.255	
	3RT1.6	<b>S10</b>		<b>3RA1962-2A</b>	2.213	
	3RT1.7	<b>S12</b>		<b>3RA1972-2A</b>	2.322	
<b>For contactor assemblies for star-delta (wye-delta) starting</b>						
	3RT2/ 3RT2/ 3RT2	<b>S2-S2-S0, S2-S2-S2</b>	For configuring contactor assemblies for star-delta (wye-delta) starting	<b>3RA2932-2F</b>	0.217	
		<b>S3-S3-S2, S3-S3-S3</b>		<b>3RA2942-2F</b>	0.261	
	3RT1/ 3RT1/ 3RT2	<b>S6-S6-S3</b>	For customer assembly of contactor assemblies for star-delta (wye-delta) starting with a <b>laterally mounted</b> timing relay	<b>3RA1952-2E</b>	1.830	
	3RT1/ 3RT1/ 3RT1	<b>S6-S6-S6</b>		10 mm distance between the contactors	<b>3RA1952-2F</b>	1.945
		<b>S10-S10-S6</b>		<b>3RA1962-2E</b>	3.136	
		<b>S10-S10-S10</b>		<b>3RA1962-2F</b>	3.392	
		<b>S12-S12-S10</b>		<b>3RA1972-2E</b>	3.644	
		<b>S12-S12-S12</b>		<b>3RA1972-2F</b>	3.681	
<b>Adapters for screw fixing</b>						
	3RT2.2	<b>S0</b>	Screw adapters for securing the contactors, two units required per contactor (1 pack = 10 sets for 10 contactors)	<b>3RT1926-4P</b>	0.002	
<b>Connection kit for one complete contactor</b>						
	3RT105	<b>S6</b>	Each set includes 6 screws, spring washers and nuts.	<b>3RT1955-4PA00</b>	0.130	
	3RT106, 3RT107	<b>S10, S12</b>		M 8 x 25 M 10 x 30	<b>3RT1966-4PA00</b>	0.260
<b>EMC suppression modules; 3-phase, up to 7.5 kW</b>						
<b>For contactors with AC or DC operation</b>						
	3RT201	<b>S00</b>	<b>RC elements</b> (3 x 220 Ω/0.22 μF) • Up to 400 V • Up to 575 V • Up to 690 V	<b>Screw terminals</b> 		
				<b>3RT2916-1PA1</b>	0.072	
				<b>3RT2916-1PA2</b>	0.072	
	3RT201	<b>S00</b>	<b>Varistors</b> • Up to 400 V • Up to 575 V • Up to 690 V	<b>3RT2916-1PA3</b>	0.074	
				<b>3RT2916-1PB1</b>	0.079	
				<b>3RT2916-1PB2</b>	0.079	
			<b>3RT2916-1PB3</b>	0.079		



1)

## Switching devices – Contactors and contactor assemblies – for switching motors

### Power contactors for switching motors

#### Spare parts for SIRIUS 3RT contactors and SIRIUS 3RH2 contactor relays > Solenoid coils

##### Selection and ordering data

For contactors		Rated control supply voltage $U_s$	Screw terminals 	Spring-loaded terminals 	Weight
Size	Type	V	Article No.	Article No.	kg

##### Withdrawable coils

200 ... 277 AC/DC

3RT1975-5PP31

--

0.156

##### **Solid-state operating mechanism for DC with 24 ... 110 V DC control signal input e.g. for control by PLC with extended application range**

(see also contactors for railway applications on page 2/107)

<b>S6</b>	3RT105..-	24 DC	--	<b>3RT1955-5XB42</b>	0.610
	.X...-OLA2	72 DC	--	<b>3RT1955-5XJ42</b>	0.609
		110 DC	--	<b>3RT1955-5XF42</b>	0.538
<b>S10</b>	3RT106..-	24 DC	--	<b>3RT1965-5XB42</b>	0.805
	.X...-OLA2	72 DC	--	<b>3RT1965-5XJ42</b>	0.959
		110 DC	--	<b>3RT1965-5XF42</b>	0.925
<b>S12</b>	3RT107..-	24 DC	--	<b>3RT1975-5XB42</b>	1.335
	.X...-OLA2	72 DC	--	<b>3RT1975-5XJ42</b>	1.425
		110 DC	--	<b>3RT1975-5XF42</b>	1.314



3RT1955-5X.42

##### Note:









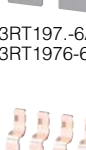
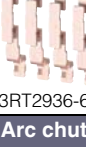

In the case of 3RT10...-S contactors with fail-safe control inputs, removing and replacing the operating mechanism are not permitted.

# Switching devices – Contactors and contactor assemblies – for switching motors

## Power contactors for switching motors

Spare parts for SIRIUS 3RT contactors and SIRIUS 3RH2 contactor relays &gt; Contacts and arc chutes

## Selection and ordering data

For contactors		Version	Article No.	Weight	
Size	Type			kg	
<b>Contacts with fixing parts</b>					
<b>For contactors with 3 main contacts</b>					
	<b>S2</b>	3RT2035	Main contacts (3 NO contacts) for utilization category AC-3 (1 set = 3 movable and 6 fixed switching elements with fixing parts)	<b>3RT2935-6A</b>	0.088
		3RT2036		<b>3RT2936-6A</b>	0.089
		3RT2037		<b>3RT2937-6A</b>	0.096
		3RT2038		<b>3RT2938-6A</b>	0.096
	<b>S3</b>	3RT2045		<b>3RT2945-6A</b>	0.240
		3RT2046		<b>3RT2946-6A</b>	0.238
		3RT2047		<b>3RT2947-6A</b>	0.239
	<b>S6</b>	3RT1054		<b>3RT1954-6A</b>	0.248
		3RT1055		<b>3RT1955-6A</b>	0.288
		3RT1056		<b>3RT1956-6A</b>	0.300
	<b>S10</b>	3RT1064		<b>3RT1964-6A</b>	0.470
		3RT1065		<b>3RT1965-6A</b>	0.540
		3RT1066		<b>3RT1966-6A</b>	0.559
	<b>S12</b>	3RT1075		<b>3RT1975-6A</b>	0.755
		3RT1076		<b>3RT1976-6A</b>	0.920
	<b>S3</b>	3RT2446	Main contacts (3 NO contacts) for utilization category AC-1 (1 set = 3 movable and 6 fixed switching elements with fixing parts)	<b>3RT2946-6D</b>	0.237
		3RT2448		<b>3RT2948-6D</b>	0.238
	<b>S6</b>	3RT1456		<b>3RT1956-6D</b>	0.290
	<b>S10</b>	3RT1466		<b>3RT1966-6D</b>	0.550
		3RT1467		<b>3RT1967-6D</b>	0.555
	<b>S12</b>	3RT1476		<b>3RT1976-6D</b>	0.915
<b>For contactors with 4 main contacts</b>					
	<b>S2</b>	3RT2336	Main contacts (4 NO contacts) for utilization category AC-1 (1 set = 3 movable and 6 fixed switching elements and replacement pole with fixing parts)	<b>3RT2936-6E</b>	0.310
		3RT2337		<b>3RT2937-6E</b>	0.272
<b>Arc chutes</b>					
<b>For contactors with 3 main contacts</b>					
	<b>S6</b>	3RT1054	Only for contactors with AC/DC coil	<b>3RT1954-7A</b>	0.760
		3RT1055		<b>3RT1955-7A</b>	0.765
		3RT1056		<b>3RT1956-7A</b>	0.800
		3RT1456		<b>3RT1956-7B</b>	0.780
	<b>S10</b>	3RT1064		<b>3RT1964-7A</b>	1.290
		3RT1065		<b>3RT1965-7A</b>	1.320
		3RT1066		<b>3RT1966-7A</b>	1.280
		3RT1466		<b>3RT1966-7B</b>	1.358
	<b>S12</b>	3RT1075		<b>3RT1975-7A</b>	1.646
		3RT1076		<b>3RT1976-7A</b>	1.642
		3RT1476		<b>3RT1976-7B</b>	1.654

## Switching devices – Contactors and contactor assemblies – Special applications

### Contactors for special applications

#### Introduction

#### Overview

##### More information

Homepage, see [www.siemens.com/sirius](http://www.siemens.com/sirius)

Industry Mall, see [www.siemens.com/product?3RT\\_3TK\\_3TC](http://www.siemens.com/product?3RT_3TK_3TC)

Conversion tool, see [www.siemens.com/conversion-tool](http://www.siemens.com/conversion-tool)

TIA Selection Tool Cloud (TST Cloud), see [www.siemens.com/tstcloud/?node=Contactor](http://www.siemens.com/tstcloud/?node=Contactor)



Size	<b>S3</b>	<b>S6</b>	<b>S10</b>	<b>S12</b>
Type	3RT244.	3RT1456	3RT146.	3RT1476

#### 3-pole 3RT244 and 3RT145 to 3RT147 contactors

Type	<b>3RT2446</b>	<b>3RT2448</b>	<b>3RT1456</b>	<b>3RT1466</b>	<b>3RT1467</b>	<b>3RT1476</b>
Number of main contacts	3 NO	3 NO	3 NO	3 NO	3 NO	3 NO
AC, AC/DC operation	(p. 2/86)		(p. 2/87)	(p. 2/87)		(p. 2/87)

#### AC-1

$U_i$	V	1 000				
$U_e$	V	690				
$I_e$ up to 690 V	40 °C A	<b>140</b>	<b>160</b>	<b>275</b>	<b>400</b>	<b>500</b>
	60 °C A	130	140	250	380	450
						<b>690</b> Standard operating mechanism: 650, solid-state operating mechanism: 600

#### Accessories for contactors

<b>Auxiliary switches</b>	<b>3RH29</b>	(p. 2/59)	<b>3RH19</b>	(p. 2/60, 2/62, 2/63)
<b>Function modules (direct-on-line starting, star-delta (wye-delta) starting)</b>	<b>3RA281.1)</b>		--	
<b>Terminal covers</b>	<b>3RT2946-4EA4</b>	(p. 2/72)	<b>3RT1956-4EA.1)</b>	
<b>Box terminal blocks</b>	--		<b>3RT1955/56-4G1)</b>	
<b>Surge suppressors</b>	<b>3RT2936, 3RT29461)</b>		<b>3RT1956-1C1)</b> (RC element)	

1) see Catalog IC 10.



# Switching devices – Contactors and contactor assemblies – Special applications

## Contactors for special applications

Introduction

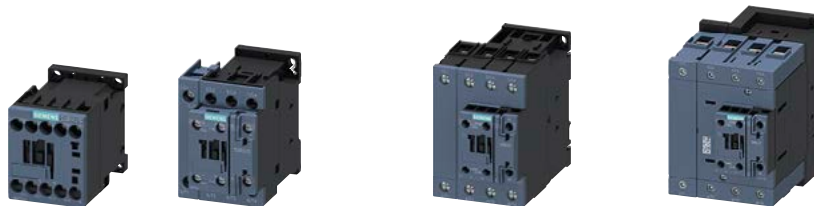

Size	<b>S00</b>		<b>S0</b>			<b>S2</b>		<b>S3</b>			
Type	3RT231.		3RT232.			3RT233.		3RT234.			
<b>4-pole 3RT23 contactors</b>											
Type	3RT2316 1)	3RT2317 1)	3RT2325 1)	3RT2326 1)	3RT2327 1)	3RT2336	3RT2337	3RT2344	3RT2346	3RT2348	
Number of main contacts AC, DC and AC/DC operation	4 NO		4 NO			4 NO		4 NO			
<b>AC-1</b>											
$U_i$	V	690									
$U_e$	V	690									
$I_e$ up to 690 V	40 °C A	18	22	35	40	50	60	110	110	140	160
	60 °C A	16	20	30	35	42	55	95	100	130	140
<b>AC-2 and AC-3</b>											
$I_e$ up to 400 V	A	9	12	15.5	15.5	15.5	--	--	--	--	--
P at 400 V	kW	4	5.5	7.5	7.5	7.5	--	--	--	--	--
<b>Accessories for contactors</b>											
Auxiliary switches	3RH29										(p. 2/59)
Function modules (direct-on-line starting, star-delta (wye-delta) starting)	3RA281.1 <sup>1)</sup>										
Terminal covers	--					3RT2936-4EA4 (p. 2/72)		3RT2946-4EA4 (p. 2/72)			
Surge suppressors	3RT2916 <sup>1)</sup>					3RT2936 <sup>1)</sup>		3RT2936, 3RT2946 <sup>1)</sup>			

1) see Catalog IC 10.

# Switching devices – Contactors and contactor assemblies – Special applications

## Contactors for special applications

### Introduction

2



Size	S00		S0		S2		S3			
Type	3RT251.		3RT252.		3RT253.		3RT254.			
<b>4-pole 3RT25 contactors</b>										
Type	3RT2516 <sup>1)</sup>		3RT2517 <sup>1)</sup>		3RT2518 <sup>1)</sup>		3RT2526 <sup>1)</sup>		3RT2535 3RT2536	
Number of main contacts	2 NO + 2 NC		2 NO + 2 NC		2 NO + 2 NC		2 NO + 2 NC		2 NO + 2 NC	
AC, DC and AC/DC operation							(p. 2/100)		(p. 2/100)	
<b>AC-1</b>										
$U_i$	V	690								
$U_e$	V	690								
$I_e$ up to 690 V	40 °C	A	18	22	22	40	60	70	100	125
	60 °C	A	16	20	20	35	55	60	90	105
<b>AC-2 and AC-3</b>										
$I_e$ up to 400 V	NO	A	9	12	16	25	35	41	65	80
	NC	A	9	9	9	25 (20) <sup>2)</sup>	35	41	65	80
<b>P</b> at 400 V	NO	kW	4	5.5	7.5	11	18.5	22	30	37
	NC	kW	4	4	4	11 (7.5) <sup>2)</sup>	18.5	22	30	37
At 230 V	NO	kW	2.2	3 / 2.2	4 / 2.2	5.5	11	11	18.5	22
	NC	kW	2.2	3 / 2.2	4 / 2.2	5.5	11	11	18.5	22
<b>Accessories for contactors</b>										
Auxiliary switches	3RH29									(p. 2/59)
Function modules (direct-on-line starting, star-delta (wye-delta) starting)	3RA281. <sup>1)</sup>									
Terminal covers	–						3RT2936-4EA4 (p. 2/72)		3RT2946-4EA4 (p. 2/72)	
Surge suppressors	3RT2916 <sup>1)</sup>			3RT2926 <sup>1)</sup>			3RT2936 <sup>1)</sup>		3RT2936, 3RT2946 <sup>1)</sup>	

<sup>1)</sup> see Catalog IC 10.

<sup>2)</sup> The value in brackets applies to the NC for DC operation.

### Connection methods

The following connection options are available for 3RT contactors depending on the size and version:

- 3RT2 contactors
  - Sizes S00 and S0: screw terminals or spring-loaded terminals both for the main as well as for the auxiliary and control circuits
  - Sizes S2 and S3: screw terminals (complete devices) or spring-loaded terminals (auxiliary circuit only)
- 3RT13 contactors, sizes S6 to S12: Busbar connections (partly with bus connectors offset), auxiliary and control circuits with screw terminals
- 3RT14 contactors: Busbar connections



Screw terminals



Spring-loaded terminals



Busbar connections

The terminals are indicated in the corresponding tables by the symbols shown on orange backgrounds.

### Further contactors

- For SIRIUS 3RT26 contactors for capacitive loads (AC-6b), 3-pole
- For 3TC contactors for switching DC voltage, 1- and 2-pole, see page 2/113
- Contactors for railway applications
  - For SIRIUS 3RT contactors with extended operating range, 3-pole, see page 2/101
  - For SIRIUS 3RH2 contactor relays with extended operating range, see page 2/109
  - For 3TH4 contactor relays, 8-pole, see page 2/135

## Switching devices – Contactors and contactor assemblies – Special applications

### Contactors for special applications

#### SIRIUS 3RT.4 contactors for weak or non-inductive loads (AC-1), 3-pole up to 2 650 A

#### Overview



3-pole AC-1 contactors  
top row: 3RT148 contactors  
bottom row: 3RT244, 3RT145 to 3RT147 contactors

#### **3RT.4 power contactors**

##### Standards

IEC 60947-1, IEC 60947-4-1, IEC 60947-5-1 (auxiliary switches)

##### Ambient conditions

If the devices are used in ambient conditions which deviate from common industrial conditions (IEC 60721-3-3 "Stationary Use, Weather-Protected"), information must be obtained about possible restrictions with regard to the reliability and endurance of the device and possible protective measures. In this case, contact our Technical Support:

[www.siemens.com/support-request](http://www.siemens.com/support-request)

##### Contactors in safety-related applications

Contactors are a significant part of safety-related applications. They are generally the actuators that perform the switching operation leading to the safe disconnection of the corresponding application or system.

Contactors with mirror contacts according to IEC 60947-4-1 are generally required for use in safety-related applications. Most of our contactors meet this requirement; a corresponding note can be found in the technical product data sheet.

##### Contactors with increased tamper protection

Increased tamper protection is ensured either by using our contactor versions with factory-installed, permanently mounted auxiliary switches which are protected against mechanical external actuation (e.g. 3RT14...-.....-3PA0), or by using the 3RT1926-4MA10 sealable cover as an accessory.

##### Surge suppression

Contactors supplied without a coil circuit can be retrofitted with RC elements, varistors, diodes or diode assemblies (combination of diode and Zener diode for short break times) for damping opening surges in the coil.

##### Note:

The break times of the contactor, the opening delay times of the NO contacts and the closing delay times of the NC contacts increase if the contactor coils are damped against voltage peaks. Different accessories are available for the contactors (time change with: interference suppression diode 6x to 10x; diode assembly 2x to 6x; suppressor diode +1 to 5 ms; varistor +2 to 5 ms).

For details, see [Equipment Manual](#).

##### Accessories and spare parts

- 3RT244 and 3RT145 to 3RT147 contactors, [see also basic units, page 2/52 onwards](#)
- For 3RT148 contactors, [see Catalog IC 10](#)

## Switching devices – Contactors and contactor assemblies – Special applications

### Contactors for special applications

#### SIRIUS 3RT.4 contactors for weak or non-inductive loads (AC-1), 3-pole up to 2 650 A

##### 3RT244 contactors

###### Main circuit

###### Connection methods

Screw terminals with box terminal; direct connection to the connecting bar possible with cable lugs when the box terminal is removed.

###### Surge suppression

The varistors and diode assemblies are plugged into the front of the contactors. The RC element is plugged into the two recesses on the front of the contactor to the left of the terminal block for the auxiliary switches.

###### Short-circuit protection

For short-circuit protection without overload relays, see [page 2/82](#).

###### Control circuit

###### Operating mechanism types

These contactors are available as versions with conventional AC or DC operating mechanisms or as versions with a wide-range solid-state operating mechanism and a universal actuating voltage (AC or DC operation).

With an operating range from 0.8 to 1.1 x  $U_s$ , control takes place via the control supply voltage connection A1 - A2.

###### Solenoid coils/operating mechanisms

Coil replacement is possible.

###### Auxiliary circuit

###### Auxiliary contact complement

The contactors contain two integrated auxiliary contacts (1 NO + 1 NC).

For detailed information about the fitting of auxiliary switches, see [pages 2/55 to 2/58](#).

##### 3RT14 contactors

###### Main circuit

###### Connection methods

- 3RT145 to 3RT147 contactors:  
Screw terminals with connecting bars that the cables can be connected to using either cable lugs or flexible or rigid busbars. Alternatively, box terminals are available as accessories.
- 3RT148 contactors:  
Busbar connections

###### Short-circuit protection

Short-circuit protection of contactors without overload relays

- For 3RT145 to 3RT147 contactors, see [page 2/82](#)
- For 3RT148 contactors, see [Catalog IC 10](#)

###### Control circuit

###### Operating mechanism types

The operating mechanisms for contactors 3RT145 to 3RT147 are powered via a supply voltage with an operating range from 0.8 to 1.1 x  $U_s$ , optionally also controlled depending on the chosen mode of operation. Alternatively, control is via the separate 24 V DC control signal input. Various rated voltage ranges for AC/DC control are available.

The following control and/or operating mechanism versions are available:

- 3RT14..-A:  
Standard operating mechanism for AC and DC operation (power consumption reduced from closing to closed)
- Solid-state operating mechanisms  
Overvoltage damping of the operating mechanism coil is already integrated in the electronics for contactors with solid-state operating mechanisms.  
The following versions are available:
  - 3RT14..-N:  
With two operating modes: direct control or via PLC input (24 V DC)
  - 3RT14..-P:  
Control via PLC input (24 V DC) only, but with additional remaining lifetime indicator (RLT)
  - 3RT14..-S:  
Control via fail-safe PLC input (24 V DC) only, for simplification of safety applications

The 3RT148 contactors are equipped with a solid-state operating mechanism for AC/DC control; coil damping is integrated. The operating range is 0.85 to 1.1 x  $U_s$ .

###### Solenoid coils/operating mechanisms

- 3RT145 to 3RT147 contactors:  
The 3RT14..-A/-N/-P operating mechanisms are removable and can be replaced simply by unlocking and pulling them out.  
  
NOTICE: Removal or changing of the operating mechanism is not permitted for 3RT14..-S contactors with fail-safe control.
- 3RT148 contactors:  
The operating mechanisms are removable and can be replaced simply by unlocking and pulling them out.

###### Surge suppression

Exchangeable operating mechanisms with integrated coil circuit (varistor) are available.

###### Auxiliary circuit

###### Auxiliary contact complement

These contactors are supplied with two laterally mounted auxiliary switches. The fitting of auxiliary switches is possible on the front and on the side.

# Switching devices – Contactors and contactor assemblies – Special applications

## Contactors for special applications



### SIRIUS 3RT.4 contactors for weak or non-inductive loads (AC-1), 3-pole up to 2 650 A

#### Technical specifications

##### More information

Technical specifications, see  
<https://support.industry.siemens.com/cs/ww/en/ps/24229/td>  
 FAQs, see <https://support.industry.siemens.com/cs/ww/en/ps/24229/faq>

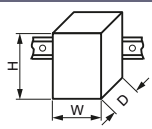
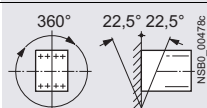
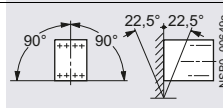
Manuals, see  
<https://support.industry.siemens.com/cs/ww/en/ps/24229/man>

Type	3RT2446, 3RT2448		3RT1456	3RT1466	3RT1467	3RT1476
Size	S3		S6	S10	S12	S12
<b>General data</b>						
<b>Dimensions (W x H x D)</b>						
<ul style="list-style-type: none"> <li>Basic units</li> <li>- Screw/spring-loaded terminals</li> </ul>		mm	70 x 140 x 152	120 x 172 x 170	145 x 210 x 202	160 x 214 x 225
<ul style="list-style-type: none"> <li>Basic unit with mounted auxiliary switch</li> <li>- Screw terminals</li> <li>- Spring-loaded terminals</li> </ul>		mm	70 x 140 x 196	120 x 172 x 217	145 x 210 x 251	160 x 214 x 271
<ul style="list-style-type: none"> <li>Basic unit with mounted function module or solid-state time-delayed auxiliary switch</li> <li>- Screw/spring-loaded terminals</li> </ul>		mm	70 x 140 x 200	--	--	--
<b>Permissible mounting position</b>						
The contactors are designed for operation on a vertical mounting surface.						
Upright mounting position				Special version required		
<b>Mechanical service life</b>						
<ul style="list-style-type: none"> <li>Basic units and basic units with mounted auxiliary switch</li> </ul>	Operating cycles		10 million			
<ul style="list-style-type: none"> <li>Basic units with solid-state compatible auxiliary switch</li> </ul>	Operating cycles		5 million	--		
<b>Electrical endurance for utilization category AC-1, at <math>U_e = 400</math> V</b>						
	Operating cycles		0.5 million		On request	0.5 million
<b>Rated insulation voltage <math>U_i</math></b> (pollution degree 3)						
	V		1 000			
<b>Rated impulse withstand voltage <math>U_{imp}</math></b>						
	kV		6	8		
<b>Protective separation</b> between the coil and the main contacts acc. to IEC 60947-1, Annex N						
	V		690			
<b>Mirror contacts</b> according to IEC 60947-4-1, Annex F						
A mirror contact is an auxiliary NC contact that cannot be closed simultaneously with an NO main contact.						
<ul style="list-style-type: none"> <li>Integrated auxiliary switches</li> <li>Removable auxiliary switch</li> </ul>			Yes	--		
			--	Yes		
<b>Permissible ambient temperature</b>						
<ul style="list-style-type: none"> <li>During operation</li> <li>During storage</li> </ul>	°C		-25 ... +60			
	°C		-55 ... +80			
<b>Degree of protection IP on the front</b> acc. to IEC 60529						
			IP20 (screw terminals and spring-loaded terminals with box terminal/cover)	IP00 (IP20 with box terminal/cover)		
<b>Touch protection on the front</b> acc. to IEC 60529						
			Finger-safe for vertical touching from the front (screw terminals and spring-loaded terminals with box terminal/cover)	Finger-safe for vertical touching from the front with box terminal/cover		
<b>Shock resistance</b>						
<ul style="list-style-type: none"> <li>Rectangular pulse</li> <li>- AC operation</li> <li>- DC operation</li> </ul>	g/ms		10.3/5 and 10.5/10	8.5/5 and 4.2/10		
	g/ms		6.7/5 and 4.0/10	8.5/5 and 4.2/10		
<ul style="list-style-type: none"> <li>Sine pulse</li> <li>- AC operation</li> <li>- DC operation</li> </ul>	g/ms		16.3/5 and 10.5/10	13.4/5 and 6.5/10		
	g/ms		10.6/5 and 6.3/10	13.4/5 and 6.5/10		





## Switching devices – Contactors and contactor assemblies – Special applications

### Contactors for special applications

#### SIRIUS 3RT.4 contactors for weak or non-inductive loads (AC-1), 3-pole up to 2 650 A

Type		3RT2446	3RT2448	3RT1456	3RT1466	3RT1467	3RT1476
Size		S3		S6	S10		S12
<b>Rated data of the main contacts</b>							
<b>Load rating with AC</b>							
<b>Utilization category AC-1</b>							
• Rated operational currents $I_e$	At 40 °C up to 690 V A	140	160	275	400	500	690
	At 60 °C up to 690 V A	130	140	250	380	450	Standard operating mechanism: 650, solid-state operating mechanism: 600
	At 40 °C up to 1 000 V A	60	80	--	--	--	--
	At 60 °C up to 1 000 V A	60	80	--	--	--	--
• Minimum cross-section in the main circuit at maximum AC-1 rated value	mm <sup>2</sup>	50	70	140	240	300	480
<b>Utilization categories AC-2 and AC-3</b>							
With an electrical endurance of 1.3 million operating cycles							
• Rated operational currents $I_e$	Up to 400 V A	44		97	138		170
	Up to 690 V A	44		97	138		170
• Rated power for slip-ring or squirrel-cage motors at 50 and 60 Hz	At 230 V kW	12.7		30	37		55
	400 V kW	22		55	75		90
	500 V kW	29.9		55	90		110
	690 V kW	38.2		90	132		160
<b>Power loss per conducting path</b>	At $I_e$ /AC-1 W	--		20	27	42	55
<b>Load rating with DC</b>							
<b>Utilization category DC-1, (<math>L/R \leq 1</math> ms)</b>							
• Rated operational currents $I_e$ (at 60 °C)							
- 1 conducting path	Up to 24 V A	130	140	250	380		500
	60 V A	80		250	380		500
	110 V A	12		18	33		
	220 V A	2.5		3.4	3.8		
	440 V A	0.8		0.8	0.9		
	600 V A	0.48		0.5	0.6		
- 2 conducting paths in series	Up to 24 V A	130	140	250	380		500
	60 V A	130	140	250	380		500
	110 V A	130	140	250	380		500
	220 V A	13		20	380		500
	440 V A	2.4		3.2	4		
	600 V A	1.3		1.6	2		
- 3 conducting paths in series	Up to 24 V A	130	140	250	380		500
	60 V A	130	140	250	380		500
	110 V A	130	140	250	380		500
	220 V A	130	140	250	380		500
	440 V A	6		11.5	11		
	600 V A	3.4		4	5.2		
<b>Utilization category DC-3/DC-5, shunt-wound and series-wound motors (<math>L/R \leq 15</math> ms)</b>							
• Rated operational currents $I_e$ (at 60 °C)							
- 1 conducting path	Up to 24 V A	6		250	380		500
	60 V A	3		7.5	11		
	110 V A	1.25		2.5	3		
	220 V A	0.35		0.6			
	440 V A	0.15		0.17	0.18		
	600 V A	0.1		0.12	0.125		
- 2 conducting paths in series	Up to 24 V A	130	140	250	380		500
	60 V A	130	140	250	380		500
	110 V A	130	140	250	380		500
	220 V A	1.75		2.5			
	440 V A	0.42		0.65			
	600 V A	0.27		0.37			
- 3 conducting paths in series	Up to 24 V A	130	140	250	380		500
	60 V A	130	140	250	380		500
	110 V A	130	140	250	380		500
	220 V A	4		250	380		500
	440 V A	0.8		1.4			
	600 V A	0.45		0.75			

## Switching devices – Contactors and contactor assemblies – Special applications

### Contactors for special applications

#### SIRIUS 3RT.4 contactors for weak or non-inductive loads (AC-1), 3-pole up to 2 650 A

Type	3RT2446	3RT2448	3RT1456	3RT1466, 3RT1467	3RT1476
Size	S3	S6	S10	S12	S12

#### Rated data of main contacts (continued)

##### Switching frequency

Switching frequency  $z$  in operating cycles/hour

Contactors without overload relays

- No-load switching frequency

Operating mechanism	3RT244..-A	3RT14...-A	3RT14...N/-P	3RT14...S	3RT2446	3RT2448	3RT1456	3RT1466, 3RT1467	3RT1476
- Standard operating mechanism	1/h	1/h	1/h	1/h	5 000	1 000	--	--	--
- Solid-state operating mechanism	1/h	1/h	1/h	1/h	--	--	2 000	1 000	500
					--	--	1 000	1 000	--

- Switching frequency  $z$  during rated operation





(Dependence of the switching frequency  $z'$  on operational current  $I'$  and operational voltage  $U'$ :  $z' = z \cdot (I'/I) \cdot (U'/U)^{1.5} \cdot 1/h$ )

Operating mechanism	$I_e/AC-1$ at 400 V	1/h	3RT2446	3RT2448	3RT1456	3RT1466, 3RT1467	3RT1476
- Standard operating mechanism 3RT244..-A	$I_e/AC-1$ at 400 V	1/h	650	--	--	--	--
- Standard operating mechanism 3RT14...-A and solid-state operating mechanism 3RT14...N/-P	$I_e/AC-1$ at 400 V	1/h	--	600	--	--	--
- Solid-state operating mechanism 3RT14...S	$I_e/AC-1$ at 400 V	1/h	--	350	--	--	--

# Switching devices – Contactors and contactor assemblies – Special applications

## Contactors for special applications

### SIRIUS 3RT.4 contactors for weak or non-inductive loads (AC-1), 3-pole up to 2 650 A

Type	3RT1456		3RT1466, 3RT1467	3RT1476	
Size	S6		S10	S12	
<b>Conductor cross-sections</b>					
<b>Main conductors</b> (1 or 2 conductors can be connected)		 <b>Screw terminals</b>			
<b>With mounted box terminals</b>		Type	3RT1955-4G	3RT1956-4G	3RT1966-4G
Terminal screws			M10 (hexagon socket, A/F 4)	M10 (hexagon socket, A/F 4)	M12 (hexagon socket, A/F 5)
• Tightening torque		Nm	10 ... 12	10 ... 12	20 ... 22
		lb.in	90 ... 110	90 ... 110	180 ... 195
<b>Front clamping point connected</b>					
	• Finely stranded with end sleeve (DIN 46228)	mm <sup>2</sup>	16 ... 70	16 ... 120	70 ... 240
	• Finely stranded without end sleeve	mm <sup>2</sup>	16 ... 70	16 ... 120	70 ... 240
	• Stranded	mm <sup>2</sup>	16 ... 70	16 ... 120	95 ... 300
	• AWG cables, solid or stranded	AWG	6 ... 2/0	6 ... 250 kcmil	3/0 ... 600 kcmil
	• Ribbon cable conductors (Number x Width x Thickness)	mm	Min. 3 x 9 x 0.8, max. 6 x 15.5 x 0.8	Min. 3 x 9 x 0.8, max. 10 x 15.5 x 0.8	Min. 6 x 9 x 0.8, max. 20 x 24 x 0.5
<b>Rear clamping point connected</b>					
	• Finely stranded with end sleeve (DIN 46228)	mm <sup>2</sup>	16 ... 70	16 ... 120	120 ... 185
	• Finely stranded without end sleeve	mm <sup>2</sup>	16 ... 70	16 ... 120	120 ... 185
	• Stranded	mm <sup>2</sup>	16 ... 70	16 ... 120	120 ... 240
	• AWG cables, solid or stranded	AWG	6 ... 2/0	6 ... 250 kcmil	250 ... 500 kcmil
	• Ribbon cable conductors (Number x Width x Thickness)	mm	Min. 3 x 9 x 0.8, max. 6 x 15.5 x 0.8	Min. 3 x 9 x 0.8, max. 10 x 15.5 x 0.8	Min. 6 x 9 x 0.8, max. 20 x 24 x 0.5
<b>Both clamping points connected</b> (minimum cross-section 16 mm <sup>2</sup> )					
	• Finely stranded with end sleeve (DIN 46228)	mm <sup>2</sup>	Max. 1 x 50, 1 x 70	Max. 1 x 95, 1 x 120	Min. 2 x 50, max. 2 x 185
	• Finely stranded without end sleeve	mm <sup>2</sup>	Max. 1 x 50, 1 x 70	Max. 1 x 95, 1 x 120	Min. 2 x 50, max. 2 x 185
	• Stranded	mm <sup>2</sup>	Max. 1 x 50, 1 x 70	Max. 1 x 95, 1 x 120	Min. 2 x 70, max. 2 x 240
	• AWG cables, solid or stranded	AWG	Max. 2 x 1/0	Max. 2 x 3/0	Min. 2 x 2/0, max. 2 x 500 kcmil
	• Ribbon cable conductors (Number x Width x Thickness)	mm	Max. 2 x (6 x 15.5 x 0.8)	Max. 2 x (10 x 15.5 x 0.8)	Max. 2 x (20 x 24 x 0.5)
<b>Busbar connections</b>					
• Connecting bar (max. width)		mm	17		25
- Bore diameter		mm	9		11
<b>Cable lug connection</b>			1)		2)
• Finely stranded with cable lug		mm <sup>2</sup>	16 ... 95		50 ... 240
• Stranded with cable lug		mm <sup>2</sup>	25 ... 120		70 ... 240
• AWG cables, solid or stranded		AWG	4 ... 250 kcmil		2/0 ... 500 kcmil
• Terminal screws			M8 x 25 (A/F 13)		M10 x 30 (A/F 17)
- Tightening torque		Nm	10 ... 14		14 ... 24
		lb.in	90 ... 124		124 ... 210
<b>Auxiliary conductors</b> (1 or 2 conductors can be connected)					
• Solid		mm <sup>2</sup>	2 x (0.5 ... 1.5) <sup>3)</sup> ; 2 x (0.75 ... 2.5) <sup>3)</sup> acc. to IEC 60947; max. 2 x (0.75 ... 4) <sup>3)</sup>		
• Finely stranded with end sleeve (DIN 46228)		mm <sup>2</sup>	2 x (0.5 ... 1.5) <sup>3)</sup> ; 2 x (0.75 ... 2.5) <sup>3)</sup>		
• AWG cables, solid or stranded		AWG	2 x (18 ... 14)		
• Terminal screws			M3 (Požadiv size 2)		
- Tightening torque		Nm	0.8 ... 1.2		
		lb.in	7 ... 10.3		
<b>Auxiliary conductors<sup>4)</sup></b> (1 or 2 conductors can be connected)			 <b>Spring-loaded terminals</b>		
• Operating devices			3.0 x 0.5; 3.5 x 0.5		
• Solid		mm <sup>2</sup>	2 x (0.25 ... 2.5)		
• Finely stranded with end sleeve (DIN 46228)		mm <sup>2</sup>	2 x (0.25 ... 1.5)		
• Finely stranded without end sleeve		mm <sup>2</sup>	2 x (0.25 ... 2.5)		
• AWG cables, solid or stranded		AWG	2 x (24 ... 14)		

## Switching devices – Contactors and contactor assemblies – Special applications

### Contactors for special applications

#### SIRIUS 3RT.4 contactors for weak or non-inductive loads (AC-1), 3-pole up to 2 650 A



##### Selection and ordering data

##### Size S3: AC operation or AC/DC operation

- Coil circuits (varistors, diodes, etc.) retrofittable
- Auxiliary switches can be retrofitted
- Main and control conductors: Screw terminals



3RT244.-1...0

Size	Rated data AC-1, $t_U$ : 40 °C   60 °C Operational current $I_e$ up to <b>690 V</b>   690 V <b>A</b>	Auxiliary contacts		Rated control supply voltage $U_s$		Screw terminals 	Weight
		Ident. No.	Version	50 Hz AC	50 Hz AC or DC		
			 	V	V	Article No.	kg

For screw fixing and snap-on mounting on TH 35-15 and TH 75-15 standard mounting rails

##### AC/DC operation

With integrated coil circuit (varistor integrated in electronics at the factory)

S3	140	130	11	1	1	--	20 ... 33	3RT2446-1NB30	1.833		
							83 ... 155			3RT2446-1NF30	1.823
							175 ... 280			3RT2446-1NP30	1.805
160	140	11	1	1	--	20 ... 33	3RT2448-1NB30	1.843			
						83 ... 155			3RT2448-1NF30	1.825	
						175 ... 280			3RT2448-1NP30	1.808	

Other voltages on request.

Accessories and spare parts, see page 2/52 onwards.

## Switching devices – Contactors and contactor assemblies – Special applications

### Contactors for special applications

#### SIRIUS 3RT.4 contactors for weak or non-inductive loads (AC-1), 3-pole up to 2 650 A

##### Sizes S6 to S12: AC/DC operation



- 3RT14...-A standard operating mechanism
- Solid-state operating mechanism
  - 3RT14...-N with 24 V DC control signal input
  - 3RT14...-P with 24 V DC control signal input and remaining lifetime indicator (RLT)
- For screw fixing
- Auxiliary and control conductors: Screw terminals
- Main conductors: Busbar connections; a connection kit with screws, spring washers and nuts is enclosed.



3RT1476-6N.36



3RT1476-6P.35

Size	Rated data	Auxiliary contacts, lateral	Rated control supply voltage $U_s$	Screw terminals 	Weight
	AC-1, $t_{ij}$ : 40 °C                      60 °C Operational current $I_e$ up to	Version	50/60 Hz AC or DC	Article No.	kg
	<b>690 V</b> <b>A</b>	  NO    NC	V		

##### Solid-state operating mechanism

##### With 24 V DC control signal input e.g. for control by PLC

With integrated coil circuit (varistor integrated in electronics at the factory)

<b>S6</b>	<b>275</b>	250	2	2	96 ... 127 200 ... 277	<b>3RT1456-6NF36</b> <b>3RT1456-6NP36</b>	3.327 3.400
<b>S10</b>	<b>400</b>	380	2	2	96 ... 127 200 ... 277	<b>3RT1466-6NF36</b> <b>3RT1466-6NP36</b>	6.707 6.531
	<b>500</b>	450	2	2	96 ... 127 200 ... 277	<b>3RT1467-6NF36</b> <b>3RT1467-6NP36</b>	6.707 6.520
<b>S12</b>	<b>690</b>	650	2	2	96 ... 127 200 ... 277 200 ... 277	<b>3RT1476-6NF36</b> <b>3RT1476-6NP36</b> <b>3RT1476-6PP35</b>	10.438 10.199 10.710

Other voltages on request.

Accessories and spare parts, see page 2/52 onwards.

## Switching devices – Contactors and contactor assemblies – Special applications

### Contactors for special applications

#### SIRIUS 3RT.3 contactors, 4-pole, up to 525 A

##### Overview



3RT231 to 3RT234 and 3RT135 to 3RT137 contactors, with screw terminals

#### **3RT.3 contactors, 4-pole**

##### Standards

IEC 60947-1, IEC 60947-4-1, IEC 60947-5-1 (auxiliary switches)

##### Surge suppression

Contactors supplied without a coil circuit can be retrofitted with RC elements, varistors, diodes or diode assemblies (combination of diode and Zener diode for short break times) for damping opening surges in the coil.

##### Note:

The break times of the contactor, the opening delay times of the NO contacts and the closing delay times of the NC contacts increase if the contactor coils are damped against voltage peaks. Different accessories are available for the contactors (time change with: Interference suppression diode 6x to 10x; diode assembly 2x to 6x; suppressor diode +1 to 5 ms; varistor +2 to 5 ms).

For details, see [Equipment Manual](#).

##### Accessories and spare parts

- 3RT231 to 3RT234 contactors, see [page 2/52 onwards](#)
- 3RT135 to 3RT137 contactors,

#### **3RT23 contactors**

##### **Main circuit**

##### Connection methods

- 3RT231 and 3RT232 contactors:  
Screw or spring-loaded terminals, spring-loaded terminals with convenient plug-in design for device connectors
- 3RT233 and 3RT234 contactors:  
Screw terminals with box terminal; direct connection to the connecting bar possible with cable lugs for 3RT234 when the box terminal is removed.

##### Short-circuit protection

For short-circuit protection of 3RT23 contactors without overload relays, see [page 2/90](#).

##### Surge suppression

- 3RT231 contactor:  
The surge suppressors are plugged onto the front of the contactors here. Space is provided for them next to a snap-on auxiliary switch.

- 3RT232 and 3RT233 contactors:  
The surge suppressors (varistors, RC elements or diode combinations) can be plugged into the front of the contactors.
- 3RT234 contactors:  
The varistors and diode assemblies are plugged into the front of the contactors. The RC element is plugged into the two recesses on the front of the contactor to the left of the terminal block for the auxiliary switches.

##### **Control circuit**

##### Connection methods

Screw or spring-loaded terminals

##### Operating mechanism types

The contactors are available as versions with conventional AC or DC operating mechanisms or as versions with a wide-range solid-state operating mechanism and a universal actuating voltage (AC or DC operation possible).

Control takes place via the control supply voltage connection A1 - A2 with varying operating ranges (see [relevant product data sheet](#) for further details).

##### **Auxiliary circuit**

##### Auxiliary contact complement

- 3RT231 contactor: An auxiliary contact is integrated in the basic unit.
- 3RT232 to 3RT234 contactors: The basic units contain two integrated auxiliary contacts (1 NO + 1 NC).

All basic units can be expanded with auxiliary switches.

For detailed information about the fitting of auxiliary switches, see [pages 2/55 to 2/58](#).

#### **3RT13 contactors**

##### **Main circuit**

##### Connection methods

- 3RT135 to 3RT137 contactors:  
Screw terminals with connecting bars that the cables can be connected to using either cable lugs or flexible or rigid busbars.
- 3RT136 and 3RT137 contactors:  
These can be fitted with bus connectors offset.

##### Short-circuit protection

For short-circuit protection of 3RT13 contactors, see [page 2/93](#).

##### **Control circuit**

##### Connection methods

Screw terminals

##### Operating mechanism types

The contactors are fitted with a wide-range solid-state operating mechanism that can be controlled with both 50/60 Hz AC and DC.

The operating range of the DC control is  $0.8 \times U_{s \text{ min}}$  and  $1.1 \times U_{s \text{ max}}$ , and for AC operation  $0.85 \times U_{s \text{ min}}$  and  $1.1 \times U_{s \text{ max}}$ .

It is not possible to change the operating mechanism.

##### **Auxiliary circuit**

##### Auxiliary contact complement

The contactors have two auxiliary contacts with 2 NO + 2 NC.

One additional auxiliary switch with 1 NO + 1 NC can be mounted on each side.



# Switching devices – Contactors and contactor assemblies – Special applications

## Contactors for special applications

SIRIUS 3RT.3 contactors, 4-pole, up to 525 A

### Application



- The 3RT.3 contactors can be used for the following applications:
- 4-pole switching of weak or non-inductive loads (AC-1)
  - Disconnecting loads or power generation plants from the grid
  - For system transfers
- We additionally offer special versions of the 3RT23 contactors for switching motor-driven loads (AC-3).

### Technical specifications

#### More information

Technical specifications, see <https://support.industry.siemens.com/cs/ww/en/ps/16165/td>  
 FAQs, see <https://support.industry.siemens.com/cs/ww/en/ps/16165/faq>

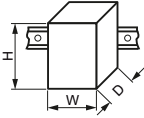
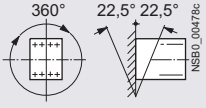
Manuals, see <https://support.industry.siemens.com/cs/ww/en/ps/16165/man>

Type		3RT2316, 3RT2317	3RT2325 to 3RT2327	3RT2336, 3RT2337	3RT2344, 3RT2346, 3RT2348	
Size		S00	S0	S2	S3	
<b>General data</b>						
<b>Dimensions (W x H x D)</b>						
AC or DC operation						
<ul style="list-style-type: none"> <li>• Basic units               <ul style="list-style-type: none"> <li>- Screw terminals</li> <li>- Spring-loaded terminals</li> </ul> </li> <li>• Basic unit with mounted auxiliary switch               <ul style="list-style-type: none"> <li>- Screw terminals</li> <li>- Spring-loaded terminals</li> </ul> </li> <li>• Basic unit with mounted function module or solid-state time-delayed auxiliary switch               <ul style="list-style-type: none"> <li>- Screw terminals</li> <li>- Spring-loaded terminals</li> </ul> </li> </ul>		(The values in brackets apply for DC operation)				
		mm	45 x 58 x 73	60 x 85 x 97 (107)	75 x 114 x 130	96 x 140 x 152
		mm	45 x 70 x 73	61 x 102 x 97 (107)	--	--
		mm	45 x 58 x 117	60 x 85 x 141 (151)	75 x 114 x 174	96 x 140 x 196
		mm	45 x 70 x 121	61 x 102 x 145 (155)	--	--
		mm	45 x 58 x 147	60 x 85 x 171 (181)	75 x 114 x 204	96 x 140 x 226
mm	45 x 70 x 147	61 x 102 x 171 (181)	--	--		
<b>Permissible mounting position</b>						
The contactors are designed for operation on a vertical mounting surface.						
						
Upright mounting position						
						
Special version required						
<b>Mechanical service life</b>						
	Operating cycles	30 million	10 million			
<b>Electrical endurance at I<sub>e</sub>/AC-1</b>						
	Operating cycles	Approx. 0.5 million				
<b>Rated insulation voltage U<sub>i</sub></b> (pollution degree 3)						
	V	690				
<b>Protective separation</b> between the coil and the main contacts acc. to IEC 60947-1, Annex N						
	V	400			690	
<b>Permissible ambient temperature</b>						
	°C	-25 ... +60				
	°C	-55 ... +80				
<b>Degree of protection IP on the front</b> according to IEC 60529						
IP20 (screw terminals and spring-loaded terminals)						
<b>Touch protection on the front</b> acc. to IEC 60529						
Finger-safe for vertical touching from the front (screw terminals and spring-loaded terminals)						

## Switching devices – Contactors and contactor assemblies – Special applications

### Contactors for special applications

#### SIRIUS 3RT.3 contactors, 4-pole, up to 525 A

Type	3RT2316, 3RT2317	3RT2325, 3RT2326	3RT2326-1...0-4AA0	3RT2327
Size	S00	S0		
<b>Short-circuit protection</b>				
<b>Main circuit</b>				
<ul style="list-style-type: none"> <li>Version of the fuse link required for short-circuit protection of the main circuit</li> <li>- for type of coordination 1</li> </ul>	gG: 35 A (690 V, 100 kA)	gG: 63 A (690 V, 100 kA)	gG: 100 A (690 V, 100 kA), aM: 50 A (690 V, 100 kA), BS88: 100 A (415 V, 80 kA)	gG: 63 A (690 V, 100 kA)
<ul style="list-style-type: none"> <li>- for type of coordination 2</li> </ul>	gG: 20 A (690 V, 100 kA)		gG: 35 A (690 V, 100 kA), aM: 20 A (690 V, 100 kA), BS88: 35 A (415 V, 80 kA)	gG: 20 A (690 V, 100 kA)
<b>Auxiliary circuit</b>				
<ul style="list-style-type: none"> <li>Version of the fuse link required for short-circuit protection of the auxiliary switch</li> </ul>	Fuse gG: 10 A (690 V, 1 kA)			
<ul style="list-style-type: none"> <li>Miniature circuit breaker version required for short-circuit protection of the auxiliary switch</li> </ul>	6 A (230 V, 400 A, C characteristic)			

Type	3RT2336, 3RT2337	3RT2344, 3RT2346	3RT2346-1...0-4AA0	3RT2348
Size	S2	S3		
<b>Short-circuit protection</b>				
<b>Main circuit</b>				
<ul style="list-style-type: none"> <li>Version of the fuse link required for short-circuit protection of the main circuit</li> <li>- for type of coordination 1</li> </ul>	gG: 160 A (690 V, 100 kA)	gG: 250 A (690 V, 100 kA)	gG: 250 A (690 V, 100 kA), aM: 160 A (690 V, 100 kA), BS88: 200 A (415 V, 80 kA)	gG: 250 A (690 V, 100 kA)
<ul style="list-style-type: none"> <li>- for type of coordination 2</li> </ul>	gG: 63 A (690 V, 100 kA)	gR: 80 A (690 V, 100 kA)	gR: 250 A (690 V, 100 kA)	gG: 160 A (690 V, 100 kA), aM: 100 A (690 V, 100 kA), BS88: 125 A (415 V, 80 kA)
<b>Auxiliary circuit</b>				
<ul style="list-style-type: none"> <li>Version of the fuse link required for short-circuit protection of the auxiliary switch</li> </ul>	Fuse gG: 10 A (690 V, 1 kA)			
<ul style="list-style-type: none"> <li>Miniature circuit breaker version required for short-circuit protection of the auxiliary switch</li> </ul>	6 A (230 V, 400 A, C characteristic)			

## Switching devices – Contactors and contactor assemblies – Special applications

### Contactors for special applications

#### SIRIUS 3RT.3 contactors, 4-pole, up to 525 A

Type		3RT2316	3RT2317	3RT2325	3RT2326, 3RT2327	3RT2336, 3RT2337	3RT2344, 3RT2346, 3RT2348
Size		S00		S0		S2	S3
<b>Control</b>							
<b>Solenoid coil operating range</b>							
• AC operation	At 50 Hz	0.8 ... 1.1 x $U_s$		0.8 ... 1.1 x $U_s$			
	At 60 Hz	0.85 ... 1.1 x $U_s$					
• DC operation	At 50 °C	0.8 ... 1.1 x $U_s$				--	
	At 60 °C	0.85 ... 1.1 x $U_s$				--	
• AC/DC operation		--				0.8 ... 1.1 x $U_s$	
<b>Power consumption of the solenoid coils</b> (for cold coil and 1.0 x $U_s$ )							
• AC operation, 50 Hz, standard version							
- Closing	VA	--		77		190	296
- P.f.		--		0.82		0.72	0.61
- Closed	VA	--		9.8		16	19
- P.f.		--		0.25		0.37	0.38
• AC operation, 50/60 Hz, standard version							
- Closing	VA	27/24.3	37/33	81/79		210/188	348/296
- P.f.		0.8/0.75		0.72/0.74		0.69/0.65	0.62/0.55
- Closed	VA	4.2/3.3	5.7/4.4	10.5/8.5		17.2/16.5	25/18
- P.f.		0.25/0.25		0.25/0.28		0.36/0.39	0.35/0.41
• AC operation, 60 Hz, USA, Canada							
- Closing	VA	31.7	43	87		188	326
- P.f.		0.77		0.76		0.67	0.55
- Closed	VA	4.8	6.5	9.4		16.5	22
- P.f.		0.25		0.28		0.37	0.4
• AC/DC operation							
- Closing for AC operation	VA	--				40	151
- P.f.		--				0.95	0.95
- Closed for AC operation	VA	--				2	3.5
- P.f.		--				0.95	0.95
- Closing for DC operation	W	--				23	76
- Closed for DC operation	W	--				1	2.7
• DC operation (closing = closed)	W	4		5.9		--	... <sup>1)</sup>
<b>Operating times within operating range</b>							
Total break time = Opening delay + Arcing time							
• AC operation							
- Closing delay	ms	9 ... 35		8 ... 40		10 ... 80	13 ... 50
- Opening delay	ms	4 ... 15		4 ... 16		10 ... 18	10 ... 21
• DC operation							
- Closing delay	ms	30 ... 100		50 ... 170		--	
- Opening delay	ms	7 ... 13		15 ... 18		--	
• AC/DC operation							
- Closing delay	ms	--				35 ... 110	50 ... 70
- Opening delay	ms	--				30 ... 55	38 ... 57
• Arcing time	ms	10 ... 15		10		10 ... 20	

<sup>1)</sup> In the case of AC/DC coils, increased pickup currents (6.5 A on average) arise during the first 200 ms.

# Switching devices – Contactors and contactor assemblies – Special applications

## Contactors for special applications

### SIRIUS 3RT.3 contactors, 4-pole, up to 525 A

Type		3RT2316	3RT2317	3RT2325	3RT2326	3RT2327	3RT2336	3RT2337	3RT2344	3RT2346	3RT2348	
Size		S00	S0				S2		S3			
<b>Rated data of the main contacts</b>												
<b>Load rating with AC</b>												
<b>Utilization category AC-1</b>												
• Rated operational currents $I_e$	At 40 °C, up to 690 V	A	18	22	35	40	50	60	110	110	140 (110) <sup>2)</sup>	160
	At 60 °C, up to 690 V	A	16	20	30	35	42	55	95	100	130 (100) <sup>2)</sup>	140
• Rated power for AC loads	At 230 V	kW	6	7.5	11	13	16	21	36	38	49	53
P.f. = 0.95 (at 60 °C)	400 V	kW	10.5	13	20	23	28	36	63	72	92	105
• Minimum cross-section in the main circuit at maximum AC-1 rated value		mm <sup>2</sup>	2.5	4	10			16	35		50 (35) <sup>2)</sup>	70
<b>Utilization categories AC-2 and AC-3</b>												
• Rated operational currents $I_e$ (at 60 °C)	At 400 V	A	9	12	15.5	15.5 (32) <sup>1)</sup>	15.5	38 (51) <sup>1)</sup>	38		-- (95) <sup>1)</sup>	--
	At 690 V	A	--	--	--	-- (21) <sup>1)</sup>	--	-- (24) <sup>1)</sup>	--		-- (58) <sup>1)</sup>	--
• Rated power for slip-ring or squirrel-cage motors at 50 and 60 Hz	At 230 V	kW	2.2	3	4	4 (7.5) <sup>1)</sup>	4	-- (15) <sup>1)</sup>	--		-- (22) <sup>1)</sup>	--
	400 V	kW	4	5.5	7.5	7.5 (15) <sup>1)</sup>	7.5	-- (22) <sup>1)</sup>	--		-- (45) <sup>1)</sup>	--
	690 V	kW	--	--	--	-- (18.5) <sup>1)</sup>	--	-- (22) <sup>1)</sup>	--		-- (55) <sup>1)</sup>	--
<b>Load rating with DC</b>												
<b>Utilization category DC-1 (<math>L/R \leq 1</math> ms)</b>												
• Rated operational currents $I_e$ (at 60 °C)												
- 1 conducting path	Up to 24 V	A	16	20	30	35	42	55		70	80	
	60 V	A	16	20				23			60	
	110 V	A	2.1		4.5						9	
	220 V	A	0.8		1						2	
	440 V	A	0.6		0.4						0.6	
- 2 conducting paths in series	Up to 24 V	A	16	20	30	35	42	55		70	80	
	60 V	A	16	20	30	35	42	55		70	80	
	110 V	A	12		30	35	42	45		70	80	
	220 V	A	1.6		1			5			10	
	440 V	A	0.8		1						1.8	
- 3 conducting paths in series	Up to 24 V	A	16	20	30	35	42	55		70	80	
	60 V	A	16	20	30	35	42	55		70	80	
	110 V	A	16	20	30	35	42	55		70	80	
	220 V	A	16	20	30	35	42	45		70	80	
	440 V	A	1.3		2.9						4.5	
- 4 conducting paths in series	Up to 24 V	A	16	20	30	35	42	55	65	70	80	
	60 V	A	16	20	30	35	42	55	65	70	80	
	110 V	A	16	20	30	35	42	55		70	80	
	220 V	A	16	20	30	35	42	45	55	70	80	
	440 V	A	1.3		2.9			3.5	2.9	4.5		
<b>Utilization category DC-3/DC-5, shunt-wound and series-wound motors (<math>L/R \leq 15</math> ms)</b>												
• Rated operational currents $I_e$ (at 60 °C)												
- 1 conducting path	Up to 24 V	A	16	20								
	60 V	A	0.5		5					6	6.5	
	110 V	A	0.15		2.5							
	220 V	A	--		1							
	440 V	A	--		0.09			0.1		0.15		
- 2 conducting paths in series	Up to 24 V	A	16	20	30	35	42	45		70	80	
	60 V	A	5		30	35	42	45		70	80	
	110 V	A	0.35		15			25		70	80	
	220 V	A	--		3			5		7		
	440 V	A	--		0.27					0.42		
- 3 conducting paths in series	Up to 24 V	A	16	20	30	35	42	45		70	80	
	60 V	A	16	20	30	35	42	45		70	80	
	110 V	A	16	20	30	35	42	45		70	80	
	220 V	A	1.5		10			25		35		
	440 V	A	0.2		0.6					0.8		
- 4 conducting paths in series	Up to 24 V	A	16	20	30	35	42	45		70	80	
	60 V	A	16	20	30	35	42	45		70	80	
	110 V	A	16	20	30	35	42	45		70	80	
	220 V	A	1.5		30	35	42	25		70	80	
	440 V	A	0.2		0.6					0.8		

<sup>1)</sup> The values in brackets apply for 3RT23.6-1...0-4AA0 versions.

#### Data for North America

For technical specifications of 3RT contactors.

# Switching devices – Contactors and contactor assemblies – Special applications

## Contactors for special applications

### SIRIUS 3RT.3 contactors, 4-pole, up to 525 A

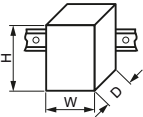
Type	3RT1355-6A.36				3RT1363-6A.36				3RT1364-6A.36				3RT1373-6A.36, 3RT1374-6A.36, 3RT1375-6A.36				
Size	S6				S10				S12				S12				
<b>General data</b>																	
<b>Dimensions</b>																	
																	
• Width	mm	120				140				184							
• Height	mm	150				196				225							
• Depth	mm	128				153				180							
<b>Mounting position</b>																	
For vertical mounting surface can be rotated $\pm 180^\circ$ , and with $0^\circ$ rotation can be tilted forward or backward $\pm 30^\circ$ , or standing																	
<b>Installation altitude at height above sea level, maximum</b>																	
m	2 000																
<b>Insulation voltage at pollution degree 3</b>																	
• Of the main circuit	V	1 000															
• Of the auxiliary circuit	V	690															
<b>Impulse withstand voltage</b>																	
• Of the main circuit	kV	8															
• Of the auxiliary circuit	kV	6															
<b>Product function, mirror contact according to IEC 60947-4-1</b>																	
Yes																	
<b>Ambient temperature</b>																	
• During operation	$^\circ\text{C}$	-40 ... +60															
• During storage	$^\circ\text{C}$	-40 ... +70															
<b>Degree of protection IP on the front according to IEC 60529</b>																	
IP00 (IP20 with cover)																	
<b>Touch protection on the front acc. to IEC 60529</b>																	
Finger-safe for vertical touching from the front with cover																	
<b>Short-circuit protection</b>																	
<b>Version of the fuse link required</b>																	
• For short-circuit protection of the main circuit for type of coordination 2		gG: 250 A (500 V, 100 kA)				gG: 355 A (500 V, 100 kA)				gG: 400 A (500 V, 100 kA)				gG: 630 A (500 V, 100 kA)			
• For short-circuit protection of the auxiliary switch		gG: 10 A (690 V, 1 kA)															
<b>Control circuit/control</b>																	
<b>Operating range factor of the control supply voltage, rated value of the solenoid coil</b>																	
• At AC at 50 Hz		0.85 ... 1.1															
• At AC at 60 Hz		0.85 ... 1.1															
• At DC		0.8 ... 1.1															
<b>Solenoid coil closing for DC</b>																	
W		210	130	135	205		130	190		205	130	190					
<b>Closing apparent power of the solenoid coil for AC</b>																	
• At 50 Hz	VA	225	170	130	205	165	175	220	185	165	175	220	185				
• At 60 Hz	VA	225	170	130	205	165	175	220	185	165	175	220	185				
<b>Solenoid coil closed for DC</b>																	
W		2.5		3	4	2.5		4	2.5			4					
<b>Closed apparent power of the solenoid coil for AC</b>																	
• At 50 Hz	VA	5.5	4	6	16	6	4	7	16	6	4	7	16				
• At 60 Hz	VA	5.5	4	6	16	6	4	7	16	6	4	7	16				
<b>Closing delay</b>																	
• At AC	ms	20 ... 55				25 ... 60											
• At DC	ms	20 ... 55				25 ... 60											
<b>Opening delay</b>																	
• At AC	ms	40 ... 70				45 ... 80											
• At DC	ms	40 ... 70				45 ... 80											
<b>Main circuit</b>																	
<b>Operational current at AC-1</b>																	
• Up to 690 V																	
- At an ambient temperature of 40 $^\circ\text{C}$	A	200				275				350							
- At an ambient temperature of 60 $^\circ\text{C}$	A	175				250				300							
• Up to 1 000 V																	
- At an ambient temperature of 40 $^\circ\text{C}$	A	--				250				275							
- At an ambient temperature of 60 $^\circ\text{C}$	A	--				225				250							
<b>No-load switching frequency</b>																	
• At AC	1/h	300															
• At DC	1/h	300															

## Switching devices – Contactors and contactor assemblies – Special applications

### Contactors for special applications

#### SIRIUS 3RT.3 contactors, 4-pole, up to 525 A

Type	3RT1373-				3RT1374-				3RT1375-				
Size	6AE36	6AF36	6AP36	6AR36	6AE36	6AF36	6AP36	6AR36	6AE36	6AF36	6AP36	6AR36	
<b>Control circuit/control</b>													
<b>Operating range factor of the control supply voltage, rated value of the solenoid coil</b>													
• At AC at 50 Hz	0.85 ... 1.1												
• At AC at 60 Hz	0.85 ... 1.1												
• At DC	0.8 ... 1.1												
<b>Solenoid coil closing for DC</b>	W	400	360	410	600	400	360	410	600	400	360	410	600
<b>Closing apparent power of the solenoid coil for AC</b>													
• At 50 Hz	VA	475	340	385	420	475	340	385	420	475	340	385	420
• At 60 Hz	VA	475	340	385	420	475	340	385	420	475	340	385	420
<b>Solenoid coil closed for DC</b>	W	3.5	2.5	4.5	4.7	3.5	2.5	4.5	4.7	3.5	2.5	4.5	4.7
<b>Closed apparent power of the solenoid coil for AC</b>													
• At 50 Hz	VA	8.5	17	17.5	21	8.5	17	17.5	21	8.5	17	17.5	21
• At 60 Hz	VA	8.5	17	17.5	21	8.5	17	17.5	21	8.5	17	17.5	21
<b>Closing delay</b>													
• At AC	ms	30 ... 60											
• At DC	ms	30 ... 60											
<b>Opening delay</b>													
• At AC	ms	45 ... 80											
• At DC	ms	45 ... 80											
<b>Main circuit</b>													
<b>Operational current at AC-1</b>													
• Up to 690 V													
- At an ambient temperature of 40 °C	A	400			500				525				
- At an ambient temperature of 60 °C	A	350			400				425				
• Up to 1 000 V													
- At an ambient temperature of 40 °C	A	350			375				400				
- At an ambient temperature of 60 °C	A	300			325				350				
<b>No-load switching frequency</b>													
• At AC	1/h	300											
• At DC	1/h	300											
<b>Conductor cross-sections</b>													
<b>Type of electrical connection for the main circuit</b>	Connecting bar				Connecting bar, bus connectors offset > 275 A required		Connecting bar		Connecting bar, bus connectors offset > 450 A required				
<b>Minimum cross-section in the main circuit at maximum AC-1 rated value</b>	mm <sup>2</sup>	95		150		240		300		370			

# Switching devices – Contactors and contactor assemblies – Special applications

## Contactors for special applications

### SIRIUS 3RT.3 contactors, 4-pole, up to 525 A

#### Selection and ordering data



AC/DC operation 



3RT233.-1N.30



3RT234.-1N.30

Rated data AC-1, $t_{ij}$ : 40 / 60 °C Operational current $I_e$ up to 690 V A	Auxiliary contacts		Rated control supply voltage $U_c$ 50/60 Hz AC or DC V	Screw terminals 	Weight kg
	Ident. No.	Version			
		 			

For screw fixing and snap-on mounting on TH 35 standard mounting rail

#### Size S2

With integrated coil circuit  
(varistor integrated in electronics at the factory)

60 / 55	11	1	1	20 ... 33 175 ... 280	3RT2336-1NB30 3RT2336-1NP30	1.255 1.266
110 / 95	11	1	1	20 ... 33 175 ... 280	3RT2337-1NB30 3RT2337-1NP30	1.279 1.260

For screw fixing and snap-on mounting on TH 35-15 and TH 75-15 standard mounting rails

#### Size S3

With integrated coil circuit  
(varistor integrated in electronics at the factory)

110 / 100	11	1	1	20 ... 33 175 ... 280	3RT2344-1NB30 3RT2344-1NP30	2.180 2.239
140 / 130	11	1	1	20 ... 33 175 ... 280	3RT2346-1NB30 3RT2346-1NP30	2.160 2.155
160 / 140	11	1	1	20 ... 33 175 ... 280	3RT2348-1NB30 3RT2348-1NP30	2.180 2.260

Other voltages on request.

Accessories and spare parts, [see page 2/52 onwards](#).



## Switching devices – Contactors and contactor assemblies – Special applications

### Contactors for special applications

#### SIRIUS 3RT.3 contactors, 4-pole, up to 525 A

##### AC/DC operation

Version for AC-3 motor loads



2



3RT2336-1NB30-4AA0



3RT2346-1NB30-4AA0

Rated data		Auxiliary contacts		Rated control supply voltage $U_c$	Screw terminals 	Weight
AC-2/AC-3, $t_{ij}$ : up to 60 °C	AC-1, $t_{ij}$ : 40 / 60 °C	Ident. No.	Version	50/60 Hz AC or DC		
Operational current $I_e$ up to 400 V A	Operational current $I_e$ up to 690 V A		 	V	Article No.	kg

#### For screw fixing and snap-on mounting on TH 35 standard mounting rail

##### Size S2

With integrated coil circuit  
(varistor integrated in electronics at the factory)

50	60 / 55	11	1	1	20 ... 33	3RT2336-1NB30-4AA0	1.270
----	---------	----	---	---	-----------	--------------------	-------

#### For screw fixing and snap-on mounting on TH 35-15 and TH 75-15 standard mounting rails

##### Size S3

With integrated coil circuit  
(varistor integrated in electronics at the factory)

95	110 / 100	11	1	1	20 ... 33	3RT2346-1NB30-4AA0	2.210
----	-----------	----	---	---	-----------	--------------------	-------

Other voltages on request.

Accessories and spare parts, [see page 2/52 onwards](#).

# Switching devices – Contactors and contactor assemblies – Special applications

## Contactors for special applications

### SIRIUS 3RT25 contactors, 4-pole, 2 NO + 2 NC

#### Overview

##### Standards

IEC 60947-1, IEC 60947-4-1, IEC 60947-5-1 (auxiliary switches)

The contactors are suitable for use in any climate. They are finger-safe according to IEC 60529.

##### Surge suppression

Contactors supplied without a coil circuit can be retrofitted with RC elements, varistors, diodes or diode assemblies (combination of diode and Zener diode for short break times) for damping opening surges in the coil.

##### Note:

The break times of the contactor, the opening delay times of the NO contacts and the closing delay times of the NC contacts increase if the contactor coils are damped against voltage peaks. Different accessories are available for the contactors (time change with: Interference suppression diode 6x to 10x; diode assembly 2x to 6x; suppressor diode +1 to 5 ms; varistor +2 to 5 ms).

For details, see [Equipment Manual](#).

##### Auxiliary contacts

Size S0 to S3 contactors have two auxiliary contacts 1 NO + 1 NC integrated in the basic version.

With sizes S00 to S3, four additional auxiliary contacts can be fitted, including no more than two NC contacts.

For a general description of sizes S00 to S3 of 3RT2 contactors.

##### Accessories

The accessories for the 3-pole SIRIUS 3RT2 contactors can also be used for the 4-pole versions.

##### Use of 3RT contactors with IE3/IE4 motors

##### Note:

For the use of 3RT25 contactors in conjunction with highly energy-efficient IE3/IE4 motors, please observe the information on dimensioning and configuring, see [Application Manual](#).

#### Application

The contactors are suitable:

- For changing the polarity of hoisting gear motors
- For switching two separate loads

##### Note:



Single device for pole reversal; not suitable for reversing duty. 3RT25 contactors are not suitable for switching a load between two current sources.

#### Technical specifications

##### More information

Technical specifications, see <https://support.industry.siemens.com/cs/ww/en/ps/16169/td>  
FAQs, see <https://support.industry.siemens.com/cs/ww/en/ps/16169/faq>

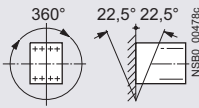
Manuals, see <https://support.industry.siemens.com/cs/ww/en/ps/16169/man>

Type	3RT2516 to 3RT2518	3RT2526	3RT2535	3RT2536	3RT2544, 3RT2545
Size	S00	S0	S2	S3	S3
General data					
Dimensions (W x H x D)	See 3RT231., page 2/89	See 3RT232., page 2/89	See 3RT233., page 2/89	See 3RT234., page 2/89	See 3RT234., page 2/89
Permissible mounting position	<p>The contactors are designed for operation on a vertical mounting surface.</p> 				
Upright mounting position	 <p>Special version required</p>				
Mechanical service life	Operating cycles	30 million	10 million		
Electrical endurance at $I_e/AC-1$	Operating cycles	Approx. 0.5 million			
Rated insulation voltage $U_i$ (pollution degree 3)	V	690			
Protective separation between the coil and the main contacts acc. to IEC 60947-1, Annex N	V	400			690
Permissible ambient temperature					
• During operation	°C	-25 ... +60			
• During storage	°C	-55 ... +80			
Degree of protection IP on the front according to IEC 60529	IP20 (screw terminals and spring-loaded terminals)				
Touch protection on the front acc. to IEC 60529	Finger-safe for vertical touching from the front (screw terminals and spring-loaded terminals)				

## Switching devices – Contactors and contactor assemblies – Special applications

### Contactors for special applications

#### SIRIUS 3RT25 contactors, 4-pole, 2 NO + 2 NC

Type	3RT2516 to 3RT2518	3RT2526	3RT2535	3RT2536	3RT2544, 3RT2545
Size	S00	S0	S2	S3	S3
<b>Short-circuit protection</b>					
<b>Main circuit</b>					
<ul style="list-style-type: none"> <li>Version of the fuse link required for short-circuit protection of the main circuit</li> <li>for type of coordination 1</li> <li>for type of coordination 2</li> </ul>	gG: 35 A (690 V, 100 kA)	gG: 63 A (690 V, 100 kA)	gG: 125 A (690 V, 100 kA)	gG: 160 A (690 V, 100 kA)	gG: 250 A (690 V, 100 kA)
	gG: 20 A (690 V, 100 kA)	gG: 35 A (690 V, 50 kA)	gG: 63 A (690 V, 100 kA)	gG: 80 A (690 V, 100 kA)	gR: 250 A (690 V, 100 kA)
<b>Auxiliary circuit</b>					
<ul style="list-style-type: none"> <li>Version of the fuse link required for short-circuit protection of the auxiliary switch</li> <li>Miniature circuit breaker version required for short-circuit protection of the auxiliary switch</li> </ul>	Fuse gG: 10 A (690 V, 1 kA)				
	6 A (230 V, 400 A, C characteristic)				

Type	3RT2516-1A	3RT2517-1A, 3RT2518-1A	3RT2516-1B, 3RT2517-1B, 3RT2518-1B	3RT2526-1A	3RT2526-1B	3RT253-1A	3RT253-1N	3RT254-1A	3RT254-1N	
Size	S00			S0		S2		S3		
<b>Control</b>										
<b>Type of operating mechanism</b>	AC		DC	AC	DC	AC	AC/DC	AC	AC/DC	
<b>Solenoid coil operating range</b>										
<ul style="list-style-type: none"> <li>AC operation</li> <li>DC operation</li> <li>AC/DC operation</li> </ul>	At 50 Hz	0.8 ... 1.1 x $U_s$	--	0.8 ... 1.1 x $U_s$	--	0.8 ... 1.1 x $U_s$	--	0.8 ... 1.1 x $U_s$	--	
	At 60 Hz	0.85 ... 1.1 x $U_s$	--	0.8 ... 1.1 x $U_s$	--	0.8 ... 1.1 x $U_s$	--	0.8 ... 1.1 x $U_s$	--	
	Up to 50 °C	--	0.8 ... 1.1 x $U_s$	--	0.8 ... 1.1 x $U_s$	--	--	--	--	
	Up to 60 °C	--	0.85 ... 1.1 x $U_s$	--	0.8 ... 1.1 x $U_s$	--	--	--	--	
		--	--	--	--	--	0.8 x $U_{s\ min}$ ... 1.1 x $U_{s\ max}$	--	0.8 x $U_{s\ min}$ ... 1.1 x $U_{s\ max}$	
<b>Power consumption of the solenoid coils</b> (for cold coil and 1.0 x $U_s$ )										
<ul style="list-style-type: none"> <li>AC operation, 50/60 Hz, standard version</li> <li>DC operation</li> </ul>										
- Closing	VA	27/24.3	37/33	--	81/79	--	210/188	110	348/296	--
- P.f.		0.8/0.75	--	--	0.72/0.74	--	0.69/0.65	0.95	0.62/0.55	--
- Closed	VA	4.2/3.3	5.7/4.4	--	10.5/8.5	--	17.2/16.5	2.5	25/18	--
- P.f.		0.25/0.25	--	--	0.25/0.28	--	0.36/0.39	0.95	0.35/0.41	--
- Closing	W	--	4	--	5.9	23	70	--	76	
- Closed	W	--	4	--	5.9	1	1.5	--	1.8	
<b>Operating times within operating range</b>										
Total break time = Opening delay + Arcing time										
<ul style="list-style-type: none"> <li>AC operation</li> <li>DC operation</li> </ul>										
- Closing delay	ms	9 ... 35	--	8 ... 40	--	10 ... 80	30 ... 110	13 ... 50	50 ... 70	
- Opening delay	ms	4 ... 15	--	4 ... 16	--	10 ... 18	30 ... 55	10 ... 21	38 ... 57	
- Closing delay	ms	30 ... 100	--	50 ... 170	--	30 ... 110	--	50 ... 70		
- Opening delay	ms	38 ... 65	7 ... 13	15 ... 18	--	30 ... 55	--	38 ... 57		
- Arcing time	ms	10 ... 15		10		10 ... 20				

# Switching devices – Contactors and contactor assemblies – Special applications

## Contactors for special applications

### SIRIUS 3RT25 contactors, 4-pole, 2 NO + 2 NC

Type		3RT2516	3RT2517	3RT2518	3RT2526	3RT2535	3RT2536	3RT2544	3RT2545	
Size		S00			S0	S2		S3		
<b>Rated data of the main contacts</b>										
<b>Load rating with AC</b>										
<b>Utilization category AC-1</b>										
• Rated operational currents $I_e$	At 40 °C up to 690 V	A	18	22		40	60	70	100	125
	At 60 °C up to 690 V	A	16	20		35	55	60	90	105
• Rated power for AC loads	At 230 V	kW	6	7.5		13.3	21	23	34	59
	P.f. = 0.95 (at 60 °C)	400 V	kW	10.5	13	23	36	39	40	69
• Minimum cross-section in the main circuit at maximum AC-1 rated value		mm <sup>2</sup>	2.5	4		10	16	25	35	50
<b>Utilization categories AC-2 and AC-3</b>										
• Rated operational currents $I_e$	NO up to 400 V	A	9	12	16	25	35	41	65	80
	(at 60 °C)	NC up to 400 V	A	9		25	20	35	41	65
• Rated power for slip-ring or squirrel-cage motors at 50 and 60 Hz	NO at 230 V	kW	2.2	3	4	5.5	11		18.5	22
	NC at 230 V	kW	2.2			5.5	11		18.5	22
	NO at 400 V	kW	4	5.5	7.5	11	18.5	22	30	37
	NC at 400 V	kW	4			11	7.5	18.5	22	30
<b>Load rating with DC</b>										
<b>Utilization category DC-1, (<math>L/R \leq 1</math> ms)</b>										
• Rated operational currents $I_e$ (at 60 °C)										
- 1 conducting path	Up to 24 V	A	16	20		35	55	60	100	
	60 V	A	16	20		20	23		60	
	110 V	A	2.1			4.5			9	
	220 V	A	0.8			1			2	
	440 V	A	0.6			0.4			0.6	
- 2 conducting paths in series	Up to 24 V	A	16	20		35	55		100	
	60 V	A	16	20		35	45		100	
	110 V	A	12			35	45		100	
	220 V	A	1.6			5			10	
	440 V	A	0.8			1			1.8	
<b>Utilization category DC-3/DC-5<sup>2)</sup>, shunt-wound and series-wound motors (<math>L/R \leq 15</math> ms)</b>										
• Rated operational currents $I_e$ (at 60 °C)										
- 1 conducting path	Up to 24 V	A	16	20			35		40	
	60 V	A	0.5			5	6			
	110 V	A	0.15			2.5				
	220 V	A	0.75			1				
	440 V	A	--			0.09	0.1		0.15	
- 2 conducting paths in series	Up to 24 V	A	16	20		35	55		100	
	60 V	A	5			35	45		100	
	110 V	A	0.35			15	25		100	
	220 V	A	--			3	5		7	
	440 V	A	--			0.27			0.42	

### Switching frequency

#### Switching frequency $z$ in operating cycles/hour

Contactors without overload relays

• No-load switching frequency	AC	1/h	--		5 000	--	5 000			
	DC	1/h	--			1 500				
	AC/DC	1/h	10 000		1 500		500		1 000	
• Switching frequency $z$ during rated operation (Dependence of the switching frequency $z'$ on operational current $I'$ and operational voltage $U'$ : $z' = z \cdot (I_e/I') \cdot (U_e/U')^{1.5} \cdot 1/h$ )	$I_e/AC-1$ at 400 V	1/h	1 000				1 200 (350) <sup>3)</sup>	1 000 (350) <sup>3)</sup>	900	

<sup>1)</sup> Values for devices with AC and DC operation: For 3RT2526 with DC operation, different values apply to AC-2 and AC-3 for the NC.

<sup>2)</sup> For  $U_e > 24$  V, the rated operational currents  $I_e$  for the NC contact conducting paths are equal to 50% of the values for the NO contact conducting paths.

<sup>3)</sup> The values in brackets apply for 3RT253.-N.

# Switching devices – Contactors and contactor assemblies – Special applications

## Contactors for special applications

### SIRIUS 3RT25 contactors, 4-pole, 2 NO + 2 NC

#### Selection and ordering data

##### AC/DC operation



Single device for pole reversal (not suitable for reversing duty)



3RT253.-1N.30



3RT254.-1N.30

Rated data			Auxiliary contacts		Rated control supply voltage $U_s$	Screw terminals 	Weight
AC-2/AC-3, $t_{ij}$ : up to 60 °C	Ratings of three-phase motors at 50 Hz and	AC-1, $t_{ij}$ : 40 / 60 °C	Ident. No.	Version	50/60 Hz AC or DC		
Operational current $I_e$ up to		Operational current $I_e$ up to		 		Article No.	
400 V	<b>400 V</b>	690		NO NC V			kg

#### For screw fixing and snap-on mounting on TH 35 standard mounting rail

##### Size S2

##### With integrated coil circuit (varistor integrated in electronics at the factory)

35	<b>18.5</b>	60 / 55	<b>11</b>	1	1	20 ... 33 83 ... 155 175 ... 280	<b>3RT2535-1NB30</b> <b>3RT2535-1NF30</b> <b>3RT2535-1NP30</b>	1.192 1.179 1.185
41	<b>22</b>	70 / 60	<b>11</b>	1	1	20 ... 33 83 ... 155 175 ... 280	<b>3RT2536-1NB30</b> <b>3RT2536-1NF30</b> <b>3RT2536-1NP30</b>	1.176 1.191 1.180

#### For screw fixing and snap-on mounting on TH 35-15 and TH 75-15 standard mounting rails

##### Size S3

##### With integrated coil circuit (varistor integrated in electronics at the factory)

65	<b>30</b>	100 / 90	<b>11</b>	1	1	20 ... 33 175 ... 280	<b>3RT2544-1NB30</b> <b>3RT2544-1NP30</b>	2.150 2.180
80	<b>37</b>	125 / 105	<b>11</b>	1	1	20 ... 33 175 ... 280	<b>3RT2545-1NB30</b> <b>3RT2545-1NP30</b>	2.150 2.125

Other voltages on request.

Accessories and spare parts, [see page 2/52 onwards](#).

# Switching devices – Contactors and contactor assemblies – Special applications

## Contactors for special applications

### Contactors for railway applications > SIRIUS 3RT contactors with extended operating range, 3-pole

#### Overview

##### Standards

IEC 60947-4-1, IEC 60077-2, EN 50155

##### Performance range

###### Sizes S00 to S3

- 3RT20 contactors for motor loads (AC-3) up to 110 A / 55 kW

###### Sizes S6 to S12

- 3RT10 contactors for motor loads (AC-3) from 55 kW to 500 A / 250 kW
- 3RT14 contactors for weak or non-inductive loads (AC-1) up to 690 A

#### Application

Besides standard approval in compliance with IEC 60947-4-1, the contactors with an extended operating range are also approved in compliance with the relevant parts of IEC 60077-2, thus fulfilling the requirement for use in railway applications.

Thus, their suitability for increased requirements such as an

- extended temperature range compared to the IEC 60947-4-1 product standard or
- extended operating range of the contactor operating mechanisms or also
- increased resistance to mechanical oscillations and vibrations is warranted. The design of the terminals in the spring-loaded connection system also contributes toward vibration resistance.

##### Versions

In addition to the complete motor contactor series (AC-3) up to 250 kW of sizes S00 to S12 (3RT.0), as from size S6, new variants of the 3RT14 contactors optimized for AC-1 operation up to 525 kW with extended operating conditions are also available.

##### Operating range of contactor operating mechanisms

The contactors with extended operating range and railway approval are available with a solid-state DC operating mechanism in all sizes from S00 to S12.

This operating mechanism version has an operating range from  $0.7$  to  $1.25 \times U_s$  in the temperature range  $-40$  to  $70$  °C. Overvoltage damping of the contactor coil with a varistor circuit is already integrated.

As from size S6, the operating mechanisms are equipped with an additional control input that can be operated between 24 DC and 110 V. This function can optionally be switched on or off via a selector switch.

##### Auxiliary switches

These devices can be equipped with auxiliary switches in the same way as their corresponding versions of the standard motor contactors (see overview diagrams of the contactors, page 2/6 onwards).

##### Ambient temperature

The permissible ambient temperature for operation of the contactors (across the full operating range of the operating mechanisms) is  $-40$  to  $+70$  °C.

##### Side-by-side mounting

###### Contactors with conventional operating mechanism

- Sizes S00 and S0:  
Side-by-side mounting is permissible at ambient temperatures up to  $60$  °C. At  $> 60$  to  $70$  °C, a clearance of at least  $10$  mm shall be provided.

###### Contactors with series resistor

- Size S00:  
Side-by-side mounting is permissible at ambient temperatures up to  $70$  °C.

###### Contactors with solid-state operating mechanism (version: 3RT.....-.....-0LA2)

- Sizes S00 to S3:  
Side-by-side mounting is permissible at ambient temperatures up to  $70$  °C.
- Sizes S6 to S12:  
Side-by-side mounting is permissible at ambient temperatures up to  $60$  °C. At  $> 60$  to  $70$  °C, a clearance of at least  $10$  mm shall be provided.

## Switching devices – Contactors and contactor assemblies – Special applications

### Contactors for special applications

#### Contactors for railway applications > SIRIUS 3RT contactors with extended operating range, 3-pole

#### Technical specifications

##### More information

Technical specifications, see  
<https://support.industry.siemens.com/cs/ww/en/ps/16177/td>  
 FAQs, see <https://support.industry.siemens.com/cs/ww/en/ps/16177/faq>

Manuals, see  
<https://support.industry.siemens.com/cs/ww/en/ps/16177/man>

Type	<b>3RT2017</b>	<b>3RT2017- 2XB4.- 0LA2</b>	<b>2XF4.- 0LA2</b>	<b>3RT2018- 2XB4.- 0LA2</b>	<b>2XF4.- 0LA2</b>	<b>3RT202.</b>	<b>3RT202.- 2XB40- 0LA2</b>	<b>2XF40- 0LA2</b>
Size	<b>S00</b>					<b>S0</b>		

##### General data

##### Upright mounting position

- Contactors with series resistor Special version (on request)
- Contactors with conventional coil Special version (on request)

##### Ambient temperature

- During operation °C -40 ... +70<sup>1)</sup> -40 ... +70
- During storage °C -55 ... +80

##### Control

<b>Solenoid coil operating range</b>	DC	0.7 ... 1.25 x U <sub>s</sub>								
<b>Power consumption of the solenoid coils</b>	For cold coil and 1.0 x U <sub>s</sub>									
• Contactors with series resistor	Closing	W	13	--	--	--	--	--	--	
	Closed	W	4.0	--	--	--	--	--	--	
• Contactors with conventional coil	Closing	W	2.8	--	--	4.5	--	--	--	
	Closed	W	2.8	--	--	4.5	--	--	--	
• Contactors with solid-state operating mechanism	Closing	W	--	4.0	4.5	4.0	4.5	--	6.7	13.2
	Closed	W	--	0.95	0.75	0.95	0.75	--	1.4	1.3

##### Rated data of the main contacts

##### Load rating with AC

##### Minimum cross-section in the main circuit

- At maximum AC-1 rated value mm<sup>2</sup> 4 10
- At maximum I<sub>th</sub> rated value mm<sup>2</sup> -- 4 -- 10

<sup>1)</sup> 3RT20...-K contactors without the article number suffix "-0LA2" are coupling contactors that are certified for the -25 to +60 °C standard temperature range. For railway applications, an additional certification approves these contactors with a minimum clearance of 10 mm for the extended temperature range from -40 to +70 °C.

All details and technical specifications not mentioned here are identical to those of the basic units, see page 2/18 onwards.

Type	<b>3RT2035- 3XB40- 0LA2</b>	<b>3XF40- 0LA2</b>	<b>3RT2036- 3XB40- 0LA2</b>	<b>3XF40- 0LA2</b>	<b>3RT2037- 3XB40- 0LA2</b>	<b>3XF40- 0LA2</b>	<b>3RT2038- 3XB40- 0LA2</b>	<b>3XF40- 0LA2</b>	<b>3RT204.- 3XB40- 0LA2</b>	<b>3XF40- 0LA2</b>
Size	<b>S2</b>							<b>S3</b>		

##### General data

##### Ambient temperature

- During operation °C -40 ... +70
- During storage °C -55 ... +80

##### Control

<b>Solenoid coil operating range</b>	DC	0.7 ... 1.25 x U <sub>s</sub>								
<b>Power consumption of the solenoid coils</b>	For cold coil and 1.0 x U <sub>s</sub>									
• Contactors with solid-state operating mechanism	Closing	W	23	--	--	--	--	--	76	64
	Closed	W	1	--	--	--	--	--	1.8	1.0

##### Rated data of the main contacts

##### Load rating with AC

##### Minimum cross-section in the main circuit

- At maximum AC-1 rated value mm<sup>2</sup> 16 25 35 50
- At maximum I<sub>th</sub> rated value mm<sup>2</sup> 16 25 35 50

All details and technical specifications not mentioned here are identical to those of the basic units, see page 2/18 onwards.



## Switching devices – Contactors and contactor assemblies – Special applications

### Contactors for special applications

#### Contactors for railway applications > SIRIUS 3RT contactors with extended operating range, 3-pole

Type		3RT1054- .X.46- 0LA2	3RT1055- .X.46- 0LA2	3RT1056- .X.46- 0LA2	3RT1064- .X.46- 0LA2	3RT1065- .X.46- 0LA2	3RT1066- .X.46- 0LA2	3RT1075- .X.46- 0LA2	3RT1076- .X.46- 0LA2
Size		S6			S10		S12		
<b>General data</b>									
<b>Ambient temperature</b>									
• During operation	°C	-40 ... +70							
• During storage	°C	-55 ... +80							
<b>Control</b>									
• Solenoid coil closing for DC	W	320			580		800		
• Solenoid coil closed for DC	W	2.8			3.4		3.6		
• Control version of the switch operating mechanism		PLC-IN or standard A1 - A2 (can be set)							
<u>Actuated via A1/A2</u>									
• Rated control supply voltage	V DC	24, 72 or 110							
• Operating range		0.7 ... 1.25							
<u>Actuated via PLC input</u>									
• Rated voltage	V DC	24 ... 110							
• Operating range		0.7 ... 1.25							
• Consumed current at PLC control input according to IEC 60947-1, maximum	mA	2							
<b>Rated data of the main contacts</b>									
<b>Load rating with AC</b>									
<b>Minimum cross-section in the main circuit</b>									
• At maximum AC-1 rated value	mm <sup>2</sup>	70	95		150	185		300	370
• At maximum $I_{th}$ rated value	mm <sup>2</sup>	70	95		150	185		300	370
<b>Switching frequency</b>									
<b>Switching frequency z</b> in operating cycles/hour									
Contactors without overload relays									
• No-load switching frequency									
- Contactors with solid-state operating mechanism	1/h	1 000			700		500		
• Switching frequency z during rated operation (Dependence of the switching frequency z' on operational current I' and operational voltage U: $z' = z \cdot (I'/I) \cdot (U_0/U)^{1.5} \cdot 1/h$ )									
- Contactors with solid-state operating mechanism		$I_0/AC-1$ at 400 V h <sup>-1</sup>			800				
		$I_0/AC-2$ at 400 V h <sup>-1</sup>			400	300			
		$I_0/AC-3$ at 400 V h <sup>-1</sup>			1 000	750			
		$I_0/AC-4$ at 400 V h <sup>-1</sup>			130				
						700			
						250	300	250	
						500	700	500	
									500
									200
									170
									420

For all details and technical specifications not mentioned here, see <https://support.industry.siemens.com/cs/ww/en/ps/16177/td>.

Type		3RT1456- .X.46- 0LA2	3RT1466- .X.46- 0LA2	3RT1467- .X.46- 0LA2	3RT1476- .X.46- 0LA2
Size		S6	S10	S12	S12
<b>General data</b>					
<b>Ambient temperature</b>					
• During operation	°C	-40 ... +70			
• During storage	°C	-55 ... +80			
<b>Control</b>					
• Solenoid coil closing for DC		320	580		800
• Solenoid coil closed for DC		2.8	3.4		3.6
• Control version of the switch operating mechanism		PLC-IN or standard A1 - A2 (can be set)			
<u>Actuated via A1/A2</u>					
• Rated control supply voltage	V DC	24, 72 or 110			
• Operating range		0.7 ... 1.25			
<u>Actuated via PLC input</u>					
• Rated voltage	V DC	24 ... 110			
• Operating range		0.7 ... 1.25			
• Consumed current at PLC control input according to IEC 60947-1, maximum	mA	2			
<b>Rated data of the main contacts</b>					
<b>Load rating with AC</b>					
<b>Minimum cross-section in the main circuit</b>					
• At maximum AC-1 rated value	mm <sup>2</sup>	140	240	300	480
• At maximum $I_{th}$ rated value	mm <sup>2</sup>	140	240		480

For all details and technical specifications not mentioned here, see <https://support.industry.siemens.com/cs/ww/en/ps/16177/td>.

# Switching devices – Contactors and contactor assemblies – Special applications

## Contactors for special applications

Contactors for railway applications > SIRIUS 3RT contactors with extended operating range, 3-pole

**IE3/IE4 ready**

### Selection and ordering data

#### DC operation



3RT201.-2K.4.



3RT201.-2K.42-0LA0

Rated data according to IEC 60947-4-1					Auxiliary contacts		Rated control supply voltage $U_s$	Spring-loaded terminals 	Weight
AC-2 and AC-3, $t_u$ : 70 °C					Ident. No.	Version	Article No.		
Operational current $I_e$ up to	Ratings of three-phase motors at				NO	NC	V DC		kg
400 V	230 V	<b>400 V</b>	500 V	690 V					
A	kW	<b>kW</b>	kW	kW					

For screw fixing and snap-on mounting on TH 35 standard mounting rail

#### Size S00

##### Coupling contactors with integrated coil circuit

- Suppressor diode integrated at the factory

12	3	<b>5.5</b>	5.5	5.5	<b>10<sup>1)</sup></b>	1	--	24 110	<b>3RT2017-2KB41</b> <b>3RT2017-2KF41</b>	0.316 0.316
12	3	<b>5.5</b>	5.5	5.5	<b>01<sup>1)</sup></b>	--	1	24 110	<b>3RT2017-2KB42</b> <b>3RT2017-2KF42</b>	0.316 0.316

- Varistor integrated at the factory

12	3	<b>5.5</b>	5.5	5.5	<b>10<sup>1)</sup></b>	1	--	24 110	<b>3RT2017-2LB41</b> <b>3RT2017-2LF41</b>	0.317 0.318
12	3	<b>5.5</b>	5.5	5.5	<b>01<sup>1)</sup></b>	--	1	24 110	<b>3RT2017-2LB42</b> <b>3RT2017-2LF42</b>	0.319 0.319

##### With plug-on series resistor and integrated coil circuit

- Suppressor diode integrated at the factory

12	3	<b>5.5</b>	5.5	5.5	<b>--<sup>2)</sup></b>	--	1 <sup>3)</sup>	24 110	<b>3RT2017-2KB42-0LA0</b> <b>3RT2017-2KF42-0LA0</b>	0.347 0.322
16	4	<b>7.5</b>	10	11	<b>--<sup>2)</sup></b>	--	1 <sup>3)</sup>	24 110	<b>3RT2018-2KB42-0LA0</b> <b>3RT2018-2KF42-0LA0</b>	0.350 0.325

- Varistor integrated at the factory

12	3	<b>5.5</b>	5.5	5.5	<b>--<sup>2)</sup></b>	--	1 <sup>3)</sup>	24 110	<b>3RT2017-2LB42-0LA0</b> <b>3RT2017-2LF42-0LA0</b>	0.332 0.340
16	4	<b>7.5</b>	10	11	<b>--<sup>2)</sup></b>	--	1 <sup>3)</sup>	24 110	<b>3RT2018-2LB42-0LA0</b> <b>3RT2018-2LF42-0LA0</b>	0.333 0.327

<sup>1)</sup> It is not possible to mount an auxiliary switch. A clearance of 10 mm is required for side-by-side mounting at ambient temperatures > 60 °C.

<sup>2)</sup> One 4-pole auxiliary switch according to EN 50005 can be mounted from -40 to 70 °C; no clearance required.

<sup>3)</sup> NC contact cannot be used because it is used for switching of the series resistor.

Accessories and spare parts, see page 2/52 onwards.

# Switching devices – Contactors and contactor assemblies – Special applications

## Contactors for special applications

IE3/IE4 ready

Contactors for railway applications &gt; SIRIUS 3RT contactors with extended operating range, 3-pole

DC operation 

3RT201.-2X.41-0LA2



3RT201.-2X.42-0LA2



3RT202.-2K.40



3RT202.-2X.40-0LA2

Rated data acc. to		Auxiliary contacts				Rated control supply voltage $U_s$	Spring-loaded terminals 	Weight
IEC 60077-2	IEC 60947-4-1	Ratings of three-phase motors at		Ident. No.	Version	Article No.		
$t_{ij}$ : 70 °C	AC-3							
Conventional thermal current $I_{th}$ up to	$t_{ij}$ : 60 °C							
690 V	Operational current $I_e$ up to	230 V	400 V	500 V	690 V			
A	A	kW	kW	kW	kW	NO	NC	V DC

For screw fixing and snap-on mounting on TH 35 standard mounting rail

**Size S00**

With integrated coil circuit (varistor integrated in electronics at the factory)

18	12	3	5.5	5.5	5.5	10	1	--	24 ... 34 72 ... 125	3RT2017-2XB41-0LA2 3RT2017-2XF41-0LA2	0.310 0.313
18	12	3	5.5	5.5	5.5	01	--	1	24 ... 34 72 ... 125	3RT2017-2XB42-0LA2 3RT2017-2XF42-0LA2	0.310 0.310
18	16	4	7.5	10	11	10	1	--	24 ... 34 72 ... 125	3RT2018-2XB41-0LA2 3RT2018-2XF41-0LA2	0.310 0.300
18	16	4	7.5	10	11	01	--	1	24 ... 34 72 ... 125	3RT2018-2XB42-0LA2 3RT2018-2XF42-0LA2	0.320 0.310

**Size S0**

With integrated coil circuit

• Coupling contactors with varistor integrated at the factory

--	17	4	7.5	10	11	11 <sup>1)</sup>	1	1	24 110	3RT2025-2KB40 3RT2025-2KF40	0.643 0.627
--	25	5.5	11	11	11	11 <sup>1)</sup>	1	1	24 110	3RT2026-2KB40 3RT2026-2KF40	0.643 0.629
--	32	7.5	15	18.5	18.5	11 <sup>1)</sup>	1	1	24 110	3RT2027-2KB40 3RT2027-2KF40	0.650 0.639

• Varistor integrated in electronics at the factory

30	17	4	7.5	10	11	11	1	1	24 110	3RT2025-2XB40-0LA2 3RT2025-2XF40-0LA2	0.612 0.578
30	25	5.5	11	11	11	11	1	1	24 110	3RT2026-2XB40-0LA2 3RT2026-2XF40-0LA2	0.613 0.583
36	32	7.5	15	18.5	18.5	11	1	1	24 110	3RT2027-2XB40-0LA2 3RT2027-2XF40-0LA2	0.617 0.591
38	38	7.5	18.5	18.5	18.5	11	1	1	24 110	3RT2028-2XB40-0LA2 3RT2028-2XF40-0LA2	0.620 0.594

<sup>1)</sup> It is not possible to mount an auxiliary switch. A clearance of 10 mm is required for side-by-side mounting at ambient temperatures > 60 °C.

Accessories and spare parts, see page 2/52 onwards.

# Switching devices – Contactors and contactor assemblies – Special applications

## Contactors for special applications

Contactors for railway applications > SIRIUS 3RT contactors with extended operating range, 3-pole

**IE3/IE4 ready**

**DC operation**

2



3RT203.-3X.40-0LA2



3RT204.-3X.40-0LA2

Rated data acc. to		Ratings of three-phase motors at				Auxiliary contacts		Rated control supply voltage $U_c$		Spring-loaded terminals for auxiliary and control circuits	Weight
IEC 60077-2	IEC 60947-4-1	230 V	400 V	500 V	690 V	Ident. No.	Version	V DC			
$t_{ij}$ : 70 °C	$t_{ij}$ : 60 °C										
Conventional thermal current $I_{th}$ up to	Operational current $I_e$ up to										
690 V	400 V	230 V	400 V	500 V	690 V						
A	A	kW	kW	kW	kW						kg

For screw fixing and snap-on mounting on TH 35 standard mounting rail

### Size S2

With integrated coil circuit (varistor integrated in electronics at the factory)

50	40	11	18.5	22	22	11	1	1	24	110	3RT2035-3XB40-0LA2	1.109
											3RT2035-3XF40-0LA2	1.115
55	50	15	22	30	22	11	1	1	24	110	3RT2036-3XB40-0LA2	1.110
											3RT2036-3XF40-0LA2	1.115
60	65	18.5	30	37	37	11	1	1	24	110	3RT2037-3XB40-0LA2	1.113
											3RT2037-3XF40-0LA2	1.117
75	80	22	37	37	45	11	1	1	24	110	3RT2038-3XB40-0LA2	1.109
											3RT2038-3XF40-0LA2	1.128

For screw fixing and snap-on mounting on TH 35-15 and TH 75-15 standard mounting rails

### Size S3

With integrated coil circuit (varistor integrated in electronics at the factory)

90	80	22	37	45	55	11	1	1	24	110	3RT2045-3XB40-0LA2	1.824
											3RT2045-3XF40-0LA2	1.817
95	95	22	45	55	75	11	1	1	24	110	3RT2046-3XB40-0LA2	1.826
											3RT2046-3XF40-0LA2	1.820
95	110	30	55	75	75	11	1	1	24	110	3RT2047-3XB40-0LA2	1.828
											3RT2047-3XF40-0LA2	1.827

Accessories and spare parts, see page 2/52 onwards.

## Switching devices – Contactors and contactor assemblies – Special applications

### Contactors for special applications

**IE3/IE4 ready** Contactors for railway applications > SIRIUS 3RT contactors with extended operating range, 3-pole

#### DC operation

- Solid-state operating mechanism with 24 to 110 V DC control signal input
- For screw fixing
- Auxiliary and control conductors: Spring-loaded terminals
- Main conductors: Busbar connections; a connection kit with screws, spring washers and nuts is enclosed.





3RT105.-2X.46-0LA2



3RT106.-2X.46-0LA2



3RT107.-2X.46-0LA2

Size	Rated data acc. to IEC 60077-2	IEC 60947-4-1 AC-3	Auxiliary contacts, lateral	Rated control supply voltage $U_s$	<b>Spring-loaded terminals</b> 	Weight
	$t_d$ : 70 °C Conventional thermal current $I_{th}$ up to	$t_d$ : 60 °C Operational current $I_e$ up to	Version			
	690 V	400 V	 	V DC	Article No.	kg
A		A	NO NC			

#### Solid-state operating mechanism

With control signal input 24 ... 110 V DC  
e. g. for control by PLC

With integrated coil circuit (varistor integrated in electronics at the factory)

Size	$I_{th}$ [A]	$I_e$ [A]	NO	NC	$U_s$ [V DC]	Article No.	Weight [kg]
<b>S6</b>	120	115	2	2	24	<b>3RT1054-2XB46-0LA2</b>	3.336
					72	<b>3RT1054-2XJ46-0LA2</b>	3.355
					110	<b>3RT1054-2XF46-0LA2</b>	3.278
	140	150	2	2	24	<b>3RT1055-2XB46-0LA2</b>	3.411
					72	<b>3RT1055-2XJ46-0LA2</b>	3.265
					110	<b>3RT1055-2XF46-0LA2</b>	3.350
	145	185	2	2	24	<b>3RT1056-2XB46-0LA2</b>	3.420
					72	<b>3RT1056-2XJ46-0LA2</b>	3.259
					110	<b>3RT1056-2XF46-0LA2</b>	3.403
<b>S10</b>	215	225	2	2	24	<b>3RT1064-2XB46-0LA2</b>	6.461
					72	<b>3RT1064-2XJ46-0LA2</b>	6.462
					110	<b>3RT1064-2XF46-0LA2</b>	6.530
	265	265	2	2	24	<b>3RT1065-2XB46-0LA2</b>	6.482
					72	<b>3RT1065-2XJ46-0LA2</b>	6.700
					110	<b>3RT1065-2XF46-0LA2</b>	6.610
	265	300	2	2	24	<b>3RT1066-2XB46-0LA2</b>	6.654
					72	<b>3RT1066-2XJ46-0LA2</b>	6.800
					110	<b>3RT1066-2XF46-0LA2</b>	6.618
<b>S12</b>	350	400	2	2	24	<b>3RT1075-2XB46-0LA2</b>	10.340
					72	<b>3RT1075-2XJ46-0LA2</b>	10.497
					110	<b>3RT1075-2XF46-0LA2</b>	10.283
	475	500	2	2	24	<b>3RT1076-2XB46-0LA2</b>	10.496
					72	<b>3RT1076-2XJ46-0LA2</b>	1.034
					110	<b>3RT1076-2XF46-0LA2</b>	10.411

Accessories and spare parts, see page 2/52 onwards.

## Switching devices – Contactors and contactor assemblies – Special applications

### Contactors for special applications

#### Contactors for railway applications > SIRIUS 3RT contactors with extended operating range, 3-pole

##### DC operation

- Solid-state operating mechanism with 24 to 110 V DC control signal input
- For screw fixing
- Auxiliary and control conductors: Spring-loaded terminals
- Main conductors: Busbar connections; a connection kit with screws, spring washers and nuts is enclosed.



3RT1456-2X.46-0LA2



3RT146.-2X.46-0LA2



3RT1476-2X.46-0LA2

Size	Rated data acc. to IEC 60077-2	IEC 60947-4-1 AC-1	Auxiliary contacts, lateral	Rated control supply voltage $U_s$	<b>Spring-loaded terminals</b> 	Weight
	$t_{ij}$ : 70 °C Conventional thermal current $I_{th}$ up to 690 V	$t_{ij}$ : 40 °C Operational current $I_e$ up to 400 V	Version			
A	A	A	NO NC	V DC	Article No.	kg

##### Solid-state operating mechanism

##### With control signal input 24 ... 110 V DC

##### e. g. for control by PLC

##### With integrated coil circuit (varistor integrated in electronics at the factory)

Size	Rated current $I_{th}$ [A]	Rated current $I_e$ [A]	NO contacts	NC contacts	Control voltage $U_s$ [V DC]	Article No.	Weight [kg]
S6	190	275	2	2	24	3RT1456-2XB46-0LA2	3.400
					72	3RT1456-2XJ46-0LA2	3.400
					110	3RT1456-2XF46-0LA2	3.342
S10	330	400	2	2	24	3RT1466-2XB46-0LA2	6.561
					72	3RT1466-2XJ46-0LA2	6.580
					110	3RT1466-2XF46-0LA2	6.707
	330	500	2	2	24	3RT1467-2XB46-0LA2	6.535
					72	3RT1467-2XJ46-0LA2	6.580
					110	3RT1467-2XF46-0LA2	6.707
S12	520	690	2	2	24	3RT1476-2XB46-0LA2	10.415
					72	3RT1476-2XJ46-0LA2	10.199
					110	3RT1476-2XF46-0LA2	10.085

Accessories and spare parts, [see page 2/52 onwards](#).

# Switching devices – Contactors and contactor assemblies – Special applications

## Contactors for special applications

### Contactors for railway applications > SIRIUS 3RH2 contactor relays with extended operating range

#### Overview

##### Standards

IEC 60947-5-1

The contactor relays are finger-safe according to IEC 60529. The size S00 contactor relays have spring-loaded connections for all terminals.

##### Ambient temperature

The permissible ambient temperature for operation of the contactor relays (across the full coil operating range) is -40 to +70 °C.

Uninterrupted duty at temperatures > +60 °C reduces the mechanical service life, the current carrying capacity of the conducting paths and the switching frequency.

##### Control and auxiliary circuits

The solenoid coils of the contactor relays have an extended coil operating range from 0.7 to 1.25 x  $U_s$  and are fitted as standard with surge suppressors. The opening delay is consequently 2 to 5 ms longer than for standard contactors.

#### Application

For operation in installations that are subject both to considerable variations in the control voltage and to high ambient temperatures, e. g. railway applications under extreme climatic conditions, rolling mills, etc.

Also for control supply voltages with battery buffering to extend the operating time in the event of battery charge failure.

##### Contactor relays with conventional coil

###### Control and auxiliary circuits

These contactor relays have an extended operating range from 0.7 to 1.25 x  $U_s$ ; the solenoid coils are fitted with suppressor diodes as standard. An additional series resistor is not required.

###### Note:

An additional auxiliary switch cannot be mounted.

###### Side-by-side mounting

A clearance of 10 mm is required for side-by-side mounting at ambient temperatures > 60 °C ≤ 70 °C.

##### Contactor relays with series resistor

###### Control and auxiliary circuits

The DC solenoid systems of the contactor relays are modified (to holding coil) by means of a series resistor.

The size S00 contactor relays are supplied prewired with a plug-on module containing the series resistor. A surge suppressor (a suppressor diode or varistor as preferred) is integrated.

A 4-pole auxiliary switch (according to EN 50005) can be mounted additionally.

###### Side-by-side mounting

Side-by-side mounting is permissible at ambient temperatures up to 70 °C.

##### Contactor relays with solid-state operating mechanism

###### Control and auxiliary circuits

The solenoid coils of these contactor relays have an extended coil operating range from 0.7 to 1.25 x  $U_s$  and are fitted as standard with varistors to provide protection against overvoltage.

The contactor relays are energized via upstream control electronics which ensure the coil operating range of 0.7 to 1.25 x  $U_s$  at an ambient temperature of 70 °C. They are supplied as complete units with integrated coil electronics. A varistor is integrated for damping opening surges in the coil.

###### Side-by-side mounting

Side-by-side mounting is permissible at ambient temperatures up to 70 °C.

#### Technical specifications

More information	
Technical specifications, see <a href="https://support.industry.siemens.com/cs/ww/en/ps/16174/td">https://support.industry.siemens.com/cs/ww/en/ps/16174/td</a> FAQs, see <a href="https://support.industry.siemens.com/cs/ww/en/ps/16174/faq">https://support.industry.siemens.com/cs/ww/en/ps/16174/faq</a>	Manuals, see <a href="https://support.industry.siemens.com/cs/ww/en/ps/16174/man">https://support.industry.siemens.com/cs/ww/en/ps/16174/man</a>
Contactor relays	Type <b>3RH21..-2K, -2L</b> <b>3RH2122-2XB40-0LA2</b> <b>3RH2122-2XF40-0LA2</b>
General data	
<b>Upright mounting position</b>	Special version (on request) Special version (on request)
• Contactors with series resistor • Contactors with conventional coil	
Ambient temperature	
• During operation	°C -40 ... +70 <sup>1)</sup>
• During storage	°C -55 ... +80
Control	
<b>Solenoid coil operating range</b>	DC 0.7 ... 1.25 x $U_s$
<b>Power consumption of the solenoid coils</b>	For cold coil and 1.0 x $U_s$
• Contactors with series resistor	- Closing W 13      --      -- - Closed W 4      --      --
• Contactors with conventional coil	- Closing W 2.8      --      -- - Closed W 2.8      --      --
• Contactors with solid-state operating mechanism	- Closing W --      4      4.5 - Closed W --      0.95      0.75

<sup>1)</sup> 3RH21...-K contactor relays without article number suffix "-0LA." are coupling contactor relays that are certified for the temperature range -25 to +60 °C. For railway applications, an additional certification approves these contactors with a minimum clearance of 10 mm for the extended temperature range from -40 to +70 °C.

All details and technical specifications not mentioned here are identical to those of the 3RH2 basic units, see page 2/125 onwards.



## Switching devices – Contactors and contactor assemblies – Special applications

### Contactors for special applications

#### Contactors for railway applications > SIRIUS 3RH2 contactor relays with extended operating range

#### Selection and ordering data

##### DC operation

2



3RH2122-2K.40



3RH2122-2K.40-0LA0

Rated operational current				Contacts Ident. No. acc. to EN 50011	Version	Rated control supply voltage $U_s$	Spring-loaded terminals 	Weight
$I_n$ /AC-15/AC-14 $t_{ij}$ : 70 °C at								
230 V	400 V	500 V	690 V				Article No.	kg
A	A	A	A		NO NC	V DC		

For screw fixing and snap-on mounting on TH 35 standard mounting rail

#### Size S00

##### With integrated coil circuit

- Suppressor diode integrated at the factory

10	3	2	1	22E	2	2 <sup>1)</sup>	24 110	3RH2122-2KB40 3RH2122-2KF40	0.316 0.309
				31E	3	1 <sup>1)</sup>	24	3RH2131-2KB40	0.316
				40E	4	0 <sup>1)</sup>	24	3RH2140-2KB40	0.315

- Varistor integrated at the factory

10	3	2	1	22E	2	2 <sup>1)</sup>	24 110	3RH2122-2LB40 3RH2122-2LF40	0.320 0.317
----	---	---	---	-----	---	-----------------	-----------	--------------------------------	----------------

##### With plug-on series resistor and integrated coil circuit

- Suppressor diode integrated at the factory

10	3	2	1	21X	2	1 <sup>2)</sup>	24 110	3RH2122-2KB40-0LA0 3RH2122-2KF40-0LA0	0.331 0.322
----	---	---	---	-----	---	-----------------	-----------	--	----------------

- Varistor integrated at the factory

10	3	2	1	21X	2	1 <sup>2)</sup>	24 110	3RH2122-2LB40-0LA0 3RH2122-2LF40-0LA0	0.332 0.323
----	---	---	---	-----	---	-----------------	-----------	--	----------------

##### With integrated coil circuit (varistor integrated in electronics at the factory)

10	3	2	1	22E	2	2 <sup>2)</sup>	24 ... 34 72 ... 125	3RH2122-2XB40-0LA2 3RH2122-2XF40-0LA2	0.310 0.310
----	---	---	---	-----	---	-----------------	-------------------------	--	----------------

<sup>1)</sup> It is not possible to mount an auxiliary switch.

<sup>2)</sup> 4-pole auxiliary switch according to EN 50005 can be mounted.

Accessories, see page 2/52 onwards.

Other voltages on request.

# Switching devices – Contactors and contactor assemblies – Special applications

## Contactors for special applications

### Contactors for railway applications > 3TC contactors for switching DC voltage, 2-pole

#### Overview

##### Standards

IEC 60947-4-1

The contactors are finger-safe according to IEC 60529 (exception: series resistor). Terminal covers may have to be fitted onto the connecting bars, depending on the configuration with other devices.

All details and technical specifications not mentioned here are identical to those of the standard 3TC contactors, see page 2/114.

##### Ambient temperature

The permissible ambient temperature for operation of the contactors (across the full coil operating range) is -50 to +70 °C. Uninterrupted duty at temperatures < -25 °C and > +55 °C reduces the mechanical service life, the current carrying capacity of the conducting paths and the switching frequency.

A clearance of 10 mm is required for side-by-side mounting of size 2 contactors at ambient temperatures > 55 °C. There is no need to reduce the technical specifications.

##### Series resistor

The DC solenoid systems of the 3TC contactors must be modified (to holding coil) by means of a series resistor. This series resistor is supplied separately packed with the contactors.

With types 3TC48, the series resistor must be attached onto the right-hand side of the auxiliary switch by means of the enclosed mounting parts and sets of links provided, while in the case of the 3TC44 it must be mounted and wired between the contactor poles. With types 3TC52 and 3TC56, the series resistor must be attached separately next to the contactors.

##### Auxiliary contacts

The contactors are equipped with two lateral auxiliary switches each with 1 NO + 1 NC contact. Further auxiliary switches cannot be mounted on the DC-operated contactors.

One NC contact is required for the series resistor function. Two NO contacts and one NC contact are thus unassigned.

##### Reversing contactors

With the 3TC52 and 3TC56 contactors, the series resistor must be connected using an additional K2 reversing contactor. This contactor is automatically included in the scope of supply.

##### Dimensions

Attaching resistors and varistors increases the width of the contactors.

#### Application

For operation in installations which are subject both to considerable variations in the control voltage and to high ambient temperatures, e.g. in railway applications.

##### Control and auxiliary circuits

The solenoid coils of the contactors have an extended coil operating range from 0.7 to 1.25 x  $U_s$  and are fitted as standard with varistors to provide protection against overvoltage. The opening delay is consequently 2 to 5 ms longer than for standard contactors.

#### Technical specifications

More information					
Technical specifications, see <a href="https://support.industry.siemens.com/cs/ww/en/ps/16180/td">https://support.industry.siemens.com/cs/ww/en/ps/16180/td</a>		Manuals, see <a href="https://support.industry.siemens.com/cs/ww/en/ps/16180/man">https://support.industry.siemens.com/cs/ww/en/ps/16180/man</a>			
Type		<b>3TC44</b>	<b>3TC48</b>	<b>3TC52</b>	<b>3TC56</b>
Size		<b>2</b>	<b>4</b>	<b>8</b>	<b>12</b>
General data					
<b>Ambient temperature</b>					
• During operation	°C	-40 ... +70			
Control					
<b>Solenoid coil operating range</b>		0.7 ... 1.25 x $U_s$			
<b>Power consumption of the solenoid coils</b>		For cold coil and 1.0 x $U_s$			
• Closing	W	48	26	40	130
• Closed	W	13	14	21	59

All details and technical specifications not mentioned here are identical to those of the basic units of the 3TC contactors, see page 2/114.

## Switching devices – Contactors and contactor assemblies – Special applications

### Contactors for special applications

#### Contactors for railway applications > 3TC contactors for switching DC voltage, 2-pole

#### Selection and ordering data

##### DC operation

3TC44: For screw fixing and snap-on mounting on 35 mm standard mounting rail  
3TC48 to 3TC56: For screw fixing



3TC48

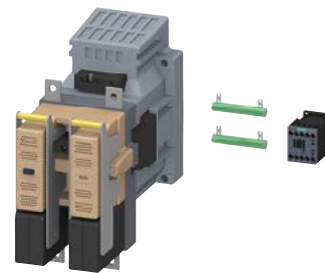

3TC56 with reversing contactor

Size	Utilization category	Rated operational current $I_e$ at	Rated power of loads at					Auxiliary contacts <sup>1)</sup>		Rated control supply voltage $U_s$	Screw terminals 	Weight
			750 V	220 V	440 V	600 V	750 V	Version				
		A	kW	kW	kW	kW	kW	NO	NC	V DC		kg

#### Contactors for switching DC voltage

##### With integrated coil circuit (varistor integrated at the factory)

2	DC-1	32	7	14	19.2	24	2	1 <sup>2)</sup>	24	<b>3TC4417-0LB4</b>	1.322
	DC-3/DC-5	7.5	5	9	9	4			110	<b>3TC4417-0LF4</b>	1.304

##### With laterally mounted coil circuit (varistor mounted externally in additional auxiliary switch enclosure on the contactor)

4	DC-1	75	16.5	33	45	56	2	1 <sup>2)</sup>	24	<b>3TC4817-0LB4</b>	4.700
	DC-3/DC-5	75	13	27	38	45			110	<b>3TC4817-0LF4</b>	4.630
8	DC-1	170	48	97	132	165	2	1 <sup>2)</sup>	24	<b>3TC5217-0LB4</b>	10.400
	DC-3/DC-5	170	41	82	110	110			110	<b>3TC5217-0LF4</b>	10.334
12	DC-1	400	88	176	240	300	2	1 <sup>2)</sup>	24	<b>3TC5617-0LB4</b>	24.450
	DC-3/DC-5	400	70	140	200	250			110	<b>3TC5617-0LF4</b>	21.837

<sup>1)</sup> No expansion auxiliary contacts can be fitted.

<sup>2)</sup> One NC contact used for series resistor.

Other rated control supply voltages according to page 2/121 on request.

#### Accessories

Accessories, see basic units of the 3TC contactors, page 2/121 onwards.

##### Spare parts for contactors with extended operating range

For contactors		Remarks	Rated control supply voltage $U_s$	Article No.	Weight
Size	Type		V DC		kg
<b>Arc chutes</b>					
2	3TC4417-0L..	With cutout for resistor mounting	--	<b>3TY2442-0B</b>	0.160
<b>Solenoid coils</b>					
2	3TC44	With series resistor, without varistor	24 110	<b>3TY6443-0LB4</b> <b>3TY6443-0LF4</b>	0.364 0.345
4	3TC48		24 110	<b>3TY6483-0LB4</b> <b>3TY6483-0LF4</b>	1.239 1.167

All spare parts not mentioned here are identical to those of the basic units of the 3TC contactors, see page 2/123.

## Switching devices – Contactors and contactor assemblies – Special applications

### Contactors for special applications

#### 3TC contactors for switching DC voltage, 1- and 2-pole

##### Overview

##### 3TC4 and 3TC5

IEC 60947-1, IEC 60947-4-1, IEC 60947-5-1 (auxiliary switches)

The contactors are finger-safe according to IEC 60529. Terminal covers may have to be fitted onto the connecting bars, depending on the configuration with other devices.

The DC motor ratings given in the tables are applicable to the DC-3 and DC-5 utilization categories with 2-pole switching of the load or with the two conducting paths of the contactor connected in series.

One contactor conducting path can switch full power up to 220 V. For voltages over 220 V, the two conducting paths are to be switched in series, [see rated data of the main contacts, page 2/116](#).

##### Surge suppression

Contactors supplied without a coil circuit can be retrofitted with RC elements, varistors, diodes or diode assemblies (combination of diode and Zener diode for short break times) for damping opening surges in the coil, [see page 2/122 onwards](#).

##### Note:

The break times of the contactor, the opening delay times of the NO contacts and the closing delay times of the NC contacts increase if the contactor coils are damped against voltage peaks. Different accessories are available for the contactors (time change with: Interference suppression diode 6x to 10x; diode assembly 2x to 6x; suppressor diode +1 to 5 ms; varistor +2 to 5 ms).

For details, [see Equipment Manual](#).

##### Auxiliary contacts

The contactors are equipped with two lateral auxiliary switches each with 1 NO + 1 NC contact. On the 3TC48 to 3TC56 contactors with AC operation, a second auxiliary switch can be mounted on the right and left. On contactors with DC operation, expansion of the auxiliary contacts is not possible.

##### Application

The contactors are suitable for switching and controlling DC motors as well as all other DC circuits.

##### 3TC7

IEC 60947-4-1

The contactors are suitable for use in any climate. They are suitable for switching and controlling DC motors as well as all other DC circuits.

The solenoid excitation is configured for a particularly large operating range. It is between 0.7 or 0.8 and  $1.2 \times U_g$ .

3TC74 contactors can be used at up to 750 V/400 A and 50 Hz in AC-1 operation. For voltages over 750 V, the two conducting paths (3TC74: two contactors) are to be switched in series, [see rated data of the main contacts, page 2/118](#).

## Switching devices – Contactors and contactor assemblies – Special applications

### Contactors for special applications

#### 3TC contactors for switching DC voltage, 1- and 2-pole

##### Technical specifications

###### More information

Technical specifications, see  
<https://support.industry.siemens.com/cs/ww/en/ps/16181/td>  
 FAQs, see  
<https://support.industry.siemens.com/cs/ww/en/ps/16181/faq>

Manuals, see  
<https://support.industry.siemens.com/cs/ww/en/ps/16181/man>

Type	3TC4 and 3TC7		3TC5
<b>Rated data of the auxiliary contacts</b>			
<b>Rated insulation voltage <math>U_i</math></b> (pollution degree 3)	V	690	
<b>Conventional thermal current <math>I_{th}</math> = rated operational current <math>I_e/AC-12</math></b>	A	10	10
<b>AC load</b>			
<b>Rated operational current <math>I_e/AC-15/AC-14</math></b>			
• At rated operational voltage $U_e$			
	24 V A	10	10
	110 V A	10	10
	125 V A	10	10
	220 V A	6	6
	230 V A	5.6	5.6
	380 V A	4	4
	400 V A	3.6	3.6
	500 V A	2.5	2.5
	660 V A	2.5	2.5
	690 V A	--	--
<b>DC load</b>			
<b>Rated operational current <math>I_e/DC-12</math></b>			
• At rated operational voltage $U_e$			
	24 V A	10	10
	60 V A	10	10
	110 V A	3.2	8
	125 V A	2.5	6
	220 V A	0.9	2
	440 V A	0.33	0.6
	600 V A	0.22	0.4
<b>Rated operational current <math>I_e/DC-13</math></b>			
• At rated operational voltage $U_e$			
	24 V A	10	10
	48 V A	5	5
	110 V A	1.14	2.4
	125 V A	0.98	2.1
	220 V A	0.48	1.1
	440 V A	0.13	0.32
	600 V A	0.07	0.21
<b>3TC44 to 3TC56</b>			
<b>Ⓢ and Ⓣ rated data of the auxiliary contacts</b>			
<b>Rated voltage, max.</b>	V AC	600	
<b>Switching capacity</b>		A 600, P 600	

# Switching devices – Contactors and contactor assemblies – Special applications

## Contactors for special applications

### 3TC contactors for switching DC voltage, 1- and 2-pole

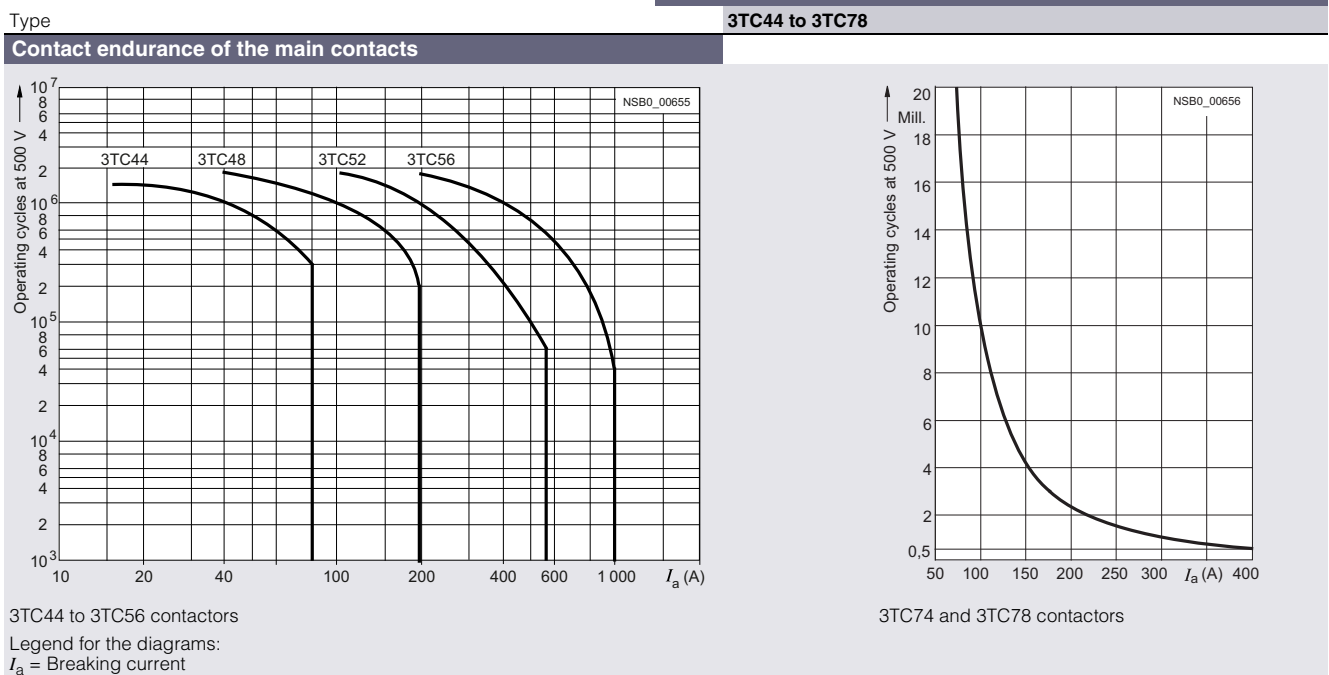

Contactor	Type	3TC44	3TC48	3TC52	3TC56	
	Size	2	4	8	12	
<b>General data</b>						
<b>Dimensions (W x H x D)</b>						
<ul style="list-style-type: none"> <li>DC operation</li> <li>AC operation</li> </ul>		mm	70 x 85 x 141	100 x 183 x 180	135 x 238 x 232	160 x 279 x 310
		mm	70 x 85 x 100	100 x 183 x 154	135 x 238 x 200	160 x 279 x 251
<b>Permissible mounting position</b>						
The contactors are designed for operation on a vertical mounting surface.						
<b>Mechanical service life</b>	Operating cycles	10 million				
<b>Electrical endurance</b>		See the endurance diagram above				
<b>Rated insulation voltage <math>U_i</math></b> (pollution degree 3)	V	800		1 000		
<b>Rated impulse withstand voltage <math>U_{imp}</math></b>	kV	8				
<b>Protective separation</b> between the coil and the main contacts acc. to IEC 60947-1, Annex N	V	Up to 300		Up to 660		
<b>Mirror contacts<sup>1)</sup></b> A mirror contact is an auxiliary NC contact that cannot be closed simultaneously with an NO main contact.		Yes, acc. to IEC 60947-4-1, Annex F				
<b>Permissible ambient temperature</b>						
• During operation	°C	-25 ... +55				
• During storage	°C	-50 ... +80				
<b>Degree of protection IP on the front</b> according to IEC 60529		IP00 (IP20 with cover)				
<b>Touch protection on the front</b> acc. to IEC 60529		-- Finger-safe for vertical touching from the front with cover				
<b>Shock resistance</b>	Rectangular pulse	g/ms	7.5/5 and 3.4/10	10/5 and 5/10	12/5 and 5.5/10	12/5 and 5.6/10
<b>Short-circuit protection</b>						
<b>Main circuit</b>						
• Type of coordination "1"			2 x 3NA3020 (50 A) in series	2 x 3NA31.. (160 A) in series	3NE1332-4D (400 A)	2 x 3NE1330-4D (315 A) parallel
• Type of coordination "2"			2 x 3NA3020 (50 A) in series	2 x 3NA31.. (63 A) in series	3NE1332-4D (400 A)	2 x 3NE1330-4D (315 A) parallel
<b>Auxiliary circuit</b> (short-circuit current $I_k \leq 1$ kA)						
• Fuse links, operational class gG: DIAZED, type 5SB; NEOZED, type 5SE	A	16				
• Miniature circuit breaker with C characteristic	A	10				

<sup>1)</sup> For 3TC44, one NC contact each must be connected in series for the right and left auxiliary switch respectively.

Rated data of the auxiliary contacts, see page 2/114.

# Switching devices – Contactors and contactor assemblies – Special applications

## Contactors for special applications

### 3TC contactors for switching DC voltage, 1- and 2-pole

Type			3TC44	3TC48	3TC52	3TC56
Size			2	4	8	12
<b>Control</b>						
<b>Solenoid coil operating range</b>						
• DC operation			0.7 ... 1.25 x $U_s$			
• AC operation			0.8 ... 1.1 x $U_s$			
<b>Power consumption of the solenoid coils</b> (for cold coil and 1.0 x $U_s$ )						
• DC operation	Closing = Closed	W	10	19	30	86
• AC operation, 50 Hz coil	Closing	VA/p.f.	68/0.86	300/0.5	640/0.48	1 780/0.3
	Closed	VA/p.f.	10/0.29	26/0.24	46/0.23	121/0.22
• AC operation, 60 Hz coil	Closing	VA/p.f.	95/0.79	365/0.45	730/0.38	2 140/0.3
	Closed	VA/p.f.	12/0.3	35/0.26	56/0.24	140/0.29
• AC operation, 50/60 Hz coil	Closing	VA/p.f.	79/73/0.83/0.78	--	--	--
	at 50/60 Hz					
	Closed	VA/p.f.	11/9/0.28/0.27	--	--	--
<b>Operating times within operating range</b>						
Total break time = Opening delay + Arcing time						
• DC operation	Closing delay	ms	35 ... 190	90 ... 380	120 ... 400	110 ... 400
	Opening delay	ms	10 ... 25	17 ... 28	22 ... 35	40 ... 110
• AC operation	Closing delay	ms	10 ... 40	20 ... 50		
	Opening delay	ms	5 ... 25	5 ... 30	10 ... 30	
• Arcing time	DC-1	ms	20			
	DC-3/DC-5	ms	30			
<b>Rated data of the main contacts</b>						
<b>Load rating with DC</b>						
<b>Utilization category DC-1, (<math>L/R \leq 1</math> ms)</b>						
• Rated operational currents $I_e$ (at 55 °C)	Up to $U_0$ 750 V	A	32	75	220	400
• Minimum conductor cross-section		mm <sup>2</sup>	6	25	95	240
• Rated power at $U_0$ ( $\leq 220$ V DC: one conducting path, > 220 V DC: two conducting paths in series)	At 220 V	kW	7	16.5	48	88
	440 V	kW	14	33	97	176
	600 V	kW	19.2	45	132	240
	750 V	kW	24	56	165	300
<b>Utilization category DC-3 and DC-5, shunt-wound and series-wound motors (<math>L/R \leq 15</math> ms)</b>						
• Rated operational currents $I_e$ (at 55 °C)	Up to 220 V	A	32	75	220	400
	440 V	A	29	75	220	400
	600 V	A	21	75	220	400
	750 V	A	7.5	75	170	400
	At 110 V	kW	2.5	6.5	20	35
• Rated power at $U_0$ ( $\leq 220$ V DC: one conducting path, > 220 V DC: two conducting paths in series)	220 V	kW	5	13	41	70
	440 V	kW	9	27	82	140
	600 V	kW	9	38	110	200
	750 V	kW	4	45	110	250
<b>Switching frequency</b>						
<b>Switching frequency z</b> in operating cycles/hour						
AC/DC operation						
• For weak or non-inductive load DC-1		h <sup>-1</sup>	1 500	1 000		
• For inductive load DC-3/DC-5		h <sup>-1</sup>	750	600		
<b>Conductor cross-sections</b>						
<b>Main conductors</b> (1 or 2 conductors can be connected)						
• Solid		mm <sup>2</sup>	2 x (2.5 ... 10)	2 x (6 ... 16)	--	
• Finely stranded with end sleeve		mm <sup>2</sup>	2 x (1.5 ... 4)	--		
• Stranded with cable lug		mm <sup>2</sup>	2 x 16	2 x 35	2 x 120	2 x 150
• Pin-end connector to DIN 46231		mm <sup>2</sup>	2 x (1 ... 6)	--		
• Busbars		mm	--	15 x 2.5	25 x 4	2 x (25 x 3)
• Terminal screw			M5	M6	M10	
<b>Auxiliary conductors</b> (1 or 2 conductors can be connected)						
• Solid		mm <sup>2</sup>	2 x (1 ... 2.5)			
• Finely stranded with end sleeve		mm <sup>2</sup>	2 x (0.75 ... 1.5)			

Rated data of the auxiliary contacts, see page 2/114.



# Switching devices – Contactors and contactor assemblies – Special applications

## Contactors for special applications

### 3TC contactors for switching DC voltage, 1- and 2-pole

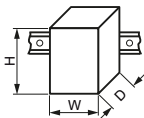
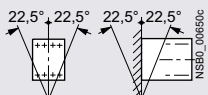
Type	3TC74		3TC78	
Design	1-pole contactors		2-pole contactors	
<b>General data</b>				
<b>Dimensions (W x H x D)</b>		mm	78 x 352 x 276	160 x 366 x 290
<b>Permissible mounting position</b>	The contactors are designed for operation on a vertical mounting surface.			
<b>Mechanical service life</b>	Operating cycles		30 million	
<b>Electrical endurance</b>	See page 2/115			
<b>Rated insulation voltage <math>U_i</math></b> (pollution degree 3)	V		1 500	
<b>Rated impulse withstand voltage <math>U_{imp}</math></b>	kV		8	
<b>Protective separation</b> between the coil and the main contacts acc. to IEC 60947-1, Annex N	V		630	
<b>Mirror contacts<sup>1)</sup></b> A mirror contact is an auxiliary NC contact that cannot be closed simultaneously with an NO main contact.			Yes, according to IEC 60947-4-1, Annex F	
<b>Permissible ambient temperature</b>	°C		-25 ... +55	
<b>Degree of protection IP on the front</b> according to IEC 60529			IP00	
<b>Short-circuit protection</b>				
<b>Main circuit</b>				
• Type of coordination "1"	A		2 x 3NE1330-4D (315 A) parallel	2 x 3NE1330-5E (315 A) parallel
• Type of coordination "2"	A		2 x 3NE1330-4D (315 A) parallel	2 x 3NE1330-5E (315 A) parallel
<b>Auxiliary circuit</b> (Short-circuit current $I_k \leq 1$ kA)				
• Fuse links, operational class gG: DIAZED, type 5SB; NEOZED, type 5SE	A		16	
• Miniature circuit breaker with C characteristic	A		10	
<b>Control</b>				
<b>Solenoid coil operating range</b>				
• DC operation	At $U_c = 24$ V		0.8 ... 1.2 x $U_s$	
	At $U_c > 24$ V		0.7 ... 1.2 x $U_s$	
• AC operation	At $U_c = 24$ V		0.7 ... 1.15 x $U_s$	
	At $U_c > 24$ V		0.7 ... 1.14 x $U_s$	
<b>Power consumption of the solenoid coils</b> (For cold coil and $1.0 \times U_s$ )				
• DC operation	Closing = Closed	W	46	92
• AC operation, 50 Hz	Closing = Closed	VA	80	160
	P.f.		0.95	
<b>Operating times within operating range</b>				
Total break time = Opening delay + Arcing time				
• AC and DC operation	Closing delay	ms	60 ... 100	
	Opening delay	ms	20 ... 35	
• Arcing time at $0.06 \dots 4 \times I_e$		ms	40 ... 70	

<sup>1)</sup> For 3TC78, one auxiliary NC contact each of the right and left conducting paths must be connected in series.

Rated data of the auxiliary contacts, see page 2/114.

# Switching devices – Contactors and contactor assemblies – Special applications

## Contactors for special applications

### 3TC contactors for switching DC voltage, 1- and 2-pole

Type	3TC74		3TC78	
Design	1-pole contactors		2-pole contactors	
<b>Rated data of the main contacts</b>				
<b>Load rating with DC</b>				
<b>Utilization category DC-1, (<math>L/R \leq 1</math> ms)</b>				
• Rated operational current $I_e$ /DC-1 (at 55 °C)	A	500		
• Minimum conductor cross-section	mm <sup>2</sup>	2 x 150		
• Rated power	At 220 V	kW	110	
( $\leq 750$ V DC: one conducting path,	440 V	kW	220	
> 750 V DC: two conducting paths in series)	600 V	kW	300	
	750 V	kW	375	
	1 200 V	kW	--	600
	1 500 V	kW	--	750
• Critical currents, without arc extinction	At 440 V	A	$\leq 7$	--
	600 V	A	$\leq 13$	--
	750 V	A	$\leq 15$	--
	$\leq 800$ V	A	--	$\leq 7$
	1 200 V	A	--	$\leq 13$
	1 500 V	A	--	$\leq 15$
<b>Utilization category DC-3 and DC-5, shunt-wound and series-wound motors (<math>L/R \leq 15</math> ms)</b>				
• Rated operational current $I_e$ (at 55 °C)	A	400		
• Rated power at $U_e$	At 110 V	kW	35	
( $\leq 750$ V DC: one conducting path,	220 V	kW	70	
> 750 V DC: two conducting paths in series)	440 V	kW	140	
	600 V	kW	200	
	750 V	kW	250	
	1 200 V	kW	--	400
	1 500 V	kW	--	500
<b>Permissible rated current for regenerative braking</b>				
At 110 ... 600 V	A	400		
<b>Switching frequency</b>				
<b>Switching frequency z</b> in operating cycles/hour				
AC/DC operation				
• For weak or non-inductive load DC-1	h <sup>-1</sup>	750		1 000
• For inductive load DC-3/DC-5	h <sup>-1</sup>	500		
<b>Conductor cross-sections</b>				
<b>Main conductors</b>				
(1 or 2 conductors can be connected)				
• Stranded with cable lug	mm <sup>2</sup>	2 x ... 150	Screw terminals	
• Busbars	mm	2 x (30 x 4)		
<b>Auxiliary conductors</b>				
(1 or 2 conductors can be connected)				
• Solid	mm <sup>2</sup>	1 ... 2.5		
• Finely stranded with end sleeve	mm <sup>2</sup>	0.75 ... 1.5		

Rated data of the auxiliary contacts, [see page 2/114](#).

# Switching devices – Contactors and contactor assemblies – Special applications

## Contactors for special applications

### 3TC contactors for switching DC voltage, 1- and 2-pole

#### Selection and ordering data

DC operation  or AC operation, 50 Hz 



3TC44



3TC48

Size	Utilization category <sup>1)</sup>	Operational current $I_e$ <sup>2)</sup>	Ratings of DC motors at					Auxiliary contacts <sup>3)</sup>		Rated control supply voltage $U_s$	Screw terminals 	Weight
			110 V	220 V	440 V	600 V	750 V	Version				
		A	kW	kW	kW	kW	kW	NO	NC	V	Article No.	kg

#### 3TC44 to 3TC56 2-pole contactors · Operational voltage up to 750 V

##### DC operation

##### For screw fixing and snap-on mounting on TH 35 standard mounting rail

2	DC-3, DC-5	32	2.5	5	9	9	4	2	2	24 DC 110 DC 220 DC	<b>3TC4417-0AB4</b> <b>3TC4417-0AF4</b> <b>3TC4417-0AM4</b>	1.060 1.043 1.000
---	------------	----	-----	---	---	---	---	---	---	---------------------------	---	-------------------------

##### For screw fixing

4	DC-3, DC-5	75	6.5	13	27	38	45	2	2	24 DC 110 DC 220 DC	<b>3TC4817-0AB4</b> <b>3TC4817-0AF4</b> <b>3TC4817-0AM4</b>	4.500 4.490 4.425
8	DC-3, DC-5	220 <sup>4)</sup>	20	41	82	110	110	2	2	24 DC 110 DC 220 DC	<b>3TC5217-0AB4</b> <b>3TC5217-0AF4</b> <b>3TC5217-0AM4</b>	10.000 9.734 9.660
12	DC-3, DC-5	400	35	70	140	200	250	2	2	24 DC 110 DC 220 DC	<b>3TC5617-0AB4</b> <b>3TC5617-0AF4</b> <b>3TC5617-0AM4</b>	23.554 21.234 23.100

<sup>1)</sup> Permissible load for DC-1 utilization category, see detailed technical specifications in the Reference Manual.

<sup>2)</sup> The following rated operational currents are permitted for reversing duty with 3TC44 to 3TC56 contactors:

Contactor Type	Rated operational voltage		
	110 V	220 V	440 V
3TC44	32 A	7 A	
3TC48	75 A	75 A	
3TC52	170 A	170 A	
3TC56	400 A	400 A	

<sup>3)</sup> The fitting of auxiliary switches cannot be altered on DC-operated contactors.

<sup>4)</sup> At > 600 V:  $I_e = 170$  A.

Other rated control supply voltages according to page 2/121 on request.

Accessories, see page 2/121 onwards.

For spare parts, see page 2/123.

## Switching devices – Contactors and contactor assemblies – Special applications

### Contactors for special applications

#### 3TC contactors for switching DC voltage, 1- and 2-pole

**DC operation**  or **AC operation, 50 Hz** 

For screw fixing



3TC74



3TC78

Size	Utilization category <sup>1)</sup>	Operational current $I_e$	Ratings of DC motors at							Auxiliary contacts <sup>2)</sup> Version	Rated control supply voltage $U_s$	Screw terminals 	Weight
			110 V	220 V	440 V	600 V	750 V	1 200 V	1 500 V				
		A	kW	kW	kW	kW	kW	kW	kW			Article No.	kg

#### 3TC74 1-pole contactors · Operational voltage up to 750 V

##### DC operation

12	DC-3, DC-5	400	35	70	140	200	250	--	--	4	4	24 DC 110 DC	<b>3TC7414-0EB</b> <b>3TC7414-0EF</b>	10.600 10.514
----	---------------	-----	----	----	-----	-----	-----	----	----	---	---	-----------------	--	------------------

#### 3TC78 2-pole contactors · Operational voltage up to 1 500 V

##### DC operation

12	DC-3, DC-5	400	35	70	140	200	250	400	500	4	4	24 DC 110 DC	<b>3TC7814-0EB</b> <b>3TC7814-0EF</b>	22.000 23.490
----	---------------	-----	----	----	-----	-----	-----	-----	-----	---	---	-----------------	--	------------------

<sup>1)</sup> Permissible load for DC-1 utilization category, see detailed technical specifications in the Reference Manual.

<sup>2)</sup> The fitting of auxiliary switches cannot be altered on DC-operated contactors.

Other rated control supply voltages according to page 2/121 on request.

For spare parts, see page 2/123.







## Switching devices – Contactors and contactor assemblies – Special applications



### Contactors for special applications

#### 3TC contactors for switching DC voltage, 1- and 2-pole

2

For contactors	Version	Rated control supply voltage $U_s$	Article No.		Weight kg		
			Size	Type			
<b>Surge suppressors · Varistors</b>							
 3TX7402-3.	2	3TC44 <sup>1)</sup>	<b>Varistors<sup>2)</sup></b> With line spacer, for mounting on the coil terminal	24 ... 48	24 ... 70	<b>3TX7402-3G</b>	0.014
				48 ... 127	70 ... 150	<b>3TX7402-3H</b>	0.015
				127 ... 240	150 ... 250	<b>3TX7402-3J</b>	0.015
				240 ... 400	--	<b>3TX7402-3K</b>	0.021
				400 ... 600	--	<b>3TX7402-3L</b>	0.023
 3TX7462-3.	4	3TC48	<b>Varistors<sup>2)</sup></b> For sticking onto the contactor base or for mounting separately	24 ... 48	24 ... 70	<b>3TX7462-3G</b>	0.014
				48 ... 127	70 ... 150	<b>3TX7462-3H</b>	0.014
				127 ... 240	150 ... 250	<b>3TX7462-3J</b>	0.015
				240 ... 400	--	<b>3TX7462-3K</b>	0.016
				400 ... 600	--	<b>3TX7462-3L</b>	0.016
 3TX7522-3.	8 and 12	3TC52, 3TC56	<b>Varistors</b> For sticking onto the contactor base or for mounting separately	24 ... 48	--	<b>3TX7462-3G</b>	0.014
				48 ... 127	--	<b>3TX7462-3H</b>	0.014
				127 ... 240	--	<b>3TX7462-3J</b>	0.015
				240 ... 400	--	<b>3TX7462-3K</b>	0.016
				400 ... 600	--	<b>3TX7462-3L</b>	0.016
 3TX7522-3.	8 and 12	3TC52, 3TC56	<b>Varistors<sup>2)</sup></b> For separate screw fixing or snapping onto TH 35 standard mounting rail	--	24 ... 70	<b>3TX7522-3G</b>	0.088
				--	70 ... 150	<b>3TX7522-3H</b>	0.086
				--	150 ... 250	<b>3TX7522-3J</b>	0.090

#### Surge suppressors · RC elements

 3TX7462-3., 3TX7522-3.	4	3TC48	<b>RC elements</b> For lateral snapping onto auxiliary switch or TH 35 standard mounting rail	24 ... 48	--	<b>3TX7462-3R</b>	0.084
				--	24 ... 70	<b>3TX7522-3R</b>	0.090
				48 ... 127	--	<b>3TX7462-3S</b>	0.083
				--	70 ... 150	<b>3TX7522-3S</b>	0.090
				127 ... 240	--	<b>3TX7462-3T</b>	0.094
	8 and 12	3TC52, 3TC56	<b>RC elements</b> For lateral snapping onto auxiliary switch or TH 35 standard mounting rail	--	150 ... 250	<b>3TX7522-3T</b>	0.083
				240 ... 400	--	<b>3TX7462-3U</b>	0.089
				400 ... 600	--	<b>3TX7462-3V</b>	0.089
				24 ... 48	--	<b>3TX7522-3R</b>	0.090
				48 ... 127	--	<b>3TX7522-3S</b>	0.090
 3TX7522-3.	8 and 12	3TC52, 3TC56	<b>RC elements</b> For lateral snapping onto auxiliary switch or TH 35 standard mounting rail	127 ... 240	--	<b>3TX7522-3T</b>	0.083
				240 ... 400	--	<b>3TX7522-3U</b>	0.088
				400 ... 600	--	<b>3TX7522-3V</b>	0.085

#### Surge suppressors · Diodes

 3TX7462-3.	4 to 12	3TC48, 3TC52, 3TC56	<b>Diode assemblies<sup>3)</sup></b> (Diode and Zener diode) for DC solenoid system, for sticking onto the contactor base or for mounting separately	--	24 ... 250	<b>3TX7462-3D</b>	0.014
---	---------	---------------------------	---	----	------------	-------------------	-------

<sup>1)</sup> The connection piece for mounting the surge suppressor must be bent slightly.

<sup>2)</sup> Includes the peak value of the alternating voltage on the DC side.

<sup>3)</sup> Not for DC operation.









For contactors	Version	Article No.	Weight kg			
				Size	Type	
<b>Terminal covers</b>						
 3TX6546-3B	2	3TC44	For protection against inadvertent contact with exposed busbar connections (1 set = 2 units)	--	<b>3TY2444-0B</b>	0.026
	6	3TC48	For protection against inadvertent contact with exposed busbar connections	M6	<b>3TX6506-3B</b>	0.076
	8 and 12	3TC52, 3TC56	Can be screwed on free screw end; covers one busbar connection (1 set = 6 units)	M10	<b>3TX6546-3B</b>	0.278

# Switching devices – Contactors and contactor assemblies – Special applications

## Contactors for special applications

### 3TC contactors for switching DC voltage, 1- and 2-pole

#### Spare parts

For contactors		Version	Auxiliary contacts	Auxiliary switches		Screw terminals 	Weight	
Size	Type		Left	Right	Article No.			
			NO	NC			kg	
<b>Auxiliary switches</b>								
<b>For lateral mounting</b>								
	2 and 4	3TC44, 3TC48	Auxiliary switch (replacement for 3TY6501-1A, 3TY6501-1B)	1	1		<b>3TY6501-1AA00</b>	0.051
	8 and 12	3TC52, 3TC56	Auxiliary switch, left	1	1		<b>3TY6561-1A</b>	0.081
			Auxiliary switch, right	1	1	--		<b>3TY6561-1B</b>
	12	3TC74	Auxiliary switch	4	4		<b>3TY2741-2J</b>	0.271
	12	3TC78	Auxiliary switch, left	2	2		<b>3TY2781-2C</b>	0.193
			Auxiliary switch, right	2	2	--		<b>3TY2781-2D</b>
For contactors		Version	Rated control supply voltage $U_s$		Article No.	Weight		
Size	Type		V AC/DC			kg		
<b>Surge suppressors · Varistors</b>								
12	3TC7	For sticking onto the contactor base		24 110	<b>3TX2746-2F</b> <b>3TX2746-2G</b>	0.012 0.014		
For contactors		Version	Article No.		Weight			
Size	Type				kg			
<b>Solenoid coils</b>								
<b>DC operation<sup>1)</sup></b>								
2	3TC44	--			<b>3TY6443-0B..</b>			
4	3TC48	--			<b>3TY6483-0B..</b>			
8	3TC52	--			<b>3TY6523-0B..</b>			
12	3TC56	--			<b>3TY6563-0B..</b>			
<b>AC operation<sup>1)</sup></b>								
2	3TC44	--			<b>3TY7403-0A..</b>			
4	3TC48	--			<b>3TY6483-0A..</b>			
8	3TC52	--			<b>3TY6523-0A..</b>			
12	3TC56	--			<b>3TY6566-0A..</b>			
<b>Contacts with fixing parts</b>								
		In order to ensure reliable operation of the contactors, only <b>original replacement contacts</b> should be used.						
2	3TC44	(1 set = 2 moving and 4 fixed switching elements)				<b>3TY2440-0A</b>	0.065	
4	3TC48					<b>3TY2480-0A</b>	0.093	
8	3TC52					<b>3TY2520-0A</b>	0.220	
12	3TC56					<b>3TY2560-0A</b>	0.421	
12	3TC7	Main contacts (1 set) For 3TC78: 2 units required per contactor				<b>3TY2740-0E</b>	0.357	
<b>Arc chutes</b>								
2	3TC44	Arc chutes, 2-pole				<b>3TY2442-0A</b>	0.157	
4	3TC48					<b>3TY2482-0A</b>	0.470	
8	3TC52					<b>3TY2522-0A</b>	1.100	
12	3TC56					<b>3TY2562-0A</b>	2.080	
12	3TC7	For 3TC78: 2 units required per contactor				<b>3TY2742-0C</b>	3.856	

3TY2482-0A

<sup>1)</sup> For rated control supply voltages, see page 2/121.  
The 10th and 11th digits of the article number must be supplemented accordingly.



# Switching devices – Contactors and contactor assemblies – Contactor relays and relays

## Contactor relays

### Introduction

### Overview

#### More information

Homepage, see [www.siemens.com/sirius](http://www.siemens.com/sirius)

Conversion tool, see [www.siemens.com/conversion-tool](http://www.siemens.com/conversion-tool)

Industry Mall, see [www.siemens.com/product?3RH\\_3TH](http://www.siemens.com/product?3RH_3TH)

#### The advantages at a glance



Size  
Type

**S00**  
3RH21

**S00**  
3RH22

3TH42

3TH43

Article No.	Page
-------------	------

#### SIRIUS 3RH2 contactor relays

<b>4-pole</b>	• Screw or spring-loaded terminals
<b>8-pole</b>	
<b>4-pole, latched</b>	
<b>Coupling contactor relays</b>	• Coils for control by the PLC
<b>Contactor relays for railway applications</b>	• Coils with extended voltage range

<b>3RH21</b>	<a href="#">2/132, 2/132</a>
<b>3RH22</b>	<a href="#">2/132, 2/132</a>
<b>3RH24</b>	<a href="#">2/132, 2/132</a>
<b>3RH21</b>	<a href="#">2/133, 2/134</a>
<b>3RH21</b>	<a href="#">2/134</a>

#### 3TH4 contactor relays

<b>8-pole</b>	• Screw terminals
<b>10-pole</b>	
<b>Contactor relays for railway applications</b>	• Coils with extended voltage range

<b>3TH42</b>	<a href="#">2/140</a>
<b>3TH43</b>	<a href="#">2/141</a>
<b>3TH42</b>	<a href="#">2/135</a>

#### Accessories for SIRIUS 3RH2 contactor relays

<b>Auxiliary switches</b>	• On front
	• Lateral
<b>Function modules (direct-on-line starting, star-delta (wye-delta) starting)</b>	• On front
<b>Surge suppressors</b>	• On front
<b>Additional load modules</b>	• On front

<b>3RH29, 3RA281.<sup>1)</sup></b>	<a href="#">from 2/59 onwards</a>
<b>3RH29</b>	<a href="#">2/61</a>
<b>3RA281., 3RA283.</b>	<sup>1)</sup>
<b>3RT2916</b>	<sup>1)</sup>
<b>3RT2916</b>	<sup>1)</sup>

<sup>1)</sup> see Catalog IC 10.

# Switching devices – Contactors and contactor assemblies – Contactor relays and relays

## Contactor relays

### SIRIUS 3RH2 contactor relays, 4- and 8-pole

#### Overview

#### Contactor relays, size S00, with accessories

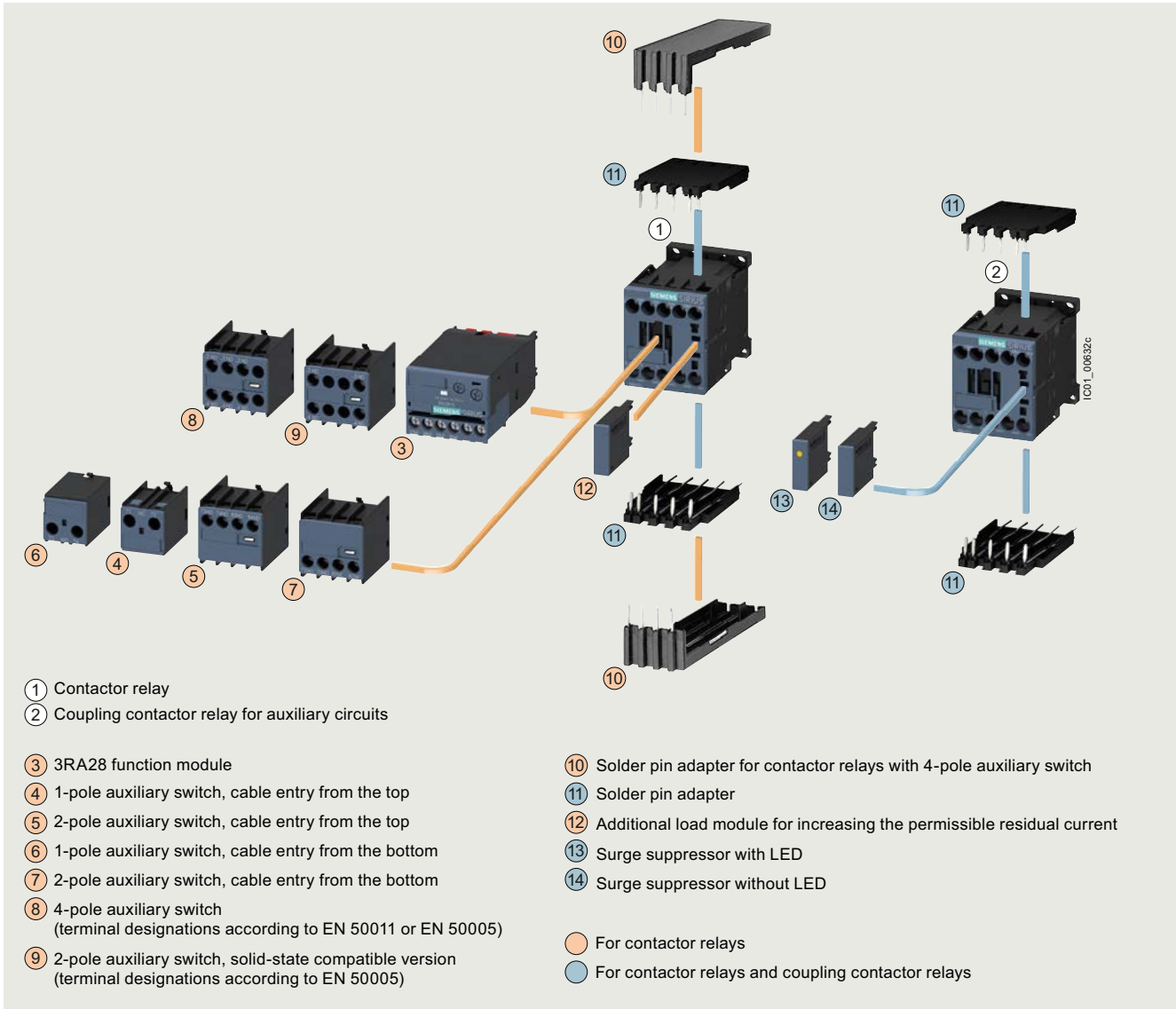

## Switching devices – Contactors and contactor assemblies – Contactor relays and relays

### Contactor relays

#### SIRIUS 3RH2 contactor relays, 4- and 8-pole

##### Standards

IEC 60947-1, IEC 60947-4-1, IEC 60947-5-1

The 3RH2 contactor relays are available with screw or spring-loaded terminals. The basic unit contains four contacts with terminal designations according to EN 50011.

The 3RH2 contactor relays are suitable for use in any climate. They are finger-safe according to IEC 60529.

The 3RH21 coupling contactor relays for switching auxiliary circuits are tailored to the special requirements of working with electronic controls.

##### Contact reliability

High contact stability at low voltages and currents, suitable for solid-state circuits with currents  $\geq 1$  mA at a voltage of  $\geq 17$  V.

##### Surge suppression

RC elements, varistors, diodes or diode assemblies (combination of a diode and a Zener diode) can be plugged onto all 3RH2 contactor relays from the front for damping opening surges in the coil. The plug-in direction is determined by a coding device.

Coupling contactor relays have a low power consumption and an extended solenoid coil operating range.

Depending on the version, the solenoid coils of the coupling contactor relays are supplied either without overvoltage damping (versions 3RH21...-HB40 or 3RH21...-MB40-0KT0) or with a diode or suppressor diode connected as standard.

##### Note:

The auxiliary contactor's OFF times, the opening delay times of the NO contacts and the closing delay times of the NC contacts increase if the contactor coils are attenuated against voltage peaks. Various accessories are available for the auxiliary contactors (time change for: interference suppression diode 6x to 10x; diode assembly 2x to 6x; suppressor diode +1 to 5 ms; varistor +2 to 5 ms).

For details, see [Equipment Manual](#).

##### Article No. scheme

Product versions		Article number			
<b>SIRIUS contactor relays</b>		<b>3RH2</b> □ □ □ - □ □ □ □ 0 - □ □ □ □			
Device type	e.g. 1 = 4-pole contactor relay	□			
Number of NO contacts	e.g. 2 = 2 NO	□			
Number of NC contacts	e.g. 2 = 2 NC	□			
Type of electrical connection	Screw terminals		1		
	Spring-loaded terminals		2		
Operating range/solenoid coil circuit	e.g. A = AC standard/without coil circuit		□		
Rated control supply voltage	e.g. P0 = 50/60 Hz 230 V AC			□ □	
Special version					□ □ □ □
Example		<b>3RH2 1 2 2 - 1 A P 0 0</b>			

##### Note:

The Article No. scheme shows an overview of product versions for better understanding of the logic behind the article numbers.

##### Accessories

The accessories for the 3RT2 contactors in size S00 can also be used for the 3RH2 contactor relays (see [page 2/52 onwards](#)).

##### Auxiliary switches

The 3RH21 contactor relays (with the exception of coupling contactor relays) can be expanded by up to four contacts by the addition of mounted auxiliary switches.

The auxiliary switch can easily be snapped onto the front of the contactor relays. The auxiliary switch has a centrally positioned release lever for disassembly.

The conventional front auxiliary contacts fulfill the characteristics of force-guided operation and are therefore suitable for safety applications.

##### Contactor relays in safety-related applications

Contactor relays are a significant part of safety-related applications. They are generally the actuators that perform the switching operation leading to the safe disconnection of the corresponding application or system.

Contactor relays with force-guided operation according to IEC 60947-5-1 are generally required for use in safety-related applications. Most of our contactors meet this requirement; a corresponding note can be found in the technical product data sheet.

##### Contactor relays with increased tamper protection

Increased tamper protection is ensured either by using our contactor relay versions with permanently mounted auxiliary switches installed in the factory (e.g. 3RH22 contactor relays), or by using the 3RT2916-4MA10 sealable cover as an accessory (see [page 2/72](#)).

For your orders, please use the article numbers quoted in the selection and ordering data.

# Switching devices – Contactors and contactor assemblies – Contactor relays and relays

## Contactor relays

### SIRIUS 3RH2 contactor relays, 4- and 8-pole

#### Technical specifications

##### More information

Technical specifications, see <https://support.industry.siemens.com/cs/ww/en/ps/16188/td>  
 FAQs, see <https://support.industry.siemens.com/cs/ww/en/ps/16188/faq>

Manuals, see <https://support.industry.siemens.com/cs/ww/en/ps/16188/man>

Type  
Size

**Contactor relays**  
**3RH2**  
**S00**

##### Permissible mounting position

The contactor relays are designed for operation on a vertical mounting surface.

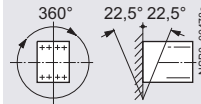

Upright mounting position



Special version required

(in the case of coupling contactor relays and contactor relays with extended operating range 3RH2122-2K.40 on request)

##### Force-guided operation of contacts in contactor relays

###### 3RH2:

**Yes**, in the basic unit and the auxiliary switch as well as between the basic unit and the mounted auxiliary switch (**removable**) acc. to:

- ZH1/457
- IEC 60947-5-1, Annex L

###### 3RH22:

**Yes**, in the basic unit and the auxiliary switch as well as between the basic unit and the mounted auxiliary switch (**permanently mounted**) acc. to:

- ZH1/457
- IEC 60947-5-1, Annex L

###### Note:

3RH2911-NF. solid-state compatible auxiliary switches have no force-guided contacts.

##### Explanations:

There is force-guided operation if it is ensured that the NC and NO contacts cannot be closed at the same time.

###### ZH1/457

Safety Rules for Controls on Power-Operated Metalworking Presses.

###### IEC 60947-5-1, Annex L

Standard for low-voltage switchgear and controlgear; Special requirements for mechanically linked contact elements

##### Contact reliability

Contact reliability at 17 V, 1 mA acc. to IEC 60947-5-4

Frequency of contact faults  $< 10^{-8}$ , i.e.  $< 1$  fault per 100 million operating cycles

##### Contact endurance for AC-15/AC-14 and DC-13 utilization categories

The contact endurance is mainly dependent on the breaking current. It is assumed that the operating mechanisms are switched randomly, i.e. not synchronized with the phase angle of the supply system.

If magnetic circuits other than the contactor operating mechanisms or solenoid valves are present, e.g. magnetic brakes, protective measures for the load circuits are necessary, e.g. in the form of RC elements and freewheel diodes.

The characteristic curves apply to

- 3RH21/3RH22 contactor relays<sup>1)</sup>
- 3RH24 latched contactor relays
- 3RH2911 auxiliary switches<sup>1)</sup>
- Auxiliary switches for snapping onto the front, max. 4-pole and for mounting onto the side in size S00

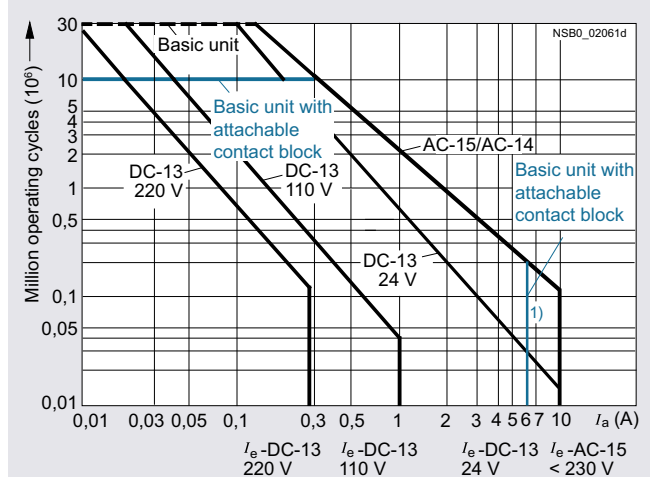

##### Diagram legend:

$I_a$  = Breaking current

$I_e$  = Rated operational current

<sup>1)</sup> 3RH22, 3RH2911:  $I_e = 6$  A for AC-15/AC-14 and DC-13.

# Switching devices – Contactors and contactor assemblies – Contactor relays and relays

## Contactor relays

### SIRIUS 3RH2 contactor relays, 4- and 8-pole

Type Size	Contactor relays					
	3RH21 S00	3RH22	3RH24			
<b>General data</b>						
<b>Dimensions (W x H x D)</b>						
<ul style="list-style-type: none"> <li>• Basic units               <ul style="list-style-type: none"> <li>- Screw terminals</li> <li>- Spring-loaded terminals</li> </ul> </li> <li>• Basic unit with mounted auxiliary switch               <ul style="list-style-type: none"> <li>- Screw terminals</li> <li>- Spring-loaded terminals</li> </ul> </li> <li>• Basic unit with mounted function module or solid-state time-delay auxiliary switch               <ul style="list-style-type: none"> <li>- Screw terminals</li> <li>- Spring-loaded terminals</li> </ul> </li> </ul>		mm	45 x 58 x 73	--	90 x 58 x 73	
		mm	45 x 70 x 73	--		
		mm	45 x 58 x 117	--		
		mm	45 x 70 x 121	--		
		mm	45 x 58 x 147	--		
		mm	45 x 70 x 147	--		
		<b>Mechanical service life</b>				
		• Basic units	Operat- ing cycles	30 million		5 million
		• Basic unit with mounted auxiliary switch	Operat- ing cycles	10 million		5 million
		• Solid-state-compatible auxiliary switch	Operat- ing cycles	5 million		
<b>Rated insulation voltage <math>U_i</math> (pollution degree 3)</b>						
	V	690				
<b>Rated impulse withstand voltage <math>U_{imp}</math></b>						
	kV	6				
<b>Protective separation</b> between coil and contacts in the basic unit, acc. to IEC 60947-1, Annex N						
	V	400				
<b>Permissible ambient temperature</b>						
• During operation	°C	-25 ... +60				
• During storage	°C	-55 ... +80				
<b>Degree of protection IP on the front</b> according to IEC 60529						
		IP20 (screw terminals and spring-loaded terminals)				
<b>Touch protection on the front</b> according to IEC 60529						
		Finger-safe for vertical touching from the front (screw and spring-loaded terminals)				
<b>Shock resistance</b>						
• Rectangular pulse						
- AC operation	<i>g/ms</i>	7.3/5 and 4.7/10				
- DC operation	<i>g/ms</i>	10/5 and 5/10				
• Sine pulse						
- AC operation	<i>g/ms</i>	11.4/5 and 7.3/10				
- DC operation	<i>g/ms</i>	15/5 and 8/10				
<b>Short-circuit protection</b>						
• Short-circuit test						
- With fuse links of operational class gG: DIAZED, type 5SB; NEOZED, type 5SE with short-circuit current $I_k = 1$ kA acc. to IEC 60947-5-1	A	10				
- With miniature circuit breakers with C characteristic with short-circuit current $I_k = 400$ A acc. to IEC 60947-5-1	A	6				

# Switching devices – Contactors and contactor assemblies – Contactor relays and relays

## Contactors relays

### SIRIUS 3RH2 contactor relays, 4- and 8-pole







Type	Contactor relays	
Size	3RH2	
Control	S00	
<b>Solenoid coil operating range</b>		
• AC operation	At 50 Hz At 60 Hz	0.8 ... 1.1 x $U_s$ 0.85 ... 1.1 x $U_s$
• DC operation	At +50 °C At +60 °C	0.8 ... 1.1 x $U_s$ 0.85 ... 1.1 x $U_s$
<b>Power consumption of the solenoid coil</b> (for cold coil and 1.0 x $U_s$ )		
• AC operation, 50 Hz		
- Closing	VA/p.f.	37/0.8
- Closed	VA/p.f.	5.7/0.25
• AC operation, 60 Hz		
- Closing	VA/p.f.	33/0.75
- Closed	VA/p.f.	4.4/0.25
• DC operation	W	4.0
Closing = Closed		
<b>Permissible residual current of the electronics</b> (with 0 signal)		
• For AC operation <sup>1)</sup>		< 4 mA x (230 V/ $U_s$ )
• For DC operation		< 10 mA x (24 V/ $U_s$ )
<b>Operating times within operating range</b>		
Total break time = Opening delay + Arcing time		
• AC operation		
- Closing delay	ms	8 ... 33
- Opening delay	ms	4 ... 15
• DC operation		
- Closing delay	ms	30 ... 100
- Opening delay	ms	38 ... 65
• Arcing time	ms	10 ... 15
3RH24 minimum operating time		
• AC operation		
- Closing	ms	≥ 35
- Opening	ms	≥ 30
• DC operation		
- Closing	ms	≥ 100
- Opening	ms	≥ 30

<sup>1)</sup> The 3RT2916-1GA00 additional load module is recommended for higher residual currents.

## Switching devices – Contactors and contactor assemblies – Contactor relays and relays

### Contactor relays

#### SIRIUS 3RH2 contactor relays, 4- and 8-pole

				Coupling contactor relays		
Type				3RH21...HB40	3RH21...JB40	3RH21...KB40
Size				S00		
<b>Control</b>						
<b>Solenoid coil operating range</b>				0.7 ... 1.25 x $U_s$		
<b>Power consumption of the solenoid coil</b> (for cold coil and 1.0 x $U_s$ ) Closing = Closed at $U_s = 24$ V				W	2.8	
<b>Permissible residual current</b> of the electronics with 0 signal				< 10 mA x (24 V/ $U_s$ )		
<b>Overvoltage configuration of the solenoid coil</b>				No overvoltage damping 	Integrated diode 	Integrated suppressor diode 
<b>Operating times within operating range</b> Total break time = Opening delay + Arcing time						
• DC operation				Closing delay	ms	25 ... 130
				Opening delay	ms	7 .. 20
						38 .. 65
						7 .. 20
<b>Upright mounting position</b>				On request		
				Coupling contactor relays		
Type				3RH21...MB40-0KT0	3RH21...VB40	3RH21...SB40
Size				S00		
<b>Control</b>						
<b>Solenoid coil operating range</b>				0.85 ... 1.85 x $U_s$		
<b>Power consumption of the solenoid coil</b> (for cold coil and 1.0 x $U_s$ ) Closing = Closed at $U_s = 24$ V				W	1.6	
<b>Permissible residual current</b> of the electronics with 0 signal				< 8 mA x (24 V/ $U_s$ )		
<b>Overvoltage configuration of the solenoid coil</b>				No overvoltage damping 	Integrated diode 	Integrated suppressor diode 
<b>Operating times within operating range</b> Total break time = Opening delay + Arcing time						
• DC operation				Closing delay	ms	25 ... 120
				Opening delay	ms	5 .. 20
						20 .. 80
						5 .. 20
<b>Upright mounting position</b>				On request		



# Switching devices – Contactors and contactor assemblies – Contactor relays and relays

## Contactor relays

### SIRIUS 3RH2 contactor relays, 4- and 8-pole

		Contactor relays	
Type		3RH2	
Size		S00	
<b>Rated data of the auxiliary contacts</b>			
<b>Load rating with AC</b>			
<b>Rated operational currents <math>I_e</math></b>			
AC-12	A	10	
AC-15/AC-14, at rated operational voltage $U_e$	Up to 230 V A	10 <sup>1)</sup>	
	400 V A	3	
	500 V A	2	
	690 V A	1	
<b>Load rating with DC</b>			
<b>Rated operational currents <math>I_e</math></b>			
DC-12, at rated operational voltage $U_e$			
• 1 conducting path	24 V A	10	
	60 V A	6	
	110 V A	3	
	220 V A	1	
	440 V A	0.3	
	600 V A	0.15	
• 2 conducting paths in series	24 V A	10	
	60 V A	10	
	110 V A	4	
	220 V A	2	
	440 V A	1.3	
	600 V A	0.65	
• 3 conducting paths in series	24 V A	10	
	60 V A	10	
	110 V A	10	
	220 V A	3.6	
	440 V A	2.5	
	600 V A	1.8	
DC-13, at rated operational voltage $U_e$			
• 1 conducting path	24 V A	10 <sup>1)</sup>	
	60 V A	2	
	110 V A	1	
	220 V A	0.3	
	440 V A	0.14	
	600 V A	0.1	
• 2 conducting paths in series	24 V A	10	
	60 V A	3.5	
	110 V A	1.3	
	220 V A	0.9	
	440 V A	0.2	
	600 V A	0.1	
• 3 conducting paths in series	24 V A	10	
	60 V A	4.7	
	110 V A	3	
	220 V A	1.2	
	440 V A	0.5	
	600 V A	0.26	
<b>Switching frequency</b>			
<b>Switching frequency <math>z</math> in operating cycles/hour</b>			
• Rated operation for utilization category	AC-12/DC-12	1/h	1 000
(Dependence of the switching frequency $z'$ on operational current $I'$ and operational voltage $U$ : $z' = z \cdot (I_e/I') \cdot (U_e/U)^{1.5} \cdot 1/h$ )	AC-15/AC-14	1/h	1 000
	DC-13	1/h	1 000
• No-load switching frequency		1/h	10 000
<b>Ⓢ and Ⓞ rated data</b>			
<b>Basic units and auxiliary switches</b>			
• Rated control supply voltage	V AC	max. 600	
• Rated voltage	V AC	600	
• Switching capacity		A 600, Q 600	
• Uninterrupted current at 240 V AC	A	10	

1) 3RH22, 3RH29:  $I_e = 6$  A for AC-15/AC-14 and DC-13.

## Switching devices – Contactors and contactor assemblies – Contactor relays and relays



## Contactor relays

## SIRIUS 3RH2 contactor relays, 4- and 8-pole

## Selection and ordering data

DC operation 

3RH2422-1B.40

Rated operational current $I_e$ /AC-15/AC-14 at <b>230 V</b>	Contacts		Rated control supply voltage $U_s$	Screw terminals 	Weight
	Ident. No.	Version			
A		 NO  NC	V DC	Article No.	kg
<b>For screw fixing and snap-on mounting onto TH 35 standard mounting rail</b>					
<b>Latched</b>					
No lateral auxiliary switches can be mounted					
<b>10</b>	<b>40E</b>	4	--	24 110 220	<b>3RH2440-1BB40</b> 0.554 <b>3RH2440-1BF40</b> 0.561 <b>3RH2440-1BM40</b> 0.563
	<b>31E</b>	3	1	24 110 220	<b>3RH2431-1BB40</b> 0.570 <b>3RH2431-1BF40</b> 0.564 <b>3RH2431-1BM40</b> 0.564
	<b>22E</b>	2	2	24 110 220	<b>3RH2422-1BB40</b> 0.571 <b>3RH2422-1BF40</b> 0.568 <b>3RH2422-1BM40</b> 0.560

Other voltages on request.

Accessories, see page 2/52 onwards.

# Switching devices – Contactors and contactor assemblies – Contactor relays and relays

## Contactor relays

### SIRIUS 3RH2 contactor relays, 4- and 8-pole

#### DC operation for direct control by PLC

- Coupling contactor relays with adapted power consumption
- Suitable for solid-state PLC outputs
- Cannot be expanded with auxiliary switches



3RH21...-2.B40

Rated operational current $I_e$ /AC-15/AC-14 at 230 V	Auxiliary contacts Ident. No. acc. to EN 50011	Version	Rated control supply voltage $U_s$	Spring-loaded terminals 	Weight
		NO NC	V DC	Article No.	kg

**A**

For screw fixing and snap-on mounting  
onto TH 35 standard mounting rail

#### Size S00

Cannot be expanded with auxiliary switches

Operating range **0.7 to 1.25 x  $U_s$** ,  
power consumption of the solenoid coils **2.8 W** at 24 V

10	40E	4	--	24
	31E	3	1	24
	22E	2	2	24

Operating range **0.85 to 1.85 x  $U_s$** ,  
power consumption of the solenoid coils **1.6 W** at 24 V

10	40E	4	--	24
	31E	3	1	24
	22E	2	2	24

Other voltages on request.

Accessories, see page 2/52 onwards.

3RH2140-2HB40	0.321
3RH2131-2HB40	0.316
3RH2122-2HB40	0.315
3RH2140-2MB40-0KT0	0.320
3RH2131-2MB40-0KT0	0.319
3RH2122-2MB40-0KT0	0.314

## Switching devices – Contactors and contactor assemblies – Contactor relays and relays

### Contactor relays



#### SIRIUS 3RH2 contactor relays, 4- and 8-pole

##### DC operation for direct control by PLC

- Coupling contactor relays with adapted power consumption
- Suitable for solid-state PLC outputs
- Cannot be expanded with auxiliary switches



3RH21...-2.B40

Rated operational current $I_{th}/AC-15/AC-14$ at <b>230 V</b>	Auxiliary contacts		Version	Rated control supply voltage $U_s$	Spring-loaded terminals 	Weight
	Ident. No. acc. to EN 50011					
					Article No.	kg
<b>A</b>			NO	NC	V DC	

For screw fixing and snap-on mounting  
onto TH 35 standard mounting rail

##### Size S00

##### With integrated coil circuit (diode integrated at factory)

Cannot be expanded with auxiliary switches

Operating range **0.7 to 1.25 x  $U_s$**

Power consumption of the solenoid coils **2.8 W** at 24 V

10					
	<b>40E</b>	4	--	24	
	<b>31E</b>	3	1	24	
	<b>22E</b>	2	2	24	

Operating range **0.85 to 1.85 x  $U_s$**

Power consumption of the solenoid coils **1.6 W** at 24 V

10					
	<b>40E</b>	4	--	24	
	<b>31E</b>	3	1	24	
	<b>22E</b>	2	2	24	

<b>3RH2140-2JB40</b>	0.315
<b>3RH2131-2JB40</b>	0.317
<b>3RH2122-2JB40</b>	0.316

##### With integrated coil circuit (suppressor diode integrated at factory)

Cannot be expanded with auxiliary switches

Operating range **0.7 to 1.25 x  $U_s$**

Power consumption of the solenoid coils **2.8 W** at 24 V

10					
	<b>40E</b>	4	--	24	
	<b>31E</b>	3	1	24	
	<b>22E</b>	2	2	24	

Operating range **0.85 to 1.85 x  $U_s$**

Power consumption of the solenoid coils **1.6 W** at 24 V

10					
	<b>40E</b>	4	--	24	
	<b>31E</b>	3	1	24	
	<b>22E</b>	2	2	24	

<b>3RH2140-2KB40</b>	0.315
<b>3RH2131-2KB40</b>	0.316
<b>3RH2122-2KB40</b>	0.316

<b>3RH2140-2SB40</b>	0.316
<b>3RH2131-2SB40</b>	0.316
<b>3RH2122-2SB40</b>	0.320

Other voltages on request.

Accessories, see page 2/52 onwards.

# Switching devices – Contactors and contactor assemblies – Contactor relays and relays

## Contactor relays

### 3TH4 contactor relays, 8- and 10-pole

#### Overview

##### Standards

IEC 60947-5-1

The contactor relays are finger-safe according to IEC 60529. Terminal covers may have to be fitted onto the connecting bars, depending on the configuration with other devices.

##### Ambient temperature

The permissible ambient temperature for operation of the contactors (across the full coil operating range) is -50 to +70 °C. Uninterrupted duty at temperatures < -25 °C and > +55 °C reduces the mechanical service life, the current carrying capacity of the conducting paths and the switching frequency.

A clearance of 10 mm is required for side-by-side mounting at ambient temperatures > 55 °C. There is no need to reduce the technical specifications.

#### Application

For operation in installations which are subject both to considerable variations in the control voltage and to high ambient temperatures, e.g. in railway applications.

##### Control and auxiliary circuits

The solenoid coils of the contactor relays have an extended coil operating range from 0.7 to 1.25 x  $U_s$  and are fitted as standard with varistors to provide protection against overvoltage. The opening delay is consequently 2 to 5 ms longer than for standard contactors.

#### Technical specifications

##### More information

Technical specifications, see <https://support.industry.siemens.com/cs/ww/en/ps/16176/td>  
FAQs, see <https://support.industry.siemens.com/cs/ww/en/ps/16176/faq>

Manuals, see <https://support.industry.siemens.com/cs/ww/en/ps/16176/man>

Contactor relays

Type **3TH42**

##### General data

##### Permissible ambient temperature

- |                    |    |                           |
|--------------------|----|---------------------------|
| • During operation | °C | -50 ... +70 <sup>1)</sup> |
| • During storage   | °C | -55 ... +80               |

##### Control

##### Solenoid coil operating range

0.7 ... 1.25 x  $U_s$

**Power consumption of the solenoid coils** (for cold coil and 1.0 x  $U_s$ )  
For cold coil: Closing = Closed

W 5.2

##### Permissible residual current of the electronics

 (with 0 signal)

- DC operation ≤ 10 mA x (24 V/ $U_s$ )

##### Operating times within operating range

Total break time = Opening delay + Arcing time

- |                |               |    |            |
|----------------|---------------|----|------------|
| • DC operation | Closing delay | ms | 40 ... 200 |
|                | Opening delay | ms | 20 ... 30  |
| • Arcing time  |               | ms | 10 ... 20  |

<sup>1)</sup> Side-by-side mounting with 10 mm clearance.

All details and technical specifications not mentioned here are identical to those of the 3TH4 basic units, see page 2/127 onwards.

## Switching devices – Contactors and contactor assemblies – Contactor relays and relays

### Contact relays

#### 3TH4 contactor relays, 8- and 10-pole

Contact relays

Type **3TH42, 3TH43**

#### Contact endurance for AC-15/AC-14 and DC-13 utilization categories

The contact endurance is mainly dependent on the breaking current. It is assumed that the operating mechanisms are switched randomly, i.e. not synchronized with the phase angle of the supply system.

If magnetic circuits other than the contactor operating mechanisms or solenoid valves are present, e.g. magnetic brakes, protective measures for the load circuits are necessary.

RC elements or freewheel diodes are suitable as protective measures for the circuits.

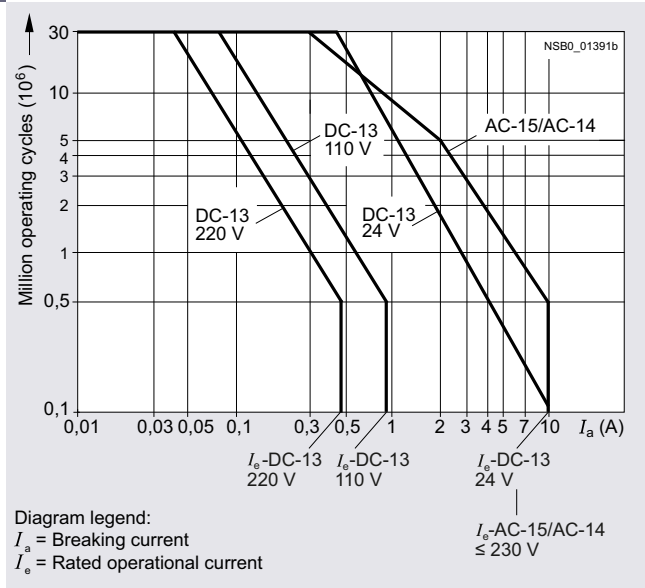

2



# Switching devices – Contactors and contactor assemblies – Contactor relays and relays

## Contactor relays

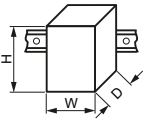
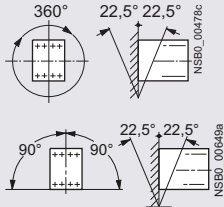
### 3TH4 contactor relays, 8- and 10-pole

Contactor relays	Type	3TH42	3TH43
<b>General data</b>			
<b>Dimensions (W x H x D)</b>			
<ul style="list-style-type: none"> <li>AC operation</li> <li>DC operation</li> </ul>		mm 45 x 78 x 97 mm 45 x 78 x 130	55 x 78 x 97 55 x 78 x 130
<b>Permissible mounting position</b>			
The contactor relays are designed for operation on a vertical mounting surface. <ul style="list-style-type: none"> <li>AC operation</li> <li>DC operation</li> </ul>			
Upright mounting position AC and DC operation		 Special version required	
<b>Mechanical service life</b>	Basic units	Operating cycles	30 million
<b>Rated insulation voltage <math>U_i</math></b> (pollution degree 3)		V	690
<b>Rated impulse withstand voltage <math>U_{imp}</math></b>		kV	8
<b>Protective separation</b> between the coil and the main contacts acc. to IEC 60947-1, Annex N		V	Up to 500
<b>Permissible ambient temperature</b>			
<ul style="list-style-type: none"> <li>During operation</li> <li>During storage</li> </ul>	°C °C	-25 ... +55 -55 ... +80	
<b>Degree of protection IP on the front</b> according to IEC 60529			IP00
<b>Shock resistance</b>			
<ul style="list-style-type: none"> <li>Rectangular pulse               <ul style="list-style-type: none"> <li>AC operation</li> <li>DC operation</li> </ul> </li> <li>Sine pulse               <ul style="list-style-type: none"> <li>AC operation</li> <li>DC operation</li> </ul> </li> </ul>	g/ms g/ms g/ms g/ms	7.7/5 and 4.4/10 9.3/5 and 5.4/10 12/5 and 6.8/10 14.7/5 and 8.5/10	
<b>Short-circuit protection</b>			
Short-circuit test			
<ul style="list-style-type: none"> <li>With fuse links of operational class gG With short-circuit current <math>I_k = 1</math> kA acc. to IEC 60947-5-1               <ul style="list-style-type: none"> <li>LV HRC, type 3NA</li> <li>DIAZED, type 5SB</li> <li>NEOZED, type 5SE, quick</li> </ul> </li> <li>With miniature circuit breakers With short-circuit current <math>I_k = 400</math> A acc. to IEC 60947-5-1               <ul style="list-style-type: none"> <li>C characteristic</li> <li>B characteristic</li> </ul> </li> </ul>	A A A A A	16 16 20 16 16	
<b>and rated data</b>			
<b>Basic units</b>			
<b>Rated control supply voltage <math>U_c</math></b>		Max. 600 V AC, 230 V DC (acc. to UL 240 V DC)	
<b>Rated voltage</b>		600 V AC, 600 V DC	
<b>Switching capacity</b>		A 600, P 600	
<b>Conductor cross-sections</b>			
<b>Auxiliary conductors and coil terminals</b> (1 or 2 conductors can be connected)			
<ul style="list-style-type: none"> <li>Solid or stranded</li> <li>Finely stranded with end sleeve</li> <li>Terminal screw</li> </ul>	mm <sup>2</sup> mm <sup>2</sup>	 <b>Screw terminals</b> 2 x (0.5 ... 1) <sup>1)</sup> ; 2 x (1 ... 2.5) <sup>1)</sup> ; 1 x 4 2 x (0.75 ... 2.5) M3.5	

<sup>1)</sup> If two different conductor cross-sections are connected to one clamping point, both cross-sections must lie in one of the ranges specified.



## Switching devices – Contactors and contactor assemblies – Contactor relays and relays

### Contactor relays

#### 3TH4 contactor relays, 8- and 10-pole

Contactor relays	Type	3TH42, 3TH43
<b>Control</b>		
<b>Solenoid coil operating range</b>		
• AC operation		$0.8 \dots 1.1 \times U_s^{1)}$
• DC operation (except 24 V)		$0.8 \dots 1.1 \times U_s$
- At 24 V DC		$0.8 \dots 1.2 \times U_s$
<b>Power consumption of the solenoid coil</b> (for cold coil and $1.0 \times U_s$ )		
• AC operation, 50 Hz, standard version		
- Closing	VA/p.f.	68/0.82
- Closed	VA/p.f.	10/0.29
• AC operation, 50/60 Hz, standard version		
- Closing, 50 Hz	VA/p.f.	77/0.81
- Closed, 50 Hz	VA/p.f.	11/0.28
- Closing, 60 Hz	VA/p.f.	71/0.75
- Closed, 60 Hz	VA/p.f.	9/0.27
• AC operation, 50 Hz, USA/Canada		
- Closing	VA/p.f.	68/0.82
- Closed	VA/p.f.	10/0.29
• AC operation, 60 Hz, USA/Canada		
- Closing	VA/p.f.	75/0.76
- Closed	VA/p.f.	9.4/0.29 ... 0.3
• AC operation, 50 Hz, Japan		
- Closing	VA/p.f.	80/0.8
- Closed	VA/p.f.	10.7/0.29
• AC operation, 60 Hz, Japan		
- Closing	VA/p.f.	75 ... 90/0.73
- Closed	VA/p.f.	8.5 ... 10.7/0.29 ... 0.3
• DC operation up to 250 V	W	6.2
Closing = Closed		
<b>Permissible residual current of the electronics</b> (with 0 signal)		
• For AC operation		$\leq 8 \text{ mA} \times (220 \text{ V}/U_s)$
• For DC operation		$\leq 1.25 \text{ mA} \times (220 \text{ V}/U_s)$
<b>Operating times within operating range</b>		
Total break time = Opening delay + Arcing time		
• AC operation		
- Closing delay	ms	8 ... 35
- Opening delay	ms	4 ... 18
• DC operation		
- Closing delay	ms	20 ... 170
- Opening delay	ms	10 ... 25
• Arcing time	ms	10 ... 20

<sup>1)</sup> Coils for USA, Canada and Japan:  $0.85$  to  $1.1 \times U_s$  at 60 Hz.

# Switching devices – Contactors and contactor assemblies – Contactor relays and relays

## Contactor relays

### 3TH4 contactor relays, 8- and 10-pole

Contactor relays	Type	3TH42, 3TH43	
<b>Rated data of the auxiliary contacts</b>			
<b>Load rating with AC</b>			
<b>Rated operational currents <math>I_e</math></b>			
• AC-12	A	16	
• AC-15/AC-14, at rated operational voltage $U_e$	230 V A	10	
	400 V A	6	
	500 V A	4	
	690 V A	2	
<b>Rated power of three-phase motors</b>			
Acc. to utilization categories AC-2 and AC-3, 50 Hz	230/220 V kW	2.4	
	400/380 V kW	4	
	500 V kW	4	
	690/660 V kW	4	
<b>Load rating with DC</b>			
<b>Rated operational currents <math>I_e</math></b>			
• DC-12, at rated operational voltage $U_e$			
- 1 conducting path	Up to 48 V A	10	
	110 V A	2.1	
	220 V A	0.8	
	440 V A	0.6	
- 2 conducting paths in series	Up to 48 V A	10	
	110 V A	10	
	220 V A	1.6	
	440 V A	0.8	
- 3 conducting paths in series	Up to 48 V A	10	
	110 V A	10	
	220 V A	10	
	440 V A	1.3	
• DC-13, at rated operational voltage $U_e$			
- 1 conducting path	Up to 24 V A	10	
	48 V A	5	
	110 V A	1	
	220 V A	0.45	
	440 V A	0.25	
	600 V A	0.2	
- 2 conducting paths in series	Up to 24 V A	10	
	48 V A	10	
	110 V A	2.5	
	220 V A	0.75	
	440 V A	0.5	
	600 V A	0.4	
- 3 conducting paths in series	Up to 24 V A	10	
	48 V A	10	
	110 V A	10	
	220 V A	2	
	440 V A	0.9	
	600 V A	0.8	
<b>Switching frequency</b>			
<b>Switching frequency <math>z</math> in operating cycles/hour</b>			
• Rated operation for utilization category (Dependence of the switching frequency $z'$ on operational current $I'$ and operational voltage $U'$ : $z' = z \cdot (I_e/I') \cdot (U_e/U')^{1.5} \cdot 1/h$ )	AC-12/DC-12	1/h	1 000
	AC-2	1/h	500
	AC-3	1/h	1 000
	AC-15/AC-14	1/h	3 600
	DC-13	1/h	3 600
• No-load switching frequency		1/h	10 000

## Switching devices – Contactors and contactor assemblies – Contactor relays and relays

### Contactor relays

#### 3TH4 contactor relays, 8- and 10-pole

#### Selection and ordering data

DC operation 



3TH4244-0L..

Contacts	Rated operational current $I_e$ /AC-15/AC-14				Contacts <sup>1)</sup> Ident. No. acc. to EN 50011	Version		Rated control supply voltage $U_s$	Screw terminals 	Weight
	230 V	400 V	500 V	690 V		NO	NC			
Number	A	A	A	A			V DC	Article No.	kg	
<b>For screw fixing and snap-on mounting on TH 35 standard mounting rail</b>										
<b>With integrated coil circuit (varistor integrated at the factory)</b>										
8	<b>10</b>	6	4	2	<b>44E</b>	4	4	24 110	<b>3TH4244-0LB4</b> <b>3TH4244-0LF4</b>	0.682 0.644
8	<b>10</b>	6	4	2	<b>53E</b>	5	3	24 110	<b>3TH4253-0LB4</b> <b>3TH4253-0LF4</b>	0.692 0.648
8	<b>10</b>	6	4	2	<b>62E</b>	6	2	24 110	<b>3TH4262-0LB4</b> <b>3TH4262-0LF4</b>	0.674 0.660

<sup>1)</sup> No expansion contacts can be fitted.

Other voltages on request.

Accessories, see page 2/142.

# Switching devices – Contactors and contactor assemblies – Contactor relays and relays

## Contactors and contactor assemblies – Contactor relays and relays

### 3TH4 contactor relays, 8- and 10-pole

#### 10-pole contactor relays

AC operation  or DC operation 



3TH4355-0BB4

Contacts	Rated operational current $I_e$ /AC-15/AC-14 at				Contacts	Ident. No. acc. to EN 50011	Version	Screw terminals 	Weight
	230 V	400 V	500 V	690 V					
Number	A	A	A	A				Article No.	kg
					NO	NC	NO		

For screw fixing and snap-on mounting onto TH 35 standard mounting rail

DC operation, rated control supply voltage  $U_s = 24$  V DC

10	10	6	4	2	100E	10	--	--	--	3TH4310-0BB4	0.709
					91E	9	1	--	--	3TH4391-0BB4	0.706
					82E	8	2	--	--	3TH4382-0BB4	0.712
					73E	7	3	--	--	3TH4373-0BB4	0.692
					73E, U	6	2	1	1	3TH4346-0BB4	0.708
					64E	6	4	--	--	3TH4364-0BB4	0.712
					55E	5	5	--	--	3TH4355-0BB4	0.702
					55E, U	4	4	1	1	3TH4394-0BB4	0.703

<sup>1)</sup> Operating range at 220 V:  $0.85$  to  $1.1 \times U_s$ ;  
lower operating range limit according to IEC 60947.

Other voltages according to page 2/141 on request.

For accessories, see page 2/142.

#### Note:

The solenoid coils of the 3TH43 contactor relays are available in various voltages as spare parts (on request).

- AC operation: 3TY7403-0A..
- DC operation: 3TY4803-0B..

The contacts cannot be replaced on 3TH43 contactor relays.

#### Options

Rated control supply voltages, possible on request (change of the 10th and 11th digits of the Article No.)

Delivery time on request

Rated control supply voltage $U_s$	Contactor type	3TH42/3TH43
<b>DC operation</b>		
12 V DC		A4
24 V DC		B4
30 V DC		C4
36 V DC		V4
42 V DC		D4
48 V DC		W4
60 V DC		E4
110 V DC		F4
125 V DC		G4
220 V DC		M4
230 V DC		P4
240 V DC		Q4

## Switching devices – Contactors and contactor assemblies – Contactor relays and relays

### Contactor relays

#### 3TH4 contactor relays, 8- and 10-pole > Accessories for 3TH4 contactor relays

##### Selection and ordering data

Version	Rated control supply voltage $U_s$		Article No.	Weight kg
	AC	DC		
	V	V		

##### Surge suppressors for 3TH4 contactor relays

 <p>3TX7402-3.</p>	<b>Interference suppression diodes</b> With line spacer, for mounting onto the coil terminal	--	24 ... 250	<b>3TX7402-3A</b>	0.014
	<b>Diode assemblies</b> (diode and Zener diode) With line spacer, DC operation, for mounting onto the coil terminal	--	24 ... 250	<b>3TX7402-3D</b>	0.015
	<b>Varistors<sup>1)</sup></b> With line spacer, for mounting onto the coil terminal	24 ... 48	24 ... 70	<b>3TX7402-3G</b>	0.014
		48 ... 127	70 ... 150	<b>3TX7402-3H</b>	0.015
		127 ... 240	150 ... 250	<b>3TX7402-3J</b>	0.015
		240 ... 400	--	<b>3TX7402-3K</b>	0.021
		400 ... 600	--	<b>3TX7402-3L</b>	0.023
	<b>RC elements</b> With line spacer, for mounting onto the coil terminal	24 ... 48	24 ... 70	<b>3TX7402-3R</b>	0.025
		48 ... 127	70 ... 150	<b>3TX7402-3S</b>	0.024
		127 ... 240	150 ... 250	<b>3TX7402-3T</b>	0.021
240 ... 400		--	<b>3TX7402-3U</b>	0.022	
400 ... 600		--	<b>3TX7402-3V</b>	0.022	
<b>Covers</b> for switch position indicator	--	--	<b>3TX4210-0P</b>	0.001	

<sup>1)</sup> Includes the peak value of the alternating voltage on the DC side.

For contactors	Version	Rated control supply voltage $U_s$ 50/60 Hz AC	Time setting range (minimum times)	Screw terminals 	Weight
Type		V	s	Article No.	kg

##### ON-delay devices

 <p>3TX4180-0A</p>	3TH42, 3TH43	<b>NTC thermistors</b> Time tolerance +100%, -50%	220 ... 230	0.1	<b>3TX4180-0A</b>	0.012
---	-----------------	---	-------------	-----	-------------------	-------

### More information

Homepage, see [www.siemens.com/relays](http://www.siemens.com/relays)  
 Industry Mall, see [www.siemens.com/product?3RQ\\_3RS\\_LZ](http://www.siemens.com/product?3RQ_3RS_LZ)  
 TIA Selection Tool Cloud (TST Cloud), see [www.siemens.com/tstcloud/?node=SignalConverters](http://www.siemens.com/tstcloud/?node=SignalConverters)  
 Conversion tool, see [www.siemens.com/conversion-tool](http://www.siemens.com/conversion-tool)



Video: Overview about SIRIUS coupling relays

### The advantages at a glance



Type

3RQ1

3RQ2





3RQ3

	Article No.	Page
<b>SIRIUS 3RQ1 force-guided coupling relays, fail-safe up to SIL 3 / PL e</b>		
<b>Coupling relays with force-guided contacts</b>	<ul style="list-style-type: none"> <li>Widths 17.5 and 22.5 mm</li> <li>Safety certification according to functional safety SIL 3 / PL e</li> <li>Can be used as output extension for SIRIUS 3SK safety relays via device connectors</li> </ul>	<b>3RQ1</b> 2/144
<b>SIRIUS 3RQ2 coupling relays with industrial enclosure</b>		
<b>Coupling relays with relay output</b>	<ul style="list-style-type: none"> <li>1, 2 or 3 changeover contacts with wide voltage range</li> <li>Also available with hard gold-plated contacts</li> </ul>	<b>3RQ2</b> 2/151
<b>SIRIUS 3RQ3 coupling relays, narrow design</b>		
<b>Coupling relays with relay output (not plug-in)</b>	<ul style="list-style-type: none"> <li>Width 6.2 mm, 1 CO, versions with hard gold-plated contacts optionally available</li> <li>- Output coupling links</li> <li>- Input coupling links</li> </ul>	<b>3RQ301</b> 2/154 <b>3RQ303</b> 2/154
<b>Coupling relays with plug-in relays</b>	<ul style="list-style-type: none"> <li>Width 6.2 mm, 1 CO, versions with hard gold-plated contacts optionally available</li> <li>- Output coupling links</li> </ul>	<b>3RQ311</b> 2/154
<b>Coupling relays with semiconductor output (not plug-in)</b>	<ul style="list-style-type: none"> <li>Width 6.2 mm, output 1 semiconductor, triac or transistor</li> <li>- Output coupling links</li> <li>- Input coupling links</li> </ul>	<b>3RQ305, 3RQ306</b> 2/154 <b>3RQ307</b> 2/154

### Connection methods

The contactor relays and the relays are available with screw terminals (box terminals) or with spring-loaded terminals.

The 3RQ coupling relays are supplied with screw terminals or spring-loaded (push-in) terminals. The plug-in bases for LZS/LZX coupling relays are also available with plug-in (push-in) terminals.

	Screw terminals
	Spring-loaded terminals, spring-loaded terminals (push-in)
	Flat connectors
	Plug-in terminals (push-in)
The terminals are indicated in the corresponding tables by the symbols shown on orange backgrounds.	

### 3RQ coupling relays: Spring-loaded terminals (push-in) with TOP-wiring

Push-in terminals are a form of spring-loaded terminals allowing fast wiring without tools for rigid conductors or conductors equipped with end sleeves.

As with other spring-loaded terminals, a screwdriver (with 3.0 x 0.5 mm blade) is required to disconnect the conductor. The same tool can also be used to wire finely-stranded or stranded conductors with no end finishing.

The advantages of the push-in terminals are found, as with all spring-loaded terminals, in speed of assembly and disassembly and vibration-proof connection. There is no need for the checking and tightening required with screw terminals.

With the TOP wiring method, the wire inlet and terminals can be reached from the front. This helps to speed up the wiring process and eliminate wiring errors.



Video: SIRIUS spring-loaded terminals – Strong, flexible, safe, fast

## Switching devices – Contactors and contactor assemblies – Contactor relays and relays

### Coupling relays

SIRIUS 3RQ1 force-guided coupling relays, fail-safe up to SIL 3 / PL e **NEW**

#### Overview

2



Figure on left: 3RQ1000-1EW00 coupling relay,  
1 NO contact + 1 NC contact, screw terminal  
Figure on right: 3RQ1000-2LW00 coupling relay,  
4 NO contacts + 1 NC contact, spring-loaded terminal (push-in)



3RQ1 coupling relay in the 3SK system

#### More information

Homepage, see [www.siemens.com/relays](http://www.siemens.com/relays)

Industry Mall, see [www.siemens.com/product?3RQ1](http://www.siemens.com/product?3RQ1)

Technical specifications, see  
<https://support.industry.siemens.com/cs/ww/en/ps/26008/td>

Manuals, see  
<https://support.industry.siemens.com/cs/ww/en/ps/26008/man>



Video: SIRIUS 3RQ1 coupling relays

The force-guided SIRIUS 3RQ1 coupling relays in a modern titanium gray industrial enclosure are available in widths of 17.5 mm and 22.5 mm, and each with a supply voltage of 24 V DC (120 mm mounting depth) and 24 to 240 V AC/DC (90 mm mounting depth).

They are used for safe coupling up to SIL 3 / PL e of control signals to and from a control system or as an output expansion for the SIRIUS 3SK safety relays.

Further fields of application are based on the force-guided operation of relays according to IEC 60947-5-1 and EN 61810-3 for reading back relay states, for reliable diagnostics or signaling, or for the use of antivalent signals. Typical fields of application here are railways, signaling technology, and elevators.

The series consists of devices with up to five outputs and can be supplied with screw or spring-loaded (push-in) terminals.

International standards and certifications including CE, UL/CSA, EAC and railway approvals ensure international usability and exportability.

An extensive range of accessories is also available, such as device connectors for easy and safe connection of the 3RQ1 devices, replacement terminals, push-in lugs for wall mounting, and coding pins, see page 2/149 onwards.



# Switching devices – Contactors and contactor assemblies – Contactor relays and relays

## Coupling relays

**NEW** SIRIUS 3RQ1 force-guided coupling relays, fail-safe up to SIL 3 / PL e

### Article No. scheme

Product versions		Article number	
<b>Coupling relays with force-guided contacts</b>		<b>3RQ1</b>	<b>□ 0 0 - □ □ □ 0 0</b>
Version	Performance level (SIL level): c (SIL 2)	<b>0</b>	
	Performance level (SIL level): e (SIL 3)	<b>2</b>	
Connection methods	Screw terminals	<b>1</b>	
	Spring-loaded terminals (push-in)	<b>2</b>	
Outputs	1 NO + 1 NC		<b>E</b> Width 17.5 mm
	2 NO + 1 NC		<b>G</b> Width 17.5 mm
	2 NO + 2 NC		<b>H</b> Width 22.5 mm
	4 NO + 1 NC		<b>L</b> Width 22.5 mm
Rated control supply voltage	24 V DC		<b>B</b> Depth 120 mm
	24 to 240 V AC/DC		<b>W</b> Depth 90 mm
Example		<b>3RQ1</b>	<b>0 0 0 - 1 E W 0 0</b>

### Note:

The Article No. scheme shows an overview of product versions for better understanding of the logic behind the article numbers.

For your orders, please use the article numbers quoted in the selection and ordering data.

### Benefits

- Wide-range voltage versions from 24 to 240 V AC/DC available with a mounting depth of 90 mm for all variants
- Permanent wiring thanks to removable terminals in screw or spring-loaded technology (push-in)
- Replacement of individual terminals minimizes wiring effort
- Can be used as output extension for SIRIUS 3SK safety relays via device connectors
- All versions with real load contacts, also in the NC circuit
- Safety certification according to functional safety SIL 3 / PL e
- International standards and certifications including CE, UL/CSA, EAC, railway approvals, and more

## Switching devices – Contactors and contactor assemblies – Contactor relays and relays

### Coupling relays

#### SIRIUS 3RQ1 force-guided coupling relays, fail-safe up to SIL 3 / PL e

#### Application

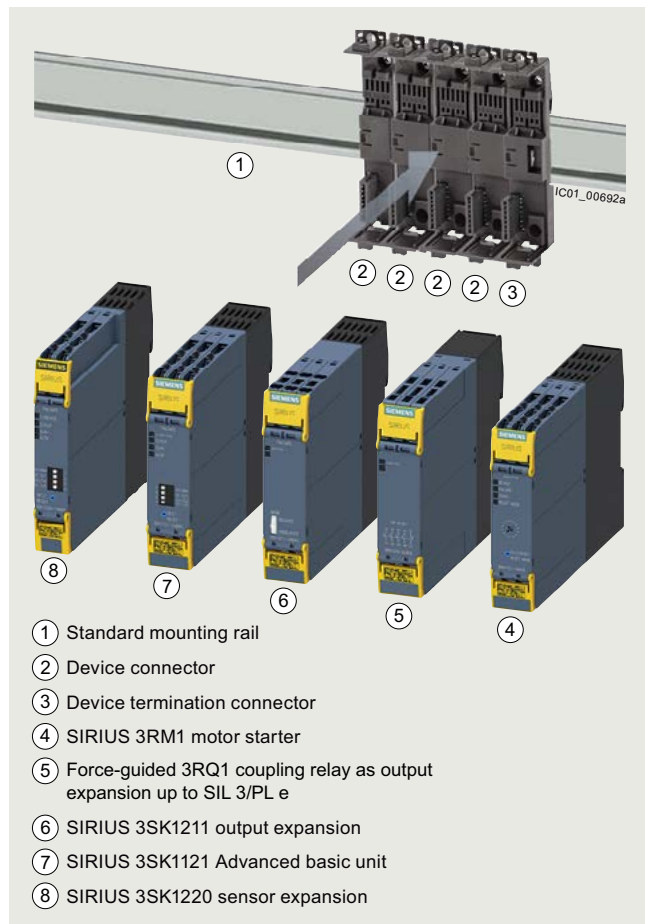

- Safe coupling up to SIL 3 / PL e of control signals from and to a control system
- Output expansion for 3SK safety relays
- Use of force-guided contacts for reading back relay states
- For reliable diagnostics or signaling or for antivalent switching of loads
- Safe coupling:
  - Electrical separation between the input and output circuit
  - Adjustment of different signal levels
  - Signal amplification
  - Contact multiplication

#### 3RQ1 output expansion (up to SIL 3 / PL e) for the 3SK system

The force-guided 3RQ1 coupling relays with a mounting depth of 120 mm can be used as an output expansion up to SIL 3 / PL e and can be connected by wiring to all 3SK basic units and by using the 3ZY12 device connector to all 3SK1 and 3SK2 Advanced basic units.

They have a switching capacity of AC-15 5/3 A (like 3SK1211) at a switching voltage of 230 V and are available in widths of 17.5 mm and 22.5 mm. Furthermore, they have NC contacts with a switching capacity of AC-15 2/1.5 A for direct switching of loads (anti-parallel switching, signaling, etc.).

System configuration example with SIRIUS 3SK safety relays

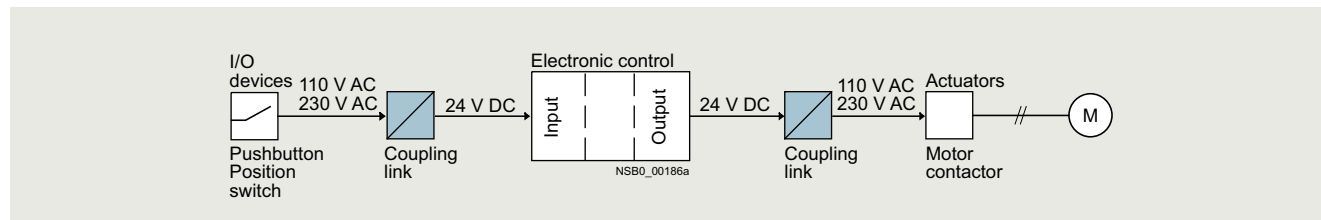

Typical application with a fail-safe control system

# Switching devices – Contactors and contactor assemblies – Contactor relays and relays

## Coupling relays

**NEW** SIRIUS 3RQ1 force-guided coupling relays, fail-safe up to SIL 3 / PL e

### Technical specifications

#### More information



Technical specifications, see  
<https://support.industry.siemens.com/cs/ww/en/ps/26008/td>

Manuals, see  
<https://support.industry.siemens.com/cs/ww/en/ps/26008/man>  
 Equipment Manual 3SK1/3RQ1, see  
<https://support.industry.siemens.com/cs/ww/en/view/67585885>

Article number	3RQ1000-EB00, 3RQ1000-GB00	3RQ1200-EB00	3RQ1000-EW00, 3RQ1000-GW00	3RQ1200-EW00	3RQ1000-HB00, 3RQ1000-LB00	3RQ1000-HW00, 3RQ1000-LW00
----------------	-------------------------------	--------------	-------------------------------	--------------	-------------------------------	-------------------------------

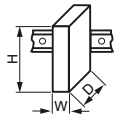
#### General data

<b>Dimensions (W x H x D)</b>		mm	17.5 x 100 x 120	17.5 x 100 x 90	22.5 x 100 x 120	22.5 x 100 x 90
<b>Safety integrity level (SIL) according to IEC 62061</b>			2	3	2	
<b>Performance level (PL) according to ISO 13849-1</b>			c	e	c	
<b>Certificate of suitability</b>						
• UL approval			Yes			
• TÜV approval			Yes			
<b>Insulation voltage for overvoltage category III acc. to IEC 60664 for pollution degree 3</b>	V		300			
<b>Ambient temperature</b>						
• During operation	°C		-25 ... +60			
• During storage	°C		-40 ... +80			
<b>Degree of protection IP</b>			IP20			
<b>Control circuit</b>						
<b>Control supply voltage</b>						
• At AC						
- At 50 Hz	V	--	24 ... 240	--	24 ... 240	
- At 60 Hz	V	--	24 ... 240	--	24 ... 240	
• At DC	V	24	24 ... 240	24	24 ... 240	
<b>Operating range factor of the control supply voltage, rated value</b>						
• At DC			0.8 ... 1.2	0.7 ... 1.1	0.8 ... 1.2	0.7 ... 1.1
<b>Load circuit</b>						
<b>Thermal current of the non-solid-state contact blocks, maximum</b>	A		5			
<b>Mechanical service life (operating cycles) typical</b>			10 000 000			

Article number	3RQ1000-1, 3RQ1200-1	3RQ1000-2, 3RQ1200-2
<b>Type of electrical connection</b>	 Screw terminals	 Spring-loaded terminals (push-in)
<b>Type of connectable conductor cross-sections</b>		
• Solid	1x (0.5 ... 4.0 mm <sup>2</sup> ), 2x (0.5 ... 2.5 mm <sup>2</sup> )	1x (0.5 ... 4 mm <sup>2</sup> )
• Finely stranded with end sleeve	1x (0.5 ... 4 mm <sup>2</sup> ), 2x (0.5 ... 1.5 mm <sup>2</sup> )	1x (0.5 ... 2.5 mm <sup>2</sup> )
• Solid for AWG cables	AWG 1x (20 ... 12), 2x (20 ... 14)	1x (20 ... 12)
<b>Tightening torque</b>	Nm 0.6 ... 0.8	--

## Switching devices – Contactors and contactor assemblies – Contactor relays and relays

### Coupling relays

**SIRIUS 3RQ1 force-guided coupling relays, fail-safe up to SIL 3 / PL e** **NEW**

#### Selection and ordering data

Control supply voltage		Number of auxiliary contacts		Depth	Suitable for use with 3ZY12 device connector	Spring-loaded terminals (push-in)	Weight
At AC at 50/60 Hz	At DC	NO	NC				
V	V	NO	NC	mm		Article No.	kg

#### Width 17.5 mm



3RQ1000-1EW00 3RQ1000-2EW00

#### Fail-safe up to SIL 2 / PL c

--	24	1	1	120	✓	<b>3RQ1000-2EB00</b>	0.200
--	24	2	1	120	✓	<b>3RQ1000-2GB00</b>	0.177
24 ... 240	24 ... 240	1	1	90	--	<b>3RQ1000-2EW00</b>	0.153
24 ... 240	24 ... 240	2	1	90	--	<b>3RQ1000-2GW00</b>	0.156

#### Fail-safe up to SIL 3 / PL e

--	24	1	-- <sup>1)</sup>	120	✓	<b>3RQ1200-2EB00</b>	0.177
24 ... 240	24 ... 240	1	1	90	--	<b>3RQ1200-2EW00</b>	0.160

#### Width 22.5 mm



3RQ1000-1LW00 3RQ1000-2LW00

#### Fail-safe up to SIL 2 / PL c

--	24	2	2	120	✓	<b>3RQ1000-2HB00</b>	0.205
--	24	4	1	120	✓	<b>3RQ1000-2LB00</b>	0.209
24 ... 240	24 ... 240	2	2	90	--	<b>3RQ1000-2HW00</b>	0.193
24 ... 240	24 ... 240	4	1	90	--	<b>3RQ1000-2LW00</b>	0.194

✓ Yes

-- No

<sup>1)</sup> NC contact designed to act as feedback contact.

#### Note:

All force-guided 3RQ1 coupling relays have safety certification up to SIL 2 / PL c or SIL 3 / PL e according to IEC 62061 / ISO 13849.

To achieve SIL 3 / PL e, two 3RQ10 devices can also be wired in series, see [Equipment Manual](#).

In addition, the 3SK1211 devices (output expansions for 3SK) provide force-guided coupling relays with 4 NO contacts and 1 NC contact up to SIL 3 / PL e with 24 V AC, 24 V DC and 110 to 240 V AC/DC.

For applications with high currents up to a switching capacity of 10 A AC-15, the 3SK1213 output expansions are also available with 24 V AC, 24 V DC and 110 to 240 V AC/DC.

These devices can be used in the same way as the 3RQ1 coupling relays for coupling to and from safe control systems, they feature 4 NO contacts and 1 NC contact, and are available as variants with 24 V AC, 24 V DC and 110 to 240 V AC/DC.

# Switching devices – Contactors and contactor assemblies – Contactor relays and relays





## Coupling relays

SIRIUS 3RQ1 force-guided coupling relays, fail-safe up to SIL 3 / PL e

### Accessories

#### More information

Manuals, see  
<https://support.industry.siemens.com/cs/ww/en/ps/26008/man>

Version	Article No.	Weight kg
<b>Device connectors for the electrical connection of SIRIUS devices in the industrial standard mounting rail enclosure</b>		
 <p>3ZY1212-1BA00    3ZY1212-2BA00</p>	<b>Device connectors</b> <ul style="list-style-type: none"> <li>Width 17.5 mm (for 3RQ1000-.EB00/-.GB00, 3RQ1200-.EB00)</li> <li>Width 22.5 mm (for 3RQ1000-.HB00/-.LB00)</li> </ul>	<p>3ZY1212-1BA00    0.022</p> <p>3ZY1212-2BA00    0.026</p>
	<b>Device termination connectors</b> <ul style="list-style-type: none"> <li>Width 17.5 mm (for 3RQ1000-.EB00/-.GB00, 3RQ1200-.EB00)</li> <li>Width 22.5 mm (for 3RQ1000-.HB00/-.LB00)</li> </ul> <p>Note: Observe positions of the slide switch for width 22.5 mm, see <a href="#">Equipment Manual</a>.</p>	<p>3ZY1212-1DA00    0.023</p> <p>3ZY1212-2DA00    0.027</p>
 <p>3ZY1212-2DA00</p>	<b>Device daisy chain connectors</b> 24 V DC, 22.5 mm, for implementation of distances between devices according to the installation guidelines	<p>3ZY1212-2AB00    0.023</p>
	<b>Device connectors</b> For height adjustment for device arrangements without electrical connection via device connector, with a width of 22.5 mm or greater	<p>3ZY1210-2AA00    0.019</p>
<b>Terminals for SIRIUS devices in the industrial standard mounting rail enclosure</b>		
 <p>3ZY1122-1BA00    3ZY1122-2BA00</p>	<b>Removable terminals</b> <ul style="list-style-type: none"> <li>2-pole, up to 1 x 4 mm<sup>2</sup> or 2 x 2.5 mm<sup>2</sup></li> <li>2-pole, up to 1 x 4 mm<sup>2</sup> or 2 x 1.5 mm<sup>2</sup> (in shared end sleeve)</li> </ul>	<p><b>Screw terminals</b> </p> <p>3ZY1122-1BA00    0.010</p> <p><b>Spring-loaded terminals (push-in)</b> </p> <p>3ZY1122-2BA00    0.008</p>





## Switching devices – Contactors and contactor assemblies – Contactor relays and relays

### Coupling relays

#### SIRIUS 3RQ1 force-guided coupling relays, fail-safe up to SIL 3 / PL e

Version	Article No.	Weight kg
---------	-------------	--------------



#### Accessories for enclosures

 <p>3ZY1321-2AA00</p>	<b>Sealing covers</b> <ul style="list-style-type: none"> <li>• 17.5 mm</li> <li>• 22.5 mm</li> </ul>	<b>3ZY1321-1AA00</b> <b>3ZY1321-2AA00</b>	0.002 0.002
	 <p>3ZY1311-0AA00</p>	<b>Push-in lugs</b> For wall mounting	<b>3ZY1311-0AA00</b>
 <p>3ZY1440-1AA00</p>	<b>Coding pins</b> For removable terminals of SIRIUS devices in the industrial standard mounting rail enclosure; they enable the mechanical coding of terminals, see <a href="#">Equipment Manual</a> .	<b>3ZY1440-1AA00</b>	
 <p>3ZY1450-1BA00    3ZY1450-1BB00</p>	<b>Hinged cover</b> Replacement cover, without terminal labeling, yellow <ul style="list-style-type: none"> <li>• 17.5 mm wide</li> <li>• 22.5 mm wide</li> </ul>	<b>3ZY1450-1BA00</b> <b>3ZY1450-1BB00</b>	0.004
			0.004

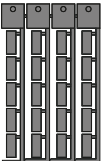
#### Blank labels

 <p>3RT2900-1SB20</p>	<b>Unit labeling plates<sup>1)</sup></b> For SIRIUS devices <ul style="list-style-type: none"> <li>• 17.5 mm: 10 mm x 7 mm, titanium gray</li> <li>• 20 mm x 7 mm, titanium gray</li> </ul>	<b>3RT2900-1SB10</b>	0.028
		<b>3RT2900-1SB20</b>	0.062

#### Tools for opening spring-loaded terminals

 <p>3RA2908-1A</p>	<b>Screwdriver</b> For all SIRIUS devices with spring-loaded terminals 3.0 mm x 0.5 mm, length approx. 200 mm, titanium gray/black, partially insulated	<b>Spring-loaded terminals (push-in)</b>  <b>3RA2908-1A</b>	0.050
---	--	---	-------

<sup>1)</sup> PC labeling system for individual inscription of unit labeling plates available from: murrplastik Systemtechnik GmbH.

# Switching devices – Contactors and contactor assemblies – Contactor relays and relays

## Coupling relays

### SIRIUS 3RQ2 coupling relays with industrial enclosure

#### Overview



SIRIUS 3RQ2 coupling relay, screw terminals, 3 changeover contacts

#### More information

Homepage, see [www.siemens.com/relays](http://www.siemens.com/relays)

Industry Mall, see [www.siemens.com/product?3RQ2](http://www.siemens.com/product?3RQ2)

TIA Selection Tool Cloud (TST Cloud), see [www.siemens.com/tstcloud/?node=SignalConverters](http://www.siemens.com/tstcloud/?node=SignalConverters)

Conversion tool, see [www.siemens.com/conversion-tool](http://www.siemens.com/conversion-tool)

3RQ2 coupling relays in their 22.5 mm industrial enclosure serve to couple control signals to and from a controller and replace the 3RS18 coupling relays. The 3RQ2 has an impressively high-quality industrial enclosure finished in modern titanium gray so that it fits in visually with the SIRIUS series of relays.

The series consists of devices with up to three changeover contacts with screw or spring-loaded terminals (push-in) and, with its wide voltage range from 24 to 240 V AC/DC, is a genuine highlight in the coupling relay market.

Thanks to terminal assignment that is identical to the previous version, existing products can easily be converted.

The reduced variety of components simplifies product selection and standardization.

Numerous accessories are available for the 3RQ2 coupling relays, for example replacement terminals, push-in lugs for wall mounting and coding pins.

#### Article No. scheme

Product versions		Article number						
<b>Coupling relays, standard</b>		<b>3RQ2000</b>	–	<input type="checkbox"/>	<input type="checkbox"/>	<input type="checkbox"/>	<b>0</b>	<input type="checkbox"/>
Connection methods	Screw terminals			<b>1</b>				
	Spring-loaded terminals (push-in)			<b>2</b>				
Outputs	1 CO contact				<b>A</b>			
	2 CO contacts				<b>B</b>			
	3 CO contacts				<b>C</b>			
Rated control supply voltage	24 ... 240 V AC/DC					<b>W</b>		
Material of switching contacts	0 = AgSnO <sub>2</sub>						<b>0</b>	
	1 = AgNi + Au						<b>1</b>	
Example		<b>3RQ2000</b>	–	<b>1</b>	<b>C</b>	<b>W</b>	<b>0</b>	<b>1</b>

#### Note:

The Article No. scheme shows an overview of product versions for better understanding of the logic behind the article numbers.

For your orders, please use the article numbers quoted in the selection and ordering data.

#### Benefits

- Permanent wiring thanks to removable terminals in screw or spring-loaded technology (push-in)
- Replacement of individual terminals minimizes wiring effort
- A product for all voltages from 24 to 240 V AC/DC
- Reduced costs thanks to fewer versions
- Especially high contact reliability even at low currents thanks to versions with hard gold-plated contacts
- International standards and certifications including CE, UL/CSA, EAC, railway approvals, and more

#### Application

- Electrical separation between the input and output circuit
- Adjustment of different signal levels
- Signal amplification
- Contact multiplication

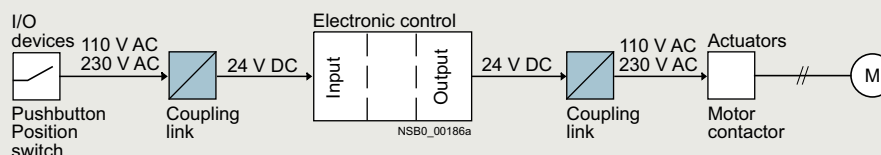

Application example motor controller





# Switching devices – Contactors and contactor assemblies – Contactor relays and relays

## Coupling relays

### SIRIUS 3RQ2 coupling relays with industrial enclosure

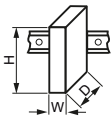
#### Technical specifications



More information			
Technical specifications, see <a href="https://support.industry.siemens.com/cs/ww/en/ps/25158/td">https://support.industry.siemens.com/cs/ww/en/ps/25158/td</a>		Operating Instructions, see <a href="https://support.industry.siemens.com/cs/ww/en/ps/25158/man">https://support.industry.siemens.com/cs/ww/en/ps/25158/man</a>	
Type		<b>3RQ2000-AW00</b> <b>3RQ2000-BW00</b> <b>3RQ2000-CW00</b>	<b>3RQ2000-CW01</b>
General data			
<b>Dimensions (W x H x D)</b>	 mm	22.5 x 100 x 90	
<b>Insulation voltage for overvoltage category III acc. to IEC 60664 for pollution degree 3</b>	V	300	
<b>Max. permissible voltage for protective separation between control circuit and auxiliary circuit acc. to IEC 60947-1</b>	V	300	
<b>Ambient temperature</b>			
• During operation	°C	-40 ... +60	
• During storage	°C	-40 ... +80	
<b>Degree of protection IP</b>		IP20	
Control circuit			
<b>Control supply voltage</b>	V	24 ... 240 AC/DC; 50/60 Hz	
<b>Operating range factor of control supply voltage</b>		0.7 ... 1.1	
Load circuit			
<b>Thermal current of the non-solid-state contact blocks, maximum</b>	A	5	
<b>Current carrying capacity of the output relay</b>			
• At AC-15 at 250 V	A	3	
• At DC-13 at 24 V	A	1	
• At DC-13 at 125 V	A	0.2	
• At DC-13 at 250 V	A	0.1	
<b>Mechanical service life (operating cycles) typical</b>		10 000 000	
<b>Electrical endurance (operating cycles) for AC-15 at 230 V, typical</b>		100 000	
<b>Material of switching contacts</b>		AgSnO <sub>2</sub>	AgNi + Au
Article number		<b>3RQ2000-1</b>	<b>3RQ2000-2</b>
<b>Type of electrical connection</b>		 <b>Screw terminals</b>	 <b>Spring-loaded terminals (push-in)</b>
<b>Type of connectable conductor cross-sections</b>			
• Solid		1x (0.5 ... 4 mm <sup>2</sup> ), 2x (0.5 ... 2.5 mm <sup>2</sup> )	1x (0.5 ... 4 mm <sup>2</sup> )
• Finely stranded with end sleeve		1x (0.5 ... 4 mm <sup>2</sup> ), 2x (0.5 ... 1.5 mm <sup>2</sup> )	1x (0.5 ... 2.5 mm <sup>2</sup> )
• Solid for AWG cables		1x (20 ... 12), 2x (20 ... 14)	1x (20 ... 12)
<b>Tightening torque</b>	Nm	0.6 ... 0.8	--

# Switching devices – Contactors and contactor assemblies – Contactor relays and relays

## Coupling relays

### SIRIUS 3RQ2 coupling relays with industrial enclosure

#### Selection and ordering data









	Control supply voltage		Number of CO contacts for auxiliary contacts	Material of switching contacts	Spring-loaded terminals (push-in) 	Weight
	At AC At 50 Hz	At DC				
	V	V	W		Article No.	kg
<b>Coupling relays with industrial enclosure, 22.5 mm</b>						
 3RQ2000-1CW00	24 ... 240	24 ... 240	1	AgSnO2	<b>3RQ2000-2AW00</b>	0.158
			2	AgSnO2	<b>3RQ2000-2BW00</b>	0.165
			3	AgSnO2	<b>3RQ2000-2CW00</b>	0.184
			3	AgNi + Au	<b>3RQ2000-2CW01</b>	0.185
 3RQ2000-2CW00						

#### Accessories

##### More information

Operating Instructions, see <https://support.industry.siemens.com/cs/ww/en/ps/25158/man>

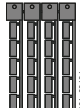
Conversion tool, see [www.siemens.com/conversion-tool](http://www.siemens.com/conversion-tool)

Version	Article No.	Weight
<b>Terminals for SIRIUS devices in the industrial standard mounting rail enclosure</b>		
 3ZY1122-1BA00	<b>Removable terminals</b> <ul style="list-style-type: none"> <li>• 2-pole, up to 1 x 4 mm<sup>2</sup> or 2 x 2.5 mm<sup>2</sup></li> <li>• 2-pole, up to 1 x 4 mm<sup>2</sup> or 2 x 1.5 mm<sup>2</sup> (in shared end sleeve)</li> </ul>	<b>Screw terminals</b>  <b>3ZY1122-1BA00</b> 0.010 <b>Spring-loaded terminals (push-in)</b>  <b>3ZY1122-2BA00</b> 0.008
 3ZY1450-1AB00	<b>Hinged cover</b> Replacement cover, without terminal labeling, titanium gray, 22.5 mm wide	<b>3ZY1450-1AB00</b> 0.004
 3ZY1311-0AA00	<b>Push-in lugs</b> For wall mounting	<b>3ZY1311-0AA00</b> 0.001
 3ZY1440-1AA00	<b>Coding pins</b> For removable terminals of SIRIUS devices in the industrial standard mounting rail enclosure; they enable the mechanical coding of terminals	<b>3ZY1440-1AA00</b>
 3RT2900-1SB20	<b>Unit labeling plates</b> For SIRIUS devices 20 mm x 7 mm, titanium gray <sup>1)</sup>	<b>3RT2900-1SB20</b> 0.062
 3RA2908-1A	<b>Screwdriver</b> For all SIRIUS devices with spring-loaded terminals 3.0 mm x 0.5 mm, length approx. 200 mm, titanium gray/black, partially insulated	<b>Spring-loaded terminals (push-in)</b>  <b>3RA2908-1A</b> 0.050

\* You can order this quantity or a multiple thereof.

## Switching devices – Contactors and contactor assemblies – Contactor relays and relays

### Coupling relays

#### SIRIUS 3RQ3 coupling relays, narrow design

##### Overview



SIRIUS 3RQ3 coupling relays

##### More information

Homepage, see [www.siemens.com/relays](http://www.siemens.com/relays)

Industry Mall, see [www.siemens.com/product?3RQ3](http://www.siemens.com/product?3RQ3)

TIA Selection Tool Cloud (TST Cloud), see [www.siemens.com/tstcloud/?node=SignalConverters](http://www.siemens.com/tstcloud/?node=SignalConverters)

Conversion tool, see [www.siemens.com/conversion-tool](http://www.siemens.com/conversion-tool)

SIRIUS 3RQ3 coupling relays in narrow design are used for coupling control signals from and to a controller, and they are available in different versions:

- Coupling relays with relay output (not plug-in)
- Coupling relays with plug-in relays
- Coupling relays with semiconductor output (not plug-in)

##### ***Coupling relays with relay output (not plug-in)***

###### **AC and DC operation**

IEC 60947-5-1

The input and output coupling relays differ with regard to the positioning of the terminals and the LEDs.

##### ***Coupling relays with plug-in relays***

###### **AC and DC operation**

IEC 60947-1

The coupling relays are plug-in, so the relay can be replaced quickly at the end of its service life without detaching the wiring.

##### ***Coupling relays with semiconductor output (not plug-in)***

###### **AC and DC operation**

IEC 60947-1, EN 60664-1 and EN 50005;  
coupling relays with semiconductor output: EN 60747-5;  
programmable controllers: IEC 61131-2

The input and output coupling relays differ with regard to the positioning of the terminals and the LEDs.

The coupling relays with semiconductor output have extremely high contact reliability, so they are especially suitable for solid-state systems.

For test purposes, versions are available with manual-off-automatic switches.

# Switching devices – Contactors and contactor assemblies – Contactor relays and relays

## Coupling relays

### SIRIUS 3RQ3 coupling relays, narrow design

#### Article No. scheme

Product versions		Article number			
<b>Coupling relays with relay output (not plug-in)</b>		<b>3RQ30 □ 8 – □ A □ 0 □</b>			
Design and type of output	Output coupler, without manual/automatic switch	1			
	Input coupler	3			
Type of electrical connection	Screw terminals		1		
	Spring-loaded terminals (push-in)		2		
Control supply voltage	24 V AC/DC			B	
	115 V AC/DC			E	
	230 V AC/DC			F	
Material of switching contacts	e.g.				
	0 = AgSnO <sub>2</sub>				□
	1 = AgSnO <sub>2</sub> hard gold-plated				□
Example		<b>3RQ30 1 8 – 1 A B 0 1</b>			

Product versions		Article number			
<b>Coupling relays with relay output (not plug-in)</b>		<b>3RQ30 1 8 – 2 A □ 0 8 – 0 A A 0</b>			
Railway version with extended operating range 0.7 ... 1.2 x U <sub>s</sub>					
Control supply voltage	24 V DC			M	
	110 V DC			N	
Example		<b>3RQ30 1 8 – 2 A M 0 8 – 0 A A 0</b>			

Product versions		Article number			
<b>Coupling relays with plug-in relays</b>		<b>3RQ31 1 8 – □ A □ 0 □</b>			
Type of electrical connection	Screw terminals		1		
	Spring-loaded terminals (push-in)		2		
Control supply voltage	24 V AC/DC			B	
	115 V AC/DC			E	
	230 V AC/DC			F	
	24 V DC			M	
Material of switching contacts	AgSnO <sub>2</sub>				0
	AgSnO <sub>2</sub> hard gold-plated				1
Example		<b>3RQ31 1 8 – 1 A B 0 1</b>			

Product versions		Article number				Control supply voltage	Switching voltage of the semiconductor output		
<b>Coupling relays with semiconductor output (not plug-in)</b>		<b>3RQ30 □ □ – □ S □ □ 0</b>							
	Current carrying capacity of the semiconductor output								
Output coupler	• Without manual/automatic switch	1 mA ... 0.5 A	5	0	□	M 5	11 ... 30 V DC	10 ... 60 V DC	
		5 mA ... 2 A	5	2	□	M 3	11 ... 30 V DC	10 ... 30 V DC	
		1 mA ... 2 A	5	2	□	M 4	11 ... 30 V DC	10 ... 60 V DC	
		5 mA ... 2 A	5	2	□	M 5	11 ... 30 V DC	20 ... 264 V AC	
		1 mA ... 3 A	5	3	□	G 3	110 ... 230 V AC/DC	10 ... 30 V DC	
	• With manual/automatic switch	5 mA ... 5 A	5	5	□	M 3	11 ... 30 V DC	10 ... 30 V DC	
		5 mA ... 5 A	6	5	□	M 3	11 ... 30 V DC	10 ... 30 V DC	
		Input coupler	10 mA ... 0.5 A	7	0	□	B 3	11 ... 30 V AC/DC	10 ... 30 V DC
				7	0	□	G 3	110 ... 230 V AC/DC	10 ... 30 V DC
		Type of electrical connection	Screw terminals						
Spring-loaded terminals (push-in)									
Example		<b>3RQ30 7 0 – 1 S B 3 0</b>							

#### Note:

This Article No. scheme shows an overview of product versions for better understanding of the logic behind the article numbers.

For your orders, please use the article numbers quoted in the selection and ordering data.

## Switching devices – Contactors and contactor assemblies – Contactor relays and relays

### Coupling relays

#### SIRIUS 3RQ3 coupling relays, narrow design

##### Benefits

###### General

- All versions with screw terminals or spring-loaded terminals (push-in technology)
- TOP wiring with spring-loaded terminals (push-in) for quick and reliable wiring
- Low space requirements in the control cabinet thanks to a consistent width of 6.2 mm
- Reduced stockkeeping due to fewer variants
- Clearly visible functional state of the coupling relay by green LED
- Integrated reverse polarity protection and EMC suppressor diode
- Standardized accessories across the entire 3RQ3 series
- Universal bridging option using connecting combs for all terminals
- Galvanic isolation plate for isolating different voltages for neighboring units
- Clip-on labels available as set for individual labeling

###### Coupling relays with relay output (not plug-in)

- Relays fixed in enclosure for increased contact reliability
- Device variants with hard gold-plated contacts, hence high contact reliability at low currents

###### Coupling relays with plug-in relays

- Fast replacement of the relays with existing wiring
- Shorter installation times thanks to certified complete units
- Individual relays available as spare parts
- Device variants with hard gold-plated contacts, hence high contact reliability at low currents

###### Coupling relays with semiconductor output (not plug-in)

- Long service life since there is no mechanical wear
- High switching frequency thanks to short make-break times
- Vibration-resistant
- No contact bounce
- Extremely high contact reliability
- Noise-free switching
- Low control power required
- Switching of DC and capacitive loads

###### Note:

With semiconductors, the switching current is not dependent on the inductance of the load, i.e. the switching current for an inductive DC-13 load is the same as that for a DC-12 load. This means that coupling links with a semiconductor output are particularly suitable for inductive loads such as solenoid valves. It is not relevant to specify the number of operating cycles, because this does not affect the endurance of the semiconductor, provided it is not overheated.

##### Application

- Electrical separation between the input and output circuit
- Adjustment of different signal levels
- Signal amplification

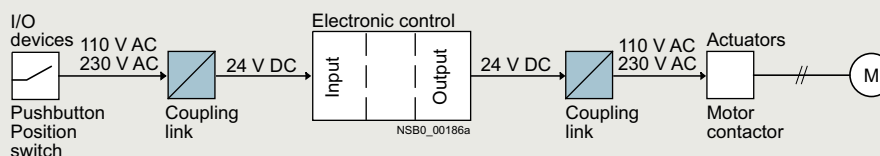

Application example motor controller

# Switching devices – Contactors and contactor assemblies – Contactor relays and relays

## Coupling relays

### SIRIUS 3RQ3 coupling relays, narrow design

#### Technical specifications

##### More information

Technical specifications, see  
<https://support.industry.siemens.com/cs/ww/en/ps/16198/td>

Operating Instructions, see  
<https://support.industry.siemens.com/cs/ww/en/ps/16198/man>  
 FAQs, see <https://support.industry.siemens.com/cs/ww/en/ps/16198/faq>

#### Coupling relays with relay output (not plug-in)

Article number	3RQ30.8- .AB00	3RQ30.8- .AB01	3RQ30.8- .AE00	3RQ30.8- .AE01	3RQ30.8- .AF00	3RQ30.8- .AF01	3RQ3018- 2AM08-0AA0	3RQ3018- 2AN08-0AA0
----------------	-------------------	-------------------	-------------------	-------------------	-------------------	-------------------	------------------------	------------------------

##### General technical specifications

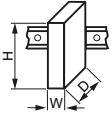
<b>Width x height x depth</b>	mm	6.2 x 93 x 72.5						
								
<b>Insulation voltage for overvoltage category III acc. to IEC 60664 for pollution degree 3</b>	V	300						
<b>Max. permissible voltage for protective separation between control circuit and auxiliary circuit</b>	V	300						
<b>Ambient temperature</b>								
• During operation	°C	-25 ... +60				-40 ... +70		
• During storage	°C	-40 ... +85						
<b>Degree of protection IP</b>		IP20						
<b>Version of the fuse link required for short-circuit protection of the auxiliary switch</b>		Fuse gG: 4 A						
<b>Operational current of the auxiliary contacts</b>								
• At AC-15								
- At 24 V	A	3						
- At 250 V	A	3						
• At DC-13								
- At 24 V	A	1						
- At 125 V	A	0.2						
- At 250 V	A	0.1						
<b>Contact reliability of the auxiliary contacts</b> (one contact failure per 100 million)		17 V, 5 mA	5 V, 1 mA	17 V, 5 mA	5 V, 1 mA	17 V, 5 mA	5 V, 1 mA	17 V, 5 mA
<b>Mechanical service life (operating cycles) typical</b>		10 000 000						
<b>Electrical endurance (operating cycles) for AC-15 at 250 V typical</b>		100 000						
<b>Operating range factor of the control supply voltage, rated value</b>								
• At AC								
- At 50 Hz		0.8 ... 1.25		0.8 ... 1.1			--	
- At 60 Hz		0.8 ... 1.25		0.8 ... 1.1			--	
• At DC		0.8 ... 1.25		0.8 ... 1.1			0.7 ... 1.25	
<b>Active power input</b>	W	0.3		0.5			1	
<b>Thermal current</b>	A	6		6			6	
• Note		--						
		Derating, see characteristic curves						

# Switching devices – Contactors and contactor assemblies – Contactor relays and relays

## Coupling relays

### SIRIUS 3RQ3 coupling relays, narrow design

#### Coupling relays with plug-in relays

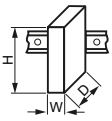
Article number		3RQ3118- .AB00	3RQ3118- .AB01	3RQ3118- .AE00	3RQ3118- .AE01	3RQ3118- .AF00	3RQ3118- .AF01	3RQ3118- .AM00	3RQ3118- .AM01
<b>General technical specifications</b>									
<b>Width x height x depth</b>	mm	6.2 x 93 x 76							
									
<b>Insulation voltage for overvoltage category III acc. to IEC 60664 for pollution degree 3</b>	V	300							
<b>Max. permissible voltage for protective separation between control circuit and auxiliary circuit</b>	V	300							
<b>Ambient temperature</b>									
• During operation	°C	-25 ... +60							
• During storage	°C	-40 ... +85							
<b>Degree of protection IP</b>		IP20							
<b>Version of the fuse link required for short-circuit protection of the auxiliary switch</b>		Fuse gG: 4 A							
<b>Operational current of the auxiliary contacts</b>									
• At AC-15									
- At 24 V	A	3							
- At 250 V	A	3							
• At DC-13									
- At 24 V	A	1							
- At 125 V	A	0.2							
- At 250 V	A	0.1							
<b>Contact reliability of the auxiliary contacts</b> (one contact failure per 100 million)		17 V, 5 mA	5 V, 1 mA	17 V, 5 mA	5 V, 1 mA	17 V, 5 mA	5 V, 1 mA	17 V, 5 mA	5 V, 1 mA
<b>Mechanical service life (operating cycles) typical</b>		10 000 000							
<b>Electrical endurance (operating cycles) for AC-15 at 250 V typical</b>		100 000							
<b>Operating range factor of the control supply voltage, rated value</b>									
• At AC									
- At 50 Hz		0.8 ... 1.25		0.8 ... 1.1				--	
- At 60 Hz		0.8 ... 1.25		0.8 ... 1.1				--	
• At DC		0.8 ... 1.25		0.8 ... 1.1				0.8 ... 1.25	
<b>Active power input</b>	W	0.3		0.5		1		0.3	
<b>Thermal current</b>	A	6							





# Switching devices – Contactors and contactor assemblies – Contactor relays and relays

## Coupling relays

### SIRIUS 3RQ3 coupling relays, narrow design

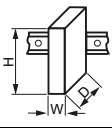
#### Coupling relays with semiconductor output (not plug-in)

Article number	3RQ3050- .SM50	3RQ3052- .SM30	3RQ3052- .SM40	3RQ3052- .SM50	3RQ3053- .SG30	3RQ3055- .SM30	3RQ3065- .SM30	3RQ3070- .SB30	3RQ3070- .SG30
<b>General technical specifications</b>									
<b>Width x height x depth</b>	 mm 6.2 x 93 x 72.5						6.2 x 93 x 75	6.2 x 93 x 72.5	
<b>Insulation voltage for overvoltage category III acc. to IEC 60664 for pollution degree 3</b>	V	50			300	50		--	
<b>Ambient temperature</b>									
• During operation	°C	-25 ... +60							
• During storage	°C	-40 ... +85							
<b>Degree of protection IP</b>		IP20							
<b>Switching voltage of the semiconductor output</b>									
• At AC	V	--			20 ... 264	--			
• At DC	V	10 ... 60	10 ... 30	10 ... 60	--	10 ... 30			
<b>Current carrying capacity of the semiconductor output</b>									
• At AC		--			5 mA ... 2 A	--			
• At DC		1 mA ... 0.5 A	5 mA ... 2 A	1 mA ... 2 A	--	1 mA ... 3 A	5 mA ... 5 A	10 mA ... 0.5 A	
<b>Operating range factor of the control supply voltage, rated value</b>									
• At AC									
- At 50 Hz		--			0.7 ... 1.1	--		1 ... 1	0.7 ... 1.1
- At 60 Hz		--			0.7 ... 1.1	--		1 ... 1	0.7 ... 1.1
• At DC		1 ... 1				0.7 ... 1.1	1 ... 1	0.7 ... 1.1	
<b>Active power input</b>	W	0.3		0.25	0.3			0.5	
<b>Thermal current</b>	A	0.5	2		3	5		0.5	
Article number	<b>3RQ3...-1...</b>				<b>3RQ3...-2...</b>				
<b>Type of electrical connection for auxiliary and control circuits</b>	 <b>Screw terminals</b>				 <b>Spring-loaded terminals (push-in)</b>				
<b>Type of connectable conductor cross-sections</b>									
• Solid	1x (0.25 ... 2.5) mm <sup>2</sup>								
• Finely stranded									
- Without end sleeves	--				1x (0.25 ... 2.5) mm <sup>2</sup>				
- With end sleeves	1x (0.25 ... 1.5) mm <sup>2</sup>								
• Solid for AWG cables	1x (20 ... 14)								

# Switching devices – Contactors and contactor assemblies – Contactor relays and relays

## Coupling relays

### SIRIUS 3RQ3 coupling relays, narrow design

#### Selection and ordering data

Type of voltage	Control supply voltage			Number of CO contacts for auxiliary contacts	Material of switching contacts	Article No.	Weight kg
	At AC		At DC				
	At 50 Hz	At 60 Hz					
	V	V	V				

#### Coupling relays with relay output (not plug-in)

##### Output coupling links

AC/DC	24	24	24	1	AgSnO2	<b>3RQ3018-□AB00</b>	0.035
					AgSnO2 hard gold-plated	<b>3RQ3018-□AB01</b>	0.035
	115	115	115	1	AgSnO2	<b>3RQ3018-□AE00</b>	0.036
	230	230	230	1	AgSnO2	<b>3RQ3018-□AF00</b>	0.035
DC	--	--	24	1	AgSnO2	<b>3RQ3018-2AM08-0AA0</b>	0.033
			110	1	AgSnO2	<b>3RQ3018-2AN08-0AA0</b>	0.033

##### Input coupling links

AC/DC	24	24	24	1	AgSnO2	<b>3RQ3038-□AB00</b>	0.035
					AgSnO2 hard gold-plated	<b>3RQ3038-□AB01</b>	0.035
	115	115	115	1	AgSnO2	<b>3RQ3038-□AE00</b>	0.035
	230	230	230	1	AgSnO2 hard gold-plated	<b>3RQ3038-□AE01</b>	0.034
DC	--	--	24	1	AgSnO2	<b>3RQ3038-□AF00</b>	0.035
			110	1	AgSnO2 hard gold-plated	<b>3RQ3038-□AF01</b>	0.035

#### Coupling relays with plug-in relays

##### Output coupling links

AC/DC	24	24	24	1	AgSnO2	<b>3RQ3118-□AB00</b>	0.035
					AgSnO2 hard gold-plated	<b>3RQ3118-□AB01</b>	0.035
	115	115	115	1	AgSnO2	<b>3RQ3118-□AE00</b>	0.035
	230	230	230	1	AgSnO2 hard gold-plated	<b>3RQ3118-□AE01</b>	0.035
DC	--	--	24	1	AgSnO2	<b>3RQ3118-□AF00</b>	0.035
			110	1	AgSnO2 hard gold-plated	<b>3RQ3118-□AF01</b>	0.035
			24	1	AgSnO2	<b>3RQ3118-□AM00</b>	0.035
			110	1	AgSnO2 hard gold-plated	<b>3RQ3118-□AM01</b>	0.035

3RQ30.8-2....  
3RQ3118-2....

#### Type of electrical connection

- Screw terminals
- Spring-loaded terminals (push-in)

1  
2

Type of voltage	Control supply voltage			Current carrying capacity of the semiconductor output		Operating mode selectable via switch position	Article No.	Weight kg
	At AC		At DC	At AC	At DC			
	At 50 Hz	At 60 Hz						

#### Coupling relays with semiconductor output (not plug-in)

##### Output coupling links

DC	--	--	11 ... 30 V	--	1 mA ... 0.5 A	--	<b>3RQ3050-□SM50</b>	0.031
					5 mA ... 2 A	--	<b>3RQ3052-□SM30</b>	0.032
					1 mA ... 2 A	--	<b>3RQ3052-□SM40</b>	0.031
				5 mA ... 2 A	--	--	<b>3RQ3052-□SM50</b>	0.034
				--	5 mA ... 5 A	--	<b>3RQ3055-□SM30</b>	0.032
						Manual/ Off/ Automatic	<b>3RQ3065-□SM30</b>	0.032
AC/DC	110 ... 230 V	110 ... 230 V	110 ... 230 V	--	1 mA ... 3 A	--	<b>3RQ3053-□SG30</b>	0.033

3RQ3050-2SM50

##### Input coupling links

AC/DC	11 ... 30 V	11 ... 30 V	11 ... 30 V	--	10 mA ... 0.5 A	--	<b>3RQ3070-□SB30</b>	0.031
	110 ... 230 V	110 ... 230 V	110 ... 230 V	--	10 mA ... 0.5 A	--	<b>3RQ3070-□SG30</b>	0.032

#### Type of electrical connection

- Screw terminals
- Spring-loaded terminals (push-in)





1  
2

# Switching devices – Contactors and contactor assemblies – Contactor relays and relays

## Coupling relays

### SIRIUS 3RQ3 coupling relays, narrow design

#### Accessories

Version	Article No.	Weight kg
<b>Galvanic isolation plates</b>		
 3RQ3900-0A For electrical separation of different potentials when devices of different types are installed side by side	<b>3RQ3900-0A</b>	0.014
<b>Connecting combs</b>		
 3RQ3901-0B For linking the same potentials, current carrying capacity for infeed max. 6 A <ul style="list-style-type: none"> <li>• 2-pole</li> <li>• 4-pole</li> <li>• 8-pole</li> <li>• 16-pole</li> </ul>	<b>3RQ3901-0A</b> <b>3RQ3901-0B</b> <b>3RQ3901-0C</b> <b>3RQ3901-0D</b>	0.001 0.001 0.002 0.004
<b>Clip-on labels<sup>1)</sup></b>		
 3RQ3902-0A For terminal and equipment labeling, white <ul style="list-style-type: none"> <li>• 5 x 5 mm</li> <li>• 6 x 12 mm</li> </ul>	<b>3RQ3902-0A</b> <b>3RQ3902-0B</b>	0.009 0.017
<b>Tools for opening spring-loaded terminals</b>		
 3RA2908-1A <b>Screwdriver</b> For all SIRIUS devices with spring-loaded terminals 3.0 mm x 0.5 mm, length approx. 200 mm, titanium gray/black, partially insulated	<b>Spring-loaded terminals (push-in)</b>  <b>3RA2908-1A</b>	0.050

<sup>1)</sup> PC labeling system for individual inscription of unit labeling plates available from Conta-Clip Verbindungstechnik GmbH.

Coupling relays with plug-in relays	Control supply voltage	Material of switching contacts	Number of CO contacts for auxiliary contacts	Article No.	Weight kg
Type	V				
<b>Replacement modules for 3RQ3118 coupling relays with plug-in relays</b>					
3RQ3118-.AM00	24 DC	AgSnO2	1	<b>3TX7014-7BM00</b>	0.007
3RQ3118-.AM01		AgSnO2 hard gold-plated		<b>3TX7014-7BM02</b>	0.007
3RQ3118-.AB00	24 AC/DC	AgSnO2	1	<b>3TX7014-7BM00</b>	0.007
3RQ3118-.AB01		AgSnO2 hard gold-plated		<b>3TX7014-7BM02</b>	0.007
3RQ3118-.AE00	115 AC/DC	AgSnO2	1	<b>3TX7014-7BP00</b>	0.006
3RQ3118-.AF00	230 AC/DC	AgSnO2			
3RQ3118-.AE01	115 AC/DC	AgSnO2 hard gold-plated	1	<b>3TX7014-7BP02</b>	0.006
3RQ3118-.AF01	230 AC/DC	AgSnO2 hard gold-plated			

## Protection equipment

### Motor starter protectors/circuit breakers

### SIRIUS 3RV2 motor starter protectors/circuit breakers

#### Introduction

#### Overview

2



Type	3RV20	3RV21	3RV23	3RV24	3RV27	3RV28
<b>SIRIUS 3RV2 motor starter protectors/circuit breakers</b>						
<b>Applications</b>						
• System protection	✓ <sup>1)</sup> / 3RV20...-.....-0DA0 <sup>2)</sup>	✓ <sup>1)</sup>	--	--	✓	✓
• Motor protection	✓	--	--	--	--	--
• Motor protection with overload relay function	--	✓	--	--	--	--
• Starter combinations	--	--	✓	--	--	--
• Transformer protection	--	--	--	✓ / 3RV24...-.....-0DA0 <sup>2)</sup>	--	✓
<b>Size</b>	S00, S0, S2, S3	S00, S0, S2, S3	S00, S0, S2, S3	S00, S0, S2	S00, S0, S3	S00, S0
<b>Rated current <math>I_n</math></b>						
• Size S00	A Up to 16	Up to 16	Up to 16	Up to 16	Up to 15	Up to 15
• Size S0	A Up to 40	Up to 32	Up to 40	Up to 25	Up to 22	Up to 22
• Size S2	A Up to 80	Up to 80	Up to 80	Up to 65	--	--
• Size S3	A Up to 100	Up to 100	Up to 100	--	Up to 70	--
<b>Rated operational voltage <math>U_e</math> acc. to IEC</b>	V 690 AC <sup>3)</sup>	690 AC <sup>3)</sup>	690 AC <sup>3)</sup>	690 AC <sup>3)</sup>	690 AC	690 AC
<b>Rated frequency</b>	Hz 50/60	50/60	50/60	50/60	50/60	50/60
<b>Trip class</b>	CLASS 10 (S00 ... S3), CLASS 20 (S2, S3)	CLASS 10	--	CLASS 10	--	--
<b>Thermal overload release</b>	A 0.11 ... 0.16 to A 80 ... 100	0.11 ... 0.16 to 80 ... 100	None <sup>4)</sup>	0.11 ... 0.16 to 54 ... 65	0.16 ... 70 Non-adjustable	0.16 to 22 Non-adjustable
<b>Electronic releases</b> A multiple of the rated current	13 times	13 times	13 times	20 times	13 times	20 times
<b>Short-circuit breaking capacity <math>I_{cu}</math> at 400 V AC</b>	kA 20/55/65/100	55/65/100	20/55/65/100	55/65/100	5) 5)	5) 5)
<b>Pages</b>	2/177 ... 2/184	2/185, 2/186	2/187 ... 2/189	2/190, 2/191	7)	7)

<b>Accessories</b>																				
<b>For sizes</b>	S00	S0	S2	S3	S00	S0	S2	S3	S00	S0	S2	S3	S00	S0	S2	S00	S0	S3	S00	S0
Auxiliary switches	✓	✓	✓	✓	✓	✓	✓	✓	✓	✓	✓	✓	✓	✓	✓	✓	✓	✓ <sup>6)</sup>	✓	✓
Signaling switches	✓	✓	✓	✓	✓	✓	✓	✓	✓	✓	✓	✓	✓	✓	✓	✓	✓	--	--	--
Undervoltage releases	✓	✓	✓	✓	--	--	--	--	✓	✓	✓	✓	✓	✓	✓	✓	✓	✓	✓	✓
Shunt releases	✓	✓	✓	✓	--	--	--	--	✓	✓	✓	✓	✓	✓	✓	✓	✓	✓	✓	✓
Isolator modules	✓	✓	✓	--	✓	✓	✓	--	✓	✓	✓	--	✓	✓	✓	--	--	--	--	--
Insulated 3-phase busbar system	✓	✓	✓	--	--	--	✓	--	✓	✓	✓	--	✓	✓	✓	✓	✓	--	✓	✓
Busbar adapters	✓	✓	✓	✓	✓	✓	✓	✓	✓	✓	✓	✓	✓	✓	✓	✓	✓	✓	✓	--
Door-coupling rotary operating mechanisms	✓	✓	✓	✓	✓	✓	✓	✓	✓	✓	✓	✓	✓	✓	✓	✓	✓	✓	✓	✓
Link modules	✓	✓	✓	✓	✓	✓	✓	✓	✓	✓	✓	✓	✓	✓	✓	--	--	--	--	--
Enclosures for surface mounting	✓	✓	✓	--	✓	✓	✓	--	✓	✓	✓	--	✓	✓	✓	--	--	--	--	--
Enclosures for flush mounting	✓	✓	--	--	✓	✓	--	--	✓	✓	--	--	✓	✓	--	--	--	--	--	--
Front plates	✓	✓	✓	✓	✓	✓	✓	✓	✓	✓	✓	✓	✓	✓	✓	--	--	--	--	--
Infeed system	✓	✓	--	--	--	--	--	--	✓	✓	--	--	✓	✓	--	✓	✓	--	✓	✓
Sealable scale covers for setting knobs	✓	✓	✓	✓	✓	✓	✓	✓	--	--	--	--	✓	✓	✓	--	--	--	--	--
Remote motorized operating mechanisms	--	--	--	✓	--	--	--	✓	--	--	--	✓	--	--	--	--	--	--	--	--

**Pages** 2/195

✓ Has this function or can use this accessory

-- Does not have this function or cannot use this accessory

1) For symmetrical loading of the three phases.

2) For 1-phase, 2-phase and 3-phase asymmetrical loading of the three phases.

3) With molded-plastic enclosure 500 V AC.

4) For overload protection of the motors, appropriate overload relays must be used.

5) According to UL 489 at 480 Y/277 V AC: 65 kA or 50 kA.

6) Only lateral auxiliary switches can be used.

7) see Catalog IC 10.

## Overview

### More information

Homepage, see [www.siemens.com/sirius-circuit-breakers](http://www.siemens.com/sirius-circuit-breakers)  
 Industry Mall, see [www.siemens.com/product?3RV2](http://www.siemens.com/product?3RV2)  
 TIA Selection Tool Cloud (TST Cloud), see [www.siemens.com/tstcloud/?node=MotorStarterProtector](http://www.siemens.com/tstcloud/?node=MotorStarterProtector)  
 Conversion tool, see [www.siemens.com/conversion-tool](http://www.siemens.com/conversion-tool)

Application Manual for controls with IE3/IE4 motors, see <https://support.industry.siemens.com/cs/ww/en/view/94770820>  
 System Manual for modular system, see <https://support.industry.siemens.com/cs/ww/en/view/60311318>  
 Equipment Manual, see <https://support.industry.siemens.com/cs/ww/en/view/60279172>  
 Certificates, see <https://support.industry.siemens.com/cs/ww/en/ps/16245/cert>

The following illustration shows 3RV2 motor starter protectors/circuit breakers with the accessories which can be mounted for the sizes S00 to S3, see also "Introduction" → "Overview", page 2/162.

For accessories, see page 2/195 onwards.

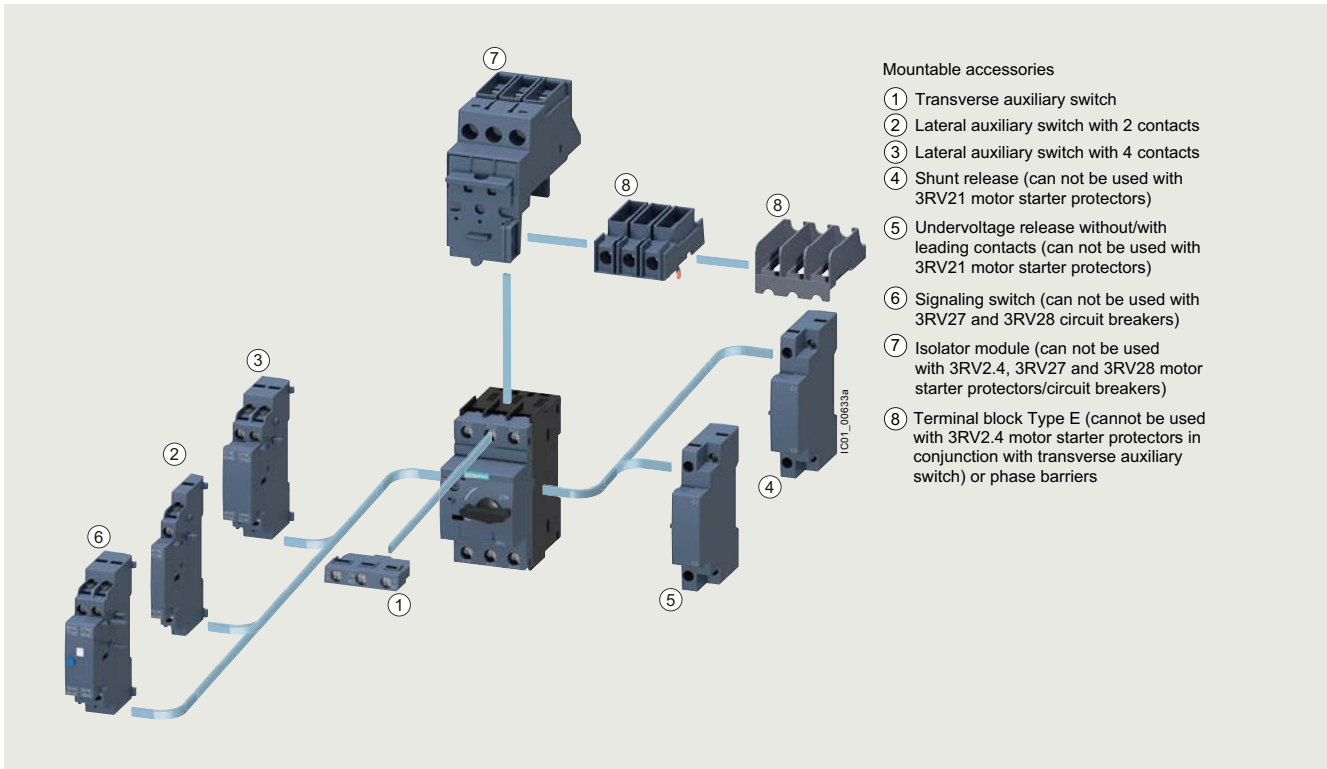

Mountable accessories for SIRIUS 3RV2 motor starter protectors/circuit breakers



Motor starter protector with spring-loaded terminals, size S0 (left) and motor starter protector with screw terminals, size S00 (right)

The SIRIUS 3RV2 motor starter protectors/circuit breakers are compact, current limiting motor starter protectors/circuit breakers which are optimized for load feeders. The motor starter protectors/circuit breakers are used for switching and protecting three-phase motors of up to 55/45 kW at 400 V AC and for other loads with rated currents of up to 100 A.

3RV2 motor starter protectors are usually approved according to IEC and UL/CSA. According to UL 508/UL 60947-4-1, the 3RV2 motor starter protectors/circuit breakers in sizes S00 to S3 are approved as:

- "Manual Motor Controllers"
- "Manual Motor Controllers" for "Group Installations"
- "Manual Motor Controllers Suitable for Tab Conductor Protection in Group Installations"
- "Self-Protected Combination Motor Controllers (Type E)"  
Please note that for this approval the 3RV20 motor starter protectors must be equipped with additional infeed terminals or phase barriers.

Corresponding short-circuit values, see page 2/166.

## Protection equipment

### Motor starter protectors/circuit breakers

#### SIRIUS 3RV2 motor starter protectors/circuit breakers

#### General data

The 3RV2...-.....-0BA0 motor starter protectors/circuit breakers can be used at low ambient temperatures down to -50 °C.

3RV20...-.....-0DA0 motor starter protectors for system protection according to IEC, 3RV24...-.....-0DA0 for transformer protection according to IEC and 3RV27 and 3RV28 circuit breakers according to UL 489 can be used for 1-phase, 2-phase and 3-phase loads, as these motor starter protectors/circuit breakers do not have asymmetry detection.

The 3RV27 and 3RV28 are approved as circuit breakers according to UL 489; they are a special version of the 3RV2 motor starter protectors.

Thanks to their dimensions, the 3RV1011 motor starter protectors are suitable for installation in enclosures or under cramped installation conditions.

#### Type of construction

The 3RV2 motor starter protectors are available in four sizes:

- Size S00 – width 45 mm, max. rated current 16 A, at 400 V AC suitable for three-phase motors up to 7.5 kW
- Size S0 – width 45 mm, max. rated current 40 A, at 400 V AC suitable for three-phase motors up to 18.5 kW
- Size S2 – width 55 mm, max. rated current 80 A, at 400 V AC suitable for three-phase motors up to 37 kW
- Size S3 – width 70 mm, max. rated current 100 A, at 400 V AC suitable for three-phase motors up to 45/55 kW



#### Circuit breakers acc. to UL 489

The 3RV27 and 3RV28 circuit breakers are available in two or three sizes:

- Size S00 – width 45 mm, max. rated current 15 A, for 480 Y/277 V AC
- Size S0 – width 45 mm, max. rated current 22 A, for 480 Y/277 V AC
- Size S3 – width 70 mm, max. rated current 70 A, for 480 Y/277 V AC

#### Connection methods

The 3RV2 motor starter protectors/circuit breakers can be supplied with screw terminals and spring-loaded terminals.

-  Screw terminals
-  Spring-loaded terminals

The terminals are indicated in the corresponding tables by the symbols shown on orange backgrounds.

#### Voltage data

The data for 3-phase power systems according to IEC 60947-4-1 are valid for the following line system configurations:

Voltage data $U_e$ in the catalog	Line system configurations	
	Three-phase Four-wire systems	Three-phase Three-wire systems
V	V	V
230	--	230
400	230/400	400
440	260/440	440
500	--	500
690	400/690	690 (only from size S3)
1 000	--	1 000

-- Not specified

#### Use in hazardous areas

The 3RV20 motor starter protectors for motor protection (without 3RV20...-.....-0BA0 and -0DA0) have certification in accordance with both the European explosion protection directive (ATEX) and the international explosion protection standard (IECEx).

In accordance with the European directive (ATEX), the 3RV20 (without 3RV20...-.....-0BA0 and -0DA0) are able to switch and protect explosion-proof motors of type of protection "Increased Safety EEx e".

In accordance with the international guideline (IECEx), the 3RV20 (without 3RV20...-.....-0BA0 and -0DA0) are able to switch and protect motors of the types "Increased Safety Ex e" or "Flameproof enclosure Ex d".

#### Article No. scheme

Product versions		Article number	
<b>Motor starter protectors/circuit breakers</b>		<b>3RV2</b> □ □ □ - □ □ □ □ - □ □ □ □	
Type of motor starter protector/circuit breaker	e.g. 0 = for motor protection/system protection	□	
Size	e.g. 1 = 16 A (7.5 kW) for size S00	□	
Breaking capacity	e.g. 1 = standard switching capacity	□	
Setting range for overload release	e.g. 1A = 1.1 ... 1.6 A		□ □
Trip class (CLASS)	e.g. A = a (adjustable CLASS 10) / n (13 or 20 x $I_n$ )		□
Connection methods	e.g. 1 = screw terminal		□
With or without auxiliary switch	e.g. 0 = without		□
Special versions			□ □ □ □
Example		<b>3RV2 0 1 1 - 1 A A 1 0</b>	

#### Note:

The Article No. scheme shows an overview of product versions for better understanding of the logic behind the article numbers.

For your orders, please use the article numbers quoted in the selection and ordering data.

## Application

### Operating conditions

3RV2 motor starter protectors/circuit breakers are suitable for use in any climate. They are intended for use in enclosed rooms in which no severe operating conditions (such as dust, caustic vapors, hazardous gases) prevail. When installed in dusty and damp areas, suitable enclosures must be provided.

3RV2 motor starter protectors/circuit breakers can optionally be fed from the top or from below.

The permissible ambient temperatures, the maximum switching capacities, the tripping currents and other boundary conditions can be found in the technical specifications and tripping characteristics.

3RV2 motor starter protectors/circuit breakers are suitable for operation in IT systems (IT networks). In this case, the different short-circuit breaking capacity in the IT system must be taken into account, [see page 2/168](#).

Since operational currents, starting currents and current peaks are different even for motors with identical power ratings due to the inrush current, the motor ratings in the selection tables are only guide values. The specific rated and startup data of the motor to be protected are always paramount to the choice of the most suitable motor starter protector/circuit breaker. This also applies to motor starter protectors for transformer protection.

### Possible uses

The 3RV motor starter protectors/circuit breakers can be used:

- For short-circuit protection
- For motor protection (also with overload relay function)
- For system protection
- For short-circuit protection for starter combinations
- For transformer protection
- As main and EMERGENCY OFF switches
- For operation in IT systems (IT networks)
- In hazardous areas (ATEX, IECEx)
- As circuit breakers according to UL 489 (3RV27 and 3RV28)
- For fuse monitoring
- For distance protection

### **Use of SIRIUS protection devices in conjunction with IE3/IE4 motors**

#### Note:

For the use of 3RV2 motor starter protectors/circuit breakers in conjunction with highly energy-efficient IE3/IE4 motors, please observe the information on dimensioning and configuring, [see Application Manual](#).



## Protection equipment

### Motor starter protectors/circuit breakers

### SIRIUS 3RV2 motor starter protectors/circuit breakers

#### General data

#### Technical specifications

##### More information

System Manual for modular system, see  
<https://support.industry.siemens.com/cs/ww/en/view/60311318>  
 Configuration Manual for load feeders, see  
<https://support.industry.siemens.com/cs/ww/en/view/39714188>

Equipment Manual, see  
<https://support.industry.siemens.com/cs/ww/en/view/60279172>  
 Technical specifications, see  
<https://support.industry.siemens.com/cs/ww/en/ps/16245/td>  
 For UL reports for the individual devices, see  
<https://support.industry.siemens.com/cs/ww/en/ps/16245/cert>

#### Short-circuit breaking capacity $I_{cu}$ , $I_{cs}$ according to IEC 60947-2

The table shows the rated ultimate short-circuit breaking capacity  $I_{cu}$  and the rated service short-circuit breaking capacity  $I_{cs}$  of the 3RV motor starter protectors/circuit breakers with different operating voltages dependent on the rated current  $I_n$  of the motor starter protectors/circuit breakers.

Power can be supplied to the motor starter protectors/circuit breakers via the terminals at the top or at the bottom without restricting the rated data. If the short-circuit current at the installation location exceeds the motor starter protector/circuit breaker's specified rated short-circuit breaking capacity, you will need to use a back-up fuse. It is also possible to install an

upstream motor starter protector/circuit breaker with a limiter function.

The maximum rated current of this back-up fuse is indicated in the tables. The rated ultimate short-circuit breaking capacity then applies as specified on the fuse.

#### Fuseless design

Motor starter protector/contactors assemblies for short-circuit currents up to 150 kA can be ordered as 3RA2 fuseless load feeders.

Motor starter protectors/circuit breakers	Rated current $I_n$	Up to 240 V AC <sup>1)</sup>			Up to 400 V AC <sup>1)/415 V AC<sup>2)</sup></sup>			Up to 440 V AC <sup>1)/460 V AC<sup>2)</sup></sup>			Up to 500 V AC <sup>1)/525 V AC<sup>2)</sup></sup>			Up to 690 V AC <sup>1)</sup>		
		$I_{cu}$	$I_{cs}$	Max. fuse (gG)	$I_{cu}$	$I_{cs}$	Max. fuse (gG) <sup>3)</sup>	$I_{cu}$	$I_{cs}$	Max. fuse (gG) <sup>3)</sup>	$I_{cu}$	$I_{cs}$	Max. fuse (gG) <sup>3)</sup>	$I_{cu}$	$I_{cs}$	Max. fuse (gG) <sup>3)4)</sup>
Type	A	kA	kA	A	kA	kA	A	kA	kA	A	kA	kA	A	kA	kA	A
<b>Size S00</b>																
<b>3RV2.11</b>	0.16 ... 1.6	100	100	--	100	100	--	100	100	--	100	100	--	100	100	--
	2; 2.5	100	100	--	100	100	--	100	100	--	100	100	--	10	10	25
	3.2	100	100	--	100	100	--	100	100	--	100	100	--	10	10	32
	4; 5	100	100	--	100	100	--	100	100	--	100	100	--	6	4	32
	6.3	100	100	--	100	100	--	100	100	--	100	100	--	6	4	50
	8	100	100	--	100	100	--	50	50	63	42	42	63	6	4	50
	10	100	100	--	100	100	--	50	50	80	42	42	63	6	4	50
	12.5	100	100	--	100	100	--	50	50	80	42	42	80	6	4	63
	16	100	100	--	55	30	100	50	12.5	80	10	5	80	4	4	63
<b>Size S0</b>																
<b>3RV2.21</b>	0.16 ... 1.6	100	100	--	100	100	--	100	100	--	100	100	--	100	100	--
	2; 2.5	100	100	--	100	100	--	100	100	--	100	100	--	10	10	25
	3.2	100	100	--	100	100	--	100	100	--	100	100	--	10	10	32
	4; 5	100	100	--	100	100	--	100	100	--	100	100	--	6	4	32
	6.3	100	100	--	100	100	--	100	100	--	100	100	--	6	4	50
	8	100	100	--	100	100	--	50	50	63	42	42	63	6	4	50
	10	100	100	--	100	100	--	50	50	80	42	42	63	6	4	50
	12.5	100	100	--	100	100	--	50	50	80	42	42	80	6	4	63
	16	100	100	--	55	25	100	50	12.5	80	10	5	80	4	2	63
	20	100	100	--	55	25	125	50	10	80	10	5	80	4	2	63
	22; 25	100	100	--	55	25	125	50	10	100	10	5	80	4	2	63
	28; 32	100	100	--	55	25	125	30	10	125	10	5	100	4	2	100
	36; 40	100	100	--	20	10	125	12	8	125	6	3	100	3	2	100

-- No back-up fuse required, since short-circuit-proof up to 100 kA

1) 10% overvoltage.

2) 5% overvoltage.

3) Back-up fuse only required if short-circuit current at the installation location is  $> I_{cu}$ .

4) Alternatively, fuseless limiter combinations for 690 V AC can also be used.

## Protection equipment

### Motor starter protectors/circuit breakers

### SIRIUS 3RV2 motor starter protectors/circuit breakers

#### General data

Motor starter protectors/circuit breakers	Rated current $I_n$	Up to 240 V AC <sup>1)</sup>			Up to 400 V AC <sup>1)/415 V AC<sup>2)</sup></sup>			Up to 440 V AC <sup>1)/460 V AC<sup>2)</sup></sup>			Up to 500 V AC <sup>1)/525 V AC<sup>2)</sup></sup>			Up to 690 V AC <sup>1)</sup>		
		$I_{cu}$	$I_{cs}$	Max. fuse (gG)	$I_{cu}$	$I_{cs}$	Max. fuse (gG) <sup>3)</sup>	$I_{cu}$	$I_{cs}$	Max. fuse (gG) <sup>3)</sup>	$I_{cu}$	$I_{cs}$	Max. fuse (gG) <sup>3)</sup>	$I_{cu}$	$I_{cs}$	Max. fuse (gG) <sup>3)4)</sup>
Type	A	kA	kA	A	kA	kA	A	kA	kA	A	kA	kA	A	kA	kA	A
<b>Size S2</b>																
<b>3RV2.31</b>	14; 17	100	100	--	65	30	100	50	25	100	12	6	63	5	3	63
	20	100	100	--	65	30	100	50	25	100	12	6	80	5	3	80
	25	100	100	--	65	30	100	50	15	100	12	6	80	5	3	80
	32; 36	100	100	--	65	30	125	50	15	125	10	5	100	4	2	100
	40; 45	100	100	--	65	30	160	50	15	125	10	5	100	4	2	100
	52	100	100	--	65	30	160	50	15	125	10	5	125	4	2	125
	59; 65	100	100	--	65	30	160	50	15	160	8	4	125	4	2	125
73; 80	100	100	--	65	30	200	50	15	200	8	4	160	4	2	125	
<b>Size S2, with increased switching capacity</b>																
<b>3RV2.32</b>	14; 17	100	100	--	100	50	--	65	30	100	18	10	63	8	5	63
	20; 25	100	100	--	100	50	--	65	30	100	18	10	80	8	5	80
	32 ... 45	100	100	--	100	50	--	65	30	125	15	8	100	6	4	100
	52	100	100	--	100	50	--	65	30	125	15	8	125	6	4	125
	59; 65	100	100	--	100	50	--	50	15	160	10	5	125	6	4	125
73; 80	100	100	--	100	50	--	50	15	200	10	5	160	6	4	125	
<b>Size S3</b>																
<b>3RV2.41</b>	40	100	100	--	65	30	125	65	30	125	12	6	100	6	3	63
	50	100	100	--	65	30	125	65	30	125	12	6	100	6	3	80
	63	100	100	--	65	30	160	65	30	160	12	6	100	6	3	80
	75	100	100	--	65	30	160	65	30	160	8	4	125	5	3	100
	84 ... 100	100	100	--	65	30	160	65	30	160	8	4	125	5	3	125
<b>Size S3, with increased switching capacity</b>																
<b>3RV2.42</b>	40	100	100	--	100	50	--	100	50	--	18	9	160	12	6	80
	50	100	100	--	100	50	--	100	50	--	15	7.5	160	10	5	100
	63	100	100	--	100	50	--	70	50	200	15	7.5	160	7.5	4	100
	75	100	100	--	100	50	--	70	50	200	10	5	160	6	3	125
	84 ... 100	100	100	--	100	50	--	70	50	200	10	5	160	6	3	160
<b>3RV2742</b>	10 ... 20	100	100	--	100	50	--	100	50	--	30	15	80	12	7	63
	25	100	100	--	100	50	--	100	50	--	22	11	100	12	7	63
	30	100	100	--	100	50	--	100	50	--	18	9	160	12	6	80
	35 ... 40	100	100	--	100	50	--	100	50	--	15	7.5	160	10	5	100
	45 ... 50	100	100	--	100	50	--	70	50	200	15	7.5	160	7.5	4	100
	60	100	100	--	100	50	--	70	50	200	10	5	160	6	3	125
	70	100	100	--	100	50	--	70	50	200	10	5	160	6	3	160

-- No back-up fuse required, since short-circuit-proof up to 100 kA

1) 10% overvoltage.

2) 5% overvoltage.

3) Back-up fuse only required if short-circuit current at the installation location is  $> I_{cu}$ .

4) Alternatively, fuseless limiter combinations for 690 V AC can also be used.

## Protection equipment

### Motor starter protectors/circuit breakers

#### SIRIUS 3RV2 motor starter protectors/circuit breakers

#### General data

#### Short-circuit breaking capacity $I_{cuIT}$ in the IT system (IT network) according to IEC 60947-2

3RV motor starter protectors/circuit breakers are suitable for use in IT systems. The values of  $I_{cu}$  and  $I_{cs}$  apply for the 3-pole short circuit. In the case of a double ground fault in different phases at the input and output side of a motor starter protector/circuit breaker, the special short-circuit breaking capacity  $I_{cuIT}$  applies. The specifications in the table below apply to 3RV motor starter protectors/circuit breakers.

If the short-circuit current at the installation location exceeds the motor starter protector/circuit breaker's specified rated short-circuit breaking capacity, you will need to use a back-up fuse. The maximum rated current of this back-up fuse is indicated in the tables. The rated short-circuit breaking capacity then applies as specified on the fuse.

Motor starter protectors/ circuit breakers	Rated current $I_n$	Up to 240 V AC <sup>1)</sup>		Up to 400 V AC <sup>1)/415 V AC<sup>2)</sup></sup>		Up to 440 V AC <sup>1)/460 V AC<sup>2)</sup></sup>		Up to 500 V AC <sup>1)/525 V AC<sup>2)</sup></sup>		Up to 690 V AC <sup>1)3)</sup>	
		$I_{cuIT}$	Max. fuse (gG) <sup>4)</sup>	$I_{cuIT}$	Max. fuse (gG) <sup>4)5)</sup>	$I_{cuIT}$	Max. fuse (gG) <sup>4)</sup>	$I_{cuIT}$	Max. fuse (gG) <sup>4)</sup>	$I_{cuIT}$	Max. fuse (gG) <sup>4)</sup>
Type	A	kA	A	kA	A	kA	A	kA	A	kA	A
<b>Size S00</b>											
<b>3RV2.11</b>	0.16 ... 0.4	100	--	100	--	100	--	100	--	100	--
	0.5	100	--	100	--	100	--	100	--	0.5	4
	0.63; 0.8	100	--	100	--	100	--	100	--	0.5	6
	1	100	--	100	--	2	10	2	10	1.5	10
	1.25	100	--	100	--	2	16	2	16	1.5	16
	1.6	100	--	100	--	2	20	2	20	1.5	16
	2; 2.5	100	--	8	25	2	25	2	25	1.5	20
	3.2	100	--	8	32	2	32	2	32	1.5	25
	4; 5	100	--	4	32	1.5	32	1.5	32	1.5	25
	6.3; 8	100	--	4	50	1	40	1	40	1	35
	10	100	--	4	50	1	40	1	40	1	40
	12.5	100	--	4	63	1	50	1	50	1	40
	16	55	80	4	63	1	50	1	50	1	40
<b>Size S0</b>											
<b>3RV2.21</b>	0.16 ... 0.4	100	--	100	--	100	--	100	--	100	--
	0.5	100	--	100	--	100	--	100	--	0.5	4
	0.63; 0.8	100	--	100	--	100	--	100	--	0.5	6
	1	100	--	100	--	2	10	2	10	1.5	10
	1.25	100	--	100	--	2	16	2	16	1.5	16
	1.6	100	--	100	--	2	20	2	20	1.5	16
	2; 2.5	100	--	8	25	2	25	2	25	1.5	20
	3.2	100	--	8	32	2	32	2	32	1.5	25
	4; 5	100	--	4	32	1.5	32	1.5	32	1.5	25
	6.3; 8	100	--	4	50	1	40	1	40	1	35
	10	100	--	4	50	1	40	1	40	1	40
	12.5	100	--	4	63	1	50	1	50	1	40
	16	55	80	4	63	1	50	1	50	1	40
	20 ... 25	55	80	4	63	1	50	1	50	1	50
	28; 32	55	80	2	63	1	63	1	63	1	63
	36; 40	20	80	2	63	1	63	1	63	1	63

-- No back-up fuse required, since short-circuit-proof up to 100 kA

1) 5% overvoltage.

2) Without overvoltage.

3) Overvoltage category II applies for applications in IT systems > 600 V.

4) Back-up fuse only required if short-circuit current at installation location is >  $I_{cuIT}$ .

5) Alternatively, fuseless limiter combinations for 690 V AC can also be used.

## Protection equipment

### Motor starter protectors/circuit breakers

### SIRIUS 3RV2 motor starter protectors/circuit breakers

#### General data

Motor starter protectors/circuit breakers	Rated current $I_n$	Up to 240 V AC <sup>1)</sup>		Up to 400 V AC <sup>1)</sup> /415 V AC <sup>2)</sup>		Up to 440 V AC <sup>1)</sup> /460 V AC <sup>2)</sup>		Up to 500 V AC <sup>1)</sup> /525 V AC <sup>2)</sup>		Up to 690 V AC <sup>1)3)</sup>	
		$I_{cuIT}$	Max. fuse (gG) <sup>4)</sup>	$I_{cuIT}$	Max. fuse (gG) <sup>4)5)</sup>	$I_{cuIT}$	Max. fuse (gG) <sup>4)</sup>	$I_{cuIT}$	Max. fuse (gG) <sup>4)</sup>	$I_{cuIT}$	Max. fuse (gG) <sup>4)</sup>
Type	A	kA	A	kA	A	kA	A	kA	A	kA	A
<b>Size S2</b>											
<b>3RV2031, 3RV2131, 3RV2331</b>	14 ... 25	100	--	8	100	6	80	6	80	4	63
	32 ... 45	100	--	6	125	4	100	4	100	3	80
	52 ... 80	100	--	4	160	3	125	3	125	2	100
<b>Size S2, with increased switching capacity</b>											
<b>3RV2032, 3RV2332</b>	14 ... 25	100	--	8	100	6	80	6	80	4	63
	32 ... 45	100	--	6	125	6	100	6	100	4	80
	52	100	--	6	160	6	125	6	125	4	100
	59 ... 80	100	--	6	160	4	125	4	125	4	100
<b>Size S3</b>											
<b>3RV2.41</b>	40	65	125	10	63	5	50	5	50	5	50
	50	65	125	8	80	3	63	3	63	3	63
	63	65	160	6	80	3	63	3	63	3	63
	75	65	160	5	100	2	80	2	80	2	80
	84; 100	65	160	5	125	2	100	2	100	2	100
<b>Size S3, with increased switching capacity</b>											
<b>3RV2.42</b>	40	100	--	12	80	6	63	6	63	6	63
	50	100	--	10	100	4	80	4	80	4	80
	63	100	--	7.5	100	4	80	4	80	4	80
	75	100	--	6	125	3	100	3	100	3	100
	84; 100	100	--	6	160	3	125	3	125	3	125

-- No back-up fuse required, since short-circuit-proof up to 100 kA

1) 10% overvoltage.

2) 5% overvoltage.

3) Overvoltage category II applies for applications in IT systems > 600 V.

4) Back-up fuse only required if short-circuit current at installation location is >  $I_{cuIT}$ .

5) Alternatively, fuseless limiter combinations for 690 V AC can also be used.

## Protection equipment

### Motor starter protectors/circuit breakers

#### SIRIUS 3RV2 motor starter protectors/circuit breakers

#### General data

##### Limiting function with standard devices for 500 V AC and 690 V AC according to IEC 60947-2

The table shows the rated ultimate short-circuit breaking capacity  $I_{cu}$  and the rated service short-circuit breaking capacity  $I_{cs}$  with an upstream standard motor starter protector/circuit breaker that fulfills the limiter function at voltages 500 V AC and 690 V AC.

The short-circuit breaking capacity can be increased significantly with an upstream standard motor starter protector/circuit breaker with limiter function. The motor starter protector/circuit breaker which is connected downstream must be set to the rated current of the load.

With motor starter protector/circuit breaker assemblies, note the clearance to grounded parts and between the motor starter protectors/circuit breakers. Short-circuit-proof wiring between the motor starter protectors/circuit breakers must be ensured. The motor starter protectors/circuit breakers can be mounted side by side in a modular arrangement.

Standard motor starter protectors/circuit breakers		Rated current $I_n$	Up to 500 V AC <sup>1)/525 V AC<sup>2)</sup></sup>		Up to 690 V AC <sup>1)3)</sup>	
With limiter			$I_{cu}$	$I_{cs}$	$I_{cu}$	$I_{cs}$
Rated current $I_n$			kA	kA	kA	kA
Type	Type	A				
<b>Size S00</b>						
<b>Size S0:</b> <b>3RV2321-4EC10</b>	<b>3RV2011</b>	2 ... 6.3 8 10 ... 16	-- 100 100	-- 50 50	50 50 20 <sup>4)</sup>	25 25 10 <sup>4)</sup>
$I_n = 32$ A						
<b>Size S2:</b> <b>3RV2331-4WC10</b>	<b>3RV2011</b>	10 ... 16	--	--	50	25
$I_n = 52$ A						
<b>Size S0</b>						
<b>Size S0:</b> <b>3RV2321-4EC10</b>	<b>3RV2021</b>	12 ... 32	100	50	20 <sup>4)</sup>	10 <sup>4)</sup>
$I_n = 32$ A						
<b>Size S2:</b> <b>3RV2331-4WC10</b>	<b>3RV2021</b>	16 ... 32	--	--	50	20
$I_n = 52$ A						
<b>Size S2, with increased switching capacity</b>						
<b>Size S2:</b> <b>3RV2332-4RC10</b>	<b>3RV2032</b>	14 ... 80	100	50	70	35
$I_n = 80$ A						
<b>Size S3, with increased switching capacity</b>						
<b>Size S3<sup>5)</sup>:</b> <b>3RV2342-4MC10</b>	<b>3RV2042</b>	40 ... 100	100	50	50	25
$I_n = 100$ A						

-- No limiter required

1) 10% overvoltage.

2) 5% overvoltage.

3) Use phase barriers 3RV29.8-1K on the infeed side.

4) Infeed to the limiter is always on the side 1L1/3L2/5L3.

5) Infeed to the limiter only on the side 2T1/4T2/6T3. At the infeed side phase barriers 3RV2948-1K have to be used.

## Protection equipment

### Motor starter protectors/circuit breakers

### SIRIUS 3RV2 motor starter protectors/circuit breakers

#### General data

#### Permissible rated data of devices approved for North America (UL/CSA)

Motor starter protectors of the 3RV2 series are approved for UL/CSA, and according to UL 508/UL 60947-4-1 and CSA C22.2 No. 14/CSA C22.2 No. 60947-4-1 they can be used on their own or as load feeders in combination with a contactor.

These motor starter protectors/circuit breakers can be used as "Manual Motor Controllers" for "Group Installations", as "Manual Motor Controllers Suitable for Tap Conductor Protection in Group Installations" and as "Self-Protected Combination Motor Controllers (Type E)".

#### 3RV motor starter protectors as "Manual Motor Controllers"

If used as a "Manual Motor Controller", the motor starter protector is always operated in combination with an upstream short-circuit protection. Approved fuses or motor starter protectors/circuit breakers according to UL 489/CSA C22.2 No. 5 may be used for this purpose. These devices must be dimensioned according to the National Electrical Code (UL) or Canadian Electrical Code (CSA).

The file numbers for the approval of the 3RV as a manual motor controller are as follows:

- UL File No. 47705, CCN: NLRV
- CSA Master Contract 165071, Product Class: 3211

Motor starter protectors/ circuit breakers		hp rating <sup>1)</sup> for FLA <sup>2)</sup> max.		Rated current $I_n$ A	240 V AC		480 V AC		600 V AC	
		1-phase	3-phase		UL $I_{bc}^{(3)}$ kA	CSA $I_{bc}^{(3)}$ kA	UL $I_{bc}^{(3)}$ kA	CSA $I_{bc}^{(3)}$ kA	UL $I_{bc}^{(3)}$ kA	CSA $I_{bc}^{(3)}$ kA
Type	V									
<b>Size S00</b>										
<b>3RV2011, 3RV2111, 3RV2311, 3RV2411</b>				0.16 ... 12.5 16	65 65	65 65	65 65	65 65	30 --	30 --
FLA <sup>2)</sup> max.	115/120	1	2							
16 A, 480 V	200/208	2	3							
12.5 A, 600 V	230/240	2	5							
	460/480	--	10							
	575/600	--	10							
<b>Size S0</b>										
<b>3RV2021, 3RV2121, 3RV2321, 3RV2421</b>				0.16 ... 12.5 16 ... 25 28, 32 36, 40	65 65 65 65	65 65 65 65	65 65 50 12	65 65 50 12	30 -- -- --	30 -- -- --
FLA <sup>2)</sup> max.	115/120	3	5							
40 A, 480 V	200/208	5	10							
12.5 A, 600 V	230/240	7 1/2	10							
	460/480	--	30							
	575/600	--	--							
<b>Size S2</b>										
<b>3RV2031, 3RV2331</b>				14 ... 36 40 ... 52 59 ... 65 73 ... 80	65 65 65 65	65 65 65 65	65 65 65 <sup>5)</sup> 65 <sup>5)</sup>	65 65 65 <sup>5)</sup> 65 <sup>5)</sup>	25 22 20 <sup>5)</sup> 20 <sup>5)</sup>	25 22 20 <sup>5)</sup> 20 <sup>5)</sup>
FLA <sup>2)</sup> max.	115/120	7 1/2	10							
80 A, 600 V	200/208	15	25							
	230/240	15	30							
	460/480	--	60							
	575/600	--	75							
<b>Size S2, with increased switching capacity</b>										
<b>3RV2032, 3RV2332</b>				14 ... 36 40 ... 52 59 ... 65 73 ... 80	100 100 100 100	100 100 100 100	100 100 100 <sup>5)</sup> 100 <sup>5)</sup>	100 100 100 <sup>5)</sup> 100 <sup>5)</sup>	25 22 25 <sup>5)</sup> 25 <sup>5)</sup>	25 22 25 <sup>5)</sup> 25 <sup>5)</sup>
FLA <sup>2)</sup> max.	115/120	7 1/2	10							
80 A, 600 V	200/208	15	25							
	230/240	15	30							
	460/480	--	60							
	575/600	--	75							
<b>Size S3</b>										
<b>3RV2.41, 3RV2.42</b>				40 ... 75 84 ... 100	65 65	65 65	65 65	65 65	30 10/30 <sup>6)</sup>	30 10/30 <sup>6)</sup>
FLA <sup>2)</sup> max.	115/120	7 1/2	15							
100 A, 600 V	200/208	15	30							
	230/240	20	40							
	460/480	--	75							
	575/600	--	100							

-- No approval

1) hp rating = Power rating in horse power (maximum motor rating).

2) FLA = Full Load Amps/motor full load current.

3) Corresponds to "short-circuit breaking capacity" according to UL/CSA.

4) Values in brackets only apply to 3RV2.23 motor starter protectors.

5) With Class J fuse.

6) With Class J fuse 300 A.

## Protection equipment

### Motor starter protectors/circuit breakers

#### SIRIUS 3RV2 motor starter protectors/circuit breakers

##### General data

3RV20 motor starter protectors (up to 100 A) as "Manual Motor Controllers Suitable for Tap Conductor Protection in Group Installations"

The application as "Manual Motor Controllers Suitable for Tap Conductor Protection in Group Installations" is only available for UL. CSA does not recognize this approval! When the motor starter protector is used as a "Manual Motor Controller Suitable for Tap Conductor Protection in Group Installations", it must always be combined with upstream short-circuit protection. Approved fuses or motor starter protectors/circuit breakers according to UL 489 may be used for this purpose. These devices must be dimensioned according to the National Electrical Code.

The 3RV20 motor starter protectors are approved as "Manual Motor Controllers Suitable for Tap Conductor Protection in Group Installations" under the following file number:

- UL File No. 47705, CCN: NLRV

Motor starter protectors/circuit breakers		hp rating <sup>1)</sup> for FLA <sup>2)</sup> max.		Rated current $I_n$ A	240 V AC	480 Y/277 V AC	600 Y/347 V AC
		1-phase	3-phase		UL $I_{bc}^{3)}$ kA	UL $I_{bc}^{3)}$ kA	UL $I_{bc}^{3)}$ kA
Type	V						
<b>Size S00</b>							
<b>3RV2011</b>							
				0.16 ... 12.5 16	65 65	65 65	30 --
FLA <sup>2)</sup> max.	115/120	1	2				
16 A, 480 V	200/208	2	3				
12.5 A, 600 V	230/240	2	5				
	460/480	--	10				
	575/600	--	10				
<b>Size S0</b>							
<b>3RV2021</b>							
				0.16 ... 12.5 16 ... 25 28; 32	65 65 50	65 65 50	30 -- --
FLA <sup>2)</sup> max.	115/120	2	5				
32 A, 480 V	200/208	3	10				
12.5 A, 600 V	230/240	5	10				
	460/480	--	20				
	575/600	--	--				
<b>Size S2</b>							
<b>3RV2031</b>							
				14 ... 36 40 ... 52 59 ... 65	65 65 65 65 65	65 65 30 20 10	25 22 -- -- --
FLA <sup>2)</sup> max.	115/120	7 1/2	10				
80 A, 480 V	200/208	15	25				
52 A, 600 V	230/240	15	30				
	460/480	--	60				
	575/600	--	75				
<b>Size S2, with increased switching capacity</b>							
<b>3RV2032</b>							
				14 ... 36 40 ... 52 59 ... 65	100 100 100 100 100	100 100 42 30 10	25 22 -- -- --
FLA <sup>2)</sup> max.	115/120	7 1/2	10				
80 A, 480 V	200/208	15	25				
52 A, 600 V	230/240	15	30				
	460/480	--	60				
	575/600	--	75				
<b>Size S3</b>							
<b>3RV204.</b>							
				40 ... 75 84 ... 100	65 65	65 65	30 --
FLA <sup>2)</sup> max.	115/120	7 1/2	15				
100 A, 480 V	200/208	15	30				
75 A, 600 V	230/240	20	40				
	460/480	--	75				
	575/600	--	75				

-- No approval

<sup>1)</sup> hp rating = Power rating in horse power (maximum motor rating).

<sup>2)</sup> FLA = Full Load Amps/motor full load current.

<sup>3)</sup> Corresponds to "short-circuit breaking capacity" according to UL.



# Protection equipment

## Motor starter protectors/circuit breakers

### SIRIUS 3RV2 motor starter protectors/circuit breakers

#### General data

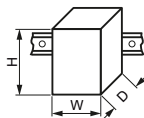
General data		3RV2.1.	3RV2.2.	3RV2.3.	3RV2.4.	3RV27, 3RV28
<b>Type</b>		S00	S0	S2	S3	S00, S0
<b>Size</b>						
Dimensions (W x H x D)		mm 45 x 97 x 92	45 x 97 x 92	55 x 140 x 149	70 x 165 x 169	45 x 144 x 92
• Screw terminals		mm 45 x 106 x 92	45 x 119 x 92	--	--	--
• Spring-loaded terminals						
<b>Standards</b>		Yes	Yes	Yes	Yes	--
• IEC 60947-1 (VDE 0660 Part 100)		Yes	Yes	Yes	Yes	--
• IEC 60947-2 (VDE 0660 Part 101)		Yes	Yes	Yes	Yes	--
• IEC 60947-4-1 (VDE 0660 Part 102)		Yes	Yes	Yes	Yes	--
• UL 508/UL 60947-4-1, CSA C22.2 No. 14/CSA C22.2 No. 60947-4-1		Yes (does not apply to 3RV2...-.....0BA0 and -0DA0 motor starter protectors)				--
• UL 489, CSA C22.2 No. 5		--				Yes
<b>Number of poles</b>		3				
<b>Max. rated current <math>I_n</math> max (= max. rated operational current <math>I_e</math>)</b>		A 16	40	80	100	22
<b>Permissible ambient temperature</b>						
• Storage/transport		°C -50 ... +80				
• Operation	$I_n$ : 0.16 ... 32 A	°C -20 (-50) <sup>1)</sup> ... +70 (current reduction above +60 °C)	--	--	--	--
	$I_n$ : 36 ... 40 A	°C --	-20 ... +40 (the devices must not be mounted side-by-side and they must not be assembled with link modules with contactors. A lateral clearance of 9 mm is required.)	--	--	--
	$I_n$ : 14 ... 80 A	°C --		-20 (-50) <sup>1)</sup> ... +70 (current reduction above +60 °C)	--	--
	$I_n$ : 40 ... 100 A	°C --			-20 ... +70 (current reduction above +60 °C)	--
<b>Permissible rated current at inside temperature of control cabinet</b>						
• +60 °C		% 100				
• +70 °C		% 87				
<b>Permissible rated current at ambient temperature of enclosure (applies to motor starter protector/circuit breaker inside enclosure: S00/S0 ≤ 32 A, S2 ≤ 52 A)</b>						
• +35 °C		% 100			--	
• +60 °C		% --				
<b>Rated operational voltage <math>U_e</math></b>						
• Acc. to IEC		V AC 690 (when a molded-plastic enclosure is used only 500 V)				
• Acc. to UL/CSA		V AC 600				
<b>Rated frequency</b>		Hz 50/60				
<b>Rated insulation voltage <math>U_i</math></b>		V 690			1 000	690
<b>Rated impulse withstand voltage <math>U_{imp}</math></b>		kV 6			8	6
<b>Utilization category</b>						
• IEC 60947-2 (motor starter protector/circuit breaker)		A				
• IEC 60947-4-1 (motor starter)		AC-3				
<b>Trip class CLASS</b>	Acc. to IEC 60947-4-1	10		10/20		--
<b>Power loss <math>P_v</math> per motor starter protector</b>						
dependent upon	$I_n$ : 0.16 ... 0.63 A	W 5.5	--	--	--	5.5
rated current $I_n$	$I_n$ : 0.8 ... 6.3 A	W 7.3	--	--	--	7.3
(upper setting range)	$I_n$ : 8 ... 16 A	W 9.3	--	--	--	9.3
	$I_n$ : 14 ... 16 A	W --	9.3	12.5	--	9.3
	$I_n$ : 17 ... 25 A	W --	10.5	14.5	--	10.5
	$I_n$ : 28 ... 32 A	W --	13.3	18	--	--
	$I_n$ : 36 ... 40 A	W --	16.3	20	--	--
	$I_n$ : 45 ... 52 A	W --	--	24.5	--	--
	$I_n$ : 59 ... 65 A	W --	--	26	--	--
	$I_n$ : 73 ... 80 A	W --	--	29.5	--	--
	$I_n$ : 40 ... 50 A	W --	--	27	--	--
	$I_n$ : 63 ... 75 A	W --	--	38	--	--
	$I_n$ : 84 ... 93 A	W --	--	39	--	--
	$I_n$ : 100 A	W --	--	44	--	--
<b>Shock resistance</b>	Acc. to IEC 60068-2-27	g/ms 25/11 (square and sine pulse)				

<sup>1)</sup> Value in brackets applies to the 3RV2...-.....0BA0 motor starter protectors.

## Protection equipment

### Motor starter protectors/circuit breakers

### SIRIUS 3RV2 motor starter protectors/circuit breakers

#### General data

##### General data (continued)

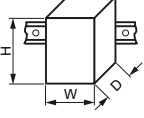
Type		3RV2.1.	3RV2.2.	3RV2.3.	3RV2.4.	3RV27, 3RV28	
Size		S00	S0	S2	S3	S00, S0	
Dimensions (W x H x D)		mm	45 x 97 x 92	45 x 97 x 92	55 x 140 x 149	70 x 165 x 169	45 x 144 x 92
• Screw terminals • Spring-loaded terminals		mm	45 x 106 x 92	45 x 119 x 92	--	--	--
<b>Degree of protection IP on the front</b>	according to IEC 60529	IP20 (screw terminals and spring-loaded terminals)					
<b>Touch protection on the front</b>	according to IEC 60529	Finger-safe for vertical touching from the front (screw and spring-loaded terminals)					
<b>Temperature compensation</b>	Acc. to IEC 60947-4-1 °C	-20 ... +60					
<b>Phase failure sensitivity</b>	Acc. to IEC 60947-4-1	Yes (does not apply to 3RV23, 3RV2...-.....-0DA0 motor starter protectors)					No
<b>Protection of motors in hazardous environments</b>		Yes (only for 3RV20 motor starter protectors, not for 3RV20...-.....-0BA0 and -0DA0) DMT 02 ATEX F 001 ⚡ II (2) GD					No
• EC type-examination certificate number according to European Directive 2014/34/EU (ATEX)		IECEx BVS14.0102 [Ex]					No
• According to international standard IECEx							No
<b>Isolating function</b>	Acc. to IEC 60947-2	Yes					
<b>Main and EMERGENCY OFF switch characteristics</b> (with corresponding accessories)	Acc. to IEC 60204-1 (VDE 0113)	Yes					
<b>Protective separation between main and auxiliary circuits required for PELV applications</b>	Acc. to IEC 60947-1	Yes					
• Up to 400 V + 10%		Yes					
• Up to 415 V + 5% (higher voltages on request)		Yes, <a href="#">see certificate</a>					
• Up to 690 V (depends on mounted accessories)							
<b>Permissible mounting position</b>		Any, acc. to IEC 60447 start command "I" right-hand side or top					
<b>Mechanical service life (operating cycles)</b>							
• 3RV2		100 000		Up to 52 A: 50 000, up to 80 A: 20 000	25 000	100 000	
• 3RV2...-.....-0BA0		500		250	--		
<b>Electrical endurance (operating cycles)</b>							
• 3RV2		100 000		Up to 52 A: 50 000, up to 80 A: 20 000	25 000	100 000	
• 3RV2...-.....-0BA0		500		250	--		
<b>Max. switching frequency per hour (motor starts)</b>	1/h	15					

##### General data

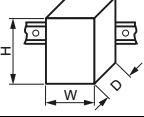
Type		3RV2742	3RV1611-0BD10 <sup>1)</sup>	3RV1011
Size		S3	S00	S00
Dimensions (W x H x D)		mm	70 x 168 x 169	45 x 90 x 70
<b>Standards</b>				
• IEC 60947-1 (VDE 0660 Part 100)		Yes		
• IEC 60947-2 (VDE 0660 Part 101)		Yes		
• UL 508/UL 60947-4-1, CSA C22.2 No.14/CSA 60947-4-1		No	Yes	
• UL 489, CSA C22.2 No. 5		Yes	No	
<b>Number of poles</b>		3		
<b>Max. rated current <math>I_{n \max}</math> (= max. rated operational current <math>I_e</math>)</b>	A	70	0.2	12
<b>Permissible ambient temperature</b>				
• Storage/transport	°C	-50 ... +80		
• Operation	°C	-20 ... +70 (current reduction above +60 °C)		
<b>Permissible rated current at inside temperature of control cabinet</b>				
• +60 °C	%	100		
• +70 °C	%	87		
<b>Permissible rated current at ambient temperature of enclosure (applies to motor starter protector/circuit breaker inside enclosure)</b>				
• +35 °C	%	--		
• +60 °C	%	--		
<b>Rated operational voltage <math>U_e</math></b>				
• Acc. to IEC	V AC	690 (with molded-plastic enclosure 500 V)		
• Acc. to UL/CSA	V AC	600		
<b>Rated frequency</b>	Hz	50/60		
<b>Rated insulation voltage <math>U_i</math></b>	V	1 000	690	
<b>Rated impulse withstand voltage <math>U_{imp}</math></b>	kV	8	6	
<b>Utilization category</b>				
• IEC 60947-2 (motor starter protector/circuit breaker)		A		
• IEC 60947-4-1 (motor starter)		AC-3		

<sup>1)</sup> "Technical specifications" for 3RV1611 voltage transformer circuit breakers.

## Protection equipment

### Motor starter protectors/circuit breakers

### SIRIUS 3RV2 motor starter protectors/circuit breakers

#### General data

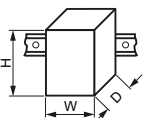
General data (continued)					
<b>Type</b>			<b>3RV2742</b>	<b>3RV1611-0BD10<sup>1)</sup></b>	<b>3RV1011</b>
Size			S3	S00	S00
Dimensions (W x H x D)		mm	70 x 168 x 169	45 x 90 x 70	45 x 90 x 70
<b>Power loss <math>P_v</math> per motor starter protector</b>	$I_n: 0.2 \text{ A}$	W	--	5	--
dependent upon	$I_n: 10 \text{ A}$	W	10	--	--
rated current $I_n$	$I_n: 15 \dots 35 \text{ A}$	W	14	--	--
(upper setting range)	$I_n: 40 \dots 70 \text{ A}$	W	23.5	--	--
$R_{\text{per conducting path}} = \frac{P}{I^2 \times 3}$	$I_n: \dots 1.25 \text{ A}$	W	--	--	5.5
	$I_n: 1.65 \dots 6.3 \text{ A}$	W	--	--	7.3
	$I_n: 8 \dots 12 \text{ A}$	W	--	--	9.3
<b>Shock resistance</b>	Acc. to IEC 60068-2-27	g/ms	25/11 (square and sine pulse)		
<b>Degree of protection IP on the front</b>	Acc. to IEC 60529		IP20		
<b>Touch protection on the front</b>	Acc. to IEC 60529		Finger-safe for vertical touching from the front		
<b>Temperature compensation</b>	Acc. to IEC 60947-4-1 °C		-20 ... +60		
<b>Phase failure sensitivity</b>	Acc. to IEC 60947-4-1		No	Yes	
<b>Explosion protection – Safe operation of motors with "increased safety" type of protection</b>			No		Yes
EC type-examination certificate number according to directive 2014/34/EU (ATEX)					
<b>Isolating function</b>	Acc. to IEC 60947-2		Yes		
<b>Main and EMERGENCY OFF switch characteristics</b>	Acc. to IEC 60204-1 (VDE 0113)		Yes		
(with corresponding accessories)					
<b>Protective separation between main and auxiliary circuits, required for PELV applications</b>	Acc. to IEC 60947-1				
• Up to 400 V + 10%					
• Up to 415 V + 5% (higher voltages on request)					
<b>Permissible mounting position</b>	Any, acc. to IEC 60447 start command "I" right-hand side or top				
<b>Mechanical service life</b>		Operat- ing cycles	25 000	100 000	
<b>Electrical endurance</b>		Operat- ing cycles	25 000	100 000	
<b>Max. switching frequency per hour (motor starts)</b>		1/h	15		

<sup>1)</sup> "Technical specifications" for 3RV1611 voltage transformer circuit breakers.

Rated data of the auxiliary switches and						
		Lateral auxiliary switch with 1 NO + 1 NC, 2 NO, 2 NC, 2 NO + 2 NC		Signaling switch	Transverse auxiliary switch with 1 CO 1 NO + 1 NC, 2 NO	
<b>Max. rated voltage</b>		V AC	600		250	
• Acc. to NEMA (UL)		V AC	600		250	
• Acc. to NEMA (CSA)						
<b>Uninterrupted current</b>		A	10		5	2.5
<b>Switching capacity</b>			1 NO + 1 NC, 2 NO, 2 NC: A600, Q300; 2 NO + 2 NC: A300, Q300	A600, Q300	B600, R300	C300, R300

## Protection equipment

### Motor starter protectors/circuit breakers

### SIRIUS 3RV2 motor starter protectors/circuit breakers

#### General data

##### Front transverse auxiliary switches

		Switching capacity for different voltages	
		1 CO	1 NO + 1 NC, 2 NO
<b>Rated operational current <math>I_e</math></b>			
• At AC-15, alternating voltage			
- 24 V	A	4	2
- 230 V	A	3	0.5
• At AC-12 = $I_{th}$ , alternating voltage			
- 24 V	A	10	2.5
- 230 V	A	10	2.5
• At DC-13, direct voltage $L/R$ 200 ms			
- 24 V	A	1	1
- 48 V	A	--	0.3
- 60 V	A	--	0.15
- 110 V	A	0.22	--
- 220 V	A	0.1	--
<b>Minimum load capacity</b>	V	17	
	mA	1	

##### Front transverse solid-state compatible auxiliary switches

		Switching capacity for different voltages	
		1 CO	
<b>Rated operational voltage <math>U_e</math></b>	Alternating voltage	V	125
<b>Rated operational current <math>I_e</math> /AC-14</b>	At $U_e = 125$ V	A	0.1
<b>Rated operational voltage <math>U_e</math></b>	Direct voltage $L/R$ 200 ms	V	60
<b>Rated operational current <math>I_e</math> /DC-13</b>	At $U_e = 60$ V	A	0.3
<b>Minimum load capacity</b>	V	5	
	mA	1	

##### Lateral auxiliary switches with signaling switch

		Switching capacity for different voltages: Lateral auxiliary switch with 1 NO + 1 NC, 2 NO, 2 NC, 2 NO + 2 NC, Signaling switch	
<b>Rated operational current <math>I_e</math></b>			
• At AC-15, alternating voltage			
- 24 V	A	6	
- 230 V	A	4	
- 400 V	A	3	
- 690 V	A	1	
• At AC-12 = $I_{th}$ , alternating voltage			
- 24 V	A	10	
- 230 V	A	10	
- 400 V	A	10	
- 690 V	A	10	
• At DC-13, direct voltage $L/R$ 200 ms			
- 24 V	A	2	
- 110 V	A	0.5	
- 220 V	A	0.25	
- 440 V	A	0.1	
<b>Minimum load capacity</b>	V	17	
	mA	1	

##### Auxiliary releases

		Undervoltage releases	Shunt releases
<b>Power consumption</b>			
• During pick-up			
- AC voltages	VA/W	20.2/13	
- DC voltages	W	20	13 ... 80
• During uninterrupted duty			
- AC voltages	VA/W	7.2/2.4	--
- DC voltages	W	2.1	--
<b>Response voltage</b>			
• Tripping	V	0.35 ... 0.7 × $U_s$	0.7 ... 1.1 × $U_s$
• Pick-up	V	0.85 ... 1.1 × $U_s$	--
<b>Opening time maximum</b>	ms	20	

##### Short-circuit protection for auxiliary and control circuits

<b>Melting fuses</b> operational class gG	A	10
<b>Miniature circuit breakers</b> C characteristic	A	6 (prospective short-circuit current < 0.4 kA)

# Protection equipment



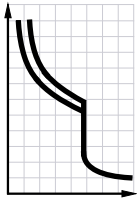

## Motor starter protectors/circuit breakers

### SIRIUS 3RV2 motor starter protectors/circuit breakers

**IE3/IE4 ready** For motor protection

**Selection and ordering data**
**CLASS 10, without auxiliary switches**

 3RV2011-..A10,  
3RV2011-..A10-0BA0

 3RV2011-..A20,  
3RV2011-..AA20-0BA0

Rated current	Suitable for three-phase motors <sup>1)</sup> with P	Setting range for thermal overload release	Instantaneous electronic release	Short-circuit breaking capacity at 400 V AC	Screw terminals 	Spring-loaded terminals 	Weight
$I_n$				$I_{cu}$	Article No.	Article No.	kg
A	kW	A	A	kA			
<b>Size S00</b>							
0.16	0.04	0.11 ... 0.16	2.1	100	<b>3RV2011-0AA10</b>	<b>3RV2011-0AA20</b>	0.300
0.2	0.06	0.14 ... 0.2	2.6	100	<b>3RV2011-0BA10</b>	<b>3RV2011-0BA20</b>	0.300
0.25	0.06	0.18 ... 0.25	3.3	100	<b>3RV2011-0CA10</b>	<b>3RV2011-0CA20</b>	0.301
0.32	0.09	0.22 ... 0.32	4.2	100	<b>3RV2011-0DA10</b>	<b>3RV2011-0DA20</b>	0.295
0.4	0.09	0.28 ... 0.4	5.2	100	<b>3RV2011-0EA10</b>	<b>3RV2011-0EA20</b>	0.299
0.5	0.12	0.35 ... 0.5	6.5	100	<b>3RV2011-0FA10</b>	<b>3RV2011-0FA20</b>	0.305
0.63	0.18	0.45 ... 0.63	8.2	100	<b>3RV2011-0GA10</b>	<b>3RV2011-0GA20</b>	0.302
0.8	0.18	0.55 ... 0.8	10	100	<b>3RV2011-0HA10</b>	<b>3RV2011-0HA20</b>	0.298
1	0.25	0.7 ... 1	13	100	<b>3RV2011-0JA10</b>	<b>3RV2011-0JA20</b>	0.365
1.25	0.37	0.9 ... 1.25	16	100	<b>3RV2011-0KA10</b>	<b>3RV2011-0KA20</b>	0.365
1.6	0.55	1.1 ... 1.6	21	100	<b>3RV2011-1AA10</b>	<b>3RV2011-1AA20</b>	0.370
2	0.75	1.4 ... 2	26	100	<b>3RV2011-1BA10</b>	<b>3RV2011-1BA20</b>	0.366
2.5	0.75	1.8 ... 2.5	33	100	<b>3RV2011-1CA10</b>	<b>3RV2011-1CA20</b>	0.385
3.2	1.1	2.2 ... 3.2	42	100	<b>3RV2011-1DA10</b>	<b>3RV2011-1DA20</b>	0.370
4	1.5	2.8 ... 4	52	100	<b>3RV2011-1EA10</b>	<b>3RV2011-1EA20</b>	0.365
5	1.5	3.5 ... 5	65	100	<b>3RV2011-1FA10</b>	<b>3RV2011-1FA20</b>	0.369
6.3	2.2	4.5 ... 6.3	82	100	<b>3RV2011-1GA10</b>	<b>3RV2011-1GA20</b>	0.372
8	3	5.5 ... 8	104	100	<b>3RV2011-1HA10</b>	<b>3RV2011-1HA20</b>	0.372
10	4	7 ... 10	130	100	<b>3RV2011-1JA10</b>	<b>3RV2011-1JA20</b>	0.373
12.5	5.5	9 ... 12.5	163	100	<b>3RV2011-1KA10</b>	<b>3RV2011-1KA20</b>	0.375
16	7.5	10 ... 16	208	55	<b>3RV2011-4AA10</b>	<b>3RV2011-4AA20</b>	0.379
<b>For special operating conditions down to -50 °C<sup>2)3)</sup></b>							
1.25	0.37	0.9 ... 1.25	16	100	<b>3RV2011-0KA10-0BA0</b>	--	0.340
1.6	0.55	1.1 ... 1.6	21	100	<b>3RV2011-1AA10-0BA0</b>	<b>3RV2011-1AA20-0BA0</b>	0.345
2.5	0.75	1.8 ... 2.5	33	100	<b>3RV2011-1CA10-0BA0</b>	--	0.347
3.2	1.1	2.2 ... 3.2	42	100	<b>3RV2011-1DA10-0BA0</b>	--	0.348
4	1.5	2.8 ... 4	52	100	<b>3RV2011-1EA10-0BA0</b>	--	0.342
5	1.5	3.5 ... 5	65	100	<b>3RV2011-1FA10-0BA0</b>	--	0.348
6.3	2.2	4.5 ... 6.3	82	100	<b>3RV2011-1GA10-0BA0</b>	--	0.351
8	3	5.5 ... 8	104	100	<b>3RV2011-1HA10-0BA0</b>	--	0.350
10	4	7 ... 10	130	100	<b>3RV2011-1JA10-0BA0</b>	--	0.353
12.5	5.5	9 ... 12.5	163	100	<b>3RV2011-1KA10-0BA0</b>	--	0.348
16	7.5	10 ... 16	208	55	<b>3RV2011-4AA10-0BA0</b>	<b>3RV2011-4AA20-0BA0</b>	0.354

<sup>1)</sup> Guide value for 4-pole standard motors at 50 Hz 400 V AC. The actual starting and rated data of the motor to be protected must be considered when selecting the units.

<sup>2)</sup> The 3RV2011-.....0BA0 motor starter protectors have a mechanical service life of 500 operating cycles.

<sup>3)</sup> The motor starter protectors do not have UL/CSA approval and are not certified either according to the European explosion protection directive ATEX or according to the international explosion protection standard (IECEx).

Auxiliary switches and other accessories can be ordered separately (see page 2/196 onwards).

## Protection equipment

### Motor starter protectors/circuit breakers

#### SIRIUS 3RV2 motor starter protectors/circuit breakers

For motor protection **IE3/IE4 ready**

**CLASS 10, without auxiliary switches**

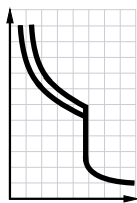

3RV2021-..A10, 3RV2021-4.A10-0BA0



3RV2021-..A20, 3RV2021-..A20-0BA0

Rated current	Suitable for three-phase motors <sup>1)</sup> with ▶	Setting range for thermal overload release	Instantaneous electronic release	Short-circuit breaking capacity at 400 V AC	Screw terminals	Spring-loaded terminals	Weight
$I_n$			$I >$	$I_{cu}$	Article No.	Article No.	kg
A	kW	A	A	kA			
<b>Size S0</b>							
0.16	0.04	0.11 ... 0.16	2.1	100	3RV2021-0AA10	--	0.280
0.2	0.06	0.14 ... 0.2	2.6	100	3RV2021-0BA10	--	0.285
0.25	0.06	0.18 ... 0.25	3.3	100	3RV2021-0CA10	--	0.300
0.32	0.09	0.22 ... 0.32	4.2	100	3RV2021-0DA10	--	0.287
0.4	0.09	0.28 ... 0.4	5.2	100	3RV2021-0EA10	--	0.285
0.5	0.12	0.35 ... 0.5	6.5	100	3RV2021-0FA10	--	0.285
0.63	0.18	0.45 ... 0.63	8.2	100	3RV2021-0GA10	3RV2021-0GA20	0.335
0.8	0.18	0.55 ... 0.8	10	100	3RV2021-0HA10	3RV2021-0HA20	0.330
1	0.25	0.7 ... 1	13	100	3RV2021-0JA10	3RV2021-0JA20	0.395
1.25	0.37	0.9 ... 1.25	16	100	3RV2021-0KA10	3RV2021-0KA20	0.403
1.6	0.55	1.1 ... 1.6	21	100	3RV2021-1AA10	3RV2021-1AA20	0.404
2	0.75	1.4 ... 2	26	100	3RV2021-1BA10	3RV2021-1BA20	0.398
2.5	0.75	1.8 ... 2.5	33	100	3RV2021-1CA10	3RV2021-1CA20	0.402
3.2	1.1	2.2 ... 3.2	42	100	3RV2021-1DA10	3RV2021-1DA20	0.400
4	1.5	2.8 ... 4	52	100	3RV2021-1EA10	3RV2021-1EA20	0.400
5	1.5	3.5 ... 5	65	100	3RV2021-1FA10	3RV2021-1FA20	0.408
6.3	2.2	4.5 ... 6.3	82	100	3RV2021-1GA10	3RV2021-1GA20	0.410
8	3	5.5 ... 8	104	100	3RV2021-1HA10	3RV2021-1HA20	0.430
10	4	7 ... 10	130	100	3RV2021-1JA10	3RV2021-1JA20	0.412
12.5	5.5	9 ... 12.5	163	100	3RV2021-1KA10	3RV2021-1KA20	0.407
16	7.5	10 ... 16	208	55	3RV2021-4AA10	3RV2021-4AA20	0.415
20	7.5	13 ... 20	260	55	3RV2021-4BA10	3RV2021-4BA20	0.413
22	11	16 ... 22	286	55	3RV2021-4CA10	3RV2021-4CA20	0.417
25	11	18 ... 25	325	55	3RV2021-4DA10	3RV2021-4DA20	0.420
28	15	23 ... 28	364	55	3RV2021-4NA10	3RV2021-4NA20	0.432
32 <sup>2)</sup>	15	27 ... 32	400	55	3RV2021-4EA10	3RV2021-4EA20	0.430
36 <sup>3)</sup>	18.5	30 ... 36	432	20	3RV2021-4PA10	--	0.387
40 <sup>3)</sup>	18.5	34 ... 40	480	20	3RV2021-4FA10	--	0.404
<b>For special operating conditions down to -50 °C<sup>4)5)</sup></b>							
1	0.25	0.7 ... 1	13	100	--	3RV2021-0JA20-0BA0	0.395
1.6	0.55	1.1 ... 1.6	21	100	--	3RV2021-1AA20-0BA0	0.400
2	0.75	1.4 ... 2	26	100	--	3RV2021-1BA20-0BA0	0.400
2.5	0.75	1.8 ... 2.5	33	100	--	3RV2021-1CA20-0BA0	0.404
4	1.5	2.8 ... 4	52	100	--	3RV2021-1EA20-0BA0	0.403
6.3	2.2	4.5 ... 6.3	82	100	--	3RV2021-1GA20-0BA0	0.414
8	3	5.5 ... 8	104	100	--	3RV2021-1HA20-0BA0	0.410
10	4	7 ... 10	130	100	--	3RV2021-1JA20-0BA0	0.411
12.5	5.5	9 ... 12.5	163	100	--	3RV2021-1KA20-0BA0	0.407
16	7.5	10 ... 16	208	55	--	3RV2021-4AA20-0BA0	0.420
20	7.5	13 ... 20	260	55	3RV2021-4BA10-0BA0	--	0.365
22	11	16 ... 22	286	55	3RV2021-4CA10-0BA0	--	0.352
25	11	18 ... 25	325	55	3RV2021-4DA10-0BA0	3RV2021-4DA20-0BA0	0.418
28	15	23 ... 28	364	55	--	3RV2021-4NA20-0BA0	0.429
32 <sup>2)</sup>	15	27 ... 32	400	55	3RV2021-4EA10-0BA0	3RV2021-4EA20-0BA0	0.430
40 <sup>3)</sup>	18.5	34 ... 40	480	20	3RV2021-4FA10-0BA0	--	0.385

<sup>1)</sup> Guide value for 4-pole standard motors at 50 Hz 400 V AC. The actual starting and rated data of the motor to be protected must be considered when selecting the units.

<sup>2)</sup> Suitable for use with IE3/IE4 motors up to a starting current of 256 A. For higher starting currents we recommend using 3RV2 motor starter protectors size S2.

<sup>3)</sup> The devices must not be mounted side-by-side and they must not be assembled with link modules with contactors. A lateral clearance of 9 mm is required. For use with IE3/IE4 motors we recommend using 3RV2 motor starter protectors size S2.

<sup>4)</sup> The 3RV2021-.....-0BA0 motor starter protectors have a mechanical service life of 500 operating cycles.

<sup>5)</sup> The motor starter protectors do not have UL/CSA approval and are not certified either according to the European explosion protection directive ATEX or according to the international explosion protection standard (IECEx).

Auxiliary switches and other accessories can be ordered separately (see page 2/196 onwards).

## Protection equipment

### Motor starter protectors/circuit breakers

### SIRIUS 3RV2 motor starter protectors/circuit breakers

**IE3/IE4 ready**    For motor protection

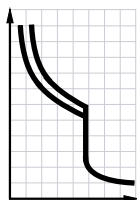
**CLASS 10, without auxiliary switches**

 3RV2031-4.A10,  
3RV2031-4.A10-0BA0

3RV2032-4.A10

Rated current	Suitable for three-phase motors <sup>1)</sup> with $P$	Setting range for thermal overload release	Instantaneous electronic release	Short-circuit breaking capacity at 400 V AC	Screw terminals	Weight
$I_n$				$I_{cu}$	Article No.	
A	kW	A	A	kA		kg
<b>Size S2</b>						
14	5.5	9.5 ... 14	208	65	3RV2031-4SA10	1.092
17	7.5	12 ... 17	260	65	3RV2031-4TA10	1.081
20	7.5	14 ... 20	260	65	3RV2031-4BA10	1.067
25	11	18 ... 25	325	65	3RV2031-4DA10	1.054
32	15	22 ... 32	416	65	3RV2031-4EA10	1.051
36	18.5	28 ... 36	520	65	3RV2031-4PA10	1.074
40	18.5	32 ... 40	585	65	3RV2031-4UA10	1.074
45	22	35 ... 45	650	65	3RV2031-4VA10	1.071
52	22	42 ... 52	741	65	3RV2031-4WA10	1.164
59	30	49 ... 59	845	65	3RV2031-4XA10	1.185
65	30	54 ... 65	845	65	3RV2031-4JA10	1.178
73	37	62 ... 73	949	65	3RV2031-4KA10	1.172
80 <sup>2)</sup>	37	70 ... 80	1 040	65	3RV2031-4RA10	1.180

**For special operating conditions down to -50 °C<sup>3)4)</sup>**

25	11	18 ... 25	325	65	3RV2031-4DA10-0BA0	1.100
32	15	22 ... 32	416	65	3RV2031-4EA10-0BA0	1.045
65	30	54 ... 65	845	65	3RV2031-4JA10-0BA0	1.166

**Size S2, with increased switching capacity**

14	5.5	9.5 ... 14	208	100	3RV2032-4SA10	1.134
17	7.5	12 ... 17	260	100	3RV2032-4TA10	1.139
20	7.5	14 ... 20	260	100	3RV2032-4BA10	1.134
25	11	18 ... 25	325	100	3RV2032-4DA10	1.114
32	15	22 ... 32	416	100	3RV2032-4EA10	1.114
36	18.5	28 ... 36	520	100	3RV2032-4PA10	1.133
40	18.5	32 ... 40	585	100	3RV2032-4UA10	1.149
45	22	35 ... 45	650	100	3RV2032-4VA10	1.157
52	22	42 ... 52	741	100	3RV2032-4WA10	1.167
59	30	49 ... 59	845	100	3RV2032-4XA10	1.181
65	30	54 ... 65	845	100	3RV2032-4JA10	1.179
73	37	62 ... 73	949	100	3RV2032-4KA10	1.170
80 <sup>2)</sup>	37	70 ... 80	1 040	100	3RV2032-4RA10	1.180

<sup>1)</sup> Guide value for 4-pole standard motors at 50 Hz 400 V AC. The actual starting and rated data of the motor to be protected must be considered when selecting the units.

<sup>2)</sup> Suitable for use with IE3/IE4 motors up to a starting current of 720 A. For higher starting currents we recommend using 3RV2 motor starter protectors size S3.

<sup>3)</sup> The 3RV2031-...-0BA0 motor starter protectors have a mechanical service life of 250 operating cycles.

<sup>4)</sup> The motor starter protectors do not have UL/CSA approval and are not certified either according to the European explosion protection directive ATEX or according to the international explosion protection standard (IECEx).

Auxiliary switches and other accessories can be ordered separately (see page 2/196 onwards).



## Protection equipment

### Motor starter protectors/circuit breakers

### SIRIUS 3RV2 motor starter protectors/circuit breakers



For motor protection **IE3/IE4 ready**

**CLASS 10, without auxiliary switches**

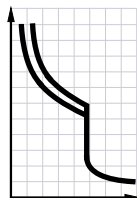
2



3RV204.-4.A10

Rated current	Suitable for three-phase motors <sup>1)</sup> with P	Setting range for thermal overload release	Instantaneous electronic release	Short-circuit breaking capacity at 400 V AC	Screw terminals 	Weight
$I_n$				$I_{cu}$	Article No.	
A	kW	A	A	kA		kg
<b>Size S3</b>						
40	18.5	28 ... 40	520	65	<b>3RV2041-4FA10</b>	2.190
50	22	36 ... 50	650	65	<b>3RV2041-4HA10</b>	2.229
63	30	45 ... 63	819	65	<b>3RV2041-4JA10</b>	2.234
75	37	57 ... 75	975	65	<b>3RV2041-4KA10</b>	2.235
84	45	65 ... 84	1 170	65	<b>3RV2041-4RA10</b>	2.272
93	45	75 ... 93	1 300	65	<b>3RV2041-4YA10</b>	2.280
100 <sup>2)</sup>	45, 55	80 ... 100	1 300	65	<b>3RV2041-4MA10</b>	2.273
<b>Size S3, with increased switching capacity</b>						
40	18.5	28 ... 40	520	100	<b>3RV2042-4FA10</b>	2.193
50	22	36 ... 50	650	100	<b>3RV2042-4HA10</b>	2.219
63	30	45 ... 63	819	100	<b>3RV2042-4JA10</b>	2.243
75	37	57 ... 75	975	100	<b>3RV2042-4KA10</b>	2.256
84	45	65 ... 84	1 170	100	<b>3RV2042-4RA10</b>	2.263
93	45	75 ... 93	1 300	100	<b>3RV2042-4YA10</b>	2.279
100 <sup>2)</sup>	45, 55	80 ... 100	1 300	100	<b>3RV2042-4MA10</b>	2.266

<sup>1)</sup> Guide value for 4-pole standard motors at 50 Hz 400 V AC. The actual starting and rated data of the motor to be protected must be considered when selecting the units.

<sup>2)</sup> Suitable for use with IE3/IE4 motors up to a starting current of 780 A. For higher starting currents we recommend using 3VA circuit breakers (see Catalog LV 10).

Auxiliary switches and other accessories can be ordered separately (see page 2/196 onwards).

# Protection equipment

## Motor starter protectors/circuit breakers

### SIRIUS 3RV2 motor starter protectors/circuit breakers

**IE3/IE4 ready** For motor protection

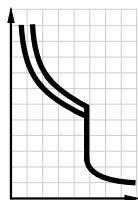
**CLASS 10, with transverse auxiliary switch (1 NO + 1 NC)**

3RV2011-...A15

3RV2011-...A25,  
3RV2011-1EA25-0BA03RV2.21-4.A15,  
3RV2021-4.A15-0BA0

3RV2021-4.A25

Rated current	Suitable for three-phase motors <sup>1)</sup> with P	Setting range for thermal overload release	Instantaneous electronic release	Short-circuit breaking capacity at 400 V AC	Screw terminals	Spring-loaded terminals	Weight
$I_n$			$I >$	$I_{cu}$	Article No.	Article No.	kg
A	kW	A	A	kA			
<b>Size S00</b>							
0.16	0.04	0.11 ... 0.16	2.1	100	3RV2011-0AA15	3RV2011-0AA25	0.310
0.2	0.06	0.14 ... 0.2	2.6	100	3RV2011-0BA15	3RV2011-0BA25	0.311
0.25	0.06	0.18 ... 0.25	3.3	100	3RV2011-0CA15	3RV2011-0CA25	0.327
0.32	0.09	0.22 ... 0.32	4.2	100	3RV2011-0DA15	3RV2011-0DA25	0.314
0.4	0.09	0.28 ... 0.4	5.2	100	3RV2011-0EA15	3RV2011-0EA25	0.330
0.5	0.12	0.35 ... 0.5	6.5	100	3RV2011-0FA15	3RV2011-0FA25	0.316
0.63	0.18	0.45 ... 0.63	8.2	100	3RV2011-0GA15	3RV2011-0GA25	0.320
0.8	0.18	0.55 ... 0.8	10	100	3RV2011-0HA15	3RV2011-0HA25	0.308
1	0.25	0.7 ... 1	13	100	3RV2011-0JA15	3RV2011-0JA25	0.375
1.25	0.37	0.9 ... 1.25	16	100	3RV2011-0KA15	3RV2011-0KA25	0.382
1.6	0.55	1.1 ... 1.6	21	100	3RV2011-1AA15	3RV2011-1AA25	0.383
2	0.75	1.4 ... 2	26	100	3RV2011-1BA15	3RV2011-1BA25	0.400
2.5	0.75	1.8 ... 2.5	33	100	3RV2011-1CA15	3RV2011-1CA25	0.380
3.2	1.1	2.2 ... 3.2	42	100	3RV2011-1DA15	3RV2011-1DA25	0.380
4	1.5	2.8 ... 4	52	100	3RV2011-1EA15	3RV2011-1EA25	0.383
5	1.5	3.5 ... 5	65	100	3RV2011-1FA15	3RV2011-1FA25	0.385
6.3	2.2	4.5 ... 6.3	82	100	3RV2011-1GA15	3RV2011-1GA25	0.410
8	3	5.5 ... 8	104	100	3RV2011-1HA15	3RV2011-1HA25	0.388
10	4	7 ... 10	130	100	3RV2011-1JA15	3RV2011-1JA25	0.390
12.5	5.5	9 ... 12.5	163	100	3RV2011-1KA15	3RV2011-1KA25	0.388
16	7.5	10 ... 16	208	55	3RV2011-4AA15	3RV2011-4AA25	0.395
<b>For special operating conditions down to -50 °C<sup>2)3)</sup></b>							
2	0.06	0.14 ... 0.2	2.6	100	3RV2011-1BA15-0BA0	--	0.368
2.5	0.75	1.8 ... 2.5	33	100	3RV2011-1CA15-0BA0	--	0.360
4	1.5	2.8 ... 4	52	100	3RV2011-1EA15-0BA0	3RV2011-1EA25-0BA0	0.361
5	1.5	3.5 ... 5	65	100	3RV2011-1FA15-0BA0	--	0.370
6.3	2.2	4.5 ... 6.3	82	100	3RV2011-1GA15-0BA0	--	0.368
8	3	5.5 ... 8	104	100	3RV2011-1HA15-0BA0	--	0.370
12.5	5.5	9 ... 12.5	163	100	3RV2011-1KA15-0BA0	--	0.365
16	7.5	10 ... 16	208	55	3RV2011-4AA15-0BA0	--	0.370
<b>Size S0</b>							
16	7.5	10 ... 16	208	55	3RV2021-4AA15	3RV2021-4AA25	0.427
20	7.5	13 ... 20	260	55	3RV2021-4BA15	3RV2021-4BA25	0.427
22	11	16 ... 22	286	55	3RV2021-4CA15	3RV2021-4CA25	0.434
25	11	18 ... 25	325	55	3RV2021-4DA15	3RV2021-4DA25	0.435
28	15	23 ... 28	364	55	3RV2021-4NA15	3RV2021-4NA25	0.445
32 <sup>4)</sup>	15	27 ... 32	400	55	3RV2021-4EA15	3RV2021-4EA25	0.470
36 <sup>5)</sup>	18.5	30 ... 36	432	20	3RV2021-4PA15	--	0.425
40 <sup>5)</sup>	18.5	34 ... 40	480	20	3RV2021-4FA15	--	0.402
<b>For special operating conditions down to -50 °C<sup>2)3)</sup></b>							
20	7.5	13 ... 20	260	55	3RV2021-4BA15-0BA0	--	0.378
32 <sup>4)</sup>	15	27 ... 32	400	55	3RV2021-4EA15-0BA0	--	0.393

<sup>1)</sup> Guide value for 4-pole standard motors at 50 Hz 400 V AC. The actual starting and rated data of the motor to be protected must be considered when selecting the units.

<sup>2)</sup> The 3RV20.1-.....-0BA0 motor starter protectors in sizes S00 and S0 have a mechanical service life of 500 operating cycles.

<sup>3)</sup> The motor starter protectors do not have UL/CSA approval and are not certified either according to the European explosion protection directive ATEX or according to the international explosion protection standard (IECEX).

<sup>4)</sup> Suitable for use with IE3/IE4 motors up to a starting current of 256 A. For higher starting currents we recommend using 3RV2 motor starter protectors size S2.

<sup>5)</sup> The devices must not be mounted side-by-side and they must not be assembled with link modules with contactors. A lateral clearance of 9 mm is required. For use with IE3/IE4 motors we recommend using 3RV2 motor starter protectors size S2.

Auxiliary switches and other accessories can be ordered separately (see page 2/196 onwards).

## Protection equipment

### Motor starter protectors/circuit breakers

### SIRIUS 3RV2 motor starter protectors/circuit breakers

For motor protection **IE3/IE4 ready**

**CLASS 10, with integrated auxiliary switch (1 NO + 1 NC)**

2

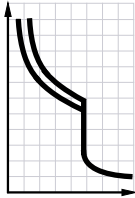



3RV2031-4..15,  
3RV2031-4.A15-0BA0



3RV2032-4.A15



3RV2041-4.A15

Rated current	Suitable for three-phase motors <sup>1)</sup> with $P$	Setting range for thermal overload release	Instantaneous electronic release	Short-circuit breaking capacity at 400 V AC	Screw terminals 	Weight
$I_n$				$I_{cu}$	Article No.	
A	kW	A	A	kA		kg
<b>Size S2</b>						
14	5.5	9.5 ... 14	208	65	3RV2031-4SA15	1.081
17	7.5	12 ... 17	260	65	3RV2031-4TA15	1.085
20	7.5	14 ... 20	260	65	3RV2031-4BA15	1.075
25	11	18 ... 25	325	65	3RV2031-4DA15	1.072
32	15	22 ... 32	416	65	3RV2031-4EA15	1.065
36	18.5	28 ... 36	520	65	3RV2031-4PA15	1.080
40	18.5	32 ... 40	585	65	3RV2031-4UA15	1.085
45	22	35 ... 45	650	65	3RV2031-4VA15	1.068
52	22	42 ... 52	741	65	3RV2031-4WA15	1.169
59	30	49 ... 59	845	65	3RV2031-4XA15	1.190
65	30	54 ... 65	845	65	3RV2031-4JA15	1.207
73	37	62 ... 73	949	65	3RV2031-4KA15	1.147
80 <sup>2)</sup>	37	70 ... 80	1 040	65	3RV2031-4RA15	1.190
<b>For special operating conditions down to -50 °C<sup>3)4)</sup></b>						
14	5.5	9.5 ... 14	208	65	3RV2031-4SA15-0BA0	1.088
20	7.5	14 ... 20	260	65	3RV2031-4BA15-0BA0	1.082
32	15	22 ... 32	416	65	3RV2031-4EA15-0BA0	1.068
45	22	35 ... 45	650	65	3RV2031-4VA15-0BA0	1.079
<b>Size S2, with increased switching capacity</b>						
14	5.5	9.5 ... 14	208	10	3RV2032-4SA15	1.145
17	7.5	12 ... 17	260	100	3RV2032-4TA15	1.152
20	7.5	14 ... 20	260	100	3RV2032-4BA15	1.141
25	11	18 ... 25	325	100	3RV2032-4DA15	1.117
32	15	22 ... 32	416	100	3RV2032-4EA15	1.130
36	18.5	28 ... 36	520	100	3RV2032-4PA15	1.149
40	18.5	32 ... 40	585	100	3RV2032-4UA15	1.159
45	22	35 ... 45	650	100	3RV2032-4VA15	1.162
52	22	42 ... 52	741	100	3RV2032-4WA15	1.177
59	30	49 ... 59	845	100	3RV2032-4XA15	1.189
65	30	54 ... 65	845	100	3RV2032-4JA15	1.186
73	37	62 ... 73	949	100	3RV2032-4KA15	1.183
80 <sup>2)</sup>	37	70 ... 80	1 040	100	3RV2032-4RA15	1.186
<b>Size S3</b>						
40	18.5	28 ... 40	520	65	3RV2041-4FA15	2.200
50	22	36 ... 50	650	65	3RV2041-4HA15	2.225
63	30	45 ... 63	819	65	3RV2041-4JA15	2.251
75	37	57 ... 75	975	65	3RV2041-4KA15	2.258
84	45	65 ... 84	1 170	65	3RV2041-4RA15	2.273
93	45	75 ... 93	1 300	65	3RV2041-4YA15	2.295
100 <sup>5)</sup>	45, 55	80 ... 100	1 300	65	3RV2041-4MA15	2.292

<sup>1)</sup> Guide value for 4-pole standard motors at 50 Hz 400 V AC. The actual starting and rated data of the motor to be protected must be considered when selecting the units.

<sup>2)</sup> Suitable for use with IE3/IE4 motors up to a starting current of 720 A. For higher starting currents we recommend using 3RV2 motor starter protectors size S3.

<sup>3)</sup> The 3RV2031-.....-0BA0 motor starter protectors have a mechanical service life of 250 operating cycles.

<sup>4)</sup> The motor starter protectors do not have UL/CSA approval and are not certified either according to the European explosion protection directive ATEX or according to the international explosion protection standard (IECEX).

<sup>5)</sup> Suitable for use with IE3/IE4 motors up to a starting current of 780 A. For higher starting currents we recommend using 3VA circuit breakers (see Catalog LV 10).

Auxiliary switches and other accessories can be ordered separately (see page 2/196 onwards).

## Protection equipment

### Motor starter protectors/circuit breakers

### SIRIUS 3RV2 motor starter protectors/circuit breakers

IE3/IE4 ready For motor protection

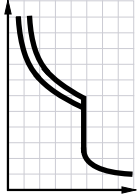
**CLASS 20, without auxiliary switches**

3RV2031-4.B10,  
14 to 45 A;  
3RV2031-4.B10-0BA0;  
32 to 40 A



3RV2031-4.B10,  
52 to 65 A



3RV2042-4.B10,  
40 to 100 A

Rated current	Suitable for three-phase motors <sup>1)</sup> with P	Setting range for thermal overload release	Instantaneous electronic release	Short-circuit breaking capacity at 400 V AC	Screw terminals	Weight
$I_n$				$I_{cu}$	Article No.	kg
A	kW	A	A	kA		
<b>Size S2</b>						
14	5.5	9.5 ... 14	208	65	3RV2031-4SB10	1.088
17	7.5	12 ... 17	260	65	3RV2031-4TB10	1.108
20	7.5	14 ... 20	260	65	3RV2031-4BB10	1.082
25	11	18 ... 25	325	65	3RV2031-4DB10	1.080
32	15	22 ... 32	416	65	3RV2031-4EB10	1.084
36	18.5	28 ... 36	520	65	3RV2031-4PB10	1.105
40	18.5	32 ... 40	585	65	3RV2031-4UB10	1.114
45	22	35 ... 45	650	65	3RV2031-4VB10	1.112
52	22	42 ... 52	741	65	3RV2031-4WB10	1.212
59	30	49 ... 59	845	65	3RV2031-4XB10	1.214
65	30	54 ... 65	845	65	3RV2031-4JB10	1.220
<b>For special operating conditions down to -50 °C<sup>2)</sup></b>						
32	15	22 ... 32	416	65	3RV2031-4EB10-0BA0	1.096
36	18.5	28 ... 36	520	65	3RV2031-4PB10-0BA0	1.105
40	18.5	32 ... 40	585	65	3RV2031-4UB10-0BA0	1.114
<b>Size S3, with increased switching capacity</b>						
40	18.5	28 ... 40	520	100	3RV2042-4FB10	2.200
50	22	36 ... 50	650	100	3RV2042-4HB10	2.229
63	30	45 ... 63	819	100	3RV2042-4JB10	2.246
75	37	57 ... 75	975	100	3RV2042-4KB10	2.268
84	45	65 ... 84	1 170	100	3RV2042-4RB10	2.300
93	45	75 ... 93	1 300	100	3RV2042-4YB10	2.307
100 <sup>4)</sup>	45, 55	80 ... 100	1 300	100	3RV2042-4MB10	2.281

<sup>1)</sup> Guide value for 4-pole standard motors at 50 Hz 400 V AC. The actual starting and rated data of the motor to be protected must be considered when selecting the units.

<sup>2)</sup> The 3RV2031-.....-0BA0 motor starter protectors have a mechanical service life of 250 operating cycles.

<sup>3)</sup> The motor starter protectors do not have UL/CSA approval and are not certified either according to the European explosion protection directive ATEX or according to the international explosion protection standard (IECEX).

<sup>4)</sup> Suitable for use with IE3/IE4 motors up to a starting current of 780 A. For higher starting currents we recommend using 3VA circuit breakers (see Catalog LV 10).

Auxiliary switches and other accessories can be ordered separately (see page 2/196 onwards).

## Protection equipment

### Motor starter protectors/circuit breakers

### SIRIUS 3RV2 motor starter protectors/circuit breakers

For motor protection **IE3/IE4 ready**

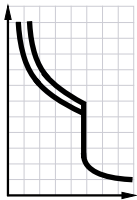

**CLASS 20, with integrated auxiliary switch (1 NO + 1 NC)**



3RV2031-4.B15,  
14 to 45 A



3RV2031-4.B15,  
52 to 65 A

Rated current	Suitable for three-phase motors <sup>1)</sup> with P	Setting range for thermal overload release	Instantaneous electronic release	Short-circuit breaking capacity at 400 V AC	Screw terminals 	Weight
$I_n$				$I_{cu}$	Article No.	
A	kW	A	A	kA		kg
<b>Size S2</b>						
14	5.5	9.5 ... 14	208	65	<b>3RV2031-4SB15</b>	1.091
17	7.5	12 ... 17	260	65	<b>3RV2031-4TB15</b>	1.114
20	7.5	14 ... 20	260	65	<b>3RV2031-4BB15</b>	1.097
25	11	18 ... 25	325	65	<b>3RV2031-4DB15</b>	1.088
32	15	22 ... 32	416	65	<b>3RV2031-4EB15</b>	1.099
36	18.5	28 ... 36	520	65	<b>3RV2031-4PB15</b>	1.133
40	18.5	32 ... 40	585	65	<b>3RV2031-4UB15</b>	1.129
45	22	35 ... 45	650	65	<b>3RV2031-4VB15</b>	1.122
52	22	42 ... 52	741	65	<b>3RV2031-4WB15</b>	1.220
59	30	49 ... 59	845	65	<b>3RV2031-4XB15</b>	1.233
65	30	54 ... 65	845	65	<b>3RV2031-4JB15</b>	1.238

<sup>1)</sup> Guide value for 4-pole standard motors at 50 Hz 400 V AC. The actual starting and rated data of the motor to be protected must be considered when selecting the units.

Auxiliary switches and other accessories can be ordered separately (see page 2/196 onwards).

## Protection equipment

### Motor starter protectors/circuit breakers

### SIRIUS 3RV2 motor starter protectors/circuit breakers

**IE3/IE4 ready** For motor protection with overload relay function

#### Selection and ordering data

**CLASS 10, with overload relay function (Automatic RESET), without auxiliary switches**

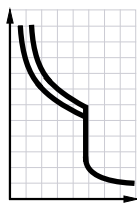

3RV2111-...A10



3RV2121-4.A10

Rated current	Suitable for three-phase motors <sup>1)</sup> with P	Setting range for thermal overload release	Instantaneous electronic release	Short-circuit breaking capacity at 400 V AC	Screw terminals	Weight
$I_n$				$I_{cu}$	Article No.	kg
A	kW	A	A	kA		
<b>Size S00<sup>2)</sup></b>						
0.16	0.04	0.11 ... 0.16	2.1	100	3RV2111-0AA10	0.360
0.2	0.06	0.14 ... 0.2	2.6	100	3RV2111-0BA10	0.337
0.25	0.06	0.18 ... 0.25	3.3	100	3RV2111-0CA10	0.334
0.32	0.09	0.22 ... 0.32	4.2	100	3RV2111-0DA10	0.340
0.4	0.09	0.28 ... 0.4	5.2	100	3RV2111-0EA10	0.339
0.5	0.12	0.35 ... 0.5	6.5	100	3RV2111-0FA10	0.341
0.63	0.18	0.45 ... 0.63	8.2	100	3RV2111-0GA10	0.338
0.8	0.18	0.55 ... 0.8	10	100	3RV2111-0HA10	0.338
1	0.25	0.7 ... 1	13	100	3RV2111-0JA10	0.401
1.25	0.37	0.9 ... 1.25	16	100	3RV2111-0KA10	0.404
1.6	0.55	1.1 ... 1.6	21	100	3RV2111-1AA10	0.407
2	0.75	1.4 ... 2	26	100	3RV2111-1BA10	0.407
2.5	0.75	1.8 ... 2.5	33	100	3RV2111-1CA10	0.406
3.2	1.1	2.2 ... 3.2	42	100	3RV2111-1DA10	0.407
4	1.5	2.8 ... 4	52	100	3RV2111-1EA10	0.406
5	1.5	3.5 ... 5	65	100	3RV2111-1FA10	0.411
6.3	2.2	4.5 ... 6.3	82	100	3RV2111-1GA10	0.411
8	3	5.5 ... 8	104	100	3RV2111-1HA10	0.432
10	4	7 ... 10	130	100	3RV2111-1JA10	0.412
12.5	5.5	9 ... 12.5	163	100	3RV2111-1KA10	0.409
16	7.5	10 ... 16	208	55	3RV2111-4AA10	0.414
<b>Size S0<sup>2)</sup></b>						
16	7.5	10 ... 16	208	55	3RV2121-4AA10	0.424
20	7.5	13 ... 20	260	55	3RV2121-4BA10	0.420
22	11	16 ... 22	286	55	3RV2121-4CA10	0.422
25	11	18 ... 25	325	55	3RV2121-4DA10	0.429
28	15	23 ... 28	364	55	3RV2121-4NA10	0.460
32 <sup>3)</sup>	15	27 ... 32	400	55	3RV2121-4EA10	0.436

<sup>1)</sup> Guide value for 4-pole standard motors at 50 Hz 400 V AC. The actual starting and rated data of the motor to be protected must be considered when selecting the units.

<sup>2)</sup> Accessories for mounting on the right and 3RV1915 3-phase busbars cannot be used.

<sup>3)</sup> Suitable for use with IE3/IE4 motors up to a starting current of 256 A. For higher starting currents we recommend using 3RV2 motor starter protectors size S2.

Auxiliary switches and other accessories can be ordered separately (see page 2/196 onwards).

## Protection equipment

### Motor starter protectors/circuit breakers

#### SIRIUS 3RV2 motor starter protectors/circuit breakers

For motor protection with overload relay function

**CLASS 10, with overload relay function (Automatic RESET), without auxiliary switches**

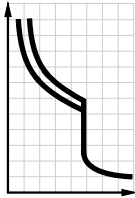

2



3RV2131-4.A10



3RV2142-4.A10

Rated current	Suitable for three-phase motors <sup>1)</sup> with P	Setting range for thermal overload release	Instantaneous electronic release	Short-circuit breaking capacity at 400 V AC	Screw terminals 	Weight
$I_n$				$I_{cu}$	Article No.	kg
A	kW	A	A	kA		
<b>Size S2<sup>2)</sup></b>						
14	5.5	9.5 ... 14	208	65	<b>3RV2131-4SA10</b>	1.143
17	7.5	12 ... 17	260	65	<b>3RV2131-4TA10</b>	1.142
20	7.5	14 ... 20	260	65	<b>3RV2131-4BA10</b>	1.135
25	11	18 ... 25	325	65	<b>3RV2131-4DA10</b>	1.122
32	15	22 ... 32	416	65	<b>3RV2131-4EA10</b>	1.122
36	18.5	28 ... 36	520	65	<b>3RV2131-4PA10</b>	1.131
40	18.5	32 ... 40	585	65	<b>3RV2131-4UA10</b>	1.129
45	22	35 ... 45	650	65	<b>3RV2131-4VA10</b>	1.124
52	32	42 ... 52	741	65	<b>3RV2131-4WA10</b>	1.220
59	30	49 ... 59	845	65	<b>3RV2131-4XA10</b>	1.247
65	30	54 ... 65	845	65	<b>3RV2131-4JA10</b>	1.241
73	37	62 ... 73	949	65	<b>3RV2131-4KA10</b>	1.235
80 <sup>3)</sup>	37	70 ... 80	1 040	65	<b>3RV2131-4RA10</b>	1.245
<b>Size S3, with increased switching capacity<sup>2)</sup></b>						
40	18.5	28 ... 40	520	100	<b>3RV2142-4FA10</b>	2.260
50	22	36 ... 50	650	100	<b>3RV2142-4HA10</b>	2.301
63	30	45 ... 63	819	100	<b>3RV2142-4JA10</b>	2.293
75	37	57 ... 75	975	100	<b>3RV2142-4KA10</b>	2.301
84	45	65 ... 84	1 170	100	<b>3RV2142-4RA10</b>	2.339
93	45	75 ... 93	1 300	100	<b>3RV2142-4YA10</b>	2.341
100 <sup>4)</sup>	45, 55	80 ... 100	1 300	100	<b>3RV2142-4MA10</b>	2.325

<sup>1)</sup> Guide value for 4-pole standard motors at 50 Hz 400 V AC. The actual starting and rated data of the motor to be protected must be considered when selecting the units.

<sup>2)</sup> Accessories for mounting on the right cannot be used.

<sup>3)</sup> Suitable for use with IE3/IE4 motors up to a starting current of 720 A. For higher starting currents we recommend using 3RV2 motor starter protectors size S3.

<sup>4)</sup> Suitable for use with IE3/IE4 motors up to a starting current of 780 A. For higher starting currents we recommend using 3VA circuit breakers (see Catalog LV 10).

Auxiliary switches and other accessories can be ordered separately (see page 2/196 onwards).



# Protection equipment

## Motor starter protectors/circuit breakers

### SIRIUS 3RV2 motor starter protectors/circuit breakers

**IE3/IE4 ready** For starter combinations

#### Selection and ordering data

##### Without auxiliary switches

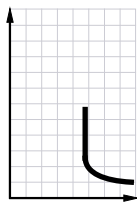

3RV2311-..C10

3RV2311-..C20,  
3RV2311-4AC20-0BA0

Rated current	Suitable for three-phase motors <sup>1)</sup> with P	Thermal overload release <sup>2)</sup>	Instantaneous electronic release	Short-circuit breaking capacity at 400 V AC	Screw terminals	Spring-loaded terminals	Weight
$I_n$			$I >$	$I_{cu}$	Article No.	Article No.	kg
A	kW	A	A	kA			
<b>Size S00</b>							
0.16	0.04	Without	2.1	100	3RV2311-0AC10	3RV2311-0AC20	0.340
0.2	0.06	Without	2.6	100	3RV2311-0BC10	3RV2311-0BC20	0.293
0.25	0.06	Without	3.3	100	3RV2311-0CC10	3RV2311-0CC20	0.300
0.32	0.09	Without	4.2	100	3RV2311-0DC10	3RV2311-0DC20	0.293
0.4	0.09	Without	5.2	100	3RV2311-0EC10	3RV2311-0EC20	0.292
0.5	0.12	Without	6.5	100	3RV2311-0FC10	3RV2311-0FC20	0.294
0.63	0.18	Without	8.2	100	3RV2311-0GC10	3RV2311-0GC20	0.292
0.8	0.18	Without	10	100	3RV2311-0HC10	3RV2311-0HC20	0.293
1	0.25	Without	13	100	3RV2311-0JC10	3RV2311-0JC20	0.365
1.25	0.37	Without	16	100	3RV2311-0KC10	3RV2311-0KC20	0.360
1.6	0.55	Without	21	100	3RV2311-1AC10	3RV2311-1AC20	0.364
2	0.75	Without	26	100	3RV2311-1BC10	3RV2311-1BC20	0.363
2.5	0.75	Without	33	100	3RV2311-1CC10	3RV2311-1CC20	0.364
3.2	1.1	Without	42	100	3RV2311-1DC10	3RV2311-1DC20	0.366
4	1.5	Without	52	100	3RV2311-1EC10	3RV2311-1EC20	0.361
5	1.5	Without	65	100	3RV2311-1FC10	3RV2311-1FC20	0.400
6.3	2.2	Without	82	100	3RV2311-1GC10	3RV2311-1GC20	0.375
8	3	Without	104	100	3RV2311-1HC10	3RV2311-1HC20	0.367
10	4	Without	130	100	3RV2311-1JC10	3RV2311-1JC20	0.350
12.5	5.5	Without	163	100	3RV2311-1KC10	3RV2311-1KC20	0.380
16	7.5	Without	208	55	3RV2311-4AC10	3RV2311-4AC20	0.377
<b>For special operating conditions down to -50 °C<sup>3)4)</sup></b>							
16	7.5	Without	208	55	--	3RV2311-4AC20-0BA0	0.375

<sup>1)</sup> Guide value for 4-pole standard motors at 50 Hz 400 V AC. The actual starting and rated data of the motor to be protected must be considered when selecting the units.

<sup>2)</sup> For overload protection of the motors, appropriate overload relays must be used.

<sup>3)</sup> The 3RV2311-.....-0BA0 motor starter protectors have a mechanical service life of 500 operating cycles.

<sup>4)</sup> The motor starter protectors do not have UL/CSA approval and are not certified either according to the European explosion protection directive ATEX or according to the international explosion protection standard (IECEx).

Auxiliary switches and other accessories can be ordered separately (see page 2/196 onwards).

## Protection equipment

### Motor starter protectors/circuit breakers

#### SIRIUS 3RV2 motor starter protectors/circuit breakers

For starter combinations **IE3/IE4 ready**

Without auxiliary switches

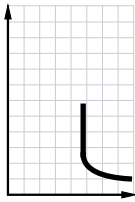

3RV2321-..C10



3RV2321-..C20,  
3RV2321-4AC20-0BA0

Rated current	Suitable for three-phase motors <sup>1)</sup> with P	Thermal overload release <sup>2)</sup>	Instantaneous electronic release	Short-circuit breaking capacity at 400 V AC	Screw terminals	Spring-loaded terminals	Weight
$I_n$				$I_{cu}$	Article No.	Article No.	kg
A	kW	A	A	kA			
<b>Size S0</b>							
1.6	0.55	Without	21	100	3RV2321-1AC10	3RV2321-1AC20	0.408
2	0.75	Without	26	100	3RV2321-1BC10	3RV2321-1BC20	0.401
2.5	0.75	Without	33	100	3RV2321-1CC10	3RV2321-1CC20	0.400
3.2	1.1	Without	42	100	3RV2321-1DC10	3RV2321-1DC20	0.403
4	1.5	Without	52	100	3RV2321-1EC10	3RV2321-1EC20	0.396
5	1.5	Without	65	100	3RV2321-1FC10	3RV2321-1FC20	0.404
6.3	2.2	Without	82	100	3RV2321-1GC10	3RV2321-1GC20	0.408
8	3	Without	104	100	3RV2321-1HC10	3RV2321-1HC20	0.410
10	4	Without	130	100	3RV2321-1JC10	3RV2321-1JC20	0.407
12.5	5.5	Without	163	100	3RV2321-1KC10	3RV2321-1KC20	0.440
16	7.5	Without	208	55	3RV2321-4AC10	3RV2321-4AC20	0.412
20	7.5	Without	260	55	3RV2321-4BC10	3RV2321-4BC20	0.410
22	11	Without	286	55	3RV2321-4CC10	3RV2321-4CC20	0.400
25	11	Without	325	55	3RV2321-4DC10	3RV2321-4DC20	0.414
28	15	Without	364	55	3RV2321-4NC10	3RV2321-4NC20	0.427
32 <sup>3)</sup>	15	Without	400	55	3RV2321-4EC10	3RV2321-4EC20	0.428
36 <sup>4)</sup>	18.5	Without	432	20	3RV2321-4PC10	--	0.300
40 <sup>4)</sup>	18.5	Without	480	20	3RV2321-4FC10	--	0.400
<b>For special operating conditions down to -50 °C<sup>5)6)</sup></b>							
16	7.5	Without	208	55	--	3RV2321-4AC20-0BA0	0.412

<sup>1)</sup> Guide value for 4-pole standard motors at 50 Hz 400 V AC. The actual starting and rated data of the motor to be protected must be considered when selecting the units.

<sup>2)</sup> For overload protection of the motors, appropriate overload relays must be used.

<sup>3)</sup> Suitable for use with IE3/IE4 motors up to a starting current of 256 A. For higher starting currents we recommend using 3RV2 motor starter protectors size S2.

<sup>4)</sup> The devices must not be mounted side-by-side and they must not be assembled with link modules with contactors. A lateral clearance of 9 mm is required. For use with IE3/IE4 motors we recommend using 3RV2 motor starter protectors size S2.

<sup>5)</sup> The 3RV2321-.....-0BA0 motor starter protectors have a mechanical service life of 500 operating cycles.

<sup>6)</sup> The motor starter protectors do not have UL/CSA approval and are not certified either according to the European explosion protection directive ATEX or according to the international explosion protection standard (IECEx).

Auxiliary switches and other accessories can be ordered separately (see page 2/196 onwards).

## Protection equipment

### Motor starter protectors/circuit breakers

### SIRIUS 3RV2 motor starter protectors/circuit breakers

**IE3/IE4 ready** For starter combinations

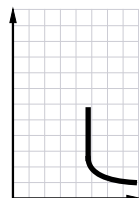
**Without auxiliary switches**

 3RV2331-4.C10,  
14 to 45 A

 3RV2331-4.C10,  
52 to 80 A

 3RV2332-4.C10,  
14 to 45 A

 3RV2332-4.C10,  
52 to 80 A

 3RV234.-4.C10,  
40 to 100 A

Rated current	Suitable for three-phase motors <sup>1)</sup> with P	Thermal overload release <sup>2)</sup>	Instantaneous electronic release	Short-circuit breaking capacity at 400 V AC	Screw terminals	Weight
$I_n$				$I_{cu}$	Article No.	
A	kW	A	A	kA		kg
<b>Size S2</b>						
14	5.5	Without	208	65	3RV2331-4SC10	1.056
17	7.5	Without	260	65	3RV2331-4TC10	1.070
20	7.5	Without	260	65	3RV2331-4BC10	1.061
25	11	Without	325	65	3RV2331-4DC10	1.044
32	15	Without	416	65	3RV2331-4EC10	1.040
36	18.5	Without	520	65	3RV2331-4PC10	1.052
40	18.5	Without	585	65	3RV2331-4UC10	1.052
45	22	Without	650	65	3RV2331-4VC10	1.050
52	22	Without	741	65	3RV2331-4WC10	1.152
59	30	Without	845	65	3RV2331-4XC10	1.173
65	30	Without	845	65	3RV2331-4JC10	1.165
73	37	Without	949	65	3RV2331-4KC10	1.162
80 <sup>3)</sup>	37	Without	1 040	65	3RV2331-4RC10	1.168
<b>Size S2, with increased switching capacity</b>						
14	5.5	Without	208	100	3RV2332-4SC10	1.132
17	7.5	Without	260	100	3RV2332-4TC10	1.130
20	7.5	Without	260	100	3RV2332-4BC10	1.121
25	11	Without	325	100	3RV2332-4DC10	1.103
32	15	Without	416	100	3RV2332-4EC10	1.111
36	18.5	Without	520	100	3RV2332-4PC10	1.131
40	18.5	Without	585	100	3RV2332-4UC10	1.138
45	22	Without	650	100	3RV2332-4VC10	1.148
52	22	Without	741	100	3RV2332-4WC10	1.149
59	30	Without	845	100	3RV2332-4XC10	1.169
65	30	Without	845	100	3RV2332-4JC10	1.167
73	37	Without	949	100	3RV2332-4KC10	1.163
80 <sup>3)</sup>	37	Without	1 040	100	3RV2332-4RC10	1.167
<b>Size S3</b>						
40	18.5	Without	520	65	3RV2341-4FC10	2.175
50	22	Without	650	65	3RV2341-4HC10	2.214
63	30	Without	819	65	3RV2341-4JC10	2.208
75	37	Without	975	65	3RV2341-4KC10	2.236
84	45	Without	1 170	65	3RV2341-4RC10	2.248
93	45	Without	1 300	65	3RV2341-4YC10	2.269
100 <sup>4)</sup>	45, 55	Without	1 300	65	3RV2341-4MC10	2.251
<b>Size S3, with increased switching capacity</b>						
40	18.5	Without	520	100	3RV2342-4FC10	2.175
50	22	Without	650	100	3RV2342-4HC10	2.208
63	30	Without	819	100	3RV2342-4JC10	2.216
75	37	Without	975	100	3RV2342-4KC10	2.234
84	45	Without	1 170	100	3RV2342-4RC10	2.240
93	45	Without	1 300	100	3RV2342-4YC10	2.259
100 <sup>4)</sup>	45, 55	Without	1 300	100	3RV2342-4MC10	2.252

<sup>1)</sup> Guide value for 4-pole standard motors at 50 Hz 400 V AC. The actual starting and rated data of the motor to be protected must be considered when selecting the units.

<sup>2)</sup> For overload protection of the motors, appropriate overload relays must be used.

<sup>3)</sup> Suitable for use with IE3/IE4 motors up to a starting current of 720 A. For higher starting currents we recommend using 3RV2 motor starter protectors size S3.

<sup>4)</sup> Suitable for use with IE3/IE4 motors up to a starting current of 780 A. For higher starting currents we recommend using 3VA circuit breakers (see Catalog LV 10).

Auxiliary switches and other accessories can be ordered separately (see page 2/196 onwards).

## Protection equipment

### Motor starter protectors/circuit breakers

#### SIRIUS 3RV2 motor starter protectors/circuit breakers

#### For transformer protection

#### Selection and ordering data

##### CLASS 10, without auxiliary switches



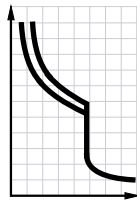

Motor starter protectors for the protection of transformers with high inrush current



3RV2411-..A10,  
3RV2411-..A10-0BA0



3RV2411-..A20

Rated current	Setting range for thermal overload release	Instantaneous electronic release	Short-circuit breaking capacity at 400 V AC	Screw terminals 	Spring-loaded terminals 	Weight
$I_n$			$I_{cu}$	Article No.	Article No.	kg
A	A	A	kA			
<b>Size S00</b>						
0.16	0.11 ... 0.16	3.3	100	3RV2411-0AA10	3RV2411-0AA20	0.297
0.2	0.14 ... 0.2	4.2	100	3RV2411-0BA10	3RV2411-0BA20	0.300
0.25	0.18 ... 0.25	5.2	100	3RV2411-0CA10	3RV2411-0CA20	0.298
0.32	0.22 ... 0.32	6.5	100	3RV2411-0DA10	3RV2411-0DA20	0.297
0.4	0.28 ... 0.4	8.2	100	3RV2411-0EA10	3RV2411-0EA20	0.299
0.5	0.35 ... 0.5	10	100	3RV2411-0FA10	3RV2411-0FA20	0.298
0.63	0.45 ... 0.63	13	100	3RV2411-0GA10	3RV2411-0GA20	0.363
0.8	0.55 ... 0.8	16	100	3RV2411-0HA10	3RV2411-0HA20	0.364
1	0.7 ... 1	21	100	3RV2411-0JA10	3RV2411-0JA20	0.366
1.25	0.9 ... 1.25	26	100	3RV2411-0KA10	3RV2411-0KA20	0.366
1.6	1.1 ... 1.6	33	100	3RV2411-1AA10	3RV2411-1AA20	0.366
2	1.4 ... 2	42	100	3RV2411-1BA10	3RV2411-1BA20	0.368
2.5	1.8 ... 2.5	52	100	3RV2411-1CA10	3RV2411-1CA20	0.364
3.2	2.2 ... 3.2	65	100	3RV2411-1DA10	3RV2411-1DA20	0.371
4	2.8 ... 4	82	100	3RV2411-1EA10	3RV2411-1EA20	0.366
5	3.5 ... 5	104	100	3RV2411-1FA10	3RV2411-1FA20	0.369
6.3	4.5 ... 6.3	130	100	3RV2411-1GA10	3RV2411-1GA20	0.373
8	5.5 ... 8	163	100	3RV2411-1HA10	3RV2411-1HA20	0.375
10	7 ... 10	208	100	3RV2411-1JA10	3RV2411-1JA20	0.381
12.5	9 ... 12.5	260	100	3RV2411-1KA10	3RV2411-1KA20	0.372
16	10 ... 16	286	55	3RV2411-4AA10	3RV2411-4AA20	0.379
<b>Without phase asymmetry/failure detection for 1-, 2- and 3-phase loads<sup>1)</sup></b>						
0.4	0.28 ... 0.4	8.2	100	--	3RV2411-0EA20-0DA0	0.302
1.6	1.1 ... 1.6	33	100	--	3RV2411-1AA20-0DA0	0.370
2	1.4 ... 2	42	100	--	3RV2411-1BA20-0DA0	0.365
2.5	1.8 ... 2.5	52	100	--	3RV2411-1CA20-0DA0	0.365
3.2	2.2 ... 3.2	65	100	--	3RV2411-1DA20-0DA0	0.365
4	2.8 ... 4	82	100	--	3RV2411-1EA20-0DA0	0.373
5	3.5 ... 5	104	100	--	3RV2411-1FA20-0DA0	0.371
6.3	4.5 ... 6.3	130	100	--	3RV2411-1GA20-0DA0	0.370
8	5.5 ... 8	163	100	--	3RV2411-1HA20-0DA0	0.420
10	7 ... 10	208	100	--	3RV2411-1JA20-0DA0	0.380
<b>For special operating conditions down to -50 °C<sup>2)3)</sup></b>						
2.5	1.8 ... 2.5	52	100	3RV2411-1CA10-0BA0	--	0.345
6.3	4.5 ... 6.3	130	100	3RV2411-1GA10-0BA0	--	0.349
8	5.5 ... 8	163	100	3RV2411-1HA10-0BA0	--	0.349
10	7 ... 10	208	100	3RV2411-1JA10-0BA0	--	0.360
16	10 ... 16	286	55	3RV2411-4AA10-0BA0	--	0.355

<sup>1)</sup> The motor starter protectors do not have UL/CSA approval and are not certified either according to the European explosion protection directive ATEX or according to the international explosion protection standard (IECEx).

<sup>2)</sup> The motor starter protectors have IEC approval, but not UL/CSA approval.

<sup>3)</sup> The 3RV2411-.....0BA0 motor starter protectors have a mechanical service life of 500 operating cycles.

Auxiliary switches and other accessories can be ordered separately (see page 2/196 onwards).

## Protection equipment

### Motor starter protectors/circuit breakers

### SIRIUS 3RV2 motor starter protectors/circuit breakers

For transformer protection

**CLASS 10, without auxiliary switches**



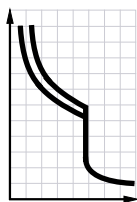

Motor starter protectors for the protection of transformers with high inrush current



3RV2421-...A10,  
3RV2421-4BA10-0BA0,  
32 A



3RV2421-4.A20;  
3RV2421-4.A20-0DA0,  
16 and 20 A

Rated current	Setting range for thermal overload release	Instantaneous electronic release	Short-circuit breaking capacity at 400 V AC	Screw terminals 	Spring-loaded terminals 	Weight
$I_n$			$I_{cu}$	Article No.	Article No.	kg
A	A	A	kA			
<b>Size S0</b>						
0.16	0.11 ... 0.16	3.3	100	<b>3RV2421-0AA10</b>	--	0.291
0.2	0.14 ... 0.2	4.2	100	<b>3RV2421-0BA10</b>	--	0.291
0.25	0.18 ... 0.25	5.2	100	<b>3RV2421-0CA10</b>	--	0.290
0.32	0.22 ... 0.32	6.5	100	<b>3RV2421-0DA10</b>	--	0.285
0.4	0.28 ... 0.4	8.2	100	<b>3RV2421-0EA10</b>	--	0.284
0.5	0.35 ... 0.5	10	100	<b>3RV2421-0FA10</b>	--	0.285
0.63	0.45 ... 0.63	13	100	<b>3RV2421-0GA10</b>	--	0.350
0.8	0.55 ... 0.8	16	100	<b>3RV2421-0HA10</b>	--	0.350
1	0.7 ... 1	21	100	<b>3RV2421-0JA10</b>	--	0.353
1.25	0.9 ... 1.25	26	100	<b>3RV2421-0KA10</b>	--	0.350
1.6	1.1 ... 1.6	33	100	<b>3RV2421-1AA10</b>	--	0.370
2	1.4 ... 2	42	100	<b>3RV2421-1BA10</b>	--	0.357
2.5	1.8 ... 2.5	52	100	<b>3RV2421-1CA10</b>	--	0.340
3.2	2.2 ... 3.2	65	100	<b>3RV2421-1DA10</b>	--	0.359
4	2.8 ... 4	82	100	<b>3RV2421-1EA10</b>	--	0.350
5	3.5 ... 5	104	100	<b>3RV2421-1FA10</b>	--	0.355
6.3	4.5 ... 6.3	130	100	<b>3RV2421-1GA10</b>	--	0.357
8	5.5 ... 8	163	100	<b>3RV2421-1HA10</b>	--	0.355
10	7 ... 10	208	100	<b>3RV2421-1JA10</b>	--	0.363
12.5	9 ... 12.5	260	100	<b>3RV2421-1KA10</b>	--	0.370
16	10 ... 16	286	55	<b>3RV2421-4AA10</b>	<b>3RV2421-4AA20</b>	0.363
20	13 ... 20	325	55	<b>3RV2421-4BA10</b>	<b>3RV2421-4BA20</b>	0.360
22	16 ... 22	364	55	<b>3RV2421-4CA10</b>	<b>3RV2421-4CA20</b>	0.375
25	18 ... 25	400	55	<b>3RV2421-4DA10</b>	<b>3RV2421-4DA20</b>	0.378

**Without phase asymmetry/failure detection for 1-, 2- and 3-phase loads<sup>1)</sup>**

16	10 ... 16	286	55	--	<b>3RV2421-4AA20-0DA0</b>	0.416
20	13 ... 20	325	55	--	<b>3RV2421-4BA20-0DA0</b>	0.415

**For special operating conditions down to -50 °C<sup>2)3)</sup>**

32	22 ... 32	656	65	<b>3RV2421-4BA10-0BA0</b>	--	0.356
----	-----------	-----	----	---------------------------	----	-------

<sup>1)</sup> The motor starter protectors do not have UL/CSA approval and are not certified either according to the European explosion protection directive ATEX or according to the international explosion protection standard (IECEx).

<sup>2)</sup> The motor starter protectors have IEC approval, but not UL/CSA approval.

<sup>3)</sup> The 3RV2431-...-0BA0 motor starter protectors have a mechanical service life of 250 operating cycles.

Auxiliary switches and other accessories can be ordered separately (see page 2/196 onwards).

## Protection equipment

### Motor starter protectors/circuit breakers

### SIRIUS 3RV2 motor starter protectors/circuit breakers

#### For transformer protection

#### CLASS 10, without auxiliary switches



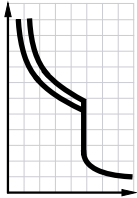

Motor starter protectors for the protection of transformers with high inrush current



3RV2431-4.A10,  
14 to 40 A;  
3RV2431-4EA10-0BA0,  
32 A



3RV2431-4.A10,  
45 to 65 A

Rated current	Setting range for thermal overload release	Instantaneous electronic release	Short-circuit breaking capacity at 400 V AC	Screw terminals 	Spring-loaded terminals 	Weight
$I_n$			$I_{cu}$	Article No.	Article No.	kg
A	A	A	kA			
<b>Size S2</b>						
14	9.5 ... 14	328	65	<b>3RV2431-4SA10</b>	--	1.067
17	12 ... 17	410	65	<b>3RV2431-4TA10</b>	--	1.058
20	14 ... 20	410	65	<b>3RV2431-4BA10</b>	--	1.063
25	18 ... 25	512	65	<b>3RV2431-4DA10</b>	--	1.072
32	22 ... 32	656	65	<b>3RV2431-4EA10</b>	--	1.056
36	28 ... 36	820	65	<b>3RV2431-4PA10</b>	--	1.054
40	32 ... 40	820	65	<b>3RV2431-4UA10</b>	--	1.052
45	35 ... 45	922	65	<b>3RV2431-4VA10</b>	--	1.162
52	42 ... 52	1 025	65	<b>3RV2431-4WA10</b>	--	1.151
59	49 ... 59	1 040	65	<b>3RV2431-4XA10</b>	--	1.186
65	54 ... 65	1 040	65	<b>3RV2431-4JA10</b>	--	1.182

#### For special operating conditions down to -50 °C<sup>1)2)</sup>

32	22 ... 32	656	65	<b>3RV2431-4EA10-0BA0</b>	--	1.048
----	-----------	-----	----	---------------------------	----	-------

1) The motor starter protectors do not have UL/CSA approval and are not certified either according to the European explosion protection directive ATEX or according to the international explosion protection standard (IECEx).

2) The 3RV2431-.....-0BA0 motor starter protectors have a mechanical service life of 250 operating cycles.

Auxiliary switches and other accessories can be ordered separately (see page 2/196 onwards).

## Protection equipment

### Motor starter protectors/circuit breakers

#### SIRIUS 3RV2 motor starter protectors/circuit breakers

For transformer protection

**CLASS 10, with transverse auxiliary switch (1 NO + 1 NC)**

Motor starter protectors for the protection of transformers with high inrush current

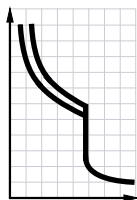

3RV2411...A15



3RV2421-4.A15

Rated current	Setting range for thermal overload release	Instantaneous electronic release	Short-circuit breaking capacity at 400 V AC	Screw terminals	Weight
$I_n$			$I_{cu}$	Article No.	kg
A	A	A	kA		
<b>Size S00</b>					
0.16	0.11 ... 0.16	3.3	100	3RV2411-0AA15	0.292
0.2	0.14 ... 0.2	4.2	100	3RV2411-0BA15	0.293
0.25	0.18 ... 0.25	5.2	100	3RV2411-0CA15	0.273
0.32	0.22 ... 0.32	6.5	100	3RV2411-0DA15	0.296
0.4	0.28 ... 0.4	8.2	100	3RV2411-0EA15	0.240
0.5	0.35 ... 0.5	10	100	3RV2411-0FA15	0.294
0.63	0.45 ... 0.63	13	100	3RV2411-0GA15	0.357
0.8	0.55 ... 0.8	16	100	3RV2411-0HA15	0.359
1	0.7 ... 1	21	100	3RV2411-0JA15	0.358
1.25	0.9 ... 1.25	26	100	3RV2411-0KA15	0.360
1.6	1.1 ... 1.6	33	100	3RV2411-1AA15	0.362
2	1.4 ... 2	42	100	3RV2411-1BA15	0.355
2.5	1.8 ... 2.5	52	100	3RV2411-1CA15	0.350
3.2	2.2 ... 3.2	65	100	3RV2411-1DA15	0.366
4	2.8 ... 4	82	100	3RV2411-1EA15	0.376
5	3.5 ... 5	104	100	3RV2411-1FA15	0.360
6.3	4.5 ... 6.3	130	100	3RV2411-1GA15	0.360
8	5.5 ... 8	163	100	3RV2411-1HA15	0.366
10	7 ... 10	208	100	3RV2411-1JA15	0.374
12.5	9 ... 12.5	260	100	3RV2411-1KA15	0.366
16	10 ... 16	286	55	3RV2411-4AA15	0.367
<b>Size S0</b>					
16	10 ... 16	286	55	3RV2421-4AA15	0.375
20	13 ... 20	325	55	3RV2421-4BA15	0.379
22	16 ... 22	364	55	3RV2421-4CA15	0.388
25	18 ... 25	400	55	3RV2421-4DA15	0.400

Auxiliary switches and other accessories can be ordered separately (see page 2/196 onwards).



## Protection equipment

### Motor starter protectors/circuit breakers

#### SIRIUS 3RV2 motor starter protectors/circuit breakers

For system protection **NEW**

#### Selection and ordering data

##### CLASS 10, without auxiliary switches

The motor starter protectors are suitable for 1-, 2- and 3-phase loads and do not feature phase asymmetry and phase failure detection. They do not have UL/CSA approval and are not certified either according to the European explosion protection directive ATEX or according to the international explosion protection standard (IECEx).

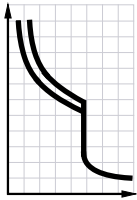

3RV2021-...A10-0DA0



3RV2021-1EA20-0DA0



3RV2041-4.A10-0DA0

Rated current	Suitable for three-phase motors <sup>1)</sup>	Setting range for thermal overload release	Instantaneous electronic release	Short-circuit breaking capacity at 400 V AC	Terminal type		Weight
					Screw terminals	Spring-loaded terminals	
$I_n$				$I_{cu}$	Article No.	Article No.	kg
A	kW	A	A	kA			
<b>Size S0</b>							
4	1.5	2.8 ... 4	52	100	<b>3RV2021-1EA10-0DA0</b>	<b>3RV2021-1EA20-0DA0</b>	0.420
6.3	2.2	4.5 ... 6.3	82	100	<b>3RV2021-1GA10-0DA0</b>	--	0.355
8	3	5.5 ... 8	104	100	<b>3RV2021-1HA10-0DA0</b>	--	0.360
10	4	7 ... 10	130	100	<b>3RV2021-1JA10-0DA0</b>	--	0.360
12.5	5.5	9 ... 12.5	163	100	<b>3RV2021-1KA10-0DA0</b>	--	0.365
16	7.5	10 ... 16	208	55	<b>3RV2021-4AA10-0DA0</b>	--	0.365
20	7.5	13 ... 20	260	55	<b>3RV2021-4BA10-0DA0</b>	--	0.357
25	11	18 ... 25	325	55	<b>3RV2021-4DA10-0DA0</b>	--	0.370
32	15	27 ... 32	400	55	<b>3RV2021-4EA10-0DA0</b>	--	0.380
<b>Size S3</b>							
40	18.5	28 ... 40	520	65	<b>3RV2041-4FA10-0DA0</b>	--	2.196
50	22	36 ... 50	650	65	<b>3RV2041-4HA10-0DA0</b>	--	2.225
63	30	45 ... 63	819	65	<b>3RV2041-4JA10-0DA0</b>	--	2.233
84	45	65 ... 84	1 170	65	<b>3RV2041-4RA10-0DA0</b>	--	2.265
100	45, 55	80 ... 100	1 300	65	<b>3RV2041-4MA10-0DA0</b>	--	2.264

<sup>1)</sup> Guide value for 4-pole standard motors at 50 Hz 400 V AC. The actual starting and rated data of the motor to be protected must be considered when selecting the units.

Auxiliary switches and other accessories can be ordered separately (see page 2/196 onwards).

# Protection equipment

## Motor starter protectors/circuit breakers

### SIRIUS 3RV2 motor starter protectors/circuit breakers

Accessories &gt; Mountable accessories

#### Overview

##### Mounting location and function

The 3RV2 motor starter protectors/circuit breakers have three main contact elements. In order to achieve maximum flexibility, auxiliary switches, signaling switches, auxiliary releases and isolator modules can be supplied separately.

These components are easily fitted to the switches without the use of any tools according to requirements.

Overview graphic, [see page 2/163](#).

<p><b>Front side</b></p> <p><u>Notes:</u></p> <ul style="list-style-type: none"> <li>A maximum of four auxiliary contacts with auxiliary switches can be mounted on each motor starter protector/circuit breaker.</li> <li>Transverse auxiliary switches cannot be used for circuit breaker 3RV2742 (size S3).</li> </ul>	<p><b>Transverse auxiliary switches, solid-state compatible transverse auxiliary switches</b></p> <p>1 NO + 1 NC or 2 NO or 1 CO</p>	<p>An auxiliary switch can be inserted transversely on the front. The overall width of the motor starter protectors/circuit breakers remains unchanged.</p>
<p><b>Left-hand side</b></p> <p><u>Notes:</u></p> <ul style="list-style-type: none"> <li>A maximum of four auxiliary contacts with auxiliary switches can be mounted on each motor starter protector/circuit breaker.</li> <li>Lateral auxiliary switches (two contacts) and signaling switches can be mounted separately or together.</li> <li>Signaling switches cannot be used for 3RV1011, 3RV27 and 3RV28 motor starter protectors/circuit breakers.</li> <li>Only lateral auxiliary switches can be used for 3RV2742 (size S3).</li> </ul>	<p><b>Lateral auxiliary switches (2 contacts)</b></p> <p>1 NO + 1 NC or 2 NO or 2 NC</p> <p><b>Lateral auxiliary switches (4 contacts)</b></p> <p>2 NO + 2 NC</p> <p><b>Signaling switches</b></p> <p>Tripping 1 NO + 1 NC Short circuit 1 NO + 1 NC</p>	<p>One of the three lateral auxiliary switches can be mounted on the left side per motor starter protector/circuit breaker. The contacts of the auxiliary switch close and open together with the main contacts of the motor starter protector/circuit breaker.</p> <p>The width of the lateral auxiliary switch with two contacts is 9 mm.</p> <p>One lateral auxiliary switch with four contacts can be mounted on the left side per motor starter protector/circuit breaker. The contacts of the auxiliary switch close and open together with the main contacts of the motor starter protector/circuit breaker.</p> <p>The width of the lateral auxiliary switch with four contacts is 18 mm.</p> <p>One signaling switch can be mounted on the left side of each motor starter protector.</p> <p>The signaling switch has two contact systems.</p> <p>One contact system always signals <b>tripping</b> irrespective of whether this was caused by a short circuit, an overload or an auxiliary release. The other contact system only switches in the event of a short circuit. There is no signaling as a result of <b>switching off</b> with the actuator.</p> <p>In order to be able to switch on the motor starter protector again after a short circuit, the signaling switch must be reset manually after the error cause has been eliminated.</p> <p>The width of the signaling switch is 18 mm.</p>
<p><b>Right-hand side</b></p> <p><u>Notes:</u></p> <ul style="list-style-type: none"> <li>One auxiliary release can be mounted per motor starter protector/circuit breaker.</li> <li>Accessories cannot be mounted on the right-hand side of the 3RV21 motor starter protectors for motor protection with overload relay function.</li> </ul>	<p><b>Auxiliary releases</b></p> <p>Shunt releases</p> <p>or</p> <p>Undervoltage releases</p> <p>or</p> <p>Undervoltage releases with leading auxiliary contacts 2 NO</p> <p>Own version for 3RV1011</p>	<p>For remote-controlled tripping of the motor starter protector/circuit breaker. The release coil should only be energized for short periods (see circuit diagrams).</p> <p>Trips the motor starter protector/circuit breaker when the voltage is interrupted and prevents the motor from being restarted accidentally when the voltage is restored. Used for remote-controlled tripping of the motor starter protector/circuit breaker.</p> <p>Particularly suitable for EMERGENCY OFF disconnection by way of corresponding EMERGENCY OFF pushbuttons according to IEC 60204-1.</p> <p>Function and use as for the undervoltage release without leading auxiliary contacts, but with the following additional function: the auxiliary contacts will open in switch position OFF to deenergize the coil of the undervoltage release, thus interrupting energy consumption. In the "tripped" position, these auxiliary contacts are not guaranteed to open. The leading contacts permit the motor starter protector/circuit breaker to reclose.</p> <p>The width of the auxiliary release is 18 mm.</p>
<p><b>Top</b></p> <p><u>Notes:</u></p> <ul style="list-style-type: none"> <li>Isolator modules cannot be used for 3RV1011, 3RV27 and 3RV28 motor starter protectors/circuit breakers.</li> <li>The isolator module for size S2 can be used only with 3RV2 motor starter protectors/circuit breakers up to max. 65 A.</li> <li>The isolator module cannot be used with the transverse auxiliary switch.</li> </ul>	<p><b>Isolator modules</b></p>	<p>Isolator modules can be mounted to the upper connection side of the motor starter protectors.</p> <p>The supply cable is connected to the motor starter protector through the isolator module.</p> <p>The plug can only be unplugged when the motor starter protector is open and isolates all 3 poles of the motor starter protector from the network. The shock-protected isolation point is clearly visible and secured with a padlock to prevent reinsertion of the plug.</p>

For a complete overview of which accessories can be used for the various motor starter protectors/circuit breakers, [see page 2/162](#).





## Protection equipment

### Motor starter protectors/circuit breakers

### SIRIUS 3RV2 motor starter protectors/circuit breakers

#### Accessories > Mountable accessories

#### Selection and ordering data

Version	For motor starter protectors/circuit breakers	Spring-loaded terminals 	Weight
Size		Article No.	kg
<b>Auxiliary switches<sup>1)</sup></b>			
	<b>Transverse auxiliary switches<sup>2)</sup></b> For front mounting		
3RV2901-2E	1 CO 1 NO + 1 NC 2 NO	S00 ... S3 -- <b>3RV2901-2E</b> <b>3RV2901-2F</b>	0.017 0.018
	<b>Lateral auxiliary switches</b> For mounting on the left		
3RV2901-2A	1 NO + 1 NC 2 NO 2 NC 2 NO + 2 NC	S00 ... S3 <b>3RV2901-2A</b> <b>3RV2901-2B</b> <b>3RV2901-2C</b> --	0.045 0.045 0.045
<b>Signaling switches<sup>3)</sup></b>			
	<b>Signaling switches</b> One signaling switch can be mounted on the left per motor starter protector. Separate tripped and short-circuit alarms, 1 NO + 1 NC each	S00 <sup>4)</sup> ... S3	
3RV2921-2M		<b>3RV2921-2M</b>	0.100

<sup>1)</sup> Each motor starter protector/circuit breaker can be fitted with one transverse and one lateral auxiliary switch. The lateral auxiliary switch with 2 NO + 2 NC is used without a transverse auxiliary switch.

<sup>2)</sup> Not for 3RV2742 circuit breakers.

## Protection equipment

### Motor starter protectors/circuit breakers

### SIRIUS 3RV2 motor starter protectors/circuit breakers

Accessories &gt; Mountable accessories



3RV2902-2AV0



3RV2902-2DB0

Rated control supply voltage $U_s$					For motor starter protectors/circuit breakers	Spring-loaded terminals	Weight
AC 50 Hz	AC 60 Hz	AC 50/60 Hz 100% ON period <sup>1)</sup>	AC/DC 50/60 Hz, DC 5 s ON period <sup>2)</sup>	DC			
V	V	V	V	V	Size	Article No.	kg
<b>Auxiliary releases<sup>3)</sup></b>							
<b>Undervoltage releases</b>							
--	--	--	--	24	S00 ... S3	--	
24	24	--	--	--	S00 ... S3	--	
110	120	--	--	--	S00 ... S3	--	
--	208	--	--	--	S00 ... S3	--	
230	240	--	--	--	S00 ... S3	<b>3RV2902-2AP0</b>	0.133
400	440	--	--	--	S00 ... S3	<b>3RV2902-2AV0</b>	0.132
415	480	--	--	--	S00 ... S3	--	
500	600	--	--	--	S00 ... S3	--	
<b>Undervoltage releases with leading auxiliary contacts 2 NO</b>							
24	24	--	--	--	S00 <sup>4)</sup> ... S3	--	
230	240	--	--	--	S00 <sup>4)</sup> ... S3	<b>3RV2922-2CP0</b>	0.136
400	440	--	--	--	S00 <sup>4)</sup> ... S3	<b>3RV2922-2CV0</b>	0.138
415	480	--	--	--	S00 <sup>4)</sup> ... S3	<b>3RV2922-2CV1</b>	0.139
<b>Shunt releases</b>							
--	--	20 ... 24	20 ... 70	--	S00 ... S3	<b>3RV2902-2DB0</b>	0.138
--	--	90 ... 110	70 ... 190	--	S00 ... S3	<b>3RV2902-2DF0</b>	0.180
--	--	210 ... 240	190 ... 330	--	S00 ... S3	<b>3RV2902-2DP0</b>	0.133
--	--	350 ... 415	330 ... 500	--	S00 ... S3	--	
--	--	500	500	--	S00 ... S3	--	

<sup>1)</sup> The voltage range is valid for 100% (infinite) ON period. The response voltage lies at 0.9 of the lower limit of the voltage range.

<sup>2)</sup> The voltage range is valid for 5 s ON period at 50/60 Hz AC and DC. The response voltage lies at 0.85 of the lower limit of the voltage range.

<sup>3)</sup> One auxiliary release can be mounted on the right per motor starter protector/circuit breaker (does not apply to 3RV21 motor starter protectors/circuit breakers with overload relay function).

<sup>4)</sup> Not for 3RV1011 motor starter protectors.

## Protection equipment

### Motor starter protectors/circuit breakers

#### SIRIUS 3RV2 motor starter protectors/circuit breakers

##### Accessories > Busbar accessories

### Overview

#### Insulated 3-phase busbar system

3-phase busbar systems provide an easy, time-saving and clearly arranged means of feeding 3RV2 motor starter protectors/circuit breakers with screw terminals. Different versions are available for sizes S00 to S2 and can be used for the various different types of motor starter protectors/circuit breakers (size S0 up to 32 A).

The 3RV1915 3-phase busbar systems are generally unsuitable for the 3RV21 motor starter protectors with sizes S00 and S0 for motor protection with overload relay function.

The busbars are suitable for between two and five motor starter protectors/circuit breakers. However, any kind of extension is possible by clamping the connection tags of an additional busbar (rotated by 180°) underneath the terminals of the respective last motor starter protector/circuit breaker.

A combination of motor starter protectors/circuit breakers of size S00 and S0 is possible. The motor starter protectors/circuit breakers are supplied by appropriate infeed terminals.

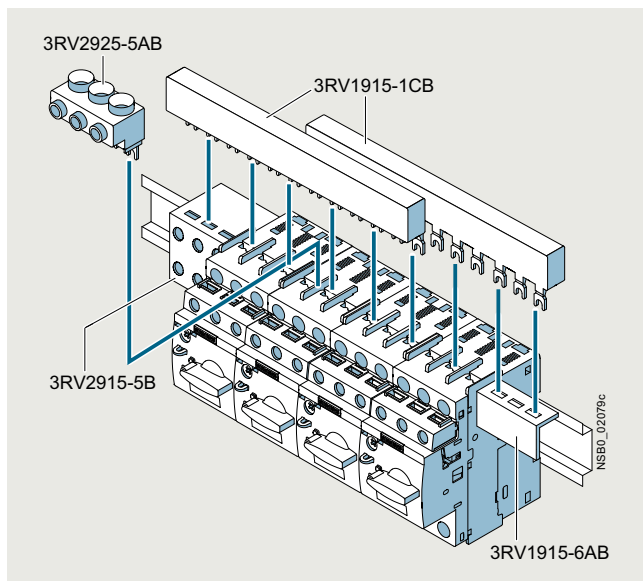

SIRIUS 3-phase busbar system size S00/S0

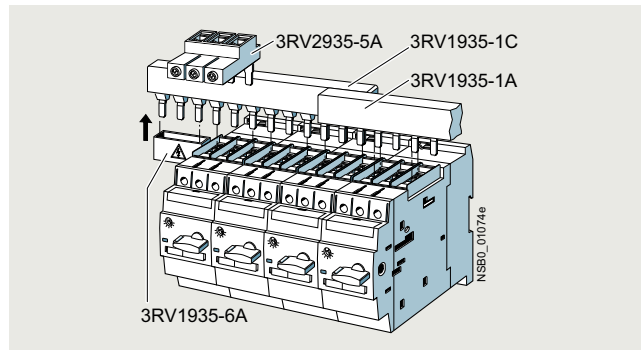

SIRIUS 3-phase busbar system size S2

The 3-phase busbar systems are finger-safe. They are designed for any short-circuit stress which can occur at the output side of connected motor starter protectors/circuit breakers.

The 3-phase busbar systems can also be used to construct "Starters (Type E)" according to UL/CSA and for 3RV27 and 3RV28 circuit breakers according to UL 489. However, special infeed terminals, 3RV2925-5EB for sizes S00/S0 and 3RV2935-5E for size S2, must be used for this purpose, see page 2/200.





# Protection equipment

## Motor starter protectors/circuit breakers

### SIRIUS 3RV2 motor starter protectors/circuit breakers

Accessories &gt; Busbar accessories

## Selection and ordering data

Modular spacing	Number of motor starter protectors that can be connected			Rated current $I_n$ at 690 V	For motor starter protectors/circuit breakers	Article No.	Weight	
	Without lateral accessories	With lateral auxiliary switch	Incl. auxiliary release					
mm				A	Size		kg	
<b>3-phase busbars</b>								
For feeding several motor starter protectors with screw terminals, mounted side by side on standard mounting rails, insulated, with touch protection								
 3RV1915-1AB	45 <sup>1)2)</sup>	2	--	--	63	S00, S0 <sup>3)</sup>	<b>3RV1915-1AB</b>	0.043
		3	--	--	63	S00, S0 <sup>3)</sup>	<b>3RV1915-1BB</b>	0.069
		4	--	--	63	S00, S0 <sup>3)</sup>	<b>3RV1915-1CB</b>	0.097
		5	--	--	63	S00, S0 <sup>3)</sup>	<b>3RV1915-1DB</b>	0.114
 3RV1915-1BB	55 <sup>1)4)</sup>	--	2	--	63	S00, S0 <sup>3)</sup>	<b>3RV1915-2AB</b>	0.051
		--	3	--	63	S00, S0 <sup>3)</sup>	<b>3RV1915-2BB</b>	0.079
		--	4	--	63	S00, S0 <sup>3)</sup>	<b>3RV1915-2CB</b>	0.111
 3RV1915-1CB		--	5	--	63	S00, S0 <sup>3)</sup>	<b>3RV1915-2DB</b>	0.140
		2	--	--	108	S2	<b>3RV1935-1A</b>	0.120
		3	--	--	108	S2	<b>3RV1935-1B</b>	0.197
 3RV1915-1DB	63 <sup>1)5)</sup>	--	--	2	63	S00, S0 <sup>3)</sup>	<b>3RV1935-1C</b>	0.290
		--	--	4	63	S00, S0 <sup>3)</sup>	<b>3RV1915-3AB</b>	0.052
	75 <sup>5)</sup>	--	2	2	108	S2	<b>3RV1915-3CB</b>	0.121
	--	3	3	108	S2	<b>3RV1935-3A</b>	0.166	
	--	4	4	108	S2	<b>3RV1935-3B</b>	0.263	
							<b>3RV1935-3C</b>	0.369

1) Not suitable for 3RV21 motor starter protectors of sizes S00 and S0 with overload relay function.

2) For 3RV2 motor starter protectors without accessories mounted on the side.

3) Approved for motor starter protectors size S0 with  $I_n \leq 32$  A.

4) For 3RV2 motor starter protectors with auxiliary switches with 1 NO + 1 NC, 2 NO and 2 NC mounted on the left (9 mm wide).

5) For 3RV2 motor starter protectors with mounted accessories (18 mm wide). Auxiliary switches with 2 NO + 2 NC or signaling switch (mounted on the left) or with auxiliary release (mounted on the right).



Version	Modular spacing	For motor starter protectors/circuit breakers	Article No.	Weight
	mm	Size		kg
	45	S00, S0	<b>3RV1915-5DB</b>	0.045

## Connecting pieces for 3-phase busbars

 3RV1915-5DB	For connecting 3-phase busbars for 3RV2 motor starter protectors of size S00/S0 (left) to the 3RV1011 motor starter protector (right)				
	45	S00, S0	<b>3RV1915-5DB</b>	0.045	

Conductor cross-section			Tightening torque	For motor starter protectors/circuit breakers	Article No.	Weight
Solid or stranded	Finely stranded with end sleeve	AWG cables, solid or stranded				
mm <sup>2</sup>	mm <sup>2</sup>	AWG	Nm	Size		kg

## 3-phase infeed terminals

Connection from top		AWG cables, solid or stranded	Tightening torque	For motor starter protectors/circuit breakers	Article No.	Weight		
Conductor cross-section	Number of conductors							
mm <sup>2</sup>	mm <sup>2</sup>	AWG	Nm	Size		kg		
 3RV2925-5AB	2.5 ... 25	4 ... 16	10 ... 4	4	S00 <sup>2)</sup> , S0	<b>3RV1915-5A</b>	0.042	
	2.5 ... 25	2.5 ... 16	10 ... 4	3 ... 4	S00, S0	<b>3RV2925-5AB</b>	0.044	
	2 x (2.5 ... 50) <sup>1)</sup> , 1 x (2.5 ... 70) <sup>1)</sup>	2 x (2.5 ... 35) <sup>1)</sup> , 1 x (2.5 ... 50) <sup>1)</sup>	2 x (10 ... 1/0) <sup>1)</sup> , 1 x (10 ... 2/0) <sup>1)</sup>	4 ... 6	S2		<b>3RV2935-5A</b>	0.181
 3RV2935-5A								
 3RV2915-5B	<b>Connection from below</b>							
	Terminal is connected in place of a switch, take space requirement into account							
2.5 ... 25	2.5 ... 16	10 ... 4	Input: 4, output: 2 ... 2.5	S00, S0	<b>3RV2915-5B</b>	0.109		

1) If two different conductor cross-sections are connected to one clamping point, both cross-sections must be in the range specified.

2) Especially suitable for 3RV1011 motor starter protectors. If the 3RV2 motor starter protector is used, the terminal block extends beyond the device width.

## Protection equipment

### Motor starter protectors/circuit breakers

#### SIRIUS 3RV2 motor starter protectors/circuit breakers

##### Accessories > Busbar accessories

2

Conductor cross-section			Tightening torque	For motor starter protectors/circuit breakers	Article No.	Weight
Solid or stranded	Finely stranded with end sleeve	AWG cables, solid or stranded				
mm <sup>2</sup>	mm <sup>2</sup>	AWG	Nm	Size		kg

#### 3-phase infeed terminals for constructing "Starters (Type E)"



3RV2925-5EB



3RV2935-5E

##### Connection from top

2.5 ... 25

2.5 ... 16

10 ... 4

3 ... 4

S00, S0

**3RV2925-5EB**

0.054

2 x (2.5 ... 50)<sup>1)</sup>,  
1 x (2.5 ... 70)<sup>1)</sup>

2 x (2.5 ... 35)<sup>1)</sup>,  
1 x (2.5 ... 50)<sup>1)</sup>

2 x  
(10 ... 1/0)<sup>1)</sup>, 1 x  
(10 ... 2/0)<sup>1)</sup>

4 ... 6

S2

**3RV2935-5E**

0.193

<sup>1)</sup> If two different conductor cross-sections are connected to one clamping point, both cross-sections must be in the range specified.

Version	For motor starter protectors/circuit breakers	Article No.	Weight
	Size		kg

#### Covers for connection tags



3RV1935-6A  
cover mounted on  
3RV1915-1CB busbar

Touch protection for empty positions

S00, S0

S2

**3RV1915-6AB**

0.003

**3RV1935-6A**

0.006



# Protection equipment

## Motor starter protectors/circuit breakers

### SIRIUS 3RV2 motor starter protectors/circuit breakers

Accessories &gt; Mounting accessories

#### Selection and ordering data

##### Accessories

Version	For motor starter protectors/circuit breakers	Article No.	Weight	
	Size		kg	
<b>Covers</b>				
	<b>Terminal covers</b> For cable lug and busbar connection for maintaining the required voltage clearances and as touch protection if box terminal is removed (2 units can be mounted per motor starter protector/circuit breaker)	S3	<b>3RT1946-4EA1</b>	0.037
3RV2 (size S3) with 3RT1946-4EA1 (below)				
	<b>Scale covers</b> Sealable, for covering the set current scale	3RV20, 3RV21, 3RV24: S00 ... S3	<b>3RV2908-0P</b>	0.051
3RV2908-0P				
	<b>Covers for devices with screw terminals (box terminals)</b> Additional touch protection to be fitted at the box terminals (two units required per device)		<b>Screw terminals</b> 	
3RT2936-4EA2	Main current level	S2	<b>3RT2936-4EA2</b>	0.014
		S3	<b>3RT2946-4EA2</b>	0.019
<b>Terminal covers for box terminals on 3RV2742 and Type E terminal block 3RT2946-4GA07</b>				
	Additional touch protection to be fitted at the 3RV2742 box terminals (two units required per device) and at 3RT2946-4GA07 Type E terminal block			
3RV2948-1LA00	Main current level	S3	<b>3RV2948-1LA00</b>	0.021
<b>Phase barrier for constructing limiter combinations of size S3<sup>1)</sup></b>				
	Infeed to the limiter is always on the side 2T1/4T2/6T3. At the infeed side, phase barrier 3RV2948-1K has to be used.			
3RV2948-1K	Main current level	S3	<b>3RV2948-1K</b>	0.240
<b>Fixing accessories</b>				
	<b>Push-in lugs</b> For screw fixing of the motor starter protector/circuit breaker onto mounting plates Two units are required for each motor starter protector.	S00, S0	<b>3RV2928-0B</b>	0.200
3RV2928-0B				
<b>Tools for opening spring-loaded terminals</b>				
	<b>Screwdrivers</b> For all SIRIUS devices with spring-loaded terminals Length approx. 200 mm, 3.0 mm x 0.5 mm, titanium gray/black, partially insulated	S00 ... S3	<b>Spring-loaded terminals</b> 	
3RA2908-1A			<b>3RA2908-1A</b>	0.050

<sup>1)</sup> Transverse auxiliary switches cannot be used.

## Protection equipment

### Motor starter protectors/circuit breakers

### SIRIUS 3RV2 motor starter protectors/circuit breakers

#### Accessories > Mounting accessories

Version	For motor starter protectors/circuit breakers	Article No.	Weight
	Size		kg

#### Terminal blocks and phase barriers for "Self-Protected Combination Motor Controllers (Type E)" according to UL 508/UL 60947-4-1

**Note:**

UL 508/UL 60947-4-1 approval demands 1-inch clearances and 2-inch creepage distances for "Self-Protected Combination Motor Controllers (Type E)". The following terminal blocks or phase barriers must be used for the 3RV20 motor starter protectors with screw terminals. This also applies to construction with the 8US busbar adapter. 3RV20 motor starter protectors with spring-loaded terminals must be assembled with the 3RV29 infeed system for approval as "Self-Protected Combination Motor Controllers (Type E)" according to UL 508/UL 60947-4-1. The 3RV1011 motor starter protectors do not have UL approval as "Starters (Type E)".

The terminal block or phase barriers cannot be used in combination with the 3RV19.5 3-phase busbars.

For construction with 3-phase busbars, see "Busbar accessories", page 2/198 onwards.



3RV2928-1H



3RT2946-4GA07

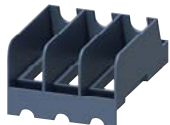

3RV2928-1K



3RV2938-1K

**Terminal blocks Type E**

For increased clearances and creepage distances (1 and 2 inch)

S00<sup>1)</sup>, S0  
S3<sup>2)</sup>

**3RV2928-1H**

0.084

**3RT2946-4GA07**

0.150

**Phase barriers**

For increased clearances and creepage distances (1 and 2 inch)

S00<sup>1)</sup>, S0  
S2

**3RV2928-1K**

0.025

**3RV2938-1K**

0.028

#### Auxiliary terminals, 3-pole



3RT2946-4F

For connection of auxiliary and control cables to the main conductor connections (for one side)

S3

**3RT2946-4F**

0.032

<sup>1)</sup> Not for 3RV1011 motor starter protectors.

<sup>2)</sup> Cannot be used on 3RV2.4. motor starter protectors in combination with transverse auxiliary switches.







# Protection equipment

## Motor starter protectors/circuit breakers

### SIRIUS 3RV2 motor starter protectors/circuit breakers

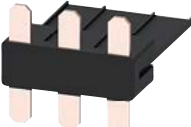
Accessories &gt; Mounting accessories

**Link modules**

For 3RV2 motor starter protectors/circuit breakers	For 3RT2 contactors	Actuating voltage of contactor	Article No.	Weight
Size	Size			kg
<b>Link modules for motor starter protector to contactor<sup>1)</sup></b>				
For connection between motor starter protector and contactor with screw terminals			<b>Screw terminals</b> 	
 3RA2921-1AA00	<b>Single-unit packaging</b>			
	S00/S0	S00	AC, DC	<b>3RA1921-1DA00</b> 0.030
	S00/S0	S0	AC	<b>3RA2921-1AA00</b> 0.046
	S00/S0	S0	DC, AC/DC	<b>3RA2921-1BA00</b> 0.055
	S2	S2	AC, DC, AC/DC	<b>3RA2931-1AA00</b> 0.104
	S3	S3	AC, DC, AC/DC	<b>3RA1941-1AA00</b> 0.090
 3RA2931-1AA00	<b>Multi-unit packaging</b>			
	S00/S0	S00	AC, DC	<b>3RA1921-1D</b> 0.020
	S00/S0	S0	AC	<b>3RA2921-1A</b> 0.045
	S00/S0	S0	DC, AC/DC	<b>3RA2921-1B</b> 0.053
	S2	S2	AC, DC, AC/DC	<b>3RA2931-1A</b> 0.071
	S3	S3	AC, DC, AC/DC	<b>3RA1941-1A</b> 0.073
 3RA1941-1AA00				
For connection between motor starter protector and contactor with spring-loaded terminals			<b>Spring-loaded terminals</b> 	
 3RA2911-2AA00	<b>Single-unit packaging</b>			
	S00	S00	AC, DC	<b>3RA2911-2AA00</b> 0.058
	S0	S0	AC <sup>2)</sup> , DC, AC/DC	<b>3RA2921-2AA00</b> 0.100
	<b>Multi-unit packaging</b>			
	S00	S00	AC, DC	<b>3RA2911-2A</b> 0.055
	S0	S0	AC <sup>2)</sup> , DC, AC/DC	<b>3RA2921-2A</b> 0.091
 3RA2911-1CA00	<b>Spacers<sup>2)</sup></b>			
	For height compensation on AC contactors size S0 with spring-loaded terminals			
	S0	S0	Single-unit packaging	<b>3RA2911-1CA00</b> 0.015
	S0	S0	Multi-unit packaging	<b>3RA2911-1C</b> 0.015

<sup>1)</sup> The link modules for motor starter protector to contactor cannot be used for 3RV1011, 3RV2.21-4PA1., 3RV2.21-4FA1., 3RV2.31-4K.1., 3RV2.31-4R.1., 3RV2.32-4K.1., 3RV2.32-4R.1., 3RV27 and 3RV28 motor starter protectors/circuit breakers.

<sup>2)</sup> A spacer for height compensation on AC contactors size S0 is optionally available.

**Note:**

Link modules can be used in

- Size S00: up to max. 16 A
- Size S0: up to max. 32 A
- Size S2: up to max. 65 A







## Protection equipment

### Motor starter protectors/circuit breakers

### SIRIUS 3RV2 motor starter protectors/circuit breakers

#### Accessories > Mounting accessories

2

	For 3RV2 motor starter protectors/ circuit breakers	For 3RW30, 3RW40 soft starters; 3RF34 solid-state contactors	Article No.	Weight
	Size	Size		kg
<b>Link modules for motor starter protector to soft starter<sup>1)</sup> and motor starter protector to solid-state contactor<sup>1)</sup></b>				
 3RA2921-1BA00	Connection between motor starter protector and soft starter/solid-state contactor with screw terminals <b>Single-unit packaging</b> S00/S0 S2 <sup>2)</sup> S3 <sup>3)</sup>		<b>Screw terminals</b>  3RA2921-1BA00 3RA2931-1AA00 3RA1941-1AA00	0.055 0.104 0.090
	<b>Multi-unit packaging</b> S00/S0 S2 <sup>2)</sup> S3 <sup>3)</sup>			
 3RA2931-1AA00	Connection between motor starter protector and soft starter with spring-loaded terminals <b>Single-unit packaging</b> S00 S0		<b>Spring-loaded terminals</b>  3RA2911-2GA00 3RA2921-2GA00	0.055 0.090
	S00 S0			
 3RA1941-1A				
 3RA2911-2GA00				

<sup>1)</sup> The link modules from motor starter protector to soft starter and motor starter protector to solid-state contactor cannot be used for the 3RV1011, 3RV2.21-4PA1., 3RV2.21-4FA1., 3RV2.31-4K.1., 3RV2.31-4R.1., 3RV2.32-4K.1., 3RV2.32-4R.1., 3RV27 and 3RV28 motor starter protectors/circuit breakers.

<sup>2)</sup> To assemble the feeder between a motor starter protector and a soft starter in size S2, the 3RA2932-1CA00 standard mounting rail adapter must be used.

<sup>3)</sup> It is only permissible to assemble the feeder between the motor starter protector and the soft starter in size S3 on a mounting plate.

#### Note:

Link modules can be used in



- Size S00: up to max. 16 A
- Size S0: up to max. 32 A
- Size S2: up to max. 65 A

## Protection equipment

### Motor starter protectors/circuit breakers

### SIRIUS 3RV2 motor starter protectors/circuit breakers

Accessories &gt; Mounting accessories

	For 3RV2 motor starter protectors/circuit breakers	For 3RT2 contactors	Actuating voltage of contactor	Article No.	Weight
	Size	Size			kg
<b>Hybrid link modules for motor starter protector to contactor<sup>1)</sup></b>					
	Mechanical and electrical connection between motor starter protector with screw terminals and contactor with spring-loaded terminals			<b>3RA2911-2FA00</b> <b>3RA2921-2FA00</b>	0.047 0.074
	<b>Single-unit packaging</b>				
	S00	S00	AC, DC		
	S0	S0	AC <sup>2)</sup> , DC, AC/DC		
	<b>Multi-unit packaging</b>				
	S00	S00	AC, DC	<b>3RA2911-2F</b>	0.042
	S0	S0	AC <sup>2)</sup> , DC, AC/DC	<b>3RA2921-2F</b>	0.072
					
3RA2921-2FA00					
	<b>Spacers<sup>2)</sup></b>			<b>3RA2911-1CA00</b> <b>3RA2911-1C</b>	0.015 0.015
	For height compensation on AC contactors size S0 with spring-loaded terminals				
	S0	S0	Single-unit packaging		
	S0	S0	Multi-unit packaging		
3RA2911-1CA00					



1) The hybrid link modules for motor starter protector to contactor cannot be used for 3RV1011, 3RV2.21-4PA1., 3RV2.21-4FA1., 3RV27 and 3RV28 motor starter protectors/circuit breakers. They are suitable only for constructing direct-on-line starters.

2) A spacer for height compensation on AC contactors size S0 is optionally available.

**Note:**

Link modules can be used in

- Size S00: up to max. 16 A
- Size S0: up to max. 32 A

	For motor starter protectors/circuit breakers	Version		Article No.	Weight
	Type				kg
<b>Connection module (adapter and plug) for motor starter protectors/circuit breakers with screw terminals</b>					
	The connection module comprises an adapter and a motor feeder connector.				
	<b>Adapter</b>			<b>3RT1926-4RD01</b>	0.035
	Ambient temperature $T_{u \max.} = 60 \text{ °C}$				
	3RV2.2	Size S0,	rated operational current $I_e$ at		
		AC-3/400 V: 25 A			
3RT1926-4RD01					
	<b>Motor feeder connector</b>			<b>3RT1900-4RE01</b>	0.042
	Size S0				
	3RV2.2				
3RT1900-4RE01					

## Protection equipment

### Motor starter protectors/circuit breakers

#### SIRIUS 3RV2 motor starter protectors/circuit breakers

#### 3RV29 infeed system

##### Overview

The 3RV29 infeed system is a convenient means of energy supply and distribution for a group of several motor starter protectors or complete load feeders with screw or spring-loaded terminals in sizes S00 and S0. Motor starter protectors or load feeders with a rated current of maximum 32 A each can be used. 3RV21 motor starter protectors/circuit breakers cannot be used in this system.

The system is based on a basic module complete with a lateral incoming unit (3-phase busbar with infeed). This infeed with spring-loaded terminals is mounted on the right or left, depending on the version, and can be supplied with a maximum conductor cross-section of 25 mm<sup>2</sup> (with end sleeve). A basic module has two sockets onto each of which a motor starter protector can be snapped.

Expansion modules (3-phase busbars for system expansion) are available for extending the system. The individual modules are connected through an expansion plug.

The electrical connection between the 3-phase busbars and the motor starter protectors is implemented through plug-in connectors. The complete system can be mounted on a TH 35 standard mounting rail according to IEC 60715, and can be expanded as required up to a maximum current carrying capacity of 63 A.

The system is mounted extremely quickly and easily thanks to the simple plug-in terminals. Thanks to the lateral infeed, the system also saves space in the control cabinet.

The additional height required for the infeed unit is only 30 mm. The alternative infeed possibilities on each side offer a high degree of flexibility for configuring the control cabinet: Infeed on left-hand or right-hand side as well as infeed on one side and outfeed on the other side to supply further loads are all possible. A terminal block with spring-loaded terminals in combination with a standard mounting rail enables the integration of not only SIRIUS motor starter protectors but also 1-phase, 2-phase and 3-phase components such as 5SY miniature circuit breakers or SIRIUS relay components.

The 3RV29 infeed system is approved in accordance with IEC up to 500 V. It is also UL-approved and authorized for "Self-Protected Combination Motor Controllers" (Starters (Type E)), for Starters (Type F) (Starters (Type E) + contactors) and for circuit breakers according to UL 489 (3RV27/3RV28).

##### Assembly kits for constructing the infeed system with spring-loaded terminals

The following versions can be ordered:

- Basic set for 2 feeders
- Expansion sets for 2 or 3 feeders

The assembly kits contain 3-phase busbars, plug-in connectors and contactor bases (see page 2/211).

##### Note:

Each set contains plug-in connectors for sizes S00 and S0.

Example: The basic set contains four plug-in connectors (two each for S00 and S0).

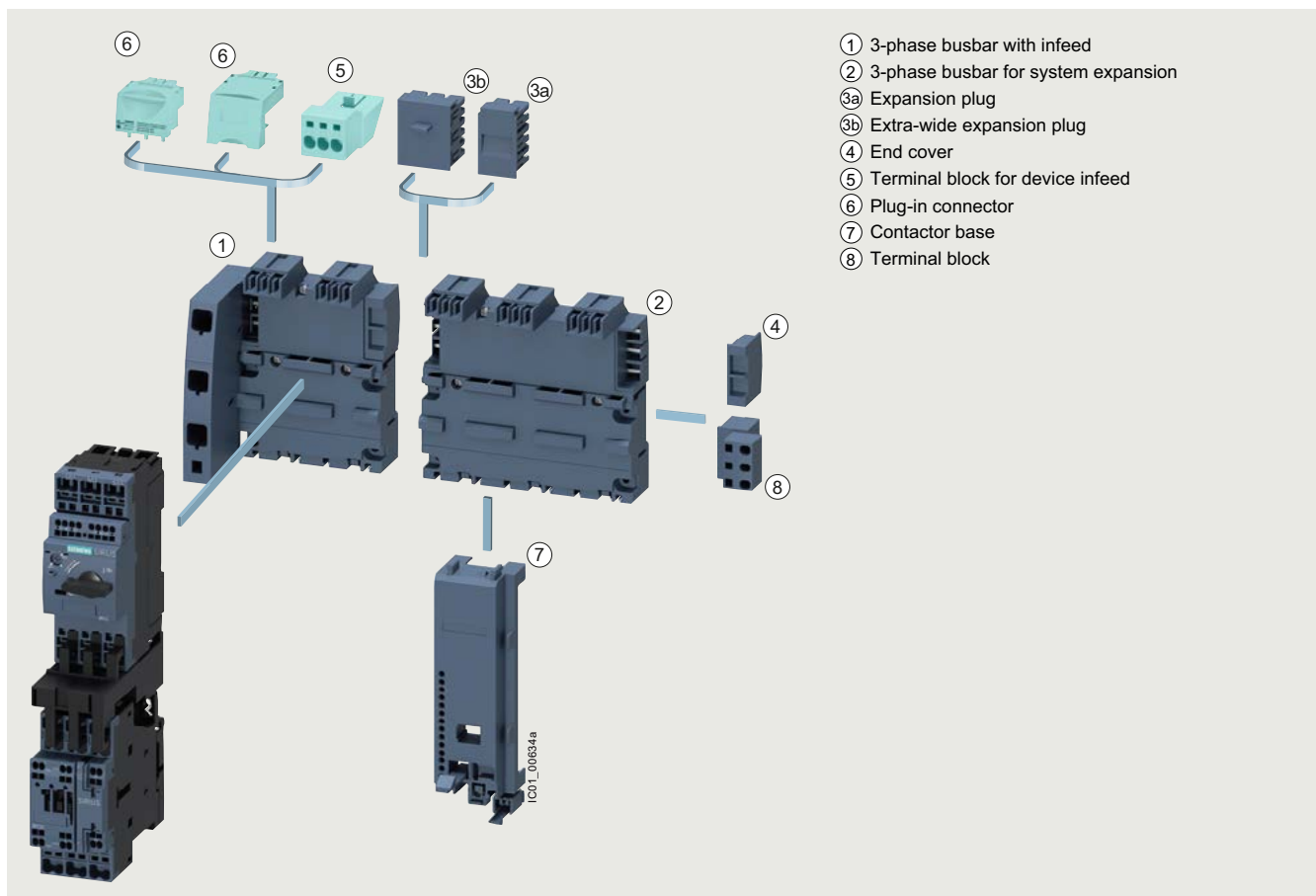

SIRIUS 3RV29 infeed system

## Protection equipment

### Motor starter protectors/circuit breakers

#### SIRIUS 3RV2 motor starter protectors/circuit breakers

#### 3RV29 infeed system

2

#### ① 3-phase busbars with infeed

A 3-phase busbar with infeed unit is required for connecting the incoming supply. These modules comprise one infeed module and two sockets which each accept one motor starter protector. A choice of two versions with infeed on the left or right is available. The infeed is connected to spring-loaded terminals. They permit an infeed with conductor cross-sections of up to 25 mm<sup>2</sup> with end sleeve. An end cover is supplied with each module.

#### ② 3-phase busbars for system expansion

The 3-phase busbars for system expansion support expansion of the system. There is a choice of modules with two or three sockets. The system can be expanded as required up to a maximum current carrying capacity of 63 A. An expansion plug is supplied with each module.

#### ③a Expansion plug

The expansion plug is used for electrical connection of adjacent 3-phase busbars. The current carrying capacity of this plug equals 63 A. One expansion plug is supplied with each 3-phase busbar for system expansion. Additional expansion plugs are therefore only required as spare parts.

#### ③b Extra-wide expansion plug

The wide expansion plug makes the electrical connection between two 3-phase busbars, thus performing the same function as the 3RV2917-5BA00 expansion plug; the electrical characteristics (e.g. a current carrying capacity of 63 A) are identical.

The 3RV2917-5E expansion plug is 10 mm wider than the 3RV2917-5BA00 expansion plug, hence in the plugged state there is a distance of 10 mm between the connected 3-phase busbars. This distance can be used to lay the auxiliary current and control current wiring ("wiring duct"). The motor starter protector and contactor can be wired from underneath, which means that the complete cable duct above the system can be omitted.

#### ④ End cover

The end cover is used to cover the 3-phase busbar at the open end of the system. This cover is therefore only required once for each system. An end cover is supplied with each 3-phase busbar system with infeed. Further end covers are therefore only required as spare parts.

#### ⑤ Terminal block for device infeed

A new addition to the system is a plug for outfeeding to a device slot within a module. This offers the option not only of connecting 3-phase loads to the system, but also of integrating 1-phase loads into the infeed system.

#### ⑥ Plug-in connector

The plug-in connector is used for the electrical connection between the 3-phase busbar and the 3RV2 or 3RV1011 motor starter protector. These plug-in connectors are available for screw or spring-loaded terminals.

#### ⑦ Contactor base

Load feeders can be assembled in the system using the S00 and S0 contactor base. The contactor bases are suitable for contactors of sizes S00 and S0 with screw and spring-loaded terminals and are simply snapped onto the 3-phase busbars. Direct-on-line starters and reversing starters are possible. One contactor base is required for direct-on-line starters and two are required for reversing starters.

To assemble load feeders for reversing starters, the contactor bases can be arranged alongside each other (90 mm overall width). In this case the mechanical interlocking of the contactors is possible. The S0 contactor bases are also suitable for soft starters size S00 and S0 with screw terminals.

The infeed system is designed for mounting on a TH 35 standard mounting rail with 7.5 mm overall depth. This standard mounting rail gives the contactor base a stable mounting surface to sit on. If standard mounting rails with a depth of 15 mm are used, the spacer connected to the bottom of the contactor base must be knocked out and plugged into the standard mounting rail mating piece, which is also located on the underside. Then the contactor base also has a stable mounting surface. When standard mounting rails with a depth of 7.5 mm are used, the spacer has no function and can be removed.

The link modules are used for direct on-line starters, in which case the use of a contactor base is not absolutely necessary. Motor starter protector and contactor assemblies can then be directly snapped onto the sockets of the 3-phase busbars. For feeders of sizes S00 and S0, the corresponding 3RA1921-1....., 3RA2911-2....., 3RA2921-1..... or 3RA2921-2..... link modules should generally be used.

#### ⑧ Terminal block

The 3RV2917-5D terminal block enables the integration of not only SIRIUS motor starter protectors but also 1-phase, 2-phase and 3-phase components. The three phases can be fed out of the system using the terminal block; which means that single-phase loads can also be integrated in the system. The terminal block is plugged into the slot of the expansion plug and thus enables outfeeding from the middle or end of the infeed system. The terminal block can be rotated through 180° and be locked to the support modules of the infeed system. In addition, the 45 mm wide TH 35 3RV1917-7B standard mounting rail option for screwing onto the support plate facilitates plugging the 1-phase, 2-phase and 3-phase components onto the infeed system.



Video:  
SIRIUS News SIRIUS 3RV29 infeed system – User-friendly energy supply and distribution



## Protection equipment

### Motor starter protectors/circuit breakers

### SIRIUS 3RV2 motor starter protectors/circuit breakers

#### 3RV29 infeed system

#### Technical specifications

##### More information

Equipment Manual, see  
<https://support.industry.siemens.com/cs/ww/en/view/60279172>

##### General data

<b>Type</b>					<b>3RV29.7</b>
Size					S00, S0
<b>Standards</b>					
• IEC 60947-2					Yes
• IEC 60947-4-1					Yes
• UL 508/UL 60947-4-1					Yes
<b>Rated current <math>I_n</math></b>	A				63
<b>Permissible rated current at inside temperature of control cabinet</b>					
Motor starter protectors	Size	Rated current	Inside temperature of control cabinet		
• 3RV2.11/3RV1011	S00	... 14 A	60 °C	%	100
		> 14 ... 16 A	40 °C	%	100
			60 °C	%	87
• 3RV2.21	S0	... 16 A	60 °C	%	100
		> 16 ... 25 A	40 °C	%	100
			60 °C	%	87
		> 25 ... 32 A	40 °C	%	87
<b>Permissible ambient temperature</b>					
• Storage/transport	°C				-50 ... +80
• Operation	°C				-20 ... +60
<b>Rated operational voltage <math>U_e</math></b>					
• Acc. to IEC	10% overvoltage		V AC	500	
	5% overvoltage		V AC	525	
• Acc. to UL/CSA			V AC	600	
<b>Rated frequency</b>	Hz				50/60
<b>Rated impulse withstand voltage <math>U_{imp}</math></b>	kV				6
<b>Short-circuit strength</b>	corresponds to the mounted motor starter protector or load feeder. The assembly instructions must be followed, see <a href="#">Operating Instructions</a>				
<b>Degree of protection IP on the front</b> according to IEC 60529	IP20 with cover and 25 mm <sup>2</sup> conductor cross-section at the infeed terminal				
<b>Touch protection on the front</b> according to IEC 60529	Finger-safe for vertical touching from the front with cover and 25 mm <sup>2</sup> conductor cross-section at the infeed terminal				

##### Conductor cross-sections

Type		<b>3-phase busbar with infeed 3RV2917-1A, 3RV2917-1E</b>	<b>Terminal block 3RV2917-5D</b>	<b>Terminal block for device infeed 3RV2917-5FA00</b>
<b>Conductor cross-sections (min./max.)</b>				
• Solid or stranded	mm <sup>2</sup>	4 ... 25	1.5 ... 6	1 ... 10
• Finely stranded with end sleeve	mm <sup>2</sup>	4 ... 25	1.5 ... 4	1 ... 6
• Finely stranded without end sleeve	mm <sup>2</sup>	6 ... 25	1.5 ... 6	--
• AWG cables	AWG	10 ... 3	15 ... 10	18 ... 8

# Protection equipment

## Motor starter protectors/circuit breakers

### SIRIUS 3RV2 motor starter protectors/circuit breakers

3RV29 infeed system

## Selection and ordering data

Type	Version	For 3RV20, 3RV23, 3RV24, 3RV27, 3RV28, 3RV1011 motor starter protectors	Article No.	Weight
		Size		kg

## 3-phase busbars with infeed



3RV2917-1A

**3-phase busbars with infeed**  
Incl. 3RV2917-6A end cover

For 2 motor starter protectors with screw or spring-loaded terminals

- With infeed on the left S00, S0
- With infeed on the right S00, S0

**3RV2917-1A**  
**3RV2917-1E**

0.417  
0.435

## 3-phase busbars for system expansion



3RV2917-4A

**3-phase busbars**  
Incl. 3RV2917-5BA00 expansion plug

For motor starter protectors with screw or spring-loaded terminals

- For 2 motor starter protectors S00, S0
- For 3 motor starter protectors S00, S0

**3RV2917-4A**  
**3RV2917-4B**

0.245  
0.435

## Plug-in connectors



3RV2917-5AA00

**Plug-in connectors** To make contact with the 3RV2 motor starter protectors

- For spring-loaded terminals

- Single-unit packaging S00<sup>1)</sup>  
S0<sup>2)</sup>
- Multi-unit packaging S00<sup>1)</sup>  
S0<sup>2)</sup>

**Spring-loaded terminals**



**3RV2917-5AA00**  
**3RV2927-5AA00**  
**3RV2917-5A**  
**3RV2927-5A**

0.059  
0.071  
0.054  
0.065



3RV2917-5CA00

**Plug-in connectors** To make contact with the 3RV1011 motor starter protectors

- For screw terminals

- Single-unit packaging S00<sup>1)3)</sup>  
S0<sup>2)4)</sup>
- Multi-unit packaging S00<sup>1)3)</sup>  
S0<sup>2)4)</sup>

**Screw terminals**



**3RV2917-5CA00**  
**3RV1927-5AA00**  
**3RV2917-5C**  
**3RV1927-5A**

0.044  
0.045  
0.038  
0.039

**Plug-in connectors** To make contact with the 3RV1011 motor starter protectors

- For screw terminals

- Single-unit packaging S00
- Multi-unit packaging S00

**3RV1917-5CA00**  
**3RV1917-5C**

0.038  
0.034

<sup>1)</sup>  $I > 14$  A, please note derating.

<sup>2)</sup>  $I > 16$  A, please note derating.

<sup>3)</sup> The plug-in connector cannot be used for the 3RV2711 and 3RV2811 motor starter protectors with size S00.

<sup>4)</sup> The plug-in connector can be used for the 3RV2711, 3RV2811 (size S00) and 3RV2721, 3RV2821 (size S0) motor starter protectors.

Type	Version	For contactors	Article No.	Weight
		Size		kg

## Contactor bases



3RV2927-7AA00

**Contactor bases**  
For mounting direct-on-line or reversing starters

Single-unit packaging

S00<sup>1)</sup>  
S00<sup>1)</sup>, S0

**3RV2917-7AA00**  
**3RV2927-7AA00**

0.069  
0.075

<sup>1)</sup> Not for 3RV1011 motor starter protectors.

## Protection equipment

### Motor starter protectors/circuit breakers

### SIRIUS 3RV2 motor starter protectors/circuit breakers

#### 3RV29 infeed system

Type	Version	Article No.	Weight kg	
<b>Terminal blocks</b>				
	<b>Terminal blocks</b> For integration of 1-phase, 2-phase and 3-phase components	Single-unit packaging	<b>3RV2917-5D</b>	0.061
<b>TH 35 standard mounting rails, width 45 mm</b>				
	<b>TH 35 standard mounting rails</b> Acc. to IEC 60715, width 45 mm For mounting on 3-phase busbars	Single-unit packaging	<b>3RV1917-7B</b>	0.016
<b>Extra-wide expansion plugs</b>				
	<b>Extra-wide expansion plugs</b> As accessory	Single-unit packaging	<b>3RV2917-5E</b>	0.044
<b>Expansion plugs</b>				
	<b>Expansion plugs<sup>1)</sup></b> As spare part	Single-unit packaging	<b>3RV2917-5BA00</b>	0.035
<b>End covers</b>				
	<b>End covers<sup>2)</sup></b> As spare part	Multi-unit packaging	<b>3RV2917-6A</b>	0.700
<b>Terminal blocks for device infeed</b>				
	<b>Terminal blocks for device infeed</b>	Single-unit packaging	<b>3RV2917-5FA00</b>	0.038

<sup>1)</sup> The expansion plug is included in the scope of supply of the 3RV2917-4.  
3-phase busbars for system expansion.

<sup>2)</sup> The end cover is included in the scope of supply of the 3RV2917-1.  
3-phase busbars with infeed system.

## Protection equipment

### Motor starter protectors/circuit breakers

### SIRIUS 3RV2 motor starter protectors/circuit breakers

**NEW** 3RV29 infeed system

Version	For motor starter protectors/circuit breakers with spring-loaded terminals	Spring-loaded terminals 	Weight
		Article No.	kg
		Size	
<b>Assembly kits for constructing the infeed system with spring-loaded terminals<sup>1)</sup></b>			
<b>Basic set for 2 feeders</b>		<b>3RV2907-1AB00</b>	1.070
contains:			
• 1 x 3-phase busbars 3RV2917-1A (incl. end cover 3RV2917-6A), with infeed left, for 2 motor starter protectors with spring-loaded terminals	S00, S0		
• 2 x plug-in connectors for spring-loaded terminals 3RV2917-5AA00	S00		
• 2 x plug-in connectors for spring-loaded terminals 3RV2927-5AA00	S0		
• 2 x 3RV2927-7AA00 contactor bases	S00, S0		
<b>Expansion set for 2 feeders</b>		<b>3RV2907-4AB00</b>	0.820
contains:			
• 1 x 3-phase busbars 3RV2917-4A (incl. expansion plug 3RV2917-5BA00), for 2 motor starter protectors with spring-loaded terminals	S00, S0		
• 2 x plug-in connectors for spring-loaded terminals 3RV2917-5AA00	S00		
• 2 x plug-in connectors for spring-loaded terminals 3RV2927-5AA00	S0		
• 2 x 3RV2927-7AA00 contactor bases	S00, S0		
<b>Expansion set for 3 feeders</b>		<b>3RV2907-4BB00</b>	1.130
contains:			
• 1 x 3-phase busbars 3RV2917-4B (incl. expansion plug 3RV2917-5BA00), for 3 motor starter protectors with spring-loaded terminals	S00, S0		
• 3 x plug-in connectors for spring-loaded terminals 3RV2917-5AA00	S00		
• 3 x plug-in connectors for spring-loaded terminals 3RV2927-5AA00	S0		
• 3 x 3RV2927-7AA00 contactor bases	S00, S0		

<sup>1)</sup> Not for 3RV1011 motor starter protectors.

# Monitoring and control devices

## Introduction

### Overview

2



Type	3RP25	3RP20
<b>Timing relays</b>		
<b>Enclosures:</b>		
• 17.5 mm industry and household equipment installation	✓	--
• 22.5 mm industry	✓	--
• 45 mm industry	--	✓
<b>Monofunction</b>	✓	✓
<b>Multifunction</b>	✓	✓
<b>Combination voltage</b>	✓	✓
<b>Wide voltage range</b>	✓	✓
<b>Application:</b>		
• Control systems and mechanical engineering	✓	✓
• Infrastructure	--	--
<b>Page</b>	2/215	2/227

✓ Corresponds to or available

-- Does not correspond to or not available



Type	3UG546	3UG451., 3UG461.	3UG463.	3RR21, 3RR22, 3UG4621, 3UG4622	3UG4641	3UG4625 with 3UL23	3UG458.	3UG4501	3UG4651	Page
<b>Monitoring relays</b>										
<b>DC load monitoring</b>	✓	--	--	--	--	--	--	--	--	2/248
<b>Line monitoring</b>	--	✓	--	--	--	--	--	--	--	2/255
<b>Voltage monitoring</b>	--	--	✓	--	--	--	--	--	--	2/260
<b>Current monitoring</b>	--	--	--	✓	--	--	--	--	--	2/233, 2/263
<b>Active current monitoring</b>	--	--	--	3RR22 ✓	✓	--	--	--	--	2/233, 2/265
<b>Power factor monitoring</b>	--	--	--	--	✓	--	--	--	--	2/265
<b>Residual-current monitoring</b>	--	--	--	--	--	✓	--	--	--	2/268
<b>Insulation monitoring</b>	--	--	--	--	--	--	✓	--	--	2/271
<b>Level monitoring</b>	--	--	--	--	--	--	--	✓	--	2/275
<b>Speed monitoring</b>	--	--	--	--	--	--	--	--	✓	2/278

✓ Available

-- Not available

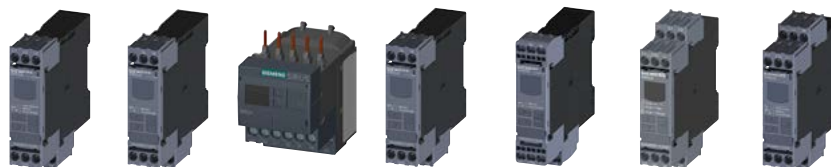

Type	3UG481.	3UG4832	3RR24	3UG4822	3UG4841	3UG4825 with 3UL23	3UG4851	Page
<b>Monitoring relays for IO-Link</b>								
<b>Line monitoring</b>	✓	--	--	--	--	--	--	2/285
<b>Voltage monitoring</b>	--	✓	--	--	--	--	--	2/288
<b>Current monitoring</b>	--	--	✓	✓	--	--	--	2/241, 2/291
<b>Power factor and active current monitoring</b>	--	--	✓	--	✓	--	--	2/241, 2/294
<b>Residual-current monitoring</b>	--	--	--	--	--	✓	--	2/298
<b>Speed monitoring</b>	--	--	--	--	--	--	✓	2/301

✓ Available

-- Not available



Type	3RS2	3RS70	Page
<b>Temperature monitoring relays</b>			
<b>Temperature monitoring</b>	✓	--	2/305
<b>Temperature monitoring relays for IO-Link</b>			
<b>Temperature monitoring for IO-Link</b>	✓	--	2/305

✓ Available

-- Not available

### Connection methods

The monitoring and control devices are available with screw or spring-loaded terminals.

SIRIUS 3RP25 timing relays, 3UG458 insulation monitoring relays, SIRIUS 3RS2 temperature monitoring relays, SIRIUS 3RN2 thermistor motor protection and SIRIUS 3RS70 signal converters are available with screw terminals or spring-loaded terminals (push-in).



Screw terminals



Spring-loaded terminals, spring-loaded terminals (push-in)

The terminals are indicated in the corresponding tables by the symbols shown on orange backgrounds.

### "Increased safety" type of protection EEx e/d according to ATEX directive 2014/34/EU

The communication-capable, modularly designed SIMOCODE pro motor management system (SIRIUS Motor Management and Control Devices) protects motors of types of protection EEx e and EEx d in hazardous areas.

The SIRIUS 3RN2 thermistor motor protection relay protects motors with types of protection EEx e and EEx d in hazardous areas.

### ATEX approval for operation in hazardous areas

The SIRIUS SIMOCODE pro 3UF7 motor management system is certified for the protection of motors in hazardous areas according to

- ATEX Ex I (M2); equipment group I, category M2 (mining)
- ATEX Ex II (2) GD; equipment group II, category 2 in area GD

The SIRIUS 3RN2011, 3RN2012-...30, 3RN2013 and 3RN2023 thermistor motor protection relays for PTC sensors are certified according to ATEX Ex II (2) G and D for environments with explosive gas or dust loads.

## Monitoring and control devices

### Relays

#### Timing relays

#### General data

#### Overview



7PV15, SIRIUS 3RP25 and SIRIUS 3RP20 timing relays

#### More information

Homepage, see [www.siemens.com/sirius-timing-relays](http://www.siemens.com/sirius-timing-relays)

Industry Mall, see [www.siemens.com/product?3RP](http://www.siemens.com/product?3RP)

Electronic timing relays are used in control, starting, and protective circuits for all switching operations involving time delays.

Their fully developed concept and space-saving, compact design make the SIRIUS 3RP timing relays ideal timer modules for control cabinet, switchgear and control manufacturers in the industry.

With their narrow design, the 7PV15 timing relays are ideal in particular for use in heating, ventilation and air-conditioning systems and in compressors. All 7PV15 timing relays in this enclosure version are suitable for snap-on mounting on TH 35 standard mounting rails according to IEC 60175. The enclosure complies with DIN 43880.

The SIRIUS 3RA28 function modules enable the assembly of starters and contactor assemblies for direct-on-line and wye-delta starting. They include the key control functions required for the particular feeder, e.g. timing and electrical interlocking. The function modules that function as timing relays are mounted quickly and simply on SIRIUS contactors – without any great wiring effort.

The SIRIUS 3RA28 solid-state time-delay auxiliary switches which can be mounted on contactors are designed for contactor coil voltages in the range from 24 to 240 V AC/DC (wide voltage range). Auxiliary switches for control and alarm signals are used specially for switching the smallest signals for electronics applications. They are used, for example, for allowing a pump or fan to run on, or for the delayed activation of a gate drive.

Simply by being plugged in place, the SIRIUS 3RT19 timing relays enable different functionalities required for the assembly of starters to be realized in the feeder. At the same time the timing relays for mounting on contactors reduce the wiring work required within the feeder and save space in the control cabinet.

#### Device series

##### SIRIUS timing relays for standard rail mounting

- SIRIUS 3RP25 timing relays, 17.5 mm and 22.5 mm, see page 2/215
- SIRIUS 3RP20 timing relays, 45 mm, see page 2/227
- 7PV15 timing relays, 17.5 mm

##### SIRIUS timing relays for mounting on contactors

- SIRIUS 3RA28 solid-state time-delay auxiliary switches for mounting on 3RT2 contactors and 3RH2 contactor relays,
- SIRIUS 3RA28 function modules for mounting on 3RT2 contactors and 3RH2 contactor relays
- SIRIUS 3RT19 timing relays for mounting on 3RT1 contactors

#### Benefits

- The right design for every application
- Clear-cut basic range with five basic units in the case of the 7PV15 timing relays, and up to seven basic units in the case of the 3RP timing relays
- Considerable logistical advantages thanks to versions with wide voltage and wide time setting range
- No tools required for assembly or disassembly on standard mounting rails
- Cadmium-free relay contacts
- Recyclable, halogen-free enclosure
- Optimum price/performance ratio
- Versions with logical separation
- Low variance: One design for distribution boards and for control cabinets
- Compliance with EMC requirements for buildings
- Environmentally friendly laser inscription instead of printing containing solvents
- Versions as snap-on modules for reducing wiring and saving space in the control cabinet
- Versions with coated printed circuit board
- Versions with screw terminals or alternatively with spring-loaded terminals

#### Application

##### Timing relays with ON-delay

- Interference pulse suppression (gating of interference pulses)
- Gradual startup of motors so as not to overload the power supply

##### Timing relays with OFF-delay

- Generation of overtravel functions following removal of voltage
- Gradual, delayed shutdown, e.g. of motors or fans, to allow a plant to be shut down selectively

##### Clock-pulse relay

- Flashing, asymmetrical

##### Wye-delta timing relays

- Switching over motors from wye to delta with a dead interval of 50 ms to prevent phase-to-phase short circuits

##### Multifunctional timing relays

- Maximum flexibility, with a device for every application
- Available with relay and semiconductor output
- Versions for railway applications for more exacting requirements (e.g. temperature range, vibration/shock resistance and EMC)

##### Watchdog function

- Monitoring of cyclic events



## Overview

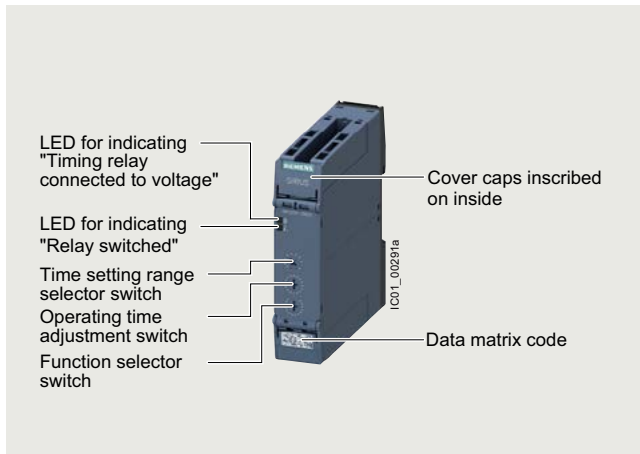

SIRIUS 3RP25 timing relay

## More information

Homepage, see [www.siemens.com/sirius-timing-relays](http://www.siemens.com/sirius-timing-relays)Industry Mall, see [www.siemens.com/product?3RP25](http://www.siemens.com/product?3RP25)Conversion tool, see [www.siemens.com/conversion-tool](http://www.siemens.com/conversion-tool)Simulator, see <https://support.industry.siemens.com/cs/ww/en/view/103556391>Video: [What are the benefits of SIRIUS 3RP25 timing relay?](#)

Electronic timing relays for general use in control systems and mechanical engineering with:

- 1 or 2 CO, 1 NO (semiconductor) or 3 NO
- Monofunction or multifunction
- Combination voltage or wide voltage range
- Single or selectable time setting ranges
- Switch position indication and voltage indication by LED
- Versions with coated printed circuit board

## Article No. scheme

Product versions		Article number	
<b>Timing relays</b>		<b>3RP25</b>	<input type="checkbox"/> <input type="checkbox"/> - <input type="checkbox"/> <input type="checkbox"/> <input type="checkbox"/> <input type="checkbox"/> 0 - <input type="checkbox"/> <input type="checkbox"/> <input type="checkbox"/> <input type="checkbox"/>
Product function/ time setting ranges	Multifunction ON-delay	0 5 1 1 1 2 1 3 2 5 2 7 3 5 4 0	7 time ranges 0.05 s ... 100 h 1 time range 0.5 ... 10 s 1 time range 1 ... 3 s 1 time range 5 ... 100 s 7 time ranges 0.05 s ... 100 h 4 time ranges 0.05 s ... 240 s 7 time ranges 0.05 s ... 100 h 7 time ranges 0.05 s ... 600 s
	OFF-delay with control signal	5 5	7 time ranges 0.05 s ... 100 h
	OFF-delay without control signal, non-volatile, passing make contact	6 0	Wye-delta 1 ... 20 s, coasting time (idling) 600 s
	Clock-pulse relay, flashing, asymmetrical	7 4	1 time range 1 ... 20 s
	Wye-delta function with coasting function (idling)	7 6	1 time range 3 ... 60 s
	Wye-delta function		
Connection type	Screw terminals Spring-loaded terminals (push-in)	1 2	
Contacts	1 CO 2 CO Semiconductors (transistor NPN) Semiconductors (thyristor), two-wire 1 NO + 1 NO (SD) 2 CO force-guided 3 NO	A B C E N R S	
Control supply voltage	24 V AC/DC 200 ... 240 V/380 ... 440 V AC 400 ... 440 V AC 12 ... 240 V AC/DC or 24 ... 240 V AC/DC (3RP2505-.RW30)	B 3 M 2 T 2 W 3	
Special versions	With coated printed circuit board		0 A X 0
Example		3RP25 0 5 - 1 A B 3 0	

## Note:

The Article No. scheme shows an overview of product versions for better understanding of the logic behind the article numbers.

For your orders, please use the article numbers quoted in the selection and ordering data.

## Monitoring and control devices

### Relays

#### Timing relays

#### SIRIUS 3RP25 timing relays, 17.5 mm and 22.5 mm

##### 3RP2505 multifunctional timing relays

###### Two setting options for implementing the multifunctions (A-M):



- ① Determination of 13 functions by the setting A to M, with 1 CO, 1 NO, 2 CO that switch in parallel.
- ② Extended function variance by selecting the time range and determining, whether 2 CO switch in parallel or whether 1 CO switches with delay + 1 CO switches immediately (1 CO + 1 CO)

Setting the functions on the device

The functions of the 3RP2505 multifunctional timing relays can be set by means of the function selector switch. Whether both CO contacts are switched in parallel or one CO contact with a delay and one instantaneously and the choice of time setting range are set by means of the time setting range selector switch. The exact operating time can be adjusted with the operating time switch.

###### Overview of functions

Identifica- tion letter	13 functions	27 functions
	1 CO contact (1 CO), 1 NO contact (1 NO) semiconductor, 2 CO contacts switched in parallel (2 CO) or 2 CO contacts force-guided and switched in parallel with delay (2 CO)	13 functions (A - M) 2 CO contacts switched in parallel (2 CO) + 13 functions (A - M) 1 delayed CO contact + 1 instantaneous CO contact (1 CO + 1 CO) and wye-delta function
<b>A</b>	ON-delay	ON-delay and instantaneous contact
<b>B</b>	OFF-delay with control signal	OFF-delay with control signal and instantaneous contact
<b>C</b>	ON-delay/OFF-delay with control signal	ON-delay/OFF-delay with control signal and instantaneous contact
<b>D</b>	Flashing, symmetrical, starting with interval	Flashing, symmetrical, starting with interval and instantaneous contact
<b>E</b>	Passing make contact, interval relay	Passing make contact, interval relay and instantaneous contact
<b>F</b>	Retriggerable interval relay with deactivated control signal (passing break contact with control signal)	Retriggerable interval relay with deactivated control signal (passing break contact with control signal) and instantaneous contact
<b>G</b>	Passing make contact, with control signal, not retriggerable (pulse-forming with control signal)	Passing make contact, with control signal, not retriggerable, (pulse-forming with control signal) and instantaneous contact
<b>H</b>	Additive ON-delay, instantaneous OFF with control signal	Additive ON-delay, instantaneous OFF with control signal and instantaneous contact
<b>I</b>	Additive ON-delay with control signal	Additive ON-delay with control signal and instantaneous contact
<b>J</b>	Flashing, symmetrical, starting with pulse	Flashing, symmetrical, starting with pulse and instantaneous contact
<b>K</b>	Pulse-delayed (fixed pulse (at 1 s) and settable pulse delay)	Pulse-delayed (fixed pulse (at 1 s) and settable pulse delay) and instantaneous contact
<b>L</b>	Pulse-delayed with control signal (fixed pulse (at 1 s) and settable pulse delay)	Pulse-delayed with control signal (fixed pulse (at 1 s) and settable pulse delay) and instantaneous contact
<b>M</b>	Retriggerable interval relay with activated control signal (watchdog)	Retriggerable interval relay with activated control signal and instantaneous contact (watchdog)
--	--	Wye-delta function

With a set of foil labels the timing relay can be legibly marked with the functions which can be selected on the timing relay. This is supplied together with the multifunctional timing relay.

The same potential must be applied to terminals A. and B.

###### Note:

The activation of loads parallel to the start input is permissible when using AC/DC control voltage.

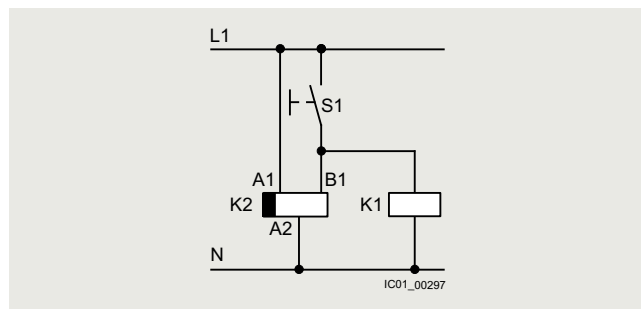

Diagram

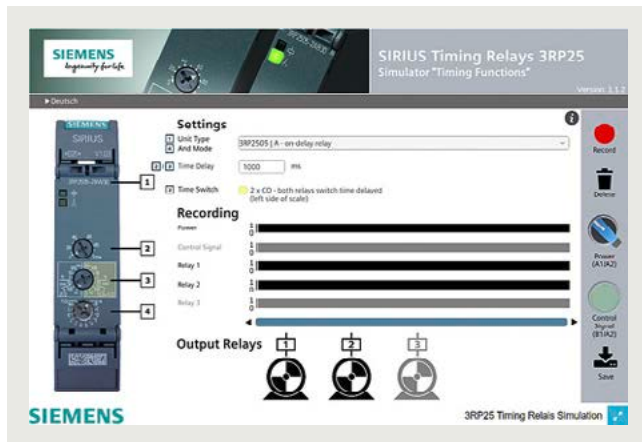
**Simulator**

3RP25 simulator

The 3RP25 simulator visualizes different time functions in the 3RP25 timing relay. Any fault scenario can be simulated.

The tool is available free of charge, see <https://support.industry.siemens.com/cs/ww/en/view/103556391>.

2

**Benefits**

- Easy stock keeping and logistics thanks to low variance of devices
- Reduced space requirement in the control cabinet thanks to variants in width 17.5 mm and 22 mm
- Consistent for all functions thanks to wide voltage range from 12 to 240 V AC/DC
- Up to 27 functions according to IEC 61812 in the multifunctional timing relay with wide voltage range
- Multifunctional timing relay with semiconductor output for high switching frequencies, bounce-free and wear-free switching

**Standards and approvals**

- IEC 60721-3-3 "Classification of environmental conditions"
- IEC 61812-1/DIN VDE 0435 Part 2021 "Specified time relays for industrial use"
- IEC 61000-6-2, IEC 61000-6-3 and IEC 61000-6-4 "Electromagnetic compatibility"
- IEC 60947-5-1 "Low-voltage switchgear and controlgear – Electromechanical control circuit devices"

**Application**

Timing relays are used in control, starting, and protective circuits for all switching operations involving time delays. They guarantee a high level of functionality and a high repeat accuracy of timer settings.

Use in environments exposed to dust, condensation, rapid temperature changes and corrosion is possible thanks to the standard coating of the printed circuit board according to IPC-610. Suitable for applications in rail, agriculture, mining, woodworking, etc.

**Enclosure version**

All timing relays are suitable for snap-on mounting on TH 35 standard mounting rails according to IEC 60715 or for screw fixing.

# Monitoring and control devices

## Relays

### Timing relays

#### SIRIUS 3RP25 timing relays, 17.5 mm and 22.5 mm **NEW**

#### Technical specifications

##### More information

Technical specifications, see  
<https://support.industry.siemens.com/cs/ww/en/ps/16354/t4>

Equipment Manual, see  
<https://support.industry.siemens.com/cs/ww/en/view/103532830>

Internal circuit diagrams, see [CAx Download Manager](#)  
<https://support.industry.siemens.com/my/ww/en/CAxOnline#CAxOnline>

FAQs, see <https://support.industry.siemens.com/cs/ww/en/ps/16354/faq>

Article number	<b>3RP2505-.A, 3RP2505-.C, 3RP251., 3RP2525-.A, 3RP2527, 3RP253., 3RP255.</b>	<b>3RP2505-.B, 3RP2505-.R, 3RP2525-.B, 3RP254., 3RP256., 3RP257.</b>
<b>Dimensions (W x H x D)</b>	mm 17.5 x 100 x 90	22.5 x 100 x 90

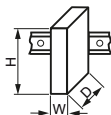

Article number	<b>3RP25...-AB30, 3RP25...-AW30, 3RP25...-AW30-0AX0 3RP25...-BB30, 3RP25...-BW30, 3RP25...-BW30-0AX0 3RP25...-NW30, 3RP25...-SW30</b>	<b>3RP25...-BT20, 3RP25...-NM20</b>	<b>3RP25...-CW30</b>	<b>3RP25...-EW30</b>	<b>3RP25...-RW30 3RP25...-2RW30-0AX0</b>
----------------	---	---	----------------------	----------------------	--

##### General technical specifications:

<b>Insulation voltage for overvoltage category III acc. to IEC 60664 for pollution degree 3, rated value</b>	V AC	300	500	300	--	300
<b>Ambient temperature</b>						
• During operation	°C	-25 ... +60				
• During storage	°C	-40 ... +85				
<b>Operating range factor of the control supply voltage, rated value</b>						
• At AC						
- At 50 Hz		0.85 ... 1.1	0.85 ... 1.1	0.8 ... 1.1	0.85 ... 1.1	0.7 ... 1.1
- At 60 Hz		0.85 ... 1.1	0.85 ... 1.1	0.8 ... 1.1	0.85 ... 1.1	0.7 ... 1.1
• At DC		0.85 ... 1.1	--	0.8 ... 1.1	0.85 ... 1.1	0.7 ... 1.1
<b>Switching capacity current with inductive load</b>	A	0.01 ... 3	0.01 ... 3	0.01 ... 1	0.01 ... 0.6	0.01 ... 3
<b>Operational current of the auxiliary contacts</b>						
• At AC-15						
- At 24 V	A	3	3	1	--	3
- At 250 V	A	3	3	1	--	3
- At 400 V	A	--	3	--	--	--
• At DC-12						
- At 24 V	A	--	--	1	--	--
- At 125 V	A	--	--	1	--	--
- At 250 V	A	--	--	1	--	--
• At DC-13						
- At 24 V	A	1	1	--	--	1
- At 125 V	A	0.2	0.2	--	--	0.2
- At 250 V	A	0.1	0.1	--	--	0.1
<b>Thermal current</b>	A	5	5	1	0.6	5
<b>Mechanical service life (operating cycles)</b>		10 000 000				
<b>Electrical endurance (operating cycles) for AC-15 at 230 V</b>		100 000		300 000	100 000	

Article number	<b>3RP25...-1...0</b>	<b>3RP25...-2...0</b>
<b>Type of electrical connection for auxiliary and control circuits</b>	<b>Screw terminals</b>	<b>Spring-loaded terminals (push-in)</b>
<b>Design of thread of connection screw</b>	M3	--
<b>Tightening torque</b>	Nm 0.6 ... 0.8	--
<b>Type of connectable conductor cross-sections</b>		
• Solid	1 x (0.5 ... 4 mm <sup>2</sup> ), 2 x (0.5 ... 2.5 mm <sup>2</sup> )	1 x (0.5 ... 4 mm <sup>2</sup> )
• Finely stranded with end sleeve	1 x (0.5 ... 4 mm <sup>2</sup> ), 2 x (0.5 ... 1.5 mm <sup>2</sup> )	1 x (0.5 ... 2.5 mm <sup>2</sup> )
• For AWG cables		
- Solid	1 x (20 ... 12), 2 x (20 ... 14)	1 x (20 ... 12)
- Stranded	1 x (20 ... 12), 2 x (20 ... 14)	1 x (20 ... 12)

**3RP25 function diagrams**

Multifunction 3RP2505-.A, 1 CO, 13 functions and 3RP2505-.C, 1 NO (semiconductor), 13 functions

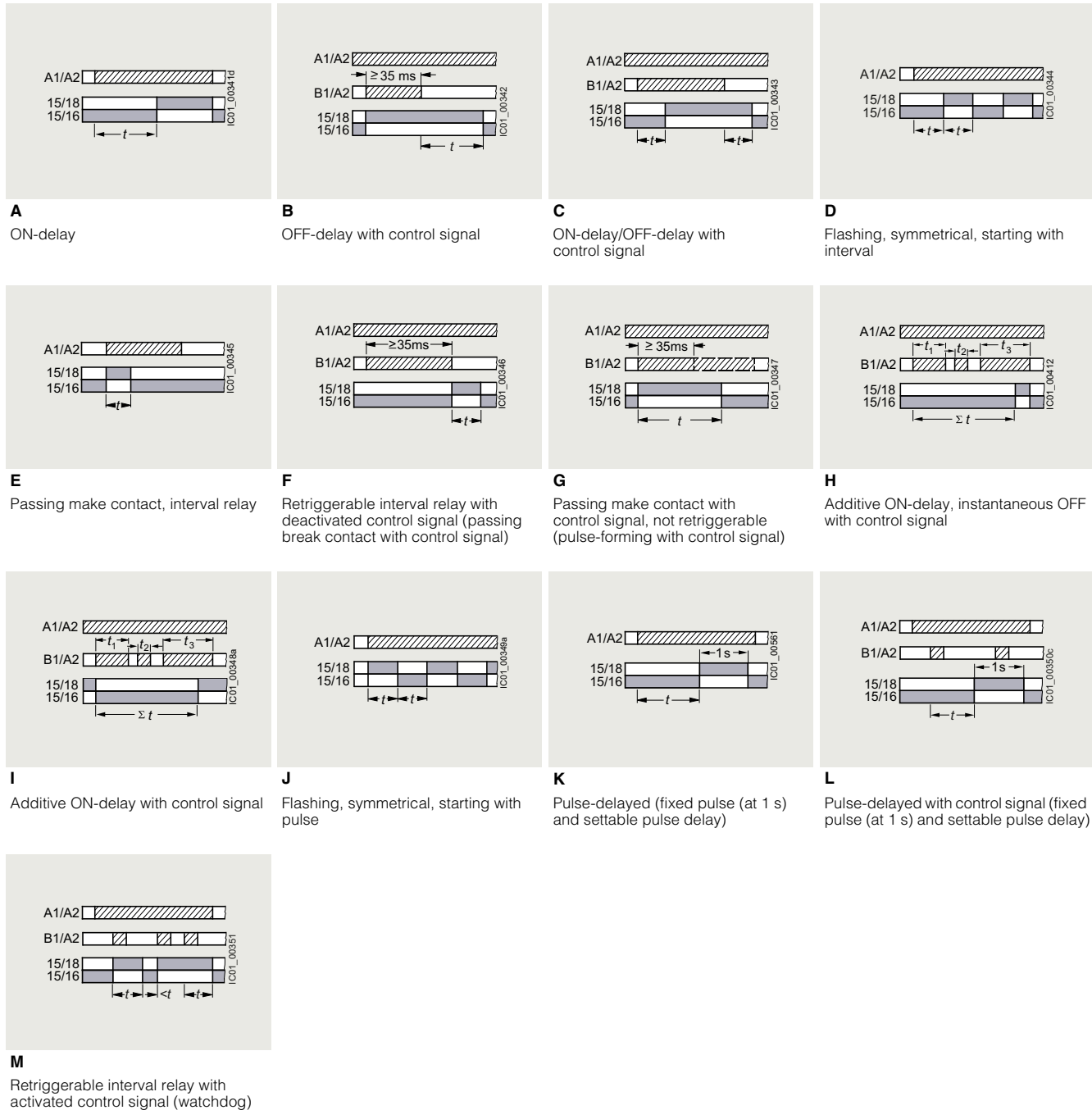
**Legend**

- A ... M** Identification letters
- ▨ Timing relay energized
- Contact closed
- Contact open

# Monitoring and control devices

## Relays

### Timing relays

#### SIRIUS 3RP25 timing relays, 17.5 mm and 22.5 mm

Multifunction 3RP2505-.R, 13 functions, 2 CO force-guided and switched in parallel with delay

2

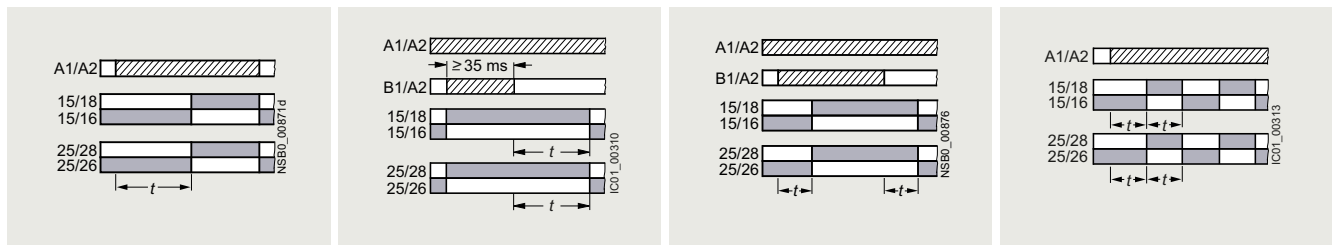

**A** ON-delay  
**B** OFF-delay with control signal  
**C** ON-delay/OFF-delay with control signal  
**D** Flashing, symmetrical, starting with interval

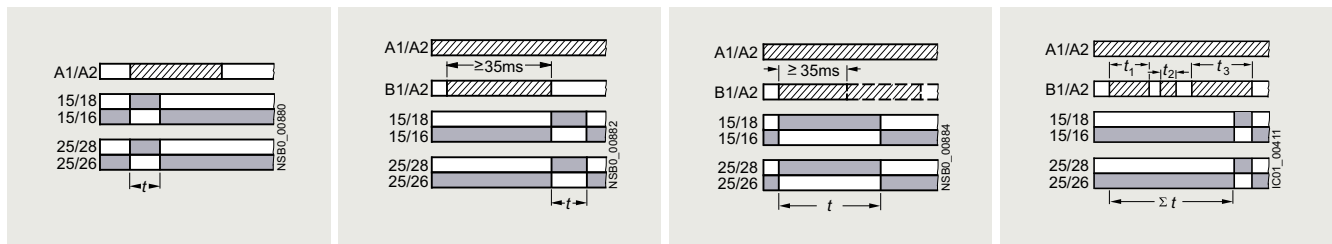

**E** Passing make contact, interval relay  
**F** Retriggerable interval relay with deactivated control signal (passing break contact with control signal)  
**G** Passing make contact with control signal, not retriggerable (pulse-forming with control signal)  
**H** Additive ON-delay, instantaneous OFF with control signal

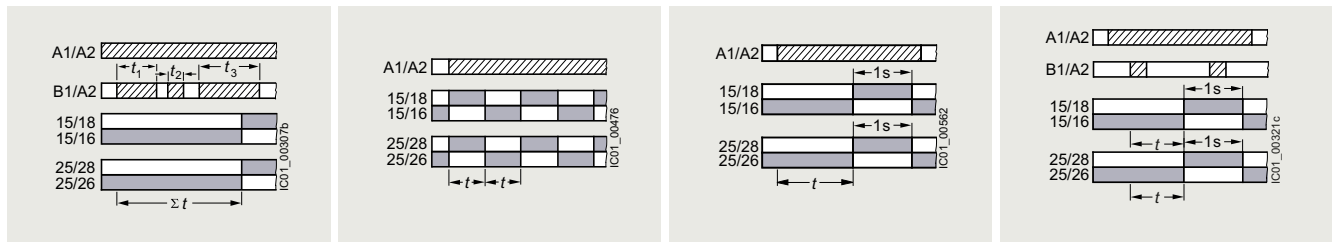

**I** Additive ON-delay with control signal  
**J** Flashing, symmetrical, starting with pulse  
**K** Pulse-delayed (fixed pulse at 1 s and settable pulse delay)  
**L** Pulse-delayed with control signal (fixed pulse at 1 s and settable pulse delay)

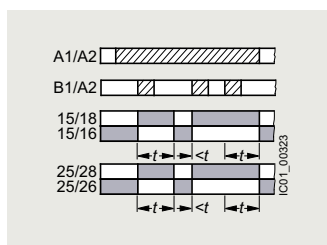

**M** Retriggerable interval relay with activated control signal (watchdog)

#### Legend

- A ... M** Identification letters
- Timing relay energized
- Contact closed
- Contact open

Multifunction 3RP2505-.B, 27 functions, 2 CO

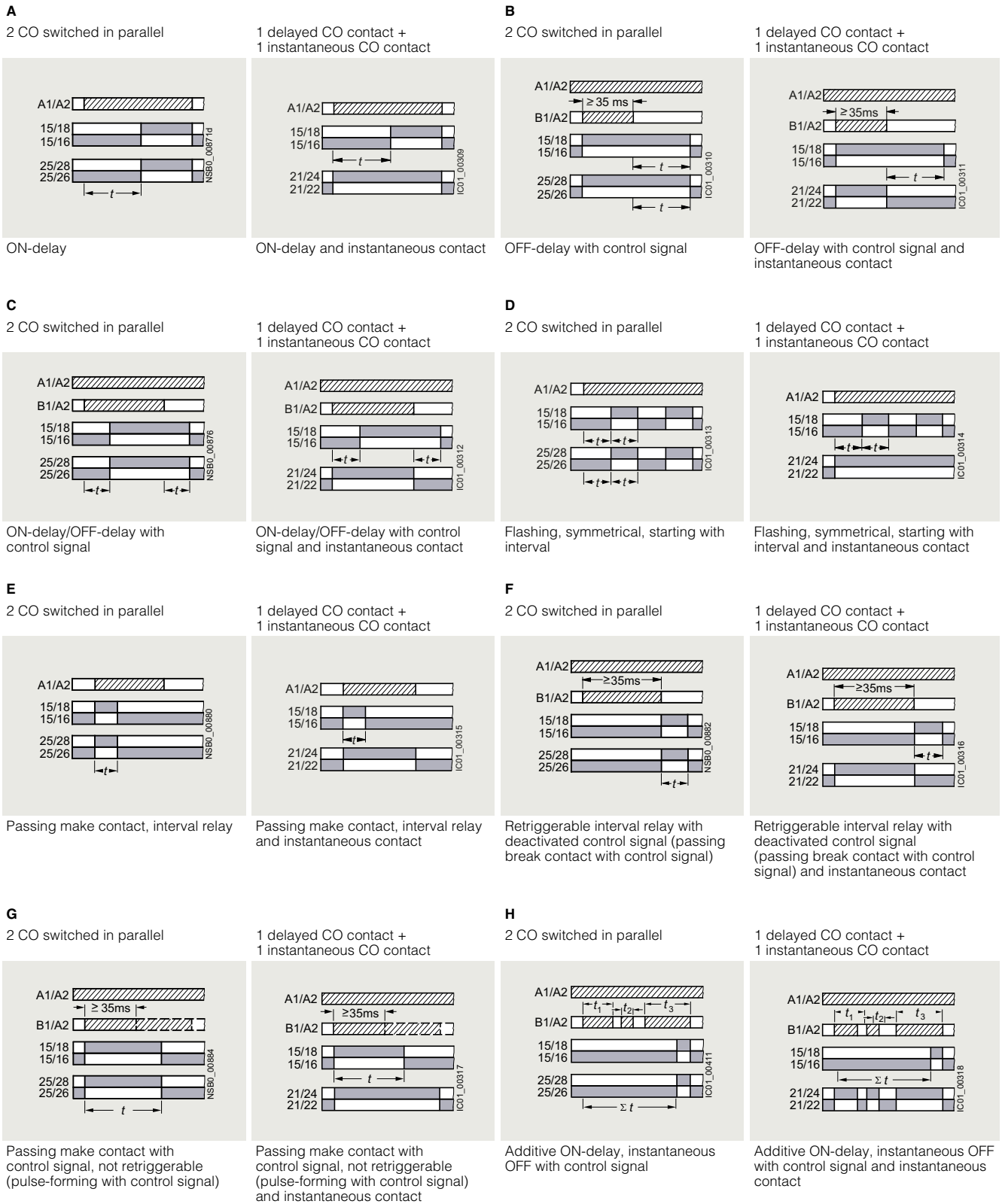

Legend

- A ... H** Identification letters
- Timing relay energized
- Contact closed
- Contact open



# Monitoring and control devices

## Relays

### Timing relays

#### SIRIUS 3RP25 timing relays, 17.5 mm and 22.5 mm

Multifunction 3RP2505-.B, 27 functions, 2 CO (continued)

2

**I**  
2 CO switched in parallel

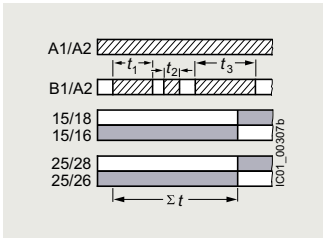

Additive ON-delay with control signal

1 delayed CO contact +  
1 instantaneous CO contact

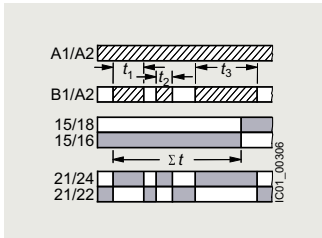

Additive ON-delay with control signal and instantaneous contact

**J**  
2 CO switched in parallel

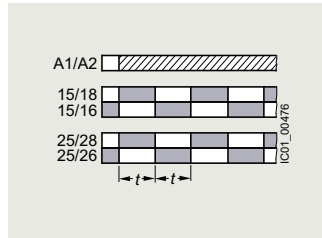

Flashing, symmetrical, starting with pulse

1 delayed CO contact +  
1 instantaneous CO contact

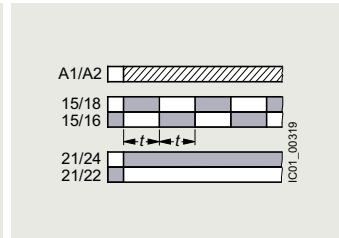

Flashing, symmetrical, starting with pulse and instantaneous contact

**K**  
2 CO switched in parallel

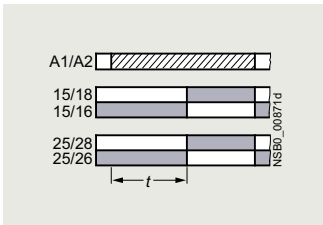

Pulse-delayed (fixed pulse at 1 s and settable pulse delay)

1 delayed CO contact +  
1 instantaneous CO contact

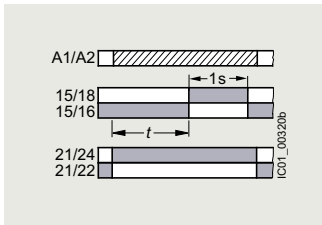

Pulse-delayed (fixed pulse at 1 s and settable pulse delay) and instantaneous contact

**L**  
2 CO switched in parallel

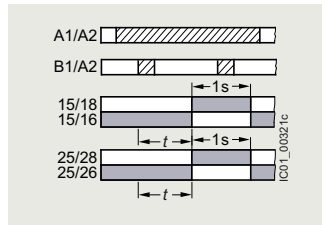

Pulse-delayed with control signal (fixed pulse at 1 s and settable pulse delay)

1 delayed CO contact +  
1 instantaneous CO contact

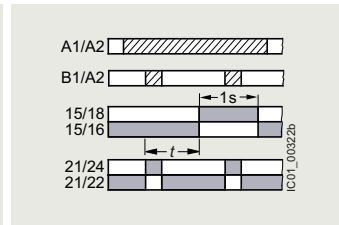

Pulse-delayed with control signal (fixed pulse at 1 s and settable pulse delay) and instantaneous contact

**M**  
2 CO switched in parallel

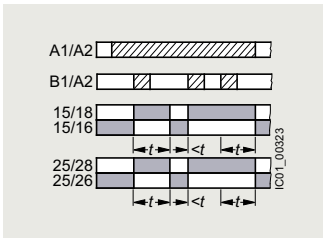

Retriggerable interval relay with activated control signal (watchdog)

1 delayed CO contact +  
1 instantaneous CO contact

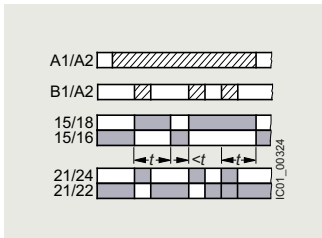

Retriggerable interval relay with activated control signal and instantaneous contact (watchdog)

**YΔ**  
2 CO contacts switched in parallel or  
1 delayed CO contact +  
1 instantaneous CO contact

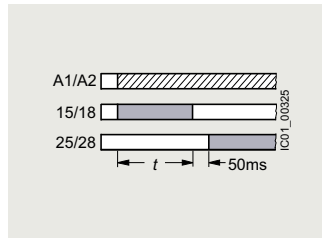

Wye-delta function

#### Legend

- I ... M Identification letters
- ▨ Timing relay energized
- Contact closed
- Contact open

SIRIUS 3RP25 timing relays, 17.5 mm and 22.5 mm

Monofunctions 3RP251. to 3RP257.<sup>1)</sup>

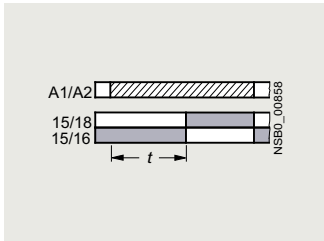

3RP251..AW30, 1 CO, ON-delay

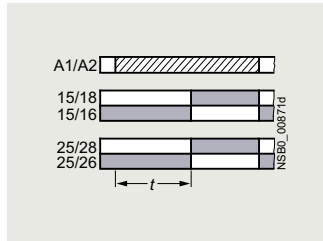

3RP2525..W30, 2 CO, ON-delay

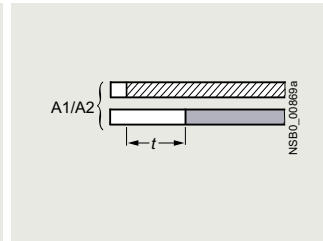

3RP2527..EW30, 1 NO (semiconductor), ON-delay

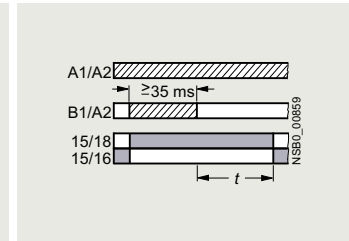

3RP2535..AW30, 1 CO, OFF-delay with control signal

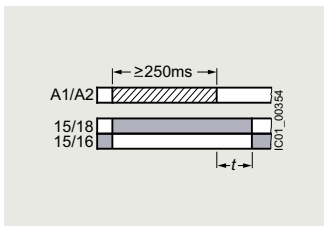

3RP2540..A.30, 1 CO, OFF-delay (N)<sup>1)</sup>

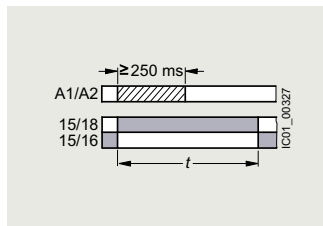

3RP2540..A.30, 1 CO, positive passing make contact (O)<sup>1)</sup>

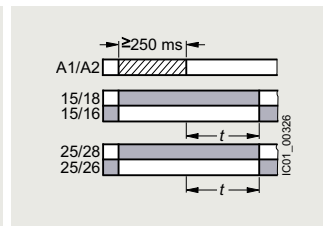

3RP2540..B.30, 2 CO, OFF-delay (N)<sup>1)</sup>

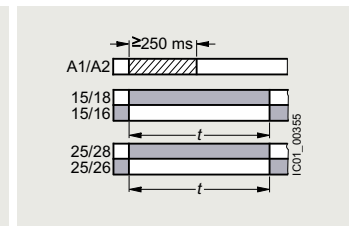

3RP2540..B.30, 2 CO, positive passing make contact (O)<sup>1)</sup>

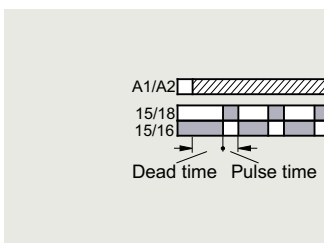

3RP2555..AW30, 1 CO, flashing, asymmetrical, starting with interval (clock-pulse relay)

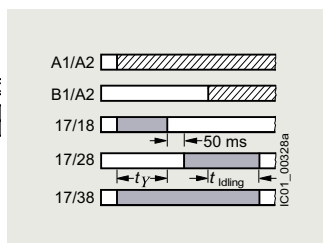

3RP2560..SW30, 3 NO, wye-delta function with overtravel function (idling)

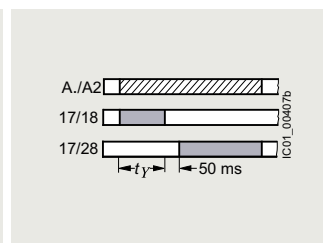

3RP257..NM20, 2 NO, wye-delta function

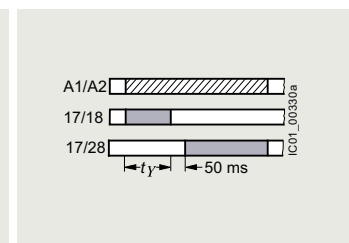

3RP257..NW30, 2 NO, wye-delta function

Legend

- Timing relay energized
- Contact closed
- Contact open

<sup>1)</sup> 3RP2540 has a double function:  
Function N = OFF-delay  
Function O = Positive passing make contact

## Monitoring and control devices

### Relays

#### Timing relays

#### SIRIUS 3RP25 timing relays, 17.5 mm and 22.5 mm

##### Possibilities of operation of the 3RP2560-.SW30 timing relay

Operation 1: Start contact B./A2 is open when control supply voltage A./A2 is applied

The control supply voltage is applied to A./A2 and there is no control signal on B./A2. This starts the  $\Upsilon\Delta$  timing. The idling time (coasting time) is started by applying a control signal to B./A2. When the set time  $t_{\text{idling}}$  (30 to 600 s) has elapsed, the output relays (17/38 and 17/28) are reset. If the control signal on B./A2 is switched off (minimum OFF period 270 ms), a new timing is started.

Note:

Observe response time (dead time) of 400 ms on energizing control supply voltage until contacts 17/18 and 17/38 close.

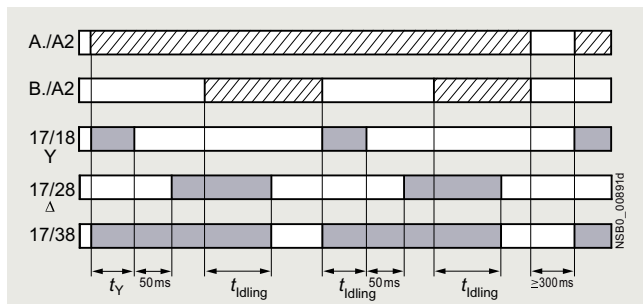

Operation 1

Operation 2: Start contact B./A2 is closed when control supply voltage A./A2 is applied

If the control signal B./A2 is already present when the control supply voltage A./A2 is applied, **no** timing is started. The timing is only started when the control signal B./A2 is switched off.

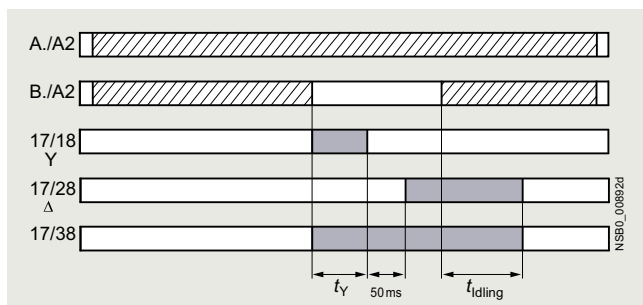

Operation 2

Operation 3: Start contact B./A2 closes while star time is running

If the control signal B./A2 is applied again during the star time, the idling time starts and the timing is terminated normally.

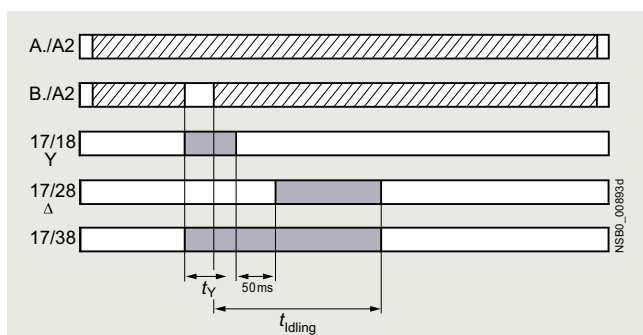

Operation 3

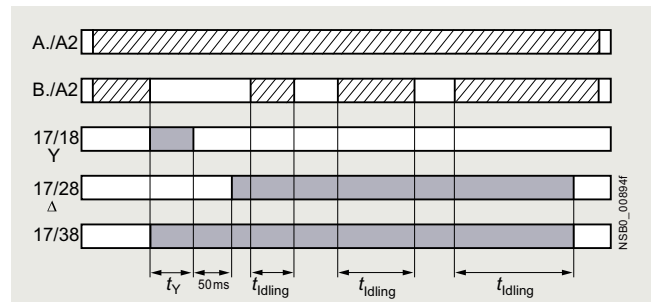

Operation 4: Start contact B./A2 opens while delta time is running and is applied again

If the control signal on B./A2 is applied and switched off again during the delta time, although the idling time has not yet elapsed, the idling time (coasting time) is reset to zero. If the control signal is re-applied to B./A2, the idling time is restarted.



Operation 4

Legend

-  Timing relay energized
-  Contact closed
-  Contact open

$t_Y$  = Star time 1 to 20 s

$t_{\text{idling}}$  = Idling time (coasting time) 30 to 600 s

Note:

The following applies to all operations: The pressure switch controls the timing via B./A2.

Application example based on standard operation (operation 1):  
For example, use of 3RP2560 for compressor control

Frequent starting of compressors strains the network, the machine, and the increased costs for the operator. The new timing relay prevents frequent starting at times when there is high demand for compressed air. A special control circuit prevents the compressor from being switched off immediately when the required air pressure in the tank has been reached. Instead, the valve in the intake tube is closed and the compressor runs in "Idling" mode, i.e. in no-load operation for a specific time which can be set from 30 to 600 s.

If the pressure falls within this time, the motor does not have to be restarted again, but can return to nominal load operation from no-load operation.

If the pressure does not fall within this idling time, the motor is switched off.

The pressure switch controls the timing via B./A2.

The control supply voltage is applied to A./A2 and the start contact B./A2 is open, i.e. there is no control signal on B./A2 when the control supply voltage is applied. The pressure switch signals "too little pressure in system" and starts the timing by way of terminal B./A2. The compressor is started, enters  $\Upsilon\Delta$  operation, and fills the pressure tank.

When the pressure switch signals "sufficient pressure", the control signal B./A2 is applied, the idling time (coasting time) is started, and the compressor enters no-load operation for the set period of time from 30 to 600 s. The compressor is then switched off. The compressor is only restarted if the pressure switch responds again (low pressure).

## Selection and ordering data



3RP2505-2AB30



3RP2505-2BB30



3RP2525-2AW30



3RP2540-2AW30



3RP2555-2AW30



3RP2576-2NW30

Number of NO contacts		Number of CO contacts		Semi-conductor output	Adjustable time	Control supply voltage		Standard coating IPC-610	Article No.	Weight
Instantaneous switching	Delayed switching	Instantaneous switching	Delayed switching			At 50/60 Hz AC	At DC			
kg										
<b>13 functions</b>										
0	0	0	1	No	0.05 s ... 100 h	24 12 ... 240	24 12 ... 240	No No Yes	<b>3RP2505-□AB30</b> <b>3RP2505-□AW30</b> <b>3RP2505-2AW30-0AX0</b>	0.143 0.146 0.140
0	1	0	0	Yes	0.05 s ... 100 h	12 ... 240	12 ... 240	No	<b>3RP2505-□CW30</b>	0.150
<b>13 functions, suitable for railway applications</b>										
0	0	0	2 <sup>1)</sup>	No	0.05 s ... 100 h	24 ... 240	24 ... 240	No Yes	<b>3RP2505-□RW30</b> <b>3RP2505-2RW30-0AX0</b>	0.180 0.176
<b>27 functions</b>										
0	0	0	2 <sup>2)</sup>	No	0.05 s ... 100 h	24 400 ... 440 12 ... 240	24 -- 12 ... 240	No No No Yes	<b>3RP2505-□BB30</b> <b>3RP2505-□BT20</b> <b>3RP2505-□BW30</b> <b>3RP2505-2BW30-0AX0</b>	0.174 0.174 0.180 0.168
<b>ON-delay</b>										
0	0	0	1	No	0.5 ... 10 s 1 ... 30 s 5 ... 100 s 0.05 s ... 100 h	12 ... 240 12 ... 240 12 ... 240 12 ... 240	12 ... 240 12 ... 240 12 ... 240 12 ... 240	No No No No	<b>3RP2511-□AW30</b> <b>3RP2512-□AW30</b> <b>3RP2513-□AW30</b> <b>3RP2525-□AW30</b>	0.138 0.137 0.138
0	0	0	2	No	0.05 s ... 100 h	24 12 ... 240	24 12 ... 240	No No	<b>3RP2525-□BB30</b> <b>3RP2525-□BW30</b>	0.165 0.167
0	1	0	0	Yes	0.05 s ... 240 s	12 ... 240	12 ... 240	No	<b>3RP2527-□EW30</b>	0.160
<b>OFF-delay with control signal</b>										
0	0	0	1	No	0.05 s ... 100 h	12 ... 240	12 ... 240	No	<b>3RP2535-□AW30</b>	0.149
<b>OFF-delay without control signal, non-volatile, passing make contact</b>										
0	0	0	1 <sup>4)</sup>	No	0.05 s ... 600 s	24 12 ... 240	24 12 ... 240	No No	<b>3RP2540-□AB30</b> <b>3RP2540-□AW30</b>	0.153 0.173
0	0	0	2 <sup>4)</sup>	No	0.05 s ... 600 s	24 12 ... 240	24 12 ... 240	No No	<b>3RP2540-□BB30</b> <b>3RP2540-□BW30</b>	0.167 0.177
<b>Clock-pulse relay, flashing, asymmetrical</b>										
0	0	0	1	No	0.05 s ... 100 h	12 ... 240	12 ... 240	No	<b>3RP2555-□AW30</b>	0.140
<b>Wye-delta function with coasting function (idling)</b>										
1	2	0	0	No	1 ... 20 s	12 ... 240	12 ... 240	No	<b>3RP2560-□SW30</b>	0.189
<b>Wye-delta function</b>										
1	1	0	0	No	1 ... 20 s	380 ... 440 <sup>3)</sup> 12 ... 240	-- 12 ... 240	No No	<b>3RP2574-□NM20</b> <b>3RP2574-□NW30</b>	0.159 0.155
1	1	0	0	No	3 ... 60 s	380 ... 440 <sup>3)</sup> 12 ... 240	-- 12 ... 240	No No	<b>3RP2576-□NM20</b> <b>3RP2576-□NW30</b>	0.160 0.153

## Type of electrical connection

- Screw terminals
- Spring-loaded terminals (push-in)

- Force-guided contacts.
- Optionally 1 CO delayed + 1 CO instantaneous.
- With 3RP2574-.NM20 and 3RP2576-.NM20, connection of 200 to 240 V AC, 50/60 Hz control voltage is also possible.
- Setting of output contacts in as-supplied state not defined (bistable relay). Application of the control supply voltage once results in contact changeover to the correct setting.

## Notes:

For accessories, see page 2/226.

In the case of 3RP2505, the functions can be adjusted by means of function selector switches on the device. With a set of foil labels the timing relay can be legibly marked with the functions which can be selected on the timing relay. This is included in the scope of supply. The same potential must be applied to terminals A. and B.

For functions, see the overview of functions on page 2/216.

## Monitoring and control devices

### Relays











### Timing relays

## SIRIUS 3RP25 timing relays, 17.5 mm and 22.5 mm

### Accessories

#### More information

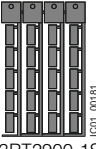
You can find information on configuring and dimensioning the accessories in the Equipment Manual, see <https://support.industry.siemens.com/cs/ww/en/view/103532830>

Version	Article No.	Weight kg
<b>Terminals for SIRIUS devices in the industrial standard mounting rail enclosure</b>		
 3ZY1122-1BA00	<b>Removable terminals</b> <ul style="list-style-type: none"> <li>• 2-pole, up to 1 x 4 mm<sup>2</sup> or 2 x 2.5 mm<sup>2</sup></li> </ul>	<b>Screw terminals</b>  <b>3ZY1122-1BA00</b> 0.010
 3ZY1122-2BA00	<b>Removable terminals</b> <ul style="list-style-type: none"> <li>• 2-pole, up to 1 x 4 mm<sup>2</sup> or 2 x 1.5 mm<sup>2</sup> (in shared end sleeve)</li> </ul>	<b>Spring-loaded terminals (push-in)</b>  <b>3ZY1122-2BA00</b> 0.008
<b>Accessories for enclosures</b>		
 3ZY1321-2AA00	<b>Sealing covers</b> <ul style="list-style-type: none"> <li>• 17.5 mm</li> <li>• 22.5 mm</li> </ul>	<b>3ZY1321-1AA00</b> 0.002 <b>3ZY1321-2AA00</b> 0.002
 3ZY1311-0AA00	<b>Push-in lugs</b> For wall mounting	<b>3ZY1311-0AA00</b> 0.001
 3ZY1440-1AA00	<b>Coding pins</b> For removable terminals of SIRIUS devices in the industrial standard mounting rail enclosure; enable the mechanical coding of terminals	<b>3ZY1440-1AA00</b> 0.002
 3ZY1450-1AB00	<b>Hinged cover</b> Replacement cover, without terminal labeling, titanium gray <ul style="list-style-type: none"> <li>• 17.5 mm wide</li> <li>• 22.5 mm wide</li> </ul>	<b>3ZY1450-1AA00</b> 0.002 <b>3ZY1450-1AB00</b> 0.004
<b>Blank labels</b>		
 3RT2900-1SB20	<b>Unit labeling plates<sup>1)</sup></b> For SIRIUS devices <ul style="list-style-type: none"> <li>• 10 mm x 7 mm, titanium gray</li> <li>• 20 mm x 7 mm, titanium gray</li> </ul>	<b>3RT2900-1SB10</b> 0.028 <b>3RT2900-1SB20</b> 0.062
<b>Tools for opening spring-loaded terminals</b>		
 3RA2908-1A	<b>Screwdrivers</b> For all SIRIUS devices with spring-loaded terminals <p>Length approx. 200 mm,            3.0 mm x 0.5 mm,            titanium gray/black,            partially insulated</p>	<b>Spring-loaded terminals (push-in)</b>  <b>3RA2908-1A</b> 0.050

<sup>1)</sup> PC labeling system for individual inscription of unit labeling plates available from: murrplastik Systemtechnik GmbH.

## Overview

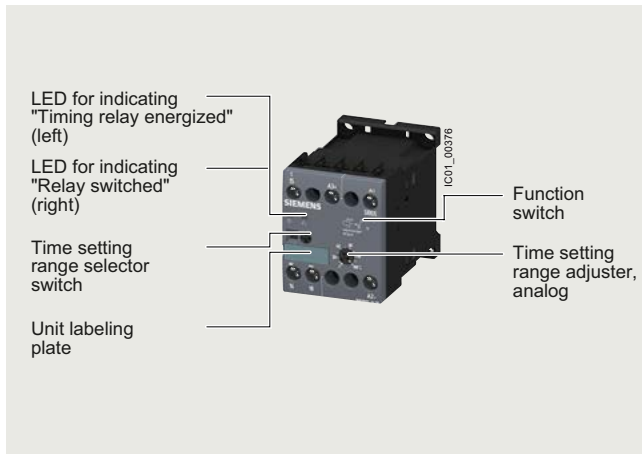

SIRIUS 3RP20 timing relay

SIRIUS 3RP20 electronic timing relays for use in control systems and mechanical engineering with:

- 1 or 2 CO contacts
- Multifunction or monofunction
- Wide voltage range or combination voltage
- Single or selectable time setting ranges
- Switch position indication and voltage indication by LED

## Standards

The timing relays comply with:

- IEC 60721-3-3 "Classification of environmental conditions"
- IEC 61812-1 "Specified time relays for industrial use"
- IEC 61000-6-2 and IEC 61000-6-4 "Electromagnetic compatibility"
- IEC 60947-5-1 "Low-voltage switchgear and controlgear – Electromechanical control circuit devices"
- IEC 60947-1, Annex N "Protective separation"

## Multifunction

The functions of the 3RP2005 multifunctional timing relays can be set by means of the function selector switch. Insert labels can be used to adjust different functions of the timing relay clearly and unmistakably. The corresponding labels can be ordered as an accessory. The same potential must be applied to terminals A. and B.

For functions, see 3RP2901 label set, page 2/232.

## Note:

The activation of loads parallel to the start input is not permissible when using AC control voltage.

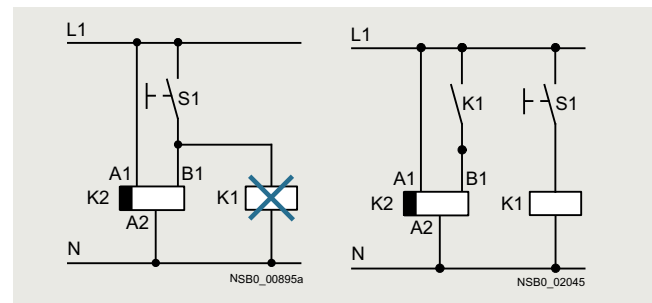

Diagrams

## Accessories

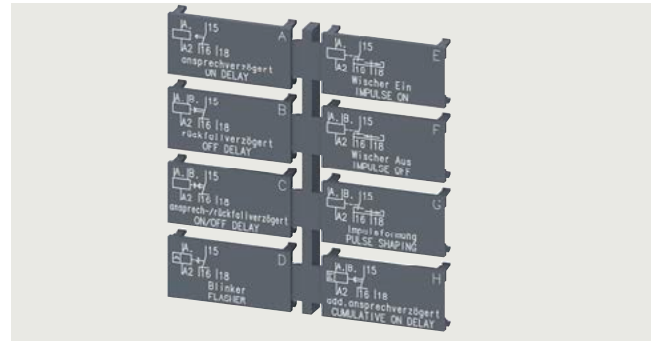

Label set for marking the multifunctional relay

## Article No. scheme

Product versions		Article number	
<b>SIRIUS timing relays, 45 mm enclosure</b>		<b>3RP20 □ □ - □ □ □ 3 0</b>	
Product function/ time setting ranges	Multifunction	<b>0 5</b>	15 time ranges 0.05 s... 100 h
	ON-delay	<b>2 5</b>	15 time ranges 0.05 s... 100 h
Connection type	Screw terminals	<b>1</b>	
	Spring-loaded terminals	<b>2</b>	
Contacts	1 CO	<b>A</b>	
	2 CO	<b>B</b>	
Control supply voltage	24 V AC/DC/100 ... 127 V AC	<b>Q</b>	Combination voltage
	24 V AC/DC/200 ... 240 V AC	<b>P</b>	Combination voltage
	24 ... 240 V AC/DC	<b>W</b>	Wide voltage range
Example		<b>3RP20 0 5 - 1 A P 3 0</b>	

## Note:

The Article No. scheme shows an overview of product versions for better understanding of the logic behind the article numbers.

For your orders, please use the article numbers quoted in the selection and ordering data.

## Monitoring and control devices

### Relays

#### Timing relays

#### SIRIUS 3RP20 timing relays, 45 mm



##### Benefits

- Suitable for 3RT miniature contactors
- Uniform design
- Ideal for small distance between standard mounting rails and/or for low mounting depth, e.g. in control boxes
- Labels are used on the multifunctional timing relay to document the function that has been set

##### Application

Timing relays are used in control, starting, and protective circuits for all switching operations involving time delays. They guarantee a high level of functionality and a high repeat accuracy of timer settings.

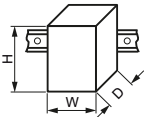
##### Technical specifications

More information	
Technical specifications, see <a href="https://support.industry.siemens.com/cs/ww/en/ps/16356/td">https://support.industry.siemens.com/cs/ww/en/ps/16356/td</a> Operating Instructions, see <a href="https://support.industry.siemens.com/cs/ww/en/view/11647144">https://support.industry.siemens.com/cs/ww/en/view/11647144</a>	Internal circuit diagrams, see CAx Download Manager <a href="https://support.industry.siemens.com/my/ww/en/CAxOnline#CAxOnline">https://support.industry.siemens.com/my/ww/en/CAxOnline#CAxOnline</a> FAQs, see <a href="https://support.industry.siemens.com/cs/ww/en/ps/16356/faq">https://support.industry.siemens.com/cs/ww/en/ps/16356/faq</a>
<b>Type</b>	<b>3RP2005, 3RP2025</b>
Dimensions (W x H x D)	mm 45 x 57 x 73
	
<b>Rated insulation voltage</b> Pollution degree 3 Overvoltage category III	V AC 300
<b>Permissible ambient temperature</b> • During operation • During storage	°C -25 ... +60 °C -40 ... +85
<b>Operating range of excitation<sup>1)</sup></b>	0.85 ... 1.1 x $U_N$ at AC; 0.8 ... 1.25 x $U_N$ at DC; 0.95 ... 1.05 times the rated frequency
<b>Mechanical service life</b>	Operating cycles 10 x 10 <sup>6</sup>
<b>Electrical endurance at <math>I_e</math></b>	Operating cycles 1 x 10 <sup>5</sup>
<b>Connection type</b>	 <b>Screw terminals</b>
• Terminal screw • Solid • Finely stranded with end sleeve • Stranded • AWG cables • Tightening torque	mm <sup>2</sup> M3 (for standard screwdriver, size 2 and Pozidriv 2) mm <sup>2</sup> 2 x (0.5 ... 1.5) <sup>2)</sup> , 2 x (0.75 ... 2.5) <sup>2)</sup> mm <sup>2</sup> 2 x (0.5 ... 1.5) <sup>2)</sup> , 2 x (0.75 ... 2.5) <sup>2)</sup> AWG 2 x (0.5 ... 1.5) <sup>2)</sup> , 2 x (0.75 ... 2.5) <sup>2)</sup> AWG 2 x (18 ... 14) Nm 0.8 ... 1.2
<b>Connection type</b>	 <b>Spring-loaded terminals</b>
• Solid • Finely stranded with end sleeve • Finely stranded without end sleeve • AWG cables, solid or stranded • Max. external diameter of the conductor insulation	mm <sup>2</sup> 2 x (0.25 ... 2.5) mm <sup>2</sup> 2 x (0.25 ... 1.5) mm <sup>2</sup> 2 x (0.25 ... 2.5) AWG 2 x (24 ... 14) mm 3.6

<sup>1)</sup> If nothing else is stated.

<sup>2)</sup> If two different conductor cross-sections are connected to one clamping point, both cross-sections must lie in one of the ranges specified.

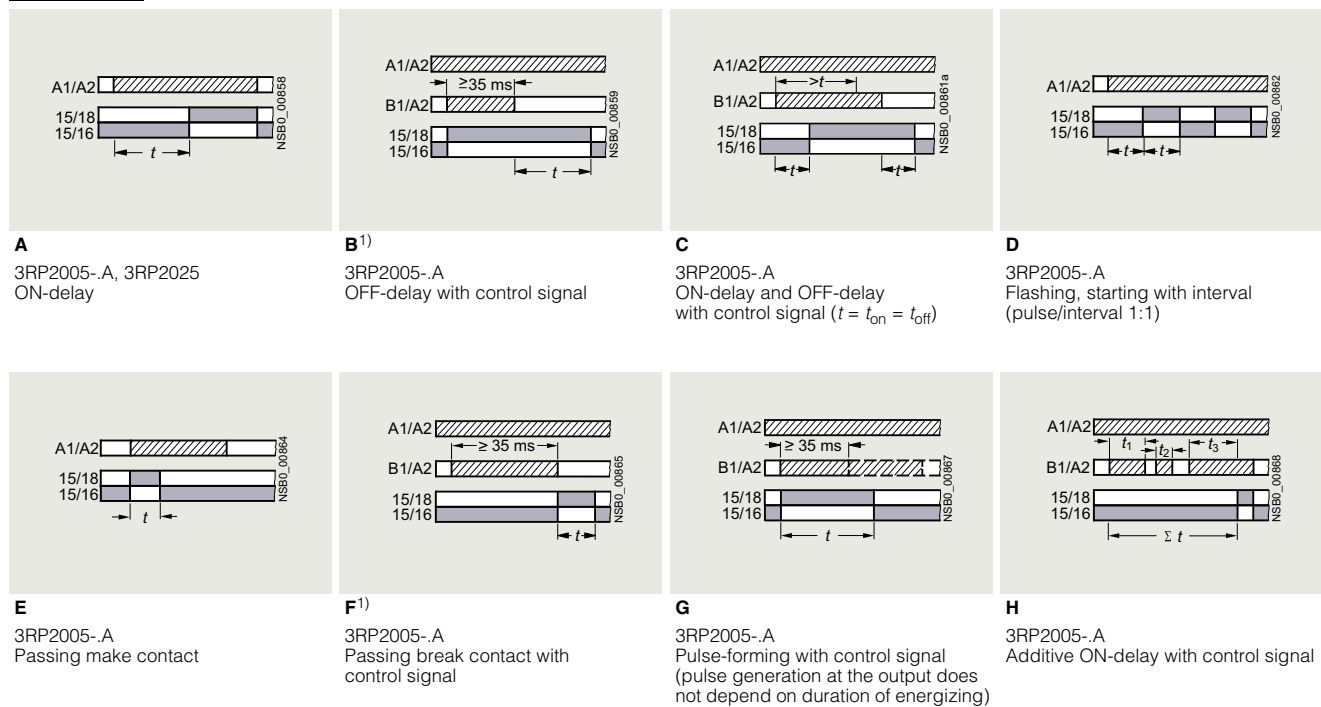
**3RP20 function diagrams and 3RP2901 label set**
**1 CO contact**

**Legend**
**A ... H** Identification letters for 3RP2005

Timing relay energized

Contact closed

Contact open

<sup>1)</sup> A new control signal at terminal B, after the operating time has started, resets the operating time to zero (retriggerable).



# Monitoring and control devices

## Relays

### Timing relays

#### SIRIUS 3RP20 timing relays, 45 mm

##### 2 CO contacts

2

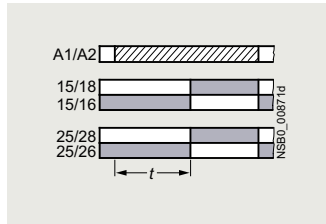

**A**  
3RP2005-.B  
ON-delay

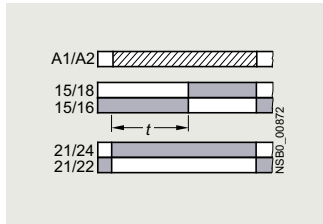

**A•**  
3RP2005-.B  
ON-delay and instantaneous contact

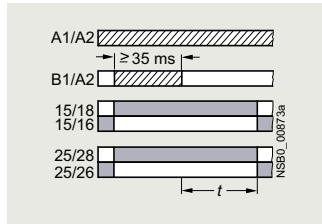

**B¹)**  
3RP2005-.B  
OFF-delay with control signal

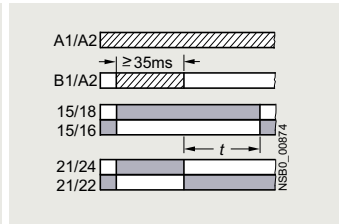

**B•¹)**  
3RP2005-.B  
OFF-delay with control signal and instantaneous contact

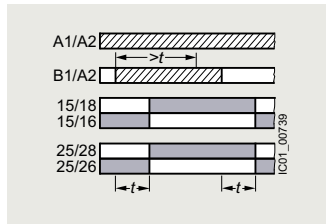

**C**  
3RP2005-.B  
ON-delay and OFF-delay with control signal ( $t = t_{on} = t_{off}$ )

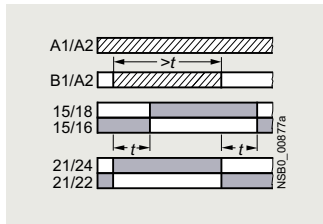

**C•**  
3RP2005-.B  
ON-delay and OFF-delay with control signal and instantaneous contact ( $t = t_{on} = t_{off}$ )

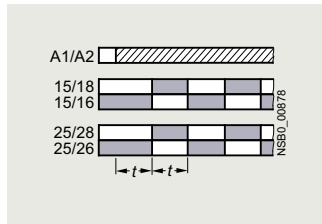

**D**  
3RP2005-.B  
Flashing, starting with interval (pulse/interval 1:1)

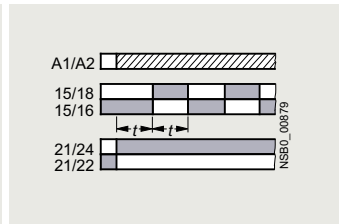

**D•**  
3RP2005-.B  
Flashing, starting with interval (pulse/interval 1:1) and instantaneous contact

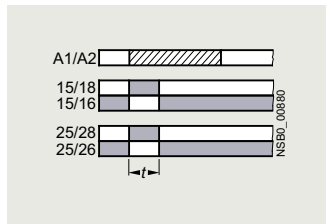

**E**  
3RP2005-.B  
Passing make contact

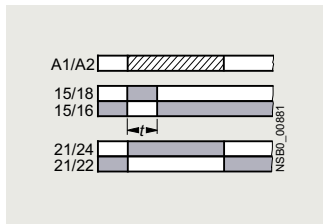

**E•**  
3RP2005-.B  
Passing make contact and instantaneous contact

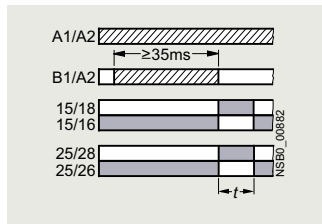

**F¹)**  
3RP2005-.B  
Passing break contact with control signal

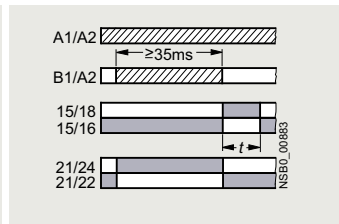

**F•¹)**  
3RP2005-.B  
Passing break contact with control signal and instantaneous contact

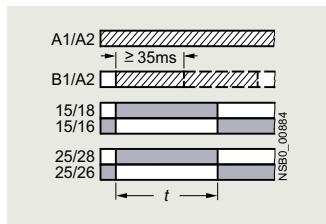

**G**  
3RP2005-.B  
Pulse-forming with control signal (pulse generation at the output does not depend on duration of energizing)

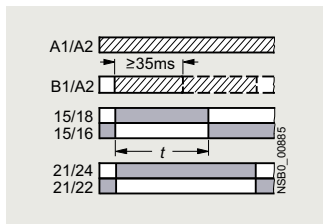

**G•**  
3RP2005-.B  
Pulse-forming with control signal and instantaneous contact (pulse generation at the output does not depend on duration of energizing)

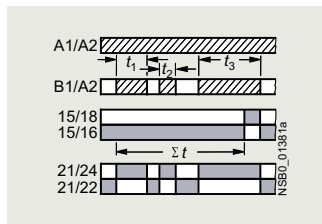

**H•**  
3RP2005-.B  
Additive ON-delay with control signal and instantaneous contact

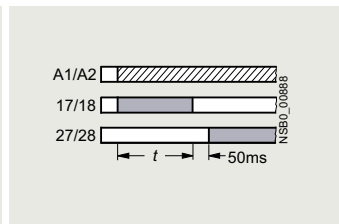

**YΔ**  
3RP2005-.B  
Wye-delta function

#### Legend

**A ... H** Identification letters for 3RP2005

▨ Timing relay energized

■ Contact closed

□ Contact open

¹) A new control signal at terminal B, after the operating time has started, resets the operating time to zero (retriggerable).

## Selection and ordering data



3RP2005-2AP30



3RP2005-2BW30

Version	Time setting range $t$	Rated control supply voltage $U_s$		Spring-loaded terminals 	Weight
		50/60 Hz AC	DC		
		V	V	Article No.	kg

**3RP2005 timing relays, multifunction, 15 time setting ranges**

The functions can be adjusted by means of rotary switches. Insert labels can be used to adjust different functions of the 3RP2005 timing relay clearly and unmistakably. The corresponding labels can be ordered as an accessory.

The same potential must be applied to terminals A. and B.

For functions, see 3RP2901 label set, page 2/232.

With LED and 1 CO contact <sup>1)</sup> , 8 functions	0.05 ... 1 s 0.15 ... 3 s 0.5 ... 10 s	24/100 ... 127 24/200 ... 240	24 24	3RP2005-2AQ30 3RP2005-2AP30	0.100 0.100
With LED and 2 CO contacts, 16 functions	1.5 ... 30 s 0.05 ... 1 min 5 ... 100 s 0.15 ... 3 min 0.5 ... 10 min 1.5 ... 30 min 0.05 ... 1 h 5 ... 100 min 0.15 ... 3 h 0.5 ... 10 h 1.5 ... 30 h 5 ... 100 h $\infty$ <sup>2)</sup>	24 ... 240 <sup>3)</sup>	24 ... 240 <sup>4)</sup>	3RP2005-2BW30	0.110

**3RP2025 timing relays, ON-delay, 15 time setting ranges**

With LED and 1 CO contact <sup>1)</sup>	0.05 ... 1 s 0.15 ... 3 s 0.5 ... 10 s 1.5 ... 30 s 0.05 ... 1 min 5 ... 100 s 0.15 ... 3 min 0.5 ... 10 min 1.5 ... 30 min 0.05 ... 1 h 5 ... 100 min 0.15 ... 3 h 0.5 ... 10 h 1.5 ... 30 h 5 ... 100 h $\infty$ <sup>2)</sup>	24/100 ... 127 24/200 ... 240	24 24	3RP2025-2AQ30 3RP2025-2AP30	0.095 0.095
---	---	----------------------------------	----------	--------------------------------	----------------

For accessories, see page 2/232.

- 1) Units with protective separation.
- 2) With  $\infty$  switch position no timing. For test purposes (ON/OFF function) on site. Relay is constantly on when activated, or relay remains constantly off when activated. Depending on which function is set.
- 3) Operating range 0.8 to 1.1  $\times U_s$ .
- 4) Operating range 0.7 to 1.1  $\times U_s$ .

## Monitoring and control devices

### Relays

#### Timing relays

#### SIRIUS 3RP20 timing relays, 45 mm

#### Accessories

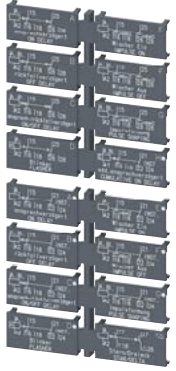
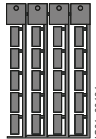
Version	Function	Identifica- tion letter	Use	Article No.	Weight kg			
<b>Label sets for 3RP20</b>								
Accessories for 3RP20 (not included in the scope of supply). The label set can be used to label timing relays with the set function in English and German.								
 3RP2901-0A	1 label set (1 unit) with 8 functions	<ul style="list-style-type: none"> <li>• ON-delay</li> <li>• OFF-delay with control signal</li> <li>• ON-delay and OFF-delay with control signal</li> <li>• Flashing, starting with interval</li> <li>• Passing make contact</li> <li>• Passing break contact with control signal</li> <li>• Pulse-forming with control signal</li> <li>• Additive ON-delay with control signal</li> </ul>	A B C D E F G H	For devices with 1 CO	<b>3RP2901-0A</b>	0.003		
	 3RP2901-0B	1 label set (1 unit) with 16 functions	<ul style="list-style-type: none"> <li>• ON-delay</li> <li>• OFF-delay with control signal</li> <li>• ON-delay and OFF-delay with control signal</li> <li>• Flashing, starting with interval</li> <li>• Passing make contact</li> <li>• Passing break contact with control signal</li> <li>• Pulse-forming with control signal</li> <li>• ON-delay and instantaneous contact</li> <li>• OFF-delay with control signal and instantaneous contact</li> <li>• ON-delay and OFF-delay with control signal and instantaneous contact</li> <li>• Flashing, starting with interval, and instantaneous contact</li> <li>• Passing make contact and instantaneous contact</li> <li>• Passing break contact with control signal and instantaneous contact</li> <li>• Pulse-forming with control signal and instantaneous contact</li> <li>• Additive ON-delay with control signal and instantaneous contact</li> <li>• Wye-delta function</li> </ul>	A B C D E F G A• B• C• D• E• F• G• H• YΔ	For devices with 2 CO	<b>3RP2901-0B</b>	0.005	
		<b>Blank labels</b>						
		 3RT2900-1SB20	<b>Unit labeling plates<sup>1)</sup></b> For SIRIUS devices	<ul style="list-style-type: none"> <li>• 20 mm x 7 mm, titanium gray</li> </ul>		For 3RP20	<b>3RT2900-1SB20</b>	0.062

<sup>1)</sup> PC labeling system for individual inscription  
of unit labeling plates available from:  
murrplastik Systemtechnik GmbH.

## SIRIUS 3RR21, 3RR22 monitoring relays for mounting on 3RT2 contactors

## Current and active current monitoring

## Overview

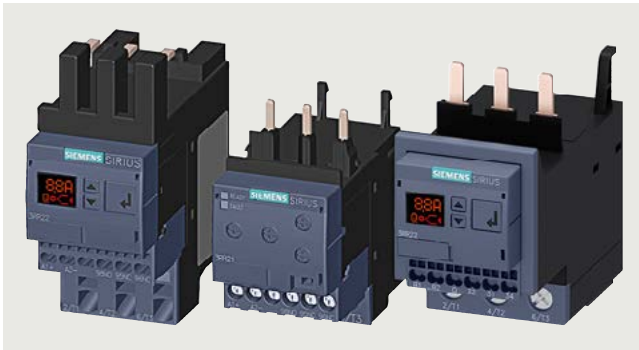

SIRIUS 3RR2242, 3RR2142, 3RR2243 current monitoring relays

## More information

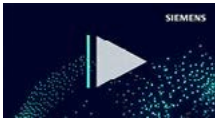
Homepage, see [www.siemens.com/sirius-monitoring-relays](http://www.siemens.com/sirius-monitoring-relays)Industry Mall, see [www.siemens.com/product?3RR21](http://www.siemens.com/product?3RR21)

Video: SIRIUS 3RR2 current monitoring relays

The SIRIUS 3RR2 current monitoring relays are suitable for load monitoring of motors or other loads. In 2 or 3 phases they monitor the rms value of AC currents for overshooting or undershooting of set threshold values.

Whereas apparent current monitoring is used above all in connection with the rated torque or in case of overload, the active current monitoring option can be used to observe and evaluate the load factor over a motor's entire torque range.

The 3RR2 current monitoring relays can be integrated directly in the feeder by mounting on the 3RT2 contactor; separate wiring of the main circuit is therefore superfluous. No separate transformers are required.

For a line-oriented configuration or simultaneous use of an overload relay, terminal supports for stand-alone installation are available for separate standard rail mounting.

## Versions

## Basic versions

The basic versions with 2-phase apparent current monitoring, a CO contact output and analog adjustability provide a high level of monitoring reliability especially in the rated and overload range.

## Standard versions

The standard versions monitor the current in 3 phases with selectable active current monitoring. They have additional diagnostics options such as residual-current monitoring and phase sequence monitoring, and they are also suitable for monitoring motors below the rated torque. These devices have an additional independent semiconductor output, an actual value indicator, and are digitally adjustable.

Both versions are available optionally with screw or spring-loaded terminals, in each case for sizes S00 and S0. With variants of size S2 the main conducting paths always have screw terminals; the control current side can have screw or spring-loaded terminals.

## Note:

In addition to the features of the standard versions, the 3RR24 monitoring relays for mounting on 3RT2 contactors for IO-Link also offer the possibility of transmitting the measured values and diagnostics data to a controller via an IO-Link. Furthermore, the devices can be parameterized on the devices themselves or via IO-Link.

For more information, see page 2/241 onwards.

## 3RR21 and 3RR22 overview table



Features	3RR21	3RR22	Benefits
<b>General data</b>			
<b>Sizes</b>	S00, S0, S2	S00, S0, S2	<ul style="list-style-type: none"> <li>Are coordinated with the dimensions, connections and technical characteristics of the other devices in the SIRIUS modular system (contactors, soft starters, etc.)</li> <li>Permit the mounting of slim-line and compact load feeders in widths of 45 mm (S00 and S0) and 55 mm (S2)</li> <li>Simplify configuration</li> </ul>
Dimensions in mm (W x H x D)	S00: 45 x 79 x 80, S0: 45 x 87 x 91, S2: 55 x 99 x 112	S00: 45 x 79 x 80, S0: 45 x 87 x 91, S2: 55 x 99 x 112	
• Screw terminals			
• Spring-loaded terminals	S00: 45 x 90 x 80, S0: 45 x 109 x 92, S2: 55 x 99 x 112	S00: 45 x 90 x 80, S0: 45 x 109 x 92, S2: 55 x 99 x 112	
<b>Current range</b>	S00: 1.6 ... 16 A S0: 4 ... 40 A S2: 8 ... 80 A	S00: 1.6 ... 16 A S0: 4 ... 40 A S2: 8 ... 80 A	<ul style="list-style-type: none"> <li>Is adapted to the other devices in the SIRIUS modular system</li> <li>Just a single version per size with a wide setting range enables easy configuration</li> </ul>
<b>Permissible ambient temperature</b>			
During operation	-25 ... +60 °C	-25 ... +60 °C	<ul style="list-style-type: none"> <li>Suitable for applications in the control cabinet, worldwide</li> </ul>

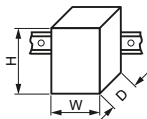

## Monitoring and control devices

### Relays

#### SIRIUS 3RR21, 3RR22 monitoring relays for mounting on 3RT2 contactors

#### Current and active current monitoring

2

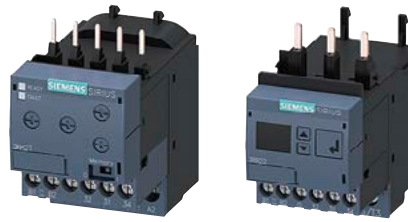

Features	3RR21	3RR22	Benefits
<b>Monitoring functions</b>			
<b>Current overshoot</b>	✓ (2-phase)	✓ (3-phase)	<ul style="list-style-type: none"> <li>Provides optimum inverse-time delayed protection of loads against excessive temperature rises due to overload</li> <li>Enables detection of filter blockages or pumping against closed gate valves</li> <li>Enables drawing conclusions about wear, poor lubrication or other maintenance-relevant phenomena</li> </ul>
<b>Current undershoot</b>	✓ (2-phase)	✓ (3-phase)	<ul style="list-style-type: none"> <li>Enables detection of overload due to a slipping or torn belt</li> <li>Guarantees protection of pumps against dry running</li> <li>Facilitates monitoring of the functions of resistive loads such as heaters</li> <li>Permits energy savings through monitoring of no-load operation</li> </ul>
<b>Apparent current monitoring</b>	✓	✓ (Selectable)	<ul style="list-style-type: none"> <li>Precision current monitoring especially in a motor's rated and upper torque range</li> </ul>
<b>Active current monitoring</b>	--	✓ (Selectable)	<ul style="list-style-type: none"> <li>Optimum current monitoring over a motor's entire torque range through the patented combination of power factor and apparent current monitoring</li> </ul>
<b>Range monitoring</b>	✓ (2-phase)	✓ (3-phase)	<ul style="list-style-type: none"> <li>Simultaneous monitoring of current overshoot and undershoot with a single device</li> </ul>
<b>Phase failure, open circuit</b>	✓ (2-phase)	✓ (3-phase)	<ul style="list-style-type: none"> <li>Minimizes heating of three-phase motors during phase failure through immediate disconnection</li> <li>Prevents operation of hoisting equipment with half the load carrying capacity</li> </ul>
<b>Phase sequence monitoring</b>	--	✓ (Selectable)	<ul style="list-style-type: none"> <li>Prevents starting of motors, pumps or compressors in the wrong direction of rotation</li> </ul>
<b>Internal ground-fault detection (residual-current monitoring)</b>	--	✓ (Selectable)	<ul style="list-style-type: none"> <li>Provides optimum protection of loads against high-resistance short circuits or ground faults due to moisture, condensed water, damage to the insulation material, etc.</li> <li>Eliminates the need for additional special equipment and thus space in the control cabinet</li> <li>Reduces wiring overhead and costs</li> </ul>
<b>Blocking current monitoring</b>	--	✓ (Selectable)	<ul style="list-style-type: none"> <li>Minimizes heating of three-phase motors when blocked during operation through immediate disconnection</li> <li>Minimizes mechanical loading of the system by acting as an electronic shear pin</li> </ul>
<b>Features</b>			
<b>RESET function</b>	✓	✓	<ul style="list-style-type: none"> <li>Allows manual or automatic resetting of the relay</li> <li>Resetting directly on the device or by switching the control supply voltage off and on (Remote RESET)</li> </ul>
<b>ON-delay time</b>	0 ... 60 s	0 ... 99 s	<ul style="list-style-type: none"> <li>Enables motor starting without evaluation of the starting current</li> <li>Can be used for monitoring motors with lengthy startup</li> </ul>
<b>Tripping delay time</b>	0 ... 30 s	0 ... 30 s	<ul style="list-style-type: none"> <li>Permits brief threshold value violations during operation</li> <li>Prevents frequent warnings and disconnections with currents near the threshold values</li> </ul>
<b>Operating and indicating elements</b>	LEDs and rotary potentiometers	Displays and buttons	<ul style="list-style-type: none"> <li>For setting the threshold values and delay times and for fast and targeted diagnostics</li> <li>For selectable functions</li> <li>Displays for permanent display of measured values</li> </ul>
<b>Integrated contacts</b>	1 CO contact	1 CO contact, 1 semiconductor output	<ul style="list-style-type: none"> <li>Enable disconnection of the system or process when there is an irregularity</li> <li>Can be used to output signals</li> </ul>

✓ Available

-- Not available

## SIRIUS 3RR21, 3RR22 monitoring relays for mounting on 3RT2 contactors

## Current and active current monitoring



Features	3RR21	3RR22	Benefits
<b>Design of load feeders</b>			
<b>Short-circuit strength up to 100 kA at 690 V</b> (in conjunction with the corresponding fuses or the corresponding motor starter protector)	✓	✓	<ul style="list-style-type: none"> <li>Provides optimum protection of the loads and operating personnel in the event of short circuits due to insulation faults or faulty switching operations</li> </ul>
<b>Electrical and mechanical matching to 3RT2 contactors</b>	✓	✓	<ul style="list-style-type: none"> <li>Simplifies configuration</li> <li>Reduces wiring overhead and costs</li> <li>Enables stand-alone installation as well as space-saving direct mounting</li> </ul>
<b>Spring-loaded terminals for main circuit (with S00, S0) and auxiliary circuits</b>	✓ (optional)	✓ (optional)	<ul style="list-style-type: none"> <li>Enables fast connections</li> <li>Permits vibration-resistant connections</li> <li>Enables maintenance-free connections</li> </ul>
<b>Other features</b>			
<b>Suitable for 1-phase and 3-phase loads</b>	✓	✓	<ul style="list-style-type: none"> <li>Enables the monitoring of 1-phase systems through parallel infeed at the contactor or looping the current through the three phase connections</li> </ul>
<b>Wide setting ranges</b>	✓	✓	<ul style="list-style-type: none"> <li>Reduce the number of versions</li> <li>Minimize the configuration overhead and costs</li> <li>Minimize storage overhead, storage costs, tied-up capital</li> </ul>
<b>Wide-voltage supply range</b>	✓ (optional)	✓ (optional)	<ul style="list-style-type: none"> <li>Reduces the number of versions</li> <li>Minimizes the configuring overhead and costs</li> <li>Minimizes storage overhead, storage costs, tied-up capital</li> </ul>

✓ Available

**Possible combinations of 3RR21/3RR22 monitoring relays with 3RT2 contactors**

Monitoring relays	Current range	Contactors (type, size, operating power)		
		3RT201 S00	3RT202 S0	3RT203 S2
Type	A	3/4/5.5/7.5 kW	5.5/7.5/11/15/18.5 kW	18.5/22/30/37 kW
<b>3RR2.41</b>				
3RR2141	1.6 ... 16	✓	With stand-alone installation support	With stand-alone installation support
3RR2241	1.6 ... 16	✓	With stand-alone installation support	With stand-alone installation support
<b>3RR2.42</b>				
3RR2142	4 ... 40	With stand-alone installation support	✓	With stand-alone installation support
3RR2242	4 ... 40	With stand-alone installation support	✓	With stand-alone installation support
<b>3RR2.43</b>				
3RR2143	8 ... 80	With stand-alone installation support	With stand-alone installation support	✓
3RR2243	8 ... 80	With stand-alone installation support	With stand-alone installation support	✓

✓ Available

## Monitoring and control devices

### Relays

#### SIRIUS 3RR21, 3RR22 monitoring relays for mounting on 3RT2 contactors

#### Current and active current monitoring

##### Article No. scheme

Product versions		Article number									
Monitoring relays		3RR2	□ 4	□ -	□ □	□ 3	0				
Type of setting	Analogically adjustable, 2-phase	1									
	Digitally adjustable, 3-phase	2									
Size	S00		1								
	S0		2								
	S2		3								
Connection type	Screw terminals				1						
	Spring-loaded terminals Size S00, S0				2						
	Size S2				3						
Number and type of outputs	1 CO contact					A					
	1 CO contact + 1 semiconductor					F					
Rated control supply voltage	24 V AC/DC						A				
	24 ... 240 V AC/DC						W				
Example		3RR2	1	4	1	-	1	A	A	3	0

##### Note:

The Article No. scheme shows an overview of product versions for better understanding of the logic behind the article numbers.

For your orders, please use the article numbers quoted in the selection and ordering data.

#### Benefits

- Can be mounted directly on 3RT2 contactors and 3RA23 reversing contactor assemblies, in other words, there is no need for additional wiring in the main circuit
- Optimally coordinated with the technical characteristics of the 3RT2 contactors
- No separate current transformer required
- Versions with wide voltage supply range
- Variably adjustable to overshoot, undershoot or range monitoring
- Freely configurable delay times and RESET response
- Display of actual value and status messages
- All versions with removable control current terminals
- All versions with screw terminals or spring-loaded terminals
- Simple determination of the threshold values through direct reference to actually measured values for setpoint loading
- Range monitoring and selectable active current measurement mean that only one device for monitoring a motor is required along the entire torque curve
- In addition to current monitoring it is also possible to monitor for broken cables, phase failure, phase sequence, residual current and motor blocking

#### Application

- Monitoring for current overshoot and undershoot
- Monitoring of broken conductors
- Monitoring of no-load operation and load shedding, e.g. in the event of a torn V-belt or no-load operation of a pump
- Monitoring of overload, e.g. on conveyor belts or cranes due to an excessive load
- Monitoring the functionality of electrical loads such as heaters
- Monitoring of wrong phase sequence on mobile equipment such as compressors or cranes
- Monitoring of high-resistance ground faults, e.g. caused by damaged insulation or moisture

Technical specifications

More information

Technical specifications, see <https://support.industry.siemens.com/cs/ww/en/ps/16205/td>  
 Configuration Manual for load feeders, see <https://support.industry.siemens.com/cs/ww/en/view/39714188>

System Manual for modular system, see <https://support.industry.siemens.com/cs/ww/en/view/60311318>  
 Equipment Manual, see <https://support.industry.siemens.com/cs/ww/en/view/54397927>  
 FAQs, see <https://support.industry.siemens.com/cs/ww/en/ps/16205/faq>

Function diagrams of 3RR214.-A.30 basic versions, analogically adjustable

Closed-circuit principle upon application of the control supply voltage

Current overshoot

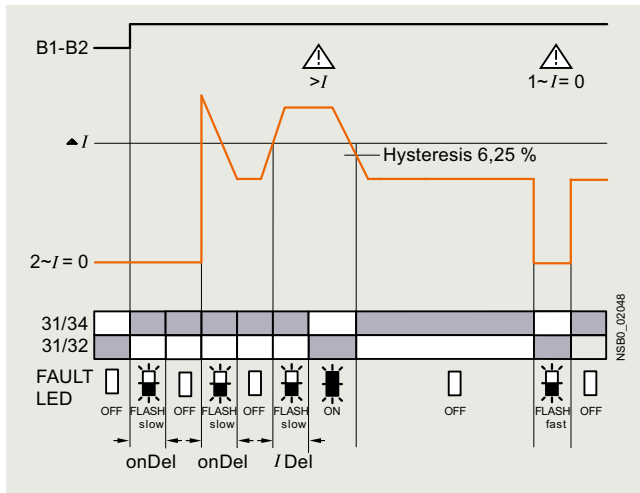

Range monitoring

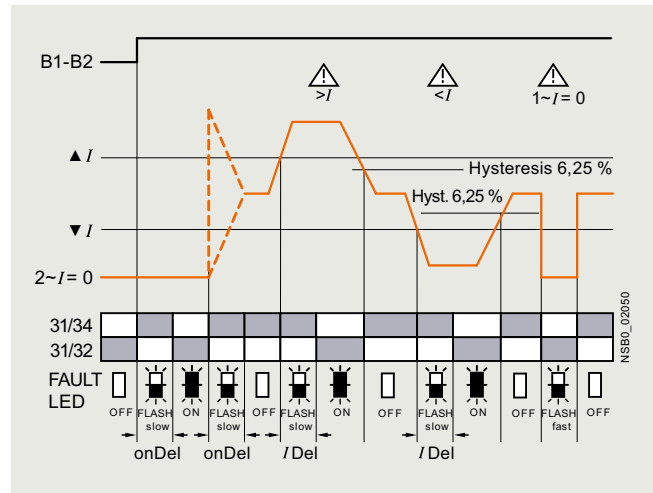

Current undershoot

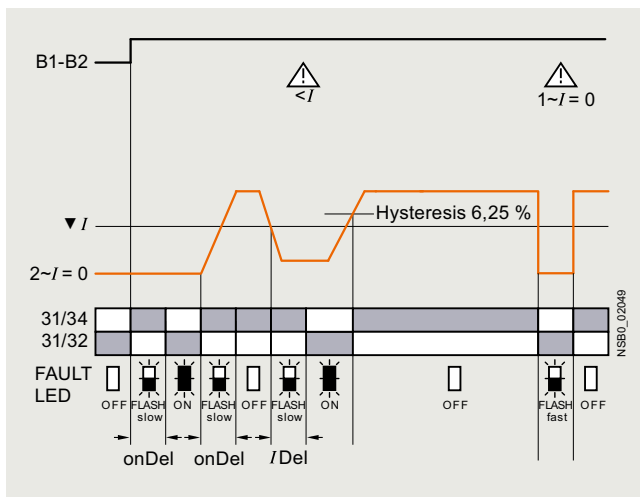





## Selection and ordering data



3RR2141-1AW30



3RR2142-1AW30



3RR2241-1FW30



3RR2242-2FW30



3RR2141-2AA30



3RR2243-3FW30

Size	Measuring range	Hysteresis	Supply voltage $U_s$	Article No.	Weight kg
	A	A	V		

## Basic versions

- Analogically adjustable
- Closed-circuit principle
- 1 CO contact
- 2-phase current monitoring
- Apparent current monitoring
- ON-delay 0 ... 60 s
- Tripping delay 0 ... 30 s

<b>S00</b>	1.6 ... 16	6.25% of threshold value	24 AC/DC 24 ... 240 AC/DC	<b>3RR2141-□AA30</b> <b>3RR2141-□AW30</b>	0.180 0.180
<b>S0</b>	4 ... 40	6.25% of threshold value	24 AC/DC 24 ... 240 AC/DC	<b>3RR2142-□AA30</b> <b>3RR2142-□AW30</b>	0.263 0.260
<b>S2</b>	8 ... 80	6.25% of threshold value	24 AC/DC 24 ... 240 AC/DC	<b>3RR2143-□AA30</b> <b>3RR2143-□AW30</b>	0.200 0.200

## Standard versions

- Digitally adjustable
- LC display
- Open-circuit or closed-circuit principle
- 1 CO, 1 semiconductor output
- 3-phase current monitoring
- Active current or apparent current monitoring
- Phase sequence monitoring
- Residual-current monitoring
- Blocking current monitoring
- Reclosing delay time 0 ... 300 min
- ON-delay 0 ... 99 s
- Separate settings for warning and alarm thresholds
- Tripping delay 0 ... 30 s

<b>S00</b>	1.6 ... 16	0.1 ... 3	24 AC/DC 24 ... 240 AC/DC	<b>3RR2241-□FA30</b> <b>3RR2241-□FW30</b>	0.200 0.200
<b>S0</b>	4 ... 40	0.1 ... 8	24 AC/DC 24 ... 240 AC/DC	<b>3RR2242-□FA30</b> <b>3RR2242-□FW30</b>	0.280 0.280
<b>S2</b>	8 ... 80	0.2 ... 16	24 AC/DC 24 ... 240 AC/DC	<b>3RR2243-□FA30</b> <b>3RR2243-□FW30</b>	0.200 0.440

## Type of electrical connection

- Screw terminals
- Spring-loaded terminals size S00, S0
- Spring-loaded terminals size S2

1  
2  
3







## Monitoring and control devices

### Relays

#### SIRIUS 3RR21, 3RR22 monitoring relays for mounting on 3RT2 contactors

#### Current and active current monitoring

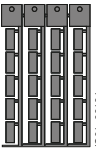
#### Accessories

Use	Version	Size	Article No.	Weight kg		
<b>Terminal supports for stand-alone installation<sup>1)</sup></b>						
 3RU2916-3AA01	For 3RR21, 3RR22	For separate mounting of the overload relays or monitoring relays; screw fixing and snap-on mounting on TH 35 standard mounting rail according to IEC 60715	<b>Screw terminals</b> 			
			• Screw terminals	S00 S0 S2	<b>3RU2916-3AA01</b> <b>3RU2926-3AA01</b> <b>3RU2936-3AA01</b>	0.060 0.078 0.181
 3RU2936-3AA01			<b>Spring-loaded terminals</b> 			
			• Spring-loaded terminals	S00 S0	<b>3RU2916-3AC01</b> <b>3RU2926-3AC01</b>	0.064 0.086
<b>Sealable covers</b>						
 3RR2940	For 3RR21, 3RR22	<b>Sealable covers</b> For securing against unintentional or unauthorized adjustment of settings	<b>3RR2940</b>	0.002		
<b>Blank labels</b>						
 3RT2900-1SB20	For 3RR21, 3RR22	<b>Unit labeling plates<sup>2)</sup></b> For SIRIUS devices	<b>3RT2900-1SB20</b>	0.062		
		• 20 mm x 7 mm, titanium gray				
<b>Tools for opening spring-loaded terminals</b>						
 3RA2908-1A	For auxiliary circuit connections	<b>Screwdrivers</b> For all SIRIUS devices with spring-loaded terminals	<b>Spring-loaded terminals</b> 	0.050		
		Length approx. 200 mm, 3.0 mm x 0.5 mm, titanium gray/black, partially insulated	<b>3RA2908-1A</b>			

<sup>1)</sup> The accessories are exactly the same as the accessories for the 3RU21 thermal overload relay and the 3RB3 electronic overload relay.

<sup>2)</sup> PC labeling system for individual inscription of unit labeling plates available from: murrplastik Systemtechnik GmbH.

## Overview

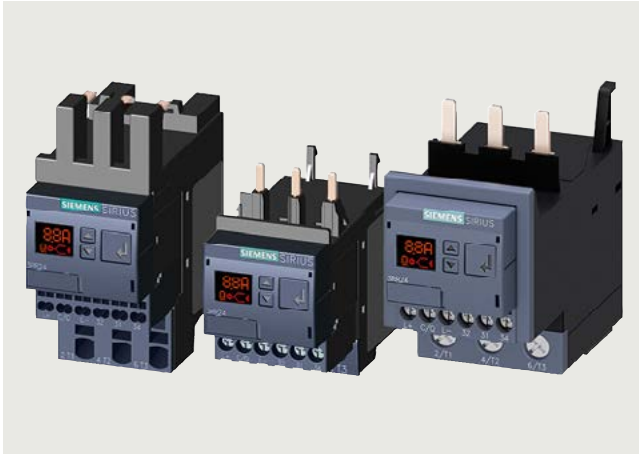

SIRIUS 3RR2441, 3RR2442 and 3RR2443 current monitoring relays

## More information

Homepage, see [www.siemens.com/sirius-monitoring-relays](http://www.siemens.com/sirius-monitoring-relays)

Industry Mall, see [www.siemens.com/product?3RR24](http://www.siemens.com/product?3RR24)



Video: SIRIUS 3RR2 current monitoring relays

The SIRIUS 3RR24 current monitoring relays for IO-Link are suitable for the load monitoring of motors or other loads. In 3 phases they monitor the rms value of AC currents for overshooting or undershooting of set threshold values.

Whereas apparent current monitoring is used above all in connection with the rated torque or in case of overload, the active current monitoring option, which is also selectable, can be used to observe and evaluate the load factor over a motor's entire torque range.

The 3RR24 current monitoring relays for IO-Link can be integrated directly in the feeder by mounting on the 3RT2 contactor; separate wiring of the main circuit is therefore superfluous. No separate transformers are required.

For a line-oriented configuration or simultaneous use of an overload relay, terminal supports for stand-alone installation are available for separate standard rail mounting.

The SIRIUS 3RR24 current monitoring relays for IO-Link also offer many other options based upon the monitoring functions of the conventional SIRIUS 3RR2 monitoring relays:

- Measured value transmission to a controller, including resolution and unit, may be parameterizable as to which value is cyclically transmitted
- Transmission of alarm flags to a controller
- Full diagnostics capability by inquiry as to the cause of the fault in the diagnostics data record
- Remote parameterization is also possible, in addition to or instead of local parameterization

- Rapid parameterization of the same devices by duplication of the parameterization in the controller
- Parameter transmission through upload to a controller by IO-Link call or by parameter server (if IO-Link master from IO-Link specification V1.1 and higher is used)
- Consistent central data storage in the event of parameter change locally or via a controller
- Automatic reparameterizing when devices are exchanged
- Blocking of local parameterization via IO-Link possible
- Faults are saved in parameterizable and non-volatile fashion to prevent an automatic startup after voltage failure and to make sure diagnostics data are not lost
- Integration into the automation level provides the option of parameterizing the monitoring relays at any time via a display unit, or displaying the measured values in a control room or locally at the machine/control cabinet.
- The MindSphere app SIRIUS Asset Monitor enables access to the SIRIUS 3RR24 current monitoring relay anytime and anywhere. It provides the user with detailed information on the device status as well as fault messages and warnings in a clearly arranged form.

Even without communication via IO-Link the devices continue to function fully autonomously:

- Parameterization can take place locally at the device, independently of a controller.
- In the event of failure or before the controller becomes available the monitoring relays work as long as the control supply voltage (24 V DC) is present.
- If the monitoring relays are operated without the controller, the 3RR24 monitoring relays for IO-Link have, thanks to the integrated SIO mode, an additional semiconductor output, which switches when the adjustable warning threshold is exceeded.

Thanks to the combination of autonomous monitoring relay function and integrated IO-Link communication, redundant sensors and/or analog signal converters – which previously took over the transmission of measured values to a controller, leading to considerable extra cost and wiring overhead – are no longer needed.

Because the output relays are still present, the monitoring relays increase the functional reliability of the system, since only the controller can fulfill the control tasks if the current measured values are available, whereas the output relays can also be used for the disconnection of the system if limit values that cannot be reached during operation are exceeded.

For more information on the IO-Link communication system.

Notes on security

In order to protect plants, systems, machines and networks against cyber threats, it is necessary to implement – and continuously maintain – a holistic, state-of-the-art industrial security concept. Siemens products and solutions represent only one component of such a concept.

For more information about the subject of Industrial Security, see [www.siemens.com/industrialsecurity](http://www.siemens.com/industrialsecurity).

## Monitoring and control devices

### Relays

#### SIRIUS 3RR24 monitoring relays for mounting on 3RT2 contactors for IO-Link

#### Current and active current monitoring

##### 3RR24 overview table



Features	3RR24	Benefits
<b>General data</b>		
<b>Sizes</b> Dimensions in mm (W x H x D) • Screw terminals  • Spring-loaded terminals	 S00, S0, S2  S00: 45 x 79 x 80, S0: 45 x 87 x 91, S2: 55 x 99 x 112  S00: 45 x 90 x 80, S0: 45 x 109 x 92, S2: 55 x 99 x 112	<ul style="list-style-type: none"> <li>• Are coordinated with the dimensions, connections and technical characteristics of the other devices in the SIRIUS modular system (contactors, soft starters, etc.)</li> <li>• Permit the mounting of slim-line and compact load feeders in widths of 45 mm (S00 and S0) and 55 mm (S2)</li> <li>• Simplify configuration</li> </ul>
<b>Current range</b>	S00: 1.6 ... 16 A S0: 4 ... 40 A S2: 8 ... 80 A	<ul style="list-style-type: none"> <li>• Is adapted to the other devices in the SIRIUS modular system</li> <li>• Just a single version per size with a wide setting range enables easy configuration</li> </ul>
<b>Permissible ambient temperature</b>		
During operation	-25 ... +60 °C	<ul style="list-style-type: none"> <li>• Suitable for applications in the control cabinet, worldwide</li> </ul>
<b>Monitoring functions</b>		
<b>Current overshoot</b>	✓ (3-phase)	<ul style="list-style-type: none"> <li>• Provides optimum inverse-time delayed protection of loads against excessive temperature rises due to overload</li> <li>• Enables detection of filter blockages or pumping against closed gate valves</li> <li>• Enables drawing conclusions about wear, poor lubrication or other maintenance-relevant phenomena</li> </ul>
<b>Current undershoot</b>	✓ (3-phase)	<ul style="list-style-type: none"> <li>• Enables detection of overload due to a slipping or torn belt</li> <li>• Guarantees protection of pumps against dry running</li> <li>• Facilitates monitoring of the functions of resistive loads such as heaters</li> <li>• Permits energy savings through monitoring of no-load operation</li> </ul>
<b>Apparent current monitoring</b>	✓ (Selectable)	<ul style="list-style-type: none"> <li>• Precision current monitoring especially in a motor's rated and upper torque range</li> </ul>
<b>Active current monitoring</b>	✓ (Selectable)	<ul style="list-style-type: none"> <li>• Optimum current monitoring over a motor's entire torque range through the patented combination of power factor and apparent current monitoring</li> </ul>
<b>Range monitoring</b>	✓ (3-phase)	<ul style="list-style-type: none"> <li>• Simultaneous monitoring of current overshoot and undershoot with a single device</li> </ul>
<b>Phase failure, open circuit</b>	✓ (3-phase)	<ul style="list-style-type: none"> <li>• Minimizes heating of three-phase motors during phase failure through immediate disconnection</li> <li>• Prevents operation of hoisting equipment with half the load carrying capacity</li> </ul>
<b>Phase sequence monitoring</b>	✓ (Selectable)	<ul style="list-style-type: none"> <li>• Prevents starting of motors, pumps or compressors in the wrong direction of rotation</li> </ul>
<b>Internal ground-fault detection (residual-current monitoring)</b>	✓ (Selectable)	<ul style="list-style-type: none"> <li>• Provides optimum protection of loads against high-resistance short circuits or ground faults due to moisture, condensed water, damage to the insulation material, etc.</li> <li>• Eliminates the need for additional special equipment</li> <li>• Saves space in the control cabinet</li> <li>• Reduces wiring overhead and costs</li> </ul>
<b>Blocking current monitoring</b>	✓ (Selectable)	<ul style="list-style-type: none"> <li>• Minimizes heating of three-phase motors when blocked during operation through immediate disconnection</li> <li>• Minimizes mechanical loading of the system by acting as an electronic shear pin</li> </ul>
<b>Operating hours counter</b>	✓	<ul style="list-style-type: none"> <li>• Gives the time during which there was a measurable current in at least 2 conducting paths</li> <li>• As an indicator for upcoming maintenance or replacement of machine and system components</li> </ul>
<b>Operating cycles counter</b>	✓	<ul style="list-style-type: none"> <li>• Is incremented by 1 each time a breaking operation is detected, in other words a transition from 3-phase current flow to no measurable current flow</li> <li>• As an indicator for upcoming maintenance or replacement of contact blocks</li> </ul>

✓ Available



Features	3RR24	Benefits
<b>Features</b>		
<b>RESET function</b>	✓	<ul style="list-style-type: none"> <li>Allows manual or automatic resetting of the relay</li> <li>Resetting directly on the device, by switching the control supply voltage off and on via IO-Link (Remote RESET)</li> </ul>
<b>ON-delay time</b>	0 ... 999.9 s	<ul style="list-style-type: none"> <li>Enables motor starting without evaluation of the starting current</li> <li>Can be used for monitoring motors with lengthy startup</li> </ul>
<b>Tripping delay time</b>	0 ... 999.9 s	<ul style="list-style-type: none"> <li>Permits brief threshold value violations during operation</li> <li>Prevents frequent warnings and disconnections with currents near the threshold values</li> </ul>
<b>Operating and indicating elements</b>	Displays and buttons	<ul style="list-style-type: none"> <li>For setting the threshold values and delay times</li> <li>For selectable functions</li> <li>For quick and selective diagnostics</li> <li>Displays for permanent display of measured values</li> </ul>
<b>Integrated contacts</b>	1 CO contact, 1 semiconductor output (in SIO mode)	<ul style="list-style-type: none"> <li>Enable disconnection of the system or process when there is an irregularity</li> <li>Can be used to output signals</li> </ul>
<b>Design of load feeders</b>		
<b>Short-circuit strength up to 100 kA at 690 V</b> (in conjunction with the corresponding fuses or the corresponding motor starter protector)	✓	<ul style="list-style-type: none"> <li>Provides optimum protection of the loads and operating personnel in the event of short circuits due to insulation faults or faulty switching operations</li> </ul>
<b>Electrical and mechanical matching to 3RT2 contactors</b>	✓	<ul style="list-style-type: none"> <li>Simplifies configuration</li> <li>Reduces wiring overhead and costs</li> <li>Enables stand-alone installation as well as space-saving direct mounting</li> </ul>
<b>Spring-loaded terminals for main circuit (with S00, S0) and auxiliary circuits</b>	✓ (optional)	<ul style="list-style-type: none"> <li>Enables fast connections</li> <li>Permits vibration-resistant connections</li> <li>Enables maintenance-free connections</li> </ul>
<b>Other features</b>		
<b>Suitable for 1-phase and 3-phase loads</b>	✓	<ul style="list-style-type: none"> <li>Enables the monitoring of 1-phase systems through parallel infeed at the contactor or looping the current through the three phase connections</li> </ul>
<b>Wide setting ranges</b>	✓	<ul style="list-style-type: none"> <li>Reduce the number of variants</li> <li>Minimize the configuration overhead and costs</li> <li>Minimize storage overhead, storage costs, tied-up capital</li> </ul>
<b>Power supply</b>	24 V DC	<ul style="list-style-type: none"> <li>Direct via IO-Link master or via an external auxiliary voltage independent of the IO-Link</li> <li>Minimizes the configuring overhead and costs</li> </ul>

✓ Available

### Possible ways of combining the 3RR24 monitoring relay with the 3RT2 contactor for IO-Link

Monitoring relays	Current range	Contactors (type, size, operating power)		
		3RT201 S00	3RT202 S0	3RT203 S2
Type	A	3/4/5.5/7.5 kW	5.5/7.5/11/15/18.5 kW	18.5/22/30/37 kW
3RR2441	1.6 ... 16	✓	With stand-alone installation support	With stand-alone installation support
3RR2442	4 ... 40	With stand-alone installation support	✓	With stand-alone installation support
3RR2443	8 ... 80	With stand-alone installation support	With stand-alone installation support	✓

✓ Available

#### Notes:

Devices required for communication via IO-Link:

- Any controller that supports IO-Link (e.g. ET 200SP with CPU or S7-1200), see [Catalog ST 70](#).
- IO-Link master (e.g. CM 4xIO-Link for SIMATIC ET 200SP or SM 1278 for S7-1200).

Each monitoring relay requires an IO-Link channel.

## Monitoring and control devices

### Relays

#### SIRIUS 3RR24 monitoring relays for mounting on 3RT2 contactors for IO-Link

#### Current and active current monitoring

##### Article No. scheme

Product versions		Article number	
<b>3RR24 monitoring relay, digitally adjustable with IO-Link</b>		<b>3RR2 4 4 □ - □ A A 4 0</b>	
Size	S00	1	
	S0	2	
	S2	3	
Connection type	Screw terminals		1
	Spring-loaded terminals Size S00, S0		2
	Size S2		3
Example		<b>3RR2 4 4 1 - 1 A A 4 0</b>	

##### Note:

The Article No. scheme shows an overview of product versions for better understanding of the logic behind the article numbers.

For your orders, please use the article numbers quoted in the selection and ordering data.

##### Benefits

- Can be mounted directly on 3RT2 contactors and 3RA23 reversing contactor assemblies, in other words, there is no need for additional wiring in the main circuit
- Optimally coordinated with the technical characteristics of the 3RT2 contactors
- No separate current transformer required
- Variably adjustable to overshoot, undershoot or range monitoring
- Freely configurable delay times and RESET response
- Display of actual value and status messages
- All versions with removable control current terminals
- All versions with screw or spring-loaded terminals
- Simple determination of the threshold values through direct reference to actually measured values for setpoint loading
- Range monitoring and selectable active current measurement mean that only one device for monitoring a motor is required along the entire torque curve
- In addition to current monitoring it is also possible to monitor for current asymmetry, broken cables, phase failure, phase sequence, residual current and motor blocking
- Integrated counter for operating cycles and operating hours to support requirements-based maintenance of the monitored machine or application
- Simple cyclical transmission of the current measured values, relay switching states and events to a controller
- Remote parameterization
- Automatic reparameterizing when devices are exchanged
- Simple duplication of identical or similar parameterizations
- Reduction of control current wiring
- Elimination of testing costs and wiring errors
- Reduction of configuration work
- Integration in TIA means clear diagnostics if a fault occurs
- Cost saving and space saving in control cabinet due to the elimination of AI and IO modules as well as analog signal converters and duplicated sensors

##### Application

- Monitoring for current overshoot and undershoot
- Monitoring of broken conductors
- Monitoring of no-load operation and load shedding, e.g. in the event of a torn V-belt or no-load operation of a pump
- Monitoring of overload, e.g. on pumps due to a dirty filter system
- Monitoring the functionality of electrical loads such as heaters
- Monitoring of wrong phase sequence on mobile equipment such as compressors or cranes
- Monitoring of high-resistance short circuits or ground faults, e.g. caused by damaged insulation or moisture

The use of SIRIUS monitoring relays for IO-Link is particularly recommended for machines and plants in which these relays, in addition to their monitoring function, are to be connected to the automation level for the rapid, simple and fault-free provision of the current measured values and/or for remote parameterization.

The monitoring relays can either relieve the controller of monitoring tasks or, as a second monitoring entity in parallel to and independent of the controller, increase the reliability in the process or in the system. In addition, the elimination of AI and IO modules allows the width of the controller to be reduced despite significantly expanded functionality.

Technical specifications

More information

Technical specifications, see <https://support.industry.siemens.com/cs/ww/en/ps/16206/td>  
 Configuration Manual for load feeders, see <https://support.industry.siemens.com/cs/ww/en/view/39714188>

System Manual for modular system, see <https://support.industry.siemens.com/cs/ww/en/view/60311318>  
 Equipment Manual, see <https://support.industry.siemens.com/cs/ww/en/view/54375430>  
 FAQs, see <https://support.industry.siemens.com/cs/ww/en/ps/16206/faq>

Function diagrams of 3RR24 for IO-Link, digitally adjustable

With the closed-circuit principle selected upon application of the control supply voltage

Current overshoot

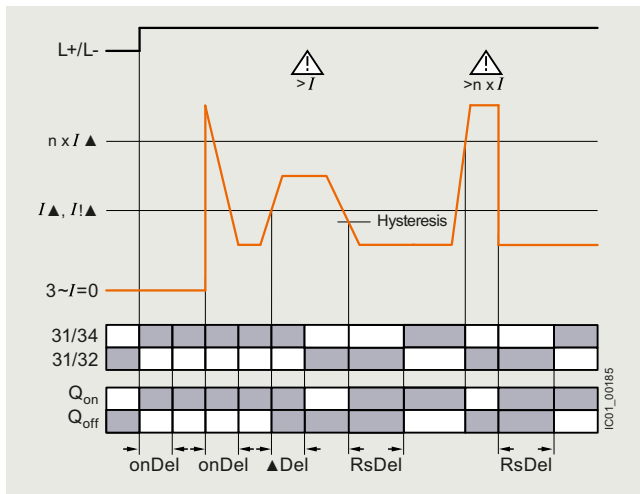

Range monitoring

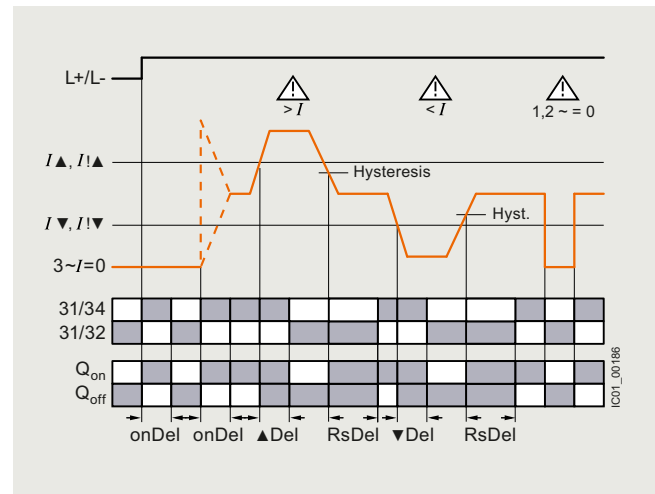

Current undershoot with residual-current monitoring

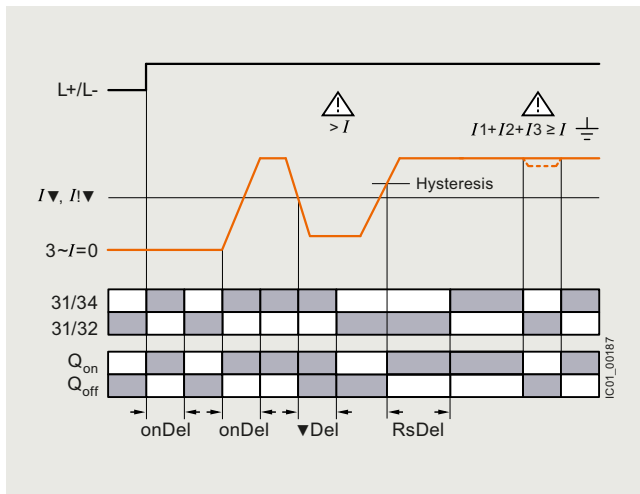

Phase sequence monitoring

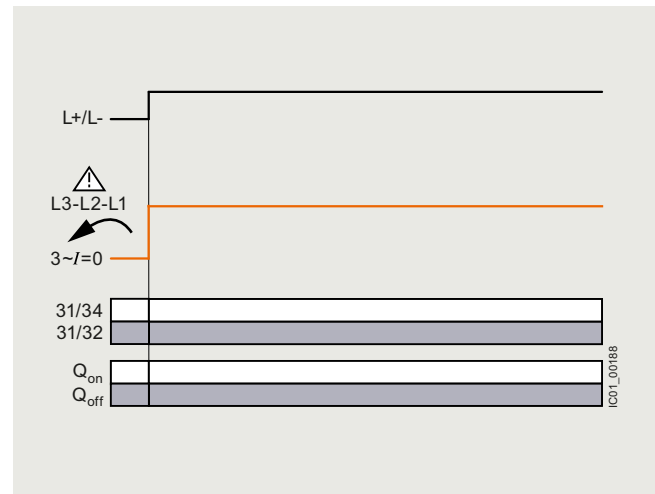



## Monitoring and control devices

### Relays

### SIRIUS 3RR24 monitoring relays for mounting on 3RT2 contactors for IO-Link

#### Current and active current monitoring

#### Selection and ordering data

#### SIRIUS 3RR24 current monitoring relays for IO-Link

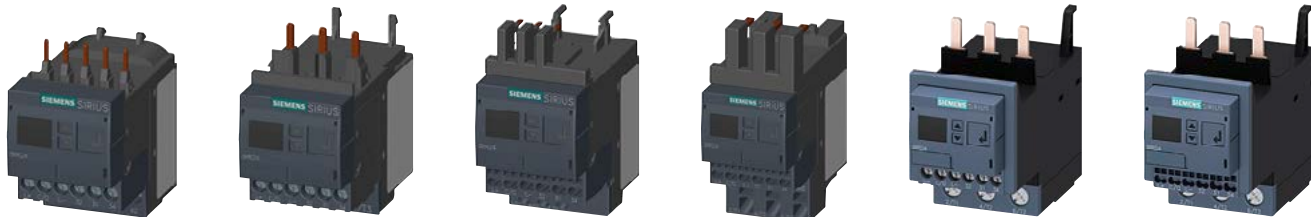

3RR2441-1AA40

3RR2442-1AA40

3RR2441-2AA40

3RR2442-2AA40

3RR2443-1AA40

3RR2443-2AA40







Size	Measuring range	Hysteresis	Supply voltage $U_s$	Article No.	Weight kg
	A	A	V		
<ul style="list-style-type: none"> <li>Digitally adjustable</li> <li>LC display</li> <li>Open-circuit or closed-circuit principle</li> <li>1 CO contact</li> <li>1 semiconductor output (in SIO mode)</li> <li>3-phase current monitoring</li> <li>Active current or apparent current monitoring</li> <li>Current asymmetry monitoring</li> <li>Phase sequence monitoring</li> <li>Residual-current monitoring</li> <li>Blocking current monitoring</li> <li>Operating hours counter</li> <li>Operating cycles counter</li> <li>Reclosing delay time 0 ... 300 min</li> <li>ON-delay 0 ... 999.9 s</li> <li>Tripping delay 0 ... 999.9 s</li> <li>Separate settings for warning and alarm thresholds</li> <li>Auto or Manual RESET</li> </ul>					
<b>S00</b>	1.6 ... 16	0.1 ... 3	24 DC	<b>3RR2441-□AA40</b>	0.200
<b>S0</b>	4 ... 40	0.1 ... 8	24 DC	<b>3RR2442-□AA40</b>	0.280
<b>S2</b>	8 ... 80	0.2 ... 16	24 DC	<b>3RR2443-□AA40</b>	0.200

#### Type of electrical connection

- Screw terminals
- Spring-loaded terminals size S00, S0
- Spring-loaded terminals size S2

1  
2  
3

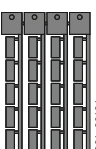
## Accessories

Use	Version	Size	Article No.	Weight kg	
<b>Terminal supports for stand-alone installation<sup>1)</sup></b>					
 3RU2916-3AA01	For 3RR24	For separate mounting of the overload relays or monitoring relays; screw fixing and snap-on mounting on TH 35 standard mounting rail according to IEC 60715 <ul style="list-style-type: none"> <li>Screw terminals</li> </ul>	<b>Screw terminals</b>  3RU2916-3AA01 3RU2926-3AA01 3RU2936-3AA01	0.060	
				S00	0.078
				S0	0.181
 3RU2936-3AA01					
				S2	
 3RU2926-3AC01		<ul style="list-style-type: none"> <li>Spring-loaded terminals</li> </ul>	<b>Spring-loaded terminals</b>  3RU2916-3AC01 3RU2926-3AC01	0.064	
				S00	0.086
 3RR2940	For 3RR24	<b>Sealable covers</b> For securing against unintentional or unauthorized adjustment of settings	3RR2940	0.002	
<b>Blank labels</b>					
 3RT2900-1SB20	For 3RR24	<b>Unit labeling plates<sup>2)</sup></b> For SIRIUS devices <ul style="list-style-type: none"> <li>20 mm x 7 mm, titanium gray</li> </ul>	3RT2900-1SB20	0.062	
<b>Tools for opening spring-loaded terminals</b>					
 3RA2908-1A	For auxiliary circuit connections	<b>Screwdrivers</b> For all SIRIUS devices with spring-loaded terminals  Length approx. 200 mm, 3,0 mm x 0,5 mm, titanium gray/black, partially insulated	<b>Spring-loaded terminals</b>  3RA2908-1A	0.050	
<b>Software</b>					
	For 3RR24	<b>SIRIUS Asset Monitor</b> The MindSphere app enables access to the SIRIUS 3RR24 monitoring relays anytime and anywhere and provides detailed information about the device status and fault messages and warnings.			

<sup>1)</sup> The accessories are exactly the same as the accessories for the 3RU21 thermal overload relay and the 3RB3 electronic overload relay.

<sup>2)</sup> PC labeling system for individual inscription of unit labeling plates available from: murrplastik Systemtechnik GmbH.

## Monitoring and control devices

### Relays

#### SIRIUS 3UG5 monitoring relays for stand-alone installation

#### DC load monitoring

#### Overview



SIRIUS 3UG546 DC load monitoring relays

#### More information

Homepage, see [www.siemens.com/sirius-monitoring-relays](http://www.siemens.com/sirius-monitoring-relays)

Industry Mall, see [www.siemens.com/product?3UG5](http://www.siemens.com/product?3UG5)

The SIRIUS 3UG546 DC load monitoring relays are suitable for monitoring motors, batteries, and other DC equipment. They are also suitable for applications where batteries are used. The devices monitor the DC current, voltage, and actual power for overshooting or undershooting of the set limit values in 1 or 2 channels. The relays have a CO contact output for alarms and operate on the closed-circuit principle (NC).

The devices are parameterized via PROFINET, and transfer the measured values and diagnostic messages to a controller. Besides providing detailed fault diagnostics, the integrated energy counters, operating hours counters, and operating cycle counters can also be read out and reset.

When metering energy consumption, the SIRIUS 3UG546 DC load monitoring relays distinguish the direction of current flow and can thus, for example, separately sense the quantities of energy stored in or drawn from a battery.

#### Article No. scheme

Product versions		Article number	
<b>Monitoring relays</b>		<b>3UG546</b>	<input type="checkbox"/> - 1 A A 4 <input type="checkbox"/>
Current measuring range	2 x 8 A/1 x 16 A	1	
	1 x 63 A	2	
Voltage range	0 ... 800 V		0
	0 ... 60 V		1
Example		<b>3UG546</b>	<b>1 - 1 A A 4 0</b>

#### Note:

The Article No. scheme shows an overview of product versions for better understanding of the logic behind the article numbers.

Features	3UG5461-1AA4., 3UG5462-1AA4.
<b>DC monitoring</b>	
Monitoring the DC current for undershoot	✓
Monitoring the DC current for overshoot	✓
Range monitoring	✓
<b>Voltage monitoring</b>	
Monitoring the voltage for undershoot	✓
Monitoring the voltage for overshoot	✓
Range monitoring	✓
<b>Power monitoring</b>	
Monitoring the power for undershoot	✓
Monitoring the power for overshoot	✓
Range monitoring	✓
<b>Delay times</b>	
ON-delay	✓
Tripping delay	✓
<b>Operating hours counter</b>	
Monitoring for overshoot	✓
<b>Operating cycles counter</b>	
Monitoring for overshoot	✓
<b>Energy recovery counter</b>	
Monitoring for overshoot	✓
<b>Energy consumption counter</b>	
Monitoring for overshoot	✓
<b>PROFINET IO functions</b>	
Ethernet services	✓
Port diagnostics	✓
Min. update time	2 ms
Resetting of communication parameters to factory settings	✓
PROFINET RT (real-time communication)	✓
Firmware update via PROFINET IO	✓
I&M identification data 0 to 3	✓
✓ Available	

For your orders, please use the article numbers quoted in the selection and ordering data.

#### Benefits

- Wide voltage measuring range of up to 800 V
- 60 V versions especially for applications where batteries are used
- Detection and monitoring of current, voltage and power in a single device
- Detailed fault diagnostics
- Energy metering with distinction of direction of current flow
- Communication and visualization via PROFINET and thus quick and easy integration for visualizing plant energy values
- Integration in the TIA Portal
- Customary screw terminals for quick and reliable wiring
- Device replacement without renewed wiring thanks to removable terminals

**Application**

- Exhaustive discharge protection on battery-operated vehicles
- Acquisition of energy flows, incl. energy recovery, e.g. for robots
- DC line monitoring
- DC heaters
- Lighting systems
- Energy management
- Condition monitoring

**Technical specifications****More information**

Technical specifications, see <https://support.industry.siemens.com/cs/ww/en/ps/25412/td>

Equipment Manual, see <https://support.industry.siemens.com/cs/ww/en/ps/25412/man>  
FAQs, see <https://support.industry.siemens.com/cs/ww/en/ps/25412/faq>

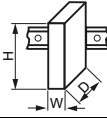
Article number		3UG5461-1AA40	3UG5461-1AA41	3UG5462-1AA40	3UG5462-1AA41
<b>General technical specifications:</b>					
<b>Dimensions (W x H x D)</b>	mm	22.5 x 100 x 141.6		45 x 100 x 141.6	
					
<b>Type of electrical separation</b>		Protective separation			
<b>Electrical endurance (operating cycles) for relay outputs, maximum</b>		100 000, 0.5 A, 125 V AC, for resistive load up to 40 °C			
<b>Mechanical service life (operating cycles), typical</b>		10 000 000			
<b>Power loss [W], maximum</b>	W	3			
<b>Adjustable response value current 1</b>	A	-8 ... +8		-63 ... +63	
<b>Adjustable response value current 2</b>	A	-8 ... +8		--	
<b>Adjustable ON-delay time</b>					
• On starting	s	0 ... 999			
• On upper or lower limit violation	s	0 ... 999			
<b>Adjustable voltage range</b>	V	0 ... 800	0 ... 60	0 ... 800	0 ... 60
<b>Minimum supply voltage failure buffering time</b>	ms	10			
<b>Reaction time, maximum</b>	ms	100			
<b>Degree of protection IP on the front according to IEC 60529</b>		IP20			
<b>Touch protection on the front according to IEC 60529</b>		Finger-safe		Finger-safe for vertical touching from the front	
<b>Type of mounting</b>		Screw fixing and snap-on mounting on 35 mm standard mounting rail			
• Mounting position		Any			
<b>Installation altitude at height above sea level, maximum</b>	m	2 000			
<b>Ambient temperature</b>					
• During operation	°C	-25 ... +60			
• During storage	°C	-40 ... +80			
<b>Relative temperature-related measurement deviation</b>	%	0.5			
<b>Number of ports at the interface 1</b>		1			
<b>Product function</b>					
• Operating cycles counter		Yes			
• Operating hours counter		Yes			
• Auto RESET		Yes			
• Manual RESET		Yes			
• Overvoltage detection DC		Yes			
• Overcurrent detection DC		Yes			
• Undervoltage detection DC		Yes			
• Undercurrent detection DC		Yes			
<b>Product component</b>					
• Removable terminal for main circuit		Yes		No	
• Removable terminal for auxiliary and control circuit		Yes			

## Monitoring and control devices

### Relays

#### SIRIUS 3UG5 monitoring relays for stand-alone installation

#### DC load monitoring

Article number	3UG5461-1AA40	3UG5461-1AA41	3UG5462-1AA40	3UG5462-1AA41
<b>Measuring circuit:</b>				
Relative measuring accuracy with reference to the full-scale value %	2			
Number of CO contacts for auxiliary contacts	1			
<b>Control circuit:</b>				
Current-carrying capacity of the output relay at DC-13 at 24 V A	1			
Thermal current of the non-solid-state contact blocks, maximum A	1			
Type of voltage for monitoring	DC			
Type of current for monitoring	DC			
Supply voltage type	DC			
Supply voltage 1 at DC, rated value V	24			
<b>Supply voltage:</b>				
Operating range factor of the supply voltage, rated value At DC	0.85 ... 1.15			

Article number	3UG5461-1AA40	3UG5461-1AA41	3UG5462-1AA40	3UG5462-1AA41
Type of electrical connection	 Screw terminals			
<b>Connectable conductor cross-section for auxiliary contacts</b>				
• Solid	mm <sup>2</sup>	1 x (0.5 ... 4), 2 x (0.5 ... 2.5)		
• Finely stranded with end sleeve	mm <sup>2</sup>	1 x (0.5 ... 4), 2 x (0.5 ... 1.5)		
• For AWG cables		1 x (20 ... 12), 2 x (20 ... 14)		
<b>Connectable conductor cross-section for main contacts</b>				
• Solid	mm <sup>2</sup>	1 x (0.5 ... 4), 2 x (0.5 ... 2.5)	2 x (1 ... 16), 1 x (1 ... 16)	
• Finely stranded with end sleeve	mm <sup>2</sup>	1 x (0.5 ... 4), 2 x (0.5 ... 2.5)	2 x (1 ... 25), 1 x (1 ... 35)	
• Stranded	mm <sup>2</sup>	1 x (0.5 ... 4), 2 x (0.5 ... 2.5)	2 x (1 ... 16), 1 x (1 ... 16)	
• For AWG cables		1 x (20 ... 12), 2 x (20 ... 14)	1 x (18 ... 1), 2 x (18 ... 2)	

The SIRIUS 3UG546 DC load monitoring relays monitor a DC load current circuit for undershooting or overshooting of set limit values in 1 or 2 channels. Current, voltage, and power can be monitored separately. When the relays measure the current, they also detect the direction of current and have separate counters for measuring energy consumption and energy recovery.

The devices count the operating cycles and the operating hours of the connected loads as well as the operating cycles of the internal relay. All counters can be monitored for settable limit values and the counter statuses can be reset (with the exception of the operating cycle counter of the internal relay).

The SIRIUS 3UG546 DC load monitoring relays are parameterized exclusively via a PROFINET interface. All measured values and counter values as well as other diagnostics data are transmitted to a controller via PROFINET. The relays can also be operated without PROFINET. If communication fails, the monitoring function continues to be reliably executed. The internal relay, which is switched as a signaling output that responds when a set limit value is undershot or overshoot, responds to detected system faults.

All monitored counter values and measured values can be additionally assigned a warning limit, which generates an alarm via PROFINET when the set value is undershot or overshoot. Violations of the set limit values are also signaled as an alarm via PROFINET.

The devices are supplied via an external 24 V DC voltage source.

The integral counters for operating hours and operating cycles support operators in requirement-oriented plant maintenance. The operating hours counter outputs the time during which a measurable current flows. The properties of the insulation material of the motor windings, for example, deteriorate during operation due to the thermal load. The operating hours serve as an indicator of upcoming maintenance or replacement of machine parts and system components.

The operating cycles counter is incremented by one each time a breaking operation of the monitored load is detected (transition from current flow to no measurable current flow). The number of operating cycles serves as an indicator of upcoming maintenance or replacement of contact blocks. Arcs in breaking operations cause high loads and wear in particular in DC current circuits.

With the closed-circuit principle selected upon application of the control supply voltage

Monitoring for overshooting and undershooting of a measured value including parameterized warning limit/current flow in one direction only/automatic RESET

Monitoring for overshooting of a measured value including parameterized warning limit/manual RESET

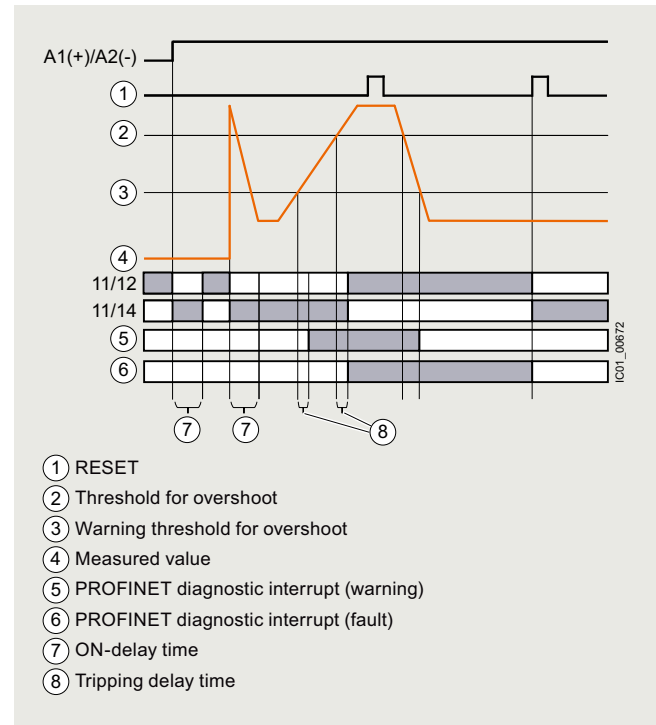
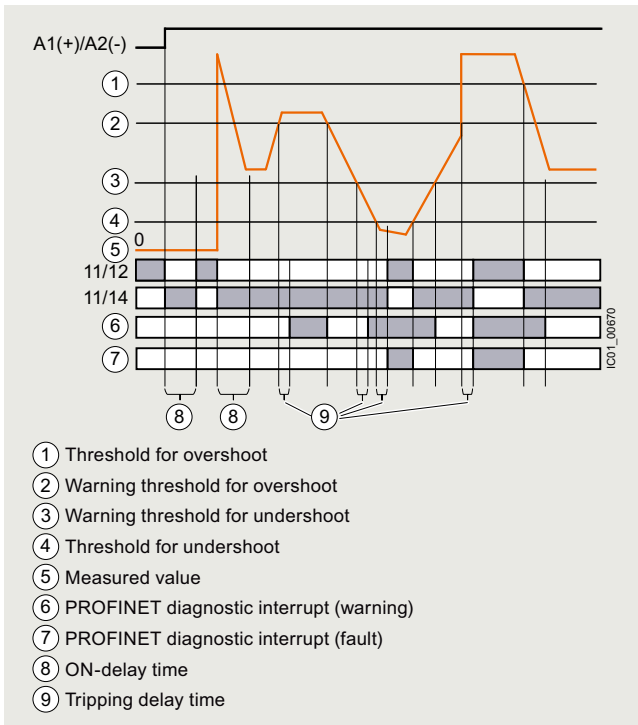

Monitoring for overshooting and undershooting of a measured value including parameterized warning limit/current flow in both directions (energy consumption and energy recovery)/ automatic RESET

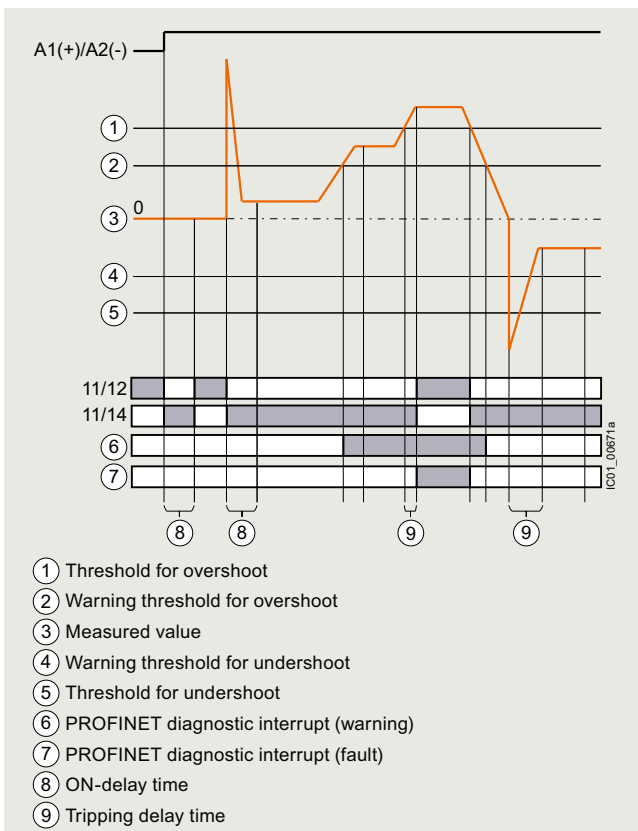

## Monitoring and control devices

### Relays

#### SIRIUS 3UG5 monitoring relays for stand-alone installation

#### DC load monitoring

#### Selection and ordering data











3UG5461-1AA40



3UG5462-1AA40

Measurable voltage	Measurable current	Width	Screw terminals 	Weight
V	A	mm	Article No.	kg
<b>DC load monitoring relay</b>				
0 ... 800	2 x 8/1 x 16	22.5	<b>3UG5461-1AA40</b>	0.255
	1 x 63	45	<b>3UG5462-1AA40</b>	0.385
0 ... 60	2 x 8/1 x 16	22.5	<b>3UG5461-1AA41</b>	0.252
	1 x 63	45	<b>3UG5462-1AA41</b>	0.381

#### Accessories

Version	Article No.	Weight
		kg
<b>Terminals for SIRIUS devices in the industrial standard mounting rail enclosure</b>		
 <b>Removable terminals</b> • 2-pole, up to 1 x 4 mm <sup>2</sup> or 2 x 2.5 mm <sup>2</sup>	<b>Screw terminals</b>  <b>3ZY1122-1BA00</b>	0.010
3ZY1122-1BA00		
<b>Accessories for enclosures</b>		
 <b>Push-in lugs</b> For wall mounting	<b>3ZY1311-0AA00</b>	0.001
3ZY1311-0AA00		
 <b>Coding pins</b> For removable terminals of SIRIUS devices in the industrial standard mounting rail enclosure; enable the mechanical coding of terminals	<b>3ZY1440-1AA00</b>	
3ZY1440-1AA00		
 <b>Hinged cover</b> Replacement cover, without terminal labeling, titanium gray • 22.5 mm wide	<b>3ZY1450-1AB00</b>	0.004
3ZY1450-1AB00		
<b>Blank labels</b>		
 <b>Unit labeling plates<sup>1)</sup></b> For SIRIUS devices • 20 mm x 7 mm, titanium gray	<b>3RT2900-1SB20</b>	0.062
3RT2900-1SB20		
<b>Tools for opening spring-loaded terminals</b>		
 <b>Screwdrivers</b> For all SIRIUS devices with spring-loaded terminals  Length approx. 200 mm, 3.0 mm x 0.5 mm, titanium gray/black, partially insulated	<b>Spring-loaded terminals (push-in)</b>  <b>3RA2908-1A</b>	0.050
3RA2908-1A		

<sup>1)</sup> PC labeling system for individual inscription of unit labeling plates available from: murrplastik Systemtechnik GmbH.

## Overview



SIRIUS 3UG4 monitoring relay

## More information

Homepage, see [www.siemens.com/sirius-monitoring-relays](http://www.siemens.com/sirius-monitoring-relays)

Industry Mall, see [www.siemens.com/product?3UG45](http://www.siemens.com/product?3UG45)

Conversion tool, see [www.siemens.com/conversion-tool](http://www.siemens.com/conversion-tool)

The field-proven SIRIUS monitoring relays for electrical and mechanical variables enable constant monitoring of all important characteristic quantities that provide information about the functional capability of a plant. Both sudden disturbances and gradual changes, which may indicate the need for maintenance, are detected. Thanks to their relay outputs, the monitoring relays permit direct disconnection of the affected system components as well as alerting (e.g. by switching a warning lamp).

Thanks to adjustable delay times the monitoring relays can respond very flexibly to brief faults such as voltage dips or load changes. This avoids unnecessary alarms and disconnections while enhancing plant availability.

The individual 3UG4 monitoring relays offer the following functions in various combinations:

- Undershooting and/or overshooting of liquid levels
- Phase sequence
- Phase failure, neutral conductor failure
- Phase asymmetry
- Undershooting and/or overshooting of limit values for voltage
- Undershooting and/or overshooting of limit values for current
- Undershooting and/or overshooting of limit values for power factor
- Monitoring of the active current or the apparent current
- Monitoring of the residual current
- Monitoring of the insulation resistance
- Undershooting and/or overshooting of limit values for speed

## Article No. scheme

Product versions	Article number
<b>Monitoring relays</b>	<b>3UG4</b> □ □ □ - □ □ □ □ 0
Type of setting	e.g. 5 = analogically adjustable □
Functions	e.g. 11 = line monitoring □ □
Connection type	Screw terminals 1
	Spring-loaded terminals 2
Contacts	e.g. A = 1 CO contact □
Supply voltage	e.g. N2 = 160 ... 260 V AC □ □
Example	<b>3UG4 5 1 1 - 1 A N 2 0</b>

## Note:

The Article No. scheme shows an overview of product versions for better understanding of the logic behind the article numbers.

For your orders, please use the article numbers quoted in the selection and ordering data.



## Monitoring and control devices

### Relays

#### SIRIUS 3UG45, 3UG46 monitoring relays for stand-alone installation

#### General data

#### Benefits

- Customary screw and spring-loaded terminals for quick and reliable wiring
- Fast commissioning thanks to menu-guided parameterization and actual value display for limit value determination
- Reduced space requirement in the control cabinet thanks to a consistent width of 22.5 mm
- Parameterizable monitoring functions, delay times, RESET response, etc.
- Reduced stockkeeping thanks to minimized variance and large measuring ranges
- Wide-voltage power supply units for global applicability
- Device replacement without renewed wiring thanks to removable terminals
- Reliable system diagnostics thanks to actual value display and connectable fault storage
- Rapid diagnostics thanks to unambiguous fault messages on the display

#### Application

The SIRIUS 3UG4 monitoring relays monitor the most diverse electrical and mechanical quantities in the feeder, and provide reliable protection against damage in the plant. For this purpose, they offer freely parameterizable limit values and diverse options for adapting to the respective task, and in the event of a fault, they provide clear diagnostics information.

The digitally adjustable products also display the current measured values direct on the device. This not only facilitates the display of valuable plant status information during operation, it also enables adjustment of the monitored limit values in accordance with the actual conditions.

The positive result: More selective avoidance of production faults – sustained increases in availability and productivity.

The 3UG4 monitoring relays are available for the following applications:

- Line and 1-phase voltage monitoring
- 1-phase current monitoring or power factor and active current monitoring
- Residual-current monitoring
- Insulation monitoring
- Level monitoring
- Speed monitoring

#### Technical specifications

##### More information

Technical specifications, see <https://support.industry.siemens.com/cs/ww/en/ps/16367/td>  
Equipment Manual and internal circuit diagrams, see <https://support.industry.siemens.com/cs/ww/en/view/54397927>

FAQs, see <https://support.industry.siemens.com/cs/ww/en/ps/16367/faq>

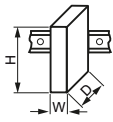
Type	3UG	
<b>General data</b>		
Dimensions (W x H x D)		
• For 2 terminal blocks	mm	22.5 x 83 x 91
- Screw terminals	mm	22.5 x 84 x 91
- Spring-loaded terminals		
• For 3 terminal blocks	mm	22.5 x 92 x 91
- Screw terminals	mm	22.5 x 94 x 91
- Spring-loaded terminals		
• For 4 terminal blocks	mm	22.5 x 103 x 91
- Screw terminals	mm	22.5 x 103 x 91
- Spring-loaded terminals		
<b>Permissible ambient temperature</b>		
• During operation	°C	-25 ... +60
<b>Connection type</b>		
<b>Screw terminals</b>		
• Terminal screw		M3 (for standard screwdriver, size 2 and Pozidriv 2)
• Solid	mm <sup>2</sup>	1 x (0.5 ... 4)/2 x (0.5 ... 2.5)
• Finely stranded with end sleeve	mm <sup>2</sup>	1 x (0.5 ... 2.5)/2 x (0.5 ... 1.5)
• AWG cables, solid or stranded	AWG	2 x (20 ... 14)
<b>Spring-loaded terminals</b>		
• Solid	mm <sup>2</sup>	2 x (0.25 ... 1.5)
• Finely stranded, with end sleeve acc. to DIN 46228	mm <sup>2</sup>	2 x (0.25 ... 1.5)
• Finely stranded	mm <sup>2</sup>	2 x (0.25 ... 1.5)
• AWG cables, solid or stranded	AWG	2 x (24 ... 16)

## Overview



SIRIUS 3UG4616 monitoring relay

Electronic line monitoring relays provide maximum protection for mobile machines and plants or for unstable networks. Network and voltage faults can thus be detected early and rectified before far greater damage ensues.

Depending on the version, the relays monitor phase sequence, phase failure with and without N conductor monitoring, phase asymmetry, undervoltage or overvoltage.

Phase asymmetry is evaluated as the difference between the greatest and the smallest phase voltage relative to the greatest phase voltage. Undervoltage or overvoltage exists when at least one phase voltage deviates by 20% from the set rated system voltage or the directly set limit values are overshoot or undershot. The rms value of the voltage is measured.

With the 3UG4617 or 3UG4618 relay, a wrong direction of rotation can also be corrected automatically.

## Benefits

- Can be used without auxiliary voltage in any network from 160 to 630 V AC worldwide thanks to wide voltage range
- Variably adjustable to overshoot, undershoot or range monitoring
- Freely configurable delay times and RESET response
- Width 22.5 mm
- Permanent display of actual value and line fault type on the digital versions
- Automatic correction of the direction of rotation by distinguishing between power system faults and wrong phase sequence
- All versions with removable terminals
- All versions with screw or spring-loaded terminals

## Application

The relays are used above all for mobile equipment, e.g. air conditioning compressors, refrigerating containers, building site compressors and cranes.

Function	Application
Phase sequence	<ul style="list-style-type: none"> <li>• Direction of rotation of the drive</li> </ul>
Phase failure	<ul style="list-style-type: none"> <li>• A fuse has tripped</li> <li>• Failure of the control supply voltage</li> <li>• Broken cable</li> </ul>
Phase asymmetry	<ul style="list-style-type: none"> <li>• Overheating of the motor due to asymmetrical voltage</li> <li>• Detection of asymmetrically loaded networks</li> </ul>
Undervoltage	<ul style="list-style-type: none"> <li>• Increased current on a motor with corresponding overheating</li> <li>• Unintentional resetting of a device</li> <li>• Network collapse, particularly with battery power</li> </ul>
Overtvoltage	<ul style="list-style-type: none"> <li>• Protection of a plant against destruction due to overvoltage</li> </ul>

## Technical specifications

### 3UG4511 monitoring relays

The 3UG4511 phase sequenced relay monitors the phase sequence in a 3-phase network. No adjustments are required for operation. The device has an internal power supply and works using the closed-circuit principle. If the phase sequence at the terminals L1-L2-L3 is correct, the output relay picks up after the delay time has elapsed and the green LED is lit. If the phase sequence is wrong, the output relay remains in its rest position.

#### Note:

When one phase fails, connected loads (motor windings, lamps, transformers, coils, etc.) create a feedback voltage at the terminal of the failed phase due to the network coupling. Because the 3UG4511 relays are not resistant to voltage feedback, such a phase failure is not detected. Should this be required, then the 3UG4512 monitoring relay must be used.

### Correct phase sequence

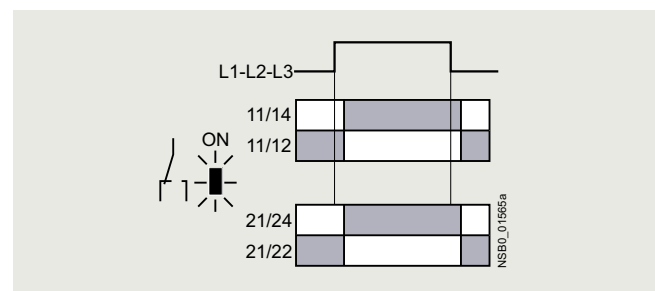

### Wrong phase sequence

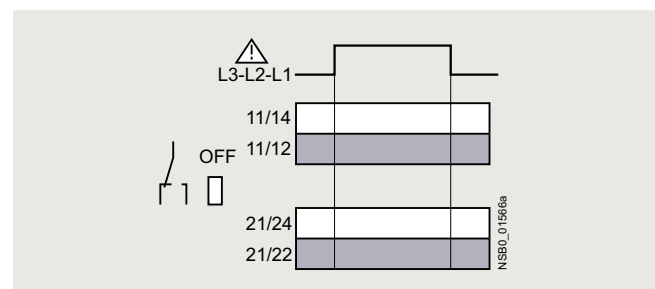

## Monitoring and control devices

### Relays

#### SIRIUS 3UG45, 3UG46 monitoring relays for stand-alone installation

#### Line monitoring

##### 3UG4512 monitoring relays

The 3UG4512 line monitoring relay monitors 3-phase networks with regard to phase sequence, phase failure and phase asymmetry of 10%. Thanks to a special measuring method, a phase failure is reliably detected in spite of the wide voltage range from 160 to 690 V AC and feedback through the load of up to 90%. The device has an internal power supply and works using the closed-circuit principle. No adjustments are required. If the line voltage is switched on, the green LED will light up. If the phase sequence at the terminals L1-L2-L3 is correct, the output relay picks up. If the phase sequence is wrong, the red LED flashes and the output relay remains in its rest position. If a phase fails, the red LED is permanently lit and the output relay drops.

##### Note:

The red LED is a fault diagnostic indicator and does not show the current relay status. The 3UG4512 monitoring relay is suitable for line frequencies of 50/60 Hz.

##### Phase failure

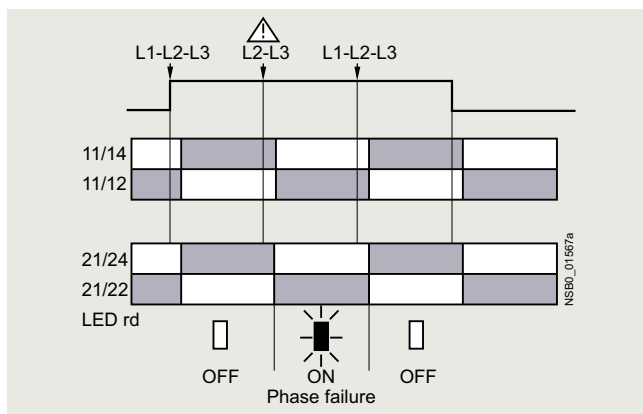

##### Wrong phase sequence

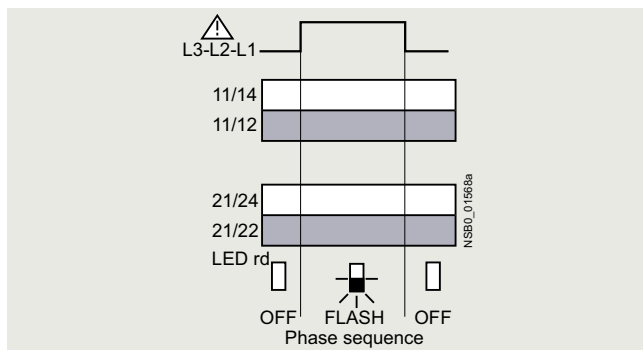

##### 3UG4513 monitoring relays

The 3UG4513 line monitoring relay monitors 3-phase networks with regard to phase sequence, phase failure, phase asymmetry and undervoltage of 20%. The device has an internal power supply and works using the closed-circuit principle. The hysteresis is 5%. The integrated response delay time T is adjustable from 0 to 20 s and responds to undervoltage. If the direction is incorrect, the device switches off immediately. Thanks to a special measuring method, a phase failure is reliably detected in spite of the wide voltage range from 160 to 690 V AC and feedback through the load of up to 80%. If the line voltage is switched on, the green LED will light up. If the phase sequence at the terminals L1-L2-L3 is correct, the output relay picks up. If the phase sequence is wrong, the red LED flashes and the output relay remains in its rest position. If a phase fails, the red LED is permanently lit and the output relay drops.

##### Note:

The red LED is a fault diagnostic indicator and does not show the current relay status. The 3UG4513 monitoring relay is suitable for line frequencies of 50/60 Hz.

##### Phase failure and undervoltage

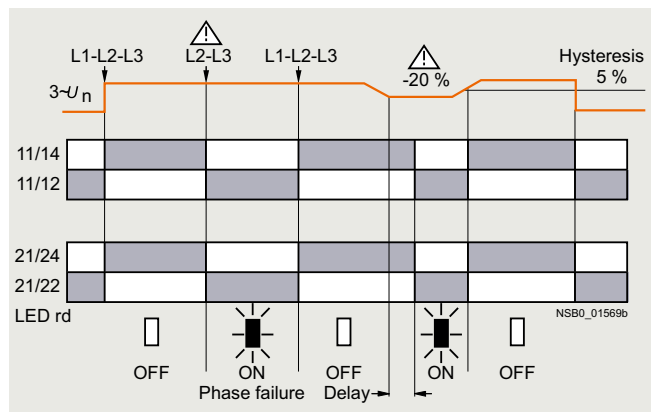

##### Wrong phase sequence

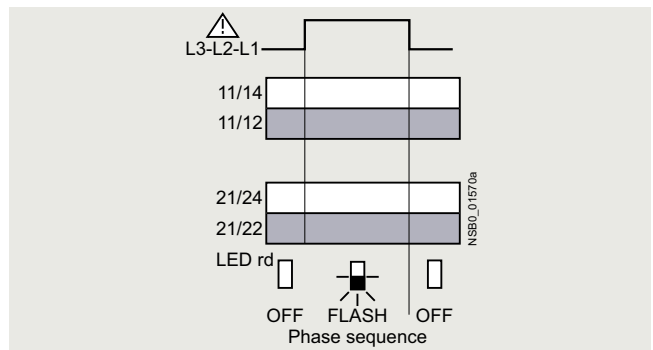

**3UG4614 monitoring relays**

The 3UG4614 line monitoring relay has a wide voltage range input and an internal power supply. The device is equipped with a display and is parameterized using three buttons. The unit monitors 3-phase networks with regard to phase asymmetry from 5 to 20%, phase failure, undervoltage and phase sequence. The hysteresis is adjustable from 1 to 20 V. In addition the device has a response delay and ON-delay from 0 to 20 s in each case. The response delay time responds to phase asymmetry and undervoltage. If the direction is incorrect, the device switches off immediately. Thanks to a special measuring method, a phase failure is reliably detected in spite of the wide voltage range from 160 to 690 V AC and feedback through the load of up to 80%.

The 3UG4614 monitoring relay can be operated on the basis of either the open-circuit or closed-circuit principle and with Manual or Auto RESET.

With the closed-circuit principle selected

Wrong phase sequence

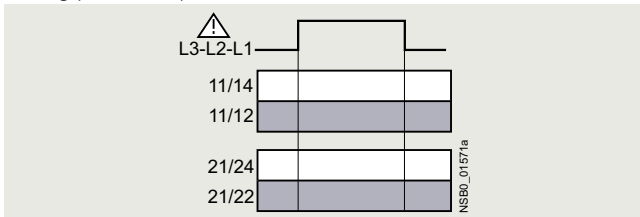

Phase failure

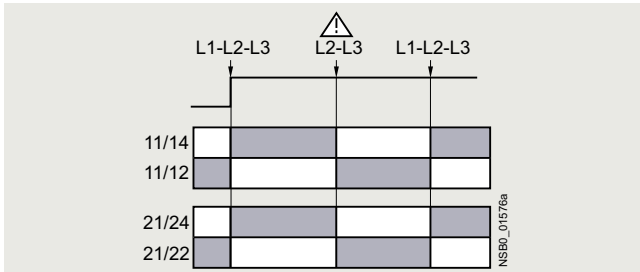

Undervoltage

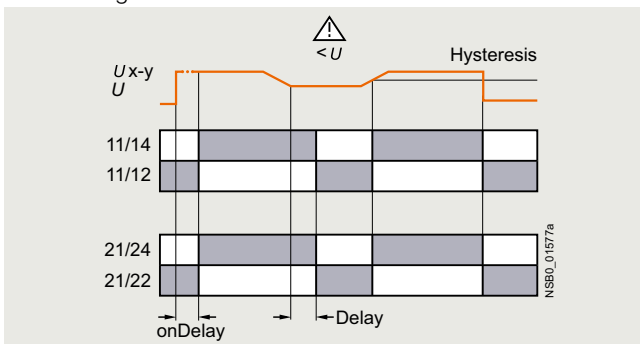

Asymmetry

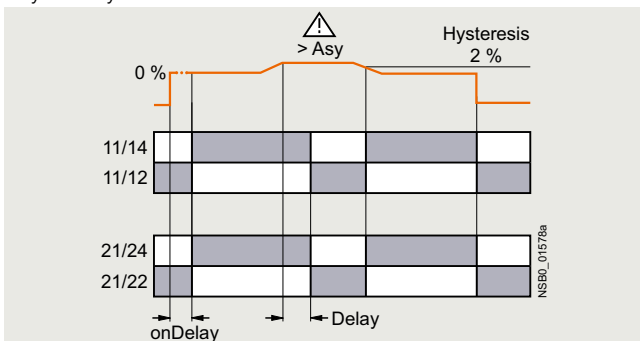
**3UG4615/3UG4616 monitoring relays**

The 3UG4615/3UG4616 line monitoring relay has a wide voltage range input and an internal power supply. The device is equipped with a display and is parameterized using three buttons. The 3UG4615 device monitors 3-phase networks with regard to phase failure, undervoltage, overvoltage and phase sequence. The 3UG4616 monitoring relay monitors the neutral conductor as well. The hysteresis is adjustable from 1 to 20 V. In addition the device has two separately adjustable delay times for overvoltage and undervoltage from 0 to 20 s in each case. If the direction of rotation is incorrect, the device switches off immediately. Thanks to a special measuring method, a phase failure is reliably detected in spite of the wide voltage range from 160 to 690 V AC and feedback through the load of up to 80%.

The 3UG4615/3UG4616 monitoring relay can be operated on the basis of either the open-circuit or closed-circuit principle and with Manual or Auto RESET.

With the closed-circuit principle selected

Wrong phase sequence

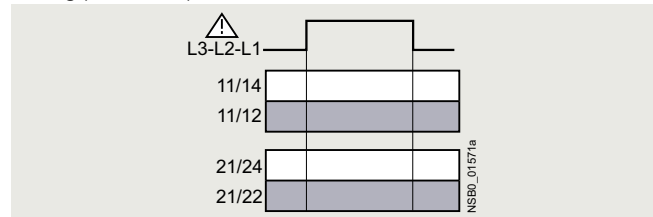

Phase failure

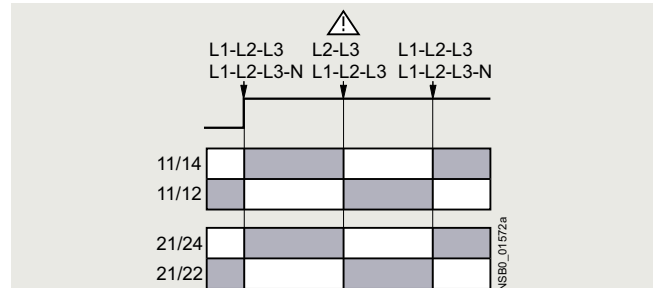

Undervoltage

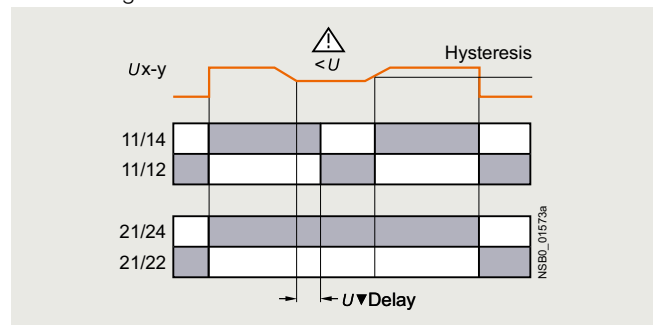

Overvoltage

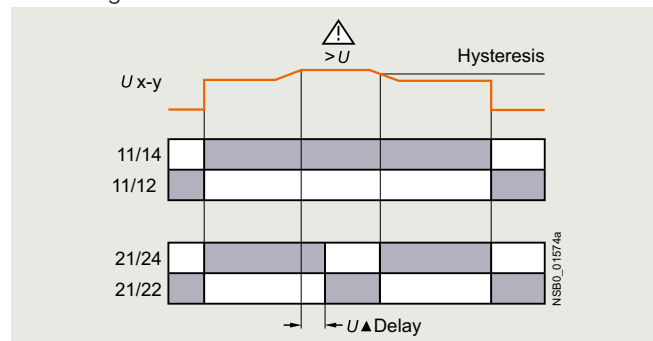

## Monitoring and control devices

### Relays

#### SIRIUS 3UG45, 3UG46 monitoring relays for stand-alone installation

#### Line monitoring

##### 3UG4617/3UG4618 monitoring relays

The 3UG4617/3UG4618 line monitoring relay has an internal power supply and can automatically correct a wrong direction of rotation. Thanks to a special measuring method, a phase failure is reliably detected in spite of the wide voltage range from 160 to 690 V AC and feedback through the load of up to 80%. The device is equipped with a display and is parameterized using three buttons. The 3UG4617 line monitoring relay unit monitors 3-phase networks with regard to phase sequence, phase failure, phase asymmetry, undervoltage and overvoltage. The 3UG4618 monitoring relay monitors the neutral conductor as well. The hysteresis is adjustable from 1 to 20 V. In addition the device has delay times from 0 to 20 s in each case for overvoltage, undervoltage, phase failure and phase asymmetry. The 3UG4617/3UG4618 monitoring relay can be operated on the basis of either the open-circuit or closed-circuit principle and with Manual or Auto RESET. The one changeover contact is used for warning or disconnection in the event of power system faults (voltage, asymmetry), the other responds only to a wrong phase sequence. In conjunction with a contactor reversing assembly it is thus possible to change the direction automatically.

With the closed-circuit principle selected

##### Phase failure

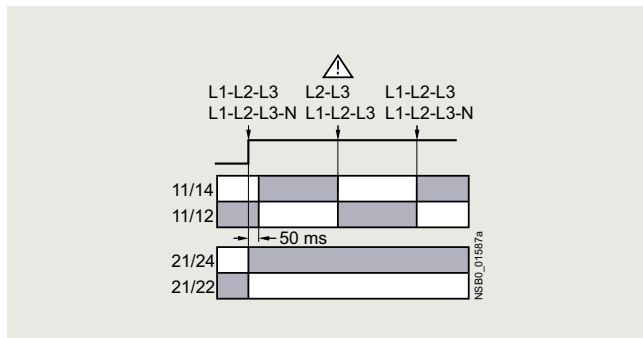

##### Undervoltage

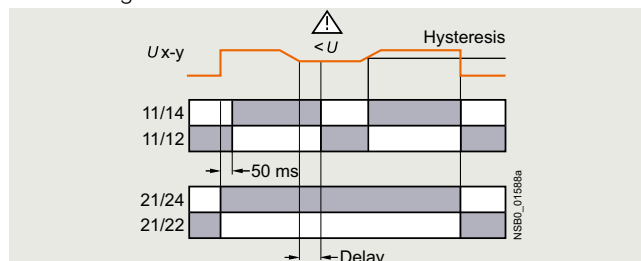

##### Overvoltage

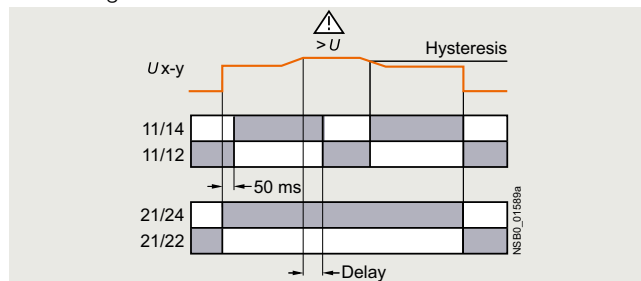

##### Asymmetry

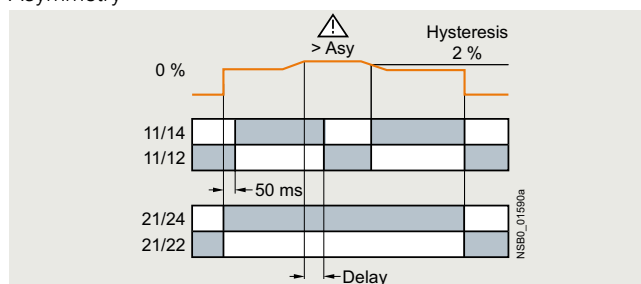

Type	3UG4511 ... 3UG4513, 3UG4614 ... 3UG4618	
<b>General data</b>		
<b>Rated insulation voltage <math>U_i</math></b>	V	690
Pollution degree 3 Overvoltage category III acc. to VDE 0110		
<b>Rated impulse withstand voltage <math>U_{imp}</math></b>	kV	6
<b>Control circuit</b>		
<b>Load capacity of the output relay</b>		
• Thermal current $I_{th}$	A	5
<b>Rated operational current <math>I_e</math> at</b>		
• AC-15/24 ... 400 V	A	3
• DC-13/24 V	A	1
• DC-13/125 V	A	0.2
• DC-13/250 V	A	0.1
<b>Minimum contact load at 17 V DC</b>	mA	5
<b>Electrical endurance AC-15</b>	million operating cycles	0.1
<b>Mechanical service life</b>	million operating cycles	10

## Selection and ordering data



3UG4511-2BP20



3UG4512-2BR20

Adjustable hysteresis	Under-voltage detection	Overvoltage detection	Stabilization time adjustable stDEL	Tripping delay time adjustable Del	Version of auxiliary contacts	Measurable line voltage <sup>1)</sup>	Spring-loaded terminals 	Article No.	Weight kg
			s	s	CO contact	V			
<b>Monitoring of phase sequence</b>									
Auto RESET									
--	--	--	--	--	1	160 ... 260 AC	<b>3UG4511-2AN20</b>		0.114
					2		<b>3UG4511-2BN20</b>		0.120
					1	320 ... 500 AC	<b>3UG4511-2AP20</b>		0.115
					2		<b>3UG4511-2BP20</b>		0.130
					1	420 ... 690 AC	<b>3UG4511-2AQ20</b>		0.119
					2		<b>3UG4511-2BQ20</b>		0.133
<b>Monitoring of phase sequence, phase failure and phase asymmetry</b>									
Auto RESET, closed-circuit principle, asymmetry threshold permanently 10%									
--	--	--	--	--	1	160 ... 690 AC	<b>3UG4512-2AR20</b>		0.120
					2		<b>3UG4512-2BR20</b>		0.140
<b>Monitoring of phase sequence, phase failure, asymmetry and undervoltage</b>									
Analogically adjustable, Auto RESET, closed-circuit principle, asymmetry and undervoltage threshold permanently 20%									
	5% of set value ✓	--	--	0.1 ... 20	2	160 ... 690 AC	<b>3UG4513-2BR20</b>		0.140
Digitally adjustable, Auto RESET or Manual RESET, open-circuit or closed-circuit principle, asymmetry threshold 0 or 5 ... 20%									
Adjustable 1 ... 20 V	✓	--	0.1 ... 20	0.1 ... 20	2	160 ... 690 AC	<b>3UG4614-2BR20</b>		0.144
<b>Monitoring of phase sequence, phase failure, overvoltage and undervoltage</b>									
Digitally adjustable, Auto RESET or Manual RESET, open-circuit or closed-circuit principle									
Adjustable 1 ... 20 V	✓	✓	--	0.1 ... 20 <sup>2)</sup>	2 <sup>2)</sup>	160 ... 690 AC	<b>3UG4615-2CR20</b>		0.141
<b>Monitoring of phase sequence, phase and N conductor failure, overvoltage and undervoltage</b>									
Digitally adjustable, Auto RESET or Manual RESET, open-circuit or closed-circuit principle									
Adjustable 1 ... 20 V	✓	✓	--	0.1 ... 20 <sup>2)</sup>	2 <sup>2)</sup>	90... 400 AC against N	<b>3UG4616-2CR20</b>		0.151
<b>Automatic correction of the direction of rotation in case of wrong phase sequence, phase failure, asymmetry, overvoltage and undervoltage</b>									
Digitally adjustable, Auto RESET or Manual RESET, open-circuit or closed-circuit principle, asymmetry threshold 0 or 5 ... 20%									
Adjustable 1 ... 20 V	✓	✓	--	0.1 ... 20	2 <sup>3)</sup>	160 ... 690 AC	<b>3UG4617-2CR20</b>		0.139
<b>Automatic correction of the direction of rotation in case of wrong phase sequence, phase and N conductor failure, phase asymmetry, overvoltage and undervoltage</b>									
Digitally adjustable, Auto RESET or Manual RESET, open-circuit or closed-circuit principle, asymmetry threshold 0 or 5 ... 20%									
Adjustable 1 ... 20 V	✓	✓	--	0.1 ... 20	2 <sup>3)</sup>	90 ... 400 AC against N	<b>3UG4618-2CR20</b>		0.149

- ✓ Function available  
 -- Function not available

For accessories, see page 2/281.

1) Absolute limit values.

2) 1 CO contact each and one tripping delay time each for  $U_{\min}$  and  $U_{\max}$ .

3) 1 CO contact each for power system fault and phase sequence correction.

## Monitoring and control devices

### Relays

#### SIRIUS 3UG45, 3UG46 monitoring relays for stand-alone installation

#### Voltage monitoring

##### Overview



SIRIUS 3UG4631 monitoring relay

The relays monitor 1-phase AC voltages (rms value) and DC voltages against the set threshold value for overshoot and undershoot. The devices differ with regard to their power supply (internal or external).

##### Benefits

- Versions with wide voltage supply range
- Variably adjustable to overshoot, undershoot or range monitoring
- Freely configurable delay times and RESET response
- Width 22.5 mm
- Display of actual value and status messages
- All versions with removable terminals
- All versions with screw or spring-loaded terminals

##### Application

- Protection of a plant against destruction due to overvoltage
- Switch-on of a plant at a defined voltage and higher
- Protection from undervoltage due to overloaded supply voltages, particularly with battery power
- Threshold switch for analog signals from 0.1 to 10 V

##### Technical specifications

###### 3UG4631/3UG4632 monitoring relays

The 3UG4631/3UG4632 voltage monitoring relay is supplied with an auxiliary voltage of 24 V AC/DC or 24 to 240 V AC/DC and performs overshoot, undershoot or range monitoring of the voltage depending on parameterization. The device is equipped with a display and is parameterized using three buttons.

The measuring range extends from 0.1 to 60 V or 10 to 600 V AC/DC. The threshold values for overshoot or undershoot can be freely configured within this range. If one of these threshold values is reached, the output relay responds according to the set principle of operation as soon as the delay time has elapsed. This delay time  $U_{Del}$  can be set from 0.1 to 20 s. The hysteresis can be set from 0.1 to 30 V or 0.1 to 300 V. The device can be operated on the basis of either the open-circuit or closed-circuit principle and with Manual or Auto RESET. One output changeover contact is available as signaling contact.

###### With the closed-circuit principle selected

###### Overvoltage

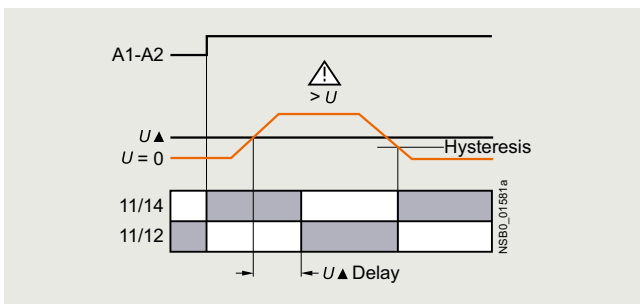

###### Undervoltage

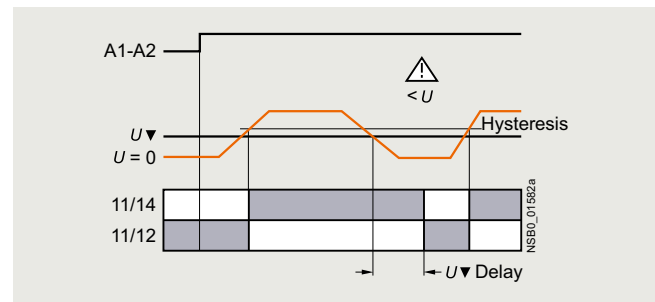

###### Range monitoring

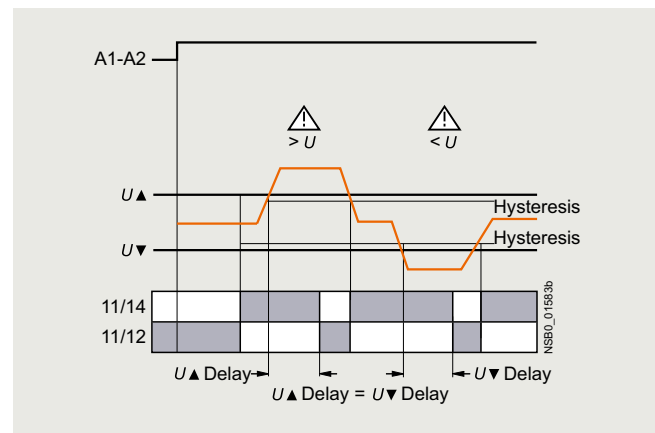

**3UG4633 monitoring relay**

The 3UG4633 voltage monitoring relay has an internal power supply and performs overshoot, undershoot or range monitoring of the voltage depending on parameterization. The device is equipped with a display and is parameterized using three buttons.

The operating and measuring range extends from 17 to 275 V AC/DC. The threshold values for overshoot or undershoot can be freely configured within this range. If one of these threshold values is reached, the output relay responds according to the set principle of operation as soon as the tripping delay time has elapsed. This delay time  $U_{Del}$  can also be adjusted, just like the ON-delay time  $onDel$  from 0.1 to 20 s.

The hysteresis is adjustable from 0.1 to 150 V. The device can be operated on the basis of either the open-circuit or closed-circuit principle and with Manual or Auto RESET. One output changeover contact is available as signaling contact.

With the closed-circuit principle selected

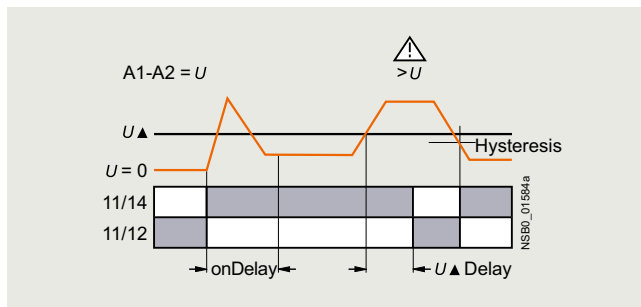
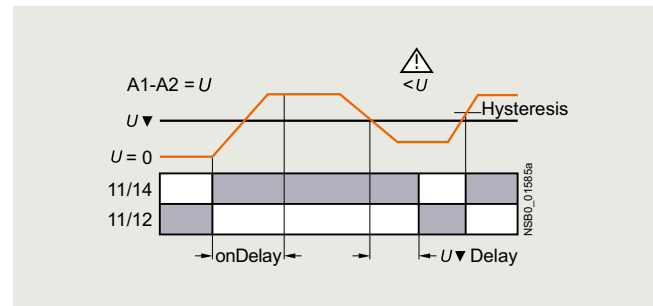
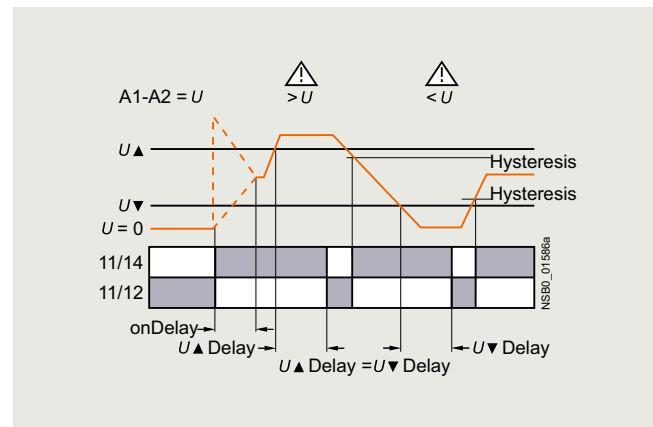
**Overvoltage****Undervoltage****Range monitoring**

Type		3UG4631	3UG4632	3UG4633
<b>General data</b>				
<b>Rated insulation voltage <math>U_i</math></b>	V	690		
Pollution degree 3 Overvoltage category III acc. to VDE 0110				
<b>Rated impulse withstand voltage <math>U_{imp}</math></b>	kV	6		
<b>Measuring circuit</b>				
<b>Permissible measuring range</b> 1-phase AC/DC voltage	V	0.1 ... 60	10 ... 650	17 ... 275
<b>Measuring frequency</b>	Hz	40 ... 500		
<b>Setting range</b> 1-phase voltage	V	0.1 ... 60	10 ... 600	17 ... 275
<b>Control circuit</b>				
<b>Load capacity of the output relay</b>				
• Thermal current $I_{th}$	A	5		
<b>Rated operational current <math>I_e</math> at</b>				
• AC-15/24 ... 400 V	A	3		
• DC-13/24 V	A	1		
• DC-13/125 V	A	0.2		
• DC-13/250 V	A	0.1		
<b>Minimum contact load</b> at 17 V DC	mA	5		



## Monitoring and control devices

### Relays

#### SIRIUS 3UG45, 3UG46 monitoring relays for stand-alone installation

#### Voltage monitoring

#### Selection and ordering data

- Digitally adjustable, with illuminated LCD
- Auto or Manual RESET
- Open-circuit or closed-circuit principle
- 1 CO contact



3UG4633-2AL30

Measuring range	Adjustable hysteresis	Rated control supply voltage $U_s$	Spring-loaded terminals 	Weight
V	V	V	Article No.	kg
<b>Internal power supply without auxiliary voltage, separately adjustable ON-delay and tripping delay time 0.1 ... 20 s</b>				
17 ... 275 AC/DC	0.1 ... 150	17 ... 275 AC/DC <sup>1)</sup>	<b>3UG4633-2AL30</b>	0.131
<b>Externally supplied with auxiliary voltage, tripping delay time adjustable 0.1 ... 20 s</b>				
0.1 ... 60 AC/DC 10 ... 600 AC/DC	0.1 ... 30 0.1 ... 300	24 AC/DC	<b>3UG4631-2AA30</b> <b>3UG4632-2AA30</b>	0.128 0.122
0.1 ... 60 AC/DC 10 ... 600 AC/DC	0.1 ... 30 0.1 ... 300	24 ... 240 AC/DC	<b>3UG4631-2AW30</b> <b>3UG4632-2AW30</b>	0.139 0.131

<sup>1)</sup> Absolute limit values.

For accessories, see [page 2/281](#).

## Overview



SIRIUS 3UG4622 monitoring relay

The relays monitor 1-phase AC currents (rms value) and DC currents against the set threshold value for overshoot and undershoot. They differ with regard to their measuring ranges and control supply voltage types.

## Benefits

- Versions with wide voltage supply range
- Variably adjustable to overshoot, undershoot or range monitoring
- Freely configurable delay times and RESET response
- Width 22.5 mm
- Display of actual value and status messages
- All versions with removable terminals
- All versions with screw or spring-loaded terminals

## Application

- Overcurrent and undercurrent monitoring
- Monitoring the functionality of electrical loads
- Open-circuit monitoring
- Threshold switch for analog signals from 4 to 20 mA

## Technical specifications

**3UG4621/3UG4622 monitoring relays**

The 3UG4621 or 3UG4622 current monitoring relay is supplied with an auxiliary voltage of 24 V AC/DC or 24 to 240 V AC/DC and performs overshoot, undershoot or range monitoring of the current depending on parameterization. The device is equipped with a display and is parameterized using three buttons.

The measuring range extends from 3 to 500 mA or 0.05 to 10 A. The rms value of the current is measured. The threshold values for overshoot or undershoot can be freely configured within this range. If one of these threshold values is reached, the output relay responds according to the set principle of operation as soon as the tripping delay time  $I_{Del}$  has elapsed. This time and the ON-delay time  $onDel$  are adjustable from 0.1 to 20 s.

The hysteresis is adjustable from 0.1 to 250 mA or 0.01 to 5 A. The device can be operated with Manual or Auto RESET and on the basis of either the open-circuit or closed-circuit principle. You can decide here whether the output relay is to respond when the supply voltage  $U_S = ON$  is applied, or not until the lower measuring range limit of the measuring current ( $I > 3 \text{ mA}/50 \text{ mA}$ ) is reached. One output changeover contact is available as signaling contact.

With the closed-circuit principle selected upon application of the control supply voltage

Current overshoot

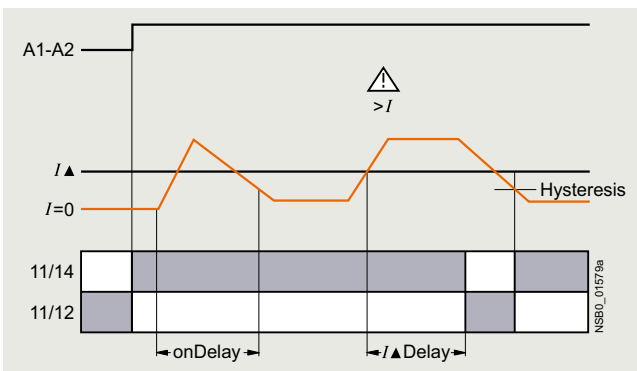

Current undershoot

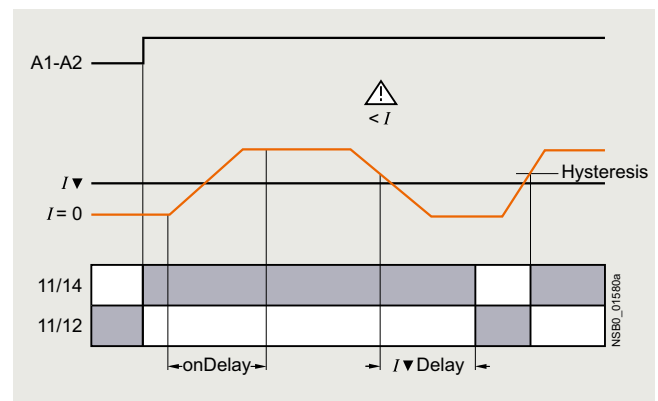

Range monitoring

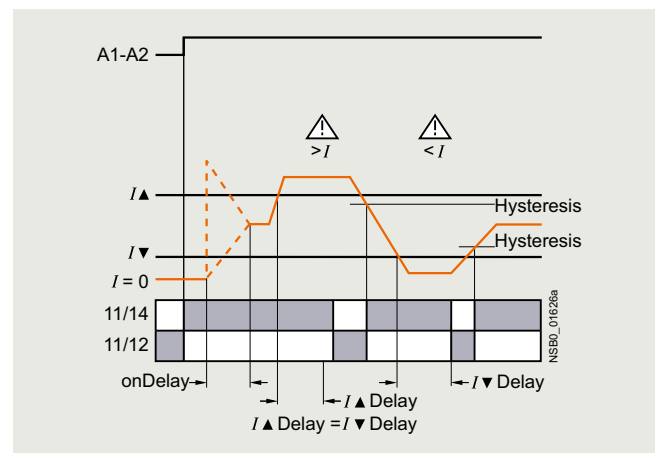

## Monitoring and control devices

### Relays

#### SIRIUS 3UG45, 3UG46 monitoring relays for stand-alone installation

#### Current monitoring

Type		3UG4621-.AA	3UG4621-.AW	3UG4622-.AA	3UG4622-.AW
<b>General data</b>					
<b>Rated insulation voltage <math>U_i</math></b> Pollution degree 3; overvoltage category III according to VDE 0110	V	690			
<b>Rated impulse withstand voltage <math>U_{imp}</math></b>	kV	6			
<b>Measuring circuit</b>					
<b>Measuring range for 1-phase AC/DC current</b>	A	0.003 ... 0.6		0.05 ... 15	
<b>Measuring frequency</b>	Hz	40 ... 500			
<b>Setting range for 1-phase current</b>	A	0.003 ... 0.5		0.05 ... 10	
<b>Load supply voltage</b>	V	24	Max. 300 <sup>1)</sup> Max. 500 <sup>2)</sup>	24	Max. 300 <sup>1)</sup> Max. 500 <sup>2)</sup>
<b>Control circuit</b>					
<b>Load capacity of the output relay</b> • Thermal current $I_{th}$	A	5			
<b>Rated operational current <math>I_e</math> at</b>					
• AC-15/24 ... 400 V	A	3			
• DC-13/24 V	A	1			
• DC-13/125 V	A	0.2			
• DC-13/250 V	A	0.1			
<b>Minimum contact load at 17 V DC</b>	mA	5			

1) With protective separation.

2) With simple separation.

#### Selection and ordering data

- Digitally adjustable, with illuminated LCD
- Auto or Manual RESET
- Open-circuit or closed-circuit principle
- 1 CO contact



3UG4622-2AW30

Measuring range	Adjustable hysteresis	Rated control supply voltage $U_s$	Spring-loaded terminals	Weight
		V	Article No.	kg
<b>Monitoring of undercurrent and overcurrent, startup delay and tripping delay times can be adjusted separately 0.1 ... 20 s</b>				
3 ... 500 mA AC/DC 0.05 ... 10 A AC/DC	0.1 ... 250 mA 0.01 ... 5 A	24 AC/DC <sup>1)</sup>	<b>3UG4621-2AA30</b> <b>3UG4622-2AA30</b>	0.132 0.130
3 ... 500 mA AC/DC 0.05 ... 10 A AC/DC	0.1 ... 250 mA 0.01 ... 5 A	24 ... 240 AC/DC <sup>2)</sup>	<b>3UG4621-2AW30</b> <b>3UG4622-2AW30</b>	0.145 0.145

1) No electrical separation. Load supply voltage 24 V.

2) Electrical separation between control circuit and measuring circuit.  
Load supply voltage for protective separation max. 300 V, for simple separation max. 500 V.

For accessories, see page 2/281.

For AC currents  $I > 10$  A it is possible to use 4NC current transformers as an accessory, see Catalog LV 10.

## Overview



SIRIUS 3UG4641 monitoring relay

The 3UG4641 power factor and active current monitoring device enables load monitoring of motors.

Whereas power factor (p.f.) monitoring is used above all for monitoring no-load operation, the active current monitoring option can be used to observe and evaluate the load factor over the entire torque range.

## Benefits

- Can be used worldwide thanks to wide voltage range from 90 to 690 V (absolute limit values)
- Monitoring of even small 1-phase motors with a no-load supply current below 0.5 A
- Simple determination of threshold values by directly referencing measured variables to motor loading
- Range monitoring and active current measurement enable detection of cable breaks between control cabinets and motors, as well as phase failures
- Power factor (p.f.) or  $I_{res}$  (active current) can be selected as the measurement principle
- Width 22.5 mm
- All versions with removable terminals
- All versions with screw or spring-loaded terminals

## Application

- No-load monitoring and load shedding, such as in the event of a V-belt tear
- Underload monitoring in the low-end performance range, e.g. in the event of pump no-load operation
- Monitoring of overload, e.g. due to a dirty filter system
- Simple power factor monitoring in power systems for control of compensation equipment
- Broken cable between control cabinet and motor

## Technical specifications

## 3UG4641 monitoring relays

The 3UG4641 monitoring relay is self-powered and serves the 1-phase monitoring of the power factor or performs overshoot, undershoot or range monitoring of the active current depending on how it is parameterized. The load to be monitored is connected upstream of the IN terminal. The load current flows through the terminals IN and Ly/N. The setting range for the power factor is 0.1 to 0.99 and for the active current  $I_{res}$  it is 0.2 to 10 A. If the control supply voltage is switched on and no load current flows, the display will show  $I < 0.2$  and a symbol for overshoot, undershoot or range monitoring. If the motor is now switched on and the current exceeds 0.2 A, the set ON-delay time begins. During this time, if the set limit values are undershot or exceeded, this does not lead to a relay reaction of the changeover contact. If the operational flowing active current and/or the power factor value falls below or exceeds the respective set threshold value, the spike delay begins. When this time has expired, the relay changes its switch position. The relevant measured variables for overshooting and undershooting in the display flash. If monitoring for active current undershoot is switched off ( $I_{res} \nabla = \text{OFF}$ ), and if the load current undershoots the lower measuring range threshold (0.2 A), the CO contacts remain unchanged. If a threshold value is set for the monitoring of active current undershooting, then undershooting of the measuring range threshold (0.2 A) will result in a response of the CO contacts.

The relay operates either according to the open-circuit or closed-circuit principle. If the device is set to Auto RESET (Memory = No), depending on the set principle of operation, the switching relay returns to its initial state and the flashing ends when the hysteresis threshold is reached.

If Manual RESET is selected in the menu (Memory = Yes), the switching relay remains in its current switching state and the current measured value and the symbol for undershooting and overshooting continue to flash, even when the measured variable reaches a permissible value again. This stored fault status can be reset by simultaneously pressing the UP▲ and DOWN▼ keys for 2 seconds, or by switching the supply voltage off and back on again.

## With the closed-circuit principle selected

Response in the event of undershooting the measuring range limit

- With activated monitoring of  $I_{res} \nabla$

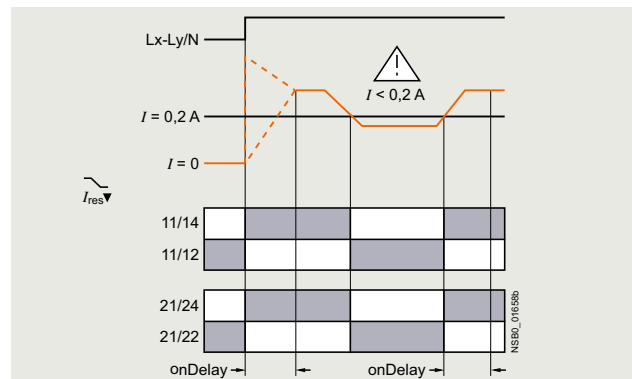

- With deactivated monitoring of active current undershooting

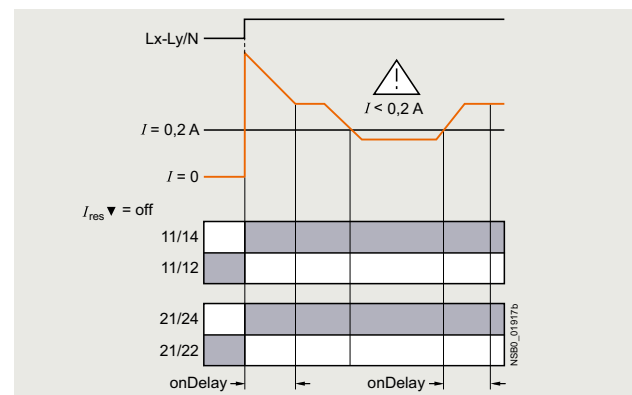

## Monitoring and control devices

### Relays

### SIRIUS 3UG45, 3UG46 monitoring relays for stand-alone installation

#### Power factor and active current monitoring

Overshooting of active current

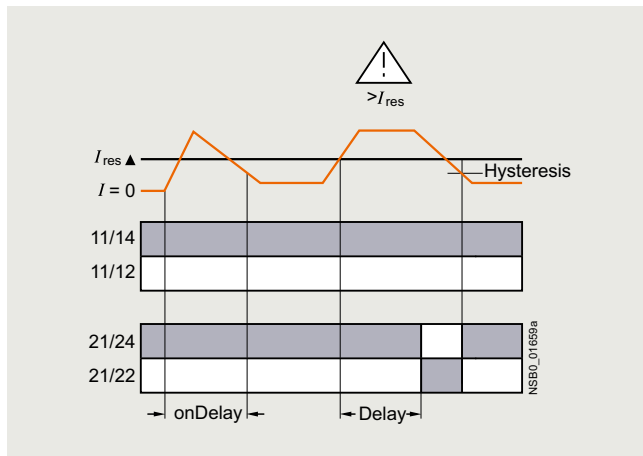

Overshooting of power factor

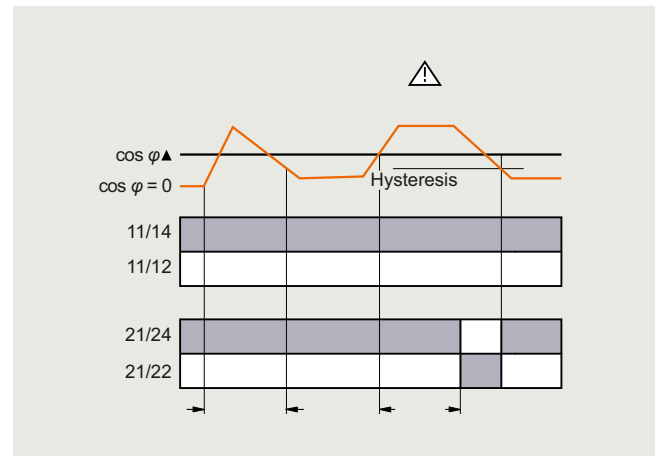

Undershooting of active current

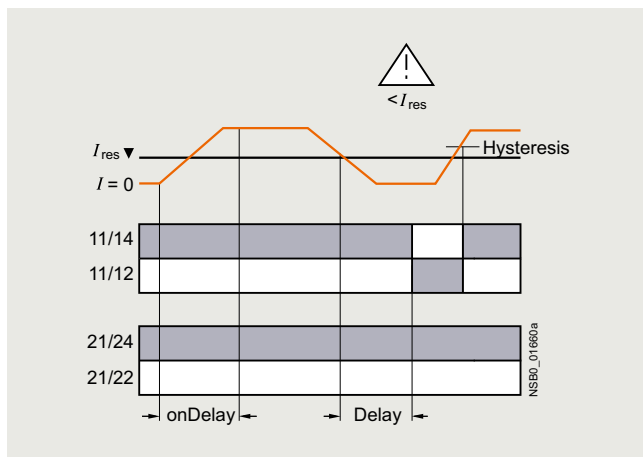

Undershooting of power factor

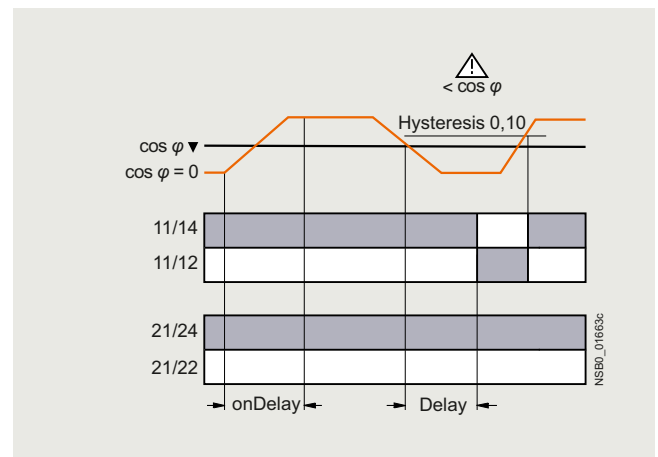

Range monitoring of active current

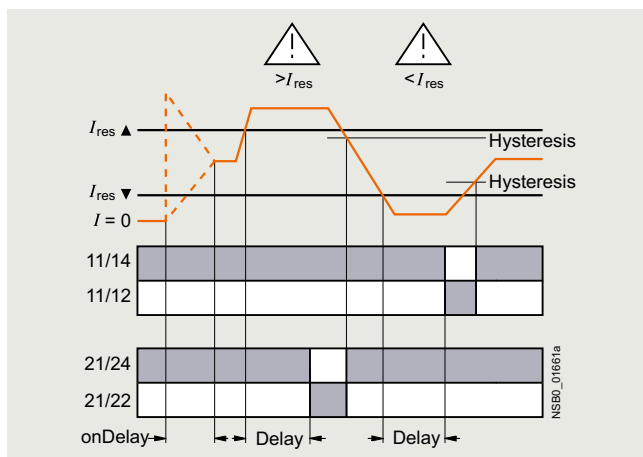

Range monitoring of power factor

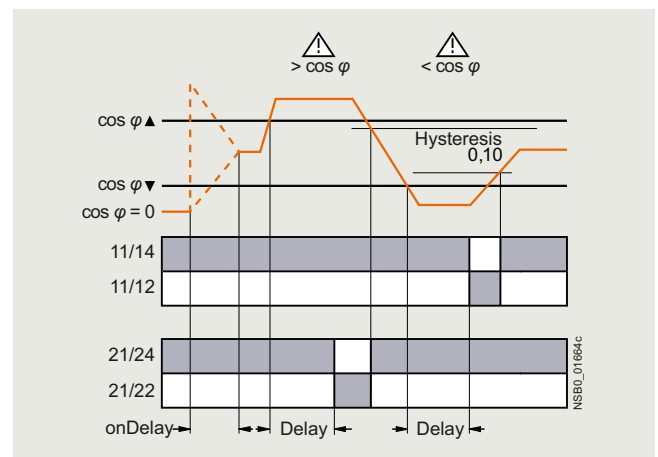

Type	3UG4641	
<b>General data</b>		
<b>Rated insulation voltage <math>U_i</math></b> Pollution degree 3 Overvoltage category III acc. to VDE 0110	V	690
<b>Rated impulse withstand voltage <math>U_{imp}</math></b>	kV	6
<b>Control circuit</b>		
<b>Number of CO contacts for auxiliary contacts</b>		2
<b>Load capacity of the output relay</b>		
• Thermal current $I_{th}$	A	5
<b>Rated operational current <math>I_e</math> at</b>		
• AC-15/24 ... 400 V	A	3
• DC-13/24 V	A	1
• DC-13/125 V	A	0.2
• DC-13/250 V	A	0.1
<b>Minimum contact load at 17 V DC</b>	mA	5

### Selection and ordering data

- For monitoring the power factor and the active current  $I_{res}$  (p.f.  $\times I$ )
- Suitable for 1-phase and 3-phase currents
- Digitally adjustable, with illuminated LCD
- Overshoot, undershoot or range monitoring adjustable
- Upper and lower threshold value can be adjusted separately
- Permanent display of actual value and tripping state
- 1 changeover contact each for undershoot/overshoot

Measuring range		Adjustable hysteresis		ON-delay time adjustable onDel	Tripping delay time adjustable $I\Delta\text{Del}/I\nabla\text{Del}, \varphi\Delta\text{Del}/\varphi\nabla\text{Del}$	Rated control supply voltage $U_s$ <sup>1)</sup>	Spring-loaded terminals 	Weight
For power factor	For active current $I_{res}$	For power factor	For active current $I_{res}$			50/60 Hz AC		
P.f.	A	P.f.	A	s	s	V	Article No.	kg
0.10 ... 0.99	0.2 ... 10.0	0.1	0.1 ... 2.0	0 ... 99	0.1 ... 20.0	90 ... 690	<b>3UG4641-2CS20</b>	0.153

<sup>1)</sup> Absolute limit values.

For accessories, see page 2/281.

For AC active currents  $I_{res} > 10$  A it is possible to use 4NC current transformers as an accessory, see Catalog LV 10.

## Monitoring and control devices

### Relays

#### SIRIUS 3UG45, 3UG46 monitoring relays for stand-alone installation

#### Residual-current monitoring > Residual-current monitoring relays

#### Overview



SIRIUS 3UG4625 monitoring relay

The 3UG4625 residual-current monitoring relays are used in conjunction with the 3UL23 residual-current transformers for monitoring plants in which higher residual currents are increasingly expected due to ambient conditions. Monitoring encompasses pure AC residual currents or AC residual currents with a pulsating DC fault current component (transformer type A in accordance with DIN VDE 0100-530/IEC TR 60755).

#### Technical specifications

##### 3UG4625 monitoring relays

The main conductor, and any neutral conductor to which a load is connected, are routed through the opening of the toroidal core of a residual-current transformer. A secondary winding is placed around this toroidal core to which the monitoring relay is connected.

If operation of a plant is fault-free, the sum of the inflowing and outward currents equals zero. No current is then induced in the secondary winding of the residual-current transformer.

However, if an insulation fault occurs, the sum of the inflowing currents is greater than that of the outward currents. The differential current – i.e. the residual current – induces a secondary current in the secondary winding of the transformer. This current is evaluated in the monitoring relay and is used on the one hand to display the actual residual current and on the other, to switch the relay if the set warning or tripping threshold is overshoot.

If the measured residual current exceeds the set warning value, the associated changeover contact instantly changes the switching state and an indication appears on the display.

If the measured residual current exceeds the set tripping value, the set delay time begins and the associated relay symbol flashes. On expiry of this time, the associated changeover contact changes the switching state.

##### ON-delay time for motor start

To be able to start a drive when a residual current is detected, the output relays switch to the OK state for an adjustable ON-delay time depending on the selected open-circuit or closed-circuit principle.

The changeover contacts do not react if the set threshold values are overshoot during this period.

#### Benefits

- Worldwide use thanks to wide voltage range from 24 to 240 V AC/DC
- High measuring accuracy of  $\pm 7.5\%$
- Permanent self-monitoring
- Variable threshold values for warning and disconnection
- Freely configurable delay times and RESET response
- Permanent display of the actual value and fault diagnostics via the display
- High level of flexibility and space saving through installation of the transformer inside or outside the control cabinet
- Width 22.5 mm
- All versions with removable terminals
- All versions with screw or spring-loaded terminals

#### Application

Monitoring of plants in which residual currents can occur, e.g. due to dust deposits or moisture, porous cables and leads, or capacitive residual currents.

##### With the closed-circuit principle selected

##### Residual-current monitoring with Auto RESET (Memory = no)

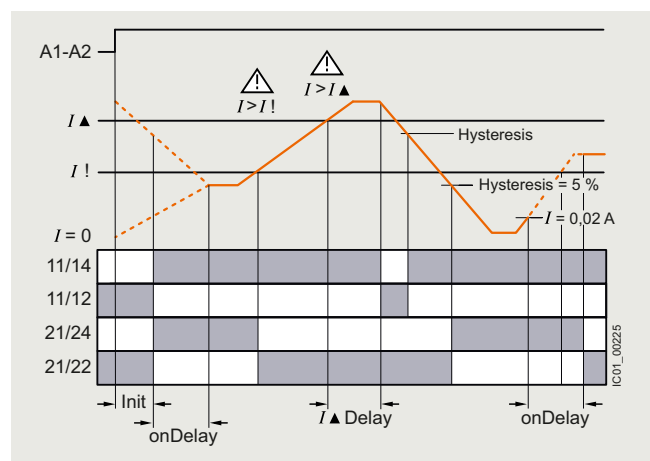

If the device is set to Auto RESET, the relay switches back to the OK state for the tripping value after tripping once the value falls below the set hysteresis threshold and the display stops flashing.

The associated relay changes its switching state if the value falls below the fixed hysteresis value of 5% of the set warning value.

Any overshoots are therefore not stored.

## Residual-current monitoring &gt; Residual-current monitoring relays

## Residual-current monitoring with Manual RESET (Memory = yes)

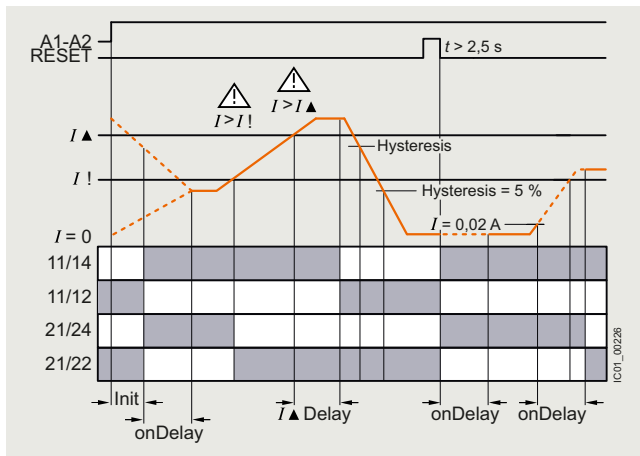

If Manual RESET is selected in the menu, the output relays remain in their current switching state and the current measured value and the symbol for overshooting continue to flash, even when the measured residual current returns to a permissible value. This stored fault status can be reset by simultaneously pressing the UP▲ and DOWN▼ keys for > 2 seconds, or by switching the supply voltage off and back on again.

**Note:**

Do not ground the neutral conductor downstream of the residual-current transformer as otherwise residual current monitoring functions can no longer be ensured.

2

Type	3UG4625-1CW30, 3UG4625-2CW30	
<b>General data</b>		
Insulation voltage for overvoltage category III acc. to IEC 60664 for pollution degree 3, rated value	V	300
Impulse withstand voltage, rated value $U_{imp}$	kV	4
<b>Control circuit</b>		
Number of CO contacts for auxiliary contacts		2
Thermal current of the non-solid-state contact blocks, maximum	A	5
<b>Current-carrying capacity of the output relay</b>		
• At AC-15 at 250 V at 50/60 Hz	A	3
• At DC-13		
- At 24 V	A	1
- At 125 V	A	0.2
- At 250 V	A	0.1
Operational current at 17 V, minimum	mA	5

**Selection and ordering data**

- For monitoring residual currents from 0.03 to 40 A, from 16 to 400 Hz
- For 3UL23 residual-current transformers with feed-through opening from 35 to 210 mm
- Permanent self-monitoring
- Certified in accordance with IEC 60947, functionality corresponds to IEC 62020
- Digitally adjustable, with illuminated LCD
- Permanent display of actual value and tripping state
- Separately adjustable limit value and warning threshold
- 1 changeover contact each for warning threshold and tripping threshold



3UG4625-2CW30

Measurable current	Adjustable response value current	Switching hysteresis	Adjustable ON-delay time	Control supply voltage			Spring-loaded terminals	Weight
				At AC at 50 Hz, rated value	At AC at 60 Hz, rated value	At DC, rated value		
A	A	%	s	V	V	V	Article No.	kg
0.01 ... 43	0.03 ... 40	0 ... 50	0 ... 20	24 ... 240	24 ... 240	24 ... 240	<b>3UG4625-2CW30</b>	0.155

For accessories, see page 2/281.

For the 3UL23 residual-current transformers, see page 2/270.



## Monitoring and control devices

### Relays

#### SIRIUS 3UG45, 3UG46 monitoring relays for stand-alone installation

#### Residual-current monitoring > 3UL23 residual-current transformers

##### Overview



SIRIUS 3UL23 residual-current transformer

The 3UL23 residual-current transformers detect residual currents in machines and plants. They are suitable for pure AC residual currents or AC residual currents with a pulsating DC fault current component (transformer type A in accordance with DIN VDE 0100-530/IEC TR 60755).

Together with the 3UG4625, 3UG4825 residual-current monitoring relays for IO-Link or the SIMOCODE 3UF motor management and control device they enable residual-current and ground-fault monitoring.

The 3UL2302-1A and 3UL2303-1A residual-current transformers with a feed-through opening from 35 to 55 mm can be mounted in conjunction with the 3UL2900 accessories on a TH 35 standard mounting rail according to IEC 60715.

##### Selection and ordering data

Diameter of the bushing opening mm	Connectable cross-section of the connecting terminal mm <sup>2</sup>	Screw terminals 	Weight kg
Residual-current transformers (essential accessories for 3UG4625, 3UG4825)		Article No.	
35	2.5	3UL2302-1A	0.130
55	2.5	3UL2303-1A	0.207
80	2.5	3UL2304-1A	0.343
110	2.5	3UL2305-1A	0.446
140	2.5	3UL2306-1A	0.800
210	4	3UL2307-1A	1.817

##### Accessories

Version	Article No.	Weight kg
 <b>Adapters</b> For mounting on standard rail for 3UL23 to diameter 55 mm	3UL2900	0.005

3UL2900

## Overview



SIRIUS 3UG458 insulation monitor

Insulation monitoring relays are used for monitoring the insulation resistance between ungrounded 1-phase or 3-phase AC supplies and a protective conductor.

Ungrounded, i.e. isolated networks (IT networks) are always used where high demands are placed on the reliability of the power supply, e.g. emergency lighting systems. IT systems are supplied via an isolating transformer or by power supply sources such as batteries or a generator. While an initial insulation fault between a phase conductor and the ground effectively grounds the conductor, as a result no circuit has been closed, so it is possible to continue work in safety (single-fault safety). However, the fault must be rectified as quickly as possible before a second insulation fault occurs (e.g. according to DIN VDE 0100-410). For this purpose insulation monitoring relays are used, which constantly measure the resistance to ground of the phase conductor and the neutral conductor, reporting a fault immediately if insulation resistance falls below the set value so that either a controlled shutdown can be performed or the fault can be rectified without interrupting the power supply.

### Two device series

- 3UG4581 insulation monitoring relays for ungrounded AC networks
- 3UG4582 and 3UG4583 insulation monitoring relays for ungrounded DC and AC networks

### Insulation monitoring for ungrounded AC networks

The 3UG4581 insulation monitoring relays are used to monitor insulation resistance according to IEC 61557-8 in ungrounded AC networks with rated voltages of up to 400 V.

These devices can monitor control circuits (1-phase) and main circuits (3-phase).

They measure insulation resistances between system cables and system ground. If the value falls below the threshold value, the output relays are switched to fault status.

In the case of 3UG4581 a higher-level DC measuring signal is used. The higher-level DC measuring signal and the resulting current are used to determine the value of the insulation resistance of the network which is to be measured.

### Insulation monitoring relay for ungrounded DC and AC networks

The 3UG4582 and 3UG4583 insulation monitoring relays are used to monitor insulation resistance in ungrounded IT AC or DC networks according to IEC 61557-8.

They measure insulation resistances between system cables and system ground. If the value falls below the threshold value, the output relays are switched to fault status. With these devices, which are suitable for both AC and DC networks, a pulsed test signal is fed into the network to be monitored and the insulation resistance is determined.

The pulsed test signal changes its form according to insulation resistance and network loss capacitance. The changed form is used to predict the changed insulation resistance.

If the predicted insulation resistance matches the insulation resistance calculated in the next measurement cycle, and is lower than the threshold value, the output relays are activated or deactivated, depending on the device configuration. This measurement principle is also suitable for identifying symmetrical insulation faults.

### 3UG4983 voltage reducer module



3UG4983 voltage reducer module

The 3UG4983-.AA01 voltage reducer module is available for the 3UG4583 insulation monitoring relay to extend the network voltage range to 690 V AC and 1000 V DC.

### Connection methods

With the updated enclosure, future-proof push-in technology is available alongside the tried-and-trusted screw terminals.

Push-in is a form of spring-loaded connection system allowing wiring of terminals without tools. These terminals are self-adjusting, i.e. the regular tightening needed with screw terminals is not necessary.

## Monitoring and control devices

### Relays

#### SIRIUS 3UG45, 3UG46 monitoring relays for stand-alone installation

#### Insulation monitoring

##### Benefits

- Devices for AC and DC systems
- All devices have a wide control supply voltage range
- Direct connection to networks with mains voltages of up to 690 V AC and 1 000 V DC by means of a voltage reducer module
- For AC supply systems: Frequency range 15 to 400 Hz
- Monitoring of broken conductors
- Monitoring of setting errors
- Safety in use thanks to integrated system test after startup
- Option of resetting and testing (by means of button on front or using control contact)
- New predictive measurement principle allows very fast response times
- All versions with screw or spring-loaded terminals with push-in functionality

##### Application

IT networks are used, for example:

- In emergency power supplies
- In safety lighting systems
- In industrial production facilities with high availability requirements (chemical industry, automobile manufacturing, printing plants)
- In shipping and railways
- For mobile generators (aircraft)
- For renewable energies, such as wind energy and photovoltaic power plants
- In the mining industry

##### Technical specifications

###### More information

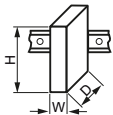

For equipment manuals, see

- <https://support.industry.siemens.com/cs/ww/en/view/54382552>
- <https://support.industry.siemens.com/cs/ww/en/view/54382528>

Type		3UG4581-.AW31	3UG4582-.AW31	3UG4583-.CW31	3UG4983-.AA01
<b>General data</b>					
Dimensions (W x H x D)	 mm	22.5 x 78 x 100		45 x 78 x 100	
Degree of protection IP on the front according to IEC 60529		IP20			
Mounting position		Any			
Type of mounting		Snap-on mounting on 35 mm standard mounting rail			
Ambient temperature during operation	°C	-25 ... +60			
Fault storage		✓	✓	✓	--
<b>Measuring circuit</b>					
<b>Measurable voltage</b>					
• At DC	V	--	0 ... 345	0 ... 600	0 ... 1000
• At AC	V	0 ... 460	0 ... 287.5	0 ... 400	0 ... 690
Measurable line frequency	Hz	50 ... 60		15 ... 400	
<b>Adjustable response value impedance</b>					
• 1	kΩ	1 ... 100		--	
• 2	kΩ	--		2 ... 200	
System leakage capacitance	μF	10		20	
<b>Control circuit</b>					
<b>Control supply voltage</b>					
• At AC					
- At 50 Hz	V	24 ... 240		--	
- At 60 Hz	V	24 ... 240		--	
• At DC	V	24 ... 240		--	
Operating frequency	Hz	15 ... 400			
Impulse withstand voltage	V	6000		4000	8000
Number of CO contacts with delayed switching		1		2	0
Thermal current of the non-solid-state contact blocks, maximum	A	4			

✓ Available

-- Not available

Type	3UG4581-1AW31 3UG4582-1AW31 3UG4583-1CW31 3UG4983-1AA01	3UG4581-2AW31 3UG4582-2AW31 3UG4583-2CW31 3UG4983-2AA01
Type of electrical connection	 Screw terminals	 Spring-loaded terminals (push-in)
Tightening torque	0.6 ... 0.8 Nm	--
Type of connectable conductor cross-sections	1x (0.5 ... 4.0 mm <sup>2</sup> ), 2x (0.5 ... 2.5 mm <sup>2</sup> )	2 x (0.5 ... 1.5 mm <sup>2</sup> )
• Finely stranded	1x (0.5 ... 2.5 mm <sup>2</sup> ), 2x (0.5 ... 1.5 mm <sup>2</sup> )	2 x (0.5 ... 1.5 mm <sup>2</sup> )
• Finely stranded	1x (0.5 ... 2.5 mm <sup>2</sup> ), 2x (0.5 ... 1.5 mm <sup>2</sup> )	2 x (0.5 ... 1.5 mm <sup>2</sup> )
- Without end sleeves		
- With end sleeves		
• For AWG cables	1 x (20 ... 12), 2x (20 ... 14)	2 x (20 ... 16)
- Solid	1 x (18 ... 14), 2x (18 ... 16)	2 x (18 ... 16)
- Stranded		

With the closed-circuit principle selected

- Insulation resistance monitoring without fault storage, with Auto RESET

- Insulation resistance monitoring with fault storage and Manual RESET

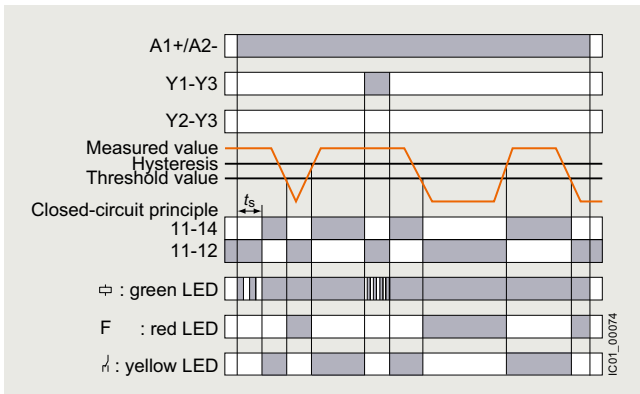

3UG4581, 3UG4582 monitoring relays

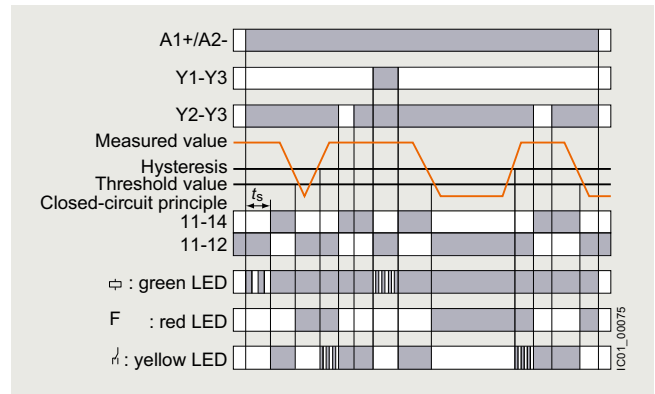

3UG4581, 3UG4582 monitoring relays

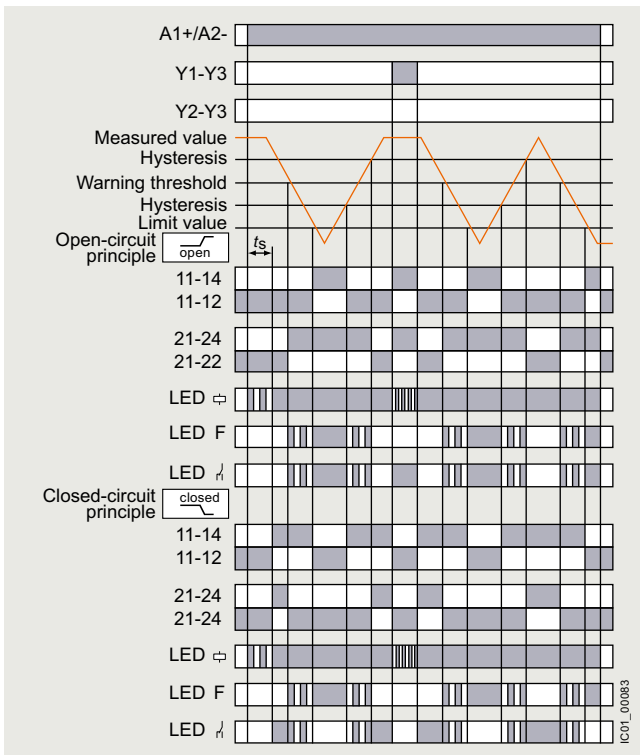

3UG4583 monitoring relays

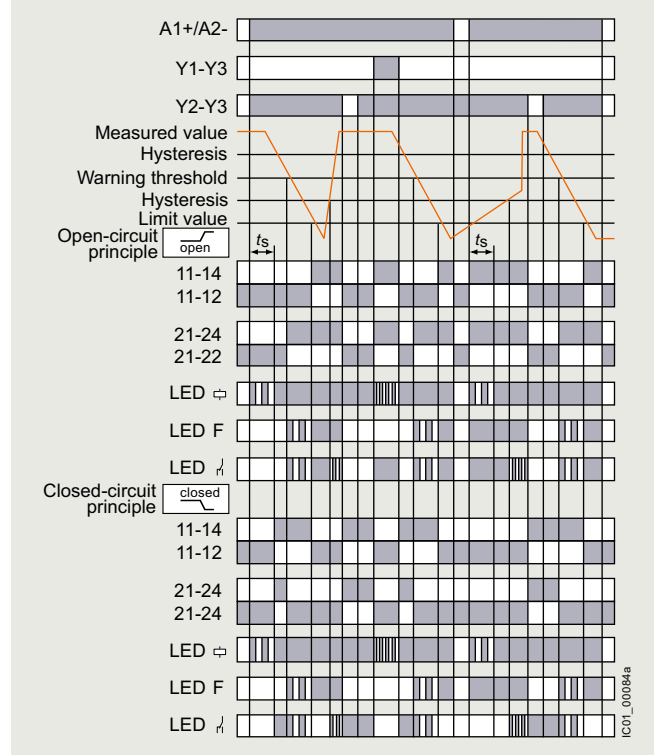

3UG4583 monitoring relays

## Monitoring and control devices

### Relays

#### SIRIUS 3UG45, 3UG46 monitoring relays for stand-alone installation

#### Insulation monitoring

#### Selection and ordering data



3UG4581-1AW31



3UG4582-1AW31



3UG4583-1CW31



3UG4583-1AA01

Measurable voltage		Type of voltage of the control supply voltage, value range	System leakage capacitance	Number of CO contacts with delayed switching	Adjustable response value impedance		Spring-loaded terminals (push-in) 	Weight
At AC	At DC				1	2		
V	V	AC/DC	μF		kΩ	kΩ		
<b>Insulation monitors</b>								
0 ... 460	--	24 ... 240	10	1	1 ... 100	--	<b>3UG4581-2AW31</b>	0.155
0 ... 287.5	0 ... 345	24 ... 240	10	1	1 ... 100	--	<b>3UG4582-2AW31</b>	0.160
0 ... 460	0 ... 690	24 ... 240	20	2	1 ... 100	2 ... 200	<b>3UG4583-2CW31</b>	0.265
<b>Voltage reducer modules</b>								
For the 3UG4583 insulation monitoring relay for extending the network voltage range to 690 V AC and 1 000 V DC								
0 ... 460	0 ... 690	--	20	0	--	--	<b>3UG4983-2AA01</b>	0.200

2

## Overview



SIRIUS 3UG4501 monitoring relay

The 3UG4501 level monitoring relay is used in combination with 2- or 3-pole sensors to monitor the levels of conductive liquids.

## Benefits

- Can be used worldwide thanks to wide voltage range from 24 to 240 V (absolute limit values)
- Individually shortenable 2- and 3-pole wire electrodes for easy mounting from above/below
- Bow electrodes for installation from the side, for larger filling levels and minimum space requirements
- Can be flexibly adapted to different conductive liquids through analog setting of the sensitivity from 2 to 200 k $\Omega$
- Compensation for wave movements through tripping delay times from 0.1 to 10 s
- Upstream or downstream function selectable
- All versions with removable terminals
- All versions with screw or spring-loaded terminals

## Application

- Single-point and two-point level monitoring
- Overflow protection
- Dry-running protection
- Leak monitoring

## Technical specifications

**3UG4501 monitoring relays**

The principle of operation of the 3UG4501 level monitoring relay is based on measuring the electrical resistance of the liquid between two immersion sensors and a reference terminal. If the measured value is lower than the sensitivity set at the front, the output relay changes its switching state. In order to preclude active current undershooting of the liquid, the sensors are supplied with alternating current.

Two-point control

The output relay changes its switching state as soon as the liquid level reaches the maximum sensor, while the minimum sensor is submerged. The relay returns to its original switching state as soon as the minimum sensor no longer has contact with the liquid.

OVER, two-point control

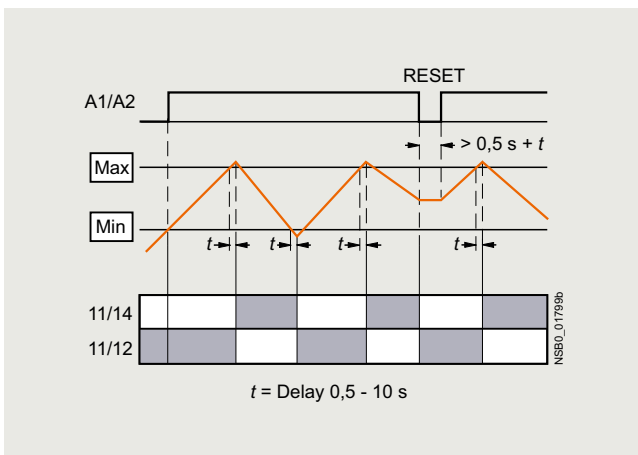

UNDER, two-point control

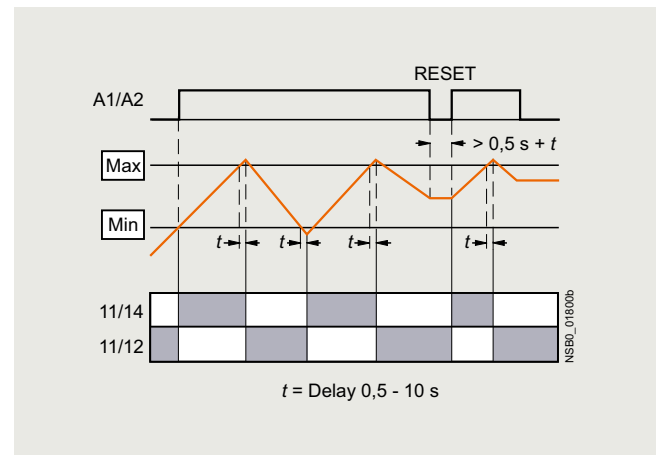
Note:

It is also possible to connect other resistance sensors to the Min and Max terminals in the range 2 to 200 k $\Omega$ , e.g. photoresistors, temperature sensors, encoders based on resistance, etc. The monitoring relay can therefore also be used for other applications as well as for monitoring the levels of liquids.

## Monitoring and control devices

### Relays

#### SIRIUS 3UG45, 3UG46 monitoring relays for stand-alone installation

#### Level monitoring

##### Single-point control

If only one level is being controlled, the terminals for Min and Max on the monitoring relay are bridged. The output relay changes its switching state as soon as the liquid level is reached and returns to its original switching state once the sensor no longer has contact with the liquid.

In order to prevent premature tripping of the switching function caused by wave motion or frothing, even though the set level has not been reached, it is possible to delay this function by 0.5 to 10 s.

For safe resetting, the control supply voltage must be interrupted for at least the set delay time of +0.5 s.

##### OVER, single-point control

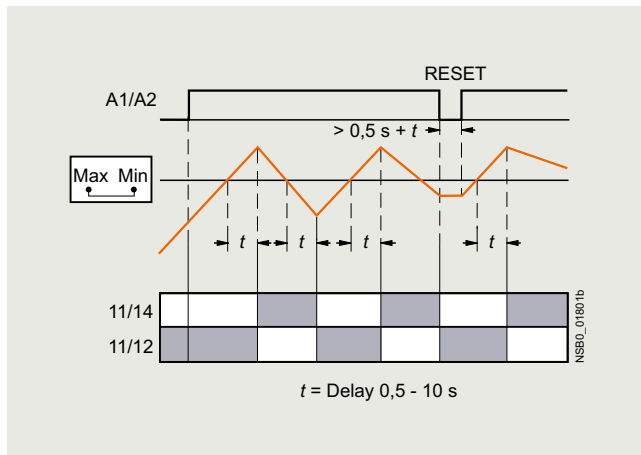

##### UNDER, single-point control

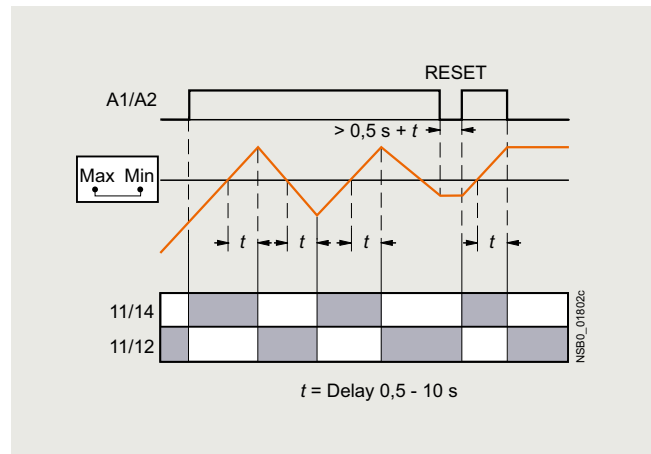

Type	3UG4501	
<b>General data</b>		
<b>Rated insulation voltage <math>U_i</math></b>	V	300
Pollution degree 3 Overvoltage category III acc. to VDE 0110		
<b>Rated impulse withstand voltage <math>U_{imp}</math></b>	kV	4
<b>Measuring circuit</b>		
<b>Electrode current, max. (typ. 70 Hz)</b>	mA	1
<b>Electrode voltage, max. (typ. 70 Hz)</b>	V	15
<b>Sensor feeder cable</b>	m	Max. 100
<b>Conductor capacitance of sensor cable<sup>1)</sup></b>	nF	Max. 10
<b>Control circuit</b>		
<b>Load capacity of the output relay</b>		
Thermal current $I_{th}$	A	5
<b>Rated operational current <math>I_o</math> at</b>		
• AC-15/24 ... 400 V	A	3
• DC-13/24 V	A	1
• DC-13/125 V	A	0.2
• DC-13/250 V	A	0.1
<b>Minimum contact load at 17 V DC</b>	mA	5

<sup>1)</sup> The sensor cable does not necessarily have to be shielded, but we do not recommend installing this cable parallel to the power supply lines. It is also possible to use a shielded cable, whereby the shield has to be connected to the M terminal.

**Selection and ordering data**

- For level monitoring of electrically conductive liquids
- Control principle: inlet or sequence control adjustable per rotary switch
- Single-point and two-point control possible
- Analogically adjustable sensitivity (specific resistance of the liquid)
- Analogically adjustable tripping delay time
- 1 yellow LED for displaying the relay state
- 1 green LED for displaying the applied control supply voltage
- 1 CO contact

Sensitivity	Tripping delay time	Rated control supply voltage $U_s$	Spring-loaded terminals 	Weight
k $\Omega$	s	V AC/DC	Article No.	kg
2 ... 200	0.5 ... 10	24 <sup>1)</sup>	<b>3UG4501-2AA30</b>	0.123
		24 ... 240	<b>3UG4501-2AW30</b>	0.123

<sup>1)</sup> The rated control supply voltage and the measuring circuit are not electrically separated.

For accessories, see page 2/281.

**Note:**

Level monitoring sensors are available from various providers. We recommend sensors made by Jacob GmbH (see "External partners"). The previous 3UG3 level sensors are also available from here.



## Monitoring and control devices

### Relays

#### SIRIUS 3UG45, 3UG46 monitoring relays for stand-alone installation

### Speed monitoring

#### Overview



SIRIUS 3UG4651 monitoring relay

The 3UG4651 monitoring relay is used in combination with a sensor to monitor motor drives for overspeed and/or underspeed.

Furthermore, the monitoring relay is ideal for all functions where a continuous pulse signal needs to be monitored (e.g. belt travel monitoring, completeness monitoring, passing monitoring, clock-time monitoring).

#### Benefits

- Can be used worldwide thanks to wide voltage range from 24 to 240 V (absolute limit values)
- Variably adjustable to overshoot, undershoot or range monitoring
- Freely configurable delay times and RESET response
- Permanent display of actual value and fault type
- Use of up to 10 sensors per rotation for extremely slowly rotating motors
- Two- or three-wire sensors and sensors with a mechanical switching output or solid-state output can be connected
- Auxiliary voltage for sensor integrated
- All versions with removable terminals
- All versions with screw or spring-loaded terminals

#### Application

- Slip or tear of a belt drive
- Overload monitoring
- Transport monitoring for completeness

#### Technical specifications

##### 3UG4651 monitoring relays

The speed monitoring relay operates according to the principle of period duration measurement.

In the monitoring relay, the time between two successive rising edges of the pulse encoder is measured and compared to the minimum and/or maximum permissible period duration calculated from the set limit values for the speed.

Thus, the period duration measurement recognizes any deviation in speed after just two pulses, even at very low speeds or in the case of extended pulse gaps.

By using up to ten pulse encoders evenly distributed around the circumference, it is possible to shorten the period duration, and in turn the response time. By taking into account the number of sensors in the monitoring relay, the speed continues to be indicated in rpm.

##### ON-delay time for motor start

To be able to start a motor drive, and depending on whether the open-circuit or closed-circuit principle is selected, the output relay switches to the OK state during the ON-delay time, even if the speed is still below the set value.

The ON-delay time is started by either switching on the auxiliary voltage or, if the auxiliary voltage is already applied, by actuating the respective NC contact (e.g. auxiliary contact).

##### Speed monitoring with Auto RESET (Memory = no)

If the device is set to Auto RESET, the output relay switches to the OK state, once the adjustable hysteresis threshold is reached in the range of 0.1 to 99.9 rpm and the flashing stops. Any overshoots or undershoots are therefore not stored.

##### Speed monitoring with Manual RESET (Memory = yes)

If Manual RESET is selected in the menu, the output relay remains in its current switching state and the current measured value and the symbol for overshooting/undershooting continue to flash, even when the speed returns to a permissible value. This stored fault status can be reset by simultaneously pressing the UP▲ and DOWN▼ buttons for > 2 s, by connecting the RESET device terminal to 24 V DC or by switching the control supply voltage off and back on again.

With the closed-circuit principle selected

Range monitoring without enable input

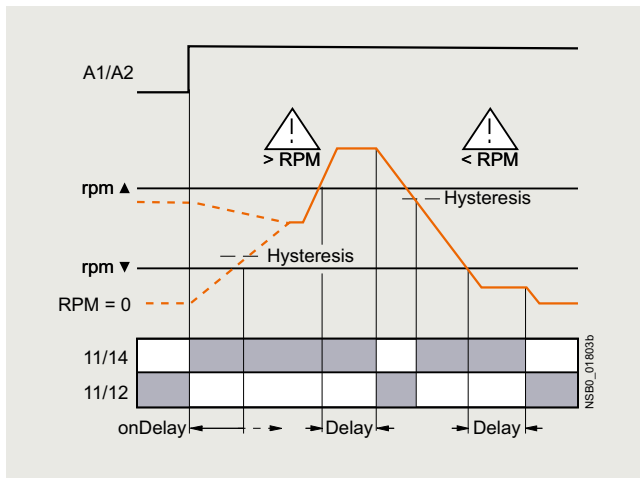

Range monitoring with enable input

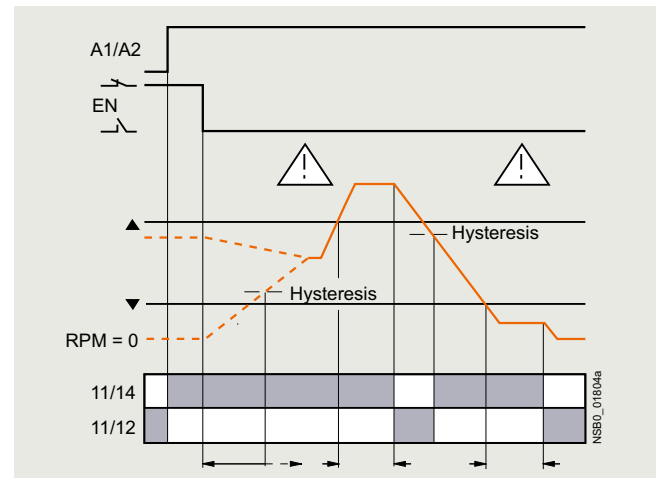

Type	3UG4651	
<b>General data</b>		
<b>Rated insulation voltage <math>U_i</math></b>	V	300
Pollution degree 3 Overvoltage category III acc. to VDE 0110		
<b>Rated impulse withstand voltage <math>U_{imp}</math></b>	kV	4
<b>Measuring circuit</b>		
<b>Sensor supply</b>		
• For three-wire sensor (24 V/0 V)	mA	Max. 50
• For two-wire NAMUR sensor (8V2)	mA	Max. 8.2
<b>Signal input</b>		
• IN1	k $\Omega$	16, three-wire sensor, pnp operation
• IN2	k $\Omega$	1, floating contact, two-wire NAMUR sensor
<b>Voltage level</b>		
• For level 1 at IN1	V	4.5 ... 30
• For level 0 at IN1	V	0 ... 1
<b>Current level</b>		
• For level 1 at IN2	mA	> 2.1
• For level 0 at IN2	mA	< 1.2
<b>Minimum pulse duration of signal</b>	ms	5
<b>Minimum interval between 2 pulses</b>	ms	5
<b>Control circuit</b>		
<b>Number of CO contacts for auxiliary contacts</b>		1
<b>Load capacity of the output relay</b>		
Thermal current $I_{th}$	A	5
<b>Rated operational current <math>I_e</math> at</b>		
• AC-15/24 ... 400 V	A	3
• DC-13/24 V	A	1
• DC-13/125 V	A	0.2
• DC-13/250 V	A	0.1
<b>Minimum contact load at 17 V DC</b>	mA	5

## Monitoring and control devices

### Relays

#### SIRIUS 3UG45, 3UG46 monitoring relays for stand-alone installation

#### Speed monitoring

##### Selection and ordering data





- For speed monitoring in revolutions per minute (rpm)
- Two- or three-wire sensor with mechanical or electronic switching output can be connected
- Two-wire NAMUR sensor can be connected
- Sensor supply 24 V DC/50 mA integrated
- Input frequency 0.1 to 2 200 pulses per minute (0.0017 to 36.7 Hz)
- With or without enable signal for the drive to be monitored
- Digitally adjustable, with illuminated LCD
- Overshoot, undershoot or range monitoring adjustable
- Number of pulses per revolution can be adjusted
- Upper and lower threshold value can be adjusted separately
- Auto, Manual or Remote RESET options after tripping
- Permanent display of actual value and tripping state
- 1 CO contact

Measuring range	Hysteresis	ON-delay time	Tripping delay time	Pulses per revolution	Rated control supply voltage $U_s$	Spring-loaded terminals 	Weight
rpm	rpm	s	s		V AC/DC	Article No.	kg
0.1 ... 2 200	OFF 0.1 ... 99.9	0 ... 900	0.1 ... 99.9	1 ... 10	24 <sup>1)</sup>	<b>3UG4651-2AA30</b>	0.145
					24 ... 240	<b>3UG4651-2AW30</b>	0.200

<sup>1)</sup> The rated control supply voltage and the measuring circuit are not electrically separated.

For accessories, see page 2/281.

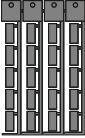
## Selection and ordering data

Use	Version	Article No.	Weight kg
<b>Accessories for enclosures</b>			
 3RP1902	For 3UG4	<b>Sealable covers</b> For securing against unauthorized adjustment of setting knobs	0.003
 3RP1903	For 3UG4	<b>Push-in lugs</b> For screw fixing, 2 units are required for each device	0.002
<b>Blank labels</b>			
 3RT2900-1SB20	For 3UG4	<b>Unit labeling plates<sup>1)</sup></b> For SIRIUS devices • 20 mm x 7 mm, titanium gray <sup>1)</sup>	0.062
<b>Tools for opening spring-loaded terminals</b>			
 3RA2908-1A	For auxiliary circuit connections	<b>Screwdrivers</b> For all SIRIUS devices with spring-loaded terminals  Length approx. 200 mm, 3.0 mm x 0.5 mm, titanium gray/black, partially insulated	<b>Spring-loaded terminals</b>  <b>3RA2908-1A</b> 0.050

<sup>1)</sup> PC labeling system for individual inscription of unit labeling plates available from: murrplastik Systemtechnik GmbH.

**Note:**

For products for mechanical bearing monitoring, e.g. condition monitoring systems, see [www.siemens.com/siplus-cms](http://www.siemens.com/siplus-cms).

## Monitoring and control devices

### Relays

#### SIRIUS 3UG48 monitoring relays for stand-alone installation for IO-Link

#### General data

#### Overview

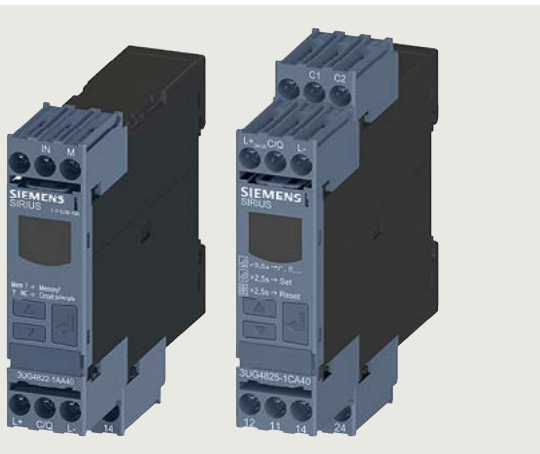

SIRIUS 3UG48 monitoring relays

#### More information

Homepage, see [www.siemens.com/sirius-monitoring-relays](http://www.siemens.com/sirius-monitoring-relays)

Industry Mall, see [www.siemens.com/product?3UG48](http://www.siemens.com/product?3UG48)

Conversion tool, see [www.siemens.com/conversion-tool](http://www.siemens.com/conversion-tool)

The SIRIUS 3UG4 monitoring relays for electronic and mechanical variables monitor all important characteristics that allow conclusions to be drawn about the functionality of a plant. Both sudden disturbances and gradual changes, which may indicate the need for maintenance, are detected.

Thanks to their relay outputs, the monitoring relays permit direct disconnection of the affected system components and alerting, e.g. by the triggering of a warning light. Thanks to adjustable delay times the 3UG4 monitoring relays can respond very flexibly to brief faults such as voltage dips or load changes and can thus avoid unnecessary alarms and disconnections and increase system availability.

#### 3UG48 monitoring relays for IO-Link

The SIRIUS 3UG48 monitoring relays for IO-Link also offer many other options based upon the monitoring functions of the tried-and-tested SIRIUS 3UG4 monitoring relays:

- Measured value transmission to a controller, including resolution and unit, may be parameterizable as to which value is cyclically transmitted
- Transmission of alarm flags to a controller
- Full diagnostics capability by inquiry as to the cause of the fault in the diagnostics data record
- Remote parameterization is also possible, in addition to or instead of local parameterization
- Rapid parameterization of the same devices by duplication of the parameterization in the controller
- Parameter transmission through uploading to a controller by IO-Link call or by parameter server (if IO-Link master from IO-Link specification V1.1 and higher is used)
- Consistent central data storage in the event of parameter change locally or via a controller
- Automatic reparameterizing when devices are exchanged
- Blocking of local parameterization via IO-Link possible
- Faults are saved in parameterizable and non-volatile fashion to prevent an automatic startup after voltage failure and to make sure diagnostics data are not lost

- Integration into the automation level provides the option of parameterizing the monitoring relays at any time via a display unit, or displaying the measured values in a control room or locally at the machine/control cabinet.
- The MindSphere app SIRIUS Asset Monitor enables access to the SIRIUS 3UG48 monitoring relay for IO-Link anytime and anywhere. It provides the user with detailed information on the device status as well as fault messages and warnings in a clearly arranged form.

Even without communication via IO-Link the devices continue to function fully autonomously:

- Parameterization can take place locally at the device, independently of a controller.
- In the event of failure or before the controller becomes available the monitoring relays work as long as the control supply voltage (24 V DC) is present.
- If the monitoring relays are operated without the controller, the 3UG48 monitoring relays have, thanks to the integrated SIO mode, an additional semiconductor output, which switches when the adjustable warning threshold is exceeded.

Thanks to the combination of autonomous monitoring relay function and integrated IO-Link communication, redundant sensors and/or analog signal converters – which previously took over the transmission of measured values to a controller, leading to considerable extra cost and wiring overhead – are no longer needed.

Because the output relays are still present, the monitoring relays increase the functional reliability of the system, since only the controller can fulfill the control tasks if the current measured values are available, whereas the output relays can also be used for the disconnection of the system if limit values that cannot be reached during operation are exceeded.

The individual 3UG48 monitoring relays for IO-Link offer the following functions in different combinations:

- Phase sequence
- Phase failure, neutral conductor failure
- Phase asymmetry
- Undershooting and/or overshooting of limit values for voltage
- Undershooting and/or overshooting of limit values for current
- Undershooting and/or overshooting of power factor limit values
- Monitoring of the active current or the apparent current
- Monitoring of the residual current
- Undershooting and/or overshooting of limit values for speed

#### Notes on security

In order to protect plants, systems, machines and networks against cyber threats, it is necessary to implement – and continuously maintain – a holistic, state-of-the-art industrial security concept. Siemens products and solutions represent only one component of such a concept.

For more information about the subject of Industrial Security, see [www.siemens.com/industrialsecurity](http://www.siemens.com/industrialsecurity).

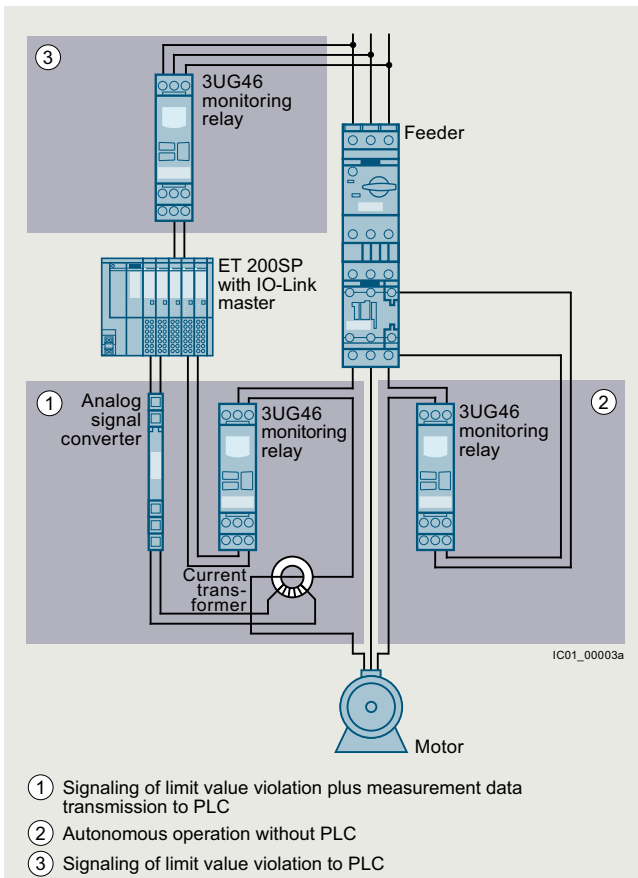

Use of conventional monitoring relays

#### Notes:

Devices required for communication via IO-Link:

- Any controller that supports IO-Link (e.g. ET 200SP with CPU or S7-1200), see [Catalog ST 70](#).
- IO-Link master (e.g. CM 4xIO-Link for SIMATIC ET 200SP or SM 1278 for S7-1200).

#### Article No. scheme

Product versions	Article number
<b>3UG4 monitoring relay with IO-Link</b>	<b>3UG4</b> □ □ □ - □ □ □ □ <b>0</b>
Type of setting	e.g. 8 = analogically adjustable □
Functions	e.g. 15 = line monitoring □ □
Connection type	Screw terminals 1
	Spring-loaded terminals 2
Contacts	e.g. A = 1 CO contact □
Supply voltage	e.g. A4 = 160 ... 690 V AC □ □
Example	<b>3UG4 8 1 5 - 1 A A 4 0</b>

#### Note:

The Article No. scheme shows an overview of product versions for better understanding of the logic behind the article numbers.

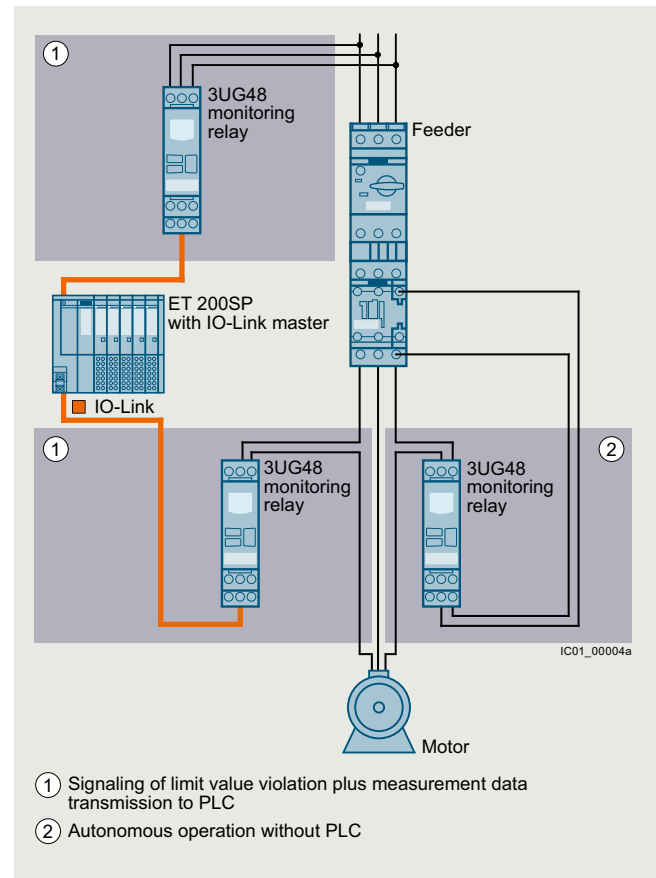

Monitoring relays for IO-Link

Each monitoring relay requires an IO-Link channel.

For your orders, please use the article numbers quoted in the selection and ordering data.

#### Benefits

- Simple cyclical transmission of the current measured values, relay switching states and events to a controller
- Remote parameterization
- Automatic reparameterizing when devices are exchanged
- Simple duplication of identical or similar parameterizations
- Reduction of control current wiring
- Elimination of testing costs and wiring errors
- Reduction of configuration work
- Integration in TIA means clear diagnostics if a fault occurs
- Cost saving and space saving in control cabinet due to the elimination of AI and IO modules as well as analog signal converters and duplicated sensors

## Monitoring and control devices

### Relays

#### SIRIUS 3UG48 monitoring relays for stand-alone installation for IO-Link

#### General data

#### Application

The use of SIRIUS monitoring relays for IO-Link is particularly recommended for machines and plants in which these relays, in addition to their monitoring function, are to be connected to the automation level for the rapid, simple and fault-free provision of the current measured values and/or for remote parameterization.

The monitoring relays can either relieve the controller of monitoring tasks or, as a second monitoring entity in parallel to and independent of the controller, increase the reliability in the process or in the system. In addition, the elimination of AI and IO modules allows the width of the controller to be reduced despite significantly expanded functionality.

#### Technical specifications

##### More information

Technical specifications, see <https://support.industry.siemens.com/cs/ww/en/ps/16368/td>  
Equipment Manual and internal circuit diagrams, see <https://support.industry.siemens.com/cs/ww/en/view/54375430>

FAQs, see <https://support.industry.siemens.com/cs/ww/en/ps/16368/faq>

##### Type

##### 3UG48

##### General technical specifications

Dimensions (W x H x D)

- For 3 terminal blocks
  - Screw terminals
  - Spring-loaded terminals
- For 4 terminal blocks
  - Screw terminals
  - Spring-loaded terminals

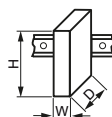

mm	22.5 x 92 x 91
mm	22.5 x 94 x 91
mm	22.5 x 103 x 91
mm	22.5 x 103 x 91

##### Permissible ambient temperature

- During operation

°C	-25 ... +60
----	-------------

##### Connection type

- Terminal screw
- Solid
- Finely stranded with end sleeve
- AWG cables, solid or stranded
- Tightening torque

	M3 (for standard screwdriver, size 2 and Pozidriv 2)
mm <sup>2</sup>	1 x (0.5 ... 4), 2 x (0.5 ... 2.5)
mm <sup>2</sup>	1 x (0.5 ... 2.5), 2 x (0.5 ... 1.5)
AWG	2 x (20 ... 14)
Nm	0.8 ... 1.2

##### Connection type

- Solid
- Finely stranded, with end sleeve acc. to DIN 46228
- Finely stranded
- AWG cables, solid or stranded

mm <sup>2</sup>	2 x (0.25 ... 1.5)
mm <sup>2</sup>	2 x (0.25 ... 1.5)
mm <sup>2</sup>	2 x (0.25 ... 1.5)
AWG	2 x (24 ... 16)

## Overview



SIRIUS 3UG4815 monitoring relay

Solid-state line monitoring relays provide maximum protection for mobile machines, plants and hoisting equipment or for unstable networks. Network and voltage faults can thus be detected early and rectified before far greater damage ensues.

The line monitoring relays with IO-Link monitor phase sequence, phase failure (with or without N conductor monitoring), phase asymmetry and undervoltage and/or overvoltage.

Phase asymmetry is evaluated as the difference between the greatest and the smallest phase voltage relative to the greatest phase voltage. Undervoltage or overvoltage exist if the set limit values for at least one phase voltage are overshoot or undershot. The rms value of the voltage is measured.

## Benefits

- Can be used in any network from 160 to 630 V AC worldwide thanks to wide voltage range
- Variably adjustable to overshoot, undershoot or range monitoring
- Freely configurable delay times and RESET response
- Width 22.5 mm
- Display and transmission of actual value and network fault type to controller
- All versions with removable terminals
- All versions with screw or spring-loaded terminals

## Application

The relays are used above all for mobile equipment, e.g. air conditioning compressors, refrigerating containers, building site compressors and cranes.

Function	Application
Phase sequence	<ul style="list-style-type: none"> <li>• Direction of rotation of the drive</li> </ul>
Phase failure	<ul style="list-style-type: none"> <li>• A fuse has tripped</li> <li>• Failure of the control supply voltage</li> <li>• Broken cable</li> </ul>
Phase asymmetry	<ul style="list-style-type: none"> <li>• Overheating of the motor due to asymmetrical voltage</li> <li>• Detection of asymmetrically loaded networks</li> </ul>
Undervoltage	<ul style="list-style-type: none"> <li>• Increased current on a motor with corresponding overheating</li> <li>• Unintentional resetting of a device</li> <li>• Network collapse, particularly with battery power</li> </ul>
Overvoltage	<ul style="list-style-type: none"> <li>• Protection of a plant against destruction due to overvoltage</li> </ul>



## Monitoring and control devices

### Relays

#### SIRIUS 3UG48 monitoring relays for stand-alone installation for IO-Link

#### Line monitoring

#### Technical specifications

##### 3UG4815/3UG4816 monitoring relays

The 3UG4815 and 3UG4816 line monitoring relays have a wide voltage range input and are supplied with power through IO-Link or from an external 24 V DC source.

The device is equipped with a display and is parameterized using three buttons. The 3UG4815 monitoring relay monitors 3-phase networks with regard to phase sequence, phase failure, phase asymmetry, undervoltage and overvoltage. The 3UG4816 monitoring relay monitors the neutral conductor as well. The hysteresis is adjustable from 1 to 20 V.

The device has two separately adjustable delay times for overvoltage and undervoltage and for line stabilization. If the direction of rotation is incorrect or a phase fails, the device switches off immediately. Thanks to a special measuring method, a phase failure is reliably detected in spite of the wide voltage range from and potentially high feedback through the load.

The 3UG4815 and 3UG4816 monitoring relays can be operated on the basis of either the open-circuit or closed-circuit principle and with Manual or Auto RESET.

If Manual RESET is selected in the menu (Memory = Yes), the switching relay remains in its current switching state and the current measured value and the symbol for undershooting and overshooting continue to flash, even when the measured variable reaches a permissible value again. This stored fault status can be reset by simultaneously pressing the UP▲ and DOWN▼ keys for 2.5 s.

With Manual RESET through IO-Link it is possible in addition to set whether fault messages are to be deleted when the control supply voltage is switched off and on (as Remote RESET) or whether the signals are to be permanently saved even in a voltage failure, with confirmation possible only through local RESET or via IO-Link.

With the closed-circuit principle selected

Wrong phase sequence

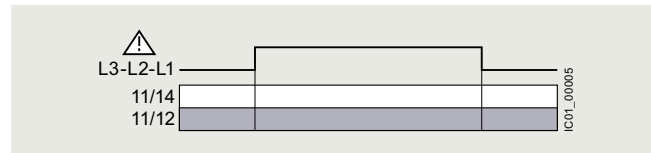

Phase failure

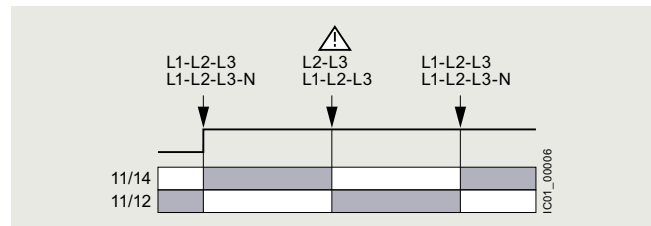

Undervoltage

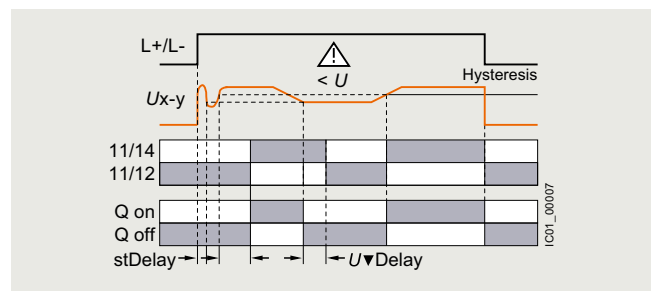

Overvoltage

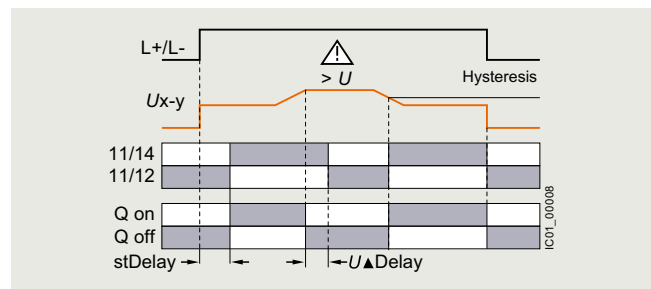

Type	3UG4815, 3UG4816	
<b>General technical specifications</b>		
<b>Rated insulation voltage <math>U_i</math></b>	V	690
Pollution degree 2 Overvoltage category III acc. to VDE 0110		
<b>Rated impulse withstand voltage <math>U_{imp}</math></b>	kV	6
<b>Control circuit</b>		
<b>Load capacity of the output relay</b>		
• Thermal current $I_{th}$	A	5
<b>Rated operational current <math>I_o</math> at</b>		
• AC-15/24 ... 400 V	A	3
• DC-13 at		
- 24 V	A	1
- 125 V	A	0.2
- 250 V	A	0.1
<b>Minimum contact load at 17 V DC</b>	mA	5
<b>Electrical endurance AC-15</b>	million operating cycles	0.1
<b>Mechanical service life</b>	million operating cycles	10

**Selection and ordering data**

- Adjustable via IO-Link and locally, with illuminated LCD
- Power supply with 24 V DC via IO-Link or external auxiliary voltage
- Auto or Manual RESET
- Open-circuit or closed-circuit principle
- 1 CO contact, 1 semiconductor output (in SIO mode)



3UG4815-2AA40



3UG4816-2AA40

Adjustable hysteresis	Undervoltage detection	Overvoltage detection	Stabilization time adjustable sDEL	Tripping delay time adjustable Del	Version of auxiliary contacts	Measurable line voltage <sup>1)</sup>	Spring-loaded terminals 	Weight
V			s	s		V AC	Article No.	kg
<b>Monitoring of phase sequence, phase failure, phase asymmetry, overvoltage and undervoltage</b>								
1 ... 20	✓	✓	0.1 ... 999.9	0.1 ... 999.9	1 CO + 1 Q <sup>2)</sup>	160 ... 690	<b>3UG4815-2AA40</b>	0.147
<b>Monitoring of phase sequence, phase and N conductor failure, phase asymmetry, overvoltage and undervoltage</b>								
1 ... 20	✓	✓	0.1 ... 999.9	0.1 ... 999.9	1 CO + 1 Q <sup>2)</sup>	90 ... 400 against N	<b>3UG4816-2AA40</b>	0.147

✓ Function supported

<sup>1)</sup> Absolute limit values.

<sup>2)</sup> In SIO mode.

For accessories, see [page 2/304](#).

## Monitoring and control devices

### Relays

#### SIRIUS 3UG48 monitoring relays for stand-alone installation for IO-Link

### Voltage monitoring

#### Overview



SIRIUS 3UG4832 monitoring relay

The relays monitor 1-phase AC voltages (rms value) and DC voltages against the set limit value for overshoot and undershoot.

#### Benefits

- Variably adjustable to overshoot, undershoot or range monitoring
- Freely configurable delay times and RESET response
- Width 22.5 mm
- Display and transmission of actual value and status messages to controller
- All versions with removable terminals
- All versions with screw or spring-loaded terminals

#### Application

- Protection of a plant against destruction due to overvoltage
- Switch-on of a plant at a defined voltage and higher
- Protection from undervoltage due to overloaded supply voltages, particularly with battery power

#### Technical specifications

##### 3UG4832 monitoring relays

The 3UG4832 voltage monitoring relays are supplied with power through IO-Link or with an external auxiliary voltage of 24 V DC and perform overshoot, undershoot or range monitoring of the voltage depending on parameterization. The devices are equipped with a display and are parameterized by means of three buttons or through IO-Link.

The measuring range extends from 10 to 600 V AC/DC. The limit values for overshoot or undershoot can be freely configured within this range. If one of these limit values is reached, the output relay responds according to the set principle of operation as soon as the delay time has elapsed. This tripping delay time  $U\blacktriangle\text{Del}/U\blacktriangledown\text{Del}$  can be set from 0 to 999.9 s, as can the ON-delay time onDel. The hysteresis is adjustable from 0.1 to 300 V.

The device can be operated on the basis of either the open-circuit or closed-circuit principle and with Manual or Auto RESET. One output changeover contact is available as a signaling contact, and a semiconductor output is available in addition in SIO mode.

If Manual RESET is selected in the menu (Memory = Yes), the switching relay remains in its current switching state and the current measured value and the symbol for undershooting and overshooting continue to flash, even when the measured variable reaches a permissible value again. This stored fault status can be reset by simultaneously pressing the UP $\blacktriangle$  and DOWN $\blacktriangledown$  keys for 2.5 s.

With Manual RESET through IO-Link it is possible in addition to set whether fault messages are to be deleted when the control supply voltage is switched off and on (as Remote RESET) or whether the signals are to be permanently saved even in a voltage failure, with confirmation possible only through local RESET or via IO-Link.

With the closed-circuit principle selected

Overvoltage

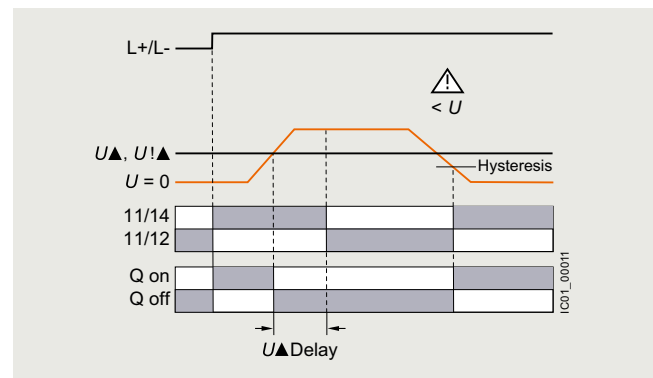

Undervoltage

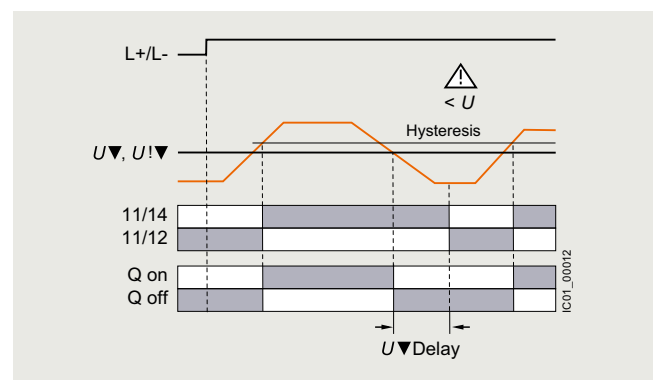

With the closed-circuit principle selected

Range monitoring

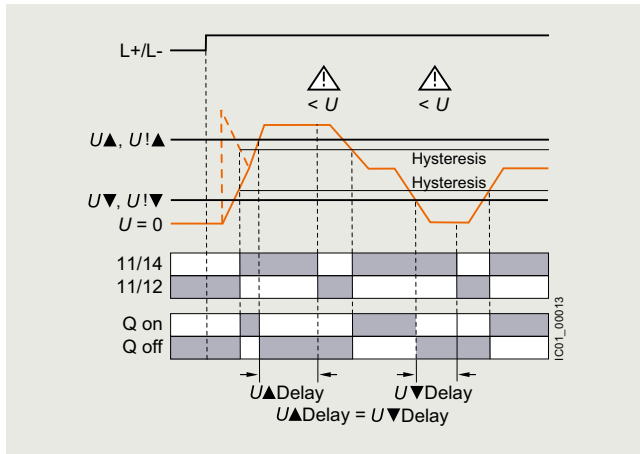

Type	3UG4832	
<b>General technical specifications</b>		
<b>Rated insulation voltage <math>U_i</math></b>	V	690
Pollution degree 2 Overvoltage category III acc. to VDE 0110		
<b>Rated impulse withstand voltage <math>U_{imp}</math></b>	kV	6
<b>Measuring circuit</b>		
<b>Permissible measuring range</b> 1-phase AC/DC voltage	V	10 ... 690
<b>Measuring frequency</b>	Hz	40 ... 500
<b>Setting range</b> 1-phase voltage	V	10 ... 600
<b>Control circuit</b>		
<b>Load capacity of the output relay</b>		
• Thermal current $I_{th}$	A	5
<b>Rated operational current <math>I_e</math> at</b>		
• AC-15/24 ... 400 V	A	3
• DC-13 at		
- 24 V	A	1
- 125 V	A	0.2
- 250 V	A	0.1
<b>Minimum contact load</b> at 17 V DC	mA	5

## Monitoring and control devices

### Relays

#### SIRIUS 3UG48 monitoring relays for stand-alone installation for IO-Link

#### Voltage monitoring

##### Selection and ordering data

- Adjustable via IO-Link and locally, with illuminated LCD
- Power supply with 24 V DC via IO-Link or external auxiliary voltage
- Auto or Manual RESET
- Open-circuit or closed-circuit principle
- 1 CO contact, 1 semiconductor output (in SIO mode)



3UG4832-2AA40

Measuring range	Adjustable hysteresis	ON-delay time adjustable onDel	Tripping delay time separately adjustable $U\blacktriangle\text{Del}/U\blacktriangledown\text{Del}$	Spring-loaded terminals	Weight
V AC/DC	V	s	s		kg
<b>Monitoring of voltage for overshooting and undershooting</b>					
10 ... 600	0.1 ... 300	0 ... 999.9	0 ... 999.9	<b>3UG4832-2AA40</b>	0.147

For accessories, see page 2/304.

## Overview



SIRIUS 3UG4822 monitoring relay

The relays monitor 1-phase AC currents (rms value) and DC currents against the set limit value for overshoot and undershoot.

## Benefits

- Variably adjustable to overshoot, undershoot or range monitoring
- Freely configurable delay times and RESET response
- Width 22.5 mm
- Display and transmission of actual value and status messages to controller
- All versions with removable terminals
- All versions with screw or spring-loaded terminals

## Application

- Overcurrent and undercurrent monitoring
- Monitoring the functionality of electrical loads
- Monitoring for broken conductors

## Technical specifications

**3UG4822 monitoring relays**

The 3UG4822 current monitoring relays are supplied with power through IO-Link or with an external voltage of 24 V DC and perform overshoot, undershoot or range monitoring of the current depending on the parameterization. The devices are equipped with a display and are parameterized using three buttons.

The measuring range extends from 0.05 to 10 A. For larger AC currents the measuring range can be extended by using commercially available current transformers. Using the adjustable transformer factor, the display of the measured primary currents up to 750 A instead of the secondary currents (max. 1 A or 5 A) is possible.

The rms value of the current is measured. The limit values for overshoot or undershoot can be freely configured within this range. If one of these limit values is reached, the output relay responds according to the set principle of operation as soon as the tripping delay time  $I\blacktriangle\text{Del}/I\blacktriangledown\text{Del}$  has elapsed. This time and the ON-delay time  $\text{onDel}$  are adjustable from 0 to 999.9 s.

The hysteresis is adjustable from 0.01 to 5 A. The device can be operated with Manual or Auto RESET and on the basis of either the open-circuit or closed-circuit principle. You can decide here whether the output relay is to respond when the supply voltage  $U_s = \text{ON}$  is applied, or not until the lower measuring range limit of the measuring current ( $I > 50 \text{ mA}$ ) is reached. One output changeover contact is available as a signaling contact, and a semiconductor output is available in addition in SIO mode.

If Manual RESET is selected in the menu (Memory = Yes), the switching relay remains in its current switching state and the current measured value and the symbol for undershooting and overshooting continue to flash, even when the measured variable reaches a permissible value again. This stored fault status can be reset by simultaneously pressing the UP  $\blacktriangle$  and DOWN  $\blacktriangledown$  keys for 2.5 s.

With Manual RESET through IO-Link it is possible in addition to set whether fault messages are to be deleted when the control supply voltage is switched off and on (as Remote RESET) or whether the signals are to be permanently saved even in a voltage failure, with confirmation possible only through local RESET or via IO-Link.

With the closed-circuit principle selected upon application of the control supply voltage  
Current overshoot

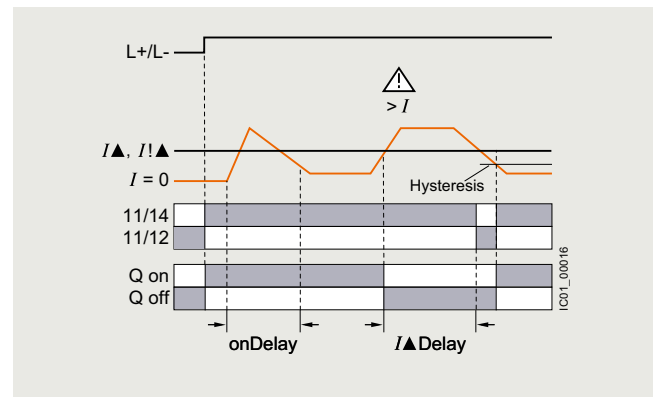

Current undershoot

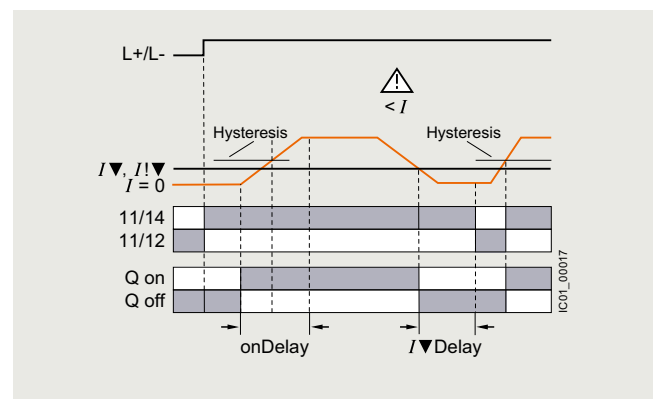

## Monitoring and control devices

### Relays

#### SIRIUS 3UG48 monitoring relays for stand-alone installation for IO-Link

#### Current monitoring

With the closed-circuit principle selected  
upon application of the control supply voltage

Range monitoring

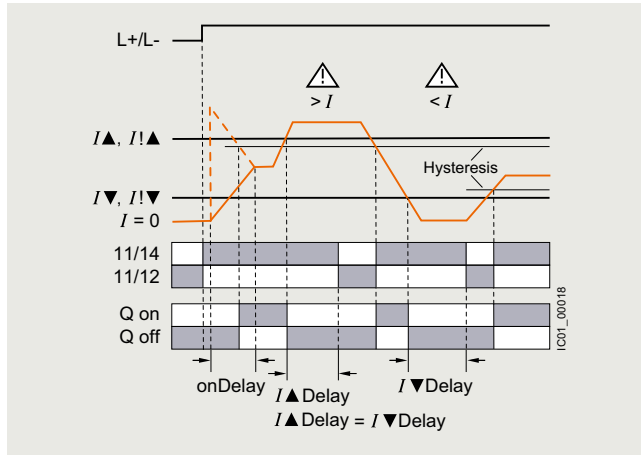

Type	3UG4822	
<b>General technical specifications</b>		
<b>Rated insulation voltage <math>U_i</math></b> Pollution degree 2 Overvoltage category III acc. to VDE 0110	V	690
<b>Rated impulse withstand voltage <math>U_{imp}</math></b>	kV	6
<b>Measuring circuit</b>		
<b>Measuring range</b> for 1-phase AC/DC current	A	0.05 ... 15
<b>Measuring frequency</b>	Hz	40 ... 500
<b>Setting range</b> for 1-phase current	A	0.05 ... 10
<b>Load supply voltage</b>	V	Max. 300 (with protective separation) Max. 500 (with simple separation)
<b>Control circuit</b>		
<b>Load capacity of the output relay</b> • Thermal current $I_{th}$	A	5
<b>Rated operational current <math>I_e</math> at</b> • AC-15/24 ... 400 V • DC-13 at	A	3
- 24 V	A	1
- 125 V	A	0.2
- 250 V	A	0.1
<b>Minimum contact load</b> at 17 V DC	mA	5

**Selection and ordering data**

- Adjustable via IO-Link and locally, with illuminated LCD
- Power supply with 24 V DC via IO-Link or external auxiliary voltage
- Adjustable transformer factor to display the measured primary current when an external current transformer is used
- Auto or Manual RESET
- Open-circuit or closed-circuit principle
- 1 CO contact, 1 semiconductor output (in SIO mode)



3UG4822-2AA40

Measuring range	Adjustable hysteresis	ON-delay time adjustable onDel	Tripping delay time separately adjustable $I_{\Delta}Del/I_{\nabla}Del$	Spring-loaded terminals 	Weight
A AC/DC	A	s	s	Article No. U	kg
<b>Monitoring of current for overshooting and undershooting</b>					
0.05 ... 10	0.01 ... 5	0.1 ... 999.9	0.1 ... 999.9	<b>3UG4822-2AA40</b>	0.144

For accessories, [see page 2/304](#).

For AC currents  $I > 10$  A it is possible to use commercially available current transformers, e.g. the Siemens 4NC current transformers, as accessories, [see Catalog LV 10](#).



## Monitoring and control devices

### Relays

#### SIRIUS 3UG48 monitoring relays for stand-alone installation for IO-Link

#### Power factor and active current monitoring

##### Overview



SIRIUS 3UG4841 monitoring relay

The 3UG4841 power factor and active current monitoring devices enable the load monitoring of motors.

Whereas power factor (p.f.) monitoring is used above all for monitoring no-load operation, the active current monitoring option can be used to observe and evaluate the load factor over the entire torque range.

##### Benefits

- Monitoring of even small 1-phase motors with a no-load supply current below 0.5 A
- Simple determination of threshold values by directly referencing measured variables to motor loading
- Range monitoring and active current measurement enable detection of cable breaks between control cabinets and motors, as well as phase failures
- Power factor (p.f.) and/or  $I_{res}$  (active current) can be selected as the measurement principle
- Width 22.5 mm
- Display and transmission of actual value and status messages to controller
- All versions with removable terminals
- All versions with screw or spring-loaded terminals

##### Application

- No-load monitoring and load shedding, such as in the event of a V-belt tear
- Underload monitoring in the low-end performance range, e.g. in the event of pump no-load operation
- Monitoring of overload, e.g. due to a dirty filter system
- Power factor monitoring in networks for control of compensation equipment
- Broken cable between control cabinet and motor

##### Technical specifications

###### 3UG4841 monitoring relays

3UG4841 monitoring relays are supplied with power through IO-Link or with an external auxiliary voltage of 24 V DC and are used for performing overshoot, undershoot or range monitoring of the power factor and/or the resulting active current, depending on parameterization. The load to be monitored is connected upstream of the IN terminal. The load current flows through the terminals IN and Ly/N. The setting range for the power factor is 0 to 0.99 and for the active current  $I_{res}$  it is 0.2 to 10 A. If the control supply voltage is switched on and no load current flows, the display will show  $I < 0.2$  and a symbol for overshoot, undershoot or range monitoring. If the motor is now switched on and the current exceeds 0.2 A, the set ON-delay time onDel begins. During this time, if the set limit values are undershot or exceeded, this does not lead to a relay reaction of the changeover contact. If the operational flowing active current and/or the p.f. value falls below or exceeds the respective set threshold value, the tripping delay time begins. When this time has expired, the relay changes its switch position. The relevant measured variables for overshooting and undershooting in the display flash. If monitoring for active current undershoot is switched off ( $I_{res} \nabla = \text{OFF}$ ), and if the load current undershoots the lower measuring range threshold (0.2 A), the CO contacts remain unchanged. If a threshold value is set for the monitoring of active current undershooting, then undershooting of the measuring range threshold (0.2 A) will result in a response of the CO contacts.

The relay operates either according to the open-circuit or closed-circuit principle.

If the device is set to Auto RESET (Memory = No), depending on the set principle of operation, the switching relay returns to its initial state and the flashing ends when the hysteresis threshold is reached.

If Manual RESET is selected in the menu (Memory = Yes), the switching relay remains in its current switching state and the current measured value and the symbol for undershooting and overshooting continue to flash, even when the measured variable reaches a permissible value again. This stored fault status can be reset by simultaneously pressing the UP▲ and DOWN▼ keys for 2.5 s.

With Manual RESET through IO-Link it is possible in addition to set whether fault messages are to be deleted when the control supply voltage is switched off and on (as Remote RESET) or whether the signals are to be permanently saved even in a voltage failure, with confirmation possible only through local RESET or via IO-Link.

With the closed-circuit principle selected

Response in the event of undershooting the measuring range limit with activated monitoring of  $I_{res}$

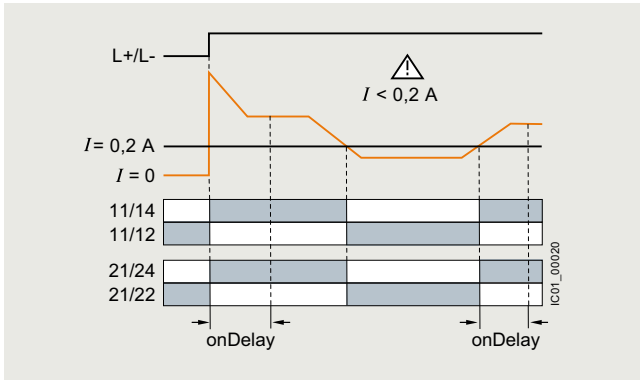

Overshooting of active current

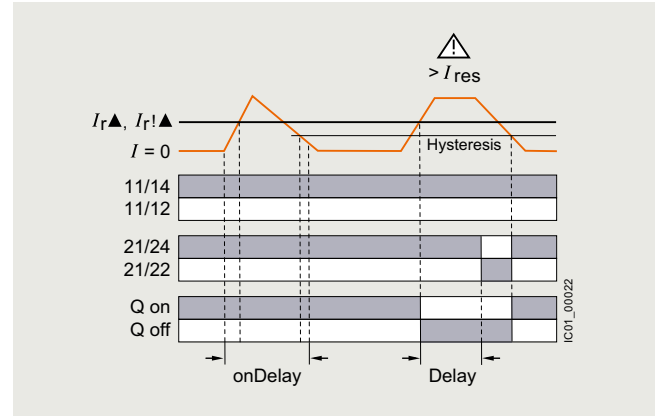

Response in the event of undershooting the measuring range limit with deactivated monitoring of active current undershooting

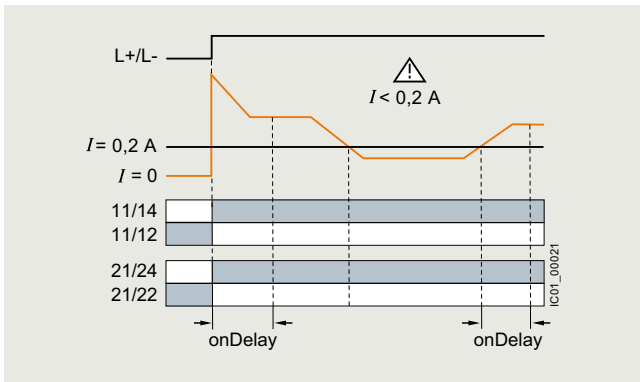

Undershooting of active current

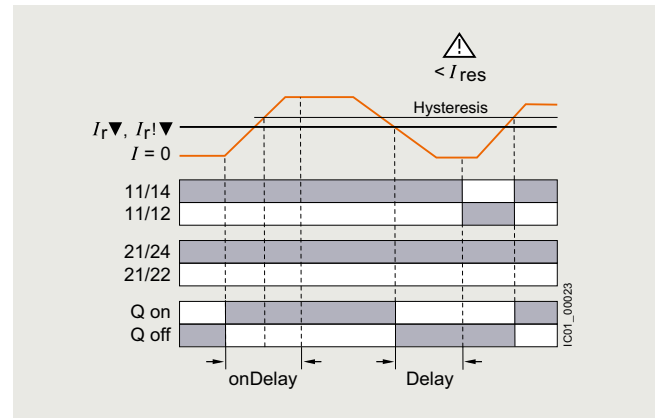

Range monitoring of active current

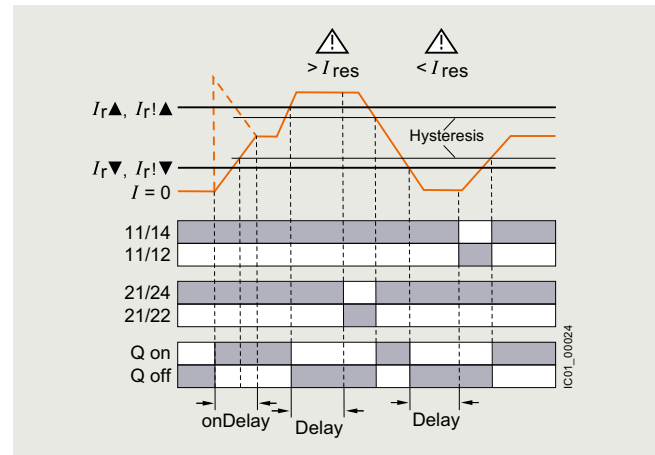

## Monitoring and control devices

### Relays

#### SIRIUS 3UG48 monitoring relays for stand-alone installation for IO-Link

#### Power factor and active current monitoring

With the closed-circuit principle selected

Overshooting of power factor

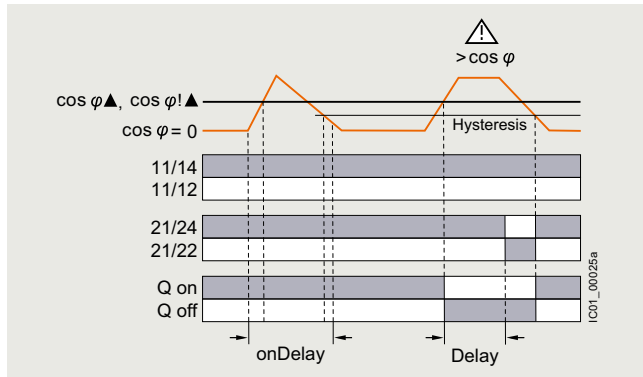

Range monitoring of power factor

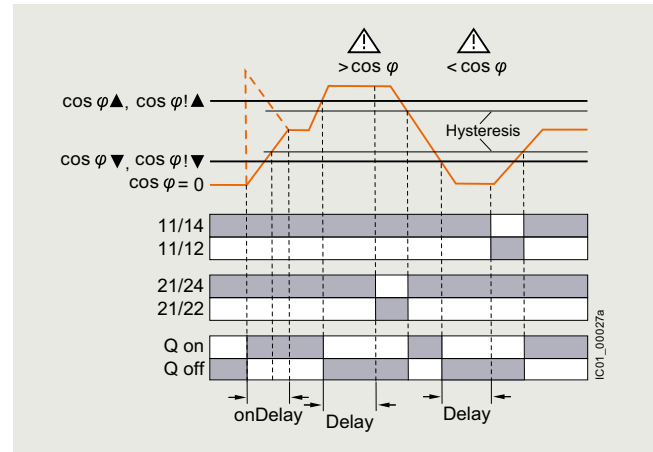

Undershooting of power factor

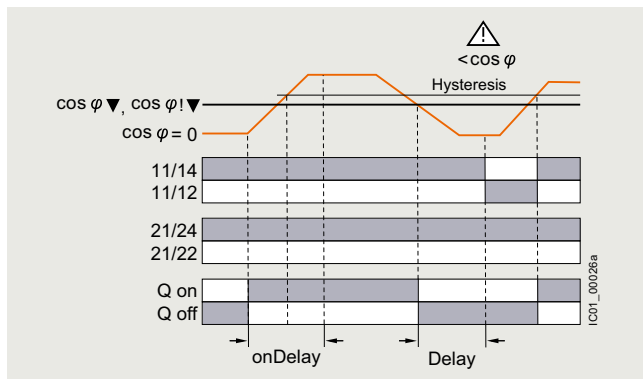

Type	3UG4841	
<b>General technical specifications</b>		
<b>Rated insulation voltage <math>U_i</math></b>	V	690
Pollution degree 2 Overvoltage category III according to IEC 60664-1		
<b>Rated impulse withstand voltage <math>U_{imp}</math></b>	kV	6
<b>Control circuit</b>		
<b>Number of CO contacts for auxiliary contacts</b>		2
<b>Load capacity of the output relay</b>		
• Thermal current $I_{th}$	A	5
<b>Rated operational current <math>I_o</math> at</b>		
• AC-15/24 ... 400 V	A	3
• DC-13 at		
- 24 V	A	1
- 125 V	A	0.2
- 250 V	A	0.1
<b>Minimum contact load at 17 V DC</b>	mA	5

## Selection and ordering data

- For monitoring the power factor and the active current  $I_{res}$  (p.f. x  $I$ )
- Suitable for 1-phase and 3-phase currents
- Adjustable via IO-Link and locally, with illuminated LCD
- Power supply with 24 V DC via IO-Link or external auxiliary voltage
- Overshoot, undershoot or range monitoring adjustable
- Upper and lower limit values can be adjusted separately
- Permanent display of actual value and tripping state
- 1 CO contact each for undershoot and overshoot, 1 semiconductor output (in SIO mode)



3UG4841-2CA40

Measuring range		Voltage range of the measuring voltage <sup>1)</sup>	Hysteresis		ON-delay time adjustable onDel	Tripping delay time separately adjustable U▲Del/ U▼Del/ φ▲Del/ φ▼Del	Spring-loaded terminals 	Weight
For power factor	For active current $I_{res}$		Adjustable for power factor	Adjustable for active current $I_{res}$				
P.f.	A	V	P.f.	A	s	s	Article No.	kg
<b>Monitoring of power factor and active current for overshooting or undershooting</b>								
0.1 ... 0.99	0.2 ... 10	90 ... 690	0.1 ... 0.2	0.1 ... 3	0 ... 999.9	0 ... 999.9	<b>3UG4841-2CA40</b>	0.168

<sup>1)</sup> Absolute limit values.

For accessories, see [page 2/304](#).

For AC active currents  $I_{res} > 10$  A it is possible to use commercially available current transformers, e.g. Siemens 4NC current transformers, as accessories, see [Catalog LV 10](#).

## Monitoring and control devices

### Relays

#### SIRIUS 3UG48 monitoring relays for stand-alone installation for IO-Link

#### Residual-current monitoring > Residual-current monitoring relays

#### Overview



SIRIUS 3UG4825 monitoring relay

The 3UG4825 residual-current monitoring relays are used in conjunction with the 3UL23 residual-current transformers for monitoring plants in which higher residual currents are increasingly expected due to ambient conditions. Monitoring encompasses pure AC residual currents or AC residual currents with a pulsating DC fault current component (transformer type A in accordance with DIN VDE 0100-530/IEC TR 60755).

#### Technical specifications

##### 3UG4825 monitoring relays

The main conductor, and any neutral conductor to which a load is connected, are routed through the opening of the toroidal core of a residual-current transformer. A secondary winding is placed around this toroidal core to which the monitoring relay is connected.

If operation of a plant is fault-free, the sum of the inflowing and outward currents equals zero. No current is then induced in the secondary winding of the residual-current transformer.

However, if an insulation fault occurs, the sum of the inflowing currents is greater than that of the outward currents. The differential current – i.e. the residual current – induces a secondary current in the secondary winding of the transformer. This current is evaluated in the monitoring relay and is used on the one hand to display the actual residual current and on the other, to switch the relay if the set warning or tripping threshold is overshot.

If the measured residual current exceeds the set warning value, the associated changeover contact instantly changes the switching state and an indication appears on the display.

If the measured residual current exceeds the set tripping value, the set delay time begins and the associated relay symbol flashes. On expiry of this time, the associated changeover contact changes the switching state.

##### ON-delay time for motor start

To be able to start a drive when a residual current is detected, the output relays switch to the OK state for an adjustable ON-delay time depending on the selected open-circuit or closed-circuit principle.

The changeover contacts do not react if the set threshold values are overshot during this period.

#### Benefits

- High measuring accuracy of  $\pm 7.5\%$
- Permanent self-monitoring
- Parameterization of the devices locally or via IO-Link possible
- Variable threshold values for warning and disconnection
- Freely configurable delay times and RESET response
- Display and transmission of actual value and status messages to controller
- High level of flexibility and space saving through installation of the transformer inside or outside the control cabinet
- Width 22.5 mm
- All versions with removable terminals
- All versions with screw or spring-loaded terminals

#### Application

Monitoring of plants in which residual currents can occur, e.g. due to dust deposits or moisture, porous cables and leads, or capacitive residual currents.

With the closed-circuit principle selected

Residual-current monitoring with Auto RESET (Memory = no)

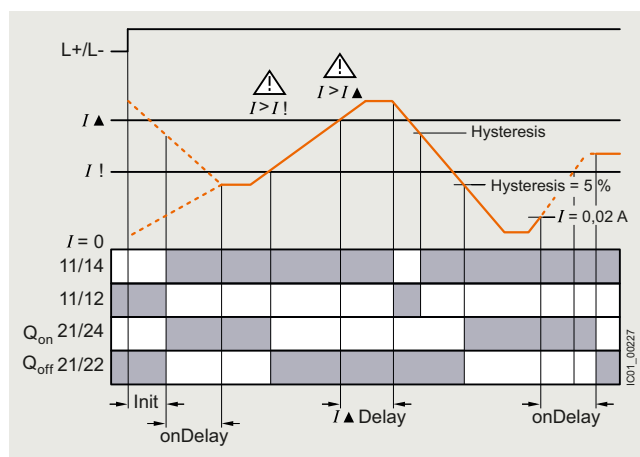

If the device is set to Auto RESET, the relay switches back to the OK state for the tripping value after tripping once the value falls below the set hysteresis threshold and the display stops flashing.

The associated relay changes its switching state if the value falls below the fixed hysteresis value of 5% of the warning value.

Any overshoots are therefore not stored.



## Monitoring and control devices

### Relays

#### SIRIUS 3UG48 monitoring relays for stand-alone installation for IO-Link

##### Residual-current monitoring > Residual-current monitoring relays

##### Selection and ordering data

- For monitoring residual currents from 0.03 to 40 A, from 16 to 400 Hz
- For 3UL23 residual-current transformers with feed-through opening from 35 to 210 mm
- Permanent self-monitoring
- Certified in accordance with IEC 60947, functionality corresponds to IEC 62020
- Digitally adjustable, with illuminated LCD
- Permanent display of actual value and tripping state
- Separately adjustable limit value and warning threshold
- 1 changeover contact each for warning threshold and tripping threshold



3UG4825-2CA40

Measurable current	Adjustable response value current	Switching hysteresis	Adjustable ON-delay time	Control supply voltage At DC, rated value	Spring-loaded terminals 	Weight
A	A	%	s	V	Article No.	kg
0.01 ... 43	0.03 ... 40	0 ... 50	0 ... 999.9	24	<b>3UG4825-2CA40</b>	0.147

For accessories, see page 2/304.

For 3UL23 residual-current transformers and accessories for 3UL23, see page 2/270.

**Overview**

SIRIUS 3UG4851 monitoring relay

3UG4851 monitoring relays are used in combination with a sensor to monitor drives for overspeed and/or underspeed.

Furthermore, the monitoring relays are ideal for all functions where a continuous pulse signal needs to be monitored (e.g. belt travel monitoring, completeness monitoring, passing monitoring, clock-time monitoring).

**Technical specifications****3UG4851 monitoring relays**

The speed monitoring relay operates according to the principle of period duration measurement.

In the monitoring relay, the time between two successive rising edges of the pulse encoder is measured and compared to the minimum and/or maximum permissible period duration calculated from the set limit values for the speed.

Thus, the period duration measurement recognizes any deviation in speed after just two pulses, even at very low speeds or in the case of extended pulse gaps.

By using up to ten pulse encoders evenly distributed around the circumference, it is possible to shorten the period duration, and in turn the response time. By taking into account the number of sensors in the monitoring relay, the speed continues to be indicated in rpm.

ON-delay time for motor start

To be able to start a motor drive, and depending on whether the open-circuit or closed-circuit principle is selected, the output relay switches to the OK state during the ON-delay time, even if the speed is still below the set value.

The ON-delay time is started by either switching on the auxiliary voltage or, if the auxiliary voltage is already applied, by actuating the respective NC contact (e.g. auxiliary contact).

**Benefits**

- Variably adjustable to overshoot, undershoot or range monitoring
- Freely configurable delay times and RESET response
- Display and transmission of actual value and fault type to controller
- Use of up to 10 sensors per rotation for extremely slowly rotating motors
- Two- or three-wire sensors and sensors with a mechanical switching output or solid-state output can be connected
- Auxiliary voltage for sensor integrated
- All versions with removable terminals
- All versions with screw or spring-loaded terminals

**Application**

- Slip or tear of a belt drive
- Overload monitoring
- Transport monitoring for completeness

Speed monitoring with Auto RESET (Memory = no)

If the device is set to Auto RESET, the output relay switches to the OK state, once the adjustable hysteresis threshold is reached in the range of 1 to 99.9 rpm and the flashing stops. Any overshoots or undershoots are therefore not stored.

Speed monitoring with Manual RESET (Memory = yes)

If Manual RESET is selected in the menu, the output relay remains in its current switching state and the current measured value and the symbol for overshooting/undershooting continue to flash, even when the speed returns to a permissible value. This stored fault status can be reset by simultaneously pressing the UP▲ and DOWN▼ buttons for > 2.5 s or by connecting the RESET device terminal to 24 V DC.

With Manual RESET through IO-Link it is possible in addition to set whether fault messages are to be deleted when the control supply voltage is switched off and on (as Remote RESET) or whether the signals are to be permanently saved even in a voltage failure, with confirmation possible only through local RESET, the Remote RESET contact, or via IO-Link.



## Monitoring and control devices

### Relays

#### SIRIUS 3UG48 monitoring relays for stand-alone installation for IO-Link

#### Speed monitoring

With the closed-circuit principle selected

Range monitoring without enable input

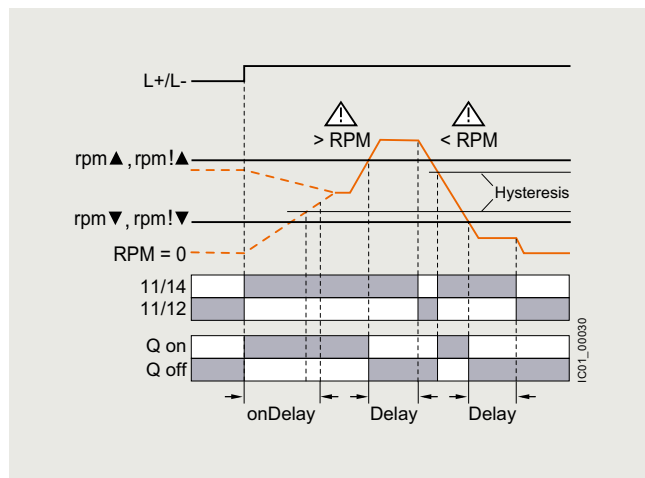

Range monitoring with enable input

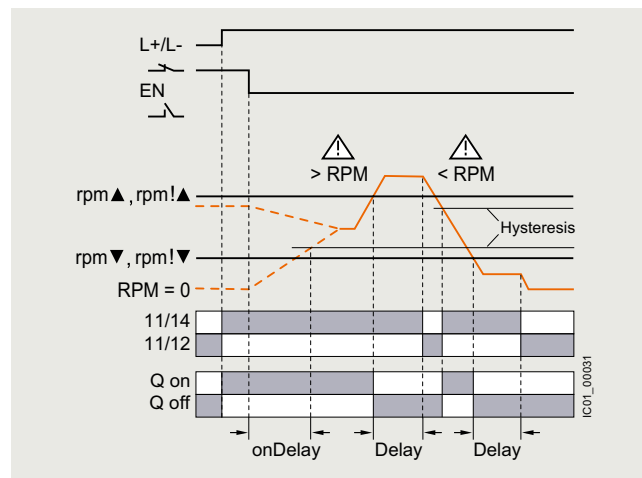

Type	3UG4851	
<b>General technical specifications</b>		
<b>Rated insulation voltage <math>U_i</math></b> Pollution degree 2 Overvoltage category III acc. to VDE 0110	V	300
<b>Rated impulse withstand voltage <math>U_{imp}</math></b>	kV	4
<b>Measuring circuit</b>		
<b>Sensor supply</b>		
• For three-wire sensor (24 V/0 V)	mA	Max. 50
• For two-wire NAMUR sensor (8V2)	mA	Max. 8.2
<b>Signal input</b>		
• IN1	k $\Omega$	16, three-wire sensor, pnp operation
• IN2	k $\Omega$	1, floating contact, two-wire NAMUR sensor
<b>Voltage level</b>		
• For level 1 at IN1	V	4.5 ... 30
• For level 0 at IN1	V	0 ... 1
<b>Current level</b>		
• For level 1 at IN2	mA	> 2.1
• For level 0 at IN2	mA	< 1.2
<b>Minimum pulse duration of signal</b>	ms	5
<b>Minimum interval between 2 pulses</b>	ms	5
<b>Control circuit</b>		
<b>Number of CO contacts for auxiliary contacts</b>		1
<b>Load capacity of the output relay</b> Thermal current $I_{th}$	A	5
<b>Rated operational current <math>I_e</math> at</b>		
• AC-15/24 ... 250 V	A	3
• DC-13 at		
- 24 V	A	1
- 125 V	A	0.2
- 250 V	A	0.1
<b>Minimum contact load at 17 V DC</b>	mA	5

**Selection and ordering data**

- For speed monitoring in revolutions per minute (rpm)
- Two- or three-wire sensor with mechanical or electronic switching output can be connected
- Two-wire NAMUR sensor can be connected
- Sensor supply 24 V DC/50 mA integrated
- Input frequency 0.1 to 2 200 pulses per minute (0.0017 to 36.7 Hz)
- With or without enable signal for the drive to be monitored
- Adjustable via IO-Link and locally, with illuminated LCD
- Power supply with 24 V DC via IO-Link or external auxiliary voltage
- Overshoot, undershoot or range monitoring adjustable
- Number of pulses per revolution can be adjusted
- Upper and lower limit values can be adjusted separately
- Auto, Manual or Remote RESET options after tripping
- Permanent display of actual value and tripping state
- 1 CO contact, 1 semiconductor output (in SIO mode)



3UG4851-2AA40

Measuring range	Adjustable hysteresis	ON-delay time adjustable onDel	Tripping delay time separately adjustable rpm▲Del/rpm▼Del	Pulses per revolution	Spring-loaded terminals 	Weight
rpm	rpm	s	s		Article No.	kg
<b>Speed monitoring for overshooting and undershooting</b>						
0.1 ... 2 200	OFF 1 ... 99.9	0 ... 999.9	0 ... 999.9	1 ... 10	<b>3UG4851-2AA40</b>	0.144

For accessories, see page 2/304.





## Monitoring and control devices

### Relays

#### SIRIUS 3UG48 monitoring relays for stand-alone installation for IO-Link

#### Accessories

#### Selection and ordering data

Use	Version	Article No.	Weight kg
<b>Accessories for enclosures</b>			
 3RP1902	For 3UG48	<b>Sealable covers</b> For securing against unauthorized adjustment of setting knobs	0.003
 3RP1903	For 3UG48	<b>Push-in lugs</b> For screw fixing, 2 units are required for each device	0.002
<b>Blank labels</b>			
 3RT2900-1SB20	For 3UG48	<b>Unit labeling plates</b> <sup>1)</sup> For SIRIUS devices • 20 mm x 7 mm, titanium gray	0.062
	For 3UG48	<b>Adhesive labels</b> For SIRIUS devices, 19 mm x 6 mm, titanium gray	0.005
<b>Tools for opening spring-loaded terminals</b>			
 3RA2908-1A	For auxiliary circuit connections	<b>Screwdrivers</b> For all SIRIUS devices with spring-loaded terminals  Length approx. 200 mm, 3.0 mm x 0.5 mm, titanium gray/black, partially insulated	<b>Spring-loaded terminals</b>   <b>3RA2908-1A</b>  0.050
<b>Software</b>			
	For 3UG48	<b>SIRIUS Asset Monitor</b>  The MindSphere app enables access to the SIRIUS 3UG48 monitoring relays anytime and anywhere and provides detailed information about the device status and fault messages and warnings.	

<sup>1)</sup> PC labeling system for individual inscription of unit labeling plates available from: murrplastik Systemtechnik GmbH.

## Overview

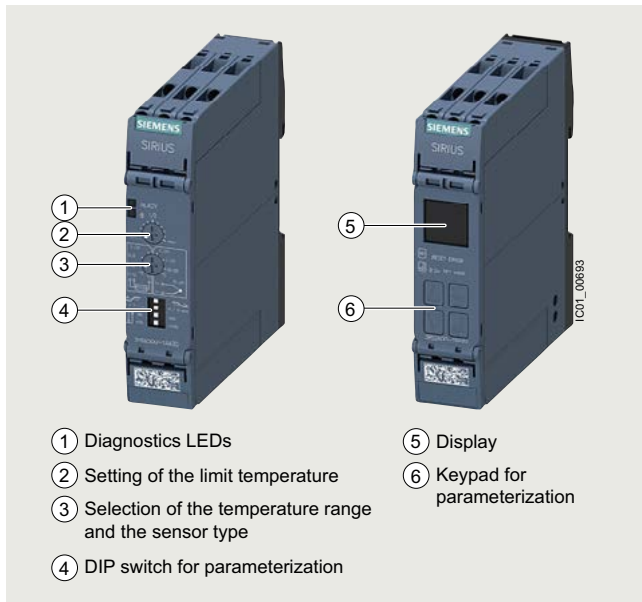

SIRIUS 3RS2 temperature monitoring relays

## More information

Homepage, see [www.siemens.com/sirius-monitoring-relays](http://www.siemens.com/sirius-monitoring-relays)

Industry Mall, see [www.siemens.com/product?3RS2](http://www.siemens.com/product?3RS2)

Conversion tool, see [www.siemens.com/conversion-tool](http://www.siemens.com/conversion-tool)

The 3RS2 temperature monitoring relays can be used to measure temperatures in solid, liquid and gas media. The temperature is acquired by means of sensors in the medium, evaluated by the device and monitored for overshoot, undershoot or location within a specified range (window function).

The family comprises an analog multi-function device which can be set using DIP switches and potentiometers, and digital devices which can be parameterized via an intuitive LC display. The digital device is also available as a version with IO-Link.

All 3RS26 digital devices, including the 3RS28 versions with IO-Link, have safety certification according to IEC 61508/62061 or ISO 13849 up to SIL 1/PL c as well as EN 14597 for heat generating systems and EN 50156 for burners.

Furthermore, the functionality of the 3RS26/3RS28 digital devices can be expanded using a 3RS29 sensor expansion module with two additional resistance sensors, e.g. for monitoring 3-phase motors or transformers.

The 3RS29 sensor expansion module also features an additional relay for outputting the sensor status, and an additional analog input 4 to 20 mA. This analog input allows ATEX applications to be implemented when using an intrinsically safe temperature sensor or other appropriate type of protection. The 3RS29 is connected wirelessly via a SIL 1-certified infrared communication interface.

## Notes:

The SIRIUS 3RS2 temperature monitoring relays fully replace the 3RS1 predecessor. The large number of 3RS1 analog devices can simply be replaced with the new 3RS25 analog multi-function device. The reduced variety of order numbers means the successors can be selected quickly and easily.

The 3RS2 digital devices fully supersede the functionality of the 3RS1 predecessor in a single device type that is now able to use resistance sensors and thermocouples – all at half the width of 22.5 mm instead of 45 mm.

## Analog multi-function devices



SIRIUS 3RS25 analog multi-function device

The analog multi-function device is parameterized using DIP switches and potentiometers. The device can be used to monitor a sensor with a limit value for overshoot or undershoot. The most common temperature ranges with Pt100 resistance sensors or type J or K thermocouples can be used for this purpose. This device can therefore also be used as a compact, easy-to-adjust two-point controller. The relay CO contact output enables loads to be switched directly. The NC contact can optionally be used as a signaling contact.

## Digital devices (1 sensor)



SIRIUS 3RS26 digital device (1 sensor) with 3RS29 sensor expansion module

The SIRIUS 3RS26 digital device with display enables sensors with two limit values to be monitored using all common resistance sensors and thermocouples.

## Monitoring and control devices

### Relays

### SIRIUS 3RS2 temperature monitoring relays

#### General data

The additional limit value means that, in addition to overshoot and undershoot, an additional warning value can be output to the relay outputs. Alternatively, the second monitoring value can also be used to implement range monitoring. The digital devices can thus also be used as compact two or three-step controllers, with Manual RESET or Remote RESET.

Thanks to safety certification, this device can be used in a wide range of applications.

The functionality of the SIRIUS 3RS26 and 3RS28 digital devices can be expanded wirelessly with the sensor expansion module via a SIL 1-certified infrared communication interface. This combination then features three sensors and is designed for monitoring large 3-phase motors and transformers. It goes without saying that the additional sensors can also be used for other applications.

#### Digital devices (1 sensor) for IO-Link



SIRIUS 3RS28 digital device (1 sensor) for IO-Link with 3RS29 sensor expansion module

The 3RS28 digital temperature monitoring relays for IO-Link feature an IO-Link communication interface in addition to a display. They include all functions of the 3RS26 digital device and can also be operated on L+/L- as a stand-alone installation with 24 V DC.

#### Note:

The IO-Link devices can be reset on the display or via IO-Link.

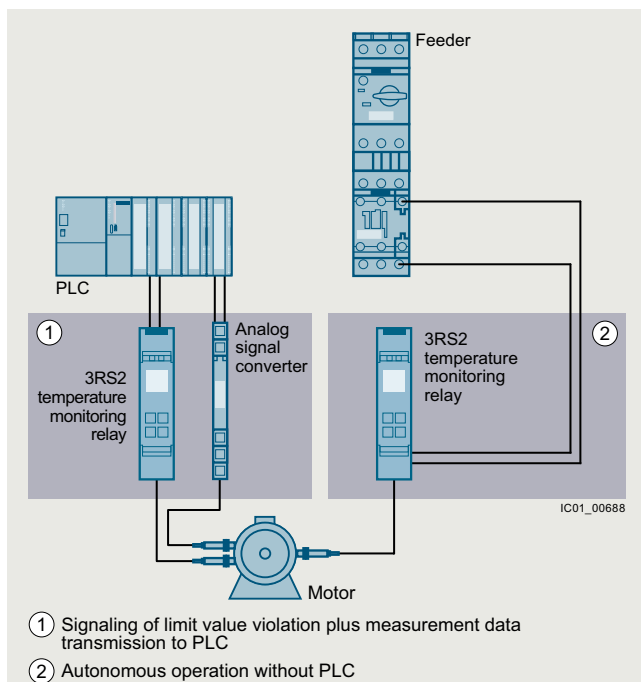

Conventional temperature monitoring relays

#### Notes:

Devices required for communication via IO-Link:

- Any controller that supports IO-Link (e.g. ET 200SP with CPU or S7-1200), see [Catalog ST 70](#).
- IO-Link master (e.g. CM 4xIO-Link for SIMATIC ET 200SP or SM 1278 for S7-1200).

Each monitoring relay requires an IO-Link channel.

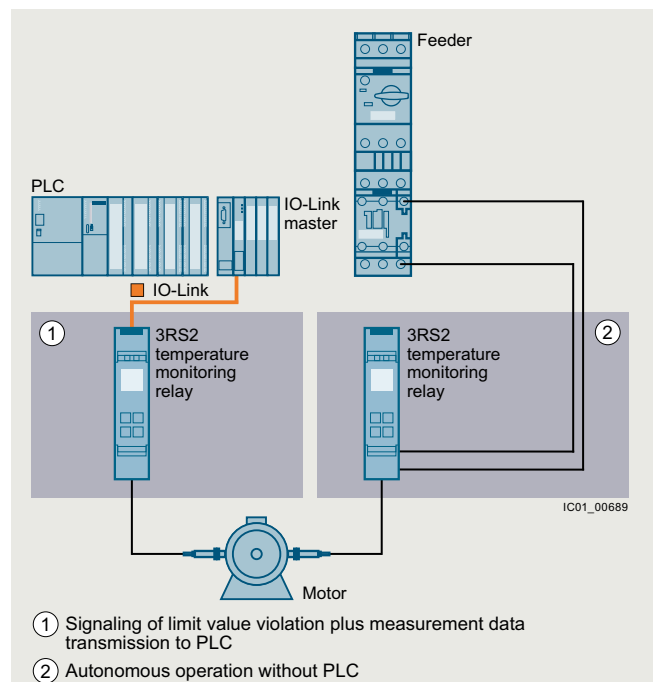

Temperature monitoring relays for IO-Link

#### Notes on security

In order to protect plants, systems, machines and networks against cyber threats, it is necessary to implement – and continuously maintain – a holistic, state-of-the-art industrial security concept. Siemens products and solutions represent only one component of such a concept.

For more information about the subject of Industrial Security, see [www.siemens.com/industrialsecurity](http://www.siemens.com/industrialsecurity).

**Article No. scheme**

Product versions		Article number	
<b>Temperature monitoring relays</b>		<b>3RS2</b> □ 0 0 - □ □ □ □ 0	
Device type	e.g. 5 = analogically adjustable	□	
Connection type	Screw terminals		1
	Spring-loaded terminals (push-in)		2
Number of CO contacts	e.g. A = 1 CO contact, B = 2 CO contacts	□	
Rated control supply voltage	A = 24 V AC/DC, W = 24 ... 240 V AC/DC		□
Type of rated control supply voltage	3 = AC/DC, 4 = DC		□
Example		<b>3RS2 5 0 0 - 1 A A 3 0</b>	

**Note:**

The Article No. scheme shows an overview of product versions for better understanding of the logic behind the article numbers. For your orders, please use the article numbers quoted in the selection and ordering data.

**Benefits**

- Customary screw and spring-loaded terminals for quick and reliable wiring
- Reduced space requirement in the control cabinet thanks to a consistent width of 22.5 mm
- Easy parameterization thanks to new display and intuitive operating concept
- Reduced stock keeping and logistics thanks to heavily reduced device variance
- Cost savings thanks to additional scalable functionality with integrated infrared interface
- Communication via IO-Link for 3RS28
- Global applicability and exportability thanks to compliance with international standards and certifications
- Problem-free use in a wide range of applications thanks to Safety bundle with certification according to SIL 1/PL c, ATEX, EN 14597 for heat generating systems and EN 50156 for burners
- All versions with removable terminals
- All versions with screw or spring-loaded terminals with push-in functionality

**Application**

The SIRIUS 3RS2 temperature monitoring relays can be used in almost any application in which temperature overshoot or undershoot is not permitted, e.g. in the monitoring of set temperature limits and the output of alarm messages for:

- Simple and compact two-point control
- Motor and system protection
- Control cabinet temperature monitoring
- Freeze monitoring
- Temperature limits for process variables e.g. in the packaging industry or electroplating
- Controlling equipment and machines such as heating, climate and ventilation systems, solar collectors, heat pumps or warm water supplies
- Motor, bearing and gear oil monitoring
- Monitoring of coolants

**Additionally for digital devices**

- Simple and compact two-point or three-point control
  - Burner acc. to EN 50156
  - Temperature monitors or temperature limiters<sup>1)</sup> according to EN 14597
  - ATEX explosion protection according to EN 50495
- <sup>1)</sup> A 3RS29 sensor expansion module with an additional sensor is required for the function as a temperature limiter.

## Monitoring and control devices

### Relays

### SIRIUS 3RS2 temperature monitoring relays

#### General data

#### Technical specifications

##### More information

Technical specifications, see <https://support.industry.siemens.com/cs/ww/en/ps/25719/td>

Equipment Manual and internal circuit diagrams, see <https://support.industry.siemens.com/cs/ww/en/ps/25719/man>

FAQs, see <https://support.industry.siemens.com/cs/ww/en/ps/25719/faq>

#### Connection of resistance-type thermometers

##### Two-wire measurement

When two-wire temperature sensors are used, the resistances of the sensor and wiring are added. The resulting systematic error must be taken into account when the evaluation unit is calibrated. A jumper must be clamped between terminals T2 and T3 for this purpose.

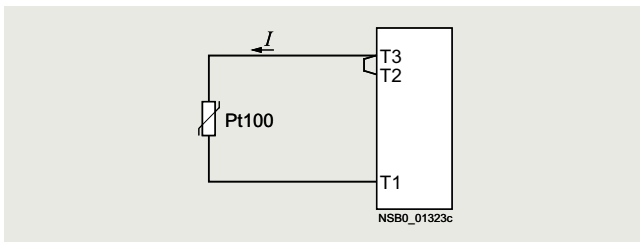

##### Wiring errors

The errors that are generated by the wiring comprise approximately 2.5 K/Ω. If the resistance of the cable is not known and cannot be measured, the wiring errors can also be estimated using the following table.

Temperature drift dependent on the length and cross-section of the cable with Pt100 sensors and an ambient temperature of 20 °C, in K:

Cable length in m	Cross-section mm <sup>2</sup>			
	0.5	0.75	1	1.5
	Temperature drift in K:			
0	0	0	0	0
10	1.8	1.2	0.9	0.6
25	4.5	3.0	2.3	1.5
50	9.0	6.0	4.5	3.0
75	13.6	9.0	6.8	4.5
100	18.1	12.1	9.0	6.0
200	36.3	24.2	18.1	12.1
500	91.6	60.8	45.5	30.2

Example: On a Pt100 sensor with a cable length of 10 m and a conductor cross-section of 1 mm<sup>2</sup> the temperature drift equals 0.9 K.

##### Three-wire measurement

To minimize the effects of the line resistances, a three-wire circuit is often used. Using the additional cable, two measuring circuits can be formed of which one is used as a reference. The evaluation unit can then automatically calculate the line resistance and take it into account.

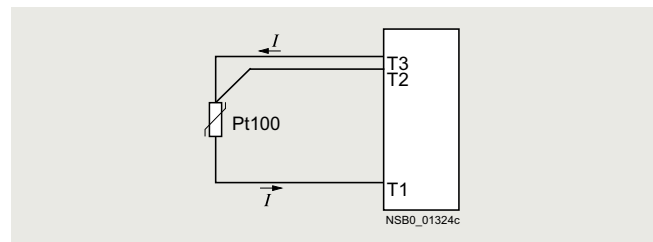

##### Connection of thermocouples

Based on the thermo-electrical effect, a differential temperature measurement will be performed between the measuring point and the evaluation unit.

This principle assumes that the evaluation unit knows the temperature at the clamping point (T2). For this reason, the 3RS2 temperature monitoring relays have an integral reference point compensation that determines this comparison temperature and builds it into the result of the measurement. The thermal sensors and cables must therefore be insulated.

The absolute temperature is therefore calculated from the ambient temperature of the evaluation unit and the temperature difference measured by the thermocouple.

Temperature detection is therefore possible (T1) without needing to know the precise ambient temperature of the clamping point at the evaluation unit (T2).

The connection cable is only permitted to be extended using compensating lines that are made from the same material as the thermocouple. If a different type of conductor is used, an error will result in the measurement.

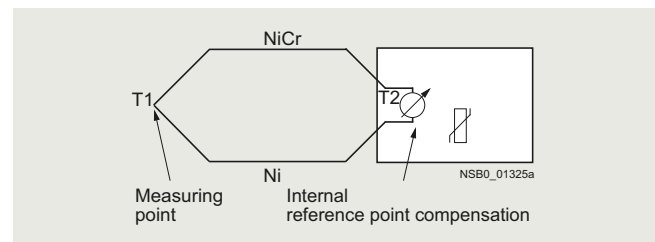

For more information, see <https://www.ephy-mess.com/en>

**Principle of operation**

Once the temperature has reached the set threshold value  $\vartheta_1$ , the K1 output relay changes its switching state as soon as the set time  $t$  has elapsed (K2 responds in the same manner to  $\vartheta_2$ ). The delay time can only be adjusted with digital units (on analog units  $t = 0$ ).

When Auto RESET (AUTO RST) is set, the relays return to their original state as soon as the temperature reaches the set hysteresis value.

The memory function (MEMORY) allows the status to be saved even in the event of a voltage failure.

**3RS25 analog multi-function devices**

Temperature overshoot

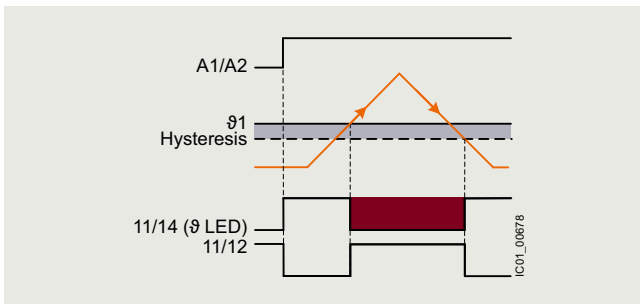

Temperature undershoot

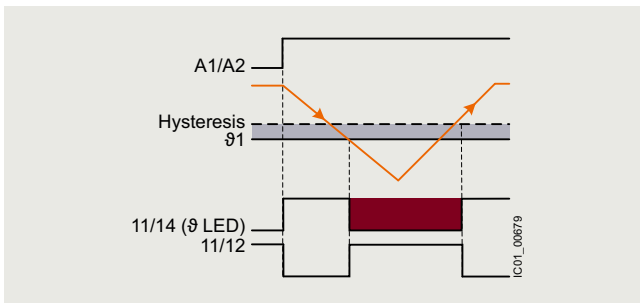

**3RS26, 3RS28 digital devices (1 sensor) with Safety function**

Temperature monitors according to EN 14597

Temperature overshoot

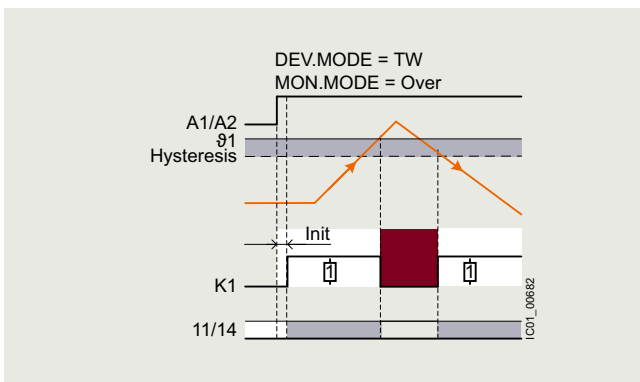

Temperature undershoot

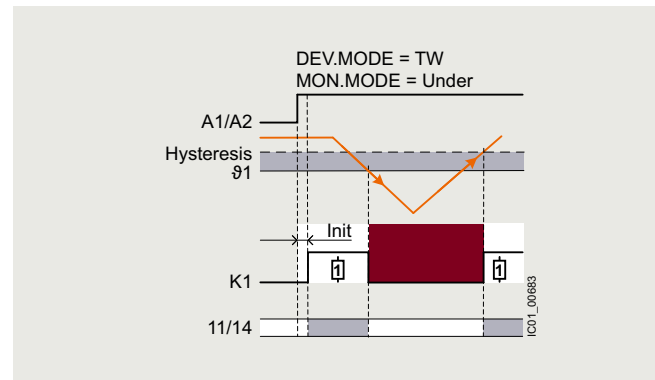

Temperature limiters according to EN 14597/ATEX

Temperature overshoot

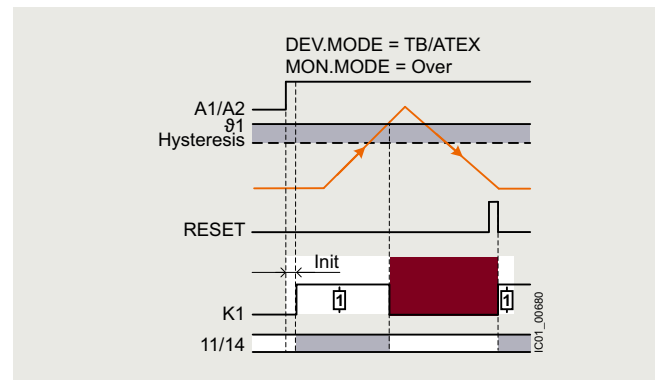

Temperature undershoot

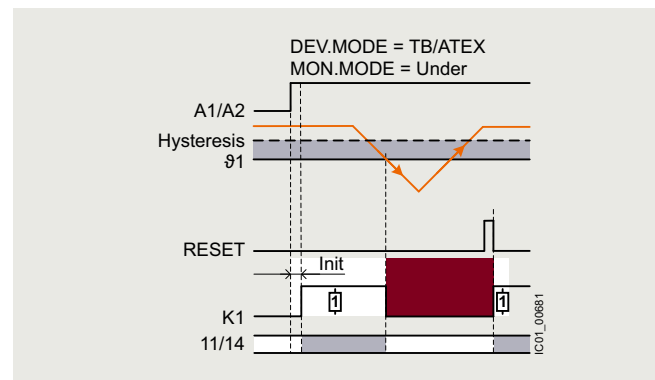



# Monitoring and control devices

## Relays

### SIRIUS 3RS2 temperature monitoring relays

#### General data

#### 3RS26, 3RS28 digital devices (1 sensor)

Temperature overshoot

Temperature undershoot

2

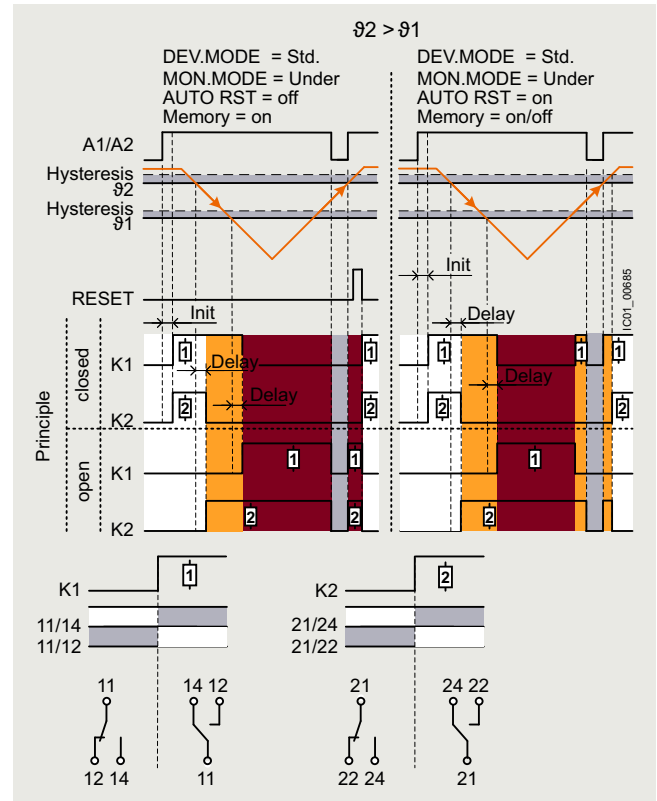
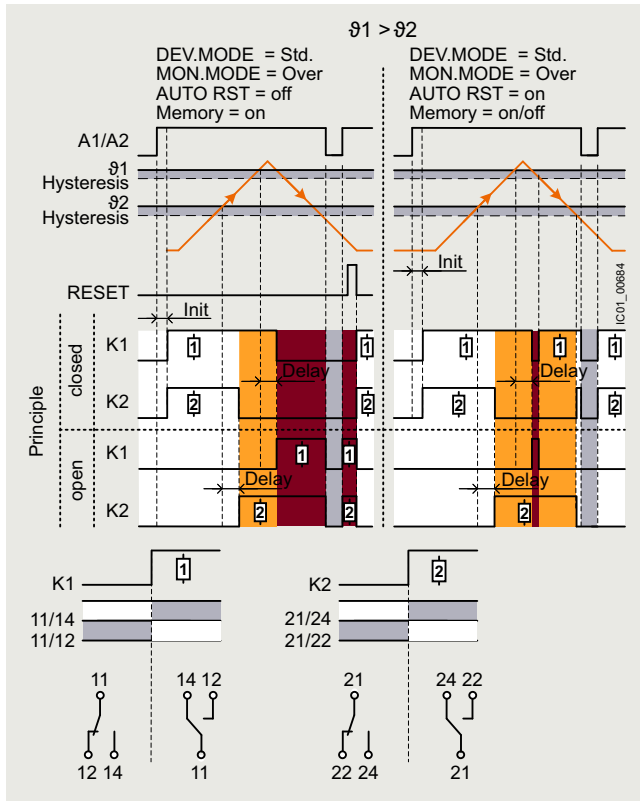

Range monitoring

Range monitoring

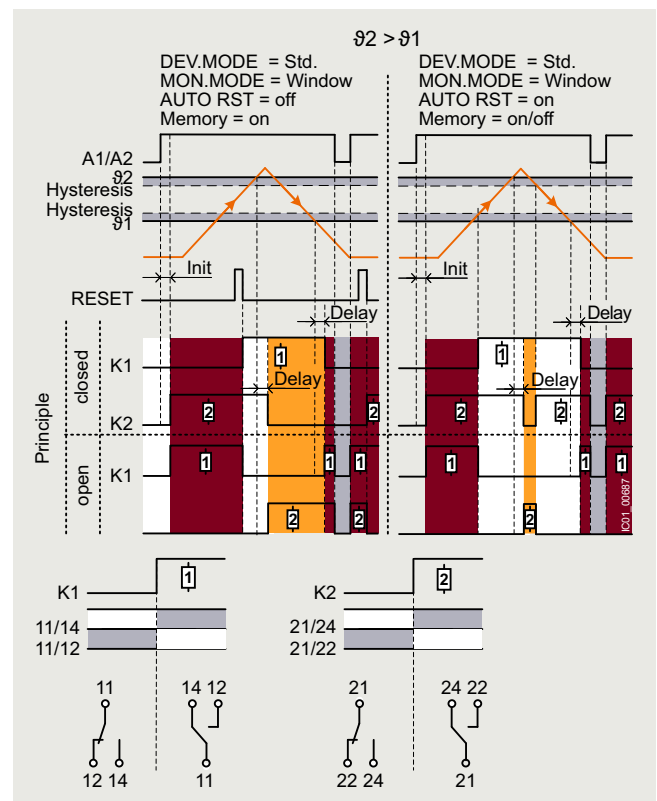
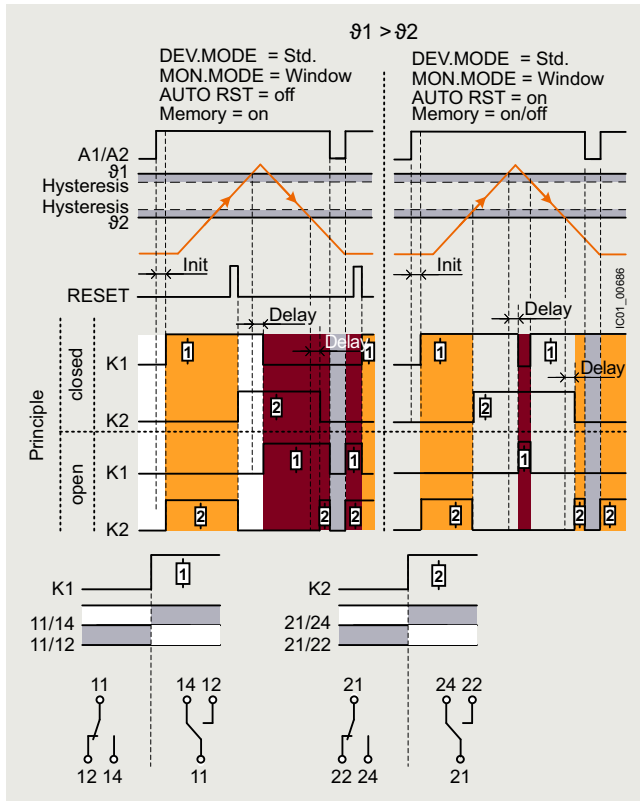

**Characteristic curves**

For resistance sensors

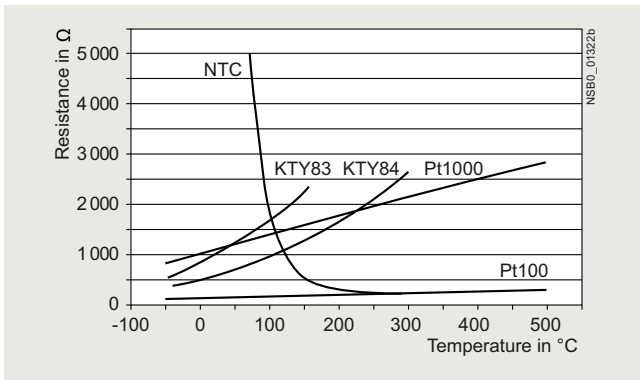

Characteristic curves for resistance sensors

The short-circuit and open-circuit detection as well as the measuring range is limited, depending on the sensor type.

Measuring ranges and switch position for analog devices in °C for Pt100 resistance sensor

Measuring range in °C	Switch position in °C										
	min.					1/2					max.
0 ... +100	0	10	20	30	40	50	60	70	80	90	100
0 ... +200	0	20	40	60	80	100	120	140	160	180	200
-50 ... +50	-50	-40	-30	-20	-10	0	10	20	30	40	50

Measuring ranges for digital devices in °C for resistance sensor

Sensor type	Short circuit	Open circuit	3RS26, 3RS28 Measuring range in °C	3RS26, 3RS28 Measuring range in °F
Pt100	✓	✓	-50 ... +750	-58 ... +1 382
Pt1000	✓	✓	-50 ... +500	-58 ... +932
KTY83-110	✓	✓	-50 ... +175	-58 ... +347
KTY84	✓	✓	-40 ... +300	-40 ... +572
NTC <sup>1)</sup>	✓	--	+80 ... +160	+176 ... +320

- ✓ Detection possible
- Detection not possible

<sup>1)</sup> NTC type: B57227-K333-A1 (100 °C: 1.8 kΩ; 25 °C: 32.762 kΩ).

For thermocouples

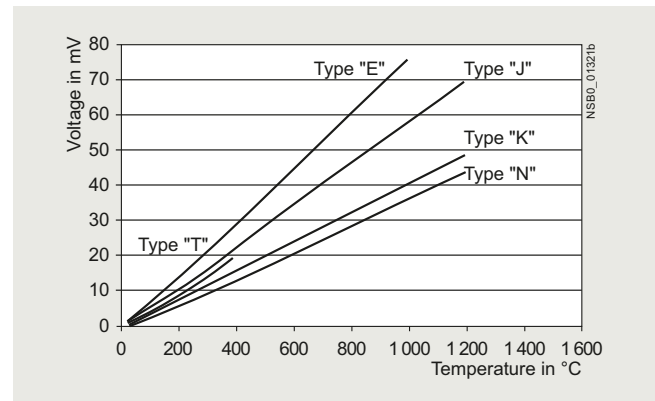

Characteristic curves for thermocouples J, K, T, E, N

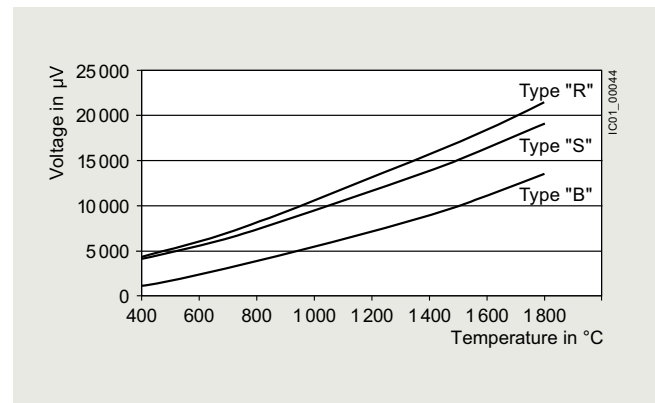

Characteristic curves for thermocouples S, R and B

Measuring ranges and switch position for analog devices in °C for thermocouple types J, K

Measuring range in °C	Switch position in °C										
	min.					1/2					max.
0 ... +200	0	20	40	60	80	100	120	140	160	180	200
0 ... +600	0	60	120	180	240	300	360	420	480	540	600
+500 ... +1 000	500	550	600	650	700	750	800	850	900	950	1 000

Measuring ranges for digital devices in °C/°F for thermocouples

Sensor type	Short circuit	Open circuit	3RS26, 3RS28 Measuring range in °C	3RS26, 3RS28 Measuring range in °F
J	--	✓	-99 ... +1 200	-146.2 ... +2 192
K	--	✓	-99 ... +1 350	-146.2 ... +2 462
T	--	✓	-99 ... +400	-146.2 ... +752
E	--	✓	-99 ... +999	-146.2 ... +1 830.2
N	--	✓	-99 ... +1 300	-146.2 ... +2 372
S	--	✓	0 ... +1 750	+32 ... +3 182
R	--	✓	0 ... +1 750	+32 ... +3 182
B	--	✓	+400 ... +1 800	+752 ... +3 272



- ✓ Detection possible
- Detection not possible

## Monitoring and control devices

### Relays

#### SIRIUS 3RS2 temperature monitoring relays

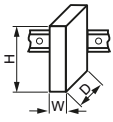
##### General data

Type		3RS25-....0	3RS26-....0	3RS28-....0	3RS29-....0
<b>General technical specifications</b>					
Dimensions (W x H x D)	 mm	22.5 x 100 x 90			
<b>Permissible ambient temperature</b>					
• During operation	°C	-25 ... +60			
• During transport	°C	-40 ... +85			
• During storage	°C	-40 ... +85			
<b>Degree of protection IP</b>		IP20			
<b>Mounting position</b>		Any			
<b>Type of mounting</b>		Screw fixing and snap-on mounting on 35 mm standard mounting rail			
<b>Auxiliary circuit</b>					
<b>Type of voltage</b>		AC/DC	DC	AC/DC	AC/DC
<b>Operating range factor of the control supply voltage, rated value</b>					
• At AC at 50 Hz		0.85 ... 1.1	--		0.85 ... 1.1
• At AC at 60 Hz		0.85 ... 1.1			0.85 ... 1.1
• At DC		0.85 ... 1.1	0.7 ... 1.25		0.85 ... 1.1
<b>Operating frequency, rated value</b>	Hz	50 ... 60			
<b>Number of measuring circuits</b>		1		3	
<b>Number of CO contacts for auxiliary contacts</b>		1	2		0
<b>Product function</b>					
• Removable terminal for auxiliary and control circuit	Yes				
• Auto RESET	Yes				--
• Fault storage	No		Yes		
• External RESET	No		Yes		
<b>ATEX</b>					
<b>Certificate of suitability</b>					
• Relative to ATEX	No		Yes, with 3RS29 sensor expansion module		Yes, with 3RS26/3RS28 digital device
<b>Safety integrity level (SIL) according to IEC 61508</b>		--	1		
<b>Performance level (PL) according to ISO 13849-1</b>		--	c		
<b>Electrical connection</b>					
<b>Type of electrical connection</b>		 <b>Screw terminals</b>		 <b>Spring-loaded terminals (push-in)</b>	
<b>Tightening torque</b>	Nm	0.6 ... 0.8		--	
<b>Type of connectable conductor cross-sections</b>					
• Solid	mm <sup>2</sup>	1 x (0.5 ... 4), 2 x (0.5 ... 2.5)		1 x (0.5 ... 4)	
• Finely stranded	mm <sup>2</sup>	--		1 x (0.5 ... 4)	
- Without end sleeves		1 x (0.5 ... 4), 2 x (0.5 ... 2.5)		1 x (0.5 ... 2.5)	
- With end sleeves		--		--	
• For AWG cables	AWG	1 x (20 ... 12), 2 x (20 ... 14)		1 x (20 ... 12)	
- Solid		--		1 x (20 ... 12)	
- Stranded		--		--	

## Selection and ordering data

Number of measuring circuits	Type of sensor/connectable	Rated control supply voltage $U_s$ 50/60 Hz AC	Suitability for use	Spring-loaded terminals (push-in)	Weight
		V			kg
				Article No.	

## Temperature monitoring relays

**Analog multi-function device, 1 sensor, 1 threshold value**

3RS2500-1AA30

1	Resistance sensors: Pt100	24 AC/DC 24 ... 240 AC/DC	-- --	<b>3RS2500-2AA30</b>	0.160
	Thermocouples: Type J, K			<b>3RS2500-2AW30</b>	0.180

**Digital device, 1 sensor, 2 threshold values**

3RS2600-1BA30

1	Resistance sensors: Pt100, Pt1000, KTY83-110, KTY84, NTC	24 AC/DC 24 ... 240 AC/DC	-- --	<b>3RS2600-2BA30</b>	0.185
	Thermocouples: Type J, K, T, E, N, S, R, B			<b>3RS2600-2BW30</b>	0.190

**Digital device for IO-Link, 1 sensor, 2 threshold values**

3RS2800-1BA40

1	Resistance sensors: Pt100, Pt1000, KTY83-110, KTY84, NTC	24 DC	--	<b>3RS2800-2BA40</b>	
	Thermocouples: Type J, K, T, E, N, S, R, B				

## Sensor expansion modules

**2 additional resistance sensors, analog input  
4 ... 20 mA, ATEX via analog input, status relay**

3RS2900-1AA30

3	Resistance sensors: Pt100, Pt1000, KTY83-110, KTY84, NTC	24 AC/DC 24 ... 240 AC/DC	For 3RS26/ 3RS28 digital devices	<b>3RS2900-2AA30</b>	0.169
				<b>3RS2900-2AW30</b>	0.181

For accessories, see page 2/314.









## Monitoring and control devices

### Relays

### SIRIUS 3RS2 temperature monitoring relays

#### Accessories

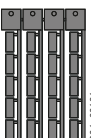
#### Selection and ordering data

Version	Article No.	Weight kg
<b>Terminals for SIRIUS devices in the industrial standard mounting rail enclosure</b>		
 3ZY1122-1BA00	<b>Removable terminals</b> <ul style="list-style-type: none"> <li>• 2-pole, up to 1 x 4 mm<sup>2</sup> or 2 x 2.5 mm<sup>2</sup></li> </ul>	<b>Screw terminals</b>  <b>3ZY1122-1BA00</b> 0.010
	<ul style="list-style-type: none"> <li>• 2-pole, up to 1 x 4 mm<sup>2</sup> or 2 x 1.5 mm<sup>2</sup> (in shared end sleeve)</li> </ul>	<b>Spring-loaded terminals (push-in)</b>  <b>3ZY1122-2BA00</b> 0.008
<b>Accessories for enclosures</b>		
 3ZY1321-2AA00	<b>Sealing covers</b> <ul style="list-style-type: none"> <li>• 22.5 mm</li> </ul>	<b>3ZY1321-2AA00</b> 0.002
 3ZY1311-0AA00	<b>Push-in lugs</b> For wall mounting	<b>3ZY1311-0AA00</b> 0.001
 3ZY1440-1AA00	<b>Coding pins</b> For removable terminals of SIRIUS devices in the industrial standard mounting rail enclosure; enable the mechanical coding of terminals	<b>3ZY1440-1AA00</b>
 3ZY1450-1AB00	<b>Hinged cover</b> Replacement cover, without terminal labeling, titanium gray <ul style="list-style-type: none"> <li>• 22.5 mm wide</li> </ul>	<b>3ZY1450-1AB00</b> 0.004
<b>Blank labels</b>		
 3RT2900-1SB20	<b>Unit labeling plates<sup>1)</sup></b> For SIRIUS devices <ul style="list-style-type: none"> <li>• 20 mm x 7 mm, titanium gray</li> </ul>	<b>3RT2900-1SB20</b> 0.062
<b>Tools for opening spring-loaded terminals</b>		
 3RA2908-1A	<b>Screwdrivers</b> For all SIRIUS devices with spring-loaded terminals  Length approx. 200 mm, 3.0 mm x 0.5 mm, titanium gray/black, partially insulated	<b>Spring-loaded terminals (push-in)</b>  <b>3RA2908-1A</b> 0.050

<sup>1)</sup> PC labeling system for individual inscription of unit labeling plates available from: murrplastik Systemtechnik GmbH.

For suitable sensors, see [www.siemens.com/temperature](http://www.siemens.com/temperature).

## Overview

3SE523.,  
3SE521.,  
3SF12.4<sup>1)</sup>3SE524.,  
3SF1244<sup>1)</sup>3SE513.,  
3SE511.1<sup>1)</sup>,  
3SF1114<sup>1)</sup>3SE512.,  
3SF1124<sup>1)</sup>

3SE516.

3SE5413,  
3SE5423

3SE5250

	Position switches				Compact design	Open-type	
	Standard						
<b>Enclosure</b>							
Plastic	✓	✓	✓	--	--	✓	
Metal	✓	--	✓	✓	✓	--	
Dimensions (W x H x D) in mm	31 x 68 x 33	50 x 53 x 33	40 x 78 x 38	56 x 78 x 38	56 x 100 x 38	30 x 50 x 16 40 x 50 x 16	30 x 48.5 x 20
Degree of protection	IP65, IP66/IP67	IP66/IP67	IP66/IP67	IP66/IP67	IP66/IP67	IP66/IP67	IP10 or IP20
<b>Standards</b>	Mounting and operating points acc. to EN 50047		Mounting and operating points acc. to EN 50041	Operating points acc. to EN 50041	Operating points acc. to EN 50041	--	Mounting and operating points acc. to EN 50047
IEC 60947-5-1							
<b>Approvals</b>	CE, TÜV, UL, CSA, CCC		CE, TÜV, UL, CSA, CCC		CE, UL, CSA, CCC	CE, TÜV, UL, CSA, CCC	
<b>Contact blocks</b>							
2 slow-action contacts	1 NO + 1 NC; 2 NC		1 NO + 1 NC; 2 NC		2 x (1 NO + 1 NC)	--	1 NO + 1 NC
2 snap-action contacts	1 NO + 1 NC		1 NO + 1 NC		2 x (1 NO + 1 NC)	1 NO + 1 NC	1 NO + 1 NC
• Short stroke	1 NO + 1 NC		✓		--	--	✓
• Contact distance 2 x 2 mm	1 NO + 1 NC		✓		--	--	✓
3 slow-action contacts	1 NO + 2 NC; 2 NO + 1 NC		1 NO + 2 NC; 2 NO + 1 NC		--	--	1 NO + 2 NC; 2 NO + 1 NC
• With make-before-break	1 NO + 2 NC		1 NO + 2 NC		2 x (1 NO + 2 NC)	--	1 NO + 2 NC
3 snap-action contacts	1 NO + 2 NC		1 NO + 2 NC		--	--	1 NO + 2 NC
<b>Special features</b>							
LED status display	✓		✓		--	--	--
Increased corrosion protection	✓		✓		✓	--	--
ASIsafe integrated	✓		✓		--	--	--
<b>Electrical specifications</b>							
Insulation voltage $U_i$	400 V		400 V		400 V	400 V	
Conventional thermal current $I_{th}$	6 A/10 A (3-/2-pole)		6 A/10 A (3-/2-pole)		6 A	6 A	
<b>Connections</b>							
Cable entry	1 x (M20 x 1.5)	2 x (M20 x 1.5)	1 x (M20 x 1.5)	3 x (M20 x 1.5)	3 x (M20 x 1.5)	--	--
M12 plug, 4-, 5- or 8-pole	✓	✓	✓	✓	✓	✓	--
Plug, 6-pole + PE	--	--	✓	✓	--	--	--
Molded cables	--	--	--	--	--	✓	--
<b>Actuators</b>							
Rounded plungers and roller plungers	✓		✓		✓	--	--
Roller levers and angular roller levers	✓		✓		✓	--	--
Spring rods	✓		✓		--	--	--
Twist levers and rod levers	✓		✓		✓	--	--
Fork lever	--		✓		--	--	--
Hinge switches	--		--		--	--	--
Plungers, twist levers	--		--		✓	✓	✓
<b>Page</b>							
Complete units	1)	1)	1)	1)	1)	2/326	2/327
Modular system	1)	1)	2/339	1)	1)	--	--
Ambient temperature -40 °C	2/334, 2/339	2/339	2/339	2/342	2/343	--	--
ASIsafe	1)	1)	1)	1)	--	--	--

✓ Available

-- Not available

<sup>1)</sup> see Catalog IC 10.

## Position and safety switches

### Introduction

2



3SE5232,  
3SE5212<sup>1)</sup>,  
3SF12.4<sup>1)</sup>

3SE5132<sup>1)</sup>,  
3SE5112<sup>1)</sup>,  
3SF11.4<sup>1)</sup>

3SE5232,  
3SE5242<sup>1)</sup>,  
3SF12.4<sup>1)</sup>

3SE5112<sup>1)</sup>,  
3SE5122<sup>1)</sup>,  
3SF11.4<sup>1)</sup>

3SE5322,  
3SE5312<sup>1)</sup>,  
3SF13.4<sup>1)</sup>

	Safety hinge switches		Safety switches with separate actuator		Safety switches with tumbler
<b>Enclosure</b>					
Plastic	✓	✓	✓	✓	✓
Metal	✓	✓	✓	✓	✓
Dimensions (W x H x D) in mm	31 x 68 x 33	40 x 78 x 38	31 x 68 x 33, 50 x 53 x 33	40 x 78 x 38, 56 x 78 x 38	54 x 185 x 44
Degree of protection	IP65, IP66/IP67	IP66/IP67	IP65, IP66/IP67	IP66/IP67	IP66/IP67, IP69 (IP69K)
<b>Standards</b>					
IEC 60947-5-1	Mounting and operating points acc. to EN 50047	Mounting and operating points acc. to EN 50041	Mounting and operating points acc. to EN 50047	Mounting acc. to EN 50041	ISO 14119, IEC 62061/IEC 61508, ISO 13849-1
<b>Approvals</b>	CE, TÜV, UL, CSA, CCC		CE, TÜV, UL, CSA, CCC		CE, TÜV, UL, CSA, CCC
<b>Contact blocks/outputs</b>					
2 slow-action contacts	--		1 NO + 1 NC; 1 NO + 2 NC		--
2 snap-action contacts	1 NO + 1 NC		--		--
• Short stroke	--		--		--
• Contact distance 2 x 2 mm	--		--		--
3 slow-action contacts	--		1 NO + 2 NC		2 x (1 NO + 2 NC)
• With make-before-break	--		--		--
3 snap-action contacts	1 NO + 2 NC		--		--
Electronic safety outputs	--		--		--
<b>Special features</b>					
LED status display	✓		✓		✓
Increased corrosion protection	✓		✓		✓
ASIsafe integrated	✓		✓		✓
<b>Electrical specifications</b>					
Insulation voltage $U_i$	400 V		400 V		400 V
Conventional thermal current $I_{th}$	6 A / 10 A (3-/2-pole)		6 A		6 A
<b>Connections</b>					
Cable entry	1 x (M20 x 1.5)	1 x (M20 x 1.5)	1 x (M20 x 1.5), 2 x (M20 x 1.5)	1 x (M20 x 1.5), 3 x (M20 x 1.5)	3 x (M20 x 1.5)
M12 plug, 4-, 5- or 8-pole	✓		✓	✓	✓
Molded cables	--		--	--	--
AS-Interface	--		✓	✓	✓
<b>Actuators</b>					
Plungers, twist levers	--		--	--	--
Separate actuators	--		✓	✓	✓
Hinge switches	✓		--	--	--
<b>Page</b>					
Complete units	1)	1)	1)	1)	1)
Modular system	--	--	--	--	--
Ambient temperature -40 °C	2/336	--	2/345	--	2/346
ASIsafe	1)	1)	1)	1)	1)

✓ Available

-- Not available

1) see Catalog IC 10.



	3SE66, 3SE67	3SE66, 3SE67	3SE63
	Safety switches, solenoid <sup>1)</sup>	Safety switches, solenoid supplementary range <sup>1)2)</sup>	RFID safety switches <sup>1)2)</sup>
<b>Enclosure</b>			
Plastic	✓	✓	✓
Metal	--	--	--
Dimensions (W x H x D) in mm	M30; 25 x 88; 25 x 33	25 x 88; 26 x 36	25 x 91 x 22
Degree of protection	IP67	IP67	IP69 (IP69K)
<b>Standards</b>	IEC 60947-5-3	IEC 60947-5-3	ISO 14119, IEC 60947-5-3, SIL 3 in accordance with IEC 62061/IEC 61508, PL e in accordance with ISO 13849-1
<b>Approvals</b>	CE, TÜV, UL, CSA, CCC	CE, TÜV, UL, CSA	CE, TÜV, UL, CSA
<b>Contact blocks/outputs</b>			
Reed contacts	1 NO + 1 NC 2 NC 1 NO + 1 NC (+ 1 NC signaling contact)	1 NO + 1 NC (+ 1 NC signaling contact) 2 NC 2 NC (+ 1 NC signaling contact)	--
<b>Special features</b>			
LED status display	--	✓	✓
Increased corrosion protection	--	--	✓
ASIsafe integrated	--	--	--
<b>Electrical specifications</b>			
Insulation voltage $U_i$	100 V AC/DC 24 V DC	75 V DC 50 V AC	--
Conventional thermal current $I_{th}$	250 mA 400 mA	250 mA	--
<b>Connections</b>			
M8 plug, 4-pole	✓	✓	--
∅ 8 mm, latching connection, plug, 6-pole	--	✓	--
M12 plug, 4-pole	✓	--	✓
Molded cables	✓	✓	--
AS-Interface	--	--	--
<b>Actuators</b>			
RFID	--	--	✓
Switching magnet	✓	✓	--

✓ Available

-- Not available

1) see Catalog IC 10.

2) CCC approval not required for voltages &lt; 36 V.



## Position and safety switches

### SIRIUS 3SE5 mechanical position switches

#### General data

#### Overview

##### Design

All enclosure variants have an integrated chlorinated rubber diaphragm for high functional safety in cold and aggressive environments.

##### Enclosure sizes

The 3SE5 switches are available in five different enclosure sizes with 2 or 3 contacts and with the XL enclosure:

- Open-type position switch IP20 or IP10
- Plastic enclosures according to EN 50047, 31 mm wide, IP65, 1 cable entry
- Metal enclosures according to EN 50047, 31 mm wide, IP66/IP67, 1 cable entry
- Plastic and metal enclosures according to EN 50041, 40 mm wide, IP66/IP67, 1 cable entry
- Plastic enclosures, 50 mm wide, IP66/IP67, 2 cable entries
- Metal enclosures, 56 mm wide, IP66/IP67, 3 cable entries
- XL metal enclosures with 4 to 6 contacts, 56 mm wide, IP66/IP67, 3 cable entries

##### Enclosure versions

Various basic switches can be selected for the enclosures of the 3SE5 series:

- With contact blocks with two or three contact elements (screw terminals) designed as slow-action or snap-action contacts; the slow-action contacts also with make-before-break
- Optional LED status display
- With assembled M12 device plug, 4- or 5-pole (available as an accessory for self-assembly for the wide enclosure)
- With 6-pole device plug + PE on the metal enclosures
- Versions with increased corrosion protection
- Versions for operating temperatures down to -40 °C
- AS-Interface version with integrated ASIsafe electronics for all enclosure designs

##### Actuator variants

All actuators can be rotated around the axis in increments of 16 x 22.5°. The following actuator variants are available:

- Plain, rounded and roller plungers
- Roller levers and angular roller levers
- Spring rods
- Twist levers and rod levers with twist actuator
- Fork levers with twist actuator

The actuator rollers are available with various materials and diameters.

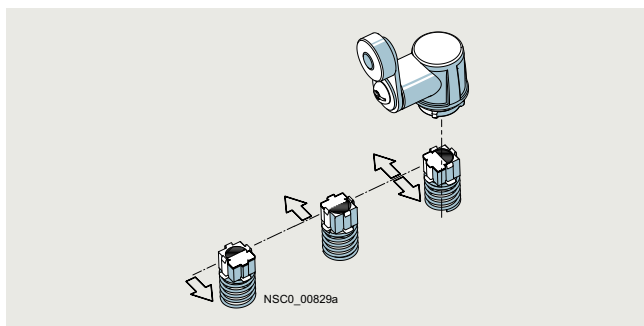

Twist actuators for twist levers and rod levers, with setting of switching direction to right, left, or right/left (standard for all twist actuators except fork levers)

##### Cover design

The mechanical position switches have a turquoise cover and the mechanical safety switches have a yellow cover.



Cover colors: position switch turquoise, safety switch yellow

On request the switches can be delivered ex works with a yellow cover. The cover has no effect on the mode of operation. Both versions can be used in safety applications.

##### Diverse contact types

Exchangeable 2-pole and 3-pole contact blocks for all enclosure sizes.



Contact block for position switches, 3 contacts

The 3-pole contact block with snap-action or slow-action contacts is regularly available for all enclosure forms. The same installation space is required as for a 2-pole block. The version with 1 NO + 2 NC offers, for example, more safety through redundant shutdowns (2 NC contacts) with simultaneous signaling (NO contact). The 3-pole blocks are also available with make-before-break and with 2 NO + 1 NC.

##### Contact reliability

The contact blocks ensure an extremely high contact stability. This applies even when the devices are switching low voltages and currents.

##### Positive opening

The NC contacts of the switch are forced open mechanically, positively driven and reliably by the plunger. This is referred to as "positive opening".

##### Optional LED indicators

LED indicators are available for all enclosure sizes except for XL. The enclosures are supplied with an LED signaling indicator (1 x green + 1 x yellow). This is the first time that optical signaling equipment is also available for small standard enclosures according to EN 50047. The LEDs are implemented in 24 V DC and 230 V AC.

### Mounting

Easy plug-in method for fast replacement of the actuator heads

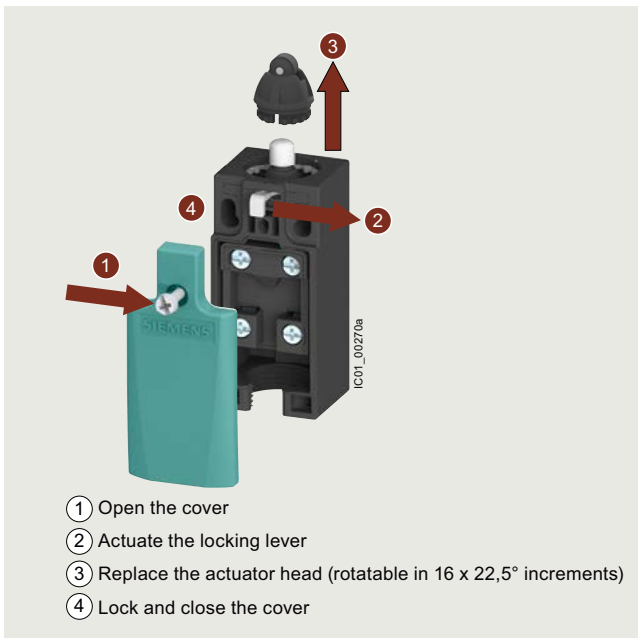

Replacement of the position switch actuator head in only four steps

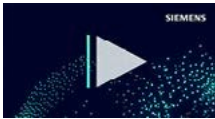

Video: What makes the SIRIUS position switches so flexible?

### Quick-connect technology

For plastic enclosure with a width of 31 mm

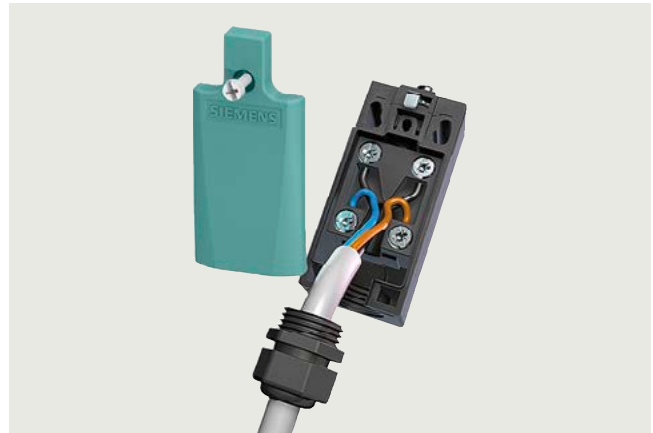

Quick-connect technology for plastic enclosures

These position switches can be wired quickly and easily as an added customer benefit. The connection cable is first connected to the terminals of the contact block and then guided through a slit into the cable gland opening. The time saved through this new connection method is approx. 20 to 25%.

A cable gland with seal must be used with the quick-connect method.



Video: How easy is it to install the 3SE5232 position switch?

### Article No. scheme

Product versions		Article number										
SIRIUS position and safety switches		3SE	<input type="checkbox"/>	<input type="checkbox"/>	<input type="checkbox"/>	<input type="checkbox"/>	-	<input type="checkbox"/>	<input type="checkbox"/>	<input type="checkbox"/>	<input type="checkbox"/>	
Series		5										
Standard	EN 50041	1										
	EN 50047	2										
	With tumbler	3										
Enclosure material and width	e.g. 1 = metal, narrow		<input type="checkbox"/>									
Connection	Cable entry					2						
	Device plug					4/5						
LEDs	None								0			
	24 V DC								1			
	115 V AC								2			
	230 V AC								3			
Version of contacts	e.g. C = snap-action 1 NO + 1 NC								<input type="checkbox"/>			
Version of operating mechanism	e.g. C02 = rounded plunger								<input type="checkbox"/>	<input type="checkbox"/>	<input type="checkbox"/>	
Example		3SE	5	1	1	2	-	0	C	C	0	2

#### Note:

The Article No. scheme shows an overview of product versions for better understanding of the logic behind the article numbers.

For your orders, please use the article numbers quoted in the selection and ordering data.

## Position and safety switches

### SIRIUS 3SE5 mechanical position switches

#### General data

#### Benefits

The 3SE5 position switches differ from the previous series through the following new characteristics:

- The modular design of the product range allows a number of versions with a smaller number of bearing types for enclosures and operating mechanisms.
- All actuators can be turned around the axis in increments of 22.5° (see figure, page 2/318).
- Rounded and roller plungers according to EN 50041 with 3 mm overtravel (total travel 9 mm) for greater tolerance when switching.
- All enclosure sizes – now also including the small enclosure 31-mm wide – are optionally available with an LED signaling indicator (see page 2/318).
- All enclosure variants have an integrated chlorinated rubber diaphragm for high functional safety in cold and aggressive environments.
- All contact blocks are replaceable.
- The 3-pole contact blocks are available for all enclosure sizes (see figure, page 2/318).

- Contact blocks with 1 NO + 2 NC slow-action contacts with make-before-break and 2 NO + 1 NC
- The short-stroke contact block 1 NO + 1 NC improves the precision of the switching operation through a reduced actuation path.
- The contact block with 1 NO + 1 NC snap-action contacts with a contact distance of 2 x 2 mm is suitable for simultaneous shutdown and signaling, particularly in the elevator industry.
- XL metal enclosures for accommodating two 2- or 3-pole contact blocks
- Versions with plugs for safe and fast connection, e.g. to fail-safe field modules of the SIMATIC ET 200eco PN or SIMATIC ET 200AL
- The plastic enclosure with a width of 31 mm has simple and fast wiring equipment which makes it possible to save approx. 20 to 25% of the time when connecting (see figure, page 2/318).
- The ASIsafe electronics are integrated in the enclosure for the versions with AS-Interface connection; an additional adapter is not required.

#### Application

With the standard position switches, mechanical positions of moving machine parts are converted into electrical signals. Through their modular and uniform design and large number of variants, the devices can comply with practically all requirements in industry.

Devices are available with enclosure versions to suit the particular ambient conditions. Different control tasks can be performed with the contact blocks best suited for the particular purpose. And many different actuator variants are available to match the mechanical configuration of the moving machine parts. Dimensions, fixing points and characteristics are largely in accordance with the EN 50041 or EN 50047 standards.

The devices are suitable for use in any climate.

#### Standards

The switches comply with IEC 60947-5-1 (electromechanical control circuit devices).

The protective measure of "total insulation" by the plastic enclosure is ensured by the use of plastic screw glands.

#### Safety position switches

For controls according to IEC 60204-1 the devices can be used as a safety position switch. They comply with ISO 14119. A TÜV Certificate is available. To secure position switches against changes in their position, positively-driven techniques must be employed on installation.

#### Safety circuits

Standards IEC 60947-5-1 require positive opening of the NC contacts. In other words, for the purposes of personal safety, the assured opening of NC contacts is expressly stipulated for the electrical equipment of machines in all safety circuits and marked in accordance with the standard IEC 60947-5-1 with the symbol .

SIL 1 according to IEC 62061/IEC 61508 or PL c according to ISO 13849-1 can be attained with the 3SE5 position switches with  if the corresponding fail-safe evaluation units are selected and correctly installed (e.g. the 3SK safety relays or matching devices from the ASIsafe, SIMATIC or SINUMERIK product ranges).

If a second position switch with  is used, SIL 3 / PL e can be attained.

In addition to positive opening, the operating mechanism (actuators) must also have a positively-driven connection to the enclosure. The corresponding operating mechanisms are marked in the catalog with .

#### Contacts for every application

- **Snap-action contacts:** NC and NO contacts switch simultaneously – regardless of the actuating speed ( $v_{\min} = 0.01$  m/s) and contact erosion.
- **Slow-action contacts:** Difference in travel between "NC contact opens" and "NO contact closes"; the switching speed is the same as or proportional to the actuating speed ( $v_{\min} = 0.4$  m/s).
- **Slow-action contacts with make-before-break:** e.g. suitable for adding a second function to a sequence control.

#### Operating mechanisms for every application

##### Plain, rounded and roller plungers

- Operation in direction of the plunger axis or in case of roller plunger with bar at right angles to the plunger axis.
- The roller plunger is recommended for lateral actuation and relatively long overtravel.

##### Roller levers and angular roller levers

- For actuators made of finely ground steel in the form of cams, bars (approach angle 30°) or cam disks.

##### Spring rods

- Can be used for undefined actuations and changing starting conditions
- Starting from any direction is possible

##### Twist levers and rod levers

- For high starting speeds ( $v = 1.5$  m/s)
- Variety of starting options
- Insensitive to oil, grinding dust, dirt and coarse-grained material
- Adjustment of the lever in increments of 10°
- Can be adjusted with left or right switching

##### Fork levers







- Switchable in two directions
- Latching actuator
- For reciprocating movements

## Position and safety switches

### SIRIUS 3SE5 mechanical position switches

General data

#### Monitoring with safe evaluation units from the 3SK series

Safe evaluation units	Maximum achievable safety level according to type of switch				
	Compact	Standard	Hinge	Separate actuator	Tumbler
 <p>3SK</p>	 <p>3SE54</p>	 <p>3SE51/3SE52</p>	 <p>3SE51/3SE52</p>	 <p>3SE51/3SE52</p>	 <p>3SE53</p>
<b>Use of only one position/safety switch</b>	<b>SIL 1 / PL c</b>				
Monitoring with 1 contact: 1 x NC contact	<b>SIL 1 / PL c</b>				
Monitoring with 2 contacts: 2 x NC contact or 1 x NC contact + 1 x NO contact	<b>SIL 1 / PL c</b>		<b>SIL 2 / PL d</b>		
<b>Use of a second position/safety switch</b>	<b>SIL 3 / PL e</b>				
Standard switch	3SE51/3SE52/3SE54				
Safety switch/hinge switch	3SE51/3SE52				
Safety switch with separate actuator	3SE51/3SE52				
Safety switch with tumbler	3SE53				

#### Note:

Taking account of certain fault exclusions (e.g. actuator breakage), use of just one hinge switch or a switch with separate actuator with or without tumbler up to SIL 2 / PL d is possible as described in the table.

Since the machine manufacturer must provide proof of fault exclusion, the component manufacturer is unable to carry out a definitive assessment of the measures taken.

For more information, see <https://support.industry.siemens.com/cs/ww/en/view/35443942>.

The maximum achievable SIL or PL always depends on other assumptions as well. Factors to be taken into account include the DC (declaration), the CCF, and the number of actuations. For information on the safe evaluation units and an introduction to safety systems.

## Position and safety switches

### SIRIUS 3SE5 mechanical position switches

#### General data

#### Technical specifications

Type		3SE51.. <sup>1)</sup> , 3SE52.. <sup>1)</sup>	3SE541.	3SE542.
<b>General data</b>				
<b>Standards</b>		IEC 60947-5-1, ISO 14119		
<b>Rated insulation voltage <math>U_i</math></b>	V	400 <sup>2)</sup>	400	
<b>Degree of pollution</b> acc. to IEC 60664-1		Class 3	Class 3	
<b>Rated impulse withstand voltage <math>U_{imp}</math></b>	kV	6	4	
<b>Rated operational voltage <math>U_e</math></b>	V	400 AC; over 300 V AC Same potential only <sup>3)</sup>	300 AC	
<b>Conventional thermal current <math>I_{th}</math></b>	A	10	10	
<b>Rated operational current <math>I_e</math></b>				
• For alternating current 50/60 Hz		$I_e$ / AC-15	$I_e$ / AC-15	
- At 24 V	A	6	6	
- At 120 V	A	6	6	
- At 240 V	A	6	3	
- At 400 V	A	4	--	
• For direct current		$I_e$ / DC-13	$I_e$ / DC-13	
- At 24 V	A	3	3	
- At 125 V	A	0.55	0.55	
- At 250 V	A	0.27	0.27	
- At 400 V	A	0.12	--	
<b>Short-circuit protection<sup>4)</sup></b>				
• With DIAZED fuse links, operational class gG	A	6	10	
• With miniature circuit breaker, characteristic C ( $I_{K < 400 A}$ )	A	1	3	
<b>Mechanical service life</b>				
• Basic switch		15 × 10 <sup>6</sup> operating cycles	10 × 10 <sup>6</sup> operating cycles	10 × 10 <sup>6</sup> operating cycles
• With spring rod, 3SE5...R..		10 × 10 <sup>6</sup> operating cycles	--	--
• With fork lever, 3SE51...T..		1 × 10 <sup>6</sup> operating cycles	--	--
<b>Electrical endurance</b>				
• With 3RH21 contactors size S00 and 3RT contactors sizes S00, S0		10 × 10 <sup>6</sup> operating cycles	500 000 operating cycles	500 000 operating cycles
• For utilization category AC-15 when switching off $I_e$ /AC-15 at 240 V		100 000 operating cycles	100 000 operating cycles	100 000 operating cycles
• With utilization category DC-12/DC-13		For direct current depending on the loading of the switch		
<b>Switching frequency</b>		6 000 operating cycles/h	1 800 operating cycles/h	
With 3RH21 contactors size S00 and 3RT contactors sizes S00, S0				
<b>Switching accuracy</b>				
• For repeated switching, measured at the plunger of the contact block	mm	0.05	0.05	
• With twist actuators		1°	1°	
<b>Rated data acc. to Ⓞ, Ⓢ and 9A</b>				
• Rated voltage	V	300	300	
• Uninterrupted current	A	6	10	
• Switching capacity		Heavy duty, A 300 / B 300 / Q 300	A 300 / Q 300	

<sup>1)</sup> Special versions, see the respective data sheet.

<sup>2)</sup> For slow-action contacts 1 NO + 2 NC with make-before-break ("M") and 2 NO + 1 NC ("P") the following applies: 250 V.

<sup>3)</sup> For slow-action contacts 1 NO + 2 NC with make-before-break ("M") and 2 NO + 1 NC ("P") the following applies: Over 250 V AC same potential only.

<sup>4)</sup> Without any welds according to IEC 60947-5-1.

Type		3SE523.	3SE513.	3SE524.	3SE521.	3SE511.	3SE512., 3SE516.	3SE54..	3SE525.
<b>Enclosure</b>									
<b>Enclosure</b>		Plastic P66			Zinc die-casting			Zn/Al	--
• Material		31			31			30/40	30
• Width	mm	31	40	50	31	40	56		
<b>Degree of protection on the front</b> acc. to IEC 60529		IP65	IP66/IP67; IP65/IP67 for actuator heads with spring rods and rod levers				IP67	IP20 <sup>1)</sup> , IP10	
<b>Ambient temperature</b>									
• During operation	°C	-25 ... +85; -40 ... +85 for 3SE51..-1AJ0 and 3SE52..-1AJ0, -1AY0					-25 ... +85	-25 ... +85	
• In operation, switch with LEDs	°C	-25 ... +60					--	--	
• Storage, transport	°C	-40 ... +90					-40 ... +90	-40 ... +90	
<b>Mounting position</b>		Any							
<b>Connection</b>									
<b>Cable entry</b>		1 x (M20 x 1.5)		2 x (M20 x 1.5)		1 x (M20 x 1.5)		3 x (M20 x 1.5)	
<b>Conductor cross-sections</b>									
• Solid	mm <sup>2</sup>	1 x (0.5 ... 1.5), 2 x (0.5 ... 0.75)							
• Finely stranded with end sleeve	mm <sup>2</sup>	1 x (0.5 ... 1.5), 2 x (0.5 ... 0.75)							
• AWG cables, solid or stranded	AWG	1 x (AWG 20 ... 16), 2 x (AWG 20 ... 18)							
<b>Tightening torque</b> , contact block	Nm	0.8 ... 1.0							
<b>Protective conductor connection</b> inside enclosure		--			M3.5			--	--

<sup>1)</sup> With the conductor connected and the clamping screw tightened.

### Circuit diagrams

Enclosure widths 31, 40, 50 and 56 mm

**Slow-action contacts**  
1 NO + 1 NC  
3SE5...-B..., -R...

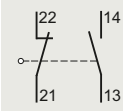

**Slow-action contacts**  
2 NO + 1 NC  
3SE5...-P...

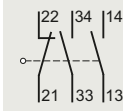

**Snap-action contacts**  
1 NO + 1 NC  
3SE5...-C..., -F..., -G..., -H..., -N...

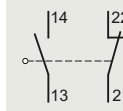

**Slow-action contacts**  
1 NO + 2 NC  
3SE5...-K..., -Q...

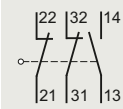

**Slow-action contacts**  
1 NO + 2 NC with  
make-before-break, 3SE5...-M...

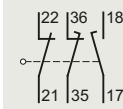

**Snap-action contacts**  
1 NO + 2 NC  
3SE5...-L...

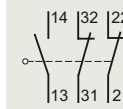

XL enclosures, width 56 mm

**Slow-action contacts**  
2 x (1 NO + 1 NC)  
3SE5162-0B...

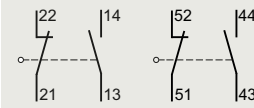

**Slow-action contacts**  
2 x (1 NO + 2 NC) with  
make-before-break,  
3SE5162-0D...

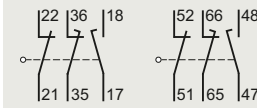

**Slow-action contacts**  
1 NO + 2 NC with make-before-break,  
1 NO + 1 NC  
3SE5162-0E...

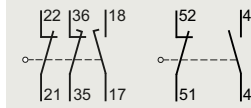

**Snap-action contacts**  
2 x (1 NO + 1 NC)  
3SE5162-0C...

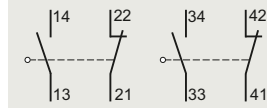

### 3SE5 pin assignment

**M12 device plugs, 4-pole**  
3SY3127



**M12 device plugs, 5-pole**  
3SY3128, 3SX5100-1SS51,  
PE on pin 3, 3SX5100-1SS05  
without PE

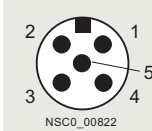

**M12 device plugs, 8-pole**  
3SX5100-1SS08

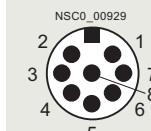

**Device plugs, 6-pole + PE**  
3SY3131

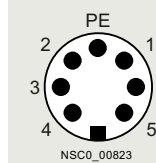

Type	Device plugs Type	Contacts Version	LEDs Version	Connections									
				Pin 1	Pin 2	Pin 3	Pin 4	Pin 5	Pin 6	Pin 7	Pin 8	PE	
<b>M12 device plugs, 4-, 5- or 8-pole</b>													
3SE5..4-0.....-1AC4, 3SE5..4-0.....-1AJ1 <sup>1)</sup>	3SY3127	1 NO + 1 NC	--	21	22	13	14	--	--	--	--	--	--
3SE5..4-0.....-1AL0, 3SE5..4-0.....-1AJ2 <sup>1)</sup>	3SY3128	1 NO + 1 NC	--	21	22	13	14	PE	--	--	--	--	--
3SE5..4-0.....-1AE0	3SY3127	2 NC	--	21	22	31	32	--	--	--	--	--	--
3SE5..4-0.....-1AE1, 3SE5..4-0.....-1AJ4 <sup>1)</sup>	3SY3128	2 NC	--	21	22	31	32	PE	--	--	--	--	--
3SE5..4-0.....-1AE2	3SX5100-1SS51	2 NC	--	21	31	--	22	32	--	--	--	--	--
3SE5..4-0.....-1AE3	3SX5100-1SS51	2 NC	--	21	31	PE	22	32	--	--	--	--	--
3SE5..4-1B...-1AF3	3SX5100-1SS05	1 NO + 1 NC slow-action	2 LEDs	21	22	14 / LED gn	13/ LED ye	Ground LED	--	--	--	--	--
3SE5..4-1C...-1AF3	3SX5100-1SS05	1 NO + 1 NC snap-action	2 LEDs	21	22	13 / LED gn	14 / LED ye	Ground LED	--	--	--	--	--
3SE5..4-1C...-1AF5	3SX5100-1SS05	1 NO + 1 NC snap-action	2 LEDs	21 21/13 jumper	22	13 / Ground LED	14 / LED ye	PE	--	--	--	--	--
3SE5..4-1L...-1AD4	--	1 NO + 2 NC snap-action	2 LEDs	21	22	13 / LED gn	14 / LED ye	31	32	Ground LED	PE	--	--
<b>Device plugs, 6-pole + PE</b>													
3SE5..5-0.....-1AD0	3SY3131	1 NO + 1 NC	--	21	22	13	14	--	--	--	--	--	✓
3SE5..5-0.....-1AD1	3SY3131	1 NO + 2 NC	--	21	22	13	14	31	32	--	--	--	✓

Legend:

gn = green, ye = yellow

✓ Connected

-- Not available

<sup>1)</sup> Version for ambient temperatures down to -40 °C.

## Position and safety switches

### SIRIUS 3SE5 mechanical position switches

#### General data

#### Options

On the following pages you will find selection tables for complete units as well as components of the modular system.

Complete units

Modular system

The differences between the units are indicated in the selection and ordering data by the symbols shown on orange backgrounds.

Using the modular system you can assemble switch variants which are not available as complete units. Each complete unit can also be supplied as a module.

A basic switch for the modular system comprises an enclosure with a contact block and a cover. Among the basic switches the following versions, for example, can be selected:

- Basic enclosure with rounded plunger
- Version with increased corrosion protection
- Version with M12 device plug and/or with 2 LEDs
- Version with M12 device plug or 6-pole + PE

#### Complete units

##### Ordering example

Required:

- Position switch according to EN 50047 in a plastic enclosure
- Contact block with slow-action contacts 1 NO + 1 NC
- Angular roller lever, metal lever and plastic roller

#### Support functions

The 3SE5/3SF1 position and safety switches can also be ordered using an online configurator.

This also enables a complete documentation to be prepared:

- Product data sheets
- Dimensional drawings
- Operating travel diagrams
- CAD data in 2D and 3D model images
- Ordering data
- Product photos

For the online configurator, see [www.siemens.com/sirius/configurators](http://www.siemens.com/sirius/configurators).

To be ordered:

Version	<b>Complete units</b>	<input type="checkbox"/>
		Article No.

#### Complete units · Enclosure width 31 mm

##### Angular roller levers

With metal lever and plastic roller 13 mm

- Slow-action contacts 1 NO + 1 NC

**3SE5232-0BF10**



#### Modular system

##### Ordering example 1

Required:

- Position switch according to EN 50047 in a plastic enclosure
- Contact block with slow-action contacts 1 NO + 1 NC
- Angular roller lever, metal lever and plastic roller

To be ordered separately:

Version	<b>Modular system</b>	<input checked="" type="checkbox"/>
		Article No.

#### Basic switches · Enclosure width 31 mm

##### Rounded plungers

- Slow-action contacts 1 NO + 1 NC

**3SE5232-0BC05**



+

#### Operating mechanisms

##### Angular roller levers

- Metal levers plastic rollers

**3SE5000-0AF10**



##### Ordering example 2

Required:

- Position switch according to EN 50047 in a plastic enclosure
- Contact block with slow-action contacts 1 NO + 1 NC
- Twist levers, high-grade steel lever and plastic roller

To be ordered separately:

Version	<b>Modular system</b>	<input checked="" type="checkbox"/>
		Article No.

#### Basic switches · Enclosure width 31 mm

##### Rounded plungers

- Slow-action contacts 1 NO + 1 NC

**3SE5232-0BC05**



+

#### Twist actuators

##### Twist actuators

**3SE5000-0AK00**



##### Twist levers

- High-grade steel levers plastic rollers

**3SE5000-0AA31**





### Overview



Compact design in width 30 mm

Particularly in harsh environments or on equipment with limited space, the small 3SE54 position switches in compact design with a depth of 16 mm and a weight of only 80 g (without cable) are ideal. Above all the versions with molded cable can be mounted in the most confined spaces.

3SE54 compact position switches are available in two different widths as complete units:

- The 3SE5413 series complies with the EU standard and features a 30-mm-wide enclosure with drilled holes at a spacing of 20 mm.
- The 3SE5423 series meets the requirements of the US market and features a 40-mm-wide enclosure with drilled holes at a spacing of 25 mm.

Both the enclosure and the actuator head are made of metal and comply with the high degree of protection IP67.

The following actuators are available:

- Rounded plungers
- Rounded plungers with central fixing
- Rounded plungers with external seal
- Roller plungers
- Roller plungers with central fixing
- Twist levers
- Twist levers with a smaller mounting depth and lower height
- Twist levers, adjustable length

The contact block is designed with snap-action contacts 1 NO + 1 NC. The NC contact complies with the requirements for positive opening acc. to IEC 60947-5-1.

Connection:

- With molded cable, length 2 m or 5 m
- With M12 device plug and connection cable, M12 socket, 5-pole, with open end, length 5 m

### Safety circuits

Standards IEC 60947-5-1 require positive opening of the NC contacts. In other words, for the purposes of personal safety, the assured opening of NC contacts is expressly stipulated for the electrical equipment of machines in all safety circuits and marked in accordance with the standard IEC 60947-5-1 with the symbol .

SIL 1 according to IEC 62061/IEC 61508 or PL c according to ISO 13849-1 can be attained with the 3SE5 position switches with  if the corresponding fail-safe evaluation units are selected and correctly installed (e.g. the 3SK safety relays or matching devices from the ASIsafe, SIMATIC or SINUMERIK product ranges).

If a second 3SE5 position switch with  is used, SIL 3 / PL e can be attained.

### Benefits

- Very compact yet with the same rating as the 3SE51 standard switches, for notable space savings in confined installation conditions
- Various actuator versions available
- Roller plungers can be rotated 90°
- Twist levers can be rotated 180°; twist lever can be adjusted in 15° increments
- Time is saved when mounting the fully assembled unit
- With metal enclosure of degree of protection IP67, ideal for use in rough industrial environments
- Insensitive to electromagnetic interference











## Position and safety switches

### SIRIUS 3SE5 mechanical position switches

#### Compact design

#### Selection and ordering data

2 snap-action contacts 1 NO + 1 NC · Degree of protection IP67 · With connecting cable or M12 device plug

	Operating mechanism	Enclosure width mm		Article No.	Weight kg
<b>Complete units · Enclosure width 30 or 40 mm</b>					
<b>Rounded plungers</b>					
<b>Standard mounting</b>					
	• With connection cable, 2 m	30	⊕	<b>3SE5413-0CC20-1EA2</b>	0.289
		40	⊕	<b>3SE5423-0CC20-1EA2</b>	0.312
	• With connection cable, 5 m	30	⊕	<b>3SE5413-0CC20-1EA5</b>	0.564
	• With M12 device plug, 5-pole	30	⊕	<b>3SE5413-0CC20-1EB1</b>	0.091
		40	⊕	<b>3SE5423-0CC20-1EB1</b>	0.113
	<b>With central fixing M12 x 1</b>				
	• With connection cable, 2 m	30	⊕	<b>3SE5413-0CC21-1EA2</b>	0.296
		40	⊕	<b>3SE5423-0CC21-1EA2</b>	0.324
	<b>With external seal</b>				
	• With connection cable, 2 m	30	⊕	<b>3SE5413-0CC22-1EA2</b>	0.288
		40	⊕	<b>3SE5423-0CC22-1EA2</b>	0.328
<b>Roller plungers</b>					
<b>Standard mounting</b>					
	• With connection cable, 2 m	30	⊕	<b>3SE5413-0CD20-1EA2</b>	0.272
		40	⊕	<b>3SE5423-0CD20-1EA2</b>	0.298
	- Actuator head rotated 90°	30	⊕	<b>3SE5413-0CD23-1EA2</b>	0.281
	• With connection cable, 5 m	30	⊕	<b>3SE5413-0CD20-1EA5</b>	0.556
	• With M12 device plug, 5-pole	30	⊕	<b>3SE5413-0CD20-1EB1</b>	0.099
		40	⊕	<b>3SE5423-0CD20-1EB1</b>	0.114
	<b>With central fixing M12 x 1</b>				
	• With connection cable, 2 m	30	⊕	<b>3SE5413-0CD21-1EA2</b>	0.300
		40	⊕	<b>3SE5423-0CD21-1EA2</b>	0.318
<b>Twist levers</b>					
<b>Standard mounting</b>					
	• With connection cable, 2 m	30	⊕	<b>3SE5413-0CN20-1EA2</b>	0.330
		40	⊕	<b>3SE5423-0CN20-1EA2</b>	0.353
	• With connection cable, 5 m	30	⊕	<b>3SE5413-0CN20-1EA5</b>	0.580
	• With M12 device plug, 5-pole	30	⊕	<b>3SE5413-0CN20-1EB1</b>	0.133
		40	⊕	<b>3SE5423-0CN20-1EB1</b>	0.148
	<b>Twist levers with a smaller mounting depth and lower height</b>				
	• With connection cable, 2 m	30	⊕	<b>3SE5413-0CP20-1EA2</b>	0.314
<b>Twist levers, adjustable length</b>					
	• With connection cable, 2 m	30	⊕	<b>3SE5413-0CQ20-1EA2</b>	0.353
<b>Connection cable</b>					
	<b>Connection cable</b> with M12 socket, 5-pole, open end, length 5 m	--		<b>3SX5601-3SB55</b>	0.206

⊕ Positive opening according to IEC 60947-5-1, Annex K, or positively driven actuator, necessary in safety circuits.

## Position and safety switches

### SIRIUS 3SE5 mechanical position switches

#### 3SE5, open-type design

Enclosure width 30 mm

### Overview



Open-type design

Their compact design makes these switches particularly suitable for use in confined conditions. The mountings and operating points comply with EN 50047.

The switches are equipped with two or three contacts in snap-action, slow-action or slow-action with make-before-break versions. The stroke is 6 mm.





The empty enclosure can be equipped with all contact block versions.

#### Improved version

The switches have a robust metal plunger with increased abrasion resistance (instead of the rounded plunger). This enables the switch to be approached from a 30° angle.

### Selection and ordering data

2 or 3 contacts · Degree of protection IP20<sup>1)</sup> (2 contacts), IP10 (3 contacts) · Mounting and operating points acc. to EN 50047

Version	Contacts		Article No.	Weight kg	
<b>Plastic enclosures - Enclosure width 30 mm</b>					
 3SE5250-0BC05   3SE5250-0KC05   3SE5250-0AC05	<b>With metal plunger</b>				
	• Slow-action contacts	1 NO + 1 NC	⊕	<b>3SE5250-0BC05</b>	0.044
		1 NO + 2 NC	⊕	<b>3SE5250-0KC05</b>	0.045
		2 NO + 1 NC	⊕	<b>3SE5250-0PC05</b>	0.044
	- With make-before-break	1 NO + 2 NC	⊕	<b>3SE5250-0MC05</b>	0.044
	• Snap-action contacts	1 NO + 1 NC	⊕	<b>3SE5250-0CC05</b>	0.043
	1 NO + 2 NC	⊕	<b>3SE5250-0LC05</b>	0.045	
	--	⊕	<b>3SE5250-0AC05</b>	0.026	
<b>Contact blocks with 2 contacts</b> For open-type design <sup>2)</sup>					
 3SE5050-0BA00	• Slow-action contacts	1 NO + 1 NC	⊕	<b>3SE5050-0BA00</b>	0.020
	• Snap-action contacts	1 NO + 1 NC	⊕	<b>3SE5050-0CA00</b>	0.020
	- Standard		⊕	<b>3SE5050-0GA00</b>	0.022
	- Contact distance 2 × 2 mm		⊕	<b>3SE5050-0NA00</b>	0.020
	- Short stroke		⊕		

⊕ Positive opening according to IEC 60947-5-1, Annex K, or positively driven actuator, necessary in safety circuits.

<sup>1)</sup> With the conductor connected and the clamping screw tightened.

<sup>2)</sup> Contact blocks with 3 contacts.

## Position and safety switches

### SIRIUS 3SE5, 3SE2 mechanical safety switches

#### With separate actuator

## General data

### Overview

#### More information

Homepage, see [www.siemens.com/sirius-position-switches](http://www.siemens.com/sirius-position-switches)

Industry Mall, see [www.siemens.com/product?3SE](http://www.siemens.com/product?3SE)

Configurator, see [www.siemens.com/sirius/configurators](http://www.siemens.com/sirius/configurators)

Configuration Manual, see

<https://support.industry.siemens.com/cs/ww/en/view/43920150>

Safety switches with separate actuator are used where the position of doors, covers or protective grilles must be monitored for safety reasons.

3SE5 safety switches with separate actuator have the same enclosures as the 3SE5 position switches (modular system).



3SE5 safety switches with head for separate actuator

#### Design

##### Enclosure sizes

The 3SE5 safety switches are available in four different enclosure sizes:

- Plastic enclosures according to EN 50047, 31 mm wide, IP65, 1 cable entry
- Metal enclosures according to EN 50047, 31 mm wide, IP66/IP67, 1 cable entry
- Plastic and metal enclosures according to EN 50041, 40 mm wide, IP66/IP67, 1 cable entry
- Plastic enclosures, 50 mm wide, IP66/IP67, 2 cable entries
- Metal enclosures, 56 mm wide, IP66/IP67, 3 cable entries

Also available are safety switches in the 3SE2 series which have been developed in this form according to general market requirements:

- Molded-plastic enclosures outside of the standards, enclosure width 52 mm, IP67

##### Enclosure versions

Various basic versions can be selected for the enclosures of the 3SE5 series:

- Available with 2- or 3-pole contact blocks designed as slow-action contacts
- Optional LED status display
- With mounted 4- or 5-pole M12 device plug, also for connection to field modules, such as SIMATIC ET 200 (available for the wide enclosures as an accessory for self-assembly)
- With 6-pole device plug + PE on the metal enclosures
- Similarly with a combination of plug and LED indicators
- AS-Interface version with integrated ASIsafe electronics for all enclosure designs

For a description of the basic switches, see [page 2/318](#).

#### Operation

The actuator head is included in the scope of supply. For actuation from four directions it can be adjusted through  $4 \times 90^\circ$ . The switches can also be approached from above.

The actuator heads of the 3SE2243 and 3SE2257 switches with special enclosures cannot be changed. The switches can be approached from the two broad sides and from above.

The actuator is not included in the scope of supply of the safety switches and must be ordered separately from a choice of different versions to suit the application (see [page 2/335](#)).

The actuator is encoded. Simple overruling by hand or auxiliary devices is impossible.

##### Radius actuators

The safety switches with radius actuators are particularly suitable for rotary protective devices. The movable actuation key allows even small radii to be approached. Damage to the switch and the actuator due to inaccurate approach is prevented.

##### Locking devices

A high-grade steel blocking insert for attaching up to eight padlocks is available for even more security.



Blocking inserts with padlock

##### Dust protection

For use in dusty environments, a protective cap made of rubber is offered that protects the actuator entries of the actuator head from contamination.

##### Contact reliability

The contact blocks ensure an extremely high contact stability. This applies even when the devices are switching low voltages and currents.

##### Positive opening

The NC contacts of the switch are forced open mechanically, positively driven and reliably by the plunger. This is referred to as "positive opening".

## Position and safety switches

### SIRIUS 3SE5, 3SE2 mechanical safety switches

#### With separate actuator

#### General data

#### Benefits

The 3SE5 safety switches with separate actuator differ from the previous series through the following new properties:

- All enclosure sizes with increased corrosion protection are optionally available with an LED signaling indicator.
- The 3-pole contact block 1 NO + 2 NC is available for all enclosure sizes.
- The plastic enclosure has simple and fast wiring equipment which makes it possible to save approx. 20 to 25% of the time when connecting.
- The ASIsafe electronics are integrated in the enclosure for the versions with AS-Interface connection; an additional adapter is not required.

#### Application

Safety switches with separate actuator are used where the position of doors, covers or protective grilles must be monitored for safety reasons.

For more information about the protective door monitoring application, [see flyer](#).

The safety switch can only be operated with the matching coded actuator. Simple overruling by hand or auxiliary devices is impossible.

Devices are available with enclosure versions to suit the particular ambient conditions. The high-grade steel actuator is suitable for extreme ambient conditions down to -40 °C. Different control tasks can be performed with the contact blocks best suited for the particular purpose. Dimensions and fixing points of the enclosure are in accordance with EN 50041 or EN 50047 standards. The devices are suitable for use in any climate.

#### Standards

The switches comply with IEC 60947-5-1 (Electromechanical Control Circuit Devices).

The protective measure of "total insulation" by the plastic enclosure is ensured by the use of plastic screw glands.

#### Safety position switches

For controls according to IEC 60204-1 the devices can be used as a safety position switch. They comply with ISO 14119. A TÜV Certificate is available. To secure position switches against changes in their position, positively-driven techniques must be employed on installation.

#### Safety circuits

Standards IEC 60947-5-1 require positive opening of the NC contacts. In other words, for the purposes of personal safety, the assured opening of NC contacts is expressly stipulated for the electrical equipment of machines in all safety circuits and marked in accordance with the standard IEC 60947-5-1 with the symbol .

SIL 2 according to IEC 62061/IEC 61508 or PL d according to ISO 13849-1 can be attained with a safety switch with a separate actuator with  if the corresponding fail-safe evaluation units are selected and correctly installed (e.g. the 3SK safety relays or matching devices from the ASIsafe, SIMATIC or SINUMERIK product ranges).

If a second 3SE5 safety switch with  is used, SIL 3 / PL e can be attained.

#### Technical specifications

Type	3SE51...V.., 3SE52...V..	3SE2257-XX..	3SE2243-XX..
<b>General data</b>			
<b>Standards</b>	IEC 60947-5-1, ISO 14119		
<b>Rated insulation voltage <math>U_i</math></b>	V	400	500
<b>Degree of pollution</b> acc. to IEC 60664-1		Class 3	Class 3
<b>Rated impulse withstand voltage <math>U_{imp}</math></b>	kV	6	
<b>Rated operational voltage <math>U_e</math></b>	V	400 AC; over 300 V AC same potential only	500 AC; over 380 V AC same potential only
<b>Conventional thermal current <math>I_{th}</math></b>	A	6	10
<b>Rated operational current <math>I_e</math></b>			
• With alternating current 50/60 Hz			
	$I_e$ / AC-15	$I_e$ / AC-12	$I_e$ / AC-15
- At 24 V	A 6	10	10
- At 120 V	A 6	10	10
- At 240 V	A 4	10	6
- At 400 V	A 4	10	4
- At 500 V	A --	10	3
• For direct current			
	$I_e$ / DC-13	$I_e$ / DC-12	$I_e$ / DC-13
- At 24 V	A 3	10	10
- At 125 V	A 0.55	--	--
- At 250 V	A 0.27	--	--
- At 110 V	A --	4	1
- At 220 V	A --	1	0.4
- At 400 V	A 0.12	--	--
- At 440 V	A --	0.5	0.2
<b>Short-circuit protection</b>			
• With DIAZED fuse links, operational class gG	A 6	6	
• With fuse links, quick	A --	10	
• With miniature circuit breaker, C characteristic ( $I_{K<400A}$ )	A 1	--	
<b>Mechanical service life</b>	1 × 10 <sup>6</sup> operating cycles		
<b>Electrical endurance</b>			
• With 3RH21 contactors size S00 and 3RT contactors sizes S00, S0	1 × 10 <sup>6</sup> operating cycles	> 1 × 10 <sup>6</sup> operating cycles	
• For utilization category AC-15 when switching off $I_e$ /AC-15 at 240 V	100 000 operating cycles	500 000 operating cycles	
<b>Switching frequency</b> with contactors 3RH21 size S00 and 3RT contactors sizes S00, S0	6 000 operating cycles/h		
<b>Minimum pull-out force</b> for positive opening	N	20	30

## Position and safety switches

### SIRIUS 3SE5, 3SE2 mechanical safety switches

#### With tumbler

#### General data

#### Overview

The safety switches with tumbler are exceptional safety-related devices which prevent an unforeseen or intentional opening of protective doors, protective grilles or other covers as long as a dangerous situation is present (i.e. follow-on motion of the switched-off machine).



3SE5 safety switch with tumbler

The safety switches with tumbler are comprised of a switch part with electromechanical tumbler and a mechanical actuator which has to be ordered separately.

They are rugged protective devices that enable the greatest possible safety for man and machine.

The safety switches with tumbler are offered in plastic or metal enclosures.

Dimensions (W × H × D): 54 mm × 185 mm × 43.5 mm

#### Operation

The actuator head is included in the scope of supply. For actuation from four directions it can be adjusted through 4 × 90°. The switches can also be approached from above.

The actuator is not included in the scope of supply of the safety switches and must be ordered separately from a choice of different versions to suit the application (see page 2/335).

Actuation data:

- Maximum actuating speed  $v_{\max} = 1.5 \text{ m/s}$
- Minimum actuating speed  $v_{\min} = 0.4 \text{ mm/s}$
- Minimum force in the direction of actuation  $F_{\min} = 30 \text{ N}$

The actuator is encoded. Simple overruling by hand or auxiliary devices is impossible.

#### Radius actuators

The safety switches with radius actuators are particularly suitable for rotary protective devices. The movable actuation key allows even small radii to be approached. Damage to the switch and the actuator due to inaccurate approach is prevented.

#### Locking devices

A high-grade steel blocking insert for attaching up to eight padlocks is available for even more security.

#### Dust protection

For use in dusty environments, a protective cap made of rubber is offered that protects the actuator entries of the actuator head from contamination.

#### Tumbler

There are two versions for interlocking the actuator:

- Spring-actuated lock (closed-circuit principle) with various release mechanisms
- Solenoid-locked (open-circuit principle)

The spring-actuated lock switch is equipped with an auxiliary release for emergency situations or setup mode. Available as options:

- Escape release or
- Emergency release

#### Contact blocks

The safety switches with tumbler have one switching block each for:



- Monitoring the actuator or the position of the protective door
- Monitoring the position of the solenoid

The mechanical design of the switch corresponds to the requirements of the fail-safe principle according to ISO 14119.

#### Optical signaling equipment

The safety switches with tumbler are available with an optional optical signaling device.

The signaling device indicates the switch position of the interlock and the protective device optically by means of two LEDs on the front.

Protective device	Tumbler	Display	Meaning
Closed	Released		Actuator able to be pulled
Closed	Locked		Actuator locked
Open	Released		Actuator pulled

Internal wiring:

- The yellow LED is pre-wired to the solenoid monitoring NO contact.
- The green LED is pre-wired to the actuator monitoring NC contact.
- LED ground is pre-wired to the ground of the solenoid.

#### Notes:

- The operational voltage must be connected to the corresponding contacts by the customer.
- This voltage for the LEDs must match the operational voltage of the solenoid (same potential).



## Position and safety switches

### SIRIUS 3SE5, 3SE2 mechanical safety switches

#### With tumbler

#### General data

#### Benefits

The 3SE53 safety switches provide:

- More safety through higher locking forces:
  - 1 300 N with plastic enclosure
  - 2 600 N with metal enclosure
- Various release mechanisms: lock release, escape release and emergency release
- Two contact blocks each with three contacts as standard equipment, hence fewer versions needed
- Same dimensions for all enclosure versions: plastic, metal or with integrated ASIsafe
- An extensive range of actuators
- An optional LED status display 24 V DC, 115 V or 230 V AC for all switch versions
- Devices with ASIsafe electronics integrated in the enclosure/ wired to 8-pole M12 device plug
- 3SE5322-1S.21-1AG4 series with high degree of protection IP69 (IP69K) in accordance with IEC 60529, cover with foamed seal

#### Application

The safety switches with tumbler are exceptional safety-related devices which prevent an unforeseen or intentional opening of protective doors, protective grilles or other covers as long as a dangerous situation is present (i.e. follow-on motion of the switched-off machine).

The safety switches with tumbler have the following functions:

- Enabling the machine or process with closed and locked protective device
- Locking the machine or process with opened protective device
- Position monitoring of the protective device and tumbler

#### Standards

The switches comply with IEC 60947-1 (Low-Voltage Switchgear and Controlgear, General) and IEC 60947-5-1 (Electromechanical Control Circuit Devices).

The mechanical design of the switch corresponds to the requirements of the fail-safe principle according to ISO 14119.

#### Approvals

The switches are approved for use with locking devices according to ISO 14119 and EN 292, Parts 1 and 2.

These switches are approved according to UL 508, UL 50 and UL 746-C.

#### Safety circuits

Standards IEC 60947-5-1 require positive opening of the NC contacts. In other words, for the purposes of personal safety, the assured opening of NC contacts is expressly stipulated for the electrical equipment of machines in all safety circuits and marked in accordance with the standard IEC 60947-5-1 with the symbol .

SIL 2 according to IEC 62061/IEC 61508 or PL d according to ISO 13849-1 can be attained with a safety switch with a tumbler with  if the corresponding fail-safe evaluation units are selected and correctly installed (e.g. the 3SK safety relays or matching devices from the ASIsafe, SIMATIC or SINUMERIK product ranges).

If a second 3SE5 safety switch with  is used, SIL 3 / PL e can be attained.

#### Tumbler

The separate actuator works like a key using coding and protects against manipulation. It transmits the locking force to the protective device and helps to monitor its position.

There are two versions of locking:

#### Spring-actuated lock (closed-circuit principle)

- In the standard version, the safety switch locks by means of spring force and releases by means of electromagnetic force. In the case of voltage failure, it reliably prevents the protective device from opening when machine parts are still moving.
- The switch is equipped with an auxiliary release for emergency situations or setup mode.
- An auxiliary release which can be secured with a lock to prevent misuse is available as a version.

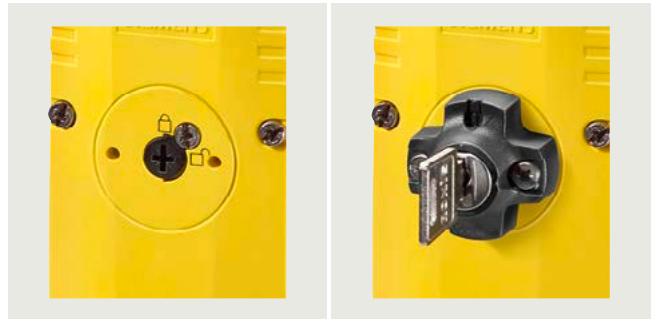

Auxiliary release

Auxiliary release with lock

The 3SE53 safety switches are also available with an escape release or emergency release.

- Personnel working inside the hazard zone can use the escape release feature to manually release the tumbler without tools from the escape side (hazardous area side) so that they can exit the hazard area. An intentional act (in this case pulling the gray actuator) is required to release the locking mechanism and restore the normal operating state.
- The emergency release enables someone in an emergency situation to manually release the tumbler without tools from the access side (outside the hazardous area). Releasing the lock and restoring the normal operating state must require effort which is comparable to repair activity: in this case disassembly of the red actuator and resetting of the mechanical lock.

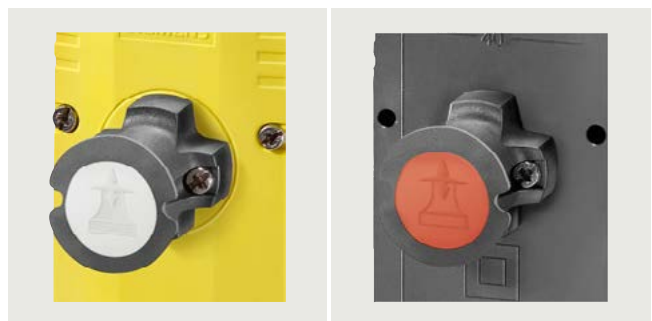

Escape release from the front

Emergency release from the back

#### Solenoid-locked (open-circuit principle)

- The second version offers locking by means of electromagnetic force and release by means of spring force. This version has an advantage when it is necessary to quickly access the machine after a power failure occurs, or in the case of very short coasting times.

## Position and safety switches

### SIRIUS 3SE5, 3SE2 mechanical safety switches

With tumbler

#### General data

##### Examples of door interlocking



X-Lock door interlocking from Axelent

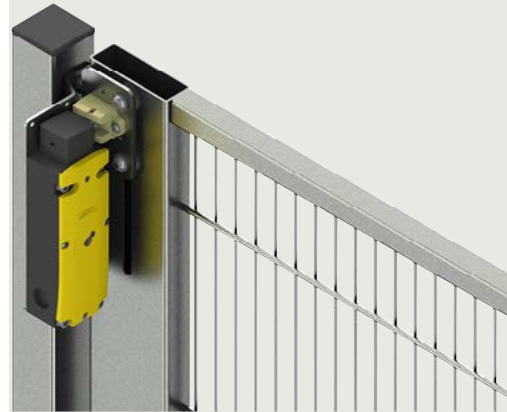

Door interlocking from Brühl

For the addresses of the door interlock manufacturers.

#### Technical specifications

Type		3SE5322	3SE5312
<b>General data</b>			
<b>Standards</b>		IEC 60947-5-1, ISO 14119, IEC 62061/IEC 61508	
<b>Rated insulation voltage <math>U_i</math></b>	V	250	
<b>Degree of pollution</b> acc. to IEC 60664-1		Class 3	
<b>Rated impulse withstand voltage <math>U_{imp}</math></b>	kV	4	
<b>Rated operational voltage <math>U_e</math></b>			
• DC	V	24	
• 50/60 Hz AC	V	230	
<b>Conventional thermal current <math>I_{th}</math></b>	A	6	
<b>Rated operational current <math>I_e</math></b>			
• With alternating current 50/60 Hz		$I_e$ / AC-15 or B300	
- At 24 V	A	6	
- At 120 V	A	6	
- At 240 V	A	3	
• For direct current		$I_e$ / DC-13 or Q300	
- At 24 V	A	3	
- At 125 V	A	0.55	
- At 250 V	A	0.27	
<b>Solenoid</b>			
• Locking force, max.	N	1 300	2 600
• Locking force according to ISO 14119	N	1 000	2 000
• Power consumption at $U_c$	W	3.5	
<b>Short-circuit protection<sup>1)</sup></b>			
• With DIAZED fuse links, utilization category gG	A	6	
• With miniature circuit breaker, characteristic C	A	0.5	
<b>Mechanical service life</b>	Operating cycles	$1 \times 10^6$	
<b>Electrical endurance</b>			
• With 3RH21 contactors size S00 and 3RT contactors sizes S00, S0	Operating cycles	$1 \times 10^6$	
• For utilization category AC-15 when switching off $I_e$ / AC-15 at 230 V	Operating cycles	100 000	
• With utilization category DC-12/DC-13		For direct current depending on the loading of the switch	
<b>Switching frequency</b> with contactors 3RH21 size S00 and 3RT contactors sizes S00, S0	Operating cycles/h	6 000	
<b>Shock resistance</b> acc. to IEC 60068-2-27	g/ms	30/11	

<sup>1)</sup> Without any welds according to IEC 60947-5-1.

## Position and safety switches

### SIRIUS 3SE5, 3SE2 mechanical safety hinge switches

General data

#### Overview

3SE5 hinge switches have the same enclosures as the 3SE5 position switches (modular system).



Hinge switches

#### Design

##### Enclosure sizes

The 3SE5 switches are available as complete units in two enclosure sizes:

- Plastic enclosures according to EN 50047, 31 mm wide, IP65, 1 cable entry
- Metal enclosures according to EN 50047, 31 mm wide, IP66/IP67, 1 cable entry
- Plastic and metal enclosures according to EN 50041, 40 mm wide, IP66/IP67, 1 cable entry

##### Enclosure versions

Various basic versions can be selected for the enclosures:

- With 2- or 3-pole contact blocks, designed as snap-action contacts
- AS-Interface version with integrated ASIsafe electronics for all enclosure designs

For a description of the basic switches, [see page 2/318](#).

##### Operating mechanism

The hinge switches are provided for mounting on hinges. The actuator head is included in the scope of supply. There are two versions:

- Operating mechanism with hollow shaft, inner diameter 8 mm, outer diameter 12 mm
- Operating mechanism with solid shaft, diameter 10 mm

#### 3SE2283 hinge switches

The 3SE2283 hinge switches with integrated hinge are available in a special design. They are particularly suitable for use in machine doors and flaps.

#### Benefits

The 3SE5 hinge switches differ from the previous series through the following new characteristics:

- All actuators can be turned around the axis in increments of 22.5° ([see figure, page 2/318](#)).
- The new 3-pole contact block 1 NO + 2 NC is available for all enclosure sizes ([see figure, page 2/318](#)).
- The plastic enclosure with a width of 31 mm has simple and fast wiring equipment which makes it possible to save approx. 20 to 25% of the time when connecting ([see figure, page 2/318](#)).
- The ASIsafe electronics are integrated in the enclosure for the versions with AS-Interface connection; an additional adapter is not required.

#### Application

The hinge switches are used in those areas where the position of swiveling protective devices such as doors or flaps must be monitored. With these switches, the position of the doors and flaps is converted into electric signals. The switches allow shutdown and signaling without delay in the event of a small opening angle through the snap-action contacts with an operating angle of 10°.

Devices are available with enclosure versions to suit the particular ambient conditions. Different control tasks can be performed with the contact blocks best suited for the particular purpose. Dimensions and fixing points of the enclosures are in accordance with EN 50041 or EN 50047 standards.

The devices are suitable for use in any climate.

#### Standards

The switches comply with IEC 60947-5-1 (Electromechanical Control Circuit Devices).

The protective measure of "total insulation" by the plastic enclosure is ensured by the use of plastic screw glands.

#### Safety position switches

For controls according to IEC 60204-1 the devices can be used as a safety position switch. To secure position switches against changes in their position, positively-driven techniques must be employed on installation.

#### Safety circuits

Standards IEC 60947-5-1 require positive opening of the NC contacts. In other words, for the purposes of personal safety, the assured opening of NC contacts is expressly stipulated for the electrical equipment of machines in all safety circuits and marked in accordance with IEC 60947-5-1 with the symbol  $\ominus$ .

SIL 2 according to IEC 62061/IEC 61508 or PL d according to ISO 13849-1 can be attained with a 3SE5 safety hinge switch with  $\ominus$  if the corresponding fail-safe evaluation units are selected and correctly installed (e.g. the 3SK safety relays or matching devices from the ASIsafe, SIMATIC or SINUMERIK product ranges).

If a second 3SE5 position switch with  $\ominus$  is used, SIL 3 / PL e can be attained.



## Position and safety switches

SIRIUS 3SE5 mechanical position switches for ambient temperatures down to -40 °C

Shock and vibration test

### SIRIUS 3SE5 mechanical position switches > 3SE5, plastic enclosures

#### Selection and ordering data

##### Enclosure width 31 mm acc. to EN 50047

Complete units

2 or 3 contacts · Degree of protection IP65 · Cable entry 1 × (M20 × 1.5) · With increased corrosion protection

Version	Contacts	Complete units	Weight
		Article No.	kg

#### Complete units<sup>1)</sup> · Enclosure width 31 mm



3SE5232-0LK21-1AY0

##### **Twist levers, 21 mm long, type A, according to EN 50047**

**With plastic roller 19 mm**

- Snap-action contacts

1 NO + 2 NC



**3SE5232-0LK21-1AY0**

0.110



3SE5232-0LE10-1AY0

##### **Roller levers, type E, acc. to EN 50047**

**With plastic roller 13 mm**

- Snap-action contacts

1 NO + 2 NC



**3SE5232-0LE10-1AY0**

0.086



3SE5232-0HK82-1AY0

##### **Rod levers, according to EN 50047**

**With plastic rod, length 200 mm**

- Snap-action contacts

1 NO + 1 NC

**3SE5232-0HK82-1AY0**

0.131



3SE5232-0HR01-1AY0

##### **Spring rods<sup>2)</sup>, acc. to EN 50047**

**Length 142.5 mm, with plastic plunger 50 mm**

- Snap-action contacts

1 NO + 1 NC

**3SE5232-0HR01-1AY0**

0.117

⊕ Positive opening according to IEC 60947-5-1, Annex K, or positively driven actuator, necessary in safety circuits.

1) Popular versions.

2) Degree of protection IP65/IP67.

# Position and safety switches

## SIRIUS 3SE5 mechanical position switches for ambient temperatures down to -40 °C

### Shock and vibration test

#### SIRIUS 3SE5 mechanical safety switches with tumbler > 3SE5, plastic enclosures

#### Selection and ordering data

##### Enclosure width 54 mm

6 slow-action contacts · 5 directions of approach · Degree of protection IP66/IP67 · Cable entry 3 × (M20 × 1.5) · ISO 14119

Tumbler <sup>1)</sup>	Solenoid, rated operational voltage	<input type="checkbox"/>	Weight
	V		kg

**Complete units**  
Position monitoring:  
Actuators: 1 NO + 2 NC  
Solenoid: 1 NO + 2 NC  
Article No.

##### 1 300 N locking force · Enclosure width 54 mm

##### Spring-actuated locks

- With auxiliary release from the front

24 DC



3SE5322-0SD21-1AY0

0.515



3SE5322-0SD21-1AY0

⊕ Positive opening according to IEC 60947-5-1, Annex K, or positively driven actuator, necessary in safety circuits.

<sup>1)</sup> Supplied without actuator. Please order separately.

Version	Article No.	Weight kg
---------	-------------	--------------

#### Accessories



3SE5000-0AV01

##### Standard actuator

- Length 75.6 mm

3SE5000-0AV01

0.035



3SE5000-0AW51

##### High-grade steel actuator, standard<sup>1)</sup>

- Length 75.6 mm

3SE5000-0AW51

0.046



3SE5000-0AW52

- With vertical fixing, length 53 mm

3SE5000-0AW52

0.073



3SE5000-0AW53

- With transverse fixing, length 47 mm

3SE5000-0AW53

0.066



3SE5000-0AW57

##### Universal radius actuators, heavy duty

- High-grade steel actuators<sup>1)</sup>, length 77 mm

3SE5000-0AW57

0.125

<sup>1)</sup> Suitable for extreme environmental conditions such as -40 °C.

## Position and safety switches

SIRIUS 3SE5 mechanical position switches for ambient temperatures down to -40 °C

Shock and vibration test

### SIRIUS 3SE5 mechanical safety hinge switches > 3SE5, plastic enclosures

#### Selection and ordering data

##### Enclosure width 31 mm acc. to EN 50047

2 contacts · Degree of protection IP65 · Cable entry 1 × (M20 × 1.5) · With increased corrosion protection

Version	Contacts	Complete units	Weight
		<input type="checkbox"/>	kg
Article No.			

#### Complete units · Enclosure width 31 mm



##### Hinge switches, according to EN 50047

With hollow shaft D = 8 mm, operating angle 10°

- Snap-action contacts

1 NO + 1 NC →

**3SE5232-0HU21-1AY0**

0.117

3SE5232-0HU21-1AY0







→ Positive opening according to IEC 60947-5-1, Annex K.

## Selection and ordering data

## Enclosure width 31 mm according to EN 50047 / 50 mm

## Complete units

2 or 3 contacts · Degree of protection IP65 (31 mm) or IP66/IP67 (50 mm) · With increased corrosion protection

Version	Contacts	Complete units	Weight
		<input type="checkbox"/>	kg
		Article No.	kg
<b>Complete units<sup>1)</sup> · Enclosure width 31 mm · Cable entry 1 x (M20 x 1.5)</b>			
	<b>Roller plungers, type C, acc. to EN 50047</b> With plastic roller 10 mm With M12 device plug, 4-pole (250 V, 4 A) <sup>2)</sup> • Snap-action contacts	1 NO + 1 NC ⊕	<b>3SE5234-0CD03-1AJ1</b> 0.083
3SE5234-0CD03-1AJ1			
	<b>Roller plungers with central fixing acc. to EN 50047</b> • Snap-action contacts	1 NO + 1 NC ⊕	<b>3SE5232-0CD10-1AJ0</b> 0.101
3SE5232-0CD10-1AJ0			
	<b>Twist levers, type A, acc. to EN 50047</b> With high-grade steel lever 21 mm and plastic roller 19 mm • Snap-action contacts	1 NO + 1 NC ⊕	<b>3SE5232-0CK31-1AJ0</b> 0.104
3SE5232-0CK31-1AJ0			
	<b>Twist levers, adjustable length, acc. to EN 50047</b> With high-grade steel lever 100 mm, with grid hole and plastic roller 19 mm • Snap-action contacts	1 NO + 1 NC ⊕ 1 NO + 2 NC ⊕	<b>3SE5232-0CK62-1AJ0</b> 0.126 <b>3SE5232-0LK62-1AJ0</b> 0.130
3SE5232-0CK62-1AJ0			
<b>Complete units<sup>1)</sup> · Enclosure width 50 mm · Cable entry 2 x (M20 x 1.5) · Operating points acc. to EN 50047</b>			
	<b>Twist levers</b> With metal lever 21 mm and plastic roller 19 mm • Snap-action contacts, integrated <sup>3)</sup>	1 NO + 1 NC ⊕	<b>3SE5242-0HK21-1AJ0</b> 0.120
3SE5242-0HK21-1AJ0			
	<b>Twist levers, adjustable length</b> With high-grade steel lever 100 mm, with grid hole and plastic roller 19 mm • Snap-action contacts, integrated <sup>3)</sup>	1 NO + 1 NC ⊕	<b>3SE5242-0HK62-1AJ0</b> 0.134
3SE5242-0HK62-1AJ0			

⊕ Positive opening according to IEC 60947-5-1, Annex K, or positively driven actuator, necessary in safety circuits.

1) Popular versions.

2) Pin assignments, see page 2/323.

3) Subsequent replacement of contact blocks is not possible.

## Note:

If the device you require is not available as a complete unit, see "Modular system", page 2/338.

## Position and safety switches

SIRIUS 3SE5 mechanical position switches for ambient temperatures down to -40 °C

Shock and vibration test according to railway standard

### SIRIUS 3SE5 mechanical position switches > 3SE5, plastic enclosures

#### Modular system

2 or 3 contacts · Degree of protection IP65 (31 mm) or IP66/IP67 (50 mm) · With increased corrosion protection

Version	Contacts	Modular system	Weight		
		Article No.	kg		
<b>Basic switches · Enclosure width 31 mm · Cable entry 1 x (M20 x 1.5)</b>					
	<b>Rounded plungers<sup>1)</sup>, type B, acc. to EN 50047</b>				
	• Slow-action contacts	1 NO + 2 NC	⊕	<b>3SE5232-0KC05-1AJ0</b>	0.068
	• Snap-action contacts	1 NO + 1 NC	⊕	<b>3SE5232-0CC05-1AJ0</b>	0.069
		1 NO + 2 NC	⊕	<b>3SE5232-0LC05-1AJ0</b>	0.070
3SE5232-0CC05-1AJ0					

<b>Basic switches · Enclosure width 50 mm · Cable entry 2 x (M20 x 1.5)</b>					
	<b>Rounded plungers<sup>1)</sup>, acc. to EN 50047</b>				
	• Slow-action contacts	1 NO + 1 NC	⊕	<b>3SE5242-0BC05-1AJ0</b>	0.088
	• Snap-action contacts, integrated <sup>2)</sup>	1 NO + 1 NC	⊕	<b>3SE5242-0HC05-1AJ0</b>	0.086
	3SE5242-0BC05-1AJ0				







⊕ Positive opening according to IEC 60947-5-1, Annex K, or positively driven actuator, necessary in safety circuits.

1) For enclosures with widths of 31 and 50 mm, the basic switch is a complete unit with rounded plungers.

2) Subsequent replacement of contact blocks is not possible.

Note:

For the selection aid, see page 2/324.

Version	Diameter	Modular system	Weight			
	mm	Article No.	kg			
<b>Operating mechanisms</b>						
	<b>Roller plungers, type C, acc. to EN 50047</b>					
	• Plastic roller	10	⊕	<b>3SE5000-0AD03-1AJ0</b>	0.030	
3SE5000-0AD03-1AJ0						
	<b>Roller levers, type E, acc. to EN 50047</b>					
	• Metal lever	Plastic roller	13	⊕	<b>3SE5000-0AE10-1AJ0</b>	0.015
	• High-grade steel lever	Plastic roller	13	⊕	<b>3SE5000-0AE12-1AJ0</b>	0.015
		High-grade steel roller	13	⊕	<b>3SE5000-0AE13-1AJ0</b>	0.023
	3SE5000-0AF10-1AJ0					
	<b>Angular roller levers</b>					
	• Metal lever	Plastic roller	13	⊕	<b>3SE5000-0AF10-1AJ0</b>	0.040
	• High-grade steel lever	Plastic roller	13	⊕	<b>3SE5000-0AF12-1AJ0</b>	0.018
3SE5000-0AF10-1AJ0						
<b>Twist actuators</b>						
	<b>Twist actuators, for 31/50 mm, EN 50047</b>					
	• Switching right and/or left, adjustable	--	⊕	<b>3SE5000-0AK00-1AJ0</b>	0.026	
3SE5000-0AK00-1AJ0						
<b>Levers</b>						
	<b>Twist levers 21 mm, straight, type A, acc. to EN 50047</b>					
	• Metal lever	Plastic roller	19	⊕	<b>3SE5000-0AA21-1AJ0</b>	0.015
	• High-grade steel lever	Plastic roller	19	⊕	<b>3SE5000-0AA31-1AJ0</b>	0.015
		High-grade steel roller	19	⊕	<b>3SE5000-0AA32-1AJ0</b>	0.030
3SE5000-0AA21-1AJ0						
	<b>Twist levers 100 mm, adjustable length, with grid hole</b>					
	• Metal lever	Plastic roller	19	⊕	<b>3SE5000-0AA60-1AJ0</b>	0.040
	• High-grade steel lever	Plastic roller	19	⊕	<b>3SE5000-0AA62-1AJ0</b>	0.031
	3SE5000-0AA60-1AJ0					

⊕ Positively driven actuator, necessary in safety circuits.

SIRIUS 3SE5 mechanical position switches for ambient temperatures down to -40 °C  
Shock and vibration test according to railway standard

## SIRIUS 3SE5 mechanical position switches &gt; 3SE5, plastic enclosures

**Enclosure width 40 mm acc. to EN 50041**

## Modular system

2 or 3 contacts · Degree of protection IP66/IP67 · Cable entry 1 × (M20 × 1.5) · With increased corrosion protection

Version	Contacts	Modular system	Weight
		Article No.	kg

**Basic switches · Enclosure width 40 mm****Rounded plungers, acc. to EN 50041**

- Slow-action contacts
- Snap-action contacts

1 NO + 2 NC →  
1 NO + 1 NC →  
1 NO + 2 NC →

**3SE5132-0KA00-1AJ0** 0.091  
**3SE5132-0CA00-1AJ0** 0.093  
**3SE5132-0LA00-1AJ0** 0.092

3SE5132-0CA00-1AJ0

→ Positive opening according to IEC 60947-5-1, Annex K, or positively driven actuator, necessary in safety circuits.

Note:

For the selection aid, see page 2/324.

Version	Diameter	Modular system	Weight
	mm	Article No.	kg

**Operating mechanisms****Rounded plungers, type B, acc. to EN 50041**

- Plastic plunger, with 3 mm overtravel

10 →

**3SE5000-0AC03-1AJ0** 0.011

3SE5000-0AC03-1AJ0

**Roller plungers, type C, acc. to EN 50041**

- Plastic plungers Plastic roller

13 →

**3SE5000-0AD05-1AJ0** 0.014

3SE5000-0AD05-1AJ0

**Roller levers**

- Metal levers with plastic base Plastic roller

22 →

**3SE5000-0AE05-1AJ0** 0.025

3SE5000-0AE05-1AJ0

**Twist actuators****Twist actuators, for 40/56/56 XL mm, EN 50041**

- Switching right and/or left, adjustable

-- →

**3SE5000-0AH00-1AJ0** 0.032

3SE5000-0AH00-1AJ0

**Levers****Twist levers 27 mm, offset, type A, acc. to EN 50041**

- Metal lever Plastic roller
- High-grade steel lever Plastic roller

19 →

**3SE5000-0AA01-1AJ0** 0.017

3SE5000-0AA01-1AJ0

**Twist levers 100 mm, adjustable length, with grid hole**

- Metal lever Plastic roller
- High-grade steel lever Plastic roller

19 →

**3SE5000-0AA60-1AJ0** 0.040

3SE5000-0AA60-1AJ0



3SE5000-0AA60-1AJ0

→ Positively driven actuator, necessary in safety circuits.

## Position and safety switches

SIRIUS 3SE5 mechanical position switches for ambient temperatures down to -40 °C

Shock and vibration test according to railway standard









SIRIUS 3SE5 mechanical position switches > 3SE5, metal enclosures

### Selection and ordering data

#### Enclosure width 31 mm acc. to EN 50047

##### Complete units

2 or 3 contacts · Degree of protection IP66/IP67 · Cable entry 1 × (M20 × 1.5) · With increased corrosion protection

Version	Contacts	Modular system	Weight
Article No.			kg
<b>Complete units · Enclosure width 31 mm</b>			
<b>Rounded plungers, type B, acc. to EN 50047</b>			
 3SE5212-0CC05-1AJ0	<ul style="list-style-type: none"> <li>• Slow-action contacts</li> </ul>	1 NO + 2 NC 	<b>3SE5212-0KC05-1AJ0</b> 0.188
	<ul style="list-style-type: none"> <li>• Snap-action contacts</li> </ul>	1 NO + 1 NC 	<b>3SE5212-0CC05-1AJ0</b> 0.185
		1 NO + 2 NC 	<b>3SE5212-0LC05-1AJ0</b> 0.197
 3SE5214-0CC05-1AJ2	<b>With M12 device plug, 5-pole (250 V, 4 A)<sup>1)</sup></b> <ul style="list-style-type: none"> <li>• Snap-action contacts</li> </ul>	1 NO + 1 NC 	<b>3SE5214-0CC05-1AJ2</b> 0.192
	<b>Twist levers, type A, acc. to EN 50047</b>		
 3SE5212-0CH22-1AJ0	<b>With metal lever 21 mm and high-grade steel roller 19 mm, with twist actuator with enclosure width 40 mm</b> <ul style="list-style-type: none"> <li>• Snap-action contacts</li> </ul>	1 NO + 1 NC 	<b>3SE5212-0CH22-1AJ0</b> 0.233

 Positive opening according to IEC 60947-5-1, Annex K, or positively driven actuator, necessary in safety circuits.

<sup>1)</sup> Pin assignments, see page 2/323.

##### Note:

If the device you require is not available as a complete unit, see "Modular system", page 2/341.

## Position and safety switches

### SIRIUS 3SE5 mechanical position switches for ambient temperatures down to -40 °C

#### Shock and vibration test according to railway standard

#### SIRIUS 3SE5 mechanical position switches > 3SE5, metal enclosures

#### Modular system

2 or 3 contacts · Degree of protection IP66/IP67 · Cable entry 1 × (M20 × 1.5) · With increased corrosion protection

Version	Contacts	Modular system	Weight
		Article No.	kg

#### Basic switches · Enclosure width 31 mm



#### **Rounded plungers<sup>1)</sup>, acc. to EN 50047**

- Slow-action contacts
- Snap-action contacts

1 NO + 2 NC	⊕
1 NO + 1 NC	⊕
1 NO + 2 NC	⊕

<b>3SE5212-0KC05-1AJ0</b>	0.188
<b>3SE5212-0CC05-1AJ0</b>	0.185
<b>3SE5212-0LC05-1AJ0</b>	0.197

3SE5212-0CC05-1AJ0

⊕ Positive opening according to IEC 60947-5-1, Annex K, or positively driven actuator, necessary in safety circuits.

<sup>1)</sup> For enclosures with widths of 31 mm, the basic switch is a complete unit with rounded plungers.

Note:

For the selection aid, see page 2/324.

Version	Diameter	Modular system	Weight
		Article No.	kg

#### Operating mechanisms



#### **Roller plungers, type C, acc. to EN 50047**

- Plastic roller

10	⊕
----	---

<b>3SE5000-0AD03-1AJ0</b>	0.030
---------------------------	-------

3SE5000-0AD03-1AJ0



#### **Roller levers, type E, acc. to EN 50047**

- Metal lever      Plastic roller
- High-grade steel lever      Plastic roller
- High-grade steel roller

13	⊕
13	⊕
13	⊕

<b>3SE5000-0AE10-1AJ0</b>	0.015
<b>3SE5000-0AE12-1AJ0</b>	0.015
<b>3SE5000-0AE13-1AJ0</b>	0.023

3SE5000-0AE10-1AJ0



#### **Angular roller levers**

- Metal lever      Plastic roller
- High-grade steel lever      Plastic roller

13	⊕
13	⊕

<b>3SE5000-0AF10-1AJ0</b>	0.040
<b>3SE5000-0AF12-1AJ0</b>	0.018

3SE5000-0AF10-1AJ0

#### Twist actuators



#### **Twist actuators, for 31/50 mm, EN 50047**

- Switching right and/or left, adjustable

--	⊕
----	---

<b>3SE5000-0AK00-1AJ0</b>	0.026
---------------------------	-------

3SE5000-0AK00-1AJ0



#### **Levers**

#### **Twist levers 21 mm, straight, type A acc. to EN 50047**

- Metal lever      Plastic roller
- High-grade steel lever      Plastic roller

19	⊕
19	⊕

<b>3SE5000-0AA21-1AJ0</b>	0.015
<b>3SE5000-0AA31-1AJ0</b>	0.015

3SE5000-0AA21-1AJ0



#### **Twist levers 100 mm, adjustable length, with grid hole**

- Metal lever      Plastic roller
- High-grade steel lever      Plastic roller

19	⊕
19	⊕

<b>3SE5000-0AA60-1AJ0</b>	0.040
<b>3SE5000-0AA62-1AJ0</b>	0.031

3SE5000-0AA60-1AJ0

⊕ Positively driven actuator, necessary in safety circuits.



## Position and safety switches

SIRIUS 3SE5 mechanical position switches for ambient temperatures down to -40 °C

Shock and vibration test according to railway standard

### SIRIUS 3SE5 mechanical position switches > 3SE5, metal enclosures

#### Enclosure width 40 mm according to EN 50041 / 56 mm, XL

Complete units

2, 3 or 4 contacts · Degree of protection IP66/IP67 · With increased corrosion protection

Version	Contacts	Complete units	Weight
		Article No.	kg
<b>Complete units · Enclosure width 40 mm · Cable entry 1 x (M20 x 1.5)</b>			
	<b>Rounded plungers, type B, acc. to EN 50041</b> With high-grade steel plunger 10 mm, with 3 mm overtravel • Snap-action contacts	1 NO + 1 NC	<input type="checkbox"/> <b>3SE5112-0CC02-1AJ0</b> 0.360
3SE5112-0CC02-1AJ0			
	<b>Roller plungers, type C, acc. to EN 50041</b> With high-grade steel plunger 13 mm, with 3 mm overtravel • Snap-action contacts	1 NO + 2 NC	<input type="checkbox"/> <b>3SE5112-0LD02-1AJ0</b> 0.365
3SE5112-0LD02-1AJ0			
	<b>Twist levers, type A, acc. to EN 50041</b> With high-grade steel lever 27 mm and plastic roller 19 mm • Snap-action contacts	1 NO + 2 NC	<input type="checkbox"/> <b>3SE5112-0LH11-1AJ0</b> 0.348
3SE5112-0LH11-1AJ0			
	<b>Twist levers, adjustable length, acc. to EN 50041</b> With high-grade steel lever 100 mm, with grid hole and plastic roller 19 mm • Snap-action contacts	1 NO + 1 NC	<input type="checkbox"/> <b>3SE5112-0CH62-1AJ0</b> 0.360
3SE5112-0CH62-1AJ0			
<b>Complete units · Enclosure width 56 mm, XL · Cable entry 3 x (M20 x 1.5) · Operating points acc. to EN 50041</b>			
	<b>Twist levers</b> With high-grade steel lever 27 mm and high-grade steel roller 19 mm • Snap-action contacts	2 x (1 NO + 1 NC)	<input type="checkbox"/> <b>3SE5162-0CH12-1AN5</b> 0.500
3SE5162-0CH12-1AN5			
	<b>Twist levers, adjustable length</b> With metal lever 100 mm, with grid hole and plastic roller 19 mm • Snap-action contacts With high-grade steel lever 100 mm and high-grade steel roller 19 mm • Snap-action contacts	2 x (1 NO + 1 NC)	<input type="checkbox"/> <b>3SE5162-0CH60-1AJ0</b> 0.509 <input type="checkbox"/> <b>3SE5162-0CH63-1AN6</b> 0.511
3SE5162-0CH60-1AJ0			

⊕ Positive opening according to IEC 60947-5-1, Annex K or positively driven actuator, necessary in safety circuits.

#### Note:

If the device you require is not available as a complete unit, see "Modular system", page 2/343.



**Position and safety switches**

SIRIUS 3SE5 mechanical position switches for ambient temperatures down to -40 °C  
Shock and vibration test according to railway standard

**SIRIUS 3SE5 mechanical position switches > 3SE5, metal enclosures****Enclosure width 40 mm according to EN 50041 / 56 mm / 56 mm, XL**

Modular system

2, 3 or 4 contacts · Degree of protection IP66/IP67 · With increased corrosion protection

Version	Contacts		Modular system	Weight
			Article No.	kg
<b>Basic switches · Enclosure width 40 mm · Cable entry 1 x (M20 x 1.5)</b>				
	<b>Rounded plungers, acc. to EN 50041</b>			
	• Slow-action contacts	1 NO + 2 NC	⊕	<b>3SE5112-0KA00-1AJ0</b> 0.298
	• Snap-action contacts	1 NO + 1 NC	⊕	<b>3SE5112-0CA00-1AJ0</b> 0.297
		1 NO + 2 NC	⊕	<b>3SE5112-0LA00-1AJ0</b> 0.304
3SE5112-0CA00-1AJ0				
<b>Basic switches · Enclosure width 56 mm · Cable entry 3 x (M20 x 1.5)</b>				
	<b>Rounded plungers, operating points acc. to EN 50041</b>			
	• Slow-action contacts	1 NO + 2 NC	⊕	<b>3SE5122-0KA00-1AJ0</b> 0.395
	• Snap-action contacts	1 NO + 1 NC	⊕	<b>3SE5122-0CA00-1AJ0</b> 0.365
		1 NO + 2 NC	⊕	<b>3SE5122-0LA00-1AJ0</b> 0.380
3SE5122-0CA00-1AJ0				
<b>Basic switches · Enclosure width 56 mm, XL · Cable entry 3 x (M20 x 1.5)</b>				
	<b>Rounded plungers, operating points acc. to EN 50041</b>			
	• Slow-action contacts	2 x (1 NO + 1 NC)	⊕	<b>3SE5162-0BA00-1AJ0</b> 0.450
	• Snap-action contacts	2 x (1 NO + 1 NC)	⊕	<b>3SE5162-0CA00-1AJ0</b> 0.450
3SE5162-0BA00-1AJ0				

⊕ Positive opening according to IEC 60947-5-1, Annex K or positively driven actuator, necessary in safety circuits.

Note:







For the selection aid, see page 2/324.

## Position and safety switches

SIRIUS 3SE5 mechanical position switches for ambient temperatures down to -40 °C

Shock and vibration test according to railway standard

### SIRIUS 3SE5 mechanical position switches > 3SE5, metal enclosures

Version	Diameter	Modular system	Weight
	mm	Article No.	kg
<b>Operating mechanisms</b>			
	<b>Rounded plungers, type B, acc. to EN 50041</b>		
3SE5000-0AC02-1AJ0	<ul style="list-style-type: none"> <li>High-grade steel plunger, with 3 mm overtravel</li> </ul>	10	⊕
		<b>3SE5000-0AC02-1AJ0</b>	0.035
	<b>Roller plungers, type C, acc. to EN 50041</b>		
3SE5000-0AD02-1AJ0	<ul style="list-style-type: none"> <li>High-grade steel roller, with 3 mm overtravel</li> </ul>	10	⊕
		<b>3SE5000-0AD02-1AJ0</b>	0.055
	<b>Roller levers</b>		
3SE5000-0AE01-1AJ0	<ul style="list-style-type: none"> <li>Metal lever Plastic roller</li> <li>High-grade steel lever Plastic roller</li> </ul>	13	⊕
		<b>3SE5000-0AE01-1AJ0</b>	0.027
		<b>3SE5000-0AE03-1AJ0</b>	0.023
	<b>Angular roller levers</b>		
3SE5000-0AF01-1AJ0	<ul style="list-style-type: none"> <li>Metal lever Plastic roller</li> <li>High-grade steel lever Plastic roller</li> </ul>	13	⊕
		<b>3SE5000-0AF01-1AJ0</b>	0.040
		<b>3SE5000-0AF03-1AJ0</b>	0.035
<b>Twist actuators</b>			
	<b>Twist actuators, for 40/56/56 XL mm, EN 50041</b>		
3SE5000-0AH00-1AJ0	<ul style="list-style-type: none"> <li>Switching right and/or left, adjustable</li> </ul>	--	⊕
		<b>3SE5000-0AH00-1AJ0</b>	0.032
<b>Levers</b>			
	<b>Twist levers 27 mm, offset, type A, acc. to EN 50041</b>		
3SE5000-0AA01-1AJ0	<ul style="list-style-type: none"> <li>Metal lever Plastic roller</li> <li>High-grade steel lever Plastic roller</li> </ul>	19	⊕
		<b>3SE5000-0AA01-1AJ0</b>	0.017
		<b>3SE5000-0AA11-1AJ0</b>	0.030
	<b>Twist levers 100 mm, adjustable length, with grid hole</b>		
3SE5000-0AA60-1AJ0	<ul style="list-style-type: none"> <li>Metal lever Plastic roller</li> <li>High-grade steel lever Plastic roller</li> </ul>	19	⊕
		<b>3SE5000-0AA60-1AJ0</b>	0.040
		<b>3SE5000-0AA62-1AJ0</b>	0.031

⊕ Positively driven actuator, necessary in safety circuits.





**Position and safety switches**

SIRIUS 3SE5 mechanical position switches for ambient temperatures down to -40 °C  
Shock and vibration test according to railway standard

SIRIUS 3SE5 mechanical safety switches with separate actuator > 3SE5, plastic enclosures/metal enclosures





**Selection and ordering data****Enclosure width 31 mm acc. to EN 50047**Complete units

2 contacts · 5 directions of approach · Degree of protection IP65 · Cable entry 1 × (M20 × 1.5) · With increased corrosion protection

Version	Contacts	Complete units	Weight
		Article No.	kg
<b>Plastic enclosures · Enclosure width 31 mm acc. to EN 50047</b>			
	<ul style="list-style-type: none"> <li>• Slow-action contacts</li> </ul> 1 NO + 1 NC 	<b>3SE5232-0RV40-1AJ0</b>	0.115
<b>Metal enclosures · Enclosure width 40 mm acc. to EN 50041</b>			
	<b>With M12 device plug, 5-pole (125 V, 4 A)<sup>1)</sup></b> <ul style="list-style-type: none"> <li>• Slow-action contacts</li> </ul> 2 NC 	<b>3SE5114-0QV10-1AJ4</b>	0.479

 Positive opening according to IEC 60947-5-1, Annex K.

<sup>1)</sup> Pin assignments, see page 2/323.

Version	Article No.	Weight
		kg
<b>Accessories</b>		
	<b>Standard actuators</b> <ul style="list-style-type: none"> <li>• With transverse fixing, plastic, length 40 mm</li> </ul>	<b>3SE5000-0AW11</b> 0.004
	<b>High-grade steel actuators<sup>1)</sup></b> <ul style="list-style-type: none"> <li>• Length 75.6 mm</li> </ul>	<b>3SE5000-0AW51</b> 0.046
	<ul style="list-style-type: none"> <li>• With vertical fixing, length 53 mm</li> </ul>	<b>3SE5000-0AW52</b> 0.073
	<ul style="list-style-type: none"> <li>• With transverse fixing, length 47 mm</li> </ul>	<b>3SE5000-0AW53</b> 0.066
	<b>Universal radius actuators, heavy duty</b> <ul style="list-style-type: none"> <li>• High-grade steel actuators<sup>1)</sup>, length 77 mm</li> </ul>	<b>3SE5000-0AW57</b> 0.125

<sup>1)</sup> Suitable for extreme environmental conditions such as -40 °C.

## Position and safety switches

SIRIUS 3SE5 mechanical position switches for ambient temperatures down to -40 °C

Shock and vibration test according to railway standard

### SIRIUS 3SE5 mechanical safety switches with tumbler > 3SE5, plastic enclosures

#### Selection and ordering data

##### Enclosure width 54 mm

6 slow-action contacts · 5 directions of approach · Degree of protection IP66/IP67 · Cable entry 3 × (M20 × 1.5)

Tumbler <sup>1)</sup>	Solenoid, rated operational voltage	Complete units Position monitoring: Actuators: 1 NO + 2 NC Solenoid: 1 NO + 2 NC Article No.	Weight
	V		kg

#### 1 300 N locking force · Enclosure width 54 mm acc. to ISO 14119



3SE5322-0SL21-1AJ0

##### Spring-actuated locks

- With escape release from the front and emergency release from the back
- With auxiliary release
- With escape release from the back and auxiliary release from the front, head rotated 180°

24 DC



<b>3SE5322-0SL21-1AJ0</b>	0.860
<b>3SE5322-0SD21-1AJ0</b>	0.505
<b>3SE5322-0SG21-1AM5</b>	0.805

⊕ Positive opening according to IEC 60947-5-1, Annex K, or positively driven actuator, necessary in safety circuits.

<sup>1)</sup> Supplied without actuator. Please order separately.

Version	Article No.	Weight
		kg

#### Accessories



3SE5000-0AV01

##### Standard actuators

- Length 75.6 mm

<b>3SE5000-0AV01</b>	0.035
----------------------	-------



3SE5000-0AW51

##### High-grade steel actuators<sup>1)</sup>

- Length 75.6 mm

<b>3SE5000-0AW51</b>	0.046
----------------------	-------



3SE5000-0AW52

- With vertical fixing, length 53 mm

<b>3SE5000-0AW52</b>	0.073
----------------------	-------



3SE5000-0AW53

- With transverse fixing, length 47 mm

<b>3SE5000-0AW53</b>	0.066
----------------------	-------



3SE5000-0AW57

##### Universal radius actuators, heavy duty

- High-grade steel actuators<sup>1)</sup>, length 77 mm

<b>3SE5000-0AW57</b>	0.125
----------------------	-------

<sup>1)</sup> Suitable for extreme environmental conditions such as -40 °C.

### Overview



3SU1.0

#### Pushbuttons and indicator lights

##### Designs

Nominal diameter	22 mm		
Version	Plastic		
	Complete units <sup>1)</sup>	Compact units <sup>1)</sup>	Actuating/ signaling elements
<b>Actuators</b>			
Pushbuttons	✓	--	✓ see p. 2/366
Illuminated pushbuttons	✓	--	✓ see p. 2/367
Mushroom pushbuttons	✓	--	✓ see p. 2/369
EMERGENCY STOP mushroom pushbuttons	✓	--	✓ see p. 2/370
Selector switches	✓	--	✓ see p. 2/372
Key-operated switches	✓	--	✓ see p. 2/374
ID key-operated switches	--	--	✓ see p. 2/376
Twin pushbuttons	--	--	✓ see p. 2/368
Quadruple pushbuttons	--	--	✓ see p. 2/368
Toggle switches	--	--	✓ see p. 2/371
Coordinate switches	✓	--	✓ see p. 2/377
Sensor switches	--	✓	--
Potentiometers	--	✓	--
Pushbuttons with extended stroke	--	✓	--
<b>Indicators</b>			
Indicator lights	✓	--	✓ see p. 2/377
Indicator lights in illuminated pushbutton design	--	--	✓ see p. 2/377
Acoustic signaling devices	--	✓	--
<b>Modules</b>			
Contact modules	✓ see p. 2/386 to 2/388		
LED modules	✓		
AS-Interface modules	✓		
Electronic modules for IO-Link	✓		
Electronic modules for ID key-operated switches	✓		
Modules for PROFINET	✓		
Support terminals	✓		
<b>Connections</b>			
Screw terminals	✓	✓	✓
Spring-loaded terminals	✓	--	✓
Solder pins	--	--	✓
AS-Interface	✓	--	✓
IO-Link	--	--	✓
PROFINET	--	--	✓

✓ Available

-- Not available

<sup>1)</sup> see Catalog IC 10.

## Commanding and signaling devices

### SIRIUS ACT pushbuttons and indicator lights

#### Introduction

2



	3SU1.5			3SU1.6			3SB2
Pushbuttons and indicator lights							
Designs							
Nominal diameter	22 mm			30 mm			16 mm
Version	Metal, shiny			Metal, matte, flat			Plastic, round <sup>1)</sup>
	Complete units <sup>1)</sup>	Compact units <sup>1)</sup>	Actuating/ signaling elements <sup>1)</sup>	Complete units	Compact units	Actuating/ signaling elements	
Actuators							
Pushbuttons	✓	--	✓	--	--	✓ see p. 2/379	✓
Illuminated pushbuttons	✓	--	✓	--	--	✓ see p. 2/379	✓
Mushroom pushbuttons	✓	--	✓	--	--	--	--
EMERGENCY STOP mushroom pushbuttons	✓	--	✓	--	--	--	✓
Selector switches	✓	--	✓	--	--	✓ see p. 2/380	✓
Key-operated switches	✓	--	✓	--	--	✓ see p. 2/381	✓
Twin pushbuttons	--	--	✓	--	--	--	--
Toggle switches	--	--	✓	--	--	--	--
Coordinate switches	✓	--	✓	--	--	--	--
Potentiometers	--	✓	--	--	--	--	--
Pushbuttons with extended stroke	--	✓	--	--	--	--	--
Indicators							
Indicator lights	✓	--	✓	--	--	✓ see p. 2/381	✓
Acoustic signaling devices	--	✓	--	--	--	--	--
Modules							
Contact modules	✓ see p. 2/386 to 2/388						
LED modules	✓ see p. 2/390						
Wedge bases	--	--	--	--	--	--	✓
AS-Interface modules	✓						
Electronic modules for IO- Link	✓						
Electronic modules for ID key-operated switches	✓						
Modules for PROFINET	✓						
Support terminals	✓						
Connections							
Plug-in connection	--	--	--	--	--	--	✓
Screw terminals	✓	✓	✓	✓	✓	✓	--
Spring-loaded terminals	✓	✓	✓	✓	✓	✓	--
Solder pins	✓	✓	✓	✓	✓	✓	✓
AS-Interface	✓	✓	✓	✓	✓	✓	--
IO-Link	✓	✓	✓	✓	✓	✓	--
PROFINET	--	--	✓	--	--	✓	--

✓ Available

-- Not available

<sup>1)</sup> see Catalog IC 10.



	3SU18	3SU18 <sup>1)</sup>	3SE7 <sup>1)</sup>	3SE29, 3SE39 <sup>1)</sup>
	Enclosures	Two-hand operation consoles	Cable-operated switches	Foot switches
<b>Enclosures</b>				
Plastic	✓	✓	--	✓
Metal	✓	✓	✓	✓
<b>Actuators</b>				
Pushbuttons	✓	--	✓	✓
Illuminated pushbuttons	--	--	--	--
Mushroom pushbuttons	✓	✓	--	--
EMERGENCY STOP mushroom pushbuttons	✓	✓	✓	--
Selector switches	✓	--	--	--
Key-operated switches	✓	--	--	--
Cable-operated switches	--	--	✓	--
<b>Indicators</b>				
Indicator lights	✓	--	✓	--
Acoustic signaling devices	✓	--	--	--
<b>Modules</b> (see p. 2/388)				
1-pole/2-pole	✓/--	✓	--/✓	--/✓
3-pole/4-pole	--	--	✓	✓
<b>Connections</b>				
Screw terminals	✓	✓	✓	✓
AS-Interface	✓	--	--	--
IO-Link	✓	--	--	--
PROFINET	✓	--	--	--
Pages	see p. 2/392	--	--	--

✓ Available

-- Not available

<sup>1)</sup> see Catalog IC 10.

	8WD42, 8WD44 <sup>1)</sup>	8WD53 <sup>1)</sup>
	Signaling columns	Integrated signal lamps
<b>Enclosures</b>		
Plastic	✓	✓
<b>Illumination</b>		
Incandescent lamps	✓	✓
LEDs	✓	✓
Flashlights	✓	✓
<b>Connections</b>		
Screw terminals	✓	✓
Spring-loaded terminals	✓	--
AS-Interface	✓	--
IO-Link	✓	--

✓ Available

-- Not available

<sup>1)</sup> see Catalog IC 10.



## Commanding and signaling devices

### SIRIUS ACT pushbuttons and indicator lights

#### General data

#### Overview

2



SIRIUS ACT pushbuttons and indicator lights

#### **SIRIUS ACT – commanding and signaling**

SIRIUS ACT is a modular system of pushbuttons and indicator lights for front plate mounting and rear-mounted electrical modules. Thanks to SIRIUS ACT with PROFINET, pushbuttons and indicator lights can be connected directly via PROFINET to the controller and HMI devices – including with Safety functions. Engineering and commissioning are simplified by the TIA Portal.

#### Extensive portfolio

- Customized variants, e.g. special tumbler arrangements, labeling, equipped enclosures
- Communication-enabled thanks to direct interfacing to AS-Interface, IO-Link or PROFINET

#### Diverse possible applications

- National and international approvals
- Many trade approvals
- Short delivery times thanks to global availability

#### Standards

- IEC 60947-1
- IEC 60947-5-1
- IEC 60947-5-5 for EMERGENCY STOP devices

#### More information

Homepage, see [www.siemens.com/sirius-act](http://www.siemens.com/sirius-act)  
 Industry Mall, see [www.siemens.com/product?3SU1](http://www.siemens.com/product?3SU1)  
 For configurator, see [www.siemens.com/sirius-act/configurator](http://www.siemens.com/sirius-act/configurator)  
 Conversion tool, see [www.siemens.com/conversion-tool](http://www.siemens.com/conversion-tool)  
 System Manual, see <https://support.industry.siemens.com/cs/ww/en/view/107542462>  
 TIA Portal, see [www.siemens.com/TIA](http://www.siemens.com/TIA)  
 TIA Selection Tool Cloud (TST Cloud), see [www.siemens.com/tstcloud/?node=SiriusActConfigurator](http://www.siemens.com/tstcloud/?node=SiriusActConfigurator)



Video: SIRIUS ACT - Teaser trailer

# Commanding and signaling devices

## SIRIUS ACT pushbuttons and indicator lights

General data

### Configurator

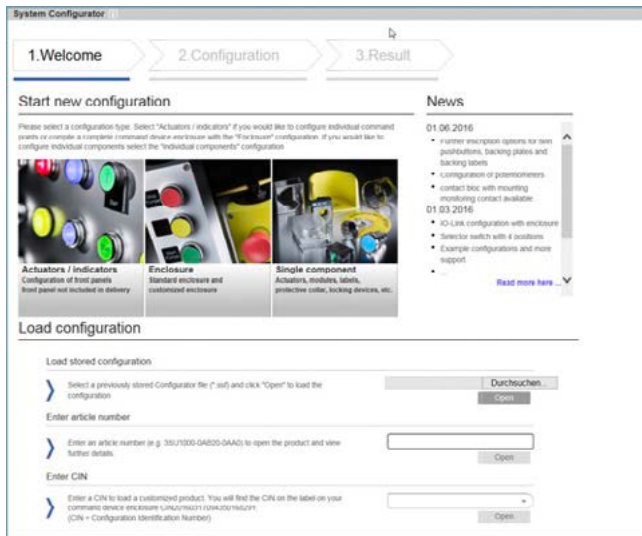

- Fast, simple selection by intuitive navigation through clearly-organized menus using drag & drop
- Image preview of selected components
- Inscription of pushbuttons and labeling plates using the interactive inscription tool
- Once created, a configuration can be ordered as often as required using the customer-specific article number and the CIN (Configuration Identification Number)
- Everything at a glance: Product data sheets, certificates, dimensional drawings, list prices, inscription tool



Video: SIRIUS ACT - Configurator

2

## Commanding and signaling devices

### SIRIUS ACT pushbuttons and indicator lights

#### General data

#### Benefits

##### Design



Video: SIRIUS ACT - Design

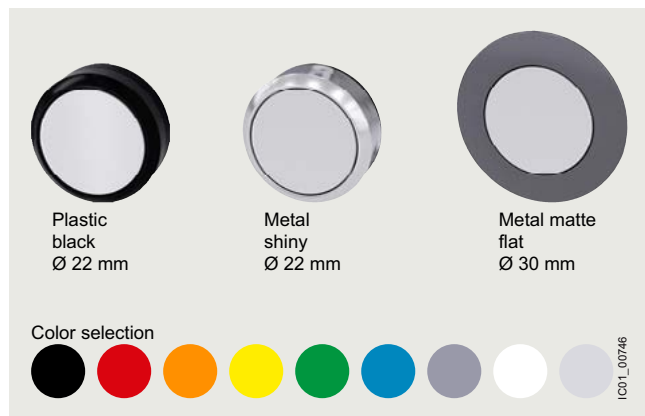

SIRIUS ACT is available in three design lines.

##### Ruggedness



Video: SIRIUS ACT - Ruggedness



- Degree of protection IP66, IP67, IP69 (IP69K)

##### IP66

6 = Protection against the ingress of dust

6 = Protection against powerful splashwater

##### IP67

6 = Protection against the ingress of dust

7 = Protection against temporary immersion

##### IP69 (IP69K)

6 = Protection against the ingress of dust

9 (9K) = Protection against water in high-pressure cleaning (approx. 80 bar) and high water jet temperatures (approx. 80 °C)

- Service life of 100 000 hours thanks to use of LEDs
- Media resistance (chemicals) thanks to solid stainless steel and high-grade plastics
- Mechanical service life of  $10 \times 10^6$  operating cycles
- Suitable for use in extreme environments
- Reliable, friction-locked fixing with just one screw
- Design stability according to use
- Simple geometry for mounting holes

##### Communication

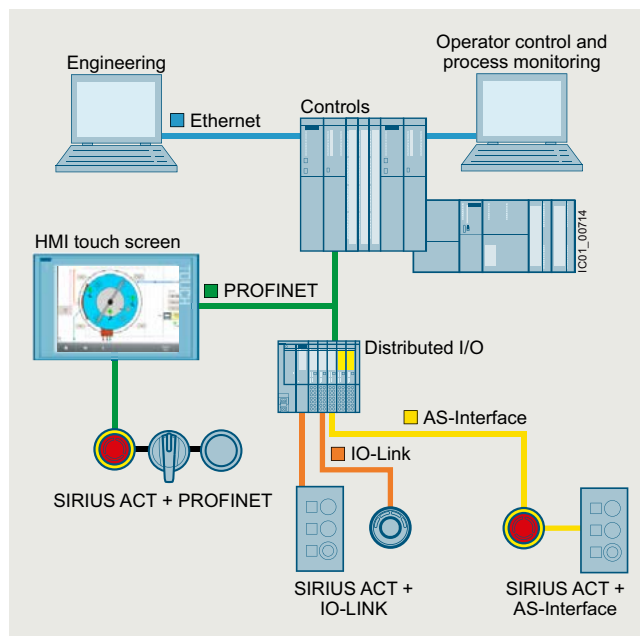

- Direct connection of the enclosure to AS-Interface or IO-Link
- Direct connection in the control cabinet to PROFINET, IO-Link or AS-Interface
- Can be integrated easily via the TIA Portal

##### Simple installation



Video: SIRIUS ACT - Installation

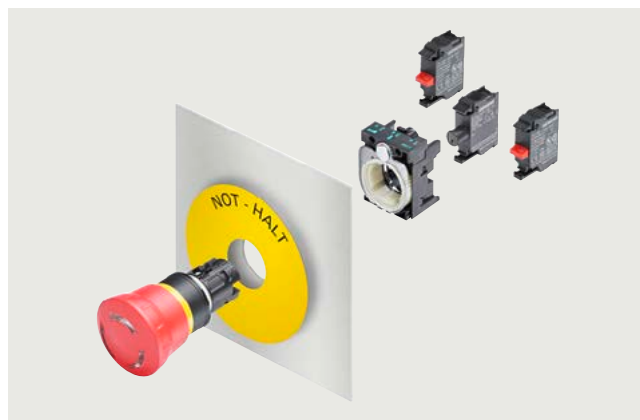

- Self-holding function of the actuator when mounting
- Twist prevention integrated into patented holder design
- Stackable contact modules
- Self-explanatory and fast installation using one hand
- Components can be mounted with holder removed
- No special tools required, simple size 2 screwdriver (cross-tip ISO 87641PZD1, flat-head ISO 2380-1 A/B 1x4.5) is sufficient

## Commanding and signaling devices

### SIRIUS ACT pushbuttons and indicator lights

General data

#### Mounting dimensions

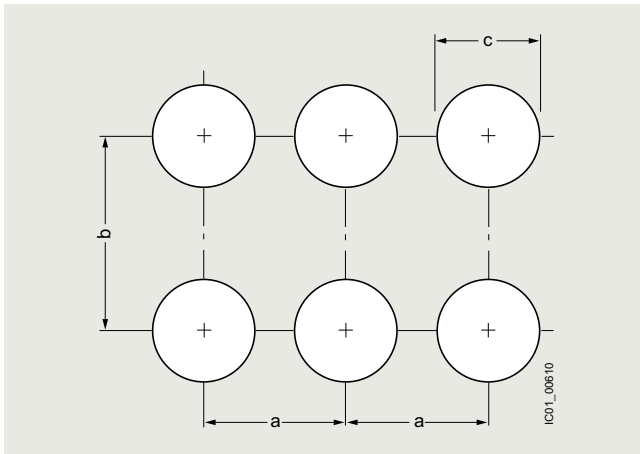

	Minimum clearance		
	a	b	c
	mm	mm	mm
<b>22 mm, plastic, black</b> <b>22 mm, metal, shiny</b> <b>For front plate thickness 1 ... 6 mm</b>			
3-slot holder	30	40	22.3 <sup>+0.4</sup>
4-slot holder	40	40	22.3 <sup>+0.4</sup>
<b>30 mm, metal, matte</b> <b>For front plate thickness 1 ... 4 mm</b>			
3-slot holder	40	45	30.5 <sup>+0.5</sup>

#### Versions

SIRIUS ACT is a modular system of pushbuttons and indicator lights with which customized variants can be configured flexibly.

One command point comprises:

- An actuating or signaling element in front of the control panel
- A holder for securing behind the control panel
- Up to six contact modules and/or one LED module (mounted on the holder), 1-pole contacts can be stacked
- A comprehensive range of accessories for inscription/markings

#### Complete units

Complete units made up of an actuating or signaling element, holder and contact modules and/or LED modules are offered for the most frequent application cases. The electrical parts are integrated and only have to be wired.

#### Compact units

Signaling devices, sensor switches, pushbuttons with extended stroke and potentiometers are available as compact units. The electronic circuitry is already integrated in these devices, i.e. it is not necessary to snap on a contact or LED module.



- 1 Actuator
- 2 Holder
- 3 LED module
- 4 NO contact



- 1 Acoustic signaling device
- 2 Holder

#### Complete units<sup>1)</sup>

Plastic, black

Metal, shiny

<sup>1)</sup> see Catalog IC 10.

#### Compact units<sup>1)</sup>

Plastic, black

Metal, shiny

## Commanding and signaling devices

### SIRIUS ACT pushbuttons and indicator lights

#### General data

#### Actuating and signaling elements

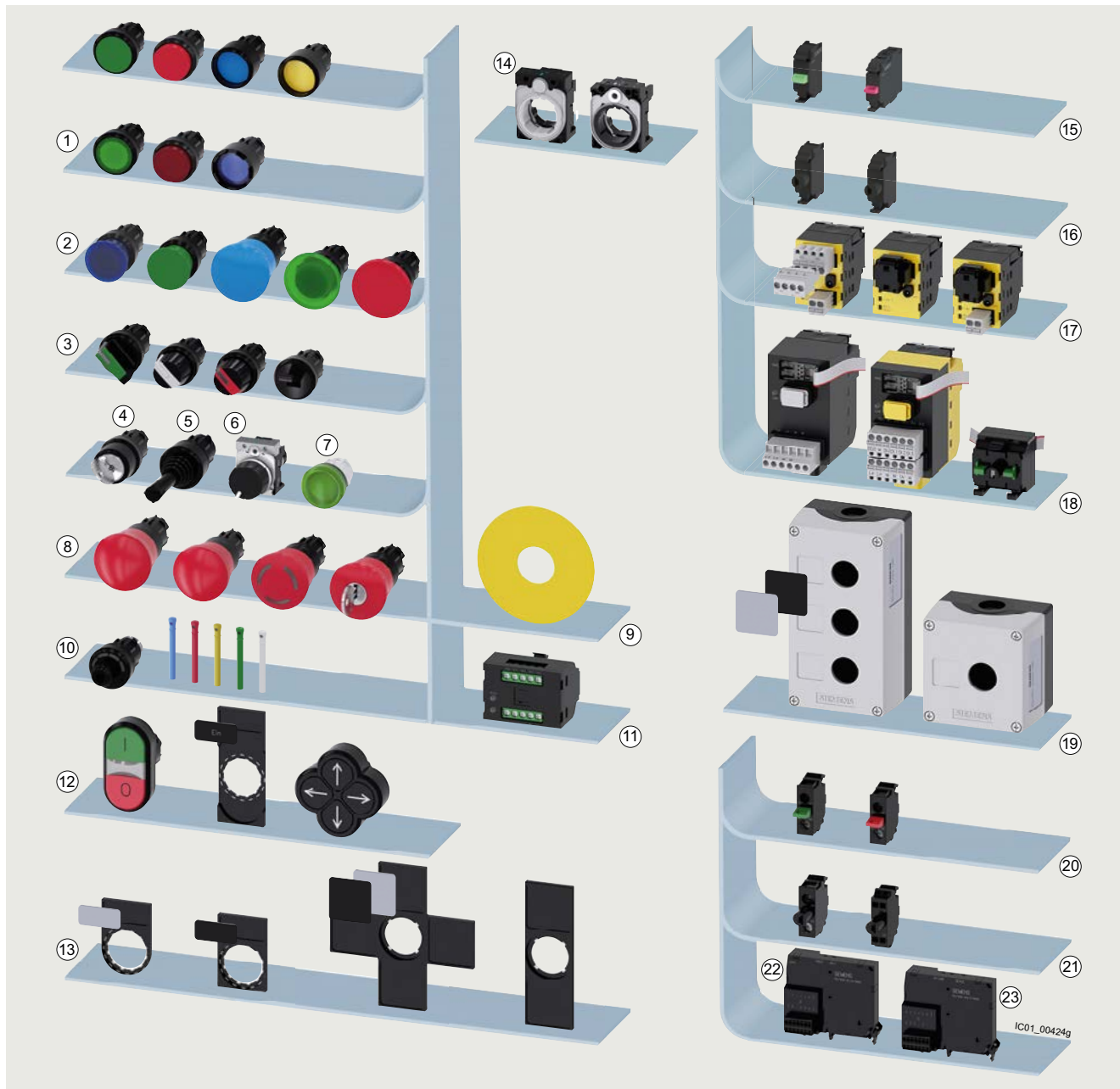

System overview of SIRIUS ACT pushbuttons and indicator lights from the plastic design line, pushbuttons and indicator lights available in three design lines.

Actuating and signaling elements	Pages	Modules for front plate mounting	Pages
① Pushbuttons, illuminated pushbuttons	--	⑮ Contact modules	From 2/386
② Mushroom pushbuttons	--	⑯ LED modules	--
③ Selector switches, toggle switches	2/371, 2/372	⑰ AS-Interface modules	--
④⑤ Key-operated switches, coordinate switches	2/374, 2/377	⑱ Electronic modules for IO-Link	--
⑥⑦ Potentiometers, indicator lights	2/377	⑲ Modules for PROFINET: Interface modules, fail-safe interface modules, terminal modules	--
⑧⑨ EMERGENCY STOP mushroom pushbuttons, backing plates	--		
⑩ ID key-operated switches, ID keys	2/376	<b>Enclosures</b>	<b>Pages</b>
⑪ Electronic modules for ID key-operated switches	--	⑳ Enclosures	From 2/392
⑫ Twin pushbuttons, label holders, labeling plates, quadruple pushbuttons	2/368	<b>Modules for floor mounting</b>	<b>Pages</b>
<b>Holders and labels</b>	<b>Pages</b>	㉑ Contact modules	From 2/388
⑬ Label holders, labeling plates	From 2/397	㉒ LED modules	From 2/390
⑭ Holder	From 2/385	㉓ AS-Interface modules	--
		㉔ Electronic modules for IO-Link	--

## Commanding and signaling devices

### SIRIUS ACT pushbuttons and indicator lights

#### General data

#### ID key-operated switches

Groups of employees or individuals can be authenticated by means of the ID key-operated switch. The ID key-operated switch is electronic and has four switch positions that are selected by keys with different codes. Using the four ID keys with different codes, it is possible to select 1 to 4 positions. The ID keys are color-coded (yellow, blue, red, green, white) so that they can be clearly differentiated at a glance and used flexibly thanks to four function levels.



Video: SIRIUS ACT ID key-operated switches

#### RFID authentication solutions

Groups of employees or individuals can be authenticated by means of the ID key-operated switch. Color-coded keys for easy distinction between users.

Different versions of ID key-operated switches are available depending on the following features:

- Front ring material
- Conventional variant: 1 + 4 non-isolated outputs
- Variant with IO-Link: Option of individual coding

#### Operation:

Insert ID key, turn key to select the position. Standard keys can also be used in conjunction with the electronic module for ID key-operated switches with IO-Link function. The white ID key is supplied without coding.



**3SU1000-4WS10-0AA0**  
Plastic, black



**3SU1500-0AA10-0AA0**  
Holder, plastic



**3SU1550-0AA10-0AA0**  
Holder, universal

#### ID key-operated switches

<b>Number of switching positions</b>	4
<b>Operating angle</b>	45°
<b>Operating principle</b>	Latching
<b>Switch position for key removal</b>	Key removal possible in all 4 positions
<b>Color</b>	Black
<b>Pages</b>	2/376



**3SU1400-1GC10-1AA0<sup>1)</sup>**



**3SU1400-1GD10-1AA0<sup>1)</sup>**

#### Electronic modules for ID key-operated switches

<b>Type of power supply</b>	--	Via IO-Link master
<b>Protocol is supported</b>	--	IO-Link protocol
<b>Number of NO contacts</b>	5	5
<b>IO-Link transfer rate</b>	--	COM2 (38.4 kBaud)

<sup>1)</sup> see Catalog IC 10.



**3SU1900-0FU60-0AA0**

**ID keys ID group individual**



**3SU1900-0FV40-0AA0**  
**3SU1900-0FW30-0AA0**  
**3SU1900-0FX20-0AA0**  
**3SU1900-0FY50-0AA0**

**ID keys**

#### ID keys

<b>Material</b>	Plastic	Plastic
<b>Version of RFID coding</b>	Individually coded, programmable several times	ID group 1 ID group 2 ID group 3 ID group 4
<b>Color</b>	White	Green Yellow Red Blue
<b>Pages</b>	2/422	2/422









## Commanding and signaling devices

### SIRIUS ACT pushbuttons and indicator lights

#### General data

##### Article No. scheme

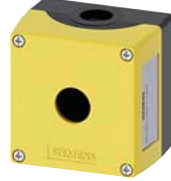
##### Device types

						
<b>3SU10</b>	<b>3SU11</b>	<b>3SU12</b>	<b>3SU14</b>	<b>3SU15</b>	<b>3SU18</b>	<b>3SU19</b>
<b>Device types</b>						
<b>Actuating and signaling elements</b>	<b>Complete units</b>	<b>Compact units</b>	<b>Modules for actuators and indicators</b>	<b>Holders with module</b>	<b>Enclosures</b>	<b>Accessories</b>

##### Actuating and signaling elements

Product versions		Article number														
<b>SIRIUS ACT pushbuttons and indicator lights</b>		<b>3SU1</b>	<input type="checkbox"/>	<input type="checkbox"/>	<input type="checkbox"/>	<input type="checkbox"/>	<input type="checkbox"/>	<input type="checkbox"/>	<input type="checkbox"/>	<input type="checkbox"/>	<input type="checkbox"/>					
Device type	Actuating and signaling elements	0														
Material (front ring)	Plastic, black Metal, shiny Metal, matte	0 5 6														
Illumination	Non-illuminated Illuminated/transparent Illuminated/non-illuminated	0 1 2														
Type of actuator/indicator	Pushbutton Mushroom pushbutton/EMERGENCY STOP mushroom pushbutton/sensor switch Selector switch Twin pushbutton, toggle switch, quadruple pushbutton Key-operated switch Indicator light/acoustic signaling device Coordinate switch	0 1  2 3 4/5 6 7														
Design of the actuator/lock	e.g. A = Flat							<input type="checkbox"/>								
Function	e.g. B = Momentary contact								<input type="checkbox"/>							
Color/key removal position	e.g. 10 = Black, 20 = Red								<input type="checkbox"/>	<input type="checkbox"/>						
Connection type	None										0					
Module/holder equipment	e.g. A = Without module, without holder										<input type="checkbox"/>					
Marking	e.g. A = None, C = "I", D = "O", R = "R"										<input type="checkbox"/>					
Ambient condition	Standard ATEX Zone 1-2: Intrinsic safety										0 2					
<b>Example</b>		<b>3SU1</b>	<b>0</b>	<b>0</b>	<b>0</b>	<b>-</b>	<b>0</b>	<b>A</b>	<b>B</b>	<b>1</b>	<b>0</b>	<b>-</b>	<b>0</b>	<b>A</b>	<b>A</b>	<b>0</b>

##### Note:

The Article No. scheme shows an overview of product versions for better understanding of the logic behind the article numbers.

For your orders, please use the article numbers quoted in the selection and ordering data.

## Commanding and signaling devices

### SIRIUS ACT pushbuttons and indicator lights

General data

#### Complete units

Product versions		Article number									
SIRIUS ACT pushbuttons and indicator lights		3SU1	□	□	□	-	□	□	□	□	□
Device type	Complete units	1									
Material (front ring)	Plastic, black	0									
	Metal, shiny	5									
	Metal, matte	6									
Illumination	Non-illuminated	0									
	Illuminated (with/without LED, various voltages)	1									
		...	8								
Type of actuator/indicator	Pushbutton	0									
	Mushroom pushbutton/EMERGENCY STOP mushroom pushbutton/sensor switch	1									
	Selector switch	2									
	Twin pushbutton, toggle switch	3									
	Key-operated switch	4/5									
	Indicator light/acoustic signaling device	6									
	Coordinate switch	7									
Design of the actuator/lock	e.g. A = Flat									□	
Function	e.g. B = Momentary contact									□	
Color/key removal position	e.g. 10 = Black, 20 = Red									□	□
Connection type	Screw terminals										1
	Spring-loaded terminals										3
Module/holder equipment including contact material	e.g.										□
	A = Without module, with holder										
	B = 1 NO contact with holder										
	C = 1 NC contact with holder										
Marking	e.g. A = None, C = "I", D = "O", R = "R"										□
Ambient condition	Standard										0
	ATEX Zone 1-2: Intrinsic safety										2
<b>Example</b>		<b>3SU1</b>	<b>1</b>	<b>0</b>	<b>0</b>	<b>-</b>	<b>0</b>	<b>A</b>	<b>B</b>	<b>1</b>	<b>0</b>
											<b>-</b>
											<b>1</b>
											<b>B</b>
											<b>A</b>
											<b>0</b>

#### Compact units

Product versions		Article number									
SIRIUS ACT pushbuttons and indicator lights		3SU1	□	□	□	-	□	□	□	□	□
Device type	Compact units	2									
Material (front ring)	Plastic, black	0									
	Metal, shiny	5									
	Metal, matte	6									
Illumination	Non-illuminated	0									
	Illuminated/non-illuminated	1									
Type of actuator/indicator	Pushbutton	0									
	Sensor switch	1									
	Potentiometers	2									
	Acoustic signaling devices	6									
Design of the actuator/lock	e.g. A = Flat										□
Function (voltage/resistance)	e.g. B = 24 V AC/DC										□
Color	e.g. 10 = Black, 20 = Red										□
Connection type	None										0
	Screw terminals										1
	M12 connection, 4-pole										2
	Spring-loaded terminals										3
Module/holder equipment including contact material	e.g.										□
	A = Without module, without holder										
	B = 1 NO contact with holder										
	C = 1 NC contact with holder										
Marking	e.g. A = None										□
Ambient condition	Standard										0
	ATEX Zone 1-2: Intrinsic safety										2
<b>Example</b>		<b>3SU1</b>	<b>2</b>	<b>0</b>	<b>1</b>	<b>-</b>	<b>6</b>	<b>A</b>	<b>B</b>	<b>1</b>	<b>0</b>
											<b>-</b>
											<b>1</b>
											<b>A</b>
											<b>A</b>
											<b>0</b>

#### Note:

The Article No. schemes show an overview of product versions for better understanding of the logic behind the article numbers.

For your orders, please use the article numbers quoted in the selection and ordering data.



## Commanding and signaling devices

### SIRIUS ACT pushbuttons and indicator lights

#### General data

##### Modules for actuators and indicators

Product versions		Article number														
SIRIUS ACT pushbuttons and indicator lights		3	S	U	1	□	□	□	-	□	□	□	□	□	□	
Device type	Modules for actuators and indicators	4														
Material (front ring)	Plastic, black	0														
Illumination	Non-illuminated	0														
	Illuminated	1														
Fixing method	Front plate mounting					1										
	Floor mounting					2										
	Printed circuit board					3										
Module type	Contact module									A						
	LED module									B						
	LED test module									C						
	Support terminal									D						
	AS-Interface module									E						
	Electronic module for ID key-operated switches									G						
	Interface modules for PROFINET									L						
Terminal modules									M							
Function/voltage	e.g. B = 24 V AC/DC										□					
Color	e.g. 10 = Black, 20 = Red										□	□				
Connection type	Screw terminals												1			
	Screw terminals + insulation piercing method												2			
	Spring-loaded terminals												3			
	Spring-loaded terminals + insulation piercing method												4			
	Socket terminals												5			
Module equipment including contact material	e.g. A = None B = 1 NO contact, silver C = 1 NC contact, silver												□			
Marking	None													A		
Ambient condition	Standard													0		
	ATEX Zone 1-2: Intrinsic safety													2		
<b>Example</b>		<b>3SU1</b>	<b>4</b>	<b>0</b>	<b>0</b>	<b>-</b>	<b>1</b>	<b>A</b>	<b>A</b>	<b>1</b>	<b>0</b>	<b>-</b>	<b>1</b>	<b>B</b>	<b>A</b>	<b>0</b>

##### Holders

Product versions		Article number														
SIRIUS ACT pushbuttons and indicator lights		3	S	U	1	□	□	□	-	□	□	□	□	□	□	
Device type	Holder	5														
Material (front ring)	Plastic, black	0														
	Metal, shiny	1														
	Universal for plastic and metal	5														
Illumination	Non-illuminated	0														
	Illuminated	1														
Fixing method	Without					0										
	Front plate mounting					1										
Holder type	3x A									A						
	4x B									B						
Function/voltage	Without									A						
	6 ... 24 V AC/DC									G						
Color	e.g. 10 = Black, 20 = Red										□	□				
Connection type	None												1			
	Screw terminals												2			
Module equipment including contact material and slot	e.g. A = None B = 1 NO contact, silver C = 1 NC contact, silver												□			
Marking	None													A		
Ambient condition	Standard													0		
	ATEX Zone 1-2: Intrinsic safety													2		
<b>Example</b>		<b>3SU1</b>	<b>5</b>	<b>0</b>	<b>0</b>	<b>-</b>	<b>0</b>	<b>A</b>	<b>A</b>	<b>1</b>	<b>0</b>	<b>-</b>	<b>0</b>	<b>A</b>	<b>A</b>	<b>0</b>

##### Note:

The Article No. schemes show an overview of product versions for better understanding of the logic behind the article numbers.

For your orders, please use the article numbers quoted in the selection and ordering data.

## Commanding and signaling devices

### SIRIUS ACT pushbuttons and indicator lights

#### General data

#### Enclosures

Product versions		Article number												
SIRIUS ACT pushbuttons and indicator lights		3SU1	□	□	□	-	□	□	□	□	□	□	□	□
Device type	Enclosures	8												
Material (enclosure/front ring)	Plastic, black plastic	0												
	Metal, shiny metal	5												
Number of command points	Command point	1												
	... Command points	6												
Type of enclosure	Surface-mounting	0												
	4-position selector switch and coordinate switch	1												
	Palm pushbutton	2												
	Two-hand operation console	3												
Equipment	e.g. command point, inscription, module								□	□				
Communication capability	Without										0			
	AS-i										1			
Ambient condition	Standard										0			
	ATEX Zone 1-2: Intrinsic safety										2			
Mounting/connection of modules	None											0		
	Front plate mounting, screw terminals											1		
	Floor mounting, screw terminals											2		
	Front mounting, spring-loaded terminals											3		
	Floor mounting, spring-loaded terminals											4		
Cable exit from enclosure	None												A	
	Direct entry of AS-i flat cable at top/on right												G	
	AS-i insulation piercing method at top/on right												H	
Design of enclosure top	Center command point												A	
	With recess for labeling plate												B	
	With protective collar												C	
	4 additional holes (two-hand operation console)												D	
	8 additional premachined breaking points (two-hand operation console)												E	
Color of enclosure top	Gray													1
	Yellow													2

#### Example

3SU1 8 0 1 - 0 A A 0 0 - 0 A A 2

#### Accessories

Product versions		Article number												
SIRIUS ACT pushbuttons and indicator lights		3SU1	□	□	□	-	□	□	□	□	□	□	□	□
Device type	Accessories	9												
Material	Plastic, black	0												
	Metal, shiny	5												
	Metal, matte	6												
Illumination	Non-illuminated	0												
	Illuminated	1												
Type of accessory (labels, protection, actuator, enclosure)	e.g. 0AB = Insert label								□	□	□			
Color	e.g. 10 = Black, 20 = Red											□	□	
Marking	e.g.												□	□
	0AA = None													
	0AB = ON													
	0AT = EMERGENCY STOP													
Ambient condition	Standard													0
	ATEX Zone 1-2: Intrinsic safety													2

#### Example

3SU1 9 0 0 - 0 A B 2 0 - 0 A B 0

#### Note:

The Article No. schemes show an overview of product versions for better understanding of the logic behind the article numbers.

For your orders, please use the article numbers quoted in the selection and ordering data.

## Commanding and signaling devices

### SIRIUS ACT pushbuttons and indicator lights

#### General data

##### Ordering notes for multi-unit packaging

SIRIUS ACT pushbuttons and indicator lights can also be ordered in various types of practical, environment-friendly multi-unit packaging.

##### Multi-unit packaging with order code X90

When ordering products in multi-unit packaging, the Article No. of the product concerned must be supplemented with **"-Z"** and, in addition, the order code **X90** must be specified.

Ordering example:  
3SU1000-OAB20-0AA0-Z X90;  
pack of 100



Examples of multi-unit packaging with order code X90

SIRIUS ACT pushbuttons and indicator lights	Multi-unit, quantity per package X90
Complete units (3SU11)	20
Compact units (3SU12)	
• Acoustic signaling devices, pushbuttons with extended stroke, potentiometers	50
Actuating and signaling elements (3SU10)	
• Pushbuttons, illuminated pushbuttons, indicator lights	100
• Stop switches, twin pushbuttons, mushroom pushbuttons 30/40 mm, EMERGENCY STOP mushroom pushbuttons 30/40 mm, toggle switches, selector switches, key-operated switches, ID key-operated switches, coordinate switches	50
• Mushroom pushbuttons 60 mm, EMERGENCY STOP mushroom pushbuttons 60 mm	40
Holders without module (3SU15)	100
Modules for actuators and indicators (3SU14)	
• Contact modules	150
• LED modules	50
Enclosures (3SU18)	
• Empty plastic enclosures	
- 3SU1801-0AA00-0AA2, 3SU1801-0AA00-0AB1	24
- 3SU1801-0AA00-0AC2	18
Accessories (3SU19)	
• Sealing plugs, label holders, EMERGENCY STOP backing plates, labeling plates for potentiometers, EMERGENCY STOP labeling plates for enclosures without recesses and without inscription, single frames, dust caps for key-operated switches, adapters for mounting on standard rails, protective collars for EMERGENCY STOP mushroom pushbuttons (40 mm, for 5 padlocks, yellow)	100
• Labeling plates	150

##### Multi-unit packaging with order code X05

When ordering products in multi-unit packaging, the Article No. of the product concerned must be supplemented with **"-Z"** and, in addition, the order code **X05** must be specified.

Ordering example:  
3SU1500-OAA10-0AA0-Z X05;  
pack of 5



Examples of multi-unit packaging with order code X05

SIRIUS ACT pushbuttons and indicator lights	Multi-unit, quantity per package X05
Holders without module (3SU15)	
• Plastic: 3SU1500-OAA10-0AA0	5
• Metal: 3SU1510-OAA10-0AA0	5
• Universal for plastic and metal: 3SU1550-OAA10-0AA0	5
Modules for actuators and indicators (3SU14)	
• Contact modules for front plate mounting	5
- Screw terminals: 3SU1400-1AA10-1BA0, 3SU1400-1AA10-1CA0	
- Spring-loaded terminals: 3SU1400-1AA10-3BA0, 3SU1400-1AA10-3CA0	
• LED modules for front plate mounting	5
- Screw terminals: 3SU1401-1BB00-1AA0, 3SU1401-1BB20-1AA0, 3SU1401-1BB30-1AA0, 3SU1401-1BB40-1AA0, 3SU1401-1BB50-1AA0, 3SU1401-1BB60-1AA0	
- Spring-loaded terminals: 3SU1401-1BB00-3AA0, 3SU1401-1BB20-3AA0, 3SU1401-1BB30-3AA0, 3SU1401-1BB40-3AA0, 3SU1401-1BB50-3AA0, 3SU1401-1BB60-3AA0	
• LED modules for floor mounting	5
- Screw terminals: 3SU1401-2BB00-1AA0, 3SU1401-2BB20-1AA0, 3SU1401-2BB30-1AA0, 3SU1401-2BB40-1AA0, 3SU1401-2BB50-1AA0, 3SU1401-2BB60-1AA0	
- Spring-loaded terminals: 3SU1401-2BB00-3AA0, 3SU1401-2BB20-3AA0, 3SU1401-2BB30-3AA0, 3SU1401-2BB40-3AA0, 3SU1401-2BB50-3AA0, 3SU1401-2BB60-3AA0	

### Application

#### Environmental conditions

The pushbuttons and indicator lights are climate-proof (KTW 24) and suitable for standard industrial applications and operation in marine applications.

#### Simple electrical equipment

Non-illuminated actuators, contact modules, enclosures and special accessories can be classified as simple electrical equipment according to IEC 60079-11. This means that they may be used in intrinsically safe circuits in potentially explosive atmospheres. An overview of the devices and atmospheres can be found in Confirmation No. 3287.01.

#### Safety EMERGENCY STOP pushbuttons according to ISO 13850

For controls according to IEC 60204-1, the SIRIUS ACT mushroom pushbuttons are suitable for use as safety EMERGENCY STOP pushbuttons.

#### Safety circuits

Standard IEC 60947-5-1 requires positive opening. This means that for the purpose of personal safety, the reliable opening of NC contacts in all safety circuits is expressly prescribed for the electrical equipment of machines and is designated according to IEC 60947-5-1 with the symbol (⊖).

PL e according to ISO 13849-1 can be attained with the EMERGENCY STOP mushroom pushbuttons if the corresponding fail-safe evaluation units are selected and correctly installed, e.g. the 3SK safety relays or matching units from the ASIsafe, SIMATIC or SINUMERIK product ranges.

### Technical specifications

#### More information

Industry Mall, see [www.siemens.com/product?3SU1](http://www.siemens.com/product?3SU1)

For configurator, see [www.siemens.com/sirius-act/configurator](http://www.siemens.com/sirius-act/configurator)

Conversion tool, see [www.siemens.com/conversion-tool](http://www.siemens.com/conversion-tool)

System Manual, see <https://support.industry.siemens.com/cs/ww/en/view/107542462>

Type	3SU1..0-AA 3SU1..0-JA	3SU1..1-AA 3SU1..1-JA	3SU1..0-AB 3SU1..0-BB 3SU1..0-CB 3SU1..0-DB 3SU1..0-JB	3SU1..1-AB 3SU1..1-BB 3SU1..1-JB	3SU10.0-FB
Type of product	Pushbuttons				
Operating principle of the actuating element	Latching		Momentary contact		
Optional expansion of product by light source	No	Yes	No	Yes	No
Mechanical service life (operating cycles) typical	500 000		10 000 000	3 000 000	200 000
Switching frequency, maximum	1/h	1 800	3 600		
Shock resistance according to IEC 60068-2-27	Half-sine wave 50 g / 11 ms				
Vibration resistance according to IEC 60068-2-6	10 ... 500 Hz: 5 g				
Degree of protection IP	IP66, IP67, IP69 (IP69K)				IP65, IP66
Environmental category during operation according to IEC 60721	3M6, 3S2, 3B2, 3C3, 3K6 (with a relative air humidity of 10 ... 95%)				
Ambient temperature					
• During operation	°C	-25 ... +70			
• During storage	°C	-40 ... +80			

## Commanding and signaling devices

### SIRIUS ACT pushbuttons and indicator lights



#### General data

Type	3SU1.00-AA 3SU1.00-BA 3SU1.00-CA 3SU1.50-AA 3SU1.50-BA 3SU1.50-CA	3SU1.50-EA	3SU1.01-AA 3SU1.01-BA 3SU1.51-AA 3SU1.51-BA 3SU1.51-CA	3SU1.00-AD 3SU1.00-BD 3SU1.00-CD 3SU1.50-AD 3SU1.50-BD 3SU1.50-CD	3SU1.50-ED	3SU1.01-AD 3SU1.01-BD
Type of product	<b>Mushroom pushbuttons</b>					
Operating principle of the actuating element	Latching			Momentary contact		
Optional expansion of product by light source	No		Yes	No		Yes
Mechanical service life (operating cycles) typical	500 000	300 000	500 000	10 000 000	300 000	3 000 000
Switching frequency, maximum	1/h	1 800		3 600	1 800	3 600
Shock resistance according to IEC 60068-2-27	Half-sine wave 50 g / 11 ms					
Vibration resistance according to IEC 60068-2-6	10 ... 500 Hz: 5 g					
Degree of protection IP	IP66, IP67, IP69 (IP69K)	IP65, IP67, IP69 (IP69K)	IP66, IP67, IP69 (IP69K)		IP65, IP67, IP69 (IP69K)	IP66, IP67, IP69 (IP69K)
Environmental category during operation according to IEC 60721	3M6, 3S2, 3B2, 3C3, 3K6 (with a relative air humidity of 10 ... 95%)					
Ambient temperature						
• During operation	°C	-25 ... +70				
• During storage	°C	-40 ... +80				
Type	<b>3SU1...-J 3SU1...-H 3SU1...-G</b>					
Type of product	<b>EMERGENCY STOP mushroom pushbuttons</b>					
Mechanical service life (operating cycles)	300 000					
Switching frequency, maximum	1/h	600				
Shock resistance according to IEC 60068-2-27	Half-sine wave 50 g / 11 ms					
Vibration resistance according to IEC 60068-2-6	10 ... 500 Hz: 5 g					
Degree of protection IP	IP66, IP67, IP69 (IP69K)					
Environmental category during operation according to IEC 60721	3M6, 3S2, 3B2, 3C3, 3K6 (with a relative air humidity of 10 ... 95%)					
Ambient temperature						
• During operation	°C	-25 ... +70				
• During storage	°C	-40 ... +80				
Type	3SU1.5.-2A 3SU1.5.-2B 3SU1.5.-2C 3SU1.5.-2D 3SU1.5.-2E	3SU1.0.-2A 3SU1.0.-2B 3SU1.0.-2C	3SU1.0.-3E 3SU1.5.-3E	3SU1.0.-4B 3SU1.0.-4C 3SU1.0.-4D 3SU1.0.-4F 3SU1.0.-4G 3SU1.0.-4H 3SU1.0.-4J 3SU1.0.-4L 3SU1.0.-5B 3SU1.0.-5H 3SU1.0.-5P 3SU1.0.-5Q 3SU1.0.-5R 3SU1.0.-5S 3SU1.0.-5T 3SU1.0.-5X	3SU1...-4B 3SU1...-4C 3SU1...-4D 3SU1...-4F 3SU1...-4G 3SU1...-4H 3SU1...-4J 3SU1...-4L 3SU1...-5B 3SU1...-5H 3SU1...-5K 3SU1...-5P 3SU1...-5Q 3SU1...-5R 3SU1...-5S 3SU1...-5T 3SU1...-5X	3SU1.0.-7A 3SU1.0.-7B 3SU1.5.-7A 3SU1.5.-7B
Type of product	<b>Selector switches</b>		<b>Toggle switches</b>	<b>Key-operated switches</b>		<b>Coordinate switches</b>
Mechanical service life (operating cycles)	300 000	1 000 000		300 000		250 000
Switching frequency, maximum	1/h	1 800		3 600		
Shock resistance according to IEC 60068-2-27	Half-sine wave 50 g / 11 ms					
Vibration resistance according to IEC 60068-2-6	10 ... 500 Hz: 5 g					
Degree of protection IP	IP66, IP67, IP69 (IP69K)		IP66, IP67, IP69 (IP69K)	IP66, IP67, IP69 (IP69K)		IP65, IP67
Ambient temperature						
• During operation	°C	-25 ... +70				
• During storage	°C	-40 ... +80				

## Commanding and signaling devices

### SIRIUS ACT pushbuttons and indicator lights



#### General data

Type	3SU1400- .AA10-1.A0	3SU1400- 1AA10-1GA0, 3SU1400- 1AA10-1RA0	3SU1400- 1AA10-1HA0	3SU1400- .AA10-3.A0	3SU1400- 1AA10-3HA0	3SU1400- 3AA10-5.A0
Type of product	<b>Contact modules</b>					
<b>Rated insulation voltage</b>	V	500				
<b>Pollution degree</b>		3				
<b>Impulse withstand voltage, rated value</b>	kV	6				
<b>Operational voltage type</b>		AC/DC				
<b>Operational voltage, rated value</b>						
• At AC at 50 Hz	V	5 ... 500				
• At DC	V	5 ... 500				
<b>Thermal current</b>	A	10				
<b>Operational current, rated value</b>						
• At AC-12						
- At 24 V	A	10				
- At 230 V	A	8				
• At AC-15						
- At 24 V	A	6				
- At 230 V	A	6				
- At 400 V	A	3				
- At 500 V	A	1.4				
• At DC-12						
- At 24 V	A	10				
- At 48 V	A	5				
- At 110 V	A	2.5				
- At 230 V	A	1				
- At 400 V	A	0.3				
- At 500 V	A	0.3				
• At DC-13						
- At 24 V	A	3				
- At 48 V	A	1.5				
- At 110 V	A	0.7				
- At 230 V	A	0.3				
- At 400 V	A	0.1				
- At 500 V	A	0.1				
<b>Contact reliability</b>		One contact failure per 100 million switching operations (17 V, 5 mA), one contact failure per 10 million switching operations (5 V, 1 mA)				
<b>Mechanical service life (operating cycles) typical</b>		10 000 000				
<b>Switching frequency, maximum</b>	1/s	3 600				
<b>Fuse link version required for short-circuit protection of the auxiliary switch with type of coordination 1</b>		gG / Dz 10 A, quick-response / Dz 10 A				
<b>Continuous current of miniature circuit breaker C characteristic</b>	A	10				
<b>Vibration resistance</b> according to IEC 60068-2-6		10 ... 500 Hz: 5 g				
<b>Shock resistance</b> according to IEC 60068-2-27		Half-sine wave 50 g / 11 ms				
<b>Climate class during operation</b> according to IEC 60721		3M6, 3S2, 3B2, 3C3, 3K6 (with a relative air humidity of 10 ... 95%, no condensation permitted in operation)				
<b>Ambient temperature</b>						
• During operation	°C	-25 ... +70				
• During storage	°C	-40 ... +80				
<b>Degree of protection IP</b>		<a href="#">See product data sheet</a>				
<b>Type of electrical connection</b>		<b>Screw terminals</b> 		<b>Spring-loaded terminals</b> 		<b>Socket terminals (THT)</b> 
<b>Type of connectable conductor cross-sections</b>						
• Solid with end sleeve	mm <sup>2</sup>	2 x (0.5 ... 0.75)		--		--
• Solid without end sleeve	mm <sup>2</sup>	2 x (1.0 ... 1.5)		2 x (0.25 ... 1.5)		--
• Finely stranded with end sleeve	mm <sup>2</sup>	2 x (0.5 ... 1.5)		2 x (0.25 ... 0.75)		--
• Finely stranded without end sleeve	mm <sup>2</sup>	2 x (1.0 ... 1.5)		2 x (0.25 ... 1.5)		--
• For AWG cables		2 x (18 ... 14)		2 x (24 ... 16)		--
<b>Tightening torque</b> for screw terminals	Nm	0.8 ... 0.9		--		--

## Commanding and signaling devices

### SIRIUS ACT pushbuttons and indicator lights

#### General data

Type	<b>3SU1401-.....-1</b>		<b>3SU1401-.....-3</b>	<b>3SU1401-.....-5</b>
Type of product	<b>LED module</b>			
<b>Light source integrated in product</b>	Yes			
<b>Type of light source</b>	LED			
<b>Rated insulation voltage</b>	V	320		
<b>Pollution degree</b>	3			
<b>Impulse withstand voltage, rated value</b>	kV	4		
<b>Relative positive tolerance of the operational voltage</b>	%	20		
<b>Relative negative tolerance of the operational voltage</b>	%	20		
<b>Operating time typical</b>	h	100 000		
<b>Vibration resistance</b> according to IEC 60068-2-6	10 ... 500 Hz: 5 g			
<b>Shock resistance</b> according to IEC 60068-2-27	Half-sine wave 50 g/ 11 ms			
<b>Environmental category during operation</b> according to IEC 60721	3M6, 3S2, 3B2, 3K6 (with a relative air humidity of 10 ... 95%, no condensation permitted in operation)			
<b>Ambient temperature</b>				
• During operation	°C	-25 ... +70		
• During storage	°C	-40 ... +80		
<b>Degree of protection IP of the terminal</b>	<a href="#">See product data sheet</a>			
<b>Type of electrical connection</b>	<b>Screw terminals</b>  <b>Spring-loaded terminals</b>  <b>Socket terminals (THT)</b> 			

Type	<b>3SU1400-1GC10-1AA0</b>		<b>3SU1400-1GD10-1AA0</b>
Type of product	<b>Electronic modules for ID key-operated switches</b>		
<b>Communication/protocol</b>			
<b>Protocol is supported by IO-Link protocol</b>	No	Yes	
<b>Product function</b>	Group ID 24 V DC		IO-Link 24 V DC
<b>IO-Link transfer rate</b>	--	COM2 (38.4 kBaud)	
<b>Point-to-point cycle time between the master and the IO-Link device, minimum</b>	ms	--	10
<b>Type of power supply via IO-Link master</b>	--	Yes	
<b>Data volume</b>			
• Of the address area of the inputs with cyclic transfer total	bytes	--	2
• Of the address area of the outputs with cyclic transfer total	bytes	--	0
<b>Number of NO contacts</b>	5		
<b>General data</b>			
<b>Impulse withstand voltage, rated value</b>	kV	0.8	
<b>Rated insulation voltage</b>	V	30	
<b>Pollution degree</b>	3		
<b>Type of voltage</b>			
• Of operational voltage	DC		
• Of input voltage	DC		
<b>Operational voltage</b>			
• At DC, rated value	V	24	
• Rated value	V	18 ... 30	
<b>Current consumed, maximum</b>	mA	49	
<b>Ambient temperature</b>			
• During operation	°C	-25 ... +70	
• During storage	°C	-40 ... +80	
<b>Degree of protection IP</b>	<a href="#">See product data sheet</a>		
<b>Touch protection against electric shock</b>	Finger-safe		
<b>Connections</b>			
<b>Type of electrical connection</b>	<b>Screw terminals</b> 		
<b>Connectable conductor cross-section for auxiliary contacts</b>			
• Solid			
- With end sleeves	mm <sup>2</sup>	1 x (0.2 ... 2.5), 2 x (0.2 ... 0.75)	
- Without end sleeves	mm <sup>2</sup>	1 x (0.2 ... 2.5), 2 x (0.2 ... 0.75)	
• Finely stranded			
- With end sleeves	mm <sup>2</sup>	1 x (0.2 ... 2.5), 2 x (0.25 ... 0.75)	
- Without end sleeves	mm <sup>2</sup>	1 x (0.2 ... 2.5), 2 x (0.2 ... 0.75)	
<b>AWG number as coded connectable conductor cross-section</b>	26 ... 14		
<b>Tightening torque for screw terminals</b>	Nm	0.35 ... 0.4	

## Commanding and signaling devices

### SIRIUS ACT pushbuttons and indicator lights

#### General data

Type	3SU1400-1LK10-1AA1	3SU1400-1LK10-3AA1	3SU1400-1LL10-1BA1	3SU1400-1LL10-3BA1
Product designation	Interface module		Fail-safe interface module	
<b>Operational voltage type</b>	DC			
<b>Supply voltage at DC rated value</b>	V	24		
<b>Current consumed, maximum</b>	mA	150		
<b>Product function at interface 1 PROFINET IO-Device</b>	Yes			
<b>Type of interface Fast Ethernet interface</b>	Yes			
<b>Type of interface 1 RJ45 (Ethernet) interface</b>	Yes			
<b>Number of ports at the interface 1</b>	1			
<b>Number of modules per rack, maximum</b>	20			
<b>Number of digital outputs</b>	0		1	
<b>Number of digital inputs</b>	0		4	
<b>Software version required for STEP 7 in the TIA Portal</b>	Integrated in the TIA Portal, version 14 SP1 or higher (HSP for V13 and V14)			
<b>Safety integrity level (SIL) according to IEC 62061</b>	--		SIL 3	
<b>Performance level (PL) according to ISO 13849-1</b>	--		e	
<b>Ambient temperature</b>				
• During operation	°C	60 ... -25		
• During storage	°C	80 ... -40		
<b>Degree of protection IP</b>	<a href="#">See product data sheet</a>			
<b>Connectable conductor cross-section</b>				
• Solid				
- With end sleeves	mm <sup>2</sup>	0.2 ... 2.5		
• Finely stranded				
- With end sleeves	mm <sup>2</sup>	0.25 ... 2.5		
- Without end sleeves	mm <sup>2</sup>	0.2 ... 2.5		



## Commanding and signaling devices

### SIRIUS ACT pushbuttons and indicator lights

#### Actuators and indicators, 22 mm, round, plastic, black

#### Actuating and signaling elements > Pushbuttons

#### Selection and ordering data

Multi-unit packaging,  
see page 2/360.

Version of actuating element	Operating principle	Color, marking	Article No.	Weight
Front ring version	Unlatching method			kg

#### Pushbuttons

 3SU1000-0AB20-0AD0	<b>Pushbuttons with flat button</b> Standard	Momentary contact	Black	<b>3SU1000-0AB10-0AA0</b>	0.015
			Black, "O"	<b>3SU1000-0AB10-0AD0</b>	0.019
			Red	<b>3SU1000-0AB20-0AA0</b>	0.015
			Red, "O"	<b>3SU1000-0AB20-0AD0</b>	0.019
			Yellow	<b>3SU1000-0AB30-0AA0</b>	0.015
			Green	<b>3SU1000-0AB40-0AA0</b>	0.015
			Green, "I"	<b>3SU1000-0AB40-0AC0</b>	0.019
			Blue	<b>3SU1000-0AB50-0AA0</b>	0.015
			Blue, "R"	<b>3SU1000-0AB50-0AR0</b>	0.017
			White	<b>3SU1000-0AB60-0AA0</b>	0.015
			White, "I"	<b>3SU1000-0AB60-0AC0</b>	0.019
			Clear	<b>3SU1000-0AB70-0AA0</b>	0.015
Gray	<b>3SU1000-0AB80-0AA0</b>	0.015			
 3SU1000-0AA30-0AA0		Latching Push to unlatch	Black	<b>3SU1000-0AA10-0AA0</b>	0.014
			Red	<b>3SU1000-0AA20-0AA0</b>	0.014
			Yellow	<b>3SU1000-0AA30-0AA0</b>	0.014
			Green	<b>3SU1000-0AA40-0AA0</b>	0.014
			Blue	<b>3SU1000-0AA50-0AA0</b>	0.017
			White	<b>3SU1000-0AA60-0AA0</b>	0.014
 3SU1000-0BB30-0AA0	<b>Pushbuttons with raised button</b> Standard	Momentary contact	Black	<b>3SU1000-0BB10-0AA0</b>	0.016
			Red	<b>3SU1000-0BB20-0AA0</b>	0.016
			Yellow	<b>3SU1000-0BB30-0AA0</b>	0.019
			Green	<b>3SU1000-0BB40-0AA0</b>	0.016
			Blue	<b>3SU1000-0BB50-0AA0</b>	0.017
			White	<b>3SU1000-0BB60-0AA0</b>	0.019
 3SU1000-0CB40-0AA0	<b>Pushbuttons with flat button</b> Raised	Momentary contact	Black	<b>3SU1000-0CB10-0AA0</b>	0.018
			Red	<b>3SU1000-0CB20-0AA0</b>	0.021
			Yellow	<b>3SU1000-0CB30-0AA0</b>	0.021
			Green	<b>3SU1000-0CB40-0AA0</b>	0.020
			Blue	<b>3SU1000-0CB50-0AA0</b>	0.019
			White	<b>3SU1000-0CB60-0AA0</b>	0.018
 3SU1000-0DB50-0AA0	<b>Pushbuttons with flat button</b> Raised, castellated	Momentary contact	Black	<b>3SU1000-0DB10-0AA0</b>	0.020
			Red	<b>3SU1000-0DB20-0AA0</b>	0.021
			Yellow	<b>3SU1000-0DB30-0AA0</b>	0.021
			Green	<b>3SU1000-0DB40-0AA0</b>	0.023
			Blue	<b>3SU1000-0DB50-0AA0</b>	0.021
			White	<b>3SU1000-0DB60-0AA0</b>	0.021

## Commanding and signaling devices

### SIRIUS ACT pushbuttons and indicator lights

#### Actuators and indicators, 22 mm, round, plastic, black

#### Actuating and signaling elements > Pushbuttons

Multi-unit packaging,  
see page 2/360.

	Version of actuating element	Operating principle	Color	Article No.	Weight
	Front ring version	Unlatching method			kg
<b>Pushbuttons</b>					
 3SU1001-0AB40-0AA0	<b>Illuminated pushbuttons with flat button</b> Standard	Momentary contact	Amber	<b>3SU1001-0AB00-0AA0</b>	0.015
			Red	<b>3SU1001-0AB20-0AA0</b>	0.015
			Yellow	<b>3SU1001-0AB30-0AA0</b>	0.015
			Green	<b>3SU1001-0AB40-0AA0</b>	0.015
			Blue	<b>3SU1001-0AB50-0AA0</b>	0.024
			White	<b>3SU1001-0AB60-0AA0</b>	0.014
			Clear	<b>3SU1001-0AB70-0AA0</b>	0.015
 3SU1001-0AA20-0AA0		Latching Push to unlatch	Red	<b>3SU1001-0AA20-0AA0</b>	0.014
			Yellow	<b>3SU1001-0AA30-0AA0</b>	0.014
			Green	<b>3SU1001-0AA40-0AA0</b>	0.014
			Blue	<b>3SU1001-0AA50-0AA0</b>	0.014
			White	<b>3SU1001-0AA60-0AA0</b>	0.014
			Clear	<b>3SU1001-0AA70-0AA0</b>	
			 3SU1001-0BB70-0AA0	<b>Illuminated pushbuttons with raised button</b> Standard	Momentary contact
Yellow	<b>3SU1001-0BB30-0AA0</b>	0.016			
Green	<b>3SU1001-0BB40-0AA0</b>	0.016			
Blue	<b>3SU1001-0BB50-0AA0</b>	0.018			
Clear	<b>3SU1001-0BB70-0AA0</b>	0.025			
 3SU1001-0DB50-0AA0	<b>Illuminated pushbuttons with flat button</b> Raised, castellated	Momentary contact	Blue	<b>3SU1001-0DB50-0AA0</b>	0.021
 3SU1000-0HC10-0AA0	<b>Stop pushbuttons</b> Standard	Momentary contact, latching by pressing in and turning to the right  Rotate to unlatch to the left	Black	<b>3SU1000-0HC10-0AA0</b>	0.023
			Red	<b>3SU1000-0HC20-0AA0</b>	0.024

## Commanding and signaling devices





### SIRIUS ACT pushbuttons and indicator lights

#### Actuators and indicators, 22 mm, round, plastic, black

#### Actuating and signaling elements > Twin pushbuttons/Quadruple pushbuttons

#### Selection and ordering data

Multi-unit packaging, see page 2/360.

Version of actuating element	Operating principle	Color	Marking Symbol No.	Article No.	Weight kg	
<b>Twin pushbuttons</b>						
	Twin pushbuttons flat, flat	Momentary contact	Green/Red	-- "I"/"O"	3SU1000-3AB42-0AA0 3SU1000-3AB42-0AK0	0.023 0.026
			White/Black	-- "I"/"O"	3SU1000-3AB61-0AA0 3SU1000-3AB61-0AK0	0.023 0.027
			White/White	-- "_" / "+" Arrows, hor. Arrows, vert.	3SU1000-3AB66-0AA0 3SU1000-3AB66-0AL0 3SU1000-3AB66-0AM0 3SU1000-3AB66-0AN0	0.024 0.026 0.027 0.025
			Black/Black	-- ⊙ ⊙ 5264/5265 (IEC 60417)	3SU1000-3AB11-0AA0 3SU1000-3AB11-0AQ0	0.023 0.023
			Green/Red	-- "I"/"O"	3SU1000-3BB42-0AA0 3SU1000-3BB42-0AK0	0.025 0.025
	Twin pushbuttons flat, raised	Momentary contact	White/Black	-- "I"/"O"	3SU1000-3BB61-0AA0 3SU1000-3BB61-0AK0	0.026 0.030
			Green/Red	-- "I"/"O" Arrows, vert.	3SU1001-3AB42-0AA0 3SU1001-3AB42-0AK0 3SU1001-3AB42-0AN0	0.022 0.024 0.026
	Twin pushbuttons flat, flat, illuminated	Momentary contact	White/Black	-- "I"/"O"	3SU1001-3AB61-0AA0 3SU1001-3AB61-0AK0	0.025 0.025
			White/White	-- "_" / "+" Arrows, vert. Symbols "Circular saw blade"/ "Tilt tipper"	3SU1001-3AB66-0AA0 3SU1001-3AB66-0AL0 3SU1001-3AB66-0AN0 3SU1001-3AB66-0AP0	0.026 0.025 0.024 0.021
			Green/Red	-- "I"/"O"	3SU1001-3BB42-0AA0 3SU1001-3BB42-0AK0	0.025 0.025
	Twin pushbuttons flat, raised, illuminated	Momentary contact	White/Black	-- "I"/"O"	3SU1001-3BB61-0AA0 3SU1001-3BB61-0AK0	0.027 0.025
			Green/Red	-- "I"/"O"	3SU1001-3BB42-0AA0 3SU1001-3BB42-0AK0	0.025 0.025

#### Selection and ordering data

Version of actuating element	Operating principle	Color	Marking	Article No.	Weight kg	
<b>Quadruple pushbuttons</b>						
	Quadruple pushbuttons flat	Momentary contact	Black	-- Arrows, vert.; arrows, hor.	3SU1000-3FB11-0AA0 3SU1000-3FB11-0AU0	0.045 0.045
			Black	-- Arrows, vert.; arrows, hor.	3SU1000-3FB11-0AA0 3SU1000-3FB11-0AU0	0.045 0.045

## Commanding and signaling devices







### SIRIUS ACT pushbuttons and indicator lights

#### Actuators and indicators, 22 mm, round, plastic, black

#### Actuating and signaling elements > Mushroom pushbuttons

#### Selection and ordering data

Multi-unit packaging,  
see page 2/360.

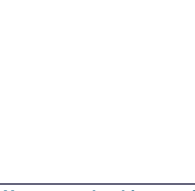
	Version of actuating element	Operating principle Unlatching method	Color, marking	Article No.	Weight kg
<b>Mushroom pushbuttons</b>					
	<b>Mushroom pushbuttons</b> 30 mm diameter, 2 positions	Momentary contact	Black	<b>3SU1000-1AD10-0AA0</b>	0.024
			Red	<b>3SU1000-1AD20-0AA0</b>	0.018
			Yellow	<b>3SU1000-1AD30-0AA0</b>	0.024
			Green	<b>3SU1000-1AD40-0AA0</b>	0.021
	Latching	Black	<b>3SU1000-1AA10-0AA0</b>	0.023	
Pull to unlatch	Red	<b>3SU1000-1AA20-0AA0</b>	0.023		
		Yellow	<b>3SU1000-1AA30-0AA0</b>	0.027	
3SU1000-1AD20-0AA0					
	<b>Mushroom pushbuttons</b> 40 mm diameter, 2 positions	Momentary contact	Black	<b>3SU1000-1BD10-0AA0</b>	0.025
			Red	<b>3SU1000-1BD20-0AA0</b>	0.026
			Yellow	<b>3SU1000-1BD30-0AA0</b>	0.025
			Green	<b>3SU1000-1BD40-0AA0</b>	0.025
	Latching	Black	<b>3SU1000-1BA10-0AA0</b>	0.027	
Pull to unlatch	Red	<b>3SU1000-1BA20-0AA0</b>	0.027		
	Red "O"	<b>3SU1000-1BA20-0AD0</b>	0.029		
	Yellow	<b>3SU1000-1BA30-0AA0</b>	0.027		
	Green	<b>3SU1000-1BA40-0AA0</b>	0.028		
3SU1000-1BD40-0AA0					
	<b>Mushroom pushbuttons</b> 60 mm diameter, 2 positions	Momentary contact	Black	<b>3SU1000-1CD10-0AA0</b>	0.029
			Red	<b>3SU1000-1CD20-0AA0</b>	0.033
			Yellow	<b>3SU1000-1CD30-0AA0</b>	0.035
			Green	<b>3SU1000-1CD40-0AA0</b>	0.032
	Latching	Black	<b>3SU1000-1CA10-0AA0</b>	0.035	
Pull to unlatch	Red	<b>3SU1000-1CA20-0AA0</b>	0.035		
3SU1000-1CD10-0AA0					
	<b>Mushroom pushbuttons</b> 30 mm diameter, 2 positions, illuminated	Momentary contact	Red	<b>3SU1001-1AD20-0AA0</b>	0.024
			Yellow	<b>3SU1001-1AD30-0AA0</b>	0.021
			Green	<b>3SU1001-1AD40-0AA0</b>	0.021
			Blue	<b>3SU1001-1AD50-0AA0</b>	0.021
			White	<b>3SU1001-1AD60-0AA0</b>	0.021
			Clear	<b>3SU1001-1AD70-0AA0</b>	0.025
	Latching	Red	<b>3SU1001-1AA20-0AA0</b>	0.030	
	Pull to unlatch	Yellow	<b>3SU1001-1AA30-0AA0</b>	0.027	
		Green	<b>3SU1001-1AA40-0AA0</b>	0.026	
		Blue	<b>3SU1001-1AA50-0AA0</b>	0.025	
	Clear	<b>3SU1001-1AA70-0AA0</b>	0.025		
3SU1001-1AD30-0AA0					
	<b>Mushroom pushbuttons</b> 40 mm diameter, 2 positions, illuminated	Momentary contact	Yellow	<b>3SU1001-1BD30-0AA0</b>	0.025
			Green	<b>3SU1001-1BD40-0AA0</b>	0.025
			White	<b>3SU1001-1BD60-0AA0</b>	0.024
			Clear	<b>3SU1001-1BD70-0AA0</b>	0.026
	Latching	Red	<b>3SU1001-1BA20-0AA0</b>	0.027	
Pull to unlatch	Yellow	<b>3SU1001-1BA30-0AA0</b>	0.028		
	Green	<b>3SU1001-1BA40-0AA0</b>	0.028		
	Blue	<b>3SU1001-1BA50-0AA0</b>	0.028		
	Clear	<b>3SU1001-1BA70-0AA0</b>	0.028		
3SU1001-1BA50-0AA0					
	<b>Mushroom pushbuttons</b> 40 mm diameter, 2 positions	With positive latching	Black	<b>3SU1000-1HB10-0AA0</b>	0.046
		Rotate to unlatch	Blue	<b>3SU1000-1HB50-0AA0</b>	
3SU1000-1HG10-0AA0					
	<b>Mushroom pushbuttons</b> 40 mm diameter, 2 positions RONIS 455	With positive latching	Black	<b>3SU1000-1HG10-0AA0</b>	0.072
		Key-operated release			
3SU1000-1HG10-0AA0					
<b>Mushroom pushbuttons,</b> 60 mm diameter, 2 positions	With positive latching	Rotate to unlatch	Black	<b>3SU1000-1JB10-0AA0</b>	0.059

## Commanding and signaling devices

### SIRIUS ACT pushbuttons and indicator lights

#### Actuators and indicators, 22 mm, round, plastic, black







#### Actuating and signaling elements > EMERGENCY STOP mushroom pushbuttons

#### Selection and ordering data

Multi-unit packaging,  
see page 2/360.

Version of actuating element	Outer diameter of mushroom	Color	Article No.	Weight
	mm			kg

#### EMERGENCY STOP mushroom pushbuttons, acc. to ISO 13850 and IEC 60947-5-5

Version of actuating element	Outer diameter of mushroom	Color	Article No.	Weight
	mm			kg
<b>With pull to unlatch</b>				
 3SU1000-1HA20-0AA0	With pull to unlatch, 2 positions	40	Red	<b>3SU1000-1HA20-0AA0</b> 0.049
<b>With rotate to unlatch</b>				
 3SU1000-1GB20-0AA0	With positive latching, 2 positions	33.8	Red	<b>3SU1000-1GB20-0AA0</b> 0.042
 3SU1000-1HB20-0AA0		40	Red	<b>3SU1000-1HB20-0AA0</b> 0.046
 3SU1000-1JB20-0AA0		60	Red	<b>3SU1000-1JB20-0AA0</b> 0.054
 3SU1000-1LB20-0AA0	With latching, 2 positions	40	Red	<b>3SU1000-1LB20-0AA0</b> 0.038
<b>With rotate to unlatch, can be illuminated</b>				
 3SU1001-1GB20-0AA0	With positive latching, 2 positions	33.8	Red	<b>3SU1001-1GB20-0AA0</b> 0.045
		40	Red	<b>3SU1001-1HB20-0AA0</b> 0.052
		60	Red	<b>3SU1001-1JB20-0AA0</b> 0.060

## Commanding and signaling devices

### SIRIUS ACT pushbuttons and indicator lights

#### Actuators and indicators, 22 mm, round, plastic, black





#### Actuating and signaling elements > EMERGENCY STOP mushroom pushbuttons/Toggle switches

Multi-unit packaging,  
see page 2/360.

Version of actuating element	Outer diameter of mushroom mm	Make of lock	Color	Number of keys	Article No.	Weight kg
------------------------------	----------------------------------	--------------	-------	----------------	-------------	--------------

#### EMERGENCY STOP mushroom pushbuttons, acc. to ISO 13850 and IEC 60947-5-5

##### With key-operated release

 3SU1000-1HF20-0AA0	With positive latching, 2 positions	40	RONIS SB30	Red	2	<b>3SU1000-1HF20-0AA0</b> <b>3SU1000-1HG20-0AA0</b>	0.071	
			RONIS 455	Red	2			
 3SU1000-1HK20-0AA0			BKS S1	Red	2	<b>3SU1000-1HK20-0AA0</b>	0.100	
				BKS E7	Red	0	<b>3SU1000-1HM20-0AA0</b>	0.096
				BKS E9	Red	0	<b>3SU1000-1HN20-0AA0</b>	0.095
 3SU1000-1HQ20-0AA0			O.M.R. 73037	Red	2	<b>3SU1000-1HQ20-0AA0</b>	0.115	
 3SU1000-1HR20-0AA0			Siemens, SSG10	Red	2	<b>3SU1000-1HR20-0AA0</b>	0.109	
			Siemens, SSP9	Red	2	<b>3SU1000-1HS20-0AA0</b>	0.111	
			Siemens, SMS1	Red	2	<b>3SU1000-1HT20-0AA0</b>	0.105	

#### Selection and ordering data

Multi-unit packaging,  
see page 2/360.

Number of switching positions	Number of command points	Color of actuating element	Operating principle of the actuating element	Article No.	Weight kg
-------------------------------	--------------------------	----------------------------	--	-------------	--------------

#### Toggle switches

 3SU1000-3EA10-0AA0	2	1	Black	Latching	<b>3SU1000-3EA10-0AA0</b> <b>3SU1000-3EC10-0AA0</b>	0.017 0.020
				Momentary contact, reset from above		

## Commanding and signaling devices

### SIRIUS ACT pushbuttons and indicator lights

#### Actuators and indicators, 22 mm, round, plastic, black

#### Actuating and signaling elements > Selector switches

#### Selection and ordering data

Multi-unit packaging,  
see page 2/360.

Version of actuating element	Operating principle	Color	Article No.	Weight kg
------------------------------	---------------------	-------	-------------	--------------

#### Selector switches

#### 2 switch positions, can be illuminated



3SU1002-2BC40-0AA0

Selector, short black actuator

Momentary contact, 45°  
(10:30/12 o'clock),  
reset from center to left



Black  
Red  
Yellow  
Green  
Blue  
White

<b>3SU1002-2BC10-0AA0</b>	0.020
<b>3SU1002-2BC20-0AA0</b>	0.023
<b>3SU1002-2BC30-0AA0</b>	0.023
<b>3SU1002-2BC40-0AA0</b>	0.020
<b>3SU1002-2BC50-0AA0</b>	0.020
<b>3SU1002-2BC60-0AA0</b>	0.023



3SU1002-2BF30-0AA0

Latching, 90°  
(10:30/1:30 o'clock)



Black  
Red  
Yellow  
Green  
Blue  
White

<b>3SU1002-2BF10-0AA0</b>	0.032
<b>3SU1002-2BF20-0AA0</b>	0.020
<b>3SU1002-2BF30-0AA0</b>	0.120
<b>3SU1002-2BF40-0AA0</b>	0.020
<b>3SU1002-2BF50-0AA0</b>	0.022
<b>3SU1002-2BF60-0AA0</b>	0.023



3SU1002-2CF20-0AA0

Selector, long black actuator

Latching, 90°  
(10:30/1:30 o'clock)



Black  
Red  
White

<b>3SU1002-2CF10-0AA0</b>	0.026
<b>3SU1002-2CF20-0AA0</b>	0.023
<b>3SU1002-2CF60-0AA0</b>	



3SU1002-2AF20-0AA0

Rotary knob

Latching, 90°  
(10:30/1:30 o'clock)



Red  
White

<b>3SU1002-2AF20-0AA0</b>	0.030
<b>3SU1002-2AF60-0AA0</b>	0.028







## Commanding and signaling devices

### SIRIUS ACT pushbuttons and indicator lights

#### Actuators and indicators, 22 mm, round, plastic, black

#### Actuating and signaling elements > Selector switches

Multi-unit packaging,  
see page 2/360.

Version of actuating element	Operating principle	Color	Article No.	Weight kg		
<b>Selector switches</b>						
 3SU1002-2BM20-0AA0	<b>3 switch positions, can be illuminated</b>					
	Selector, short black actuator	Momentary contact, 2x45° (10:30/12/1:30 o'clock), reset from left + right	Black Red Yellow Green Blue White	<b>3SU1002-2BM10-0AA0</b> <b>3SU1002-2BM20-0AA0</b> <b>3SU1002-2BM30-0AA0</b> <b>3SU1002-2BM40-0AA0</b> <b>3SU1002-2BM50-0AA0</b> <b>3SU1002-2BM60-0AA0</b>	0.022 0.037 0.020 0.020 0.024 0.024	
	 3SU1002-2BL60-0AA0	Latching, 2x45° (10:30/12/1:30 o'clock)	Black Red Yellow Green Blue White	<b>3SU1002-2BL10-0AA0</b> <b>3SU1002-2BL20-0AA0</b> <b>3SU1002-2BL30-0AA0</b> <b>3SU1002-2BL40-0AA0</b> <b>3SU1002-2BL50-0AA0</b> <b>3SU1002-2BL60-0AA0</b>	0.022 0.024 0.023 0.023 0.024 0.020	
		 3SU1002-2BP50-0AA0	Momentary contact/latching, 2x45° (10:30/12/1:30 o'clock), reset from the left, latching to the right	Black Red Yellow Green Blue White	<b>3SU1002-2BP10-0AA0</b> <b>3SU1002-2BP20-0AA0</b> <b>3SU1002-2BP30-0AA0</b> <b>3SU1002-2BP40-0AA0</b> <b>3SU1002-2BP50-0AA0</b> <b>3SU1002-2BP60-0AA0</b>	0.022 0.023 0.025 0.023 0.020
			 3SU1002-2BN30-0AA0	Latching/momentary contact, 2x45° (10:30/12/1:30 o'clock), reset from the right, latching to the left	Black Red Yellow Green Blue White	<b>3SU1002-2BN10-0AA0</b> <b>3SU1002-2BN20-0AA0</b> <b>3SU1002-2BN30-0AA0</b> <b>3SU1002-2BN40-0AA0</b> <b>3SU1002-2BN50-0AA0</b> <b>3SU1002-2BN60-0AA0</b>
<b>4 switch positions</b>						
Rotary knob				Latching, 4x90° (3/6/9/12 o'clock)	White	<b>3SU1000-2AS60-0AA0</b>



## Commanding and signaling devices

### SIRIUS ACT pushbuttons and indicator lights

#### Actuators and indicators, 22 mm, round, plastic, black

#### Actuating and signaling elements > Key-operated switches

#### Selection and ordering data

Multi-unit packaging, see page 2/360.

Operating principle	Make of lock	Switch position for key removal	Number of keys	Article No.	Weight kg
---------------------	--------------	---------------------------------	----------------	-------------	--------------

#### Key-operated switches

		Operating principle	Make of lock	Switch position for key removal	Number of keys	Article No.	Weight kg
 <p>3SU1000-4JC01-0AA0</p>	<p><b>2 switch positions</b></p> <p>Momentary contact, 45° (10:30/12 o'clock), reset from center to left</p> 	RONIS, SB30	O	2	<b>3SU1000-4BC01-0AA0</b>	0.020	
		RONIS, 455	O	2	<b>3SU1000-4CC01-0AA0</b>	0.020	
		O.M.R. 73037, red	O	2	<b>3SU1000-4FC01-0AA0</b>	0.020	
		O.M.R. 73038, light blue	O	2	<b>3SU1000-4GC01-0AA0</b>	0.020	
		O.M.R. 73034, black	O	2	<b>3SU1000-4HC01-0AA0</b>	0.020	
		O.M.R. 73033, yellow	O	2	<b>3SU1000-4JC01-0AA0</b>	0.091	
		Siemens, SSG10	O	2	<b>3SU1000-5BC01-0AA0</b>	0.020	
		Siemens, LSG1	O	2	<b>3SU1000-5HC01-0AA0</b>	0.138	
 <p>3SU1000-4BF11-0AA0</p>	<p>Latching, 90° (10:30/1:30 o'clock)</p> 	RONIS, SB30	O	2	<b>3SU1000-4BF01-0AA0</b>	0.055	
			O+l	2	<b>3SU1000-4BF11-0AA0</b>	0.055	
			l	2	<b>3SU1000-4BF21-0AA0</b>	0.180	
		RONIS, 455	O	2	<b>3SU1000-4CF01-0AA0</b>	0.020	
			O+l	2	<b>3SU1000-4CF11-0AA0</b>	0.020	
		RONIS, 421	O+l	2	<b>3SU1000-4DF11-0AA0</b>	0.056	
 <p>3SU1000-4GF11-0AA0</p>		O.M.R. 73037, red	O	2	<b>3SU1000-4FF01-0AA0</b>	0.020	
			O+l	2	<b>3SU1000-4FF11-0AA0</b>	0.020	
		O.M.R. 73038, light blue	O	2	<b>3SU1000-4GF01-0AA0</b>	0.020	
			O+l	2	<b>3SU1000-4GF11-0AA0</b>	0.020	
		O.M.R. 73034, black	O	2	<b>3SU1000-4HF01-0AA0</b>	0.020	
			O+l	2	<b>3SU1000-4HF11-0AA0</b>	0.020	
			l	2	<b>3SU1000-4HF21-0AA0</b>	0.020	
		O.M.R. 73033, yellow	O	2	<b>3SU1000-4JF01-0AA0</b>	0.020	
	O+l	2	<b>3SU1000-4JF11-0AA0</b>	0.020			
	l	2	<b>3SU1000-4JF21-0AA0</b>	0.020			
 <p>3SU1000-5BF11-0AA0</p>		Siemens, SSG10	O	2	<b>3SU1000-5BF01-0AA0</b>	0.136	
			O+l	2	<b>3SU1000-5BF11-0AA0</b>	0.020	
			l	2	<b>3SU1000-5BF21-0AA0</b>	0.020	
		Siemens, SSG10 with key monitoring	O	2	<b>3SU1000-5JF01-0AA0</b>	0.133	
		Siemens, LSG1	O	2	<b>3SU1000-5HF01-0AA0</b>	0.020	
			O+l	2	<b>3SU1000-5HF11-0AA0</b>	0.020	
 <p>3SU1000-5PF11-0AA0</p>		BKS, S1	O	2	<b>3SU1000-5PF01-0AA0</b>	0.020	
			O+l	2	<b>3SU1000-5PF11-0AA0</b>	0.020	
			l	2	<b>3SU1000-5PF21-0AA0</b>	0.020	
		BKS, E1	O	0	<b>3SU1000-5QF01-0AA0</b>	0.020	
			O+l	0	<b>3SU1000-5QF11-0AA0</b>	0.020	
		BKS, E2	O	0	<b>3SU1000-5RF01-0AA0</b>	0.020	
			O+l	0	<b>3SU1000-5RF11-0AA0</b>	0.020	
		BKS, E7	O	0	<b>3SU1000-5SF01-0AA0</b>	0.020	
			O+l	0	<b>3SU1000-5SF11-0AA0</b>	0.020	
		BKS, E9	O	0	<b>3SU1000-5TF01-0AA0</b>	0.020	
			O+l	0	<b>3SU1000-5TF11-0AA0</b>	0.020	

## Commanding and signaling devices

### SIRIUS ACT pushbuttons and indicator lights

#### Actuators and indicators, 22 mm, round, plastic, black

#### Actuating and signaling elements > Key-operated switches

Multi-unit packaging,  
see page 2/360.

Operating principle	Make of lock	Switch position for key removal	Number of keys	Article No.	Weight
					kg

#### Key-operated switches

##### 3 switch positions



3SU1000-4BM01-0AA0

Momentary contact, 2x45°  
(10:30/12/  
1:30 o'clock),  
reset from left + right



Latching, 2x45°  
(10:30/12/  
1:30 o'clock)



3SU1000-4FL01-0AA0



3SU1000-5BL01-0AA0

	RONIS, SB30	O	2	<b>3SU1000-4BM01-0AA0</b>	0.020
	O.M.R. 73037, red	O	2	<b>3SU1000-4FM01-0AA0</b>	0.020
	O.M.R. 73034, black	O	2	<b>3SU1000-4HM01-0AA0</b>	0.090
	Siemens, SSG10	O	2	<b>3SU1000-5BM01-0AA0</b>	0.020
	BKS, S1	O	2	<b>3SU1000-5PM01-0AA0</b>	0.020
	RONIS, SB30	O	2	<b>3SU1000-4BL01-0AA0</b>	0.020
		I+O+II	2	<b>3SU1000-4BL11-0AA0</b>	0.020
		I	2	<b>3SU1000-4BL21-0AA0</b>	0.020
		II	2	<b>3SU1000-4BL31-0AA0</b>	0.055
		I+II	2	<b>3SU1000-4BL41-0AA0</b>	0.054
		O+I	2	<b>3SU1000-4BL51-0AA0</b>	0.057
	RONIS, 455	O	2	<b>3SU1000-4CL01-0AA0</b>	0.058
		I+O+II	2	<b>3SU1000-4CL11-0AA0</b>	0.056
	O.M.R. 73037, red	O	2	<b>3SU1000-4FL01-0AA0</b>	0.020
		O+I	2	<b>3SU1000-4FL51-0AA0</b>	0.020
	O.M.R. 73038, light blue	O	2	<b>3SU1000-4GL01-0AA0</b>	0.091
		I+O+II	2	<b>3SU1000-4GL11-0AA0</b>	0.020
	O.M.R. 73034, black	O	2	<b>3SU1000-4HL01-0AA0</b>	0.093
		I+O+II	2	<b>3SU1000-4HL11-0AA0</b>	0.091
	O.M.R. 73033, yellow	I+O+II	2	<b>3SU1000-4JL11-0AA0</b>	0.020
	Siemens, SSG10	O	2	<b>3SU1000-5BL01-0AA0</b>	0.020
		I+O+II	2	<b>3SU1000-5BL11-0AA0</b>	0.020
		I	2	<b>3SU1000-5BL21-0AA0</b>	0.139
		II	2	<b>3SU1000-5BL31-0AA0</b>	0.137
		I+II	2	<b>3SU1000-5BL41-0AA0</b>	0.020
		O+I	2	<b>3SU1000-5BL51-0AA0</b>	0.020
	Siemens, SSG10 with key monitoring	O	2	<b>3SU1000-5JL01-0AA0</b>	0.132
	BKS, S1	O	2	<b>3SU1000-5PL01-0AA0</b>	0.134
		I+O+II	2	<b>3SU1000-5PL11-0AA0</b>	0.020
		I	2	<b>3SU1000-5PL21-0AA0</b>	0.134
		II	2	<b>3SU1000-5PL31-0AA0</b>	0.020
		I+II	2	<b>3SU1000-5PL41-0AA0</b>	0.132
	BKS, E2	I+O+II	0	<b>3SU1000-5RL11-0AA0</b>	0.020
	BKS, E9	I+O+II	0	<b>3SU1000-5TL11-0AA0</b>	0.020

## Commanding and signaling devices

### SIRIUS ACT pushbuttons and indicator lights

#### Actuators and indicators, 22 mm, round, plastic, black

#### Actuating and signaling elements > Key-operated switches/ID key-operated switches

Multi-unit packaging,  
see page 2/360.

Operating principle	Make of lock	Switch position for key removal	Number of keys	Article No.	Weight
---------------------	--------------	---------------------------------	----------------	-------------	--------

kg

#### Key-operated switches

##### 3 switch positions



3SU1000-4BP01-0AA0

Momentary contact/latching, 2x45° (10:30/12/1:30 o'clock), reset from the left, latching to the right



RONIS, SB30

O

2

**3SU1000-4BP01-0AA0**

0.056

II

2

**3SU1000-4BP31-0AA0**

0.059

O+II

2

**3SU1000-4BP61-0AA0**

0.061

Siemens, SSG10

O

2

**3SU1000-5BP01-0AA0**

0.020

II

2

**3SU1000-5BP31-0AA0**

0.140

O+II

2

**3SU1000-5BP61-0AA0**

0.136

BKS, S1

O

2

**3SU1000-5PP01-0AA0**

0.020



3SU1000-5BP01-0AA0

Latching/momentary contact, 2x45° (10:30/12/1:30 o'clock), reset from right, latching to the left



RONIS, SB30

O

2

**3SU1000-4BN01-0AA0**

0.020

I

2

**3SU1000-4BN21-0AA0**

0.020

O+I

2

**3SU1000-4BN51-0AA0**

0.056

O.M.R. 73038, light blue

O

2

**3SU1000-4GN01-0AA0**

0.087

O.M.R. 73034, black

I

2

**3SU1000-4HN21-0AA0**

0.092

Siemens, SSG10

O

2

**3SU1000-5BN01-0AA0**

0.020

I

2

**3SU1000-5BN21-0AA0**

0.020

O+I

2

**3SU1000-5BN51-0AA0**

0.020

BKS, S1

I

2

**3SU1000-5PN21-0AA0**

0.020

O+I

2

**3SU1000-5PN51-0AA0**

0.020



3SU1000-4GN01-0AA0

#### Selection and ordering data

Multi-unit packaging,  
see page 2/360.

Operating angle	Operating principle	Switch position for key removal	Color	Article No.	Weight
-----------------	---------------------	---------------------------------	-------	-------------	--------

kg

#### ID key-operated switches

##### 4 switch positions



3SU1000-4WS10-0AA0

45°

Latching

Key removal possible in all 4 positions

Black

**3SU1000-4WS10-0AA0**

0.023

For ID keys, see page 2/422.

For plastic holders for ID key-operated switches, see page 2/385.

## Commanding and signaling devices



### SIRIUS ACT pushbuttons and indicator lights

Actuators and indicators, 22 mm, round, plastic, black

#### Actuating and signaling elements > Coordinate switches/Indicator lights



#### Selection and ordering data

Multi-unit packaging,  
see page 2/360.

	Product function Locking in zero position	Number of switching posi- tions	Operating princi- ple	Direction of actua- tion	Article No.	Weight  kg
<b>Coordinate switches</b>						
 3SU1000-7AA10-0AA0	No	2	Momentary con- tact	Horizontal	<b>3SU1000-7AC10-0AA0</b>	0.036
				Vertical	<b>3SU1000-7AD10-0AA0</b>	0.037
		4	Latching	Horizontal/ Vertical	<b>3SU1000-7AA10-0AA0</b>	0.036
				Vertical	<b>3SU1000-7AB10-0AA0</b>	0.038
		4	Momentary con- tact	Horizontal/ Vertical	<b>3SU1000-7AF10-0AA0</b>	0.037
				Latching	Horizontal/ Vertical	<b>3SU1000-7AE10-0AA0</b>
 3SU1000-7BA10-0AA0	Yes	2	Momentary con- tact	Horizontal	<b>3SU1000-7BC10-0AA0</b>	0.040
				Vertical	<b>3SU1000-7BD10-0AA0</b>	0.044
		4	Latching	Horizontal/ Vertical	<b>3SU1000-7BA10-0AA0</b>	0.045
				Vertical	<b>3SU1000-7BB10-0AA0</b>	0.037
		4	Momentary con- tact	Horizontal/ Vertical	<b>3SU1000-7BF10-0AA0</b>	0.044
				Latching	Horizontal/ Vertical	<b>3SU1000-7BE10-0AA0</b>

#### Selection and ordering data

Multi-unit packaging,  
see page 2/360.

	Type of product	Color	Article No.	Weight  kg
<b>Indicator lights</b>				
 3SU1001-6AA40-0AA0	<b>With smooth lens</b>	Amber	<b>3SU1001-6AA00-0AA0</b>	0.011
		Red	<b>3SU1001-6AA20-0AA0</b>	0.012
		Yellow	<b>3SU1001-6AA30-0AA0</b>	0.012
		Green	<b>3SU1001-6AA40-0AA0</b>	0.012
		Blue	<b>3SU1001-6AA50-0AA0</b>	0.012
		White	<b>3SU1001-6AA60-0AA0</b>	0.012
		Clear	<b>3SU1001-6AA70-0AA0</b>	0.011
		<b>Indicator lights in illuminated pushbutton design</b>		
 3SU1001-0AD50-0AA0	--	Red	<b>3SU1001-0AD20-0AA0</b>	0.014
		Yellow	<b>3SU1001-0AD30-0AA0</b>	0.014
		Green	<b>3SU1001-0AD40-0AA0</b>	0.014
		Blue	<b>3SU1001-0AD50-0AA0</b>	0.018
		Clear	<b>3SU1001-0AD70-0AA0</b>	0.014

## Commanding and signaling devices

### SIRIUS ACT pushbuttons and indicator lights

#### Actuators and indicators, 22 mm, round, plastic, black

#### Actuating and signaling elements > Sealing plugs, USB and RJ45 connections

#### Selection and ordering data

Multi-unit packaging, see page 2/360.

Mounting diameter mm	Material	Color	Article No.	Weight kg
-------------------------	----------	-------	-------------	--------------

#### Sealing plugs<sup>1)</sup>



3SU1900-0FA10-0AA0

<sup>1)</sup> The sealing plug is mounted with a holder.  
Modules might already be mounted on the holder.

22	Plastic	Black	<b>3SU1900-0FA10-0AA0</b>	0.011
----	---------	-------	---------------------------	-------

Type of product	Mounting diameter	Accessory material	Accessory color	<b>Screw terminals</b> 	Weight
-----------------	-------------------	--------------------	-----------------	--	--------

	mm			Article No.	kg
--	----	--	--	-------------	----

#### USB connections



3SU1900-0GA10-0AA0

USB 3.0	22	Plastic	Black	<b>3SU1900-0GA10-0AA0</b>	0.027
---------	----	---------	-------	---------------------------	-------

#### RJ45 connections



3SU1900-0GB10-0AA0

RJ-45 Cat. 5e	22	Plastic	Black	<b>3SU1900-0GB10-0AA0</b>	0.025
---------------	----	---------	-------	---------------------------	-------

## Commanding and signaling devices

### SIRIUS ACT pushbuttons and indicator lights

#### Actuators and indicators, flat, 30 mm, metal, matte

Actuating and signaling elements &gt; Pushbuttons

### Overview

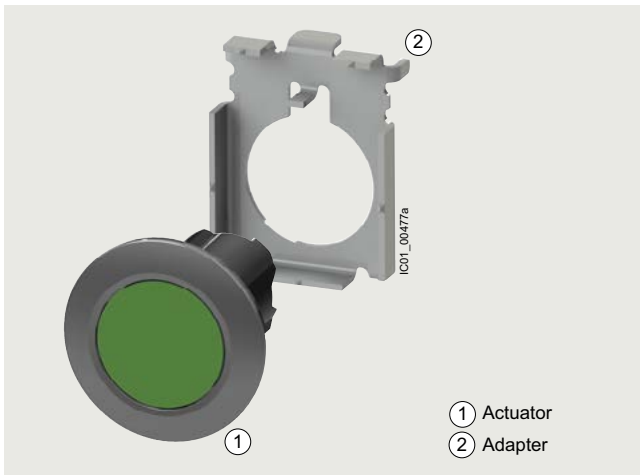

Actuators and indicators, flat, 30 mm, metal, matte, including adapter (adapter included in scope of supply)

### Selection and ordering data

Multi-unit packaging, see page 2/360.

Version	Operating principle	Unlatching method	Color	Article No.	Weight kg
<b>Pushbuttons</b>					
 3SU1060-0JB50-0AA0	Pushbuttons with flat button	Momentary contact	Black	3SU1060-0JB10-0AA0	0.075
			Red	3SU1060-0JB20-0AA0	0.074
			Yellow	3SU1060-0JB30-0AA0	0.065
			Green	3SU1060-0JB40-0AA0	0.075
			Blue	3SU1060-0JB50-0AA0	0.075
			White	3SU1060-0JB60-0AA0	0.074
			Gray	3SU1060-0JB80-0AA0	0.064
Amber	3SU1060-0JB00-0AA0	0.065			
 3SU1060-0JA20-0AA0	Latching	Push to unlatch	Black	3SU1060-0JA10-0AA0	0.072
			Red	3SU1060-0JA20-0AA0	0.064
			Yellow	3SU1060-0JA30-0AA0	0.064
			Green	3SU1060-0JA40-0AA0	0.063
			Blue	3SU1060-0JA50-0AA0	0.065
			White	3SU1060-0JA60-0AA0	0.064
 3SU1061-0JB40-0AA0	Illuminated push-buttons with flat button	Momentary contact	Red	3SU1061-0JB20-0AA0	0.074
			Yellow	3SU1061-0JB30-0AA0	0.074
			Green	3SU1061-0JB40-0AA0	0.073
			Blue	3SU1061-0JB50-0AA0	0.074
			Clear	3SU1061-0JB70-0AA0	0.074
 3SU1061-0JA30-0AA0	Latching	Push to unlatch	Red	3SU1061-0JA20-0AA0	0.064
			Yellow	3SU1061-0JA30-0AA0	0.073
			Green	3SU1061-0JA40-0AA0	0.064
			Blue	3SU1061-0JA50-0AA0	0.070
			Clear	3SU1061-0JA70-0AA0	0.064

## Commanding and signaling devices









### SIRIUS ACT pushbuttons and indicator lights

#### Actuators and indicators, flat, 30 mm, metal, matte

#### Actuating and signaling elements > Selector switches

#### Selection and ordering data

Multi-unit packaging, see page 2/360.

Version	Operating principle	Color	Article No.	Weight kg		
<b>Selector switches</b>						
 3SU1062-2DC40-0AA0	<b>2 switch positions, can be illuminated</b>					
	Selector, short black actuator and front ring for flat mounting	Momentary contact, 45° (10:30/12 o'clock), reset from center to left	Black Red Green White	<b>3SU1062-2DC10-0AA0</b> <b>3SU1062-2DC20-0AA0</b> <b>3SU1062-2DC40-0AA0</b> <b>3SU1062-2DC60-0AA0</b>	0.073 0.083 0.075 0.080	
		 Latching, 90° (10:30/12 o'clock)	Black Red Green Blue White	<b>3SU1062-2DF10-0AA0</b> <b>3SU1062-2DF20-0AA0</b> <b>3SU1062-2DF40-0AA0</b> <b>3SU1062-2DF50-0AA0</b> <b>3SU1062-2DF60-0AA0</b>	0.073 0.020 0.075 0.073 0.078	
	 3SU1062-2EC20-0AA0	Selector, long black actuator and front ring for flat mounting	Momentary contact, 45° (10:30/12 o'clock), reset from center to left	Black Red Green White	<b>3SU1062-2EC10-0AA0</b> <b>3SU1062-2EC20-0AA0</b> <b>3SU1062-2EC40-0AA0</b> <b>3SU1062-2EC60-0AA0</b>	0.085 0.086 0.085 0.072
			 Latching, 90° (10:30/12 o'clock)	Black Red Green White	<b>3SU1062-2EF10-0AA0</b> <b>3SU1062-2EF20-0AA0</b> <b>3SU1062-2EF40-0AA0</b> <b>3SU1062-2EF60-0AA0</b>	0.075 0.078 0.073 0.020
		<b>3 switch positions (I+O+II), can be illuminated</b>				
 3SU1062-2DL60-0AA0	Selector, short black actuator and front ring for flat mounting	Momentary contact, 2x45° (10:30/12/1:30 o'clock), reset from left + right	Black Red Green White	<b>3SU1062-2DM10-0AA0</b> <b>3SU1062-2DM20-0AA0</b> <b>3SU1062-2DM40-0AA0</b> <b>3SU1062-2DM60-0AA0</b>	0.074 0.072 0.020 0.073	
		 Latching, 2x45° (10:30/12/1:30 o'clock)	Black Red Yellow Green White	<b>3SU1062-2DL10-0AA0</b> <b>3SU1062-2DL20-0AA0</b> <b>3SU1062-2DL30-0AA0</b> <b>3SU1062-2DL40-0AA0</b> <b>3SU1062-2DL60-0AA0</b>	0.020 0.020 0.080 0.070 0.072	
		Momentary contact to the right, latching to the left, 2x45° (10:30/12/1:30 o'clock)	White	<b>3SU1062-2DN60-0AA0</b>	0.073	
	 3SU1062-2EL20-0AA0	Selector, long black actuator and front ring for flat mounting	Momentary contact, 2x45° (10:30/12/1:30 o'clock), reset from left + right	Black Red Green White	<b>3SU1062-2EM10-0AA0</b> <b>3SU1062-2EM20-0AA0</b> <b>3SU1062-2EM40-0AA0</b> <b>3SU1062-2EM60-0AA0</b>	0.073 0.072 0.084 0.020
			 Latching, 2x45° (10:30/12/1:30 o'clock)	Black Red Green White	<b>3SU1062-2EL10-0AA0</b> <b>3SU1062-2EL20-0AA0</b> <b>3SU1062-2EL40-0AA0</b> <b>3SU1062-2EL60-0AA0</b>	0.075 0.020 0.084 0.020



## Commanding and signaling devices

### SIRIUS ACT pushbuttons and indicator lights

#### Actuators and indicators, flat, 30 mm, metal, matte

#### Actuating and signaling elements > Key-operated switches/Indicator lights

#### Selection and ordering data

Multi-unit packaging,  
see page 2/360.

Make of lock	Operating principle	Switch position for key removal	Number of keys	Article No.	Weight kg
--------------	---------------------	---------------------------------	----------------	-------------	--------------

#### Key-operated switches



3SU1060-4LF11-0AA0

#### 2 switch positions

RONIS, SB30 and front ring for flat installation

Momentary contact, 45°  
(10:30/12 o'clock),  
reset from center to left



Latching, 90°  
(10:30/1:30 o'clock)



O

2

**3SU1060-4LC01-0AA0**

0.116

O

2

**3SU1060-4LF01-0AA0**

0.103

O+I

2

**3SU1060-4LF11-0AA0**

0.100

I

2

**3SU1060-4LF21-0AA0**

0.102



3SU1060-4LL11-0AA0

#### 3 switch positions

RONIS, SB30 and front ring for flat installation

Latching, 2x45°  
(10:30/12/  
1:30 o'clock)



Momentary contact, 2x45°  
(10:30/12/  
1:30 o'clock),  
reset from left + right



I+O+II

2

**3SU1060-4LL11-0AA0**

0.020

O

2

**3SU1060-4LM01-0AA0**

0.102

#### Selection and ordering data

Multi-unit packaging,  
see page 2/360.

Version	Color	Article No.	Weight kg
---------	-------	-------------	--------------

#### Indicator lights



3SU1061-0JD40-0AA0

#### With flat lens

Red  
Yellow  
Green  
Blue  
Clear

**3SU1061-0JD20-0AA0**

0.073

**3SU1061-0JD30-0AA0**

0.073

**3SU1061-0JD40-0AA0**

0.073

**3SU1061-0JD50-0AA0**

0.062

**3SU1061-0JD70-0AA0**

0.073



**Commanding and signaling devices****SIRIUS ACT pushbuttons and indicator lights**

Actuators and indicators, flat, 30 mm, metal, matte

**Actuating and signaling elements > Sealing plugs, USB and RJ45 connections****Selection and ordering data****Multi-unit packaging, see page 2/360.**

Mounting diameter mm	Material	Color	Article No.	Weight kg
-------------------------	----------	-------	-------------	--------------

**Sealing plugs<sup>1)</sup>**

3SU1960-0FA80-0AA0

30	Metal, matte	Sand gray	<b>3SU1960-0FA80-0AA0</b>	0.070
----	--------------	-----------	---------------------------	-------

<sup>1)</sup> The sealing plug is mounted with a holder.  
Modules might already be mounted on the holder.

Type of product	Mounting diameter mm	Accessory material	Accessory color	<b>Screw terminals</b> 	Weight kg
-----------------	-------------------------	--------------------	-----------------	--	--------------

**USB connections**

3SU1960-0GA80-0AA0

USB 3.0	30	Metal, matte	Sand gray	<b>3SU1960-0GA80-0AA0</b>	0.081
---------	----	--------------	-----------	---------------------------	-------

**RJ45 connections**

3SU1960-0GB80-0AA0

RJ-45 Cat. 5e	30	Metal, matte	Sand gray	<b>3SU1960-0GB80-0AA0</b>	0.072
---------------	----	--------------	-----------	---------------------------	-------



## Options

### Special locks for key-operated switches

The plastic and metal key-operated switches of type RONIS, BKS and Siemens (compatible with CES) can be optionally ordered with additional locks.

In this case **"-Z"**, the order code **"Y01"** and the required lock number must be added to the article number of the relevant key-operated switch for standard locking.

Order code	Y01
Standard delivery time	25 working days
Additional price per unit	
Ordering example	3SU1000-5BF01-0AA0-Z Y01 Z = SSG18

### Ordering notes

- For all special locks, an additional price applies.
- The order code **"Y01"** must be quoted in accordance with the above table. Automated processing of the order with a defined delivery time can be guaranteed only for correctly submitted orders.
- For applications in which access security is important and several lock numbers are used, we recommend the use of BKS or Siemens key-operated switches.
- Special locks for VW (E1, E2, ...) will be delivered without keys, all others with two keys.
- Available special locks
  - Siemens lock (compatible with CES locks): SSG1 to SSG100; SMS1 to SMS100; LSG1; BAZ1, BAZ6, BAZ8, BAZ11, BAZ20, BAZ27, BAZ30, BAZ34; VL1, VL5; TAB501; STGH10; SSP9
  - BKS lock: S1 to S99; E1 to E25 (VW – without key); G3751 (VW – without key)
  - RONIS lock: SB30, SB31, 421, 455
  - OMR lock: 73038, 73037, 73034, 73033
  - For key-operated switches with key monitoring and Siemens lock, locks SSG1 to SSG100 are possible.
  - With the Siemens locks VL1 and VL5, key removal is possible in the O, I, II, O+I and O+II positions.

### Note:

Mixing of the special locks listed above from different key-operated switch brands is not possible.

### Example:

A RONIS key-operated switch cannot be combined with an SSG10 lock.

### Master and master-pass key systems

The following key systems can be supplied with BKS or Siemens locks:

- Central lock systems
- Master key systems
- Central master key systems
- Master-pass key systems

When placing an order you must supplement the article number of the matching key-operated switches with **"-Z"** and quote the order code **"Y03"**.

Price and delivery time on request.

Email: [sirius-attach.aud@siemens.com](mailto:sirius-attach.aud@siemens.com)

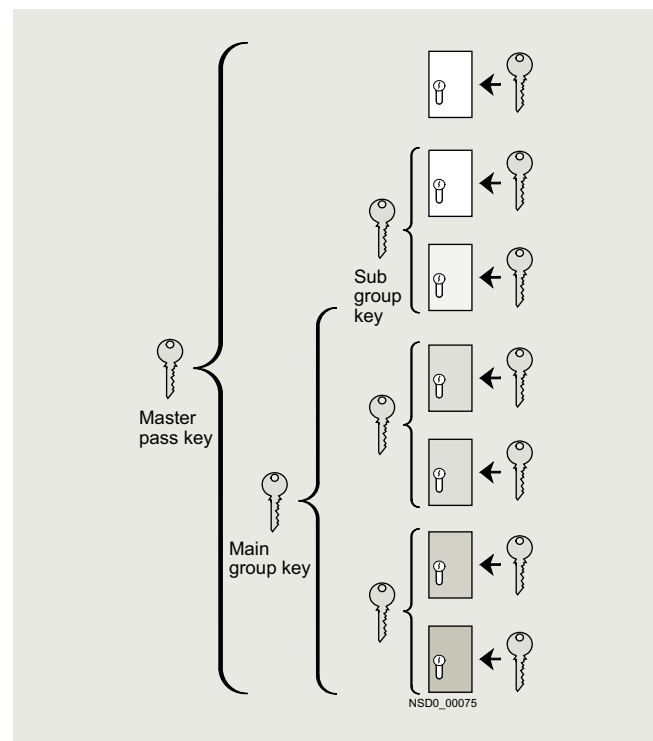

Example of master-pass key system

## Commanding and signaling devices

### SIRIUS ACT pushbuttons and indicator lights

#### Actuators and indicators, customized designs

#### Laser inscriptions

#### Options

##### Inscription of actuating and signaling elements

Actuating and signaling elements in both plastic and metal version can be optionally inscribed with a laser.



Example of laser inscription

The actuators of the pushbuttons, illuminated pushbuttons, twin pushbuttons, mushroom pushbuttons, illuminated mushroom pushbuttons, EMERGENCY STOP mushroom pushbuttons (without lock), the lenses of the indicator lights, and the acoustic signaling devices can all be inscribed.

##### Version

The default typeface used for inscriptions with text is Arial and the text is centered.

The font size for illuminated actuators is 2.5 mm, for non-illuminated actuators 3 mm.

Up to 8 characters per line are possible.

##### Notes:

Selected pushbuttons and twin pushbuttons can be supplied as standard with inscribed letters or symbols.

Selector switches, key-operated switches and toggle switches can only be inscribed on the front ring in the design lines

- 22 mm, plastic, black and
- Flat, 30 mm, metal matte

(only one text line and the supplement Y19).

##### Assignment of the positions on the actuator

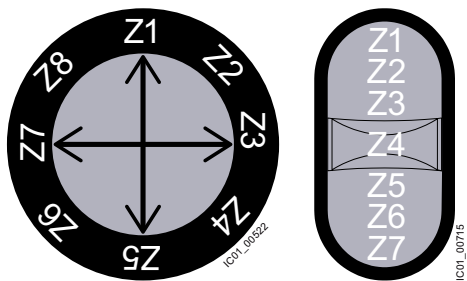

Front ring and twin pushbutton

##### Ordering notes

To order, the inscribed actuating and signaling elements can be selected via the SIRIUS ACT configurator. An electronic order form is then generated. For configurator, see [www.siemens.com/sirius-act/configurator](http://www.siemens.com/sirius-act/configurator)

When ordering, add "-Z" and one of the following codes to the article number of the actuator element or the indicator light:

- **Y10:** Text in upper/lower case, always upper case for beginning of line, e.g. Z1=Lift Z2=Lower
- **Y11:** Text in upper case, e.g. Z1=LIFT Z2=LOWER
- **Y12:** Text in lower case, e.g. Z1=lift off Z2=lower off
- **Y15:** Text in upper/lower case, all words begin with upper case letters, e.g. Z1=Lift Off Z2=Lower Off
- **Y13:** Symbol with number according to ISO 7000 or IEC 60417
- **Y19:** Inscription of choice, text or symbol, can only be ordered via SIRIUS ACT configurator with a Configuration Identification Number (CIN)

When ordering, specify the required inscription without spaces after Z=, Z1=, etc., in addition to the article number and order code (see ordering examples 1 to 3).

In the case of symbols, specify the symbol No. and the standard (see ordering example 2)

In the case of multi-line inscriptions, the text must be assigned to the respective line, e.g. Z1=Lift, Z2=Lower. (see ordering examples 1 and 3)

The SIRIUS ACT configurator must be used to select special inscriptions and symbols (see ordering example 4). In this case a CIN (Configuration Identification Number) is generated for placement of future orders. It is then possible to place an order directly via the SIRIUS ACT configurator using the CIN (shopping cart in the Industry Mall) or via the standard ordering channels.

Standard ordering:

- Configurator: [www.siemens.com/sirius-act/configurator](http://www.siemens.com/sirius-act/configurator)
- Industry Mall: [www.siemens.com/industrymall](http://www.siemens.com/industrymall)

##### Ordering example 1

A round pushbutton with 2 lines of text is required:

**3SU1000-0AB20-0AA0-Z**  
**Y10**

Z1=Lift  
Z2=Lower

##### Ordering example 2

A pushbutton inscribed with symbol No. 5389 according to IEC 60417 is required:

**3SU1000-0AB20-0AA0-Z**  
**Y13**

Z=5389 IEC

##### Ordering example 3

A selector switch with 2 switch positions and multi-line inscription on the front ring is required:

**3SU1002-2BF10-0AA0-Z**  
**Y11**

Z8=0  
Z2=I

##### Ordering example 4

An indicator light with customized inscription is required:

**3SU1001-6AA50-0AA0-Z**  
**Y19**

CIN.....  
(20-digit number generated from the SIRIUS ACT configurator)

#### Overview

- Plastic holders are attached to actuators and indicators made of plastic (3SU100).
- Metal holders can be attached to all versions of actuators and indicators, with the exception of ID key-operated switches.
- Universal holders can be attached to actuators and indicators made of plastic or metal.
- All metal and universal holders are automatically grounded by their fastening screw. A grounding stud can also be fitted (see page 2/426).

#### Selection and ordering data

Multi-unit packaging, see page 2/360.

Version	Article No.	Weight kg
---------	-------------	--------------

#### Holders without module, plastic



3SU1500-0AA10-0AA0

**3x without module**

**3SU1500-0AA10-0AA0**

0.024

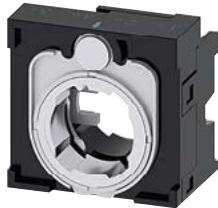

3SU1500-0BA10-0AA0

**4x without module**

For selector switches with 4 switch positions and for coordinate switches

**3SU1500-0BA10-0AA0**

0.035

#### Holders without module, metal



3SU1510-0AA10-0AA0

**3x without module**

**3SU1510-0AA10-0AA0**

0.044



3SU1550-0BA10-0AA0

**4x without module**

For selector switches with 4 switch positions and for coordinate switches

**3SU1550-0BA10-0AA0**

0.064

#### Holders without module, universal for plastic and metal



3SU1550-0AA10-0AA0

**3x without module**

**3SU1550-0AA10-0AA0**

0.044

## Commanding and signaling devices

### SIRIUS ACT pushbuttons and indicator lights

#### Modules

#### Contact modules

#### Overview

The contact modules are fitted with slow-action contacts (NO contacts or NC contacts). These ensure a high level of contact reliability even with small voltages and currents, such as 5 V/1 mA. They are suitable for use in electronic systems as well as conventional controls. The contact pieces of the NC contacts are positively driven.

#### Mounting system

- Front plate mounting:  
The contact modules are mounted on the rear face of a holder.
- Floor mounting:  
The contact modules are used in the 3SU18 enclosures and are snapped into the lower part of the enclosure.

#### Connection methods











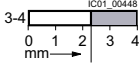

The contact modules are available with:

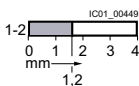
- Screw terminals
- Spring-loaded terminals
- Socket connection (THT) for PCB mounting

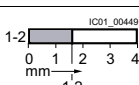
The terminal designations of the contact modules comply with EN 50013.

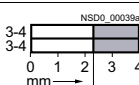
#### Selection and ordering data

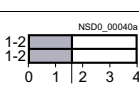
Multi-unit packaging, see page 2/360.

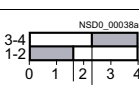
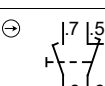
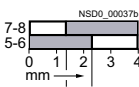
	Contact version	Number of				Spring-loaded terminals	Weight
		NO contacts	NC contacts				
						Article No.	kg
	Silver alloy	1	0			<b>3SU1400-1AA10-3BA0</b>	0.009
		0	1			<b>3SU1400-1AA10-3CA0</b>	0.009
		0	1 with installation monitoring <sup>1)</sup>			<b>3SU1400-1AA10-3HA0</b>	0.018
		2	0			<b>3SU1400-1AA10-3DA0</b>	0.018
		0	2			<b>3SU1400-1AA10-3EA0</b>	0.017
		1	1			<b>3SU1400-1AA10-3FA0</b>	0.017
		1 leading	1 lagging			<b>3SU1400-1AA10-3GA0</b>	0.016

⊕ Positive opening according to IEC 60947-5-1, Annex K. Can be used with 3SK safety relays. Certificate:



<sup>1)</sup> The contact module has 1 NO internal contact + 1 NC internal contact. The NO contact is connected in series with the NC contact and brought out at terminal 1-2. When the module is snapped onto the holder, the NO contact closes. It opens when the module is detached from the holder again (the NC contact remains closed). The NC contact opens when the EMERGENCY STOP device is actuated (the NO contact remains closed). The contact is closed only when both the NC and NO contacts are closed. Only suitable for installation in 3SU18 enclosure with one command point and in connection with the adapter 3SU1900-0JF10-0AA0.







# Commanding and signaling devices

## SIRIUS ACT pushbuttons and indicator lights

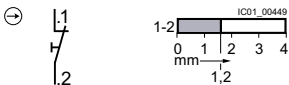
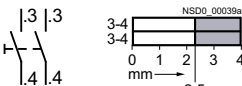
### Modules

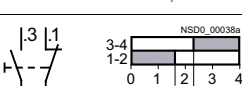
#### Contact modules

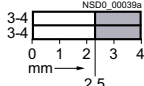
Multi-unit packaging, see page 2/360.

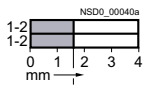
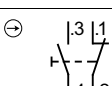
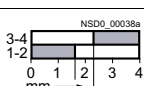
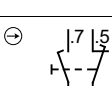
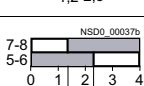
Contact version	Number of					Spring-loaded terminals	Weight
	NO contacts	NC contacts					
Contact modules for front plate mounting						Article No.	kg
Gold-plated	1	0				<b>3SU1400-1AA10-3LA0</b>	0.010
	0	1				<b>3SU1400-1AA10-3MA0</b>	0.010
	2	0				<b>3SU1400-1AA10-3NA0</b>	0.017
	0	2				<b>3SU1400-1AA10-3PA0</b>	0.017
	1	1				<b>3SU1400-1AA10-3QA0</b>	0.017
	1 leading	1 lagging				<b>3SU1400-1AA10-3RA0</b>	0.017

⊖ Positive opening according to IEC 60947-5-1, Annex K.  
Can be used with 3SK safety relays.  
Certificate:



# Commanding and signaling devices

## SIRIUS ACT pushbuttons and indicator lights



### Modules

#### Contact modules

Multi-unit packaging, see page 2/360.

Contact version	Number of NO contacts	NC contacts		Screw terminals	Weight
				Article No.	kg

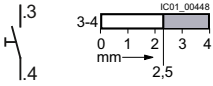
#### Contact modules for floor mounting

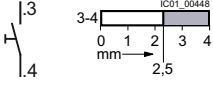
Contact version	Number of NO contacts	NC contacts		Spring-loaded terminals	Weight
				Article No.	kg
 3SU1400-2AA10-3BA0	Silver alloy	1	0		<b>3SU1400-2AA10-3BA0</b> 0.010
		0	1		
 3SU1400-2AA10-3LA0	Gold-plated	1	0		<b>3SU1400-2AA10-3LA0</b> 0.010

Multi-unit packaging, see page 2/360.

Contact version	Number of NO contacts	NC contacts		Socket terminals (THT)	Weight
				Article No.	kg

#### Contact modules for mounting on printed circuit boards

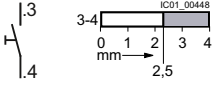
 3SU1400-3AA10-5BA0	Silver alloy	1	0		<b>3SU1400-3AA10-5BA0</b> 0.004
		0	1		

⊖ Positive opening according to IEC 60947-5-1, Annex K.  
Can be used with 3SK safety relays.  
Certificate:



## Commanding and signaling devices

### SIRIUS ACT pushbuttons and indicator lights

#### Modules

#### LED modules

#### Overview

##### LED modules

The commanding and signaling devices can be illuminated via LED modules with integrated LEDs.

##### Mounting system

- Front plate mounting:  
The LED modules are mounted on the rear face of a holder in the center position.
- Floor mounting:  
The LED modules are used in the 3SU18 enclosures and are snapped into the lower part of enclosure.

##### Connection methods

The LED modules are available with:

- Screw terminals
- Spring-loaded terminals
- Socket connection (THT) for PCB mounting



The terminal designations of the LED modules comply with EN 50013.

##### LED test modules

The LED test modules are used to test the LED modules (AC/DC versions). One LED module is connected to each test module for testing, [see page 2/391](#).

#### Selection and ordering data

Multi-unit packaging, see page 2/360.

	Operational voltage at AC	Operational voltage at DC	Color	Spring-loaded terminals	Weight			
	V	V		Article No.		kg		
<b>LED modules<sup>1)</sup> for front plate mounting</b>								
 3SU1401-1BB30-3AA0	24	24	Amber		0.008			
			Red			0.008		
			Yellow			0.008		
			Green			0.008		
			Blue			0.008		
			White			0.008		
			Red/Yellow/ Green			0.015		
			110			--	Amber	0.012
							Red	0.011
							Yellow	0.008
Green	0.009							
Blue	0.008							
White	0.009							
Red/Yellow/ Green	0.012							
230	--	Amber	0.009					
		Red	0.009					
		Yellow	0.009					
		Green	0.013					
		Blue	0.009					
		White	0.012					
		Red/Yellow/ Green	0.012					
6 ... 24	6 ... 24	Amber	0.009					
		Red	0.009					
		Yellow	0.010					
		Green	0.009					
		Blue	0.008					
		White	0.009					
		Red/Yellow/ Green	0.017					
24 ... 240	24 ... 240	Amber	0.140					
		Red	0.010					
		Yellow	0.010					
		Green	0.010					
		Blue	0.011					
		White	0.011					
		Red/Yellow/ Green	0.010					

<sup>1)</sup> Only for use with SIRIUS commanding and signaling devices.



## Commanding and signaling devices

### SIRIUS ACT pushbuttons and indicator lights

#### Modules

#### LED modules

Multi-unit packaging,  
see page 2/360.

Operational voltage at AC	Operational voltage at DC	Color	Screw terminals	Weight
V	V		Article No.	kg

#### LED modules for front plate mounting: ATEX Zone 1-2: Intrinsic safety



3SU1401-1BB20-3AA2

Operational voltage at AC	Operational voltage at DC	Color	Screw terminals	Weight
V	V		Article No.	kg
24	24	Amber Red Yellow Green Blue White	Spring-loaded terminals 3SU1401-1BB00-3AA2 3SU1401-1BB20-3AA2 3SU1401-1BB30-3AA2 3SU1401-1BB40-3AA2 3SU1401-1BB50-3AA2 3SU1401-1BB60-3AA2	0.008 0.009 0.008 0.010 0.008 0.008

Multi-unit packaging,  
see page 2/360.

Operational voltage at AC	Operational voltage at DC	Color	Screw terminals	Weight
V	V		Article No.	kg

#### LED modules<sup>1)</sup> for floor mounting



3SU1401-2BB20-3AA0

Operational voltage at AC	Operational voltage at DC	Color	Screw terminals	Weight
V	V		Article No.	kg
24	24	Amber Red Yellow Green Blue White	Spring-loaded terminals 3SU1401-2BB00-3AA0 3SU1401-2BB20-3AA0 3SU1401-2BB30-3AA0 3SU1401-2BB40-3AA0 3SU1401-2BB50-3AA0 3SU1401-2BB60-3AA0	0.010 0.009 0.009 0.009 0.009 0.010
110	--	Amber Red Yellow Green Blue White	3SU1401-2BC00-3AA0 3SU1401-2BC20-3AA0 3SU1401-2BC30-3AA0 3SU1401-2BC40-3AA0 3SU1401-2BC50-3AA0 3SU1401-2BC60-3AA0	0.010 0.010 0.017 0.008 0.008 0.008
230	--	Amber Red Yellow Green Blue White	3SU1401-2BF00-3AA0 3SU1401-2BF20-3AA0 3SU1401-2BF30-3AA0 3SU1401-2BF40-3AA0 3SU1401-2BF50-3AA0 3SU1401-2BF60-3AA0	0.008 0.019 0.011 0.010 0.008 0.012
6 ... 24	6 ... 24	Amber Red Yellow Green Blue White	3SU1401-2BG00-3AA0 3SU1401-2BG20-3AA0 3SU1401-2BG30-3AA0 3SU1401-2BG40-3AA0 3SU1401-2BG50-3AA0 3SU1401-2BG60-3AA0	0.008 0.009 0.008 0.008 0.008 0.010
24 ... 240	24 ... 240	Amber Red Yellow Green Blue White	3SU1401-2BH00-3AA0 3SU1401-2BH20-3AA0 3SU1401-2BH30-3AA0 3SU1401-2BH40-3AA0 3SU1401-2BH50-3AA0 3SU1401-2BH60-3AA0	0.008 0.008 0.012 0.008 0.008 0.010

<sup>1)</sup> Only for use with SIRIUS commanding and signaling devices.

Multi-unit packaging,  
see page 2/360.

Operational voltage at AC	Operational voltage at DC	Color	Screw terminals	Weight
V	V		Article No.	kg

#### LED modules for floor mounting: ATEX Zone 1-2: Intrinsic safety



3SU1401-2BB00-3AA2

Operational voltage at AC	Operational voltage at DC	Color	Screw terminals	Weight
V	V		Article No.	kg
24	24	Amber Red Yellow Green Blue White	Spring-loaded terminals 3SU1401-2BB00-3AA2 3SU1401-2BB20-3AA2 3SU1401-2BB30-3AA2 3SU1401-2BB40-3AA2 3SU1401-2BB50-3AA2 3SU1401-2BB60-3AA2	0.012 0.008 0.008 0.008 0.008 0.008

## Commanding and signaling devices

### SIRIUS ACT pushbuttons and indicator lights

#### Modules

#### LED modules

Multi-unit packaging,  
see page 2/360.

Operational voltage at AC	Operational voltage at DC	Color	Socket terminals (THT)	Weight
			Article No.	kg
V	V			

#### LED modules<sup>1)</sup> for PCB mounting



3SU1401-3BA20-5AA0

<sup>1)</sup> Only for use with SIRIUS commanding and signaling devices.

--	5	Amber Red Yellow Green Blue White	<b>3SU1401-3BA00-5AA0</b> <b>3SU1401-3BA20-5AA0</b> <b>3SU1401-3BA30-5AA0</b> <b>3SU1401-3BA40-5AA0</b> <b>3SU1401-3BA50-5AA0</b> <b>3SU1401-3BA60-5AA0</b>	0.008 0.080 0.005 0.008 0.006 0.003
----	---	--	--	--

Multi-unit packaging,  
see page 2/360.

Operational voltage at AC	Operational voltage at DC	Screw terminals	Weight
		Article No.	kg
V	V		

#### LED test modules<sup>1)</sup> for front plate mounting



3SU1400-1CK10-1AA0

6 ... 240	6 ... 240	<b>3SU1400-1CK10-1AA0</b>	0.011
-----------	-----------	---------------------------	-------

#### LED test modules<sup>1)</sup> for floor mounting



3SU1400-2CK10-1AA0

6 ... 240	6 ... 240	<b>3SU1400-2CK10-1AA0</b>	0.010
-----------	-----------	---------------------------	-------

<sup>1)</sup> Only to be used for SIRIUS ACT LED modules  
(6 to 24 V AC/DC, 24 V AC/DC, 24 to 240 V AC/DC).

## Commanding and signaling devices

### SIRIUS ACT pushbuttons and indicator lights

#### Enclosures

#### General data

#### Overview

#### Pushbuttons and indicator lights in the enclosure



Enclosures with standard fittings

Enclosed SIRIUS ACT pushbuttons and indicator lights are used as hand-operated command devices for separately allocated control units and cabinets. The devices are suitable for use in any climate and all have degree of protection IP66, IP67, IP69 (IP69K), including those with cable glands.

#### Standards

IEC 60947-5-1

#### Versions

The enclosed pushbuttons and indicator lights are available with conventional controls as well as for connection to AS-Interface. The following versions are available:

- Empty enclosures with 1 to 6 command points. The installed components must be ordered separately; modules for floor mounting or 1-pole contact and LED modules for front plate mounting can be used, [see page 2/386 onwards](#).
- Enclosures with standard fittings with 1 to 3 command points, e.g. EMERGENCY STOP enclosure with EMERGENCY STOP mushroom pushbutton
- Enclosures with customized fittings with 1 to 6 command points
- Special enclosure for selector switches (4 switch positions), coordinate switches, ID key-operated switches and sensor switches

#### Color of the enclosures

Top:

- Gray, RAL 7035
- Pantone yellow C, for EMERGENCY STOP

Lower part:

- Black, RAL 9005

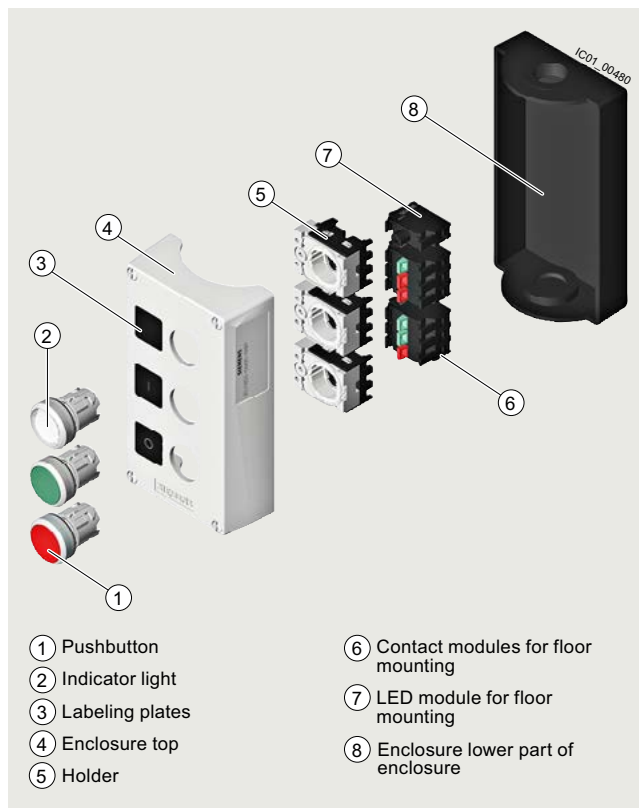

Setup of the pushbuttons and indicator lights in the enclosure

#### Customized enclosures

The fittings and labeling of the command points can be chosen using the configurator on the internet. The prices depend on the equipment selected, [see \[www.siemens.com/sirius-act/configurator\]\(http://www.siemens.com/sirius-act/configurator\)](#).

It is also possible to create a combination of two enclosures using connectors.

#### Application

The enclosures are climate-proof (KTW 24) according to EN ISO 6270-2 and are suitable for stationary use, and for use in marine applications.

# Commanding and signaling devices

## SIRIUS ACT pushbuttons and indicator lights

### Enclosures

Empty enclosures

## Selection and ordering data

Color of enclosure top	Number of command points	Enclosure version	Article No.	Weight kg
------------------------	--------------------------	-------------------	-------------	--------------

## Enclosures for surface mounting

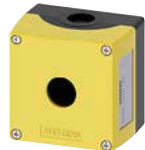
**Plastic**

3SU1801-0AA00-0AA2

Yellow	1	Center command point	<b>3SU1801-0AA00-0AA2</b>	0.251
--------	---	----------------------	---------------------------	-------

		With protective collar	<b>3SU1801-0AA00-0AC2</b>	0.311
--	--	------------------------	---------------------------	-------

		With recess for labeling plate	<b>3SU1801-0AA00-0AB2</b>	0.253
--	--	--------------------------------	---------------------------	-------

	2	With recess for labeling plate	<b>3SU1802-0AA00-0AB2</b>	0.300
--	---	--------------------------------	---------------------------	-------



3SU1802-0AA00-0AB1

Gray	1	With recess for labeling plate	<b>3SU1801-0AA00-0AB1</b>	0.253
------	---	--------------------------------	---------------------------	-------

	2	With recess for labeling plate	<b>3SU1802-0AA00-0AB1</b>	0.305
--	---	--------------------------------	---------------------------	-------

	3	With recess for labeling plate	<b>3SU1803-0AA00-0AB1</b>	0.373
--	---	--------------------------------	---------------------------	-------

	4	With recess for labeling plate	<b>3SU1804-0AA00-0AB1</b>	0.440
--	---	--------------------------------	---------------------------	-------

	6	With recess for labeling plate	<b>3SU1806-0AA00-0AB1</b>	0.615
--	---	--------------------------------	---------------------------	-------

**Metal**

3SU1851-0AA00-0AC2

Yellow	1	Center command point	<b>3SU1851-0AA00-0AA2</b>	0.485
--------	---	----------------------	---------------------------	-------

		With protective collar	<b>3SU1851-0AA00-0AC2</b>	0.612
--	--	------------------------	---------------------------	-------

		With recess for labeling plate	<b>3SU1851-0AA00-0AB2</b>	0.499
--	--	--------------------------------	---------------------------	-------

		With protective collar for 5 padlocks, EMERGENCY STOP mushroom 40 mm and EMERGENCY STOP mushroom 40 mm with RONIS key-operated release	<b>3SU1851-0AA00-0AF2</b>	0.580
--	--	--	---------------------------	-------

		With protective collar for 5 padlocks, EMERGENCY STOP mushroom 40 mm with BKS, Siemens, OMR key-operated release	<b>3SU1851-0AA00-0AG2</b>	0.593
--	--	--	---------------------------	-------

		With protective collar for 5 padlocks, mushroom 60 mm	<b>3SU1851-0AA00-0AH2</b>	0.590
--	--	---	---------------------------	-------

		With protective collar for 5 padlocks, mushroom 60 mm, horizontal mounting	<b>3SU1851-0AA00-0AJ2</b>	0.584
--	--	--	---------------------------	-------



3SU1851-0AA00-0AH1

Gray	1	With protective collar for 5 padlocks, mushroom 60 mm	<b>3SU1851-0AA00-0AH1</b>	0.602
------	---	---	---------------------------	-------

		With protective collar for 5 padlocks, mushroom 60 mm, horizontal mounting	<b>3SU1851-0AA00-0AJ1</b>	0.571
--	--	--	---------------------------	-------

		With recess for labeling plate	<b>3SU1851-0AA00-0AB1</b>	0.505
--	--	--------------------------------	---------------------------	-------

		With protective collar	<b>3SU1851-0AA00-0AC1</b>	0.605
--	--	------------------------	---------------------------	-------

	2	With recess for labeling plate	<b>3SU1852-0AA00-0AB1</b>	0.570
--	---	--------------------------------	---------------------------	-------

	3	With recess for labeling plate	<b>3SU1853-0AA00-0AB1</b>	0.700
--	---	--------------------------------	---------------------------	-------



3SU1853-0AA00-0AB1

	4	With recess for labeling plate	<b>3SU1854-0AA00-0AB1</b>	0.830
--	---	--------------------------------	---------------------------	-------



3SU1854-0AA00-0AB1

	6	With recess for labeling plate	<b>3SU1856-0AA00-0AB1</b>	1.082
--	---	--------------------------------	---------------------------	-------

## Enclosure for selector switches (4 switch positions), coordinate switches, ID key-operated switches and sensor switches

**Plastic, front plate mounting**

3SU1801-1AA00-1AA1

Gray	1	Center command point	<b>3SU1801-1AA00-1AA1</b>	0.264
------	---	----------------------	---------------------------	-------

**Metal, front plate mounting**

Gray	1	Center command point	<b>3SU1851-1AA00-1AA1</b>	0.487
------	---	----------------------	---------------------------	-------

## Commanding and signaling devices

### SIRIUS ACT pushbuttons and indicator lights

#### Accessories

#### Labels > Insert labels

#### Overview

Labels can be inserted for identification purposes for the 22 mm and 30 mm design lines of the pushbuttons (clear) and illuminated pushbuttons with flat button. These insert labels are made of transparent plastic with black inscription; they can be fitted in any 90° angle.

#### Inscription

The inscription is in upper/lower case, all words begin with upper case letters. Graphic symbols, including those not listed in the catalog, are according to ISO 7000 or IEC 60417.

The insert labels without inscription are suitable for user marking with permanent pen.

For customized inscriptions, see "Options", page 2/396.

#### Selection and ordering data

Color	Marking	Article No.	Weight kg
<b>Insert labels</b>			
<b>For self-inscription</b>			
Milky white/black (label/lettering)	None	<b>3SU1900-0AB71-0AA0</b>	36.000
<b>With customized inscription</b>			
Milky white/black (label/lettering)	For inscriptions or symbols, see "Options", page 2/396.	<b>3SU1900-0AB71-0AZ0</b>	
<b>Inscription in German</b>			
Milky white/black (label/lettering)	Ein	<b>3SU1900-0AB71-0AB0</b>	0.400
	Aus	<b>3SU1900-0AB71-0AC0</b>	0.040
	Auf	<b>3SU1900-0AB71-0AD0</b>	0.100
	Ab	<b>3SU1900-0AB71-0AE0</b>	
	Vor	<b>3SU1900-0AB71-0AF0</b>	0.040
	Zurück	<b>3SU1900-0AB71-0AG0</b>	0.020
	Rechts	<b>3SU1900-0AB71-0AH0</b>	0.400
	Links	<b>3SU1900-0AB71-0AJ0</b>	0.100
	Halt	<b>3SU1900-0AB71-0AK0</b>	0.100
	Zu	<b>3SU1900-0AB71-0AL0</b>	
	Schnell	<b>3SU1900-0AB71-0AM0</b>	
	Langsam	<b>3SU1900-0AB71-0AN0</b>	0.200
	Betrieb	<b>3SU1900-0AB71-0AP0</b>	0.100
	Störung	<b>3SU1900-0AB71-0AQ0</b>	0.033
Einrichten	<b>3SU1900-0AB71-0AR0</b>	0.600	
<b>Inscription in English</b>			
Milky white/black (label/lettering)	On	<b>3SU1900-0AB71-0DJ0</b>	1.000
	Off	<b>3SU1900-0AB71-0DK0</b>	0.059
	Up	<b>3SU1900-0AB71-0DL0</b>	0.050
	Down	<b>3SU1900-0AB71-0DM0</b>	0.050
	Forward	<b>3SU1900-0AB71-0DN0</b>	0.050
	Right	<b>3SU1900-0AB71-0DQ0</b>	
	Left	<b>3SU1900-0AB71-0DR0</b>	0.100
	Stop	<b>3SU1900-0AB71-0DS0</b>	0.400
	Start	<b>3SU1900-0AB71-0DT0</b>	
	Reset	<b>3SU1900-0AB71-0DU0</b>	0.046
	Test	<b>3SU1900-0AB71-0DV0</b>	0.038
	Open	<b>3SU1900-0AB71-0DW0</b>	0.040
	Close	<b>3SU1900-0AB71-0DX0</b>	0.040
	Running	<b>3SU1900-0AB71-0EB0</b>	0.400
	Fast	<b>3SU1900-0AB71-0EE0</b>	0.400
	Slow	<b>3SU1900-0AB71-0EF0</b>	0.400



3SU1900-0AB71-0AA0



3SU1900-0AB71-0AB0





























3SU1900-0AB71-0DN0

# Commanding and signaling devices

## SIRIUS ACT pushbuttons and indicator lights

### Accessories

Labels &gt; Insert labels

Color	Marking	Symbol No.	Article No.	Weight kg	
<b>Insert labels</b>					
<b>With symbol (ON/OFF)</b>					
	Milky white/black (label/lettering)	O	5008 IEC	<b>3SU1900-0AB71-0QA0</b>	0.046
		I	5007 IEC	<b>3SU1900-0AB71-0QB0</b>	0.036
		II	--	<b>3SU1900-0AB71-0QC0</b>	0.039
		III	--	<b>3SU1900-0AB71-0QD0</b>	0.100
3SU1900-0AB71-0QC0					
<b>With symbol (graphic)</b>					
	Milky white/black (label/lettering)	 ARROW DIRECTION TO RIGHT	5022 IEC	<b>3SU1900-0AB71-0QR0</b>	0.080
		 ARROW DIRECTION UP AND TO LEFT	--	<b>3SU1900-0AB71-0QS0</b>	0.050
		 CLOCKWISE ROTATION	0004 ISO	<b>3SU1900-0AB71-0QT0</b>	0.060
		 COUNTERCLOCKWISE ROTATION	--	<b>3SU1900-0AB71-0QU0</b>	0.050
		 RAPID TRAVERSE	0266 ISO	<b>3SU1900-0AB71-0QV0</b>	0.050
		 FEED	0259 ISO	<b>3SU1900-0AB71-0QW0</b>	
		 INCREASE, PLUS	5005 IEC	<b>3SU1900-0AB71-0QX0</b>	0.080
		 DECREASE, MINUS	5006 IEC	<b>3SU1900-0AB71-0QY0</b>	0.040
		 ELECTRIC MOTOR	0011 ISO	<b>3SU1900-0AB71-0RA0</b>	0.200
		 HORN	5014 IEC	<b>3SU1900-0AB71-0RB0</b>	0.063
		 WATER INLET	--	<b>3SU1900-0AB71-0RC0</b>	0.300
		 PUMP	0134 ISO	<b>3SU1900-0AB71-0RD0</b>	0.200
		 COOLANT PUMP	0355 ISO	<b>3SU1900-0AB71-0RE0</b>	0.100
		 CLAMP	5653 IEC	<b>3SU1900-0AB71-0RF0</b>	0.030
		 UNLOCK, UNCLAMP	5652 IEC	<b>3SU1900-0AB71-0RG0</b>	0.039
		 BRAKE	--	<b>3SU1900-0AB71-0RH0</b>	0.100
		 RELEASE BRAKE	0021 ISO	<b>3SU1900-0AB71-0RJ0</b>	0.060
		 INTERLOCK	0022 ISO	<b>3SU1900-0AB71-0RK0</b>	
		 UNLOCK	0023 ISO	<b>3SU1900-0AB71-0RL0</b>	0.067
		 SET UP	0910 ISO	<b>3SU1900-0AB71-0RM0</b>	1.400
		 ON/OFF, MOMENTARY CONTACT TYPE	5011 IEC	<b>3SU1900-0AB71-0RN0</b>	0.039
 MANUAL OPERATION	0096 ISO	<b>3SU1900-0AB71-0RP0</b>	0.200		
 AUTOMATIC CYCLE	0017 ISO	<b>3SU1900-0AB71-0RQ0</b>	0.039		
 SUCTION	--	<b>3SU1900-0AB71-0RR0</b>	0.050		
 BLOWING	--	<b>3SU1900-0AB71-0RS0</b>	0.100		
3SU1900-0AB71-0QT0					
3SU1900-0AB71-0QB0					
3SU1900-0AB71-0RB0					
3SU1900-0AB71-0RN0					

2

## Commanding and signaling devices

### SIRIUS ACT pushbuttons and indicator lights

#### Accessories

#### Labels > Insert labels

#### Options

##### Customized inscriptions

The labels can be inscribed with text and symbols not listed in the ordering data.

The default typeface used for inscriptions with text is Arial and the text is centered.

The font height is 2.5 mm.

Up to 6 characters per line are possible.

##### Examples of customized inscriptions



Two-line inscription in upper/lower case (Q0Y)

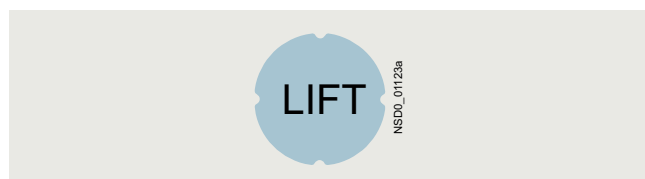

Single-line inscription in upper case (Q1Y)

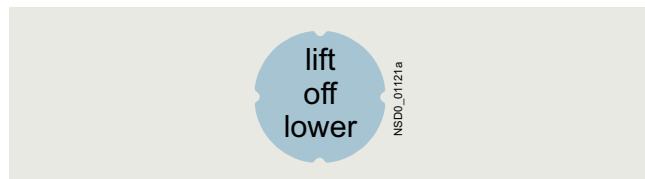

Three-line inscription in lower case (Q2Y)

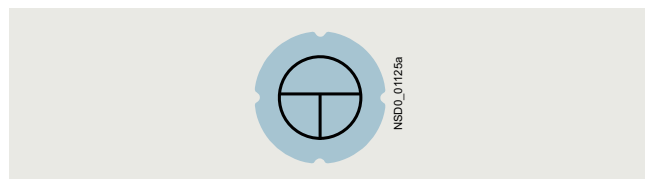

Symbol number 5011 according to IEC 60417 (Q3Y)

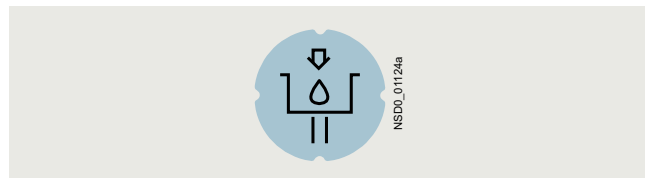

Any symbol according to order form supplement (Q9Y)

##### Ordering notes

Append the following order codes to the article number:

- **Q0Y:** Text line(s) in upper/lower case, always upper case for beginning of line, e.g. Z1=Lift Z2=Lower
- **Q1Y:** Text line(s) in upper case, e.g. Z1=LIFT Z2=LOWER
- **Q2Y:** Text line(s) in lower case, e.g. Z1=lift off Z2=lower off
- **Q5Y:** Text line(s) in upper/lower case, all words begin with upper case letters, e.g. Z1=Lift Off Z2=Lower Off
- **Q3Y:** Symbol with number according to ISO 7000 or IEC 60417
- **Q9Y:** Inscription of choice, text or symbol, can only be ordered via SIRIUS ACT configurator with a Configuration Identification Number (CIN)

When ordering, specify the required inscription without spaces after Z=, Z1=, etc., in addition to the article number and order code (see ordering examples 1 to 3).

In the case of multi-line inscriptions, the text must be assigned to the respective line,

e.g. Z1=LIFT Z2=LOWER (see ordering example 1).

Symbols can also be ordered with numbers according to ISO 7000 or IEC 60417 (see ordering examples 2 and 3).

The SIRIUS ACT configurator must be used to select special inscriptions and symbols (see ordering examples 4). In this case a CIN (Configuration Identification Number) is generated for placement of future orders. It is then possible to place an order directly via the SIRIUS ACT configurator using the CIN (Mail shopping cart) or via the standard ordering channels.

Standard ordering channels:

- Configurator: [www.siemens.com/sirius-act/configurator](http://www.siemens.com/sirius-act/configurator)
- Industry Mall: [www.siemens.com/industrymall](http://www.siemens.com/industrymall)

##### Ordering example 1

A label with 2 lines of text is required:

**3SU1900-0AB71-0AZ0**

**Q1Y**

Z1=LIFT

Z2=LOWER

##### Ordering example 2

A label inscribed with symbol No. 5011 according to IEC 60417 is required:

**3SU1900-0AB71-0AZ0**

**Q3Y**

Z=5011 IEC

##### Ordering example 3

A label inscribed with symbol No. 1118 according to ISO 7000 is required:

**3SU1900-0AB71-0AZ0**

**Q3Y**

Z=1118 ISO

##### Ordering example 4

A label with customized inscription is required:

**3SU1900-0AB71-0AZ0**

**Q9Y**

CIN.....

(20-digit number generated from the SIRIUS ACT configurator)



#### Selection and ordering data

Multi-unit packaging,  
see page 2/360.

	Material, label holder shape	Mounting diameter mm	Label holder color	Label fastening method	Labeling plate size		Article No.	Weight kg				
					Height mm	Width mm						
<b>Label holders for labeling plates</b>												
<b>For 1 labeling plate</b>												
	Plastic, with rounded bottom	22	Black	Self-adhesive	12.5	27	<b>3SU1900-0AG10-0AA0</b>	0.200				
					17.5	27	<b>3SU1900-0AH10-0AA0</b>	0.200				
					27	27	<b>3SU1900-0AJ10-0AA0</b>	0.200				
								Snap-on	12.5	27	<b>3SU1900-0AR10-0AA0</b>	0.200
									17.5	27	<b>3SU1900-0AS10-0AA0</b>	0.200
									27	27	<b>3SU1900-0AT10-0AA0</b>	0.200
3SU1900-0AG10-0AA0												
	Plastic, with square bottom	22	Black	Self-adhesive	12.5	27	<b>3SU1900-0AN10-0AA0</b>	0.200				
					17.5	27	<b>3SU1900-0AP10-0AA0</b>	0.200				
					27	27	<b>3SU1900-0AQ10-0AA0</b>	0.300				
3SU1900-0AN10-0AA0												
<b>For 2 labeling plates</b>												
	Plastic, with rounded bottom	22	Black	Self-adhesive	17.5	27	<b>3SU1900-0BQ10-0AA0</b>	0.003				
					Snap-on	17.5	27	<b>3SU1900-0BR10-0AA0</b>	0.003			
3SU1900-0BQ10-0AA0												
<b>For 4 labeling plates</b>												
	Plastic, with rounded bottom	22	Black	Self-adhesive	17.5	27	<b>3SU1900-0BS10-0AA0</b>	0.006				
					Snap-on	17.5	27	<b>3SU1900-0BT10-0AA0</b>	0.005			
3SU1900-0BT10-0AA0												
<b>For actuators and indicators</b>												
	Plastic, with rounded bottom	30	Black	Self-adhesive	17.5	27	<b>3SU1960-0AH10-0AA0</b>	0.002				
					Snap-on	17.5	27	<b>3SU1960-0AS10-0AA0</b>	0.002			
3SU1960-0AH10-0AA0												
<b>Label holders for labeling plates, coordinate switches</b>												
	Plastic, with square bottom	22	Black	Self-adhesive	27	27	<b>3SU1900-0AL10-0AA0</b>	0.005				
3SU1900-0AL10-0AA0												
	Plastic, cross	22	Black	Self-adhesive	27	27	<b>3SU1900-0AM10-0AA0</b>	0.010				
3SU1900-0AM10-0AA0												



## Commanding and signaling devices

### SIRIUS ACT pushbuttons and indicator lights

#### Accessories

#### Labels > Label holders for labeling plates

Multi-unit packaging,  
see page 2/360.

Material, label holder shape	Mounting diameter mm	Label holder color	Label fastening method	Labeling plate size		Article No.	Weight kg
				Height mm	Width mm		

#### Label holders for labeling plates, twin pushbuttons



Plastic,  
rectangular

22

Black

Self-  
adhesive

12.5

27

**3SU1900-0AK10-0AA0**

0.300

3SU1900-0AK10-0AA0

#### Single frames



Plastic,  
square

22

Black

--

29.8

29.8

**3SU1900-0AX10-0AA0**

0.001

3SU1900-0AX10-0AA0

### Overview

Label holders of black plastic, and labeling plates (black with white print or silver-colored with black print) for sticking or snapping in place, are available for labeling. They are not suitable for EMERGENCY STOP buttons. Note mounting dimensions!

The label holders cannot be used in conjunction with sealing plugs, protective caps, protective collars and locking devices.

### Inscription

The inscription is in upper/lower case, all words begin with upper case letters. Graphic symbols, including those not listed in the catalog, are according to ISO 7000 or IEC 60417.

For customized inscriptions, see "Options", page 2/405.

### Labeling plates for sticking/snapping in place



The labels are available in three sizes:

- 12.5 mm × 27 mm
- 17.5 mm × 27 mm
- 27 mm × 27 mm

For mounting the labeling plates, you can choose between label holders for stick-on or snap-on mounting.

### Selection and ordering data

Multi-unit packaging, see page 2/360.

	Color	Marking	Symbol No.	Article No.	Weight kg
<b>Labeling plates 12.5 mm x 27 mm</b>					
	<b>For self-inscription</b>				
	Black/white (label/lettering)	None	--	<b>3SU1900-0AC16-0AA0</b>	0.052
3SU1900-0AC16-0AA0	<b>With customized inscription</b>				
	Black/white (label/lettering)	For inscriptions or symbols, see "Options", page 2/405.	--	<b>3SU1900-0AC16-0AZ0</b>	
	<b>Inscription in German</b>				
	Black/white (label/lettering)	Ein	--	<b>3SU1900-0AC16-0AB0</b>	0.005
		Aus	--	<b>3SU1900-0AC16-0AC0</b>	0.067
		Auf	--	<b>3SU1900-0AC16-0AD0</b>	
		Ab	--	<b>3SU1900-0AC16-0AE0</b>	0.200
		Vor	--	<b>3SU1900-0AC16-0AF0</b>	0.200
		Zurück	--	<b>3SU1900-0AC16-0AG0</b>	
		Rechts	--	<b>3SU1900-0AC16-0AH0</b>	0.200
		Links	--	<b>3SU1900-0AC16-0AJ0</b>	0.050
		Halt	--	<b>3SU1900-0AC16-0AK0</b>	0.100
		Zu	--	<b>3SU1900-0AC16-0AL0</b>	0.200
		Betrieb	--	<b>3SU1900-0AC16-0AP0</b>	0.200
		Störung	--	<b>3SU1900-0AC16-0AQ0</b>	0.050
		Hand Auto	--	<b>3SU1900-0AC16-0DB0</b>	0.050
		Hand O Auto	--	<b>3SU1900-0AC16-0DD0</b>	0.052
		<b>Inscription in English</b>			
	Black/white (label/lettering)	On	--	<b>3SU1900-0AC16-0DJ0</b>	0.200
		Off	--	<b>3SU1900-0AC16-0DK0</b>	0.100
		Up	--	<b>3SU1900-0AC16-0DL0</b>	
		Down	--	<b>3SU1900-0AC16-0DM0</b>	0.200
		Forward	--	<b>3SU1900-0AC16-0DN0</b>	
		Reverse	--	<b>3SU1900-0AC16-0DP0</b>	0.400
		Right	--	<b>3SU1900-0AC16-0DQ0</b>	0.040
		Left	--	<b>3SU1900-0AC16-0DR0</b>	0.080
		Stop	--	<b>3SU1900-0AC16-0DS0</b>	0.033
		Start	--	<b>3SU1900-0AC16-0DT0</b>	0.040
		Reset	--	<b>3SU1900-0AC16-0DU0</b>	0.055
		Test	--	<b>3SU1900-0AC16-0DV0</b>	0.050
		Open	--	<b>3SU1900-0AC16-0DW0</b>	0.200
		Close	--	<b>3SU1900-0AC16-0DX0</b>	0.200
		Jog	--	<b>3SU1900-0AC16-0DE0</b>	0.200
		Running	--	<b>3SU1900-0AC16-0EB0</b>	0.200
		Fault	--	<b>3SU1900-0AC16-0EC0</b>	0.060
		Run	--	<b>3SU1900-0AC16-0ED0</b>	0.063
		Stop Start	--	<b>3SU1900-0AC16-0DC0</b>	0.200
		Off On	--	<b>3SU1900-0AC16-0DH0</b>	0.040
		Power off	--	<b>3SU1900-0AC16-0DF0</b>	0.300
		Power on	--	<b>3SU1900-0AC16-0DG0</b>	0.400
		Man O Auto	--	<b>3SU1900-0AC16-0DY0</b>	0.059
		Man Auto	--	<b>3SU1900-0AC16-0EA0</b>	0.400

# Commanding and signaling devices

## SIRIUS ACT pushbuttons and indicator lights

### Accessories

#### Labels > Labeling plates

Multi-unit packaging,  
see page 2/360.

Color	Marking	Symbol No.	Article No.	Weight kg
-------	---------	------------	-------------	--------------

#### Labeling plates 12.5 mm x 27 mm

2



3SU1900-0AC16-0GA0

#### Inscription in French

Black/white (label/lettering)	Marche	--	3SU1900-0AC16-0GA0	0.070
	Arrêt	--	3SU1900-0AC16-0GB0	0.100
	Montée	--	3SU1900-0AC16-0GC0	0.050
	Descente	--	3SU1900-0AC16-0GD0	0.100
	Avant	--	3SU1900-0AC16-0GE0	0.050
	Retour	--	3SU1900-0AC16-0GF0	0.050
	Droite	--	3SU1900-0AC16-0GG0	0.200
	Gauche	--	3SU1900-0AC16-0GH0	
	Ouvert	--	3SU1900-0AC16-0GJ0	0.300
	Fermé	--	3SU1900-0AC16-0GK0	0.600
	Rapide	--	3SU1900-0AC16-0GL0	
	En service	--	3SU1900-0AC16-0GM0	0.200
	Défaut	--	3SU1900-0AC16-0GN0	0.060
	Réglage	--	3SU1900-0AC16-0GP0	0.100
	Arrêt d'urgence	--	3SU1900-0AC16-0GQ0	0.039
	Hors service	--	3SU1900-0AC16-0GR0	0.100
	Sous tension	--	3SU1900-0AC16-0GS0	0.040
	Manu Auto	--	3SU1900-0AC16-0GT0	0.050
	Marche Arrêt	--	3SU1900-0AC16-0GU0	0.080
	Réarmement	--	3SU1900-0AC16-0GV0	0.060



3SU1900-0AC16-0QG0

#### With symbol

Black/white (label/lettering)	O	--	3SU1900-0AC16-0QA0	
	I	--	3SU1900-0AC16-0QB0	
	O I	--	3SU1900-0AC16-0QG0	0.046
	1 2	--	3SU1900-0AC16-0QJ0	0.300
	↑ ARROW DIRECTION UP	--	3SU1900-0AC16-0QS0	0.400

# Commanding and signaling devices



## SIRIUS ACT pushbuttons and indicator lights

### Accessories

#### Labels > Labeling plates

Multi-unit packaging,  
see page 2/360.

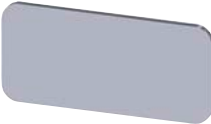
#### Labeling plates 12.5 mm x 27 mm

	Color	Marking	Symbol No.	Article No.	Weight kg
	Silver/black (label/lettering)	None	--	<b>3SU1900-0AC81-0AA0</b>	0.052
<b>For self-inscription</b>					
	Silver/black (label/lettering)	For inscriptions or symbols, see "Options", page 2/405.		<b>3SU1900-0AC81-0AZ0</b>	
<b>With customized inscription</b>					
<b>Inscription in German</b>					
3SU1900-0AC81-0AB0	Silver/black (label/lettering)	Ein	--	<b>3SU1900-0AC81-0AB0</b>	0.100
		Aus	--	<b>3SU1900-0AC81-0AC0</b>	0.100
		Auf	--	<b>3SU1900-0AC81-0AD0</b>	0.080
		Ab	--	<b>3SU1900-0AC81-0AE0</b>	0.100
		Vor	--	<b>3SU1900-0AC81-0AF0</b>	0.100
		Zurück	--	<b>3SU1900-0AC81-0AG0</b>	0.001
		Rechts	--	<b>3SU1900-0AC81-0AH0</b>	0.200
		Links	--	<b>3SU1900-0AC81-0AJ0</b>	0.200
		Halt	--	<b>3SU1900-0AC81-0AK0</b>	0.300
		Zu	--	<b>3SU1900-0AC81-0AL0</b>	0.050
		Schnell	--	<b>3SU1900-0AC81-0AM0</b>	0.050
		Langsam	--	<b>3SU1900-0AC81-0AN0</b>	0.050
		Betrieb	--	<b>3SU1900-0AC81-0AP0</b>	0.080
		Störung	--	<b>3SU1900-0AC81-0AQ0</b>	0.059
		Einrichten	--	<b>3SU1900-0AC81-0AR0</b>	0.200
		Hand Auto	--	<b>3SU1900-0AC81-0DB0</b>	0.080
Stop Start	--	<b>3SU1900-0AC81-0DC0</b>	6.600		
Hand O Auto	--	<b>3SU1900-0AC81-0DD0</b>			
<b>Inscription in English</b>					
3SU1900-0AC81-0DK0	Silver/black (label/lettering)	On	--	<b>3SU1900-0AC81-0DJ0</b>	0.400
		Off	--	<b>3SU1900-0AC81-0DK0</b>	0.200
		Up	--	<b>3SU1900-0AC81-0DL0</b>	0.050
		Down	--	<b>3SU1900-0AC81-0DM0</b>	
		Stop	--	<b>3SU1900-0AC81-0DS0</b>	0.200
		Start	--	<b>3SU1900-0AC81-0DT0</b>	0.040
		Reset	--	<b>3SU1900-0AC81-0DU0</b>	0.060
		Test	--	<b>3SU1900-0AC81-0DV0</b>	0.200
		Open	--	<b>3SU1900-0AC81-0DW0</b>	0.050
		Close	--	<b>3SU1900-0AC81-0DX0</b>	0.050
		Man O Auto	--	<b>3SU1900-0AC81-0DY0</b>	0.080
		Man Auto	--	<b>3SU1900-0AC81-0EA0</b>	0.053
		Running	--	<b>3SU1900-0AC81-0EB0</b>	
		Fault	--	<b>3SU1900-0AC81-0EC0</b>	
		Fast	--	<b>3SU1900-0AC81-0EE0</b>	0.050
		Slow	--	<b>3SU1900-0AC81-0EF0</b>	0.050
<b>With symbol</b>					
3SU1900-0AC81-0QK0	Silver/black (label/lettering)	O	5008 IEC	<b>3SU1900-0AC81-0QA0</b>	0.100
		I	5007 IEC	<b>3SU1900-0AC81-0QB0</b>	0.050
		II	--	<b>3SU1900-0AC81-0QC0</b>	0.080
		III	--	<b>3SU1900-0AC81-0QD0</b>	0.100
		O I	--	<b>3SU1900-0AC81-0QG0</b>	0.040
		I O II	--	<b>3SU1900-0AC81-0QK0</b>	0.060
		I O 2	--	<b>3SU1900-0AC81-0QL0</b>	0.100
		→ ARROW DIRECTION TO RIGHT	5022 IEC	<b>3SU1900-0AC81-0QR0</b>	0.040
		↑ ARROW DIRECTION UP	--	<b>3SU1900-0AC81-0QS0</b>	0.050

# Commanding and signaling devices



## SIRIUS ACT pushbuttons and indicator lights

### Accessories

#### Labels > Labeling plates

Multi-unit packaging,  
see page 2/360.

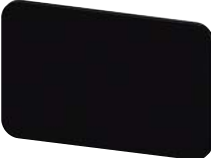
#### Labeling plates 17.5 mm x 27 mm

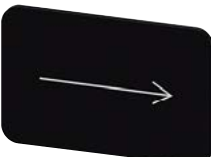
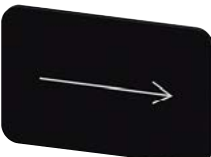
	Color	Marking	Symbol No.	Article No.	Weight kg			
	Black/white (label/lettering)	<b>For self-inscription</b>			None	--	3SU1900-0AD16-0AA0	0.065
		<b>With customized inscription</b>						
3SU1900-0AD16-0AA0								
	Black/white (label/lettering)	<b>Inscription in German</b>			Ein Aus Auf Ab Vor Zurück Halt Zu Betrieb Störung Hand Auto	-- -- -- -- -- -- -- -- -- -- -- --	3SU1900-0AD16-0AB0	0.080
		3SU1900-0AD16-0AC0	0.400					
		3SU1900-0AD16-0AD0	0.050					
		3SU1900-0AD16-0AE0	0.050					
		3SU1900-0AD16-0AF0	0.100					
		3SU1900-0AD16-0AG0	0.050					
		3SU1900-0AD16-0AK0	0.050					
		3SU1900-0AD16-0AL0	0.300					
		3SU1900-0AD16-0AP0	0.100					
		3SU1900-0AD16-0AQ0	0.070					
3SU1900-0AD16-0DB0	0.060							
	Black/white (label/lettering)	<b>Inscription in English</b>			Stop Start On Off Up Down Forward Reverse Right Stop Start Open Close Man Auto Running Fault	-- -- -- -- -- -- -- -- -- -- -- -- -- -- --	3SU1900-0AD16-0DC0	0.200
		3SU1900-0AD16-0DJ0	0.070					
		3SU1900-0AD16-0DK0	0.060					
		3SU1900-0AD16-0DL0	0.050					
		3SU1900-0AD16-0DM0	0.005					
		3SU1900-0AD16-0DN0	0.100					
		3SU1900-0AD16-0DP0	0.100					
		3SU1900-0AD16-0DQ0	0.071					
		3SU1900-0AD16-0DT0	0.010					
		3SU1900-0AD16-0DW0	0.100					
		3SU1900-0AD16-0DX0	0.100					
		3SU1900-0AD16-0EA0	0.050					
		3SU1900-0AD16-0EB0	0.060					
		3SU1900-0AD16-0EC0	0.050					
			Black/white (label/lettering)	<b>Inscription in French</b>			Marche Arrêt Droite Gauche En service Défaut Sous tension Manu Auto Marche Arrêt Réarmement	-- -- -- -- -- -- -- -- -- --
3SU1900-0AD16-0GB0	0.100							
3SU1900-0AD16-0GG0	0.100							
3SU1900-0AD16-0GH0	0.200							
3SU1900-0AD16-0GM0	0.100							
3SU1900-0AD16-0GN0	0.100							
3SU1900-0AD16-0GS0	0.100							
3SU1900-0AD16-0GT0	0.050							
3SU1900-0AD16-0GU0	0.100							
3SU1900-0AD16-0GV0	0.100							
	Black/white (label/lettering)	<b>With symbol</b>			O I O I → ARROW DIRECTION TO RIGHT ↑ ARROW DIRECTION UP	5008 IEC 5007 IEC -- 5022 IEC --	3SU1900-0AD16-0QA0	0.080
		3SU1900-0AD16-0QB0	0.050					
		3SU1900-0AD16-0QG0	0.080					
		3SU1900-0AD16-0QR0	0.200					
		3SU1900-0AD16-0QS0	0.060					



# Commanding and signaling devices

## SIRIUS ACT pushbuttons and indicator lights

### Accessories

#### Labels > Labeling plates

Multi-unit packaging,  
see page 2/360.

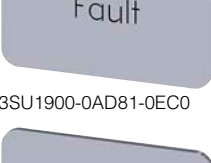
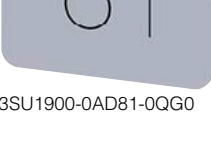
	Color	Marking	Symbol No.	Article No.	Weight kg		
<b>Labeling plates 17.5 mm x 27 mm</b>							
	<b>For self-inscription</b>						
	Silver/black (label/lettering)	None	--	<b>3SU1900-0AD81-0AA0</b>	0.060		
	<b>With customized inscription</b>						
	Silver/black (label/lettering)	For inscriptions or symbols, see "Options", page 2/405.		<b>3SU1900-0AD81-0AZ0</b>			
3SU1900-0AD81-0AA0							
	<b>Inscription in German</b>						
	Silver/black (label/lettering)	Ein	--	<b>3SU1900-0AD81-0AB0</b>	0.400		
		Aus	--	<b>3SU1900-0AD81-0AC0</b>	0.100		
		Auf	--	<b>3SU1900-0AD81-0AD0</b>	0.400		
		Ab	--	<b>3SU1900-0AD81-0AE0</b>			
		Vor	--	<b>3SU1900-0AD81-0AF0</b>			
		Zurück	--	<b>3SU1900-0AD81-0AG0</b>	0.050		
		Rechts	--	<b>3SU1900-0AD81-0AH0</b>	0.100		
		Halt	--	<b>3SU1900-0AD81-0AK0</b>	0.050		
		Zu	--	<b>3SU1900-0AD81-0AL0</b>	0.400		
		Betrieb	--	<b>3SU1900-0AD81-0AP0</b>	0.080		
		Störung	--	<b>3SU1900-0AD81-0AQ0</b>	0.059		
		Hand Auto	--	<b>3SU1900-0AD81-0DB0</b>	0.400		
		Hand O Auto	--	<b>3SU1900-0AD81-0DD0</b>			
3SU1900-0AD81-0AP0							
	<b>Inscription in English</b>						
	Silver/black (label/lettering)	On	--	<b>3SU1900-0AD81-0DJ0</b>	0.200		
		Off	--	<b>3SU1900-0AD81-0DK0</b>			
		Stop	--	<b>3SU1900-0AD81-0DS0</b>	0.200		
		Start	--	<b>3SU1900-0AD81-0DT0</b>	0.080		
		Reset	--	<b>3SU1900-0AD81-0DU0</b>	0.100		
		Man O Auto	--	<b>3SU1900-0AD81-0DY0</b>	0.300		
		Fault	--	<b>3SU1900-0AD81-0EC0</b>	0.070		
3SU1900-0AD81-0EC0							
	<b>With symbol</b>						
	Silver/black (label/lettering)	O	5008 IEC	<b>3SU1900-0AD81-0QA0</b>	0.100		
		I	5007 IEC	<b>3SU1900-0AD81-0QB0</b>	0.200		
		O I	--	<b>3SU1900-0AD81-0QG0</b>	0.080		
		I O II	--	<b>3SU1900-0AD81-0QK0</b>	0.060		
		1 O 2	--	<b>3SU1900-0AD81-0QL0</b>	0.400		
		→	ARROW DIRECTION TO RIGHT	5022 IEC	<b>3SU1900-0AD81-0QR0</b>	0.200	
		↑	ARROW DIRECTION UP	--	<b>3SU1900-0AD81-0QS0</b>	0.100	
		3SU1900-0AD81-0QG0					

# Commanding and signaling devices







## SIRIUS ACT pushbuttons and indicator lights

### Accessories

#### Labels > Labeling plates

Multi-unit packaging,  
see page 2/360.

#### Labeling plates 27 mm x 27 mm

	Color	Marking	Symbol No.	Article No.	Weight kg
	Black/white (label/lettering)	None	--	<b>3SU1900-0AE16-0AA0</b>	0.094
	Silver/black (label/lettering)	None	--	<b>3SU1900-0AE81-0AA0</b>	0.094
	<b>With customized inscription</b>			<b>3SU1900-0AE16-0AZ0</b>	
	Black/white (label/lettering)	For inscriptions or symbols, see "Options", page 2/405.			
3SU1900-0AE16-0AA0	Silver/black (label/lettering)			<b>3SU1900-0AE81-0AZ0</b>	
3SU1900-0AE81-0AA0					
	<b>Inscription in German</b>				
	Black/white (label/lettering)	Ein	--	<b>3SU1900-0AE16-0AB0</b>	0.100
		Aus	--	<b>3SU1900-0AE16-0AC0</b>	0.100
		Auf	--	<b>3SU1900-0AE16-0AD0</b>	0.050
		Ab	--	<b>3SU1900-0AE16-0AE0</b>	0.100
		Vor	--	<b>3SU1900-0AE16-0AF0</b>	0.200
		Zurück	--	<b>3SU1900-0AE16-0AG0</b>	0.200
		Rechts	--	<b>3SU1900-0AE16-0AH0</b>	0.050
		Links	--	<b>3SU1900-0AE16-0AJ0</b>	0.100
		Halt	--	<b>3SU1900-0AE16-0AK0</b>	0.400
		Zu	--	<b>3SU1900-0AE16-0AL0</b>	0.300
		Betrieb	--	<b>3SU1900-0AE16-0AP0</b>	0.100
		Störung	--	<b>3SU1900-0AE16-0AQ0</b>	0.200
3SU1900-0AE16-0AD0	Hand Auto	--	<b>3SU1900-0AE16-0DB0</b>	0.200	
	<b>Inscription in English</b>				
	Black/white (label/lettering)	On	--	<b>3SU1900-0AE16-0DJ0</b>	0.200
		Off	--	<b>3SU1900-0AE16-0DK0</b>	0.100
		Up	--	<b>3SU1900-0AE16-0DL0</b>	0.100
		Down	--	<b>3SU1900-0AE16-0DM0</b>	0.090
		Forward	--	<b>3SU1900-0AE16-0DN0</b>	0.300
		Reverse	--	<b>3SU1900-0AE16-0DP0</b>	0.100
		Stop	--	<b>3SU1900-0AE16-0DS0</b>	0.100
		Start	--	<b>3SU1900-0AE16-0DT0</b>	0.100
		EMERGENCY STOP	--	<b>3SU1900-0AE16-0DA0</b>	0.300
3SU1900-0AE16-0DK0	Stop Start	--	<b>3SU1900-0AE16-0DC0</b>	0.100	
	<b>Inscription in French</b>				
	Black/white (label/lettering)	Marche	--	<b>3SU1900-0AE16-0GA0</b>	0.070
		Arrêt	--	<b>3SU1900-0AE16-0GB0</b>	0.100
		Montée	--	<b>3SU1900-0AE16-0GC0</b>	0.100
		Descente	--	<b>3SU1900-0AE16-0GD0</b>	0.100
		En service	--	<b>3SU1900-0AE16-0GM0</b>	0.100
		Défaut	--	<b>3SU1900-0AE16-0GN0</b>	0.100
		Sous tension	--	<b>3SU1900-0AE16-0GS0</b>	0.100
		Manu Auto	--	<b>3SU1900-0AE16-0GT0</b>	0.050
3SU1900-0AE16-0GB0	Marche Arrêt		<b>3SU1900-0AE16-0GU0</b>	0.080	
	<b>With symbol</b>				
	Black/white (label/lettering)	O I → ARROW DIRECTION TO RIGHT	5022 IEC	<b>3SU1900-0AE16-0QG0</b> <b>3SU1900-0AE16-0QR0</b>	0.200 0.086
3SU1900-0AE16-0QG0					

## Options

### Customized inscriptions

The labels can be inscribed with text and symbols not listed in the ordering data.

The default typeface used for inscriptions with text is Arial and the text is centered.

Up to 11 characters per line are possible.

#### Font height

Label size 12.5 mm × 27 mm, max. 3 lines:

Font height	1-line	4 mm
	2-line	3 mm
	3-line	1.75 mm

Label size 17.5 mm × 27 mm, max. 3 lines:

Font height	1- to 2-line	4 mm
	3-line	3 mm

Label size 27 mm × 27 mm, max. 5 lines:

Font height	1- to 3-line	4 mm
	4-line	3.5 mm
	5-line	3 mm

#### Examples of customized inscriptions



Two-line inscription in upper/lower case (Q0Y)



Single-line inscription in upper case (Q1Y)



Three-line inscription in lower case (Q2Y)

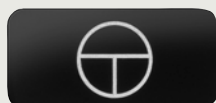

Symbol number 5011 according to IEC 60417 (Q3Y)



Any symbol according to order form supplement (Q9Y)

### Ordering notes

Append the following order codes to the article number:

- **Q0Y:** Text line(s) in upper/lower case, always upper case for beginning of line, e.g. Z1=Lift Z2=Lower
- **Q1Y:** Text line(s) in upper case, e.g. Z1=LIFT Z2=LOWER
- **Q2Y:** Text line(s) in lower case, e.g. Z1=lift off Z2=lower off
- **Q5Y:** Text line(s) in upper/lower case, all words begin with upper case letters, e.g. Z1=Lift Off Z2=Lower Off
- **Q3Y:** Symbol with number according to ISO 7000 or IEC 60417
- **Q9Y:** Inscription of choice, text or symbol, can only be ordered via SIRIUS ACT configurator with a Configuration Identification Number (CIN)

When ordering, specify the required inscription without spaces after Z=, Z1=, etc., in addition to the article number and order code (see ordering examples 1 to 3).

In the case of multi-line inscriptions, the text must be assigned to the respective line, e.g. Z1=LIFT Z2=LOWER (see ordering example 1).

Symbols can also be ordered with numbers according to ISO 7000 or IEC 60417 (see ordering examples 2 and 3).

The SIRIUS ACT configurator must be used to select special inscriptions and symbols (see ordering examples 4). In this case a CIN (Configuration Identification Number) is generated for placement of future orders. It is then possible to place an order directly via the SIRIUS ACT configurator using the CIN (Mall shopping cart) or via the standard ordering channels.

Standard ordering channels:

- Configurator: [www.siemens.com/sirius-act/configurator](http://www.siemens.com/sirius-act/configurator)
- Industry Mall: [www.siemens.com/industrymall](http://www.siemens.com/industrymall)

#### Ordering example 1

A label with 2 lines of text is required:

**3SU1900-0AC16-0AZ0**

**Q1Y**

Z1=LIFT

Z2=LOWER

#### Ordering example 2

A label inscribed with symbol No. 5011 according to IEC 60417 is required:

**3SU1900-0AC16-0AZ0**

**Q3Y**

Z=5011 IEC

#### Ordering example 3

A label inscribed with symbol No. 1118 according to ISO 7000 is required:

**3SU1900-0AC16-0AZ0**

**Q3Y**

Z=1118 ISO

#### Ordering example 4

An indicator light with customized inscription is required:

**3SU1900-0AC16-0AZ0**

**Q9Y**

CIN.....

(20-digit number generated from the SIRIUS ACT configurator)



## Commanding and signaling devices

### SIRIUS ACT pushbuttons and indicator lights

#### Accessories

#### Labels > Labeling plates for enclosures

#### Overview

The labeling plates in size 22 mm x 22 mm can be attached to enclosures with recesses for labels. There are versions in black with white print or silver-colored with black print.







#### Inscription

The inscription is in upper/lower case, all words begin with upper case letters. Graphic symbols, including those not listed in the catalog, are according to ISO 7000 or IEC 60417.

For customized inscriptions, see "Options", page 2/409.

#### Selection and ordering data

Multi-unit packaging, see page 2/360.

	Color	Marking	Symbol No.	Article No.	Weight kg	
<b>Labeling plates 22 mm x 22 mm</b>						
	<b>For self-inscription</b>					
	Black/white (label/lettering)	None	--	<b>3SU1900-0AF16-0AA0</b>	0.073	
	<b>With customized inscription</b>					
	Black/white (label/lettering)	For inscriptions or symbols, see "Options", page 2/409.		<b>3SU1900-0AF16-0AZ0</b>		
	<b>Inscription in German</b>					
	Black/white (label/lettering)	Ein	--	<b>3SU1900-0AF16-0AB0</b>	0.001	
		Aus	--	<b>3SU1900-0AF16-0AC0</b>	0.001	
		Auf	--	<b>3SU1900-0AF16-0AD0</b>	0.001	
		Ab	--	<b>3SU1900-0AF16-0AE0</b>	0.001	
		Vor	--	<b>3SU1900-0AF16-0AF0</b>	0.002	
		Zurück	--	<b>3SU1900-0AF16-0AG0</b>	0.001	
		Rechts	--	<b>3SU1900-0AF16-0AH0</b>	0.001	
		Links	--	<b>3SU1900-0AF16-0AJ0</b>	0.001	
		Halt	--	<b>3SU1900-0AF16-0AK0</b>	0.001	
		Zu	--	<b>3SU1900-0AF16-0AL0</b>	0.001	
		Schnell	--	<b>3SU1900-0AF16-0AM0</b>	0.001	
		Langsam	--	<b>3SU1900-0AF16-0AN0</b>	0.002	
		Betrieb	--	<b>3SU1900-0AF16-0AP0</b>	0.001	
		Störung	--	<b>3SU1900-0AF16-0AQ0</b>	0.001	
		Einrichten	--	<b>3SU1900-0AF16-0AR0</b>	0.002	
		NOT AUS	--	<b>3SU1900-0AF16-0AS0</b>	0.001	
	<b>Inscription in English</b>					
		Black/white (label/lettering)	On	--	<b>3SU1900-0AF16-0DJ0</b>	0.001
			Off	--	<b>3SU1900-0AF16-0DK0</b>	0.001
		Up	--	<b>3SU1900-0AF16-0DL0</b>	0.001	
		Down	--	<b>3SU1900-0AF16-0DM0</b>	0.004	
		Forward	--	<b>3SU1900-0AF16-0DN0</b>	0.001	
		Right	--	<b>3SU1900-0AF16-0DQ0</b>	0.001	
		Left	--	<b>3SU1900-0AF16-0DR0</b>	0.001	
		Stop	--	<b>3SU1900-0AF16-0DS0</b>	0.001	
		Start	--	<b>3SU1900-0AF16-0DT0</b>	0.001	
		Reset	--	<b>3SU1900-0AF16-0DU0</b>	0.001	
		Test	--	<b>3SU1900-0AF16-0DV0</b>	0.001	
		Open	--	<b>3SU1900-0AF16-0DW0</b>	0.001	
		Close	--	<b>3SU1900-0AF16-0DX0</b>	0.001	
		Running	--	<b>3SU1900-0AF16-0EB0</b>	0.004	
		Fault	--	<b>3SU1900-0AF16-0EC0</b>	0.001	
		Fast	--	<b>3SU1900-0AF16-0EE0</b>	0.001	
	Slow	--	<b>3SU1900-0AF16-0EF0</b>	0.001		
	EMERGENCY STOP	--	<b>3SU1900-0AF16-0DA0</b>	0.001		









# Commanding and signaling devices

## SIRIUS ACT pushbuttons and indicator lights

### Accessories

#### Labels > Labeling plates for enclosures

Multi-unit packaging,  
see page 2/360.

	Color	Marking	Symbol No.	Article No.	Weight kg	
<b>Labeling plates 22 mm x 22 mm</b>						
<b>Inscription in French</b>						
 3SU1900-0AF16-0GA0	Black/white (label/lettering)	Marche	--	<b>3SU1900-0AF16-0GA0</b>	0.001	
		Arrêt	--	<b>3SU1900-0AF16-0GB0</b>	0.001	
		Montée	--	<b>3SU1900-0AF16-0GC0</b>	0.001	
		Descente	--	<b>3SU1900-0AF16-0GD0</b>	0.001	
		Retour	--	<b>3SU1900-0AF16-0GF0</b>	0.001	
		Droite	--	<b>3SU1900-0AF16-0GG0</b>	0.001	
		Gauche	--	<b>3SU1900-0AF16-0GH0</b>	0.003	
		Ouvert	--	<b>3SU1900-0AF16-0GJ0</b>	0.001	
		Fermé	--	<b>3SU1900-0AF16-0GK0</b>	0.001	
		Rapide	--	<b>3SU1900-0AF16-0GL0</b>	0.001	
		En service	--	<b>3SU1900-0AF16-0GM0</b>	0.003	
		Défaut	--	<b>3SU1900-0AF16-0GN0</b>	0.003	
		Sous tension	--	<b>3SU1900-0AF16-0GS0</b>	0.003	
		Manu Auto	--	<b>3SU1900-0AF16-0GT0</b>	0.004	
Marche Arrêt	--	<b>3SU1900-0AF16-0GU0</b>	0.004			
Réarmement	--	<b>3SU1900-0AF16-0GV0</b>	0.004			
Lent	--	<b>3SU1900-0AF16-0GW0</b>	0.004			
Arrêt d'urgence	--	<b>3SU1900-0AF16-0GQ0</b>	0.001			
 3SU1900-0AF16-0QQ0	Black/white (label/lettering)	O	5008 IEC	<b>3SU1900-0AF16-0QA0</b>	0.001	
		I	5007 IEC	<b>3SU1900-0AF16-0QB0</b>	0.001	
		II	--	<b>3SU1900-0AF16-0QC0</b>	0.002	
		III	--	<b>3SU1900-0AF16-0QD0</b>	0.004	
		O I	--	<b>3SU1900-0AF16-0QG0</b>	0.004	
		I O II	--	<b>3SU1900-0AF16-0QK0</b>	0.004	
		I	--	<b>3SU1900-0AF16-0QP0</b>	0.001	
		O (below each other)	--	<b>3SU1900-0AF16-0QQ0</b>	0.001	
		II	--	<b>3SU1900-0AF16-0QQ0</b>	0.001	
		O (below each other)	--	<b>3SU1900-0AF16-0QQ0</b>	0.001	
 3SU1900-0AF16-0RW0	Black/white (label/lettering)	→	ARROW DIRECTION TO RIGHT	5022 IEC	<b>3SU1900-0AF16-0QR0</b>	0.001
			PUMP	0134 ISO	<b>3SU1900-0AF16-0RD0</b>	0.004
			FAN	--	<b>3SU1900-0AF16-0RV0</b>	0.001
			COOLING	--	<b>3SU1900-0AF16-0RW0</b>	0.001
			ILLUMINATION	--	<b>3SU1900-0AF16-0RX0</b>	0.001
			MOTOR	--	<b>3SU1900-0AF16-0RY0</b>	0.001





# Commanding and signaling devices

## SIRIUS ACT pushbuttons and indicator lights

### Accessories

#### Labels > Labeling plates for enclosures

Multi-unit packaging,  
see page 2/360.

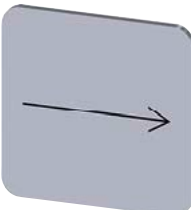
	Color	Marking	Symbol No.	Article No.	Weight kg	
<b>Labeling plates 22 mm x 22 mm</b>						
	<b>For self-inscription</b>					
	Silver/black (label/lettering)	None	--	<b>3SU1900-0AF81-0AA0</b>	0.067	
	<b>With customized inscription</b>					
	Silver/black (label/lettering)	For inscriptions or symbols, see "Options", page 2/409.		<b>3SU1900-0AF81-0AZ0</b>		
3SU1900-0AF81-0AA0						
	<b>Inscription in German</b>					
	Silver/black (label/lettering)	Ein	--		<b>3SU1900-0AF81-0AB0</b>	0.004
		Aus	--		<b>3SU1900-0AF81-0AC0</b>	0.001
		Auf	--		<b>3SU1900-0AF81-0AD0</b>	0.001
		Ab	--		<b>3SU1900-0AF81-0AE0</b>	0.001
		Vor	--		<b>3SU1900-0AF81-0AF0</b>	0.001
		Zurück	--		<b>3SU1900-0AF81-0AG0</b>	0.002
		Rechts	--		<b>3SU1900-0AF81-0AH0</b>	
		Links	--		<b>3SU1900-0AF81-0AJ0</b>	0.004
		Halt	--		<b>3SU1900-0AF81-0AK0</b>	0.001
		Zu	--		<b>3SU1900-0AF81-0AL0</b>	0.002
		Schnell	--		<b>3SU1900-0AF81-0AM0</b>	0.002
		Langsam	--		<b>3SU1900-0AF81-0AN0</b>	
		Betrieb	--		<b>3SU1900-0AF81-0AP0</b>	0.001
		Störung	--		<b>3SU1900-0AF81-0AQ0</b>	
		Einrichten	--		<b>3SU1900-0AF81-0AR0</b>	0.001
		NOT AUS	--		<b>3SU1900-0AF81-0AS0</b>	
NOT-HALT		--		<b>3SU1900-0AF81-0AT0</b>	0.001	
Hand O Auto	--		<b>3SU1900-0AF81-0DD0</b>			
3SU1900-0AF81-0DD0						
	<b>Inscription in English</b>					
	Silver/black (label/lettering)	Stop	--		<b>3SU1900-0AF81-0DS0</b>	0.004
		Start	--		<b>3SU1900-0AF81-0DT0</b>	0.001
		Reset	--		<b>3SU1900-0AF81-0DU0</b>	0.001
		Test	--		<b>3SU1900-0AF81-0DV0</b>	0.001
		Open	--		<b>3SU1900-0AF81-0DW0</b>	
3SU1900-0AF81-0DU0						
	<b>With symbol (ON/OFF)</b>					
	Silver/black (label/lettering)	O	5008 IEC		<b>3SU1900-0AF81-0QA0</b>	0.004
		I	5007 IEC		<b>3SU1900-0AF81-0QB0</b>	0.001
		II	--		<b>3SU1900-0AF81-0QC0</b>	
		III	--		<b>3SU1900-0AF81-0QD0</b>	0.004
		O I	--		<b>3SU1900-0AF81-0QG0</b>	
		I O II	--		<b>3SU1900-0AF81-0QK0</b>	
		I	--		<b>3SU1900-0AF81-0QP0</b>	0.001
		O (below each other)	--			
		II	--		<b>3SU1900-0AF81-0QQ0</b>	
O (below each other)		--				
3SU1900-0AF81-0QK0						
	<b>With symbol (graphic)</b>					
	Silver/black (label/lettering)	→ ARROW DIRECTION TO RIGHT	5022 IEC	<b>3SU1900-0AF81-0QR0</b>		
3SU1900-0AF81-0QR0						

## Options

### Customized inscriptions

The labels can be inscribed with texts and symbols not listed in the ordering data.

The default typeface used for inscriptions with text is Arial and the text is centered.

The font height is 4 mm (1- and 2-line) and 3.5 mm (3-line).

Up to 8 characters per line are possible.

#### Examples of customized inscriptions

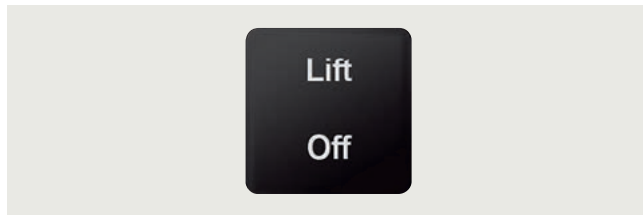

Two-line inscription in upper/lower case (Q0Y)

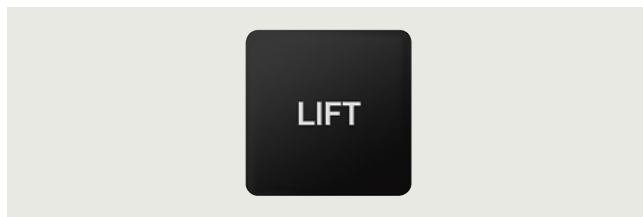

Single-line inscription in upper case (Q1Y)

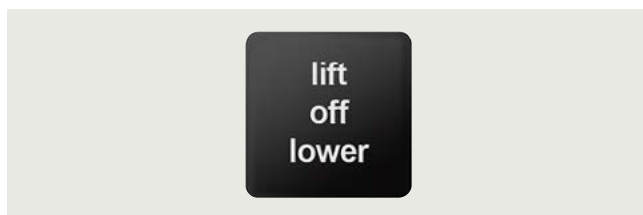

Backing plate for enclosures, customized inscription (Q2Y)

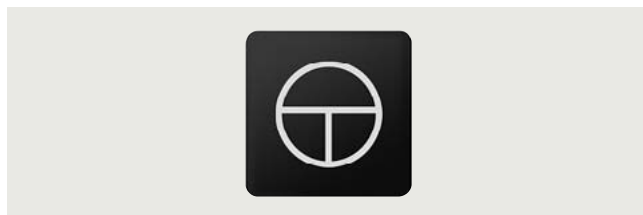

Symbol number 5011 according to IEC 60417 (Q3Y)

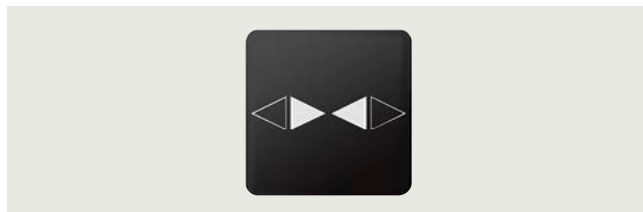

Any symbol according to order form supplement (Q9Y)

### Ordering notes

Append the following order codes to the article number:

- **Q0Y:** Text line(s) in upper/lower case, always upper case for beginning of line, e.g. Z1=Lift Z2=Lower
- **Q1Y:** Text line(s) in upper case, e.g. Z1=LIFT Z2=LOWER
- **Q2Y:** Text line(s) in lower case, e.g. Z1=lift off Z2=lower off
- **Q5Y:** Text line(s) in upper/lower case, all words begin with upper case letters, e.g. Z1=Lift Off Z2=Lower Off
- **Q3Y:** Symbol with number according to ISO 7000 or IEC 60417
- **Q9Y:** Inscription of choice, text or symbol, can only be ordered via SIRIUS ACT configurator with a Configuration Identification Number (CIN)

When ordering, specify the required inscription without spaces after Z=, Z1=, etc., in addition to the article number and order code (see ordering examples 1 to 3).

In the case of multi-line inscriptions, the text must be assigned to the respective line, e.g. Z1=LIFT Z2=LOWER (see ordering example 1).

Symbols can also be ordered with numbers according to ISO 7000 or IEC 60417 (see ordering example 2 and 3).

The SIRIUS ACT configurator must be used to select special inscriptions and symbols (see ordering example 4). In this case a CIN (Configuration Identification Number) is generated for placement of future orders. It is then possible to place an order directly via the SIRIUS ACT configurator using the CIN (Mall shopping cart) or via the standard ordering channels.

Standard ordering channels:

- Configurator: [www.siemens.com/sirius-act/configurator](http://www.siemens.com/sirius-act/configurator)
- Industry Mall: [www.siemens.com/industrymall](http://www.siemens.com/industrymall)

#### Ordering example 1

A label with 2 lines of text is required:

**3SU1900-0AF16-0AZ0**

**Q1Y**

Z1=LIFT

Z2=LOWER

#### Ordering example 2

A label inscribed with symbol No. 5011 according to IEC 60417 is required:

**3SU1900-0AF16-0AZ0**

**Q3Y**

Z=5011 IEC

#### Ordering example 3

A label inscribed with symbol No. 1118 according to ISO 7000 is required:

**3SU1900-0AF16-0AZ0**

**Q3Y**

Z=1118 ISO

#### Ordering example 4

A label with customized inscription is required:

**3SU1900-0AF16-0AZ0**

**Q9Y**

CIN.....

(20-digit number generated from the SIRIUS ACT configurator)

## Commanding and signaling devices

### SIRIUS ACT pushbuttons and indicator lights

#### Accessories

#### Labels > Labels for laser printers

#### Overview

##### More information

For the Label Designer software, see [www.siemens.com/sirius-label-designer](http://www.siemens.com/sirius-label-designer)

##### Label inscriptions

Using the *Label Designer* software, which can be downloaded from the internet, and the labeling plates for laser inscription you can create your own customized labels with a standard laser printer. The self-adhesive or snap-on labels can be stuck or snapped onto the corresponding label holders. Round labels are provided for inserting in illuminated pushbuttons and switches.

The labels are suitable for inscription with one to three lines of text or symbols.



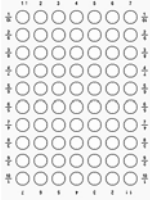
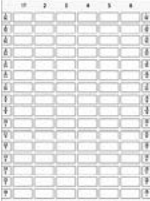

For applications with more exacting requirements we recommend factory-printed labeling plates and insert labels (laser-printed or engraved depending on the type).

#### Selection and ordering data

Fixing method	Height mm	Width mm	Article No.	Weight kg
<b>Labels for printing – insert labels</b>				
 Insert	--	--	<b>3SU1900-0BH60-0AA0</b>	0.029
<b>Labels for printing – labeling plates</b>				
 Self-adhesive	12.5 17.5 27 22	27.5 27 27 22	<b>3SU1900-0BJ61-0AA0</b> <b>3SU1900-0BK61-0AA0</b> <b>3SU1900-0BL61-0AA0</b> <b>3SU1900-0BM61-0AA0</b>	0.033 0.034 0.050 0.035
3SU1900-0BJ61-0AA0				

#### Selection and ordering data

Multi-unit packaging, see page 2/360.



	Color	Mounting diameter	Fixing method	Outer diameter	Marking	Article No.	Weight
		mm		mm			kg
<b>EMERGENCY STOP backing plates (2 mm thick)</b>							
 3SU1900-0BB31-0AT0	Yellow/black (label/lettering)	22	None	45	None	3SU1900-0BA31-0AA0	0.002
					EMERGENCY OFF (Polish)	3SU1900-0BA31-0ND0	0.002
	None	60	NOT-HALT, EMERGENCY STOP, ARRÊT D'URGENCE, EMERGENZA (German, English, French, Italian)	3SU1900-0BN31-0NC0	0.004		
				None	3SU1900-0BB31-0AA0	0.007	
				NOT-AUS	3SU1900-0BB31-0AS0	0.007	
None	75	NOT-HALT	3SU1900-0BB31-0AT0	0.007			
			EMERGENCY STOP	3SU1900-0BB31-0DA0	0.007		
EMERGENCY OFF (Polish)	3SU1900-0BB31-0ND0	0.007					
<b>With customized inscription</b>							
	Yellow/black (label/lettering)	22	None	45	For inscriptions or symbols, see "Options", page 2/413.	3SU1900-0BA31-0AZ0	
				75		3SU1900-0BB31-0AZ0	
<b>EMERGENCY STOP backing plates (5 mm thick), illuminated (24 V AC/DC)</b>							
 3SU1901-0BD31-0AA0	Yellow/black (label/lettering)	22	Self-adhesive	60	None	3SU1901-0BD31-0AA0	0.018
					NOT-AUS	3SU1901-0BD31-0AS0	0.018
					NOT-HALT	3SU1901-0BD31-0AT0	0.018
					EMERGENCY STOP	3SU1901-0BD31-0DA0	0.018
					NOT-HALT, EMERGENCY STOP, EMERGENZA, EMERGENCIA (German, English, Italian, Spanish)	3SU1901-0BD31-0NB0	0.018
<b>With customized inscription</b>							
	Yellow/black (label/lettering)	22	None	60	For inscriptions or symbols, see "Options", page 2/413.	3SU1901-0BD31-0AZ0	
<b>EMERGENCY STOP backing plates (0.3 mm thick)</b>							
 3SU1900-0BC31-0NB0	Yellow/black (label/lettering)	22	Self-adhesive	75	None	3SU1900-0BC31-0AA0	0.002
					NOT-AUS	3SU1900-0BC31-0AS0	0.001
					NOT-HALT	3SU1900-0BC31-0AT0	0.001
					EMERGENCY STOP	3SU1900-0BC31-0DA0	0.001
					ARRÊT D'URGENCE	3SU1900-0BC31-0GQ0	0.001
					EMERGENZA	3SU1900-0BC31-0JA0	0.002
					Nodstop	3SU1900-0BC31-0LA0	0.002
					EMERGENCY OFF (Chinese)	3SU1900-0BC31-0MA0	0.001
					NOT-HALT, EMERGENCY STOP, EMERGENZA, EMERGENCIA (German, English, Italian, Spanish)	3SU1900-0BC31-0NB0	0.001
					<b>With customized inscription</b>		
	Yellow/black (label/lettering)	22	Self-adhesive	75	For inscriptions or symbols, see "Options", page 2/413.	3SU1900-0BC31-0AZ0	
<b>Labeling plates (1.2 mm thick) for potentiometers</b>							
 3SU1900-0BG16-0RU0	Black/white (label/lettering)	22	None	40	--	3SU1900-0BG16-0AA0	0.002
					SYMBOL: 0 ... 9	3SU1900-0BG16-0RT0	0.001
					SYMBOL: 0 ... 10	3SU1900-0BG16-0SA0	0.002
					SYMBOL: Power up	3SU1900-0BG16-0RU0	0.001

## Commanding and signaling devices

### SIRIUS ACT pushbuttons and indicator lights

#### Accessories

#### Labels > Other labels

	Color	Mounting diameter mm	Label fastening method	Height mm	Width mm	Marking	Article No.	Weight kg
<b>Labeling plates (0.3 mm thick) for enclosures with EMERGENCY STOP without recess</b>								
	Yellow/black (label/lettering)	22	Self-adhesive	38	112	None NOT-AUS NOT-HALT	<b>3SU1900-0BE31-0AA0</b> <b>3SU1900-0BE31-0AS0</b> <b>3SU1900-0BE31-0AT0</b>	0.002 0.002 0.004
3SU1900-0BE31-0AS0								
<b>Labeling plates (0.3 mm thick) for enclosures with EMERGENCY STOP with recess</b>								
	Yellow/black (label/lettering)	22	Self-adhesive	38	112	None	<b>3SU1900-0BF31-0AA0</b>	0.001
3SU1900-0BF31-0AA0								
<b>Device labeling plates for modules with front-plate mounting</b>								
	White/black (label/lettering)	22	Insert	9.5	10.5	None	<b>3SU1900-0AY61-0AA0</b>	0.029
3SU1900-0AY61-0AA0								

## Options

### Customized inscriptions

The labels can be inscribed with text not listed in the ordering data.

The EMERGENCY STOP backing plates can be divided into as many as four radial segments. Each segment can be custom-labeled.

The default typeface used for inscriptions with text is Arial and the text is centered.

#### EMERGENCY STOP backing plate 75 mm:

The font height is 5 mm.

With two radial segments, up to 20 characters are permissible.  
With four radial segments, up to 10 characters are permissible.

#### EMERGENCY STOP backing plate 60 mm:

The font height is 4 mm.

With two radial segments, up to 16 characters are permissible.  
With four radial segments, up to 8 characters are permissible.

#### EMERGENCY STOP backing plate 45 mm:

The font height is 4 mm.

With two radial segments, up to 10 characters are permissible.

### Ordering notes

Append the following order codes to the article number:

- **Q0Y:** Segment(s) in upper/lower case, always upper case for beginning of segment, e.g. Z1=Not halt Z2=Emergency stop
- **Q1Y:** Segment(s) in upper case, e.g. Z1=NOT HALT Z2=EMERGENCY STOP
- **Q2Y:** Segment(s) in lower case, e.g. Z1=not halt Z2=emergency stop
- **Q5Y:** Segment(s) in upper/lower case, all words begin with upper case letters, e.g. Z1=Not Halt Z2=Emergency Stop
- **Q3Y:** Symbol with number according to ISO 7000 or IEC 60417
- **Q9Y:** Inscription of choice, text or symbol, can only be ordered via SIRIUS ACT configurator with a Configuration Identification Number (CIN)

When ordering, specify the required inscription without spaces after Z=, Z1=, etc., in addition to the article number and order code (see ordering examples 1 to 4).

Symbols can also be ordered with numbers according to ISO 7000 or IEC 60417 (see ordering examples 2 and 3).

The SIRIUS ACT configurator must be used to select special inscriptions and symbols (see ordering example 5). In this case a CIN (Configuration Identification Number) is generated for placement of future orders. It is then possible to place an order directly via the SIRIUS ACT configurator using the CIN (Mall shopping cart) or via the standard ordering channels.

Standard ordering channels:

- Configurator: [www.siemens.com/sirius-act/configurator](http://www.siemens.com/sirius-act/configurator)
- Industry Mall: [www.siemens.com/industrymall](http://www.siemens.com/industrymall)

With ordering options Q0Y, Q1Y, Q2Y, Q3Y and Q5Y, a single-line inscription of two or four radial segments can be implemented. The text or symbol must be assigned to the respective radial segments as follows:

#### Ordering example 1, two radial segments

An EMERGENCY STOP backing plate, diameter 75 mm, with two radial segments is required



#### **3SU1900-0BB31-0AZ0**

##### **Q1Y**

Z1=NOT  
Z2=HALT

#### Ordering example 2, four radial segments

An EMERGENCY STOP backing plate, diameter 75 mm, with four radial segments is required



#### **3SU1900-0BB31-0AZ0**

##### **Q1Y**

Z1=E-STOP  
Z2=EMERGENCIA  
Z3=NOT-HALT  
Z4=EMERGENZA

#### Ordering example 3

An EMERGENCY STOP backing plate, diameter 75 mm, with symbol No. 5011 according to IEC 60417 is required:

#### **3SU1900-0BB31-0AZ0**

##### **Q3Y**

Z=5011 IEC

#### Ordering example 4

An EMERGENCY STOP backing plate, diameter 75 mm, with symbol No. 1118 according to ISO 7000 is required:

#### **3SU1900-0BB31-0AZ0**

##### **Q3Y**

Z=1118 ISO

#### Ordering example 5

An EMERGENCY STOP backing plate, diameter 75 mm, with customized inscription is required:

#### **3SU1900-0BB31-0AZ0**

##### **Q9Y**

CIN.....

(20-digit number generated from the SIRIUS ACT configurator)



## Commanding and signaling devices

### SIRIUS ACT pushbuttons and indicator lights

#### Accessories

#### Protection/access protection

#### Overview

Protection and access protection are suitable for actuators and indicators with diameters 22 mm and 30 mm.

The protective collars cannot be used in conjunction with label holders or single frames.

#### Selection and ordering data

	Product designation Product version	Mounting diameter mm	Material	Color	Article No.	Weight kg
 3SU1900-0DA10-0AA0	<b>Sealable cap for pushbuttons, flat</b>	22	Plastic	Black	<b>3SU1900-0DA10-0AA0</b>	0.006
				Clear		<b>3SU1900-0DA70-0AA0</b>
 3SU1900-0EL70-0AA0	<b>Sealable caps for</b> for <ul style="list-style-type: none"> <li>• Pushbuttons, raised</li> <li>• Pushbuttons with front ring, raised</li> <li>• Pushbuttons with front ring, raised, castellated</li> </ul>	22	Plastic	Black	<b>3SU1900-0EL10-0AA0</b>	0.008
				Clear		<b>3SU1900-0EL70-0AA0</b>
 3SU1960-0DA70-0AA0	<b>Sealable cap for pushbuttons, flat</b>	30	Plastic	Clear	<b>3SU1960-0DA70-0AA0</b>	0.012
 3SU1960-0EY70-0AA0	<b>Sealable caps for selector switches, short</b>	30	Plastic	Clear	<b>3SU1960-0EY70-0AA0</b>	0.025
 3SU1900-0DB70-0AA0	<b>Silicone protective caps for pushbuttons, flat</b>	22	Plastic	Clear	<b>3SU1900-0DB70-0AA0</b>	0.007

## Commanding and signaling devices

### SIRIUS ACT pushbuttons and indicator lights

#### Accessories

#### Protection/access protection

Product designation Product version	Mounting diameter mm	Material	Color	Article No.	Weight kg
 3SU1900-0ED70-0AA0 <b>Silicone-free protective caps for pushbuttons, flat</b>	22	Plastic	Clear	<b>3SU1900-0ED70-0AA0</b>	0.007
 3SU1900-0DC70-0AA0 <b>Silicone protective caps for pushbuttons, raised</b>	22	Plastic	Clear	<b>3SU1900-0DC70-0AA0</b>	0.050
 3SU1900-0EE70-0AA0 <b>Silicone-free protective caps for pushbuttons, raised</b>	22	Plastic	Clear	<b>3SU1900-0EE70-0AA0</b>	0.006
 3SU1900-0DD70-0AA0 <b>Silicone protective caps for selectors, short</b>	22	Plastic	Clear	<b>3SU1900-0DD70-0AA0</b>	0.009
 3SU1900-0EF70-0AA0 <b>Silicone-free protective caps for selectors, short</b>	22	Plastic	Clear	<b>3SU1900-0EF70-0AA0</b>	0.007
 3SU1900-0DE70-0AA0 <b>Silicone protective caps for mushroom pushbuttons, 40 mm</b>	22	Plastic	Clear	<b>3SU1900-0DE70-0AA0</b>	0.012

## Commanding and signaling devices

### SIRIUS ACT pushbuttons and indicator lights

#### Accessories

#### Protection/access protection

Multi-unit packaging,  
see page 2/360.

	Product designation Product version	Mounting diameter mm	Material	Color	Article No.	Weight kg
<b>Protective caps</b>						
	<b>Silicone-free protective caps for mushroom pushbuttons, 40 mm</b>	22	Plastic	Clear	<b>3SU1900-0EG70-0AA0</b>	0.009
3SU1900-0EG70-0AA0						
	<b>Silicone protective caps for EMERGENCY STOP, 30 mm</b>	22	Plastic	Clear	<b>3SU1900-0EN70-0AA0</b>	0.031
	<b>Silicone protective caps for EMERGENCY STOP, 40 mm</b>	22	Plastic	Clear	<b>3SU1900-0DF70-0AA0</b>	0.018
3SU1900-0DF70-0AA0						
	<b>Silicone protective caps for twin pushbuttons, flat</b>	22	Plastic	Clear	<b>3SU1900-0DG70-0AA0</b>	0.011
3SU1900-0DG70-0AA0						
	<b>Silicone protective caps for twin pushbuttons, raised</b>	22	Plastic	Clear	<b>3SU1900-0DH70-0AA0</b>	0.011
3SU1900-0DH70-0AA0						
	<b>Silicone-free protective caps for twin pushbuttons, raised</b>	22	Plastic	Clear	<b>3SU1900-0EK70-0AA0</b>	0.012
3SU1900-0EK70-0AA0						
	<b>Dust caps for key-operated switches</b> For Siemens, BKS, RONIS and O.M.R.	22	Plastic	Clear	<b>3SU1900-0EB10-0AA0</b>	0.006
3SU1900-0EB10-0AA0						
	<b>Dust caps for ID key-operated switches</b>	22	Plastic	Clear	<b>3SU1900-0EM70-0AA0</b>	0.003
3SU1900-0EM70-0AA0						

## Commanding and signaling devices

### SIRIUS ACT pushbuttons and indicator lights

#### Accessories

#### Protection/access protection

Product designation Product version	Mounting diameter mm	Material	Color	Article No.	Weight kg
<b>Protective collars</b>					
 3SU1900-0DJ10-0AA0	<b>Sun collars for illuminated pushbuttons</b>	22	Plastic	Black	<b>3SU1900-0DJ10-0AA0</b> 0.004
 3SU1900-0DW10-0AA0	<b>360° protective collars for pushbuttons and selectors, short</b>	22	Plastic	Black	<b>3SU1900-0DW10-0AA0</b> 0.009
 3SU1950-0DK80-0AA0	<b>360° protective collars for pushbuttons</b> Visibility from the side	22	Metal	Silver	<b>3SU1950-0DK80-0AA0</b> 0.022
 3SU1950-0DL80-0AA0	<b>360° protective collar for mushroom pushbuttons</b> 40 mm, visibility from the side	22	Metal	Silver	<b>3SU1950-0DL80-0AA0</b> 0.039
 3SU1900-0DY30-0AA0	<b>Protective collars for EMERGENCY STOP mushroom pushbuttons</b> Without lock or with RONIS lock	22	Plastic	Yellow Gray	<b>3SU1900-0DY30-0AA0</b> <b>3SU1900-0DY80-0AA0</b> 0.035 0.033





## Commanding and signaling devices

### SIRIUS ACT pushbuttons and indicator lights

#### Accessories

#### Protection/access protection

Multi-unit packaging,  
see page 2/360.

	Product designation Product version	Mounting diameter mm	Material	Color	Article No.	Weight kg
<b>Protective collars</b>   3SU1900-0JH30-0AA0   3SU1950-0DX30-0AA0   3SU1900-0EA30-0AA0   3SU1900-0EC10-0AA0	<b>Protective collars for EMERGENCY STOP mushroom push-buttons</b> 30 and 40 mm, can be mounted in the top position	22	Plastic	Yellow	<b>3SU1900-0JH30-0AA0</b>	0.036
	<b>Protective collars for EMERGENCY STOP mushroom push-buttons</b> Without lock or with RONIS lock, 40 mm, for 5 padlocks	22	Metal	Yellow Gray	<b>3SU1950-0DX30-0AA0</b> <b>3SU1950-0DX80-0AA0</b>	0.150 0.150
	<b>Protective collars for EMERGENCY STOP mushroom push-buttons</b> 60 mm, for 3 padlocks	22	Plastic	Yellow	<b>3SU1900-0EX30-0AA0</b>	0.039
	<b>360° protective collars</b> for <ul style="list-style-type: none"> <li>Mushroom pushbuttons (30, 40 and 60 mm)</li> <li>EMERGENCY STOP mushroom pushbuttons without lock (40 and 60 mm)</li> <li>EMERGENCY STOP mushroom pushbuttons with RONIS lock (40 mm)</li> </ul>	22	Plastic	Yellow	<b>3SU1900-0EA30-0AA0</b>	0.054
	<b>Protection for sensor switches</b>	22	Plastic	Black	<b>3SU1900-0EC10-0AA0</b>	0.115

## Commanding and signaling devices

### SIRIUS ACT pushbuttons and indicator lights

#### Accessories

#### Protection/access protection

Type of product	Mounting diameter mm	Material	Color	Article No.	Weight kg
 Locking devices for pushbuttons Flat, for raised front ring and raised, castellated front ring 3SU1950-0DM80-0AA0	22	Metal	Silver	<b>3SU1950-0DM80-0AA0</b>	0.051
 Locking devices for pushbuttons Raised 3SU1950-0DN80-0AA0	22	Metal	Silver	<b>3SU1950-0DN80-0AA0</b>	0.047
 Locking devices for mushroom pushbuttons D30, D40 3SU1950-0DP80-0AA0	22	Metal	Silver	<b>3SU1950-0DP80-0AA0</b>	
 Locking devices for selectors Short/long actuator, in the left position 3SU1950-0DQ80-0AA0	22	Metal	Silver	<b>3SU1950-0DQ80-0AA0</b>	0.057
 Locking devices for selectors Short/long actuator, in the center position 3SU1950-0DR80-0AA0	22	Metal	Silver	<b>3SU1950-0DR80-0AA0</b>	0.059
 Locking devices for selectors Short/long actuator, in the right position 3SU1950-0DS80-0AA0	22	Metal	Silver	<b>3SU1950-0DS80-0AA0</b>	0.056
 Locking devices for selectors Short/long actuator, window from center to right, blocked on left 3SU1950-0DT80-0AA0	22	Metal	Silver	<b>3SU1950-0DT80-0AA0</b>	0.055
 Locking devices for selectors Short/long actuator, window from center to left, blocked on right 3SU1950-0DU80-0AA0	22	Metal	Silver	<b>3SU1950-0DU80-0AA0</b>	
 Locking device with cover 3SU1950-0DV80-0AA0	22	Metal	Silver	<b>3SU1950-0DV80-0AA0</b>	0.043

## Commanding and signaling devices

### SIRIUS ACT pushbuttons and indicator lights

#### Accessories

#### Actuators

#### Selection and ordering data

**Multi-unit packaging, see page 2/360.**

#### Sealing plugs<sup>1)</sup>

Mounting diameter mm	Material	Color	Article No.	Weight kg
22	Plastic	Black	<b>3SU1900-0FA10-0AA0</b>	0.011
	Metal, shiny	Silver	<b>3SU1950-0FA80-0AA0</b>	0.041
30	Metal, matte	Sand gray	<b>3SU1960-0FA80-0AA0</b>	0.070



3SU1900-0FA10-0AA0



3SU1950-0FA80-0AA0

<sup>1)</sup> The sealing plug is mounted with a holder.  
Modules might already be mounted on the holder.

Type of product	Mounting diameter	Accessory material	Accessory color	<b>Screw terminals</b> 	Weight
	mm			Article No.	kg

#### USB connections

USB 3.0	22	Plastic	Black	<b>3SU1900-0GA10-0AA0</b>	0.027
	30	Metal, shiny	Silver	<b>3SU1950-0GA80-0AA0</b>	0.046
		Metal, matte	Sand gray	<b>3SU1960-0GA80-0AA0</b>	0.081



3SU1900-0GA10-0AA0



3SU1960-0GA80-0AA0

#### RJ45 connections

RJ-45 Cat. 5e	22	Plastic	Black	<b>3SU1900-0GB10-0AA0</b>	0.025
	30	Metal, shiny	Silver	<b>3SU1950-0GB80-0AA0</b>	0.043
		Metal, matte	Sand gray	<b>3SU1960-0GB80-0AA0</b>	0.072



3SU1900-0GB10-0AA0







3SU1950-0GB80-0AA0

# Commanding and signaling devices

## SIRIUS ACT pushbuttons and indicator lights

### Accessories

#### Actuators

Material	Color	Article No.	Weight kg	
<b>Buttons, flat<sup>1)</sup></b>				
 3SU1900-0FT20-0AA0	<b>For pushbuttons</b>			
	Plastic	Black	3SU1900-0FT10-0AA0	0.090
		Red	3SU1900-0FT20-0AA0	0.060
		Yellow	3SU1900-0FT30-0AA0	
		Green	3SU1900-0FT40-0AA0	0.080
		Blue	3SU1900-0FT50-0AA0	0.066
		White	3SU1900-0FT60-0AA0	0.080
 3SU1901-0FT30-0AA0	<b>For illuminated pushbuttons</b>			
	Plastic	Amber	3SU1901-0FT00-0AA0	0.080
		Red	3SU1901-0FT20-0AA0	0.070
		Yellow	3SU1901-0FT30-0AA0	
		Green	3SU1901-0FT40-0AA0	
		Blue	3SU1901-0FT50-0AA0	0.071
		White	3SU1901-0FT60-0AA0	0.072
		Clear	3SU1901-0FT70-0AA0	0.073
<b>Buttons, raised<sup>1)</sup></b>				
 3SU1900-0FS30-0AA0	<b>For pushbuttons</b>			
	Plastic	Black	3SU1900-0FS10-0AA0	0.002
		Red	3SU1900-0FS20-0AA0	
		Yellow	3SU1900-0FS30-0AA0	
	Green	3SU1900-0FS40-0AA0		
 3SU1901-0FS40-0AA0	<b>For illuminated pushbuttons</b>			
	Plastic	Red	3SU1901-0FS20-0AA0	0.001
		Yellow	3SU1901-0FS30-0AA0	0.002
		Green	3SU1901-0FS40-0AA0	0.001
		Blue	3SU1901-0FS50-0AA0	0.001
		Clear	3SU1901-0FS70-0AA0	0.002

<sup>1)</sup> Buttons are not interchangeable between pushbuttons and illuminated pushbuttons with a raised front ring and with a raised, castellated front ring.









## Commanding and signaling devices

### SIRIUS ACT pushbuttons and indicator lights

#### Accessories

#### Actuators

	Material	Key number	Version of RFID coding	Color	Article No.	Weight kg
<b>RONIS keys</b>						
	Metal	SB30 <sup>1)</sup> 455	--	Silver	<b>3SU1950-0FB80-0AA0</b>	0.009
					<b>3SU1950-0FC80-0AA0</b>	0.010
<b>BKS keys</b>						
	Metal	S1 <sup>1)</sup>	--	Silver	<b>3SU1950-0FD80-0AA0</b>	0.010
<b>O.M.R. keys</b>						
	Metal	73038	--	Blue	<b>3SU1950-0FJ50-0AA0</b>	0.008
		73037		Red	<b>3SU1950-0FK20-0AA0</b>	0.013
		73034		Black	<b>3SU1950-0FL10-0AA0</b>	0.008
		73033		Yellow	<b>3SU1950-0FM30-0AA0</b>	0.014
<b>Siemens keys</b>						
	Metal	LSG1	--	Silver	<b>3SU1950-0FN80-0AA0</b>	0.011
		SSG10 <sup>1)</sup>			<b>3SU1950-0FP80-0AA0</b>	0.008
		VL5			<b>3SU1950-0FQ80-0AA0</b>	
<b>ID keys ID group individual</b>						
	Plastic	--	Individually coded, White programmable several times		<b>3SU1900-0FU60-0AA0</b>	0.006
<b>ID keys</b>						
	Plastic	--	ID group 1	Green	<b>3SU1900-0FV40-0AA0</b>	0.060
			ID group 2	Yellow	<b>3SU1900-0FW30-0AA0</b>	0.005
			ID group 3	Red	<b>3SU1900-0FX20-0AA0</b>	0.006
			ID group 4	Blue	<b>3SU1900-0FY50-0AA0</b>	0.004

<sup>1)</sup> Also available with special lock. Supplement the Article No. with "-Z" and the order code "Y04" and specify the required lock in plain text. Additional price on request.

### Overview

The accessories can be used for plastic and metal enclosures.

### Selection and ordering data

Type of product	Material	Color	Article No.	Weight kg	
<b>Metric cable glands</b>					
 <p>3SU1900-0HG10-0AA0</p>	<b>M20 for round cable and enclosures</b> With 1 to 3 command points	Plastic	Black	<b>3SU1900-0HG10-0AA0</b>	0.017
	<b>M25 for round cable and enclosure</b> With 4 and 6 command points	Plastic	Black	<b>3SU1900-0HH10-0AA0</b>	0.021
	<b>M20 for round cable and AS-i enclosure</b> With 1 to 3 command points with 2-pole plug-in connector for AS-i module	Plastic	Black	<b>3SU1900-0JA10-0AA0</b>	0.024
	<b>M25 for round cable and AS-i enclosure</b> With 4 and 6 command points with 2-pole plug-in connector for AS-i module	Plastic	Black	<b>3SU1900-0JB10-0AA0</b>	0.020
	<b>M20 for round cable and IO-Link enclosure</b> With 1 to 3 command points with 10-pole plug-in connector for IO-Link	Plastic	Black	<b>3SU1900-0JC10-0AA0</b>	0.033
	<b>M25 for round cable and IO-Link enclosure</b> With 4 and 6 command points with 10-pole plug-in connector for IO-Link	Plastic	Black	<b>3SU1900-0JD10-0AA0</b>	0.038
	<b>M20 for AS-i shaped cable and AS-i enclosure</b> With 1 to 3 command points with 2-pole plug-in connector for AS-i module	Plastic	Black	<b>3SU1900-0HE10-0AA0</b>	0.046
	<b>M25 for AS-i shaped cable and AS-i enclosure</b> With 4 and 6 command points with 2-pole plug-in connector for AS-i module	Plastic	Black	<b>3SU1900-0HF10-0AA0</b>	0.056
<b>Connection pieces</b>					
 <p>3SU1900-0JQ10-0AA0</p>	<b>M20 and M25 cable entries</b> for connecting two enclosures	Plastic	Black	<b>3SU1900-0JQ10-0AA0</b>	0.050

## Commanding and signaling devices

### SIRIUS ACT pushbuttons and indicator lights







#### Accessories

#### Enclosures

Type of product	Material	Color	Insulation piercing method 	Weight	
			Article No.	kg	
<b>Adapters for AS-i shaped cable</b>					
	M20 cable entry	Plastic	Black	<b>3SU1900-0HX10-0AA0</b>	0.036
	M25 cable entry	Plastic	Black	<b>3SU1900-0HY10-0AA0</b>	0.045
<b>Adapters for tab connection</b>					
	<b>Adapter, M12 plug</b>				
	M20/M25 cable entry				
	4-pole	Plastic	Black	<b>3SU1900-0JJ10-0AA0</b>	0.013
5-pole	Plastic	Black	<b>3SU1900-0JK10-0AA0</b>		
8-pole	Plastic	Black	<b>3SU1900-0JL10-0AA0</b>		
3SU1900-0JJ10-0AA0	<b>Adapter, M12 socket</b>				
	M20/M25 cable entry				
	4-pole	Plastic	Black	<b>3SU1900-0JM10-0AA0</b>	0.013
	5-pole	Plastic	Black	<b>3SU1900-0JN10-0AA0</b>	
8-pole	Plastic	Black	<b>3SU1900-0JP10-0AA0</b>		
3SU1900-0JM10-0AA0	<b>Adapters for enclosures with 1 command point</b>				
	Between enclosure top and lower part, Plastic for installation of 2-pole or two 1-pole contact modules with front plate mounting. Not suitable for 3SU1801-1AA00-1AA1.		Black	<b>3SU1900-0JF10-0AA0</b>	0.077
	3SU1900-0JF10-0AA0				
<b>Adapters for modules with floor mounting</b>					
	Without fixing screws	Plastic	Black	<b>3SU1900-0JG10-0AA0</b>	0.008
	3SU1900-0JG10-0AA0				
<b>Enclosure cover monitoring<sup>1)</sup></b>					
	Module with extension plunger	Plastic	Black	<b>3SU1900-0HM10-0AA0</b>	0.006
	3SU1900-0HM10-0AA0				

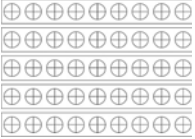
<sup>1)</sup> In addition, a 3SU1400-2AA10-.BA0 contact module is required.

## Selection and ordering data

Product designation Type of product	Material	Color	Article No.	Weight kg
 <p><b>PCB carriers</b></p> <p>3SU1900-0KA10-0AA0</p>	Plastic	Black	<b>3SU1900-0KA10-0AA0</b>	0.500
 <p><b>Pressure plates for selectors and locks</b></p> <p>3SU1900-0CK10-0AA0</p>	Plastic	White	<b>3SU1900-0CK10-0AA0</b>	0.032
 <p><b>Drilling template for grid</b></p> <p>30 mm x 40 mm, horizontal</p> <p>3SU1900-0KF10-0AA0</p>	Plastic	Black	<b>3SU1900-0KF10-0AA0</b>	0.059
 <p><b>Extension plungers</b></p> <p>For compensation of the distance between the pushbutton and the unlatching button of an overload relay</p> <p>3SU1900-0KG10-0AA0</p>	Plastic	Gray	<b>3SU1900-0KG10-0AA0</b>	0.008
 <p><b>Strut profile mounting adapters</b></p> <p>3SU1950-0JE80-0AA0</p>	Metal	Sand gray	<b>3SU1950-0JE80-0AA0</b>	0.105
 <p><b>Cable clip for cable adapters</b></p> <p>For enclosure with AS-Interface shaped cable</p> <p>3RK1901-3QA00</p>	Plastic	Black	<b>3RK1901-3QA00</b>	0.100







## Commanding and signaling devices

### SIRIUS ACT pushbuttons and indicator lights

#### Accessories

#### Miscellaneous accessories

Multi-unit packaging,  
see page 2/360.

	Product designation Type of product	Material	Color	Article No.	Weight kg
 3SU1900-0KH80-0AA0	<b>Adapters for standard rail mounting</b>	Plastic	Black	<b>3SU1900-0KH80-0AA0</b>	0.049
	 3SU1950-0KJ80-0AA0	<b>Adapters for actuators and indicators with 30 mm diameter</b> With front ring for flat mounting	Metal	Silver	<b>3SU1950-0KJ80-0AA0</b>
 3SU1950-0KB10-0AA0	<b>Adapters for 30.5 mm to 22.5 mm mounting hole</b> (for 22 mm range)	Metal, shiny Metal, matte	Silver Sand gray	<b>3SU1950-0KB10-0AA0</b> <b>3SU1960-0KB10-0AA0</b>	0.031 0.031
	 3SU1910-0KK80-0AA0	<b>Grounding studs</b> For grounding metal actuators for fitting in front plates made of non-conducting materials			
 3SU1900-0KL10-0AA0	<ul style="list-style-type: none"> <li>• For metal holders</li> </ul>	Metal	Silver	<b>3SU1910-0KK80-0AA0</b>	40.000
	<ul style="list-style-type: none"> <li>• For universal holders for plastic and metal</li> </ul>	Metal	Silver	<b>3SU1950-0KK80-0AA0</b>	0.060
	<b>Plugs for sensor switches, angled socket with screw terminal connection</b>	Plastic	Black	<b>3SU1900-0KL10-0AA0</b>	0.017
 3SU1900-0KP80-0AA0	<b>Flat ribbon cable</b> 7 cores				
	<ul style="list-style-type: none"> <li>• Length 5 m</li> <li>• Length 10 m</li> </ul>	Plastic Plastic	Gray Gray	<b>3SU1900-0KQ80-0AA0</b> <b>3SU1900-0KP80-0AA0</b>	0.063 0.124

## SENTRON Protection, Switching, Measuring and Monitoring Devices



3/2	<b>Get all the information you need – with just one click</b>
3/3	<b>Protection Devices</b> Introduction
3/4 3/6 3/10 3/11 3/14	<b>5SY Miniature Circuit Breakers</b> Introduction 5SY4, 10000 A 5SY5, universal current, 10000 A 5SY7, 15000 A 5SY17 Circuit Breaker for Equipment
3/15 3/17	<b>5SL Miniature Circuit Breakers, 1+N in 1 MW</b> 5SL60, 6000 A 5SL6 COM miniature circuit breakers with communication and measuring function
3/18	<b>Additional Components</b> Electrical components
3/20	<b>Busbars</b> 5ST standard busbars
3/28 3/30 3/38 3/40 3/45 3/50	<b>Residual Current Protective Devices / Arc Fault Detection Devices (AFDDs)</b> Introduction 5SV RCCBs 5SV1 electromechanic RCBOs Additional components RCCB accessories 5SM6 / 5SV6 arc fault detection devices (AFDDs)
3/54	<b>Overvoltage Protection Devices</b> Introduction
3/55 3/57 3/59	<b>Fuse Systems</b> LV HRC fuse links LV HRC fuse bases For power distribution
3/60 3/61 3/65	<b>Switching Devices</b> Introduction 5TT4 remote control switches Socket outlets
3/66 3/69 3/70	<b>Power Monitoring</b> Hardware and software components PC-based power monitoring system 7KN Powercenter 1000
3/71 3/73	<b>7KM PAC Measuring Devices</b> Introduction 7KM PAC expansion modules
3/75 3/76	<b>3VA Molded Case Circuit Breakers</b> Introduction 3VA2 molded case circuit breakers

## SENTRON Protection, Switching, Measuring and Monitoring Devices

Get all the information you need – with just one click

### Overview

#### Find the right product faster using intuitive product selection

The configurators are available online in the Siemens Industry Mall and offline in Catalog CA01. A product selection process could hardly be made any clearer, faster or easier.

You can find our configurators at the following website:

[www.siemens.com/lowvoltage/configurators](http://www.siemens.com/lowvoltage/configurators)

3VA molded case circuit breaker | i
Language
Additional actions

The configuration is not complete, please set all blue values.

Basic configuration
Release
1.95

**Product range**

Please choose:

3VA1 - Standard applications
 

1, 2, 3, 4-pole  
In 16 A - 250 A  
Icu 16 kA - 70 kA @ 415 Vac  
Icu 8 kA - 85 kA @ 500 Vdc  
Thermal-magnetic release  
Compact size

3VA2 - Selective applications
 

3-, 4-pole  
In 25 A - 250 A  
Icu 55 kA - 150 kA @ 415 V  
Electronic trip unit  
Communication-capable  
Integrated measurement function  
Voltage Ue to 690 V

**Application**

Application

System protection

Switch disconnector, MCCB design

Motor protection

Starter protection

**Frame size**

Please choose.

100 A

160 A

250 A

400 A

630 A

**Electrical parameters**

Number of poles







Rated current In/A

Rated operational voltage Ue/Vac

Breaking capacity Icu/Ics/kA

Switching capacity class

### Overview

Devices	Page	Application	Standards
	3/4	For all applications from 0.3 A to 80 A with a rated breaking capacity of 10 000 A and 15 000 A acc. to EN 60898-1. Applications for universal current from 0.3 A to 63 A, version 25 kA, acc. to EN 60947-2.	EN 60898-1/-2 EN 60947-2 UL 1077 CSA 22.2 GB 10963.1/2
	3/14	Circuit Breaker for Equipment offer optimum protection for all applications in AC and DC control circuits in industrial applications and plant engineering. They protect solenoid valves, servo motors, signal lamps or even PLC inputs.	EN 61373 EN 45545-2 UL 1077 IEC 60934
	3/15	For socket outlet and lighting circuits in all building installations where a switchable neutral conductor is required.  The miniature circuit breaker 1+N saves space in the distribution board.	EN 60898-1
	3/17	The new communication-capable MCB's record measured values and status information and transmit this data wirelessly to higher-level systems.	--
	3/18	Auxiliary switches, fault signal contacts, shunt trips, undervoltage releases for higher system availability, RC units for personal safety and remote controlled mechanisms for remote switching.	
	3/20	Busbars in 10 mm <sup>2</sup> and 16 mm <sup>2</sup> save space in the distribution board and time during mounting. Busbars in 18 mm <sup>2</sup> and 25 mm <sup>2</sup> acc. to UL 508 and CSA.	UL 508

<sup>1)</sup> See Catalog LV 10.



## SENTRON Protection, Switching, Measuring and Monitoring Devices

### Protection Devices

#### 5SY Miniature Circuit Breakers

#### Introduction

#### Overview

Miniature circuit breakers are used to protect systems and installations in buildings and for industrial applications.

Used in industrial applications and plant engineering, miniature circuit breakers can be supplemented with additional components, such as auxiliary switches, fault signal contacts, shunt trips, undervoltage releases, remote controlled mechanisms, RC units, and arc fault detection devices.

The devices are approved for worldwide use according to IEC standards for power supply systems up to 250/440 V AC. 72 V DC per pole is permitted in DC systems.

For North America, there is an additional approval according to UL 1077 for use as "supplementary protectors" in systems up to 480/277 V AC. For use in ship building, the devices also have numerous certifications according to shipping classifications BV, DNV, GL and LRS.

#### Benefits



- Optional top or bottom infeed as the terminals are identical
- Clear and visible conductor connection in front of the rear busbar facilitates controls
- The conductor is easily inserted into the terminal thanks to the large and easily accessible wiring space

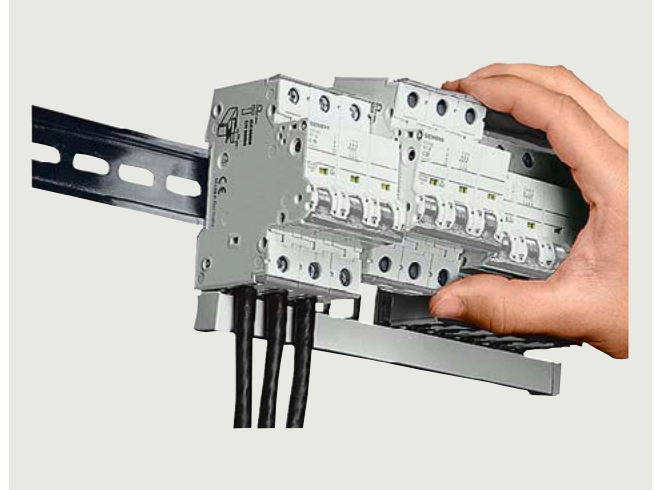

- Quick and easy manual removal of miniature circuit breakers from the busbar assembly, for example if connections need to be changed
- Time-saving replacement of parts as busbars no longer need to be freed from adjacent devices



- Double terminal chambers permit accommodation of 2 wires of different cross-sections.



- The 5SY miniature circuit breakers are ideal for the quick and easy mounting of auxiliary switches and fault signal contacts. Captive metal brackets on the additional components ensure the quick and easy mounting of devices on the miniature circuit breakers without the need for tools.

## Technical specifications

		5SY6	5SY4	5SY5	5SY7	5SY8
<b>Standards</b>		EN 60898-1	EN 60898-1	EN 60898-2	EN 60898-1	EN 60947-2
<b>Rated voltage <math>U_n</math></b>	V AC V DC	230/400 --	230/400 --	230/400 220/440/ 880 <sup>5)</sup>	230/400 --	230/400 --
<b>Operational voltage</b>						
Acc. to EN 60898-1/-2 and EN 60947-2	Min. V AC/DC/pole	24	24	24	24	24
	Max. V DC/pole	72 <sup>4)</sup>	72 <sup>4)</sup>	250	72 <sup>4)</sup>	72 <sup>4)</sup>
Acc. to UL 1077 and CSA C22.2 No.235	Max. V AC	250/440	250/440	250/440	250/440	250/440
	Max. V DC	480/277	480/277	--	480/277	480/277
Max. V DC		60	60 <sup>6)</sup>	--	60 <sup>6)</sup>	60 <sup>6)</sup>
<b>Breaking capacity<sup>1)</sup></b>						
• $I_{cn}$ acc. to IEC/EN 60898-1	kA AC	6	10	10	15	--
• $I_{cn}$ acc. to IEC/EN 60898-2	kA DC	10	10	10	15	--
• $I_{cu}$ acc. to IEC/EN 60947-2	kA AC	30 ... 10 <sup>1)</sup>	35 ... 10 <sup>1)</sup>	35 ... 10 <sup>1)</sup>	50 ... 15 <sup>1)</sup>	70 ... 20 <sup>1)</sup>
	kA DC	15	15	15	15	15
• Acc. to UL1077 and CSA C22.2 No.235	kA AC	5	5	--	5	5
<b>Insulation coordination</b>						
• Rated insulation voltage	V AC V DC/pole	250/440 --	--	250	--	--
• Rated impulse withstand voltage $U_{imp}$	kV AC	4	--	--	--	--
<b>Pollution degree for overvoltage category</b>		3/III <sup>3)</sup>				
<b>Rated frequency</b>	Hz	50/60				
<b>Touch protection</b>	Acc. to EN 50274	Yes				
<b>Handle end position, sealable</b>		Yes				
<b>Degree of protection</b>	Acc. to EN 60529	IP20 with connected conductors, IP40 in the area of the handle with distribution cover				
<b>CFC and silicone-free</b>		Yes				
<b>Mounting</b>						
• Snap-on fixing system		Yes				
• Standard mounting rail and screw fixing		--				
<b>Terminals</b>	± screw (Pozidriv)	2				
• Tunnel terminals at both ends		--				
• Combined terminals at both ends		Yes				
• Terminal tightening torque	Nm lb-in	2.5 ... 3.5 max. 22 ... 26				
<b>Conductor cross-sections</b>						
• Solid and stranded	mm <sup>2</sup>	0.75 ... 35				
• Finely stranded, with end sleeve	mm <sup>2</sup>	0.75 ... 25				
• AWG conductors (Cu 60/75 °C $I_n \leq 40$ A; 60 °C $I_n > 40$ A)	AWG	14 ... 4				
<b>Mains connection</b>						
• AC		Any				
• DC		Any				
<b>Mounting position</b>		Any				
<b>Service life</b>						
On average, with rated load	Actuations Actuations	20000 10000, for 5SY5 at 40 A, 50 A and 63 A				
<b>Ambient temperature</b>	°C	-25 ... +55, max. 95% humidity				
<b>Storage temperature</b>	°C	-40 ... +75				
<b>Resistance to climate</b>	Acc. to IEC 60068-2-30	6 cycles				
<b>Shock</b>	Acc. to IEC 60068-2-27	m/s <sup>2</sup> 150 at 11 ms half-sine				
<b>Resistance to vibrations</b>	Acc. to IEC 60068-2-6	m/s <sup>2</sup> 50 at 25 ... 150 Hz and 60 at 35 Hz (4 s)				

<sup>1)</sup> For detailed information, see Configuration Manual "Miniature Circuit Breakers" ([www.siemens.com/lowvoltage/manuals](http://www.siemens.com/lowvoltage/manuals)).

<sup>2)</sup> Ensure compliance with the specified polarity when connecting DC.

<sup>3)</sup> 5SY54.. 4-pole, degree of pollution 2 for overvoltage category II.

<sup>4)</sup> Exempt: C/D 0.3 A ... 0.5 A

<sup>5)</sup> 5SY54.. 4-pole 880 V is not a standardized voltage acc. to EN 60898-1, suitable for max. 1000 V DC if the four poles are connected in series.

<sup>6)</sup> Valid for 1-pole switching devices only.





# SENTRON Protection, Switching, Measuring and Monitoring Devices

Protection Devices

5SY Miniature Circuit Breakers





5SY4, 10.000 A

## Selection and ordering data

 	$I_n$	Mounting width MW <sup>1)</sup>	Characteristic		Weight kg
			Characteristic A Article No.	Characteristic B Article No.	
<b>Miniature circuit breakers 10000 A</b>					
	<b>1P, 230/400 V AC</b>				
	0.5	1	5SY4105-5	--	0.167
	1		5SY4101-5	--	0.167
	1.6		5SY4115-5	--	0.166
	2		5SY4102-5	5SY4102-6	0.170
	3		5SY4103-5	--	0.160
	4		5SY4104-5	5SY4104-6	0.157
	6		5SY4106-5	5SY4106-6	0.153
	8		5SY4108-5	--	0.168
	10		5SY4110-5	5SY4110-6	0.152
	13		5SY4113-5	5SY4113-6	0.152
	16		5SY4116-5	5SY4116-6	0.153
	20		5SY4120-5	5SY4120-6	0.165
	25		5SY4125-5	5SY4125-6	0.163
	32		5SY4132-5	5SY4132-6	0.156
	40		5SY4140-5	5SY4140-6	0.167
	50		5SY4150-5	5SY4150-6	0.168
63		5SY4163-5	5SY4163-6	0.175	
80		--	5SY4180-6	0.175	
	<b>1P+N, 230 V AC</b>				
	1	2	5SY4501-5	--	0.326
	1.6		5SY4515-5	--	0.325
	2		5SY4502-5	--	0.323
	3		5SY4503-5	--	0.347
	4		5SY4504-5	--	0.321
	6		5SY4506-5	5SY4506-6	0.313
	8		5SY4508-5	--	0.318
	10		5SY4510-5	5SY4510-6	0.304
	13		5SY4513-5	5SY4513-6	0.306
	16		5SY4516-5	5SY4516-6	0.302
	20		5SY4520-5	5SY4520-6	0.310
	25		5SY4525-5	5SY4525-6	0.320
	32		5SY4532-5	5SY4532-6	0.322
40		5SY4540-5	5SY4540-6	0.321	
50		5SY4550-5	5SY4550-6	0.319	
63		5SY4563-5	5SY4563-6	0.337	
	<b>2P, 400 V AC</b>				
	0.5	2	5SY4205-5	--	0.328
	1		5SY4201-5	--	0.323
	1.6		5SY4215-5	--	0.323
	2		5SY4202-5	5SY4202-6	0.327
	3		5SY4203-5	--	0.327
	4		5SY4204-5	5SY4204-6	0.322
	6		5SY4206-5	5SY4206-6	0.306
	8		5SY4208-5	--	0.315
	10		5SY4210-5	5SY4210-6	0.304
	13		5SY4213-5	5SY4213-6	0.321
	16		5SY4216-5	5SY4216-6	0.304
	20		5SY4220-5	5SY4220-6	0.317
	25		5SY4225-5	5SY4225-6	0.323
	32		5SY4232-5	5SY4232-6	0.328
	40		5SY4240-5	5SY4240-6	0.321
	50		5SY4250-5	5SY4250-6	0.328
63		5SY4263-5	5SY4263-6	0.338	
80		--	5SY4280-6	0.339	

<sup>1)</sup> 1 MW (modular width) = 18 mm.

## Selection and ordering data (continued)

 	$I_n$	Mounting width MW <sup>1)</sup>	Characteristic A	Characteristic B	Weight kg
			Article No.	Article No.	
<b>Miniature circuit breakers 10000 A</b>					
	<b>3P, 400 V AC</b>				
	0.5	3	5SY4305-5	--	0.480
	1		5SY4301-5	--	0.492
	1.6		5SY4315-5	--	0.478
	2		5SY4302-5	--	0.487
	3		5SY4303-5	--	0.489
	4		5SY4304-5	--	0.478
	6		5SY4306-5	5SY4306-6	0.461
	8		5SY4308-5	--	0.467
	10		5SY4310-5	5SY4310-6	0.439
	13		5SY4313-5	5SY4313-6	0.473
	16		5SY4316-5	5SY4316-6	0.462
	20		5SY4320-5	5SY4320-6	0.458
	25		5SY4325-5	5SY4325-6	0.469
	32		5SY4332-5	5SY4332-6	0.470
	40		5SY4340-5	5SY4340-6	0.485
50		5SY4350-5	5SY4350-6	0.484	
63		5SY4363-5	5SY4363-6	0.501	
80		--	5SY4380-6	0.508	
	<b>3P+N, 400 V AC</b>				
	1	4	5SY4601-5	--	0.650
	1.6		5SY4615-5	--	0.638
	2		5SY4602-5	--	0.636
	3		5SY4603-5	--	0.655
	4		5SY4604-5	--	0.632
	6		5SY4606-5	5SY4606-6	0.614
	8		5SY4608-5	--	0.619
	10		5SY4610-5	5SY4610-6	0.612
	13		5SY4613-5	5SY4613-6	0.614
	16		5SY4616-5	5SY4616-6	0.617
	20		5SY4620-5	5SY4620-6	0.611
	25		5SY4625-5	5SY4625-6	0.624
32		5SY4632-5	5SY4632-6	0.631	
40		5SY4640-5	5SY4640-6	0.631	
50		5SY4650-5	5SY4650-6	0.645	
63		5SY4663-5	5SY4663-6	0.677	
	<b>4P, 400 V AC</b>				
	1	4	5SY4401-5	--	0.649
	1.6		5SY4415-5	--	0.649
	2		5SY4402-5	--	0.638
	3		5SY4403-5	--	0.644
	4		5SY4404-5	--	0.634
	6		5SY4406-5	5SY4406-6	0.612
	8		5SY4408-5	--	0.622
	10		5SY4410-5	5SY4410-6	0.613
	13		5SY4413-5	5SY4413-6	0.617
	16		5SY4416-5	5SY4416-6	0.621
	20		5SY4420-5	5SY4420-6	0.610
	25		5SY4425-5	5SY4425-6	0.622
	32		5SY4432-5	5SY4432-6	0.633
	40		5SY4440-5	5SY4440-6	0.627
50		5SY4450-5	5SY4450-6	0.650	
63		5SY4463-5	5SY4463-6	0.660	
80		--	5SY4480-6	0.669	

1) 1 MW (modular width) = 18 mm.





# SENTRON Protection, Switching, Measuring and Monitoring Devices

Protection Devices

5SY Miniature Circuit Breakers

5SY4, 10.000 A

## Selection and ordering data (continued)

10000 3		$I_n$ A	Mounting width MW <sup>1)</sup>	Characteristic C	Characteristic D	Weight kg
				Article No.	Article No.	
<b>Miniature circuit breakers 10000 A</b>						
	<b>1P, 230/400 V AC</b>		1	5SY4114-7	5SY4114-8	0.166
	0.3			5SY4105-7	5SY4105-8	0.166
	0.5			5SY4101-7	5SY4101-8	0.170
	1			5SY4115-7	5SY4115-8	0.162
	1.6			5SY4102-7	5SY4102-8	0.155
	2			5SY4103-7	5SY4103-8	0.152
	3			5SY4104-7	5SY4104-8	0.149
	4			5SY4111-7	--	0.160
	5			5SY4106-7	5SY4106-8	0.151
	6			5SY4108-7	5SY4108-8	0.155
	8			5SY4110-7	5SY4110-8	0.147
	10			5SY4113-7	5SY4113-8	0.155
	13			5SY4118-7	--	0.157
	15			5SY4116-7	5SY4116-8	0.147
	16			5SY4120-7	5SY4120-8	0.162
	20			5SY4125-7	5SY4125-8	0.163
	25			5SY4130-7	--	0.162
	30			5SY4132-7	5SY4132-8	0.167
	32			5SY4135-7	--	0.161
	35			5SY4140-7	5SY4140-8	0.166
40		5SY4145-7	--	0.168		
45		5SY4150-7	5SY4150-8	0.164		
50		5SY4160-7	--	0.173		
60		5SY4163-7	5SY4163-8	0.166		
63		5SY4180-7	--	0.172		
80						
	<b>1P+N, 230 V AC</b>		2	5SY4514-7	5SY4514-8	0.324
	0.3			5SY4505-7	5SY4505-8	0.322
	0.5			5SY4501-7	5SY4501-8	0.319
	1			5SY4515-7	5SY4515-8	0.321
	1.6			5SY4502-7	5SY4502-8	0.317
	2			5SY4503-7	5SY4503-8	0.314
	3			5SY4504-7	5SY4504-8	0.315
	4			5SY4506-7	5SY4506-8	0.311
	6			5SY4508-7	5SY4508-8	0.302
	8			5SY4510-7	5SY4510-8	0.311
	10			5SY4513-7	5SY4513-8	0.301
	13			5SY4516-7	5SY4516-8	0.303
	16			5SY4520-7	5SY4520-8	0.315
	20			5SY4525-7	5SY4525-8	0.313
	25			5SY4532-7	5SY4532-8	0.323
	32			5SY4540-7	5SY4540-8	0.326
40		5SY4550-7	5SY4550-8	0.322		
50		5SY4563-7	5SY4563-8	0.324		
63		5SY4580-7	--	0.341		
80						
	<b>2P, 400 V AC</b>		2	5SY4214-7	5SY4214-8	0.322
	0.3			5SY4205-7	5SY4205-8	0.323
	0.5			5SY4201-7	5SY4201-8	0.328
	1			5SY4215-7	5SY4215-8	0.317
	1.6			5SY4202-7	5SY4202-8	0.311
	2			5SY4203-7	5SY4203-8	0.307
	3			5SY4204-7	5SY4204-8	0.302
	4			5SY4211-7	--	0.313
	5			5SY4206-7	5SY4206-8	0.304
	6			5SY4208-7	5SY4208-8	0.309
	8			5SY4210-7	5SY4210-8	0.296
	10			5SY4213-7	5SY4213-8	0.309
	13			5SY4218-7	--	0.304
	15			5SY4216-7	5SY4216-8	0.295
	16			5SY4220-7	5SY4220-8	0.322
	20			5SY4225-7	5SY4225-8	0.322
	25			5SY4230-7	--	0.316
	30			5SY4232-7	5SY4232-8	0.330
	32			5SY4235-7	--	0.317
	35			5SY4240-7	5SY4240-8	0.322
40		5SY4245-7	--	0.329		
45		5SY4250-7	5SY4250-8	0.320		
50		5SY4260-7	--	0.339		
60		5SY4263-7	5SY4263-8	0.325		
63		5SY4280-7	--	0.336		
80						



## SENTRON Protection, Switching, Measuring and Monitoring Devices

Protection Devices

5SY Miniature Circuit Breakers

5SY4, 10.000 A

## Selection and ordering data (continued)

10000 3	D/E	$I_n$ A	Mounting width MW <sup>1)</sup>	Characteristic C	Characteristic D	Weight kg
				Article No.	Article No.	
<b>Miniature circuit breakers 10000 A</b>						
	<b>3P, 400 V AC</b>		3			
	0.3			5SY4314-7	5SY4314-8	0.481
	0.5			5SY4305-7	5SY4305-8	0.484
	1			5SY4301-7	5SY4301-8	0.475
	1.6			5SY4315-7	5SY4315-8	0.468
	2			5SY4302-7	5SY4302-8	0.472
	3			5SY4303-7	5SY4303-8	0.467
	4			5SY4304-7	5SY4304-8	0.453
	5			5SY4311-7	--	0.464
	6			5SY4306-7	5SY4306-8	0.456
	8			5SY4308-7	5SY4308-8	0.449
	10			5SY4310-7	5SY4310-8	0.445
	13			5SY4313-7	5SY4313-8	0.447
	15			5SY4318-7	--	0.449
	16			5SY4316-7	5SY4316-8	0.445
	20			5SY4320-7	5SY4320-8	0.463
	25			5SY4325-7	5SY4325-8	0.464
	30			5SY4330-7	--	0.469
	32			5SY4332-7	5SY4332-8	0.474
	35			5SY4335-7	--	0.470
40		5SY4340-7	5SY4340-8	0.487		
45		5SY4345-7	--	0.486		
50		5SY4350-7	5SY4350-8	0.487		
60		5SY4360-7	--	0.503		
63		5SY4363-7	5SY4363-8	0.478		
80		5SY4380-7	--	0.499		
	<b>3P+N, 400 V AC</b>		4			
	0.3			5SY4614-7	5SY4614-8	0.634
	0.5			5SY4605-7	5SY4605-8	0.636
	1			5SY4601-7	5SY4601-8	0.632
	1.6			5SY4615-7	5SY4615-8	0.622
	2			5SY4602-7	5SY4602-8	0.623
	3			5SY4603-7	5SY4603-8	0.615
	4			5SY4604-7	5SY4604-8	0.605
	6			5SY4606-7	5SY4606-8	0.610
	8			5SY4608-7	5SY4608-8	0.595
	10			5SY4610-7	5SY4610-8	0.599
	13			5SY4613-7	5SY4613-8	0.600
	16			5SY4616-7	5SY4616-8	0.597
	20			5SY4620-7	5SY4620-8	0.621
	25			5SY4625-7	5SY4625-8	0.615
32		5SY4632-7	5SY4632-8	0.633		
40		5SY4640-7	5SY4640-8	0.633		
50		5SY4650-7	5SY4650-8	0.635		
63		5SY4663-7	5SY4663-8	0.641		
80		5SY4680-7	--	0.664		
	<b>4P, 400 V AC</b>		4			
	0.3			5SY4414-7	5SY4414-8	0.632
	0.5			5SY4405-7	5SY4405-8	0.633
	1			5SY4401-7	5SY4401-8	0.632
	1.6			5SY4415-7	5SY4415-8	0.623
	2			5SY4402-7	5SY4402-8	0.631
	3			5SY4403-7	5SY4403-8	0.616
	4			5SY4404-7	5SY4404-8	0.610
	6			5SY4406-7	5SY4406-8	0.605
	8			5SY4408-7	5SY4408-8	0.594
	10			5SY4410-7	5SY4410-8	0.592
	13			5SY4413-7	5SY4413-8	0.598
	16			5SY4416-7	5SY4416-8	0.603
	20			5SY4420-7	5SY4420-8	0.622
	25			5SY4425-7	5SY4425-8	0.630
	32			5SY4432-7	5SY4432-8	0.643
	40			5SY4440-7	5SY4440-8	0.642
50		5SY4450-7	5SY4450-8	0.637		
63		5SY4463-7	5SY4463-8	0.647		
80		5SY4480-7	--	0.664		

1) 1 MW (modular width) = 18 mm.







**SENTRON Protection, Switching, Measuring and Monitoring Devices**

Protection Devices

5SY Miniature Circuit Breakers

**5SY5, universal current, 10.000 A****Selection and ordering data**

 	$I_n$	Mounting width MW <sup>1)</sup>	Characteristic B		Characteristic C		Weight kg
			Article No.	Article No.	Article No.	Article No.	
<b>Miniature circuit breakers 10.000 A, universal current</b>							
	<b>1P, 230/400 V AC, 220 V DC</b>						
	0.3	1	--		5SY5114-7		0.171
	0.5		--		5SY5105-7		0.171
	1		--		5SY5101-7		0.169
	1.6		--		5SY5115-7		0.167
	2		5SY5102-6		5SY5102-7		0.171
	3		--		5SY5103-7		0.165
	4		5SY5104-6		5SY5104-7		0.167
	6		5SY5106-6		5SY5106-7		0.167
	8		--		5SY5108-7		0.164
	10		5SY5110-6		5SY5110-7		0.164
	13		5SY5113-6		5SY5113-7		0.168
	16		5SY5116-6		5SY5116-7		0.164
	20		5SY5120-6		5SY5120-7		0.167
	25		5SY5125-6		5SY5125-7		0.166
32		5SY5132-6		5SY5132-7		0.168	
40		5SY5140-6		5SY5140-7		0.167	
50		5SY5150-6		5SY5150-7		0.172	
63		5SY5163-6		5SY5163-7		0.178	
	<b>2P, 400 V AC 440 V DC</b>						
	0.3	2	--		5SY5214-7		0.330
	0.5		--		5SY5205-7		0.329
	1		--		5SY5201-7		0.326
	1.6		--		5SY5215-7		0.322
	2		--		5SY5202-7		0.321
	3		--		5SY5203-7		0.310
	4		--		5SY5204-7		0.310
	6		5SY5206-6		5SY5206-7		0.309
	8		--		5SY5208-7		0.314
	10		5SY5210-6		5SY5210-7		0.306
	13		5SY5213-6		5SY5213-7		0.322
	16		5SY5216-6		5SY5216-7		0.305
	20		5SY5220-6		5SY5220-7		0.320
	25		5SY5225-6		5SY5225-7		0.320
32		5SY5232-6		5SY5232-7		0.321	
40		5SY5240-6		5SY5240-7		0.322	
50		5SY5250-6		5SY5250-7		0.333	
63		5SY5263-6		5SY5263-7		0.344	
	<b>4P, 400 V AC, 880 V DC (max. 1000 V DC)</b>						
	0.3	1	--		5SY5414-7		0.653
	0.5		--		5SY5405-7		0.646
	1		--		5SY5401-7		0.634
	1.6		--		5SY5415-7		0.625
	2		--		5SY5402-7		0.648
	3		--		5SY5403-7		0.625
	4		--		5SY5404-7		0.623
	6		5SY5406-6		5SY5406-7		0.625
	8		--		5SY5408-7		0.611
	10		5SY5410-6		5SY5410-7		0.617
	13		5SY5413-6		5SY5413-7		0.630
	16		5SY5416-6		5SY5416-7		0.610
	20		5SY5420-6		5SY5420-7		0.629
	25		5SY5425-6		5SY5425-7		0.626
32		5SY5432-6		5SY5432-7		0.629	
40		5SY5440-6		5SY5440-7		0.631	
50		5SY5450-6		5SY5450-7		0.651	
63		5SY5463-6		5SY5463-7		0.667	









1) 1 MW (modular width) = 18 mm.

**Note:**

The 5ST3600 or 5ST3630 busbars enable simple wiring of 4-pole miniature circuit breakers see page 3/22.

For application examples, see Configuration Manual "Miniature Circuit Breakers" at: [www.siemens.com/lowvoltage/manuals](http://www.siemens.com/lowvoltage/manuals).

## Selection and ordering data

		$I_n$	Mounting width MW <sup>1)</sup>	Characteristic B	
				Article No.	Weight kg
<b>Miniature circuit breakers 15.000 A</b>					
	<b>1P, 230/400 V AC</b>		1		
	6	5SY7106-6		0.166	
	10	5SY7110-6		0.159	
	13	5SY7113-6		0.162	
	16	5SY7116-6		0.166	
	20	5SY7120-6		0.161	
	25	5SY7125-6		0.163	
	32	5SY7132-6		0.165	
	40	5SY7140-6		0.165	
	50	5SY7150-6		0.170	
63	5SY7163-6	0.173			
	<b>1P+N, 230 V AC</b>		2		
	6	5SY7506-6		0.314	
	10	5SY7510-6		0.313	
	13	5SY7513-6		0.318	
	16	5SY7516-6		0.315	
	20	5SY7520-6		0.310	
	25	5SY7525-6		0.316	
	32	5SY7532-6		0.321	
	40	5SY7540-6		0.322	
	50	5SY7550-6		0.328	
63	5SY7563-6	0.340			
	<b>2P, 400 V AC</b>		2		
	6	5SY7206-6		0.312	
	10	5SY7210-6		0.311	
	13	5SY7213-6		0.313	
	16	5SY7216-6		0.314	
	20	5SY7220-6		0.310	
	25	5SY7225-6		0.317	
	32	5SY7232-6		0.321	
	40	5SY7240-6		0.322	
	50	5SY7250-6		0.328	
63	5SY7263-6	0.339			
	<b>3P, 400 V AC</b>		3		
	6	5SY7306-6		0.463	
	10	5SY7310-6		0.458	
	13	5SY7313-6		0.467	
	16	5SY7316-6		0.465	
	20	5SY7320-6		0.461	
	25	5SY7325-6		0.469	
	32	5SY7332-6		0.476	
	40	5SY7340-6		0.474	
	50	5SY7350-6		0.486	
63	5SY7363-6	0.503			
	<b>3P+N, 400 V AC</b>		4		
	6	5SY7606-6		0.632	
	10	5SY7610-6		0.591	
	13	5SY7613-6		0.622	
	16	5SY7616-6		0.624	
	20	5SY7620-6		0.614	
	25	5SY7625-6		0.617	
	32	5SY7632-6		0.634	
	40	5SY7640-6		0.637	
	50	5SY7650-6		0.648	
63	5SY7663-6	0.669			
	<b>4P, 400 V AC</b>		4		
	6	5SY7406-6		0.621	
	10	5SY7410-6		0.610	
	13	5SY7413-6		0.616	
	16	5SY7416-6		0.616	
	20	5SY7420-6		0.613	
	25	5SY7425-6		0.630	
	32	5SY7432-6		0.633	
	40	5SY7440-6		0.635	
	50	5SY7450-6		0.647	
63	5SY7463-6	0.671			

1) 1 MW (modular width) = 18 mm.







# SENTRON Protection, Switching, Measuring and Monitoring Devices

Protection Devices

5SY Miniature Circuit Breakers





5SY7, 15.000 A

## Selection and ordering data (continued)

15000		$I_n$	Mounting width MW <sup>1)</sup>	Characteristic C	Characteristic D	Weight kg
				Article No.	Article No.	
<b>Miniature circuit breakers 15.000 A</b>						
	<b>1P, 230/400 V AC</b>		1			
	0.3			5SY7114-7	5SY7114-8	0.164
	0.5			5SY7105-7	5SY7105-8	0.165
	1			5SY7101-7	5SY7101-8	0.164
	1.6			5SY7115-7	5SY7115-8	0.163
	2			5SY7102-7	5SY7102-8	0.162
	3			5SY7103-7	5SY7103-8	0.161
	4			5SY7104-7	5SY7104-8	0.159
	6			5SY7106-7	5SY7106-8	0.160
	8			5SY7108-7	5SY7108-8	0.156
	10			5SY7110-7	5SY7110-8	0.157
	13			5SY7113-7	5SY7113-8	0.159
	16			5SY7116-7	5SY7116-8	0.156
	20			5SY7120-7	5SY7120-8	0.165
	25			5SY7125-7	5SY7125-8	0.163
	32			5SY7132-7	5SY7132-8	0.165
40		5SY7140-7	5SY7140-8	0.165		
50		5SY7150-7	5SY7150-8	0.171		
63		5SY7163-7	5SY7163-8	0.165		
	<b>1P+N, 230 V AC</b>		2			
	0.3			5SY7514-7	5SY7514-8	0.323
	0.5			5SY7505-7	5SY7505-8	0.312
	1			5SY7501-7	5SY7501-8	0.319
	1.6			5SY7515-7	5SY7515-8	0.319
	2			5SY7502-7	5SY7502-8	0.319
	3			5SY7503-7	5SY7503-8	0.313
	4			5SY7504-7	5SY7504-8	0.308
	6			5SY7506-7	5SY7506-8	0.310
	8			5SY7508-7	5SY7508-8	0.302
	10			5SY7510-7	5SY7510-8	0.303
	13			5SY7513-7	5SY7513-8	0.304
	16			5SY7516-7	5SY7516-8	0.307
	20			5SY7520-7	5SY7520-8	0.320
	25			5SY7525-7	5SY7525-8	0.313
	32			5SY7532-7	5SY7532-8	0.326
40		5SY7540-7	5SY7540-8	0.323		
50		5SY7550-7	5SY7550-8	0.324		
63		5SY7563-7	5SY7563-8	0.325		
	<b>2P, 400 V AC</b>		2			
	0.3			5SY7214-7	5SY7214-8	0.322
	0.5			5SY7205-7	5SY7205-8	0.325
	1			5SY7201-7	5SY7201-8	0.321
	1.6			5SY7215-7	5SY7215-8	0.330
	2			5SY7202-7	5SY7202-8	0.318
	3			5SY7203-7	5SY7203-8	0.313
	4			5SY7204-7	5SY7204-8	0.307
	6			5SY7206-7	5SY7206-8	0.313
	8			5SY7208-7	5SY7208-8	0.302
	10			5SY7210-7	5SY7210-8	0.301
	13			5SY7213-7	5SY7213-8	0.302
	16			5SY7216-7	5SY7216-8	0.304
	20			5SY7220-7	5SY7220-8	0.316
	25			5SY7225-7	5SY7225-8	0.318
	32			5SY7232-7	5SY7232-8	0.323
40		5SY7240-7	5SY7240-8	0.330		
50		5SY7250-7	5SY7250-8	0.323		
63		5SY7263-7	5SY7263-8	0.332		

<sup>1)</sup> 1 MW (modular width) = 18 mm.

## Selection and ordering data (continued)

15000		$I_n$	Mounting width MW <sup>1)</sup>	Characteristic		Weight kg
				Characteristic C Article No.	Characteristic D Article No.	
<b>Miniature circuit breakers 15.000 A</b>						
	<b>3P, 400 V AC</b>		3			
	0.3			5SY7314-7	5SY7314-8	0.479
	0.5			5SY7305-7	5SY7305-8	0.480
	1			5SY7301-7	5SY7301-8	0.477
	1.6			5SY7315-7	5SY7315-8	0.470
	2			5SY7302-7	5SY7302-8	0.471
	3			5SY7303-7	5SY7303-8	0.460
	4			5SY7304-7	5SY7304-8	0.452
	6			5SY7306-7	5SY7306-8	0.458
	8			5SY7308-7	5SY7308-8	0.447
	10			5SY7310-7	5SY7310-8	0.449
	13			5SY7313-7	5SY7313-8	0.450
	16			5SY7316-7	5SY7316-8	0.451
	20			5SY7320-7	5SY7320-8	0.473
	25			5SY7325-7	5SY7325-8	0.469
	32			5SY7332-7	5SY7332-8	0.480
40		5SY7340-7	5SY7340-8	0.478		
50		5SY7350-7	5SY7350-8	0.484		
63		5SY7363-7	5SY7363-8	0.492		
	<b>3P+N, 400 V AC</b>		4			
	0.3			5SY7614-7	5SY7614-8	0.660
	0.5			5SY7605-7	5SY7605-8	0.660
	1			5SY7601-7	5SY7601-8	0.660
	1.6			5SY7615-7	5SY7615-8	0.660
	2			5SY7602-7	5SY7602-8	0.624
	3			5SY7603-7	5SY7603-8	0.660
	4			5SY7604-7	5SY7604-8	0.606
	6			5SY7606-7	5SY7606-8	0.610
	8			5SY7608-7	5SY7608-8	0.594
	10			5SY7610-7	5SY7610-8	0.593
	13			5SY7613-7	5SY7613-8	0.599
	16			5SY7616-7	5SY7616-8	0.595
	20			5SY7620-7	5SY7620-8	0.617
	25			5SY7625-7	5SY7625-8	0.621
	32			5SY7632-7	5SY7632-8	0.642
40		5SY7640-7	5SY7640-8	0.645		
50		5SY7650-7	5SY7650-8	0.660		
63		5SY7663-7	5SY7663-8	0.648		
	<b>4P, 400 V AC</b>		4			
	0.3			5SY7414-7	5SY7414-8	0.635
	0.5			5SY7405-7	5SY7405-8	0.655
	1			5SY7401-7	5SY7401-8	0.629
	1.6			5SY7415-7	5SY7415-8	0.660
	2			5SY7402-7	5SY7402-8	0.624
	3			5SY7403-7	5SY7403-8	0.616
	4			5SY7404-7	5SY7404-8	0.606
	6			5SY7406-7	5SY7406-8	0.610
	8			5SY7408-7	5SY7408-8	0.593
	10			5SY7410-7	5SY7410-8	0.602
	13			5SY7413-7	5SY7413-8	0.597
	16			5SY7416-7	5SY7416-8	0.598
	20			5SY7420-7	5SY7420-8	0.621
	25			5SY7425-7	5SY7425-8	0.622
	32			5SY7432-7	5SY7432-8	0.634
40		5SY7440-7	5SY7440-8	0.635		
50		5SY7450-7	5SY7450-8	0.638		
63		5SY7463-7	5SY7463-8	0.654		

1) 1 MW (modular width) = 18 mm.

**SENTRON Protection, Switching, Measuring and Monitoring Devices**

Protection Devices

5SY Miniature Circuit Breakers

**5SY17 Circuit Breaker for Equipment****Selection and ordering data**

Protection Device	$I_n$	Mounting width MW <sup>1)</sup>	Characteristic F1 (quick)	Characteristic F2 (slow)	Weight kg
	A		Article No.	Article No.	
	<b>1P+AS</b>	1			
	0,5		<b>5SY1705-2</b>	<b>5SY1705-4</b>	0.107
	1		<b>5SY1701-2</b>	<b>5SY1701-4</b>	0.121
	2		<b>5SY1702-2</b>	<b>5SY1702-4</b>	0.122
	4		<b>5SY1704-2</b>	<b>5SY1704-4</b>	0.115
	6		<b>5SY1706-2</b>	<b>5SY1706-4</b>	0.122
	8		<b>5SY1708-2</b>	<b>5SY1708-4</b>	
	10		<b>5SY1710-2</b>	<b>5SY1710-4</b>	0.122
	16		<b>5SY1716-2</b>	<b>5SY1716-4</b>	0.123

1) 1 MW (modular width) = 18 mm.





# SENTRON Protection, Switching, Measuring and Monitoring Devices

Protection Devices

5SL Miniature Circuit Breakers, 1+N in 1 MW

5SL60, 6000 A

## Selection and ordering data

 	$I_n$ A	Mounting width MW <sup>1)</sup>	Characteristic B		Characteristic C		Weight kg
			Article No.	Article No.	Article No.	Article No.	
<b>Miniature circuit breakers, compact, 1+N (1P+N), 230 V AC</b>							
	<b>N pole, right</b>						
	2	1	--		5SL6002-7		0.121
	4		--		5SL6004-7		0.121
	6		5SL6006-6		5SL6006-7		0.120
	8		--		5SL6008-7		0.121
	10		5SL6010-6		5SL6010-7		0.121
	13		5SL6013-6		5SL6013-7		0.112
	16		5SL6016-6		5SL6016-7		0.113
	20		5SL6020-6		5SL6020-7		0.122
	25		5SL6025-6		5SL6025-7		0.126
	32		5SL6032-6		5SL6032-7		0.151
40		5SL6040-6		5SL6040-7		0.150	
	<b>N pole, left</b>						
	2	1	--		5SL6002-7KL		0.121
	4		--		5SL6004-7KL		0.120
	6		--		5SL6006-7KL		0.119
	8		--		5SL6008-7KL		0.121
	10		--		5SL6010-7KL		0.120
	13		--		5SL6013-7KL		0.118
	16		--		5SL6016-7KL		0.118
	20		--		5SL6020-7KL		0.118
	25		--		5SL6025-7KL		0.126
	32		--		5SL6032-7KL		0.149
40		--		5SL6040-7KL		0.149	

<sup>1)</sup> 1 MW (modular width) = 18 mm.



3

# SENTRON Protection, Switching, Measuring and Monitoring Devices

Protection Devices

5SL Miniature Circuit Breakers, 1+N in 1 MW

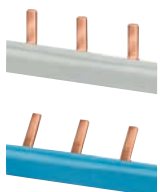
## 5SL60, 6000 A

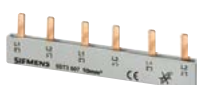
	Version	Pin spacing	Length	Article No.	Weight
		MW <sup>1)</sup>	mm		
<b>5ST37 busbar system, 10 mm<sup>2</sup>, for 1+N miniature circuit breakers in 1 MW of the compact range, can be cut, with end caps</b>					
	<b>Single-phase, 12 MW</b> For 12 MCBs 1+N, gray	1	216	<b>5ST3762</b>	0.033
	For 12 MCBs 1+N, blue		216	<b>5ST3763</b>	0.034
<b>End caps for 5ST376 busbars</b>					
	1 set comprises a right and a left cap Gray			<b>5ST3766</b>	0.001
	Blue			<b>5ST3767</b>	0.001
<b>5ST36 busbar systems, 10 mm<sup>2</sup>, for miniature circuit breakers, fixed lengths, cannot be cut, fully insulated</b>					
	<b>Three-phase</b> For 6 MCBs 1+N For 9 MCBs 1+N For 12 MCBs 1+N	1	102 257.5 210	<b>5ST3613</b> <b>5ST3614</b> <b>5ST3615</b>	0.033 0.055 0.078

1) 1 MW (modular width) = 18 mm.

## Dimensional drawings

### 5ST36

#### Pin spacing in MW

Dimensions of side view in mm (approx.).

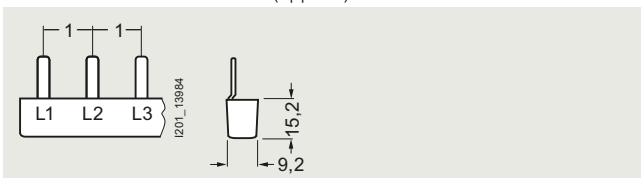

5ST3613  
5ST3614  
5ST3615

### 5ST37

#### Pin spacing in MW

Dimensions of side view in mm (approx.).

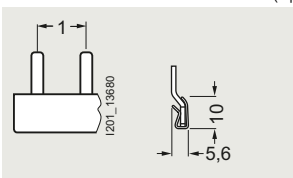

5ST3762  
5ST3764

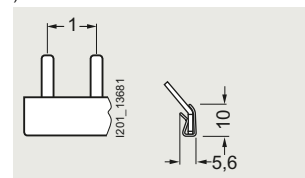

5ST3763  
5ST3765

**SENTRON Protection, Switching, Measuring and Monitoring Devices**

Protection Devices

5SL Miniature Circuit Breakers, 1+N in 1 MW

**5SL6 COM miniature circuit breakers with communication and measuring function****Selection and ordering data**

$I_n$ A	Mounting width MW <sup>1)</sup>	Charakteristik B	Charakteristik C	Weight kg	
		Article No.	Article No.		
<b>1P+N 6 kA compact miniature circuit breakers</b>					
	1	<b>1P+N (N pole right) 230 V AC</b>			
		2	5SL6002-6MC	5SL6002-7MC	0.135
		4	5SL6004-6MC	5SL6004-7MC	0.137
		6	5SL6006-6MC	5SL6006-7MC	0.137
		8	--	5SL6008-7MC	
		10	5SL6010-6MC	5SL6010-7MC	0.137
		13	5SL6013-6MC	5SL6013-7MC	0.137
		16	5SL6016-6MC	5SL6016-7MC	0.138
		20	5SL6020-6MC	5SL6020-7MC	0.137
		25	5SL6025-6MC	5SL6025-7MC	0.137
		32	5SL6032-6MC	5SL6032-7MC	0.137

<sup>1)</sup> 1 MW (modular width) = 18 mm.

**Note:**

Please note the country-specific radio licenses of the products in SIOS:

[www.siemens.com/lowvoltage/certificates](http://www.siemens.com/lowvoltage/certificates) (109801197)

3

# SENTRON Protection, Switching, Measuring and Monitoring Devices

Protection Devices  
Additional Components







## Electrical components

### Technical specifications

	Auxiliary switches (AS)		Fault signal contacts (FC)
	5ST3010, 5ST3010-2 5ST3011, 5ST3011-2 5ST3012, 5ST3012-2	5ST3013 <sup>1)</sup> , 5ST3013-2 <sup>2)</sup> 5ST3014 <sup>1)</sup> , 5ST3014-2 <sup>2)</sup> 5ST3015 <sup>1)</sup> , 5ST3015-2 <sup>2)</sup>	5ST3020, 5ST3020-2 5ST3021, 5ST3021-2 5ST3022, 5ST3022-2
<b>Standards</b>	IEC/EN 62019; IEC/EN 60947-5-1; UL 1077; CSA C22.2 No. 235		
<b>Short-circuit protection</b>	<ul style="list-style-type: none"> <li>&lt; 500 A: 5SL B6/C6 miniature circuit breakers</li> <li>Up to 1 kA: 5SY B6/C6 miniature circuit breakers or fuse gG 6 A</li> </ul>		
<b>Contact load</b>			
• Min.	50 mA, 24 V	1 mA/5 V DC	50 mA, 24 V
• Max.	--	1) = 100 mA/30 V DC 2) = 50 mA/30 V DC	--
• Acc. to IEC/EN 62019 and 60947-5-1:			
- 400 V AC, AC-14, NO	A 2	--	2
- 230 V AC, AC-14, NO	A 6	--	6
- 400 V AC, AC-13, NC	A 2	--	2
- 230 V AC, AC-13, NC	A 6	--	6
• Acc. to IEC/EN 62019 (acc. to IEC/EN 60947-5-1):			
- 220 V DC, DC-13, NO + NC	A 1 (0.5)	--	1 (0.5)
- 110 V DC, DC-13, NO + NC	A 1 (0.75)	--	1 (0.75)
- 60 V DC, DC-13, NO + NC	A 3 (1.5)	--	3 (1.5)
- 24 V DC, DC-13, NO + NC	A 6 (3)	--	6 (3)
<b>Service life, on average, with rated load</b>	20000 actuations		20000 actuations
<b>Conductor cross-sections</b>	mm <sup>2</sup> AWG	0.5 ... 2.5 22 ... 14	0.5 ... 2.5 22 ... 14
<b>Terminals</b>			
• Terminal tightening torque	Nm lb-in	0.5 4.5	0.5 4.5
<b>Rated frequency</b>	Hz	50/60	
<b>Mounting position</b>	Any		
<b>Ambient temperature</b>	°C	-25 ... +55	
<b>Storage temperature</b>	°C	-40 ... +75	
<b>Resistance to climate</b>	Acc. to IEC 60068-2-30 Cycles	28	
<b>Shock</b>	Acc. to IEC 60068-2-27 m/s	50 at 11 ms half-sine	
<b>Resistance to vibrations</b>	Acc. to IEC 60068-2-6 m/s <sup>2</sup>	50 at 10 ... 150 Hz	

	Undervoltage releases (UR)		Shunt trips (ST)	
	5ST304.	5ST3030	5ST3031	
<b>Standards</b>	EN 60947-1			
<b>Rated voltages <math>U_n</math></b>	V AC	230	110 ... 415	24 ... 48
	V DC	24, 110	110	24 ... 48
• Operating range $U_n$		0.85 ... 1.1 x $U_n$	0.7 ... 1.1 x $U_n$	
• Rated frequency $f_n$	Hz	--	50 ... 60	
<b>Response limits: Tripping</b>		< 0.35 ... 0.7 x $U_n$	--	
<b>Short-circuit protection</b>	Miniature circuit breakers B/C 6 A or fuse gG 6 A			
<b>Minimum contact load</b>	50 mA, 24 V		50 mA, 24 V	
<b>Tripping operations</b>	max. 2000		max. 2000	
<b>Service life, on average, with rated load</b>	20000 actuations		20000 actuations	
<b>Conductor cross-sections</b>	mm <sup>2</sup> AWG	0.5 ... 2.5 22 ... 14	0.5 ... 2.5 22 ... 14	
<b>Terminals</b>				
• Terminal tightening torque	Nm lb-in	0.8 6.8	0.8 6.8	
<b>Mounting position</b>	Any			
<b>Ambient temperature</b>	°C	-25 ... +55		
<b>Storage temperature</b>	°C	-40 ... +75		
<b>Resistance to climate</b>	Acc. to IEC 60068-2-30 Cycles	28		
<b>Shock</b>	Acc. to IEC 60068-2-27 m/s	50 at 11 ms half-sine		
<b>Resistance to vibrations</b>	Acc. to IEC 60068-2-6 m/s <sup>2</sup>	50 at 10 ... 150 Hz		
<b>Switching frequency</b>	--			
<b>Switching duration</b>	s	--		
<b>Minimum command duration</b>	s	--		
<b>Rated power dissipation</b>	VA	--		
<b>Rated frequency</b>	Hz	50/60		
<b>Behavior in the event of control voltage failure</b>	--			

## Selection and ordering data

Version	Rated voltage	Mounting width	Article No.	Weight	
	V	MW <sup>1)</sup>		kg	
<b>Auxiliary switches/fault signal contacts</b>					
	<b>Auxiliary switches (AS)</b> For 5SL, 5SY, 5SP, 5TL1 miniature circuit breakers 5SU1 RCBOs, for 5SV residual current protective device and 5TE8 switches				
	1 NO + 1 NC For low power For low power (with diode)	0.5	<b>5ST3010</b> <b>5ST3013</b> <b>5ST3013-0XX01</b>	0.056 0.061 0.063	
	2 NO For low power		<b>5ST3011</b> <b>5ST3014</b>	0.063 0.060	
	2 NC For low power		<b>5ST3012</b> <b>5ST3015</b>	0.065 0.064	
	<b>Auxiliary switches (AS) with TEST button</b> For 5SL, 5SY, 5SP, 5TL1 miniature circuit breakers 5SU1, 5TL1 RCBOs for 5SV residual current protective device and 5TE8 switches				
1 NO + 1 NC For low power	0.5	<b>5ST3010-2</b> <b>5ST3013-2</b>	0.066 0.069		
2 NO For low power		<b>5ST3011-2</b> <b>5ST3014-2</b>	0.068 0.065		
2 NC For low power		<b>5ST3012-2</b> <b>5ST3015-2</b>	0.071 0.071		
	<b>Auxiliary switches (AS) acc. to UL 489</b> For 5SL, 5SY, 5SP miniature circuit breakers, 5SU1 RCBOs, for 5SV residual current protective devices and 5TE8 switches (for 5SU1 the 5ST3805-1 handle coupler is required)				
	1 NO + 1 NC	0.5	<b>5ST3010-OHG</b>	0.061	
	2 NO 2 NC		<b>5ST3011-OHG</b> <b>5ST3012-OHG</b>	0.086 0.085	
	<b>Fault signal contacts (FC)</b> For 5SL, 5SY, 5SP miniature circuit breakers 5SU1 RCBOs, for 5SV residual current protective device				
	1 NO + 1 NC	0.5	<b>5ST3020</b>	0.065	
	2 NO		<b>5ST3021</b>	0.066	
	2 NC		<b>5ST3022</b>	0.066	
	<b>Fault signal contacts (FC) with TEST and ACKNOWLEDGE button</b> For 5SL, 5SY, 5SP miniature circuit breakers 5SU1 RCBOs, for 5SV residual current protective device				
	1 NO + 1 NC	0.5	<b>5ST3020-2</b>	0.071	
	2 NO		<b>5ST3021-2</b>	0.071	
	2 NC		<b>5ST3022-2</b>	0.067	
	<b>Undervoltage releases (UR)</b> For 5SL4, 5SY, 5SP miniature circuit breakers, 5SU1 RCBOs, for 5SV residual current protective devices, but not for 5SY60.. and 5SL6 miniature circuit breakers With integrated auxiliary switch				
		230 AC	1	<b>5ST3040</b>	0.115
		110 DC		<b>5ST3041</b>	0.109
		24 DC		<b>5ST3042</b>	0.110
	Without integrated auxiliary switch				
		230 AC	1	<b>5ST3043</b>	0.102
	110 DC		<b>5ST3044</b>	0.095	
	24 DC		<b>5ST3045</b>	0.095	
	<b>Shunt trips (ST)</b> For 5SL4, 5SY, 5SP miniature circuit breakers, 5SU1 RCBOs, for 5SV residual current protective devices, but not for 5SY60.. and 5SL6 miniature circuit breakers				
		110 ... 415 V AC	1	<b>5ST3030</b>	0.098
		24 ... 48 V AC/DC	1	<b>5ST3031</b>	0.098

1) 1 MW (modular width) = 18 mm.



## SENTRON Protection, Switching, Measuring and Monitoring Devices

### Protection Devices

#### Busbars

#### 5ST standard busbars

##### Overview

The busbar system with pin-type connections can be used for all 5SL6, 5SJ6 ...-KS and 5SY miniature circuit breakers with or without mounted auxiliary switch (AS) or fault signal contact (FC).

Busbars in 10 mm<sup>2</sup> and 16 mm<sup>2</sup> versions are available.

With bars that can be cut to length, the 5ST37 busbar system can be tailored to any requirements.

The extremely flexible 5ST36 busbar system with fixed lengths also enables installation in any length as the busbars can be overlapped.

There is no further need for time-consuming tasks, such as cutting, cutting to length, deburring, cleaning of cut surfaces and mounting of end caps.

Any free pins on the busbars can be made safe by covering with touch protection.

##### Benefits



- Between the rows of devices, the busbar, which is located at the bottom and behind the conductor, provides an optimum wiring space with easy view of the inserted conductor. This enables easy control of connections.

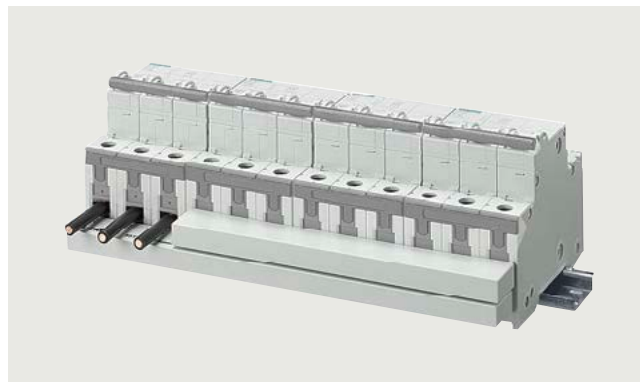

- The ability to overlap when mounting the busbars enables a cross-section enlargement of up to 32 mm<sup>2</sup> using the respective components, 10 mm<sup>2</sup> and 16 mm<sup>2</sup>.

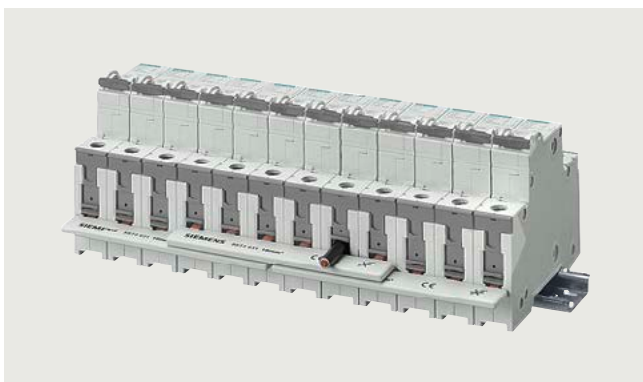

- By overlapping the busbars with fixed lengths, it is possible to achieve device combinations with any number of devices.



- The fact that the connection of the conductor is always clearly visible facilitates cable entry of all pole types and considerably reduces mounting times.

## Technical specifications

		5ST3
<b>Standards</b>		EN 60439-1 (VDE 0660-500): 2005-01
<b>Busbar material</b>		SF-Cu F 24
<b>Partition material</b>		Plastic, Cycloyl 3600 heat-resistant over 90 °C flame-retardant and self-extinguishing, dioxin and halogen-free
<b>Rated operational voltage <math>U_c</math></b>	V AC	400
<b>Rated current <math>I_n</math></b>		
• Cross-section 10 mm <sup>2</sup>	A	63
• Cross-section 16 mm <sup>2</sup>	A	80
<b>Rated impulse withstand voltage <math>U_{imp}</math></b>	kV	4
<b>Test pulse voltage (1.2/50)</b>	kV	6.2
<b>Rated conditional short-circuit current <math>I_{cc}</math></b>	kA	25
<b>Resistance to climate</b>		
• Constant atmosphere	Acc. to DIN 50015	23/83; 40/92; 55/20
• Humid heat	Acc. to IEC 60068-2-30	28 cycles
<b>Insulation coordination</b>		
• Overvoltage category		III
• Pollution degree		2
<b>Maximum busbar current <math>I_S</math> per phase</b>		
• Infeed at the start of the busbar		
- Cross-section 10 mm <sup>2</sup>	A	63
- Cross-section 16 mm <sup>2</sup>	A	80
• Infeed at the center of the busbar		
- Cross-section 10 mm <sup>2</sup>	A	100
- Cross-section 16 mm <sup>2</sup>	A	130

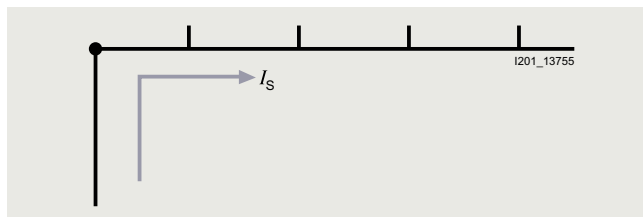
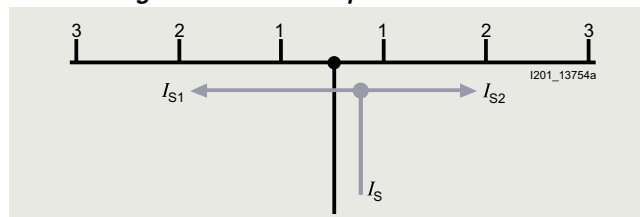
*Infeed at the start or end of the busbar**Infeed along the busbar or midpoint infeed*

The sum of the outgoing current per branch (1, 2, 3 ... n) must not be greater than the max. busbar current  $I_S$ /phase.









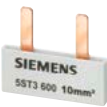

# SENTRON Protection, Switching, Measuring and Monitoring Devices

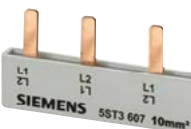
Protection Devices

Busbars

## 5ST standard busbars

### Selection and ordering data

Version	Pin spacing MW <sup>1)</sup>	Length mm	Article No.	Weight kg	
<b>5ST36 busbar systems, 10 mm<sup>2</sup>, for miniature circuit breakers, fixed lengths, cannot be cut, fully insulated</b>					
<b>Single-phase</b>					
	For 2 MCBs 1P	1	33	<b>5ST3600</b>	0.008
	For 6 MCBs 1P		105	<b>5ST3601</b>	0.021
	For 12 MCBs 1P		210	<b>5ST3602</b>	0.048
<b>Single-phase, for MCBs with AS or FC</b>					
	For 2 MCBs 1P	1.5	40	<b>5ST3603</b>	0.010
	For 6 MCBs 1P		156.5	<b>5ST3604</b>	0.032
	For 9 MCBs 1P		237	<b>5ST3605</b>	0.051
<b>Two-phase</b>					
	For 2 MCBs 2P	1	75.5	<b>5ST3606</b>	0.019
	For 3 MCBs 2P		105	<b>5ST3607</b>	0.028
	For 6 MCBs 2P		210	<b>5ST3608</b>	0.061
<b>Three-phase</b>					
	For 2 MCBs 3P	1	102	<b>5ST3613</b>	0.033
	For 3 MCBs 3P		157.5	<b>5ST3614</b>	0.055
	For 4 MCBs 3P		210	<b>5ST3615</b>	0.078
<b>Three-phase, for MCBs with AS or FC</b>					
	For 2 MCBs 3P	1+1+1.5	115	<b>5ST3616</b>	0.038
	For 4 MCBs 3P		237	<b>5ST3617</b>	0.090
	For 6 MCBs 1P	1.5	125	<b>5ST3618</b>	0.046
	For 9 MCBs 1P		229	<b>5ST3620</b>	0.079
<b>Three-phase</b>					
	For 1 RCCB 4P N right and 8 MCBs 1P	1	210	<b>5ST3624</b>	0.079
	For 1 RCCB 4P N left and 8 MCBs 1P	1	192	<b>5ST3667</b>	0.070
<b>Four-phase</b>					
	For 2 MCBs 4P or 3P+N	1	145	<b>5ST3621</b>	0.053
	For 3 MCBs 4P or 3P+N		215	<b>5ST3622</b>	0.092
	For 6 MCBs 2P or 1P+N		215	<b>5ST3623</b>	0.087
<b>5ST36 busbars, 16 mm<sup>2</sup>, for miniature circuit breakers, fixed lengths, cannot be cut, fully insulated</b>					
<b>Single-phase</b>					
	For 2 MCBs 1P	1	33	<b>5ST3630</b>	0.009
	For 6 MCBs 1P		105	<b>5ST3631</b>	0.026
	For 12 MCBs 1P		210	<b>5ST3632</b>	0.053
<b>Single-phase, for MCBs with AS or FC</b>					
	For 2 MCBs 1P	1.5	40	<b>5ST3633</b>	0.011
	For 6 MCBs 1P		156.5	<b>5ST3634</b>	0.036
	For 9 MCBs 1P		237	<b>5ST3635</b>	0.055
<b>Two-phase</b>					
	For 2 MCBs 2P	1	75.5	<b>5ST3636</b>	0.026
	For 3 MCBs 2P		105	<b>5ST3637</b>	0.042
	For 6 MCBs 2P		210	<b>5ST3638</b>	0.089
<b>Two-phase, for MCBs with AS or FC</b>					
	For 2 MCBs 2P	1 + 1.5	75.5	<b>5ST3640</b>	0.029
	For 3 MCBs 2P		120.5	<b>5ST3641</b>	0.047
	For 5 MCBs 2P		210	<b>5ST3642</b>	0.086

1) 1 MW (modular width) = 18 mm.

## Selection and ordering data (continued)

Version	Pin spacing	Length	Article No.	Weight
	MW <sup>1)</sup>	mm		kg
<b>5ST36 busbars, 16 mm<sup>2</sup>, for miniature circuit breakers, fixed lengths, cannot be cut, fully insulated</b>				
<b>Three-phase</b>				
For 2 MCBs 3P	1	102.5	<b>5ST3643</b>	0.048
For 3 MCBs 3P		157.5	<b>5ST3644</b>	0.082
For 4 MCBs 3P		210	<b>5ST3645</b>	0.113
<b>Three-phase, for MCBs with AS or FC</b>				
For 2 MCBs 3P	1+1+1.5	115	<b>5ST3646</b>	0.054
For 4 MCBs 3P		237	<b>5ST3647</b>	0.130
For 6 MCBs 1P	1.5	156	<b>5ST3648</b>	0.067
For 9 MCBs 1P		245	<b>5ST3650</b>	0.111
<b>Three-phase</b>				
For 1 RCCB 4P N right and 8 MCBs 1P	1	210	<b>5ST3654</b>	0.113
For 1 RCCB 4P N left and 8 MCBs 1P	1	210	<b>5ST3668</b>	0.100
<b>Four-phase</b>				
For 2 MCBs 4P or 3P+N	1		<b>5ST3651</b>	0.079
For 3 MCBs 4P or 3P+N			<b>5ST3652</b>	0.136
For 6 MCBs 2P or 1P+N			<b>5ST3653</b>	0.126
<b>Touch protection</b>				
For free connections, yellow (RAL 1004) 5 x 1 pin			<b>5ST3655</b>	0.008
<b>10 mm<sup>2</sup></b>				
20 x 5ST3613 + 10 x 5ST3614 + 50 x 5ST3615 + 50 x 5ST3655			<b>5ST3656</b>	5.348
<b>16 mm<sup>2</sup></b>				
20 x 5ST3643 + 10 x 5ST3644 + 50 x 5ST3645 + 50 x 5ST3655			<b>5ST3657</b>	6.632
<b>5ST37 busbar system, 10 mm<sup>2</sup>, 12 MW for miniature circuit breakers, can be cut, with end caps</b>				
<b>Single-phase, angled</b>				
For 12 MCBs 1P	1	214	<b>5ST3730</b>	0.033
For 9 MCBs 1P with AS or FC	1.5		<b>5ST3732</b>	0.030
<b>Two-phase</b>				
For 6 MCBs 2P	1		<b>5ST3734</b>	0.071
For 4 MCBs 2P with AS or FC	1+1.5		<b>5ST3736</b>	0.071
<b>Three-phase</b>				
For 4 MCBs 3P	1		<b>5ST3738</b>	0.086
For 3 MCBs 3P with AS or FC	1+1+1.5		<b>5ST3741</b>	0.075
For 3 MCBs 1P with AS or FC	1.5		<b>5ST3743</b>	0.075
<b>Four-phase</b>				
For 3 MCBs 4P or 3P+N	1		<b>5ST3745</b>	0.110
<b>5ST37 busbar system, 10 mm<sup>2</sup>, 56 MW for miniature circuit breakers, can be cut, without end caps</b>				
<b>Single-phase, angled</b>				
For MCBs 1P	1	1016	<b>5ST3731</b>	0.153
For MCBs 1P with AS or FC	1.5		<b>5ST3733</b>	0.157
<b>Two-phase</b>				
For MCBs 1P and UR or AR	2		<b>5ST3735-2</b>	0.304
For MCBs 2P	1		<b>5ST3735</b>	0.343
For MCBs 2P with AS or FC	1+1.5		<b>5ST3737</b>	0.327
<b>Three-phase</b>				
For MCBs 3P	1		<b>5ST3740</b>	0.430
For MCBs 3P with AS or FC	1+1+1.5		<b>5ST3742</b>	0.421
For MCBs 1P with AS or FC	1.5		<b>5ST3744</b>	0.380
<b>Four-phase</b>				
For MCBs 4P or 3P+N	1		<b>5ST3746</b>	0.600
For MCBs 2P with AS or FC and RCBOs 1P+N with AS or FC	1+1.5		<b>5ST3746-2</b>	0.505

<sup>1)</sup> 1 MW (modular width) = 18 mm.



# SENTRON Protection, Switching, Measuring and Monitoring Devices

## Protection Devices

### Busbars

#### 5ST standard busbars

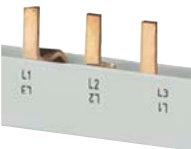
#### Selection and ordering data (continued)

Version	Pin spacing MW <sup>1)</sup>	Length mm	Article No.	Weight kg	
<b>5ST37 busbar system, 16 mm<sup>2</sup>, 12 MW for miniature circuit breakers, can be cut, with end caps</b>					
	<b>Single-phase, angled</b>				
	For MCBs 1P	1	214	<b>5ST3700</b>	0.042
	For MCBs 1P with AS or FC	1.5		<b>5ST3702</b>	0.040
	<b>Two-phase</b>				
	For MCBs 2P	1		<b>5ST3704</b>	0.096
	For MCBs 2P with AS or FC	1+1.5		<b>5ST3706</b>	0.094
	<b>Three-phase</b>				
	For MCBs 3P	1		<b>5ST3708</b>	0.118
	For MCBs 3P with AS or FC	1+1+1.5		<b>5ST3711</b>	0.100
	For MCBs 1P with AS or FC	1.5		<b>5ST3713</b>	0.102
<b>Four-phase</b>					
For MCBs 4P or 3P+N	1		<b>5ST3715</b>	0.150	
<b>5ST37 busbar system, 16 mm<sup>2</sup>, 56 MW for miniature circuit breakers, can be cut, without end caps</b>					
	<b>Single-phase, angled</b>				
	For MCBs 1P	1	1016	<b>5ST3701</b>	0.201
	For MCBs 1P with AS or FC	1.5		<b>5ST3703</b>	0.185
	<b>Two-phase</b>				
	For MCBs 2P	1		<b>5ST3705</b>	0.452
	For MCBs 2P with AS or FC	1+1.5		<b>5ST3707</b>	0.454
	<b>Three-phase</b>				
	For MCBs 3P	1		<b>5ST3710</b>	0.601
	For MCBs 3P with AS or FC	1+1+1.5		<b>5ST3712</b>	0.570
	For MCBs 1P with AS or FC	1.5		<b>5ST3714</b>	0.540
<b>Four-phase</b>					
For MCBs 4P or 3P+N	1		<b>5ST3716</b>	0.798	
<b>5ST37 busbar system, 10 mm<sup>2</sup>, 56 MW can be cut, without end caps, with touch protection</b>					
<b>Four-phase</b>					
For MCBs 2P and RCBOs 1P+N	1	1000	<b>5ST3770-2</b>	0.578	
<b>5ST37 busbar system, 16 mm<sup>2</sup>, 56 MW can be cut, without end caps, with touch protection</b>					
<b>Four-phase</b>					
For MCBs 2P and RCBOs 1P+N	1	1000	<b>5ST3770-3</b>	0.770	
<b>5ST37 busbar system, 10 mm<sup>2</sup>, 16 MW can be cut, with end caps, with touch protection</b>					
<b>Four-phase</b>					
For RCCBs 4P, N right and 6 MCBs 1P+N	1	292	<b>5ST3770-4</b>	0.153	
<b>5ST37 busbar system, 16 mm<sup>2</sup>, 16 MW can be cut, with end caps, with touch protection</b>					
<b>Four-phase</b>					
For RCCBs 4P, N right and 6 MCBs 1P+N	1	292	<b>5ST3770-5</b>	0.203	
<b>End caps for 5ST37, can be cut</b>					
	For single-phase busbars		<b>5ST3748</b>	0.001	
	For two-phase and three-phase busbars		<b>5ST3750</b>		
	For four-phase busbars		<b>5ST3718</b>	0.002	
<b>Terminals for 5ST36 and 5ST37 busbars</b>					
	<b>Terminals for conductors up to 25 mm<sup>2</sup></b>				
	• With cable entry in the center		<b>5ST3768-3</b>	0.014	
	• With cable entry on the left		<b>5ST3768-4</b>	0.013	
	• With cable entry on the right		<b>5ST3768-5</b>	0.014	
	<b>Terminals for conductors up to 50 mm<sup>2</sup></b>				
	• With cable entry in the center		<b>5ST3760-3</b>	0.023	
• With cable entry on the left		<b>5ST3760-4</b>	0.021		
• With cable entry on the right		<b>5ST3760-5</b>	0.023		
<b>Note</b>					
The terminals are not suitable for 5ST376.					

<sup>1)</sup> 1 MW (modular width) = 18 mm.

**Dimensional drawings**

**5ST36**

**Pin spacing in MW (modular width; 1 MW = 18 mm)**

Dimensions of side view in mm (approx.)

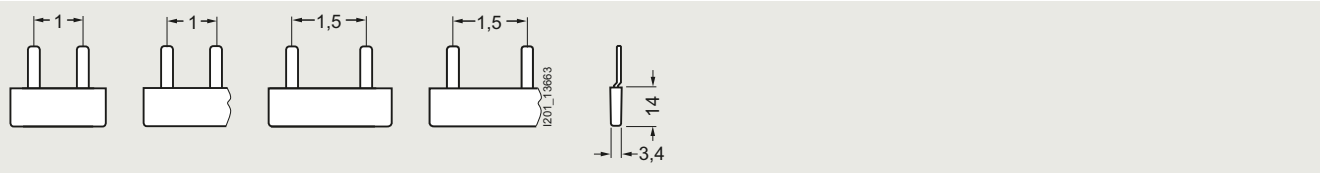

- |         |         |         |         |
|---------|---------|---------|---------|
| 5ST3600 | 5ST3601 | 5ST3603 | 5ST3604 |
| 5ST3630 | 5ST3602 | 5ST3633 | 5ST3605 |
|         | 5ST3631 |         | 5ST3634 |
|         | 5ST3632 |         | 5ST3635 |

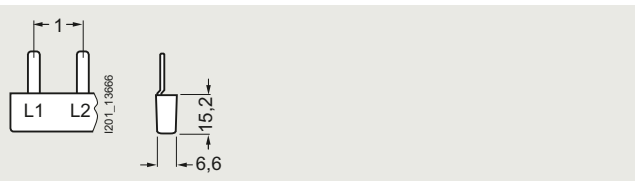

- 5ST3606  
5ST3607  
5ST3608

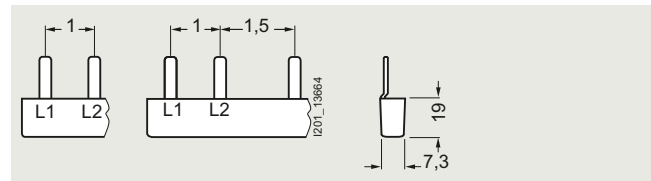

- |         |         |
|---------|---------|
| 5ST3636 | 5ST3640 |
| 5ST3637 | 5ST3641 |
| 5ST3638 | 5ST3642 |

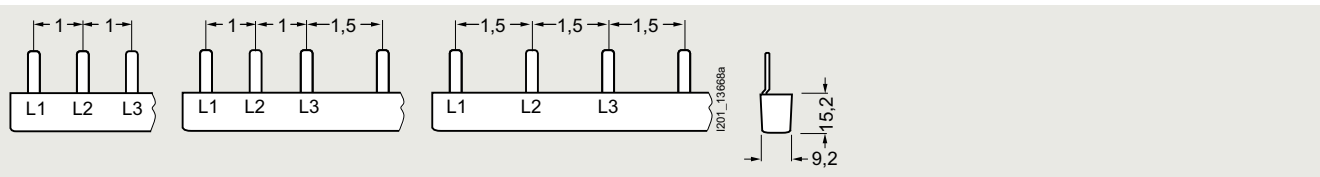

- |         |         |         |
|---------|---------|---------|
| 5ST3613 | 5ST3616 | 5ST3618 |
| 5ST3614 | 5ST3617 | 5ST3620 |
| 5ST3615 |         |         |
| 5ST3667 |         |         |

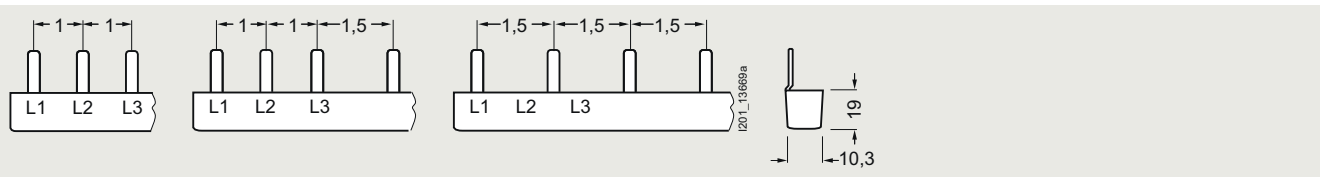

- |         |         |         |
|---------|---------|---------|
| 5ST3643 | 5ST3646 | 5ST3648 |
| 5ST3644 | 5ST3647 | 5ST3650 |
| 5ST3645 |         |         |
| 5ST3668 |         |         |

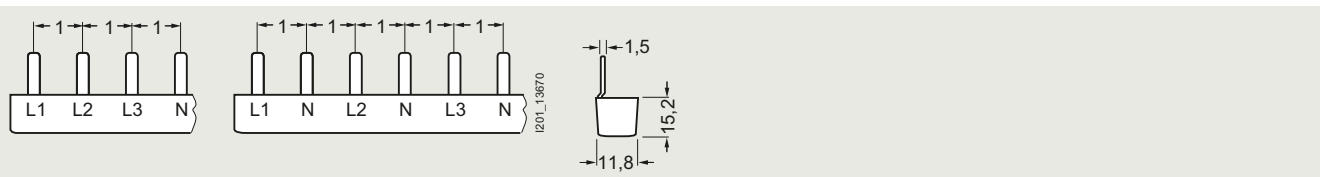

- |         |         |
|---------|---------|
| 5ST3621 | 5ST3623 |
| 5ST3622 |         |

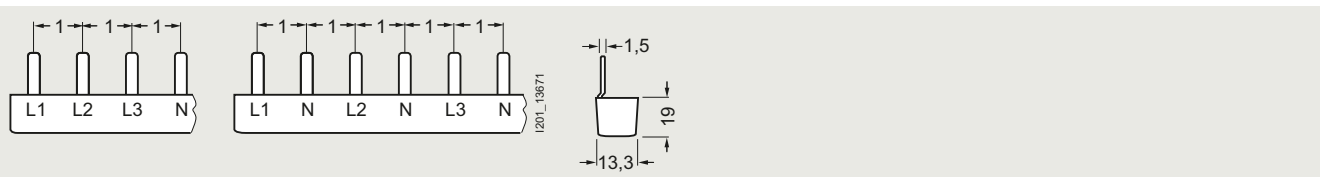

- |         |         |
|---------|---------|
| 5ST3651 | 5ST3653 |
| 5ST3652 |         |

# SENTRON Protection, Switching, Measuring and Monitoring Devices

## Protection Devices

### Busbars

#### 5ST standard busbars

#### Dimensional drawings (continued)

##### 5ST36

##### Pin spacing in MW (modular width; 1 MW = 18 mm)

Dimensions of side view in mm (approx.)

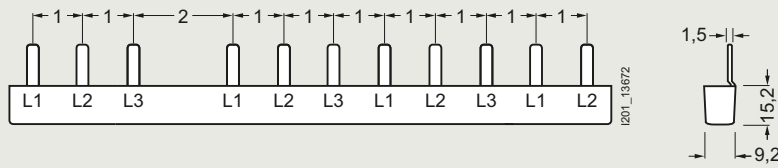

5ST3624

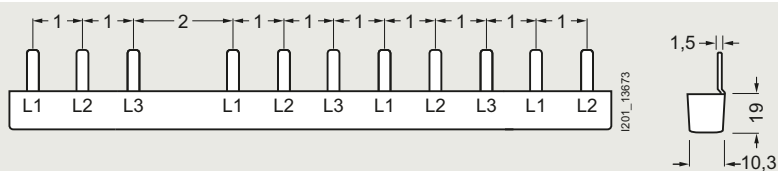

5ST3654

##### 5ST37

##### Pin spacing in MW (modular width; 1 MW = 18 mm)

Dimensions of side view in mm (approx.)

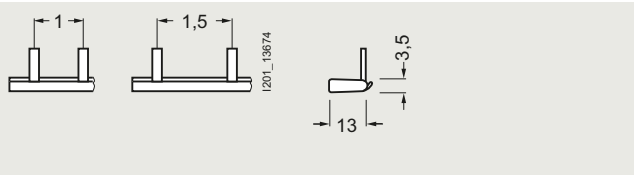

5ST3700 5ST3702  
5ST3701 5ST3703  
5ST3730 5ST3732  
5ST3731 5ST3733  
Single-phase Single-phase

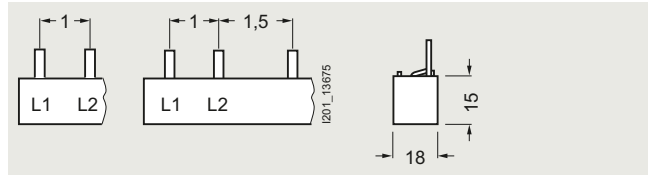

5ST3704 5ST3706  
5ST3705 5ST3707  
5ST3734 5ST3736  
5ST3735 5ST3737  
Two-phase Two-phase

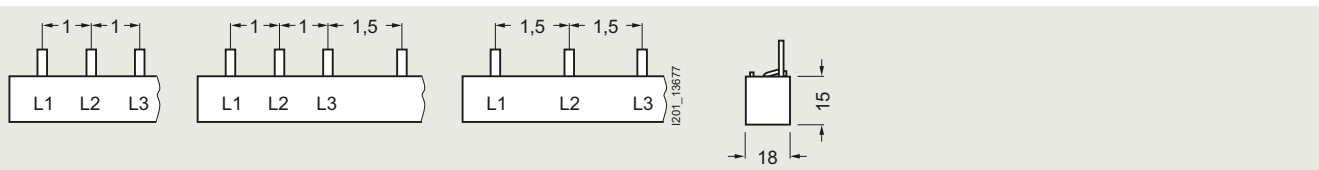

5ST3708 5ST3711 5ST3713  
5ST3710 5ST3712 5ST3714  
5ST3738 5ST3741 5ST3743  
5ST3740 5ST3742 5ST3744

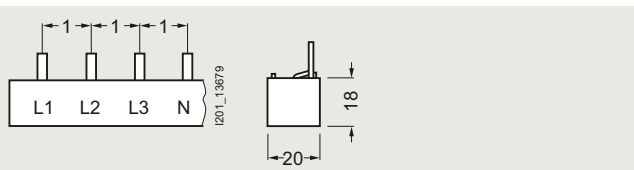

5ST3715  
5ST3716  
5ST3745  
5ST3746

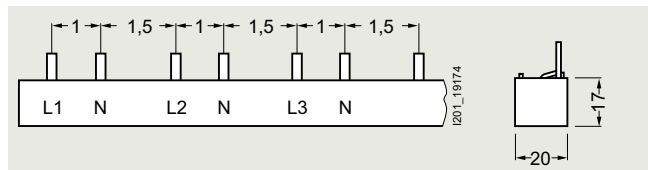

5ST3746-2

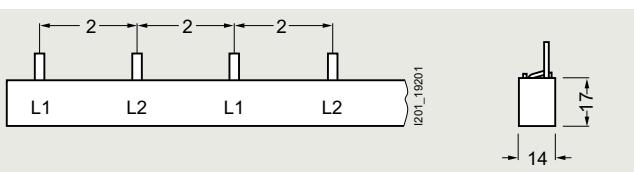

5ST3735-2

## Dimensional drawings (continued)

## 5ST37

## Pin spacing in MW (modular width; 1 MW = 18 mm)

Dimensions of side view in mm (approx.)

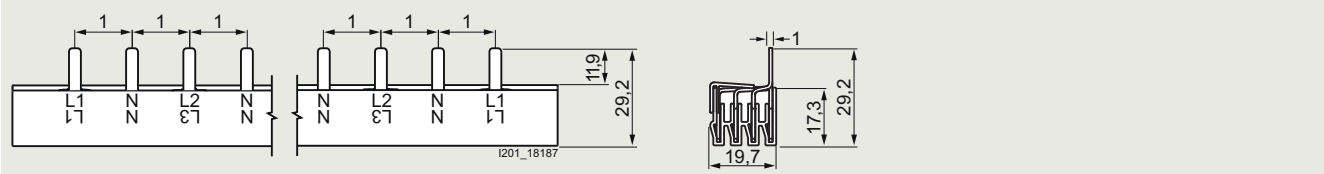

5ST3770-2

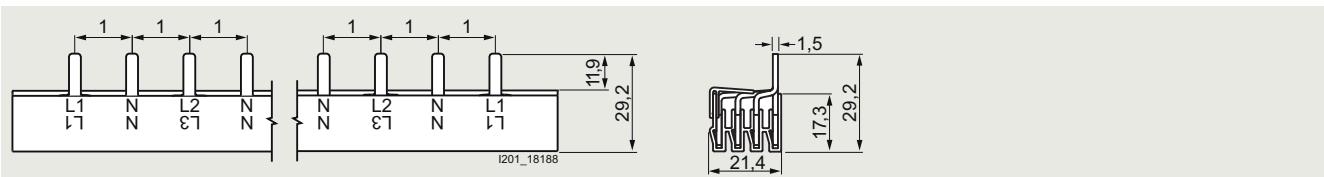

5ST3770-3

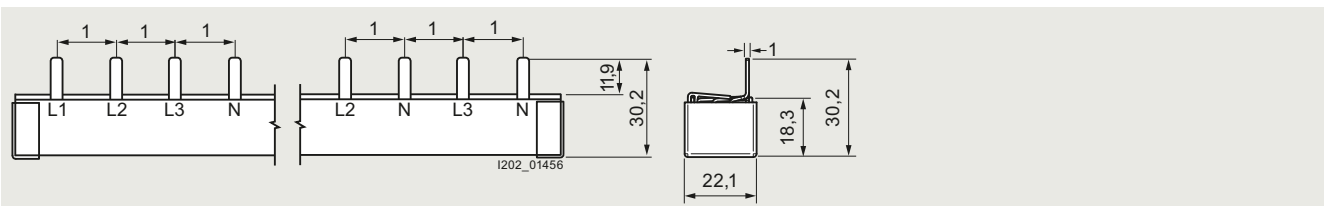

5ST3770-4

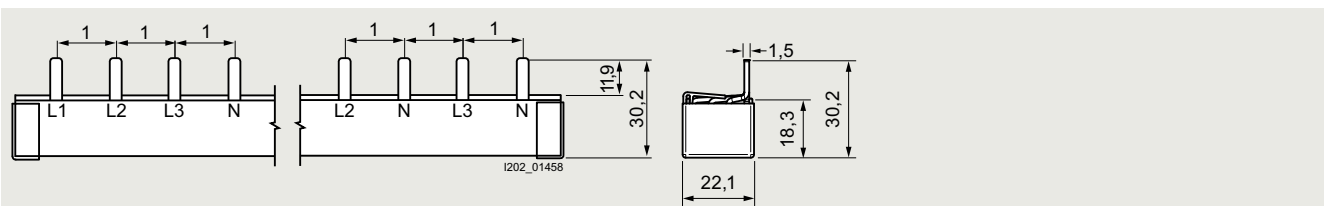

5ST3770-5

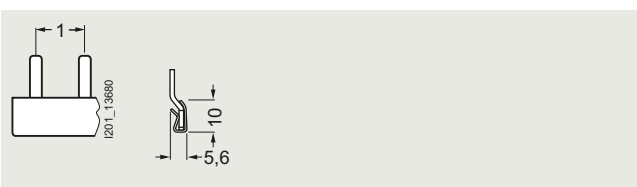
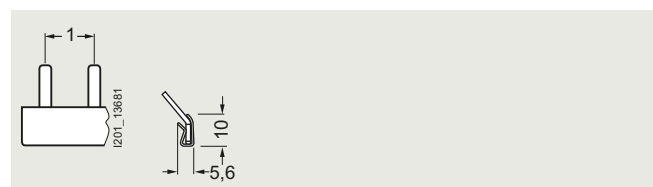
5ST3762  
5ST37645ST3763  
5ST3765











## SENTRON Protection, Switching, Measuring and Monitoring Devices

### Residual Current Protective Devices / Arc Fault Detection Devices (AFDDs)

#### Introduction

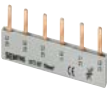
#### Overview

Devices	Page	Application	Standards	Used in		
				Non-residential buildings	Residential buildings	Industry
 <b>5SV RCCBs</b>	3/30	Personnel, material and fire protection, as well as protection against direct contact. SIGRES with active condensation protection for use in harsh environments. Super resistant and selective versions	IEC/EN 61008 ÖVE EN 61008 ÖVE/ÖNORM E 8601 IEC/EN 62423	✓	✓	✓
 <b>SIQUENCE 5SV3/5SU1 universal current-sensitive RCCBs, type B and type B+</b>	3/39	SIQUENCE, the technology of universal current-sensitive residual current protective devices	VDE 0664-100 VDE 0664-200 VDE V 0664-110	✓	--	✓
 <b>Additional components</b>	3/40	Remote controlled mechanisms, auxiliary switches for all residual current operated circuit breakers  Leakage current measurement device for fault locating and optimum selection of RCCBs	IEC/EN 62019	✓	--	✓
 <b>5SM2 RC units</b>	1)	The freely selectable combination of RC units with miniature circuit breakers permits the flexible configuration of RCBO combinations	IEC/EN 61009	✓	--	✓
 <b>5SU1 RCBOs</b>	1)	The ideal protection combination for all electrical circuits due to the compact device versions of RCCBs and miniature circuit breakers in a single device	IEC/EN 61009	✓	✓	✓
 <b>5SM6 AFD units</b>	3/50	Enhanced fire protection through the detection and isolation of arcing faults	IEC/EN 62606	✓	✓	--
 <b>5ST busbars for modular installation devices</b>	1)	Busbars in 10 mm <sup>2</sup> and 16 mm <sup>2</sup> save space in the distribution board and time during mounting	--	✓	✓	✓
 <b>Accessories</b>	1)	Locking devices, covers – everything you need for mounting	--	✓	✓	✓

1) See Catalog LV 10.

# SENTRON Protection, Switching, Measuring and Monitoring Devices

## Residual Current Protective Devices / Arc Fault Detection Devices (AFDDs)

## Introduction

## Overview (continued)

**SIGRES**

SIGRES RCCBs were developed for use in harsh ambient conditions, such as swimming baths as protection against chlorine and ozone, in the agricultural sector (ammonia), on building sites and in the chemical industry (nitrogen oxide, sulfur dioxide, solvents), in the food processing industry (hydrogen sulfide) and in unheated rooms (dampness). The patented active condensation protection requires a continuous power supply and bottom infeed if the RCCB is switched off.

When used in ambient conditions as defined in product standard EN 61008-1, the operation interval for pressing the test button can be extended to once a year.

**Super resistant** **K**

Super resistant (short-time delayed) RCCBs meet the maximum permissible break times for instantaneous devices. However, by implementing a short-time delay they prevent unnecessary tripping operations, and thus plant faults, when pulse-shaped leakage currents occur – as is the case when capacitors are switched on.

**Selective** **S**

Can be used as upstream group switch for selective tripping contrary to downstream, instantaneous or short-time delayed RCCBs.

**Short-time delayed** **G**

If installations/equipment whose inadvertent tripping could lead to personal injury or material damage (such as freezers, computers) are protected by residual current protective devices, the tripping time of these devices must be at least 10 ms as defined according to ÖVE/ÖNORM E 8001-1.

Note:

You will find further information on the subject of residual current protective devices in the technology primer "Residual Current Protective Devices", Article No.: E10003-E38-2B-G0090 and in the Configuration Manual Residual Current Protective Devices/ Arc Fault Detection Devices (AFDDs) ([www.siemens.com/lowvoltage/manuals](http://www.siemens.com/lowvoltage/manuals)).

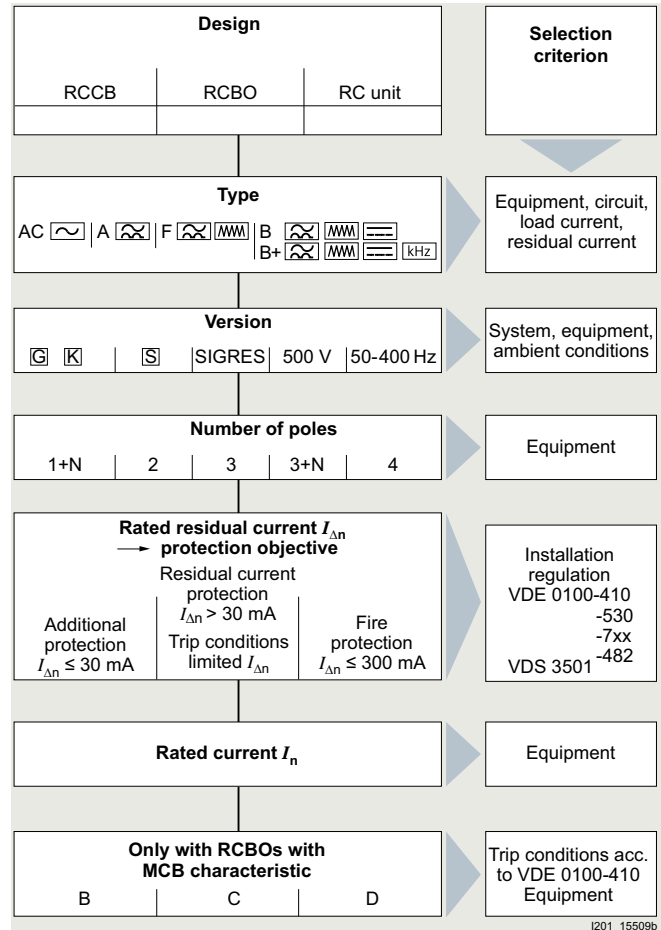

Selection aid for finding the appropriate residual current protective device

## SENTRON Protection, Switching, Measuring and Monitoring Devices

### Residual Current Protective Devices / Arc Fault Detection Devices (AFDDs)

#### 5SV RCCBs

##### Overview

RCCBs are used in all systems up to 240/415 V AC. Devices of type AC trip in the event of sinusoidal AC residual currents, type A also trips in the event of pulsating DC residual currents.

In addition, RCCBs type F also detect residual currents with mixed frequencies up to 1 kHz.

RCCBs with a rated residual current of maximum 30 mA are used for personnel, material and fire protection, as well as for protection against direct contact. RCCBs with a rated residual current of 10 mA are primarily used in areas that represent an increased risk for personnel.

Since the introduction of DIN VDE 0100-410, all socket outlet current circuits up to 20 A must also be fitted with residual current protective devices with a rated residual current of max. 30 mA. This also applies to outdoor electrical circuits up to 32 A for the connection of portable equipment.

Devices with a rated residual current of maximum 300 mA are used as preventive fire protection in case of insulation faults. RCCBs with a rated residual current of 100 mA are primarily used in European countries outside Germany.

##### Benefits

- Instantaneous residual current operated circuit breakers with the N connection on the left or right-hand side enable simple bus mounting with standard pin busbars with miniature circuit breakers installed on the right-hand side.
- Instantaneous type A devices have a surge current withstand capability with current waveform 8/20  $\mu$ s of more than 1 kA, super resistant devices of more than 3 kA and selective devices of more than 5 kA. This ensures safe operation.
- SIGRES has an extremely long service life due to patented active condensation protection, and identical dimensions enable the quick and easy replacement of existing instantaneous RCCBs.
- Super resistant devices increase system availability, as unnecessary tripping is prevented in power supply systems with short-time glitches.
- Selective RCCBs increase system availability as a staggered tripping time enables the selective tripping of RCCBs connected in series in the event of a fault.
- Auxiliary switches, fault signal contacts, undervoltage releases and shunt trips are also available as additional components.
- By means of internal contacts, effective touch protection is provided when grasping and manually operating the latching slide.
- To facilitate entry of pin busbars with connection cables up to 35 mm<sup>2</sup>, the devices are equipped with rectangular terminals for the accommodation of funnel-shaped cable entries.
- By means of standardized clearances of the terminals in modular width dimensions, the RCCBs and MCBs can be optionally connected to busbars on the top or on the bottom.

# SENTRON Protection, Switching, Measuring and Monitoring Devices

## Residual Current Protective Devices / Arc Fault Detection Devices (AFDDs)

5SV RCCBs

### Technical specifications

		Instantaneous	SIGRES	Super resistant	Selective
<b>Standards</b>		IEC/EN 61008-1 (VDE 0664-10); IEC/EN 61008-2-1 (VDE 0664-11); IEC/EN 61543 (VDE 0664-30); IEC/EN 62423 (VDE 0664-40)			
<b>Surge current withstand capability</b>					
• Type A with current waveform 8/20 μs	Acc. to EN 60060-2 (VDE 0432-2)	kA	> 1	> 3	> 5
• Type F with current waveform 8/20 μs	Acc. to EN 60060-2 (VDE 0432-2)	kA	--	> 3	--
<b>Minimum operational voltage for test function operation</b>					
• 30-mA devices		V AC	195		
• Non-30-mA devices		V AC	100		
• 24-V devices		V AC	20		
<b>Test cycles</b>		1/2 year	1 year	1/2 year	
<b>Insulation coordination</b>					
• Overvoltage category			III		
<b>Pollution degree</b>			2		
<b>Terminal conductor cross-sections</b>					
• 1-wire					
- Solid ( $\leq 10 \text{ mm}^2$ ) / stranded ( $\geq 16 \text{ mm}^2$ )		mm <sup>2</sup>	0.75 ... 35		
- Finely stranded with non-insulated end sleeve		mm <sup>2</sup>	0.75 ... 25		
- Finely stranded with insulated end sleeve		mm <sup>2</sup>	0.75 ... 25		
- Finely stranded without end sleeve		mm <sup>2</sup>	1 ... 35		
• 2-wire, same cross-section, same conductor type					
- Solid ( $\leq 10 \text{ mm}^2$ ) / stranded ( $\geq 16 \text{ mm}^2$ )		mm <sup>2</sup>	0.75 ... 10		
- Finely stranded with non-insulated end sleeve		mm <sup>2</sup>	0.75 ... 4		
- Finely stranded with insulated end sleeve		mm <sup>2</sup>	0.75 ... 4		
- Finely stranded without end sleeve		mm <sup>2</sup>	1 ... 4		
• 1-wire + busbar (pin thickness 1.5 mm)					
- Solid ( $\leq 10 \text{ mm}^2$ ) / stranded ( $\geq 16 \text{ mm}^2$ )		mm <sup>2</sup>	10 ... 25		
- Finely stranded with non-insulated end sleeve		mm <sup>2</sup>	6 ... 25		
- Finely stranded with insulated end sleeve		mm <sup>2</sup>	6 ... 16		
<b>Terminal tightening torque</b>					
• Up to $I_n = 80 \text{ A}$		Nm	2.5		
• At $I_n = 100 \text{ A}, 125 \text{ A}$		Nm	3.0 ... 3.5		
<b>Mains connection</b>					
					Optionally top or bottom (top for the SIGRES function to also be effective in the deactivated state)
<b>Rated frequency</b>		Hz	50	50	50/60
<b>Mounting position (on a standard mounting rail)</b>					Any
<b>Degree of protection</b>	Acc. to EN 60529 (VDE 0470-1)				IP20, if the distribution board is installed, with connected conductors
<b>Touch protection</b>	Acc. to EN 50274 (VDE 0660-514)				Finger and back-of-hand safe
<b>Service life</b>	Average number of operating cycles Test cycle acc. to IEC/EN 61008				> 10000
<b>Storage temperature</b>		°C	-40 ... +75		
<b>Ambient temperature</b>		°C	-25 ... +45, marked with 		
<b>Resistance to climate</b>	Acc. to IEC 60068-2-30				28 cycles (55 °C; 95% rel. air humidity)
<b>CFC and silicone-free</b>					Yes







3

# SENTRON Protection, Switching, Measuring and Monitoring Devices

## Residual Current Protective Devices / Arc Fault Detection Devices (AFDDs)

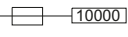
### 5SV RCCBs

#### Selection and ordering data

 (Type A)			Rated residual current	Rated current	Max. permissible short-circuit back-up fuse	Mounting width	Article No.	Weight		
			$I_{\Delta n}$ mA	$I_n$ A	 A	MW <sup>1)</sup>			kg	
<b>RCCBs, type A, instantaneous</b>										
<b>1P+N; 230 V AC</b>										
N connection, right										
	10		16	63		2	<b>5SV3111-6</b>	0.199		
	30		16	63		2	<b>5SV3311-6</b>	0.188		
					Bulk packaging 36 units			<b>5SV3311-6GV01</b>	0.192	
	40		25	63				<b>5SV3312-6</b>	0.187	
					Bulk packaging 36 units			<b>5SV3312-6GV01</b>	0.193	
	40 <sup>2)</sup>			40	63			<b>5SV3314-6</b>	0.188	
						Bulk packaging 36 units		<b>5SV3314-6GV01</b>	0.193	
					63			<b>5SV3314-6LA</b>	0.212	
					63	80		<b>5SV3316-6</b>	0.219	
	100			80				<b>5SV3317-6</b>	0.216	
				25	63		2	<b>5SV3412-6</b>	0.182	
				40				<b>5SV3414-6</b>	0.181	
			63	80			<b>5SV3416-6</b>	0.198		
300			80				<b>5SV3417-6</b>	0.208		
			25	63		2	<b>5SV3612-6</b>	0.187		
			40				<b>5SV3614-6</b>	0.188		
			63	80			<b>5SV3616-6</b>	0.202		
		80				<b>5SV3617-6</b>	0.193			
<b>3P+N; 400 V AC</b>										
N connection, right										
	30		25	80		4	<b>5SV3342-6</b>	0.317		
	40				Bulk packaging 18 units		<b>5SV3342-6GV01</b>	0.334		
					80			<b>5SV3344-6</b>	0.317	
	40 <sup>2)</sup>					Bulk packaging 18 units		<b>5SV3344-6GV01</b>	0.333	
					80			<b>5SV3344-6LA</b>	0.374	
	63				100			<b>5SV3346-6</b>	0.374	
						Bulk packaging 18 units		<b>5SV3346-6GV01</b>	0.400	
					80			<b>5SV3346-6LA</b>	0.370	
					80	100		<b>5SV3347-6</b>	0.384	
	100			25	80		4	<b>5SV3442-6</b>	0.339	
				40				<b>5SV3444-6</b>	0.339	
				40 <sup>2)</sup>	80			<b>5SV3444-6LA</b>	0.341	
			63	100			<b>5SV3446-6</b>	0.341		
63 <sup>2)</sup>				100			<b>5SV3446-6LA</b>	0.340		
							<b>5SV3447-6</b>	0.341		
	300			25	80		4	<b>5SV3642-6</b>	0.305	
				40				<b>5SV3644-6</b>	0.306	
			63	100			<b>5SV3646-6</b>	0.336		
			80				<b>5SV3647-6</b>	0.358		
500			25	80		4	<b>5SV3742-6</b>	0.336		
			40				<b>5SV3744-6</b>	0.338		
			63	100			<b>5SV3746-6</b>	0.337		
					Bulk packaging 18 units		<b>5SV3746-6GV01</b>	0.375		
		80				<b>5SV3747-6</b>	0.336			
<b>1P+N; 230 V AC</b>										
N connection, left										
	10		16	63		2	<b>5SV3111-6KL</b>	0.198		
	30		16	63		2	<b>5SV3311-6KL</b>	0.188		
								<b>5SV3312-6KL</b>	0.187	
	40			40				<b>5SV3314-6KL</b>	0.192	
					63	80		<b>5SV3316-6KL</b>	0.212	
	80							<b>5SV3317-6KL</b>	0.223	
		100			25	63		<b>5SV3412-6KL</b>	0.197	
					40				<b>5SV3414-6KL</b>	0.182
					63	80			<b>5SV3416-6KL</b>	0.206
				80				<b>5SV3417-6KL</b>	0.207	
	300			25	63		2	<b>5SV3612-6KL</b>	0.175	
				40				<b>5SV3614-6KL</b>	0.180	
			63	80			<b>5SV3616-6KL</b>	0.194		
			80				<b>5SV3617-6KL</b>	0.200		

<sup>1)</sup> 1 MW (modular width) = 18 mm.





<sup>2)</sup> Thermal overload protection according to ÖVE/ÖNORM E 8001 possible up to rated current of the RCCB (40 A, 63 A).

## SENTRON Protection, Switching, Measuring and Monitoring Devices

### Residual Current Protective Devices / Arc Fault Detection Devices (AFDDs)

5SV RCCBs

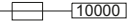
#### Selection and ordering data (continued)

 (Type A)	 25	 D/E	Rated residual current	Rated current	Max. permissible short-circuit back-up fuse	Mounting width	Article No.	Weight
			$I_{\Delta n}$ mA	$I_n$ A	 A	MW <sup>1)</sup>		
<b>3P+N; 400 V AC</b>								
N connection, left								
	30		25	80	4	<b>5SV3342-6KL</b> <b>5SV3344-6KL</b> <b>5SV3346-6KL</b> <b>5SV3347-6KL</b>	0.316 0.317 0.373 0.372	
			40	80				
			63	80				
			80	80				
300			25	80	4	<b>5SV3642-6KL</b> <b>5SV3644-6KL</b> <b>5SV3646-6KL</b> <b>5SV3647-6KL</b>	0.304 0.305 0.336 0.336	
			40					
			63					
			80					
500			63	80	4	<b>5SV3746-6KL</b>	0.336 0.338	









<sup>1)</sup> 1 MW (modular width) = 18 mm.

# SENTRON Protection, Switching, Measuring and Monitoring Devices

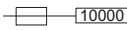
## Residual Current Protective Devices / Arc Fault Detection Devices (AFDDs)

### 5SV RCCBs

#### Selection and ordering data (continued)

 (Type A)	 25	 D/E	Rated residual current	Rated current	Max. permissible short-circuit back-up fuse	Mounting width	Article No.	Weight
			$I_{\Delta n}$ mA	$I_n$ A	 A	MW <sup>1)</sup>		
<b>RCCBs, type A, short-time delayed <span style="border: 1px solid black; padding: 0 2px;">G</span></b>								
			<b>2P, 125 ... 230 V AC</b>					
	N connection, right							
	30		40 <sup>2)</sup>	63		2	<b>5SV3314-6LA01</b>	0.214
			<b>4P, 230 ... 400 V AC</b>					
	N connection, right							
	30		40	100		4	<b>5SV3344-6LB01</b>	0.376
			40 <sup>2)</sup>				<b>5SV3344-6LA01</b>	0.376
			63				<b>5SV3346-6LB01</b>	0.378
	100		63 <sup>2)</sup>				<b>5SV3346-6LA01</b>	0.377
		40	100		4	<b>5SV3444-6LB01</b>	0.378	
		40 <sup>2)</sup>				<b>5SV3444-6LA01</b>	0.377	
		63				<b>5SV3446-6LB01</b>	0.376	
		63 <sup>2)</sup>				<b>5SV3446-6LA01</b>	0.377	
<b>RCCBs, type A, super resistant <span style="border: 1px solid black; padding: 0 2px;">K</span></b>								
			<b>1P+N; 230 V AC</b>					
	N connection, right							
	30		25	63		2	<b>5SV3312-6KK01</b>	0.215
			40				<b>5SV3314-6KK01</b>	0.213
			63	80			<b>5SV3316-6KK01</b>	0.213
			80				<b>5SV3317-6KK01</b>	0.225
300		25	63		2	<b>5SV3612-6KK01</b>	0.204	
		40				<b>5SV3614-6KK01</b>	0.204	
		63	80			<b>5SV3616-6KK01</b>	0.216	
		80				<b>5SV3617-6KK01</b>	0.215	
			<b>3P+N; 400 V AC</b>					
	N connection, right							
	30		25	100		4	<b>5SV3342-6KK01</b>	0.375
			40				<b>5SV3344-6KK01</b>	0.377
			63				<b>5SV3346-6KK01</b>	0.377
			80				<b>5SV3347-6KK01</b>	0.374
300		25	100		4	<b>5SV3642-6KK01</b>	0.375	
		40				<b>5SV3644-6KK01</b>	0.377	
		63				<b>5SV3646-6KK01</b>	0.376	
		80				<b>5SV3647-6KK01</b>	0.374	
<b>RCCBs, type A, selective <span style="border: 1px solid black; padding: 0 2px;">S</span></b>								
			<b>1P+N; 230 V AC</b>					
	N connection, right							
	100		63	80		2	<b>5SV3416-8</b>	0.213
	300		25	63		2	<b>5SV3612-8</b>	0.205
			40				<b>5SV3614-8</b>	0.204
		63	80			<b>5SV3616-8</b>	0.204	
		80				<b>5SV3617-8</b>	0.207	

<sup>1)</sup> 1 MW (modular width) = 18 mm.











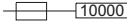

<sup>2)</sup> Thermal overload protection according to ÖVE/ÖNORM E 8001 possible up to rated current of the RCCB (40 A, 63 A).

## SENTRON Protection, Switching, Measuring and Monitoring Devices

### Residual Current Protective Devices / Arc Fault Detection Devices (AFDDs)

5SV RCCBs

## Selection and ordering data (continued)

 (Type A) 			Rated residual current	Rated current	Max. permissible short-circuit back-up fuse	Mounting width	Article No.	Weight
			$I_{\Delta n}$ mA	$I_n$ A	 10000	MW <sup>1)</sup>		kg
<b>3P+N; 400 V AC</b>								
N connection, right								
	100		40	40 <sup>1)</sup>	100	4	<b>5SV3444-8</b>	0.378
			63	63 <sup>1)</sup>			<b>5SV3444-8LA</b>	0.376
			63	63 <sup>1)</sup>			<b>5SV3446-8</b>	0.378
			63	63 <sup>1)</sup>			<b>5SV3446-8LA</b>	0.377
	300		25	40	100	4	<b>5SV3642-8</b>	0.377
			40	40 <sup>1)</sup>			<b>5SV3644-8</b>	0.379
			40	40 <sup>1)</sup>			<b>5SV3644-8LA</b>	0.376
			63	63 <sup>1)</sup>			<b>5SV3646-8</b>	0.378
			63	63 <sup>1)</sup>			<b>5SV3646-8LA</b>	0.378
		80	80			<b>5SV3647-8</b>	0.378	
		63	63	100		4	<b>5SV3846-8</b>	0.378
<b>1P+N; 230 V AC</b>								
N connection, left								
	300		40	63	80	2	<b>5SV3614-8KLL</b>	0.216
			63	80			<b>5SV3616-8KLL</b>	0.216
<b>3P+N; 400 V AC</b>								
N connection, left								
	300		63	80		4	<b>5SV3646-8KLL</b>	0.377
<b>RCCBs, type A, SIGRES, instantaneous</b>								
<b>1P+N; 230 V AC</b>								
N connection, right								
	30		16	25	63	2	<b>5SV3311-6KK12</b>	0.212
			25	40			<b>5SV3312-6KK12</b>	0.211
			40	63	80		<b>5SV3314-6KK12</b>	0.213
			63	80			<b>5SV3316-6KK12</b>	0.224
<b>3P+N; 400 V AC</b>								
N connection, right								
	30		25	40	100	4	<b>5SV3342-6KK12</b>	0.374
			40	63			<b>5SV3344-6KK12</b>	0.372
			63	80			<b>5SV3346-6KK12</b>	0.372
			80				<b>5SV3347-6KK12</b>	0.373
	300		25	40	100	4	<b>5SV3642-6KK12</b>	0.335
			40	63			<b>5SV3644-6KK12</b>	0.336
			63	80			<b>5SV3646-6KK12</b>	0.336
			80				<b>5SV3647-6KK12</b>	0.366
<b>RCCBs, type A, SIGRES, selective S</b>								
<b>3P+N; 400 V AC</b>								
N connection, right								
	300		63	100		4	<b>5SV3646-8KK12</b>	0.394

1) 1 MW (modular width) = 18 mm.

2) Thermal overload protection according to ÖVE/ÖNORM E 8001 possible up to rated current of the RCCB (40 A, 63 A).





## SENTRON Protection, Switching, Measuring and Monitoring Devices

### Residual Current Protective Devices / Arc Fault Detection Devices (AFDDs)

#### 5SV RCCBs

#### Selection and ordering data (continued)

	Rated residual current	Rated current	Max. permissible short-circuit back-up fuse	Mounting width	Article No.	Weight	
	$I_{\Delta n}$	$I_n$					
	mA	A	A	MW <sup>1)</sup>		kg	
<b>RCCBs, type F, super resistant <span style="border: 1px solid black; padding: 0 2px;">K</span></b>							
	<b>1P + N; 230 V AC</b>						
	N connection, right						
	30	25 40 63 80	63 80	2	<b>5SV3312-3</b> <b>5SV3314-3</b> <b>5SV3316-3</b> <b>5SV3317-3</b>	0.213 0.214 0.224 0.220	
	300	25 40 63 80	63 80	2	<b>5SV3612-3</b> <b>5SV3614-3</b> <b>5SV3616-3</b> <b>5SV3617-3</b>	0.204 0.205 0.214 0.205	
	<b>3P + N; 400 V AC</b>						
	N connection, right 100						
	30	25 40 63 80	100	4	<b>5SV3342-3</b> <b>5SV3344-3</b> <b>5SV3346-3</b> <b>5SV3347-3</b>	0.375 0.376 0.373 0.402	
	300	25 40 63 80	100	4	<b>5SV3642-3</b> <b>5SV3644-3</b> <b>5SV3646-3</b> <b>5SV3647-3</b>	0.373 0.375 0.374 0.376	
	<b>RCCBs, type F, selective <span style="border: 1px solid black; padding: 0 2px;">S</span></b>						
		<b>1P + N; 230 V AC</b>					
N connection, right							
300		40 80	63 80	2	<b>5SV3614-7</b> <b>5SV3617-7</b>	0.215 0.211	
<b>3P + N; 400 V AC</b>							
N connection, right							
300		40 80	100	4	<b>5SV3644-7</b> <b>5SV3647-7</b>	0.377 0.377	





<sup>1)</sup> 1 MW (modular width) = 18 mm.

# SENTRON Protection, Switching, Measuring and Monitoring Devices

## Residual Current Protective Devices / Arc Fault Detection Devices (AFDDs)

5SV RCCBs

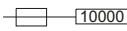
## Selection and ordering data (continued)

 (Type A)	 25	 D/E	Rated residual current	Rated current	Max. permissible short-circuit back-up fuse	Mounting width	Article No.	Weight
			$I_{\Delta n}$ mA	$I_n$ A	 A	MW <sup>1)</sup>		
<b>RCCBs, type A, instantaneous</b>								
			<b>1P+N; 24 ... 125 V AC</b>					
			N connection, right					
	30		16	63	2	<b>5SV3311-6KK13</b> <b>5SV3312-6KK13</b> <b>5SV3314-6KK13</b> <b>5SV3316-6KK13</b>	0.192	
			25		2		0.191	
			40		2		0.191	
		63	80	2	0.221			
			<b>3P+N; 500 V AC</b>					
			N connection, right					
	30		25	63	4	<b>5SV3352-6</b> <b>5SV3354-6</b> <b>5SV3356-6</b> <b>5SV3357-6</b>	0.372	
			40		4		0.372	
			63		4		0.373	
			80	80	4		0.399	
	300		25	63	4	<b>5SV3652-6</b> <b>5SV3654-6</b> <b>5SV3656-6</b> <b>5SV3657-6</b>	0.338	
			40		4		0.335	
			63		4		0.338	
			80	80	4		0.351	
		<b>3P+N; 230 V AC; 400 Hz</b>						
		N connection, right						
30		25	80	4	<b>5SV3342-6KK03</b> <b>5SV3344-6KK03</b>	0.380		
		40		4		0.377		

1) 1 MW (modular width) = 18 mm.

3

## SENTRON Protection, Switching, Measuring and Monitoring Devices

Residual Current Protective Devices / Arc Fault Detection Devices (AFDDs)

### 5SV1 electromechanic RCBOs

#### Overview

Residual current circuit breakers with overload protection combine residual current detection, short circuit and overcurrent protection in one device, thus enabling combined electric-shock and line protection. The protection devices enhance reliable operation and system availability, simplifying planning.

The new 5SV1 is the first electromechanic (voltage independent) RCD on the IEC market in only one modular width. In combination with the 5SM6 AFD unit, preventive fire protection is thus possible in a total of only 2 modular widths.

#### Selection and ordering data

$I_n$	Characteristic B Article No.	Characteristic C Article No.	Weight kg
A			
<b>5SV1 RCBO 4.5 kA in only 1 MW</b>			
<b>Type A, 30 mA</b>			
2	--	5SV1313-7KK02	0.134
4	--	5SV1313-7KK04	0.134
6	5SV1313-6KK06	5SV1313-7KK06	0.130
10	5SV1313-6KK10	5SV1313-7KK10	0.130
13	5SV1313-6KK13	5SV1313-7KK13	0.132
16	5SV1313-6KK16	5SV1313-7KK16	0.129
<b>Type AC, 30 mA</b>			
2	--	5SV1313-1KK02	0.131
4	--	5SV1313-1KK04	0.135
6	--	5SV1313-1KK06	0.129
10	--	5SV1313-1KK10	0.131
13	--	5SV1313-1KK13	0.133
16	--	5SV1313-1KK16	0.129
<b>5SV1 RCBO 6 kA in only 1 MW</b>			
<b>Type A, 30 mA</b>			
2	--	5SV1316-7KK02	0.132
4	--	5SV1316-7KK04	0.132
6	5SV1316-6KK06	5SV1316-7KK06	0.131
10	5SV1316-6KK10	5SV1316-7KK10	0.131
13	5SV1316-6KK13	5SV1316-7KK13	0.129
16	5SV1316-6KK16	5SV1316-7KK16	0.129
<b>Type AC, 30 mA</b>			
2	--	5SV1316-1KK02	0.132
4	--	5SV1316-1KK04	0.132
6	5SV1316-0KK06	5SV1316-1KK06	0.129
10	5SV1316-0KK10	5SV1316-1KK10	0.131
13	5SV1316-0KK13	5SV1316-1KK13	0.133
16	5SV1316-0KK16	5SV1316-1KK16	0.128









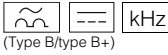

## SENTRON Protection, Switching, Measuring and Monitoring Devices

### Residual Current Protective Devices / Arc Fault Detection Devices (AFDDs)

5SV1 electromechanic RCBOs

**Selection and ordering data**

 (Type B/type B+)	Rated residual current	Rated current	Max. permissible short-circuit back-up fuse	Mounting width	Article No.	Weight	
 	$I_{\Delta n}$ mA	$I_n$ A	 A	MW <sup>1)</sup>		kg	
<b>SIQUENCE RCCBs, type B, super resistant <span style="border: 1px solid black; padding: 0 2px;">K</span></b>							
	<b>1P+N; 230 V AC; 50 ... 60 Hz</b>						
	30	16 25 40 63	100	4	5SV3321-4 5SV3322-4 5SV3324-4 5SV3326-4	0.378 0.377 0.378 0.380	
	300	16 25 40 63	100	4	5SV3621-4 5SV3622-4 5SV3624-4 5SV3626-4	0.377 0.379 0.377 0.380	
	<b>3P+N; 230 ... 400 V AC; 50 ... 60 Hz</b>						
	30	25 40 63 80	100	4	5SV3342-4 5SV3344-4 5SV3346-4 5SV3347-4	0.450 0.449 0.447 0.451	
	300	25 40 63 80	100	4	5SV3642-4 5SV3644-4 5SV3646-4 5SV3647-4	0.449 0.452 0.451 0.454	
500	25 40 63 80	100	4	5SV3742-4 5SV3744-4 5SV3746-4 5SV3747-4	0.453 0.454 0.451 0.456		
<b>SIQUENCE RCCBs, type B, selective <span style="border: 1px solid black; padding: 0 2px;">S</span></b>							
	<b>3P+N; 230 ... 400 V AC; 50 ... 60 Hz</b>						
	300	63 80	100	4	5SV3646-5 5SV3647-5	0.453 0.454	
	500	63 80	100	4	5SV3746-5 5SV3747-5	0.453 0.454	
<b>SIQUENCE RCCBs, type B+, super resistant <span style="border: 1px solid black; padding: 0 2px;">K</span></b>							
	<b>3P+N; 230 ... 400 V AC; 50 ... 60 Hz</b>						
	30	25 40 63 80	100	4	5SV3342-4KK14 5SV3344-4KK14 5SV3346-4KK14 5SV3347-4KK14	0.453 0.449 0.452 0.454	
	300	25 40 63 80	100	4	5SV3642-4KK14 5SV3644-4KK14 5SV3646-4KK14 5SV3647-4KK14	0.455 0.454 0.449 0.451	
	<b>SIQUENCE RCCBs, type B+, selective <span style="border: 1px solid black; padding: 0 2px;">S</span></b>						
		<b>3P+N; 230 ... 400 V AC; 50 ... 60 Hz</b>					
		300	63 80	100	4	5SV3646-5KK14 5SV3647-5KK14	0.450 0.455

<sup>1)</sup> 1 MW (modular width) = 18 mm.

## SENTRON Protection, Switching, Measuring and Monitoring Devices

Residual Current Protective Devices / Arc Fault Detection Devices (AFDDs)

### Additional components

#### Benefits

##### Can be universally retrofitted with all additional components

- Captive metal brackets on the additional components ensure the quick and easy mounting of devices without the need for tools.
- Fault signal contacts with TEST and RESET button enable simple testing of auxiliary circuits and, in the event of a fault, acknowledgement of the fault over the RESET button without the need to switch the RCCBs.
- The auxiliary switches with TEST button enable simple manual testing of control circuits during operation of the entire installation without the need to switch the RCCBs.
- Bus systems, such as *instabus* KNX, AS-Interface bus or PROFIBUS, can be integrated in the communication over binary inputs
- The leakage current measurement device enables the systematic selection of the rated residual current, thus preventing inadvertent tripping of an RCCB.

##### Remote controlled mechanisms

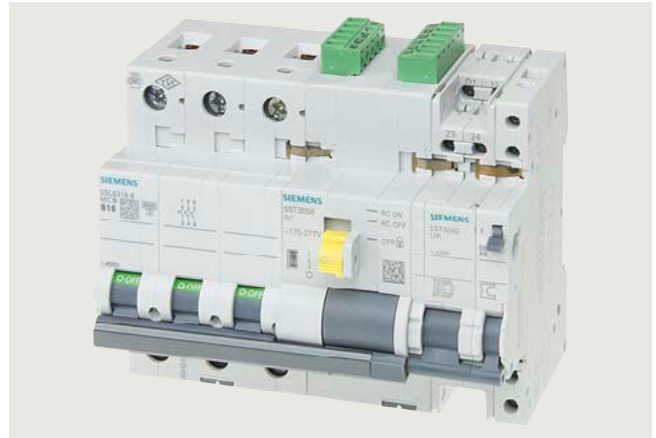

- Remote controlled mechanisms with ARD and Power have integrated auxiliary switches and fault signal contacts.
- More 5ST3... additional components, such as AS, FC, ST and UR, can be added to the right-hand side of the remote controlled mechanism in line with the Siemens mounting concept.
- The remote controlled mechanisms with ARD and Power have an LED display on the front of the device to show the switching state and for diagnostics.
- The 5ST3070 remote controlled mechanism has an extended temperature range from -40 °C to +70 °C

#### Benefits

##### Portfolio overview

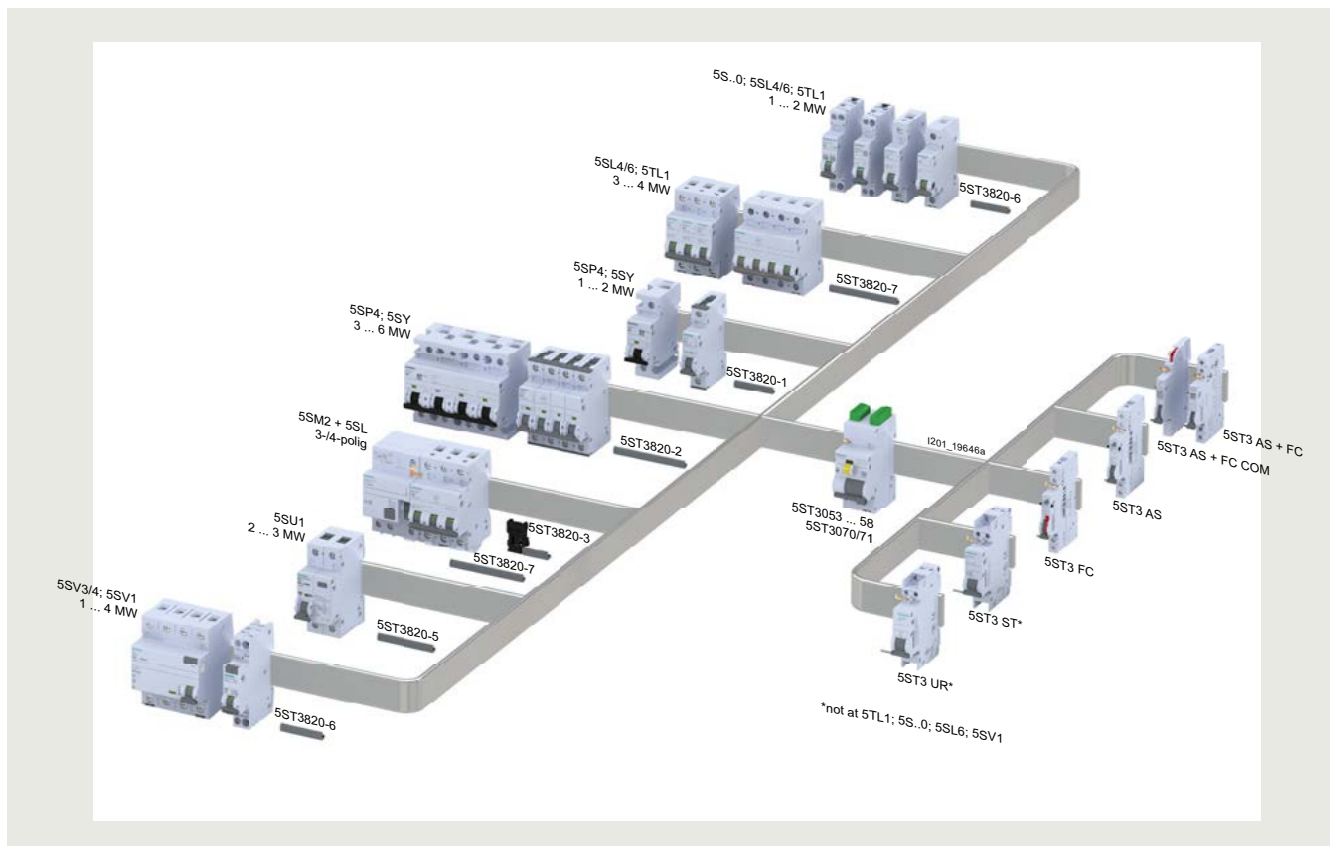

## SENTRON Protection, Switching, Measuring and Monitoring Devices

### Residual Current Protective Devices / Arc Fault Detection Devices (AFDDs)

#### Additional components

#### Benefits

#### *Combination options remote controlled mechanism – adapter – mount-on device*

			Mounting width	
			MW <sup>1)</sup>	<b>RC mech. Power (2 MW) 5ST3070 / 5ST3071, 12 V - 30 V AC, 12 V - 48 V DC</b>
<b>5SL4/6</b> 	<b>5TL1</b> 	<b>5SV1</b> 	1 - 2 MW	 Adapter 5ST3820-6
<b>5SY4/5/6/7/8</b> 	<b>5SY60</b> 		1 - 2 MW	 Adapter 5ST3820-1
<b>5SL4/6</b> 	<b>5TL1</b> 		3 - 4 MW	 Adapter 5ST3820-7
<b>5SY4/5/6/7/8</b> 			3 - 4 MW	 Adapter 5ST3820-2
<b>5SU1</b> 			2 MW, 3 MW	 Adapter 5ST3820-5
<b>5SV3</b> 			--	 Adapter 5ST3820-6
<b>5SM2 + 5SL, 2-pole</b> 				 Adapter 5ST3820-3 add. 5ST3820-7
<b>5SM2 + 5SY 2-pole</b> 				 Adapter 5ST3820-3 add. 5ST3820-1
<b>5SM2 + 5SL, 3-4-pole</b> 				 Adapter 5ST3820-3 add. 5ST3820-7
<b>5SM2 + 5SY</b> 				 Adapter 5ST3820-3 add. 5ST3820-2

<sup>1)</sup> 1 MW (modular width) = 18 mm.

**SENTRON Protection, Switching, Measuring and Monitoring Devices**

Residual Current Protective Devices / Arc Fault Detection Devices (AFDDs)

**Additional components****Technical specifications**Remote controlled mechanisms  
Power with extended function

5ST3070

5ST3071

**Standards**



<b>Rated voltages <math>U_n</math></b>	V AC	12 ... 30	170 ... 277
	V DC	12 ... 48	77 ... 286
• Rated frequency $f_n$	Hz		
<b>Rated power dissipation</b>	VA		
<b>Module width</b>	mm		
<b>Ambient temperature</b>	°C	-40 ... +70	
<b>Storage temperature</b>	°C	-40 ... +70	
<b>Degree of protection</b>			
<b>Pollution degree for overvoltage category</b>		3/II	3/II
<b>Service life, on average, with rated load</b>			
<b>Conductor cross-sections</b>	mm <sup>2</sup> AWG		
<b>Terminal tightening torque</b>	Nm lb-in		
<b>Cable length in the control circuit</b>	m		
<b>Number of remote switching operations/min.</b>			
<b>Number of automatic reclose attempts</b>		--	
<b>Sliding selector with locking device</b>			
<b>Integrated auxiliary switches</b>			
<b>Integrated fault signal contact</b>			
<b>Possible device combinations</b>			

## SENTRON Protection, Switching, Measuring and Monitoring Devices

### Residual Current Protective Devices / Arc Fault Detection Devices (AFDDs)

#### Additional components

#### Selection and ordering data

	Version	Rated voltage	Mounting width MW <sup>1)</sup>	Article No.	Weight kg
	<b>Remote controlled mechanisms (RC mech.)</b>				
	<ul style="list-style-type: none"> <li>• Remote controlled mechanisms with extended function</li> </ul>	12 ... 30 V AC 12 ... 48 V DC	2	<b>5ST3070</b>	0.229
		170 ... 277 V AC 77 ... 286 V DC	2	<b>5ST3071</b>	0.243
	<b>Note</b> Matching adapters must be ordered separately.				
	<b>Accessories for remote controlled mechanisms</b>				
	<ul style="list-style-type: none"> <li>• Adapters for 5SY MCBs               <ul style="list-style-type: none"> <li>- 1-2-pole</li> <li>- 3-4-pole</li> </ul> </li> </ul>			<b>5ST3820-1</b>	0.009
				<b>5ST3820-2</b>	0.011
	<ul style="list-style-type: none"> <li>• Adapters for 5SM2 RC units</li> </ul>			<b>5ST3820-3</b>	0.013
	<ul style="list-style-type: none"> <li>• Adapters for 5SU1 RCBOs</li> </ul>			<b>5ST3820-5</b>	0.010
	<ul style="list-style-type: none"> <li>• Adapters for 5SL MCBs               <ul style="list-style-type: none"> <li>- 1-2-pole, 5SV3 residual current switches</li> <li>- 3-4-pole</li> </ul> </li> </ul>			<b>5ST3820-6</b>	0.013
				<b>5ST3820-7</b>	0.011
<ul style="list-style-type: none"> <li>• Adapters for 5TL1 ON/OFF switches               <ul style="list-style-type: none"> <li>- 3-4-pole</li> </ul> </li> </ul>			<b>5ST3821-1</b>	0.009	

<sup>1)</sup> 1 MW (modular width) = 18 mm.



## SENTRON Protection, Switching, Measuring and Monitoring Devices

Residual Current Protective Devices / Arc Fault Detection Devices (AFDDs)

### Additional components

### Technical specifications







		Undervoltage releases (UR)		Shunt trips (ST)	
		5ST304.	5ST3030	5ST3031	
<b>Standards</b>		EN 60947-1			
<b>Rated voltages <math>U_n</math></b>	V AC	230	110 ... 415	24 ... 48	
	V DC	24, 110	110	24 ... 48	
• Operating range $U_n$		0.85 ... 1.1 x $U_n$	0.7 ... 1.1 x $U_n$		
• Rated frequency $f_n$	Hz	--	50 ... 60		
<b>Response limits</b>					
• Tripping		< 0.35 ... 0.7 x $U_n$	--		
<b>Short-circuit protection</b>		Miniature circuit breakers B/C 6 A or fuse gG 6 A			
<b>Minimum contact load</b>		50 mA, 24 V	50 mA, 24 V		
<b>Tripping operations</b>		max. 2000	max. 2000		
<b>Service life, on average, with rated load</b>		20000 actuations		20000 actuations	
<b>Conductor cross-sections</b>	mm <sup>2</sup>	0.5 ... 2.5	0.5 ... 2.5		
	AWG	22 ... 14	22 ... 14		
<b>Terminals</b>					
• Terminal tightening torque	Nm	0.8	0.8		
	lb-in	6.8	6.8		
<b>Mounting position</b>		Any		Any	
<b>Ambient temperature</b>	°C	-25 ... +55		-25 ... +55	
<b>Storage temperature</b>	°C	-40 ... +75		-40 ... +75	
<b>Resistance to climate</b>	Acc. to IEC 60068-2-30	Cycles	28		
<b>Shock</b>	Acc. to IEC 60068-2-27	m/s	50 at 11 ms half-sine		
<b>Resistance to vibrations</b>	Acc. to IEC 60068-2-6	m/s <sup>2</sup>	50 at 10 ... 150 Hz		

# SENTRON Protection, Switching, Measuring and Monitoring Devices

## Residual Current Protective Devices / Arc Fault Detection Devices (AFDDs)

RCCB accessories

## Selection and ordering data

	Version	Mounting width MW <sup>1)</sup>	Article No.	Weight kg
	<b>Auxiliary switches (AS)</b> For 5SM3 residual current protective devices, 100 ... 125 A, 3P+N 1 NO + 1 NC	0.5	<b>5SW3330</b>	0.064
	<b>Auxiliary switches (AS)</b> For 5SL, 5SY, 5SP miniature circuit breakers, 5SU1 RCBOs, for 5SV residual current protective devices and 5TE8 switches (for 5SU1 the 5ST3805-1 handle coupler is required) 1 NO + 1 NC - For low power - For low power (with diode) 2 NO - For low power 2 NC - For low power 1 CO	0.5	<b>5ST3010</b> <b>5ST3013</b> <b>5ST3013-0XX01</b> <b>5ST3011</b> <b>5ST3014</b> <b>5ST3012</b> <b>5ST3015</b> <b>5ST3016</b> <b>5ST1010-0FP</b>	0.056 0.061 0.063 0.063 0.060 0.065 0.064 0.051 0.056
	<b>Auxiliary switches (AS) with TEST button</b> For 5SL, 5SY, 5SP miniature circuit breakers, 5SU1 RCBOs, for 5SV residual current protective devices and 5TE8 switches (for 5SU1 the 5ST3805-1 handle coupler is required) 1 NO + 1 NC - For low power 2 NO - For low power 2 NC - For low power		<b>5ST3010-2</b> <b>5ST3013-2</b> <b>5ST3011-2</b> <b>5ST3014-2</b> <b>5ST3012-2</b> <b>5ST3015-2</b>	0.066 0.069 0.068 0.065 0.071 0.071
	<b>Auxiliary switches and fault signal contacts (AS+FC)</b> 1 CO (AS) + 1 CO (FC) 5ST3 COM (AS+FC)	0.5	<b>5ST3062</b> <b>5ST3062-0MC</b>	0.069 0.047
	<b>Fault signal contacts (FC)</b> For 5SL, 5SY, 5SP miniature circuit breakers, 5SU1 RCBOs, and for 5SV residual current protective devices (for 5SU1 the 5ST3805-1 handle coupler is required) 1 NO + 1 NC 2 NO 2 NC	0.5	<b>5ST3020</b> <b>5ST3021</b> <b>5ST3022</b>	0.065 0.066 0.066
	<b>Fault signal contacts (FC) with TEST and ACKNOWLEDGE button</b> For 5SL, 5SY, 5SP miniature circuit breakers, 5SU1 RCBOs, and for 5SV residual current protective devices (for 5SU1 the 5ST3805-1 handle coupler is required) 1 NO + 1 NC 2 NO 2 NC	0.5	<b>5ST3020-2</b> <b>5ST3021-2</b> <b>5ST3022-2</b>	0.071 0.071 0.067





1) 1 MW (modular width) = 18 mm.

## SENTRON Protection, Switching, Measuring and Monitoring Devices

### Residual Current Protective Devices / Arc Fault Detection Devices (AFDDs)

#### RCCB accessories

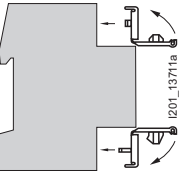
#### Selection and ordering data (continued)

Version	Rated voltage	Mounting width	Article No.	Weight	
	V	MW <sup>1)</sup>		kg	
<b>Undervoltage releases (UR)</b>					
For 5SY, 5SP miniature circuit breakers, 5SV residual current protective devices and 5SU1 RCBOs (for 5SU1 the 5ST3805-1 handle coupler is required)					
	With integrated auxiliary switch	230 AC 110 DC 24 DC	1	<b>5ST3040</b> <b>5ST3041</b> <b>5ST3042</b>	0.115 0.109 0.110
	Without integrated auxiliary switch	230 AC 110 DC 24 DC	1	<b>5ST3043</b> <b>5ST3044</b> <b>5ST3045</b>	0.102 0.095 0.095
<b>Remote controlled (RC) mechanisms</b>					
	Basic	12 ... 30 V AC, 12 ... 48 V DC 177 ... 270 V AC		<b>5ST3053</b> <b>5ST3054</b> <b>5ST3055</b>	0.191 0.235 0.235
	Power	12 ... 30 V AC, 12 ... 48 V DC 177 ... 270 V AC		<b>5ST3056</b> <b>5ST3057</b>	0.241 0.230
	Power with ARD	12 ... 30 V AC, 12 ... 48 V DC 177 ... 270 V AC		<b>5ST3058</b> <b>5ST3070</b>	0.242 0.229
	Power with extended function	12 ... 30 V AC, 12 ... 48 V DC 177 ... 270 V AC		<b>5ST3071</b>	0.243
	<b>Shunt trips (ST)</b>				
For 5SY, 5SP miniature circuit breakers, 5SV residual current protective devices and 5SU1 RCBOs (for 5SU1 the 5ST3805-1 handle coupler is required)					
		110 ... 415 V AC	1	<b>5ST3030</b>	0.098
		24 ... 48 V AC/DC	1	<b>5ST3031</b>	0.098
		12 V DC		<b>5ST3031-0XX01</b>	0.100
<b>Covers for connection terminals</b>					
For 5SM3 RCCBs up to 80 A, sealable (2 units in plastic bag)					
			2	<b>5SW3010</b>	0.012
			4	<b>5SW3008</b>	0.015
<b>Handle locking devices</b>					
	<ul style="list-style-type: none"> <li>• For 5SV RCCBs</li> <li>• For padlock with 3 ... 6 mm shackle</li> </ul>			<b>5ST3806</b>	0.004
	<b>Padlocks</b>				
	For 5SW3303 locking device			<b>5ST3802</b>	0.033



<sup>1)</sup> 1 MW (modular width) = 18 mm.

# SENTRON Protection, Switching, Measuring and Monitoring Devices

## Residual Current Protective Devices / Arc Fault Detection Devices (AFDDs)

RCCB accessories

## Selection and ordering data

 (Type A)		Rated residual current $I_{\Delta n}$ mA	Rated current $I_n$ A	Mounting width MW <sup>1)</sup>	Tripping characteristic B	Tripping characteristic C	Weight kg	
					Article No.	Article No.		
<b>RCBOs, type A, instantaneous</b>								
	<b>1P+N; 230 V AC</b>							
	4 500							
	3							
	N connection, right							
	30	6	2	--	<b>5SU1353-7KK06</b>	0.286		
		8		--	<b>5SU1353-7KK08</b>	0.272		
		10		--	<b>5SU1353-7KK10</b>	0.271		
		13		--	<b>5SU1353-7KK13</b>	0.270		
		16		--	<b>5SU1353-7KK16</b>	0.270		
		20		--	<b>5SU1353-7KK20</b>	0.280		
		25		--	<b>5SU1353-7KK25</b>	0.281		
		32		--	<b>5SU1353-7KK32</b>	0.285		
		40		--	<b>5SU1353-7KK40</b>	0.285		
	300	6	2	--	<b>5SU1653-7KK06</b>	0.268		
		10		--	<b>5SU1653-7KK10</b>	0.266		
		13		--	<b>5SU1653-7KK13</b>	0.292		
		16		--	<b>5SU1653-7KK16</b>	0.268		
		20		--	<b>5SU1653-7KK20</b>	0.276		
		25		--	<b>5SU1653-7KK25</b>	0.279		
		32		--	<b>5SU1653-7KK32</b>	0.279		
	40		--	<b>5SU1653-7KK40</b>	0.280			
N connection, left								
30	6	2	--	<b>5SU1353-7KL06</b>	0.276			
	10		--	<b>5SU1353-7KL10</b>	0.284			
	16		--	<b>5SU1353-7KL16</b>	0.278			
	20		--	<b>5SU1353-7KL20</b>	0.298			
	25		--	<b>5SU1353-7KL25</b>	0.288			
	32		--	<b>5SU1353-7KL32</b>	0.296			
	40		--	<b>5SU1353-7KL40</b>	0.294			







<sup>1)</sup> 1 MW (modular width) = 18 mm.

# SENTRON Protection, Switching, Measuring and Monitoring Devices

## Residual Current Protective Devices / Arc Fault Detection Devices (AFDDs)

### RCCB accessories

#### Selection and ordering data (continued)

 (Type A)			Rated residual current	Rated current	Mounting width	Tripping characteristic B Article No.	Tripping characteristic C Article No.	Weight	
			$I_{\Delta n}$ mA	$I_n$ A	MW <sup>1)</sup>			kg	
<b>RCBOs, type A, instantaneous</b>									
			<b>1P+N; 230 V AC</b>						
			6 000						
			3						
			N connection, right						
	30	6	2		5SU1356-6KK06	5SU1356-7KK06	0.272		
		8			--	5SU1356-7KK08	0.271		
		10			5SU1356-6KK10	5SU1356-7KK10	0.271		
	Bulk packaging 36 units				5SU1356-6GV10	5SU1356-7GV10	0.277		
		13			5SU1356-6KK13	5SU1356-7KK13	0.273		
		16			5SU1356-6KK16	5SU1356-7KK16	0.267		
	Bulk packaging 36 units				5SU1356-6GV16	5SU1356-7GV16	0.274		
		20			5SU1356-6KK20	5SU1356-7KK20	0.281		
		25			5SU1356-6KK25	5SU1356-7KK25	0.280		
		32			5SU1356-6KK32	5SU1356-7KK32	0.284		
		40			5SU1356-6KK40	5SU1356-7KK40	0.284		
	300	6	2		5SU1656-6KK06	5SU1656-7KK06	0.267		
	10			5SU1656-6KK10	5SU1656-7KK10	0.268			
	13			5SU1656-6KK13	5SU1656-7KK13	0.273			
	16			5SU1656-6KK16	5SU1656-7KK16	0.267			
	20			5SU1656-6KK20	5SU1656-7KK20	0.276			
	25			5SU1656-6KK25	5SU1656-7KK25	0.278			
	32			5SU1656-6KK32	5SU1656-7KK32	0.277			
	40			5SU1656-6KK40	5SU1656-7KK40	0.277			
			<b>1P+N; 230 V AC</b>						
			10 000						
			3						
	10	6	2		5SU1154-6KK06	5SU1154-7KK06	0.275		
		10			5SU1154-6KK10	5SU1154-7KK10	0.274		
		13			5SU1154-6KK13	5SU1154-7KK13	0.282		
		16			5SU1154-6KK16	5SU1154-7KK16	0.274		
	30	6	2		5SU1354-6KK06	5SU1354-7KK06	0.274		
		8			--	5SU1354-7KK08	0.273		
		10			5SU1354-6KK10	5SU1354-7KK10	0.272		
	Bulk packaging 36 units				5SU1354-6GV10	5SU1354-7GV10	0.278		
		13			5SU1354-6KK13	5SU1354-7KK13	0.277		
		16			5SU1354-6KK16	5SU1354-7KK16	0.274		
	Bulk packaging 36 units				5SU1354-6GV16	5SU1354-7GV16	0.276		
		20			5SU1354-6KK20	5SU1354-7KK20	0.277		
		25			5SU1354-6KK25	5SU1354-7KK25	0.276		
	32			5SU1354-6KK32	5SU1354-7KK32	0.282			
	40			5SU1354-6KK40	5SU1354-7KK40	0.280			
300	6	2		5SU1654-6KK06	5SU1654-7KK06	0.272			
	10			5SU1654-6KK10	5SU1654-7KK10	0.272			
	13			5SU1654-6KK13	5SU1654-7KK13	0.274			
	16			5SU1654-6KK16	5SU1654-7KK16	0.271			
	20			5SU1654-6KK20	5SU1654-7KK20	0.273			
	25			5SU1654-6KK25	5SU1654-7KK25	0.274			
	32			5SU1654-6KK32	5SU1654-7KK32	0.273			
	40			5SU1654-6KK40	5SU1654-7KK40	0.275			
			<b>2P, 230 V AC</b>						
			10 000						
			3						
	30	6	3		5SU1324-6FA06	5SU1324-7FA06	0.401		
		10			5SU1324-6FA10	5SU1324-7FA10	0.405		
		13			5SU1324-6FA13	5SU1324-7FA13	0.413		
		16			5SU1324-6FA16	5SU1324-7FA16	0.404		
		20			5SU1324-6FA20	5SU1324-7FA20	0.412		
		25			5SU1324-6FA25	5SU1324-7FA25	0.410		
		32			5SU1324-6FA32	5SU1324-7FA32	0.417		
	40			5SU1324-6FA40	5SU1324-7FA40	0.420			













<sup>1)</sup> 1 MW (modular width) = 18 mm.

# SENTRON Protection, Switching, Measuring and Monitoring Devices

## Residual Current Protective Devices / Arc Fault Detection Devices (AFDDs)

RCCB accessories

## Selection and ordering data (continued)

 (Type A)			Rated residual current	Rated current	Mounting width	Tripping characteristic B	Tripping characteristic C	Weight
			$I_{\Delta n}$ mA	$I_n$ A	MW <sup>1)</sup>	Article No.	Article No.	
<b>2P, 110 V AC</b>								
			10 000					
			3					
			30	6	3	5SU1324-6KX06	5SU1324-7KX06	0.403
				10		5SU1324-6KX10	5SU1324-7KX10	0.401
				13		5SU1324-6KX13	5SU1324-7KX13	0.413
				16		5SU1324-6KX16	5SU1324-7KX16	0.403
				20		5SU1324-6KX20	5SU1324-7KX20	0.411
				25		5SU1324-6KX25	5SU1324-7KX25	0.418
				32		5SU1324-6KX32	5SU1324-7KX32	0.417
				40		5SU1324-6KX40	5SU1324-7KX40	0.416
<b>2P, 400 V AC</b>								
			10 000					
			30	125	6.5	5SU1324-6KK82	5SU1324-7KK82	1.212
			300	125		5SU1624-6KK82	5SU1624-7KK82	1.106
<b>4P, 400 V AC</b>								
			10 000					
			30	125	11	5SU1344-6KK82	5SU1344-7KK82	2.022
			300	125		5SU1644-6KK82	5SU1644-7KK82	2.029
<b>RCBOs, type A, short-time delayed , super resistant </b>								
<b>1P+N; 230 V AC</b>								
			10 000					
			3					
			30	10	2	5SU1354-6LB10	5SU1354-7LB10	0.275
				13		5SU1354-6LB13	5SU1354-7LB13	0.278
				16		5SU1354-6LB16	5SU1354-7LB16	0.273
				20		5SU1354-6LB20	5SU1354-7LB20	0.277
				25		5SU1354-6LB25	5SU1354-7LB25	0.286
				32		5SU1354-6LB32	5SU1354-7LB32	0.282
				40		5SU1354-6LB40	5SU1354-7LB40	0.287
<b>RCBOs, type A, selective </b>								
<b>2P, 400 V AC</b>								
			10 000					
			300	125	6.5	5SU1624-6WK82	5SU1624-7WK82	1.155
<b>4P, 400 V AC</b>								
			10 000					
			300	125	11	5SU1644-6WK82	5SU1644-7WK82	2.031
			1000	125		5SU1844-6WK82	5SU1844-7WK82	2.010
<b>RCBOs, type F, super resistant</b>								
<b>1P+N; 230 V AC</b>								
			10 000					
			3					
			30	6	2	5SU1354-3KK06	5SU1354-4KK06	0.275
				10		5SU1354-3KK10	5SU1354-4KK10	0.275
				13		5SU1354-3KK13	5SU1354-4KK13	0.278
				16		5SU1354-3KK16	5SU1354-4KK16	0.271
				20		5SU1354-3KK20	5SU1354-4KK20	0.278
				25		5SU1354-3KK25	5SU1354-4KK25	0.277
				32		5SU1354-3KK32	5SU1354-4KK32	0.283
				40		5SU1354-3KK40	5SU1354-4KK40	0.293

1) 1 MW (modular width) = 18 mm.

## SENTRON Protection, Switching, Measuring and Monitoring Devices

Residual Current Protective Devices / Arc Fault Detection Devices (AFDDs)

### 5SM6 / 5SV6 arc fault detection devices (AFDDs)

#### Overview



5SM6 arc fault detection devices, AFDDs



5SV6 AFDDs with integrated MCB in only 1 MW

#### Characteristics

The Siemens portfolio of protective devices has been proving itself in the field for many years. This range of fuses, miniature circuit breakers and residual current protective devices has now been expanded to include AFDDs (arc fault detection devices). These AFDDs detect arcing faults caused by serial faults or loose contacts or as a result of insulation faults that enable contact between phase conductors or between phase and protective conductors. They therefore offer extremely effective protection against fires started by electrical faults.

Generally speaking, arcing faults in the circuit can result from damage to cables and other insulations and from contamination. Insulation faults result, for example, from vibrations, thermal expansion and contraction, mechanical loads and aging.

A distinction is made between 3 types of arcing faults:

#### Serial arcing faults

These are caused by breaks in the conductor or when a loose contact is in the circuit in series with the load. As the current flow in such cases is always lower than the operational load current, miniature circuit breakers and residual current protective devices are unable to detect such faults and initiate tripping.

The AFDD is specially designed to detect the specific characteristics of these arcing faults, and it reliably disconnects the affected circuit as soon as the limit values are exceeded.

#### Parallel arcing faults between phase conductor/neutral conductor or phase conductor/phase conductor

These are caused by electric arcs resulting from damage to the insulation that permits contact between the two conductors. In this case, the level of current is determined by the impedances in the circuit. Depending on the rated current of the overcurrent protection device (for instance a miniature circuit breaker), this can be disconnected. However, if the impedance in the circuit is too high to reach the trip current of the overcurrent protection device, no tripping takes place. AFDDs disconnect the currents of arcing faults upwards of 2.5 A, thus providing reliable protection in the case of such faults.

#### Parallel arcing faults between phase conductor/protective conductor

Arcing faults against the protective conductor are reliably detected and shut down by residual current protective devices. Residual current protective devices with rated residual currents up to max. 300 mA have already been providing effective fire protection in such cases for many years. AFDDs also detect these arcing faults and provide adequate fire protection where no residual current protective device is implemented.

#### Preventing undesired tripping operations

Electric arcs and high-frequency signals occur during normal operation in networks with multiple electrical loads (e.g. electric motors, light switches, dimmers). The AFDD must not break the circuit in such cases.

Thanks to the sophisticated detection logic of our AFDDs, they are able to clearly distinguish between normal operational interference signals and hazardous arcing faults.

#### Product versions

Modern electrical devices and the rising number of communication and multimedia devices lead to a higher current loading in the electrical installation of buildings – in new buildings as well as in the modernization of existing buildings. In case of faults, there is above all the danger of electric fires, in addition to electric shock or the destruction of electrical systems. With SENTRON components, Siemens offers secure protection in electrical installations.

#### 5SM6 arc fault detection devices, AFDDs

Siemens offers four product versions which can be used in various combinations with a range of 1MW/2MW wide miniature circuit breakers and/or RCBOs up to 16 A or 40 A rated current.

This simplifies product selection and reduces inventory, while enabling coverage of every conceivable application. It also means that our tried and tested protective devices (MCBs, RCBOs) can be combined with the new functionality provided by arc fault protection. In particular, the version with RCBOs offers a protective device that provides comprehensive personnel, short-circuit, overload and fire protection in a single device.

The 5SM6 AFDDs can be connected easily and quickly. The miniature circuit breakers or RCBOs can be mounted quickly and simply by just snapping them onto the mounting rail without the need for tools. For a fast and reliable power supply, the infeed can be implemented via a busbar assembly.

The version with a compact RCBO (5SV1) in 1 MW is a space-saving alternative that is ideal for retrofitting.

Whether auxiliary switch or fault signal contact – the AFDDs can be combined at random with the versatile range of additional components from the familiar portfolio of 5SY miniature circuit breakers and 5SU1 RCBOs.

This also enables connection to a higher-level I&C system.



# SENTRON Protection, Switching, Measuring and Monitoring Devices

## Residual Current Protective Devices / Arc Fault Detection Devices (AFDDs)

### 5SM6 / 5SV6 arc fault detection devices (AFDDs)

#### Overview (continued)

##### 5SV6 AFDDs with integrated MCB in only 1 MW

Arc fault detection devices detect serial and parallel arcing faults and provide protection from electrical fires. According to DIN VDE 0100-420, they are mandated for use in many areas of application.

Thanks to the width identical to the MCB, the 5SV6 AFDD with integrated MCB is not only easily installable in new buildings, it also features straight-forward retrofitting in existing buildings. This provides an enhanced protection function without additional space requirement. The standards-compliant extension of the electrical installation for protection against electrical fires is thus quickly possible at any time.

#### Benefits

- 50% space saving
- Easy retrofitting
- Increased system availability
- New busbar concept
- 1000 V ISO testing without removing conductors

#### Status displays and self tests

In order to facilitate fault locating in the event of tripping, AFDDs have a display with 5 LEDs that provide information on the cause of tripping (serial/parallel arcing faults, overvoltage). The sophisticated detection electronics system also automatically checks the functionality of the AFDD. If the self-monitoring process detects a fault, the AFDD switches off and displays the corresponding indication.

#### Integrated overvoltage protection

Depending on the load distribution in the three-phase current system, an interruption on the infeed side of the neutral conductor may cause a shift of the neutral point and thus an increase in voltage between the phase conductor and the neutral conductor. This increase in voltage can damage the loads or present a fire risk due to overloaded components.

In order to ensure all-round protection, the AFDDs are fitted with an overvoltage release that disconnects when the voltage between phase conductor and neutral conductor exceeds 275 V, thus isolating downstream loads from the hazardous line voltage.

#### Technical specifications

		5SM6	5SV6
<b>Standards</b>		IEC/EN 62606	
<b>Versions</b>		2-pole	
<b>Rated voltage <math>U_n</math></b>	V	230	
<b>Rated current <math>I_n</math></b>	A	Up to 16/40	6 ... 32
<b>Rated frequency</b>	Hz	50	
<b>Mains connection</b>		Bottom	On two sides
<b>Tripping in the event of overvoltage</b>	V	> 275; for 5SV6 > 285 V	
<b>Degree of protection</b>	Acc. to EN 60529 (VDE 0470-1)	IP20, with connected conductors	
<b>Touch protection</b>	Acc. to EN 50274 (VDE 0660-514)	Finger and back-of-hand safe	
<b>Terminal tightening torque</b>	Nm	2.0 ... 2.5	
<b>Terminal/conductor cross-sections</b>			
• Solid and stranded	mm <sup>2</sup>	0.75 ... 16	
• Finely stranded with end sleeve	mm <sup>2</sup>	0.75 ... 10	
<b>Overvoltage category</b>		III	
<b>Mounting position</b>		Any	
<b>Service life</b>	Average number of switching cycles	> 10000	
<b>Ambient temperature</b>	°C	-25 ... +40	
<b>Storage temperature</b>	°C	-40 ... +75	
<b>Resistance to climate</b>	Acc. to IEC 60068-2-30	28 cycles (55 °C; 95% rel. air humidity)	
<b>Pollution degree</b>		2	
<b>CFC and silicone-free</b>		Yes	
<b>Power loss</b>	W	0.6	







## SENTRON Protection, Switching, Measuring and Monitoring Devices

### Residual Current Protective Devices / Arc Fault Detection Devices (AFDDs)

#### 5SM6 / 5SV6 arc fault detection devices (AFDDs)

#### Selection and ordering data

Version	Rated current $I_n$	Mounting width MW <sup>1)</sup>	Article No.	Weight kg
<b>AFD units</b>				
	<b>2-pole; 230 V AC; 50 Hz</b>			
	• for 5SY60 miniature circuit breakers (1 MW)		Up to 16 1	<b>5SM6011-2</b> 0.097
			Up to 40 1	<b>5SM6014-2</b> 0.098
	• for 5SU1.5 (2 MW) RCBOs, 5SU1 ... FA (3 MW) RCBOs, 5SY/5SL4 (2 MW) miniature circuit breakers, but not suitable for 5SY5, 5SY8, 5SY60		Up to 16 1	<b>5SM6021-2</b> 0.103
		Up to 40 1	<b>5SM6024-2</b> 0.103	
	<b>2-pole; 230 V AC; 50 Hz</b>			
	• for 5SY60 miniature circuit breakers (1 MW)		Up to 16 1	<b>5SM6011-2</b> 0.097
			Up to 40 1	<b>5SM6014-2</b> 0.098
	• for 5SU1.5 (2 MW) RCBOs, 5SU1 ... FA (3 MW) RCBOs, 5SY/5SL4 (2 MW) miniature circuit breakers, but not suitable for 5SY5, 5SY8, 5SY60		Up to 16 1	<b>5SM6021-2</b> 0.103
		Up to 40 1	<b>5SM6024-2</b> 0.103	
<b>5SV6 AFDDs with integrated MCB 6 kA in only 1 MW</b>				
	<b>2-pole; 230 V AC; 50 Hz</b>			
	$I_n$	<b>Characteristic B</b>	<b>Characteristic C</b>	Weight
	A	<b>Article No.</b>	<b>Article No.</b>	kg
	6	<b>5SV6016-6KK06</b>	<b>5SV6016-7KK06</b>	0.133
	10	<b>5SV6016-6KK10</b>	<b>5SV6016-7KK10</b>	0.135
	13	<b>5SV6016-6KK13</b>	<b>5SV6016-7KK13</b>	0.130
	16	<b>5SV6016-6KK16</b>	<b>5SV6016-7KK16</b>	0.130
	20	<b>5SV6016-6KK20</b>	<b>5SV6016-7KK20</b>	0.133
	25	<b>5SV6016-6KK25</b>	<b>5SV6016-7KK25</b>	0.139
	32	<b>5SV6016-6KK32</b>	<b>5SV6016-7KK32</b>	0.139
40	<b>5SV6016-6KK40</b>	<b>5SV6016-7KK40</b>	0.142	
<b>5SV6 AFDDs with integrated MCB 6 kA in only 1 MW, with pigtail</b>				
	<b>2-pole; 230 V AC; 50 Hz</b>			
	$I_n$	<b>Characteristic B</b>	<b>Characteristic C</b>	Weight
	A	<b>Article No.</b>	<b>Article No.</b>	kg
	6	<b>5SV6016-6KP06</b>	<b>5SV6016-7KP06</b>	0.189
	10	<b>5SV6016-6KP10</b>	<b>5SV6016-7KP10</b>	0.190
	13	<b>5SV6016-6KP13</b>	<b>5SV6016-7KP13</b>	0.189
	16	<b>5SV6016-6KP16</b>	<b>5SV6016-7KP16</b>	0.189
	20	<b>5SV6016-6KP20</b>	<b>5SV6016-7KP20</b>	0.203
	25	<b>5SV6016-6KP25</b>	<b>5SV6016-7KP25</b>	0.160
	32	<b>5SV6016-6KP32</b>	<b>5SV6016-7KP32</b>	0.211
40	<b>5SV6016-6KP40</b>	<b>5SV6016-7KP40</b>	0.211	
<b>5SV6 AFDDs with integrated MCB 6 kA in only 1 MW, with pigtail</b>				
	<b>1P+N; 230 V AC; 50 Hz</b>			
	$I_n$	<b>Characteristic B</b>	<b>Characteristic C</b>	Weight
	A	<b>Article No.</b>	<b>Article No.</b>	kg
	6	<b>5SV6016-6MC06</b>	<b>5SV6016-7MC06</b>	0.138
	10	<b>5SV6016-6MC10</b>	<b>5SV6016-7MC10</b>	0.139
	13	<b>5SV6016-6MC13</b>	<b>5SV6016-7MC13</b>	0.138
	16	<b>5SV6016-6MC16</b>	<b>5SV6016-7MC16</b>	0.137
	20	<b>5SV6016-6MC20</b>	<b>5SV6016-7MC20</b>	0.138
25	<b>5SV6016-6MC25</b>	<b>5SV6016-7MC25</b>	0.145	
32	<b>5SV6016-6MC32</b>	<b>5SV6016-7MC32</b>	0.145	







<sup>1)</sup> 1 MW (modular width) = 18 mm.

## SENTRON Protection, Switching, Measuring and Monitoring Devices

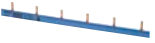
### Residual Current Protective Devices / Arc Fault Detection Devices (AFDDs)

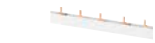
#### 5SM6 / 5SV6 arc fault detection devices (AFDDs)

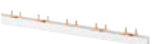
#### Selection and ordering data (continued)

Version	Pin spacing MW <sup>1)</sup>	Length mm	Article No.	Weight kg
<b>Pin busbars for AFDDs (1+N)</b>				
<b>10 mm<sup>2</sup>, can be cut</b>				
<b>Single-phase, for 5SM601.-.</b>				
 Insulation, gray	2	962	<b>5ST3764-1</b>	0.145
<b>Single-phase, for 5SM601.-.</b>				
 Insulation, blue, not angled	2	962	<b>5ST3765-2</b>	0.138
 Insulation, blue, angled	2	962	<b>5ST3765-1</b>	0.145
<b>3-pole, for combination with MCB (1 WM/2 WM)</b>				
 Insulation, gray	2	1032	<b>5ST3740-1</b>	0.420
<b>2-pole (1+N), for combination with RCBO (2 MW)</b>				
 Insulation, gray	1+2	996	<b>5ST3735-1</b>	0.350
<b>4-pole (3+N), for combination with RCBO (2 MW)</b>				
 Insulation, gray	1+2	926	<b>5ST3746-1</b>	0.505
<b>10 mm<sup>2</sup>, fixed length, cannot be cut</b>				
<b>3-pole, for 5SM601.-.</b>				
 Insulation, gray	2	216	<b>5ST3615-1</b>	0.056
<b>16 mm<sup>2</sup>, fixed length, cannot be cut</b>				
<b>Two-phase, for 5SV3 (1P+N) and 5SM601.-.</b>				
 Insulation, gray	2	216	<b>5ST3772</b>	0.093

<sup>1)</sup> 1 MW (modular width) = 18 mm.

Version	Pin spacing MW <sup>1)</sup>	Article No.	Weight kg
<b>Pin busbars for AFDDs</b>			
<b>10 mm<sup>2</sup></b>			
 3P+N 12x Compact <sup>2)</sup>	12 MW	<b>5ST3673-0</b>	0.133
1P+N 12x Compact <sup>2)</sup>	12 MW	<b>5ST3674-0</b>	0.106
3P+N 6x AFD + 6x Compact <sup>2)</sup>	12 MW	<b>5ST3675-0</b>	0.099
1P+N 6x AFD + 6x Compact <sup>2)</sup>	12 MW	<b>5ST3676-0</b>	0.084
1 x RCCB 3P+N + 8x Compact <sup>2)</sup>	12 MW	<b>5ST3783-0</b>	0.133
3P+N Compact <sup>2)</sup> + AS 1000 mm		<b>5ST3777-0</b>	0.635
1P+N AFD + Compact <sup>2)</sup> + AS 1000 mm		<b>5ST3780-0</b>	0.392
3P+N Compact <sup>2)</sup> 1000 mm		<b>5ST3773-0</b>	0.679
1P+N Compact <sup>2)</sup> 1000 mm		<b>5ST3774-0</b>	0.512
3P+N AFD + Compact <sup>2)</sup> 1000 mm		<b>5ST3775-0</b>	0.580
1P+N AFD + Compact <sup>2)</sup> 1000 mm		<b>5ST3776-0</b>	0.412
1P+N Compact <sup>2)</sup> + AS 1000 mm		<b>5ST3778-0</b>	0.440
1 x RCCB 3P+N + 8x Compact <sup>2)</sup> (N left)	12 MW	<b>5ST3783-OKL</b>	0.126
<b>16 mm<sup>2</sup></b>			
1 x RCCB 1P+N + 10x Compact <sup>2)</sup>	12 MW	<b>5ST3784-0</b>	0.098
1 x RCCB 1P+N + 10x Compact <sup>2)</sup> (N left)	12 MW	<b>5ST3784-OKL</b>	0.106
1 x RCCB 1P+N + 5x AFD + Compact <sup>2)</sup>	12 MW	<b>5ST3685-0</b>	0.094
End cap for listed busbar that can be cut to length		<b>5ST3788-0</b>	0.002

<sup>1)</sup> 1 MW (modular width) = 18 mm.

<sup>2)</sup> Compact = 5SV1 / 5SV6 / 5S..0 compact devices.

#### Note:

All 5ST37.. busbars can be cut to length.

# SENTRON Protection, Switching, Measuring and Monitoring Devices

## Overvoltage Protection Devices

### Introduction

#### Overview

##### Basic units<sup>1)</sup>



5SD74 lightning arresters, type 1



5SD74 combination surge arresters, type 1 + type 2



5SD74 surge arresters, type 1 + type 2 + type 3 for 40 mm busbar system



5SD74 combination surge arresters, type 1/type 2



5SD74 surge arresters, type 2 (standard design)



5SD74 surge arresters, type 3

##### Spare part plugs<sup>1)</sup>



N-PE



L-N, L-PEN (type 1)



L-PEN

<sup>1)</sup> See Catalog LV 10.





3

# SENTRON Protection, Switching, Measuring and Monitoring Devices

## Fuse Systems

### LV HRC fuse links

#### Selection and ordering data





	Size	$I_n$ A	$U_n$ V/AC V/DC	Mounting width mm	Non-insulated grip lugs		Insulated grip lugs		Weight kg			
					Article No.	Article No.						
<b>LV HRC fuse links with combination alarm, operational class gG</b>												
	000	10	500/ 250	21	3NA7803	3NA6803	0.130					
		16								3NA7805	3NA6805	0.128
		20								3NA7807	3NA6807	0.129
		25								3NA7810	3NA6810	0.132
		32								3NA7812	3NA6812	0.130
		35								3NA7814	3NA6814	0.130
		40								3NA7817	3NA6817	0.132
		50								3NA7820	3NA6820	0.131
		63								3NA7822	3NA6822	0.132
		80								3NA7824	3NA6824	0.131
100	3NA7830	3NA6830	0.132									
	00	80	500/ 250	30	3NA7824-7	3NA6824-7	0.202					
		100								3NA7830-7	3NA6830-7	0.202
		125								3NA7832	3NA6832	0.196
		160								3NA7836	3NA6836	0.202
	1	16	500/ 440	30	3NA7105	3NA6105	0.286					
		20								3NA7107	3NA6107	0.287
		25								3NA7110	3NA6110	0.282
		35								3NA7114	3NA6114	0.289
		40								3NA7117	3NA6117	0.284
		50								3NA7120	3NA6120	0.282
		63								3NA7122	3NA6122	0.287
		80								3NA7124	3NA6124	0.288
		100								3NA7130	3NA6130	0.290
		125								3NA7132	3NA6132	0.288
		160								3NA7136	3NA6136	0.287
		200								3NA7140	3NA6140	0.447
		224								3NA7142	3NA6142	0.443
250	3NA7144	3NA6144	0.450									
	2	35	500/ 440	47.2	3NA7214	3NA6214	0.463					
		50								3NA7220	3NA6220	0.463
		63								3NA7222	3NA6222	0.465
		80								3NA7224	3NA6224	0.459
		100								3NA7230	3NA6230	0.462
		125								3NA7232	3NA6232	0.463
		160								3NA7236	3NA6236	0.464
		200								3NA7240	3NA6240	0.470
		224								3NA7242	3NA6242	0.464
		250								3NA7244	3NA6244	0.466
		300								--	3NA6250	0.658
		315								3NA7252	3NA6252	0.658
		355								--	3NA6254	0.664
		400								3NA7260	3NA6260	0.661

# SENTRON Protection, Switching, Measuring and Monitoring Devices

## Fuse Systems

### LV HRC fuse links

#### Selection and ordering data (continued)

	Size	$I_n$ A	$U_n$ V AC/V DC	Mounting width mm	Non-insulated grip lugs		Weight kg
					Article No.		
<b>LV HRC fuse links with front indicator, operational class gG</b>							
	000	10		21	3NA3803		0.130
		16			3NA3805		0.129
		20			3NA3807		0.129
		25			3NA3810		0.129
		32			3NA3812		0.130
		35			3NA3814		0.129
		40			3NA3817		0.129
		50			3NA3820		0.129
		63			3NA3822		0.129
		80			3NA3824		0.130
100	3NA3830	0.129					
	00	35	500/250	30	3NA3814-7		0.202
		50			3NA3820-7		0.200
		63			3NA3822-7		0.198
		80			3NA3824-7		0.199
		100			3NA3830-7		0.201
		125			3NA3832		0.200
160	3NA3836	0.200					
	1	16	500/440	30	3NA3105		0.289
		20			3NA3107		0.283
		25			3NA3110		0.288
		35			3NA3114		0.288
		40			3NA3117		0.289
		50			3NA3120		0.285
		63			3NA3122		0.288
		80			3NA3124		0.289
		100			3NA3130		0.286
		125			3NA3132		0.290
		160			3NA3136		0.289
		200			3NA3140		0.440
		224			3NA3142		0.433
250	3NA3144	0.442					
<b>LV HRC fuse links with front indicator, operational class gG</b>							
	2	35	500/440	47.2	3NA3214		0.462
		50			3NA3220		0.462
		63			3NA3222		0.446
		80			3NA3224		0.453
		100			3NA3230		0.458
		125			3NA3232		0.448
		160			3NA3236		0.451
		200			3NA3240		0.461
		224			3NA3242		0.457
		250			3NA3244		0.460
		300			3NA3250		0.657
		315			3NA3252		0.656
		355			3NA3254		0.654
400	3NA3260	0.654					
	3	315	500/440	57.8	3NA3352		0.657
		400			3NA3360		0.671
		500			3NA3365		0.969
		500			3NA3372		0.970
		630					

# SENTRON Protection, Switching, Measuring and Monitoring Devices

## Fuse Systems

### LV HRC fuse bases

#### Selection and ordering data

	Size	$I_n$ A	Version	Article No.	Weight kg
<b>LV HRC fuse bases</b>					
	Made of molded plastic, for standard rail mounting or screw fixing				
	<b>000/00</b>	160	1P With flat terminals, screw	<b>3NH3051</b>	0.139
	Made of ceramic for screw fixing				
	<b>000/00</b>	160	1P With flat terminals, screw	<b>3NH3030</b>	0.217
			3P (incl. two partitions) With flat terminals	<b>3NH4030</b>	0.709
	Made of ceramic for screw fixing				
<b>1</b>	250	1P With flat terminals	<b>3NH3230</b>	0.760	
	Ceramic supports on base plate for screw fixing				
	<b>1</b>	250	3P (incl. two partitions) With flat terminals	<b>3NH4230</b>	2.090
	Made of ceramic for screw fixing				
<b>2</b>	400	1P With flat terminals	<b>3NH3330</b>	0.809	
	Made of ceramic for screw fixing				
<b>3</b>	630	1P With flat terminals	<b>3NH3430</b>	1.070	





3

# SENTRON Protection, Switching, Measuring and Monitoring Devices

## Fuse Systems

### LV HRC fuse bases

#### Selection and ordering data (continued)

	Size	$I_n$ A	Version	Article No.	Weight kg
<b>LV HRC fuse bases with swivel mechanism</b>					
	With flat terminals <sup>1)</sup>				
	000/00	160	1P With screw fixing for mounting plate	3NH7030	0.419
	1	250	1P With screw fixing for mounting plate	3NH7230	1.090
<b>LV HRC protective covers for LV HRC fuse bases</b>					
	As touch protection for contact pieces				
	000/00			3NX3105	0.011
	0			3NX3114	0.013
	1			3NX3106	0.027
	2			3NX3107	0.034
	3			3NX3108	0.032
<b>LV HRC partitions for LV HRC fuse bases</b>					
	As intermediate phase and end barrier				
			Type		
	000/00		3NH30/3NH4 0	3NX2023	0.025
	0		3NH31	3NX2030	0.039
	1		3NH32	3NX2024	0.043
	2		3NH33	3NX2025	0.065
	3		3NH34	3NX2026	0.073
<b>LV HRC protective covers</b>					
	000/00		1P and 3P	3NX3115	0.045
	000/00		When using fuse links with non-insulated grip lugs	3NX3116	0.016



<sup>1)</sup> Size 000/00 with additionally enclosed saddle-type terminals

# SENTRON Protection, Switching, Measuring and Monitoring Devices

## Fuse Systems

For power distribution

### Selection and ordering data

	Rated current $I_U$ A	Size	Article No.	Weight kg
<b>For 45 mm cover level</b>				
	<b>Basic units</b>			
	<b>Flat terminals</b>			
	160	00	3NP1133-1CA10	0.801
	<b>Box terminals</b>			
100 <sup>1)</sup>	000	3NP1123-1CA20	0.533	
160	00	3NP1133-1CA20	0.829	
<b>For 70 mm cover level</b>				
	<b>Basic units</b>			
	<b>Flat terminals</b>			
	250	1	3NP1143-1DA10	2.750
	400	2	3NP1153-1DA10	3.729
	630	3	3NP1163-1DA10	4.539
	<b>Box terminals</b>			
250	1	3NP1143-1DA20	2.924	
400	2	3NP1153-1DA20	4.401	
630	3	3NP1163-1DA20	5.150	
<b>With reach-around protection suitable for Siemens 8US busbar systems and Rittal 40 mm busbar system without base<sup>1)</sup></b>				
	<b>Basic units</b>			
	<b>Flat terminals</b>			
	160	00	3NP1133-1BB10	1.092
	<b>Box terminals</b>			
100 <sup>2)</sup>	000	3NP1123-1BB20	0.934	
160	00	3NP1133-1BB20	1.101	
<b>With reach-around protection suitable for Siemens 8US, Wöhner Classic, and Rittal RiLine60 busbar systems without base</b>				
	<b>Basic units</b>			
	<b>Flat terminals</b>			
	160	00	3NP1133-1BC10	1.091
	400	2	3NP1153-1BC10	4.280
	630	3	3NP1163-1BC10	5.299
	<b>Box terminals</b>			
	100 <sup>1)</sup>	000	3NP1123-1BC20	0.945
	160	00	3NP1133-1BC20	1.086
	250	1	3NP1143-1BC20	3.350
400	2	3NP1153-1BC20	4.597	
630	3	3NP1163-1BC20	5.438	

<sup>1)</sup> 160 A available in combination with feeder terminal 3NP1923-1BD00

<sup>2)</sup> Cannot be used with T profile rails

#### Note:

Delivered from factory with cable feeder at bottom and convertible by the customer



# SENTRON Protection, Switching, Measuring and Monitoring Devices

## Switching Devices

### Introduction

### Overview

#### Installation switching devices<sup>1)</sup>



5TE8  
control switches



5TE48  
pushbuttons



5TE58  
light indicators



5TE81/82, 5TL1  
On/Off switches



5TE  
DC isolators



5TE  
busbars



5TT41, 5TT44  
remote control  
switches



5TT4, 5TT5  
auxiliary switches



5TT42  
switching relays



5TT50, 5TT58  
Insta contactors



5TT3  
soft-starting  
devices

#### Accessories<sup>1)</sup>



Auxiliary switches  
(AS)



Shunt trips  
(ST)



Undervoltage  
releases (UR)



Remote control  
mechanisms  
(RC mech.)



Handle locking  
devices



LEDs



Caps/covers



Connectors

#### Timers<sup>1)</sup>



7LF4 digital  
time switches



7LF5 mechanical  
time switches



7LF6 timers for  
buildings



5TT3 timers  
for industrial  
applications

#### Accessories<sup>1)</sup>



Holders

<sup>1)</sup> See Catalog LV 10.

### Overview

#### Remote control switches up to 16 A and 20 up to 63 A



5TT4101-0 remote control switch for AC applications, up to 16 A, 2 NO contacts (left)  
 5TT44 remote control switch for AC applications, 2 CO contacts (center)  
 5TT4930 auxiliary switch for 5TT44 remote control switches, 1 NO + 1 NC (right)

Remote control switches are used in residential and non-residential buildings, as well as the switchboard engineering sector. They trip in the event of "current inrushes", i.e. pulses, and then electromechanically save the switching position, even in the event of a power failure.

All the devices have the CE mark and can also be equipped with an additional auxiliary switch. All devices have a switching position indication and are operated manually. The switching noise is particularly quiet and meets the requirements of residential buildings.

In addition to the 5TT41 remote control switch for up to 16 A, the 5TT44 version is now also available for 20 ... 63 A (up to 32 A DC).

### Benefits

- Remote control switches with central/group switching support convenient and high feature applications
- High functional reliability due to electromechanical design without fault-prone electronics
- The devices have no standby losses
- All devices have a switching position indication and are operated manually
- All the remote control switches can be fitted with an additional auxiliary switch
- The remote control switches can be bus-mounted on 5TE9100 and 5TE9101 busbars; e.g.: bus mounting of the N conductor and/or infeed

### Central switching functions

Versions with central On/Off function allow the central switching of all connected remote control switches. This type of central switching can also be actuated using a time switch. All remote control switches can be switched to the ON or OFF switching state, regardless of their current switching state.

#### Note:

Synchronous switching of the contacts cannot be guaranteed with parallel switching. Products with central/group switching must be used for the mutual control of several remote control switches.

#### Contact sequences for remote control switches up to 16 A

1 – 2 – 1+2 – 0 or 1 – 0 – 2 – 0 means:

0: No contact closed

1: Only contact 1 closed

2: Only contact 2 closed

1+2: Contact 1 and contact 2 are closed.

The contact positions are constantly changing with each pushbutton impulse.

#### Note:

Synchronous switching of the contacts cannot be guaranteed with parallel switching. Products with central/group switching must be used for the mutual control of several remote control switches.

#### Bus mounting



All 5TT41 remote control switches up to 16 A and 5TT44 from 20 ... 63 A can be bus-mounted with each other.

# SENTRON Protection, Switching, Measuring and Monitoring Devices

## Switching Devices

### 5TT4 remote control switches

#### Application

Example for 5TT44 remote control switches up to 63 A

3

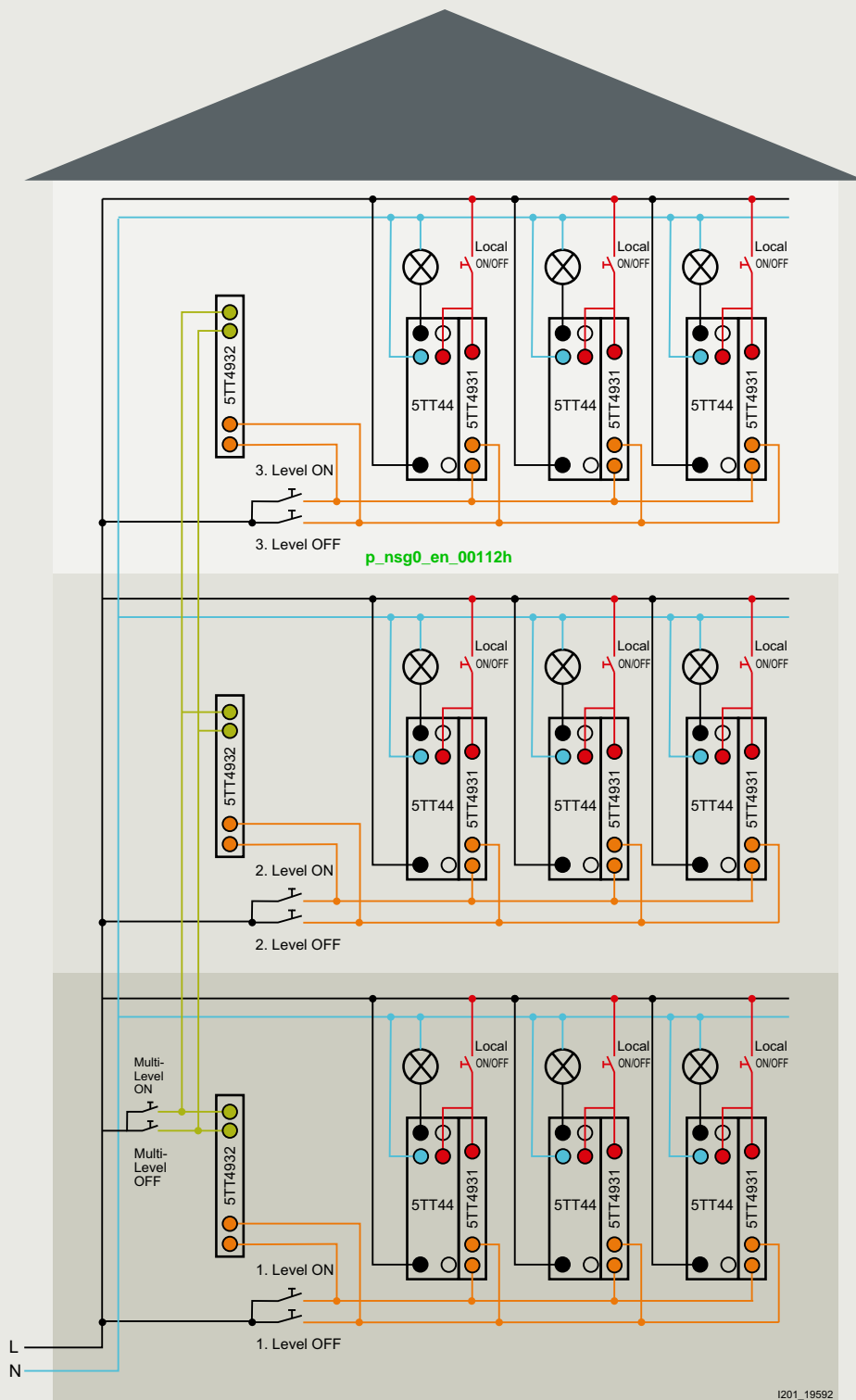

# SENTRON Protection, Switching, Measuring and Monitoring Devices

## Switching Devices

### 5TT4 remote control switches

#### Technical specifications

	5TT41 remote control switches up to 16 A				Auxiliary switches for 5TT41		5TT44 remote control switches from 20 ... 63 A	Auxiliary switches for 5TT44		
	5TT4101 5TT4102 5TT4105 5TT4111 5TT4112 5TT4114 5TT4115	5TT4103 5TT4104	5TT412 5TT415	5TT413 5TT414	5TT4900	5TT4901		5TT4930	5TT4931	5TT4932
<b>Standards</b>	IEC 60669-1, IEC 60669-2, IEC 60669-3, EN 60669 (VDE 0632), EN 60669-2-2, EN 60669-2-2/A1				EN 60947-1 (VDE 0660 Part 100) EN 60947-5-1 (VDE 0660 Part 200)		IEC 60669-2-2 (up to 32 A) EN IEC 60947-4-1 (40 ... 63 A)	IEC/EN60947-5-1		
<b>Approvals</b>	VDE						CE, CCC (only 20 A, 25 A)	CE, EAC		
<b>Contact type</b>	1 NO 2 NO 1 NO + 1 NC	3 NO 4 NO	1 NO 2 NO 3 NO 1 NO + 1 NC	Series Shutter/ blind	1 CO	1 CO	2 NO 4 NO 1 NO + 1 NC 2 NO + 2 NC 1 CO 2 CO	1 NO + 1 NC	Central	Group
<b>Manual operation</b>	Yes				--		Yes	No		
<b>Switching position indication</b>	Yes				--		Yes	No		
<b>Rated control voltage <math>U_c</math></b>	V AC V DC	8 ... 230 12 ... 110		-- --		230, 24 24	250 --			
<b>Primary operating range</b>	$\times U_c$	0.8 ... 1.1		--		--	--			
<b>Rated frequency <math>f_c</math> (AC types)</b>	Hz	50		--		50/60	50/60			
<b>Rated impulse withstand voltage <math>U_{imp}</math></b>	kV	4		1		3	1			
<b>Rated power dissipation <math>P_v</math></b>	W	--		--		--	0.3 per pole			
• Magnet coil, only pulse at 16 A	W/VA	4.5/7	9/13	4.5/7	--	--	--	--	--	
• Magnet coil, for "on" pulse at 20...25 A	W/VA	--	--	--	--	--	13/18; DC: 9/9	--	--	
• Magnet coil, for "on" pulse at 40...63 A	W/VA	--	--	--	--	--	12/26	--	--	
• Per contact at 16 A	W	1.2	--	--	--	--	--	--	--	
• Per contact at 20 A	W	--	--	--	--	1.5	--	--	--	
• Per contact at 25 A	W	--	--	--	--	2	--	--	--	
• Per contact at 32 A	W	--	--	--	--	3	--	--	--	
• Per contact at 40 A	W	--	--	--	--	3	--	--	--	
• Per contact at 63 A	W	--	--	--	--	3.5	--	--	--	
<b>Minimum contact load</b>	V; mA	10; 100 AC				AC/DC 5;1	10; 100 AC	12; 5	--	--
<b>Rated operational current <math>I_e</math></b> At p.f. = 0.6 ... 1 (AC-15)	A	16				--	5TT440../41...: 20 5TT442../43...: 25 5TT445...: 32 5TT446...: 40 5TT447...: 63	4	--	--
<b>Rated operational voltage <math>U_e</math></b>	V AC	--				--	--	--	250	250
• 1 NO	V AC	250	--	250	--	250	30 AC/DC	--	--	--
• 2 NO	V AC	400	--	400	250	--	--	440	--	--
• 3 NO	V AC	--	400	400	--	--	--	440	--	--
• 4 NO	V AC	400	400	--	--	--	--	440	--	--
• 1 NO + 1 NC	V AC	250	--	250	--	--	--	440	250	--
<b>Glow lamp load at 230 V</b>	mA	5				--	--	--	--	--
• With 1 5TT4920 compensator	mA	25				--	--	--	--	--
• With 2 5TT4920 compensators	mA	45				--	--	--	--	--
<b>Incandescent lamp load</b> With AC-5b (230V) switching of incandescent lamps for 15000 switching cycles	W	1200				--	5TT440../41...: 4400 5TT442../43...: 5500 5TT445...: 7000 5TT446...: 8800 5TT447...: 13800	--	--	--
<b>Rated operational power (AC-3)</b>										
• Single-phase, at 230 V	kW	--	--	--	--	--	5TT440../41...: 0.5 5TT442../43...: 0.75 5TT445...: 1.1 5TT446...: 2.2 5TT447...: 4	--	--	--
• Three-phase, at 230 V	kW	--	--	--	--	--	5TT440../41...: 1.5 5TT442../43...: 2.2 5TT445...: 3 5TT446...: 5.5 5TT447...: 11	--	--	--
• Three-phase, at 400 V	kW	--	--	--	--	--	5TT440../41...: 3 5TT442../43...: 4 5TT445...: 5.5 5TT446...: 11 5TT447...: 18.5	--	--	--

# SENTRON Protection, Switching, Measuring and Monitoring Devices

## Switching Devices

### 5TT4 remote control switches

#### Technical specifications (continued)

	5TT41 remote control switches up to 16 A				Auxiliary switches for 5TT41		5TT44 remote control switches from 20 ... 63 A	Auxiliary switches for 5TT44			
	5TT4101 5TT4102 5TT4105 5TT4111 5TT4112 5TT4114 5TT4115	5TT4103 5TT4104	5TT412 5TT415	5TT413 5TT414	5TT4900	5TT4901		5TT4930	5TT4931	5TT4932	
<b>Different phases</b> Between magnet coil/contact	Permissible				--	--	Permissible	--			
<b>Contact gap</b>	mm	> 1.2				< 1.2		> 3			
<b>Safe separation</b> Creepage distances and clearances between magnet coil/contact	mm	> 6						--	--		
<b>Pushbutton malfunction</b> Protected against continuous voltage, safe due to design		Yes	PTC	Yes <sup>1)</sup>	Yes	Yes	Yes	--			
<b>Minimum pulse duration</b>	ms	50						--	--		
<b>Max. switching speed</b> In switching cycles per hour	h <sup>-1</sup>	--						5TT440../41...: 600 5TT442../43...: 450 5TT445../43...: 450 5TT446...: 360 5TT447...: 360	--		
<b>Electrical service life</b> At $I_e/U_e$ , p.f. = 0.6; incandescent lamp load 600 W (switching cycles)		50000						50000	100000	--	
<b>Terminals</b> ± screw (Pozidriv)		1						Coil: 1; Contact: 2	1		
<b>Torque</b>	Nm	0.8 ... 1.0				max. 0.5		see conductor cross-sections	0.8		
<b>Conductor cross-sections</b>											
• Rigid	mm <sup>2</sup>	1 ... 6				0.5 ... 2.5		<b>Coil:</b> 1 ... 4, Torque: 0.6 Nm <b>Contacts:</b> 20 ... 32 A: 1 ... 10, Torque: 1.2 Nm 40 ... 63 A: 2.5 ... 25, Tightening torque: 2.0 Nm	1 ... 4		
• Flexible, with end sleeve	mm <sup>2</sup>	1 ... 6				0.5 ... 2.5			<b>Coil:</b> 1 ... 4, Torque: 0.6 Nm <b>Contacts:</b> 20 ... 32 A: 1 ... 10 Torque: 1.2 Nm 40 ... 63 A: 2.5 ... 25 Torque: 2.0 Nm	1 ... 4	
<b>Resistance to climate</b> At 95% relative humidity acc. to DIN 50015	°C	35						55	55		
<b>Permissible ambient temperature</b>	°C	-10 ... +40						Storage temperature: -30 ... +80 Operating temperature: -25 ... +55	Storage temperature: -30 ... +80 Operating temperature: -25 ... +70		
<b>Degree of protection</b> Acc. to EN 60529		IP20, with connected conductors						IP20	IP20		
<b>Mounting position</b>		Any						Any (not upside down)			



<sup>1)</sup> For 2.5 MW 5TT4123-0 devices with PTC.

# SENTRON Protection, Switching, Measuring and Monitoring Devices

## Switching Devices

### Socket outlets

#### Selection and ordering data

Version	$U_e$	$I_e$	Conductor cross-section	Mounting width	Article No.	Weight		
	V AC	A	mm <sup>2</sup>	MW <sup>1)</sup>		kg		
<b>Socket outlets</b>								
	<b>SCHUKO® socket outlets according to DIN VDE 0620-1</b> • Without hinged lid				5TE6800	0.080		
	230	16	6	2.5				
	<b>SCHUKO® socket outlets according to DIN VDE 0620-1</b> • With hinged lid						5TE6801	0.091
	230	16	6	2.5				
	<b>SCHUKO® socket outlets according to DIN VDE 0620-1</b> • Without hinged lid, yellow RAL 1018						5TE6810	0.085
	230	16	6	2.5				
	<b>Socket outlets according to CEI 23-50</b> • With hinged lid						5TE6802	0.091
	230	16	6	2.5				
	<b>Socket outlets according to CEE 7 Standard sheet V</b> • Without hinged lid, with grounding pin				5TE6803	0.087		
	230	16	6	2.5				
	<b>UL 498 socket outlets</b> • Without hinged lid				5TE6804	0.087		
	125	15	6	2.5				

<sup>1)</sup> 1 MW (modular width) = 18 mm.

# SENTRON Protection, Switching, Measuring and Monitoring Devices

## Power Monitoring

### Hardware and software components

#### Overview

##### Measuring devices and circuit breakers

	7KT PAC1200	SEM3	7KT PAC1600	7KM PAC2200	7KM PAC3100	7KM PAC3200T
						
	The flexible solution for multi-channel monitoring in the final circuit up to 63 A	The flexible solution for multichannel monitoring up to 1200 A	The entry-level solution when it comes to energy measurement	The energy meter solution for the standard mounting rail	The cost-effective solution for digital measurement	The compact solution for precise energy measurement
<b>Measuring range/connection</b>						
Max. input voltage L-L/L-N	400 V/230 V	480 V/277 V	400 V/230 V	480 V/277 V	480 V/276 V	480 V/277 V
Transformer connection version	x/5 A	50 ... 1200 A/0.1 A	x/5 A	x/1 A or x/5 A	x/5 A	x/1 A or x/5 A
Direct connection version	40/63 A	–	63 A/80 A	✓ (up to 65 A)	–	–
DC power supply unit w. extra-low volt. version	–	–	–	–	–	–
Single-phase counter version	–	✓	✓	✓	–	–
Electrically isolated voltage inputs	–	–	–	–	–	–
Version without display (for web interface)	–	✓	–	–	–	✓
<b>Measured quantities</b>						
Voltage, current, frequency,	✓	✓	✓	✓	✓	✓
Power, power factor	✓	✓	✓	✓	✓	✓
<b>Energy measurement</b>						
• Apparent, active, reactive energy, cos phi	–   ✓   ✓   ✓   –	✓   ✓   ✓   ✓   ✓	✓   ✓   ✓   ✓   –	✓   ✓   ✓   ✓   –	–   ✓   ✓   ✓   –	✓   ✓   ✓   ✓   –
<b>Extended measured quantities</b>						
• Distortion factor THD (voltage, current)	–	–	–	–	–	✓
• Harmonics (voltage, current)	–	–	–	–	–	–
• Phase angle/phase chart	–	–	–	–	–	–
• Load profile recording	–	✓	–	–	–	–
• Flicker acc. to IEC 61000-4-15	–	–	–	–	–	–
<b>Monitoring functions</b>						
Operating hours counter	–	✓	✓	✓	–	✓
Limit monitoring	–	–	✓	–	–	✓
Logic functions	–	✓	–	–	–	✓
Event log	–	✓	–	–	–	–
Gateway function	–	–	–	–	–	–
Reporting acc. to EN 50160	–	–	–	–	–	–
Integrated fault recorder	–	–	–	–	–	–
<b>System integration and communication</b>						
Digital inputs/digital outputs	–	✓	✓	1/1	2/2	1/1
S0 interface	–	–	✓	✓	✓	✓
4DI/2DO expansion module	–	–	–	–	–	–
Communication modules or protocols:						
• BACnet IP and BACnet MSTP	–	✓	–	–	–	–
• M-Bus	–	–	Optional	✓	–	–
• Instabus KNX	–	–	–	–	–	–
• Modbus RTU	–	✓	Optional	✓	✓	–
• Ethernet with Modbus TCP	✓	✓	–	✓	–	✓
• PROFIBUS DPV1	–	–	–	–	–	–
• PROFINET IO/ PROFIenergy	–	–	–	–	–	–
Expansion module I(N), I(Diff) analog	–	–	–	–	–	–
Parameterization software	powerconfig	Own web interface	powerconfig	powerconfig	powerconfig	powerconfig
Integration of power monitoring system	powermanager	powermanager	powermanager	powermanager	powermanager	powermanager
Web interface	✓	✓	–	✓	–	✓
Measuring accuracy, active/reactive energy	2	0.2 or 1.0	1   2	1   3	1   3	0.5 S   2
MID version	–	–	✓	✓	–	–
Installation	Standard mounting rail	Screw mounting	Standard mounting rail	Standard mounting rail	Front mounting	Standard mounting rail
Dimensions in MW (1 MW = 18 mm) or in mm	4 MW	–	2/4 MW	6 MW	96 × 96 × 56	6 MW

1) With the exception of devices with power supply units with extra-low voltage.

2) THD indication.

# SENTRON Protection, Switching, Measuring and Monitoring Devices

## Power Monitoring

### Hardware and software components

3

7KM PAC3200	7KM PAC4200	7KM PAC5100	7KM PAC5200	3WL	3VA ETU8
					
The specialist solution for precise energy measurement	The professional solution for communication and monitoring	The specialist solution for measured value acquisition	The expert solution for power supply quality	The specialist solution for protection and energy measurement	The specialist solution for protection and energy measurement
690 V/400 V <sup>1)</sup> x/1 A or x/5 A – 22 ... 65 V – – –	690 V/400 V <sup>1)</sup> x/1 A or x/5 A – 22 ... 65 V – – –	690 V/400 V x/1 A or x/5 A – – – ✓ ✓	690 V/400 V x/1 A or x/5 A – – – ✓ ✓	690 V/400 V Integrated – 24 V – – –	690 V/400 V Integrated – 24 V – – –
✓ ✓ ✓   ✓   ✓   ✓   – ✓ <sup>2)</sup> – – –	✓ ✓ ✓   ✓   ✓   ✓   ✓ ✓ 2 ... 64. ✓ ✓ –	✓ ✓ ✓   ✓   ✓   ✓   ✓ ✓ 2 ... 40. ✓ – –	✓ ✓ ✓   ✓   ✓   ✓   ✓ ✓ 2 ... 40. ✓ ✓ ✓	✓ ✓ ✓   ✓   ✓   ✓   ✓ ✓ – ✓ –	✓ ✓ ✓   ✓   ✓   ✓   ✓ ✓ – ✓ –
✓ ✓ ✓ – – –	✓ ✓ ✓ – – – – – – –	– ✓ ✓ ✓ – – – – –	– ✓ ✓ ✓ – – – – –	✓ ✓ – ✓ – – – – –	✓ ✓ – ✓ – – – – –
1/1 ✓ – – – Optional ✓ Optional Optional Optional powerconfig, TIA Portal powermanager SIMATIC Energy Suite –	2/2 ✓ Optional – – Optional ✓ Optional Optional Optional powerconfig, TIA Portal powermanager SIMATIC Energy Suite –	0/2 – – – – – ✓ – – powerconfig powermanager ✓	0/2 – – – – – ✓ – – powerconfig powermanager ✓	– Optional Optional – – Optional ✓ Optional Optional – powerconfig powermanager –	– Optional Optional – – Optional ✓ Optional Optional – powerconfig, TIA Portal V14 powermanager SIMATIC Energy Suite –
0.5 S I 2 – Front mounting 96 × 96 × 56	0.2 S I 2 – Front mounting 96 × 96 × 82	0.5 S I 2 – Front mounting/standard rail 96 × 96 × 100	0.5 S I 2 – – 96 × 96 × 100	2 S I 2 <sup>3)</sup> – – 96 × 96 × 82 <sup>4)</sup>	2 S I 2 <sup>3)</sup> – – 96 × 96 × 82 <sup>4)</sup>

<sup>3)</sup> Measuring accuracy including current transformer

✓ Available / possible -- Not available / not possible

<sup>4)</sup> DSP800



# SENTRON Protection, Switching, Measuring and Monitoring Devices

## Power Monitoring

### Hardware and software components

#### Overview (continued)

#### Expansion modules for 7KM PAC measuring devices

					
	Switched Ethernet For 7KM PAC3200, 7KM PAC4200 and 3VA COM100/COM800	PROFIBUS DP For 7KM PAC3200, 7KM PAC4200 and 3VA COM100/COM800	RS 485 For 7KM PAC3200, 7KM PAC4200 and 3VA COM100/COM800	4DI/2DO For 7KM PAC4200 (number of digital inputs/outputs per module 4/2)	7KM PAC I(N), I(Diff), analog For 7KM PAC4200 and 3200
Protocol	PROFINET IO PROEnergy Modbus TCP	DPV1	Modbus RTU	--	--
Maximum number of connectable expansion modules of the same type	1	1	1	2	1

#### The powerconfig software for commissioning

	Software tool for the efficient commissioning and diagnosis of communication-capable SENTRON components
License	Free use
Supported devices	All PAC measuring devices incl. expansion modules, 3WL/3VL/3VA circuit breakers and further communication-capable components, e.g. ATC6300
General range of functions	The PC-based tool facilitates parameterization of the devices, resulting in substantial time savings, particularly when several devices have to be set up. The device settings can be stored in the PC and printed out. The tool enables monitoring of instantaneous measured quantities, which can be saved or printed out if required. Execution of specific device functions, such as resetting of devices and setting of energy counters
Supported languages	German, English, Chinese, Spanish, Portuguese, Italian, Turkish
Service functions	Firmware updates and switching of language packs for 7KM PAC measuring devices
Functional scope with 7KM PAC4200 and 3VA	Readout of data stored in the device (events; load profile history; daily energy counters), which are saved in csv format

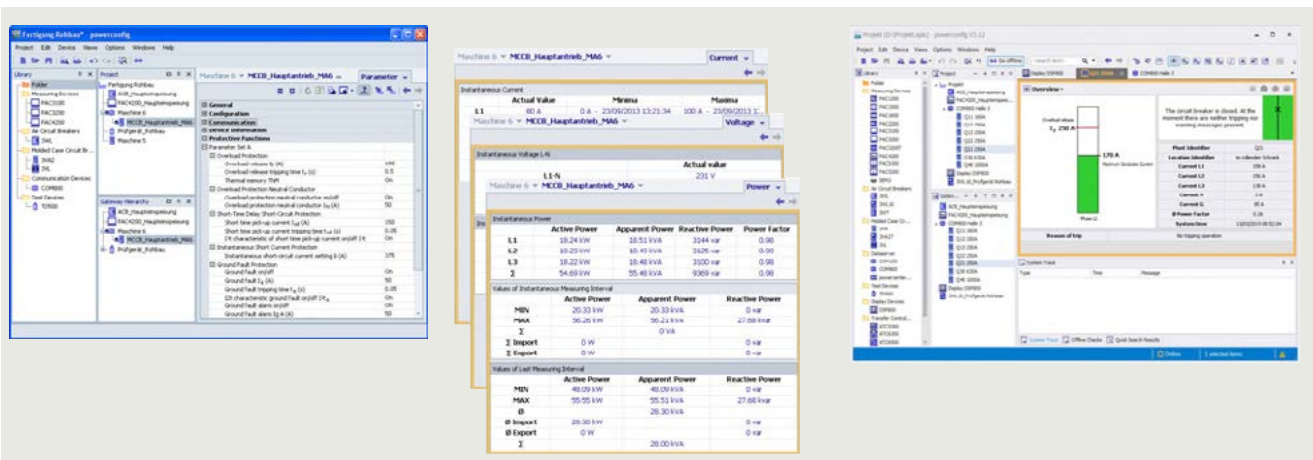

Setting of parameter values

Display of actual measured quantities

Display of the circuit breaker state

### Overview



Hardware components of the PC-based power monitoring system



Software component of the power monitoring software: powermanager

#### **Power monitoring system with SENTRON components**

The TÜV-certified power monitoring system from the SENTRON portfolio consists of the 7KT/7KM PAC measuring devices, the 3WL/3VA/3VL circuit breakers, and the powermanager power monitoring software. This forms the technical basis for supporting a corporate energy management system as specified by ISO 50001.

The hardware and software components are optimally coordinated with each other. For example, special drivers for the SENTRON devices are integrated in the powermanager power monitoring software. They enable energy data to be captured without any great configuration effort and they indicate the key measured values or the status by means of predefined views.

This reduces the engineering overhead. The device functions are optimally supported in the software.

#### **Features of the powermanager power monitoring software**

The powermanager power monitoring software constitutes the optimum technical basis for supporting a corporate power monitoring system as specified by ISO 50001 and EN 16247:

- Independent power monitoring software
- Can be operated using a Windows PC, circuit breakers and measuring devices with Ethernet connection
- Easy getting started with basic license (Basic Package), can be extended with flexible licensing concept according to customer requirements
- Fully scalable, relative to number of devices and software functions
- Optimum integration of 7KT/7KM PAC measuring devices, 3WL/3VL/3VA circuit breakers, 7KM PAC 5200 power quality devices and any other Modbus devices
- Support of the various device and communication interfaces (Modbus RTU, Modbus TCP)
- Status display of devices
- Available languages: German, English, Spanish, Portuguese, Italian, French, Turkish, Chinese

## SENTRON Protection, Switching, Measuring and Monitoring Devices

### Power Monitoring

#### 7KN Powercenter 1000

##### Overview

The 7KN Powercenter 1000 data transceiver is designed to enable comprehensive data acquisition of communication and metering-capable circuit protection devices. This increases transparency in the final circuit, through which optimization measures can be derived to increase system availability.

Up to 24 devices can communicate wirelessly with 7KN Powercenter 1000 via radio link. This means that no increased installation effort is required for communication. Selected measured values of the circuit protection devices are stored in the data transceiver for up to 30 days. These can be visualized to ensure extensive data availability.

The compact design of the 7KN Powercenter 1000, in a single modular width, results in an extremely small footprint in the distribution board so as to enable wireless, comprehensive data acquisition.

This is complemented by easy mounting on a 35 mm DIN rail and plug-in terminals for a 24 V DC power supply, which can be immediately looped through (daisy chain) to supply other devices.

The integrated Bluetooth interface enables simple on-site communication and commissioning via the SENTRON powerconfig mobile app. Connection to various configuration or power monitoring systems, such as SENTRON powerconfig, SENTRON powermanager or customized solutions, is ensured via the Modbus TCP interface. Furthermore, this interface also enables a connection via e.g. 7KN Powercenter 3000 or via LOGO! to cloud applications.

##### Selection and ordering data

	Mounting	Power supply	Devices that can be connected	Interfaces	Article No.	Weight
						kg
<b>7KN Powercenter 1000</b>	DIN-rail mounting	24 V DC SELV	24 circuit protection devices via radio link	1× Ethernet (Modbus TCP) 1× Bluetooth	<b>7KN1110-0MC00</b>	0.070



##### Note:

Please note the country-specific radio licenses of the products in SIOS:

[www.siemens.com/lowvoltage/certificates](http://www.siemens.com/lowvoltage/certificates) (109801197)

##### Datentransceiver 7KN Powercenter 1000

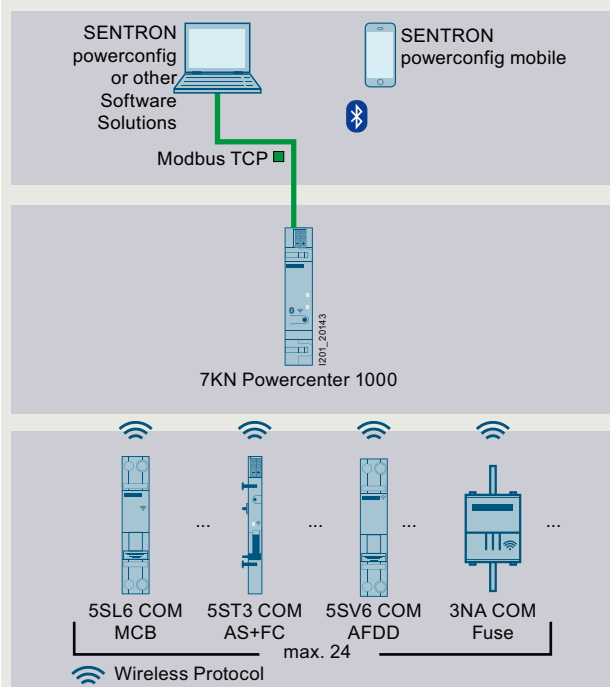

- Wireless radio transmission of measured values and data to the 7KN Powercenter data transceiver
- Parameter assignment, firmware updates and further processing of the data via the 7KN Powercenter 1000 data transceiver



You will find further information under:

Quick Installation Guide – 7KN Powercenter 1000 (109791805)



System Manual – Circuit protection devices with communication and metering functions (109791806)



## Overview

Devices	Page	Application	Standards	Used in		
				Non-residential buildings	Residential buildings	Industry
<b>7KM PAC measuring devices</b>						
<p>The 7KM PAC measuring devices are used to measure and display all relevant system parameters in low-voltage power distribution. They can be used for both single-phase and multi-phase measurements in 3 and 4-conductor power supply systems (TN, TT, IT).</p> <p>They record energy values for main distribution boards, electrical branches or individual loads precisely and reliably, and also supply key measured values for assessment of the state of the plant and the quality of the power supply.</p>						
 <p><b>7KM PAC2200 measuring device</b> Screw terminals</p>		<p>Standard rail instrument with graphics display, one integrated digital input and output and integrated communication interfaces (Modbus TCP– 3 simultaneous connections, Modbus RTU, M-Bus) for the transmission of measured values and for configuration.</p> <p>Display of 30 electrical measured values and consumption values in switchboard assemblies, infeeds or outgoing feeders.</p> <p>Versions available with or without MID.</p> <p>International standards and multi-lingual displays for worldwide use.</p>	Measurement accuracy for energy acc. to IEC 61557-12	✓	--	✓
 <p><b>7KM PAC3100 measuring device</b> AC/DC wide-range power supply unit, screw connection</p>		<p>Control panel instrument with graphics display, integrated digital inputs and outputs and an RS 485 interface for the transmission of measured values and for configuration.</p> <p>Display of 30 electrical measured values and consumption values in switchboard assemblies, infeeds or outgoing feeders.</p> <p>International standards and multi-lingual displays for worldwide use.</p>	Measurement accuracy for energy acc. to IEC 61557-12	✓	--	✓
 <p><b>7KM PAC3200T measuring device</b> Screw terminals</p>		<p>Standard rail instrument without graphics display with integrated web interface, one integrated digital input and output and a Modbus TCP interface for the transmission (3 simultaneous connections) of measured values and for configuration.</p> <p>Display of 50 electrical measured values and consumption values in switchboard assemblies, infeeds or outgoing feeders.</p> <p>International standards for worldwide use.</p>	Measurement accuracy for energy acc. to IEC 61557-12	✓	--	✓
 <p><b>7KM PAC3200 measuring device</b> 3 versions:</p> <ul style="list-style-type: none"> <li>AC/DC wide-range power supply unit, screw connection</li> <li>DC power supply unit with extra-low voltage, screw connection</li> <li>AC/DC wide-range power supply unit, ring cable lug connection</li> </ul>		<p>Control panel instrument with graphics display, integrated digital inputs and outputs and an integrated Ethernet interface for the transmission of measured values and for configuration.</p> <p>Display of over 50 electrical measured values for switchboard assemblies, infeeds or outgoing feeders. Dual-tariff measuring devices for precise energy measurement for power import and feedback.</p> <p>The following expansion modules are available:</p> <ul style="list-style-type: none"> <li>7KM PAC Switched Ethernet PROFINET</li> <li>7KM PAC RS 485</li> <li>7KM PAC PROFIBUS DP</li> <li>7KM PAC I(N), I(Diff), analog</li> </ul>	Measuring accuracy for energy acc. to IEC 62053-22/23 and IEC 61557-12	✓	--	✓
 <p><b>7KM PAC4200 measuring device</b> 3 versions:</p> <ul style="list-style-type: none"> <li>AC/DC wide-range power supply unit, screw connection</li> <li>DC power supply unit with extra-low voltage, screw connection</li> <li>AC/DC wide-range power supply unit, ring cable lug connection</li> </ul>		<p>Control panel instrument with graphics display, user-defined displays, memory, clock and calendar function, digital inputs and outputs and an integrated Ethernet interface with gateway function to transfer measured values and for configuration.</p> <p>Display of over 200 electrical measured values for switchboard assemblies, infeeds or outgoing feeders. Extensive functions for precise energy measurement for power import and feedback and assessment of the system quality.</p> <p>The following expansion modules are available:</p> <ul style="list-style-type: none"> <li>7KM PAC Switched Ethernet PROFINET</li> <li>7KM PAC RS 485</li> <li>7KM PAC PROFIBUS DP</li> <li>7KM PAC 4DI/2DO</li> <li>7KM PAC I(N), I(Diff), analog</li> </ul>	Measuring accuracy for energy acc. to IEC 62053-22/23 and IEC 61557-12	✓	--	✓



# SENTRON Protection, Switching, Measuring and Monitoring Devices

Power Monitoring

7KM PAC Measuring Devices

## Introduction

### Overview (continued)

Devices	Page	Application	Standards	Used in		
				Non-residential buildings	Residential buildings	Industry
 <p><b>7KM PAC5100 measuring device</b> <sup>1)</sup> 2 versions:</p> <ul style="list-style-type: none"> <li>Control panel instrument with graphics display</li> <li>Standard rail instrument without display</li> </ul>		<p>Control panel instrument with graphics display and user-defined displays, or instrument for standard rail mounting in accordance with EN 60750, web interface for parameterization, visualization and data management, 2 binary outputs, electrically isolated voltage inputs, synchronization via internal RTC clock or externally via NTP, 4 freely parameterizable LEDs for device status or limit violations, as well as an integrated RJ45 Ethernet interface.</p> <p>Recording of more than 250 electrical measured values for switchboard assemblies, infeeds or outgoing feeders, extensive functions for precise energy measurement for power import and feedback, and for assessment of the system quality.</p>	Measuring accuracy for energy acc. to IEC 62053-22/23 and IEC 61557-12	✓	--	✓
 <p><b>7KM PAC5200 measuring device</b> <sup>1)</sup> 2 versions:</p> <ul style="list-style-type: none"> <li>Control panel instrument with graphics display</li> <li>Standard rail instrument without display</li> </ul>		<p>Control panel instrument with graphics display and user-defined displays or instrument for standard rail mounting in accordance with EN 60750, web interface for parameterization, visualization and data management, 2 binary outputs, electrically isolated voltage inputs, flicker in accordance with IEC 61000-4-15, synchronization via internal RTC clock or externally via NTP, 4 freely parameterizable LEDs for device status or limit violations, 2 GB memory, integrated fault recorder, reporting in accordance with EN 50160, rms recorder, as well as an integrated RJ45 Ethernet interface.</p> <p>Recording of more than 250 electrical measured values for switchboard assemblies, infeeds or outgoing feeders. Extensive functions for precise energy measurement for power import and feedback and assessment of the system quality.</p>	Measuring accuracy for energy acc. to IEC 62053-22/23 and IEC 61557-12	✓	--	✓
 <p><b>7KM PAC expansion modules</b></p>	3/73	<ul style="list-style-type: none"> <li>The 7KM PAC Switched Ethernet PROFINET expansion module is used to connect the 7KM PAC3200 and 7KM PAC4200 measuring devices and 3VA molded case circuit breakers to Switched Ethernet PROFINET (PROFenergy).</li> <li>The 7KM PAC PROFIBUS DP expansion module is used to connect the 7KM PAC3200 and 7KM PAC4200 measuring devices and 3VA molded case circuit breakers to the PROFIBUS DPV1</li> <li>The 7KM PAC RS 485 expansion module is used to connect simple devices with RS 485 interface, such as the 7KM PAC3200 and 3VA molded case circuit breaker, and supports the Modbus RTU protocol.</li> <li>The 7KM PAC 4DI/2DO expansion module is used to expand the 7KM PAC4200 measuring device to up to 10 digital inputs and 6 digital outputs.</li> <li>The 7KM PAC I(N), I(Diff), analog expansion module adds the following functions for 7KM PAC3200 and 7KM PAC4200 devices: <ul style="list-style-type: none"> <li>N-conductor measurement</li> <li>Two analog inputs with 0/4 ... 20 mA signaling to measure electrical and non-electrical quantities</li> <li>Residual current measurement</li> </ul> </li> </ul>	IEC 61784-2  IEC 61158  RS 485  IEC 62053-31	✓	--	✓

<sup>1)</sup> See Catalog LV 10.



## Overview



Expansion modules are used as communication interfaces and for expanding the digital inputs/outputs and analog measuring inputs for the 7KM PAC3200/4200 measuring devices.

The expansion modules are plugged in at the back of the measuring device. The device identifies the module automatically and presents the relevant parameters for this module for selection in the parameterization menu.

## Versions

The following expansion modules are available (shown from left to right in the figure on the left):

- 7KM PAC Switched Ethernet PROFINET expansion module
- 7KM PAC PROFIBUS DP expansion module
- 7KM PAC RS 485 expansion module
- 7KM PAC 4DI/2DO expansion module
- 7KM PAC I(N), I(Diff), analog expansion module

## Connection for 3VA molded case circuit breakers

The following expansion modules can also be mounted on the front of the COM800/COM100 breaker data servers of the 3VA molded case circuit breaker:

- 7KM PAC Switched Ethernet PROFINET and
- 7KM PAC PROFIBUS DP
- 7KM PAC RS 485

For further details see in the manual at <http://support.automation.siemens.com/WW/view/en/90318775>

## More information

For more information about the software components, see page 1/293 and on the internet at [www.siemens.com/lowvoltage/powermonitoring](http://www.siemens.com/lowvoltage/powermonitoring)

Version	Use in							
	7KM PAC						3VA	
	PAC2200	PAC3100	PAC3200T	PAC3200	PAC4200	PAC5100	PAC5200	COM800/ COM100
<b>7KM PAC expansion modules</b>								
<b>7KM PAC Switched Ethernet PROFINET expansion module</b>	--	--	--	✓	✓	--	--	✓
The 7KM PAC Switched Ethernet PROFINET expansion module is a plug-in communication module for 7KM PAC3200 and 7KM PAC4200 measuring devices and 3VA molded case circuit breakers.								
It provides the following features:								
<ul style="list-style-type: none"> <li>• Standardized PROFINergy interface to the measured quantities</li> <li>• The measured quantities can be individually selected using a GSDML file. This permits use of cost-effective S7 CPUs</li> <li>• Easy parameter assignment using the device display or powerconfig or TIA Portal</li> <li>• Integrated Ethernet switching allows networking with short cables without additional switches</li> <li>• Direct integration in production machine networks using IRT (IRT = Isochronous-Real-Time)</li> <li>• Full support of PROFINET IO (DHC, DNS, SNMP, SNTP)</li> <li>• Device replacement without PG in the PROFINET assembly using LLDP</li> <li>• Deterministic reversing time through ring redundancy (MRP)</li> <li>• Modbus TCP communication</li> <li>• Communication with powermanager or powerconfig</li> <li>• 2 x Ethernet (RJ45) sockets</li> <li>• Transmission rates 10 and 100 Mbit/s</li> <li>• Protocols PROFINET IO, PROFINergy and Modbus TCP</li> <li>• No external auxiliary power necessary</li> <li>• Additional display via the device display and via LEDs on the module</li> </ul>								
All measured variables from 7KM PAC3200 and 7KM PAC4200 can be individually selected and cyclically transmitted by means of the GSDML file. This enables optimum use of the process image of the PROFINET controller, e.g. CPU 315-2 PN/DP of SIMATIC S7.								
The measured quantities can be read out in acyclic mode using PROFINergy, a PNO protocol profile. Thanks to PROFINergy, it is possible to assemble a power monitoring system with devices from various manufacturers using PROFINET.								

## 7KM PAC expansion modules



## 7KM PAC Switched Ethernet PROFINET expansion module

The 7KM PAC Switched Ethernet PROFINET expansion module is a plug-in communication module for 7KM PAC3200 and 7KM PAC4200 measuring devices and 3VA molded case circuit breakers.

It provides the following features:

- Standardized PROFINergy interface to the measured quantities
- The measured quantities can be individually selected using a GSDML file. This permits use of cost-effective S7 CPUs
- Easy parameter assignment using the device display or powerconfig or TIA Portal
- Integrated Ethernet switching allows networking with short cables without additional switches
- Direct integration in production machine networks using IRT (IRT = Isochronous-Real-Time)
- Full support of PROFINET IO (DHC, DNS, SNMP, SNTP)
- Device replacement without PG in the PROFINET assembly using LLDP
- Deterministic reversing time through ring redundancy (MRP)
- Modbus TCP communication
- Communication with powermanager or powerconfig
- 2 x Ethernet (RJ45) sockets
- Transmission rates 10 and 100 Mbit/s
- Protocols PROFINET IO, PROFINergy and Modbus TCP
- No external auxiliary power necessary
- Additional display via the device display and via LEDs on the module

All measured variables from 7KM PAC3200 and 7KM PAC4200 can be individually selected and cyclically transmitted by means of the GSDML file. This enables optimum use of the process image of the PROFINET controller, e.g. CPU 315-2 PN/DP of SIMATIC S7.

The measured quantities can be read out in acyclic mode using PROFINergy, a PNO protocol profile. Thanks to PROFINergy, it is possible to assemble a power monitoring system with devices from various manufacturers using PROFINET.

# SENTRON Protection, Switching, Measuring and Monitoring Devices

Power Monitoring

7KM PAC Measuring Devices

## 7KM PAC expansion modules

### Overview (continued)

Version	Use in							3VA
	7KM PAC							
	PAC2200	PAC3100	PAC3200T	PAC3200	PAC4200	PAC5100	PAC5200	COM800/ COM100
 <p><b>7KM PAC PROFIBUS DP expansion module</b></p> <p>The 7KM PAC PROFIBUS DP expansion module is a plug-in communication module for 7KM PAC3200 and 7KM PAC4200 measuring devices and 3VA molded case circuit breakers. The 7KM PAC PROFIBUS DP expansion module has the following features:</p> <ul style="list-style-type: none"> <li>• Plug-in communication module for measuring devices for connection to PROFIBUS DPV1</li> <li>• For 7KM PAC3200 and 7KM PAC4200</li> <li>• Easy parameter assignment using the device display or powerconfig or TIA Portal</li> <li>• Data can be transferred both cyclically and acyclically via PROFIBUS DPV1</li> <li>• Easy integration via device master data (GSD file) for other programming systems</li> <li>• Optimum use of process image of a control system for selection of individual measured quantities for cyclical transfer</li> <li>• Supports all baud rates from 9.6 kbit/s up to 12 Mbit/s</li> <li>• Connection through 9-pole Sub-D connector according to IEC 61158</li> <li>• No external auxiliary power necessary</li> <li>• Additional display via the device display and via LEDs on the module</li> </ul>	--	--	--	✓	✓	--	--	✓
 <p><b>7KM PAC RS 485 expansion module</b></p> <p>The 7KM PAC RS 485 expansion module has the following features:</p> <ul style="list-style-type: none"> <li>• Plug-in 7KM PAC RS 485 communication module for 7KM PAC3200 and 7KM PAC4200 measuring devices and 3VA molded case circuit breakers</li> <li>• Easy parameter assignment using the device display or powerconfig</li> <li>• Support for the Modbus RTU protocol</li> <li>• Plug and play</li> <li>• Supports transmission rates of 4.8/9.6/19.2 and 38.4 kbit/s</li> <li>• Connection by means of 6-pole screw terminals</li> <li>• No external auxiliary power necessary</li> <li>• Status indication by LED on the module</li> <li>• The 7KM PAC RS 485 expansion module is required for the gateway function of the 7KM PAC4200 for communication with simple devices with RS 485 interface, such as the 7KM PAC3100, via Ethernet (Modbus TCP).</li> </ul>	--	--	--	✓	✓	--	--	✓
 <p><b>7KM PAC 4DI/2DO expansion module</b></p> <p>The 7KM PAC 4DI/2DO expansion module is used to expand the 7KM PAC4200 measuring device to up to 10 digital inputs and 6 digital outputs and offers the following features:</p> <ul style="list-style-type: none"> <li>• Up to two 7KM PAC 4DI/2DO modules can be plugged onto a 7KM PAC4200.</li> <li>• The 7KM PAC 4DI/2DO expansion modules mean that the internal digital inputs and outputs can be expanded by up to 8 inputs and 4 outputs.</li> <li>• Easy parameter assignment using the device display or powerconfig</li> <li>• The digital inputs can be used without the need for an external power supply as they are self-powered. This is particularly useful for the integration of non-electric measuring devices, such as water or compressed-air counters</li> <li>• All functions of the integrated multifunctional inputs/outputs on the 7KM PAC4200 are also available in the 7KM PAC 4DI/2DO expansion module</li> <li>• Inputs and outputs can be used as an S0 interface conforming to IEC 62053-31</li> <li>• The connection is made via a 9-pole screw terminal</li> <li>• No external auxiliary power supply is required</li> </ul>	--	--	--	--	✓	--	--	--
 <p><b>7KM PAC I(N), I(Diff), analog expansion module</b></p> <p>The 7KM PAC I(N), I(Diff), analog expansion module adds the following features for 7KM PAC4200 and 7KM PAC3200 devices:</p> <ul style="list-style-type: none"> <li>• N-conductor measurement (IN), Class 1, in accordance with IEC 61557-12 via x/5A current transformers</li> <li>• Two analog inputs: The analog inputs can be used without an external voltage source via imposed direct currents from 0/4 to 20 mA. This is especially advantageous for measuring non-electrical quantities such as temperature, water or air pressure.</li> <li>• Residual current measurement: One of the two analog inputs can be used for residual current measurement via Type A or Type B summation current transformers.</li> <li>• Easy parameter assignment using the device display or powerconfig</li> <li>• The connection is made via a 6-pole screw terminal</li> <li>• One 7KM PAC I(N), I(Diff), analog module can be plugged onto a 7KM PAC4200 or 7KM PAC3200.</li> <li>• No external auxiliary power supply is required</li> </ul>	--	--	--	✓	✓	--	--	--

### Overview

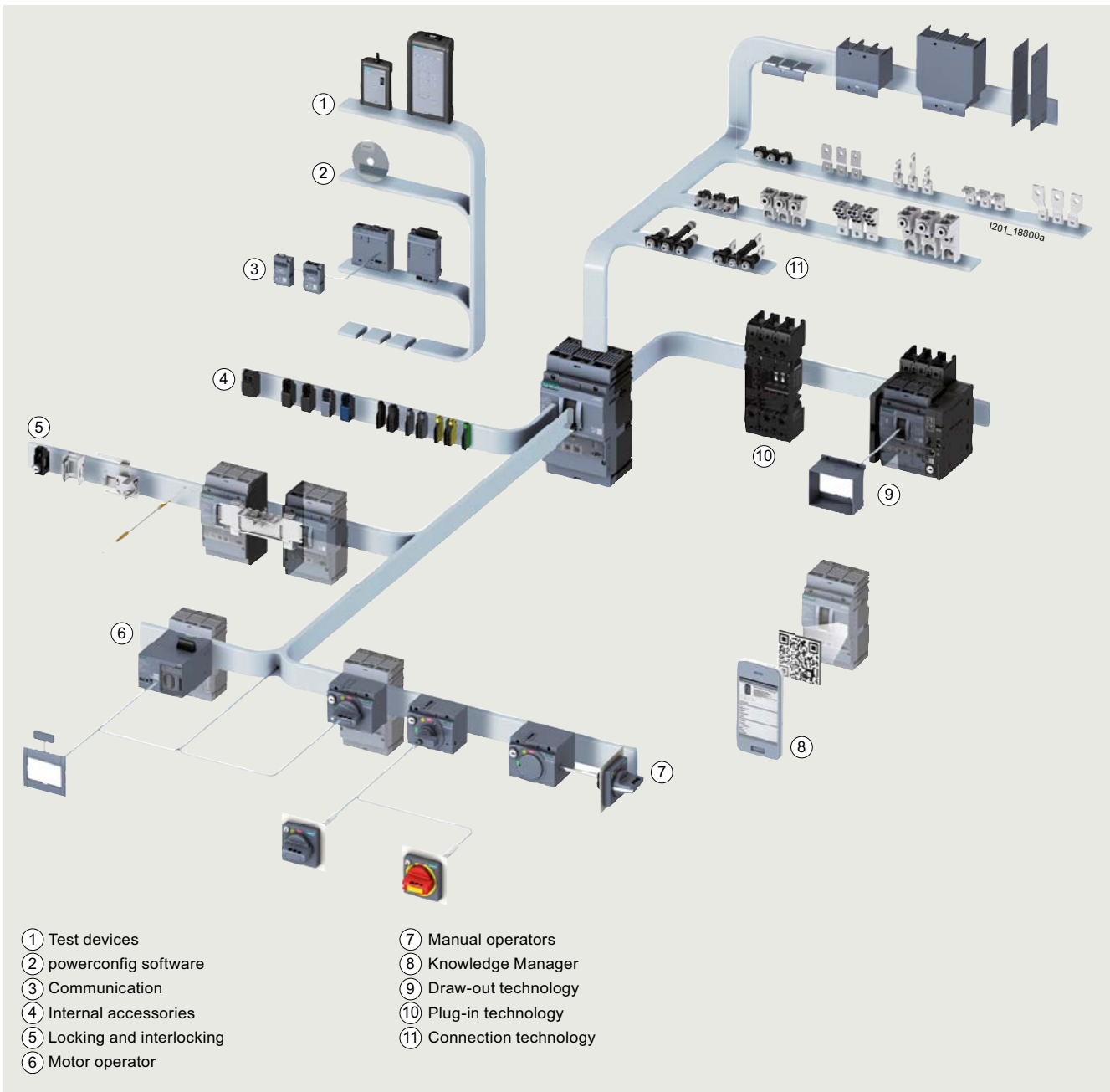

3VA molded case circuit breakers from the portfolio of SENTRON protection, switching, measuring and monitoring devices ensure the reliable protection of people and property as integral components of efficient power distribution systems. With a wide range of accessories they can be adapted flexibly, quickly and easily to individual requirements.



# SENTRON Protection, Switching, Measuring and Monitoring Devices

## 3VA Molded Case Circuit Breakers

### 3VA2 molded case circuit breakers

#### Selection and ordering data

Design of electrical connection for main circuit	Number of poles	Uninterrupted current Rated value	Current setting of the inverse-time delayed overload protection "L" $I_r$	Operating current of the instantaneous short-circuit protection "I" $I_i$	Article No.	Weight
		A				kg

#### 3VA21 up to 160 A (line protection) Fixed-mounted

#### Electronic trip units ETU320 LI with adjustable overload protection $I_r$ and adjustable instantaneous short-circuit protection $I_i$

#### $I_{cu}$ up to 55 kA at 415 V (medium breaking capacity M)

Box terminals	3	25	10 ... 25	38 ... 300	<b>3VA2125-5HL36-0AA0</b>	2.306
		40	16 ... 40	60 ... 480	<b>3VA2140-5HL36-0AA0</b>	2.305
		63	25 ... 63	95 ... 756	<b>3VA2163-5HL36-0AA0</b>	2.294
		100	40 ... 100	240 ... 1600	<b>3VA2110-5HL36-0AA0</b>	2.269
		160	63 ... 160	150 ... 1200	<b>3VA2116-5HL36-0AA0</b>	2.245
Lug terminals		25	10 ... 25	38 ... 300	<b>3VA2125-5HL32-0AA0</b>	2.159
		40	16 ... 40	60 ... 480	<b>3VA2140-5HL32-0AA0</b>	2.165
		63	25 ... 63	95 ... 756	<b>3VA2163-5HL32-0AA0</b>	2.174
		100	40 ... 100	150 ... 1200	<b>3VA2110-5HL32-0AA0</b>	2.125
		160	63 ... 160	240 ... 1600	<b>3VA2116-5HL32-0AA0</b>	2.121
			63 ... 160	240 ... 1920	<b>3VA2216-5HL32-0AA0</b>	2.240
		250	100 ... 250	375 ... 2500	<b>3VA2225-5HL32-0AA0</b>	2.234
			100 ... 250	375 ... 3000	<b>3VA2325-5HL32-0AA0</b>	4.715
		400	160 ... 400	600 ... 4000	<b>3VA2340-5HL32-0AA0</b>	4.694
			160 ... 400	600 ... 4800 <sup>1)</sup>	<b>3VA2440-5HL32-0AA0</b>	4.751
		630	250 ... 630	945 ... 5670	<b>3VA2463-5HL32-0AA0</b>	5.221

<sup>1)</sup> At breaking capacity L 440 A



## Fire protection for rolling stock



4/2

**Spot Detector for Rail**

4/6

**Aspiration Smoke Detection for Rail**

## Fire protection for rolling stock Fire Safety Application Center

### Spot Detector for Rail

#### Overview

##### **Spot Detector for Rail - based on High End Multi-Sensor DS1 024R-AT, DS1 110R-AT – Standard Base**

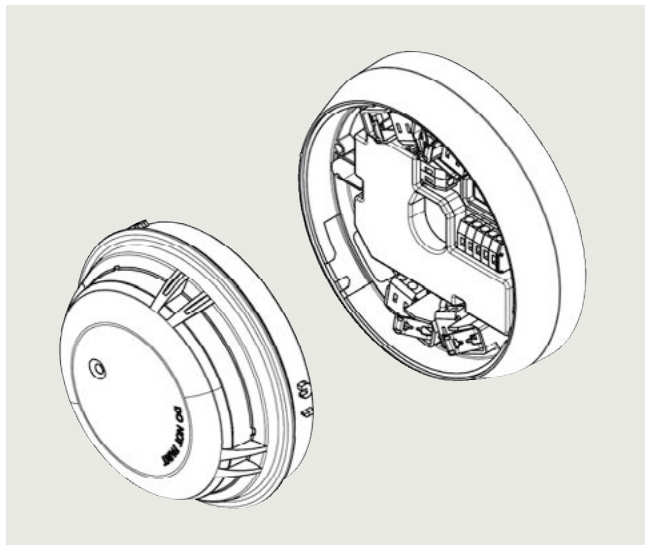

##### Sensor Technology:

- Multi criteria sensor (heat & smoke)
- Signal processing with ASAtechnology
- Highly developed immunity to deceptive phenomena
- Resistant to environmental and interfering influences such as dust, fibers, moisture, electromagnetic interference, corrosive vapors, artificial aerosols and atypical fire phenomena

##### Detector base designed for Rail Application:

- Rail base for standard ceiling installation
- Power supply 24 VDC or 110 VDC
- Alarm and Fault signaling via relay output
- 3 parameters selectable
- Stand-alone connectivity

##### Standards:

- Railway Applications EN 50155
- Extended temperature range OT4
- Requirements for fire behavior of materials and components EN 45545
- Fire detection and fire alarm systems EN 54
- Safety Integrity Level SIL2 acc. EN 5012x

##### **Spot Detector for Rail - based on High End Multi-Sensor DS2 024R-AT, DS2 110R-AT – Connector Base**



##### Sensor Technology:

- Multi criteria sensor (heat & smoke)
- Signal processing with ASAtechnology
- Highly developed immunity to deceptive phenomena
- Resistant to environmental and interfering influences such as dust, fibers, moisture, electromagnetic interference, corrosive vapors, artificial aerosols and atypical fire phenomena

##### Detector base designed for Rail Application:

- Rail base with external industry standard plug
- Plug & Play solution
- Power supply 24 VDC or 110 VDC
- Alarm and Fault signaling via relay output
- 3 parameters selectable
- Stand-alone connectivity

##### Standards:

- Railway Applications EN 50155
- Extended temperature range OT4
- Requirements for fire behavior of materials and components EN 45545
- Fire detection and fire alarm systems EN 54
- Safety Integrity Level SIL2 acc. EN 5012x

**Spot Detector for Rail - based on High End Multi-Sensor**  
**DSW 024R-AT, DSW 110R-AT – Wet Base**

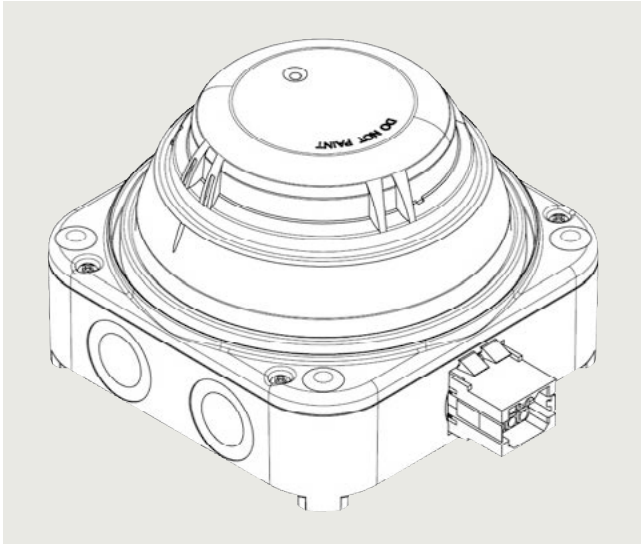

Sensor Technology:

- Multi criteria sensor (heat & smoke)
- Signal processing with ASAtechnology
- Highly developed immunity to deceptive phenomena
- Resistant to environmental and interfering influences such as dust, fibers, moisture, electromagnetic interference, corrosive vapors, artificial aerosols and atypical fire phenomena

Detector base designed for Rail Application:

- Solution for rough environmental conditions
- Rail base with external industry standard plug
- Plug & Play solution
- Power supply 24 VDC or 110 VDC
- Alarm and Fault signaling via relay output
- 3 parameters selectable
- Stand-alone connectivity

Standards:

- Railway Applications EN 50155
- Extended temperature range OT4
- Requirements for fire behavior of materials and components EN 45545
- Fire detection and fire alarm systems EN 54
- Safety Integrity Level SIL2 acc. EN 5012x

**Spot Detector for Rail - based on Smoke-only Sensor**  
**DSWOP 024R-AT, DSWOP 110R-AT – Wet Base**

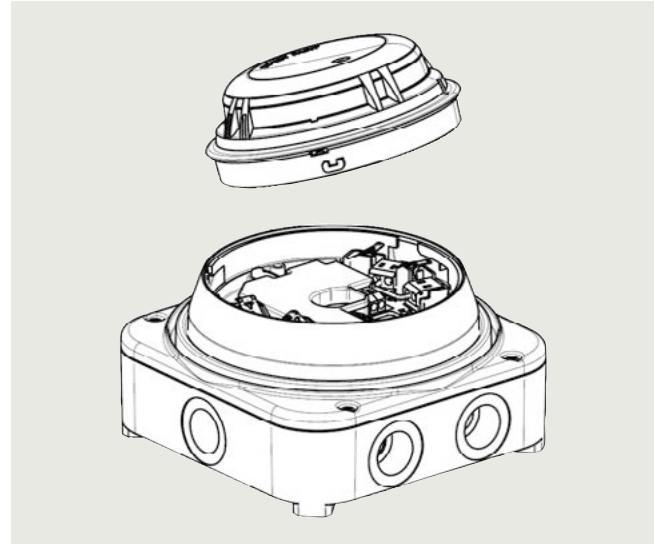

Sensor Technology:

- Single criteria sensor (smoke)
- Signal processing with detection algorithm
- 3-color LED indicator
- Drift compensation and internal error monitoring

Detector base designed for Rail Application:

- Solution for rough environmental conditions
- Rail base with external industry standard plug
- Plug & Play solution
- Power supply 24 VDC or 110 VDC
- Alarm and Fault signaling via relay output
- 2 parameters selectable
- Stand-alone connectivity

Standards:

- Railway Applications EN 50155
- Extended temperature range OT4
- Requirements for fire behavior of materials and components EN 45545
- Fire detection and fire alarm systems EN 54

## Fire protection for rolling stock Fire Safety Application Center

### Spot Detector for Rail

#### **Spot Detector for Rail - based on Heat-only Sensor DSWH10 024R-AT, DSWH10 110R-AT – Wet Base**

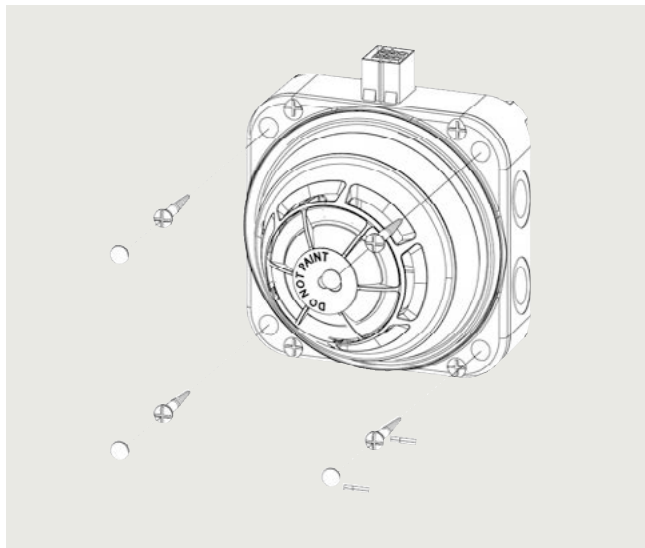

##### Sensor Technology:

- Single criteria sensor (heat, static and differential)
- Signal processing with detection algorithm
- 3-color LED indicator
- Drift compensation and internal error monitoring

##### Detector base designed for Rail Application:

- Solution for rough environmental conditions
- Rail base with external industry standard plug
- Plug & Play solution
- Power supply 24 VDC or 110 VDC
- Alarm and Fault signaling via relay output
- Fixed parameter
- Stand-alone connectivity

##### Standards:

- Railway Applications EN 50155
- Extended temperature range OT4
- Requirements for fire behavior of materials and components EN 45545
- Fire detection and fire alarm systems EN 54

#### **Spot Detector for Rail - based on Heat-only Sensor DSWH12 024R-AT, DSWH12 110R-AT – Wet Base**

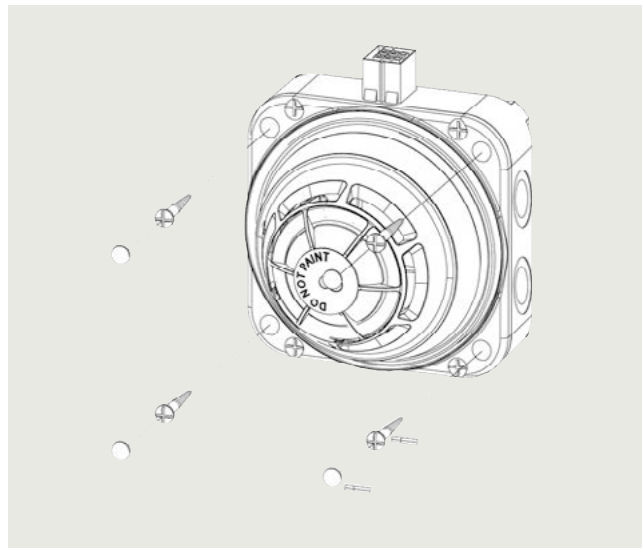

##### Sensor Technology:

- Single criteria sensor (heat, static)
- Signal processing with detection algorithm
- 3-color LED indicator
- Drift compensation and internal error monitoring

##### Detector base designed for Rail Application:

- Solution for rough environmental conditions
- Rail base with external industry standard plug
- Plug & Play solution
- Power supply 24 VDC or 110 VDC
- Alarm and Fault signaling via relay output
- 2 parameters selectable
- Stand-alone connectivity

##### Standards:

- Railway Applications EN 50155
- Extended temperature range OT4
- Requirements for fire behavior of materials and components EN 45545
- Fire detection and fire alarm systems EN 54

**Technical specifications**

Typ	Multi-sensor incl. Base
<b>Operating voltage (modulated)</b>	DC 19 ... 30 V (24 V Print Version), DC 70 ... 140 V (110 V Print Version)
<b>Operating current (quiescent)</b>	10 ... 11 mA (24 V Print Version), 3 ... 3,5 mA (110 V Print Version)
<b>Max. number of external alarm indicators that can be connected</b>	2
<b>Operating temperature</b>	-25 ... +55 °C
<b>Rail specific approval</b>	Temperature class OT4: -40 ... +70 °C
<b>Storage temperature</b>	-30 ... +70 °C
<b>Air humidity (short-term moisture condensation permitted)</b>	≤ 95% rel.
<b>Communication protocol</b>	Potential-free contacts
<b>Color</b>	~RAL 9010 pure white
<b>Weight</b>	~0.230 kg
<b>Protection category (IEC 60529)</b>	IP40
<b>Standards</b>	CEA 4021, EN 54-5, EN 54-7, EN 54-17
<b>Approvals</b>	
OOH740 only:	
• VdS	G21 1070
• LPCB	126bh/05
• FM	3051081
• DNV GL (Marine)	MEDB00003UK
OOH740 incl. Base (DBxR-AT):	
• Standards	EN 50155, EN 50121-3-2, EN 61000-4-2/3/4/5/6 EN 60068-2-1/2/27/30, EN 61373, EN 45545-2
• TUEV	Test Report TÜV Austria EN 50155 Railway applications Test Report TÜV Austria EN 50121-3-2, EN 50155 EMV Test Report AIT EN 60068-2-27, EN 61373 Shock and vibration tests Test Report TÜV Austria ÖNORM EN 60068-2-1 SIL Report & Certificate acc. EN 50126, EN 50128, EN 50129
<b>Permissible wind speed</b>	Max. 5 m/s

**Selection and ordering data**

Type	Designation	Article No.	Weight kg
<b>Multi-sensor type</b>			
DS1 024R-AT	Complete Detector Set 1, 24 V DC Version	<b>6500007594</b>	0.223
DS1 110R-AT	Complete Detector Set 1, 110 V DC Version	<b>6500007595</b>	0.226
DS2 024R-AT	Complete Detector Set 2, 24 V DC Version	<b>6500007587</b>	0.236
DS2 110R-AT	Complete Detector Set 2, 110 V DC Version	<b>6500007588</b>	0.239
DSW024R-AT	Detector Set Wet, 24 V DC	<b>6500007569</b>	0.500
DSW110R-AT	Detector Set Wet, 110 V DC	<b>6500007593</b>	0.503
<b>Accessories</b>			
LP720	Detector locking device	<b>S54319-F9-A1</b>	0.001
<b>Smoke-only type</b>			
DSWOP 024R-AT	Detector Set Wet smoke-only, 24 V DC Version	<b>6500008237</b>	0.397
DSWOP 110R-AT	Detector Set Wet smoke-only, 110 V DC Version	<b>6500008240</b>	0.398
<b>Heat-only type</b>			
DSWH10 024R-AT	Detector Set Wet heat-only, 24 V DC Version	<b>6500007740</b>	0.450
DSWH10 110R-AT	Detector Set Wet heat-only, 110 V DC Version	<b>6500007997</b>	0.451
DSWH12 024R-AT	Detector Set Wet heat max-only, 24 V DC Version	<b>6500007741</b>	0.450
DSWH12 110R-AT	Detector Set Wet heat max-only, 110 V DC Version	<b>6500007998</b>	0.451

## Fire protection for rolling stock Fire Safety Application Center

### Aspiration Smoke Detection for Rail

#### Overview

##### **Aspiration smoke detection for Rail**



##### Designed for Rail Application:

- Power supply 24 VDC
- Stand-alone connectivity
- Alarm and Fault signaling via relay output
- Variation of selectable parameter settings to meet all project specific requirements
- Fast start-up and configuration sequence

##### Standards:

- Railway Applications EN 50155
- Extended temperature range OT4
- Requirements for fire behavior of materials and components EN 45545
- Fire detection and fire alarm systems EN 54
- SIL 2 according EN 50126/128/129

##### Further Fire Safety applications

<https://new.siemens.com/global/en/products/buildings/fire-safety/applications.html>

##### Sensor Technology:

- Patented technology
- Early detection of a wide spectrum of particle size in the air
- Configuration using the USB interface
- ASD Asyst-Tool' software to assist with pipe configuration
- Unique dust-resistant detection chamber
- Intuitive front indicator for airflow and smoke value
- Access to service functions
- Different event protocols
- Offline/Online configuration supported
- Cleaning function (FDA241)

**Technical specifications**

Typ	FDA241	FDA221
<b>Operating voltage</b>	DC 19 ... 30 V	
<b>Operating current at DC 24 V</b>	150 mA (nominal), 250 mA (during alarm)	
<b>Dimensions (W x H x D)</b>	162 x 285 x 120 mm	
<b>Protection category</b>	IP30	
<b>Installation position</b>	Vertically upward, vertically downward	
<b>Sound power level LWA (dBA)</b>	--	
<b>At suction speed</b>		
• High	37	33
• Medium	33	30
• Low	30	26
<b>Operating temperature</b>	-20 ... +60 °C	
<b>Rail specific approval</b>	Temperature class OT4: -40 ... +70 °C	
<b>Air humidity</b>	5 ... 95% (no moisture condensation)	
<b>Dust indicator</b>	Yes	--
<b>Maximum pipe length</b>		
• Single line	60 m	30 m
• Branched lines	2 x 60 m	2 x 25 m
<b>Options for aspirating holes</b>	Prefabricated option or the maximum pipe length must correspond to the calculation made using the "FXS2056 ASD Asyst Tool V2" software	
<b>Air intake/exhaust pipe</b>	Metric: 25 mm outer diameter (OD)	
<b>Monitoring area (dependent on local provisions and standards)</b>	Up to 800 m <sup>2</sup>	Up to 500 m <sup>2</sup>
<b>Relay alarm outputs can be selected with/without lock nominal current 2.0 A at DC 30 V. Contact: NO/NC</b>	4	3
<b>Fault relay</b>	1	1
<b>Cable inlet</b>	10 cm x 2.5 cm on the rear or from above	
<b>Terminal configuration</b>	Screw terminals	
<b>Cable cross section</b>	0.2 ... 2.5 mm <sup>2</sup> (AWG 12 ... 30)	
<b>Other interfaces</b>	Power supply, 4 ... 20 mA	
<b>Alarm threshold for parameter sets</b>		
• Fire 1	10 sets; 0.05 ... 2.0%/m obs	5 sets; 0.20 ... 2.0%/m obs
• Fire 2	10 sets; 2.0 ... 20%/m obs	5 sets; 6.0 ... 20%/m obs
<b>Alarm delay, can be set individually</b>	0 ... 300 seconds: default value 0 seconds smoke density and 15 seconds flow	
<b>Indication</b>	<ul style="list-style-type: none"> <li>• 4 x alarm status indicators (FDA241)</li> <li>• 3 x alarm status indicators (FDA221)</li> <li>• Faults</li> <li>• Blowing out (FDA241)</li> <li>• Dust (FDA241)</li> <li>• Smoke density and flow indicator</li> </ul>	
<b>Service area</b>	<ul style="list-style-type: none"> <li>• LED "Status OK"</li> <li>• USB</li> <li>• Settings for reset functions</li> <li>• Settings for smoke density and airflow</li> </ul>	
<b>Event log</b>	Non-volatile event memory with time and date stamp for: smoke density, airflow, detector status, and faults	
<b>Normalization of smoke value and airflow</b>	<ul style="list-style-type: none"> <li>• Setting of threshold values for smoke alarms and faults</li> <li>• User setting for normalization of smoke density and airflow</li> <li>• Preset values are retained during the normalization period</li> </ul>	
<b>Warranty period</b>	2 years	
<b>Approvals</b>		
• VdS	G213050	
• Standards	EN 50155, EN 50121-3-2, EN 61000-4-2/3/4/5/6, EN 60068-2-1/2/27/30, EN 61373, EN 45545-2	
• TUEV	Test Report TÜV Austria EN 50155 Railway applications Test Report TÜV Austria EN 50121-3-2, EN 50155 EMV Test Report AIT EN 60068-2-27, EN 61373 Shock and vibration tests Test Report TÜV Austria ÖNORM EN 60068-2-1 SIL Report & Certificate acc. EN 50126, EN 50128, EN 50129	



**Fire protection**  
for rolling stock  
Fire Safety Application Center

**Aspiration Smoke Detection for Rail**

**Selection and ordering data**

Type	Designation	Article No.	Weight kg
FDA241 (Rail)	Aspirating smoke detector	<b>S54333-F17-A1 Rail</b>	1.495
FDA221 (Rail)	Aspirating smoke detector	<b>S54333-F15-A1 Rail</b>	1.495
<b>Accessories</b>			
FDAZ292	ASD filter box	<b>S54333-C92-A1</b>	0.220
<b>Spare parts</b>			
FDAZ292-AA	ASD filter set	<b>S54333-S91-A1</b>	0.009
FDAZ291	Aspirator (FDA241/FDA221)	<b>S54333-G1-A1</b>	0.106

## Damper actuators for rail vehicles



5/2

OpenAir fits everywhere

## Damper actuators for rail vehicles

### OpenAir fits everywhere

#### Overview

##### **Certified, reliable, space-saving**

The challenge: harsh environmental and operating conditions.

Air conditioning units and air distribution systems in rail vehicle applications must ensure passenger comfort at all times. These systems are subject to special conditions: vibrations, extreme temperature fluctuations, special safety and fire protection regulations and confined spaces. To accomplish their task under these demanding conditions, they must have components that are precisely tailored to applications in rail vehicles. All components and materials must be certified in accordance with application-specific standards, must function reliably under harsh conditions and must be as compact as possible.

More information see [www.siemens.com/openair](http://www.siemens.com/openair)

##### Highlights

- All standards are met
- New extended voltage range (110 V/24 V)
- More safety due to Actuators with spring return function
- Compact design due to integrated auxiliary switches

Relevant standards for the certification of damper actuators:





- EN 50155 - Electronic equipment used on rolling stock
- EN 45545 - Fire protection on railway vehicles (interior applications)
- EN 61373 - Shock and vibration, railway applications

#### Selection and ordering data

##### **Air damper actuators with spring return**

Actuators for rail vehicles	Control signal	Operating voltage	Standard model	Feedback potentiometer	2 integrated auxiliary switches	Rotary direction switch
 <p><b>GPC series</b> 4 Nm 60 s running time 15 s SR time</p>	Modulating	DC 24 V	<b>GPC161.1A/RW</b>	--	--	No
	DC 0/2 ... 10 V	DC 110 V	<b>GPC261.1A/RW</b>	--	--	No
	2-position	DC 24 V	<b>GPC121.1A/RW</b>	--	<b>GPC126.1A/RW</b>	No
		DC 110 V	<b>GPC221.1A/RW</b>	--	<b>GPC226.1A/RW</b>	No

##### **Air damper actuators without spring return**

Actuators for rail vehicles	Control signal	Operating voltage	Standard model	Feedback potentiometer	2 integrated auxiliary switches	Rotary direction switch
 <p><b>GDD series</b> 5 Nm 30 s running time</p>	Modulating	DC 24 V	<b>GDD161.1E/RW</b>	--	--	Yes
	DC 0/2 ... 10 V	DC 110 V	<b>GDD261.1E/RW</b>	--	--	Yes
	2-position	DC 24 V	<b>GDD141.1E/RW</b>	<b>GDD142.1E/RW</b>	<b>GDD146.1E/RW</b>	Yes
	3-position	DC 110 V	<b>GDD241.1E/RW</b>	<b>GDD242.1E/RW</b>	<b>GDD246.1E/RW</b>	Yes
 <p><b>GDA series</b> 5 Nm 90 s running time</p>	Modulating	DC 24 V	<b>GDA161.1E/RW</b>	--	--	Yes
	DC 0/2 ... 10 V					
	2-position 3-position	DC 110 V	<b>GDA141.1E/RW</b>	<b>GDA142.1E/RW</b>	<b>GDA146.1E/RW</b>	Yes
 <p><b>GLD series</b> 8 Nm 30 s running time</p>	Modulating	DC 24 V	<b>GLD161.1E/RW</b>	--	--	Yes
	DC 0/2 ... 10 V	DC 110 V	<b>GLD261.1E/RW</b>	--	--	Yes
	2-position	DC 24 V	<b>GLD141.1E/RW</b>	<b>GLD142.1E/RW</b>	<b>GLD146.1E/RW</b>	Yes
	3-position	DC 110 V	<b>GLD241.1E/RW</b>	<b>GLD242.1E/RW</b>	<b>GLD246.1E/RW</b>	Yes
 <p><b>GLA series</b> 10 Nm 90 s running time</p>	Modulating DC 0/2 ... 10 V	DC 24 V	<b>GLA161.1E/RW</b>	--	--	Yes
	2-position 3-position	DC 24 V	<b>GLA141.1E/RW</b>	<b>GLA142.1E/RW</b>	<b>GLDA146.1E/RW</b>	Yes

**The solution: OpenAir damper actuators**

With OpenAir, we offer you technically perfected damper actuators that can be **used the world over** and meet all the requisite standards (EN 45545, EN 50155, EN 61373) for use in rail vehicles - certified and documented, of course. These rugged devices with a tested service life of up to 100.000 full cycles and 5.000.000 partial cycles are available with 5 and 10(8) Nm of torque and running times of 30 and 90 seconds. You benefit from loadindependent running times thanks to robust, brushless DC (BLDC) motors and an extremely low sound power level of <28 dB(A).

**Easy and safe in any area**

The halogen-free printed circuit boards completely covered with a protective coating and the extremely wide temperature operating range (from -40 to +70 °C; short-term +85 °C) ensure maximum reliability and flexibility. The housings are also extremely compact because the two auxiliary switches for indicating damper position are integrated. Installation is with a single screw and the direction of rotation to be instantly adapted thanks to a rotary direction switch. To make your work easier, the actuators come preassembled with the plug of your choice and you also choose the length of the railway-specific, halogen-free connecting cables. For safety-relevant applications, damper actuators with spring return function are now also available. These are required when air dampers have to be moved to an emergency position in the event of a power failure.

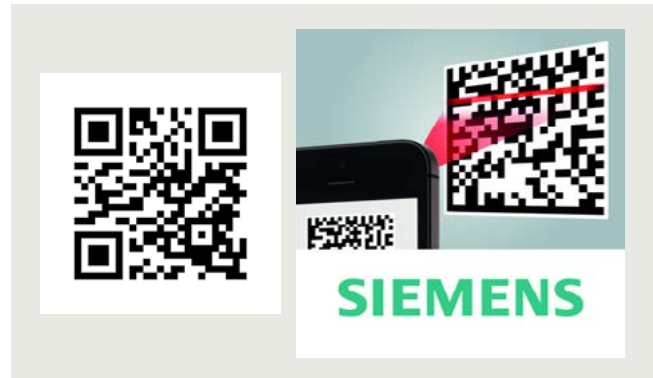
**Where's the datasheet?**

EA question that never needs asking again. With the Scan to HIT app, you can simply scan in the data matrix code on the actuators and immediately obtain access to all important product information such as datasheets and installation instructions. The app is available free of charge for iOS and Android in the corresponding stores.

## Damper actuators for rail vehicles

Note

5

## SIPLUS RAIL

**SIPLUS S7-1200 RAIL**

6/2	<a href="#">SIPLUS extreme RAIL standard CPUs</a>
6/2	<a href="#">SIPLUS S7-1200 CPU 1212C RAIL</a>
6/6	<a href="#">SIPLUS S7-1200 CPU 1214C RAIL</a>
6/10	<a href="#">SIPLUS extreme RAIL digital modules</a>
6/10	<a href="#">SIPLUS S7-1200 SM 1221 RAIL</a>
6/13	<a href="#">SIPLUS S7-1200 SM 1222 RAIL</a>
6/16	<a href="#">SIPLUS S7-1200 SM 1223 RAIL</a>
6/20	<a href="#">SIPLUS S7-1200 SB 1223 RAIL</a>
6/23	<a href="#">SIPLUS extreme RAIL analog modules</a>
6/23	<a href="#">SIPLUS extreme S7-1200 SM 1231 RTD RAIL</a>
6/26	<a href="#">SIPLUS extreme S7-1200 SM 1232 RAIL</a>
6/29	<a href="#">SIPLUS extreme S7-1200 SM 1234 RAIL</a>
6/32	<a href="#">SIPLUS extreme RAIL communication</a>
6/32	<a href="#">SIPLUS S7-1200 CM 1241 RAIL</a>
6/35	<a href="#">SIPLUS S7-1200 CB 1241 RS485 RAIL</a>
6/38	<a href="#">SIPLUS S7-1200 CM 1242-5 RAIL</a>
6/41	<a href="#">SIPLUS S7-1200 CM 1243-5 RAIL</a>
6/45	<a href="#">SIPLUS S7-1200 CP 1243-1 RAIL</a>

**SIPLUS S7-1500 RAIL**

6/51	<a href="#">SIPLUS extreme RAIL standard CPUs</a>
6/51	<a href="#">SIPLUS S7-1500 CPU 1511-1 PN RAIL</a>
6/56	<a href="#">SIPLUS S7-1500 CPU 1516-3 PN/DP RAIL</a>
6/62	<a href="#">SIPLUS extreme RAIL fail-safe CPUs</a>
6/62	<a href="#">SIPLUS S7-1500 CPU 1515F-2 PN RAIL</a>
6/67	<a href="#">SIPLUS S7-1500 CPU 1516F-3 PN/DP RAIL</a>
6/73	<a href="#">SIPLUS extreme RAIL redundant CPUs</a>
6/73	<a href="#">SIPLUS S7-1500 CPU 1515R-2 PN RAIL</a>
6/77	<a href="#">SIPLUS extreme RAIL digital modules</a>
6/77	<a href="#">SIPLUS extreme RAIL digital input modules</a>
6/81	<a href="#">SIPLUS extreme RAIL digital output modules</a>
6/85	<a href="#">SIPLUS extreme RAIL analog modules</a>
6/85	<a href="#">SIPLUS extreme RAIL analog input modules</a>
6/90	<a href="#">SIPLUS extreme RAIL analog output modules</a>
6/93	<a href="#">SIPLUS extreme RAIL technology modules</a>
6/93	<a href="#">SIPLUS extreme RAIL TM Timer DIDQ 16x24V</a>
6/97	<a href="#">SIPLUS extreme RAIL communication</a>
6/97	<a href="#">SIPLUS extreme RAIL CM PtP</a>
6/100	<a href="#">SIPLUS extreme RAIL F-digital/analog modules</a>
6/100	<a href="#">SIPLUS extreme RAIL F-digital input modules</a>
6/103	<a href="#">SIPLUS extreme RAIL F-digital output modules</a>

**SIPLUS Distributed Controller RAIL**

6/106	<a href="#">based on SIPLUS ET 200SP</a>
6/106	<a href="#">SIPLUS extreme RAIL standard CPUs</a>
6/112	<a href="#">- SIPLUS ET 200SP CPU 1510SP-1 PN RAIL</a>
6/118	<a href="#">- SIPLUS ET 200SP CPU 1512SP-1 PN RAIL</a>
6/124	<a href="#">SIPLUS extreme RAIL fail-safe CPUs</a>
6/129	<a href="#">- SIPLUS ET 200SP CPU 1510SP F-1 PN T1 RAIL</a>
6/134	<a href="#">- SIPLUS ET 200SP CPU 1512SP F-1 PN T1 RAIL</a>
6/140	<a href="#">SIPLUS extreme RAIL Open Controller</a>
6/142	<a href="#">- SIPLUS ET 200SP CPU 1515SP PC2 RAIL</a>
6/149	<a href="#">- SIPLUS ET 200SP CPU 1515SP PC2 F RAIL</a>

**SIPLUS ET 200SP RAIL**

6/155	<a href="#">SIPLUS extreme RAIL interface modules</a>
6/161	<a href="#">SIPLUS extreme RAIL I/O modules</a>
6/161	<a href="#">SIPLUS extreme RAIL digital inputs</a>
6/167	<a href="#">SIPLUS extreme RAIL digital outputs</a>
6/177	<a href="#">SIPLUS extreme RAIL analog inputs</a>
6/191	<a href="#">SIPLUS extreme RAIL analog outputs</a>
6/196	<a href="#">SIPLUS extreme RAIL technology modules</a>
6/196	<a href="#">- SIPLUS extreme RAIL TM COUNT 1X24 V T1 counter module</a>
6/201	<a href="#">- SIPLUS ET 200SP TM Pulse 2x24 V T1 RAIL pulse output module</a>
6/206	<a href="#">SIPLUS extreme RAIL communication</a>
6/206	<a href="#">- SIPLUS extreme RAIL CM PtP serial interface</a>
6/210	<a href="#">- SIPLUS extreme RAIL CM 4x IO-Link</a>
6/215	<a href="#">- SIPLUS ET 200SP CM CAN RAIL</a>
6/219	<a href="#">- SIPLUS extreme RAIL CP 1542SP-1 IRC</a>
6/224	<a href="#">- SIPLUS extreme RAIL CP 1543SP-1 ISEC</a>
6/229	<a href="#">SIPLUS extreme RAIL failsafe I/O modules</a>
6/230	<a href="#">- SIPLUS extreme RAIL digital F-Input modules</a>
6/234	<a href="#">- SIPLUS extreme RAIL digital F-output modules</a>
6/239	<a href="#">- SIPLUS extreme RAIL digital F-output module relay</a>
6/242	<a href="#">- SIPLUS extreme RAIL analog F-input modules</a>
6/247	<a href="#">- SIPLUS extreme RAIL fail-safe special modules</a>
6/251	<a href="#">SIPLUS extreme RAIL BaseUnits</a>
6/260	<a href="#">SIPLUS extreme RAIL BusAdapter</a>

**SIPLUS ET 200MP RAIL**

6/264	<a href="#">SIPLUS extreme RAIL interface modules</a>
6/264	<a href="#">SIPLUS ET 200MP IM 155-5 PN ST TX RAIL</a>

**SIPLUS extreme RAIL gateways**

6/268	<a href="#">SIPLUS NET PN/PN Coupler T1 RAIL</a>
6/273	<a href="#">SIPLUS PN/CAN LINK T1 RAIL</a>
6/277	<a href="#">SIPLUS PN/J1939 LINK TX RAIL</a>

**SIPLUS extreme RAIL operator control and monitoring devices**

6/281	<a href="#">SIPLUS extreme RAIL Basic Panels (1st Generation)</a>
6/286	<a href="#">SIPLUS HMI Comfort Panels Outdoor RAIL</a>

**SIPLUS extreme RAIL Industrial PC**

6/291	<a href="#">SIPLUS extreme RAIL Box PC</a>
6/291	<a href="#">SIPLUS IPC227E ET RAIL</a>

**SIPLUS Power supplies**

6/295	<a href="#">1-phase, 24 V DC (for S7-300 and ET200M)</a>
-------	--

**SIPLUS RAIL**

SIPLUS S7-1200 RAIL

SIPLUS extreme RAIL standard CPUs

**SIPLUS S7-1200 CPU 1212C RAIL****Overview**

- The superior compact solution
- Approved in accordance with the EN 50155, EN 15121, EN 50124, EN 50125 and EN 45545 railway standards for use in rail traffic
- With 14 integral input/outputs
- Expandable by:
  - 1 signal board (SB) or communication board (CB)
  - 2 signal modules (SM)
  - Max. 3 communications modules (CM)

**Design**

The compact CPU 1212C has:

- Integrated power supply, either as wide-range AC or DC power supply (24 V DC).
- Integrated 24 V encoder/load current supply: For direct connection of sensors and encoders. With 300 mA output current also for use as load power supply.
- 8 integrated digital inputs 24 V DC (current sinking/current sourcing (IEC type 1 current sinking)).
- 6 integrated digital outputs, 24 V DC.
- 2 integrated analog inputs 0 ... 10 V.
- 2 pulse outputs (PTO) with a frequency of up to 100 MHz.
- Pulse-width modulated outputs (PWM) with a frequency of up to 100 kHz.
- Integrated Ethernet interface (TCP/IP native, ISO-on-TCP).
- 4 fast counters (3 with max. 100 kHz; 1 with max. 30 kHz), with configurable enable and reset inputs, can be used simultaneously as up and down counters with 2 separate inputs or for connecting incremental encoders.
- Expansion by additional communication interfaces, e.g. RS485 or RS232.
- Expansion by analog or digital signals directly on the CPU via signal board (with retention of CPU mounting dimensions).
- Expansion by a wide range of analog and digital input and output signals via signal modules.
- Optional memory expansion (SIMATIC Memory Card).
- PID controller with auto-tuning functionality.
- Integral real-time clock.
- Interrupt inputs: For extremely fast response to rising or falling edges of process signals.
- Removable terminals on all modules.
- Simulator (optional): For simulating the integrated inputs and for testing the user program.

**Function**

- Comprehensive instruction set: A wide range of operations facilitates programming:
  - Basic operations such as binary logic operations, result allocation, save, count, create times, load, transfer, compare, shift, rotate, create complement, call subprogram (with local variables),
  - integral communication commands (e.g. USS protocol, Modbus RTU, S7 communication "T-Send/T-Receive" or Freeport),
  - user-friendly functions such as pulse-width modulation, pulse sequence function, arithmetic functions, floating point arithmetic, PID closed-loop control, jump functions, loop functions and code conversions,
  - mathematical functions, e.g. SIN, COS, TAN, LN, EXP.
- Counting: User-friendly counting functions in conjunction with integrated counters and special commands for high-speed counters open up new application areas for the user.
- Interrupt processing:
  - Edge-triggered interrupts (activated by rising or falling edges of process signals on interrupt inputs) support a rapid response to process events.
  - Time-triggered interrupts.
  - Counter interrupts can be triggered when a setpoint is reached or when the direction of counting changes.
  - Communication interrupts allow the rapid and easy exchange of information with peripheral devices such as printers or bar code readers.
- Password protection
- Test and diagnostics functions: Easy-to-use functions support testing and diagnostics, e.g. online/offline diagnostics.
- "Forcing" of inputs and outputs during testing and diagnostics: Inputs and outputs can be set independently of the cycle and thus permanently, for example, to test the user program.
- Motion Control in accordance with PLCopen for simple control of movement
- Library functionality

**Programming**

The STEP 7 Basic programming package permits complete programming of all S7-1200 controllers and the associated I/O.

## Technical specifications

Article number	<b>6AG2212-1AE40-1XB0</b> SIPLUS S7-1200 CPU 1212C DC/DC/DC RAIL
<b>General information</b>	
<b>Product type designation</b>	CPU 1212C DC/DC/DC
<b>Engineering with</b> • STEP 7 TIA Portal configurable/integrated from version	see entry ID: 109746275
<b>Supply voltage</b>	
<b>Rated value (DC)</b> • 24 V DC	Yes
<b>Encoder supply</b>	
<b>24 V encoder supply</b> • 24 V	Permissible range: 20.4V to 28.8V
<b>Memory</b>	
<b>Work memory</b> • integrated	50 kbyte
<b>Load memory</b> • integrated • Plug-in (SIMATIC Memory Card), max.	1 Mbyte 2 Gbyte; with SIMATIC memory card
<b>Backup</b> • without battery	Yes
<b>CPU processing times</b>	
<b>for bit operations, typ.</b>	0.085 µs; / Operation
<b>for word operations, typ.</b>	1.7 µs; / Operation
<b>for floating point arithmetic, typ.</b>	2.3 µs; / Operation
<b>Data areas and their retentivity</b>	
<b>Flag</b> • Size, max.	4 kbyte; Size of bit memory address area
<b>Address area</b>	
<b>I/O address area</b> • Inputs • Outputs	1 024 byte 1 024 byte
<b>Process image</b> • Inputs, adjustable • Outputs, adjustable	1 kbyte 1 kbyte
<b>Time of day</b>	
<b>Clock</b> • Hardware clock (real-time)	Yes
<b>Digital inputs</b>	
<b>Number of digital inputs</b> • of which inputs usable for technological functions	8; Integrated 6; HSC (High Speed Counting)
<b>Digital outputs</b>	
<b>Number of digital outputs</b> • of which high-speed outputs	6 4; 100 kHz Pulse Train Output
<b>Analog inputs</b>	
<b>Number of analog inputs</b>	2
<b>Input ranges</b> • Voltage	Yes
<b>Analog outputs</b>	
<b>Number of analog outputs</b>	0
<b>1. Interface</b>	
<b>Interface type</b>	PROFINET
<b>Protocols</b> • PROFINET IO Controller • PROFINET IO Device • Open IE communication • Web server	Yes Yes Yes Yes
<b>Protocols</b>	
<b>Open IE communication</b> • TCP/IP • ISO-on-TCP (RFC1006) • UDP	Yes Yes Yes
<b>Web server</b> • supported	Yes
<b>communication functions / header</b>	
<b>S7 communication</b> • supported	Yes
<b>Number of connections</b> • overall	16; dynamically



# SIPLUS RAIL

## SIPLUS S7-1200 RAIL

### SIPLUS extreme RAIL standard CPUs

#### SIPLUS S7-1200 CPU 1212C RAIL

Article number	<b>6AG2212-1AE40-1XB0</b> SIPLUS S7-1200 CPU 1212C DC/DC/DC RAIL
<b>Integrated Functions</b>	
<b>Counter</b>	4
• Number of counters	100 kHz
• Counting frequency, max.	
<b>Frequency measurement</b>	Yes
<b>Controlled positioning</b>	Yes
<b>Number of position-controlled positioning axes, max.</b>	8
<b>Number of positioning axes via pulse-direction interface</b>	4; With integrated DO
<b>PID controller</b>	Yes
<b>Number of alarm inputs</b>	4
<b>Number of pulse outputs</b>	4
<b>Limit frequency (pulse)</b>	100 kHz
<b>Standards, approvals, certificates</b>	
<b>Railway application</b>	Yes; EMC for rail vehicles Yes; EMC for signal and telecommunications systems Yes; Railway applications - overvoltage category OV2; pollution degree PD2; rated surge voltage UNi = 0.5 kV; UNm = 24 V DC Yes; Rail vehicles - see ambient conditions Yes; Stationary electrical equipment - see ambient conditions Yes; Signal and telecommunications systems - see ambient conditions; vibrations and shocks: Application point outside of tracks (1 m to 3 m away from track) Yes; Rail vehicles - temperature class OT1, ST1/ST2, horizontal mounting position Yes; Rail vehicles - vibrations and shocks: Category 1 Class A/B Yes; For proof of conformity, see Service & Support
• EN 50121-3-2	
• EN 50121-4	
• EN 50124-1	
• EN 50125-1	
• EN 50125-2	
• EN 50125-3	
• EN 50155	
• EN 61373	
• Fire protection acc. to EN 45545-2	
<b>Ambient conditions</b>	
<b>Altitude during operation relating to sea level</b>	2 000 m
• Installation altitude above sea level, max.	Tmin ... Tmax at 1 140 hPa ... 795 hPa (-1 000 m ... +2 000 m)
• Ambient air temperature-barometric pressure-altitude	
<b>Relative humidity</b>	100 %; RH incl. condensation / frost (no commissioning in bedewed state), horizontal installation
• With condensation, tested in accordance with IEC 60068-2-38, max.	
<b>Resistance</b>	
• Coolants and lubricants	Yes; Incl. diesel and oil droplets in the air
- Resistant to commercially available coolants and lubricants	
<b>Use in stationary industrial systems</b>	
• to biologically active substances according to EN 60721-3-3	Yes; Class 3B2 mold, fungus and dry rot spores (with the exception of fauna); Class 3B3 on request
• to chemically active substances according to EN 60721-3-3	Yes; Class 3C4 (RH < 75 %) incl. salt spray acc. to EN 60068-2-52 (severity degree 3); *
• to mechanically active substances according to EN 60721-3-3	Yes; Class 3S4 incl. sand, dust, *
<b>Use on land craft, rail vehicles and special-purpose vehicles</b>	
• to biologically active substances according to EN 60721-3-5	Yes; Class 5B2 mold, fungus and dry rot spores (with the exception of fauna); Class 5B3 on request
• to chemically active substances according to EN 60721-3-5	Yes; Class 5C3 (RH < 75 %) incl. salt spray acc. to EN 60068-2-52 (severity degree 3); *
• to mechanically active substances according to EN 60721-3-5	Yes; Class 5S3 incl. sand, dust; *
<b>Usage in industrial process technology</b>	
• Against chemically active substances acc. to EN 60654-4	Yes; Class 3 (excluding trichlorethylene)
• Environmental conditions for process, measuring and control systems acc. to ANSI/ISA-71.04	Yes; Level GX group A/B (excluding trichlorethylene; harmful gas concentrations up to the limits of EN 60721-3-3 class 3C4 permissible); level LC3 (salt spray) and level LB3 (oil)
<b>Remark</b>	
• Note regarding classification of environmental conditions acc. to EN 60721, EN 60654-4 and ANSI/ISA-71.04	* The supplied plug covers must remain in place over the unused interfaces during operation!
<b>Conformal coating</b>	
• Coatings for printed circuit board assemblies acc. to EN 61086	Yes; Class 2 for high reliability
• Protection against fouling acc. to EN 60664-3	Yes; Type 1 protection
• Electronic equipment on rolling stock acc. to EN 50155	Yes; Class PC2 protective coating acc. to EN 50155:2017
• Military testing according to MIL-I-46058C, Amendment 7	Yes; Discoloration of coating possible during service life
• Qualification and Performance of Electrical Insulating Compound for Printed Board Assemblies according to IPC-CC-830A	Yes; Conformal coating, Class A
<b>Configuration / header</b>	
<b>Configuration / programming / header</b>	
<b>Programming language</b>	
• LAD	Yes
• FBD	Yes
• SCL	Yes

**SIPLUS S7-1200 CPU 1212C RAIL**

Article number	<b>6AG2212-1AE40-1XB0</b> SIPLUS S7-1200 CPU 1212C DC/DC/DC RAIL
<b>Dimensions</b>	
<b>Width</b>	90 mm
<b>Height</b>	100 mm
<b>Depth</b>	75 mm
<b>Weights</b>	
<b>Weight, approx.</b>	370 g
<b>Other</b>	
<b>Note:</b>	for use in railway applications, also observe the product information "SIPLUS extreme RAIL" A5E37661960A, Online Support article 109736776

**Selection and ordering data**

Version	Article No.
<p><b>SIPLUS S7-1200 CPU 1212C RAIL</b>            Approved in accordance with the EN 50155, EN 15121, EN 50124, EN 50125 and EN 45545 railway standards for use in rail traffic            Integrated program/data memory 75 KB, load memory 1 MB;            Supply voltage 24 V DC;            Boolean execution times 0.1 µs per operation;            8 digital inputs, 6 digital outputs, 2 analog inputs;            Expandable by up to 3 communications modules, 2 signal modules, and 1 signal board/communication board;            Digital inputs can be used as HSC at 100 kHz, 24 V DC digital outputs can be used as pulse outputs (PTO) or pulse-width modulated outputs (PWM) at 100 kHz</p> <ul style="list-style-type: none"> <li>For areas with extreme exposure to environmental substances (conformal coating); ambient temperature -25 ... +70 °C</li> </ul>	<b>6AG2212-1AE40-1XB0</b>

**SIPLUS RAIL**

SIPLUS S7-1200 RAIL

SIPLUS extreme RAIL standard CPUs

**SIPLUS S7-1200 CPU 1214C RAIL****Overview**

- The compact high-performance CPU
- Approved in accordance with the EN 50155, EN 15121, EN 50124, EN 50125 and EN 45545 railway standards for use in rail traffic
- With 24 integrated I/Os
- Expandable by:
  - 1 signal board (SB) or communication board (CB)
  - 8 signal modules (SM)
  - Max. 3 communications modules (CM)

**Design**

The compact CPU 1214C has:

- Integrated power supply, either as wide-range AC or DC power supply (24 V DC).
- Integrated 24 V encoder/load current supply: For direct connection of sensors and encoders. With a 400 mA output current, it can also be used as load power supply.
- 14 integrated digital inputs 24 V DC (current sinking/current sourcing (IEC type 1 current sinking)).
- 10 integrated digital outputs, 24 V DC.
- 2 integrated analog inputs 0 ... 10 V.
- 2 pulse outputs (PTO) with a frequency of up to 100 MHz.
- Pulse-width modulated outputs (PWM) with a frequency of up to 100 kHz.
- Integrated Ethernet interface (TCP/IP native, ISO-on-TCP).
- 6 high-speed counters (3 with max. 100 kHz; 3 with max. 30 kHz), with configurable enable and reset inputs, can be used simultaneously as up and down counters with 2 separate inputs or for connecting incremental encoders.
- Expansion by additional communication interfaces, e.g. RS485 or RS232.
- Expansion by analog or digital signals directly on the CPU via signal board (with retention of CPU mounting dimensions).
- Expansion by a wide range of analog and digital input and output signals via signal modules.
- Optional memory expansion (SIMATIC Memory Card).
- PID controller with auto-tuning functionality.
- Integral real-time clock.
- Interrupt inputs: For extremely fast response to rising or falling edges of process signals.
- Removable terminals on all modules.
- Simulator (optional): For simulating the integrated inputs and for testing the user program.

**Function**

- Comprehensive instruction set: A wide range of operations facilitates programming:
  - Basic operations such as binary logic operations, result allocation, save, count, create times, load, transfer, compare, shift, rotate, create complement, call subprogram (with local variables),
  - Integral communication commands (e.g. USS protocol, Modbus RTU, S7 communication "T-Send/T-Receive" or Freeport),
  - user-friendly functions such as pulse-width modulation, pulse sequence function, arithmetic functions, floating point arithmetic, PID closed-loop control, jump functions, loop functions and code conversions,
  - mathematical functions, e.g. SIN, COS, TAN, LN, EXP.
- Counting: User-friendly counting functions in conjunction with integrated counters and special commands for high-speed counters open up new application areas for the user.
- Interrupt processing:
  - Edge-triggered interrupts (activated by rising or falling edges of process signals on interrupt inputs) support a rapid response to process events.
  - Time-triggered interrupts.
  - Counter interrupts can be triggered when a setpoint is reached or when the direction of counting changes.
  - Communication interrupts allow the rapid and easy exchange of information with peripheral devices such as printers or bar code readers.
- Password protection
- Test and diagnostics functions: Easy-to-use functions support testing and diagnostics, e.g. online/offline diagnostics.
- "Forcing" of inputs and outputs during testing and diagnostics: Inputs and outputs can be set independently of the cycle and thus permanently, for example, to test the user program.
- Motion Control in accordance with PLCopen for simple control of movement.
- Library functionality

**Programming**

The STEP 7 Basic programming package permits complete programming of all S7-1200 controllers and the associated I/O.

**Technical specifications**

Article number	<b>6AG2214-1AG40-1XB0</b> SIPLUS S7-1200 CPU 1214C DC/DC/DC RAIL
<b>General information</b>	
<b>Product type designation</b>	CPU 1214C DC/DC/DC
<b>Engineering with</b> • STEP 7 TIA Portal configurable/integrated from version	see entry ID: 109746275
<b>Supply voltage</b>	
<b>Rated value (DC)</b> • 24 V DC	Yes
<b>Encoder supply</b>	
<b>24 V encoder supply</b> • 24 V	L+ minus 4 V DC min.
<b>Memory</b>	
<b>Work memory</b> • integrated	100 kbyte
<b>Load memory</b> • integrated • Plug-in (SIMATIC Memory Card), max.	4 Mbyte with SIMATIC memory card
<b>Backup</b> • without battery	Yes
<b>CPU processing times</b>	
<b>for bit operations, typ.</b>	0.085 µs; / instruction
<b>for word operations, typ.</b>	1.7 µs; / instruction
<b>for floating point arithmetic, typ.</b>	2.3 µs; / instruction
<b>Data areas and their retentivity</b>	
<b>Flag</b> • Size, max.	8 kbyte; Size of bit memory address area
<b>Address area</b>	
<b>Process image</b> • Inputs, adjustable • Outputs, adjustable	1 kbyte 1 kbyte
<b>Time of day</b>	
<b>Clock</b> • Hardware clock (real-time)	Yes
<b>Digital inputs</b>	
<b>Number of digital inputs</b> • of which inputs usable for technological functions	14; Integrated 6; HSC (High Speed Counting)
<b>Digital outputs</b>	
<b>Number of digital outputs</b> • of which high-speed outputs	10 4; 100 kHz Pulse Train Output
<b>Analog inputs</b>	
<b>Number of analog inputs</b>	2
<b>Input ranges</b> • Voltage	Yes
<b>Analog outputs</b>	
<b>Number of analog outputs</b>	0
<b>1. Interface</b>	
<b>Interface type</b>	PROFINET
<b>Protocols</b> • PROFINET IO Controller • PROFINET IO Device • Open IE communication • Web server	Yes Yes Yes Yes
<b>Protocols</b>	
<b>Open IE communication</b> • TCP/IP • ISO-on-TCP (RFC1006) • UDP	Yes Yes Yes
<b>Web server</b> • supported	Yes
<b>communication functions / header</b>	
<b>S7 communication</b> • supported	Yes
<b>Number of connections</b> • overall	16; dynamically
<b>Integrated Functions</b>	
<b>Counter</b> • Number of counters • Counting frequency, max.	6 100 kHz

# SIPLUS RAIL

## SIPLUS S7-1200 RAIL

### SIPLUS extreme RAIL standard CPUs

#### SIPLUS S7-1200 CPU 1214C RAIL

Article number	<b>6AG2214-1AG40-1XB0</b> SIPLUS S7-1200 CPU 1214C DC/DC/DC RAIL
<b>Frequency measurement</b>	Yes
<b>controlled positioning</b>	Yes
<b>Number of position-controlled positioning axes, max.</b>	8
<b>Number of positioning axes via pulse-direction interface</b>	4; With integrated DO
<b>PID controller</b>	Yes
<b>Number of alarm inputs</b>	4
<b>Number of pulse outputs</b>	4
<b>Limit frequency (pulse)</b>	100 kHz
<b>Standards, approvals, certificates</b>	
<b>Railway application</b> <ul style="list-style-type: none"> <li>EN 50121-3-2</li> <li>EN 50121-4</li> <li>EN 50124-1</li> <li>EN 50125-1</li> <li>EN 50125-2</li> <li>EN 50125-3</li> <li>EN 50155</li> <li>EN 61373</li> <li>Fire protection acc. to EN 45545-2</li> </ul>	Yes; EMC for rail vehicles Yes; EMC for signal and telecommunications systems Yes; Railway applications - overvoltage category OV2; pollution degree PD2; rated surge voltage UNi = 0.5 kV; UNm = 24 V DC Yes; Rail vehicles - see ambient conditions Yes; Stationary electrical equipment - see ambient conditions Yes; Signal and telecommunications systems - see ambient conditions; vibrations and shocks: Application point outside of tracks (1 m to 3 m away from track) Yes; Rail vehicles - temperature class OT1, ST1/ST2, horizontal mounting position Yes; Rail vehicles - vibrations and shocks: Category 1 Class A/B Yes; For proof of conformity, see Service & Support
<b>Ambient conditions</b>	
<b>Altitude during operation relating to sea level</b> <ul style="list-style-type: none"> <li>Installation altitude above sea level, max.</li> <li>Ambient air temperature-barometric pressure-altitude</li> </ul>	2 000 m Tmin ... Tmax at 1 140 hPa ... 795 hPa (-1 000 m ... +2 000 m)
<b>Relative humidity</b> <ul style="list-style-type: none"> <li>With condensation, tested in accordance with IEC 60068-2-38, max.</li> </ul>	100 %; RH incl. condensation / frost (no commissioning in bedewed state), horizontal installation
<b>Resistance</b>	
<b>Coolants and lubricants</b> <ul style="list-style-type: none"> <li>Resistant to commercially available coolants and lubricants</li> </ul>	Yes; Incl. diesel and oil droplets in the air
<b>Use in stationary industrial systems</b> <ul style="list-style-type: none"> <li>to biologically active substances according to EN 60721-3-3</li> <li>to chemically active substances according to EN 60721-3-3</li> <li>to mechanically active substances according to EN 60721-3-3</li> </ul>	Yes; Class 3B2 mold, fungus and dry rot spores (with the exception of fauna); Class 3B3 on request Yes; Class 3C4 (RH < 75 %) incl. salt spray acc. to EN 60068-2-52 (severity degree 3); * Yes; Class 3S4 incl. sand, dust, *
<b>Use on land craft, rail vehicles and special-purpose vehicles</b> <ul style="list-style-type: none"> <li>to biologically active substances according to EN 60721-3-5</li> <li>to chemically active substances according to EN 60721-3-5</li> <li>to mechanically active substances according to EN 60721-3-5</li> </ul>	Yes; Class 5B2 mold, fungus and dry rot spores (with the exception of fauna); Class 5B3 on request Yes; Class 5C3 (RH < 75 %) incl. salt spray acc. to EN 60068-2-52 (severity degree 3); * Yes; Class 5S3 incl. sand, dust; *
<b>Usage in industrial process technology</b> <ul style="list-style-type: none"> <li>Against chemically active substances acc. to EN 60654-4</li> <li>Environmental conditions for process, measuring and control systems acc. to ANSI/ISA-71.04</li> </ul>	Yes; Class 3 (excluding trichlorethylene) Yes; Level GX group A/B (excluding trichlorethylene; harmful gas concentrations up to the limits of EN 60721-3-3 class 3C4 permissible); level LC3 (salt spray) and level LB3 (oil)
<b>Remark</b> <ul style="list-style-type: none"> <li>Note regarding classification of environmental conditions acc. to EN 60721, EN 60654-4 and ANSI/ISA-71.04</li> </ul>	* The supplied plug covers must remain in place over the unused interfaces during operation!
<b>Conformal coating</b> <ul style="list-style-type: none"> <li>Coatings for printed circuit board assemblies acc. to EN 61086</li> <li>Protection against fouling acc. to EN 60664-3</li> <li>Electronic equipment on rolling stock acc. to EN 50155</li> <li>Military testing according to MIL-I-46058C, Amendment 7</li> <li>Qualification and Performance of Electrical Insulating Compound for Printed Board Assemblies according to IPC-CC-830A</li> </ul>	Yes; Class 2 for high reliability Yes; Type 1 protection Yes; Class PC2 protective coating acc. to EN 50155:2017 Yes; Discoloration of coating possible during service life Yes; Conformal coating, Class A
<b>Configuration / header</b>	
<b>Configuration / programming / header</b> <ul style="list-style-type: none"> <li>Programming language</li> <li>LAD</li> <li>FBD</li> <li>SCL</li> </ul>	Yes Yes Yes
<b>Dimensions</b>	
<b>Width</b>	110 mm
<b>Height</b>	100 mm
<b>Depth</b>	75 mm
<b>Weights</b>	
<b>Weight, approx.</b>	415 g
<b>Other</b>	
<b>Note:</b>	for use in railway applications, also observe the product information "SIPLUS extreme RAIL" A5E37661960A, Online Support article 109736776

**Selection and ordering data**

Version	Article No.
<p><b>SIPLUS S7-1200 CPU 1214C RAIL</b></p> <p>Approved in accordance with the EN 50155, EN 15121, EN 50124, EN 50125 and EN 45545 railway standards for use in rail traffic</p> <p>Integrated program/data memory 100 KB, load memory 2 MB;            Supply voltage 24 V DC;            Boolean execution times 0.1 µs per operation;            14 digital inputs, 10 digital outputs, 2 analog inputs;            Expandable by up to 3 communications modules, 8 signal modules, and 1 signal board/communication board;            Digital inputs can be used as HSC at 100 kHz, 24 V DC digital outputs can be used as pulse outputs (PTO) or pulse-width modulated outputs (PWM) at 100 kHz</p> <ul style="list-style-type: none"> <li>For areas with extreme exposure to environmental substances (conformal coating); ambient temperature -25 ... +70 °C</li> </ul>	<p><b>6AG2214-1AG40-1XB0</b></p>

**SIPLUS RAIL**

SIPLUS S7-1200 RAIL

SIPLUS extreme RAIL digital modules

**SIPLUS S7-1200 SM 1221 RAIL****Overview**

- Digital inputs as supplement to the integral I/O of the CPUs
- Approved in accordance with the railway standards EN 50155, EN 15121, EN 50124, EN 50125 and EN 45545 for use in rail traffic
- For flexible adaptation of the controller to the corresponding task
- For subsequent expansion of the system with additional inputs

**Application**

Digital input modules allow the connection of the controller to digital signals of the process.

This provides users with the following advantages:

- Optimum adaptation: with signal modules which can be mixed as desired, users can adapt their controllers exactly to the relevant task. This avoids superfluous investments.
- Flexibility: if the task is expanded subsequently, the controller can be upgraded. Updating of the user program is extremely simple.

**Function**

The SM 1221 digital input signal modules convert the level of the external digital signals from the process into the internal signal level of the S7-1200.

6

**Technical specifications**

Article number	<b>6AG2221-1BF32-1XB0</b> SIPLUS S7-1200 SM 1221 8DI RAIL
<b>General information</b>	
Product type designation	SM 1221, DI 8x24 V DC
<b>Supply voltage</b>	
Rated value (DC)	24 V
<b>Input current</b>	
from backplane bus 5 V DC, max.	105 mA
<b>Digital inputs</b>	
• from load voltage L+ (without load), max.	4 mA; per channel
<b>Output voltage / header</b>	
supply voltage of the transmitters / header	Yes
<b>Digital inputs</b>	
Number of digital inputs	8
• in groups of	2
Input characteristic curve in accordance with IEC 61131, type 1	Yes
<b>Number of simultaneously controllable inputs</b>	
• all mounting positions	8
- up to 40 °C, max.	8
• horizontal installation	8
- up to 40 °C, max.	8
- up to 50 °C, max.	8
• vertical installation	8
- up to 40 °C, max.	8
<b>Input voltage</b>	
• Rated value (DC)	24 V
• for signal "0"	5 V DC at 1 mA
• for signal "1"	15 V DC at 2.5 mA
<b>Input current</b>	
• for signal "0", max. (permissible quiescent current)	1 mA
• for signal "1", min.	2.5 mA
• for signal "1", typ.	4 mA
<b>Input delay (for rated value of input voltage)</b>	
• for standard inputs	Yes; 0.2 ms, 0.4 ms, 0.8 ms, 1.6 ms, 3.2 ms, 6.4 ms and 12.8 ms, selectable in groups of four
- parameterizable	
• for interrupt inputs	Yes
- parameterizable	

Article number	<b>6AG2221-1BF32-1XB0</b> SIPLUS S7-1200 SM 1221 8DI RAIL
<b>Interrupts/diagnostics/status information</b>	
<b>Diagnostics function</b>	Yes
<b>Alarms</b>	
• Diagnostic alarm	Yes
<b>Diagnoses</b>	
• Monitoring the supply voltage	Yes
<b>Diagnostics indication LED</b>	
• for status of the inputs	Yes
• for maintenance	Yes
<b>Potential separation</b>	
<b>Potential separation digital inputs</b>	
• between the channels, in groups of	2
<b>Degree and class of protection</b>	
<b>IP degree of protection</b>	IP20
<b>Standards, approvals, certificates</b>	
<b>Railway application</b>	
• EN 50121-3-2	Yes; EMC for rail vehicles
• EN 50121-4	Yes; EMC for signal and telecommunications systems
• EN 50124-1	Yes; Railway applications - overvoltage category OV2; pollution degree PD2; rated surge voltage UNi = 0.5 kV; UNm = 24 V DC
• EN 50125-1	Yes; Rail vehicles - see ambient conditions
• EN 50125-2	Yes; Stationary electrical equipment - see ambient conditions
• EN 50125-3	Yes; Signal and telecommunications systems - see ambient conditions; vibrations and shocks: Application point outside of tracks (1 m to 3 m away from track)
• EN 50155	Yes; Rail vehicles - temperature class OT1, ST1/ST2, horizontal mounting position
• EN 61373	Yes; Rail vehicles - vibrations and shocks: Category 1 Class A/B
• Fire protection acc. to EN 45545-2	Yes; For proof of conformity, see Service & Support
<b>Ambient conditions</b>	
<b>Ambient temperature during operation</b>	
• min.	-25 °C; = Tmin (incl. condensation/frost)
• max.	60 °C; = Tmax; +70 °C for 10 min (OT1, ST1/ST2 acc. to EN 50155)
<b>Altitude during operation relating to sea level</b>	
• Installation altitude above sea level, max.	2 000 m
• Ambient air temperature-barometric pressure-altitude	Tmin ... Tmax at 1 140 hPa ... 795 hPa (-1 000 m ... +2 000 m)
<b>Relative humidity</b>	
• With condensation, tested in accordance with IEC 60068-2-38, max.	100 %; RH incl. condensation / frost (no commissioning in bedewed state), horizontal installation
<b>Resistance</b>	
<b>Coolants and lubricants</b>	
• Resistant to commercially available coolants and lubricants	Yes; Incl. diesel and oil droplets in the air
<b>Use in stationary industrial systems</b>	
• to biologically active substances according to EN 60721-3-3	Yes; Class 3B2 mold, fungus and dry rot spores (with the exception of fauna); Class 3B3 on request
• to chemically active substances according to EN 60721-3-3	Yes; Class 3C4 (RH < 75 %) incl. salt spray acc. to EN 60068-2-52 (severity degree 3); *
• to mechanically active substances according to EN 60721-3-3	Yes; Class 3S4 incl. sand, dust; *
<b>Use on land craft, rail vehicles and special-purpose vehicles</b>	
• to biologically active substances according to EN 60721-3-5	Yes; Class 5B2 mold, fungus and dry rot spores (with the exception of fauna); Class 5B3 on request
• to chemically active substances according to EN 60721-3-5	Yes; Class 5C3 (RH < 75 %) incl. salt spray acc. to EN 60068-2-52 (severity degree 3); *
• to mechanically active substances according to EN 60721-3-5	Yes; Class 5S3 incl. sand, dust; *
<b>Usage in industrial process technology</b>	
• Against chemically active substances acc. to EN 60654-4	Yes; Class 3 (excluding trichlorethylene)
• Environmental conditions for process, measuring and control systems acc. to ANSI/ISA-71.04	Yes; Level GX group A/B (excluding trichlorethylene; harmful gas concentrations up to the limits of EN 60721-3-3 class 3C4 permissible); level LC3 (salt spray) and level LB3 (oil)
<b>Remark</b>	
• Note regarding classification of environmental conditions acc. to EN 60721, EN 60654-4 and ANSI/ISA-71.04	* The supplied plug covers must remain in place over the unused interfaces during operation!
<b>Conformal coating</b>	
• Coatings for printed circuit board assemblies acc. to EN 61086	Yes; Class 2 for high reliability
• Protection against fouling acc. to EN 60664-3	Yes; Type 1 protection
• Electronic equipment on rolling stock acc. to EN 50155	Yes; Class PC2 protective coating acc. to EN 50155:2017
• Military testing according to MIL-I-46058C, Amendment 7	Yes; Discoloration of coating possible during service life
• Qualification and Performance of Electrical Insulating Compound for Printed Board Assemblies according to IPC-CC-830A	Yes; Conformal coating, Class A
<b>Connection method / header</b>	
<b>Required front connector</b>	Yes



## SIPLUS RAIL

### SIPLUS S7-1200 RAIL

### SIPLUS extreme RAIL digital modules

#### SIPLUS S7-1200 SM 1221 RAIL

Article number	<b>6AG2221-1BF32-1XB0</b> SIPLUS S7-1200 SM 1221 8DI RAIL
<b>Mechanics/material</b>	
<b>Enclosure material (front)</b> • Plastic	Yes
<b>Dimensions</b>	
<b>Width</b>	45 mm
<b>Height</b>	100 mm
<b>Depth</b>	75 mm
<b>Weights</b>	
<b>Weight, approx.</b>	170 g
<b>Other</b>	
<b>Note:</b>	for use in railway applications, also observe the product information "SIPLUS extreme RAIL" A5E37661960A, Online Support article 109736776

#### Selection and ordering data

Version	Article No.
<b>SIPLUS SM 1221 RAIL digital input module</b> Approved in accordance with the EN 50155, EN 15121, EN 50124, EN 50125 and EN 45545 railway standards for use in rail traffic 8 inputs, 24 V DC, isolated, current sourcing/sinking • For areas with extreme exposure to environmental substances (conformal coating); ambient temperature -25 ... +70 °C	<b>6AG2221-1BF32-1XB0</b>

**Overview**

- Digital outputs as a supplement to the integral I/O of the CPUs
- Approved in accordance with the railway standards EN 50155, EN 15121, EN 50124, EN 50125 and EN 45545 for use in rail traffic
- For flexible adaptation of the controller to the corresponding task
- For subsequent expansion of the system with additional outputs

**Application**

Digital output modules permit the output of digital signals from the controller to the process.

This provides users with the following advantages:

- Optimum adaptation:  
with signal modules which can be mixed as desired, users can adapt their controllers exactly to the relevant task. This avoids superfluous investments.
- Flexibility:  
if the task is expanded subsequently, the controller can be upgraded. Updating of the user program is extremely simple.

**Function**

The SM 1222 digital output signal modules convert the internal signal level of the SIMATIC S7-1200 into the external signal level required by the process.

**Technical specifications**

Article number	<b>6AG2222-1BF32-1XB0</b> SIPLUS S7-1200 SM 1222 8DQ RAIL	<b>6AG2222-1HF32-1XB0</b> SIPLUS S7-1200 SM 1222 8DQ RLY RAIL
<b>General information</b>		
<b>Product type designation</b>	SM 1222, DQ 8x24 V DC/0.5 A	SM 1222, DQ 8x relay/2 A
<b>Input current</b>		
<b>From backplane bus 5 V DC, max.</b>	120 mA	120 mA
<b>Digital outputs</b> • from load voltage L+, max.		11 mA/relay coil
<b>Digital outputs</b>		
<b>Number of digital outputs</b> • in groups of	8 1	8 2
<b>Short-circuit protection</b>	No; to be provided externally	No; to be provided externally
<b>Limitation of inductive shutdown voltage to</b>	typ. (L+) -48 V	
<b>Switching capacity of the outputs</b> • with resistive load, max. • on lamp load, max.	0.5 A 5 W	2 A 30 W with DC, 200 W with AC
<b>Output voltage</b> • Rated value (DC) • Rated value (AC) • for signal "0", max. • for signal "1", min.	24 V  0.1 V; with 10 kOhm load 20 V DC	5 V DC to 30 V DC 5 V AC to 250 V AC
<b>Output current</b> • for signal "1" rated value • for signal "0" residual current, max.	0.5 A 10 µA	2 A
<b>Output delay with resistive load</b> • "0" to "1", max. • "1" to "0", max.	50 µs 200 µs	10 ms 10 ms
<b>Total current of the outputs (per group)</b> • horizontal installation - up to 50 °C, max.	4 A; Current per mass	10 A; Current per mass
<b>Relay outputs</b> • Number of relay outputs • Rated supply voltage of relay coil L+ (DC) • Number of operating cycles, max.		8 24 V mechanically 10 million, at rated load voltage 100 000
<b>Switching capacity of contacts</b> • with inductive load, max. • on lamp load, max. • with resistive load, max.	0.5 A 5 W 0.5 A	2 A 30 W with DC, 200 W with AC 2 A

# SIPLUS RAIL

## SIPLUS S7-1200 RAIL

### SIPLUS extreme RAIL digital modules

#### SIPLUS S7-1200 SM 1222 RAIL

Article number	6AG2222-1BF32-1XB0 SIPLUS S7-1200 SM 1222 8DQ RAIL	6AG2222-1HF32-1XB0 SIPLUS S7-1200 SM 1222 8DQ RLY RAIL
<b>Interrupts/diagnostics/status information</b>		
<b>Diagnostics function</b>	Yes	
<b>Alarms</b> • Diagnostic alarm	Yes	Yes
<b>Diagnoses</b> • Monitoring the supply voltage	Yes	
<b>Diagnostics indication LED</b> • for status of the outputs • for maintenance	Yes Yes	Yes
<b>Potential separation</b>		
<b>Potential separation digital outputs</b> • between the channels • between the channels, in groups of • between the channels and backplane bus	1 500 V AC	Relays 2 1 500 V AC for 1 minute
<b>Degree and class of protection</b>		
<b>IP degree of protection</b>	IP20	IP20
<b>Standards, approvals, certificates</b>		
<b>Railway application</b> • EN 50121-3-2 • EN 50121-4 • EN 50124-1  • EN 50125-1 • EN 50125-2  • EN 50125-3  • EN 50155  • EN 61373  • Fire protection acc. to EN 45545-2	Yes; EMC for rail vehicles Yes; EMC for signal and telecommunications systems Yes; Railway applications - overvoltage category OV2; pollution degree PD2; rated surge voltage UNi = 0.5 kV; UNm = 24 V DC Yes; Rail vehicles - see ambient conditions Yes; Stationary electrical equipment - see ambient conditions Yes; Signal and telecommunications systems - see ambient conditions; vibrations and shocks: Application point outside of tracks (1 m to 3 m away from track) Yes; Rail vehicles - temperature class OT1, ST1/ST2, horizontal mounting position Yes; Rail vehicles - vibrations and shocks: Category 1 Class A/B Yes; For proof of conformity, see Service & Support	Yes; EMC for rail vehicles Yes; EMC for signal and telecommunications systems Yes; Railway applications - overvoltage category OV2; pollution degree PD2; rated surge voltage UNi = 0.5 kV; UNm = 24 V DC Yes; Rail vehicles - see ambient conditions Yes; Stationary electrical equipment - see ambient conditions Yes; Signal and telecommunications systems - see ambient conditions; vibrations and shocks: Application point outside of tracks (1 m to 3 m away from track) Yes; Rail vehicles - temperature class OT1, ST1/ST2, horizontal mounting position Yes; Rail vehicles - vibrations and shocks: Category 1 Class A/B Yes; For proof of conformity, see Service & Support
<b>Ambient conditions</b>		
<b>Ambient temperature during operation</b> • min. • max.	-25 °C; = Tmin (incl. condensation/frost) 60 °C; = Tmax; +70 °C for 10 min (OT1, ST1/ST2 acc. to EN 50155)	-25 °C; = Tmin (incl. condensation/frost) 60 °C; = Tmax; +70 °C for 10 min (OT1, ST1/ST2 acc. to EN 50155)
<b>Altitude during operation relating to sea level</b> • Installation altitude above sea level, max. • Ambient air temperature-barometric pressure-altitude	2 000 m Tmin ... Tmax at 1 140 hPa ... 795 hPa (-1 000 m ... + 2 000 m)	2 000 m Tmin ... Tmax at 1 140 hPa ... 795 hPa (-1 000 m ... + 2 000 m)
<b>Relative humidity</b> • With condensation, tested in accordance with IEC 60068-2-38, max.	100 %; RH incl. condensation / frost (no commissioning in bedewed state), horizontal installation	100 %; RH incl. condensation / frost (no commissioning in bedewed state), horizontal installation
<b>Coolants and lubricants</b> • Resistant to commercially available coolants and lubricants	Yes; Incl. diesel and oil droplets in the air	Yes; Incl. diesel and oil droplets in the air
<b>Use in stationary industrial systems</b> • to biologically active substances according to EN 60721-3-3 • to chemically active substances according to EN 60721-3-3 • to mechanically active substances according to EN 60721-3-3	Yes; Class 3B2 mold, fungus and dry rot spores (with the exception of fauna); Class 3B3 on request Yes; Class 3C4 (RH < 75 %) incl. salt spray acc. to EN 60068-2-52 (severity degree 3); * Yes; Class 3S4 incl. sand, dust, *	Yes; Class 3B2 mold, fungus and dry rot spores (with the exception of fauna); Class 3B3 on request Yes; Class 3C4 (RH < 75 %) incl. salt spray acc. to EN 60068-2-52 (severity degree 3); * Yes; Class 3S4 incl. sand, dust, *
<b>Use on land craft, rail vehicles and special-purpose vehicles</b> • to biologically active substances according to EN 60721-3-5 • to chemically active substances according to EN 60721-3-5 • to mechanically active substances according to EN 60721-3-5	Yes; Class 5B2 mold, fungus and dry rot spores (with the exception of fauna); Class 5B3 on request Yes; Class 5C3 (RH < 75 %) incl. salt spray acc. to EN 60068-2-52 (severity degree 3); * Yes; Class 5S3 incl. sand, dust; *	Yes; Class 5B2 mold, fungus and dry rot spores (with the exception of fauna); Class 5B3 on request Yes; Class 5C3 (RH < 75 %) incl. salt spray acc. to EN 60068-2-52 (severity degree 3); * Yes; Class 5S3 incl. sand, dust; *
<b>Usage in industrial process technology</b> • Against chemically active substances acc. to EN 60654-4 • Environmental conditions for process, measuring and control systems acc. to ANSI/ISA-71.04	Yes; Class 3 (excluding trichlorethylene)  Yes; Level GX group A/B (excluding trichlorethylene; harmful gas concentrations up to the limits of EN 60721-3-3 class 3C4 permissible); level LC3 (salt spray) and level LB3 (oil)	Yes; Class 3 (excluding trichlorethylene)  Yes; Level GX group A/B (excluding trichlorethylene; harmful gas concentrations up to the limits of EN 60721-3-3 class 3C4 permissible); level LC3 (salt spray) and level LB3 (oil)
<b>Remark</b> • Note regarding classification of environmental conditions acc. to EN 60721, EN 60654-4 and ANSI/ISA-71.04	* The supplied plug covers must remain in place over the unused interfaces during operation!	* The supplied plug covers must remain in place over the unused interfaces during operation!

**SIPLUS S7-1200 SM 1222 RAIL**

Article number	<b>6AG2222-1BF32-1XB0</b> SIPLUS S7-1200 SM 1222 8DQ RAIL	<b>6AG2222-1HF32-1XB0</b> SIPLUS S7-1200 SM 1222 8DQ RLY RAIL
<b>Conformal coating</b>		
<ul style="list-style-type: none"> <li>• Coatings for printed circuit board assemblies acc. to EN 61086</li> <li>• Protection against fouling acc. to EN 60664-3</li> <li>• Electronic equipment on rolling stock acc. to EN 50155</li> <li>• Military testing according to MIL-I-46058C, Amendment 7</li> <li>• Qualification and Performance of Electrical Insulating Compound for Printed Board Assemblies according to IPC-CC-830A</li> </ul>	<ul style="list-style-type: none"> <li>Yes; Class 2 for high reliability</li> <li>Yes; Type 1 protection</li> <li>Yes; Class PC2 protective coating acc. to EN 50155:2017</li> <li>Yes; Discoloration of coating possible during service life</li> <li>Yes; Conformal coating, Class A</li> </ul>	<ul style="list-style-type: none"> <li>Yes; Class 2 for high reliability</li> <li>Yes; Type 1 protection</li> <li>Yes; Class PC2 protective coating acc. to EN 50155:2017</li> <li>Yes; Discoloration of coating possible during service life</li> <li>Yes; Conformal coating, Class A</li> </ul>
<b>Connection method / header</b>		
<b>Required front connector</b>	Yes	Yes
<b>Mechanics/material</b>		
<b>Enclosure material (front)</b>		
<ul style="list-style-type: none"> <li>• Plastic</li> </ul>	Yes	Yes
<b>Dimensions</b>		
<b>Width</b>	45 mm	45 mm
<b>Height</b>	100 mm	100 mm
<b>Depth</b>	75 mm	75 mm
<b>Weights</b>		
<b>Weight, approx.</b>	180 g	190 g
<b>Other</b>		
<b>Note:</b>	for use in railway applications, also observe the product information "SIPLUS extreme RAIL" A5E37661960A, Online Support article 109736776	for use in railway applications, also observe the product information "SIPLUS extreme RAIL" A5E37661960A, Online Support article 109736776

**Selection and ordering data**

Version	Article No.
<b>SIPLUS signal module SM 1222 RAIL digital output module</b>	
Approved in accordance with the EN 50155, EN 15121, EN 50124, EN 50125 and EN 45545 railway standards for use in rail traffic	
8 outputs, 24 V DC; 0.5 A, 5 W, isolated	
<ul style="list-style-type: none"> <li>• For areas subject to exceptional medial exposure (conformal coating); ambient temperature range -25 ... +70 °C</li> </ul>	<b>6AG2222-1BF32-1XB0</b>
8 outputs, 5 ... 30 V DC / 5 ... 250 V AC, relay 2 A, 30 W DC / 200 W AC	
<ul style="list-style-type: none"> <li>• For areas subject to exceptional medial exposure (conformal coating); ambient temperature -25 ... +60 °C</li> </ul>	<b>6AG2222-1HF32-1XB0</b>

# SIPLUS RAIL

## SIPLUS S7-1200 RAIL

### SIPLUS extreme RAIL digital modules

#### SIPLUS S7-1200 SM 1223 RAIL

#### Overview



- Digital inputs and outputs as supplement to the integral I/O of the CPUs
- Approved in accordance with the railway standards EN 50155, EN 15121, EN 50124, EN 50125 and EN 45545 for use in rail traffic
- For flexible adaptation of the controller to the corresponding task
- For subsequent expansion of the system with additional inputs and outputs

#### Application

Digital input/output modules permit:

- Connection of the controller to digital signals of the process
- Output of digital signals from the controller to the process.

This provides users with the following advantages:

- Optimum adaptation:  
with signal modules which can be mixed as desired, users can adapt their controllers exactly to the relevant task. This avoids superfluous investments. Modules with 8 and 16 input/output channels are available.
- Flexibility:  
if the task is expanded subsequently, the controller can be upgraded. Updating of the user program is extremely simple.

#### Function

The SM 1223 digital input/output signal modules convert

- the level of the external digital signals from the process into the internal signal level of the S7-1200 and
- the internal signal level of the S7-1200 into the external signal level required by the process.

#### Technical specifications

Article number	6AG2223-1BH32-1XB0 SIPLUS S7-1200 SM 1223 8DI/8DQ RAIL	6AG2223-1PL32-1XB0 SIPLUS S7-1200 SM 1223 16DI/16DQ RAIL
<b>General information</b>		
<b>Product type designation</b>	SM 1223, DI 8x24 V DC, DQ 8x24 V DC	SM 1223, DI 16x24 V DC, DQ 16x relay
<b>Supply voltage</b>		
<b>Rated value (DC)</b>	24 V	24 V
<b>Input current</b>		
<b>From backplane bus 5 V DC, max.</b>	145 mA	180 mA
<b>Digital inputs</b>		
• from load voltage L+ (without load), max.	4 mA; per channel	4 mA/input 11 mA/relay
<b>Output voltage / header</b>		
<b>Supply voltage of the transmitters / header</b>		
• product function / supply voltage for transmitters	Yes	Yes
<b>Digital inputs</b>		
<b>Number of digital inputs</b>	8	16
• in groups of	2	2
<b>Input characteristic curve in accordance with IEC 61131, type 1</b>	Yes	Yes
<b>Number of simultaneously controllable inputs</b>		
• all mounting positions		
- up to 40 °C, max.	8	16
• horizontal installation		
- up to 40 °C, max.	8	16
- up to 50 °C, max.	8	16
• vertical installation		
- up to 40 °C, max.	8	16
<b>Input voltage</b>		
• Type of input voltage	DC	DC
• Rated value (DC)	24 V	24 V
• for signal "0"	5 V DC at 1 mA	5 V DC at 1 mA
• for signal "1"	15 V DC at 2.5 mA	15 V DC at 2.5 mA
<b>Input current</b>		
• for signal "0", max. (permissible quiescent current)	1 mA	1 mA
• for signal "1", min.	2.5 mA	2.5 mA
• for signal "1", typ.	4 mA	4 mA
<b>Input delay (for rated value of input voltage)</b>		
• for standard inputs		
- parameterizable	Yes; 0.2 ms, 0.4 ms, 0.8 ms, 1.6 ms, 3.2 ms, 6.4 ms and 12.8 ms, selectable in groups of four	Yes; 0.2 ms, 0.4 ms, 0.8 ms, 1.6 ms, 3.2 ms, 6.4 ms and 12.8 ms, selectable in groups of four
• for interrupt inputs		
- parameterizable	Yes	Yes

Article number	<b>6AG2223-1BH32-1XB0</b> SIPLUS S7-1200 SM 1223 8DI/8DQ RAIL	<b>6AG2223-1PL32-1XB0</b> SIPLUS S7-1200 SM 1223 16DI/16DQ RAIL
<b>Digital outputs</b>		
<b>Number of digital outputs</b>	8	16
• in groups of	1	4
<b>Short-circuit protection</b>	No; to be provided externally	No; to be provided externally
<b>Limitation of inductive shutdown voltage to</b>	L+ (-48 V)	
<b>Switching capacity of the outputs</b>		
• with resistive load, max.	0.5 A	2 A
• on lamp load, max.	5 W	30 W with DC, 200 W with AC
<b>Output voltage</b>		
• Rated value (DC)	24 V	5 V DC to 30 V DC
• Rated value (AC)		5 V AC to 250 V AC
• for signal "0", max.	0.1 V; with 10 kOhm load	
• for signal "1", min.	20 V DC	
<b>Output current</b>		
• for signal "1" rated value	0.5 A	2 A
• for signal "0" residual current, max.	10 µA	
<b>Output delay with resistive load</b>		
• "0" to "1", max.	50 µs	10 ms
• "1" to "0", max.	200 µs	10 ms
<b>Total current of the outputs (per group)</b>		
• horizontal installation		
- up to 50 °C, max.	4 A; Current per mass	8 A; Current per mass
<b>Relay outputs</b>		
• Number of relay outputs		16
• Rated supply voltage of relay coil L+ (DC)		24 V
• Number of operating cycles, max.		mechanically 10 million, at rated load voltage 100 000
<b>Switching capacity of contacts</b>		
• with inductive load, max.	0.5 A	2 A
• on lamp load, max.	5 W	30 W with DC, 200 W with AC
• with resistive load, max.	0.5 A	2 A
<b>Interrupts/diagnostics/status information</b>		
<b>Alarms</b>		
<b>Alarms</b>	Yes	Yes
<b>Diagnostics function</b>	Yes	Yes
<b>Alarms</b>		
• Diagnostic alarm	Yes	Yes
<b>Diagnostics</b>		
• Monitoring the supply voltage	Yes	Yes
<b>Diagnostics indication LED</b>		
• for status of the inputs	Yes	Yes
• for status of the outputs	Yes	Yes
• for maintenance	Yes	Yes
<b>Potential separation</b>		
<b>Potential separation digital inputs</b>		
• between the channels, in groups of	2	2
<b>Potential separation digital outputs</b>		
• between the channels		Relays
• between the channels, in groups of	1	4
• between the channels and backplane bus	500 V AC	1 500 V AC for 1 minute
<b>Degree and class of protection</b>		
<b>IP degree of protection</b>	IP20	IP20
<b>Standards, approvals, certificates</b>		
<b>Railway application</b>		
• EN 50121-3-2	Yes; EMC for rail vehicles	Yes; EMC for rail vehicles
• EN 50121-4	Yes; EMC for signal and telecommunications systems	Yes; EMC for signal and telecommunications systems
• EN 50124-1	Yes; Railway applications - overvoltage category OV2; pollution degree PD2; rated surge voltage UNi = 0.5 kV; UNm = 24 V DC	Yes; Railway applications - overvoltage category OV2; pollution degree PD2; rated surge voltage UNi = 0.5 kV; UNm = 24 V DC
• EN 50125-1	Yes; Rail vehicles - see ambient conditions	Yes; Rail vehicles - see ambient conditions
• EN 50125-2	Yes; Stationary electrical equipment - see ambient conditions	Yes; Stationary electrical equipment - see ambient conditions
• EN 50125-3	Yes; Signal and telecommunications systems - see ambient conditions; vibrations and shocks: Application point outside of tracks (1 m to 3 m away from track)	Yes; Signal and telecommunications systems - see ambient conditions; vibrations and shocks: Application point outside of tracks (1 m to 3 m away from track)
• EN 50155	Yes; Rail vehicles - temperature class OT1, ST1/ST2, horizontal mounting position	Yes; Rail vehicles - temperature class OT1, ST1/ST2, horizontal mounting position
• EN 61373	Yes; Rail vehicles - vibrations and shocks: Category 1 Class A/B	Yes; Rail vehicles - vibrations and shocks: Category 1 Class A/B
• Fire protection acc. to EN 45545-2	Yes; For proof of conformity, see Service & Support	Yes; For proof of conformity, see Service & Support

# SIPLUS RAIL

## SIPLUS S7-1200 RAIL

### SIPLUS extreme RAIL digital modules

#### SIPLUS S7-1200 SM 1223 RAIL

Article number	<b>6AG2223-1BH32-1XB0</b> SIPLUS S7-1200 SM 1223 8DI/8DQ RAIL	<b>6AG2223-1PL32-1XB0</b> SIPLUS S7-1200 SM 1223 16DI/16DQ RAIL
<b>Ambient conditions</b>		
<b>Ambient temperature during operation</b> • min. • max.	-25 °C; = Tmin (incl. condensation/frost) 60 °C; = Tmax; +70 °C for 10 min (OT1, ST1/ST2 acc. to EN 50155)	-25 °C; = Tmin (incl. condensation/frost) 60 °C; = Tmax; +70 °C for 10 min (OT1, ST1/ST2 acc. to EN 50155); number of simultaneously switched on outputs: 8 (no adjacent points) at 60 °C horizontal or 50 °C vertical, 16 at 55 °C horizontal or 45 °C vertical
<b>Altitude during operation relating to sea level</b> • Installation altitude above sea level, max. • Ambient air temperature-barometric pressure-altitude	2 000 m Tmin ... Tmax at 1 140 hPa ... 795 hPa (-1 000 m ... +2 000 m)	2 000 m Tmin ... Tmax at 1 140 hPa ... 795 hPa (-1 000 m ... +2 000 m)
<b>Relative humidity</b> • With condensation, tested in accordance with IEC 60068-2-38, max.	100 %; RH incl. condensation / frost (no commissioning in bedewed state), horizontal installation	100 %; RH incl. condensation / frost (no commissioning in bedewed state), horizontal installation
<b>Resistance</b> • Coolants and lubricants - Resistant to commercially available coolants and lubricants • Use in stationary industrial systems - to biologically active substances according to EN 60721-3-3 - to chemically active substances according to EN 60721-3-3 - to mechanically active substances according to EN 60721-3-3 • Use on land craft, rail vehicles and special-purpose vehicles - to biologically active substances according to EN 60721-3-5 - to chemically active substances according to EN 60721-3-5 - to mechanically active substances according to EN 60721-3-5 • Usage in industrial process technology - Against chemically active substances acc. to EN 60654-4 - Environmental conditions for process, measuring and control systems acc. to ANSI/ISA-71.04  • Remark - Note regarding classification of environmental conditions acc. to EN 60721, EN 60654-4 and ANSI/ISA-71.04	Yes; Incl. diesel and oil droplets in the air  Yes; Class 3B2 mold, fungus and dry rot spores (with the exception of fauna); Class 3B3 on request Yes; Class 3C4 (RH < 75 %) incl. salt spray acc. to EN 60068-2-52 (severity degree 3); * Yes; Class 3S4 incl. sand, dust; *  Yes; Class 5B2 mold, fungus and dry rot spores (with the exception of fauna); Class 5B3 on request Yes; Class 5C3 (RH < 75 %) incl. salt spray acc. to EN 60068-2-52 (severity degree 3); * Yes; Class 5S3 incl. sand, dust; *  Yes; Class 3 (excluding trichlorethylene)  Yes; Level GX group A/B (excluding trichlorethylene; harmful gas concentrations up to the limits of EN 60721-3-3 class 3C4 permissible); level LC3 (salt spray) and level LB3 (oil)  * The supplied plug covers must remain in place over the unused interfaces during operation!	Yes; Incl. diesel and oil droplets in the air  Yes; Class 3B2 mold, fungus and dry rot spores (with the exception of fauna); Class 3B3 on request Yes; Class 3C4 (RH < 75 %) incl. salt spray acc. to EN 60068-2-52 (severity degree 3); * Yes; Class 3S4 incl. sand, dust; *  Yes; Class 5B2 mold, fungus and dry rot spores (with the exception of fauna); Class 5B3 on request Yes; Class 5C3 (RH < 75 %) incl. salt spray acc. to EN 60068-2-52 (severity degree 3); * Yes; Class 5S3 incl. sand, dust; *  Yes; Class 3 (excluding trichlorethylene)  Yes; Level GX group A/B (excluding trichlorethylene; harmful gas concentrations up to the limits of EN 60721-3-3 class 3C4 permissible); level LC3 (salt spray) and level LB3 (oil)  * The supplied plug covers must remain in place over the unused interfaces during operation!
<b>Conformal coating</b> • Coatings for printed circuit board assemblies acc. to EN 61086 • Protection against fouling acc. to EN 60664-3 • Electronic equipment on rolling stock acc. to EN 50155 • Military testing according to MIL-I-46058C, Amendment 7 • Qualification and Performance of Electrical Insulating Compound for Printed Board Assemblies according to IPC-CC-830A	Yes; Class 2 for high reliability  Yes; Type 1 protection Yes; Class PC2 protective coating acc. to EN 50155:2017 Yes; Discoloration of coating possible during service life Yes; Conformal coating, Class A	Yes; Class 2 for high reliability  Yes; Type 1 protection Yes; Class PC2 protective coating acc. to EN 50155:2017 Yes; Discoloration of coating possible during service life Yes; Conformal coating, Class A
<b>Connection method / header</b>		
<b>Required front connector</b>	Yes	Yes
<b>Mechanics / material</b>		
<b>Enclosure material (front)</b> • Plastic	Yes	Yes
<b>Dimensions</b>		
<b>Width</b>	45 mm	70 mm
<b>Height</b>	100 mm	100 mm
<b>Depth</b>	75 mm	75 mm
<b>Weights</b>		
<b>Weight, approx.</b>	210 g	350 g
<b>Other</b>		
<b>Note:</b>	for use in railway applications, also observe the product information "SIPLUS extreme RAIL" A5E37661960A, Online Support article 109736776	for use in railway applications, also observe the product information "SIPLUS extreme RAIL" A5E37661960A, Online Support article 109736776

### Selection and ordering data

Version	Article No.
<p><b>SIPLUS SM 1223 RAIL digital input/output signal module</b>            Approved in accordance with the EN 50155, EN 15121, EN 50124, EN 50125 and EN 45545 railway standards for use in rail traffic            8 inputs, 24 V DC, IEC type 1 current sinking;            8 transistor outputs, 24 V DC, 0.5 A, 5 W</p> <ul style="list-style-type: none"> <li>For areas with extreme exposure to environmental substances (conformal coating);              ambient temperature -25 ... +70 °C              16 inputs, 24 V DC, IEC type 1 current sinking; 16 relay outputs, 5 ... 30 V DC / 5 ... 250 V AC, 2 A, 30 W DC / 200 W AC</li> <li>For areas with extreme exposure to environmental substances (conformal coating);              ambient temperature -25 ... +70 °C</li> </ul>	<p><b>6AG2223-1BH32-1XB0</b></p> <p><b>6AG2223-1PL32-1XB0</b></p>



**SIPLUS RAIL**

SIPLUS S7-1200 RAIL

SIPLUS extreme RAIL digital modules

**SIPLUS S7-1200 SB 1223 RAIL****Overview**

- Digital inputs and outputs as supplement to the integral I/O of the SIPLUS S7-1200-CPU's
- Approved in accordance with the railway standards EN 50155, EN 15121, EN 50124, EN 50125 and EN 45545 for use in rail traffic
- Can be plugged directly into the CPU

**Application**

The SB 1223 digital input/output signal board permits:

- Connection of the controller to digital signals of the process
- Output of digital signals from the controller to the process.

**Design**

The signal boards are plugged directly into the receptacle on the front of each S7-1200 CPU.

- Mounting:  
Signal boards are plugged directly into the SIMATIC S7-1200 CPU and are thus electrically and mechanically connected to the CPU
- The CPU mounting dimensions remain unchanged
- All signal boards are easy to replace thanks to removable connecting terminals ("independent wiring")

**Function**

The SB 1223 digital input/output signal board converts

- the level of the external digital signals from the process into the internal signal level of the S7-1200 and
- the internal signal level of the S7-1200 into the external signal level required by the process

**Technical specifications**

Article number	<b>6AG2223-0BD30-1XB0</b> SIPLUS S7-1200 SB 1223 2DI/2DO RAIL
<b>General information</b>	
Product type designation	SB 1223, DI 2x24 V DC/DQ 2x24 V DC
Engineering with	see entry ID: 109746275
<b>Input current</b>	
From backplane bus 5 V DC, typ.	50 mA
<b>Output voltage / header</b>	
supply voltage of the transmitters / header	4 mA; per channel
<b>Digital inputs</b>	
Number of digital inputs	2; Current-sinking
• in groups of	1
Input characteristic curve in accordance with IEC 61131, type 1	Yes
Number of simultaneously controllable inputs	2
• all mounting positions	
- up to 40 °C, max.	
Input voltage	DC
• Type of input voltage	24 V
• Rated value (DC)	0 to 5 V
• for signal "0"	+15 to +30 V
• for signal "1"	
Input current	1 mA
• for signal "0", max. (permissible quiescent current)	0.5 A
• for signal "1", typ.	
Input delay (for rated value of input voltage)	Yes; 0.2 ms, 0.4 ms, 0.8 ms, 1.6 ms, 3.2 ms, 6.4 ms and 12.8 ms, selectable in groups of four
• for standard inputs	
- parameterizable	
• for interrupt inputs	Yes
- parameterizable	
• for technological functions	Yes
- parameterizable	
<b>Digital outputs</b>	
Number of digital outputs	2; MOSFET, solid-state (current-sinking/current-sourcing)
• in groups of	1
Short-circuit protection	No
Switching capacity of the outputs	0.5 A
• with resistive load, max.	5 W
• on lamp load, max.	
Load resistance range	0.6 Ω
• upper limit	

Article number	<b>6AG2223-0BD30-1XB0</b> SIPLUS S7-1200 SB 1223 2DI/2DQ RAIL
<b>Output voltage</b> • Rated value (DC) • for signal "0", max. • for signal "1", min.	24 V 0.1 V; with 10 kOhm load 20 V
<b>Output current</b> • for signal "1" permissible range, max. • for signal "0" residual current, max.	0.5 A 10 µA
<b>Interrupts/diagnostics/status information</b>	
<b>Alarms</b>	Yes
<b>Diagnostics function</b>	Yes
<b>Diagnostics indication LED</b> • for status of the inputs • for status of the outputs	Yes Yes
<b>Standards, approvals, certificates</b>	
<b>Railway application</b> • EN 50121-3-2 • EN 50121-4 • EN 50124-1  • EN 50125-1 • EN 50125-2 • EN 50125-3  • EN 50155 • EN 61373 • Fire protection acc. to EN 45545-2	Yes; EMC for rail vehicles Yes; EMC for signal and telecommunications systems Yes; Railway applications - overvoltage category OV2; pollution degree PD2; rated surge voltage UNi = 0.5 kV; UNm = 24 V DC Yes; Rail vehicles - see ambient conditions Yes; Stationary electrical equipment - see ambient conditions Yes; Signal and telecommunications systems - see ambient conditions; vibrations and shocks: Application point outside of tracks (1 m to 3 m away from track) Yes; Rail vehicles - temperature class OT1, ST1/ST2, horizontal mounting position Yes; Rail vehicles - vibrations and shocks: Category 1 Class A/B Yes; For proof of conformity, see Service & Support
<b>Ambient conditions</b>	
<b>Ambient temperature during operation</b> • min. • max.	-25 °C; = Tmin (incl. condensation/frost) 60 °C; = Tmax; +70 °C for 10 min (OT1, ST1/ST2 acc. to EN 50155)
<b>Altitude during operation relating to sea level</b> • Installation altitude above sea level, max. • Ambient air temperature-barometric pressure-altitude	2 000 m Tmin ... Tmax at 1 140 hPa ... 795 hPa (-1 000 m ... +2 000 m)
<b>Relative humidity</b> • With condensation, tested in accordance with IEC 60068-2-38, max.	100 %; RH incl. condensation / frost (no commissioning in bedewed state), horizontal installation
<b>Resistance</b> • Coolants and lubricants - Resistant to commercially available coolants and lubricants • Use in stationary industrial systems - to biologically active substances according to EN 60721-3-3  - to chemically active substances according to EN 60721-3-3 - to mechanically active substances according to EN 60721-3-3 • Use on land craft, rail vehicles and special-purpose vehicles - to biologically active substances according to EN 60721-3-5  - to chemically active substances according to EN 60721-3-5 - to mechanically active substances according to EN 60721-3-5 • Usage in industrial process technology - Against chemically active substances acc. to EN 60654-4 - Environmental conditions for process, measuring and control systems acc. to ANSI/ISA-71.04  • Remark - Note regarding classification of environmental conditions acc. to EN 60721, EN 60654-4 and ANSI/ISA-71.04	Yes; Incl. diesel and oil droplets in the air  Yes; Class 3B2 mold, fungus and dry rot spores (with the exception of fauna); Class 3B3 on request Yes; Class 3C4 (RH < 75 %) incl. salt spray acc. to EN 60068-2-52 (severity degree 3); * Yes; Class 3S4 incl. sand, dust, *  Yes; Class 5B2 mold, fungus and dry rot spores (with the exception of fauna); Class 5B3 on request Yes; Class 5C3 (RH < 75 %) incl. salt spray acc. to EN 60068-2-52 (severity degree 3); * Yes; Class 5S3 incl. sand, dust; *  Yes; Class 3 (excluding trichlorethylene) Yes; Level GX group A/B (excluding trichlorethylene; harmful gas concentrations up to the limits of EN 60721-3-3 class 3C4 permissible); level LC3 (salt spray) and level LB3 (oil)  * The supplied plug covers must remain in place over the unused interfaces during operation!
<b>Conformal coating</b> • Coatings for printed circuit board assemblies acc. to EN 61086 • Protection against fouling acc. to EN 60664-3 • Electronic equipment on rolling stock acc. to EN 50155 • Military testing according to MIL-I-46058C, Amendment 7 • Qualification and Performance of Electrical Insulating Compound for Printed Board Assemblies according to IPC-CC-830A	Yes; Class 2 for high reliability Yes; Type 1 protection Yes; Level GX group A/B (excluding trichlorethylene; harmful gas concentrations up to the limits of EN 60721-3-3 class 3C4 permissible); level LC3 (salt spray) and level LB3 (oil) Yes; Discoloration of coating possible during service life Yes; Conformal coating, Class A
<b>Mechanics/material</b>	
<b>Enclosure material (front)</b> • Plastic	Yes
<b>Dimensions</b>	
<b>Width</b>	38 mm
<b>Height</b>	62 mm
<b>Depth</b>	21 mm
<b>Weights</b>	
<b>Weight, approx.</b>	40 g
<b>Other</b>	
<b>Note:</b>	for use in railway applications, also observe the product information "SIPLUS extreme RAIL" A5E37661960A, Online Support article 109736776

**SIPLUS RAIL**  
 SIPLUS S7-1200 RAIL  
 SIPLUS extreme RAIL digital modules

**SIPLUS S7-1200 SB 1223 RAIL**

**Selection and ordering data**

Version	Article No.
<p><b>SIPLUS SB 1223 RAIL digital input/output signal board</b>            Approved in accordance with the EN 50155, EN 15121, EN 50124, EN 50125 and EN 45545 railway standards for use in rail traffic            2 inputs, 24 V DC, IEC type 1 current sinking;            2 transistor outputs 24 V DC, 0.5 A, 5 W;            can be used as HSC at up to 30 kHz</p> <p>For areas with extreme exposure to environmental substances (conformal coating);            ambient temperature -25 ... +70 °C</p>	<p><b>6AG2223-0BD30-1XB0</b></p>

**Overview**

- For the convenient recording of temperatures with great accuracy
- Approved in accordance with the EN 50155, EN 15121, EN 50124, EN 50125 and EN 45545 railway standards for use in rail traffic
- 4 inputs
- Most popular resistance temperature detectors can be used
- Can easily be retrofitted to existing plant

**Application**

The SM 1231 RTD modules enable temperatures to be measured with high precision using established resistance temperature detectors. They can be used with CPU 1211, 1212 and 1214.

**Design**

The SM 1231 RTD modules exhibit the same structural features as the other modules of the S7-1200 series:

- Mounting on a DIN rail:  
The modules are snapped onto the rail just to the right of the CPU and connected to one another and with the CPU 12xx by means of the integral backplane bus.

- Direct mounting:  
Drilled holes permit the module to be bolted directly to walls. This type of mounting is recommended for applications subject to strong vibrations.
- Resistance temperature detectors:  
The most popular resistance temperature detectors can be used: Pt 100, Pt 200, Pt 500, Pt 1000, Pt 10000, Ni 100, Ni 120, Ni 1000, Cu 10, FS 150, FS 30, FS 600. They are connected directly to the module without amplifiers and all RTDs must be of the same type. The detectors can be connected with 2, 3 or 4 cables.
- Mounting location:  
For maximum possible measurement and repeat accuracy, the RTD module should be mounted in locations with low temperature variations.
- DIP switches:  
Required settings, e.g. selection of the connected RTDs, should be made using the DIP switches on the module.

**Function**

- Different measurement ranges:  
Resistance temperature detectors of types Pt 100, Pt 200, Pt 500, Pt 1000, Pt 10000, Ni 100, Ni 120, Ni 1000, Cu 10, FS 150, FS 30, FS 600.
- Temperature scaling:  
The measured temperature can be shown in °C or °F.

**Technical specifications**

Article number	<b>6AG2231-5PD32-1XB0</b> SIPLUS S7-1200 SM 1231 RTD RAIL
<b>General information</b>	
Product type designation	SM 1231, AI 4x16 bit RTD
Supply voltage	
Rated value (DC)	24 V
<b>Input current</b>	
Current consumption, typ.	40 mA
From backplane bus 5 V DC, typ.	80 mA
<b>Analog inputs</b>	
Number of analog inputs	4; Resistance thermometer
permissible input voltage for voltage input (destruction limit), max.	±35 V
Technical unit for temperature measurement adjustable	Degrees Celsius/degrees Fahrenheit
<b>Input ranges</b>	
• Voltage	No
• Current	No
• Thermocouple	No
• Resistance thermometer	Yes; Resistance-type transmitter: Pt10, Pt50, Pt100, Pt200, Pt500, Pt1000, Ni100, Ni120, Ni200, Ni500, Ni1000, Cu10, Cu50, Cu100, LG-Ni1000
• Resistance	Yes; 150 Ω, 300 Ω, 600 Ω
<b>Input ranges (rated values), resistance thermometer</b>	
• Cu 10	Yes
• Ni 100	Yes
• Ni 1000	Yes
• LG-Ni 1000	Yes
• Ni 120	Yes
• Ni 200	Yes
• Ni 500	Yes
• Pt 100	Yes
• Pt 1000	Yes
• Pt 200	Yes
• Pt 500	Yes
<b>Input ranges (rated values), resistors</b>	
• 0 to 150 ohms	Yes
• 0 to 300 ohms	Yes
• 0 to 600 ohms	Yes
<b>Thermocouple (TC)</b>	
• Temperature compensation - parameterizable	No
<b>Analog value generation for the inputs</b>	
<b>Integration and conversion time/resolution per channel</b>	
• Resolution with overrange (bit including sign), max.	15 bit; + sign

**SIPLUS RAIL**

SIPLUS S7-1200 RAIL

SIPLUS extreme RAIL analog modules

**SIPLUS extreme S7-1200 SM 1231 RTD RAIL**

Article number	<b>6AG2231-5PD32-1XB0</b>	
<ul style="list-style-type: none"> <li>Integration time, parameterizable</li> <li>Interference voltage suppression for interference frequency <math>f_1</math> in Hz</li> </ul>	SIPLUS S7-1200 SM 1231 RTD RAIL No 85 dB at 50 / 60 / 400 Hz	
<b>Errors/accuracies</b>		
<b>Temperature error (relative to input range), (+/-)</b>	25 °C $\pm$ 0.1%, to 55 °C $\pm$ 0.2% total measurement range	
<b>Repeat accuracy in steady state at 25 °C (relative to output range), (+/-)</b>	0.05 %	
<b>Interference voltage suppression for <math>f = n \times (f_1 \pm 1 \%)</math>, <math>f_1 =</math> interference frequency</b> <ul style="list-style-type: none"> <li>Common mode interference, min.</li> </ul>	120 dB	
<b>Interrupts/diagnostics/status information</b>		
<b>Alarms</b>	Yes	
<b>Diagnostics function</b>	Yes; Can be read out	
<b>Alarms</b> <ul style="list-style-type: none"> <li>Diagnostic alarm</li> </ul>	Yes	
<b>Diagnoses</b> <ul style="list-style-type: none"> <li>Monitoring the supply voltage</li> <li>Wire-break</li> </ul>	Yes Yes	
<b>Diagnostics indication LED</b> <ul style="list-style-type: none"> <li>for status of the inputs</li> <li>for maintenance</li> </ul>	Yes Yes	
<b>Degree and class of protection</b>		
<b>IP degree of protection</b>	IP20	
<b>Standards, approvals, certificates</b>		
<b>CE mark</b>	Yes	
<b>Railway application</b> <ul style="list-style-type: none"> <li>EN 50121-3-2</li> <li>EN 50121-4</li> <li>EN 50124-1</li> <li>EN 50125-1</li> <li>EN 50125-2</li> <li>EN 50125-3</li> <li>EN 50155</li> <li>EN 61373</li> <li>Fire protection acc. to EN 45545-2</li> </ul>	Yes; EMC for rail vehicles Yes; EMC for signal and telecommunications systems Yes; Railway applications - overvoltage category OV2; pollution degree PD2; rated surge voltage $UN_i = 0.5$ kV; $UN_m = 24$ V DC Yes; Rail vehicles - see ambient conditions Yes; Stationary electrical equipment - see ambient conditions Yes; Signal and telecommunications systems - see ambient conditions; vibrations and shocks: Application point outside of tracks (1 m to 3 m away from track) Yes; Rail vehicles - temperature class OT1, ST1/ST2, horizontal mounting position Yes; Rail vehicles - vibrations and shocks: Category 1 Class A/B Yes; For proof of conformity, see Service & Support	
<b>Ambient conditions</b>		
<b>Ambient temperature during operation</b> <ul style="list-style-type: none"> <li>min.</li> <li>max.</li> </ul>	-25 °C; = $T_{min}$ (incl. condensation/frost) 60 °C; = $T_{max}$ ; +70 °C for 10 min (OT1, ST1/ST2 acc. to EN 50155)	
<b>Altitude during operation relating to sea level</b> <ul style="list-style-type: none"> <li>Installation altitude above sea level, max.</li> <li>Ambient air temperature-barometric pressure-altitude</li> </ul>	2 000 m $T_{min} \dots T_{max}$ at 1 140 hPa ... 795 hPa (-1 000 m ... +2 000 m)	
<b>Relative humidity</b> <ul style="list-style-type: none"> <li>With condensation, tested in accordance with IEC 60068-2-38, max.</li> </ul>	100 %; RH incl. condensation / frost (no commissioning in bedewed state), horizontal installation	
<b>Resistance</b>		
<ul style="list-style-type: none"> <li>Coolants and lubricants <ul style="list-style-type: none"> <li>Resistant to commercially available coolants and lubricants</li> </ul> </li> <li>Use in stationary industrial systems <ul style="list-style-type: none"> <li>to biologically active substances according to EN 60721-3-3</li> <li>to chemically active substances according to EN 60721-3-3</li> <li>to mechanically active substances according to EN 60721-3-3</li> </ul> </li> <li>Use on land craft, rail vehicles and special-purpose vehicles <ul style="list-style-type: none"> <li>to biologically active substances according to EN 60721-3-5</li> <li>to chemically active substances according to EN 60721-3-5</li> <li>to mechanically active substances according to EN 60721-3-5</li> </ul> </li> <li>Usage in industrial process technology <ul style="list-style-type: none"> <li>Against chemically active substances acc. to EN 60654-4</li> <li>Environmental conditions for process, measuring and control systems acc. to ANSI/ISA-71.04</li> </ul> </li> <li>Remark <ul style="list-style-type: none"> <li>Note regarding classification of environmental conditions acc. to EN 60721, EN 60654-4 and ANSI/ISA-71.04</li> </ul> </li> </ul>	Yes; Incl. diesel and oil droplets in the air Yes; Class 3B2 mold, fungus and dry rot spores (with the exception of fauna); Class 3B3 on request Yes; Class 3C4 (RH < 75 %) incl. salt spray acc. to EN 60068-2-52 (severity degree 3); * Yes; Class 3S4 incl. sand, dust, * Yes; Class 5B2 mold, fungus and dry rot spores (with the exception of fauna); Class 5B3 on request Yes; Class 5C3 (RH < 75 %) incl. salt spray acc. to EN 60068-2-52 (severity degree 3); * Yes; Class 5S3 incl. sand, dust; * Yes; Class 3 (excluding trichlorethylene) Yes; Level GX group A/B (excluding trichlorethylene; harmful gas concentrations up to the limits of EN 60721-3-3 class 3C4 permissible); level LC3 (salt spray) and level LB3 (oil) * The supplied plug covers must remain in place over the unused interfaces during operation!	
<b>Conformal coating</b> <ul style="list-style-type: none"> <li>Coatings for printed circuit board assemblies acc. to EN 61086</li> <li>Protection against fouling acc. to EN 60664-3</li> <li>Electronic equipment on rolling stock acc. to EN 50155</li> <li>Military testing according to MIL-I-46058C, Amendment 7</li> <li>Qualification and Performance of Electrical Insulating Compound for Printed Board Assemblies according to IPC-CC-830A</li> </ul>		Yes; Class 2 for high reliability Yes; Type 1 protection Yes; Class PC2 protective coating acc. to EN 50155:2017 Yes; Discoloration of coating possible during service life Yes; Conformal coating, Class A

**SIPLUS extreme S7-1200 SM 1231 RTD RAIL**

Article number	<b>6AG2231-5PD32-1XB0</b> SIPLUS S7-1200 SM 1231 RTD RAIL
<b>Connection method/header</b>	
Required front connector	Yes
<b>Mechanics/material</b>	
<b>Enclosure material (front)</b>	
• Plastic	Yes
<b>Dimensions</b>	
<b>Width</b>	45 mm
<b>Height</b>	100 mm
<b>Depth</b>	75 mm
<b>Weights</b>	
<b>Weight, approx.</b>	220 g
<b>Other</b>	
<b>Note:</b>	for use in railway applications, also observe the product information "SIPLUS extreme RAIL" A5E37661960A, Online Support article 109736776

**Selection and ordering data**

Version	Article No.
<p><b>SIPLUS RTD signal module SM 1231 RAIL</b>            Approved in accordance with the EN 50155, EN 15121, EN 50124, EN 50125 and EN 45545 railway standards for use in rail traffic            4 inputs for resistance temperature detectors Pt10/50/100/200/500/1000, Ni100/120/200/500/1000, Cu10/50/100, LG-Ni1000; resistance 150/300/600 Ohm, resolution 15 bits + sign            For areas subject to exceptional medial exposure (conformal coating); ambient temperature range -25 ... +60 °C</p>	<b>6AG2231-5PD32-1XB0</b>

**SIPLUS RAIL**

SIPLUS S7-1200 RAIL

SIPLUS extreme RAIL analog modules

**SIPLUS extreme S7-1200 SM 1232 RAIL****Overview**

- Analog outputs for SIPLUS S7-1200
- Approved in accordance with the EN 50155, EN 15121, EN 50124, EN 50125 and EN 45545 railway standards for use in rail traffic
- With extremely short conversion times
- For connecting analog actuators without additional amplifiers
- Even solves more complex automation tasks

This provides users with the following advantages:

- **Optimal adaptation:**  
With analog signal modules, users can optimally adapt their controllers even to more complex tasks.
- **Direct connection of actuators:**  
up to 14 bit resolution permit the connection of actuators without an additional amplifier.
- **Flexibility:**  
if the task is expanded subsequently, the controller can be upgraded. Updating of the user program is extremely simple.

**Design**

The signal modules have the same design features as the basic devices.

- **Installation on DIN rails:**  
The modules are snapped onto the rail next to the CPU on the right and are electrically and mechanically connected to each other and to the CPU by the integral slide mechanism.
- **Direct installation:**  
Horizontal or vertical mounting on DIN rail or direct mounting in the cabinet using integral lugs.

**Function**

SM 1232 analog output signal modules convert digital signals of the SIMATIC S7-1200 into signals for controlling the respective process.

6

**Application**

SM 1232 analog output signal modules permit the use of analog outputs.

**Technical specifications**

Article number	<b>6AG2232-4HD32-1XB0</b> SIPLUS S7-1200 SM 1232 4AQ RAIL
<b>General information</b>	
<b>Product type designation</b>	SM 1232 AQ 4x 14 bit
<b>Supply voltage</b>	
<b>Rated value (DC)</b>	24 V
<b>Input current</b>	
<b>Current consumption, typ.</b>	45 mA
<b>From backplane bus 5 V DC, typ.</b>	80 mA
<b>Analog outputs</b>	
<b>Number of analog outputs</b>	4; Current or voltage
<b>Output ranges, voltage</b> • -10 V to +10 V	Yes
<b>Output ranges, current</b> • 0 to 20 mA	Yes
<b>Load impedance (in rated range of output)</b> • with voltage outputs, min. • with current outputs, max.	1 000 Ω 600 Ω
<b>Analog value generation for the outputs</b>	
<b>Integration and conversion time/resolution per channel</b> • Resolution with overrange (bit including sign), max.	14 bit; Voltage: 14 bit; Current : 13 bit
<b>Errors/accuracies</b>	
<b>Temperature error (relative to output range), (+/-)</b>	25 °C ±0.3%, to 55 °C ±0.6% total measurement range
<b>Basic error limit (operational limit at 25 °C)</b> • Voltage, relative to output range, (+/-) • Current, relative to output range, (+/-)	0.3 % 0.3 %
<b>Interference voltage suppression for <math>f = n \times (f_1 \pm 1 \%)</math>, <math>f_1 =</math> interference frequency</b> • Common mode voltage, max.	12 V

Article number	<b>6AG2232-4HD32-1XB0</b> SIPLUS S7-1200 SM 1232 4AQ RAIL
<b>Interrupts/diagnostics/status information</b>	
<b>Alarms</b>	Yes
<b>Diagnostics function</b>	Yes
<b>Alarms</b>	Yes
• Diagnostic alarm	Yes
<b>Diagnoses</b>	Yes
• Monitoring the supply voltage	Yes
• Wire-break	Yes
• Short-circuit	Yes
<b>Diagnostics indication LED</b>	Yes
• for status of the outputs	Yes
• for maintenance	Yes
<b>Degree and class of protection</b>	
<b>IP degree of protection</b>	IP20
<b>Standards, approvals, certificates</b>	
<b>CE mark</b>	Yes
<b>Railway application</b>	Yes; EMC for rail vehicles Yes; EMC for signal and telecommunications systems Yes; Railway applications - overvoltage category OV2; pollution degree PD2; rated surge voltage UNi = 0.5 kV; UNm = 24 V DC Yes; Rail vehicles - see ambient conditions Yes; Stationary electrical equipment - see ambient conditions Yes; Signal and telecommunications systems - see ambient conditions; vibrations and shocks: Application point outside of tracks (1 m to 3 m away from track) Yes; Rail vehicles - temperature class OT1, ST1/ST2, horizontal mounting position Yes; Rail vehicles - vibrations and shocks: Category 1 Class A/B Yes; For proof of conformity, see Service & Support
• EN 50121-3-2	
• EN 50121-4	
• EN 50124-1	
• EN 50125-1	
• EN 50125-2	
• EN 50125-3	
• EN 50155	
• EN 61373	
• Fire protection acc. to EN 45545-2	
<b>Ambient conditions</b>	
<b>Ambient temperature during operation</b>	
• min.	-25 °C; = Tmin (incl. condensation/frost)
• max.	60 °C; = Tmax; +70 °C for 10 min (OT1, ST1/ST2 acc. to EN 50155)
<b>Altitude during operation relating to sea level</b>	
• Installation altitude above sea level, max.	2 000 m
• Ambient air temperature-barometric pressure-altitude	Tmin ... Tmax at 1 140 hPa ... 795 hPa (-1 000 m ... +2 000 m)
<b>Relative humidity</b>	
• With condensation, tested in accordance with IEC 60068-2-38, max.	100 %; RH incl. condensation / frost (no commissioning in bedewed state), horizontal installation
<b>Resistance</b>	
• Coolants and lubricants	Yes; Incl. diesel and oil droplets in the air
- Resistant to commercially available coolants and lubricants	
• Use in stationary industrial systems	Yes; Class 3B2 mold, fungus and dry rot spores (with the exception of fauna); Class 3B3 on request
- to biologically active substances according to EN 60721-3-3	
- to chemically active substances according to EN 60721-3-3	Yes; Class 3C4 (RH < 75 %) incl. salt spray acc. to EN 60068-2-52 (severity degree 3); *
- to mechanically active substances according to EN 60721-3-3	Yes; Class 3S4 incl. sand, dust; *
• Use on land craft, rail vehicles and special-purpose vehicles	
- to biologically active substances according to EN 60721-3-5	Yes; Class 5B2 mold, fungus and dry rot spores (with the exception of fauna); Class 5B3 on request
- to chemically active substances according to EN 60721-3-5	Yes; Class 5C3 (RH < 75 %) incl. salt spray acc. to EN 60068-2-52 (severity degree 3); *
- to mechanically active substances according to EN 60721-3-5	Yes; Class 5S3 incl. sand, dust; *
• Usage in industrial process technology	
- Against chemically active substances acc. to EN 60654-4	Yes; Class 3 (excluding trichlorethylene)
- Environmental conditions for process, measuring and control systems acc. to ANSI/ISA-71.04	Yes; Level GX group A/B (excluding trichlorethylene; harmful gas concentrations up to the limits of EN 60721-3-3 class 3C4 permissible); level LC3 (salt spray) and level LB3 (oil)
• Remark	
- Note regarding classification of environmental conditions acc. to EN 60721, EN 60654-4 and ANSI/ISA-71.04	* The supplied plug covers must remain in place over the unused interfaces during operation!
<b>Conformal coating</b>	
• Coatings for printed circuit board assemblies acc. to EN 61086	Yes; Class 2 for high reliability
• Protection against fouling acc. to EN 60664-3	Yes; Type 1 protection
• Electronic equipment on rolling stock acc. to EN 50155	Yes; Class PC2 protective coating acc. to EN 50155:2017
• Military testing according to MIL-I-46058C, Amendment 7	Yes; Discoloration of coating possible during service life
• Qualification and Performance of Electrical Insulating Compound for Printed Board Assemblies according to IPC-CC-830A	Yes; Conformal coating, Class A



**SIPLUS RAIL**

SIPLUS S7-1200 RAIL

SIPLUS extreme RAIL analog modules

**SIPLUS extreme S7-1200 SM 1232 RAIL**

Article number	<b>6AG2232-4HD32-1XB0</b> SIPLUS S7-1200 SM 1232 4AQ RAIL
<b>Connection method/header</b>	
<b>Required front connector</b>	Yes
<b>Mechanics/material</b>	
<b>Enclosure material (front)</b> • Plastic	Yes
<b>Dimensions</b>	
<b>Width</b>	45 mm
<b>Height</b>	100 mm
<b>Depth</b>	75 mm
<b>Weights</b>	
<b>Weight, approx.</b>	180 g
<b>Other</b>	
<b>Note:</b>	for use in railway applications, also observe the product information "SIPLUS extreme RAIL" A5E37661960A, Online Support article 109736776

**Selection and ordering data**

Version	Article No.
<b>Analog output SIPLUS signal module SM 1232 RAIL</b> Approved in accordance with the EN 50155, EN 15121, EN 50124, EN 50125 and EN 45545 railway standards for use in rail traffic 4 analog outputs, $\pm 10$ V with 14 bits or 0 ... 20 mA with 13 bits For areas subject to exceptional medial exposure (conformal coating); ambient temperature range -25 ... +60 °C	<b>6AG2232-4HD32-1XB0</b>

## Overview

- Analog inputs and outputs for SIPLUS S7-1200
- Approved in accordance with the EN 50155, EN 15121, EN 50124, EN 50125 and EN 45545 railway standards for use in rail traffic
- With extremely short conversion times
- For connecting analog actuators and sensors without additional amplifiers
- Even solves more complex automation tasks
- From +60 °C to +70 °C, max. 50% of the inputs and outputs can be controlled simultaneously

## Application

SM 1234 analog input/outputs permit the use of analog inputs/outputs.

This provides users with the following advantages:

- **Optimal adaptation:**  
With analog and digital expansion modules, users can optimally match their controllers even to more complex tasks.
- **Direct connection of sensors and actuators:**  
up to 14 bit resolution plus sign and different input/output ranges permit the connection of sensors and actuators without an additional amplifier.
- **Flexibility:**  
if the task is expanded subsequently, the controller can be upgraded. Updating of the user program is extremely simple.

## Design

The SM 1234 analog input/output signal modules have the same design features as the basic devices.

- **Installation on DIN rails:**  
The modules are snapped onto the rail next to the CPU on the right and are electrically and mechanically connected to each other and to the CPU by the integral slide mechanism.
- **Direct installation:**  
Horizontal or vertical mounting on DIN rail or direct mounting in the cabinet using integral lugs.

## Function

The SM 1234 analog input/output signal modules

- convert analog signals from the process into digital signals for internal processing by the SIMATIC S7-1200.
- convert digital signals of the SIMATIC S7-1200 into signals for controlling the respective process.

## Technical specifications

Article number	<b>6AG2234-4HE32-1XB1</b> SIPLUS S7-1200 SM 1234 4AI/2AQ RAIL
<b>General information</b>	
<b>Product type designation</b>	SM 1234, AI 4x13 bit/AQ 2x14 bit
<b>Supply voltage</b>	
<b>Rated value (DC)</b>	24 V
<b>Input current</b>	
<b>Current consumption, typ.</b>	60 mA
<b>From backplane bus 5 V DC, typ.</b>	80 mA
<b>Analog inputs</b>	
<b>Number of analog inputs</b>	4; Current or voltage differential inputs
<b>Permissible input voltage for voltage input (destruction limit), max.</b>	35 V
<b>Permissible input current for current input (destruction limit), max.</b>	40 mA
<b>Cycle time (all channels) max.</b>	625 µs
<b>Input ranges</b>	
• Voltage	Yes; ±10V, ±5V, ±2.5V
• Current	Yes; 4 to 20 mA, 0 to 20 mA
<b>Input ranges (rated values), voltages</b>	
• -10 V to +10 V	Yes
• -2.5 V to +2.5 V	Yes
• -5 V to +5 V	Yes
<b>Input ranges (rated values), currents</b>	
• 0 to 20 mA	Yes
• 4 mA to 20 mA	Yes
<b>Analog outputs</b>	
<b>Number of analog outputs</b>	2; Current or voltage
<b>Output ranges, voltage</b>	
• -10 V to +10 V	Yes
<b>Output ranges, current</b>	
• 0 to 20 mA	Yes
• 4 mA to 20 mA	Yes
<b>Load impedance (in rated range of output)</b>	
• with voltage outputs, min.	1 000 Ω
• with current outputs, max.	600 Ω

**SIPLUS RAIL**

SIPLUS S7-1200 RAIL

SIPLUS extreme RAIL analog modules

**SIPLUS extreme S7-1200 SM 1234 RAIL**

Article number	<b>6AG2234-4HE32-1XB1</b> SIPLUS S7-1200 SM 1234 4AI/2AQ RAIL
<b>Analog value generation for the inputs</b>	
<b>Integration and conversion time/resolution per channel</b> • Resolution with overrange (bit including sign), max. • Integration time, parameterizable • Interference voltage suppression for interference frequency f1 in Hz	12 bit; + sign Yes 40 dB, DC to 60 V for interference frequency 50 / 60 Hz
<b>Smoothing of measured values</b> • parameterizable	Yes
<b>Analog value generation for the outputs</b>	
<b>Integration and conversion time/resolution per channel</b> • Resolution with overrange (bit including sign), max.	14 bit; Voltage: 14 bit; Current : 13 bit
<b>Errors/accuracies</b>	
<b>Temperature error (relative to input range), (+/-)</b>	25 °C ±0.1%, to 55 °C ±0.2% total measurement range
<b>Temperature error (relative to output range), (+/-)</b>	25 °C ±0.3%, to 55 °C ±0.6% total measurement range
<b>Basic error limit (operational limit at 25 °C)</b> • Voltage, relative to input range, (+/-) • Current, relative to input range, (+/-) • Voltage, relative to output range, (+/-) • Current, relative to output range, (+/-)	0.1 % 0.1 % 0.3 % 0.3 %
<b>Interference voltage suppression for <math>f = n \times (f1 \pm 1 \%)</math>, f1 = interference frequency</b> • Common mode voltage, max.	12 V
<b>Interrupts/diagnostics/status information</b>	
<b>Alarms</b>	Yes
<b>Diagnostics function</b>	Yes
<b>Alarms</b> • Diagnostic alarm	Yes
<b>Diagnoses</b> • Monitoring the supply voltage • Wire-break • Short-circuit	Yes Yes Yes
<b>Diagnostics indication LED</b> • for status of the inputs • for status of the outputs • for maintenance	Yes Yes Yes
<b>Potential separation</b>	
<b>Potential separation analog outputs</b> • between the channels and the power supply of the electronics	No
<b>Standards, approvals, certificates</b>	
<b>CE mark</b>	Yes
<b>Railway application</b> • EN 50121-3-2  • EN 50121-4  • EN 50124-1  • EN 50125-1 • EN 50125-2 • EN 50125-3  • EN 50155 • EN 61373 • Fire protection acc. to EN 45545-2	Yes; EMC for rail vehicles - 24 V supply of assembly: Cable length <3 m or with upstream filter for supply cable Yes; EMC for signal and telecommunications systems - 24 V supply of the assembly: with upstream filter for supply cable Yes; Railway applications - overvoltage category OV2; pollution degree PD2; rated surge voltage UNi = 0.5 kV; UNm = 24 V DC Yes; Rail vehicles - see ambient conditions Yes; Stationary electrical equipment - see ambient conditions Yes; Signal and telecommunications systems - see ambient conditions; vibrations and shocks: Application point outside of tracks (1 m to 3 m away from track) Yes; Rail vehicles - temperature class OT1, ST1/ST2, horizontal mounting position Yes; Rail vehicles - vibrations and shocks: Category 1 Class A/B Yes; For proof of conformity, see Service & Support
<b>Ambient conditions</b>	
<b>Ambient temperature during operation</b> • min. • max.	-25 °C; = Tmin (incl. condensation/frost) 60 °C; = Tmax; +70 °C for 10 min (OT1, ST1/ST2 acc. to EN 50155)
<b>Altitude during operation relating to sea level</b> • Installation altitude above sea level, max. • Ambient air temperature-barometric pressure-altitude	2 000 m Tmin ... Tmax at 1 140 hPa ... 795 hPa (-1 000 m ... +2 000 m)
<b>Relative humidity</b> • With condensation, tested in accordance with _IEC 60068-2-38, max.	100 %; RH incl. condensation / frost (no commissioning in bedewed state), horizontal installation

## SIPLUS extreme S7-1200 SM 1234 RAIL

Article number	<b>6AG2234-4HE32-1XB1</b> SIPLUS S7-1200 SM 1234 4AI/2AQ RAIL
<b>Resistance</b>	
<ul style="list-style-type: none"> <li>• Coolants and lubricants               <ul style="list-style-type: none"> <li>- Resistant to commercially available coolants and lubricants</li> </ul> </li> <li>• Use in stationary industrial systems               <ul style="list-style-type: none"> <li>- to biologically active substances according to EN 60721-3-3</li> <li>- to chemically active substances according to EN 60721-3-3</li> <li>- to mechanically active substances according to EN 60721-3-3</li> </ul> </li> <li>• Use on land craft, rail vehicles and special-purpose vehicles               <ul style="list-style-type: none"> <li>- to biologically active substances according to EN 60721-3-5</li> <li>- to chemically active substances according to EN 60721-3-5</li> <li>- to mechanically active substances according to EN 60721-3-5</li> </ul> </li> <li>• Usage in industrial process technology               <ul style="list-style-type: none"> <li>- Against chemically active substances acc. to EN 60654-4</li> <li>- Environmental conditions for process, measuring and control systems acc. to ANSI/ISA-71.04</li> </ul> </li> <li>• Remark               <ul style="list-style-type: none"> <li>- Note regarding classification of environmental conditions acc. to EN 60721, EN 60654-4 and ANSI/ISA-71.04</li> </ul> </li> </ul>	<p>Yes; Incl. diesel and oil droplets in the air</p> <p>Yes; Class 3B2 mold, fungus and dry rot spores (with the exception of fauna); Class 3B3 on request</p> <p>Yes; Class 3C4 (RH &lt; 75 %) incl. salt spray acc. to EN 60068-2-52 (severity degree 3); * Yes; Class 3S4 incl. sand, dust; *</p> <p>Yes; Class 5B2 mold, fungus and dry rot spores (with the exception of fauna); Class 5B3 on request</p> <p>Yes; Class 5C3 (RH &lt; 75 %) incl. salt spray acc. to EN 60068-2-52 (severity degree 3); * Yes; Class 5S3 incl. sand, dust; *</p> <p>Yes; Class 3 (excluding trichlorethylene)</p> <p>Yes; Level GX group A/B (excluding trichlorethylene; harmful gas concentrations up to the limits of EN 60721-3-3 class 3C4 permissible); level LC3 (salt spray) and level LB3 (oil)</p> <p>* The supplied plug covers must remain in place over the unused interfaces during operation!</p>
<b>Conformal coating</b>	
<ul style="list-style-type: none"> <li>• Coatings for printed circuit board assemblies acc. to EN 61086</li> <li>• Protection against fouling acc. to EN 60664-3</li> <li>• Electronic equipment on rolling stock acc. to EN 50155</li> <li>• Military testing according to MIL-I-46058C, Amendment 7</li> <li>• Qualification and Performance of Electrical Insulating Compound for Printed Board Assemblies according to IPC-CC-830A</li> </ul>	<p>Yes; Class 2 for high reliability</p> <p>Yes; Type 1 protection</p> <p>Yes; Class PC2 protective coating acc. to EN 50155:2017</p> <p>Yes; Discoloration of coating possible during service life</p> <p>Yes; Conformal coating, Class A</p>
<b>Connection method / header</b>	
<b>Required front connector</b>	Yes
<b>Mechanics/material</b>	
<b>Enclosure material (front)</b>	
<ul style="list-style-type: none"> <li>• Plastic</li> </ul>	Yes
<b>Dimensions</b>	
<b>Width</b>	45 mm
<b>Height</b>	100 mm
<b>Depth</b>	75 mm
<b>Weights</b>	
<b>Weight, approx.</b>	220 g
<b>Other</b>	
<b>Note:</b>	for use in railway applications, also observe the product information "SIPLUS extreme RAIL" A5E37661960A, Online Support article 109736776

## Selection and ordering data

Version	Article No.
<p><b>Analog input/output SIPLUS signal module SM 1234 RAIL</b></p> <p>Approved in accordance with the EN 50155, EN 15121, EN 50124, EN 50125 and EN 45545 railway standards for use in rail traffic</p> <p><u>Ambient temperature range -25 ... +70 °C</u> incl. +15 °C/K temperature rise for 10 minutes</p> <p>4 analog inputs, ±10 V, ±5 V, ±2.5 V, or 0 ... 20 mA, 12 bits + sign; 2 analog outputs, ±10 V with 14 bits or 0 ... 20 mA with 13 bits</p>	<b>6AG2234-4HE32-1XB1</b>

# SIPLUS RAIL

## SIPLUS S7-1200 RAIL

### SIPLUS extreme RAIL communication

#### SIPLUS S7-1200 CM 1241 RAIL

##### Overview

- For fast, high-performance serial data exchange via point-to-point connection
- Approved in accordance with EN 50155, EN 15121, EN 50124, EN 50125 and EN 45545 railway standards for use in rail traffic
- Implemented protocols: ASCII, USS drive protocol, Modbus RTU
- Additional protocols can be loaded later
- Simple parameterization with STEP 7 Basic

##### Application

The CM 1241 communications modules are used for quick, high-performance serial data exchange via point-to-point connection.

Point-to-point connection is possible to, e.g.:

- SIMATIC S7 automation systems and the systems of many other manufacturers
- Printers
- Robot controls
- Modems
- Scanners
- Bar code readers, etc.

##### Design

The CM 1241 communications modules have the same design features as the basic devices.

- Installation on DIN rails:  
The modules are snapped onto the rail next to the CPU on the right and are electrically and mechanically connected to each other and to the CPU by the integral slide mechanism.
- Direct installation:  
Horizontal or vertical mounting on DIN rail or direct mounting in the cabinet using integral lugs.

The communications modules are equipped with the following:

- Status LEDs for indicating “Send”, “Receive” and “Error”
- Communication interface:  
available for the RS232 or RS422/485 physical transmission properties

##### Function

The following standard protocols are available on the CM 1241 communications modules:

- ASCII:  
For interfacing to third-party systems with simple transmission protocols, e.g. protocols with start and end characters or with block check characters. The interface handshake signals can be called and controlled via the user program.
- Modbus:  
For communication according to the Modbus protocol with RTU format:
  - Modbus Master:  
Master-slave interfacing with SIMATIC S7 as master.
  - Modbus slave:  
master-slave interfacing with SIMATIC S7 as slave; message frame traffic from slave to slave not possible.
- USS drive protocol:  
instructions for connection of USS protocol drives are especially supported. In this case, drives exchange data over RS485. It is then possible to control these drives, and to read and write parameters.

Further drivers for downloading are also available.

##### Parameterization

Parameterization of the CM 1241 communications module is particularly user-friendly and simple with STEP 7 Basic:

- The user assigns the module characteristics via a parameterization environment integrated in STEP 7 Basic, e.g.:
  - The implemented protocol drivers that are used.
  - The driver-specific characteristics that are used.

##### Technical specifications

Article number	6AG2241-1AH32-1XB0 SIPLUS S7-1200 CM1241 RS232 RAIL	6AG2241-1CH32-1XB0 SIPLUS S7-1200 CM1241 RS422/485 RAIL
<b>General information</b>		
<b>Product type designation</b>	CM 1241 RS 232	CM 1241 RS 422 / 485
<b>Supply voltage</b>		
<b>Rated value (DC)</b>	24 V	24 V
<b>Input current</b>		
<b>Current consumption, max.</b>	200 mA; From backplane bus 5 V DC	220 mA; From backplane bus 5 V DC
<b>Interfaces</b>		
<b>Interfaces/bus type</b>	RS 232C (V.24)	RS 422 / 485 (X.27)
<b>Number of interfaces</b>	1	1
<b>Point-to-point connection</b>		
• Cable length, max.	10 m	1 000 m
<b>Integrated protocol driver</b>		
• Freeprot	Yes	Yes
• ASCII	Yes; Available as library function	Yes; Available as library function
• Modbus RTU master	Yes	Yes
• MODBUS RTU slave	Yes	Yes
• USS	Yes	Yes; Available as library function

Article number	<b>6AG2241-1AH32-1XB0</b>	<b>6AG2241-1CH32-1XB0</b>
	SIPLUS S7-1200 CM1241 RS232 RAIL	SIPLUS S7-1200 CM1241 RS422/485 RAIL
<b>Protocols</b>		
<b>Integrated protocols</b>		
<ul style="list-style-type: none"> <li>• Freeprot               <ul style="list-style-type: none"> <li>- Bits per character</li> <li>- Number of stop bits</li> <li>- Parity</li> </ul> </li> <li>• 3964 (R)               <ul style="list-style-type: none"> <li>- Bits per character</li> <li>- Number of stop bits</li> <li>- Parity</li> </ul> </li> <li>• Modbus RTU master               <ul style="list-style-type: none"> <li>- Address area</li> <li>- Number of slaves, max.</li> </ul> </li> <li>• MODBUS RTU slave               <ul style="list-style-type: none"> <li>- Address area</li> </ul> </li> </ul>	<p>7 or 8 1 (Standard), 2 No parity (standard); even, uneven, mark (parity bit always 1); space (parity bit always 0)</p> <p>7 or 8 1 (Standard), 2 No parity (standard); even, uneven, mark (parity bit always 1); space (parity bit always 0)</p> <p>1 through 49 999 (Standard Modbus addressing) 247; slave numbers 1 through 247, per MODBUS network segment maximum 32 devices, additional repeaters needed to expand the network to maximum configuration</p> <p>1 through 49 999 (Standard Modbus addressing)</p>	<p>7 or 8 1 (Standard), 2 No parity (standard); even, uneven, mark (parity bit always 1); space (parity bit always 0)</p> <p>7 or 8 1 (Standard), 2 No parity (standard); even, uneven, mark (parity bit always 1); space (parity bit always 0)</p> <p>1 through 49 999 (Standard Modbus addressing) 247; slave numbers 1 through 247, per MODBUS network segment maximum 32 devices, additional repeaters needed to expand the network to maximum configuration</p> <p>1 through 49 999 (Standard Modbus addressing)</p>
<b>Interrupts/diagnostics/status information</b>		
<b>Diagnostics function</b>	Yes	Yes
<b>Diagnostics indication LED</b>		
<ul style="list-style-type: none"> <li>• for status of the outputs</li> </ul>	Yes	Yes
<b>Degree and class of protection</b>		
<b>IP degree of protection</b>	IP20	IP20
<b>Standards, approvals, certificates</b>		
<b>Railway application</b>		
<ul style="list-style-type: none"> <li>• EN 50121-3-2</li> <li>• EN 50121-4</li> <li>• EN 50124-1</li> <li>• EN 50125-1</li> <li>• EN 50125-2</li> <li>• EN 50125-3</li> <li>• EN 50155</li> <li>• EN 61373</li> <li>• Fire protection acc. to EN 45545-2</li> </ul>	<p>Yes; EMC for rail vehicles Yes; EMC for signal and telecommunications systems Yes; Railway applications - overvoltage category OV2; pollution degree PD2; rated surge voltage UNI = 0.5 kV; UNm = 24 V DC Yes; Rail vehicles - see ambient conditions Yes; Stationary electrical equipment - see ambient conditions Yes; Signal and telecommunications systems - see ambient conditions; vibrations and shocks: Application point outside of tracks (1 m to 3 m away from track) Yes; Rail vehicles - temperature class OT1, ST1/ST2, horizontal mounting position Yes; Rail vehicles - vibrations and shocks: Category 1 Class A/B Yes; For proof of conformity, see Service &amp; Support</p>	<p>Yes; EMC for rail vehicles Yes; EMC for signal and telecommunications systems Yes; Railway applications - overvoltage category OV2; pollution degree PD2; rated surge voltage UNI = 0.5 kV; UNm = 24 V DC Yes; Rail vehicles - see ambient conditions Yes; Stationary electrical equipment - see ambient conditions Yes; Signal and telecommunications systems - see ambient conditions; vibrations and shocks: Application point outside of tracks (1 m to 3 m away from track) Yes; Rail vehicles - temperature class OT1, ST1/ST2, horizontal mounting position Yes; Rail vehicles - vibrations and shocks: Category 1 Class A/B Yes; For proof of conformity, see Service &amp; Support</p>
<b>Ambient conditions</b>		
<b>Ambient temperature during operation</b>		
<ul style="list-style-type: none"> <li>• min.</li> <li>• max.</li> </ul>	-25 °C; = Tmin (incl. condensation/frost) 60 °C; = Tmax; +70 °C for 10 min (OT1, ST1/ST2 acc. to EN 50155)	-25 °C; = Tmin (incl. condensation/frost) 60 °C; = Tmax; +70 °C for 10 min (OT1, ST1/ST2 acc. to EN 50155)
<b>Altitude during operation relating to sea level</b>		
<ul style="list-style-type: none"> <li>• Installation altitude above sea level, max.</li> <li>• Ambient air temperature-barometric pressure-altitude</li> </ul>	2 000 m Tmin ... Tmax at 1 140 hPa ... 795 hPa (-1 000 m ... +2 000 m)	2 000 m Tmin ... Tmax at 1 140 hPa ... 795 hPa (-1 000 m ... +2 000 m)
<b>Relative humidity</b>		
<ul style="list-style-type: none"> <li>• With condensation, tested in accordance with IEC 60068-2-38, max.</li> </ul>	100 %; RH incl. condensation / frost (no commissioning in bedewed state), horizontal installation	100 %; RH incl. condensation / frost (no commissioning in bedewed state), horizontal installation
<b>Resistance</b>		
<ul style="list-style-type: none"> <li>• Coolants and lubricants               <ul style="list-style-type: none"> <li>- Resistant to commercially available coolants and lubricants</li> </ul> </li> <li>• Use in stationary industrial systems               <ul style="list-style-type: none"> <li>- to biologically active substances according to EN 60721-3-3</li> <li>- to chemically active substances according to EN 60721-3-3</li> <li>- to mechanically active substances according to EN 60721-3-3</li> </ul> </li> <li>• Use on land craft, rail vehicles and special-purpose vehicles               <ul style="list-style-type: none"> <li>- to biologically active substances according to EN 60721-3-5</li> <li>- to chemically active substances according to EN 60721-3-5</li> <li>- to mechanically active substances according to EN 60721-3-5</li> </ul> </li> </ul>	<p>Yes; Incl. diesel and oil droplets in the air</p> <p>Yes; Class 3B2 mold, fungus and dry rot spores (with the exception of fauna); Class 3B3 on request Yes; Class 3C4 (RH &lt; 75 %) incl. salt spray acc. to EN 60068-2-52 (severity degree 3); * Yes; Class 3S4 incl. sand, dust, *</p> <p>Yes; Class 5B2 mold, fungus and dry rot spores (with the exception of fauna); Class 5B3 on request Yes; Class 5C3 (RH &lt; 75 %) incl. salt spray acc. to EN 60068-2-52 (severity degree 3); * Yes; Class 5S3 incl. sand, dust; *</p>	<p>Yes; Incl. diesel and oil droplets in the air</p> <p>Yes; Class 3B2 mold, fungus and dry rot spores (with the exception of fauna); Class 3B3 on request Yes; Class 3C4 (RH &lt; 75 %) incl. salt spray acc. to EN 60068-2-52 (severity degree 3); * Yes; Class 3S4 incl. sand, dust, *</p> <p>Yes; Class 5B2 mold, fungus and dry rot spores (with the exception of fauna); Class 5B3 on request Yes; Class 5C3 (RH &lt; 75 %) incl. salt spray acc. to EN 60068-2-52 (severity degree 3); * Yes; Class 5S3 incl. sand, dust; *</p>

# SIPLUS RAIL

## SIPLUS S7-1200 RAIL

### SIPLUS extreme RAIL communication

#### SIPLUS S7-1200 CM 1241 RAIL

Article number	<b>6AG2241-1AH32-1XB0</b> SIPLUS S7-1200 CM1241 RS232 RAIL	<b>6AG2241-1CH32-1XB0</b> SIPLUS S7-1200 CM1241 RS422/485 RAIL
<ul style="list-style-type: none"> <li>Usage in industrial process technology               <ul style="list-style-type: none"> <li>Against chemically active substances acc. to EN 60654-4</li> <li>Environmental conditions for process, measuring and control systems acc. to ANSI/ISA-71.04</li> </ul> </li> <li>Remark               <ul style="list-style-type: none"> <li>Note regarding classification of environmental conditions acc. to EN 60721, EN 60654-4 and ANSI/ISA-71.04</li> </ul> </li> </ul>	Yes; Class 3 (excluding trichlorethylene)  Yes; Level GX group A/B (excluding trichlorethylene; harmful gas concentrations up to the limits of EN 60721-3-3 class 3C4 permissible); level LC3 (salt spray) and level LB3 (oil)  * The supplied plug covers must remain in place over the unused interfaces during operation!	Yes; Class 3 (excluding trichlorethylene)  Yes; Level GX group A/B (excluding trichlorethylene; harmful gas concentrations up to the limits of EN 60721-3-3 class 3C4 permissible); level LC3 (salt spray) and level LB3 (oil)  * The supplied plug covers must remain in place over the unused interfaces during operation!
<b>Conformal coating</b> <ul style="list-style-type: none"> <li>Coatings for printed circuit board assemblies acc. to EN 61086</li> <li>Protection against fouling acc. to EN 60664-3</li> <li>Electronic equipment on rolling stock acc. to EN 50155</li> <li>Military testing according to MIL-I-46058C, Amendment 7</li> <li>Qualification and Performance of Electrical Insulating Compound for Printed Board Assemblies according to IPC-CC-830A</li> </ul>	Yes; Class 2 for high reliability  Yes; Type 1 protection Yes; Class PC2 protective coating acc. to EN 50155:2017 Yes; Discoloration of coating possible during service life Yes; Conformal coating, Class A	Yes; Class 2 for high reliability  Yes; Type 1 protection Yes; Class PC2 protective coating acc. to EN 50155:2017 Yes; Discoloration of coating possible during service life Yes; Conformal coating, Class A
<b>Dimensions</b>		
<b>Width</b>	30 mm	30 mm
<b>Height</b>	100 mm	100 mm
<b>Depth</b>	75 mm	75 mm
<b>Weights</b>		
<b>Weight, approx.</b>	150 g	155 g
<b>Other</b>		
<b>Note:</b>	for use in railway applications, also observe the product information "SIPLUS extreme RAIL" A5E37661960A, Online Support article 109736776	for use in railway applications, also observe the product information "SIPLUS extreme RAIL" A5E37661960A, Online Support article 109736776

#### Selection and ordering data

Version	Article No.
<b>SIPLUS S7-1200 CM1241 RS232 T1 RAIL</b> Approved in accordance with EN 50155, EN 15121, EN 50124, EN 50125 and EN 45545 railway standards for use in rail traffic	<b>6AG2241-1AH32-1XB0</b>
<b>SIPLUS S7-1200 CM1241 RS422/485 T1 RAIL</b> Approved in accordance with EN 50155, EN 15121, EN 50124, EN 50125 and EN 45545 railway standards for use in rail traffic	<b>6AG2241-1CH32-1XB0</b>

### Overview

- For fast, high-performance serial data exchange via point-to-point connection
- Approved in accordance with the EN 50155, EN 15121, EN 50124, EN 50125 and EN 45545 railway standards for use in rail traffic
- Implemented protocols: ASCII, USS drive protocol, Modbus RTU
- Additional protocols can be loaded later
- Simple parameterization with STEP 7 Basic
- Can be plugged directly into the CPU

### Application

The Communication Board CB 1241 RS 485 is used for fast, high-performance serial data exchange via point-to-point connections.

Point-to-point coupling is possible, for example, to:

- SIMATIC S7 automation systems and systems of many other manufacturers
- Printers
- Robot controls
- Modems
- Scanners
- Bar code readers, etc.

The Communication Board CB 1241 RS 485 can be plugged directly into all SIMATIC S7-1200 CPUs.

This provides users with the following advantages:

- **Optimal adaptation:**  
With communication boards, users can optimally adapt their controllers even to more complex tasks.
- **Flexibility:**  
If the task is expanded subsequently, the controller can be upgraded. Updating of the user program is extremely simple.
- **Use where space is limited:**  
The communication boards are directly plugged into the CPU, enabling the controller to be expanded without taking up any additional space.

### Design

The communication boards are plugged straight into the holder on the front of the S7-1200 CPU.

- **Installation:**  
Communication boards are plugged directly into the SIPLUS extreme S7-1200 RAIL-CPU, and are thus connected electrically and mechanically with the CPU.
- The installation dimensions of the CPU remain unchanged.
- Replacement of all communication boards is facilitated by removable terminals ("permanent wiring").

### Function

On the Communication Board CB 1241 RS 485, the following standard protocols are available:

- **ASCII:**  
For interfacing to third-party systems with simple transmission protocols, e.g. protocols with start and end characters or with block check characters. The interface handshake signals can be queried and controlled via the user program.
- **Modbus:**  
For communication according to the Modbus protocol with RTU format:
  - Modbus Master:  
Master-slave interfacing with SIMATIC S7 as master.
  - Modbus slave:  
Master-slave interfacing with SIMATIC S7 as slave; message frame traffic from slave to slave not possible.
- **USS drive protocol:**  
Instructions for connection of USS protocol drives are specifically supported. In this case, drives exchange data over RS485. It is then possible to control these drives, and to read and write parameters.

Additional drivers can also be downloaded.

### Parameterization

The parameterization of the Communication Board CB 1241 is particularly user-friendly and simple with STEP 7 Basic:

The user specifies the properties of the module by means of a parameterization environment integrated into STEP 7 Basic.



# SIPLUS RAIL

## SIPLUS S7-1200 RAIL

### SIPLUS extreme RAIL communication

#### SIPLUS S7-1200 CB 1241 RS485 RAIL

#### Technical specifications

Article number	<b>6AG2241-1CH30-1XB0</b> SIPLUS S7-1200 CB 1241 RS485 T1 RAIL
<b>General information</b>	
<b>Product type designation</b>	CB 1241 RS 485
<b>Input current</b>	
<b>from backplane bus 5 V DC, typ.</b>	50 mA
<b>Interfaces</b>	
<b>Point-to-point connection</b>	
• Cable length, max.	1 000 m
<b>Integrated protocol driver</b>	
• Freepoint	Yes
• ASCII	Yes; Available as library function
• Modbus RTU master	Yes
• MODBUS RTU slave	Yes
• USS	Yes; Available as library function
<b>Protocols</b>	
<b>Integrated protocols</b>	
• Freepoint	
- Telegram length, max.	1 kbyte
- Bits per character	7 or 8
- Number of stop bits	1 (Standard), 2
- Parity	No parity (standard); even, uneven, mark (parity bit always 1); space (parity bit always 0)
• 3964 (R)	
- Telegram length, max.	1 kbyte
- Bits per character	7 or 8
- Number of stop bits	1 (Standard), 2
- Parity	No parity (standard); even, uneven, mark (parity bit always 1); space (parity bit always 0)
• Modbus RTU master	
- Address area	1 through 49 999 (Standard Modbus addressing)
- Number of slaves, max.	247; slave numbers 1 through 247, per MODBUS network segment maximum 32 devices, additional repeaters needed to expand the network to maximum configuration
• MODBUS RTU slave	
- Address area	1 through 49 999 (Standard Modbus addressing)
<b>Interrupts/diagnostics/status information</b>	
<b>Diagnostics function</b>	Yes
<b>Degree and class of protection</b>	
<b>IP degree of protection</b>	IP20
<b>Standards, approvals, certificates</b>	
<b>Railway application</b>	
• EN 50121-3-2	Yes; EMC for rail vehicles
• EN 50121-4	Yes; EMC for signal and telecommunications systems
• EN 50124-1	Yes; Railway applications - overvoltage category OV2; pollution degree PD2; rated surge voltage UNi = 0.5 kV; UNm = 24 V DC
• EN 50125-1	Yes; Rail vehicles - see ambient conditions
• EN 50125-2	Yes; Stationary electrical equipment - see ambient conditions
• EN 50125-3	Yes; Signal and telecommunications systems - see ambient conditions; vibrations and shocks: Application point outside of tracks (1 m to 3 m away from track)
• EN 50155	Yes; Rail vehicles - temperature class OT1, ST1/ST2, horizontal mounting position
• EN 61373	Yes; Rail vehicles - vibrations and shocks: Category 1 Class A/B
• Fire protection acc. to EN 45545-2	Yes; For proof of conformity, see Service & Support
<b>Ambient conditions</b>	
<b>Ambient temperature during operation</b>	
• min.	-25 °C; = Tmin (incl. condensation/frost)
• max.	60 °C; = Tmax; +70 °C for 10 min (OT1, ST1/ST2 acc. to EN 50155)
<b>Altitude during operation relating to sea level</b>	
• Installation altitude above sea level, max.	2 000 m
• Ambient air temperature-barometric pressure-altitude	Tmin ... Tmax at 1 140 hPa ... 795 hPa (-1 000 m ... +2 000 m)
<b>Relative humidity</b>	
• With condensation, tested in accordance with IEC 60068-2-38, max.	100 %; RH incl. condensation / frost (no commissioning in bedewed state), horizontal installation

Article number	<b>6AG2241-1CH30-1XB0</b> SIPLUS S7-1200 CB 1241 RS485 T1 RAIL
<b>Resistance</b>	
<ul style="list-style-type: none"> <li>• Coolants and lubricants             <ul style="list-style-type: none"> <li>- Resistant to commercially available coolants and lubricants</li> </ul> </li> <li>• Use in stationary industrial systems             <ul style="list-style-type: none"> <li>- to biologically active substances according to EN 60721-3-3</li> <li>- to chemically active substances according to EN 60721-3-3</li> <li>- to mechanically active substances according to EN 60721-3-3</li> </ul> </li> <li>• Use on land craft, rail vehicles and special-purpose vehicles             <ul style="list-style-type: none"> <li>- to biologically active substances according to EN 60721-3-5</li> <li>- to chemically active substances according to EN 60721-3-5</li> <li>- to mechanically active substances according to EN 60721-3-5</li> </ul> </li> <li>• Usage in industrial process technology             <ul style="list-style-type: none"> <li>- Against chemically active substances acc. to EN 60654-4</li> <li>- Environmental conditions for process, measuring and control systems acc. to ANSI/ISA-71.04</li> </ul> </li> <li>• Remark             <ul style="list-style-type: none"> <li>- Note regarding classification of environmental conditions acc. to EN 60721, EN 60654-4 and ANSI/ISA-71.04</li> </ul> </li> </ul>	<p>Yes; Incl. diesel and oil droplets in the air</p> <p>Yes; Class 3B2 mold, fungus and dry rot spores (with the exception of fauna); Class 3B3 on request</p> <p>Yes; Class 3C4 (RH &lt; 75 %) incl. salt spray acc. to EN 60068-2-52 (severity degree 3); *</p> <p>Yes; Class 3S4 incl. sand, dust; *</p> <p>Yes; Class 5B2 mold, fungus and dry rot spores (with the exception of fauna); Class 5B3 on request</p> <p>Yes; Class 5C3 (RH &lt; 75 %) incl. salt spray acc. to EN 60068-2-52 (severity degree 3); *</p> <p>Yes; Class 5S3 incl. sand, dust; *</p> <p>Yes; Class 3 (excluding trichlorethylene)</p> <p>Yes; Level GX group A/B (excluding trichlorethylene; harmful gas concentrations up to the limits of EN 60721-3-3 class 3C4 permissible); level LC3 (salt spray) and level LB3 (oil)</p> <p>* The supplied plug covers must remain in place over the unused interfaces during operation!</p>
<b>Conformal coating</b>	
<ul style="list-style-type: none"> <li>• Coatings for printed circuit board assemblies acc. to EN 61086</li> <li>• Protection against fouling acc. to EN 60664-3</li> <li>• Electronic equipment on rolling stock acc. to EN 50155</li> <li>• Military testing according to MIL-I-46058C, Amendment 7</li> <li>• Qualification and Performance of Electrical Insulating Compound for Printed Board Assemblies according to IPC-CC-830A</li> </ul>	<p>Yes; Class 2 for high reliability</p> <p>Yes; Type 1 protection</p> <p>Yes; Class PC2 protective coating acc. to EN 50155:2017</p> <p>Yes; Discoloration of coating possible during service life</p> <p>Yes; Conformal coating, Class A</p>
<b>Mechanics/material</b>	
<b>Enclosure material (front)</b>	
<ul style="list-style-type: none"> <li>• Plastic</li> </ul>	Yes
<b>Dimensions</b>	
<b>Width</b>	38 mm
<b>Height</b>	62 mm
<b>Depth</b>	21 mm
<b>Weights</b>	
<b>Weight, approx.</b>	40 g
<b>Other</b>	
<b>Note:</b>	for use in railway applications, also observe the product information "SIPLUS extreme RAIL" A5E37661960A, Online Support article 109736776

### Selection and ordering data

Version	Article No.
<b>SIPLUS CB 1241 communication board RS 485 RAIL</b> Approved in accordance with the EN 50155, EN 15121, EN 50124, EN 50125 and EN 45545 railway standards for use in rail traffic for point-to-point connection, with 1 RS 485 interface	<b>6AG2241-1CH30-1XB0</b>

**SIPLUS RAIL**

SIPLUS S7-1200 RAIL

SIPLUS extreme RAIL communication

**SIPLUS S7-1200 CM 1242-5 RAIL****Overview**

DP-M	DP-S	FMS	PG/OP	S7
	●			

The SIPLUS S7-1200 CM 1242-5 RAIL communication module is used to connect a SIPLUS extreme RAIL S7-1200 to PROFIBUS as a DP slave and has the following characteristics:

- Approved in accordance with the railway standards EN 50155, EN 15121, EN 50124, EN 50125 and EN 45545 for use in rail traffic
- PROFIBUS DPV1 slave in accordance with IEC 61158
- Module replacement without PG supported
- Power is supplied via the backplane bus so that no extra cabling is required
- Support of all standard baud rates from 9.6 Kbps to 12 Mbps
- Compact industry-standard enclosure in S7-1200 design for mounting on a DIN rail
- Fast commissioning thanks to easy configuration using STEP 7 without additional programming overhead

The SIPLUS S7-1200 CM 1242-5 RAIL is intended for use in rail traffic. Low-cost PROFIBUS-based automation solutions can be created on the basis of the S7-1200.

**Benefits**

PROFIBUS-based systems can be operated effectively for lower operating and maintenance costs:

- Low costs since an automation solution requires no fixed wiring and less hardware
- Fast response to faults thanks to comprehensive diagnostics options
- Optimized plant and inventory management

The SIPLUS S7-1200 CM 1242-5 RAIL also offers further benefits especially for the requirements of micro-automation solutions:

- Uncomplicated connection of the S7-1200 to PROFIBUS without extra power supply
- Low-cost implementation of automation solutions based on PROFIBUS
- Fast commissioning, as no programming overhead is required

**Application**

The SIPLUS S7-1200 CM 1242-5 RAIL is designed for use in rail traffic.

With the CM 1242-5 RAIL, low-cost, distributed automation solutions can be implemented on the basis of the S7-1200, or in simple cases even complete plant automation systems.

**Design**

The SIPLUS S7-1200 CM 1242-5 RAIL offers all the benefits of the S7-1200 design.

- Rugged, compact plastic enclosure
- Easily accessible connection and diagnostics elements, protected by front flaps
- Removable terminals
- Simple mounting on the mounting rail of the S7-1200
- 9-pin sub-D socket for the bus interface to PROFIBUS

The CM 1242-5 RAIL is plugged into the left-hand system bus interface of the S7-1200. Power is supplied via the system bus of the S7-1200 so that no extra cabling is required. The rugged RS485 interface is located on the underside of the module, protected by the lower front flap.

**Function**

The SIPLUS S7-1200 CM 1242-5 RAIL provides the communication services for integrating an S7-1200 into an automation solution as a PROFIBUS DP slave.

**PROFIBUS DP slave**

The CM 1242-5 RAIL works as a DPV1 slave in accordance with IEC 61158, handles data traffic completely autonomously, and thus relieves the CPU of communication tasks.

The data areas of the distributed I/Os are transferred consistently between CP and CPU.

**Diagnostics**

Extensive diagnostic options are available via STEP 7, including

- Operating status of the CM
- General diagnostics functions
- Connection diagnostics
- Alarm buffer

STEP 7 Basic is required for configuring the full functional scope of the CM 1242-5.

## Technical specifications

Article number	<b>6AG2242-5DX30-1XE0</b>
product type designation	SIPLUS S7-1200 CM 1242-5 RAIL
<b>Transfer rate</b>	
<b>Transfer rate</b> • at the 1st interface according to PROFIBUS	9.6 kbit/s ... 12 Mbit/s
<b>Interfaces</b>	
<b>Number of interfaces according to Industrial Ethernet</b>	0
<b>Number of electrical connections</b> • at the 1st interface according to PROFIBUS • for power supply	1 0
<b>Type of electrical connection</b> • at the 1st interface according to PROFIBUS	9-pin Sub-D socket (RS485)
<b>Supply voltage, current consumption, power loss</b>	
<b>Type of voltage of the supply voltage</b>	DC
<b>Supply voltage 1 from backplane bus</b>	5 V
<b>Consumed current</b> • from backplane bus at DC at 5 V typical	0.15 A
<b>Power loss [W]</b>	0.75 W
<b>Ambient conditions</b>	
<b>Ambient temperature</b> • during operation • during storage • during transport • note	-25 ... +55 °C -40 ... +70 °C -40 ... +70 °C +70 °C for 10 min (OT1, ST1/ST2 according to EN 50155)
<b>Installation altitude at height above sea level maximum</b>	2 000 m
<b>Ambient condition relating to ambient temperature - air pressure - installation altitude</b>	Tmin ... Tmax at 1 140 hPa ... 795 hPa (-1 000 m ... +2 000 m)
<b>Relative humidity</b> • with condensation according to IEC 60068-2-38 maximum	100 %; RH including condensation/frost (no commissioning when condensation is present), horizontal installation
<b>chemical resistance to commercially available cooling lubricants</b>	Yes; incl. airborne diesel and oil droplets
<b>Resistance to biologically active substances</b> • conformity according to EN 60721-3-3 • conformity according to EN 60721-3-5	Yes; Class 3B2 mold and fungal spores (excluding fauna), Class 3B3 on request Yes; Class 5B2 mold and fungal spores (excluding fauna), Class 5B3 on request
<b>Resistance to chemically active substances</b> • conformity according to EN 60721-3-3  • conformity according to EN 60721-3-5	Yes; Class 3C4 (RH < 75 %) incl. salt spray in accordance with EN 60068-2-52 (Severity 3). The supplied plug covers must remain in place on the unused interfaces during operation. Yes; Class 5C3 (RH < 75%) including salt spray acc. to EN 60068-2-52 (Severity level 3). The supplied plug covers must remain in place over the unused interfaces during operation!
<b>Resistance to mechanically active substances</b> • conformity according to EN 60721-3-3  • conformity according to EN 60721-3-5	Yes; Class 3S4 incl. sand, dust. The supplied plug covers must remain in place over the unused interfaces during operation. Yes; Class 5S3 incl. sand, dust. The supplied plug covers must remain in place over the unused interfaces during operation.
<b>Conformal coating</b> • coating for equipped printed circuit board according to EN 61086 • type of coating protection against pollution according to EN 60664-3 • type of coating for electronic devices in railway applications according to EN 50155 • type of test of the coating according to MIL-I-46058C • product conformity of the coating Qualification and Performance of Electrical Insulating Compound for Printed Board Assemblies according to IPC-CC-830A • protection class IP	Yes; Class 2 for high availability Yes; Protection of the type 1 Yes; Protective coating of the Class PC2 according to EN 50155:2017 Yes; Coating discoloration during service life possible Yes; Conformal coating, class A  IP20
<b>Design, dimensions and weights</b>	
<b>Module format</b>	Compact module S7-1200 single width
<b>Width</b>	30 mm
<b>Height</b>	100 mm
<b>Depth</b>	75 mm
<b>Net weight</b>	0.115 kg
<b>Fastening method</b> • 35 mm top hat DIN rail mounting • S7-300 rail mounting • wall mounting	Yes No Yes
<b>Product features, product functions, product components general</b>	
<b>Number of units</b> • per CPU maximum	3

# SIPLUS RAIL

## SIPLUS S7-1200 RAIL

### SIPLUS extreme RAIL communication

#### SIPLUS S7-1200 CM 1242-5 RAIL

Article number	<b>6AG2242-5DX30-1XE0</b>
product type designation	SIPLUS S7-1200 CM 1242-5 RAIL
<b>Performance data PROFIBUS DP</b>	
<b>Service as DP slave</b>	
• DPV0	Yes
• DPV1	Yes
<b>Data volume</b>	
• of the address range of the inputs as DP slave total	240 byte
<b>Performance data telecontrol</b>	
<b>Protocol is supported</b>	
• TCP/IP	No
<b>Standards, specifications, approvals</b>	
<b>Certificate of suitability</b>	
• fire protection in accordance with EN 45545-2	Yes; Railway vehicles - for proof, see Service & Support
<b>Railway application</b>	
<b>Certificate of suitability railway application in accordance with EN 50121-3-2</b>	Yes; EMC for railway vehicles
<b>Certificate of suitability railway application in accordance with EN 50121-4</b>	Yes; EMC for signal and telecommunication equipment
<b>Certificate of suitability railway application in accordance with EN 50124-1</b>	Yes; Railway applications - Overvoltage category OV2 pollution degree PD2 rated impulse voltage UNi = 0.5 kVUNm = DC 24
<b>Certificate of suitability railway application in accordance with EN 50125-1</b>	Yes; Railway vehicles - See ambient conditions
<b>Certificate of suitability railway application in accordance with EN 50125-2</b>	Yes; Fixed-electrical installations - see ambient conditions
<b>Certificate of suitability railway application in accordance with EN 50125-3</b>	Yes; Signal and telecommunications equipment - see Ambient conditions vibrations and shocks: Application point outside the rails (distance 1 m to 3 m from rail)
<b>Certificate of suitability railway application in accordance with EN 50155</b>	Yes; Railway vehicles - temperature class OT1, ST1/ST2, horizontal mounting position
<b>Certificate of suitability railway application in accordance with EN 61373</b>	Yes; Railway vehicles - Vibrations and shocks Category 1 Class A/B

#### Selection and ordering data

Version	Article No.
<b>SIPLUS CM 1242-5 RAIL communication module</b> Approved in accordance with the EN 50155, EN 15121, EN 50124, EN 50125 and EN 45545 railway standards for use in rail traffic Communication module for electrical connection of SIPLUS S7-1200 RAIL to PROFIBUS as a DPV1 slave <ul style="list-style-type: none"> <li>For areas with extreme exposure to environmental substances (conformal coating); ambient temperature -25 ... +70 °C</li> </ul>	<b>6AG2242-5DX30-1XE0</b>

## Overview



DP-M	DP-S	FMS	PG/OP	S7
●			●	●

The SIPLUS S7-1200 CM 1243-5 RAIL communication module is used to connect a SIPLUS extreme RAIL S7-1200 to PROFIBUS as a DP master and has the following characteristics:

- Approved in accordance with the railway standards EN 50155, EN 15121, EN 50124, EN 50125 and EN 45545 for use in rail traffic
- PROFIBUS DPV1 master in accordance with IEC 61158
- Support of up to 16 PROFIBUS DP slaves
- Communication with other S7 controllers based on S7 communication
- Allows the connection of programming devices and operator panels with a PROFIBUS interface to the S7-1200
- Module replacement without PG supported
- Support of all standard baud rates from 9.6 Kbps to 12 Mbps
- Compact industry-standard enclosure in S7-1200 design for mounting on a DIN rail
- Fast commissioning thanks to easy configuration using STEP 7 without additional programming overhead

The SIPLUS S7-1200 CM 1243-5 RAIL is intended for use in rail traffic. Low-cost PROFIBUS-based automation solutions can be created on the basis of the S7-1200 for optimal production.

## Benefits



PROFIBUS-based systems can be operated effectively for lower operating and maintenance costs:

- Low costs since an automation solution requires no fixed wiring and less hardware
- Fast response to faults thanks to excellent diagnostics options
- Optimized plant and inventory management

The SIPLUS S7-1200 CM 1243-5 RAIL also offers further benefits especially for the requirements of micro-automation solutions:

- Uncomplicated connection of the S7-1200 to PROFIBUS
- Low-cost implementation of automation solutions based on PROFIBUS
- Fast commissioning, as no programming overhead is required

Use of PROFIBUS-based micro-automation solutions enables optimal operation of the plant.

## Application

The SIPLUS S7-1200 CM 1243-5 RAIL is designed for use in rail traffic.

With the CM 1243-5 RAIL, low-cost, distributed automation solutions can be implemented on the basis of the S7-1200, or in simple cases even complete plant automation systems. It can be used in all sectors of discrete automation.

## Design



The SIPLUS S7-1200 CM 1243-5 RAIL offers all the benefits of the S7-1200 design.

- Rugged, compact plastic enclosure
- Easily accessible connection and diagnostics elements, protected by front flaps
- Removable terminals
- Simple mounting on the mounting rail of the S7-1200
- 9-pin sub-D socket for the bus interface to PROFIBUS
- 3-pin plug-in terminal strip for connection of the 24 V DC external supply voltage

The CM 1243-5 RAIL is plugged into the left-hand system bus interface of the S7-1200. The power is supplied via a 3-pin terminal strip on top of the module. The rugged RS485 interface is located on the underside of the module, protected by the lower front flap.

**SIPLUS RAIL**

SIPLUS S7-1200 RAIL

SIPLUS extreme RAIL communication

**SIPLUS S7-1200 CM 1243-5 RAIL****Function**

The SIPLUS S7-1200 CM 1243-5 RAIL provides access to different communication services on the basis of PROFIBUS:

- PROFIBUS DP (according to IEC 61158, master)
- PG/OP communication
- S7 communication

**PROFIBUS DP master**

The CM 1243-5 RAIL works as a DP-V1 master in accordance with IEC 61158, handles data traffic completely autonomously, and thus relieves the CPU of communication tasks.

The data areas of the distributed I/Os are transferred consistently between CP and CPU. As a DP master, it allows the connection of up to 16 PROFIBUS-compliant DP slaves

**PG/OP communication**

The S7-1200 to which the CM 1243-5 RAIL is connected can be programmed with the help of PG/OP communication.

**S7 communication**

Communication with the following other systems can be implemented with the mechanisms familiar from the S7 world (Put/Get) on the basis of S7 communication:

- To other SIMATIC S7 programmable controllers
- To HMI devices
- To PCs, laptops, field PGs with PROFIBUS cards

**Diagnostics**

Extensive diagnostic options are available via STEP 7, including

- Operating status of the CM
- General diagnostics and statistics functions
- Connection diagnostics
- Alarm buffer

STEP 7 Basic is required for configuring the full functional scope of the CM 1243-5 RAIL.

**Technical specifications**

Article number	<b>6AG2243-5DX30-1XE0</b>
product type designation	SIPLUS S7-1200 CM 1243-5 RAIL
<b>Transfer rate</b>	
<b>Transfer rate</b>	
• at the 1st interface according to PROFIBUS	9.6 kbit/s ... 12 Mbit/s
<b>Interfaces</b>	
<b>Number of interfaces according to Industrial Ethernet</b>	0
• number of electrical connections	
- at the 1st interface according to PROFIBUS	1
- for power supply	1
• type of electrical connection	
- at the 1st interface according to PROFIBUS	9-pin Sub-D socket (RS485)
- for power supply	3-pole terminal block
<b>Supply voltage, current consumption, power loss</b>	
<b>Type of voltage of the supply voltage</b>	DC
<b>Supply voltage external</b>	24 V
<b>Supply voltage external at DC rated value</b>	24 V
<b>Relative positive tolerance at DC at 24 V</b>	20 %
<b>Relative negative tolerance at DC at 24 V</b>	20 %
<b>Consumed current</b>	
• from external supply voltage at DC at 24 V typical	0.1 A
<b>Power loss [W]</b>	2.4 W
<b>Ambient conditions</b>	
<b>Ambient temperature</b>	
• during operation	-25 ... +55 °C
• during storage	-40 ... +70 °C
• during transport	-40 ... +70 °C
• note	+70 °C for 10 min (OT1, ST1/ST2 according to EN 50155)
<b>Installation altitude at height above sea level maximum</b>	2 000 m
<b>Ambient condition relating to ambient temperature - air pressure - installation altitude</b>	Tmin ... Tmax at 1 140 hPa ... 795 hPa (-1 000 m ... +2 000 m)
<b>Relative humidity</b>	
• with condensation according to IEC 60068-2-38 maximum	100 %; RH including condensation/frost (no commissioning when condensation is present), horizontal installation
<b>Chemical resistance to commercially available cooling lubricants</b>	Yes; incl. airborne diesel and oil droplets
<b>Resistance to biologically active substances</b>	
• conformity according to EN 60721-3-3	Yes; Class 3B2 mold and fungal spores (excluding fauna), Class 3B3 on request
• conformity according to EN 60721-3-5	Yes; Class 5B2 mold and fungal spores (excluding fauna), Class 5B3 on request
<b>Resistance to chemically active substances</b>	
• conformity according to EN 60721-3-3	Yes; Class 3C4 (RH < 75 %) incl. salt spray in accordance with EN 60068-2-52 (Severity 3). The supplied plug covers must remain in place on the unused interfaces during operation.
• conformity according to EN 60721-3-5	Yes; Class 5C3 (RH < 75%) including salt spray acc. to EN 60068-2-52 (Severity level 3). The supplied plug covers must remain in place over the unused interfaces during operation!



Article number	<b>6AG2243-5DX30-1XE0</b>
product type designation	SIPLUS S7-1200 CM 1243-5 RAIL
<b>Resistance to mechanically active substances</b>	
<ul style="list-style-type: none"> <li>conformity according to EN 60721-3-3</li> <li>conformity according to EN 60721-3-5</li> </ul>	<p>Yes; Class 3S4 incl. sand, dust. The supplied plug covers must remain in place over the unused interfaces during operation.</p> <p>Yes; Class 5S3 incl. sand, dust. The supplied plug covers must remain in place over the unused interfaces during operation.</p>
<b>Conformal coating</b>	
<ul style="list-style-type: none"> <li>coating for equipped printed circuit board according to EN 61086</li> <li>type of coating protection against pollution according to EN 60664-3</li> <li>type of coating for electronic devices in railway applications according to EN 50155</li> <li>type of test of the coating according to MIL-I-46058C</li> <li>product conformity of the coating Qualification and Performance of Electrical Insulating Compound for Printed Board Assemblies according to IPC-CC-830A</li> </ul>	<p>Yes; Class 2 for high availability</p> <p>Yes; Protection of the type 1</p> <p>Yes; Protective coating of the Class PC2 according to EN 50155:2018</p> <p>Yes; Coating discoloration during service life possible</p> <p>Yes; Conformal coating, class A</p>
<b>Protection class IP</b>	IP20
<b>Design, dimensions and weights</b>	
<b>Module format</b>	Compact module S7-1200 single width
<b>Width</b>	30 mm
<b>Height</b>	100 mm
<b>Depth</b>	75 mm
<b>Net weight</b>	0.134 kg
<b>Fastening method</b>	
<ul style="list-style-type: none"> <li>35 mm top hat DIN rail mounting</li> <li>S7-300 rail mounting</li> <li>wall mounting</li> </ul>	<p>Yes</p> <p>No</p> <p>Yes</p>
<b>Product features, product functions, product components general</b>	
<b>Number of units</b>	
<ul style="list-style-type: none"> <li>per CPU maximum</li> </ul>	1
<b>Performance data PROFIBUS DP</b>	
<b>Service as DP master</b>	
<ul style="list-style-type: none"> <li>DPV1</li> </ul>	Yes
<b>Number of DP slaves</b>	
<ul style="list-style-type: none"> <li>on DP master operable</li> </ul>	16
<b>Data volume</b>	
<ul style="list-style-type: none"> <li>of the address range of the inputs as DP master total</li> <li>of the address range of the outputs as DP master total</li> <li>of the address range of the inputs per DP slave</li> <li>of the address range of the outputs per DP slave</li> <li>of the address range of the diagnostic data per DP slave</li> </ul>	<p>512 byte</p> <p>512 byte</p> <p>244 byte</p> <p>244 byte</p> <p>240 byte</p>
<b>Service as DP slave</b>	
<ul style="list-style-type: none"> <li>DPV0</li> <li>DPV1</li> </ul>	<p>No</p> <p>No</p>
<b>Performance data S7 communication</b>	
<b>Number of possible connections for S7 communication</b>	
<ul style="list-style-type: none"> <li>maximum</li> <li>with PG connections maximum</li> <li>with PG/OP connections maximum</li> </ul>	<p>8; max. 4 connections to other S7 stations</p> <p>1</p> <p>3</p>
<b>Performance data multi-protocol mode</b>	
<b>Number of active connections with multi-protocol mode</b>	
<ul style="list-style-type: none"> <li>without DP maximum</li> <li>with DP maximum</li> </ul>	<p>8</p> <p>8</p>
<b>Performance data telecontrol</b>	
<b>Protocol is supported</b>	
<ul style="list-style-type: none"> <li>TCP/IP</li> </ul>	No
<b>Standards, specifications, approvals</b>	
<b>Certificate of suitability</b>	
<ul style="list-style-type: none"> <li>fire protection in accordance with EN 45545-2</li> </ul>	Yes; Railway vehicles - for proof, see Service & Support



# SIPLUS RAIL

## SIPLUS S7-1200 RAIL

### SIPLUS extreme RAIL communication

#### SIPLUS S7-1200 CM 1243-5 RAIL

Article number	<b>6AG2243-5DX30-1XE0</b>
product type designation	SIPLUS S7-1200 CM 1243-5 RAIL
<b>Railway application</b>	
<b>Certificate of suitability railway application in accordance with EN 50121-3-2</b>	Yes; EMC for railway vehicles
<b>Certificate of suitability railway application in accordance with EN 50121-4</b>	Yes; EMC for signal and telecommunication equipment
<b>Certificate of suitability railway application in accordance with EN 50124-1</b>	Yes; Railway applications - Overvoltage category OV2 pollution degree PD2 rated impulse voltage UNi = 0.5 kVUNm = DC 24
<b>Certificate of suitability railway application in accordance with EN 50125-1</b>	Yes; Railway vehicles - See ambient conditions
<b>Certificate of suitability railway application in accordance with EN 50125-2</b>	Yes; Fixed-electrical installations - see ambient conditions
<b>Certificate of suitability railway application in accordance with EN 50125-3</b>	Yes; Signal and telecommunications equipment - see Ambient conditions vibrations and shocks: Application point outside the rails (distance 1 m to 3 m from rail)
<b>Certificate of suitability railway application in accordance with EN 50155</b>	Yes; Railway vehicles - temperature class OT1, ST1/ST2, horizontal mounting position
<b>Certificate of suitability railway application in accordance with EN 61373</b>	Yes; Railway vehicles - Vibrations and shocks Category 1 Class A/B

#### Selection and ordering data

Version	Article No.
<p><b>SIPLUS CM 1243-5 RAIL Communications Module</b></p> <p>Approved in accordance with railway standards EN 50155, EN 15121, EN 50124, EN 50125 and EN 45545 for use in rail traffic</p> <p>Communications module for electrical connection of SIPLUS S7-1200 CM 1243-5 T1 RAIL to PROFIBUS as a DPV1 master</p> <ul style="list-style-type: none"> <li>For areas with extreme exposure to environmental substances (conformal coating); ambient temperature -25 ... +55 °C, OT1 with ST1/2, (+70 °C for 10 min.)</li> </ul>	<b>6AG2243-5DX30-1XE0</b>

## Overview

The CP 1243-1 communications processor is used for connecting the SIMATIC S7-1200 to telecontrol centers via remote networks and telecontrol protocols (DNP3, IEC 60870-5-104, TeleControl Basic), and for safe communication via IP-based networks.

The CP has the following features:

- Ethernet-based connection to TeleControl Server Basic, e.g. via Internet
- Approved in accordance with EN 50155, EN 15121, EN 50124, EN 50125 and EN 45545 railway standards for use in rail traffic
- Data transfer of measured values, control variables, or alarms optimized for telecontrol systems
- Automatic sending of alert emails
- Data buffering of up to 64,000 values ensures a secure database even with temporary connection failures
- Secure communication via VPN connections based on IPSec
- Access protection via Stateful Inspection Firewall
- Support of SINEMA Remote Connect with autoconfiguration
- Clearly laid out LED signaling for fast and easy diagnostics
- Compact industrial enclosure in S7-1200 design for mounting on a standard mounting rail
- Fast commissioning thanks to easy configuration using STEP 7

## Benefits



- **Data security**  
The CP 1243-1 has a large buffer for several thousand data values. Downtimes in the transmission link can then be bridged.
- **Fully automatic time stamp**  
To enable subsequent and correct archiving of process data in the control system, all data frames are time-stamped at their place of origin.
- **Fast and flexible data communication**  
Operators are quickly provided with alarms, statuses and values from the process, and they can influence process control by entering commands or setpoints at any time.
- **Simple, low-cost engineering**  
The cyclic or event-controller transfer of measurements, setpoints or alarms can be implemented in just a few steps, without any programming effort.

## Remote diagnostics

Saving of traveling and maintenance costs due to cost-effective remote programming, diagnostics, control and monitoring via the Internet

## Industrial Security

Securing plant networks against unauthorized access by means of:

- Central access protection for any devices within an automation cell, e.g. by means of authentication of the network stations
- Secure remote access via the Internet by means of data encryption (VPN) and data integrity checking

## Application

By using the CP 1243-1, the S7-1200 can be used as a remote terminal unit (substation) in telecontrol applications. Typical uses include the collection of measured values in geographically widely distributed outdoor areas (level measurement for water tanks) or centralized opening and closing of valves (oil/gas transport in pipelines).

- Plants in water, wastewater or environmental sectors:
  - Irrigation systems
  - Drinking water supply
- Monitoring of power networks for consumption metering and cost control
  - District heating networks
  - Wind farms
- Plants in the oil and gas sector
  - Oilfield water injection
  - Pipelines
- Transportation systems
  - Ventilation control in tunnel systems
  - Traffic control

Regardless of the telecontrol features of the CP, it can also be used purely for security applications if the automation system is to be connected securely to a higher-level IT network. This ensures that, within the framework of a network segmentation, the SIMATIC S7-1200 is protected against unauthorized access from Industrial Ethernet networks. The CP 1243-1 allows secure access via an Industrial Ethernet connection and allows the data transferred between devices or network segments to be protected from manipulation and industrial espionage.

## Design

The CP 1243-1 offers all the advantages of the S7-1200 design:

- Rugged, compact plastic enclosure
- Easily accessible connection and diagnostics elements, protected by front flaps
- Simple mounting on the mounting rail of the S7-1200

The CP 1243-1 is plugged into the left-hand system bus interface of the S7-1200. Power is supplied directly via the S7-1200. No additional wiring is necessary. Any required modems or routers are connected via the Ethernet interface on the underside of the module.

# SIPLUS RAIL

## SIPLUS S7-1200 RAIL

### SIPLUS extreme RAIL communication

#### SIPLUS S7-1200 CP 1243-1 RAIL

#### Function

The CP 1243-1 communications processor is used for connecting the SIMATIC S7-1200 to control centers via Ethernet in tele-control applications and is also used in secure communications via IP-based networks (security functions).

#### Virtual Private Network (IPsec)

The connection of S7-1200 via a VPN network ensures that only authenticated network nodes can communicate with the controller. Secure encryption of the data and verification of the data integrity protect the data traffic from espionage and manipulation.

#### Stateful inspection firewall

By using a firewall, the S7-1200 can provide additional protection against unauthorized access and attempted manipulation.

The firewall filters data packets and checks the communication connections in accordance with the filter list. Both incoming and outgoing communication can be filtered based on IP and MAC addresses.

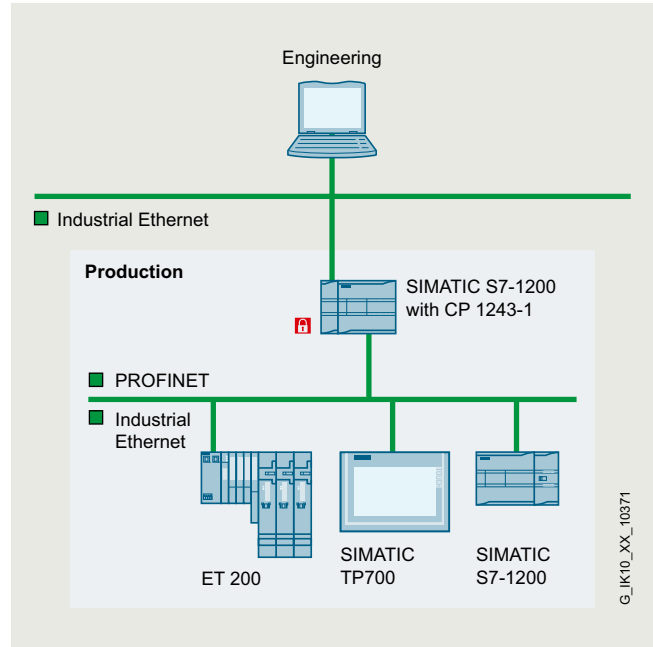

Cell protection for SIMATIC S7-1200 with CP 1243-1 (Security Integrated) e.g. safe engineering access to the S7-1200

6

#### Connection to a control center with TeleControl Server Basic

With the help of the CP 1243-1, S7-1200-based remote stations in telecontrol applications can be directly connected via an IP-based network to the TeleControl Server Basic. By using addi-

tional routers (e.g. SCALANCE M for communication via mobile wireless or DSL), it is possible to make the connection via other media.

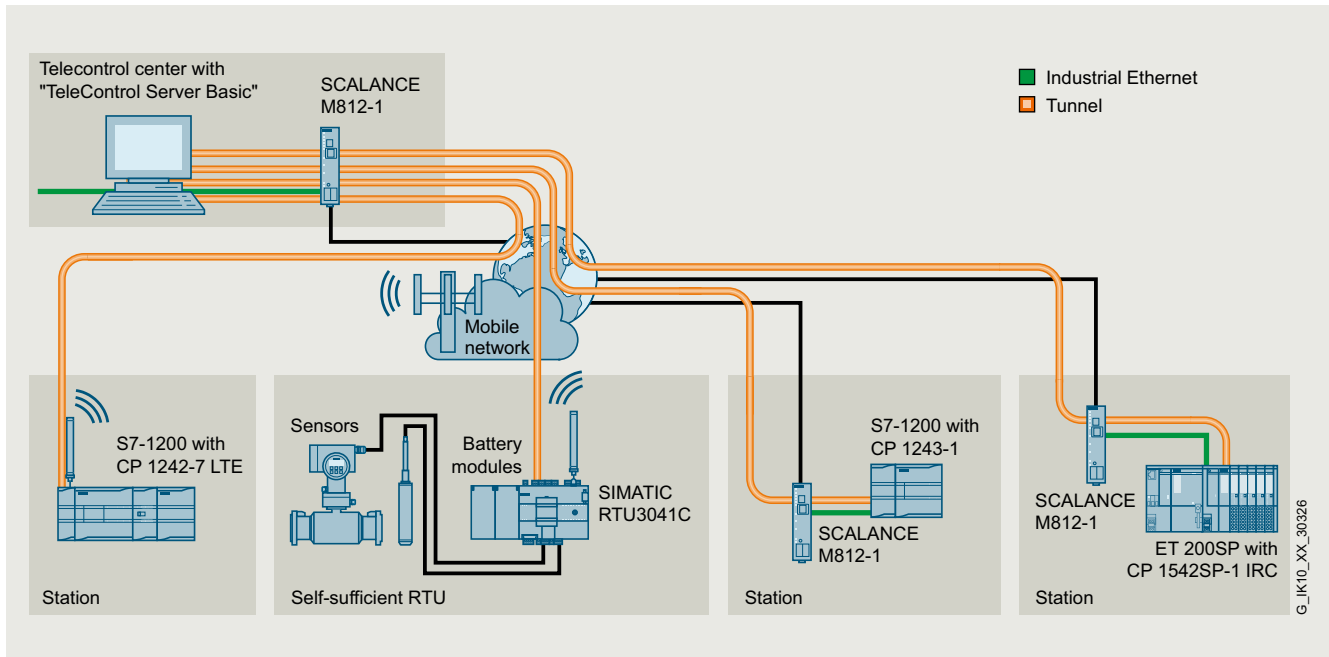

Telecontrol application with the S7-1200 as RTU, connected via mobile wireless (CP 1242-7) and DSL (with CP 1243-1 and SCALANCE M812-1)

### Connection to WinCC based or 3rd party control centers

With CP1243-1, it is possible in just a few steps to connect the remote station S7-1200 to a DNP3 or IEC 60870-5-104 based control center (e.g. WinCC or PCS 7).

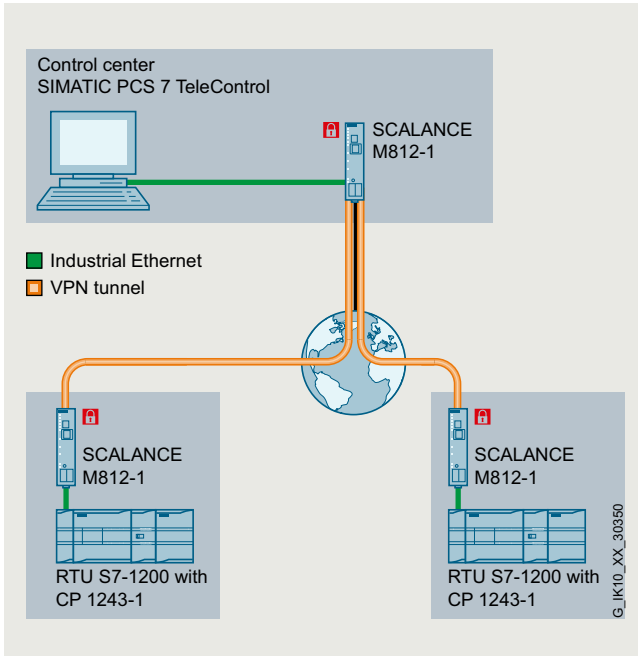

Telecontrol application with the S7-1200 as RTU, connected via DSL to a PCS 7 control center with Telecontrol Add On

### Completely configurable application using "data point configuration"

"Data point configuration" in STEP 7 eliminates all programming effort for transmission of data to the control center.

The data of the CPU relevant to the control center is selected via user-friendly "item browsing" in STEP 7. In a clearly-arranged menu, the data transfer parameters are then assigned to the data points selected in this way. The cyclic or event-controller transfer of measured values, setpoints or alarms can thus be implemented in only a few operations and without programming effort.

### Data buffering

Data losses are prevented by the data buffering mechanisms integrated in the product.

In the event of a connection failure, up to 64 000 time-stamped values are buffered. When the connection returns, the buffered values are automatically transferred to the control center in the right order.

### DNP3 protocol

Communication with the control center is based on the established standard of DNP3 specification 2 (2007/2009).

Thanks to support of the object and data transfer mechanisms defined in the specification, compatibility with PCS 7, WinCC (with corresponding telecontrol packages), and all other control center systems available on the market is ensured.

The security mechanisms already defined in the DNP3 standard for secure data transfer through trunk networks are fully supported.

### IEC 60870 standard

Communication with the control center is based on the established communication standard in accordance with IEC 60870-5-104. This ensures that telecontrol and instrumentation and control devices and systems from Siemens or other vendors can communicate with each other without any fundamental adaptations. The variance and variabilities provided by this standard allow different vendor-specific profiles (e.g. the frame types and functions used). The profiles can be coordinated with each other with the help of an interoperability list. This standard has become widely used, especially in Europe and Asia. The IEC 60870-5-104 telecontrol protocol is also suitable as a field or station bus. Use as a station bus also enables direct communication between individual devices.

### Email alerts

Email alerts can be configured for timely provision of station states to service or maintenance personnel. When previously defined events (such as threshold violation) occur, application-specific information is sent automatically by email.

### Diagnostics

The CP1243-1 offers comprehensive diagnostic options for quick and informative analysis of the station status and VPN connections. Elementary diagnostic information is signaled directly via LEDs at the CP.

Extensive information, such as connection history, buffer status and transferred measured values, can be called up via STEP 7.

### Remote maintenance

For remote access from the control center to the substation, the CP provides a remote maintenance port parallel to process operation. This ensures monitoring access for firmware updates or program changes. Support of SINEMA Remote Connect with autoconfiguration.

### Interfaces

The CP1243-1 has an Ethernet interface. The S7-1200 can be connected directly via an existing network, or using additional routers via other media (e.g. SCALANCE M for mobile wireless communication).

### Power supply

Extra wiring for the CP power supply is not required. Power is supplied directly via the backplane bus of the S7-1200.

**SIPLUS RAIL**

SIPLUS S7-1200 RAIL

SIPLUS extreme RAIL communication

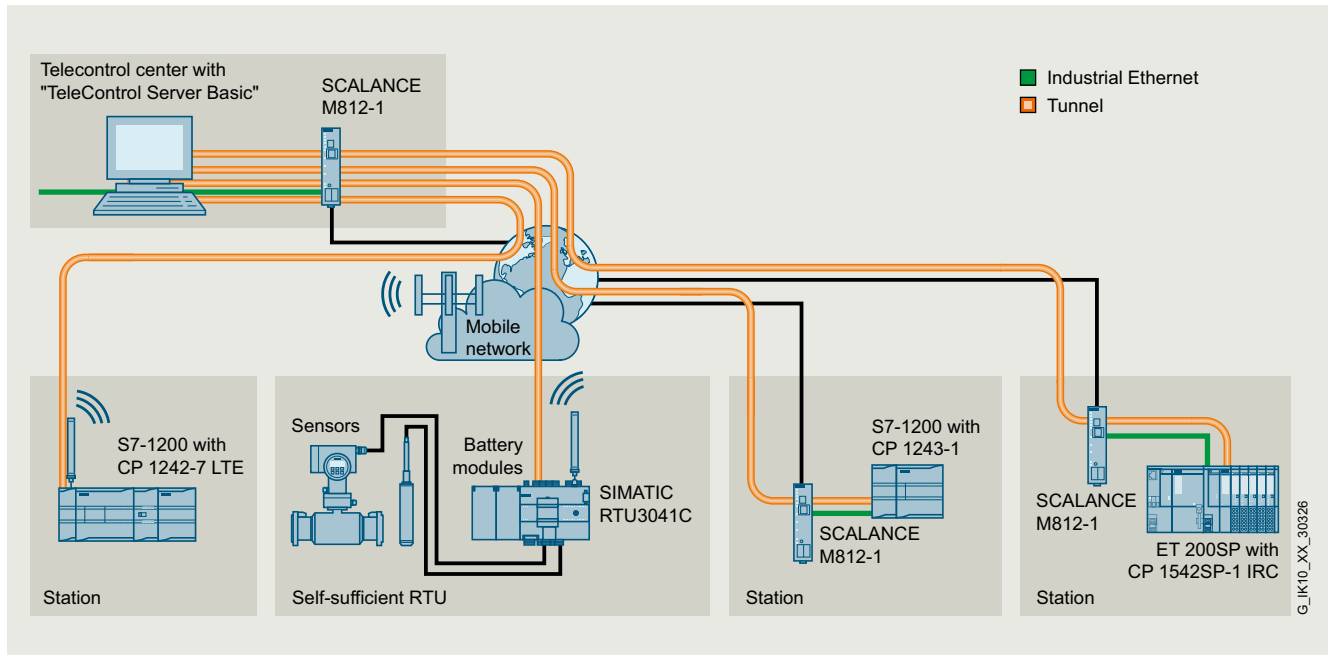
**SIPLUS S7-1200 CP 1243-1 RAIL****Integration**

Connection of S7-1200 to Telecontrol Server via mobile network and DSL Internet access

6

**Technical specifications**

Article number	<b>6AG2243-1BX30-1XE0</b>
product type designation	SIPLUS S7-1200 CP 1243-1 RAIL
<b>Transfer rate</b>	
<b>transfer rate</b>	
• at the 1st interface	10 ... 100 Mbit/s
<b>Interfaces</b>	
<b>number of interfaces according to Industrial Ethernet</b>	1
<b>number of electrical connections</b>	
• at the 1st interface according to Industrial Ethernet	1
• for power supply	0
<b>type of electrical connection</b>	
• at the 1st interface according to Industrial Ethernet	RJ45 port
<b>Supply voltage, current consumption, power loss</b>	
<b>type of voltage of the supply voltage</b>	DC
<b>supply voltage 1 from backplane bus</b>	5 V
<b>consumed current</b>	
• from backplane bus at DC at 5 V typical	0.25 A
<b>power loss [W]</b>	1.25 W
<b>Ambient conditions</b>	
<b>ambient temperature</b>	
• for vertical installation during operation	-25 ... +60 °C
• for horizontally arranged busbars during operation	-25 ... +70 °C
• during storage	-40 ... +70 °C
• during transport	-40 ... +70 °C
• note	+70 °C for 10 min (OT1, ST1/ST2 according to EN 50155)
<b>installation altitude at height above sea level maximum</b>	2 000 m
<b>ambient condition relating to ambient temperature - air pressure - installation altitude</b>	Tmin ... Tmax at 1 140 hPa ... 795 hPa (-1 000 m ... +2 000 m)
<b>relative humidity</b>	
• with condensation according to IEC 60068-2-38 maximum	100 %; RH including condensation/frost (no commissioning when condensation is present), horizontal installation
<b>chemical resistance to commercially available cooling lubricants</b>	Yes; incl. airborne diesel and oil droplets
<b>resistance to biologically active substances</b>	
• conformity according to EN 60721-3-3	Yes; Class 3B2 mold and fungal spores (excluding fauna), Class 3B3 on request
• conformity according to EN 60721-3-5	Yes; Class 5B2 mold and fungal spores (excluding fauna), Class 5B3 on request

G\_JK10\_XX\_30326

Article number	<b>6AG2243-1BX30-1XE0</b>
product type designation	SIPLUS S7-1200 CP 1243-1 RAIL
<b>resistance to chemically active substances</b>	
<ul style="list-style-type: none"> <li>conformity according to EN 60721-3-3</li> </ul>	Yes; Class 3C4 (RH < 75 %) incl. salt spray in accordance with EN 60068-2-52 (Severity 3). The supplied plug covers must remain in place on the unused interfaces during operation.
<ul style="list-style-type: none"> <li>conformity according to EN 60721-3-5</li> </ul>	Yes; Class 5C3 (RH < 75%) including salt spray acc. to EN 60068-2-52 (Severity level 3). The supplied plug covers must remain in place over the unused interfaces during operation!
<b>resistance to mechanically active substances</b>	
<ul style="list-style-type: none"> <li>conformity according to EN 60721-3-3</li> </ul>	Yes; Class 3S4 incl. sand, dust. The supplied plug covers must remain in place over the unused interfaces during operation.
<ul style="list-style-type: none"> <li>conformity according to EN 60721-3-5</li> </ul>	Yes; Class 5S3 incl. sand, dust. The supplied plug covers must remain in place over the unused interfaces during operation.
<b>coating for equipped printed circuit board according to EN 61086</b>	Yes; Class 2 for high availability
<b>type of coating protection against pollution according to EN 60664-3</b>	Yes; Protection of the type 1
<b>type of coating for electronic devices in railway applications according to EN 50155</b>	Yes; Protective coating of the Class PC2 according to EN 50155:2017
<b>type of test of the coating according to MIL-I-46058C</b>	Yes; Coating discoloration during service life possible
<b>product conformity of the coating Qualification and Performance of Electrical Insulating Compound for Printed Board Assemblies according to IPC-CC-830A</b>	Yes; Conformal coating, class A
<b>protection class IP</b>	IP20
<b>Design, dimensions and weights</b>	
<b>module format</b>	Compact module S7-1200 single width
<b>width</b>	30 mm
<b>height</b>	110 mm
<b>depth</b>	75 mm
<b>net weight</b>	0.122 kg
<b>fastening method</b>	
<ul style="list-style-type: none"> <li>35 mm top hat DIN rail mounting</li> <li>wall mounting</li> </ul>	Yes Yes
<b>Product features, product functions, product components general</b>	
<b>number of units</b>	
<ul style="list-style-type: none"> <li>per CPU maximum</li> </ul>	3
<b>Performance data open communication</b>	
<b>number of possible connections for open communication</b>	
<ul style="list-style-type: none"> <li>by means of T blocks maximum</li> </ul>	like CPU
<b>Performance data S7 communication</b>	
<b>number of possible connections for S7 communication</b>	
<ul style="list-style-type: none"> <li>maximum</li> </ul>	like CPU
<b>Performance data IT functions</b>	
<b>number of possible connections</b>	
<ul style="list-style-type: none"> <li>as email client maximum</li> </ul>	1
<b>Performance data telecontrol</b>	
<b>suitability for use</b>	
<ul style="list-style-type: none"> <li>node station</li> <li>substation</li> <li>TIM control center</li> <li>control center connection</li> <li>by means of a permanent connection</li> <li>note</li> </ul>	No Yes No For use with TeleControl Server Basic, WinCC and PCS7 supported Connection to SCADA system via Telecontrol Server Basic and Standard Telecontrol protocols
<b>protocol is supported</b>	
<ul style="list-style-type: none"> <li>DNP3</li> <li>IEC 60870-5</li> </ul>	Yes Yes
<b>product function data buffering if connection is aborted</b>	Yes; 64,000 events
<b>number of data points per station maximum</b>	200
<b>number of stations for direct communication with Telecontrol Server Basic</b>	
<ul style="list-style-type: none"> <li>in send direction maximum</li> <li>in receive direction maximum</li> </ul>	3 15
<b>Performance data teleservice</b>	
<b>diagnostics function online diagnostics with SIMATIC STEP 7</b>	Yes
<b>product function</b>	
<ul style="list-style-type: none"> <li>program download with SIMATIC STEP 7</li> <li>remote firmware update</li> </ul>	Yes Yes
<b>Product functions management, configuration, engineering</b>	
<b>configuration software</b>	
<ul style="list-style-type: none"> <li>required</li> </ul>	STEP 7 Basic/Professional

**SIPLUS RAIL**

SIPLUS S7-1200 RAIL

SIPLUS extreme RAIL communication

**SIPLUS S7-1200 CP 1243-1 RAIL**

Article number	<b>6AG2243-1BX30-1XE0</b>
product type designation	SIPLUS S7-1200 CP 1243-1 RAIL
<b>Product functions diagnostics</b>	
<b>product function web-based diagnostics</b>	Yes
<b>Product functions security</b>	
<b>firewall version</b>	stateful inspection
<b>product function with VPN connection</b>	IPsec, SINEMA RC
<b>type of encryption algorithms with VPN connection</b>	AES-256, AES-192, AES-128, 3DES-168
<b>type of authentication procedure with VPN connection</b>	Preshared key (PSK), X.509v3 certificates
<b>type of hashing algorithms with VPN connection</b>	MD5, SHA-1, SHA-2
<b>number of possible connections with VPN connection</b>	8
<b>product function</b>	No
• password protection for Web applications	No
• password protection for teleservice access	Yes
• encrypted data transmission	No
• ACL - IP-based	No
• ACL - IP-based for PLC/routing	Yes
• switch-off of non-required services	No
• blocking of communication via physical ports	No
• log file for unauthorized access	No
<b>Product functions time</b>	
<b>protocol is supported</b>	Yes
• NTP	Yes
• NTP (secure)	Yes
<b>time synchronization</b>	Yes
• from NTP-server	Yes
• from control center	Yes
<b>Standards, specifications, approvals</b>	
<b>certificate of suitability</b>	Yes; Railway vehicles - for proof, see Service & Support
• fire protection in accordance with EN 45545-2	
<b>Railway application</b>	
<b>certificate of suitability railway application in accordance with EN 50121-3-2</b>	Yes; EMC for railway vehicles
<b>certificate of suitability railway application in accordance with EN 50121-4</b>	Yes; EMC for signal and telecommunication equipment
<b>certificate of suitability railway application in accordance with EN 50124-1</b>	Yes; Railway applications - Overvoltage category OV2 pollution degree PD2 rated impulse voltage UNi = 0.5 kVUNm = DC 24
<b>certificate of suitability railway application in accordance with EN 50125-1</b>	Yes; Railway vehicles - See ambient conditions
<b>certificate of suitability railway application in accordance with EN 50125-2</b>	Yes; Fixed-electrical installations - see ambient conditions
<b>certificate of suitability railway application in accordance with EN 50125-3</b>	Yes; Signal and telecommunications equipment - see Ambient conditions vibrations and shocks: Application point outside the rails (distance 1 m to 3 m from rail)
<b>certificate of suitability railway application in accordance with EN 50155</b>	Yes; Railway vehicles - temperature class OT1, ST1/ST2, horizontal mounting position
<b>certificate of suitability railway application in accordance with EN 61373</b>	Yes; Railway vehicles - Vibrations and shocks Category 1 Class A/B

**Selection and ordering data**

Version	Article No.
<b>SIPLUS S7-1200 CP 1243-1 RAIL</b> Approved in accordance with railway standards EN 50155, EN 15121, EN 50124, EN 50125 and EN 45545 for use in rail traffic Communications processor for connecting SIMATIC S7-1200 as an additional Ethernet interface and for connection to control centers via telecontrol protocols (DNP3, IEC 60870, TeleControl Basic), security (firewall, VPN) <ul style="list-style-type: none"> <li>For areas with extreme exposure to environmental substances (conformal coating): ambient temperature -25 ... +70 °C (T1 with 70 °C for 10 minutes)</li> </ul>	<b>6AG2243-1BX30-1XE0</b>

**More information****Technical requirements/compatibility**

An S7-1200 CPU with firmware version 4.1 is required to operate the CP 1243-1.

The CP 1243-1 can be configured with STEP 7 Basic/Professional V14 SP1 update (TIA Portal) or higher.

The TeleControl Server Basic V3 software package is required to connect to the PCS 7/WinCC control center systems.



## Overview



- Entry-level CPU in the SIPLUS extreme RAIL S7-1500 Controller product range
- Approved in accordance with the EN 50155, EN 15121, EN 50124, EN 50125 and EN 45545 railway standards for use in rail traffic
- Suitable for applications with medium requirements for program scope and processing speed
- PROFINET IO IRT interface with 2-port switch
- PROFINET IO controller for operating distributed I/O on PROFINET
- PROFINET I-Device for connecting the CPU as an intelligent PROFINET device under a SIMATIC or non-Siemens PROFINET IO controller
- Isochronous mode
- SIMATIC Memory Card required for operation of the CPU

## Application

The SIPLUS S7-1500 CPU 1511-1 PN RAIL is the most cost-effective entry-level CPU for applications with medium requirements for processing speed and speed of response. The CPU can be used as a PROFINET IO Controller or as distributed intelligence (PROFINET I-Device). The integrated PROFINET IO IRT interface is designed as a 2-port switch so that a linear topology can be set up. In addition, the CPU offers comprehensive control functionalities via easy-to-configure blocks as well as the ability to connect drives via standardized PLC-open blocks.

## Design

The SIPLUS S7-1500 CPU 1511-1 PN RAIL has:

- A powerful processor:  
The CPU achieves command execution times as low as 60 ns per binary instruction.
- A large work memory:  
150 KB for program, 1 MB for data
- SIMATIC Memory Cards as load memory;  
permit additional functions such as datalog and archives
- Flexible expansion capability:  
single-tier configuration with max. 32 modules (CPU + 31 modules)
- PROFINET IO IRT interface for connecting distributed I/O via PROFINET

## Function

- Performance
  - Faster command processing, depending on the CPU type, language extensions and new data types
  - Even shorter response times of the CPUs due to considerably faster backplane bus
  - Powerful network connection:  
each CPU is equipped with PROFINET IO IRT (2-port switch) as standard interface.
- Integrated technology
  - Connection of analog and PROFIdrive-capable drives via standardized blocks (PLCopen)
  - Support of speed-controlled and positioning axes as well as external encoders, positionally precise gearing between axes.
  - Trace functions for all CPU tags, both for diagnostics in real time as well as for sporadic error detection
  - Comprehensive control functionalities, e.g. easily configurable blocks for automatic optimization of the control parameters for optimum control quality
- Security Integrated
  - Password-based know-how protection against unauthorized read-out and modification of program blocks
  - Copy protection for tying individual blocks to the serial number of the SIMATIC Memory Card: The block can only run if the configured memory card is inserted into the CPU.
  - 4-level authorization concept:  
Communication to the HMI devices can also be restricted.
  - Manipulation protection:  
The controller recognizes changed or unauthorized transmissions of the engineering data.
- Integrated system diagnostics
  - System diagnostics information is displayed consistently and in plain text in the TIA Portal, HMI devices and Web server, even for messages from the drives, and is updated even if the CPU is in STOP mode.
  - Integrated into the firmware of the CPU, no special configuration is required
- SIMATIC Memory Card (required for operation of the CPU)
  - Used as a plug-in load memory or for updating the firmware.
  - Also for storing additional documents or csv files (for recipes and archives)
  - Creation of data blocks for storage/reading of data via SFCs of the user program
- Datalog (archives) and recipes
  - Storage of csv files for recipes and archives on the SIMATIC Memory Card;  
easy access to plant-relevant operating data using Office tools or via a Web server
  - Easy access to machine configuration data by means of a Web browser or SD card reader (two-way data exchange from and to the controller)
- Programming
  - Programming with STEP 7 Professional



# SIPLUS RAIL

## SIPLUS S7-1500 RAIL

### SIPLUS extreme RAIL standard CPUs

#### SIPLUS S7-1500 CPU 1511-1 PN RAIL

#### Technical specifications

Article number	<b>6AG2511-1AK02-1AB0</b> SIPLUS S7-1500 CPU 1511-1 PN T1 RAIL	<b>6AG2511-1AK02-4AB0</b> SIPLUS S7-1500 CPU 1511-1 PN TX RAIL
<b>General information</b>		
<b>Product type designation</b>	CPU 1511-1 PN	CPU 1511-1 PN
<b>Engineering with</b>		
• STEP 7 TIA Portal configurable/integrated from version	see entry ID: 109746275	see entry ID: 109746275
<b>Display</b>		
<b>Screen diagonal [cm]</b>	3.45 cm	3.45 cm
<b>Supply voltage</b>		
<b>Rated value (DC)</b>	24 V	24 V
<b>Memory</b>		
<b>Work memory</b>		
• integrated (for program)	150 kbyte	150 kbyte
• integrated (for data)	1 Mbyte	1 Mbyte
<b>Load memory</b>		
• Plug-in (SIMATIC Memory Card), max.	32 Gbyte	32 Gbyte
<b>CPU processing times</b>		
<b>for bit operations, typ.</b>	60 ns	60 ns
<b>for word operations, typ.</b>	72 ns	72 ns
<b>for fixed point arithmetic, typ.</b>	96 ns	96 ns
<b>for floating point arithmetic, typ.</b>	384 ns	384 ns
<b>Counters, timers and their retentivity</b>		
<b>S7 counter</b>		
• Number	2 048	2 048
<b>IEC counter</b>		
• Number	Any (only limited by the main memory)	Any (only limited by the main memory)
<b>S7 times</b>		
• Number	2 048	2 048
<b>IEC timer</b>		
• Number	Any (only limited by the main memory)	Any (only limited by the main memory)
<b>Data areas and their retentivity</b>		
<b>Flag</b>		
• Size, max.	16 kbyte	16 kbyte
<b>Address area</b>		
<b>I/O address area</b>		
• Inputs	32 kbyte; All inputs are in the process image	32 kbyte; All inputs are in the process image
• Outputs	32 kbyte; All outputs are in the process image	32 kbyte; All outputs are in the process image
<b>Time of day</b>		
<b>Clock</b>		
• Type	Hardware clock	Hardware clock
<b>1. Interface</b>		
<b>Interface types</b>		
• RJ 45 (Ethernet)	Yes; X1	Yes; X1
• Number of ports	2	2
• integrated switch	Yes	Yes
<b>Protocols</b>		
• IP protocol	Yes; IPv4	Yes; IPv4
• PROFINET IO Controller	Yes	Yes
• PROFINET IO Device	Yes	Yes
• SIMATIC communication	Yes	Yes
• Open IE communication	Yes; Optionally also encrypted	Yes; Optionally also encrypted
• Web server	Yes	Yes
• Media redundancy	Yes	Yes

**SIPLUS S7-1500 CPU 1511-1 PN RAIL**

Article number	<b>6AG2511-1AK02-1AB0</b> SIPLUS S7-1500 CPU 1511-1 PN T1 RAIL	<b>6AG2511-1AK02-4AB0</b> SIPLUS S7-1500 CPU 1511-1 PN TX RAIL
<b>PROFINET IO Controller</b>		
<ul style="list-style-type: none"> <li>• Services           <ul style="list-style-type: none"> <li>- PG/OP communication</li> <li>- Isochronous mode</li> <li>- Direct data exchange</li> </ul> </li> <li>- IRT</li> <li>- PROFINergy</li> <li>- Prioritized startup</li> <li>- Number of connectable IO Devices, max.</li> <li>- Of which IO devices with IRT, max.</li> <li>- Number of connectable IO Devices for RT, max.</li> <li>- of which in line, max.</li> <li>- Number of IO Devices that can be simultaneously activated/deactivated, max.</li> <li>- Number of IO Devices per tool, max.</li> <li>- Updating times</li> </ul>	Yes Yes Yes; Requirement: IRT and isochronous mode (MRPD optional) Yes Yes; per user program Yes; Max. 32 PROFINET devices 128; In total, up to 256 distributed I/O devices can be connected via AS-i, PROFIBUS or PROFINET 64 128 128 8; in total across all interfaces 8 The minimum value of the update time also depends on communication share set for PROFINET IO, on the number of IO devices, and on the quantity of configured user data	Yes Yes Yes; Requirement: IRT and isochronous mode (MRPD optional) Yes Yes; per user program Yes; Max. 32 PROFINET devices 128; In total, up to 256 distributed I/O devices can be connected via AS-i, PROFIBUS or PROFINET 64 128 128 8; in total across all interfaces 8 The minimum value of the update time also depends on communication share set for PROFINET IO, on the number of IO devices, and on the quantity of configured user data
<b>PROFINET IO Device</b>		
<ul style="list-style-type: none"> <li>• Services           <ul style="list-style-type: none"> <li>- PG/OP communication</li> <li>- Isochronous mode</li> <li>- IRT</li> <li>- PROFINergy</li> <li>- Shared device</li> <li>- Number of IO Controllers with shared device, max.</li> <li>- Asset management record</li> </ul> </li> </ul>	Yes No Yes Yes; per user program Yes 4 Yes; per user program	Yes No Yes Yes; per user program Yes 4 Yes; per user program
<b>Protocols</b>		
<b>Number of connections</b>		
<ul style="list-style-type: none"> <li>• Number of connections, max.</li> </ul>	96; via integrated interfaces of the CPU and connected CPs / CMs	96; via integrated interfaces of the CPU and connected CPs / CMs
<b>Redundancy mode</b>		
<ul style="list-style-type: none"> <li>• Media redundancy           <ul style="list-style-type: none"> <li>- MRP</li> </ul> </li> <li>- MRPD</li> <li>- Switchover time on line break, typ.</li> <li>- Number of stations in the ring, max.</li> </ul>	Yes; as MRP redundancy manager and/or MRP client; max. number of devices in the ring: 50 Yes; Requirement: IRT 200 ms; For MRP, bumpless for MRPD 50	Yes; as MRP redundancy manager and/or MRP client; max. number of devices in the ring: 50 Yes; Requirement: IRT 200 ms; For MRP, bumpless for MRPD 50
<b>SIMATIC communication</b>		
<ul style="list-style-type: none"> <li>• S7 routing</li> </ul>	Yes	Yes
<b>OPC UA</b>		
<ul style="list-style-type: none"> <li>• OPC UA Client</li> <li>• OPC UA Server</li> </ul>	Yes Yes; Data access (read, write, subscribe), method call, custom address space	Yes Yes; Data access (read, write, subscribe), method call, custom address space
<b>Supported technology objects</b>		
<b>Motion Control</b>		
<ul style="list-style-type: none"> <li>• Number of available Motion Control resources for technology objects</li> <li>• Required Motion Control resources           <ul style="list-style-type: none"> <li>- per speed-controlled axis</li> <li>- per positioning axis</li> <li>- per synchronous axis</li> <li>- per external encoder</li> <li>- per output cam</li> <li>- per cam track</li> <li>- per probe</li> </ul> </li> </ul>	Yes; Note: The number of axes affects the cycle time of the PLC program; selection guide via the TIA Selection Tool or SIZER 800 40 80 160 80 20 160 40	Yes; Note: The number of axes affects the cycle time of the PLC program; selection guide via the TIA Selection Tool or SIZER 800 40 80 160 80 20 160 40
<b>Controller</b>		
<ul style="list-style-type: none"> <li>• PID_Compact</li> <li>• PID_3Step</li> <li>• PID-Temp</li> </ul>	Yes; Universal PID controller with integrated optimization Yes; PID controller with integrated optimization for valves Yes; PID controller with integrated optimization for temperature	Yes; Universal PID controller with integrated optimization Yes; PID controller with integrated optimization for valves Yes; PID controller with integrated optimization for temperature
<b>Counting and measuring</b>		
<ul style="list-style-type: none"> <li>• High-speed counter</li> </ul>	Yes	Yes

**SIPLUS RAIL**

SIPLUS S7-1500 RAIL

SIPLUS extreme RAIL standard CPUs

**SIPLUS S7-1500 CPU 1511-1 PN RAIL**

Article number	<b>6AG2511-1AK02-1AB0</b> SIPLUS S7-1500 CPU 1511-1 PN T1 RAIL	<b>6AG2511-1AK02-4AB0</b> SIPLUS S7-1500 CPU 1511-1 PN TX RAIL
<b>Standards, approvals, certificates</b>		
<b>Railway application</b> <ul style="list-style-type: none"> <li>EN 50121-3-2</li> <li>EN 50121-4</li> <li>EN 50124-1</li> <li>EN 50125-1</li> <li>EN 50125-2</li> <li>EN 50125-3</li> <li>EN 50155</li> <li>EN 61373</li> <li>Fire protection acc. to EN 45545-2</li> </ul>	<p>Yes; EMC for rail vehicles</p> <p>Yes; EMC for signal and telecommunications systems</p> <p>Yes; Railway applications - overvoltage category OV2; pollution degree PD2; rated surge voltage UNi = 0.5 kV; UNm = 24 V DC</p> <p>Yes; Rail vehicles - see ambient conditions</p> <p>Yes; Stationary electrical equipment - see ambient conditions</p> <p>Yes; Signal and telecommunications systems - see ambient conditions; vibrations and shocks: Application point outside of tracks (1 m to 3 m away from track)</p> <p>Yes; Rail vehicles - temperature class OT2, ST1/ST2, horizontal mounting position</p> <p>Yes; Rail vehicles - vibrations and shocks: Category 1 Class A/B</p> <p>Yes; For proof of conformity, see Service &amp; Support</p>	<p>Yes; EMC for rail vehicles</p> <p>Yes; EMC for signal and telecommunications systems</p> <p>Yes; Railway applications - overvoltage category OV2; pollution degree PD2; rated surge voltage UNi = 0.5 kV; UNm = 24 V DC</p> <p>Yes; Rail vehicles - see ambient conditions</p> <p>Yes; Stationary electrical equipment - see ambient conditions</p> <p>Yes; Signal and telecommunications systems - see ambient conditions; vibrations and shocks: Application point outside of tracks (1 m to 3 m away from track)</p> <p>Yes; Rail vehicles - temperature class OT4, ST1/ST2, horizontal mounting position</p> <p>Yes; Rail vehicles - vibrations and shocks: Category 1 Class A/B</p> <p>Yes; For proof of conformity, see Service &amp; Support</p>
<b>Ambient conditions</b>		
<b>Ambient temperature during operation</b> <ul style="list-style-type: none"> <li>horizontal installation, min.</li> <li>horizontal installation, max.</li> <li>vertical installation, min.</li> <li>vertical installation, max.</li> </ul>	<p>-40 °C; = Tmin (incl. condensation/frost)</p> <p>60 °C; = Tmax; +70 °C for 10 min (OT2, ST1/ST2 acc. to EN 50155); display: 50 °C, the display is switched off at an operating temperature of typically 50 °C</p> <p>-40 °C; = Tmin</p> <p>40 °C; = Tmax; display: 40 °C, at an operating temperature of typically 40 °C, the display is switched off</p>	<p>-40 °C; = Tmin (incl. condensation/frost)</p> <p>70 °C; = Tmax; +85 °C for 10 min (OT4, ST1/ST2 acc. to EN 50155); display: 50 °C, the display is switched off at an operating temperature of typically 50 °C</p> <p>-40 °C; = Tmin</p> <p>40 °C; = Tmax; display: 40 °C, at an operating temperature of typically 40 °C, the display is switched off</p>
<b>Altitude during operation relating to sea level</b> <ul style="list-style-type: none"> <li>Installation altitude above sea level, max.</li> <li>Ambient air temperature-barometric pressure-altitude</li> </ul>	<p>2 000 m</p> <p>Tmin ... Tmax at 1 140 hPa ... 795 hPa (-1 000 m ... +2 000 m)</p>	<p>2 000 m</p> <p>Tmin ... Tmax at 1 140 hPa ... 795 hPa (-1 000 m ... +2 000 m)</p>
<b>Relative humidity</b> <ul style="list-style-type: none"> <li>With condensation, tested in accordance with IEC 60068-2-38, max.</li> </ul>	<p>100 %; RH incl. condensation / frost (no commissioning in bedewed state), horizontal installation</p>	<p>100 %; RH incl. condensation / frost (no commissioning in bedewed state), horizontal installation</p>
<b>Resistance</b> <ul style="list-style-type: none"> <li>Coolants and lubricants <ul style="list-style-type: none"> <li>Resistant to commercially available coolants and lubricants</li> </ul> </li> <li>Use in stationary industrial systems <ul style="list-style-type: none"> <li>to biologically active substances according to EN 60721-3-3</li> <li>to chemically active substances according to EN 60721-3-3</li> <li>to mechanically active substances according to EN 60721-3-3</li> </ul> </li> <li>Use on land craft, rail vehicles and special-purpose vehicles <ul style="list-style-type: none"> <li>to biologically active substances according to EN 60721-3-5</li> <li>to chemically active substances according to EN 60721-3-5</li> <li>to mechanically active substances according to EN 60721-3-5</li> </ul> </li> <li>Usage in industrial process technology <ul style="list-style-type: none"> <li>Against chemically active substances acc. to EN 60654-4</li> <li>Environmental conditions for process, measuring and control systems acc. to ANSI/ISA-71.04</li> </ul> </li> <li>Remark <ul style="list-style-type: none"> <li>Note regarding classification of environmental conditions acc. to EN 60721, EN 60654-4 and ANSI/ISA-71.04</li> </ul> </li> </ul>	<p>Yes; Incl. diesel and oil droplets in the air</p> <p>Yes; Class 3B2 mold, fungus and dry rot spores (with the exception of fauna); Class 3B3 on request</p> <p>Yes; Class 3C4 (RH &lt; 75 %) incl. salt spray acc. to EN 60068-2-52 (severity degree 3); *</p> <p>Yes; Class 3S4 incl. sand, dust, *</p> <p>Yes; Class 5B2 mold, fungus and dry rot spores (with the exception of fauna); Class 5B3 on request</p> <p>Yes; Class 5C3 (RH &lt; 75 %) incl. salt spray acc. to EN 60068-2-52 (severity degree 3); *</p> <p>Yes; Class 5S3 incl. sand, dust; *</p> <p>Yes; Class 3 (excluding trichlorethylene)</p> <p>Yes; Level GX group A/B (excluding trichlorethylene; harmful gas concentrations up to the limits of EN 60721-3-3 class 3C4 permissible); level LC3 (salt spray) and level LB3 (oil)</p> <p>* The supplied plug covers must remain in place over the unused interfaces during operation!</p>	<p>Yes; Incl. diesel and oil droplets in the air</p> <p>Yes; Class 3B2 mold, fungus and dry rot spores (with the exception of fauna); Class 3B3 on request</p> <p>Yes; Class 3C4 (RH &lt; 75 %) incl. salt spray acc. to EN 60068-2-52 (severity degree 3); *</p> <p>Yes; Class 3S4 incl. sand, dust, *</p> <p>Yes; Class 5B2 mold, fungus and dry rot spores (with the exception of fauna); Class 5B3 on request</p> <p>Yes; Class 5C3 (RH &lt; 75 %) incl. salt spray acc. to EN 60068-2-52 (severity degree 3); *</p> <p>Yes; Class 5S3 incl. sand, dust; *</p> <p>Yes; Class 3 (excluding trichlorethylene)</p> <p>Yes; Level GX group A/B (excluding trichlorethylene; harmful gas concentrations up to the limits of EN 60721-3-3 class 3C4 permissible); level LC3 (salt spray) and level LB3 (oil)</p> <p>* The supplied plug covers must remain in place over the unused interfaces during operation!</p>
<b>Conformal coating</b> <ul style="list-style-type: none"> <li>Coatings for printed circuit board assemblies acc. to EN 61086</li> <li>Protection against fouling acc. to EN 60664-3</li> <li>Electronic equipment on rolling stock acc. to EN 50155</li> <li>Military testing according to MIL-I-46058C, Amendment 7</li> <li>Qualification and Performance of Electrical Insulating Compound for Printed Board Assemblies according to IPC-CC-830A</li> </ul>	<p>Yes; Class 2 for high reliability</p> <p>Yes; Type 1 protection</p> <p>Yes; Class PC2 protective coating acc. to EN 50155:2017</p> <p>Yes; Discoloration of coating possible during service life</p> <p>Yes; Conformal coating, Class A</p>	<p>Yes; Class 2 for high reliability</p> <p>Yes; Type 1 protection</p> <p>Yes; Class PC2 protective coating acc. to EN 50155:2017</p> <p>Yes; Discoloration of coating possible during service life</p> <p>Yes; Conformal coating, Class A</p>

**SIPLUS S7-1500 CPU 1511-1 PN RAIL**

Article number	<b>6AG2511-1AK02-1AB0</b>	<b>6AG2511-1AK02-4AB0</b>
	SIPLUS S7-1500 CPU 1511-1 PN T1 RAIL	SIPLUS S7-1500 CPU 1511-1 PN TX RAIL
<b>Configuration/header</b>		
<b>Configuration / programming / header</b>		
• Programming language	Yes	Yes
- LAD	Yes	Yes
- FBD	Yes	Yes
- STL	Yes	Yes
- SCL	Yes	Yes
- GRAPH	Yes	Yes
<b>Know-how protection</b>		
• User program protection/password protection	Yes	Yes
• Copy protection	Yes	Yes
• Block protection	Yes	Yes
<b>Access protection</b>		
• Password for display	Yes	Yes
• Protection level: Write protection	Yes	Yes
• Protection level: Read/write protection	Yes	Yes
• Protection level: Complete protection	Yes	Yes
<b>Dimensions</b>		
<b>Width</b>	35 mm	70 mm
<b>Height</b>	147 mm	147 mm
<b>Depth</b>	129 mm	129 mm
<b>Weights</b>		
<b>Weight, approx.</b>	405 g	590 g
<b>Other</b>		
<b>Note:</b>	for use in railway applications, also observe the product information "SIPLUS extreme RAIL" A5E37661960A, Online Support article 109736776	for use in railway applications, also observe the product information "SIPLUS extreme RAIL" A5E37661960A, Online Support article 109736776

**Selection and ordering data**

Version	Article No.
<p><b>SIPLUS S7-1500 CPU 1511-1 PN T1 RAIL</b> Approved in accordance with the EN 50155, EN 15121, EN 50124, EN 50125 and EN 45545 railway standards for use in rail traffic 150 KB work memory for program, 1 MB for data, PROFINET IO IRT interface; SIMATIC Memory Card required For areas with extreme exposure to media (conformal coating); ambient temperature -25 ... +55 °C (+70 °C for 10 min.)</p>	<b>6AG2511-1AK02-1AB0</b>
<p><b>SIPLUS S7-1500 CPU 1511-1 PN TX RAIL</b> Approved in accordance with the EN 50155, EN 15121, EN 50124, EN 50125 and EN 45545 railway standards for use in rail traffic Without display; 150 KB work memory for program, 1 MB for data, PROFINET IO IRT interface; SIMATIC Memory Card required For areas with extreme exposure to media (conformal coating); ambient temperature -40 ... +70 °C (+85 °C for 10 min.)</p>	<b>6AG2511-1AK02-4AB0</b>
<b>Accessories</b>	
<b>SIMATIC Memory Card</b>	
4 MB	<b>6ES7954-8LC03-0AA0</b>
12 MB	<b>6ES7954-8LE03-0AA0</b>
24 MB	<b>6ES7954-8LF03-0AA0</b>
256 MB	<b>6ES7954-8LL03-0AA0</b>
2 GB	<b>6ES7954-8LP03-0AA0</b>
32 GB	<b>6ES7954-8LT03-0AA0</b>

**SIPLUS RAIL**

SIPLUS S7-1500 RAIL

SIPLUS extreme RAIL standard CPUs

**SIPLUS S7-1500 CPU 1516-3 PN/DP RAIL****Overview**

- The CPU with a large program and data memory in the SIPLUS extreme RAIL S7-1500 Controller product range for applications with demanding requirements regarding program scope and networking.
- Approved in accordance with the EN 50155, EN 15121, EN 50124, EN 50125 and EN 45545 railway standards for use in rail traffic.
- High processing speed for binary and floating-point arithmetic.
- Used as central controller in production lines with central and distributed I/O.
- PROFINET IO IRT interface with 2-port switch.
- PROFINET IO controller for operating distributed I/O on PROFINET.
- PROFINET I-Device for connecting the CPU as an intelligent PROFINET device under a SIMATIC or non-Siemens PROFINET IO controller.
- Additional PROFINET interface with separate IP address for network separation, for connecting further PROFINET IO RT devices, or for high-speed communication as an I-Device.
- PROFIBUS DP master interface.
- UA Server and Client as runtime option for the easy connection of SIMATIC S7-1500 to third-party devices/systems with the functions:
  - OPC UA Data Access
  - OPC UA Security
  - OPC UA Methods Call
  - Support of OPC UA Companion Specifications
  - OPC UA Alarms and Conditions
- Central and distributed isochronous mode on PROFIBUS and PROFINET.
- Integrated motion control functionalities for controlling speed-controlled and positioning axes, support for external encoders, output cams/cam tracks and probes.
- Integrated web server for diagnostics with the option of creating user-defined web pages.

Note:

SIMATIC Memory Card required for operation of the CPU

**Application**

The SIPLUS S7-1500 CPU 1516-3 PN/DP TX RAIL is the railway controller CPU with a large program and data memory for demanding tasks in applications that also contain distributed automation structures alongside central I/O.

It can be used as a PROFINET IO Controller or as distributed intelligence (PROFINET I-Device). The integrated PROFINET IO IRT interface is designed as a 2-port switch so that a linear topology can be set up.

The additional integrated PROFINET interface with separate IP address can be used, for example, for network separation.

Distributed I/O can be connected via PROFIBUS via the integrated PROFIBUS interface.

In addition, the CPU offers comprehensive control functionalities as well as the ability to connect drives via standardized PLCOpen blocks.

**Design**

The SIPLUS S7-1500 CPU 1516-3 PN/DP TX RAIL has:

- A powerful processor:
  - The CPU achieves command execution times as low as 10 ns per binary instruction.
- A large work memory:
  - 1 MB for program, 5 MB for data
- SIMATIC Memory Cards as load memory;
  - permit additional functions such as datalog and archives
- Flexible expansion capability:
  - single-tier configuration with max. 32 modules (CPU + 31 modules)
- Display with the functions for
  - Display of overview information such as IP address of the integrated interface, station name, plant designation, location designation, etc.
  - Display and acknowledgement of diagnostic and user messages
  - Display of module information
  - Showing display settings
  - Display of a user-definable logo
  - Setting of IP addresses
  - Setting of date and time
  - Selection of the operating mode
  - Resetting of the CPU to factory settings
  - Backup and restoring of the project
  - Disabling/enabling of the display
  - Enabling of protection levels
- PROFINET IO IRT interface for connecting distributed I/O via PROFINET
- PROFINET interface for network separation
- PROFIBUS DP interface for connecting distributed I/O via PROFIBUS

**SIPLUS S7-1500 CPU 1516-3 PN/DP RAIL**

### Function

- Performance
  - Faster command processing, depending on the CPU type, language extensions and new data types
  - Even shorter response times of the CPUs due to considerably faster backplane bus
  - High-performance network connection:  
Each CPU is equipped with PROFINET IO IRT (2-port switch) as standard interface. In addition, the CPU 1516-3 PN/DP features a second PROFINET interface, e.g. for network separation, for connecting further PROFINET IO RT devices, or for high-speed communication as an I-Device.
- Integrated technology
  - Connection of analog and PROFIdrive-capable drives via standardized blocks (PLCopen)
  - Support of speed-controlled and positioning axes as well as external encoders, precise position gearing between axes, output cams/output cam tracks and probes
  - Trace functions for all CPU tags, both for diagnostics in real time as well as for sporadic error detection; can also be called via the web server of the CPU
  - Comprehensive control functionalities, e.g. easily configurable blocks for automatic optimization of the control parameters for optimum control quality
- Security Integrated
  - Password-based know-how protection against unauthorized read-out and modification of program blocks
  - Copy protection for tying individual blocks to the serial number of the SIMATIC Memory Card: The block can only run if the configured memory card is inserted into the CPU.
  - 4-level authorization concept:  
Communication to the operating panels can also be restricted.
  - Manipulation protection:  
The controller recognizes changed or unauthorized transmissions of the engineering data.
- Design and handling
  - Display of overview information:  
E.g. Station name, plant designation, location identifier, etc., diagnostic information, module information, display settings.
  - Possible operations on the display:  
Set addresses of the CPU or connected Ethernet communications processors, set date and time, select operating mode of CPU, reset CPU to factory settings, disable/enable display, activate protection levels, acknowledge messages, back up and restore projects
- Integrated system diagnostics
  - System diagnostics information is displayed consistently and in plain text in the TIA Portal, operating panels and web server, even for messages from the drives, and is updated even if the CPU is in STOP mode.
  - Integrated into the firmware of the CPU, no special configuration is required
- SIMATIC Memory Card (required for operation of the CPU)
  - Used as a plug-in load memory or for updating the firmware.
  - Also for storing additional documents or csv files (for recipes and archives)
  - Creation of data blocks for storage/reading of data via SFCs of the user program
- Datalog (archives) and recipes
  - Storage of csv files for recipes and archives on the SIMATIC Memory Card;  
easy access to plant-relevant operating data using Office tools or via a web server
  - Easy access to machine configuration data by means of a web browser or SD card reader (two-way data exchange from and to the controller)
- Programming
  - Programming with STEP 7 Professional

### Technical specifications

Article number	<b>6AG2516-3AN02-4AB0</b> SIPLUS S7-1500 CPU 1516-3 PN/DP RAIL
<b>General information</b>	
<b>Product type designation</b>	CPU 1516-3 PN/DP
<b>Engineering with</b>	
• STEP 7 TIA Portal configurable/integrated from version	see entry ID: 109746275
<b>Display</b>	
<b>Screen diagonal [cm]</b>	6.1 cm
<b>Supply voltage</b>	
<b>Rated value (DC)</b>	24 V
<b>Memory</b>	
<b>Work memory</b>	
• integrated (for program)	1 Mbyte
• integrated (for data)	5 Mbyte
<b>Load memory</b>	
• Plug-in (SIMATIC Memory Card), max.	32 Gbyte
<b>CPU processing times</b>	
<b>for bit operations, typ.</b>	10 ns
<b>for word operations, typ.</b>	12 ns
<b>for fixed point arithmetic, typ.</b>	16 ns
<b>for floating point arithmetic, typ.</b>	64 ns
<b>Counters, timers and their retentivity</b>	
<b>S7 counter</b>	
• Number	2 048
<b>IEC counter</b>	
• Number	Any (only limited by the main memory)
<b>S7 times</b>	
• Number	2 048
<b>IEC timer</b>	
• Number	Any (only limited by the main memory)

# SIPLUS RAIL

## SIPLUS S7-1500 RAIL

### SIPLUS extreme RAIL standard CPUs

#### SIPLUS S7-1500 CPU 1516-3 PN/DP RAIL

Article number	<b>6AG2516-3AN02-4AB0</b> SIPLUS S7-1500 CPU 1516-3 PN/DP RAIL
<b>Data areas and their retentivity</b>	
<b>Flag</b> • Size, max.	16 kbyte
<b>Address area</b>	
<b>I/O address area</b> • Inputs • Outputs	32 kbyte; All inputs are in the process image 32 kbyte; All outputs are in the process image
<b>Time of day</b>	
<b>Clock</b> • Type	Hardware clock
<b>1. Interface</b>	
<b>Interface types</b> • RJ 45 (Ethernet) • Number of ports • integrated switch	Yes; X1 2 Yes
<b>Protocols</b> • IP protocol • PROFINET IO Controller • PROFINET IO Device • SIMATIC communication • Open IE communication • Web server • Media redundancy	Yes; IPv4 Yes Yes Yes Yes; Optionally also encrypted Yes Yes
<b>PROFINET IO Controller</b> • Services - PG/OP communication - Isochronous mode - Direct data exchange - IRT - PROFlenergy - Prioritized startup - Number of connectable IO Devices, max.  - Of which IO devices with IRT, max. - Number of connectable IO Devices for RT, max. - of which in line, max. - Number of IO Devices that can be simultaneously activated/deactivated, max. - Number of IO Devices per tool, max. - Updating times	Yes Yes Yes; Requirement: IRT and isochronous mode (MRPD optional) Yes Yes; per user program Yes; Max. 32 PROFINET devices 256; In total, up to 1 000 distributed I/O devices can be connected via AS-i, PROFIBUS or PROFINET 64 256 256 8; in total across all interfaces 8 The minimum value of the update time also depends on communication share set for PROFINET IO, on the number of IO devices, and on the quantity of configured user data
<b>PROFINET IO Device</b> • Services - PG/OP communication - Isochronous mode - IRT - PROFlenergy - Shared device - Number of IO Controllers with shared device, max. - Asset management record	Yes No Yes Yes; per user program Yes 4 Yes; per user program
<b>2. Interface</b>	
<b>Interface types</b> • RJ 45 (Ethernet) • Number of ports • integrated switch	Yes; X2 1 No
<b>Protocols</b> • IP protocol • PROFINET IO Controller • PROFINET IO Device • SIMATIC communication • Open IE communication • Web server • Media redundancy	Yes; IPv4 Yes Yes Yes Yes; Optionally also encrypted Yes No



Article number	<b>6AG2516-3AN02-4AB0</b> SIPLUS S7-1500 CPU 1516-3 PN/DP RAIL
<b>PROFINET IO Controller</b>	
<ul style="list-style-type: none"> <li>• Services</li> <li>- PG/OP communication</li> <li>- Isochronous mode</li> <li>- Direct data exchange</li> <li>- IRT</li> <li>- PROFlenergy</li> <li>- Prioritized startup</li> <li>- Number of connectable IO Devices, max.</li> <li>- Number of connectable IO Devices for RT, max.</li> <li>- of which in line, max.</li> <li>- Number of IO Devices that can be simultaneously activated/deactivated, max.</li> <li>- Number of IO Devices per tool, max.</li> <li>- Updating times</li> </ul>	<ul style="list-style-type: none"> <li>Yes</li> <li>No</li> <li>No</li> <li>No</li> <li>Yes; per user program</li> <li>No</li> <li>32; In total, up to 1 000 distributed I/O devices can be connected via AS-i, PROFIBUS or PROFINET</li> <li>32</li> <li>32</li> <li>8; in total across all interfaces</li> <li>8</li> <li>The minimum value of the update time also depends on communication share set for PROFINET IO, on the number of IO devices, and on the quantity of configured user data</li> </ul>
<b>PROFINET IO Device</b>	
<ul style="list-style-type: none"> <li>• Services</li> <li>- PG/OP communication</li> <li>- Isochronous mode</li> <li>- IRT</li> <li>- PROFlenergy</li> <li>- Prioritized startup</li> <li>- Shared device</li> <li>- Number of IO Controllers with shared device, max.</li> <li>- Asset management record</li> </ul>	<ul style="list-style-type: none"> <li>Yes</li> <li>No</li> <li>No</li> <li>Yes; per user program</li> <li>No</li> <li>Yes</li> <li>4</li> <li>Yes; per user program</li> </ul>
<b>3. Interface</b>	
<b>Interface types</b>	
<ul style="list-style-type: none"> <li>• RS 485</li> <li>• Number of ports</li> </ul>	<ul style="list-style-type: none"> <li>Yes; X3</li> <li>1</li> </ul>
<b>Protocols</b>	
<ul style="list-style-type: none"> <li>• PROFIBUS DP master</li> <li>• PROFIBUS DP slave</li> <li>• SIMATIC communication</li> </ul>	<ul style="list-style-type: none"> <li>Yes</li> <li>No</li> <li>Yes</li> </ul>
<b>PROFIBUS DP master</b>	
<ul style="list-style-type: none"> <li>• Number of DP slaves, max.</li> </ul>	125; In total, up to 1 000 distributed I/O devices can be connected via AS-i, PROFIBUS or PROFINET
<b>Protocols</b>	
<b>Number of connections</b>	
<ul style="list-style-type: none"> <li>• Number of connections, max.</li> </ul>	256; via integrated interfaces of the CPU and connected CPs / CMs
<b>Redundancy mode</b>	
<ul style="list-style-type: none"> <li>• Media redundancy</li> <li>- MRP</li> <li>- MRPD</li> <li>- Switchover time on line break, typ.</li> <li>- Number of stations in the ring, max.</li> </ul>	<ul style="list-style-type: none"> <li>Yes; as MRP redundancy manager and/or MRP client; max. number of devices in the ring: 50</li> <li>Yes; Requirement: IRT</li> <li>200 ms; For MRP, bumpless for MRPD</li> <li>50</li> </ul>
<b>SIMATIC communication</b>	
<ul style="list-style-type: none"> <li>• S7 routing</li> </ul>	Yes
<b>OPC UA</b>	
<ul style="list-style-type: none"> <li>• OPC UA Client</li> <li>• OPC UA Server</li> </ul>	<ul style="list-style-type: none"> <li>Yes</li> <li>Yes; Data access (read, write, subscribe), method call, custom address space</li> </ul>
<b>Supported technology objects</b>	
<b>Motion Control</b>	
<ul style="list-style-type: none"> <li>• Number of available Motion Control resources for technology objects</li> <li>• Required Motion Control resources</li> <li>- per speed-controlled axis</li> <li>- per positioning axis</li> <li>- per synchronous axis</li> <li>- per external encoder</li> <li>- per output cam</li> <li>- per cam track</li> <li>- per probe</li> </ul>	<ul style="list-style-type: none"> <li>Yes; Note: The number of axes affects the cycle time of the PLC program; selection guide via the TIA Selection Tool or SIZER</li> <li>2 400</li> <li>40</li> <li>80</li> <li>160</li> <li>80</li> <li>20</li> <li>160</li> <li>40</li> </ul>



# SIPLUS RAIL

## SIPLUS S7-1500 RAIL

### SIPLUS extreme RAIL standard CPUs

#### SIPLUS S7-1500 CPU 1516-3 PN/DP RAIL

Article number	<b>6AG2516-3AN02-4AB0</b> SIPLUS S7-1500 CPU 1516-3 PN/DP RAIL
<b>Controller</b> <ul style="list-style-type: none"> <li>• PID_Compact</li> <li>• PID_3Step</li> <li>• PID-Temp</li> </ul>	Yes; Universal PID controller with integrated optimization Yes; PID controller with integrated optimization for valves Yes; PID controller with integrated optimization for temperature
<b>Counting and measuring</b> <ul style="list-style-type: none"> <li>• High-speed counter</li> </ul>	Yes
<b>Standards, approvals, certificates</b>	
<b>Railway application</b> <ul style="list-style-type: none"> <li>• EN 50121-3-2</li> <li>• EN 50121-4</li> <li>• EN 50124-1</li>   <li>• EN 50125-1</li> <li>• EN 50125-2</li> <li>• EN 50125-3</li>   <li>• EN 50155</li>   <li>• EN 61373</li> <li>• Fire protection acc. to EN 45545-2</li> </ul>	Yes; EMC for rail vehicles Yes; EMC for signal and telecommunications systems Yes; Railway applications - overvoltage category OV2; pollution degree PD2; rated surge voltage UNi = 0.5 kV; UNm = 24 V DC Yes; Rail vehicles - see ambient conditions Yes; Stationary electrical equipment - see ambient conditions Yes; Signal and telecommunications systems - see ambient conditions; vibrations and shocks: Application point outside of tracks (1 m to 3 m away from track) Yes; Rail vehicles - temperature class OT4, ST1/ST2, horizontal mounting position Yes; Rail vehicles - vibrations and shocks: Category 1 Class A/B Yes; For proof of conformity, see Service & Support
<b>Ambient conditions</b>	
<b>Ambient temperature during operation</b> <ul style="list-style-type: none"> <li>• horizontal installation, min.</li> <li>• horizontal installation, max.</li>   <li>• vertical installation, min.</li> <li>• vertical installation, max.</li> </ul>	-40 °C; = Tmin (incl. condensation/frost) 70 °C; = Tmax; +85 °C for 10 min (OT4, ST1/ST2 acc. to EN 50155); display: 50 °C, the display is switched off at an operating temperature of typically 50 °C -40 °C; = Tmin 40 °C; = Tmax; display: 40 °C, at an operating temperature of typically 40 °C, the display is switched off
<b>Altitude during operation relating to sea level</b> <ul style="list-style-type: none"> <li>• Installation altitude above sea level, max.</li> <li>• Ambient air temperature-barometric pressure-altitude</li> </ul>	2 000 m Tmin ... Tmax at 1 140 hPa ... 795 hPa (-1 000 m ... +2 000 m)
<b>Relative humidity</b> <ul style="list-style-type: none"> <li>• With condensation, tested in accordance with IEC 60068-2-38, max.</li> </ul>	100 %; RH incl. condensation / frost (no commissioning in bedewed state), horizontal installation
<b>Resistance</b> <ul style="list-style-type: none"> <li>• Coolants and lubricants               <ul style="list-style-type: none"> <li>- Resistant to commercially available coolants and lubricants</li> </ul> </li> <li>• Use in stationary industrial systems               <ul style="list-style-type: none"> <li>- to biologically active substances according to EN 60721-3-3</li> <li>- to chemically active substances according to EN 60721-3-3</li> <li>- to mechanically active substances according to EN 60721-3-3</li> </ul> </li> <li>• Use on land craft, rail vehicles and special-purpose vehicles               <ul style="list-style-type: none"> <li>- to biologically active substances according to EN 60721-3-5</li> <li>- to chemically active substances according to EN 60721-3-5</li> <li>- to mechanically active substances according to EN 60721-3-5</li> </ul> </li> <li>• Usage in industrial process technology               <ul style="list-style-type: none"> <li>- Against chemically active substances acc. to EN 60654-4</li> <li>- Environmental conditions for process, measuring and control systems acc. to ANSI/ISA-71.04</li> </ul> </li> <li>• Remark               <ul style="list-style-type: none"> <li>- Note regarding classification of environmental conditions acc. to EN 60721, EN 60654-4 and ANSI/ISA-71.04</li> </ul> </li> </ul>	Yes; Incl. diesel and oil droplets in the air  Yes; Class 3B2 mold, fungus and dry rot spores (with the exception of fauna); Class 3B3 on request Yes; Class 3C4 (RH < 75 %) incl. salt spray acc. to EN 60068-2-52 (severity degree 3); * Yes; Class 3S4 incl. sand, dust, *  Yes; Class 5B2 mold, fungus and dry rot spores (with the exception of fauna); Class 5B3 on request Yes; Class 5C3 (RH < 75 %) incl. salt spray acc. to EN 60068-2-52 (severity degree 3); * Yes; Class 5S3 incl. sand, dust; *  Yes; Class 3 (excluding trichlorethylene) Yes; Level GX group A/B (excluding trichlorethylene; harmful gas concentrations up to the limits of EN 60721-3-3 class 3C4 permissible); level LC3 (salt spray) and level LB3 (oil)
	* The supplied plug covers must remain in place over the unused interfaces during operation!

**SIPLUS S7-1500 CPU 1516-3 PN/DP RAIL**

Article number	<b>6AG2516-3AN02-4AB0</b> SIPLUS S7-1500 CPU 1516-3 PN/DP RAIL
<b>Conformal coating</b>	
<ul style="list-style-type: none"> <li>• Coatings for printed circuit board assemblies acc. to EN 61086</li> <li>• Protection against fouling acc. to EN 60664-3</li> <li>• Electronic equipment on rolling stock acc. to EN 50155</li> <li>• Military testing according to MIL-I-46058C, Amendment 7</li> <li>• Qualification and Performance of Electrical Insulating Compound for Printed Board Assemblies according to IPC-CC-830A</li> </ul>	<ul style="list-style-type: none"> <li>Yes; Class 2 for high reliability</li> <li>Yes; Type 1 protection</li> <li>Yes; Class PC2 protective coating acc. to EN 50155:2017</li> <li>Yes; Discoloration of coating possible during service life</li> <li>Yes; Conformal coating, Class A</li> </ul>
<b>Configuration / header</b>	
<b>Configuration / programming / header</b>	
<ul style="list-style-type: none"> <li>• Programming language</li> <li>- LAD</li> <li>- FBD</li> <li>- STL</li> <li>- SCL</li> <li>- GRAPH</li> </ul>	<ul style="list-style-type: none"> <li>Yes</li> <li>Yes</li> <li>Yes</li> <li>Yes</li> <li>Yes</li> </ul>
<b>Know-how protection</b>	
<ul style="list-style-type: none"> <li>• User program protection/password protection</li> <li>• Copy protection</li> <li>• Block protection</li> </ul>	<ul style="list-style-type: none"> <li>Yes</li> <li>Yes</li> <li>Yes</li> </ul>
<b>Access protection</b>	
<ul style="list-style-type: none"> <li>• Password for display</li> <li>• Protection level: Write protection</li> <li>• Protection level: Read/write protection</li> <li>• Protection level: Complete protection</li> </ul>	<ul style="list-style-type: none"> <li>Yes</li> <li>Yes</li> <li>Yes</li> <li>Yes</li> </ul>
<b>Dimensions</b>	
<b>Width</b>	105 mm
<b>Height</b>	147 mm
<b>Depth</b>	129 mm
<b>Weights</b>	
<b>Weight, approx.</b>	830 g
<b>Other</b>	
<b>Note:</b>	for use in railway applications, also observe the product information "SIPLUS extreme RAIL" A5E37661960A, Online Support article 109736776

**Selection and ordering data**

Version	Article No.
<p><b>SIPLUS S7-1500 CPU 1516-3 PN/DP TX RAIL</b> Approved in accordance with the EN 50155, EN 15121, EN 50124, EN 50125 and EN 45545 railway standards for use in rail traffic Without display; 1 MB work memory for program, 5 MB for data, PROFINET IO IRT interface, PROFINET/PROFIBUS interface; SIMATIC Memory Card required For areas with extreme exposure to media (conformal coating); ambient temperature -40 ... +70 °C (+85 °C for 10 min.)</p>	<b>6AG2516-3AN01-4AB0</b>
<p><b>SIPLUS S7-1500 CPU 1516-3 PN/DP RAIL</b> Approved in accordance with the EN 50155, EN 15121, EN 50124, EN 50125 and EN 45545 railway standards for use in rail traffic Heat sink, no usable power unit, CPU with 1 MB work memory for program and 5 MB for data, PROFINET IRT interface, PROFINET/PROFIBUS interface; SIMATIC Memory Card required For areas with extreme exposure to media (conformal coating); ambient temperature -40 ... +70 °C, OT4 with ST1/2, (+85 °C for 10 min.)</p>	<b>6AG2516-3AN02-4AB0</b>
<b>Accessories</b>	
<b>SIMATIC Memory Card</b>	
4 MB	<b>6ES7954-8LC03-0AA0</b>
12 MB	<b>6ES7954-8LE03-0AA0</b>
24 MB	<b>6ES7954-8LF03-0AA0</b>
256 MB	<b>6ES7954-8LL03-0AA0</b>
2 GB	<b>6ES7954-8LP03-0AA0</b>
32 GB	<b>6ES7954-8LT03-0AA0</b>

## SIPLUS RAIL

### SIPLUS S7-1500 RAIL

### SIPLUS extreme RAIL fail-safe CPUs

#### SIPLUS S7-1500 CPU 1515F-2 PN RAIL

##### Overview

- The CPU for applications with medium to high requirements for program/data memory in the S7-1500 controller product range
- Approved in accordance with EN 50155, EN 15121, EN 50124, EN 50125 and EN 45545 railway standards for use in rail traffic
- Can be used for safety functions up to SIL 3 according to IEC 61508 and up to PL e according to ISO 13849
- Medium to high processing speed for binary and floating-point arithmetic
- Used as central PLC in production lines with central and distributed I/O
- Supports PROFIsafe in centralized and distributed configurations
- PROFINET IO IRT interface with 2-port switch
- Additional PROFINET interface with separate IP address
- PROFINET IO controller for operating distributed I/O on PROFINET
- PROFINET I-device for connecting the CPU as an intelligent PROFINET device under a SIMATIC or non-Siemens PROFINET I/O controller
- Isochronous mode
- Integrated Motion Control functionalities for controlling speed-controlled and positioning axes, support for external encoders
- Integrated web server with the option of creating user-defined web pages

##### Note

SIMATIC Memory Card required for operation of the CPU

##### Application

SIPLUS S7-1500 CPU 1515F-2 PN RAIL is the CPU with a medium program and data memory for standard and fail-safe applications that also contain distributed automation structures alongside central I/O. It can be used as a PROFINET IO controller or as distributed intelligence (PROFINET I-Device). The integrated PROFINET IO IRT interface is designed as a 2-port switch, enabling a linear topology to be set up in the system. The additional integrated PROFINET interface with separate IP address can be used, for example, for network separation. In addition, the CPU offers comprehensive control functionalities as well as the option to connect drives via standardized PLCopen blocks.

##### Design

SIPLUS S7-1500 CPU 1515F-2 PN T2 RAIL features:

- A powerful processor:  
The CPU achieves command execution times as low as 30 ns per binary instruction.
- Large work memory:  
750 KB for program, 3 MB for data
- SIMATIC Memory Cards as load memory;  
permit additional functions such as datalog and archives
- Flexible expansion capability:  
single-tier configuration with max. 32 modules (CPU + 31 modules)

- Display with functions for
  - Displaying overview information such as IP address of the integrated interface, station name, plant designation, location identifier, etc.
  - Displaying safety mode, collective signature and date of the last download with signature change
  - Displaying diagnostic information
  - Displaying module information
  - Showing display settings
  - Displaying a user-definable logo
  - Setting IP addresses
  - Setting the date and time
  - Selecting the operating mode
  - Resetting the CPU to factory settings
  - Disabling/enabling the display
  - Enabling protection levels
- PROFINET IO IRT interface for connecting distributed I/O via PROFINET
- PROFINET interface for network separation

##### Function

- Performance
  - Faster command processing, depending on the CPU type, language extensions and new data types
  - Even shorter response times of the CPUs due to considerably faster backplane bus
  - Powerful network connection:  
Each CPU is equipped with PROFINET IO IRT (2-port switch) as standard interface.
- Integrated technology
  - Connection of analog and PROFIdrive-capable drives via standardized blocks (PLCopen)
  - Support of speed-controlled and positioning axes as well as external encoders
  - Trace functions for all CPU tags, both for diagnostics in real time and for sporadic error detection
  - Comprehensive control functionalities, e.g. easy to configure blocks for automatic optimization of the control parameters for optimum control quality
- Security Integrated
  - Password-based know-how protection against unauthorized read-out and modification of program blocks
  - Copy protection for tying individual blocks to the serial number of the SIMATIC Memory Card: The block can only run if the configured memory card is inserted in the CPU.
  - 4-level authorization concept:  
Communication to the operator panels can also be restricted.
  - Manipulation protection:  
The controller recognizes changed or unauthorized transmissions of the engineering data.
- Design and handling
  - Display of overview information:  
E.g. Station name, plant designation, location identifier, etc., diagnostic information, module information, display settings.
  - Operator control options on the display:  
set addresses of the CPU or connected Ethernet communications processors, set date and time, select operating mode of CPU, reset CPU to factory settings, disable/enable display, activate protection levels.
- Integrated system diagnostics
  - System diagnostics information is displayed consistently and in plain text in the display, TIA Portal, operator panels and web server, even for messages from the drives, and updated even if the CPU is in STOP mode.
  - Integrated in the firmware of the CPU, no special configuration is required

**SIPLUS S7-1500 CPU 1515F-2 PN RAIL**

- SIMATIC Memory Card (required for operation of the CPU)
  - Used as a plug-in load memory or for updating the firmware.
  - Also for storing additional documents or csv files (for recipes and archives)
  - Storage of data blocks and storage/reading of data via SFCs of the user program
- Datalog (archives) and recipes
  - Storage of csv files for recipes and archives on the SIMATIC Memory Card;
  - easy access to plant-relevant operating data using Office tools or via a web server
  - Easy access to configuration data of the machine by means of a web browser or SD card reader (two-way data exchange from and to the PLC)
- Programming of the standard program section
  - Programming with STEP 7 Professional, V13 and higher
  - Migration tool for migrating from SIMATIC S7-300/S7-400 to S7-1500, converts the standard program code largely automatically. Non-convertible code is logged and can be manually adapted.
  - S7-1200 basic programs can be transferred to S7-1500 by copy-paste.
- Programming of the fail-safe program section
  - Programming of the safety-related program section with the "STEP 7 Safety Advanced" option package

## Technical specifications

Article number	<b>6AG2515-2FM02-4AB0</b> SIPLUS S7-1500 CPU 1515F-2 PN RAIL
<b>General information</b>	
<b>Product type designation</b>	CPU 1515F-2 PN
<b>Engineering with</b>	see entry ID: 109746275
<b>Display</b>	
<b>Screen diagonal [cm]</b>	6.1 cm
<b>Supply voltage</b>	
<b>Rated value (DC)</b>	24 V
<b>Memory</b>	
<b>Work memory</b>	750 kbyte 3 Mbyte
• integrated (for program)	
• integrated (for data)	
<b>Load memory</b>	32 Gbyte
• Plug-in (SIMATIC Memory Card), max.	
<b>CPU processing times</b>	
<b>for bit operations, typ.</b>	30 ns
<b>for word operations, typ.</b>	36 ns
<b>for fixed point arithmetic, typ.</b>	48 ns
<b>for floating point arithmetic, typ.</b>	192 ns
<b>Counters, timers and their retentivity</b>	
<b>S7 counter</b>	2 048
• Number	
<b>IEC counter</b>	Any (only limited by the main memory)
• Number	
<b>S7 times</b>	2 048
• Number	
<b>IEC timer</b>	Any (only limited by the main memory)
• Number	
<b>Data areas and their retentivity</b>	
<b>Flag</b>	16 kbyte
• Size, max.	
<b>Address area</b>	
<b>I/O address area</b>	32 kbyte; All inputs are in the process image 32 kbyte; All outputs are in the process image
• Inputs	
• Outputs	
<b>Time of day</b>	
<b>Clock</b>	Hardware clock
• Type	
<b>1. Interface</b>	
<b>Interface types</b>	Yes; X1 2 Yes
• RJ 45 (Ethernet)	
• Number of ports	
• integrated switch	
<b>Protocols</b>	Yes; IPv4 Yes Yes Yes Yes; Optionally also encrypted Yes Yes; MRP Automanager according to IEC 62439-2 Edition 2.0
• IP protocol	
• PROFINET IO Controller	
• PROFINET IO Device	
• SIMATIC communication	
• Open IE communication	
• Web server	
• Media redundancy	

# SIPLUS RAIL

## SIPLUS S7-1500 RAIL

### SIPLUS extreme RAIL fail-safe CPUs

#### SIPLUS S7-1500 CPU 1515F-2 PN RAIL

Article number	<b>6AG2515-2FM02-4AB0</b> SIPLUS S7-1500 CPU 1515F-2 PN RAIL
<b>PROFINET IO Controller</b>	
<ul style="list-style-type: none"> <li>• Services</li> <li>- PG/OP communication</li> <li>- Isochronous mode</li> <li>- Direct data exchange</li> <li>- IRT</li> <li>- PROFlenergy</li> <li>- Prioritized startup</li> <li>- Number of connectable IO Devices, max.</li> <li>- Of which IO devices with IRT, max.</li> <li>- Number of connectable IO Devices for RT, max.</li> <li>- of which in line, max.</li> <li>- Number of IO Devices that can be simultaneously activated/deactivated, max.</li> <li>- Number of IO Devices per tool, max.</li> <li>- Updating times</li> </ul>	<ul style="list-style-type: none"> <li>Yes</li> <li>Yes</li> <li>Yes; Requirement: IRT and isochronous mode (MRPD optional)</li> <li>Yes</li> <li>Yes</li> <li>Yes; Max. 32 PROFINET devices</li> <li>256; In total, up to 1 000 distributed I/O devices can be connected via AS-i, PROFIBUS or PROFINET</li> <li>64</li> <li>256</li> <li>256</li> <li>8; in total across all interfaces</li> <li>8</li> <li>The minimum value of the update time also depends on communication share set for PROFINET IO, on the number of IO devices, and on the quantity of configured user data</li> </ul>
<b>PROFINET IO Device</b>	
<ul style="list-style-type: none"> <li>• Services</li> <li>- PG/OP communication</li> <li>- Isochronous mode</li> <li>- IRT</li> <li>- PROFlenergy</li> <li>- Shared device</li> <li>- Number of IO Controllers with shared device, max.</li> <li>- Asset management record</li> </ul>	<ul style="list-style-type: none"> <li>Yes</li> <li>No</li> <li>Yes</li> <li>Yes; per user program</li> <li>Yes</li> <li>4</li> <li>Yes; per user program</li> </ul>
<b>2. Interface</b>	
<b>Interface types</b>	
<ul style="list-style-type: none"> <li>• RJ 45 (Ethernet)</li> <li>• Number of ports</li> <li>• integrated switch</li> </ul>	<ul style="list-style-type: none"> <li>Yes; X2</li> <li>1</li> <li>No</li> </ul>
<b>Protocols</b>	
<ul style="list-style-type: none"> <li>• IP protocol</li> <li>• PROFINET IO Controller</li> <li>• PROFINET IO Device</li> <li>• SIMATIC communication</li> <li>• Open IE communication</li> <li>• Web server</li> <li>• Media redundancy</li> </ul>	<ul style="list-style-type: none"> <li>Yes; IPv4</li> <li>Yes</li> <li>Yes</li> <li>Yes</li> <li>Yes</li> <li>Yes</li> <li>No</li> </ul>
<b>PROFINET IO Controller</b>	
<ul style="list-style-type: none"> <li>• Services</li> <li>- PG/OP communication</li> <li>- Isochronous mode</li> <li>- Direct data exchange</li> <li>- IRT</li> <li>- PROFlenergy</li> <li>- Prioritized startup</li> <li>- Number of connectable IO Devices, max.</li> <li>- Number of connectable IO Devices for RT, max.</li> <li>- of which in line, max.</li> <li>- Number of IO Devices that can be simultaneously activated/deactivated, max.</li> <li>- Number of IO Devices per tool, max.</li> <li>- Updating times</li> </ul>	<ul style="list-style-type: none"> <li>Yes</li> <li>No</li> <li>No</li> <li>No</li> <li>Yes</li> <li>No</li> <li>32; In total, up to 1 000 distributed I/O devices can be connected via AS-i, PROFIBUS or PROFINET</li> <li>32</li> <li>32</li> <li>8; in total across all interfaces</li> <li>8</li> <li>The minimum value of the update time also depends on communication share set for PROFINET IO, on the number of IO devices, and on the quantity of configured user data</li> </ul>
<b>PROFINET IO Device</b>	
<ul style="list-style-type: none"> <li>• Services</li> <li>- PG/OP communication</li> <li>- Isochronous mode</li> <li>- IRT</li> <li>- PROFlenergy</li> <li>- Prioritized startup</li> <li>- Shared device</li> <li>- Number of IO Controllers with shared device, max.</li> <li>- Asset management record</li> </ul>	<ul style="list-style-type: none"> <li>Yes</li> <li>No</li> <li>No</li> <li>Yes</li> <li>No</li> <li>Yes</li> <li>4</li> <li>Yes; per user program</li> </ul>
<b>Protocols</b>	
<b>Number of connections</b>	
<ul style="list-style-type: none"> <li>• Number of connections, max.</li> </ul>	192; via integrated interfaces of the CPU and connected CPs / CMs
<b>Redundancy mode</b>	
<ul style="list-style-type: none"> <li>• Media redundancy</li> <li>- MRP</li> <li>- MRPD</li> <li>- Switchover time on line break, typ.</li> <li>- Number of stations in the ring, max.</li> </ul>	<ul style="list-style-type: none"> <li>Yes; MRP Automanager acc. to IEC 62439-2 Edition 2.0; MRP Manager; MRP Client; max. number of devices in the ring: 50</li> <li>Yes; Requirement: IRT</li> <li>200 ms; For MRP, bumpless for MRPD</li> <li>50</li> </ul>
<b>OPC UA</b>	
<ul style="list-style-type: none"> <li>• OPC UA Client</li> <li>• OPC UA Server</li> </ul>	<ul style="list-style-type: none"> <li>Yes</li> <li>Yes; Data access (read, write, subscribe), method call, custom address space</li> </ul>

Article number	<b>6AG2515-2FM02-4AB0</b> SIPLUS S7-1500 CPU 1515F-2 PN RAIL
<b>Supported technology objects</b>	
<b>Motion Control</b>	Yes; Note: The number of axes affects the cycle time of the PLC program; selection guide via the TIA Selection Tool or SIZER 2 400
<ul style="list-style-type: none"> <li>• Number of available Motion Control resources for technology objects</li> <li>• Required Motion Control resources <ul style="list-style-type: none"> <li>- per speed-controlled axis 40</li> <li>- per positioning axis 80</li> <li>- per synchronous axis 160</li> <li>- per external encoder 80</li> <li>- per output cam 20</li> <li>- per cam track 160</li> <li>- per probe 40</li> </ul> </li> </ul>	
<b>Controller</b>	Yes; Universal PID controller with integrated optimization
<ul style="list-style-type: none"> <li>• PID_Compact</li> <li>• PID_3Step</li> <li>• PID-Temp</li> </ul>	Yes; PID controller with integrated optimization for valves Yes; PID controller with integrated optimization for temperature
<b>Counting and measuring</b>	
<ul style="list-style-type: none"> <li>• High-speed counter</li> </ul>	Yes
<b>Standards, approvals, certificates</b>	
<b>Highest safety class achievable in safety mode</b>	
<ul style="list-style-type: none"> <li>• SIL in accordance with EN 50126, 50128, 50129</li> </ul>	SIL 2; a higher safety integrity level is possible if tested and approved for the specific application under consideration of all local regulations.
<b>Probability of failure (for service life of 20 years and repair time of 100 hours)</b>	
<ul style="list-style-type: none"> <li>• Low demand mode: PFDavg in accordance with SIL3</li> <li>• High demand/continuous mode: PFH in accordance with SIL3</li> </ul>	< 2.00E-05 < 1.00E-09
<b>Railway application</b>	
<ul style="list-style-type: none"> <li>• EN 50121-3-2</li> <li>• EN 50121-4</li> <li>• EN 50124-1</li>   <li>• EN 50125-1</li> <li>• EN 50125-2</li> <li>• EN 50125-3</li>   <li>• EN 50155</li> <li>• EN 61373</li> <li>• Fire protection acc. to EN 45545-2</li> </ul>	Yes; EMC for rail vehicles Yes; EMC for signal and telecommunications systems Yes; Railway applications - overvoltage category OV2; pollution degree PD2; rated surge voltage UNi = 0.5 kV; UNm = 24 V DC Yes; Rail vehicles - see ambient conditions Yes; Stationary electrical equipment - see ambient conditions Yes; Signal and telecommunications systems - see ambient conditions; vibrations and shocks: Application point outside of tracks (1 m to 3 m away from track) Yes; Rail vehicles - temperature class OT4, ST1/ST2, horizontal mounting position Yes; Rail vehicles - vibrations and shocks: Category 1 Class A/B Yes; For proof of conformity, see Service & Support
<b>Ambient conditions</b>	
<b>Ambient temperature during operation</b>	
<ul style="list-style-type: none"> <li>• horizontal installation, min.</li> <li>• horizontal installation, max.</li>   <li>• vertical installation, min.</li> <li>• vertical installation, max.</li> </ul>	-40 °C; = Tmin (incl. condensation/frost) 70 °C; = Tmax; +85 °C for 10 min (OT4, ST1/ST2 acc. to EN 50155); display: 50 °C, the display is switched off at an operating temperature of typically 50 °C -40 °C; = Tmin 40 °C; = Tmax; display: 40 °C, at an operating temperature of typically 40 °C, the display is switched off
<b>Altitude during operation relating to sea level</b>	
<ul style="list-style-type: none"> <li>• Installation altitude above sea level, max.</li> <li>• Ambient air temperature-barometric pressure-altitude</li> </ul>	2 000 m Tmin ... Tmax at 1 140 hPa ... 795 hPa (-1 000 m ... +2 000 m)
<b>Relative humidity</b>	
<ul style="list-style-type: none"> <li>• With condensation, tested in accordance with IEC 60068-2-38, max.</li> </ul>	100 %; RH incl. condensation / frost (no commissioning in bedewed state), horizontal installation
<b>Resistance</b>	
<ul style="list-style-type: none"> <li>• Coolants and lubricants <ul style="list-style-type: none"> <li>- Resistant to commercially available coolants and lubricants</li> </ul> </li> <li>• Use in stationary industrial systems <ul style="list-style-type: none"> <li>- to biologically active substances according to EN 60721-3-3</li> <li>- to chemically active substances according to EN 60721-3-3</li> <li>- to mechanically active substances according to EN 60721-3-3</li> </ul> </li> <li>• Use on land craft, rail vehicles and special-purpose vehicles <ul style="list-style-type: none"> <li>- to biologically active substances according to EN 60721-3-5</li> <li>- to chemically active substances according to EN 60721-3-5</li> <li>- to mechanically active substances according to EN 60721-3-5</li> </ul> </li> <li>• Usage in industrial process technology <ul style="list-style-type: none"> <li>- Against chemically active substances acc. to EN 60654-4</li> <li>- Environmental conditions for process, measuring and control systems acc. to ANSI/ISA-71.04</li> </ul> </li> <li>• Remark <ul style="list-style-type: none"> <li>- Note regarding classification of environmental conditions acc. to EN 60721, EN 60654-4 and ANSI/ISA-71.04</li> </ul> </li> </ul>	Yes; Incl. diesel and oil droplets in the air Yes; Class 3B2 mold, fungus and dry rot spores (with the exception of fauna); Class 3B3 on request Yes; Class 3C4 (RH < 75 %) incl. salt spray acc. to EN 60068-2-52 (severity degree 3); * Yes; Class 3S4 incl. sand, dust, * Yes; Class 5B2 mold, fungus and dry rot spores (with the exception of fauna); Class 5B3 on request Yes; Class 5C3 (RH < 75 %) incl. salt spray acc. to EN 60068-2-52 (severity degree 3); * Yes; Class 5S3 incl. sand, dust, * Yes; Class 3 (excluding trichlorethylene) Yes; Level GX group A/B (excluding trichlorethylene; harmful gas concentrations up to the limits of EN 60721-3-3 class 3C4 permissible); level LC3 (salt spray) and level LB3 (oil) * The supplied plug covers must remain in place over the unused interfaces during operation!

**SIPLUS RAIL**

SIPLUS S7-1500 RAIL

SIPLUS extreme RAIL fail-safe CPUs

**SIPLUS S7-1500 CPU 1515F-2 PN RAIL**

Article number	<b>6AG2515-2FM02-4AB0</b> SIPLUS S7-1500 CPU 1515F-2 PN RAIL
<b>Conformal coating</b>	
<ul style="list-style-type: none"> <li>• Coatings for printed circuit board assemblies acc. to EN 61086</li> <li>• Protection against fouling acc. to EN 60664-3</li> <li>• Electronic equipment on rolling stock acc. to EN 50155</li> <li>• Military testing according to MIL-I-46058C, Amendment 7</li> <li>• Qualification and Performance of Electrical Insulating Compound for Printed Board Assemblies according to IPC-CC-830A</li> </ul>	<ul style="list-style-type: none"> <li>Yes; Class 2 for high reliability</li> <li>Yes; Type 1 protection</li> <li>Yes; Class PC2 protective coating acc. to EN 50155:2017</li> <li>Yes; Discoloration of coating possible during service life</li> <li>Yes; Conformal coating, Class A</li> </ul>
<b>Configuration / header</b>	
<b>Configuration / programming / header</b>	
<ul style="list-style-type: none"> <li>• Programming language</li> <li>- LAD</li> <li>- FBD</li> <li>- STL</li> <li>- SCL</li> <li>- GRAPH</li> </ul>	<ul style="list-style-type: none"> <li>Yes; incl. failsafe</li> <li>Yes; incl. failsafe</li> <li>Yes</li> <li>Yes</li> <li>Yes</li> </ul>
<b>Know-how protection</b>	
<ul style="list-style-type: none"> <li>• User program protection/password protection</li> <li>• Copy protection</li> <li>• Block protection</li> </ul>	<ul style="list-style-type: none"> <li>Yes</li> <li>Yes</li> <li>Yes</li> </ul>
<b>Access protection</b>	
<ul style="list-style-type: none"> <li>• Password for display</li> <li>• Protection level: Write protection</li> <li>• Protection level: Read/write protection</li> <li>• Protection level: Complete protection</li> </ul>	<ul style="list-style-type: none"> <li>Yes</li> <li>Yes; Specific write protection both for Standard and for Failsafe</li> <li>Yes</li> <li>Yes</li> </ul>
<b>Dimensions</b>	
<b>Width</b>	105 mm
<b>Height</b>	147 mm
<b>Depth</b>	129 mm
<b>Weights</b>	
<b>Weight, approx.</b>	820 g
<b>Other</b>	
<b>Note:</b>	for use in railway applications, also observe the product information "SIPLUS extreme RAIL" A5E37661960A, Online Support article 109736776

**Selection and ordering data**

Version	Article No.
<b>SIPLUS S7-1500 CPU 1515F-2 PN RAIL</b> Approved in accordance with EN 50155, EN 15121, EN 50124, EN 50125 and EN 45545 railway standards for use in rail traffic Fail-safe CPU, 750 KB work memory for program, 3 MB for data, PROFINET IRT interface with 2-port switch; PROFINET RT interface; 30 NS bit performance SIMATIC Memory Card required For areas with extreme exposure to environmental substances (conformal coating); ambient temperature -40 ... +55 °C (+70 °C for 10 min.)	<b>6AG2515-2FM02-4AB0</b>
<b>Accessories</b>	
<b>SIMATIC Memory Card</b>	
4 MB	<b>6ES7954-8LC03-0AA0</b>
12 MB	<b>6ES7954-8LE03-0AA0</b>
24 MB	<b>6ES7954-8LF03-0AA0</b>
256 MB	<b>6ES7954-8LL03-0AA0</b>
2 GB	<b>6ES7954-8LP03-0AA0</b>
32 GB	<b>6ES7954-8LT03-0AA0</b>



## Overview

- The CPU with a large program and data memory in the S7-1500 Controller product range for fail-safe applications with high requirements regarding program scope and networking.
- Approved in accordance with the EN 50155, EN 15121, EN 50124, EN 50125 and EN 45545 railway standards for use in rail traffic
- Can be used for failsafe functions up to SIL 3 according to IEC 61508 and up to PLe according to ISO 13849.
- High processing speed for binary and floating-point arithmetic
- Supports PROFIsafe in centralized and distributed configuration.
- PROFINET IO IRT interface with 2-port switch.
- Additional PROFINET interface with separate IP address.
- PROFINET IO controller for operating distributed I/O on PROFINET.
- PROFINET I-Device for connecting the CPU as an intelligent PROFINET device under a SIMATIC or non-Siemens PROFINET IO controller.
- PROFIBUS DP master interface.
- Isochronous mode on PROFIBUS and PROFINET.
- Integrated Motion Control functionalities for controlling speed-controlled and positioning axes, support for external encoders.
- Integrated web server with the option of creating user-defined web pages.

### Note:

SIMATIC Memory Card required for operation of the CPU

## Application

The SIPLUS CPU 1516F-3 PN/DP RAIL is the CPU with a large program and data memory for demanding standard and fail-safe applications that also contain distributed automation structures alongside central I/O.

It can be used as a PROFINET IO Controller or as distributed intelligence (PROFINET I-Device). The integrated PROFINET IO IRT interface is designed as a 2-port switch so that a linear topology can be set up in the system. The additional integrated PROFINET interface with separate IP address can be used, for example, for network separation. Distributed I/O can be connected via PROFIBUS (or PROFIsafe) via the integrated PROFIBUS interface. In addition, the CPU offers comprehensive control functionalities as well as the ability to connect drives via standardized PLCopen blocks.

## Design

The SIPLUS CPU 1516F-3 PN/DP RAIL has:

- A powerful processor:  
The CPU achieves a command execution time as low as 10 ns per binary command.
- Extensive work memory:  
1.5 MB for program, 5 MB for data
- SIMATIC Memory Cards as load memory;  
permit additional functions such as datalog and archives
- Flexible expansion possibilities:  
single-tier configuration with max. 32 modules (CPU + 31 modules)

- Display with functions for:
  - Displaying overview information such as IP address of the integrated interface, station name, plant designation, location identifier, etc.
  - Displaying safety mode, overall signature and date of the last download with signature change
  - Display of diagnostic information
  - Display of module information
  - Showing display settings
  - Display of a user-definable logo
  - Setting IP addresses
  - Setting of date and time
  - Selection of operating mode
  - Resetting of the CPU to factory settings
  - Disabling/enabling of display
  - Enabling of protection levels
  - Display of safety mode, overall signature and date of the last download with signature change.
- PROFINET IO IRT interface for connecting distributed I/O via PROFINET
- PROFINET interface for network separation
- PROFIBUS DP interface for connecting distributed I/O via PROFIBUS
- Supports PROFIsafe in centralized and distributed configuration

## Function

Thanks to a variety of innovations and integrated functions, the SIMATIC S7-1500 CPUs offer added value with regard to performance and engineering efficiency. A host of features support users in programming, commissioning, and servicing the S7-1500:

- Performance
  - Faster command processing, depending on the CPU type, language extensions and new data types
  - Even shorter response times of the CPUs due to considerably faster backplane bus
  - High-performance network connection: PROFINET IO IRT (2-port switch) as standard interface. Additional PROFINET interface integrated, e.g. for network separation.
- Integrated technology
  - Connection of analog and PROFIdrive-capable drives via standardized blocks (PLCopen)
  - Support of speed-controlled and positioning axes as well as external encoders
  - Trace functions for all CPU tags, both for diagnostics in real time as well as for sporadic error detection
  - Comprehensive control functionalities, e.g. easily configurable blocks for automatic optimization of the control parameters for optimum control quality
- Security Integrated
  - Password-based know-how protection against unauthorized reading and modification of program blocks
  - Copy protection for tying individual blocks to the serial number of the SIMATIC Memory Card:  
The block can only run if the configured memory card is inserted in the CPU.  
4-level authorization concept:  
Communication to the HMI devices can also be restricted.
  - Manipulation protection:  
The controller recognizes changed or unauthorized transmissions of the engineering data.
- Design and handling
  - Display of overview information:  
e.g. station name, plant identifier, location ID, diagnostic information, module information, display settings, etc.
  - Possible operations on the display:  
set addresses, set date and time, select operating mode of CPU, reset CPU to factory settings, disable/enable display, activate protection levels.



**SIPLUS RAIL**

SIPLUS S7-1500 RAIL

SIPLUS extreme RAIL fail-safe CPUs

**SIPLUS S7-1500 CPU 1516F-3 PN/DP RAIL**

- Integrated system diagnostics
  - System diagnostics information is displayed consistently and in plain text in the display, TIA Portal, HMI devices and Web server, even for messages from the drives, and updated even if the CPU is in STOP mode.
  - Integrated in the firmware of the CPU, no special configuration is required
- SIMATIC Memory Card (required for operation of the CPU)
  - Used as plug-in load memory or for updating the firmware.
  - Also for storing additional documents or csv files (for recipes and archives)
  - Creation of data blocks for storage/reading of data via SFCs of the user program
- Datalog (archives) and recipes
  - Storage of csv files for recipes and archives on the SIMATIC Memory Card;
  - easy access to plant-relevant operating data using Office tools or via a Web server
  - Easy access to configuration data of the machine by means of a Web browser or SD card reader (two-way data exchange from and to the controller)
- Programming of the standard program section
  - Programming with STEP 7 from V13 or higher.
- Programming of the failsafe program section
  - Programming of the safety-related program section with the option package "STEP 7 Safety Advanced".

**Technical specifications**

Article number	<b>6AG2516-3FN02-2AB0</b> SIPLUS S7-1500 CPU 1516F-3 PN/DP RAIL	<b>6AG2516-3FN02-4AB0</b> SIPLUS S7-1500 CPU 1516F-3 PN/DP RAIL
<b>General information</b>		
<b>Product type designation</b>	CPU 1516F-3 PN/DP	CPU 1516F-3 PN/DP
<b>Engineering with</b>		
• STEP 7 TIA Portal configurable/integrated from version	see entry ID: 109746275	see entry ID: 109746275
<b>Display</b>		
<b>Screen diagonal [cm]</b>	6.1 cm	6.1 cm
<b>Supply voltage</b>		
<b>Rated value (DC)</b>	24 V	24 V
<b>Memory</b>		
<b>Work memory</b>		
• integrated (for program)	1.5 Mbyte	1.5 Mbyte
• integrated (for data)	5 Mbyte	5 Mbyte
<b>Load memory</b>		
• Plug-in (SIMATIC Memory Card), max.	32 Gbyte	32 Gbyte
<b>CPU processing times</b>		
<b>for bit operations, typ.</b>	10 ns	10 ns
<b>for word operations, typ.</b>	12 ns	12 ns
<b>for fixed point arithmetic, typ.</b>	16 ns	16 ns
<b>for floating point arithmetic, typ.</b>	64 ns	64 ns
<b>Counters, timers and their retentivity</b>		
<b>S7 counter</b>		
• Number	2 048	2 048
<b>IEC counter</b>		
• Number	Any (only limited by the main memory)	Any (only limited by the main memory)
<b>S7 times</b>		
• Number	2 048	2 048
<b>IEC timer</b>		
• Number	Any (only limited by the main memory)	Any (only limited by the main memory)
<b>Data areas and their retentivity</b>		
<b>Flag</b>		
• Size, max.	16 kbyte	16 kbyte
<b>Address area</b>		
<b>I/O address area</b>		
• Inputs	32 kbyte; All inputs are in the process image	32 kbyte; All inputs are in the process image
• Outputs	32 kbyte; All outputs are in the process image	32 kbyte; All outputs are in the process image
<b>Time of day</b>		
<b>Clock</b>		
• Type	Hardware clock	Hardware clock
<b>1. Interface</b>		
<b>Interface types</b>		
• RJ 45 (Ethernet)	Yes; X1	Yes; X1
• Number of ports	2	2
• integrated switch	Yes	Yes
<b>Protocols</b>		
• IP protocol	Yes; IPv4	Yes; IPv4
• PROFINET IO Controller	Yes	Yes
• PROFINET IO Device	Yes	Yes
• SIMATIC communication	Yes	Yes
• Open IE communication	Yes; Optionally also encrypted	Yes; Optionally also encrypted
• Web server	Yes	Yes
• Media redundancy	Yes; MRP Automanager according to IEC 62439-2 Edition 2.0	Yes; MRP Automanager according to IEC 62439-2 Edition 2.0

Article number	<b>6AG2516-3FN02-2AB0</b> SIPLUS S7-1500 CPU 1516F-3 PN/DP RAIL	<b>6AG2516-3FN02-4AB0</b> SIPLUS S7-1500 CPU 1516F-3 PN/DP RAIL
<b>PROFINET IO Controller</b> <ul style="list-style-type: none"> <li>• Services <ul style="list-style-type: none"> <li>- PG/OP communication</li> <li>- Isochronous mode</li> <li>- Direct data exchange</li> </ul> </li> <li>- IRT</li> <li>- PROFINET energy</li> <li>- Prioritized startup</li> <li>- Number of connectable IO Devices, max.</li>   <li>- Of which IO devices with IRT, max.</li> <li>- Number of connectable IO Devices for RT, max.</li> <li>- of which in line, max.</li> <li>- Number of IO Devices that can be simultaneously activated/deactivated, max.</li> <li>- Number of IO Devices per tool, max.</li> <li>- Updating times</li> </ul>	Yes Yes Yes; Requirement: IRT and isochronous mode (MRPD optional) Yes Yes Yes; Max. 32 PROFINET devices 256; In total, up to 1 000 distributed I/O devices can be connected via AS-i, PROFIBUS or PROFINET 64 256 256 8; in total across all interfaces  8 The minimum value of the update time also depends on communication share set for PROFINET IO, on the number of IO devices, and on the quantity of configured user data	Yes Yes Yes; Requirement: IRT and isochronous mode (MRPD optional) Yes Yes Yes; Max. 32 PROFINET devices 256; In total, up to 1 000 distributed I/O devices can be connected via AS-i, PROFIBUS or PROFINET 64 256 256 8; in total across all interfaces  8 The minimum value of the update time also depends on communication share set for PROFINET IO, on the number of IO devices, and on the quantity of configured user data
<b>PROFINET IO Device</b> <ul style="list-style-type: none"> <li>• Services <ul style="list-style-type: none"> <li>- PG/OP communication</li> <li>- Isochronous mode</li> <li>- IRT</li> <li>- PROFINET energy</li> <li>- Shared device</li> <li>- Number of IO Controllers with shared device, max.</li> <li>- Asset management record</li> </ul> </li> </ul>	Yes No Yes Yes; per user program Yes 4 Yes; per user program	Yes No Yes Yes; per user program Yes 4 Yes; per user program
<b>2. Interface</b>		
<b>Interface types</b> <ul style="list-style-type: none"> <li>• RJ 45 (Ethernet)</li> <li>• Number of ports</li> <li>• integrated switch</li> </ul>	Yes; X2 1 No	Yes; X2 1 No
<b>Protocols</b> <ul style="list-style-type: none"> <li>• IP protocol</li> <li>• PROFINET IO Controller</li> <li>• PROFINET IO Device</li> <li>• SIMATIC communication</li> <li>• Open IE communication</li> <li>• Web server</li> <li>• Media redundancy</li> </ul>	Yes; IPv4 Yes Yes Yes Yes; Optionally also encrypted Yes No	Yes; IPv4 Yes Yes Yes Yes; Optionally also encrypted Yes No
<b>PROFINET IO Controller</b> <ul style="list-style-type: none"> <li>• Services <ul style="list-style-type: none"> <li>- PG/OP communication</li> <li>- Isochronous mode</li> <li>- Direct data exchange</li> <li>- IRT</li> <li>- PROFINET energy</li> <li>- Prioritized startup</li> <li>- Number of connectable IO Devices, max.</li>   <li>- Number of connectable IO Devices for RT, max.</li> <li>- of which in line, max.</li> <li>- Number of IO Devices that can be simultaneously activated/deactivated, max.</li> <li>- Number of IO Devices per tool, max.</li> <li>- Updating times</li> </ul> </li> </ul>	Yes No No No Yes No 32; In total, up to 1 000 distributed I/O devices can be connected via AS-i, PROFIBUS or PROFINET 32 32 8; in total across all interfaces  8 The minimum value of the update time also depends on communication share set for PROFINET IO, on the number of IO devices, and on the quantity of configured user data	Yes No No No Yes No 32; In total, up to 1 000 distributed I/O devices can be connected via AS-i, PROFIBUS or PROFINET 32 32 8; in total across all interfaces  8 The minimum value of the update time also depends on communication share set for PROFINET IO, on the number of IO devices, and on the quantity of configured user data
<b>PROFINET IO Device</b> <ul style="list-style-type: none"> <li>• Services <ul style="list-style-type: none"> <li>- PG/OP communication</li> <li>- Isochronous mode</li> <li>- IRT</li> <li>- PROFINET energy</li> <li>- Prioritized startup</li> <li>- Shared device</li> <li>- Number of IO Controllers with shared device, max.</li> <li>- Asset management record</li> </ul> </li> </ul>	Yes No No Yes; per user program No Yes 4 Yes; per user program	Yes No No Yes; per user program No Yes 4 Yes; per user program

# SIPLUS RAIL

## SIPLUS S7-1500 RAIL

### SIPLUS extreme RAIL fail-safe CPUs

#### SIPLUS S7-1500 CPU 1516F-3 PN/DP RAIL

Article number	<b>6AG2516-3FN02-2AB0</b> SIPLUS S7-1500 CPU 1516F-3 PN/DP RAIL	<b>6AG2516-3FN02-4AB0</b> SIPLUS S7-1500 CPU 1516F-3 PN/DP RAIL
<b>3. Interface</b>		
<b>Interface types</b>		
• RS 485	Yes; X3	Yes; X3
• Number of ports	1	1
<b>Protocols</b>		
• PROFIBUS DP master	Yes	Yes
• PROFIBUS DP slave	No	No
• SIMATIC communication	Yes	Yes
<b>PROFIBUS DP master</b>		
• Number of DP slaves, max.	125; In total, up to 1 000 distributed I/O devices can be connected via AS-i, PROFIBUS or PROFINET	125; In total, up to 1 000 distributed I/O devices can be connected via AS-i, PROFIBUS or PROFINET
<b>Protocols</b>		
<b>Number of connections</b>		
• Number of connections, max.	256; via integrated interfaces of the CPU and connected CPs / CMs	256; via integrated interfaces of the CPU and connected CPs / CMs
<b>Redundancy mode</b>		
• Media redundancy		
- Media redundancy	only via 1st interface (X1)	only via 1st interface (X1)
- MRP	Yes; MRP Automanager acc. to IEC 62439-2 Edition 2.0; MRP Manager; MRP Client; max. number of devices in the ring: 50	Yes; MRP Automanager acc. to IEC 62439-2 Edition 2.0; MRP Manager; MRP Client; max. number of devices in the ring: 50
- MRPD	Yes; Requirement: IRT	Yes; Requirement: IRT
- Switchover time on line break, typ.	200 ms; For MRP, bumpless for MRPD	200 ms; For MRP, bumpless for MRPD
- Number of stations in the ring, max.	50	50
<b>SIMATIC communication</b>		
• S7 routing	Yes	Yes
<b>OPC UA</b>		
• OPC UA Client	Yes	Yes
• OPC UA Server	Yes; Data access (read, write, subscribe), method call, custom address space	Yes; Data access (read, write, subscribe), method call, custom address space
<b>Supported technology objects</b>		
<b>Motion Control</b>		
• Number of available Motion Control resources for technology objects	Yes; Note: The number of axes affects the cycle time of the PLC program; selection guide via the TIA Selection Tool or SIZER 2 400	Yes; Note: The number of axes affects the cycle time of the PLC program; selection guide via the TIA Selection Tool or SIZER 2 400
• Required Motion Control resources		
- per speed-controlled axis	40	40
- per positioning axis	80	80
- per synchronous axis	160	160
- per external encoder	80	80
- per output cam	20	20
- per cam track	160	160
- per probe	40	40
<b>Controller</b>		
• PID_Compact	Yes; Universal PID controller with integrated optimization	Yes; Universal PID controller with integrated optimization
• PID_3Step	Yes; PID controller with integrated optimization for valves	Yes; PID controller with integrated optimization for valves
• PID-Temp	Yes; PID controller with integrated optimization for temperature	Yes; PID controller with integrated optimization for temperature
<b>Counting and measuring</b>		
• High-speed counter	Yes	Yes
<b>Standards, approvals, certificates</b>		
<b>Highest safety class achievable in safety mode</b>		
• SIL in accordance with EN 50126, 50128, 50129	SIL 2; a higher safety integrity level is possible if tested and approved for the specific application under consideration of all local regulations.	SIL 2; a higher safety integrity level is possible if tested and approved for the specific application under consideration of all local regulations.
<b>Probability of failure (for service life of 20 years and repair time of 100 hours)</b>		
• Low demand mode: PFDavg in accordance with SIL3	< 2.00E-05	< 2.00E-05
• High demand/continuous mode: PFH in accordance with SIL3	< 1.00E-09	< 1.00E-09

Article number	<b>6AG2516-3FN02-2AB0</b> SIPLUS S7-1500 CPU 1516F-3 PN/DP RAIL	<b>6AG2516-3FN02-4AB0</b> SIPLUS S7-1500 CPU 1516F-3 PN/DP RAIL
<b>Railway application</b> <ul style="list-style-type: none"> <li>EN 50121-3-2</li> <li>EN 50121-4</li> <li>EN 50124-1</li> <li>EN 50125-1</li> <li>EN 50125-2</li> <li>EN 50125-3</li> <li>EN 50155</li> <li>EN 61373</li> <li>Fire protection acc. to EN 45545-2</li> </ul>	<p>Yes; EMC for rail vehicles Yes; EMC for signal and telecommunications systems Yes; Railway applications - overvoltage category OV2; pollution degree PD2; rated surge voltage UNi = 0.5 kV; UNm = 24 V DC Yes; Rail vehicles - see ambient conditions Yes; Stationary electrical equipment - see ambient conditions Yes; Signal and telecommunications systems - see ambient conditions; vibrations and shocks: Application point outside of tracks (1 m to 3 m away from track) Yes; Rail vehicles - temperature class OT2, ST1/ST2, horizontal mounting position Yes; Rail vehicles - vibrations and shocks: Category 1 Class A/B Yes; For proof of conformity, see Service &amp; Support</p>	<p>Yes; EMC for rail vehicles Yes; EMC for signal and telecommunications systems Yes; Railway applications - overvoltage category OV2; pollution degree PD2; rated surge voltage UNi = 0.5 kV; UNm = 24 V DC Yes; Rail vehicles - see ambient conditions Yes; Stationary electrical equipment - see ambient conditions Yes; Signal and telecommunications systems - see ambient conditions; vibrations and shocks: Application point outside of tracks (1 m to 3 m away from track) Yes; Rail vehicles - temperature class OT4, ST1/ST2, horizontal mounting position Yes; Rail vehicles - vibrations and shocks: Category 1 Class A/B Yes; For proof of conformity, see Service &amp; Support</p>
<b>Ambient conditions</b> <b>Ambient temperature during operation</b> <ul style="list-style-type: none"> <li>horizontal installation, min.</li> <li>horizontal installation, max.</li> <li>vertical installation, min.</li> <li>vertical installation, max.</li> </ul>	<p>-40 °C; = Tmin (incl. condensation/frost) 60 °C; = Tmax; +70 °C for 10 min (OT2, ST1/ST2 acc. to EN 50155); display: 50 °C, the display is switched off at an operating temperature of typically 50 °C -40 °C; = Tmin 40 °C; = Tmax; display: 40 °C, at an operating temperature of typically 40 °C, the display is switched off</p>	<p>-40 °C; = Tmin (incl. condensation/frost) 70 °C; = Tmax; +85 °C for 10 min (OT4, ST1/ST2 acc. to EN 50155); display: 50 °C, the display is switched off at an operating temperature of typically 50 °C -40 °C; = Tmin 40 °C; = Tmax; display: 40 °C, at an operating temperature of typically 40 °C, the display is switched off</p>
<b>Altitude during operation relating to sea level</b> <ul style="list-style-type: none"> <li>Installation altitude above sea level, max.</li> <li>Ambient air temperature-barometric pressure-altitude</li> </ul>	<p>2 000 m Tmin ... Tmax at 1 140 hPa ... 795 hPa (-1 000 m ... +2 000 m)</p>	<p>2 000 m Tmin ... Tmax at 1 140 hPa ... 795 hPa (-1 000 m ... +2 000 m)</p>
<b>Relative humidity</b> <ul style="list-style-type: none"> <li>With condensation, tested in accordance with IEC 60068-2-38, max.</li> </ul>	<p>100 %; RH incl. condensation / frost (no commissioning in bedewed state), horizontal installation</p>	<p>100 %; RH incl. condensation / frost (no commissioning in bedewed state), horizontal installation</p>
<b>Resistance</b> <ul style="list-style-type: none"> <li>Coolants and lubricants <ul style="list-style-type: none"> <li>Resistant to commercially available coolants and lubricants</li> </ul> </li> <li>Use in stationary industrial systems <ul style="list-style-type: none"> <li>to biologically active substances according to EN 60721-3-3</li> <li>to chemically active substances according to EN 60721-3-3</li> <li>to mechanically active substances according to EN 60721-3-3</li> </ul> </li> <li>Use on land craft, rail vehicles and special-purpose vehicles <ul style="list-style-type: none"> <li>to biologically active substances according to EN 60721-3-5</li> <li>to chemically active substances according to EN 60721-3-5</li> <li>to mechanically active substances according to EN 60721-3-5</li> </ul> </li> <li>Usage in industrial process technology <ul style="list-style-type: none"> <li>Against chemically active substances acc. to EN 60654-4</li> <li>Environmental conditions for process, measuring and control systems acc. to ANSI/ISA-71.04</li> </ul> </li> <li>Remark <ul style="list-style-type: none"> <li>Note regarding classification of environmental conditions acc. to EN 60721, EN 60654-4 and ANSI/ISA-71.04</li> </ul> </li> </ul>	<p>Yes; Incl. diesel and oil droplets in the air Yes; Class 3B2 mold, fungus and dry rot spores (with the exception of fauna); Class 3B3 on request Yes; Class 3C4 (RH &lt; 75 %) incl. salt spray acc. to EN 60068-2-52 (severity degree 3); * Yes; Class 3S4 incl. sand, dust, *</p> <p>Yes; Class 5B2 mold, fungus and dry rot spores (with the exception of fauna); Class 5B3 on request Yes; Class 5C3 (RH &lt; 75 %) incl. salt spray acc. to EN 60068-2-52 (severity degree 3); * Yes; Class 5S3 incl. sand, dust; *</p> <p>Yes; Class 3 (excluding trichlorethylene) Yes; Level GX group A/B (excluding trichlorethylene; harmful gas concentrations up to the limits of EN 60721-3-3 class 3C4 permissible); level LC3 (salt spray) and level LB3 (oil)</p> <p>* The supplied plug covers must remain in place over the unused interfaces during operation!</p>	<p>Yes; Incl. diesel and oil droplets in the air Yes; Class 3B2 mold, fungus and dry rot spores (with the exception of fauna); Class 3B3 on request Yes; Class 3C4 (RH &lt; 75 %) incl. salt spray acc. to EN 60068-2-52 (severity degree 3); * Yes; Class 3S4 incl. sand, dust, *</p> <p>Yes; Class 5B2 mold, fungus and dry rot spores (with the exception of fauna); Class 5B3 on request Yes; Class 5C3 (RH &lt; 75 %) incl. salt spray acc. to EN 60068-2-52 (severity degree 3); * Yes; Class 5S3 incl. sand, dust; *</p> <p>Yes; Class 3 (excluding trichlorethylene) Yes; Level GX group A/B (excluding trichlorethylene; harmful gas concentrations up to the limits of EN 60721-3-3 class 3C4 permissible); level LC3 (salt spray) and level LB3 (oil)</p> <p>* The supplied plug covers must remain in place over the unused interfaces during operation!</p>
<b>Conformal coating</b> <ul style="list-style-type: none"> <li>Coatings for printed circuit board assemblies acc. to EN 61086</li> <li>Protection against fouling acc. to EN 60664-3</li> <li>Electronic equipment on rolling stock acc. to EN 50155</li> <li>Military testing according to MIL-I-46058C, Amendment 7</li> <li>Qualification and Performance of Electrical Insulating Compound for Printed Board Assemblies according to IPC-CC-830A</li> </ul>	<p>Yes; Class 2 for high reliability Yes; Type 1 protection Yes; Class PC2 protective coating acc. to EN 50155:2017 Yes; Discoloration of coating possible during service life Yes; Conformal coating, Class A</p>	<p>Yes; Class 2 for high reliability Yes; Type 1 protection Yes; Class PC2 protective coating acc. to EN 50155:2017 Yes; Discoloration of coating possible during service life Yes; Conformal coating, Class A</p>

# SIPLUS RAIL

## SIPLUS S7-1500 RAIL

### SIPLUS extreme RAIL fail-safe CPUs

#### SIPLUS S7-1500 CPU 1516F-3 PN/DP RAIL

Article number	<b>6AG2516-3FN02-2AB0</b> SIPLUS S7-1500 CPU 1516F-3 PN/DP RAIL	<b>6AG2516-3FN02-4AB0</b> SIPLUS S7-1500 CPU 1516F-3 PN/DP RAIL
<b>Configuration / header</b>		
<b>Configuration / programming / header</b>		
<ul style="list-style-type: none"> <li>Programming language</li> <li>- LAD</li> <li>- FBD</li> <li>- STL</li> <li>- SCL</li> <li>- GRAPH</li> </ul>	Yes; incl. failsafe Yes; incl. failsafe Yes Yes Yes	Yes; incl. failsafe Yes; incl. failsafe Yes Yes Yes
<b>Know-how protection</b>		
<ul style="list-style-type: none"> <li>User program protection/password protection</li> <li>Copy protection</li> <li>Block protection</li> </ul>	Yes Yes Yes	Yes Yes Yes
<b>Access protection</b>		
<ul style="list-style-type: none"> <li>Password for display</li> <li>Protection level: Write protection</li> <li>Protection level: Read/write protection</li> <li>Protection level: Complete protection</li> </ul>	Yes Yes; Specific write protection both for Standard and for Failsafe Yes Yes	Yes Yes; Specific write protection both for Standard and for Failsafe Yes Yes
<b>Dimensions</b>		
<b>Width</b>	70 mm	105 mm
<b>Height</b>	147 mm	147 mm
<b>Depth</b>	129 mm	129 mm
<b>Weights</b>		
<b>Weight, approx.</b>	560 g	830 g
<b>Other</b>		
<b>Note:</b>	for use in railway applications, also observe the product information "SIPLUS extreme RAIL" A5E37661960A, Online Support article 109736776	for use in railway applications, also observe the product information "SIPLUS extreme RAIL" A5E37661960A, Online Support article 109736776

#### Selection and ordering data

Version	Article No.
<b>SIPLUS CPU 1516F-3 PN/DP RAIL OT2</b> Approved in accordance with railway standards EN 50155, EN 15121, EN 50124, EN 50125 and EN 45545 for use in rail traffic Fail-safe CPU, 1.5 MB work memory for program, 5 MB for data, PROFINET IRT interface with 2-port switch, PROFINET RT interface, PROFIBUS interface; SIMATIC Memory Card required For areas with extreme exposure to environmental substances (conformal coating); ambient temperature -40 ... +55 °C (+70 °C for 10 min.)	<b>6AG2516-3FN02-2AB0</b>
<b>SIPLUS CPU 1516F-3 PN/DP RAIL OT4</b> Approved in accordance with railway standards EN 50155, EN 15121, EN 50124, EN 50125 and EN 45545 for use in rail traffic Fail-safe CPU, 1.5 MB work memory for program, 5 MB for data, PROFINET IRT interface with 2-port switch, PROFINET RT interface, PROFIBUS interface; SIMATIC Memory Card required For areas with extreme exposure to environmental substances (conformal coating); ambient temperature -40 ... +70 °C (+85 °C for 10 min.)	<b>6AG2516-3FN02-4AB0</b>
<b>Accessories</b> <b>SIMATIC Memory Card</b> 4 MB 12 MB 24 MB 256 MB 2 GB 32 GB	<b>6ES7954-8LC03-0AA0</b> <b>6ES7954-8LE03-0AA0</b> <b>6ES7954-8LF03-0AA0</b> <b>6ES7954-8LL03-0AA0</b> <b>6ES7954-8LP03-0AA0</b> <b>6ES7954-8LT03-0AA0</b>

## Overview

- The CPU for applications with medium/high requirements for program scope, networking and processing speed, and with increased requirements for availability
- Approved in accordance with the EN 50155, EN 15121, EN 50124, EN 50125 and EN 45545 railway standards for use in rail traffic
- High processing speed for binary and floating-point arithmetic
- PROFINET IO RT interface with 2-port switch
- Additional PROFINET interface with separate IP address
- PROFINET IO controller for operating distributed I/O on PROFINET

### Note:

SIMATIC Memory Card required for operation of the CPU.

## Application

The SIPLUS S7-1500 CPU 1515R-2 PN RAIL is the CPU with a large program and data memory for applications which have higher requirements for availability compared with standard CPUs. It can be used as the PROFINET IO controller. The integrated PROFINET IO RT interface is configured as a 2-port switch, enabling a ring topology required for SIPLUS S7-1500R to be set up in the system. The additional integrated PROFINET interface with separate IP address can be used, for example, for network separation.

## Design

The SIPLUS S7-1500CPU 1515R-2 PN RAIL features:

- A powerful processor:  
The CPU achieves a command execution time as low as 60 ns per binary command.
- Large work memory:  
500 KB for program, 3 MB for data
- SIMATIC Memory Cards as load memory
- Display with functions for:
  - Display of overview information such as station name, higher level designation, location designation, etc.
  - Display of diagnostic information
  - Display of module information
  - Showing display settings
  - Setting IP addresses
  - Setting date and time
  - Displaying operating mode (redundant or non-redundant)
  - Displaying status (stop, primary or backup)
  - Resetting of CPU to factory settings
  - Disabling/enabling the display
  - Enabling protection levels
- PROFINET IO RT interface for connecting distributed I/O via PROFINET

## Function

- Performance
  - Faster command processing, depending on the CPU type, language extensions and new data types
  - Even shorter response times of the CPUs due to considerably faster backplane bus
  - Powerful network connection:  
Each CPU is equipped with PROFINET IO RT (2-port switch) as the standard interface.
- Security Integrated
  - Password-based know-how protection against unauthorized read-out and modification of program blocks
  - Copy protection for tying individual blocks to the serial number of the SIMATIC Memory Card: The block can only run if the configured memory card is inserted into the CPU.
  - 4-level authorization concept:  
Communication to the operator panels can also be restricted.
  - Manipulation protection:  
The controller recognizes changed or unauthorized transmissions of the engineering data.
- Design and handling
  - Display of overview information:  
E.g. Station name, plant identifier, location designation, etc., diagnostic information, module information, display settings.
  - Possible operations on the display:  
set addresses, set date and time, select operating mode of CPU, reset CPU to factory settings, disable/enable display, activate protection levels.
- Integrated system diagnostics
  - System diagnostics information is displayed consistently and in plain text in the display, TIA Portal, operator panels and web server, even for messages from the drives, and updated even if the CPU is in STOP mode.
  - Integrated in the firmware of the CPU, no special configuration is required
- SIMATIC Memory Card (required for operation of the CPU)
  - Used as a plug-in load memory or for updating the firmware.
  - Also for storing additional documents or csv files (for recipes and archives)
- Programming of the standard program section
  - Programming with STEP 7 V15.1

**SIPLUS RAIL**

SIPLUS S7-1500 RAIL

SIPLUS extreme RAIL redundant CPUs

**SIPLUS S7-1500 CPU 1515R-2 PN RAIL****Technical specifications**

Article number	<b>6AG2515-2RM00-4AB0</b> SIPLUS S7-1500 CPU 1515R-2 PN TX RAIL
<b>General information</b>	
<b>Product type designation</b>	CPU 1515R-2 PN
<b>Engineering with</b> • STEP 7 TIA Portal configurable/integrated from version	see entry ID: 109746275
<b>Supply voltage</b>	
<b>Rated value (DC)</b>	24 V
<b>Memory</b>	
<b>Work memory</b> • integrated (for program) • integrated (for data)	500 kbyte 3 Mbyte
<b>Load memory</b> • Plug-in (SIMATIC Memory Card), max.	32 Gbyte
<b>CPU processing times</b>	
<b>for bit operations, typ.</b>	60 ns
<b>for word operations, typ.</b>	72 ns
<b>for fixed point arithmetic, typ.</b>	96 ns
<b>for floating point arithmetic, typ.</b>	384 ns
<b>Counters, timers and their retentivity</b>	
<b>S7 counter</b> • Number	2 048
<b>IEC counter</b> • Number	Any (only limited by the main memory)
<b>S7 times</b> • Number	2 048
<b>IEC timer</b> • Number	Any (only limited by the main memory)
<b>Data areas and their retentivity</b>	
<b>Flag</b> • Size, max.	16 kbyte
<b>Address area</b>	
<b>I/O address area</b> • Inputs • Outputs	32 kbyte; All inputs are in the process image 32 kbyte; All outputs are in the process image
<b>1. Interface</b>	
<b>Interface types</b> • RJ 45 (Ethernet) • Number of ports • integrated switch	Yes; X1 2 Yes
<b>Protocols</b> • IP protocol • PROFINET IO Controller • PROFINET IO Device • SIMATIC communication • Open IE communication • Web server • Media redundancy	Yes; IPv4 Yes No Yes; Only Server Yes No Yes
<b>PROFINET IO Controller</b> • Services - PG/OP communication - Isochronous mode - IRT - PROFinergy - Number of connectable IO Devices, max. - Updating times	Yes No No Yes 64 The minimum value of the update time also depends on communication share set for PROFINET IO, on the number of IO devices, and on the quantity of configured user data
<b>2. Interface</b>	
<b>Interface types</b> • RJ 45 (Ethernet) • Number of ports • integrated switch	Yes; X2 1 No
<b>Protocols</b> • IP protocol • PROFINET IO Controller • PROFINET IO Device • SIMATIC communication • Open IE communication • Web server • Media redundancy	Yes; IPv4 No No Yes; Only Server Yes No No



Article number	<b>6AG2515-2RM00-4AB0</b> SIPLUS S7-1500 CPU 1515R-2 PN TX RAIL
<b>Protocols</b>	
<b>Number of connections</b> • Number of connections, max.	108
<b>Redundancy mode</b> • Media redundancy - MRP  - MRPD - Switchover time on line break, typ. - Number of stations in the ring, max.	Yes; Manager Auto is permanently set in TIA. Max. 50 nodes are possible, 16 are recommended No 200 ms; PROFINET MRP 50; Only 16 are recommended, however
<b>SIMATIC communication</b> • S7 routing	No
<b>OPC UA</b> • OPC UA Client • OPC UA Server	No No
<b>Supported technology objects</b>	
<b>Motion Control</b>	No
<b>Controller</b> • PID_Compact • PID_3Step • PID-Temp	No No No
<b>Counting and measuring</b> • High-speed counter	No
<b>Standards, approvals, certificates</b>	
<b>Railway application</b> • EN 50121-3-2 • EN 50121-4 • EN 50124-1  • EN 50125-1 • EN 50125-2 • EN 50125-3  • EN 50155 • EN 61373 • Fire protection acc. to EN 45545-2	Yes; EMC for rail vehicles Yes; EMC for signal and telecommunications systems Yes; Railway applications - overvoltage category OV2; pollution degree PD2; rated surge voltage UNi = 0.5 kV; UNm = 24 V DC Yes; Rail vehicles - see ambient conditions Yes; Stationary electrical equipment - see ambient conditions Yes; Signal and telecommunications systems - see ambient conditions; vibrations and shocks: Application point outside of tracks (1 m to 3 m away from track) Yes; Rail vehicles - temperature class OT4, ST1/ST2, horizontal mounting position Yes; Rail vehicles - vibrations and shocks: Category 1 Class A/B Yes; For proof of conformity, see Service & Support
<b>Ambient conditions</b>	
<b>Ambient temperature during operation</b> • horizontal installation, min. • horizontal installation, max. • vertical installation, min. • vertical installation, max.	-40 °C; = Tmin (incl. condensation/frost) 70 °C; = Tmax; +85 °C for 10 min (OT4, ST1/ST2 acc. to EN 50155) -40 °C; = Tmin 40 °C; = Tmax
<b>Altitude during operation relating to sea level</b> • Installation altitude above sea level, max. • Ambient air temperature-barometric pressure-altitude	2 000 m Tmin ... Tmax at 1 140 hPa ... 795 hPa (-1 000 m ... +2 000 m)
<b>Relative humidity</b> • With condensation, tested in accordance with IEC 60068-2-38, max.	100 %; RH incl. condensation / frost (no commissioning in bedewed state), horizontal installation
<b>Resistance</b> • Coolants and lubricants - Resistant to commercially available coolants and lubricants • Use in stationary industrial systems - to biologically active substances according to EN 60721-3-3  - to chemically active substances according to EN 60721-3-3  - to mechanically active substances according to EN 60721-3-3 • Use on land craft, rail vehicles and special-purpose vehicles - to biologically active substances according to EN 60721-3-5  - to chemically active substances according to EN 60721-3-5  - to mechanically active substances according to EN 60721-3-5 • Usage in industrial process technology - Against chemically active substances acc. to EN 60654-4 - Environmental conditions for process, measuring and control systems acc. to ANSI/ISA-71.04  • Remark - Note regarding classification of environmental conditions acc. to EN 60721, EN 60654-4 and ANSI/ISA-71.04	Yes; Incl. diesel and oil droplets in the air  Yes; Class 3B2 mold, fungus and dry rot spores (with the exception of fauna); Class 3B3 on request Yes; Class 3C4 (RH < 75 %) incl. salt spray acc. to EN 60068-2-52 (severity degree 3); * Yes; Class 3S4 incl. sand, dust, *  Yes; Class 5B2 mold, fungus and dry rot spores (with the exception of fauna); Class 5B3 on request Yes; Class 5C3 (RH < 75 %) incl. salt spray acc. to EN 60068-2-52 (severity degree 3); * Yes; Class 5S3 incl. sand, dust; *  Yes; Class 3 (excluding trichlorethylene) Yes; Level GX group A/B (excluding trichlorethylene; harmful gas concentrations up to the limits of EN 60721-3-3 class 3C4 permissible); level LC3 (salt spray) and level LB3 (oil)  * The supplied plug covers must remain in place over the unused interfaces during operation!
<b>Conformal coating</b> • Coatings for printed circuit board assemblies acc. to EN 61086 • Protection against fouling acc. to EN 60664-3 • Electronic equipment on rolling stock acc. to EN 50155 • Military testing according to MIL-I-46058C, Amendment 7 • Qualification and Performance of Electrical Insulating Compound for Printed Board Assemblies according to IPC-CC-830A	Yes; Class 2 for high reliability Yes; Type 1 protection Yes; Class PC2 protective coating acc. to EN 50155:2017 Yes; Discoloration of coating possible during service life Yes; Conformal coating, Class A



**SIPLUS RAIL**

SIPLUS S7-1500 RAIL

SIPLUS extreme RAIL redundant CPUs

**SIPLUS S7-1500 CPU 1515R-2 PN RAIL**

Article number	<b>6AG2515-2RM00-4AB0</b> SIPLUS S7-1500 CPU 1515R-2 PN TX RAIL
<b>Configuration / header</b>	
<b>Configuration / programming / header</b>	
• Programming language	Yes
- LAD	Yes
- FBD	Yes
- STL	Yes
- SCL	Yes
- CFC	No
- GRAPH	No
<b>Know-how protection</b>	
• User program protection/password protection	Yes
• Copy protection	No
• Block protection	Yes
<b>Access protection</b>	
• Protection level: Write protection	Yes
• Protection level: Read/write protection	Yes
• Protection level: Complete protection	Yes
<b>Dimensions</b>	
<b>Width</b>	105 mm
<b>Height</b>	147 mm
<b>Depth</b>	129 mm
<b>Weights</b>	
<b>Weight, approx.</b>	1 100 g
<b>Other</b>	
<b>Note:</b>	for use in railway applications, also observe the product information "SIPLUS extreme RAIL" A5E37661960A, Online Support article 109736776

**Selection and ordering data**

Version	Article No.
<b>SIPLUS CPU 1515R-2 PN TX RAIL</b> Approved in accordance with the EN 50155, EN 15121, EN 50124, EN 50125 and EN 45545 railway standards for use in rail traffic SIPLUS S7-1500R CPU, 500 KB work memory for program, 3 MB for data, PROFINET RT interface with 2-port switch, PROFINET interface; SIMATIC Memory Card required For areas with extreme exposure to media (conformal coating); ambient temperature -40 ... +70 °C (+85 °C for 10 min.)	<b>6AG2515-2RM00-4AB0</b>
<b>Accessories</b> <b>SIMATIC Memory Card</b> 4 MB 12 MB 24 MB 256 MB 2 GB 32 GB	<b>6ES7954-8LC03-0AA0</b> <b>6ES7954-8LE03-0AA0</b> <b>6ES7954-8LF03-0AA0</b> <b>6ES7954-8LL03-0AA0</b> <b>6ES7954-8LP03-0AA0</b> <b>6ES7954-8LT03-0AA0</b>

6

## Overview



- 16-channel digital input module
- Approved in accordance with the railway standards EN 50155, EN 15121, EN 50124, EN 50125 and EN 45545 for use in rail traffic
- For flexible adaptation of the controller to the corresponding task
- For subsequent expansion of the system with additional inputs

## Application

The digital module inputs records 24 V DC signals in the system and forwards them to the controller. Switches and 2-wire proximity switches can be connected.

Input modules have settable parameters and diagnostic functions and can thus be adapted flexibly to the respective process requirements.

## Design

- Installation on the S7-1500 mounting rail using one single screw
- Standardized 40-pin front connector using screw terminal or push-in technology
- Standardized, harmonized front connector assignment for easier wiring
- Connectable core cross-sections: 0.25 mm<sup>2</sup> to 1.5 mm<sup>2</sup> (AWG24 to 16)
- Integrated potential bridges for flexible creation of potential groups
- Front connector can be set to prewiring position
- Front flap with expandable cable compartment, even if fully wired
- Unambiguous labeling on front of module:
  - Module type
  - Article No.
  - Hardware and firmware version
  - Channel numbers labeling
  - Cabling diagram

Included in the scope of delivery:

- One labeling strip for manual labeling
- One U connector
- Printed front door

## Function

- Uniform display and diagnostics concept:
  - Module status display for ERROR (red LED) and RUN (green LED)
  - Channel status display for signal state log. "0" and log. "1" (green LED) or indication of wire break (red LED)
  - Display for monitoring the 24 V DC supply voltage (green LED)
- Supported functions:
  - Identification and maintenance data IMO to IM3
  - Firmware update
  - Module-granular shared device and MSI (modular shared input); in combination with PROFINET these allow assignment to several IO controllers
  - Channel-specific parameter assignment (only HF modules)
  - Hardware interrupts (only HF modules)
  - Channel-granular diagnostics (only HF modules)
  - Isochronous mode (dependent on the module)

# SIPLUS RAIL

## SIPLUS S7-1500 RAIL

### SIPLUS extreme RAIL digital modules

#### SIPLUS extreme RAIL digital input modules

#### Technical specifications

Article number	<b>6AG2521-1BH00-4AB0</b>	<b>6AG2521-7EH00-4AB0</b>
	SIPLUS S7-1500 DI 16x24VDC HF TX RAIL	SIPLUS S7-1500 DI 16x110VDC HF TX RAIL
<b>General information</b>		
<b>Product type designation</b>	DI 16x24VDC HF	DI 16x110VDC HF
<b>Product function</b>		
• Isochronous mode	Yes	No
• Prioritized startup	Yes	Yes
<b>Operating mode</b>		
• DI	Yes	Yes
• Counter	Yes	No
• Oversampling		No
• MSI	Yes	Yes
<b>Supply voltage</b>		
<b>Rated value (DC)</b>	24 V	
<b>Reverse polarity protection</b>	Yes	
<b>Digital inputs</b>		
<b>Number of digital inputs</b>	16	16; > +60 °C number of simultaneously controllable inputs max. 4 (no adjacent points)
<b>Digital inputs, parameterizable</b>	Yes	Yes
<b>Source/sink input</b>	P-reading	P-reading
<b>Input characteristic curve in accordance with IEC 61131, type 3</b>	Yes	Yes; At 24 V DC
<b>Digital input functions, parameterizable</b>		
• Gate start/stop	Yes	
• Freely usable digital input	Yes	
<b>Input voltage</b>		
• Rated value (DC)	24 V	24 V; 48 V, 72 V, 96 V, 110 V, 125 V
• Rated value (AC)		24 V; 48 V, 125 V (50 - 60 Hz)
• for signal "0"	-30 to +5 V	-5 ... +5 V
• for signal "1"	+11 to +30V	+11 V DC to +146 V DC, as well as +154 V DC for 1 s according to EN 50155
<b>Input current</b>		
• for signal "1", typ.	2.5 mA	3 mA; At 24 V DC
<b>Input delay (for rated value of input voltage)</b>		
• for standard inputs - parameterizable	Yes; 0.05 / 0.1 / 0.4 / 1.6 / 3.2 / 12.8 / 20 ms	Yes; 0.05 / 0.1 / 0.4 / 1.6 / 3.2 / 12.8 / 20 ms parameterizable with DC, 20 ms fixed with AC
• for interrupt inputs - parameterizable	Yes	Yes
• for technological functions - parameterizable	Yes	No
<b>Encoder</b>		
<b>Connectable encoders</b>		
• 2-wire sensor	Yes	Yes
- permissible quiescent current (2-wire sensor), max.	1.5 mA	1.5 mA
<b>Isochronous mode</b>		
<b>Filtering and processing time (TCI), min.</b>	80 µs; At 50 µs filter time	
<b>Bus cycle time (TDP), min.</b>	250 µs	
<b>Interrupts/diagnostics/status information</b>		
<b>Diagnostics function</b>	Yes	Yes
<b>Alarms</b>		
• Diagnostic alarm	Yes	Yes
• Hardware interrupt	Yes	Yes
<b>Diagnoses</b>		
• Monitoring the supply voltage	Yes	No
• Wire-break	Yes; to I < 350 µA	Yes; To I < 550 µA
• Short-circuit	No	No
• Fuse blown	No	No
<b>Diagnostics indication LED</b>		
• RUN LED	Yes; green LED	Yes; green LED
• ERROR LED	Yes; red LED	Yes; red LED
• Monitoring of the supply voltage (PWR-LED)	Yes; green LED	No
• Channel status display	Yes; green LED	Yes; green LED
• for channel diagnostics	Yes; red LED	Yes; red LED
• for module diagnostics	Yes; red LED	Yes; red LED
<b>Potential separation</b>		
<b>Potential separation channels</b>		
• between the channels and backplane bus	Yes	Yes

Article number	<b>6AG2521-1BH00-4AB0</b> SIPLUS S7-1500 DI 16x24VDC HF TX RAIL	<b>6AG2521-7EH00-4AB0</b> SIPLUS S7-1500 DI 16x110VDC HF TX RAIL
<b>Standards, approvals, certificates</b>		
<b>Suitable for safety functions</b>	No	No
<b>Railway application</b>		
<ul style="list-style-type: none"> <li>• EN 50121-3-2</li> <li>• EN 50121-4</li>   <li>• EN 50124-1</li>     <li>• EN 50125-1</li> <li>• EN 50125-2</li> <li>• EN 50125-3</li>     <li>• EN 50155</li> <li>• EN 61373</li> <li>• Fire protection acc. to EN 45545-2</li> </ul>	<p>Yes; EMC for rail vehicles Yes; EMC for signal and telecommunications systems Yes; Railway applications - overvoltage category OV2; pollution degree PD2; rated surge voltage UNi = 0.5 kV; UNm = 24 V DC</p> <p>Yes; Rail vehicles - see ambient conditions Yes; Stationary electrical equipment - see ambient conditions Yes; Signal and telecommunications systems - see ambient conditions; vibrations and shocks: Application point outside of tracks (1 m to 3 m away from track) Yes; Rail vehicles - temperature class OT4, ST1/ST2, horizontal mounting position Yes; Rail vehicles - vibrations and shocks: Category 1 Class A/B Yes; For proof of conformity, see Service &amp; Support</p>	<p>Yes; EMC for rail vehicles Yes; EMC for signal and telecommunications systems Yes; Railway applications - overvoltage category OV3 (channels to backplane bus and ground); OV2 (between the channels); pollution degree PD2; rated impulse voltage UNi = 1.5 kV; UNm = 125 V DC Yes; Rail vehicles - see ambient conditions Yes; Stationary electrical equipment - see ambient conditions Yes; Signal and telecommunications systems - see ambient conditions; vibrations and shocks: Application point outside of tracks (1 m to 3 m away from track) Yes; Rail vehicles - temperature class OT4, ST1/ST2, horizontal mounting position Yes; Rail vehicles - vibrations and shocks: Category 1 Class A/B Yes; For proof of conformity, see Service &amp; Support</p>
<b>Ambient conditions</b>		
<b>Ambient temperature during operation</b>		
<ul style="list-style-type: none"> <li>• horizontal installation, min.</li> <li>• horizontal installation, max.</li>    <li>• vertical installation, min.</li> <li>• vertical installation, max.</li> </ul>	<p>-40 °C; = Tmin (incl. condensation/frost) 70 °C; = Tmax; +85 °C for 10 min (OT4, ST1/ST2 acc. to EN 50155) -40 °C; = Tmin 40 °C; = Tmax</p>	<p>-40 °C; = Tmin (incl. condensation/frost) 70 °C; = Tmax; +85 °C for 10 min (OT4, ST1/ST2 acc. to EN 50155) -40 °C; = Tmin 40 °C; = Tmax</p>
<b>Altitude during operation relating to sea level</b>		
<ul style="list-style-type: none"> <li>• Installation altitude above sea level, max.</li> <li>• Ambient air temperature-barometric pressure-altitude</li> </ul>	<p>2 000 m Tmin ... Tmax at 1 140 hPa ... 795 hPa (-1 000 m ... +2 000 m)</p>	<p>2 000 m Tmin ... Tmax at 1 140 hPa ... 795 hPa (-1 000 m ... +2 000 m)</p>
<b>Relative humidity</b>		
<ul style="list-style-type: none"> <li>• With condensation, tested in accordance with IEC 60068-2-38, max.</li> </ul>	100 %; RH incl. condensation / frost (no commissioning in bedewed state), horizontal installation	100 %; RH incl. condensation / frost (no commissioning in bedewed state), horizontal installation
<b>Resistance</b>		
<ul style="list-style-type: none"> <li>• Coolants and lubricants <ul style="list-style-type: none"> <li>- Resistant to commercially available coolants and lubricants</li> </ul> </li> <li>• Use in stationary industrial systems <ul style="list-style-type: none"> <li>- to biologically active substances according to EN 60721-3-3</li> <li>- to chemically active substances according to EN 60721-3-3</li> <li>- to mechanically active substances according to EN 60721-3-3</li> </ul> </li> <li>• Use on land craft, rail vehicles and special-purpose vehicles <ul style="list-style-type: none"> <li>- to biologically active substances according to EN 60721-3-5</li> <li>- to chemically active substances according to EN 60721-3-5</li> <li>- to mechanically active substances according to EN 60721-3-5</li> </ul> </li> <li>• Usage in industrial process technology <ul style="list-style-type: none"> <li>- Against chemically active substances acc. to EN 60654-4</li> <li>- Environmental conditions for process, measuring and control systems acc. to ANSI/ISA-71.04</li> </ul> </li> <li>• Remark <ul style="list-style-type: none"> <li>- Note regarding classification of environmental conditions acc. to EN 60721, EN 60654-4 and ANSI/ISA-71.04</li> </ul> </li> </ul>	<p>Yes; Incl. diesel and oil droplets in the air</p> <p>Yes; Class 3B2 mold, fungus and dry rot spores (with the exception of fauna); Class 3B3 on request Yes; Class 3C4 (RH &lt; 75 %) incl. salt spray acc. to EN 60068-2-52 (severity degree 3); * Yes; Class 3S4 incl. sand, dust, *</p> <p>Yes; Class 5B2 mold, fungus and dry rot spores (with the exception of fauna); Class 5B3 on request Yes; Class 5C3 (RH &lt; 75 %) incl. salt spray acc. to EN 60068-2-52 (severity degree 3); * Yes; Class 5S3 incl. sand, dust; *</p> <p>Yes; Class 3 (excluding trichlorethylene)</p> <p>Yes; Level GX group A/B (excluding trichlorethylene; harmful gas concentrations up to the limits of EN 60721-3-3 class 3C4 permissible); level LC3 (salt spray) and level LB3 (oil)</p> <p>* The supplied plug covers must remain in place over the unused interfaces during operation!</p>	<p>Yes; Incl. diesel and oil droplets in the air</p> <p>Yes; Class 3B2 mold, fungus and dry rot spores (with the exception of fauna); Class 3B3 on request Yes; Class 3C4 (RH &lt; 75 %) incl. salt spray acc. to EN 60068-2-52 (severity degree 3); * Yes; Class 3S4 incl. sand, dust, *</p> <p>Yes; Class 5B2 mold, fungus and dry rot spores (with the exception of fauna); Class 5B3 on request Yes; Class 5C3 (RH &lt; 75 %) incl. salt spray acc. to EN 60068-2-52 (severity degree 3); * Yes; Class 5S3 incl. sand, dust; *</p> <p>Yes; Class 3 (excluding trichlorethylene)</p> <p>Yes; Level GX group A/B (excluding trichlorethylene; harmful gas concentrations up to the limits of EN 60721-3-3 class 3C4 permissible); level LC3 (salt spray) and level LB3 (oil)</p> <p>* The supplied plug covers must remain in place over the unused interfaces during operation!</p>
<b>Conformal coating</b>		
<ul style="list-style-type: none"> <li>• Coatings for printed circuit board assemblies acc. to EN 61086</li> <li>• Protection against fouling acc. to EN 60664-3</li> <li>• Electronic equipment on rolling stock acc. to EN 50155</li> <li>• Military testing according to MIL-I-46058C, Amendment 7</li> <li>• Qualification and Performance of Electrical Insulating Compound for Printed Board Assemblies according to IPC-CC-830A</li> </ul>	<p>Yes; Class 2 for high reliability</p> <p>Yes; Type 1 protection Yes; Class PC2 protective coating acc. to EN 50155:2017 Yes; Discoloration of coating possible during service life Yes; Conformal coating, Class A</p>	<p>Yes; Class 2 for high reliability</p> <p>Yes; Type 1 protection Yes; Class PC2 protective coating acc. to EN 50155:2017 Yes; Discoloration of coating possible during service life Yes; Conformal coating, Class A</p>

## SIPLUS RAIL

### SIPLUS S7-1500 RAIL

### SIPLUS extreme RAIL digital modules

#### SIPLUS extreme RAIL digital input modules

Article number	<b>6AG2521-1BH00-4AB0</b> SIPLUS S7-1500 DI 16x24VDC HF TX RAIL	<b>6AG2521-7EH00-4AB0</b> SIPLUS S7-1500 DI 16x110VDC HF TX RAIL
<b>Dimensions</b>		
<b>Width</b>	35 mm	35 mm
<b>Height</b>	147 mm	147 mm
<b>Depth</b>	129 mm	129 mm
<b>Weights</b>		
<b>Weight, approx.</b>	240 g	240 g
<b>Other</b>		
<b>Note:</b>	for use in railway applications, also observe the product information "SIPLUS extreme RAIL" A5E37661960A, Online Support article 109736776	for use in railway applications, also observe the product information "SIPLUS extreme RAIL" A5E37661960A, Online Support article 109736776

#### Selection and ordering data

Version	Article No.
<b>SIPLUS extreme SM 521 RAIL digital input modules</b> Approved in accordance with EN 50155, EN 15121, EN 50124, EN 50125 and EN 45545 railway standards for use in rail traffic	
<b>SIPLUS S7-1500 DI 16 x 24 V DC HF TX RAIL</b> 16 inputs, 24 V DC, isolated, configurable diagnostics and hardware interrupts; for areas with extreme exposure to environmental substances (conformal coating); ambient temperature -40 ... +70 °C (+85 °C for 10 min.)	<b>6AG2521-1BH00-4AB0</b>
<b>SIPLUS S7-1500 DI 16 x 110 V DC HF TX RAIL</b> 16 inputs, 24 ... 125 V UC, input delay 0.05 ... 20 ms, parameterizable diagnostics and hardware interrupts; for areas with extreme exposure to environmental substances (conformal coating); ambient temperature -40 ... +70 °C (+85 °C for 10 min.)	<b>6AG2521-7EH00-4AB0</b>

### Overview



- 8 and 16-channel digital output modules
- Approved in accordance with the railway standards EN 50155, EN 15121, EN 50124, EN 50125 and EN 45545 for use in rail traffic
- For flexible adaptation of the controller to the corresponding task
- For subsequent expansion of the system with additional outputs

### Application

Digital output modules switch 24 V DC or 230 V AC voltages in the plant and thus transfer internal signals from the controller to the plant. Solenoid valves, DC contactors, and indicator lights can be connected.

The output modules have settable parameters and diagnostic functions and can thus be adapted flexibly to the respective process requirements.

### Design

- Installation on the S7-1500 mounting rail using one single screw
- Standardized 40-pin front connector using screw terminal or push-in technology
- Standardized, harmonized front connector assignment for easier wiring
- Connectable core cross-sections: 0.25 mm<sup>2</sup> to 1.5 mm<sup>2</sup> (AWG24 to 16)
- Integrated potential bridges for flexible creation of potential groups
- Front connector can be set to prewiring position
- Front flap with expandable cable compartment, even if fully wired
- Unambiguous labeling on front of module:
  - Module type
  - Article No.
  - Hardware and firmware version
  - Channel numbers labeling
  - Cabling diagram

Included in the scope of delivery:

- One labeling strip for manual labeling
- One U connector
- Printed front door

### Function

- Uniform display and diagnostics concept:
  - Module status display for ERROR (red LED) and RUN (green LED)
  - Channel status indicator for signal state log. "0" and log. "1" (green LED) or indication of short-circuit (red LED)
  - Display for monitoring the 24 V DC supply voltage (green LED)
- Supported functions:
  - Identification and maintenance data IM0 to IM3
  - Firmware update
  - Channel-granular parameter assignment (HF modules only)
  - Channel-granular diagnostics (HF modules only)
  - Isochronous mode (dependent on the module)
  - Substitute values can be parameterized for the outputs

### Technical specifications

Article number	6AG2522-1BH01-4AB0	6AG2522-5EH00-4AB0	6AG2522-5HF00-1AB0
	SIPLUS S7-1500 DQ 16x24VDC HF TX RAIL	SIPLUS S7-1500 DQ 16x110VDC ST TX RAIL	SIPLUS S7-1500 DQ 8x230VAC ST 5A T1 RAIL
<b>General information</b>			
<b>Product type designation</b>	DQ 16x24VDC/0.5A HF	DQ 16x110VDC ST	DQ 8x230 V AC/5 A ST (relay)
<b>Product function</b>			
• Isochronous mode	Yes	No	No
• Fast startup	Yes	Yes	Yes; 500 ms
• Prioritized startup	Yes	Yes	
<b>Operating mode</b>			
• DQ		Yes	
• DQ with energy-saving function		No	
• PWM		No	
• Oversampling		No	
• MSO	Yes	Yes	
<b>Supply voltage</b>			
<b>Rated value (DC)</b>	24 V		24 V
<b>Reverse polarity protection</b>	Yes; through internal protection with 7 A per group		
<b>Digital outputs</b>			
<b>Type of digital output</b>	Transistor	Transistor	Relays
<b>Number of digital outputs</b>	16	16; > +60 °C max. 0.25 A per output	8
<b>Current-sinking</b>		Yes	

# SIPLUS RAIL

## SIPLUS S7-1500 RAIL

### SIPLUS extreme RAIL digital modules

#### SIPLUS extreme RAIL digital output modules

Article number	<b>6AG2522-1BH01-4AB0</b>	<b>6AG2522-5EH00-4AB0</b>	<b>6AG2522-5HF00-1AB0</b>
	SIPLUS S7-1500 DQ 16x24VDC HF TX RAIL	SIPLUS S7-1500 DQ 16x110VDC ST TX RAIL	SIPLUS S7-1500 DQ 8x230VAC ST 5A T1 RAIL
<b>Current-sourcing</b>	Yes	Yes	
<b>Digital outputs, parameterizable</b>	Yes	Yes	Yes
<b>Short-circuit protection</b>	Yes; Clocked electronically		No
<b>Open-circuit detection</b>	Yes		
<b>Limitation of inductive shutdown voltage to</b>	L+ (-53 V)	200 V (suppressor diode)	
<b>Controlling a digital input</b>	Yes	Yes	possible
<b>Size of motor starters according to NEMA, max.</b>			5
<b>Switching capacity of the outputs</b>			
<ul style="list-style-type: none"> <li>with resistive load, max.</li> <li>on lamp load, max.</li> <li>Low energy/fluorescent lamps with electronic control gear</li> <li>Fluorescent tubes, conventionally compensated</li> <li>Fluorescent tubes, uncompensated</li> </ul>	0.5 A 5 W	0.5 A 40 W; At 125 V DC, 10 W at 48 V UC, 5 W at 24 V UC	1 500 W; 10 000 operating cycles 10x 58 W (25 000 operating cycles) 1x 58 W (25 000 operating cycles) 10x 58 W (25 000 operating cycles)
<b>Load resistance range</b>			
<ul style="list-style-type: none"> <li>lower limit</li> <li>upper limit</li> </ul>	48 Ω 12 kΩ		
<b>Output voltage</b>			
• for signal "1", min.	L+ (-0.8 V)	L+ (-1.0 V)	
<b>Output current</b>			
<ul style="list-style-type: none"> <li>for signal "1" rated value</li> <li>for signal "0" residual current, max.</li> </ul>	0.5 A 0.5 mA	0.5 A	5 A 0 A
<b>Output delay with resistive load</b>			
<ul style="list-style-type: none"> <li>"0" to "1", max.</li> <li>"1" to "0", max.</li> </ul>	100 μs 100 μs; at rated load	5 ms 5 ms	
<b>Parallel switching of two outputs</b>			
<ul style="list-style-type: none"> <li>for logic links</li> <li>for uprating</li> <li>for redundant control of a load</li> </ul>	Yes Yes Yes	Yes No Yes	Yes No Yes
<b>Switching frequency</b>			
<ul style="list-style-type: none"> <li>with resistive load, max.</li> <li>with inductive load, max.</li> <li>on lamp load, max.</li> </ul>	100 Hz 0.5 Hz; According to IEC 60947-5-1, DC-13 10 Hz	25 Hz 0.5 Hz 10 Hz	2 Hz 0.5 Hz 2 Hz
<b>Total current of the outputs</b>			
<ul style="list-style-type: none"> <li>Current per channel, max.</li> <li>Current per group, max.</li> <li>Current per module, max.</li> </ul>	0.5 A; see additional description in the manual 4 A; see additional description in the manual 8 A; see additional description in the manual	0.5 A 0.5 A 8 A	8 A; see additional description in the manual 8 A; see additional description in the manual 64 A; see additional description in the manual
<b>Relay outputs</b>			
<ul style="list-style-type: none"> <li>Number of relay outputs</li> <li>Rated supply voltage of relay coil L+ (DC)</li> <li>Current consumption of relays (coil current of all relays), max.</li> <li>external protection for relay outputs</li> <li>Contact connection (internal)</li> <li>Number of operating cycles, max.</li> <li>Relay approved acc. to UL 508</li> </ul>			8 24 V 80 mA  With miniature circuit breaker with characteristic B for: cos φ 1.0: 600 A cos φ 0.5 ... 0.7: 900 A with 8 A Diazed fuse: 1 000 A No 4 000 000; see additional description in the manual Yes; 250 V AC/5 A g.p.; 120 V AC TV-4 tungsten; A300, R300
<b>Switching capacity of contacts</b>			
<ul style="list-style-type: none"> <li>with inductive load, max.</li> <li>with resistive load, max.</li> </ul>			see additional description in the manual see additional description in the manual
<b>Isochronous mode</b>			
<b>Execution and activation time (TCO), min.</b>	70 μs		
<b>Bus cycle time (TDP), min.</b>	250 μs		
<b>Interrupts/diagnostics/status information</b>			
<b>Diagnostics function</b>	Yes	No	Yes
<b>Substitute values connectable</b>	Yes	Yes	Yes
<b>Alarms</b>			
• Diagnostic alarm	Yes	No	Yes
<b>Diagnoses</b>			
<ul style="list-style-type: none"> <li>Monitoring the supply voltage</li> <li>Wire-break</li> <li>Short-circuit</li> <li>Fuse blown</li> </ul>	Yes Yes Yes No	No No No	Yes No No

## SIPLUS extreme RAIL digital output modules

Article number	6AG2522-1BH01-4AB0	6AG2522-5EH00-4AB0	6AG2522-5HF00-1AB0
	SIPLUS S7-1500 DQ 16x24VDC HF TX RAIL	SIPLUS S7-1500 DQ 16x110VDC ST TX RAIL	SIPLUS S7-1500 DQ 8x230VAC ST 5A T1 RAIL
<b>Diagnostics indication LED</b>			
<ul style="list-style-type: none"> <li>• RUN LED</li> <li>• ERROR LED</li> <li>• Monitoring of the supply voltage (PWR-LED)</li> <li>• Channel status display</li> <li>• for channel diagnostics</li> <li>• for module diagnostics</li> </ul>	<ul style="list-style-type: none"> <li>Yes; green LED</li> <li>Yes; red LED</li> <li>Yes; green LED</li> <li>Yes; green LED</li> <li>Yes; red LED</li> <li>Yes; red LED</li> </ul>	<ul style="list-style-type: none"> <li>Yes; green LED</li> <li>Yes; red LED</li> <li>No</li> <li>Yes; green LED</li> <li>No</li> <li>Yes; red LED</li> </ul>	<ul style="list-style-type: none"> <li>Yes; green LED</li> <li>Yes; red LED</li> <li>Yes; green LED</li> <li>Yes; green LED</li> <li>No</li> <li>Yes; red LED</li> </ul>
<b>Potential separation</b>			
<b>Potential separation channels</b>			
<ul style="list-style-type: none"> <li>• between the channels and backplane bus</li> </ul>	Yes	Yes	Yes
<b>Standards, approvals, certificates</b>			
<b>Suitable for safety functions</b>	No	No	No
<b>Suitable for safety-related tripping of standard modules</b>			No
<b>Railway application</b>			
<ul style="list-style-type: none"> <li>• EN 50121-3-2</li> <li>• EN 50121-4</li> <li>• EN 50124-1</li> <li>• EN 50125-1</li> <li>• EN 50125-2</li> <li>• EN 50125-3</li> <li>• EN 50155</li> <li>• EN 61373</li> <li>• Fire protection acc. to EN 45545-2</li> </ul>	<ul style="list-style-type: none"> <li>Yes; EMC for rail vehicles</li> <li>Yes; EMC for signal and telecommunications systems</li> <li>Yes; Railway applications - over-voltage category OV2; pollution degree PD2; rated surge voltage UNi = 0.5 kV; UNm = 24 V DC</li> <li>Yes; Rail vehicles - see ambient conditions</li> <li>Yes; Stationary electrical equipment - see ambient conditions</li> <li>Yes; Signal and telecommunications systems - see ambient conditions; vibrations and shocks: Application point outside of tracks (1 m to 3 m away from track)</li> <li>Yes; Rail vehicles - temperature class OT4, ST1/ST2, horizontal mounting position</li> <li>Yes; Rail vehicles - vibrations and shocks: Category 1 Class A/B</li> <li>Yes; For proof of conformity, see Service &amp; Support</li> </ul>	<ul style="list-style-type: none"> <li>Yes; EMC for rail vehicles</li> <li>Yes; EMC for signal and telecommunications systems</li> <li>Yes; Railway applications - over-voltage category OV3 (channels to backplane bus and ground); OV2 (between the channels); pollution degree PD2; rated impulse voltage UNi = 1.5 kV; UNm = 125 V DC</li> <li>Yes; Rail vehicles - see ambient conditions</li> <li>Yes; Stationary electrical equipment - see ambient conditions</li> <li>Yes; Signal and telecommunications systems - see ambient conditions; vibrations and shocks: Application point outside of tracks (1 m to 3 m away from track)</li> <li>Yes; Rail vehicles - temperature class OT4, ST1/ST2, horizontal mounting position</li> <li>Yes; Rail vehicles - vibrations and shocks: Category 1 Class A/B</li> <li>Yes; For proof of conformity, see Service &amp; Support</li> </ul>	<ul style="list-style-type: none"> <li>Yes; EMC for rail vehicles</li> <li>Yes; EMC for signal and telecommunications systems</li> <li>Yes; Railway applications - over-voltage category OV3; pollution degree PD2; UNm = 230 V AC</li> <li>Yes; Rail vehicles - see ambient conditions</li> <li>Yes; Stationary electrical equipment - see ambient conditions</li> <li>Yes; Signal and telecommunications systems - see ambient conditions; vibrations and shocks: Application point outside of tracks (1 m to 3 m away from track)</li> <li>Yes; Rail vehicles - temperature class OT1, ST1/ST2, horizontal mounting position</li> <li>Yes; Rail vehicles - vibrations and shocks: Category 1 Class A/B</li> <li>Yes; For proof of conformity, see Service &amp; Support</li> </ul>
<b>Ambient conditions</b>			
<b>Ambient temperature during operation</b>			
<ul style="list-style-type: none"> <li>• horizontal installation, min.</li> <li>• horizontal installation, max.</li> <li>• vertical installation, min.</li> <li>• vertical installation, max.</li> </ul>	<ul style="list-style-type: none"> <li>-40 °C; = Tmin (incl. condensation/frost)</li> <li>70 °C; = Tmax; &gt; +60 °C number of simultaneously controllable outputs max. 8x 0.5 A, max. total current per group 2 A; +85 °C for 10 minutes (OT4, ST1/ST2 acc. to EN 50155)</li> <li>-40 °C; = Tmin</li> <li>40 °C; = Tmax</li> </ul>	<ul style="list-style-type: none"> <li>-40 °C; = Tmin (incl. condensation/frost)</li> <li>70 °C; = Tmax; +85 °C for 10 min (OT4, ST1/ST2 acc. to EN 50155)</li> <li>-40 °C; = Tmin</li> <li>40 °C; = Tmax</li> </ul>	<ul style="list-style-type: none"> <li>-25 °C; = Tmin (incl. condensation/frost)</li> <li>60 °C; = Tmax; +70 °C for 10 min (OT1, ST1/ST2 acc. to EN 50155)</li> <li>-25 °C; = Tmin</li> <li>60 °C; = Tmax</li> </ul>
<b>Altitude during operation relating to sea level</b>			
<ul style="list-style-type: none"> <li>• Installation altitude above sea level, max.</li> <li>• Ambient air temperature-barometric pressure-altitude</li> </ul>	<ul style="list-style-type: none"> <li>2 000 m</li> <li>Tmin ... Tmax at 1 140 hPa ... 795 hPa (-1 000 m ... +2 000 m)</li> </ul>	<ul style="list-style-type: none"> <li>2 000 m</li> <li>Tmin ... Tmax at 1 140 hPa ... 795 hPa (-1 000 m ... +2 000 m)</li> </ul>	<ul style="list-style-type: none"> <li>2 000 m</li> <li>Tmin ... Tmax at 1 140 hPa ... 795 hPa (-1 000 m ... +2 000 m)</li> </ul>
<b>Relative humidity</b>			
<ul style="list-style-type: none"> <li>• With condensation, tested in accordance with IEC 60068-2-38, max.</li> </ul>	<ul style="list-style-type: none"> <li>100 %; RH incl. condensation / frost (no commissioning in bedewed state), horizontal installation</li> </ul>	<ul style="list-style-type: none"> <li>100 %; RH incl. condensation / frost (no commissioning in bedewed state), horizontal installation</li> </ul>	<ul style="list-style-type: none"> <li>100 %; RH incl. condensation / frost (no commissioning in bedewed state), horizontal installation</li> </ul>
<b>Resistance</b>			
<ul style="list-style-type: none"> <li>• Coolants and lubricants <ul style="list-style-type: none"> <li>- Resistant to commercially available coolants and lubricants</li> </ul> </li> <li>• Use in stationary industrial systems <ul style="list-style-type: none"> <li>- to biologically active substances according to EN 60721-3-3</li> <li>- to chemically active substances according to EN 60721-3-3</li> <li>- to mechanically active substances according to EN 60721-3-3</li> </ul> </li> </ul>	<ul style="list-style-type: none"> <li>Yes; Incl. diesel and oil droplets in the air</li> <li>Yes; Class 3B2 mold, fungus and dry rot spores (with the exception of fauna); Class 3B3 on request</li> <li>Yes; Class 3C4 (RH &lt; 75 %) incl. salt spray acc. to EN 60068-2-52 (severity degree 3); *</li> <li>Yes; Class 3S4 incl. sand, dust, *</li> </ul>	<ul style="list-style-type: none"> <li>Yes; Incl. diesel and oil droplets in the air</li> <li>Yes; Class 3B2 mold, fungus and dry rot spores (with the exception of fauna); Class 3B3 on request</li> <li>Yes; Class 3C4 (RH &lt; 75 %) incl. salt spray acc. to EN 60068-2-52 (severity degree 3); *</li> <li>Yes; Class 3S4 incl. sand, dust, *</li> </ul>	<ul style="list-style-type: none"> <li>Yes; Incl. diesel and oil droplets in the air</li> <li>Yes; Class 3B2 mold, fungus and dry rot spores (with the exception of fauna); Class 3B3 on request</li> <li>Yes; Class 3C4 (RH &lt; 75 %) incl. salt spray acc. to EN 60068-2-52 (severity degree 3); *</li> <li>Yes; Class 3S4 incl. sand, dust, *</li> </ul>



# SIPLUS RAIL

## SIPLUS S7-1500 RAIL

### SIPLUS extreme RAIL digital modules

#### SIPLUS extreme RAIL digital output modules

Article number	6AG2522-1BH01-4AB0	6AG2522-5EH00-4AB0	6AG2522-5HF00-1AB0
	SIPLUS S7-1500 DQ 16x24VDC HF TX RAIL	SIPLUS S7-1500 DQ 16x110VDC ST TX RAIL	SIPLUS S7-1500 DQ 8x230VAC ST 5A T1 RAIL
<ul style="list-style-type: none"> <li>Use on land craft, rail vehicles and special-purpose vehicles               <ul style="list-style-type: none"> <li>to biologically active substances according to EN 60721-3-5</li> <li>to chemically active substances according to EN 60721-3-5</li> <li>to mechanically active substances according to EN 60721-3-5</li> </ul> </li> <li>Usage in industrial process technology               <ul style="list-style-type: none"> <li>Against chemically active substances acc. to EN 60654-4</li> <li>Environmental conditions for process, measuring and control systems acc. to ANSI/ISA-71.04</li> </ul> </li> <li>Remark               <ul style="list-style-type: none"> <li>Note regarding classification of environmental conditions acc. to EN 60721, EN 60654-4 and ANSI/ISA-71.04</li> </ul> </li> </ul>	<p>Yes; Class 5B2 mold, fungus and dry rot spores (with the exception of fauna); Class 5B3 on request</p> <p>Yes; Class 5C3 (RH &lt; 75 %) incl. salt spray acc. to EN 60068-2-52 (severity degree 3); *</p> <p>Yes; Class 5S3 incl. sand, dust; *</p> <p>Yes; Class 3 (excluding trichlorethylene)</p> <p>Yes; Level GX group A/B (excluding trichlorethylene; harmful gas concentrations up to the limits of EN 60721-3-3 class 3C4 permissible); level LC3 (salt spray) and level LB3 (oil)</p> <p>* The supplied plug covers must remain in place over the unused interfaces during operation!</p>	<p>Yes; Class 5B2 mold, fungus and dry rot spores (with the exception of fauna); Class 5B3 on request</p> <p>Yes; Class 5C3 (RH &lt; 75 %) incl. salt spray acc. to EN 60068-2-52 (severity degree 3); *</p> <p>Yes; Class 5S3 incl. sand, dust; *</p> <p>Yes; Class 3 (excluding trichlorethylene)</p> <p>Yes; Level GX group A/B (excluding trichlorethylene; harmful gas concentrations up to the limits of EN 60721-3-3 class 3C4 permissible); level LC3 (salt spray) and level LB3 (oil)</p> <p>* The supplied plug covers must remain in place over the unused interfaces during operation!</p>	<p>Yes; Class 5B2 mold, fungus and dry rot spores (with the exception of fauna); Class 5B3 on request</p> <p>Yes; Class 5C3 (RH &lt; 75 %) incl. salt spray acc. to EN 60068-2-52 (severity degree 3); *</p> <p>Yes; Class 5S3 incl. sand, dust; *</p> <p>Yes; Class 3 (excluding trichlorethylene)</p> <p>Yes; Level GX group A/B (excluding trichlorethylene; harmful gas concentrations up to the limits of EN 60721-3-3 class 3C4 permissible); level LC3 (salt spray) and level LB3 (oil)</p> <p>* The supplied plug covers must remain in place over the unused interfaces during operation!</p>
<ul style="list-style-type: none"> <li><b>Conformal coating</b></li> <li>Coatings for printed circuit board assemblies acc. to EN 61086</li> <li>Protection against fouling acc. to EN 60664-3</li> <li>Electronic equipment on rolling stock acc. to EN 50155</li> <li>Military testing according to MIL-I-46058C, Amendment 7</li> <li>Qualification and Performance of Electrical Insulating Compound for Printed Board Assemblies according to IPC-CC-830A</li> </ul>	<p>Yes; Class 2 for high reliability</p> <p>Yes; Type 1 protection</p> <p>Yes; Class PC2 protective coating acc. to EN 50155:2017</p> <p>Yes; Discoloration of coating possible during service life</p> <p>Yes; Conformal coating, Class A</p>	<p>Yes; Class 2 for high reliability</p> <p>Yes; Type 1 protection</p> <p>Yes; Class PC2 protective coating acc. to EN 50155:2017</p> <p>Yes; Discoloration of coating possible during service life</p> <p>Yes; Conformal coating, Class A</p>	<p>Yes; Class 2 for high reliability</p> <p>Yes; Type 1 protection</p> <p>Yes; Class PC2 protective coating acc. to EN 50155:2017</p> <p>Yes; Discoloration of coating possible during service life</p> <p>Yes; Conformal coating, Class A</p>
<b>Dimensions</b>			
<b>Width</b>	35 mm	35 mm	35 mm
<b>Height</b>	147 mm	147 mm	147 mm
<b>Depth</b>	129 mm	129 mm	129 mm
<b>Weights</b>			
<b>Weight, approx.</b>	230 g	230 g	350 g
<b>Other</b>			
<b>Note:</b>	for use in railway applications, also observe the product information "SIPLUS extreme RAIL" A5E37661960A, Online Support article 109736776	for use in railway applications, also observe the product information "SIPLUS extreme RAIL" A5E37661960A, Online Support article 109736776	for use in railway applications, also observe the product information "SIPLUS extreme RAIL" A5E37661960A, Online Support article 109736776

#### Selection and ordering data

Version	Article No.
<b>SIPLUS extreme SM 522 RAIL digital output modules</b>	
Approved in accordance with EN 50155, EN 15121, EN 50124, EN 50125 and EN 45545 railway standards for use in rail traffic	
<b>SIPLUS S7-1500 DQ 16 x 24 V DC HF TX RAIL</b>	<b>6AG2522-1BH01-4AB0</b>
16 outputs, 24 V DC; 0.5 A, isolated; for areas with extreme exposure to environmental substances (conformal coating); ambient temperature -40 ... +70 °C (+85 °C for 10 min.)	
<b>SIPLUS S7-1500 DQ 8 x 230 V AC ST 5A T1 RAIL</b>	<b>6AG2522-5HF00-1AB0</b>
8 relay outputs, 230 V AC; 5 A; for areas with extreme exposure to environmental substances (conformal coating); ambient temperature -25 ... +55 °C (+70 °C for 10 min.)	
<b>SIPLUS S7-1500 DQ 16 x 110 V DC ST TX RAIL</b>	<b>6AG2522-5EH00-4AB0</b>
16 outputs, 24 ... 48 V UC, 125 V DC, 0.5 A, isolated; for areas with extreme exposure to environmental substances (conformal coating); ambient temperature -40 ... +70 °C (+85 °C for 10 min.)	

## Overview



- 8-channel analog input modules
- Approved in accordance with the railway standards EN 50155, EN 15121, EN 50124, EN 50125 and EN 45545 for use in rail traffic
- Optionally with extremely short conversion times
- For the connection of analog sensors without additional amplifiers
- Even solves more complex automation tasks

## Application

Analog input modules record process signals such as pressure or temperature and forward them in digitalized format (16-bit format) to the control. They are suitable for measuring current (2-wire and 4-wire transducers), voltage, and resistance, as well as for the connection of resistance thermometers and thermocouples (measurement types depend on the module).

## Design

- Installation on the S7-1500 mounting rail using one single screw
- Standardized 40-pin front connector using screw terminal or push-in technology
- Connectable core cross-sections: 0.25 mm<sup>2</sup> to 1.5 mm<sup>2</sup> (AWG24 to 16), regardless of the front connector used
- Front connector can be set to prewiring position
- Front flap with expandable cable compartment, even if fully wired
- Integrated shielding concept
- Unambiguous labeling on front of module:
  - Module type
  - Article No.
  - Hardware and firmware version
  - Channel numbers labeling
  - Cabling diagram

Included in the scope of delivery:

- Infeed element, shield clamp, and shield terminal
- One labeling strip for manual labeling
- One U connector
- Printed front door

## Function

- Uniform display and diagnostics concept:
  - Module status display for ERROR (red LED) and RUN (green LED)
  - Channel status display (channel activated or deactivated, green LED) or diagnostics display (red LED)
  - Display for monitoring the 24 V DC supply voltage (green LED)
- Supported functions:
  - Consistently high resolution of 16 bits
  - Identification and maintenance data IM0 to IM3
  - Firmware update
  - Channel-specific parameter assignment
  - Hardware interrupts; two upper and two lower limits can be parameterized
  - Channel-granular diagnostics (depends on measurement type/measuring range)
  - Isochronous mode (dependent on the module)
  - Calibration during runtime

**SIPLUS RAIL**

SIPLUS S7-1500 RAIL

SIPLUS extreme RAIL analog modules

**SIPLUS extreme RAIL analog input modules****Technical specifications**

Article number	<b>6AG2531-7NF10-4AB0</b> SIPLUS S7-1500 AI 8xU/I HS TX RAIL	<b>6AG2531-7KF00-4AB0</b> SIPLUS S7-1500 AI 8xU/I/RTD/TC TX RAIL
<b>General information</b>		
<b>Product type designation</b>	AI 8xU/I HS	AI 8xU/I/RTD/TC ST
<b>Product function</b>		
• Isochronous mode	Yes	No
• Prioritized startup	Yes	No
• Measuring range scalable	No	No
• Scalable measured values	No	No
• Adjustment of measuring range	No	No
<b>Engineering with</b>		
• STEP 7 TIA Portal configurable/integrated from version	see entry ID: 109746275	see entry ID: 109746275
<b>Operating mode</b>		
• Oversampling	Yes	No
• MSI	Yes	Yes
<b>Supply voltage</b>		
<b>Rated value (DC)</b>	24 V	24 V
<b>Reverse polarity protection</b>	Yes	Yes
<b>Analog inputs</b>		
<b>Number of analog inputs</b>	8; > +60 °C max. 4x ±20 mA or 4x ±10 V permissible	8; > +60 °C max. 2x ±20 mA or 4x ±10 V or 4x RTD permissible
• For current measurement	8	8
• For voltage measurement	8	8
• For resistance/resistance thermometer measurement		4
• For thermocouple measurement		8
<b>permissible input voltage for voltage input (destruction limit), max.</b>	28.8 V	28.8 V
<b>permissible input current for current input (destruction limit), max.</b>	40 mA	40 mA
<b>Technical unit for temperature measurement adjustable</b>		Yes; °C/°F/K
<b>Input ranges (rated values), voltages</b>		
• 0 to +5 V	No	No
• 0 to +10 V	No	No
• 1 V to 5 V	Yes	Yes
• -1 V to +1 V		Yes
• -10 V to +10 V	Yes	Yes
• -2.5 V to +2.5 V	No	Yes
• -25 mV to +25 mV	No	No
• -250 mV to +250 mV	No	Yes
• -5 V to +5 V	Yes	Yes
• -50 mV to +50 mV	No	Yes
• -500 mV to +500 mV	No	Yes
• -80 mV to +80 mV	No	Yes
<b>Input ranges (rated values), currents</b>		
• 0 to 20 mA	Yes	Yes
• -20 mA to +20 mA	Yes	Yes
• 4 mA to 20 mA	Yes	Yes
<b>Input ranges (rated values), thermocouples</b>		
• Type B	No	Yes
• Type C	No	No
• Type E	No	Yes
• Type J	No	Yes
• Type K	No	Yes
• Type L	No	No
• Type N	No	Yes
• Type R	No	Yes
• Type S	No	Yes
• Type T	No	Yes
• Type TXK/TXK(L) to GOST	No	No

Article number	<b>6AG2531-7NF10-4AB0</b>	<b>6AG2531-7KF00-4AB0</b>
	SIPLUS S7-1500 AI 8xU/I HS TX RAIL	SIPLUS S7-1500 AI 8xU/I/RTD/TC TX RAIL
<b>Input ranges (rated values), resistance thermometer</b>		
• Cu 10	No	No
• Cu 10 according to GOST	No	No
• Cu 50	No	No
• Cu 50 according to GOST	No	No
• Cu 100	No	No
• Cu 100 according to GOST	No	No
• Ni 10	No	No
• Ni 10 according to GOST	No	No
• Ni 100	No	Yes; Standard/climate
• Ni 100 according to GOST	No	No
• Ni 1000	No	Yes; Standard/climate
• Ni 1000 according to GOST	No	No
• LG-Ni 1000	No	Yes; Standard/climate
• Ni 120	No	No
• Ni 120 according to GOST	No	No
• Ni 200	No	No
• Ni 200 according to GOST	No	No
• Ni 500	No	No
• Ni 500 according to GOST	No	No
• Pt 10	No	No
• Pt 10 according to GOST	No	No
• Pt 50	No	No
• Pt 50 according to GOST	No	No
• Pt 100	No	Yes; Standard/climate
• Pt 100 according to GOST	No	No
• Pt 1000	No	Yes; Standard/climate
• Pt 1000 according to GOST	No	No
• Pt 200	No	Yes; Standard/climate
• Pt 200 according to GOST	No	No
• Pt 500	No	Yes; Standard/climate
• Pt 500 according to GOST	No	No
<b>Input ranges (rated values), resistors</b>		
• 0 to 150 ohms	No	Yes
• 0 to 300 ohms	No	Yes
• 0 to 600 ohms	No	Yes
• 0 to 3000 ohms	No	No
• 0 to 6000 ohms	No	Yes
• PTC	No	Yes
<b>Thermocouple (TC)</b>		
<b>Temperature compensation</b>		
• parameterizable		Yes
<b>Cable length</b>		
• shielded, max.	800 m	800 m; for U/I, 200 m for R/RTD, 50 m for TC
<b>Analog value generation for the inputs</b>		
<b>Integration and conversion time/resolution per channel</b>		
• Resolution with overrange (bit including sign), max.	16 bit	16 bit
• Integration time, parameterizable		Yes
• Integration time (ms)		2,5 / 16,67 / 20 / 100 ms
• Basic conversion time, including integration time (ms)		9 / 23 / 27 / 107 ms
- additional conversion time for resistance measurement		150 ohm, 300 ohm, 600 ohm, Pt100, Pt200, Ni100: 2 ms, 6000 ohm, Pt500, Pt1000, Ni1000, LG-Ni1000, PTC: 4 ms
• Interference voltage suppression for interference frequency f1 in Hz		400 / 60 / 50 / 10 Hz
• Basic execution time of the module (all channels released)	62.5 µs; independent of number of activated channels	
<b>Smoothing of measured values</b>		
• parameterizable	Yes	Yes
<b>Encoder</b>		
<b>Connection of signal encoders</b>		
• for voltage measurement	Yes	Yes
• for current measurement as 2-wire transducer	Yes	Yes
- Burden of 2-wire transmitter, max.	820 Ω	820 Ω
• for current measurement as 4-wire transducer	Yes	Yes
• for resistance measurement with two-wire connection	No	Yes; Only for PTC
• for resistance measurement with three-wire connection	No	Yes; All measuring ranges except PTC; internal compensation of the cable resistances
• for resistance measurement with four-wire connection	No	Yes; All measuring ranges except PTC

**SIPLUS RAIL**

## SIPLUS S7-1500 RAIL

## SIPLUS extreme RAIL analog modules

**SIPLUS extreme RAIL analog input modules**

Article number	<b>6AG2531-7NF10-4AB0</b> SIPLUS S7-1500 AI 8xU/I HS TX RAIL	<b>6AG2531-7KF00-4AB0</b> SIPLUS S7-1500 AI 8xU/I/RTD/TC TX RAIL
<b>Errors/accuracies</b>		
<b>Basic error limit (operational limit at 25 °C)</b> • Voltage, relative to input range, (+/-) • Current, relative to input range, (+/-) • Resistance, relative to input range, (+/-) • Resistance thermometer, relative to input range, (+/-)  • Thermocouple, relative to input range, (+/-)	0.2 % 0.2 %	0.1 % 0.1 % 0.1 % Ptxxx standard: ±0.7 K, Ptxxx climate: ±0.2 K, Nixxx standard: ±0.3 K, Nixxx climate: ±0.15 K Type B: > 600 °C ±1.7 K, type E: > -200 °C ±0.7 K, type J: > -210 °C ±0.8 K, type K: > -200 °C ±1.2 K, type N: > -200 °C ±1.2 K, type R: > 0 °C ±1.9 K, type S: > 0 °C ±1.9 K, type T: > -200 °C ±0.8 K
<b>Interference voltage suppression for <math>f = n \times (f1 \pm 1 \%)</math>, <math>f1 = \text{interference frequency}</math></b> • Series mode interference (peak value of interference < rated value of input range), min.  • Common mode voltage, max. • Common mode interference, min.	10 V 50 dB at 400 Hz; 60 dB at 60 / 50 / 10 Hz	40 dB 10 V 60 dB
<b>Isochronous mode</b>		
<b>Filtering and processing time (TCI), min.</b>	80 µs	
<b>Bus cycle time (TDP), min.</b>	250 µs	
<b>Interrupts/diagnostics/status information</b>		
<b>Diagnostics function</b>	Yes	Yes
<b>Alarms</b> • Diagnostic alarm • Limit value alarm	Yes Yes; two upper and two lower limit values in each case	Yes Yes; two upper and two lower limit values in each case
<b>Diagnoses</b> • Monitoring the supply voltage • Wire-break  • Overflow/underflow	Yes Yes; only for 1 ... 5 V and 4 ... 20 mA  Yes	Yes Yes; Only for 1 to 5 V, 4 to 20 mA, TC, R, and RTD Yes
<b>Diagnostics indication LED</b> • RUN LED • ERROR LED • Monitoring of the supply voltage (PWR-LED) • Channel status display • for channel diagnostics • for module diagnostics	Yes; green LED Yes; red LED Yes; green LED Yes; green LED Yes; red LED Yes; red LED	Yes; green LED Yes; red LED Yes; green LED Yes; green LED Yes; red LED Yes; red LED
<b>Potential separation</b>		
<b>Potential separation channels</b> • between the channels and backplane bus	Yes	Yes
<b>Standards, approvals, certificates</b>		
<b>Railway application</b> • EN 50121-3-2 • EN 50121-4  • EN 50124-1  • EN 50125-1 • EN 50125-2  • EN 50125-3  • EN 50155  • EN 61373  • Fire protection acc. to EN 45545-2	Yes; EMC for rail vehicles Yes; EMC for signal and telecommunications systems Yes; Railway applications - overvoltage category OV2; pollution degree PD2; rated surge voltage UNi = 0.5 kV; UNm = 24 V DC Yes; Rail vehicles - see ambient conditions Yes; Stationary electrical equipment - see ambient conditions Yes; Signal and telecommunications systems - see ambient conditions; vibrations and shocks: Application point outside of tracks (1 m to 3 m away from track) Yes; Rail vehicles - temperature class OT4, ST1/ST2, horizontal mounting position Yes; Rail vehicles - vibrations and shocks: Category 1 Class A/B Yes; For proof of conformity, see Service & Support	Yes; EMC for rail vehicles Yes; EMC for signal and telecommunications systems Yes; Railway applications - overvoltage category OV2; pollution degree PD2; rated surge voltage UNi = 0.5 kV; UNm = 24 V DC Yes; Rail vehicles - see ambient conditions Yes; Stationary electrical equipment - see ambient conditions Yes; Signal and telecommunications systems - see ambient conditions; vibrations and shocks: Application point outside of tracks (1 m to 3 m away from track) Yes; Rail vehicles - temperature class OT4, ST1/ST2, horizontal mounting position Yes; Rail vehicles - vibrations and shocks: Category 1 Class A/B Yes; For proof of conformity, see Service & Support
<b>Ambient conditions</b>		
<b>Ambient temperature during operation</b> • horizontal installation, min. • horizontal installation, max.  • vertical installation, min. • vertical installation, max.	-40 °C; = Tmin (incl. condensation/frost) 70 °C; = Tmax; +85 °C for 10 min (OT4, ST1/ST2 acc. to EN 50155) -40 °C; = Tmin 40 °C; = Tmax	-40 °C; = Tmin (incl. condensation/frost) 70 °C; = Tmax; +85 °C for 10 min (OT4, ST1/ST2 acc. to EN 50155) -40 °C; = Tmin 40 °C; = Tmax
<b>Altitude during operation relating to sea level</b> • Installation altitude above sea level, max. • Ambient air temperature-barometric pressure-altitude	2 000 m Tmin ... Tmax at 1 140 hPa ... 795 hPa (-1 000 m ... +2 000 m)	2 000 m Tmin ... Tmax at 1 140 hPa ... 795 hPa (-1 000 m ... +2 000 m)
<b>Relative humidity</b> • With condensation, tested in accordance with IEC 60068-2-38, max.	100 %; RH incl. condensation / frost (no commissioning in bedewed state), horizontal installation	100 %; RH incl. condensation / frost (no commissioning in bedewed state), horizontal installation

# SIPLUS RAIL

## SIPLUS S7-1500 RAIL

### SIPLUS extreme RAIL analog modules

#### SIPLUS extreme RAIL analog input modules

Article number	<b>6AG2531-7NF10-4AB0</b> SIPLUS S7-1500 AI 8xU/I HS TX RAIL	<b>6AG2531-7KF00-4AB0</b> SIPLUS S7-1500 AI 8xU/I/RTD/TC TX RAIL
<b>Resistance</b>		
<ul style="list-style-type: none"> <li>Coolants and lubricants               <ul style="list-style-type: none"> <li>Resistant to commercially available coolants and lubricants</li> </ul> </li> <li>Use in stationary industrial systems               <ul style="list-style-type: none"> <li>to biologically active substances according to EN 60721-3-3</li> <li>to chemically active substances according to EN 60721-3-3</li> <li>to mechanically active substances according to EN 60721-3-3</li> </ul> </li> <li>Use on land craft, rail vehicles and special-purpose vehicles               <ul style="list-style-type: none"> <li>to biologically active substances according to EN 60721-3-5</li> <li>to chemically active substances according to EN 60721-3-5</li> <li>to mechanically active substances according to EN 60721-3-5</li> </ul> </li> <li>Usage in industrial process technology               <ul style="list-style-type: none"> <li>Against chemically active substances acc. to EN 60654-4</li> <li>Environmental conditions for process, measuring and control systems acc. to ANSI/ISA-71.04</li> </ul> </li> <li>Remark               <ul style="list-style-type: none"> <li>Note regarding classification of environmental conditions acc. to EN 60721, EN 60654-4 and ANSI/ISA-71.04</li> </ul> </li> </ul>	<p>Yes; Incl. diesel and oil droplets in the air</p> <p>Yes; Class 3B2 mold, fungus and dry rot spores (with the exception of fauna); Class 3B3 on request Yes; Class 3C4 (RH &lt; 75 %) incl. salt spray acc. to EN 60068-2-52 (severity degree 3); * Yes; Class 3S4 incl. sand, dust, *</p> <p>Yes; Class 5B2 mold, fungus and dry rot spores (with the exception of fauna); Class 5B3 on request Yes; Class 5C3 (RH &lt; 75 %) incl. salt spray acc. to EN 60068-2-52 (severity degree 3); * Yes; Class 5S3 incl. sand, dust; *</p> <p>Yes; Class 3 (excluding trichlorethylene) Yes; Level GX group A/B (excluding trichlorethylene; harmful gas concentrations up to the limits of EN 60721-3-3 class 3C4 permissible); level LC3 (salt spray) and level LB3 (oil)</p> <p>* The supplied plug covers must remain in place over the unused interfaces during operation!</p>	<p>Yes; Incl. diesel and oil droplets in the air</p> <p>Yes; Class 3B2 mold, fungus and dry rot spores (with the exception of fauna); Class 3B3 on request Yes; Class 3C4 (RH &lt; 75 %) incl. salt spray acc. to EN 60068-2-52 (severity degree 3); * Yes; Class 3S4 incl. sand, dust, *</p> <p>Yes; Class 5B2 mold, fungus and dry rot spores (with the exception of fauna); Class 5B3 on request Yes; Class 5C3 (RH &lt; 75 %) incl. salt spray acc. to EN 60068-2-52 (severity degree 3); * Yes; Class 5S3 incl. sand, dust; *</p> <p>Yes; Class 3 (excluding trichlorethylene) Yes; Level GX group A/B (excluding trichlorethylene; harmful gas concentrations up to the limits of EN 60721-3-3 class 3C4 permissible); level LC3 (salt spray) and level LB3 (oil)</p> <p>* The supplied plug covers must remain in place over the unused interfaces during operation!</p>
<b>Conformal coating</b>		
<ul style="list-style-type: none"> <li>Coatings for printed circuit board assemblies acc. to EN 61086</li> <li>Protection against fouling acc. to EN 60664-3</li> <li>Electronic equipment on rolling stock acc. to EN 50155</li> <li>Military testing according to MIL-I-46058C, Amendment 7</li> <li>Qualification and Performance of Electrical Insulating Compound for Printed Board Assemblies according to IPC-CC-830A</li> </ul>	<p>Yes; Class 2 for high reliability</p> <p>Yes; Type 1 protection Yes; Class PC2 protective coating acc. to EN 50155:2017 Yes; Discoloration of coating possible during service life Yes; Conformal coating, Class A</p>	<p>Yes; Class 2 for high reliability</p> <p>Yes; Type 1 protection Yes; Class PC2 protective coating acc. to EN 50155:2017 Yes; Discoloration of coating possible during service life Yes; Conformal coating, Class A</p>
<b>Dimensions</b>		
<b>Width</b>	35 mm	35 mm
<b>Height</b>	147 mm	147 mm
<b>Depth</b>	129 mm	129 mm
<b>Weights</b>		
<b>Weight, approx.</b>	300 g	310 g
<b>Other</b>		
<b>Note:</b>	for use in railway applications, also observe the product information "SIPLUS extreme RAIL" A5E37661960A, Online Support article 109736776	for use in railway applications, also observe the product information "SIPLUS extreme RAIL" A5E37661960A, Online Support article 109736776

#### Selection and ordering data

Version	Article No.
<b>SIPLUS extreme SM 531 RAIL analog input modules</b> Approved in accordance with the EN 50155, EN 15121, EN 50124, EN 50125 and EN 45545 railway standards for use in rail traffic	
<b>SIPLUS S7-1500 AI 8xU/I HS T1 RAIL</b> 8 analog inputs, ±10 V, ±5 V, 1 ... 5 V or 0/4 ... 20 mA, ±20 mA, 16-bit + sign; incl. infeed element, shield clamp, shield terminal, labeling strips, U connector, printed front door; for areas with extreme exposure to environmental substances (conformal coating) Ambient temperature -40 ... +70 °C (+85 °C for 10 min.)	<b>6AG2531-7NF10-4AB0</b>
<b>SIPLUS S7-1500 AI 8xU/I/RTD/TC T1 RAIL</b> 8 analog inputs, ±10 V, ±5 V, ±2.5 V, ±1 V, ±500 mV, ±250 mV, ±80 mV, ±50 mV, 1 ... 5 V, 0/4 ... 20 mA, ±20 mA, thermocouples type B, E, J, K, N, R, S, T, resistance thermometers Ni 100, Ni 1000, LG-Ni 1000, Pt 100, Pt 1000, Pt 250, Pt 500, resistors 0...150/300/600/6000 ohms, 16-bit; for areas with extreme exposure to environmental substances (conformal coating); Ambient temperature -25 ... +55 °C (+70 °C for 10 min.)	<b>6AG2531-7KF00-4AB0</b>

**SIPLUS RAIL**

SIPLUS S7-1500 RAIL

SIPLUS extreme RAIL analog modules

**SIPLUS extreme RAIL analog output modules****Overview**

- 4-channel analog output module
- Approved in accordance with the railway standards EN 50155, EN 15121, EN 50124, EN 50125 and EN 45545 for use in rail traffic
- Optionally with extremely short conversion times
- For connecting analog actuators without additional amplifiers
- Even solves more complex automation tasks

**Application**

Analog output modules convert a 16-bit digital value into a current or a voltage and output this to the process. They are suitable, for example, for controlling proportional valves or small servo drives.

**Design**

- Installation on the S7-1500 mounting rail using one single screw
- Standardized 40-pin front connector using screw terminal or push-in technology
- Connectable core cross-sections: 0.25 mm<sup>2</sup> to 1.5 mm<sup>2</sup> (AWG24 to 16), regardless of the front connector used
- Front connector can be set to prewiring position
- Front flap with expandable cable compartment, even if fully wired
- Integrated shielding concept
- Unambiguous labeling on front of module:
  - Module type
  - Article No.
  - Hardware and firmware version
  - Channel numbers labeling
  - Cabling diagram

Included in the scope of delivery:

- Infeed element, shield clamp, and shield terminal
- One labeling strip for manual labeling
- One U connector
- Printed front door

**Function**

- Uniform display and diagnostics concept:
  - Module status display for ERROR (red LED) and RUN (green LED)
  - Channel status display (channel activated or deactivated, green LED) or diagnostics display (red LED)
  - Display for monitoring the 24 V DC supply voltage (green LED)
- Supported functions:
  - Consistently high resolution of 16 bits
  - Identification and maintenance data IMO to IM3
  - Firmware update
  - Channel-specific parameter assignment
  - Channel-granular diagnostics (depends on measurement type/measuring range)
  - Substitute values can be parameterized for the outputs
  - Calibration during runtime
  - Isochronous mode (dependent on the module)

**Technical specifications**

Article number	<b>6AG2532-5HD00-4AB0</b> SIPLUS S7-1500 AQ 4xU/I ST TX RAIL
<b>General information</b>	
<b>Product type designation</b>	AQ 4xU/I ST
<b>Product function</b>	
• Isochronous mode	No
• Prioritized startup	No
• Output range scalable	No
<b>Engineering with</b>	
• STEP 7 TIA Portal configurable/integrated from version	see entry ID: 109746275
<b>Operating mode</b>	
• Oversampling	No
• MSO	Yes
<b>Supply voltage</b>	
<b>Rated value (DC)</b>	24 V
<b>Reverse polarity protection</b>	Yes
<b>Analog outputs</b>	
<b>Number of analog outputs</b>	4; > +60 °C max. 4x ±10 V permissible
<b>Cycle time (all channels), min.</b>	3.2 ms; independent of number of activated channels



Article number	<b>6AG2532-5HD00-4AB0</b> SIPLUS S7-1500 AQ 4xU/I ST TX RAIL
<b>Output ranges, voltage</b> • 0 to 10 V • 1 V to 5 V • -5 V to +5 V • -10 V to +10 V	Yes Yes No Yes
<b>Output ranges, current</b> • 0 to 20 mA • -20 mA to +20 mA • 4 mA to 20 mA	Yes Yes Yes
<b>Connection of actuators</b> • for voltage output two-wire connection • for voltage output four-wire connection • for current output two-wire connection	Yes Yes Yes
<b>Load impedance (in rated range of output)</b> • with voltage outputs, min. • with voltage outputs, capacitive load, max. • with current outputs, max. • with current outputs, inductive load, max.	1 kΩ; 0.5 kΩhm at 1 to 5 V 1 μF 750 Ω 10 mH
<b>Cable length</b> • shielded, max.	800 m; for current, 200 m for voltage
<b>Analog value generation for the outputs</b>	
<b>Integration and conversion time/resolution per channel</b> • Resolution with overrange (bit including sign), max. • Conversion time (per channel)	16 bit 0.5 ms
<b>Settling time</b> • for resistive load • for capacitive load • for inductive load	1.5 ms 2.5 ms 2.5 ms
<b>Errors/accuracies</b>	
<b>Basic error limit (operational limit at 25 °C)</b> • Voltage, relative to output range, (+/-) • Current, relative to output range, (+/-)	0.2 % 0.2 %
<b>Interrupts/diagnostics/status information</b>	
<b>Diagnostics function</b>	Yes
<b>Substitute values connectable</b>	Yes
<b>Alarms</b> • Diagnostic alarm	Yes
<b>Diagnoses</b> • Monitoring the supply voltage • Wire-break • Short-circuit • Overflow/underflow	Yes Yes; Only for output type "current" Yes; Only for output type "voltage" Yes
<b>Diagnostics indication LED</b> • RUN LED • ERROR LED • Monitoring of the supply voltage (PWR-LED) • Channel status display • for channel diagnostics • for module diagnostics	Yes; green LED Yes; red LED Yes; green LED Yes; green LED Yes; red LED Yes; red LED
<b>Potential separation</b>	
<b>Potential separation channels</b> • between the channels and backplane bus	Yes
<b>Standards, approvals, certificates</b>	
<b>Railway application</b> • EN 50121-3-2 • EN 50121-4 • EN 50124-1  • EN 50125-1 • EN 50125-2 • EN 50125-3  • EN 50155 • EN 61373 • Fire protection acc. to EN 45545-2	Yes; EMC for rail vehicles Yes; EMC for signal and telecommunications systems Yes; Railway applications - overvoltage category OV2; pollution degree PD2; rated surge voltage UNi = 0.5 kV; UNm = 24 V DC Yes; Rail vehicles - see ambient conditions Yes; Stationary electrical equipment - see ambient conditions Yes; Signal and telecommunications systems - see ambient conditions; vibrations and shocks: Application point outside of tracks (1 m to 3 m away from track) Yes; Rail vehicles - temperature class OT4, ST1/ST2, horizontal mounting position Yes; Rail vehicles - vibrations and shocks: Category 1 Class A/B Yes; For proof of conformity, see Service & Support
<b>Ambient conditions</b>	
<b>Ambient temperature during operation</b> • horizontal installation, min. • horizontal installation, max. • vertical installation, min. • vertical installation, max.	-40 °C; = Tmin (incl. condensation/frost) 70 °C; = Tmax; +85 °C for 10 min (OT4, ST1/ST2 acc. to EN 50155) -40 °C; = Tmin 40 °C; = Tmax
<b>Altitude during operation relating to sea level</b> • Installation altitude above sea level, max. • Ambient air temperature-barometric pressure-altitude	2 000 m Tmin ... Tmax at 1 140 hPa ... 795 hPa (-1 000 m ... +2 000 m)



# SIPLUS RAIL

## SIPLUS S7-1500 RAIL

### SIPLUS extreme RAIL analog modules

#### SIPLUS extreme RAIL analog output modules

Article number	<b>6AG2532-5HD00-4AB0</b> SIPLUS S7-1500 AQ 4xU/I ST TX RAIL
<b>Relative humidity</b> • With condensation, tested in accordance with IEC 60068-2-38, max.	100 %; RH incl. condensation / frost (no commissioning in bedewed state), horizontal installation
<b>Resistance</b> • Coolants and lubricants - Resistant to commercially available coolants and lubricants • Use in stationary industrial systems - to biologically active substances according to EN 60721-3-3 - to chemically active substances according to EN 60721-3-3 - to mechanically active substances according to EN 60721-3-3 • Use on land craft, rail vehicles and special-purpose vehicles - to biologically active substances according to EN 60721-3-5 - to chemically active substances according to EN 60721-3-5 - to mechanically active substances according to EN 60721-3-5 • Usage in industrial process technology - Against chemically active substances acc. to EN 60654-4 - Environmental conditions for process, measuring and control systems acc. to ANSI/ISA-71.04 • Remark - Note regarding classification of environmental conditions acc. to EN 60721, EN 60654-4 and ANSI/ISA-71.04	Yes; Incl. diesel and oil droplets in the air  Yes; Class 3B2 mold, fungus and dry rot spores (with the exception of fauna); Class 3B3 on request Yes; Class 3C4 (RH < 75 %) incl. salt spray acc. to EN 60068-2-52 (severity degree 3); *  Yes; Class 3S4 incl. sand, dust, *  Yes; Class 5B2 mold, fungus and dry rot spores (with the exception of fauna); Class 5B3 on request Yes; Class 5C3 (RH < 75 %) incl. salt spray acc. to EN 60068-2-52 (severity degree 3); *  Yes; Class 5S3 incl. sand, dust; *  Yes; Class 3 (excluding trichlorethylene)  Yes; Level GX group A/B (excluding trichlorethylene; harmful gas concentrations up to the limits of EN 60721-3-3 class 3C4 permissible); level LC3 (salt spray) and level LB3 (oil)  * The supplied plug covers must remain in place over the unused interfaces during operation!
<b>Conformal coating</b> • Coatings for printed circuit board assemblies acc. to EN 61086 • Protection against fouling acc. to EN 60664-3 • Electronic equipment on rolling stock acc. to EN 50155 • Military testing according to MIL-I-46058C, Amendment 7 • Qualification and Performance of Electrical Insulating Compound for Printed Board Assemblies according to IPC-CC-830A	Yes; Class 2 for high reliability  Yes; Type 1 protection Yes; Class PC2 protective coating acc. to EN 50155:2017 Yes; Discoloration of coating possible during service life Yes; Conformal coating, Class A
<b>Dimensions</b>	
<b>Width</b>	35 mm
<b>Height</b>	147 mm
<b>Depth</b>	129 mm
<b>Weights</b>	
<b>Weight, approx.</b>	310 g
<b>Other</b>	
<b>Note:</b>	for use in railway applications, also observe the product information "SIPLUS extreme RAIL" A5E37661960A, Online Support article 109736776

#### Selection and ordering data

Version	Article No.
<b>SIPLUS extreme RAIL SM 532 analog output modules</b> Approved in accordance with the EN 50155, EN 15121, EN 50124, EN 50125 and EN 45545 railway standards for use in rail traffic	
<b>SIPLUS S7-1500 AQ 4xU/I ST TX RAIL</b> 4 analog outputs, ±10 V, 1 ... 5 V, 0 ... 10 V or ±20 mA, 0/4 ... 20 mA, 16-bit; for areas with extreme exposure to environmental substances (conformal coating); ambient temperature -40 ... +70 °C (+85 °C for 10 min.)	<b>6AG2532-5HD00-4AB0</b>

## Overview



- 8 digital inputs, 16 digital outputs, of which up to 16 can be used in different configurations as technological, time-controlled channels
- Inputs for detecting the input edges with  $\mu\text{s}$  accuracy
- Outputs for outputting switching signals with  $\mu\text{s}$  accuracy
- 32x oversampling
- PWM output
- Counter function
- Outputs can be switched between 0.5 A standard and especially fast 0.1 A high-speed operation

## Application

Time-based IO modules read in switching edges at digital inputs with a high time resolution, and supply time information, as well as the status, to the CPU.

For the digital outputs, switching commands with additional time information are transferred from the CPU. The outputs switch at a pre-defined time.

The modules can be used for diverse applications requiring accuracy below the resolution of the PLC or bus cycle. This requires no more than storage of the relevant instructions in the controller.

The following time-based I/O modules are available:

- **Timer DIDQ 16x24V**  
Time-controlled timer module with 8 inputs and 16 outputs, of which up to 16 with time stamp function; counter function up to 50 kHz, oversampling, pulse width modulation; requires isochronous mode

## Design

- Installation on the S7-1500 mounting rail using one single screw
- Standardized 40-pin front connector
- Connectable core cross-sections: 0.25 mm<sup>2</sup> to 1.5 mm<sup>2</sup> (AWG24 to 16)
- Prewiring position of the front connector
- Front flap with expandable cable compartment, even if fully wired
- Integrated shielding concept

Included in the scope of delivery:

- One labeling strip for manual labeling
- One U connector
- Printed front door
- Shield clamp, and shield terminal

## Function

- Uniform display and diagnostics concept:
  - Module status display for ERROR (red LED) and RUN (green LED)
  - Channel status indicator for signal state log. "0" and log. "1" (green LED) or diagnostics display (red LED)
  - Display for monitoring the 24 V DC supply voltage (green LED)
- Supported functions:
  - Inputs with time tagging (requires isochronous mode)
  - Outputs with time tagging (requires isochronous mode)
  - 32x oversampling of the inputs (requires isochronous mode)
  - 32x oversampling of the outputs (requires isochronous mode)
  - Counter for 1 track or 2 tracks with 90° phase-shifted signal (does not require isochronous mode)
  - Pulse width modulation (does not require isochronous mode)
  - Inputs can be used as an enabler for inputs or outputs
  - Isochronous mode
- Uniform system functions of SIMATIC S7-1500 and ET 200MP:
  - Identification and maintenance data IMO
  - Firmware update
  - Unambiguous labeling on front of module
  - Uniform front connector

# SIPLUS RAIL

## SIPLUS S7-1500 RAIL

### SIPLUS extreme RAIL technology modules

#### SIPLUS extreme RAIL TM Timer DIDQ 16x24V

#### Technical specifications

Article number	<b>6AG2552-1AA00-4AB0</b> SIPLUS S7-1500 TM TIMER DIDQ 16x24V RAIL
<b>General information</b>	
<b>Product type designation</b>	TM Timer DIDQ 16x24V
<b>Product function</b>	
• I&M data	Yes; I&M 0
• Isochronous mode	Yes
<b>Installation type/mounting</b>	
<b>Rail mounting</b>	Yes; S7-1500 mounting rail
<b>Supply voltage</b>	
<b>Load voltage 1L+</b>	
• Rated value (DC)	24 V
• Reverse polarity protection	Yes; against destruction
<b>Load voltage 2L+</b>	
• Rated value (DC)	24 V
• Reverse polarity protection	Yes; against destruction
<b>Encoder supply</b>	
<b>Number of outputs</b>	8; max. depending on parameterization
<b>24 V encoder supply</b>	
• 24 V	Yes; L+ (-0.8 V)
• Short-circuit protection	Yes
• Output current, max.	1.2 A; Total current of all encoders / channels, max. 0.5 A per output
<b>Digital inputs</b>	
<b>Number of digital inputs</b>	8; max. depending on parameterization
• in groups of	8
<b>Digital inputs, parameterizable</b>	Yes
<b>Input characteristic curve in accordance with IEC 61131, type 3</b>	Yes
<b>Digital input functions, parameterizable</b>	
• Digital input with time stamp	Yes
- Number, max.	8
• Counter	Yes
- Number, max.	4
• Counter for incremental encoder	Yes
- Number, max.	4
• Digital input with oversampling	Yes
- Number, max.	8
• HW enable for digital input	Yes
- Number, max.	4
• HW enable for digital output	Yes
- Number, max.	4
<b>Input voltage</b>	
• Type of input voltage	DC
• Rated value (DC)	24 V
• for signal "0"	-5 ... +5 V
• for signal "1"	+11 to +30V
• permissible voltage at input, min.	-30 V; -5 V continuous, -30 V brief reverse polarity protection
• permissible voltage at input, max.	30 V
<b>Input current</b>	
• for signal "1", typ.	2.5 mA
<b>Input delay (for rated value of input voltage)</b>	
• Minimum pulse width for program reactions	3 µs for parameterization "none"
<b>for standard inputs</b>	
• parameterizable	Yes; none / 0.05 / 0.1 / 0.4 / 0.8 ms
• at "0" to "1", min.	4 µs; for parameterization "none"
• at "1" to "0", min.	4 µs; for parameterization "none"
<b>Digital outputs</b>	
<b>Type of digital output</b>	Transistor
<b>Number of digital outputs</b>	16; max. depending on parameterization
• in groups of	8
<b>Digital outputs, parameterizable</b>	Yes
<b>Short-circuit protection</b>	Yes; electronic/thermal
<b>Limitation of inductive shutdown voltage to</b>	-0.8 V
<b>Controlling a digital input</b>	Yes
<b>Digital output functions, parameterizable</b>	
• Digital output with time stamp	Yes
- Number, max.	16
• PWM output	Yes
- Number, max.	16
• Digital output with oversampling	Yes
- Number, max.	16
<b>Switching capacity of the outputs</b>	
• with resistive load, max.	0.5 A; 0.1 A with High Speed output
• on lamp load, max.	5 W; 1 W with High Speed output

**SIPLUS extreme RAIL TM Timer DIDQ 16x24V**

Article number	<b>6AG2552-1AA00-4AB0</b> SIPLUS S7-1500 TM TIMER DIDQ 16x24V RAIL
<b>Load resistance range</b> • lower limit • upper limit	48 Ω; 240 ohm with High Speed output 12 kΩ
<b>Output voltage</b> • Type of output voltage • for signal "0", max. • for signal "1", min.	DC 1 V; With High Speed output 23.2 V; L+ (-0.8 V)
<b>Output current</b> • for signal "1" rated value • for signal "0" residual current, max.	0.5 A; 0.1 A with High Speed output, observe derating 0.5 mA
<b>Output delay with resistive load</b> • "0" to "1", max. • "1" to "0", max.	1 μs; With High Speed output, 5 μs with Standard output 1 μs; With High Speed output, 6 μs with Standard output
<b>Switching frequency</b> • with resistive load, max. • on lamp load, max.	10 kHz 10 Hz
<b>Total current of the outputs</b> • Current per group, max. • Current per module, max.	4 A 8 A; Observe derating
<b>Encoder</b>	
<b>Connectable encoders</b> • Incremental encoder (asymmetrical) • 24 V initiator • 2-wire sensor - permissible quiescent current (2-wire sensor), max.	Yes Yes Yes 1.5 mA
<b>Encoder signals, incremental encoder (asymmetrical)</b> • Input voltage • Input frequency, max. • Counting frequency, max. • Cable length, shielded, max. • Incremental encoder with A/B tracks, 90° phase offset • pulse encoder	24 V 50 kHz 200 kHz; with quadruple evaluation 600 m; Depending on input frequency, encoder and cable quality; max. 200 m at 50 kHz Yes Yes
<b>Interface types</b> • Input characteristic curve in accordance with IEC 61131, type 3	Yes
<b>Isochronous mode</b>	
<b>Bus cycle time (TDP), min.</b>	250 μs
<b>Interrupts/diagnostics/status information</b>	
<b>Diagnostics function</b>	Yes
<b>Substitute values connectable</b>	Yes
<b>Alarms</b>	
• Diagnostic alarm	Yes
<b>Diagnoses</b>	
• Monitoring the supply voltage • Short-circuit	Yes Yes
<b>Diagnostics indication LED</b>	
• RUN LED • ERROR LED • MAINT LED • Monitoring of the supply voltage (PWR-LED) • Channel status display • for channel diagnostics	Yes; green LED Yes; red LED Yes; Yellow LED Yes; green LED Yes; green LED Yes; red LED
<b>Integrated Functions</b>	
<b>Counter</b>	
• Number of counters • Counting frequency, max.	Yes 4 200 kHz; with quadruple evaluation
<b>Counting functions</b>	
• Continuous counting	Yes
<b>Position detection</b>	
• Incremental acquisition	Yes
<b>Potential separation</b>	
<b>Potential separation channels</b>	
• between the channels and backplane bus	Yes
<b>Standards, approvals, certificates</b>	
<b>Railway application</b>	
• EN 50121-3-2 • EN 50121-4 • EN 50124-1  • EN 50125-1 • EN 50125-2 • EN 50125-3  • EN 50155 • EN 61373 • Fire protection acc. to EN 45545-2	Yes; EMC for rail vehicles Yes; EMC for signal and telecommunications systems Yes; Railway applications - overvoltage category OV2; pollution degree PD2; rated surge voltage UNi = 0.5 kV; UNm = 24 V DC Yes; Rail vehicles - see ambient conditions Yes; Stationary electrical equipment - see ambient conditions Yes; Signal and telecommunications systems - see ambient conditions; vibrations and shocks: Application point outside of tracks (1 m to 3 m away from track) Yes; Rail vehicles - temperature class OT4, ST1/ST2, horizontal mounting position Yes; Rail vehicles - vibrations and shocks: Category 1 Class A/B Yes; For proof of conformity, see Service & Support

**SIPLUS RAIL**

SIPLUS S7-1500 RAIL

SIPLUS extreme RAIL technology modules

**SIPLUS extreme RAIL TM Timer DIDQ 16x24V**

Article number	<b>6AG2552-1AA00-4AB0</b> SIPLUS S7-1500 TM TIMER DIDQ 16x24V RAIL
<b>Ambient conditions</b>	
<b>Ambient temperature during operation</b>	
<ul style="list-style-type: none"> <li>horizontal installation, min.</li> <li>horizontal installation, max.</li> <li>vertical installation, min.</li> <li>vertical installation, max.</li> </ul>	-40 °C; = Tmin (incl. condensation/frost) 60 °C; = Tmax; +85 °C for 10 min (OT4, ST1/ST2 acc. to EN 50155) -40 °C; = Tmin 40 °C; = Tmax; Note derating
<b>Altitude during operation relating to sea level</b>	
<ul style="list-style-type: none"> <li>Installation altitude above sea level, max.</li> <li>Ambient air temperature-barometric pressure-altitude</li> </ul>	2 000 m Tmin ... Tmax at 1 140 hPa ... 795 hPa (-1 000 m ... +2 000 m)
<b>Relative humidity</b>	
<ul style="list-style-type: none"> <li>With condensation, tested in accordance with IEC 60068-2-38, max.</li> </ul>	100 %; RH incl. condensation / frost (no commissioning in bedewed state), horizontal installation
<b>Resistance</b>	
<ul style="list-style-type: none"> <li>Coolants and lubricants               <ul style="list-style-type: none"> <li>Resistant to commercially available coolants and lubricants</li> </ul> </li> <li>Use in stationary industrial systems               <ul style="list-style-type: none"> <li>to biologically active substances according to EN 60721-3-3</li> <li>to chemically active substances according to EN 60721-3-3</li> <li>to mechanically active substances according to EN 60721-3-3</li> </ul> </li> <li>Use on land craft, rail vehicles and special-purpose vehicles               <ul style="list-style-type: none"> <li>to biologically active substances according to EN 60721-3-5</li> <li>to chemically active substances according to EN 60721-3-5</li> <li>to mechanically active substances according to EN 60721-3-5</li> </ul> </li> <li>Usage in industrial process technology               <ul style="list-style-type: none"> <li>Against chemically active substances acc. to EN 60654-4</li> <li>Environmental conditions for process, measuring and control systems acc. to ANSI/ISA-71.04</li> </ul> </li> <li>Remark               <ul style="list-style-type: none"> <li>Note regarding classification of environmental conditions acc. to EN 60721, EN 60654-4 and ANSI/ISA-71.04</li> </ul> </li> </ul>	Yes; Incl. diesel and oil droplets in the air  Yes; Class 3B2 mold, fungus and dry rot spores (with the exception of fauna); Class 3B3 on request Yes; Class 3C4 (RH < 75 %) incl. salt spray acc. to EN 60068-2-52 (severity degree 3); * Yes; Class 3S4 incl. sand, dust, *  Yes; Class 5B2 mold, fungus and dry rot spores (with the exception of fauna); Class 5B3 on request Yes; Class 5C3 (RH < 75 %) incl. salt spray acc. to EN 60068-2-52 (severity degree 3); * Yes; Class 5S3 incl. sand, dust; *  Yes; Class 3 (excluding trichlorethylene)  Yes; Level GX group A/B (excluding trichlorethylene; harmful gas concentrations up to the limits of EN 60721-3-3 class 3C4 permissible); level LC3 (salt spray) and level LB3 (oil)  * The supplied plug covers must remain in place over the unused interfaces during operation!
<b>Conformal coating</b>	
<ul style="list-style-type: none"> <li>Coatings for printed circuit board assemblies acc. to EN 61086</li> <li>Protection against fouling acc. to EN 60664-3</li> <li>Electronic equipment on rolling stock acc. to EN 50155</li> <li>Military testing according to MIL-I-46058C, Amendment 7</li> <li>Qualification and Performance of Electrical Insulating Compound for Printed Board Assemblies according to IPC-CC-830A</li> </ul>	Yes; Class 2 for high reliability Yes; Type 1 protection Yes; Class PC2 protective coating acc. to EN 50155:2017 Yes; Discoloration of coating possible during service life Yes; Conformal coating, Class A
<b>Decentralized operation</b>	
<b>to SIMATIC S7-1500</b>	Yes
<b>Dimensions</b>	
<b>Width</b>	35 mm
<b>Height</b>	147 mm
<b>Depth</b>	129 mm
<b>Weights</b>	
<b>Weight, approx.</b>	320 g
<b>Other</b>	
<b>Note:</b>	for use in railway applications, also observe the product information "SIPLUS extreme RAIL" A5E37661960A, Online Support article 109736776

**Selection and ordering data**

Version	Article No.
<b>SIPLUS S7-1500 TM Timer DIDQ 16x24 V RAIL DI/DQ 16x24 V RAIL</b> <ul style="list-style-type: none"> <li>Approved in accordance with the EN 50155, EN 15121, EN 50124, EN 50125 and EN 45545 railway standards for use in rail traffic</li> </ul> Time-controlled digital inputs and outputs max. 8 DI, 16 DQ of which max. 16 with time stamp, counting, PWM, oversampling for areas with extreme exposure to media (conformal coating); ambient temperature -40 ... +70 °C, OT4 with ST 1/2, (+85 °C for 10 min.)	<b>6AG2552-1AA00-4AB0</b>

## Overview



- Module for serial communication connections
- Approved in accordance with the EN 50155, EN 15121, EN 50124, EN 50125 and EN 45545 railway standards for use in rail traffic
- Physical transmission media:
  - RS 232C, max. 115.2 Kbps
  - RS 422/RS 485, max. 115.2 kbps
- Protocols supported
  - Freeport: User-parameterizable frame format for universal communication
  - 3964(R) for improved transmission reliability
  - Modbus RTU Master
  - Modbus RTU Slave
  - USS, implemented through instructions

## Application

Communications modules enable connection with an external communication partner to exchange data. Comprehensive parameterization options make it possible to adapt the control flexibly to the communication partner. Modbus RTU master creates a Modbus RTU network for up to 30 Modbus slaves.

The following communication module is available:

- SIPLUS S7-1500 CM PtP RS232 HF TX RAIL; communication module with RS232 interface for the Freeport, 3964(R), USS and Modbus RTU protocols; 9-pin D-sub connector, max. 115.2 Kbps, 4 KB frame length, 8 KB receive buffer
- SIPLUS S7-1500 CM PtP RS422/485 HF TX RAIL; communication module with RS422 and RS485 interface for the protocols Freeport, 3964(R), USS and Modbus RTU; 15-pin sub D socket, max. 115.2 Kbit/s, 4 KB frame length, 8 KB receive buffer

## Design

- Mounting on the S7-1500 mounting rail using one single screw
- Unique sub D connector, cannot be interchanged
- Front flap with expandable cable compartment

Included in the scope of delivery:

- One U connector
- Front door

## Function

- Uniform display and diagnostics concept:
  - Module status display for ERROR (red LED) and RUN (green LED)
  - Communication display for sending and receiving
- Protocols supported:
  - Freeport: User-parameterizable frame format for universal communication
  - 3964(R) for improved transmission reliability
  - Modbus RTU Master
  - Modbus RTU Slave
  - USS, implemented through instructions
- Interface properties:
  - RS 232 with auxiliary signals
  - RS 422 for full-duplex connections
  - RS485 for half-duplex and multi-point connections
  - Transmission rates from 300 to 115 200 bps
  - Connection via D-sub connector
- Uniform system functions of SIMATIC ET 200MP:
  - Identification and maintenance data IMO
  - Firmware update
  - Unambiguous labeling on front of module

## Technical specifications

Article number	6AG2541-1AB00-4AB0	6AG2541-1AD00-4AB0
	SIPLUS S7-1500 CM PTP RS422/485 TX RAIL	SIPLUS S7-1500 CM PtP RS232 HF TX RAIL
<b>General information</b>		
<b>Product type designation</b>	CM PtP RS 422 / 485 HF	CM PtP RS 232 HF
<b>Product function</b>		
• I&M data	Yes; I&M 0	Yes; I&M 0
• Fast startup	Yes	Yes
<b>Engineering with</b>		
• STEP 7 TIA Portal configurable/integrated from version	see entry ID: 109746275	see entry ID: 109746275
<b>Installation type/mounting</b>		
<b>Rail mounting</b>	Yes; S7-1500 mounting rail	Yes; S7-1500 mounting rail
<b>Interface types</b>		
<b>RS 232</b>		
• Transmission rate, max.		115.2 kbit/s
• Cable length, max.		15 m
• RS 232 auxiliary signals		RTS, CTS, DTR, DSR, RI, DCD
<b>RS 485</b>		
• Transmission rate, max.	115.2 kbit/s	
• Cable length, max.	1 200 m	
<b>RS 422</b>		
• Transmission rate, max.	115.2 kbit/s	
• Cable length, max.	1 200 m	
• 4-wire full duplex connection	Yes	
• 4-wire multipoint connection	No	

# SIPLUS RAIL

## SIPLUS S7-1500 RAIL

### SIPLUS extreme RAIL communication

#### SIPLUS extreme RAIL CM PtP

Article number	<b>6AG2541-1AB00-4AB0</b> SIPLUS S7-1500 CM PTP RS422/485 TX RAIL	<b>6AG2541-1AD00-4AB0</b> SIPLUS S7-1500 CM PtP RS232 HF TX RAIL
<b>Protocols</b>		
<b>Integrated protocols</b>		
<ul style="list-style-type: none"> <li>• Freeprot           <ul style="list-style-type: none"> <li>- Telegram length, max.</li> <li>- Bits per character</li> <li>- Number of stop bits</li> <li>- Parity</li> </ul> </li> <li>• 3964 (R)           <ul style="list-style-type: none"> <li>- Telegram length, max.</li> <li>- Bits per character</li> <li>- Number of stop bits</li> <li>- Parity</li> </ul> </li> <li>• Modbus RTU master           <ul style="list-style-type: none"> <li>- Address area</li> <li>- Number of slaves, max.</li> </ul> </li> <li>• MODBUS RTU slave           <ul style="list-style-type: none"> <li>- Address area</li> </ul> </li> </ul>	4 kbyte 7 or 8 1 or 2 bit None, even, odd, always 1, always 0, any  4 kbyte 7 or 8 1 or 2 bit None, even, odd, always 1, always 0, any  1 to 247, extended 1 to 65535 32  1 to 247, extended 1 to 65535	4 kbyte 7 or 8 1 or 2 bit None, even, odd, always 1, always 0, any  4 kbyte 7 or 8 1 or 2 bit None, even, odd, always 1, always 0, any  1 to 247, extended 1 to 65535 1  1 to 247, extended 1 to 65535
<b>Telegram buffer</b>		
<ul style="list-style-type: none"> <li>• Buffer memory for telegrams</li> <li>• Number of telegrams which can be buffered</li> </ul>	8 kbyte 255	8 kbyte 255
<b>Interrupts/diagnostics/status information</b>		
<b>Diagnostics function</b>	Yes	Yes
<b>Alarms</b>		
<ul style="list-style-type: none"> <li>• Diagnostic alarm</li> <li>• Hardware interrupt</li> </ul>	Yes No	Yes No
<b>Diagnostics</b>		
<ul style="list-style-type: none"> <li>• Wire-break</li> </ul>	Yes	Yes
<b>Diagnostics indication LED</b>		
<ul style="list-style-type: none"> <li>• RUN LED</li> <li>• ERROR LED</li> <li>• Receive RxD</li> <li>• Transmit TxD</li> </ul>	Yes; green LED Yes; red LED Yes; Yellow LED Yes; Yellow LED	Yes; green LED Yes; red LED Yes; Yellow LED Yes; Yellow LED
<b>Potential separation</b>		
between backplane bus and interface	Yes	Yes
<b>Standards, approvals, certificates</b>		
<b>Railway application</b>		
<ul style="list-style-type: none"> <li>• EN 50121-3-2</li> <li>• EN 50121-4</li> <li>• EN 50124-1</li> <li>• EN 50125-1</li> <li>• EN 50125-2</li> <li>• EN 50125-3</li> <li>• EN 50155</li> <li>• EN 61373</li> <li>• Fire protection acc. to EN 45545-2</li> </ul>	Yes; EMC for rail vehicles Yes; EMC for signal and telecommunications systems Yes; Railway applications - overvoltage category OV2; pollution degree PD2; rated surge voltage UNi = 0.5 kV; UNm = 24 V DC Yes; Rail vehicles - see ambient conditions Yes; Stationary electrical equipment - see ambient conditions Yes; Signal and telecommunications systems - see ambient conditions; vibrations and shocks: Application point outside of tracks (1 m to 3 m away from track) Yes; Rail vehicles - temperature class OT4, ST1/ST2, horizontal mounting position Yes; Rail vehicles - vibrations and shocks: Category 1 Class A/B Yes; For proof of conformity, see Service & Support	Yes; EMC for rail vehicles Yes; EMC for signal and telecommunications systems Yes; Railway applications - overvoltage category OV2; pollution degree PD2; rated surge voltage UNi = 0.5 kV; UNm = 24 V DC Yes; Rail vehicles - see ambient conditions Yes; Stationary electrical equipment - see ambient conditions Yes; Signal and telecommunications systems - see ambient conditions; vibrations and shocks: Application point outside of tracks (1 m to 3 m away from track) Yes; Rail vehicles - temperature class OT4, ST1/ST2, horizontal mounting position Yes; Rail vehicles - vibrations and shocks: Category 1 Class A/B Yes; For proof of conformity, see Service & Support
<b>Ambient conditions</b>		
<b>Ambient temperature during operation</b>		
<ul style="list-style-type: none"> <li>• horizontal installation, min.</li> <li>• horizontal installation, max.</li> <li>• vertical installation, min.</li> <li>• vertical installation, max.</li> </ul>	-40 °C; = Tmin (incl. condensation/frost) 70 °C; = Tmax; +85 °C for 10 min (OT4, ST1/ST2 acc. to EN 50155) -40 °C; = Tmin 40 °C; = Tmax	-40 °C; = Tmin (incl. condensation/frost) 70 °C; = Tmax; +85 °C for 10 min (OT4, ST1/ST2 acc. to EN 50155) -40 °C; = Tmin 40 °C; = Tmax
<b>Altitude during operation relating to sea level</b>		
<ul style="list-style-type: none"> <li>• Installation altitude above sea level, max.</li> <li>• Ambient air temperature-barometric pressure-altitude</li> </ul>	2 000 m Tmin ... Tmax at 1 140 hPa ... 795 hPa (-1 000 m ... +2 000 m)	2 000 m Tmin ... Tmax at 1 140 hPa ... 795 hPa (-1 000 m ... +2 000 m)
<b>Relative humidity</b>		
<ul style="list-style-type: none"> <li>• With condensation, tested in accordance with IEC 60068-2-38, max.</li> </ul>	100 %; RH incl. condensation / frost (no commissioning in bedewed state), horizontal installation	100 %; RH incl. condensation / frost (no commissioning in bedewed state), horizontal installation



Article number	<b>6AG2541-1AB00-4AB0</b> SIPLUS S7-1500 CM PtP RS422/485 TX RAIL	<b>6AG2541-1AD00-4AB0</b> SIPLUS S7-1500 CM PtP RS232 HF TX RAIL
<b>Resistance</b>		
<ul style="list-style-type: none"> <li>Coolants and lubricants               <ul style="list-style-type: none"> <li>Resistant to commercially available coolants and lubricants</li> </ul> </li> <li>Use in stationary industrial systems               <ul style="list-style-type: none"> <li>to biologically active substances according to EN 60721-3-3</li> <li>to chemically active substances according to EN 60721-3-3</li> <li>to mechanically active substances according to EN 60721-3-3</li> </ul> </li> <li>Use on land craft, rail vehicles and special-purpose vehicles               <ul style="list-style-type: none"> <li>to biologically active substances according to EN 60721-3-5</li> <li>to chemically active substances according to EN 60721-3-5</li> <li>to mechanically active substances according to EN 60721-3-5</li> </ul> </li> <li>Usage in industrial process technology               <ul style="list-style-type: none"> <li>Against chemically active substances acc. to EN 60654-4</li> <li>Environmental conditions for process, measuring and control systems acc. to ANSI/ISA-71.04</li> </ul> </li> <li>Remark               <ul style="list-style-type: none"> <li>Note regarding classification of environmental conditions acc. to EN 60721, EN 60654-4 and ANSI/ISA-71.04</li> </ul> </li> </ul>	<p>Yes; Incl. diesel and oil droplets in the air</p> <p>Yes; Class 3B2 mold, fungus and dry rot spores (with the exception of fauna); Class 3B3 on request</p> <p>Yes; Class 3C4 (RH &lt; 75 %) incl. salt spray acc. to EN 60068-2-52 (severity degree 3); * Yes; Class 3S4 incl. sand, dust, *</p> <p>Yes; Class 5B2 mold, fungus and dry rot spores (with the exception of fauna); Class 5B3 on request</p> <p>Yes; Class 5C3 (RH &lt; 75 %) incl. salt spray acc. to EN 60068-2-52 (severity degree 3); * Yes; Class 5S3 incl. sand, dust, *</p> <p>Yes; Class 3 (excluding trichlorethylene) Yes; Level GX group A/B (excluding trichlorethylene; harmful gas concentrations up to the limits of EN 60721-3-3 class 3C4 permissible); level LC3 (salt spray) and level LB3 (oil)</p> <p>* The supplied plug covers must remain in place over the unused interfaces during operation!</p>	<p>Yes; Incl. diesel and oil droplets in the air</p> <p>Yes; Class 3B2 mold, fungus and dry rot spores (with the exception of fauna); Class 3B3 on request</p> <p>Yes; Class 3C4 (RH &lt; 75 %) incl. salt spray acc. to EN 60068-2-52 (severity degree 3); * Yes; Class 3S4 incl. sand, dust, *</p> <p>Yes; Class 5B2 mold, fungus and dry rot spores (with the exception of fauna); Class 5B3 on request</p> <p>Yes; Class 5C3 (RH &lt; 75 %) incl. salt spray acc. to EN 60068-2-52 (severity degree 3); * Yes; Class 5S3 incl. sand, dust, *</p> <p>Yes; Class 3 (excluding trichlorethylene) Yes; Level GX group A/B (excluding trichlorethylene; harmful gas concentrations up to the limits of EN 60721-3-3 class 3C4 permissible); level LC3 (salt spray) and level LB3 (oil)</p> <p>* The supplied plug covers must remain in place over the unused interfaces during operation!</p>
<b>Conformal coating</b>		
<ul style="list-style-type: none"> <li>Coatings for printed circuit board assemblies acc. to EN 61086</li> <li>Protection against fouling acc. to EN 60664-3</li> <li>Electronic equipment on rolling stock acc. to EN 50155</li> <li>Military testing according to MIL-I-46058C, Amendment 7</li> <li>Qualification and Performance of Electrical Insulating Compound for Printed Board Assemblies according to IPC-CC-830A</li> </ul>	<p>Yes; Class 2 for high reliability Yes; Type 1 protection Yes; Class PC2 protective coating acc. to EN 50155:2017 Yes; Discoloration of coating possible during service life Yes; Conformal coating, Class A</p>	<p>Yes; Class 2 for high reliability Yes; Type 1 protection Yes; Class PC2 protective coating acc. to EN 50155:2017 Yes; Discoloration of coating possible during service life Yes; Conformal coating, Class A</p>
<b>Decentralized operation</b>		
<b>to SIMATIC S7-300</b>	Yes	Yes
<b>to SIMATIC S7-400</b>	Yes	Yes
<b>to SIMATIC S7-1500</b>	Yes	Yes
<b>to standard PROFINET controller</b>	Yes	Yes
<b>Dimensions</b>		
<b>Width</b>	35 mm	35 mm
<b>Height</b>	147 mm	147 mm
<b>Depth</b>	127 mm	127 mm
<b>Weights</b>		
<b>Weight, approx.</b>	0.22 kg	0.22 kg
<b>Other</b>		
<b>Note:</b>	for use in railway applications, also observe the product information "SIPLUS extreme RAIL" A5E37661960A, Online Support article 109736776	for use in railway applications, also observe the product information "SIPLUS extreme RAIL" A5E37661960A, Online Support article 109736776

### Selection and ordering data

Version	Article No.
<b>SIPLUS S7-1500 CM PtP RS422/485 HF TX RAIL communications module</b> Approved in accordance with EN 50155, EN 15121, EN 50124, EN 50125 and EN 45545 railway standards for use in rail traffic High Feature communications module with 1 RS 422/485 interface, and Freeport, 3964(R), USS and Modbus RTU protocols, 15-pin D-sub female connector, max. 115.2 kbps; For areas with extreme exposure to environmental substances (conformal coating); Ambient temperature -40 ... +70 °C (+85 °C for 10 min.)	<b>6AG2541-1AB00-4AB0</b>
<b>SIPLUS S7-1500 CM PtP RS232 HF TX RAIL communications module</b> Approved in accordance with EN 50155, EN 15121, EN 50124, EN 50125 and EN 45545 railway standards for use in rail traffic High Feature communications module with 1 RS232 interface, and Freeport, 3964(R), USS and Modbus RTU protocols, 9-pin D-sub connector, max. 115.2 Kbps; for areas with extreme exposure to environmental substances (conformal coating); Ambient temperature -40 ... +70 °C (+85 °C for 10 min.)	<b>6AG2541-1AD00-4AB0</b>



**SIPLUS RAIL**

SIPLUS S7-1500 RAIL

SIPLUS extreme RAIL F-digital/analog modules

**SIPLUS extreme RAIL F-digital input modules****Overview**

SIPLUS extreme RAIL digital fail-safe input module:

F-DI 16x24 V DC

Important properties:

- 16-channel fail-safe digital input module for ET 200MP/S7-1500
- Approved in accordance with the railway standards EN 50155, EN 15121, EN 50124, EN 50125 and EN 45545 for use in rail traffic
- For fail-safe reading of sensor information (1 or 2 channels)
- Provides integral discrepancy evaluation for 2-out-of-2 signals

- 4 internal sensor supplies (incl. test function) onboard
- Certified up to SIL 3 (IEC 61508), PL e (ISO 13849)
- LED display for error, operation, supply voltage and status
- Clear module labeling
  - Plain text identification of the module type
  - Complete Article No.
  - 2D matrix code (order and serial number)
  - Connection diagram
  - Hardware and firmware version
- Optional labeling accessories
  - Labeling sheets, yellow
- The modules support PROFIsafe in both PROFIBUS and PROFINET configurations. Can be used with all fail-safe SIPLUS extreme RAIL S7-1500 F-CPU's in the central configuration, as well as with all other SIPLUS extreme RAIL S7 F-CPU's, as an ET 200MP distributed I/O.

**Application**

Using fail-safe ET 200MP/S7-1500 modules makes it possible to implement safety-related application requirements as an integral part of the overall automation. The safety functions required for fail-safe operation are integrated in the modules. Communication with the fail-safe SIMATIC S7 CPUs is performed by means of PROFIsafe.

The modules can be operated both in centralized and distributed configurations.

**Technical specifications**

Article number	<b>6AG2526-1BH00-1AB0</b> SIPLUS S7-1500 F-DI 16x24VDC T1 RAIL
<b>General information</b>	
<b>Product type designation</b>	F-DI 16x24VDC
<b>Operating mode</b>	Yes
• DI	
<b>Supply voltage</b>	
<b>Rated value (DC)</b>	24 V
<b>Reverse polarity protection</b>	Yes
<b>Encoder supply</b>	
<b>Number of outputs</b>	4
<b>Short-circuit protection</b>	Yes; Electronic (response threshold 0.7 A to 1.8 A)
<b>24 V encoder supply</b>	Yes; min. L+ (-1.5 V)
• 24 V	Yes
• Short-circuit protection	Yes
• Output current, max.	300 mA; Max. 100 mA when mounted vertically
<b>Digital inputs</b>	
<b>Number of digital inputs</b>	16
<b>Source/sink input</b>	Yes; P-reading
<b>Input characteristic curve in accordance with IEC 61131, type 1</b>	Yes
<b>Input voltage</b>	24 V
• Rated value (DC)	-30 to +5 V
• for signal "0"	+15 to +30 V
• for signal "1"	
<b>Input current</b>	3.7 mA
• for signal "1", typ.	
<b>Input delay (for rated value of input voltage)</b>	Yes
• for standard inputs	
- parameterizable	

Article number	<b>6AG2526-1BH00-1AB0</b> SIPLUS S7-1500 F-DI 16x24VDC T1 RAIL
<b>Interrupts/diagnostics/status information</b>	
<b>Diagnostics function</b>	Yes
<b>Alarms</b>	Yes
• Diagnostic alarm	No
• Hardware interrupt	
<b>Diagnoses</b>	Yes
• Monitoring the supply voltage	No
• Wire-break	Yes
• Short-circuit	Yes
• Group error	Yes
<b>Diagnostics indication LED</b>	
• RUN LED	Yes; green LED
• ERROR LED	Yes; red LED
• Channel status display	Yes; green LED
• for channel diagnostics	Yes; red LED
• for module diagnostics	Yes; red LED
<b>Potential separation</b>	
<b>Potential separation channels</b>	
• between the channels and backplane bus	Yes
<b>Standards, approvals, certificates</b>	
<b>Suitable for safety functions</b>	Yes
<b>Highest safety class achievable in safety mode</b>	
• Performance level according to ISO 13849-1	PLe
• SIL acc. to IEC 61508	SIL 3
• SIL in accordance with EN 50126, 50128, 50129	SIL 2; a higher safety integrity level is possible if tested and approved for the specific application under consideration of all local regulations.
<b>Railway application</b>	
• EN 50121-3-2	Yes; EMC for rail vehicles
• EN 50121-4	Yes; EMC for signal and telecommunications systems
• EN 50124-1	Yes; Railway applications - overvoltage category OV2; pollution degree PD2; rated surge voltage UNi = 0.5 kV; UNm = 24 V DC
• EN 50125-1	Yes; Rail vehicles - see ambient conditions
• EN 50125-2	Yes; Stationary electrical equipment - see ambient conditions
• EN 50125-3	Yes; Signal and telecommunications systems - see ambient conditions; vibrations and shocks: Application point outside of tracks (1 m to 3 m away from track)
• EN 50155	Yes; Rail vehicles - temperature class OT1, ST1/ST2, horizontal mounting position
• EN 61373	Yes; Rail vehicles - vibrations and shocks: Category 1 Class A/B
• Fire protection acc. to EN 45545-2	Yes; For proof of conformity, see Service & Support
<b>Ambient conditions</b>	
<b>Ambient temperature during operation</b>	
• horizontal installation, min.	-30 °C; = Tmin (incl. condensation/frost)
• horizontal installation, max.	60 °C; = Tmax; +70 °C for 10 min (OT1, ST1/ST2 acc. to EN 50155)
• vertical installation, min.	-30 °C; = Tmin
• vertical installation, max.	40 °C; = Tmax
<b>Altitude during operation relating to sea level</b>	
• Installation altitude above sea level, max.	2 000 m
• Ambient air temperature-barometric pressure-altitude	Tmin ... Tmax at 1 140 hPa ... 795 hPa (-1 000 m ... +2 000 m)
<b>Relative humidity</b>	
• With condensation, tested in accordance with IEC 60068-2-38, max.	100 %; RH incl. condensation / frost (no commissioning in bedewed state), horizontal installation
<b>Resistance</b>	
• Coolants and lubricants	Yes; Incl. diesel and oil droplets in the air
• Resistant to commercially available coolants and lubricants	
• Use in stationary industrial systems	Yes; Class 3B2 mold, fungus and dry rot spores (with the exception of fauna); Class 3B3 on request
• to biologically active substances according to EN 60721-3-3	Yes; Class 3C4 (RH < 75 %) incl. salt spray acc. to EN 60068-2-52 (severity degree 3); *
• to chemically active substances according to EN 60721-3-3	Yes; Class 3S4 incl. sand, dust, *
• to mechanically active substances according to EN 60721-3-3	
• Use on land craft, rail vehicles and special-purpose vehicles	Yes; Class 5B2 mold, fungus and dry rot spores (with the exception of fauna); Class 5B3 on request
• to biologically active substances according to EN 60721-3-5	Yes; Class 5C3 (RH < 75 %) incl. salt spray acc. to EN 60068-2-52 (severity degree 3); *
• to chemically active substances according to EN 60721-3-5	Yes; Class 5S3 incl. sand, dust; *
• to mechanically active substances according to EN 60721-3-5	
• Usage in industrial process technology	Yes; Class 3 (excluding trichlorethylene)
• Against chemically active substances acc. to EN 60654-4	Yes; Level GX group A/B (excluding trichlorethylene; harmful gas concentrations up to the limits of EN 60721-3-3 class 3C4 permissible); level LC3 (salt spray) and level LB3 (oil)
• Environmental conditions for process, measuring and control systems acc. to ANSI/ISA-71.04	
• Remark	* The supplied plug covers must remain in place over the unused interfaces during operation!
• Note regarding classification of environmental conditions acc. to EN 60721, EN 60654-4 and ANSI/ISA-71.04	
<b>Conformal coating</b>	
• Coatings for printed circuit board assemblies acc. to EN 61086	Yes; Class 2 for high reliability
• Protection against fouling acc. to EN 60664-3	Yes; Type 1 protection
• Electronic equipment on rolling stock acc. to EN 50155	Yes; Class PC2 protective coating acc. to EN 50155:2017
• Military testing according to MIL-I-46058C, Amendment 7	Yes; Discoloration of coating possible during service life
• Qualification and Performance of Electrical Insulating Compound for Printed Board Assemblies according to IPC-CC-830A	Yes; Conformal coating, Class A

**SIPLUS RAIL**

SIPLUS S7-1500 RAIL

SIPLUS extreme RAIL F-digital/analog modules

**SIPLUS extreme RAIL F-digital input modules**

Article number	<b>6AG2526-1BH00-1AB0</b> SIPLUS S7-1500 F-DI 16x24VDC T1 RAIL
<b>Dimensions</b>	
<b>Width</b>	35 mm
<b>Height</b>	147 mm
<b>Depth</b>	129 mm
<b>Weights</b>	
<b>Weight, approx.</b>	280 g
<b>Other</b>	
<b>Note:</b>	for use in railway applications, also observe the product information "SIPLUS extreme RAIL" A5E37661960A, Online Support article 109736776

**Selection and ordering data**

Version	Article No.
<b>SIPLUS S7-1500 F-DI 16x24VDC HF T1 RAIL</b> Approved in accordance with the railway standards EN 50155, EN 15121, EN 50124, EN 50125 and EN 45545 for use in rail traffic 16 inputs, 24 V DC, PROFISAFE; for areas with extreme exposure to environmental substances (conformal coating); ambient temperature -25 ... +55 °C (+70 °C for 10 min.)	<b>6AG2526-1BH00-1AB0</b>

**SIPLUS extreme RAIL F-digital output modules**

## Overview



SIPLUS extreme RAIL digital fail-safe output module:  
F-DQ 8x24 V DC 2 A PPM

Important properties:

- 8-channel digital fail-safe output module for ET 200MP/S7-1500
- Approved in accordance with the EN 50155, EN 15121, EN 50124, EN 50125 and EN 45545 railway standards for use in rail traffic
- Fail-safe 2-channel activation (parameterizable PM/PP switching) of actuators
- Actuators can be controlled up to 2 A

- Certified up to SIL 3 (IEC 61508), PL e (ISO 13849)
- LED display for error, operation, supply voltage and status
- Clear module labeling
  - Plain text identification of the module type
  - Complete Article No.
  - 2D matrix code (order and serial number)
  - Connection diagram
  - Hardware and firmware version
- Optional labeling accessories
  - Labeling sheets, yellow
- The module supports PROFIsafe in both PROFIBUS and PROFINET configurations.
- Can be used with all fail-safe SIMATIC S7-1500 F-CPU's in the central configuration, as well as ET 200MP distributed I/O with all other SIMATIC S7 F-CPU's

## Application

Using fail-safe ET 200MP/S7-1500 modules makes it possible to implement safety-related application requirements as an integral part of the overall automation. The safety functions required for fail-safe operation are integrated in the modules. Communication with the fail-safe SIMATIC S7 CPUs is performed by means of PROFIsafe.

The modules can be operated both in centralized and distributed configurations.

## Technical specifications

Article number	<b>6AG2526-2BF00-1AB0</b> SIPLUS S7-1500 F-DQ 8x24VDC 2A T1 RAIL
<b>General information</b>	
Product type designation	F-DQ 8x24VDC/2A PPM
Operating mode	Yes
• DQ	Yes
<b>Supply voltage</b>	
Rated value (DC)	24 V
Reverse polarity protection	Yes
<b>Digital outputs</b>	
Type of digital output	Transistor
Number of digital outputs	8
Current-sinking	Yes
Current-sourcing	Yes
Short-circuit protection	Yes
Open-circuit detection	Yes
Overload protection	Yes
Limitation of inductive shutdown voltage to	PM-switching: -24 V + (-47 V), PP-switching: -24 V
Switching capacity of the outputs	
• with resistive load, max.	2 A
• on lamp load, max.	10 W
Load resistance range	
• lower limit	12 Ω
• upper limit	2 000 Ω
Output voltage	
• for signal "1", min.	24 V; L+ (-0.5 V)
Output current	
• for signal "1" rated value	2 A
• for signal "0" residual current, max.	0.5 A; Current-sourcing, or current sourcing and sinking switches individually, current sinking: max. 1 mA
Switching frequency	
• with resistive load, max.	30 Hz
• with inductive load, max.	0.1 Hz
• on lamp load, max.	10 Hz

**SIPLUS RAIL**

SIPLUS S7-1500 RAIL

SIPLUS extreme RAIL F-digital/analog modules

**SIPLUS extreme RAIL F-digital output modules**

Article number	<b>6AG2526-2BF00-1AB0</b> SIPLUS S7-1500 F-DQ 8x24VDC 2A T1 RAIL
<b>Total current of the outputs</b> • Current per channel, max.	2 A
<b>Total current of the outputs (per module)</b> • horizontal installation - up to 40 °C, max. - up to 60 °C, max. • vertical installation - up to 40 °C, max.	16 A 8 A 8 A
<b>Interrupts/diagnostics/status information</b>	
<b>Diagnostics function</b>	Yes
<b>Substitute values connectable</b>	No
<b>Alarms</b> • Diagnostic alarm	Yes
<b>Diagnoses</b> • Monitoring the supply voltage • Wire-break • Short-circuit • Group error	Yes Yes Yes Yes
<b>Diagnostics indication LED</b> • RUN LED • ERROR LED • Monitoring of the supply voltage (PWR-LED) • Channel status display • for channel diagnostics • for module diagnostics	Yes; green LED Yes; red LED Yes Yes; green LED Yes; red LED Yes; red LED
<b>Potential separation</b>	
<b>Potential separation channels</b> • between the channels and backplane bus	Yes
<b>Standards, approvals, certificates</b>	
<b>Suitable for safety functions</b>	Yes
<b>Highest safety class achievable in safety mode</b> • Performance level according to ISO 13849-1 • SIL acc. to IEC 61508 • SIL in accordance with EN 50126, 50128, 50129	PLe SIL 3 SIL 2; a higher safety integrity level is possible if tested and approved for the specific application under consideration of all local regulations.
<b>Railway application</b> • EN 50121-3-2 • EN 50121-4 • EN 50124-1  • EN 50125-1 • EN 50125-2 • EN 50125-3  • EN 50155 • EN 61373 • Fire protection acc. to EN 45545-2	Yes; EMC for rail vehicles Yes; EMC for signal and telecommunications systems Yes; Railway applications - overvoltage category OV2; pollution degree PD2; rated surge voltage UNi = 0.5 kV; UNm = 24 V DC Yes; Rail vehicles - see ambient conditions Yes; Stationary electrical equipment - see ambient conditions Yes; Signal and telecommunications systems - see ambient conditions; vibrations and shocks: Application point outside of tracks (1 m to 3 m away from track) Yes; Rail vehicles - temperature class OT1, ST1/ST2, horizontal mounting position Yes; Rail vehicles - vibrations and shocks: Category 1 Class A/B Yes; For proof of conformity, see Service & Support
<b>Ambient conditions</b>	
<b>Ambient temperature during operation</b> • horizontal installation, min. • horizontal installation, max. • vertical installation, min. • vertical installation, max.	-30 °C; = Tmin (incl. condensation/frost) 60 °C; = Tmax; +70 °C for 10 min (OT1, ST1/ST2 acc. to EN 50155) -30 °C; = Tmin 40 °C; = Tmax
<b>Altitude during operation relating to sea level</b> • Installation altitude above sea level, max. • Ambient air temperature-barometric pressure-altitude	2 000 m Tmin ... Tmax at 1 140 hPa ... 795 hPa (-1 000 m ... +2 000 m)
<b>Relative humidity</b> • With condensation, tested in accordance with IEC 60068-2-38, max.	100 %; RH incl. condensation / frost (no commissioning in bedewed state), horizontal installation
<b>Resistance</b> • Coolants and lubricants - Resistant to commercially available coolants and lubricants • Use in stationary industrial systems - to biologically active substances according to EN 60721-3-3 - to chemically active substances according to EN 60721-3-3 - to mechanically active substances according to EN 60721-3-3 • Use on land craft, rail vehicles and special-purpose vehicles - to biologically active substances according to EN 60721-3-5 - to chemically active substances according to EN 60721-3-5 - to mechanically active substances according to EN 60721-3-5	Yes; Incl. diesel and oil droplets in the air  Yes; Class 3B2 mold, fungus and dry rot spores (with the exception of fauna); Class 3B3 on request Yes; Class 3C4 (RH < 75 %) incl. salt spray acc. to EN 60068-2-52 (severity degree 3); * Yes; Class 3S4 incl. sand, dust, *  Yes; Class 5B2 mold, fungus and dry rot spores (with the exception of fauna); Class 5B3 on request Yes; Class 5C3 (RH < 75 %) incl. salt spray acc. to EN 60068-2-52 (severity degree 3); * Yes; Class 5S3 incl. sand, dust; *

## SIPLUS extreme RAIL F-digital output modules

Article number	<b>6AG2526-2BF00-1AB0</b> SIPLUS S7-1500 F-DQ 8x24VDC 2A T1 RAIL
<ul style="list-style-type: none"> <li>Usage in industrial process technology           <ul style="list-style-type: none"> <li>Against chemically active substances acc. to EN 60654-4</li> <li>Environmental conditions for process, measuring and control systems acc. to ANSI/ISA-71.04</li> </ul> </li> <li>Remark           <ul style="list-style-type: none"> <li>Note regarding classification of environmental conditions acc. to EN 60721, EN 60654-4 and ANSI/ISA-71.04</li> </ul> </li> </ul>	<p>Yes; Class 3 (excluding trichlorethylene)</p> <p>Yes; Level GX group A/B (excluding trichlorethylene; harmful gas concentrations up to the limits of EN 60721-3-3 class 3C4 permissible); level LC3 (salt spray) and level LB3 (oil)</p> <p>* The supplied plug covers must remain in place over the unused interfaces during operation!</p>
<b>Conformal coating</b> <ul style="list-style-type: none"> <li>Coatings for printed circuit board assemblies acc. to EN 61086</li> <li>Protection against fouling acc. to EN 60664-3</li> <li>Electronic equipment on rolling stock acc. to EN 50155</li> <li>Military testing according to MIL-I-46058C, Amendment 7</li> <li>Qualification and Performance of Electrical Insulating Compound for Printed Board Assemblies according to IPC-CC-830A</li> </ul>	<p>Yes; Class 2 for high reliability</p> <p>Yes; Type 1 protection</p> <p>Yes; Class PC2 protective coating acc. to EN 50155:2017</p> <p>Yes; Discoloration of coating possible during service life</p> <p>Yes; Conformal coating, Class A</p>
<b>Dimensions</b>	
<b>Width</b>	35 mm
<b>Height</b>	147 mm
<b>Depth</b>	129 mm
<b>Weights</b>	
<b>Weight, approx.</b>	300 g
<b>Other</b>	
<b>Note:</b>	for use in railway applications, also observe the product information "SIPLUS extreme RAIL" A5E37661960A, Online Support article 109736776

## Selection and ordering data

Version	Article No.
<b>SIPLUS S7-1500 F DQ 8 x 24 V DC 2A T1 RAIL</b> 8 outputs, 24 V DC, 2 A, PROFISAFE, sinking/sourcing; for areas with extreme exposure to environmental substances (conformal coating); Ambient temperature -25 ... +55 °C (+70 °C for 10 min.)	<b>6AG2526-2BF00-1AB0</b>

**SIPLUS RAIL**

SIPLUS Distributed Controller RAIL  
based on SIPLUS ET 200SP

**SIPLUS extreme RAIL standard CPUs****Overview**

Two graded-performance standard CPUs based on SIPLUS extreme RAIL ET 200SP:

- SIPLUS ET 200SP CPU 1510SP-1 PN RAIL
- SIPLUS ET 200SP CPU 1512SP-1 PN RAIL

Characteristics	SIPLUS ET 200SP CPU 1510SP-1 PN RAIL	SIPLUS ET 200SP CPU 1512SP-1 PN RAIL
<b>Work memory for program, integrated</b>	100 KB	200 KB
<b>Work memory for data, integrated</b>	750 KB	1.0 MB
<b>Load memory</b>	Plug-in via SIMATIC Memory Card	Plug-in via SIMATIC Memory Card
<b>Command execution times</b>		
• Bit operations	0.072 µs	0.048 µs
• Word operations	0.086 µs	0.058 µs
• Fixed-point operations	0.115 µs	0.077 µs
• Floating-point operations	0.461 µs	0.307 µs
<b>Bit memories, timers, counters</b>		
<b>S7 counters/timers</b>	2 048 each	2 048 each
<b>IEC counters</b>	Arbitrary (only limited by the work memory)	Arbitrary (only limited by the work memory)
<b>IEC timers</b>	Arbitrary (only limited by the work memory)	Arbitrary (only limited by the work memory)
<b>Bit memories</b>	16 KB	16 KB
<b>I/O address range</b>		
<b>Inputs</b>	32 KB (all inputs are stored in the process image)	32 KB (all inputs are stored in the process image)
<b>Outputs</b>	32 KB (all outputs are stored in the process image)	32 KB (all outputs are stored in the process image)
<b>Motion</b>		
<b>No. of axes</b>	Up to 6	Up to 6
<b>Communication</b>		
<b>PtP</b>	Yes (via CM)	Yes (via CM)
<b>PROFINET IO</b>	1 x PN IO IRT (3-port switch)	1 x PN IO IRT (3-port switch)
<b>PROFIBUS DP</b>	Yes (via CM DP)	Yes (via CM DP)
<b>Web server</b>	Yes	Yes

**Application**

A range of performance-graded CPUs are available for the SIPLUS extreme RAIL ET 200SP:

**Standard CPUs**

- SIPLUS ET 200SP CPU 1510SP-1 PN RAIL:  
For smaller applications with average requirements regarding the program scope and processing speed, for distributed setup via PROFINET IO or PROFIBUS DP.
- SIPLUS ET 200SP CPU 1512SP-1 PN RAIL:  
For applications with average requirements regarding the program scope and processing speed, for distributed setup via PROFINET IO or PROFIBUS DP.

## Technical specifications

Article number	<b>6AG2510-1DJ01-1AB0</b> SIPLUS ET 200SP CPU 1510SP-1 PN RAIL	<b>6AG2510-1DJ01-4AB0</b> SIPLUS ET 200SP CPU 1510SP-1 PN RAIL	<b>6AG2512-1DK01-1AB0</b> SIPLUS ET 200SP CPU 1512SP-1 PN RAIL	<b>6AG2512-1DK01-4AB0</b> SIPLUS ET 200SP CPU 1512SP-1 PN RAIL
<b>General information</b>				
<b>Product type designation</b>	CPU 1510SP-1 PN	CPU 1510SP-1 PN	CPU 1512SP-1 PN	CPU 1512SP-1 PN
<b>Engineering with</b> • STEP 7 TIA Portal configurable/integrated from version	see entry ID: 109746275	see entry ID: 109746275	see entry ID: 109746275	see entry ID: 109746275
<b>Supply voltage</b>				
<b>Rated value (DC)</b>	24 V	24 V	24 V	24 V
<b>Memory</b>				
<b>Work memory</b> • integrated (for program) • integrated (for data)	100 kbyte 750 kbyte	100 kbyte 750 kbyte	200 kbyte 1 Mbyte	200 kbyte 1 Mbyte
<b>Load memory</b> • Plug-in (SIMATIC Memory Card), max.	32 Gbyte	32 Gbyte	32 Gbyte	32 Gbyte
<b>CPU processing times</b>				
<b>for bit operations, typ.</b>	72 ns	72 ns	48 ns	48 ns
<b>for word operations, typ.</b>	86 ns	86 ns	58 ns	58 ns
<b>for fixed point arithmetic, typ.</b>	115 ns	115 ns	77 ns	77 ns
<b>for floating point arithmetic, typ.</b>	461 ns	461 ns	307 ns	307 ns
<b>Counters, timers and their retentivity</b>				
<b>S7 counter</b> • Number	2 048	2 048	2 048	2 048
<b>IEC counter</b> • Number	Any (only limited by the main memory)	Any (only limited by the main memory)	Any (only limited by the main memory)	Any (only limited by the main memory)
<b>S7 times</b> • Number	2 048	2 048	2 048	2 048
<b>IEC timer</b> • Number	Any (only limited by the main memory)	Any (only limited by the main memory)	Any (only limited by the main memory)	Any (only limited by the main memory)
<b>Data areas and their retentivity</b>				
<b>Flag</b> • Size, max.	16 kbyte	16 kbyte	16 kbyte	16 kbyte
<b>Address area</b>				
<b>I/O address area</b> • Inputs	32 kbyte; All inputs are in the process image	32 kbyte; All inputs are in the process image	32 kbyte; All inputs are in the process image	32 kbyte; All inputs are in the process image
• Outputs	32 kbyte; All outputs are in the process image	32 kbyte; All outputs are in the process image	32 kbyte; All outputs are in the process image	32 kbyte; All outputs are in the process image
<b>Address space per module</b> • Address space per module, max.	288 byte; For input and out- put data respectively	288 byte; For input and out- put data respectively	288 byte; For input and out- put data respectively	288 byte; For input and out- put data respectively
<b>Address space per station</b> • Address space per station, max.	2 560 byte; for central inputs and outputs; depending on configuration; 2 048 bytes for ET 200SP modules + 512 bytes for ET 200AL modules	2 560 byte; for central inputs and outputs; depending on configuration; 2 048 bytes for ET 200SP modules + 512 bytes for ET 200AL modules	2 560 byte; for central inputs and outputs; depending on configuration; 2 048 bytes for ET 200SP modules + 512 bytes for ET 200AL modules	2 560 byte; for central inputs and outputs; depending on configuration; 2 048 bytes for ET 200SP modules + 512 bytes for ET 200AL modules
<b>Time of day</b>				
<b>Clock</b> • Type	Hardware clock	Hardware clock	Hardware clock	Hardware clock
<b>1. Interface</b>				
<b>Interface types</b> • RJ 45 (Ethernet)	Yes; X1 P3; opt. X1 P1 and X1 P2 via BusAdapter BA 2x RJ45	Yes; X1 P3	Yes; X1 P3; opt. X1 P1 and X1 P2 via BusAdapter BA 2x RJ45	Yes; X1 P3
• Number of ports	3; 1. integr. + 2. via Bus- Adapter	1	3; 1. integr. + 2. via Bus- Adapter	1
• integrated switch	Yes	No	Yes	No
• BusAdapter (PROFINET)	Yes; compatible BusAdapt- ers: BA 2x RJ45, BA 2x FC, BA 2x M12		Yes; compatible BusAdapt- ers: BA 2x RJ45, BA 2x M12, BA 2x FC, BA 2x LC, BA LC/RJ45, BA LC/FC, BA 2x SCRJ, BA SCRJ/RJ45, BA SCRJ/FC,	



**SIPLUS RAIL**SIPLUS Distributed Controller RAIL  
based on SIPLUS ET 200SP**SIPLUS extreme RAIL standard CPUs**

Article number	<b>6AG2510-1DJ01-1AB0</b> SIPLUS ET 200SP CPU 1510SP-1 PN RAIL	<b>6AG2510-1DJ01-4AB0</b> SIPLUS ET 200SP CPU 1510SP-1 PN RAIL	<b>6AG2512-1DK01-1AB0</b> SIPLUS ET 200SP CPU 1512SP-1 PN RAIL	<b>6AG2512-1DK01-4AB0</b> SIPLUS ET 200SP CPU 1512SP-1 PN RAIL
<b>Protocols</b>				
<ul style="list-style-type: none"> <li>IP protocol</li> <li>PROFINET IO Controller</li> <li>PROFINET IO Device</li> <li>SIMATIC communication</li> <li>Open IE communication</li> </ul>	<ul style="list-style-type: none"> <li>Yes; IPv4</li> <li>Yes</li> <li>Yes</li> <li>Yes</li> <li>Yes; Optionally also encrypted</li> <li>Yes</li> <li>Yes; MRP Automanager according to IEC 62439-2 Edition 2.0</li> </ul>	<ul style="list-style-type: none"> <li>Yes; IPv4</li> <li>Yes</li> <li>Yes</li> <li>Yes</li> <li>Yes; Optionally also encrypted</li> <li>Yes</li> <li>No</li> </ul>	<ul style="list-style-type: none"> <li>Yes; IPv4</li> <li>Yes</li> <li>Yes</li> <li>Yes</li> <li>Yes; Optionally also encrypted</li> <li>Yes</li> <li>Yes; MRP Automanager according to IEC 62439-2 Edition 2.0</li> </ul>	<ul style="list-style-type: none"> <li>Yes; IPv4</li> <li>Yes</li> <li>Yes</li> <li>Yes</li> <li>Yes; Optionally also encrypted</li> <li>Yes</li> <li>No</li> </ul>
<b>PROFINET IO Controller</b>				
<ul style="list-style-type: none"> <li>Services <ul style="list-style-type: none"> <li>PG/OP communication</li> <li>Isochronous mode</li> <li>Direct data exchange</li> </ul> </li> <li>IRT</li> <li>PROFenergy</li> <li>Prioritized startup</li> <li>Number of connectable IO Devices, max.</li> <li>Of which IO devices with IRT, max.</li> <li>Number of connectable IO Devices for RT, max.</li> <li>of which in line, max.</li> <li>Number of IO Devices that can be simultaneously activated/deactivated, max.</li> <li>Number of IO Devices per tool, max.</li> <li>Updating times</li> </ul>	<ul style="list-style-type: none"> <li>Yes</li> <li>Yes</li> <li>Yes; Requirement: IRT and isochronous mode (MRPD optional)</li> <li>Yes</li> <li>Yes; per user program</li> <li>Yes; Max. 32 PROFINET devices</li> <li>64; In total, up to 256 distributed I/O devices can be connected via AS-i, PROFIBUS or PROFINET</li> <li>64</li> <li>64</li> <li>64</li> <li>8; in total across all interfaces</li> <li>8</li> <li>The minimum value of the update time also depends on communication share set for PROFINET IO, on the number of IO devices, and on the quantity of configured user data</li> </ul>	<ul style="list-style-type: none"> <li>Yes</li> <li>Yes</li> <li>Yes; Requirement: IRT and isochronous mode (MRPD optional)</li> <li>Yes</li> <li>Yes; per user program</li> <li>Yes; Max. 32 PROFINET devices</li> <li>64; In total, up to 256 distributed I/O devices can be connected via AS-i, PROFIBUS or PROFINET</li> <li>64</li> <li>64</li> <li>64</li> <li>8; in total across all interfaces</li> <li>8</li> <li>The minimum value of the update time also depends on communication share set for PROFINET IO, on the number of IO devices, and on the quantity of configured user data</li> </ul>	<ul style="list-style-type: none"> <li>Yes</li> <li>Yes</li> <li>Yes; Requirement: IRT and isochronous mode (MRPD optional)</li> <li>Yes</li> <li>Yes; per user program</li> <li>Yes; Max. 32 PROFINET devices</li> <li>128; In total, up to 512 distributed I/O devices can be connected via AS-i, PROFIBUS or PROFINET</li> <li>64</li> <li>128</li> <li>128</li> <li>8; in total across all interfaces</li> <li>8</li> <li>The minimum value of the update time also depends on communication share set for PROFINET IO, on the number of IO devices, and on the quantity of configured user data</li> </ul>	<ul style="list-style-type: none"> <li>Yes</li> <li>Yes</li> <li>Yes; Requirement: IRT and isochronous mode (MRPD optional)</li> <li>Yes</li> <li>Yes; per user program</li> <li>Yes; Max. 32 PROFINET devices</li> <li>128; In total, up to 512 distributed I/O devices can be connected via AS-i, PROFIBUS or PROFINET</li> <li>64</li> <li>128</li> <li>128</li> <li>8; in total across all interfaces</li> <li>8</li> <li>The minimum value of the update time also depends on communication share set for PROFINET IO, on the number of IO devices, and on the quantity of configured user data</li> </ul>
<b>PROFINET IO Device</b>				
<ul style="list-style-type: none"> <li>Services <ul style="list-style-type: none"> <li>PG/OP communication</li> <li>Isochronous mode</li> <li>IRT</li> <li>PROFenergy</li> <li>Shared device</li> <li>Number of IO Controllers with shared device, max.</li> <li>activation/deactivation of I-devices</li> <li>Asset management record</li> </ul> </li> </ul>	<ul style="list-style-type: none"> <li>Yes</li> <li>No</li> <li>Yes</li> <li>Yes; per user program</li> <li>Yes</li> <li>4</li> <li>Yes; per user program</li> <li>Yes; per user program</li> </ul>	<ul style="list-style-type: none"> <li>Yes</li> <li>No</li> <li>Yes</li> <li>Yes; per user program</li> <li>Yes</li> <li>4</li> <li>Yes; per user program</li> <li>Yes; per user program</li> </ul>	<ul style="list-style-type: none"> <li>Yes</li> <li>No</li> <li>Yes</li> <li>Yes; per user program</li> <li>Yes</li> <li>4</li> <li>Yes; per user program</li> <li>Yes; per user program</li> </ul>	<ul style="list-style-type: none"> <li>Yes</li> <li>No</li> <li>Yes</li> <li>Yes; per user program</li> <li>Yes</li> <li>4</li> <li>Yes; per user program</li> <li>Yes; per user program</li> </ul>
<b>2. Interface</b>				
<b>Interface types</b>				
<ul style="list-style-type: none"> <li>RS 485</li> <li>Number of ports</li> </ul>	<ul style="list-style-type: none"> <li>Yes; Via CM DP module</li> <li>1</li> </ul>	<ul style="list-style-type: none"> <li>Yes; Via CM DP module</li> <li>1</li> </ul>	<ul style="list-style-type: none"> <li>Yes; Via CM DP module</li> <li>1</li> </ul>	<ul style="list-style-type: none"> <li>Yes; Via CM DP module</li> <li>1</li> </ul>
<b>Protocols</b>				
<ul style="list-style-type: none"> <li>PROFIBUS DP master</li> <li>PROFIBUS DP slave</li> <li>SIMATIC communication</li> </ul>	<ul style="list-style-type: none"> <li>Yes</li> <li>Yes</li> <li>Yes</li> </ul>	<ul style="list-style-type: none"> <li>Yes</li> <li>Yes</li> <li>Yes</li> </ul>	<ul style="list-style-type: none"> <li>Yes</li> <li>Yes</li> <li>Yes</li> </ul>	<ul style="list-style-type: none"> <li>Yes</li> <li>Yes</li> <li>Yes</li> </ul>
<b>PROFIBUS DP master</b>				
<ul style="list-style-type: none"> <li>Number of DP slaves, max.</li> </ul>	<ul style="list-style-type: none"> <li>125; In total, up to 256 distributed I/O devices can be connected via AS-i, PROFIBUS or PROFINET</li> </ul>	<ul style="list-style-type: none"> <li>125; In total, up to 256 distributed I/O devices can be connected via AS-i, PROFIBUS or PROFINET</li> </ul>	<ul style="list-style-type: none"> <li>125; In total, up to 512 distributed I/O devices can be connected via AS-i, PROFIBUS or PROFINET</li> </ul>	<ul style="list-style-type: none"> <li>125; In total, up to 512 distributed I/O devices can be connected via AS-i, PROFIBUS or PROFINET</li> </ul>
<b>Protocols</b>				
<b>Number of connections</b>				
<ul style="list-style-type: none"> <li>Number of connections, max.</li> </ul>	<ul style="list-style-type: none"> <li>96; via integrated interfaces of the CPU and connected CPs / CMs</li> </ul>	<ul style="list-style-type: none"> <li>96; via integrated interfaces of the CPU and connected CPs / CMs</li> </ul>	<ul style="list-style-type: none"> <li>128; via integrated interfaces of the CPU and connected CPs / CMs</li> </ul>	<ul style="list-style-type: none"> <li>128; via integrated interfaces of the CPU and connected CPs / CMs</li> </ul>

# SIPLUS RAIL

## SIPLUS Distributed Controller RAIL based on SIPLUS ET 200SP

### SIPLUS extreme RAIL standard CPUs

Article number	6AG2510-1DJ01-1AB0 SIPLUS ET 200SP CPU 1510SP-1 PN RAIL	6AG2510-1DJ01-4AB0 SIPLUS ET 200SP CPU 1510SP-1 PN RAIL	6AG2512-1DK01-1AB0 SIPLUS ET 200SP CPU 1512SP-1 PN RAIL	6AG2512-1DK01-4AB0 SIPLUS ET 200SP CPU 1512SP-1 PN RAIL
<b>Redundancy mode</b>				
<ul style="list-style-type: none"> <li>Media redundancy</li> <li>Media redundancy</li> <li>MRP</li> </ul>	Yes; only via BusAdapter Yes; MRP Automanager according to IEC 62439-2 Edition 2.0, MRP Manager; MRP Client	No No	Yes; only via BusAdapter Yes; MRP Automanager according to IEC 62439-2 Edition 2.0, MRP Manager; MRP Client	No No
- MRP interconnection, supported	Yes; as MRP ring node according to IEC 62439-2 Edition 3.0	No	Yes; as MRP ring node according to IEC 62439-2 Edition 3.0	No
- MRPD	Yes; Requirement: IRT 200 ms; For MRP, bumpless for MRPD	No	Yes; Requirement: IRT 200 ms; For MRP, bumpless for MRPD	No
- Switchover time on line break, typ.	50		50	
- Number of stations in the ring, max.	50		50	
<b>SIMATIC communication</b>				
• S7 routing	Yes	Yes	Yes	Yes
<b>OPC UA</b>				
• OPC UA Client	Yes	Yes	Yes	Yes
• OPC UA Server	Yes; Data access (read, write, subscribe), method call, custom address space	Yes; Data access (read, write, subscribe), method call, custom address space	Yes; Data access (read, write, subscribe), method call, custom address space	Yes; Data access (read, write, subscribe), method call, custom address space
• Alarms and Conditions	Yes	Yes	Yes	Yes
<b>Supported technology objects</b>				
Motion Control	Yes; Note: The number of technology objects affects the cycle time of the PLC program; selection guide via the TIA Selection Tool	Yes; Note: The number of technology objects affects the cycle time of the PLC program; selection guide via the TIA Selection Tool	Yes; Note: The number of technology objects affects the cycle time of the PLC program; selection guide via the TIA Selection Tool	Yes; Note: The number of technology objects affects the cycle time of the PLC program; selection guide via the TIA Selection Tool
• Number of available Motion Control resources for technology objects	800	800	800	800
• Required Motion Control resources				
- per speed-controlled axis	40	40	40	40
- per positioning axis	80	80	80	80
- per synchronous axis	160	160	160	160
- per external encoder	80	80	80	80
- per output cam	20	20	20	20
- per cam track	160	160	160	160
- per probe	40	40	40	40
<b>Controller</b>				
• PID_Compact	Yes; Universal PID controller with integrated optimization	Yes; Universal PID controller with integrated optimization	Yes; Universal PID controller with integrated optimization	Yes; Universal PID controller with integrated optimization
• PID_3Step	Yes; PID controller with integrated optimization for valves	Yes; PID controller with integrated optimization for valves	Yes; PID controller with integrated optimization for valves	Yes; PID controller with integrated optimization for valves
• PID-Temp	Yes; PID controller with integrated optimization for temperature	Yes; PID controller with integrated optimization for temperature	Yes; PID controller with integrated optimization for temperature	Yes; PID controller with integrated optimization for temperature
<b>Counting and measuring</b>				
• High-speed counter	Yes	Yes	Yes	Yes
<b>Standards, approvals, certificates</b>				
<b>Railway application</b>				
• EN 50121-3-2	Yes; EMC for rail vehicles	Yes; EMC for rail vehicles	Yes; EMC for rail vehicles	Yes; EMC for rail vehicles
• EN 50121-4	Yes; EMC for signal and telecommunications systems	Yes; EMC for signal and telecommunications systems	Yes; EMC for signal and telecommunications systems	Yes; EMC for signal and telecommunications systems
• EN 50124-1	Yes; Railway applications - overvoltage category OV2; pollution degree PD2; rated surge voltage UNi = 0.5 kV; UNm = 24 V DC	Yes; Railway applications - overvoltage category OV2; pollution degree PD2; rated surge voltage UNi = 0.5 kV; UNm = 24 V DC	Yes; Railway applications - overvoltage category OV2; pollution degree PD2; rated surge voltage UNi = 0.5 kV; UNm = 24 V DC	Yes; Railway applications - overvoltage category OV2; pollution degree PD2; rated surge voltage UNi = 0.5 kV; UNm = 24 V DC
• EN 50125-1	Yes; Rail vehicles - see ambient conditions	Yes; Rail vehicles - see ambient conditions	Yes; Rail vehicles - see ambient conditions	Yes; Rail vehicles - see ambient conditions
• EN 50125-2	Yes; Stationary electrical equipment - see ambient conditions	Yes; Stationary electrical equipment - see ambient conditions	Yes; Stationary electrical equipment - see ambient conditions	Yes; Stationary electrical equipment - see ambient conditions
• EN 50125-3	Yes; Signal and telecommunications systems - see ambient conditions; vibrations and shocks: Application point outside of tracks (1 m to 3 m away from track)	Yes; Signal and telecommunications systems - see ambient conditions; vibrations and shocks: Application point outside of tracks (1 m to 3 m away from track)	Yes; Signal and telecommunications systems - see ambient conditions; vibrations and shocks: Application point outside of tracks (1 m to 3 m away from track)	Yes; Signal and telecommunications systems - see ambient conditions; vibrations and shocks: Application point outside of tracks (1 m to 3 m away from track)
• EN 50155	Yes; Rail vehicles - temperature class OT1, ST1/ST2, horizontal mounting position	Yes; Rail vehicles - temperature class OT4, ST1/ST2, horizontal mounting position	Yes; Rail vehicles - temperature class OT1, ST1/ST2, horizontal mounting position	Yes; Rail vehicles - temperature class OT4, ST1/ST2, horizontal mounting position
• EN 61373	Yes; Rail vehicles - vibrations and shocks: Category 1 Class A/B	Yes; Rail vehicles - vibrations and shocks: Category 1 Class A/B	Yes; Rail vehicles - vibrations and shocks: Category 1 Class A/B	Yes; Rail vehicles - vibrations and shocks: Category 1 Class A/B
• Fire protection acc. to EN 45545-2	Yes; For proof of conformity, see Service & Support	Yes; For proof of conformity, see Service & Support	Yes; For proof of conformity, see Service & Support	Yes; For proof of conformity, see Service & Support

**SIPLUS RAIL**SIPLUS Distributed Controller RAIL  
based on SIPLUS ET 200SP**SIPLUS extreme RAIL standard CPUs**

Article number	<b>6AG2510-1DJ01-1AB0</b> SIPLUS ET 200SP CPU 1510SP-1 PN RAIL	<b>6AG2510-1DJ01-4AB0</b> SIPLUS ET 200SP CPU 1510SP-1 PN RAIL	<b>6AG2512-1DK01-1AB0</b> SIPLUS ET 200SP CPU 1512SP-1 PN RAIL	<b>6AG2512-1DK01-4AB0</b> SIPLUS ET 200SP CPU 1512SP-1 PN RAIL
<b>Ambient conditions</b>				
<b>Ambient temperature during operation</b>				
• horizontal installation, min.	-40 °C; = Tmin (incl. condensation/frost)	-40 °C; = Tmin (incl. condensation/frost)	-40 °C; = Tmin (incl. condensation/frost)	-40 °C; = Tmin (incl. condensation/frost)
• horizontal installation, max.	60 °C; = Tmax; +70 °C for 10 min (OT1, ST1/ST2 acc. to EN 50155)	70 °C; = Tmax; +85 °C for 10 min (OT4, ST1/ST2 acc. to EN 50155)	60 °C; = Tmax; +70 °C for 10 min (OT1, ST1/ST2 acc. to EN 50155)	70 °C; = Tmax; +85 °C for 10 min (OT4, ST1/ST2 acc. to EN 50155)
• vertical installation, min.	-40 °C; = Tmin	-40 °C; = Tmin	-40 °C; = Tmin	-40 °C; = Tmin
• vertical installation, max.	50 °C; = Tmax	50 °C; = Tmax	50 °C; = Tmax	50 °C; = Tmax
<b>Altitude during operation relating to sea level</b>				
• Installation altitude above sea level, max.	2 000 m	2 000 m	2 000 m	2 000 m
• Ambient air temperature-barometric pressure-altitude	Tmin ... Tmax at 1 140 hPa ... 795 hPa (-1 000 m ... +2 000 m)	Tmin ... Tmax at 1 140 hPa ... 795 hPa (-1 000 m ... +2 000 m)	Tmin ... Tmax at 1 140 hPa ... 795 hPa (-1 000 m ... +2 000 m)	Tmin ... Tmax at 1 140 hPa ... 795 hPa (-1 000 m ... +2 000 m)
<b>Relative humidity</b>				
• With condensation, tested in accordance with IEC 60068-2-38, max.	100 %; RH incl. condensation / frost (no commissioning in bedewed state), horizontal installation	100 %; RH incl. condensation / frost (no commissioning in bedewed state), horizontal installation	100 %; RH incl. condensation / frost (no commissioning in bedewed state), horizontal installation	100 %; RH incl. condensation / frost (no commissioning in bedewed state), horizontal installation
<b>Resistance</b>				
• Coolants and lubricants	Yes; Incl. diesel and oil droplets in the air	No	Yes; Incl. diesel and oil droplets in the air	No
• Use in stationary industrial systems	Yes; Class 3B2 mold, fungus and dry rot spores (with the exception of fauna); Class 3B3 on request	Yes; Class 3B2 mold, fungus and dry rot spores (with the exception of fauna); Class 3B3 on request	Yes; Class 3B2 mold, fungus and dry rot spores (with the exception of fauna); Class 3B3 on request	Yes; Class 3B2 mold, fungus and dry rot spores (with the exception of fauna); Class 3B3 on request
- to biologically active substances according to EN 60721-3-3	Yes; Class 3C4 (RH < 75 %) incl. salt spray acc. to EN 60068-2-52 (severity degree 3); *	Yes; Class 3C4 (RH < 75 %) incl. salt spray acc. to EN 60068-2-52 (severity degree 3); *	Yes; Class 3C4 (RH < 75 %) incl. salt spray acc. to EN 60068-2-52 (severity degree 3); *	Yes; Class 3C4 (RH < 75 %) incl. salt spray acc. to EN 60068-2-52 (severity degree 3); *
- to chemically active substances according to EN 60721-3-3	Yes; Class 3S4 incl. sand, dust; *	Yes; Class 3S4 incl. sand, dust; *	Yes; Class 3S4 incl. sand, dust; *	Yes; Class 3S4 incl. sand, dust; *
- to mechanically active substances according to EN 60721-3-3	Yes; Class 3M8 using the SIPLUS Mounting Kit ET 200SP (6AG1193-6AA00-0AA0)	Yes; Class 3M8 using the SIPLUS Mounting Kit ET 200SP (6AG1193-6AA00-0AA0)	Yes; Class 3M8 using the SIPLUS Mounting Kit ET 200SP (6AG1193-6AA00-0AA0)	Yes; Class 3M8 using the SIPLUS Mounting Kit ET 200SP (6AG1193-6AA00-0AA0)
- Against mechanical environmental conditions acc. to EN 60721-3-3	Yes; Class 5B2 mold, fungus and dry rot spores (with the exception of fauna); Class 5B3 on request	Yes; Class 5B2 mold, fungus and dry rot spores (with the exception of fauna); Class 5B3 on request	Yes; Class 5B2 mold, fungus and dry rot spores (with the exception of fauna); Class 5B3 on request	Yes; Class 5B2 mold, fungus and dry rot spores (with the exception of fauna); Class 5B3 on request
• Use on land craft, rail vehicles and special-purpose vehicles	Yes; Class 5C3 (RH < 75 %) incl. salt spray acc. to EN 60068-2-52 (severity degree 3); *	Yes; Class 5C3 (RH < 75 %) incl. salt spray acc. to EN 60068-2-52 (severity degree 3); *	Yes; Class 5C3 (RH < 75 %) incl. salt spray acc. to EN 60068-2-52 (severity degree 3); *	Yes; Class 5C3 (RH < 75 %) incl. salt spray acc. to EN 60068-2-52 (severity degree 3); *
- to biologically active substances according to EN 60721-3-5	Yes; Class 5S3 incl. sand, dust; *	Yes; Class 5S3 incl. sand, dust; *	Yes; Class 5S3 incl. sand, dust; *	Yes; Class 5S3 incl. sand, dust; *
- to chemically active substances according to EN 60721-3-5	Yes; Class 5M2 using the SIPLUS Mounting Kit ET 200SP (6AG1193-6AA00-0AA0)	Yes; Class 5M2 using the SIPLUS Mounting Kit ET 200SP (6AG1193-6AA00-0AA0)	Yes; Class 5M2 using the SIPLUS Mounting Kit ET 200SP (6AG1193-6AA00-0AA0)	Yes; Class 5M2 using the SIPLUS Mounting Kit ET 200SP (6AG1193-6AA00-0AA0)
- to mechanically active substances according to EN 60721-3-5	Yes; level 1 (Location LE) using the SIPLUS Mounting Kit ET 200SP (6AG1193-6AA00-0AA0)	Yes; level 1 (Location LE) using the SIPLUS Mounting Kit ET 200SP (6AG1193-6AA00-0AA0)	Yes; level 1 (Location LE) using the SIPLUS Mounting Kit ET 200SP (6AG1193-6AA00-0AA0)	Yes; level 1 (Location LE) using the SIPLUS Mounting Kit ET 200SP (6AG1193-6AA00-0AA0)
- Against mechanical environmental conditions acc. to EN 60721-3-5	Yes; Class 3 (excluding trichlorethylene)	Yes; Class 3 (excluding trichlorethylene)	Yes; Class 3 (excluding trichlorethylene)	Yes; Class 3 (excluding trichlorethylene)
• Use in industrial process technology	Yes; Level GX group A/B (excluding trichlorethylene; harmful gas concentrations up to the limits of EN 60721-3-3 class 3C4 permissible); level LC3 (salt spray) and level LB3 (oil)	Yes; Level GX group A/B (excluding trichlorethylene; harmful gas concentrations up to the limits of EN 60721-3-3 class 3C4 permissible); level LC3 (salt spray) and level LB3 (oil)	Yes; Level GX group A/B (excluding trichlorethylene; harmful gas concentrations up to the limits of EN 60721-3-3 class 3C4 permissible); level LC3 (salt spray) and level LB3 (oil)	Yes; Level GX group A/B (excluding trichlorethylene; harmful gas concentrations up to the limits of EN 60721-3-3 class 3C4 permissible); level LC3 (salt spray) and level LB3 (oil)
- Against chemically active substances acc. to EN 60654-4				
- Environmental conditions for process, measuring and control systems acc. to ANSI/ISA-71.04				
• Remark	* The supplied plug covers must remain in place over the unused interfaces during operation!	* The supplied plug covers must remain in place over the unused interfaces during operation!	* The supplied plug covers must remain in place over the unused interfaces during operation!	* The supplied plug covers must remain in place over the unused interfaces during operation!
- Note regarding classification of environmental conditions acc. to EN 60721, EN 60654-4 and ANSI/ISA-71.04				

# SIPLUS RAIL

## SIPLUS Distributed Controller RAIL based on SIPLUS ET 200SP

### SIPLUS extreme RAIL standard CPUs

Article number	6AG2510-1DJ01-1AB0 SIPLUS ET 200SP CPU 1510SP-1 PN RAIL	6AG2510-1DJ01-4AB0 SIPLUS ET 200SP CPU 1510SP-1 PN RAIL	6AG2512-1DK01-1AB0 SIPLUS ET 200SP CPU 1512SP-1 PN RAIL	6AG2512-1DK01-4AB0 SIPLUS ET 200SP CPU 1512SP-1 PN RAIL
<b>Conformal coating</b>				
<ul style="list-style-type: none"> <li>Coatings for printed circuit board assemblies acc. to EN 61086</li> <li>Protection against fouling acc. to EN 60664-3</li> <li>Electronic equipment on rolling stock acc. to EN 50155</li> <li>Military testing according to MIL-I-46058C, Amendment 7</li> <li>Qualification and Performance of Electrical Insulating Compound for Printed Board Assemblies according to IPC-CC-830A</li> </ul>	Yes; Class 2 for high reliability Yes; Type 1 protection  Yes; Class PC2 protective coating acc. to EN 50155:2017 Yes; Discoloration of coating possible during service life Yes; Conformal coating, Class A	Yes; Class 2 for high reliability Yes; Type 1 protection  Yes; Class PC2 protective coating acc. to EN 50155:2017 Yes; Discoloration of coating possible during service life Yes; Conformal coating, Class A	Yes; Class 2 for high reliability Yes; Type 1 protection  Yes; Class PC2 protective coating acc. to EN 50155:2017 Yes; Discoloration of coating possible during service life Yes; Conformal coating, Class A	Yes; Class 2 for high reliability Yes; Type 1 protection  Yes; Class PC2 protective coating acc. to EN 50155:2017 Yes; Discoloration of coating possible during service life Yes; Conformal coating, Class A
<b>Configuration / header</b>				
<b>Configuration / programming / header</b>				
<ul style="list-style-type: none"> <li>Programming language</li> <li>- LAD</li> <li>- FBD</li> <li>- STL</li> <li>- SCL</li> <li>- GRAPH</li> </ul>	Yes Yes Yes Yes Yes	Yes Yes Yes Yes Yes	Yes Yes Yes Yes Yes	Yes Yes Yes Yes Yes
<b>Know-how protection</b>				
<ul style="list-style-type: none"> <li>User program protection/password protection</li> <li>Copy protection</li> <li>Block protection</li> </ul>	Yes Yes Yes	Yes Yes Yes	Yes Yes Yes	Yes Yes Yes
<b>Access protection</b>				
<ul style="list-style-type: none"> <li>protection of confidential configuration data</li> <li>Protection level: Write protection</li> <li>Protection level: Read/write protection</li> <li>Protection level: Complete protection</li> </ul>	Yes Yes Yes Yes	Yes Yes Yes Yes	Yes Yes Yes Yes	Yes Yes Yes Yes
<b>Dimensions</b>				
<b>Width</b>	100 mm	100 mm	100 mm	100 mm
<b>Height</b>	117 mm	117 mm	117 mm	117 mm
<b>Depth</b>	75 mm	75 mm	75 mm	75 mm
<b>Weights</b>				
<b>Weight, approx.</b>	310 g	470 g	310 g	470 g
<b>Other</b>				
<b>Note:</b>	for use in railway applications, also observe the product information "SIPLUS extreme RAIL" A5E37661960A, Online Support article 109736776	for use in railway applications, also observe the product information "SIPLUS extreme RAIL" A5E37661960A, Online Support article 109736776	for use in railway applications, also observe the product information "SIPLUS extreme RAIL" A5E37661960A, Online Support article 109736776	for use in railway applications, also observe the product information "SIPLUS extreme RAIL" A5E37661960A, Online Support article 109736776

### More information

#### Additional information and downloads

##### Manuals

The manuals for ET 200SP can be downloaded free of charge from the Internet (SIMATIC Customer Support).  
<http://support.automation.siemens.com/WWW/view/en/84133942>

##### General information

<http://www.siemens.com/et200sp>

##### SIMATIC Selection Tool

<http://www.siemens.com/tia-selection-tool>

## SIPLUS RAIL

SIPLUS Distributed Controller RAIL  
based on SIPLUS ET 200SP

### SIPLUS extreme RAIL standard CPUs > SIPLUS ET 200SP CPU 1510SP-1 PN RAIL

#### Overview



- SIPLUS ET 200SP CPU 1510SP-1 PN RAIL for SIPLUS extreme RAIL ET 200SP based on SIPLUS S7-1500 CPU 1511-1 PN
- Approved in accordance with the EN 50155, EN 15121, EN 50124, EN 50125 and EN 45545 railway standards for use in rail traffic
- For high-performance control solutions using ET 200SP
- Increase in availability of systems and machines
- PROFINET IO controller for up to 64 IO devices
- PROFINET I-Device for connecting the CPU as an intelligent PROFINET device with a SIMATIC or third-party PROFINET IO controller
- PROFINET shared I-device for 4 controllers
- PROFINET IO IRT interface with integrated 3-port switch
- Isochronous mode on PROFINET
- With multiple communication options: PG/OP communication, PROFINET IO, open IE communication (TCP, ISO-on-TCP and UDP), web server and S7 communication (with loadable FBs)
- Optional PROFIBUS DP master for 125 PROFIBUS DP slaves (with CM DP module 6ES7545-5DA00-0AB0)
- Optional PROFIBUS DP slave (with CM DP module 6ES7545-5DA00-0AB0)
- Configuration control (option handling)
- Integrated motion control functionalities for controlling speed-controlled and positioning axes, support for external encoders

#### Note

SIMATIC Memory Card required for operation of the CPU. BusAdapter not included in scope of delivery and to be ordered separately.

#### Application

SIPLUS ET 200SP CPU 1510SP-1 PN RAIL is a cost-effective, entry-level CPU for applications with average requirements in terms of processing performance and response speed in discrete production technology. SIPLUS ET 200SP CPU 1510SP-1 PN RAIL can be used as a PROFINET IO controller or as distributed intelligence (PROFINET I-Device). The integrated PROFINET IO IRT interface is designed as a 3-port switch enabling configuration of a linear topology in the system via port 1 and 2, such that a PG/PC or HMI device can also be connected via port 3.

When used as an I-device, the SIPLUS ET 200SP CPU 1510SP-1 PN RAIL facilitates distributed preprocessing of process data locally and only delivers the information actually required to the higher-level controller. This has the following advantages:

- Less load on central controller
- Short response times to critical local signals
- Less load on the bus system due to smaller data volumes
- Faster commissioning due to pre-tested units and parallel commissioning
- Increased availability and flexibility thanks to autonomous machine units
- Transparent configuration

The SIPLUS ET 200SP CPU 1510SP-1 PN RAIL operates completely independently of the central controller. If it fails, the SIPLUS ET 200SP CPU 1510SP-1 PN RAIL continues to run.

The bit-modular design of the ET 200SP I/O system, together with SIPLUS ET 200SP CPU 1510SP-1 PN RAIL, enables functionally oriented station design.

In addition, the CPU offers comprehensive control functionalities via easy-to-configure blocks as well as the ability to connect drives via standardized PLC-open blocks.

#### Design

The SIPLUS ET 200SP CPU 1510SP-1 PN CPU RAIL is directly snapped onto the standard DIN rail and features:

- A powerful processor:  
The CPU achieves command execution times as low as 72 ns per binary instruction.
- A large work memory:  
100 KB for program, 750 KB for data
- SIMATIC Memory Cards as load memories  
Permits additional functions such as firmware updates, data-log and archives
- Bit-modular expandability for maximum flexibility  
Up to 64 I/O modules (I/O, technology, and communication modules) in any combination. Station width up to 1 m.
- Mixed configuration with ET 200AL  
Possible to integrate up to 16 I/O modules of the ET 200AL (IP65/IP67) I/O system in a scalable I/O system ET 200SP (IP20) installation via a "BU-Send" BaseUnit and a "BA-Send" BusAdapter.
- PROFINET IO IRT interface with 3 integrated switch ports:
  - Port 1 and 2 via BusAdapter (SIPLUS ET 200SP CPU 1510SP-1 PN CPU RAIL is supplied without the BusAdapter and can also be operated without it. An appropriate BusAdapter can be ordered separately if needed)
  - Port 3 via integrated RJ45 socket
- Integrated communication functions:
  - PG/OP communication
  - PROFINET IO
  - Open IE communication (TCP, ISO-on-TCP and UDP)
  - OPC UA server (data access)
  - Web server
  - S7 communication
  - S7 routing
  - Data set routing
- Maintenance-free data backup without battery
- Diagnostics displays for errors (Error), operation (RUN/Stop), maintenance (MT), power supply (PWR) and one link LED per port

### SIPLUS extreme RAIL standard CPUs > SIPLUS ET 200SP CPU 1510SP-1 PN RAIL

- Optional labeling using light gray or yellow labeling strips.  
Choice of 2 materials:
    - Foil and roll with 500 strips, for thermal transfer roll printers
    - Paper (280 g/m<sup>2</sup>), DIN A4 sheets with 100 strips each, for laser printers
  - The ET 200SP CPU can be equipped with a reference ID label
  - Different PROFINET connection types by means of Bus-Adapter
    - SIMATIC BusAdapters with an RJ45 interface, e.g. Bus-Adapter BA 2xRJ45, can be used in standard applications with moderate mechanical and low EMC loads
    - For machines and systems in which higher mechanical and/or EMC loads act on the devices, SIMATIC BusAdapters with connection via FastConnect (FC) are recommended.
    - The use of SIMATIC BusAdapters with a FO cable connection (SCRJ, LC) is not possible with the SIPLUS ET 200SP CPU 1510SP-1 PN CPU RAIL.
  - Dark BaseUnit as first BaseUnit behind the ET 200SP CPU when using an AC I/O module or an AI Energy Meter ST as the first I/O module
- Scope of delivery:  
SIPLUS ET 200SP CPU 1510SP-1 PN CPU RAIL including server module, 24 V DC connector and cover for BusAdapter port (BusAdapter must be ordered separately)
- 
- #### Function
- Performance
    - High-speed command processing
    - Powerful network connection:  
CPU is equipped with a PROFINET IO IRT (3-port switch) as the standard interface
  - Integrated technology
    - Connection of analog and PROFIdrive-capable drives via standardized blocks (PLCopen)
    - Support of speed-controlled and positioning axes as well as external encoders
    - Precise position gearing for synchronous operation between axes
    - Trace functions for all CPU tags, both for diagnostics in real time as well as for sporadic error detection
    - Comprehensive control functionalities, e.g. easily configurable blocks for automatic optimization of the control parameters for optimum control quality
  - Isochronous mode
    - Synchronous coupling of distributed signal acquisition, signal transmission, and program execution to the PROFINET cycle with constant bus cycle time
  - Security Integrated
    - Password-based know-how protection against unauthorized read-out and modification of program blocks
    - Copy protection for tying individual blocks to the serial number of the SIMATIC Memory Card: The block can only run if the configured memory card is inserted into the CPU.
    - 4-level authorization concept:  
Communication to the HMI devices can also be restricted.
    - Manipulation protection:  
The controller recognizes changed or unauthorized transmissions of the engineering data.
  - Integrated system diagnostics
    - System diagnostics information is displayed consistently and in plain text in the TIA Portal, HMI devices and Web server, even for messages from the drives, and is updated even if the CPU is in STOP mode.
    - Integrated into the firmware of the CPU, no special configuration is required
  - Configuration control (option handling) in central setup
    - Various hardware configurations can be stored in the controller:  
Modification of the configuration in the user program (startup OB100)  
Retrofitting of options at end of configuration  
Use of placeholder modules is possible.
  - SIMATIC Memory Card (required for operation of the CPU)
    - Used as a plug-in load memory or for updating the firmware.
    - Also for storing additional documents or csv files (for recipes and archives)
    - Creation of data blocks for storage/reading of data via SFCs of the user program
  - Datalog (archives) and recipes
    - Storage of csv files for recipes and archives on the SIMATIC Memory Card;  
easy access to plant-relevant operating data using Office tools or via a Web server
    - Easy access to machine configuration data by means of a Web browser or SD card reader (two-way data exchange from and to the controller)
  - Programming
    - Programming with STEP 7 Professional, V13 update 3 and higher



**SIPLUS RAIL**

SIPLUS Distributed Controller RAIL  
based on SIPLUS ET 200SP

**SIPLUS extreme RAIL standard CPUs > SIPLUS ET 200SP CPU 1510SP-1 PN RAIL****Technical specifications**

Article number	<b>6AG2510-1DJ01-1AB0</b> SIPLUS ET 200SP CPU 1510SP-1 PN RAIL	<b>6AG2510-1DJ01-4AB0</b> SIPLUS ET 200SP CPU 1510SP-1 PN RAIL
<b>General information</b>		
<b>Product type designation</b>	CPU 1510SP-1 PN	CPU 1510SP-1 PN
<b>Engineering with</b> • STEP 7 TIA Portal configurable/integrated from version	see entry ID: 109746275	see entry ID: 109746275
<b>Supply voltage</b>		
<b>Rated value (DC)</b>	24 V	24 V
<b>Memory</b>		
<b>Work memory</b> • integrated (for program) • integrated (for data)	100 kbyte 750 kbyte	100 kbyte 750 kbyte
<b>Load memory</b> • Plug-in (SIMATIC Memory Card), max.	32 Gbyte	32 Gbyte
<b>CPU processing times</b>		
<b>for bit operations, typ.</b>	72 ns	72 ns
<b>for word operations, typ.</b>	86 ns	86 ns
<b>for fixed point arithmetic, typ.</b>	115 ns	115 ns
<b>for floating point arithmetic, typ.</b>	461 ns	461 ns
<b>Counters, timers and their retentivity</b>		
<b>S7 counter</b> • Number	2 048	2 048
<b>IEC counter</b> • Number	Any (only limited by the main memory)	Any (only limited by the main memory)
<b>S7 times</b> • Number	2 048	2 048
<b>IEC timer</b> • Number	Any (only limited by the main memory)	Any (only limited by the main memory)
<b>Data areas and their retentivity</b>		
<b>Flag</b> • Size, max.	16 kbyte	16 kbyte
<b>Address area</b>		
<b>I/O address area</b> • Inputs • Outputs	32 kbyte; All inputs are in the process image 32 kbyte; All outputs are in the process image	32 kbyte; All inputs are in the process image 32 kbyte; All outputs are in the process image
<b>Address space per module</b> • Address space per module, max.	288 byte; For input and output data respectively	288 byte; For input and output data respectively
<b>Address space per station</b> • Address space per station, max.	2 560 byte; for central inputs and outputs; depending on configuration; 2 048 bytes for ET 200SP modules + 512 bytes for ET 200AL modules	2 560 byte; for central inputs and outputs; depending on configuration; 2 048 bytes for ET 200SP modules + 512 bytes for ET 200AL modules
<b>Time of day</b>		
<b>Clock</b> • Type	Hardware clock	Hardware clock
<b>1. Interface</b>		
<b>Interface types</b> • RJ 45 (Ethernet)  • Number of ports • integrated switch • BusAdapter (PROFINET)	Yes; X1 P3; opt. X1 P1 and X1 P2 via BusAdapter BA 2x RJ45 3; 1. integr. + 2. via BusAdapter Yes Yes; compatible BusAdapters: BA 2x RJ45, BA 2x FC, BA 2x M12	Yes; X1 P3  1  No
<b>Protocols</b> • IP protocol • PROFINET IO Controller • PROFINET IO Device • SIMATIC communication • Open IE communication • Web server • Media redundancy	Yes; IPv4 Yes Yes Yes Yes; Optionally also encrypted Yes Yes; MRP Automanager according to IEC 62439-2 Edition 2.0	Yes; IPv4 Yes Yes Yes Yes; Optionally also encrypted Yes No

### SIPLUS extreme RAIL standard CPUs > SIPLUS ET 200SP CPU 1510SP-1 PN RAIL

Article number	6AG2510-1DJ01-1AB0 SIPLUS ET 200SP CPU 1510SP-1 PN RAIL	6AG2510-1DJ01-4AB0 SIPLUS ET 200SP CPU 1510SP-1 PN RAIL
<b>PROFINET IO Controller</b>		
<ul style="list-style-type: none"> <li>Services <ul style="list-style-type: none"> <li>PG/OP communication</li> <li>Isochronous mode</li> <li>Direct data exchange</li> </ul> </li> <li>IRT</li> <li>PROFenergy</li> <li>Prioritized startup</li> <li>Number of connectable IO Devices, max.</li> <li>Of which IO devices with IRT, max.</li> <li>Number of connectable IO Devices for RT, max.</li> <li>of which in line, max.</li> <li>Number of IO Devices that can be simultaneously activated/deactivated, max.</li> <li>Number of IO Devices per tool, max.</li> <li>Updating times</li> </ul>	<ul style="list-style-type: none"> <li>Yes</li> <li>Yes</li> <li>Yes; Requirement: IRT and isochronous mode (MRPD optional)</li> <li>Yes</li> <li>Yes; per user program</li> <li>Yes; Max. 32 PROFINET devices</li> <li>64; In total, up to 256 distributed I/O devices can be connected via AS-i, PROFIBUS or PROFINET</li> <li>64</li> <li>64</li> <li>64</li> <li>8; in total across all interfaces</li> <li>8</li> <li>The minimum value of the update time also depends on communication share set for PROFINET IO, on the number of IO devices, and on the quantity of configured user data</li> </ul>	<ul style="list-style-type: none"> <li>Yes</li> <li>Yes</li> <li>Yes; Requirement: IRT and isochronous mode (MRPD optional)</li> <li>Yes</li> <li>Yes; per user program</li> <li>Yes; Max. 32 PROFINET devices</li> <li>64; In total, up to 256 distributed I/O devices can be connected via AS-i, PROFIBUS or PROFINET</li> <li>64</li> <li>64</li> <li>64</li> <li>8; in total across all interfaces</li> <li>8</li> <li>The minimum value of the update time also depends on communication share set for PROFINET IO, on the number of IO devices, and on the quantity of configured user data</li> </ul>
<b>PROFINET IO Device</b>		
<ul style="list-style-type: none"> <li>Services <ul style="list-style-type: none"> <li>PG/OP communication</li> <li>Isochronous mode</li> <li>IRT</li> <li>PROFenergy</li> <li>Shared device</li> <li>Number of IO Controllers with shared device, max.</li> <li>activation/deactivation of I-devices</li> <li>Asset management record</li> </ul> </li> </ul>	<ul style="list-style-type: none"> <li>Yes</li> <li>No</li> <li>Yes</li> <li>Yes; per user program</li> <li>Yes</li> <li>4</li> <li>Yes; per user program</li> <li>Yes; per user program</li> </ul>	<ul style="list-style-type: none"> <li>Yes</li> <li>No</li> <li>Yes</li> <li>Yes; per user program</li> <li>Yes</li> <li>4</li> <li>Yes; per user program</li> <li>Yes; per user program</li> </ul>
<b>2. Interface</b>		
<b>Interface types</b>		
<ul style="list-style-type: none"> <li>RS 485</li> <li>Number of ports</li> </ul>	<ul style="list-style-type: none"> <li>Yes; Via CM DP module 1</li> </ul>	<ul style="list-style-type: none"> <li>Yes; Via CM DP module 1</li> </ul>
<b>Protocols</b>		
<ul style="list-style-type: none"> <li>PROFIBUS DP master</li> <li>PROFIBUS DP slave</li> <li>SIMATIC communication</li> </ul>	<ul style="list-style-type: none"> <li>Yes</li> <li>Yes</li> <li>Yes</li> </ul>	<ul style="list-style-type: none"> <li>Yes</li> <li>Yes</li> <li>Yes</li> </ul>
<b>PROFIBUS DP master</b>		
<ul style="list-style-type: none"> <li>Number of DP slaves, max.</li> </ul>	125; In total, up to 256 distributed I/O devices can be connected via AS-i, PROFIBUS or PROFINET	125; In total, up to 256 distributed I/O devices can be connected via AS-i, PROFIBUS or PROFINET
<b>Protocols</b>		
<b>Number of connections</b>		
<ul style="list-style-type: none"> <li>Number of connections, max.</li> </ul>	96; via integrated interfaces of the CPU and connected CPs / CMs	96; via integrated interfaces of the CPU and connected CPs / CMs
<b>Redundancy mode</b>		
<ul style="list-style-type: none"> <li>Media redundancy <ul style="list-style-type: none"> <li>Media redundancy</li> <li>MRP</li> </ul> </li> <li>MRP interconnection, supported</li> <li>MRPD</li> <li>Switchover time on line break, typ.</li> <li>Number of stations in the ring, max.</li> </ul>	<ul style="list-style-type: none"> <li>Yes; only via BusAdapter</li> <li>Yes; MRP Automanager according to IEC 62439-2 Edition 2.0, MRP Manager; MRP Client</li> <li>Yes; as MRP ring node according to IEC 62439-2 Edition 3.0</li> <li>Yes; Requirement: IRT</li> <li>200 ms; For MRP, bumpless for MRPD</li> <li>50</li> </ul>	<ul style="list-style-type: none"> <li>No</li> <li>No</li> <li>No</li> <li>No</li> </ul>
<b>SIMATIC communication</b>		
<ul style="list-style-type: none"> <li>S7 routing</li> </ul>	Yes	Yes
<b>OPC UA</b>		
<ul style="list-style-type: none"> <li>OPC UA Client</li> <li>OPC UA Server</li> <li>Alarms and Conditions</li> </ul>	<ul style="list-style-type: none"> <li>Yes</li> <li>Yes; Data access (read, write, subscribe), method call, custom address space</li> <li>Yes</li> </ul>	<ul style="list-style-type: none"> <li>Yes</li> <li>Yes; Data access (read, write, subscribe), method call, custom address space</li> <li>Yes</li> </ul>
<b>Supported technology objects</b>		
<b>Motion Control</b>		
<ul style="list-style-type: none"> <li>Number of available Motion Control resources for technology objects</li> <li>Required Motion Control resources <ul style="list-style-type: none"> <li>per speed-controlled axis</li> <li>per positioning axis</li> <li>per synchronous axis</li> <li>per external encoder</li> <li>per output cam</li> <li>per cam track</li> <li>per probe</li> </ul> </li> </ul>	<ul style="list-style-type: none"> <li>Yes; Note: The number of technology objects affects the cycle time of the PLC program; selection guide via the TIA Selection Tool</li> <li>800</li> <li>40</li> <li>80</li> <li>160</li> <li>80</li> <li>20</li> <li>160</li> <li>40</li> </ul>	<ul style="list-style-type: none"> <li>Yes; Note: The number of technology objects affects the cycle time of the PLC program; selection guide via the TIA Selection Tool</li> <li>800</li> <li>40</li> <li>80</li> <li>160</li> <li>80</li> <li>20</li> <li>160</li> <li>40</li> </ul>



**SIPLUS RAIL**

SIPLUS Distributed Controller RAIL  
based on SIPLUS ET 200SP

**SIPLUS extreme RAIL standard CPUs > SIPLUS ET 200SP CPU 1510SP-1 PN RAIL**

Article number	<b>6AG2510-1DJ01-1AB0</b> SIPLUS ET 200SP CPU 1510SP-1 PN RAIL	<b>6AG2510-1DJ01-4AB0</b> SIPLUS ET 200SP CPU 1510SP-1 PN RAIL
<b>Controller</b> • PID_Compact  • PID_3Step  • PID-Temp	Yes; Universal PID controller with integrated optimization Yes; PID controller with integrated optimization for valves Yes; PID controller with integrated optimization for temperature	Yes; Universal PID controller with integrated optimization Yes; PID controller with integrated optimization for valves Yes; PID controller with integrated optimization for temperature
<b>Counting and measuring</b> • High-speed counter	Yes	Yes
<b>Standards, approvals, certificates</b>		
<b>Railway application</b> • EN 50121-3-2 • EN 50121-4  • EN 50124-1  • EN 50125-1 • EN 50125-2  • EN 50125-3  • EN 50155  • EN 61373  • Fire protection acc. to EN 45545-2	Yes; EMC for rail vehicles Yes; EMC for signal and telecommunications systems Yes; Railway applications - overvoltage category OV2; pollution degree PD2; rated surge voltage UNi = 0.5 kV; UNm = 24 V DC Yes; Rail vehicles - see ambient conditions Yes; Stationary electrical equipment - see ambient conditions Yes; Signal and telecommunications systems - see ambient conditions; vibrations and shocks: Application point outside of tracks (1 m to 3 m away from track) Yes; Rail vehicles - temperature class OT1, ST1/ST2, horizontal mounting position Yes; Rail vehicles - vibrations and shocks: Category 1 Class A/B Yes; For proof of conformity, see Service & Support	Yes; EMC for rail vehicles Yes; EMC for signal and telecommunications systems Yes; Railway applications - overvoltage category OV2; pollution degree PD2; rated surge voltage UNi = 0.5 kV; UNm = 24 V DC Yes; Rail vehicles - see ambient conditions Yes; Stationary electrical equipment - see ambient conditions Yes; Signal and telecommunications systems - see ambient conditions; vibrations and shocks: Application point outside of tracks (1 m to 3 m away from track) Yes; Rail vehicles - temperature class OT4, ST1/ST2, horizontal mounting position Yes; Rail vehicles - vibrations and shocks: Category 1 Class A/B Yes; For proof of conformity, see Service & Support
<b>Ambient conditions</b>		
<b>Ambient temperature during operation</b> • horizontal installation, min. • horizontal installation, max.  • vertical installation, min. • vertical installation, max.	-40 °C; = Tmin (incl. condensation/frost) 60 °C; = Tmax; +70 °C for 10 min (OT1, ST1/ST2 acc. to EN 50155) -40 °C; = Tmin 50 °C; = Tmax	-40 °C; = Tmin (incl. condensation/frost) 70 °C; = Tmax; +85 °C for 10 min (OT4, ST1/ST2 acc. to EN 50155) -40 °C; = Tmin 50 °C; = Tmax
<b>Altitude during operation relating to sea level</b> • Installation altitude above sea level, max. • Ambient air temperature-barometric pressure-altitude	2 000 m Tmin ... Tmax at 1 140 hPa ... 795 hPa (-1 000 m ... +2 000 m)	2 000 m Tmin ... Tmax at 1 140 hPa ... 795 hPa (-1 000 m ... +2 000 m)
<b>Relative humidity</b> • With condensation, tested in accordance with IEC 60068-2-38, max.	100 %; RH incl. condensation / frost (no commissioning in bedewed state), horizontal installation	100 %; RH incl. condensation / frost (no commissioning in bedewed state), horizontal installation
<b>Resistance</b> • Coolants and lubricants - Resistant to commercially available coolants and lubricants • Use in stationary industrial systems - to biologically active substances according to EN 60721-3-3 - to chemically active substances according to EN 60721-3-3 - to mechanically active substances according to EN 60721-3-3 - Against mechanical environmental conditions acc. to EN 60721-3-3 • Use on land craft, rail vehicles and special-purpose vehicles - to biologically active substances according to EN 60721-3-5 - to chemically active substances according to EN 60721-3-5 - to mechanically active substances according to EN 60721-3-5 - Against mechanical environmental conditions acc. to EN 60721-3-5 - against mechanical environmental conditions in agriculture acc. to ISO 15003 • Usage in industrial process technology - Against chemically active substances acc. to EN 60654-4 - Environmental conditions for process, measuring and control systems acc. to ANSI/ISA-71.04	Yes; Incl. diesel and oil droplets in the air  Yes; Class 3B2 mold, fungus and dry rot spores (with the exception of fauna); Class 3B3 on request Yes; Class 3C4 (RH < 75 %) incl. salt spray acc. to EN 60068-2-52 (severity degree 3); * Yes; Class 3S4 incl. sand, dust, *  Yes; Class 3M8 using the SIPLUS Mounting Kit ET 200SP (6AG1193-6AA00-0AA0)  Yes; Class 5B2 mold, fungus and dry rot spores (with the exception of fauna); Class 5B3 on request Yes; Class 5C3 (RH < 75 %) incl. salt spray acc. to EN 60068-2-52 (severity degree 3); * Yes; Class 5S3 incl. sand, dust, *  Yes; Class 5M2 using the SIPLUS Mounting Kit ET 200SP (6AG1193-6AA00-0AA0) Yes; level 1 (Location LE) using the SIPLUS Mounting Kit ET 200SP (6AG1193-6AA00-0AA0)  Yes; Class 3 (excluding trichlorethylene)  Yes; Level GX group A/B (excluding trichlorethylene; harmful gas concentrations up to the limits of EN 60721-3-3 class 3C4 permissible); level LC3 (salt spray) and level LB3 (oil)	No  Yes; Class 3B2 mold, fungus and dry rot spores (with the exception of fauna); Class 3B3 on request Yes; Class 3C4 (RH < 75 %) incl. salt spray acc. to EN 60068-2-52 (severity degree 3); * Yes; Class 3S4 incl. sand, dust, *  Yes; Class 5B2 mold, fungus and dry rot spores (with the exception of fauna); Class 5B3 on request Yes; Class 5C3 (RH < 75 %) incl. salt spray acc. to EN 60068-2-52 (severity degree 3); * Yes; Class 5S3 incl. sand, dust, *  Yes; Class 3 (excluding trichlorethylene)  Yes; Level GX group A/B (excluding trichlorethylene; harmful gas concentrations up to the limits of EN 60721-3-3 class 3C4 permissible); level LC3 (salt spray) and level LB3 (oil)

## SIPLUS extreme RAIL standard CPUs > SIPLUS ET 200SP CPU 1510SP-1 PN RAIL

Article number	6AG2510-1DJ01-1AB0 SIPLUS ET 200SP CPU 1510SP-1 PN RAIL	6AG2510-1DJ01-4AB0 SIPLUS ET 200SP CPU 1510SP-1 PN RAIL
<ul style="list-style-type: none"> <li>Remark</li> <li>Note regarding classification of environmental conditions acc. to EN 60721, EN 60654-4 and ANSI/ISA-71.04</li> </ul>	* The supplied plug covers must remain in place over the unused interfaces during operation!	* The supplied plug covers must remain in place over the unused interfaces during operation!
<b>Conformal coating</b> <ul style="list-style-type: none"> <li>Coatings for printed circuit board assemblies acc. to EN 61086</li> <li>Protection against fouling acc. to EN 60664-3</li> <li>Electronic equipment on rolling stock acc. to EN 50155</li> <li>Military testing according to MIL-I-46058C, Amendment 7</li> <li>Qualification and Performance of Electrical Insulating Compound for Printed Board Assemblies according to IPC-CC-830A</li> </ul>	Yes; Class 2 for high reliability  Yes; Type 1 protection Yes; Class PC2 protective coating acc. to EN 50155:2017 Yes; Discoloration of coating possible during service life Yes; Conformal coating, Class A	Yes; Class 2 for high reliability  Yes; Type 1 protection Yes; Class PC2 protective coating acc. to EN 50155:2017 Yes; Discoloration of coating possible during service life Yes; Conformal coating, Class A
<b>Configuration / header</b>		
<b>Configuration / programming / header</b>		
<ul style="list-style-type: none"> <li>Programming language</li> <li>LAD</li> <li>FBD</li> <li>STL</li> <li>SCL</li> <li>GRAPH</li> </ul>	Yes Yes Yes Yes Yes	Yes Yes Yes Yes Yes
<b>Know-how protection</b> <ul style="list-style-type: none"> <li>User program protection/password protection</li> <li>Copy protection</li> <li>Block protection</li> </ul>	Yes Yes Yes	Yes Yes Yes
<b>Access protection</b> <ul style="list-style-type: none"> <li>protection of confidential configuration data</li> <li>Protection level: Write protection</li> <li>Protection level: Read/write protection</li> <li>Protection level: Complete protection</li> </ul>	Yes Yes Yes Yes	Yes Yes Yes Yes
<b>Dimensions</b>		
<b>Width</b>	100 mm	100 mm
<b>Height</b>	117 mm	117 mm
<b>Depth</b>	75 mm	75 mm
<b>Weights</b>		
<b>Weight, approx.</b>	310 g	470 g
<b>Other</b>		
<b>Note:</b>	for use in railway applications, also observe the product information "SIPLUS extreme RAIL" A5E37661960A, Online Support article 109736776	for use in railway applications, also observe the product information "SIPLUS extreme RAIL" A5E37661960A, Online Support article 109736776

### Selection and ordering data

Version	Article No.
<b>SIPLUS ET 200SP CPU 1510SP-1 PN T1 RAIL</b> Approved in accordance with EN 50155, EN 15121, EN 50124, EN 50125 and EN 45545 railway standards for use in rail traffic Work memory 100 KB for program, 750 KB for data, PROFINET IO IRT interface; SIMATIC Memory Card required For areas with extreme exposure to environmental substances (conformal coating); Ambient temperature -25 ... +55 °C (+70 °C for 10 min.)	<b>6AG2510-1DJ01-1AB0</b>
<b>SIPLUS ET 200SP CPU 1510SP-1 PN TX RAIL</b> Approved in accordance with EN 50155, EN 15121, EN 50124, EN 50125 and EN 45545 railway standards for use in rail traffic Work memory 100 KB for program, 750 KB for data, PROFINET IO IRT interface; SIMATIC Memory Card required For areas with extreme exposure to environmental substances (conformal coating); Ambient temperature -40 ... +70 °C (+85 °C for 10 min.)	<b>6AG2510-1DJ01-4AB0</b>
<b>Accessories</b>	
<b>SIPLUS ET 200SP BA 2XRJ45 TX RAIL BusAdapter</b> For PROFINET interface modules in Standard function class or above; max. cable length 50 m; For areas with extreme exposure to environmental substances (conformal coating) Ambient temperature -40 ... +70 °C (+85 °C for 10 min.)	<b>6AG2193-6AR00-4AA0</b>
<b>SIPLUS ET 200SP BA 2XFC TX RAIL BusAdapter</b> For PROFINET interface modules in Standard function class or above; for increased vibration and EMC load rating; max. cable length 50 m; for areas with extreme exposure to environmental substances (conformal coating); Ambient temperature -40 ... +70 °C (+85 °C for 10 min.)	<b>6AG2193-6AF00-4AA0</b>
<b>SIPLUS Mounting Kit ET 200SP</b> Mounting accessories for use with increased mechanical vibration and shock loads. Not approved for SIPLUS CPU 6AG2510-1DJ01-4AB0 and BusAdapter BA 2xRJ45	<b>6AG1193-6AA00-0AA0</b>

## SIPLUS RAIL

SIPLUS Distributed Controller RAIL  
based on SIPLUS ET 200SP

### SIPLUS extreme RAIL standard CPUs > SIPLUS ET 200SP CPU 1512SP-1 PN RAIL

#### Overview



- SIPLUS ET 200SP CPU 1512SP-1 PN RAIL for SIPLUS extreme RAIL ET 200SP based on SIPLUS S7-1500 CPU 1513-1 PN
- Approved in accordance with the EN 50155, EN 15121, EN 50124, EN 50125 and EN 45545 railway standards for use in rail traffic
- For applications with average requirements regarding the program scope and processing speed, for distributed setup via PROFINET IO or PROFIBUS DP
- Increase in availability of systems and machines
- PROFINET IO controller for up to 128 IO devices
- PROFINET I-Device for connecting the CPU as an intelligent PROFINET device with a SIMATIC or third-party PROFINET IO controller
- PROFINET shared I-device for 4 controllers
- PROFINET IO IRT interface with integrated 3-port switch
- Isochronous mode on PROFINET
- With multiple communication options: PG/OP communication, PROFINET IO, open IE communication (TCP, ISO-on-TCP and UDP), web server and S7 communication (with loadable FBs)
- Optional PROFIBUS DP master for 125 PROFIBUS DP slaves (with CM DP module 6ES7545-5DA00-0AB0)
- Optional PROFIBUS DP slave (with CM DP module 6ES7545-5DA00-0AB0)
- Configuration control (option handling)
- Integrated motion control functionalities for controlling speed-controlled and positioning axes, support for external encoders

#### Note

SIMATIC Memory Card required for operation of the CPU.  
BusAdapter not included in scope of delivery and to be ordered separately.

#### Application

SIPLUS ET 200SP CPU 1512SP-1 PN RAIL is designed for applications with average requirements in terms of processing performance and response speed in discrete production technology. SIPLUS ET 200SP CPU 1512SP-1 PN RAIL can be used as a PROFINET IO controller or as distributed intelligence (PROFINET I-Device). The integrated PROFINET IO IRT interface is designed as a 3-port switch enabling configuration of a linear topology in the system via port 1 and 2, such that a PG/PC or HMI device can also be connected via port 3.

When used as an I-device, the SIPLUS ET 200SP CPU 1512SP-1 PN RAIL facilitates local preprocessing of process data and only delivers the information actually required to the higher-level controller. This has the following advantages:

- Less load on central controller
- Short response times to critical local signals
- Less load on the bus system due to smaller data volumes
- Faster commissioning due to pre-tested units and parallel commissioning
- Increased availability and flexibility thanks to autonomous machine units
- Transparent configuration

The SIPLUS ET 200SP CPU 1512SP-1 PN RAIL operates completely independently of the central controller. If it fails, the SIPLUS ET 200SP CPU 1512SP-1 PN RAIL continues to run.

The bit-modular design of the ET 200SP I/O system, together with SIPLUS ET 200SP CPU 1512SP-1 PN RAIL, enables functionally oriented station design.

In addition, the CPU offers comprehensive control functionalities via easy-to-configure blocks as well as the ability to connect drives via standardized PLC-open blocks.

#### Design

The SIPLUS ET 200SP CPU 1512SP-1 PN CPU RAIL is directly snapped onto the standard DIN rail and features:

- Powerful processor:  
CPU achieves command execution times as low as 48 ns per binary instruction.
- Large work memory:  
200 KB for programs, 1 MB for data
- SIMATIC Memory Cards as load memories  
Permits additional functions such as firmware updates, data-log and archives
- Bit-modular expandability for maximum flexibility  
Up to 64 I/O modules (I/O, technology, and communication modules) in any combination. Station width up to 1 m.
- Mixed configuration with ET 200AL  
Possible to integrate up to 16 I/O modules of the ET 200AL (IP65/IP67) I/O system in a scalable I/O system ET 200SP (IP20) installation via a "BU-Send" BaseUnit and a "BA-Send" BusAdapter.
- PROFINET IO IRT interface with 3 integrated switch ports:
  - Port 1 and 2 via BusAdapter (SIPLUS ET 200SP CPU 1512SP-1 PN CPU RAIL is supplied without the BusAdapter and can also be operated without it. An appropriate BusAdapter can be ordered separately if needed)
  - Port 3 integrated RJ45 socket
- Integrated communication functions:
  - PG/OP communication
  - PROFINET IO
  - Open IE communication (TCP, ISO-on-TCP and UDP)
  - OPC UA server (data access)
  - Web server
  - S7 communication
  - S7 routing
  - Data set routing
- Maintenance-free data backup without battery
- Diagnostics displays for errors (Error), operation (RUN/Stop), maintenance (MT), power supply (PWR) and one link LED per port

### SIPLUS extreme RAIL standard CPUs > SIPLUS ET 200SP CPU 1512SP-1 PN RAIL

- Optional labeling using light gray or yellow labeling strips.  
Choice of 2 materials:
    - Foil and roll with 500 strips, for thermal transfer roll printers
    - Paper (280 g/m<sup>2</sup>), DIN A4 sheets with 100 strips each, for laser printers
  - The ET 200SP CPU can be equipped with an equipment labeling plate.
  - Different PROFINET connection types by means of Bus-Adapter
    - SIMATIC BusAdapters with an RJ45 interface, e.g. Bus-Adapter BA 2xRJ45, can be used in standard applications with moderate mechanical and low EMC loads
    - For machines and systems in which higher mechanical and/or EMC loads act on the devices, a SIMATIC Bus-Adapter with connection via FastConnect (FC) or FO cable (SCRJ or LC) is recommended. Likewise, all SIMATIC Bus-Adapters with an FO cable connection (SCRJ, LC) can be used with increased loads.
    - BusAdapters with connections for FO cables can be used to cover high potential differences between two stations and/or with high EMC loads.
  - Dark BaseUnit as first BaseUnit behind the ET 200SP CPU when using an AC I/O module or an AI Energy Meter ST as the first I/O module.
- Scope of delivery:  
CPU 1512SP-1 PN including server module, 24 V DC connector and cover for BusAdapter port (BusAdapter must be ordered separately).
- 
- #### Function
- Performance
    - High-speed command processing
    - Powerful network connection:  
CPU is equipped with a PROFINET IO IRT (3-port switch) as the standard interface
  - Integrated technology
    - Connection of analog and PROFIdrive-capable drives via standardized blocks (PLCopen)
    - Support of speed-controlled and positioning axes as well as external encoders
    - Precise position gearing for synchronous operation between axes
    - Trace functions for all CPU tags, both for diagnostics in real time as well as for sporadic error detection
    - Comprehensive control functionalities, e.g. easily configurable blocks for automatic optimization of the control parameters for optimum control quality
  - Isochronous mode
    - Synchronous coupling of distributed signal acquisition, signal transmission, and program execution to the PROFINET cycle with constant bus cycle time
  - Security Integrated
    - Password-based know-how protection against unauthorized read-out and modification of program blocks
    - Copy protection for tying individual blocks to the serial number of the SIMATIC Memory Card: The block can only run if the configured memory card is inserted into the CPU.
    - 4-level authorization concept: Communication to the HMI devices can also be restricted.
    - Manipulation protection: The controller recognizes changed or unauthorized transmissions of the engineering data.
  - Integrated system diagnostics
    - System diagnostics information is displayed consistently and in plain text in the TIA Portal, HMI devices and Web server, even for messages from the drives, and is updated even if the CPU is in STOP mode.
    - Integrated into the firmware of the CPU, no special configuration is required
  - Configuration control (option handling) in central setup
    - Various hardware configurations can be stored in the controller:  
Modification of the configuration in the user program (startup OB100)  
Retrofitting of options at end of configuration  
Use of placeholder modules is possible.
  - SIMATIC Memory Card (required for operation of the CPU)
    - Used as a plug-in load memory or for updating the firmware.
    - Also for storing additional documents or csv files (for recipes and archives)
    - Creation of data blocks for storage/reading of data via SFCs of the user program
  - Datalog (archives) and recipes
    - Storage of csv files for recipes and archives on the SIMATIC Memory Card;  
easy access to plant-relevant operating data using Office tools or via a Web server
    - Easy access to machine configuration data by means of a Web browser or SD card reader (two-way data exchange from and to the controller)
  - Programming
    - Programming with STEP 7 Professional, V13 update 3 and higher

**SIPLUS RAIL**

SIPLUS Distributed Controller RAIL  
based on SIPLUS ET 200SP

**SIPLUS extreme RAIL standard CPUs > SIPLUS ET 200SP CPU 1512SP-1 PN RAIL****Technical specifications**

Article number	<b>6AG2512-1DK01-1AB0</b> SIPLUS ET 200SP CPU 1512SP-1 PN RAIL	<b>6AG2512-1DK01-4AB0</b> SIPLUS ET 200SP CPU 1512SP-1 PN RAIL
<b>General information</b>		
<b>Product type designation</b>	CPU 1512SP-1 PN	CPU 1512SP-1 PN
<b>Engineering with</b> • STEP 7 TIA Portal configurable/integrated from version	see entry ID: 109746275	see entry ID: 109746275
<b>Supply voltage</b>		
<b>Rated value (DC)</b>	24 V	24 V
<b>Memory</b>		
<b>Work memory</b> • integrated (for program) • integrated (for data)	200 kbyte 1 Mbyte	200 kbyte 1 Mbyte
<b>Load memory</b> • Plug-in (SIMATIC Memory Card), max.	32 Gbyte	32 Gbyte
<b>CPU processing times</b>		
<b>for bit operations, typ.</b>	48 ns	48 ns
<b>for word operations, typ.</b>	58 ns	58 ns
<b>for fixed point arithmetic, typ.</b>	77 ns	77 ns
<b>for floating point arithmetic, typ.</b>	307 ns	307 ns
<b>Counters, timers and their retentivity</b>		
<b>S7 counter</b> • Number	2 048	2 048
<b>IEC counter</b> • Number	Any (only limited by the main memory)	Any (only limited by the main memory)
<b>S7 times</b> • Number	2 048	2 048
<b>IEC timer</b> • Number	Any (only limited by the main memory)	Any (only limited by the main memory)
<b>Data areas and their retentivity</b>		
<b>Flag</b> • Size, max.	16 kbyte	16 kbyte
<b>Address area</b>		
<b>I/O address area</b> • Inputs • Outputs	32 kbyte; All inputs are in the process image 32 kbyte; All outputs are in the process image	32 kbyte; All inputs are in the process image 32 kbyte; All outputs are in the process image
<b>Address space per module</b> • Address space per module, max.	288 byte; For input and output data respectively	288 byte; For input and output data respectively
<b>Address space per station</b> • Address space per station, max.	2 560 byte; for central inputs and outputs; depending on configuration; 2 048 bytes for ET 200SP modules + 512 bytes for ET 200AL modules	2 560 byte; for central inputs and outputs; depending on configuration; 2 048 bytes for ET 200SP modules + 512 bytes for ET 200AL modules
<b>Time of day</b>		
<b>Clock</b> • Type	Hardware clock	Hardware clock
<b>1. Interface</b>		
<b>Interface types</b> • RJ 45 (Ethernet)  • Number of ports • integrated switch • BusAdapter (PROFINET)	Yes; X1 P3; opt. X1 P1 and X1 P2 via Bus-Adapter BA 2x RJ45 3; 1. integr. + 2. via BusAdapter Yes Yes; compatible BusAdapters: BA 2x RJ45, BA 2x M12, BA 2x FC, BA 2x LC, BA LC/RJ45, BA LC/FC, BA 2x SCRJ, BA SCRJ/RJ45, BA SCRJ/FC,	Yes; X1 P3  1  No
<b>Protocols</b> • IP protocol • PROFINET IO Controller • PROFINET IO Device • SIMATIC communication • Open IE communication • Web server • Media redundancy	Yes; IPv4 Yes Yes Yes Yes; Optionally also encrypted Yes Yes; MRP Automanager according to IEC 62439-2 Edition 2.0	Yes; IPv4 Yes Yes Yes Yes; Optionally also encrypted Yes No

### SIPLUS extreme RAIL standard CPUs > SIPLUS ET 200SP CPU 1512SP-1 PN RAIL

Article number	6AG2512-1DK01-1AB0 SIPLUS ET 200SP CPU 1512SP-1 PN RAIL	6AG2512-1DK01-4AB0 SIPLUS ET 200SP CPU 1512SP-1 PN RAIL
<b>PROFINET IO Controller</b>		
<ul style="list-style-type: none"> <li>Services <ul style="list-style-type: none"> <li>PG/OP communication</li> <li>Isochronous mode</li> <li>Direct data exchange</li> </ul> </li> <li>IRT</li> <li>PROFenergy</li> <li>Prioritized startup</li> <li>Number of connectable IO Devices, max.</li> </ul>	<ul style="list-style-type: none"> <li>Yes</li> <li>Yes</li> <li>Yes; Requirement: IRT and isochronous mode (MRPD optional)</li> <li>Yes</li> <li>Yes; per user program</li> <li>Yes; Max. 32 PROFINET devices</li> <li>128; In total, up to 512 distributed I/O devices can be connected via AS-i, PROFIBUS or PROFINET</li> <li>64</li> <li>128</li> <li>128</li> <li>8; in total across all interfaces</li> <li>8</li> <li>The minimum value of the update time also depends on communication share set for PROFINET IO, on the number of IO devices, and on the quantity of configured user data</li> </ul>	<ul style="list-style-type: none"> <li>Yes</li> <li>Yes</li> <li>Yes; Requirement: IRT and isochronous mode (MRPD optional)</li> <li>Yes</li> <li>Yes; per user program</li> <li>Yes; Max. 32 PROFINET devices</li> <li>128; In total, up to 512 distributed I/O devices can be connected via AS-i, PROFIBUS or PROFINET</li> <li>64</li> <li>128</li> <li>128</li> <li>8; in total across all interfaces</li> <li>8</li> <li>The minimum value of the update time also depends on communication share set for PROFINET IO, on the number of IO devices, and on the quantity of configured user data</li> </ul>
<b>PROFINET IO Device</b>		
<ul style="list-style-type: none"> <li>Services <ul style="list-style-type: none"> <li>PG/OP communication</li> <li>Isochronous mode</li> <li>IRT</li> <li>PROFenergy</li> <li>Shared device</li> <li>Number of IO Controllers with shared device, max.</li> <li>activation/deactivation of I-devices</li> <li>Asset management record</li> </ul> </li> </ul>	<ul style="list-style-type: none"> <li>Yes</li> <li>No</li> <li>Yes</li> <li>Yes; per user program</li> <li>Yes</li> <li>4</li> <li>Yes; per user program</li> <li>Yes; per user program</li> </ul>	<ul style="list-style-type: none"> <li>Yes</li> <li>No</li> <li>Yes</li> <li>Yes; per user program</li> <li>Yes</li> <li>4</li> <li>Yes; per user program</li> <li>Yes; per user program</li> </ul>
<b>2. Interface</b>		
<b>Interface types</b>		
<ul style="list-style-type: none"> <li>RS 485</li> <li>Number of ports</li> </ul>	<ul style="list-style-type: none"> <li>Yes; Via CM DP module</li> <li>1</li> </ul>	<ul style="list-style-type: none"> <li>Yes; Via CM DP module</li> <li>1</li> </ul>
<b>Protocols</b>		
<ul style="list-style-type: none"> <li>PROFIBUS DP master</li> <li>PROFIBUS DP slave</li> <li>SIMATIC communication</li> </ul>	<ul style="list-style-type: none"> <li>Yes</li> <li>Yes</li> <li>Yes</li> </ul>	<ul style="list-style-type: none"> <li>Yes</li> <li>Yes</li> <li>Yes</li> </ul>
<b>PROFIBUS DP master</b>		
<ul style="list-style-type: none"> <li>Number of DP slaves, max.</li> </ul>	<ul style="list-style-type: none"> <li>125; In total, up to 512 distributed I/O devices can be connected via AS-i, PROFIBUS or PROFINET</li> </ul>	<ul style="list-style-type: none"> <li>125; In total, up to 512 distributed I/O devices can be connected via AS-i, PROFIBUS or PROFINET</li> </ul>
<b>Protocols</b>		
<b>Number of connections</b>		
<ul style="list-style-type: none"> <li>Number of connections, max.</li> </ul>	<ul style="list-style-type: none"> <li>128; via integrated interfaces of the CPU and connected CPs / CMs</li> </ul>	<ul style="list-style-type: none"> <li>128; via integrated interfaces of the CPU and connected CPs / CMs</li> </ul>
<b>Redundancy mode</b>		
<ul style="list-style-type: none"> <li>Media redundancy <ul style="list-style-type: none"> <li>Media redundancy</li> <li>MRP</li> </ul> </li> <li>MRP interconnection, supported</li> <li>MRPD <ul style="list-style-type: none"> <li>Switchover time on line break, typ.</li> <li>Number of stations in the ring, max.</li> </ul> </li> </ul>	<ul style="list-style-type: none"> <li>Yes; only via BusAdapter</li> <li>Yes; MRP Automanager according to IEC 62439-2 Edition 2.0, MRP Manager; MRP Client</li> <li>Yes; as MRP ring node according to IEC 62439-2 Edition 3.0</li> <li>Yes; Requirement: IRT</li> <li>200 ms; For MRP, bumpless for MRPD</li> <li>50</li> </ul>	<ul style="list-style-type: none"> <li>No</li> <li>No</li> <li>No</li> <li>No</li> </ul>
<b>SIMATIC communication</b>		
<ul style="list-style-type: none"> <li>S7 routing</li> </ul>	<ul style="list-style-type: none"> <li>Yes</li> </ul>	<ul style="list-style-type: none"> <li>Yes</li> </ul>
<b>OPC UA</b>		
<ul style="list-style-type: none"> <li>OPC UA Client</li> <li>OPC UA Server</li> <li>Alarms and Conditions</li> </ul>	<ul style="list-style-type: none"> <li>Yes</li> <li>Yes; Data access (read, write, subscribe), method call, custom address space</li> <li>Yes</li> </ul>	<ul style="list-style-type: none"> <li>Yes</li> <li>Yes; Data access (read, write, subscribe), method call, custom address space</li> <li>Yes</li> </ul>
<b>Supported technology objects</b>		
<b>Motion Control</b>		
<ul style="list-style-type: none"> <li>Number of available Motion Control resources for technology objects</li> <li>Required Motion Control resources <ul style="list-style-type: none"> <li>per speed-controlled axis</li> <li>per positioning axis</li> <li>per synchronous axis</li> <li>per external encoder</li> <li>per output cam</li> <li>per cam track</li> <li>per probe</li> </ul> </li> </ul>	<ul style="list-style-type: none"> <li>Yes; Note: The number of technology objects affects the cycle time of the PLC program; selection guide via the TIA Selection Tool</li> <li>800</li> <li>40</li> <li>80</li> <li>160</li> <li>80</li> <li>20</li> <li>160</li> <li>40</li> </ul>	<ul style="list-style-type: none"> <li>Yes; Note: The number of technology objects affects the cycle time of the PLC program; selection guide via the TIA Selection Tool</li> <li>800</li> <li>40</li> <li>80</li> <li>160</li> <li>80</li> <li>20</li> <li>160</li> <li>40</li> </ul>



**SIPLUS RAIL**

SIPLUS Distributed Controller RAIL  
based on SIPLUS ET 200SP

**SIPLUS extreme RAIL standard CPUs > SIPLUS ET 200SP CPU 1512SP-1 PN RAIL**

Article number	<b>6AG2512-1DK01-1AB0</b> SIPLUS ET 200SP CPU 1512SP-1 PN RAIL	<b>6AG2512-1DK01-4AB0</b> SIPLUS ET 200SP CPU 1512SP-1 PN RAIL
<b>Controller</b> • PID_Compact  • PID_3Step  • PID-Temp	Yes; Universal PID controller with integrated optimization Yes; PID controller with integrated optimization for valves Yes; PID controller with integrated optimization for temperature	Yes; Universal PID controller with integrated optimization Yes; PID controller with integrated optimization for valves Yes; PID controller with integrated optimization for temperature
<b>Counting and measuring</b> • High-speed counter	Yes	Yes
<b>Standards, approvals, certificates</b>		
<b>Railway application</b> • EN 50121-3-2 • EN 50121-4  • EN 50124-1  • EN 50125-1 • EN 50125-2  • EN 50125-3  • EN 50155  • EN 61373  • Fire protection acc. to EN 45545-2	Yes; EMC for rail vehicles Yes; EMC for signal and telecommunications systems Yes; Railway applications - overvoltage category OV2; pollution degree PD2; rated surge voltage UNi = 0.5 kV; UNm = 24 V DC Yes; Rail vehicles - see ambient conditions Yes; Stationary electrical equipment - see ambient conditions Yes; Signal and telecommunications systems - see ambient conditions; vibrations and shocks: Application point outside of tracks (1 m to 3 m away from track) Yes; Rail vehicles - temperature class OT1, ST1/ST2, horizontal mounting position Yes; Rail vehicles - vibrations and shocks: Category 1 Class A/B Yes; For proof of conformity, see Service & Support	Yes; EMC for rail vehicles Yes; EMC for signal and telecommunications systems Yes; Railway applications - overvoltage category OV2; pollution degree PD2; rated surge voltage UNi = 0.5 kV; UNm = 24 V DC Yes; Rail vehicles - see ambient conditions Yes; Stationary electrical equipment - see ambient conditions Yes; Signal and telecommunications systems - see ambient conditions; vibrations and shocks: Application point outside of tracks (1 m to 3 m away from track) Yes; Rail vehicles - temperature class OT4, ST1/ST2, horizontal mounting position Yes; Rail vehicles - vibrations and shocks: Category 1 Class A/B Yes; For proof of conformity, see Service & Support
<b>Ambient conditions</b>		
<b>Ambient temperature during operation</b> • horizontal installation, min. • horizontal installation, max.  • vertical installation, min. • vertical installation, max.	-40 °C; = Tmin (incl. condensation/frost) 60 °C; = Tmax; +70 °C for 10 min (OT1, ST1/ST2 acc. to EN 50155) -40 °C; = Tmin 50 °C; = Tmax	-40 °C; = Tmin (incl. condensation/frost) 70 °C; = Tmax; +85 °C for 10 min (OT4, ST1/ST2 acc. to EN 50155) -40 °C; = Tmin 50 °C; = Tmax
<b>Altitude during operation relating to sea level</b> • Installation altitude above sea level, max. • Ambient air temperature-barometric pressure-altitude	2 000 m Tmin ... Tmax at 1 140 hPa ... 795 hPa (-1 000 m ... +2 000 m)	2 000 m Tmin ... Tmax at 1 140 hPa ... 795 hPa (-1 000 m ... +2 000 m)
<b>Relative humidity</b> • With condensation, tested in accordance with IEC 60068-2-38, max.	100 %; RH incl. condensation / frost (no commissioning in bedewed state), horizontal installation	100 %; RH incl. condensation / frost (no commissioning in bedewed state), horizontal installation
<b>Resistance</b> • Coolants and lubricants - Resistant to commercially available coolants and lubricants • Use in stationary industrial systems - to biologically active substances according to EN 60721-3-3  - to chemically active substances according to EN 60721-3-3  - to mechanically active substances according to EN 60721-3-3 - Against mechanical environmental conditions acc. to EN 60721-3-3 • Use on land craft, rail vehicles and special-purpose vehicles - to biologically active substances according to EN 60721-3-5  - to chemically active substances according to EN 60721-3-5  - to mechanically active substances according to EN 60721-3-5 - Against mechanical environmental conditions acc. to EN 60721-3-5 - against mechanical environmental conditions in agriculture acc. to ISO 15003  • Usage in industrial process technology - Against chemically active substances acc. to EN 60654-4 - Environmental conditions for process, measuring and control systems acc. to ANSI/ISA-71.04	Yes; Incl. diesel and oil droplets in the air  Yes; Class 3B2 mold, fungus and dry rot spores (with the exception of fauna); Class 3B3 on request Yes; Class 3C4 (RH < 75 %) incl. salt spray acc. to EN 60068-2-52 (severity degree 3); * Yes; Class 3S4 incl. sand, dust, *  Yes; Class 3M8 using the SIPLUS Mounting Kit ET 200SP (6AG1193-6AA00-0AA0)  Yes; Class 5B2 mold, fungus and dry rot spores (with the exception of fauna); Class 5B3 on request Yes; Class 5C3 (RH < 75 %) incl. salt spray acc. to EN 60068-2-52 (severity degree 3); * Yes; Class 5S3 incl. sand, dust, *  Yes; Class 5M2 using the SIPLUS Mounting Kit ET 200SP (6AG1193-6AA00-0AA0) Yes; level 1 (Location LE) using the SIPLUS Mounting Kit ET 200SP (6AG1193-6AA00-0AA0)  Yes; Class 3 (excluding trichlorethylene) Yes; Level GX group A/B (excluding trichlorethylene; harmful gas concentrations up to the limits of EN 60721-3-3 class 3C4 permissible); level LC3 (salt spray) and level LB3 (oil)	No  Yes; Class 3B2 mold, fungus and dry rot spores (with the exception of fauna); Class 3B3 on request Yes; Class 3C4 (RH < 75 %) incl. salt spray acc. to EN 60068-2-52 (severity degree 3); * Yes; Class 3S4 incl. sand, dust, *  Yes; Class 5B2 mold, fungus and dry rot spores (with the exception of fauna); Class 5B3 on request Yes; Class 5C3 (RH < 75 %) incl. salt spray acc. to EN 60068-2-52 (severity degree 3); * Yes; Class 5S3 incl. sand, dust, *  Yes; Class 3 (excluding trichlorethylene) Yes; Level GX group A/B (excluding trichlorethylene; harmful gas concentrations up to the limits of EN 60721-3-3 class 3C4 permissible); level LC3 (salt spray) and level LB3 (oil)

## SIPLUS extreme RAIL standard CPUs > SIPLUS ET 200SP CPU 1512SP-1 PN RAIL

Article number	<b>6AG2512-1DK01-1AB0</b> SIPLUS ET 200SP CPU 1512SP-1 PN RAIL	<b>6AG2512-1DK01-4AB0</b> SIPLUS ET 200SP CPU 1512SP-1 PN RAIL
<ul style="list-style-type: none"> <li>Remark               <ul style="list-style-type: none"> <li>Note regarding classification of environmental conditions acc. to EN 60721, EN 60654-4 and ANSI/ISA-71.04</li> </ul> </li> </ul>	* The supplied plug covers must remain in place over the unused interfaces during operation!	* The supplied plug covers must remain in place over the unused interfaces during operation!
<b>Conformal coating</b> <ul style="list-style-type: none"> <li>Coatings for printed circuit board assemblies acc. to EN 61086</li> <li>Protection against fouling acc. to EN 60664-3</li> <li>Electronic equipment on rolling stock acc. to EN 50155</li> <li>Military testing according to MIL-I-46058C, Amendment 7</li> <li>Qualification and Performance of Electrical Insulating Compound for Printed Board Assemblies according to IPC-CC-830A</li> </ul>	Yes; Class 2 for high reliability Yes; Type 1 protection Yes; Class PC2 protective coating acc. to EN 50155:2017 Yes; Discoloration of coating possible during service life Yes; Conformal coating, Class A	Yes; Class 2 for high reliability Yes; Type 1 protection Yes; Class PC2 protective coating acc. to EN 50155:2017 Yes; Discoloration of coating possible during service life Yes; Conformal coating, Class A
<b>Configuration / header</b>		
<b>Configuration / programming / header</b>		
<ul style="list-style-type: none"> <li>Programming language               <ul style="list-style-type: none"> <li>LAD</li> <li>FBD</li> <li>STL</li> <li>SCL</li> <li>GRAPH</li> </ul> </li> </ul>	Yes Yes Yes Yes Yes	Yes Yes Yes Yes Yes
<b>Know-how protection</b> <ul style="list-style-type: none"> <li>User program protection/password protection</li> <li>Copy protection</li> <li>Block protection</li> </ul>	Yes Yes Yes	Yes Yes Yes
<b>Access protection</b> <ul style="list-style-type: none"> <li>protection of confidential configuration data</li> <li>Protection level: Write protection</li> <li>Protection level: Read/write protection</li> <li>Protection level: Complete protection</li> </ul>	Yes Yes Yes Yes	Yes Yes Yes Yes
<b>Dimensions</b>		
<b>Width</b>	100 mm	100 mm
<b>Height</b>	117 mm	117 mm
<b>Depth</b>	75 mm	75 mm
<b>Weights</b>		
<b>Weight, approx.</b>	310 g	470 g
<b>Other</b>		
<b>Note:</b>	for use in railway applications, also observe the product information "SIPLUS extreme RAIL" A5E37661960A, Online Support article 109736776	for use in railway applications, also observe the product information "SIPLUS extreme RAIL" A5E37661960A, Online Support article 109736776

### Selection and ordering data

Version	Article No.
<b>SIPLUS ET 200SP CPU 1512SP-1 PN T1 RAIL</b> Approved in accordance with EN 50155, EN 15121, EN 50124, EN 50125 and EN 45545 railway standards for use in rail traffic Work memory 200 KB for program, 1 MB for data, PROFINET IO IRT interface; SIMATIC Memory Card required For areas with extreme exposure to environmental substances (conformal coating); Ambient temperature -25 ... +60 °C (+70 °C for 10 min.)	<b>6AG2512-1DK01-1AB0</b>
<b>SIPLUS ET 200SP CPU 1512SP-1 PN TX RAIL</b> Approved in accordance with EN 50155, EN 15121, EN 50124, EN 50125 and EN 45545 railway standards for use in rail traffic Work memory 100 KB for program, 750 KB for data, PROFINET IO IRT interface; SIMATIC Memory Card required For areas with extreme exposure to environmental substances (conformal coating); Ambient temperature -40 ... +70 °C (+85 °C for 10 min.)	<b>6AG2512-1DK01-4AB0</b>
<b>Accessories</b>	
<b>SIPLUS ET 200SP BA 2XRJ45 TX RAIL BusAdapter</b> For PROFINET interface modules in Standard function class or above; max. cable length 50 m; For areas with extreme exposure to environmental substances (conformal coating); Ambient temperature -40 ... +70 °C (+85 °C for 10 min.)	<b>6AG2193-6AR00-4AA0</b>
<b>SIPLUS ET 200SP BA 2XFC TX RAIL BusAdapter</b> For PROFINET interface modules in Standard function class or above; for increased vibration and EMC load rating; max. cable length 50 m; for areas with extreme exposure to environmental substances (conformal coating); Ambient temperature -40 ... +70 °C (+85 °C for 10 min.)	<b>6AG2193-6AF00-4AA0</b>
<b>SIPLUS Mounting Kit ET 200SP</b> Mounting accessories for use with increased mechanical vibration and shock loads. Not approved for SIPLUS CPU 6AG2510-1DJ01-4AB0 and BusAdapter BA 2xRJ45	<b>6AG1193-6AA00-0AA0</b>



**SIPLUS RAIL**

SIPLUS Distributed Controller RAIL  
based on SIPLUS ET 200SP

**SIPLUS extreme RAIL fail-safe CPUs****Overview**

- 2 fail-safe, performance graded CPUs based on SIPLUS extreme RAIL ET 200SP:
  - SIPLUS ET 200SP CPU 1510SP F-1 PN T1 RAIL
  - SIPLUS ET 200SP CPU 1512SP F-1 PN T1 RAIL

Features	SIPLUS ET 200SP CPU 1510SP F-1 PN T1 RAIL	SIPLUS ET 200SP CPU 1512SP F-1 PN T1 RAIL
<b>Work memory for program, integrated</b>	150 KB	300 KB
<b>Work memory for data, integrated</b>	750 KB	1 MB
<b>Load memory</b>	Plug-in via SIMATIC Memory Card, max. 32 GB	Plug-in via SIMATIC Memory Card, max. 32 GB
<b>Command execution times</b>		
• Bit operations	72 ns	48 ns
• Word operations	86 ns	58 ns
• Fixed-point operations	115 ns	77 ns
• Floating-point operations	461 ns	307 ns
<b>Integral interfaces</b>		
• PROFINET IO IRT	1 x PN IO IRT (3-port switch)	1 x PN IO IRT (3-port switch)
• PROFIBUS DP	Yes (via CM DP)	Yes (via CM DP)
<b>Standards, approvals, certificates</b>	SIL 2 acc. to EN 50126, 50128, 50129	SIL 2 acc. to EN 50126, 50128, 50129

**Application**

A range of fail-safe, performance-graded CPUs are available for the SIPLUS extreme RAIL ET 200SP:

**Fail-safe CPUs**

- SIPLUS ET 200SP CPU 1510SP F-1 PN T1 RAIL:  
The entry-level CPU for standard and fail-safe applications with average requirements in terms of processing performance and response speed in discrete production technology. SIPLUS ET 200SP CPU 1510SP F-1 PN T1 RAIL can be used as a PROFINET IO controller or as distributed intelligence (PROFINET I-Device).
- SIPLUS ET 200SP CPU 1512SP F-1 PN T1 RAIL:  
The CPU for standard and fail-safe applications with average requirements in terms of processing performance and response speed in discrete production technology. SIPLUS ET 200SP CPU 1512SP F-1 PN T1 RAIL can be used as a PROFINET IO controller or as distributed intelligence (PROFINET I-Device).

**Technical specifications**

Article number	<b>6AG2510-1SJO1-1AB0</b> SIPLUS ET 200SP CPU 1510 F-1 PN RAIL	<b>6AG2512-1SK01-1AB0</b> SIPLUS ET 200SP CPU 1512 F-1 PN RAIL
<b>General information</b>		
<b>Product type designation</b>	CPU 1510SP F-1 PN	CPU 1512SP F-1 PN
<b>Engineering with</b> • STEP 7 TIA Portal configurable/integrated from version	see entry ID: 109746275	see entry ID: 109746275
<b>Supply voltage</b>		
<b>Rated value (DC)</b>	24 V	24 V
<b>Memory</b>		
<b>Work memory</b> • integrated (for program) • integrated (for data)	150 kbyte 750 kbyte	300 kbyte 1 Mbyte
<b>Load memory</b> • Plug-in (SIMATIC Memory Card), max.	32 Gbyte	32 Gbyte
<b>CPU processing times</b>		
<b>for bit operations, typ.</b>	72 ns	48 ns
<b>for word operations, typ.</b>	86 ns	58 ns
<b>for fixed point arithmetic, typ.</b>	115 ns	77 ns
<b>for floating point arithmetic, typ.</b>	461 ns	307 ns
<b>Counters, timers and their retentivity</b>		
<b>S7 counter</b> • Number	2 048	2 048
<b>IEC counter</b> • Number	Any (only limited by the main memory)	Any (only limited by the main memory)
<b>S7 times</b> • Number	2 048	2 048
<b>IEC timer</b> • Number	Any (only limited by the main memory)	Any (only limited by the main memory)
<b>Data areas and their retentivity</b>		
<b>Flag</b> • Size, max.	16 kbyte	16 kbyte

# SIPLUS RAIL

## SIPLUS Distributed Controller RAIL based on SIPLUS ET 200SP

### SIPLUS extreme RAIL fail-safe CPUs

Article number	<b>6AG2510-1SJ01-1AB0</b> SIPLUS ET 200SP CPU 1510 F-1 PN RAIL	<b>6AG2512-1SK01-1AB0</b> SIPLUS ET 200SP CPU 1512 F-1 PN RAIL
<b>Address area</b>		
<b>I/O address area</b>		
• Inputs	32 kbyte; All inputs are in the process image	32 kbyte; All inputs are in the process image
• Outputs	32 kbyte; All outputs are in the process image	32 kbyte; All outputs are in the process image
<b>Address space per module</b>		
• Address space per module, max.	288 byte; For input and output data respectively	288 byte; For input and output data respectively
<b>Address space per station</b>		
• Address space per station, max.	2 560 byte; for central inputs and outputs; depending on configuration; 2 048 bytes for ET 200SP modules + 512 bytes for ET 200AL modules	2 560 byte; for central inputs and outputs; depending on configuration; 2 048 bytes for ET 200SP modules + 512 bytes for ET 200AL modules
<b>Time of day</b>		
<b>Clock</b>		
• Type	Hardware clock	Hardware clock
<b>1. Interface</b>		
<b>Interface types</b>		
• RJ 45 (Ethernet)	Yes; X1 P3; opt. X1 P1 and X1 P2 via Bus-Adapter BA 2x RJ45	Yes; X1 P3; opt. X1 P1 and X1 P2 via Bus-Adapter BA 2x RJ45
• Number of ports	3; 1. integr. + 2. via BusAdapter	3; 1. integr. + 2. via BusAdapter
• integrated switch	Yes	Yes
• BusAdapter (PROFINET)	Yes; compatible BusAdapters: BA 2x RJ45, BA 2x FC, BA 2x M12	Yes; compatible BusAdapters: BA 2x RJ45, BA 2x FC, BA 2x M12
<b>Protocols</b>		
• IP protocol	Yes; IPv4	Yes; IPv4
• PROFINET IO Controller	Yes	Yes
• PROFINET IO Device	Yes	Yes
• SIMATIC communication	Yes	Yes
• Open IE communication	Yes; Optionally also encrypted	Yes; Optionally also encrypted
• Web server	Yes	Yes
• Media redundancy	Yes; MRP Automanager according to IEC 62439-2 Edition 2.0	Yes; MRP Automanager according to IEC 62439-2 Edition 2.0
<b>PROFINET IO Controller</b>		
• Services		
- PG/OP communication	Yes	Yes
- Isochronous mode	Yes	Yes
- Direct data exchange	Yes; Requirement: IRT and isochronous mode (MRPD optional)	Yes; Requirement: IRT and isochronous mode (MRPD optional)
- IRT	Yes	Yes
- PROFlenergy	Yes; per user program	Yes; per user program
- Prioritized startup	Yes; Max. 32 PROFINET devices	Yes; Max. 32 PROFINET devices
- Number of connectable IO Devices, max.	64; In total, up to 256 distributed I/O devices can be connected via AS-i, PROFIBUS or PROFINET	128; In total, up to 512 distributed I/O devices can be connected via AS-i, PROFIBUS or PROFINET
- Of which IO devices with IRT, max.	64	64
- Number of connectable IO Devices for RT, max.	64	128
- of which in line, max.	64	128
- Number of IO Devices that can be simultaneously activated/deactivated, max.	8; in total across all interfaces	8; in total across all interfaces
- Number of IO Devices per tool, max.	8	8
- Updating times	The minimum value of the update time also depends on communication share set for PROFINET IO, on the number of IO devices, and on the quantity of configured user data	The minimum value of the update time also depends on communication share set for PROFINET IO, on the number of IO devices, and on the quantity of configured user data
<b>PROFINET IO Device</b>		
• Services		
- PG/OP communication	Yes	Yes
- Isochronous mode	No	No
- IRT	Yes	Yes
- PROFlenergy	Yes; per user program	Yes; per user program
- Shared device	Yes	Yes
- Number of IO Controllers with shared device, max.	4	4
- activation/deactivation of I-devices	Yes; per user program	Yes; per user program
- Asset management record	Yes; per user program	Yes; per user program
<b>2. Interface</b>		
<b>Interface types</b>		
• RS 485	Yes; Via CM DP module	Yes; Via CM DP module
• Number of ports	1	1
<b>Protocols</b>		
• PROFIBUS DP master	Yes	Yes
• PROFIBUS DP slave	Yes	Yes
• SIMATIC communication	Yes	Yes
<b>PROFIBUS DP master</b>		
• Number of DP slaves, max.	125; In total, up to 256 distributed I/O devices can be connected via AS-i, PROFIBUS or PROFINET	125; In total, up to 512 distributed I/O devices can be connected via AS-i, PROFIBUS or PROFINET

**SIPLUS RAIL**SIPLUS Distributed Controller RAIL  
based on SIPLUS ET 200SP**SIPLUS extreme RAIL fail-safe CPUs**

Article number	<b>6AG2510-1SJ01-1AB0</b> SIPLUS ET 200SP CPU 1510 F-1 PN RAIL	<b>6AG2512-1SK01-1AB0</b> SIPLUS ET 200SP CPU 1512 F-1 PN RAIL
<b>Protocols</b>		
<b>Number of connections</b> • Number of connections, max.	96; via integrated interfaces of the CPU and connected CPs / CMs	128; via integrated interfaces of the CPU and connected CPs / CMs
<b>Redundancy mode</b> • Media redundancy - Media redundancy - MRP  - MRP interconnection, supported  - MRPD - Switchover time on line break, typ. - Number of stations in the ring, max.	Yes; only via BusAdapter Yes; MRP Automanager according to IEC 62439-2 Edition 2.0, MRP Manager; MRP Client Yes; as MRP ring node according to IEC 62439-2 Edition 3.0 Yes; Requirement: IRT 200 ms; For MRP, bumpless for MRPD 50	Yes; only via BusAdapter Yes; MRP Automanager according to IEC 62439-2 Edition 2.0, MRP Manager; MRP Client Yes; as MRP ring node according to IEC 62439-2 Edition 3.0 Yes; Requirement: IRT 200 ms; For MRP, bumpless for MRPD 50
<b>SIMATIC communication</b> • S7 routing	Yes	Yes
<b>OPC UA</b> • OPC UA Client • OPC UA Server  • Alarms and Conditions	Yes Yes; Data access (read, write, subscribe), method call, custom address space Yes	Yes Yes; Data access (read, write, subscribe), method call, custom address space
<b>Supported technology objects</b>		
<b>Motion Control</b>  • Number of available Motion Control resources for technology objects • Required Motion Control resources - per speed-controlled axis - per positioning axis - per synchronous axis - per external encoder - per output cam - per cam track - per probe	Yes; Note: The number of technology objects affects the cycle time of the PLC program; selection guide via the TIA Selection Tool 800  40 80 160 80 20 160 40	Yes; Note: The number of technology objects affects the cycle time of the PLC program; selection guide via the TIA Selection Tool 800  40 80 160 80 20 160 40
<b>Controller</b> • PID_Compact  • PID_3Step  • PID-Temp	Yes; Universal PID controller with integrated optimization Yes; PID controller with integrated optimization for valves Yes; PID controller with integrated optimization for temperature	Yes; Universal PID controller with integrated optimization Yes; PID controller with integrated optimization for valves Yes; PID controller with integrated optimization for temperature
<b>Counting and measuring</b> • High-speed counter	Yes	Yes
<b>Standards, approvals, certificates</b>		
<b>Highest safety class achievable in safety mode</b> • SIL in accordance with EN 50126, 50128, 50129	SIL 2; a higher safety integrity level is possible if tested and approved for the specific application under consideration of all local regulations.	SIL 2; a higher safety integrity level is possible if tested and approved for the specific application under consideration of all local regulations.
<b>Probability of failure (for service life of 20 years and repair time of 100 hours)</b> • Low demand mode: PFDavg in accordance with SIL3 • High demand/continuous mode: PFH in accordance with SIL3	< 2.00E-05 < 1.00E-09	< 2.00E-05 < 1.00E-09
<b>Railway application</b> • EN 50121-3-2 • EN 50121-4  • EN 50124-1  • EN 50125-1 • EN 50125-2  • EN 50125-3  • EN 50155 • EN 61373  • Fire protection acc. to EN 45545-2	Yes; EMC for rail vehicles Yes; EMC for signal and telecommunications systems Yes; Railway applications - overvoltage category OV2; pollution degree PD2; rated surge voltage UNi = 0.5 kV; UNm = 24 V DC Yes; Rail vehicles - see ambient conditions Yes; Stationary electrical equipment - see ambient conditions Yes; Signal and telecommunications systems - see ambient conditions; vibrations and shocks: Application point outside of tracks (1 m to 3 m away from track) Yes; Rail vehicles - temperature class OT1, ST1/ST2, horizontal mounting position Yes; Rail vehicles - vibrations and shocks: Category 1 Class A/B Yes; For proof of conformity, see Service & Support	Yes; EMC for rail vehicles Yes; EMC for signal and telecommunications systems Yes; Railway applications - overvoltage category OV2; pollution degree PD2; rated surge voltage UNi = 0.5 kV; UNm = 24 V DC Yes; Rail vehicles - see ambient conditions Yes; Stationary electrical equipment - see ambient conditions Yes; Signal and telecommunications systems - see ambient conditions; vibrations and shocks: Application point outside of tracks (1 m to 3 m away from track) Yes; Rail vehicles - temperature class OT1, ST1/ST2, horizontal mounting position Yes; Rail vehicles - vibrations and shocks: Category 1 Class A/B Yes; For proof of conformity, see Service & Support

# SIPLUS RAIL

## SIPLUS Distributed Controller RAIL

### based on SIPLUS ET 200SP

#### SIPLUS extreme RAIL fail-safe CPUs

Article number	6AG2510-1SJ01-1AB0 SIPLUS ET 200SP CPU 1510 F-1 PN RAIL	6AG2512-1SK01-1AB0 SIPLUS ET 200SP CPU 1512 F-1 PN RAIL
<b>Ambient conditions</b>		
<b>Ambient temperature during operation</b> • horizontal installation, min. • horizontal installation, max.  • vertical installation, min. • vertical installation, max.	-25 °C; = Tmin (incl. condensation/frost) 60 °C; = Tmax; +70 °C for 10 min (OT1, ST1/ST2 acc. to EN 50155) -25 °C; = Tmin 50 °C; = Tmax	-25 °C; = Tmin (incl. condensation/frost) 60 °C; = Tmax; +70 °C for 10 min (OT1, ST1/ST2 acc. to EN 50155) -25 °C; = Tmin 50 °C; = Tmax
<b>Altitude during operation relating to sea level</b> • Installation altitude above sea level, max. • Ambient air temperature-barometric pressure-altitude	2 000 m Tmin ... Tmax at 1 140 hPa ... 795 hPa (-1 000 m ... +2 000 m)	2 000 m Tmin ... Tmax at 1 140 hPa ... 795 hPa (-1 000 m ... +2 000 m)
<b>Relative humidity</b> • With condensation, tested in accordance with IEC 60068-2-38, max.	100 %; RH incl. condensation / frost (no commissioning in bedewed state), horizontal installation	100 %; RH incl. condensation / frost (no commissioning in bedewed state), horizontal installation
<b>Resistance</b> • Coolants and lubricants - Resistant to commercially available coolants and lubricants • Use in stationary industrial systems - to biologically active substances according to EN 60721-3-3 - to chemically active substances according to EN 60721-3-3 - to mechanically active substances according to EN 60721-3-3 - Against mechanical environmental conditions acc. to EN 60721-3-3 • Use on land craft, rail vehicles and special-purpose vehicles - to biologically active substances according to EN 60721-3-5 - to chemically active substances according to EN 60721-3-5 - to mechanically active substances according to EN 60721-3-5 - Against mechanical environmental conditions acc. to EN 60721-3-5 - against mechanical environmental conditions in agriculture acc. to ISO 15003 • Usage in industrial process technology - Against chemically active substances acc. to EN 60654-4 - Environmental conditions for process, measuring and control systems acc. to ANSI/ISA-71.04  • Remark - Note regarding classification of environmental conditions acc. to EN 60721, EN 60654-4 and ANSI/ISA-71.04	Yes; Incl. diesel and oil droplets in the air  Yes; Class 3B2 mold, fungus and dry rot spores (with the exception of fauna); Class 3B3 on request Yes; Class 3C4 (RH < 75 %) incl. salt spray acc. to EN 60068-2-52 (severity degree 3); * Yes; Class 3S4 incl. sand, dust; *  Yes; Class 3M8 using the SIPLUS Mounting Kit ET 200SP (6AG1193-6AA00-0AA0)  Yes; Class 5B2 mold, fungus and dry rot spores (with the exception of fauna); Class 5B3 on request Yes; Class 5C3 (RH < 75 %) incl. salt spray acc. to EN 60068-2-52 (severity degree 3); * Yes; Class 5S3 incl. sand, dust; *  Yes; Class 5M2 using the SIPLUS Mounting Kit ET 200SP (6AG1193-6AA00-0AA0) Yes; level 1 (Location LE) using the SIPLUS Mounting Kit ET 200SP (6AG1193-6AA00-0AA0)  Yes; Class 3 (excluding trichlorethylene) Yes; Level GX group A/B (excluding trichlorethylene; harmful gas concentrations up to the limits of EN 60721-3-3 class 3C4 permissible); level LC3 (salt spray) and level LB3 (oil)  * The supplied plug covers must remain in place over the unused interfaces during operation!	Yes; Incl. diesel and oil droplets in the air  Yes; Class 3B2 mold, fungus and dry rot spores (with the exception of fauna); Class 3B3 on request Yes; Class 3C4 (RH < 75 %) incl. salt spray acc. to EN 60068-2-52 (severity degree 3); * Yes; Class 3S4 incl. sand, dust; *  Yes; Class 3M8 using the SIPLUS Mounting Kit ET 200SP (6AG1193-6AA00-0AA0)  Yes; Class 5B2 mold, fungus and dry rot spores (with the exception of fauna); Class 5B3 on request Yes; Class 5C3 (RH < 75 %) incl. salt spray acc. to EN 60068-2-52 (severity degree 3); * Yes; Class 5S3 incl. sand, dust; *  Yes; Class 5M2 using the SIPLUS Mounting Kit ET 200SP (6AG1193-6AA00-0AA0) Yes; level 1 (Location LE) using the SIPLUS Mounting Kit ET 200SP (6AG1193-6AA00-0AA0)  Yes; Class 3 (excluding trichlorethylene) Yes; Level GX group A/B (excluding trichlorethylene; harmful gas concentrations up to the limits of EN 60721-3-3 class 3C4 permissible); level LC3 (salt spray) and level LB3 (oil)  * The supplied plug covers must remain in place over the unused interfaces during operation!
<b>Conformal coating</b> • Coatings for printed circuit board assemblies acc. to EN 61086 • Protection against fouling acc. to EN 60664-3 • Electronic equipment on rolling stock acc. to EN 50155  • Military testing according to MIL-I-46058C, Amendment 7 • Qualification and Performance of Electrical Insulating Compound for Printed Board Assemblies according to IPC-CC-830A	Yes; Class 2 for high reliability  Yes; Type 1 protection Yes; Class PC2 protective coating acc. to EN 50155:2017 Yes; Discoloration of coating possible during service life Yes; Conformal coating, Class A	Yes; Class 2 for high reliability  Yes; Type 1 protection Yes; Class PC2 protective coating acc. to EN 50155:2017 Yes; Discoloration of coating possible during service life Yes; Conformal coating, Class A
<b>Configuration / header</b>		
<b>Configuration / programming / header</b> • Programming language - LAD - FBD - STL - SCL - GRAPH	Yes; incl. failsafe Yes; incl. failsafe Yes Yes Yes	Yes; incl. failsafe Yes; incl. failsafe Yes Yes Yes
<b>Know-how protection</b> • User program protection/password protection • Copy protection • Block protection	Yes Yes Yes	Yes Yes Yes
<b>Access protection</b> • protection of confidential configuration data • Protection level: Write protection • Protection level: Read/write protection • Protection level: Write protection for Failsafe • Protection level: Complete protection	Yes Yes Yes Yes Yes	Yes Yes Yes Yes

**SIPLUS RAIL**

SIPLUS Distributed Controller RAIL  
based on SIPLUS ET 200SP

**SIPLUS extreme RAIL fail-safe CPUs**

Article number	<b>6AG2510-1SJ01-1AB0</b> SIPLUS ET 200SP CPU 1510 F-1 PN RAIL	<b>6AG2512-1SK01-1AB0</b> SIPLUS ET 200SP CPU 1512 F-1 PN RAIL
<b>Dimensions</b>		
<b>Width</b>	100 mm	100 mm
<b>Height</b>	117 mm	117 mm
<b>Depth</b>	75 mm	75 mm
<b>Weights</b>		
<b>Weight, approx.</b>	310 g	310 g
<b>Other</b>		
<b>Note:</b>	for use in railway applications, also observe the product information "SIPLUS extreme RAIL" A5E37661960A, Online Support article 109736776	for use in railway applications, also observe the product information "SIPLUS extreme RAIL" A5E37661960A, Online Support article 109736776

**More information****Additional information and downloads**Manuals

The manuals for ET 200SP can be downloaded free of charge from the Internet (SIMATIC Customer Support).

<http://support.automation.siemens.com/WW/view/en/84133942>

General information

<http://www.siemens.com/et200sp>

SIMATIC Selection Tool

<http://www.siemens.com/tia-selection-tool>

#### Overview



- SIPLUS ET 200SP CPU 1510SP F-1 PN T1 RAIL for SIPLUS extreme RAIL ET 200SP based on S7-1500 CPU 1511F-1 PN
- Approved in accordance with EN 50155, EN 15121, EN 50124, EN 50125 and EN 45545 railway standards for use in rail traffic
- For high-performance control solutions using ET 200SP
- Increase in availability of systems and machines
- Supports PROFIsafe in centralized and distributed configurations
- PROFINET IO controller for up to 64 IO devices
- PROFINET I-Device for connecting the CPU as an intelligent PROFINET device with a SIMATIC or third-party PROFINET IO controller
- PROFINET shared I-device for 4 controllers
- PROFINET IO IRT interface with integrated 3-port switch
- Isochronous mode on PROFINET
- With multiple communication options: PG/OP communication, PROFINET IO, open IE communication (TCP, ISO-on-TCP and UDP), web server and S7 communication (with loadable FBs)
- Configuration control (option handling)
- Integrated motion control functions for controlling speed-controlled and positioning axes, support for external encoders

#### Application

SIPLUS ET 200SP CPU 1510SP F-1 PN T1 RAIL is a cost-effective entry-level CPU for standard and fail-safe applications with average requirements in terms of processing performance and response speed in discrete production technology. SIPLUS ET 200SP CPU 1510SP F-1 PN T1 RAIL can be used as a PROFINET IO controller or as distributed intelligence (PROFINET I-Device). The integrated PROFINET IO IRT interface is designed as a 3-port switch enabling configuration of a linear topology in the system via port 1 and 2, such that a PG/PC or HMI device can also be connected via port 3.

When used as an I-device, the SIPLUS ET 200SP CPU 1510SP F-1 PN T1 RAIL enables distributed preprocessing of process data locally and only delivers the information actually required to the higher-level controller. This has the following advantages:

- Less load on central controller
- Short response times to critical local signals
- Less load on the bus system due to smaller data volumes
- Faster commissioning due to pre-tested units and parallel commissioning
- Increased availability and flexibility due to autonomous machine units
- Easy-to-understand configuration

SIPLUS ET 200SP CPU 1510SP F-1 PN T1 RAIL operates fully independently of the central controller. If the controller fails, the CPU simply continues to operate.

The bit-modular design of the ET 200SP I/O system, together with the SIPLUS ET 200SP CPU 1510SP F-1 PN T1 RAIL, enables functionally oriented station design.

In addition, the CPU offers comprehensive control functionalities via easy-to-configure blocks as well as the ability to connect drives via standardized PLC-open blocks.

#### Design

SIPLUS ET 200SP CPU 1510SP F-1 PN T1 RAIL is snapped directly onto the standard DIN rail and features:

- A high-performance processor; the CPU achieves command execution times as low as 72 ns per binary instruction
- Extensive work memory: 150 KB for program, 750 KB for data
- SIMATIC Memory Cards as load memory; permitting additional functions such as firmware update, datalog and archiving
- Bit-modular expandability for maximum flexibility; up to 64 I/O modules (I/O, technology, and communications modules) in any combination. Station width up to 1 m.
- PROFINET IO IRT interface with 3 integrated switch ports:
  - Port 1 and 2 via BusAdapter (SIPLUS ET 200SP CPU 1510SP F-1 PN T1 RAIL is supplied without the BusAdapter and can also be operated without it). The appropriate BusAdapter (BA 2xRJ45 or BA 2xFC) is to be ordered separately if needed.
  - Port 3 via integrated RJ45 socket.
- Integrated communication functions:
  - PG/OP communication
  - PROFINET IO
  - Open IE communication (TCP, ISO-on-TCP and UDP)
  - Web server
  - S7 communication
  - S7 routing
  - Data set routing
- Maintenance-free data backup without battery
- Diagnostics displays for errors (Error), operation (RUN/Stop), maintenance (MT), power supply (PWR) and one link LED per port
- Optional labeling using light gray or yellow labeling strips. There is a choice of 2 materials:
  - Foil and roll with 500 strips, for thermal transfer roll printer
  - Paper (280 g/m<sup>2</sup>), DIN A4 sheets with 100 strips each, for laser printer
- The ET 200SP CPU can be equipped with a reference ID label.



**SIPLUS RAIL**

SIPLUS Distributed Controller RAIL  
based on SIPLUS ET 200SP

**SIPLUS extreme RAIL fail-safe CPUs > SIPLUS ET 200SP CPU 1510SP F-1 PN T1 RAIL**

- Different PROFINET connection types by means of Bus-Adapter:
  - Under standard ambient conditions, BA 2xRJ45 for connection via RJ45 plug
  - In the case of mechanical loading during operation and/or an increased EMC requirements BA 2xFC for direct connection of the PROFINET cable
- Dark BaseUnit as first BaseUnit behind the ET 200SP CPU when using an AC I/O module or an AI Energy Meter ST as the first I/O module

Scope of delivery

SIPLUS ET 200SP CPU 1510SP F-1 PN T1 RAIL including server module, 24 V DC connector and cover for BusAdapter port (BusAdapter must be ordered separately)

**Function**

- Performance
  - High-speed command processing
  - High-performance network connection: CPU comes equipped with a PROFINET IO IRT interface (3-port switch) as standard.
- Integrated technology
  - Connection of analog and PROFIdrive-capable drives via standardized blocks (PLCopen)
  - Support of speed-controlled and positioning axes as well as external encoders
  - Precise position gearing for synchronous operation between axes
  - Trace functions for all CPU tags, both for diagnostics in real time and for sporadic error detection
  - Comprehensive control functionalities, e.g. easily configurable blocks for automatic optimization of the control parameters for optimum control quality
- Isochronous mode
  - Synchronous coupling of distributed signal acquisition, signal transmission, and program execution to the PROFINET cycle with constant bus cycle time
- Security Integrated
  - Password-based know-how protection against unauthorized read-out and modification of program blocks
  - Copy protection for tying individual blocks to the serial number of the SIMATIC Memory Card: The block can only run if the configured Memory Card is inserted in the CPU.
  - 4-stage authorization concept: Communication to operator panels can also be restricted.
  - Manipulation protection: The controller recognizes changed or unauthorized transmissions of the engineering data.
- Integrated system diagnostics
  - System diagnostics information is displayed consistently and in plain text in the TIA Portal, operator panels and web server, even for messages from the drives, and updated even if the CPU is in STOP mode.
  - Integrated in the firmware of the CPU, no special configuration is required
- Configuration control (option handling) in central setup
  - Various hardware configurations can be stored in the PLC: Modification of the configuration in the user program (startup OB100), Retrofitting of options at end of configuration; Use of placeholder modules is possible.
- SIMATIC Memory Card (required for operation of the CPU)
  - Used as plug-in load memory or for updating the firmware
  - Also for storing additional documents or csv files (for recipes and archives)
  - Creation of data blocks and storage/reading of data via SFCs of the user program
- Datalog (archives) and recipes
  - Storage of csv files for recipes and archives on the SIMATIC Memory Card; easy access to plant-relevant operating data using Office tools and via web server.
  - Easy access to configuration data of the machine by means of a web browser or SD card reader (two-way data exchange from and to the PLC)
- Programming of the standard program section
  - Programming with STEP 7 Professional, V13 SP1 and higher
- Programming of the fail-safe program section
  - Programming of the safety-related program section with the "STEP 7 Safety Advanced" option package.

**Technical specifications**

Article number	<b>6AG2510-1SJ01-1AB0</b> SIPLUS ET 200SP CPU 1510 F-1 PN RAIL
<b>General information</b>	
<b>Product type designation</b>	CPU 1510SP F-1 PN
<b>Engineering with</b>	
• STEP 7 TIA Portal configurable/integrated from version	see entry ID: 109746275
<b>Supply voltage</b>	
<b>Rated value (DC)</b>	24 V
<b>Memory</b>	
<b>Work memory</b>	
• integrated (for program)	150 kbyte
• integrated (for data)	750 kbyte
<b>Load memory</b>	
• Plug-in (SIMATIC Memory Card), max.	32 Gbyte
<b>CPU processing times</b>	
<b>for bit operations, typ.</b>	72 ns
<b>for word operations, typ.</b>	86 ns
<b>for fixed point arithmetic, typ.</b>	115 ns
<b>for floating point arithmetic, typ.</b>	461 ns

**SIPLUS extreme RAIL fail-safe CPUs > SIPLUS ET 200SP CPU 1510SP F-1 PN T1 RAIL**

Article number	<b>6AG2510-1SJ01-1AB0</b> SIPLUS ET 200SP CPU 1510 F-1 PN RAIL
<b>Counters, timers and their retentivity</b>	
<b>S7 counter</b> • Number	2 048
<b>IEC counter</b> • Number	Any (only limited by the main memory)
<b>S7 times</b> • Number	2 048
<b>IEC timer</b> • Number	Any (only limited by the main memory)
<b>Data areas and their retentivity</b>	
<b>Flag</b> • Size, max.	16 kbyte
<b>Address area</b>	
<b>I/O address area</b> • Inputs • Outputs	32 kbyte; All inputs are in the process image 32 kbyte; All outputs are in the process image
<b>Address space per module</b> • Address space per module, max.	288 byte; For input and output data respectively
<b>Address space per station</b> • Address space per station, max.	2 560 byte; for central inputs and outputs; depending on configuration; 2 048 bytes for ET 200SP modules + 512 bytes for ET 200AL modules
<b>Time of day</b>	
<b>Clock</b> • Type	Hardware clock
<b>1. Interface</b>	
<b>Interface types</b> • RJ 45 (Ethernet) • Number of ports • integrated switch • BusAdapter (PROFINET)	Yes; X1 P3; opt. X1 P1 and X1 P2 via BusAdapter BA 2x RJ45 3; 1. integr. + 2. via BusAdapter Yes Yes; compatible BusAdapters: BA 2x RJ45, BA 2x FC, BA 2x M12
<b>Protocols</b> • IP protocol • PROFINET IO Controller • PROFINET IO Device • SIMATIC communication • Open IE communication • Web server • Media redundancy	Yes; IPv4 Yes Yes Yes Yes; Optionally also encrypted Yes Yes; MRP Automanager according to IEC 62439-2 Edition 2.0
<b>PROFINET IO Controller</b> • Services - PG/OP communication - Isochronous mode - Direct data exchange - IRT - PROFlenergy - Prioritized startup - Number of connectable IO Devices, max.  - Of which IO devices with IRT, max. - Number of connectable IO Devices for RT, max. - of which in line, max. - Number of IO Devices that can be simultaneously activated/deactivated, max. - Number of IO Devices per tool, max. - Updating times	Yes Yes Yes; Requirement: IRT and isochronous mode (MRPD optional) Yes Yes; per user program Yes; Max. 32 PROFINET devices 64; In total, up to 256 distributed I/O devices can be connected via AS-i, PROFIBUS or PROFINET 64 64 64 8; in total across all interfaces 8 The minimum value of the update time also depends on communication share set for PROFINET IO, on the number of IO devices, and on the quantity of configured user data
<b>PROFINET IO Device</b> • Services - PG/OP communication - Isochronous mode - IRT - PROFlenergy - Shared device - Number of IO Controllers with shared device, max. - activation/deactivation of I-devices - Asset management record	Yes No Yes Yes; per user program Yes 4 Yes; per user program Yes; per user program
<b>2. Interface</b>	
<b>Interface types</b> • RS 485 • Number of ports	Yes; Via CM DP module 1
<b>Protocols</b> • PROFIBUS DP master • PROFIBUS DP slave • SIMATIC communication	Yes Yes Yes
<b>PROFIBUS DP master</b> • Number of DP slaves, max.	125; In total, up to 256 distributed I/O devices can be connected via AS-i, PROFIBUS or PROFINET



**SIPLUS RAIL**

SIPLUS Distributed Controller RAIL  
based on SIPLUS ET 200SP

**SIPLUS extreme RAIL fail-safe CPUs > SIPLUS ET 200SP CPU 1510SP F-1 PN T1 RAIL**

Article number	<b>6AG2510-1SJ01-1AB0</b> SIPLUS ET 200SP CPU 1510 F-1 PN RAIL
<b>Protocols</b>	
<b>Number of connections</b> • Number of connections, max.	96; via integrated interfaces of the CPU and connected CPs / CMs
<b>Redundancy mode</b> • Media redundancy - Media redundancy - MRP  - MRP interconnection, supported - MRPD - Switchover time on line break, typ. - Number of stations in the ring, max.	Yes; only via BusAdapter Yes; MRP Automanager according to IEC 62439-2 Edition 2.0, MRP Manager; MRP Client  Yes; as MRP ring node according to IEC 62439-2 Edition 3.0 Yes; Requirement: IRT 200 ms; For MRP, bumpless for MRPD 50
<b>SIMATIC communication</b> • S7 routing	Yes
<b>OPC UA</b> • OPC UA Client • OPC UA Server • Alarms and Conditions	Yes Yes; Data access (read, write, subscribe), method call, custom address space Yes
<b>Supported technology objects</b>	
<b>Motion Control</b>  • Number of available Motion Control resources for technology objects • Required Motion Control resources - per speed-controlled axis - per positioning axis - per synchronous axis - per external encoder - per output cam - per cam track - per probe	Yes; Note: The number of technology objects affects the cycle time of the PLC program; selection guide via the TIA Selection Tool 800  40 80 160 80 20 160 40
<b>Controller</b> • PID_Compact • PID_3Step • PID-Temp	Yes; Universal PID controller with integrated optimization Yes; PID controller with integrated optimization for valves Yes; PID controller with integrated optimization for temperature
<b>Counting and measuring</b> • High-speed counter	Yes
<b>Standards, approvals, certificates</b>	
<b>Highest safety class achievable in safety mode</b> • SIL in accordance with EN 50126, 50128, 50129  • Probability of failure (for service life of 20 years and repair time of 100 hours) - Low demand mode: PFDavg in accordance with SIL3 - High demand/continuous mode: PFH in accordance with SIL3	SIL 2; a higher safety integrity level is possible if tested and approved for the specific application under consideration of all local regulations.  < 2.00E-05 < 1.00E-09
<b>Railway application</b> • EN 50121-3-2 • EN 50121-4 • EN 50124-1  • EN 50125-1 • EN 50125-2 • EN 50125-3  • EN 50155 • EN 61373 • Fire protection acc. to EN 45545-2	Yes; EMC for rail vehicles Yes; EMC for signal and telecommunications systems Yes; Railway applications - overvoltage category OV2; pollution degree PD2; rated surge voltage UNi = 0.5 kV; UNm = 24 V DC Yes; Rail vehicles - see ambient conditions Yes; Stationary electrical equipment - see ambient conditions Yes; Signal and telecommunications systems - see ambient conditions; vibrations and shocks: Application point outside of tracks (1 m to 3 m away from track) Yes; Rail vehicles - temperature class OT1, ST1/ST2, horizontal mounting position Yes; Rail vehicles - vibrations and shocks: Category 1 Class A/B Yes; For proof of conformity, see Service & Support
<b>Ambient conditions</b>	
<b>Ambient temperature during operation</b> • horizontal installation, min. • horizontal installation, max. • vertical installation, min. • vertical installation, max.	-25 °C; = Tmin (incl. condensation/frost) 60 °C; = Tmax; +70 °C for 10 min (OT1, ST1/ST2 acc. to EN 50155) -25 °C; = Tmin 50 °C; = Tmax
<b>Altitude during operation relating to sea level</b> • Installation altitude above sea level, max. • Ambient air temperature-barometric pressure-altitude	2 000 m Tmin ... Tmax at 1 140 hPa ... 795 hPa (-1 000 m ... +2 000 m)
<b>Relative humidity</b> • With condensation, tested in accordance with IEC 60068-2-38, max.	100 %; RH incl. condensation / frost (no commissioning in bedewed state), horizontal installation
<b>Resistance</b> • Coolants and lubricants - Resistant to commercially available coolants and lubricants • Use in stationary industrial systems - to biologically active substances according to EN 60721-3-3  - to chemically active substances according to EN 60721-3-3 - to mechanically active substances according to EN 60721-3-3 - Against mechanical environmental conditions acc. to EN 60721-3-3	Yes; Incl. diesel and oil droplets in the air  Yes; Class 3B2 mold, fungus and dry rot spores (with the exception of fauna); Class 3B3 on request Yes; Class 3C4 (RH < 75 %) incl. salt spray acc. to EN 60068-2-52 (severity degree 3); * Yes; Class 3S4 incl. sand, dust, * Yes; Class 3M8 using the SIPLUS Mounting Kit ET 200SP (6AG1193-6AA00-0AA0)

## SIPLUS extreme RAIL fail-safe CPUs > SIPLUS ET 200SP CPU 1510SP F-1 PN T1 RAIL

Article number	<b>6AG2510-1SJ01-1AB0</b> SIPLUS ET 200SP CPU 1510 F-1 PN RAIL
<ul style="list-style-type: none"> <li>Use on land craft, rail vehicles and special-purpose vehicles <ul style="list-style-type: none"> <li>to biologically active substances according to EN 60721-3-5</li> <li>to chemically active substances according to EN 60721-3-5</li> <li>to mechanically active substances according to EN 60721-3-5</li> </ul> </li> <li>Against mechanical environmental conditions acc. to EN 60721-3-5</li> <li>against mechanical environmental conditions in agriculture acc. to ISO 15003</li> <li>Usage in industrial process technology <ul style="list-style-type: none"> <li>Against chemically active substances acc. to EN 60654-4</li> <li>Environmental conditions for process, measuring and control systems acc. to ANSI/ISA-71.04</li> </ul> </li> <li>Remark <ul style="list-style-type: none"> <li>Note regarding classification of environmental conditions acc. to EN 60721, EN 60654-4 and ANSI/ISA-71.04</li> </ul> </li> </ul>	<p>Yes; Class 5B2 mold, fungus and dry rot spores (with the exception of fauna); Class 5B3 on request</p> <p>Yes; Class 5C3 (RH &lt; 75 %) incl. salt spray acc. to EN 60068-2-52 (severity degree 3); *</p> <p>Yes; Class 5S3 incl. sand, dust; *</p> <p>Yes; Class 5M2 using the SIPLUS Mounting Kit ET 200SP (6AG1193-6AA00-0AA0)</p> <p>Yes; level 1 (Location LE) using the SIPLUS Mounting Kit ET 200SP (6AG1193-6AA00-0AA0)</p> <p>Yes; Class 3 (excluding trichlorethylene)</p> <p>Yes; Level GX group A/B (excluding trichlorethylene; harmful gas concentrations up to the limits of EN 60721-3-3 class 3C4 permissible); level LC3 (salt spray) and level LB3 (oil)</p> <p>* The supplied plug covers must remain in place over the unused interfaces during operation!</p>
<b>Conformal coating</b> <ul style="list-style-type: none"> <li>Coatings for printed circuit board assemblies acc. to EN 61086</li> <li>Protection against fouling acc. to EN 60664-3</li> <li>Electronic equipment on rolling stock acc. to EN 50155</li> <li>Military testing according to MIL-I-46058C, Amendment 7</li> <li>Qualification and Performance of Electrical Insulating Compound for Printed Board Assemblies according to IPC-CC-830A</li> </ul>	<p>Yes; Class 2 for high reliability</p> <p>Yes; Type 1 protection</p> <p>Yes; Class PC2 protective coating acc. to EN 50155:2017</p> <p>Yes; Discoloration of coating possible during service life</p> <p>Yes; Conformal coating, Class A</p>
<b>Configuration / header</b>	
<b>Configuration / programming / header</b> <ul style="list-style-type: none"> <li>Programming language <ul style="list-style-type: none"> <li>LAD</li> <li>FBD</li> <li>STL</li> <li>SCL</li> <li>GRAPH</li> </ul> </li> </ul>	<p>Yes; incl. failsafe</p> <p>Yes; incl. failsafe</p> <p>Yes</p> <p>Yes</p> <p>Yes</p>
<b>Know-how protection</b> <ul style="list-style-type: none"> <li>User program protection/password protection</li> <li>Copy protection</li> <li>Block protection</li> </ul>	<p>Yes</p> <p>Yes</p> <p>Yes</p>
<b>Access protection</b> <ul style="list-style-type: none"> <li>protection of confidential configuration data</li> <li>Protection level: Write protection</li> <li>Protection level: Read/write protection</li> <li>Protection level: Write protection for Failsafe</li> <li>Protection level: Complete protection</li> </ul>	<p>Yes</p> <p>Yes</p> <p>Yes</p> <p>Yes</p> <p>Yes</p>
<b>Dimensions</b>	
<b>Width</b>	100 mm
<b>Height</b>	117 mm
<b>Depth</b>	75 mm
<b>Weights</b>	
<b>Weight, approx.</b>	310 g
<b>Other</b>	
<b>Note:</b>	for use in railway applications, also observe the product information "SIPLUS extreme RAIL" A5E37661960A, Online Support article 109736776

### Selection and ordering data

Version	Article No.
<b>SIPLUS ET 200SP CPU 1510SP F-1 PN T1 RAIL</b> (Extended temperature range and exposure to environmental substances) Work memory 150 KB for program, 750 KB for data, PROFINET IO IRT interface; SIMATIC Memory Card required; for areas with extreme exposure to environmental substances (conformal coating); Ambient temperature -25 ... +60 °C (+70 °C for 10 min.)	<b>6AG2510-1SJ01-1AB0</b>
<b>Accessories</b>	
<b>SIPLUS extreme RAIL BusAdapter</b> <b>SIPLUS ET 200SP BA 2XRJ45 TX RAIL</b> For PROFINET interface modules in Standard function class or above; max. cable length 50 m; for areas with extreme exposure to environmental substances (conformal coating); ambient temperature -40 ... +70 °C (+85 °C for 10 min.)	<b>6AG2193-6AR00-4AA0</b>
<b>SIPLUS ET 200SP BA 2XFC TX RAIL</b> For PROFINET interface modules in Standard function class or above; for increased vibration and EMC load rating; max. cable length 50 m; for areas with extreme exposure to environmental substances (conformal coating); ambient temperature -40 ... +70 °C (+85 °C for 10 min.)	<b>6AG2193-6AF00-4AA0</b>
<b>SIPLUS Mounting Kit ET 200SP</b> Mounting accessories for use with increased mechanical vibration and shock loads. Not approved for SIPLUS BusAdapter BA 2xRJ45	<b>6AG1193-6AA00-0AA0</b>

\* You can order this quantity or a multiple thereof.

## SIPLUS RAIL

SIPLUS Distributed Controller RAIL  
based on SIPLUS ET 200SP

### SIPLUS extreme RAIL fail-safe CPUs > SIPLUS ET 200SP CPU 1512SP F-1 PN T1 RAIL

#### Overview



- SIPLUS ET 200SP CPU 1512SP F-1 PN RAIL for SIPLUS extreme RAIL ET 200SP based on S7-1500 CPU 1513F-1 PN
- Approved in accordance with EN 50155, EN 15121, EN 50124, EN 50125 and EN 45545 railway standards for use in rail traffic
- For applications with average requirements regarding the program scope and processing speed, for distributed setup via PROFINET IO or PROFIBUS DP
- Increase in availability of systems and machines
- Supports PROFIsafe in centralized and distributed configurations
- PROFINET IO controller for up to 128 IO devices
- PROFINET I-Device for connecting the CPU as an intelligent PROFINET device with a SIMATIC or third-party PROFINET IO controller
- PROFINET shared I-device for 4 controllers
- PROFINET IO IRT interface with integrated 3-port switch
- Isochronous mode on PROFINET
- With multiple communication options: PG/OP communication, PROFINET IO, open IE communication (TCP, ISO-on-TCP and UDP), web server and S7 communication (with loadable FBs)
- Configuration control (option handling)
- Integrated motion control functions for controlling speed-controlled and positioning axes, support for external encoders

#### Application

SIPLUS ET 200SP CPU 1512SP F-1 PN RAIL for standard and fail-safe applications with average requirements in terms of processing performance and response speed in discrete production technology. SIPLUS ET 200SP CPU 1512SP F-1 PN RAIL can be used as a PROFINET IO controller or as distributed intelligence (PROFINET I-Device). The integrated PROFINET IO IRT interface is designed as a 3-port switch enabling configuration of a linear topology in the system via port 1 and 2, such that a PG/PC or HMI device can also be connected via port 3.

When used as an I-device, the SIPLUS ET 200SP CPU 1512SP F-1 PN RAIL enables distributed preprocessing of process data locally and only delivers the information actually required to the higher-level controller. This has the following advantages:

- Less load on central controller
- Short response times to critical local signals
- Less load on the bus system due to smaller data volumes
- Faster commissioning due to pre-tested units and parallel commissioning
- Increased availability and flexibility due to autonomous machine units
- Easy-to-understand configuration

SIPLUS ET 200SP CPU 1512SP F-1 PN RAIL operates fully independently of the central controller. If the controller fails, the CPU simply continues to operate.

The bit-modular design of the ET 200SP I/O system, together with SIPLUS ET 200SP CPU 1512SP F-1 PN RAIL, enables functionally oriented station design.

In addition, the CPU offers comprehensive control functionalities via easy-to-configure blocks as well as the ability to connect drives via standardized PLCopen blocks.

#### Design

SIPLUS ET 200SP CPU 1512SP F-1 PN RAIL is directly snapped onto the DIN rail and features:

- A high-performance processor; the CPU achieves command execution times as low as 48 ns per binary instruction
- Extensive work memory: 300 KB for program, 1 MB for data
- SIMATIC Memory Cards as load memory; permitting additional functions such as firmware update, datalog and archiving
- Bit-modular expandability for maximum flexibility; up to 64 I/O modules (I/O, technology, and communications modules) in any combination. Station width up to 1 m.
- PROFINET IO IRT interface with 3 integrated switch ports:
  - Port 1 and 2 via BusAdapter (SIPLUS ET 200SP CPU 1512SP F-1 PN T1 RAIL is supplied without the BusAdapter and can also be operated without it). The appropriate BusAdapter (BA 2xRJ45 or BA 2xFC) is to be ordered separately if needed.
  - Port 3 via integrated RJ45 socket.
- Integrated communication functions:
  - PG/OP communication
  - PROFINET IO
  - Open IE communication (TCP, ISO-on-TCP and UDP)
  - Web server
  - S7 communication
  - S7 routing
  - Data set routing
- Maintenance-free data backup without battery
- Diagnostics displays for errors (Error), operation (RUN/Stop), maintenance (MT), power supply (PWR) and one link LED per port
- Optional labeling using light gray or yellow labeling strips. There is a choice of 2 materials:
  - Foil and roll with 500 strips, for thermal transfer roll printer
  - Paper (280 g/m<sup>2</sup>), DIN A4 sheets with 100 strips each, for laser printer
- The ET 200SP CPU can be equipped with a reference ID label.

### SIPLUS extreme RAIL fail-safe CPUs > SIPLUS ET 200SP CPU 1512SP F-1 PN T1 RAIL

- Different PROFINET connection types by means of Bus-Adapter:
    - Under standard ambient conditions, BA 2xRJ45 for connection via RJ45 plug
    - In the case of mechanical loading during operation and/or an increased EMC requirements BA 2xFC for direct connection of the PROFINET cable
  - Dark BaseUnit as first BaseUnit behind the ET 200SP CPU when using an AC I/O module or an AI Energy Meter ST as the first I/O module
- Scope of delivery
- SIPLUS ET 200SP CPU 1512SP F-1 PN RAIL including server module, 24 V DC connector and cover for BusAdapter port (BusAdapter must be ordered separately)

#### Function

- Performance
  - High-speed command processing
  - High-performance network connection: CPU comes equipped with a PROFINET IO IRT interface (3-port switch) as standard.
- Integrated technology
  - Connection of analog and PROFIdrive-capable drives via standardized blocks (PLCopen)
  - Support of speed-controlled and positioning axes as well as external encoders
  - Precise position gearing for synchronous operation between axes
  - Trace functions for all CPU tags, both for diagnostics in real time and for sporadic error detection
  - Comprehensive control functionalities, e.g. easily configurable blocks for automatic optimization of the control parameters for optimum control quality
- Isochronous mode
  - Synchronous coupling of distributed signal acquisition, signal transmission, and program execution to the PROFINET cycle with constant bus cycle time
- Security Integrated
  - Password-based know-how protection against unauthorized read-out and modification of program blocks
  - Copy protection for tying individual blocks to the serial number of the SIMATIC Memory Card: The block can only run if the configured Memory Card is inserted in the CPU.
  - 4-stage authorization concept: Communication to operator panels can also be restricted.
  - Manipulation protection: The controller recognizes changed or unauthorized transmissions of the engineering data.
- Integrated system diagnostics
  - System diagnostics information is displayed consistently and in plain text in the TIA Portal, operator panels and web server, even for messages from the drives, and updated even if the CPU is in STOP mode.
  - Integrated in the firmware of the CPU, no special configuration is required
- Configuration control (option handling) in central setup
  - Various hardware configurations can be stored in the PLC: Modification of the configuration in the user program (startup OB100), Retrofitting of options at end of configuration; Use of placeholder modules is possible.
- SIMATIC Memory Card (required for operation of the CPU)
  - Used as plug-in load memory or for updating the firmware
  - Also for storing additional documents or csv files (for recipes and archives)
  - Creation of data blocks and storage/reading of data via SFCs of the user program
- Datalog (archives) and recipes
  - Storage of csv files for recipes and archives on the SIMATIC Memory Card; easy access to plant-relevant operating data using Office tools and via web server.
  - Easy access to configuration data of the machine by means of a web browser or SD card reader (two-way data exchange from and to the PLC)
- Programming of the standard program section
  - Programming with STEP 7 Professional, V13 SP1 and higher
- Programming of the fail-safe program section
  - Programming of the safety-related program section with the "STEP 7 Safety Advanced" option package.

#### Technical specifications

Article number	6AG2512-1SK01-1AB0 SIPLUS ET 200SP CPU 1512 F-1 PN RAIL	6AG2512-1SK01-4AB0 SIPLUS ET 200SP CPU 1512 F-1 PN RAIL
<b>General information</b>		
<b>Product type designation</b>	CPU 1512SP F-1 PN	CPU 1512SP F-1 PN
<b>Engineering with</b>		
• STEP 7 TIA Portal configurable/integrated from version	see entry ID: 109746275	see entry ID: 109746275
<b>Supply voltage</b>		
<b>Rated value (DC)</b>	24 V	24 V
<b>Memory</b>		
<b>Work memory</b>		
• integrated (for program)	300 kbyte	300 kbyte
• integrated (for data)	1 Mbyte	1 Mbyte
<b>Load memory</b>		
• Plug-in (SIMATIC Memory Card), max.	32 Gbyte	32 Gbyte
<b>CPU processing times</b>		
<b>for bit operations, typ.</b>	48 ns	48 ns
<b>for word operations, typ.</b>	58 ns	58 ns
<b>for fixed point arithmetic, typ.</b>	77 ns	77 ns
<b>for floating point arithmetic, typ.</b>	307 ns	307 ns

**SIPLUS RAIL**

SIPLUS Distributed Controller RAIL  
based on SIPLUS ET 200SP

**SIPLUS extreme RAIL fail-safe CPUs > SIPLUS ET 200SP CPU 1512SP F-1 PN T1 RAIL**

Article number	<b>6AG2512-1SK01-1AB0</b> SIPLUS ET 200SP CPU 1512 F-1 PN RAIL	<b>6AG2512-1SK01-4AB0</b> SIPLUS ET 200SP CPU 1512 F-1 PN RAIL
<b>Counters, timers and their retentivity</b>		
<b>S7 counter</b>		
• Number	2 048	2 048
<b>IEC counter</b>		
• Number	Any (only limited by the main memory)	Any (only limited by the main memory)
<b>S7 times</b>		
• Number	2 048	2 048
<b>IEC timer</b>		
• Number	Any (only limited by the main memory)	Any (only limited by the main memory)
<b>Data areas and their retentivity</b>		
<b>Flag</b>		
• Size, max.	16 kbyte	16 kbyte
<b>Address area</b>		
<b>I/O address area</b>		
• Inputs	32 kbyte; All inputs are in the process image	32 kbyte; All inputs are in the process image
• Outputs	32 kbyte; All outputs are in the process image	32 kbyte; All outputs are in the process image
<b>Address space per module</b>		
• Address space per module, max.	288 byte; For input and output data respectively	288 byte; For input and output data respectively
<b>Address space per station</b>		
• Address space per station, max.	2 560 byte; for central inputs and outputs; depending on configuration; 2 048 bytes for ET 200SP modules + 512 bytes for ET 200AL modules	2 560 byte; for central inputs and outputs; depending on configuration; 2 048 bytes for ET 200SP modules + 512 bytes for ET 200AL modules
<b>Time of day</b>		
<b>Clock</b>		
• Type	Hardware clock	Hardware clock
<b>1. Interface</b>		
<b>Interface types</b>		
• RJ 45 (Ethernet)	Yes; X1 P3; opt. X1 P1 and X1 P2 via BusAdapter BA 2x RJ45	Yes; X1 P3
• Number of ports	3; 1. integr. + 2. via BusAdapter	1
• integrated switch	Yes	No
• BusAdapter (PROFINET)	Yes; compatible BusAdapters: BA 2x RJ45, BA 2x FC, BA 2x M12	No
<b>Protocols</b>		
• IP protocol	Yes; IPv4	Yes; IPv4
• PROFINET IO Controller	Yes	Yes
• PROFINET IO Device	Yes	Yes
• SIMATIC communication	Yes	Yes
• Open IE communication	Yes; Optionally also encrypted	Yes; Optionally also encrypted
• Web server	Yes	Yes
• Media redundancy	Yes; MRP Automanager according to IEC 62439-2 Edition 2.0	No
<b>PROFINET IO Controller</b>		
- Services	Yes	Yes
- PG/OP communication	Yes	Yes
- Isochronous mode	Yes; Requirement: IRT and isochronous mode (MRPD optional)	Yes; Requirement: IRT and isochronous mode (MRPD optional)
- Direct data exchange	Yes	Yes
- IRT	Yes; per user program	Yes; per user program
- PROFlenergy	Yes; Max. 32 PROFINET devices	Yes; Max. 32 PROFINET devices
- Prioritized startup	128; In total, up to 512 distributed I/O devices can be connected via AS-i, PROFIBUS or -PROFINET	128; In total, up to 512 distributed I/O devices can be connected via AS-i, PROFIBUS or PROFINET
- Number of connectable IO Devices, max.	64	64
- Of which IO devices with IRT, max.	128	128
- Number of connectable IO Devices for RT, max.	128	128
- of which in line, max.	8; in total across all interfaces	8; in total across all interfaces
- Number of IO Devices that can be simultaneously activated/deactivated, max.	8	8
- Number of IO Devices per tool, max.	The minimum value of the update time also depends on communication share set for PROFINET IO, on the number of IO devices, and on the quantity of configured user data	The minimum value of the update time also depends on communication share set for PROFINET IO, on the number of IO devices, and on the quantity of configured user data
- Updating times		
<b>PROFINET IO Device</b>		
• Services		
- PG/OP communication	Yes	Yes
- Isochronous mode	No	No
- IRT	Yes	Yes
- PROFlenergy	Yes; per user program	Yes; per user program
- Shared device	Yes	Yes
- Number of IO Controllers with shared device, max.	4	4
- activation/deactivation of I-devices	Yes; per user program	Yes; per user program
- Asset management record	Yes; per user program	Yes; per user program

## SIPLUS extreme RAIL fail-safe CPUs > SIPLUS ET 200SP CPU 1512SP F-1 PN T1 RAIL

Article number	<b>6AG2512-1SK01-1AB0</b> SIPLUS ET 200SP CPU 1512 F-1 PN RAIL	<b>6AG2512-1SK01-4AB0</b> SIPLUS ET 200SP CPU 1512 F-1 PN RAIL
<b>2. Interface</b>		
<b>Interface types</b> • RS 485 • Number of ports	Yes; Via CM DP module 1	Yes; Via CM DP module 1
<b>Protocols</b> • PROFIBUS DP master • PROFIBUS DP slave • SIMATIC communication	Yes Yes Yes	Yes Yes Yes
<b>PROFIBUS DP master</b> • Number of DP slaves, max.	125; In total, up to 512 distributed I/O devices can be connected via AS-i, PROFIBUS or PROFINET	125; In total, up to 512 distributed I/O devices can be connected via AS-i, PROFIBUS or PROFINET
<b>Protocols</b>		
<b>Number of connections</b> • Number of connections, max.	128; via integrated interfaces of the CPU and connected CPs / CMs	128; via integrated interfaces of the CPU and connected CPs / CMs
<b>Redundancy mode</b> • Media redundancy - Media redundancy - MRP  - MRP interconnection, supported  - MRPD - Switchover time on line break, typ. - Number of stations in the ring, max.	Yes; only via BusAdapter Yes; MRP Automanager according to IEC 62439-2 Edition 2.0, MRP Manager; MRP Client Yes; as MRP ring node according to IEC 62439-2 Edition 3.0 Yes; Requirement: IRT 200 ms; For MRP, bumpless for MRPD 50	No No  No No
<b>SIMATIC communication</b> • S7 routing	Yes	Yes
<b>OPC UA</b> • OPC UA Client • OPC UA Server	Yes Yes; Data access (read, write, subscribe), method call, custom address space	Yes Yes; Data access (read, write, subscribe), method call, custom address space
<b>Supported technology objects</b>		
<b>Motion Control</b>  • Number of available Motion Control resources for technology objects • Required Motion Control resources - per speed-controlled axis - per positioning axis - per synchronous axis - per external encoder - per output cam - per cam track - per probe	Yes; Note: The number of technology objects affects the cycle time of the PLC program; selection guide via the TIA Selection Tool 800  40 80 160 80 20 160 40	Yes; Note: The number of technology objects affects the cycle time of the PLC program; selection guide via the TIA Selection Tool 800  40 80 160 80 20 160 40
<b>Controller</b> • PID_Compact  • PID_3Step  • PID-Temp	Yes; Universal PID controller with integrated optimization Yes; PID controller with integrated optimization for valves Yes; PID controller with integrated optimization for temperature	Yes; Universal PID controller with integrated optimization Yes; PID controller with integrated optimization for valves Yes; PID controller with integrated optimization for temperature
<b>Counting and measuring</b> • High-speed counter	Yes	Yes
<b>Standards, approvals, certificates</b>		
<b>Highest safety class achievable in safety mode</b> • SIL in accordance with EN 50126, 50128, 50129  • Probability of failure (for service life of 20 years and repair time of 100 hours) - Low demand mode: PFDavg in accordance with SIL3 - High demand/continuous mode: PFH in accordance with SIL3	SIL 2; a higher safety integrity level is possible if tested and approved for the specific application under consideration of all local regulations.  < 2.00E-05 < 1.00E-09	SIL 2; a higher safety integrity level is possible if tested and approved for the specific application under consideration of all local regulations.  < 2.00E-05 < 1.00E-09



**SIPLUS RAIL**SIPLUS Distributed Controller RAIL  
based on SIPLUS ET 200SP**SIPLUS extreme RAIL fail-safe CPUs > SIPLUS ET 200SP CPU 1512SP F-1 PN T1 RAIL**

Article number	<b>6AG2512-1SK01-1AB0</b> SIPLUS ET 200SP CPU 1512 F-1 PN RAIL	<b>6AG2512-1SK01-4AB0</b> SIPLUS ET 200SP CPU 1512 F-1 PN RAIL
<b>Railway application</b> • EN 50121-3-2 • EN 50121-4  • EN 50124-1  • EN 50125-1 • EN 50125-2  • EN 50125-3  • EN 50155  • EN 61373  • Fire protection acc. to EN 45545-2	Yes; EMC for rail vehicles Yes; EMC for signal and telecommunications systems Yes; Railway applications - overvoltage category OV2; pollution degree PD2; rated surge voltage UNi = 0.5 kV; UNm = 24 V DC Yes; Rail vehicles - see ambient conditions Yes; Stationary electrical equipment - see ambient conditions Yes; Signal and telecommunications systems - see ambient conditions; vibrations and shocks: Application point outside of tracks (1 m to 3 m away from track) Yes; Rail vehicles - temperature class OT1, ST1/ST2, horizontal mounting position Yes; Rail vehicles - vibrations and shocks: Category 1 Class A/B Yes; For proof of conformity, see Service & Support	Yes; EMC for rail vehicles Yes; EMC for signal and telecommunications systems Yes; Railway applications - overvoltage category OV2; pollution degree PD2; rated surge voltage UNi = 0.5 kV; UNm = 24 V DC Yes; Rail vehicles - see ambient conditions Yes; Stationary electrical equipment - see ambient conditions Yes; Signal and telecommunications systems - see ambient conditions; vibrations and shocks: Application point outside of tracks (1 m to 3 m away from track) Yes; Rail vehicles - temperature class OT4, ST1/ST2, horizontal mounting position Yes; Rail vehicles - vibrations and shocks: Category 1 Class A/B Yes; For proof of conformity, see Service & Support
<b>Ambient conditions</b> <b>Ambient temperature during operation</b> • horizontal installation, min. • horizontal installation, max.  • vertical installation, min. • vertical installation, max.	-25 °C; = Tmin (incl. condensation/frost) 60 °C; = Tmax; +70 °C for 10 min (OT1, ST1/ST2 acc. to EN 50155) -25 °C; = Tmin 50 °C; = Tmax	-40 °C; = Tmin (incl. condensation/frost) 70 °C; = Tmax; +85 °C for 10 min (OT4, ST1/ST2 acc. to EN 50155) -40 °C; = Tmin 50 °C; = Tmax
<b>Altitude during operation relating to sea level</b> • Installation altitude above sea level, max. • Ambient air temperature-barometric pressure-altitude	2 000 m Tmin ... Tmax at 1 140 hPa ... 795 hPa (-1 000 m ... +2 000 m)	2 000 m Tmin ... Tmax at 1 140 hPa ... 795 hPa (-1 000 m ... +2 000 m)
<b>Relative humidity</b> • With condensation, tested in accordance with IEC 60068-2-38, max.	100 %; RH incl. condensation / frost (no commissioning in bedewed state), horizontal installation	100 %; RH incl. condensation / frost (no commissioning in bedewed state), horizontal installation
<b>Resistance</b> • Coolants and lubricants - Resistant to commercially available coolants and lubricants • Use in stationary industrial systems - to biologically active substances according to EN 60721-3-3 - to chemically active substances according to EN 60721-3-3 - to mechanically active substances according to EN 60721-3-3 - Against mechanical environmental conditions acc. to EN 60721-3-3 • Use on land craft, rail vehicles and special-purpose vehicles - to biologically active substances according to EN 60721-3-5 - to chemically active substances according to EN 60721-3-5 - to mechanically active substances according to EN 60721-3-5 - Against mechanical environmental conditions acc. to EN 60721-3-5 - against mechanical environmental conditions in agriculture acc. to ISO 15003 • Usage in industrial process technology - Against chemically active substances acc. to EN 60654-4 - Environmental conditions for process, measuring and control systems acc. to ANSI/ISA-71.04  • Remark - Note regarding classification of environmental conditions acc. to EN 60721, EN 60654-4 and ANSI/ISA-71.04	Yes; Incl. diesel and oil droplets in the air  Yes; Class 3B2 mold, fungus and dry rot spores (with the exception of fauna); Class 3B3 on request Yes; Class 3C4 (RH < 75 %) incl. salt spray acc. to EN 60068-2-52 (severity degree 3); * Yes; Class 3S4 incl. sand, dust; *  Yes; Class 3M8 using the SIPLUS Mounting Kit ET 200SP (6AG1193-6AA00-0AA0)  Yes; Class 5B2 mold, fungus and dry rot spores (with the exception of fauna); Class 5B3 on request Yes; Class 5C3 (RH < 75 %) incl. salt spray acc. to EN 60068-2-52 (severity degree 3); * Yes; Class 5S3 incl. sand, dust; *  Yes; Class 5M2 using the SIPLUS Mounting Kit ET 200SP (6AG1193-6AA00-0AA0) Yes; level 1 (Location LE) using the SIPLUS Mounting Kit ET 200SP (6AG1193-6AA00-0AA0)  Yes; Class 3 (excluding trichlorethylene)  Yes; Level GX group A/B (excluding trichlorethylene; harmful gas concentrations up to the limits of EN 60721-3-3 class 3C4 permissible); level LC3 (salt spray) and level LB3 (oil)  * The supplied plug covers must remain in place over the unused interfaces during operation!	No  Yes; Class 3B2 mold, fungus and dry rot spores (with the exception of fauna); Class 3B3 on request Yes; Class 3C4 (RH < 75 %) incl. salt spray acc. to EN 60068-2-52 (severity degree 3); * Yes; Class 3S4 incl. sand, dust; *  Yes; Class 5B2 mold, fungus and dry rot spores (with the exception of fauna); Class 5B3 on request Yes; Class 5C3 (RH < 75 %) incl. salt spray acc. to EN 60068-2-52 (severity degree 3); * Yes; Class 5S3 incl. sand, dust; *  Yes; Class 3 (excluding trichlorethylene)  Yes; Level GX group A/B (excluding trichlorethylene; harmful gas concentrations up to the limits of EN 60721-3-3 class 3C4 permissible); level LC3 (salt spray) and level LB3 (oil)  * The supplied plug covers must remain in place over the unused interfaces during operation!
<b>Conformal coating</b> • Coatings for printed circuit board assemblies acc. to EN 61086 • Protection against fouling acc. to EN 60664-3 • Electronic equipment on rolling stock acc. to EN 50155  • Military testing according to MIL-I-46058C, Amendment 7 • Qualification and Performance of Electrical Insulating Compound for Printed Board Assemblies according to IPC-CC-830A	Yes; Class 2 for high reliability  Yes; Type 1 protection Yes; Class PC2 protective coating acc. to EN 50155:2017 Yes; Discoloration of coating possible during service life Yes; Conformal coating, Class A	Yes; Class 2 for high reliability  Yes; Type 1 protection Yes; Class PC2 protective coating acc. to EN 50155:2017 Yes; Discoloration of coating possible during service life Yes; Conformal coating, Class A

## SIPLUS extreme RAIL fail-safe CPUs > SIPLUS ET 200SP CPU 1512SP F-1 PN T1 RAIL

Article number	<b>6AG2512-1SK01-1AB0</b> SIPLUS ET 200SP CPU 1512 F-1 PN RAIL	<b>6AG2512-1SK01-4AB0</b> SIPLUS ET 200SP CPU 1512 F-1 PN RAIL
<b>Configuration / header</b>		
<b>Configuration / programming / header</b>		
• Programming language	Yes; incl. failsafe	Yes; incl. failsafe
- LAD	Yes; incl. failsafe	Yes; incl. failsafe
- FBD	Yes	Yes
- STL	Yes	Yes
- SCL	Yes	Yes
- GRAPH	Yes	Yes
<b>Know-how protection</b>		
• User program protection/password protection	Yes	Yes
• Copy protection	Yes	Yes
• Block protection	Yes	Yes
<b>Access protection</b>		
• Protection level: Write protection	Yes	Yes
• Protection level: Read/write protection	Yes	Yes
• Protection level: Complete protection	Yes	Yes
<b>Dimensions</b>		
<b>Width</b>	100 mm	100 mm
<b>Height</b>	117 mm	117 mm
<b>Depth</b>	75 mm	75 mm
<b>Weights</b>		
<b>Weight, approx.</b>	310 g	470 g
<b>Other</b>		
<b>Note:</b>	for use in railway applications, also observe the product information "SIPLUS extreme RAIL" A5E37661960A, Online Support article 109736776	for use in railway applications, also observe the product information "SIPLUS extreme RAIL" A5E37661960A, Online Support article 109736776

### Selection and ordering data

Version	Article No.
<p><b>SIPLUS ET 200SP CPU 1512SP F-1 PN RAIL</b> Approved in accordance with the EN 50155, EN 15121, EN 50124, EN 50125 and EN 45545 railway standards for use in rail traffic Work memory 300 KB for program, 1 MB for data, PROFINET IO IRT interface; SIMATIC Memory Card required; for areas with extreme exposure to environmental substances (conformal coating); Ambient temperature -25 ... +60 °C, OT1 with ST1/2, (+70 °C for 10 min.)</p> <p><b>SIPLUS ET 200SP CPU 1512SP F-1 PN RAIL</b> No BusAdapter can be inserted, work memory 300 KB for program, 1 MB for data, PROFINET IO IRT interface with 3-port switch, 48 ns bit performance, SIMATIC Memory Card required; for areas with extreme exposure to environmental substances (conformal coating); Ambient temperature -40 ... +70 °C, OT4 with ST1/2, (+85 °C for 10 min.)</p>	<p><b>6AG2510-1SJ01-1AB0</b></p> <p><b>6AG2512-1SK01-4AB0</b></p>
<b>Accessories</b>	
<p><b>SIPLUS extreme RAIL BusAdapter</b></p> <p><b>SIPLUS ET 200SP BA 2XRJ45 TX RAIL</b> For PROFINET interface modules in Standard function class or above; max. cable length 50 m; for areas with extreme exposure to environmental substances (conformal coating); ambient temperature -40 ... +70 °C (+85 °C for 10 min.)</p>	<b>6AG2193-6AR00-4AA0</b>
<p><b>SIPLUS ET 200SP BA 2XFC TX RAIL</b> For PROFINET interface modules in Standard function class or above; for increased vibration and EMC load rating; max. cable length 50 m; for areas with extreme exposure to environmental substances (conformal coating); ambient temperature -40 ... +70 °C (+85 °C for 10 min.)</p>	<b>6AG2193-6AF00-4AA0</b>
<p><b>SIPLUS Mounting Kit ET 200SP</b> Mounting accessories for use with increased mechanical vibration and shock loads. Not approved for SIPLUS BusAdapter BA 2xRJ45</p>	<b>6AG1193-6AA00-0AA0</b>



## SIPLUS RAIL

SIPLUS Distributed Controller RAIL  
based on SIPLUS ET 200SP

### SIPLUS extreme RAIL Open Controller

#### Overview

##### Compact and powerful

SIPLUS ET 200SP RAIL Open Controller, SIPLUS CPU 1515SP PC RAIL is a rugged, compact control system that combines the functionality of a SIPLUS ET 200SP RAIL controller with a PC-based platform. It can be used to control special-purpose and series machines, or plants in a distributed configuration.

The SIPLUS ET 200SP RAIL I/O modules can be inserted centrally and communicate via the integrated backplane bus. S7 communication can be established and distributed I/Os can be

connected via the PROFINET adapter of the SIPLUS ET 200SP system. The PROFIBUS CM DP module provides simple expandability for PROFIBUS communication.

The SIPLUS CPU 1515SP PC2 RAIL is used wherever special automation functions are to be integrated with support from SIMATIC ODK 1500S via the programming language C or C++, or if a close connection of independent applications is required in Windows for the software controller.

Characteristics	SIPLUS CPU 1515SP PC2 RAIL
<b>DDR3 DRAM</b>	8 GB
<b>CFast card</b>	30 GB
<b>Operating system</b>	Windows 10 Enterprise LTSC 2016
<b>Work memory for program, integrated</b>	1 MB (1.5 MB for F)
<b>Work memory for data, integrated</b>	5 MB
<b>Load memory</b>	320 MB
<b>Command execution times</b>	
• Bit operations	10 ns
• Word operations	12 ns
• Fixed-point operations	16 ns
• Floating-point operations	64 ns
<b>Bit memories, timers, counters</b>	
• S7 counters/timers	2048
• IEC counter	Arbitrary (only limited by the work memory)
• IEC timer	Arbitrary (only limited by the work memory)
• Bit memories	16 KB
<b>I/O address range</b>	
• Inputs	32 KB (all inputs are stored in the process image)
• Outputs	32 KB (all inputs are stored in the process image)
<b>Motion</b>	
• Motion control resources	2400
<b>Communication</b>	
• PiP	Yes (via CM)
• PROFINET IO	1 x PN IO IRT (BusAdapter not included in scope of delivery)
• PROFIBUS DP	Yes (via CM DP)
• Web server	Yes
• GB Ethernet	Yes, 1 x via GB Ethernet RJ45 interface

#### Application

##### ET 200SP Open Controller

##### Compact dimensions

The open controller is a particularly compact and energy-efficient controller for the DIN rail. Thanks to its minimal size, it can be used in extremely confined spaces. Signals can be detected centrally via the backplane bus or distributed via PROFIBUS or PROFINET.

##### Rugged design

All designs aim to achieve maximum safety in the case of vibration and shock loads. With its fan-free design and the use of CFast cards (flash memory), the open controller is particularly suitable for maintenance-free 24/7 continuous operation in the industrial environment, at temperatures of up to 60 degrees Celsius.

##### Interfaces

The open controller is connected to the controllers/cell levels via the integrated onboard Ethernet interfaces. I/O data communication can be implemented via PROFINET using a BusAdapter or an optional PROFIBUS CM-DP module. External monitors or displays can be connected via a DVI-I or DisplayPort interface.

##### Flexibility

The open controller has CE certification for use in industrial and domestic/commercial environments and can therefore be used in building automation or public installations in addition to industrial applications.

##### Continuity

The open controller offers a new part availability of at least three years. Moreover, a spare part availability of at least another five years is guaranteed. This is a unique long-term availability for PC technology which is unprecedented in the industry.

##### System availability

The open controller is delivered ready-for-use in various bundle variants. The high system availability by design can be further extended by means of additional data backup options (e.g. SIMATIC IPC Image & Partition Creator) and efficient software for self-diagnostics (SIMATIC IPC DiagMonitor).

**More information*****Further information and downloads***Manuals

The manuals for the ET 200SP Open Controller can be downloaded online for free from SIMATIC Customer Support.

<https://support.industry.siemens.com/cs/ww/en/ps/13891/man>

General information

<http://www.siemens.com/open-controller>

SIMATIC Selection Tool

<http://www.siemens.com/tia-selection-tool>

## SIPLUS RAIL

SIPLUS Distributed Controller RAIL  
based on SIPLUS ET 200SP

### SIPLUS extreme RAIL Open Controller > SIPLUS ET 200SP CPU 1515SP PC2 RAIL

#### Overview



SIPLUS extreme RAIL Open Controller, SIPLUS ET 200SP CPU 1515SP PC2 RAIL, combines robustness and compact dimensions with the flexibility of centralized or decentralized communication in the highest industrial functionality. Furthermore, the CPU offers the entire value added of the SIPLUS ET 200SP system, the SIPLUS S7-1500 controller family and the TIA world together.

- Rugged, compact control system
- Combines the functions of a SIPLUS ET 200SP controller with those of a PC-based platform
- Turnkey all-in-one controller
- High performance automation tasks with the use of new generation Intel Quad Core processors
- Connects high-level language applications and processes high data volumes with support from SIMATIC ODK 1500S

#### Application

The SIPLUS ET 200SP CPU 1515SP PC2 RAIL can be used to control special and series machines as well as plants in a centralized or distributed configuration. The standard and fail-safe user program is generated in the TIA Portal. The controller is especially suitable for machines with high data volumes, e.g. for quality assurance with camera inspection and image transmission, or printer connection.

The SIPLUS ET 200SP CPU 1515SP PC2 RAIL shows its strength in particular:

- When special automation functions have to be integrated using the C or C++ programming languages
- When a close connection of Windows software to the software controller is required
- When large volumes of data have to be stored

#### Design

The SIPLUS ET 200SP CPU 1515SP PC2 RAIL is mounted on the standard DIN rail like all SIPLUS ET 200SP CPUs.

The SIPLUS ET 200SP I/O modules can be used directly and centrally, and they communicate via the integrated backplane bus.

PN IO and S7 communication can be established and distributed I/Os can be connected via the PROFINET BusAdapters of the SIPLUS ET 200SP system (not included in scope of supply). This way, the system can be integrated into existing automation environments with little effort.

The PROFIBUS CM DP module extends the SIPLUS ET 200SP CPU 1515SP PC2 RAIL to include PROFIBUS communication.

The following interfaces are available:

- 1 x Gb Ethernet
- 1 x PN IO interface via SIPLUS ET 200SP BusAdapter with 2 ports
- 2 x USB 2.0 / 2x USB 3.0 at the front, for connecting a keyboard, mouse and USB flash drive, for example
- 1 x display port, for connecting a SIMATIC Flat Panel or multi-touch device, for example

The CPU also features the following:

- Mode switch
- Replaceable mass storage CFast with security seal
- Additional memory slot for SD/MMC
- Status LEDs
- Connection for 24 V DC supply voltage

#### Function

- Configuring and programming with the STEP 7 engineering tool (and WinCC Advanced for the HMI option) in the TIA Portal:
  - Programmable according to IEC 61131-3
  - Supported programming languages: SCL (IL), LAD, FBD, STL, GRAPH7 (SFC)
- Innovative real-time system based on visualization technology:
  - The real-time system of the integrated S7-1500 software controllers enables parallel operation independent of the operating system:
    - Maximum real-time and deterministic properties
    - Supports restart of Windows while the controller is in operation
- High-speed program execution with multiple priority-controlled execution levels (cyclic, time-controlled, isochronous with PROFINET or PROFIBUS, event-driven via process and diagnostics alarms)
- Saving of retentive data:
  - The SIPLUS ET 200SP CPU 1515SP PC2 RAIL ensures the security of the plant data, even when the power fails:
    - Saving of retentive data on the NVRAM of the CPU possible during voltage dips (default)
    - Retentive data storage possible on CPU CFast card (UPS required)
- Communication:
  - PROFINET IO communication via the ET 200SP BusAdapter; PROFIBUS communication via ET 200SP CM DP; PROFINET IO RT/IRT, isochronous mode, IO controller, I-device, media redundancy, PROFIenergy, PROFIBUS DP master
  - SIMATIC and open user communication with Windows applications or external devices via the Windows interfaces (Gb Ethernet) of the CPU
- Configuration control (option handling) for flexible variations of the central configuration
  - Configuration of a controller and operation of variants (options) that differ from this configuration
- Integrated web server:
  - Scanning the CPU via the web server is supported by all CPUs of the S7-1500 automation system. The CPU web server offers the following diagnostics options:
    - Image of the CPU with LEDs and the current operating state
    - Readout of the diagnostics buffer entries
    - Query of module status
    - Query of current messages
    - Information on the status of the topology/PROFINET devices
    - Transfer and management of user data on the load memory of the CPU
    - User-programmable web pages for supporting servicing and commissioning of specific machine functions

### SIPLUS extreme RAIL Open Controller > SIPLUS ET 200SP CPU 1515SP PC2 RAIL

- **Trace functionality:**  
The trace function is supported by all CPUs of the S7-1500 automation system. It enables recording of analog and digital variables for each cycle and their representation as a curve with STEP 7. This is especially useful for motion control or closed-loop control applications
- **Integrated technology:**
  - Control of PROFIdrive-capable drives and drives with analog setpoint interfaces via standardized motion control instructions (PLCopen).
  - Trace functions for all CPU tags, both for diagnostics in real time as well as for sporadic error detection; can also be called via the web server of the CPU.
  - Comprehensive control functionalities, e.g. easy to configure blocks for automatic optimization of the control parameters for maximum control performance.
- **Integrated system diagnostics:**  
System diagnostics can be displayed via a connected monitor, an HMI device, the web server, or the operator panel of the software controller. Drive messages are also displayed in this way. System diagnostics are also available when the CPU is in STOP mode. If new hardware components are configured, the diagnostic information is updated automatically.
- **Integrated safety:**
  - **Know-how protection:**  
Algorithms and program blocks can be reliably password-protected against unauthorized access and modification.
  - **Access protection:**  
Extended access protection provides comprehensive protection against unauthorized configuration changes. Various authorization levels are available for assigning separate rights to different user groups.
  - **Integrity protection:**  
The system protects the data transferred to the CPU against unauthorized tampering. Modified or third-party transmission of engineering data are safely detected by the CPU.

#### Note

Some functions of the SIPLUS ET 200SP CPU 1515SP PC2 RAIL, such as Windows Hello, Cortana with voice output, support for 5-point touch, etc., may require extended hardware. This hardware can be connected as a USB device.

### Technical specifications

Article number	6AG2677-2DB40-2AA0	6AG2677-2DB42-2GB0	6AG2677-2DB40-2GB0
	SIPLUS ET 200SP CPU1515SP PC2 RAIL	SIPLUS ET 200SP CPU 1515SP PC2 RAIL	SIPLUS ET 200SP CPU 1515SP PC2 L RAIL
<b>General information</b>			
<b>Product type designation</b>	CPU 1515SP PC2	CPU 1515SP PC2	CPU 1515SP PC2 L
<b>Engineering with</b>			
• STEP 7 TIA Portal configurable/integrated from version	see entry ID: 109746275	see entry ID: 109746275	see entry ID: 109746275
<b>Installed software</b>			
• Visualization	No	No	No
• Control	No	S7-1500 Software Controller CPU 1505SP	S7-1500 Software Controller CPU 1505SP
<b>Supply voltage</b>			
<b>Rated value (DC)</b>	24 V	24 V	24 V
<b>Processor</b>			
<b>Processor type</b>	Intel Atom E3940, 1.6 GHz, 4 cores	Intel Atom E3940, 1.6 GHz, 4 cores	Intel Atom E3940, 1.6 GHz, 4 cores
<b>Memory</b>			
<b>Type of memory</b>	DDR3L	DDR3L	DDR3L
<b>Main memory</b>	8 GB RAM	8 GB RAM	8 GB RAM
<b>CFast memory card</b>	No	Yes; 128 GB flash memory	Yes; 128 GB flash memory
<b>Work memory</b>			
• integrated (for program)	1 Mbyte	1 Mbyte	1 Mbyte
• integrated (for data)	5 Mbyte	5 Mbyte	5 Mbyte
• integrated (for CPU function library of CPU Runtime)	20 Mbyte	20 Mbyte	20 Mbyte
<b>Load memory</b>			
• integrated (on PC mass storage)	320 Mbyte	320 Mbyte	320 Mbyte
<b>CPU processing times</b>			
<b>for bit operations, typ.</b>	10 ns	10 ns	10 ns
<b>for word operations, typ.</b>	12 ns	12 ns	12 ns
<b>for fixed point arithmetic, typ.</b>	16 ns	16 ns	16 ns
<b>for floating point arithmetic, typ.</b>	64 ns	64 ns	64 ns
<b>Counters, timers and their retentivity</b>			
<b>S7 counter</b>			
• Number	2 048	2 048	2 048
<b>IEC counter</b>			
• Number	Any (only limited by the main memory)	Any (only limited by the main memory)	Any (only limited by the main memory)
<b>S7 times</b>			
• Number	2 048	2 048	2 048

**SIPLUS RAIL**

SIPLUS Distributed Controller RAIL  
based on SIPLUS ET 200SP

**SIPLUS extreme RAIL Open Controller > SIPLUS ET 200SP CPU 1515SP PC2 RAIL**

Article number	<b>6AG2677-2DB40-2AA0</b>	<b>6AG2677-2DB42-2GB0</b>	<b>6AG2677-2DB40-2GB0</b>
	SIPLUS ET 200SP CPU1515SP PC2 RAIL	SIPLUS ET 200SP CPU 1515SP PC2 RAIL	SIPLUS ET 200SP CPU 1515SP PC2 L RAIL
<b>IEC timer</b>			
• Number	Any (only limited by the main memory)	Any (only limited by the main memory)	Any (only limited by the main memory)
<b>Data areas and their retentivity</b>			
<b>Flag</b>			
• Size, max.	16 kbyte	16 kbyte	16 kbyte
<b>Address area</b>			
<b>I/O address area</b>			
• Inputs	32 kbyte; All inputs are in the process image	32 kbyte; All inputs are in the process image	16 kbyte; All inputs are in the process image
• Outputs	32 kbyte; All outputs are in the process image	32 kbyte; All outputs are in the process image	16 kbyte; All outputs are in the process image
<b>Hardware configuration</b>			
<b>Integrated power supply</b>	Yes	Yes	Yes
<b>Time of day</b>			
<b>Clock</b>			
• Type	Hardware clock	Hardware clock	Hardware clock
• Hardware clock (real-time)		Yes; Resolution: 1 s	Yes; Resolution: 1 s
<b>Interfaces</b>			
<b>Number of industrial Ethernet interfaces</b>	2	2	2
<b>Number of RS 485 interfaces</b>	1; Via CM DP module	1; Via CM DP module	
<b>Number of USB interfaces</b>	4; 2x USB 2.0, 2x USB 3.0 on front side	4; 2x USB 2.0, 2x USB 3.0 on front side	4; 2x USB 2.0, 2x USB 3.0 on front side
<b>Number of SD card slots</b>	1	1	1
<b>Video interfaces</b>			
• Graphics interface	1x DisplayPort	1x DisplayPort	1x DisplayPort
<b>1. Interface</b>			
<b>Interface type</b>	PROFINET	PROFINET	PROFINET
<b>automatic detection of transmission rate</b>	Yes	Yes	Yes
<b>Autonegotiation</b>	Yes	Yes	Yes
<b>Autocrossing</b>	Yes	Yes	Yes
<b>Number of connections</b>	88	88	88
<b>Interface types</b>			
• RJ 45 (Ethernet)	Yes; Via BusAdapter BA 2x RJ45	Yes; Via BusAdapter BA 2x RJ45	Yes; Via BusAdapter BA 2x RJ45
- Transmission rate, max.	100 Mbit/s	100 Mbit/s	100 Mbit/s
- Industrial Ethernet status LED	Yes	Yes	Yes
• Number of ports	2	2	2
• integrated switch	Yes	Yes	Yes
• BusAdapter (PROFINET)	Yes; Compatible BusAdapter: BA 2x RJ45, BA 2x FC, BA 2x SCRJ (from FS03, V2.2), BA SCRJ / RJ45 (from FS03, V3.1), BA SCRJ / FC (from FS03, V3.1), BA 2x LC (from FS03, V3.3), BA LC / RJ45 (from FS03, V3.3), BA LC / FC (from FS03, V3.3)	Yes; Compatible BusAdapter: BA 2x RJ45, BA 2x FC, BA 2x SCRJ (from FS03, V2.2), BA SCRJ / RJ45 (from FS03, V3.1), BA SCRJ / FC (from FS03, V3.1), BA 2x LC (from FS03, V3.3), BA LC / RJ45 (from FS03, V3.3), BA LC / FC (from FS03, V3.3)	Yes; Compatible BusAdapter: BA 2x RJ45, BA 2x FC, BA 2x SCRJ (from FS03, V2.2), BA SCRJ / RJ45 (from FS03, V3.1), BA SCRJ / FC (from FS03, V3.1), BA 2x LC (from FS03, V3.3), BA LC / RJ45 (from FS03, V3.3), BA LC / FC (from FS03, V3.3)
<b>Protocols</b>			
• PROFINET IO Controller	Yes	Yes	Yes
• PROFINET IO Device	Yes	Yes	Yes
• SIMATIC communication	Yes	Yes	Yes
• Open IE communication	Yes	Yes	Yes
• Web server	Yes	Yes	Yes
<b>PROFINET IO Controller</b>			
• Services			
- Isochronous mode	Yes	Yes	Yes
- shortest clock pulse	500 µs	500 µs	500 µs
- IRT	Yes	Yes	Yes
- PROFinergy	Yes	Yes	Yes
- Prioritized startup	Yes; max. 32 PROFINET devices; if you want to use the "Prioritized startup" functionality in STEP 7 for the PROFINET interface of the CPU, the CPU and the device must be separated by means of a switch (e.g. SCALANCE X205)	Yes; max. 32 PROFINET devices; if you want to use the "Prioritized startup" functionality in STEP 7 for the PROFINET interface of the CPU, the CPU and the device must be separated by means of a switch (e.g. SCALANCE X205)	Yes; max. 32 PROFINET devices; if you want to use the "Prioritized startup" functionality in STEP 7 for the PROFINET interface of the CPU, the CPU and the device must be separated by means of a switch (e.g. SCALANCE X205)
- Number of connectable IO Devices, max.	128	128	128
- Of which IO devices with IRT, max.	64	64	64
- of which in line, max.	64	64	64
- Number of connectable IO Devices for RT, max.	128	128	128
- of which in line, max.	128	128	128
- Number of IO Devices that can be simultaneously activated/deactivated, max.	8	8	8
- IO Devices changing during operation (partner ports), supported	Yes	Yes	Yes
- Number of IO Devices per tool, max.	8	8	8

#### SIPLUS extreme RAIL Open Controller > SIPLUS ET 200SP CPU 1515SP PC2 RAIL

Article number	6AG2677-2DB40-2AA0	6AG2677-2DB42-2GB0	6AG2677-2DB40-2GB0
	SIPLUS ET 200SP CPU1515SP PC2 RAIL	SIPLUS ET 200SP CPU 1515SP PC2 RAIL	SIPLUS ET 200SP CPU 1515SP PC2 L RAIL
- Updating times	The minimum value of the update time also depends on communication share set for PROFINET IO, on the number of IO devices, and on the quantity of configured user data	The minimum value of the update time also depends on communication share set for PROFINET IO, on the number of IO devices, and on the quantity of configured user data	The minimum value of the update time also depends on communication share set for PROFINET IO, on the number of IO devices, and on the quantity of configured user data
• Address area			
- Inputs, max.	8 kbyte	8 kbyte	8 kbyte
- Outputs, max.	8 kbyte	8 kbyte	8 kbyte
<b>PROFINET IO Device</b>			
• Services			
- Isochronous mode	No	No	No
- shortest clock pulse	500 µs	500 µs	500 µs
- IRT	Yes	Yes	Yes
- PROFlenergy	Yes	Yes	Yes
- Prioritized startup	Yes	Yes	Yes
- Shared device	Yes	Yes	Yes
- Number of IO Controllers with shared device, max.	4	4	4
- Asset management record	Yes	Yes	Yes
<b>2. Interface</b>			
<b>Interface type</b>	Integrated Ethernet interface	Integrated Ethernet interface	Integrated Ethernet interface
<b>automatic detection of transmission rate</b>	Yes	Yes	Yes
<b>Autonegotiation</b>	Yes	Yes	Yes
<b>Autocrossing</b>	Yes	Yes	Yes
<b>Interface types</b>			
• RJ 45 (Ethernet)	Yes; Integrated	Yes; Integrated	Yes; Integrated
- Transmission rate, max.	1 000 Mbit/s	1 000 Mbit/s	1 000 Mbit/s
- Industrial Ethernet status LED	No	No	No
• Number of ports	1	1	1
<b>3. Interface</b>			
<b>Interface type</b>	PROFIBUS with CM DP	PROFIBUS with CM DP	PROFIBUS with CM DP
<b>Number of connections</b>	44	44	44
<b>Interface types</b>			
• RS 485	Yes	Yes	Yes
<b>Protocols</b>			
• PROFIBUS DP master	Yes	Yes	Yes
• PROFIBUS DP slave	Yes	Yes	Yes
• SIMATIC communication	Yes	Yes	Yes
<b>PROFIBUS DP master</b>			
• Number of DP slaves, max.	125	125	125
• Services			
- Equidistance	No	No	No
- Isochronous mode	No	No	No
• Address area			
- Inputs, max.	8 kbyte	8 kbyte	8 kbyte
- Outputs, max.	8 kbyte	8 kbyte	8 kbyte
<b>Protocols</b>			
<b>Number of connections</b>			
• Number of connections, max.	88	88	88
<b>Redundancy mode</b>			
• Media redundancy			
- MRP	Yes	Yes	Yes
- MRPD	Yes	Yes	Yes
- Switchover time on line break, typ.	200 ms	200 ms	200 ms
- Number of stations in the ring, max.	50	50	50
<b>SIMATIC communication</b>			
• S7 routing	Yes	Yes	No
<b>OPC UA</b>			
• OPC UA Client	Yes; From SW CPU 1505SP V2.6	Yes; From SW CPU 1505SP V2.6	Yes; Data access (read, write), method call
• OPC UA Server	Yes; Data access (read, write, subscribe), runtime license required	Yes; Data access (read, write, subscribe), runtime license required	Yes; Data access (read, write, subscribe), runtime license required
<b>Supported technology objects</b>			
<b>Motion Control</b>	Yes	Yes	Yes
• Number of available Motion Control resources for technology objects	2 400	2 400	2 400
• Required Motion Control resources			
- per speed-controlled axis	40; per axis	40; per axis	40; per axis
- per positioning axis	80; per axis	80; per axis	80; per axis
- per synchronous axis	160; per axis	160; per axis	160; per axis
- per external encoder	80; per external encoder	80; per external encoder	80; per external encoder
- per output cam	20; per cam	20; per cam	20; per cam
- per cam track	160; per cam track	160; per cam track	160; per cam track
- per probe	40; per probe	40; per probe	40; per probe



**SIPLUS RAIL**

SIPLUS Distributed Controller RAIL  
based on SIPLUS ET 200SP

**SIPLUS extreme RAIL Open Controller > SIPLUS ET 200SP CPU 1515SP PC2 RAIL**

Article number	<b>6AG2677-2DB40-2AA0</b>	<b>6AG2677-2DB42-2GB0</b>	<b>6AG2677-2DB40-2GB0</b>
	SIPLUS ET 200SP CPU1515SP PC2 RAIL	SIPLUS ET 200SP CPU 1515SP PC2 RAIL	SIPLUS ET 200SP CPU 1515SP PC2 L RAIL
<b>Controller</b>			
• PID_Compact	Yes; Universal PID controller with integrated optimizations	Yes; Universal PID controller with integrated optimization	Yes; Universal PID controller with integrated optimization
• PID_3Step	Yes; PID controller with integrated optimization for valves	Yes; PID controller with integrated optimization for valves	Yes; PID controller with integrated optimization for valves
• PID-Temp	Yes; PID controller with integrated optimization for temperature	Yes; PID controller with integrated optimization for temperature	Yes; PID controller with integrated optimization for temperature
<b>Counting and measuring</b>			
• High-speed counter	Yes	Yes	Yes
<b>Standards, approvals, certificates</b>			
<b>Railway application</b>			
• EN 50121-3-2	Yes; EMC for rail vehicles	Yes; EMC for rail vehicles	Yes; EMC for rail vehicles
• EN 50121-4	Yes; EMC for signal and telecommunications systems	Yes; EMC for signal and telecommunications systems	Yes; EMC for signal and telecommunications systems
• EN 50124-1	Yes; Railway applications - overvoltage category OV2; pollution degree PD2; rated surge voltage UNi = 0.5 kV; UNm = 24 V DC	Yes; Railway applications - overvoltage category OV2; pollution degree PD2; rated surge voltage UNi = 0.5 kV; UNm = 24 V DC	Yes; Railway applications - overvoltage category OV2; pollution degree PD2; rated surge voltage UNi = 0.5 kV; UNm = 24 V DC
• EN 50125-1	Yes; Rail vehicles - see ambient conditions	Yes; Rail vehicles - see ambient conditions	Yes; Rail vehicles - see ambient conditions
• EN 50125-2	Yes; Stationary electrical equipment - see ambient conditions	Yes; Stationary electrical equipment - see ambient conditions	Yes; Stationary electrical equipment - see ambient conditions
• EN 50125-3	Yes; Signal and telecommunications systems - see ambient conditions; vibrations and shocks: Application point outside of tracks (1 m to 3 m away from track)	Yes; Signal and telecommunications systems - see ambient conditions; vibrations and shocks: Application point outside of tracks (1 m to 3 m away from track)	Yes; Signal and telecommunications systems - see ambient conditions; vibrations and shocks: Application point outside of tracks (1 m to 3 m away from track)
• EN 50155	Yes; Rail vehicles - temperature class OT2, ST1/ST2, horizontal mounting position	Yes; Rail vehicles - temperature class OT4, ST1/ST2, horizontal mounting position	Yes; Rail vehicles - temperature class OT2, ST1/ST2, horizontal mounting position
• EN 61373	Yes; Rail vehicles - vibrations and shocks: Category 1 Class A/B	Yes; Rail vehicles - vibrations and shocks: Category 1 Class A/B	Yes; Rail vehicles - vibrations and shocks: Category 1 Class A/B
• Fire protection acc. to EN 45545-2	Yes; For proof of conformity, see Service & Support	Yes; For proof of conformity, see Service & Support	Yes; For proof of conformity, see Service & Support
<b>Ambient conditions</b>			
<b>Ambient temperature during operation</b>			
• min.	-40 °C; = Tmin	-40 °C; = Tmin	-40 °C; = Tmin
• max.	Up to 60 °C with max. 32 ET 200SP modules; up to 55 °C with max. 64 ET 200SP modules	Up to 55 °C with max. 64 ET 200SP modules, max. 2x 900 mA USB load and max. 2x 500 mA USB load; up to 60 °C with max. 32 ET 200SP modules and 4x 500 mA USB load; FS06 or higher; up to 70 °C with max. 16 ET 200SP modules, 4x 100 mA USB load and no visualization	Up to 60 °C with max. 32 ET 200SP modules; up to 55 °C with max. 64 ET 200SP modules
• horizontal installation, min.	-40 °C; = Tmin (incl. condensation/frost)	-40 °C; = Tmin (incl. condensation/frost)	-40 °C; = Tmin (incl. condensation/frost)
• horizontal installation, max.	60 °C; = Tmax; +70 °C for 10 min (OT2, ST1/ST2 acc. to EN 50155)	70 °C; = Tmax; +85 °C for 10 min (OT4, ST1/ST2 acc. to EN 50155)	60 °C; = Tmax; +70 °C for 10 min (OT2, ST1/ST2 acc. to EN 50155)
• vertical installation, min.	-40 °C; = Tmin	-40 °C; = Tmin	-40 °C; = Tmin
• vertical installation, max.	50 °C; = Tmax; with max. 32 ET 200SP modules	50 °C; = Tmax; with max. 32 ET 200SP modules and max. 4x 500 mA USB load	50 °C; = Tmax; with max. 32 ET 200SP modules
<b>Altitude during operation relating to sea level</b>			
• Installation altitude above sea level, max.	2 000 m	2 000 m	2 000 m
• Ambient air temperature-barometric pressure-altitude	Tmin ... Tmax at 1 140 hPa ... 795 hPa (-1 000 m ... +2 000 m)	Tmin ... Tmax at 1 140 hPa ... 795 hPa (-1 000 m ... +2 000 m)	Tmin ... Tmax at 1 140 hPa ... 795 hPa (-1 000 m ... +2 000 m)
<b>Relative humidity</b>			
• With condensation, tested in accordance with IEC 60068-2-38, max.	100 %; RH incl. condensation / frost (no commissioning in bedewed state), horizontal installation	100 %; RH incl. condensation / frost (no commissioning in bedewed state), horizontal installation	100 %; RH incl. condensation / frost (no commissioning in bedewed state), horizontal installation
<b>Resistance</b>			
• Coolants and lubricants			
- Resistant to commercially available coolants and lubricants	Yes; Incl. diesel and oil droplets in the air	Yes; Incl. diesel and oil droplets in the air	Yes; Incl. diesel and oil droplets in the air
• Use in stationary industrial systems			
- to biologically active substances according to EN 60721-3-3	Yes; Class 3B2 mold, fungus and dry rot spores (with the exception of fauna); Class 3B3 on request	Yes; Class 3B2 mold, fungus and dry rot spores (with the exception of fauna); Class 3B3 on request	Yes; Class 3B2 mold, fungus and dry rot spores (with the exception of fauna); Class 3B3 on request
- to chemically active substances according to EN 60721-3-3	Yes; Class 3C4 (RH < 75 %) incl. salt spray acc. to EN 60068-2-52 (severity degree 3); *	Yes; Class 3C4 (RH < 75 %) incl. salt spray acc. to EN 60068-2-52 (severity degree 3); *	Yes; Class 3C4 (RH < 75 %) incl. salt spray acc. to EN 60068-2-52 (severity degree 3); *
- to mechanically active substances according to EN 60721-3-3	Yes; Class 3S4 incl. sand, dust, *	Yes; Class 3S4 incl. sand, dust, *	Yes; Class 3S4 incl. sand, dust, *
- Against mechanical environmental conditions acc. to EN 60721-3-3	Yes; Class 3M8 using the SIPLUS Mounting Kit ET 200SP (6AG1193-6AA00-0AA0/6AG1193-6AB00-0AA0)	Yes; Class 3M8 using the SIPLUS Mounting Kit ET 200SP (6AG1193-6AA00-0AA0/6AG1193-6AB00-0AA0)	Yes; Class 3M8 using the SIPLUS Mounting Kit ET 200SP (6AG1193-6AA00-0AA0/6AG1193-6AB00-0AA0)

# SIPLUS RAIL

## SIPLUS Distributed Controller RAIL

### based on SIPLUS ET 200SP

#### SIPLUS extreme RAIL Open Controller > SIPLUS ET 200SP CPU 1515SP PC2 RAIL

Article number	6AG2677-2DB40-2AA0	6AG2677-2DB42-2GB0	6AG2677-2DB40-2GB0
	SIPLUS ET 200SP CPU1515SP PC2 RAIL	SIPLUS ET 200SP CPU 1515SP PC2 RAIL	SIPLUS ET 200SP CPU 1515SP PC2 L RAIL
<ul style="list-style-type: none"> <li>Use on land craft, rail vehicles and special-purpose vehicles               <ul style="list-style-type: none"> <li>to biologically active substances according to EN 60721-3-5</li> <li>to chemically active substances according to EN 60721-3-5</li> <li>to mechanically active substances according to EN 60721-3-5</li> <li>Against mechanical environmental conditions acc. to EN 60721-3-5</li> <li>against mechanical environmental conditions in agriculture acc. to ISO 15003</li> </ul> </li> <li>Usage in industrial process technology               <ul style="list-style-type: none"> <li>Against chemically active substances acc. to EN 60654-4</li> <li>Environmental conditions for process, measuring and control systems acc. to ANSI/ISA-71.04</li> </ul> </li> <li>Remark               <ul style="list-style-type: none"> <li>Note regarding classification of environmental conditions acc. to EN 60721, EN 60654-4 and ANSI/ISA-71.04</li> </ul> </li> </ul>	<p>Yes; Class 5B2 mold, fungus and dry rot spores (with the exception of fauna); Class 5B3 on request</p> <p>Yes; Class 5C3 (RH &lt; 75 %) incl. salt spray acc. to EN 60068-2-52 (severity degree 3); *</p> <p>Yes; Class 5S3 incl. sand, dust; *</p> <p>Yes; Class 5M2 using the SIPLUS Mounting Kit ET 200SP (6AG1193-6AA00-0AA0/6AG1193-6AB00-0AA0)</p> <p>Yes; Level 1 (Location LE) using the SIPLUS Mounting Kit ET 200SP (6AG1193-6AA00-0AA0/6AG1193-6AB00-0AA0)</p> <p>Yes; Class 3 (excluding trichlorethylene)</p> <p>Yes; Level GX group A/B (excluding trichlorethylene; harmful gas concentrations up to the limits of EN 60721-3-3 class 3C4 permissible); level LC3 (salt spray) and level LB3 (oil)</p> <p>* The supplied plug covers must remain in place over the unused interfaces during operation!</p>	<p>Yes; Class 5B2 mold, fungus and dry rot spores (with the exception of fauna); Class 5B3 on request</p> <p>Yes; Class 5C3 (RH &lt; 75 %) incl. salt spray acc. to EN 60068-2-52 (severity degree 3); *</p> <p>Yes; Class 5S3 incl. sand, dust; *</p> <p>Yes; Class 5M2 using the SIPLUS Mounting Kit ET 200SP (6AG1193-6AA00-0AA0/6AG1193-6AB00-0AA0)</p> <p>Yes; Level 1 (Location LE) using the SIPLUS Mounting Kit ET 200SP (6AG1193-6AA00-0AA0/6AG1193-6AB00-0AA0)</p> <p>Yes; Class 3 (excluding trichlorethylene)</p> <p>Yes; Level GX group A/B (excluding trichlorethylene; harmful gas concentrations up to the limits of EN 60721-3-3 class 3C4 permissible); level LC3 (salt spray) and level LB3 (oil)</p> <p>* The supplied plug covers must remain in place over the unused interfaces during operation!</p>	<p>Yes; Class 5B2 mold, fungus and dry rot spores (with the exception of fauna); Class 5B3 on request</p> <p>Yes; Class 5C3 (RH &lt; 75 %) incl. salt spray acc. to EN 60068-2-52 (severity degree 3); *</p> <p>Yes; Class 5S3 incl. sand, dust; *</p> <p>Yes; Class 5M2 using the SIPLUS Mounting Kit ET 200SP (6AG1193-6AA00-0AA0/6AG1193-6AB00-0AA0)</p> <p>Yes; Level 1 (Location LE) using the SIPLUS Mounting Kit ET 200SP (6AG1193-6AA00-0AA0/6AG1193-6AB00-0AA0)</p> <p>Yes; Class 3 (excluding trichlorethylene)</p> <p>Yes; Level GX group A/B (excluding trichlorethylene; harmful gas concentrations up to the limits of EN 60721-3-3 class 3C4 permissible); level LC3 (salt spray) and level LB3 (oil)</p> <p>* The supplied plug covers must remain in place over the unused interfaces during operation!</p>
<b>Conformal coating</b> <ul style="list-style-type: none"> <li>Coatings for printed circuit board assemblies acc. to EN 61086</li> <li>Protection against fouling acc. to EN 60664-3</li> <li>Electronic equipment on rolling stock acc. to EN 50155</li> <li>Military testing according to MIL-I-46058C, Amendment 7</li> <li>Qualification and Performance of Electrical Insulating Compound for Printed Board Assemblies according to IPC-CC-830A</li> </ul>	<p>Yes; Class 2 for high reliability</p> <p>Yes; Type 1 protection</p> <p>Yes; Class PC2 protective coating acc. to EN 50155:2017</p> <p>Yes; Discoloration of coating possible during service life</p> <p>Yes; Conformal coating, Class A</p>	<p>Yes; Class 2 for high reliability</p> <p>Yes; Type 1 protection</p> <p>Yes; Class PC2 protective coating acc. to EN 50155:2017</p> <p>Yes; Discoloration of coating possible during service life</p> <p>Yes; Conformal coating, Class A</p>	<p>Yes; Class 2 for high reliability</p> <p>Yes; Type 1 protection</p> <p>Yes; Class PC2 protective coating acc. to EN 50155:2017</p> <p>Yes; Discoloration of coating possible during service life</p> <p>Yes; Conformal coating, Class A</p>
<b>Operating systems</b>			
<b>pre-installed operating system</b>	No	Windows 10 IoT Enterprise 2016 LTSB, 64bit, MUI	No
<b>Configuration / header</b>			
<b>Configuration / programming / header</b> <ul style="list-style-type: none"> <li>Programming language               <ul style="list-style-type: none"> <li>LAD</li> <li>FBD</li> <li>STL</li> <li>SCL</li> <li>CFC</li> <li>GRAPH</li> </ul> </li> </ul>	<p>Yes</p> <p>Yes</p> <p>Yes</p> <p>Yes</p> <p>No</p> <p>Yes</p>	<p>Yes</p> <p>Yes</p> <p>Yes</p> <p>Yes</p> <p>No</p> <p>Yes</p>	<p>Yes</p> <p>Yes</p> <p>Yes</p> <p>Yes</p> <p>No</p> <p>Yes</p>
<b>Know-how protection</b> <ul style="list-style-type: none"> <li>User program protection/password protection</li> <li>Copy protection</li> <li>Block protection</li> </ul>	<p>Yes</p> <p>Yes</p> <p>Yes</p>	<p>Yes</p> <p>Yes</p> <p>Yes</p>	<p>Yes</p> <p>Yes</p> <p>Yes</p>
<b>Access protection</b> <ul style="list-style-type: none"> <li>Protection level: Write protection</li> <li>Protection level: Read/write protection</li> <li>Protection level: Complete protection</li> </ul>	<p>Yes</p> <p>Yes</p> <p>Yes</p>	<p>Yes</p> <p>Yes</p> <p>Yes</p>	<p>Yes</p> <p>Yes</p> <p>Yes</p>
<b>Open Development interfaces</b> <ul style="list-style-type: none"> <li>Size of ODK SO file, max.</li> </ul>	5.8 Mbyte	5.8 Mbyte	5.8 Mbyte



**SIPLUS RAIL**

SIPLUS Distributed Controller RAIL  
based on SIPLUS ET 200SP

**SIPLUS extreme RAIL Open Controller > SIPLUS ET 200SP CPU 1515SP PC2 RAIL**

Article number	<b>6AG2677-2DB40-2AA0</b>	<b>6AG2677-2DB42-2GB0</b>	<b>6AG2677-2DB40-2GB0</b>
	SIPLUS ET 200SP CPU1515SP PC2 RAIL	SIPLUS ET 200SP CPU 1515SP PC2 RAIL	SIPLUS ET 200SP CPU 1515SP PC2 L RAIL
<b>Peripherals/Options</b>			
<b>SD card</b>	Optionally for additional mass storage	Optionally for additional mass storage	Optionally for additional mass storage
<b>Dimensions</b>			
<b>Width</b>	160 mm	160 mm	160 mm
<b>Height</b>	117 mm	117 mm	117 mm
<b>Depth</b>	75 mm	75 mm	75 mm
<b>Weights</b>			
<b>Weight, approx.</b>	0.83 kg	0.83 kg	0.83 kg
<b>Other</b>			
<b>Note:</b>	for use in railway applications, also observe the product information "SIPLUS extreme RAIL" A5E37661960A, Online Support article 109736776	for use in railway applications, also observe the product information "SIPLUS extreme RAIL" A5E37661960A, Online Support article 109736776	for use in railway applications, also observe the product information "SIPLUS extreme RAIL" A5E37661960A, Online Support article 109736776

**Selection and ordering data**

Version	Article No.
<p><b>SIPLUS ET 200SP Open Controller CPU 1515SP PC2 RAIL</b> Approved in accordance with EN 50155, EN 15121, EN 50124, EN 50125 and EN 45545 railway standards for use in rail traffic SIPLUS ET 200SP CPU with Windows 10 IoT Enterprise 64-bit and pre-installed SIMATIC S7-1500 Software Controller; 8 GB RAM, 30 GB CFast card <b>Type of delivery:</b> English, German, Chinese, Italian, French, Spanish</p> <ul style="list-style-type: none"> <li>• <b>SIPLUS ET 200SP CPU 1515SP PC2 RAIL OT2</b> For areas with extreme exposure to environmental substances (conformal coating); Ambient temperature -40 ... +55 °C (+70 °C for 10 min.)</li> <li>• <b>SIPLUS ET 200SP CPU 1515SP PC2 RAIL Spare OT2</b> Spare part, without CFast card</li> <li>• <b>SIPLUS ET 200SP CPU 1515SP PC2 L RAIL</b> 8 GB RAM, 128 GB CFast card, Ready4Linux For areas with extreme exposure to environmental substances (conformal coating); Ambient temperature -40 ... +55 °C (+70 °C for 10 min.)</li> </ul>	<p><b>6AG2677-2DB42-2GB0</b></p> <p><b>6AG2677-2DB40-2AA0</b></p> <p><b>6AG2677-2DB40-2GB0</b></p>
<p><b>Accessories</b></p> <p><b>SIPLUS ET 200SP BA 2XRJ45 TX RAIL</b> For PROFINET interface modules in Standard function class or above; max. cable length 50 m; for areas with extreme exposure to environmental substances (conformal coating); ambient temperature -40 ... +70 °C (+85 °C for 10 min.)</p>	<b>6AG2193-6AR00-4AA0</b>
<p><b>SIPLUS ET 200SP BA 2XFC TX RAIL</b> For PROFINET interface modules in Standard function class or above; for increased vibration and EMC load rating; max. cable length 50 m; for areas with extreme exposure to environmental substances (conformal coating); ambient temperature -40 ... +70 °C (+85 °C for 10 min.)</p>	<b>6AG2193-6AF00-4AA0</b>
<p><b>SIPLUS Mounting Kit ET 200SP</b> Mounting accessories for use with increased mechanical vibration and shock loads. Not approved for SIPLUS BusAdapter BA 2xRJ45</p>	<b>6AG1193-6AA00-0AA0</b>

6

### Overview

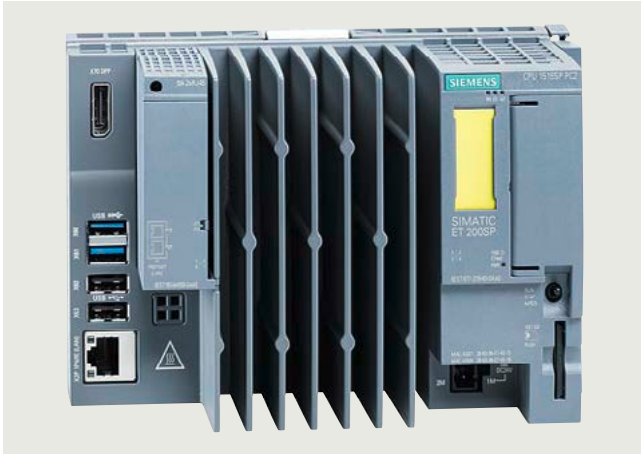

SIPLUS ET 200SP CPU 1515SP PC2 F RAIL combines robustness and compact dimensions with the flexibility of centralized or distributed communication in the highest industrial functionality.

Furthermore, the CPU offers the entire value added of the ET 200SP system, the S7-1500 controller family and the TIA world together.

- Rugged, compact control system
- Combines the functions of an ET 200SP controller with those of a PC-based platform
- Turnkey all-in-one controller
- Can be used up to safety class SIL3 (Safety Integrity Level) according to IEC 61508 2nd Edition or PL e (Performance Level) according to ISO 13849
- High performance automation tasks with the use of new generation Intel Quad Core processors
- Connects high-level language applications and processes high data volumes with support from SIMATIC ODK 1500S

#### Note

SIPLUS extreme products are based on SIMATIC standard products. The contents listed here were taken from the corresponding standard products. SIPLUS extreme-specific information was added.

### Application

The CPU 1515SP PC2 F can be used to control special and series machines as well as plants in a centralized or distributed configuration. The standard and fail-safe user program is generated in the TIA Portal. The controller is especially suitable for machines with high data volumes, e.g. for quality assurance with camera inspection and image transmission, or printer connection.

The CPU 1515SP PC2 shows its strengths in particular

- When special automation functions have to be integrated using the C or C++ programming languages
- When a close connection of Windows software to the Software Controller is required
- When large volumes of data have to be stored.

The CPU 1515SP PC2 F + HMI with preinstalled WinCC Runtime Advanced is offered for additional HMI functionality. This enables control and visualization to be integrated on a single device.

### Design

The CPU 1515SP PC2 F is mounted on the standard DIN rail like all ET 200SP CPUs.

ET 200SP I/O modules can be used directly and centrally, and they communicate via the integrated backplane bus.

PN IO and S7 communication can be established and distributed I/Os can be connected via the PROFINET BusAdapters of the ET 200SP system (not included in scope of supply). This way, the system can be integrated into existing automation environments with little effort.

The PROFIBUS CM DP module extends the CPU 1515SP PC2 F to include PROFIBUS communication. The fail-safe versions support the PROFIsafe communication mechanisms.

The following interfaces are available:

- 1 x Gb Ethernet
- 1 x PN IO interface via ET 200SP BusAdapter with 2 ports
- 2 x USB 2.0 / 2x USB 3.0 at the front, for connecting a keyboard, mouse and USB flash drive, for example
- 1 x display port, for connecting a SIMATIC Flat Panel or multi-touch device, for example

The CPU also features the following:

- Mode switch
- Replaceable mass storage CFast with security seal
- Additional memory slot for SD/MMC
- Status LEDs
- Connection for 24 V DC supply voltage

Various turnkey and preconfigured variants are available with Windows 10 Enterprise on a 30 GB CFast card to suit different requirements:

- CPU 1515SP PC2 F
- CPU 1515SP PC2 F + HMI (incl. WinCC Runtime Advanced with 128/512/2 048 PowerTags)

### Function

- Configuring and programming with the STEP 7 engineering tool (and WinCC Advanced for the HMI option) in the TIA Portal:
  - Programmable according to IEC 61131-3
  - Supported programming languages: SCL (IL), LAD, FBD, STL, GRAPH7 (SFC)
- Innovative real-time system based on visualization technology:
  - The real-time system of the integrated S7-1500 software controllers enables parallel operation independent of the operating system:
    - Maximum real-time and deterministic properties
    - Supports restart of Windows while the controller is in operation
- High-speed program execution with several priority-controlled execution levels (cyclic, time-controlled, isochronous with PROFINET or PROFIBUS, event-driven via process and diagnostics alarms)
- Saving of retentive data:
  - The CPU 1515SP PC2 F ensures the security of the plant data, even when the power fails:
    - Saving of retentive data on the NVRAM of the CPU possible during voltage dips (default)
    - Retentive data storage possible on CPU CFast card (UPS required)

**SIPLUS RAIL**

SIPLUS Distributed Controller RAIL  
based on SIPLUS ET 200SP

**SIPLUS extreme RAIL Open Controller > SIPLUS ET 200SP CPU 1515SP PC2 F RAIL**

- **Communication:**
  - PROFINET IO communication via the ET 200SP BusAdapter; PROFIBUS communication via ET 200SP CM DP: PROFINET IO RT/IRT, isochronous mode, IO controller, I-Device, media redundancy, PROFlenergy, PROFIBUS DP master
  - SIMATIC and Open User communication with Windows applications or external devices via the Windows interfaces (GB Ethernet) of the CPU
- **Configuration control (option handling) for flexible variations of the central configuration**
  - Configure a controller and operate variants (options) that differ from this configuration
- **Integrated web server:**  
Scanning the CPU via the web server is supported by all CPUs of the S7-1500 automation system. The CPU Web server offers the following diagnostics options:
  - Image of the CPU with LEDs and the current operating state
  - Readout of the diagnostics buffer entries
  - Query of module status
  - Query of current messages
  - Information on the status of the topology/PROFINET devices
  - Transfer and management of user data on the load memory of the CPU
  - User-programmable Web pages for supporting servicing and commissioning of specific machine functions
- **Trace functionality:**  
The trace function is supported by all CPUs of the S7-1500 automation system. It enables recording of analog and digital variables for each cycle and their representation as a curve with STEP 7. This is especially useful for motion control or closed-loop control applications
- **Integrated technology:**
  - S7-1500 Motion Control PLCopen blocks for programming the motion functionality via PROFINET IO IRT interface. The functionality supports speed-controlled axes, positioning axes and external encoders.
  - Trace functions for all CPU tags, both for diagnostics in real time as well as for sporadic error detection; can also be called via the web server of the CPU
  - Integral closed-loop control functionality: Universal PID or 3-step controller with integrated optimization. Integrated temperature controller.
- **Integrated system diagnostics:**  
System diagnostics can be displayed via a connected monitor, an HMI device, the web server, or the operator panel of the software controller. Drive messages are also displayed in this way. System diagnostics are also available when the CPU is in STOP mode. If new hardware components are configured, the diagnostic information is updated automatically.
- **Integrated safety:**
  - Know-how protection:  
Algorithms and program blocks can be reliably password-protected against unauthorized access and modification.
  - Access protection:  
Extended access protection provides comprehensive protection against unauthorized configuration changes. Various authorization levels are available for assigning separate rights to different user groups.
  - Integrity protection:  
The system protects the data transferred to the CPU against unauthorized tampering. Modified or third-party transmission of engineering data are safely detected by the CPU.
  - Fail-safe:  
The use of a fail-safe SIMATIC S7-1500 Software Controller allows processing of standard and safety programs on the same controller. Generation of the fail-safe and standard user program is carried out in the TIA Portal with the same editors. Due to this integration the system benefits and the comprehensive functionality of SIMATIC are also available for fail-safe applications.

**Note**

Some functions of the CPU 1515SP PC2 F, such as Windows Hello, Cortana with voice output, support for 5-point touch, etc., may require extended hardware. This hardware can be connected as a USB device.

**Technical specifications**

Article number	<b>6AG2677-2SB42-2GB0</b> SIPLUS ET 200SP CPU1515SP PC2 F RAIL
<b>General information</b>	
<b>Product type designation</b>	CPU 1515SP PC2 F
<b>Engineering with</b>	see entry ID: 109746275
<b>Installed software</b>	No
• Visualization	S7-1500 Software Controller CPU 1505SP F
• Control	
<b>Supply voltage</b>	
<b>Rated value (DC)</b>	24 V
<b>Processor</b>	
<b>Processor type</b>	Intel Atom E3940, 1.6 GHz, 4 cores
<b>Memory</b>	
<b>Type of memory</b>	DDR3L
<b>Main memory</b>	8 GB RAM
<b>CFast memory card</b>	Yes; 30 GB flash memory
<b>Work memory</b>	1.5 Mbyte
• integrated (for program)	5 Mbyte
• integrated (for data)	20 Mbyte
• integrated (for CPU function library of CPU Runtime)	
<b>Load memory</b>	320 Mbyte
• integrated (on PC mass storage)	

**SIPLUS extreme RAIL Open Controller > SIPLUS ET 200SP CPU 1515SP PC2 F RAIL**

Article number	<b>6AG2677-2SB42-2GB0</b> SIPLUS ET 200SP CPU1515SP PC2 F RAIL
<b>CPU processing times</b>	
<b>for bit operations, typ.</b>	10 ns
<b>for word operations, typ.</b>	12 ns
<b>for fixed point arithmetic, typ.</b>	16 ns
<b>for floating point arithmetic, typ.</b>	64 ns
<b>Counters, timers and their retentivity</b>	
<b>S7 counter</b>	
• Number	2 048
<b>IEC counter</b>	
• Number	Any (only limited by the main memory)
<b>S7 times</b>	
• Number	2 048
<b>IEC timer</b>	
• Number	Any (only limited by the main memory)
<b>Data areas and their retentivity</b>	
<b>Flag</b>	
• Size, max.	16 kbyte
<b>Address area</b>	
<b>I/O address area</b>	
• Inputs	32 kbyte; All inputs are in the process image
• Outputs	32 kbyte; All outputs are in the process image
<b>Hardware configuration</b>	
<b>Integrated power supply</b>	Yes
<b>Time of day</b>	
<b>Clock</b>	
• Type	Hardware clock
• Hardware clock (real-time)	Yes; Resolution: 1 s
<b>Interfaces</b>	
<b>Number of industrial Ethernet interfaces</b>	2
<b>Number of RS 485 interfaces</b>	1; Via CM DP module
<b>Number of USB interfaces</b>	4; 2x USB 2.0, 2x USB 3.0 on front side
<b>Number of SD card slots</b>	1
<b>Video interfaces</b>	
• Graphics interface	1x DisplayPort
<b>1. Interface</b>	
<b>Interface type</b>	PROFINET
<b>automatic detection of transmission rate</b>	Yes
<b>Autonegotiation</b>	Yes
<b>Autocrossing</b>	Yes
<b>Number of connections</b>	88
<b>Interface types</b>	
• RJ 45 (Ethernet)	Yes; Via BusAdapter BA 2x RJ45
- Transmission rate, max.	100 Mbit/s
- Industrial Ethernet status LED	Yes
• Number of ports	2
• integrated switch	Yes
• BusAdapter (PROFINET)	Yes; Compatible BusAdapter: BA 2x RJ45, BA 2x FC, BA 2x SCRJ (from FS03, V2.2), BA SCRJ / RJ45 (from FS03, V3.1), BA SCRJ / FC (from FS03, V3.1), BA 2x LC (from FS03, V3.3), BA LC / RJ45 (from FS03, V3.3), BA LC / FC (from FS03, V3.3)
<b>Protocols</b>	
• PROFINET IO Controller	Yes
• PROFINET IO Device	Yes
• SIMATIC communication	Yes
• Open IE communication	Yes
• Web server	Yes

**SIPLUS RAIL**

SIPLUS Distributed Controller RAIL  
based on SIPLUS ET 200SP

**SIPLUS extreme RAIL Open Controller > SIPLUS ET 200SP CPU 1515SP PC2 F RAIL**

Article number	<b>6AG2677-2SB42-2GB0</b> SIPLUS ET 200SP CPU1515SP PC2 F RAIL
<b>PROFINET IO Controller</b>	
• Services	
- Isochronous mode	Yes
- shortest clock pulse	500 µs
- IRT	Yes
- PROFlenergy	Yes
- Prioritized startup	Yes; max. 32 PROFINET devices; if you want to use the "Prioritized startup" functionality in STEP 7 for the PROFINET interface of the CPU, the CPU and the device must be separated by means of a switch (e.g. SCALANCE X205)
- Number of connectable IO Devices, max.	128
- Of which IO devices with IRT, max.	64
- of which in line, max.	64
- Number of connectable IO Devices for RT, max.	128
- of which in line, max.	128
- Number of IO Devices that can be simultaneously activated/deactivated, max.	8
- IO Devices changing during operation (partner ports), supported	Yes
- Number of IO Devices per tool, max.	8
- Updating times	The minimum value of the update time also depends on communication share set for PROFINET IO, on the number of IO devices, and on the quantity of configured user data
• Address area	
- Inputs, max.	8 kbyte
- Outputs, max.	8 kbyte
<b>PROFINET IO Device</b>	
• Services	
- Isochronous mode	No
- shortest clock pulse	500 µs
- IRT	Yes
- PROFlenergy	Yes
- Prioritized startup	Yes
- Shared device	Yes
- Number of IO Controllers with shared device, max.	4
- Asset management record	Yes
<b>2. Interface</b>	
<b>Interface type</b>	Integrated Ethernet interface
<b>automatic detection of transmission rate</b>	Yes
<b>Autonegotiation</b>	Yes
<b>Autocrossing</b>	Yes
<b>Interface types</b>	
• RJ 45 (Ethernet)	Yes; Integrated
- Transmission rate, max.	1 000 Mbit/s
- Industrial Ethernet status LED	No
• Number of ports	1
<b>3. Interface</b>	
<b>Interface type</b>	PROFIBUS with CM DP
<b>Number of connections</b>	44
<b>Interface types</b>	
• RS 485	Yes
<b>Protocols</b>	
• PROFIBUS DP master	Yes
• PROFIBUS DP slave	Yes
• SIMATIC communication	Yes
<b>PROFIBUS DP master</b>	
• Number of DP slaves, max.	125
• Services	
- Equidistance	No
- Isochronous mode	No
• Address area	
- Inputs, max.	8 kbyte
- Outputs, max.	8 kbyte
<b>Protocols</b>	
<b>Number of connections</b>	
• Number of connections, max.	88
<b>Redundancy mode</b>	
• Media redundancy	
- MRP	Yes
- MRPD	Yes
- Switchover time on line break, typ.	200 ms
- Number of stations in the ring, max.	50
<b>SIMATIC communication</b>	
• S7 routing	Yes
<b>OPC UA</b>	
• OPC UA Client	Yes; From SW CPU 1505SP V2.6
• OPC UA Server	Yes; Data access (read, write, subscribe), runtime license required

**SIPLUS extreme RAIL Open Controller > SIPLUS ET 200SP CPU 1515SP PC2 F RAIL**

Article number	<b>6AG2677-2SB42-2GB0</b> SIPLUS ET 200SP CPU1515SP PC2 F RAIL
<b>Supported technology objects</b>	
<b>Motion Control</b> • Number of available Motion Control resources for technology objects • Required Motion Control resources - per speed-controlled axis - per positioning axis - per synchronous axis - per external encoder - per output cam - per cam track - per probe	Yes 2 400  40; per axis 80; per axis 160; per axis 80; per external encoder 20; per cam 160; per cam track 40; per probe
<b>Controller</b> • PID_Compact • PID_3Step • PID-Temp	Yes; Universal PID controller with integrated optimization Yes; PID controller with integrated optimization for valves Yes; PID controller with integrated optimization for temperature
<b>Counting and measuring</b> • High-speed counter	Yes
<b>Standards, approvals, certificates</b>	
<b>Highest safety class achievable in safety mode</b> • Performance level according to ISO 13849-1 • SIL acc. to IEC 61508 • Probability of failure (for service life of 20 years and repair time of 100 hours) - Low demand mode: PFDavg in accordance with SIL3 - High demand/continuous mode: PFH in accordance with SIL3	PLe SIL 3  < 2.00E-05 < 1.00E-09 1/h
<b>Railway application</b> • EN 50121-3-2 • EN 50121-4 • EN 50124-1  • EN 50125-1 • EN 50125-2 • EN 50125-3  • EN 50155 • EN 61373 • Fire protection acc. to EN 45545-2	Yes; EMC for rail vehicles Yes; EMC for signal and telecommunications systems Yes; Railway applications - overvoltage category OV2; pollution degree PD2; rated surge voltage UNi = 0.5 kV; UNm = 24 V DC Yes; Rail vehicles - see ambient conditions Yes; Stationary electrical equipment - see ambient conditions Yes; Signal and telecommunications systems - see ambient conditions; vibrations and shocks: Application point outside of tracks (1 m to 3 m away from track) Yes; Rail vehicles - temperature class OT2, ST1/ST2, horizontal mounting position Yes; Rail vehicles - vibrations and shocks: Category 1 Class A/B Yes; For proof of conformity, see Service & Support
<b>Ambient conditions</b>	
<b>Ambient temperature during operation</b> • min. • max. • horizontal installation, min. • horizontal installation, max. • vertical installation, min. • vertical installation, max.	-40 °C; = Tmin Up to 60 °C with max. 32 ET 200SP modules; up to 55 °C with max. 64 ET 200SP modules -40 °C; = Tmin (incl. condensation/frost) 60 °C; = Tmax; +70 °C for 10 min (OT2, ST1/ST2 acc. to EN 50155) -40 °C; = Tmin 50 °C; = Tmax; with max. 32 ET 200SP modules
<b>Altitude during operation relating to sea level</b> • Installation altitude above sea level, max. • Ambient air temperature-barometric pressure-altitude	2 000 m Tmin ... Tmax at 1 140 hPa ... 795 hPa (-1 000 m ... +2 000 m)
<b>Relative humidity</b> • With condensation, tested in accordance with IEC 60068-2-38, max.	100 %; RH incl. condensation / frost (no commissioning in bedewed state), horizontal installation
<b>Resistance</b> • Coolants and lubricants - Resistant to commercially available coolants and lubricants • Use in stationary industrial systems - to biologically active substances according to EN 60721-3-3 - to chemically active substances according to EN 60721-3-3 - to mechanically active substances according to EN 60721-3-3 • Use on land craft, rail vehicles and special-purpose vehicles - to biologically active substances according to EN 60721-3-5 - to chemically active substances according to EN 60721-3-5 - to mechanically active substances according to EN 60721-3-5 • Usage in industrial process technology - Against chemically active substances acc. to EN 60654-4 - Environmental conditions for process, measuring and control systems acc. to ANSI/ISA-71.04 • Remark - Note regarding classification of environmental conditions acc. to EN 60721, EN 60654-4 and ANSI/ISA-71.04	Yes; Incl. diesel and oil droplets in the air  Yes; Class 3B2 mold, fungus and dry rot spores (with the exception of fauna); Class 3B3 on request Yes; Class 3C4 (RH < 75 %) incl. salt spray acc. to EN 60068-2-52 (severity degree 3); *  Yes; Class 3S4 incl. sand, dust, *  Yes; Class 5B2 mold, fungus and dry rot spores (with the exception of fauna); Class 5B3 on request Yes; Class 5C3 (RH < 75 %) incl. salt spray acc. to EN 60068-2-52 (severity degree 3); *  Yes; Class 5S3 incl. sand, dust; *  Yes; Class 3 (excluding trichlorethylene)  Yes; Level GX group A/B (excluding trichlorethylene; harmful gas concentrations up to the limits of EN 60721-3-3 class 3C4 permissible); level LC3 (salt spray) and level LB3 (oil)  * The supplied plug covers must remain in place over the unused interfaces during operation!



**SIPLUS RAIL**

SIPLUS Distributed Controller RAIL  
based on SIPLUS ET 200SP

**SIPLUS extreme RAIL Open Controller > SIPLUS ET 200SP CPU 1515SP PC2 F RAIL**

Article number	<b>6AG2677-2SB42-2GB0</b> SIPLUS ET 200SP CPU1515SP PC2 F RAIL
<b>Conformal coating</b>	
<ul style="list-style-type: none"> <li>Coatings for printed circuit board assemblies acc. to EN 61086</li> <li>Protection against fouling acc. to EN 60664-3</li> <li>Electronic equipment on rolling stock acc. to EN 50155</li> <li>Military testing according to MIL-I-46058C, Amendment 7</li> <li>Qualification and Performance of Electrical Insulating Compound for Printed Board Assemblies according to IPC-CC-830A</li> </ul>	<p>Yes; Class 2 for high reliability</p> <p>Yes; Type 1 protection</p> <p>Yes; Class PC2 protective coating acc. to EN 50155:2017</p> <p>Yes; Discoloration of coating possible during service life</p> <p>Yes; Conformal coating, Class A</p>
<b>Operating systems</b>	
<b>pre-installed operating system</b>	Windows 10 IoT Enterprise 2016 LTSP, 64bit, MUI
<b>Configuration / header</b>	
<b>Configuration / programming / header</b>	
<ul style="list-style-type: none"> <li>Programming language</li> <li>- LAD</li> <li>- FBD</li> <li>- STL</li> <li>- SCL</li> <li>- CFC</li> <li>- GRAPH</li> </ul>	<p>Yes; incl. failsafe</p> <p>Yes; incl. failsafe</p> <p>Yes</p> <p>Yes</p> <p>No</p> <p>Yes</p>
<b>Know-how protection</b>	
<ul style="list-style-type: none"> <li>User program protection/password protection</li> <li>Copy protection</li> <li>Block protection</li> </ul>	<p>Yes</p> <p>Yes</p> <p>Yes</p>
<b>Access protection</b>	
<ul style="list-style-type: none"> <li>Protection level: Write protection</li> <li>Protection level: Read/write protection</li> <li>Protection level: Complete protection</li> </ul>	<p>Yes</p> <p>Yes</p> <p>Yes</p>
<b>Open Development interfaces</b>	
<ul style="list-style-type: none"> <li>Size of ODK SO file, max.</li> </ul>	5.8 Mbyte
<b>Peripherals/Options</b>	
<b>SD card</b>	Optionally for additional mass storage
<b>Dimensions</b>	
<b>Width</b>	160 mm
<b>Height</b>	117 mm
<b>Depth</b>	75 mm
<b>Weights</b>	
<b>Weight, approx.</b>	0.83 kg
<b>Other</b>	
<b>Note:</b>	for use in railway applications, also observe the product information "SIPLUS extreme RAIL" A5E37661960A, Online Support article 109736776

**Selection and ordering data**

Version	Article No.
<b>SIPLUS ET 200SP CPU 1515SP PC2 F RAIL</b> Approved in accordance with EN 50155, EN 15121, EN 50124, EN 50125 and EN 45545 railway standards for use in rail traffic Work memory 8 GB for program, 300 GB CFAST, with Windows IoT, Enterprise 64 bit and S7-1500 Software Controller, PROFINET IO IRT interface; for areas with extreme exposure to environmental substances (conformal coating); Ambient temperature -40 ... +55 °C (+70 °C for 10 min.)	<b>6AG2677-2SB42-2GB0</b>
<b>Accessories</b> <b>SIPLUS extreme RAIL BusAdapter</b> <b>SIPLUS ET 200SP BA 2XRJ45 TX RAIL</b> For PROFINET interface modules in Standard function class or above; max. cable length 50 m; for areas with extreme exposure to environmental substances (conformal coating); ambient temperature -40 ... +70 °C (+85 °C for 10 min.)	<b>6AG2193-6AR00-4AA0</b>
<b>SIPLUS ET 200SP BA 2XFC TX RAIL</b> For PROFINET interface modules in Standard function class or above; for increased vibration and EMC load rating; max. cable length 50 m; for areas with extreme exposure to environmental substances (conformal coating); ambient temperature -40 ... +70 °C (+85 °C for 10 min.)	<b>6AG2193-6AF00-4AA0</b>
<b>SIPLUS ET 200SP BA 2xM12 RAIL</b> 2 x M12 push-pull sockets, D-coding, also for standard M12, suitable for PROFINET For areas with extreme exposure to environmental substances (conformal coating); ambient temperature -40 ... +70 °C (+85 °C for 10 min.)	<b>6AG2193-6AM00-4AA0</b>
<b>SIPLUS Mounting Kit ET 200SP</b> Mounting accessories for use with increased mechanical vibration and shock loads. Not approved for SIPLUS BusAdapter BA 2xRJ45	<b>6AG1193-6AA00-0AA0</b>

**Overview**

Thanks to their wide scope of functions, the interface modules of the scalable SIPLUS extreme RAIL ET 200SP I/O system, even in their basic versions, cover a wide range of applications. The basic functions of the interface modules include:

- Approved in accordance with EN 50155, EN 15121, EN 50124, EN 50125 and EN 45545 railway standards for use in rail traffic
- Short data update times of typically 1 ms
- Single Hot Swap (withdrawing and insertion of an I/O module during operation without impairing the communication with the remaining modules)
- Operation with gaps (empty BaseUnits)
- Complete diagnostic support, extending to channel-by-channel diagnostics
- Configuration control / option handling (adaptation of the actual configuration via user software)
- Device replacement without PG I&M data 0 to 3 (electronic rating plate with non-volatile storage of plant data)
- Firmware update
- Pluggable 24 V DC supply connection
- Network / power failure bridging time of 5 ms
- Labeling option via optional labeling strips and equipment labeling plates

When using PROFINET interface modules, the following basic functions are also included:

- Media redundancy (MRP) integrated 2-port switch
- Freely selectable connection method via SIMATIC BusAdapter
- Reset button for simple return to factory settings without the need for programming device
- Replacement without programming device even in case of non-topological configuration with subsequent automatic launching
- Automatic synchronization of the backplane bus to the PROFINET cycle to minimize the response time fluctuations (jitter)

**SIPLUS ET 200SP IM 155-6PN ST BA TX RAIL with PROFINET interface**

- Max. 32 I/O modules, also PROFIsafe modules, with complete diagnostic support
- Expansion option with max. 16 modules from the ET 200AL series using the BU-Send BaseUnit and the BA-Send BusAdapter
- Max. 256 bytes in each case for input and output data per module and max. 512 bytes per station (depending on configuration)
- Data update time: typ. 1 ms
- Selection of the type of connection of the PROFINET by means of SIMATIC BusAdapter (BusAdapter for copper cables only)

**SIPLUS ET 200SP IM 155-6PN ST TX RAIL with PROFINET interface**

- Max. 32 I/O modules, also PROFIsafe modules, with complete diagnostic support
- Expansion option with max. 16 modules from the ET 200AL series using the BU-Send BaseUnit and the BA-Send BusAdapter
- Max. 256 bytes in each case for input and output data per module and max. 512 bytes per station (depending on configuration)
- Data update time: typ. 1 ms
- Selection of the type of connection of the PROFINET by means of SIMATIC BusAdapter (BusAdapter for copper cables only)

**SIPLUS ET 200SP IM 155-6PN HF T1 RAIL and SIPLUS ET 200SP IM 155-6PN HF TX RAIL with PROFINET interface**

- Max. 64 I/O modules, also PROFIsafe modules, with complete diagnostic support
- Expansion option with max. 16 modules from the ET 200AL series using the BU-Send BaseUnit and the BA-Send BusAdapter
- Max. 288 bytes in each case for input and output data per module and max. 1440 bytes per station (depending on configuration)
- Fast data refresh time: from 250  $\mu$ s, also in isochronous mode
- S2 system redundancy
- Choice of connection type and physical connection of the PROFINET by means of SIMATIC BusAdapter. All BusAdapters with a connection for copper and/or fiber-optic cables can be used; BusAdapter must be ordered separately
- Package inclusive of server module



# SIPLUS RAIL

## SIPLUS ET 200SP RAIL

### SIPLUS extreme RAIL interface modules

#### Application

##### SIPLUS ET 200SP IM 155-6PN ST (BA) TX RAIL

The SIPLUS ET 200SP IM 155-6PN ST (BA) TX RAIL is designed mainly for standard PROFINET applications with average station expansion of up to 32 modules (max. 512 IO signals). All I/O modules, including PROFI-safe, can be used. In addition, the station can be expanded with as many as 16 IP67 modules of the SIMATIC ET 200AL series using BA-Send/BU-Send.

##### SIPLUS ET 200SP IM 155-6PN HF T1/TX RAIL

The SIPLUS ET 200SP IM 155-6PN HF T1 RAIL/ET 200SP IM 155-6PN HF TX RAIL are designed mainly for PROFINET applications with a high, flexible demand for functions, as well as large station expansion of up to 64 modules (max. 1024 IO signals). All I/O modules, including PROFI-safe, can be used. In addition, the station can be expanded with as many as 16 IP67 modules of the SIMATIC ET 200AL series using BA-Send/BU-Send.

Unlike the other interface modules, the SIPLUS ET 200SP IM 155-6PN HF T1 RAIL/ET 200SP IM 155-6PN HF TX RAIL support the following additional functions:

- Use of BusAdapters with fiber-optic cable connection
- Increased data volume of up to 1440 bytes for both input and output data and up to 288 bytes per module
- Multi Hot Swap (withdrawing and insertion of any number of I/O modules during operation without impairing the communication with the remaining modules)
- S2 redundancy
- Isochronous mode from 250 µs
- Oversampling
- MSI/MSO
- Shared device with up to four controllers
- Up to four subslots per module

#### Design

The SIPLUS ET 200SP IM 155-6PN RAIL interface module is snapped directly onto the DIN rail (7.5 x 35 mm or 15 x 35 mm).

- Optional labeling using light gray or yellow labeling strips. There is a choice of 2 materials:
  - Film strips on a roll with 500 strips, for thermal transfer roll printer
  - Card (180 g/m<sup>2</sup>), DIN A4 sheets with 100 strips each, for laser printer
- Optional equipment marking using slide-in equipment labeling plates
- Different connection types of the PROFINET by means of SIMATIC BusAdapter
  - Under ambient conditions in accordance with SIMATIC standard using BA 2xRJ45 for connection via RJ45 plug
  - In the case of mechanical loading during operation and/or an increased EMC requirements BA 2xFC for direct connection of the PROFINET cable

6

#### Technical specifications

Article number	6AG2155-6AA01-4BN0 SIPLUS ET 200SP IM155-6PN ST BA TX RAIL	6AG2155-6AU01-4BN0 SIPLUS ET 200SP IM155-6PN ST TX RAIL	6AG2155-6AU01-1CN0 SIPLUS ET 200SP IM155-6PN HF T1 RAIL	6AG2155-6AU01-4CN0 SIPLUS ET 200SP IM155-6PN HF TX RAIL
<b>General information</b>				
<b>Product type designation</b>	IM 155-6 PN ST	IM 155-6 PN ST	IM 155-6 PN/2 HF	IM 155-6 PN/2 HF
<b>Product function</b>				
• I&M data	Yes; I&M0 to I&M3	Yes; I&M0 to I&M3	Yes; I&M0 to I&M3	Yes; I&M0 to I&M3
• Module swapping during operation (hot swapping)	Yes; Single hot swapping	Yes; Single hot swapping	Yes; Multi-hot swapping	Yes; Multi-hot swapping
• Isochronous mode	No	No	Yes	Yes
• Tool changer			Yes; Docking station and docking unit	Yes; Docking station and docking unit
• Local coupling, IO data			No	No
• Local coupling, data records			No	No
<b>Engineering with</b>				
• STEP 7 TIA Portal configurable/integrated from version	see entry ID: 109746275	see entry ID: 109746275	see entry ID: 109746275	see entry ID: 109746275
<b>Supply voltage</b>				
<b>Rated value (DC)</b>	24 V	24 V	24 V	24 V
<b>Reverse polarity protection</b>	Yes	Yes	Yes	Yes
<b>Short-circuit protection</b>	Yes	Yes		
<b>Input current</b>				
<b>Current consumption (rated value)</b>	450 mA	450 mA		
<b>Address area</b>				
<b>Address space per station</b>				
• Address space per station, max.	512 byte; Dependent on configuration	512 byte; Dependent on configuration	1 440 byte; Dependent on configuration	1 440 byte; Dependent on configuration

**SIPLUS extreme RAIL interface modules**

Article number	<b>6AG2155-6AA01-4BN0</b> SIPLUS ET 200SP IM155-6PN ST BA TX RAIL	<b>6AG2155-6AU01-4BN0</b> SIPLUS ET 200SP IM155-6PN ST TX RAIL	<b>6AG2155-6AU01-1CN0</b> SIPLUS ET 200SP IM155-6PN HF T1 RAIL	<b>6AG2155-6AU01-4CN0</b> SIPLUS ET 200SP IM155-6PN HF TX RAIL
<b>Hardware configuration</b>				
<b>Rack</b> • Modules per rack, max.	32; + 16 ET 200AL modules	32; + 16 ET 200AL modules	64; + 16 ET 200AL modules	64; + 16 ET 200AL modules
<b>Submodules</b> • Number of submodules per station, max.	256	256	256	256
<b>Time stamping</b>				
<b>Accuracy</b>			10 ms	10 ms
<b>Interfaces</b>				
<b>Number of PROFINET interfaces</b>	1; 2 ports (switch)	1; 2 ports (switch)	1; 2 ports (switch)	1; 2 ports (switch)
<b>1. Interface</b>				
<b>Interface types</b> • RJ 45 (Ethernet) • Number of ports • integrated switch • BusAdapter (PROFINET)	Yes; Pre-assembled BusAdapter BA 2x RJ45 2 Yes Yes; Applicable Bus-Adapter: BA 2x RJ45, BA 2x FC	2 Yes Yes; Applicable Bus-Adapter: BA 2x RJ45, BA 2x FC	2; via BusAdapter Yes Yes; Compatible Bus-Adapter: BA 2x RJ45, BA 2x FC, BA 2x SCRJ, BA SCRJ / RJ45, BA SCRJ / FC, BA 2x LC, BA LC / RJ45, BA LC / FC	2; via BusAdapter Yes Yes; Compatible Bus-Adapter: BA 2x RJ45, BA 2x FC, BA 2x SCRJ, BA SCRJ / RJ45, BA SCRJ / FC, BA 2x LC, BA LC / RJ45, BA LC / FC
<b>Protocols</b> • PROFINET IO Device • Open IE communication • Media redundancy	Yes Yes Yes; PROFINET MRP	Yes Yes Yes; PROFINET MRP	Yes Yes Yes; PROFINET MRP	Yes Yes Yes; PROFINET MRP
<b>Interface types</b>				
<b>RJ 45 (Ethernet)</b> • Transmission procedure  • 10 Mbps • 100 Mbps  • Autonegotiation • Autocrossing	PROFINET with 100 Mbit/s full duplex (100BASE-TX) Yes; for Ethernet services Yes; PROFINET with 100 Mbit/s full duplex (100BASE-TX) Yes Yes	PROFINET with 100 Mbit/s full duplex (100BASE-TX) Yes; for Ethernet services Yes; PROFINET with 100 Mbit/s full duplex (100BASE-TX) Yes Yes	PROFINET with 100 Mbit/s full duplex (100BASE-TX) No Yes; PROFINET with 100 Mbit/s full duplex (100BASE-TX) Yes Yes	PROFINET with 100 Mbit/s full duplex (100BASE-TX) No Yes; PROFINET with 100 Mbit/s full duplex (100BASE-TX) Yes Yes
<b>Protocols</b>				
<b>Number of connections</b> • Number of MtM communication relationships/connections, max.			16	16
<b>PROFINET IO Device</b> • Services - IRT  - PROFenergy - Prioritized startup - Shared device - Number of IO Controllers with shared device, max.	Yes; with send cycles of between 250 µs and 4 ms in increments of 125 µs  Yes Yes Yes 2	Yes; with send cycles of between 250 µs and 4 ms in increments of 125 µs  Yes Yes Yes 2	Yes; 250 µs, 500 µs, 1 ms, 2 ms, 4 ms additionally with IRT with high performance: 250 µs to 4 ms in 125 µs frame Yes Yes Yes 4	Yes; 250 µs, 500 µs, 1 ms, 2 ms, 4 ms additionally with IRT with high performance: 250 µs to 4 ms in 125 µs frame Yes Yes Yes 4
<b>Redundancy mode</b> • PROFINET system redundancy (S2) • Redundant PROFINET configuration (R1) • H-Sync forwarding • Media redundancy - MRP - MRPD	No   Yes No	No   Yes No	Yes; NAP S2 No  Yes  Yes No	Yes; NAP S2 No  Yes  Yes No
<b>Open IE communication</b> • TCP/IP • SNMP • LLDP	Yes Yes Yes	Yes Yes Yes	Yes Yes Yes	Yes Yes Yes
<b>Isochronous mode</b>				
<b>Equidistance</b>			Yes	Yes
<b>shortest clock pulse</b>			250 µs	250 µs
<b>max. cycle</b>			4 ms	4 ms
<b>Bus cycle time (TDP), min.</b>			250 µs	250 µs

# SIPLUS RAIL

## SIPLUS ET 200SP RAIL

### SIPLUS extreme RAIL interface modules

Article number	6AG2155-6AA01-4BN0	6AG2155-6AU01-4BN0	6AG2155-6AU01-1CN0	6AG2155-6AU01-4CN0
	SIPLUS ET 200SP IM155-6PN ST BA TX RAIL	SIPLUS ET 200SP IM155-6PN ST TX RAIL	SIPLUS ET 200SP IM155-6PN HF T1 RAIL	SIPLUS ET 200SP IM155-6PN HF TX RAIL
<b>Interrupts/diagnostics/status information</b>				
<b>Status indicator</b>	Yes	Yes	Yes	Yes
<b>Alarms</b>	Yes	Yes	Yes	Yes
<b>Diagnostics function</b>	Yes	Yes	Yes	Yes
<b>Diagnostics indication LED</b>				
• RUN LED	Yes; green LED	Yes; green LED	Yes; green LED	Yes; green LED
• ERROR LED	Yes; red LED	Yes; red LED	Yes; red LED	Yes; red LED
• MAINT LED	Yes; Yellow LED	Yes; Yellow LED	Yes; Yellow LED	Yes; Yellow LED
• Monitoring of the supply voltage (PWR-LED)	Yes; green PWR LED	Yes; green PWR LED	Yes; green PWR LED	Yes; green PWR LED
• Connection display LINK TX/RX	Yes; 2x green link LEDs on BusAdapter	Yes; 2x green link LEDs on BusAdapter	Yes; 2x green link LEDs on BusAdapter	Yes; 2x green link LEDs on BusAdapter
<b>Standards, approvals, certificates</b>				
<b>Network loading class</b>	2	2	3	3
<b>Security level</b>	According to Security Level 1 Test Cases V1.1.1	According to Security Level 1 Test Cases V1.1.1	According to Security Level 1 Test Cases V1.1.1	According to Security Level 1 Test Cases V1.1.1
<b>Railway application</b>				
• EN 50121-3-2	Yes; EMC for rail vehicles	Yes; EMC for rail vehicles	Yes; EMC for rail vehicles	Yes; EMC for rail vehicles
• EN 50121-4	Yes; EMC for signal and telecommunications systems	Yes; EMC for signal and telecommunications systems	Yes; EMC for signal and telecommunications systems	Yes; EMC for signal and telecommunications systems
• EN 50124-1	Yes; Railway applications - overvoltage category OV2; pollution degree PD2; rated surge voltage UNi = 0.5 kV; UNm = 24 V DC	Yes; Railway applications - overvoltage category OV2; pollution degree PD2; rated surge voltage UNi = 0.5 kV; UNm = 24 V DC	Yes; Railway applications - overvoltage category OV2; pollution degree PD2; rated surge voltage UNi = 0.5 kV; UNm = 24 V DC	Yes; Railway applications - overvoltage category OV2; pollution degree PD2; rated surge voltage UNi = 0.5 kV; UNm = 24 V DC
• EN 50125-1	Yes; Rail vehicles - see ambient conditions	Yes; Rail vehicles - see ambient conditions	Yes; Rail vehicles - see ambient conditions	Yes; Rail vehicles - see ambient conditions
• EN 50125-2	Yes; Stationary electrical equipment - see ambient conditions	Yes; Stationary electrical equipment - see ambient conditions	Yes; Stationary electrical equipment - see ambient conditions	Yes; Stationary electrical equipment - see ambient conditions
• EN 50125-3	Yes; Signal and telecommunications systems - see ambient conditions; vibrations and shocks: Application point outside of tracks (1 m to 3 m away from track)	Yes; Signal and telecommunications systems - see ambient conditions; vibrations and shocks: Application point outside of tracks (1 m to 3 m away from track)	Yes; Signal and telecommunications systems - see ambient conditions; vibrations and shocks: Application point outside of tracks (1 m to 3 m away from track)	Yes; Signal and telecommunications systems - see ambient conditions; vibrations and shocks: Application point outside of tracks (1 m to 3 m away from track)
• EN 50155	Yes; Rail vehicles - temperature class OT4, ST1/ST2, horizontal mounting position	Yes; Rail vehicles - temperature class OT4, ST1/ST2, horizontal mounting position	Yes; Rail vehicles - temperature class OT1, ST1/ST2, horizontal mounting position	Yes; Rail vehicles - temperature class OT4, ST1/ST2, horizontal mounting position
• EN 61373	Yes; Rail vehicles - vibrations and shocks: Category 1 Class A/B	Yes; Rail vehicles - vibrations and shocks: Category 1 Class A/B	Yes; Rail vehicles - vibrations and shocks: Category 1 Class A/B	Yes; Rail vehicles - vibrations and shocks: Category 1 Class A/B
• Fire protection acc. to EN 45545-2	Yes; For proof of conformity, see Service & Support	Yes; For proof of conformity, see Service & Support	Yes; For proof of conformity, see Service & Support	Yes; For proof of conformity, see Service & Support
<b>Ambient conditions</b>				
<b>Ambient temperature during operation</b>				
• horizontal installation, min.	-40 °C; = Tmin (incl. condensation/frost)	-40 °C; = Tmin (incl. condensation/frost)	-30 °C; = Tmin (incl. condensation/frost)	-40 °C; = Tmin (incl. condensation/frost)
• horizontal installation, max.	70 °C; = Tmax; +85 °C for 10 min (OT4, ST1/ST2 acc. to EN 50155)	70 °C; = Tmax; +85 °C for 10 min (OT4, ST1/ST2 acc. to EN 50155)	60 °C; = Tmax; +70 °C for 10 min (OT1, ST1/ST2 acc. to EN 50155)	70 °C; = Tmax; +85 °C for 10 min (OT4, ST1/ST2 acc. to EN 50155)
• vertical installation, min.	-40 °C; = Tmin	-40 °C; = Tmin	-30 °C; = Tmin	-40 °C; = Tmin
• vertical installation, max.	50 °C; = Tmax	50 °C; = Tmax	50 °C; = Tmax	50 °C; = Tmax
<b>Altitude during operation relating to sea level</b>				
• Installation altitude above sea level, max.	2 000 m	2 000 m	2 000 m	2 000 m
• Ambient air temperature-barometric pressure-altitude	Tmin ... Tmax at 1 140 hPa ... 795 hPa (-1 000 m ... +2 000 m)	Tmin ... Tmax at 1 140 hPa ... 795 hPa (-1 000 m ... +2 000 m)	Tmin ... Tmax at 1 140 hPa ... 795 hPa (-1 000 m ... +2 000 m)	Tmin ... Tmax at 1 140 hPa ... 795 hPa (-1 000 m ... +2 000 m)
<b>Relative humidity</b>				
• With condensation, tested in accordance with IEC 60068-2-38, max.	100 %; RH incl. condensation / frost (no commissioning in bedewed state), horizontal installation	100 %; RH incl. condensation / frost (no commissioning in bedewed state), horizontal installation	100 %; RH incl. condensation / frost (no commissioning in bedewed state), horizontal installation	100 %; RH incl. condensation / frost (no commissioning in bedewed state), horizontal installation

### SIPLUS extreme RAIL interface modules

Article number	6AG2155-6AA01-4BN0 SIPLUS ET 200SP IM155-6PN ST BA TX RAIL	6AG2155-6AU01-4BN0 SIPLUS ET 200SP IM155-6PN ST TX RAIL	6AG2155-6AU01-1CN0 SIPLUS ET 200SP IM155-6PN HF T1 RAIL	6AG2155-6AU01-4CN0 SIPLUS ET 200SP IM155-6PN HF TX RAIL
<b>Resistance</b>				
<ul style="list-style-type: none"> <li>Coolants and lubricants               <ul style="list-style-type: none"> <li>Resistant to commercially available coolants and lubricants</li> </ul> </li> <li>Use in stationary industrial systems               <ul style="list-style-type: none"> <li>to biologically active substances according to EN 60721-3-3</li> <li>to chemically active substances according to EN 60721-3-3</li> <li>to mechanically active substances according to EN 60721-3-3</li> <li>Against mechanical environmental conditions acc. to EN 60721-3-3</li> </ul> </li> <li>Use on land craft, rail vehicles and special-purpose vehicles               <ul style="list-style-type: none"> <li>to biologically active substances according to EN 60721-3-5</li> <li>to chemically active substances according to EN 60721-3-5</li> <li>to mechanically active substances according to EN 60721-3-5</li> <li>Against mechanical environmental conditions acc. to EN 60721-3-5</li> <li>against mechanical environmental conditions in agriculture acc. to ISO 15003</li> </ul> </li> <li>Usage in industrial process technology               <ul style="list-style-type: none"> <li>Against chemically active substances acc. to EN 60654-4</li> <li>Environmental conditions for process, measuring and control systems acc. to ANSI/ISA-71.04</li> </ul> </li> <li>Remark               <ul style="list-style-type: none"> <li>Note regarding classification of environmental conditions acc. to EN 60721, EN 60654-4 and ANSI/ISA-71.04</li> </ul> </li> </ul>	<ul style="list-style-type: none"> <li>Yes; Incl. diesel and oil droplets in the air</li> <li>Yes; Class 3B2 mold, fungus and dry rot spores (with the exception of fauna); Class 3B3 on request</li> <li>Yes; Class 3C4 (RH &lt; 75 %) incl. salt spray acc. to EN 60068-2-52 (severity degree 3); *</li> <li>Yes; Class 3S4 incl. sand, dust, *</li> <li>Yes; Class 3M8 using the SIPLUS Mounting Kit ET 200SP (6AG1193-6AA00-0AA0)</li> <li>Yes; Class 5B2 mold, fungus and dry rot spores (with the exception of fauna); Class 5B3 on request</li> <li>Yes; Class 5C3 (RH &lt; 75 %) incl. salt spray acc. to EN 60068-2-52 (severity degree 3); *</li> <li>Yes; Class 5S3 incl. sand, dust; *</li> <li>Yes; Class 5M2 using the SIPLUS Mounting Kit ET 200SP (6AG1193-6AA00-0AA0)</li> <li>Yes; level 1 (Location LE) using the SIPLUS Mounting Kit ET 200SP (6AG1193-6AA00-0AA0)</li> <li>Yes; Class 3 (excluding trichlorethylene)</li> <li>Yes; Level GX group A/B (excluding trichlorethylene; harmful gas concentrations up to the limits of EN 60721-3-3 class 3C4 permissible); level LC3 (salt spray) and level LB3 (oil)</li> <li>* The supplied plug covers must remain in place over the unused interfaces during operation!</li> </ul>	<ul style="list-style-type: none"> <li>Yes; Incl. diesel and oil droplets in the air</li> <li>Yes; Class 3B2 mold, fungus and dry rot spores (with the exception of fauna); Class 3B3 on request</li> <li>Yes; Class 3C4 (RH &lt; 75 %) incl. salt spray acc. to EN 60068-2-52 (severity degree 3); *</li> <li>Yes; Class 3S4 incl. sand, dust, *</li> <li>Yes; Class 3M8 using the SIPLUS Mounting Kit ET 200SP (6AG1193-6AA00-0AA0)</li> <li>Yes; Class 5B2 mold, fungus and dry rot spores (with the exception of fauna); Class 5B3 on request</li> <li>Yes; Class 5C3 (RH &lt; 75 %) incl. salt spray acc. to EN 60068-2-52 (severity degree 3); *</li> <li>Yes; Class 5S3 incl. sand, dust; *</li> <li>Yes; Class 5M2 using the SIPLUS Mounting Kit ET 200SP (6AG1193-6AA00-0AA0)</li> <li>Yes; level 1 (Location LE) using the SIPLUS Mounting Kit ET 200SP (6AG1193-6AA00-0AA0)</li> <li>Yes; Class 3 (excluding trichlorethylene)</li> <li>Yes; Level GX group A/B (excluding trichlorethylene; harmful gas concentrations up to the limits of EN 60721-3-3 class 3C4 permissible); level LC3 (salt spray) and level LB3 (oil)</li> <li>* The supplied plug covers must remain in place over the unused interfaces during operation!</li> </ul>	<ul style="list-style-type: none"> <li>Yes; Incl. diesel and oil droplets in the air</li> <li>Yes; Class 3B2 mold, fungus and dry rot spores (with the exception of fauna); Class 3B3 on request</li> <li>Yes; Class 3C4 (RH &lt; 75 %) incl. salt spray acc. to EN 60068-2-52 (severity degree 3); *</li> <li>Yes; Class 3S4 incl. sand, dust, *</li> <li>Yes; Class 3M8 using the SIPLUS Mounting Kit ET 200SP (6AG1193-6AA00-0AA0)</li> <li>Yes; Class 5B2 mold, fungus and dry rot spores (with the exception of fauna); Class 5B3 on request</li> <li>Yes; Class 5C3 (RH &lt; 75 %) incl. salt spray acc. to EN 60068-2-52 (severity degree 3); *</li> <li>Yes; Class 5S3 incl. sand, dust; *</li> <li>Yes; Class 5M2 using the SIPLUS Mounting Kit ET 200SP (6AG1193-6AA00-0AA0)</li> <li>Yes; level 1 (Location LE) using the SIPLUS Mounting Kit ET 200SP (6AG1193-6AA00-0AA0)</li> <li>Yes; Class 3 (excluding trichlorethylene)</li> <li>Yes; Level GX group A/B (excluding trichlorethylene; harmful gas concentrations up to the limits of EN 60721-3-3 class 3C4 permissible); level LC3 (salt spray) and level LB3 (oil)</li> <li>* The supplied plug covers must remain in place over the unused interfaces during operation!</li> </ul>	<ul style="list-style-type: none"> <li>Yes; Incl. diesel and oil droplets in the air</li> <li>Yes; Class 3B2 mold, fungus and dry rot spores (with the exception of fauna); Class 3B3 on request</li> <li>Yes; Class 3C4 (RH &lt; 75 %) incl. salt spray acc. to EN 60068-2-52 (severity degree 3); *</li> <li>Yes; Class 3S4 incl. sand, dust, *</li> <li>Yes; Class 3M8 using the SIPLUS Mounting Kit ET 200SP (6AG1193-6AA00-0AA0)</li> <li>Yes; Class 5B2 mold, fungus and dry rot spores (with the exception of fauna); Class 5B3 on request</li> <li>Yes; Class 5C3 (RH &lt; 75 %) incl. salt spray acc. to EN 60068-2-52 (severity degree 3); *</li> <li>Yes; Class 5S3 incl. sand, dust; *</li> <li>Yes; Class 5M2 using the SIPLUS Mounting Kit ET 200SP (6AG1193-6AA00-0AA0)</li> <li>Yes; level 1 (Location LE) using the SIPLUS Mounting Kit ET 200SP (6AG1193-6AA00-0AA0)</li> <li>Yes; Class 3 (excluding trichlorethylene)</li> <li>Yes; Level GX group A/B (excluding trichlorethylene; harmful gas concentrations up to the limits of EN 60721-3-3 class 3C4 permissible); level LC3 (salt spray) and level LB3 (oil)</li> <li>* The supplied plug covers must remain in place over the unused interfaces during operation!</li> </ul>
<b>Conformal coating</b>				
<ul style="list-style-type: none"> <li>Coatings for printed circuit board assemblies acc. to EN 61086</li> <li>Protection against fouling acc. to EN 60664-3</li> <li>Electronic equipment on rolling stock acc. to EN 50155</li> <li>Military testing according to MIL-I-46058C, Amendment 7</li> <li>Qualification and Performance of Electrical Insulating Compound for Printed Board Assemblies according to IPC-CC-830A</li> </ul>	<ul style="list-style-type: none"> <li>Yes; Class 2 for high reliability</li> <li>Yes; Type 1 protection</li> <li>Yes; Class PC2 protective coating acc. to EN 50155:2017</li> <li>Yes; Discoloration of coating possible during service life</li> <li>Yes; Conformal coating, Class A</li> </ul>	<ul style="list-style-type: none"> <li>Yes; Class 2 for high reliability</li> <li>Yes; Type 1 protection</li> <li>Yes; Class PC2 protective coating acc. to EN 50155:2017</li> <li>Yes; Discoloration of coating possible during service life</li> <li>Yes; Conformal coating, Class A</li> </ul>	<ul style="list-style-type: none"> <li>Yes; Class 2 for high reliability</li> <li>Yes; Type 1 protection</li> <li>Yes; Class PC2 protective coating acc. to EN 50155:2017</li> <li>Yes; Discoloration of coating possible during service life</li> <li>Yes; Conformal coating, Class A</li> </ul>	<ul style="list-style-type: none"> <li>Yes; Class 2 for high reliability</li> <li>Yes; Type 1 protection</li> <li>Yes; Class PC2 protective coating acc. to EN 50155:2017</li> <li>Yes; Discoloration of coating possible during service life</li> <li>Yes; Conformal coating, Class A</li> </ul>
<b>Connection method / header</b>				
<b>ET-Connection</b>				
<ul style="list-style-type: none"> <li>via BU/BA Send</li> </ul>	Yes; + 16 ET 200AL modules	Yes; + 16 ET 200AL modules	Yes; + 16 ET 200AL modules	Yes; + 16 ET 200AL modules
<b>Mechanics/material</b>				
<b>Strain relief</b>			Yes; Optional	Yes; Optional
<b>Dimensions</b>				
<b>Width</b>	50 mm	50 mm	50 mm	50 mm
<b>Height</b>	117 mm	117 mm	117 mm	117 mm
<b>Depth</b>	74 mm	74 mm	74 mm	74 mm

# SIPLUS RAIL

## SIPLUS ET 200SP RAIL

### SIPLUS extreme RAIL interface modules

Article number	6AG2155-6AA01-4BN0	6AG2155-6AU01-4BN0	6AG2155-6AU01-1CN0	6AG2155-6AU01-4CN0
	SIPLUS ET 200SP IM155-6PN ST BA TX RAIL	SIPLUS ET 200SP IM155-6PN ST TX RAIL	SIPLUS ET 200SP IM155-6PN HF T1 RAIL	SIPLUS ET 200SP IM155-6PN HF TX RAIL
<b>Weights</b>				
<b>Weight, approx.</b>	190 g; IM 155-6 PN BA with 2x RJ45 ports and server module	147 g; without BusAdapter	120 g; without BusAdapter	120 g; without BusAdapter
<b>Other</b>				
<b>Note:</b>	for use in railway applications, also observe the product information "SIPLUS extreme RAIL" A5E37661960A, Online Support article 109736776	for use in railway applications, also observe the product information "SIPLUS extreme RAIL" A5E37661960A, Online Support article 109736776	for use in railway applications, also observe the product information "SIPLUS extreme RAIL" A5E37661960A, Online Support article 109736776	for use in railway applications, also observe the product information "SIPLUS extreme RAIL" A5E37661960A, Online Support article 109736776

### Selection and ordering data

Version	Article No.
<p><b>SIPLUS extreme RAIL SIPLUS IM155-6PN Standard PROFINET interface module</b> With server module</p> <ul style="list-style-type: none"> <li>• <b>SIPLUS ET 200SP IM155-6PN ST BA TX RAIL</b> With server module and installed SIMATIC BusAdapter BA 2xRJ45; for areas with extreme exposure to environmental substances (conformal coating); Ambient temperature -40 ... +70 °C (+85 °C for 10 min.); extended power failure backup time</li> <li>• <b>SIPLUS ET 200SP IM155-6PN ST TX RAIL</b> With server module, without SIMATIC BusAdapter; for areas with extreme exposure to environmental substances (conformal coating); Ambient temperature -40 ... +70 °C (+85 °C for 10 min.); extended power failure backup time</li> <li>• <b>SIPLUS ET 200SP IM155-6PN HF T1 RAIL</b> With server module, without SIMATIC BusAdapter; for areas with extreme exposure to environmental substances (conformal coating); Ambient temperature -25 ... +55 °C (+70 °C for 10 min.)</li> <li>• <b>SIPLUS ET 200SP IM155-6PN HF TX RAIL</b> With server module, without SIMATIC BusAdapter; for areas with extreme exposure to environmental substances (conformal coating); Ambient temperature -40 ... +70 °C (+85 °C for 10 min.)</li> </ul>	<p><b>6AG2155-6AA01-4BN0</b></p> <p><b>6AG2155-6AU01-4BN0</b></p> <p><b>6AG2155-6AU01-1CN0</b></p> <p><b>6AG2155-6AU01-4CN0</b></p>
<p><b>Accessories</b></p> <p><b>SIPLUS extreme RAIL BusAdapter</b></p> <p><b>SIPLUS ET 200SP BA 2XRJ45 TX RAIL</b> For PROFINET interface modules in Standard function class or above; max. cable length 50 m; for areas with extreme exposure to environmental substances (conformal coating); ambient temperature -40 ... +70 °C (+85 °C for 10 min.)</p>	<b>6AG2193-6AR00-4AA0</b>
<p><b>SIPLUS ET 200SP BA 2XFC TX RAIL</b> For PROFINET interface modules in Standard function class or above; for increased vibration and EMC load rating; max. cable length 50 m; for areas with extreme exposure to environmental substances (conformal coating); ambient temperature -40 ... +70 °C (+85 °C for 10 min.)</p>	<b>6AG2193-6AF00-4AA0</b>
<p><b>SIPLUS Mounting Kit ET 200SP</b> Mounting accessories for use with increased mechanical vibration and shock loads. Not approved for SIPLUS BusAdapter BA 2xRJ45</p>	<b>6AG1193-6AA00-0AA0</b>

## Overview



- 4, 8 and 16-channel digital input (DI) modules
- Approved in accordance with the railway standards EN 50155, EN 15121, EN 50124, EN 50125 and EN 45545 for use in rail traffic

For different requirements, the digital input modules offer:

- Function classes Standard and High Feature
- BaseUnits for single or multiple-conductor connection with automatic slot coding
- Individual system-integrated load group formation with self-assembling voltage distribution bars (a separate power module is no longer required for ET 200SP)
- Connection option of sensors compliant with IEC 61131 Type 1, 2 or 3 (module-dependent) for rated voltages of up to 24 V DC or 230 V AC
- Clear labeling on front of module
- LEDs for diagnostics, status, supply voltage and faults
- Electronically readable and non-volatile writable rating plate (I&M data 0 to 3)
- Optional accessories
  - Labeling strips (film or card)
  - Reference identification label
  - Color-coded label with module-specific CC Code
  - Shielding terminal

A quick and clear comparison of the functions of the different DI modules is offered by the TIA Selection Tool.

### Overview of digital input modules

Digital input	PU	Article No.	CC code	BU type
DI 16 x 24 V DC ST	1	6AG2131-6BH00-4BA0	CC00	A0
DI 8 x NAMUR HF	1	6AG2131-6TF00-4CA0	CC01	A0
DI 4 x 120 ... 230 V AC ST	1	6AG2131-6FD00-4BB1	CC41	B1

### Overview of BaseUnits

BaseUnit	PU	Article No.	CC codes for process terminals	CC codes for AUX terminals
<b>BU type A0</b> • New load group (light) • 16 process terminals • With 10 AUX terminals	1	6AG2193-6BP20-4DA0	CC01 to CC05	CC71 to CC73
<b>BU type A0</b> • New load group (light) • 16 process terminals • Without AUX terminals	1	6AG2193-6BP00-4DA0	CC01 to CC05	--
<b>BU type A0</b> • Forwarding of load group (dark) • 16 process terminals • With 10 AUX terminals	1	6AG2193-6BP20-4BA0	CC01 to CC05	CC71 to CC73
<b>BU type A0</b> • Forwarding of load group (dark) • 16 process terminals • Without AUX terminals	1	6AG2193-6BP00-4BA0	CC01 to CC05	--

## Application

The signals from digital sensors (switches, inductive and optical sensors etc.) can be recorded and transferred to the higher-level controller via the digital input modules.

## Design

### Usable BaseUnits (BU)

BaseUnits with an appropriate number of terminals are available for single or multi-conductor connection.

All variants that correspond to the BU type of the I/O module used can be used as BaseUnits (see Selection and ordering data).

### Load group formation

A light-colored BU separates the self-assembling, internal voltage buses (P1, P2, AUX) and thus opens a new load group. The power supply of a load group must be fed in at the light BU of this load group.

A dark BU forwards the power supply of the adjacent light BU on the left via the self-assembling voltage buses P1, P2 and AUX. A new infeed is therefore only required on the next light BU to the right. The setting of a further light BU is required whenever

- a new load group is to be formed (for example, for isolating the supply voltage from module groups) or
- the maximum current simultaneously required by the load group exceeds the permissible limit of 10 A.



**SIPLUS RAIL**

SIPLUS ET 200SP RAIL

SIPLUS extreme RAIL I/O modules

**SIPLUS extreme RAIL digital inputs****Color identification of the terminals**

The potentials at the terminals of the BaseUnit are defined by the inserted I/O module in each case. To prevent wiring faults, the potentials of the terminals can optionally be identified by means of module-specific color-coded labels. The color-coded label that matches the respective I/O module is defined by the color code CCxx of the I/O module. This color code is also printed on the front of the module.

In BaseUnits with the additional ten internally jumpered AUX terminals, these can also be identified with color-coded labels. For the ten AUX terminals, color-coded labels are available in red, blue, and yellow/green.

**Labeling**Labeling strips

Labeling strips can be inserted on the front of the interface modules or I/O modules and individually labeled via STEP 7, macros, etc. No special additional holder is required. If required, they can be easily replaced with the component.

Equipment labeling plates

Equipment labeling plates enable the equipment to be easily identified (e.g. compliant with EN 81346). They are easily plugged onto the required component (interface modules, I/O modules and BaseUnits) and when required, they can be easily replaced with the component.

The following labeling components are available:

- Film labeling strips, light-gray, roll with 500 strips, perforated, for thermal transfer printers
- Film labeling strips, yellow, roll with 500 strips, perforated, for thermal transfer printers
- Card labeling strips (180 g/m<sup>2</sup>), light gray, DIN A4 sheets with 100 strips each, perforated, for laser printer
- Card labeling strips (180 g/m<sup>2</sup>), yellow, DIN A4 sheets with 100 strips each, for laser printer
- Equipment labeling plates, white, ten sheets each with 16 labels, for thermal transfer card printers or labels

**System-integrated shield connection**

For the space-saving and EMC-optimized connection of cable shields, a shield connection is available that is quick and easy to mount. This consists of one shield connection element that can be plugged onto the BaseUnit and one shield terminal for each module. The low-impedance connection to the functional ground (DIN rail) is achieved without any additional wiring by the user.

**Technical specifications**

Article number	<b>6AG2131-6BH01-4BA0</b> SIPLUS ET 200SP DI 16X24-VDC ST TX RAIL	<b>6AG2131-6TF00-4CA0</b> SIPLUS ET 200SP DI 8xNAMUR HF TX RAIL	<b>6AG2131-6FD01-4BB1</b> SIPLUS ET 200SP DI 4X120/230VAC TX RAIL	<b>6AG2131-6CF00-4AU0</b> SIPLUS ET 200SP DI 8x48VUC TX RAIL
<b>General information</b>				
<b>Product type designation</b>	DI 16x24VDC ST	DI 8xNAMUR HF	DI 4x120 ... 230 V AC ST	DI 8x24VAC/48VUC BA
<b>Product function</b>				
• Isochronous mode	No	No	No	No
<b>Operating mode</b>				
• DI	Yes	Yes	Yes	Yes
• Counter	No	No	No	No
• Oversampling	No	No	No	No
• MSI	No	No	No	No
<b>Supply voltage</b>				
<b>Rated value (DC)</b>	24 V	24 V		48 V
<b>Rated value (AC)</b>			230 V	48 V; 24 V/48 V; 50 Hz/60 Hz
<b>Reverse polarity protection</b>	Yes	Yes	No	Yes
<b>Encoder supply</b>				
<b>Number of outputs</b>		8	4	8
<b>Short-circuit protection</b>		Yes	No; when using BU type B1, a fuse with 10 A tripping current must be provided	Yes; Per module, 5x 20 mm fuse, 2 A/250 V, quick-response, replaceable
<b>Output current</b>			10 A	1 A
• up to 60 °C, max.				
• up to 70 °C, max.				
<b>24 V encoder supply</b>				
• 24 V	No	No		No
• Short-circuit protection		No		
<b>Digital inputs</b>				
<b>Number of digital inputs</b>	16	8; > +60 °C number of simultaneously controllable inputs max. 4 (no adjacent points)	4	8
<b>Digital inputs, parameterizable</b>	Yes	Yes		
<b>Source/sink input</b>	P-reading			P-reading
<b>Input characteristic curve in accordance with IEC 61131, type 1</b>				Yes
<b>Input characteristic curve in accordance with IEC 61131, type 2</b>				No
<b>Input characteristic curve in accordance with IEC 61131, type 3</b>	Yes		Yes	No
<b>Pulse extension</b>		Yes; 0,5 s, 1 s, 2 s		No
<b>Edge evaluation</b>		Yes; rising edge, falling edge, edge change		

#### SIPLUS extreme RAIL digital inputs

Article number	6AG2131-6BH01-4BA0 SIPLUS ET 200SP DI 16X24-VDC ST TX RAIL	6AG2131-6TF00-4CA0 SIPLUS ET 200SP DI 8xNAMUR HF TX RAIL	6AG2131-6FD01-4BB1 SIPLUS ET 200SP DI 4X120/230VAC TX RAIL	6AG2131-6CF00-4AU0 SIPLUS ET 200SP DI 8x48VUC TX RAIL
<b>Signal change flutter</b>		Yes; 2 to 32 signal changes		
<b>Flutter observation window</b>		Yes; 0.5 s, 1 s to 100 s in 1-s steps		
<b>Input voltage</b> • Rated value (DC) • Rated value (AC) • for signal *0* • for signal *1*	24 V  -30 to +5 V +11 to +30V	8.2 V	230 V 0V AC to 40V AC 74 V AC to 264 V AC	AC/DC < 10 V AC > 14 V, DC > 34 V
<b>Input current</b> • for signal *1*, typ. • for 10 k switched contact - for signal *0* - for signal *1* • for unswitched contact - for signal *0*, max. (permissible quiescent current) - for signal *1* • for NAMUR encoders - for signal *0*, min. - for signal *0*, max. - for signal *1*, min. - for signal *1*, max.	2.5 mA	0.35 to 1.2 mA 2.1 to 7 mA  0.5 mA  typ. 8 mA  0.35 mA 1.2 mA 2.1 mA 7 mA	10.8 mA	3.5 mA
<b>Input delay (for rated value of input voltage)</b> • tolerated changeover time for changeover contacts • for standard inputs - parameterizable  • for NAMUR inputs - at *0* to *1*, max. - at *1* to *0*, max.	Yes; 0.05 / 0.1 / 0.4 / 0.8 / 1.6 / 3.2 / 12.8 / 20 ms (in each case + delay of 30 to 500 µs, depending on line length)	300 ms  No  12 ms 12 ms	No	No
<b>Encoder</b>				
<b>Connectable encoders</b> • NAMUR encoder/changeover contact according to EN 60947 • Single contact / changeover contact unconnected • Single contact / changeover contact connected with 10 kΩ • 2-wire sensor - permissible quiescent current (2-wire sensor), max.	Yes 1.5 mA	Yes  Yes  Yes	Yes	Yes
<b>Interrupts/diagnostics/status information</b>				
<b>Diagnostics function</b>	Yes	Yes		Yes
<b>Alarms</b> • Diagnostic alarm • Hardware interrupt	Yes	Yes; channel by channel Yes; Parameterizable, channels 0 to 7	No No	Yes
<b>Diagnoses</b> • Diagnostic information readable • Monitoring the supply voltage • parameterizable • Monitoring of encoder power supply • Wire-break  • Short-circuit • Group error	Yes Yes Yes No Yes; Module-by-module, optional protective circuit for preventing wire-break diagnostics in the case of simple encoder contacts: 25 kOhm to 45 kOhm  No Yes	Yes Yes Yes Yes; channel by channel Yes; channel by channel  Yes; channel by channel Yes	No  No	Yes Yes  Yes  Yes
<b>Diagnostics indication LED</b> • Monitoring of the supply voltage (PWR-LED) • Channel status display • for channel diagnostics • for module diagnostics	Yes; green PWR LED  Yes; green LED No Yes; green/red DIAG LED	Yes; green PWR LED  Yes; green LED Yes; red LED Yes; green/red DIAG LED	Yes; green PWR LED  Yes; green LED No Yes; green/red DIAG LED	Yes; green PWR LED  Yes; green LED No Yes; green/red DIAG LED
<b>Potential separation</b>				
<b>Potential separation channels</b> • between the channels and back-plane bus	Yes	Yes	Yes	Yes



# SIPLUS RAIL

## SIPLUS ET 200SP RAIL

### SIPLUS extreme RAIL I/O modules

#### SIPLUS extreme RAIL digital inputs

Article number	<b>6AG2131-6BH01-4BA0</b> SIPLUS ET 200SP DI 16X24-VDC ST TX RAIL	<b>6AG2131-6TF00-4CA0</b> SIPLUS ET 200SP DI 8xNAMUR HF TX RAIL	<b>6AG2131-6FD01-4BB1</b> SIPLUS ET 200SP DI 4X120/230VAC TX RAIL	<b>6AG2131-6CF00-4AU0</b> SIPLUS ET 200SP DI 8x48VUC TX RAIL
<b>Standards, approvals, certificates</b>				
<b>Suitable for safety functions</b>	No	No	No	No
<b>Railway application</b>				
<ul style="list-style-type: none"> <li>EN 50121-3-2</li> <li>EN 50121-4</li> </ul>	Yes; EMC for rail vehicles Yes; EMC for signal and tele-communications systems	Yes; EMC for rail vehicles Yes; EMC for signal and tele-communications systems	Yes; EMC for rail vehicles Yes; EMC for signal and tele-communications systems	Yes; EMC for rail vehicles Yes; EMC for signal and tele-communications systems
EN 50124-1	Yes; Railway applications - overvoltage category OV2; pollution degree PD2; rated surge voltage UNi = 0.5 kV; UNm = 24 V DC	Yes; Railway applications - overvoltage category OV2; pollution degree PD2; rated surge voltage UNi = 0.5 kV; UNm = 24 V DC	Yes; Railway applications - overvoltage category OV3; pollution degree PD2; UNm = 230 V AC	Yes; Railway applications - overvoltage category OV2; pollution degree PD2; rated surge voltage UNi = 0.5 kV; UNm = 48 V AC/DC
EN 50125-1	Yes; Rail vehicles - see ambient conditions	Yes; Rail vehicles - see ambient conditions	Yes; Rail vehicles - see ambient conditions	Yes; Rail vehicles - see ambient conditions
EN 50125-2	Yes; Stationary electrical equipment - see ambient conditions	Yes; Stationary electrical equipment - see ambient conditions	Yes; Stationary electrical equipment - see ambient conditions	Yes; Stationary electrical equipment - see ambient conditions
EN 50125-3	Yes; Signal and telecommunications systems - see ambient conditions; vibrations and shocks: Application point outside of tracks (1 m to 3 m away from track)	Yes; Signal and telecommunications systems - see ambient conditions; vibrations and shocks: Application point outside of tracks (1 m to 3 m away from track)	Yes; Signal and telecommunications systems - see ambient conditions; vibrations and shocks: Application point outside of tracks (1 m to 3 m away from track)	Yes; Signal and telecommunications systems - see ambient conditions; vibrations and shocks: Application point outside of tracks (1 m to 3 m away from track)
EN 50155	Yes; Rail vehicles - temperature class OT4, ST1/ST2, horizontal mounting position	Yes; Rail vehicles - temperature class OT4, ST1/ST2, horizontal mounting position	Yes; Rail vehicles - temperature class OT4, ST1/ST2, horizontal mounting position	Yes; Rail vehicles - temperature class OT4, ST1/ST2, horizontal mounting position
EN 61373	Yes; Rail vehicles - vibrations and shocks: Category 1 Class A/B	Yes; Rail vehicles - vibrations and shocks: Category 1 Class A/B	Yes; Rail vehicles - vibrations and shocks: Category 1 Class A/B	Yes; Rail vehicles - vibrations and shocks: Category 1 Class A/B
Fire protection acc. to EN 45545-2	Yes; For proof of conformity, see Service & Support	Yes; For proof of conformity, see Service & Support	Yes; For proof of conformity, see Service & Support	Yes; For proof of conformity, see Service & Support
<b>Ambient conditions</b>				
<b>Ambient temperature during operation</b>				
horizontal installation, min.	-40 °C; = Tmin (incl. condensation/frost)	-40 °C; = Tmin (incl. condensation/frost)	-40 °C; = Tmin (incl. condensation/frost)	-40 °C; = Tmin (incl. condensation/frost)
horizontal installation, max.	70 °C; = Tmax; +85 °C for 10 min (OT4, ST1/ST2 acc. to EN 50155)	70 °C; = Tmax; +85 °C for 10 min (OT4, ST1/ST2 acc. to EN 50155)	70 °C; = Tmax; +85 °C for 10 min (OT4, ST1/ST2 acc. to EN 50155)	70 °C; = Tmax; +85 °C for 10 min (OT4, ST1/ST2 acc. to EN 50155)
vertical installation, min.	-40 °C; = Tmin	-40 °C; = Tmin	-40 °C; = Tmin	-40 °C; = Tmin
vertical installation, max.	50 °C; = Tmax	50 °C; = Tmax	50 °C; = Tmax	50 °C; = Tmax
<b>Altitude during operation relating to sea level</b>				
Installation altitude above sea level, max.	2 000 m	2 000 m	2 000 m	2 000 m
Ambient air temperature-barometric pressure-altitude	Tmin ... Tmax at 1 140 hPa ... 795 hPa (-1 000 m ... +2 000 m)	Tmin ... Tmax at 1 140 hPa ... 795 hPa (-1 000 m ... +2 000 m)	Tmin ... Tmax at 1 140 hPa ... 795 hPa (-1 000 m ... +2 000 m)	Tmin ... Tmax at 1 140 hPa ... 795 hPa (-1 000 m ... +2 000 m)
<b>Relative humidity</b>				
With condensation, tested in accordance with IEC 60068-2-38, max.	100 %; RH incl. condensation / frost (no commissioning in bedewed state), horizontal installation	100 %; RH incl. condensation / frost (no commissioning in bedewed state), horizontal installation	100 %; RH incl. condensation / frost (no commissioning in bedewed state), horizontal installation	100 %; RH incl. condensation / frost (no commissioning in bedewed state), horizontal installation
<b>Resistance</b>				
Coolants and lubricants				
- Resistant to commercially available coolants and lubricants	Yes; Incl. diesel and oil droplets in the air	Yes; Incl. diesel and oil droplets in the air	Yes; Incl. diesel and oil droplets in the air	Yes; Incl. diesel and oil droplets in the air
Use in stationary industrial systems				
- to biologically active substances according to EN 60721-3-3	Yes; Class 3B2 mold, fungus and dry rot spores (with the exception of fauna); Class 3B3 on request	Yes; Class 3B2 mold, fungus and dry rot spores (with the exception of fauna); Class 3B3 on request	Yes; Class 3B2 mold, fungus and dry rot spores (with the exception of fauna); Class 3B3 on request	Yes; Class 3B2 mold, fungus and dry rot spores (with the exception of fauna); Class 3B3 on request
- to chemically active substances according to EN 60721-3-3	Yes; Class 3C4 (RH < 75 %) incl. salt spray acc. to EN 60068-2-52 (severity degree 3); *	Yes; Class 3C4 (RH < 75 %) incl. salt spray acc. to EN 60068-2-52 (severity degree 3); *	Yes; Class 3C4 (RH < 75 %) incl. salt spray acc. to EN 60068-2-52 (severity degree 3); *	Yes; Class 3C4 (RH < 75 %) incl. salt spray acc. to EN 60068-2-52 (severity degree 3); *
- to mechanically active substances according to EN 60721-3-3	Yes; Class 3S4 incl. sand, dust, *	Yes; Class 3S4 incl. sand, dust, *	Yes; Class 3S4 incl. sand, dust, *	Yes; Class 3S4 incl. sand, dust, *
- Against mechanical environmental conditions acc. to EN 60721-3-3	Yes; Class 3M8 using the SIPLUS Mounting Kit ET 200SP (6AG1193-6AA00-0AA0)	Yes; Class 3M8 using the SIPLUS Mounting Kit ET 200SP (6AG1193-6AA00-0AA0)	Yes; Class 3M8 using the SIPLUS Mounting Kit ET 200SP (6AG1193-6AA00-0AA0)	Yes; Class 3M8 using the SIPLUS Mounting Kit ET 200SP (6AG1193-6AA00-0AA0)

# SIPLUS RAIL

## SIPLUS ET 200SP RAIL

### SIPLUS extreme RAIL I/O modules

#### SIPLUS extreme RAIL digital inputs

Article number	<b>6AG2131-6BH01-4BA0</b> SIPLUS ET 200SP DI 16X24-VDC ST TX RAIL	<b>6AG2131-6TF00-4CA0</b> SIPLUS ET 200SP DI 8xNAMUR HF TX RAIL	<b>6AG2131-6FD01-4BB1</b> SIPLUS ET 200SP DI 4X120/230VAC TX RAIL	<b>6AG2131-6CF00-4AU0</b> SIPLUS ET 200SP DI 8x48VUC TX RAIL
<ul style="list-style-type: none"> <li>Use on land craft, rail vehicles and special-purpose vehicles               <ul style="list-style-type: none"> <li>to biologically active substances according to EN 60721-3-5</li> </ul> </li> <li>to chemically active substances according to EN 60721-3-5</li> <li>to mechanically active substances according to EN 60721-3-5</li> <li>Against mechanical environmental conditions acc. to EN 60721-3-5</li> <li>against mechanical environmental conditions in agriculture acc. to ISO 15003</li> </ul>	<p>Yes; Class 5B2 mold, fungus and dry rot spores (with the exception of fauna); Class 5B3 on request Yes; Class 5C3 (RH &lt; 75 %) incl. salt spray acc. to EN 60068-2-52 (severity degree 3); * Yes; Class 5S3 incl. sand, dust; * Yes; Class 5M2 using the SIPLUS Mounting Kit ET 200SP (6AG1193-6AA00-0AA0) Yes; level 1 (Location LE) using the SIPLUS Mounting Kit ET 200SP (6AG1193-6AA00-0AA0)</p>	<p>Yes; Class 5B2 mold, fungus and dry rot spores (with the exception of fauna); Class 5B3 on request Yes; Class 5C3 (RH &lt; 75 %) incl. salt spray acc. to EN 60068-2-52 (severity degree 3); * Yes; Class 5S3 incl. sand, dust; * Yes; Class 5M2 using the SIPLUS Mounting Kit ET 200SP (6AG1193-6AA00-0AA0) Yes; level 1 (Location LE) using the SIPLUS Mounting Kit ET 200SP (6AG1193-6AA00-0AA0)</p>	<p>Yes; Class 5B2 mold, fungus and dry rot spores (with the exception of fauna); Class 5B3 on request Yes; Class 5C3 (RH &lt; 75 %) incl. salt spray acc. to EN 60068-2-52 (severity degree 3); * Yes; Class 5S3 incl. sand, dust; * Yes; Class 5M2 using the SIPLUS Mounting Kit ET 200SP (6AG1193-6AA00-0AA0) Yes; level 1 (Location LE) using the SIPLUS Mounting Kit ET 200SP (6AG1193-6AA00-0AA0)</p>	<p>Yes; Class 5B2 mold, fungus and dry rot spores (with the exception of fauna); Class 5B3 on request Yes; Class 5C3 (RH &lt; 75 %) incl. salt spray acc. to EN 60068-2-52 (severity degree 3); * Yes; Class 5S3 incl. sand, dust; * Yes; Class 5M2 using the SIPLUS Mounting Kit ET 200SP (6AG1193-6AA00-0AA0) Yes; level 1 (Location LE) using the SIPLUS Mounting Kit ET 200SP (6AG1193-6AA00-0AA0)</p>
<ul style="list-style-type: none"> <li>Usage in industrial process technology               <ul style="list-style-type: none"> <li>Against chemically active substances acc. to EN 60654-4</li> <li>Environmental conditions for process, measuring and control systems acc. to ANSI/ISA-71.04</li> </ul> </li> </ul>	<p>Yes; Class 3 (excluding trichlorethylene) Yes; Level GX group A/B (excluding trichlorethylene; harmful gas concentrations up to the limits of EN 60721-3-3 class 3C4 permissible); level LC3 (salt spray) and level LB3 (oil)</p>	<p>Yes; Class 3 (excluding trichlorethylene) Yes; Level GX group A/B (excluding trichlorethylene; harmful gas concentrations up to the limits of EN 60721-3-3 class 3C4 permissible); level LC3 (salt spray) and level LB3 (oil)</p>	<p>Yes; Class 3 (excluding trichlorethylene) Yes; Level GX group A/B (excluding trichlorethylene; harmful gas concentrations up to the limits of EN 60721-3-3 class 3C4 permissible); level LC3 (salt spray) and level LB3 (oil)</p>	<p>Yes; Class 3 (excluding trichlorethylene) Yes; Level GX group A/B (excluding trichlorethylene; harmful gas concentrations up to the limits of EN 60721-3-3 class 3C4 permissible); level LC3 (salt spray) and level LB3 (oil)</p>
<ul style="list-style-type: none"> <li>Remark               <ul style="list-style-type: none"> <li>Note regarding classification of environmental conditions acc. to EN 60721, EN 60654-4 and ANSI/ISA-71.04</li> </ul> </li> </ul>	* The supplied plug covers must remain in place over the unused interfaces during operation!	* The supplied plug covers must remain in place over the unused interfaces during operation!	* The supplied plug covers must remain in place over the unused interfaces during operation!	* The supplied plug covers must remain in place over the unused interfaces during operation!
<ul style="list-style-type: none"> <li><b>Conformal coating</b> <ul style="list-style-type: none"> <li>Coatings for printed circuit board assemblies acc. to EN 61086</li> <li>Protection against fouling acc. to EN 60664-3</li> <li>Electronic equipment on rolling stock acc. to EN 50155</li> <li>Military testing according to MIL-I-46058C, Amendment 7</li> <li>Qualification and Performance of Electrical Insulating Compound for Printed Board Assemblies according to IPC-CC-830A</li> </ul> </li> </ul>	<p>Yes; Class 2 for high reliability Yes; Type 1 protection</p> <p>Yes; Class PC2 protective coating acc. to EN 50155:2017 Yes; Discoloration of coating possible during service life Yes; Conformal coating, Class A</p>	<p>Yes; Class 2 for high reliability Yes; Type 1 protection</p> <p>Yes; Class PC2 protective coating acc. to EN 50155:2017 Yes; Discoloration of coating possible during service life Yes; Conformal coating, Class A</p>	<p>Yes; Class 2 for high reliability Yes; Type 1 protection</p> <p>Yes; Class PC2 protective coating acc. to EN 50155:2017 Yes; Discoloration of coating possible during service life Yes; Conformal coating, Class A</p>	<p>Yes; Class 2 for high reliability Yes; Type 1 protection</p> <p>Yes; Class PC2 protective coating acc. to EN 50155:2017 Yes; Discoloration of coating possible during service life Yes; Conformal coating, Class A</p>
<b>Dimensions</b>				
<b>Width</b>	15 mm	15 mm	20 mm	20 mm
<b>Height</b>	73 mm	73 mm	73 mm	73 mm
<b>Depth</b>	58 mm	58 mm	58 mm	58 mm
<b>Weights</b>				
<b>Weight, approx.</b>	28 g	32 g	36 g	40 g
<b>Other</b>				
<b>Note:</b>	for use in railway applications, also observe the product information "SIPLUS extreme RAIL" A5E37661960A, Online Support article 109736776	for use in railway applications, also observe the product information "SIPLUS extreme RAIL" A5E37661960A, Online Support article 109736776	for use in railway applications, also observe the product information "SIPLUS extreme RAIL" A5E37661960A, Online Support article 109736776	for use in railway applications, also observe the product information "SIPLUS extreme RAIL" A5E37661960A, Online Support article 109736776

**SIPLUS RAIL**

SIPLUS ET 200SP RAIL

SIPLUS extreme RAIL I/O modules

**SIPLUS extreme RAIL digital inputs****Selection and ordering data**

Version	Article No.
<p><b>SIPLUS extreme RAIL digital inputs</b></p> <p>Approved in accordance with EN 50155, EN 15121, EN 50124, EN 50125 and EN 45545 railway standards for use in rail traffic</p> <p>SIPLUS ET 200SP DI 16X24VDC ST TX RAIL, BU type A0, color code CC00; for areas with extreme exposure to environmental substances (conformal coating); ambient temperature -40 ... +70 °C (+85 °C for 10 min.)</p> <p>SIPLUS ET 200SP DI 8xNAMUR HF TX RAIL, BU type A0, color code CC01; for areas with extreme exposure to environmental substances (conformal coating); ambient temperature -40 ... +70 °C (+85 °C for 10 min.)</p> <p>SIPLUS ET 200SP DI 4X120/230VAC TX RAIL, BU type B1, color code CC41; for areas with extreme exposure to environmental substances (conformal coating); ambient temperature -40 ... +70 °C (+85 °C for 10 min.)</p> <p>SIPLUS ET 200SP DI 8x48VUC TX RAIL, BU type U0, color code CC20, module diagnostics; for areas with extreme exposure to environmental substances (conformal coating); ambient temperature -40 ... +70 °C (+85 °C for 10 min.)</p>	<p><b>6AG2131-6BH01-4BA0</b></p> <p><b>6AG2131-6TF00-4CA0</b></p> <p><b>6AG2131-6FD01-4BB1</b></p> <p><b>6AG2131-6CF00-4AU0</b></p>
<p><b>Suitable SIPLUS extreme RAIL BaseUnits</b></p> <p><b>SIPLUS ET 200SP BU15-P16+A0+2D TX RAIL</b></p> <p>Approved in accordance with EN 50155, EN 15121, EN 50124, EN 50125 and EN 45545 railway standards for use in rail traffic</p> <p>BU type A0; BaseUnit (light) with 16 process terminals to the module; for starting a new load group (max. 10 A); for areas with extreme exposure to environmental substances (conformal coating); ambient temperature -40 ... +70 °C (+85 °C for 10 min.)</p>	<b>6AG2193-6BP00-4DA0</b>
<p><b>SIPLUS ET 200SP BU15-P16+A0+2B TX RAIL</b></p> <p>Approved in accordance with EN 50155, EN 15121, EN 50124, EN 50125 and EN 45545 railway standards for use in rail traffic</p> <p>BU type A0; BaseUnit (dark) with 16 process terminals to the module; for continuing the load group; for areas with extreme exposure to environmental substances (conformal coating); ambient temperature -40 ... +70 °C (+85 °C for 10 min.)</p>	<b>6AG2193-6BP00-4BA0</b>
<p><b>SIPLUS ET 200SP BU15-P16+A10+2D TX RAIL</b></p> <p>Approved in accordance with EN 50155, EN 15121, EN 50124, EN 50125 and EN 45545 railway standards for use in rail traffic</p> <p>BU type A0; BaseUnit (light) with 16 process terminals (1...16) to the module and an additional 10 internally jumpered AUX terminals (1 A to 10 A); for starting a new load group (max. 10 A); for areas with extreme exposure to environmental substances (conformal coating); ambient temperature -40 ... +70 °C (+85 °C for 10 min.)</p>	<b>6AG2193-6BP20-4DA0</b>
<p><b>SIPLUS ET 200SP BU15-P16+A10+2B TX RAIL</b></p> <p>Approved in accordance with EN 50155, EN 15121, EN 50124, EN 50125 and EN 45545 railway standards for use in rail traffic</p> <p>BU type A0; BaseUnit (dark) with 16 process terminals (1...16) to the module and an additional 10 internally jumpered AUX terminals (1 A to 10 A); for continuing the load group; for areas with extreme exposure to environmental substances (conformal coating); ambient temperature -40 ... +70 °C (+85 °C for 10 min.)</p>	<b>6AG2193-6BP20-4BA0</b>
<p><b>SIPLUS ET 200SP BU20-P12+A0+4B TX RAIL</b></p> <p>Approved in accordance with EN 50155, EN 15121, EN 50124, EN 50125 and EN 45545 railway standards for use in rail traffic</p> <p>BU type B1; BaseUnit (dark) with 12 process terminals to the module; for continuing the load group; 1 unit</p>	<b>6AG2193-6BP20-4BB1</b>
<p><b>SIPLUS ET 200SP BU20-P16+A0+2B TX RAIL</b></p> <p>Approved in accordance with EN 50155, EN 15121, EN 50124, EN 50125 and EN 45545 railway standards for use in rail traffic</p> <p>BU type U0; BaseUnit (dark) with 16 process terminals to the module; for continuing the load group</p>	<b>6AG2193-6BP00-4BU0</b>
<p><b>SIPLUS ET 200SP BU20-P16+A0+2D TX RAIL</b></p> <p>Approved in accordance with EN 50155, EN 15121, EN 50124, EN 50125 and EN 45545 railway standards for use in rail traffic</p> <p>BU type U0; BaseUnit (light) with 16 process terminals to the module; for starting a new load group (max. 10 A)</p>	<b>6AG2193-6BP00-4DU0</b>
<p><b>Accessories</b></p> <p><b>SIPLUS Mounting Kit ET 200SP</b></p> <p>Mounting accessories for use with increased mechanical vibration and shock loads.</p>	<b>6AG1193-6AA00-0AA0</b>

6

**Overview**

- 4, 8 and 16-channel digital output (DQ) modules
- Approved in accordance with the EN 50155, EN 15121, EN 50124, EN 50125 and EN 45545 railway standards for use in rail traffic

For different requirements, the digital output modules offer:

Overview of digital output modules

Digital output	PU	Article No.	CC code	BU type
DQ 16 x 24 V DC/0.5 A ST	1	6AG2132-6BH01-4BA0	CC00	A0
DQ 8 x 24 V DC/0.5 A HF	1	6AG2132-6BF00-4CA0	CC02	A0
DQ 4 x 24 V DC/2 A ST	1	6AG2132-6BD20-4BA0	CC02	A0
DQ 4 x 24 ... 230 V AC/2 A HF	1	6AG2132-6FD00-4CU0	CC20	U0
With two operating modes:				
• DQ				
• PC: Power control via phase angle, half-wave or full-wave control				
RQ 4 x UC 24 V/2A ST	1	6AG2132-6GD51-4BA0	CC00	A0
RQ 4 x DC 120 V-AC 230 V/ 5 A NO ST	1	6AG2132-6HD01-4BB1	--	B0, B1
RQ MA 4 x 120 V DC ... 230 V AC/5 A NO ST	1	6AG2132-6MD00-4BB1	--	B0, B1

Overview of BaseUnits

BaseUnit	PU	Article No.	CC codes for process terminals	CC codes for AUX terminals
<b>BU type A0</b> • New load group (light) • 16 process terminals • With 10 AUX terminals	1	6AG2193-6BP20-4DA0	CC01 to CC05	CC71 to CC73
<b>BU type A0</b> • New load group (light) • 16 process terminals • Without AUX terminals	1	6AG2193-6BP00-4DA0	CC01 to CC05	--
<b>BU type A0</b> • Forwarding of load group (dark) • 16 process terminals • With 10 AUX terminals	1	6AG2193-6BP20-4BA0	CC01 to CC05	CC71 to CC73
<b>BU type A0</b> • Forwarding of load group (dark) • 16 process terminals • Without AUX terminals	1	6AG2193-6BP00-4BA0	CC01 to CC05	--
<b>BU type B1</b> • Forwarding of load group (dark) • 12 process terminals • 2 x 2 (1L, 2L, 1N, 2N) direct infeed module • Without AUX terminals	1	6AG2193-6BP20-0BB1	CC41	--
<b>BU type U0</b> • Forwarding of load group (dark) • 16 process terminals • Without AUX terminals	1	6AG2193-6BP00-4BU0	CC20	--
<b>BU type U0</b> • New load group (light) • 16 process terminals • Without AUX terminals	1	6AG2193-6BP00-4DU0	CC20	--

- Function classes Basic and High Feature
- BaseUnits for single or multiple-conductor connection with automatic slot coding
- Individual system-integrated load group formation with self-assembling voltage distribution bars (a separate power module is no longer required for ET 200SP)
- Option of connecting actuators with rated load voltages of up to 120 V DC or 230 V AC and load currents of up to 5 A (depending on module)
- Clear labeling on front of module
- LEDs for diagnostics, status, supply voltage and faults
- Electronically readable and non-volatile writable rating plate (I&M data 0 to 3)
- Optional accessories
  - Labeling strips (film or card)
  - Equipment labeling plate
  - Color-coded label with module-specific CC code
  - Shielding terminal

A quick and clear comparison of the functions of the different DQ modules is offered by the TIA Selection Tool.

**SIPLUS RAIL**

SIPLUS ET 200SP RAIL

SIPLUS extreme RAIL I/O modules

**SIPLUS extreme RAIL digital outputs****Application**

Digital actuators (magnetic valves, contactors and signal lamps, etc.) can be controlled by means of the digital output modules.

**Design****Usable BaseUnits (BU)**

BaseUnits with an appropriate number of terminals are available for single or multi-conductor connection.

All variants that correspond to the BU type of the I/O module used can be used as BaseUnits (see Selection and ordering data).

**Load group formation**

A light-colored BU separates the self-assembling, internal voltage buses (P1, P2, AUX) and thus opens a new load group. The supply voltage of a load group must be fed in at the light BU of this load group.

A dark BU forwards the supply voltage of the adjacent light BU on the left via the self-assembling voltage buses P1, P2 and AUX. A new infeed is therefore only required on the next light BU to the right. The setting of a further light BU is required whenever

- a new load group is to be formed (for example, for isolating the supply voltage from module groups) or
- the maximum current simultaneously required by the load group exceeds the permissible limit of 10 A.

**Color identification of the terminals**

The potentials at the terminals of the BaseUnit are defined by the inserted I/O module in each case. To prevent wiring faults, the potentials of the terminals can optionally be identified by means of module-specific color-coded labels. The color-coded label that matches the respective I/O module is defined by the color code CCxx of the I/O module. This color code is also printed on the front of the module.

In BaseUnits with the additional ten internally jumpered AUX terminals, these can also be identified with color-coded labels. For the ten AUX terminals, color-coded labels are available in red, blue, and yellow/green.

**Labeling**Labeling strips

Labeling strips can be inserted on the front of the interface modules or I/O modules and individually labeled via STEP 7, macros, etc. No special additional holder is required. If required, they can be easily replaced with the component.

Equipment labeling plates

Equipment labeling plates enable the equipment to be easily identified (e.g. compliant with EN 81346). They are easily plugged onto the required component (interface modules, I/O modules and BaseUnits) and when required, they can be easily replaced with the component.

The following labeling components are available:

- Film labeling strips, light-gray, roll with 500 strips, perforated, for thermal transfer printers
- Film labeling strips, yellow, roll with 500 strips, perforated, for thermal transfer printers
- Card labeling strips (180 g/m<sup>2</sup>), light gray, DIN A4 sheets with 100 strips each, perforated, for laser printer
- Card labeling strips (180 g/m<sup>2</sup>), yellow, DIN A4 sheets with 100 strips each, perforated, for laser printer

Equipment labeling plates, white, ten sheets each with 16 labels, for thermal transfer card printers or labels

**System-integrated shielded connection**

For the space-saving and EMC-optimized connection of cable shields, a shield connection is available that is quick and easy to mount. This consists of one shield connection element that can be plugged onto the BaseUnit and one shield terminal for each module. The low-impedance connection to the functional ground (DIN rail) is achieved without any additional wiring by the user.

6

**Technical specifications**

Article number	<b>6AG2132-6BD20-4BA0</b> SIPLUS ET 200SP DQ 4X24-VDC/2A ST TX RAIL	<b>6AG2132-6BF00-4CA0</b> SIPLUS ET 200SP DQ 8X24-VDC/0.5A TX RAIL	<b>6AG2132-6BH01-4BA0</b> SIPLUS ET 200SP DQ 16X24VDC/0.5A TX RAIL	<b>6AG2132-6FD00-4CU0</b> SIPLUS ET 200SP DQ 4X24...230VAC TX RAIL
<b>General information</b>				
<b>Product type designation</b>	DQ 4x24 V DC/2 A ST	DQ 8x24 VDC/0.5 A ST	DQ 16x24VDC/0.5A ST	DQ 4x24 ... 230 V AC/2 A HF
<b>Product function</b>				
• Isochronous mode	No	Yes	No	No
<b>Engineering with</b>				
• STEP 7 TIA Portal configurable/integrated from version				see entry ID: 109746275
<b>Operating mode</b>				
• DQ	Yes	Yes	Yes	Yes
• DQ with energy-saving function	No	No	No	Yes
• PWM	No	No	No	No
• Oversampling	No	No	No	No
• MSO	No	Yes	No	No
• Phase control				Yes; Control area: 8.5 ... 100% of the phase angle
• Trailing-edge phase				No
• Half-wave				Yes
• Full-wave				Yes
<b>Supply voltage</b>				
<b>Rated value (DC)</b>	24 V	24 V	24 V	
<b>Rated value (AC)</b>				230 V; 47 ... 63 Hz, max. rate of change of frequency 1 mHz/s
<b>Reverse polarity protection</b>	Yes	Yes	Yes	

# SIPLUS RAIL

## SIPLUS ET 200SP RAIL

### SIPLUS extreme RAIL I/O modules

#### SIPLUS extreme RAIL digital outputs

Article number	6AG2132-6BD20-4BA0 SIPLUS ET 200SP DQ 4X24-VDC/2A ST TX RAIL	6AG2132-6BF00-4CA0 SIPLUS ET 200SP DQ 8X24-VDC/0.5A TX RAIL	6AG2132-6BH01-4BA0 SIPLUS ET 200SP DQ 16X24VDC/0.5A TX RAIL	6AG2132-6FD00-4CU0 SIPLUS ET 200SP DQ 4X24..230VAC TX RAIL
<b>Digital outputs</b>				
<b>Type of digital output</b>	Source output (PNP, current-sourcing)	Source output (PNP, current-sourcing)	Source output (PNP, current-sourcing)	Triac
<b>Number of digital outputs</b>	4; > +60 °C number of simultaneously controllable outputs max. 2x 0.25 A or max. 4x 0.125 A, max. total current 0.5 A	8; > +60 °C max. total current 1.0 A	16; > +60 °C max. total current 1.0 A	4
<b>Current-sinking</b>	No	No	No	No
<b>Current-sourcing</b>	Yes	Yes	Yes	Yes
<b>Digital outputs, parameterizable</b>	Yes	Yes	Yes	Yes
<b>Short-circuit protection</b>	Yes	Yes	Yes	No; external fusing necessary
<b>Open-circuit detection</b>			Yes	Yes; channel by channel
<b>Overload protection</b>				No; A miniature fuse with 10 tripping current and tripping characteristic "quick response" must be provided in the module supply
<b>Limitation of inductive shutdown voltage to</b>	Typ. L+ (-50 V)	Typ. L+ (-50 V)	Typ. L+ (-50 V)	
<b>Controlling a digital input</b>	Yes	Yes	Yes	Yes
<b>Switching capacity of the outputs</b>				
• with resistive load, max.	2 A	0.5 A	0.5 A	2 A; Max. 4 A, see additional description in manual
• with inductive load, max.	10 W	5 W	5 W	2 A
• on lamp load, max.				100 W; Tungsten rating in accordance with UL; for thermistors with higher power ratings, see the notes in the manual
<b>Load resistance range</b>				
• lower limit	12 Ω	48 Ω	48 Ω	
• upper limit	3 400 Ω	12 kΩ	12 kΩ	
<b>Output voltage</b>				
• for signal "1", min.				20.4 V
<b>Output current</b>				
• for signal "1" rated value	2 A	0.5 A	0.5 A	2 A
• for signal "0" residual current, max.	0.1 mA	0.1 mA	0.1 mA	3 mA
<b>Output delay with resistive load</b>				
• "0" to "1", typ.	50 μs	50 μs	50 μs	40 ms; 2 AC cycles
• "0" to "1", max.	50 μs			
• "1" to "0", typ.	100 μs	100 μs	100 μs	20 ms; 1 AC cycle
• "1" to "0", max.	100 μs			
<b>Parallel switching of two outputs</b>				
• for logic links	No	No	No	No
• for uprating	Yes	Yes	Yes	No
• for redundant control of a load				Yes
<b>Switching frequency</b>				
• with resistive load, max.	100 Hz	100 Hz	100 Hz	10 Hz; Applies to DQ mode; limited by line frequency in PC mode
• with inductive load, max.	2 Hz	2 Hz	2 Hz	10 Hz; Applies to DQ mode; limited by line frequency in PC mode
• with inductive load (acc. to IEC 60947-5-1, AC15), max.				1 Hz; Applies to DQ mode; limited by line frequency in PC mode
• on lamp load, max.	10 Hz	10 Hz	10 Hz	
<b>Total current of the outputs</b>				
• Current per channel, max.	2 A	0.5 A	0.5 A	2 A; Max. 4 A, see additional description in manual
• Current per module, max.	8 A	4 A	8 A	8 A



**SIPLUS RAIL**

SIPLUS ET 200SP RAIL

SIPLUS extreme RAIL I/O modules

**SIPLUS extreme RAIL digital outputs**

Article number	<b>6AG2132-6BD20-4BA0</b> SIPLUS ET 200SP DQ 4X24-VDC/2A ST TX RAIL	<b>6AG2132-6BF00-4CA0</b> SIPLUS ET 200SP DQ 8X24-VDC/0.5A TX RAIL	<b>6AG2132-6BH01-4BA0</b> SIPLUS ET 200SP DQ 16X24VDC/0.5A TX RAIL	<b>6AG2132-6FD00-4CU0</b> SIPLUS ET 200SP DQ 4X24..230VAC TX RAIL
<b>Total current of the outputs (per module)</b>				
• horizontal installation				
- up to 30 °C, max.	8 A		8 A	8 A; Applicable for current channels up to 2 A. For current channels between 2 A and 4 A, note derating data in the manual 6 A; Applicable for current channels up to 2 A. For current channels between 2 A and 4 A, note derating data in the manual 4 A; Applicable for current channels up to 2 A. For current channels between 2 A and 4 A, note derating data in the manual 2 A; Applicable for current channels up to 2 A
- up to 40 °C, max.	8 A		8 A	
- up to 50 °C, max.	6 A		6 A	
- up to 60 °C, max.	4 A	4 A	4 A	
- up to 70 °C, max.	0.5 A	1 A	1 A	
• vertical installation				
- up to 30 °C, max.	8 A		8 A; in all other mounting positions	
- up to 40 °C, max.	6 A		6 A; in all other mounting positions	
- up to 50 °C, max.	4 A	4 A; in all other mounting positions	4 A; in all other mounting positions	
- up to 60 °C, max.	4 A			
<b>Isochronous mode</b>				
<b>Execution and activation time (TCO), min.</b>		48 µs		
<b>Bus cycle time (TDP), min.</b>		500 µs		
<b>Interrupts/diagnostics/status information</b>				
<b>Diagnostics function</b>	Yes	Yes	Yes	Yes
<b>Substitute values connectable</b>	Yes	Yes	Yes	Yes
<b>Alarms</b>				
• Diagnostic alarm	Yes	Yes	Yes	Yes
<b>Diagnoses</b>				
• Diagnostic information readable	Yes	Yes	Yes	Yes
• Monitoring the supply voltage	Yes; Module-wise	Yes; channel by channel	Yes; Module-wise	Yes; channel by channel
• Wire-break	Yes; Module-wise	Yes; channel by channel	Yes; Module-wise	No
• Short-circuit				
• Short-circuit to M			Yes; Module-wise	
• Short-circuit to L+			Yes; Module-wise	
• Group error	Yes	Yes		Yes
<b>Diagnostics indication LED</b>				
• Monitoring of the supply voltage (PWR-LED)	Yes; green PWR LED	Yes; green PWR LED	Yes; green PWR LED	Yes; green PWR LED
• Channel status display	Yes; green LED	Yes; green LED	Yes; green LED	Yes; green LED
• for channel diagnostics	No	Yes; red LED	No	Yes; red Fn LED
• for module diagnostics	Yes; green/red DIAG LED	Yes; green/red DIAG LED	Yes; green/red DIAG LED	Yes; green/red DIAG LED
<b>Potential separation</b>				
<b>Potential separation channels</b>				
• between the channels and back-plane bus	Yes	Yes	Yes	Yes
<b>Standards, approvals, certificates</b>				
<b>Suitable for safety functions</b>	No	No	No	No
<b>Suitable for safety-related tripping of standard modules</b>			Yes	
<b>Railway application</b>				
• EN 50121-3-2	Yes; EMC for rail vehicles	Yes; EMC for rail vehicles	Yes; EMC for rail vehicles	Yes; EMC for rail vehicles
• EN 50121-4	Yes; EMC for signal and telecommunications systems	Yes; EMC for signal and telecommunications systems	Yes; EMC for signal and telecommunications systems	Yes; EMC for signal and telecommunications systems
• EN 50124-1	Yes; Railway applications - overvoltage category OV2; pollution degree PD2; rated surge voltage UNi = 0.5 kV; UNm = 24 V DC	Yes; Railway applications - overvoltage category OV2; pollution degree PD2; rated surge voltage UNi = 0.5 kV; UNm = 24 V DC	Yes; Railway applications - overvoltage category OV2; pollution degree PD2; rated surge voltage UNi = 0.5 kV; UNm = 24 V DC	Yes; Railway applications - overvoltage category OV3; pollution degree PD2; UNm = 230 V AC
• EN 50125-1	Yes; Rail vehicles - see ambient conditions	Yes; Rail vehicles - see ambient conditions	Yes; Rail vehicles - see ambient conditions	Yes; Rail vehicles - see ambient conditions
• EN 50125-2	Yes; Stationary electrical equipment - see ambient conditions	Yes; Stationary electrical equipment - see ambient conditions	Yes; Stationary electrical equipment - see ambient conditions	Yes; Stationary electrical equipment - see ambient conditions

# SIPLUS RAIL

## SIPLUS ET 200SP RAIL

### SIPLUS extreme RAIL I/O modules

#### SIPLUS extreme RAIL digital outputs

Article number	6AG2132-6BD20-4BA0	6AG2132-6BF00-4CA0	6AG2132-6BH01-4BA0	6AG2132-6FD00-4CU0
	SIPLUS ET 200SP DQ 4X24-VDC/2A ST TX RAIL	SIPLUS ET 200SP DQ 8X24-VDC/0.5A TX RAIL	SIPLUS ET 200SP DQ 16X24VDC/0.5A TX RAIL	SIPLUS ET 200SP DQ 4X24..230VAC TX RAIL
• EN 50125-3	Yes; Signal and telecommunications systems - see ambient conditions; vibrations and shocks: Application point outside of tracks (1 m to 3 m away from track)	Yes; Signal and telecommunications systems - see ambient conditions; vibrations and shocks: Application point outside of tracks (1 m to 3 m away from track)	Yes; Signal and telecommunications systems - see ambient conditions; vibrations and shocks: Application point outside of tracks (1 m to 3 m away from track)	Yes; Signal and telecommunications systems - see ambient conditions; vibrations and shocks: Application point outside of tracks (1 m to 3 m away from track)
• EN 50155	Yes; Rail vehicles - temperature class OT4, ST1/ST2, horizontal mounting position	Yes; Rail vehicles - temperature class OT4, ST1/ST2, horizontal mounting position	Yes; Rail vehicles - temperature class OT4, ST1/ST2, horizontal mounting position	Yes; Rail vehicles - temperature class OT4, ST1/ST2, horizontal mounting position
• EN 61373	Yes; Rail vehicles - vibrations and shocks: Category 1 Class A/B	Yes; Rail vehicles - vibrations and shocks: Category 1 Class A/B	Yes; Rail vehicles - vibrations and shocks: Category 1 Class A/B	Yes; Rail vehicles - vibrations and shocks: Category 1 Class A/B
• Fire protection acc. to EN 45545-2	Yes; For proof of conformity, see Service & Support	Yes; For proof of conformity, see Service & Support	Yes; For proof of conformity, see Service & Support	Yes; For proof of conformity, see Service & Support
<b>Ambient conditions</b>				
<b>Ambient temperature during operation</b>				
• horizontal installation, min.	-40 °C; = Tmin (incl. condensation/frost)	-40 °C; = Tmin (incl. condensation/frost)	-40 °C; = Tmin (incl. condensation/frost)	-40 °C; = Tmin (incl. condensation/frost)
• horizontal installation, max.	70 °C; = Tmax; +85 °C for 10 min (OT4, ST1/ST2 acc. to EN 50155)	70 °C; = Tmax; +85 °C for 10 min (OT4, ST1/ST2 acc. to EN 50155)	70 °C; = Tmax; +85 °C for 10 min (OT4, ST1/ST2 acc. to EN 50155)	70 °C; = Tmax; +85 °C for 10 min (OT4, ST1/ST2 acc. to EN 50155)
• vertical installation, min.	-40 °C; = Tmin	-40 °C; = Tmin	-40 °C; = Tmin	-40 °C; = Tmin
• vertical installation, max.	50 °C; = Tmax	50 °C; = Tmax	50 °C; = Tmax	50 °C; = Tmax
<b>Altitude during operation relating to sea level</b>				
• Installation altitude above sea level, max.	2 000 m	2 000 m	2 000 m	2 000 m
• Ambient air temperature-barometric pressure-altitude	Tmin ... Tmax at 1 140 hPa ... 795 hPa (-1 000 m ... +2 000 m)	Tmin ... Tmax at 1 140 hPa ... 795 hPa (-1 000 m ... +2 000 m)	Tmin ... Tmax at 1 140 hPa ... 795 hPa (-1 000 m ... +2 000 m)	Tmin ... Tmax at 1 140 hPa ... 795 hPa (-1 000 m ... +2 000 m)
<b>Relative humidity</b>				
• With condensation, tested in accordance with IEC 60068-2-38, max.	100 %; RH incl. condensation/frost (no commissioning under condensation conditions)	100 %; RH incl. condensation/frost (no commissioning under condensation conditions)	100 %; RH incl. condensation/frost (no commissioning under condensation conditions)	100 %; RH incl. condensation / frost (no commissioning in bedewed state), horizontal installation
<b>Resistance</b>				
• Coolants and lubricants	Yes; Incl. diesel and oil droplets in the air	Yes; Incl. diesel and oil droplets in the air	Yes; Incl. diesel and oil droplets in the air	Yes; Incl. diesel and oil droplets in the air
• Use in stationary industrial systems	Yes; Class 3B2 mold, fungus and dry rot spores (with the exception of fauna); Class 3B3 on request	Yes; Class 3B2 mold, fungus and dry rot spores (with the exception of fauna); Class 3B3 on request	Yes; Class 3B2 mold, fungus and dry rot spores (with the exception of fauna); Class 3B3 on request	Yes; Class 3B2 mold, fungus and dry rot spores (with the exception of fauna); Class 3B3 on request
- to biologically active substances according to EN 60721-3-3	Yes; Class 3C4 (RH < 75 %) incl. salt spray acc. to EN 60068-2-52 (severity degree 3); *	Yes; Class 3C4 (RH < 75 %) incl. salt spray acc. to EN 60068-2-52 (severity degree 3); *	Yes; Class 3C4 (RH < 75 %) incl. salt spray acc. to EN 60068-2-52 (severity degree 3); *	Yes; Class 3C4 (RH < 75 %) incl. salt spray acc. to EN 60068-2-52 (severity degree 3); *
- to chemically active substances according to EN 60721-3-3	Yes; Class 3S4 incl. sand, dust; *	Yes; Class 3S4 incl. sand, dust; *	Yes; Class 3S4 incl. sand, dust; *	Yes; Class 3S4 incl. sand, dust; *
- to mechanically active substances according to EN 60721-3-3	Yes; Class 3M8 using the SIPLUS Mounting Kit ET 200SP (6AG1193-6AA00-0AA0)	Yes; Class 3M8 using the SIPLUS Mounting Kit ET 200SP (6AG1193-6AA00-0AA0)	Yes; Class 3M8 using the SIPLUS Mounting Kit ET 200SP (6AG1193-6AA00-0AA0)	Yes; Class 3M8 using the SIPLUS Mounting Kit ET 200SP (6AG1193-6AA00-0AA0)
• Use on land craft, rail vehicles and special-purpose vehicles	Yes; Class 5B2 mold, fungus and dry rot spores (with the exception of fauna); Class 5B3 on request	Yes; Class 5B2 mold, fungus and dry rot spores (with the exception of fauna); Class 5B3 on request	Yes; Class 5B2 mold, fungus and dry rot spores (with the exception of fauna); Class 5B3 on request	Yes; Class 5B2 mold, fungus and dry rot spores (with the exception of fauna); Class 5B3 on request
- to biologically active substances according to EN 60721-3-5	Yes; Class 5C3 (RH < 75 %) incl. salt spray acc. to EN 60068-2-52 (severity degree 3); *	Yes; Class 5C3 (RH < 75 %) incl. salt spray acc. to EN 60068-2-52 (severity degree 3); *	Yes; Class 5C3 (RH < 75 %) incl. salt spray acc. to EN 60068-2-52 (severity degree 3); *	Yes; Class 5C3 (RH < 75 %) incl. salt spray acc. to EN 60068-2-52 (severity degree 3); *
- to chemically active substances according to EN 60721-3-5	Yes; Class 5S3 incl. sand, dust; *	Yes; Class 5S3 incl. sand, dust; *	Yes; Class 5S3 incl. sand, dust; *	Yes; Class 5S3 incl. sand, dust; *
- to mechanically active substances according to EN 60721-3-5	Yes; Class 5M2 using the SIPLUS Mounting Kit ET 200SP (6AG1193-6AA00-0AA0)	Yes; Class 5M2 using the SIPLUS Mounting Kit ET 200SP (6AG1193-6AA00-0AA0)	Yes; Class 5M2 using the SIPLUS Mounting Kit ET 200SP (6AG1193-6AA00-0AA0)	Yes; Class 5M2 using the SIPLUS Mounting Kit ET 200SP (6AG1193-6AA00-0AA0)
- against mechanical environmental conditions acc. to EN 60721-3-5	Yes; level 1 (Location LE) using the SIPLUS Mounting Kit ET 200SP (6AG1193-6AA00-0AA0)	Yes; level 1 (Location LE) using the SIPLUS Mounting Kit ET 200SP (6AG1193-6AA00-0AA0)	Yes; level 1 (Location LE) using the SIPLUS Mounting Kit ET 200SP (6AG1193-6AA00-0AA0)	Yes; level 1 (Location LE) using the SIPLUS Mounting Kit ET 200SP (6AG1193-6AA00-0AA0)
- against mechanical environmental conditions in agriculture acc. to ISO 15003				



## SIPLUS RAIL

SIPLUS ET 200SP RAIL

SIPLUS extreme RAIL I/O modules

### SIPLUS extreme RAIL digital outputs

Article number	6AG2132-6BD20-4BA0 SIPLUS ET 200SP DQ 4X24-VDC/2A ST TX RAIL	6AG2132-6BF00-4CA0 SIPLUS ET 200SP DQ 8X24-VDC/0.5A TX RAIL	6AG2132-6BH01-4BA0 SIPLUS ET 200SP DQ 16X24VDC/0.5A TX RAIL	6AG2132-6FD00-4CU0 SIPLUS ET 200SP DQ 4X24..230VAC TX RAIL
<ul style="list-style-type: none"> <li>Usage in industrial process technology               <ul style="list-style-type: none"> <li>Against chemically active substances acc. to EN 60654-4</li> <li>Environmental conditions for process, measuring and control systems acc. to ANSI/ISA-71.04</li> </ul> </li> <li>Remark               <ul style="list-style-type: none"> <li>Note regarding classification of environmental conditions acc. to EN 60721, EN 60654-4 and ANSI/ISA-71.04</li> </ul> </li> </ul>	Yes; Class 3 (excluding trichlorethylene) Yes; Level GX group A/B (excluding trichlorethylene; harmful gas concentrations up to the limits of EN 60721-3-3 class 3C4 permissible); level LC3 (salt spray) and level LB3 (oil)	Yes; Class 3 (excluding trichlorethylene) Yes; Level GX group A/B (excluding trichlorethylene; harmful gas concentrations up to the limits of EN 60721-3-3 class 3C4 permissible); level LC3 (salt spray) and level LB3 (oil)	Yes; Class 3 (excluding trichlorethylene) Yes; Level GX group A/B (excluding trichlorethylene; harmful gas concentrations up to the limits of EN 60721-3-3 class 3C4 permissible); level LC3 (salt spray) and level LB3 (oil)	Yes; Class 3 (excluding trichlorethylene) Yes; Level GX group A/B (excluding trichlorethylene; harmful gas concentrations up to the limits of EN 60721-3-3 class 3C4 permissible); level LC3 (salt spray) and level LB3 (oil)
<b>Conformal coating</b> <ul style="list-style-type: none"> <li>Coatings for printed circuit board assemblies acc. to EN 61086</li> <li>Protection against fouling acc. to EN 60664-3</li> <li>Electronic equipment on rolling stock acc. to EN 50155</li> <li>Military testing according to MIL-I-46058C, Amendment 7</li> <li>Qualification and Performance of Electrical Insulating Compound for Printed Board Assemblies according to IPC-CC-830A</li> </ul>	Yes; Class 2 for high reliability Yes; Type 1 protection  Yes; Class PC2 protective coating acc. to EN 50155:2017 Yes; Discoloration of coating possible during service life Yes; Conformal coating, Class A	Yes; Class 2 for high reliability Yes; Type 1 protection  Yes; Class PC2 protective coating acc. to EN 50155:2017 Yes; Discoloration of coating possible during service life Yes; Conformal coating, Class A	Yes; Class 2 for high reliability Yes; Type 1 protection  Yes; Class PC2 protective coating acc. to EN 50155:2017 Yes; Discoloration of coating possible during service life Yes; Conformal coating, Class A	Yes; Class 2 for high reliability Yes; Type 1 protection  Yes; Class PC2 protective coating acc. to EN 50155:2017 Yes; Discoloration of coating possible during service life Yes; Conformal coating, Class A
<b>Dimensions</b>				
<b>Width</b>	15 mm	15 mm	15 mm	20 mm
<b>Height</b>	73 mm	73 mm	73 mm	73 mm
<b>Depth</b>	58 mm	58 mm	58 mm	58 mm
<b>Weights</b>				
<b>Weight, approx.</b>	30 g	30 g	30 g	50 g
<b>Other</b>				
<b>Note:</b>	for use in railway applications, also observe the product information "SIPLUS extreme RAIL" A5E37661960A, Online Support article 109736776	for use in railway applications, also observe the product information "SIPLUS extreme RAIL" A5E37661960A, Online Support article 109736776	for use in railway applications, also observe the product information "SIPLUS extreme RAIL" A5E37661960A, Online Support article 109736776	for use in railway applications, also observe the product information "SIPLUS extreme RAIL" A5E37661960A, Online Support article 109736776

Article number	6AG2132-6HD01-4BB1 SIPLUS ET 200SP RQ 4x120VDC/230 TX RAIL	6AG2132-6GD51-4BA0 SIPLUS ET 200SP RQ 4x24VUC/2A ST TX RAIL	6AG2132-6MD00-4BB1 SIPLUS ET 200SP RQ 4x120/230 MA TX RAIL
<b>General information</b>			
<b>Product type designation</b>	RQ 4x120 VDC ... 230 VAC/5 A NO ST	RQ CO 4x24VDC/2A ST	RQ 4x120 V DC ... 230 V AC/5 A NO MA ST
<b>Product function</b>			
• Isochronous mode	No	No	No
<b>Operating mode</b>			
• DQ	Yes	Yes	Yes
• DQ with energy-saving function	No	No	No
• PWM	No	No	No
• Oversampling	No	No	No
• MSO	No	No	No
<b>Supply voltage</b>			
<b>Rated value (DC)</b>	24 V	24 V	24 V
<b>Reverse polarity protection</b>	Yes	Yes	Yes
<b>Digital outputs</b>			
<b>Type of digital output</b>	Relays	Relays	Relays
<b>Number of digital outputs</b>	4	4	4
<b>Current-sinking</b>	Yes	Yes	
<b>Current-sourcing</b>	Yes	Yes	
<b>Digital outputs, parameterizable</b>	Yes	Yes	
<b>Short-circuit protection</b>	No	No	No
<b>Parallel switching of two outputs</b>			
• for logic links	Yes	Yes	
• for uprating	No	No	
• for redundant control of a load	Yes	Yes	

**SIPLUS extreme RAIL digital outputs**

Article number	<b>6AG2132-6HD01-4BB1</b> SIPLUS ET 200SP RQ 4x120VDC/230 TX RAIL	<b>6AG2132-6GD51-4BA0</b> SIPLUS ET 200SP RQ 4x24VUC/2A ST TX RAIL	<b>6AG2132-6MD00-4BB1</b> SIPLUS ET 200SP RQ 4x120/230 MA TX RAIL
<b>Switching frequency</b> • with resistive load, max. • with inductive load, max. • on lamp load, max.	2 Hz 0.5 Hz 2 Hz	2 Hz	2 Hz 0.5 Hz 2 Hz
<b>Total current of the outputs</b> • Current per channel, max.  • Current per module, max.	5 A; > +60 °C max. continuous current per relay 3 A 20 A	2 A  8 A	5 A  20 A
<b>Total current of the outputs (per module)</b> • horizontal installation - up to 40 °C, max. - up to 50 °C, max. - up to 60 °C, max. - up to 70 °C, max. • vertical installation - up to 30 °C, max. - up to 40 °C, max. - up to 50 °C, max.	20 A 16 A 12 A  20 A 16 A; in all other mounting positions	8 A 6 A 4 A 2 A  8 A 6 A 4 A; in all other mounting positions	20 A 16 A 12 A  20 A 16 A
<b>Relay outputs</b> • Number of relay outputs • Rated supply voltage of relay coil L+ (DC) • Current consumption of relays (coil current of all relays), max. • external protection for relay outputs • Number of operating cycles, max.	4 24 V 40 mA Yes, with 6A 7 000 000; see additional description in the manual	4 24 V 40 mA	4 24 V 40 mA Yes, with 6A 7 000 000; see additional description in the manual
<b>Switching capacity of contacts</b> • with inductive load, max.  • with resistive load, max.  • Thermal continuous current, max. • Switching current, min. • Rated switching voltage (DC) • Rated switching voltage (AC)	2 A; see additional description in the manual 5 A; see additional description in the manual 5 A; Max. 1 385 VA, 150 W 100 mA; 5 V DC 24 V DC to 120 V DC 24V AC to 230V AC	2 A  2 A 1 mA; 5 V DC 24 V 24 V	2 A; see additional description in the manual 5 A; see additional description in the manual 5 A 100 mA; 5 V DC 24 V DC to 120 V DC 24V AC to 230V AC
<b>Interrupts/diagnostics/status information</b>			
<b>Diagnostics function</b>	Yes	Yes	Yes
<b>Substitute values connectable</b>	Yes	Yes	Yes
<b>Alarms</b> • Diagnostic alarm	Yes	Yes	Yes
<b>Diagnoses</b> • Monitoring the supply voltage • Wire-break • Short-circuit • Group error	Yes No No No	Yes No No No	Yes No No Yes
<b>Diagnostics indication LED</b> • Monitoring of the supply voltage (PWR-LED) • Channel status display • for channel diagnostics • for module diagnostics	Yes; green PWR LED Yes; green LED No Yes; green/red DIAG LED	Yes; green PWR LED Yes; green LED No Yes; green/red DIAG LED	Yes; green PWR LED Yes; green LED No Yes; green/red DIAG LED
<b>Potential separation</b>			
<b>Potential separation channels</b> • between the channels and back-plane bus	Yes	Yes	Yes
<b>Standards, approvals, certificates</b>			
<b>Suitable for safety functions</b>	No	No	No
<b>Railway application</b> • EN 50121-3-2 • EN 50121-4  • EN 50124-1  • EN 50125-1  • EN 50125-2	Yes; EMC for rail vehicles Yes; EMC for signal and telecommunications systems  Yes; Railway applications - overvoltage category OV3; pollution degree PD2; UNm = 230 V AC  Yes; Rail vehicles - see ambient conditions Yes; Stationary electrical equipment - see ambient conditions	Yes; EMC for rail vehicles Yes; EMC for signal and telecommunications systems  Yes; Railway applications - overvoltage category OV2; pollution degree PD2; rated surge voltage UNI = 0.5 kV; UNm = 24 V DC  Yes; Rail vehicles - see ambient conditions Yes; Stationary electrical equipment - see ambient conditions	Yes; EMC for rail vehicles Yes; EMC for signal and telecommunications systems  Yes; Railway applications - overvoltage category OV3; pollution degree PD2; UNm = 230 V AC  Yes; Rail vehicles - see ambient conditions Yes; Stationary electrical equipment - see ambient conditions

# SIPLUS RAIL

## SIPLUS ET 200SP RAIL

### SIPLUS extreme RAIL I/O modules

#### SIPLUS extreme RAIL digital outputs

Article number	6AG2132-6HD01-4BB1	6AG2132-6GD51-4BA0	6AG2132-6MD00-4BB1
	SIPLUS ET 200SP RQ 4x120VDC/230 TX RAIL	SIPLUS ET 200SP RQ 4x24VUC/2A ST TX RAIL	SIPLUS ET 200SP RQ 4x120/230 MA TX RAIL
• EN 50125-3	Yes; Signal and telecommunications systems - see ambient conditions; vibrations and shocks: Application point outside of tracks (1 m to 3 m away from track)	Yes; Signal and telecommunications systems - see ambient conditions; vibrations and shocks: Application point outside of tracks (1 m to 3 m away from track)	Yes; Signal and telecommunications systems - see ambient conditions; vibrations and shocks: Application point outside of tracks (1 m to 3 m away from track)
• EN 50155	Yes; Rail vehicles - temperature class OT4, ST1/ST2, horizontal mounting position	Yes; Rail vehicles - temperature class OT4, ST1/ST2, horizontal mounting position	Yes; Rail vehicles - temperature class OT4, ST1/ST2, horizontal mounting position
• EN 61373	Yes; Rail vehicles - vibrations and shocks: Category 1 Class A/B	Yes; Rail vehicles - vibrations and shocks: Category 1 Class A/B	Yes; Rail vehicles - vibrations and shocks: Category 1 Class A/B
• Fire protection acc. to EN 45545-2	Yes; For proof of conformity, see Service & Support	Yes; For proof of conformity, see Service & Support	Yes; For proof of conformity, see Service & Support
<b>Ambient conditions</b>			
<b>Ambient temperature during operation</b>			
• horizontal installation, min.	-40 °C; = Tmin (incl. condensation/frost)	-40 °C; = Tmin (incl. condensation/frost)	-40 °C; = Tmin (incl. condensation/frost)
• horizontal installation, max.	70 °C; = Tmax; +85 °C for 10 min (OT4, ST1/ST2 acc. to EN 50155)	70 °C; = Tmax; +85 °C for 10 min (OT4, ST1/ST2 acc. to EN 50155)	70 °C; = Tmax; +85 °C for 10 min (OT4, ST1/ST2 acc. to EN 50155)
• vertical installation, min.	-40 °C; = Tmin	-40 °C; = Tmin	-40 °C; = Tmin
• vertical installation, max.	50 °C; = Tmax	50 °C; = Tmax	50 °C; = Tmax
<b>Altitude during operation relating to sea level</b>			
• Installation altitude above sea level, max.	2 000 m	2 000 m	2 000 m
• Ambient air temperature-barometric pressure-altitude	Tmin ... Tmax at 1 140 hPa ... 795 hPa (-1 000 m ... +2 000 m)	Tmin ... Tmax at 1 140 hPa ... 795 hPa (-1 000 m ... +2 000 m)	Tmin ... Tmax at 1 140 hPa ... 795 hPa (-1 000 m ... +2 000 m)
<b>Relative humidity</b>			
• With condensation, tested in accordance with IEC 60068-2-38, max.	100 %; RH incl. condensation/frost (no commissioning under condensation conditions)	100 %; RH incl. condensation / frost (no commissioning in bedewed state), horizontal installation	100 %; RH incl. condensation / frost (no commissioning in bedewed state), horizontal installation
<b>Resistance</b>			
• Coolants and lubricants - Resistant to commercially available coolants and lubricants	Yes; Incl. diesel and oil droplets in the air	Yes; Incl. diesel and oil droplets in the air	Yes; Incl. diesel and oil droplets in the air
• Use in stationary industrial systems - to biologically active substances according to EN 60721-3-3	Yes; Class 3B2 mold, fungus and dry rot spores (with the exception of fauna); Class 3B3 on request	Yes; Class 3B2 mold, fungus and dry rot spores (with the exception of fauna); Class 3B3 on request	Yes; Class 3B2 mold, fungus and dry rot spores (with the exception of fauna); Class 3B3 on request
- to chemically active substances according to EN 60721-3-3	Yes; Class 3C4 (RH < 75 %) incl. salt spray acc. to EN 60068-2-52 (severity degree 3); *	Yes; Class 3C4 (RH < 75 %) incl. salt spray acc. to EN 60068-2-52 (severity degree 3); *	Yes; Class 3C4 (RH < 75 %) incl. salt spray acc. to EN 60068-2-52 (severity degree 3); *
- to mechanically active substances according to EN 60721-3-3	Yes; Class 3S4 incl. sand, dust, *	Yes; Class 3S4 incl. sand, dust, *	Yes; Class 3S4 incl. sand, dust, *
- Against mechanical environmental conditions acc. to EN 60721-3-3	Yes; Class 3M8 using the SIPLUS Mounting Kit ET 200SP (6AG1193-6AA00-0AA0)	Yes; Class 3M8 using the SIPLUS Mounting Kit ET 200SP (6AG1193-6AA00-0AA0)	
• Use on land craft, rail vehicles and special-purpose vehicles - to biologically active substances according to EN 60721-3-5	Yes; Class 5B2 mold, fungus and dry rot spores (with the exception of fauna); Class 5B3 on request	Yes; Class 5B2 mold, fungus and dry rot spores (with the exception of fauna); Class 5B3 on request	Yes; Class 5B2 mold, fungus and dry rot spores (with the exception of fauna); Class 5B3 on request
- to chemically active substances according to EN 60721-3-5	Yes; Class 5C3 (RH < 75 %) incl. salt spray acc. to EN 60068-2-52 (severity degree 3); *	Yes; Class 5C3 (RH < 75 %) incl. salt spray acc. to EN 60068-2-52 (severity degree 3); *	Yes; Class 5C3 (RH < 75 %) incl. salt spray acc. to EN 60068-2-52 (severity degree 3); *
- to mechanically active substances according to EN 60721-3-5	Yes; Class 5S3 incl. sand, dust; *	Yes; Class 5S3 incl. sand, dust; *	Yes; Class 5S3 incl. sand, dust; *
- Against mechanical environmental conditions acc. to EN 60721-3-5	Yes; Class 5M2 using the SIPLUS Mounting Kit ET 200SP (6AG1193-6AA00-0AA0)	Yes; Class 5M2 using the SIPLUS Mounting Kit ET 200SP (6AG1193-6AA00-0AA0)	
- against mechanical environmental conditions in agriculture acc. to ISO 15003	Yes; level 1 (Location LE) using the SIPLUS Mounting Kit ET 200SP (6AG1193-6AA00-0AA0)	Yes; level 1 (Location LE) using the SIPLUS Mounting Kit ET 200SP (6AG1193-6AA00-0AA0)	
• Usage in industrial process technology - Against chemically active substances acc. to EN 60654-4	Yes; Class 3 (excluding trichlorethylene)	Yes; Class 3 (excluding trichlorethylene)	Yes; Class 3 (excluding trichlorethylene)
- Environmental conditions for process, measuring and control systems acc. to ANSI/ISA-71.04	Yes; Level GX group A/B (excluding trichlorethylene; harmful gas concentrations up to the limits of EN 60721-3-3 class 3C4 permissible); level LC3 (salt spray) and level LB3 (oil)	Yes; Level GX group A/B (excluding trichlorethylene; harmful gas concentrations up to the limits of EN 60721-3-3 class 3C4 permissible); level LC3 (salt spray) and level LB3 (oil)	Yes; Level GX group A/B (excluding trichlorethylene; harmful gas concentrations up to the limits of EN 60721-3-3 class 3C4 permissible); level LC3 (salt spray) and level LB3 (oil)
• Remark - Note regarding classification of environmental conditions acc. to EN 60721, EN 60654-4 and ANSI/ISA-71.04	* The supplied plug covers must remain in place over the unused interfaces during operation!	* The supplied plug covers must remain in place over the unused interfaces during operation!	* The supplied plug covers must remain in place over the unused interfaces during operation!

# SIPLUS RAIL

## SIPLUS ET 200SP RAIL

### SIPLUS extreme RAIL I/O modules

#### SIPLUS extreme RAIL digital outputs

Article number	<b>6AG2132-6HD01-4BB1</b>	<b>6AG2132-6GD51-4BA0</b>	<b>6AG2132-6MD00-4BB1</b>
	SIPLUS ET 200SP RQ 4x120VDC/230 TX RAIL	SIPLUS ET 200SP RQ 4x24VUC/2A ST TX RAIL	SIPLUS ET 200SP RQ 4x120/230 MA TX RAIL
<b>Conformal coating</b>			
<ul style="list-style-type: none"> <li>Coatings for printed circuit board assemblies acc. to EN 61086</li> <li>Protection against fouling acc. to EN 60664-3</li> <li>Electronic equipment on rolling stock acc. to EN 50155</li> <li>Military testing according to MIL-I-46058C, Amendment 7</li> <li>Qualification and Performance of Electrical Insulating Compound for Printed Board Assemblies according to IPC-CC-830A</li> </ul>	Yes; Class 2 for high reliability Yes; Type 1 protection Yes; Class PC2 protective coating acc. to EN 50155:2017 Yes; Discoloration of coating possible during service life Yes; Conformal coating, Class A	Yes; Class 2 for high reliability Yes; Type 1 protection Yes; Class PC2 protective coating acc. to EN 50155:2017 Yes; Discoloration of coating possible during service life Yes; Conformal coating, Class A	Yes; Class 2 for high reliability Yes; Type 1 protection Yes; Class PC2 protective coating acc. to EN 50155:2017 Yes; Discoloration of coating possible during service life Yes; Conformal coating, Class A
<b>Dimensions</b>			
<b>Width</b>	20 mm	15 mm	20 mm
<b>Height</b>	73 mm	73 mm	73 mm
<b>Depth</b>	58 mm	58 mm	58 mm
<b>Weights</b>			
<b>Weight, approx.</b>	40 g	30 g	45 g
<b>Other</b>			
<b>Note:</b>	for use in railway applications, also observe the product information "SIPLUS extreme RAIL" A5E37661960A, Online Support article 109736776	for use in railway applications, also observe the product information "SIPLUS extreme RAIL" A5E37661960A, Online Support article 109736776	for use in railway applications, also observe the product information "SIPLUS extreme RAIL" A5E37661960A, Online Support article 109736776

#### Selection and ordering data

Version	Article No.
<p><b>SIPLUS extreme RAIL digital outputs</b></p> <p>Approved in accordance with EN 50155, EN 15121, EN 50124, EN 50125 and EN 45545 railway standards for use in rail traffic</p> <p>SIPLUS ET 200SP DQ 16X24VDC/0.5A TX RAIL, BU type A0, color code CC00; for areas with extreme exposure to environmental substances (conformal coating); ambient temperature -40 ... +70 °C (+85 °C for 10 min.)</p> <p>SIPLUS ET 200SP DQ 8X24VDC/0.5A TX RAIL, BU type A0, color code CC02; for areas with extreme exposure to environmental substances (conformal coating); ambient temperature -40 ... +70 °C (+85 °C for 10 min.)</p> <p>SIPLUS ET 200SP DQ 4X24VDC/2A ST TX RAIL, BU type A0, color code CC02; for areas with extreme exposure to environmental substances (conformal coating); ambient temperature -40 ... +70 °C (+85 °C for 10 min.)</p> <p>SIPLUS ET 200SP DQ 4x24VAC...230VAC/2A High Feature for BU type U0, color code CC20, 2 operating modes: DQ and PC (power control with phase angle, half- and full-wave control); For areas with extreme exposure to environmental substances (conformal coating); Ambient temperature -40 ... +70 °C (+85 °C for 10 min.)</p> <p>SIPLUS ET 200SP RQ CO 4x24VUC/2A Standard, change-over contact, BU type A0, color code CC00; For areas with extreme exposure to environmental substances (conformal coating); Ambient temperature -40 ... +70 °C (+85 °C for 10 min.)</p> <p>SIPLUS ET 200SP RQ 4x120VDC/230 TX RAIL, normally open, BU type B0, B1, color code CC40; For areas with extreme exposure to environmental substances (conformal coating); Ambient temperature -40 ... +70 °C (+85 °C for 10 min.)</p> <p>SIPLUS ET 200SP RQ NO 4x120VDC-230VAC/5A Standard, normally open, with manual operation, BU type B0, B1; For areas with extreme exposure to environmental substances (conformal coating); Ambient temperature -40 ... +70 °C (+85 °C for 10 min.)</p>	<p><b>6AG2132-6BH01-4BA0</b></p> <p><b>6AG2132-6BF00-4CA0</b></p> <p><b>6AG2132-6BD20-4BA0</b></p> <p><b>6AG2132-6FD00-4CU0</b></p> <p><b>6AG2132-6GD51-4BA0</b></p> <p><b>6AG2132-6HD01-4BB1</b></p> <p><b>6AG2132-6MD00-4BB1</b></p>

# SIPLUS RAIL

## SIPLUS ET 200SP RAIL

### SIPLUS extreme RAIL I/O modules

#### SIPLUS extreme RAIL digital outputs

Version	Article No.
<b>Suitable SIPLUS extreme RAIL BaseUnits</b>	
<b>SIPLUS ET 200SP BU15-P16+A0+2D TX RAIL</b> Approved in accordance with EN 50155, EN 15121, EN 50124, EN 50125 and EN 45545 railway standards for use in rail traffic BU type A0; BaseUnit (light) with 16 process terminals to the module; for starting a new load group (max. 10 A); for areas with extreme exposure to environmental substances (conformal coating); ambient temperature -40 ... +70 °C (+85 °C for 10 min.)	<b>6AG2193-6BP00-4DA0</b>
<b>SIPLUS ET 200SP BU15-P16+A0+2B TX RAIL</b> Approved in accordance with EN 50155, EN 15121, EN 50124, EN 50125 and EN 45545 railway standards for use in rail traffic BU type A0; BaseUnit (dark) with 16 process terminals to the module; for continuing the load group; for areas with extreme exposure to environmental substances (conformal coating); ambient temperature -40 ... +70 °C (+85 °C for 10 min.)	<b>6AG2193-6BP00-4BA0</b>
<b>SIPLUS ET 200SP BU15-P16+A10+2D TX RAIL</b> Approved in accordance with EN 50155, EN 15121, EN 50124, EN 50125 and EN 45545 railway standards for use in rail traffic BU type A0; BaseUnit (light) with 16 process terminals (1...16) to the module and an additional 10 internally jumpered AUX terminals (1 A to 10 A); for starting a new load group (max. 10 A); for areas with extreme exposure to environmental substances (conformal coating); ambient temperature -40 ... +70 °C (+85 °C for 10 min.)	<b>6AG2193-6BP20-4DA0</b>
<b>SIPLUS ET 200SP BU15-P16+A10+2B TX RAIL</b> Approved in accordance with EN 50155, EN 15121, EN 50124, EN 50125 and EN 45545 railway standards for use in rail traffic BU type A0; BaseUnit (dark) with 16 process terminals (1...16) to the module and an additional 10 internally jumpered AUX terminals (1 A to 10 A); for continuing the load group; for areas with extreme exposure to environmental substances (conformal coating); ambient temperature -40 ... +70 °C (+85 °C for 10 min.)	<b>6AG2193-6BP20-4BA0</b>
<b>SIPLUS ET 200SP BU20-P12+A0+4B TX RAIL</b> Approved in accordance with EN 50155, EN 15121, EN 50124, EN 50125 and EN 45545 railway standards for use in rail traffic BU type B1; BaseUnit (dark) with 12 process terminals to the module; for continuing the load group; 1 unit	<b>6AG2193-6BP20-4BB1</b>
<b>SIPLUS ET 200SP BU20-P16+A0+2B TX RAIL</b> Approved in accordance with EN 50155, EN 15121, EN 50124, EN 50125 and EN 45545 railway standards for use in rail traffic BU type U0; BaseUnit (dark) with 16 process terminals to the module; for continuing the load group	<b>6AG2193-6BP00-4BU0</b>
<b>SIPLUS ET 200SP BU20-P16+A0+2D TX RAIL</b> Approved in accordance with EN 50155, EN 15121, EN 50124, EN 50125 and EN 45545 railway standards for use in rail traffic BU type U0; BaseUnit (light) with 16 process terminals to the module; for starting a new load group (max. 10 A)	<b>6AG2193-6BP00-4DU0</b>
<b>Accessories</b>	
<b>SIPLUS Mounting Kit ET 200SP</b> Mounting accessories for use with increased mechanical vibration and shock loads.	<b>6AG1193-6AA00-0AA0</b>

**Overview**

- 2, 4 and 8-channel analog input (AI) modules
- Approved in accordance with EN 50155, EN 15121, EN 50124, EN 50125 and EN 45545 railway standards for use in rail traffic

For different requirements, the analog input modules offer:

- Function classes Basic and High Feature
- BaseUnits for single or multiple-conductor connection with automatic slot coding
- Individual system-integrated load group formation with self-assembling voltage distribution bars (a separate power module is no longer required for ET 200SP)
- Option of connecting current, voltage and resistance sensors, as well as thermocouples
- Energy Meter for recording up to 200 electrical variables
- Clear labeling on front of module
- LEDs for diagnostics, status, supply voltage and faults
- Electronically readable and non-volatile writable rating plate (I&M data 0 to 3)
- Extended functions and additional operating modes in some cases
  - Scalable measuring range (adaptation of measuring range, increase of the 16-bit resolution by adapting the measuring range to a limited section)
- Optional accessories
  - Labeling strips (film or card)
  - Equipment labeling plate
  - Color-coded label with module-specific CC code
  - Shielding terminal

A quick and clear comparison of the functions of the AI modules is offered by the TIA Selection Tool.

Overview of analog input modules

Analog input	PU	Article No.	CC code	BU type
AI 8 x I 2/4-wire BA	1	6AG2134-6GF00-4AA1	CC01	A0, A1
AI 4 x I 2/4-wire ST	1	6AG2134-6GD01-1BA1	CC03	A0, A1
AI 4 x I 2/4-wire ST	1	6AG2134-6GD01-4BA1	CC03	A0, A1
AI 4 x U/I 2-wire ST	1	6AG2134-6HD01-1BA1	CC03	A0, A1
AI 4 x U/I 2-wire ST	1	6AG2134-6HD01-4BA1	CC03	A0, A1
AI 2 x U/I 2/4-wire HF	1	6AG2134-6HB00-1CA1	CC05	A0, A1
AI 8 x RTD/TC 2-wire HF	1	6AG2134-6JF00-1CA1	CC00	A0, A1
AI 4 x RTD/TC 2/3/4-wire HF	1	6AG2134-6JD00-1CA1	CC00	A0, A1
AI Energy Meter 480 V AC/CT High Feature	1	6AG2134-6PA00-4CU0	--	U0
AI Energy Meter 480 V AC ST	1	6AG2134-6PA20-4BD0	CC00	D0



**SIPLUS RAIL**

## SIPLUS ET 200SP RAIL

## SIPLUS extreme RAIL I/O modules

**SIPLUS extreme RAIL analog inputs**Overview of BaseUnits

BaseUnit	PU	Article No.	CC codes for process terminals	CC codes for AUX terminals
<b>BU type A0</b> • New load group (light) • 16 process terminals • With 10 AUX terminals	1	6AG2193-6BP20-4DA0	CC01 to CC05	CC71 to CC73
<b>BU type A0</b> • New load group (light) • 16 process terminals • Without AUX terminals	1	6AG2193-6BP00-4DA0	CC01 to CC05	--
<b>BU type A0</b> • Forwarding of load group (dark) • 16 process terminals • With 10 AUX terminals	1	6AG2193-6BP20-4BA0	CC01 to CC05	CC71 to CC73
<b>BU type A0</b> • Forwarding of load group (dark) • 16 process terminals • Without AUX terminals	1	6AG2193-6BP00-4BA0	CC01 to CC05	--
<b>BU type D0</b> • Forwarding of load group (dark) • 12 process terminals • Without AUX terminals	1	6AG2193-6BP00-4BD0	--	--
<b>BU type U0</b> • New load group (light) • 16 process terminals • Without AUX terminals	1	6AG2193-6BP00-4DU0	CC00	--
<b>BU type U0</b> • Forwarding of load group (dark) • 16 process terminals • Without AUX terminals	1	6AG2193-6BP00-4BU0	CC00	--

6

**Application**

The measured values of analog sensors (current, voltage, resistance, temperature etc.) can be recorded and transferred to the higher-level controller via the analog input modules.

**Design****Usable BaseUnits (BU)**

BaseUnits with an appropriate number of terminals are available for single or multi-conductor connection.

All variants that correspond to the BU type of the I/O module used can be used as BaseUnits (see Selection and ordering data).

**Load group formation**

A light-colored BU separates the self-assembling, internal voltage buses (P1, P2, AUX) and thus opens a new load group. The supply voltage of a load group must be fed in at the light BU of this load group.

A dark BU forwards the supply voltage of the adjacent light BU on the left via the self-assembling voltage buses P1, P2 and AUX. A new infeed is therefore only required on the next light BU to the right. The setting of a further light BU is required whenever

- a new load group is to be formed (for example, for isolating the supply voltage from module groups) or
- the maximum current simultaneously required by the load group exceeds the permissible limit of 10 A.

**Color identification of the terminals**

The potentials at the terminals of the BaseUnit are defined by the inserted I/O module in each case. To prevent wiring faults, the potentials of the terminals can optionally be identified by means of module-specific color-coded labels. The color-coded label that matches the respective I/O module is defined by the color code CCxx of the I/O module. This color code is also printed on the front of the module.

In BaseUnits with the additional ten internally jumpered AUX terminals or 2x5 additional terminals, these can also be identified with color-coded labels. For the ten AUX terminals, color-coded labels are available in red, blue, and yellow/green.

**Labeling**Labeling strips

Labeling strips can be inserted on the front of the interface modules or I/O modules and individually labeled by means of STEP7, macros, etc. No special additional holder is required. If required, they can be easily replaced with the component.

Equipment labeling plates

Equipment labeling plates enable the equipment to be easily identified (e.g. compliant with EN 81346). They are easily plugged onto the required component (interface modules, I/O modules and BaseUnits) and when required, they can be easily replaced with the component.

The following labeling components are available:

Film labeling strips, light-gray, roll with 500 strips, perforated, for thermal transfer printers

- Film labeling strips, yellow, roll with 500 strips, perforated, for thermal transfer printers
- Card labeling strips (180 g/m<sup>2</sup>), light gray, DIN A4 sheets with 100 strips each, perforated, for laser printer
- Card labeling strips (180 g/m<sup>2</sup>), yellow, DIN A4 sheets with 100 strips each, perforated, for laser printer
- Equipment labeling plates, white, ten sheets each with 16 labels, for thermal transfer card printers or labels

**System-integrated shielded connection**

For the space-saving and EMC-optimized connection of cable shields, a shield connection is available that is quick and easy to mount. This consists of one shield connection element that can be plugged onto the BaseUnit and one shield terminal for each module. The low-impedance connection to the functional ground (DIN rail) is achieved without any additional wiring by the user.

**Technical specifications**

Article number	<b>6AG2134-6GD01-1BA1</b> SIPLUS ET 200SP AI 4X1 2- /4-WIRE T1 RAIL	<b>6AG2134-6GD01-4BA1</b> SIPLUS ET 200SP AI 4X1 2- /4-WIRE TX RAIL	<b>6AG2134-6HD01-1BA1</b> SIPLUS ET 200SP AI 4XU/I 2-WIRE T1 RAIL	<b>6AG2134-6HD01-4BA1</b> SIPLUS ET 200SP AI 4XU/I 2-WIRE TX RAIL
<b>General information</b>				
<b>Product type designation</b>	AI 4x1 2-/4-wire ST	AI 4x1 2-/4-wire ST	AI 4x U/I 2-wire	AI 4x U/I 2-wire
<b>Product function</b> • Isochronous mode • Measuring range scalable	No No	No No	No No	No No
<b>Operating mode</b> • Oversampling • MSI	No No	No No	No No	No No
<b>Supply voltage</b>				
<b>Rated value (DC)</b>	24 V	24 V	24 V	24 V
<b>Reverse polarity protection</b>	Yes	Yes	Yes	Yes
<b>Analog inputs</b>				
<b>Number of analog inputs</b>	4; Differential inputs	4; > 60 °C max. 1x ±20 mA permissible	4; Differential inputs	4; > 60 °C max. 1x ±20 mA or 4x ±10 V permissible
<b>permissible input voltage for voltage input (destruction limit), max.</b>			30 V	30 V
<b>permissible input current for current input (destruction limit), max.</b>	50 mA	50 mA	50 mA	50 mA
<b>Cycle time (all channels), min.</b>	Sum of the basic conversion times and additional processing times (depending on the parameterization of the active channels)	Sum of the basic conversion times and additional processing times (depending on the parameterization of the active channels)	Sum of the basic conversion times and additional processing times (depending on the parameterization of the active channels)	Sum of the basic conversion times and additional processing times (depending on the parameterization of the active channels)
<b>Input ranges (rated values), voltages</b> • 0 to +10 V • 1 V to 5 V • -10 V to +10 V • -5 V to +5 V			Yes; 15 bit Yes; 15 bit Yes; 16 bit incl. sign Yes; 16 bit incl. sign	Yes; 15 bit Yes; 15 bit Yes; 16 bit incl. sign Yes; 16 bit incl. sign
<b>Input ranges (rated values), currents</b> • 0 to 20 mA • -20 mA to +20 mA • 4 mA to 20 mA	Yes; 16 bit incl. sign Yes Yes; 15 bit	Yes; 16 bit incl. sign Yes Yes; 15 bit	Yes; 15 bit Yes; 15 bit	Yes; 15 bit Yes; 15 bit
<b>Cable length</b> • shielded, max.	1 000 m	1 000 m	1 000 m; 200 m for voltage measurement	1 000 m; 200 m for voltage measurement
<b>Analog value generation for the inputs</b>				
<b>Integration and conversion time/resolution per channel</b> • Resolution with overrange (bit including sign), max. • Integration time, parameterizable • Interference voltage suppression for interference frequency f1 in Hz • Conversion time (per channel)	16 bit Yes 16.6 / 50 / 60 Hz 180 / 60 / 50 ms	16 bit Yes 16.6 / 50 / 60 Hz 180 / 60 / 50 ms	16 bit Yes 16.6 / 50 / 60 Hz 180 / 60 / 50 ms	16 bit Yes 16.6 / 50 / 60 Hz 180 / 60 / 50 ms
<b>Smoothing of measured values</b> • Number of smoothing levels • parameterizable	4; None; 4/8/16 times Yes	4; None; 4/8/16 times Yes	4; None; 4/8/16 times Yes	4; None; 4/8/16 times Yes
<b>Encoder</b>				
<b>Connection of signal encoders</b> • for voltage measurement • for current measurement as 2-wire transducer - Burden of 2-wire transmitter, max. • for current measurement as 4-wire transducer	No Yes 650 Ω Yes	No Yes 650 Ω Yes	Yes Yes 650 Ω No	Yes Yes 650 Ω No
<b>Errors/accuracies</b>				
<b>Basic error limit (operational limit at 25 °C)</b> • Voltage, relative to input range, (+/-) • Current, relative to input range, (+/-)	0.3 %	0.3 %	0.3 % 0.3 %	0.3 % 0.3 %
<b>Interference voltage suppression for f = n x (f1 +/- 1 %), f1 = interference frequency</b> • Series mode interference (peak value of interference < rated value of input range), min. • Common mode voltage, max. • Common mode interference, min.	70 dB 10 V 90 dB	70 dB 10 V 90 dB	70 dB 10 V 90 dB	70 dB 10 V 90 dB



# SIPLUS RAIL

## SIPLUS ET 200SP RAIL

### SIPLUS extreme RAIL I/O modules

#### SIPLUS extreme RAIL analog inputs

Article number	6AG2134-6GD01-1BA1	6AG2134-6GD01-4BA1	6AG2134-6HD01-1BA1	6AG2134-6HD01-4BA1
	SIPLUS ET 200SP AI 4XI 2-/4-WIRE T1 RAIL	SIPLUS ET 200SP AI 4XI 2-/4-WIRE TX RAIL	SIPLUS ET 200SP AI 4XU/I 2-WIRE T1 RAIL	SIPLUS ET 200SP AI 4XU/I 2-WIRE TX RAIL
<b>Interrupts/diagnostics/status information</b>				
<b>Diagnostics function</b>	Yes	Yes	Yes	Yes
<b>Alarms</b>				
• Diagnostic alarm	Yes	Yes	Yes	Yes
• Limit value alarm	No	No	No	No
<b>Diagnostics</b>				
• Monitoring the supply voltage	Yes	Yes	Yes	Yes
• Wire-break	Yes; at 4 to 20 mA	Yes; at 4 to 20 mA	Yes; at 4 to 20 mA	Yes; at 4 to 20 mA
• Short-circuit	Yes; 2-wire mode: Short-circuit of the encoder supply to ground or of an input to the encoder supply	Yes; 2-wire mode: Short-circuit of the encoder supply to ground or of an input to the encoder supply	Yes; with 1 to 5 V or 2-wire mode: Short-circuit of the encoder supply to ground or of an input to the encoder supply	Yes; with 1 to 5 V or 2-wire mode: Short-circuit of the encoder supply to ground or of an input to the encoder supply
• Group error	Yes	Yes	Yes	Yes
• Overflow/underflow	Yes	Yes	Yes	Yes
<b>Diagnostics indication LED</b>				
• Monitoring of the supply voltage (PWR-LED)	Yes; green LED	Yes; green LED	Yes; green LED	Yes; green LED
• Channel status display	Yes; green LED	Yes; green LED	Yes; green LED	Yes; green LED
• for channel diagnostics	No	No	No	No
• for module diagnostics	Yes; green/red LED	Yes; green/red LED	Yes; green/red LED	Yes; green/red LED
<b>Potential separation</b>				
<b>Potential separation channels</b>				
• between the channels and back-plane bus	Yes	Yes	Yes	Yes
<b>Standards, approvals, certificates</b>				
<b>Railway application</b>				
• EN 50121-3-2	Yes; EMC for rail vehicles	Yes; EMC for rail vehicles	Yes; EMC for rail vehicles	Yes; EMC for rail vehicles
• EN 50121-4	Yes; EMC for signal and telecommunications systems	Yes; EMC for signal and telecommunications systems	Yes; EMC for signal and telecommunications systems	Yes; EMC for signal and telecommunications systems
• EN 50124-1	Yes; Railway applications - overvoltage category OV2; pollution degree PD2; rated surge voltage UNi = 0.5 kV; UNm = 24 V DC	Yes; Railway applications - overvoltage category OV2; pollution degree PD2; rated surge voltage UNi = 0.5 kV; UNm = 24 V DC	Yes; Railway applications - overvoltage category OV2; pollution degree PD2; rated surge voltage UNi = 0.5 kV; UNm = 24 V DC	Yes; Railway applications - overvoltage category OV2; pollution degree PD2; rated surge voltage UNi = 0.5 kV; UNm = 24 V DC
• EN 50125-1	Yes; Rail vehicles - see ambient conditions	Yes; Rail vehicles - see ambient conditions	Yes; Rail vehicles - see ambient conditions	Yes; Rail vehicles - see ambient conditions
• EN 50125-2	Yes; Stationary electrical equipment - see ambient conditions	Yes; Stationary electrical equipment - see ambient conditions	Yes; Stationary electrical equipment - see ambient conditions	Yes; Stationary electrical equipment - see ambient conditions
• EN 50125-3	Yes; Signal and telecommunications systems - see ambient conditions; vibrations and shocks: Application point outside of tracks (1 m to 3 m away from track)	Yes; Signal and telecommunications systems - see ambient conditions; vibrations and shocks: Application point outside of tracks (1 m to 3 m away from track)	Yes; Signal and telecommunications systems - see ambient conditions; vibrations and shocks: Application point outside of tracks (1 m to 3 m away from track)	Yes; Signal and telecommunications systems - see ambient conditions; vibrations and shocks: Application point outside of tracks (1 m to 3 m away from track)
• EN 50155	Yes; Rail vehicles - temperature class OT1, ST1/ST2, horizontal mounting position	Yes; Rail vehicles - temperature class OT4, ST1/ST2, horizontal mounting position	Yes; Rail vehicles - temperature class OT1, ST1/ST2, horizontal mounting position	Yes; Rail vehicles - temperature class OT4, ST1/ST2, horizontal mounting position
• EN 61373	Yes; Rail vehicles - vibrations and shocks: Category 1 Class A/B	Yes; Rail vehicles - vibrations and shocks: Category 1 Class A/B	Yes; Rail vehicles - vibrations and shocks: Category 1 Class A/B	Yes; Rail vehicles - vibrations and shocks: Category 1 Class A/B
• Fire protection acc. to EN 45545-2	Yes; For proof of conformity, see Service & Support	Yes; For proof of conformity, see Service & Support	Yes; For proof of conformity, see Service & Support	Yes; For proof of conformity, see Service & Support
<b>Ambient conditions</b>				
<b>Ambient temperature during operation</b>				
• horizontal installation, min.	-40 °C; = Tmin (incl. condensation/frost); start-up @ -30 °C	-40 °C; = Tmin (incl. condensation/frost)	-40 °C; = Tmin (incl. condensation/frost); start-up @ -30 °C	-40 °C; = Tmin (incl. condensation/frost)
• horizontal installation, max.	60 °C; = Tmax; +70 °C for 10 min (OT1, ST1/ST2 acc. to EN 50155)	70 °C; = Tmax; +85 °C for 10 min (OT4, ST1/ST2 acc. to EN 50155)	60 °C; = Tmax; +70 °C for 10 min (OT1, ST1/ST2 acc. to EN 50155)	70 °C; = Tmax; +85 °C for 10 min (OT4, ST1/ST2 acc. to EN 50155)
• vertical installation, min.	-40 °C; = Tmin; startup @ -30 °C	-40 °C; = Tmin	-40 °C; = Tmin; startup @ -30 °C	-40 °C; = Tmin
• vertical installation, max.	50 °C; = Tmax	50 °C; = Tmax	50 °C; = Tmax	50 °C; = Tmax
<b>Altitude during operation relating to sea level</b>				
• Installation altitude above sea level, max.	2 000 m	2 000 m	2 000 m	2 000 m
• Ambient air temperature-barometric pressure-altitude	Tmin ... Tmax at 1 140 hPa ... 795 hPa (-1 000 m ... +2 000 m)	Tmin ... Tmax at 1 140 hPa ... 795 hPa (-1 000 m ... +2 000 m)	Tmin ... Tmax at 1 140 hPa ... 795 hPa (-1 000 m ... +2 000 m)	Tmin ... Tmax at 1 140 hPa ... 795 hPa (-1 000 m ... +2 000m)

# SIPLUS RAIL

## SIPLUS ET 200SP RAIL

### SIPLUS extreme RAIL I/O modules

#### SIPLUS extreme RAIL analog inputs

Article number	6AG2134-6GD01-1BA1 SIPLUS ET 200SP AI 4XI 2- /4-WIRE T1 RAIL	6AG2134-6GD01-4BA1 SIPLUS ET 200SP AI 4XI 2- /4-WIRE TX RAIL	6AG2134-6HD01-1BA1 SIPLUS ET 200SP AI 4XU/I 2-WIRE T1 RAIL	6AG2134-6HD01-4BA1 SIPLUS ET 200SP AI 4XU/I 2-WIRE TX RAIL
<b>Relative humidity</b>	100 %; RH incl. condensation / frost (no commissioning in bedewed state), horizontal installation	100 %; RH incl. condensation / frost (no commissioning in bedewed state), horizontal installation	100 %; RH incl. condensation / frost (no commissioning in bedewed state), horizontal installation	100 %; RH incl. condensation / frost (no commissioning in bedewed state), horizontal installation
<b>Resistance</b>				
<ul style="list-style-type: none"> <li>Coolants and lubricants <ul style="list-style-type: none"> <li>Resistant to commercially available coolants and lubricants</li> </ul> </li> <li>Use in stationary industrial systems <ul style="list-style-type: none"> <li>to biologically active substances according to EN 60721-3-3</li> <li>to chemically active substances according to EN 60721-3-3</li> <li>to mechanically active substances according to EN 60721-3-3</li> <li>Against mechanical environmental conditions acc. to EN 60721-3-3</li> </ul> </li> <li>Use on land craft, rail vehicles and special-purpose vehicles <ul style="list-style-type: none"> <li>to biologically active substances according to EN 60721-3-5</li> <li>to chemically active substances according to EN 60721-3-5</li> <li>to mechanically active substances according to EN 60721-3-5</li> <li>Against mechanical environmental conditions acc. to EN 60721-3-5</li> <li>against mechanical environmental conditions in agriculture acc. to ISO 15003</li> </ul> </li> <li>Usage in industrial process technology <ul style="list-style-type: none"> <li>Against chemically active substances acc. to EN 60654-4</li> <li>Environmental conditions for process, measuring and control systems acc. to ANSI/ISA-71.04</li> </ul> </li> <li>Remark <ul style="list-style-type: none"> <li>Note regarding classification of environmental conditions acc. to EN 60721, EN 60654-4 and ANSI/ISA-71.04</li> </ul> </li> </ul>	<ul style="list-style-type: none"> <li>Yes; Incl. diesel and oil droplets in the air</li> <li>Yes; Class 3B2 mold, fungus and dry rot spores (with the exception of fauna); Class 3B3 on request</li> <li>Yes; Class 3C4 (RH &lt; 75 %) incl. salt spray acc. to EN 60068-2-52 (severity degree 3); *</li> <li>Yes; Class 3S4 incl. sand, dust; *</li> <li>Yes; Class 3M8 using the SIPLUS Mounting Kit ET 200SP (6AG1193-6AA00-0AA0)</li> <li>Yes; Class 5B2 mold, fungus and dry rot spores (with the exception of fauna); Class 5B3 on request</li> <li>Yes; Class 5C3 (RH &lt; 75 %) incl. salt spray acc. to EN 60068-2-52 (severity degree 3); *</li> <li>Yes; Class 5S3 incl. sand, dust; *</li> <li>Yes; Class 5M2 using the SIPLUS Mounting Kit ET 200SP (6AG1193-6AA00-0AA0)</li> <li>Yes; level 1 (Location LE) using the SIPLUS Mounting Kit ET 200SP (6AG1193-6AA00-0AA0)</li> <li>Yes; Class 3 (excluding trichlorethylene)</li> <li>Yes; Level GX group A/B (excluding trichlorethylene; harmful gas concentrations up to the limits of EN 60721-3-3 class 3C4 permissible); level LC3 (salt spray) and level LB3 (oil)</li> <li>* The supplied plug covers must remain in place over the unused interfaces during operation!</li> <li>Yes; Class 2 for high reliability</li> <li>Yes; Type 1 protection</li> <li>Yes; Class PC2 protective coating acc. to EN 50155:2017</li> <li>Yes; Discoloration of coating possible during service life</li> <li>Yes; Conformal coating, Class A</li> </ul>	<ul style="list-style-type: none"> <li>Yes; Incl. diesel and oil droplets in the air</li> <li>Yes; Incl. diesel and oil droplets in the air</li> <li>Yes; Class 3B2 mold, fungus and dry rot spores (with the exception of fauna); Class 3B3 on request</li> <li>Yes; Class 3C4 (RH &lt; 75 %) incl. salt spray acc. to EN 60068-2-52 (severity degree 3); *</li> <li>Yes; Class 3S4 incl. sand, dust; *</li> <li>Yes; Class 3M8 using the SIPLUS Mounting Kit ET 200SP (6AG1193-6AA00-0AA0)</li> <li>Yes; Class 5B2 mold, fungus and dry rot spores (with the exception of fauna); Class 5B3 on request</li> <li>Yes; Class 5C3 (RH &lt; 75 %) incl. salt spray acc. to EN 60068-2-52 (severity degree 3); *</li> <li>Yes; Class 5S3 incl. sand, dust; *</li> <li>Yes; Class 5M2 using the SIPLUS Mounting Kit ET 200SP (6AG1193-6AA00-0AA0)</li> <li>Yes; level 1 (Location LE) using the SIPLUS Mounting Kit ET 200SP (6AG1193-6AA00-0AA0)</li> <li>Yes; Class 3 (excluding trichlorethylene)</li> <li>Yes; Level GX group A/B (excluding trichlorethylene; harmful gas concentrations up to the limits of EN 60721-3-3 class 3C4 permissible); level LC3 (salt spray) and level LB3 (oil)</li> <li>* The supplied plug covers must remain in place over the unused interfaces during operation!</li> <li>Yes; Class 2 for high reliability</li> <li>Yes; Type 1 protection</li> <li>Yes; Class PC2 protective coating acc. to EN 50155:2017</li> <li>Yes; Discoloration of coating possible during service life</li> <li>Yes; Conformal coating, Class A</li> </ul>	<ul style="list-style-type: none"> <li>Yes; Incl. diesel and oil droplets in the air</li> <li>Yes; Class 3B2 mold, fungus and dry rot spores (with the exception of fauna); Class 3B3 on request</li> <li>Yes; Class 3C4 (RH &lt; 75 %) incl. salt spray acc. to EN 60068-2-52 (severity degree 3); *</li> <li>Yes; Class 3S4 incl. sand, dust; *</li> <li>Yes; Class 3M8 using the SIPLUS Mounting Kit ET 200SP (6AG1193-6AA00-0AA0)</li> <li>Yes; Class 5B2 mold, fungus and dry rot spores (with the exception of fauna); Class 5B3 on request</li> <li>Yes; Class 5C3 (RH &lt; 75 %) incl. salt spray acc. to EN 60068-2-52 (severity degree 3); *</li> <li>Yes; Class 5S3 incl. sand, dust; *</li> <li>Yes; Class 5M2 using the SIPLUS Mounting Kit ET 200SP (6AG1193-6AA00-0AA0)</li> <li>Yes; level 1 (Location LE) using the SIPLUS Mounting Kit ET 200SP (6AG1193-6AA00-0AA0)</li> <li>Yes; Class 3 (excluding trichlorethylene)</li> <li>Yes; Level GX group A/B (excluding trichlorethylene; harmful gas concentrations up to the limits of EN 60721-3-3 class 3C4 permissible); level LC3 (salt spray) and level LB3 (oil)</li> <li>* The supplied plug covers must remain in place over the unused interfaces during operation!</li> <li>Yes; Class 2 for high reliability</li> <li>Yes; Type 1 protection</li> <li>Yes; Class PC2 protective coating acc. to EN 50155:2017</li> <li>Yes; Discoloration of coating possible during service life</li> <li>Yes; Conformal coating, Class A</li> </ul>	<ul style="list-style-type: none"> <li>Yes; Incl. diesel and oil droplets in the air</li> <li>Yes; Class 3B2 mold, fungus and dry rot spores (with the exception of fauna); Class 3B3 on request</li> <li>Yes; Class 3C4 (RH &lt; 75 %) incl. salt spray acc. to EN 60068-2-52 (severity degree 3); *</li> <li>Yes; Class 3S4 incl. sand, dust; *</li> <li>Yes; Class 3M8 using the SIPLUS Mounting Kit ET 200SP (6AG1193-6AA00-0AA0)</li> <li>Yes; Class 5B2 mold, fungus and dry rot spores (with the exception of fauna); Class 5B3 on request</li> <li>Yes; Class 5C3 (RH &lt; 75 %) incl. salt spray acc. to EN 60068-2-52 (severity degree 3); *</li> <li>Yes; Class 5S3 incl. sand, dust; *</li> <li>Yes; Class 5M2 using the SIPLUS Mounting Kit ET 200SP (6AG1193-6AA00-0AA0)</li> <li>Yes; level 1 (Location LE) using the SIPLUS Mounting Kit ET 200SP (6AG1193-6AA00-0AA0)</li> <li>Yes; Class 3 (excluding trichlorethylene)</li> <li>Yes; Level GX group A/B (excluding trichlorethylene; harmful gas concentrations up to the limits of EN 60721-3-3 class 3C4 permissible); level LC3 (salt spray) and level LB3 (oil)</li> <li>* The supplied plug covers must remain in place over the unused interfaces during operation!</li> <li>Yes; Class 2 for high reliability</li> <li>Yes; Type 1 protection</li> <li>Yes; Class PC2 protective coating acc. to EN 50155:2017</li> <li>Yes; Discoloration of coating possible during service life</li> <li>Yes; Conformal coating, Class A</li> </ul>

**SIPLUS RAIL**

SIPLUS ET 200SP RAIL

SIPLUS extreme RAIL I/O modules

**SIPLUS extreme RAIL analog inputs**

Article number	<b>6AG2134-6GD01-1BA1</b> SIPLUS ET 200SP AI 4XI 2- /4-WIRE T1 RAIL	<b>6AG2134-6GD01-4BA1</b> SIPLUS ET 200SP AI 4XI 2- /4-WIRE TX RAIL	<b>6AG2134-6HD01-1BA1</b> SIPLUS ET 200SP AI 4XU/I 2-WIRE T1 RAIL	<b>6AG2134-6HD01-4BA1</b> SIPLUS ET 200SP AI 4XU/I 2-WIRE TX RAIL
<b>Dimensions</b>				
<b>Width</b>	15 mm	15 mm	15 mm	15 mm
<b>Height</b>	73 mm	73 mm	73 mm	73 mm
<b>Depth</b>	58 mm	58 mm	58 mm	58 mm
<b>Weights</b>				
<b>Weight, approx.</b>	31 g	31 g	31 g	31 g
<b>Other</b>				
<b>Note:</b>	for use in railway applica- tions, also observe the prod- uct information "SIPLUS extreme RAIL" A5E37661960A, Online Support article 109736776	for use in railway applica- tions, also observe the prod- uct information "SIPLUS extreme RAIL" A5E37661960A, Online Support article 109736776	for use in railway applica- tions, also observe the prod- uct information "SIPLUS extreme RAIL" A5E37661960A, Online Support article 109736776	for use in railway applica- tions, also observe the prod- uct information "SIPLUS extreme RAIL" A5E37661960A, Online Support article 109736776

Article number	<b>6AG2134-6GF00-4AA1</b> SIPLUS ET 200SP AI 8xI 2- /4-W BA TX RAIL	<b>6AG2134-6HB00-1CA1</b> SIPLUS ET 200SP AI 2XU/I 2/4W HF T1 RAIL	<b>6AG2134-6JF00-1CA1</b> SIPLUS ET 200SP AI 8XRTD/TC T1 RAIL	<b>6AG2134-6JD00-1CA1</b> SIPLUS ET 200SP AI 4xRTD/TC HF RAIL
<b>General information</b>				
<b>Product type designation</b>	AI 8xI 2-/4-wire BA	AI 2xU/I 2-4-wire HF	AI 8xRTD/TC 2-wire HF	AI 4xRTD/TC 2-/3-/4-wire HF
<b>Product function</b>				
• Isochronous mode	No	Yes	No	No
• Measuring range scalable	No	No		Yes
• Adjustment of measuring range				
<b>Operating mode</b>				
• Oversampling	No	No	No	No
• MSI	No	Yes	No	No
<b>Supply voltage</b>				
<b>Rated value (DC)</b>	24 V	24 V	24 V	24 V
<b>Reverse polarity protection</b>	Yes	Yes	Yes	Yes
<b>Analog inputs</b>				
<b>Number of analog inputs</b>	8; Single-ended	2; Differential inputs	8	4
• For current measurement	8			
<b>permissible input voltage for volt- age input (destruction limit), max.</b>		30 V	30 V	30 V
<b>permissible input current for cur- rent input (destruction limit), max.</b>	50 mA	50 mA		
<b>Constant measurement current for resistance-type transmitter, typ.</b>			2 mA	0.7 mA; 1.7 mA for Cu10 sensors
<b>Cycle time (all channels), min.</b>	1 ms; per channel		Sum of the basic conversion times and additional pro- cessing times (depending on the parameterization of the active channels)	Sum of the basic conversion times and additional pro- cessing times (depending on the parameterization of the active channels); for line compensation in case of a three-wire connection, an additional cycle is necessary
<b>Technical unit for temperature measurement adjustable</b>			Yes; °C/°F/K	Yes; °C/°F/K
<b>Analog input with oversampling</b>		No		
<b>Standardization of measured values</b>		Yes		
<b>Input ranges (rated values), voltages</b>				
• 0 to +10 V		Yes; 15 bit		
• 1 V to 5 V		Yes; 15 bit		
• -1 V to +1 V			Yes; 16 bit incl. sign	Yes; 16 bit incl. sign
• -10 V to +10 V		Yes; 16 bit incl. sign	Yes; 16 bit incl. sign	Yes; 16 bit incl. sign
• -250 mV to +250 mV		Yes; 16 bit incl. sign	Yes; 16 bit incl. sign	Yes; 16 bit incl. sign
• -5 V to +5 V			Yes; 16 bit incl. sign	Yes; 16 bit incl. sign
• -50 mV to +50 mV			Yes; 16 bit incl. sign	Yes; 16 bit incl. sign
• -80 mV to +80 mV			Yes; 16 bit incl. sign	Yes; 16 bit incl. sign
<b>Input ranges (rated values), currents</b>				
• 0 to 20 mA	Yes	Yes; 15 bit		
• -20 mA to +20 mA	Yes	Yes; 16 bit incl. sign		
• 4 mA to 20 mA	Yes	Yes; 15 bit		

**SIPLUS extreme RAIL analog inputs**

Article number	<b>6AG2134-6GF00-4AA1</b> SIPLUS ET 200SP AI 8xI 2- /4-W BA TX RAIL	<b>6AG2134-6HB00-1CA1</b> SIPLUS ET 200SP AI 2XU/I 2/4W HF T1 RAIL	<b>6AG2134-6JF00-1CA1</b> SIPLUS ET 200SP AI 8XRTD/TC T1 RAIL	<b>6AG2134-6JD00-1CA1</b> SIPLUS ET 200SP AI 4xRTD/TC HF RAIL
<b>Input ranges (rated values), thermocouples</b> • Type B • Type C • Type E • Type J • Type K • Type L • Type N • Type R • Type S • Type T • Type U • Type TXK/TXK(L) to GOST			Yes; 16 bit incl. sign Yes; 16 bit incl. sign Yes; 16 bit incl. sign Yes; 16 bit incl. sign Yes; 16 bit incl. sign Yes; 16 bit incl. sign Yes; 16 bit incl. sign Yes; 16 bit incl. sign Yes; 16 bit incl. sign Yes; 16 bit incl. sign Yes; 16 bit incl. sign Yes; 16 bit incl. sign	Yes; 16 bit incl. sign Yes; 16 bit incl. sign Yes; 16 bit incl. sign Yes; 16 bit incl. sign Yes; 16 bit incl. sign Yes; 16 bit incl. sign Yes; 16 bit incl. sign Yes; 16 bit incl. sign Yes; 16 bit incl. sign Yes; 16 bit incl. sign Yes; 16 bit incl. sign Yes; 16 bit incl. sign
<b>Input ranges (rated values), resistance thermometer</b> • Cu 10 • Ni 100 • Ni 1000 • LG-Ni 1000 • Ni 120 • Ni 200 • Ni 500 • Pt 100 • Pt 1000 • Pt 200 • Pt 500			Yes; 16 bit incl. sign Yes; 16 bit incl. sign Yes; 16 bit incl. sign Yes; 16 bit incl. sign Yes; 16 bit incl. sign Yes; 16 bit incl. sign Yes; 16 bit incl. sign Yes; 16 bit incl. sign Yes; 16 bit incl. sign Yes; 16 bit incl. sign Yes; 16 bit incl. sign Yes; 16 bit incl. sign	Yes; 16 bit incl. sign Yes; 16 bit incl. sign Yes; 16 bit incl. sign Yes; 16 bit incl. sign Yes; 16 bit incl. sign Yes; 16 bit incl. sign Yes; 16 bit incl. sign Yes; 16 bit incl. sign Yes; 16 bit incl. sign Yes; 16 bit incl. sign Yes; 16 bit incl. sign Yes; 16 bit incl. sign
<b>Input ranges (rated values), resistors</b> • 0 to 150 ohms • 0 to 300 ohms • 0 to 600 ohms • 0 to 3000 ohms • 0 to 6000 ohms • PTC			Yes; 15 bit Yes; 15 bit Yes; 15 bit Yes; 15 bit Yes; 15 bit Yes; 15 bit	Yes; 15 bit Yes; 15 bit Yes; 15 bit Yes; 15 bit Yes; 15 bit Yes; 15 bit
<b>Thermocouple (TC)</b> • Temperature compensation - parameterizable			Yes	Yes
<b>Cable length</b> • shielded, max.	200 m	1 000 m; 200 m for voltage measurement	200 m; 50 m with thermocouples	200 m; 50 m with thermocouples
<b>Analog value generation for the inputs</b>				
<b>Integration and conversion time/resolution per channel</b> • Resolution with overrange (bit including sign), max. • Integration time, parameterizable • Interference voltage suppression for interference frequency f1 in Hz • Conversion time (per channel)  • Basic execution time of the module (all channels released)	16 bit  Yes 16.67 / 50 / 60 / 4 800 (16.67 / 50 / 60) 180 / 60 / 50 / 0.625 (67.5 / 22.5 / 18.75) ms	16 bit  Yes 16.6 / 50 / 60 / 300 / 600 / 1 200 / 2 400 / 4 800  1 ms	16 bit  Yes 16.6 / 50 / 60 Hz  180 / 60 / 50 ms	16 bit  Yes 16.6 / 50 / 60 Hz  180 / 60 / 50 ms
<b>Smoothing of measured values</b> • Number of smoothing levels • parameterizable	4; None; 4/8/16 times Yes	6; none; 2-/4-/8-/16-/32-fold Yes	4; None; 4/8/16 times Yes	4; None; 4/8/16 times Yes
<b>Encoder</b>				
<b>Connection of signal encoders</b> • for voltage measurement • for current measurement as 2-wire transducer • Burden of 2-wire transmitter, max. • for current measurement as 4-wire transducer • for resistance measurement with two-wire connection • for resistance measurement with three-wire connection • for resistance measurement with four-wire connection	No Yes  650 Ω Yes	Yes Yes  650 Ω Yes	Yes   Yes  No No	Yes   Yes  Yes Yes
<b>Errors/accuracies</b>				
<b>Basic error limit (operational limit at 25 °C)</b> • Voltage, relative to input range, (+/-)  • Current, relative to input range, (+/-)  • Resistance, relative to input range, (+/-)	  0.3 %	0.05 %; 0.1 % at SFU 4.8 kHz 0.05 %; 0.1 % at SFU 4.8 kHz	0.05 %  0.05 %	0.05 %  0.05 %

**SIPLUS RAIL**

SIPLUS ET 200SP RAIL

SIPLUS extreme RAIL I/O modules

**SIPLUS extreme RAIL analog inputs**

Article number	<b>6AG2134-6GF00-4AA1</b> SIPLUS ET 200SP AI 8x1 2- /4-W BA TX RAIL	<b>6AG2134-6HB00-1CA1</b> SIPLUS ET 200SP AI 2XU/I 2/4W HF T1 RAIL	<b>6AG2134-6JF00-1CA1</b> SIPLUS ET 200SP AI 8XRTD/TC T1 RAIL	<b>6AG2134-6JD00-1CA1</b> SIPLUS ET 200SP AI 4xRTD/TC HF RAIL
<b>Interference voltage suppression for <math>f = n \times (f_1 \pm 1\%)</math>, <math>f_1 =</math> interference frequency</b> • Series mode interference (peak value of interference < rated value of input range), min. • Common mode voltage, max. • Common mode interference, min.	70 dB; With conversion time 67.5 / 22.5 / 18.75 ms: 40 dB		70 dB	70 dB
<b>Isochronous mode</b>		35 V 90 dB	10 V 90 dB	10 V 90 dB
<b>Filtering and processing time (TCI), min.</b>		800 µs		
<b>Bus cycle time (TDP), min.</b>		1 ms		
<b>Interrupts/diagnostics/status information</b>				
<b>Diagnostics function</b>	Yes	Yes	Yes	Yes
<b>Alarms</b> • Diagnostic alarm • Limit value alarm	Yes No	Yes Yes; two upper and two lower limit values in each case	Yes Yes; two upper and two lower limit values in each case	Yes Yes; two upper and two lower limit values in each case
<b>Diagnoses</b> • Monitoring the supply voltage • Wire-break  • Short-circuit  • Group error • Overflow/underflow	Yes Yes; at 4 to 20 mA  Yes; Sensor supply to M; module by module  Yes Yes	Yes Yes; Measuring range 4 to 20 mA only Yes; channel-by-channel, at 1 to 5 V or for short-circuit in encoder supply Yes Yes	Yes Yes; channel by channel  Yes Yes; channel by channel	Yes Yes; channel by channel  Yes Yes; channel by channel
<b>Diagnostics indication LED</b> • Monitoring of the supply voltage (PWR-LED) • Channel status display for channel diagnostics • for module diagnostics	Yes; green LED  Yes; green LED No Yes; green/red DIAG LED	Yes; green PWR LED  Yes; green LED Yes; red LED Yes; green/red DIAG LED	Yes; green PWR LED  Yes; green LED Yes; red LED Yes; green/red DIAG LED	Yes; green PWR LED  Yes; green LED Yes; red LED Yes; green/red DIAG LED
<b>Potential separation</b>				
<b>Potential separation channels</b> • between the channels and back-plane bus	Yes	Yes	Yes	Yes
<b>Standards, approvals, certificates</b>				
<b>Railway application</b> • EN 50121-3-2 • EN 50121-4  • EN 50124-1  • EN 50125-1 • EN 50125-2  • EN 50125-3  • EN 50155 • EN 61373  • Fire protection acc. to EN 45545-2	Yes; EMC for rail vehicles Yes; EMC for signal and telecommunications systems  Yes; Railway applications - overvoltage category OV2; pollution degree PD2; rated surge voltage UNi = 0.5 kV; UNm = 24 V DC  Yes; Rail vehicles - see ambient conditions Yes; Stationary electrical equipment - see ambient conditions  Yes; Signal and telecommunications systems - see ambient conditions; vibrations and shocks: Application point outside of tracks (1 to 3 m away from track)  Yes; Rail vehicles - temperature class OT4, ST1/ST2, horizontal mounting position Yes; Rail vehicles - vibrations and shocks: Category 1 Class A/B Yes; For proof of conformity, see Service & Support	Yes; EMC for rail vehicles Yes; EMC for signal and telecommunications systems  Yes; Railway applications - overvoltage category OV2; pollution degree PD2; rated surge voltage UNi = 0.5 kV; UNm = 24 V DC  Yes; Rail vehicles - see ambient conditions Yes; Stationary electrical equipment - see ambient conditions  Yes; Signal and telecommunications systems - see ambient conditions; vibrations and shocks: Application point outside of tracks (1 m to 3 m away from track)  Yes; Rail vehicles - temperature class OT1, ST1/ST2, horizontal mounting position Yes; Rail vehicles - vibrations and shocks: Category 1 Class A/B Yes; For proof of conformity, see Service & Support	Yes; EMC for rail vehicles Yes; EMC for signal and telecommunications systems  Yes; Railway applications - overvoltage category OV2; pollution degree PD2; rated surge voltage UNi = 0.5 kV; UNm = 24 V DC  Yes; Rail vehicles - see ambient conditions Yes; Stationary electrical equipment - see ambient conditions  Yes; Signal and telecommunications systems - see ambient conditions; vibrations and shocks: Application point outside of tracks (1 m to 3 m away from track)  Yes; Rail vehicles - temperature class OT2, ST1/ST2, horizontal mounting position Yes; Rail vehicles - vibrations and shocks: Category 1 Class A/B Yes; For proof of conformity, see Service & Support	Yes; EMC for rail vehicles Yes; EMC for signal and telecommunications systems  Yes; Railway applications - overvoltage category OV2; pollution degree PD2; rated surge voltage UNi = 0.5 kV; UNm = 24 V DC  Yes; Rail vehicles - see ambient conditions Yes; Stationary electrical equipment - see ambient conditions  Yes; Signal and telecommunications systems - see ambient conditions; vibrations and shocks: Application point outside of tracks (1 m to 3 m away from track)  Yes; Rail vehicles - temperature class OT2, ST1/ST2, horizontal mounting position Yes; Rail vehicles - vibrations and shocks: Category 1 Class A/B Yes; Rail vehicles - verification on request

# SIPLUS RAIL

## SIPLUS ET 200SP RAIL

### SIPLUS extreme RAIL I/O modules

#### SIPLUS extreme RAIL analog inputs

Article number	6AG2134-6GF00-4AA1 SIPLUS ET 200SP AI 8xI 2- /4-W BA TX RAIL	6AG2134-6HB00-1CA1 SIPLUS ET 200SP AI 2XU/I 2/4W HF T1 RAIL	6AG2134-6JF00-1CA1 SIPLUS ET 200SP AI 8XRTD/TC T1 RAIL	6AG2134-6JD00-1CA1 SIPLUS ET 200SP AI 4xRTD/TC HF RAIL
<b>Ambient conditions</b>				
<b>Ambient temperature during operation</b>				
• horizontal installation, min.	-40 °C; = Tmin (incl. condensation/frost)	-40 °C; = Tmin (incl. condensation/frost); start-up @ -30 °C	-40 °C; = Tmin (incl. condensation/frost)	-40 °C; = Tmin (incl. condensation/frost)
• horizontal installation, max.	70 °C; = Tmax; +85 °C for 10 min (OT4, ST1/ST2 acc. to EN 50155)	60 °C; = Tmax; +70 °C for 10 min (OT1, ST1/ST2 acc. to EN 50155); +70 °C continuously with configured slots to the left and right of the module (OT3, ST0 acc. to EN 50155)	60 °C; = Tmax; +70 °C for 10 min (OT1, ST1/ST2 acc. to EN 50155); +70 °C continuously with configured slots to the left and right of the module (OT3, ST0 acc. to EN 50155)	60 °C; = Tmax; +70 °C for 10 min (OT1, ST1/ST2 acc. to EN 50155); +70 °C continuously with configured slots to the left and right of the module (OT3, ST0 acc. to EN 50155)
• vertical installation, min.	-40 °C; = Tmin	-40 °C; = Tmin (incl. condensation/frost); start-up @ -30 °C	-40 °C; = Tmin	-40 °C; = Tmin
• vertical installation, max.	50 °C; = Tmax	50 °C; = Tmax	50 °C; = Tmax	50 °C; = Tmax
<b>Altitude during operation relating to sea level</b>				
• Installation altitude above sea level, max.	2 000 m	2 000 m	2 000 m	2 000 m
• Ambient air temperature-barometric pressure-altitude	Tmin ... Tmax at 1 140 hPa ... 795 hPa (-1 000 m ... +2 000 m)	Tmin ... Tmax at 1 140 hPa ... 795 hPa (-1 000 m ... +2 000 m)	Tmin ... Tmax at 1 140 hPa ... 795 hPa (-1 000 m ... +2 000 m)	Tmin ... Tmax at 1 140 hPa ... 795 hPa (-1 000 m ... +2 000 m)
<b>Relative humidity</b>				
• With condensation, tested in accordance with IEC 60068-2-38, max.	100 %; RH incl. condensation / frost (no commissioning in bedewed state), horizontal installation	100 %; RH incl. condensation / frost (no commissioning in bedewed state), horizontal installation	100 %; RH incl. condensation / frost (no commissioning in bedewed state), horizontal installation	100 %; RH incl. condensation / frost (no commissioning in bedewed state), horizontal installation
<b>Resistance</b>				
• Coolants and lubricants				
- Resistant to commercially available coolants and lubricants	Yes; Incl. diesel and oil droplets in the air	Yes; Incl. diesel and oil droplets in the air	Yes; Incl. diesel and oil droplets in the air	Yes; Incl. diesel and oil droplets in the air
• Use in stationary industrial systems				
- to biologically active substances according to EN 60721-3-3	Yes; Class 3B2 mold, fungus and dry rot spores (with the exception of fauna); Class 3B3 on request	Yes; Class 3B2 mold, fungus and dry rot spores (with the exception of fauna); Class 3B3 on request	Yes; Class 3B2 mold, fungus and dry rot spores (with the exception of fauna); Class 3B3 on request	Yes; Class 3B2 mold, fungus and dry rot spores (with the exception of fauna); Class 3B3 on request
- to chemically active substances according to EN 60721-3-3	Yes; Class 3C4 (RH < 75 %) incl. salt spray acc. to EN 60068-2-52 (severity degree 3); *	Yes; Class 3C4 (RH < 75 %) incl. salt spray acc. to EN 60068-2-52 (severity degree 3); *	Yes; Class 3C4 (RH < 75 %) incl. salt spray acc. to EN 60068-2-52 (severity degree 3); *	Yes; Class 3C4 (RH < 75 %) incl. salt spray acc. to EN 60068-2-52 (severity degree 3); *
- to mechanically active substances according to EN 60721-3-3	Yes; Class 3S4 incl. sand, dust; *	Yes; Class 3S4 incl. sand, dust; *	Yes; Class 3S4 incl. sand, dust; *	Yes; Class 3S4 incl. sand, dust; *
- Against mechanical environmental conditions acc. to EN 60721-3-3	Yes; Class 3M8 using the SIPLUS Mounting Kit ET 200SP (6AG1193-6AA00-0AA0)	Yes; Class 3M8 using the SIPLUS Mounting Kit ET 200SP (6AG1193-6AA00-0AA0)	Yes; Class 3M8 using the SIPLUS Mounting Kit ET 200SP (6AG1193-6AA00-0AA0)	Yes; Class 3M8 using the SIPLUS Mounting Kit ET 200SP (6AG1193-6AA00-0AA0)
• Use on land craft, rail vehicles and special-purpose vehicles				
- to biologically active substances according to EN 60721-3-5	Yes; Class 5B2 mold, fungus and dry rot spores (with the exception of fauna); Class 5B3 on request	Yes; Class 5B2 mold, fungus and dry rot spores (with the exception of fauna); Class 5B3 on request	Yes; Class 5B2 mold, fungus and dry rot spores (with the exception of fauna); Class 5B3 on request	Yes; Class 5B2 mold, fungus and dry rot spores (with the exception of fauna); Class 5B3 on request
- to chemically active substances according to EN 60721-3-5	Yes; Class 5C3 (RH < 75 %) incl. salt spray acc. to EN 60068-2-52 (severity degree 3); *	Yes; Class 5C3 (RH < 75 %) incl. salt spray acc. to EN 60068-2-52 (severity degree 3); *	Yes; Class 5C3 (RH < 75 %) incl. salt spray acc. to EN 60068-2-52 (severity degree 3); *	Yes; Class 5C3 (RH < 75 %) incl. salt spray acc. to EN 60068-2-52 (severity degree 3); *
- to mechanically active substances according to EN 60721-3-5	Yes; Class 5S3 incl. sand, dust; *	Yes; Class 5S3 incl. sand, dust; *	Yes; Class 5S3 incl. sand, dust; *	Yes; Class 5S3 incl. sand, dust; *
- Against mechanical environmental conditions acc. to EN 60721-3-5	Yes; Class 5M2 using the SIPLUS Mounting Kit ET 200SP (6AG1193-6AA00-0AA0)	Yes; Class 5M2 using the SIPLUS Mounting Kit ET 200SP (6AG1193-6AA00-0AA0)	Yes; Class 5M2 using the SIPLUS Mounting Kit ET 200SP (6AG1193-6AA00-0AA0)	Yes; Class 5M2 using the SIPLUS Mounting Kit ET 200SP (6AG1193-6AA00-0AA0)
- against mechanical environmental conditions in agriculture acc. to ISO 15003	Yes; level 1 (Location LE) using the SIPLUS Mounting Kit ET 200SP (6AG1193-6AA00-0AA0)	Yes; level 1 (Location LE) using the SIPLUS Mounting Kit ET 200SP (6AG1193-6AA00-0AA0)	Yes; level 1 (Location LE) using the SIPLUS Mounting Kit ET 200SP (6AG1193-6AA00-0AA0)	Yes; level 1 (Location LE) using the SIPLUS Mounting Kit ET 200SP (6AG1193-6AA00-0AA0)



# SIPLUS RAIL

## SIPLUS ET 200SP RAIL

### SIPLUS extreme RAIL I/O modules

#### SIPLUS extreme RAIL analog inputs

Article number	6AG2134-6GF00-4AA1 SIPLUS ET 200SP AI 8xI 2- /4-W BA TX RAIL	6AG2134-6HB00-1CA1 SIPLUS ET 200SP AI 2XU/I 2/4W HF T1 RAIL	6AG2134-6JF00-1CA1 SIPLUS ET 200SP AI 8XRTD/TC T1 RAIL	6AG2134-6JD00-1CA1 SIPLUS ET 200SP AI 4xRTD/TC HF RAIL
<ul style="list-style-type: none"> <li>Usage in industrial process technology               <ul style="list-style-type: none"> <li>Against chemically active substances acc. to EN 60654-4</li> <li>Environmental conditions for process, measuring and control systems acc. to ANSI/ISA-71.04</li> </ul> </li> <li>Remark               <ul style="list-style-type: none"> <li>Note regarding classification of environmental conditions acc. to EN 60721, EN 60654-4 and ANSI/ISA-71.04</li> </ul> </li> </ul>	Yes; Class 3 (excluding trichlorethylene)  Yes; Level GX group A/B (excluding trichlorethylene; harmful gas concentrations up to the limits of EN 60721-3-3 class 3C4 permissible); level LC3 (salt spray) and level LB3 (oil)	Yes; Class 3 (excluding trichlorethylene)  Yes; Level GX group A/B (excluding trichlorethylene; harmful gas concentrations up to the limits of EN 60721-3-3 class 3C4 permissible); level LC3 (salt spray) and level LB3 (oil)	Yes; Class 3 (excluding trichlorethylene)  Yes; Level GX group A/B (excluding trichlorethylene; harmful gas concentrations up to the limits of EN 60721-3-3 class 3C4 permissible); level LC3 (salt spray) and level LB3 (oil)	Yes; Class 3 (excluding trichlorethylene)  Yes; Level GX group A/B (excluding trichlorethylene; harmful gas concentrations up to the limits of EN 60721-3-3 class 3C4 permissible); level LC3 (salt spray) and level LB3 (oil)
<b>Conformal coating</b> <ul style="list-style-type: none"> <li>Coatings for printed circuit board assemblies acc. to EN 61086</li> <li>Protection against fouling acc. to EN 60664-3</li> <li>Electronic equipment on rolling stock acc. to EN 50155</li> <li>Military testing according to MIL-I-46058C, Amendment 7</li> <li>Qualification and Performance of Electrical Insulating Compound for Printed Board Assemblies according to IPC-CC-830A</li> </ul>	Yes; Class 2 for high reliability  Yes; Type 1 protection  Yes; Class PC2 protective coating acc. to EN 50155:2017  Yes; Discoloration of coating possible during service life  Yes; Conformal coating, Class A	Yes; Class 2 for high reliability  Yes; Type 1 protection  Yes; Class PC2 protective coating acc. to EN 50155:2017  Yes; Discoloration of coating possible during service life  Yes; Conformal coating, Class A	Yes; Class 2 for high reliability  Yes; Type 1 protection  Yes; Class PC2 protective coating acc. to EN 50155:2017  Yes; Discoloration of coating possible during service life  Yes; Conformal coating, Class A	Yes; Class 2 for high reliability  Yes; Type 1 protection  Yes; Class PC2 protective coating acc. to EN 50155:2017  Yes; Discoloration of coating possible during service life  Yes; Conformal coating, Class A
<b>Dimensions</b>				
<b>Width</b>	15 mm	15 mm	15 mm	15 mm
<b>Height</b>	73 mm	73 mm	73 mm	73 mm
<b>Depth</b>	58 mm	58 mm	58 mm	58 mm
<b>Weights</b>				
<b>Weight, approx.</b>	31 g	32 g	32 g	
<b>Other</b>				
<b>Note:</b>	for use in railway applications, also observe the product information "SIPLUS extreme RAIL" A5E37661960A, Online Support article 109736776	for use in railway applications, also observe the product information "SIPLUS extreme RAIL" A5E37661960A, Online Support article 109736776	for use in railway applications, also observe the product information "SIPLUS extreme RAIL" A5E37661960A, Online Support article 109736776	for use in railway applications, also observe the product information "SIPLUS extreme RAIL" A5E37661960A, Online Support article 109736776

Article number	6AG2134-6PA20-4BD0 SIPLUS ET 200SP AI EMETER 480VAC TX RAIL
<b>General information</b>	
<b>Product type designation</b>	AI Energy Meter 480VAC ST
<b>Product function</b>	
<ul style="list-style-type: none"> <li>Voltage measurement               <ul style="list-style-type: none"> <li>with voltage transformer</li> </ul> </li> <li>Current measurement               <ul style="list-style-type: none"> <li>without current transformer</li> <li>with current transformer</li> </ul> </li> <li>Energy measurement</li> <li>Frequency measurement</li> <li>Power measurement</li> <li>Active power measurement</li> <li>Reactive power measurement</li> <li>I&amp;M data</li> <li>Isochronous mode</li> </ul>	Yes Yes Yes No Yes Yes Yes Yes Yes Yes Yes Yes; I&M0 to I&M3 No
<b>Engineering with</b>	
<ul style="list-style-type: none"> <li>STEP 7 TIA Portal configurable/integrated from version</li> </ul>	see entry ID: 109746275
<b>Operating mode</b>	
<ul style="list-style-type: none"> <li>cyclic measurement</li> <li>acyclic measurement</li> <li>Acyclic measured value access</li> <li>Fixed measured value sets</li> <li>Freely definable measured value sets</li> </ul>	Yes Yes Yes Yes Yes
<b>Installation type/mounting</b>	
<b>Mounting position</b>	any

**SIPLUS extreme RAIL analog inputs**

Article number	<b>6AG2134-6PA20-4BD0</b> SIPLUS ET 200SP AI EMETER 480VAC TX RAIL
<b>Supply voltage</b>	
<b>Design of the power supply</b>	Supply via voltage measurement channel L1
<b>Rated value (AC)</b>	AC 100 - 277 V
<b>Line frequency</b>	47 Hz 63 Hz
<ul style="list-style-type: none"> <li>• permissible range, lower limit</li> <li>• permissible range, upper limit</li> </ul>	
<b>Analog inputs</b>	
<b>Cycle time (all channels), typ.</b>	50 ms; Time for consistent update of all measured and calculated values (cyclic und acyclic data)
<b>Interrupts/diagnostics/status information</b>	
<b>Alarms</b>	
<ul style="list-style-type: none"> <li>• Diagnostic alarm</li> <li>• Limit value alarm</li> <li>• Hardware interrupt</li> </ul>	Yes Yes Yes; Monitoring of up to 16 freely selectable process values (exceeding or undershooting of value)
<b>Diagnostics indication LED</b>	
<ul style="list-style-type: none"> <li>• Monitoring of the supply voltage (PWR-LED)</li> <li>• Channel status display</li> <li>• for channel diagnostics</li> <li>• for module diagnostics</li> </ul>	Yes Yes; green LED Yes; red Fn LED Yes; green/red DIAG LED
<b>Integrated Functions</b>	
<b>Measuring functions</b>	
<ul style="list-style-type: none"> <li>• Measuring procedure for voltage measurement</li> <li>• Measuring procedure for current measurement</li> <li>• Type of measured value acquisition</li> <li>• Curve shape of voltage</li> <li>• Buffering of measured variables</li> <li>• Parameter length</li> <li>• Bandwidth of measured value acquisition</li> </ul>	TRMS TRMS seamless Sinusoidal or distorted Yes 74 byte 2 kHz; Harmonics: 39 / 50 Hz, 32 / 60 Hz
<b>Measuring range</b>	
<ul style="list-style-type: none"> <li>• Frequency measurement, min.</li> <li>• Frequency measurement, max.</li> </ul>	45 Hz 65 Hz
<b>Measuring inputs for voltage</b>	
<ul style="list-style-type: none"> <li>• Measurable line voltage between phase and neutral conductor</li> <li>• Measurable line voltage between the line conductors</li> <li>• Measurable line voltage between phase and neutral conductor, min.</li> <li>• Measurable line voltage between phase and neutral conductor, max.</li> <li>• Measurable line voltage between the line conductors, min.</li> <li>• Measurable line voltage between the line conductors, max.</li> <li>• Internal resistance line conductor and neutral conductor</li> <li>• Power consumption per phase</li> <li>• Impulse voltage resistance 1,2/50µs</li> <li>• Measurement category for voltage measurement in accordance with IEC 61010-2-030</li> </ul>	277 V 480 V 90 V 293 V 155 V 508 V 3.4 MΩ 20 mW 1 kV CAT II; CAT III in case of guaranteed protection level of 1.5 kV
<b>Measuring inputs for current</b>	
<ul style="list-style-type: none"> <li>• measurable relative current (AC), min.</li> <li>• measurable relative current (AC), max.</li> <li>• Continuous current with AC, maximum permissible</li> <li>• Apparent power consumption per phase for measuring range 5 A</li> <li>• Rated value short-time withstand current restricted to 1 s</li> <li>• Input resistance measuring range 0 to 5 A</li> <li>• Surge strength</li> <li>• Zero point suppression</li> </ul>	1 %; Relative to the secondary rated current 5 A 100 %; Relative to the secondary rated current 5 A 5 A; at > +60 °C max. permissible current 1 A per phase 0.6 VA 100 A 25 mΩ; At the terminal 10 A; for 1 minute Parameterizable: 2 ... 250 mA, default 50 mA
<b>Accuracy class according to IEC 61557-12</b>	
<ul style="list-style-type: none"> <li>• Measured variable voltage</li> <li>• Measured variable current</li> <li>• Measured variable apparent power</li> <li>• Measured variable active power</li> <li>• Measured variable reactive power</li> <li>• Measured variable power factor</li> <li>• Measured variable active energy</li> <li>• Measured variable reactive energy</li> <li>• Measured variable neutral current</li> <li>• Measured variable phase angle</li> <li>• Measured variable frequency</li> </ul>	0,2 0,2 0,5 0,5 1 0,5 0,5 1 0,5; calculated ±1 °; not covered by IEC 61557-12 0,05
<b>Potential separation</b>	
<b>Potential separation channels</b>	
<ul style="list-style-type: none"> <li>• between the channels and backplane bus</li> </ul>	Yes; 3 700V AC (type test) CAT III



# SIPLUS RAIL

## SIPLUS ET 200SP RAIL

### SIPLUS extreme RAIL I/O modules

#### SIPLUS extreme RAIL analog inputs

Article number	<b>6AG2134-6PA20-4BD0</b> SIPLUS ET 200SP AI EMETER 480VAC TX RAIL
<b>Standards, approvals, certificates</b>	
<b>Railway application</b>	
<ul style="list-style-type: none"> <li>EN 50121-3-2</li> <li>EN 50121-4</li> <li>EN 50124-1</li> <li>EN 50125-1</li> <li>EN 50125-2</li> <li>EN 50125-3</li> <li>EN 50155</li> <li>EN 61373</li> <li>Fire protection acc. to EN 45545-2</li> </ul>	<p>Yes; EMC for rail vehicles          Yes; EMC for signal and telecommunications systems          Yes; Railway applications - overvoltage category OV3; pollution degree PD2; UNm = 277/480 V AC          Yes; Rail vehicles - see ambient conditions          Yes; Stationary electrical equipment - see ambient conditions          Yes; Signal and telecommunications systems - see ambient conditions; vibrations and shocks: Application point outside of tracks (1 m to 3 m away from track)          Yes; Rail vehicles - temperature class OT4, ST1/ST2, horizontal mounting position          Yes; Rail vehicles - vibrations and shocks: Category 1 Class A/B          Yes; For proof of conformity, see Service &amp; Support</p>
<b>Ambient conditions</b>	
<b>Ambient temperature during operation</b>	
<ul style="list-style-type: none"> <li>horizontal installation, min.</li> <li>horizontal installation, max.</li> <li>vertical installation, min.</li> <li>vertical installation, max.</li> </ul>	<p>-40 °C; = Tmin (incl. condensation/frost)          70 °C; = Tmax; +85 °C for 10 min (OT4, ST1/ST2 acc. to EN 50155)          -40 °C; = Tmin          50 °C; = Tmax</p>
<b>Altitude during operation relating to sea level</b>	
<ul style="list-style-type: none"> <li>Installation altitude above sea level, max.</li> <li>Ambient air temperature-barometric pressure-altitude</li> </ul>	<p>2 000 m          Tmin ... Tmax at 1 140 hPa ... 795 hPa (-1 000 m ... +2 000 m)</p>
<b>Relative humidity</b>	
<ul style="list-style-type: none"> <li>With condensation, tested in accordance with IEC 60068-2-38, max.</li> </ul>	<p>100 %; RH incl. condensation / frost (no commissioning in bedewed state), horizontal installation</p>
<b>Resistance</b>	
<ul style="list-style-type: none"> <li>Coolants and lubricants             <ul style="list-style-type: none"> <li>Resistant to commercially available coolants and lubricants</li> </ul> </li> <li>Use in stationary industrial systems             <ul style="list-style-type: none"> <li>to biologically active substances according to EN 60721-3-3</li> <li>to chemically active substances according to EN 60721-3-3</li> <li>to mechanically active substances according to EN 60721-3-3</li> <li>Against mechanical environmental conditions acc. to EN 60721-3-3</li> </ul> </li> <li>Use on land craft, rail vehicles and special-purpose vehicles             <ul style="list-style-type: none"> <li>to biologically active substances according to EN 60721-3-5</li> <li>to chemically active substances according to EN 60721-3-5</li> <li>to mechanically active substances according to EN 60721-3-5</li> <li>Against mechanical environmental conditions acc. to EN 60721-3-5</li> <li>against mechanical environmental conditions in agriculture acc. to ISO 15003</li> </ul> </li> <li>Usage in industrial process technology             <ul style="list-style-type: none"> <li>Against chemically active substances acc. to EN 60654-4</li> <li>Environmental conditions for process, measuring and control systems acc. to ANSI/ISA-71.04</li> </ul> </li> <li>Remark             <ul style="list-style-type: none"> <li>Note regarding classification of environmental conditions acc. to EN 60721, EN 60654-4 and ANSI/ISA-71.04</li> </ul> </li> </ul>	<p>Yes; Incl. diesel and oil droplets in the air</p> <p>Yes; Class 3B2 mold, fungus and dry rot spores (with the exception of fauna); Class 3B3 on request          Yes; Class 3C4 (RH &lt; 75 %) incl. salt spray acc. to EN 60068-2-52 (severity degree 3); *          Yes; Class 3S4 incl. sand, dust, *          Yes; Class 3M8 using the SIPLUS Mounting Kit ET 200SP (6AG1193-6AA00-0AA0)</p> <p>Yes; Class 5B2 mold, fungus and dry rot spores (with the exception of fauna); Class 5B3 on request          Yes; Class 5C3 (RH &lt; 75 %) incl. salt spray acc. to EN 60068-2-52 (severity degree 3); *          Yes; Class 5S3 incl. sand, dust; *          Yes; Class 5M2 using the SIPLUS Mounting Kit ET 200SP (6AG1193-6AA00-0AA0)          Yes; level 1 (Location LE) using the SIPLUS Mounting Kit ET 200SP (6AG1193-6AA00-0AA0)</p> <p>Yes; Class 3 (excluding trichlorethylene)          Yes; Level GX group A/B (excluding trichlorethylene; harmful gas concentrations up to the limits of EN 60721-3-3 class 3C4 permissible); level LC3 (salt spray) and level LB3 (oil)</p> <p>* The supplied plug covers must remain in place over the unused interfaces during operation!</p>
<b>Conformal coating</b>	
<ul style="list-style-type: none"> <li>Coatings for printed circuit board assemblies acc. to EN 61086</li> <li>Protection against fouling acc. to EN 60664-3</li> <li>Electronic equipment on rolling stock acc. to EN 50155</li> <li>Military testing according to MIL-I-46058C, Amendment 7</li> <li>Qualification and Performance of Electrical Insulating Compound for Printed Board Assemblies according to IPC-CC-830A</li> </ul>	<p>Yes; Class 2 for high reliability          Yes; Type 1 protection          Yes; Class PC2 protective coating acc. to EN 50155:2017          Yes; Discoloration of coating possible during service life          Yes; Conformal coating, Class A</p>
<b>Dimensions</b>	
<b>Width</b>	20 mm
<b>Height</b>	73 mm
<b>Depth</b>	58 mm
<b>Weights</b>	
<b>Weight, approx.</b>	45 g
<b>Other</b>	
<b>Note:</b>	for use in railway applications, also observe the product information "SIPLUS extreme RAIL" A5E37661960A, Online Support article 109736776
<b>Data for selecting a current transformer</b>	
<ul style="list-style-type: none"> <li>Burden power current transformer x/1A, min.</li> <li>Burden power current transformer x/5A, min.</li> </ul>	<p>As a function of cable length and cross section, see device manual          As a function of cable length and cross section, see device manual</p>

**Selection and ordering data**

Version	Article No.
<b>SIPLUS extreme RAIL analog inputs</b>	
Approved in accordance with EN 50155, EN 15121, EN 50124, EN 50125 and EN 45545 railway standards for use in rail traffic	
SIPLUS ET 200SP AI 8xI 2-/4-W BA TX RAIL, BU type A0 or A1, color code CC01, 16-bit, ± 0.3 %, for areas with extreme exposure to environmental substances (conformal coating); Ambient temperature -40 ... +70 °C (+85 °C for 10 min.)	<b>6AG2134-6GF00-4AA1</b>
SIPLUS ET 200SP AI 4xI 2-/4-WIRE T1 RAIL, BU type A0 or A1, color code CC03; 16-bit, ±0.3%, for areas with extreme exposure to environmental substances (conformal coating); Ambient temperature -25 ... +55 °C (+70 °C for 10 min.)	<b>6AG2134-6GD01-1BA1</b>
SIPLUS ET 200SP AI 4xI 2-/4-WIRE TX RAIL, BU type A0 or A1, color code CC03, 16-bit, ±0.3%, for areas with extreme exposure to environmental substances (conformal coating); Ambient temperature -40 ... +70 °C (+85 °C for 10 min.)	<b>6AG2134-6GD01-4BA1</b>
SIPLUS ET 200SP AI 4xU/I 2-W ST T1 RAIL, BU type A0 or A1, color code CC03, 16-bit, ±0.3%, for areas with extreme exposure to environmental substances (conformal coating); Ambient temperature -25 ... +55 °C (+70 °C for 10 min.)	<b>6AG2134-6HD01-1BA1</b>
SIPLUS ET 200SP AI 4xU/I 2-W ST TX RAIL, BU type A0 or A1, color code CC03, 16-bit, ±0.3%, for areas with extreme exposure to environmental substances (conformal coating); Ambient temperature -40 ... +70 °C (+85 °C for 10 min.)	<b>6AG2134-6HD01-4BA1</b>
SIPLUS ET 200SP AI 2xU/I 2/4W HF T1 RAIL, BU type A0 or A1, color code CC05, for areas with extreme exposure to environmental substances (conformal coating); Ambient temperature -25 ... +60 °C (+70 °C for 10 min.)	<b>6AG2134-6HB00-1CA1</b>
SIPLUS ET 200SP AI 4xRTD/TC HF RAIL OT2, BU type A0 or A1, color code CC00; 16-bit, ±0.1%, scalable measuring range, for areas with extreme exposure to environmental substances (conformal coating); ambient temperature -40 ... +60 °C (+70 °C for 10 min.)	<b>6AG2134-6JD00-1CA1</b>
SIPLUS ET 200SP AI 8xRTD/TC HF T1 RAIL, BU type A0 or A1, color code CC00; 16-bit, ±0.1%, scalable measuring range, for areas with extreme exposure to environmental substances (conformal coating); ambient temperature -25 ... +60 °C (+70 °C for 10 min.)	<b>6AG2134-6JF00-1CA1</b>
SIPLUS ET 200SP AI Energy Meter 480VAC TX RAIL, BU type D0; for areas with extreme exposure to environmental substances (conformal coating); ambient temperature -40 ... +70 °C (+85 °C for 10 min.)	<b>6AG2134-6PA20-4BD0</b>
<b>Suitable SIPLUS extreme RAIL BaseUnits, type A0</b>	
<b>SIPLUS ET 200SP BU15-P16+A0+2D TX RAIL</b>	<b>6AG2193-6BP00-4DA0</b>
Approved in accordance with EN 50155, EN 15121, EN 50124, EN 50125 and EN 45545 railway standards for use in rail traffic	
BU type A0; BaseUnit (light) with 16 process terminals to the module; for starting a new load group (max. 10 A); for areas with extreme exposure to environmental substances (conformal coating); ambient temperature -40 ... +70 °C (+85 °C for 10 min.)	
<b>SIPLUS ET 200SP BU15-P16+A0+2B TX RAIL</b>	<b>6AG2193-6BP00-4BA0</b>
Approved in accordance with EN 50155, EN 15121, EN 50124, EN 50125 and EN 45545 railway standards for use in rail traffic	
BU type A0; BaseUnit (dark) with 16 process terminals to the module; for continuing the load group; for areas with extreme exposure to environmental substances (conformal coating); ambient temperature -40 ... +70 °C (+85 °C for 10 min.)	
<b>SIPLUS ET 200SP BU15-P16+A10+2D TX RAIL</b>	<b>6AG2193-6BP20-4DA0</b>
Approved in accordance with EN 50155, EN 15121, EN 50124, EN 50125 and EN 45545 railway standards for use in rail traffic	
BU type A0; BaseUnit (light) with 16 process terminals (1...16) to the module and an additional 10 internally jumpered AUX terminals (1 A to 10 A); for starting a new load group (max. 10 A); for areas with extreme exposure to environmental substances (conformal coating); ambient temperature -40 ... +70 °C (+85 °C for 10 min.)	
<b>SIPLUS ET 200SP BU15-P16+A10+2B TX RAIL</b>	<b>6AG2193-6BP20-4BA0</b>
Approved in accordance with EN 50155, EN 15121, EN 50124, EN 50125 and EN 45545 railway standards for use in rail traffic	
BU type A0; BaseUnit (dark) with 16 process terminals (1...16) to the module and an additional 10 internally jumpered AUX terminals (1 A to 10 A); for continuing the load group; for areas with extreme exposure to environmental substances (conformal coating); ambient temperature -40 ... +70 °C (+85 °C for 10 min.)	

**SIPLUS RAIL**  
 SIPLUS ET 200SP RAIL  
 SIPLUS extreme RAIL I/O modules

**SIPLUS extreme RAIL analog inputs**

Version	Article No.
<p><b>Suitable SIPLUS extreme RAIL BaseUnits, type D0</b></p> <p><b>SIPLUS ET 200SP BU20-P12+A0+0B TX RAIL</b>            Approved in accordance with EN 50155, EN 15121, EN 50124, EN 50125 and EN 45545 railway standards for use in rail traffic            BU type D0; BaseUnit with 12 push-in terminals, without AUX terminals, bridged to the left; for areas with extreme exposure to environmental substances (conformal coating); ambient temperature -40 ... +70 °C (+85 °C for 10 min.)</p>	<p><b>6AG2193-6BP00-4BD0</b></p>
<p><b>Suitable SIPLUS extreme RAIL BaseUnits, type U0</b></p> <p><b>SIPLUS ET 200SP BU20-P16+A0+2B TX RAIL</b>            Approved in accordance with EN 50155, EN 15121, EN 50124, EN 50125 and EN 45545 railway standards for use in rail traffic            BU type U0; BaseUnit (dark) with 16 process terminals to the module; for continuing the load group</p>	<p><b>6AG2193-6BP00-4BU0</b></p>
<p><b>SIPLUS ET 200SP BU20-P16+A0+2D TX RAIL</b>            Approved in accordance with EN 50155, EN 15121, EN 50124, EN 50125 and EN 45545 railway standards for use in rail traffic            BU type U0; BaseUnit (light) with 16 process terminals to the module; for starting a new load group (max. 10 A)</p>	<p><b>6AG2193-6BP00-4DU0</b></p>
<p><b>Accessories</b></p> <p><b>SIPLUS Mounting Kit ET 200SP</b>            Mounting accessories for use with increased mechanical vibration and shock loads.</p>	<p><b>6AG1193-6AA00-0AA0</b></p>

## Overview



- 2 and 4-channel analog output (AQ) modules
- Approved in accordance with EN 50155, EN 15121, EN 50124, EN 50125 and EN 45545 railway standards for use in rail traffic

For different requirements, the analog output modules offer:

- Function classes Standard and High Speed
- BaseUnits for single or multiple-conductor connection with automatic slot coding
- Potential distributor modules for system-integrated expansion with potential terminals
- Individual system-integrated load group formation with self-assembling voltage distribution bars (a separate power module is no longer required for ET 200SP)

### Overview of analog output modules

Analog output	PU	Article No.	CC code	BU type
AQ 4 x U/I ST	1	6AG2135-6HD00-4BA1	CC00	A0, A1
AQ 2xU/I HS With two operating modes: • High-speed isochronous AQ • Oversampling	1	6AG2135-6HB00-1DA1	CC00	A0, A1

### Overview of BaseUnits

BaseUnit	PU	Article No.	CC codes for process terminals	CC codes for AUX terminals
<b>BU type A0</b> • New load group (light) • 16 process terminals • With 10 AUX terminals	1	6AG2193-6BP20-4DA0	CC01 to CC05	CC71 to CC73
<b>BU type A0</b> • New load group (light) • 16 process terminals • Without AUX terminals	1	6AG2193-6BP00-4DA0	CC01 to CC05	--
<b>BU type A0</b> • Forwarding of load group (dark) • 16 process terminals • With 10 AUX terminals	1	6AG2193-6BP20-4BA0	CC01 to CC05	CC71 to CC73
<b>BU type A0</b> • Forwarding of load group (dark) • 16 process terminals • Without AUX terminals	1	6AG2193-6BP00-4BA0	CC01 to CC05	--

## Application

The analog output modules enable analog actuators (proportional valves, drives, etc.) to be controlled.

- Option for connecting current and voltage actuators
- Clear labeling on front of module
- LEDs for diagnostics, status, supply voltage and faults
- Electronically readable and non-volatile writable rating plate (I&M data 0 to 3)
- Extended functions and additional operating modes in some cases
  - Oversampling operating mode (n-fold equidistant output of an analog value within one PN cycle and thus the precisely timed output of an analog value or a sequence of analog values)
  - Isochronous mode (simultaneous equidistant output of analog values)
  - Output of substitute value in the event of interruptions to communication (shutdown, output adjustable substitute value, or keep last value)
  - Calibration during runtime
  - Re-parameterization during operation
  - Firmware update
  - Diagnostics of wire break, short circuit, overflow, underflow
  - Value status (optional binary validity information of the analog value status in the process image)
  - Supports the PROFenergy profile
- Optional accessories
  - Labeling strips (film or card)
  - Equipment labeling plate
  - Color-coded label with module-specific CC code
  - Shielding terminal

A quick and clear comparison of the functions of the AQ modules is offered by the TIA Selection Tool.

**SIPLUS RAIL**

SIPLUS ET 200SP RAIL

SIPLUS extreme RAIL I/O modules

**SIPLUS extreme RAIL analog outputs****Design****Usable BaseUnits (BU)**

BaseUnits with an appropriate number of terminals are available for single or multi-conductor connection.

All variants that correspond to the BU type of the I/O module used can be used as BaseUnits (see Selection and ordering data).

**Load group formation**

A light-colored BU separates the self-assembling, internal voltage buses (P1, P2, AUX) and thus opens a new load group. The supply voltage of a load group must be fed in at the light BU of this load group.

A dark BU forwards the supply voltage of the adjacent light BU on the left via the self-assembling voltage buses P1, P2 and AUX. A new infeed is therefore only required on the next light BU to the right. The setting of a further light BU is required whenever

- a new load group is to be formed (for example, for isolating the supply voltage from module groups) or
- the maximum current simultaneously required by the load group exceeds the permissible limit of 10 A.

**Color identification of the terminals**

The potentials at the terminals of the BaseUnit are defined by the inserted I/O module in each case. To prevent wiring faults, the potentials of the terminals can optionally be identified by means of module-specific color-coded labels. The color-coded label that matches the respective I/O module is defined by the color code CCxx of the I/O module. This color code is also printed on the front of the module.

In BaseUnits with the additional ten internally jumpered AUX terminals, these can also be identified with color-coded labels. For the ten AUX terminals, color-coded labels are available in red, blue, and yellow/green.

**Labeling**Labeling strips

Labeling strips can be inserted on the front of the interface modules or I/O modules and individually labeled via STEP 7, macros, etc. No special additional holder is required. If required, they can be easily replaced with the component.

Equipment labeling plates

Equipment labeling plates enable the equipment to be easily identified (e.g. compliant with EN 81346). They are easily plugged onto the required component (interface modules, I/O modules and BaseUnits) and when required, they can be easily replaced with the component.

The following labeling components are available:

- Film labeling strips, light-gray, roll with 500 strips, perforated, for thermal transfer printers
- Film labeling strips, yellow, roll with 500 strips, perforated, for thermal transfer printers
- Card labeling strips (180 g/m<sup>2</sup>), light gray, DIN A4 sheets with 100 strips each, perforated, for laser printer
- Card labeling strips (180 g/m<sup>2</sup>), yellow, DIN A4 sheets with 100 strips each, perforated, for laser printer
- Equipment labeling plates, white, ten sheets each with 16 labels, for thermal transfer card printers or labels

6

**Technical specifications**

Article number	6AG2135-6HD00-4BA1 SIPLUS ET 200SP AQ 4XU/I ST TX RAIL	6AG2135-6HB00-1DA1 SIPLUS ET 200SP AQ 2x U/I HS RAIL
<b>General information</b>		
<b>Product type designation</b>	AQ 4XU/I ST	AQ 2XU/I HS
<b>Product function</b>		
• Isochronous mode	No	Yes
• Output range scalable	No	
<b>Operating mode</b>		
• Oversampling	No	Yes; 2 channels per module
• MSO	No	No
<b>Supply voltage</b>		
<b>Rated value (DC)</b>	24 V	24 V
<b>Reverse polarity protection</b>	Yes	Yes
<b>Analog outputs</b>		
<b>Number of analog outputs</b>	4; > +60 °C max. 2x ±10 V permissible	2
<b>Cycle time (all channels), min.</b>	5 ms	125 µs
<b>Analog output with oversampling</b>	No	Yes
• Values per cycle, max.		16
• Resolution, min.		45 µs; (2 channels), 35 µs (1 channel)
<b>Output ranges, voltage</b>		
• 0 to 10 V	Yes; 15 bit	Yes; 15 bit
• 1 V to 5 V	Yes; 13 bit	Yes; 13 bit
• -5 V to +5 V	Yes; 15 bit incl. sign	Yes; 15 bit incl. sign
• -10 V to +10 V	Yes; 16 bit incl. sign	Yes; 16 bit incl. sign
<b>Output ranges, current</b>		
• 0 to 20 mA	Yes; 15 bit	Yes; 15 bit
• -20 mA to +20 mA	Yes; 16 bit incl. sign	Yes; 16 bit incl. sign
• 4 mA to 20 mA	Yes; 14 bit	Yes; 14 bit
<b>Connection of actuators</b>		
• for voltage output two-wire connection	Yes	Yes
• for voltage output four-wire connection	Yes	Yes
• for current output two-wire connection	Yes	Yes

**SIPLUS extreme RAIL analog outputs**

Article number	<b>6AG2135-6HD00-4BA1</b> SIPLUS ET 200SP AQ 4XU/I ST TX RAIL	<b>6AG2135-6HB00-1DA1</b> SIPLUS ET 200SP AQ 2x U/I HS RAIL
<b>Load impedance (in rated range of output)</b> • with voltage outputs, min. • with voltage outputs, capacitive load, max. • with current outputs, max. • with current outputs, inductive load, max.	2 kΩ 1 μF 500 Ω 1 mH	2 kΩ 1 μF 500 Ω 1 mH
<b>Cable length</b> • shielded, max.	1 000 m; 200 m for voltage output	1 000 m; 200 m for voltage output
<b>Analog value generation for the outputs</b>		
<b>Integration and conversion time/resolution per channel</b> • Resolution with overrange (bit including sign), max.	16 bit	16 bit
<b>Settling time</b> • for resistive load • for capacitive load • for inductive load	0.1 ms 1 ms 0.5 ms	0.05 ms 0.05 ms; Max. 47 nF and 20 m cable length 0.05 ms
<b>Errors/accuracies</b>		
<b>Basic error limit (operational limit at 25 °C)</b> • Voltage, relative to output range, (+/-) • Current, relative to output range, (+/-)	0.3 % 0.3 %	0.1 % 0.1 %
<b>Isochronous mode</b>		
<b>Execution and activation time (TCO), min.</b>		70 μs
<b>Bus cycle time (TDP), min.</b>		125 μs
<b>Interrupts/diagnostics/status information</b>		
<b>Diagnostics function</b>	Yes	Yes
<b>Substitute values connectable</b>	Yes	Yes
<b>Alarms</b> • Diagnostic alarm	Yes	Yes
<b>Diagnoses</b> • Monitoring the supply voltage • Wire-break  • Short-circuit  • Group error • Overflow/underflow	Yes Yes  Yes  Yes Yes	Yes Yes; channel-by-channel, only for output type "current" Yes; channel-by-channel, only for output type "voltage" Yes Yes
<b>Diagnostics indication LED</b> • Monitoring of the supply voltage (PWR-LED) • Channel status display • for channel diagnostics • for module diagnostics	Yes; green PWR LED Yes; green LED No Yes; green/red DIAG LED	Yes; green PWR LED Yes; green LED Yes; red LED Yes; green/red DIAG LED
<b>Potential separation</b>		
<b>Potential separation channels</b> • between the channels and backplane bus	Yes	Yes
<b>Standards, approvals, certificates</b>		
<b>Railway application</b> • EN 50121-3-2 • EN 50121-4  • EN 50124-1  • EN 50125-1 • EN 50125-2  • EN 50125-3  • EN 50155 • EN 61373  • Fire protection acc. to EN 45545-2	Yes; EMC for rail vehicles Yes; EMC for signal and telecommunications systems  Yes; Railway applications - overvoltage category OV2; pollution degree PD2; rated surge voltage UNi = 0.5 kV; UNm = 24 V DC Yes; Rail vehicles - see ambient conditions Yes; Stationary electrical equipment - see ambient conditions Yes; Signal and telecommunications systems - see ambient conditions; vibrations and shocks: Application point outside of tracks (1 m to 3 m away from track) Yes; Rail vehicles - temperature class OT4, ST1/ST2, horizontal mounting position Yes; Rail vehicles - vibrations and shocks: Category 1 Class A/B Yes; For proof of conformity, see Service & Support	Yes; EMC for rail vehicles Yes; EMC for signal and telecommunications systems  Yes; Railway applications - overvoltage category OV2; pollution degree PD2; rated surge voltage UNi = 0.5 kV; UNm = 24 V DC Yes; Rail vehicles - see ambient conditions Yes; Stationary electrical equipment - see ambient conditions Yes; Signal and telecommunications systems - see ambient conditions; vibrations and shocks: Application point outside of tracks (1 m to 3 m away from track) Yes; Rail vehicles - temperature class OT2, ST1/ST2, horizontal mounting position Yes; Rail vehicles - vibrations and shocks: Category 1 Class A/B Yes; Rail vehicles - verification on request
<b>Ambient conditions</b>		
<b>Ambient temperature during operation</b> • horizontal installation, min. • horizontal installation, max.  • vertical installation, min. • vertical installation, max.	-40 °C; = Tmin (incl. condensation/frost) 70 °C; = Tmax; +85 °C for 10 min (OT4, ST1/ST2 acc. to EN 50155)  -40 °C; = Tmin 50 °C; = Tmax	-40 °C; = Tmin (incl. condensation/frost) 60 °C; = Tmax; +70 °C for 10 min (OT1, ST1/ST2 acc. to EN 50155); +70 °C continuously with configured slots to the left and right of the module (OT3, ST0 acc. to EN 50155) -40 °C; = Tmin (incl. condensation/frost) 50 °C; = Tmax



# SIPLUS RAIL

## SIPLUS ET 200SP RAIL

### SIPLUS extreme RAIL I/O modules

#### SIPLUS extreme RAIL analog outputs

Article number	<b>6AG2135-6HD00-4BA1</b> SIPLUS ET 200SP AQ 4XU/I ST TX RAIL	<b>6AG2135-6HB00-1DA1</b> SIPLUS ET 200SP AQ 2x U/I HS RAIL
<b>Altitude during operation relating to sea level</b> • Installation altitude above sea level, max. • Ambient air temperature-barometric pressure-altitude	2 000 m Tmin ... Tmax at 1 140 hPa ... 795 hPa (-1 000 m ... +2 000 m)	2 000 m Tmin ... Tmax at 1 140 hPa ... 795 hPa (-1 000 m ... +2 000 m)
<b>Relative humidity</b> • With condensation, tested in accordance with IEC 60068-2-38, max.	100 %; RH incl. condensation / frost (no commissioning in bedewed state), horizontal installation	100 %; RH incl. condensation / frost (no commissioning in bedewed state), horizontal installation
<b>Resistance</b> • Coolants and lubricants - Resistant to commercially available coolants and lubricants • Use in stationary industrial systems - to biologically active substances according to EN 60721-3-3 - to chemically active substances according to EN 60721-3-3 - to mechanically active substances according to EN 60721-3-3 - Against mechanical environmental conditions acc. to EN 60721-3-3 • Use on land craft, rail vehicles and special-purpose vehicles - to biologically active substances according to EN 60721-3-5 - to chemically active substances according to EN 60721-3-5 - to mechanically active substances according to EN 60721-3-5 - Against mechanical environmental conditions acc. to EN 60721-3-5 - against mechanical environmental conditions in agriculture acc. to ISO 15003 • Usage in industrial process technology - Against chemically active substances acc. to EN 60654-4 - Environmental conditions for process, measuring and control systems acc. to ANSI/ISA-71.04 • Remark - Note regarding classification of environmental conditions acc. to EN 60721, EN 60654-4 and ANSI/ISA-71.04	Yes; Incl. diesel and oil droplets in the air  Yes; Class 3B2 mold, fungus and dry rot spores (with the exception of fauna); Class 3B3 on request Yes; Class 3C4 (RH < 75 %) incl. salt spray acc. to EN 60068-2-52 (severity degree 3); * Yes; Class 3S4 incl. sand, dust, * Yes; Class 3M8 using the SIPLUS Mounting Kit ET 200SP (6AG1193-6AA00-0AA0) Yes; Class 5B2 mold, fungus and dry rot spores (with the exception of fauna); Class 5B3 on request Yes; Class 5C3 (RH < 75 %) incl. salt spray acc. to EN 60068-2-52 (severity degree 3); * Yes; Class 5S3 incl. sand, dust; * Yes; Class 5M2 using the SIPLUS Mounting Kit ET 200SP (6AG1193-6AA00-0AA0) Yes; level 1 (Location LE) using the SIPLUS Mounting Kit ET 200SP (6AG1193-6AA00-0AA0) Yes; Class 3 (excluding trichlorethylene) Yes; Level GX group A/B (excluding trichlorethylene; harmful gas concentrations up to the limits of EN 60721-3-3 class 3C4 permissible); level LC3 (salt spray) and level LB3 (oil) * The supplied plug covers must remain in place over the unused interfaces during operation!	Yes; Incl. diesel and oil droplets in the air  Yes; Class 3B2 mold, fungus and dry rot spores (with the exception of fauna); Class 3B3 on request Yes; Class 3C4 (RH < 75 %) incl. salt spray acc. to EN 60068-2-52 (severity degree 3); * Yes; Class 3S4 incl. sand, dust, * Yes; Class 3M8 using the SIPLUS Mounting Kit ET 200SP (6AG1193-6AA00-0AA0) Yes; Class 5B2 mold, fungus and dry rot spores (with the exception of fauna); Class 5B3 on request Yes; Class 5C3 (RH < 75 %) incl. salt spray acc. to EN 60068-2-52 (severity degree 3); * Yes; Class 5S3 incl. sand, dust; * Yes; Class 5M2 using the SIPLUS Mounting Kit ET 200SP (6AG1193-6AA00-0AA0) Yes; Class 3 (excluding trichlorethylene) Yes; Level GX group A/B (excluding trichlorethylene; harmful gas concentrations up to the limits of EN 60721-3-3 class 3C4 permissible); level LC3 (salt spray) and level LB3 (oil) * The supplied plug covers must remain in place over the unused interfaces during operation!
<b>Conformal coating</b> • Coatings for printed circuit board assemblies acc. to EN 61086 • Protection against fouling acc. to EN 60664-3 • Electronic equipment on rolling stock acc. to EN 50155 • Military testing according to MIL-I-46058C, Amendment 7 • Qualification and Performance of Electrical Insulating Compound for Printed Board Assemblies according to IPC-CC-830A	Yes; Class 2 for high reliability Yes; Type 1 protection Yes; Class PC2 protective coating acc. to EN 50155:2017 Yes; Discoloration of coating possible during service life Yes; Conformal coating, Class A	Yes; Class 2 for high reliability Yes; Type 1 protection Yes; Class PC2 protective coating acc. to EN 50155:2017 Yes; Discoloration of coating possible during service life Yes; Conformal coating, Class A
<b>Dimensions</b>		
<b>Width</b>	15 mm	15 mm
<b>Height</b>	73 mm	73 mm
<b>Depth</b>	58 mm	58 mm
<b>Weights</b>		
<b>Weight, approx.</b>	31 g	31 g
<b>Other</b>		
<b>Note:</b>	for use in railway applications, also observe the product information "SIPLUS extreme RAIL" A5E37661960A, Online Support article 109736776	for use in railway applications, also observe the product information "SIPLUS extreme RAIL" A5E37661960A, Online Support article 109736776

### Selection and ordering data

Version	Article No.
<p><b>SIPLUS extreme RAIL analog outputs</b> Approved in accordance with EN 50155, EN 15121, EN 50124, EN 50125 and EN 45545 railway standards for use in rail traffic</p> <p>SIPLUS ET 200SP AQ 4XU/I ST TX RAIL, BU type A0 or A1, color code CC00; for areas with extreme exposure to environmental substances (conformal coating); ambient temperature -40 ... +70 °C (+85 °C for 10 min.)</p> <p>SIPLUS ET 200SP AQ 2XU/I HS RAIL OT2, BU type A0 or A1, color code CC00; for areas with extreme exposure to environmental substances (conformal coating); ambient temperature -40 ... +70 °C (+85 °C for 10 min.)</p>	<p><b>6AG2135-6HD00-4BA1</b></p> <p><b>6AG2135-6HB00-1DA1</b></p>
<p><b>Suitable SIPLUS extreme RAIL BaseUnits, type A0</b></p> <p><b>SIPLUS ET 200SP BU15-P16+A0+2D TX RAIL</b> Approved in accordance with EN 50155, EN 15121, EN 50124, EN 50125 and EN 45545 railway standards for use in rail traffic BU type A0; BaseUnit (light) with 16 process terminals to the module; for starting a new load group (max. 10 A); for areas with extreme exposure to environmental substances (conformal coating); ambient temperature -40 ... +70 °C (+85 °C for 10 min.)</p>	<p><b>6AG2193-6BP00-4DA0</b></p>
<p><b>SIPLUS ET 200SP BU15-P16+A0+2B TX RAIL</b> Approved in accordance with EN 50155, EN 15121, EN 50124, EN 50125 and EN 45545 railway standards for use in rail traffic BU type A0; BaseUnit (dark) with 16 process terminals to the module; for continuing the load group; for areas with extreme exposure to environmental substances (conformal coating); ambient temperature -40 ... +70 °C (+85 °C for 10 min.)</p>	<p><b>6AG2193-6BP00-4BA0</b></p>
<p><b>SIPLUS ET 200SP BU15-P16+A10+2D TX RAIL</b> Approved in accordance with EN 50155, EN 15121, EN 50124, EN 50125 and EN 45545 railway standards for use in rail traffic BU type A0; BaseUnit (light) with 16 process terminals (1...16) to the module and an additional 10 internally jumpered AUX terminals (1 A to 10 A); for starting a new load group (max. 10 A); for areas with extreme exposure to environmental substances (conformal coating); ambient temperature -40 ... +70 °C (+85 °C for 10 min.)</p>	<p><b>6AG2193-6BP20-4DA0</b></p>
<p><b>SIPLUS ET 200SP BU15-P16+A10+2B TX RAIL</b> Approved in accordance with EN 50155, EN 15121, EN 50124, EN 50125 and EN 45545 railway standards for use in rail traffic BU type A0; BaseUnit (dark) with 16 process terminals (1...16) to the module and an additional 10 internally jumpered AUX terminals (1 A to 10 A); for continuing the load group; for areas with extreme exposure to environmental substances (conformal coating); ambient temperature -40 ... +70 °C (+85 °C for 10 min.)</p>	<p><b>6AG2193-6BP20-4BA0</b></p>
<p><b>Accessories</b></p> <p><b>SIPLUS Mounting Kit ET 200SP</b> Mounting accessories for use with increased mechanical vibration and shock loads.</p>	<p><b>6AG1193-6AA00-0AA0</b></p>



**SIPLUS RAIL**

SIPLUS ET 200SP RAIL

SIPLUS extreme RAIL I/O modules

**SIPLUS extreme RAIL technology modules > SIPLUS extreme RAIL TM Count 1X24 V T1 RAIL counter module****Overview****Technical properties**

- Counter module for ET 200SP
- Interfaces:
  - 24 V encoder signals A, B and N from P, M or push-pull-switching encoders and sensors
  - 24 V encoder supply output, short-circuit proof
  - 3 digital inputs for controlling the count operation, for saving or for setting the count value
  - 2 digital outputs for fast reactions regardless of the counter status or measured value
- Counting frequency 200 kHz (800 kHz with quadruple evaluation)
- Counting range: +/- 31 bits
- Measurement function
- Parameterizable hardware interrupts
- Parameterizable input filters for suppressing interferences at sensor and digital inputs

**Supported types of encoders/signals**

- 24 V incremental encoder with and without signal N
- 24 V pulse encoder with direction signal
- 24 V pulse encoder without direction signal
- 24 V pulse encoder for pulse up and down respectively

**Supported system functions**

- Isochronous mode
- Firmware update
- Identification data I&M

**Application**

In particular, the TM Count 1x24V counter module detects high-speed signals with high frequencies and returns the counter reading and the current speed to the control. The counter control ensures a precise counter result and rapid response in the system via integrated digital input and output signals. Comprehensive parameterization options provide optimum adaptation to the task at hand and reduce control load.

In particular, the TM Count 1x24V counter module is suitable for position detection for HTL incremental encoders for use with Motion Control technology objects of the SIMATIC S7-1500 Advanced Controller.

**Design****Suitable BaseUnits**

The standard BaseUnits Type A0 of ET 200SP are available for connection. The individual signals of the counter module are connected to the appropriate terminals.

A light BaseUnit opens a new load group. The supply voltage must be fed in via this BaseUnit. The first BaseUnit next to the interface module must always be a light BaseUnit.

A dark BaseUnit forwards the supply voltage of the adjacent light BaseUnit on the left via self-assembling voltage buses. A new infeed is therefore only required on the next light BaseUnit to the right.

All variants that correspond to BaseUnit type A0 can be used as BaseUnits.

**System-integrated shield connection**

For the space-saving and EMC-optimized connection of cable shields, a shield connection is available that is quick and easy to mount. This consists of one shield connection element that can be plugged onto the BaseUnit and one shield terminal for each module. The low-impedance connection to functional ground (DIN rail) is carried out by the user and requires no additional wiring.

**Technical specifications**

Article number	<b>6AG2138-6AA01-1BA0</b> SIPLUS ET 200SP TM COUNT 1X24V T1 RAIL
<b>General information</b>	
<b>Product type designation</b>	TM Count 1x24V
<b>Product function</b>	
• I&M data	Yes; I&M0 to I&M3
• Isochronous mode	Yes
<b>Supply voltage</b>	
<b>Load voltage L+</b>	
• Rated value (DC)	24 V
• Reverse polarity protection	Yes
<b>Encoder supply</b>	
<b>Number of outputs</b>	1
<b>24 V encoder supply</b>	
• 24 V	Yes; L+ (-0.8 V)
• Short-circuit protection	Yes; electronic/thermal
• Output current, max.	300 mA

**SIPLUS extreme RAIL technology modules > SIPLUS extreme RAIL TM Count 1X24 V T1 RAIL counter module**

Article number	<b>6AG2138-6AA01-1BA0</b> SIPLUS ET 200SP TM COUNT 1X24V T1 RAIL
<b>Digital inputs</b>	
Number of digital inputs	3
Digital inputs, parameterizable	Yes
Input characteristic curve in accordance with IEC 61131, type 3	Yes
Digital input functions, parameterizable	
• Gate start/stop	Yes
• Capture	Yes
• Synchronization	Yes
• Freely usable digital input	Yes
Input voltage	
• Rated value (DC)	24 V
• for signal "0"	-5 ... +5 V
• for signal "1"	+11 to +30V
• permissible voltage at input, min.	-30 V; -5 V continuous, -30 V brief reverse polarity protection
• permissible voltage at input, max.	30 V
Input current	
• for signal "1", typ.	2.5 mA
Input delay (for rated value of input voltage)	
• for standard inputs	
- parameterizable	Yes; none / 0.05 / 0.1 / 0.4 / 0.8 / 1.6 / 3.2 / 12.8 / 20 ms
- at "0" to "1", min.	6 μs; for parameterization "none"
- at "1" to "0", min.	6 μs; for parameterization "none"
• for technological functions	
- parameterizable	Yes
<b>Digital outputs</b>	
Type of digital output	Transistor
Number of digital outputs	2
Digital outputs, parameterizable	Yes
Short-circuit protection	Yes; electronic/thermal
Limitation of inductive shutdown voltage to	L+ (-53 V)
Controlling a digital input	Yes
Digital output functions, parameterizable	
• Switching tripped by comparison values	Yes
• Freely usable digital output	Yes
Switching capacity of the outputs	
• with resistive load, max.	0.5 A; Per digital output
• on lamp load, max.	5 W
Load resistance range	
• lower limit	48 Ω
• upper limit	12 kΩ
Output voltage	
• for signal "1", min.	23.2 V; L+ (-0.8 V)
Output current	
• for signal "1" rated value	0.5 A; Per digital output
• for signal "0" residual current, max.	0.5 mA
Output delay with resistive load	
• "0" to "1", max.	50 μs
• "1" to "0", max.	50 μs
Switching frequency	
• with resistive load, max.	10 kHz
• with inductive load, max.	0.5 Hz; Acc. to IEC 60947-5-1, DC-13; observe derating curve
• on lamp load, max.	10 Hz
Total current of the outputs	
• Current per module, max.	1 A
<b>Encoder</b>	
Connectable encoders	
• 2-wire sensor	Yes
- permissible quiescent current (2-wire sensor), max.	1.5 mA
Encoder signals, incremental encoder (asymmetrical)	
• Input voltage	24 V
• Input frequency, max.	200 kHz
• Counting frequency, max.	800 kHz; with quadruple evaluation
• Cable length, shielded, max.	600 m; depending on input frequency, encoder and cable quality; max. 50 m at 200 kHz
• Signal filter, parameterizable	Yes
• Incremental encoder with A/B tracks, 90° phase offset	Yes
• Incremental encoder with A/B tracks, 90° phase offset and zero track	Yes
• pulse encoder	Yes
• pulse encoder with direction	Yes
• pulse encoder with one impulse signal per count direction	Yes
Interface types	
• Source/sink input	Yes
• Input characteristic curve in accordance with IEC 61131, type 3	Yes

**SIPLUS RAIL**

SIPLUS ET 200SP RAIL

SIPLUS extreme RAIL I/O modules

**SIPLUS extreme RAIL technology modules > SIPLUS extreme RAIL TM Count 1X24 V T1 RAIL counter module**

Article number	<b>6AG2138-6AA01-1BA0</b> SIPLUS ET 200SP TM COUNT 1X24V T1 RAIL
<b>Interrupts/diagnostics/status information</b>	
<b>Substitute values connectable</b>	Yes; Parameterizable
<b>Alarms</b>	
• Diagnostic alarm	Yes
• Hardware interrupt	Yes
<b>Diagnoses</b>	
• Monitoring the supply voltage	Yes
• Wire-break	Yes
• Short-circuit	Yes
• A/B transition error at incremental encoder	Yes
• Group error	Yes
<b>Diagnostics indication LED</b>	
• Monitoring of the supply voltage (PWR-LED)	Yes; green PWR LED
• Channel status display	Yes; green LED
• for module diagnostics	Yes; green/red DIAG LED
• Status indicator forward counting (green)	Yes
• Status indicator backward counting (green)	Yes
<b>Integrated Functions</b>	
<b>Counter</b>	Yes
• Number of counters	1
• Counting frequency, max.	800 kHz; with quadruple evaluation
<b>Fast mode</b>	Yes
<b>Counting functions</b>	
• Can be used with TO High_Speed_Counter	Yes
• Continuous counting	Yes
• Counter response parameterizable	Yes
• Hardware gate via digital input	Yes
• Software gate	Yes
• Event-controlled stop	Yes
• Synchronization via digital input	Yes
• Counting range, parameterizable	Yes
<b>Comparator</b>	
• Number of comparators	2
• Direction dependency	Yes
• Can be changed from user program	Yes
<b>Position detection</b>	
• Incremental acquisition	Yes
• Suitable for S7-1500 Motion Control	Yes
<b>Measuring functions</b>	
• Measuring time, parameterizable	Yes
• Dynamic measurement period adjustment	Yes
• Number of thresholds, parameterizable	2
<b>Measuring range</b>	
• Frequency measurement, min.	0.04 Hz
• Frequency measurement, max.	800 kHz
• Cycle duration measurement, min.	1.25 µs
• Cycle duration measurement, max.	25 s
<b>Accuracy</b>	
• Frequency measurement	100 ppm; depending on measuring interval and signal evaluation
• Cycle duration measurement	100 ppm; depending on measuring interval and signal evaluation
• Velocity measurement	100 ppm; depending on measuring interval and signal evaluation
<b>Potential separation</b>	
<b>Potential separation channels</b>	
• between the channels and backplane bus	Yes
<b>Standards, approvals, certificates</b>	
<b>Suitable for safety functions</b>	No
<b>Railway application</b>	
• EN 50121-3-2	Yes; EMC for rail vehicles
• EN 50121-4	Yes; EMC for signal and telecommunications systems
• EN 50124-1	Yes; Railway applications - overvoltage category OV2; pollution degree PD2; rated surge voltage UNi = 0.5 kV; UNm = 24 V DC
• EN 50125-1	Yes; Rail vehicles - see ambient conditions
• EN 50125-2	Yes; Stationary electrical equipment - see ambient conditions
• EN 50125-3	Yes; Signal and telecommunications systems - see ambient conditions; vibrations and shocks: Application point outside of tracks (1 m to 3 m away from track)
• EN 50155	Yes; Rail vehicles - temperature class OT1, ST1/ST2, horizontal mounting position
• EN 61373	Yes; Rail vehicles - vibrations and shocks: Category 1 Class A/B
• Fire protection acc. to EN 45545-2	Yes; For proof of conformity, see Service & Support

**SIPLUS extreme RAIL technology modules > SIPLUS extreme RAIL TM Count 1X24 V T1 RAIL counter module**

Article number	<b>6AG2138-6AA01-1BA0</b> SIPLUS ET 200SP TM COUNT 1X24V T1 RAIL
<b>Ambient conditions</b>	
<b>Ambient temperature during operation</b> • horizontal installation, min. • horizontal installation, max.  • vertical installation, min. • vertical installation, max.	-40 °C; = Tmin (incl. condensation/frost) 60 °C; = Tmax; +70 °C for 10 min (OT1, ST1/ST2 acc. to EN 50155); +70 °C continuously with configured slots to the left and right of the module (OT3, ST0 acc. to EN 50155) -40 °C; = Tmin 50 °C; = Tmax
<b>Altitude during operation relating to sea level</b> • Installation altitude above sea level, max. • Ambient air temperature-barometric pressure-altitude	2 000 m Tmin ... Tmax at 1 140 hPa ... 795 hPa (-1 000 m ... +2 000 m)
<b>Relative humidity</b> • With condensation, tested in accordance with IEC 60068-2-38, max.	100 %; RH incl. condensation / frost (no commissioning in bedewed state), horizontal installation
<b>Resistance</b> • Coolants and lubricants - Resistant to commercially available coolants and lubricants • Use in stationary industrial systems - to biologically active substances according to EN 60721-3-3  - to chemically active substances according to EN 60721-3-3 - to mechanically active substances according to EN 60721-3-3 - Against mechanical environmental conditions acc. to EN 60721-3-3 • Use on land craft, rail vehicles and special-purpose vehicles - to biologically active substances according to EN 60721-3-5  - to chemically active substances according to EN 60721-3-5 - to mechanically active substances according to EN 60721-3-5 - Against mechanical environmental conditions acc. to EN 60721-3-5 - against mechanical environmental conditions in agriculture acc. to ISO 15003 • Usage in industrial process technology - Against chemically active substances acc. to EN 60654-4 - Environmental conditions for process, measuring and control systems acc. to ANSI/ISA-71.04  • Remark - Note regarding classification of environmental conditions acc. to EN 60721, EN 60654-4 and ANSI/ISA-71.04	Yes; Incl. diesel and oil droplets in the air  Yes; Class 3B2 mold, fungus and dry rot spores (with the exception of fauna); Class 3B3 on request Yes; Class 3C4 (RH < 75 %) incl. salt spray acc. to EN 60068-2-52 (severity degree 3); * Yes; Class 3S4 incl. sand, dust, * Yes; Class 3M8 using the SIPLUS Mounting Kit ET 200SP (6AG1193-6AA00-0AA0)  Yes; Class 5B2 mold, fungus and dry rot spores (with the exception of fauna); Class 5B3 on request Yes; Class 5C3 (RH < 75 %) incl. salt spray acc. to EN 60068-2-52 (severity degree 3); * Yes; Class 5S3 incl. sand, dust, * Yes; Class 5M2 using the SIPLUS Mounting Kit ET 200SP (6AG1193-6AA00-0AA0) Yes; level 1 (Location LE) using the SIPLUS Mounting Kit ET 200SP (6AG1193-6AA00-0AA0)  Yes; Class 3 (excluding trichlorethylene)  Yes; Level GX group A/B (excluding trichlorethylene; harmful gas concentrations up to the limits of EN 60721-3-3 class 3C4 permissible); level LC3 (salt spray) and level LB3 (oil)  * The supplied plug covers must remain in place over the unused interfaces during operation!
<b>Conformal coating</b> • Coatings for printed circuit board assemblies acc. to EN 61086 • Protection against fouling acc. to EN 60664-3 • Electronic equipment on rolling stock acc. to EN 50155 • Military testing according to MIL-I-46058C, Amendment 7 • Qualification and Performance of Electrical Insulating Compound for Printed Board Assemblies according to IPC-CC-830A	Yes; Class 2 for high reliability Yes; Type 1 protection Yes; Class PC2 protective coating acc. to EN 50155:2017 Yes; Discoloration of coating possible during service life Yes; Conformal coating, Class A
<b>Decentralized operation</b>	
<b>to SIMATIC S7-300</b>	Yes
<b>to SIMATIC S7-400</b>	Yes
<b>to SIMATIC S7-1200</b>	Yes
<b>to SIMATIC S7-1500</b>	Yes
<b>to standard PROFIBUS master</b>	Yes
<b>to standard PROFINET controller</b>	Yes
<b>Dimensions</b>	
<b>Width</b>	15 mm
<b>Height</b>	73 mm
<b>Depth</b>	58 mm
<b>Weights</b>	
<b>Weight, approx.</b>	45 g
<b>Other</b>	
<b>Note:</b>	for use in railway applications, also observe the product information "SIPLUS extreme RAIL" A5E37661960A, Online Support article 109736776

**SIPLUS RAIL**

SIPLUS ET 200SP RAIL

SIPLUS extreme RAIL I/O modules

**SIPLUS extreme RAIL technology modules > SIPLUS extreme RAIL TM Count 1X24 V T1 RAIL counter module****Selection and ordering data**

Version	Article No.
<p><b>SIPLUS ET 200SP TM COUNT 1X24V T1 RAIL counter module</b></p> <p>Approved in accordance with EN 50155, EN 15121, EN 50124, EN 50125 and EN 45545 railway standards for use in rail traffic</p> <p>With one channel, max. 200 kHz; for 24 V encoder, BU type A0, color code CC00; for areas with extreme exposure to environmental substances (conformal coating); ambient temperature -25 ... +55 °C (+70 °C for 10 min.)</p>	<b>6AG2138-6AA01-1BA0</b>
<b>Suitable SIPLUS extreme RAIL BaseUnits, type A0</b>	
<p><b>SIPLUS ET 200SP BU15-P16+A0+2D TX RAIL</b></p> <p>Approved in accordance with EN 50155, EN 15121, EN 50124, EN 50125 and EN 45545 railway standards for use in rail traffic</p> <p>BU type A0; BaseUnit (light) with 16 process terminals to the module; for starting a new load group (max. 10 A); for areas with extreme exposure to environmental substances (conformal coating); ambient temperature -40 ... +70 °C (+85 °C for 10 min.)</p>	<b>6AG2193-6BP00-4DA0</b>
<p><b>SIPLUS ET 200SP BU15-P16+A0+2B TX RAIL</b></p> <p>Approved in accordance with EN 50155, EN 15121, EN 50124, EN 50125 and EN 45545 railway standards for use in rail traffic</p> <p>BU type A0; BaseUnit (dark) with 16 process terminals to the module; for continuing the load group; for areas with extreme exposure to environmental substances (conformal coating); ambient temperature -40 ... +70 °C (+85 °C for 10 min.)</p>	<b>6AG2193-6BP00-4BA0</b>
<p><b>SIPLUS ET 200SP BU15-P16+A10+2D TX RAIL</b></p> <p>Approved in accordance with EN 50155, EN 15121, EN 50124, EN 50125 and EN 45545 railway standards for use in rail traffic</p> <p>BU type A0; BaseUnit (light) with 16 process terminals (1...16) to the module and an additional 10 internally jumpered AUX terminals (1 A to 10 A); for starting a new load group (max. 10 A); for areas with extreme exposure to environmental substances (conformal coating); ambient temperature -40 ... +70 °C (+85 °C for 10 min.)</p>	<b>6AG2193-6BP20-4DA0</b>
<p><b>SIPLUS ET 200SP BU15-P16+A10+2B TX RAIL</b></p> <p>Approved in accordance with EN 50155, EN 15121, EN 50124, EN 50125 and EN 45545 railway standards for use in rail traffic</p> <p>BU type A0; BaseUnit (dark) with 16 process terminals (1...16) to the module and an additional 10 internally jumpered AUX terminals (1 A to 10 A); for continuing the load group; for areas with extreme exposure to environmental substances (conformal coating); ambient temperature -40 ... +70 °C (+85 °C for 10 min.)</p>	<b>6AG2193-6BP20-4BA0</b>
<b>Accessories</b>	
<p><b>SIPLUS Mounting Kit ET 200SP</b></p> <p>Mounting accessories for use with increased mechanical vibration and shock loads.</p>	<b>6AG1193-6AA00-0AA0</b>

## Overview



- 2-channel pulse output module for SIPLUS ET 200SP
- Approved in accordance with the EN 50155, EN 15121, EN 50124, EN 50125 and EN 45545 railway standards for use in rail traffic
- Operating modes:
  - Single pulse with defined length
  - Pulse chain with defined number of pulses
  - Pulse width modulation (with flexible ON period, optional current control and dither function)
  - PWM signal for controlling a DC motor
  - On and OFF delay; rising and falling edge can be delayed separately to the microsecond
  - Frequency output with defined output frequency
- Hardware:
  - 2 24V channels, 2A output current can be switched in parallel to boost performance to 4A of output current
  - Switching frequencies to 10 kHz; at reduced output current to 0.1 A up to 100 kHz
  - Push/pull output driver for especially steep edges at the outputs
  - Polarity change in DC motor operation for direction reversal
  - 1 high-speed 24 V digital input per channel with parameterizable input delay from 4  $\mu$ s
- Channel functions:
  - HW enable; Start of signal output with the onboard digital input
  - Parameterizable ON delay; for precise deceleration between the HW enable and the start of output
  - Current measurement in the operating modes pulse-width modulation and pulse chain; enables control of the output current mean value over a period. Temperature influences can thus be balanced to the resistance of the actuator.
  - Cyclic control of the respective main setpoint from the PLC in every operating mode; other values can be modified flexibly from the user program.
- Supported system functions:
  - Isochronous mode; enables precision-timed connection of the setpoint output to a higher-level controller
  - Firmware update
  - Identification data I&M

## Application

A host of tasks can be solved with the pulse output module TM Pulse 2x24V.

- In the operating mode input/output delay, precisely adjustable, reproducible and extremely short response times can be implemented between an input and an output. Enabling of the response can be controlled flexibly from the CPU using the software enable bit.
- The operating mode pulse output allows precise proportioning by means of a pulse that can be specified to the microsecond.
- The operating mode pulse width modulation is suitable for controlling proportional valves without further amplification electronics. The integrated dither function overlays the setpoint, if required, with an oscillation that keeps the valve in motion and thus allows precise control of the valve position. The optional current control compensates for temperatures that would change the current in the valve.
- When operating with simple DC motors, setpoints of -100% to +100% can be specified, allowing the motor to be controlled with variable voltage in both directions.
- The pulse chain allows precise filling of number-dependent packaging
- If a higher current is required, both of the module's channels can be combined to allow a current of up to 4A.

## Design

- 2 24 V channels each with up to 2 A of output current; Parallel switching of both channels to boost power up to 4 A of output current
- 1 high-speed 24 V digital input per channel with parameterizable input delay from 4  $\mu$ s

## Suitable BaseUnits

The ET 200SP type B1 BaseUnit is available for connection. The individual signals of the pulse output module are connected to the appropriate terminals.

The type B1 BaseUnit is a dark BaseUnit and forwards the supply voltage of the BaseUnit on the left to its neighbor on the right via self-assembling voltage busbars. The TM Pulse is supplied direct via the infeed terminals of the BaseUnit and is not connected to the neighboring modules.

## Shield connection

Due to the high-speed input and output signals, a shielded cable and a low-impedance connection to function ground (DIN rail) are recommended. The type B1 BaseUnit does NOT offer an integrated connection to the DIN rail. Users must ensure correct shielding themselves. Please observe the information in the manual.

## Accessories (not included in the scope of supply of the module)

- Labeling strips
- Equipment labeling plates

## Function

Operating modes

- Single pulse with defined length
- Pulse chain with defined number of pulses
- Pulse width modulation with flexible ON period, optional current control and dither function (the dither function overlays the setpoint, if required, with an oscillation that keeps the valve in motion and thus allows precise control of the valve position).
- Control of a DC motor with a PWM signal and direction reversal
- ON and OFF delay; forwards the input signal to the output. The rising and falling edge can be delayed separately to the microsecond.
- Frequency output with defined output frequency

**SIPLUS RAIL**

SIPLUS ET 200SP RAIL

SIPLUS extreme RAIL I/O modules

**SIPLUS extreme RAIL technology modules > SIPLUS extreme RAIL TM Pulse 2x24V T1 RAIL pulse output module**

## Hardware functions

- Switching frequencies to 10 kHz; at reduced output current to 0.1 A up to 100 kHz
- Push/pull output driver for especially steep edges at the outputs
- Polarity change in DC motor operation for direction reversal

Channel functions for flexible adaptation to the requirements of a machine and the respective sequence

- HW enable; Start of signal output with the onboard digital input
- Parameterizable ON delay; allows precise delay between the HW enable and the start of output  
Current measurement in the operating modes pulse-width modulation and pulse chain; enables control of the output current to the mean value over a period. Temperature influences can thus be balanced to the resistance of the actuator.
- The respective main setpoint in each operating mode is controlled cyclically by the PLC, and other values can be modified flexibly from the user program.

## Supported system functions

- Isochronous mode enables precision-timed connection of the setpoint output to a higher-level controller
- Firmware update
- Identification data I&M

**Technical specifications**

Article number	<b>6AG2138-6DB00-1BB1</b> SIPLUS ET 200SP TM PULSE 2x24V T1 RAIL
<b>General information</b>	
<b>Product type designation</b>	TM Pulse 2x24 V
<b>Product function</b>	
• I&M data	Yes; I&M 0
• Isochronous mode	Yes
<b>Supply voltage</b>	
<b>Load voltage L+</b>	
• Rated value (DC)	24 V
• Short-circuit protection	Yes
• Reverse polarity protection	Yes; against destruction
<b>Encoder supply</b>	
<b>Number of outputs</b>	2; A common 24V encoder supply for both channels
<b>24 V encoder supply</b>	
• 24 V	Yes; L+ (-0.8 V)
• Short-circuit protection	Yes; per module, electronic
• Output current, max.	300 mA
<b>Digital inputs</b>	
<b>Number of digital inputs</b>	2; 1 per channel
<b>Digital inputs, parameterizable</b>	Yes
<b>Input characteristic curve in accordance with IEC 61131, type 3</b>	Yes
<b>Digital input functions, parameterizable</b>	
• Freely usable digital input	Yes
• HW enable for digital output	Yes
<b>Input voltage</b>	
• Type of input voltage	DC
• Rated value (DC)	24 V
• for signal "0"	-30 to +5 V
• for signal "1"	+11 to +30V
• permissible voltage at input, min.	-30 V
• permissible voltage at input, max.	30 V
<b>Input current</b>	
• for signal "1", typ.	2.5 mA
<b>Input delay (for rated value of input voltage)</b>	
• for standard inputs	
- parameterizable	Yes; none / 0.05 / 0.1 / 0.4 / 0.8 / 1.6 / 3.2 / 12.8 / 20 ms
- at "0" to "1", min.	4 µs; for parameterization "none"
- at "1" to "0", min.	4 µs; for parameterization "none"
<b>Digital outputs</b>	
<b>Type of digital output</b>	P- and M-switching
<b>Number of digital outputs</b>	2; 1 per channel
<b>Digital outputs, parameterizable</b>	Yes
<b>Short-circuit protection</b>	Yes; electronic/thermal
<b>Limitation of inductive shutdown voltage to</b>	-0.8 V
<b>Controlling a digital input</b>	Yes



**SIPLUS extreme RAIL technology modules > SIPLUS extreme RAIL TM Pulse 2x24V T1 RAIL pulse output module**

Article number	<b>6AG2138-6DB00-1BB1</b> SIPLUS ET 200SP TM PULSE 2x24V T1 RAIL
<b>Digital output functions, parameterizable</b> <ul style="list-style-type: none"> <li>• Freely usable digital output</li> <li>• PWM output <ul style="list-style-type: none"> <li>- Number, max.</li> <li>- Cycle duration, parameterizable</li> </ul> </li> <li>• Connection of a proportional valve</li> <li>• Dithering</li> <li>• Current measurement</li> <li>• Current control</li> <li>• Connection of a DC motor</li> <li>• ON-delay</li> <li>• OFF-delay</li> <li>• Frequency output</li> <li>• Pulse train</li> <li>• Pulse output</li> </ul>	Yes Yes 2; 1 per channel Yes; Max. 85 s Yes Yes Yes Yes Yes Yes Yes Yes Yes Yes Yes
<b>Switching capacity of the outputs</b> <ul style="list-style-type: none"> <li>• with resistive load, max.</li> <li>• on lamp load, max.</li> </ul>	2 A 10 W; 1 W with High Speed output
<b>Load resistance range</b> <ul style="list-style-type: none"> <li>• lower limit</li> <li>• upper limit</li> </ul>	12 Ω; 240 ohm with High Speed output 12 kΩ
<b>Output voltage</b> <ul style="list-style-type: none"> <li>• Type of output voltage</li> <li>• for signal "0", max.</li> <li>• for signal "1", min.</li> </ul>	DC 1 V 23.2 V; L+ (-0.8 V)
<b>Output current</b> <ul style="list-style-type: none"> <li>• for signal "1" rated value</li> </ul>	2 A; 0.1 A with High Speed output, observe derating
<b>Output delay with resistive load</b> <ul style="list-style-type: none"> <li>• "0" to "1", typ.</li> <li>• "0" to "1", max.</li> <li>• "1" to "0", typ.</li> <li>• "1" to "0", max.</li> </ul>	0 μs; With High Speed output, 4.5 μs with Standard output 0.8 μs; With High Speed output, 9 μs with Standard output 0 μs; With High Speed output, 4.5 μs with Standard output 0.8 μs; With High Speed output, 9 μs with Standard output
<b>Parallel switching of two outputs</b> <ul style="list-style-type: none"> <li>• for uprating</li> </ul>	Yes
<b>Switching frequency</b> <ul style="list-style-type: none"> <li>• with resistive load, max.</li> <li>• with inductive load, max.</li> <li>• on lamp load, max.</li> </ul>	100 kHz; With High Speed output, 10 kHz with standard output 100 kHz; With High Speed output, 10 kHz with standard output 10 Hz
<b>Total current of the outputs</b> <ul style="list-style-type: none"> <li>• Current per channel, max.</li> <li>• Current per group, max.</li> <li>• Current per module, max.</li> </ul>	2 A 4 A 4 A
<b>Isochronous mode</b>	
<b>Bus cycle time (TDP), min.</b>	250 μs; with 1 channel configuration, 375 μs with 2 channel configuration
<b>Interrupts/diagnostics/status information</b>	
<b>Diagnostics function</b>	Yes
<b>Substitute values connectable</b>	Yes; Parameterizable
<b>Alarms</b> <ul style="list-style-type: none"> <li>• Diagnostic alarm</li> </ul>	Yes
<b>Diagnoses</b> <ul style="list-style-type: none"> <li>• Monitoring the supply voltage</li> <li>• Short-circuit</li> </ul>	Yes Yes
<b>Diagnostics indication LED</b> <ul style="list-style-type: none"> <li>• Monitoring of the supply voltage (PWR-LED)</li> <li>• Channel status display</li> <li>• for module diagnostics</li> </ul>	Yes; green PWR LED Yes Yes; green/red DIAG LED
<b>Integrated Functions</b>	
<b>Counter</b>	No
<b>Potential separation</b>	
<b>Potential separation channels</b> <ul style="list-style-type: none"> <li>• between the channels and backplane bus</li> </ul>	Yes
<b>Standards, approvals, certificates</b>	
<b>Suitable for safety functions</b>	No
<b>Railway application</b> <ul style="list-style-type: none"> <li>• EN 50121-3-2</li> <li>• EN 50121-4</li> <li>• EN 50124-1</li>   <li>• EN 50125-1</li> <li>• EN 50125-2</li> <li>• EN 50125-3</li>   <li>• EN 50155</li> <li>• EN 61373</li> <li>• Fire protection acc. to EN 45545-2</li> </ul>	Yes; EMC for rail vehicles Yes; EMC for signal and telecommunications systems Yes; Railway applications - overvoltage category OV2; pollution degree PD2; rated surge voltage UNi = 0.5 kV; UNm = 24 V DC Yes; Rail vehicles - see ambient conditions Yes; Stationary electrical equipment - see ambient conditions Yes; Signal and telecommunications systems - see ambient conditions; vibrations and shocks: Application point outside of tracks (1 m to 3 m away from track) Yes; Rail vehicles - temperature class OT2, ST1/ST2, horizontal mounting position Yes; Rail vehicles - vibrations and shocks: Category 1 Class A/B Yes; For proof of conformity, see Service & Support

**SIPLUS RAIL**

SIPLUS ET 200SP RAIL

SIPLUS extreme RAIL I/O modules

**SIPLUS extreme RAIL technology modules > SIPLUS extreme RAIL TM Pulse 2x24V T1 RAIL pulse output module**

Article number	<b>6AG2138-6DB00-1BB1</b> SIPLUS ET 200SP TM PULSE 2x24V T1 RAIL
<b>Ambient conditions</b>	
<b>Ambient temperature during operation</b>	
<ul style="list-style-type: none"> <li>horizontal installation, min.</li> <li>horizontal installation, max.</li> </ul>	-40 °C; = Tmin (incl. condensation/frost) 60 °C; = Tmax; +70 °C for 10 min (OT1, ST1/ST2 acc. to EN 50155); +70 °C continuously with configured slots to the left and right of the module (OT3, ST0 acc. to EN 50155)
<ul style="list-style-type: none"> <li>vertical installation, min.</li> <li>vertical installation, max.</li> </ul>	-40 °C; = Tmin 50 °C; = Tmax
<b>Altitude during operation relating to sea level</b>	
<ul style="list-style-type: none"> <li>Installation altitude above sea level, max.</li> <li>Ambient air temperature-barometric pressure-altitude</li> </ul>	2 000 m Tmin ... Tmax at 1 140 hPa ... 795 hPa (-1 000 m ... +2 000 m)
<b>Relative humidity</b>	
<ul style="list-style-type: none"> <li>With condensation, tested in accordance with IEC -2-38, max.</li> </ul>	100 %; RH incl. condensation / frost (no commissioning in bedewed state), horizontal installation
<b>Resistance</b>	
<ul style="list-style-type: none"> <li>Coolants and lubricants <ul style="list-style-type: none"> <li>Resistant to commercially available coolants and lubricants</li> </ul> </li> <li>Use in stationary industrial systems <ul style="list-style-type: none"> <li>to biologically active substances according to EN 60721-3-3</li> <li>to chemically active substances according to EN 60721-3-3</li> <li>to mechanically active substances according to EN 60721-3-3</li> <li>Against mechanical environmental conditions acc. to EN 60721-3-3</li> </ul> </li> <li>Use on land craft, rail vehicles and special-purpose vehicles <ul style="list-style-type: none"> <li>to biologically active substances according to EN 60721-3-5</li> <li>to chemically active substances according to EN 60721-3-5</li> <li>to mechanically active substances according to EN 60721-3-5</li> <li>Against mechanical environmental conditions acc. to EN 60721-3-5</li> <li>against mechanical environmental conditions in agriculture acc. to ISO 15003</li> </ul> </li> <li>Usage in industrial process technology <ul style="list-style-type: none"> <li>Against chemically active substances acc. to EN 60654-4</li> <li>Environmental conditions for process, measuring and control systems acc. to ANSI/ISA-71.04</li> </ul> </li> <li>Remark <ul style="list-style-type: none"> <li>Note regarding classification of environmental conditions acc. to EN 60721, EN 60654-4 and ANSI/ISA-71.04</li> </ul> </li> </ul>	<p>Yes; Incl. diesel and oil droplets in the air</p> <p>Yes; Class 3B2 mold, fungus and dry rot spores (with the exception of fauna); Class 3B3 on request Yes; Class 3C4 (RH &lt; 75 %) incl. salt spray acc. to EN 60068-2-52 (severity degree 3); * Yes; Class 3S4 incl. sand, dust, * Yes; Class 3M8 using the SIPLUS Mounting Kit ET 200SP (6AG1193-6AA00-0AA0)</p> <p>Yes; Class 5B2 mold, fungus and dry rot spores (with the exception of fauna); Class 5B3 on request Yes; Class 5C3 (RH &lt; 75 %) incl. salt spray acc. to EN 60068-2-52 (severity degree 3); * Yes; Class 5S3 incl. sand, dust; * Yes; Class 5M2 using the SIPLUS Mounting Kit ET 200SP (6AG1193-6AA00-0AA0) Yes; level 1 (Location LE) using the SIPLUS Mounting Kit ET 200SP (6AG1193-6AA00-0AA0)</p> <p>Yes; Class 3 (excluding trichlorethylene) Yes; Level GX group A/B (excluding trichlorethylene; harmful gas concentrations up to the limits of EN 60721-3-3 class 3C4 permissible); level LC3 (salt spray) and level LB3 (oil)</p> <p>* The supplied plug covers must remain in place over the unused interfaces during operation!</p>
<b>Conformal coating</b>	
<ul style="list-style-type: none"> <li>Coatings for printed circuit board assemblies acc. to EN 61086</li> <li>Protection against fouling acc. to EN 60664-3</li> <li>Electronic equipment on rolling stock acc. to EN 50155</li> <li>Military testing according to MIL-I-46058C, Amendment 7</li> <li>Qualification and Performance of Electrical Insulating Compound for Printed Board Assemblies according to IPC-CC-830A</li> </ul>	<p>Yes; Class 2 for high reliability Yes; Type 1 protection Yes; Class PC2 protective coating acc. to EN 50155:2017 Yes; Discoloration of coating possible during service life Yes; Conformal coating, Class A</p>
<b>Decentralized operation</b>	
<b>to SIMATIC S7-300</b>	Yes
<b>to SIMATIC S7-400</b>	Yes
<b>to SIMATIC S7-1200</b>	Yes
<b>to SIMATIC S7-1500</b>	Yes
<b>to standard PROFIBUS master</b>	Yes
<b>to standard PROFINET controller</b>	Yes
<b>Dimensions</b>	
<b>Width</b>	20 mm
<b>Height</b>	73 mm
<b>Depth</b>	58 mm
<b>Weights</b>	
<b>Weight, approx.</b>	50 g
<b>Other</b>	
<b>Note:</b>	for use in railway applications, also observe the product information "SIPLUS extreme RAIL" A5E37661960A, Online Support article 109736776

### Selection and ordering data

Version	Article No.
<p><b>SIPLUS ET 200SP TM Pulse 2x24V T1 RAIL pulse output module</b>            Approved in accordance with EN 50155, EN 15121, EN 50124, EN 50125 and EN 45545 railway standards for use in rail traffic            PWM and pulse output, 2 channels 2 A for proportional valves and DC motors;            For areas with extreme exposure to environmental substances (conformal coating); ambient temperature -25 ... +55 °C (+70 °C for 10 min.)</p>	<b>6AG2138-6DB00-1BB1</b>
<b>Accessories</b>	
<b>Suitable SIPLUS extreme RAIL BaseUnits, type B1</b>	
<p><b>SIPLUS ET 200SP BU20-P12+A0+4B TX RAIL</b>            Approved in accordance with EN 50155, EN 15121, EN 50124, EN 50125 and EN 45545 railway standards for use in rail traffic            BU type B1; BaseUnit (dark) with 12 process terminals to the module; for continuing the load group; 1 unit</p>	<b>6AG2193-6BP20-4BB1</b>
<p><b>SIPLUS Mounting Kit ET 200SP</b>            Mounting accessories for use with increased mechanical vibration and shock loads.</p>	<b>6AG1193-6AA00-0AA0</b>

**SIPLUS RAIL**

SIPLUS ET 200SP RAIL

SIPLUS extreme RAIL I/O modules

**SIPLUS extreme RAIL communication > SIPLUS extreme RAIL CM PtP serial interface****Overview**

- CM PtP communications module; module for serial communication connections with RS232 and RS422 interfaces. RS485 for the Freeport, 3964(R), Modbus RTU, and USS protocols, max. 115.2 kbit/s, 2 KB frame length, 4 KB receive buffer.
- Protocols supported
  - Freeport: User-parameterizable frame format for universal communication
  - 3964(R) for improved transmission reliability
  - Modbus RTU master (requires instructions in SIMATIC S7)
  - Modbus RTU slave (requires instructions in SIMATIC S7)
  - USS, implemented through instructions
- Interface properties
  - RS232 with auxiliary signals
  - RS422 for full-duplex connections
  - RS485 for half-duplex and multi-point connections
  - Transfer rates from 300 to 115 200 bps for RS232 and RS422
  - Transfer rates from 300 to 25 000 bps for RS485
  - Frame lengths
    - In universal mode: 2 KB each in send and receive direction
    - In performance-optimized operation: 30 bytes in send direction, 24 bytes in receive direction
- Can be plugged into type A0 BaseUnits (BU) with automatic coding
- LED display for errors, operation, and supply voltage
- Communication display for sending and receiving
- Clear labeling on front of module
  - Plain text identification of the module type and function class
  - 2D matrix code (order and serial number)
  - Connection diagram
  - Color coding of the module type
  - Hardware and firmware version
  - Complete Article No.
- Optional labeling accessories
  - Labeling strips
  - Equipment labeling plate
- Optional system-integrated shield connection

**Application**

- Communications modules connect the PLC with an external communication partner to exchange data.
- Comprehensive parameterization options make it possible to adapt the PLC flexibly to the communication partner.
- Modbus RTU master creates a Modbus RTU network for up to 30 Modbus slaves.
- Lights and devices are controlled from the stage area with DMX512.
- Performance-optimized operation is particularly suitable for sending and receiving large numbers of short frames with multiple CM PtP in a station. Frames of max. 24 bytes in send direction and 30 bytes in receive direction are possible.

**Design****Suitable BaseUnits**

The standard BaseUnits of ET 200SP are available for connection. The individual signals of the serial connection are connected with appropriate terminals.

A light BaseUnit opens a new load group. The supply voltage must be fed in via this BaseUnit.

A dark BaseUnit forwards the supply voltage of the adjacent light BaseUnit on the left via self-assembling voltage buses. A new infeed is therefore only required on the next light BaseUnit to the right.

All variants that correspond to BaseUnit type A0 can be used as BaseUnits.

**System-integrated shield connection**

For the space-saving and EMC-optimized connection of cable shields, a shield connection is available that is quick and easy to mount. This consists of one shield connection element that can be plugged onto the BaseUnit and one shield terminal for each module. The low-impedance connection to functional ground (DIN rail) is carried out by the user and requires no additional wiring.

## Technical specifications

Article number	<b>6AG2137-6AA01-4BA0</b> SIPLUS ET 200SP CM PTP RAIL
<b>General information</b>	
<b>Product type designation</b>	CM PtP
<b>Product function</b> • I&M data	Yes; I&M0 to I&M3
<b>Supply voltage</b>	
<b>Rated value (DC)</b>	24 V
<b>Reverse polarity protection</b>	Yes
<b>1. Interface</b>	
<b>Interface types</b> • RS 485 • RS 422 • RS 232 • Design of the connection	Yes Yes Yes Push-in terminal
<b>Interface types</b>	
<b>RS 232</b> • Transmission rate, max. • Cable length, max. • RS 232 auxiliary signals	115.2 kbit/s 15 m RTS, CTS, DTR, DSR, RI, DCD
<b>RS 485</b> • Transmission rate, max. • Cable length, max.	250 kbit/s 1 200 m; 100 to 1200 m, depending on transmission speed
<b>RS 422</b> • Transmission rate, max. • Cable length, max. • 4-wire full duplex connection • 4-wire multipoint connection	115.2 kbit/s 1 200 m Yes Yes
<b>Protocols</b>	
<b>Integrated protocols</b> • Freeprot - Telegram length, max. - Bits per character - Number of stop bits - Parity • 3964 (R) - Telegram length, max. - Bits per character - Number of stop bits - Parity • Modbus RTU master - Address area - Number of slaves, max. • MODBUS RTU slave - Address area	2 kbyte; performance mode: receive data max. 24 byte and send data max. 30 byte 7 or 8 1 or 2 bit None, even, odd, always 1, always 0, any  2 kbyte; performance mode: receive data max. 24 byte and send data max. 30 byte 7 or 8 1 or 2 bit None, even, odd, always 1, always 0, any  1 to 247, extended 1 to 65535 32  1 to 247, extended 1 to 65535
<b>Telegram buffer</b> • Buffer memory for telegrams • Number of telegrams which can be buffered	4 kbyte 255
<b>Interrupts/diagnostics/status information</b>	
<b>Diagnostics function</b>	Yes
<b>Alarms</b> • Diagnostic alarm • Hardware interrupt	Yes No
<b>Diagnostics</b> • Wire-break	Yes
<b>Diagnostics indication LED</b> • Monitoring of the supply voltage (PWR-LED) • for module diagnostics • Receive RxD • Transmit TxD	Yes; green PWR LED Yes; green/red DIAG LED Yes; green LED Yes; green LED
<b>Potential separation</b>	
<b>between backplane bus and interface</b>	Yes
<b>Standards, approvals, certificates</b>	
<b>Railway application</b> • EN 50121-3-2 • EN 50121-4 • EN 50124-1  • EN 50125-1 • EN 50125-2 • EN 50125-3  • EN 50155 • EN 61373 • Fire protection acc. to EN 45545-2	Yes; EMC for rail vehicles Yes; EMC for signal and telecommunications systems Yes; Railway applications - overvoltage category OV2; pollution degree PD2; rated surge voltage UNi = 0.5 kV; UNm = 24 V DC Yes; Rail vehicles - see ambient conditions Yes; Stationary electrical equipment - see ambient conditions Yes; Signal and telecommunications systems - see ambient conditions; vibrations and shocks: Application point outside of tracks (1 m to 3 m away from track) Yes; Rail vehicles - temperature class OT4, ST1/ST2, horizontal mounting position Yes; Rail vehicles - vibrations and shocks: Category 1 Class A/B Yes; For proof of conformity, see Service & Support

**SIPLUS RAIL**

SIPLUS ET 200SP RAIL

SIPLUS extreme RAIL I/O modules

**SIPLUS extreme RAIL communication > SIPLUS extreme RAIL CM PtP serial interface**

Article number	<b>6AG2137-6AA01-4BA0</b> SIPLUS ET 200SP CM PTP RAIL
<b>Ambient conditions</b>	
<b>Ambient temperature during operation</b>	
• horizontal installation, min.	-40 °C; = Tmin (incl. condensation/frost)
• horizontal installation, max.	70 °C; = Tmax; +85 °C for 10 min (OT4, ST1/ST2 acc. to EN 50155)
• vertical installation, min.	-40 °C; = Tmin
• vertical installation, max.	50 °C; = Tmax
<b>Altitude during operation relating to sea level</b>	
• Installation altitude above sea level, max.	2 000 m
• Ambient air temperature-barometric pressure-altitude	Tmin ... Tmax at 1 140 hPa ... 795 hPa (-1 000 m ... +2 000 m)
<b>Relative humidity</b>	
• With condensation, tested in accordance with IEC 60068-2-38, max.	100 %; RH incl. condensation / frost (no commissioning in bedewed state), horizontal installation
<b>Resistance</b>	
• Coolants and lubricants	
- Resistant to commercially available coolants and lubricants	Yes; Incl. diesel and oil droplets in the air
• Use in stationary industrial systems	
- to biologically active substances according to EN 60721-3-3	Yes; Class 3B2 mold, fungus and dry rot spores (with the exception of fauna); Class 3B3 on request
- to chemically active substances according to EN 60721-3-3	Yes; Class 3C4 (RH < 75 %) incl. salt spray acc. to EN 60068-2-52 (severity degree 3); *
- to mechanically active substances according to EN 60721-3-3	Yes; Class 3S4 incl. sand, dust, *
- Against mechanical environmental conditions acc. to EN 60721-3-5	Yes; Class 3M8 using the SIPLUS Mounting Kit ET 200SP (6AG1193-6AA00-0AA0)
• Use on land craft, rail vehicles and special-purpose vehicles	
- to biologically active substances according to EN 60721-3-5	Yes; Class 5B2 mold, fungus and dry rot spores (with the exception of fauna); Class 5B3 on request
- to chemically active substances according to EN 60721-3-5	Yes; Class 5C3 (RH < 75 %) incl. salt spray acc. to EN 60068-2-52 (severity degree 3); *
- to mechanically active substances according to EN 60721-3-5	Yes; Class 5S3 incl. sand, dust; *
- Against mechanical environmental conditions acc. to EN 60721-3-5	Yes; Class 5M2 using the SIPLUS Mounting Kit ET 200SP (6AG1193-6AA00-0AA0)
- against mechanical environmental conditions in agriculture acc. to ISO 15003	Yes; level 1 (Location LE) using the SIPLUS Mounting Kit ET 200SP (6AG1193-6AA00-0AA0)
• Usage in industrial process technology	
- Against chemically active substances acc. to EN 60654-4	Yes; Class 3 (excluding trichlorethylene)
- Environmental conditions for process, measuring and control systems acc. to ANSI/ISA-71.04	Yes; Level GX group A/B (excluding trichlorethylene; harmful gas concentrations up to the limits of EN 60721-3-3 class 3C4 permissible); level LC3 (salt spray) and level LB3 (oil)
• Remark	
- Note regarding classification of environmental conditions acc. to EN 60721, EN 60654-4 and ANSI/ISA-71.04	* The supplied plug covers must remain in place over the unused interfaces during operation!
<b>Conformal coating</b>	
• Coatings for printed circuit board assemblies acc. to EN 61086	Yes; Class 2 for high reliability
• Protection against fouling acc. to EN 60664-3	Yes; Type 1 protection
• Electronic equipment on rolling stock acc. to EN 50155	Yes; Class PC2 protective coating acc. to EN 50155:2017
• Military testing according to MIL-I-46058C, Amendment 7	Yes; Discoloration of coating possible during service life
• Qualification and Performance of Electrical Insulating Compound for Printed Board Assemblies according to IPC-CC-830A	Yes; Conformal coating, Class A
<b>Decentralized operation</b>	
<b>to SIMATIC S7-300</b>	Yes
<b>to SIMATIC S7-400</b>	Yes
<b>to SIMATIC S7-1200</b>	Yes
<b>to SIMATIC S7-1500</b>	Yes
<b>to standard PROFINET controller</b>	Yes
<b>Dimensions</b>	
<b>Width</b>	15 mm
<b>Height</b>	73 mm
<b>Depth</b>	58 mm
<b>Weights</b>	
<b>Weight, approx.</b>	30 g
<b>Other</b>	
<b>Note:</b>	for use in railway applications, also observe the product information "SIPLUS extreme RAIL" A5E37661960A, Online Support article 109736776

### Selection and ordering data

Version	Article No.
<p><b>Serial interface SIPLUS ET 200SP CM PtP RAIL OT4</b></p> <p>Approved in accordance with railway standards EN 50155, EN 15121, EN 50124, EN 50125 and EN 45545 for use in rail traffic</p> <p>With conformal coating, ambient temperature (-40 ... +70 °C) (+85 °C for 10 min.) For serial connection RS-422, RS-485 and RS-232, Freeport, 3964 (R), USS, MODBUS RTU master, slave, max. 250 Kbps, suitable for BU type A0, pack quantity: 1 unit</p>	<b>6AG2137-6AA01-4BA0</b>
<p><b>Suitable SIPLUS extreme RAIL BaseUnits, type A0</b></p> <p><b>SIPLUS ET 200SP BU15-P16+A0+2D TX RAIL</b></p> <p>Approved in accordance with railway standards EN 50155, EN 15121, EN 50124, EN 50125 and EN 45545 for use in rail traffic</p> <p>BU type A0; BaseUnit (light) with 16 push-in terminals to the module; for starting a new load group (max. 10 A); for areas with extreme exposure to environmental substances (conformal coating); ambient temperature -40 ... +70 °C (+85 °C for 10 min.)</p>	<b>6AG2193-6BP00-4DA0</b>
<p><b>SIPLUS ET 200SP BU15-P16+A0+2B TX RAIL</b></p> <p>Approved in accordance with railway standards EN 50155, EN 15121, EN 50124, EN 50125 and EN 45545 for use in rail traffic</p> <p>BU type A0; BaseUnit (dark) with 16 push-in terminals to the module; for continuing the load group; for areas with extreme exposure to environmental substances (conformal coating); ambient temperature -40 ... +70 °C (+85 °C for 10 min.)</p>	<b>6AG2193-6BP00-4BA0</b>
<p><b>SIPLUS ET 200SP BU15-P16+A10+2D TX RAIL</b></p> <p>Approved in accordance with railway standards EN 50155, EN 15121, EN 50124, EN 50125 and EN 45545 for use in rail traffic</p> <p>BU type A0; BaseUnit (light) with 16 push-in terminals (1...16) to the module and an additional 10 internally jumpered AUX terminals (1 A to 10 A); for starting a new load group (max. 10 A); for areas with extreme exposure to environmental substances (conformal coating); ambient temperature -40 ... +70 °C (+85 °C for 10 min.)</p>	<b>6AG2193-6BP20-4DA0</b>
<p><b>SIPLUS ET 200SP BU15-P16+A10+2B TX RAIL</b></p> <p>Approved in accordance with railway standards EN 50155, EN 15121, EN 50124, EN 50125 and EN 45545 for use in rail traffic</p> <p>BU type A0; BaseUnit (dark) with 16 push-in terminals (1...16) to the module and an additional 10 internally jumpered AUX terminals (1 A to 10 A); for continuing the load group; for areas with extreme exposure to environmental substances (conformal coating); ambient temperature -40 ... +70 °C (+85 °C for 10 min.)</p>	<b>6AG2193-6BP20-4BA0</b>
<p><b>Accessories</b></p> <p><b>SIPLUS Mounting Kit ET 200SP</b></p> <p>Mounting accessories for use with increased mechanical vibration and shock loads.</p>	<b>6AG1193-6AA00-0AA0</b>



**SIPLUS RAIL**

SIPLUS ET 200SP RAIL

SIPLUS extreme RAIL I/O modules

**SIPLUS extreme RAIL communication > SIPLUS extreme RAIL CM 4x IO-Link****Overview**

- SIPLUS ET 200SP CM 4XIO-LINK ST T1 RAIL communication module:  
Serial communication module for connecting up to 4 IO-Link devices in accordance with IO-Link specification V1.0 and V1.1. The IO-Link parameters are configured using the Port Configuration Tool (PCT), version V3.0 and higher.
- Approved in accordance with the railway standards EN 50155, EN 15121, EN 50124, EN 50125 and EN 45545 for use in rail traffic
- Time-based IO  
Time-based IO ensures that signals are output with a precisely defined response time. By combining inputs and outputs, for example, passing products can be accurately measured or fluids dosed in precise quantities.
- Supported data transfer rates
  - COM1 (4.8 kbps)
  - COM2 (38.4 kbps)
  - COM3 (230.4 kbps)

- Expansion limits
  - Length of cable: Max. 20 m
  - Max. 32 bytes of input and output data per port
  - Max. 144 bytes of input data and 128 bytes of output data per module
- Supported ET 200SP system functions
  - Replacement without PG with automatic backup without the engineering tool of the IO Link Device Parameter (V1.1 devices only) and the IO-Link master parameters by means of redundant saving of parameters on the e-coding element
  - Re-parameterization during operation
  - Identification data I&M
  - Firmware update
  - PROFlenergy
- Can be plugged into Type A0 BaseUnits (BU) with automatic e-coding
- LED indicators
  - DIAG: Operating state indicator (green/red) of the module
  - C1..C4: Port status indicator (green) for Port 1, 2, 3 and 4
  - Q1..Q4: Channel status indicator (green) for Port 1, 2, 3 and 4
  - F1..F4: Port fault indicator (red) for Port 1, 2, 3 and 4
  - PWR: Supply voltage indicator (green)
- Clear labeling on front of module
  - Plain text identification of the module type and function class
  - 2D matrix code (order and serial number)
  - Connection diagram
  - Color-coding of the module class CM: Silver
  - Hardware and firmware version
  - Complete Article No.
- Optional accessories
  - Labeling strips
  - Reference identification label
  - Color-coding plate with color code CC04
- Optional system-integrated shield connection

Overview of CM 4xIO-Link

Communication module	Article No.	CC code	BU type	PU
CM 4xIO-Link	6AG2137-6BD00-1BA0	CC04	A0	1

Overview of BaseUnits

BaseUnit	Article No.	CC codes for process terminals	CC codes for AUX terminals	PU
<b>BU type A0</b> • New load group (light) • 16 process terminals • With 10 AUX terminals	6AG2193-6BP20-4DA0	CC01 to CC05	CC71 to CC73	1
<b>BU type A0</b> • New load group (light) • 16 process terminals • Without AUX terminals	6AG2193-6BP00-4DA0	CC01 to CC05	--	1
<b>BU type A0</b> • Forwarding of load group (dark) • 16 process terminals • With 10 AUX terminals	6AG2193-6BP20-4BA0	CC01 to CC05	CC71 to CC73	1
<b>BU type A0</b> • Forwarding of load group (dark) • 16 process terminals • Without AUX terminals	6AG2193-6BP00-4BA0	CC01 to CC05	--	1

### Application

- The SIPLUS ET 200SP CM 4XIO-LINK ST T1 RAIL communication module enables data exchange with up to 4 external IO Link devices via one 3-wire cable each.
- Comprehensive parameterization options make it possible to adapt the controller flexibly to the communication partner.
- Thanks to the compatibility of IO-Link with standard sensors, commercially available sensors in accordance with IEC 61131 Type 1 can also be operated on the IO-Link master.

### Design

#### Usable BaseUnits (BU)

All BUs of type A0 are available for the SIPLUS ET 200SP CM 4XIO-LINK ST T1 RAIL communication module.

#### Load group formation

A light-colored BU separates the self-assembling, internal voltage buses (P1, P2, AUX) and thus opens a new load group. The supply voltage of a load group must be fed in at the light BU of this load group.

A dark BU forwards the supply voltage of the adjacent light BU on the left via the self-assembling voltage buses P1, P2 and AUX. A new infeed is therefore only required on the next light BU to the right. The setting of a further light BU is required whenever

- a new load group is to be formed (for example, for isolating the supply voltage from module groups) or
- the maximum current simultaneously required by the load group exceeds the permissible limit of 10 A.

#### Color identification of the terminals

The potentials at the terminals of the BaseUnit are defined by the inserted I/O module in each case. To prevent wiring faults, the potentials of the terminals can optionally be identified by means of module-specific color-coded labels. The color-coded label that matches the respective I/O module is defined by the color code CCxx of the I/O module. This color code is also printed on the front of the module.

For the communications module "CM 4x IO-Link", the color-coding label with the color code CC04 is to be used.

In BaseUnits with the additional ten internally jumpered AUX terminals, these can also be identified with color-coded labels. For the ten AUX terminals, color-coded labels are available in red, blue, and yellow/green.

### Labeling

#### Labeling strips

Labeling strips can be inserted on the front of the interface modules or I/O modules and individually labeled via STEP 7, macros, etc. No special additional holder is required. If required, they can be easily replaced with the component.

#### Equipment labeling plates

Equipment labeling plates enable the equipment to be easily identified (e.g. compliant with EN 81346). They are easily plugged onto the required component (interface modules, I/O modules and BaseUnits) and when required, they can be easily replaced with the component.

The following labeling components are available:

- Film labeling strips, light-gray, roll with 500 strips, perforated, for thermal transfer printers
- Film labeling strips, yellow, roll with 500 strips, perforated, for thermal transfer printers
- Card labeling strips (180 g/m<sup>2</sup>), light gray, DIN A4 sheets with 100 strips each, perforated, for laser printer
- Card labeling strips (180 g/m<sup>2</sup>), yellow, DIN A4 sheets with 100 strips each, perforated, for laser printer
- Equipment labeling plates, white, ten sheets each with 16 labels, for thermal transfer card printers or labels

#### System-integrated shield connection

For the space-saving and EMC-optimized connection of cable shields, a shield connection is available that is quick and easy to mount. This consists of one shield connection element that can be plugged onto the BaseUnit and one shield terminal for each module. The low-impedance connection to the functional ground (DIN rail) is achieved without any additional wiring by the user.

**SIPLUS RAIL**

SIPLUS ET 200SP RAIL

SIPLUS extreme RAIL I/O modules

**SIPLUS extreme RAIL communication > SIPLUS extreme RAIL CM 4x IO-Link****Technical specifications**

Article number	<b>6AG2137-6BD00-1BA0</b> SIPLUS ET 200SP CM 4XIO-LINK ST T1 RAIL
<b>General information</b>	
<b>Product type designation</b>	CM 4 x IO-Link ST
<b>Product function</b>	
• I&M data	Yes
• Isochronous mode	Yes; For PROFINET only
<b>Engineering with</b>	
• STEP 7 TIA Portal configurable/integrated from version	see entry ID: 109746275
<b>Supply voltage</b>	
<b>Rated value (DC)</b>	24 V
<b>Reverse polarity protection</b>	Yes
<b>Encoder supply</b>	
<b>Number of outputs</b>	4
<b>Output current</b>	
• Rated value	200 mA
<b>IO-Link</b>	
<b>Number of ports</b>	4
• of which simultaneously controllable	4
<b>IO-Link protocol 1.0</b>	Yes
<b>IO-Link protocol 1.1</b>	Yes
<b>Transmission rate</b>	4.8 kBaud (COM1); 38.4 kBaud (COM2), 230.4 kBaud (COM3)
<b>Cycle time, min.</b>	2 ms; dynamic, depending on user data length
<b>Size of process data, input per port</b>	32 byte; max.
<b>Size of process data, input per module</b>	32 byte; max.
<b>Size of process data, output per port</b>	32 byte; max.
<b>Size of process data, output per module</b>	32 byte; max.
<b>Memory size for device parameter</b>	2 kbyte; for each port
<b>Cable length unshielded, max.</b>	20 m; max.
<b>Operating modes</b>	
• IO-Link	Yes
• DI	Yes
• DQ	Yes; max. 100 mA
<b>Time Based IO</b>	
• TIO IO-Link IN	Yes
• TIO IO-Link OUT	Yes
• TIO IO-Link IN/OUT	Yes
• TIO Jitter	36 µs; typically ±
<b>Connection of IO-Link devices</b>	
• Port type A	Yes
• Port type B	Yes; 24 V DC via external terminal
<b>Isochronous mode</b>	
<b>Equidistance</b>	Yes
<b>Bus cycle time (TDP), min.</b>	250 µs
<b>Interrupts/diagnostics/status information</b>	
<b>Diagnostics function</b>	Yes
<b>Alarms</b>	
• Diagnostic alarm	Yes; The port diagnosis is available in the IO-Link mode only.
<b>Diagnoses</b>	
• Monitoring the supply voltage	Yes
<b>Diagnostics indication LED</b>	
• Monitoring of the supply voltage (PWR-LED)	Yes; green PWR LED
• Channel status display	Yes; one green LED for channel status Qn (SIO mode) and port status Cn (IO-Link mode) per channel
• for channel diagnostics	Yes; red Fn LED
• for module diagnostics	Yes; green/red DIAG LED
<b>Potential separation</b>	
<b>Potential separation channels</b>	
• between the channels and backplane bus	Yes

**SIPLUS extreme RAIL communication > SIPLUS extreme RAIL CM 4x IO-Link**

Article number	<b>6AG2137-6BD00-1BA0</b> SIPLUS ET 200SP CM 4XIO-LINK ST T1 RAIL
<b>Standards, approvals, certificates</b>	
<b>Railway application</b> <ul style="list-style-type: none"> <li>• EN 50121-3-2</li> <li>• EN 50121-4</li> <li>• EN 50124-1</li>   <li>• EN 50125-1</li> <li>• EN 50125-2</li> <li>• EN 50125-3</li>   <li>• EN 50155</li> <li>• EN 61373</li> <li>• Fire protection acc. to EN 45545-2</li> </ul>	<p>Yes; EMC for rail vehicles          Yes; EMC for signal and telecommunications systems          Yes; Railway applications - overvoltage category OV2; pollution degree PD2; rated surge voltage UNi = 0.5 kV; UNm = 24 V DC          Yes; Rail vehicles - see ambient conditions          Yes; Stationary electrical equipment - see ambient conditions          Yes; Signal and telecommunications systems - see ambient conditions; vibrations and shocks: Application point outside of tracks (1 m to 3 m away from track)          Yes; Rail vehicles - temperature class OT2, ST1/ST2, horizontal mounting position          Yes; Rail vehicles - vibrations and shocks: Category 1 Class A/B          Yes; For proof of conformity, see Service &amp; Support</p>
<b>Ambient conditions</b>	
<b>Ambient temperature during operation</b> <ul style="list-style-type: none"> <li>• horizontal installation, min.</li> <li>• horizontal installation, max.</li> <li>• vertical installation, min.</li> <li>• vertical installation, max.</li> </ul>	<p>-40 °C; = Tmin (incl. condensation/frost)          60 °C; = Tmax; +70 °C for 10 min (OT1, ST1/ST2 acc. to EN 50155)          -40 °C; = Tmin          50 °C; = Tmax</p>
<b>Altitude during operation relating to sea level</b> <ul style="list-style-type: none"> <li>• Installation altitude above sea level, max.</li> <li>• Ambient air temperature-barometric pressure-altitude</li> </ul>	<p>2 000 m          Tmin ... Tmax at 1 140 hPa ... 795 hPa (-1 000 m ... +2 000 m)</p>
<b>Relative humidity</b> <ul style="list-style-type: none"> <li>• With condensation, tested in accordance with IEC 60068-2-38, max.</li> </ul>	<p>100 %; RH incl. condensation / frost (no commissioning in bedewed state), horizontal installation</p>
<b>Resistance</b> <ul style="list-style-type: none"> <li>• Coolants and lubricants             <ul style="list-style-type: none"> <li>- Resistant to commercially available coolants and lubricants</li> </ul> </li> <li>• Use in stationary industrial systems             <ul style="list-style-type: none"> <li>- to biologically active substances according to EN 60721-3-3</li> <li>- to chemically active substances according to EN 60721-3-3</li> <li>- to mechanically active substances according to EN 60721-3-3</li> <li>- Against mechanical environmental conditions acc. to EN 60721-3-3</li> </ul> </li> <li>• Use on land craft, rail vehicles and special-purpose vehicles             <ul style="list-style-type: none"> <li>- to biologically active substances according to EN 60721-3-5</li> <li>- to chemically active substances according to EN 60721-3-5</li> <li>- to mechanically active substances according to EN 60721-3-5</li> <li>- Against mechanical environmental conditions acc. to EN 60721-3-5</li> <li>- against mechanical environmental conditions in agriculture acc. to ISO 15003</li> </ul> </li> <li>• Usage in industrial process technology             <ul style="list-style-type: none"> <li>- Against chemically active substances acc. to _EN 60654-4</li> <li>- Environmental conditions for process, measuring and control systems acc. to ANSI/ISA-71.04</li> </ul> </li> <li>• Remark             <ul style="list-style-type: none"> <li>- Note regarding classification of environmental conditions acc. to EN 60721, EN 60654-4 and ANSI/ISA-71.04</li> </ul> </li> </ul>	<p>Yes; Incl. diesel and oil droplets in the air</p> <p>Yes; Class 3B2 mold, fungus and dry rot spores (with the exception of fauna); Class 3B3 on request          Yes; Class 3C4 (RH &lt; 75 %) incl. salt spray acc. to EN 60068-2-52 (severity degree 3); *          Yes; Class 3S4 incl. sand, dust, *          Yes; Class 3M8 using the SIPLUS Mounting Kit ET 200SP (6AG1193-6AA00-0AA0)</p> <p>Yes; Class 5B2 mold, fungus and dry rot spores (with the exception of fauna); Class 5B3 on request          Yes; Class 5C3 (RH &lt; 75 %) incl. salt spray acc. to EN 60068-2-52 (severity degree 3); *          Yes; Class 5S3 incl. sand, dust; *          Yes; Class 5M2 using the SIPLUS Mounting Kit ET 200SP (6AG1193-6AA00-0AA0)          Yes; level 1 (Location LE) using the SIPLUS Mounting Kit ET 200SP (6AG1193-6AA00-0AA0)</p> <p>Yes; Class 3 (excluding trichlorethylene)          Yes; Level GX group A/B (excluding trichlorethylene; harmful gas concentrations up to the limits of EN 60721-3-3 class 3C4 permissible); level LC3 (salt spray) and level LB3 (oil)</p> <p>* The supplied plug covers must remain in place over the unused interfaces during operation!</p>
<b>Conformal coating</b> <ul style="list-style-type: none"> <li>• Coatings for printed circuit board assemblies acc. to EN 61086</li> <li>• Protection against fouling acc. to EN 60664-3</li> <li>• Electronic equipment on rolling stock acc. to EN 50155</li> <li>• Military testing according to MIL-I-46058C, Amendment 7</li> <li>• Qualification and Performance of Electrical Insulating Compound for Printed Board Assemblies according to IPC-CC-830A</li> </ul>	<p>Yes; Class 2 for high reliability          Yes; Type 1 protection          Yes; Class PC2 protective coating acc. to EN 50155:2017          Yes; Discoloration of coating possible during service life          Yes; Conformal coating, Class A</p>
<b>Dimensions</b>	
<b>Width</b>	15 mm
<b>Height</b>	73 mm
<b>Depth</b>	58 mm
<b>Weights</b>	
<b>Weight, approx.</b>	30 g
<b>Other</b>	
<b>Note:</b>	for use in railway applications, also observe the product information "SIPLUS extreme RAIL" A5E37661960A, Online Support article 109736776

**SIPLUS RAIL**

SIPLUS ET 200SP RAIL

SIPLUS extreme RAIL I/O modules

**SIPLUS extreme RAIL communication > SIPLUS extreme RAIL CM 4x IO-Link****Selection and ordering data**

Version	Article No.
<p><b>SIPLUS extreme RAIL CM 4x IO-Link communication module</b></p> <p>Approved in accordance with EN 50155, EN 15121, EN 50124, EN 50125 and EN 45545 railway standards for use in rail traffic</p> <p>Serial communication module for connecting up to 4 IO-Link devices, time-based IO, BU type A0, color code CC04; for areas with extreme exposure to environmental substances (conformal coating); ambient temperature -40 ... +60 °C (+70 °C for 10 min.)</p>	<b>6AG2137-6BD00-1BA0</b>
<b>Suitable SIPLUS extreme RAIL BaseUnits, type A0</b>	
<p><b>SIPLUS ET 200SP BU15-P16+A0+2D TX RAIL</b></p> <p>Approved in accordance with EN 50155, EN 15121, EN 50124, EN 50125 and EN 45545 railway standards for use in rail traffic</p> <p>BU type A0; BaseUnit (light) with 16 process terminals to the module; for starting a new load group (max. 10 A); for areas with extreme exposure to environmental substances (conformal coating); ambient temperature -40 ... +70 °C (+85 °C for 10 min.)</p>	<b>6AG2193-6BP00-4DA0</b>
<p><b>SIPLUS ET 200SP BU15-P16+A0+2B TX RAIL</b></p> <p>Approved in accordance with EN 50155, EN 15121, EN 50124, EN 50125 and EN 45545 railway standards for use in rail traffic</p> <p>BU type A0; BaseUnit (dark) with 16 process terminals to the module; for continuing the load group; for areas with extreme exposure to environmental substances (conformal coating); ambient temperature -40 ... +70 °C (+85 °C for 10 min.)</p>	<b>6AG2193-6BP00-4BA0</b>
<p><b>SIPLUS ET 200SP BU15-P16+A10+2D TX RAIL</b></p> <p>Approved in accordance with EN 50155, EN 15121, EN 50124, EN 50125 and EN 45545 railway standards for use in rail traffic</p> <p>BU type A0; BaseUnit (light) with 16 process terminals (1...16) to the module and an additional 10 internally jumpered AUX terminals (1 A to 10 A); for starting a new load group (max. 10 A); for areas with extreme exposure to environmental substances (conformal coating); ambient temperature -40 ... +70 °C (+85 °C for 10 min.)</p>	<b>6AG2193-6BP20-4DA0</b>
<p><b>SIPLUS ET 200SP BU15-P16+A10+2B TX RAIL</b></p> <p>Approved in accordance with EN 50155, EN 15121, EN 50124, EN 50125 and EN 45545 railway standards for use in rail traffic</p> <p>BU type A0; BaseUnit (dark) with 16 process terminals (1...16) to the module and an additional 10 internally jumpered AUX terminals (1 A to 10 A); for continuing the load group; for areas with extreme exposure to environmental substances (conformal coating); ambient temperature -40 ... +70 °C (+85 °C for 10 min.)</p>	<b>6AG2193-6BP20-4BA0</b>
<b>Accessories</b>	
<p><b>SIPLUS Mounting Kit ET 200SP</b></p> <p>Mounting accessories for use with increased mechanical vibration and shock loads.</p>	<b>6AG1193-6AA00-0AA0</b>

## Overview



- For data exchange between an ET 200SP system and CAN 2.0A/B or CANopen Manager or Slave (according to CiA 301 & 302)
- CANopen features:
  - Node/lifeguarding
  - Heartbeat
  - SYNC (producer / consumer)
- Integrated in TIA via HSP, TIA Portal V15.1 or higher
- CAN connection with push-in terminals
- Integrated CAN terminating resistor
- Up to 60 CAN nodes
- 128 receiver and 128 transmitter PDOs
- Galvanic isolation between the two networks
- Diagnostic interrupts
- Optionally with function block SIMATIC ECC CHAdeMO: Realization of digital communication as basis for conductible DC charging of electric vehicles in line with the CHAdeMO standard

## Application

The SIPLUS ET 200SP communications module CM CAN is designed to connect an ET 200SP system with the CAN or CANopen fieldbus and enables data exchange.

This gives the option of communicating with up to 60 CAN nodes.

The configuration is carried out in TIA Portal (V15.1 or higher). A corresponding HSP is available to the user.

In CANopen mode, external device description files (.eds files) can be imported and exported.

## Design

- Design as ET 200SP module with a width of 15 mm.
- Use with type "A0" BaseUnits.
- Connection at CAN Bus via push-in terminals on the BaseUnit.
- Terminating resistors can be connected by wiring to the BaseUnit.
- LEDs for visualizing the operating conditions of the module and connected CAN network.
- Power supply via backplane bus. No external power supply required.
- Operation without fans or batteries. Maintenance-free.
- The maximum allowable wire length of the CAN network is 1 000 m (depending on data transfer rate, cable cross-section, number of participants).

## Mode of operation

The cyclic data exchange between the module and the corresponding CPU or interface module takes place via the backplane bus and by updating the I/O image.

Acyclic communication takes place via the "Read/write data record" services.

CAN components are represented as submodules in TIA Portal. Up to 126 CAN components can be integrated.

The communications module supports 128 receiver and 128 transmitter PDOs.

## Function

- Three different operating modes:
  - CANtransparent
  - CANopen Manager
  - CANopen Slave
- Easy engineering and extensive diagnostics options due to optimum TIA integration.
- Data transfer options:
  - After value change/acyclic
  - Cyclic (after parameter assignment at first to 240th "SYNC")
  - On request from the application (RTR)
- Data transfer rates on the CAN side from 10 to 1 000 kBd.
- Optionally with function block SIMATIC ECC CHAdeMO: Realization of digital communication between a DC charging station and an electric vehicle as basis for conductible DC charging of electric vehicles in line with the standard CHAdeMO 1.x...2.0 charging mode 4

## Configuration

An HSP is available for configuration and data mapping of the communications module (TIA Portal V15.1 or higher).

In CANopen Manager and CANtransparent operating modes (CAN 2.0A/B), configuration of the communications module takes place completely in TIA Portal. External software is not required for this purpose.

In CANopen Slave operating mode, the user configures the object directory (OD) of the SIMATIC ET 200SP CM CAN and provides it in the form of an .eds file export to the CANopen Manager.

The configuration data of the communications module is saved in the higher-level SIMATIC S7 controller and transferred during ramp-up. A corresponding function block needs to be called for this purpose.

TIA Portal and Siemens Automation Tool (SAT) are available as update mechanisms.

**SIPLUS RAIL**

SIPLUS ET 200SP RAIL

SIPLUS extreme RAIL I/O modules

**SIPLUS extreme RAIL communication > SIPLUS ET 200SP CM CAN RAIL****Technical specifications**

Article number	<b>6AG2137-6EA00-2BA0</b> SIPLUS ET 200SP CM CAN RAIL
<b>General information</b>	
<b>Product type designation</b>	CM 1x CAN ST
<b>Product function</b>	
• I&M data	Yes; I&M0 to I&M3
• Module swapping during operation (hot swapping)	Yes
• Isochronous mode	No
<b>Supply voltage</b>	
<b>Rated value (DC)</b>	24 V
<b>Reverse polarity protection</b>	Yes
<b>1. Interface</b>	
<b>Interface type</b>	CAN according to CiA 303-1
<b>Isolated</b>	Yes; 500 V AC or 707 V DC
<b>Interface types</b>	
• Number of ports	1
• Design of the connection	Push-in terminal
<b>CAN</b>	
• CAN operating modes	CAN Standard CAN 2.0A/B; CANopen Manager / Slave acc. to CiA
• Specification acc. to CiA	CiA 301 & CiA 302
• Transmission rate, min.	10 kbit/s
• Transmission rate, max.	1 000 kbit/s
• Number of slaves, max.	60
• Number of SDOs in parallel	16; Parallel
• Number of PDOs	128; Send / receive
<b>Services</b>	
• Node/life-guarding	Yes
• Heartbeat	Yes
• SYNC	Yes
<b>Interrupts/diagnostics/status information</b>	
<b>Alarms</b>	Yes
<b>Diagnostics function</b>	Yes
<b>Diagnostics indication LED</b>	
• RUN LED	Yes
• ERROR LED	Yes
• MAINT LED	No
• Monitoring of the supply voltage (PWR-LED)	Yes; green PWR LED
<b>Potential separation</b>	
<b>between backplane bus and interface</b>	Yes
<b>Standards, approvals, certificates</b>	
<b>CE mark</b>	Yes
<b>RoHS conformity</b>	Yes
<b>Railway application</b>	
• EN 50121-3-2	Yes; EMC for rail vehicles
• EN 50121-4	Yes; EMC for signal and telecommunications systems
• EN 50124-1	Yes; Railway applications - overvoltage category OV2; pollution degree PD2; rated surge voltage UNi = 0.5 kV; UNm = 24 V DC
• EN 50125-1	Yes; Rail vehicles - see ambient conditions
• EN 50125-2	Yes; Stationary electrical equipment - see ambient conditions
• EN 50125-3	Yes; Signal and telecommunications systems - see ambient conditions; vibrations and shocks: Application point outside of tracks (1 m to 3 m away from track)
• EN 50155	Yes; Rail vehicles - temperature class OT2, ST1/ST2, horizontal mounting position
• EN 61373	Yes; Rail vehicles - vibrations and shocks: Category 1 Class A/B
• Fire protection acc. to EN 45545-2	Yes; For proof of conformity, see Service & Support
<b>Ambient conditions</b>	
<b>Ambient temperature during operation</b>	
• horizontal installation, min.	-40 °C; = Tmin (incl. condensation/frost)
• horizontal installation, max.	60 °C; = Tmax; +70 °C for 10 min (OT1, ST1/ST2 acc. to EN 50155); +70 °C continuously with configured slots to the left and right of the module (OT3, ST0 acc. to EN 50155)
• vertical installation, min.	-40 °C; = Tmin
• vertical installation, max.	50 °C; = Tmax
<b>Altitude during operation relating to sea level</b>	
• Installation altitude above sea level, max.	2 000 m
• Ambient air temperature-barometric pressure-altitude	Tmin ... Tmax at 1 140 hPa ... 795 hPa (-1 000 m ... +2 000 m)
<b>Relative humidity</b>	
• With condensation, tested in accordance with IEC 60068-2-38, max.	100 %; RH incl. condensation / frost (no commissioning in bedewed state), horizontal installation



**SIPLUS extreme RAIL communication > SIPLUS ET 200SP CM CAN RAIL**

Article number	<b>6AG2137-6EA00-2BA0</b> SIPLUS ET 200SP CM CAN RAIL
<b>Resistance</b>	
<ul style="list-style-type: none"> <li>• Coolants and lubricants               <ul style="list-style-type: none"> <li>- Resistant to commercially available coolants and lubricants</li> </ul> </li> <li>• Use in stationary industrial systems               <ul style="list-style-type: none"> <li>- to biologically active substances according to EN 60721-3-3</li> <li>- to chemically active substances according to EN 60721-3-3</li> <li>- to mechanically active substances according to EN 60721-3-3</li> <li>- Against mechanical environmental conditions acc. to EN 60721-3-3</li> </ul> </li> <li>• Use on land craft, rail vehicles and special-purpose vehicles               <ul style="list-style-type: none"> <li>- to biologically active substances according to EN 60721-3-5</li> <li>- to chemically active substances according to EN 60721-3-5</li> <li>- to mechanically active substances according to EN 60721-3-5</li> </ul> </li> <li>- Against mechanical environmental conditions acc. to EN 60721-3-5</li> <li>- against mechanical environmental conditions in agriculture acc. to ISO 15003</li> <li>• Usage in industrial process technology               <ul style="list-style-type: none"> <li>- Against chemically active substances acc. to EN 60654-4</li> <li>- Environmental conditions for process, measuring and control systems acc. to ANSI/ISA-71.04</li> </ul> </li> <li>• Remark               <ul style="list-style-type: none"> <li>- Note regarding classification of environmental conditions acc. to EN 60721, EN 60654-4 and ANSI/ISA-71.04</li> </ul> </li> </ul>	<p>Yes; Incl. diesel and oil droplets in the air</p> <p>Yes; Class 3B2 mold, fungus and dry rot spores (with the exception of fauna); Class 3B3 on request</p> <p>Yes; Class 3C4 (RH &lt; 75 %) incl. salt spray acc. to EN 60068-2-52 (severity degree 3); * Yes; Class 3S4 incl. sand, dust, *</p> <p>Yes; Class 3M8 using the SIPLUS Mounting Kit ET 200SP (6AG1193-6AA00-0AA0)</p> <p>Yes; Class 5B2 mold, fungus and dry rot spores (with the exception of fauna); Class 5B3 on request</p> <p>Yes; Class 5C3 (RH &lt; 75 %) incl. salt spray acc. to EN 60068-2-52 (severity degree 3); * Yes; Class 5S3 incl. sand, dust, *</p> <p>Yes; Class 5M2 using the SIPLUS Mounting Kit ET 200SP (6AG1193-6AA00-0AA0)</p> <p>Yes; level 1 (Location LE) using the SIPLUS Mounting Kit ET 200SP (6AG1193-6AA00-0AA0)</p> <p>Yes; Class 3 (excluding trichlorethylene)</p> <p>Yes; Level GX group A/B (excluding trichlorethylene; harmful gas concentrations up to the limits of EN 60721-3-3 class 3C4 permissible); level LC3 (salt spray) and level LB3 (oil)</p> <p>* The supplied plug covers must remain in place over the unused interfaces during operation!</p>
<b>Conformal coating</b>	
<ul style="list-style-type: none"> <li>• Coatings for printed circuit board assemblies acc. to EN 61086</li> <li>• Protection against fouling acc. to EN 60664-3</li> <li>• Electronic equipment on rolling stock acc. to EN 50155</li> <li>• Military testing according to MIL-I-46058C, Amendment 7</li> <li>• Qualification and Performance of Electrical Insulating Compound for Printed Board Assemblies according to IPC-CC-830A</li> </ul>	<p>Yes; Class 2 for high reliability</p> <p>Yes; Type 1 protection</p> <p>Yes; Class PC2 protective coating acc. to EN 50155:2017</p> <p>Yes; Discoloration of coating possible during service life</p> <p>Yes; Conformal coating, Class A</p>
<b>Decentralized operation</b>	
<b>to SIMATIC S7-300</b>	No
<b>to SIMATIC S7-400</b>	No
<b>to SIMATIC S7-1200</b>	Yes
<b>to SIMATIC S7-1500</b>	Yes
<b>Dimensions</b>	
<b>Width</b>	15 mm
<b>Height</b>	73 mm
<b>Depth</b>	58 mm
<b>Weights</b>	
<b>Weight, approx.</b>	32 g
<b>Other</b>	
<b>Note:</b>	for use in railway applications, also observe the product information "SIPLUS extreme RAIL" A5E37661960A, Online Support article 109736776

**SIPLUS RAIL**

SIPLUS ET 200SP RAIL

SIPLUS extreme RAIL I/O modules

**SIPLUS extreme RAIL communication > SIPLUS ET 200SP CM CAN RAIL****Selection and ordering data**

Version	Article No.
<b>SIPLUS ET 200SP CM CAN RAIL communications module</b> Approved in accordance with EN 50155, EN 15121, EN 50124, EN 50125 and EN 45545 railway standards for use in rail traffic To connect ET 200SP with CAN or CANopen networks CAN 2.0A/B, CANopen Manager according to CiA 301/302, CANopen Slave according to CiA 301/302 With conformal coating, ambient temperature -40...+55°C (70°C for 10 min)	<b>6AG2137-6EA00-2BA0</b>
<b>Suitable SIPLUS extreme BaseUnits, type A0</b>	
<b>BU15-P16+A10+2D</b> (Extended temperature range and exposure to environmental substances) BU type A0; BaseUnit (light) with 16 push-in terminals (1...16) to the module and an additional 10 internally jumpered AUX terminals (1 A to 10 A); for starting a new load group (max. 10 A)	<b>6AG1193-6BP20-7DA0</b>
<b>BU15-P16+A0+2D</b> (Extended temperature range and exposure to environmental substances) BU type A0; BaseUnit (light) with 16 push-in terminals to the module; for starting a new load group (max. 10 A)	<b>6AG1193-6BP00-7DA0</b>
<b>BU15-P16+A10+2B</b> (Extended temperature range and exposure to environmental substances) BU type A0; BaseUnit (dark) with 16 push-in terminals (1...16) to the module and an additional 10 internally jumpered AUX terminals (1 A to 10 A); for continuing the load group	<b>6AG1193-6BP20-7BA0</b>
<b>BU15-P16+A0+2B</b> (Extended temperature range and exposure to environmental substances) BU type A0; BaseUnit (dark) with 16 push-in terminals to the module; for continuing the load group	<b>6AG1193-6BP00-7BA0</b>
<b>Accessories</b>	
<b>SIPLUS Mounting Kit ET 200SP</b> Mounting accessories for use with increased mechanical vibration and shock loads.	<b>6AG1193-6AA00-0AA0</b>
<b>Other accessories</b>	See SIMATIC ET 200SP CM CAN gateway

## Overview



ISO	TCP/UDP	PN	MRP	IT	IP-R	PG/OP	S7
	●			●		●	●

G\_IK10\_XX\_50790

The SIPLUS ET 200SP CP 1542SP-1 IRC TX RAIL communication processor connects the SIPLUS extreme RAIL ET 200SP Distributed Controller with Industrial Ethernet networks.

The module can also be used for integrating the SIPLUS extreme RAIL ET 200SP Distributed Controller into an IPv6-based network. All functions are configured using STEP 7 Professional V14 (TIA Portal) or higher.

The SIPLUS ET 200SP CP 1542SP-1 IRC TX RAIL supports the following communication services:

- PG/OP communication
- S7 communication
- Open communication (Open User Communication)
- IT communication
  - Sending emails via SMTP for authentication on an email server (also with IPv6)
  - SNMPv1 for transfer of network analysis information
- Integration of the ET 200SP Distributed Controller into IPv6-based networks

The SIPLUS ET 200SP CP 1542SP-1 IRC TX RAIL is approved in accordance with EN 50155, EN 15121, EN 50124, EN 50125 and EN 45545 railway standards for use in rail traffic.

## Benefits

**get** Designed for Industry

- Network separation for setting up identical machines with the same IP addresses
- Optimum support of maintenance due to
  - Simple diagnostics via the central web server
  - Monitoring with IT network management tools (SNMP)
  - Module replacement without a PG
- Securing the system against unauthorized access with
  - Central access protection for any S7 station
  - Access to the central web server
- Simple alerting by email
- Protection of investment thanks to simple integration of the SIPLUS extreme RAIL ET 200SP Distributed Controller in existing networks with SIMATIC S7-300 / S7-400 via Industrial Ethernet using the SIPLUS ET 200SP CP 1542SP-1 IRC TX RAIL
- Accessibility of the SIPLUS extreme RAIL ET 200SP Distributed Controller from an IPv6-based infrastructure

## Application

The SIPLUS ET 200SP CP 1542SP-1 IRC TX RAIL is used for connecting the SIPLUS extreme RAIL ET 200SP Distributed Controller to Industrial Ethernet networks. With its own processor, it relieves the CPU of communication tasks.

The SIPLUS ET 200SP CP 1542SP-1 IRC TX RAIL offers communication possibilities with:

- PGs/PCs
- Master computers
- Operator control and monitoring systems
- SIMATIC S7 systems

The SIPLUS ET 200SP CP 1542SP-1 IRC TX RAIL is used in the SIPLUS extreme RAIL ET 200SP system to operate lower-level networks separately, or to implement a separation from the higher-level network.

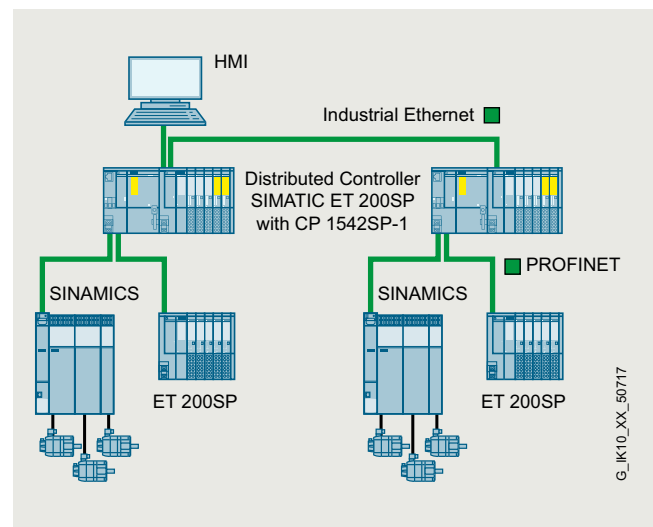

Application: automation network and lower-level networks are to be operated separately

**SIPLUS RAIL**

SIPLUS ET 200SP RAIL

SIPLUS extreme RAIL I/O modules

**SIPLUS extreme RAIL communication > SIPLUS extreme RAIL CP 1542SP-1 IRC****Design**

The SIPLUS ET 200SP CP 1542SP-1 IRC TX RAIL exhibits all the advantages of the ET 200SP design:

- Compact, space-saving design:
  - Module powered via separate power supply
  - Three LEDs for displaying the operating state and communication state of the module as well as LEDs on the BusAdapter.
  - Can be operated simultaneously with BA Send module and CM DP module.
- Simple installation:
 

The SIPLUS ET 200SP CP 1542SP-1 IRC TX RAIL is mounted on the ET 200SP DIN rail and is connected to the adjacent modules via the backplane bus.

  - The BusAdapter (not included in scope of delivery) makes various connection methods possible
  - For standard ambient conditions, BA 2xRJ45 for connection via RJ45 connector
  - For mechanical loading during operation and/or increased EMC requirements
    - BA 2xFC, BA 2xSCRJ, BA SCRJ/RJ45, BA SCRJ/FC
  - The SIPLUS ET 200SP CP 1542SP-1 IRC TX RAIL can be operated without a fan; no back-up battery is necessary
  - The module can be replaced without the need for a programming device
- The CP can be equipped with an equipment labeling plate.
- Optional labeling using light gray or yellow labeling strips.
 

Choice of 2 materials:

  - Film and roll with 500 strips, for thermal transfer roll printer
  - Paper (280 g/m<sup>2</sup>), DIN A4 sheets with 100 strips each, for laser printer

Scope of delivery:

SIPLUS ET 200SP CP 1542SP-1 IRC TX RAIL, 24 V DC connector (BusAdapter must be ordered separately)

**Function**

- 2-port interface via BusAdapter with an RJ45 connection with 10/100 Mbps full/half duplex with autosensing functionality
- The SIPLUS ET 200SP CP 1542SP-1 IRC TX RAIL communications processor connects the SIPLUS extreme RAIL ET 200SP Distributed Controllers to additional Industrial Ethernet networks
- Communications services:
  - Open communication (TCP/IP, UDP, ISO-on-TCP):
    - Multicast with UDP
  - PG/OP communication: Inter-network with S7 routing
  - S7 communication (client, server)
  - S7 routing
  - IT communication:
    - HTTP communication allows access to the web server of the CPU.
  - The e-mail client function enables sending of emails direct from the user program.
    - IP address assignment via DHCP for IPv4 or via direct entry in the engineering software and via the T\_CONFIG function block
    - STEP 7 Professional V14 (TIA Portal) or higher
- Diagnostics and network management:
  - Extensive diagnostic functions of all modules in the ET 200SP system
  - Integration in network management systems through the support of SNMP V1
- Configuration of all functions with STEP 7 Professional V14 (TIA Portal) or higher
- Module replacement without programming device: All information can be stored on the memory card of the CPU.

6

**Technical specifications**

Article number	<b>6AG2542-6VX00-4XE0</b>
product type designation	SIPLUS ET 200SP CP 1542SP-1 IRC TX RAIL
<b>transfer rate</b>	
<b>at the 1st interface</b>	10 ... 100 Mbit/s
<b>interfaces</b>	
<b>number of interfaces according to Industrial Ethernet</b>	1
<b>number of electrical connections</b>	
• at the 1st interface according to Industrial Ethernet	2
<b>type of electrical connection</b>	
• at the 1st interface according to Industrial Ethernet	via ET 200SP bus adapter (RJ45, FC, SCRJ), integrated switch
<b>supply voltage, current consumption, power loss</b>	
<b>type of voltage of the supply voltage</b>	DC
<b>supply voltage</b>	24 V
<b>supply voltage</b>	19.2 ... 28.8 V
<b>power loss [W]</b>	6 W
<b>ambient conditions</b>	
<b>ambient temperature</b>	
• for vertical installation during operation	-40 ... +50 °C
• for horizontally arranged busbars during operation	-40 ... +70 °C
• during storage	-40 ... +70 °C
• during transport	-40 ... +70 °C
• note	+85 °C for 10 min (OT4, ST1/ST2 according to EN 50155)
<b>installation altitude at height above sea level maximum</b>	2 000 m
<b>ambient condition relating to ambient temperature - air pressure - installation altitude</b>	Tmin ... Tmax at 1 140 hPa ... 795 hPa (-1 000 m ... +2 000 m)
<b>relative humidity</b>	
• with condensation according to IEC 60068-2-38 maximum	100 %; RH including condensation/frost (no commissioning when condensation is present), horizontal installation
<b>chemical resistance to commercially available cooling lubricants</b>	Yes; incl. airborne diesel and oil droplets

**SIPLUS extreme RAIL communication > SIPLUS extreme RAIL CP 1542SP-1 IRC**

Article number	<b>6AG2542-6VX00-4XE0</b>
product type designation	SIPLUS ET 200SP CP 1542SP-1 IRC TX RAIL
<b>resistance to biologically active substances</b> • conformity according to EN 60721-3-3 • conformity according to EN 60721-3-5	Yes; Class 3B2 mold and fungal spores (excluding fauna), Class 3B3 on request Yes; Class 5B2 mold and fungal spores (excluding fauna), Class 5B3 on request
<b>resistance to chemically active substances</b> • conformity according to EN 60721-3-3  • conformity according to EN 60721-3-5	Yes; Class 3C4 (RH < 75 %) incl. salt spray in accordance with EN 60068-2-52 (Severity 3). The supplied plug covers must remain in place on the unused interfaces during operation. Yes; Class 5C3 (RH < 75%) including salt spray acc. to EN 60068-2-52 (Severity level 3). The supplied plug covers must remain in place over the unused interfaces during operation!
<b>resistance to mechanically active substances</b> • conformity according to EN 60721-3-3  • conformity according to EN 60721-3-5	Yes; Class 3S4 incl. sand, dust. The supplied plug covers must remain in place over the unused interfaces during operation. Yes; Class 5S3 incl. sand, dust. The supplied plug covers must remain in place over the unused interfaces during operation.
<b>coating for equipped printed circuit board according to EN 61086</b>	Yes; Class 2 for high availability
<b>type of coating protection against pollution according to EN 60664-3</b>	Yes; Protection of the type 1
<b>type of coating for electronic devices in railway applications according to EN 50155</b>	Yes; Protective coating of the Class PC2 according to EN 50155:2017
<b>type of test of the coating according to MIL-I-46058C</b>	Yes; Coating discoloration during service life possible
<b>product conformity of the coating Qualification and Performance of Electrical Insulating Compound for Printed Board Assemblies according to IPC-CC-830A</b>	Yes; Conformal coating, class A
<b>protection class IP</b>	IP20
<b>design, dimensions and weights</b>	
<b>width</b>	60 mm
<b>height</b>	117 mm
<b>depth</b>	74 mm
<b>net weight</b>	0.18 kg
<b>fastening method</b> • 35 mm top hat DIN rail mounting	Yes
<b>product features, product functions, product components general</b>	
<b>number of units</b> • per CPU maximum • note	2 2 CPUs can be plugged in per CPU, simultaneous operation with BA Send and CM DP is possible
<b>performance data open communication</b>	
<b>number of possible connections for open communication</b> • by means of T blocks maximum	32
<b>data volume</b> • as user data per ISO on TCP connection for open communication by means of T blocks maximum	65 536 byte
<b>performance data S7 communication</b>	
<b>number of possible connections for S7 communication</b> • maximum • with OP connections maximum	16 16
<b>performance data multi-protocol mode</b>	
<b>number of active connections with multi-protocol mode</b>	32
<b>performance data IT functions</b>	
<b>number of possible connections</b> • as email client maximum	1
<b>performance data telecontrol</b>	
<b>suitability for use</b> • node station • substation • TIM control center	No Yes No
<b>control center connection</b>  • by means of a permanent connection • by means of demand-oriented connection • note	IEC 60870-5, DNP3, (Modbus TCP by block solutions of the CPU) capable control stations, connection to Telecontrol Server Basic and ST7 capable control station supported supported Connection to SCADA system by IEC 60870-5 104, DNP3, Telecontrol Server Basic and ST7 capable control center
<b>protocol is supported</b> • DNP3 • IEC 60870-5 • SINAUT ST7 protocol	Yes Yes Yes
<b>product function data buffering if connection is aborted</b>	Yes; TCSB 64000 events, SINAUT ST7 32000 telegrams, DNP3 100000 events, IEC 60870-5 100000 events
<b>number of data points per station maximum</b>	500

**SIPLUS RAIL**

SIPLUS ET 200SP RAIL

SIPLUS extreme RAIL I/O modules

**SIPLUS extreme RAIL communication > SIPLUS extreme RAIL CP 1542SP-1 IRC**

Article number	<b>6AG2542-6VX00-4XE0</b>
product type designation	SIPLUS ET 200SP CP 1542SP-1 IRC TX RAIL
<b>number of stations for direct communication with Telecontrol Server Basic</b>	
• in send direction maximum	3
• in receive direction maximum	15
<b>product functions management, configuration, engineering</b>	
<b>product function MIB support</b>	Yes
<b>protocol is supported</b>	
• SNMP v1	Yes
• SNMP v3	No
• DCP	Yes
• LLDP	Yes
<b>configuration software</b>	
• required	STEP 7 Professional V14 (TIA Portal) or higher
<b>identification &amp; maintenance function</b>	
• I&MO - device-specific information	Yes
• I&M1 – higher level designation/location designation	Yes
<b>product functions diagnostics</b>	
<b>product function web-based diagnostics</b>	Yes; via ET 200SP CPU
<b>product functions security</b>	
<b>product function with VPN connection</b>	SINEMA RC
<b>product function</b>	
• blocking of communication via physical ports	Yes
<b>product functions time</b>	
<b>product function SICLOCK support</b>	Yes
<b>product function pass on time synchronization</b>	Yes
<b>protocol is supported</b>	
• NTP	Yes
• NTP (secure)	No
<b>time synchronization</b>	
• from NTP-server	Yes
• from control center	Yes
<b>standards, specifications, approvals</b>	
<b>certificate of suitability</b>	
• fire protection in accordance with EN 45545-2	Yes; Railway vehicles - for proof, see Service & Support
<b>railway application</b>	
<b>certificate of suitability railway application in accordance with EN 50121-3-2</b>	Yes; EMC for railway vehicles
<b>certificate of suitability railway application in accordance with EN 50121-4</b>	Yes; EMC for signal and telecommunication equipment
<b>certificate of suitability railway application in accordance with EN 50124-1</b>	Yes; Railway applications - Overvoltage category OV2 pollution degree PD2 rated impulse voltage UNi = 0.5 kVUNm = DC 24
<b>certificate of suitability railway application in accordance with EN 50125-1</b>	Yes; Railway vehicles - See ambient conditions
<b>certificate of suitability railway application in accordance with EN 50125-2</b>	Yes; Fixed-electrical installations - see ambient conditions
<b>certificate of suitability railway application in accordance with EN 50125-3</b>	Yes; Signal and telecommunications equipment - see Ambient conditions vibrations and shocks: Application point outside the rails (distance 1 m to 3 m from rail)
<b>certificate of suitability railway application in accordance with EN 50155</b>	Yes; Railway vehicles - temperature class OT4, ST1/ST2, horizontal mounting position
<b>certificate of suitability railway application in accordance with EN 61373</b>	Yes; Railway vehicles - Vibrations and shocks Category 1 Class A/B

### Selection and ordering data

Version	Article No.
<p><b>SIPLUS ET 200SP CP 1542SP-1 IRC TX RAIL communications processor</b> Approved in accordance with EN 50155, EN 15121, EN 50124, EN 50125 and EN 45545 railway standards for use in rail traffic For connection of SIMATIC S7 ET 200SP to Industrial Ethernet, open IE communication (TCP/IP, ISO-ON-TCP, UDP), PG/OP, S7 routing, IP broadcast/multicast, SNMPV1, DHCP, email, IPv4/IPv6, time synchronization via NTP, access to web server of CPU, BusAdapter required; For areas with extreme medial exposure (conformal coating); Ambient temperature -40 ... +70 °C (+85 °C for 10 min.)</p>	<b>6AG2542-6VX00-4XE0</b>
<p><b>SIPLUS extreme RAIL BusAdapter</b></p> <p><b>SIPLUS ET 200SP BA 2XRJ45 TX RAIL</b> For PROFINET interface modules in Standard function class or above; max. cable length 50 m; For areas with extreme exposure to environmental substances (conformal coating) Ambient temperature -40 ... +70 °C (+85 °C for 10 min.)</p>	<b>6AG2193-6AR00-4AA0</b>
<p><b>SIPLUS ET 200SP BA 2XFC TX RAIL</b> For PROFINET interface modules in Standard function class or above; for increased vibration and EMC load rating; max. cable length 50 m; for areas with extreme exposure to environmental substances (conformal coating); ambient temperature -40 ... +70 °C (+85 °C for 10 min.)</p>	<b>6AG2193-6AF00-4AA0</b>
<p><b>Accessories</b></p> <p><b>SIPLUS Mounting Kit ET 200SP</b> Mounting accessories for use with increased mechanical vibration and shock loads.</p>	<b>6AG1193-6AA00-0AA0</b>

### More information

You will find further information on ET 200SP at:  
<http://www.siemens.com/simatic-et200sp>

The TIA Selection Tool is available to assist you in selecting ET 200SP equipment and configuring modular variants:  
<http://www.siemens.com/tst>

You will find more information on the topic of Industrial Security on the Internet at:  
An ET 200SP Distributed Controller firmware version  $\geq 2.0$  is required for operation of the CP 1542SP-1.



**SIPLUS RAIL**

SIPLUS ET 200SP RAIL

SIPLUS extreme RAIL I/O modules

**SIPLUS extreme RAIL communication > SIPLUS extreme RAIL CP 1543SP-1 ISEC****Overview**

ISO	TCP/UDP	PN	MRP	IT	IP-R	PG/OP	S7
	●			●		●	●

G. IK10...XX\_50790

The SIPLUS ET 200SP CP 1543SP-1 ISEC TX RAIL communications processor connects the ET 200SP Distributed Controller with Industrial Ethernet networks. By combining a variety of security features such as an SPI (Stateful Packet Inspection) firewall, VPN and data encryption protocols (e.g. SNMPv3), the communications processor protects individual ET 200SP Distributed Controllers or even entire automation cells against unauthorized access.

The module can also be used for integrating the ET 200SP Distributed Controller into an IPv6-based network. All functions can be configured with STEP 7 Professional, V14 (TIA Portal) and higher.

The SIPLUS ET 200SP CP 1543SP-1 ISEC TX RAIL supports the following communication services:

- PG/OP communication
- S7 communication
- Open communication (Open User Communication)
- IT communication
  - Sending emails via SMTP or ESMTP with "SMTP-Auth" for authentication on an email server (also with IPv6)
- Support of SINEMA Remote Connect with autoconfiguration
- Security Integrated
  - Stateful Packet Inspection Firewall
  - Secure communication via VPN (IPsec)
- Protocols for secure communication
  - Secure access to the web server of the CPU via the HTTPS protocol
  - Secure transfer of the time of day (NTP)
  - SNMPv3 for tap-proof transfer of network analysis information
- Integration of the ET 200SP Distributed Controller into IPv6-based networks

The SIPLUS ET 200SP CP 1543SP-1 ISEC TX RAIL is approved in accordance with EN 50155, EN 15121, EN 50124, EN 50125 and EN 45545 railway standards for use in rail traffic.

**Benefits**

**get** Designed for Industry

- Prevention of data loss, production disruptions or machine damage by protecting against unauthorized access to the SIPLUS extreme Rail ET 200SP Distributed Controller and lower-level networks
- Network segmentation and network separation for setting up identical machines with the same IP addresses
- Connection to SINEMA RC:
  - With the optional SINEMA Remote Connect, you can benefit from the user-friendly, secure SINEMA Remote Connect management platform for remote maintenance.
- Optimum support of maintenance due to
  - Simple diagnostics via the central web server
  - Monitoring with IT network management tools (SNMP)
  - Module replacement without a PG
- Securing the system against unauthorized access with
  - Central access protection for any S7 station
  - Secure access to the central web server
- Simple alerting by email
- Protection of investment thanks to simple integration of the SIPLUS extreme RAIL ET 200SP Distributed Controller in existing networks with SIMATIC S7-300 / S7-400 / via Industrial Ethernet using the SIPLUS ET 200SP CP 1543SP-1 ISEC TX RAIL
- Accessibility of the SIPLUS extreme RAIL ET 200SP Distributed Controller from an IPv6-based infrastructure

**Application**

The SIPLUS ET 200SP CP 1543P-1 ISEC TX RAIL is used for connecting the SIPLUS extreme RAIL ET 200SP Distributed Controller to Industrial Ethernet networks. With its own processor, it relieves the CPU of communication tasks.

The SIPLUS ET 200SP CP 1543P-1 ISEC TX RAIL offers communication possibilities with:

- PGs/PCs
- Master computers
- Operator control and monitoring systems
- SIMATIC S7 systems

It can be used to protect the SIPLUS extreme RAIL ET 200SP Distributed Controller automation system from unauthorized access from an Ethernet network. The SIPLUS ET 200SP CP 1543P-1 ISEC TX RAIL allows secure remote access via a LAN and enables the data transfer between devices or network segments to be protected from data manipulation/espionage.

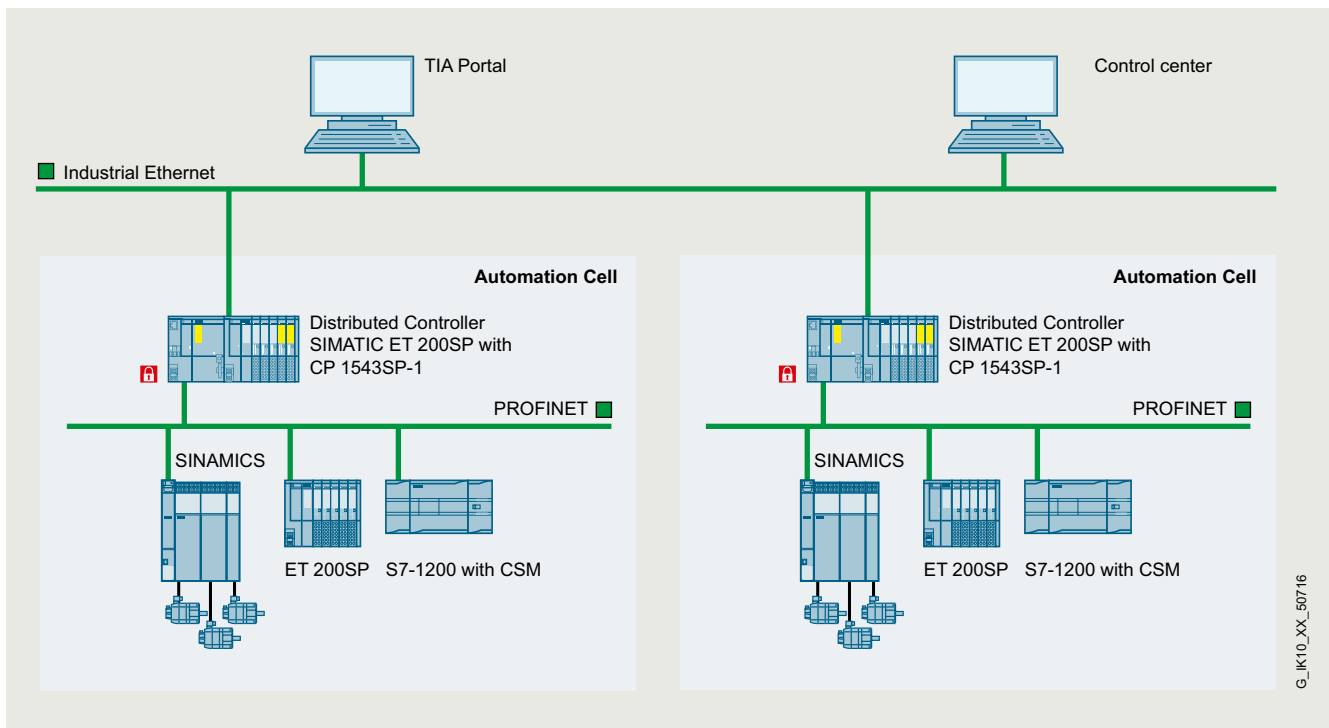

G\_IK10\_XX\_50716

Connection to higher-level network and network separation of automation cells

## Design

The SIPLUS ET 200SP CP 1543P-1 ISEC TX RAIL exhibits all the advantages of the ET 200SP design:

- Compact, space-saving design:
  - Module powered via separate power supply
  - Three LEDs for displaying the operating state and communication state of the module as well as LEDs on the BusAdapter.
  - Simultaneously operable with BA Send module and CM DP module.
- Simple installation:
  - The SIPLUS ET 200SP CP 1543P-1 ISEC TX RAIL is mounted on the ET 200SP DIN rail and is connected to the adjacent modules via the backplane bus.
  - The BusAdapter (not included in scope of delivery) makes various connection methods possible;
  - For standard ambient conditions, BA 2xRJ45 for connection via RJ45 connector
  - For mechanical loading during operation and/or increased EMC requirements  
BA 2xFC, BA 2xSCRJ, BA SCRJ/RJ45, BA SCRJ/FC
  - The SIPLUS ET 200SP CP 1543P-1 ISEC TX RAIL can be operated without a fan; no back-up battery is necessary
  - The module can be replaced without the need for a programming device
- The CP can be equipped with an equipment labeling plate.
- Optional labeling using light gray or yellow labeling strips. There is a choice of two materials:
  - Film and roll with 500 strips, for thermal transfer roll printer
  - Paper (280 g/m<sup>2</sup>), DIN A4 sheets with 100 strips each, for laser printer

Scope of delivery:

SIPLUS ET 200SP CP 1543P-1 ISEC TX RAIL, 24 V DC connector (BusAdapter must be ordered separately)

## Function

- 2-port interface via BusAdapter with an RJ45 connection with 10/100 Mbps full/half duplex with autosensing functionality
- The SIPLUS ET 200SP CP 1543P-1 ISEC TX RAIL communication processor connects the SIPLUS extreme RAIL ET 200SP Distributed Controller to additional Industrial Ethernet networks
- Communications services:
  - Open communication (TCP/IP, UDP, ISO-on-TCP):  
Multicast with UDP
  - PG/OP communication: Inter-network with S7 routing
  - S7 communication (client, server)
  - S7 routing
  - IT communication:  
HTTP communication allows access to the web server of the CPU. With the CP 1543SP-1, HTTPS communication is also possible.  
The email client function allows e-mails to be sent directly from the user program.  
IP address assignment via DHCP for IPv4 or via direct entry in the engineering software and via the T\_CONFIG function block  
STEP 7 Professional V14 (TIA Portal) or higher
- Support of SINEMA Remote Connect with autoconfiguration
- Diagnostics and network management:
  - Extensive diagnostic functions of all modules in the ET 200SP system
  - Integration in network management systems due to support of SNMP v1/v3
- Security mechanisms:
  - Access protection with firewall for filtering connections on the basis of their IP and MAC addresses
  - Secure communication via VPN (IPsec)
  - Encrypted HTML pages using SSL (HTTPS)
  - Secure transfer of the time of day (NTPS)
- Configuration of all functions with STEP 7 Professional V14 (TIA Portal) or higher
- Module replacement without programming device: All information can be stored on the memory card of the CPU.

**SIPLUS RAIL**

SIPLUS ET 200SP RAIL

SIPLUS extreme RAIL I/O modules

**SIPLUS extreme RAIL communication > SIPLUS extreme RAIL CP 1543SP-1 ISEC****Technical specifications**

Article number	<b>6AG2543-6WX00-4XE0</b>
product type designation	SIPLUS ET 200SP CP 1543SP-1 ISEC TX RAIL
<b>transfer rate</b>	
<b>transfer rate</b>	
• at the 1st interface	10 ... 100 Mbit/s
<b>interfaces</b>	
<b>number of interfaces according to Industrial Ethernet</b>	1
<b>number of electrical connections</b>	
• at the 1st interface according to Industrial Ethernet	2
<b>type of electrical connection</b>	
• at the 1st interface according to Industrial Ethernet	via ET 200SP bus adapter (RJ45, FC, SCRJ), integrated switch
<b>supply voltage, current consumption, power loss</b>	
<b>type of voltage of the supply voltage</b>	DC
<b>supply voltage</b>	24 V
<b>supply voltage</b>	19.2 ... 28.8 V
<b>power loss [W]</b>	6 W
<b>ambient conditions</b>	
<b>ambient temperature</b>	
• for vertical installation during operation	-40 ... +50 °C
• for horizontally arranged busbars during operation	-40 ... +70 °C
• during storage	-40 ... +70 °C
• during transport	-40 ... +70 °C
• note	+85 °C for 10 min (OT4, ST1/ST2 according to EN 50155)
<b>installation altitude at height above sea level maximum</b>	2 000 m
<b>ambient condition relating to ambient temperature - air pressure - installation altitude</b>	Tmin ... Tmax at 1 140 hPa ... 795 hPa (-1 000 m ... +2 000 m)
<b>relative humidity</b>	
• with condensation according to IEC 60068-2-38 maximum	100 %; RH including condensation/frost (no commissioning when condensation is present), horizontal installation
<b>chemical resistance to commercially available cooling lubricants</b>	Yes; incl. airborne diesel and oil droplets
<b>resistance to biologically active substances</b>	
• conformity according to EN 60721-3-3	Yes; Class 3B2 mold and fungal spores (excluding fauna), Class 3B3 on request
• conformity according to EN 60721-3-5	Yes; Class 5B2 mold and fungal spores (excluding fauna), Class 5B3 on request
<b>resistance to chemically active substances</b>	
• conformity according to EN 60721-3-3	Yes; Class 3C4 (RH < 75 %) incl. salt spray in accordance with EN 60068-2-52 (Severity 3). The supplied plug covers must remain in place on the unused interfaces during operation.
• conformity according to EN 60721-3-5	Yes; Class 5C3 (RH < 75%) including salt spray acc. to EN 60068-2-52 (Severity level 3). The supplied plug covers must remain in place over the unused interfaces during operation!
<b>resistance to mechanically active substances</b>	
• conformity according to EN 60721-3-3	Yes; Class 3S4 incl. sand, dust. The supplied plug covers must remain in place over the unused interfaces during operation.
• conformity according to EN 60721-3-5	Yes; Class 5S3 incl. sand, dust. The supplied plug covers must remain in place over the unused interfaces during operation.
<b>coating for equipped printed circuit board according to EN 61086</b>	Yes; Class 2 for high availability
<b>type of coating protection against pollution according to EN 60664-3</b>	Yes; Protection of the type 1
<b>type of coating for electronic devices in railway applications according to EN 50155</b>	Yes; Protective coating of the Class PC2 according to EN 50155:2017
<b>type of test of the coating according to MIL-I-46058C</b>	Yes; Coating discoloration during service life possible
<b>product conformity of the coating Qualification and Performance of Electrical Insulating Compound for Printed Board Assemblies according to IPC-CC-830A</b>	Yes; Conformal coating, class A
<b>protection class IP</b>	IP20
<b>design, dimensions and weights</b>	
<b>width</b>	60 mm
<b>height</b>	117 mm
<b>depth</b>	74 mm
<b>net weight</b>	0.18 kg
<b>fastening method</b>	
• 35 mm top hat DIN rail mounting	Yes
<b>product features, product functions, product components general</b>	
<b>number of units</b>	
• per CPU maximum	2
• note	2 CPs can be plugged in per CPU, simultaneous operation with BA Send and CM DP is possible

**SIPLUS extreme RAIL communication > SIPLUS extreme RAIL CP 1543SP-1 ISEC**

Article number	<b>6AG2543-6WX00-4XE0</b>
product type designation	SIPLUS ET 200SP CP 1543SP-1 ISEC TX RAIL
<b>performance data open communication</b>	
<b>number of possible connections for open communication</b> • by means of T blocks maximum	32
<b>data volume</b> • as user data per ISO on TCP connection for open communication by means of T blocks maximum	65 536 byte
<b>performance data S7 communication</b>	
<b>number of possible connections for S7 communication</b> • maximum • with OP connections maximum	16 16
<b>performance data multi-protocol mode</b>	
<b>number of active connections with multi-protocol mode</b>	32
<b>performance data IT functions</b>	
<b>number of possible connections</b> • as email client maximum	1
<b>product functions management, configuration, engineering</b>	
<b>product function MIB support</b>	Yes
<b>protocol is supported</b> • SNMP v1 • SNMP v3 • DCP • LLDP	Yes Yes Yes Yes
<b>configuration software</b> • required	STEP 7 Professional V14 (TIA Portal) or higher
<b>identification &amp; maintenance function</b> • I&MO - device-specific information • I&M1 – higher level designation/location designation	Yes Yes
<b>product functions diagnostics</b>	
<b>product function web-based diagnostics</b>	Yes; via ET 200SP CPU
<b>product functions security</b>	
<b>firewall version</b>	stateful inspection
<b>product function with VPN connection</b>	IPsec, SINEMA RC
<b>type of encryption algorithms with VPN connection</b>	AES-256, AES-192, AES-128, 3DES-168, DES-56
<b>type of authentication procedure with VPN connection</b>	Preshared key (PSK), X.509v3 certificates
<b>type of hashing algorithms with VPN connection</b>	MD5, SHA-1
<b>number of possible connections with VPN connection</b>	4
<b>product function</b> • switch-off of non-required services • blocking of communication via physical ports • log file for unauthorized access	Yes Yes Yes
<b>product functions time</b>	
<b>product function SICLOCK support</b>	Yes
<b>product function pass on time synchronization</b>	No
<b>protocol is supported</b> • NTP • NTP (secure)	Yes Yes
<b>time synchronization</b> • from NTP-server	Yes
<b>standards, specifications, approvals</b>	
<b>certificate of suitability</b> • fire protection in accordance with EN 45545-2	Yes; Railway vehicles - for proof, see Service & Support
<b>railway application</b>	
<b>certificate of suitability railway application in accordance with EN 50121-3-2</b>	Yes; EMC for railway vehicles
<b>certificate of suitability railway application in accordance with EN 50121-4</b>	Yes; EMC for signal and telecommunication equipment
<b>certificate of suitability railway application in accordance with EN 50124-1</b>	Yes; Railway applications - Overvoltage category OV2 pollution degree PD2 rated impulse voltage UNi = 0.5 kVUNm = DC 24
<b>certificate of suitability railway application in accordance with EN 50125-1</b>	Yes; Railway vehicles - See ambient conditions
<b>certificate of suitability railway application in accordance with EN 50125-2</b>	Yes; Fixed-electrical installations - see ambient conditions
<b>certificate of suitability railway application in accordance with EN 50125-3</b>	Yes; Signal and telecommunications equipment - see Ambient conditions vibrations and shocks: Application point outside the rails (distance 1 m to 3 m from rail)
<b>certificate of suitability railway application in accordance with EN 50155</b>	Yes; Railway vehicles - temperature class OT4, ST1/ST2, horizontal mounting position
<b>certificate of suitability railway application in accordance with EN 61373</b>	Yes; Railway vehicles - Vibrations and shocks Category 1 Class A/B

**SIPLUS RAIL**

SIPLUS ET 200SP RAIL

SIPLUS extreme RAIL I/O modules

**SIPLUS extreme RAIL communication > SIPLUS extreme RAIL CP 1543SP-1 ISEC****Selection and ordering data**

Version	Article No.
<p><b>SIPLUS ET 200SP CP 1543SP-1 ISEC TX RAIL communications processor</b></p> <p>Approved in accordance with EN 50155, EN 15121, EN 50124, EN 50125 and EN 45545 railway standards for use in rail traffic</p> <p>For connecting SIPLUS extreme RAIL ET 200SP to Industrial Ethernet, Security (firewall and VPN), open IE communication (TCP/IP, ISO-on-TCP, UDP) PG/OP, S7 routing, IP broadcast/multicast, SNMPv1/V3, DHCP, secure email, IPV4/IPV6, time synchronization via NTP, access to web server of CPU, BusAdapter required;</p> <p>For areas with extreme exposure to environmental substances (conformal coating); ambient temperature -40 ... +70 °C (+85 °C for 10 min.)</p>	<b>6AG2543-6WX00-4XE0</b>
<p><b>SIPLUS extreme RAIL BusAdapter</b></p> <p><b>SIPLUS ET 200SP BA 2XRJ45 TX RAIL</b></p> <p>For PROFINET interface modules in Standard function class or above; max. cable length 50 m; for areas with extreme exposure to environmental substances (conformal coating) Ambient temperature -40 ... +70 °C (+85 °C for 10 min.)</p> <p><b>SIPLUS ET 200SP BA 2XFC TX RAIL</b></p> <p>For PROFINET interface modules in Standard function class or above; for increased vibration and EMC load rating; max. cable length 50 m; for areas with extreme exposure to environmental substances (conformal coating); ambient temperature -40 ... +70 °C (+85 °C for 10 min.)</p>	<p><b>6AG2193-6AR00-4AA0</b></p> <p><b>6AG2193-6AF00-4AA0</b></p>
<p><b>Accessories</b></p> <p><b>SIPLUS Mounting Kit ET 200SP</b></p> <p>Mounting accessories for use with increased mechanical vibration and shock loads.</p>	<b>6AG1193-6AA00-0AA0</b>

**6****More information**

You can find further information on ET 200SP at:

<http://www.siemens.com/simatic-et200sp>

The TIA Selection Tool is available to assist you in selecting ET 200SP equipment and configuring modular variants:

<http://www.siemens.com/tst>

An ET 200SP Distributed Controller firmware version  $\geq 2.0$  is required for operation of the CP 1543SP-1.

## Overview

The fail-safe modules of SIPLUS extreme RAIL ET 200SP expand the range of the ET 200SP series. They are incorporated seamlessly into the Safety Integrated concept as with ET 200S / ET 200M / ET 200iSP and ET200pro. Safety-related communication via PROFIsafe is also supported. The fail-safe modules for digital inputs and outputs (DI and DQ) are the same size as the standard modules. Their functional safety is certified in accordance with IEC 61508. They are designed for safety-related use up to SIL 2 according to EN 50126, 50128, 50129.

One special feature of the F modules of SIPLUS extreme RAIL ET 200SP is that the F-addresses no longer have to be set manually by means of the DIP switches on the module. They are now assigned during commissioning using the engineering function. When replacing a module, the F-addresses of the module remain in the coding of the BaseUnit. If a new module is inserted, these F-addresses are transferred automatically. New assignment of the F-addresses is therefore unnecessary. This new feature simplifies the set-up process and saves time.

### **Totally Integrated Automation (TIA)**

Safety technology (Safety Integrated) is a component of Totally Integrated Automation and provides complete integration of safety and standard automation.

Whereas standard automation (classical PLCs) and safety automation (electro-mechanics) are still separate today, these two worlds are growing together into a uniform, integrated overall system. Siemens is thus able to present itself as a complete supplier of automation technology, in which safety engineering is part of the standard automation and system-wide integration exists.

### **Safety Integrated**

Information on functional safety, including for ET 200SP:

<http://www.siemens.com/safety-integrated>

## More information

### **Safety Integrated**

Information on functional safety, also for ET 200SP, can be found here:

<http://www.siemens.com/safety-integrated>

**SIPLUS RAIL**

SIPLUS ET 200SP RAIL

SIPLUS extreme RAIL I/O modules

SIPLUS extreme RAIL failsafe I/O modules &gt; SIPLUS extreme RAIL digital F-input modules

**Overview**

Digital fail-safe input module:  
SIPLUS ET 200SP F-DI 4/8X24VDC RAIL for BU type A0, color  
code CC01

Important features:

- 8-channel digital fail-safe input module for SIPLUS extreme ET 200SP RAIL
- Approved in accordance with railway standards EN 50155, EN 15121, EN 50124, EN 50125 and EN 45545 for use in rail traffic
- For fail-safe reading of sensor information (1 or 2 channels)
- Provides integral discrepancy evaluation for 2-out-of-2 signals
- 8 internal sensor supplies (incl. test function) onboard
- Certified up to SIL 3 (IEC 61508), PL e (ISO 13849)
- Can be plugged into type A0 BaseUnits (BU) with automatic coding
- LED display for error, operation, supply voltage and status
- Clear labeling on the front of module
  - Plain text identification of the module type and function class
  - 2D matrix code (order and serial number)
  - Connection diagram
  - Color coding of the DI module type: White
  - Hardware and firmware version
  - CC color code for module-specific color coding of the potentials at the terminals of the BU
  - Complete article no.
- Optional labeling accessories
  - Labeling strips
  - Equipment labeling plate
- Optional module-specific color identification of the terminals according to the color code CC
- Optional system-integrated shield connection
- The modules support PROFIsafe in both PROFIBUS and PROFINET configurations. They can be used with all fail-safe SIMATIC S7 CPUs.

**Application**

The fail-safe modules of SIPLUS extreme ET 200SP RAIL can be used to implement the safety-related application requirements as an integral part of the overall automation. The safety functions required for fail-safe operation are integrated in these modules. Communication with the fail-safe SIMATIC S7 CPUs is performed by means of PROFIsafe.

The modules can be operated both in centralized and distributed configurations.

**Design****Usable BaseUnits**

For a single- or multi-conductor connection, BaseUnits with an appropriate number of terminals are available.

A light BaseUnit opens a new load group. The power supply to the sensors must be fed via this BU. The first BU next to the interface module must always be a light BU.

A dark BaseUnit forwards the power supply of the adjacent light BaseUnit on the left via self-assembling voltage buses. A new in-feed is therefore only required on the next light BaseUnit to the right.

All variants that correspond to the BU type of the I/O module can be used as BaseUnits.

**Color identification of the terminals**

The potentials at the terminals of the BaseUnit are defined by the I/O module. Optionally, the potentials of the terminals can be identified by module-specific color-coding labels to prevent wiring errors. The color-coded label that matches the respective I/O module is defined by the color code CCxx of the I/O module. This color code is also printed on the front of the module.

In BaseUnits with the 10 internally jumpered AUX terminals, these can also be identified with color coding labels. For the 10 AUX terminals, color-coding labels are available in red, blue, and yellow/green.

**System-integrated shielded connection**

For the connection of cable shields that is both space-saving as well as optimized in terms of EMC, a shield connection is available that is quick and easy to mount. This consists of one shield connection element that can be plugged onto the BaseUnit and one shield terminal for each module. The low-impedance connection to the functional ground (DIN rail) is achieved without any additional wiring by the user.



## Technical specifications

Article number	<b>6AG2136-6BA00-1CA0</b> SIPLUS ET 200SP F-DI 4/8X24VDC RAIL
<b>General information</b>	
<b>Product type designation</b>	F-DI 8x24VDC HF
<b>Supply voltage</b>	
<b>Rated value (DC)</b>	24 V
<b>Reverse polarity protection</b>	Yes
<b>Encoder supply</b>	
<b>Number of outputs</b>	8
<b>Short-circuit protection</b>	Yes; Electronic (response threshold 0.7 A to 1.8 A)
<b>Output current</b> • up to 60 °C, max.	0.3 A
<b>24 V encoder supply</b> • 24 V • Short-circuit protection • Output current, max.	Yes; min. L+ (-1.5 V) Yes 800 mA; Total current of all encoders
<b>Digital inputs</b>	
<b>Number of digital inputs</b>	8
<b>Source/sink input</b>	Yes; P-reading
<b>Input characteristic curve in accordance with IEC 61131, type 1</b>	Yes
<b>Input voltage</b> • Rated value (DC) • for signal "0" • for signal "1"	24 V -30 to +5 V +15 to +30 V
<b>Input current</b> • for signal "1", typ.	3.7 mA
<b>Input delay (for rated value of input voltage)</b> • for standard inputs - parameterizable • for technological functions - parameterizable	Yes No
<b>Interrupts/diagnostics/status information</b>	
<b>Diagnostics function</b>	Yes
<b>Alarms</b> • Diagnostic alarm • Hardware interrupt	Yes No
<b>Diagnostics indication LED</b> • RUN LED • ERROR LED • Monitoring of the supply voltage (PWR-LED) • Channel status display • for channel diagnostics • for module diagnostics	Yes; green LED Yes; red LED Yes; green PWR LED Yes; green LED Yes; red LED Yes; green/red DIAG LED
<b>Potential separation</b>	
<b>Potential separation channels</b> • between the channels and backplane bus	Yes
<b>Standards, approvals, certificates</b>	
<b>Suitable for safety functions</b>	Yes
<b>Highest safety class achievable in safety mode</b> • Performance level according to ISO 13849-1 • SIL acc. to IEC 61508 • SIL in accordance with EN 50126, 50128, 50129	PLe SIL 3 SIL 2; a higher safety integrity level is possible if tested and approved for the specific application under consideration of all local regulations.
<b>Railway application</b> • EN 50121-3-2 • EN 50121-4 • EN 50124-1  • EN 50125-1 • EN 50125-2 • EN 50125-3  • EN 50155 • EN 61373 • Fire protection acc. to EN 45545-2	Yes; EMC for rail vehicles Yes; EMC for signal and telecommunications systems Yes; Railway applications - overvoltage category OV2; pollution degree PD2; rated surge voltage UNi = 0.5 kV; UNm = 24 V DC Yes; Rail vehicles - see ambient conditions Yes; Stationary electrical equipment - see ambient conditions Yes; Signal and telecommunications systems - see ambient conditions; vibrations and shocks: Application point outside of tracks (1 m to 3 m away from track) Yes; Rail vehicles - temperature class OT1, ST1/ST2, horizontal mounting position Yes; Rail vehicles - vibrations and shocks: Category 1 Class A/B Yes; For proof of conformity, see Service & Support

**SIPLUS RAIL**

SIPLUS ET 200SP RAIL

SIPLUS extreme RAIL I/O modules

**SIPLUS extreme RAIL failsafe I/O modules > SIPLUS extreme RAIL digital F-input modules**

Article number	<b>6AG2136-6BA00-1CA0</b> SIPLUS ET 200SP F-DI 4/8X24VDC RAIL
<b>Ambient conditions</b>	
<b>Ambient temperature during operation</b> • horizontal installation, min. • horizontal installation, max.  • vertical installation, min. • vertical installation, max.	-30 °C; = Tmin (incl. condensation/frost) 60 °C; = Tmax; +70 °C for 10 min (OT1, ST1/ST2 acc. to EN 50155); +70 °C continuously with configured slots to the left and right of the module (OT3, ST0 acc. to EN 50155) -30 °C; = Tmin 50 °C; = Tmax
<b>Altitude during operation relating to sea level</b> • Installation altitude above sea level, max. • Ambient air temperature-barometric pressure-altitude	2 000 m Tmin ... Tmax at 1 140 hPa ... 795 hPa (-1 000 m ... +2 000 m)
<b>Relative humidity</b> • With condensation, tested in accordance with IEC 60068-2-38, max.	100 %; RH incl. condensation / frost (no commissioning in bedewed state), horizontal installation
<b>Resistance</b> • Coolants and lubricants - Resistant to commercially available coolants and lubricants • Use in stationary industrial systems - to biologically active substances according to EN 60721-3-3  - to chemically active substances according to EN 60721-3-3 - to mechanically active substances according to EN 60721-3-3 - Against mechanical environmental conditions acc. to EN 60721-3-3 • Use on land craft, rail vehicles and special-purpose vehicles - to biologically active substances according to EN 60721-3-5  - to chemically active substances according to EN 60721-3-5 - to mechanically active substances according to EN 60721-3-5 - Against mechanical environmental conditions acc. to EN 60721-3-5 - against mechanical environmental conditions in agriculture acc. to ISO 15003 • Usage in industrial process technology - Against chemically active substances acc. to EN 60654-4 - Environmental conditions for process, measuring and control systems acc. to ANSI/ISA-71.04  • Remark - Note regarding classification of environmental conditions acc. to EN 60721, EN 60654-4 and ANSI/ISA-71.04	Yes; Incl. diesel and oil droplets in the air  Yes; Class 3B2 mold, fungus and dry rot spores (with the exception of fauna); Class 3B3 on request Yes; Class 3C4 (RH < 75 %) incl. salt spray acc. to EN 60068-2-52 (severity degree 3); * Yes; Class 3S4 incl. sand, dust, * Yes; Class 3M8 using the SIPLUS Mounting Kit ET 200SP (6AG1193-6AA00-0AA0)  Yes; Class 5B2 mold, fungus and dry rot spores (with the exception of fauna); Class 5B3 on request Yes; Class 5C3 (RH < 75 %) incl. salt spray acc. to EN 60068-2-52 (severity degree 3); * Yes; Class 5S3 incl. sand, dust, * Yes; Class 5M2 using the SIPLUS Mounting Kit ET 200SP (6AG1193-6AA00-0AA0) Yes; level 1 (Location LE) using the SIPLUS Mounting Kit ET 200SP (6AG1193-6AA00-0AA0)  Yes; Class 3 (excluding trichlorethylene)  Yes; Level GX group A/B (excluding trichlorethylene; harmful gas concentrations up to the limits of EN 60721-3-3 class 3C4 permissible); level LC3 (salt spray) and level LB3 (oil)  * The supplied plug covers must remain in place over the unused interfaces during operation!
<b>Conformal coating</b> • Coatings for printed circuit board assemblies acc. to EN 61086 • Protection against fouling acc. to EN 60664-3 • Electronic equipment on rolling stock acc. to EN 50155 • Military testing according to MIL-I-46058C, Amendment 7 • Qualification and Performance of Electrical Insulating Compound for Printed Board Assemblies according to IPC-CC-830A	Yes; Class 2 for high reliability Yes; Type 1 protection Yes; Class PC2 protective coating acc. to EN 50155:2017 Yes; Discoloration of coating possible during service life Yes; Conformal coating, Class A
<b>Dimensions</b>	
<b>Width</b>	15 mm
<b>Height</b>	73 mm
<b>Depth</b>	58 mm
<b>Weights</b>	
<b>Weight, approx.</b>	49 g
<b>Other</b>	
<b>Note:</b>	for use in railway applications, also observe the product information "SIPLUS extreme RAIL" A5E37661960A, Online Support article 109736776

**Selection and ordering data**

Version	Article No.
<b>SIPLUS ET 200SP F-DI 8x24VDC High Feature T1 RAIL</b> Approved in accordance with railway standards EN 50155, EN 15121, EN 50124, EN 50125 and EN 45545 for use in rail traffic BU type A0, for areas with extreme exposure to environmental substances (conformal coating); ambient temperature -25 ... +60 °C (+70 °C for 10 min.)	<b>6AG2136-6BA00-1CA0</b>
<b>SIPLUS ET 200SP F-DI 4/8X24VDC RAIL OT4</b> Approved in accordance with railway standards EN 50155, EN 15121, EN 50124, EN 50125 and EN 45545 for use in rail traffic BU type A0, CC01, for areas with extreme exposure to environmental substances (conformal coating); ambient temperature -40 ... +70 °C ST1/2 (+85 °C for 10 min.)	<b>6AG2136-6BA01-2CA0</b>
<b>Suitable BaseUnits</b>	
<b>SIPLUS ET 200SP BU15-P16+A0+2D TX RAIL</b> Approved in accordance with railway standards EN 50155, EN 15121, EN 50124, EN 50125 and EN 45545 for use in rail traffic BU type A0; BaseUnit (light) with 16 process terminals to the module; for starting a new load group (max. 10 A); for areas with extreme exposure to environmental substances (conformal coating); ambient temperature -40 ... +70 °C (+85 °C for 10 min.)	<b>6AG2193-6BP00-4DA0</b>
<b>SIPLUS ET 200SP BU15-P16+A0+2B TX RAIL</b> Approved in accordance with railway standards EN 50155, EN 15121, EN 50124, EN 50125 and EN 45545 for use in rail traffic BU type A0; BaseUnit (dark) with 16 process terminals to the module; for continuing the load group; for areas with extreme exposure to environmental substances (conformal coating); ambient temperature -40 ... +70 °C (+85 °C for 10 min.)	<b>6AG2193-6BP00-4BA0</b>
<b>SIPLUS ET 200SP BU15-P16+A10+2D TX RAIL</b> Approved in accordance with railway standards EN 50155, EN 15121, EN 50124, EN 50125 and EN 45545 for use in rail traffic BU type A0; BaseUnit (light) with 16 process terminals (1...16) to the module and an additional 10 internally jumpered AUX terminals (1 A to 10 A); for starting a new load group (max. 10 A); for areas with extreme exposure to environmental substances (conformal coating); ambient temperature -40 ... +70 °C (+85 °C for 10 min.)	<b>6AG2193-6BP20-4DA0</b>
<b>SIPLUS ET 200SP BU15-P16+A10+2B TX RAIL</b> Approved in accordance with railway standards EN 50155, EN 15121, EN 50124, EN 50125 and EN 45545 for use in rail traffic BU type A0; BaseUnit (dark) with 16 process terminals (1...16) to the module and an additional 10 internally jumpered AUX terminals (1 A to 10 A); for continuing the load group; for areas with extreme exposure to environmental substances (conformal coating); ambient temperature -40 ... +70 °C (+85 °C for 10 min.)	<b>6AG2193-6BP20-4BA0</b>
<b>Accessories</b>	
<b>SIPLUS Mounting Kit ET 200SP</b> Mounting accessories for use with increased mechanical vibration and shock loads.	<b>6AG1193-6AA00-0AA0</b>

**SIPLUS RAIL**

SIPLUS ET 200SP RAIL

SIPLUS extreme RAIL I/O modules

SIPLUS extreme RAIL failsafe I/O modules &gt; SIPLUS extreme RAIL digital F-output modules

**Overview**

Important properties:

- 4-channel digital fail-safe output module for SIPLUS extreme ET 200SP RAIL
- Approved in accordance with EN 50155, EN 15121, EN 50124, EN 50125 and EN 45545 railway standards for use in rail traffic
- Fail-safe 2-channel activation (sinking/sourcing output) by actuators
- Actuators can be controlled up to 2 A or 0.5 A
- Certified up to SIL 3 (IEC 61508), PL e (ISO 13849)
- Can be plugged into type A0 BaseUnits (BU) with automatic coding
- LED display for error, operation, supply voltage and status
- Clear labeling on front of module
  - Plain text identification of the module type and function class
  - 2D matrix code (order and serial number)
  - Connection diagram
  - Color coding of the DI module type: White
  - Hardware and firmware version
  - CC color code for module-specific color coding of the potentials at the terminals of the BU
  - Complete Article No.
- Optional labeling accessories
  - Labeling strips
  - Equipment labeling plate
- Optional module-specific color identification of the terminals according to the color code CC
- Optional system-integrated shield connection
- The modules support PROFIsafe in both PROFIBUS and PROFINET configurations
- They can be used with all fail-safe SIMATIC S7 CPUs

**Application**

The fail-safe modules of SIPLUS extreme ET 200SP RAIL can be used to implement the safety-related application requirements as an integral part of the overall automation. The safety functions required for fail-safe operation are integrated in these modules. Communication with the fail-safe SIMATIC S7 CPUs is performed by means of PROFIsafe.

The modules can be operated both in centralized and distributed configurations.

**Design****Suitable BaseUnits**

BaseUnits with an appropriate number of terminals are available for single and multi-conductor connections.

A light BaseUnit opens a new load group. The supply voltage to the sensors must be fed via this BU. The first BU next to the interface module must always be a light BU.

A dark BaseUnit forwards the supply voltage of the adjacent light BaseUnit on the left via self-assembling voltage buses. A new infeed is therefore only required on the next light BaseUnit to the right.

All variants that correspond to the BU type of the I/O module can be used as BaseUnits.

**Color coding of the terminals**

The potentials at the terminals of the BaseUnit are defined by the I/O module. Optionally, the potentials of the terminals can be identified by module-specific color-coding labels to prevent wiring errors. The color-coded label that matches the respective I/O module is defined by the color code CCxx of the I/O module. This color code is also printed on the front of the module.

In BaseUnits with the 10 internally jumpered AUX terminals, these can also be identified with color-coding labels. For the 10 AUX terminals, color-coding labels are available in red, blue, and yellow/green.

**System-integrated shield connection**

For the space-saving and EMC-optimized connection of cable shields, a shield connection is available that is quick and easy to mount. This consists of one shield connection element that can be plugged onto the BaseUnit and one shield terminal for each module. The low-impedance connection to the functional ground (DIN rail) is achieved without any additional wiring by the user.

**Technical specifications**

Article number	<b>6AG2136-6DB00-1CA0</b> SIPLUS ET 200SP F-DQ 4x24VDC/2A PM RAIL	<b>6AG2136-6DC00-1CA0</b> SIPLUS ET 200SP F-DQ 8x24VDC 0.5A RAIL
<b>General information</b>		
<b>Product type designation</b>	F-DQ 4x24VDC HF	F-DQ 8x24 V DC/0.5 A PP HF
<b>Supply voltage</b>		
<b>Rated value (DC)</b>	24 V	24 V
<b>Reverse polarity protection</b>	Yes	Yes
<b>Digital outputs</b>		
<b>Type of digital output</b>	Transistor	Transistor
<b>Number of digital outputs</b>	4	8
<b>Digital outputs, parameterizable</b>	Yes	Yes
<b>Short-circuit protection</b>	Yes	Yes
<b>Open-circuit detection</b>	Yes	No
<b>Overload protection</b>	Yes	
<b>Limitation of inductive shutdown voltage to</b>	typ. 2*47V	Typ. -39 V
<b>Controlling a digital input</b>		Yes
<b>Switching capacity of the outputs</b> • with resistive load, max. • on lamp load, max.	2 A 10 W	0.5 A 2 W
<b>Load resistance range</b> • lower limit • upper limit	12 Ω 2 000 Ω	48 Ω 12 000 Ω
<b>Output voltage</b> • for signal *1*, min.	24 V; L+ (-0.5 V)	24 V; L+ (-0.5 V)
<b>Output current</b> • for signal *1* rated value • for signal *0* residual current, max.	2 A 0.5 mA	0.5 A 0.5 mA
<b>Switching frequency</b> • with resistive load, max. • with inductive load, max.  • with capacitive load, max. • on lamp load, max.	30 Hz; Symmetrical 0.1 Hz; according to IEC 60947-5-1, DC-13, symmetrical  10 Hz; Symmetrical	30 Hz; Symmetrical 0.1 Hz; according to IEC 60947-5-1, DC-13, symmetrical 2 Hz; Symmetrical 10 Hz; Symmetrical
<b>Total current of the outputs</b> • Current per channel, max. • Current per module, max.	2 A; note derating data in the manual 6 A; note derating data in the manual	0.5 A; note derating data in the manual 3 A; note derating data in the manual
<b>Total current of the outputs (per module)</b> • horizontal installation - up to 40 °C, max. - up to 50 °C, max. - up to 60 °C, max. - up to 70 °C, max.  • vertical installation - up to 50 °C, max.	6 A; note derating data in the manual 5 A; note derating data in the manual 4 A; note derating data in the manual 4 A; note derating information in the manual; only with configured slots to the left and right of the module	3 A; note derating data in the manual 2.5 A; note derating data in the manual 2 A; note derating data in the manual 2 A; note derating information in the manual; only with configured slots to the left and right of the module  2 A; note derating data in the manual
<b>Interrupts/diagnostics/status information</b>		
<b>Diagnostics function</b>	Yes	Yes
<b>Substitute values connectable</b>	No	No
<b>Alarms</b> • Diagnostic alarm	Yes	Yes
<b>Diagnostics indication LED</b> • RUN LED • ERROR LED • Monitoring of the supply voltage (PWR-LED) • Channel status display • for channel diagnostics • for module diagnostics	Yes; green LED Yes; red LED Yes; green PWR LED Yes; green LED Yes; red LED Yes; green/red DIAG LED	Yes; green LED Yes; red LED Yes; green PWR LED Yes; green LED Yes; red LED Yes; green/red DIAG LED
<b>Potential separation</b>		
<b>Potential separation channels</b> • between the channels and backplane bus	Yes	Yes
<b>Standards, approvals, certificates</b>		
<b>Suitable for safety functions</b>	Yes	Yes
<b>Highest safety class achievable in safety mode</b> • Performance level according to ISO 13849-1 • SIL acc. to IEC 61508 • SIL in accordance with EN 50126, 50128, 50129	PLe SIL 3 SIL 2; a higher safety integrity level is possible if tested and approved for the specific application under consideration of all local regulations.	PLe SIL 3 SIL 2; a higher safety integrity level is possible if tested and approved for the specific application under consideration of all local regulations.

# SIPLUS RAIL

## SIPLUS ET 200SP RAIL

### SIPLUS extreme RAIL I/O modules

#### SIPLUS extreme RAIL failsafe I/O modules > SIPLUS extreme RAIL digital F-output modules

Article number	<b>6AG2136-6DB00-1CA0</b> SIPLUS ET 200SP F-DQ 4X24VDC/2A PM RAIL	<b>6AG2136-6DC00-1CA0</b> SIPLUS ET 200SP F-DQ 8x24VDC 0.5A RAIL
<b>Railway application</b>		
<ul style="list-style-type: none"> <li>EN 50121-3-2</li> <li>EN 50121-4</li> <li>EN 50124-1</li> <li>EN 50125-1</li> <li>EN 50125-2</li> <li>EN 50125-3</li> <li>EN 50155</li> <li>EN 61373</li> <li>Fire protection acc. to EN 45545-2</li> </ul>	<ul style="list-style-type: none"> <li>Yes; EMC for rail vehicles</li> <li>Yes; EMC for signal and telecommunications systems</li> <li>Yes; Railway applications - overvoltage category OV2; pollution degree PD2; rated surge voltage UNi = 0.5 kV; UNm = 24 V DC</li> <li>Yes; Rail vehicles - see ambient conditions</li> <li>Yes; Stationary electrical equipment - see ambient conditions</li> <li>Yes; Signal and telecommunications systems - see ambient conditions; vibrations and shocks: Application point outside of tracks (1 m to 3 m away from track)</li> <li>Yes; Rail vehicles - temperature class OT1, ST1/ST2, horizontal mounting position</li> <li>Yes; Rail vehicles - vibrations and shocks: Category 1 Class A/B</li> <li>Yes; For proof of conformity, see Service &amp; Support</li> </ul>	<ul style="list-style-type: none"> <li>Yes; EMC for rail vehicles</li> <li>Yes; EMC for signal and telecommunications systems</li> <li>Yes; Railway applications - overvoltage category OV2; pollution degree PD2; rated surge voltage UNi = 0.5 kV; UNm = 24 V DC</li> <li>Yes; Rail vehicles - see ambient conditions</li> <li>Yes; Stationary electrical equipment - see ambient conditions</li> <li>Yes; Signal and telecommunications systems - see ambient conditions; vibrations and shocks: Application point outside of tracks (1 m to 3 m away from track)</li> <li>Yes; Rail vehicles - temperature class OT1, ST1/ST2, horizontal mounting position</li> <li>Yes; Rail vehicles - vibrations and shocks: Category 1 Class A/B</li> <li>Yes; For proof of conformity, see Service &amp; Support</li> </ul>
<b>Ambient conditions</b>		
<b>Ambient temperature during operation</b>		
<ul style="list-style-type: none"> <li>horizontal installation, min.</li> <li>horizontal installation, max.</li> <li>vertical installation, min.</li> <li>vertical installation, max.</li> </ul>	<ul style="list-style-type: none"> <li>-30 °C; = Tmin (incl. condensation/frost)</li> <li>60 °C; = Tmax; +70 °C for 10 min (OT1, ST1/ST2 acc. to EN 50155); +70 °C continuously with configured slots to the left and right of the module (OT3, ST0 acc. to EN 50155)</li> <li>-30 °C; = Tmin</li> <li>50 °C; = Tmax</li> </ul>	<ul style="list-style-type: none"> <li>-30 °C; = Tmin (incl. condensation/frost)</li> <li>60 °C; = Tmax; +70 °C for 10 min (OT1, ST1/ST2 acc. to EN 50155); +70 °C continuously with configured slots to the left and right of the module (OT3, ST0 acc. to EN 50155)</li> <li>-30 °C; = Tmin</li> <li>50 °C; = Tmax</li> </ul>
<b>Altitude during operation relating to sea level</b>		
<ul style="list-style-type: none"> <li>Installation altitude above sea level, max.</li> <li>Ambient air temperature-barometric pressure-altitude</li> </ul>	<ul style="list-style-type: none"> <li>2 000 m</li> <li>Tmin ... Tmax at 1 140 hPa ... 795 hPa (-1 000 m ... +2 000 m)</li> </ul>	<ul style="list-style-type: none"> <li>2 000 m</li> <li>Tmin ... Tmax at 1 140 hPa ... 795 hPa (-1 000 m ... +2 000 m)</li> </ul>
<b>Relative humidity</b>		
<ul style="list-style-type: none"> <li>With condensation, tested in accordance with IEC 60068-2-38, max.</li> </ul>	<ul style="list-style-type: none"> <li>100 %; RH incl. condensation / frost (no commissioning in bedewed state), horizontal installation</li> </ul>	<ul style="list-style-type: none"> <li>100 %; RH incl. condensation / frost (no commissioning in bedewed state), horizontal installation</li> </ul>
<b>Resistance</b>		
<ul style="list-style-type: none"> <li>Coolants and lubricants <ul style="list-style-type: none"> <li>Resistant to commercially available coolants and lubricants</li> </ul> </li> <li>Use in stationary industrial systems <ul style="list-style-type: none"> <li>to biologically active substances according to EN 60721-3-3</li> <li>to chemically active substances according to EN 60721-3-3</li> <li>to mechanically active substances according to EN 60721-3-3</li> <li>Against mechanical environmental conditions acc. to EN 60721-3-3</li> </ul> </li> <li>Use on land craft, rail vehicles and special-purpose vehicles <ul style="list-style-type: none"> <li>to biologically active substances according to EN 60721-3-5</li> <li>to chemically active substances according to EN 60721-3-5</li> <li>to mechanically active substances according to EN 60721-3-5</li> <li>Against mechanical environmental conditions acc. to EN 60721-3-5</li> <li>against mechanical environmental conditions in agriculture acc. to ISO 15003</li> </ul> </li> </ul>	<ul style="list-style-type: none"> <li>Yes; Incl. diesel and oil droplets in the air</li> <li>Yes; Class 3B2 mold, fungus and dry rot spores (with the exception of fauna); Class 3B3 on request</li> <li>Yes; Class 3C4 (RH &lt; 75 %) incl. salt spray acc. to EN 60068-2-52 (severity degree 3); *</li> <li>Yes; Class 3S4 incl. sand, dust, *</li> <li>Yes; Class 3M8 using the SIPLUS Mounting Kit ET 200SP (6AG1193-6AA00-0AA0)</li> <li>Yes; Class 5B2 mold, fungus and dry rot spores (with the exception of fauna); Class 5B3 on request</li> <li>Yes; Class 5C3 (RH &lt; 75 %) incl. salt spray acc. to EN 60068-2-52 (severity degree 3); *</li> <li>Yes; Class 5S3 incl. sand, dust; *</li> <li>Yes; Class 5M2 using the SIPLUS Mounting Kit ET 200SP (6AG1193-6AA00-0AA0)</li> <li>Yes; level 1 (Location LE) using the SIPLUS Mounting Kit ET 200SP (6AG1193-6AA00-0AA0)</li> </ul>	<ul style="list-style-type: none"> <li>Yes; Incl. diesel and oil droplets in the air</li> <li>Yes; Class 3B2 mold, fungus and dry rot spores (with the exception of fauna); Class 3B3 on request</li> <li>Yes; Class 3C4 (RH &lt; 75 %) incl. salt spray acc. to EN 60068-2-52 (severity degree 3); *</li> <li>Yes; Class 3S4 incl. sand, dust, *</li> <li>Yes; Class 3M8 using the SIPLUS Mounting Kit ET 200SP (6AG1193-6AA00-0AA0)</li> <li>Yes; Class 5B2 mold, fungus and dry rot spores (with the exception of fauna); Class 5B3 on request</li> <li>Yes; Class 5C3 (RH &lt; 75 %) incl. salt spray acc. to EN 60068-2-52 (severity degree 3); *</li> <li>Yes; Class 5S3 incl. sand, dust; *</li> <li>Yes; Class 5M2 using the SIPLUS Mounting Kit ET 200SP (6AG1193-6AA00-0AA0)</li> <li>Yes; level 1 (Location LE) using the SIPLUS Mounting Kit ET 200SP (6AG1193-6AA00-0AA0)</li> </ul>

**SIPLUS extreme RAIL failsafe I/O modules > SIPLUS extreme RAIL digital F-output modules**

Article number	<b>6AG2136-6DB00-1CA0</b> SIPLUS ET 200SP F-DQ 4X24VDC/2A PM RAIL	<b>6AG2136-6DC00-1CA0</b> SIPLUS ET 200SP F-DQ 8x24VDC 0.5A RAIL
<ul style="list-style-type: none"> <li>• Usage in industrial process technology               <ul style="list-style-type: none"> <li>- Against chemically active substances acc. to EN 60654-4</li> <li>- Environmental conditions for process, measuring and control systems acc. to ANSI/ISA-71.04</li> </ul> </li> <li>• Remark               <ul style="list-style-type: none"> <li>- Note regarding classification of environmental conditions acc. to EN 60721, EN 60654-4 and ANSI/ISA-71.04</li> </ul> </li> </ul>	<p>Yes; Class 3 (excluding trichlorethylene)</p> <p>Yes; Level GX group A/B (excluding trichlorethylene; harmful gas concentrations up to the limits of EN 60721-3-3 class 3C4 permissible); level LC3 (salt spray) and level LB3 (oil)</p> <p>* The supplied plug covers must remain in place over the unused interfaces during operation!</p>	<p>Yes; Class 3 (excluding trichlorethylene)</p> <p>Yes; Level GX group A/B (excluding trichlorethylene; harmful gas concentrations up to the limits of EN 60721-3-3 class 3C4 permissible); level LC3 (salt spray) and level LB3 (oil)</p> <p>* The supplied plug covers must remain in place over the unused interfaces during operation!</p>
<p><b>Conformal coating</b></p> <ul style="list-style-type: none"> <li>• Coatings for printed circuit board assemblies acc. to EN 61086</li> <li>• Protection against fouling acc. to EN 60664-3</li> <li>• Electronic equipment on rolling stock acc. to EN 50155</li> <li>• Military testing according to MIL-I-46058C, Amendment 7</li> <li>• Qualification and Performance of Electrical Insulating Compound for Printed Board Assemblies according to IPC-CC-830A</li> </ul>	<p>Yes; Class 2 for high reliability</p> <p>Yes; Type 1 protection</p> <p>Yes; Class PC2 protective coating acc. to EN 50155:2017</p> <p>Yes; Discoloration of coating possible during service life</p> <p>Yes; Conformal coating, Class A</p>	<p>Yes; Class 2 for high reliability</p> <p>Yes; Type 1 protection</p> <p>Yes; Class PC2 protective coating acc. to EN 50155:2017</p> <p>Yes; Discoloration of coating possible during service life</p> <p>Yes; Conformal coating, Class A</p>
<b>Dimensions</b>		
<b>Width</b>	15 mm	15 mm
<b>Height</b>	73 mm	73 mm
<b>Depth</b>	58 mm	58 mm
<b>Weights</b>		
<b>Weight, approx.</b>	57 g	48 g
<b>Other</b>		
<b>Note:</b>	for use in railway applications, also observe the product information "SIPLUS extreme RAIL" A5E37661960A, Online Support article 109736776	for use in railway applications, also observe the product information "SIPLUS extreme RAIL" A5E37661960A, Online Support article 109736776



**SIPLUS RAIL**

SIPLUS ET 200SP RAIL

SIPLUS extreme RAIL I/O modules

SIPLUS extreme RAIL failsafe I/O modules &gt; SIPLUS extreme RAIL digital F-output modules

**Selection and ordering data**

Version	Article No.
<p><b>SIPLUS ET 200SP F-DQ 4x24VDC High Feature T1 RAIL</b> Approved in accordance with EN 50155, EN 15121, EN 50124, EN 50125 and EN 45545 railway standards for use in rail traffic BU type A0, color code CC02; for areas with extreme exposure to environmental substances (conformal coating); ambient temperature -25 ... +60 °C (+70 °C for 10 min.)</p>	<b>6AG2136-6DB00-1CA0</b>
<p><b>SIPLUS ET 200SP F-DQ 8x24VDC 0.5A RAIL</b> Approved in accordance with EN 50155, EN 15121, EN 50124, EN 50125 and EN 45545 railway standards for use in rail traffic BU type A0, color code CC02; for areas with extreme exposure to environmental substances (conformal coating); ambient temperature -30 ... +60 °C (+70 °C for 10 min.)</p>	<b>6AG2136-6DC00-1CA0</b>
<b>Suitable BaseUnits</b>	
<p><b>SIPLUS ET 200SP BU15-P16+A0+2D TX RAIL</b> Approved in accordance with EN 50155, EN 15121, EN 50124, EN 50125 and EN 45545 railway standards for use in rail traffic BU type A0; BaseUnit (light) with 16 push-in terminals to the module; for starting a new load group (max. 10 A); for areas with extreme exposure to environmental substances (conformal coating); ambient temperature -40 ... +70 °C (+85 °C for 10 min.)</p>	<b>6AG2193-6BP00-4DA0</b>
<p><b>SIPLUS ET 200SP BU15-P16+A0+2B TX RAIL</b> Approved in accordance with EN 50155, EN 15121, EN 50124, EN 50125 and EN 45545 railway standards for use in rail traffic BU type A0; BaseUnit (dark) with 16 push-in terminals to the module; for continuing the load group; for areas with extreme exposure to environmental substances (conformal coating); ambient temperature -40 ... +70 °C (+85 °C for 10 min.)</p>	<b>6AG2193-6BP00-4BA0</b>
<p><b>SIPLUS ET 200SP BU15-P16+A10+2D TX RAIL</b> Approved in accordance with EN 50155, EN 15121, EN 50124, EN 50125 and EN 45545 railway standards for use in rail traffic BU type A0; BaseUnit (light) with 16 push-in terminals (1...16) to the module and an additional 10 internally jumpered AUX terminals (1 A to 10 A); for starting a new load group (max. 10 A); for areas with extreme exposure to environmental substances (conformal coating); ambient temperature -40 ... +70 °C (+85 °C for 10 min.)</p>	<b>6AG2193-6BP20-4DA0</b>
<p><b>SIPLUS ET 200SP BU15-P16+A10+2B TX RAIL</b> Approved in accordance with EN 50155, EN 15121, EN 50124, EN 50125 and EN 45545 railway standards for use in rail traffic BU type A0; BaseUnit (dark) with 16 push-in terminals (1...16) to the module and an additional 10 internally jumpered AUX terminals (1 A to 10 A); for continuing the load group; for areas with extreme exposure to environmental substances (conformal coating); ambient temperature -40 ... +70 °C (+85 °C for 10 min.)</p>	<b>6AG2193-6BP20-4BA0</b>
<b>Accessories</b>	
<p><b>SIPLUS Mounting Kit ET 200SP</b> Mounting accessories for use with increased mechanical vibration and shock loads.</p>	<b>6AG1193-6AA00-0AA0</b>

## Overview



The digital F-electronic module SIPLUS ET 200SP F-RQ 24VDC230VAC/5A RAIL has the following properties:

- Approved in accordance with the EN 50155, EN 15121, EN 50124, EN 50125 and EN 45545 railway standards for use in rail traffic
- 1 relay output (2 NO contacts)
- Total output current 5 A
- Rated load voltage 24 V DC and 24 ... 230 V AC
- The control circuit of the two safety relays must be routed from the outside to the respective terminals.

The attainable safety integrity level is SIL 3 (IEC 61508) when the control of the F-RQ module is implemented via a fail-safe output (e.g. of SIPLUS ET 200SP F-DQ 4x24VDC High Feature T1 RAIL).

## Application

The 1 F-RQ module is very versatile and can be used in multiple ways, e.g.

- for switching of external voltages,
- when floating signals are needed,
- for controller releases,
- when higher switching capacities (> 2 A) or other voltage levels are needed.

## Design

Control must be carried out from the outside via a fail-safe electronic module to the respective IN P and IN M terminals. The ET 200SP 4 F-DQ (6AG2136-6DB00-1CA0) can be used for this, for example.

One channel of the 4 F-DQ module can be used to control a further 1 F-RQ module. The output signal can be looped through for this purpose: OUT P and OUT M of the first 1F-RQ module are wired to IN P and IN M of the second 1F-RQ module.

## Technical specifications

Article number	<b>6AG2136-6RA00-1BF0</b> SIPLUS ET 200SP F-RQ 24VDC230VAC/5A RAIL
<b>General information</b>	
<b>Product type designation</b>	F-RQ 1x24 V DC/24 ... 230 V AC/5 A
<b>Supply voltage</b>	
<b>Rated value (DC)</b>	24 V; Coil voltage
<b>Digital outputs</b>	
<b>Type of digital output</b>	Relays
<b>Number of digital outputs</b>	1
<b>Limitation of inductive shutdown voltage to</b>	No
<b>Controlling a digital input</b>	Yes
<b>Switching capacity of the outputs</b>	
• with resistive load, max.	5 A
• on lamp load, max.	25 W
<b>Switching frequency</b>	
• with resistive load, max.	2 Hz
• with inductive load, max.	0.1 Hz; See data in manual
• with inductive load (acc. to IEC 60947-5-1, DC13), max.	0.1 Hz
• with inductive load (acc. to IEC 60947-5-1, AC15), max.	2 Hz
<b>Total current of the outputs (per module)</b>	
• horizontal installation	
- up to 40 °C, max.	5 A; note derating data in the manual
- up to 50 °C, max.	4 A; note derating data in the manual
- up to 60 °C, max.	3 A; note derating data in the manual
- up to 70 °C, max.	3 A; note derating information in the manual; only with configured slots to the left and right of the module
• vertical installation	
- up to 50 °C, max.	3 A; note derating data in the manual
<b>Relay outputs</b>	
• Number of relay outputs	1; 2 NO contacts
• Rated supply voltage of relay coil L+ (DC)	24 V
• Current consumption of relays (coil current of all relays), max.	70 mA
• external protection for relay outputs	yes; 6 A, see data in manual
• Relay approved acc. to UL 508	Yes; Pilot Duty B300, R300

**SIPLUS RAIL**

SIPLUS ET 200SP RAIL

SIPLUS extreme RAIL I/O modules

**SIPLUS extreme RAIL failsafe I/O modules > SIPLUS extreme RAIL digital F-output module relay**

Article number	<b>6AG2136-6RA00-1BF0</b> SIPLUS ET 200SP F-RQ 24VDC230VAC/5A RAIL
<b>Switching capacity of contacts</b>	
<ul style="list-style-type: none"> <li>with inductive load, max.</li> <li>with resistive load, max.</li> <li>Thermal continuous current, max.</li> <li>Switching current, min.</li> <li>Switching current after exceeding 300 mA, min.</li> <li>Switching current after exceeding 300 mA, max.</li> <li>Rated switching voltage (DC)</li> <li>Rated switching voltage (AC)</li> </ul>	see additional description in the manual see additional description in the manual 5 A 1 mA 10 mA 5 A 24 V 230 V
<b>Interrupts/diagnostics/status information</b>	
<b>Diagnostics function</b>	Yes
<b>Diagnostics indication LED</b>	
<ul style="list-style-type: none"> <li>RUN LED</li> <li>Channel status display</li> </ul>	Yes; green/red DIAG LED Yes; green LED
<b>Potential separation</b>	
<b>Potential separation channels</b>	
<ul style="list-style-type: none"> <li>between the channels and backplane bus</li> </ul>	Yes
<b>Standards, approvals, certificates</b>	
<b>Suitable for safety functions</b>	Yes
<b>Highest safety class achievable in safety mode</b>	
<ul style="list-style-type: none"> <li>Performance level according to ISO 13849-1</li> <li>SIL acc. to IEC 61508</li> <li>SIL in accordance with EN 50126, 50128, 50129</li> </ul>	PL <sub>e</sub> SIL 3 SIL 2; a higher safety integrity level is possible if tested and approved for the specific application under consideration of all local regulations.
<b>Railway application</b>	
<ul style="list-style-type: none"> <li>EN 50121-3-2</li> <li>EN 50121-4</li> <li>EN 50124-1</li> <li>EN 50125-1</li> <li>EN 50125-2</li> <li>EN 50125-3</li> <li>EN 50155</li> <li>EN 61373</li> <li>Fire protection acc. to EN 45545-2</li> </ul>	Yes; EMC for rail vehicles Yes; EMC for signal and telecommunications systems Yes; Railway applications - overvoltage category OV3; pollution degree PD2; UNm = 230 V AC Yes; Rail vehicles - see ambient conditions Yes; Stationary electrical equipment - see ambient conditions Yes; Signal and telecommunications systems - see ambient conditions; vibrations and shocks: Application point outside of tracks (1 m to 3 m away from track) Yes; Rail vehicles - temperature class OT1, ST1/ST2, horizontal mounting position Yes; Rail vehicles - vibrations and shocks: Category 1 Class A/B Yes; For proof of conformity, see Service & Support
<b>Ambient conditions</b>	
<b>Ambient temperature during operation</b>	
<ul style="list-style-type: none"> <li>horizontal installation, min.</li> <li>horizontal installation, max.</li> <li>vertical installation, min.</li> <li>vertical installation, max.</li> </ul>	-30 °C; = Tmin (incl. condensation/frost) 60 °C; = Tmax; +70 °C for 10 min (OT1, ST1/ST2 acc. to EN 50155); +70 °C continuously with configured slots to the left and right of the module (OT3, ST0 acc. to EN 50155) -30 °C; = Tmin 50 °C; = Tmax
<b>Altitude during operation relating to sea level</b>	
<ul style="list-style-type: none"> <li>Installation altitude above sea level, max.</li> <li>Ambient air temperature-barometric pressure-altitude</li> </ul>	2 000 m Tmin ... Tmax at 1 140 hPa ... 795 hPa (-1 000 m ... +2 000 m)
<b>Relative humidity</b>	
<ul style="list-style-type: none"> <li>With condensation, tested in accordance with IEC 60068-2-38, max.</li> </ul>	100 %; RH incl. condensation / frost (no commissioning in bedewed state), horizontal installation
<b>Resistance</b>	
<ul style="list-style-type: none"> <li>Coolants and lubricants               <ul style="list-style-type: none"> <li>Resistant to commercially available coolants and lubricants</li> </ul> </li> <li>Use in stationary industrial systems               <ul style="list-style-type: none"> <li>to biologically active substances according to EN 60721-3-3</li> <li>to chemically active substances according to EN 60721-3-3</li> <li>to mechanically active substances according to EN 60721-3-3</li> </ul> </li> <li>Use on land craft, rail vehicles and special-purpose vehicles               <ul style="list-style-type: none"> <li>to biologically active substances according to EN 60721-3-5</li> <li>to chemically active substances according to EN 60721-3-5</li> <li>to mechanically active substances according to EN 60721-3-5</li> </ul> </li> <li>Usage in industrial process technology               <ul style="list-style-type: none"> <li>Against chemically active substances acc. to EN 60654-4</li> <li>Environmental conditions for process, measuring and control systems acc. to ANSI/ISA-71.04</li> </ul> </li> <li>Remark               <ul style="list-style-type: none"> <li>Note regarding classification of environmental conditions acc. to EN 60721, EN 60654-4 and ANSI/ISA-71.04</li> </ul> </li> </ul>	Yes; Incl. diesel and oil droplets in the air Yes; Class 3B2 mold, fungus and dry rot spores (with the exception of fauna); Class 3B3 on request Yes; Class 3C4 (RH < 75 %) incl. salt spray acc. to EN 60068-2-52 (severity degree 3); * Yes; Class 3S4 incl. sand, dust, * Yes; Class 5B2 mold, fungus and dry rot spores (with the exception of fauna); Class 5B3 on request Yes; Class 5C3 (RH < 75 %) incl. salt spray acc. to EN 60068-2-52 (severity degree 3); * Yes; Class 5S3 incl. sand, dust; * Yes; Class 3 (excluding trichlorethylene) Yes; Level GX group A/B (excluding trichlorethylene; harmful gas concentrations up to the limits of EN 60721-3-3 class 3C4 permissible); level LC3 (salt spray) and level LB3 (oil) * The supplied plug covers must remain in place over the unused interfaces during operation!
<b>Conformal coating</b>	
<ul style="list-style-type: none"> <li>Coatings for printed circuit board assemblies acc. to EN 61086</li> <li>Protection against fouling acc. to EN 60664-3</li> <li>Electronic equipment on rolling stock acc. to EN 50155</li> <li>Military testing according to MIL-I-46058C, Amendment 7</li> <li>Qualification and Performance of Electrical Insulating Compound for Printed Board Assemblies according to IPC-CC-830A</li> </ul>	Yes; Class 2 for high reliability Yes; Type 1 protection Yes; Class PC2 protective coating acc. to EN 50155:2017 Yes; Discoloration of coating possible during service life Yes; Conformal coating, Class A

**SIPLUS extreme RAIL failsafe I/O modules > SIPLUS extreme RAIL digital F-output module relay**

Article number	<b>6AG2136-6RA00-1BF0</b> SIPLUS ET 200SP F-RQ 24VDC230VAC/5A RAIL
<b>Dimensions</b>	
<b>Width</b>	20 mm
<b>Height</b>	73 mm
<b>Depth</b>	58 mm
<b>Weights</b>	
<b>Weight, approx.</b>	56 g
<b>Other</b>	
<b>Note:</b>	for use in railway applications, also observe the product information "SIPLUS extreme RAIL" A5E37661960A, Online Support article 109736776

**Selection and ordering data**

Version	Article No.
<p><b>SIPLUS ET 200SP F-RQ 24VDC230VAC/5A RAIL</b> Approved in accordance with the EN 50155, EN 15121, EN 50124, EN 50125 and EN 45545 railway standards for use in rail traffic BU type F0, relay output (2 NO contacts), total output current 5 A, load voltages 24 V DC and 24 ... 230 V AC; can be used up to SIL3 / Category 4/PL e if controlled via F-DQ</p>	<b>6AG2136-6RA00-1BF0</b>
<p><b>Suitable BaseUnits</b> <b>SIPLUS ET 200SP BU20-P8+A4+0B TX RAIL</b> Approved in accordance with the EN 50155, EN 15121, EN 50124, EN 50125 and EN 45545 railway standards for use in rail traffic BU type F0; BaseUnit (dark) with 8 process terminals to the module and additional 4 internally jumpered AUX terminals (1 A to 4 A); for continuing the load group</p>	<b>6AG2193-6BP20-4BF0</b>

**SIPLUS RAIL**

SIPLUS ET 200SP RAIL

SIPLUS extreme RAIL I/O modules

**SIPLUS extreme RAIL failsafe I/O modules > SIPLUS extreme RAIL analog F-input modules****Overview**

Analog fail-safe input module:

- F-AI 4xI 0(4)..20 mA 2/4-wire High Feature for BU types A0 and A1, color code CC00
- F-AI 4xU 0..10 V HF, BU type A0, A1, color code CC00

Important features:

- Approved in accordance with railway standards EN 50155, EN 15121, EN 50124, EN 50125 and EN 45545 for use in rail traffic
- 4-channel analog fail-safe input module for ET 200SP
- 4 analog inputs with galvanic isolation between channels and backplane bus
- Measuring ranges: (0)4...20 mA
- Connection option for current sensors for measuring temperature, pressure, flow, level, distance measurement, etc.
- Short-circuit-proof power supply for analog sensors
- Resolution: 16 bits including sign
- Certified up to SIL 3 (IEC 61508), PL e (ISO 13849)
- Can be plugged onto type A0 and A1 BaseUnits (BU)
- LED display for error, operation, supply voltage and status
- Interference frequency suppression, smoothing
- Diagnostics: Wire break, short-circuit
- Firmware update
- Identification data I&M
- Value status
- Clear labeling on the front of module
  - Plain text identification of the module type and function class
  - 2D matrix code (order and serial number)
  - Connection diagram
  - Color coding of the DI module type: White
  - Hardware and firmware version
  - CC color code for module-specific color coding of the potentials at the terminals of the BU
  - Complete article no.
- Optional labeling accessories
  - Labeling strips
  - Equipment labeling plate
- Optional module-specific color identification of the terminals according to the color code CC
- Optional system-integrated shield connection
- The modules support PROFIsafe in both PROFIBUS and PROFINET configurations. They can be used with all fail-safe SIMATIC S7 CPUs.

**Application**

The fail-safe modules of ET 200SP can be used to implement the safety-related application requirements as an integral part of the overall automation. The safety functions required for fail-safe operation are integrated in these modules. Communication with the fail-safe SIMATIC S7 CPUs is performed by means of PROFIsafe.

The modules can be operated both in centralized and distributed configurations.

**Design**Suitable BaseUnits

BaseUnits with an appropriate number of terminals are available for single and multi-conductor connections.

A light BaseUnit opens a new load group. The supply voltage to the sensors must be fed via this BU. The first BU next to the interface module must always be a light BU.

A dark BaseUnit forwards the supply voltage of the adjacent light BaseUnit on the left via self-assembling voltage buses. A new feed is therefore only required on the next light BaseUnit to the right.

All variants that correspond to the BU type of the I/O module can be used as BaseUnits.

Color identification of the terminals

The potentials at the terminals of the BaseUnit are defined by the I/O module. Optionally, the potentials of the terminals can be identified by module-specific color-coding labels to prevent wiring errors. The color-coded label that matches the respective I/O module is defined by the color code CCxx of the I/O module. This color code is also printed on the front of the module.

System-integrated shield connection

For the space-saving and EMC-optimized connection of cable shields, a shield connection is available that is quick and easy to mount. It consists of one shield connection element that can be plugged onto the BaseUnit and one shield terminal for each module. The low-impedance connection to the functional ground (DIN rail) is achieved without any additional wiring by the user.

**SIPLUS extreme RAIL failsafe I/O modules > SIPLUS extreme RAIL analog F-input modules**
**Technical specifications**

Article number	<b>6AG2136-6AA00-1CA1</b> SIPLUS ET 200SP F-AI 4xI 2/4-w HF RAIL	<b>6AG2136-6AB00-1CA1</b> SIPLUS ET 200SP F-AI 4xU 0..10V HF RAIL
<b>General information</b>		
<b>Product type designation</b>	F-AI 4xI 0(4)..20mA 2-/4-wire HF	F-AI 4xU 0..10V HF
<b>Operating mode</b> • cyclic measurement • Oversampling • MSI		Yes No No
<b>Supply voltage</b>		
<b>Rated value (DC)</b>	24 V	24 V
<b>Reverse polarity protection</b>	Yes	Yes
<b>Analog inputs</b>		
<b>Number of analog inputs</b> • For current measurement • For voltage measurement	4 4	4 4
<b>permissible input voltage for voltage input (destruction limit), max.</b>		35 V
<b>permissible input current for current input (destruction limit), max.</b>	35 mA	
<b>Input ranges (rated values), voltages</b> • 0 to +10 V		Yes
<b>Input ranges (rated values), currents</b> • 0 to 20 mA • 4 mA to 20 mA	Yes Yes	
<b>Cable length</b> • shielded, max.	1 000 m	200 m
<b>Analog value generation for the inputs</b>		
<b>Integration and conversion time/resolution per channel</b> • Resolution with overrange (bit including sign), max. • Integration time, parameterizable • Integration time (ms) • Interference voltage suppression for interference frequency $f_1$ in Hz	16 bit Yes 20 / 16,667 50 / 60 Hz	16 bit Yes 20 / 16,667 50 / 60 Hz
<b>Smoothing of measured values</b> • Number of smoothing levels • parameterizable • Average value filter	7 Yes	7 Yes Yes
<b>Encoder</b>		
<b>Connection of signal encoders</b> • for voltage measurement • for current measurement as 2-wire transducer - Burden of 2-wire transmitter, max. • for current measurement as 4-wire transducer	Yes 650 $\Omega$ Yes	Yes
<b>Errors/accuracies</b>		
<b>Basic error limit (operational limit at 25 °C)</b> • Voltage, relative to input range, (+/-) • Current, relative to input range, (+/-)	0.1 %	0.1 %
<b>Interference voltage suppression for <math>f = n \times (f_1 \pm 1 \%)</math>, <math>f_1 =</math> interference frequency</b> • Series mode interference (peak value of interference < rated value of input range), min. • Common mode voltage, max. • Common mode interference, min.	40 dB 70 dB	40 dB 10 V 70 dB
<b>Interrupts/diagnostics/status information</b>		
<b>Diagnostics function</b>	Yes	Yes
<b>Alarms</b> • Diagnostic alarm • Limit value alarm	Yes Yes	Yes No
<b>Diagnoses</b> • Monitoring the supply voltage • Wire-break • Short-circuit	Yes Yes; Measuring range 4 to 20 mA only Yes	Yes Yes
<b>Diagnostics indication LED</b> • RUN LED • ERROR LED • Monitoring of the supply voltage (PWR-LED) • Channel status display • for channel diagnostics • for module diagnostics	Yes; green LED Yes; red LED Yes; green PWR LED Yes; green LED Yes; red LED Yes; green/red LED	Yes; green LED Yes; red LED Yes; green PWR LED Yes; green LED Yes; red LED Yes; green/red DIAG LED
<b>Potential separation</b>		
<b>Potential separation channels</b> • between the channels and backplane bus	Yes	Yes

# SIPLUS RAIL

## SIPLUS ET 200SP RAIL

### SIPLUS extreme RAIL I/O modules

#### SIPLUS extreme RAIL failsafe I/O modules > SIPLUS extreme RAIL analog F-input modules

Article number	6AG2136-6AA00-1CA1 SIPLUS ET 200SP F-AI 4xI 2/4-w HF RAIL	6AG2136-6AB00-1CA1 SIPLUS ET 200SP F-AI 4xU 0..10V HF RAIL
<b>Standards, approvals, certificates</b>		
<b>Highest safety class achievable in safety mode</b> • Performance level according to ISO 13849-1 • SIL acc. to IEC 61508 • SIL in accordance with EN 50126, 50128, 50129	PLe SIL 3 SIL 2; a higher safety integrity level is possible if tested and approved for the specific application under consideration of all local regulations.	PLe SIL 3 SIL 2; a higher safety integrity level is possible if tested and approved for the specific application under consideration of all local regulations.
<b>Probability of failure (for service life of 20 years and repair time of 100 hours)</b> • Low demand mode: PFDavg in accordance with SIL3 • High demand/continuous mode: PFH in accordance with SIL3	< 5.00E-05 < 1.00E-09 1/h	< 5.00E-05 < 1.00E-09 1/h
<b>Railway application</b> • EN 50121-3-2 • EN 50121-4  • EN 50124-1  • EN 50125-1 • EN 50125-2  • EN 50125-3  • EN 50155  • EN 61373  • Fire protection acc. to EN 45545-2	Yes; EMC for rail vehicles Yes; EMC for signal and telecommunications systems  Yes; Railway applications - overvoltage category OV2; pollution degree PD2; rated surge voltage UNi = 0.5 kV; UNm = 24 V DC  Yes; Rail vehicles - see ambient conditions Yes; Stationary electrical equipment - see ambient conditions  Yes; Signal and telecommunications systems - see ambient conditions; vibrations and shocks: Application point outside of tracks (1 m to 3 m away from track)  Yes; Rail vehicles - temperature class OT1, ST1/ST2, horizontal mounting position Yes; Rail vehicles - vibrations and shocks: Category 1 Class A/B Yes; For proof of conformity, see Service & Support	Yes; EMC for rail vehicles Yes; EMC for signal and telecommunications systems  Yes; Railway applications - overvoltage category OV2; pollution degree PD2; rated surge voltage UNi = 0.5 kV; UNm = 24 V DC  Yes; Rail vehicles - see ambient conditions Yes; Stationary electrical equipment - see ambient conditions  Yes; Signal and telecommunications systems - see ambient conditions; vibrations and shocks: Application point outside of tracks (1 m to 3 m away from track)  Yes; Rail vehicles - temperature class OT1, ST1/ST2, horizontal mounting position Yes; Rail vehicles - vibrations and shocks: Category 1 Class A/B Yes; For proof of conformity, see Service & Support
<b>Ambient conditions</b>		
<b>Ambient temperature during operation</b> • horizontal installation, min. • horizontal installation, max.  • vertical installation, min. • vertical installation, max.	-30 °C; = Tmin (incl. condensation/frost) 60 °C; = Tmax; +70 °C for 10 min (OT1, ST1/ST2 acc. to EN 50155); +70 °C continuously with configured slots to the left and right of the module (OT3, ST0 acc. to EN 50155) -30 °C; = Tmin 50 °C; = Tmax	-30 °C; = Tmin (incl. condensation/frost) 60 °C; = Tmax; +70 °C for 10 min (OT1, ST1/ST2 acc. to EN 50155); +70 °C continuously with configured slots to the left and right of the module (OT3, ST1/ST2 acc. to EN 50155) -30 °C; = Tmin 50 °C; = Tmax
<b>Altitude during operation relating to sea level</b> • Installation altitude above sea level, max. • Ambient air temperature-barometric pressure-altitude	2 000 m Tmin ... Tmax at 1 140 hPa ... 795 hPa (-1 000 m ... +2 000 m)	2 000 m Tmin ... Tmax at 1 140 hPa ... 795 hPa (-1 000 m ... +2 000 m)
<b>Relative humidity</b> • With condensation, tested in accordance with IEC 60068-2-38, max.	100 %; RH incl. condensation / frost (no commissioning in bedewed state), horizontal installation	100 %; RH incl. condensation / frost (no commissioning in bedewed state), horizontal installation
<b>Resistance</b> • Coolants and lubricants - Resistant to commercially available coolants and lubricants • Use in stationary industrial systems - to biologically active substances according to EN 60721-3-3 - to chemically active substances according to EN 60721-3-3 - to mechanically active substances according to EN 60721-3-3 - Against mechanical environmental conditions acc. to EN 60721-3-3	Yes; Incl. diesel and oil droplets in the air  Yes; Class 3B2 mold, fungus and dry rot spores (with the exception of fauna); Class 3B3 on request Yes; Class 3C4 (RH < 75 %) incl. salt spray acc. to EN 60068-2-52 (severity degree 3); * Yes; Class 3S4 incl. sand, dust, * Yes; Class 3M8 using the SIPLUS Mounting Kit ET 200SP (6AG1193-6AA00-0AA0)	Yes; Incl. diesel and oil droplets in the air  Yes; Class 3B2 mold, fungus and dry rot spores (with the exception of fauna); Class 3B3 on request Yes; Class 3C4 (RH < 75 %) incl. salt spray acc. to EN 60068-2-52 (severity degree 3); * Yes; Class 3S4 incl. sand, dust, * Yes; Class 3M8 using the SIPLUS Mounting Kit ET 200SP (6AG1193-6AA00-0AA0)



**SIPLUS extreme RAIL failsafe I/O modules > SIPLUS extreme RAIL analog F-input modules**

Article number	<b>6AG2136-6AA00-1CA1</b> SIPLUS ET 200SP F-AI 4xI 2/4-w HF RAIL	<b>6AG2136-6AB00-1CA1</b> SIPLUS ET 200SP F-AI 4xU 0..10V HF RAIL
<ul style="list-style-type: none"> <li>• Use on land craft, rail vehicles and special-purpose vehicles               <ul style="list-style-type: none"> <li>- to biologically active substances according to EN 60721-3-5</li> <li>- to chemically active substances according to EN 60721-3-5</li> <li>- to mechanically active substances according to EN 60721-3-5</li> <li>- Against mechanical environmental conditions acc. to EN 60721-3-5</li> <li>- against mechanical environmental conditions in agriculture acc. to ISO 15003</li> </ul> </li> <li>• Usage in industrial process technology               <ul style="list-style-type: none"> <li>- Against chemically active substances acc. to EN 60654-4</li> <li>- Environmental conditions for process, measuring and control systems acc. to ANSI/ISA-71.04</li> </ul> </li> <li>• Remark               <ul style="list-style-type: none"> <li>- Note regarding classification of environmental conditions acc. to EN 60721, EN 60654-4 and ANSI/ISA-71.04</li> </ul> </li> </ul>	<p>Yes; Class 5B2 mold, fungus and dry rot spores (with the exception of fauna); Class 5B3 on request</p> <p>Yes; Class 5C3 (RH &lt; 75 %) incl. salt spray acc. to EN 60068-2-52 (severity degree 3); *</p> <p>Yes; Class 5S3 incl. sand, dust; *</p> <p>Yes; Class 5M2 using the SIPLUS Mounting Kit ET 200SP (6AG1193-6AA00-0AA0)</p> <p>Yes; level 1 (Location LE) using the SIPLUS Mounting Kit ET 200SP (6AG1193-6AA00-0AA0)</p> <p>Yes; Class 3 (excluding trichlorethylene)</p> <p>Yes; Level GX group A/B (excluding trichlorethylene; harmful gas concentrations up to the limits of EN 60721-3-3 class 3C4 permissible); level LC3 (salt spray) and level LB3 (oil)</p> <p>* The supplied plug covers must remain in place over the unused interfaces during operation!</p>	<p>Yes; Class 5B2 mold, fungus and dry rot spores (with the exception of fauna); Class 5B3 on request</p> <p>Yes; Class 5C3 (RH &lt; 75 %) incl. salt spray acc. to EN 60068-2-52 (severity degree 3); *</p> <p>Yes; Class 5S3 incl. sand, dust; *</p> <p>Yes; Class 5M2 using the SIPLUS Mounting Kit ET 200SP (6AG1193-6AA00-0AA0)</p> <p>Yes; level 1 (Location LE) using the SIPLUS Mounting Kit ET 200SP (6AG1193-6AA00-0AA0)</p> <p>Yes; Class 3 (excluding trichlorethylene)</p> <p>Yes; Level GX group A/B (excluding trichlorethylene; harmful gas concentrations up to the limits of EN 60721-3-3 class 3C4 permissible); level LC3 (salt spray) and level LB3 (oil)</p> <p>* The supplied plug covers must remain in place over the unused interfaces during operation!</p>
<b>Conformal coating</b>		
<ul style="list-style-type: none"> <li>• Coatings for printed circuit board assemblies acc. to EN 61086</li> <li>• Protection against fouling acc. to EN 60664-3</li> <li>• Electronic equipment on rolling stock acc. to EN 50155</li> <li>• Military testing according to MIL-I-46058C, Amendment 7</li> <li>• Qualification and Performance of Electrical Insulating Compound for Printed Board Assemblies according to IPC-CC-830A</li> </ul>	<p>Yes; Class 2 for high reliability</p> <p>Yes; Type 1 protection</p> <p>Yes; Class PC2 protective coating acc. to EN 50155:2017</p> <p>Yes; Discoloration of coating possible during service life</p> <p>Yes; Conformal coating, Class A</p>	<p>Yes; Class 2 for high reliability</p> <p>Yes; Type 1 protection</p> <p>Yes; Class PC2 protective coating acc. to EN 50155:2017</p> <p>Yes; Discoloration of coating possible during service life</p> <p>Yes; Conformal coating, Class A</p>
<b>Dimensions</b>		
<b>Width</b>	15 mm	15 mm
<b>Height</b>	73 mm	73 mm
<b>Depth</b>	58 mm	58 mm
<b>Weights</b>		
<b>Weight, approx.</b>	48 g	48 g
<b>Other</b>		
<b>Note:</b>	for use in railway applications, also observe the product information "SIPLUS extreme RAIL" A5E37661960A, Online Support article 109736776	for use in railway applications, also observe the product information "SIPLUS extreme RAIL" A5E37661960A, Online Support article 109736776

**SIPLUS RAIL**

SIPLUS ET 200SP RAIL

SIPLUS extreme RAIL I/O modules

SIPLUS extreme RAIL failsafe I/O modules &gt; SIPLUS extreme RAIL analog F-input modules

**Selection and ordering data**

Version	Article No.
<p><b>SIPLUS ET 200SP F-AI 4xI 2/4-w HF RAIL</b></p> <p>Approved in accordance with railway standards EN 50155, EN 15121, EN 50124, EN 50125 and EN 45545 for use in rail traffic</p> <p>BU type A0, A1, color code CC00; for areas with extreme exposure to environmental substances (conformal coating); ambient temperature -30 ... +55 °C T1 (+70 °C for 10 min.)</p>	<b>6AG2136-6AA00-1CA1</b>
<p><b>SIPLUS ET 200SP F-AI 4xU 0..10V HF RAIL OT2</b></p> <p>Approved in accordance with railway standards EN 50155, EN 15121, EN 50124, EN 50125 and EN 45545 for use in rail traffic</p> <p>BU type A0, A1, color code CC00; for areas with extreme exposure to environmental substances (conformal coating); ambient temperature -25 ... +70 °C ST1/2 (85 °C for 10min)</p>	<b>6AG2136-6AB00-1CA1</b>
<b>Suitable SIPLUS extreme RAIL BaseUnits, type A0</b>	
<p><b>SIPLUS ET 200SP BU15-P16+A0+2D TX RAIL</b></p> <p>Approved in accordance with railway standards EN 50155, EN 15121, EN 50124, EN 50125 and EN 45545 for use in rail traffic</p> <p>BU type A0; BaseUnit (light) with 16 process terminals to the module; for starting a new load group (max. 10 A); for areas with extreme exposure to environmental substances (conformal coating); ambient temperature -40 ... +70 °C (+85 °C for 10 min.)</p>	<b>6AG2193-6BP00-4DA0</b>
<p><b>SIPLUS ET 200SP BU15-P16+A0+2B TX RAIL</b></p> <p>Approved in accordance with railway standards EN 50155, EN 15121, EN 50124, EN 50125 and EN 45545 for use in rail traffic</p> <p>BU type A0; BaseUnit (dark) with 16 process terminals to the module; for continuing the load group; for areas with extreme exposure to environmental substances (conformal coating); ambient temperature -40 ... +70 °C (+85 °C for 10 min.)</p>	<b>6AG2193-6BP00-4BA0</b>
<p><b>SIPLUS ET 200SP BU15-P16+A10+2D TX RAIL</b></p> <p>Approved in accordance with railway standards EN 50155, EN 15121, EN 50124, EN 50125 and EN 45545 for use in rail traffic</p> <p>BU type A0; BaseUnit (light) with 16 process terminals (1...16) to the module and an additional 10 internally jumpered AUX terminals (1 A to 10 A); for starting a new load group (max. 10 A); for areas with extreme exposure to environmental substances (conformal coating); ambient temperature -40 ... +70 °C (+85 °C for 10 min.)</p>	<b>6AG2193-6BP20-4DA0</b>
<p><b>SIPLUS ET 200SP BU15-P16+A10+2B TX RAIL</b></p> <p>Approved in accordance with railway standards EN 50155, EN 15121, EN 50124, EN 50125 and EN 45545 for use in rail traffic</p> <p>BU type A0; BaseUnit (dark) with 16 process terminals (1...16) to the module and an additional 10 internally jumpered AUX terminals (1 A to 10 A); for continuing the load group; for areas with extreme exposure to environmental substances (conformal coating); ambient temperature -40 ... +70 °C (+85 °C for 10 min.)</p>	<b>6AG2193-6BP20-4BA0</b>
<b>SIPLUS extreme RAIL BaseUnits type A1 (with temperature detection)</b>	
<p><b>SIPLUS ET 200SP BU15-P16+A0+2D/T TX RAIL</b></p> <p>Approved in accordance with railway standards EN 50155, EN 15121, EN 50124, EN 50125 and EN 45545 for use in rail traffic</p> <p>BU type A1; BaseUnit (light) with 16 process terminals to the module; for starting a new load group (max. 10 A)</p>	<b>6AG2193-6BP00-4DA1</b>
<b>Accessories</b>	
<p><b>SIPLUS Mounting Kit ET 200SP</b></p> <p>Mounting accessories for use with increased mechanical vibration and shock loads. Can be used with SIPLUS BaseUnits with heights up to 117 mm, types A0/A1 without AUX or add-on terminals as well as types B0, B1, C0, C1, D0, U0</p>	<b>6AG1193-6AA00-0AA0</b>
<b>Other accessories</b>	See SIMATIC ET 200SP analog F-input modules

## Overview

Digital fail-safe power module:  
F-PM-E PPM 24 V DC/8 A for BU type C0, color code CC52

Other properties:

- Certified up to SIL 3 (IEC 61508), PL e (ISO 13849)
- Approved in accordance with EN 50155, EN 15121, EN 50124, EN 50125 and EN 45545 railway standards for use in rail traffic
- Safety-related shutdown of output modules within the potential group of the F-PM-E
- Two fail-safe digital inputs, for reading of sensor information (1 or 2 channels)
- One fail-safe digital output onboard (ppm switching, up to 2 A, up to SIL 3/PL e)
- Fail-safe digital output and potential supply pp or pm switching can be parameterized
- Parameterizable onboard evaluation of the fail-safe inputs for control of the fail-safe digital outputs and of the potential group
- Digital standard output modules can be shut down up to PL d (ISO 13849) and SIL 2 (IEC 61508) (up to 8 A).
- Can be plugged into type C0 BaseUnits (BU) with automatic coding
- LED display for error, operation, supply voltage and status
- Clear labeling on front of module
  - Plain text identification of the module type and function class
  - 2D matrix code (order and serial number)
  - Connection diagram
  - Color coding of the module type DI: white
  - Hardware and firmware version
  - Color code CC for module-specific color coding of the potentials at the BU terminals
  - Complete Article No.
- Optional labeling accessories
  - Labeling strips
  - Equipment labeling plate
- Optional module-specific color identification of the terminals according to the color code CC
- Optional system-integrated shield connection
- The modules support PROFIsafe in both PROFIBUS and PROFINET configurations.
- They can be used with all fail-safe SIMATIC S7 CPUs

## Application

The fail-safe modules of SIPLUS extreme ET 200SP RAIL can be used to implement the safety-related application requirements as an integral part of the overall automation. The safety functions required for fail-safe operation are integrated in these modules. Communication with the fail-safe SIMATIC S7 CPUs is performed by means of PROFIsafe.

The modules can be operated both in centralized and distributed configurations.

## Design

### Usable BaseUnits

For a single- or multi-conductor connection, BaseUnits with an appropriate number of terminals are available.

A light BaseUnit opens a new load group. The power supply to the sensors must be fed via this BU. The first BU next to the interface module must always be a light BU.

A dark BaseUnit forwards the power supply of the adjacent light BaseUnit on the left via self-assembling voltage buses. A new in-feed is therefore only required on the next light BaseUnit to the right.

All variants that correspond to the BU type of the I/O module can be used as BaseUnits.

### Color identification of the terminals

The potentials at the terminals of the BaseUnit are defined by the I/O module. Optionally, the potentials of the terminals can be identified by module-specific color-coding labels to prevent wiring errors. The color-coded label that matches the respective I/O module is defined by the color code CCxx of the I/O module. This color code is also printed on the front of the module.

In BaseUnits with the 10 internally jumpered AUX terminals, these can also be identified with color coding labels. For the 10 AUX terminals, color-coding labels are available in red, blue, and yellow/green.

### System-integrated shielded connection

For the connection of cable shields that is both space-saving as well as optimized in terms of EMC, a shield connection is available that is quick and easy to mount. This consists of one shield connection element that can be plugged onto the BaseUnit and one shield terminal for each module. The low-impedance connection to the functional ground (DIN rail) is achieved without any additional wiring by the user.

## Technical specifications

Article number	<b>6AG2136-6PA00-1BC0</b> SIPLUS ET 200SP F-PM-E 24VDC/8A PPM RAIL
<b>General information</b>	
<b>Product type designation</b>	F-PM-E PPM 24VDC
<b>Product function</b>	
• I&M data	Yes; I&M0 to I&M3
<b>Supply voltage</b>	
<b>Rated value (DC)</b>	24 V
<b>Reverse polarity protection</b>	Yes
<b>Encoder supply</b>	
<b>Number of outputs</b>	2
<b>Short-circuit protection</b>	Yes; Electronic (response threshold 0.7 A to 2.1 A)
<b>Output current</b>	
• up to 60 °C, max.	0.3 A
<b>24 V encoder supply</b>	
• 24 V	Yes; min. L+ (-1.5 V)
• Short-circuit protection	Yes
• Output current, max.	600 mA; Total current of all encoders

**SIPLUS RAIL**

SIPLUS ET 200SP RAIL

SIPLUS extreme RAIL I/O modules

**SIPLUS extreme RAIL failsafe I/O modules > SIPLUS extreme RAIL fail-safe special modules**

Article number	<b>6AG2136-6PA00-1BC0</b> SIPLUS ET 200SP F-PM-E 24VDC/8A PPM RAIL
<b>Digital inputs</b>	
Number of digital inputs	2
Source/sink input	Yes; P-reading
Input characteristic curve in accordance with IEC 61131, type 1	Yes
<b>Input voltage</b>	
• Type of input voltage	DC
• Rated value (DC)	24 V
• for signal "0"	-30 to +5 V
• for signal "1"	+15 to +30 V
<b>Input current</b>	
• for signal "1", typ.	3.7 mA
<b>Input delay (for rated value of input voltage)</b>	
• for standard inputs	Yes
- parameterizable	
• for technological functions	No
- parameterizable	
<b>Digital outputs</b>	
Number of digital outputs	1
Digital outputs, parameterizable	Yes
Short-circuit protection	Yes
Open-circuit detection	Yes
Overload protection	Yes
Limitation of inductive shutdown voltage to	max. 1.5 V
<b>Switching capacity of the outputs</b>	
• with resistive load, max.	8 A
• on lamp load, max.	100 W
<b>Load resistance range</b>	
• lower limit	3 Ω
• upper limit	2 000 Ω
<b>Output voltage</b>	
• for signal "1", min.	24 V; L+ (-0.5 V)
<b>Output current</b>	
• for signal "1" rated value	8 A
• for signal "0" residual current, max.	1.5 mA; PP-switching: max. 1.5 mA; PM-switching: max. 1 mA
<b>Switching frequency</b>	
• with resistive load, max.	10 Hz; Symmetrical
• with inductive load, max.	0.1 Hz; according to IEC 60947-5-1, DC-13, symmetrical
• on lamp load, max.	4 Hz; Symmetrical
<b>Total current of the outputs</b>	
• Current per channel, max.	8 A; note derating data in the manual
• Current per module, max.	8 A; note derating data in the manual
<b>Total current of the outputs (per module)</b>	
• horizontal installation	8 A; note derating data in the manual
- up to 40 °C, max.	6 A; note derating data in the manual
- up to 50 °C, max.	4 A; note derating data in the manual
- up to 60 °C, max.	4 A; note derating information in the manual; only with configured slots to the left and right of the module
- up to 70 °C, max.	
<b>Cable length</b>	
• shielded, max.	1 000 m
• unshielded, max.	500 m
<b>Interrupts/diagnostics/status information</b>	
Substitute values connectable	No
<b>Alarms</b>	
• Diagnostic alarm	Yes
• Hardware interrupt	No
<b>Diagnostics indication LED</b>	
• RUN LED	Yes; green LED
• ERROR LED	Yes; red LED
• Monitoring of the supply voltage (PWR-LED)	Yes; green PWR LED
• Channel status display	Yes; green LED
• for channel diagnostics	Yes; red LED
• for module diagnostics	Yes; green/red DIAG LED
<b>Potential separation</b>	
<b>Potential separation channels</b>	
• between the channels and backplane bus	Yes
<b>Standards, approvals, certificates</b>	
Suitable for safety functions	Yes
<b>Highest safety class achievable in safety mode</b>	
• Performance level according to ISO 13849-1	PLe
• SIL acc. to IEC 61508	SIL 3
• SIL in accordance with EN 50126, 50128, 50129	SIL 2; a higher safety integrity level is possible if tested and approved for the specific application under consideration of all local regulations.

**SIPLUS extreme RAIL failsafe I/O modules > SIPLUS extreme RAIL fail-safe special modules**

Article number	<b>6AG2136-6PA00-1BC0</b> SIPLUS ET 200SP F-PM-E 24VDC/8A PPM RAIL
<b>Probability of failure (for service life of 20 years and repair time of 100 hours)</b>	
<ul style="list-style-type: none"> <li>• Low demand mode: PFDavg in accordance with SIL2</li> <li>• Low demand mode: PFDavg in accordance with SIL3</li> <li>• High demand/continuous mode: PFH in accordance with SIL2</li> <li>• High demand/continuous mode: PFH in accordance with SIL3</li> </ul>	<ul style="list-style-type: none"> <li>&lt; 2.00E-04</li> <li>&lt; 2.00E-05</li> <li>&lt; 1.00E-08 1/h</li> <li>&lt; 1.00E-09 1/h</li> </ul>
<b>Railway application</b>	
<ul style="list-style-type: none"> <li>• EN 50121-3-2</li> <li>• EN 50121-4</li> <li>• EN 50124-1</li> <li>• EN 50125-1</li> <li>• EN 50125-2</li> <li>• EN 50125-3</li> <li>• EN 50155</li> <li>• EN 61373</li> <li>• Fire protection acc. to EN 45545-2</li> </ul>	<ul style="list-style-type: none"> <li>Yes; EMC for rail vehicles</li> <li>Yes; EMC for signal and telecommunications systems</li> <li>Yes; Railway applications - overvoltage category OV2; pollution degree PD2; rated surge voltage UNi = 0.5 kV; UNm = 24 V DC</li> <li>Yes; Rail vehicles - see ambient conditions</li> <li>Yes; Stationary electrical equipment - see ambient conditions</li> <li>Yes; Signal and telecommunications systems - see ambient conditions; vibrations and shocks: Application point outside of tracks (1 m to 3 m away from track)</li> <li>Yes; Rail vehicles - temperature class OT1, ST1/ST2, horizontal mounting position</li> <li>Yes; Rail vehicles - vibrations and shocks: Category 1 Class A/B</li> <li>Yes; For proof of conformity, see Service &amp; Support</li> </ul>
<b>Ambient conditions</b>	
<b>Ambient temperature during operation</b>	
<ul style="list-style-type: none"> <li>• horizontal installation, min.</li> <li>• horizontal installation, max.</li> <li>• vertical installation, min.</li> <li>• vertical installation, max.</li> </ul>	<ul style="list-style-type: none"> <li>-30 °C; = Tmin (incl. condensation/frost)</li> <li>60 °C; = Tmax; +70 °C for 10 min (OT1, ST1/ST2 acc. to EN 50155); +70 °C continuously with configured slots to the left and right of the module (OT3, ST0 acc. to EN 50155)</li> <li>-30 °C; = Tmin</li> <li>50 °C; = Tmax</li> </ul>
<b>Altitude during operation relating to sea level</b>	
<ul style="list-style-type: none"> <li>• Installation altitude above sea level, max.</li> <li>• Ambient air temperature-barometric pressure-altitude</li> </ul>	<ul style="list-style-type: none"> <li>2 000 m</li> <li>Tmin ... Tmax at 1 140 hPa ... 795 hPa (-1 000 m ... +2 000 m)</li> </ul>
<b>Relative humidity</b>	
<ul style="list-style-type: none"> <li>• With condensation, tested in accordance with IEC 60068-2-38, max.</li> </ul>	100 %; RH incl. condensation / frost (no commissioning in bedewed state), horizontal installation
<b>Resistance</b>	
<ul style="list-style-type: none"> <li>• Coolants and lubricants <ul style="list-style-type: none"> <li>- Resistant to commercially available coolants and lubricants</li> </ul> </li> <li>• Use in stationary industrial systems <ul style="list-style-type: none"> <li>- to biologically active substances according to EN 60721-3-3</li> <li>- to chemically active substances according to EN 60721-3-3</li> <li>- to mechanically active substances according to EN 60721-3-3</li> <li>- Against mechanical environmental conditions acc. to EN 60721-3-3</li> </ul> </li> <li>• Use on land craft, rail vehicles and special-purpose vehicles <ul style="list-style-type: none"> <li>- to biologically active substances according to EN 60721-3-5</li> <li>- to chemically active substances according to EN 60721-3-5</li> <li>- to mechanically active substances according to EN 60721-3-5</li> <li>- Against mechanical environmental conditions acc. to EN 60721-3-5</li> <li>- against mechanical environmental conditions in agriculture acc. to ISO 15003</li> </ul> </li> <li>• Usage in industrial process technology <ul style="list-style-type: none"> <li>- Against chemically active substances acc. to EN 60654-4</li> <li>- Environmental conditions for process, measuring and control systems acc. to ANSI/ISA-71.04</li> </ul> </li> <li>• Remark <ul style="list-style-type: none"> <li>- Note regarding classification of environmental conditions acc. to EN 60721, EN 60654-4 and ANSI/ISA-71.04</li> </ul> </li> </ul>	<ul style="list-style-type: none"> <li>Yes; Incl. diesel and oil droplets in the air</li> <li>Yes; Class 3B2 mold, fungus and dry rot spores (with the exception of fauna); Class 3B3 on request</li> <li>Yes; Class 3C4 (RH &lt; 75 %) incl. salt spray acc. to EN 60068-2-52 (severity degree 3); *</li> <li>Yes; Class 3S4 incl. sand, dust, *</li> <li>Yes; Class 3M8 using the SIPLUS Mounting Kit ET 200SP (6AG1193-6AA00-0AA0)</li> <li>Yes; Class 5B2 mold, fungus and dry rot spores (with the exception of fauna); Class 5B3 on request</li> <li>Yes; Class 5C3 (RH &lt; 75 %) incl. salt spray acc. to EN 60068-2-52 (severity degree 3); *</li> <li>Yes; Class 5S3 incl. sand, dust, *</li> <li>Yes; Class 5M2 using the SIPLUS Mounting Kit ET 200SP (6AG1193-6AA00-0AA0)</li> <li>Yes; level 1 (Location LE) using the SIPLUS Mounting Kit ET 200SP (6AG1193-6AA00-0AA0)</li> <li>Yes; Class 3 (excluding trichlorethylene)</li> <li>Yes; Level GX group A/B (excluding trichlorethylene; harmful gas concentrations up to the limits of EN 60721-3-3 class 3C4 permissible); level LC3 (salt spray) and level LB3 (oil)</li> <li>* The supplied plug covers must remain in place over the unused interfaces during operation!</li> </ul>
<b>Conformal coating</b>	
<ul style="list-style-type: none"> <li>• Coatings for printed circuit board assemblies acc. to EN 61086</li> <li>• Protection against fouling acc. to EN 60664-3</li> <li>• Electronic equipment on rolling stock acc. to EN 50155</li> <li>• Military testing according to MIL-I-46058C, Amendment 7</li> <li>• Qualification and Performance of Electrical Insulating Compound for Printed Board Assemblies according to IPC-CC-830A</li> </ul>	<ul style="list-style-type: none"> <li>Yes; Class 2 for high reliability</li> <li>Yes; Type 1 protection</li> <li>Yes; Class PC2 protective coating acc. to EN 50155:2017</li> <li>Yes; Discoloration of coating possible during service life</li> <li>Yes; Conformal coating, Class A</li> </ul>
<b>Dimensions</b>	
<b>Width</b>	20 mm
<b>Height</b>	72 mm
<b>Depth</b>	55 mm
<b>Weights</b>	
<b>Weight, approx.</b>	70 g
<b>Other</b>	
<b>Note:</b>	for use in railway applications, also observe the product information "SIPLUS extreme RAIL" A5E37661960A, Online Support article 109736776

**SIPLUS RAIL**

SIPLUS ET 200SP RAIL

SIPLUS extreme RAIL I/O modules

SIPLUS extreme RAIL failsafe I/O modules &gt; SIPLUS extreme RAIL fail-safe special modules

**Selection and ordering data**

Version	Article No.
<p><b>SIPLUS ET 200SP F-PM-E 24VDC/8A PPM RAIL</b>            Approved in accordance with EN 50155, EN 15121, EN 50124, EN 50125 and EN 45545 railway standards for use in rail traffic            BU type C0, color code CC52. 2 inputs, 1 output, SIL3/Cat.4/PLe;            for areas with extreme exposure to media (conformal coating);            ambient temperature -25 ... +55 °C (+70 °C for 10 min.)</p>	<b>6AG2136-6PA00-1BC0</b>
<p><b>Suitable SIPLUS extreme RAIL BaseUnits, type C0</b>  <b>SIPLUS ET 200SP BU20-P6+A2+4D TX RAIL</b>            Approved in accordance with EN 50155, EN 15121, EN 50124, EN 50125 and EN 45545 railway standards for use in rail traffic            BU type C0; BaseUnit (light) with 6 push-in terminals (1...6) to the module and 2 AUX terminals; new load group</p>	<b>6AG2193-6BP20-4DC0</b>
<p><b>Accessories</b>  <b>SIPLUS Mounting Kit ET 200SP</b>            Mounting accessories for use with increased mechanical vibration and shock loads.</p>	<b>6AG1193-6AA00-0AA0</b>

## Overview



With the BaseUnits (BUs), the SIPLUS extreme RAIL ET 200SP offers a rugged and service-friendly design with permanent wiring:

- Approved in accordance with the railway standards EN 50155, EN 15121, EN 50124, EN 50125 and EN 45545 for use in rail traffic
- No tools needed for one-handed wiring using push-in terminals
- Actuation of the spring NC contacts with a standard screwdriver, with a blade width up to 3.5 mm
- Outstanding access due to arrangement of measuring tap, spring NC contacts and cable entry in columns, while at the same time reducing the space required by 64%
- Fault-proof color coding of the spring NC contacts for better orientation in the terminal panel
- Replacement of I/O modules during operation without affecting the wiring
- Operation with module gaps (gaps without I/O module)
- Automatic coding of the I/O modules prevents destruction of the electronics if a module is accidentally inserted in the wrong slot during replacement
- High EMC interference immunity:
  - Self-assembling shielded backplane bus
  - multi-layer conductor plate with shield levels for interference-free signal transmission from the terminal to the I/O module,
  - System-integrated, space-saving shield connection for quick installation
- Self-assembling potential groups without external wiring or jumpers
- Replaceable terminal box
- Side-by-side latching of the BUs for high mechanical and EMC loads
- Optional module-specific color identification of the terminals according to the color code CC
- Optional equipment marking using slide-in equipment labeling plates

## Design

The different BaseUnits (BU) facilitate the exact adaptation to the required type of wiring. This enables users to select economical connection systems for the I/O modules used for their task. The TIA Selection Tool assists in the selection of the BaseUnits most suitable for the application.

BaseUnits with the following functions are available:

- Single-conductor connection, with direct connection of the shared return conductor
- Direct multi-conductor connection (2, 3 or 4-wire connection)
- Recording of the terminal temperature for the internal temperature compensation for thermocouple measurements
- AUX or additional terminals for individual use as voltage distribution terminal

The BaseUnits (BU) can be plugged onto DIN mounting rails compliant with EN 60715 (35 x 7.5 mm or 35 mm x 15 mm). The BUs are arranged next to one another beside the interface module, thereby safeguarding the electromechanical link between the individual system components. An I/O module is plugged onto the BUs, which ultimately determines the function of the respective slot and the potentials of the terminals.

### Load group formation

Scalable I/O systems usually offer the possibility of individual load group formation. In the case of distributed I/O devices, this previously required an additional power module (feed module) that provided the separation from the left-hand load group as well as the infeed, display, monitoring, and diagnostics of the load voltage. It also featured a filter function against external interference and offered protection against polarity reversal.

All of these functions are now integrated into the basic components of the system in the ET 200SP. For users, this means the elimination of the power module. This saves an additional slot for each load group, resulting in greater flexibility in terms of configuration and ultimately, a saving of storage space.

A light-colored BU separates the self-assembling, internal voltage buses (P1, P2, AUX) and thus opens a new load group. The power supply of a load group must be fed in at the light BU of this load group.

A dark BU forwards the power supply of the adjacent light BU on the left via the self-assembling voltage buses P1, P2 and AUX. A new infeed is therefore only required on the next light BU to the right. The setting of a further light BU is required whenever

- a new load group is to be formed (for example, for isolating the supply voltage from module groups) or
- the maximum current simultaneously required by the load group exceeds the permissible limit of 10 A.

### Labeling

#### Equipment labeling plates

Equipment labeling plates enable the equipment to be easily identified (e.g. compliant with EN 81346). They are easily plugged onto the required component (interface modules, I/O modules and BaseUnits) and when required, they can be easily replaced with the component.

The following labeling components are available:

- Equipment labeling plates, white, ten sheets each with 16 labels, for thermal transfer card printers or labels



# SIPLUS RAIL

## SIPLUS ET 200SP RAIL

### SIPLUS extreme RAIL BaseUnits

#### Color identification of the terminals

The potentials at the terminals of the BaseUnit are defined by the I/O module. Optionally, the potentials of the terminals can be identified by module-specific color-coded labels to prevent wiring errors. The color-coded label that matches the respective I/O module is defined by the color code CCxx of the I/O module. This color code is also printed on the front of the module.

In BaseUnits with 10 internally jumpered AUX terminals, these can also be identified with color-coded labels. For the 10 AUX terminals, color-coded labels are available in red, blue, and yellow/green.

#### System-integrated shielded connection

For the space-saving and EMC-optimized connection of cable shields, a shield connection is available that is quick and easy to mount. This consists of one shield connection element that can be plugged onto the BaseUnit and one shield terminal for each module. The low-impedance connection to the functional ground (DIN rail) is achieved without any additional wiring by the user.

The BaseUnits can be equipped with an equipment labeling plate.

### Technical specifications

Article number	6AG2193-6BP00-4BA0 SIPLUS ET 200SP BU15-P16+A0+2B TX RAIL	6AG2193-6BP00-4DA0 SIPLUS ET 200SP BU15-P16+A0+2D TX RAIL	6AG2193-6BP20-4BA0 SIPLUS ET 200SP BU15-P16+A10+2B TX RAIL	6AG2193-6BP20-4DA0 SIPLUS ET 200SP BU15-P16+A10+2D TX RAIL
<b>General information</b>				
<b>Product type designation</b>	BU type A0	BU type A0	BU type A0	BU type A0
<b>Hardware configuration</b>				
<b>Slots</b>				
• Number of slots	1	1	1	1
<b>Standards, approvals, certificates</b>				
<b>Railway application</b>				
• EN 50121-3-2	Yes; EMC for rail vehicles	Yes; EMC for rail vehicles	Yes; EMC for rail vehicles	Yes; EMC for rail vehicles
• EN 50121-4	Yes; EMC for signal and telecommunications systems	Yes; EMC for signal and telecommunications systems	Yes; EMC for signal and telecommunications systems	Yes; EMC for signal and telecommunications systems
• EN 50124-1	Yes; Railway applications - overvoltage category OV2; pollution degree PD2; rated surge voltage UNi = 0.5 kV; UNm = 24 V DC	Yes; Railway applications - overvoltage category OV2; pollution degree PD2; rated surge voltage UNi = 0.5 kV; UNm = 24 V DC	Yes; Railway applications - overvoltage category OV2; pollution degree PD2; rated surge voltage UNi = 0.5 kV; UNm = 24 V DC	Yes; Railway applications - overvoltage category OV2; pollution degree PD2; rated surge voltage UNi = 0.5 kV; UNm = 24 V DC
• EN 50125-1	Yes; Rail vehicles - see ambient conditions	Yes; Rail vehicles - see ambient conditions	Yes; Rail vehicles - see ambient conditions	Yes; Rail vehicles - see ambient conditions
• EN 50125-2	Yes; Stationary electrical equipment - see ambient conditions	Yes; Stationary electrical equipment - see ambient conditions	Yes; Stationary electrical equipment - see ambient conditions	Yes; Stationary electrical equipment - see ambient conditions
• EN 50125-3	Yes; Signal and telecommunications systems - see ambient conditions; vibrations and shocks: Application point outside of tracks (1 m to 3 m away from track)	Yes; Signal and telecommunications systems - see ambient conditions; vibrations and shocks: Application point outside of tracks (1 m to 3 m away from track)	Yes; Signal and telecommunications systems - see ambient conditions; vibrations and shocks: Application point outside of tracks (1 m to 3 m away from track)	Yes; Signal and telecommunications systems - see ambient conditions; vibrations and shocks: Application point outside of tracks (1 m to 3 m away from track)
• EN 50155	Yes; Rail vehicles - temperature class OT4, ST1/ST2, horizontal mounting position	Yes; Rail vehicles - temperature class OT4, ST1/ST2, horizontal mounting position	Yes; Rail vehicles - temperature class OT4, ST1/ST2, horizontal mounting position	Yes; Rail vehicles - temperature class OT4, ST1/ST2, horizontal mounting position
• EN 61373	Yes; Rail vehicles - vibrations and shocks: Category 1 Class A/B	Yes; Rail vehicles - vibrations and shocks: Category 1 Class A/B	Yes; Rail vehicles - vibrations and shocks: Category 1 Class A/B	Yes; Rail vehicles - vibrations and shocks: Category 1 Class A/B
• Fire protection acc. to EN 45545-2	Yes; For proof of conformity, see Service & Support	Yes; For proof of conformity, see Service & Support	Yes; For proof of conformity, see Service & Support	Yes; For proof of conformity, see Service & Support
<b>Ambient conditions</b>				
<b>Ambient temperature during operation</b>				
• horizontal installation, min.	-40 °C; = Tmin (incl. condensation/frost)	-40 °C; = Tmin (incl. condensation/frost)	-40 °C; = Tmin (incl. condensation/frost)	-40 °C; = Tmin (incl. condensation/frost)
• horizontal installation, max.	70 °C; = Tmax; +85 °C for 10 min (OT4, ST1/ST2 acc. to EN 50155)	70 °C; = Tmax; +85 °C for 10 min (OT4, ST1/ST2 acc. to EN 50155)	70 °C; = Tmax; +85 °C for 10 min (OT4, ST1/ST2 acc. to EN 50155)	70 °C; = Tmax; +85 °C for 10 min (OT4, ST1/ST2 acc. to EN 50155)
• vertical installation, min.	-40 °C; = Tmin	-40 °C; = Tmin	-40 °C; = Tmin	-40 °C; = Tmin
• vertical installation, max.	50 °C; = Tmax	50 °C; = Tmax	50 °C; = Tmax	50 °C; = Tmax
<b>Altitude during operation relating to sea level</b>				
• Installation altitude above sea level, max.	2 000 m	2 000 m	2 000 m	2 000 m
• Ambient air temperature-barometric pressure-altitude	Tmin ... Tmax at 1 140 hPa ... 795 hPa (-1 000 m ... +2 000 m)	Tmin ... Tmax at 1 140 hPa ... 795 hPa (-1 000 m ... +2 000 m)	Tmin ... Tmax at 1 140 hPa ... 795 hPa (-1 000 m ... +2 000 m)	Tmin ... Tmax at 1 140 hPa ... 795 hPa (-1 000 m ... +2 000 m)
<b>Relative humidity</b>				
• With condensation, tested in accordance with IEC 60068-2-38, max.	100 %; RH incl. condensation / frost (no commissioning in bedewed state), horizontal installation	100 %; RH incl. condensation / frost (no commissioning in bedewed state), horizontal installation	100 %; RH incl. condensation / frost (no commissioning in bedewed state), horizontal installation	100 %; RH incl. condensation / frost (no commissioning in bedewed state), horizontal installation

Article number	6AG2193-6BP00-4BA0 SIPLUS ET 200SP BU15- P16+A0+2B TX RAIL	6AG2193-6BP00-4DA0 SIPLUS ET 200SP BU15- P16+A0+2D TX RAIL	6AG2193-6BP20-4BA0 SIPLUS ET 200SP BU15- P16+A10+2B TX RAIL	6AG2193-6BP20-4DA0 SIPLUS ET 200SP BU15- P16+A10+2D TX RAIL
<b>Resistance</b>				
<ul style="list-style-type: none"> <li>Coolants and lubricants <ul style="list-style-type: none"> <li>Resistant to commercially available coolants and lubricants</li> </ul> </li> <li>Use in stationary industrial systems <ul style="list-style-type: none"> <li>to biologically active substances according to EN 60721-3-3</li> <li>to chemically active substances according to EN 60721-3-3</li> <li>to mechanically active substances according to EN 60721-3-3</li> <li>Against mechanical environmental conditions acc. to EN 60721-3-3</li> </ul> </li> <li>Use on land craft, rail vehicles and special-purpose vehicles <ul style="list-style-type: none"> <li>to biologically active substances according to EN 60721-3-5</li> <li>to chemically active substances according to EN 60721-3-5</li> <li>to mechanically active substances according to EN 60721-3-5</li> <li>Against mechanical environmental conditions acc. to EN 60721-3-5</li> <li>against mechanical environmental conditions in agriculture acc. to ISO 15003</li> </ul> </li> <li>Usage in industrial process technology <ul style="list-style-type: none"> <li>Against chemically active substances acc. to EN 60654-4</li> <li>Environmental conditions for process, measuring and control systems acc. to ANSI/ISA-71.04</li> </ul> </li> <li>Remark <ul style="list-style-type: none"> <li>Note regarding classification of environmental conditions acc. to EN 60721, EN 60654-4 and ANSI/ISA-71.04</li> </ul> </li> </ul>	<ul style="list-style-type: none"> <li>Yes; Incl. diesel and oil droplets in the air</li> <li>Yes; Class 3B2 mold, fungus and dry rot spores (with the exception of fauna); Class 3B3 on request</li> <li>Yes; Class 3C4 (RH &lt; 75 %) incl. salt spray acc. to EN 60068-2-52 (severity degree 3); *</li> <li>Yes; Class 3S4 incl. sand, dust; *</li> <li>Yes; Class 3M8 using the SIPLUS Mounting Kit ET 200SP (6AG1193-6AA00-0AA0)</li> <li>Yes; Class 5B2 mold, fungus and dry rot spores (with the exception of fauna); Class 5B3 on request</li> <li>Yes; Class 5C3 (RH &lt; 75 %) incl. salt spray acc. to EN 60068-2-52 (severity degree 3); *</li> <li>Yes; Class 5S3 incl. sand, dust; *</li> <li>Yes; Class 5M2 using the SIPLUS Mounting Kit ET200SP (6AG1193-6AA00-0AA0)</li> <li>Yes; level 1 (Location LE) using the SIPLUS Mounting Kit ET 200SP (6AG1193-6AA00-0AA0)</li> <li>Yes; Class 3 (excluding trichlorethylene)</li> <li>Yes; Level GX group A/B (excluding trichlorethylene; harmful gas concentrations up to the limits of EN 60721-3-3 class 3C4 permissible); level LC3 (salt spray) and level LB3 (oil)</li> <li>* The supplied plug covers must remain in place over the unused interfaces during operation!</li> </ul>	<ul style="list-style-type: none"> <li>Yes; Incl. diesel and oil droplets in the air</li> <li>Yes; Class 3B2 mold, fungus and dry rot spores (with the exception of fauna); Class 3B3 on request</li> <li>Yes; Class 3C4 (RH &lt; 75 %) incl. salt spray acc. to EN 60068-2-52 (severity degree 3); *</li> <li>Yes; Class 3S4 incl. sand, dust; *</li> <li>Yes; Class 3M8 using the SIPLUS Mounting Kit ET 200SP (6AG1193-6AA00-0AA0)</li> <li>Yes; Class 5B2 mold, fungus and dry rot spores (with the exception of fauna); Class 5B3 on request</li> <li>Yes; Class 5C3 (RH &lt; 75 %) incl. salt spray acc. to EN 60068-2-52 (severity degree 3); *</li> <li>Yes; Class 5S3 incl. sand, dust; *</li> <li>Yes; Class 5M2 using the SIPLUS Mounting Kit ET 200SP (6AG1193-6AA00-0AA0)</li> <li>Yes; level 1 (Location LE) using the SIPLUS Mounting Kit ET 200SP (6AG1193-6AA00-0AA0)</li> <li>Yes; Class 3 (excluding trichlorethylene)</li> <li>Yes; Level GX group A/B (excluding trichlorethylene; harmful gas concentrations up to the limits of EN 60721-3-3 class 3C4 permissible); level LC3 (salt spray) and level LB3 (oil)</li> <li>* The supplied plug covers must remain in place over the unused interfaces during operation!</li> </ul>	<ul style="list-style-type: none"> <li>Yes; Incl. diesel and oil droplets in the air</li> <li>Yes; Class 3B2 mold, fungus and dry rot spores (with the exception of fauna); Class 3B3 on request</li> <li>Yes; Class 3C4 (RH &lt; 75 %) incl. salt spray acc. to EN 60068-2-52 (severity degree 3); *</li> <li>Yes; Class 3S4 incl. sand, dust; *</li> <li>Yes; Class 3M8 using the SIPLUS Mounting Kit ET 200SP (6AG1193-6AA00-0AA0)</li> <li>Yes; Class 5B2 mold, fungus and dry rot spores (with the exception of fauna); Class 5B3 on request</li> <li>Yes; Class 5C3 (RH &lt; 75 %) incl. salt spray acc. to EN 60068-2-52 (severity degree 3); *</li> <li>Yes; Class 5S3 incl. sand, dust; *</li> <li>Yes; Class 5M2 using the SIPLUS Mounting Kit ET 200SP (6AG1193-6AA00-0AA0)</li> <li>Yes; level 1 (Location LE) using the SIPLUS Mounting Kit ET 200SP (6AG1193-6AA00-0AA0)</li> <li>Yes; Class 3 (excluding trichlorethylene)</li> <li>Yes; Level GX group A/B (excluding trichlorethylene; harmful gas concentrations up to the limits of EN 60721-3-3 class 3C4 permissible); level LC3 (salt spray) and level LB3 (oil)</li> <li>* The supplied plug covers must remain in place over the unused interfaces during operation!</li> </ul>	<ul style="list-style-type: none"> <li>Yes; Incl. diesel and oil droplets in the air</li> <li>Yes; Class 3B2 mold, fungus and dry rot spores (with the exception of fauna); Class 3B3 on request</li> <li>Yes; Class 3C4 (RH &lt; 75 %) incl. salt spray acc. to EN 60068-2-52 (severity degree 3); *</li> <li>Yes; Class 3S4 incl. sand, dust; *</li> <li>Yes; Class 3M8 using the SIPLUS Mounting Kit ET 200SP (6AG1193-6AA00-0AA0)</li> <li>Yes; Class 5B2 mold, fungus and dry rot spores (with the exception of fauna); Class 5B3 on request</li> <li>Yes; Class 5C3 (RH &lt; 75 %) incl. salt spray acc. to EN 60068-2-52 (severity degree 3); *</li> <li>Yes; Class 5S3 incl. sand, dust; *</li> <li>Yes; Class 5M2 using the SIPLUS Mounting Kit ET (6AG1193-6AA00-0AA0)</li> <li>Yes; level 1 (Location LE) using the SIPLUS Mounting Kit ET 200SP (6AG1193-6AA00-0AA0)</li> <li>Yes; Class 3 (excluding trichlorethylene)</li> <li>Yes; Level GX group A/B (excluding trichlorethylene; harmful gas concentrations up to the limits of EN 60721-3-3 class 3C4 permissible); level LC3 (salt spray) and level LB3 (oil)</li> <li>* The supplied plug covers must remain in place over the unused interfaces during operation!</li> </ul>
<b>Conformal coating</b>				
<ul style="list-style-type: none"> <li>Coatings for printed circuit board assemblies acc. to EN 61086</li> <li>Protection against fouling acc. to EN 60664-3</li> <li>Electronic equipment on rolling stock acc. to EN 50155</li> <li>Military testing according to MIL-I-46058C, Amendment 7</li> <li>Qualification and Performance of Electrical Insulating Compound for Printed Board Assemblies according to IPC-CC-830A</li> </ul>	<ul style="list-style-type: none"> <li>Yes; Class 2 for high reliability</li> <li>Yes; Type 1 protection</li> <li>Yes; Class PC2 protective coating acc. to EN 50155:2017</li> <li>Yes; Discoloration of coating possible during service life</li> <li>Yes; Conformal coating, Class A</li> </ul>	<ul style="list-style-type: none"> <li>Yes; Class 2 for high reliability</li> <li>Yes; Type 1 protection</li> <li>Yes; Class PC2 protective coating acc. to EN 50155:2017</li> <li>Yes; Discoloration of coating possible during service life</li> <li>Yes; Conformal coating, Class A</li> </ul>	<ul style="list-style-type: none"> <li>Yes; Class 2 for high reliability</li> <li>Yes; Type 1 protection</li> <li>Yes; Class PC2 protective coating acc. to EN 50155:2017</li> <li>Yes; Discoloration of coating possible during service life</li> <li>Yes; Conformal coating, Class A</li> </ul>	<ul style="list-style-type: none"> <li>Yes; Class 2 for high reliability</li> <li>Yes; Type 1 protection</li> <li>Yes; Class PC2 protective coating acc. to EN 50155:2017</li> <li>Yes; Discoloration of coating possible during service life</li> <li>Yes; Conformal coating, Class A</li> </ul>
<b>Dimensions</b>				
<b>Width</b>	15 mm	15 mm	15 mm	15 mm
<b>Height</b>	117 mm	117 mm	141 mm	141 mm
<b>Depth</b>	35 mm	35 mm	35 mm	35 mm
<b>Weights</b>				
<b>Weight, approx.</b>	40 g	40 g	50 g	50 g

# SIPLUS RAIL

## SIPLUS ET 200SP RAIL

### SIPLUS extreme RAIL BaseUnits

Article number	<b>6AG2193-6BP00-4BA0</b>	<b>6AG2193-6BP00-4DA0</b>	<b>6AG2193-6BP20-4BA0</b>	<b>6AG2193-6BP20-4DA0</b>
	SIPLUS ET 200SP BU15-P16+A0+2B TX RAIL	SIPLUS ET 200SP BU15-P16+A0+2D TX RAIL	SIPLUS ET 200SP BU15-P16+A10+2B TX RAIL	SIPLUS ET 200SP BU15-P16+A10+2D TX RAIL
<b>Other</b>				
<b>Note:</b>	for use in railway applications, also observe the product information "SIPLUS extreme RAIL" A5E37661960A, Online Support article 109736776	for use in railway applications, also observe the product information "SIPLUS extreme RAIL" A5E37661960A, Online Support article 109736776	for use in railway applications, also observe the product information "SIPLUS extreme RAIL" A5E37661960A, Online Support article 109736776	for use in railway applications, also observe the product information "SIPLUS extreme RAIL" A5E37661960A, Online Support article 109736776

Article number	SIPLUS ET 200SP BU20-P12+A0+4B TX RAIL	SIPLUS ET 200SP BU20-P6+A2+4D TX RAIL	SIPLUS ET 200SP BU20-P12+A0+0B TX RAIL	SIPLUS ET 200SP BU15-P16+A0+2D/T TX RAIL	SIPLUS ET 200SP BU20-P8+A4+0B TX RAIL
----------------	--	---------------------------------------	--	--	---------------------------------------

General information					
Product type designation	BU type B1	BU type C0	BU type D0	BU type A1	BU type F0
Hardware configuration					
Slots					
• Number of slots	1	1	1	1	1

Standards, approvals, certificates					
Railway application					
• EN 50121-3-2	Yes; EMC for rail vehicles	Yes; EMC for rail vehicles	Yes; EMC for rail vehicles	Yes; EMC for rail vehicles	Yes; EMC for rail vehicles
• EN 50121-4	Yes; EMC for signal and telecommunications systems	Yes; EMC for signal and telecommunications systems	Yes; EMC for signal and telecommunications systems	Yes; EMC for signal and telecommunications systems	Yes; EMC for signal and telecommunications systems
• EN 50124-1	Yes; Railway applications - overvoltage category OV3; pollution degree PD2; UNm = 230 V AC	Yes; Railway applications - overvoltage category OV2; pollution degree PD2; rated surge voltage UNI = 0.5 kV; UNm = 24 V DC	Yes; Railway applications - overvoltage category OV3; pollution degree PD2; UNm = 230 V AC	Yes; Railway applications - overvoltage category OV2; pollution degree PD2; rated surge voltage UNI = 0.5 kV; UNm = 24 V DC	Yes; Railway applications - overvoltage category OV3; pollution degree PD2; UNm = 230 V AC
• EN 50125-1	Yes; Rail vehicles - see ambient conditions	Yes; Rail vehicles - see ambient conditions	Yes; Rail vehicles - see ambient conditions	Yes; Rail vehicles - see ambient conditions	Yes; Rail vehicles - see ambient conditions
• EN 50125-2	Yes; Stationary electrical equipment - see ambient conditions	Yes; Stationary electrical equipment - see ambient conditions	Yes; Stationary electrical equipment - see ambient conditions	Yes; Stationary electrical equipment - see ambient conditions	Yes; Stationary electrical equipment - see ambient conditions
• EN 50125-3	Yes; Signal and telecommunications systems - see ambient conditions; vibrations and shocks: Application point outside of tracks (1 m to 3 m away from track)	Yes; Signal and telecommunications systems - see ambient conditions; vibrations and shocks: Application point outside of tracks (1 m to 3 m away from track)	Yes; Signal and telecommunications systems - see ambient conditions; vibrations and shocks: Application point outside of tracks (1 m to 3 m away from track)	Yes; Signal and telecommunications systems - see ambient conditions; vibrations and shocks: Application point outside of tracks (1 m to 3 m away from track)	Yes; Signal and telecommunications systems - see ambient conditions; vibrations and shocks: Application point outside of tracks (1 m to 3 m away from track)
• EN 50155	Yes; Rail vehicles - temperature class OT4, ST1/ST2, horizontal mounting position	Yes; Rail vehicles - temperature class OT4, ST1/ST2, horizontal mounting position	Yes; Rail vehicles - temperature class OT4, ST1/ST2, horizontal mounting position	Yes; Rail vehicles - temperature class OT4, ST1/ST2, horizontal mounting position	Yes; Rail vehicles - temperature class OT4, ST1/ST2, horizontal mounting position
• EN 61373	Yes; Rail vehicles - vibrations and shocks: Category 1 Class A/B	Yes; Rail vehicles - vibrations and shocks: Category 1 Class A/B	Yes; Rail vehicles - vibrations and shocks: Category 1 Class A/B	Yes; Rail vehicles - vibrations and shocks: Category 1 Class A/B	Yes; Rail vehicles - vibrations and shocks: Category 1 Class A/B
• Fire protection acc. to EN 45545-2	Yes; For proof of conformity, see Service & Support	Yes; For proof of conformity, see Service & Support	Yes; For proof of conformity, see Service & Support	Yes; For proof of conformity, see Service & Support	Yes; For proof of conformity, see Service & Support

Ambient conditions					
Ambient temperature during operation					
• horizontal installation, min.	-40 °C; = Tmin (incl. condensation/frost)	-40 °C; = Tmin (incl. condensation/frost)	-40 °C; = Tmin (incl. condensation/frost)	-40 °C; = Tmin (incl. condensation/frost)	-40 °C; = Tmin (incl. condensation/frost)
• horizontal installation, max.	70 °C; = Tmax; +85 °C for 10 min (OT4, ST1/ST2 acc. to EN 50155)	70 °C; = Tmax; +85 °C for 10 min (OT4, ST1/ST2 acc. to EN 50155)	70 °C; = Tmax; +85 °C for 10 min (OT4, ST1/ST2 acc. to EN 50155)	70 °C; = Tmax; +85 °C for 10 min (OT4, ST1/ST2 acc. to EN 50155)	70 °C; = Tmax; +85 °C for 10 min (OT4, ST1/ST2 acc. to EN 50155)
• vertical installation, min.	-40 °C; = Tmin	-40 °C; = Tmin	-40 °C; = Tmin	-40 °C; = Tmin	-40 °C; = Tmin
• vertical installation, max.	50 °C; = Tmax	50 °C; = Tmax	50 °C; = Tmax	50 °C; = Tmax	50 °C; = Tmax
Altitude during operation relating to sea level					
• Installation altitude above sea level, max.	2 000 m	2 000 m	2 000 m	2 000 m	2 000 m
• Ambient air temperature-barometric pressure-altitude	Tmin ... Tmax at 1 140 hPa ... 795 hPa (-1 000 m ... +2 000 m)	Tmin ... Tmax at 1 140 hPa ... 795 hPa (-1 000 m ... +2 000 m)	Tmin ... Tmax at 1 140 hPa ... 795 hPa (-1 000 m ... +2 000 m)	Tmin ... Tmax at 1 140 hPa ... 795 hPa (-1 000 m ... +2 000 m)	Tmin ... Tmax at 1 140 hPa ... 795 hPa (-1 000 m ... +2 000 m)

### SIPLUS extreme RAIL BaseUnits

Article number	SIPLUS ET 200SP BU20-P12+A0+4B TX RAIL	SIPLUS ET 200SP BU20-P6+A2+4D TX RAIL	SIPLUS ET 200SP BU20-P12+A0+0B TX RAIL	SIPLUS ET 200SP BU15-P16+A0+2D/T TX RAIL	SIPLUS ET 200SP BU20-P8+A4+0B TX RAIL
<b>Relative humidity</b> With condensation, tested in accordance with IEC 60068-2-38, max.	100 %; RH incl. condensation / frost (no commissioning in bedewed state), horizontal installation	100 %; RH incl. condensation / frost (no commissioning in bedewed state), horizontal installation	100 %; RH incl. condensation / frost (no commissioning in bedewed state), horizontal installation	100 %; RH incl. condensation / frost (no commissioning in bedewed state), horizontal installation	100 %; RH incl. condensation / frost (no commissioning in bedewed state), horizontal installation
<b>Resistance</b>					
<ul style="list-style-type: none"> <li>Coolants and lubricants <ul style="list-style-type: none"> <li>Resistant to commercially available coolants and lubricants</li> </ul> </li> <li>Use in stationary industrial systems <ul style="list-style-type: none"> <li>to biologically active substances according to EN 60721-3-3</li> <li>to chemically active substances according to EN 60721-3-3</li> <li>to mechanically active substances according to EN 60721-3-3</li> <li>Against mechanical environmental conditions acc. to EN 60721-3-3</li> </ul> </li> <li>Use on land craft, rail vehicles and special-purpose vehicles <ul style="list-style-type: none"> <li>to biologically active substances according to EN 60721-3-5</li> <li>to chemically active substances according to EN 60721-3-5</li> <li>to mechanically active substances according to EN 60721-3-5</li> <li>Against mechanical environmental conditions acc. to EN 60721-3-5</li> <li>against mechanical environmental conditions in agriculture acc. to ISO 15003</li> </ul> </li> <li>Usage in industrial process technology <ul style="list-style-type: none"> <li>Against chemically active substances acc. to EN 60654-4</li> <li>Environmental conditions for process, measuring and control systems acc. to ANSI/ISA-71.04</li> </ul> </li> <li>Remark <ul style="list-style-type: none"> <li>Note regarding classification of environmental conditions acc. to EN 60721, EN 60654-4 and ANSI/ISA-71.04</li> </ul> </li> </ul>	<ul style="list-style-type: none"> <li>Yes; Incl. diesel and oil droplets in the air</li> <li>Yes; Class 3B2 mold, fungus and dry rot spores (with the exception of fauna); Class 3B3 on request</li> <li>Yes; Class 3C4 (RH &lt; 75 %) incl. salt spray acc. to EN 60068-2-52 (severity degree 3); *</li> <li>Yes; Class 3S4 incl. sand, dust; *</li> <li>Yes; Class 3M8 using the SIPLUS Mounting Kit ET 200SP (6AG1193-6AA00-0AA0)</li> <li>Yes; Class 5B2 mold, fungus and dry rot spores (with the exception of fauna); Class 5B3 on request</li> <li>Yes; Class 5C3 (RH &lt; 75 %) incl. salt spray acc. to EN 60068-2-52 (severity degree 3); *</li> <li>Yes; Class 5S3 incl. sand, dust; *</li> <li>Yes; Class 5M2 using the SIPLUS Mounting Kit ET 200SP (6AG1193-6AA00-0AA0)</li> <li>Yes; level 1 (Location LE) using the SIPLUS Mounting Kit ET 200SP (6AG1193-6AA00-0AA0)</li> <li>Yes; Class 3 (excluding trichlorethylene)</li> <li>Yes; Level GX group A/B (excluding trichlorethylene; harmful gas concentrations up to the limits of EN 60721-3-3 class 3C4 permissible); level LC3 (salt spray) and level LB3 (oil)</li> <li>* The supplied plug covers must remain in place over the unused interfaces during operation!</li> </ul>	<ul style="list-style-type: none"> <li>Yes; Incl. diesel and oil droplets in the air</li> <li>Yes; Class 3B2 mold, fungus and dry rot spores (with the exception of fauna); Class 3B3 on request</li> <li>Yes; Class 3C4 (RH &lt; 75 %) incl. salt spray acc. to EN 60068-2-52 (severity degree 3); *</li> <li>Yes; Class 3S4 incl. sand, dust; *</li> <li>Yes; Class 3M8 using the SIPLUS Mounting Kit ET 200SP (6AG1193-6AA00-0AA0)</li> <li>Yes; Class 5B2 mold, fungus and dry rot spores (with the exception of fauna); Class 5B3 on request</li> <li>Yes; Class 5C3 (RH &lt; 75 %) incl. salt spray acc. to EN 60068-2-52 (severity degree 3); *</li> <li>Yes; Class 5S3 incl. sand, dust; *</li> <li>Yes; Class 5M2 using the SIPLUS Mounting Kit ET 200SP (6AG1193-6AA00-0AA0)</li> <li>Yes; level 1 (Location LE) using the SIPLUS Mounting Kit ET 200SP (6AG1193-6AA00-0AA0)</li> <li>Yes; Class 3 (excluding trichlorethylene)</li> <li>Yes; Level GX group A/B (excluding trichlorethylene; harmful gas concentrations up to the limits of EN 60721-3-3 class 3C4 permissible); level LC3 (salt spray) and level LB3 (oil)</li> <li>* The supplied plug covers must remain in place over the unused interfaces during operation!</li> </ul>	<ul style="list-style-type: none"> <li>Yes; Incl. diesel and oil droplets in the air</li> <li>Yes; Class 3B2 mold, fungus and dry rot spores (with the exception of fauna); Class 3B3 on request</li> <li>Yes; Class 3C4 (RH &lt; 75 %) incl. salt spray acc. to EN 60068-2-52 (severity degree 3); *</li> <li>Yes; Class 3S4 incl. sand, dust; *</li> <li>Yes; Class 3M8 using the SIPLUS Mounting Kit ET 200SP (6AG1193-6AA00-0AA0)</li> <li>Yes; Class 5B2 mold, fungus and dry rot spores (with the exception of fauna); Class 5B3 on request</li> <li>Yes; Class 5C3 (RH &lt; 75 %) incl. salt spray acc. to EN 60068-2-52 (severity degree 3); *</li> <li>Yes; Class 5S3 incl. sand, dust; *</li> <li>Yes; Class 5M2 using the SIPLUS Mounting Kit ET 200SP (6AG1193-6AA00-0AA0)</li> <li>Yes; level 1 (Location LE) using the SIPLUS Mounting Kit ET 200SP (6AG1193-6AA00-0AA0)</li> <li>Yes; Class 3 (excluding trichlorethylene)</li> <li>Yes; Level GX group A/B (excluding trichlorethylene; harmful gas concentrations up to the limits of EN 60721-3-3 class 3C4 permissible); level LC3 (salt spray) and level LB3 (oil)</li> <li>* The supplied plug covers must remain in place over the unused interfaces during operation!</li> </ul>	<ul style="list-style-type: none"> <li>Yes; Incl. diesel and oil droplets in the air</li> <li>Yes; Class 3B2 mold, fungus and dry rot spores (with the exception of fauna); Class 3B3 on request</li> <li>Yes; Class 3C4 (RH &lt; 75 %) incl. salt spray acc. to EN 60068-2-52 (severity degree 3); *</li> <li>Yes; Class 3S4 incl. sand, dust; *</li> <li>Yes; Class 3M8 using the SIPLUS Mounting Kit ET 200SP (6AG1193-6AA00-0AA0)</li> <li>Yes; Class 5B2 mold, fungus and dry rot spores (with the exception of fauna); Class 5B3 on request</li> <li>Yes; Class 5C3 (RH &lt; 75 %) incl. salt spray acc. to EN 60068-2-52 (severity degree 3); *</li> <li>Yes; Class 5S3 incl. sand, dust; *</li> <li>Yes; Class 5M2 using the SIPLUS Mounting Kit ET 200SP (6AG1193-6AA00-0AA0)</li> <li>Yes; level 1 (Location LE) using the SIPLUS Mounting Kit ET 200SP (6AG1193-6AA00-0AA0)</li> <li>Yes; Class 3 (excluding trichlorethylene)</li> <li>Yes; Level GX group A/B (excluding trichlorethylene; harmful gas concentrations up to the limits of EN 60721-3-3 class 3C4 permissible); level LC3 (salt spray) and level LB3 (oil)</li> <li>* The supplied plug covers must remain in place over the unused interfaces during operation!</li> </ul>	<ul style="list-style-type: none"> <li>Yes; Incl. diesel and oil droplets in the air</li> <li>Yes; Class 3B2 mold, fungus and dry rot spores (with the exception of fauna); Class 3B3 on request</li> <li>Yes; Class 3C4 (RH &lt; 75 %) incl. salt spray acc. to EN 60068-2-52 (severity degree 3); *</li> <li>Yes; Class 3S4 incl. sand, dust; *</li> <li>Yes; Class 3M8 using the SIPLUS Mounting Kit ET 200SP (6AG1193-6AA00-0AA0)</li> <li>Yes; Class 5B2 mold, fungus and dry rot spores (with the exception of fauna); Class 5B3 on request</li> <li>Yes; Class 5C3 (RH &lt; 75 %) incl. salt spray acc. to EN 60068-2-52 (severity degree 3); *</li> <li>Yes; Class 5S3 incl. sand, dust; *</li> <li>Yes; Class 5M2 using the SIPLUS Mounting Kit ET 200SP (6AG1193-6AA00-0AA0)</li> <li>Yes; level 1 (Location LE) using the SIPLUS Mounting Kit ET 200SP (6AG1193-6AA00-0AA0)</li> <li>Yes; Class 3 (excluding trichlorethylene)</li> <li>Yes; Level GX group A/B (excluding trichlorethylene; harmful gas concentrations up to the limits of EN 60721-3-3 class 3C4 permissible); level LC3 (salt spray) and level LB3 (oil)</li> <li>* The supplied plug covers must remain in place over the unused interfaces during operation!</li> </ul>

# SIPLUS RAIL

## SIPLUS ET 200SP RAIL

### SIPLUS extreme RAIL BaseUnits

Article number	SIPLUS ET 200SP BU20-P12+A0+4B TX RAIL	SIPLUS ET 200SP BU20-P6+A2+4D TX RAIL	SIPLUS ET 200SP BU20-P12+A0+0B TX RAIL	SIPLUS ET 200SP BU15-P16+A0+2D/T TX RAIL	SIPLUS ET 200SP BU20-P8+A4+0B TX RAIL
<b>Conformal coating</b>					
• Coatings for printed circuit board assemblies acc. to EN 61086	Yes; Class 2 for high reliability	Yes; Class 2 for high reliability	Yes; Class 2 for high reliability	Yes; Class 2 for high reliability	Yes; Class 2 for high reliability
• Protection against fouling acc. to EN 60664-3	Yes; Type 1 protection	Yes; Type 1 protection	Yes; Type 1 protection	Yes; Type 1 protection	Yes; Type 1 protection
• Electronic equipment on rolling stock acc. to EN 50155	Yes; Class PC2 protective coating acc. to EN 50155:2017	Yes; Class PC2 protective coating acc. to EN 50155:2017	Yes; Class PC2 protective coating acc. to EN 50155:2017	Yes; Class PC2 protective coating acc. to EN 50155:2017	Yes; Class PC2 protective coating acc. to EN 50155:2017
• Military testing according to MIL-I-46058C, Amendment 7	Yes; Discoloration of coating possible during service life	Yes; Discoloration of coating possible during service life	Yes; Discoloration of coating possible during service life	Yes; Discoloration of coating possible during service life	Yes; Discoloration of coating possible during service life
• Qualification and Performance of Electrical Insulating Compound for Printed Board Assemblies according to IPC-CC-830A	Yes; Conformal coating, Class A	Yes; Conformal coating, Class A	Yes; Conformal coating, Class A	Yes; Conformal coating, Class A	Yes; Conformal coating, Class A
<b>Dimensions</b>					
<b>Width</b>	20 mm	20 mm	20 mm	15 mm	20 mm
<b>Height</b>	117 mm	117 mm	117 mm	117 mm	117 mm
<b>Depth</b>	35 mm	35 mm	35 mm	35 mm	35 mm
<b>Weights</b>					
<b>Weight, approx.</b>	48 g	47 g	47 g	40 g	48 g
<b>Other</b>					
<b>Note:</b>	for use in railway applications, also observe the product information "SIPLUS extreme RAIL" A5E37661960A, Online Support article 109736776	for use in railway applications, also observe the product information "SIPLUS extreme RAIL" A5E37661960A, Online Support article 109736776	for use in railway applications, also observe the product information "SIPLUS extreme RAIL" A5E37661960A, Online Support article 109736776	for use in railway applications, also observe the product information "SIPLUS extreme RAIL" A5E37661960A, Online Support article 109736776	for use in railway applications, also observe the product information "SIPLUS extreme RAIL" A5E37661960A, Online Support article 109736776

6

Article number	6AG2193-6BP00-4DU0 SIPLUS ET 200SP BU20-P16+A0+2D TX RAIL	6AG2193-6BP00-4BU0 SIPLUS ET 200SP BU20-P16+A0+2B TX RAIL
<b>General information</b>		
<b>Product type designation</b>	BU type U0	BU type U0
<b>Hardware configuration</b>		
<b>Slots</b>		
• Number of slots	1	1
<b>Standards, approvals, certificates</b>		
<b>Railway application</b>		
• EN 50121-3-2	Yes; EMC for rail vehicles	Yes; EMC for rail vehicles
• EN 50121-4	Yes; EMC for signal and telecommunications systems	Yes; EMC for signal and telecommunications systems
• EN 50124-1	Yes; Railway applications - overvoltage category OV3; pollution degree PD2; UNm = 230 V AC	Yes; Railway applications - overvoltage category OV3; pollution degree PD2; UNm = 230 V AC
• EN 50125-1	Yes; Rail vehicles - see ambient conditions	Yes; Rail vehicles - see ambient conditions
• EN 50125-2	Yes; Stationary electrical equipment - see ambient conditions	Yes; Stationary electrical equipment - see ambient conditions
• EN 50125-3	Yes; Signal and telecommunications systems - see ambient conditions; vibrations and shocks: Application point outside of tracks (1 m to 3 m away from track)	Yes; Signal and telecommunications systems - see ambient conditions; vibrations and shocks: Application point outside of tracks (1 m to 3 m away from track)
• EN 50155	Yes; Rail vehicles - temperature class OT4, ST1/ST2, horizontal mounting position	Yes; Rail vehicles - temperature class OT4, ST1/ST2, horizontal mounting position
• EN 61373	Yes; Rail vehicles - vibrations and shocks: Category 1 Class A/B	Yes; Rail vehicles - vibrations and shocks: Category 1 Class A/B
• Fire protection acc. to EN 45545-2	Yes; For proof of conformity, see Service & Support	Yes; For proof of conformity, see Service & Support
<b>Ambient conditions</b>		
<b>Ambient temperature during operation</b>		
• horizontal installation, min.	-40 °C; = Tmin (incl. condensation/frost)	-40 °C; = Tmin (incl. condensation/frost)
• horizontal installation, max.	70 °C; = Tmax; +85 °C for 10 min (OT4, ST1/ST2 acc. to EN 50155)	70 °C; = Tmax; +85 °C for 10 min (OT4, ST1/ST2 acc. to EN 50155)
• vertical installation, min.	-40 °C; = Tmin	-40 °C; = Tmin
• vertical installation, max.	50 °C; = Tmax	50 °C; = Tmax
<b>Altitude during operation relating to sea level</b>		
• Installation altitude above sea level, max.	2 000 m	2 000 m
• Ambient air temperature-barometric pressure-altitude	Tmin ... Tmax at 1 140 hPa ... 795 hPa (-1 000 m ... +2 000 m)	Tmin ... Tmax at 1 140 hPa ... 795 hPa (-1 000 m ... +2 000 m)
<b>Relative humidity</b>		
• With condensation, tested in accordance with IEC 60068-2-38, max.	100 %; RH incl. condensation / frost (no commissioning in bedewed state), horizontal installation	100 %; RH incl. condensation / frost (no commissioning in bedewed state), horizontal installation



Article number	<b>6AG2193-6BP00-4DU0</b> SIPLUS ET 200SP BU20-P16+A0+2D TX RAIL	<b>6AG2193-6BP00-4BU0</b> SIPLUS ET 200SP BU20-P16+A0+2B TX RAIL
<b>Resistance</b>		
<ul style="list-style-type: none"> <li>Coolants and lubricants               <ul style="list-style-type: none"> <li>Resistant to commercially available coolants and lubricants</li> </ul> </li> <li>Use in stationary industrial systems               <ul style="list-style-type: none"> <li>to biologically active substances according to EN 60721-3-3</li> <li>to chemically active substances according to EN 60721-3-3</li> <li>to mechanically active substances according to EN 60721-3-3</li> <li>Against mechanical environmental conditions acc. to EN 60721-3-3</li> </ul> </li> <li>Use on land craft, rail vehicles and special-purpose vehicles               <ul style="list-style-type: none"> <li>to biologically active substances according to EN 60721-3-5</li> <li>to chemically active substances according to EN 60721-3-5</li> <li>to mechanically active substances according to EN 60721-3-5</li> <li>Against mechanical environmental conditions acc. to EN 60721-3-5</li> <li>against mechanical environmental conditions in agriculture acc. to ISO 15003</li> </ul> </li> <li>Usage in industrial process technology               <ul style="list-style-type: none"> <li>Against chemically active substances acc. to EN 60654-4</li> <li>Environmental conditions for process, measuring and control systems acc. to ANSI/ISA-71.04</li> </ul> </li> <li>Remark               <ul style="list-style-type: none"> <li>Note regarding classification of environmental conditions acc. to EN 60721, EN 60654-4 and ANSI/ISA-71.04</li> </ul> </li> </ul>	Yes; Incl. diesel and oil droplets in the air  Yes; Class 3B2 mold, fungus and dry rot spores (with the exception of fauna); Class 3B3 on request Yes; Class 3C4 (RH < 75 %) incl. salt spray acc. to EN 60068-2-52 (severity degree 3); * Yes; Class 3S4 incl. sand, dust, *  Yes; Class 3M8 using the SIPLUS Mounting Kit ET 200SP (6AG1193-6AA00-0AA0)  Yes; Class 5B2 mold, fungus and dry rot spores (with the exception of fauna); Class 5B3 on request Yes; Class 5C3 (RH < 75 %) incl. salt spray acc. to EN 60068-2-52 (severity degree 3); * Yes; Class 5S3 incl. sand, dust; *  Yes; Class 5M2 using the SIPLUS Mounting Kit ET 200SP (6AG1193-6AA00-0AA0) Yes; level 1 (Location LE) using the SIPLUS Mounting Kit ET 200SP (6AG1193-6AA00-0AA0)  Yes; Class 3 (excluding trichlorethylene)  Yes; Level GX group A/B (excluding trichlorethylene; harmful gas concentrations up to the limits of EN 60721-3-3 class 3C4 permissible); level LC3 (salt spray) and level LB3 (oil)  * The supplied plug covers must remain in place over the unused interfaces during operation!	Yes; Incl. diesel and oil droplets in the air  Yes; Class 3B2 mold, fungus and dry rot spores (with the exception of fauna); Class 3B3 on request Yes; Class 3C4 (RH < 75 %) incl. salt spray acc. to EN 60068-2-52 (severity degree 3); * Yes; Class 3S4 incl. sand, dust, *  Yes; Class 3M8 using the SIPLUS Mounting Kit ET 200SP (6AG1193-6AA00-0AA0)  Yes; Class 5B2 mold, fungus and dry rot spores (with the exception of fauna); Class 5B3 on request Yes; Class 5C3 (RH < 75 %) incl. salt spray acc. to EN 60068-2-52 (severity degree 3); * Yes; Class 5S3 incl. sand, dust; *  Yes; Class 5M2 using the SIPLUS Mounting Kit ET 200SP (6AG1193-6AA00-0AA0) Yes; level 1 (Location LE) using the SIPLUS Mounting Kit ET 200SP (6AG1193-6AA00-0AA0)  Yes; Class 3 (excluding trichlorethylene)  Yes; Level GX group A/B (excluding trichlorethylene; harmful gas concentrations up to the limits of EN 60721-3-3 class 3C4 permissible); level LC3 (salt spray) and level LB3 (oil)  * The supplied plug covers must remain in place over the unused interfaces during operation!
<b>Conformal coating</b>		
<ul style="list-style-type: none"> <li>Coatings for printed circuit board assemblies acc. to EN 61086</li> <li>Protection against fouling acc. to EN 60664-3</li> <li>Electronic equipment on rolling stock acc. to EN 50155</li> <li>Military testing according to MIL-I-46058C, Amendment 7</li> <li>Qualification and Performance of Electrical Insulating Compound for Printed Board Assemblies according to IPC-CC-830A</li> </ul>	Yes; Class 2 for high reliability  Yes; Type 1 protection Yes; Class PC2 protective coating acc. to EN 50155:2017 Yes; Discoloration of coating possible during service life Yes; Conformal coating, Class A	Yes; Class 2 for high reliability  Yes; Type 1 protection Yes; Class PC2 protective coating acc. to EN 50155:2017 Yes; Discoloration of coating possible during service life Yes; Conformal coating, Class A
<b>connection method / header</b>		
<b>Terminals</b>		
<ul style="list-style-type: none"> <li>Terminal type</li> <li>Conductor cross-section, min.</li> <li>Conductor cross-section, max.</li> <li>Number of process terminals to I/O module</li> <li>Number of terminals to AUX bus</li> <li>Number of add-on terminals</li> <li>Number of terminals with connection to P1 and P2 bus</li> </ul>	Push-in terminal 0.14 mm <sup>2</sup> ; 0.2 mm <sup>2</sup> without wire end ferrule 2.5 mm <sup>2</sup> ; 1.5 mm <sup>2</sup> with wire end ferrule 16 0 0 2	Push-in terminal 0.14 mm <sup>2</sup> ; 0.2 mm <sup>2</sup> without wire end ferrule 2.5 mm <sup>2</sup> ; 1.5 mm <sup>2</sup> with wire end ferrule 16 0 0 2
<b>Dimensions</b>		
<b>Width</b>	20 mm	20 mm
<b>Height</b>	117 mm	117 mm
<b>Depth</b>	35 mm	35 mm
<b>Weights</b>		
<b>Weight, approx.</b>	50 g	50 g
<b>Other</b>		
<b>Note:</b>	for use in railway applications, also observe the product information "SIPLUS extreme RAIL" A5E37661960A, Online Support article 109736776	for use in railway applications, also observe the product information "SIPLUS extreme RAIL" A5E37661960A, Online Support article 109736776

# SIPLUS RAIL

## SIPLUS ET 200SP RAIL

### SIPLUS extreme RAIL BaseUnits

#### Selection and ordering data

Version	Article No.
<b>Suitable SIPLUS extreme RAIL BaseUnits, type A0</b>	
<b>SIPLUS ET 200SP BU15-P16+A0+2D TX RAIL</b> Approved in accordance with EN 50155, EN 15121, EN 50124, EN 50125 and EN 45545 railway standards for use in rail traffic BU type A0; BaseUnit (light) with 16 process terminals to the module; for starting a new load group (max. 10 A); for areas with extreme exposure to environmental substances (conformal coating); ambient temperature -40 ... +70 °C (+85 °C for 10 min.)	<b>6AG2193-6BP00-4DA0</b>
<b>SIPLUS ET 200SP BU15-P16+A0+2B TX RAIL</b> Approved in accordance with EN 50155, EN 15121, EN 50124, EN 50125 and EN 45545 railway standards for use in rail traffic BU type A0; BaseUnit (dark) with 16 process terminals to the module; for continuing the load group; for areas with extreme exposure to environmental substances (conformal coating); ambient temperature -40 ... +70 °C (+85 °C for 10 min.)	<b>6AG2193-6BP00-4BA0</b>
<b>SIPLUS ET 200SP BU15-P16+A10+2D TX RAIL</b> Approved in accordance with EN 50155, EN 15121, EN 50124, EN 50125 and EN 45545 railway standards for use in rail traffic BU type A0; BaseUnit (light) with 16 process terminals (1...16) to the module and an additional 10 internally jumpered AUX terminals (1 A to 10 A); for starting a new load group (max. 10 A); for areas with extreme exposure to environmental substances (conformal coating); ambient temperature -40 ... +70 °C (+85 °C for 10 min.)	<b>6AG2193-6BP20-4DA0</b>
<b>SIPLUS ET 200SP BU15-P16+A10+2B TX RAIL</b> Approved in accordance with EN 50155, EN 15121, EN 50124, EN 50125 and EN 45545 railway standards for use in rail traffic BU type A0; BaseUnit (dark) with 16 process terminals (1...16) to the module and an additional 10 internally jumpered AUX terminals (1 A to 10 A); for continuing the load group; for areas with extreme exposure to environmental substances (conformal coating); ambient temperature -40 ... +70 °C (+85 °C for 10 min.)	<b>6AG2193-6BP20-4BA0</b>
<b>Suitable SIPLUS extreme RAIL BaseUnits, type B1</b>	
<b>SIPLUS ET 200SP BU20-P12+A0+4B TX RAIL</b> Approved in accordance with EN 50155, EN 15121, EN 50124, EN 50125 and EN 45545 railway standards for use in rail traffic BU type B1; BaseUnit (dark) with 12 process terminals to the module; for continuing the load group; 1 unit	<b>6AG2193-6BP20-4BB1</b>
<b>Suitable SIPLUS extreme RAIL BaseUnits, type C0</b>	
<b>SIPLUS ET 200SP BU20-P6+A2+4D TX RAIL</b> Approved in accordance with EN 50155, EN 15121, EN 50124, EN 50125 and EN 45545 railway standards for use in rail traffic BU type C0; BaseUnit (light) with 6 push-in terminals (1...6) to the module and 2 AUX terminals; new load group	<b>6AG2193-6BP20-4DC0</b>
<b>Suitable SIPLUS extreme RAIL BaseUnits, type D0</b>	
<b>SIPLUS ET 200SP BU20-P12+A0+0B TX RAIL</b> Approved in accordance with EN 50155, EN 15121, EN 50124, EN 50125 and EN 45545 railway standards for use in rail traffic BU type D0; BaseUnit with 12 push-in terminals, without AUX terminals, bridged to the left; for areas with extreme exposure to environmental substances (conformal coating); ambient temperature -40 ... +70 °C (+85 °C for 10 min.)	<b>6AG2193-6BP00-4BD0</b>
<b>Suitable SIPLUS extreme type A1 RAIL BaseUnits (with temperature detection)</b>	
<b>SIPLUS ET 200SP BU15-P16+A0+2D/T TX RAIL</b> Approved in accordance with EN 50155, EN 15121, EN 50124, EN 50125 and EN 45545 railway standards for use in rail traffic BU type A1; BaseUnit (light) with 16 process terminals to the module; for starting a new load group (max. 10 A)	<b>6AG2193-6BP00-4DA1</b>
<b>Suitable SIPLUS extreme RAIL BaseUnits, type F0</b>	
<b>SIPLUS ET 200SP BU20-P8+A4+0B TX RAIL</b> Approved in accordance with EN 50155, EN 15121, EN 50124, EN 50125 and EN 45545 railway standards for use in rail traffic BU type F0; BaseUnit (dark) with 8 process terminals to the module and an additional 4 internally jumpered AUX terminals (1 A to 4 A); for continuing the load group	<b>6AG2193-6BP20-4BF0</b>



Version	Article No.
<b>Usable SIPLUS extreme RAIL BaseUnits, type U0</b>	
<b>SIPLUS ET 200SP BU20-P16+A0+2B TX RAIL</b> Approved in accordance with EN 50155, EN 15121, EN 50124, EN 50125 and EN 45545 railway standards for use in rail traffic BU type U0; BaseUnit (dark) with 16 process terminals to the module; for continuing the load group	<b>6AG2193-6BP00-4BU0</b>
<b>SIPLUS ET 200SP BU20-P16+A0+2D TX RAIL</b> Approved in accordance with EN 50155, EN 15121, EN 50124, EN 50125 and EN 45545 railway standards for use in rail traffic BU type U0; BaseUnit (light) with 16 process terminals to the module; for starting a new load group (max. 10 A)	<b>6AG2193-6BP00-4DU0</b>
<b>Accessories</b>	
<b>SIPLUS Mounting Kit ET 200SP</b> Mounting accessories for use with increased mechanical vibration and shock loads. Can be used with SIPLUS BaseUnits with heights up to 117 mm, types A0/A1 without AUX or add-on terminals as well as types B0, B1, C0, C1, D0, U0	<b>6AG1193-6AA00-0AA0</b>

## SIPLUS RAIL

### SIPLUS ET 200SP RAIL

#### SIPLUS extreme RAIL BusAdapters

##### Overview



BusAdapters (BA) are available for the SIPLUS extreme RAIL ET 200SP:

- SIPLUS extreme RAIL BusAdapter for the free selection of the connection system (pluggable or direct connection) of PROFINET to devices with a SIPLUS extreme RAIL BusAdapter interface. Another benefit of the SIPLUS extreme RAIL BusAdapter: only the adapter needs to be replaced for subsequent conversion to the rugged FastConnect technology or to repair defective RJ45 sockets.

##### Application

###### SIPLUS extreme RAIL BusAdapter

In standard applications with moderate mechanical and EMC loads, SIMATIC BusAdapters with an RJ45 interface can be used, e.g. the BusAdapter BA 2xRJ45.

For machines and systems in which higher mechanical and/or EMC loads act on the devices, a SIMATIC BusAdapter with connection via FastConnect (FC) or fiber-optic cable (SCRJ or LC) is recommended.

An overview of the essential properties of the PN interfaces is shown in the table below

PN interfaces for SIMATIC BusAdapters	Cable connection (FOC)	max. cable length	EMC and mechanical loading	Can be used on devices with SIMATIC BA-interface
RJ45	PROFINET copper cable, pluggable	50 m	Moderate	All
FC (FastConnect)	PROFINET copper cable, direct connection	50 m	Increased 5 times	All

##### Design

###### SIPLUS extreme RAIL BusAdapter

- Are plugged onto the device with SIMATIC BusAdapter interface and can be equipped with an equipment labeling plate for identification of the equipment.
- BusAdapters with a copper interface can be used on all devices with a SIPLUS extreme RAIL BusAdapter interface.
- BusAdapter with FOC interface can be used on selected devices with SIMATIC BusAdapter interface (e.g. ET 200SP interface modules with High Feature function class or above, CPU 1512SP (F), etc.)
- Versions with two PN copper interfaces (RJ45 or FastConnect (FC)):
  - BA 2xRJ45 with 2 RJ45 sockets
  - BA 2xFC with 2 FastConnect connections

##### Assembly

###### FastConnect (FC)

Using the FastConnect stripping tool, the outer sheath and braided shielding can be quickly and conveniently removed from Industrial Ethernet FastConnect cables in one simple operation. The detached PN bus cable is connected directly to the FC connector by means of the FastConnect terminals – in a similar way to the PROFIBUS connector, tried and tested in millions of applications. It is then only necessary to close the cover and lock it with the slider (no tools required).



FastConnect stripping tool

## RJ45

In principle, all industry standard RJ45 Ethernet connectors can be used here. If the PN cable is to be assembled on site, the FastConnect stripping tool can also be used here in connection with the "Industrial Ethernet FastConnect RJ45 Plug 180" connector.

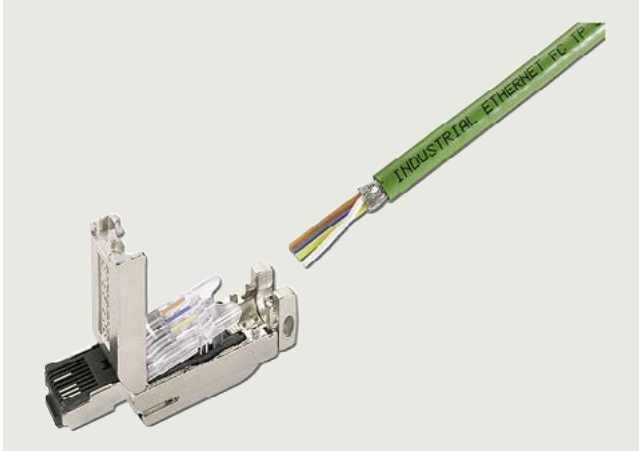

IE FC RJ45 Plug 180

## Technical specifications

Article number	<b>6AG2193-6AR00-4AA0</b> SIPLUS ET 200SP BA 2XRJ45 TX RAIL	<b>6AG2193-6AF00-4AA0</b> SIPLUS ET 200SP BA 2XFC TX RAIL	<b>6AG2193-6AM00-4AA0</b> SIPLUS ET 200SP BA 2xM12 RAIL
<b>General information</b>			
<b>Product type designation</b>	BA 2x RJ45	BA 2xFC	BA 2x M12 BusAdapter
<b>Interfaces</b>			
<b>Number of PROFINET interfaces</b>	1	1	1
<b>Supports protocol for PROFINET IO</b>			
<ul style="list-style-type: none"> <li>Number of RJ45 ports</li> <li>Number of FC (FastConnect) connections</li> <li>Number of M12 ports</li> </ul>	2	2	2
<b>Cable length</b>			
<ul style="list-style-type: none"> <li>Cu conductors</li> </ul>	100 m	100 m	100 m
<b>Standards, approvals, certificates</b>			
<b>Railway application</b>			
<ul style="list-style-type: none"> <li>EN 50121-3-2</li> <li>EN 50121-4</li> <li>EN 50124-1</li> <li>EN 50125-1</li> <li>EN 50125-2</li> <li>EN 50125-3</li> <li>EN 50155</li> <li>EN 61373</li> <li>Fire protection acc. to EN 45545-2</li> </ul>	<p>Yes; EMC for rail vehicles</p> <p>Yes; EMC for signal and telecommunications systems</p> <p>Yes; Railway applications - overvoltage category OV2; pollution degree PD2; rated surge voltage UNi = 0.5 kV; UNm = 24 V DC</p> <p>Yes; Rail vehicles - see ambient conditions</p> <p>Yes; Stationary electrical equipment - see ambient conditions</p> <p>Yes; Signal and telecommunications systems - see ambient conditions; vibrations and shocks: Application point outside of tracks (1 m to 3 m away from track)</p> <p>Yes; Rail vehicles - temperature class OT4, ST1/ST2, horizontal mounting position</p> <p>Yes; Rail vehicles - vibrations and shocks: Category 1 Class A/B</p> <p>Yes; For proof of conformity, see Service &amp; Support</p>	<p>Yes; EMC for rail vehicles</p> <p>Yes; EMC for signal and telecommunications systems</p> <p>Yes; Railway applications - overvoltage category OV2; pollution degree PD2; rated surge voltage UNi = 0.5 kV; UNm = 24 V DC</p> <p>Yes; Rail vehicles - see ambient conditions</p> <p>Yes; Stationary electrical equipment - see ambient conditions</p> <p>Yes; Signal and telecommunications systems - see ambient conditions; vibrations and shocks: Application point outside of tracks (1 m to 3 m away from track)</p> <p>Yes; Rail vehicles - temperature class OT4, ST1/ST2, horizontal mounting position</p> <p>Yes; Rail vehicles - vibrations and shocks: Category 1 Class A/B</p> <p>Yes; For proof of conformity, see Service &amp; Support</p>	<p>Yes; EMC for rail vehicles</p> <p>Yes; EMC for signal and telecommunications systems</p> <p>Yes; Railway applications - overvoltage category OV2; pollution degree PD2; rated surge voltage UNi = 0.5 kV; UNm = 24 V DC</p> <p>Yes; Rail vehicles - see ambient conditions</p> <p>Yes; Stationary electrical equipment - see ambient conditions</p> <p>Yes; Signal and telecommunications systems - see ambient conditions; vibrations and shocks: Application point outside of tracks (1 m to 3 m away from track)</p> <p>Yes; Rail vehicles - temperature class OT4, ST1/ST2, horizontal mounting position</p> <p>Yes; Rail vehicles - vibrations and shocks: Category 1 Class A/B</p> <p>Yes; For proof of conformity, see Service &amp; Support</p>

# SIPLUS RAIL

## SIPLUS ET 200SP RAIL

### SIPLUS extreme RAIL BusAdapters

Article number	<b>6AG2193-6AR00-4AA0</b> SIPLUS ET 200SP BA 2XRJ45 TX RAIL	<b>6AG2193-6AF00-4AA0</b> SIPLUS ET 200SP BA 2XFC TX RAIL	<b>6AG2193-6AM00-4AA0</b> SIPLUS ET 200SP BA 2xM12 RAIL
<b>Ambient conditions</b>			
<b>Altitude during operation relating to sea level</b>			
<ul style="list-style-type: none"> <li>Installation altitude above sea level, max.</li> <li>Ambient air temperature-barometric pressure-altitude</li> </ul>	2 000 m Tmin ... Tmax at 1 140 hPa ... 795 hPa (-1 000 m ... +2 000 m)	2 000 m Tmin ... Tmax at 1 140 hPa ... 795 hPa (-1 000 m ... +2 000 m)	2 000 m Tmin ... Tmax at 1 140 hPa ... 795 hPa (-1 000 m ... +2 000 m)
<b>Relative humidity</b>			
<ul style="list-style-type: none"> <li>With condensation, tested in accordance with IEC 60068-2-38, max.</li> </ul>	100 %; RH incl. condensation / frost (no commissioning in bedewed state), horizontal installation	100 %; RH incl. condensation / frost (no commissioning in bedewed state), horizontal installation	100 %; RH incl. condensation / frost (no commissioning in bedewed state), horizontal installation
<b>Resistance</b>			
<ul style="list-style-type: none"> <li>Coolants and lubricants <ul style="list-style-type: none"> <li>Resistant to commercially available coolants and lubricants</li> </ul> </li> <li>Use in stationary industrial systems <ul style="list-style-type: none"> <li>to biologically active substances according to EN 60721-3-3</li> <li>to chemically active substances according to EN 60721-3-3</li> <li>to mechanically active substances according to EN 60721-3-3</li> <li>Against mechanical environmental conditions acc. to EN 60721-3-3</li> </ul> </li> <li>Use on land craft, rail vehicles and special-purpose vehicles <ul style="list-style-type: none"> <li>to biologically active substances according to EN 60721-3-5</li> <li>to chemically active substances according to EN 60721-3-5</li> <li>to mechanically active substances according to EN 60721-3-5</li> <li>Against mechanical environmental conditions acc. to EN 60721-3-5</li> <li>against mechanical environmental conditions in agriculture acc. to ISO 15003</li> </ul> </li> <li>Usage in industrial process technology <ul style="list-style-type: none"> <li>Against chemically active substances acc. to EN 60654-4</li> <li>Environmental conditions for process, measuring and control systems acc. to ANSI/ISA-71.04</li> </ul> </li> <li>Remark <ul style="list-style-type: none"> <li>Note regarding classification of environmental conditions acc. to EN 60721, EN 60654-4 and ANSI/ISA-71.04</li> </ul> </li> </ul>	<ul style="list-style-type: none"> <li>Yes; Incl. diesel and oil droplets in the air</li> <li>Yes; Class 3B2 mold, fungus and dry rot spores (with the exception of fauna); Class 3B3 on request</li> <li>Yes; Class 3C4 (RH &lt; 75 %) incl. salt spray acc. to EN 60068-2-52 (severity degree 3); *</li> <li>Yes; Class 3S4 incl. sand, dust, *</li> <li>Yes; Class 5B2 mold, fungus and dry rot spores (with the exception of fauna); Class 5B3 on request</li> <li>Yes; Class 5C3 (RH &lt; 75 %) incl. salt spray acc. to EN 60068-2-52 (severity degree 3); *</li> <li>Yes; Class 5S3 incl. sand, dust; *</li> <li>Yes; Class 3 (excluding trichlorethylene)</li> <li>Yes; Level GX group A/B (excluding trichlorethylene; harmful gas concentrations up to the limits of EN 60721-3-3 class 3C4 permissible); level LC3 (salt spray) and level LB3 (oil)</li> <li>* The supplied plug covers must remain in place over the unused interfaces during operation!</li> </ul>	<ul style="list-style-type: none"> <li>Yes; Incl. diesel and oil droplets in the air</li> <li>Yes; Class 3B2 mold, fungus and dry rot spores (with the exception of fauna); Class 3B3 on request</li> <li>Yes; Class 3C4 (RH &lt; 75 %) incl. salt spray acc. to EN 60068-2-52 (severity degree 3); *</li> <li>Yes; Class 3S4 incl. sand, dust, *</li> <li>Yes; Class 3M8 using the SIPLUS Mounting Kit ET 200SP (6AG1193-6AA00-0AA0)</li> <li>Yes; Class 5B2 mold, fungus and dry rot spores (with the exception of fauna); Class 5B3 on request</li> <li>Yes; Class 5C3 (RH &lt; 75 %) incl. salt spray acc. to EN 60068-2-52 (severity degree 3); *</li> <li>Yes; Class 5S3 incl. sand, dust; *</li> <li>Yes; Class 5M2 using the SIPLUS Mounting Kit ET 200SP (6AG1193-6AA00-0AA0)</li> <li>Yes; level 1 (Location LE) using the SIPLUS Mounting Kit ET 200SP (6AG1193-6AA00-0AA0)</li> <li>Yes; Class 3 (excluding trichlorethylene)</li> <li>Yes; Level GX group A/B (excluding trichlorethylene; harmful gas concentrations up to the limits of EN 60721-3-3 class 3C4 permissible); level LC3 (salt spray) and level LB3 (oil)</li> <li>* The supplied plug covers must remain in place over the unused interfaces during operation!</li> </ul>	<ul style="list-style-type: none"> <li>Yes; Incl. diesel and oil droplets in the air</li> <li>Yes; Class 3B2 mold, fungus and dry rot spores (with the exception of fauna); Class 3B3 on request</li> <li>Yes; Class 3C4 (RH &lt; 75 %) incl. salt spray acc. to EN 60068-2-52 (severity degree 3); *</li> <li>Yes; Class 3S4 incl. sand, dust, *</li> <li>Yes; Class 3M8 using the SIPLUS Mounting Kit ET 200SP (6AG1193-6AA00-0AA0)</li> <li>Yes; Class 5B2 mold, fungus and dry rot spores (with the exception of fauna); Class 5B3 on request</li> <li>Yes; Class 5C3 (RH &lt; 75 %) incl. salt spray acc. to EN 60068-2-52 (severity degree 3); *</li> <li>Yes; Class 5S3 incl. sand, dust; *</li> <li>Yes; Class 5M2 using the SIPLUS Mounting Kit ET 200SP (6AG1193-6AA00-0AA0)</li> <li>Yes; level 1 (Location LE) using the SIPLUS Mounting Kit ET 200SP (6AG1193-6AA00-0AA0)</li> <li>Yes; Class 3 (excluding trichlorethylene)</li> <li>Yes; Level GX group A/B (excluding trichlorethylene; harmful gas concentrations up to the limits of EN 60721-3-3 class 3C4 permissible); level LC3 (salt spray) and level LB3 (oil)</li> <li>* The supplied plug covers must remain in place over the unused interfaces during operation!</li> </ul>
<b>Conformal coating</b>			
<ul style="list-style-type: none"> <li>Coatings for printed circuit board assemblies acc. to EN 61086</li> <li>Protection against fouling acc. to EN 60664-3</li> <li>Electronic equipment on rolling stock acc. to EN 50155</li> <li>Military testing according to MIL-I-46058C, Amendment 7</li> <li>Qualification and Performance of Electrical Insulating Compound for Printed Board Assemblies according to IPC-CC-830A</li> </ul>	<ul style="list-style-type: none"> <li>Yes; Class 2 for high reliability</li> <li>Yes; Type 1 protection</li> <li>Yes; Class PC2 protective coating acc. to EN 50155:2017</li> <li>Yes; Discoloration of coating possible during service life</li> <li>Yes; Conformal coating, Class A</li> </ul>	<ul style="list-style-type: none"> <li>Yes; Class 2 for high reliability</li> <li>Yes; Type 1 protection</li> <li>Yes; Class PC2 protective coating acc. to EN 50155:2017</li> <li>Yes; Discoloration of coating possible during service life</li> <li>Yes; Conformal coating, Class A</li> </ul>	<ul style="list-style-type: none"> <li>Yes; Class 2 for high reliability</li> <li>Yes; Type 1 protection</li> <li>Yes; Class PC2 protective coating acc. to EN 50155:2017</li> <li>Yes; Discoloration of coating possible during service life</li> <li>Yes; Conformal coating, Class A</li> </ul>
<b>Dimensions</b>			
<b>Width</b>	20 mm	20 mm	20 mm
<b>Height</b>	69.5 mm	69.5 mm	73.5 mm
<b>Depth</b>	59 mm	59 mm	59 mm

**SIPLUS extreme RAIL BusAdapters**

Article number	<b>6AG2193-6AR00-4AA0</b> SIPLUS ET 200SP BA 2XRJ45 TX RAIL	<b>6AG2193-6AF00-4AA0</b> SIPLUS ET 200SP BA 2XFC TX RAIL	<b>6AG2193-6AM00-4AA0</b> SIPLUS ET 200SP BA 2xM12 RAIL
<b>Weights</b>			
<b>Weight, approx.</b>	46 g	53 g	59 g
<b>Other</b>			
<b>Note:</b>	for use in railway applications, also observe the product information "SIPLUS extreme RAIL" A5E37661960A, Online Support article 109736776	for use in railway applications, also observe the product information "SIPLUS extreme RAIL" A5E37661960A, Online Support article 109736776	for use in railway applications, also observe the product information "SIPLUS extreme RAIL" A5E37661960A, Online Support article 109736776

**Selection and ordering data**

Version	Article No.
<b>SIPLUS extreme RAIL BusAdapter</b> <b>SIPLUS ET 200SP BA 2XRJ45 TX RAIL</b> For PROFINET interface modules in Standard function class or above; max. cable length 50 m; for areas with extreme exposure to environmental substances (conformal coating); ambient temperature -40 ... +70 °C (+85 °C for 10 min.) <b>SIPLUS ET 200SP BA 2XFC TX RAIL</b> For PROFINET interface modules in Standard function class or above; for increased vibration and EMC load rating; max. cable length 50 m; for areas with extreme exposure to environmental substances (conformal coating); ambient temperature -40 ... +70 °C (+85 °C for 10 min.)	<b>6AG2193-6AR00-4AA0</b>  <b>6AG2193-6AF00-4AA0</b>
<b>SIPLUS ET 200SP BA 2xM12 RAIL OT4</b> 2 x M12 push-pull sockets, D-coding, also suitable for standard M12, suitable for PROFINET For areas with extreme exposure to environmental substances (conformal coating); ambient temperature -40 ... +70 °C ST1/2 (+85 °C for 10 min.)	<b>6AG2193-6AM00-4AA0</b>
<b>Accessories</b> <b>Equipment labeling plate</b> 10 sheets of 16 labels, for printing with thermal transfer card printer or plotter	<b>6ES7193-6LF30-0AW0</b>
<b>SIPLUS Mounting Kit ET 200SP</b> Mounting accessories for use with increased mechanical vibration and shock loads. Not approved for SIPLUS BusAdapter BA 2xRJ45	<b>6AG1193-6AA00-0AA0</b>

**SIPLUS RAIL**

SIPLUS ET 200MP RAIL

SIPLUS extreme RAIL interface modules

**SIPLUS ET 200MP IM 155-5 PN ST TX RAIL****Overview**

- Interface modules for linking the ET 200MP to PROFINET
- Approved in accordance with the EN 50155, EN 15121, EN 50124, EN 50125 and EN 45545 railway standards for use in rail traffic
- They handle data exchange with the PROFINET IO Controller in the PLC
- Integrated 2-port switch for line topology
- Max. 30 I/O modules
- Shortest bus cycle 250 µs

- Linking to the isochronous task of the CPU
- Prioritized fast startup (FSU) with 500 ms (max. 12 I/O modules)
- Media Redundancy Protocol (MRP)
- Shared device on up to 2 I/O controllers (when configuring using GSD file; depends on the respective configuration tool)
- Omission of SIMATIC Memory Card (SMC); IM replacement without PG using LLDP
- Operation of F-modules and PROFIsafe

As of firmware version 2.0.0, the SIPLUS ET 200MP interface module IM 155-5 PN ST TX RAIL offers the following new functions:

- Submodule-granular shared device with up to two IO controllers
- Configuration control (option handling)
- Module shared input and module shared output (MSI/MSO), i.e. the inputs or outputs of a module can be made available simultaneously to up to two IO controllers

SIPLUS ET 200MP interface module IM155-5 PN HF T1 RAIL features the following additional functions:

- Shared device on up to 4 IO controllers
- Module internal shared input and module shared output (MSI/MSO) on up to four IO controllers
- Operation on a high-availability SIMATIC S7-400H
- Support for the MRPD function (media redundancy with planned duplication)

Article number	<b>IM 155-5 PN ST TX RAIL</b>	<b>IM155-5 PN HF T1 RAIL</b>
	6AG2155-5AA00-4AB0	6AG2155-5AA00-1AC0
<b>Quantity structures</b>		
IO modules	All	All
Max. number IO modules / IM	30	30
Max. number of bytes / slot	256 inputs, 256 outputs	256 inputs, 256 outputs
Max. number bytes / station	512 inputs, 512 outputs	512 inputs, 512 outputs
Update time	250 µs	250 µs
<b>Configuration</b>		
GSDML	Yes	Yes
STEP 7	GSDML	GSDML
TIA Portal	Yes	Yes
PCS 7	No	No
<b>General functions</b>		
Reset to factory settings	TIA Portal	TIA Portal
Device replacement without programming device	LLDP	LLDP
Configuration management (option handling)	Yes	Yes
I&M data	IM 0 ... 3	IM 0 ... 3
Isochronous mode	Yes	Yes
PROFIsafe	Yes	Yes
<b>PROFINET functions</b>		
RT	Yes	Yes
IRT	Yes	Yes
MRP	Yes	Yes
MRPD	No	No
S2 redundancy	No	Yes
Fast startup	Yes	Yes
Shared device	Yes; up to 2 ctrls.	Yes; up to 4 ctrls.
MSI / MSO	Yes	Yes
Submodules	Yes	Yes

**Application**

SIPLUS ET 200MP IM 155-5 PN ST TX RAIL and IM 155-5 PN HF T1 RAIL interface modules enables connection of the ET 200MP to PROFINET and handle communication between the modules and the higher-level I/O controller autonomously.

**Design**

SIPLUS ET 200MP IM 155-5 PN ST TX RAIL and IM 155-5 PN HF T1 RAIL interface modules are directly screwed onto the S7-1500 mounting rail. They feature:

- Diagnostics displays for errors (Error), operation (RUN), maintenance (MAINT), and one link LED per port
- Connection to PROFINET using RJ45 connector
- 24 V DC supply unit for looping through the supply voltage
- Protection of interface module against unauthorized access possible using lock, seal or cable tie

**Technical specifications**

Article number	6AG2155-5AA00-1AC0	6AG2155-5AA01-4AB0
	SIPLUS ET 200MP IM 155-5 PN HF T1 RAIL	SIPLUS ET 200MP IM155-5 PN ST TX RAIL
<b>General information</b>		
<b>Product type designation</b>	IM 155-5 PN HF	IM 155-5 PN ST
<b>Product function</b>		
• I&M data	Yes; I&M0 to I&M3	Yes; I&M0 to I&M3
• Isochronous mode	Yes	Yes
<b>Engineering with</b>		
• STEP 7 TIA Portal configurable/integrated from version	see entry ID: 109746275	see entry ID: 109746275
<b>Supply voltage</b>		
<b>Rated value (DC)</b>	24 V	24 V
<b>Reverse polarity protection</b>	Yes	Yes
<b>Short-circuit protection</b>	Yes	Yes
<b>Input current</b>		
<b>Current consumption (rated value)</b>	0.2 A	0.2 A
<b>Address area</b>		
<b>Address space per station</b>		
• Address space per station, max.	512 byte; per input / output	512 byte; per input / output
<b>Hardware configuration</b>		
<b>Integrated power supply</b>	Yes	Yes
<b>Rack</b>		
• Modules per rack, max.	30; I/O modules	30; I/O modules
<b>Interfaces</b>		
<b>Number of PROFINET interfaces</b>	1	1
<b>1. Interface</b>		
<b>Interface types</b>		
• RJ 45 (Ethernet)	Yes	Yes
• Number of ports	2	2
• integrated switch	Yes	Yes
<b>Protocols</b>		
• PROFINET IO Device	Yes	Yes
• Media redundancy	Yes; PROFINET MRP	Yes; PROFINET MRP
<b>Interface types</b>		
<b>RJ 45 (Ethernet)</b>		
• Transmission procedure	PROFINET with 100 Mbit/s full duplex (100BASE-TX)	PROFINET with 100 Mbit/s full duplex (100BASE-TX)
• 100 Mbps	Yes	Yes
• Autonegotiation	Yes	Yes
• Autocrossing	Yes	Yes
<b>Protocols</b>		
<b>PROFINET IO Device</b>		
• Services		
- IRT	Yes	Yes
- PROFIenergy	No	No
- Prioritized startup	Yes	Yes
- Shared device	Yes	Yes
- Number of IO Controllers with shared device, max.	4	2
<b>Redundancy mode</b>		
• PROFINET system redundancy (S2)	Yes	No
<b>Media redundancy</b>		
• MRP	Yes	Yes
• MRPD	No	No
<b>Open IE communication</b>		
• TCP/IP	Yes	Yes
• SNMP	Yes	Yes
• LLDP	Yes	Yes



**SIPLUS RAIL**

SIPLUS ET 200MP RAIL

SIPLUS extreme RAIL interface modules

**SIPLUS ET 200MP IM 155-5 PN ST TX RAIL**

Article number	<b>6AG2155-5AA00-1AC0</b> SIPLUS ET 200MP IM 155-5 PN HF T1 RAIL	<b>6AG2155-5AA01-4AB0</b> SIPLUS ET 200MP IM155-5 PN ST TX RAIL
<b>Isochronous mode</b>		
<b>Equidistance</b>	Yes	Yes
<b>shortest clock pulse</b>	250 µs	250 µs
<b>max. cycle</b>	4 ms	4 ms
<b>Interrupts/diagnostics/status information</b>		
<b>Status indicator</b>	Yes	Yes
<b>Alarms</b>	Yes	Yes
<b>Diagnostics function</b>	Yes	Yes
<b>Diagnostics indication LED</b>		
• RUN LED	Yes; green LED	Yes; green LED
• ERROR LED	Yes; red LED	Yes; red LED
• MAINT LED	Yes; Yellow LED	Yes; Yellow LED
• Connection display LINK TX/RX	Yes; Yellow LED	Yes; 2x green-yellow LEDs
<b>Standards, approvals, certificates</b>		
<b>Railway application</b>		
• EN 50121-3-2	Yes; EMC for rail vehicles	Yes; EMC for rail vehicles
• EN 50121-4	Yes; EMC for signal and telecommunications systems	Yes; EMC for signal and telecommunications systems
• EN 50124-1	Yes; Railway applications - overvoltage category OV2; pollution degree PD2; rated surge voltage UNi = 0.5 kV; UNm = 24 V DC	Yes; Railway applications - overvoltage category OV2; pollution degree PD2; rated surge voltage UNi = 0.5 kV; UNm = 24 V DC
• EN 50125-1	Yes; Rail vehicles - see ambient conditions	Yes; Rail vehicles - see ambient conditions
• EN 50125-2	Yes; Stationary electrical equipment - see ambient conditions	Yes; Stationary electrical equipment - see ambient conditions
• EN 50125-3	Yes; Signal and telecommunications systems - see ambient conditions; vibrations and shocks: Application point outside of tracks (1 m to 3 m away from track)	Yes; Signal and telecommunications systems - see ambient conditions; vibrations and shocks: Application point outside of tracks (1 m to 3 m away from track)
• EN 50155	Yes; Rail vehicles - temperature class OT1, ST1/ST2, horizontal mounting position	Yes; Rail vehicles - temperature class OT4, ST1/ST2, horizontal mounting position
• EN 61373	Yes; Rail vehicles - vibrations and shocks: Category 1 Class A/B	Yes; Rail vehicles - vibrations and shocks: Category 1 Class A/B
• Fire protection acc. to EN 45545-2	Yes; For proof of conformity, see Service & Support	Yes; For proof of conformity, see Service & Support
<b>Ambient conditions</b>		
<b>Ambient temperature during operation</b>		
• horizontal installation, min.	-40 °C; = Tmin (incl. condensation/frost); start-up @ -25 °C	-40 °C; = Tmin (incl. condensation/frost)
• horizontal installation, max.	60 °C; = Tmax; +70 °C for 10 min (OT1, ST1/ST2 acc. to EN 50155)	70 °C; = Tmax; from > +60 °C no module permissible left of the IM; +85 °C for 10 min. (OT4, ST1/ST2 acc. to EN 50155)
• vertical installation, min.	-40 °C; = Tmin; Startup @ -25 °C	-40 °C; = Tmin
• vertical installation, max.	40 °C; = Tmax	40 °C; = Tmax
<b>Altitude during operation relating to sea level</b>		
• Installation altitude above sea level, max.	2 000 m	2 000 m
• Ambient air temperature-barometric pressure-altitude	Tmin ... Tmax at 1 140 hPa ... 795 hPa (-1 000 m ... +2 000 m)	Tmin ... Tmax at 1 140 hPa ... 795 hPa (-1 000 m ... +2 000 m)
<b>Relative humidity</b>		
• With condensation, tested in accordance with IEC 60068-2-38, max.	100 %; RH incl. condensation / frost (no commissioning in bedewed state), horizontal installation	100 %; RH incl. condensation / frost (no commissioning in bedewed state), horizontal installation
<b>Resistance</b>		
• Coolants and lubricants		
- Resistant to commercially available coolants and lubricants	Yes; Incl. diesel and oil droplets in the air	Yes; Incl. diesel and oil droplets in the air
- Use in stationary industrial systems		
- to biologically active substances according to EN 60721-3-3	Yes; Class 3B2 mold, fungus and dry rot spores (with the exception of fauna); Class 3B3 on request	Yes; Class 3B2 mold, fungus and dry rot spores (with the exception of fauna); Class 3B3 on request
• to chemically active substances according to EN60721-3-3	Yes; Class 3C4 (RH < 75 %) incl. salt spray acc. to EN 60068-2-52 (severity degree 3); *	Yes; Class 3C4 (RH < 75 %) incl. salt spray acc. to EN 60068-2-52 (severity degree 3); *
- to mechanically active substances according to EN 60721-3-3	Yes; Class 3S4 incl. sand, dust, *	Yes; Class 3S4 incl. sand, dust, *
• Use on land craft, rail vehicles and special-purpose vehicles		
- to biologically active substances according to EN 60721-3-5	Yes; Class 5B2 mold, fungus and dry rot spores (with the exception of fauna); Class 5B3 on request	Yes; Class 5B2 mold, fungus and dry rot spores (with the exception of fauna); Class 5B3 on request
• to chemically active substances according to EN60721-3-5	Yes; Class 5C3 (RH < 75 %) incl. salt spray acc. to EN 60068-2-52 (severity degree 3); *	Yes; Class 5C3 (RH < 75 %) incl. salt spray acc. to EN 60068-2-52 (severity degree 3); *
- to mechanically active substances according to EN 60721-3-5	Yes; Class 5S3 incl. sand, dust; *	Yes; Class 5S3 incl. sand, dust; *

**SIPLUS ET 200MP IM 155-5 PN ST TX RAIL**

Article number	<b>6AG2155-5AA00-1AC0</b> SIPLUS ET 200MP IM 155-5 PN HF T1 RAIL	<b>6AG2155-5AA01-4AB0</b> SIPLUS ET 200MP IM155-5 PN ST TX RAIL
<ul style="list-style-type: none"> <li>Usage in industrial process technology</li> <li>Against chemically active substances acc. to EN60654-4               <ul style="list-style-type: none"> <li>Environmental conditions for process, measuring and control systems acc. to ANSI/ISA-71.04</li> </ul> </li> <li>Remark               <ul style="list-style-type: none"> <li>Note regarding classification of environmental conditions acc. to EN 60721, EN 60654-4 and ANSI/ISA-71.04</li> </ul> </li> </ul>	<p>Yes; Class 3 (excluding trichlorethylene)</p> <p>Yes; Level GX group A/B (excluding trichlorethylene; harmful gas concentrations up to the limits of EN 60721-3-3 class 3C4 permissible); level LC3 (salt spray) and level LB3 (oil)</p> <p>* The supplied plug covers must remain in place over the unused interfaces during operation!</p>	<p>Yes; Class 3 (excluding trichlorethylene)</p> <p>Yes; Level GX group A/B (excluding trichlorethylene; harmful gas concentrations up to the limits of EN 60721-3-3 class 3C4 permissible); level LC3 (salt spray) and level LB3 (oil)</p> <p>* The supplied plug covers must remain in place over the unused interfaces during operation!</p>
<p><b>Conformal coating</b></p> <ul style="list-style-type: none"> <li>Coatings for printed circuit board assemblies acc. to EN 61086</li> <li>Protection against fouling acc. to EN 60664-3</li> <li>Electronic equipment on rolling stock acc. to EN50155</li> <li>Military testing according to MIL-I-46058C, Amendment 7</li> <li>Qualification and Performance of Electrical Insulating Compound for Printed Board Assemblies according to IPC-CC-830A</li> </ul>	<p>Yes; Class 2 for high reliability</p> <p>Yes; Type 1 protection</p> <p>Yes; Class PC2 protective coating acc. to EN 50155:2017</p> <p>Yes; Discoloration of coating possible during service life</p> <p>Yes; Conformal coating, Class A</p>	<p>Yes; Class 2 for high reliability</p> <p>Yes; Type 1 protection</p> <p>Yes; Class PC2 protective coating acc. to EN 50155:2017</p> <p>Yes; Discoloration of coating possible during service life</p> <p>Yes; Conformal coating, Class A</p>
<b>connection method / header</b>		
<b>ET-Connection</b>		
<ul style="list-style-type: none"> <li>via BU/BA Send</li> </ul>	No	No
<b>Dimensions</b>		
<b>Width</b>	35 mm	35 mm
<b>Height</b>	147 mm	147 mm
<b>Depth</b>	129 mm	129 mm
<b>Weights</b>		
<b>Weight, approx.</b>	350 g	250 g
<b>Other</b>		
<b>Note:</b>	for use in railway applications, also observe the product information "SIPLUS extreme RAIL" A5E37661960A, Online Support article 109736776	for use in railway applications, also observe the product information "SIPLUS extreme RAIL" A5E37661960A, Online Support article 109736776

**Selection and ordering data**

Version	Article No.
<p><b>SIPLUS ET 200MP interface module IM 155-5 PN ST TX RAIL</b></p> <p>Approved in accordance with EN 50155, EN 15121, EN 50124, EN 50125 and EN 45545 railway standards for use in rail traffic</p> <p>IP 20 degree of protection, module width 35 mm, mounted on S7-1500 mounting rail; standard functions; for areas with extreme exposure to environmental substances (conformal coating); ambient temperature -40 ... +70 °C (+85 °C for 10 min.)</p>	<b>6AG2155-5AA01-4AB0</b>
<p><b>SIPLUS ET 200MP interface module IM 155-5 PN HF T1 RAIL</b></p> <p>Approved in accordance with EN 50155, EN 15121, EN 50124, EN 50125 and EN 45545 railway standards for use in rail traffic</p> <p>IP 20 degree of protection, module width 35 mm, mounted on S7-1500 mounting rail; High Feature version with additional functions for areas with extreme exposure to environmental substances (conformal coating); ambient temperature -40 ... +70 °C (+85 °C for 10 min.)</p>	<b>6AG2155-5AA00-1AC0</b>

## SIPLUS RAIL

### SIPLUS extreme RAIL gateways

#### SIPLUS NET PN/PN Coupler T1 RAIL

##### Overview

- Fast deterministic data exchange between CPUs with PROFINET controller, even beyond network boundaries
- Configuration with two PROFINET devices completely independent of the communication technology

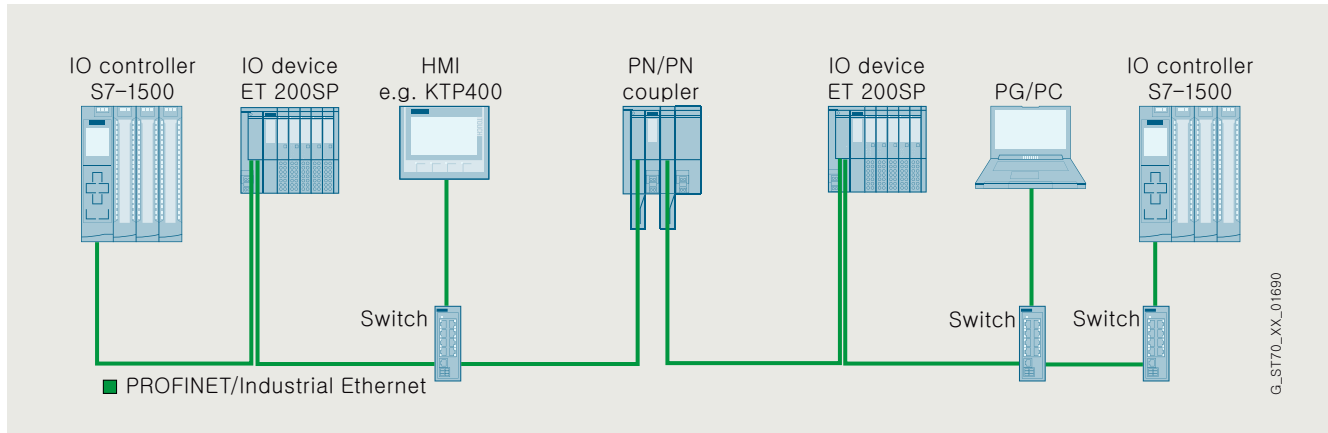

Data transmission between two S7-1500 IO controllers beyond a PROFINET limit

- Very simple configuration of the data exchange via virtual IO modules or alternatively via data records for larger amounts of data
- Simultaneous data transfer to up to 3 CPUs on own network side and/or up to 4 CPUs on opposite network side
- Easy to integrate into any PROFINET network with 2 ports per network side
- Fieldbus connection via a SIMATIC BusAdapter; this allows free selection of the connection system (RJ45, FC cable direct connection) and connection hardware (copper, POF, PCF, glass fiber). FO-to-copper media conversion can also be realized economically and without external converters.

##### Additional functions

- Quantity structures
  - Cyclic transmission: Up to 1440 bytes each for input and output data
  - Data record transfer: Up to 4096 bytes per slot. Buffering of up to eight data records per slot
  - Maximum 16 input/output areas for data exchange
  - Max. 254 bytes of input and 253 bytes of output data per module
- Exchange of fail-safe data between two F-CPU's via F-SendDP and F\_ReceiveDP
- Shared device with up to four IO controllers per network side
- Module-internal shared input / shared output (MSI/MSO)
- Device replacement without programming device
  - With topological configuration via proximity detection (LLDP)
  - Without topological configuration via redundant storage of the station name in the BusAdapter. A separate removable memory card is not required.
- Reset button for restoring the factory settings
- Redundant power supply
- Electrical isolation between the two PROFINET IO subnets
- Media redundancy (MRP and MRPD)
- I&M data
- Firmware update
- Support for Ethernet services (ping, arp, SNMP, MIP-2, LLDP)
- Comprehensive diagnostics via LED displays and interrupts
- Extensive compatibility with the PN/PN coupler up to firmware version V3.0

##### Application

The PN/PN coupler is used whenever easy-to-configure, fast (deterministic) data exchange between PROFINET controllers is required. Data transmission can be performed both beyond network boundaries as well as within a single network side.

##### Design

The PN/PN coupler features an enclosure with the dimensions 100 x 117 x 75 mm (WxHxD). It is snapped onto a DIN rail (7.5 mm or 15 mm).

Two galvanically isolated plug-in connections are available for the power supply.

Accessories (not included in the PN/PN coupler scope of supply):

- SIMATIC BusAdapter: For connecting the PN/PN coupler to the PROFINET PN IO networks.
- Labeling strips (material: Foil or paper, color: light gray or yellow) and reference identification labels: For the labeling.
- Strain relief: The space-saving system-integrated strain relief for the PROFINET cable is quickly assembled and allows the use of the PN/PN coupler even with increased mechanical stress.
- Connector: Suitable connectors for the PROFINET cable may be required depending on the BusAdapter used.

## Function

The PN/PN coupler provides the output data of the writing CPU as input data to the receiving CPUs within a PN cycle. Both fail-safe data (via F\_SendDP/F\_ReceiveDP of a SIMATIC F-CPU only) and standard data can be transmitted.

- Transfer to the opposite side of the network:  
In a PN cycle, the writing CPU provides its output data as input data at the same time as up to four CPUs connected to the other side of the network. The network separation between the two network sides remains completely intact.
- Transfer to the same side of the network:  
In a PN cycle, the writing CPU provides its output data as input data at the same time as up to three other CPUs connected to its own side of the network.

Two basically different methods are available for data transmission:

- Data exchange via virtual I/O modules (coupling modules):  
The local CPU reads the values that the CPU of the other subnet writes over the configured outputs of the coupling partner through the configured inputs of a slot. The local CPU writes values via the configured outputs of a slot. These values are received by the CPU of the other subnet via the configured inputs of the coupling partner.
- Data record transfer:  
Publisher and Storage modules types are used. These consist of read and write combinations. The module types address the data record order by module addresses during data record transfer.

The PN/PN coupler provides extensive diagnostic information about LEDs, interrupts and status bytes. In this way, errors can be quickly located and commissioning and downtimes minimized.

The PN/PN coupler supports a variety of SIMATIC BusAdapters for flexible connection to PROFINET.

## Technical specifications

Article number	<b>6AG2158-3AD10-4XA0</b> SIPLUS PN/PN Coupler TX RAIL
<b>General information</b>	
<b>Product type designation</b>	PN/PN coupler
<b>Product function</b>	
• I&M data	Yes; I&M0 to I&M3
• Isochronous mode	No; For operation on isochronous bus
• Tool changer	Yes; Docking station and docking unit
• Local coupling, IO data	Yes
- Number of coupling modules	16
- Number of coupling submodules per module	4; 1x write, 3x read
• Local coupling, data records	Yes
- Number of coupling modules	16
- Number of coupling submodules per module	4; 1x write, 3x read
- Record length, max.	4 096 byte
- FIFO depth in storage mode	8
<b>Engineering with</b>	
• STEP 7 TIA Portal configurable/integrated from version	see entry ID: 109746275
<b>Installation type/mounting</b>	
<b>Mounting</b>	Mounting rail 7.5 mm and 15 mm
<b>Supply voltage</b>	
<b>Rated value (DC)</b>	24 V
<b>Reverse polarity protection</b>	Yes
<b>Mains buffering</b>	
• Mains/voltage failure stored energy time	10 ms
<b>Input current</b>	
<b>Current consumption, max.</b>	360 mA; For 19.2 V input voltage at the right-hand supply terminal, including 2 plugged BA 2x LC
<b>from supply voltage 1L+, max.</b>	320 mA; For 19.2 V input voltage at the left-hand supply terminal, including 2 plugged BA 2x LC
<b>Power loss</b>	
<b>Power loss, typ.</b>	4 W; For 24 V input voltage and 2 plugged BA 2x RJ45 If BusAdapters with an optical interface are plugged, there is an additional 750 mW per optical interface (3 W with 2 plugged BA 2x LC)
<b>Address area</b>	
<b>Address space per module</b>	
• Address space per module, max.	254 byte; max. 254 bytes of input data and 253 bytes of output data
<b>Address space per station</b>	
• Address space per station, max.	1 440 byte; per input / output
<b>Hardware configuration</b>	
<b>Submodules</b>	
• Number of submodules per station, max.	116
<b>Interfaces</b>	
<b>Number of PROFINET interfaces</b>	2; One PROFINET interface per line side
<b>Optical interface</b>	Yes; Via SIMATIC BusAdapter
<b>Transmission rate, max.</b>	100 Mbit/s

**SIPLUS RAIL**

## SIPLUS extreme RAIL gateways

**SIPLUS NET PN/PN Coupler T1 RAIL**

Article number	<b>6AG2158-3AD10-4XA0</b> SIPLUS PN/PN Coupler TX RAIL
<b>1. Interface</b>	
<b>Interface types</b> • Number of ports • integrated switch • BusAdapter (PROFINET)	2; via BusAdapter Yes Yes; Compatible BusAdapter: BA 2x RJ45, BA 2x FC, BA 2x SCRJ, BA SCRJ / RJ45, BA SCRJ / FC, BA 2x LC, BA LC / RJ45, BA LC / FC
<b>Protocols</b> • PROFINET IO Device • Open IE communication • Media redundancy	Yes Yes Yes; As MRP or MRPD client; max. 50 or 30 devices in the ring
<b>2. Interface</b>	
<b>Interface types</b> • Number of ports • integrated switch	2; via BusAdapter Yes
<b>Protocols</b> • PROFINET IO Device • Open IE communication • Media redundancy	Yes Yes Yes; As MRP or MRPD client; max. 50 or 30 devices in the ring
<b>Interface types</b>	
<b>RJ 45 (Ethernet)</b> • Transmission procedure • 10 Mbps • 100 Mbps • Autonegotiation • Autocrossing	PROFINET with 100 Mbit/s full duplex (100BASE-TX) No Yes; PROFINET with 100 Mbit/s full duplex (100BASE-TX) Yes Yes
<b>Protocols</b>	
<b>Supports protocol for PROFINET IO</b>	Yes
<b>Protocols (Ethernet)</b> • TCP/IP • SNMP • LLDP • ping • ARP	Yes Yes Yes Yes Yes
<b>PROFINET IO Device</b> • Services • IRT • PROFlenergy • Prioritized startup • Shared device • Number of IO Controllers with shared device, max.	Yes No Yes Yes 4; per line side
<b>Redundancy mode</b> • PROFINET system redundancy (S2) • H-Sync forwarding	Yes; NAP S2 acc. to IEC Yes
<b>Media redundancy</b> • MRP • MRPD	Yes Yes
<b>Open IE communication</b> • TCP/IP • SNMP • LLDP	Yes Yes Yes
<b>Interrupts/diagnostics/status information</b>	
<b>Status indicator</b>	Yes
<b>Alarms</b>	Yes
<b>Diagnostics function</b>	Yes; Parameterizable
<b>Diagnostics indication LED</b> • RUN LED • ERROR LED • MAINT LED • LINK LED • Monitoring of the supply voltage (PWR-LED)	Yes; green LED Yes; red LED Yes; Yellow LED Yes; 2x green link LEDs on BusAdapter Yes; green PWR LED
<b>Potential separation</b>	
<b>between supply voltage and electronics</b>	Yes; to power input 2
<b>between Ethernet and electronics</b>	Yes

Article number	<b>6AG2158-3AD10-4XA0</b> SIPLUS PN/PN Coupler TX RAIL
<b>Standards, approvals, certificates</b>	
<b>Network loading class</b>	3
<b>Security level</b>	According to Security Level 1 Test Cases V1.1.4
<b>Railway application</b> <ul style="list-style-type: none"> <li>EN 50121-3-2</li> <li>EN 50121-4</li> <li>EN 50124-1</li> <li>EN 50125-1</li> <li>EN 50125-2</li> <li>EN 50125-3</li> <li>EN 50155</li> <li>EN 61373</li> <li>Fire protection acc. to EN 45545-2</li> </ul>	<p>Yes; EMC for rail vehicles          Yes; EMC for signal and telecommunications systems          Yes; Railway applications - overvoltage category OV2; pollution degree PD2; rated surge voltage UNi = 0.5 kV; UNm = 24 V DC          Yes; Rail vehicles - see ambient conditions          Yes; Stationary electrical equipment - see ambient conditions          Yes; Signal and telecommunications systems - see ambient conditions; vibrations and shocks: Application point outside of tracks (1 m to 3 m away from track)          Yes; Rail vehicles - temperature class OT4, ST1/ST2, horizontal mounting position          Yes; Rail vehicles - vibrations and shocks: Category 1 Class A/B          Yes; For proof of conformity, see Service &amp; Support</p>
<b>Ambient conditions</b>	
<b>Ambient temperature during operation</b> <ul style="list-style-type: none"> <li>min.</li> <li>max.</li> </ul>	-40 °C; = Tmin (incl. condensation/frost) 70 °C; = Tmax; +85 °C for 10 min (OT4, ST1/ST2 acc. to EN 50155)
<b>Altitude during operation relating to sea level</b> <ul style="list-style-type: none"> <li>Installation altitude above sea level, max.</li> <li>Ambient air temperature-barometric pressure-altitude</li> </ul>	2 000 m Tmin ... Tmax at 1 140 hPa ... 795 hPa (-1 000 m ... +2 000 m)
<b>Resistance</b> <ul style="list-style-type: none"> <li>Coolants and lubricants             <ul style="list-style-type: none"> <li>Resistant to commercially available coolants and lubricants</li> </ul> </li> <li>Use in stationary industrial systems             <ul style="list-style-type: none"> <li>to biologically active substances according to EN 60721-3-3</li> <li>to chemically active substances according to EN 60721-3-3</li> <li>to mechanically active substances according to EN 60721-3-3</li> <li>Against mechanical environmental conditions acc. to EN 60721-3-3</li> </ul> </li> <li>Use on land craft, rail vehicles and special-purpose vehicles             <ul style="list-style-type: none"> <li>to biologically active substances according to EN 60721-3-5</li> <li>to chemically active substances according to EN 60721-3-5</li> <li>to mechanically active substances according to EN 60721-3-5</li> <li>Against mechanical environmental conditions acc. to EN 60721-3-5</li> <li>against mechanical environmental conditions in agriculture acc. to ISO 15003</li> </ul> </li> <li>Usage in industrial process technology             <ul style="list-style-type: none"> <li>Against chemically active substances acc. to EN 60654-4</li> <li>Environmental conditions for process, measuring and control systems acc. to ANSI/ISA-71.04</li> </ul> </li> <li>Remark             <ul style="list-style-type: none"> <li>Note regarding classification of environmental conditions acc. to EN 60721, EN 60654-4 and ANSI/ISA-71.04</li> </ul> </li> </ul>	<p>Yes; Incl. diesel and oil droplets in the air</p> <p>Yes; Class 3B2 mold, fungus and dry rot spores (with the exception of fauna); Class 3B3 on request          Yes; Class 3C4 (RH &lt; 75 %) incl. salt spray acc. to EN 60068-2-52 (severity degree 3); *</p> <p>Yes; Class 3S4 incl. sand, dust, *</p> <p>Yes; Class 3M8 using the SIPLUS Mounting Kit ET 200SP (6AG1193-6AA00-0AA0)</p> <p>Yes; Class 5B2 mold, fungus and dry rot spores (with the exception of fauna); Class 5B3 on request          Yes; Class 5C3 (RH &lt; 75 %) incl. salt spray acc. to EN 60068-2-52 (severity degree 3); *</p> <p>Yes; Class 5S3 incl. sand, dust; *</p> <p>Yes; Class 5M2 using the SIPLUS Mounting Kit ET 200SP (6AG1193-6AA00-0AA0)</p> <p>Yes; level 1 (Location LE) using the SIPLUS Mounting Kit ET 200SP (6AG1193-6AA00-0AA0)</p> <p>Yes; Class 3 (excluding trichlorethylene)</p> <p>Yes; Level GX group A/B (excluding trichlorethylene; harmful gas concentrations up to the limits of EN 60721-3-3 class 3C4 permissible); level LC3 (salt spray) and level LB3 (oil)</p> <p>* The supplied plug covers must remain in place over the unused interfaces during operation!</p>
<b>Conformal coating</b> <ul style="list-style-type: none"> <li>Coatings for printed circuit board assemblies acc. to EN 61086</li> <li>Protection against fouling acc. to EN 60664-3</li> <li>Electronic equipment on rolling stock acc. to EN 50155</li> <li>Military testing according to MIL-I-46058C, Amendment 7</li> <li>Qualification and Performance of Electrical Insulating Compound for Printed Board Assemblies according to IPC-CC-830A</li> </ul>	<p>Yes; Class 2 for high reliability</p> <p>Yes; Type 1 protection          Yes; Class PC2 protective coating acc. to EN 50155:2017          Yes; Discoloration of coating possible during service life          Yes; Conformal coating, Class A</p>
<b>Mechanics/material</b>	
<b>Strain relief</b>	Yes; Optional, for RJ45 and FC BusAdapter only
<b>Dimensions</b>	
<b>Width</b>	100 mm; Minimized with good handling
<b>Height</b>	117 mm
<b>Depth</b>	74 mm; with mounting rail
<b>Weights</b>	
<b>Weight, approx.</b>	200 g; without BusAdapter
<b>Other</b>	
<b>Note:</b>	for use in railway applications, also observe the product information "SIPLUS extreme RAIL" A5E37661960A, Online Support article 109736776

**SIPLUS RAIL**

SIPLUS extreme RAIL gateways

**SIPLUS NET PN/PN Coupler T1 RAIL****Selection and ordering data**

Version	Article No.
<p><b>SIPLUS PN/PN Coupler TX RAIL</b></p> <p>Approved in accordance with EN 50155, EN 15121, EN 50124, EN 50125 and EN 45545 railway standards for use in rail traffic</p> <p>For deterministic data exchange between max. 4 PN controllers per side, also beyond network boundaries; transfer of PROFIsafe, I/O, MSI, MSO and data record communication, redundant power supply PN connection via SIMATIC BusAdapter (BA); supplied without BusAdapter;</p> <p>Suitable for areas with extreme exposure to environmental substances (conformal coating); Ambient temperature -40 ... +70 °C (+85 °C for 10 min.)</p>	<p><b>6AG2158-3AD10-4XA0</b></p>



#### Overview



- For data exchange between PROFINET and CAN Bus 2.0A/B or CANopen Manager or Slave (according to CiA 301 & 302)
- Approved in accordance with the EN 50155, EN 15121, EN 50124, EN 50125 and EN 45545 railway standards for use in rail traffic
- CANopen features:
  - Node / lifeguarding
  - Heartbeat
  - SYNC (producer / consumer)
- Integrated in TIA via HSP, TIA Portal V14 or higher
- PROFINET switch and 9-pin D-sub plug integrated for CAN
- Up to 126 CAN nodes
- 512 receiver/transmitter PDOs
- Electrical isolation between the two networks
- Diagnostic interrupts
- Controllers supported: S7-1200, S7-1500, ET 200SP, Open Controller

#### Application

The SIMATIC PN/CAN LINK connects a PROFINET network to the CAN or CANopen fieldbus, and enables the data exchange.

This gives the user the option of communicating with up to 126 CAN nodes.

The configuration is made in the TIA Portal V14 or higher. A corresponding HSP is available to the user.

In CANopen mode, external device description files (.eds files) can be imported and exported.

The SIMATIC PN/CAN LINK has an internal PROFINET switch and integrates itself seamlessly into a PROFINET network.

#### Design

- S7-1200-type enclosure, width 70 mm
- Can be mounted on a standard DIN rail or a control panel
- Connection to PROFINET PN IO networks exclusively via PROFINET by RJ45 connectors
- Connection to CAN Bus via a D-sub connector (9-pin, socket)
- 3-pin connection of the external 24 V DC supply voltage
- Operation without fans or batteries
- LED for visualization of the operating states for CAN, PROFINET and PROFINET ports
- Maximum permissible cable length of the CAN network up to 1 000 m (depending on data transmission rate, cable cross-section, number of participants)

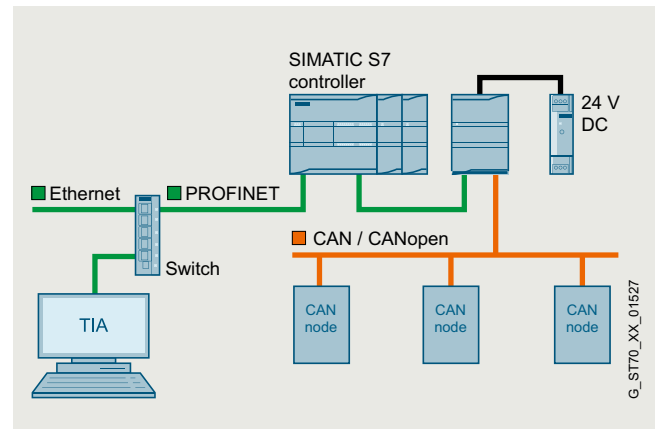

SIMATIC PN/CAN link gateway System configuration

#### Mode of operation

The following overview diagram shows the communication relationships between CAN and PROFINET:

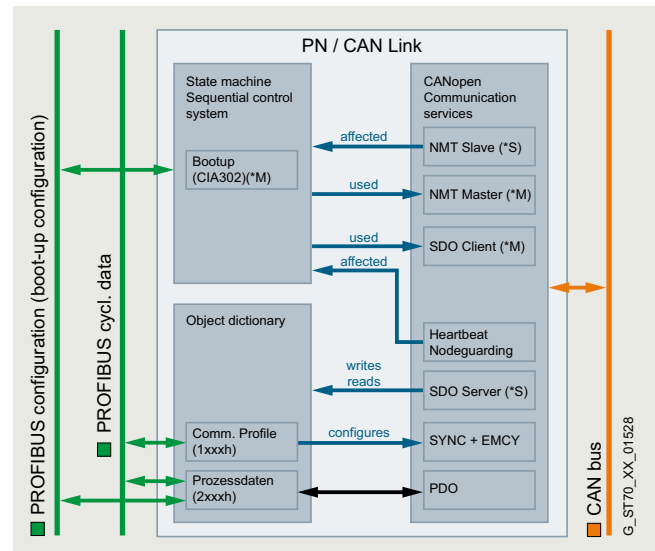

SIMATIC PN/CAN link gateway CANopen communication principle

**SIPLUS RAIL**

## SIPLUS extreme RAIL gateways

**SIPLUS PN/CAN LINK TX RAIL****Function**

- PROFINET IO device
- Controllers supported: S7-1200, S7-1500, ET 200SP, Open Controller
- Supports 512 receiver and 512 transmitter PDOs
- Baud rate from 50 kbaud to 1 000 kbaud on the CAN side
- Three different operating modes:
  - CANtransparent
  - CANopen Manager
  - CANopen Slave
- Data transmission options:
  - After value change / acyclic
  - Cyclic (after parameter assignment at first to 240th "SYNC")
  - On request out of the application (RTR)
- Cyclic data exchange between the PN/CAN LINK and the connected SIMATIC S7-CPU via update of the IO image
- Acyclic communication via the "Read/write data record" services
- Easy engineering and extensive diagnostics options due to optimum TIA integration

**Configuration**

- Configuration or data mapping of the SIMATIC PN/CAN LINK via HSP (TIA Portal V14 and higher)
  - CANopen Manager and CANtransparent operating modes (CAN Bus 2.0A/B):  
Complete configuration of the PN/CAN LINK in the TIA Portal. External software is not required.
  - CANopen Slave operating mode  
Configuration of the object directory (OD) of the PN/CAN LINK. The OD is then made available to the CANopen Manager with .EDS file export.
- Saving the configuration data of the SIMATIC PN/CAN LINK in the higher-level SIMATIC S7 controller, automatic transmission during start up
- Representation of the CAN components as submodules in the TIA Portal. Up to 126 CAN components can be integrated.
- Update mechanisms: TIA Portal and Siemens Automation Tool (SAT)

**Technical specifications**

Article number	<b>6AG2620-0AA00-4AA0</b> SIPLUS PN/CAN LINK TX RAIL
<b>General information</b>	
<b>Product type designation</b>	PN/CAN Link
<b>Engineering with</b>	see entry ID: 109746275
<b>Installation type/mounting</b>	
<b>Mounting</b>	DIN rail, wall mounting, portrait mounting
<b>Mounting position</b>	any
<b>Recommended mounting position</b>	Horizontal
<b>Rail mounting</b>	Yes
<b>Control cabinet installation</b>	Yes
<b>Supply voltage</b>	
<b>Type of supply voltage</b>	DC
<b>Rated value (DC)</b>	24 V
<b>Reverse polarity protection</b>	Yes
<b>Overtoltage protection</b>	Yes
<b>Short-circuit protection</b>	Yes
<b>Mains buffering</b>	
• Mains/voltage failure stored energy time	10 ms
<b>Input current</b>	
<b>Current consumption (rated value)</b>	0.09 A
<b>Current consumption, max.</b>	0.11 A
<b>Power loss</b>	
<b>Power loss, typ.</b>	2.2 W
<b>Interfaces</b>	
<b>Interfaces/bus type</b>	2x Ethernet (RJ45), 1x Sub-D (9-pin)
<b>Supports protocol for PROFINET IO</b>	
• automatic detection of transmission rate	No
• Transmission rate, max.	100 Mbit/s
• Number of RJ45 ports	2
• Number of FC (FastConnect) connections	2
<b>PROFINET functions</b>	
• Assignment of the IP address, supported	Yes
• Assignment of the device name, supported	Yes
<b>1. Interface</b>	
<b>Interface type</b>	CAN according to CiA 303-1
<b>Isolated</b>	Yes; 500 V AC or 707 V DC
<b>Interface types</b>	
• Number of ports	1
• Design of the connection	9-pin sub D socket

Article number	<b>6AG2620-0AA00-4AA0</b> SIPLUS PN/CAN LINK TX RAIL
<b>CAN</b>	
<ul style="list-style-type: none"> <li>CAN operating modes</li> <li>Specification acc. to CiA</li> <li>Transmission rate, min.</li> <li>Transmission rate, max.</li> <li>Number of slaves, max.</li> <li>Number of SDOs in parallel</li> <li>Number of PDOs</li> </ul>	CAN Standard CAN 2.0A/B; CANopen Manager / Slave acc. to CiA CiA 301 & CiA 302 50 kbit/s 1 000 kbit/s 126 16; Parallel 512; Send / receive
<b>Services</b>	
<ul style="list-style-type: none"> <li>Node/life-guarding</li> <li>Heartbeat</li> <li>SYNC</li> </ul>	Yes Yes Yes
<b>2. Interface</b>	
<b>Interface type</b>	PROFINET
<b>Isolated</b>	Yes; 1 500 V AC or 2 250 V DC
<b>Interface types</b>	
<ul style="list-style-type: none"> <li>RJ 45 (Ethernet)</li> <li>Number of ports</li> <li>integrated switch</li> </ul>	Yes 2 Yes
<b>Protocols</b>	
<ul style="list-style-type: none"> <li>PROFINET IO Device</li> </ul>	Yes
<b>Interrupts/diagnostics/status information</b>	
<b>Status indicator</b>	Yes
<b>Alarms</b>	Yes
<b>Diagnostics function</b>	Yes
<b>Diagnostics indication LED</b>	
<ul style="list-style-type: none"> <li>RUN LED</li> <li>ERROR LED</li> <li>MAINT LED</li> <li>LINK LED</li> <li>RX/TX LED</li> </ul>	Yes Yes Yes Yes Yes
<b>Potential separation</b>	
<b>Potential separation exists</b>	Yes
<b>Degree and class of protection</b>	
<b>IP degree of protection</b>	IP20
<b>Standards, approvals, certificates</b>	
<b>Railway application</b>	
<ul style="list-style-type: none"> <li>EN 50121-3-2</li> <li>EN 50121-4</li> <li>EN 50124-1</li> <li>EN 50125-1</li> <li>EN 50125-2</li> <li>EN 50125-3</li> <li>EN 50155</li> <li>EN 61373</li> <li>Fire protection acc. to EN 45545-2</li> </ul>	Yes; EMC for rail vehicles Yes; EMC for signal and telecommunications systems Yes; Railway applications - overvoltage category OV2; pollution degree PD2; rated surge voltage UNi = 0.5 kV; UNm = 24 V DC Yes; Rail vehicles - see ambient conditions Yes; Stationary electrical equipment - see ambient conditions Yes; Signal and telecommunications systems - see ambient conditions; vibrations and shocks: Application point outside of tracks (1 m to 3 m away from track) Yes; Rail vehicles - temperature class OT4, ST1/ST2, horizontal mounting position Yes; Rail vehicles - vibrations and shocks: Category 1 Class A/B Yes; For proof of conformity, see Service & Support
<b>Ambient conditions</b>	
<b>Ambient temperature during operation</b>	
<ul style="list-style-type: none"> <li>horizontal installation, min.</li> <li>horizontal installation, max.</li> <li>vertical installation, min.</li> <li>vertical installation, max.</li> <li>ceiling installation, min.</li> <li>ceiling installation, max.</li> <li>floor installation, min.</li> <li>floor installation, max.</li> </ul>	-40 °C; = Tmin (incl. condensation/frost) 70 °C; = Tmax; +85 °C for 10 min (OT4, ST1/ST2 acc. to EN 50155) -40 °C; = Tmin 55 °C; = Tmax -40 °C; = Tmin 45 °C; = Tmax -40 °C; = Tmin 45 °C; = Tmax
<b>Ambient temperature during storage/transportation</b>	
<ul style="list-style-type: none"> <li>min.</li> <li>max.</li> </ul>	-40 °C 85 °C
<b>Altitude during operation relating to sea level</b>	
<ul style="list-style-type: none"> <li>Installation altitude above sea level, max.</li> <li>Ambient air temperature-barometric pressure-altitude</li> </ul>	2 000 m Tmin ... Tmax at 1 140 hPa ... 795 hPa (-1 000 m ... +2 000 m)
<b>Relative humidity</b>	
<ul style="list-style-type: none"> <li>With condensation, tested in accordance with IEC 60068-2-38, max.</li> </ul>	100 %; RH incl. condensation / frost (no commissioning in bedewed state), horizontal installation

**SIPLUS RAIL**

## SIPLUS extreme RAIL gateways

**SIPLUS PN/CAN LINK TX RAIL**

Article number	<b>6AG2620-0AA00-4AA0</b> SIPLUS PN/CAN LINK TX RAIL
<b>Resistance</b>	
<ul style="list-style-type: none"> <li>Coolants and lubricants           <ul style="list-style-type: none"> <li>Resistant to commercially available coolants and lubricants</li> </ul> </li> <li>Use in stationary industrial systems           <ul style="list-style-type: none"> <li>to biologically active substances according to EN 60721-3-3</li> <li>to chemically active substances according to EN 60721-3-3</li> <li>to mechanically active substances according to EN 60721-3-3</li> </ul> </li> <li>Use on land craft, rail vehicles and special-purpose vehicles           <ul style="list-style-type: none"> <li>to biologically active substances according to EN 60721-3-5</li> <li>to chemically active substances according to EN 60721-3-5</li> <li>to mechanically active substances according to EN 60721-3-5</li> </ul> </li> <li>Usage in industrial process technology           <ul style="list-style-type: none"> <li>Against chemically active substances acc. to EN 60654-4</li> <li>Environmental conditions for process, measuring and control systems acc. to ANSI/ISA-71.04</li> </ul> </li> <li>Remark           <ul style="list-style-type: none"> <li>Note regarding classification of environmental conditions acc. to EN 60721, EN 60654-4 and ANSI/ISA-71.04</li> </ul> </li> </ul>	<p>Yes; Incl. diesel and oil droplets in the air</p> <p>Yes; Class 3B2 mold, fungus and dry rot spores (with the exception of fauna); Class 3B3 on request Yes; Class 3C4 (RH &lt; 75 %) incl. salt spray acc. to EN 60068-2-52 (severity degree 3); *</p> <p>Yes; Class 3S4 incl. sand, dust, *</p> <p>Yes; Class 5B2 mold, fungus and dry rot spores (with the exception of fauna); Class 5B3 on request Yes; Class 5C3 (RH &lt; 75 %) incl. salt spray acc. to EN 60068-2-52 (severity degree 3); *</p> <p>Yes; Class 5S3 incl. sand, dust; *</p> <p>Yes; Class 3 (excluding trichlorethylene)</p> <p>Yes; Level GX group A/B (excluding trichlorethylene; harmful gas concentrations up to the limits of EN 60721-3-3 class 3C4 permissible); level LC3 (salt spray) and level LB3 (oil)</p> <p>* The supplied plug covers must remain in place over the unused interfaces during operation!</p>
<b>Conformal coating</b>	
<ul style="list-style-type: none"> <li>Coatings for printed circuit board assemblies acc. to EN 61086</li> <li>Protection against fouling acc. to EN 60664-3</li> <li>Electronic equipment on rolling stock acc. to EN 50155</li> <li>Military testing according to MIL-I-46058C, Amendment 7</li> <li>Qualification and Performance of Electrical Insulating Compound for Printed Board Assemblies according to IPC-CC-830A</li> </ul>	<p>Yes; Class 2 for high reliability</p> <p>Yes; Type 1 protection Yes; Class PC2 protective coating acc. to EN 50155:2017 Yes; Discoloration of coating possible during service life Yes; Conformal coating, Class A</p>
<b>Dimensions</b>	
<b>Width</b>	70 mm
<b>Height</b>	112 mm
<b>Depth</b>	75 mm
<b>Weights</b>	
<b>Weight, approx.</b>	212 g
<b>Other</b>	
<b>Note:</b>	for use in railway applications, also observe the product information "SIPLUS extreme RAIL" A5E37661960A, Online Support article 109736776

**Selection and ordering data**

Version	Article No.
<b>SIPLUS PN/CAN LINK TX RAIL</b> Approved in accordance with the EN 50155, EN 15121, EN 50124, EN 50125 and EN 45545 railway standards for use in rail traffic PROFINET network transition according to CAN Bus 2.0A/B, CANopen Manager according to CiA301/302, CANopen Slave according to CiA301/302; IP20 Ambient temperature -40 ... +70 °C (+85 °C for 10 min.)	<b>6AG2620-0AA00-4AA0</b>

## Overview



- For data exchange between PROFINET and SAE J1939 networks
- Approved in accordance with EN 50155, EN 15121, EN 50124, EN 50125 and EN 45545 railway standards for use in rail traffic
- J1939 functions:
  - Broadcast Announce Message (BAM)
  - Connection Mode Data Transfer (CMDT)
  - PDU 1 & 2
- Integrated into Totally Integrated Automation via gsdml file in TIA Portal. No separate software required
- Integrated PROFINET switch with 9-pin D-sub socket for J1939
- Up to 253 logical nodes
- Up to 30 addressable ECUs
- Electrical isolation between the two networks
- Diagnostic interrupts
- Supported controllers: S7-1200, S7-1500, ET 200SP, Open Controller

## Application

The SIMATIC PN/J1939 LINK integrates seamlessly into PROFINET networks and facilitates data exchange between the network and the SAE J1939 fieldbus. Communication with up to 253 logical nodes is possible.

## Design

- S7-1200-type enclosure, width 70 mm
- Can be mounted on a DIN rail or a control panel
- LEDs for visualizing the operating states for J1939, PROFINET and PROFINET ports
- Internal PROFINET switch
- Connection to PROFINET PN IO networks exclusively via PROFINET with RJ45 plug connectors
- Connection to SAEJ1939 bus via D-sub (9-pin, socket)
- 3-pin connection of the external 24 V DC supply voltage
- Operation without fans or batteries
- Maximum permissible cable length of the J1939 network up to 1 000 m (depending on data transmission rate, cable cross-section, number of participants). Baud rates of 100 kbaud, 250 kbaud and 500 kbaud are supported.

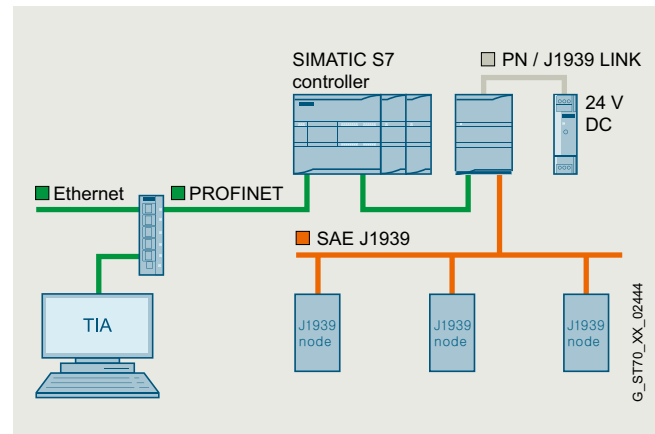

SIMATIC PN/J1939 LINK Gateway system configuration

## Mode of operation

The SIMATIC PN/J1939 LINK configuration data is stored in the higher-level SIMATIC S7 PLC and automatically transmitted during start up.

Cyclic data exchange between the PN/J1939 LINK and the connected SIMATIC S7 CPUs is performed by updating the IO image.

Acyclic communication is via the "Read/write data record" services.

LEDs visualize the operating states for J1939, PROFINET and PROFINET ports.

## Function

- PROFINET IO device
- Supported controllers: S7-1200, S7-1500, ET 200SP, Open Controller
- Easy engineering and extensive diagnostics options due to optimum TIA integration
- Update mechanisms via TIA Portal and the Siemens Automation Tool (SAT)
- J1939 functions:
  - Broadcast Announce Message (BAM)
  - Connection Mode Data Transfer (CMDT)
  - PDU 1 & 2

## Configuration

- Configuration in the TIA Portal via .gsdml file. No separate software required
- PGNs (Parameter Group Number) freely configurable

**SIPLUS RAIL**

## SIPLUS extreme RAIL gateways

**SIPLUS PN/J1939 LINK TX RAIL****Technical specifications**

Article number	<b>6AG2623-0AA00-4AA0</b> SIPLUS PN/J1939 LINK TX RAIL
<b>General information</b>	
<b>Product type designation</b>	PN/J1939 LINK
<b>Product function</b>	
• I&M data	Yes
• Isochronous mode	No
<b>Engineering with</b>	
• STEP 7 TIA Portal configurable/integrated from version	see entry ID: 109746275
<b>Installation type/mounting</b>	
<b>Mounting</b>	DIN rail, wall mounting, portrait mounting
<b>Mounting position</b>	any
<b>Recommended mounting position</b>	Horizontal
<b>Rail mounting</b>	Yes
<b>Control cabinet installation</b>	Yes
<b>Supply voltage</b>	
<b>Type of supply voltage</b>	DC
<b>Rated value (DC)</b>	24 V
<b>Reverse polarity protection</b>	Yes
<b>Overvoltage protection</b>	Yes
<b>Short-circuit protection</b>	Yes
<b>Mains buffering</b>	
• Mains/voltage failure stored energy time	10 ms; PN side
<b>Input current</b>	
<b>Current consumption (rated value)</b>	0.09 A
<b>Current consumption, max.</b>	0.11 A
<b>Power loss</b>	
<b>Power loss, typ.</b>	2.2 W
<b>Interfaces</b>	
<b>Interfaces/bus type</b>	2x Ethernet (RJ45), 1x Sub-D (9-pin)
<b>Supports protocol for PROFINET IO</b>	
• automatic detection of transmission rate	No
• Transmission rate, max.	100 Mbit/s
• Number of RJ45 ports	2
• Number of FC (FastConnect) connections	2
<b>PROFINET functions</b>	
• Assignment of the IP address, supported	Yes
• Assignment of the device name, supported	Yes
<b>1. Interface</b>	
<b>Interface type</b>	J1939 according to the standard "SAE J1939"
<b>Isolated</b>	Yes; 500 V AC or 707 V DC
<b>Interface types</b>	
• Number of ports	1
• Design of the connection	9-pin sub D socket
<b>CAN</b>	
• CAN operating modes	J1939 according to the standard "SAE J1939"
• Transmission rate, min.	100 kbit/s
• Transmission rate, max.	500 kbit/s
• Number of slaves, max.	30
<b>J1939</b>	
• Addressable ECUs, max.	30
• Logical nodes, max.	253
• PDU 1	Yes
• PDU 2	Yes
• DM data	Yes
• BAM	Yes
• CMTD	Yes
<b>2. Interface</b>	
<b>Interface type</b>	PROFINET
<b>Isolated</b>	Yes; 1 500 V AC or 2 250 V DC
<b>Interface types</b>	
• RJ 45 (Ethernet)	Yes
• Number of ports	2
• integrated switch	Yes
<b>Protocols</b>	
• PROFINET IO Device	Yes

Article number	<b>6AG2623-0AA00-4AA0</b> SIPLUS PN/J1939 LINK TX RAIL
<b>Interrupts/diagnostics/status information</b>	
<b>Status indicator</b>	Yes
<b>Alarms</b>	Yes
<b>Diagnostics function</b>	Yes
<b>Diagnostics indication LED</b>	
• RUN LED	Yes
• ERROR LED	Yes
• MAINT LED	Yes
• LINK LED	Yes
• RX/TX LED	Yes
<b>Potential separation</b>	
<b>Potential separation exists</b>	Yes
<b>Degree and class of protection</b>	
<b>IP degree of protection</b>	IP20
<b>Standards, approvals, certificates</b>	
<b>Railway application</b>	
• EN 50121-3-2	Yes; EMC for rail vehicles
• EN 50121-4	Yes; EMC for signal and telecommunications systems
• EN 50124-1	Yes; Railway applications - overvoltage category OV2; pollution degree PD2; rated surge voltage UNi = 0.5 kV; UNm = 24 V DC
• EN 50125-1	Yes; Rail vehicles - see ambient conditions
• EN 50125-2	Yes; Stationary electrical equipment - see ambient conditions
• EN 50125-3	Yes; Signal and telecommunications systems - see ambient conditions; vibrations and shocks: Application point outside of tracks (1 m to 3 m away from track)
• EN 50155	Yes; Rail vehicles - temperature class OT4, ST1/ST2, horizontal mounting position
• EN 61373	Yes; Rail vehicles - vibrations and shocks: Category 1 Class A/B
• Fire protection acc. to EN 45545-2	Yes; For proof of conformity, see Service & Support
<b>Ambient conditions</b>	
<b>Ambient temperature during operation</b>	
• horizontal installation, min.	-40 °C; = Tmin (incl. condensation/frost)
• horizontal installation, max.	70 °C; = Tmax; +85 °C for 10 min (OT4, ST1/ST2 acc. to EN 50155)
• vertical installation, min.	-40 °C; = Tmin
• vertical installation, max.	55 °C; = Tmax
• ceiling installation, min.	-40 °C; = Tmin
• ceiling installation, max.	45 °C; = Tmax
• floor installation, min.	-40 °C; = Tmin
• floor installation, max.	45 °C; = Tmax
<b>Ambient temperature during storage/transportation</b>	
• min.	-40 °C
• max.	85 °C
<b>Altitude during operation relating to sea level</b>	
• Installation altitude above sea level, max.	2 000 m
• Ambient air temperature-barometric pressure-altitude	Tmin ... Tmax at 1 140 hPa ... 795 hPa (-1 000 m ... +2 000 m)
<b>Relative humidity</b>	
• With condensation, tested in accordance with IEC 60068-2-38, max.	100 %; RH incl. condensation / frost (no commissioning in bedewed state), horizontal installation
<b>Resistance</b>	
• Coolants and lubricants	
- Resistant to commercially available coolants and lubricants	Yes; Incl. diesel and oil droplets in the air
• Use in stationary industrial systems	
- to biologically active substances according to EN 60721-3-3	Yes; Class 3B2 mold, fungus and dry rot spores (with the exception of fauna); Class 3B3 on request
- to chemically active substances according to EN 60721-3-3	Yes; Class 3C4 (RH < 75 %) incl. salt spray acc. to EN 60068-2-52 (severity degree 3); *
- to mechanically active substances according to EN 60721-3-3	Yes; Class 3S4 incl. sand, dust, *
• Use on land craft, rail vehicles and special-purpose vehicles	
- to biologically active substances according to EN 60721-3-5	Yes; Class 5B2 mold, fungus and dry rot spores (with the exception of fauna); Class 5B3 on request
- to chemically active substances according to EN 60721-3-5	Yes; Class 5C3 (RH < 75 %) incl. salt spray acc. to EN 60068-2-52 (severity degree 3); *
- to mechanically active substances according to EN 60721-3-5	Yes; Class 5S3 incl. sand, dust; *
• Usage in industrial process technology	
- Against chemically active substances acc. to EN 60654-4	Yes; Class 3 (excluding trichlorethylene)
- Environmental conditions for process, measuring and control systems acc. to ANSI/ISA-71.04	Yes; Level GX group A/B (excluding trichlorethylene; harmful gas concentrations up to the limits of EN 60721-3-3 class 3C4 permissible); level LC3 (salt spray) and level LB3 (oil)
• Remark	
- Note regarding classification of environmental conditions acc. to EN 60721, EN 60654-4 and ANSI/ISA-71.04	* The supplied plug covers must remain in place over the unused interfaces during operation!
<b>Conformal coating</b>	
• Coatings for printed circuit board assemblies acc. to EN 61086	Yes; Class 2 for high reliability
• Protection against fouling acc. to EN 60664-3	Yes; Type 1 protection
• Electronic equipment on rolling stock acc. to EN 50155	Yes; Class PC2 protective coating acc. to EN 50155:2017
• Military testing according to MIL-I-46058C, Amendment 7	Yes; Discoloration of coating possible during service life
• Qualification and Performance of Electrical Insulating Compound for Printed Board Assemblies according to IPC-CC-830A	Yes; Conformal coating, Class A



**SIPLUS RAIL**

SIPLUS extreme RAIL gateways

**SIPLUS PN/J1939 LINK TX RAIL**

Article number	<b>6AG2623-0AA00-4AA0</b> SIPLUS PN/J1939 LINK TX RAIL
<b>Dimensions</b>	
<b>Width</b>	70 mm
<b>Height</b>	112 mm
<b>Depth</b>	75 mm
<b>Weights</b>	
<b>Weight, approx.</b>	212 g
<b>Other</b>	
<b>Note:</b>	for use in railway applications, also observe the product information "SIPLUS extreme RAIL" A5E37661960A, Online Support article 109736776

**Selection and ordering data**

Version	Article No.
<b>SIPLUS PN/J1939 LINK TX RAIL</b> Approved in accordance with EN 50155, EN 15121, EN 50124, EN 50125 and EN 45545 railway standards for use in rail traffic Network transition from PROFINET to J1939 networks; IP20 Ambient temperature -40 ... +70 °C (+85 °C for 10 min.)	<b>6AG2623-0AA00-4AA0</b>

## Overview

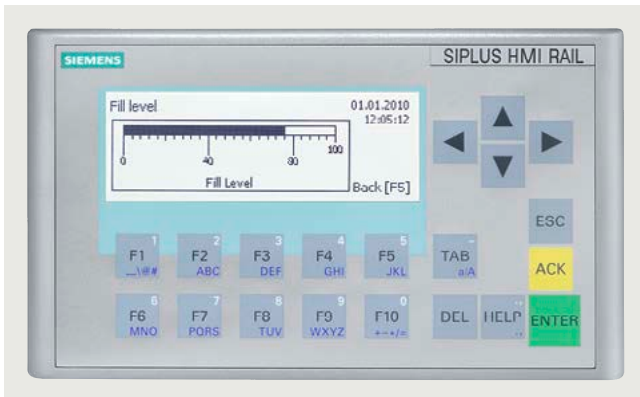

- Basic Panel 3.6 inches for operating and monitoring compact machines and systems
- Approved in accordance with the railway standards EN 50155, EN 15121, EN 50124, EN 50125 and EN 45545 for use in rail traffic
- Clear process representation through the use of full-graphic displays
- Intuitive operation via touch and tactile function keys
- Equipped with all the necessary basic functions such as reporting, recipe management, curve representation, vector graphics, and language selection
- Easy connection to the controller via integrated Ethernet interface

## Benefits

- An integral component of Totally Integrated Automation (TIA): Increased productivity, minimum engineering overhead, reduction in life-cycle costs
  - Short configuring and commissioning times
  - Service-friendly thanks to maintenance-free design and long service life of the backlighting display
- Simple and user-friendly representation of process values thanks to, for example, input/output fields, vector graphics, trend curves, bar charts, text and bitmaps
- Graphics library available with off-the-shelf picture objects
- Can be used worldwide:
  - 32 languages can be configured (incl. Asian and Cyrillic character sets)
  - You can switch between up to 5 languages online
  - Language-dependent texts and graphics

## Application

The SIMATIC HMI Basic Panels can be used wherever compact machines and plants are controlled and monitored locally.

## Design

The SIMATIC HMI Basic Panels are installation-compatible with the existing touch devices of the product family of Panels and Multi Panels.

### KP300 Basic mono PN

- 3.6" FSTN pixel graphics, monochrome
- 1 Ethernet interface (TCP/IP, PROFINET)
- Touch device with 10 function keys and 10 system keys
- Innovative successor to the Text Displays (TD 100C, TD 200/TD 200C, TD 400C) as well as the OP 73 and OP 73micro

## Function

- Input/output fields for displaying and modifying process parameters
- Buttons are used for direct triggering of functions and actions. Up to 16 functions can be configured simultaneously on buttons.
- Graphics can be used as icons instead of text to "label" function keys or buttons. They can also be used as full-screen background images. The configuration tool contains a library with extensive graphics and diverse objects. All editors with an OLE interface (such as PaintShop, Designer or CorelDraw) can be used as graphics editors
- Vector graphics Simple geometric basic forms (line, circle and rectangle) can be created direct in the configuring tool
- Predefined texts for labeling function keys, process pictures and process values in different font sizes
- Curve functions and bars are used for graphical display of dynamic values
- Language switching:
  - 5 online languages, 32 configuration languages incl. Asian and Cyrillic character sets
  - Language-dependent texts and graphics
- User administration (security) in accordance with the requirements of the different industries
  - Authentication with user ID and password
  - User-group-specific rights
- Alarm logging system
  - Discrete messages
  - Analog messages
  - Freely-definable message classes (e.g. status/fault messages) for definition of acknowledgment response and display of message events
  - Message history
- Recipe management
- Help texts for process screens, messages and variables
- Arithmetic functions
- Limit value monitoring for reliable process control of inputs and outputs
- Indicator light for indicating machine and plant statuses
- Scheduler for global function execution in case of global events
- Template concept for creation of screen templates (screen elements configured in the template appear in every screen)
- Simple maintenance and configuration thanks to
  - Backup/restore of configuration, operating system and firmware on/from a PC using ProSave
  - Configuration download via MPI/PROFIBUS DP or PROFINET
  - Automatic transfer detection
  - Individual contrast or brightness setting (except 6" color) and calibration
  - Clean screen
  - No battery required

## Configuration

The configuration is implemented using the engineering software SIMATIC WinCC Basic, Comfort, Professional or SIMATIC STEP 7 Basic (with integrated WinCC Basic).

## SIPLUS RAIL

SIPLUS extreme RAIL operator control and monitoring devices

### SIPLUS extreme RAIL Basic Panels (1st Generation)

#### Integration

The Basic Panels can be connected to:

- SIMATIC S7 controllers
- Non-Siemens controllers (applies for DP devices)
  - Allen Bradley DF1
  - Modicon Modbus RTU
  - Mitsubishi FX
  - Omron Hostlink/Multilink

- Non-Siemens controllers (non-Siemens drivers for PN devices)
  - Allen Bradley Ethernet/IP
  - Modicon Modbus TCP/IP
  - Mitsubishi MC TCP/IP

Note:

For further information, see "System interfaces".

#### Technical specifications

Article number	<b>6AG2647-0AH11-1AX0</b> SIPLUS HMI KP300 BASIC MONO 3,6" T1 RAIL
<b>General information</b>	
<b>Product type designation</b>	KP300 Basic mono PN
<b>Display</b>	
<b>Design of display</b>	FSTN
<b>Screen diagonal</b>	3.6 in
<b>Number of colors</b>	4; backlit display only (white, red, green, yellow)
<b>Resolution (pixels)</b>	
• Horizontal image resolution	240 pixel
• Vertical image resolution	80 pixel
<b>Backlighting</b>	
• MTBF backlighting (at 25 °C)	50 000 h
<b>Control elements</b>	
<b>Keyboard fonts</b>	
• Function keys	
- Number of function keys	10
<b>Touch operation</b>	
• Design as touch screen	No; without
<b>Installation type/mounting</b>	
<b>Mounting in portrait format possible</b>	No
<b>Supply voltage</b>	
<b>Rated value (DC)</b>	24 V
<b>Memory</b>	
<b>Memory available for user data</b>	1 Mbyte
<b>Type of output</b>	
<b>Acoustics</b>	
• Buzzer	No
<b>Time of day</b>	
<b>Clock</b>	
• Software clock	Yes
• retentive	No
• synchronizable	Yes
<b>Interfaces</b>	
<b>Number of industrial Ethernet interfaces</b>	1
<b>Number of RS 485 interfaces</b>	0
<b>Number of USB interfaces</b>	0
<b>Number of SD card slots</b>	0
<b>Protocols</b>	
<b>PROFINET</b>	Yes
<b>IRT</b>	No
<b>PROFIBUS</b>	No
<b>MPI</b>	No
<b>Degree and class of protection</b>	
<b>IP (at the front)</b>	IP65
<b>IP (rear)</b>	IP20
<b>NEMA (front)</b>	
• Enclosure Type 4x at the front	Yes

Article number	<b>6AG2647-0AH11-1AX0</b> SIPLUS HMI KP300 BASIC MONO 3,6" T1 RAIL
<b>Standards, approvals, certificates</b>	
<b>Railway application</b> <ul style="list-style-type: none"> <li>• EN 50121-3-2</li> <li>• EN 50121-4</li> <li>• EN 50124-1</li> <li>• EN 50125-1</li> <li>• EN 50125-2</li> <li>• EN 50125-3</li> <li>• EN 50155</li> <li>• EN 61373</li> <li>• Fire protection acc. to EN 45545-2</li> </ul>	<p>Yes; EMC for rail vehicles  Yes; EMC for signal and telecommunications systems  Yes; Railway applications - overvoltage category OV2; pollution degree PD2; rated surge voltage UNi = 0,5 kV; UNm = 24 V DC  Yes; Rail vehicles - see ambient conditions  Yes; Stationary electrical equipment - see ambient conditions  Yes; Signal and telecommunications systems - see ambient conditions; vibrations and shocks: Application point outside of tracks (1 m to 3 m away from track)  Yes; rail vehicles - temperature class OT1, ST1/ST2, horizontal at vertical mounting position  Yes; Rail vehicles - vibrations and shocks: Category 1 Class A/B  Yes; For proof of conformity, see Service &amp; Support</p>
<b>Ambient conditions</b>	
<b>Ambient temperature during operation</b> <ul style="list-style-type: none"> <li>• Operation (vertical installation) <ul style="list-style-type: none"> <li>- For vertical installation, min.</li> <li>- For vertical installation, max.</li> </ul> </li> </ul>	<p>-25 °C; = Tmin  55 °C; = Tmax; +70 °C for 10 min (OT1, ST1/ST2 acc. to EN 50155)</p>
<b>Altitude during operation relating to sea level</b> <ul style="list-style-type: none"> <li>• Installation altitude above sea level, max.</li> <li>• Ambient air temperature-barometric pressure-altitude</li> </ul>	<p>2 000 m  Tmin ... Tmax at 1 140 hPa ... 795 hPa (-1 000 m ... +2 000 m)</p>
<b>Relative humidity</b> <ul style="list-style-type: none"> <li>• With condensation, tested in accordance with IEC 60068-2-38, max.</li> </ul>	<p>100 %; RH incl. condensation/frost (no commissioning when condensation present), horizontal at vertical mounting position</p>
<b>Resistance</b> <ul style="list-style-type: none"> <li>• Coolants and lubricants <ul style="list-style-type: none"> <li>- Resistant to commercially available coolants and lubricants</li> </ul> </li> <li>• Use in stationary industrial systems <ul style="list-style-type: none"> <li>- to biologically active substances according to EN 60721-3-3</li> <li>- to chemically active substances according to EN 60721-3-3</li> <li>- to mechanically active substances according to EN 60721-3-3</li> </ul> </li> <li>• Use on land craft, rail vehicles and special-purpose vehicles <ul style="list-style-type: none"> <li>- to biologically active substances according to EN 60721-3-5</li> <li>- to chemically active substances according to EN 60721-3-5</li> <li>- to mechanically active substances according to EN 60721-3-5</li> </ul> </li> <li>• Usage in industrial process technology <ul style="list-style-type: none"> <li>- Against chemically active substances acc. to EN 60654-4</li> <li>- Environmental conditions for process, measuring and control systems acc. to ANSI/ISA-71.04</li> </ul> </li> <li>• Remark <ul style="list-style-type: none"> <li>- Note regarding classification of environmental conditions acc. to EN 60721, EN 60654-4 and ANSI/ISA-71.04</li> </ul> </li> </ul>	<p>Yes; Incl. diesel and oil droplets in the air</p> <p>Yes; Class 3B2 mold, fungus and dry rot spores (with the exception of fauna); Class 3B3 on request  Yes; Class 3C4 (RH &lt; 75 %) incl. salt spray acc. to EN 60068-2-52 (severity degree 3); *  Yes; Class 3S4 incl. sand, dust, *</p> <p>Yes; Class 5B2 mold, fungus and dry rot spores (with the exception of fauna); Class 5B3 on request  Yes; Class 5C3 (RH &lt; 75 %) incl. salt spray acc. to EN 60068-2-52 (severity degree 3); *  Yes; Class 5S3 incl. sand, dust; *</p> <p>Yes; Class 3 (excluding trichlorethylene)  Yes; Level GX group A/B (excluding trichlorethylene; harmful gas concentrations up to the limits of EN 60721-3-3 class 3C4 permissible); level LC3 (salt spray) and level LB3 (oil)</p> <p>* The supplied plug covers must remain in place over the unused interfaces during operation!</p>
<b>Conformal coating</b> <ul style="list-style-type: none"> <li>• Coatings for printed circuit board assemblies acc. to EN 61086</li> <li>• Protection against fouling acc. to EN 60664-3</li> <li>• Electronic equipment on rolling stock acc. to EN 50155</li> <li>• Military testing according to MIL-I-46058C, Amendment 7</li> <li>• Qualification and Performance of Electrical Insulating Compound for Printed Board Assemblies according to IPC-CC-830A</li> </ul>	<p>Yes; Class 2 for high reliability  Yes; Type 1 protection  Yes; Class PC2 protective coating acc. to EN 50155:2017  Yes; Discoloration of coating possible during service life  Yes; Conformal coating, Class A</p>
<b>configuration / header</b>	
<b>Configuration software</b> <ul style="list-style-type: none"> <li>• STEP 7 Basic (TIA Portal)</li> <li>• WinCC flexible Compact</li> <li>• WinCC Basic (TIA Portal)</li> </ul>	<p>Yes; via integrated WinCC Basic (TIA Portal)  No  Yes</p>
<b>Languages</b>	
<b>Online languages</b> <ul style="list-style-type: none"> <li>• Number of online/runtime languages</li> </ul>	<p>5</p>
<b>Functionality under WinCC (TIA Portal)</b>	
<b>Task planner</b> <ul style="list-style-type: none"> <li>• time-controlled</li> <li>• task-controlled</li> </ul>	<p>No  Yes</p>
<b>Message system</b> <ul style="list-style-type: none"> <li>• Bit messages <ul style="list-style-type: none"> <li>- Number of bit messages</li> </ul> </li> <li>• Analog messages <ul style="list-style-type: none"> <li>- Number of analog messages</li> </ul> </li> <li>• Message buffer <ul style="list-style-type: none"> <li>- Number of entries</li> <li>- Circulating buffer</li> <li>- retentive</li> </ul> </li> </ul>	<p>200  15  256  Yes  Yes</p>
<b>Recipe management</b> <ul style="list-style-type: none"> <li>• Number of recipes</li> <li>• Size of internal recipe memory</li> <li>• Recipe memory expandable</li> </ul>	<p>5  40 kbyte  No</p>

## SIPLUS RAIL

SIPLUS extreme RAIL operator control and monitoring devices

### SIPLUS extreme RAIL Basic Panels (1st Generation)

Article number	<b>6AG2647-0AH11-1AX0</b> SIPLUS HMI KP300 BASIC MONO 3,6" T1 RAIL
<b>Variables</b> • Number of variables per device • Number of variables per screen	250 30
<b>Images</b> • Number of configurable images	50
<b>Archiving</b> • Number of archives per device	0
<b>Security</b> • Number of user groups • Number of users • SIMATIC Logon	50 50 No
<b>Transfer (upload/download)</b> • MPI/PROFIBUS DP • Ethernet	No Yes
<b>Process coupling</b> • S7-1200 • S7-1500 • S7-200 • S7-300/400 • LOGO! • WinAC • SIMOTION • Allen Bradley (EtherNet/IP) • Allen Bradley (DF1) • Mitsubishi (MC TCP/IP) • Mitsubishi (FX) • OMRON (FINS TCP) • OMRON (LINK/Multilink) • Modicon (Modbus TCP/IP) • Modicon (Modbus)	Yes Yes Yes Yes Yes Yes No Yes No No Yes No No Yes No
<b>Peripherals/Options</b>	
<b>Printer</b>	No
<b>SIMATIC HMI MM memory card: Multi Media Card</b>	No
<b>SIMATIC HMI SD memory card: Secure Digital memory card</b>	No
<b>USB memory</b>	No
<b>Mechanics/material</b>	
<b>Enclosure material (front)</b> • Plastic • Aluminum • Stainless steel	Yes No No
<b>Dimensions</b>	
<b>Width of the housing front</b>	165 mm
<b>Height of housing front</b>	97 mm
<b>Mounting cutout, width</b>	149 mm
<b>Mounting cutout, height</b>	82 mm
<b>Overall depth</b>	30 mm
<b>Weights</b>	
<b>Weight (without packaging)</b>	0.25 kg
<b>Other</b>	
<b>Note:</b>	for use in railway applications, also observe the product information "SIPLUS extreme RAIL" A5E37661960A, Online Support article 109736776

### Selection and ordering data

Version	Article No.
<b>SIPLUS HMI KP300 Basic mono PN T1 RAIL</b> Approved in accordance with the railway standards EN 50155, EN 15121, EN 50124, EN 50125 and EN 45545 for use in rail traffic Key operation; 3" FSTN LCD display, black and white, PROFINET interface For areas with extreme exposure to environmental substances (conformal coating); ambient temperature -25 ... +55 °C (+70 °C for 10 min.)	<b>6AG2647-0AH11-1AX0</b>

**Dimensional drawings**

All dimensions in mm. For installation cutout, see technical specifications.

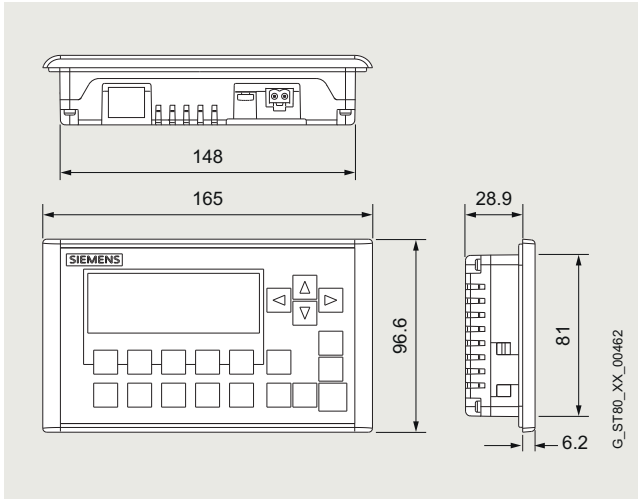

KP300 Basic

**More information**

More information is available on the internet at <http://www.siemens.com/simatic-basic-panels>

Note

Do you require a specific modification or extension to the products described here? Then look up "Customized products", where you will find information about additional and generally available sector-specific products as well as options for customer-specific modifications and adaptations.

## SIPLUS RAIL

### SIPLUS extreme RAIL operator control and monitoring devices

#### SIPLUS HMI Comfort Panels Outdoor RAIL

##### Overview

##### **SIPLUS HMI Comfort Panels Outdoor RAIL**

Special HMI Panels have been developed which are designed to withstand outdoor environments.

It's not only extreme temperatures which call for robust hardware. Direct sunlight, too, must not be allowed to impair display readability and the panel front must be protected from UV radiation. The specially-bonded Outdoor fronts and the rugged hardware of the Outdoor Panels make the SIMATIC HMI Comfort Panels Outdoor a reliable partner in this environment.

- Approved in accordance with the railway standards EN 50155, EN 15121, EN 50124, EN 50125 and EN 45545 for use in rail traffic
- For outdoor operation without additional measures
- 7" and 15" daylight-readable display, widescreen
- Automatic, central or manual dimming of the backlight, with integrated sensor
- Panel front 100% UV protected
- Front resistant to salt mist
- Front IP66 and Nema4 x (indoor/outdoor)
- Extended operating temperature range: from -30 °C to +60 °C at 3 000 m installation altitude
- TIA Portal central engineering tool (WinCC V13 SP1&HSP or higher)
- Comfort Panel functionality and performance

##### Notice:

The 7" Comfort Panel corresponds to a 7" Comfort Panel Standard, the 15" Comfort Panel Outdoor corresponds to a 12" Comfort Panel Standard in respect of performance, functionality and quantity structure.

##### Benefits

- No additional expense or measures in the outdoor area for:
  - Climatic adaptations
  - UV protection
  - Glare protection
  - Automatic dimming
- Integral component of Totally Integrated Automation (TIA): Increased productivity, minimum engineering overhead, reduction in life-cycle costs.
- Can also be deployed in an upright position in a laterally limited installation space (all touch devices).
- Seamless compatibility across the Comfort Panel range for existing projects from Standard to Outdoor. This means that TP700 Comfort Standard and TP1200 Comfort Standard projects can be used without issue on TP700 Comfort Outdoor and/or TP1500 Comfort Outdoor Panels. The TP1500 Comfort Outdoor Panel displays the configuration of the TP1200 Comfort Standard proportionately larger.
- Projects can be created with a Standard Panel, and subsequently also used on an Outdoor Panel (device switchover).

##### Application

The Outdoor Panels can be operated in outdoor environments without the need for additional measures. Additional heating or cooling units are not required. The daylight-readable display is optically bonded to the unit and is glare-free thanks to special polarizing films. So the screen contents are highly legible even in daylight.

The Panel is just at home in the marine sector as it is offshore. Drilling platforms, ships, special vehicles or other, awkwardly located fields of application can now be easily accessed.

##### Design

- The mechanical design of the SIMATIC HMI Comfort Outdoor Panels differentiates them from other units in that they have an extremely rugged appearance.
- The front is made from milled, powder-coated aluminum.
- Special powder coating protects the front against ultraviolet radiation and salt mist.
- The GFG Touch (glass-foil-glass) is bonded to the display to form a single optical unit. This ensures that no moisture can get between the two layers to cause fogging and also prevents reflective phenomena to the largest possible extent.
- This high-quality bonding enables energy-saving backlight to be used, in contrast to very bright, energy-intensive backlit displays which achieve the same effects.
- The dimension drawings can be found in the manual available as a free download in the SIMATIC Support area. Online 3D CAD drawings are also available.
- An integrated PN switch provides two PN interfaces for operation in ring or line topologies. This enables hardware configurations that do not require additional network components.
- For applications where there are aggressive substances in the atmosphere, the electrical components can have customized hardening (see also SIPLUS variants).

##### Function

The functionality is identical to that of the corresponding Standard Panel - a TP700 Comfort Standard is the equivalent of TP700 Comfort Outdoor, just as a TP1200 Comfort Standard is the equivalent of a TP1500 Comfort Outdoor. The sole distinguishing feature is their size.

The complete functionality and all the details of the devices are thoroughly described in their corresponding manuals. A comprehensive online help resource is also available for direct support in the TIA Portal.

##### Integration

SIMATIC HMI Comfort Outdoor Panels can be connected to:

- SIMATIC S7 controllers
- Third-party controllers
  - Allen Bradley DF1, Allen Bradley Ethernet/IP
  - Modicon MODBUS RTU, Modicon MODBUS TCP/IP
  - Mitsubishi FX, Mitsubishi MC TCP/IP
  - Omron Hostlink/Multilink
- OPC UA client or OPC DA server
- Multi-protocol capability
- http communication with other SIMATIC HMI systems
- Over Ethernet (TCP/IP) to a higher-level PC, network printer

##### Note:

Further information can be found under "System interfaces".



## Technical specifications

Article number	6AG2124-0GC13-1AX0 SIPLUS HMI TP700 OUTDOOR T1 RAIL	6AG2124-0QC13-1AX0 SIPLUS HMI TP1500 OUTDOOR T1 RAIL
<b>General information</b>		
<b>Product type designation</b>	TP700 Outdoor	TP1500 Outdoor
<b>Display</b>		
<b>Design of display</b>	TFT, bonded, daylight-readable	TFT, bonded, daylight-readable
<b>Screen diagonal</b>	7 in	15.4 in
<b>Number of colors</b>	16 777 216	16 777 216
<b>Resolution (pixels)</b>	800 pixel 480 pixel	1 280 pixel 800 pixel
<b>Backlighting</b>		
• MTBF backlighting (at 25 °C)	50 000 h	50 000 h
<b>Control elements</b>		
<b>Keyboard fonts</b>		
• Function keys		
- Number of function keys	0	0
<b>Touch operation</b>		
• Design as touch screen	Yes; Analog-resistive	Yes; Analog-resistive
<b>Installation type/mounting</b>		
<b>Mounting in portrait format possible</b>	Yes	Yes
<b>Supply voltage</b>		
<b>Rated value (DC)</b>	24 V	24 V
<b>Memory</b>		
<b>Memory available for user data</b>	12 Mbyte	12 Mbyte
<b>Type of output</b>		
<b>Acoustics</b>		
• Speaker	Yes	Yes
<b>Time of day</b>		
<b>Clock</b>		
• Hardware clock (real-time)	Yes	Yes
• retentive	Yes; Back-up duration typically 6 weeks	Yes; Back-up duration typically 6 weeks
• synchronizable	Yes	Yes
<b>Interfaces</b>		
<b>Number of industrial Ethernet interfaces</b>	2	2
<b>Number of RS 485 interfaces</b>	1; RS 422 / 485 combined	1; RS 422 / 485 combined
<b>Number of USB interfaces</b>	2; USB 2.0, see Entry ID: 64847814	2; USB 2.0, see Entry ID: 64847814
• USB Mini B	1; 5-pole	1; 5-pole
<b>Number of SD card slots</b>	2	2
<b>Industrial Ethernet</b>		
• Number of ports of the integrated switch	2	2
<b>Protocols</b>		
<b>PROFINET</b>	Yes	Yes
<b>IRT</b>	Yes	Yes
<b>PROFIBUS</b>	Yes	Yes
<b>MPI</b>	Yes	Yes
<b>Redundancy mode</b>		
<b>Media redundancy</b>		
• MRP	Yes	Yes
<b>Degree and class of protection</b>		
<b>IP (at the front)</b>	IP66	IP66
<b>IP (rear)</b>	IP20	IP20
<b>NEMA (front)</b>		
• Enclosure Type 4x at the front	Yes	Yes

**SIPLUS RAIL**

## SIPLUS extreme RAIL operator control and monitoring devices

**SIPLUS HMI Comfort Panels Outdoor RAIL**

Article number	<b>6AG2124-0GC13-1AX0</b> SIPLUS HMI TP700 OUTDOOR T1 RAIL	<b>6AG2124-0QC13-1AX0</b> SIPLUS HMI TP1500 OUTDOOR T1 RAIL
<b>Standards, approvals, certificates</b>		
<b>CE mark</b>	Yes	Yes
<b>Railway application</b>	Yes; EMC for rail vehicles Yes; EMC for signal and telecommunications systems Yes; Railway applications - overvoltage category OV2; pollution degree PD2; rated surge voltage UNi = 0.5 kV; UNm = 24 V DC Yes; Rail vehicles - see ambient conditions Yes; Stationary electrical equipment - see ambient conditions Yes; Signal and telecommunications systems - see ambient conditions; vibrations and shocks: Application point outside of tracks (1 m to 3 m away from track) Yes; rail vehicles - temperature class OT1, ST1/ST2, horizontal at vertical mounting position Yes; Rail vehicles - vibrations and shocks: Category 1 Class A/B Yes; For proof of conformity, see Service & Support	Yes; EMC for rail vehicles Yes; EMC for signal and telecommunications systems Yes; Railway applications - overvoltage category OV2; pollution degree PD2; rated surge voltage UNi = 0.5 kV; UNm = 24 V DC Yes; Rail vehicles - see ambient conditions Yes; Stationary electrical equipment - see ambient conditions Yes; Signal and telecommunications systems - see ambient conditions; vibrations and shocks: Application point outside of tracks (1 m to 3 m away from track) Yes; rail vehicles - temperature class OT1, ST1/ST2, horizontal at vertical mounting position Yes; Rail vehicles - vibrations and shocks: Category 1 Class A/B Yes; For proof of conformity, see Service & Support
<ul style="list-style-type: none"> <li>EN 50121-3-2</li> <li>EN 50121-4</li> <li>EN 50124-1</li> <li>EN 50125-1</li> <li>EN 50125-2</li> <li>EN 50125-3</li> <li>EN 50155</li> <li>EN 61373</li> <li>Fire protection acc. to EN 45545-2</li> </ul>		
<b>Ambient conditions</b>		
<b>Suited for indoor use</b>	Yes	Yes
<b>Suited for outdoor use</b>	Yes; Powder-coated, UV resistant	Yes; Powder-coated, UV resistant
<b>Ambient temperature during operation</b>	-30 °C; = Tmin (incl. condensation/frost) 60 °C; = Tmax; +70 °C for 10 min (OT1, ST1/ST2 acc. to EN 50155)	-30 °C; = Tmin (incl. condensation/frost) 60 °C; = Tmax; +70 °C for 10 min (OT1, ST1/ST2 acc. to EN 50155)
<b>Altitude during operation relating to sea level</b>	2 000 m Tmin ... Tmax at 1 140 hPa ... 795 hPa (-1 000 m ... +2 000 m)	2 000 m Tmin ... Tmax at 1 140 hPa ... 795 hPa (-1 000 m ... +2 000 m)
<b>Relative humidity</b>	100 %; RH incl. condensation/frost (no commissioning when condensation present), horizontal at vertical mounting position	100 %; RH incl. condensation/frost (no commissioning when condensation present), horizontal at vertical mounting position
<b>Resistance</b>		
<ul style="list-style-type: none"> <li>Coolants and lubricants <ul style="list-style-type: none"> <li>Resistant to commercially available coolants and lubricants</li> </ul> </li> <li>Use in stationary industrial systems <ul style="list-style-type: none"> <li>to biologically active substances according to EN 60721-3-3</li> <li>to chemically active substances according to EN 60721-3-3</li> <li>to mechanically active substances according to EN -3-3</li> </ul> </li> <li>Use on land craft, rail vehicles and special-purpose vehicles <ul style="list-style-type: none"> <li>to biologically active substances according to EN 60721-3-5</li> <li>to chemically active substances according to EN 60721-3-5</li> <li>to mechanically active substances according to EN 60721-3-5</li> <li>Against contaminant acc. to EN 60721-3-5</li> </ul> </li> <li>Usage in industrial process technology <ul style="list-style-type: none"> <li>Against chemically active substances acc. to EN 60654-4</li> <li>Environmental conditions for process, measuring and control systems acc. to ANSI/ISA-71.04</li> </ul> </li> <li>Remark <ul style="list-style-type: none"> <li>Note regarding classification of environmental conditions acc. to EN 60721, EN 60654-4 and ANSI/ISA-71.04</li> </ul> </li> </ul>	<ul style="list-style-type: none"> <li>Yes; Incl. diesel and oil droplets in the air</li> <li>Yes; Class 3B2 mold, fungus and dry rot spores (with the exception of fauna); Class 3B3 on request</li> <li>Yes; Class 3C4 (RH &lt; 75 %) incl. salt spray acc. to EN 60068-2-52 (severity degree 3); *</li> <li>Yes; Class 3S4 incl. sand, dust; *</li> <li>Yes; Class 5B2 mold, fungus and dry rot spores (with the exception of fauna); Class 5B3 on request</li> <li>Yes; Class 5C3 (RH &lt; 75 %) incl. salt spray acc. to EN 60068-2-52 (severity degree 3); *</li> <li>Yes; Class 5S3 incl. sand, dust; *</li> <li>Yes; Class 5F3 (excluding gasoline)</li> <li>Yes; Class 3 (excluding trichlorethylene)</li> <li>Yes; Level GX group A/B (excluding trichlorethylene; harmful gas concentrations up to the limits of EN 60721-3-3 class 3C4 permissible); level LC3 (salt spray) and level LB3 (oil)</li> <li>* The supplied plug covers must remain in place over the unused interfaces during operation!</li> </ul>	<ul style="list-style-type: none"> <li>Yes; Incl. diesel and oil droplets in the air</li> <li>Yes; Class 3B2 mold, fungus and dry rot spores (with the exception of fauna); Class 3B3 on request</li> <li>Yes; Class 3C4 (RH &lt; 75 %) incl. salt spray acc. to EN 60068-2-52 (severity degree 3); *</li> <li>Yes; Class 3S4 incl. sand, dust; *</li> <li>Yes; Class 5B2 mold, fungus and dry rot spores (with the exception of fauna); Class 5B3 on request</li> <li>Yes; Class 5C3 (RH &lt; 75 %) incl. salt spray acc. to EN 60068-2-52 (severity degree 3); *</li> <li>Yes; Class 5S3 incl. sand, dust; *</li> <li>Yes; Class 5F3 (excluding gasoline)</li> <li>Yes; Class 3 (excluding trichlorethylene)</li> <li>Yes; Level GX group A/B (excluding trichlorethylene; harmful gas concentrations up to the limits of EN 60721-3-3 class 3C4 permissible); level LC3 (salt spray) and level LB3 (oil)</li> <li>* The supplied plug covers must remain in place over the unused interfaces during operation!</li> </ul>



## SIPLUS RAIL

SIPLUS extreme RAIL operator control and monitoring devices

### SIPLUS HMI Comfort Panels Outdoor RAIL

Article number	<b>6AG2124-0GC13-1AX0</b> SIPLUS HMI TP700 OUTDOOR T1 RAIL	<b>6AG2124-0QC13-1AX0</b> SIPLUS HMI TP1500 OUTDOOR T1 RAIL
<b>Peripherals/Options</b>		
Printer	Yes	Yes
SIMATIC HMI MM memory card: Multi Media Card	Yes	Yes
SIMATIC HMI SD memory card: Secure Digital memory card	Yes	Yes
USB memory	Yes	Yes
Network camera	Yes	Yes; See FAQ Entry ID: 62383298 and entry ID: 65647473
<b>Mechanics/material</b>		
Enclosure material (front)	No	No
• Plastic	Yes; Powder-coated, UV resistant	Yes; Powder-coated, UV resistant
• Aluminum	Yes	Yes
• Stainless steel	No	No
<b>Dimensions</b>		
Width of the housing front	214 mm	415 mm
Height of housing front	158 mm	310 mm
Mounting cutout, width	197 mm	396 mm
Mounting cutout, height	141 mm	291 mm
Overall depth	67 mm	77 mm
<b>Weights</b>		
Weight (without packaging)	1.5 kg	4 kg
<b>Other</b>		
Note:	for use in railway applications, also observe the product information "SIPLUS extreme RAIL" A5E37661960A, Online Support article 109736776	for use in railway applications, also observe the product information "SIPLUS extreme RAIL" A5E37661960A, Online Support article 109736776

6

### Selection and ordering data

Version	Article No.
<p><b>SIPLUS HMI Comfort Outdoor Panels RAIL</b></p> <p><b>SIPLUS HMI TP700 Comfort Panel Outdoor RAIL</b> Approved in accordance with the railway standards EN 50155, EN 15121, EN 50124, EN 50125 and EN 45545 for use in rail traffic Touch operation, 7" widescreen TFT display, 16 million colors, PROFINET interface, MPI/PROFIBUS DP interface, 12 MB configuration memory, Windows CE 6.0, configurable as from WinCC Comfort V13, SP1, HSP For areas with extreme exposure to environmental substances (conformal coating); ambient temperature -25 ... +60 °C (+70 °C for 10 min.)</p>	<b>6AG2124-0GC13-1AX0</b>
<p><b>SIPLUS HMI TP1500 Comfort Panel Outdoor RAIL</b> Approved in accordance with the railway standards EN 50155, EN 15121, EN 50124, EN 50125 and EN 45545 for use in rail traffic Touch operation, 15" widescreen TFT display, 16 million colors, PROFINET interface, MPI/PROFIBUS DP interface, 12 MB configuration memory, Windows CE 6.0, configurable as from WinCC Comfort V13, SP1, HSP For areas with extreme exposure to environmental substances (conformal coating); ambient temperature -25 ... +70 °C (+85 °C for 10 min.)</p>	<b>6AG2124-0QC13-1AX0</b>
<b>Accessories</b>	See "Operator Control and Monitoring Systems SIMATIC HMI" -> "Accessories"

### More information

#### Note:

The SIPLUS HMI TP700 Comfort Panel Outdoor RAIL is compatible with the TP700 Comfort Panel Standard.

The SIPLUS HMI TP1500 Comfort Panel Outdoor RAIL is compatible with the TP1200 Comfort Panel Standard with a 15" display.

A TP1500 Comfort Standard unit with the maximum possible configuration cannot be installed on a SIPLUS HMI TP1500 Comfort Panel Outdoor.

## Overview

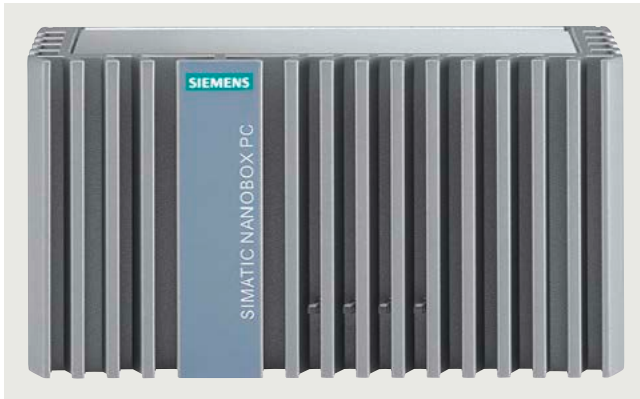

SIPLUS IPC227E ET RAIL (Nanobox PC): The Box PC with optimized performance in compact design – maintenance-free and rugged

The Nanobox PC is an extremely compact and flexible embedded industrial PC.

Thanks to its closed, dust-protected all-metal enclosure, the IPC227E offers maximum industrial functionality for flexible use under harsh conditions – while remaining maintenance-free.

Modern interfaces and the option for expansion via a PCIe slot mean this box PC can be easily integrated into the automation system. In the version with pre-installed Industrial Edge Runtime, it also supports modern Edge architectures. The latest Intel Quad Core processors ensure excellent performance here in an ultra-compact design.

## Benefits

### Low space requirements and installation flexibility

- Maximum compactness with approx. 1 liter enclosure volume or more with integrated industrial power supply for minimum space requirements in the control cabinet
- Excellent flexibility thanks to three installation variants and interfaces on one side suitable for any installation situation

### High degree of ruggedness for maintenance-free continuous operation

- Maximum industrial functionality thanks to closed enclosure for optimum dust protection and high electromagnetic compatibility
- Backup of important system data thanks to non-volatile retentive memory (NVRAM, optional)
- Designed for continuous operation at ambient temperatures up to 60 °C and high vibration/shock requirements
- Maintenance-free operation – without fans (operation without battery possible)

### Optimized for use as gateway and for control and visualization tasks

- High-performance and energy-saving Quad Core Intel processors
- Diverse interfaces and configuration options (USB 3.0, 2 x Gbit Ethernet, RS232/RS485/RS422, SSD/CFast/HDD)
- Optimized for headless operation with LEDs for efficient self-diagnostics

### High level of investment security for reducing engineering costs

- Long-term availability: Service & support period up to 11 years
- Ideal platform for SIMATIC Software Controller and/or WinCC RT Advanced / WinCC Unified PC RT
- Simple integration into automation solutions with the TIA Portal and on-board PROFINET interfaces

### Extended temperature range

The SIPLUS IPC227E ET RAIL is also available for the extended temperature range from -25 °C to +60 °C.

The following options for this are available and must always be selected together when configuring the device:

- Celeron E3845 ET (4C/4T) / TPM
- 4 GB RAM ET / NVRAM
- 60 GB SSD ET

## Application

The Nanobox PC has a diverse range of applications:

- Control, visualization and communication tasks in areas like mechanical engineering, transportation systems or power transmission
- Acquisition, further processing and visualization of data
- Machine-level applications that additionally require C/C++ programs
- Applications such as shipbuilding, building automation, and storage & logistics
- For Industrial Edge applications for simple, scalable and reliable use of software for data processing (with pre-installed Industrial Edge Runtime):
  - Collection, analysis, saving and forwarding of production data
  - Installation and scaling of software using container technology
  - Central management of devices and software on location or in the cloud
  - Full data control from the shop floor to the cloud

## Design

### **Basic design**

- All-metal enclosure, resistant to vibrations and shocks, also with high electromagnetic compatibility
- Isolated power supply:
  - 24 V DC (19.2 to 28.8 V)
- Graphics connection DisplayPort
  - Resolution: Up to 2 560 x 1 600 pixels
- Interfaces (accessible from one side):
  - 2 x LAN 10/100/1000 Mbps Ethernet interface (RJ45)
  - 1 x USB V3.0, 3 x USB V2.0
- Fieldbus
  - PROFINET Realtime via Standard Ethernet interface

### SIPLUS IPC227E ET RAIL with extended temperature range

The following options are available for this version and must always be selected together when configuring the device:

- Celeron E3845 ET (4C/4T) / TPM
- 4 GB RAM ET / NVRAM
- 60 GB SSD ET

**SIPLUS RAIL**

SIPLUS extreme RAIL Industrial PC

SIPLUS extreme RAIL Box PC

**SIPLUS IPC227E ET RAIL****SIPLUS IPC227E ET RAIL (bottom)****Integrated diagnostics DiagBase**

- Integrated, parameterizable monitoring functions (program execution/watchdog, internal enclosure temperature, mass storage)

**Technical specifications**

Article number	<b>6AG2647-8BE72-1HA1</b> SIPLUS IPC 227E ET RAIL
<b>General information</b>	
<b>Product type designation</b>	IPC227E
<b>Installation type/mounting</b>	
<b>Mounting</b>	DIN rail, wall mounting, portrait mounting
<b>Design</b>	
<b>Supply voltage</b>	Box PC, built-in unit
<b>Type of supply voltage</b>	24 V DC
<b>Mains buffering</b>	
• Mains/voltage failure stored energy time	20 ms
<b>Processor</b>	
<b>Processor type</b>	Intel Atom E3845
<b>Chipset</b>	SoC
<b>Graphic</b>	
<b>Graphics controller</b>	Integrated
<b>Drives</b>	
<b>SSD</b>	Yes
<b>Memory</b>	
<b>Type of memory</b>	DDR3L SO-DIMM
<b>Data areas and their retentivity</b>	
<b>Retentive data area (incl. timers, counters, flags), max.</b>	512 kbyte; 128 KB can be stored in the buffer time; optional
<b>Hardware configuration</b>	
<b>Slots</b>	
• free slots	1x PCIe (x1) (optional)
<b>Interfaces</b>	
<b>Number of industrial Ethernet interfaces</b>	2; 2x Ethernet (RJ45)
<b>Number of PROFINET interfaces</b>	1
<b>USB port</b>	1x USB 3.0 / 3x USB 2.0
<b>Connection for keyboard/mouse</b>	USB / USB
<b>serial interface</b>	Without / 2x COM (RS 232 / 422 / 485), selectable in the BIOS
<b>Video interfaces</b>	
• Graphics interface	1x DisplayPort
<b>Industrial Ethernet</b>	
• Industrial Ethernet interface	2x Ethernet (RJ45)
- 100 Mbps	Yes
- 1000 Mbps	Yes
<b>Integrated Functions</b>	
<b>Monitoring functions</b>	
• Temperature monitoring	Yes
• Watchdog	Yes
• Status LEDs	1x power, 3x user
• Fan	No
• Monitoring function via network	Optional

Article number	<b>6AG2647-8BE72-1HA1</b> SIPLUS IPC 227E ET RAIL
<b>EMC</b>	
<b>Interference immunity against discharge of static electricity</b> • Interference immunity against discharge of static electricity	±6 kV contact discharge acc. to IEC 61000-4-2; ±8 kV air discharge acc. to IEC 61000-4-2
<b>Interference immunity against high-frequency electromagnetic fields</b> • Interference immunity against high frequency radiation	20 V/m for 80 ... 1 000 MHz, 80 % AM acc. to IEC 61000-4-3; 10 V/m for 1 ... 6 GHz, 80 % AM acc. to IEC 61000-4-3
<b>Interference immunity to cable-borne interference</b> • Interference immunity on supply cables  • Interference immunity on signal cables >30m • Interference immunity on signal cables < 30m	±2 kV acc. to IEC 61000-4-4, burst; ±1 kV acc. to IEC 61000-4-5, surge symmetric; ±2 kV acc. to IEC 61000-4-5, surge asymmetric ±2 kV acc. to IEC 61000-4-5, surge, length > 30 m ±1 kV acc. to IEC 61000-4-4; burst; length < 3 m; ±2 kV acc. to IEC 61000-4-4; burst; length > 3 m
<b>Interference immunity against voltage surge</b> • asymmetric interference • symmetric interference	±2 kV acc. to IEC 61000-4-5, surge asymmetric ±1 kV acc. to IEC 61000-4-5, surge symmetric
<b>Interference immunity to magnetic fields</b> • Interference immunity to magnetic fields at 50 Hz	100 A/m; to IEC 61000-4-8
<b>Emission of conducted and non-conducted interference</b> • Interference emission via line/AC current cables	EN 61000-6-3, EN 61000-6-4, CISPR 22 Class B, FCC Class A
<b>Degree and class of protection</b>	
<b>IP (rear)</b>	IP40
<b>Standards, approvals, certificates</b>	
<b>Railway application</b> • EN 50121-3-2 • EN 50121-4 • EN 50124-1  • EN 50125-1 • EN 50125-2 • EN 50125-3  • EN 50155 • EN 61373 • Fire protection acc. to EN 45545-2	Yes; EMC for rail vehicles Yes; EMC for signal and telecommunications systems Yes; Railway applications - overvoltage category OV2; pollution degree PD2; rated surge voltage UNi = 0.5 kV; UNm = 24 V DC Yes; Rail vehicles - see ambient conditions Yes; Stationary electrical equipment - see ambient conditions Yes; Signal and telecommunications systems - see ambient conditions; vibrations and shocks: Application point outside of tracks (1 m to 3 m away from track) Yes; Rail vehicles - temperature class OT1, ST1/ST2, horizontal mounting position Yes; Rail vehicles - vibrations and shocks: Category 1 Class A/B Yes; For proof of conformity, see Service & Support
<b>Ambient conditions</b>	
<b>Altitude during operation relating to sea level</b> • Installation altitude above sea level, max. • Ambient air temperature-barometric pressure-altitude	2 000 m Tmin ... Tmax at 1 140 hPa ... 795 hPa (-1 000 m ... +2 000 m)
<b>Relative humidity</b> • With condensation, tested in accordance with IEC 60068-2-38, max.	100 %; RH incl. condensation / frost (no commissioning in bedewed state), horizontal installation
<b>Vibrations</b> • Vibration resistance during operation acc. to IEC 60068-2-6	tested to DIN IEC 60068-2-6: 10 Hz to 58 Hz: 0.075 mm, 58 Hz to 200 Hz: 9.8 m/s <sup>2</sup> (1 g)
<b>Shock testing</b> • Shock load during operation	Tested according to IEC 60068-2-27: 150 m/s <sup>2</sup> , 11 ms
<b>Resistance</b> • Coolants and lubricants - Resistant to commercially available coolants and lubricants • Use in stationary industrial systems - to biologically active substances according to EN 60721-3-3  - to chemically active substances according to EN 60721-3-3 - to mechanically active substances according to EN 60721-3-3 • Use on land craft, rail vehicles and special-purpose vehicles - to biologically active substances according to EN 60721-3-5  - to chemically active substances according to EN 60721-3-5 - to mechanically active substances according to EN 60721-3-5 • Usage in industrial process technology - Against chemically active substances acc. to EN 60654-4 - Environmental conditions for process, measuring and control systems acc. to ANSI/ISA-71.04 • Remark - Note regarding classification of environmental conditions acc. to EN 60721, EN 60654-4 and ANSI/ISA-71.04	Yes; Incl. diesel and oil droplets in the air  Yes; Class 3B2 mold, fungus and dry rot spores (with the exception of fauna); Class 3B3 on request Available soon Yes; Class 3S4 incl. sand, dust, *  Yes; Class 5B2 mold, fungus and dry rot spores (with the exception of fauna); Class 5B3 on request Available soon Yes; Class 5S3 incl. sand, dust; *  Available soon Available soon  * The supplied plug covers must remain in place over the unused interfaces during operation!
<b>Conformal coating</b> • Coatings for printed circuit board assemblies acc. to EN 61086 • Protection against fouling acc. to EN 60664-3 • Electronic equipment on rolling stock acc. to EN 50155 • Military testing according to MIL-I-46058C, Amendment 7 • Qualification and Performance of Electrical Insulating Compound for Printed Board Assemblies according to IPC-CC-830A	Yes; Class 2 for high reliability Yes; Type 1 protection Yes; Class PC2 protective coating acc. to EN 50155:2017 Yes; Discoloration of coating possible during service life Yes; Conformal coating, Class A



**SIPLUS RAIL**

SIPLUS extreme RAIL Industrial PC

SIPLUS extreme RAIL Box PC

**SIPLUS IPC227E ET RAIL**

Article number	<b>6AG2647-8BE72-1HA1</b> SIPLUS IPC 227E ET RAIL
<b>Operating systems</b>	
<b>pre-installed operating system</b>	Windows 10 IoT Enterprise 2019 LTSC, 64 bit, MUI
<b>without operating system</b>	Yes; Optional
<b>Software</b>	
<b>SIMATIC Software</b>	Optionally with pre-installed SIMATIC WinCC RT Advanced / Software Controller CPU 1500S software bundle
<b>Dimensions</b>	
<b>Width</b>	191 mm
<b>Height</b>	100 mm
<b>Depth</b>	60 mm
<b>Other</b>	
<b>Note:</b>	for use in railway applications, also observe the product information "SIPLUS extreme RAIL" A5E37661960A, Online Support article 109736776

**Selection and ordering data**

Version	Article No.
<b>SIPLUS IPC227E ET RAIL (Box PC)</b> Approved in accordance with the EN 50155, EN 15121, EN 50124, EN 50125 and EN 45545 railway standards for use in rail traffic with conformal coating, -25...+60 °C, OT1 with ST1/2 (+70 °C for 10 min.), 1x display port; 2x 10/100/1000 Mbps Ethernet RJ45; 1x USB3.0, 3x USB2.0; CFast slot; 24 V DC industrial power supply Celeron E3845 ET (4C/4T) with TPM (not for China); 4 GB ET with NVRAM; box: Basis with COM 1/2; Windows 10 IoT Enterprise LTSB 2016, 64 bit, MUI (en, de, fr, it, es) 60 GB SSD ET, not replaceable	<b>6AG2647-8BE72-1HA1</b>

**Overview**

The design and functionality of the SIPLUS PS 305 and PS 307 1-phase load power supplies (system and load current supply) with automatic range switchover of the input voltage are an optimal match for the SIMATIC S7-300 in design and functionality. By means of the connecting comb that is supplied with the system and load current supply, the supply to the CPU is quickly established. It is also possible to provide a 24 V supply to other S7-300 system components, input/output circuits of the input/output modules and, if necessary, the sensors and actuators. Comprehensive certifications, such as UL, ATEX or GL facilitate universal use (does not apply to outdoor use).

**Note**

SIPLUS extreme products are based on Siemens standard products. The contents listed here were taken from the respective standard products. SIPLUS extreme-specific information was added.

**SIPLUS PS 305, PS 307**

Article No.	6AG1305-1BA80-2AA0	6AG1307-1EA01-7AA0	6AG1307-1KA02-7AA0
Article No. based on	6ES7305-1BA80-0AA0	6ES7307-1EA01-0AA0	6ES7307-1KA02-0AA0
Ambient temperature range	-25 ... +70 °C		
Conformal coating	Coating of the printed circuit boards and the electronic components		
Technical specifications	The technical specifications of the standard product apply, except for the ambient conditions.		
<b>Ambient conditions</b>			
Extended range of environmental conditions • with reference to ambient temperature, air pressure and altitude	Tmin ... Tmax at 1080 hPa ... 795 hPa (-1000 m ... +2000 m) // Tmin ... (Tmax - 10K) at 795 hPa ... 658 hPa (+2000 m ... +3500 m) // Tmin ... (Tmax - 20K) at 658 hPa ... 540 hPa (+3500 m ... +5000 m)		
Relative humidity • with condensation, max.	100 %; RH incl. bedewing/frost (no commissioning in bedewed state)		
Resistance • to biologically active substances/compliance with EN 60721-3-3 • to chemically active substances/compliance with EN 60721-3-3 • to mechanically active substances, compliance with EN 60721-3-3	Yes; Class 3B2 mold and fungal spores (except fauna); the supplied plug covers must remain in place on the unused interfaces during operation. Yes; Class 3C4 (RH < 75%) incl. salt spray in accordance with EN 60068-2-52 (severity 3); the supplied plug covers must remain in place on the unused interfaces during operation. Yes; Class 3S4 incl. sand, dust; the supplied plug covers must remain in place on unused interfaces during operation.		

**Design**

- The system and load current supplies are screwed directly onto the S7-300 DIN rail and can be mounted directly to the left of the CPU (no installation clearance required)
- Diagnostics LED for indicating "Output voltage 24 V DC OK"
- ON/OFF switches (operation/stand-by) for possible swapping of modules
- Strain-relief assembly for input voltage connection cable

**Function**

- Connection to all 1-phase 50/60 Hz networks (120 / 230 V AC) through automatic range switching (PS307) or manual switching (PS307, outdoor)
- Short-term power failure backup
- Output voltage 24 V DC, stabilized, short circuit-proof, open circuit-proof
- Parallel connection of two power supplies for enhanced performance

**Technical specifications**

Article number	6AG1305-1BA80-2AA0	6AG1307-1EA01-7AA0	6AG1307-1KA02-7AA0
	SIPLUS S7-300 PS 305 2 A (EN50155)	SIPLUS PS307 AC 120/230V / DC 24 V/5 A	SIPLUS_PS307_10A
<b>Supply voltage</b>			
<b>Rated value (DC)</b>			
• 24 V DC	Yes		
• 48 V DC	Yes		
• 72 V DC	Yes		
• 96 V DC	Yes		
• 120 V DC	Yes; Rated value 110 V DC		
<b>Rated value (AC)</b>			
• 120 V AC		Yes; 85 to 132 V AC	Yes; 85 to 132 V AC
• 230 V AC		Yes; 170 to 264 V AC	Yes; 170 to 264 V AC
<b>Overvoltage strength</b>		2.3x Ue rated, 1.3 ms	2.3x Ue rated, 1.3 ms

# SIPLUS RAIL

## Power supplies

### 1-phase, 24 V DC (for S7-300 and ET200M)

Article number	<b>6AG1305-1BA80-2AA0</b> SIPLUS S7-300 PS 305 2 A (EN50155)	<b>6AG1307-1EA01-7AA0</b> SIPLUS PS307 AC 120/230V / DC 24 V/5 A	<b>6AG1307-1KA02-7AA0</b> SIPLUS_PS307_10A
<b>Line frequency</b>			
<ul style="list-style-type: none"> <li>permissible range, lower limit</li> <li>permissible range, upper limit</li> </ul>		47 Hz 63 Hz	47 Hz 63 Hz
<b>Mains buffering</b>			
<ul style="list-style-type: none"> <li>Mains/voltage failure stored energy time</li> <li>Repeat rate, min.</li> </ul>	10 ms; Corresponds to S2 and C1 of EN 50155 1 s	20 ms; min., for Ia rated 1 s	20 ms; min., for Ia rated and Ue = 93 / 187 V 1 s
<b>Input current</b>			
<b>Rated value at 24 V DC</b>	2.7 A		
<b>Rated value at 48 V DC</b>	1.3 A		
<b>Rated value at 72 V DC</b>	0.9 A		
<b>Rated value at 96 V DC</b>	0.65 A		
<b>Rated value at 110 V DC</b>	0.6 A		
<b>Rated value at 120 V AC</b>		2.3 A	4.2 A
<b>Rated value at 230 V AC</b>		1.2 A	1.9 A
<b>Inrush current, max.</b>	20 A	20 A; max. at 25 °C, duration max. 3 ms	55 A; max. at 25 °C, duration max. 3 ms
<b>I<sup>2</sup>t</b>	5 A <sup>2</sup> ·s	1.2 A <sup>2</sup> ·s	3.3 A <sup>2</sup> ·s
<b>Leakage current, typ.</b>	0.7 mA	0.5 mA	0.6 mA
<b>Leakage current, max.</b>	3.5 mA	3.5 mA	3.5 mA
<b>Overcurrent overload capability</b>	270 ms on short circuit during startup and operation		80 ms on short circuit during startup and operation
<b>output voltage / header</b>			
<b>Rated value (DC)</b>	24 V	24 V	24 V; stable at no-load max. 2.5 s
<b>Power up time, max.</b>	3 s	2 s	2 s
<b>Voltage rise time, typ.</b>		10 ms	10 ms
<b>Overvoltage protection</b>		Additional control circuit, cutoff at < 28.8 V, automatic restart	Additional control circuit, cutoff at < 28.8 V, automatic restart
<b>Short-circuit protection</b>		electronic trip, automatic restart	electronic trip, automatic restart
<b>Residual ripple, typ.</b>	30 mV; Peak - peak	10 mV; Peak - peak	15 mV; Peak - peak
<b>Residual ripple, max.</b>	150 mV; Peak - peak	50 mV; Peak - peak	50 mV; Peak - peak
<b>Output current</b>			
<b>Current output (rated value)</b>	2 A; 2 for connection in parallel	5 A; 3 A @ > 60 °C, can be switched in parallel	10 A; 7 A @ > 60 °C, can be switched in parallel
<b>Short-circuit protection</b>	Yes; Electronic		Yes; Electronic
<b>Continuous short-circuit current, max.</b>			12 A
<b>Power</b>			
<b>Active power input, typ.</b>	64 W	138 W	267 W
<b>Efficiency</b>	75 %	87 %; approx., at Ua rated, Ia rated	90 %; approx., at Ua rated, Ia rated
<b>Interrupts/diagnostics/status information</b>			
<b>Diagnostics indication LED</b>			
<ul style="list-style-type: none"> <li>Status indicator output 24 V OK (green)</li> </ul>	Yes	Yes	Yes
<b>Potential separation</b>			
<b>primary/secondary</b>	Yes; SELV output voltage Ua according to EN 60950-1 and EN 50178	Yes; SELV output voltage Ua according to EN 60950-1 and EN 50178	Yes; SELV output voltage Ua according to EN 60950-1 and EN 50178
<b>EMC</b>			
<b>EMC interference immunity</b>	EN 61000-6-2	EN 61000-6-2	EN 61000-6-2
<b>EMC interference emission</b>	EN 55011 Class A	EN 55022 Class B	EN 55022 Class B
<b>Degree and class of protection</b>			
<b>Equipment protection class</b>	I	I	I, with protective conductor
<b>Standards, approvals, certificates</b>			
<b>CE mark</b>	Yes	Yes	Yes
<b>Standard for line harmonics limit</b>		EN 61000-3-2	EN 61000-3-2
<b>Railway application</b>			
<ul style="list-style-type: none"> <li>EN 50155</li> </ul>	Yes; Sections 4, 5 and 12; no further agreements apply; T1, Category 1, Class A/B, EN 50155:2007		

**1-phase, 24 V DC (for S7-300 and ET200M)**

Article number	<b>6AG1305-1BA80-2AA0</b> SIPLUS S7-300 PS 305 2 A (EN50155)	<b>6AG1307-1EA01-7AA0</b> SIPLUS PS307 AC 120/230V / DC 24 V/5 A	<b>6AG1307-1KA02-7AA0</b> SIPLUS_PS307_10A
<b>Ambient conditions</b>			
<b>Ambient temperature during operation</b>			
• min.	-25 °C; = Tmin	-25 °C; = Tmin	-25 °C; = Tmin
• max.	70 °C; = Tmax; for use on railway vehicles according to EN 50155, the rated temperature range -25 ... +55 °C (T1) or 60 °C @ UL/UL hazardous use applies	70 °C; = Tmax; 60 °C @ UL/cUL, ATEX and FM use	70 °C; = Tmax; 60 °C @ UL/cUL, ATEX and FM use
<b>Altitude during operation relating to sea level</b>			
• Installation altitude above sea level, max.	2 000 m	2 000 m	2 000 m
• Ambient air temperature-barometric pressure-altitude	Tmin ... Tmax at 1 140 hPa ... 795 hPa (-1 000 m ... +2 000 m) // Tmin ... (Tmax - 10 K) at 795 hPa ... 658 hPa (+2 000 m ... +3 500 m) // Tmin ... (Tmax - 20 K) at 658 hPa ... 540 hPa (+3 500 m ... +5 000 m); above 2 000 m max. 75 V DC	Tmin ... Tmax at 1 140 hPa ... 795 hPa (-1 000 m ... +2 000 m) // Tmin ... (Tmax - 10 K) at 795 hPa ... 658 hPa (+2 000 m ... +3 500 m) // Tmin ... (Tmax - 20 K) at 658 hPa ... 540 hPa (+3 500 m ... +5 000 m); above 2 000 m max. 75 V DC	Tmin ... Tmax at 1 140 hPa ... 795 hPa (-1 000 m ... +2 000 m) // Tmin ... (Tmax - 10 K) at 795 hPa ... 658 hPa (+2 000 m ... +3 500 m) // Tmin ... (Tmax - 20 K) at 658 hPa ... 540 hPa (+3 500 m ... +5 000 m); above 2 000 m max. 75 V DC
<b>Relative humidity</b>			
• With condensation, tested in accordance with IEC 60068-2-38, max.	100 %; RH incl. condensation/frost (no commissioning under condensation conditions)	100 %; RH incl. condensation/frost (no commissioning under condensation conditions)	100 %; RH incl. condensation/frost (no commissioning under condensation conditions)
<b>Resistance</b>			
• Use in stationary industrial systems			
- to biologically active substances according to EN 60721-3-3	Yes; Class 3B2 mold, fungus and dry rot spores (with the exception of fauna); Class 3B3 on request	Yes; Class 3B2 mold, fungus and dry rot spores (with the exception of fauna); Class 3B3 on request	Yes; Class 3B2 mold, fungus and dry rot spores (with the exception of fauna); Class 3B3 on request
- to chemically active substances according to EN 60721-3-3	Yes; Class 3C4 (RH < 75 %) incl. salt spray acc. to EN 60068-2-52 (severity degree 3); *	Yes; Class 3C4 (RH < 75 %) incl. salt spray acc. to EN 60068-2-52 (severity degree 3); *	Yes; Class 3C4 (RH < 75 %) incl. salt spray acc. to EN 60068-2-52 (severity degree 3); *
- to mechanically active substances according to EN 60721-3-3	Yes; Class 3S4 incl. sand, dust, *	Yes; Class 3S4 incl. sand, dust, *	Yes; Class 3S4 incl. sand, dust, *
• Use on land craft, rail vehicles and special-purpose vehicles			
- to biologically active substances according to EN 60721-3-5	Yes; Class 5B2 mold, fungus and dry rot spores (with the exception of fauna); Class 5B3 on request	Yes; Class 5B2 mold, fungus and dry rot spores (with the exception of fauna); Class 5B3 on request	Yes; Class 5B2 mold, fungus and dry rot spores (with the exception of fauna); Class 5B3 on request
- to chemically active substances according to EN 60721-3-5	Yes; Class 5C3 (RH < 75 %) incl. salt spray acc. to EN 50155 (ST2); *	Yes; Class 5C3 (RH < 75 %) incl. salt spray acc. to EN 50155 (ST2); *	Yes; Class 5C3 (RH < 75 %) incl. salt spray acc. to EN 50155 (ST2); *
- to mechanically active substances according to EN 60721-3-5	Yes; Class 5S3 incl. sand, dust; *	Yes; Class 5S3 incl. sand, dust; *	Yes; Class 5S3 incl. sand, dust; *
• Use on ships/at sea			
- to biologically active substances according to EN 60721-3-6	Yes; Class 6B2 mold and fungal spores (excluding fauna); Class 6B3 on request	Yes; Class 6B2 mold and fungal spores (excluding fauna); Class 6B3 on request	Yes; Class 6B2 mold and fungal spores (excluding fauna); Class 6B3 on request
- to chemically active substances according to EN 60721-3-6	Yes; Class 6C3 (RH < 75 %) incl. salt spray acc. to EN 60068-2-52 (severity degree 3); *	Yes; Class 6C3 (RH < 75 %) incl. salt spray acc. to EN 60068-2-52 (severity degree 3); *	Yes; Class 6C3 (RH < 75 %) incl. salt spray acc. to EN 60068-2-52 (severity degree 3); *
- to mechanically active substances according to EN 60721-3-6	Yes; Class 6S3 incl. sand, dust; *	Yes; Class 6S3 incl. sand, dust; *	Yes; Class 6S3 incl. sand, dust; *
• Usage in industrial process technology			
- Against chemically active substances acc. to EN 60654-4	Yes; Class 3 (excluding trichlorethylene)	Yes; Class 3 (excluding trichlorethylene)	Yes; Class 3 (excluding trichlorethylene)
- Environmental conditions for process, measuring and control systems acc. to ANSI/ISA-71.04	Yes; Level GX group A/B (excluding trichlorethylene; harmful gas concentrations up to the limits of EN 60721-3-3 class 3C4 permissible); level LC3 (salt spray) and level LB3 (oil)	Yes; Level GX group A/B (excluding trichlorethylene; harmful gas concentrations up to the limits of EN 60721-3-3 class 3C4 permissible); level LC3 (salt spray) and level LB3 (oil)	Yes; Level GX group A/B (excluding trichlorethylene; harmful gas concentrations up to the limits of EN 60721-3-3 class 3C4 permissible); level LC3 (salt spray) and level LB3 (oil)
• Remark			
- Note regarding classification of environmental conditions acc. to EN 60721, EN 60654-4 and ANSI/ISA-71.04	* The supplied plug covers must remain in place over the unused interfaces during operation!	* The supplied plug covers must remain in place over the unused interfaces during operation!	* The supplied plug covers must remain in place over the unused interfaces during operation!
<b>Dimensions</b>			
<b>Width</b>	80 mm	60 mm	80 mm
<b>Height</b>	125 mm	125 mm	125 mm
<b>Depth</b>	120 mm	120 mm	120 mm
<b>Weights</b>			
<b>Weight, approx.</b>	740 g	0.6 kg	0.8 kg

## SIPLUS RAIL

### Power supplies

1-phase, 24 V DC (for S7-300 and ET200M)

#### Selection and ordering data

Version	Article No.
<b>SIPLUS power supplies</b>	
<b>For industrial applications with extended ambient conditions</b>	
<b>SIPLUS S7-300 PS 305</b> (Extended temperature range and medial exposure) Input: 24 ... 110 V DC, Output: 24 V DC/2 A	<b>6AG1305-1BA80-2AA0</b>
<b>SIPLUS S7-300 PS 307 5 A</b> (Extended temperature range and medial exposure) Incl. connection bracket 120/230 V AC; 24 V DC Output current 5 A (dimensions 60 x 125 x 120)	<b>6AG1307-1EA01-7AA0</b>
<b>SIPLUS S7-300 PS 307 10 A</b> (Extended temperature range and medial exposure) Incl. connection bracket 120/230 V AC; 24 V DC Output current 10 A (dimensions 80 x 125 x 120)	<b>6AG1307-1KA02-7AA0</b>
<b>For rolling stock railway applications</b>	
<b>SIPLUS S7-300 PS 305</b> (Extended temperature range and medial exposure) Input: 24 ... 110 V DC, Output: 24 V DC/2 A	<b>6AG1305-1BA80-2AA0</b>
<b>Accessories</b>	
<b>SIMATIC S7-300 mounting adapter</b> For snapping the PS 307 onto a 35 mm DIN rail (EN 60715)	<b>6EP1971-1BA00</b>
<b>Spare part</b> SIMATIC S7-300 mounting adapter; for snapping the PS 307 onto 35 mm standard rails	<b>6ES7390-6BA00-0AA0</b>

# SIDOOR



## **SIDOOR automatic door controls for railway applications**

- 7/2 Controller
- 7/2 Platform screen door / gate drive
- 7/5 Control unit for gap filler
- 7/7 Interior railway door drives
- 7/10 Additional units
- 7/10 SIDOOR Software Kit, SIDOOR Service Tool
- 7/11 Geared motors
- 7/13 Direct drives
- 7/14 Accessories

## SIDOOR

SIDOOR automatic door controls  
for railway applications

Controller > Platform screen door / gate drive

### Overview

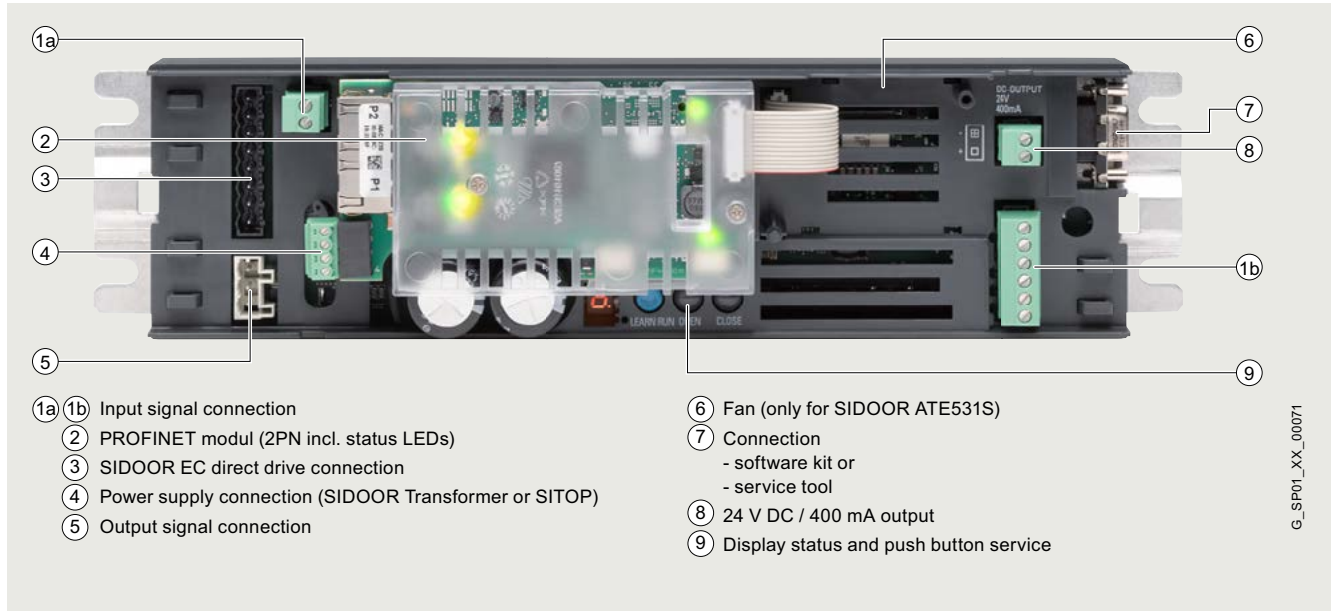

①a ①b Input signal connection

② PROFINET modul (2PN incl. status LEDs)

③ SIDOOR EC direct drive connection

④ Power supply connection (SIDOOR Transformer or SITOP)

⑤ Output signal connection

⑥ Fan (only for SIDOOR ATE531S)

⑦ Connection  
- software kit or  
- service tool

⑧ 24 V DC / 400 mA output

⑨ Display status and push button service

G\_SP01\_XX\_00071

SIDOOR ATE530S coated/531S wiring diagram

The SIDOOR ATE53xS door controller is an “intelligent” door drive which can be used for safety-oriented operation of platform screen doors and gates (PSDs & PSGs), according to individual requirements.

Siemens has once again shown just how easy integration can be with the innovative SIDOOR ATE53xS platform screen door drive in conjunction with SIDOOR MED280 or MEG251 motors. The PROFINET module integrated in the SIDOOR ATE53xS enables standardized, certified connection to PROFINET IO systems.

- Use of standard automation components
- Full integration into TIA Portal and STEP 7 thanks to PROFINET connection
- Parameter assignment and monitoring of door control parameters via the PROFINET interface (function blocks available as example applications in SIOS).

- Application example:  
Synchronization of two-panel and independent platform screen doors with SIDOOR ATE530S PROFINET EC door drive and S7-1500 CPU via TIA Portal  
<https://support.industry.siemens.com/cs/de/en/view/109480495>
- Application example:  
Safety-oriented automation of platform screen doors with SIDOOR ATE530S PROFINET EC door drive and S7-1500 CPU via TIA Portal  
<https://support.industry.siemens.com/cs/de/en/view/109477186>
- Read-in of two safe signals (two-channel, antivalent)
- High level of system safety thanks to safe torque off (e.g. self-release in the event of a fault)
- Firmware update for all SIDOOR controllers on an entire platform possible centrally via TCP/IP
- SIL 2 according to IEC 62061

### Technical specifications

Article number	<b>6FB1231-3BM12-7AT0</b> SIDOOR ATE530S COATED	<b>6FB1231-3BM11-7AT0</b> SIDOOR ATE531S
<b>General information</b>		
<b>Product brand name</b>	SIDOOR	
<b>Product version</b>	With PROFINET interface and protective coating	With PROFINET interface, protective coating, and temperature extension
<b>Optional product expansion</b>	Standard mounting rail holder 6FB1144-0AT00-3AS0	
<b>Manufacturer's article no. of the usable motor</b>	6FB1203-0AT12-7DA0, 6FB1203-5AT00-7MPO, 6FB1203-5AT01-7MPO	
<b>Manufacturer's article no. of the usable power supply unit</b>	6FB1112-0AT20-2TR0	
<b>Installation type/mounting</b>		
<b>Installation and mounting instructions</b>	No direct exposure to the sun	
<b>Supply voltage</b>		
<b>Rated value (DC)</b>	36 V; With MED280: At 24 V DC max. door speed of 500 mm/s, at 28.8 V DC max. door speed of 800 mm/s. With MEG251: At 24 V DC max. door speed of 500 mm/s, at 28.8 V DC max. door speed of 750 mm/s	
<b>Power</b>		
<b>Active power input (standby mode)</b>	7 W	
<b>Digital inputs</b>		
<b>Control inputs isolated</b>	Yes	
<b>Control inputs p-switching</b>	Yes	
<b>Protection in case of DC supply</b>	Use of a circuit breaker in the supply path according to 60898-1, 8A, C-characteristic type SIEMENS: 5SY4108-7 or 5SY4108-7KK11	



# SIDOOR

SIDOOR automatic door controls  
for railway applications

## Controller > Platform screen door / gate drive

Article number	6FB1231-3BM12-7AT0 SIDOOR ATE530S COATED	6FB1231-3BM11-7AT0 SIDOOR ATE531S
<b>Input voltage</b> • per DC input, min. • per DC input, max.	10 V; Observe polarity ! 28 V; Observe polarity !	
<b>Input current</b> • per DC input, min. • per DC input, max.	3 mA 15 mA	
<b>Digital outputs</b>		
<b>short-circuit proof</b>	Yes	
<b>Overload-proof</b>	Yes	
<b>Remark</b>	Ensure correct polarity! CAUTION: Do not supply with external voltage!	
<b>Output voltage</b> • Output voltage (DC)	24 V	
<b>Output current</b> • For output (24 V DC), max.	400 mA	
<b>Relay outputs</b>		
<b>Switching capacity of contacts</b> • at 30 V DC, min. • at 30 V DC, max.	0.01 A 0.5 A	
<b>Mechanical data</b>		
<b>Opening width of door, min.</b>	0.35 m	
<b>Opening width of door, max.</b>	5 m	
<b>Weight of door, max.</b>	280 kg	
<b>Operating cycle frequency of door, max.</b>	180 1/h	
<b>Kinetic energy, max.</b>	75 J	
<b>Interfaces</b>		
<b>Interfaces/bus type</b>	PROFINET according to Conformance Class A, B, C; integrated switch for linear and ring structure	
<b>Isolation</b>		
<b>Overvoltage category</b>	2	
<b>Degree and class of protection</b>		
<b>IP degree of protection</b>	IP20	
<b>Standards, approvals, certificates</b>		
<b>CE mark</b>	Yes	No
<b>UL approval</b>	No	
<b>TÜV Inspectorate approval</b>	Yes	
<b>Standard for EMC</b>	EN 61000-6-2 / EN 61000-6-4 / EN 61326-3-1 / EN 50121-3-2 / EN50121-4 / EN50121-5	
<b>Standard for safety</b>	EN 60950-1 / EN 60335-1 / EN 14752 / EN ISO 13849-1 Cat. 2 PL d / IEC 62061: SIL 2	
<b>Ambient conditions</b>		
<b>Ambient temperature during operation</b> • min. • max. • Remark	-25 °C 50 °C Screw control device thermally conductive onto a metallic mounting surface or standard rail mounting, otherwise the maximum operating temperature is only 40 °C	
		70 °C To ensure compliance with MTBF value, ensure that the ambient temperature is less than 50 °C for 90 % of operating time and screw the control unit onto a metallic mounting surface in a manner that ensures thermal conductivity or use standard rail mounting. At operating temperatures above 50 °C, the maximum output current of the 24 V DC output is a maximum of 0.1 A and the maximum number of cycles is 60/h.
<b>Ambient temperature during storage/transportation</b> • Storage, min. • Storage, max.	-40 °C 85 °C	
<b>Air pressure acc. to IEC 60068-2-13</b> • Installation altitude above sea level, max.	2 000 m	
<b>Relative humidity</b> • No condensation, min. • No condensation, max.	10 % 93 %	
<b>Mechanics/material</b>		
<b>Service life</b> • Mean time between failures (MTBF)	13 y	
<b>Dimensions</b>		
<b>Width</b>	320 mm	
<b>Height</b>	60 mm	
<b>Depth</b>	80 mm	

**SIDOOR**

SIDOOR automatic door controls  
for railway applications

Controller > Platform screen door / gate drive

**Selection and ordering data**

Version	Article No.
<b>SIDOOR ATE530S COATED</b> SIDOOR ATE530S COATED, version with protective coating	<b>6FB1231-3BM12-7AT0</b>
<b>SIDOOR ATE531S</b> SIDOOR ATE531S, version with protectivecoating and extended temperature range	<b>6FB1231-3BM11-7AT0</b>

## Overview



The SIDOOR ATE530G drive control is designed for controlling gap fillers between external train doors and the platform edge. The gap filler facilitates easy access for passengers. The innovative SIDOOR ATE530G drive solution enables operation of a gap filler with adjustable speed, acceleration and motor currents. Depending on the application, a project-specific motor is used. In this case the firmware of the controller might be adapted to the specific project.

The SIDOOR ATE530G is activated by digital signals from a higher-level door control, and reports information about its current state via digital signals back to the door control.

The following drive functions are supported:

- System start-up after power failure
- "Extend", "Retract" command
- Gap filler is moved by a travel curve profile
- Obstruction detection
- Ice-breaker function  
Icing can be shifted broken by repeated extension and retraction of the gap filler with increased force.
- Reversing at the platform edge

The SIDOOR ATE530G control unit fulfills Basic Integrity in accordance with EN 50657:2017

## Technical specifications

Article No.	<b>6FB1221-5SM10-7BP0</b> SIDOOR ATE530G COATED
<b>General information</b>	
Product brand name	SIDOOR
Product category	Controller
Type of product	ATE530G with protective coating
Area of application	For gap filling in railway vehicles
Installation type/mounting	
• Installation and mounting note	Do not expose to direct sunlight
<b>Supply voltage</b>	
Rated value (DC)	36 V
Permissible range, lower limit (DC)	19.2 V
Permissible range, upper limit (DC)	37.1 V
DC supply protection	Use of a miniature circuit breaker in the supply branch
<b>Digital inputs</b>	
Control inputs isolated	Yes
Control inputs p-switching	Yes
DC supply protection	Use of a miniature circuit breaker in the supply branch 230/400 V 10 kA, 1-pin, C, 8A for railway applications, 5SY5108-7KK11
<b>Input voltage</b>	
Per DC input, min.	10 V; ensure correct polarity!
Per DC input, max.	28 V; ensure correct polarity!
<b>Digital outputs</b>	
Short-circuit proof	Yes
Overload-proof	Yes
Note	Ensure correct polarity! CAUTION: Do not supply with external voltage!
Output voltage	
• Output voltage (DC)	24 V
Output current	
• For output (24 V DC), max.	400 mA
<b>Relay outputs</b>	
Switching capacity of contacts	
• At 30 V DC, min.	0.01 A
• At 30 V DC, max.	0.5 A
<b>Isolation</b>	
Overvoltage category	2
<b>Degree of protection and protection class</b>	
IP degree of protection	IP20
<b>Standards, approvals, certificates</b>	
CE mark	Yes
UL approval	No
China RoHS compliance	Yes
Standard for EMC	EN 61000-6-2 / EN 61000-6-4 / EN 61326-3-1 / EN 50121- 3-2

**SIDOOR**

SIDOOR automatic door controls  
for railway applications

**Controller > Control unit for gap filler**

Article No.	<b>6FB1221-5SM10-7BP0</b> SIDOOR ATE530G COATED
<b>Ambient conditions</b>	
<b>Ambient temperature during operation</b>	
• Min.	-25 °C
• Max.	50 °C
• Note	Screw the control unit thermally conductive to a metal mounting surface or use standard rail mounting, otherwise maximum operating temperature is only 40 °C
<b>Ambient temperature during storage/transport</b>	
• Storage, min.	-40 °C
• Storage, max.	85 °C
<b>Air pressure acc. to IEC 60068-2-13</b>	
• Installation altitude above sea level, max.	2 000 m
<b>Relative humidity</b>	
• No condensation, min.	10%
• No condensation, max.	93%
<b>Mechanics/material</b>	
<b>Dimensions</b>	
• Width	320 mm
• Height	60 mm
• Depth	80 mm

**Selection and ordering data**

Version	Article No.
<b>SIDOOR ATE530G COATED</b> SIDOOR ATE530G coated,controlling gap fillers between external train doors and the platform edge	<b>6FB1221-5SM10-7BP0</b>

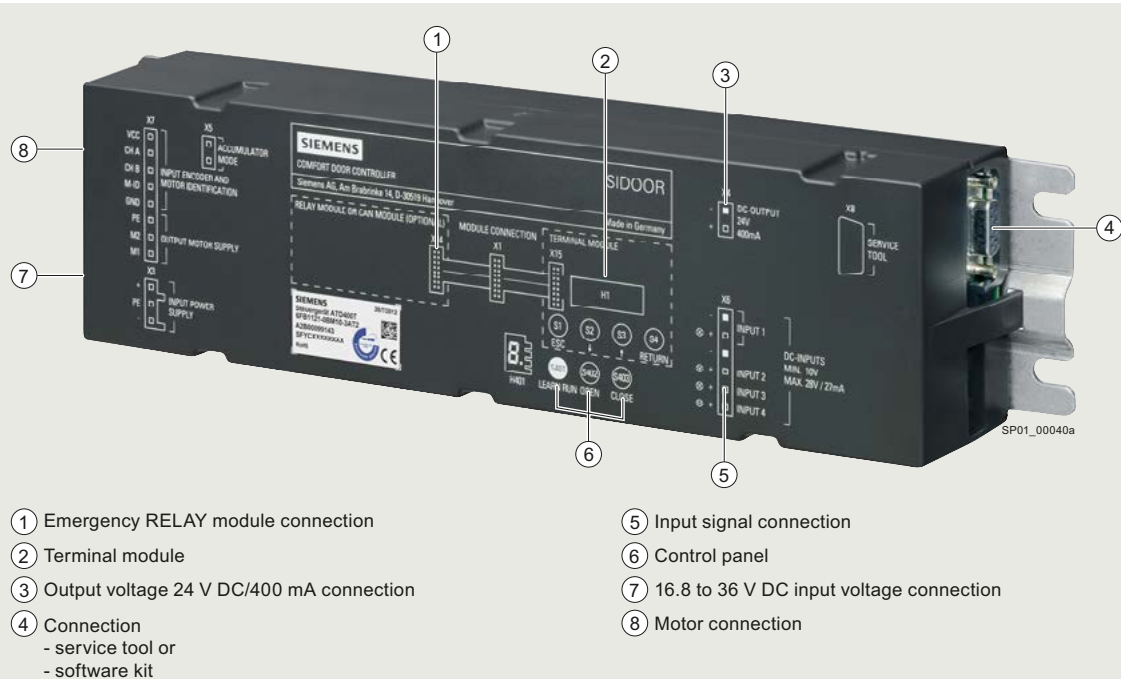
**Overview**

SIDOOR ATD400T interior railway door drive

The SIDOOR ATD400T interior railway door drive is an "intelligent" door drive which enables gangway doors to be opened and closed at adjustable speeds and accelerations.

- Relay module design
- For dynamic door weights up to 180 kg
- Automatic door weight detection
- Operating temperature -20 to +70 °C<sup>1)</sup>
- Flexible motor management (two different motor types), automatic detection
- Opening width 0.25 to 4 m
- Door can be operated with and without closing springs (60 to 80 N)
- With two identical door leaves, can be used up to a train inclination of 0 to 10%
- Forces and energies are limited in accordance with EN 14752
- EMC according to EN 50121-3-2
- Fulfills HL3 according to fire protection standard EN 45545-2 (Railway applications – Fire protection on rail vehicles)
- Vandal-proof

**Note:**

- Maximum output current at 24 V DC:
  - 0.4 A at ≤ 55 °C ambient temperature during operation
  - 0.1 A from 55 °C to 70 °C ambient temperature during operation, with restrictions at operating temperatures > 55 °C
- Maximum ambient temperature during operation:
  - 55 °C
  - 70 °C with restrictions at operating temperatures > 55 °C
- Restrictions at operating temperatures > 55 °C:
  - Use the 24 V output voltage only for operating the control inputs (max. 0.1 A)
  - Use a sufficiently large (at least 350 x 350 mm), unpainted, metal mounting plate
  - The maximum drive parameters are restricted to the default values
  - If temperature class T3 according to EN 50155 is used, the maximum air temperature of 85 °C must not be exceeded near the printed-circuit board

**SIDOOR**

SIDOOR automatic door controls  
for railway applications

Controller > Interior railway door drives

**Technical specifications**

Article number	<b>6FB1121-0BM13-3AT2</b> SIDOOR ATD400T RELAY
<b>General information</b>	
Product brand name	SIDOOR
Product version	With relay outputs
Manufacturer's article no. of the usable motor	6FB1103-0AT10-4MB0, 6FB1103-0AT11-4MB0, 6FB1103-0AT15-4MB0, 6FB1103-0AT16-4MB0
<b>Installation type/mounting</b>	
Installation and mounting instructions	At operating temperatures > 55 °C a sufficiently large (at least 350 mm x 350 mm), unpainted, metal mounting plate must be used
<b>Supply voltage</b>	
Rated value (DC)	24 V
<b>Input current</b>	
Current consumption, max.	15 A
<b>Digital inputs</b>	
Control inputs isolated	Yes
Control inputs p-switching	Yes
Input voltage	10 V; Observe polarity ! 28 V; Observe polarity !
Input current	9 mA 27 mA
<b>Digital outputs</b>	
short-circuit proof	Yes
Overload-proof	Yes
Remark	Ensure correct polarity! CAUTION: Do not supply with external voltage!
Output voltage	24 V
Output current	400 mA 100 mA
<b>Relay outputs</b>	
Switching capacity of contacts	0.01 A; 50 V DC switching voltage not released for NFPA-relevant countries 1 A; 50 V DC switching voltage not released for NFPA-relevant countries
	0.01 A 1 A
<b>Mechanical data</b>	
Opening width of door, min.	0.25 m
Opening width of door, max.	4 m
Weight of door, max.	180 kg
Operating cycle frequency of door, max.	180 1/h
Counterforce, max.	80 N
Counterweight	6 kg
	• with SIDOOR M3 geared motor, max.
<b>Interfaces</b>	
Interfaces/bus type	without
<b>Isolation</b>	
Overvoltage category	2
<b>Degree and class of protection</b>	
IP degree of protection	IP20
<b>Standards, approvals, certificates</b>	
CE mark	Yes
UL approval	No
Standard for EMC	EN 50121-3-2

Article number	<b>6FB1121-0BM13-3AT2</b> SIDOOR ATD400T RELAY
<b>Ambient conditions</b>	
<b>Ambient temperature class according to EN 50155</b>	T3
<b>Ambient temperature during operation</b> • min. • max. • Remark	-25 °C 70 °C; At operating temperatures > 55 °C the operating parameters are limited to default values At operating temperatures > 55 °C, the maximum air temperature of 85 °C must not be exceeded near the printed-circuit board if Temperature class T3 according to EN 50155 is used
<b>Ambient temperature during storage/transportation</b> • Storage, min. • Storage, max.	-40 °C 50 °C
<b>Air pressure acc. to IEC 60068-2-13</b> • Installation altitude above sea level, max.	2 000 m
<b>Relative humidity</b> • No condensation, min. • No condensation, max.	10 % 93 %
<b>Fire resistance</b> • Behavior in fire	complies with EN 45545-2 Hazard Level HL3
<b>Dimensions</b>	
<b>Width</b>	320 mm
<b>Height</b>	60 mm
<b>Depth</b>	80 mm

**Selection and ordering data**

Version	Article No.
<b>SIDOOR ATD400T</b> SIDOOR ATD400T Controller for interior.railway doors, relay module design	<b>6FB1121-0BM13-3AT2</b>



## SIDOOR

SIDOOR automatic door controls  
for railway applications

Additional units > SIDOOR Software kit, SIDOOR Service tool

### Overview

#### SIDOOR Software Kit



SIDOOR Software Kit

The scope of delivery of the SIDOOR Software Kit includes an installation CD

which includes the following functionalities:

SIDOOR User Software	The component that enables the door control system to be configured, parameters to be assigned, and analyzed.
Siemens HCS12 Firmware Loader	This component is used to update the operating software of the door controller.
SIDOOR USB to UART Bridge Driver	This driver is essential for operation of the USB adapter.

#### Note:

Some firmware updates are offered as free downloads in the Siemens Industry Online Support (SIOS Service & Support Portal). For information on the availability and acquisition of more firmware, please contact Technical Support.

### Selection and ordering data

Version	Article No.
SIDOOR Software Kit	6FB1105-0AT01-6SW0

### Overview

#### SIDOOR Service Tool



The Service Tool can be used to input run commands, change run parameters and read out learned parameters, door states, input/output signals and service data.

The Service Tool is connected to the various controllers by the respective cable.

- SIDOOR ATD400T, SIDOOR ATE530S coated and SIDOOR ATE531S platform screen door drives

There is no need to dismount the cover for connecting the Service Tool to the controller.

#### Note:

If the Service Tool is in the "Quick adjustment" or "Total adjustment" menu, the run commands of the controller are blocked via the command inputs.

### Selection and ordering data

Version	Article No.
SIDOOR Service Tool Hand-held terminal for parameter assignment of controllers	6FB1105-0AT01-6ST0

## Overview

SIDOOR motors are speed controlled, taking set force and speed limits into account. The gear outlet direction is defined as left or right when viewing the gear unit from the front. Force transmission is via a toothed belt. The toothed belt passes over a deflector pulley and can be fitted with two door clutch holders. This enables it to drive both single-side and centrally opening doors.

SIDOOR geared motors are available in two technological versions.

- 1. DC technology in version  
(area of application: interior railway doors)
  - DC geared motor  
SIDOOR geared motors are a combination of gear unit, motor, and encoder. They are easy to connect to the controller via the interface provided and are automatically detected during commissioning. The variable speed drive unit comprises a speed-controlled DC motor with non-self-locking gearing.
- 2. EC technology in version  
(area of application: platform screen doors)
  - EC direct drive  
SIDOOR direct drives are a combination of motor and sensor. They are easy to connect to the controller via the interface provided and are automatically detected during commissioning. The maintenance-free drive unit consists of a gearless, speed-controlled, electronically commutated motor. The EC direct drive can be fitted in various mounting orientations, facilitating reduced inventory management and minimizing assets.
  - EC geared motors  
EC geared motors are electronically commutated DC motors with non-self-locking gearing and are speed-controlled. They are easy to connect to the controller via the interface provided and are automatically detected during commissioning. Due to the brushless drive technology, EC geared motors are subject to less abrasion compared with DC geared motors and thus have a longer service life. On account of the brushless drive technology, no commutation noises come from this motor, so it generates less noise than the DC geared motors.

### Motors for interior railway door drives (for controllers ATD400T)

The following DC geared motors **are available for interior railway door drives**. They should be selected according to the dynamic door weight.

- SIDOOR MDG180 geared motors, compliance with fire protection standard EN 45545-2 (max. door weight 180 kg)
  - SIDOOR MDG180 L EN 45545-2 (pinion left) 6FB1103-0AT16-4MB0
  - SIDOOR MDG180 R EN 45545-2 (pinion right) 6FB1103-0AT15-4MB0
- SIDOOR M3 geared motors (max. door weight 180 kg)
  - SIDOOR M3 L (pinion left) 6FB1103-0AT10-4MB0
  - SIDOOR M3 R (pinion right) 6FB1103-0AT11-4MB0

### Motors for platform screen door drives (for controllers ATE530S, ATE531S)

#### EC technology:

- SIDOOR MEG251 geared motors (max. door weight 250 kg)
  - SIDOOR MEG251 L (pinion left), 6FB1203-5AT00-7MP0
  - SIDOOR MEG251 R (pinion right), 6FB1203-5AT01-7MP0



Photo: DC geared motor SIDOOR M3 L, 6FB1103-0AT10-4MB0 or SIDOOR MDG180 L, 6FB1103-0AT16-4MB0. (version with pinion left)



Photo: EC geared motor SIDOOR MEG251 L, 6FB1203-5AT00-7MP0. (version with pinion left)

**SIDOOR**

SIDOOR automatic door controls  
for railway applications

**Geared motors****Technical specifications**

Article number	6FB1103-0AT16-4MB0	6FB1103-0AT15-4MB0	6FB1103-0AT10-4MB0	6FB1103-0AT11-4MB0	6FB1203-5AT00-7MP0	6FB1203-5AT01-7MP0
	SIDOOR MDG180 L DIN EN 45545-2	SIDOOR MDG180 R DIN EN 45545-2	SIDOOR M3 L	SIDOOR M3 R	SIDOOR MEG251 L	SIDOOR MEG251 R
<b>General information</b>						
<b>Product brand name</b>	SIDOOR					
<b>Product version</b>	With driven gear on the left	With driven gear on the right	With driven gear on the left	With driven gear on the right	With driven gear on the left	With driven gear on the right
<b>Input current</b>						
<b>Operational current (rated value)</b>	4 A				6.8 A	
<b>Mechanical data</b>						
<b>Torque of the rotary operating mechanism (rated value)</b>	3 Nm				4.1 N·m	
<b>Speed, max.</b>	0.65 m/s					
<b>Gear ratio</b>	15					
<b>Number of pulses per revolution, max.</b>	100					
<b>Weight of door, max.</b>	180 kg				250 kg	
<b>Degree and class of protection</b>						
<b>IP degree of protection</b>					IP40	
• of the motor	IP54					
• of the gear unit	IP40					
<b>Ambient conditions</b>						
<b>Ambient temperature during operation</b>						
• min.	-20 °C					
• max.	50 °C				70 °C	
<b>Ambient temperature during storage/transportation</b>						
• Storage, min.	-40 °C					
• Storage, max.	85 °C					
<b>Fire resistance</b>						
• Behavior in fire	complies with EN 45545-2 Hazard Level HL3					
<b>Dimensions</b>						
<b>Height of motor</b>	98 mm				100 mm	
<b>Length of motor</b>	236 mm				249 mm	
<b>Diameter of motor</b>	63 mm				62 mm	
<b>Width of gear unit, including drive pinion</b>	85 mm				86 mm	

**Selection and ordering data**

Version	Article No.
<b>Motors for interior railway door drives</b>	
<b>SIDOOR MDG180 geared motors</b>	
MDG180 L, EN 45545-2	<b>6FB1103-0AT16-4MB0</b>
MDG180 R, EN 45545-2	<b>6FB1103-0AT15-4MB0</b>
<b>SIDOOR M3 geared motors</b>	
M3 L	<b>6FB1103-0AT10-4MB0</b>
M3 R	<b>6FB1103-0AT11-4MB0</b>
<b>Motors for platform screen doors</b>	
<b>SIDOOR MEG251 EC technology geared motor</b>	
MEG251 L	<b>6FB1203-5AT00-7MP0</b>
MEG251 R	<b>6FB1203-5AT01-7MP0</b>

## Overview



### SIDOOR MED280 direct drive

SIDOOR direct drives are a combination of motor and sensor. They are easy to connect to the controller via the interface provided and are automatically detected during commissioning.

The maintenance-free drive unit consists of a gearless, speed-controlled, electronically commutated motor with non-self-locking gearing.

Direct drives are designed for certain maximum dynamic door weights and can control both drive directions.

- SIDOOR MED280 direct drive for dynamic door weights up to 280 kg (6FB1203-0AT12-7DA0)

## Technical specifications

Article number	<b>6FB1203-0AT12-7DA0</b> SIDOOR MED280
<b>General information</b>	
Product brand name	SIDOOR
Product designation	Motor for door control
Product version	MED280
<b>Input current</b>	
Operational current (rated value)	9.7 A
<b>Mechanical data</b>	
Torque of the rotary operating mechanism (rated value)	4.7 N·m
Speed, max.	0.8 m/s
Number of pulses per revolution, max.	1 024
Weight of door, max.	280 kg
<b>Degree and class of protection</b>	
IP degree of protection • of the motor	IP54
<b>Ambient conditions</b>	
Ambient temperature during operation • min. • max.	-25 °C 70 °C
Ambient temperature during storage/transportation • Storage, min. • Storage, max.	-40 °C 85 °C
<b>Dimensions</b>	
Width of motor	160 mm
Height of motor	140 mm
Length of motor • including drive pinion	56 mm 91 mm

## Selection and ordering data

Version	Article No.
<b>SIDOOR MED280 direct drive</b> Motor for door control	<b>6FB1203-0AT12-7DA0</b>

## SIDOOR

### SIDOOR automatic door controls for railway applications

#### Accessories

##### Overview

A comprehensive range of accessories is available for the SIDOOR systems. This is necessary to ensure low-noise operation of the door by the controller.

##### **Accessories for SIDOOR DC and EC geared motors**

###### Rubber-metal anti-vibration mount

To ensure low-noise door operation, the SIDOOR geared motors are integrated in the door system using rubber-metal anti-vibration mounts.

- Rubber-metal anti-vibration mount 6FB1104-0AT02-0AD0 for SIDOOR M3 and SIDOOR MDG180 DC geared motors (also for EN 45545-2) and SIDOOR MEG251 EC geared motors (door weights up to 250 kg)



Rubber-metal anti-vibration mount 6FB1104-0AT02-0AD0

###### Mounting bracket

Two different mounting brackets are available with elongated holes:

- Mounting bracket 6FB1104-0AT01-0AS0 for SIDOOR M3 and SIDOOR MDG180 DC geared motors (also for EN 45545-2) and SIDOOR MEG251 EC geared motors for flexible accommodation of the rubber-bonded metal.
- Mounting bracket 6FB1104-0AT02-0AS0 for the deflector unit, this enables the toothed belt to be set to the required belt tension.



Mounting bracket 6FB1104-0AT01-0AS0 for mounting the geared motor



Mounting bracket 6FB1104-0AT02-0AS0 for the deflector unit

###### Door clutch holder

The door clutch holder 6FB1104-0AT01-0CP0 serves to connect the respective door leaf by means of a toothed belt while also functioning as a toothed-belt lock. One door clutch holder per door leaf is required. The toothed-belt lock can accommodate both open ends of the toothed belt.



Door clutch holder 6FB1104-0AT01-0CP0 (packaging size = 1 unit)

###### Deflector unit

The deflector unit 6FB1104-0AT03-0AS0 contains an embedded belt pulley which can be mounted on the door system.

The STS toothed belt is redirected via this deflector unit.



Deflector unit 6FB1104-0AT03-0AS0

###### **STS toothed belt**

The door system is moved between the end positions of the door using the STS toothed belt 6FB1104-0AT0.-0AB0. Two different toothed belt lengths are available.

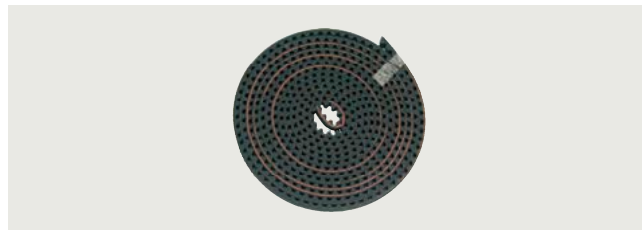

Toothed belt 6FB1104-0AT01-0AB0, length 4 m



Toothed belt 6FB1104-0AT02-0AB0, length 45 m

### Accessories for the SIDOOR MED280 EC direct drive, for the controller for the SIDOOR ATE530S coated/ATE531S platform screen door drive

#### Motor holder

- Motor holder 6FB1104-0AT03-0AD0 for accommodation of the SIDOOR MED280 direct drive.

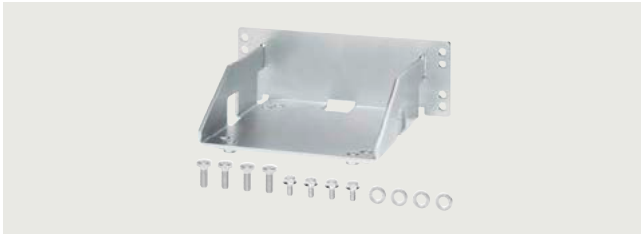

SIDOOR motor holder

#### Mounting bracket

- For mounting the SIDOOR motor holder 6FB1104-0AT01-0AS0  
Identical to the mounting bracket 6FB1104-0AT01-0AS0 for DC geared motors.



Mounting bracket for geared motor

- With tensioning device for mounting the deflector unit and setting the toothed belt to the required tension (large) 6FB1104-0AT05-0AS4



SIDOOR mounting bracket, large

- With tensioning device for mounting the deflector unit and setting the toothed belt to the required tension (small) 6FB1104-0AT05-0AS5



SIDOOR mounting bracket, small

#### Door clutch holder

- For attaching both ends of the toothed belt and connecting the respective door panel to the toothed belt, width 20 mm, 6FB1104-0AT05-0AS1



SIDOOR door clutch holder

#### Deflector unit

- For attaching the SIDOOR toothed belt and fixing to the door 6FB1104-0AT07-0AS0



SIDOOR deflector unit

#### STD toothed belt

- As a connection between the door system and the end positions of the door, toothed belt width 20 mm. Length 4 m, 6FB1104-0AT05-0AB0



SIDOOR toothed belt, small

- Toothed belt width 20 mm. Length 45 m 6FB1104-0AT06-0AB1



SIDOOR toothed belt, large

**SIDOOR**

SIDOOR automatic door controls  
for railway applications

**Accessories****Selection and ordering data**

Version	Article No.
<b>Accessories for SIDOOR DC and EC geared motors</b>	
<b>Rubber-metal anti-vibration mounts for geared motors</b> • SIDOOR rubber-metal anti-vibration mount for geared motors for door weights up to 250 kg	6FB1104-0AT02-0AD0
<b>Mounting bracket</b> • SIDOOR mounting bracket for geared motor • SIDOOR mounting bracket with tensioning device for deflector pulley	6FB1104-0AT01-0AS0 6FB1104-0AT02-0AS0
<b>SIDOOR door clutch holder</b> • For toothed belt, width 12 mm	6FB1104-0AT01-0CP0
<b>SIDOOR deflector unit</b>	6FB1104-0AT03-0AS0
<b>SIDOOR toothed belt STS</b> Width 12 mm • 4 m • 45 m	6FB1104-0AT01-0AB0 6FB1104-0AT02-0AB0
<b>Accessories for the SIDOOR MED280 EC direct drive, for the controller for the SIDOOR ATE530S coated/ATE531S platform screen door drive</b>	
<b>Motor holder for SIDOOR MED280 direct drive</b>	6FB1104-0AT03-0AD0
<b>Mounting bracket for mounting the motor holder</b>	6FB1104-0AT01-0AS0
<b>Mounting bracket with tensioning device for mounting the deflector unit</b> • Large • Small	6FB1104-0AT05-0AS4 6FB1104-0AT05-0AS5
<b>SIDOOR door clutch holder</b> • For toothed belt, width 20 mm	6FB1104-0AT05-0AS1
<b>SIDOOR deflector unit</b>	6FB1104-0AT07-0AS0
<b>SIDOOR toothed belt STD</b> Width 20 mm • 4 m • 45 m	6FB1104-0AT05-0AB0 6FB1104-0AT06-0AB1



## SCALANCE and RUGGEDCOM Network Components



8/2	<b>SCALANCE X – Industrial Ethernet Switches</b>	8/94	<b>RUGGEDCOM – Layer 2 Switches</b>
8/2	SCALANCE X005EEC	8/94	RUGGEDCOM RSG907R and RSG909R
8/5	SCALANCE XC-200 managed	8/98	RUGGEDCOM RSG920P
8/22	SCALANCE XP-200 managed	8/102	RUGGEDCOM RS900G / RUGGEDCOM RS900GP
8/26	SCALANCE X308-2M TS	8/106	RUGGEDCOM RSG908C / RSG910C
8/33	SCALANCE XR324-4M PoE TS / SCALANCE XR324-4M EEC / SCALANCE XR324-12M TS	8/110	RUGGEDCOM RST916P / RSG916C
8/49	SCALANCE XM-400 managed	8/114	RUGGEDCOM RSG2100 / RUGGEDCOM RSG2300
8/55	Port Extender for SCALANCE XM-400 managed	8/115	RUGGEDCOM RST2228
8/58	<b>Communication for PC-based systems</b>	8/121	RUGGEDCOM RSG2488
8/58	CP 1604	8/125	<b>RUGGEDCOM – Layer 3 Switches / Routers</b>
8/61	<b>SCALANCE M / RUGGEDCOM – Mobile Wireless Routers</b>	8/125	RUGGEDCOM RX1400
8/61	RUGGEDCOM RM1224	8/127	RUGGEDCOM RX1500 / RX1501 / RX1510 / RX1524 / RX1536
8/63	SCALANCE MUM856-1	8/131	RUGGEDCOM RX5000
8/63	SCALANCE M876-4	8/132	<b>RUGGEDCOM – Wireless</b>
8/67	ANT896-6MH	8/132	RUGGEDCOM WIN7200
8/73	<b>SCALANCE W – Industrial Wireless LAN</b>	8/134	RUGGEDCOM WIN5100
8/73	SCALANCE W774-1 M12 EEC	8/136	RUGGEDCOM WIN5200
8/78	SCALANCE W778-1 M12 EEC		
8/82	SCALANCE W1788-2 M12 EEC		
8/86	SCALANCE WAM766-1 EEC		
8/90	ANT795-4MX / ANT795-6MN / ANT795-6MT / ANT793-8DL / ANT793-8DP / ANT795-6DC / ANT793-6DG		

## Network Components

### SCALANCE X – Industrial Ethernet Switches

#### SCALANCE X005EEC

##### Overview



The unmanaged Industrial Ethernet switch SCALANCE X005 is ideally suited for economical setup of small Industrial Ethernet networks with data transfer rates of 10/100 Mbps in line and star structures.

- Five electrical station or network connections
- Rugged metal housing for space-saving control cabinet installation on a standard mounting rail or S7-300 mounting rail or for wall mounting
- Rugged, industry-compatible station connections with RJ45 plug connectors that are locked into place on the housing to provide additional strain relief and bending relief
- Diagnostics on the device by means of LEDs (power, link status, data communication)

##### SCALANCE X005EEC

- For setting up electrical star and line structures with five electrical ports for use in rail and road transport with extended temperature range

##### Benefits

- Ideal solution for setup of small Industrial Ethernet line and star structures
- Space-saving installation in the control cabinet thanks to its compact size in S7-300 format
- Reliable plug-in connection thanks to rugged, industry-compatible device connection in combination with FastConnect connectors
- Installation without patch field is possible using IE FC RJ45 plug 180 and IE FC standard cable
- Integrated autocrossover function enables use of uncrossed connection cables

##### Application

- For economical setup of small, electrical Industrial Ethernet star and line structures with switching functionality, e.g. machine or plant islands
- For use in the control cabinet
- The SCALANCE X005EEC is suitable for use in rail and road transport due to its specification according to EN 50155 and e1/E1

##### Design

The SCALANCE Industrial Ethernet switches with a rugged metal housing (IP30) are optimized for mounting on a standard mounting rail and an S7-300 mounting rail. Direct wall mounting in different mounting positions is also possible. Due to the housing dimensions, which correspond to those of the SIMATIC S7-300, the devices are very well suited for integration into an automation solution with S7-300 components.

The SCALANCE X005 switch is equipped with:

- Supply voltage 1 x 24 V DC
- A row of LEDs for displaying status information (power, link status, data communication)
- 5 x 10/100BaseTX, RJ45 ports: automatic detection of the data rate (10 or 100 Mbps), with autosensing and autocrossover function for connecting IE FC cables via IE FC RJ45 Plug 180 up to 100 m

##### Technical specifications

Article number	<b>6GK5005-0BA10-1CA3</b>
Product type designation	SCALANCE X005EEC
<b>Transmission rate</b>	
Transmission rate	10/100 Mbps
<b>Integrated interfaces for communication</b>	
<b>Number of electrical connections</b>	
• for network components or data terminal equipment	5; RJ45 with securing collar
<b>Number of 100 Mbps SC ports</b>	
• for multimode	0
<b>Number of 1000 Mbps LC ports</b>	
• for multimode	0
• for single-mode (LD)	0
<b>Other interfaces</b>	
<b>Number of electrical connections</b>	
• for power supply	1
<b>Type of electrical connection</b>	
• for power supply	2-pin terminal block

Article number	<b>6GK5005-0BA10-1CA3</b>
Product type designation	SCALANCE X005EEC
<b>Supply voltage, current consumption, power loss</b>	
<b>Type of supply voltage</b>	DC
<b>Supply voltage</b>	24 V
• External	18 ... 32 V
• External	
<b>Product component: fusing at power supply input</b>	Yes
<b>Type of fusing at input for supply voltage</b>	0.5 A / 60 V
<b>Current consumption, maximum</b>	0.08 A
<b>Power loss [W]</b>	
• with 24 V DC	2 Watts
<b>Permissible ambient conditions</b>	
<b>Ambient temperature</b>	
• during operation	-40 ... +75°C
• during storage	-40 ... +80°C
• during transport	-40 ... +80°C
<b>Relative humidity</b>	
• Relative humidity at 25 °C, without condensation during operation, maximum	95%
<b>IP degree of protection</b>	IP30
<b>Design, dimensions and weights</b>	
<b>Model</b>	Compact
<b>Width</b>	40 mm
<b>Height</b>	125 mm
<b>Depth</b>	124 mm
<b>Net weight</b>	0.55 kg
<b>Product property: conformal coating</b>	No
<b>Mounting type</b>	
• 35 mm DIN rail mounting	Yes
• Wall mounting	Yes
• S7-300 rail mounting	Yes
• S7-1500 rail mounting	No
<b>Product functions - Management, configuration, engineering</b>	
<b>Product function</b>	
• Multiport mirroring	No
• CoS	Yes
• Switch-managed	No
<b>Product functions - Redundancy</b>	
<b>Product function</b>	
• Parallel Redundancy Protocol (PRP)/use in PRP network	Yes
• Parallel Redundancy Protocol (PRP)/Redundant Network Access (RNA)	No
<b>Standards, specifications, approvals</b>	
<b>Standard</b>	
• for safety, from CSA and UL	UL 60950-1, CSA C22.2 No. 60950-1
• for emitted interference	EN 61000-6-4 (Class A)
• for noise immunity	EN 61000-6-2
<b>Standards, specifications, approvals - CE</b>	
<b>Proof of suitability, CE mark</b>	Yes
<b>Standards, specifications, approvals - Other</b>	
<b>Proof of suitability</b>	EN 61000-6-2, EN 61000-6-4
• C-Tick	Yes
• E1 approval	Yes
• e1 approval	Yes
• Railway application in accordance with EN 50155	Yes
• KC approval	Yes
<b>Standards, specifications, approvals - Marine classification</b>	
<b>Marine classification association</b>	
• American Bureau of Shipping Europe Ltd. (ABS)	Yes
• Bureau Veritas (BV)	Yes
• Det Norske Veritas (DNV)	Yes
• Germanischer Lloyd (GL)	No
• Lloyds Register of Shipping (LRS)	Yes
• Nippon Kaiji Kyokai (NK)	Yes
• Polski Rejestr Statkow (PRS)	Yes
• Royal Institution of Naval Architects (RINA)	Yes
<b>Standards, specifications, approvals - Product conformity</b>	
<b>MTBF at 40 °C</b>	167.1 y

## Network Components

### SCALANCE X – Industrial Ethernet Switches

#### SCALANCE X005EEC

#### Selection and ordering data

Version	Article No.
<b>SCALANCE X005EEC</b> Industrial Ethernet switch for 10/100 Mbps; with five 10/100 Mbps RJ45 ports for setup of small star and line structures with extended temperature range and approvals for use in rail and road transport	<b>6GK5005-0BA10-1CA3</b>
<b>Accessories</b>	
<b>IE FC Stripping Tool</b> Preset insulation stripping tool for fast stripping of Industrial Ethernet FC cables	<b>6GK1901-1GA00</b>
<b>IE FC RJ45 Plug 180 2 x 2</b> 180° cable outlet; for network components and CPs/CPUs with Industrial Ethernet interface • 1 pack = 1 unit	<b>6GK1901-1BB10-2AA0</b>
<b>IE TP Train Cable GP 2x2 (Type C)</b> 4-core, shielded TP installation cable for connection to IE FC outlet RJ45/IE FC RJ45 plug 180/90 for train applications: PROFINET-compliant; sold by the meter; maximum delivery unit 1000 m, minimum order quantity 20 m	<b>6XV1871-2T</b>
<b>IE Connecting Cable IE FC RJ45 Plug-180/IE FC RJ45 Plug-180</b> Preassembled IE FC TP trailing cable GP 2 x 2 (PROFINET type C) with two IE FC RJ45 Plug-180, IP20 degree of protection; length: • 1.0 m • 5.0 m • 10.0 m	<b>6XV1871-5BH10</b> <b>6XV1871-5BH50</b> <b>6XV1871-5BN10</b>
<b>2-pole screw-terminal block for power supply (24 V DC)</b> for SCALANCE X/W/S 1 pack = 5 units	<b>6GK5980-0BB00-0AA5</b>

#### More information

##### Selection tools:

To assist in selecting the right Industrial Ethernet switches as well as configuration of modular variants, the TIA Selection Tool is available at:

TIA Selection Tool:

<http://www.siemens.com/tia-selection-tool>

#### Overview



The managed Industrial Ethernet switches of the SCALANCE XC-200 product line are optimized for setting up Industrial Ethernet networks with data transfer rates of 10/100/1000 Mbit/s as well as 2 x 10 Gbps (e.g. SCALANCE XC206-2G PoE).

- Electrical or optical connection to stations or networks according to port characteristics of the devices
- Versions with transmission rates up to 10 Gbps optical or 1 Gbps electrical
- Rugged station connections with industry-standard RJ45 connectors that offer additional strain and bending strain relief thanks to latching on the enclosure
- Redundant power supply
- Console port for direct access to device
- Display of comprehensive operating mode and status information via LEDs and selection pushbuttons
- Signaling contact for connecting to an error signaling system
- Slot for optional C-PLUG removable data storage medium for easy device replacement without additional equipment such as a field PG
- Grounding screw for external ground connection
- Virtual LANs (VLAN) for easy structuring of large networks into smaller, logical subnetworks. Reasons for the subdivision into logical subnetworks are, for example, separation of the Ethernet networks to reduce the broadcast load, separation of sensitive areas from the main network, and subdivision of the network into logical working groups
- By learning the multicast sources and destinations (Internet Group Management Protocol (IGMP) Snooping), SCALANCE XC-200 switches can also filter multicast data traffic and thus limit the load on the network
- Integrated security functions offer protection against unauthorized network access and configuration (e.g. authentication via IEEE 802.1X)

#### Product versions

- Switches with electrical ports:
  - SCALANCE XC208G with 8x RJ45 ports 10/100/1000 Mbit/s
  - SCALANCE XC208; with 8x RJ45 ports 10/100 Mbps for mounting in the control cabinet
  - SCALANCE XC216 with 16x RJ45 ports 10/100 Mbps for mounting in the control cabinet
  - SCALANCE XC224; with 24x RJ45 ports 10/100 Mbps for mounting in the control cabinet
- Switches with Power over Ethernet:
  - SCALANCE XC206-2G PoE with 6x RJ45 PoE ports 10/100/1000 Mbps and 2x SFP+ 1000/10000 Mbps
  - SCALANCE XC206-2G PoE (DC 54 V) with 6x RJ45 PoE ports 10/100/1000 Mbps and 2x SFP+ 1000/10000 Mbps, PoE support for 54 V DC Infeed
  - SCALANCE XC206-2G PoE EEC with 6x RJ45 PoE ports 10/100/1000 Mbps and 2x SFP+ 1000/10000 Mbps, PoE support for 54 V DC Infeed
  - SCALANCE XC208G PoE with 6x RJ45 PoE ports 10/100/1000 Mbps and 2x RJ45 ports 10/100/1000 Mbps
  - SCALANCE XC208G PoE (DC 54 V) with 6x RJ45 PoE ports 10/100/1000 Mbps and 2x RJ45 ports 10/100/1000 Mbps, PoE support for 54 V DC Infeed
- Switches with electrical and optical ports
  - SCALANCE XC206-2; with 6x RJ45 ports 10/100 Mbps and 2x ST/BFOC ports 100 Mbps
  - SCALANCE XC206-2; with 6x RJ45 ports 10/100 Mbps and 2x SC ports 100 Mbps
  - SCALANCE XC206-2SFP; with 6x RJ45 ports 10/100 Mbps and 2x SFP plug-in transceivers with 100 or 1000 Mbps

#### Benefits

- Operational reliability in industrial environments, e.g. due to rugged enclosure, redundancy, temperature range from -40 °C to +70 °C
- Fast mobile diagnostics by smartphone or tablet in existing WLAN using NFC (near field communication)
- Integration of SCALANCE XC-200 switches into existing network management infrastructure (e.g. SINEC NMS) through SNMP accession thanks to rugged, industry-standard device connects
- Reliable plug-in connection in conjunction with industry-standard FastConnect connectors

## Network Components

### SCALANCE X - Industrial Ethernet Switches

#### SCALANCE XC-200 managed

#### Function

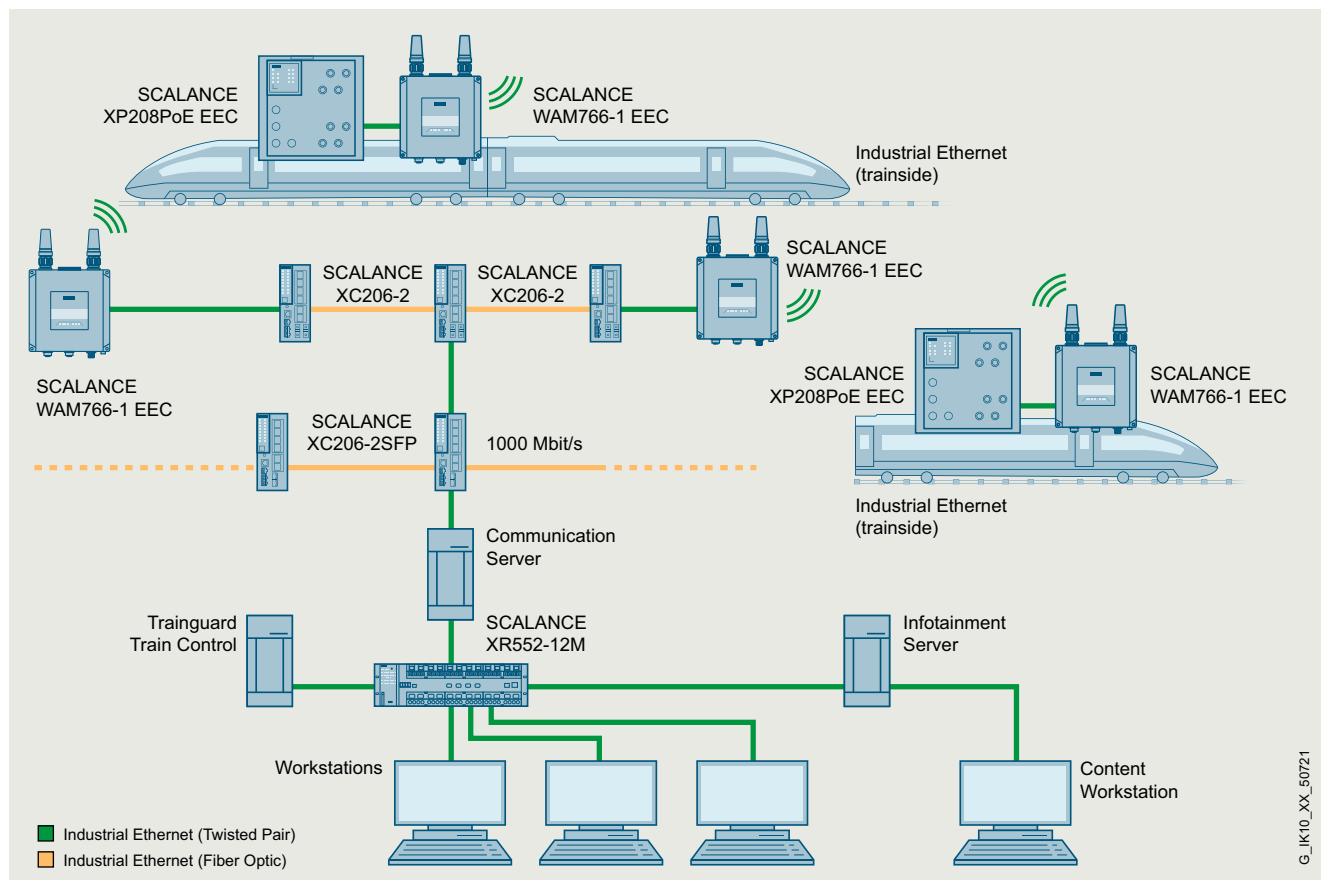

Set-up of distributed access points along track segments with SCALANCE XC206-2SFP

#### Technical specifications

Article number	6GK5206-2BB00-2AC2	6GK5206-2BD00-2AC2	6GK5206-2BS00-2AC2
Product type designation	SCALANCE XC206-2 (ST/BFOC)	SCALANCE XC206-2 (SC)	SCALANCE XC206-2SFP
<b>Transmission rate</b>			
<b>Transfer rate</b>	10/100 Mbit/s	10/100 Mbit/s	10/100/1000 Mbit/s
<b>Interfaces for communication integrated</b>			
<b>Number of electrical connections</b> • for network components or terminal equipment	6; RJ45	6; RJ45	6; RJ45
<b>Number of 10/100 Mbit/s RJ45 ports integrated</b> • with securing collar	6	6	6
<b>Number of 100 Mbit/s ST(BFOC) ports</b> • for multimode	2		
<b>Number of 100 Mbit/s SC ports</b> • for multimode		2	
<b>Interfaces for communication pluggable maximum</b>			
<b>Number of electrical connections</b> • for SFP			2; 100 Mbit/s or 1000 Mbit/s SFP plug-in transceiver
<b>Interfaces others</b>			
<b>Number of electrical connections</b> • for operator console • for signaling contact • for power supply • for redundant voltage supply	1 1 1 1	1 1 1 1	1 1 1 1
<b>Type of electrical connection</b> • for operator console • for signaling contact • for power supply	RJ11 2-pole terminal block 4-pole terminal block	RJ11 2-pole terminal block 4-pole terminal block	RJ11 2-pole terminal block 4-pole terminal block
<b>design of the removable storage</b> • C-PLUG	Yes	Yes	Yes

## Network Components

### SCALANCE X - Industrial Ethernet Switches

#### SCALANCE XC-200 managed

Article number	6GK5206-2BB00-2AC2	6GK5206-2BD00-2AC2	6GK5206-2BS00-2AC2
Product type designation	SCALANCE XC206-2 (ST/BFOC)	SCALANCE XC206-2 (SC)	SCALANCE XC206-2SFP
<b>Signal-Inputs/outputs</b>			
<b>Operating voltage of the signaling contacts</b> • at DC Rated value	24 V	24 V	24 V
<b>Operating current of the signaling contacts</b> • at DC maximum	0.1 A	0.1 A	0.1 A
<b>Supply voltage, current consumption, power loss</b>			
<b>Type of voltage of the supply voltage</b>	DC	DC	DC
<b>Supply voltage</b> • external • external minimum • external maximum	24 V 9.6 V 31.2 V	24 V 9.6 V 31.2 V	24 V 9.6 V 31.2 V
<b>Supply voltage 4 Rated value</b> • Consumed current 4 at rated supply voltage maximum	0.25 A	0.25 A	0.25 A
<b>Product component fusing at power supply input</b>	Yes	Yes	Yes
<b>Fuse protection type at input for supply voltage</b>	2.5 A / 125 V	2.5 A / 125 V	2.5 A / 125 V
<b>Consumed current maximum</b>	0.5 A	0.5 A	0.5 A
<b>Power loss [W]</b> • at DC at 24 V	6 W	6 W	6 W
<b>Permitted ambient conditions</b>			
<b>Ambient temperature</b> • during operation • during storage • during transport	-40 ... +70 °C -40 ... +85 °C -40 ... +85 °C	-40 ... +70 °C -40 ... +85 °C -40 ... +85 °C	-40 ... +70 °C -40 ... +85 °C -40 ... +85 °C
<b>Relative humidity</b> • at 25 °C without condensation during operation maximum	95 %	95 %	95 %
Protection class IP	IP20	IP20	IP20
<b>Design, dimensions and weight</b>			
<b>Design</b>	compact	compact	compact
<b>Width</b>	60 mm	60 mm	60 mm
<b>Height</b>	147 mm	147 mm	147 mm
<b>Depth</b>	125 mm	125 mm	125 mm
<b>Net weight</b>	0.54 kg	0.54 kg	0.52 kg
<b>Material of the enclosure</b>	Polycarbonate (PC-GF10) / pressure die cast aluminum	Polycarbonate (PC-GF10) / pressure die cast aluminum	Polycarbonate (PC-GF10) / pressure die cast aluminum
<b>Mounting type</b> • 35 mm DIN rail mounting • wall mounting • S7-300 rail mounting • S7-1500 rail mounting	Yes Yes Yes Yes	Yes Yes Yes Yes	Yes Yes Yes Yes
<b>Product properties, functions, components general</b>			
<b>Cascading in the case of a redundant ring at reconfiguration time of &lt;math&gt;\leq 0.3&lt;/math&gt;-s</b>	50	50	50
<b>Cascading in cases of star topology</b>	any (depending only on signal propagation time)	any (depending only on signal propagation time)	any (depending only on signal propagation time)
<b>Product function QoS according to DSCP</b>	Yes	Yes	Yes
<b>Product feature</b> • Cut Through switching method • Store & Forward switching method	No Yes	No Yes	No Yes
<b>Product functions management, configuration</b>			
<b>Product function</b> • CLI • web-based management • MIB support • TRAPs via email • Configuration with STEP 7 • RMON • SMTP server • Port mirroring • multiport mirroring • CoS • PROFINET IO diagnosis • switch-managed	Yes Yes Yes Yes Yes Yes No Yes Yes Yes Yes Yes Yes	Yes Yes Yes Yes Yes Yes No Yes Yes Yes Yes Yes Yes	Yes Yes Yes Yes Yes Yes No Yes Yes Yes Yes Yes Yes
<b>Telegram length for Ethernet maximum</b>	1 632 byte	1 632 byte	1 632 byte



## Network Components

### SCALANCE X - Industrial Ethernet Switches

#### SCALANCE XC-200 managed

Article number	6GK5206-2BB00-2AC2	6GK5206-2BD00-2AC2	6GK5206-2BS00-2AC2
Product type designation	SCALANCE XC206-2 (ST/BFOC)	SCALANCE XC206-2 (SC)	SCALANCE XC206-2SFP
<b>Protocol is supported</b>			
• Telnet	Yes	Yes	Yes
• HTTP	Yes	Yes	Yes
• HTTPS	Yes	Yes	Yes
• TFTP	Yes	Yes	Yes
• BOOTP	No	No	No
• GMRP	Yes	Yes	Yes
• DCP	Yes	Yes	Yes
• LLDP	Yes	Yes	Yes
• EtherNet/IP	Yes	Yes	Yes
• SNMP v1	Yes	Yes	Yes
• SNMP v2	Yes	Yes	Yes
• SNMP v3	Yes	Yes	Yes
• IGMP (snooping/querier)	Yes	Yes	Yes
<b>Identification &amp; maintenance function</b>			
• I&MO - device-specific information	Yes	Yes	Yes
• I&M1 - higher-level designation/location designation	Yes	Yes	Yes
<b>Product functions Diagnosis</b>			
<b>Product function</b>			
• Port diagnostics	Yes	Yes	Yes
• Statistics Packet Size	Yes	Yes	Yes
• Statistics packet type	Yes	Yes	Yes
• Error statistics	Yes	Yes	Yes
• SysLog	Yes	Yes	Yes
<b>Product functions VLAN</b>			
<b>Product function</b>			
• VLAN - port based	Yes	Yes	Yes
• VLAN - protocol-based	No	No	No
• VLAN - IP-based	No	No	No
• VLAN dynamic	Yes	Yes	Yes
<b>Number of VLANs maximum</b>	257	257	257
<b>Number of VLANs - dynamic maximum</b>	257	257	257
<b>Protocol is supported GVRP</b>	Yes	Yes	Yes
<b>Product functions DHCP</b>			
<b>Product function</b>			
• DHCP server	Yes	Yes	Yes
• DHCP client	Yes	Yes	Yes
• DHCP Option 82	Yes	Yes	Yes
• DHCP Option 66	Yes	Yes	Yes
• DHCP Option 67	Yes	Yes	Yes
<b>Product functions Redundancy</b>			
<b>Product function</b>			
• Ring redundancy	Yes	Yes	Yes
• High Speed Redundancy Protocol (HRP)	Yes	Yes	Yes
• high speed redundancy protocol (HRP) with redundancy manager	Yes	Yes	Yes
• high speed redundancy protocol (HRP) with standby redundancy	Yes	Yes	Yes
<b>Protocol is supported Media Redundancy Protocol (MRP)</b>	Yes	Yes	Yes
<b>Product function</b>			
• media redundancy protocol (MRP) with redundancy manager	Yes	Yes	Yes
• redundancy procedure STP	Yes	Yes	Yes
• redundancy procedure RSTP	Yes	Yes	Yes
• redundancy procedure MSTP	Yes	Yes	Yes
• Passive listening	Yes	Yes	Yes
<b>Protocol is supported</b>			
• LACP	Yes	Yes	Yes
<b>Product functions Security</b>			
<b>Product function</b>			
• IEEE 802.1x (radius)	Yes	Yes	Yes
• Broadcast/Multicast/Unicast Limiter	Yes	Yes	Yes
• broadcast blocking	Yes	Yes	Yes
<b>Protocol is supported</b>			
• SSH	Yes	Yes	Yes
• SSL	Yes	Yes	Yes
<b>Product functions Time</b>			
<b>Product function</b>			
• SICLOCK support	Yes	Yes	Yes
• NTP-client	Yes	Yes	Yes
• SNTP client	Yes	Yes	Yes
<b>Protocol is supported</b>			
• NTP	Yes	Yes	Yes
• SNTP	Yes	Yes	Yes

## Network Components

### SCALANCE X - Industrial Ethernet Switches

#### SCALANCE XC-200 managed

Article number	<b>6GK5206-2BB00-2AC2</b>	<b>6GK5206-2BD00-2AC2</b>	<b>6GK5206-2BS00-2AC2</b>
Product type designation	SCALANCE XC206-2 (ST/BFOC)	SCALANCE XC206-2 (SC)	SCALANCE XC206-2SFP
<b>Standards, specifications, approvals CE</b>			
<b>Certificate of suitability CE marking</b>	Yes	Yes	Yes
<b>Product conformity according to EMC-guideline</b>	2014/30/EU	2014/30/EU	2014/30/EU
<b>Standard</b> • for EMC interference emission • for immunity to EMI	EN 61000-6-4, EN 50121-4 EN 61000-6-2, EN 50121-4	EN 61000-6-4, EN 50121-4 EN 61000-6-2, EN 50121-4	EN 61000-6-4, EN 50121-4 EN 61000-6-2, EN 50121-4
<b>Certificate of suitability RoHS conformity</b>	Yes; 2011/65/EU	Yes; 2011/65/EU	Yes; 2011/65/EU
<b>Standards, specifications, approvals hazardous environments</b>			
<b>Certificate of suitability</b> • ATEX • IECEX • FM registration	Yes Yes Yes	Yes Yes Yes	Yes Yes Yes
<b>Standards, specifications, approvals miscellaneous</b>			
<b>Certificate of suitability</b> • Railway application in accordance with EN 50121-4 • Regulatory Compliance Mark (RCM) • EAC approval	Yes Yes Yes	Yes Yes Yes	Yes Yes Yes
<b>Standards, specifications, approvals ship classification</b>			
<b>Marine classification association</b> • American Bureau of Shipping Europe Ltd. (ABS) • DNV GL • Polski Rejestr Statkow (PRS)	Yes Yes Yes	Yes Yes Yes	Yes Yes Yes
<b>Standards, specifications, approvals product conformity</b>			
<b>MTBF at 40 °C</b>	46.43 y	46.43 y	47.06 y
<b>Accessories</b>			
<b>Product extension optional C-PLUG</b>	Yes	Yes	Yes

Article number	<b>6GK5208-0BA00-2AC2</b>	<b>6GK5216-0BA00-2AC2</b>	<b>6GK5224-0BA00-2AC2</b>
Product type designation	SCALANCE XC208	SCALANCE XC216	SCALANCE XC224
<b>Transmission rate</b>			
<b>Transfer rate</b>	10/100 Mbit/s	10 /100 Mbit/s	10/100 Mbit/s
<b>Interfaces for communication integrated</b>			
<b>Number of electrical connections</b> • for network components or terminal equipment	8; RJ45	16; RJ45	24; RJ45
<b>Number of 10/100 Mbit/s RJ45 ports integrated</b> • with securing collar	8	16	24
<b>Interfaces others</b>			
<b>Number of electrical connections</b> • for operator console • for signaling contact • for power supply • for redundant voltage supply • Type of electrical connection • for operator console • for signaling contact • for power supply	1 1 1 1 RJ11 2-pole terminal block 4-pole terminal block	1 1 1 1 RJ11 2-pole terminal block 4-pole terminal block	1 1 1 1 RJ11 2-pole terminal block 4-pole terminal block
<b>Design of the removable storage</b> • C-PLUG	Yes	Yes	Yes
<b>Signal-Inputs/outputs</b>			
<b>Operating voltage of the signaling contacts</b> • at DC Rated value	24 V	24 V	24 V
<b>Operating current of the signaling contacts</b> • at DC maximum	0.1 A	0.1 A	0.1 A
<b>Supply voltage, current consumption, power loss</b>			
<b>Type of voltage of the supply voltage</b>	DC	DC	DC
<b>Supply voltage</b> • external • external minimum • external maximum	24 V 9.6 V 31.2 V	24 V 9.6 V 31.2 V	24 V 9.6 V 31.2 V
<b>Supply voltage 4 Rated value</b> • Consumed current 4 at rated supply voltage maximum	0.175 A	0.275 A	0.375 A
<b>Product component fusing at power supply input</b>	Yes	Yes	Yes
<b>Fuse protection type at input for supply voltage</b>	2.5 A / 125 V	2.5 A / 125 V	2.5 A / 125 V
<b>Consumed current maximum</b>	0.35 A	0.55 A	0.75 A
<b>Power loss [W]</b> • at DC at 24 V	4.2 W	6.6 W	9 W

## Network Components

### SCALANCE X - Industrial Ethernet Switches

#### SCALANCE XC-200 managed

Article number	6GK5208-0BA00-2AC2	6GK5216-0BA00-2AC2	6GK5224-0BA00-2AC2
Product type designation	SCALANCE XC208	SCALANCE XC216	SCALANCE XC224
<b>Permitted ambient conditions</b>			
<b>Ambient temperature</b>			
• during operation	-40 ... +70 °C	-40 ... +70 °C	-40 ... +70 °C
• during storage	-40 ... +85 °C	-40 ... +85 °C	-40 ... +85 °C
• during transport	-40 ... +85 °C	-40 ... +85 °C	-40 ... +85 °C
<b>Relative humidity</b>			
• at 25 °C without condensation during operation maximum	95 %	95 %	95 %
<b>Protection class IP</b>	IP20	IP20	IP20
<b>Design, dimensions and weight</b>			
<b>Design</b>	compact	compact	compact
<b>Width</b>	60 mm	120 mm	120 mm
<b>Height</b>	147 mm	147 mm	147 mm
<b>Depth</b>	125 mm	125 mm	125 mm
<b>Net weight</b>	0.52 kg	0.8 kg	0.88 kg
<b>Material of the enclosure</b>	Polycarbonate (PC-GF10) / pressure die cast aluminum	Polycarbonate (PC-GF10) / pressure die cast aluminum	Polycarbonate (PC-GF10) / pressure die cast aluminum
<b>Mounting type</b>			
• 35 mm DIN rail mounting	Yes	Yes	Yes
• wall mounting	Yes	Yes	Yes
• S7-300 rail mounting	Yes	Yes	Yes
• S7-1500 rail mounting	Yes	Yes	Yes
<b>Product properties, functions, components general</b>			
<b>Cascading in the case of a redundant ring at reconfiguration time of &lt;math&gt;\leq 0.3&lt;/math&gt;-s</b>	50	50	50
<b>Cascading in cases of star topology</b>	any (depending only on signal propagation time)	any (depending only on signal propagation time)	any (depending only on signal propagation time)
<b>Product function QoS according to DSCP</b>		Yes	Yes
<b>Product feature</b>			
• Cut Through switching method	No	No	No
• Store & Forward switching method	Yes	Yes	Yes
<b>Product functions management, configuration</b>			
<b>Product function</b>			
• CLI	Yes	Yes	Yes
• web-based management	Yes	Yes	Yes
• MIB support	Yes	Yes	Yes
• TRAPs via email	Yes	Yes	Yes
• Configuration with STEP 7	Yes	Yes	Yes
• RMON	Yes	Yes	Yes
• SMTP server	No	No	No
• Port mirroring	Yes	Yes	Yes
• multiport mirroring	Yes	Yes	Yes
• CoS	Yes	Yes	Yes
• PROFINET IO diagnosis	Yes	Yes	Yes
• switch-managed	Yes	Yes	Yes
<b>Telegram length for Ethernet maximum</b>	1 632 byte	1 632 byte	1 632 byte
<b>Protocol is supported</b>			
• Telnet	Yes	Yes	Yes
• HTTP	Yes	Yes	Yes
• HTTPS	Yes	Yes	Yes
• TFTP	Yes	Yes	Yes
• BOOTP	No	No	No
• GMRP	Yes	Yes	Yes
• DCP	Yes	Yes	Yes
• LLDP	Yes	Yes	Yes
• EtherNet/IP	Yes	Yes	Yes
• SNMP v1	Yes	Yes	Yes
• SNMP v2	Yes	Yes	Yes
• SNMP v3	Yes	Yes	Yes
• IGMP (snooping/querier)	Yes	Yes	Yes
<b>Identification &amp; maintenance function</b>			
• I&M0 - device-specific information	Yes	Yes	Yes
• I&M1 – higher-level designation/location designation	Yes	Yes	Yes
<b>Product functions Diagnosis</b>			
<b>Product function</b>			
• Port diagnostics	Yes	Yes	Yes
• Statistics Packet Size	Yes	Yes	Yes
• Statistics packet type	Yes	Yes	Yes
• Error statistics	Yes	Yes	Yes
• SysLog	Yes	Yes	Yes

## Network Components

### SCALANCE X - Industrial Ethernet Switches

#### SCALANCE XC-200 managed

Article number	6GK5208-0BA00-2AC2	6GK5216-0BA00-2AC2	6GK5224-0BA00-2AC2
Product type designation	SCALANCE XC208	SCALANCE XC216	SCALANCE XC224
<b>Product functions VLAN</b>			
<b>Product function</b>			
• VLAN - port based	Yes	Yes	Yes
• VLAN - protocol-based	No	No	No
• VLAN - IP-based	No	No	No
• VLAN dynamic	Yes	Yes	Yes
<b>Number of VLANs maximum</b>	257	257	257
<b>Number of VLANs - dynamic maximum</b>	257	257	257
<b>Protocol is supported GVRP</b>	Yes	Yes	Yes
<b>Product functions DHCP</b>			
<b>Product function</b>			
• DHCP server	Yes	Yes	Yes
• DHCP client	Yes	Yes	Yes
• DHCP Option 82	Yes	Yes	Yes
• DHCP Option 66	Yes	Yes	Yes
• DHCP Option 67	Yes	Yes	Yes
<b>Product functions Redundancy</b>			
<b>Product function</b>			
• Ring redundancy	Yes	Yes	Yes
• High Speed Redundancy Protocol (HRP)	Yes	Yes	Yes
• high speed redundancy protocol (HRP) with redundancy manager	Yes	Yes	Yes
• high speed redundancy protocol (HRP) with standby redundancy	Yes	Yes	Yes
<b>Protocol is supported Media Redundancy Protocol (MRP)</b>	Yes	Yes	Yes
<b>Product function</b>			
• media redundancy protocol (MRP) with redundancy manager	Yes	Yes	Yes
• redundancy procedure STP	Yes	Yes	Yes
• redundancy procedure RSTP	Yes	Yes	Yes
• redundancy procedure MSTP	Yes	Yes	Yes
• Parallel Redundancy Protocol (PRP)/operation in the PRP-network	No	No	No
• Parallel Redundancy Protocol (PRP)/Redundant Network Access (RNA)	No	No	No
• Passive listening	Yes	Yes	Yes
<b>Protocol is supported</b>			
• LACP	Yes	Yes	Yes
<b>Product functions Security</b>			
<b>Product function</b>			
• IEEE 802.1x (radius)	Yes	Yes	Yes
• Broadcast/Multicast/Unicast Limiter	Yes	Yes	Yes
• broadcast blocking	Yes	Yes	Yes
<b>Protocol is supported</b>			
• SSH	Yes	Yes	Yes
• SSL	Yes	Yes	Yes
<b>Product functions Time</b>			
<b>Product function</b>			
• SICLOCK support	Yes	Yes	Yes
• NTP-client	Yes	Yes	Yes
• Sntp client	Yes	Yes	Yes
<b>Protocol is supported</b>			
• NTP	Yes	Yes	Yes
• Sntp	Yes	Yes	Yes
<b>Standards, specifications, approvals CE</b>			
<b>Certificate of suitability CE marking</b>	Yes	Yes	Yes
<b>Product conformity according to EMC-guideline</b>	2014/30/EU	2014/30/EU	2014/30/EU
<b>Standard</b>			
• for EMC interference emission	EN 61000-6-4, EN 50121-4	EN 61000-6-4, EN 50121-4	EN 61000-6-4, EN 50121-4
• for immunity to EMI	EN 61000-6-2, EN 50121-4	EN 61000-6-2, EN 50121-4	EN 61000-6-2, EN 50121-4
<b>Certificate of suitability RoHS conformity</b>	Yes; 2011/65/EU	Yes; 2011/65/EU	Yes; 2011/65/EU
<b>Standards, specifications, approvals miscellaneous</b>			
<b>Certificate of suitability</b>			
• Railway application in accordance with EN 50121-4	Yes	Yes	Yes
• Regulatory Compliance Mark (RCM)	Yes	Yes	Yes
• EAC approval	Yes	Yes	Yes
<b>Standards, specifications, approvals product conformity</b>			
<b>MTBF at 40 °C</b>	57.15 y	48.09 y	41.36 y
<b>Accessories</b>			
<b>Product extension optional C-PLUG</b>	Yes	Yes	Yes

## Network Components

### SCALANCE X - Industrial Ethernet Switches

#### SCALANCE XC-200 managed

Article number	6GK5208-0GA00-2AC2	6GK5206-2RS00-2AC2	6GK5206-2RS00-5AC2
Product type designation	SCALANCE XC208G	SCALANCE XC206-2G PoE	SCALANCE XC206-2G PoE (DC 54 V)
<b>Transfer rate</b>			
<b>Transfer rate</b>	10/100/1000 Mbit/s	10/100/1000 Mbit/s, 10 Gbit/s	10/100/1000 Mbit/s, 10 Gbit/s
<b>Interfaces for communication integrated</b>			
<b>Number of electrical connections</b> • for network components or terminal equipment	8; RJ45	6; RJ45	6; RJ45
<b>Number of 10/100 Mbit/s RJ45 ports integrated</b> • with securing collar	8	4 PoE ports according to IEEE 802.3at (30 W), 2 PoE ports according to IEEE 802.3bt (60 W)	4 PoE ports according to IEEE 802.3at (30 W), 2 PoE ports according to IEEE 802.3bt (60 W)
• with securing collar with PoE	--	6	6
<b>number of electrical connections</b> • for SFP	--	2	2
<b>Interfaces for communication plug-in</b>			
<b>Number of electrical connections</b> • for SFP+	--	2; SFPs with 1000 Mbps or 10,000 Mbps possible; 100 Mbps with SFP991-1(LD) A possible	2; SFPs with 1000 Mbps or 10,000 Mbps possible; 100 Mbps with SFP991-1(LD) A possible
<b>Interfaces others</b>			
<b>Number of electrical connections</b> • for operator console • for signaling contact • for power supply	1 1 1	1 1 --	1 1 --
<b>Type of electrical connection</b> • for operator console • for signaling contact • for power supply	RJ11 2-pole terminal block 4-pole terminal block	RJ11 2-pole terminal block 4-pole terminal block	RJ11 2-pole terminal block 4-pole terminal block
<b>design of the removable storage</b> • C-PLUG	Yes	Yes	Yes
<b>Signal-inputs/outputs</b>			
<b>Operating voltage of the signaling contacts</b> • at DC rated value	24 V	24 V	54 V
<b>Operating current of the signaling contacts</b> • at DC maximum	0.1 A	0.1 A	0.1 A
<b>Supply voltage, current consumption, power loss</b>			
<b>product component connection for redundant voltage supply</b>	Yes	Yes	Yes
<b>supplied active power of PSE with PoE</b> • total maximum		144 W	260 W
<b>Type of voltage 1 of the supply voltage</b> • Supply voltage 1 rated value • power loss (W) 1 rated value • consumed current 1 at rated supply voltage maximum • supply voltage 1 rated value • consumed current 1 maximum • type of electrical connection 1 for power supply • product component 1 fusing at power supply input • fuse protection type 1 at input for supply voltage	DC 24 V 4.3 W 0.26 A 9.6 ... 31.2 V 0.36 A 4-pole terminal block Yes 2.5 A / 125 V	DC 24 V 18 W -- 19.2 ... 31.2 V 6 A -- Yes 15 A / 125 V	DC 54 V 10 W -- 52 ... 57 V 5 A -- Yes 15 A / 125 V
<b>ambient conditions</b>			
<b>ambient temperature</b> • during operation • during storage • during transport • Note	-40 ... +70 °C -40 ... +85 °C -40 ... +85 °C --	-40 ... +60 °C -40 ... +85 °C -40 ... +85 °C installation position and SFPs used during the operation have to be considered (see manual)	-40 ... +60 °C -40 ... +85 °C -40 ... +85 °C installation position and SFPs used during the operation have to be considered (see manual)
<b>relative humidity</b> • at 25 °C without condensation during operation maximum	95 %	95 %	95 %
<b>protection class IP</b>	IP20	IP20	IP20
<b>Design, dimensions and weight</b>			
<b>Design</b>	compact	compact	compact
<b>Width</b>	60 mm	100 mm	60 mm
<b>Height</b>	147 mm	147 mm	147 mm
<b>Depth</b>	125 mm	125 mm	125 mm
<b>Net weight</b>	0.52 kg	0.955 kg	0.54 kg
<b>product feature conformal coating</b>	No	No	No
<b>Material of the enclosure</b>	Polycarbonate (PC-GF10) pressure die cast aluminum	Polycarbonate (PC-GF10) pressure die cast aluminum	Polycarbonate (PC-GF10) pressure die cast aluminum

## Network Components

### SCALANCE X - Industrial Ethernet Switches

#### SCALANCE XC-200 managed

Article number	6GK5208-0GA00-2AC2	6GK5206-2RS00-2AC2	6GK5206-2RS00-5AC2
Product type designation	SCALANCE XC208G	SCALANCE XC206-2G PoE	SCALANCE XC206-2G PoE (DC 54 V)
<b>Fastening method</b>			
• 35 mm top hat DIN rail mounting	Yes	Yes	Yes
• wall mounting	Yes	Yes	Yes
• S7-300 rail mounting	Yes	Yes	Yes
• S7-1500 rail mounting	Yes	Yes	Yes
<b>Product properties, functions, components general</b>			
<b>Cascading in the case of a redundant ring at reconfiguration time of &lt;math&gt;\leq 0.3&lt;/math&gt;-s</b>	50	50	50
<b>Cascading in cases of star topology</b>	any (depending only on signal propagation time)	any (depending only on signal propagation time)	any (depending only on signal propagation time)
<b>Product function QoS according to DSCP</b>	Yes	Yes	Yes
<b>Product feature</b>			
• Cut Through switching method	No	No	No
• Store & Forward switching method	Yes	Yes	Yes
<b>Product functions management, configuration, engineering</b>			
<b>Product function</b>			
• CLI	Yes	Yes	Yes
• web-based management	Yes	Yes	Yes
• MIB support	Yes	Yes	Yes
• TRAPs via email	Yes	Yes	Yes
• Configuration with STEP 7	Yes	Yes	Yes
• RMON	Yes	Yes	Yes
• SMTP server	No	No	No
• Port mirroring	Yes	Yes	Yes
• multiport mirroring	Yes	Yes	Yes
• CoS	Yes	Yes	Yes
• PROFINET IO diagnosis	Yes	Yes	Yes
<b>PROFINET conformity class</b>	B	B	B
<b>Network load class according to PROFINET</b>	3	3	3
<b>Product function switch-managed</b>	Yes	Yes	Yes
<b>Telegram length for Ethernet maximum</b>	10240 byte	10240 byte	10240 byte
<b>Protocol is supported</b>			
• Telnet	Yes	Yes	Yes
• HTTP	Yes	Yes	Yes
• HTTPS	Yes	Yes	Yes
• TFTP	Yes	Yes	Yes
• BOOTP	No	No	No
• GMRP	Yes	Yes	Yes
• DCP	Yes	Yes	Yes
• LLDP	Yes	Yes	Yes
• EtherNet/IP	Yes	Yes	Yes
• SNMP v1	Yes	Yes	Yes
• SNMP v2	Yes	Yes	Yes
• SNMP v3	Yes	Yes	Yes
• IGMP (snooping/querier)	Yes	Yes	Yes
<b>Identification &amp; maintenance function</b>			
• I&MO - device-specific information	Yes	Yes	Yes
• I&M1 - higher-level designation/location designation	Yes	Yes	Yes
<b>Product functions Diagnosis</b>			
<b>Product function</b>			
• Port diagnostics	Yes	Yes	Yes
• Statistics packet size	Yes	Yes	Yes
• Statistics packet type	Yes	Yes	Yes
• Error statistics	Yes	Yes	Yes
• SysLog	Yes	Yes	Yes
<b>Product functions VLAN</b>			
<b>Product function</b>			
• VLAN - port based	Yes	Yes	Yes
• VLAN - protocol-based	No	No	No
• VLAN - IP-based	No	No	No
<b>Number of VLANs maximum</b>	257	257	257
<b>Number of VLANs - dynamic maximum</b>	257	257	257
<b>number of VLANs / at ring redundancy (HRP; MRP; standby link)</b>	35	35	35
<b>Protocol is supported GVRP</b>	Yes	Yes	Yes
<b>Product functions DHCP</b>			
<b>Product function</b>			
• DHCP server	Yes	Yes	Yes
• DHCP client	Yes	Yes	Yes
• DHCP Option 82	Yes	Yes	Yes
• DHCP Option 66	Yes	Yes	Yes
• DHCP Option 67	Yes	Yes	Yes

## Network Components

### SCALANCE X - Industrial Ethernet Switches

#### SCALANCE XC-200 managed

Article number	6GK5208-0GA00-2AC2	6GK5206-2RS00-2AC2	6GK5206-2RS00-5AC2
Product type designation	SCALANCE XC208G	SCALANCE XC206-2G PoE	SCALANCE XC206-2G PoE (DC 54 V)
<b>Product functions redundancy</b>			
<b>Product function</b>			
• of the PROFINET IO device is supported PROFINET system redundancy	Yes	Yes	Yes
• Ring redundancy	Yes	Yes	Yes
• High Speed Redundancy Protocol (HRP)	Yes	Yes	Yes
• high speed redundancy protocol (HRP) with redundancy manager	Yes	Yes	Yes
• high speed redundancy protocol (HRP) with standby redundancy	Yes	Yes	Yes
<b>Protocol is supported Media Redundancy Protocol (MRP)</b>	Yes	Yes	Yes
<b>Product function</b>			
• media redundancy protocol (MRP) with redundancy manager	Yes	Yes	Yes
• Media Redundancy Protocol Interconnection (MRPI)	Yes	Yes	Yes
• of the PROFINET IO device / is supported / H-Sync forwarding	Yes	Yes	Yes
• redundancy procedure STP	Yes	Yes	Yes
• redundancy procedure RSTP	Yes	Yes	Yes
• redundancy procedure RSTP+	Yes	Yes	Yes
• redundancy procedure MSTP	Yes	Yes	Yes
• Parallel Redundancy Protocol (PRP)/operation in the PRP-network	Yes	Yes	Yes
• Parallel Redundancy Protocol (PRP)/Redundant Network Access (RNA)	No	No	No
• Passive listening	Yes	Yes	Yes
<b>Protocol is supported</b>			
• LACP	Yes	Yes	Yes
<b>Product functions Security</b>			
<b>Product function</b>			
• IEEE 802.1x (radius)	Yes	Yes	Yes
• Broadcast/Multicast/Unicast Limiter	Yes	Yes	Yes
• broadcast blocking	Yes	Yes	Yes
<b>Protocol is supported</b>			
• SSH	Yes	Yes	Yes
• SSL	Yes	Yes	Yes
<b>Product functions Time</b>			
<b>Product function</b>			
• SICLOCK support	Yes	Yes	Yes
• NTP-client	Yes	Yes	Yes
• SNTP client	Yes	Yes	Yes
<b>Protocol is supported</b>			
• NTP	Yes	Yes	Yes
• SNTP	Yes	Yes	Yes
<b>system modification during operation</b>			
<b>product function configuration in RUN via CiR/H-CiR</b>	Yes	Yes	Yes
<b>standards, specifications, approvals</b>			
<b>Standard</b>			
• for emitted interference	--	EN 61000-6-4:2001 (Class A)	EN 61000-6-4:2001 (Class A)
• for interference immunity	--	EN 61000-6-2:2001	EN 61000-6-2:2001
<b>IT security for industrial automation systems / according to IEC 62443-4-2:2019</b>	Yes	Yes	Yes
<b>MTBF</b>	54 y	42 y	37 y
<b>Reference code</b>			
• according to IEC 81346-2	KF	KF	KF
• according to IEC 81346-2:2019	KFE	KFE	KFE
<b>Standards, specifications, approvals CE</b>			
<b>Certificate of suitability CE marking</b>	Yes	Yes	Yes
<b>Product conformity according to EMC-guideline</b>	2014/30/EU	2014/30/EU	2014/30/EU
<b>Standard</b>			
• for EMC interference emission	EN 61000-6-4, EN 50121-9	EN 61000-6-4, EN 50121-15	EN 61000-6-4, EN 50121-15
• for immunity to EMI	EN 61000-6-2, EN 50121-4	EN 61000-6-2, EN 50121-4	EN 61000-6-2, EN 50121-4
<b>Certificate of suitability RoHS conformity</b>	Yes; 2011/65/EU	Yes; 2011/65/EU	Yes; 2011/65/EU



## Network Components

### SCALANCE X - Industrial Ethernet Switches

#### SCALANCE XC-200 managed

Article number	6GK5208-0GA00-2AC2	6GK5206-2RS00-2AC2	6GK5206-2RS00-5AC2
Product type designation	SCALANCE XC208G	SCALANCE XC206-2G PoE	SCALANCE XC206-2G PoE (DC 54 V)
<b>Standards, specifications, approvals / hazardous environments</b>			
<b>Certificate of suitability</b>			
<ul style="list-style-type: none"> <li>• ATEX</li> <li>• for ATEX as marking</li> <li>• for ATEX as certificate</li> <li>• IECEx</li> <li>• for IECEx as marking</li> <li>• for IECEx as certificate</li> <li>• CCC for hazardous zone according to GB standard</li> <li>• for cULus HazLoc as marking</li> <li>• for cULus HazLoc as File Nr.</li> <li>• FM registration</li> <li>• for FM as marking</li> <li>• for FM as certificate</li> </ul>	Yes; EN 60079-0, EN 60079-15 II 3 G Ex nA II T4 Gc KEMA 07ATEX0145 X Yes; IEC 60079-0, IEC 60079-15 Ex nA II T4 Gc IECEx DEK 14.0025X Yes CL1, DIV2, Group A,B,C,D T4, CL1, Zone 2, Group IIC, T4 E240480 (NWHP, NWHP7) Yes; FM class 3600:2011, FM class 3611:2004, FM class 3810:2005, ANSI/ISA-61010-1:2004 CL1, DIV2, group A,B,C,D T4, CL1, Zone 2, group IIC, T4 Ta: -40 °C +70 °C FM16US0205X	Yes -- -- Yes -- -- -- CL1, DIV2, Group A,B,C,D T4, CL1, Zone 2, Group IIC, T4 -- Yes CL1, DIV2, group A,B,C,D T4, CL1, Zone 2, group IIC, T4 Ta: -40 °C +70 °C --	Yes -- -- Yes Yes CL1, DIV2, Group A,B,C,D T4, CL1, Zone 2, Group IIC, T4 Yes -- CL1, DIV2, group A,B,C,D T4, CL1, Zone 2, group IIC, T4 Ta: -40 °C +70 °C --
<b>standards, specifications, approvals other</b>			
<b>Certificate of suitability</b>			
<ul style="list-style-type: none"> <li>• KC approval</li> <li>• Railway application in accordance with EN 50121-4</li> <li>• Regulatory Compliance Mark (RCM)</li> <li>• for UL 61010-2-201 as File Nr.</li> <li>• for UL 60950-1 as File Nr.</li> <li>• EAC approval</li> </ul>	-- Yes Yes E85972 (NRAQ, NRAQ7) E115352 (NWGQ, NWGQ7) Yes	Yes Yes Yes E85972 (NRAQ, NRAQ7) -- Yes	Yes Yes Yes E85972 (NRAQ, NRAQ7) -- Yes
<b>Accessories</b>			
<b>Product extension optional C-PLUG</b>	Yes	Yes	
<b>Transfer rate</b>			
<b>Transfer rate</b>	10/100/1000 Mbit/s, 10 Gbit/s	10/100/1000 Mbit/s, 10 Gbit/s	10/100/1000 Mbit/s, 10 Gbit/s
<b>Interfaces for communication integrated</b>			
<b>Number of electrical connections</b>			
• for network components or terminal equipment	6; RJ45	8; RJ45	8; RJ45
<b>Number of 10/100 Mbit/s RJ45 ports integrated</b>			
• with securing collar	4 PoE ports according to IEEE 802.3at (30 W), 2 PoE ports according to IEEE 802.3bt (60 W) 6	2; 4 PoE ports according to IEEE 802.3at (30 W), 2 PoE ports according to IEEE 802.3bt (60 W) 6	2; 4 PoE ports according to IEEE 802.3at (30 W), 2 PoE ports according to IEEE 802.3bt (60 W) 6
• with securing collar with PoE	6	6	6
<b>number of electrical connections</b>			
• for SFP	2	--	--
<b>Interfaces for communication plug-in</b>			
<b>Number of electrical connections</b>			
• for SFP+	2; SFPs with 1000 Mbps or 10,000 Mbps possible; 100 Mbps with SFP991-1(LD) A possible	--	--
<b>Interfaces others</b>			
<b>Number of electrical connections</b>			
• for operator console	1	1	1
• for signaling contact	1	1	1
<b>Type of electrical connection</b>			
• for operator console	RJ11	RJ11	RJ11
• for signaling contact	2-pole terminal block	2-pole terminal block	2-pole terminal block
• for power supply	4-pole terminal block	4-pole terminal block	4-pole terminal block
<b>design of the removable storage</b>			
• C-PLUG	Yes	Yes	Yes
<b>Signal-inputs/outputs</b>			
<b>Operating voltage of the signaling contacts</b>			
• at DC rated value	54 V	24 V	54 V
<b>Operating current of the signaling contacts</b>			
• at DC maximum	0.1 A	0.1 A	0.1 A

## Network Components

### SCALANCE X - Industrial Ethernet Switches

#### SCALANCE XC-200 managed

Article number	6GK5206-2RS00-5FC2	6GK5208-0RA00-2AC2	6GK5208-0RA00-5AC2
Product type designation	SCALANCE XC206-2G PoE EEC (DC 54 V)	SCALANCE XC208G PoE	SCALANCE XC208G PoE (DC 54 V)
<b>Supply voltage, current consumption, power loss</b>			
<b>product component connection for redundant voltage supply</b>	Yes	Yes	Yes
<b>supplied active power of PSE with PoE</b>			
• total maximum	260 W	144 W	260 W
<b>Type of voltage 1 of the supply voltage</b>	DC	DC	DC
• Supply voltage 1 rated value	54 V	24 V	54 V
• power loss (W) 1 rated value	10 W	--	--
• consumed current 1 at rated supply voltage maximum	--	6 A	5 A
• supply voltage 1 rated value	52 ... 57 V	19.2 ... 31.2 V	52 ... 57 V
• consumed current 1 maximum	5 A	7.5 A	5 A
• product component 1 fusing at power supply input	Yes	--	--
• fuse protection type 1 at input for supply voltage	15 A / 125 V	15 A / 125 V	15 A / 125 V
<b>Ambient conditions</b>			
<b>ambient temperature</b>			
• during operation	-40 ... +60 °C	-40 ... +60 °C	-40 ... +60 °C
• during storage	-40 ... +85 °C	-40 ... +85 °C	-40 ... +85 °C
• during transport	-40 ... +85 °C	-40 ... +85 °C	-40 ... +85 °C
• Note	installation position and SFPs used during the operation have to be considered (see manual)	installation position and SFPs used during the operation have to be considered (see manual)	installation position and SFPs used during the operation have to be considered (see manual)
<b>Installation altitude / at height above sea level / maximum</b>	4000 m	--	
<b>relative humidity</b>			
• at 25 °C without condensation during operation maximum	95 %	95 %	95 %
<b>protection class IP</b>	IP20	IP20	IP20
<b>Design, dimensions and weight</b>			
<b>Design</b>	compact	compact	compact
<b>Width</b>	60 mm	100 mm	60 mm
<b>Height</b>	147 mm	147 mm	147 mm
<b>Depth</b>	125 mm	125 mm	125 mm
<b>Net weight</b>	0.54 kg	0.955 kg	0.54 kg
<b>product feature conformal coating</b>	Yes	No	No
<b>Material of the enclosure</b>	Polycarbonate (PC-GF10) pressure die cast aluminum	Polycarbonate (PC-GF10) pressure die cast aluminum	Polycarbonate (PC-GF10) pressure die cast aluminum
<b>Fastening method</b>			
• 35 mm top hat DIN rail mounting	Yes	Yes	Yes
• wall mounting	Yes	Yes	Yes
• S7-300 rail mounting	Yes	Yes	Yes
• S7-1500 rail mounting	Yes	Yes	Yes
<b>Product properties, functions, components general</b>			
<b>Cascading in the case of a redundant ring at reconfiguration time of &lt;math&gt;\leq 0.3&lt;/math&gt;-s</b>	50	50	50
<b>Cascading in cases of star topology</b>	any (depending only on signal propagation time)	any (depending only on signal propagation time)	any (depending only on signal propagation time)
<b>Product function QoS according to DSCP</b>	Yes	Yes	Yes
<b>Product feature</b>			
• Cut Through switching method	No	No	No
• Store & Forward switching method	Yes	Yes	Yes
<b>Product functions management, configuration, engineering</b>			
<b>Product function</b>			
• CLI	Yes	Yes	Yes
• web-based management	Yes	Yes	Yes
• MIB support	Yes	Yes	Yes
• TRAPs via email	Yes	Yes	Yes
• Configuration with STEP 7	Yes	Yes	Yes
• RMON	Yes	Yes	Yes
• SMTP server	No	No	No
• Port mirroring	Yes	Yes	Yes
• multipoint mirroring	Yes	Yes	Yes
• CoS	Yes	Yes	Yes
• PROFINET IO diagnosis	Yes	Yes	Yes
<b>PROFINET conformity class</b>	B	B	B
<b>Network load class according to PROFINET</b>	3	3	3
<b>Product function switch-managed</b>	Yes	Yes	Yes
<b>Telegram length for Ethernet maximum</b>	10240 byte	10240 byte	10240 byte

## Network Components

### SCALANCE X - Industrial Ethernet Switches

#### SCALANCE XC-200 managed

Article number	6GK5206-2RS00-5FC2	6GK5208-0RA00-2AC2	6GK5208-0RA00-5AC2
Product type designation	SCALANCE XC206-2G PoE EEC (DC 54 V)	SCALANCE XC208G PoE	SCALANCE XC208G PoE (DC 54 V)
<b>Protocol is supported</b>			
• Telnet	Yes	Yes	Yes
• HTTP	Yes	Yes	Yes
• HTTPS	Yes	Yes	Yes
• TFTP	Yes	Yes	Yes
• BOOTP	No	No	No
• GMRP	Yes	Yes	Yes
• DCP	Yes	Yes	Yes
• LLDP	Yes	Yes	Yes
• EtherNet/IP	Yes	Yes	Yes
• SNMP v1	Yes	Yes	Yes
• SNMP v2	Yes	Yes	Yes
• SNMP v3	Yes	Yes	Yes
• IGMP (snooping/querier)	Yes	Yes	Yes
<b>Identification &amp; maintenance function</b>			
• I&MO - device-specific information	Yes	Yes	Yes
• I&M1 - higher-level designation/location designation	Yes	Yes	Yes
<b>Product functions Diagnosis</b>			
<b>Product function</b>			
• Port diagnostics	Yes	Yes	Yes
• Statistics packet size	Yes	Yes	Yes
• Statistics packet type	Yes	Yes	Yes
• Error statistics	Yes	Yes	Yes
• SysLog	Yes	Yes	Yes
<b>Product functions VLAN</b>			
<b>Product function</b>			
• VLAN - port based	Yes	Yes	Yes
• VLAN - protocol-based	No	No	No
• VLAN - IP-based	No	No	No
<b>Number of VLANs maximum</b>	257	257	257
<b>Number of VLANs - dynamic maximum</b>	257	257	257
<b>number of VLANs / at ring redundancy (HRP; MRP; standby link)</b>	35	35	35
<b>Protocol is supported GVRP</b>	Yes	Yes	Yes
<b>Product functions DHCP</b>			
<b>Product function</b>			
• DHCP server	Yes	Yes	Yes
• DHCP client	Yes	Yes	Yes
• DHCP Option 82	Yes	Yes	Yes
• DHCP Option 66	Yes	Yes	Yes
• DHCP Option 67	Yes	Yes	Yes
<b>Product functions redundancy</b>			
<b>Product function</b>			
• of the PROFINET IO device is supported PROFINET system redundancy	Yes	Yes	Yes
• Ring redundancy	Yes	Yes	Yes
• High Speed Redundancy Protocol (HRP)	Yes	Yes	Yes
• high speed redundancy protocol (HRP) with redundancy manager	Yes	Yes	Yes
• high speed redundancy protocol (HRP) with standby redundancy	Yes	Yes	Yes
<b>Protocol is supported Media Redundancy Protocol (MRP)</b>	Yes	Yes	Yes
<b>Product function</b>			
• media redundancy protocol (MRP) with redundancy manager	Yes	Yes	Yes
• Media Redundancy Protocol Interconnection (MRPI)	Yes	Yes	Yes
• of the PROFINET IO device / is supported / H-Sync forwarding	Yes	Yes	Yes
• redundancy procedure STP	Yes	Yes	Yes
• redundancy procedure RSTP	Yes	Yes	Yes
• redundancy procedure RSTP+	Yes	Yes	Yes
• redundancy procedure MSTP	Yes	Yes	Yes
• Parallel Redundancy Protocol (PRP)/operation in the PRP-network	Yes	Yes	Yes
• Parallel Redundancy Protocol (PRP)/Redundant Network Access (RNA)	No	No	No
• Passive listening	Yes	Yes	Yes
<b>Protocol is supported</b>			
• LACP	Yes	Yes	Yes
<b>Product functions Security</b>			
<b>Product function</b>			
• IEEE 802.1x (radius)	Yes	Yes	Yes
• Broadcast/Multicast/Unicast Limiter	Yes	Yes	Yes
• broadcast blocking	Yes	Yes	Yes
<b>Protocol is supported</b>			
• SSH	Yes	Yes	Yes
• SSL	Yes	Yes	Yes

## Network Components

### SCALANCE X - Industrial Ethernet Switches

#### SCALANCE XC-200 managed

Article number	6GK5206-2RS00-5FC2	6GK5208-0RA00-2AC2	6GK5208-0RA00-5AC2
Product type designation	SCALANCE XC206-2G PoE EEC (DC 54 V)	SCALANCE XC208G PoE	SCALANCE XC208G PoE (DC 54 V)
<b>Product functions time</b>			
<b>Product function</b>			
• SICLOCK support	Yes	Yes	Yes
• NTP-client	Yes	Yes	Yes
• SNTP client	Yes	Yes	Yes
<b>Protocol is supported</b>			
• NTP	Yes	Yes	Yes
• SNTP	Yes	Yes	Yes
<b>system modification during operation</b>			
<b>product function configuration in RUN via CiR/H-CiR</b>	Yes	Yes	Yes
<b>standards, specifications, approvals</b>			
<b>standard</b>			
• for emitted interference	EN 61000-6-4:2001 (Class A)s	EN 61000-6-4:2001 (Class A)	--
• for interference immunity	EN 61000-6-2:2001	EN 61000-6-2:2001	--
<b>IT security for industrial automation systems / according to IEC 62443-4-2:2019</b>	Yes	Yes	Yes
<b>MTBF</b>	37 y	42 y	37 y
<b>reference code</b>			
• according to IEC 81346-2	KF	KF	KF
• according to IEC 81346-2:2019	KFE	KFE	KFE
<b>Standards, specifications, approvals CE</b>			
<b>Certificate of suitability CE marking</b>	Yes	Yes	Yes
<b>Product conformity according to EMC-guideline</b>	2014/30/EU	2014/30/EU	2014/30/EU
<b>Standard</b>			
• for EMC interference emission	EN 61000-6-4, EN 50121-15	EN 61000-6-4, EN 50121-15	EN 61000-6-4, EN 50121-15
• for immunity to EMI	EN 61000-6-2, EN 50121-4	EN 61000-6-2, EN 50121-4	EN 61000-6-2, EN 50121-4
Certificate of suitability RoHS conformity	Yes; 2011/65/EU	Yes; 2011/65/EU	Yes; 2011/65/EU
<b>Standards, specifications, approvals / hazardous environments</b>			
<b>Certificate of suitability</b>			
• ATEX	Yes	Yes	Yes
• IECEX	Yes; IEC 60079-0, IEC 60079-15	Yes	Yes
• for IECEX as marking	Ex nA II T4 Gc	--	--
• for IECEX as certificate	IECEX DEK 14.0025X	--	--
• CCC for hazardous zone according to GB standard	Yes	Yes	Yes
• for cULus HazLoc as marking	CL1, DIV2, Group A,B,C,D T4, CL1, Zone 2, Group IIC, T4	CL1, DIV2, Group A,B,C,D T4, CL1, Zone 2, Group IIC, T4	CL1, DIV2, Group A,B,C,D T4, CL1, Zone 2, Group IIC, T4
• FM registration	Yes; FM class 3600:2011, FM class 3611:2004, FM class 3810:2005, ANSI/ISA-61010-1:2004	Yes	--
• for FM as marking	CL1, DIV2, group A,B,C,D T4, CL1, Zone 2, group IIC, T4 Ta: -40 °C +70 °C	CL1, DIV2, group A,B,C,D T4, CL1, Zone 2, group IIC, T4 Ta: -40 °C +70 °C	CL1, DIV2, group A,B,C,D T4, CL1, Zone 2, group IIC, T4 Ta: -40 °C +70 °C
<b>standards, specifications, approvals other</b>			
<b>Certificate of suitability</b>			
• KC approval	Yes	Yes	Yes
• Railway application in accordance with EN 50121-4	Yes	Yes	Yes
• Regulatory Compliance Mark (RCM)	Yes	Yes	Yes
• for UL 61010-2-201 as File Nr.	E85972 (NRAQ, NRAQ7)	E85972 (NRAQ, NRAQ7)	E85972 (NRAQ, NRAQ7)
• EAC approval	Yes	Yes	Yes
<b>Accessories</b>			
<b>Product extension optional C-PLUG</b>	Yes	Yes	Yes

### Selection and ordering data

Version	Article No.
<b>SCALANCE XC-200 Industrial Ethernet switches</b> Industrial Ethernet switches with integrated SNMP access, online diagnostics, copper cable diagnostics and PROFINET diagnostics for configuring line, star and ring topologies; with integrated redundancy manager; incl. operating instructions, Industrial Ethernet network manual and configuration software on CD-ROM	
<ul style="list-style-type: none"> <li>• <b>SCALANCE XC208G</b> with 8x RJ45 ports 10/100/1000 Mbit/s</li> <li>• <b>SCALANCE XC206-2G PoE</b> with 6x RJ45 PoE ports 10/100/1000 Mbps and 2x SFP+ 1000/10000 Mbps</li> <li>• <b>SCALANCE XC206-2G PoE (DC 54 V)</b> with 6x RJ45 PoE ports 10/100/1000 Mbps and 2x SFP+ 1000/10000 Mbps, PoE support for 54 V DC Infeed</li> <li>• <b>SCALANCE XC206-2G PoE EEC (DC 54 V)</b> with 6x RJ45 PoE ports 10/100/1000 Mbps and 2x SFP+ 1000/10000 Mbps, PoE support for 54 V DC Infeed</li> <li>• <b>SCALANCE XC208G PoE</b> with 6x RJ45 PoE ports 10/100/1000 Mbps and 2x RJ45 ports 10/100/1000 Mbps</li> <li>• <b>SCALANCE XC208G PoE (DC 54 V)</b> with 6x RJ45 PoE ports 10/100/1000 Mbps and 2x RJ45 ports 10/100/1000 Mbps, PoE support for 54 V DC Infeed</li> <li>• <b>SCALANCE XC206-2 (ST/BFOC)</b> with six RJ45 ports 10/100 Mbps and two ST/BFOC ports 100 Mbps</li> <li>• <b>SCALANCE XC206-2 (SC)</b> with six RJ45 ports 10/100 Mbps and two SC ports 100 Mbps</li> <li>• <b>SCALANCE XC206-2SFP</b> with six RJ45 ports 10/100 Mbps and two SFP slots for SFPs with 100 or 1 000 Mbps</li> <li>• <b>SCALANCE XC208</b> with eight RJ45 ports 10/100 Mbps</li> <li>• <b>SCALANCE XC216</b> with sixteen RJ45 ports 10/100 Mbps</li> <li>• <b>SCALANCE XC224</b> with twenty-four RJ45 ports 10/100 Mbps</li> </ul>	<b>6GK5208-0GA00-2AC2</b>  <b>6GK5206-2RS00-2AC2</b>  <b>6GK5206-2RS00-5AC2</b>  <b>6GK5206-2RS00-5FC2</b>  <b>6GK5208-0RA00-2AC2</b>  <b>6GK5208-0RA00-5AC2</b>  <b>6GK5206-2BB00-2AC2</b>  <b>6GK5206-2BD00-2AC2</b>  <b>6GK5206-2BS00-2AC2</b>  <b>6GK5208-0BA00-2AC2</b>  <b>6GK5216-0BA00-2AC2</b>  <b>6GK5224-0BA00-2AC2</b>
<b>Accessories</b>	
<b>FC RJ 45 port lock</b> Mechanical locking of unused RJ45 ports at network components and end devices. For use on devices with and without retaining collar <sup>2)</sup>	<b>6GK1901-1BB50-0AA0</b>
<b>C-PLUG</b> Removable data storage medium for simple replacement of devices in the event of a fault; for storing configuration or engineering and application data; can be used for SIMATIC NET products with C-PLUG slot <ul style="list-style-type: none"> <li>• 1 pack = 1 unit</li> </ul>	<b>6GK1900-0AB10</b>
<b>Push-in terminal block</b> For Scalance X/S <ul style="list-style-type: none"> <li>• 2-pin for signaling contact (24 V DC) 1 pack = 5 units</li> <li>• 4-pin for power supply (24 V DC) 1 pack = 5 units</li> </ul>	<b>6GK5980-0BB10-0AA5</b>  <b>6GK5980-1DB10-0AA5</b>
<b>Screw-type terminal block</b> For Scalance X/W/S <ul style="list-style-type: none"> <li>• 2-pin for signaling contact (24 V DC) 1 pack = 5 units</li> <li>• 4-pin for power supply (24 V DC) 1 pack = 5 units</li> </ul>	<b>6GK5980-0BB00-0AA5</b>  <b>6GK5980-1DB00-0AA5</b>
<b>Fixing screw</b> for SCALANCE X/W Screw for mounting on an S7-1500 and S7-300 mounting rail 1 pack = 5 units	<b>6GK5980-4AA00-0AA5</b>
<b>SFP plug-in transceiver</b> See "Plug-in transceivers for SCALANCE XR-500" / "Media modules for modular SCALANCE X-500"	
<b>IE FC RJ45 plug 180 2x2</b> Industrial Ethernet FastConnect RJ45 plug 180 2x2, RJ45 connector (10/100 Mbps) with rugged metal enclosure and FC connection technology, for IE FC cable 2x2 180° cable outlet 1 pack = 1 unit	<b>6GK1901-1BB10-2AA0</b>
<b>IE FC RJ45 plug 4x2</b> RJ45 plug-in data connector (10/100/1000 Mbps), for connection to IE FC TP cables 4x2, with rugged metal enclosure and FastConnect connection technology	<b>6GK1901-1BB11-2AA0</b>

## Network Components

### SCALANCE X - Industrial Ethernet Switches

#### SCALANCE XC-200 managed

Version	Article No.
<b>IE FC TP standard cable GP 2 x 2 (Type A)</b> 4-core, shielded TP installation cable for connection to IE FC outlet RJ45/IE FC RJ45 plug; PROFINET-compliant; with UL approval; sold by the meter; max. length 1 000 m, minimum order 20 m	<b>6XV1840-2AH10</b>
<b>IE FC TP standard cable GP 4x2</b> TP installation cable Cat 6 for connection to IE FC RJ45 plug 4x2, AWG24, sold by the meter; max. length 1 000 m, minimum order quantity 20 m	<b>6XV1878-2A</b>
<b>IE FC TP standard cable GP 4x2</b> Shielded TP installation cable capable of 1 000 Mbps, for connection to FC RJ45 modular outlet, 8-wire, AWG22, with rigid cores for final assembly	<b>6XV1870-2E</b>
<b>IE connecting cable IE FC RJ45 plug 180/IE FC RJ45 plug 180</b> IE FC trailing cable GP, preassembled with 2x IE FC RJ45 plugs 180; length: <ul style="list-style-type: none"> <li>• 1.0 m</li> <li>• 5.0 m</li> <li>• 10.0 m</li> </ul>	<b>6XV1871-5BH10</b> <b>6XV1871-5BH50</b> <b>6XV1871-5BN10</b>
<b>FastConnect stripping tool</b> Industrial Ethernet FastConnect stripping tool, for fast stripping of the Industrial Ethernet FastConnect cable	<b>6GK1901-1GA00</b>
<b>FC FO standard cable GP 62.5/200/230<sup>1) 2)</sup></b> FC FO standard cable (62.5/200/230) for field assembly, cULus approval, standard cable divisible	<b>6XV1847-2A</b>
<b>FO standard cable GP 50/125/1400<sup>1) 2)</sup></b> Multimode cable, sold by the meter; max. length 1 000 m; minimum order 20 m	<b>6XV1873-2A</b>
<b>MM FO cord LC/LC</b> 50/125; preassembled with 2x2 LC duplex connectors; length 1.0 m	<b>6XV1843-5EH10-0AA0</b>
<b>MM FO cord SC/LC</b> 50/125; preassembled with 1x SC duplex connector and 1x LC duplex connector; length 1.0 m	<b>6XV1843-5EH10-0CA0</b>
<b>MM FO cord SC/BFOC</b> 50/125; preassembled with 1x SC duplex connector and 1x BFOC connector; length 1.0 m	<b>6XV1843-5EH10-0CB0</b>
<b>MM FO cord SC/SC</b> 50/125; preassembled with 2x SC duplex connectors; length 1.0 m	<b>6XV1843-5EH10-0CC0</b>
<b>MM FO cord LC/LC</b> 9/125; preassembled with 2x2 LC duplex connectors; length 1.0 m	<b>6XV1843-5FH10-0AA0</b>
<b>MM FO cord SC/LC</b> 9/125; preassembled with 1x SC duplex connector and 1x LC duplex connector; length 1.0 m	<b>6XV1843-5FH10-0CA0</b>
<b>MM FO cord SC/BFOC</b> 9/125; preassembled with 1x SC duplex connector and 1x BFOC connector; length 1.0 m	<b>6XV1843-5FH10-0CB0</b>
<b>MM FO cord SC/SC</b> 9/125; preassembled with 2x2 SC duplex connectors; length 1.0 m	<b>6XV1843-5FH10-0CC0</b>
<b>MM FO robust cable GP</b> FO robust cable GP 50/125, preassembled with 2 x LC duplex connectors Length: <ul style="list-style-type: none"> <li>• 1.0 m</li> <li>• 2.0 m</li> <li>• 3.0 m</li> <li>• 10.0 m</li> <li>• 30.0 m</li> <li>• 50.0 m</li> <li>• 100.0 m</li> <li>• 150.0 m</li> </ul>	<b>6XV1873-5RH10</b> <b>6XV1873-5RH20</b> <b>6XV1873-5RH30</b> <b>6XV1873-5RN10</b> <b>6XV1873-5RN30</b> <b>6XV1873-5RN50</b> <b>6XV1873-5RT10</b> <b>6XV1873-5RT15</b>
<b>5 x FC SC duplex plugs</b> FC FO SC plugs for on-site mounting on FC FO cables (62.5/200/230)	<b>6GK1900-1LB00-0AC0</b>

Version	Article No.
<b>MM FO SC connector set</b> 10 duplex connectors for FO cable; standard, trailing, indoor and marine cable; Note: special tools and skilled personnel are required for assembly; adhesive bonding and polishing technology	<b>6GK1901-0LB10-2AA0</b>
<b>MM FO LC duplex plug</b> 10 units for MM FO robust cable GP (2G50/125); Note: special tools and skilled personnel are required for assembly; adhesive bonding and polishing technology	<b>6GK1901-0RB10-2AB0</b>
<b>FC FO Termination Kit</b> Termination Kit for local assembly of FC SC and FC BFOC connectors to FC FO standard cable; comprising a stripping tool, Kevlar cutters, fiber breaking tool and microscope	<b>6GK1900-1GL00-0AA0</b>
<b>FC ST/ BFOC plug</b> Screw connector for on-site assembly on FC fiber-optic cable; (1 pack = 10 units + cleaning cloths)	<b>6GK1900-1GB00-0AC0</b>
<b>Serial cable RJ11/RS232</b> Preassembled serial cable with RJ11 and RS232 connectors; length: 3 m; 1 pack = 1 unit	<b>6GK5980-3BB00-0AA5</b>
<b>SCALANCE TAP104</b> Test access port for the reaction-free extraction of Ethernet data frames (10/100 Mbps) from both transmission directions; extracts entire data traffic (including incomplete diagrams) for further diagnostics.	<b>6GK5104-0BA00-1SA2</b>

<sup>1)</sup> Special fiber-optic cables; lengths and accessories available on request

<sup>2)</sup> Special tools and trained personnel are required for pre-assembling glass fiber-optic cables

#### More information

##### **Selection tool:**

To assist in selecting the right Industrial Ethernet switches as well as configuration of modular variants, the TIA Selection Tool is available at:

TIA Selection Tool:

<http://www.siemens.com/tia-selection-tool>



## Network Components

### SCALANCE X – Industrial Ethernet Switches

#### SCALANCE XP-200 managed

##### Overview



SCALANCE XP216EEC



SCALANCE XP208EEC

##### Product versions

###### SCALANCE XP208EEC

- with 8 electrical ports (10/100 Mbps, M12 D-coded)

###### SCALANCE XP208PoE EEC

- with 4 electrical ports (10/100 Mbps, M12 D-coded) and 4 electrical PoE ports (10/100 Mbps M12 D-coded)

###### SCALANCE XP216EEC

- with 12 electrical ports (10/100 Mbps, M12 D-coded) and 4 electrical ports (10/100/1000 Mbps, M12 X-coded)

###### SCALANCE XP216PoE EEC

- with 12 electrical ports (10/100 Mbps, M12 D-coded) and 4 electrical ports (10/100/1000 Mbps, M12 X-coded)  
A total of 8 ports with PoE can be used.

The switch is suitable for mounting outside a control cabinet especially in railway applications (EN 50155/45545), extended range (-40 to +70 °C).

##### Benefits

- Ideal solution for setup of Industrial Ethernet line, star and ring structures
- Industry-compatible plug-in connection (10/100 Mbps M12 D-coded and 10/100/1000 Mbps, X-coded)
- High network availability through setup of redundant ring structures (redundancy manager integrated)
- Integration of the SCALANCE XP-200 Industrial Ethernet switches in the existing network management infrastructure through SNMP access
- Easy integration in the process diagnostics and system diagnostics
- Fast device replacement under fault conditions through the use of C-PLUG
- Use under extreme ambient conditions (-40 to +70 °C)
- Use outside the control cabinet also possible (IP65/67 degree of protection)

## 8

The managed Industrial Ethernet switches of the SCALANCE XP-200 product line with 8 or 16 Ethernet ports are optimally suited for setup of cabinet-free automation concepts of Industrial Ethernet networks with transmission rates of 10/100/1000 Mbps in a line, star or ring structure.

- Integrated redundancy manager for setup of high availability networks in a ring structure
- Electrical station or network connection
- Rugged metal housing for mounting on SIMATIC ET 200pro rack, ITEM rail mounting or direct wall mounting
- Rugged industry-compatible station connections with industrial-compatible M12 plug connectors, (M12 D-coded for FastEthernet (10/100 Mbps) interfaces, M12 X-coded for 1000 Mbps interfaces)
- Redundant power supply (M12, A-coded)
- Console port (M12, D-coded)
- Diagnostics on the device by means of prominent LED display with integrated SELECT/SET button (power, link status, data communication, display mode)
- Error signaling contact with easy setting using SELECT/SET button
- Configuration storage using C-PLUG removable data storage medium
- Grounding screw for external ground connection

### Technical specifications

Article number	<b>6GK5 208-0HA00-2ES6</b>	<b>6GK5 216-0HA00-2ES6</b>
Product type designation	<b>6GK5 208-0UA00-5ES6</b> SCALANCE XP208EEC, SCALANCE XP208PoE EEC	<b>6GK5 216-0UA00-5ES6</b> SCALANCE XP216EEC, SCALANCE XP216PoE EEC
<b>Transmission rate</b>		
Port speed	8 x 10/100 Mbps (D-coded)	12 x 10/100 Mbps (D-coded), 4 x 1000 Mbps (X-coded)
<b>Supply voltage</b>		
Supply voltage	2 x M12 A-coded (24 V DC) XP208PoE EEC: 2 x M12 A-coded (54 V DC)	2 x M12 A-coded (24 V DC) XP216PoE EEC: 2 x M12 A-coded (54 V DC)
<b>Dimensions and weights</b>		
Width	200 mm	200 mm
Height	200 mm	280 mm
Depth	49 mm	49 mm
Weight	1.8 kg	2.5 kg
<b>Product properties, functions, components - General</b>		
Coated printed circuit boards (conformal coating)	Yes	Yes
Port type	M12 D-coded	M12 D-coded and X-coded
Power-over-Ethernet (PoE)	XP208PoE EEC: 4 ports IEEE 802.3at Type 2 (max. 120 W)	XP216PoE EEC: 8 ports IEEE 802.3at Type 2 (max. 120 W)
<b>Permissible ambient conditions</b>		
IP degree of protection	IP65/IP67	IP65/IP67
<b>Standards, specifications, approvals - Other</b>		
• e1/E1 motor vehicle approval	Yes	Yes
• Railway application in accordance with EN 50155	Yes	Yes
• Railway application in accordance with EN 45545	Yes	Yes

### Selection and ordering data

Version	Article No.
<p><b>Industrial Ethernet switches SCALANCE XP-200</b></p> <p>Industrial Ethernet switches with integrated SNMP access, web diagnostics, copper cable diagnostics and PROFINET diagnostics, for setup of line, star and ring structures; with integrated redundancy manager; incl. operating instructions, Industrial Ethernet network manual and configuration software on CD-ROM</p> <ul style="list-style-type: none"> <li>• <b>SCALANCE XP208EEC</b> with eight 10/100 Mbps M12 ports (D-coded)</li> <li>• <b>SCALANCE XP208PoE EEC</b> with four 10/100 Mbps M12 ports (D-coded) and four 10/100 Mbps M12 PoE ports (D-coded)</li> <li>• <b>SCALANCE XP216EEC</b> with twelve 10/100 Mbps M12 ports (D-coded) and four 10/100/1000 Mbps M12 ports (X-coded)</li> <li>• <b>SCALANCE XP216PoE EEC</b> with twelve 10/100 Mbps, M12 ports (D-coded) and four 10/100/1000 Mbps M12 ports (X-coded), A total of eight PoE ports are possible.</li> </ul>	<p><b>6GK5 208-0HA00-2ES6</b></p> <p><b>6GK5 208-0UA00-5ES6</b></p> <p><b>6GK5 216-0HA00-2ES6</b></p> <p><b>6GK5 216-0UA00-5ES6</b></p>
<p><b>Accessories</b></p> <p><b>C-PLUG</b></p> <p>Removable data storage medium (conformal coating) for easy replacement of devices under fault conditions; for recording configuration data or engineering and application data; can be used in SIMATIC NET products with C-PLUG slot</p>	<b>6GK1900-0AQ00</b>
<p><b>IE FC Stripping Tool</b></p> <p>Preset insulation stripping tool for fast stripping of Industrial Ethernet FC cables</p>	<b>6GK1901-1GA00</b>
<p><b>IE TP Train Cable GP 2x2 (Type C)</b></p> <p>4-core, shielded TP installation cable for connection to IE FC outlet RJ45/IE FC RJ45 plug 180/90 for train applications: PROFINET-compliant; sold by the meter; maximum delivery unit 1000 m, minimum order quantity 20 m</p>	<b>6XV1871-2T</b>
<p><b>IE Train Cable GP 4x2</b></p> <p>8-core, shielded TP installation cable for connection to IE FC M12 Plug PRO 4x2 for use in railway applications; with railway approval; sold by the meter; maximum delivery unit 1000 m, minimum order quantity 20 m</p>	<b>6XV1878-2T</b>

## Network Components

### SCALANCE X – Industrial Ethernet Switches

#### SCALANCE XP-200 managed

Version	Article No.
<p><b>IE Connecting Cable M12-180/M12-180</b></p> <p>Flexible plug-in cable (4-core), pre-assembled with 4-pin M12 connectors (D-coded), for connection of IE devices, IP65/67</p> <p>Length:</p> <ul style="list-style-type: none"> <li>• 0.3 m</li> <li>• 0.5 m</li> <li>• 1 m</li> <li>• 1.5 m</li> <li>• 2 m</li> <li>• 3 m</li> <li>• 5 m</li> <li>• 10 m</li> <li>• 15 m</li> </ul>	<p>6XV1870-8AE30</p> <p>6XV1870-8AE50</p> <p>6XV1870-8AH10</p> <p>6XV1870-8AH15</p> <p>6XV1870-8AH20</p> <p>6XV1870-8AH30</p> <p>6XV1870-8AH50</p> <p>6XV1870-8AN10</p> <p>6XV1870-8AN15</p>
<p><b>M12 Robust Connecting Cable M12-180/M12-180</b></p> <p>Flexible plug-in cable (4-core), pre-assembled with 4-pin M12 connectors (D-coded), for connection of IE devices such as SCALANCE XP-200 and ET 200, IP69</p> <p>Length:</p> <ul style="list-style-type: none"> <li>• 1 m</li> <li>• 2 m</li> <li>• 3 m</li> <li>• 5 m</li> </ul>	<p>6XV1881-5AH10</p> <p>6XV1881-5AH20</p> <p>6XV1881-5AH30</p> <p>6XV1881-5AH50</p>
<p><b>M12 Power Connecting Cable M12-180/M12-180</b></p> <p>Flexible plug-in cable (4-core), pre-assembled with one 4-pin M12 male connector/female connector each (A-coded), for connection of 24 V voltage supply to SCALANCE XP-200 and ET 200, IP 65/67</p> <p>Length:</p> <ul style="list-style-type: none"> <li>• 0.3 m</li> <li>• 0.5 m</li> <li>• 1 m</li> <li>• 1.5 m</li> <li>• 2 m</li> <li>• 3 m</li> <li>• 5 m</li> <li>• 10 m</li> <li>• 15 m</li> </ul>	<p>6XV1801-5DE30</p> <p>6XV1801-5DE50</p> <p>6XV1801-5DH10</p> <p>6XV1801-5DH15</p> <p>6XV1801-5DH20</p> <p>6XV1801-5DH30</p> <p>6XV1801-5DH50</p> <p>6XV1801-5DN10</p> <p>6XV1801-5DN15</p>
<p><b>Robust Power Connecting Cable M12-180/M12-180</b></p> <p>Preassembled cable with M12 male connector and M12 female connector for power supply of SCALANCE XP-200 and ET 200, A-coded, 4-pin, IP69</p> <p>Length:</p> <ul style="list-style-type: none"> <li>• 1 m</li> <li>• 2 m</li> <li>• 3 m</li> <li>• 5 m</li> </ul>	<p>6XV1801-5AH10</p> <p>6XV1801-5AH20</p> <p>6XV1801-5AH30</p> <p>6XV1801-5AH50</p>
<p><b>IE FC M12 Plug PRO 2 x 2</b></p> <p>M12 plug-in connector with rugged metal housing and FC connection technology, with axial cable outlet, D-coded, for SCALANCE XP-200 and ET 200</p> <ul style="list-style-type: none"> <li>• 1 pack = 1 unit</li> <li>• 1 pack = 8 units</li> </ul>	<p>6GK1901-0DB20-6AA0</p> <p>6GK1901-0DB20-6AA8</p>
<p><b>IE FC M12 Plug PRO 4 x 2</b></p> <p>M12 plug-in connector with rugged metal housing and FC connection technology, with axial cable outlet, X-coded, for SCALANCE W and XP-200</p> <ul style="list-style-type: none"> <li>• 1 pack = 1 unit</li> <li>• 1 pack = 8 units</li> </ul>	<p>6GK1901-0DB30-6AA0</p> <p>6GK1901-0DB30-6AA8</p>
<p><b>IE FC M12 Cable Connector PRO 4 x 2</b></p> <p>Field-assembled M12 plug-in connector with metal housing and FC connection technology, female contact insert, X-coded, 8-pin</p> <ul style="list-style-type: none"> <li>• 1 pack = 1 unit</li> <li>• 1 pack = 8 units</li> </ul>	<p>6GK1901-0DB40-6AA0</p> <p>6GK1901-0DB40-6AA8</p>
<p><b>IE M12 Panel Feedthrough</b></p> <p>Control cabinet bushing for transition from M12 (D-coded) connection technology (IP65) to RJ45 connection technology (IP20), 5 units</p>	<p>6GK1901-0DM20-2AA5</p>
<p><b>IE M12 Panel Feedthrough PRO</b></p> <p>Control cabinet bushing for transition from M12 (D-coded) connection technology (IP65) to M12 (D-coded) connection technology (IP65), 5 units</p>	<p>6GK1901-0DM30-2AA5</p>

Version	Article No.
<b>IE M12 Panel Feedthrough 4 x 2</b> M12 control cabinet bushing for transition from M12 connection technology (X-coded, IP65/67) to RJ45 connection technology (X-coded, IP20), 5 units	<b>6GK1901-0DM40-2AA5</b>
<b>M12 Power T-Tap</b> T-function for looping through the energy supply if redundant supply is not needed (24 V DC), 5 units	<b>6GK1907-0DC00-6AA5</b>
<b>Serial Cable M12/RS232</b> Serial connection cable (M12 / Sub-D) for direct configuration of switch using laptop	<b>6GK5980-3BC00-0AA5</b>
<b>IE Power M12 Plug PRO</b> Plug-in connector for connection to PS791-1PRO power supply for 24 V DC supply voltage with installation instructions, 4-pin, A-coded, 3 units	<b>6GK1907-0DB10-6AA3</b>
<b>Signaling Contact M12 Cable Connector PRO</b> Connection socket for connection of SCALANCE X208PRO for signaling contact with installation instructions, 5-pin, B-coded, 3 items	<b>6GK1908-0DC10-6AA3</b>

#### More information

##### **Selection tools:**

To assist in selecting the right Industrial Ethernet switches as well as configuration of modular variants, the TIA Selection Tool is available at:

TIA Selection Tool:

<http://www.siemens.com/tia-selection-tool>

## Network Components

### SCALANCE X – Industrial Ethernet Switches

#### SCALANCE X308-2M TS

##### Overview



The SCALANCE X-300 product line comprises compact Industrial Ethernet switches for setup of electrical and/or optical line, star and ring structures with transmission rates of 10/100/1000 Mbps.

- Fast media redundancy through integral redundancy manager for Gigabit Ethernet (SCALANCE X-300, X-400) and Fast Ethernet (e.g. in combination with SCALANCE X-200 switches)
- Seamless integration of automation networks into existing corporate networks thanks to support of a large number of IT standards: Setup of virtual networks (VLANs)
- Redundant integration into higher-level networks thanks to support of standardized redundancy procedures (Rapid Spanning Tree Protocol)
- PROFINET diagnostics, SNMP access, integrated web server and automatic e-mail transmission function for remote diagnostics and signaling via the network

##### Benefits

- High availability of the network thanks to
  - Redundant power supply
  - Redundant network structures based on fiber-optic or twisted pair cable (redundancy manager, standby function and RSTP are integrated)
  - Easy device replacement by means of plug-in C-PLUG removable data storage medium
  - Very fast reconfiguration of the network in event of a fault
- Lower susceptibility to failure and higher availability of the plant networking due to locking of the RJ45 FastConnect plug connectors in place in the securing collar of the RJ45 ports
- Protection of investment through integration in existing network management systems by means of standardized SNMP access
- Easy adaptation to different network structures, and reduction in stock keeping costs through flexibility of the partially modular versions

##### Application

SCALANCE X-300 products enable the setup of switched networks in the field level area and the control level area where high transmission speed is required in addition to high network availability and extensive diagnostic capabilities.

The main area of application is found in high-performance plant networks with connection to the corporate network.

The X308-2M TS is suitable for use in railway applications due to its specification according to EN 50155.

##### SCALANCE X308-2M TS

- For setup of optical line, ring or star structures
- Hub in the plant bus (redundant connection possible)
- SCALANCE X308-2M TS (TS = Transportation Systems); 4 x 10/100/1000 Mbps RJ45 ports, electrical  
2 x free module slots for 4 x 10/100/1000 Mbps media modules (electrical or optical)

### Technical specifications

Article number	<b>6GK5308-2GG10-2CA2</b>
Product type designation	SCALANCE X308-2M TS
<b>Transmission rate</b>	
Transmission rate	10/100/1000 Mbps
<b>Integrated interfaces for communication</b>	
<b>Number of electrical connections</b> • for network components or data terminal equipment	4
<b>Number of 100 Mbps ST(BFOC) ports</b> • for multimode	4
<b>Number of 100 Mbps SC ports</b> • for multimode	4
<b>Number of 1000 Mbps LC ports</b> • for multimode • for single-mode (LD)	4 4
<b>Other interfaces</b>	
<b>Number of electrical connections</b> • for signaling contact • for media module • for power supply • for redundant power supply	1 2 1 1
<b>Type of electrical connection</b> • for signaling contact • for power supply	2-pin terminal block 4-pin terminal block
<b>Type of removable data storage medium</b> • C-PLUG	Yes
<b>Signal inputs/outputs</b>	
<b>Operating current of the signaling contacts</b> • with DC, nominal value	24 V
<b>Operating current of the signaling contacts</b> • with DC, maximum	0.1 A
<b>Supply voltage, current consumption, power loss</b>	
<b>Type of power supply: redundant power supply</b>	No
<b>Type of supply voltage</b>	DC
<b>Supply voltage</b> • External • External	12 V 20 ... 30 V
<b>Supply voltage with DC</b> • Rated value	24 V 20 ... 30 V
<b>Product component: fusing at power supply input</b>	Yes
<b>Type of fusing at input for supply voltage</b>	F 3 A / 32 V
<b>Current consumption, maximum</b>	0.7 A
<b>Power loss [W]</b> • with 24 V DC	16.6 W
<b>Permissible ambient conditions</b>	
<b>Ambient temperature</b> • during operation • during storage • during transport • Remark	-40 ... +70 °C -40 ... +70 °C -40 ... +70 °C Reduced operating temperature through use of media modules (-40 to +70 °C) or SFP plug-in transceivers (-40 to +60 °C). In the case of vertical mounting position, the maximum operating temperature is reduced to +50 °C.
<b>Relative humidity</b> • Relative humidity at 25 °C, without condensation during operation, maximum	95%
<b>IP degree of protection</b>	IP20
<b>Design, dimensions and weights</b>	
<b>Model</b>	Compact
<b>Width</b>	120 mm
<b>Height</b>	125 mm
<b>Depth</b>	124 mm
<b>Net weight</b>	1.4 kg
<b>Product property: conformal coating</b>	Yes
<b>Mounting type</b> • 19-inch installation • 35 mm DIN rail mounting • Wall mounting • S7-300 rail mounting • S7-1500 rail mounting	In marine applications, mounting on the 35 mm DIN rail is not permissible. No Yes Yes Yes No

## Network Components

### SCALANCE X – Industrial Ethernet Switches

#### SCALANCE X308-2M TS

Article number	<b>6GK5308-2GG10-2CA2</b>
Product type designation	SCALANCE X308-2M TS
<b>Product properties, functions, components - General</b>	
<b>Cascading with redundant ring and reconfiguration time of &lt; 0.3 s</b>	100
<b>Cascading with star structure</b>	Any (only dependent on signal propagation time)
<b>Product functions - Management, configuration, engineering</b>	
<b>Product function</b>	
• CLI	Yes
• Web-based management	Yes
• MIB support	Yes
• TRAPs via e-mail	Yes
• Configuration with STEP 7	Yes
• RMON	Yes
• Port mirroring	Yes
• Multiport mirroring	Yes
• CoS	Yes
• PROFINET IO diagnostics	Yes
• Switch-managed	Yes
<b>Protocol is supported</b>	
• Telnet	Yes
• HTTP	Yes
• HTTPS	Yes
• TFTP	Yes
• FTP	Yes
• BOOTP	Yes
• GMRP	Yes
• DCP	Yes
• LLDP	Yes
• IGMP (snooping/querier)	Yes
<b>Product functions - Management, configuration, engineering (continued)</b>	
<b>Identification &amp; Maintenance function</b>	
• I&MO - Device-specific information	Yes
• I&M1 - Higher level designation/location designation	Yes
<b>Protocol is supported</b>	
• SNMP v1	Yes
• SNMP v2	Yes
• SNMP v3	Yes
<b>Product functions - Diagnostics</b>	
<b>Product function</b>	
• Port diagnostics	Yes
• Packet size statistics	Yes
• Packet type statistics	Yes
• Error statistics	Yes
• SysLog	Yes
<b>Product functions - VLAN</b>	
<b>Product function</b>	
• VLAN - port-based	Yes
• VLAN - protocol-based	No
• VLAN - IP-based	No
• VLAN - dynamic	Yes
<b>Number of VLANs, maximum</b>	255
<b>Number of dynamic VLANs, maximum</b>	255
<b>GVRP protocol is supported</b>	Yes
<b>Product functions - DHCP</b>	
<b>Product function</b>	
• DHCP client	Yes
• DHCP option 82	Yes
• DHCP option 66	Yes
• DHCP option 67	Yes
<b>Product functions - Redundancy</b>	
<b>Product function</b>	
• Ring redundancy	Yes
• High Speed Redundancy Protocol (HRP)	Yes
• High Speed Redundancy Protocol (HRP) with redundancy manager	Yes
• High Speed Redundancy Protocol (HRP) with standby redundancy	Yes
<b>Media Redundancy Protocol (MRP) is supported</b>	
<b>Product function</b>	
• Media Redundancy Protocol (MRP) with redundancy manager	Yes
• Redundancy procedure STP	Yes
• Redundancy procedure RSTP	Yes
• Redundancy procedure MSTP	Yes
• Parallel Redundancy Protocol (PRP)/use in PRP network	Yes
• Parallel Redundancy Protocol (PRP)/Redundant Network Access (RNA)	No
• Passive listening	Yes



Article number	<b>6GK5308-2GG10-2CA2</b>
Product type designation	SCALANCE X308-2M TS
<b>Protocol is supported</b>	
• STP/RSTP	Yes
• STP	Yes
• RSTP	Yes
• MSTP	No
• RSTP Big Network Support	Yes
• LACP	Yes
<b>Product functions - Security</b>	
<b>Product function</b>	
• ACL - MAC-based	Yes
• ACL - Port/MAC-based	Yes
• IEEE 802.1X (RADIUS)	Yes
• Broadcast/Multicast/Unicast Limiter	Yes
• Broadcast blocking	Yes
<b>Protocol is supported</b>	
• SSH	Yes
<b>Product functions - Time of day</b>	
<b>Product function</b>	
• SICLOCK support	Yes
<b>Protocol is supported</b>	
• NTP	Yes
• SNTP	Yes
• IEEE 1588 profile default	Yes
<b>Standards, specifications, approvals</b>	
<b>Standard</b>	
• for FM	FM3611: Class 1, Division 2, Group A, B, C, D / T4, Class 1, Zone 2, Group IIC, T4
• for hazardous zone	EN 60079-0: 2006, EN60079-15: 2005, II 3 G Ex nA II T4 KEMA 07 ATEX 0145X
• for safety, from CSA and UL	UL 60950-1, CSA C22.2 No. 60950-1
• for hazardous zone, from CSA and UL	UL 1604 and UL 2279-15 (Hazardous Location), CSA C22.2 No. 213-M1987, Class 1 / Division 2 / Group A, B, C, D / T4, Class 1 / Zone 2 / Group IIC / T4
• for emitted interference	EN 61000-6-4
• for noise immunity	EN 61000-6-2
<b>Standards, specifications, approvals - CE</b>	
<b>Proof of suitability, CE mark</b>	Yes
<b>Standards, specifications, approvals - Other</b>	
<b>Proof of suitability</b>	EN 61000-6-2, EN 61000-6-4
• C-Tick	Yes
• Railway application in accordance with EN 50155	Yes
• Railway application in accordance with EN 50121-4	Yes
• Fire protection in accordance with EN 45545-2	Yes
• KC approval	Yes
<b>Standards, specifications, approvals - Product conformity</b>	
<b>MTBF at 40 °C</b>	40 y

## Network Components

### SCALANCE X – Industrial Ethernet Switches

#### SCALANCE X308-2M TS

#### Selection and ordering data

Version	Article No.
<p><b>Industrial Ethernet switches SCALANCE X-300</b></p> <p>Industrial Ethernet switches for setting up electrical and/or optical Industrial Ethernet networks; integrated redundancy manager, IT functions (RSTP, VLAN, etc.), network management via SNMP and web server; incl. operating instructions, Industrial Ethernet network manual and configuration software on CD-ROM; C-PLUG included in scope of delivery</p> <p><u>Full Gigabit Ethernet switches</u></p> <ul style="list-style-type: none"> <li>• <b>SCALANCE X308-2M TS;</b> 4 x 10/100/1000 Mbps RJ45 ports, electrical 2 x 10/100/1000 Mbps slots for 2-port media modules, electrical or optical, with extended temperature range and EN 50155 approval for railway applications</li> </ul>	<b>6GK5308-2GG10-2CA2</b>
<p><b>Media modules</b></p> <p><b>Electrical Media Modules</b></p> <p>With 2 x 10/100/1000 Mbps RJ45 ports, electrical</p> <ul style="list-style-type: none"> <li>• MM992-2CUC with securing collar and coated PCBs (conformal coating)</li> </ul> <p>With 2 x 10/100/1000 Mbps M12 ports, electrical</p> <ul style="list-style-type: none"> <li>• MM992-2 M12 interface (x-coded) and coated PCBs (conformal coating)</li> </ul>	<b>6GK5992-2GA00-8FA0</b>
<p><b>Optical Media Modules</b></p> <p>with 2 x 1000 Mbps SC ports, optical</p> <ul style="list-style-type: none"> <li>• MM992-2 multimode, glass, up to 750 m, coated PCBs (conformal coating)</li> </ul>	<b>6GK5992-2AL00-8FA0</b>
<p><b>Accessories</b></p> <p><b>S7-1500 Mounting Kit</b></p> <p>Mounting bracket for installation of SCALANCE X-300 on S7-1500 mounting rail</p>	<b>6GK5980-2EA00-0AA1</b>
<p><b>IE FC Stripping Tool</b></p> <p>Preset insulation stripping tool for fast stripping of Industrial Ethernet FC cables</p>	<b>6GK1901-1GA00</b>
<p><b>IE FC RJ45 Plug 180 2 x 2</b></p> <p>RJ45 plug connector for Industrial Ethernet with rugged metal housing and integrated insulation displacement contacts for connecting Industrial Ethernet FC installation cables; with 180° cable outlet; for network components and CPs/CPUs with Industrial Ethernet interface</p> <ul style="list-style-type: none"> <li>• 1 pack = 1 unit</li> </ul>	<b>6GK1901-1BB10-2AA0</b>
<p><b>IE TP Train Cable GP 2x2 (Type C)</b></p> <p>4-core, shielded TP installation cable for connection to IE FC outlet RJ45/IE FC RJ45 plug 180/90 for train applications: PROFINET-compliant; <u>sold by the meter</u>; maximum delivery unit 1000 m, minimum order quantity 20 m</p>	<b>6XV1871-2T</b>
<p><b>IE FC RJ45 Plug 4 x 2</b></p> <p>RJ45 plug connector for Industrial Ethernet (10/100/1000 Mbps) with rugged metal housing and integrated insulation displacement contacts for connecting Industrial Ethernet FC installation cables; 180° cable outlet; for network components and CPs/CPUs with Industrial Ethernet interface</p> <ul style="list-style-type: none"> <li>• 1 pack = 1 unit</li> </ul>	<b>6GK1901-1BB12-2AA0</b>
<p><b>IE FC M12 Plug PRO 4x2</b></p> <p>M12 plug connector (X-coded, IP65/IP67) that can be assembled in the field, metal enclosure, insulation displacement fast connection method, for SCALANCE W</p> <ul style="list-style-type: none"> <li>• 1 unit</li> </ul>	<b>6GK1901-0DB30-6AA0</b>
<p><b>IE M12 Panel Feedthrough 4x2</b></p> <p>Control cabinet feedthrough for transition from M12 connection method (X-coded, IP65/IP67) to RJ45 connection method (IP20)</p> <ul style="list-style-type: none"> <li>• 1 pack = 5 units</li> </ul>	<b>6GK1901-0DM40-2AA5</b>
<p><b>IE FC M12 Cable Connector PRO 4x2</b></p> <p>M12 plug-in connector (X-coded, IP65/IP67, female contact insert) that can be assembled in the field, metal housing, insulation displacement fast connection method</p> <ul style="list-style-type: none"> <li>• 1 unit</li> </ul>	<b>6GK1901-0DB40-6AA0</b>

Version	Article No.
<b>IE Train Cable GP 4x2</b> 8-core, shielded TP installation cable for connection to IE FC M12 Plug PRO 4x2 for use in railway applications; with railway approval; sold by the meter; maximum delivery unit 1000 m, minimum order quantity 20 m	6XV1878-2T
<b>IE Connecting Cable</b> <b>IE FC RJ45 Plug-180/IE FC RJ45 Plug-180</b> Preassembled IE FC TP trailing cable GP 2 x 2 (PROFINET type C) with two IE FC RJ45 Plug-180, IP20 degree of protection; Length: <ul style="list-style-type: none"> <li>• 1.0 m</li> <li>• 5.0 m</li> <li>• 10.0 m</li> </ul>	6XV1871-5BH10 6XV1871-5BH50 6XV1871-5BN10
<b>IE SC RJ POF Plug</b> Screw connector for local assembly on POF FOC (1 pack = 20 units)	6GK1900-0MB00-0AC0
<b>POF Standard Cable GP 980/1000</b> POF standard cable for fixed installation indoors with PVC sheath; sold by the meter; maximum delivery unit 1000 m, minimum order quantity 20 m.	6XV1874-2A
<b>IE SC RJ PCF Plug</b> Screw connector for local assembly on PCF FOC (1 pack = 10 units)	6GK1900-0NB00-0AC0
<b>PCF Standard Cable GP 200/230</b> Standard cable, fan-out, sold by the meter; Maximum delivery unit 2000 m; minimum order quantity 20 m	6XV1861-2A
<b>FC FO Termination Kit</b> Termination kit for local assembly of FC SC and FC BFOC connectors on FC FO standard cable; contains a stripping tool, Kevlar cutters, fiber breaking tool and microscope.	6GK1900-1GL00-0AA0
<b>FC BFOC Plug</b> Screw connector for local assembly on FC FOC; (1 pack = 20 units + cleaning cloths)	6GK1900-1GB00-0AC0
<b>FC SC Plug</b> Screw connector for local assembly on FC FOC; (1 pack = 10 units duplex plugs + cleaning cloths)	6GK1900-1LB00-0AC0
<b>FC FO Standard Cable GP 62.5/200/230</b> FC FO standard cable for fixed installation indoors with PVC sheath; sold by the meter; maximum delivery unit 1000 m, minimum order quantity 20 m	6XV1847-2A
<b>Multimode FO BFOC Connector Set</b> For FO standard cable (50/125/1400), FO ground cable (50/125/1400), flexible FO trailing cable, INDOOR FO cable (62.5/125/900), 20 units	6GK1901-0DA20-0AA0
<b>Multi-mode FO SC Duplex Connector Set</b> For FO standard cable (50/125/1400), FO ground cable (50/125/1400), flexible FO trailing cable, INDOOR FO cable (62.5/125/900), 10 units	6GK1901-0LB10-2AA0
<b>LC Plug MM<sup>2</sup>)</b>	6GK1901-0RB10-2AB0
<b>FO Standard Cable GP 50/125/1400 <sup>1) 2)</sup></b> Multimode cable sold by the meter; maximum delivery unit 1000 m, minimum order quantity 20 m	6XV1873-2A
<b>Pre-Assembled FO Patch Cables</b> <u>Multimode</u>	
<b>MM FO Cord SC/LC</b> With one SC duplex connector and one LC duplex connector, 1 m	6XV1843-5EH10-0CA0
<b>MM FO Cord SC/BFOC</b> With one SC duplex connector and two BFOC connectors, 1 m	6XV1843-5EH10-0CB0
<b>MM FO Cord SC/SC</b> With two SC duplex connectors, 1 m	6XV1843-5EH10-0CC0

## Network Components

### SCALANCE X – Industrial Ethernet Switches

#### SCALANCE X308-2M TS

Version	Article No.
Single-mode	
<b>SM FO Cord SC/LC</b> With one SC duplex connector and one LC duplex connector, 1 m	<b>6XV1843-5FH10-0CA0</b>
<b>SM FO Cord SC/BFOC</b> With one SC duplex connector and two BFOC connectors, 1 m	<b>6XV1843-5FH10-0CB0</b>
<b>SM FO Cord SC/SC</b> With two SC duplex connectors, 1 m	<b>6XV1843-5FH10-0CC0</b>
<b>IE TP Cord RJ45/RJ45</b> TP cable 4 x 2 with two RJ45 connectors <ul style="list-style-type: none"> <li>• 1 m</li> <li>• 6 m</li> <li>• 10 m</li> </ul>	<b>6XV1870-3QH10</b> <b>6XV1870-3QH60</b> <b>6XV1870-3QN10</b>
<b>Screw-Type Terminal Block</b> For SCALANCE X/W/S <ul style="list-style-type: none"> <li>• 2-pole for signaling contact (24 V DC) 1 pack = 5 units</li> <li>• 4-pole for power supply (24 V DC) 1 pack = 5 units</li> </ul>	<b>6GK5980-0BB00-0AA5</b> <b>6GK5980-1DB00-0AA5</b>
<b>C-PLUG</b> Removable data storage medium (conformal coating) for easy replacement of devices under fault conditions; for recording configuration data or engineering and application data; can be used in SIMATIC NET products with C-PLUG slot	<b>6GK1900-0AQ00</b>

<sup>1)</sup> Special fiber-optic cables, lengths and accessories available on request

<sup>2)</sup> Special tools and specially trained personnel are required for assembling glass FOC

#### More information

##### **Selection Tool:**

To assist in selecting the right Industrial Ethernet switches as well as configuration of modular variants, the TIA Selection Tool is available at:

TIA Selection Tool:

<http://www.siemens.com/tia-selection-tool>

## Overview



SCALANCE XR324-4M PoE TS



SCALANCE XR324-4M EEC

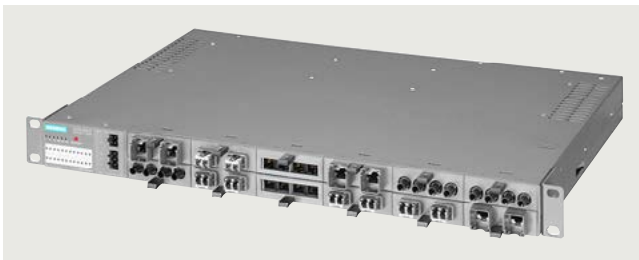

SCALANCE XR324-12M TS

- Fast media redundancy through integrated redundancy manager both for Gigabit Ethernet (with SCALANCE X-300, X-400) and Fast Ethernet (e.g. in combination with SCALANCE X-200 switches)
- Seamless integration of automation networks in existing corporate networks thanks to support of a large number of IT standard functions (VLANs, IGMP-Snooping/Querier, STP/RSTP, Link Aggregation, Quality of Service)
- Redundant integration in higher-level networks thanks to support of standardized redundancy procedures (Spanning Tree Protocol/Rapid Reconfiguration Spanning Tree Protocol/MRP)
- Remote diagnostics by means of PROFINET diagnostics, web browser, CLI or SNMP

### SCALANCE XR324-4M PoE TS

The SCALANCE XR-300PoE Industrial Ethernet switches are partly modular, high-performance, industry-standard switches for setup of electrical and/or optical line, ring and star structures with transmission rates of 10/100/1000 Mbps, designed for installation in 19" control cabinets

- Up to 24 electrical and/or optical interfaces (10/100/1000 Mbps), of which 16 are integrated RJ45 ports, eight of which are PoE-capable; up to four electrical and/or optical 2-port media modules can also be inserted in the media module slots of the basic device.

### SCALANCE XR324-4M EEC

The SCALANCE XR-300EEC (Enhanced Environmental Conditions) industrial Ethernet switches are partly modular, high-performance, industry-standard switches for the construction of electrical and/or optical line, ring and star topologies at data transfer rates of 10/100/1000 Mbps, designed for installation in 19" control cabinets.

- Up to 24 electrical and/or optical interfaces (10/100/1000 Mbps), of which 16 are integral RJ45 ports; up to four electrical and/or optical 2-port media modules can also be inserted in the media module slots of the basic device

### SCALANCE XR324-12M TS

The SCALANCE XR-300 Industrial Ethernet switches are fully modular, high-performance, industry-standard switches for setup of electrical and optical line, ring and star structures with transmission rates of 10/100/1000 Mbps, designed for installation in 19" control cabinets.

- Up to 24 electrical and/or optical interfaces (10/100/1000 Mbps); up to 12 electrical and/or optical 2-port media modules can be inserted at any position in the basic device

## Benefits

- Unlimited flexibility for network expansions (e.g. more terminals) or upgrade (e.g. switching from copper to fiber-optic cable) and reduction of stock keeping costs due to the modular configuration with port modules
- High availability of the network thanks to
  - Redundant power supply
  - Redundant network structures based on fiber-optic or twisted pair cable (redundancy manager, standby function and STP/RSTP integrated)
  - Easy device replacement by means of plug-in C-PLUG removable data storage medium
  - Very fast reconfiguration of the network in event of a fault
- Lower susceptibility to failure and higher availability of the plant networking due to locking of the RJ45 FastConnect plug connectors in place in the securing collar of the RJ45 port modules
- Protection of investment through integration in existing network management systems by means of standardized SNMP access
- Space savings in control cabinet due to flexible cable outlet on the front or rear of the device

### SCALANCE XR324-4M PoE TS

- No need for additional power supply units and cabling for terminal devices due to PoE power supply

## Network Components

### SCALANCE X – Industrial Ethernet Switches

#### SCALANCE XR324-4M PoE TS / SCALANCE XR324-4M EEC / SCALANCE XR324-12M TS

#### Technical specifications

Article number	<b>6GK5324-4QG00-1CR2</b>
Product type designation	SCALANCE XR324-4M PoE TS
<b>Transmission rate</b>	
Transmission rate	10 /100/1000 Mbps
<b>Integrated interfaces for communication</b>	
<b>Number of electrical connections</b>	
• for network components or data terminal equipment	16
• with Power-over-Ethernet for network components or terminal equipment	8
<b>Number of 100 Mbps ST(BFOC) ports</b>	
• for multimode	8
<b>Number of 100 Mbps SC ports</b>	
• for multimode	8
<b>Number of 1000 Mbps LC ports</b>	
• for multimode	8
• for single-mode (LD)	8
<b>Other interfaces</b>	
<b>Number of electrical connections</b>	
• for operation panel	1
• for signaling contact	1
• for media module	4
• for power supply	1
• for redundant power supply	0
<b>Type of electrical connection</b>	
• for operation panel	RJ11 port
• for signaling contact	2-pin terminal block
• for power supply	4-pin terminal block
<b>Type of removable data storage medium</b>	
• C-PLUG	Yes
<b>Signal inputs/outputs</b>	
<b>Operating current of the signaling contacts</b>	
• with DC, nominal value	24 V
<b>Operating current of the signaling contacts</b>	
• with DC, maximum	0.1 A
<b>Supply voltage, current consumption, power loss</b>	
<b>Type of power supply: redundant power supply</b>	No
<b>Type of supply voltage</b>	DC
<b>Supply voltage</b>	
• External	24 V
• External	19.2 ... 28.8 V
<b>Product component: fusing at power supply input</b>	Yes
<b>Type of fusing at input for supply voltage</b>	F 5 A / 250 V
<b>Current consumption, maximum</b>	4.2 A
<b>Power loss [W]</b>	
• with 24 V DC	46 W
<b>Permissible ambient conditions</b>	
<b>Ambient temperature</b>	
• during operation	-40 ... +70 °C
• during storage	-40 ... +85 °C
• during transport	-40 ... +85 °C
• Remark	In the case of vertical mounting position, the maximum operating temperature is reduced to 60 °C
<b>Relative humidity</b>	
• Relative humidity at 25 °C, without condensation during operation, maximum	95%
<b>IP degree of protection</b>	IP20

### SCALANCE XR324-4M PoE TS / SCALANCE XR324-4M EEC / SCALANCE XR324-12M TS

Article number	<b>6GK5324-4QG00-1CR2</b>
Product type designation	SCALANCE XR324-4M PoE TS
<b>Design, dimensions and weights</b>	
<b>Model</b>	19-inch rack
<b>Number of modular height units for 19-inch cabinet</b>	1
<b>Width</b>	449 mm
<b>Height</b>	43.6 mm
<b>Depth</b>	305 mm
<b>Net weight</b>	6.8 kg
<b>Product property: conformal coating</b>	Yes
<b>Mounting type</b>	For 19-inch rack mounting, 4-point fixing is required for marine engineering applications
<ul style="list-style-type: none"> <li>• 19-inch installation</li> <li>• 35 mm DIN rail mounting</li> <li>• Wall mounting</li> <li>• S7-300 rail mounting</li> <li>• S7-1500 rail mounting</li> </ul>	Yes No No No No
<b>Product properties, functions, components - General</b>	
<b>Cascading with redundant ring and reconfiguration time of &lt; 0.3 s</b>	100
<b>Cascading with star structure</b>	Any (only dependent on signal propagation time)
<b>Product functions - Management, configuration, engineering</b>	
<b>Product function</b>	
<ul style="list-style-type: none"> <li>• CLI</li> <li>• Web-based management</li> <li>• MIB support</li> <li>• TRAPs via e-mail</li> <li>• Configuration with STEP 7</li> <li>• RMON</li> <li>• Port mirroring</li> <li>• Multiport mirroring</li> <li>• CoS</li> <li>• PROFINET IO diagnostics</li> <li>• Switch-managed</li> </ul>	Yes Yes Yes Yes Yes Yes Yes Yes Yes Yes Yes
<b>Protocol is supported</b>	
<ul style="list-style-type: none"> <li>• Telnet</li> <li>• HTTP</li> <li>• HTTPS</li> <li>• TFTP</li> <li>• FTP</li> <li>• BOOTP</li> <li>• GMRP</li> <li>• DCP</li> <li>• LLDP</li> <li>• IGMP (snooping/querier)</li> </ul>	Yes Yes Yes Yes Yes Yes Yes Yes Yes Yes
<b>Identification &amp; Maintenance function</b>	
<ul style="list-style-type: none"> <li>• I&amp;MO - Device-specific information</li> <li>• I&amp;M1 - Higher level designation/location designation</li> </ul>	Yes Yes
<b>Protocol is supported</b>	
<ul style="list-style-type: none"> <li>• SNMP v1</li> <li>• SNMP v2</li> <li>• SNMP v3</li> </ul>	Yes Yes Yes
<b>Product functions - Diagnostics</b>	
<b>Product function</b>	
<ul style="list-style-type: none"> <li>• Port diagnostics</li> <li>• Packet size statistics</li> <li>• Packet type statistics</li> <li>• Error statistics</li> <li>• SysLog</li> </ul>	Yes Yes Yes Yes Yes
<b>Product functions - VLAN</b>	
<b>Product function</b>	
<ul style="list-style-type: none"> <li>• VLAN - port-based</li> <li>• VLAN - protocol-based</li> <li>• VLAN - IP-based</li> <li>• VLAN - dynamic</li> </ul>	Yes No No Yes
<b>Number of VLANs, maximum</b>	255
<b>Number of dynamic VLANs, maximum</b>	255
<b>GVRP protocol is supported</b>	Yes
<b>Product functions - DHCP</b>	
<b>Product function</b>	
<ul style="list-style-type: none"> <li>• DHCP client</li> <li>• DHCP option 82</li> <li>• DHCP option 66</li> <li>• DHCP option 67</li> </ul>	Yes Yes Yes Yes



## Network Components

### SCALANCE X – Industrial Ethernet Switches

#### SCALANCE XR324-4M PoE TS / SCALANCE XR324-4M EEC / SCALANCE XR324-12M TS

Article number	<b>6GK5324-4QG00-1CR2</b>
Product type designation	SCALANCE XR324-4M PoE TS
<b>Product functions - Redundancy</b>	
<b>Product function</b>	
• Ring redundancy	Yes
• High Speed Redundancy Protocol (HRP)	Yes
• High Speed Redundancy Protocol (HRP) with redundancy manager	Yes
• High Speed Redundancy Protocol (HRP) with standby redundancy	Yes
<b>Media Redundancy Protocol (MRP) is supported</b>	Yes
<b>Product function</b>	
• Media Redundancy Protocol (MRP) with redundancy manager	Yes
• Redundancy procedure STP	Yes
• Redundancy procedure RSTP	Yes
• Redundancy procedure MSTP	Yes
• Passive listening	Yes
<b>Protocol is supported</b>	
• STP/RSTP	Yes
• STP	Yes
• RSTP	Yes
• MSTP	No
• RSTP Big Network Support	Yes
• LACP	Yes
<b>Product functions - Security</b>	
<b>Product function</b>	
• ACL - MAC-based	Yes
• ACL - Port/MAC-based	Yes
• IEEE 802.1X (RADIUS)	Yes
• Broadcast/Multicast/Unicast Limiter	Yes
• Broadcast blocking	Yes
<b>Protocol is supported</b>	
• SSH	Yes
<b>Product functions - Time of day</b>	
<b>Product function</b>	
• SICLOCK support	Yes
<b>Protocol is supported</b>	
• NTP	Yes
• SNTP	Yes
• IEEE 1588 profile default	Yes
<b>Standards, specifications, approvals</b>	
<b>Standard</b>	
• for FM	FM3611: Class 1, Division 2, Group A, B, C, D / T4, Class 1, Zone 2, Group IIC, T4
• for hazardous zone	EN 60079-0: 2006, EN 60079-15: 2005, II 3 G Ex nA II T4 KEMA 07 ATEX 0145X
• for safety, from CSA and UL	UL 60950-1, CSA C22.2 No. 60950-1
• for hazardous zone, from CSA and UL	UL 1604 and UL 2279-15 (Hazardous Location), CSA C22.2 No. 213-M1987, Class 1 / Division 2 / Group A, B, C, D / T4, Class 1 / Zone 2 / Group IIC / T4
• for emitted interference	EN 61000-6-4: 2007 (Class A)
• for noise immunity	EN 61000-6-2:2006
<b>Standards, specifications, approvals - CE</b>	
<b>Proof of suitability, CE mark</b>	Yes
<b>Standards, specifications, approvals - Other</b>	
<b>Proof of suitability</b>	EN 61000-6-2:2006, EN 61000-6-4:2007
• C-Tick	Yes
• Railway application in accordance with EN 50155	Yes
• Railway application in accordance with EN 50121-4	Yes
• Fire protection in accordance with EN 45545-2	Yes
• KC approval	No
<b>Standards, specifications, approvals - Product conformity</b>	
<b>MTBF at 40 °C</b>	

## Network Components

### SCALANCE X – Industrial Ethernet Switches

#### SCALANCE XR324-4M PoE TS / SCALANCE XR324-4M EEC / SCALANCE XR324-12M TS

Article number	6GK5324-4GG00-1ER2 SCALANCE XR324-4M EEC	6GK5324-4GG00-1JR2 SCALANCE XR324-4M EEC	6GK5324-4GG00-2ER2 SCALANCE XR324-4M EEC	6GK5324-4GG00-2JR2 SCALANCE XR324-4M EEC
<b>Transmission rate</b>				
<b>Transfer rate</b>	10/100 /1000 Mbit/s	10/100 /1000 Mbit/s	10/100 /1000 Mbit/s	10/100 /1000 Mbit/s
<b>Interfaces for communication integrated</b>				
<b>Number of electrical connections</b> • for network components or terminal equipment	16; RJ45	16; RJ45	16; RJ45	16; RJ45
<b>Number of 100 Mbit/s ST(BFOC) ports</b> • for multimode	8	8	8	8
<b>Number of 100 Mbit/s SC ports</b> • for multimode	8	8	8	8
<b>Number of 1000 Mbit/s LC ports</b> • for multimode • for single mode (LD)	8 8	8 8	8 8	8 8
<b>Interfaces others</b>				
<b>Number of electrical connections</b> • for operator console • for signaling contact • for media module • for power supply • for redundant voltage supply	1 1 4 1 1	1 1 4 1 1	1 1 4 2 1	1 1 4 2 1
<b>Type of electrical connection</b> • for operator console • for signaling contact • for power supply	RJ11 2-pole terminal block 4-pole terminal block	RJ11 2-pole terminal block 4-pole terminal block	RJ11 2 x 2-pole terminal block 2 x 4-pole terminal block	RJ11 2 x 2-pole terminal block 2 x 4-pole terminal block
<b>design of the removable storage</b> • C-PLUG	Yes	Yes	Yes	Yes
<b>Signal-Inputs/outputs</b>				
<b>Operating voltage of the signaling contacts</b> • at DC Rated value	24 V	24 V	24 V	24 V
<b>Operating current of the signaling contacts</b> • at DC maximum	0.1 A	0.1 A	0.1 A	0.1 A
<b>Supply voltage, current consumption, power loss</b>				
<b>Type of voltage supply redundant power supply unit</b>	No	No	Yes	Yes
<b>Type of voltage of the supply voltage</b>	DC	DC	DC	DC
<b>Supply voltage</b> • external • external minimum • external maximum	24 V 19.2 V 57.6 V	24 V 19.2 V 57.6 V	24 V 19.2 V 57.6 V	24 V 19.2 V 57.6 V
<b>Supply voltage 2 Rated value</b> • Type of voltage 2 of the supply voltage	DC	DC	DC	DC
<b>Supply voltage at DC</b> • rated value	24 V 19.2 ... 57.6 V	24 V 19.2 ... 57.6 V	24 V 19.2 ... 57.6 V	24 V 19.2 ... 57.6 V
<b>Product component fusing at power supply input</b>	Yes	Yes	Yes	Yes
<b>Fuse protection type at input for supply voltage</b>	T2H / 250 V	T2H / 250 V	T2H / 250 V	T2H / 250 V
<b>Consumed current maximum</b>	1.6 A	1.6 A	1.6 A	1.6 A
<b>Power loss [W]</b> • at DC at 24 V	40 W	40 W	40 W	40 W
<b>Permitted ambient conditions</b>				
<b>Ambient temperature</b> • during operation • during storage • during transport • Note	-40 ... +70 °C -40 ... +85 °C -40 ... +85 °C Extended temperature upper limit of +85° C permitted for 16 hours. Reduced operating temperature through the use of media modules (-40 °C to +70 °C) or SFP plug-in transceivers (-40 °C to +60 °C)	-40 ... +70 °C -40 ... +85 °C -40 ... +85 °C Extended temperature upper limit of +85° C permitted for 16 hours. Reduced operating temperature through the use of media modules (-40 °C to +70 °C) or SFP plug-in transceivers (-40 °C to +60 °C)	-40 ... +70 °C -40 ... +85 °C -40 ... +85 °C Extended temperature upper limit of +85° C permitted for 16 hours. Reduced operating temperature through the use of media modules (-40 °C to +70 °C) or SFP plug-in transceivers (-40 °C to +60 °C)	-40 ... +70 °C -40 ... +85 °C -40 ... +85 °C Extended temperature upper limit of +85° C permitted for 16 hours. Reduced operating temperature through the use of media modules (-40 °C to +70 °C) or SFP plug-in transceivers (-40 °C to +60 °C)
<b>Relative humidity</b> • at 25 °C without condensation during operation maximum	95 %	95 %	95 %	95 %
<b>Protection class IP</b>	IP20	IP20	IP20	IP20

## Network Components

### SCALANCE X – Industrial Ethernet Switches

#### SCALANCE XR324-4M PoE TS / SCALANCE XR324-4M EEC / SCALANCE XR324-12M TS

Article number	6GK5324-4GG00-1ER2 SCALANCE XR324-4M EEC	6GK5324-4GG00-1JR2 SCALANCE XR324-4M EEC	6GK5324-4GG00-2ER2 SCALANCE XR324-4M EEC	6GK5324-4GG00-2JR2 SCALANCE XR324-4M EEC
<b>Design, dimensions and weight</b>				
<b>Design</b>	19" rack	19" rack	19" rack	19" rack
<b>Number of modular height units relating to 19-inch cabinet</b>	1	1	1	1
<b>Width</b>	483 mm	483 mm	483 mm	483 mm
<b>Height</b>	44 mm	44 mm	44 mm	44 mm
<b>Depth</b>	305 mm	305 mm	305 mm	305 mm
<b>Net weight</b>	6.5 kg	6.5 kg	6.8 kg	6.8 kg
<b>Mounting type</b>	When used in shipbuilding, the device must be secured in the 19" rack at four points Yes No No No No	When used in shipbuilding, the device must be secured in the 19" rack at four points Yes No No No No	When used in shipbuilding, the device must be secured in the 19" rack at four points Yes No No No No	When used in shipbuilding, the device must be secured in the 19" rack at four points Yes No No No No
<ul style="list-style-type: none"> <li>• 19-inch installation</li> <li>• 35 mm DIN rail mounting</li> <li>• wall mounting</li> <li>• S7-300 rail mounting</li> <li>• S7-1500 rail mounting</li> </ul>				
<b>Product properties, functions, components general</b>				
<b>Cascading in the case of a redundant ring at reconfiguration time of &lt;math&gt;\leq 0.3\text{s}&lt;/math&gt;</b>	100	100	100	100
<b>Cascading in cases of star topology</b>	any (depending only on signal propagation time)	any (depending only on signal propagation time)	any (depending only on signal propagation time)	any (depending only on signal propagation time)
<b>Product functions management, configuration</b>				
<b>Product function</b>				
• CLI	Yes	Yes	Yes	Yes
• web-based management	Yes	Yes	Yes	Yes
• MIB support	Yes	Yes	Yes	Yes
• TRAPs via email	Yes	Yes	Yes	Yes
• Configuration with STEP 7	Yes	Yes	Yes	Yes
• RMON	Yes	Yes	Yes	Yes
• Port mirroring	Yes	Yes	Yes	Yes
• multiport mirroring	Yes	Yes	Yes	Yes
• CoS	Yes	Yes	Yes	Yes
• PROFINET IO diagnosis	Yes	Yes	Yes	Yes
• switch-managed	Yes	Yes	Yes	Yes
<b>Protocol is supported</b>				
• Telnet	Yes	Yes	Yes	Yes
• HTTP	Yes	Yes	Yes	Yes
• HTTPS	Yes	Yes	Yes	Yes
• TFTP	Yes	Yes	Yes	Yes
• FTP	Yes	Yes	Yes	Yes
• BOOTP	Yes	Yes	Yes	Yes
• GMRP	Yes	Yes	Yes	Yes
• DCP	Yes	Yes	Yes	Yes
• LLDP	Yes	Yes	Yes	Yes
• SNMP v1	Yes	Yes	Yes	Yes
• SNMP v2	Yes	Yes	Yes	Yes
• SNMP v3	Yes	Yes	Yes	Yes
• IGMP (snooping/querier)	Yes	Yes	Yes	Yes
<b>Identification &amp; maintenance function</b>				
• I&MO - device-specific information	Yes	Yes	Yes	Yes
• I&M1 – higher-level designation/location designation	Yes	Yes	Yes	Yes
<b>Product functions Diagnosis</b>				
<b>Product function</b>				
• Port diagnostics	Yes	Yes	Yes	Yes
• Statistics Packet Size	Yes	Yes	Yes	Yes
• Statistics packet type	Yes	Yes	Yes	Yes
• Error statistics	Yes	Yes	Yes	Yes
• SysLog	Yes	Yes	Yes	Yes
<b>Product functions VLAN</b>				
<b>Product function</b>				
• VLAN - port based	Yes	Yes	Yes	Yes
• VLAN - protocol-based	No	No	No	No
• VLAN - IP-based	No	No	No	No
• VLAN dynamic	Yes	Yes	Yes	Yes
<b>Number of VLANs maximum</b>	255	255	255	255
<b>Number of VLANs - dynamic maximum</b>	255	255	255	255
<b>Protocol is supported GVRP</b>	Yes	Yes	Yes	Yes

## Network Components

### SCALANCE X – Industrial Ethernet Switches

#### SCALANCE XR324-4M PoE TS / SCALANCE XR324-4M EEC / SCALANCE XR324-12M TS

Article number	6GK5324-4GG00-1ER2 SCALANCE XR324-4M EEC	6GK5324-4GG00-1JR2 SCALANCE XR324-4M EEC	6GK5324-4GG00-2ER2 SCALANCE XR324-4M EEC	6GK5324-4GG00-2JR2 SCALANCE XR324-4M EEC
<b>Product functions DHCP</b>				
<b>Product function</b>				
• DHCP client	Yes	Yes	Yes	Yes
• DHCP Option 82	Yes	Yes	Yes	Yes
• DHCP Option 66	Yes	Yes	Yes	Yes
• DHCP Option 67	Yes	Yes	Yes	Yes
<b>Product functions Redundancy</b>				
<b>Product function</b>				
• Ring redundancy	Yes	Yes	Yes	Yes
• High Speed Redundancy Protocol (HRP)	Yes	Yes	Yes	Yes
• high speed redundancy protocol (HRP) with redundancy manager	Yes	Yes	Yes	Yes
• high speed redundancy protocol (HRP) with standby redundancy	Yes	Yes	Yes	Yes
<b>Protocol is supported Media Redundancy Protocol (MRP)</b>				
<b>Product function</b>				
• media redundancy protocol (MRP) with redundancy manager	Yes	Yes	Yes	Yes
• redundancy procedure STP	Yes	Yes	Yes	Yes
• redundancy procedure RSTP	Yes	Yes	Yes	Yes
• redundancy procedure MSTP	Yes	Yes	Yes	Yes
• Parallel Redundancy Protocol (PRP)/operation in the PRP-network	Yes	Yes	Yes	Yes
• Parallel Redundancy Protocol (PRP)/Redundant Network Access (RNA)	No	No	No	No
• Passive listening	Yes	Yes	Yes	Yes
<b>Protocol is supported</b>				
• STP/RSTP	Yes	Yes	Yes	Yes
• STP	Yes	Yes	Yes	Yes
• RSTP	Yes	Yes	Yes	Yes
• MSTP	Yes	Yes	Yes	Yes
• RSTP big network support	Yes	Yes	Yes	Yes
• LACP	Yes	Yes	Yes	Yes
<b>Product functions Security</b>				
<b>Product function</b>				
• ACL - MAC-based	Yes	Yes	Yes	Yes
• ACL - port/MAC-based	Yes	Yes	Yes	Yes
• IEEE 802.1x (radius)	Yes	Yes	Yes	Yes
• Broadcast/Multicast/Unicast Limiter	Yes	Yes	Yes	Yes
• broadcast blocking	Yes	Yes	Yes	Yes
<b>Protocol is supported</b>				
• SSH	Yes	Yes	Yes	Yes
<b>Product functions Time</b>				
<b>Product function</b>				
• SICLOCK support	Yes	Yes	Yes	Yes
<b>Protocol is supported</b>				
• NTP	Yes	Yes	Yes	Yes
• SNTP	Yes	Yes	Yes	Yes
• IEEE 1588 profile default	Yes	Yes	Yes	Yes
<b>Standards, specifications, approvals</b>				
<b>Standard</b>				
• for FM	FM3611: Class 1, Division 2, Group A, B, C, D / T4, Class 1, Zone 2, Group IIC, T4	FM3611: Class 1, Division 2, Group A, B, C, D / T4, Class 1, Zone 2, Group IIC, T4	FM3611: Class 1, Division 2, Group A, B, C, D / T4, Class 1, Zone 2, Group IIC, T4	FM3611: Class 1, Division 2, Group A, B, C, D / T4, Class 1, Zone 2, Group IIC, T4
• for hazardous zone	EN 60079-0 : 2006, EN 60079-15: 2005, II 3 G Ex nA II T4 KEMA 07 ATEX 0145X	EN 60079-0 : 2006, EN 60079-15: 2005, II 3 G Ex nA II T4 KEMA 07 ATEX 0145X	EN 60079-0 : 2006, EN 60079-15: 2005, II 3 G Ex nA II T4 KEMA 07 ATEX 0145X	EN 60079-0 : 2006, EN 60079-15: 2005, II 3 G Ex nA II T4 KEMA 07 ATEX 0145X
• for safety from CSA and UL	UL 60950-1, CSA C22.2 No. 60950-1-03	UL 60950-1, CSA C22.2 No. 60950-1-03	UL 60950-1, CSA C22.2 No. 60950-1-03	UL 60950-1, CSA C22.2 No. 60950-1-03
• for hazardous zone from CSA and UL	ANSI / ISA 12.12.01, CSA C22.2 No. 142-M1987, CL. 1 / Div. 2 / GP. A, B, C, D T4, CL. 1 / Zone 2 / GP. IIC, T4	ANSI / ISA 12.12.01, CSA C22.2 No. 142-M1987, CL. 1 / Div. 2 / GP. A, B, C, D T4, CL. 1 / Zone 2 / GP. IIC, T4	ANSI / ISA 12.12.01, CSA C22.2 No. 142-M1987, CL. 1 / Div. 2 / GP. A, B, C, D T4, CL. 1 / Zone 2 / GP. IIC, T4	ANSI / ISA 12.12.01, CSA C22.2 No. 142-M1987, CL. 1 / Div. 2 / GP. A, B, C, D T4, CL. 1 / Zone 2 / GP. IIC, T4
• for emitted interference	EN 61000-6-4:2007 (Class A)	EN 61000-6-4:2007 (Class A)	EN 61000-6-4:2007 (Class A)	EN 61000-6-4:2007 (Class A)
• for interference immunity	EN 61000-6-2:2005	EN 61000-6-2:2005	EN 61000-6-2:2005	EN 61000-6-2:2005
<b>Standards, specifications, approvals CE</b>				
<b>Certificate of suitability CE marking</b>				
<b>Standard</b>				
• for EMC	IEC 61850, IEEE 1613	IEC 61850, IEEE 1613	IEC 61850, IEEE 1613	IEC 61850, IEEE 1613

## Network Components

### SCALANCE X – Industrial Ethernet Switches

#### SCALANCE XR324-4M PoE TS / SCALANCE XR324-4M EEC / SCALANCE XR324-12M TS

Article number	6GK5324-4GG00-1ER2 SCALANCE XR324-4M EEC	6GK5324-4GG00-1JR2 SCALANCE XR324-4M EEC	6GK5324-4GG00-2ER2 SCALANCE XR324-4M EEC	6GK5324-4GG00-2JR2 SCALANCE XR324-4M EEC
<b>Standards, specifications, approvals miscellaneous</b>				
<b>Certificate of suitability</b>	EN 61000-6-2:2005, EN 61000-6-4:2007	EN 61000-6-2:2005, EN 61000-6-4:2007	EN 61000-6-2:2005, EN 61000-6-4:2007	EN 61000-6-2:2005, EN 61000-6-4:2007
<ul style="list-style-type: none"> <li>• C-Tick</li> <li>• IEC 61850-3</li> <li>• KC approval</li> </ul>	Yes Yes Yes	Yes Yes Yes	Yes Yes Yes	Yes Yes Yes
<b>Standards, specifications, approvals ship classification</b>				
<b>Marine classification association</b>				
<ul style="list-style-type: none"> <li>• American Bureau of Shipping Europe Ltd. (ABS)</li> <li>• Bureau Veritas (BV)</li> <li>• Det Norske Veritas (DNV)</li> <li>• Germanische Lloyd (GL)</li> <li>• DNV GL</li> <li>• Lloyds Register of Shipping (LRS)</li> <li>• Nippon Kaiji Kyokai (NK)</li> <li>• Polski Rejestr Statkow (PRS)</li> <li>• Royal Institution of Naval Architects (RINA)</li> </ul>	Yes Yes No No Yes Yes Yes No Yes	Yes Yes No No Yes Yes Yes No Yes	Yes Yes No No Yes Yes Yes No Yes	Yes Yes No No Yes Yes Yes No Yes
<b>Standards, specifications, approvals product conformity</b>				
<b>MTBF</b>	15 y	15 y	20 y	20 y

Article number	6GK5324-4GG00-3ER2 SCALANCE XR324-4M EEC	6GK5324-4GG00-3JR2 SCALANCE XR324-4M EEC	6GK5324-4GG00-4ER2 SCALANCE XR324-4M EEC	6GK5324-4GG00-4JR2 SCALANCE XR324-4M EEC
<b>Transmission rate</b>				
<b>Transfer rate</b>	10/100/1000 Mbit/s	10/100/1000 Mbit/s	10/100/1000 Mbit/s	10/100/1000 Mbit/s
<b>Interfaces for communication integrated</b>				
<b>Number of electrical connections</b> • for network components or terminal equipment	16; RJ45	16; RJ45	16; RJ45	16; RJ45
<b>Number of 100 Mbit/s ST(BFOC) ports</b> • for multimode	8	8	8	8
<b>Number of 100 Mbit/s SC ports</b> • for multimode	8	8	8	8
<b>Number of 1000 Mbit/s LC ports</b> • for multimode • for single mode (LD)	8 8	8 8	8 8	8 8
<b>Interfaces others</b>				
<b>Number of electrical connections</b> • for operator console • for signaling contact • for media module • for power supply • for redundant voltage supply	1 1 4 1 0	1 1 4 1 0	1 1 4 2 0	1 1 4 2 0
<b>Type of electrical connection</b> • for operator console • for signaling contact • for power supply	RJ11 3-pole terminal block 3-pole terminal block	RJ11 3-pole terminal block 3-pole terminal block	RJ11 2 x 3-pole terminal block 2 x 3-pole terminal block	RJ11 2 x 3-pole terminal block 2 x 3-pole terminal block
<b>design of the removable storage</b> • C-PLUG	Yes	Yes	Yes	Yes
<b>Signal-Inputs/outputs</b>				
<b>Operating voltage of the signaling contacts</b> • at AC Rated value • at DC Rated value	276 V 230 V	276 V 230 V	276 V 230 V	276 V 230 V
<b>Operating current of the signaling contacts</b> • at AC maximum • at DC maximum	5 A 0.1 A	5 A 0.1 A	5 A 0.1 A	5 A 0.1 A
<b>Supply voltage, current consumption, power loss</b>				
<b>Type of voltage supply redundant power supply unit</b>	No	No	Yes	Yes
<b>Type of voltage of the supply voltage</b>	AC	AC	AC	AC
<b>Supply voltage</b> • at AC • at AC rated value	230 V 80 ... 276 V	230 V 80 ... 276 V	230 V 80 ... 276 V	230 V 80 ... 276 V
<b>Supply voltage 2 Rated value</b> • Type of voltage 2 of the supply voltage	DC	DC	DC	DC
<b>Supply voltage at DC</b> • rated value	220 V 48 ... 300 V	220 V 48 ... 300 V	220 V 48 ... 300 V	220 V 48 ... 300 V

## Network Components

### SCALANCE X – Industrial Ethernet Switches

#### SCALANCE XR324-4M PoE TS / SCALANCE XR324-4M EEC / SCALANCE XR324-12M TS

Article number	6GK5324-4GG00-3ER2 SCALANCE XR324-4M EEC	6GK5324-4GG00-3JR2 SCALANCE XR324-4M EEC	6GK5324-4GG00-4ER2 SCALANCE XR324-4M EEC	6GK5324-4GG00-4JR2 SCALANCE XR324-4M EEC
<b>Product component fusing at power supply input</b>	Yes	Yes	Yes	Yes
<b>Fuse protection type at input for supply voltage</b>	3.15 A / 250 V	3.15 A / 250 V	3.15 A / 250 V	3.15 A / 250 V
<b>Consumed current maximum</b>	0.7 A	0.7 A	0.7 A	0.7 A
<b>Power loss [W]</b> • at AC at 230 V • at DC at 250 V	42 W 42 W	42 W 42 W	42 W 42 W	42 W 42 W
<b>Permitted ambient conditions</b>				
<b>Ambient temperature</b> • during operation • during storage • during transport • Note	-40 ... +70 °C -40 ... +85 °C -40 ... +85 °C Extended temperature upper limit of +85° C permitted for 16 hours. Reduced operating temperature through the use of media modules (-40 °C to +70 °C) or SFP plug-in transceivers (-40 °C to +60 °C)	-40 ... +70 °C -40 ... +85 °C -40 ... +85 °C Extended temperature upper limit of +85° C permitted for 16 hours. Reduced operating temperature through the use of media modules (-40 °C to +70 °C) or SFP plug-in transceivers (-40 °C to +60 °C)	-40 ... +70 °C -40 ... +85 °C -40 ... +85 °C Extended temperature upper limit of +85° C permitted for 16 hours. Reduced operating temperature through the use of media modules (-40 °C to +70 °C) or SFP plug-in transceivers (-40 °C to +60 °C)	-40 ... +70 °C -40 ... +85 °C -40 ... +85 °C Extended temperature upper limit of +85° C permitted for 16 hours. Reduced operating temperature through the use of media modules (-40 °C to +70 °C) or SFP plug-in transceivers (-40 °C to +60 °C)
<b>Relative humidity</b> • at 25 °C without condensation during operation maximum	95 %	95 %	95 %	95 %
<b>Protection class IP</b>	IP20	IP20	IP20	IP20
<b>Design, dimensions and weight</b>				
<b>Design</b>	19" rack	19" rack	19" rack	19" rack
<b>Number of modular height units relating to 19-inch cabinet</b>	1	1	1	1
<b>Width</b>	483 mm	483 mm	483 mm	483 mm
<b>Height</b>	44 mm	44 mm	44 mm	44 mm
<b>Depth</b>	305 mm	305 mm	305 mm	305 mm
<b>Net weight</b>	6.6 kg	6.6 kg	7 kg	7 kg
<b>Mounting type</b>  • 19-inch installation • 35 mm DIN rail mounting • wall mounting • S7-300 rail mounting • S7-1500 rail mounting	When used in shipbuilding, the device must be secured in the 19" rack at four points Yes No No No No	When used in shipbuilding, the device must be secured in the 19" rack at four points Yes No No No No	When used in shipbuilding, the device must be secured in the 19" rack at four points Yes No No No No	When used in shipbuilding, the device must be secured in the 19" rack at four points Yes No No No No
<b>Product properties, functions, components general</b>				
<b>Cascading in the case of a redundant ring at reconfiguration time of &lt;math&gt;\leq 0.3&lt;/math&gt;-s</b>	100	100	100	100
<b>Cascading in cases of star topology</b>	any (depending only on signal propagation time)	any (depending only on signal propagation time)	any (depending only on signal propagation time)	any (depending only on signal propagation time)
<b>Product functions management, configuration</b>				
<b>Product function</b> • CLI • web-based management • MIB support • TRAPs via email • Configuration with STEP 7 • RMON • Port mirroring • multiport mirroring • CoS • PROFINET IO diagnosis • switch-managed	Yes Yes Yes Yes Yes Yes Yes Yes Yes Yes Yes	Yes Yes Yes Yes Yes Yes Yes Yes Yes Yes Yes	Yes Yes Yes Yes Yes Yes Yes Yes Yes Yes Yes	Yes Yes Yes Yes Yes Yes Yes Yes Yes Yes Yes
<b>Protocol is supported</b> • Telnet • HTTP • HTTPS • TFTP • FTP • BOOTP • GMRP • DCP • LLDP • SNMP v1 • SNMP v2 • SNMP v3 • IGMP (snooping/querier)	Yes Yes Yes Yes Yes Yes Yes Yes Yes Yes Yes Yes Yes	Yes Yes Yes Yes Yes Yes Yes Yes Yes Yes Yes Yes Yes	Yes Yes Yes Yes Yes Yes Yes Yes Yes Yes Yes Yes Yes	Yes Yes Yes Yes Yes Yes Yes Yes Yes Yes Yes Yes Yes

## Network Components

### SCALANCE X – Industrial Ethernet Switches

#### SCALANCE XR324-4M PoE TS / SCALANCE XR324-4M EEC / SCALANCE XR324-12M TS

Article number	6GK5324-4GG00-3ER2 SCALANCE XR324-4M EEC	6GK5324-4GG00-3JR2 SCALANCE XR324-4M EEC	6GK5324-4GG00-4ER2 SCALANCE XR324-4M EEC	6GK5324-4GG00-4JR2 SCALANCE XR324-4M EEC
<b>Identification &amp; maintenance function</b>				
• I&M0 - device-specific information	Yes	Yes	Yes	Yes
• I&M1 – higher-level designation/ location designation	Yes	Yes	Yes	Yes
<b>Product functions Diagnosis</b>				
<b>Product function</b>				
• Port diagnostics	Yes	Yes	Yes	Yes
• Statistics Packet Size	Yes	Yes	Yes	Yes
• Statistics packet type	Yes	Yes	Yes	Yes
• Error statistics	Yes	Yes	Yes	Yes
• SysLog	Yes	Yes	Yes	Yes
<b>Product functions VLAN</b>				
<b>Product function</b>				
• VLAN - port based	Yes	Yes	Yes	Yes
• VLAN - protocol-based	No	No	No	No
• VLAN - IP-based	No	No	No	No
• VLAN dynamic	Yes	Yes	Yes	Yes
<b>Number of VLANs maximum</b>	255	255	255	255
<b>Number of VLANs - dynamic maximum</b>	255	255	255	255
<b>Protocol is supported GVRP</b>	Yes	Yes	Yes	Yes
<b>Product functions DHCP</b>				
<b>Product function</b>				
• DHCP client	Yes	Yes	Yes	Yes
• DHCP Option 82	Yes	Yes	Yes	Yes
• DHCP Option 66	Yes	Yes	Yes	Yes
• DHCP Option 67	Yes	Yes	Yes	Yes
<b>Product functions Redundancy</b>				
<b>Product function</b>				
• Ring redundancy	Yes	Yes	Yes	Yes
• High Speed Redundancy Protocol (HRP)	Yes	Yes	Yes	Yes
• high speed redundancy protocol (HRP) with redundancy manager	Yes	Yes	Yes	Yes
• high speed redundancy protocol (HRP) with standby redundancy	Yes	Yes	Yes	Yes
<b>Protocol is supported Media Redundancy Protocol (MRP)</b>	Yes	Yes	Yes	Yes
<b>Product function</b>				
• media redundancy protocol (MRP) with redun- dancy manager	Yes	Yes	Yes	Yes
• redundancy procedure STP	Yes	Yes	Yes	Yes
• redundancy procedure RSTP	Yes	Yes	Yes	Yes
• redundancy procedure MSTP	Yes	Yes	Yes	Yes
• Passive listening	Yes	Yes	Yes	Yes
<b>Protocol is supported</b>				
• STP/RSTP	Yes	Yes	Yes	Yes
• STP	Yes	Yes	Yes	Yes
• RSTP	Yes	Yes	Yes	Yes
• MSTP	Yes	Yes	Yes	Yes
• RSTP big network support	Yes	Yes	Yes	Yes
• LACP	Yes	Yes	Yes	Yes
<b>Product functions Security</b>				
<b>Product function</b>				
• ACL - MAC-based	Yes	Yes	Yes	Yes
• ACL - port/MAC-based	Yes	Yes	Yes	Yes
• IEEE 802.1x (radius)	Yes	Yes	Yes	Yes
• Broadcast/Multicast/Unicast Limiter	Yes	Yes	Yes	Yes
• broadcast blocking	Yes	Yes	Yes	Yes
<b>Protocol is supported</b>				
• SSH	Yes	Yes	Yes	Yes
<b>Product functions Time</b>				
<b>Product function</b>				
• SICLOCK support	Yes	Yes	Yes	Yes
<b>Protocol is supported</b>				
• NTP	Yes	Yes	Yes	Yes
• SNTP	Yes	Yes	Yes	Yes
• IEEE 1588 profile default	Yes	Yes	Yes	Yes
<b>Standards, specifications, approvals</b>				
<b>Standard</b>				
• for hazardous zone	-	-	-	-
• for safety from CSA and UL	UL 508, CSA C22.2 No. 142-M1987	UL 508, CSA C22.2 No. 142-M1987	UL 508, CSA C22.2 No. 142-M1987	UL 508, CSA C22.2 No. 142-M1987
• for hazardous zone from CSA and UL	No	No	No	No
• for emitted interference	EN 61000-6-4:2007 (Class A)	EN 61000-6-4:2007 (Class A)	EN 61000-6-4:2007 (Class A)	EN 61000-6-4:2007 (Class A)
• for interference immunity	EN 61000-6-2:2005	EN 61000-6-2:2005	EN 61000-6-2:2005	EN 61000-6-2:2005



## Network Components

### SCALANCE X – Industrial Ethernet Switches

#### SCALANCE XR324-4M PoE TS / SCALANCE XR324-4M EEC / SCALANCE XR324-12M TS

Article number	6GK5324-4GG00-3ER2 SCALANCE XR324-4M EEC	6GK5324-4GG00-3JR2 SCALANCE XR324-4M EEC	6GK5324-4GG00-4ER2 SCALANCE XR324-4M EEC	6GK5324-4GG00-4JR2 SCALANCE XR324-4M EEC
<b>Standards, specifications, approvals CE</b>				
<b>Certificate of suitability CE marking</b>	Yes	Yes	Yes	Yes
<b>Standard</b> • for EMC	IEC 61850, IEC 61853	IEC 61850, IEC 61853	IEC 61850, IEC 61853	IEC 61850, IEC 61853
<b>Standards, specifications, approvals miscellaneous</b>				
<b>Certificate of suitability</b>	EN 61000-6-2:2005, EN 61000-6-4:2007	EN 61000-6-2:2005, EN 61000-6-4:2007	EN 61000-6-2:2005, EN 61000-6-4:2007	EN 61000-6-2:2005, EN 61000-6-4:2007
• C-Tick	Yes	Yes	Yes	Yes
• IEC 61850-3	Yes	Yes	Yes	Yes
• KC approval	Yes	Yes	Yes	Yes
<b>Standards, specifications, approvals ship classification</b>				
<b>Marine classification association</b>				
• American Bureau of Shipping Europe Ltd. (ABS)	Yes	Yes	Yes	Yes
• Bureau Veritas (BV)	Yes	Yes	Yes	Yes
• Det Norske Veritas (DNV)	No	No	No	No
• Germanische Lloyd (GL)	No	No	No	No
• DNV GL	Yes	Yes	Yes	Yes
• Lloyds Register of Shipping (LRS)	Yes	Yes	Yes	Yes
• Nippon Kaiji Kyokai (NK)	Yes	Yes	Yes	Yes
• Polski Rejestr Statkow (PRS)	No	No	No	No
• Royal Institution of Naval Architects (RINA)	Yes	Yes	Yes	Yes
<b>Standards, specifications, approvals product conformity</b>				
<b>MTBF</b>	15 y	15 y	20 y	20 y

Article number	<b>6GK5324-0GG00-1CR2</b>
Product type designation	SCALANCE XR324-12M TS
<b>Transmission rate</b>	
<b>Transmission rate</b>	10/100/1000 Mbps
<b>Integrated interfaces for communication</b>	
<b>Number of electrical connections</b> • for network components or data terminal equipment • with Power-over-Ethernet for network components or terminal equipment	
<b>Number of 100 Mbps ST(BFOC) ports</b> • for multimode	24
<b>Number of 100 Mbps SC ports</b> • for multimode	24
<b>Number of 1000 Mbps LC ports</b> • for multimode • for single-mode (LD)	24 24
<b>Other interfaces</b>	
<b>Number of electrical connections</b> • for operation panel • for signaling contact • for media module • for power supply • for redundant power supply	1 1 12 1 1
<b>Type of electrical connection</b> • for operation panel • for signaling contact • for power supply	RJ11 port 2-pin terminal block 4-pin terminal block
<b>Type of removable data storage medium</b> • C-PLUG	Yes
<b>Signal inputs/outputs</b>	
<b>Operating current of the signaling contacts</b> • with DC, nominal value	24 V
<b>Operating current of the signaling contacts</b> • with DC, maximum	0.1 A
<b>Supply voltage, current consumption, power loss</b>	
<b>Type of power supply: redundant power supply</b>	No
<b>Type of supply voltage</b>	DC
<b>Supply voltage</b> • External • External	24 V 19.2 ... 28.8 V
<b>Product component: fusing at power supply input</b>	Yes
<b>Type of fusing at input for supply voltage</b>	F 5 A / 125 V
<b>Current consumption, maximum</b>	1.8 A
<b>Power loss [W]</b>	

## Network Components

### SCALANCE X – Industrial Ethernet Switches

#### SCALANCE XR324-4M PoE TS / SCALANCE XR324-4M EEC / SCALANCE XR324-12M TS

Article number	<b>6GK5324-0GG00-1CR2</b>
Product type designation	SCALANCE XR324-12M TS
<ul style="list-style-type: none"> <li>with 24 V DC</li> </ul>	44 W
<b>Permissible ambient conditions</b>	
<b>Ambient temperature</b> <ul style="list-style-type: none"> <li>during operation</li> <li>during storage</li> <li>during transport</li> <li>Remark</li> </ul>	-40 ... +70 °C -40 ... +85 °C -40 ... +85 °C Reduced operating temperature through use of media modules (-40 to +70 °C) or SFP plug-in transceivers (-40 to +60 °C). In the case of vertical mounting position, the maximum operating temperature is reduced to +50 °C.
<b>Relative humidity</b> <ul style="list-style-type: none"> <li>Relative humidity at 25 °C, without condensation during operation, maximum</li> </ul>	95%
<b>IP degree of protection</b>	IP20
<b>Design, dimensions and weights</b>	
<b>Model</b>	19-inch rack
<b>Number of modular height units for 19-inch cabinet</b>	1
<b>Width</b>	483 mm
<b>Height</b>	44 mm
<b>Depth</b>	305 mm
<b>Net weight</b>	5.5 kg
<b>Product property: conformal coating</b>	Yes
<b>Mounting type</b> <ul style="list-style-type: none"> <li>19-inch installation</li> <li>35 mm DIN rail mounting</li> <li>Wall mounting</li> <li>S7-300 rail mounting</li> <li>S7-1500 rail mounting</li> </ul>	For 19-inch rack mounting, 4-point fixing is required for marine engineering applications Yes No No No No
<b>Product properties, functions, components - General</b>	
<b>Cascading with redundant ring and reconfiguration time of &lt; 0.3 s</b>	100
<b>Cascading with star structure</b>	Any (only dependent on signal propagation time)
<b>Product functions - Management, configuration, engineering</b>	
<b>Product function</b> <ul style="list-style-type: none"> <li>CLI</li> <li>Web-based management</li> <li>MIB support</li> <li>TRAPs via e-mail</li> <li>Configuration with STEP 7</li> <li>RMON</li> <li>Port mirroring</li> <li>Multiport mirroring</li> <li>CoS</li> <li>PROFINET IO diagnostics</li> <li>Switch-managed</li> </ul>	Yes Yes Yes Yes Yes Yes Yes Yes Yes Yes Yes Yes
<b>Protocol is supported</b> <ul style="list-style-type: none"> <li>Telnet</li> <li>HTTP</li> <li>HTTPS</li> <li>TFTP</li> <li>FTP</li> <li>BOOTP</li> <li>GMRP</li> <li>DCP</li> <li>LLDP</li> <li>IGMP (snooping/querier)</li> </ul>	Yes Yes Yes Yes Yes Yes Yes Yes Yes Yes
<b>Identification &amp; Maintenance function</b> <ul style="list-style-type: none"> <li>I&amp;MO - Device-specific information</li> <li>I&amp;M1 - Higher level designation/location designation</li> </ul>	Yes Yes
<b>Protocol is supported</b> <ul style="list-style-type: none"> <li>SNMP v1</li> <li>SNMP v2</li> <li>SNMP v3</li> </ul>	Yes Yes Yes
<b>Product functions - Diagnostics</b>	
<b>Product function</b> <ul style="list-style-type: none"> <li>Port diagnostics</li> <li>Packet size statistics</li> <li>Packet type statistics</li> <li>Error statistics</li> <li>SysLog</li> </ul>	Yes Yes Yes Yes Yes

## Network Components

### SCALANCE X – Industrial Ethernet Switches

#### SCALANCE XR324-4M PoE TS / SCALANCE XR324-4M EEC / SCALANCE XR324-12M TS

Article number	<b>6GK5324-0GG00-1CR2</b>
Product type designation	SCALANCE XR324-12M TS
<b>Product functions - VLAN</b>	
<b>Product function</b>	
• VLAN - port-based	Yes
• VLAN - protocol-based	No
• VLAN - IP-based	No
• VLAN - dynamic	Yes
<b>Number of VLANs, maximum</b>	255
<b>Number of dynamic VLANs, maximum</b>	255
<b>GVRP protocol is supported</b>	Yes
<b>Product functions - DHCP</b>	
<b>Product function</b>	
• DHCP client	Yes
• DHCP option 82	Yes
• DHCP option 66	Yes
• DHCP option 67	Yes
<b>Product functions - Redundancy</b>	
<b>Product function</b>	
• Ring redundancy	Yes
• High Speed Redundancy Protocol (HRP)	Yes
• High Speed Redundancy Protocol (HRP) with redundancy manager	Yes
• High Speed Redundancy Protocol (HRP) with standby redundancy	Yes
<b>Media Redundancy Protocol (MRP) is supported</b>	Yes
<b>Product function</b>	
• Media Redundancy Protocol (MRP) with redundancy manager	Yes
• Redundancy procedure STP	Yes
• Redundancy procedure RSTP	Yes
• Redundancy procedure MSTP	Yes
• Passive listening	Yes
<b>Protocol is supported</b>	
• STP/RSTP	Yes
• STP	Yes
• RSTP	Yes
• MSTP	No
• RSTP Big Network Support	Yes
• LACP	Yes
<b>Product functions - Security</b>	
<b>Product function</b>	
• ACL - MAC-based	Yes
• ACL - Port/MAC-based	Yes
• IEEE 802.1X (RADIUS)	Yes
• Broadcast/Multicast/Unicast Limiter	Yes
• Broadcast blocking	Yes
<b>Protocol is supported</b>	
• SSH	Yes
<b>Product functions - Time of day</b>	
<b>Product function</b>	
• SICLOCK support	Yes
<b>Protocol is supported</b>	
• NTP	Yes
• SNTP	Yes
• IEEE 1588 profile default	Yes
<b>Standards, specifications, approvals</b>	
<b>Standard</b>	
• for FM	FM3611: Class 1, Division 2, Group A, B, C, D / T4, Class 1, Zone 2, Group IIC, T4
• for hazardous zone	EN 60079-0: 2006, EN 60079-15: 2005, II 3 G Ex nA II T4 KEMA 07 ATEX 0145X
• for safety, from CSA and UL	UL 60950-1, CSA C22.2 No. 60950-1-03
• for hazardous zone, from CSA and UL	UL 1604 and UL 2279-15 (Hazardous Location), CSA C22.2 No. 213-M1987, Class 1 / Division 2 / Group A, B, C, D / T4, Class 1 / Zone 2 / Group IIC / T4
• for emitted interference	EN 61000-6-4:2007 (Class A)
• for noise immunity	EN 61000-6-2:2005
<b>Standards, specifications, approvals - CE</b>	
<b>Proof of suitability, CE mark</b>	Yes
<b>Standards, specifications, approvals - Other</b>	
<b>Proof of suitability</b>	EN 61000-6-2:2005, EN 61000-6-4:2007
• C-Tick	Yes
• Railway application in accordance with EN 50155	Yes
• Railway application in accordance with EN 50121-4	Yes
• Fire protection in accordance with EN 45545-2	Yes
• KC approval	Yes
<b>Standards, specifications, approvals - Product conformity</b>	
<b>MTBF at 40 °C</b>	25 y

## Network Components

### SCALANCE X – Industrial Ethernet Switches

#### SCALANCE XR324-4M PoE TS / SCALANCE XR324-4M EEC / SCALANCE XR324-12M TS

#### Selection and ordering data

Version	Article No.
<p><b>Industrial Ethernet switches SCALANCE XR324-4M PoE</b></p> <p>Partially modular 19" Industrial Ethernet switches for setup of electrical and optical Industrial Ethernet networks; eight PoE-capable ports, can be optionally equipped with optical or electrical 2-port media modules;</p> <p>All ports support Gigabit Ethernet (blocking), integrated redundancy manager, RSTP, RMON, IGMP-Snooping/Querier, network management via SNMP, PROFINET, and web server</p> <p>16 x 10/100/1000 Mbps RJ45 ports of which eight support PoE;</p> <p>4 x 10/100/1000 Mbps slots for 2-port media modules, electrical or optical</p>	
<p><b>SCALANCE XR324-4M PoE TS</b></p> <p>For railway applications (EN 50155 approval); 24 V DC power supply</p> <ul style="list-style-type: none"> <li>Data cable outlet at front</li> </ul>	<b>6GK5324-4QG00-1CR2</b>
<p><b>SCALANCE XR324-4M EEC Industrial Ethernet switches</b></p> <p>Partially modular 19" Industrial Ethernet switches for establishing electrical and optical Industrial Ethernet networks; all ports can be optionally equipped with optical or electrical 2-port media modules);</p> <p>All ports support Gigabit Ethernet (blocking), integrated redundancy manager, RSTP, RMON, IGMP snooping querier, network management via SNMP, PROFINET and Web server</p> <p>16 x 10/100/1000 Mbps RJ45 ports, electrical 4 x 10/100/1000 Mbps slots for 2-port media modules, electrical or optical</p>	
<p><b>SCALANCE XR324-4M EEC</b></p> <p><u>Power supply 1 x 24 V DC</u></p> <ul style="list-style-type: none"> <li>Front data cable outlet, rear power supply</li> <li>Rear data cable outlet, front power supply</li> </ul> <p><u>Power supply 1 x 100-240 AC/60-250 V DC</u></p> <ul style="list-style-type: none"> <li>Front data cable outlet, rear power supply</li> <li>Rear data cable outlet, front power supply</li> </ul> <p><u>Power supply 2 x 24 V DC</u></p> <ul style="list-style-type: none"> <li>Front data cable outlet, rear power supply</li> <li>Rear data cable outlet, front power supply</li> </ul> <p><u>Power supply 2 x 100-240 AC/60-250 V DC</u></p> <ul style="list-style-type: none"> <li>Front data cable outlet, rear power supply</li> <li>Rear data cable outlet, front power supply</li> </ul>	<p><b>6GK5324-4GG00-1ER2</b></p> <p><b>6GK5324-4GG00-1JR2</b></p> <p><b>6GK5324-4GG00-3ER2</b></p> <p><b>6GK5324-4GG00-3JR2</b></p> <p><b>6GK5324-4GG00-2ER2</b></p> <p><b>6GK5324-4GG00-2JR2</b></p> <p><b>6GK5324-4GG00-4ER2</b></p> <p><b>6GK5324-4GG00-4JR2</b></p>
<p><b>Industrial Ethernet switches SCALANCE XR324-12M TS</b></p> <p>Fully modular 19" Industrial Ethernet switches for setup of electrical and/or optical Industrial Ethernet networks; all ports can optionally be equipped with optical or electrical 2-port media modules;</p> <p>All ports support Gigabit Ethernet (blocking), integrated redundancy manager, RSTP, RMON, IGMP-Snooping/Querier, network management via SNMP, PROFINET, and web server</p> <p>12 x 10/100/1000 Mbps slots for 2-port media modules, electrical or optical</p>	
<p><b>SCALANCE XR324-12M TS</b></p> <p>For railway applications (EN 50155 approval) 24 V DC power supply</p> <ul style="list-style-type: none"> <li>Data cable outlet at front</li> </ul>	<b>6GK5324-0GG00-1CR2</b>
<p><b>Media modules</b></p>	
<p><b>Electrical Media Modules</b></p> <p>With 2 x 10/100/1000 Mbps RJ45 ports, electrical</p> <ul style="list-style-type: none"> <li>MM992-2CUC with securing collar and coated PCBs (conformal coating)</li> </ul> <p>With 2 x 10/100/1000 Mbps M12 ports, electrical</p> <ul style="list-style-type: none"> <li>MM992-2 M12 interface (x-coded) and coated PCBs (conformal coating)</li> </ul>	
<p><b>Optical Media Modules</b></p> <p>With 2 x 1000 Mbps SC ports, optical</p> <ul style="list-style-type: none"> <li>MM992-2 multi-mode, glass, up to 750 m, coated PCBs (conformal coating)</li> </ul>	<b>6GK5992-2GA00-8FA0</b>
<p><b>Accessories</b></p>	
<p><b>IE FC Stripping Tool</b></p> <p>Preset insulation stripping tool for fast stripping of Industrial Ethernet FC cables</p>	<b>6GK1901-1GA00</b>
<p><b>IE FC RJ45 Plug 180 2 x 2</b></p> <p>RJ45 plug connector for Industrial Ethernet with rugged metal housing and integrated insulation displacement contacts for connecting Industrial Ethernet FC installation cables; with 180° cable outlet; for network components and CPs/CPU's with Industrial Ethernet interface</p> <ul style="list-style-type: none"> <li>1 pack = 1 unit</li> </ul>	<b>6GK1901-1BB10-2AA0</b>
<p><b>IE TP Train Cable GP 2x2 (Type C)</b></p> <p>4-core, shielded TP installation cable for connection to IE FC outlet RJ45/IE FC RJ45 plug 180/90 for train applications: PROFINET-compliant;</p> <p>sold by the meter;</p> <p>maximum delivery unit 1000 m, minimum order quantity 20 m</p>	<b>6XV1871-2T</b>

### SCALANCE XR324-4M PoE TS / SCALANCE XR324-4M EEC / SCALANCE XR324-12M TS

Version	Article No.
<p><b>IE FC RJ45 Plug 4 x 2</b> RJ45 plug connector for Industrial Ethernet (10/100/1000 Mbps) with rugged metal enclosure and integrated insulation displacement contacts for connecting Industrial Ethernet FC installation cables; 180° cable outlet; for network components and CPs/CPUs with Industrial Ethernet interface</p> <ul style="list-style-type: none"> <li>• 1 pack = 1 unit</li> </ul>	<b>6GK1901-1BB12-2AA0</b>
<p><b>IE FC M12 Plug PRO 4x2</b> M12 plug connector (X-coded, IP65/IP67) that can be assembled in the field, metal enclosure, insulation displacement fast connection method, for SCALANCE W</p> <ul style="list-style-type: none"> <li>• 1 unit</li> </ul>	<b>6GK1901-0DB30-6AA0</b>
<p><b>IE M12 Panel Feedthrough 4x2</b> Control cabinet feedthrough for transition from M12 connection method (X-coded, IP65/IP67) to RJ45 connection method (IP20)</p> <ul style="list-style-type: none"> <li>• 1 pack = 5 units</li> </ul>	<b>6GK1901-0DM40-2AA5</b>
<p><b>IE FC M12 Cable Connector PRO 4x2</b> M12 plug-in connector (X-coded, IP65/IP67, female contact insert) that can be assembled in the field, metal housing, insulation displacement fast connection method</p> <ul style="list-style-type: none"> <li>• 1 unit</li> </ul>	<b>6GK1901-0DB40-6AA0</b>
<p><b>IE Train Cable GP 4x2</b> 8-core, shielded TP installation cable for connection to IE FC M12 Plug PRO 4x2 for use in railway applications; with railway approval; <u>sold by the meter</u>; maximum delivery unit 1000 m, minimum order quantity 20 m</p>	<b>6XV1878-2T</b>
<p><b>IE Connecting Cable</b> <b>IE FC RJ45 Plug-180/IE FC RJ45 Plug-180</b> Preassembled IE FC TP trailing cable GP 2 x 2 (PROFINET type C) with two IE FC RJ45 Plug-180, IP20 degree of protection; Length:  <ul style="list-style-type: none"> <li>• 1.0 m</li> <li>• 5.0 m</li> <li>• 10.0 m</li> </ul> </p>	<b>6XV1871-5BH10</b> <b>6XV1871-5BH50</b> <b>6XV1871-5BN10</b>
<p><b>IE TP Cord RJ45/RJ45</b> TP cable 4 x 2 with two RJ45 connectors</p> <ul style="list-style-type: none"> <li>• 1 m</li> <li>• 6 m</li> <li>• 10 m</li> </ul>	<b>6XV1870-3QH10</b> <b>6XV1870-3QH60</b> <b>6XV1870-3QN10</b>
<p><b>IE SC RJ POF Plug</b> Screw connector for local assembly on POF FOC (1 pack = 20 units)</p>	<b>6GK1900-0MB00-0AC0</b>
<p><b>POF Standard Cable GP 980/1000</b> POF standard cable for fixed installation indoors with PVC sheath; <u>sold by the meter</u>; maximum delivery unit 1000 m, minimum order quantity 20 m</p>	<b>6XV1874-2A</b>
<p><b>IE SC RJ PCF Plug</b> Screw connector for local assembly on PCF FOC (1 pack = 10 units)</p>	<b>6GK1900-0NB00-0AC0</b>
<p><b>PCF Standard Cable GP 200/230</b> Standard cable, fan-out, <u>sold by the meter</u>; maximum delivery unit 2000 m; minimum order quantity 20 m</p>	<b>6XV1861-2A</b>
<p><b>FC FO Termination Kit</b> Termination kit for local assembly of FC SC and FC BFOC connectors on FC FO standard cable; contains a stripping tool, Kevlar cutters, fiber breaking tool and microscope.</p>	<b>6GK1900-1GL00-0AA0</b>
<p><b>FC BFOC Plug</b> Screw connector for local assembly on FC FOC; (1 pack = 20 units + cleaning cloths)</p>	<b>6GK1900-1GB00-0AC0</b>
<p><b>FC SC Plug</b> Screw connector for local assembly on FC FOC; (1 pack = 10 units duplex plugs + cleaning cloths)</p>	<b>6GK1900-1LB00-0AC0</b>
<p><b>FC FO Standard Cable GP 62.5/200/230</b> FC FO standard cable for fixed installation indoors with PVC sheath; <u>sold by the meter</u>; maximum delivery unit 1000 m, minimum order quantity 20 m</p>	<b>6XV1847-2A</b>
<p><b>Multimode FO BFOC Connector Set</b> For FO standard cable (50/125/1400), FO ground cable (50/125/1400), flexible FO trailing cable, INDOOR FO cable (62.5/125/900), 20 units</p>	<b>6GK1901-0DA20-0AA0</b>

## Network Components

### SCALANCE X – Industrial Ethernet Switches

#### SCALANCE XR324-4M PoE TS / SCALANCE XR324-4M EEC / SCALANCE XR324-12M TS

Version	Article No.
<b>Multi-mode FO SC Duplex Connector Set</b> For FO standard cable (50/125/1400), FO ground cable (50/125/1400), flexible FO trailing cable, INDOOR FO cable (62.5/125/900), 10 units	<b>6GK1901-0LB10-2AA0</b>
<b>LC Plug MM<sup>2</sup></b>	<b>6GK1901-0RB10-2AB0</b>
<b>FO Standard Cable GP 50/125/1400 <sup>1) 2)</sup></b> Multimode cable sold by the meter; maximum delivery unit 1000 m, minimum order quantity 20 m	<b>6XV1873-2A</b>
<b>Pre-Assembled FO Patch Cables</b> <u>Multimode</u>	
<b>MM FO Cord SC/LC</b> With one SC duplex connector and one LC duplex connector, 1 m	<b>6XV1843-5EH10-0CA0</b>
<b>MM FO Cord SC/BFOC</b> With one SC duplex connector and two BFOC connectors, 1 m	<b>6XV1843-5EH10-0CB0</b>
<b>MM FO Cord SC/SC</b> With two SC duplex connectors, 1 m <u>Single-mode</u>	<b>6XV1843-5EH10-0CC0</b>
<b>SM FO Cord SC/LC</b> With one SC duplex connector and one LC duplex connector, 1 m	<b>6XV1843-5FH10-0CA0</b>
<b>SM FO Cord SC/BFOC</b> With one SC duplex connector and two BFOC connectors, 1 m	<b>6XV1843-5FH10-0CB0</b>
<b>SM FO Cord SC/SC</b> With two SC duplex connectors, 1 m	<b>6XV1843-5FH10-0CC0</b>
<b>Screw-Type Terminal Block</b> For SCALANCE X/W/S/M <ul style="list-style-type: none"> <li>• 2-pole for signaling contact (24 V DC) 1 pack = 5 units</li> <li>• 2-pole for power supply (230 V AC) 1 pack = 5 units</li> <li>• 4-pole for power supply (24 V DC) 1 pack = 5 units</li> </ul>	<b>6GK5980-0BB00-0AA5</b> <b>6GK5980-1BC00-0AA5</b> <b>6GK5980-1DB00-0AA5</b>
<b>C-PLUG</b> Removable data storage medium (conformal coating) for easy replacement of devices under fault conditions; for recording configuration data or engineering and application data; can be used in SIMATIC NET products with C-PLUG slot	<b>6GK1900-0AQ00</b>

<sup>1)</sup> Special fiber-optic cables; lengths and accessories available on request

<sup>2)</sup> Special tools and specially trained personnel are required for assembling glass FOC

## 8

### More information

#### Selection Tool:

To assist in selecting the right Industrial Ethernet switches as well as configuration of modular variants, the TIA Selection Tool is available at:

TIA Selection Tool:

<http://www.siemens.com/tia-selection-tool>

### Overview



The new SCALANCE XM-400 product range comprises modular Industrial Ethernet switches, expandable by various port extenders and plug-in transceivers for a maximum configuration with up to 24 ports. It supports 10/100/1000 Mbit technology for various transmission media (twisted pair, fiber optic) and increased port requirements. Thanks to the flexible, modular design, the XM-400 product line is also designed for future requirements and can be adapted to the relevant task.

- Combo ports for the flexible use of interfaces: A combo port consists of an electric port and an SFP slot. Only one of the two ports can ever be active. If an SFP plug-in transceiver is inserted, the electric port is deactivated
- Fast mobile diagnosis with smartphone/tablet thanks to WLAN and NFC: Fast access to the web-based management of the SCALANCE XM-400 via mobile websites. The function can be started using existing WLAN and NFC (Near Field Communication)

- High-speed media redundancy through integral redundancy manager even for large networks, for both Gigabit Ethernet and Fast Ethernet
- Seamless integration of automation networks into existing corporate networks thanks to support for a host of IT standards: Establishment of virtual networks (VLANs)
- Integration into higher-level enterprise networks thanks to support for standardized redundancy procedures (Rapid Spanning Tree Protocol, Link Aggregation)
- By learning the multicast sources and destinations (Internet Group Management Protocol (IGMP) Snooping), SCALANCE XM-400 switches can also filter multicast data traffic and thus limit the load on the network
- Optional activation of the Layer 3 functions for IPv4 and IPv6 in connection with the KEY-PLUG XM-400
- Creation of IP subnets and IP router communication by means of Layer 3 switching (IP routing)
  - Static routing
  - Dynamic routing OSPF (Open Shortest Path First) and RIPv2 (Routing Information Protocol)
  - Redundant routing VRRP (Virtual Router Redundancy Protocol)

### Product versions - basic devices

#### XM408-8C

- 8 ports available in total, of which
  - up to 8 x 10/100/1000 Mbit/s are RJ45 ports with retaining collars
  - up to 8 x SFP slots (combo ports), 100 or 1000 Mbit/s
- Two port extenders with 8 ports each can be connected to implement a maximum of 24 ports in one switch

### Technical specifications

Article number	6GK5408-8GS00-2AM2
<b>Transmission rate</b>	
Transfer rate	10/100/1000 Mbit/s
Number of ports maximum	24
<b>Interfaces for communication maximum configuration for modular devices</b>	
Number of electrical ports maximum	24
Number of electrical ports with PoE maximum	16
Number of optical ports maximum	24
<b>Interfaces for communication integrated</b>	
Number of electrical connections	8; RJ45 with securing collar
• for network components or terminal equipment	
Number of 10/100/1000 Mbit/s RJ45 ports Integrated	8
• with securing collar	
Number of electrical connections	8; 100 Mbit/s or 1000 Mbit/s SFP plug-in transceiver
• for SFP	
Number of combo ports with RJ45 interface for optical plug-in transceiver	8; 100 Mbit/s or 1000 Mbit/s SFP plug-in transceiver
Number of connectable extender modules	2
<b>Interfaces for communication pluggable maximum</b>	
Number of 10/100/1000 Mbit/s RJ45 ports	16
• with securing collar	16
• with securing collar with PoE	

## Network Components

### SCALANCE X – Industrial Ethernet Switches

#### SCALANCE XM-400 managed

Article number	6GK5408-8GS00-2AM2
<b>Number of 100 Mbit/s LC ports</b>	
• for multimode	24
• for single mode (LD)	24
• for single mode (LH+)	24
• for single mode (ELH200)	24
<b>Number of 1000 Mbit/s LC ports</b>	
• for multimode	24
• for single mode (LD)	24
• for single mode (LH)	24
• for single mode (LH+)	24
• for single mode (ELH)	24
<b>Number of electrical connections</b>	
• for SFP	24; 100 Mbit/s or 1000 Mbit/s SFP plug-in transceiver
<b>Interfaces others</b>	
<b>Number of electrical connections</b>	
• for operator console	1
• for management purposes	1
• for signaling contact	1
• for power supply	1
• for redundant voltage supply	1
• Type of electrical connection	
• for operator console	RJ11
• for management purposes	RJ45
• for signaling contact	2-pole terminal block
• for power supply	4-pole terminal block
<b>Number of extender expansion interfaces</b>	2
<b>design of the removable storage</b>	
• C-PLUG/KEY-PLUG	Yes
<b>Product feature hot-swappable interface modules</b>	Yes
<b>Signal-Inputs/outputs</b>	
<b>Operating voltage of the signaling contacts</b>	
• at DC Rated value	24 V
<b>Operating current of the signaling contacts</b>	
• at DC maximum	0.1 A
<b>Supply voltage, current consumption, power loss</b>	
<b>Type of voltage supply redundant power supply unit</b>	No
<b>Type of voltage of the supply voltage</b>	DC
<b>Supply voltage</b>	
• external	24 V
• external minimum	19.2 V
• external maximum	28.8 V
<b>Product component fusing at power supply input</b>	Yes
<b>Fuse protection type at input for supply voltage</b>	F 15 A / 125 V
<b>Consumed current maximum</b>	2 A
<b>Power loss [W]</b>	
• at DC at 24 V	48 W
<b>Supplied active power of PSE with PoE</b>	
• per port maximum	30 W
• total maximum	360 W
<b>Permitted ambient conditions</b>	
<b>Ambient temperature</b>	
• during operation	-40 ... +70 °C
• during storage	-40 ... +85 °C
• during transport	-40 ... +85 °C
<b>Relative humidity</b>	
• at 25 °C without condensation during operation maximum	95 %
<b>Protection class IP</b>	IP20
<b>Design, dimensions and weight</b>	
<b>Design</b>	modular
<b>Width</b>	140 mm
<b>Height</b>	147 mm
<b>Depth</b>	125 mm
<b>Net weight</b>	1.15 kg
<b>Mounting type</b>	
• 19-inch installation	No
• 35 mm DIN rail mounting	Yes
• wall mounting	No
• S7-300 rail mounting	Yes
• S7-1500 rail mounting	Yes



Article number	6GK5408-8GS00-2AM2
<b>Product properties, functions, components general</b>	
<b>Cascading in cases of star topology</b>	any (depending only on signal propagation time)
<b>Product functions management, configuration</b>	
<b>Product function</b>	
• CLI	Yes
• web-based management	Yes
• MIB support	Yes
• TRAPs via email	Yes
• Configuration with STEP 7	Yes
• RMON	Yes
• Port mirroring	Yes
• multiport mirroring	Yes
• CoS	Yes
• PROFINET IO diagnosis	Yes
• switch-managed	Yes
<b>Telegram length for Ethernet maximum</b>	9 216 byte
<b>Protocol is supported</b>	
• Telnet	Yes
• HTTP	Yes
• HTTPS	Yes
• TFTP	Yes
• FTP	Yes
• BOOTP	Yes
• GMRP	Yes
• DCP	Yes
• LLDP	Yes
• SNMP v1	Yes
• SNMP v2	Yes
• SNMP v3	Yes
• IGMP (snooping/querier)	Yes
<b>Identification &amp; maintenance function</b>	
• I&MO - device-specific information	Yes
• I&M1 – higher-level designation/location designation	Yes
<b>Product functions Diagnosis</b>	
<b>Product function</b>	
• Port diagnostics	Yes
• Statistics Packet Size	Yes
• Statistics packet type	Yes
• Error statistics	Yes
• SysLog	Yes
<b>Product functions VLAN</b>	
<b>Product function</b>	
• VLAN - port based	Yes
• VLAN - protocol-based	Yes
• VLAN - IP-based	Yes
• VLAN dynamic	Yes
<b>Number of VLANs maximum</b>	255
<b>Number of VLANs - dynamic maximum</b>	255
<b>Protocol is supported GVRP</b>	Yes
<b>Product functions DHCP</b>	
<b>Product function</b>	
• DHCP client	Yes
• DHCP Option 82	Yes
• DHCP Option 66	Yes
• DHCP Option 67	Yes
<b>Product functions Routing</b>	
<b>Product function</b>	
• Static IP routing	Yes
• Static IP routing IPv6	Yes
• dynamic IP routing	Yes
• dynamic IP routing IPv6	Yes
<b>Protocol is supported</b>	
• RIPv2	Yes
• RIPnG for IPv6	Yes
• OSPFv2	Yes
• OSPFv3 for IPv6	Yes
• VRRP	Yes
• VRRP for IPv6	Yes
<b>Product functions Redundancy</b>	
<b>Product function</b>	
• Ring redundancy	Yes
• High Speed Redundancy Protocol (HRP)	Yes
• high speed redundancy protocol (HRP) with redundancy manager	Yes
• high speed redundancy protocol (HRP) with standby redundancy	Yes

## Network Components

### SCALANCE X – Industrial Ethernet Switches

#### SCALANCE XM-400 managed

Article number	6GK5408-8GS00-2AM2
<b>Protocol is supported Media Redundancy Protocol (MRP)</b>	Yes
<b>Product function</b>	
• media redundancy protocol (MRP) with redundancy manager	Yes
• redundancy procedure STP	Yes
• redundancy procedure RSTP	Yes
• redundancy procedure MSTP	Yes
• Passive listening	Yes
<b>Protocol is supported</b>	
• LACP	Yes
<b>Product functions Security</b>	
<b>Product function</b>	
• ACL - MAC-based	Yes
• ACL - port/MAC-based	Yes
• IEEE 802.1x (radius)	Yes
• Broadcast/Multicast/Unicast Limiter	Yes
• broadcast blocking	Yes
<b>Protocol is supported</b>	
• SSH	Yes
<b>Product functions Time</b>	
<b>Product function</b>	
• SICLOCK support	Yes
<b>Protocol is supported</b>	
• NTP	Yes
• SNTP	Yes
<b>Standards, specifications, approvals</b>	
<b>Standard</b>	
• for FM	FM3611: Class 1, Divison 2, Group A, B, C, D / T4, Class 1, Zone 2, Group IIC, T4
<b>Standards, specifications, approvals CE</b>	
<b>Certificate of suitability CE marking</b>	Yes
<b>Standards, specifications, approvals miscellaneous</b>	
<b>Certificate of suitability</b>	EN 61000-6-2, EN 61000-6-4
• C-Tick	Yes
• Railway application in accordance with EN 50121-4	Yes
• KC approval	Yes
<b>Standards, specifications, approvals product conformity</b>	
<b>MTBF at 40 °C</b>	28 y

### Selection and ordering data

Version	Article No.
<b>SCALANCE XM-400 Industrial Ethernet switches</b>	
<b>SCALANCE XM408-8C;</b> 8 x 10/100/1000 Mbps, of which 8 x RJ45/SFP combo ports; 8 x 1000 Mbps maximum basic device configuration <ul style="list-style-type: none"> <li>• IP routing in combination with KEY PLUG XM-400</li> <li>• IP routing integrated</li> </ul>	<b>6GK5408-8GS00-2AM2</b> <b>6GK5408-8GR00-2AM2</b>
<b>Accessories</b>	
<b>Power supplies</b>	
<b>SIMATIC PM 1507 24 V</b> stabilized power supply for SIMATIC S7-1500 <ul style="list-style-type: none"> <li>• Power supply S7-1500 PM1507 SIMATIC PM 1507 24 V/3 A stabilized power supply for SIMATIC S7-1500 input: 120/230 V AC; output: 24 V DC/3 A</li> <li>• Power supply S7-1500 PM1507 SIMATIC PM 1507 24 V/8 A stabilized power supply for SIMATIC S7-1500 input: 120/230 V AC; output: 24 V DC/8 A</li> </ul>	<b>6EP1332-4BA00</b> <b>6EP1333-4BA00</b>
<b>KEY-PLUG XM-400</b> Swap medium for expansion of the device functions with IP routing (Layer 3), for integration of configuration data and easy replacement of SCALANCE XM-400 in the event of a fault	<b>6GK5904-0PA00</b>
<b>IE FC Stripping Tool</b> Pre-adjusted stripping tool for fast stripping of Industrial Ethernet FC cables	<b>6GK1901-1GA00</b>
<b>IE FC RJ45 Plug 180 2 x 2</b> 180° cable outlet; for network components and CPs/CPUs with Industrial Ethernet interface <ul style="list-style-type: none"> <li>• 1 pack = 1 unit</li> </ul>	<b>6GK1901-1BB10-2AA0</b>
<b>IE FC TP Standard Cable GP 2 x 2 (Type A)</b> 4-core, shielded TP installation cable for connection to IE FC Outlet RJ45/IE FC RJ45 Plug; PROFINET-compliant; with UL approval; sold by the meter; max. length 1000 m, minimum order 20 m	<b>6XV1840-2AH10</b>
<b>IE FC RJ45 Plug 4 x 2</b> IE FC RJ45 plug 180 4 x 2; RJ45 connector; Cat6A; (10/100/1000/10000 Mbps) with rugged metal enclosure; FC connection method; for IE FC cable 4 x 2 (AWG24); 180° cable outlet <ul style="list-style-type: none"> <li>• 1 pack = 1 unit</li> </ul>	<b>6GK1901-1BB12-2AA0</b>
<b>IE FC TP Standard Cable GP 4 x 2</b> 8-core, shielded TP installation cable for universal applications; with UL approval; sold by the meter; max. length per delivery unit 1000 m, minimum order 20 m <ul style="list-style-type: none"> <li>• AWG24, for connecting to IE FC RJ45 Plug 4 x 2, IE FC M12 Plug PRO 4 x 2</li> </ul>	<b>6XV1878-2A</b>
<b>IE Connecting Cable IE FC RJ45 Plug-180/IE FC RJ45 Plug-180</b> Preassembled IE FC TP Trailing Cable GP 2 x 2 (PROFINET type C) with two IE FC RJ45 Plug-180, IP20 degree of protection Length: <ul style="list-style-type: none"> <li>• 1.0 m</li> <li>• 5.0 m</li> <li>• 10.0 m</li> </ul>	<b>6XV1871-5BH10</b> <b>6XV1871-5BH50</b> <b>6XV1871-5BN10</b>
<b>FC FO Termination Kit</b> Termination Kit for local assembly of FC SC and FC BFOC connectors to FC FO Standard Cable, comprising a stripping tool, Kevlar cutters, fiber breaking tool and microscope	<b>6GK1900-1GL00-0AA0</b>
<b>FC BFOC Plug</b> Screw connector for on-site assembly on FC fiber-optic cable; (1 pack = 20 units + cleaning cloths)	<b>6GK1900-1GB00-0AC0</b>
<b>FC SC Plug</b> Screw connector for on-site assembly on FC fiber-optic cable; (1 pack = 10 duplex plugs + cleaning cloths)	<b>6GK1900-1LB00-0AC0</b>
<b>FC FO Standard Cable GP 62.5/200/230</b> FC FO Standard Cable for fixed routing indoors with PVC sheath; sold by the meter; max. length 1000 m; minimum order 20 m	<b>6XV1847-2A</b>

## Network Components

### SCALANCE X – Industrial Ethernet Switches

#### SCALANCE XM-400 managed

Version	Article No.
<b>Multi-mode FO BFOC connector set</b> For FO Standard Cable (50/125/1400), FO Ground Cable (50/125/1400), flexible FO Trailing Cable, INDOOR FC Cable (62.5/125/900), 20 units	6GK1901-0DA20-0AA0
<b>Multi-mode FO SC duplex connector set</b> For FO Standard Cable (50/125/1400), FO Ground Cable (50/125/1400), flexible FO Trailing Cable, INDOOR FC Cable (62.5/125/900), 10 units	6GK1901-0LB10-2AA0
<b>LC Plug MM<sup>2)</sup></b>	6GK1901-0RB10-2AB0
<b>FO Standard Cable GP 50/125/1400<sup>1) 2)</sup></b> Multimode cable, sold by the meter; max. length 1000 m; minimum order 20 m	6XV1873-2A
<b>Pre-assembled FO patch cables</b> Multimode	
<b>MM FO Cord SC/LC</b> With one SC duplex connector and one LC duplex connector, 1 m	6XV1843-5EH10-0CA0
<b>MM FO Cord SC/BFOC</b> With one SC duplex connector and two BFOC connectors, 1 m	6XV1843-5EH10-0CB0
<b>MM FO Cord SC/SC</b> With two SC duplex connectors, 1 m Single-mode	6XV1843-5EH10-0CC0
<b>SM FO Cord SC/LC</b> With one SC duplex connector and one LC duplex connector, 1 m	6XV1843-5FH10-0CA0
<b>SM FO Cord SC/BFOC</b> With one SC duplex connector and two BFOC connectors, 1 m	6XV1843-5FH10-0CB0
<b>SM FO Cord SC/SC</b> With two SC duplex connectors, 1 m	6XV1843-5FH10-0CC0
<b>C-PLUG</b> Swap medium for simple replacement of devices in the event of a fault; for storing configuration or application data; can be used for SIMATIC NET products with C-PLUG slot	6GK1900-0AB00
<b>Other accessories</b>	
<b>Spring-loaded terminal block</b> Spring-type terminal block for SCALANCE X/W/S/M; 1 pack = 5 units <ul style="list-style-type: none"> <li>• 2-pole for signaling contact (24 V DC)</li> <li>• 4-pole for power supply (24 V DC)</li> </ul>	6GK5980-0BB10-0AA5 6GK5980-1DB10-0AA5
<b>Connecting cable (RJ11/RS232)</b> Preassembled serial cable with RJ11 and RS232 connectors; length: 5 m; 1 item per pack	6GK5980-3BB00-0AA5
<b>Screw for fixing to S7-1500 and S7-300 rails</b> Mounting screw for SCALANCE X/W/S/M; 1 pack = 5 items	6GK5980-4AA00-0AA5
<b>SCALANCE TAP104</b> Test access port for the reaction-free extraction of Ethernet data frames (10/100 Mbps) from both transmission directions; extracts entire data traffic (including incomplete diagrams) for further diagnostics.	6GK5104-0BA00-1SA2

<sup>1)</sup> Special fiber-optic cables; lengths and accessories available on request

<sup>2)</sup> Special tools and trained personnel are required for pre-assembling glass fiber-optic cables

#### More information

##### Selection tools:

To assist in selecting the right Industrial Ethernet switches as well as configuration of modular variants, the TIA Selection Tool is available at:

[www.siemens.com/tia-selection-tool-standalone](http://www.siemens.com/tia-selection-tool-standalone)

## Network Components

### SCALANCE X – Industrial Ethernet Switches

#### Port Extender for SCALANCE XM-400 managed

#### Overview



- Port extender for flexible expansion to up to 24 ports, can be connected to the SCALANCE XM-400 Industrial Ethernet switches
- Each port extender has eight ports
- There are three different versions, with different connections

#### Product versions

##### PE 408PoE

- 8 x 10/100/1000 Mbps RJ45 ports with retaining collar with PoE according to IEEE802.3 Type 1 and Type 2
- Extended operating temperature range from -40 °C to +60 °C
- A separate power supply is required for PoE power (SCALANCE PS924 PoE or SCALANCE PS9230 PoE are available)

#### Benefits

- Cost savings due to the modular system. The modular system allows the setup of electrical and optical Industrial Ethernet networks and the network topology and port type to easily be adapted to the plant structure and expanded at any time
- Integrated industrial network for data, speech, and video
- Mounting of a port extender on the basic device or another port extender without tools
- High performance due to Gigabit ports

#### Design

- Extender connection on the left for connection to a SCALANCE XM-400 basic device or a port extender
- Extender connection on the right for connecting another port extender
- 8 ports for Ethernet connection, different design depending on the version
- LEDs to display the port and device status
- 2 terminal blocks for Power-over-Ethernet supply with 54 V DC input (only PE408PoE)
- Operating temperature range from -40 °C to +70 °C
- IP20 degree of protection

#### Technical specifications

Article number	<b>6GK5408-0PA00-8AP2</b>
Product type designation	PE408PoE
<b>Transmission rate</b>	
<b>Transfer rate</b>	10/100/1000 Mbit/s
<b>Interfaces for communication integrated</b>	
<b>Number of electrical connections</b>	
• for network components or terminal equipment	8
• for Power-over-Ethernet for network components or terminal equipment	8
<b>Number of 10/100/1000 Mbit/s RJ45 ports integrated</b>	
• with securing collar	8
• with securing collar with PoE	
<b>Number of electrical connections</b>	
• for SFP	
<b>Interfaces for communication pluggable maximum</b>	
<b>Number of electrical connections</b>	
• for SFP	0
<b>Interfaces others</b>	
<b>Type of electrical connection</b>	
• for power supply	2-pole terminal block
<b>Number of extender expansion interfaces</b>	2
<b>Product feature hot-swappable interface modules</b>	Yes
<b>Supply voltage, current consumption, power loss</b>	
<b>Type of voltage of the supply voltage</b>	DC
<b>Supply voltage</b>	
• external	54 V
• external minimum	51.3 V
• external maximum	56.7 V
<b>Product component fusing at power supply input</b>	Yes
<b>Fuse protection type at input for supply voltage</b>	F 4 A / 60 V

## Network Components

### SCALANCE X – Industrial Ethernet Switches

#### Port Extender for SCALANCE XM-400 managed

Article number	<b>6GK5408-0PA00-8AP2</b>
Product type designation	PE408PoE
<b>Consumed current maximum</b>	0.2 A
<b>Power loss [W]</b>	4.8 W
• at DC at 24 V	
<b>Supplied active power of PSE with PoE</b>	30 W
• per port maximum	180 W
• total maximum	
<b>Permitted ambient conditions</b>	
<b>Ambient temperature</b>	
• during operation	-40 ... +60 °C
• during storage	-40 ... +85 °C
• during transport	-40 ... +85 °C
<b>Relative humidity</b>	95 %
• at 25 °C without condensation during operation maximum	
<b>Protection class IP</b>	IP20
<b>Design, dimensions and weight</b>	
<b>Design</b>	SIMATIC S7-1500 device design
<b>Number of modular height units relating to 19-inch cabinet</b>	
<b>Width</b>	70 mm
<b>Height</b>	147 mm
<b>Depth</b>	125 mm
<b>Net weight</b>	0.7 kg
<b>Mounting type</b>	
• 19-inch installation	No
• 35 mm DIN rail mounting	Yes
• wall mounting	No
• S7-300 rail mounting	Yes
• S7-1500 rail mounting	Yes
<b>Standards, specifications, approvals</b>	
<b>Standard</b>	
• for FM	FM3611: Class 1, Division 2, Group A, B, C, D / T4, Class 1, Zone 2, Group IIC, T4
• for hazardous zone	EN 60079-0: 2009, EN60079-15: 2010, II 3 G Ex nA IIC T4 Gc, KEMA 07 ATEX 0145 X, IECEx DEK 14.0025X
• for safety from CSA and UL	UL 508, UL 60950-1, CSA C22.2 Nr. 60950-1-03
• for hazardous zone from CSA and UL	ISA 12.12.01-2012 (Hazardous Location), Class 1 / Division 2 / Group A, B, C, D / T4, Class 1 / Zone 2 / Group IIC / T4
• for emitted interference	EN 61000-6-4 (Class A)
• for interference immunity	EN 61000-6-2
<b>Standards, specifications, approvals CE</b>	
<b>Certificate of suitability CE marking</b>	Yes
<b>Standards, specifications, approvals miscellaneous</b>	
<b>Certificate of suitability</b>	EN 61000-6-2, EN 61000-6-4
• C-Tick	Yes
• Railway application in accordance with EN 50121-4	Yes
• KC approval	Yes
<b>Standards, specifications, approvals ship classification</b>	
<b>Marine classification association</b>	
• American Bureau of Shipping Europe Ltd. (ABS)	Yes
• Bureau Veritas (BV)	No
• Det Norske Veritas (DNV)	No
• Germanische Lloyd (GL)	No
• DNV GL	Yes
• Lloyds Register of Shipping (LRS)	Yes
• Nippon Kaiji Kyokai (NK)	Yes
• Polski Rejestr Statkow (PRS)	Yes
• Royal Institution of Naval Architects (RINA)	Yes
<b>Standards, specifications, approvals product conformity</b>	
<b>MTBF at 40°C</b>	58 y

#### Selection and ordering data

Version	Article No.
<b>Port extender for SCALANCE XM-400</b>	
<ul style="list-style-type: none"> <li>• PE408PoE; with 8 x 10/100/1000 Mbps TP ports Power over Ethernet according to 802.3at Type 1/2</li> </ul>	<b>6GK5408-0PA00-8AP2</b>
<b>SCALANCE PS924 PoE or SCALANCE PS9230 PoE</b>	
<b>SCALANCE PS924 PoE</b> power supply for Power-over-Ethernet, Input: 24 V DC Output: 54 V DC/1.6 A NEC Class 2	<b>6GK5924-0PS00-1AA2</b>
<b>SCALANCE PS9230 PoE</b> power supply for Power-over-Ethernet, Input: 120/230 V AC, Output: 54 V DC/1.6 A NEC Class	<b>6GK5923-0PS00-3AA2</b>
<b>Accessories</b>	
<b>IE FC Stripping Tool</b> Pre-adjusted stripping tool for fast stripping of Industrial Ethernet FC cables	<b>6GK1901-1GA00</b>
<b>IE FC RJ45 Plug 180 2 x 2</b> 180° cable outlet; for network components and CPs/CPU with Industrial Ethernet interface <ul style="list-style-type: none"> <li>• 1 pack = 1 unit</li> </ul>	<b>6GK1901-1BB10-2AA0</b>
<b>IE FC TP Standard Cable GP 2 x 2 (Type A)</b> 4-core, shielded TP installation cable for connection to IE FC Outlet RJ45/IE FC RJ45 Plug; PROFINET-compliant; with UL approval; sold by the meter; max. length 1000 m, minimum order quantity 20 m	<b>6XV1840-2AH10</b>
<b>IE FC RJ45 Plug 4 x 2</b> RJ45 plug-in connector for Industrial Ethernet (10/100/1000 Mbps) with a rugged metal enclosure and integrated insulation displacement contacts for connecting Industrial Ethernet FC installation cables; 180° cable outlet; for network components and CPs/CPU with Industrial Ethernet interface <ul style="list-style-type: none"> <li>• 1 pack = 1 unit</li> </ul>	<b>6GK1901-1BB11-2AA0</b>
<b>IE FC TP Standard Cable GP 4 x 2</b> 8-core, shielded TP installation cable for universal applications; with UL approval; sold by the meter; max. length per delivery unit 1000 m, minimum order 20 m <ul style="list-style-type: none"> <li>• AWG24, for connecting to IE FC RJ45 Plug 4 x 2, IE FC M12 Plug PRO 4 x 2</li> </ul>	<b>6XV1878-2A</b>
<b>IE Connecting Cable IE FC RJ45 Plug-180/IE FC RJ45 Plug-180</b> Preassembled IE FC TP Trailing Cable GP 2 x 2 (PROFINET type C) with two IE FC RJ45 Plug-180, IP20 degree of protection Length: <ul style="list-style-type: none"> <li>• 1.0 m</li> <li>• 5.0 m</li> <li>• 10.0 m</li> </ul>	<b>6XV1871-5BH10</b> <b>6XV1871-5BH50</b> <b>6XV1871-5BN10</b>
<b>Other accessories</b>	
<b>Spring-loaded terminal block</b> Spring-type terminal block for SCALANCE X/W/S/M; 1 pack = 5 units <ul style="list-style-type: none"> <li>• 2-pole for signaling contact (24 V DC)</li> </ul>	<b>6GK5980-0BB10-0AA5</b>
<b>Screw for fixing to S7-1500 and S7-300 rails</b> Mounting screw for SCALANCE X/W/S/M; 1 pack = 5 items	<b>6GK5980-4AA00-0AA5</b>

#### More information

##### Selection tools:

To assist in selecting the right Industrial Ethernet switches as well as configuration of modular variants, the TIA Selection Tool is available at:

[www.siemens.com/tia-selection-tool-standalone](http://www.siemens.com/tia-selection-tool-standalone)

## Network Components

Communication for PC-based systems

### CP 1604

#### Overview



ISO	TCP/UDP	PN	MRP	OPC	PG/OP	S7/S5	IT
	●	●	●				

- Integral 4-port real-time switch
- High performance through direct memory access
- Integration in network management systems through the support of SNMP
- Comprehensive diagnostics possibilities for installation, start-up and operation of the module
- Powerful configuration tools are part of the scope of delivery of the module
- The CP 1604 EEC (Enhanced Environmental Conditions) is suitable for use in extremely harsh industrial environments

#### Benefits

- Ideally suited for design of small local networks through integral 4-port real-time switch
- Simple portability to various operating system environments using DK-16xx PN IO development kit
- Uncrossed connecting cables can be used due to the integrated Autocrossover function
- Suitable for railway applications acc. to EN 50155 / IEC 60571 (EEC variant 6GK1160-4AT01 only)

#### Application

The CP 1604 provides high-performance support for control tasks on the PC (PC based Control, Numeric Control, Robot Control).

With IRT (Isochronous Real-Time), the CP is ideally suited to time-critical applications that are in the range of strictly isochronous closed-loop control in the motion control sector.

The integrated 4-port switch supports low-cost system solutions and the configuration of different topologies.

The DK-16xx PN IO development kit enables integration of the module into any operating systems.

The CP 1604 EEC (Enhanced Environmental Conditions) is suitable for use in extremely harsh industrial environments

#### Design

- Industrial Ethernet (via "Connection Board for CP 1604")
  - Ethernet real-time ASIC ERTEC 400
  - 4 x RJ45 connection
  - Integral 4-port real-time switch for 10/100 Mbit/s Ethernet
  - Half/full duplex
  - Autosensing/Autocrossover/Autonegotiation
- PCI-104-Plus interface:
  - PCI 2.2
  - 32 bits
  - 33 MHz or 66 MHz
  - Installation through PCI standard mechanisms (Plug & Play)
- Host interface/processor:
  - Dual-port RAM onboard
  - Flash for program memory onboard
  - ARM 946 RISK processor (32-bit) onboard for preprocessing
- Power supply:
  - Operating voltage: 5 V through PCI-104
- Size:
  - PCI-104 format

#### Product versions

CP 1604 EEC (6GK1160-4AT01), version suitable for use in railway applications

- Suitable for use in extreme environmental conditions



## Technical specifications

Article number	6GK1160-4AT01
Product type designation	CP 1604 EEC
<b>Transmission rate</b>	
Transfer rate	100 Mbit/s
<b>Interfaces</b>	
<b>Number of electrical connections</b> • at the 1st interface acc. to Industrial Ethernet • for power supply	4 1
<b>Type of electrical connection</b> • at the 1st interface acc. to Industrial Ethernet • for power supply	RJ45 port via connection board 4-pole terminal block through power supply board
<b>Supply voltage, current consumption, power loss</b>	
Type of voltage of the supply voltage	DC
Type of voltage supply optional external supply	Yes
<b>Supply voltage</b> • 1 from backplane bus • external • Note	5 V
<b>Relative symmetrical tolerance at DC</b> • at 5 V	5 %
<b>Consumed current</b> • 1 from backplane bus at DC maximum • from external supply voltage at DC at 24 V maximum	0.8 A
<b>Power loss [W]</b>	4 W
<b>Power loss [W] in switch mode maximum</b>	4.1 W
<b>Permitted ambient conditions</b>	
<b>Ambient temperature</b> • during operation • during storage • during transport	-40 ... +70 °C -20 ... +60 °C -20 ... +60 °C
<b>Relative humidity at 25 °C without condensation during operation maximum</b>	95 %
<b>Protection class IP</b>	IP00
<b>Design, dimensions and weight</b>	
<b>Module format</b>	PC/104-Plus
<b>Width</b>	90 mm
<b>Height</b>	24 mm
<b>Depth</b>	95 mm
<b>Net weight</b>	110 g
<b>Mounting type</b>	Screw mounting
<b>Number of plug-in cards of same design plug-in per PC station</b>	1
<b>Number of units Note</b>	-
<b>Product functions switch</b>	
<b>Product feature Switch</b>	Yes
<b>Product function switch-managed</b>	No
<b>Product functions Redundancy</b>	
<b>Software for redundancy function required</b>	No
<b>Product function</b> • Ring redundancy • Redundancy manager	Yes Yes Yes
<b>Protocol is supported Media Redundancy Protocol (MRP)</b>	Yes
<b>Standards, specifications, approvals</b>	
<b>Standard</b> • for EMC • for safety from CSA and UL • for emitted interference • for interference immunity	2004/108/EC CAN/CSA C22.2 & UL 60950-1 EN 61000-6-3, EN 61000-6-4 EN 61000-6-1, EN 61000-6-2
<b>Certificate of suitability</b> • CE marking • C-Tick	Yes Yes
<b>Accessories</b>	
<b>accessories</b>	optional: Connection board for CP 1604, power supply board for CP 1604, HARDNET-IE DK (development kit)

## Network Components

Communication for PC-based systems

### CP 1604

#### Selection and ordering data

Version	Article No.
<p><b>CP 1604 EEC communications processor</b>            PCI-104 card (32-bit) with ASIC ERTEC 400 for connecting PCI-104 systems to PROFINET IO with 4-port real-time switch (RJ45); incl. IO-Base software for PROFINET IO Controller and NCM PC; single license for one installation, runtime software, software and electronic manual on CD-ROM, Class A, for 32-bit Windows XP Professional and Windows 7; other operating systems using DK-16xx PN IO Development Kit English/German</p>	<b>6GK1160-4AT01</b>
<b>Accessories</b>	
<p><b>Connection board for CP 1604</b>            Connection board for CP 1604 with four RJ45 sockets incl. connecting cable</p>	<b>6GK1160-4AC00</b>
<p><b>Power supply for CP 1604</b>            Redundant power supply for CP 1604 for operating the integral 4-port switch of the CP 1604 with the PC-104 system switched off; includes connecting cable</p>	<b>6GK1160-4AP00</b>
<p><b>Development Kit DK-16xx PN IO</b>            Software Development Kit for CP 1616/CP 1604; driver and IO-Base software for CP 1616/CP 1604 as PN IO Controller and PN IO Device in source code for transfer to other PC-based operating systems; incl. executable sample code for SUSE Linux 10, Windows XP Professional and Windows 7</p>	See <a href="https://support.industry.siemens.com/cs/de/en/view/109480928">https://support.industry.siemens.com/cs/de/en/view/109480928</a>
<p><b>IE TP Cord RJ45/RJ45</b>            TP cable 4 x 2 with 2 RJ45 connectors</p> <ul style="list-style-type: none"> <li>• 0.5 m</li> <li>• 1 m</li> <li>• 2 m</li> <li>• 6 m</li> </ul>	<b>6XV1870-3QE50</b> <b>6XV1870-3QH10</b> <b>6XV1870-3QH20</b> <b>6XV1870-3QH60</b>

#### More information

The DK-16xx PN IO Development Kit is available on the Internet at:  
<https://support.industry.siemens.com/cs/de/en/view/109480928>

**Overview**

The RUGGEDCOM RM1224 is a small form-factor industrial 4G cellular router with integrated switch, which enables secure and cost effective connections to and from remote applications.

**Features**

- 4 copper fast Ethernet ports
- Available with LTE-Modem for Europe and North America
- 2 SMA antenna connectors for MIMO and diversity
- Digital in/out (I/O)
- Redundant Power Supply Inputs 24 V DC
- For use at ambient temperatures from -40 °C to +70 °C without the use of fans

**Product versions**

## RUGGEDCOM RM1224

- Small form-factor industrial Ethernet-switch and TCP/IP router with LTE WAN option

**Benefits**

- Economical industrial graded cellular modem designed for space-saving integration in the cabinet
- Two antenna connectors for reliable wireless transmission
- Supports SINEMA Remote Connect
- Built-in Digital I/O which enables push-button VPN connectivity
- Robust plastic housing which fulfills a critical safety requirement in order to avoid using grounding in Mid & Low Voltage installations

## Network Components

### SCALANCE M / RUGGEDCOM – Mobile Wireless Routers

#### RUGGEDCOM RM1224

#### Integration

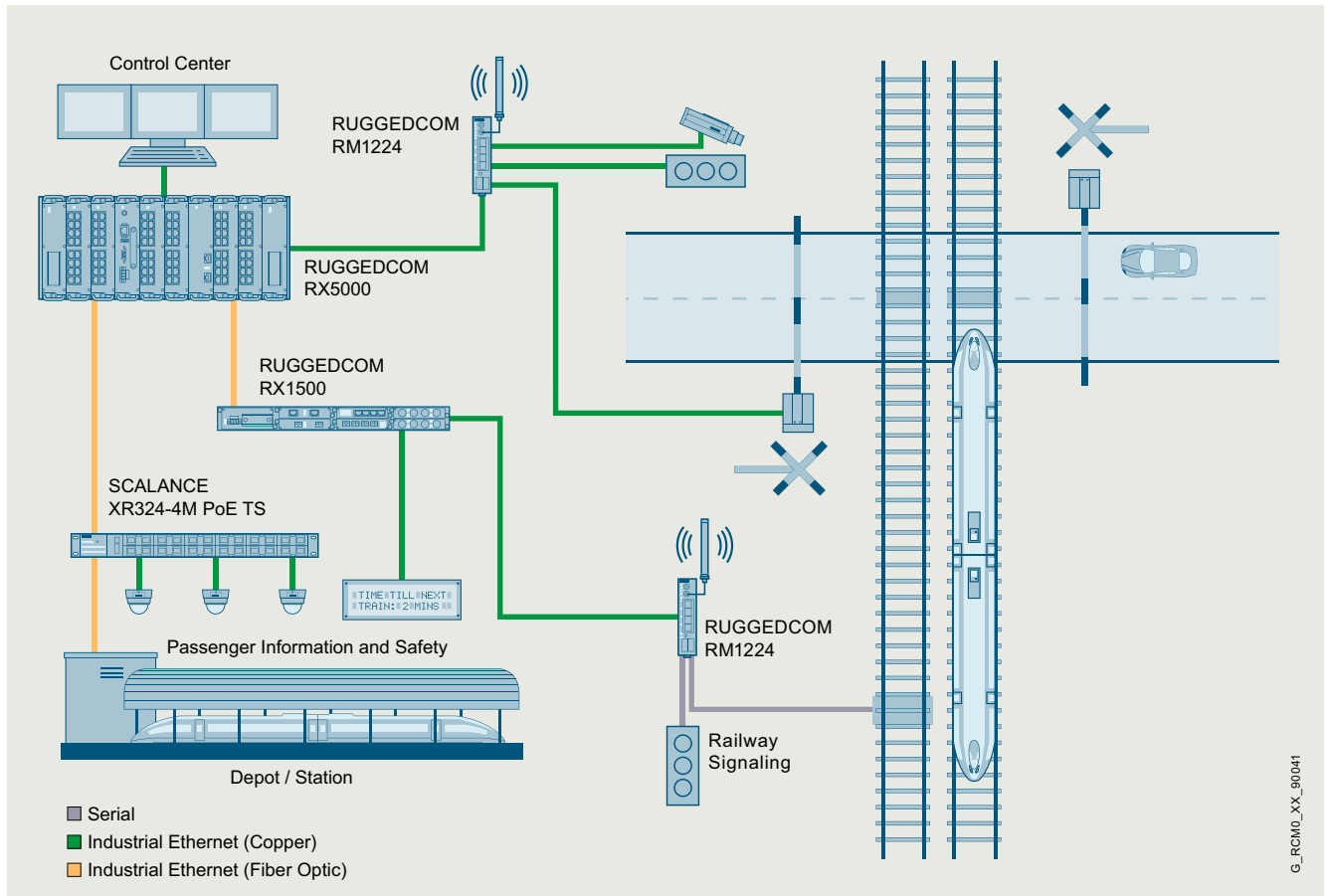

Redundant connection to end-devices used in conjunction with signaling and monitoring when wireline backhaul is combined with cellular connectivity.

#### Selection and ordering data

Version

Article No.

##### RUGGEDCOM RM1224

The RUGGEDCOM RM1224 is a small form-factor industrial Ethernet-switch and TCP/IP router with 4 copper Ethernet ports, 1 digital I/O, and cellular LTE modem.

- RUGGEDCOM RM1224-EU
- RUGGEDCOM RM1224-NAM

6GK6108-4AM00-2BA2  
6GK6108-4AM00-2DA2

#### More information

To assist in selecting the right RUGGEDCOM products as well as configuration of variants, the RUGGEDCOM Selector is available at:

<http://www.siemens.com/ruggedcom-selector>

## Overview



SCALANCE MUM856-1 are mobile wireless routers for high-performance and secure connection of Ethernet-based subnets and automation devices via mobile wireless networks with 5G, 4G (LTE) and 3G (UMTS). The devices can also be integrated as user equipment in private 5G networks.

SCALANCE MUM856-1 supports 5G Release 15. The device enables high transmission rates of up to 1000 Mbps in the downlink and up to 500 Mbps in the uplink.

Thanks to IPv6 support, the devices can also be connected to modern mobile wireless networks.

With an integrated firewall, the mobile routers offer data traffic control and thereby help protect against unauthorized access. Authentication of communication partners and encryption of transmitted data are performed via VPN, thus protecting against espionage and manipulation. The 5G routers offer a digital input and output. The digital output can be controlled remotely and used for example to put a remote device to sleep.

## Features

- Rugged IP65 metal enclosure
- Wall mounting, top hat DIN rail mounting with adapter or top hat DIN rail mounting in control cabinet with angle adapter
- 1 x M12 Gbit Ethernet interface with 1x10/100/1000 Mbps, can also be used for power supply of the device via Power over Ethernet (PoE)
- M12 connector for redundant connection to the 24 V DC supply voltage
- Combined M12 connector for one digital input/output
- 4 x N-Connect antenna port
- Diagnostics LEDs for modem status, field strength, connection control, and DI/DO channels
- SET button
- CLP slot for connection of a removable data storage medium
- Micro SIM card slot on the back of the device

## Product versions

### SCALANCE MUM856-1 (EU):

- Support for 5G (downlink: up to 1000 Mbps, uplink: up to 500 Mbps)
- EU radio approval, further approvals available soon
- Without 5G network automatic switching to 4G or 3G
- Connection to SINEMA Remote Connect via VPN
- Rugged design in IP65 enclosure also enables use outside the control cabinet
- Power supply of the device also possible via Power over Ethernet (PoE)
- Meets the railway standards EN 50155, EN 45545 and EN 5012
- Ambient temperature -30 °C to +60 °C

## Technical specifications

Article number	<b>6GK5856-2EA00-3DA1</b>
Product type designation	SCALANCE MUM856-1 (EU)
<b>Transfer rate</b>	
<b>Transfer rate</b>	10/100/1000 Mbit/s
• with UMTS transmission with downlink maximum	42 Mbit/s
• with UMTS transmission with uplink maximum	5.76 Mbit/s
• for LTE transmission with downlink maximum	1000 Mbit/s
• for LTE transmission with uplink maximum	200 Mbit/s
• for 5G transmission with downlink maximum	1000 Mbit/s
• for 5G transmission with uplink maximum	500 Mbit/s
<b>Interfaces</b>	
<b>Number of electrical/optical connections for gigabit Ethernet maximum</b>	1
<b>Number of electrical connections</b>	
• for network components or terminal equipment	1
<b>Number of electrical connections</b>	
• for external antenna(s)	4
• for operator console	1
• for management purposes	1
<b>Type of electrical connection</b>	
• for network components or terminal equipment	M12 (8-pin, X-coded), PoE
• for redundant voltage supply	M12 (4-pin, L-coded)
<b>Memory</b>	
<b>Number of slots for Micro-SIM card</b>	1
<b>Design of the removable storage CLP</b>	Yes

## Network Components

### SCALANCE M / RUGGEDCOM – Mobile Wireless Routers

#### SCALANCE MUM856-1

Article number	<b>6GK5856-2EA00-3DA1</b>
Product type designation	SCALANCE MUM856-1 (EU)
<b>Signal inputs/outputs</b>	
Number of digital inputs	1
Number of digital outputs	1
Type of electrical connection at the digital inputs/outputs	M12 (4-pin, A-coded)
Signal range	
• at digital input	DC, -30 V ... 30 V
• at digital output	DC 24 V/0.5 A
Operational current of the signaling contacts at DC at 30 V maximum	0.008 A
<b>WAN connection</b>	
Type of wireless network is supported	5G public networks, 5G private networks, LTE, UMTS
Type of mobile wireless service is supported	HSDPA, HSUPA, HSPA+
Frequency band is supported	
• 5G Non-Standalone (NSA)	n1, n3, n7, n20, n28, n38, n41, n77, n78, n79
• LTE	B1, B2, B3, B4, B5, B7, B8, B12, B13, B14, B17, B18, B19, B20, B25, B26, B28, B29, B30, B32, B66, B71, B34, B38, B39, B40, B41, B42, B43, B46, B48
• UMTS	B1, B2, B3, B4, B5, B8
<b>Supply voltage, current consumption, power loss</b>	
Supply voltage from Power-over-Ethernet according to IEEE802.3at for type 1 and IEEE802.3af	48 V
Type of voltage of the supply voltage	redundant supply, DC, 24 V, M12, L-coded
Consumed current	
• at DC at 24 V typical	0.55 A
• with Power-over-Ethernet according to IEEE802.3at for type 1 and IEEE802.3af typical	0.27 A
Power loss (W)	
• at DC at 24 V typical	13.2 W
• with Power-over-Ethernet according to IEEE802.3at for type 1 and IEEE802.3af typical	12.96 W
Type of voltage 1 of the supply voltage	DC
• supply voltage 1 rated value	24 V
Type of voltage 2 of the supply voltage	DC
• supply voltage 2 rated value	24 V
Type of voltage 3 of the supply voltage	DC, PoE
• supply voltage 3 rated value	48 V
<b>Ambient conditions</b>	
Ambient temperature	
• during operation	-30 ... +65 °C
• during storage	-40 ... +85 °C
relative humidity at 25 °C during operation maximum	95%
Protection class IP	IP65
<b>Design, dimensions and weights</b>	
Depth	45 mm
Height	179 mm
Width	166 mm
Net weight	1100 g
Fastening method	Wall mounting, mounting on a DIN rail with a separate mounting adapter
• 35 mm top hat DIN rail mounting	Yes
• wall mounting	Yes
<b>Product features, product functions, product components general</b>	
Product function	
• DynDNS client	Yes
• no-ip.com client	Yes

Article number	<b>6GK5856-2EA00-3DA1</b>
Product type designation	SCALANCE MUM856-1 (EU)
<b>Product functions management, configuration, engineering</b>	
<b>Product function</b>	
• CLI	Yes
• web-based management	Yes
• MIB support	Yes
• TRAP via email	Yes
<b>Protocol is supported</b>	
• Telnet	Yes
• HTTP	Yes
• HTTPS	Yes
<b>type of configuration</b>	web-based management
<b>Product functions diagnostics</b>	
<b>Protocol is supported</b>	
• SNMP v1	Yes
• SNMP v2	Yes
• SNMP v2c	Yes
• SNMP v3	Yes
<b>Product function</b>	
• statistic packet size	No
• statistic packet type	No
• error statistics	No
• SysLog	Yes
• packet filter log	Yes
<b>Product functions DHCP</b>	
<b>Product function</b>	
• DHCP client	Yes
• DHCP server - internal network	Yes
<b>Product functions routing</b>	
<b>router function</b>	
• NAT (IP masquerading)	Yes
• port forwarding	Yes
• NAT traversal	Yes
• 1:1 NAT	Yes
• DNS cache	Yes
<b>Product functions security</b>	
<b>suitability for operation Virtual Private Network</b>	Yes
<b>firewall version</b>	Statefull Inspection
<b>Product function</b>	
• password protection	Yes
• packet filter	Yes
• broadcast/multicast/unicast limiter	No
• broadcast blocking	No
• with VPN connection	IPsec, OpennVPN (as client)
<b>number of possible connection with VPN connection</b>	20
<b>type of authentication with Virtual Private Network/PSK</b>	Yes
<b>Protocol is supported</b>	
• IPsec tunnel and transport mode	Yes
<b>Key length</b>	
• 1 with IPsec AES with Virtual Private Network	128 bit
• 2 with IPsec AES with Virtual Private Network	192 bit
• 3 with IPsec AES with Virtual Private Network	256 bit
• with IPsec 3DES with Virtual Private Network	168 bit
<b>Type of internet key exchange with Virtual Private Network</b>	
• main mode	Yes
• quick mode	Yes
<b>Type of packet authentication with Virtual Private Network</b>	MD5, SHA-1, SHA-256, SHA-384, SHA-512
<b>IETF profile with Virtual Private Network/X.509v3 certificate</b>	Yes

## Network Components

### SCALANCE M / RUGGEDCOM – Mobile Wireless Routers

#### SCALANCE MUM856-1

Article number	<b>6GK5856-2EA00-3DA1</b>
Product type designation	SCALANCE MUM856-1 (EU)
<b>Product functions time</b>	
<b>Protocol is supported</b>	
• NTP	Yes
• SNTP	Yes
<b>Standards, specifications, approvals</b>	
<b>Certificate of suitability</b>	
• EC Declaration of Conformity	Yes
• CE marking	Yes
• Power-over-Ethernet according IEEE802.3at for type 1 and IEEE802.3af	Yes

#### Selection and ordering data

Version	Article No.
<b>SCALANCE MUM856-1 (EU)</b> Mobile wireless router for wireless IP communication of Industrial Ethernet-based applications via public 3/4/5G mobile wireless networks and private 5G networks, VPN, firewall, NAT, IPv6, and connection to SINEMA Remote Connect via CLP. • <b>SCALANCE MUM856-1 (EU)</b>	<b>6GK5856-2EA00-3DA1</b>

#### More information

To assist in selecting the right RUGGEDCOM products as well as configuration of variants, the RUGGEDCOM Selector is available at:

<http://www.siemens.com/ruggedcom-selector>



### Overview



SCALANCE M876-4 is a mobile wireless router for cost-effective and secure connection of Ethernet-based subnets and programmable controllers via mobile networks of the 4th (LTE), 3rd (UMTS) or 2nd (GSM) generation.

SCALANCE M876-4 supports LTE (Long Term Evolution). As a result, high transmission rates of up to 100 Mbps in the downlink and up to 50 Mbps in the uplink are possible (depending on the infrastructure of the mobile wireless provider).

Secure access and communication is ensured by the security functions of the integrated firewall and by VPN tunnels (end-to-end encryption of the communication connection by creation of IPsec tunnels).

### Product versions

#### SCALANCE M876-4 (EU)

- Pentaband LTE with frequency bands 800/900/1800/2100/2600 MHz
- Support of LTE (Downlink: up to 100 Mbps, uplink: up to 50 Mbps)
- Optimized for use in Europe
- Without LTE network, automatic switchover to UMTS (HSPA+) or GSM (EDGE, eGPRS or GPRS mode) data services

#### SCALANCE M876-4 (NAM)

- Pentaband LTE with frequency bands 700/850/AWS-1 (1700/2100)/1900 MHz
- Support of LTE (Downlink: up to 100 Mbps, uplink: up to 50 Mbps)
- Optimized for use in North America
- Without LTE network, automatic switchover to UMTS (HSPA+) or GSM (EDGE, eGPRS or GPRS mode) data services

### Technical specifications

Article number	6GK5876-4AA00-2BA2	6GK5876-4AA00-2DA2
Product type designation	SCALANCE M876-4 (EU)	SCALANCE M876-4 (NAM)
<b>Transmission rate</b>		
<b>Transmission rate</b>	10 Mbps, 100 Mbps	10 Mbps, 100 Mbps
• GPRS transmission, in downlink, maximum	85.6 Kbps	85.6 Kbps
• GPRS transmission, in uplink, maximum	85.6 Kbps	85.6 Kbps
• eGPRS transmission, in downlink, maximum	236.8 Kbps	236.8 Kbps
• eGPRS transmission, in uplink, maximum	236.8 Kbps	236.8 Kbps
• UMTS transmission, in downlink, maximum	14.4 Mbps	14.4 Mbps
• UMTS transmission, in uplink, maximum	5.76 Mbps	5.76 Mbps
• LTE transmission, in downlink, maximum	100 Mbps	100 Mbps
• LTE transmission, in uplink, maximum	50 Mbps	50 Mbps
<b>Interfaces</b>		
<b>Number of electrical connections</b>		
• for internal network	4	4
• for external network	2	2
• for power supply	2	2
<b>Type of electrical connection</b>		
• for internal network	RJ45 port (10/100 Mbps, TP, autocrossover)	RJ45 port (10/100 Mbps, TP, autocrossover)
• for external network	SMA antenna socket (50 ohms)	SMA antenna socket (50 ohms)
• for power supply	Terminal strip	Terminal strip
<b>Signal inputs/outputs</b>		
<b>Number of electrical connections</b>		
• for digital input signals	1	1
• for digital output signals	1	1
<b>Type of electrical connection</b>		
• for digital input signals	Terminal strip	Terminal strip
• for digital output signals	Terminal strip	Terminal strip
<b>WAN connection</b>		
<b>Type of wireless network is supported</b>	GSM, UMTS, LTE	GSM, UMTS, LTE
<b>Type of mobile wireless service is supported</b>	GPRS, eGPRS, HSPA+	GPRS, eGPRS, HSPA+
<b>Operating frequency for GSM transmission</b>	900 MHz, 1800 MHz	850 MHz, 900 MHz, 1800 MHz, 1900 MHz
<b>Operating frequency for UMTS transmission</b>	900 MHz, 1800 MHz, 2100 MHz	850 MHz, AWS-1 (1700/2100 MHz), 1900 MHz
<b>Operating frequency for LTE transmission</b>	800 MHz, 900 MHz, 1800 MHz, 2100 MHz, 2600 MHz	700 MHz, 850 MHz, AWS-1 (1700/2100 MHz), 1900 MHz

## Network Components

### SCALANCE M – Mobile Wireless Routers

#### SCALANCE M876-4

Article number	6GK5876-4AA00-2BA2	6GK5876-4AA00-2DA2
Product type designation	SCALANCE M876-4 (EU)	SCALANCE M876-4 (NAM)
<b>Supply voltage, current consumption, power loss</b>		
<b>Supply voltage, nominal value</b>	24 V	24 V
<b>Supply voltage, rated value</b>	10.8 ... 28.8	10.8 ... 28.8
<b>Type of supply voltage</b>	DC	DC
<b>Current consumed at nominal value of supply voltage, maximum</b>	330 mA	330 mA
<b>Power loss [W]</b>		
• Typical	8 W	8 W
<b>Permissible ambient conditions</b>		
<b>Ambient temperature</b>		
• during operation	-20 ... +60 °C	-20 ... +60 °C
• during storage	-40 ... +85 °C	-40 ... +85 °C
<b>Relative humidity at 25 °C during operation, maximum</b>	95%	95%
<b>IP degree of protection</b>	IP20	IP20
<b>Design, dimensions and weights</b>		
<b>Model</b>	Compact	Compact
<b>Depth</b>	127 mm	127 mm
<b>Height</b>	147 mm	147 mm
<b>Width</b>	35 mm	35 mm
<b>Mounting type</b>		
• 35 mm DIN rail mounting	Yes	Yes
• S7-300 rail mounting	Yes	Yes
• S7-1500 rail mounting	Yes	Yes
• Wall mounting	Yes	Yes
<b>Product properties, functions, components - General</b>		
<b>Product function</b>		
• DynDNS client	Yes	Yes
• no-ip.com client	Yes	Yes
<b>Product functions - Management, configuration, engineering</b>		
<b>Product function</b>		
• CLI	Yes	Yes
• Web-based management	Yes	Yes
• MIB support	Yes	Yes
• TRAPs via e-mail	Yes	Yes
<b>Protocol is supported</b>		
• Telnet	Yes	Yes
• HTTP	Yes	Yes
• HTTPS	Yes	Yes
<b>Type of configuring</b>	Web-based management	Web-based management
<b>Product functions - Diagnostics</b>		
<b>Protocol is supported</b>		
• SNMP v1	Yes	Yes
• SNMP v2	Yes	Yes
• SNMP v2c	Yes	Yes
• SNMP v3	Yes	Yes
<b>Product function</b>		
• Packet size statistics	No	No
• Packet type statistics	No	No
• Error statistics	No	No
• SysLog	Yes	Yes
• Packet filter log	Yes	Yes
<b>Product functions - DHCP</b>		
<b>Product function</b>		
• DHCP client	Yes	Yes
• DHCP server - internal network	Yes	Yes
<b>Product functions - Routing</b>		
<b>Router function</b>		
• NAT (IP masquerading)	Yes	Yes
• Port forwarding	Yes	Yes
• NAT traversal	Yes	Yes
• 1:1 NAT	Yes	Yes
• DNS cache	Yes	Yes
<b>Product functions - Security</b>		
<b>Suitability for use of virtual private network</b>	Yes	Yes
<b>Type of firewall</b>	Stateful inspection	Stateful inspection
<b>Product function</b>		
• Password protection	Yes	Yes
• Packet filter	Yes	Yes
• Broadcast/Multicast/Unicast Limiter	No	No
<b>Product function</b>		
• Broadcast blocking	No	No
• with VPN connection	IPsec, OpenVPN (as client for SINEMA RC)	IPsec, OpenVPN (as client for SINEMA RC)

## Network Components

### SCALANCE M – Mobile Wireless Routers

#### SCALANCE M876-4

Article number	<b>6GK5876-4AA00-2BA2</b>	<b>6GK5876-4AA00-2DA2</b>
Product type designation	SCALANCE M876-4 (EU)	SCALANCE M876-4 (NAM)
<b>Number of possible connections when using VPN connection</b>	20	20
<b>PSK authentication method when using virtual private network</b>	Yes	Yes
<b>Protocol is supported</b>		
• IPsec tunnel and transport mode	Yes	Yes
<b>Key length</b>		
• 1 with IPsec AES and virtual private network	128 bits	128 bits
• 2 with IPsec AES and virtual private network	192 bits	192 bits
• 3 with IPsec AES and virtual private network	256 bits	256 bits
• with IPsec 3DES and virtual private network	168 bits	168 bits
<b>Internet key exchange mode when using virtual private network</b>		
• Main mode	Yes	Yes
• Quick mode	Yes	Yes
<b>Packet authentication method when using virtual private network</b>	MD5, SHA-1, SHA-256, SHA-384, SHA-512	MD5, SHA-1, SHA-256, SHA-384, SHA-512
<b>IETF profile X.509v3 certificate when using virtual private network</b>	Yes	Yes
<b>Product functions - Time of day</b>		
<b>Protocol is supported</b>		
• NTP	Yes	Yes
• Sntp	Yes	Yes
<b>Standards, specifications, approvals</b>		
<b>Standard</b>		
• for EMC	ETSI EN 301 489-1, ETSI EN 301 489-7, ETSI EN 301 489-24, EN 61000-6-2, EN 61000-6-4	FCC CFR 47, Part 15, Subpart B
• for FM		FM 3611: Class I, Division 2, Groups A,B,C,D, T4 / Class 1, Zone 2, Group IIC, T4
• for safety, from CSA and UL		UL 60950-1, CAN/CSA C22.2 No. 60950-1-07, UL E115352 Vol. X2
• for hazardous zone	EN 60079-15, EN 60079-0, II 3 G Ex nA IIC T4 Gc, KEMA 07ATEX0145 X	
• for hazardous zone, from CSA and UL		ANSI/ISA 12.12.01-2013, CAN/CSA C22.2 No.213-M1987, CL. 1, Div. 2, GP A,B,C,D, T4 / CL. 1, Zone 2, GP IIC
• for emitted interference	ETSI EN 301 489-1, ETSI EN 301 489-7, ETSI EN 301 489-24, EN 61000-6-4	
• for noise immunity	ETSI EN 301 489-1, ETSI EN 301 489-7, ETSI EN 301 489-24, EN 61000-6-2	
<b>Proof of suitability</b>		
• CE mark	Yes	Yes
• Railway application in accordance with EN 50121-3-2	Yes	Yes
• Railway application in accordance with EN 50121-4	Yes	Yes
• Railway application in accordance with EN 50155	Yes; no coated printed-circuit boards	Yes; no coated printed-circuit boards
<b>Standards, specifications, approvals product conformity</b>		
<b>MTBF at 40 °C</b>	55 y	55 y

#### Selection and ordering data

Version	Article No.
<p><b>Mobile wireless router SCALANCE M876</b></p> <p>Mobile wireless router for wireless IP communication of Industrial Ethernet-based subnets and programmable controllers via LTE, UMTS or GSM mobile networks; with integrated firewall and VPN with IPsec (OpenVPN for connection to SINEMA RC); 4 x RJ45 ports, 2 x antenna port</p> <ul style="list-style-type: none"> <li>• <b>SCALANCE M876-4 (EU)</b> <sup>1)</sup></li> <li>• <b>SCALANCE M876-4 (NAM)</b> <sup>1)</sup></li> </ul>	<p><b>6GK5876-4AA00-2BA2</b></p> <p><b>6GK5876-4AA00-2DA2</b></p>
<p><b>Accessories</b></p> <p><b>Lightning Protector LP798-1N</b></p> <p>Lightning protector with N/N female/female connection, IP67 (-40 to +85 °C), frequency range: 0 ... 6 GHz</p>	<p><b>6GK5798-2LP00-2AA6</b></p>
<p><b>N-Connect male/male flexible connection cable, pre-assembled</b></p> <p>suitable for railway applications; flexible cable, for example, for the connection to antennas, suitable for IWLAN and mobile radio</p> <ul style="list-style-type: none"> <li>• length 1 m</li> <li>• length 2 m</li> <li>• length 5 m</li> </ul>	<p><b>6XV1875-5SH10</b></p> <p><b>6XV1875-5SH20</b></p> <p><b>6XV1875-5SH50</b></p>

## Network Components

### SCALANCE M – Mobile Wireless Routers

#### SCALANCE M876-4

Version	Article No.
<b>N-Connect/ SMA male/male Flexible connection cable pre-assembled</b> suitable for railway applications; flexible connecting cable e.g. for SCALANCE M antenna <ul style="list-style-type: none"> <li>• length 1 m</li> <li>• length 2 m</li> <li>• length 5 m</li> </ul>	<b>6XV1875-5UH10</b> <b>6XV1875-5UH20</b> <b>6XV1875-5UH50</b>
<b>SIMATIC NET N-Connect/N-Connect Female/Female Panel Feedthrough</b> Cabinet feedthrough for wall thicknesses up to 4.5 mm, two N-Connect female connections	<b>6GK5798-2PP00-2AA6</b>
<b>C-PLUG</b> Removable data storage medium for easy replacement of devices under fault conditions; for storing configuration and application data; can be used in SIMATIC NET products with C-PLUG slot	<b>6GK1900-0AB00</b>
<b>KEY-PLUG SINEMA RC</b> Removable data storage medium for activating the connection to SINEMA Remote Connect for S615 and SCALANCE M874-x and M876-x, for easy device replacement under fault conditions, and for storing configuration data.	<b>6GK5908-0PB00</b>
<b>SCALANCE M Desktop Pedestal</b> SCALANCE M-800 desktop pedestal for table mounting for SCALANCE M812 / M816 / M874-x / M876-x / S615	<b>6GK5898-8MD00</b>
<b>IE TP Cord RJ45/RJ45</b> TP cable 4 x 2 with 2 RJ45 plugs <ul style="list-style-type: none"> <li>• 0.5 m</li> <li>• 1 m</li> <li>• 2 m</li> <li>• 6 m</li> <li>• 10 m</li> </ul>	<b>6XV1870-3QE50</b> <b>6XV1870-3QH10</b> <b>6XV1870-3QH20</b> <b>6XV1870-3QH60</b> <b>6XV1870-3QN10</b>
<b>IE TP Train Cable GP 2x2 (Type C)</b> 4-core, shielded TP installation cable for connection to IE FC outlet RJ45/IE FC RJ45 plug 180/90 for train applications: PROFINET-compliant; <u>sold by the meter;</u> maximum delivery unit 1000 m, minimum order quantity 20 m	<b>6XV1871-2T</b>
<b>IE Train Cable GP 4x2</b> 8-core, shielded TP installation cable for connection to IE FC M12 Plug PRO 4x2 for use in railway applications; with railway approval; <u>sold by the meter;</u> maximum delivery unit 1000 m, minimum order quantity 20 m	<b>6XV1878-2T</b>

<sup>1)</sup> Note national approvals under  
<http://www.siemens.com/mobilenetwork-approvals>

## 8

### More information

You can find more information on remote networks on the Internet at:

<http://www.siemens.com/remote-networks>

You will find more information on industrial security on the Internet at:

<http://www.siemens.com/industrialsecurity>

#### **Selection tool:**

Our TIA Selection Tool is available to assist you in selecting the right remote networks products:

<http://www.siemens.com/tia-selection-tool>

### Overview



Remote antennas increase the reliability of wireless links by optimizing signal reception and emission.

- Used for routers, modems and communications processors for the mobile network standards GSM/GPRS (2G), UMTS (3G), LTE (4G)

### Benefits

- Cost-effective connection to devices in remote, difficult-to-access or hostile environments
- Establishment of a reliable mobile network infrastructure through the use of remote antennas, even if the mobile network devices are installed in the control cabinet, for example

### Application

Remote antennas optimize transmission and reception conditions and enable use of remote network products in a large number of industrial applications.

In addition to antennas with directional radiation characteristics, omnidirectional antennas concentrate the radio field around the antenna in the shape of a disc. Both designs therefore result in improved radio communication quality.

### Technical specifications

Article No.	<b>6GK5896-6MH00-0AA0</b>
Product type designation	Antenna ANT896-6MH
<b>Radio frequencies</b>	
<b>Type of wireless network is supported</b>	GSM, UMTS, LTE
<b>Operating frequency</b>	2.4 ... 2.7 GHz
• For WLAN in 2.4 GHz frequency band	
<b>Operating frequency</b>	700 MHz, 800 MHz, 850 MHz, 900 MHz, 1575.42 MHz, 1700 MHz, 1800 MHz, 1900 MHz, 2100 MHz, 2600 MHz
<b>Electrical specifications</b>	
<b>Impedance</b>	50 ohms
<b>Polarization</b>	Linear vertical
<b>Radiation characteristic</b>	Omnidirectional
<b>Antenna gain compared with the spherical radiator</b>	5 dB
• With linear radiation	
<b>Voltage standing wave ratio (VSWR), max.</b>	2.2
<b>Radiating angle of the antenna</b>	360°
• Horizontal	
<b>Number of electrical connections of the antenna</b>	1
<b>Design of the electrical connection of the antenna</b>	N-connector
<b>Connection version</b>	Female
<b>Transmit power, maximum</b>	100 W; at 50 °C ambient temperature
<b>Permissible ambient conditions</b>	
<b>Ambient temperature</b>	-40 ... +85 °C
• during operation	
• during storage	-40 ... +85 °C
<b>IP degree of protection</b>	IP69K
<b>Maximum wind load</b>	Survival at 500 km/h

## Network Components

### SCALANCE M – Mobile Wireless Routers

#### ANT896-6MH

Article No.	<b>6GK5896-6MH00-0AA0</b>
Product type designation	Antenna ANT896-6MH
<b>Design, dimensions and weight</b>	
<b>Width</b>	100 mm
<b>Height</b>	40 mm
<b>Depth</b>	145 mm
<b>Net weight</b>	0.488 kg
<b>Mounting type</b>	
• Flat-roof mounting	Yes
• Directly on the device	No
<b>Product properties, functions, components - General</b>	
<b>Product property silicone-free</b>	Yes
<b>Standards, specifications, approvals</b>	
<b>Certificate of suitability</b>	Railway application acc. to DIN5510-2, BS6853, NF-F-16-101, NF-F-16-102
<b>Certificate of suitability</b>	
• RoHS compliance	Yes
• Railway application in accordance with EN 50155	Yes
• Fire protection in accordance with EN 45545-2	Yes
<b>Wireless approval</b>	Current national approvals can be found on the Internet under <a href="http://www.siemens.com/wireless-approvals">www.siemens.com/wireless-approvals</a>

#### Selection and ordering data

Version	Article No.
<b>2G/3G/4G Antenna ANT896-6MH</b> Omnidirectional mobile radio antenna for GSM (2G), UMTS (3G) and LTE (4G) networks; suitable for railway applications; omnidirectional characteristic; with N-female connector; mounting on vehicle roof; antenna gain 5/6 dBi, IP69K	<b>6GK5896-6MH00-0AA0</b>
<b>Accessories</b>	
<b>Lightning Protector LP798-1N</b> Lightning protection element with N/N Female/female connection, IP66/68 (-40...+85 °C), 0...6 GHz; with gas discharge technology for SCALANCE W and M antennas, compact instructions as hard copy German/English	<b>6GK5798-2LP00-2AA6</b>
<b>N-Connect Female/female Panel feedthrough</b> cabinet bushing, 2.4 GHz and 5 GHz for Wall thickness max. 4.5 mm.	<b>6GK5798-2PP00-2AA6</b>
<b>N-Connect male/male flexible connection cable pre-assembled</b> flexible cable, for example, for the connection to antennas, suitable for IWLAN and mobile radio <ul style="list-style-type: none"> <li>• length 1 m</li> <li>• length 2 m</li> <li>• length 5 m</li> <li>• length 10 m</li> </ul>	<b>6XV1875-5AH10</b> <b>6XV1875-5AH20</b> <b>6XV1875-5AH50</b> <b>6XV1875-5AN10</b>
<b>N-Connect/SMA male/ male flexible connection cable pre-assembled</b> flexible connecting cable SCALANCE M antenna <ul style="list-style-type: none"> <li>• length 0,3 m</li> <li>• length 1 m</li> <li>• length 2 m</li> <li>• length 5 m</li> </ul>	<b>6XV1875-5LE30</b> <b>6XV1875-5LH10</b> <b>6XV1875-5LH20</b> <b>6XV1875-5LH50</b>

#### More information

##### Cabling range:

Pre-assembled connecting cables for IRC products can be found in the Industry Mall under Antenna Connection System.

You can order components supplementary to the SIMATIC NET cabling range from your local contact. Technical advice on this subject is available from:

J. Hertlein  
 PD PA CI PRM 4  
 Phone: +49 (911) 750 44 65  
 E-Mail: [juergen.hertlein@siemens.com](mailto:juergen.hertlein@siemens.com)

### Overview



- Industrial Wireless LAN access points for installation in control cabinets or in indoor areas with support of IEEE 802.11a/b/g/h/n and data rates of up to 300 Mbps

### Design

- Low-profile, compact aluminum housing, shock and vibration resistant for stringent mechanical requirements
- Special coating of the printed circuit boards (conformal coating)
- Resistant to condensation
- Railroad approval in accordance with EN 50155
- Degree of protection IP30
- For use at ambient temperatures from -30 ... +65 °C
- Support of 2.4 GHz and 5 GHz frequency bands
- 2 x R-SMA sockets for connection of directly mountable and remote antennas
- Optimized antenna placement for 2x2 MIMO technology; antennas do not interfere with each other when mounted directly on the device
- 2 x M12 connections for 10/100 Mbps, one with Power-over-Ethernet according to IEEE 802.3at
- 1 x M12 socket for power supply (24 V DC)
- 1 x PLUG slot (KEY-PLUG/C-PLUG)
- Function LEDs for optical signaling of faults and operating states
- Mounting: Wall, S7-1500 mounting rail, S7-300 mounting rail or 35 mm standard mounting rail
- A wireless card is permanently installed in the device; functional scope can be expanded by using a KEY-PLUG W780 iFeatures

### Function

The SCALANCE W774-1 M12 EEC (Extended Environmental Conditions) access points are designed for use in a railway environment. The devices are EN 50155-approved for railway applications and can thus be used for rail traffic. Combined with antennas approved for the rail sector, which are connected via R-SMA antenna connections (female), these products can be used to set up a reliable IWLAN infrastructure.

The devices can be mounted at an optimal location for the wireless link. The housing and the connection plugs are resistant to high shock and vibration loads because all the connections are screwed or locked. The SCALANCE W774 M12 EEC is ideally suited for environments in which a compact size is important. Through its coated printed-circuit boards (conformal coating), the module is resistant to condensation caused, for example, by use in environments with large temperature variations.

SCALANCE W774-1 M12 EEC access points can also be operated as client modules.

Provided that a time delay (several 100 ms), which arises from the roaming defined in IEEE 802.11, is tolerated by all communication stations following a change from one radio cell to another, the communication continues uninterrupted.

For real-time requirements, the SCALANCE W774-1 M12 EEC can be equipped with KEY-PLUG functionality for activating iFeatures.

## Network Components

### SCALANCE W – Industrial Wireless LAN

#### SCALANCE W774-1 M12 EEC

#### Technical specifications

Article number	<b>6GK5774-1FY00-0TA0</b> , <b>6GK5774-1FY00-0TB0</b> <sup>1)</sup>
Product type designation	SCALANCE W774-1 M12 EEC
<b>Transmission rate</b>	
<b>Transmission rate</b> • on WLAN, maximum • on Industrial Ethernet	300 Mbps 10 Mbps, 100 Mbps, 10 Mbps, 100 Mbps
<b>Interfaces</b>	
<b>Number of electrical connections</b> • for network components or data terminal equipment • for power supply • for redundant power supply	2 1 1
<b>Type of electrical connection</b> • for network components or data terminal equipment • for power supply	M12 interface (4-pin, D-coded), PoE M12 interface (4-pin, A-coded)
<b>Type of removable data storage medium</b> • C-PLUG • KEY-PLUG	Yes Yes
<b>Wireless interfaces</b>	
<b>Number of permanently installed wireless cards</b>	1
<b>Type of transmission for multiple input multiple output (MIMO)</b>	2x2
<b>Number of spatial streams</b>	2
<b>Number of electrical connections for external antenna(s)</b>	2
<b>Type of electrical connection for external antenna(s)</b>	R-SMA (socket)
<b>Product property: external antenna can be mounted directly on device</b>	Yes
<b>Supply voltage, current consumption, power loss</b>	
<b>Type of supply voltage</b>	DC
<b>Supply voltage 1</b> • from M12 power connector (A-coded) for redundant power supply	16.8 V
<b>Supply voltage 2</b> • from M12 power connector (A-coded) for redundant power supply	31.2 V
<b>Supply voltage</b> • from Power-over-Ethernet in accordance with IEEE802.3af for Type 1 and IEEE802.3af	48 V
<b>Permissible ambient conditions</b>	
<b>Ambient temperature</b> • during operation • during storage • during transport	-30 ... +65 °C -40 ... +85 °C -40 ... +85 °C
<b>Relative humidity at 25 °C, without condensation during operation, maximum</b>	100%
<b>Ambient conditions for operation</b>	When used under explosion protection conditions (Zone 2), the SCALANCE W774-1 M12 EEC product must be installed in an enclosure with at least IP54 degree of protection according to EN 60529 within the jurisdiction of EN 50021.
<b>IP degree of protection</b>	IP30
<b>Design, dimensions and weights</b>	
<b>Width</b>	26 mm
<b>Height</b>	156 mm
<b>Depth</b>	127 mm
<b>Width of housing without antenna</b>	26 mm
<b>Height of housing without antenna</b>	147 mm
<b>Depth of housing without antenna</b>	127 mm
<b>Net weight</b>	0.52 kg
<b>Product property: conformal coating</b>	Yes
<b>Mounting type</b> • S7-300 rail mounting • S7-1500 rail mounting • Wall mounting	Wall mounting only when mounted flat Yes Yes Yes
<b>Radio frequencies</b>	
<b>Operating frequency</b> • for WLAN in 2.4 GHz frequency band • for WLAN in 5 GHz frequency band	2.41 ... 2.48 GHz 4.9 ... 5.8 GHz



Article number	<b>6GK5774-1FY00-0TA0,</b> <b>6GK5774-1FY00-0TB0</b> <sup>1)</sup>
Product type designation	SCALANCE W774-1 M12 EEC
<b>Product properties, functions, components - General</b>	
<b>Product function - Access point mode</b>	Yes
<b>Product function - Client mode</b>	Yes
<b>Number of SSIDs</b>	4
<b>Product function</b>	No
• Dual client	Yes; only in combination with the 'KEY-PLUG W780 iFeatures'
• iPCF access point	Yes; only in combination with the 'KEY-PLUG W740 iFeatures'
• iPCF client	No
• iPCF-MC access point	Yes; only in combination with the 'KEY-PLUG W740 iFeatures'
• iPCF-MC client	Yes; only in combination with the 'KEY-PLUG W740 iFeatures'
<b>Number of iPCF-enabled wireless modules</b>	1
<b>Product function - iREF</b>	No
<b>Number of iREF-enabled wireless modules</b>	0
<b>Product functions - Management, configuration, engineering</b>	
<b>Number of manageable IP addresses in the client</b>	8
<b>Product function</b>	Yes
• CLI	Yes
• Web-based management	Yes
• MIB support	Yes
• TRAPs via e-mail	Yes
• Configuration with STEP 7	Yes
• Configuration with STEP 7 in the TIA Portal	Yes
• Forced roaming with IWLAN	No
• WDS	Yes
<b>Protocol is supported</b>	Yes
• Address Resolution Protocol (ARP)	Yes
• ICMP	Yes
• Telnet	Yes
• HTTP	Yes
• HTTPS	Yes
• TFTP	Yes
• DCP	Yes
• LLDP	Yes
<b>Identification &amp; Maintenance function</b>	Yes
• I&MO - Device-specific information	Yes
• I&M1 - Higher level designation/location designation	Yes
<b>Product functions - Diagnostics</b>	
<b>Product function</b>	Yes
• PROFINET IO diagnostics	No
• Link check	No
• Connection monitoring IP-Alive	No
• Localization using Aeroscout	No
• SysLog	Yes
<b>Protocol is supported</b>	Yes
• SNMP v1	Yes
• SNMP v2	Yes
• SNMP v3	Yes
<b>Product functions - VLAN</b>	
<b>Product function</b>	Yes
• VLAN function for IWLAN	Yes
<b>Product functions - DHCP</b>	
<b>Product function</b>	Yes
• DHCP client	No
• In Client Mode, DHCP server via LAN	No
<b>Product functions - Redundancy</b>	
<b>Protocol is supported</b>	Yes
• STP/RSTP	Yes
<b>Product functions - Security</b>	
<b>Product function</b>	No
• ACL - MAC-based	Yes
• Management security with IP-based ACL	Yes
• IEEE 802.1X (RADIUS)	No
• NAT/NAPT	Yes
• Access protection in accordance with IEEE802.11i	Yes
• WPA/WPA2	Yes
• TKIP/AES	Yes
<b>Protocol is supported</b>	Yes
• SSH	Yes
<b>Product functions - Time of day</b>	
<b>Protocol is supported</b>	Yes
• SNTP	Yes
• SIMATIC Time	Yes

## Network Components

### SCALANCE W – Industrial Wireless LAN

#### SCALANCE W774-1 M12 EEC

Article number	<b>6GK5774-1FY00-0TA0,</b> <b>6GK5774-1FY00-0TB0</b> <sup>1)</sup>
Product type designation	SCALANCE W774-1 M12 EEC
<b>Standards, specifications, approvals</b>	
<b>Standard</b>	
<ul style="list-style-type: none"> <li>• for FM</li> <li>• for hazardous zone</li> <li>• for safety, from CSA and UL</li> <li>• for hazardous zone, from CSA and UL</li> </ul>	FM 3611: Class I, Division 2, Groups A,B,C,D, T4 / Class 1, Zone 2, Group IIC, T4 EN 60079-15:2005, EN 60079-0:2006, II 3 G Ex nA II T4 KEMA 07 ATEX 0145X UL 60950-1, CSA C22.2 No. 60950-1 ANSI/ISA 12.12.01-2013, CAN/CSA C22.2 No.213-M1987, CL. CL.1, Div. 2 GP. A,B,C,D, T4 / CL. 1, Zone 2, GP IIC
<b>Proof of suitability</b>	
<ul style="list-style-type: none"> <li>• EC Declaration of Conformity</li> <li>• CE mark</li> <li>• C-Tick</li> <li>• CCC</li> <li>• E1 approval</li> <li>• Railway application in accordance with EN 50155</li> <li>• Railway application in accordance with EN 50121-4</li> <li>• Fire protection in accordance with EN 45545-2</li> <li>• NEMA TS2</li> <li>• IEC 61375</li> <li>• IEC 61850-3</li> <li>• NEMA4X</li> <li>• Power-over-Ethernet in accordance with IEEE802.3at for Type 1 and IEEE802.3af</li> <li>• Power-over-Ethernet in accordance with IEEE802.3at for Type 2</li> </ul>	Yes Yes Yes No Yes Yes Yes Yes No No No No Yes Yes
<b>Standard for wireless communication</b>	
<ul style="list-style-type: none"> <li>• IEEE 802.11a</li> <li>• IEEE 802.11b</li> <li>• IEEE 802.11e</li> <li>• IEEE 802.11g</li> <li>• IEEE 802.11h</li> <li>• IEEE 802.11i</li> <li>• IEEE 802.11n</li> </ul>	Yes Yes Yes Yes Yes Yes Yes
<b>Wireless approval</b>	You will find the current list of countries at: <a href="http://www.siemens.com/wireless-approvals">www.siemens.com/wireless-approvals</a>
<b>Marine classification association</b>	
<ul style="list-style-type: none"> <li>• American Bureau of Shipping Europe Ltd. (ABS)</li> <li>• Bureau Veritas (BV)</li> <li>• Det Norske Veritas (DNV)</li> <li>• Germanischer Lloyd (GL)</li> <li>• Lloyds Register of Shipping (LRS)</li> <li>• Nippon Kaiji Kyokai (NK)</li> <li>• Polski Rejestr Statkow (PRS)</li> </ul>	No No No No No No No

<sup>1)</sup> Wireless approval in the USA

### Selection and ordering data

Version	Article No.
<b>SCALANCE W774-1 M12 EEC Access Points</b>	
IWLAN access points with built-in wireless interface; wireless networks IEEE 802.11a/b/g/h/n at 2.4/5 GHz up to 300 Mbps; railway approval in accordance with EN 50155; conformal coating; WPA2/AES; Power over Ethernet (PoE), IP20 degree of protection; scope of delivery: mounting hardware; manual on CD-ROM, German/English	
<b>SCALANCE W774-1 M12 EEC</b>	
IWLAN access point with one built-in wireless interface	
<ul style="list-style-type: none"> <li>National approvals for operation outside the U.S.</li> <li>National approvals for operation within the U.S.<sup>1)</sup></li> </ul>	<b>6GK5774-1FY00-0TA0</b> <b>6GK5774-1FY00-0TB0</b>
<b>Accessories</b>	
<b>KEY-PLUG W780 iFeatures</b>	<b>6GK5907-8PA00</b>
Removable data storage medium for activating additional iFeatures, for easy device replacement under fault conditions and for recording configuration data; can be used in SCALANCE W access points with PLUG slot	
<b>C-PLUG</b>	<b>6GK1900-0AB00</b>
Removable data storage medium for easy replacement of devices under fault conditions; for recording configuration data; can be used in SIMATIC NET products with PLUG slot	
<b>IE FC M12 Plug PRO 2 x 2</b>	
M12 plug connector (D-coded, IP65/IP67) that can be assembled in the field, metal enclosure, FastConnect connection method, for SCALANCE W774-1 M12 EEC	
<ul style="list-style-type: none"> <li>1 unit</li> <li>8 units</li> </ul>	<b>6GK1901-0DB20-6AA0</b> <b>6GK1901-0DB30-6AA8</b>
<b>IE TP Train Cable GP 2x2 (Type C)</b>	<b>6XV1871-2T</b>
4-core, shielded TP installation cable for connection to IE FC outlet RJ45/IE FC RJ45 plug 180/90 for train applications: PROFINET-compliant; <u>sold by the meter</u> ; maximum delivery unit 1000 m, minimum order quantity 20 m	
<b>IE FC Stripping Tool</b>	<b>6GK1901-1GA00</b>
Preset insulation stripping tool for fast stripping of Industrial Ethernet FC cables	
<b>Power M12 Cable Connector PRO</b>	<b>6GK1907-0DC10-6AA3</b>
Connector socket for connection of SCALANCE W700 for 24 V DC supply voltage; 4-pin, A-coded, with assembly instructions, 3 units	
<b>Power Cable 2 x 0.75</b>	<b>6XV1812-8A</b>
Connecting cable for Power M12 Cable Connector PRO, sold by the meter	
<b>N-Connect/SMA female/female panel feedthrough</b>	<b>6GK5798-0PT00-2AA0</b>
Cabinet bushing with fastening flange for wall thicknesses up to 5.5 mm, SMA female and N-Connect female connections	
<b>N-Connect/N-Connect female/female panel feedthrough</b>	<b>6GK5798-2PP00-2AA6</b>
Cabinet bushing for wall thicknesses up to 4.5 mm, two N-Connect female connections	

<sup>1)</sup> Note national approvals under  
<http://www.siemens.com/wireless-approvals>

### More information

#### Selection tools:

To assist in selecting Industrial Ethernet components, the TIA Selection Tool is available at:  
<http://www.siemens.com/tia-selection-tool>

#### Wireless approvals:

Current approvals can be found on the Internet at:  
<http://www.siemens.com/wireless-approvals>

## Network Components

### SCALANCE W – Industrial Wireless LAN

#### SCALANCE W778-1 M12 EEC

#### Overview



#### Product variant

##### SCALANCE W778-1 M12 EEC

- Access point with a permanently installed radio card; functional scope can be expanded using a KEY-PLUG W780 iFeature; 1 radio; 2 N-CON antenna port; IEEE 802.11a/b/g/h/n; 2.4/5 GHz; gross data rate 300 Mbit/s; 2x M12 max. 100 Mbit/s; PoE integrated 2-port switch; redundant 24 V DC; M12 A-coded IP65; -30... 70 °C; plug slot WPA2/802.11i/e

#### Technical specifications

Article number	6GK5778-1GY00-0TA0	6GK5778-1GY00-0TB0 <sup>1)</sup>
<b>Transmission rate</b>		
<b>Transfer rate</b>		
• with WLAN maximum	300 Mbit/s	300 Mbit/s
• for Industrial Ethernet	10, 100 Mbit/s	10, 100 Mbit/s
<b>Transfer rate for Industrial Ethernet</b>		
• minimum	10 Mbit/s	10 Mbit/s
• maximum	100 Mbit/s	100 Mbit/s
<b>Interfaces</b>		
<b>Number of electrical connections</b>		
• for network components or terminal equipment	2	2
• for power supply	1	1
• for redundant voltage supply	1	1
<b>Type of electrical connection</b>		
• for network components or terminal equipment	M12 interface (4-pole, D-coded), PoE	M12 interface (4-pole, D-coded), PoE
• for power supply	M12 interface (4-pole, A-coded)	M12 interface (4-pole, A-coded)
<b>design of the removable storage</b>		
• C-PLUG	Yes	Yes
• KEY-PLUG	Yes	Yes
<b>Interfaces wireless</b>		
<b>Number of radio cards permanently installed</b>	1	1
<b>Transmission mode for multiple input multiple output (MIMO)</b>	2x2	2x2
<b>Number of spatial streams</b>	2	2
<b>Number of electrical connections for external antenna(s)</b>	2	2
<b>Type of electrical connection for external antenna(s)</b>	N-Connect (socket)	N-Connect (socket)
<b>Product feature external antenna can be mounted directly on device</b>	Yes	Yes
<b>Supply voltage, current consumption, power loss</b>		
<b>Type of voltage of the supply voltage</b>	DC	DC
<b>Supply voltage 1</b>		
• from M12 Power Connector (A-coded) for redundant power supply	16.8 V	16.8 V
<b>Supply voltage 2</b>		
• from M12 Power Connector (A-coded) for redundant power supply	31.2 V	31.2 V
<b>Supply voltage</b>		
• from Power-over-Ethernet acc. to IEEE802.3at for type 1 and IEEE802.3af	48 V	48 V
<b>Consumed current</b>		
• at DC at 24 V typical	0.25 A	0.25 A
• with Power-over-Ethernet acc. to IEEE802.3at for type 1 and IEEE802.3af typical	0.125 A	0.125 A
<b>Power loss [W]</b>		
• at DC at 24 V typical	6 W	6 W
• with Power-over-Ethernet acc. to IEEE802.3at for type 1 and IEEE802.3af typical	6 W	6 W

<sup>1)</sup>Wireless approval in the USA

Article number	6GK5778-1GY00-0TA0	6GK5778-1GY00-0TB0 <sup>1)</sup>
<b>Permitted ambient conditions</b>		
<b>Ambient temperature</b>		
• during operation	-30 ... +75 °C	-30 ... +75 °C
• during storage	-40 ... +85 °C	-40 ... +85 °C
• during transport	-40 ... +85 °C	-40 ... +85 °C
<b>Relative humidity at 25 °C without condensation during operation maximum</b>	95 %	95 %
<b>Protection class IP</b>	IP65	IP65
<b>Design, dimensions and weight</b>		
<b>Width</b>	140 mm	140 mm
<b>Height</b>	160 mm	160 mm
<b>Depth</b>	45 mm	45 mm
<b>Width of the enclosure without antenna</b>	140 mm	140 mm
<b>Height of the enclosure without antenna</b>	149 mm	149 mm
<b>Depth of the enclosure without antenna</b>	45 mm	45 mm
<b>Net weight</b>	0.95 kg	0.95 kg
<b>Product feature conformal coating</b>	Yes	Yes
<b>Mounting type</b>		
• S7-300 rail mounting	No	No
• S7-1500 rail mounting	No	No
• 35 mm DIN rail mounting	Yes	Yes
• wall mounting	Yes	Yes
<b>Wireless frequencies</b>		
<b>Operating frequency</b>		
• for WLAN in 2.4 GHz frequency band	2.41 ... 2.48 GHz	2.41 ... 2.48 GHz
• for WLAN in 5 GHz frequency band	4.9 ... 5.8 GHz	4.9 ... 5.8 GHz
<b>Product properties, functions, components general</b>		
<b>Product function Access Point Mode</b>	Yes	Yes
<b>Product function Client Mode</b>	Yes	Yes
<b>Number of SSIDs</b>	4	4
<b>Product function</b>		
• iPCF Access Point	Yes; Only in combination with the 'KEY-PLUG W780 iFeatures'	Yes; Only in combination with the 'KEY-PLUG W780 iFeatures'
• iPCF client	Yes; Only in combination with the 'KEY-PLUG W780 iFeatures' or 'KEY-PLUG W740 iFeatures'	Yes; Only in combination with the 'KEY-PLUG W780 iFeatures' or 'KEY-PLUG W740 iFeatures'
• iPCF-MC Access Point	No	No
• iPCF-MC client	Yes; Only in combination with 'KEY-PLUG W780 iFeatures' or 'KEY-PLUG W740 iFeatures'	Yes; Only in combination with 'KEY-PLUG W780 iFeatures' or 'KEY-PLUG W740 iFeatures'
<b>Number of iPCF-capable radio modules</b>	1	1
<b>Product function iREF</b>	Yes	Yes
<b>Number of iREF-capable radio modules</b>	1	1
<b>Product function iPRP</b>	Yes; In combination with the 'KEY-PLUG W780 iFeatures' only	Yes; In combination with the 'KEY-PLUG W780 iFeatures' only
<b>Product functions management, configuration</b>		
<b>Number of manageable IP addresses in client</b>	8	8
<b>Product function</b>		
• CLI	Yes	Yes
• web-based management	Yes	Yes
• MIB support	Yes	Yes
• TRAPs via email	Yes	Yes
• Configuration with STEP 7	Yes	Yes
• configuration with STEP 7 in the TIA Portal	Yes	Yes
• operation with IWLAN controller	No	No
• operation with Enterasys WLAN controller	No	No
• forced roaming on IP down with IWLAN	Yes	Yes
• forced roaming on link down with IWLAN	Yes	Yes
• WDS	Yes	Yes
<b>Protocol is supported</b>		
• Address Resolution Protocol (ARP)	Yes	Yes
• ICMP	Yes	Yes
• Telnet	Yes	Yes
• HTTP	Yes	Yes
• HTTPS	Yes	Yes
• TFTP	Yes	Yes
• DCP	Yes	Yes
• LLDP	Yes	Yes
<b>Identification &amp; maintenance function</b>		
• I&MO - device-specific information	Yes	Yes
• I&M1 - higher-level designation/location designation	Yes	Yes

<sup>1)</sup>Wireless approval in the USA

## Network Components

### SCALANCE W – Industrial Wireless LAN

#### SCALANCE W778-1 M12 EEC

Article number	6GK5778-1GY00-0TA0	6GK5778-1GY00-0TB0 <sup>1)</sup>
<b>Product functions Diagnosis</b>		
<b>Product function</b>		
• PROFINET IO diagnosis	Yes	Yes
• Link Check	No	No
• connection monitoring IP-Alive	No	No
• localization via Aeroscout	Yes	Yes
• SysLog	Yes	Yes
<b>Protocol is supported</b>		
• SNMP v1	Yes	Yes
• SNMP v2	Yes	Yes
• SNMP v3	Yes	Yes
<b>Product functions VLAN</b>		
<b>Product function</b>		
• function VLAN with IWLAN	Yes	Yes
<b>Product functions DHCP</b>		
<b>Product function</b>		
• DHCP client	Yes	Yes
• in Client Mode DHCP server via LAN	Yes	Yes
• DHCP Option 82	Yes	Yes
<b>Product functions Redundancy</b>		
<b>Protocol is supported</b>		
• STP/RSTP	Yes	Yes
• MSTP	Yes	Yes
• RSTP	Yes	Yes
<b>Product functions Security</b>		
<b>Product function</b>		
• ACL - MAC-based	Yes	Yes
• Management security, ACL-IP based	Yes	Yes
• IEEE 802.1x (radius)	Yes	Yes
• NAT/NAPT	Yes	Yes
• access protection according to IEEE802.11i	Yes	Yes
• WPA/WPA2	Yes	Yes
• TKIP/AES	Yes	Yes
<b>Protocol is supported</b>		
• SSH	Yes	Yes
• RADIUS	Yes	Yes
<b>Product functions Time</b>		
<b>Protocol is supported</b>		
• NTP	Yes	Yes
• SNTP	Yes	Yes
• SIMATIC Time	Yes	Yes
<b>Standards, specifications, approvals</b>		
<b>Standard</b>		
• for FM	FM 3611: Class I, Division 2, Groups A,B,C,D, T4 / Class 1, Zone 2, Group IIC, T4	FM 3611: Class I, Division 2, Groups A,B,C,D, T4 / Class 1, Zone 2, Group IIC, T4
• for hazardous zone	EN 60079-15:2005, EN 60079-0:2006, II 3 G Ex nA II T4 KEMA 07 ATEX 0145X	EN 60079-15:2005, EN 60079-0:2006, II 3 G Ex nA II T4 KEMA 07 ATEX 0145X
• for safety from CSA and UL	UL 60950-1 CSA C22.2 No. 60950-1	UL 60950-1 CSA C22.2 No. 60950-1
• for hazardous zone from CSA and UL	ANSI/ISA 12.12.01-2013, CAN/CSA C22.2 No.213-M1987, CL. 1, Div. 2, GP. A,B,C,D, T4 / CL. 1, Zone 2, GP IIC	ANSI/ISA 12.12.01-2013, CAN/CSA C22.2 No.213-M1987, CL. 1, Div. 2, GP. A,B,C,D, T4 / CL. 1, Zone 2, GP IIC
<b>Certificate of suitability</b>		
• EC declaration of conformity	Yes	Yes
• CE marking	Yes	Yes
• C-Tick	Yes	Yes
• E1 approval	No	No
• Railway application in accordance with EN 50155	Yes	Yes
• Railway application in accordance with EN 50121-4	Yes	Yes
• Fire protection in accordance with EN 45545-2	Yes	Yes
• NEMA TS2	No	No
• IEC 61375	No	No
• IEC 61850-3	No	No
• NEMA4X	No	No
• Power-over-Ethernet acc. to IEEE802.3at for type 1 and IEEE802.3af	Yes	Yes
• Power-over-Ethernet acc. to IEEE802.3at for type 2	Yes	Yes
<b>Standard for wireless communication</b>		
• IEEE 802.11a	Yes	Yes
• IEEE 802.11b	Yes	Yes
• IEEE 802.11e	Yes	Yes
• IEEE 802.11g	Yes	Yes
• IEEE 802.11h	Yes	Yes
• IEEE 802.11i	Yes	Yes
• IEEE 802.11n	Yes	Yes

<sup>1)</sup>Wireless approval in the USA

Article number	6GK5778-1GY00-0TA0	6GK5778-1GY00-0TB0 <sup>1)</sup>
<b>Wireless approval</b>	You will find the current list of countries at: <a href="http://www.siemens.com/wireless-approvals">www.siemens.com/wireless-approvals</a>	You will find the current list of countries at: <a href="http://www.siemens.com/wireless-approvals">www.siemens.com/wireless-approvals</a>
<b>Marine classification association</b>		
• American Bureau of Shipping Europe Ltd. (ABS)	Yes	Yes
• Bureau Veritas (BV)	Yes	Yes
• DNV GL	Yes	Yes
• Lloyds Register of Shipping (LRS)	Yes	Yes
• Nippon Kaiji Kyokai (NK)	Yes	Yes
• Polski Rejestr Statkow (PRS)	Yes	Yes
• Royal Institution of Naval Architects (RINA)	Yes	Yes

<sup>1)</sup>Wireless approval in the USA

### Selection and ordering data

Version	Article No.
<b>Access Points SCALANCE W778-1 M12 EEC</b> IWLAN access point with built-in wireless interfaces (radio) IEEE 802.11a/b/g/h/n wireless network with 2.4/5 GHz up to 300 Mbps; 2x M12 max. 100 Mbps; M12 A-coded; plug slot WPA2/802.11i/e; integrated Power over Ethernet (PoE) 2-port switch; 2 N-CON antenna port, iFeatures support via KEY-PLUG; IP65 degree of protection; redundant 24 V DC; -30 ... 75°C; Conformal Coating; EN 50155; EN45545; scope of delivery: Manuals on CD-ROM, English/German; M12 sealing caps	
<b>SCALANCE W778-1 M12 EEC</b> • Country approvals for operation outside the USA <sup>1)</sup> • Country approvals for operation within the USA <sup>1)</sup>	<b>6GK5778-1GY00-0TA0</b> <b>6GK5778-1GY00-0TB0</b>
<b>Accessories</b>	
<b>KEY-PLUG W780 iFeatures</b> Removable data storage medium for enabling additional iFeatures, simple device replacement in the event of a fault and storage of configuration data. Can be used in SCALANCE W access points with PLUG compartments	<b>6GK5907-8PA00</b>
<b>C-plug</b> Removable data storage medium for simple device replacement in the event of a fault and storage of configuration data; can be used in SIMATIC NET products with PLUG compartment	<b>6GK1900-0AB00</b>
<b>IE FC M12 plug PRO 2 x 2</b> M12 connector for on-site assembly (D-coded, IP65/IP67), metal enclosure, FastConnect connection technology, for SCALANCE W778-1 M12 • 1 unit • 8 units	<b>6GK1901-0DB20-6AA0</b> <b>6GK1901-0DB30-6AA8</b>
<b>IE FC standard cable GP 2 x 2 /Type A</b> 4-wire, shielded TP installation cable for connection to IE FC RJ45 outlet/ IE FC RJ45 plug; PROFINET-compatible; with UL approval; sold by the meter; max. length per delivery unit 1 000 m, minimum order quantity 20 m	<b>6XV1840-2AH10</b>
<b>IE FC stripping tool</b> Pre-adjusted stripping tool for fast stripping of Industrial Ethernet FC cables	<b>6GK1901-1GA00</b>
<b>Power M12 Cable Connector PRO</b> Terminal socket for connection of SCALANCE W700 for 24 V DC supply voltage; 4-pin, A-coded, with assembly instructions, 3 units	<b>6GK1907-0DC10-6AA3</b>
<b>Power cable 2 x 0.75</b> Connecting cable for Power M12 Cable Connector PRO, sold by the meter	<b>6XV1812-8A</b>
<b>N-Connect/SMA female/female panel feedthrough</b> Cabinet bushing with fastening flange for wall thicknesses up to 5.5 mm, SMA female and N-Connect female connections	<b>6GK5798-0PT00-2AA0</b>
<b>N-Connect/N-Connect female/female panel feedthrough</b> Cabinet bushing for wall thicknesses up to 4.5 mm, two N-Connect female connections	<b>6GK5798-2PP00-2AA6</b>

<sup>1)</sup> Please note country approvals under:  
<http://www.siemens.com/mobilenetwork-approvals>

### More information

#### Selection tools:

To assist in selecting Industrial Ethernet components, the TIA Selection Tool is available at:  
<http://www.siemens.com/tia-selection-tool>

#### Wireless approvals:

Current approvals can be found on the Internet at:  
<http://www.siemens.com/wireless-approvals>

## Network Components

### SCALANCE W – Industrial Wireless LAN

#### SCALANCE W1788-2 M12 EEC

#### Overview



- Industrial Wireless LAN access point for installation in control cabinets or in indoor areas with support of IEEE 802.11a/b/g/n/ac and data rates of up to 1733 Mbit/s

#### Design

- Rugged aluminum housing, shock and vibration-resistant, for stringent mechanical requirements
- Special coating of the printed circuit boards (conformal coating)
- Resistant to condensation
- Railway approval in accordance with EN 50155 and NEMA TS2
- Special features in addition to EN 50155, EN 45545-2, EN 50121-4, EN 50121-3-2, EN 50125-3
- High IP65 degree of protection against dust and water jets
- For use at ambient temperatures from -40 °C to +75 °C
- 8 x N-Connect sockets for the connection of direct mountable and remote antennas
- Optimized antenna placement for the 4x4 MIMO technology; antennas do not interfere with each other when mounted directly on the device
- Suitable for 2.4 GHz and 5 GHz
- 2 x M12 Ethernet x-coded Managed switch (1.000 Mbit/s), Power-over-Ethernet according to IEEE 802.3at
- 1 x M12 socket for power supply (24 V DC)
- 1 x C-PLUG slot (KEY-PLUG/C-PLUG)
- Function LEDs for optical signaling of faults and operating states
- VESA 100 mounting system
  - Wall mounting
  - DIN rail T35 (S7-1200) DIN rail S7-300
  - DIN rail S7-1500
- Two wireless cards are permanently installed in the device; functional scope can be expanded by using a CLP

#### Technical specifications

Article number	<b>6GK5788-2GY01-0TA0<sup>1)</sup></b>
Product type designation	SCALANCE W1788-2 M12 EEC
<b>Transmission rate</b>	
<b>Transmission rate</b>	
• on WLAN, maximum	1733 Mbps
• on Industrial Ethernet	10 Mbps, 100 Mbps, 1 000 Mbps
<b>Interfaces</b>	
<b>Number of electrical connections</b>	
• for network components or data terminal equipment	1
• for power supply	1
• for redundant power supply	1
<b>Type of electrical connection</b>	
• for network components or data terminal equipment	M12 interface (8-pin, X-coded), PoE
• for power supply	M12 interface (4-pin, A-coded)
<b>Type of removable data storage medium</b>	
• C-PLUG	Yes
• KEY-PLUG	Yes
<b>Wireless interfaces</b>	
<b>Number of permanently installed wireless cards</b>	2
<b>Type of transmission for multiple input multiple output (MIMO)</b>	4x4
<b>Number of spatial streams</b>	3
<b>Number of electrical connections for external antenna(s)</b>	8
<b>Type of electrical connection for external antenna(s)</b>	N-Connect (female)
<b>Product property: external antenna can be mounted directly on device</b>	Yes
<b>Supply voltage, current consumption, power loss</b>	
<b>Type of supply voltage</b>	DC
<b>Supply voltage 1</b>	
• from M12 power connector (A-coded) for redundant power supply	16.8 V
<b>Supply voltage 2</b>	
• from M12 power connector (A-coded) for redundant power supply	31.2 V
<b>Supply voltage</b>	
• from Power-over-Ethernet in accordance with IEEE802.3at for Type 1 and IEEE802.3af	48 V
• from Power-over-Ethernet in accordance with IEEE802.3at for Type 2	50 V



Article number	<b>6GK5788-2GY01-0TA0<sup>1)</sup></b>
Product type designation	SCALANCE W1788-2 M12 EEC
<b>Current consumption</b>	
• with 24 V DC, typical	0.7 A
• with Power-over-Ethernet in accordance with IEEE802.3at for Type 1 and IEEE802.3af, typical	0.385 A
• with Power-over-Ethernet in accordance with IEEE802.3at for Type 2, typical	0.3 A
<b>Power loss [W]</b>	
• with 24 V DC, typical	16.8 W
• with Power-over-Ethernet in accordance with IEEE802.3at for Type 1 and IEEE802.3af, typical	18.5 W
• with Power-over-Ethernet in accordance with IEEE802.3at for Type 2, typical	15 W
<b>Permissible ambient conditions</b>	
<b>Ambient temperature</b>	
• during operation	-40 ... +75 °C
• during storage	-40 ... +85 °C
• during transport	-40 ... +85 °C
<b>Relative humidity at 25 °C, without condensation during operation</b>	90%
<b>Ambient conditions for operation</b>	When used under explosion protection conditions (Zone 2), the SCALANCE W788-x or W748-x product must be installed in an enclosure with at least IP54 degree of protection according to EN 60529 within the jurisdiction of EN 50021.
<b>IP degree of protection</b>	IP65
<b>Design, dimensions and weights</b>	
<b>Width of housing without antenna</b>	258 mm
<b>Height of housing without antenna</b>	258 mm
<b>Depth of housing without antenna</b>	80 mm
<b>Net weight</b>	2.7 kg
<b>Mounting type</b>	For 35 mm DIN rail mounting, an additional mounting adapter is needed
• S7-300 rail mounting	Yes
• S7-1500 rail mounting	Yes
• Wall mounting	Yes
<b>Radio frequencies</b>	
<b>Operating frequency</b>	
• for WLAN in 2.4 GHz frequency band	2.41 ... 2.48 GHz
• for WLAN in 5 GHz frequency band	4.9 ... 5.8 GHz
<b>Product properties, functions, components - General</b>	
<b>Product function - Access point mode</b>	Yes
<b>Product function - Client mode</b>	Yes
<b>Number of SSIDs</b>	16
<b>Product function</b>	No
• Dual client	Yes; only in combination with the 'KEY-PLUG W780 iFeatures'
• iPCF access point	Yes; only in combination with the 'KEY-PLUG W780 iFeatures' or 'KEY-PLUG W740 iFeatures'
• iPCF client	Yes; only in combination with the 'KEY-PLUG W780 iFeatures'
• iPCF-MC access point	Yes; only in combination with the 'KEY-PLUG W780 iFeatures' or 'KEY-PLUG W740 iFeatures'
• iPCF-MC client	Yes; only in combination with the 'KEY-PLUG W780 iFeatures' or 'KEY-PLUG W740 iFeatures'
<b>Number of iPCF-enabled wireless modules</b>	0
<b>Product function - iREF</b>	Yes; only in combination with the 'KEY-PLUG W780 iFeatures'
<b>Number of iREF-enabled wireless modules</b>	0
<b>Product functions - Management, configuration, engineering</b>	
<b>Number of manageable IP addresses in the client</b>	8
<b>Product function</b>	
• CLI	Yes
• Web-based management	Yes
• MIB support	Yes
• TRAPs via e-mail	Yes
• Configuration with STEP 7	Yes
• Configuration with STEP 7 in the TIA Portal	Yes
• Operation with IWLAN controller	No
• Operation with Enterasys WLAN controller	No
• Forced roaming with IWLAN	Yes
• WDS	Yes
<b>Protocol is supported</b>	
• Address Resolution Protocol (ARP)	Yes
• ICMP	Yes
• Telnet	Yes
• HTTP	Yes
• HTTPS	Yes
• TFTP	Yes
• DCP	Yes
• LLDP	Yes

## Network Components

### SCALANCE W – Industrial Wireless LAN

#### SCALANCE W1788-2 M12 EEC

Article number	<b>6GK5788-2GY01-0TA0<sup>1)</sup></b>
Product type designation	SCALANCE W1788-2 M12 EEC
<b>Identification &amp; Maintenance function</b>	
• I&M0 - Device-specific information	Yes
• I&M1 - Higher level designation/location designation	Yes
<b>Product functions - Diagnostics</b>	
<b>Product function</b>	
• PROFINET IO diagnostics	Yes
• Link check	No
• Connection monitoring IP-Alive	No
• SysLog	Yes
<b>Protocol is supported</b>	
• SNMP v1	Yes
• SNMP v2	Yes
• SNMP v3	Yes
<b>Product functions - VLAN</b>	
<b>Product function</b>	
• VLAN function for IWLAN	Yes
<b>Product functions - DHCP</b>	
<b>Product function</b>	
• DHCP client	Yes
• In Client Mode, DHCP server via LAN	No
<b>Product functions - Redundancy</b>	
<b>Protocol is supported</b>	
• STP/RSTP	Yes
<b>Product functions - Security</b>	
<b>Product function</b>	
• Management security with IP-based ACL	Yes
• IEEE 802.1X (RADIUS)	Yes
• NAT/NAPT	No
• Access protection in accordance with IEEE802.11i	Yes
• WPA/WPA2	Yes
• TKIP/AES	Yes
<b>Protocol is supported</b>	
• SSH	Yes
<b>Product functions - Time of day</b>	
<b>Protocol is supported</b>	
• SNTP	Yes
• SIMATIC Time	Yes
<b>Standards, specifications, approvals</b>	
<b>Standard</b>	
• for FM	FM 3611: Class I, Division 2, Groups A,B,C,D, T4 / Class 1, Zone 2, Group IIC, T4
• for hazardous zone	EN 60079-15:2005, EN 60079-0:2006, II 3 G Ex nA II T4 KEMA 07 ATEX 0145X
• for safety, from CSA and UL	UL 60950-1, CSA C22.2 No. 60950-1
• for hazardous zone, from CSA and UL	ANSI/ISA 12.12.01-2013, CAN/CSA C22.2 No.213-M1987, CL. 1, Div. 2, GP A,B,C,D, T4 / CL. 1, Zone 2, GP IIC
<b>Proof of suitability</b>	
• EC Declaration of Conformity	Yes
• CE mark	Yes
• C-Tick	Yes
• CCC	No
• E1 approval	Yes
• Railway application in accordance with EN 50155	Yes
• Railway application in accordance with EN 50121-4	Yes
• Fire protection in accordance with EN 45545-2	Yes
• NEMA TS2	Yes
• IEC 61375	No
• IEC 61850-3	No
• NEMA4X	No
• Power-over-Ethernet in accordance with IEEE802.3at for Type 1 and IEEE802.3af	Yes
• Power-over-Ethernet in accordance with IEEE802.3at for Type 2	Yes
<b>Standard for wireless communication</b>	
• IEEE 802.11a	Yes
• IEEE 802.11ac	Yes
• IEEE 802.11b	Yes
• IEEE 802.11g	Yes
• IEEE 802.11n	Yes
<b>Wireless approval</b>	You will find the current list of countries at: <a href="http://www.siemens.com/wireless-approvals">www.siemens.com/wireless-approvals</a>
<b>Marine classification association</b>	
• American Bureau of Shipping Europe Ltd. (ABS)	No
• Bureau Veritas (BV)	No
• Det Norske Veritas (DNV)	No
• Germanischer Lloyd (GL)	No
• Lloyds Register of Shipping (LRS)	No
• Nippon Kaiji Kyokai (NK)	No
• Polski Rejestr Statkow (PRS)	No

<sup>1)</sup> Wireless approval in the USA

### Selection and ordering data

Version	Article No.
<b>SCALANCE W1788-2 M12 EEC Access Points</b>	
IWLAN access points with built-in wireless interfaces; wireless networks IEEE 802.11a/ac/b/g/n at 2.4/5 GHz up to 1733 Mbps; railway approval in accordance with EN 50155 / NEMA TS2; conformal coating; WPA2/AES; Power over Ethernet (PoE), IP65 degree of protection; scope of delivery: mounting hardware; manual on CD-ROM, German/English	
<b>SCALANCE W1788-2 M12 EEC</b>	
IWLAN dual access point with <u>two</u> built-in wireless interfaces	
<ul style="list-style-type: none"> <li>National approvals for operation outside the U.S.<sup>1)</sup></li> <li>National approvals for operation within the U.S.<sup>1)</sup></li> </ul>	<b>6GK5788-2GY01-0TA0</b> <b>6GK5788-2GY01-0TB0</b>
<b>Accessories</b>	
<b>KEY-PLUG W780 iFeatures</b>	
Removable data storage medium for activating additional iFeatures, for easy device replacement under fault conditions and for recording configuration data; can be used in SCALANCE W access points with PLUG slot	<b>6GK5907-8PA00</b>
<b>C-PLUG</b>	
Removable data storage medium for easy replacement of devices under fault conditions; for recording configuration data; can be used in SIMATIC NET products with PLUG slot	<b>6GK1900-0AB00</b>
<b>DIN Rail Mounting Adapter</b>	
DIN rail mounting adapter for SCALANCE W788 M12 and SCALANCE W788 RJ45; screw mounting for mounting on a 35 mm DIN rail according to EN 50022; scope of delivery: 3 units per pack	<b>6GK5798-8ML00-0AB3</b>
<b>IE FC M12 Plug PRO 4 x 2</b>	
M12 plug connector (X-coded, IP65/IP67) that can be assembled in the field, metal enclosure, insulation displacement fast connection method, for SCALANCE W	
<ul style="list-style-type: none"> <li>1 unit</li> <li>8 units</li> </ul>	<b>6GK1901-0DB30-6AA0</b> <b>6GK1901-0DB30-6AA8</b>
<b>IE Train Cable GP 4x2</b>	
8-core, shielded TP installation cable for connection to IE FC M12 Plug PRO 4x2 for use in railway applications; with railway approval; sold by the meter; maximum delivery unit 1000 m, minimum order quantity 20 m	<b>6XV1878-2T</b>
<b>IE FC Stripping Tool</b>	
Preset insulation stripping tool for fast stripping of Industrial Ethernet FC cables	<b>6GK1901-1GA00</b>
<b>Power M12 Cable Connector PRO</b>	
Connector socket for connection of SCALANCE W700 for 24 V DC supply voltage; 4-pin, A-coded, with assembly instructions, 3 units	<b>6GK1907-0DC10-6AA3</b>
<b>Power Cable 2 x 0.75</b>	
Connecting cable for Power M12 Cable Connector PRO, sold by the meter	<b>6XV1812-8A</b>

<sup>1)</sup> Note national approvals under  
<http://www.siemens.com/wireless-approvals>

### More information

#### Selection tools:

To assist in selecting Industrial Ethernet components, the TIA Selection Tool is available at:  
<http://www.siemens.com/tia-selection-tool>

#### Wireless approvals:

Current approvals can be found on the Internet at:  
<http://www.siemens.com/wireless-approvals>

## Network Components

### SCALANCE W – Industrial Wireless LAN

#### SCALANCE WAM766-1 EEC

#### Overview



Industrial access point according to IEEE 802.11ax (WiFi 6).

- Particularly suitable for industrial applications with cabinet-free setup

#### Design

- Rugged enclosure, shock and vibration resistant for stringent mechanical requirements
- High IP65 degree of protection against dust and water jets
- For use at ambient temperatures from -30 °C to +75 °C (EEC variant)
- 2 x N-Connect sockets for the connection of direct mountable and remote antennas
- Supports channels in 2.4 GHz and 5 GHz band
- 1 x M12 connection for 10/100/1 000 Mbps with Power over Ethernet according to IEEE 802.3bt Type 1, Class 3
- 1 x M12 socket for redundant energy supply (24 V DC)
- 1 x M12 socket with digital input/digital output (DI/DO)
- 1 x CLP slot
- Function LEDs for optical signaling of faults/errors and operating states
- Mounting: Wall, VESA, 35 mm DIN rail (also in 90°) with mounting adapter

#### Product variants

SCALANCE WAM766-1 (6GK5766-1GE00-7DA0)

- Industrial access point for indoors, functional scope can be expanded using a CLP removable data storage medium.

SCALANCE WAM766-1 EEC (6GK5766-1GE00-7TA0)

- Industrial access point for extended ambient conditions, functional scope can be expanded using a CLP removable data storage medium.

#### Technical specifications

Article number	<b>6GK5766-1GE00-7TA0,</b> <b>6GK5766-1GE00-7TB0</b>
Product type designation	SCALANCE WAM766-1 EEC
<b>Transfer rate</b>	
<b>Transfer rate</b>	
• with WLAN, maximum	1201 Mbit/s
• for Industrial Ethernet	10/100/1000 Mbit/s
<b>Transfer rate for Industrial Ethernet</b>	
• minimum	10 Mbit/s
• maximum	1000 Mbit/s
<b>Interfaces</b>	
<b>Number of electrical/optical connections for gigabit Ethernet maximum</b>	1
<b>number of electrical connections</b>	
• for network components or terminal equipment	1
• for power supply	1
• for redundant voltage supply	1
<b>Type of electrical connection</b>	
• for network components or terminal equipment	M12 interface (8-pole, X-coded), PoE
• for redundant voltage supply	M12 interface (4-pin, L-coded)
<b>design of the removable storage</b>	
• CLP	Yes
• CLP iFeatures	Yes
<b>Memory</b>	
<b>design of the removable storage</b>	
• CLP	Yes
• CLP iFeatures	Yes
<b>Interfaces wireless</b>	
<b>Number of radio cards permanently installed</b>	2
<b>Transmission mode for multiple input multiple output (MIMO)</b>	2x2
<b>Number of spatial streams</b>	2
<b>Number of electrical connections for external antenna(s)</b>	2
<b>Type of electrical connection for external antenna(s)</b>	N-Connect (socket)
<b>Product feature external antenna can be mounted directly on device</b>	Yes

Article number	<b>6GK5766-1GE00-7TA0,</b> <b>6GK5766-1GE00-7TB0</b>
Product type designation	SCALANCE WAM766-1 EEC
<b>Signal inputs/outputs</b>	
Number of digital inputs	1
Number of digital outputs	1
Type of electrical connection at the digital inputs/outputs	M12 interface (4-pin, A-coded)
Signal range at digital input	-30 V DC 30 V
Signal range at digital output	24 V / 0.5 A DC
Operational current of the signaling contacts at DC at 30 V maximum	0.008 A
<b>Supply voltage, current consumption, power loss</b>	
Type of voltage of the supply voltage	Redundant 24 V DC Power Supply, M12, L-coded
Supply voltage	48 V
• from Power-over-Ethernet acc. to IEEE802.3at for type 1 and IEEE802.3af	
Consumed current	0.55 V
• at DC at 24 V typical	0.27 V
• with Power-over-Ethernet according to IEEE802.3at for type 1 and IEEE802.3af typical	
Power loss (W)	13.2 W
• at DC at 24 V typical	12.96 W
• with Power-over-Ethernet according to IEEE802.3at for type 1 and IEEE802.3af typical	
Supply voltage 1	24 V
• from M12 power Connector (L-coded) for redundant voltage supply	
Supply voltage 1 rated value	24 V
• type of voltage 1 of the supply voltage	DC
Supply voltage 2	24 V
• from M12 power Connector (L-coded) for redundant voltage supply	
Supply voltage 2 rated value	24 V
• type of voltage 2 of the supply voltage	DC
Supply voltage 3 rated value	48 V
<b>Ambient conditions</b>	
Ambient temperature	-30 ... +75 °C
• during operation	-40 ... +85 °C
• during storage	-40 ... +85 °C
• during transport	
Relative humidity at 25 °C, without condensation during operation maximum	90%
Protection class IP	IP65
<b>Design, dimensions and weights</b>	
Width	150 mm
Height	179.5 mm
Depth	45 mm
Width of housing without antenna	150 mm
Height of housing without antenna	179.5 mm
Depth of housing without antenna	45 mm
Net weight	1.1 kg
Product feature conformal coating	Yes
Fastening method	Yes
• 35 mm top hat DIN rail mounting	Yes
• Wall mounting	Yes
• VESA mounting	Yes
<b>Radio frequencies</b>	
Operating frequency	2.41 ... 2.48 GHz; depending on the country approvals
• for WLAN in 2.4 GHz frequency band	4.9 ... 5.8 GHz; depending on the country approvals
• for WLAN in 5 GHz frequency band	
<b>Product features, functions, components general</b>	
Product function	Yes
• access point mode	Yes
• client mode	No
• iPCF access point	Yes
• iPRP	Yes
• automatic selection of the fastest transfer rate	
Number of SSIDs	1
<b>Product functions, management, configuration, engineering</b>	
Product function	Yes
• CLI	Yes
• Web-based management	Yes
• MIB support	Yes
• TRAPs via e-mail	Yes
• Configuration with STEP 7	Yes
• Configuration with STEP 7 in the TIA Portal	Yes
• WDS	No

## Network Components

### SCALANCE W – Industrial Wireless LAN

#### SCALANCE WAM766-1 EEC

Article number	<b>6GK5766-1GE00-7TA0, 6GK5766-1GE00-7TB0</b>
Product type designation	SCALANCE WAM766-1 EEC
<b>Protocol is supported</b>	
<ul style="list-style-type: none"> <li>• Address Resolution Protocol (ARP)</li> <li>• ICMP</li> <li>• Telnet</li> <li>• HTTP</li> <li>• HTTPS</li> <li>• TFTP</li> <li>• DCP</li> <li>• LLDP</li> </ul>	<ul style="list-style-type: none"> <li>Yes</li> <li>Yes</li> <li>Yes</li> <li>Yes</li> <li>Yes</li> <li>Yes</li> <li>Yes</li> <li>Yes</li> </ul>
<b>Identification &amp; Maintenance function</b>	
<ul style="list-style-type: none"> <li>• I&amp;M0 - Device-specific information</li> <li>• I&amp;M1 - Higher level designation/location designation</li> </ul>	<ul style="list-style-type: none"> <li>Yes</li> <li>Yes</li> </ul>
<b>Product functions diagnostics</b>	
<b>Product function</b>	
<ul style="list-style-type: none"> <li>• PROFINET IO diagnostics</li> <li>• SysLog</li> </ul>	<ul style="list-style-type: none"> <li>Yes</li> <li>Yes</li> </ul>
<b>Protocol is supported</b>	
<ul style="list-style-type: none"> <li>• SNMP v1</li> <li>• SNMP v2</li> <li>• SNMP v3</li> </ul>	<ul style="list-style-type: none"> <li>Yes</li> <li>Yes</li> <li>Yes</li> </ul>
<b>Product functions VLAN</b>	
<b>Product function</b>	
<ul style="list-style-type: none"> <li>• VLAN function for IWLAN</li> </ul>	<ul style="list-style-type: none"> <li>Yes</li> </ul>
<b>Number of VLANs maximum</b>	24
<b>Product functions DHCP</b>	
<b>Product function</b>	
<ul style="list-style-type: none"> <li>• DHCP client</li> </ul>	<ul style="list-style-type: none"> <li>Yes</li> </ul>
<b>Product functions Redundancy</b>	
<b>Protocol is supported</b>	
<ul style="list-style-type: none"> <li>• STP/RSTP</li> <li>• MSTP</li> <li>• RSTP</li> </ul>	<ul style="list-style-type: none"> <li>Yes</li> <li>Yes</li> <li>Yes</li> </ul>
<b>Product functions security</b>	
<b>Product function</b>	
<ul style="list-style-type: none"> <li>• Management security with IP-based ACL</li> <li>• IEEE 802.1X (RADIUS)</li> <li>• NAT/NAPT</li> <li>• Access protection in accordance with IEEE802.11i</li> <li>• WPA/WPA2</li> <li>• TKIP/AES</li> </ul>	<ul style="list-style-type: none"> <li>No</li> <li>Yes</li> <li>Yes</li> <li>Yes</li> <li>Yes</li> <li>Yes</li> </ul>
<b>Protocol is supported</b>	
<ul style="list-style-type: none"> <li>• SSH</li> </ul>	<ul style="list-style-type: none"> <li>Yes</li> </ul>
<b>Product functions time</b>	
<b>Protocol is supported</b>	
<ul style="list-style-type: none"> <li>• NTP</li> <li>• SNTP</li> <li>• SIMATIC time synchronization (SIMATIC Time)</li> </ul>	<ul style="list-style-type: none"> <li>Yes</li> <li>Yes</li> <li>Yes</li> </ul>
<b>Standards, specifications, approvals</b>	
<b>Certificate of suitability</b>	
<ul style="list-style-type: none"> <li>• EC Declaration of Conformity</li> <li>• CE marking</li> <li>• E1 approval</li> <li>• Railway application in accordance with EN 50155</li> <li>• Fire protection in accordance with EN 45545-2</li> <li>• Power-over-Ethernet in accordance IEEE802.3at for Type 1 and IEEE802.3af</li> </ul>	<ul style="list-style-type: none"> <li>Yes</li> <li>Yes</li> <li>Yes</li> <li>Yes</li> <li>Yes</li> <li>Yes</li> </ul>
<b>Standard for wireless communication</b>	
<ul style="list-style-type: none"> <li>• IEEE 802.11a</li> <li>• IEEE 802.11b</li> <li>• IEEE 802.11e</li> <li>• IEEE 802.11g</li> <li>• IEEE 802.11h</li> <li>• IEEE 802.11i</li> <li>• IEEE 802.11n</li> <li>• IEEE 802.11ac</li> <li>• IEEE 802.11ax</li> </ul>	<ul style="list-style-type: none"> <li>Yes</li> <li>Yes</li> <li>Yes</li> <li>Yes</li> <li>Yes</li> <li>Yes</li> <li>Yes</li> <li>Yes</li> <li>Yes</li> <li>Yes</li> </ul>
<b>Wireless approval</b>	You will find the current list of countries at: <a href="http://www.siemens.com/wireless-approvals">www.siemens.com/wireless-approvals</a> or directly on the device

### Selection and ordering data

Version	Article No.
<b>SCALANCE WAM766-1 EEC Access Points</b> WLAN access point; 1 radio, 2.4/5 GHz, 2 N-Connect connectors, iFeatures support via CLP, IEEE 802.11ax (Wi-Fi 6), 1 201 Mbps (gross) per radio, 1x10/100/1 000 Mbps M12 socket, redundant 24 V DC, M12 L-coded, PoE, IP65 (-30°C to +75°C); CLP slot, DI/DQ, A-coded, observe national approvals! CERT ID: MSAX65-W1-M12-E2, FCCID: LYHMSAX*, scope of delivery: Manuals on DVD, English/German, sealing caps for connectors	
<b>SCALANCE WAM766-1 EEC</b> <ul style="list-style-type: none"> <li>Country approvals for operation outside the USA/Israel</li> <li>National approvals for operation in the USA <sup>1)</sup></li> </ul>	<b>6GK5766-1GE00-7TA0</b> <b>6GK5766-1GE00-7TB0</b>
<b>Accessories</b>	
<b>SCALANCE CLP EEC 2GB</b> Removable data storage medium for simple device replacement in the event of a fault and storage of configuration data; can be used in SIMATIC NET products with CLP slot	<b>6GK1900-0UQ00-0AA0</b>
<b>SCALANCE CLP 2GB W700 AP iFeatures</b> Removable data storage medium for simple device replacement in the event of a fault and storage of configuration data; can be used in SIMATIC NET products with CLP slot	<b>6GK5907-8UA00-0AA0</b>
<b>IE TP cord M12/M12 4 x 2</b> Pre-assembled flexible connecting cable 4 x 2 with two M12 plugs (X-coded) <ul style="list-style-type: none"> <li>0.3 m</li> <li>0.5 m</li> <li>1 m</li> <li>1.5 m</li> <li>2 m</li> <li>3 m</li> <li>5 m</li> <li>10 m</li> <li>15 m</li> </ul>	<b>6XV1878-5HE30</b> <b>6XV1878-5HE50</b> <b>6XV1878-5HH10</b> <b>6XV1878-5HH15</b> <b>6XV1878-5HH20</b> <b>6XV1878-5HH30</b> <b>6XV1878-5HH50</b> <b>6XV1878-5HN10</b> <b>6XV1878-5HN15</b>
<b>IE FC standard cable GP 4x2</b> 8-wire, shielded TP installation cable for connection to IE FC RJ45 plug 4 x 2 and IE M12 plug PRO 4 x 2; PROFINET-compatible; with UL approval; sold by the meter; maximum delivery unit 1000 m, minimum order quantity 20 m	<b>6XV1878-2A</b>
<b>IE FC M12 plug PRO 4 x 2</b> M12 plug-in connector suitable for on-site assembly (X-coded, IP65/IP67), metal enclosure, insulation displacement fast connection method, for SCALANCE W <ul style="list-style-type: none"> <li>1 unit</li> <li>8 units</li> </ul>	<b>6GK1901-0DB30-6AA0</b> <b>6GK1901-0DB30-6AA0</b>

<sup>1)</sup> Note national approvals under  
<http://www.siemens.com/wireless-approvals>

### More information

#### Selection tools:

To assist in selecting Industrial Ethernet components, the TIA Selection Tool is available at:  
<http://www.siemens.com/tia-selection-tool>

#### Wireless approvals:

Current approvals can be found on the Internet at:  
<http://www.siemens.com/wireless-approvals>

## Network Components

### SCALANCE W – Industrial Wireless LAN

ANT795-4MX / ANT795-6MN / ANT795-6MT / ANT793-8DL / ANT793-8DP / ANT795-6DC / ANT793-6DG

#### Overview



Remote antennas increase the reliability of wireless links by optimizing signal reception and emission.

- Use in Industrial Wireless LAN (IWLAN) and WLAN in accordance with IEEE 802.11 at 2.4 GHz and 5 GHz
- Coordinated range of antennas for the most diverse applications both indoors and outdoors

#### Benefits

- Investment protection thanks to compliance with the globally recognized standard IEEE 802.11 and – depending on the version – suitability for 2.4 GHz and/or 5 GHz
- Cost-effective connection to devices in remote, difficult-to-access or hostile environments
- Establishment of a reliable IWLAN wireless infrastructure through the use of remote antennas, even if the access points and client modules are installed in the control cabinet, for example

#### Application

Remote antennas optimize transmission and reception conditions and enable use of IWLAN products in a number of industrial applications.

With sector antennas, for example, conveyor lines or corridors can be specifically covered with radio links, or strongly directional antennas can be used to implement point-to-point connections over distances of up to several 1000 meters.

Alternatively, an omnidirectional antenna concentrates the radio field around the antenna in the shape of a disc, which enhances the quality of the connection.

#### Application examples:

##### Omnidirectional antennas

- Coverage of an area which has at its center a mast for mounting the antenna
- Installation of the antenna on the roof in the case of automated guided vehicle systems for reliable data exchange with the vehicles
- Wide-area coverage of a production cell or robot station

##### Directional antennas

- Communication between buildings over long distances with the help of an antenna with narrow beam angle and high gain

##### Sector antennas

- Selective coverage of warehouse/high-bay warehouse aisles with the help of a wide-angle antenna prevents interference with neighboring wireless fields

All antennas can be connected to SCALANCE W via an antenna connection cable from the range of IWLAN cabling technology.

For details and direct ordering, please see: <https://mall.industry.siemens.com/mall/de/de/Catalog/Products/10090612?tree=CatalogTree>

#### Technical specifications

Article number	6GK5795-4MX00-0AA0	6GK5795-6MN10-0AA6	6GK5795-6MT00-0AA0
Product type designation	Antenna ANT795-4MX	Antenna ANT795-6MN	Antenna ANT795-6MT
<b>Radio frequencies</b>			
Type of mobile network is supported	5G private networks, WLAN	5G private networks, WLAN	WLAN
Operating frequency 1	1700 ... 2000 MHz	2400 ... 2700 MHz	
Operating frequency 2	2000 ... 2700 MHz	3400 ... 3800 MHz	
Operating frequency 3	2700 ... 3800 MHz	4900 ... 5925 MHz	
Operating frequency 4	4900 ... 5925 MHz	5925 ... 7125 MHz	
Operating frequency	5925 ... 7125 MHz		
Antenna gain compared to spherical radiator			2.4 ... 2.69 GHz 5.15 ... 5.35 GHz 5.47 ... 5.935 GHz
• for WLAN in 2.4 GHz frequency band			
• for WLAN in 5 GHz frequency band 1			
• for WLAN in 5 GHz frequency band 2			
Antenna gain compared to spherical radiator			
• of the WLAN antenna in the 2.4 GHz frequency band	2 dB	6 dB	5 dB
• of the WLAN antenna in the 5 GHz frequency band	2.5 dB	8 dB	7 dB
<b>Electrical data</b>			
Impedance	50 Ω	50 Ω	50 Ω
Polarization	linear vertical	linear vertical	3 ports: linear vertical
Radiation characteristic	omnidirectional	omnidirectional	omnidirectional
Antenna gain compared to spherical radiator			
• of the WLAN antenna in the 2.4 GHz frequency band	2 dB	6 dB	5 dB
• of the WLAN antenna in the 5 GHz frequency band	2.5 dB	8 dB	7 dB
Standing wave ratio (VSWR) maximum	2	2	1.5



## Network Components

### SCALANCE W – Industrial Wireless LAN

#### ANT795-4MX / ANT795-6MN / ANT795-6MT / ANT793-8DL / ANT793-8DP / ANT795-6DC / ANT793-6DG

Article number	6GK5795-4MX00-0AA0	6GK5795-6MN10-0AA6	6GK5795-6MT00-0AA0
Product type designation	Antenna ANT795-4MX	Antenna ANT795-6MN	Antenna ANT795-6MT
<b>Radiating angle of the antenna</b>			
• horizontal	360°	360°	360°
• in the 2.4 GHz frequency band horizontal			
• in the 2.4 GHz frequency band vertical	360°	150°	360°
• in the 5 GHz frequency band horizontal		take the antenna diagram into account regarding the horizontal beam angle	
• in the 5 GHz frequency band vertical			
<b>Number of electrical connections of the antenna</b>	1	1	
<b>Type of electrical connection of the antenna</b>	N-Connector	N-Connector	QMA Connector
<b>Design of plug-in connection</b>	male, straight	female	female
<b>Angle of inclination downward maximum</b>	0°	0°	0°
<b>Crosstalk attenuation between the antenna connections</b>	10 W; at 25° ambient temperature		20 dB
<b>Mechanical data</b>			
<b>Material</b>			
• of outer shell	ASA	Polycarbonate	Polycarbonate
<b>Ambient conditions</b>			
<b>Ambient temperature</b>			
• during operation	-40 ... +85 °C	-40 ... +80 °C	-40 ... +85 °C
• during storage	-40 ... +85 °C	-40 ... +80 °C	-40 ... +85 °C
• during transport	-40 ... +85 °C	-40 ... +80 °C	-40 ... +85 °C
<b>Protection class IP</b>	IP68/IP69K	IP65	IP65
<b>Shock resistance</b>	according to EN 61373, category 1, class b (for railway carriage)		
<b>Wind load maximum</b>		10 N; at 160 km/h	
<b>Design, dimensions and weight</b>			
<b>Width</b>		86 mm	282 mm
<b>Height</b>	55 mm	43 mm	32 mm
<b>Depth</b>		86 mm	92 mm
<b>Diameter</b>	22 mm		
<b>Net weight</b>	50 g	300 g	320 g
<b>Fastening method</b>			
• mast mounting		No	No
• flat roof mounting		Yes	
• wall mounting	No	Yes	Yes
• roof mounting	No	Yes	Yes
• directly on the device	Yes	No	No
<b>Product features, functions, components general</b>			
<b>Product feature silicon-free</b>	Yes	Yes	Yes
<b>Standards, specifications, approvals</b>			
<b>Certificate of suitability</b>		Railway application in accordance with NF-F-16-101, NF-F-16-102	
<b>Certificate of suitability</b>			
• RoHS conformity	Yes	Yes	Yes
• Railway application in accordance with EN 50155	Yes	Yes	Yes
• Fire protection in accordance with EN 45545-2	Yes	Yes	Yes
• Marine classification association / Korean Register of Shipping (KRS)		Yes	Yes
<b>Product conformity</b>	UL 94-HB	UL 94-V0	UL 94-V0
<b>Wireless approval</b>	Current national approvals can be found on the Internet under <a href="http://www.siemens.com/funkzulassungen">www.siemens.com/funkzulassungen</a>	Current national approvals can be found on the Internet under <a href="http://www.siemens.com/funkzulassungen">www.siemens.com/funkzulassungen</a>	Current national approvals can be found on the Internet under <a href="http://www.siemens.com/funkzulassungen">www.siemens.com/funkzulassungen</a>
<b>Reference code</b>			
• according to IEC 81346-2	TF	TF	TF
• according to IEC 81346-2:2019	TFB	TFB	TFB

## Network Components

### SCALANCE W – Industrial Wireless LAN

#### ANT795-4MX / ANT795-6MN / ANT795-6MT / ANT793-8DL / ANT793-8DP / ANT795-6DC / ANT793-6DG

Article number	6GK5793-8DL00-0AA0	6GK5793-8DP00-0AA0	6GK5795-6DC00-0AA0	6GK5793-6DG00-0AA0
Product type designation	Antenna ANT793-8DL	Antenna ANT793-8DP	Antenna ANT795-6DC	Antenna ANT793-6DG
<b>Wireless frequencies</b>				
<b>Type of mobile network is supported</b>	WLAN	WLAN	WLAN	WLAN
<b>Operating frequency</b> • for WLAN in 2.4 GHz frequency band • for WLAN in 5 GHz frequency band 1	4.9 ... 5.9 GHz	4.9 ... 5.35 GHz	2.4 ... 2.5 GHz 5.15 ... 5.875 GHz	5.15 ... 5.875 GHz
<b>Antenna gain compared to spherical radiator of the WLAN antenna in the 2.4 GHz frequency band</b>			9 dB	
<b>of the WLAN antenna in the 5 GHz frequency band</b>	14 dB	13.5 dB	9 dB	9 dB
<b>Electrical data</b>				
<b>Impedance</b>	50 Ω	50 Ω	50 Ω	50 Ω
<b>Polarization</b>	dual linear vertical-horizontal	linear vertical	linear vertical	dual linear +/- 45° slant
<b>Radiation characteristic</b>	directional	directional	Sector antenna	Sector antenna
<b>Antenna gain compared to spherical radiator</b> • of the WLAN antenna in the 2.4 GHz frequency band • of the WLAN antenna in the 5 GHz frequency band	14 dB	13.5 dB	9 dB 9 dB	9 dB
<b>Standing wave ratio (VSWR) maximum</b>	2.5	1.5	2	2
<b>Radiating angle of the antenna</b> • in the 2.4 GHz frequency band horizontal • in the 2.4 GHz frequency band vertical • in the 5 GHz frequency band horizontal • in the 5 GHz frequency band vertical	30° 30°, take the antenna diagram into account	40° 35°	75° 55° 55° 55°	70° 60°
<b>Number of electrical connections of the antenna</b>	2	1	1	2
<b>Opening angle Note</b>	Note antenna diagram			
<b>Number of electrical connections of the antenna</b>	2	1	1	2
<b>Type of electrical connection of the antenna</b>	N-Connector	N-Connector	N-Connector	N-Connector
<b>Design of plug-in connection</b>	female	female	female	female
<b>Angle of inclination downward maximum</b>		0°	0°	0°
<b>Crosstalk attenuation between the antenna connections</b>	19 dB		25 dB	20 dB
<b>Front-to-back ratio</b>	35 dB	20 dB	15 dB	20 dB
<b>Mechanical data</b>				
<b>Material</b> • of outer shell	ASA	Lexan EXL 9330	Lexan EXL 9330	Lexan EXL 9330
<b>Permitted ambient conditions</b>				
<b>Ambient temperature</b> • during operation • during storage • during transport	-40 ... +70 °C -40 ... +70 °C -40 ... +70 °C	-40 ... +80 °C -40 ... +80 °C -40 ... +80 °C	-40 ... +80 °C -40 ... +80 °C -40 ... +80 °C	-40 ... +80 °C -40 ... +80 °C -40 ... +80 °C
<b>Protection class IP</b>	IP66	IP66/67	IP66/67	IP66/67
<b>Wind load maximum</b>	suitable for wind speeds up to 200 km/h	15 N; frontal at 160 km/h	15 N; at 160 km/h	15 N; frontal at 160 km/h
<b>Design, dimensions and weight</b>				
<b>Width</b>	100 mm	80 mm	80 mm	80 mm
<b>Height</b>	283 mm; incl. bracket	101 mm	101 mm	101 mm
<b>Depth</b>	40 mm	35 mm	35 mm	35 mm
<b>Net weight</b>	520 g	110 g	110 g	110 g
<b>Mounting type</b> • mast mounting • flat-roof mounting • wall mounting • roof mounting • directly on the device	Yes No Yes No No	Yes Yes No No	Yes Yes No No	Yes Yes No No
<b>Product features, functions, components general</b>				
<b>Product feature silicon-free</b>	Yes	Yes	Yes	

## Network Components

### SCALANCE W – Industrial Wireless LAN

ANT795-4MX / ANT795-6MN / ANT795-6MT / ANT793-8DL / ANT793-8DP / ANT795-6DC / ANT793-6DG

Article number	<b>6GK5793-8DL00-0AA0</b>	<b>6GK5793-8DP00-0AA0</b>	<b>6GK5795-6DC00-0AA0</b>	<b>6GK5793-6DG00-0AA0</b>
Product type designation	Antenna ANT793-8DL	Antenna ANT793-8DP	Antenna ANT795-6DC	Antenna ANT793-6DG
<b>Standards, specifications, approvals</b>				
<b>Certificate of suitability</b>				
• RoHS conformity	Yes	Yes	Yes	Yes
• Railway application in accordance with EN 50155	Yes	Yes	Yes	Yes
• Fire protection in accordance with EN 45545-2	Yes	Yes	Yes	Yes
• Marine classification association / Korean Register of Shipping (KRS)			Yes	Yes
<b>Product conformity</b>		UL 94-V0	UL 94-V0	
<b>Wireless approval</b>	Current national approvals can be found on the Internet under <a href="http://www.siemens.com/funkzulassungen">www.siemens.com/funkzulassungen</a>	Current national approvals can be found on the Internet under <a href="http://www.siemens.com/funkzulassungen">www.siemens.com/funkzulassungen</a>	Current national approvals can be found on the Internet under <a href="http://www.siemens.com/funkzulassungen">www.siemens.com/funkzulassungen</a>	Current national approvals can be found on the Internet under <a href="http://www.siemens.com/funkzulassungen">www.siemens.com/funkzulassungen</a>
<b>Reference code</b>				
• according to IEC 81346-2	TF	TF	TF	TF
• according to IEC 81346-2:2019	TFB	TFB	TFB	TFB

### Selection and ordering data

Version	Article No.
<b>Antennas with omnidirectional characteristic</b>	
National approvals, compact instructions on paper German/English	
<u>Direct mount</u>	
<ul style="list-style-type: none"> <li>• <b>ANT795-4MX IWLAN antenna</b> with omnidirectional characteristic; incl. N-Connect Male connector straight: 2/2.5 dBi; IP67/69K (-40/+85°C), 2.4/5GHz; Wi-Fi compliance and Observe national approvals;</li> </ul>	<b>6GK5795-4MX00-0AA0</b>
<ul style="list-style-type: none"> <li>• <b>ANT795-6MN IWLAN antenna</b> Antenna gain incl. N-Connect connector 6/8 dBi, 2.4/5 GHz; IP65 (-40 to +80 °C) with terminating resistor 1 x TI795-1R</li> </ul>	<b>6GK5795-6MN10-0AA6</b>
<ul style="list-style-type: none"> <li>• <b>Antenna Mounting Tool (ANT795-6MN)</b> Mounting aid for installing ANT795-6MN below a roof</li> </ul>	<b>6GK5795-6MN01-0AA6</b>
<ul style="list-style-type: none"> <li>• <b>ANT795-6MT IWLAN antenna</b> MIMO antenna with 3 QMA sockets, antenna gain 6 dBi, 2.4/5 GHz; (-40 to +85 °C), incl. mounting bracket</li> </ul>	<b>6GK5795-6MT00-0AA0</b>
<b>Directional antennas</b>	
Including mounting hardware for wall or mast mounting	
<u>Strongly directional antennas</u>	
<ul style="list-style-type: none"> <li>• <b>ANT793-8DL IWLAN antenna</b> Vertical-horizontal polarized antenna; antenna gain incl. two N-Connect connectors 14 dBi, 5 GHz; -45 to +70 °C, suitable for railway applications (especially for the railway line)</li> </ul>	<b>6GK5793-8DL00-0AA0</b>
<ul style="list-style-type: none"> <li>• <b>ANT793-8DP IWLAN antenna</b> Antenna gain 13.5 dBi incl. N-connect connector, 4.9 GHz, -40 to +85°C, especially for use in Japan</li> </ul>	<b>6GK5793-8DP00-0AA0</b>
<b>Sector antennas</b>	
Including mounting hardware for wall or mast mounting	
<ul style="list-style-type: none"> <li>• <b>ANT795-6DC IWLAN antenna</b> with weak directional effect; incl. N-female connector: 9 dBi; IP67 (-40 to +80°C), 2.4/5GHz; Wi-Fi compliance and Observe national approvals</li> </ul>	<b>6GK5795-6DC00-0AA0</b>
<ul style="list-style-type: none"> <li>• <b>ANT793-6DG IWLAN antenna</b> Dual-slant antenna with weak directional effect incl. 2x N-female connectors: 9 dBi; IP67 (-40 to +80°C), 5 GHz; Wi-Fi compliance and Observe national approvals</li> </ul>	<b>6GK5793-6DG00-0AA0</b>

### More information

#### Selection tools:

To assist in selecting Industrial Ethernet components, the TIA Selection Tool is available at:  
<http://www.siemens.com/tia-selection-tool>

For all details about the cabling technology portfolio and direct order, please see the Industry Mall:  
<https://mall.industry.siemens.com/mall/en/de/Catalog/Products/9300238?tree=CatalogTree>

For current information about cabling technology, including further information material, please visit the website:  
[www.siemens.com/fastconnect](http://www.siemens.com/fastconnect)

#### Cabling range:

You can order components supplementary to the SIMATIC NET cabling range from your local contact. Technical advice on this subject is available from:

J. Hertlein  
 DI PA DCP IWA  
 Phone: +49 (172) 3172810  
 E-Mail: [juergen.hertlein@siemens.com](mailto:juergen.hertlein@siemens.com)

## Network Components

### RUGGEDCOM – Layer 2 Switches

#### RUGGEDCOM RSG907R and RSG909R

#### Overview



The RUGGEDCOM RSG907R and RSG909R, two full Gigabit switches in a compact design, offering both HSR and PRP functionality to mitigate the risk of communication disruptions and downtime. These rugged Gigabit switches are designed to operate in harsh environments with widely varying climatic and environmental conditions. Tested and certified to withstand extreme temperature, vibration and shock, the RUGGEDCOM RSG907R and RSG909R offer exceptional reliability for industrial applications such as electric utility substations, transportation systems and oil&gas.

The RUGGEDCOM RSG907R and RSG909R are ideal for applications that require high bandwidths and accommodate future network expansions. Three Redundant Network Access SFP ports providing ultimate flexibility in media and distance, with support for Gigabit bandwidth. The RSG907R connects up to 4 IEDs via 100BASE-FX fiber optics and RSG909R connects up to 6 IEDs via copper Ethernet on the Singly Attached Node ports.

Both products offer various network design options and cost savings through increased redundancy, reduced downtimes and high reliability.

#### HSR / PRP with Gigabit/s interfaces

Avoid revenue loss by mitigating the risk of communication disruptions and downtime with a redundant fault tolerant network supporting high bandwidth.

#### SFP RNA ports

SFP ports can be modified at any time allowing deployment flexibility for varying customer needs.

#### Power redundancy

Maintain continuous safe and reliable operations even during power failures, diminishing the risk of revenue and data loss.

#### Full fiber solution

Reduce failure rates due to increased immunity from electromagnetic phenomena. IEEE 1588The RSG907R and RSG909R enable the creation of a future proof network with support for IEEE 1588 time synchronisation.

#### Technical specifications

Article number	<b>6GK6498-0RB00....</b>	<b>6GK6490-7RB00....</b>
Product type designation	RUGGEDCOM RSG909R	RUGGEDCOM RSG907R
<b>Transfer rate</b>		
<b>Transfer rate</b>	10/100/1000 Mbit/s	10/100/1000 Mbit/s
<b>Number of ports maximum</b>	9	7
<b>Interfaces for communication integrated</b>		
<b>Number of electrical connections</b> • for network components or terminal equipment	9	7
<b>Number of 100 Mbit/s LC ports</b> • for multimode		4
<b>Number of 10/100/1000 Mbit/s RJ45 ports integrated</b>	6	
<b>Number of electrical connections</b> • for SFP	3	3
<b>Interfaces other</b>		
<b>Number of electrical connections</b> • for operator console • for management purposes • for signaling contact • for power supply	1 9 1 2	1 7 1 2
<b>Type of electrical connection</b> • for operator console • for management purposes • for signaling contact • for power supply	USB USB 3-pole terminal block, screwable 5-pole terminal block, screwable	USB USB 3-pole terminal block, screwable 5-pole terminal block, screwable
<b>Signal inputs/outputs</b>		
<b>Relay design</b>	Form-C contact relay (SPDT)	Form-C contact relay (SPDT)
<b>Type of relay output</b>	changeover contact (CO)	changeover contact (CO)
<b>Number of relay outputs as CO contact</b>	1	1
<b>Operating voltage of the signaling contacts</b> • at AC maximum • at DC maximum	250 V 30 V	250 V 30 V
<b>operational current of the signaling contacts</b> • at AC maximum • at DC maximum	2 A 2 A	2 A 2 A

## Network Components

### RUGGEDCOM – Layer 2 Switches

#### RUGGEDCOM RSG907R and RSG909R

Article number	6GK6498-0RB00....	6GK6490-7RB00....
Product type designation	RUGGEDCOM RSG909R	RUGGEDCOM RSG907R
<b>Supply voltage, current consumption, power loss</b>		
<b>Product options wide range power supply</b>	Yes	Yes
<b>Product component connection for redundant voltage supply</b>	Yes	Yes
<b>Type of voltage 1 of the supply voltage</b> • power loss [W] 1 rated value • supply voltage 1 rated value	DC 15.5 W 10 ... 60 V	DC 15.5 W 10 ... 60 V
<b>Type of voltage 2 of the supply voltage</b> • supply voltage 2 rated value	DC 88 ... 300 V	DC 88 ... 300 V
<b>Type of voltage 3 of the supply voltage</b> • supply voltage 3 rated value	AC 85 ... 264 V	AC 85 ... 264 V
<b>Ambient conditions</b>		
<b>Ambient temperature</b> • during operation • during storage • during transport • note	-40 ... +85 °C -40 ... +85 °C -40 ... +85 °C A maximum operating temperature of +85 °C is permissible for a duration of 16 hours	-40 ... +85 °C -40 ... +85 °C -40 ... +85 °C A maximum operating temperature of +85 °C is permissible for a duration of 16 hours
<b>Operating condition fanless operation</b>	Yes	Yes
<b>Protection class IP</b>	IP40	IP40
<b>Design, dimensions and weights</b>		
<b>Design</b>	compact	compact
<b>Width</b>	90 mm	90 mm
<b>Height</b>	177 mm	177 mm
<b>Depth</b>	163 mm	163 mm
<b>Net weight</b>	2.4 kg	2.4 kg
<b>Product feature onformal coating</b>	optional	optional
<b>Material of the enclosure</b>	Cast Aluminum Enclosure	Cast Aluminum Enclosure
<b>Fastening method</b> • 19-inch installation • 35 mm top hat DIN rail mounting • wall mounting	No Yes Yes	No Yes Yes
<b>Product features, product functions, product components general</b>		
<b>Number of automatically learnable MAC addresses</b>	16384	16384
<b>Storage capacity</b> • of message buffer maximum	2048 Kibyte	2048 Kibyte
<b>Switch latency period</b>	3 µs	3 µs
<b>Transfer rate of the switch</b>	58 Gbit/s	58 Gbit/s
<b>Number of priority channels</b>	8	8
<b>Product feature</b> • No head-off-line-blocking • Cut Through switching method • Store & Forward switching method • Zero-Packet-Loss technology	Yes Yes Yes Yes; Zero-Packet-Loss applies to fiber optic interfaces	Yes Yes Yes Yes; Zero-Packet-Loss applies to fiber optic interfaces
<b>Product functions management, configuration, engineering</b>		
<b>Product function</b> • CLI • web-based management • MIB support • RMON • port mirroring • CoS	Yes Yes Yes Yes Yes Yes	Yes Yes Yes Yes Yes Yes
<b>Product function switch-managed</b>	Yes	Yes
<b>Protocol is supported</b> • Telnet • HTTP • HTTPS • TFTP • SFTP • GMRP • LLDP • SNMP v1 • SNMP v2 • SNMP v2c • SNMP v3 • IGMP (snooping/querier)	Yes Yes Yes Yes Yes Yes Yes Yes No Yes Yes Yes Yes	Yes Yes Yes Yes Yes Yes Yes Yes No Yes Yes Yes Yes
<b>Number of groups of IGMP</b>	1024	1024

## Network Components

### RUGGEDCOM – Layer 2 Switches

#### RUGGEDCOM RSG907R and RSG909R

Article number	6GK6498-0RB00....	6GK6490-7RB00....
Product type designation	RUGGEDCOM RSG909R	RUGGEDCOM RSG907R
<b>Product functions VLAN</b>		
<b>Product function</b>		
• VLAN - port based	Yes	Yes
<b>Number of VLANs maximum</b>	255	255
<b>Protocol is supported GVRP</b>	Yes	Yes
<b>Product functions DHCP</b>		
<b>Product function</b>		
• DHCP client	Yes	Yes
• DHCP Option 82	Yes	Yes
• DHCP Option 66	No	No
• DHCP Option 67	No	No
<b>Product functions redundancy</b>		
<b>Product function</b>		
• High Speed Redundancy Protocol (HRP)	No	No
• redundancy procedure STP	Yes	Yes
• redundancy procedure RSTP	Yes	Yes
• redundancy procedure MSTP	Yes	Yes
• High-availability Seamless Redundancy (HSR)	Yes	Yes
• Parallel Redundancy Protocol (PRP)/operation in the PRP-network	Yes	Yes
• Parallel Redundancy Protocol (PRP)/Redundant Network Access (RNA)	Yes	Yes
• High-availability Seamless Redundancy (HSR) and Parallel Redundancy Protocol (PRP) coupling	Yes	Yes
• eRSTP	Yes	Yes
<b>Protocol is supported</b>		
• STP	Yes	Yes
• RSTP	Yes	Yes
• MSTP	Yes	Yes
<b>Product functions security</b>		
<b>Product function</b>		
• IEEE 802.1x (radius)	Yes	Yes
<b>Protocol is supported</b>		
• RADIUS	Yes	Yes
• TACACS+	Yes	Yes
• SSH	Yes	Yes
• SSL	Yes	Yes
<b>Key length</b>		
• with SSL	256 bit	256 bit
• with RSA	3072 bit	3072 bit
<b>Product function port-rate-limiting</b>	Yes	Yes
<b>Product functions time</b>		
<b>Product function</b>		
• NTP-client	Yes	Yes
• SNTP client	Yes	Yes
• SNTP server	Yes	Yes
• IEEE 1588 v2 transparent forwarding	Yes	Yes
<b>Protocol is supported</b>		
• SNTP	Yes	Yes
<b>Product function hardware-supported timestamp at all ports</b>	Yes	Yes
<b>Standards, specifications, approvals</b>		
<b>Standard</b>		
• for safety from CSA and UL	cCSAus (Compliant with CSA C22.2 No. 60950, UL 60950, EN 60950)	cCSAus (Compliant with CSA C22.2 No. 60950, UL 60950, EN 60950)
<b>Reference code</b>		
• according to IEC 81346-2	KF	KF
• according to IEC 81346-2:2019	KFE	KFE
<b>Standards, specifications, approvals CE</b>		
<b>Certificate of suitability CE marking</b>	Yes	Yes
<b>Standard</b>		
• for EMC	FCC Part 15 (Class A), EN 55022 (CISPR22 Class A)	FCC Part 15 (Class A), EN 55022 (CISPR22 Class A)
<b>Standards, specifications, approvals other</b>		
<b>Laser protection class</b>	Complies with 21 CFR chapter 1, subchapter J	Complies with 21 CFR chapter 1, subchapter J
<b>Certificate of suitability</b>		
• IEC 61850-3	Yes	Yes
• IEEE 1613	Yes	Yes

#### Selection and ordering data

Version	Article No.
<b>RUGGEDCOM RSG909R</b> RUGGEDCOM RSG909R is a 9 port industrially hardened, fully managed Ethernet switch featuring an integrated HSR/PRP RedBox for use in harsh industrial environments. The product has 3x 1Gbit/s SFP slots and 6x 10/100/1000Mbit/s RJ45 Ethernet ports. -40°C to +85°C operating temperature (fanless).	<b>6GK6498-0RB00-..N.</b>
<b>RUGGEDCOM RSG907R</b> RUGGEDCOM RSG907R is a 7 port industrially hardened, fully managed Ethernet switch featuring an integrated HSR/PRP RedBox for use in harsh industrial environments. The product has 3x 1Gbit/s SFP slots and 4x 100Mbit/s multimode LC ports (max 2km). -40°C to +85°C operating temperature (fanless).	<b>6GK6490-7RB00-..N.</b>
<b>RUGGEDCOM accessories</b> <ul style="list-style-type: none"> <li>• <b>USB Console cable</b> USB 2.0 A type to B type Cable Assembly 10 feet / 3 meters</li> <li>• <b>Panel mounting kit</b> Allows wall and other lateral mounting possible, requires assembly and even mounting plane</li> <li>• <b>Power cable without lugs</b> Power Cable with north-american plug for pluggable terminal blocks (6 ft.) for RUGGEDCOM products</li> </ul>	<b>6GK6000-8DT01-0AA0</b>  <b>6GK6000-8MR00-0AA1</b>  <b>6GK6000-8BB00-0AA0</b>
<b>Fiber Optic SFPs (Gigabit)</b> <ul style="list-style-type: none"> <li>• <b>RUGGEDCOM SFP1122-1SX</b> 1000BASE-SX, LC-Interface, Optical: Multi Mode Fiber Optic up to max. 500m, 850nm, -40 °C ...+85 °C</li> <li>• <b>RUGGEDCOM SFP1122-1SX2</b> 1000BASE-SX, LC-Interface, Optical: Multi Mode Fiber Optic up to max. 2km, 1310nm, -40 °C ...+85 °C</li> <li>• <b>RUGGEDCOM SFP1132-1LX10</b> 1000BASE-LX, LC-Interface, Optical: Single Mode Fiber Optic up to max. 10km, 1310nm, -40 °C ...+85 °C</li> <li>• <b>RUGGEDCOM SFP1132-1LX25</b> 1000BASE-LX, LC-Interface, Optical: Single Mode Fiber Optic up to max. 25km, 1310nm, -40 °C ...+85 °C</li> <li>• <b>RUGGEDCOM SFP1132-1LX40</b> 1000BASE-LX, LC-Interface, Optical: Single Mode Fiber Optic up to max. 40km, 1550nm, -40 °C ...+85 °C</li> <li>• <b>RUGGEDCOM SFP1132-1LX70</b> 1000BASE-LX, LC-Interface, Optical: Single Mode Fiber Optic up to max. 70km, 1550nm, -40 °C ...+85 °C</li> <li>• <b>RUGGEDCOM SFP1132-1LX100</b> 1000BASE-LX, LC-Interface, Optical: Single Mode Fiber Optic up to max. 100km, 1550nm, 0 °C ...+70 °C</li> <li>• <b>RUGGEDCOM SFP1132-1LX115</b> 1000BASE-LX, LC-Interface, Optical: Single Mode Fiber Optic up to max. 115km, 1550nm, -10 °C ...+70 °C</li> </ul>	<b>6GK6000-8FG51-0AA0</b>  <b>6GK6000-8FE58-0AA0</b>  <b>6GK6000-8FG52-0AA0</b>  <b>6GK6000-8FG53-0AA0</b>  <b>6GK6000-8FG57-0AA0</b>  <b>6GK6000-8FG54-0AA0</b>  <b>6GK6000-8FG55-0AA0</b>  <b>6GK6000-8FE56-0AA0</b>
<b>Fiber Optic Bi-Directional SFPs (Gigabit)</b> <ul style="list-style-type: none"> <li>• <b>RUGGEDCOM SFP1132-1BX10R</b> 1000BASE-BX-U, LC-Interface, Optical: Single Mode Fiber Optic up to max. 10km, 1310nm TX/1490 nm RX, -40 °C ...+85 °C</li> <li>• <b>RUGGEDCOM SFP1132-1BX10T</b> 1000BASE-BX-D, LC-Interface, Optical: Single Mode Fiber Optic up to max. 10km, 1490nm TX/1310 nm RX, -40 °C ...+85 °C</li> <li>• <b>RUGGEDCOM SFP1132-1BX40R</b> 1000BASE-BX-U, LC-Interface, Optical: Single Mode Fiber Optic up to max. 40km, 1310nm TX/1490 nm RX, -40 °C ...+85 °C</li> <li>• <b>RUGGEDCOM SFP1132-1BX40T</b> 1000BASE-BX-D, 1 X 1000MBIT/S, LC-Interface, Optical: Single Mode Fiber Optic up to max. 40km, 1490nm TX/1310 nm RX, -40 °C ...+85 °C</li> </ul>	<b>6GK6000-8FB51-0AA0</b>  <b>6GK6000-8FB52-0AA0</b>  <b>6GK6000-8FB53-0AA0</b>  <b>6GK6000-8FB54-0AA0</b>

#### More information

The RUGGEDCOM Selector assists you in selecting the right RUGGEDCOM products and in configuring variants and is available at:

<http://www.siemens.com/ruggedcom-selector>



## Network Components

### RUGGEDCOM – Layer 2 Switches

#### RUGGEDCOM RSG920P

#### Overview



The RUGGEDCOM RSG920P is a rugged Layer 2 Gigabit switch with high port density in small form factor with Power-over-Ethernet (PoE) capability that has been designed for control cabinets with limited space and for high bandwidth requirements. The RUGGEDCOM RSG920P provides maximum reliability for industrial applications, such as in transportation and oil & gas applications, and is tested and certified to withstand extreme temperatures, vibrations and shocks.

The Power-over-Ethernet interfaces of the RUGGEDCOM RSG920P are fed by an external power supply. RUGGEDCOM RPS1300 is the related power supply. It is adequately sized to operate all 4 Power-over-Ethernet interfaces simultaneously.

#### Technical specifications

Article number	6GK6092-0PS1-....	6GK6092-0PS2-....
Product type designation	RUGGEDCOM RSG920PNC	RUGGEDCOM RSG920P
<b>Transfer rate</b>		
<b>Transfer rate</b>	10/100/1000 Mbit/s	10/100/1000 Mbit/s
<b>Number of ports maximum</b>	20	20
<b>Interfaces for communication integrated</b>		
<b>Number of electrical connections</b> • for network components or terminal equipment • for Power-over-Ethernet / for network components or terminal equipment	16 4	16 4
<b>Number of electrical connections</b> • for SFP	4	4
<b>Interfaces other</b>		
<b>Number of electrical connections</b> • for operator console • for management purposes • for signaling contact • for power supply	2 2 1 1	2 2 1 1
<b>Type of electrical connection</b> • for operator console • for management purposes • for signaling contact • for power supply	RJ45, USB RJ45, USB 3-pole terminal block, screwable 3-pole or 4-pole terminal block, screwable	RJ45, USB RJ45, USB 3-pole terminal block, screwable 3-pole or 4-pole terminal block, screwable
<b>Signal inputs/outputs</b>		
<b>Relay design</b>	Form-C contact relay (SPDT)	Form-C contact relay (SPDT)
<b>Type of relay output</b>	changeover contact (CO)	changeover contact (CO)
<b>Operational current of the signaling contacts</b> • at DC at 30 V maximum	2 A	2 A
<b>Supply voltage, current consumption, power loss</b>		
<b>Product options wide range power supply</b>	Yes	Yes
<b>Type of voltage 1 of the supply voltage</b> • power loss (W) 1 rated value • supply voltage 1 rated value	DC 27 W 9 ... 60 V	DC 27 W 9 ... 60 V
<b>Type of voltage 3 of the supply voltage</b> • supply voltage 3 rated value	DC 98 ... 300 V	DC 98 ... 300 V
<b>Type of voltage 4 of the supply voltage</b> • supply voltage 4 rated value	AC 88 ... 264 V	AC 88 ... 264 V
<b>Ambient conditions</b>		
<b>Ambient temperature</b> • during operation • during storage • during transport • note	-40 ... +85 °C -40 ... +85 °C -40 ... +85 °C A maximum operating temperature of +85 °C is permissible for a duration of 16 hours	-40 ... +85 °C -40 ... +85 °C -40 ... +85 °C A maximum operating temperature of +85 °C is permissible for a duration of 16 hours
<b>Operating condition fanless operation</b>	Yes	Yes
<b>Protection class IP</b>	IP40	IP40



Article number	6GK6092-0PS1-.....	6GK6092-0PS2-.....
Product type designation	RUGGEDCOM RSG920PNC	RUGGEDCOM RSG920P
<b>Design, dimensions and weights</b>		
<b>Design</b>	compact	compact
<b>Width</b>	152 mm	152 mm
<b>Height</b>	177 mm	177 mm
<b>Depth</b>	165.6 mm	165.6 mm
<b>Net weight</b>	4.7 kg	4.7 kg
<b>Product feature onformal coating</b>	optional	optional
<b>Material of the enclosure</b>	Cast Aluminum Enclosure	Cast Aluminum Enclosure
<b>Fastening method</b>		
• 19-inch installation	No	No
• 35 mm top hat DIN rail mounting	Yes	Yes
• wall mounting	Yes	Yes
<b>Product features, product functions, product components general</b>		
<b>Storage capacity</b>		
• of message buffer maximum	1536 Kibyte	1536 Kibyte
<b>Switch latency period</b>	4 µs	4 µs
<b>Transfer rate of the switch</b>	108.92 Gbit/s	108.92 Gbit/s
<b>Product feature</b>		
• No head-off-line-blocking	Yes	Yes
• Store & Forward switching method	Yes	Yes
<b>Product functions management, configuration, engineering</b>		
<b>Product function</b>		
• CLI	Yes	Yes
• web-based management	Yes	Yes
• MIB support	Yes	Yes
• RMON	Yes	Yes
• port mirroring	Yes	Yes
• CoS	Yes	Yes
<b>Product function switch-managed</b>	Yes	Yes
<b>Protocol is supported</b>		
• Telnet	Yes	Yes
• HTTP	Yes	Yes
• HTTPS	Yes	Yes
• TFTP	Yes	Yes
• SFTP	Yes	Yes
• GMRP	Yes	Yes
• LLDP	Yes	Yes
• SNMP v1	Yes	Yes
• SNMP v2	No	No
• SNMP v2c	Yes	Yes
• SNMP v3	Yes	Yes
• IGMP (snooping/querier)	Yes	Yes
<b>Number of groups / at IGMP</b>	256	256
<b>Product function</b>		
• for MIB support by BRIDGE-MIB	RFC4188	RFC4188
• for MIB support / by IF-MIB	RFC2863	RFC2863
• for MIB support / by RMON-MIB	RFC2819	RFC2819
• for MIB support / by RSTP-MIB	RFC4318	RFC4318
• for MIB support / by SNMPv2-MIB	RFC1907	RFC1907
• for MIB support / by SNMPv2-SMI	RFC2578	RFC2578
• for MIB support / by SNMPv2-TC	RFC2579	RFC2579
• for MIB support / by TCP-MIB	RFC2012	RFC2012
• for MIB support / by UDP-MIB	RFC2013	RFC2013
<b>Product functions VLAN</b>		
<b>Product function</b>		
• VLAN - port based	Yes	Yes
<b>Number of VLANs maximum</b>	255	255
<b>Protocol is supported GVRP</b>	Yes	Yes
<b>Product functions DHCP</b>		
<b>Product function</b>		
• DHCP client	Yes	Yes
• DHCP Option 82	Yes	Yes
• DHCP Option 66	No	No
• DHCP Option 67	No	No

## Network Components

### RUGGEDCOM – Layer 2 Switches

#### RUGGEDCOM RSG920P

Article number	6GK6092-0PS1-.....	6GK6092-0PS2-.....
Product type designation	RUGGEDCOM RSG920PNC	RUGGEDCOM RSG920P
<b>Product functions redundancy</b>		
<b>Product function</b>		
• redundancy procedure STP	Yes	Yes
• redundancy procedure RSTP	Yes	Yes
• redundancy procedure MSTP	Yes	Yes
• eRSTP	Yes	Yes
<b>Protocol is supported</b>		
• STP	Yes	Yes
• RSTP	Yes	Yes
• MSTP	Yes	Yes
<b>Product functions security</b>		
<b>Product function</b>		
• IEEE 802.1x (radius)	Yes	Yes
<b>Protocol is supported</b>		
• TACACS+	Yes	Yes
• SSH	Yes	Yes
• SSL	Yes	Yes
<b>Key length</b>		
• with SSL	56 bit	128 bit
• with RSA	1024 bit	1024 bit
<b>Product function port-rate-limiting</b>	Yes	Yes
<b>adjustable port-rate-limitation</b>	128 kbit/s ... 8 Mbit/s	128 kbit/s ... 8 Mbit/s
<b>Product functions time</b>		
<b>Product function</b>		
• SNMP client	Yes	Yes
• SNMP server	Yes	Yes
<b>Protocol is supported</b>		
• SNMP	Yes	Yes
<b>Standards, specifications, approvals</b>		
<b>Reference code</b>		
• according to IEC 81346-2	KF	KF
• according to IEC 81346-2:2019	KFE	KFE
<b>Standards, specifications, approvals CE</b>		
<b>Certificate of suitability CE marking</b>	Yes	Yes
<b>Standard for EMC</b>	FCC Part 15 (Class A), EN 55022 (CISPR22 Class A)	FCC Part 15 (Class A), EN 55022 (CISPR22 Class A)
<b>Standards, specifications, approvals other</b>		
<b>Laser protection class</b>	Complies with 21 CFR chapter 1, subchapter J	Complies with 21 CFR chapter 1, subchapter J
<b>Certificate of suitability</b>		
• IEC 61850-3	Yes	Yes
<b>Standards, specifications, approvals product conformity</b>		
<b>Product conformity</b>		
• according to IEEE 802.3-10BaseT	Yes	Yes
• according to IEEE 802.3u-100BaseTX	Yes	Yes
• according to IEEE 802.3u-100BaseFX	Yes	Yes
• according to IEEE 802.3ab-1000BaseT	Yes	Yes
• according to IEEE 802.3z-1000BaseLX	Yes	Yes
• according to IEEE 802.3ad-Link Aggregation	Yes	Yes
• according to IEEE 802.3af-Power-over-Ethernet	Yes	Yes
• according to IEEE 802.3x-Flow Control	Yes	Yes
• according to IEEE 802.1d-MAC Bridges	Yes	Yes
• according to IEEE 802.1d-STP	Yes	Yes
• according to IEEE 802.1p-class of service	Yes	Yes
• according to IEEE 802.1Q-VLAN tagging	Yes	Yes
• according to IEEE 802.1Q-2005 (formerly IEEE 802.1s) MSTP	Yes	Yes
• according to IEEE 802.1w-RRST	Yes	Yes
• according to IEEE 802.1x-port based Network Access Control	Yes	Yes
• RFC768-UDP	Yes	Yes
• RFC783-TFTP	Yes	Yes
• RFC791-IP	Yes	Yes
• RFC792-ICMP	Yes	Yes
• RFC793-TCP	Yes	Yes
• RFC826-ARP	Yes	Yes
• RFC854-Telnet	Yes	Yes
• RFC894-IP over Ethernet	Yes	Yes
• RFC1112-IGMPv1	Yes	Yes
• RFC1519-CIDR	Yes	Yes
• RFC1541-DHCP (client)	Yes	Yes
• RFC2068-HTTP	Yes	Yes
• RFC2236-IGMPv2	Yes	Yes
• RFC2284-EAP	Yes	Yes
• RFC2475-Differentiated Service	Yes	Yes
• RFC2865-RADIUS	Yes	Yes
• RFC3414-SNMPv3-USM	Yes	Yes
• RFC3415-SNMPv3-VACM	Yes	Yes

#### Selection and ordering data

Version	Article No.
<b>RUGGEDCOM RSG920PNC</b> RUGGEDCOM RSG920PNC is a fully-managed Ethernet switch with 56-bit encryption and 20 non-blocking Gigabit Ethernet ports; supports 4 SFP modules and 4 PoE ports; operating temperature -40°C to +85°C (without fan)	<b>6GK6092-0PS1-.....</b>
<b>RUGGEDCOM RSG920P</b> RUGGEDCOM RSG920P is a fully-managed Ethernet switch with 128-bit encryption and 20 non-blocking Gigabit Ethernet ports; supports 4 SFP modules and 4 PoE ports; operating temperature -40°C to +85°C (without fan)	<b>6GK6092-0PS2-.....</b>
<b>RUGGEDCOM RPS1300 Power Supply</b> 54 V/2.6 A power supply, input: 120/230 V AC, output: 54 V DC /2.6 A, -40°C to 75°C, suitable for RUGGEDCOM PoE applications	<b>6GK6000-8HS01-0AA0</b>

#### More information

The RUGGEDCOM Selector assists you in selecting the right RUGGEDCOM products and in configuring variants and is available at:

<http://www.siemens.com/ruggedcom-selector>

## Network Components

### RUGGEDCOM – Layer 2 Switches

#### RUGGEDCOM RS900G / RUGGEDCOM RS900GP

#### Overview



The RUGGEDCOM RS900 product family for use in the power supply sector comprises a number of fully-managed Ethernet switches that are specially designed for reliable use in hostile operating environments for electrical equipment and demanding climatic conditions. They provide a high degree of immunity to electromagnetic interference and strong electrical disturbances, which are typically present in factory buildings and in roadside traffic control cabinets. A temperature range

from -40 °C to +85 °C enables them to be placed almost anywhere.

#### Characteristics

- Many different copper and fiber-optic port configurations with transmission rates up to 1 Gbps
- Fiber-optic cable variants are available with multimode or single-mode optical transceiver-receivers and various interfaces (LC, SC, SFP)
- Options for 24 V DC to 48 V DC or high voltage (88-300 V DC / 85-264 V AC) for worldwide operation
- Operation without fans for operating temperatures from -40 °C to +85 °C
- Variety of management interfaces: web-based, Telnet, command line
- Available in a version that supports Power over Ethernet (PoE)

#### Product versions

##### RUGGEDCOM RS900G

- Managed Ethernet switch with 10 ports, Gigabit fiber-optic uplinks and 56- or 128-bit encryption

##### RUGGEDCOM RS900GP

- Managed Ethernet switch with 10 ports, including 8 Power over Ethernet (PoE) ports and 2 Gigabit uplinks, with 56- or 128-bit encryption

#### Technical specifications

Article number	6GK6090-0GS2-....	6GK6090-0GS1-....	6GK6090-0PS2-0.A.	6GK6090-0PS1-0.A.
Product type designation	RUGGEDCOM RS900G	RUGGEDCOM RS900GNC	RUGGEDCOM RS900GP	RUGGEDCOM RS900GPNC
<b>Transfer rate</b>				
<b>Transfer rate</b>	10/100/1000 Mbit/s	10/100/1000 Mbit/s	10/100/1000 Mbit/s	10/100/1000 Mbit/s
<b>Number of ports maximum</b>	10	10	10; Number of ports depending on configuration	10; Number of ports depending on configuration
<b>Interfaces for communication integrated</b>				
<b>Number of electrical connections</b> • for network components or terminal equipment	8	8	--	--
<b>Interfaces other</b>				
<b>Number of electrical connections</b> • for operator console • for management purposes	1 0	1 0	1 0	1 0
<b>Type of electrical connection</b> • for operator console • for signaling contact  • for power supply	RS232 3-pole terminal block, screwable  5-pole terminal block, screwable	RS232 3-pole terminal block, screwable  5-pole terminal block, screwable	RS232 3-pole terminal block, screwable  5-pole terminal block, screwable	RS232 3-pole terminal block, screwable  5-pole terminal block, screwable
<b>Signal inputs/outputs</b>				
<b>Relay design</b>	Form-C contact relay (SPDT)	Form-C contact relay (SPDT)	Form-C contact relay (SPDT)	Form-C contact relay (SPDT)
<b>Type of relay output</b>	changeover contact (CO)	changeover contact (CO)	changeover contact (CO)	changeover contact (CO)
<b>Operational current of the signaling contacts</b> • at DC at 30 V maximum	2 A	2 A	2 A	2 A
<b>Supply voltage, current consumption, power loss</b>				
<b>Product options wide range power supply</b>	Yes	Yes	No	No
<b>Type of voltage 1 of the supply voltage</b> • power loss (W) 1 rated value • supply voltage 1 rated value • consumed current 1 at rated supply voltage maximum • supply voltage 1 rated value	DC 10 W 24 V 0.4 A  10 ... 36 V	DC 10 W 24 V 0.4 A  10 ... 36 V	DC 15 W -- -- --	DC 15 W -- -- --
<b>Type of voltage 2 of the supply voltage</b> • supply voltage 2 rated value • consumed current 2 at rated supply voltage maximum • supply voltage 2 rated value	DC 48 V 0.2 A  36 ... 72 V	DC 48 V 0.2 A  36 ... 72 V	DC 54 V --  45 ... 57 V	DC 54 V --  45 ... 57 V
<b>Type of voltage 3 of the supply voltage</b> • supply voltage 3 rated value	DC 88 ... 300 V	DC 88 ... 300 V	-- --	-- --

## Network Components

### RUGGEDCOM – Layer 2 Switches

#### RUGGEDCOM RS900G / RUGGEDCOM RS900GP

Article number	6GK6090-0GS2-....	6GK6090-0GS1-....	6GK6090-0PS2.-0.A.	6GK6090-0PS1.-0.A.
Product type designation	RUGGEDCOM RS900G	RUGGEDCOM RS900GNC	RUGGEDCOM RS900GP	RUGGEDCOM RS900GPNC
<b>Type of voltage 4 of the supply voltage</b> • supply voltage 4 rated value	AC 85 ... 265 V	AC 85 ... 265 V	-- --	-- --
<b>Ambient conditions</b>				
<b>Ambient temperature</b> • during operation • note	-40 ... +85 °C A maximum operating temperature of +85 °C is permissible for a duration of 16 hours	-40 ... +85 °C A maximum operating temperature of +85 °C is permissible for a duration of 16 hours	-40 ... +85 °C A maximum operating temperature of +85 °C is permissible for a duration of 16 hours	-40 ... +85 °C A maximum operating temperature of +85 °C is permissible for a duration of 16 hours
<b>Operating condition / fanless operation</b>	Yes	Yes	Yes	Yes
<b>Protection class IP</b>	IP40	IP40	IP40	IP40
<b>Design, dimensions and weights</b>				
<b>Design</b>	compact	compact	compact	compact
<b>Width</b>	66 mm	66 mm	90 mm	90 mm
<b>Height</b>	188 mm	188 mm	176.53 mm	176.53 mm
<b>Depth</b>	127 mm	127 mm	154.432 mm	154.432 mm
<b>Net weight</b>	1.22 kg	1.22 kg	2.3 kg	2.3 kg
<b>Product feature on formal coating</b>	optional	optional	optional	optional
<b>Material of the enclosure</b>	20 AWG galvanized steel enclosure	20 AWG galvanized steel enclosure	Cast Aluminum Enclosure	Cast Aluminum Enclosure
<b>Fastening method</b> • 19-inch installation • 35 mm top hat DIN rail mounting • wall mounting • S7-300 rail mounting • fixed-mounted	No Yes Yes No Yes	No Yes Yes No Yes	No Yes Yes -- --	No Yes Yes -- --
<b>Product features, product functions, product components general</b>				
<b>number of automatically learnable MAC addresses</b>	8192	8192	8192	8192
<b>Storage capacity</b> • of message buffer maximum • of the MAC-address table	128 Kibyte 32 Kibyte	128 Kibyte 32 Kibyte	128 Kibyte 32 Kibyte	128 Kibyte 32 Kibyte
<b>Switch latency period</b>	4 µs	4 µs	4 µs	4 µs
<b>Transfer rate of the switch</b>	7.6 Gbit/s	7.6 Gbit/s	5.6 Gbit/s	5.6 Gbit/s
<b>Number of priority channels</b>	4	4	4	4
<b>Product feature</b> • No head-off-line-blocking • Store & Forward switching method • Zero-Packet-Loss technology	Yes Yes Yes; Zero-Packet-Loss applies to fiber optic interfaces	Yes Yes Yes; Zero-Packet-Loss applies to fiber optic interfaces	Yes Yes No	Yes Yes No
<b>Product functions management, configuration, engineering</b>				
<b>Product function</b> • CLI • web-based management • MIB support • RMON	Yes Yes Yes Yes	Yes Yes Yes Yes	Yes Yes Yes Yes	Yes Yes Yes Yes
<b>Product function switch-managed</b>	Yes	Yes	Yes	Yes
<b>Protocol is supported</b> • Telnet • HTTP • HTTPS • TFTP • SFTP • LLDP • SNMP v1 • SNMP v2 • SNMP v2c • SNMP v3 • IGMP (snooping/querier)	Yes Yes Yes Yes Yes Yes Yes No Yes Yes Yes Yes	Yes Yes Yes Yes NO Yes Yes No Yes Yes Yes Yes	Yes Yes Yes Yes Yes Yes Yes No Yes Yes Yes Yes	Yes Yes Yes Yes Yes Yes Yes No Yes Yes Yes Yes
<b>Number of groups / at IGMP</b>	256	256	256	256
<b>Product function</b> • for MIB support by BRIDGE-MIB • for MIB support / by IF-MIB • for MIB support / by RMON-MIB • for MIB support / by RSTP-MIB • for MIB support / by SNMPv2-MIB • for MIB support / by SNMPv2-SMI • for MIB support / by SNMPv2-TC • for MIB support / by TCP-MIB • for MIB support / by UDP-MIB	RFC4188 RFC2863 RFC2819 RFC4318 RFC1907 RFC2578 RFC2579 RFC2012 RFC2013	RFC4188 RFC2863 RFC2819 RFC4318 RFC1907 RFC2578 RFC2579 RFC2012 RFC2013	RFC4188 RFC2863 RFC2819 RFC4318 RFC1907 RFC2578 RFC2579 RFC2012 RFC20L13	RFC4188 RFC2863 RFC2819 RFC4318 RFC1907 RFC2578 RFC2579 RFC2012 RFC20L13

## Network Components

### RUGGEDCOM – Layer 2 Switches

#### RUGGEDCOM RS900G / RUGGEDCOM RS900GP

Article number	6GK6090-0GS2-....	6GK6090-0GS1-....	6GK6090-0PS2-0.A.	6GK6090-0PS1-0.A.
Product type designation	RUGGEDCOM RS900G	RUGGEDCOM RS900GNC	RUGGEDCOM RS900GP	RUGGEDCOM RS900GPNC
<b>Product functions VLAN</b>				
<b>Product function</b> • VLAN - port based	Yes	Yes	Yes	Yes
<b>Number of VLANs maximum</b>	255	255	255	255
<b>Protocol is supported GVRP</b>	Yes	Yes	Yes	Yes
<b>Product functions DHCP</b>				
<b>Product function</b> • DHCP client • DHCP Option 82 • DHCP Option 66 • DHCP Option 67	Yes Yes No No	Yes Yes No No	Yes Yes No No	Yes Yes No No
<b>Product functions redundancy</b>				
<b>Product function</b> • redundancy procedure STP • redundancy procedure RSTP • redundancy procedure MSTP • eRSTP	Yes Yes Yes Yes	Yes Yes Yes Yes	Yes Yes Yes Yes	Yes Yes Yes Yes
<b>Protocol is supported</b> • STP/RSTP • STP • RSTP • MSTP	Yes Yes Yes Yes	Yes Yes Yes Yes	-- Yes Yes Yes	-- Yes Yes Yes
<b>Product functions security</b>				
<b>Product function</b> • IEEE 802.1x (radius)	Yes	Yes	Yes	Yes
<b>Protocol is supported</b> • TACACS+ • SSH • SSL	Yes Yes Yes	Yes NO Yes	Yes Yes Yes	Yes Yes Yes
<b>Key length</b> • with SSL • with RSA	128 bit 1024 bit	56 bit 1024 bit	128 bit 1024 bit	56 bit 1024 bit
<b>Product function port-rate-limiting</b>	Yes	Yes	Yes	Yes
<b>adjustable port-rate-limitation</b>	128 kbit/s ... 8 Mbit/s	128 kbit/s ... 8 Mbit/s	128 kbit/s ... 8 Mbit/s	128 kbit/s ... 8 Mbit/s
<b>Product functions time</b>				
<b>Product function</b> • SNTP client • SNTP server	Yes Yes	Yes Yes	Yes Yes	Yes Yes
<b>Protocol is supported</b> • SNTP	Yes	Yes	Yes	Yes
<b>Standards, specifications, approvals</b>				
<b>Standard</b> • for safety from CSA and UL	cCSAus (Compliant with CSA C22.2 No 60950, UL 60950, EN 60950)	cCSAus (Compliant with CSA C22.2 No 60950, UL 60950, EN 60950)	cCSAus (Compliant with CSA C22.2 No 60950, UL 60950, EN 60950)	cCSAus (Compliant with CSA C22.2 No 60950, UL 60950, EN 60950)
<b>Reference code</b> • according to IEC 81346-2 • according to IEC 81346-2:2019	KF KFE	KF KFE	KF KFE	KF KFE
<b>Standards, specifications, approvals CE</b>				
<b>Certificate of suitability CE marking</b>	Yes	Yes	Yes	Yes
<b>Standard</b> • for EMC	FCC Part 15 (Class A), EN 55022 (CISPR22 Class A)	FCC Part 15 (Class A), EN 55022 (CISPR22 Class A)	FCC Part 15 (Class A), EN 55022 (CISPR22 Class A)	FCC Part 15 (Class A), EN 55022 (CISPR22 Class A)
<b>Standards, specifications, approvals other</b>				
<b>Laser protection class</b>	Complies with 21 CFR chapter 1, subchapter J	Complies with 21 CFR chapter 1, subchapter J	Complies with 21 CFR chapter 1, subchapter J	Complies with 21 CFR chapter 1, subchapter J
<b>Certificate of suitability</b> • railway application in according with EN 50155 • IEC 61850-3 • according to FIPS 140-2 • according to Common Criteria (CC)	No Yes No No	No Yes No No	-- Yes No No	-- Yes No No
<b>Standards, specifications, approvals</b>				
<b>Laser protection class</b>	Complies with 21 CFR chapter 1, subchapter J	Complies with 21 CFR chapter 1, subchapter J		

## Network Components

### RUGGEDCOM – Layer 2 Switches

#### RUGGEDCOM RS900G / RUGGEDCOM RS900GP

Article number	6GK6090-0GS2.-....	6GK6090-0GS1.-....	6GK6090-0PS2.-0.A.	6GK6090-0PS1.-0.A.
Product type designation	RUGGEDCOM RS900G	RUGGEDCOM RS900GNC	RUGGEDCOM RS900GP	RUGGEDCOM RS900GPNC
<b>Standards, specifications, approvals - Marine classification</b>				
<b>Marine classification association</b>				
• American Bureau of Shipping Europe Ltd. (ABS)	Yes	No	--	
• Bureau Veritas (BV)	Yes	No	--	
• Det Norske Veritas (DNV)	Yes	No	--	
• Germanischer Lloyd (GL)	No	No	--	
• Lloyds Register of Shipping (LRS)	Yes	No	--	
• Nippon Kaiji Kyokai (NK)	Yes	No	--	
• Polski Rejestr Statkow (PRS)	Yes	No	--	
<b>Standards, specifications, approvals product conformity</b>				
<b>Product conformity</b>				
• according to IEEE 802.3-10BaseT	Yes	Yes	Yes	Yes
• according to IEEE 802.3u-100BaseTX	Yes	Yes	Yes	Yes
• according to IEEE 802.3u-100BaseFX	Yes	Yes	Yes	Yes
• according to IEEE 802.3ab-1000BaseT	Yes	Yes	Yes	Yes
• according to IEEE 802.3z-1000BaseLX	Yes	Yes	Yes	Yes
• according to IEEE 802.3ad-Link Aggregation	Yes	Yes	Yes	Yes
• according to IEEE 802.3af-Power-over-Ethernet	No	No	Yes	Yes
• according to IEEE 802.3x-Flow Control	Yes	Yes	Yes	Yes
• according to IEEE 802.1d-MAC Bridges	Yes	Yes	Yes	Yes
• according to IEEE 802.1d-STP	Yes	Yes	Yes	Yes
• according to IEEE 802.1p-class of service	Yes	Yes	Yes	Yes
• according to IEEE 802.1Q-VLAN tagging	Yes	Yes	Yes	Yes
• according to IEEE 802.1Q-2005 (formerly IEEE 802.1s) MSTP	Yes	Yes	Yes	Yes
• according to IEEE 802.1w-RRST	Yes	Yes	Yes	Yes
• according to IEEE 802.1x-port based Network Access Control	Yes	Yes	Yes	Yes
• RFC768-UDP	Yes	Yes	Yes	Yes
• RFC783-TFTP	Yes	Yes	Yes	Yes
• RFC791-IP	Yes	Yes	Yes	Yes
• RFC792-ICMP	Yes	Yes	Yes	Yes
• RFC793-TCP	Yes	Yes	Yes	Yes
• RFC826-ARP	Yes	Yes	Yes	Yes
• RFC854-Telnet	Yes	Yes	Yes	Yes
• RFC894-IP over Ethernet	Yes	Yes	Yes	Yes
• RFC1112-IGMPv1	Yes	Yes	Yes	Yes
• RFC1519-CIDR	Yes	Yes	Yes	Yes
• RFC1541-DHCP (client)	Yes	Yes	Yes	Yes
• RFC2068-HTTP	Yes	Yes	Yes	Yes
• RFC2236-IGMPv2	Yes	Yes	Yes	Yes
• RFC2284-EAP	Yes	Yes	Yes	Yes
• RFC2475-Differentiated Service	Yes	Yes	Yes	Yes
• RFC2865-RADIUS	Yes	Yes	Yes	Yes
• RFC3414-SNMPv3-USM	Yes	Yes	Yes	Yes
• RFC3415-SNMPv3-VACM	Yes	Yes	Yes	Yes

#### Selection and ordering data

Version	Article No.
<p><b>RUGGEDCOM RS900G</b></p> <p>The RUGGEDCOM RS900G is a fully-managed Ethernet switch that has two Gigabit Ethernet fiber-optic ports and eight Fast Ethernet copper ports; 56- or 128-bit encryption; 2 Gigabit Ethernet fiber-optic ports (1000BaseX); 8 Fast Ethernet ports (10/100BaseTX); various fiber-optic connection options (pluggable LC, SC, SFP optics); support of bidirectional single strand fiber-optic cable; long-distance fiber-optic connections enable distances up to 70 km in the Gigabit range</p> <ul style="list-style-type: none"> <li>• <b>RUGGEDCOM RS900GNC</b> (not subject to export controls)</li> <li>• <b>RUGGEDCOM RS900G</b> (subject to export controls)</li> </ul>	<p><b>6GK6090-0GS1.-....</b></p> <p><b>6GK6090-0GS2.-....</b></p>
<p><b>RUGGEDCOM RS900GP</b></p> <p>The RUGGEDCOM RS900GP is a fully-managed Ethernet switch that has two Gigabit Ethernet fiber-optic ports and eight Fast Ethernet copper ports; 56- or 128-bit encryption; 2 Gigabit Ethernet fiber-optic ports (1000BaseX); 8 Fast Ethernet ports (10/100BaseTX); various fiber-optic connection options (pluggable LC, SC, SFP optics); support of bidirectional single strand fiber-optic cable; long-distance fiber-optic connections enable distances up to 70 km in the Gigabit range</p> <ul style="list-style-type: none"> <li>• <b>RUGGEDCOM RS900GPNC</b> (not subject to export controls)</li> <li>• <b>RUGGEDCOM RS900GP</b> (subject to export controls)</li> </ul>	<p><b>6GK6090-0PS1.-0.A.</b></p> <p><b>6GK6090-0PS2.-0.A.</b></p>

#### More information

The RUGGEDCOM Selector assists you in selecting the right RUGGEDCOM products and in configuring variants and is

available at:  
<http://www.siemens.com/ruggedcom-selector>



## Network Components

### RUGGEDCOM – Layer 2 Switches

#### RUGGEDCOM RSG908C / RUGGEDCOM RSG910C

#### Overview



The RUGGEDCOM RSG910C and RSG908C are compact all Gigabit, IEEE 1588 compatible Ethernet switches. The RSG910C supports 4 Gigabit SFP uplink ports and 6 10/100/1000TX copper ethernet ports while the RSG908C supports 4 Gigabit SFP uplink ports and 4 multi mode fiber 100FX ports with LC connectors. Both products come with an integrated DIN rail mount and front-facing interfaces for easy installation in space-limited areas. They offer redundant power inputs for both DC and high voltage AC/DC applications, eliminating a single point of failure. Designed to operate in harsh environments with widely varying climatic and environmental conditions, these devices can be used for precise time synchronization in the Electric Power industry; for high-bandwidth applications such as video streaming in the Transportation industry and for time-critical applications such as drilling automation, SCADA (Supervisory Control and Data Acquisition) and RTU (Remote terminal unit) solutions for wellhead automation, pipeline monitoring, compression or pumping stations in the oil & gas industry.

#### Characteristics

- 4 Fiber optic (100BASE-FX, LC) or 6 Copper (10/100/1000BASE-X, RJ45) ports
- Industry standard connectors: SFP, LC and/or RJ45
- Fully integrated power supply with redundant power inputs
  - Universal high-voltage dual inputs: 100 VAC – 240 VAC/ 100 VDC – 300 VDC
  - Universal low-voltage DC dual inputs with nominal voltages: 12 VDC, 24 VDC, 48 VDC (10 – 60 VDC)
- Non-blocking store and forward switching
- For use at ambient temperatures from –40 °C to +85 °C without the use of fans

#### Product versions

##### RUGGEDCOM RSG910C

- The RUGGEDCOM RSG910C is a compact Gigabit IEEE 1588 compatible Ethernet switch, providing 4 Gigabit SFP ports and 6 Gigabit copper ports

##### RUGGEDCOM RSG908C

- The RUGGEDCOM RSG908C is a compact Gigabit IEEE 1588 compatible Ethernet switch, providing 4 Gigabit SFP ports and 4 100 FX multimode fiber optic ports with LC connectors.

#### Technical specifications

Article number	6GK6491-0CB..-....	6GK6490-8CB..-....
Product type designation	RUGGEDCOM RSG910C	RUGGEDCOM RSG908C
<b>Transfer rate</b>		
Transfer rate	10/100/1000 Mbit/s	10/100/1000 Mbit/s
Number of ports maximum	10	8
<b>Interfaces for communication integrated</b>		
Number of electrical connections • for network components or terminal equipment	10	8
Number of 10/100/1000 Mbit/s RJ45 ports integrated	6	
Number of 100 Mbit/s LC ports • for multimode		4
Number of electrical connections • for SFP	4	4
<b>Interfaces other</b>		
Number of electrical connections • for operator console	1	1
• for management purposes	10	8
• for signaling contact	1	1
• for power supply	2	2
Type of electrical connection • for operator console	USB	USB
• for management purposes	USB	USB
• for signaling contact	3-pole terminal block, screwable	3-pole terminal block, screwable
• for power supply	5-pole terminal block, screwable	5-pole terminal block, screwable



## Network Components

### RUGGEDCOM – Layer 2 Switches

#### RUGGEDCOM RSG908C / RUGGEDCOM RSG910C

Article number	<b>6GK6491-0CB..-....</b>	<b>6GK6490-8CB..-....</b>
Product type designation	RUGGEDCOM RSG910C	RUGGEDCOM RSG908C
<b>Signal inputs/outputs</b>		
<b>Relay design</b>	Form-C contact relay (SPDT)	Form-C contact relay (SPDT)
<b>Type of relay output</b>	changeover contact (CO)	changeover contact (CO)
<b>Number of relay outputs as CO contact</b>	1	1
<b>Operating voltage of the signaling contacts</b> • at AC maximum • at DC maximum	250 V 30 V	250 V 30 V
<b>Operational current of the signaling contacts</b> • at AC maximum • at DC maximum	2 A 2 A	2 A 2 A
<b>Supply voltage, current consumption, power loss</b>		
<b>Product options wide range power supply</b>	Yes	Yes
<b>Product component connection for redundant voltage supply</b>	Yes	Yes
<b>Type of voltage 1 of the supply voltage</b> • power loss (W) 1 rated value • supply voltage 1 rated value	DC 15.5 W 10 ... 60 V	DC 15.5 W 10 ... 60 V
<b>Type of voltage 2 of the supply voltage</b> • supply voltage 2 rated value	DC 88 ... 300 V	DC 88 ... 300 V
<b>Type of voltage 3 of the supply voltage</b> • supply voltage 3 rated value	AC 85 ... 264 V	AC 85 ... 264 V
<b>Ambient conditions</b>		
<b>Ambient temperature</b> • during operation • during storage • during transport • note	-40 ... +85 °C -40 ... +85 °C -40 ... +85 °C A maximum operating temperature of +85 °C is permissible for a duration of 16 hours	-40 ... +85 °C -40 ... +85 °C -40 ... +85 °C A maximum operating temperature of +85 °C is permissible for a duration of 16 hours
<b>Operating condition / fanless operation</b>	Yes	Yes
<b>Protection class IP</b>	IP40	IP40
<b>Design, dimensions and weights</b>		
<b>Design</b>	compact	compact
<b>Width</b>	90 mm	90 mm
<b>Height</b>	177 mm	177 mm
<b>Depth</b>	163 mm	163 mm
<b>Net weight</b>	2.4 kg	2.4 kg
<b>Product feature onformal coating</b>	optional	optional
<b>Material of the enclosure</b>	Cast Aluminum Enclosure	Cast Aluminum Enclosure
<b>Fastening method</b> • 19-inch installation • 35 mm top hat DIN rail mounting • wall mounting	No Yes Yes	No Yes Yes
<b>Product features, product functions, product components general</b>		
<b>Number of automatically learnable MAC addresses</b>	16384	16384
<b>Storage capacity</b> • of message buffer maximum	2048 Kibyte	2048 Kibyte
<b>Switch latency period</b>	3 µs	3 µs
<b>Transfer rate of the switch</b>	58 Gbit/s	58 Gbit/s
<b>Number of priority channels</b>	8	8
<b>Product feature</b> • No head-off-line-blocking • Cut Through switching method • Store & Forward switching method • Zero-Packet-Loss technology	Yes Yes Yes Yes; Zero-Packet-Loss applies to fiber optic interfaces	Yes Yes Yes Yes; Zero-Packet-Loss applies to fiber optic interfaces

## Network Components

### RUGGEDCOM – Layer 2 Switches

#### RUGGEDCOM RSG908C / RUGGEDCOM RSG910C

Article number	6GK6491-0CB..-....	6GK6490-8CB..-....
Product type designation	RUGGEDCOM RSG910C	RUGGEDCOM RSG908C
<b>Product functions management, configuration, engineering</b>		
<b>Product function</b>		
• CLI	Yes	Yes
• web-based management	Yes	Yes
• MIB support	Yes	Yes
• RMON	Yes	Yes
• port mirroring	Yes	Yes
• CoS	Yes	Yes
<b>Product function switch-managed</b>	Yes	Yes
<b>Protocol is supported</b>		
• Telnet	Yes	Yes
• HTTP	Yes	Yes
• HTTPS	Yes	Yes
• TFTP	Yes	Yes
• SFTP	Yes	Yes
• GMRP	Yes	Yes
• LLDP	Yes	Yes
• SNMP v1	Yes	Yes
• SNMP v2	No	No
• SNMP v2c	Yes	Yes
• SNMP v3	Yes	Yes
• IGMP (snooping/querier)	Yes	Yes
Number of groups / at IGMP	1024	1024
<b>Product functions VLAN</b>		
<b>Product function</b>		
• VLAN - port based	Yes	Yes
<b>Number of VLANs maximum</b>	255	255
<b>Protocol is supported GVRP</b>	Yes	Yes
<b>Product functions DHCP</b>		
<b>Product function</b>		
• DHCP client	Yes	Yes
• DHCP Option 82	Yes	Yes
• DHCP Option 66	No	No
• DHCP Option 67	No	No
<b>Product functions redundancy</b>		
<b>Product function</b>		
• High Speed Redundancy Protocol (HRP)	No	No
• redundancy procedure STP	Yes	Yes
• redundancy procedure RSTP	Yes	Yes
• redundancy procedure MSTP	Yes	Yes
• eRSTP	Yes	Yes
<b>Protocol is supported</b>		
• STP	Yes	Yes
• RSTP	Yes	Yes
• MSTP	Yes	Yes
<b>Product functions security</b>		
<b>Product function</b>		
• IEEE 802.1x (radius)	Yes	Yes
<b>Protocol is supported</b>		
• RADIUS	Yes	Yes
• TACACS+	Yes	Yes
• SSH	Yes	Yes
• SSL	Yes	Yes
<b>Key length</b>		
• with SSL	256 bit	256 bit
• with RSA	3072 bit	3072 bit
<b>Product function port-rate-limiting</b>	Yes	Yes
<b>Product functions time</b>		
<b>Product function</b>		
• NTP-client	Yes	Yes
• SNTP client	Yes	Yes
• SNTP server	Yes	Yes
• IEEE 1588 v2 transparent forwarding	Yes	Yes
<b>Protocol is supported</b>		
• SNTP	Yes	Yes
<b>product function hardware-supported timestamp at all ports</b>	Yes	Yes

## Network Components

### RUGGEDCOM – Layer 2 Switches

#### RUGGEDCOM RSG908C / RUGGEDCOM RSG910C

Article number	<b>6GK6491-0CB..-....</b>	<b>6GK6490-8CB..-....</b>
Product type designation	RUGGEDCOM RSG910C	RUGGEDCOM RSG908C
<b>Standards, specifications, approvals</b>		
<b>Standard</b> • for safety from CSA and UL	cCSAus (Compliant with CSA C22.2 No. 60950, UL 60950, EN 60950)	cCSAus (Compliant with CSA C22.2 No. 60950, UL 60950, EN 60950)
<b>Reference code</b> • according to IEC 81346-2 • according to IEC 81346-2:2019	KF KFE	KF KFE
<b>Standards, specifications, approvals CE</b>		
<b>Certificate of suitability CE marking</b>	Yes	Yes
<b>Standard</b> • for EMC	FCC Part 15 (Class A), EN 55022 (CISPR22 Class A)	FCC Part 15 (Class A), EN55022 (CISPR22 Class A)
<b>Standards, specifications, approvals other</b>		
<b>Laser protection class</b>	Complies with 21 CFR chapter 1, subchapter J	Complies with 21 CFR chapter 1, subchapter J
<b>Certificate of suitability</b> • IEC 61850-3 • IEEE 1613	Yes Yes	Yes Yes

#### Selection and ordering data

Version	Article No.
<b>RUGGEDCOM RSG910C</b> The RUGGEDCOM RSG910C is a 10 port industrially hardened, fully managed Ethernet switch featuring integrated IEEE 1588 support for use in harsh industrial environments. The product has 4x 1 Gbit/s SFP slots and 6x 10/100/1000Mbit/s RJ 45 Ethernet ports. -40°C to +85°C operating temperature (fanless). • <b>RUGGEDCOM RSG910C</b> (not subject to export controls)	<b>6GK6491-0CB..-....</b>
<b>RUGGEDCOM RSG908C</b> The RUGGEDCOM RSG908C is an 8 port industrially hardened, fully managed Ethernet switch featuring integrated IEEE 1588 support for use in harsh industrial environments. The product has 4x 1 Gbit/s SFP slots and 4x 100Mbit/s multimode LC ports (max 2km). -40°C to +85°C operating temperature (fanless). • <b>RUGGEDCOM RSG908C</b> (not subject to export controls)	<b>6GK6490-8CB..-....</b>

#### More information

The RUGGEDCOM Selector assists you in selecting the right RUGGEDCOM products and in configuring variants and is available at:  
<http://www.siemens.com/ruggedcom-selector>

## Network Components

### RUGGEDCOM – Layer 2 Switches

#### RUGGEDCOM RST916P / RUGGEDCOM RST916C

##### Overview



The RUGGEDCOM RST916 product family are utility-grade, fully-managed 16-port compact Ethernet switches designed for reliable high-bandwidth connectivity in harsh industrial

environments, and CSA/UL 62368 safety approved from -40 °C to +85 °C.

##### Characteristics

- 12 x 10/100/1000BASE-T RJ45 ports
- 4 x 1G/10G BASE-X/1000BASE-X SFP+
- Long-haul fiber optics allow Gigabit distances of up to 115 km
- IEEE 1588 v2 Transparent Clock
- Removable storage medium, CLP, for device configuration back-up

##### Product versions

###### RUGGEDCOM RST916P

16-port managed 10 Gigabit PoE switch

- 10 x 10/100/1000BASE-T IEEE 802.3bt Types 1, 2, and 3 compliant PoE ports (up to 60 W/port)
- Supplies up to 420 W of PoE power

###### RUGGEDCOM RST916C

16-port managed 10 Gigabit Ethernet switch with redundant

##### Technical specifications

Article number	6GK6491-6PD..-....	6GK6491-6CD..-....
Product type designation	RUGGEDCOM RST916P	RUGGEDCOM RST916C
<b>Transfer rate</b>		
Transfer rate	10/100/1000 Mbit/s	10/100/1000 Mbit/s
Number of ports maximum	16	16
<b>Interfaces for communication integrated</b>		
Number of electrical connections	16	16
• for network components or terminal equipment	10	--
• for Power-over-Ethernet for network components or terminal equipment		
Number of 10/100/1000 Mbit/s RJ45 ports integrated	12	12
• with PoE	10	--
Number of electrical connections	4	4
• for SFP+		
<b>Interfaces other</b>		
Number of electrical connections	1	1
• for operator console	1	1
• for signaling contact	2	2
• for power supply		
Type of electrical connection	USB	USB
• for operator console	USB	USB
• for management purposes	3-pole terminal block, screwable	3-pole terminal block, screwable
• for signaling contact	5-pole terminal block, screwable	5-pole terminal block, screwable
• for power supply		
Design of the removable storage	Yes	Yes
• CLP		
<b>Signal inputs/outputs</b>		
Relay design	Fully sealed contact relay with changeover contact (SPDT)	Fully sealed contact relay with changeover contact (SPDT)
Type of relay output	changeover contact (CO)	changeover contact (CO)
Number of relay outputs as CO contact	1	1
Operating voltage of the signaling contacts	250 V	250 V
• at AC maximum	30 V	30 V
• at DC maximum		
Operational current of the signaling contacts	2 A	2 A
• at AC maximum	2 A	2 A
• at DC maximum		
<b>Supply voltage, current consumption, power loss</b>		
product options wide range power supply	--	Yes
Supplied active power of PSE with PoE	60 W	--
• per port maximum	420 W	--
• total maximum		
Type of voltage 1 of the supply voltage	DC	DC
• supply voltage 1 rated value	54 V	--
• supply voltage 1 rated value	52 ... 57 V	10 ... 60 V

### RUGGEDCOM RST916P / RUGGEDCOM RST916C

Article number	<b>6GK6491-6PD..-....</b>	<b>6GK6491-6CD..-....</b>
Product type designation	RUGGEDCOM RST916P	RUGGEDCOM RST916C
<b>Type of voltage 2 of the supply voltage</b> • supply voltage 2 rated value	-- --	DC 88 ... 300 V
<b>Type of voltage 3 of the supply voltage</b> • supply voltage 3 rated value	-- --	AC 85 ... 264 V
<b>Ambient conditions</b>		
<b>Ambient temperature</b> • during operation • during storage • during transport	-40 ... +85 °C -40 ... +85 °C -40 ... +85 °C	-40 ... +85 °C -40 ... +85 °C -40 ... +85 °C
<b>Operating condition fanless operation</b>	Yes	Yes
<b>Protection class IP</b>	IP30	IP30
<b>Design, dimensions and weights</b>		
<b>Design</b>	compact	compact
<b>Width</b>	116 mm	116 mm
<b>Height</b>	177 mm	177 mm
<b>Depth</b>	163 mm	163 mm
<b>Net weight</b>	3.75 kg	3.75 kg
<b>Product feature onformal coating</b>	optional	optional
<b>Material f the enclosure</b>	Cast Aluminum Enclosure	Cast Aluminum Enclosure
<b>Fastening method</b> • 19-inch installation • 35 mm top hat DIN rail mounting • wall mounting	No Yes Yes	No Yes Yes
<b>Product features, product functions, product components general</b>		
<b>Number of automatically learnable MAC addresses</b>	16384	16384
<b>Storage capacity</b> • of message buffer maximum	2048 Kibyte	2048 Kibyte
<b>Switch latency period</b>	3 µs	3 µs
<b>Transfer rate of the switch</b>	68 Gbit/s	68 Gbit/s
<b>Number of priority channels</b>	8	8
<b>Product feature</b> • No head-off-line-blocking • Cut Through switching method • Store & Forward switching method • Zero-Packet-Loss technology	Yes Yes Yes Yes; Zero-Packet-Loss applies to fiber optic interfaces	Yes Yes Yes Yes; Zero-Packet-Loss applies to fiber optic interfaces
<b>Product functions management, configuration, engineering</b>		
<b>Product function</b> • CLI • web-based management • MIB support • RMON • port mirroring • CoS	Yes Yes Yes Yes Yes Yes	Yes Yes Yes Yes Yes Yes
<b>Product function switch-managed</b>	Yes	Yes
<b>Protocol is supported</b> • Telnet • HTTP • HTTPS • TFTP • SFTP • GMRP • LLDP • SNMP v1 • SNMP v2 • SNMP v2c • SNMP v3 • IGMP (snooping/querier)	Yes Yes Yes Yes Yes Yes Yes Yes No Yes Yes Yes Yes	Yes Yes Yes Yes Yes Yes Yes Yes No Yes Yes Yes Yes
<b>Number of groups at IGMP</b>	1024	1024
<b>Product functions VLAN</b>		
<b>Product function</b> • VLAN - port based	Yes	Yes
<b>Number of VLANs maximum</b>	255	255
<b>Protocol is supported GVRP</b>	Yes	Yes
<b>Product functions DHCP</b>		
<b>Product function</b> • DHCP client • DHCP Option 82 • DHCP Option 66 • DHCP Option 67	Yes Yes No No	Yes Yes No No

## Network Components

### RUGGEDCOM – Layer 2 Switches

#### RUGGEDCOM RST916P / RUGGEDCOM RST916C

Article number	6GK6491-6PD..-....	6GK6491-6CD..-....
Product type designation	RUGGEDCOM RST916P	RUGGEDCOM RST916C
<b>Product functions redundancy</b>		
<b>Product function</b>		
• redundancy procedure STP	Yes	Yes
• redundancy procedure RSTP	Yes	Yes
• redundancy procedure MSTP	Yes	Yes
• eRSTP	Yes	Yes
<b>Protocol is supported</b>		
• STP	Yes	Yes
• RSTP	Yes	Yes
• MSTP	Yes	Yes
<b>Product functions security</b>		
<b>Product function</b>		
• IEEE 802.1x (radius)	Yes	Yes
<b>Protocol is supported</b>		
• RADIUS	Yes	Yes
• TACACS+	Yes	Yes
• SSH	Yes	Yes
• SSL	Yes	Yes
<b>Key length</b>		
• with SSL	256 bit	256 bit
• with RSA	3072 bit	3072 bit
<b>Product function port-rate-limiting</b>	Yes	Yes
<b>Product functions time</b>		
<b>Product function</b>		
• NTP-client	Yes	Yes
• SNTP client	Yes	Yes
• SNTP server	Yes	Yes
• IEEE 1588 v2 transparent forwarding	Yes	Yes
<b>Protocol is supported</b>		
• SNTP	Yes	Yes
<b>product function hardware-supported timestamp at all ports</b>	Yes	Yes
<b>Standards, specifications, approvals</b>		
<b>Standard</b>		
• for safety from CSA and UL	cTUVus (Compliant with CSA C22.2 No. 60950, UL 60950, EN 60950)	cTUVus (Compliant with CSA C22.2 No. 60950, UL 60950, EN 60950)
<b>Reference code</b>		
• according to IEC 81346-2	KF	KF
• according to IEC 81346-2:2019	KFE	KFE
<b>Standards, specifications, approvals CE</b>		
<b>Certificate of suitability CE marking</b>	Yes	Yes
<b>Standard</b>		
• for EMC	FCC Part 15 (Class A), EN 55022 (CISPR22 Class A)	FCC Part 15 (Class A), EN 55022 (CISPR22 Class A)
<b>Standards, specifications, approvals other</b>		
<b>Laser protection class</b>	Complies with 21 CFR chapter 1, subchapter J	Complies with 21 CFR chapter 1, subchapter J
<b>Certificate of suitability</b>		
• IEC 61850-3	Yes	Yes
• IEEE 1613	Yes	Yes
<b>Accessories</b>		
<b>Product extension optional C-PLUG</b>	Yes	Yes

#### Selection and ordering data

Version	Article No.
<p><b>RUGGEDCOM RST916P</b></p> <p>RUGGEDCOM RST916P is a 16 port industrially hardened, fully managed 10 G Ethernet switch featuring integrated 60 W PoE++ ports and a power budget of 420 W for use in harsh industrial environments. The product has 4x 1/10 Gbit/s SFP+ slots and 12x 10/100/1000 Mbit/s RJ45 ports, 10x of which are PoE++ capable -40°C to +85°C operating temperature (fanless).</p> <ul style="list-style-type: none"> <li>• <b>RUGGEDCOM RST916P</b></li> </ul>	<p><b>6GK6491-6PD..-....</b></p>
<p><b>RUGGEDCOM RST916C</b></p> <p>RUGGEDCOM RST916C is a 16 port industrially hardened, fully managed 10 G Ethernet switch featuring integrated IEEE 1588 support for use in harsh industrial environments. The product has 4x 1/10 Gbit/s SFP+ slots and 12x 10/100/1000 Mbit/s RJ45 ports. -40°C to +85°C operating temperature (fanless).</p> <ul style="list-style-type: none"> <li>• <b>RUGGEDCOM RST916C</b></li> </ul>	<p><b>6GK6491-6CD..-....</b></p>

#### More information

The RUGGEDCOM Selector assists you in selecting the right RUGGEDCOM products and in configuring variants and is available at:

<http://www.siemens.com/ruggedcom-selector>

## Network Components

### RUGGEDCOM – Layer 2 Switches

#### RUGGEDCOM RSG2100 / RUGGEDCOM RSG2300

##### Overview



RUGGEDCOM RSG2100



RUGGEDCOM RSG2300

RUGGEDCOM RSG2100

The RUGGEDCOM RSG2100 is a modular fully-managed Ethernet switch that is especially well-suited for use in hostile operating environments for electrical equipment and demanding climatic conditions.

RUGGEDCOM RSG2300

The RUGGEDCOM RSG2300 product family consists of fully-managed Ethernet switches with 32 ports and 4 modular Gigabit uplink ports.

##### Characteristics

- Fully integrated dual redundant (optional) high voltage and low voltage power supplies
- Operation without fans for operating temperatures from -40 °C to +85 °C

##### RUGGEDCOM RSG2100

- Modular managed Ethernet switch with 19 ports, Gigabit uplinks and 56- or 128-bit encryption
- Up to 3 Gigabit Ethernet ports and 16 Fast Ethernet ports - copper and/or fiber-optic
- 2-port modules for outstanding flexibility
- Store und Forward switching
- Support of many different fiber-optic cable types (multimode, single-mode) with a variety of connections (ST, MTRJ, LC, SC, SFP)
- Variant with 4 fixed 10/100BaseTX, 802.3af-compliant (PoE) Ethernet ports (RUGGEDCOM RSG2100P and RSG2100PNC)

##### RUGGEDCOM RSG2300

- Managed Ethernet switch with 32 ports, Gigabit uplinks and 56- or 128-bit encryption
- 24 Fast Ethernet copper ports
- Optional: Up to 4x 1000LX Gigabit Ethernet ports (copper and/or fiber-optic) and up to 8x 100FX Fast Ethernet fiber-optic ports
- Non-blocking, Store und Forward switching
- Support of many different fiber-optic cable types (multimode, single-mode, bidirectional single strand) with a variety of connections (ST, MTRJ, LC, SC, SFP)
- Variant available with up to four 802.3af-compliant ports (10/100BaseTX) (RUGGEDCOM RSG2300P and RSG2300PNC)

##### Selection and ordering data

Version	Article No.
<p><b>RUGGEDCOM RSG2100</b></p> <p>The RUGGEDCOM RSG2100 is a fully-managed Ethernet switch; 56- or 128-bit encryption; up to 3 Gigabit Ethernet ports - copper and/or fiber-optic; up to 16 Fast Ethernet ports - copper and/or fiber-optic; 2-port modules for outstanding flexibility; non-blocking, Store and Forward switching; support of many different fiber-optic cable types (multimode, single-mode, bidirectional single strand); long-distance fiber-optic connections enable distances up to 70 km in the Gigabit range; variety of connection types (ST, MTRJ, LC, SC, RJ45, Micro-D)</p> <ul style="list-style-type: none"> <li>• <b>RUGGEDCOM RSG2100NC</b> (not subject to export controls)</li> <li>• <b>RUGGEDCOM RSG2100</b> (subject to export controls)</li> <li>• <b>RUGGEDCOM RSG2100PNC</b> (not subject to export controls)</li> <li>• <b>RUGGEDCOM RSG2100P</b> (subject to export controls)</li> </ul>	<p><b>6GK6021-0AS1-.....</b></p> <p><b>6GK6021-0AS2-.....</b></p> <p><b>6GK6021-0PS1-.....</b></p> <p><b>6GK6021-0PS2-.....</b></p>
<p><b>RUGGEDCOM RSG2300</b></p> <p>The RUGGEDCOM RSG2300 is a modular fully-managed Ethernet switch; 24x 10/100TX copper ports; optional: up to 4x 1000LX Gigabit Ethernet ports (copper and/or fiber-optic) and up to 8x 100FX Fast Ethernet fiber-optic ports; 2-port modules for outstanding flexibility; non-blocking, Store and Forward switching; multimode, single-mode; long-distance fiber-optic connections enable distances up to 90 km; variety of connection types (ST, MTRJ, LC, SC)</p> <ul style="list-style-type: none"> <li>• <b>RUGGEDCOM RSG2300NC</b> (not subject to export controls)</li> <li>• <b>RUGGEDCOM RSG2300</b> (subject to export controls)</li> <li>• <b>RUGGEDCOM RSG2300PNC</b> (not subject to export controls)</li> <li>• <b>RUGGEDCOM RSG2300P</b> (subject to export controls)</li> </ul>	<p><b>6GK6023-0AS1-.....</b></p> <p><b>6GK6023-0AS2-.....</b></p> <p><b>6GK6023-0PS1-.....</b></p> <p><b>6GK6023-0PS2-.....</b></p>

##### More information

The RUGGEDCOM Selector assists you in selecting the right RUGGEDCOM products and in configuring variants and is

available at:  
<http://www.siemens.com/ruggedcom-selector>



### Overview



The RUGGEDCOM RST2228 is a high port density field modular 19" Layer 2 rack switch with 10 Gbit/s uplinks, support for IEEE 1588.

### Design

- Up to 28 Ethernet ports – 4 x 1000BASE-X/10GBASE-X integrated uplinks and up to 24 x 10/100/1000BASE-X ports
- 6 slots for 4-port Media Modules for tremendous flexibility
- Media modules with 4 x 10/100/1000 Mbit/s RJ45, FastConnect or 100/1000 Mbit/s SFP interfaces
- Supports precision timing according to IEEE 1588 (transparent clock). Support HSR/PRP functions (with RedBox, QuadBox and Coupling capabilities) with the help of RUGGEDCOM RMM2972-2RNA, Media Module, 2 x 100/1000 Base-X SFPs (SFPs not included)
- Non-blocking, store and forward switching
- Dual-redundant (optional), load sharing, high-voltage power supplies
- For use at ambient temperatures from –40 °C to +85 °C without the use of fans
- Power-over-Ethernet variant available supporting IEEE 802.3at/802.3bt (draft) with up to 60 W/port and a maximum power budget from 500 W. RUGGEDCOM RST2228P is compatible with the rack-mount RUGGEDCOM RPS2410 600 W PoE power supply.

### Product versions

#### RUGGEDCOM RST2228

- 28-port field modular managed layer 2 Gigabit/s switch with 10 Gbit/s uplinks supporting IEEE 1588

#### RUGGEDCOM RST2228P

- 28-port field modular managed layer 2 Gigabit/s switch with 10 Gbit/s uplinks supporting IEEE 1588 and Power-over-Ethernet according IEEE 802.3at/803.bt (draft)

### Benefits

- Future-proof Ethernet switch with high port density to minimize capital expense by reducing the number of devices needed.
- Field-modular media modules with RJ45, FastConnect & SFP interfaces and build-to-order design ensures seamless servicing and tremendous flexibility in tailoring the device configuration resulting in lower operating expenses
- Suitable for usage in electric power, transportation and oil & gas applications due to a utility grade design with immunity against EMI and heavy electrical surges
- Future-proof due to support of modern IEEE 1588 time synchronization features. Improved network reliability with 0s failover time providing seamless redundancy.
- Suitable for usage in harsh environments with the minimal risk of mechanical failures due to an operating temperature from –40 °C to +85 °C without fans

### Technical specifications

Article number	6GK6222-6AB..-....	6GK6222-6PB..-....
Product type designation	RUGGEDCOM RST2228	RUGGEDCOM RST2228P
<b>Transfer rate</b>		
<b>Transfer rate</b>	110/100/1000 Mbit/s, 10 Gbit/s	10/100/1000 Mbit/s, 10 Gbit/s
<b>Number of ports maximum</b>	28; Number of ports depending on configuration	28; Number of ports depending on configuration
<b>Interfaces for communication maximum configuration for modular devices</b>		
<b>Number of electrical ports maximum</b>	24	24
<b>Number of electrical ports with PoE maximum</b>	0	24
<b>Number of optical ports maximum</b>	28	28
<b>Interfaces for communication integrated</b>		
<b>Number of optical interfaces for network components or terminal equipment</b>	28; Depending on device configuration	28; Depending on device configuration
<b>Number of electrical connections</b> • for SFP+	4; Compatible with SFP (1000BASE-X) and SFP+ (10GBASE-X)	4; Compatible with SFP (1000BASE-X) and SFP+ (10GBASE-X)
<b>Number of connectable media modules</b> • with 4 ports	6	6

## Network Components

### RUGGEDCOM – Layer 2 Switches

#### RUGGEDCOM RST2228

Article number	6GK6222-6AB..-....	6GK6222-6PB..-....
Product type designation	RUGGEDCOM RST2228	RUGGEDCOM RST2228P
<b>interfaces for communication plug-in</b>		
<b>Number of 10/100/1000 Mbit/s RJ45 ports</b>	24	24
• with PoE	0	24
• with securing collar	24	24
• with securing collar / with PoE	0	24
<b>Number of 100 Mbit/s LC ports</b>	24	24
• for multimode		
<b>Number of electrical connections</b>		
• for SFP	24; Compatible with Fast Ethernet (100BASE-X) and Gigabit (1000BASE-X) SFPs	24; Compatible with Fast Ethernet (100BASE-X) and Gigabit (1000BASE-X) SFPs
• for SFP+	4; Compatible with SFP (1000BASE-X) and SFP+ (10GBASE-X)	4; Compatible with SFP (1000BASE-X) and SFP+ (10GBASE-X)
<b>Interfaces other</b>		
<b>Number of electrical connections</b>		
• for operator console	1	1
• for signaling contact	1	1
• for media module	6	6
• for power supply	1	1
<b>Type of electrical connection</b>		
• for operator console	USB	USB
• for power supply and signaling contact	3-pole terminal block, screwable or plugable	3-pole terminal block, screwable or plugable
<b>Design of the removable storage</b>		
• CLP	Yes	Yes
<b>Product feature hot-swappable interface modules</b>	No	No
<b>Signal inputs/outputs</b>		
<b>Relay design</b>	Form-C contact relay (SPDT)	Form-C contact relay (SPDT)
<b>Type of relay output</b>	changeover contact (CO)	changeover contact (CO)
<b>Operating voltage of the signaling contacts</b>		
• at AC maximum	230 V	230 V
• at DC maximum	250 V	250 V
<b>Operational current of the signaling contacts</b>		
• at AC at 250 V maximum	2 A	2 A
• at DC at 30 V maximum	2 A	2 A
<b>Supply voltage, current consumption, power loss</b>		
<b>Product options wide range power supply</b>	Yes	Yes
<b>Product component connection for redundant voltage supply</b>	Yes	Yes
<b>Product feature</b>		
• modular power supply	No	No
• hot-swappable power supply	No	No
<b>Type of voltage supply redundant power supply unit</b>	Yes	Yes
<b>Type of voltage 1 of the supply voltage</b>	DC	DC
• supply voltage 1 rated value	12 V	12 V
• supply voltage 1 rated value	10 ... 15 V	10 ... 15 V
<b>Type of voltage 2 of the supply voltage</b>	DC	DC
• supply voltage 2 rated value	24 V	24 V
• power loss (W) 2 rated value	72 W	72 W
• supply voltage 2 rated value	13 ... 36 V	13 ... 36 V
<b>Type of voltage 3 of the supply voltage</b>	DC	DC
• supply voltage 3 rated value	48 V	48 V
• power loss (W) 3 rated value	72 W	72 W
• supply voltage 3 rated value	36 ... 72 V	36 ... 72 V
<b>Type of voltage 4 of the supply voltage</b>	DC	DC
• power loss (W) 4 rated value	77 W	77 W
• supply voltage 4 rated value	88 ... 300 V	88 ... 300 V
<b>Type of voltage 5 of the supply voltage</b>	AC	AC
• power loss (W) 5 rated value	76 W	76 W
• supply voltage 5 rated value	85 ... 264 V	85 ... 264 V
<b>Ambient conditions</b>		
<b>Ambient temperature</b>		
• during operation	-40 ... +85 °C	-40 ... +85 °C
• note	A maximum operating temperature of +85 °C is permissible for a duration of 16 hours	A maximum operating temperature of +85 °C is permissible for a duration of 16 hours
<b>relative humidity</b>		
• at 25 °C /without condensation during operation / maximum	95 %	95 %
<b>Operating condition / fanless operation</b>	Yes	Yes
<b>Protection class IP</b>	IP3X	IP3X

Article number	6GK6222-6AB..-....	6GK6222-6PB..-....
Product type designation	RUGGEDCOM RST2228	RUGGEDCOM RST2228P
<b>Design, dimensions and weights</b>		
<b>Display version LED panel mounted on the front or on the rear side</b>	Yes	Yes
<b>Design</b>	19" rack	19" rack
<b>Number of modular height units relating to 19-inch cabinet</b>	1	1
<b>Number of slots</b>	6	6
<b>Width</b>	446 mm	446 mm
<b>Height</b>	43.6 mm	43.6 mm
<b>Depth</b>	340 mm	340 mm
<b>Net weight</b>	8.6 kg; Weight depends on selected options	8.6 kg; Weight depends on selected options
<b>Product feature on formal coating</b>	Yes; optional	Yes; optional
<b>Material of the enclosure</b>	Aluminum 18 AWG galvanized steel enclosure	Aluminum 18 AWG galvanized steel enclosure
<b>Fastening method</b> • 19-inch installation • 35 mm top hat DIN rail mounting • wall mounting	Yes No Yes	Yes No Yes
<b>Product features, product functions, product components general</b>		
<b>Number of automatically learnable MAC addresses</b>	16384	16384
<b>Storage capacity</b> • of the MAC-address table • of message buffer maximum	64 Kibyte 2000 Kibyte	64 Kibyte 2000 Kibyte
<b>Switch latency period</b>	3 µs	3 µs
<b>Transfer rate of the switch</b>	128 Gbit/s	128 Gbit/s
<b>Number of priority channels</b>	8	8
<b>Number of QoS queues per port</b>	4	4
<b>Size per QoS queues</b>	1536 frames	1536 frames
<b>Product function QoS according to IEEE 802.1Q</b>	Yes	Yes
<b>Product feature</b> • No head-off-line-blocking • Store & Forward switching method • Zero-Packet-Loss technology	Yes Yes Yes; Zero-Packet-Loss applies to fiber optic interfaces	Yes Yes Yes; Zero-Packet-Loss applies to fiber optic interfaces
<b>Product functions management, configuration, engineering</b>		
<b>Product function</b> • CLI • web-based management • MIB support • RMON	Yes Yes Yes Yes	Yes Yes Yes Yes
<b>Product function switch-managed</b>	Yes	Yes
<b>Protocol is supported</b> • Telnet • HTTP • HTTPS • TFTP • SNMP v1 • SNMP v2 • SNMP v2c • SNMP v3 • IGMP (snooping/querier)	Yes Yes Yes Yes Yes No Yes Yes Yes	Yes Yes Yes Yes Yes No Yes Yes Yes
<b>Number of groups / at IGMP</b>	256	256
<b>Product functions VLAN</b>		
<b>Product function</b> • VLAN - port based	Yes	Yes
<b>Number of VLANs maximum</b>	255	255
<b>VLAN identification number</b>	1 ... 4094	1 ... 4094
<b>Protocol is supported GVRP</b>	Yes	Yes
<b>Product functions DHCP</b>		
<b>Product function</b> • DHCP client • DHCP Option 82 • DHCP Option 66 • DHCP Option 67	Yes Yes No No	Yes Yes No No

## Network Components

### RUGGEDCOM – Layer 2 Switches

#### RUGGEDCOM RST2228

Article number	6GK6222-6AB..-....	6GK6222-6PB..-....
Product type designation	RUGGEDCOM RST2228	RUGGEDCOM RST2228P
<b>Product functions redundancy</b>		
<b>Product function</b>		
• ring redundancy	Yes	Yes
• media redundancy protocol (MRP) with redundancy manager	Yes	Yes
• redundancy procedure STP	Yes	Yes
• redundancy procedure RSTP	Yes	Yes
• redundancy procedure MSTP	Yes	Yes
• eRSTP	Yes	Yes
<b>Protocol is supported Media Redundancy Protocol (MRP)</b>	Yes	Yes
<b>Protocol is supported</b>		
• STP	Yes	Yes
• RSTP	Yes	Yes
• MSTP	Yes	Yes
<b>Product functions security</b>		
<b>Product function</b>		
• ACL - MAC-based	Yes	Yes
• IEEE 802.1x (radius)	Yes	Yes
• blocking of communication via physical ports	Yes	Yes
<b>Protocol is supported</b>		
• TACACS+	Yes	Yes
• SSH	Yes	Yes
• SSL	Yes	Yes
<b>Key length</b>		
• with SSL	128 bit	128 bit
• with RSA	1024 bit	1024 bit
<b>Product function port-rate-limiting</b>	Yes	Yes
<b>Product functions time</b>		
<b>Product function</b>		
• SNMP client	Yes	Yes
• SNMP server	Yes	Yes
• IEEE 1588 v2 master	No	No
• IEEE 1588 v2 slave	No	No
• IEEE 1588 v2 transparent forwarding	Yes	Yes
<b>Protocol is supported</b>		
• NTP	Yes	Yes
• SNTP	Yes	Yes
• product function hardware-supported timestamp at all ports	Yes	Yes
• product component hardware real time clock	Yes	Yes
<b>Standards, specifications, approvals</b>		
<b>Standard</b>		
• for safety / from CSA and UL	cCSAus (Compliant with CSA C22.2 No. 60950-1, UL60950-1, EN60950-1, IEC60950-1)	cCSAus (Compliant with CSA C22.2 No. 60950-1, UL 60950-1, EN 60950-1, IEC 60950-1)
• for emitted interference	CISPR32, EN 55032, FCC Part15 Class A, CAN ICES-3 Class A / NMB-3 Class A	CISPR32, EN 55032, FCC Part15 Class A, CAN ICES-3 Class A / NMB-3 Class A
• for interference immunity	IEC 61000-6-2	IEC 61000-6-2
<b>Reference code</b>		
• according to IEC 81346-2	KF	KF
• according to IEC 81346-2:2019	KFE	KFE
<b>Standards, specifications, approvals CE</b>		
<b>Certificate of suitability CE marking</b>	Yes	Yes
<b>Standard</b>		
• for EMC	EN55032, IEC/EN 61000-6-2	EN 55032, IEC/EN 61000-6-2
• for immunity to EMC	CISPR32, EN 55032, FCC Part15 Class A, CAN ICES-3 Class A / NMB-3 Class A	CISPR32, EN 55032, FCC Part15 Class A, CAN ICES-3 Class A / NMB-3 Class A
<b>Certificate of suitability / RoHS conformity</b>	Yes	Yes
<b>Standards, specifications, approvals other</b>		
<b>Laser protection class</b>	Complies with 21 CFR chapter 1, subchapter J (Health and safety, class I laser)	Complies with 21 CFR chapter 1, subchapter J
<b>Certificate of suitability</b>		
• relating to NEMA	NEMA TS-2	Yes; 12/24/48 V DC
• KC approval	Yes	Yes
• railway application in accordance with EN 50155	Yes	Yes
• railway application in accordance with EN 50121-4	Yes	Yes
• railway application in accordance with EN 50124-1	No	No
• fire protection in accordance with EN 45545-2	Yes	Yes
• IEC 61850-3	Yes	Yes
• IEEE 1613	Yes	Yes
• Regulatory Compliance Mark (RCM)	No	No
• EAC approval	Yes	Yes
<b>Standards, specifications, approvals marine classification</b>		
<b>Marine classification association</b>		
• American Bureau of Shipping Europe Ltd. (ABS)	Yes	Yes
• DNV GL	Yes; 12/24/48 V DC	No

### Selection and ordering data

Version	Article No.
<b>RUGGEDCOM RST2228</b> RUGGEDCOM RST2228 is a field modular, fully managed Layer 2 Ethernet switch with 4 x 1/10 GBit/s and 24 x 100/1000 MBit/s non-blocking ethernet ports. Support for up to six 4-port media modules with RJ45, SFP or LC interfaces; -40 °C ...+85 °C operating temperature (fanless)	<b>6GK6222-6AB00-....</b>
<b>RUGGEDCOM RST2228P</b> RUGGEDCOM RST2228P is a field modular, fully managed Layer 2 Ethernet switch with 4 x 1/10 GBit/s and 24 x 100/1000 MBit/s non-blocking ethernet ports with Power-over-Ethernet support. Support for up to six 4-port media modules with RJ45, SFP or LC interfaces; -40 °C ...+85 °C operating temperature (fanless)	<b>6GK6222-6PB00-....</b>
<b>RUGGEDCOM accessories</b> <ul style="list-style-type: none"> <li>• <b>USB Console cable</b> USB 2.0 A type to B type Cable Assembly 10 feet / 3 meters</li> <li>• <b>Power cable with lugs</b> Power Cable with north-american plug for screw terminal blocks (6 ft.) for RUGGEDCOM products</li> <li>• <b>Power cable without lugs</b> Power Cable with north-american plug for pluggable terminal blocks (6 ft.) for RUGGEDCOM products</li> <li>• <b>Pluggable terminal block RST2228</b> Connector Kit RST2228 Pluggable terminal blocks (5 sets)</li> <li>• <b>Screw terminal block RST2228</b> Connector Kit RST2228 Screw terminal blocks (5 sets)</li> <li>• <b>Rack / Panel Mounting Kit for RUGGEDCOM RST2228</b> Allows for mounting in a 19" rack or in a panel</li> </ul>	<b>6GK6000-8DT01-0AA0</b>  <b>6GK6000-8BA00-0AA0</b>  <b>6GK6000-8BB00-0AA0</b>  <b>6GK6000-8HC05-0AA0</b>  <b>6GK6000-8HC06-0AA0</b>  <b>6GK6000-8MA01-0AA0</b>
<b>RUGGEDCOM Storage Media</b> <ul style="list-style-type: none"> <li>• <b>RUGGEDCOM CLP 2GB</b> Storage media for simple device exchange in case of failure, for storage of configuration or user data with 2 GB capacity.</li> <li>• <b>RUGGEDCOM CLP 2GB CC</b> Storage media for simple device exchange in case of failure, for storage of configuration or user data with 2 GB capacity and Conformal Coating.</li> </ul>	<b>6GK6000-8RA00-1HA0</b>  <b>6GK6000-8RA00-1HA1</b>
<b>RUGGEDCOM SFPs</b> <p><b>Copper Ethernet SFP</b></p> <ul style="list-style-type: none"> <li>• <b>RUGGEDCOM SFP1112-1</b> Copper SFP, 10/100/1000MBIT/S, RJ45-Interface, Copper, up to max. 100m, 0 °C ...+70 °C</li> </ul> <p><b>Fiber Optic SFPs (Fast Ethernet)</b></p> <ul style="list-style-type: none"> <li>• <b>RUGGEDCOM SFP1121-1FX2</b> 100BASE-FX, LC-Interface, Optical: Multi Mode Fiber Optic up to max. 2km, 1310nm, -40 °C ...+85 °C</li> <li>• <b>RUGGEDCOM SFP1121-1FX2A</b> 100BASE-FX, LC-Interface, Optical: Multi Mode Fiber Optic up to max. 2km, 1310nm, -40 °C ...+85 °C. Active SFP which is only compatible with the RUGGEDCOM RX1400 and RST2228 uplink interfaces.</li> <li>• <b>SFP1131-1FX20</b> 100BASE-FX, LC-Interface, Optical: Single Mode Fiber Optic up to max. 20km, 1310nm, -40 °C ...+85 °C</li> <li>• <b>SFP1131-1XF50</b> 100BASE-FX, LC-Interface, Optical: Single Mode Fiber Optic up to max. 50km, 1310nm, -40 °C ...+85 °C</li> <li>• <b>SFP1131-1FX90</b> 100BASE-FX, LC-Interface, Optical: Single Mode Fiber Optic up to max. 90km, 1550nm, -40 °C ...+85 °C</li> </ul> <p><b>Fiber Optic SFPs (Gigabit)</b></p> <ul style="list-style-type: none"> <li>• <b>RUGGEDCOM SFP1122-1SX</b> 1000BASE-SX, LC-Interface, Optical: Multi Mode Fiber Optic up to max. 500m, 850nm, -40 °C ...+85 °C</li> <li>• <b>RUGGEDCOM SFP1122-1SX2</b> 1000BASE-SX, LC-Interface, Optical: Multi Mode Fiber Optic up to max. 2km, 1310nm, -40 °C ...+85 °C</li> <li>• <b>RUGGEDCOM SFP1132-1LX10</b> 1000BASE-LX, LC-Interface, Optical: Single Mode Fiber Optic up to max. 10km, 1310nm, -40 °C ...+85 °C</li> <li>• <b>RUGGEDCOM SFP1132-1LX25</b> 1000BASE-LX, LC-Interface, Optical: Single Mode Fiber Optic up to max. 25km, 1310nm, -40 °C ...+85 °C</li> <li>• <b>RUGGEDCOM SFP1132-1LX40</b> 1000BASE-LX, LC-Interface, Optical: Single Mode Fiber Optic up to max. 40km, 1550nm, -40 °C ...+85 °C</li> <li>• <b>RUGGEDCOM SFP1132-1LX70</b> 1000BASE-LX, LC-Interface, Optical: Single Mode Fiber Optic up to max. 70km, 1550nm, -40 °C ...+85 °C</li> </ul>	<b>6GK6000-8CG01-0AA0</b>  <b>6GK6000-8FE51-0AA0</b>  <b>6GK6000-8FE50-0AA0</b>  <b>6GK6000-8FE52-0AA0</b>  <b>6GK6000-8FE53-0AA0</b>  <b>6GK6000-8FE54-0AA0</b>  <b>6GK6000-8FG51-0AA0</b>  <b>6GK6000-8FE58-0AA0</b>  <b>6GK6000-8FG52-0AA0</b>  <b>6GK6000-8FG53-0AA0</b>  <b>6GK6000-8FG57-0AA0</b>  <b>6GK6000-8FG54-0AA0</b>

## Network Components

### RUGGEDCOM – Layer 2 Switches

#### RUGGEDCOM RST2228

Version	Article No.
<ul style="list-style-type: none"> <li>• <b>RUGGEDCOM SFP1132-1LX100</b> 1000BASE-LX, LC-Interface, Optical: Single Mode Fiber Optic up to max. 100km, 1550nm, 0 °C ...+70 °C</li> <li>• <b>RUGGEDCOM SFP1132-1LX115</b> 1000BASE-LX, LC-Interface, Optical: Single Mode Fiber Optic up to max. 115km, 1550nm, -10 °C ...+70 °C</li> </ul>	<p><b>6GK6000-8FG55-0AA0</b></p> <p><b>6GK6000-8FE56-0AA0</b></p>
<p><b>Fiber Optic Bi-Directional SFPs (Gigabit)</b></p> <ul style="list-style-type: none"> <li>• <b>RUGGEDCOM SFP1132-1BX10R</b> 1000BASE-BX-U, LC-Interface, Optical: Single Mode Fiber Optic up to max. 10km, 1310nm TX/1490 nm RX, -40 °C ...+85 °C</li> <li>• <b>RUGGEDCOM SFP1132-1BX10T</b> 1000BASE-BX-D, LC-Interface, Optical: Single Mode Fiber Optic up to max. 10km, 1490nm TX/1310 nm RX, -40 °C ...+85 °C</li> <li>• <b>RUGGEDCOM SFP1132-1BX40R</b> 1000BASE-BX-U, LC-Interface, Optical: Single Mode Fiber Optic up to max. 40km, 1310nm TX/1490 nm RX, -40 °C ...+85 °C</li> <li>• <b>RUGGEDCOM SFP1132-1BX40T</b> 1000BASE-BX-D, 1 X 1000MBIT/S, LC-Interface, Optical: Single Mode Fiber Optic up to max. 40km, 1490nm TX/1310 nm RX, -40 °C ...+85 °C</li> </ul>	<p><b>6GK6000-8FB51-0AA0</b></p> <p><b>6GK6000-8FB52-0AA0</b></p> <p><b>6GK6000-8FB53-0AA0</b></p> <p><b>6GK6000-8FB54-0AA0</b></p>
<p><b>Fiber Optic SFP+ (10 Gigabit)</b></p> <ul style="list-style-type: none"> <li>• <b>RUGGEDCOM SFP2133-1LR10</b> 10GBASE-LR, LC- Interface, Optical: Single Mode Fiber Optic up to max. 10km, 1310nm, -40 °C ...+85 °C</li> <li>• <b>RUGGEDCOM SFP2133-1ER40</b> 10GBASE-ER, LC- Interface, Optical: Single Mod e Fiber Optic up to max. 40km, 1550nm, -40 °C ...+85 °C</li> <li>• <b>RUGGEDCOM SFP2133-1ZR80</b> 10GBASE-ZR, LC- Interface, Optical: Single Mode Fiber Optic up to max. 80km, 1550nm, -40 °C ...+85 °C</li> </ul>	<p><b>6GK6000-8FT51-0AA0</b></p> <p><b>6GK6000-8FT53-0AA0</b></p> <p><b>6GK6000-8FT52-0AA0</b></p>

#### More information

To assist in selecting the right RUGGEDCOM products as well as configuration of variants, the RUGGEDCOM Selector is available at:

<http://www.siemens.com/ruggedcom-selector>

### Overview



The RUGGEDCOM RSG2488 is the first locally upgradable Layer 2 switch with 28 non-blocking Gigabit ports and dual redundant power supplies that are replaceable during operation.

### Characteristics

- Up to 28 Gigabit Ethernet ports - copper and/or fiber-optic; 19-inch, 1 HU rack mounting
- Fully modular; field-replaceable Ethernet media modules with 2/4 ports for outstanding flexibility
- Support of media modules with 100FX or 1000SX fiber-optic ports
- Optional PTP module provides GPS time source and IRIG-B input/output
- Support of IEEE 1588 (PTP), SNTP, IRIG-B; the time of day can be converted between all these formats
- Non-blocking, Store und Forward switching
- Support of many different fiber-optic cable types (multimode, single-mode, bidirectional single strand) with a variety of connections (LC, SC, SFP, ST)
- Dual redundant (optional) load-dividing high voltage and low voltage power supplies that are replaceable during operation
- Operation without fans for operating temperatures from -40 °C to +85 °C

### Product versions

RUGGEDCOM RSG2488

- Modular managed Gigabit Ethernet switch with 28 ports and 128-bit encryption

RUGGEDCOM RSG2488NC

- Modular managed Gigabit Ethernet switch with 28 ports and 56-bit encryption

### Technical specifications

Article number	6GK6024-8GS1-....	6GK6024-8GS2-....
Product type designation	RUGGEDCOM RSG2488	RUGGEDCOM RSG2488NC
<b>Transfer rate</b>		
Transfer rate	10/100/1000 Mbit/s	10/100/1000 Mbit/s
Number of ports maximum	28; Number of ports depending on configuration	28; Number of ports depending on configuration
<b>Interfaces other</b>		
Number of electrical connections		
• for operator console	1	1
• for management purposes	1	1
Type of electrical connection		
• for operator console	RS232	RS232
• for signaling contact	RJ45	RJ45
• for power supply and signaling contact	10-pole terminal block, screwable or plugable, screw contact	10-pole terminal block, screwable or plugable, screw contact
<b>Supply voltage, current consumption, power loss</b>		
Product options wide range power supply	Yes	Yes
Product feature		
• modular power supply	Yes	Yes
• hot-swappable power supply	Yes	Yes
Type of voltage supply redundant power supply unit	Yes	Yes
Type of voltage 1 of the supply voltage		
• supply voltage 1 rated value	DC 24 V	DC 24 V
• supply voltage 1 rated value	13 ... 36 V	13 ... 36 V
• product component 1 fusing at power supply input	Yes	Yes
Type of voltage 2 of the supply voltage		
• supply voltage 2 rated value	DC 48 V	DC 48 V
• supply voltage 2 rated value	38 ... 72 V	38 ... 72 V
Type of voltage 3 of the supply voltage		
• supply voltage 3 rated value	DC 98 ... 300 V	DC 98 ... 300 V
Type of voltage 4 of the supply voltage		
• supply voltage 4 rated value	AC 85 ... 264 V	AC 85 ... 264 V



## Network Components

### RUGGEDCOM – Layer 2 Switches

#### RUGGEDCOM RSG2488

Article number	<b>6GK6024-8GS1-.....</b>	<b>6GK6024-8GS2-.....</b>
Product type designation	RUGGEDCOM RSG2488	RUGGEDCOM RSG2488NC
<b>Ambient conditions</b>		
<b>Ambient temperature</b> • during operation • note	-40 ... +85 °C A maximum operating temperature of +85 °C is permissible for a duration of 16 hours	-40 ... +85 °C A maximum operating temperature of +85 °C is permissible for a duration of 16 hours
<b>Operating condition fanless operation</b>	Yes	Yes
<b>Protection class IP</b>	IP30	IP30
<b>Design, dimensions and weights</b>		
<b>Display version LED panel mounted on the front or on the rear side</b>	Yes	Yes
<b>Design</b>	19" rack	19" rack
<b>Number of modular height units relating to 19-inch cabinet</b>	1	1
<b>Number of slots</b>	8	8
<b>Width</b>	442.4 mm	442.4 mm
<b>Height</b>	44 mm	44 mm
<b>Depth</b>	376 mm	376 mm
<b>Net weight</b>	8.6 kg	8.6 kg
<b>Product feature onformal coating</b>	optional	optional
<b>Material of the enclosure</b>	Aluminum	Aluminum
<b>Fastening method</b>  • 19-inch installation • 35 mm top hat DIN rail mounting • wall mounting	Mounting Kits for different mounting options Yes Yes Yes	Mounting Kits for different mounting options Yes Yes Yes
<b>Product features, product functions, product components general</b>		
<b>Number of automatically learnable MAC addresses</b>	8192	8192
<b>Storage capacity</b> • of message buffer maximum • of the MAC-address table	1536 Kibyte 64 Kibyte	1536 Kibyte 64 Kibyte
<b>Switch latency period</b>	4 µs	4 µs
<b>Transfer rate of the switch</b>	56000 Gbit/s	56000 Gbit/s
<b>Number of priority channels</b>	4	4
<b>Product feature</b> • No head-off-line-blocking • Store & Forward switching method • Zero-Packet-Loss technology	Yes Yes Yes; Zero-Packet-Loss applies to fiber optic interfaces	Yes Yes Yes; Zero-Packet-Loss applies to fiber optic interfaces
<b>Product functions management, configuration, engineering</b>		
<b>Product function</b> • CLI • web-based management • MIB support • RMON	Yes Yes Yes Yes	Yes Yes Yes Yes
<b>Product function switch-managed</b>	Yes	Yes
<b>Protocol is supported</b> • Telnet • HTTP • HTTPS • TFTP • SNMP v1 • SNMP v2 • SNMP v2c • SNMP v3 • IGMP (snooping/querier)	Yes Yes Yes Yes Yes No Yes Yes Yes	Yes Yes Yes Yes Yes No Yes Yes Yes
<b>Number of groups at IGMP</b>	256	256
<b>Product function</b> • for MIB support by BRIDGE-MIB • for MIB support / by IF-MIB • for MIB support / by RMON-MIB • for MIB support / by RSTP-MIB • for MIB support / by SNMPv2-MIB • for MIB support / by SNMPv2-SMI • for MIB support / by SNMPv2-TC • for MIB support / by TCP-MIB • for MIB support / by UDP-MIB	RFC4188 RFC2863 RFC2819 RFC4318 RFC1907 RFC2578 RFC2579 RFC2012 RFC2013	RFC4188 RFC2863 RFC2819 RFC4318 RFC1907 RFC2578 RFC2579 RFC2012 RFC2013
<b>Product functions VLAN</b>		
<b>Product function</b> • VLAN - port based	Yes	Yes
<b>Number of VLANs maximum</b>	255	255
<b>VLAN identification number</b>	1 ... 4094	1 ... 4094
<b>Protocol is supported GVRP</b>	Yes	Yes



Article number	6GK6024-8GS1-.....	6GK6024-8GS2-.....
Product type designation	RUGGEDCOM RSG2488	RUGGEDCOM RSG2488NC
<b>Product functions DHCP</b>		
<b>Product function</b>		
• DHCP client	Yes	Yes
• DHCP Option 82	Yes	Yes
• DHCP Option 66	No	No
• DHCP Option 67	No	No
<b>Product functions redundancy</b>		
<b>Product function</b>		
• ring redundancy	Yes	Yes
<b>Protocol is supported Media Redundancy Protocol (MRP)</b>	Yes	Yes
<b>Product function</b>		
• media redundancy protocol (MRP) with redundancy manager	Yes	Yes
• redundancy procedure STP	Yes	Yes
• redundancy procedure RSTP	Yes	Yes
• redundancy procedure MSTP	Yes	Yes
• eRSTP	Yes	Yes
<b>Protocol is supported</b>		
• STP	Yes	Yes
• RSTP	Yes	Yes
• MSTP	Yes	Yes
<b>Product functions security</b>		
<b>Product function</b>		
• IEEE 802.1x (radius)	Yes	Yes
<b>Protocol is supported</b>		
• TACACS+	Yes	Yes
• SSL	Yes	Yes
<b>Key length</b>		
• with SSL	56 bit	128 bit
• with RSA	1024 bit	1024 bit
<b>Product function port-rate-limiting</b>	Yes	Yes
<b>Product functions time</b>		
<b>Product function</b>		
• SNTP client	Yes	Yes
• SNTP server	Yes	Yes
<b>Protocol is supported</b>		
• SNTP	Yes	Yes
<b>Standards, specifications, approvals</b>		
<b>Standard</b>		
• for interference immunity	IEC 61000-6-2, IEEE 1613 Class 2, IEC 61850-3, IEC 61800-3	IEC 61000-6-2, IEEE 1613 Class 2, IEC 61850-3, IEC 61800-3
<b>Reference code</b>		
• according to IEC 81346-2	KF	KF
• according to IEC 81346-2:2019	KFE	KFE
<b>Standards, specifications, approvals CE</b>		
<b>Certificate of suitability CE marking</b>	Yes	Yes
<b>Standards, specifications, approvals other</b>		
<b>Certificate of suitability</b>		
• IEC 61850-3	Yes	Yes
• according to FIPS 140-2	No	No
• according to Common Criteria (CC)	No	No
<b>Standards, specifications, approvals product conformity</b>		
<b>Product conformity</b>		
• according to IEEE 1588 v2-Precision Time Protocol	Yes	Yes
<b>accessories</b>		
<b>accessories</b>	Mounting kits, port modules, power supplies, cables, connectors additional available	Mounting kits, port modules, power supplies, cables, connectors additional available

## Network Components

### RUGGEDCOM – Layer 2 Switches

#### RUGGEDCOM RSG2488

#### Selection and ordering data

Version	Article No.
<p><b>RUGGEDCOM RSG2488</b></p> <p>The RUGGEDCOM RSG2488 is a rugged fully-managed Ethernet switch; up to 28 non-blocking ports; configured as follows: 10/100/1000TX copper ports, 100FX or 1000SX fiber-optic ports; support of six 4-port modules plus two 2-port modules; combination of Gigabit copper and fiber-optic ports with up to 28 Gigabit Ethernet ports; operating temperatures from -40 °C to +85 °C (operation without fan)</p> <ul style="list-style-type: none"> <li>• <b>RUGGEDCOM RSG2488NC</b> (not subject to export controls)</li> <li>• <b>RUGGEDCOM RSG2488</b> (subject to export controls)</li> </ul>	<p><b>6GK6024-8GS1-....</b></p> <p><b>6GK6024-8GS2-....</b></p>

#### More information

The RUGGEDCOM Selector assists you in selecting the right RUGGEDCOM products and in configuring variants and is available at:

<http://www.siemens.com/ruggedcom-selector>

### Overview



The RUGGEDCOM RX1400 is a rugged Industrial Ethernet switch and TCP/IP router with LTE and fiber-optic WAN options in compact size for reliable, cost-effective implementation of comprehensive communication applications and a high processing output in harsh industrial environments.

### Characteristics

- 4x Fast Ethernet copper ports and 2x Gigabit SFP (small form factor pluggable) slots
- Support of multimode and single-mode SFPs for distances of 500 m up to 100 km
- Equipped with GPS input
- Available with or without LTE modem for Europe, North America, the Asia-Pacific region and Japan. Fully integrated power supply, +/-12-24 V DC
- Operation without fans for operating temperatures from -40 °C to +85 °C
- RUGGEDCOM VPE1400: Virtualization enables a complete Linux image (with dedicated memory media and I/O ports) that can run in parallel with the RUGGEDCOM ROX II operating system.

### Technical specifications

Article number	<b>6GK6014-0AM2-....</b>
Product type designation	RUGGEDCOM RX1400
<b>Transmission rate</b>	
<b>On Industrial Ethernet</b>	Autosensing with 10/100 Mbps
<b>Through WAN connection</b>	Up to 100 Mbps
<b>Through fiber-optic connection</b>	1 Gbps
<b>WAN connection</b>	
<b>EDGE/GPRS/GSM</b>	850/900/1800/1900 MHz
<b>UMTS/HSDPA+</b>	850/900/1900/2100 MHz
<b>LTE</b>	B1, B2, B3, B4, B7, B8, B13, B17, B19, B20, B21, B25
<b>Number of supported SIM cards</b>	2
<b>Interfaces</b>	
<b>Communication interfaces</b>	LAN: 4 x RJ45 10/100, 2 x SFP slot 1000 LX SFP / Serial: 2 x DB9 connector/ Console: 1 x DB9 connector
<b>WAN (Wide Area Network) interfaces</b>	2 x SMA-type
<b>GPS interface</b>	1 x SMA-type
<b>Permissible ambient conditions</b>	
<b>Operating temperature</b>	-40 °C to +85 °C
<b>Degree of protection</b>	IP40
<b>Design, dimensions and weight</b>	
<b>Dimensions (W x H x D) in mm</b>	88 x 120 x 150
<b>Weight</b>	2.5 kg
<b>Mounting</b>	DIN rail, control panel, rack
<b>Power consumption</b>	< 15 W
<b>Reliability</b>	
<b>MTBF (calculated in accordance with MIL-HDBK-217)</b>	52 years (at 55 °C)

## Network Components

### RUGGEDCOM – Layer 3 Switches / Routers

#### RUGGEDCOM RX1400

##### Selection and ordering data

Version	Article No.
<b>RUGGEDCOM RX1400</b> The RUGGEDCOM RX1400 is a rugged Industrial Ethernet switch and TCP/IP router in compact size with 4 Gigabit Ethernet copper ports, 2 serial ports (DB9) and 2 SFP slots. Optionally equipped with LTE modem, SFPs and GPS/GLONASS support.	<b>6GK6014-0AM2-....</b>
<b>RUGGEDCOM VPE1400 License</b> License for activating the RUGGEDCOM VPE1400 virtual environment on the RX1400	<b>6GK6014-0AL50-0AA0</b>
<b>RUGGEDCOM RX1400 Layer 3 Security License</b> License for activating the Layer 3 security functions on the RX1400	<b>6GK6014-0AL53-0AA0</b>

##### More information

The RUGGEDCOM Selector assists you in selecting the right RUGGEDCOM products and in configuring variants and is available at:

<http://www.siemens.com/ruggedcom-selector>

#### Overview



RUGGEDCOM RX1500/RX1524



RUGGEDCOM RX1501/RX1536



RUGGEDCOM RX1510

The RUGGEDCOM RX1500 series is a multi-service platform for the power supply sector, available in different sizes for 19-inch rack mounting and DIN/panel mounting. The RUGGEDCOM RX1500 series has a modular, field-replaceable platform that allows customers to choose between various WAN options, serial options and Ethernet options and is thus extremely well-suited for rail and traffic control systems.

#### Characteristics

- General device characteristics
  - Field-replaceable line modules
- RUGGEDCOM RX1500/RX1524:
  - Up to 24x 100FX ports
  - Up to 24x 10/100TX ports
  - Up to 12x 10FL/100SX ports
  - Up to 8 Gigabit Ethernet ports
  - Up to 24 serial ports
- RUGGEDCOM RX1501/RX1536:
  - Up to 36 ports 100FX
  - Up to 36 ports 10/100TX
  - Up to 18 ports 10FL / 100SX
  - Up to 4 ports Gigabit Ethernet
  - Up to 36 Serial Ports
- RUGGEDCOM RX1510:
  - Up to 24x 100FX ports
  - Up to 24x 10/100TX ports
  - Up to 12x 10FL/100SX ports
  - Up to 8 Gigabit Ethernet ports
  - Up to 24 serial ports

- WAN port options
  - T1/E1 (channelized)
  - E1 75 ohms via BNC
  - Mobile wireless
  - DDS
- Power supply
  - RUGGEDCOM RX1500, RX1510:
    - Modular power supply that is replaceable during operation
    - Input voltage range 24 V DC, 48 V DC, 88-300 V DC and 85-264 V AC for worldwide operation
    - Fully integrated power supply (no external adapters)
    - Safety approval according to CSA/UL 60950 up to +85 °C
- Cyber security
  - Integrated router, firewall and VPN functionality
  - Stateful firewall with NAT
  - Complete IPsec Virtual Private Networking
  - VPN with support for 3DES, AES128, AES256
  - RUGGEDCOM CROSSBOW for cyber security conformity in accordance with NERC CIP
  - Central RADIUS password management
  - Multilevel passwords
  - SSH/SSL encryption
  - Enable/disable ports, MAC-based port security
  - VLAN (802.1Q) for separation and protection of network traffic
  - SNMPv3-encrypted authentication and access protection
  - Optional checkpoint firewall and IPS (see RUGGEDCOM APE module)
- WAN protocols
  - Frame relay RFC 1490 or RFC 1294
  - PPP RFC 1661, 1332, 1321, 1334, PAP, CHAP authentication
  - GOOSE message support
- IP
  - Routing: OSPF, BGP, RIPv1 and RIPv2
  - VRRP
  - Traffic control, NTP server
  - IP multicast routing
  - DHCP agent (option 82 possible)
  - MPLS
- Reliability in harsh environments
  - EMC and immunity from electrical interference in the high voltage range
  - Meets requirements of IEEE 1613 (electric power stations for power supply and distribution)
  - Exceeds requirements of IEEE 61850-3 (electric power stations for power supply and distribution)
  - Exceeds requirements of IEC 61800-3 (drive systems with variable speed)
  - Exceeds requirements of IEC 61000-6-2 (general industrial environment)
  - Exceeds requirements of NEMA TS-2 (traffic control systems)
  - Operating temperature -40°C to +85°C (operation without fan)
  - Fail-safe output relay: For signaling of critical failures or errors
  - Zinc-plated steel housing (18 AWG) and adapter for 19-inch rack mounting

#### Product versions

##### RUGGEDCOM RX1500/RX1524

- Modular, 19-inch rack-mounted Layer 2 and Layer 3 switch and router with optional redundant power supply

##### RUGGEDCOM RX1501/RX1536

- Modular, 19-inch rack-mounted Layer 2 and Layer 3 switch and router with single power supply

##### RUGGEDCOM RX1510

- Modular Layer 2 and Layer 3 switch and router in compact size

## Network Components

### RUGGEDCOM – Layer 3 Switches / Routers

#### RUGGEDCOM RX1500 / RX1501 / RX1510 / RX1524 / RX1536

#### Technical specifications

Article number	6GK6015-0AM2-....	6GK6015-0BM2-....	6GK6015-1AM2-....	6GK6015-0CM2-....	6GK6015-0DM2-....
Product type designation	RUGGEDCOM RX1500	RUGGEDCOM RX1501	RUGGEDCOM RX1510	RUGGEDCOM RX1524	RUGGEDCOM RX1536
<b>Transfer rate</b>					
<b>Transfer rate</b>	10/100/1000 Mbit/s	10/100/1000 Mbit/s	10/100/1000 Mbit/s	10/100/1000 Mbit/s	10/100/1000 Mbit/s
<b>Interfaces other</b>					
<b>Number of electrical connections</b>	24	36	24	24	36
• for serial interfaces according to RS 232/RS 422/RS 485 maximum					
• for operator console	1	1	1	1	1
• for management purposes	1	1	1	1	1
• for signaling contact				1	1
• for power supply				1	1
<b>Type of electrical connection</b>	RS232	RS232	RS232	RS232	RS232
• for operator console	RJ45	RJ45	RJ45	RJ45	RJ45
• for management purposes	--	--	--	3-pole terminal block, screwable	3-pole terminal block, screwable
• for signaling contact	--	--	--	5-pole terminal block, screwable	5-pole terminal block, screwable
• for power supply	--	--	--	--	--
<b>Signal inputs/outputs</b>					
<b>Relay design</b>					
<b>Type of relay output</b>	changeover contact (CO)	changeover contact (CO)	changeover contact (CO)	changeover contact (CO)	changeover contact (CO)
<b>Number of relay outputs as CO contact</b>				1	1
<b>Supply voltage, current consumption, power loss</b>					
<b>Product options wide range power supply</b>				Yes	Yes
<b>Product component power supply for PoE</b>				No	No
<b>Product feature</b>				Yes	Yes
• modular power supply				Yes	No
• hot-swappable power supply					
<b>Type of voltage 1 of the supply voltage</b>				DC	DC
• supply voltage 1 rated value				12 V	12 V
• supply voltage 1 rated value				9 ... 15 V	9 ... 15 V
<b>Type of voltage 2 of the supply voltage</b>				DC	DC
• supply voltage 2 rated value				24 V	24 V
• supply voltage 2 rated value				15 ... 36 V	15 ... 36 V
<b>Type of voltage 3 of the supply voltage</b>				DC	DC
• supply voltage 3 rated value				48 V	48 V
• supply voltage 3 rated value				36 ... 42 V	36 ... 42 V
<b>Type of voltage 4 of the supply voltage</b>				DC	DC
• supply voltage 4 rated value				88 ... 300 V	88 ... 300 V
<b>Ambient conditions</b>					
<b>Operating condition fanless operation</b>	Yes	Yes	Yes	Yes	Yes
<b>Protection class IP</b>	IP3X	IP3X	IP40	IP30	IP30
<b>Ambient temperature</b>					
• during operation	--	--		-40 ... +85 °C	-40 ... +85 °C
• note	--	--		A maximum operating temperature of +85 °C is permissible for a duration of 16 hours	A maximum operating temperature of +85 °C is permissible for a duration of 16 hours
<b>Design, dimensions and weights</b>					
<b>Design</b>	19" rack	19" rack	compact	19" rack	19" rack
<b>Number of modular height units relating to 19-inch cabinet</b>	1	1		1	1
<b>Number of slots</b>	4	6	4	4	6
<b>Width</b>	440.944 mm	440.944 mm	237.7 mm	440.944 mm	440.944 mm
<b>Height</b>	44.2 mm	44.2 mm	122.7 mm	44.2 mm	44.2 mm
<b>Depth</b>	302.26 mm	302.26 mm	194.6 mm	302.26 mm	302.26 mm
<b>Net weight</b>	5.13 kg; Weight is depending on the built in modules	5.13 kg; Weight is depending on the built in modules	Weight is depending on the built in modules	5.13 kg; Weight is depending on the built in modules	5.13 kg; Weight is depending on the built in modules
<b>Product feature conformal coating</b>	optional	optional	optional	optional	optional
<b>Material of the enclosure</b>	Aluminum	Aluminum	Aluminum	Aluminum	Aluminum



## Network Components

### RUGGEDCOM – Layer 3 Switches / Routers

#### RUGGEDCOM RX1500 / RX1501 / RX1510 / RX1524 / RX1536

Article number	6GK6015-0AM2-....	6GK6015-0BM2-....	6GK6015-1AM2-....	6GK6015-0CM2-....	6GK6015-0DM2-....
Product type designation	RUGGEDCOM RX1500	RUGGEDCOM RX1501	RUGGEDCOM RX1510	RUGGEDCOM RX1524	RUGGEDCOM RX1536
<ul style="list-style-type: none"> <li>• RFC1112-IGMPv1</li> <li>• RFC1294-Frame Relay</li> <li>• RFC1321-PPP (MD5)</li> <li>• RFC1332-PPP (IPCP)</li> <li>• RFC1334-PPP Authentication</li> <li>• RFC1490-Frame Relay</li> <li>• RFC1519-CIDR</li> <li>• RFC1541-DHCP (client)</li> <li>• RFC1661-PPP</li> <li>• RFC2030-SNTP</li> <li>• RFC2068-HTTP</li> <li>• RFC2236-IGMPv2</li> <li>• RFC2284-EAP</li> <li>• RFC2338-VRRP</li> <li>• RFC2475-Differentiated Service</li> <li>• RFC2865-RADIUS</li> <li>• RFC3414-SNMPv3-USM</li> <li>• RFC3415-SNMPv3-VACM</li> </ul>	Yes Yes	Yes Yes	Yes Yes	Yes No Yes	Yes Yes

#### Selection and ordering data

Version	Article No.
<p><b>RUGGEDCOM RX1500</b></p> <p>The RUGGEDCOM RX1500 series comprises Layer 2 and Layer 3 switches and routers. 2x power supplies (replaceable during operation); locally replaceable line modules; up to 24x 100FX ports; up to 24x 10/100TX ports; up to 8x Gigabit Ethernet ports; up to 12x 10FL/100SX ports - SC, ST, LC and MTRJ; pluggable fiber-optic connection (SFP); up to 4x T1/E1 ports; mobile wireless (EVDO / HSPA); DDS (56K masters/slaves, 64K slaves); up to 24x RS232/422/485 ports</p>	6GK6015-0AM2-....
<p><b>RUGGEDCOM RX1501</b></p> <p>The RUGGEDCOM RX1501 series is a utility grade Layer 2 and Layer 3 switch and router. 1x power supply Field replaceable line modules Up to 36-ports 100FX; up to 36-ports 10/100TX; up to 4-ports Gigabit Ethernet up to 18 ports 10FL/100SX SC, ST, LC and MTRJ; pluggable Optics (SFP); up to 4 T1/E1 ports cellular (EVDO / HSPA), DDS (56K master/slave, 64K slave); up to 24 RS232/422/485</p>	6GK6015-0BM2-....
<p><b>RUGGEDCOM RX1510</b></p> <p>The RUGGEDCOM RX1510 series comprises Layer 2 and Layer 3 switches and routers in compact size. 2x power supplies - redundant, load-dividing power supplies; locally replaceable line modules; up to 24x 100FX ports; up to 24x 10/100TX ports; up to 8x Gigabit Ethernet ports; up to 12x 10FL/100SX ports - SC, ST, LC and MTRJ; pluggable fiber-optic connection (SFP); up to 4x T1/E1 ports; mobile wireless (EVDO / HSPA); DDS (56K masters/slaves, 64K slaves); up to 24x RS232/422/485 ports</p>	6GK6015-1AM2-....
<p><b>RUGGEDCOM RX1524</b></p> <p>The RUGGEDCOM RX1524 is a rugged, modular layer 2 switch + layer 3 router that supports up to 2 load sharing, hot swappable power supplies. Field replaceable line module options include: Up to 24-ports 100FX; Up to 24-ports 10/100TX; Up to 8-ports Gigabit Ethernet; Up to 12 ports 10FL/100SX; ST, LC and M12 connector types on various modules; Up to 4 cellular ports (3G / LTE); Up to 24 RS232/422/485 serial interface ports; Up to 2 APE1808 application hosting modules.</p>	6GK6015-0CM2-....
<p><b>RUGGEDCOM RX1536</b></p> <p>The RUGGEDCOM RX1536 is a rugged, modular layer 2 switch + layer 3 router that supports 1 replaceable power supply. Field replaceable line module options include: Up to 36-ports 100FX; Up to 36-ports 10/100TX; Up to 8-ports Gigabit Ethernet; Up to 18 ports 10FL/100SX; ST, LC and M12 connector types on various modules; Up to 6 cellular ports (3G / LTE); Up to 36 RS232/422/485 serial interface ports; Up to 2 APE1808 application hosting modules.</p>	6GK6015-0DM2-....

#### More information

The RUGGEDCOM Selector assists you in selecting the right RUGGEDCOM products and in configuring variants and is available at:

<http://www.siemens.com/ruggedcom-selector>



### Overview



The RUGGEDCOM RX5000 is an Ethernet routing and switching platform with high connection density for use in harsh environments. These integrated switches and routers can withstand strong electromagnetic interference and radio frequency interference as well as a wide temperature range from -40 °C to +85 °C. The platform was developed for demanding climatic and environmental conditions, such as in power generation and distribution grids as well as in the industrial and military sectors.

### Characteristics

- RUGGEDCOM RX5000:
  - Up to two 10 Gigabit uplinks
  - Up to 26 Gigabit ports
  - Up to 96x 10/100TX copper ports
  - Up to 48x 100 FX optical ports
  - Long-distance fiber-optic connections enable distances up to 90 km
- Power supply
  - Modular, redundant power supplies
  - Universal high voltage ranges: 88-300 V DC or 85-264 V AC
- Reliability in harsh environments
  - EMC and immunity from electrical interference in the high voltage range
  - Exceeds requirements of NEMA TS-2 (traffic control systems)
- Operating temperature -40°C to +85°C (operation without fan)
- Printed-circuit boards with protective coating (optional)

### Selection and ordering data

Version	Article No.
<b>RUGGEDCOM RX5000</b> The RUGGEDCOM RX5000 is a routing and switching platform with high port density. Up to 96x 10/100TX copper ports + 2x 10/100/1000T copper ports; up to 48x 100FX fiber-optic ports; up to 2x Gigabit Ethernet ports; long-distance fiber-optic connections enable distances up to 90 km	<b>6GK6050-0AM2-.....</b>

### More information

The RUGGEDCOM Selector assists you in selecting the right RUGGEDCOM switches and in configuring variants and is available at:  
<http://www.siemens.com/ruggedcom-selector>

## Network Components

### RUGGEDCOM – Wireless

#### RUGGEDCOM WIN7200

##### Overview



The RUGGEDCOM WIN7200 is a light-weight IEEE 802.16e-compliant wireless broadband base station that has been developed for use in unlicensed and "lightly" licensed or completely licensed frequency bands in harsh environments. The RUGGEDCOM WIN7200 is a light-weight base station with a sector antenna that can be easily mounted on masts, street lamps or walls. It supports subscribers in a stationary or mobile environment. The RUGGEDCOM Win7200, which is singly powered and connected via a single Power over Ethernet (PoE) connection, reduces operating costs and complexity. The RUGGEDCOM WIN7200 system is powered by OFDMA radio technology, which has proven to be robust in adverse channel conditions and enables non-line-of-sight (NLOS) operation. Algorithms for link adjustment, modulation and coding are continuously adapted to the prevailing link conditions for an optimal balance between robustness and efficiency.

##### Characteristics

- Mobile WiMAX-compliant in accordance with IEEE 802.16e and WiMAX Forum Wave 2 (MIMO) certification
- Support of worldwide WiMAX usage in the 2.X-GHz, 3.X-GHz, 4.9-GHz and 5.8-GHz bands
- Adaptive modulation: For optimization of throughput and improvement of performance
- Ecosystem compatibility with all RUGGEDCOM WIN products or 802.16e-compliant WiMAX network equipment
- Large range: Transmission and reception diversity in combination with high output power for improved range and NLOS performance
- High bandwidth: RUGGEDCOM WIN has two integrated wireless units that operate simultaneously on the same frequency (MIMO) for improving the bandwidth (up to 40 Mbps) and spectral efficiency.
- Efficient frequency use: Use of OFDMA technology and integrated GPS so that users can use a complete network on a single frequency channel.
- Usage models: Developed for support of long-distance connections to stationary, portable and mobile end points with simultaneous support of seamless mobility of vehicles and backhaul mode
- Quality of service (QoS): With RUGGEDCOM WIN, users can separate data traffic types by air as well as guarantee latency, minimal bandwidth and jitter according to application requirements.
- Rugged design: RUGGEDCOM WIN features a rugged design and can be used flexibly outdoors. The RUGGEDCOM products have been developed for use in harsh environments, such as are found in power stations, oil refineries, the military sector, roadside traffic control cabinets and metal and mineral processing plants.
- Standalone architecture: Commercial wireless broadband equipment requires the existence of a complete network infrastructure. This includes a special mobile router called an ASN gateway that acts as a central point for all network traffic. This infrastructure can be very costly and complicated to implement. Siemens has developed a mode that requires this comprehensive infrastructure but at the same time retains the interoperability and technological advantages of wireless broadband.
- Secure: RUGGEDCOM WIN is equipped with many integrated functions for assuring compliance with NERC CIP, such as mutual authentication, AES encryption and protection of integrity of messages using CMAC

**Selection and ordering data**

Version	Article No.
<b>RUGGEDCOM WIN7225-5</b> The RUGGEDCOM WIN7225-5 base station in compact size for outside use includes a power supply, 2x antenna cables 1.6 m, GPS receiver, GPS antenna and mounting set - antenna and data cables must be ordered separately, from 2483 MHz to 2690 MHz	<b>RUM:WIN7225-5</b>
<b>RUGGEDCOM WIN7233-5</b> The RUGGEDCOM WIN7233-5 base station in compact size for outside use includes a power supply, 2x antenna cables 1.6 m, GPS receiver, GPS antenna and mounting set - antenna and data cables must be ordered separately, from 3300 MHz to 3400 MHz	<b>RUM:WIN7233-5</b>
<b>RUGGEDCOM WIN7235-5</b> The RUGGEDCOM WIN7235-5 base station in compact size for outside use includes a power supply, 2x antenna cables 1.6 m, GPS receiver, GPS antenna and mounting set - antenna and data cables must be ordered separately, from 3400 MHz to 3600 MHz	<b>RUM:WIN7235-5</b>
<b>RUGGEDCOM WIN7237-5</b> The RUGGEDCOM WIN7237-5 base station in compact size for outside use includes a power supply, 2x antenna cables 1.6 m, GPS receiver, GPS antenna and mounting set - antenna and data cables must be ordered separately, from 3600 MHz to 3720 MHz	<b>RUM:WIN7237-5</b>
<b>RUGGEDCOM WIN7249-5</b> The RUGGEDCOM WIN7249-5 base station in compact size for outside use includes a power supply, 2x antenna cables 1.6 m, GPS receiver, GPS antenna and mounting set - antenna and data cables must be ordered separately, from 4900 MHz to 5000 MHz	<b>RUM:WIN7249-5</b>
<b>RUGGEDCOM WIN7251</b> The RUGGEDCOM WIN7251 base station in compact size for outside use includes a power supply, 2x antenna cables 1.6 m, GPS receiver, GPS antenna and mounting set - antenna and data cables must be ordered separately, from 5000 MHz to 5150 MHz	<b>RUM:WIN7251</b>
<b>RUGGEDCOM WIN7258-5</b> The RUGGEDCOM WIN7258-5 base station in compact size for outside use includes a power supply, 2x antenna cables 1.6 m, GPS receiver, GPS antenna and mounting set - antenna and data cables must be ordered separately, from 5725 MHz to 5850 MHz	<b>RUM:WIN7258-5</b>

**More information**

The RUGGEDCOM Selector assists you in selecting the right RUGGEDCOM products and in configuring variants and is available at:

<http://www.siemens.com/ruggedcom-selector>

## Network Components

### RUGGEDCOM – Wireless

#### RUGGEDCOM WIN5100

##### Overview



The RUGGEDCOM WIN5100 is an IEEE 802.16e-compliant wireless broadband subscriber unit that is equipped with external radio frequency connections for stationary or mobile applications in harsh environments. The self-learning subscriber device automatically detects the base station using the best available signal and enables plug-and-play installation and maintenance-free operation. The RUGGEDCOM WIN5100 has external antenna ports and is available with optional 10-30 V DC power input.

##### Characteristics

- Mobile WiMAX-compliant in accordance with IEEE 802.16e and WiMAX Forum Wave 2 profiles
- 2 N-type antenna ports for connection of roof antennas
- Excellent performance in NLOS conditions – insensitive to multipath and deep fade, providing for an extended range and easy installation
- Automatic Transmit Power Control (ATPC) for optimal power system utilization, tight frequency reuse and interference prevention
- Numerous applications and services – guaranteed voice, video and data services based on enhanced quality of service (QoS)
- Rugged hardware supports an operating temperature range from -40 °C to +75 °C
- Developed for mast installation or installation in the vehicle or control cabinet

##### Selection and ordering data

Version	Article No.
<b>RUGGEDCOM WIN5114-5-AC</b> RUGGEDCOM WIN5114-5-AC vehicle subscriber unit with external antenna ports, radio frequency cable - 5 m, power cable - 5 m (use of power supply in the vehicle as well as external power supply), mounting set, from 1350 MHz to 1525 MHz, with commercially available AC power injector, power/data cables must be ordered separately	<b>RUM:WIN5114-5-AC</b>
<b>RUGGEDCOM WIN5114-5-DC</b> RUGGEDCOM WIN5114-5-DC vehicle subscriber unit with external antenna ports, radio frequency cable - 5 m, power cable - 5 m (use of power supply in the vehicle as well as external power supply), mounting set, from 1350 MHz to 1525 MHz, direct 10-30 V DC power input with separate Ethernet connection, equipped with DC power cable, data cables must be ordered separately	<b>RUM:WIN5114-5-DC</b>
<b>RUGGEDCOM WIN5118-5-AC</b> RUGGEDCOM WIN5118-5-AC vehicle subscriber unit with external antenna ports, radio frequency cable - 5 m, power cable - 5 m (use of power supply in the vehicle as well as external power supply), mounting set, from 1800 MHz to 1830 MHz, with commercially available AC power injector, power/data cables must be ordered separately	<b>RUM:WIN5118-5-AC</b>
<b>RUGGEDCOM WIN5118-5-DC</b> RUGGEDCOM WIN5118-5-DC vehicle subscriber unit with external antenna ports, radio frequency cable - 5 m, power cable - 5 m (use of power supply in the vehicle as well as external power supply), mounting set, from 1800 MHz to 1830 MHz, direct 10-30 V DC power input with separate Ethernet connection, equipped with DC power cable, data cables must be ordered separately	<b>RUM:WIN5118-5-DC</b>
<b>RUGGEDCOM WIN5123-5-AC</b> RUGGEDCOM WIN5123-5-AC vehicle subscriber unit with external antenna ports, radio frequency cable - 5 m, power cable - 5 m (use of power supply in the vehicle as well as external power supply), mounting set, from 2300 MHz to 2400 MHz, with commercially available AC power injector, power/data cables must be ordered separately	<b>RUM:WIN5123-5-AC</b>
<b>RUGGEDCOM WIN5123-5-DC</b> RUGGEDCOM WIN5123-5-DC vehicle subscriber unit with external antenna ports, radio frequency cable - 5 m, power cable - 5 m (use of power supply in the vehicle as well as external power supply), mounting set, from 2300 MHz to 2400 MHz, direct 10-30 V DC power input with separate Ethernet connection, equipped with DC power cable, data cables must be ordered separately	<b>RUM:WIN5123-5-DC</b>
<b>RUGGEDCOM WIN5125-5-AC</b> RUGGEDCOM WIN5125-5-AC vehicle subscriber unit with external antenna ports, radio frequency cable - 5 m, power cable - 5 m (use of power supply in the vehicle as well as external power supply), mounting set, from 2496 MHz to 2690 MHz, with commercially available AC power injector, power/data cables must be ordered separately	<b>RUM:WIN5125-5-AC</b>

Version	Article No.
<b>RUGGEDCOM WIN5125-5-DC</b> RUGGEDCOM WIN5125-5-DC vehicle subscriber unit with external antenna ports, radio frequency cable - 5 m, power cable - 5 m (use of power supply in the vehicle as well as external power supply), mounting set, from 2496 MHz to 2690 MHz, direct 10-30 V DC power input with separate Ethernet connection, equipped with DC power cable, data cables must be ordered separately	<b>RUM:WIN5125-5-DC</b>
<b>RUGGEDCOM WIN5135-5-AC</b> RUGGEDCOM WIN5135-5-AC vehicle subscriber unit with external antenna ports, radio frequency cable - 5 m, power cable - 5 m (use of power supply in the vehicle as well as external power supply), mounting set, from 3300 MHz to 3600 MHz, with commercially available AC power injector, power/data cables must be ordered separately	<b>RUM:WIN5135-5-AC</b>
<b>RUGGEDCOM WIN5135-5-DC</b> RUGGEDCOM WIN5135-5-DC vehicle subscriber unit with external antenna ports, radio frequency cable - 5 m, power cable - 5 m (use of power supply in the vehicle as well as external power supply), mounting set, from 3300 MHz to 3600 MHz, direct 10-30 V DC power input with separate Ethernet connection, equipped with DC power cable, data cables must be ordered separately	<b>RUM:WIN5135-5-DC</b>
<b>RUGGEDCOM WIN5137-5-AC</b> RUGGEDCOM WIN5137-5-AC vehicle subscriber unit with external antenna ports, radio frequency cable - 5 m, power cable - 5 m (use of power supply in the vehicle as well as external power supply), mounting set, from 3600 MHz to 3800 MHz, with commercially available AC power injector, power/data cables must be ordered separately	<b>RUM:WIN5137-5-AC</b>
<b>RUGGEDCOM WIN5137-5-DC</b> RUGGEDCOM WIN5137-5-DC vehicle subscriber unit with external antenna ports, radio frequency cable - 5 m, power cable - 5 m (use of power supply in the vehicle as well as external power supply), mounting set, from 3600 MHz to 3800 MHz, direct 10-30 V DC power input with separate Ethernet connection, equipped with DC power cable, data cables must be ordered separately	<b>RUM:WIN5137-5-DC</b>
<b>RUGGEDCOM WIN5149-5-AC</b> RUGGEDCOM WIN5149-5-AC vehicle subscriber unit with external antenna ports, radio frequency cable - 5 m, power cable - 5 m (use of power supply in the vehicle as well as external power supply), mounting set, from 4900 MHz to 5000 MHz, with commercially available AC power injector, power/data cables must be ordered separately	<b>RUM:WIN5149-5-AC</b>
<b>RUGGEDCOM WIN5149-5-DC</b> RUGGEDCOM WIN5149-5-DC vehicle subscriber unit with external antenna ports, radio frequency cable - 5 m, power cable - 5 m (use of power supply in the vehicle as well as external power supply), mounting set, from 4900 MHz to 5000 MHz, direct 10-30 V DC power input with separate Ethernet connection, equipped with DC power cable, data cables must be ordered separately	<b>RUM:WIN5149-5-DC</b>
<b>RUGGEDCOM WIN5151-5-AC</b> RUGGEDCOM WIN5151-5-AC vehicle subscriber unit with external antenna ports, radio frequency cable - 5 m, power cable - 5 m (use of power supply in the vehicle as well as external power supply), mounting set, from 4900 MHz to 5200 MHz, with commercially available AC power injector, power/data cables must be ordered separately This product is intended for the air transportation market and AeroMACS frequency bands.	<b>RUM:WIN5151-5-AC</b>
<b>RUGGEDCOM WIN5151-5-DC</b> RUGGEDCOM WIN5151-5-DC vehicle subscriber unit with external antenna ports, radio frequency cable - 5 m, power cable - 5 m (use of power supply in the vehicle as well as external power supply), mounting set, from 4900 MHz to 5250 MHz, direct 10-30 V DC power input with separate Ethernet connection, equipped with DC power cable, data cables must be ordered separately This product is intended for the air transportation market and AeroMACS frequency bands.	<b>RUM:WIN5151-5-DC</b>
<b>RUGGEDCOM WIN5158-5-AC</b> RUGGEDCOM WIN5158-5-AC vehicle subscriber unit with external antenna ports, radio frequency cable - 5 m, power cable - 5 m (use of power supply in the vehicle as well as external power supply), mounting set, from 5725 MHz to 5850 MHz, with commercially available AC power injector, power/data cables must be ordered separately	<b>RUM:WIN5158-5-AC</b>
<b>RUGGEDCOM WIN5158-5-DC</b> RUGGEDCOM WIN5158-5-DC vehicle subscriber unit with external antenna ports, radio frequency cable - 5 m, power cable - 5 m (use of power supply in the vehicle as well as external power supply), mounting set, from 5725 MHz to 5850 MHz, direct 10-30 V DC power input with separate Ethernet connection, equipped with DC power cable, data cables must be ordered separately	<b>RUM:WIN5158-5-DC</b>

### More information

The RUGGEDCOM Selector assists you in selecting the right RUGGEDCOM products and in configuring variants and is available at:  
<http://www.siemens.com/ruggedcom-selector>

## Network Components

### RUGGEDCOM – Wireless

#### RUGGEDCOM WIN5200

##### Overview



The RUGGEDCOM WIN5200 is an IEEE 802.16e-compliant wireless broadband subscriber unit that is equipped with an integrated dual-slant directional antenna for harsh environments. The RUGGEDCOM WIN5200 is much simpler to install thanks to LEDs for signal strength alignment, automatic connection to the strongest available base station and automatic service delivery based on authentication data. Specially developed for point-to-multipoint broadband applications with wireless access, the RUGGEDCOM WIN5200 enables efficient use of the wireless frequency spectrum and supports many different applications.

##### Characteristics

- Mobile WiMAX-compliant in accordance with IEEE 802.16e and WiMAX Forum Wave 2 profiles
- Integrated antenna with high strength
- Excellent performance in NLOS conditions – insensitive to multipath and deep fade, providing for an extended range and easy installation
- Automatic Transmit Power Control (ATPC) for optimal power system utilization, tight frequency reuse and interference prevention
- Numerous applications and services – guaranteed voice, video and data services based on enhanced quality of service (QoS)
- Low operating costs due to easy installation and needs-based expansion so that owners can quickly enter new market segments with minimum investment
- Rugged hardware supports an operating temperature range from -40 °C to +75 °C
- Mean time between failures (MTBF) of over 1 million hours
- A single Power over Ethernet (PoE) cable
- Broad frequency band supports worldwide use
- Subscriber unit for outside use

**Selection and ordering data**

Version	Article No.
<b>RUGGEDCOM WIN5218-1-WR-AC</b> RUGGEDCOM WIN5218-1-WR-AC vehicle subscriber unit with external antenna ports, radio frequency cable - 5 m, power cable - 5 m (use of power supply in the vehicle as well as external power supply), mounting set, from 1785 MHz to 1805 MHz, with commercially available AC power injector, power/data cables must be ordered separately. This article number can only be ordered for China	<b>RUM:WIN5218-1-WR-A</b>
<b>RUGGEDCOM WIN5218-1-WR-DC</b> RUGGEDCOM WIN5218-1-WR-DC vehicle subscriber unit with external antenna ports, radio frequency cable - 5 m, power cable - 5 m (use of power supply in the vehicle as well as external power supply), mounting set, from 1785 MHz to 1805 MHz, direct 10-30 V DC power input with separate Ethernet connection, equipped with DC power cable, data cables must be ordered separately. This article number can only be ordered for China	<b>RUM:WIN5218-1-WR-D</b>
<b>RUGGEDCOM WIN5218-1-WR-OD</b> RUGGEDCOM WIN5218-1-WR-OD subscriber unit for outside use with high strength and integrated dual-slant directional antenna, includes commercial-quality power supply, from 1785 MHz to 1805 MHz. This article number can only be ordered for China	<b>RUM:WIN5218-1-WR-O</b>
<b>RUGGEDCOM WIN5218-5</b> RUGGEDCOM WIN5218-5 subscriber unit for outside use with high strength and integrated dual-slant directional antenna, includes commercial-quality power supply, from 1800 MHz to 1830 MHz	<b>RUM:WIN5218-5</b>
<b>RUGGEDCOM WIN5223-5</b> RUGGEDCOM WIN5223-5 subscriber unit for outside use with high strength and integrated dual-slant directional antenna, includes commercial-quality power supply, from 2300 MHz to 2400 MHz	<b>RUM:WIN5223-5</b>
<b>RUGGEDCOM WIN5225-5</b> RUGGEDCOM WIN5225-5 subscriber unit for outside use with high strength and integrated dual-slant directional antenna, includes commercial-quality power supply, from 2496 MHz to 2690 MHz	<b>RUM:WIN5225-5</b>
<b>RUGGEDCOM WIN5235-5</b> RUGGEDCOM WIN5235-5 subscriber unit for outside use with high strength and integrated dual-slant directional antenna, includes commercial-quality power supply, from 3300 MHz to 3600 MHz	<b>RUM:WIN5235-5</b>
<b>RUGGEDCOM WIN5237-5</b> RUGGEDCOM WIN5237-5 subscriber unit for outside use with high strength and integrated dual-slant directional antenna, includes commercial-quality power supply, from 3600 MHz to 3800 MHz	<b>RUM:WIN5237-5</b>
<b>RUGGEDCOM WIN5249-5</b> RUGGEDCOM WIN5249-5 subscriber unit for outside use with high strength and integrated dual-slant directional antenna, includes commercial-quality power supply, from 4900 MHz to 5000 MHz	<b>RUM:WIN5249-5</b>
<b>RUGGEDCOM WIN5251</b> RUGGEDCOM WIN5251 subscriber unit for outside use with high strength and integrated dual-slant directional antenna, includes commercial-quality power supply, from 4900 MHz to 5200 MHz This product is intended for the air transportation market and AeroMACS frequency bands.	<b>RUM:WIN5251</b>
<b>RUGGEDCOM WIN5137-5-DC</b> RUGGEDCOM WIN5258-5 subscriber unit for outside use with high strength and integrated dual-slant directional antenna, includes commercial-quality power supply, from 5725 MHz to 5850 MHz	<b>RUM:WIN5137-5-DC</b>
<b>RUGGEDCOM WIN5258-5</b> RUGGEDCOM WIN5149-5-AC vehicle subscriber unit with external antenna ports, radio frequency cable - 5 m, power cable - 5 m (use of power supply in the vehicle as well as external power supply), mounting set, from 4900 MHz to 5000 MHz, with commercially available AC power injector, power/data cables must be ordered separately	<b>RUM:WIN5258-5</b>

**More information**

The RUGGEDCOM Selector assists you in selecting the right RUGGEDCOM products and in configuring variants and is available at:

<http://www.siemens.com/ruggedcom-selector>

## Network Components

### Notes



## Medium-Voltage Components



9/2

**Vacuum interrupters**

9/3

**3AH47 vacuum circuit breakers**

## Medium-Voltage Components

### Vacuum interrupters

#### Overview



Vacuum switching technology is the preferred technology for medium-voltage applications worldwide, and is therefore state-of-the-art.

Our experience in developing and manufacturing these challenging products dates back over 40 years. The major part relates to the special requirements for railway applications.

Over this period, more than 8 million Siemens interrupters have been installed worldwide.

Close cooperation with our customers enables us to continuously innovate the products and to maintain our quality requirements at the highest possible level.

For this reason, we manufacture the contact material in-house and subject the individual components as well as the complete interrupters to intensive tests before delivery.

We therefore offer:

- High reliability
- Maximum switching capacity
- Leading technology
- Excellent technical support

#### Selection and ordering data

Rated voltage kV	Rated frequency Hz	Rated short-circuit breaking current kA	Rated current A	Lightning impulse withstand voltage kV
up to 17.5	16.7/25/50/60	25/31.5/40/50	up to 2 500	95/125
25	50/60	up to 31.5	up to 2 500	145/170
27.5	50/60	up to 31.5	up to 2 500	170/200
36	50/60	up to 31.5	up to 2 500	200/250

- Mechanical operating cycles 30 000
- Temperature range: -40 °C to 120 °C
- Optionally available siliconized
- Dimensions and further details on request

The vacuum interrupters are fully developed products which can be supplied with customized connection dimensions.

For further information, please contact:

Email: [lino.garcia@siemens.com](mailto:lino.garcia@siemens.com), or

Tel.: +49 (174) 1408934

### Overview

The 3AH47 vacuum circuit breakers are based on the successful 3AH vacuum circuit breaker series which has been well proven in practice in over 500 000 installations.

The 3AH47 vacuum circuit breaker can control up to 60 000 operating cycles depending on the version. With minimum maintenance work, such as greasing of operating mechanisms after 10 000 operating cycles and replacing the interrupters after 30 000 operating cycles, the reliability of these circuit breakers is maintained throughout the entire service life.



### Selection and ordering data

Rated voltage kV	Rated frequency Hz	Rated short-circuit breaking current kA	Rated operational current (A)					
			1 250		2 000		2 500	
			Single-pole	Two-pole	Single-pole	Two-pole	Single-pole	Two-pole
17.5	16.7	25			3AH4754-4			
		31.5			3AH4755-4			
		40					3AH47 56/66-6	
		50					3AH4757-6	
25	25	25 <sup>1)</sup>	3AH4714-2	3AH4714-2 "D31"	3AH4714-4	3AH4714-4 "D31"	3AH4714-6	3AH4714-6 "D31"
27.5	50/60	25	3AH4784-2	3AH4784-2 "D31"	3AH4784-4	3AH4784-4 "D31"	3AH4784-6	
		31.5	3AH4785-2	3AH4785-2 "D31"	3AH4785-4		3AH4785-6	3AH4785-6 "D31"

<sup>1)</sup> Further values on request.

### More information

For detailed information see Product Catalog HG 11.52, "3AH47 Vacuum Circuit Breakers for Traction Applications".

## Medium-Voltage Components

### Notes

## Surge Arresters for Railway Applications



10/2	<b>Introduction</b>
10/4	<b>3EB4 surge arresters</b>
10/7	<b>3EB5 surge arresters</b>

# Surge Arresters for Railway Applications

## Introduction

### Overview

#### **Siemens surge arresters for railway applications – particularly reliable, stable and safe overvoltage protection**

Siemens has developed and manufactured medium and high-voltage surge arresters for standard and special applications since 1925. We have been producing surge arresters for railway systems for over 80 years. Continuous research and development, comprehensive know-how and worldwide experience give Siemens surge arresters a leading edge in overvoltage protection. Their uncompromising quality ensures a long service life and reliability in any application.

Siemens surge arresters are an indispensable aid to insulation coordination in electrical power supply systems.

Valuable equipment, such as traction units, is ideally protected against lightning and switching overvoltages.

Siemens surge arresters have been designed to meet the requirements of a wide range of common installation environments, from arctic cold to the heat of the desert and the dampness of tropical climates.

#### **Definition of surge arresters**

Surge arresters are used to protect electrical equipment, such as transformers, circuit breakers and bushings, against the effects of overvoltages caused by incoming surges. Such overvoltages can be caused by a direct or nearby lightning strike, electromagnetic discharges or switching operations in the power supply system as well as in devices. Some overvoltages are very high in energy. The current from the surge is diverted through the arrester, in most cases to ground. Effective overvoltage protection requires that different surge arrester types be used depending on the particular application.

#### **Always the best solution for traction systems**

Electrical power for traction systems is generally transmitted to traction substations of the (national) utility or the railway systems' own high-voltage network by high voltage transmission lines with rated voltages of 110 kV and above at frequencies of 16 2/3 Hz, 25 Hz, 50 Hz or 60 Hz. The voltage is then stepped down to the supply voltage of the traction system and converted into DC voltage where necessary. The high-voltage transmission lines, the traction substations, the catenary system and the traction units are exposed to lightning overvoltages that may result in huge damage to the insulation of the electrical equipment.

Siemens surge arresters for railway applications protect every part of a railway system, from railway substations through transmission lines, cable and catenary systems to rail vehicles for mass-transit, mainline and high-speed transportation up to 420 km/h. Siemens offers several surge arrester product families for AC and DC railway applications up to 45 kV:

- **3EB4** – silicone rubber surge arrester with composite hollow-core enclosure for use on traction units and for fixed installation in AC and DC systems.
- **3EB5** – silicone rubber surge arrester in a cage design for use on traction units and for fixed installation in AC and DC systems.

Siemens provides each of these types in several versions, making it possible to find the ideal surge arrester for any conceivable application and meet even specific demands, such as:

- high mechanical stability to withstand vibrations and high wind speeds,
- extremely reliable pressure relief behavior for use in areas requiring special protection,
- excellent pollution layer characteristics for use in coastal and desert regions or in areas with extreme air pollution.

All Siemens surge arresters feature a superior sealing system that reliably prevents moisture ingress to ensure the highest possible degree of overvoltage protection and decades of trouble-free service. Moreover, the choice of materials used in the production of Siemens surge arresters contributes to protection of the environment.

**The best choice for every application**

Whether it is high-speed, intercity trains between the major cities of the world, train shuttle services from train stations to airports that run every few minutes, or everyday mass transit, the requirements of rail transport vary from one extreme to the other.

Siemens supplies a complete portfolio of surge arresters that meets all the requirements for overvoltage protection of rail vehicles and rail electrification worldwide. Apart from the system voltage, the main criterion for the selection of the appropriate surge arrester is the type of application, which defines travel speed and resulting load.

The 3EB4 and 3EB5 surge arresters are highly suitable for every possible railway application, including:

- High-speed and intercity trains
- Mass transit and regional trains
- Urban public transport: Light rail vehicles, metros, trams, electric buses
- Locomotives
- Drive systems

And for every power supply system, such as:

- 12.5 kV, 25 Hz/60 Hz
- 15 kV, 16 2/3 Hz
- 25 kV, 50 Hz/60 Hz
- 750 V DC
- 1 500 V DC
- 3 000 V DC

**Standards and tests – reliability you really can depend on**

Siemens surge arresters have been designed and tested in compliance with the latest IEC 60099-4, IEEE C62.11 and GB 11032 standards. All type tests are performed by independent, PEHLA-certified laboratories; the test reports are available on request. Please contact your Siemens representative for details.

Moreover, every single surge arrester that leaves the Siemens factory undergoes a routine test and is delivered with a routine test certificate.

Siemens meets all requirements of ISO 9001:2008, ISO 14002:2004 and BS OHSAS 18001:2007. All Siemens suppliers have to be certified according to ISO standards or are audited by Siemens.

To maintain sustainable quality improvement, Siemens introduced corporate quality guidelines that contribute to each step of the quality process.

The 3EB4 and 3EB5 surge arresters comply with the following international standards:

- **IEC 60099-4**, Metal oxide surge arresters for AC systems
- **EN 50526-1**, Railway applications – Fixed installations – D.C. surge arresters and voltage limiting devices
- **EN 45545-2**, Railway applications – Fire protection on railway vehicles
- **IEC 61373**, Railway applications – Rolling stock equipment – Shock and vibration tests

## Surge Arresters for Railway Applications

### 3EB4 surge arresters

#### Overview

#### **3EB4 – silicone rubber surge arrester with composite hollow core design**

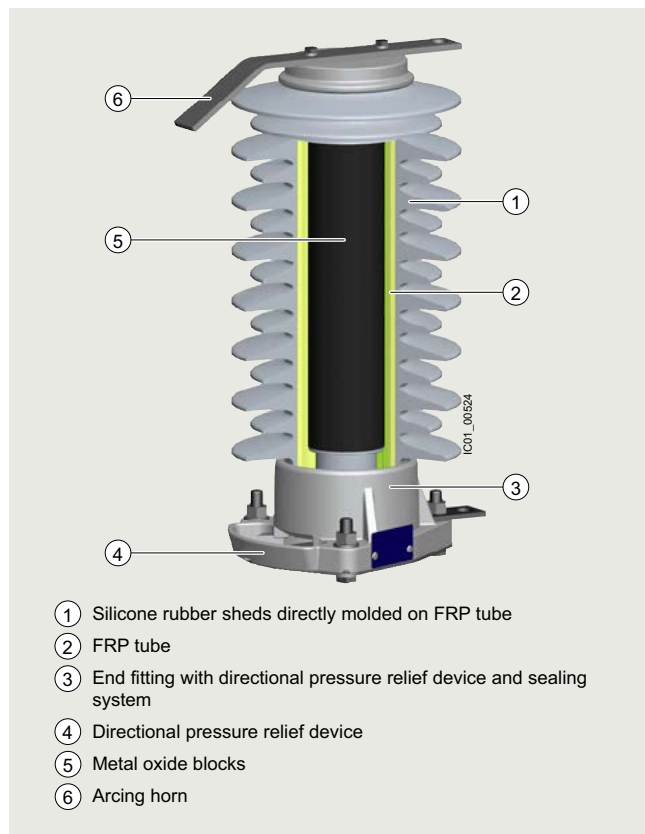

#### **Reliable and safe – 3EB4 railway surge arresters**

3EB4 type railway surge arresters have to withstand a great deal, including the influence of extreme weather conditions, temperatures from  $-40\text{ °C}$  to  $+70\text{ °C}$  and the effects of UV radiation and hydrophobicity. They have been designed for precisely this, and are effectively protected with suitable fault-tolerant technology and durable materials to ensure trouble-free operation under all conditions of use.

Within the composite housing, the arrester's enclosure materials consist of silicone and glass-fiber reinforced plastic (GFRP). The silicone, which is directly applied onto the GFRP tube in an injection molding process, ensures reliability and an excellent special seal at both ends of the surge arrester effectively prevents partial discharges and moisture ingress, guaranteeing decades of trouble-free operation. The combination of silicone and a glass-fiber-reinforced plastic tube also ensures excellent mechanical resilience of the design.

The 3EB4 surge arrester enclosure is designed for extreme mechanical loads and it is ideally suited for high speeds up to 420 km/h (260 mph).

The silicone arrester with composite hollow core enclosure design provides a very high degree of safety: In the case of an overload or the extremely rare case of an arrester short circuit, the arc escapes directly through a directional pressure relief device. The surge arrester, therefore, can be installed in a way that will minimize the risk of any damage to the equipment and passengers nearby. Internal parts are not ejected and the shatter-proof housing remains intact.

#### **A reliable, rugged and economical choice**

Siemens 3EB4 composite hollow core design surge arresters are virtually indestructible during transportation, installation, storms, and vandalism. While the composite hollow core enclosure design provides the highest possible mechanical strength, the silicone rubber insulation is ideal for outdoor applications in severe environmental conditions. No matter how tough environmental and operating conditions may be, 3EB4 arresters assure 100% reliable pressure relief performance and provide the ultimate in protection.



## Technical specifications

Electrical characteristics														
Line voltage	Rated voltage	Continuous voltage	Arrester article number	Maximum travel speed	Arrester class	Rated discharge current	Discharge capacity	Thermal rated energy absorption capacity	Maximum residual voltages					
$U_n$	$U_r$	$U_c$				$I_n$	$Q_{rs}$	$W_{th}$	30/60 $\mu$ s 500 A	30/60 $\mu$ s 1000 A	30/60 $\mu$ s 2000 A	8/20 $\mu$ s 5 kA	8/20 $\mu$ s 10 kA	8/20 $\mu$ s 20 kA
kV	kV	kV		km/h		kA	C	kJ	kV	kV	kV	kV	kV	kV
<b>AC</b>														
15	23	18	3EB4 230 - 5 A L 3 2 - 0.	420	SL	10	1.2	115	45.2	46.9	49.3	54.6	58.7	65.7
	23	18	3EB4 230 - 6 A L 3 2 - 0.	420	SM	10	2.0	161	43.2	44.3	46.5	50.8	54.1	60.0
	23	18	3EB4 230 - 7 A L 3 2 - 0.	420	SH	20	2.8	230	42.8	43.9	46.0	49.7	52.9	58.2
25	37	30	3EB4 370 - 5 A X 3 2 - 0.	420	SL	10	1.2	185	72.7	75.5	79.3	87.8	94.4	106
	37	30	3EB4 370 - 6 A X 3 2 - 0.	420	SM	10	2.0	259	69.6	71.3	74.8	81.7	87.0	96.5
	37	30	3EB4 370 - 7 A X 3 2 - 0.	420	SH	20	2.8	370	68.9	70.6	74.0	80.0	85.1	93.6
	42	34	3EB4 420 - 5 A X 3 2 - 0.	420	SL	10	1.2	210	82.5	85.7	90.0	99.6	107	120
	42	34	3EB4 420 - 6 A X 3 2 - 0.	420	SM	10	2.0	297	79.0	80.9	84.9	92.8	98.7	110
	42	34	3EB4 420 - 7 A X 3 2 - 0.	420	SH	20	2.8	420	78.2	80.2	84.0	90.8	96.6	106
<b>DC</b>														
0.75	1.0	1.0	3EB4 010 - 7 D S 3 2 - 0.	420	DC-B	20	2.5	10	1.9	2.0	2.1	2.3	2.4	2.6
	1.0	1.0	3EB4 010 - 7 D M 3 2 - 0.	420	DC-B	20	2.5	10	1.9	2.0	2.1	2.3	2.4	2.6
1.5	2.0	2.0	3EB4 020 - 7 D S 3 2 - 0.	420	DC-B	20	2.5	20	3.9	4.0	4.2	4.5	4.8	5.3
	2.0	2.0	3EB4 020 - 7 D M 3 2 - 0.	420	DC-B	20	2.5	20	3.9	4.0	4.2	4.5	4.8	5.3
3.0	4.0	4.0	3EB4 040 - 7 D S 3 2 - 0.	420	DC-B	20	2.5	40	7.8	8.0	8.4	9.0	9.6	10.6
	4.0	4.0	3EB4 040 - 7 D M 3 2 - 0.	420	DC-B	20	2.5	40	7.8	8.0	8.4	9.0	9.6	10.6
<b>Mechanical properties</b>														
Line voltage	Height	Creepage path	Rated short-circuit current	Lighting impulse withstand voltage 1.2/50 $\mu$ s	Power frequency withstand voltage, wet 1 min.	Defined short-time load SSL	Defined continuous load SLL	Weight	Flashover distance	Figure				
$U_n$	H													
kV	mm	mm	kA	kV	kV	N	N	kg	mm					
<b>AC</b>														
15	275	710	50	110	45	9450	6610	6.8	238	A				
	275	710	50	110	45	9450	6610	7.3	238	A				
	275	710	50	110	45	9450	6610	8.3	238	A				
25	395	1175	50	170	70	6580	4600	9.2	358	A				
	395	1175	50	170	70	6580	4600	10.1	358	A				
	395	1175	50	170	70	6580	4600	12.1	358	A				
	395	1175	50	170	70	6580	4600	9.6	358	A				
	395	1175	50	170	70	6580	4600	10.8	358	A				
	395	1175	50	170	70	6580	4600	12.8	358	A				
<b>DC</b>														
0.75	155	243	40	55	30	16770	11740	3.9	92	A				
	195	399	40	70	40	13330	9330	4.1	124	A				
1.5	155	243	40	55	30	16770	11740	4.1	92	A				
	195	399	40	70	40	13330	9330	4.3	124	A				
3.0	155	243	40	55	30	16770	11740	4.5	92	A				
	195	399	40	70	40	13330	9330	4.6	124	A				

# Surge Arresters for Railway Applications

## 3EB4 surge arresters

### Connections

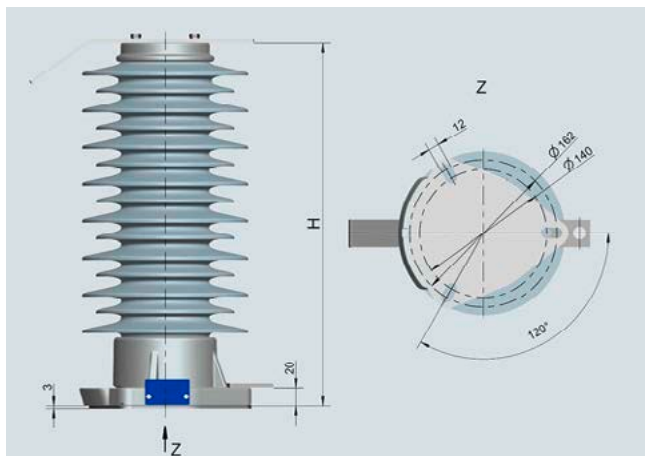

3EB4 .....-D  
Figure A

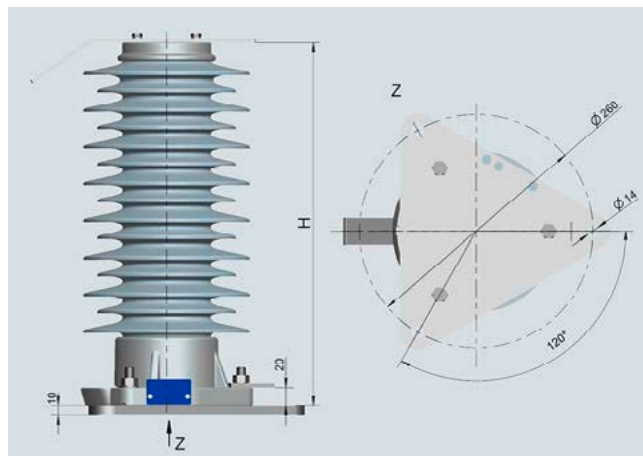

3EB4 .....-E  
Figure A

## Overview

### 3EB5 silicone rubber surge arrester in a cage design

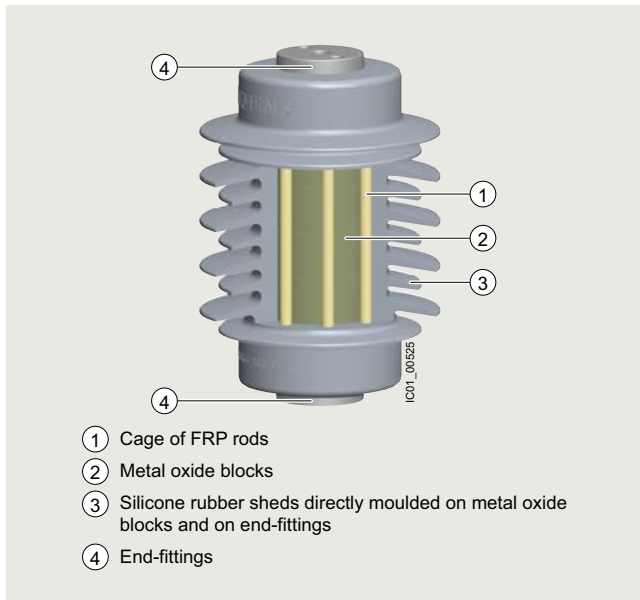

Siemens 3EB5 surge arresters in a cage design offer excellent protection from overvoltage in railway applications.

The metal oxide varistors (MOVs) are encased in a cage of rods made out of glass-fiber-reinforced plastic (FRP), which produces a rigid, reinforced construction.

Reliability is ensured by directly injecting the silicone onto the MO varistors and the FRP rods. This ensures complete embedding of all components without entrapment and gaps, and thus excellent sealing against partial discharges or the ingress of moisture.

In the extremely rare case of an MOV overload, arcing does not produce any critical pressure in the interior because the MOV elements are not situated in a sealed mechanical enclosure. The arc can escape directly through the soft silicone housing, without damaging the mechanical enclosure support. The ejection of internal parts that could damage other nearby equipment is prevented almost completely. The innovative cage design from Siemens ensures an excellent safety response.

The silicone is highly hydrophobic and retains its water and dirt-repellent effect throughout its use. This results in high tracking and erosion resistance. The silicone enclosure is self-extinguishing and flame-retardant. These advantages ensure maintenance-free and reliable use of 3EB5 surge arresters.

# Surge Arresters for Railway Applications

## 3EB5 surge arresters

### Technical specifications

Electrical characteristics														
Line voltage	Rated voltage	Continuous voltage	Arrester article number	Maximum travel speed	Arrester class	Rated discharge current	Discharge capacity	Thermal rated energy absorption capacity	Maximum residual voltages					
$U_n$	$U_r$	$U_c$				$I_n$	$Q_{rs}$	$W_{th}$	30/60 $\mu$ s 500 A	30/60 $\mu$ s 1000 A	30/60 $\mu$ s 2000 A	8/20 $\mu$ s 5 kA	8/20 $\mu$ s 10 kA	8/20 $\mu$ s 20 kA
kV	kV	k		km/h		kA	C	kJ	kV	kV	kV	kV	kV	kV
<b>AC</b>														
15	23	18	3EB5 230 - 6 A E 3 0 - 0.	200	SM	10	2.0	161	43.2	44.3	46.5	50.8	54.1	60.0
	23	18	3EB5 230 - 7 A E 3 0 - 0.	200	SH	20	2.8	230	43.0	44.3	45.5	48.9	51.8	56.4
	23	18	3EB5 230 - 8 A E 3 0 - 0.	200	SH	20	3.6	322	43.0	44.3	45.5	48.9	51.8	56.4
25	37	30	3EB5 370 - 6 A H 3 0 - 0.	200	SM	10	2.0	259	69.6	71.3	74.8	81.7	87.0	96.5
	37	30	3EB5 370 - 7 A H 3 0 - 0.	200	SH	20	2.8	370	69.1	71.2	73.3	78.7	83.3	90.8
	37	30	3EB5 370 - 8 A H 3 0 - 0.	200	SH	20	3.6	518	69.1	71.2	73.3	78.7	83.3	90.8
	42	34	3EB5 420 - 6 A J 3 0 - 0.	200	SM	10	2.0	294	79.0	80.9	84.9	92.8	98.7	110
	42	34	3EB5 420 - 7 A J 3 0 - 0.	200	SH	20	2.8	420	78.5	80.8	83.2	89.3	94.5	103
	42	34	3EB5 420 - 8 A J 3 0 - 0.	200	SH	20	3.6	588	78.5	80.8	83.2	89.3	94.5	103
	45	36	3EB5 450 - 6 A J 3 0 - 0.	200	SM	10	2.0	315	84.6	86.7	90.9	99.4	106	117
	45	36	3EB5 450 - 7 A J 3 0 - 0.	200	SH	20	2.8	450	84.1	86.6	89.1	95.7	101	110
	45	36	3EB5 450 - 8 A J 3 0 - 0.	200	SH	20	3.6	630	84.1	86.6	89.1	95.7	101	110
<b>DC</b>														
0.75	1.0	1.0	3EB5 010 - 8 D B 3 0 - 0.	200	DC-B	20	3.6	14	1.9	1.9	2.0	2.1	2.3	2.5
	1.5	1.5	3EB5 015 - 8 D B 3 0 - 0.	200	DC-B	20	3.6	21	2.8	2.9	3.0	3.2	3.4	3.7
1.5	2.0	2.0	3EB5 020 - 8 D B 3 0 - 0.	200	DC-B	20	3.6	28	3.7	3.8	4.0	4.3	4.5	4.9
	3.0	3.0	3EB5 030 - 8 D B 3 0 - 0.	200	DC-B	20	3.6	42	5.6	5.8	5.9	6.4	6.8	7.4
3.0	4.5	4.5	3EB5 045 - 8 D B 3 0 - 0.	200	DC-B	20	3.6	63	8.4	8.7	8.9	9.6	10.1	11.0
	4.8	4.8	3EB5 048 - 8 D B 3 0 - 0.	200	DC-B	20	3.6	67	9.0	9.2	9.5	10.2	10.8	11.8
<b>Mechanical properties</b>														
Line voltage	Height	Creepage path	Rated short-circuit current	Lighting impulse withstand voltage 1.2/50 $\mu$ s	Power frequency withstand voltage, wet 1 min.	Defined short-time load SSL	Defined continuous load SLL	Weight	Flashover distance	Figure				
$U_n$	H		kA	kV	kV	N	N	kg	mm					
kV	mm	mm												
<b>AC</b>														
15	301	920	50	175	80	3320	2320	6.4	306	B				
	281	860	65	165	75	5330	3730	10.1	288	C				
	281	860	65	165	75	5330	3730	10.1	288	C				
25	436	1420	50	250	120	2290	1600	8.7	438	B				
	389	1330	65	230	105	3850	2690	13.6	395	C				
	389	1330	65	230	105	3850	2690	14.1	395	C				
	481	1580	50	275	130	2070	1450	9.6	482	B				
	425	1480	65	250	115	3520	2470	15.1	430	C				
	425	1480	65	250	115	3520	2470	15.6	430	C				
	481	1580	50	275	130	2070	1450	9.9	482	B				
	425	1480	65	250	115	3520	2470	15.6	430	C				
425	1480	65	250	115	3520	2470	16.0	430	C					
<b>DC</b>														
0.75	172	390	65	105	50	8720	6100	4.9	182	C				
	172	390	65	105	50	8720	6100	5.0	182	C				
1.5	172	390	65	105	50	8720	6100	5.1	182	C				
	172	390	65	105	50	8720	6100	5.2	182	C				
3.0	172	390	65	105	50	8720	6100	5.5	182	C				
	172	390	65	105	50	8720	6100	5.5	182	C				

Connections

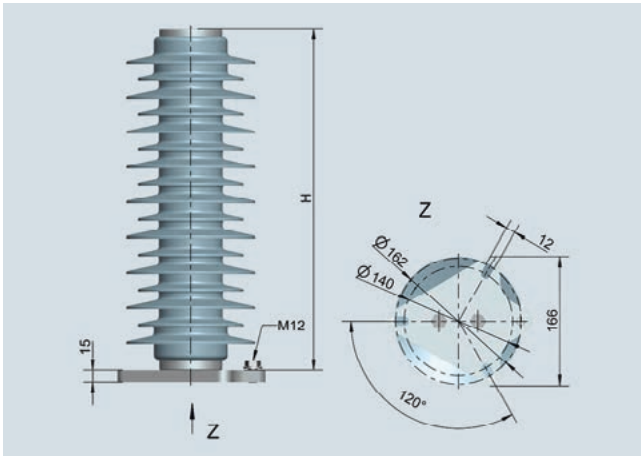

3EB5 .....-D  
Figure B

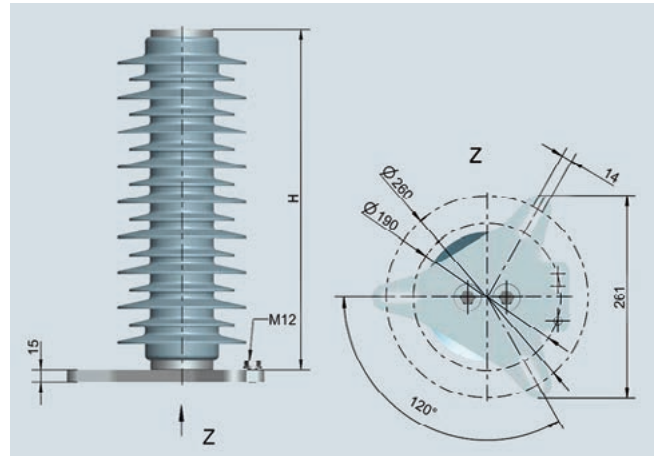

3EB5 .....-E  
Figure B

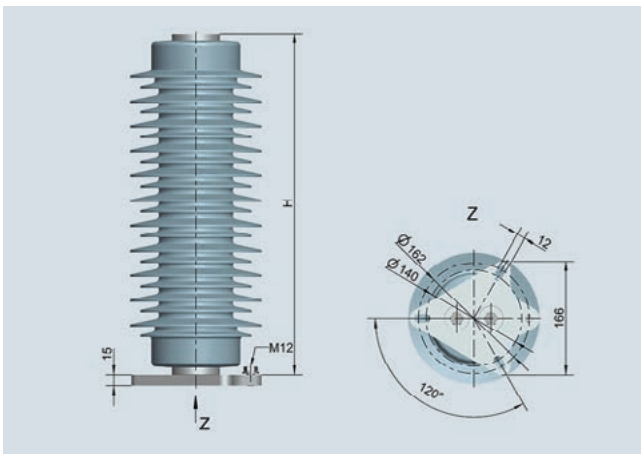

3EB5 .....-D  
Figure C

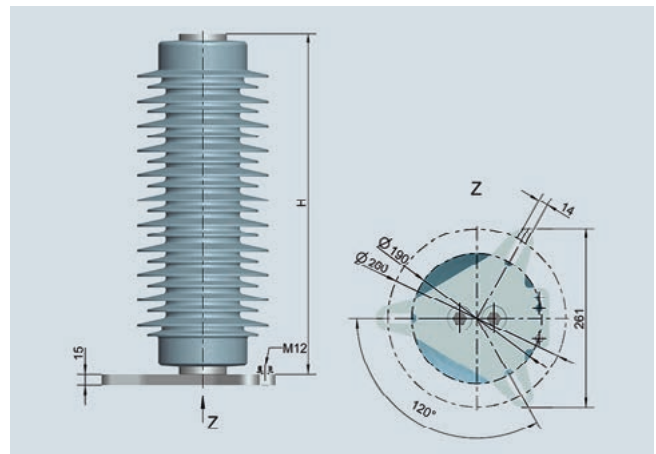

3EB5 .....-E  
Figure C

## Surge Arresters for Railway Applications

### Notes

10

## Appendix



11/2	<b>SITRAIN – Digital Industry Academy</b>
11/4	<b>Logistics</b>
11/8	<b>Standards and approvals</b>
11/14	<b>Quality management</b>
11/15	<b>Partners at Siemens</b>
11/15	<b>Siemens Partner Program</b>
11/17	<b>Industry Services</b>
11/17	<b>Online Support</b>
11/20	<b>Software licenses</b>
11/22	<b>Conditions of sale and delivery</b>

## Appendix

### SITRAIN – Digital Industry Academy

#### Introduction

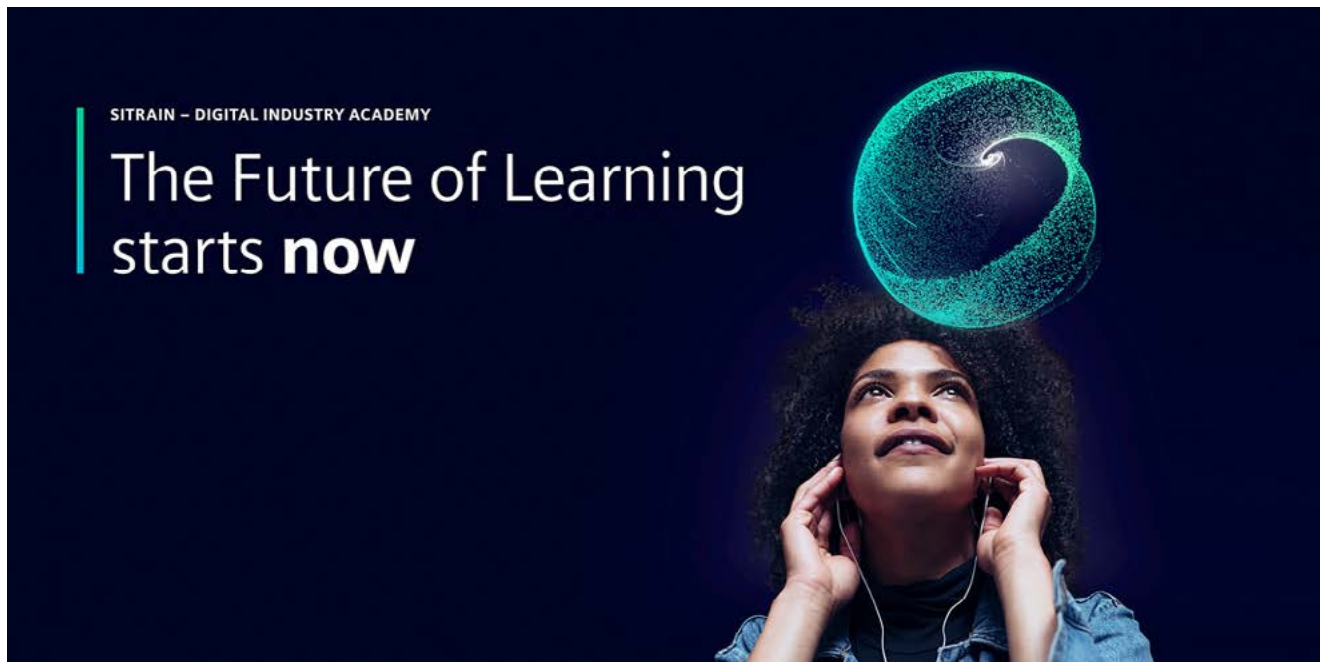

#### **The Future of Learning starts now**

Globalization, digitalization, new work, Internet of Things, new business models – our way of working, living and learning is changing rapidly. With SITRAIN, the future of learning begins today: SITRAIN stands for a modern learning culture that focuses on the needs of learners and the demands of innovative companies.

With SITRAIN – Digital Industry Academy, the future of learning is yours.

Face-to-face training or digital training, location-independent, 24/7, on-demand or learning at fixed dates and course times? With a personal learning consultant, in a team, or on your own responsibility? Everything is possible. SITRAIN offers a wide range of different learning options with the "Learning Journey", "Learning Membership" and "Learning Event".

#### **The three learning formats of SITRAIN – Digital Industry Academy**



##### **Learning Journey**

The combination for sustainable learning success

- The optimal mix of self-study units and guided live modules
- Includes a Learning Membership to work through the self-study modules and access on-demand content
- The SITRAIN learning consultant is available for questions and one-on-one consultations
- Ideal integration into the daily work routine and adaptation to one's own learning pace.



##### **Learning Membership**

Securing knowledge through continuous learning on your own responsibility

- With access to the comprehensive and constantly growing range of self-study units on SITRAIN access, the digital learning platform
- Search and find specific learning content or simply have a look around – anytime and anywhere
- A modern learning culture through continuous learning on your own responsibility and transparency about your learning success in the team or company.



##### **Learning Event**

Acquire theoretical and practical knowledge in a compact and guided format

- You achieve a defined learning goal in the shortest possible time
- The learning consultant guides you through the practical exercises and is also exclusively available to you during the theoretical sessions for the entire duration
- Focused learning, outside of the daily work routine, in a protected learning environment – virtually, in the training center, or at your company.



## Introduction

### **Expand your knowledge, apply what you have learned, develop future skills**

The SITRAIN Digital Industry Academy combines didactically effective methods and modular options.



Effective



Flexible



Relevant



Continuous

### **The four building blocks of SITRAIN – Digital Industry Academy**

Different methods for maximum learning success:

- Live
- On your own responsibility
- On demand
- Individual

Learn the way you want to learn. For learning success that takes you further.

### **Education and training directly from the manufacturer**

For individual knowledge building, the following topics concerning the industrial product and solution portfolio of Siemens are available. Experience the new learning culture with SITRAIN.

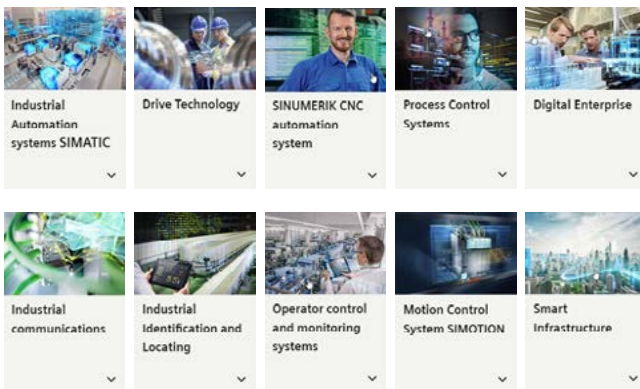

### **Training cases catalog**

<https://www.siemens.com/sitrain-catalog-training-cases>



Find  
your local  
offer here



### **SITRAIN – Digital Industry Academy worldwide**

You will find the regional knowledge offer in the country selection. One click will take you to the corresponding website.

### **SITRAIN – Digital Industry Academy**

[www.siemens.com/sitrain](http://www.siemens.com/sitrain)

- SITRAIN Learning Journey:  
[www.siemens.com/sitrain-learning-journey](http://www.siemens.com/sitrain-learning-journey)
- SITRAIN Learning Membership:  
[www.siemens.com/sitrain-learning-membership](http://www.siemens.com/sitrain-learning-membership)
- SITRAIN Learning Event:  
[www.siemens.com/sitrain-learning-event](http://www.siemens.com/sitrain-learning-event)

## Appendix

### Logistics

#### Overview

##### General

With regard to delivery service, communications and environmental protection, our logistics service ensures "quality from the moment of ordering right through to delivery". By designing our infrastructure according to customer requirements and implementing electronic order processing, we have successfully optimized our logistics processes.

Our delivery processes are designed such that, as a rule, a confirmed deadline is not generally exceeded. In fact, wherever possible, we aim to deliver up to three working days ahead of schedule to optimize the overall delivery situation (e.g. in anticipation of holidays and peak order periods).

We are proud of our personal consulting service, on-time deliveries and one-day delivery within Germany.

**To achieve this, we supply the preferred types marked with ► ex warehouse.**

We regard the ISO 9001 certification and consistent quality checks as an integral part of our services.

Electronic order processing is fast, cost-efficient and error-free. Please contact us if you want to benefit from these advantages.

##### Packaging, packing units

The packaging in which our equipment is dispatched provides protection against dust and mechanical damage during transport, thus ensuring that you receive our products in a perfect state.

We select our packaging for maximum environmental compatibility and reusability (e.g. crumpled paper for protection during transport in packages up to 32 kg) and, in particular, with a view to reducing waste.

With our multi-unit packaging and reusable packaging, we offer you specific types of packaging that are both kind to the environment and tailored to your requirements.

##### Your advantages at a glance:

- Lower order costs
- Cost savings through uniform-type packaging: low/no disposal costs
- Reduced time and cost thanks to short unpacking times
- "Just-in-time" delivery directly to the production line helps reduce stock: cost savings through reduction of storage area
- Fast assembly thanks to supply in sets
- Standard Euro boxes – corresponding to the Euro pallet modular system – suitable for most conveyor systems
- Active contribution to environmental protection

Unless stated otherwise in the "Selection and ordering data" of this catalog, our products are supplied individually packed.

For small parts/accessories, we offer you economical packing units as standard packs containing more than one item, e.g. 5, 10, 50 or 100 units. It is essential that whole number multiples of these quantities be ordered to ensure satisfactory quality of the products and problem-free order processing.

The products are delivered in a neutral carton. The label includes warning notices, the CE mark and product description information in English and German.

In addition to the Article No. (MLFB) and the packed number of items in the packaging the Instr. Order No. is also specified for the operating instructions. It can be obtained from your local Siemens representative (you will find a list of your local Siemens contacts at [www.siemens.com/automation-contact](http://www.siemens.com/automation-contact)).

The device Article No. of most devices can also be acquired through the EAN barcode to simplify ordering and storage logistics.

The related master data are available from your local Siemens representative.

### Multi-unit and reusable packaging

The devices listed in the tables from page 11/6 onwards can be ordered in multi-unit or reusable packaging (further versions on request).

If ordering multi-unit or reusable packaging for the first time, please first consult your local Siemens representative with regard to pack type, quantity, delivery time and the precise order designation. Use of the reusable packaging is reserved solely for customers that have signed a packaging return agreement with their Siemens representative in advance.

Multi-unit and reusable packaging is not available as a pack type for all products. Some products are unsuited for this pack type and would only involve an increased risk of damage in transit.

For both pack types, the quantity of devices ordered (per Article No.) must be divisible by the pack quantity. If this is not the case, the electronic order processing system rounds up to the next integer multiple of packaging.

#### Multi-unit packaging



Products in a quantity sufficient to fill a multi-unit packaging: 1/2 (W96) and 1/4 (W97) ENK

As standard, multi-unit packs contain uniform-type, unpacked individual products (one device type) in an appropriately sized carton made of recyclable cardboard. The products of the SIRIUS range can be ordered in units of 1/1, 1/2, 1/4 and 1/8 standard Euro boxes (ENK).

### Reusable packaging (uniform type)



Standard Euro box (ENK) made of durable molded plastic with foam inserts

Standard reusable packaging contains uniform-type, non-packed individual products (one device type) in a reusable standard Euro box (ENK) made of durable molded plastic with foam inserts for protection during transport.

The standard Euro box (ENK) also serves as transport packaging. The reusable packaging (ENK) plus foam inserts are returned by the customer (free of charge) to the supply base.

Please contact your Siemens representative to clarify the delivery details or conditions for set supply or delivery in reusable packaging (ENK) (to find Siemens representatives, see [www.siemens.com/automation-contact](http://www.siemens.com/automation-contact)). Suitable arrangements will then be agreed with you.

#### Set deliveries (reusable, different devices)

On request, we also deliver order-related packs of larger quantities of different types of devices in a standard Euro box (ENK).

Please contact your Siemens representative to clarify the delivery details or conditions for set supply or delivery in reusable packaging. Suitable arrangements will then be agreed with you.

#### Packaging dimensions

Packing material	Length mm	Height mm	Width mm
ENK	596	219	396
W95	575	190	375
W96	375	190	290
W97	290	190	195
W98	290	100	195

## Appendix

### Logistics

**Multi-unit and reusable packaging, quantity in units, supplied in indivisible pack quantities with delivery time on request**

#### SIRIUS

Devices	Size	Reusable	Multi-unit			
		X95 (1/1 ENK)	W95 (1/1 ENK)	W96 (1/2 ENK)	W97 (1/4 ENK)	W98 (1/8 ENK)
<b>Contactors</b>						
3RT201.-1A..1/2	S00	144	--	72	40	--
3RT201.-1B..1/2	S00	72	--	72	40	--
3RT201.-2A/B...	S00	120	--	60	32	--
3RT202.-1A/B..0	S0	48	--	24	12	--
3RT202.-2A/B..0	S0	40	--	18	8	--
3RT203.-...0	S2	30	--	15	6	--
3RT203.-...4	S2	30	--	15	--	--
<b>Snap-on auxiliary switches</b>						
3RH2911-1F./GA/HA..	--	351	--	240	120	60
3RH2911-2F./G./H./N./X...	--	321	--	196	100	50
<b>Contactor relays</b>						
3RH21.-1A..0	S00	144	--	72	40	--
3RH21.-1B..0	S00	72	--	72	40	--
3RH21.-2A/B..0	S00	120	--	60	32	--
<b>Motor starter protectors</b>						
3RV2011-...1/0/5	S00	43	--	24	12	--
3RV2011-...2/0/5	S00	40	--	16	8	--
3RV2021-...1/0/5	S0	43	--	24	12	--
3RV2021-...2/0/5	S0	35	--	16	8	--
3RV2031-...0/5	S2	24	--	12	5	--
<b>Thermally delayed overload relays</b>						
3RU2116-..B0	S00	64	--	32	16	--
3RU2116-..C0	S00	56	--	24	12	--
3RU2126-..B0	S0	56	--	32	16	--
3RU2126-..C0	S0	48	--	24	12	--
3RU2136-..B0	S2	36	--	18	9	--
<b>3RP25 electronic timing relays</b>	On request					

When ordering products in multi-unit packaging for devices from the SIRIUS range, the Article No. of the product concerned must be supplemented with "**-Z**" and, in addition, the order code **W9**.

Ordering example:  
3RT2015-1AB02-Z W97 → Packed number of items: 40

For products packed in reusable packaging, the Article No. must be supplemented with "**-Z**" and the order code **X95**.

Ordering example:  
3RT2018-1AB01-Z X95 → Packed number of items: 144

## SIRIUS ACT

Multi-unit packaging with order code X90

Pushbuttons and indicator lights	Multi-unit or quantity per pack X90
Complete units (3SU11)	20
Compact units (3SU12)	
• Acoustic signaling devices, pushbuttons with extended stroke, potentiometers	50
Actuating and signaling elements (3SU10)	
• Pushbuttons, illuminated pushbuttons, indicator lights	100
• Stop switches, twin pushbuttons, mushroom pushbuttons 30/40 mm, EMERGENCY STOP mushroom pushbuttons 30/40 mm, toggle switches, selector switches, key-operated switches, ID key-operated switches, coordinate switches	50
• Mushroom pushbuttons 60 mm, EMERGENCY STOP mushroom pushbuttons 60 mm	40
Holders without module (3SU15)	100
Modules for actuators and indicators (3SU14)	
• Contact modules	150
• LED modules	50
Enclosures (3SU18)	
• Empty plastic enclosures	
- 3SU1801-0AA00-0AA2, 3SU1801-0AA00-0AB1	24
- 3SU1801-0AA00-0AC2	18
Accessories (3SU19)	
• Sealing plugs, label holders, EMERGENCY STOP backing plates, labeling plates for potentiometers, EMERGENCY STOP labeling plates for enclosures without recesses and without inscription, single frames, dust caps for key-operated switches, adapters for mounting on standard rails, protective collars for EMERGENCY STOP mushroom pushbuttons (40 mm, for 5 padlocks, yellow)	100
• Labeling plates	150

When ordering products in multi-unit packaging for devices from the SIRIUS ACT range, the Article No. of the product concerned must be supplemented with **"-Z"** and, in addition, the order code **X90**.

Ordering example:  
3SU1000-0AB20-0AA0-Z X90;  
pack of 100 (1 pack = 100 units)

Multi-unit packaging with order code X05

Pushbuttons and indicator lights	Multi-unit or quantity per pack X05
Holders without module (3SU15)	
• Plastic: 3SU1500-0AA10-0AA0	5
• Metal: 3SU1510-0AA10-0AA0	5
• Universal for plastic and metal: 3SU1550-0AA10-0AA0	5
Modules for actuators and indicators (3SU14)	
• Contact modules for front plate mounting	5
- Screw terminals: 3SU1400-1AA10-1BA0, 3SU1400-1AA10-1CA0	
- Spring-loaded terminals: 3SU1400-1AA10-3BA0, 3SU1400-1AA10-3CA0	
• LED modules for front plate mounting	5
- Screw terminals: 3SU1401-1BB00-1AA0, 3SU1401-1BB20-1AA0, 3SU1401-1BB30-1AA0, 3SU1401-1BB40-1AA0, 3SU1401-1BB50-1AA0, 3SU1401-1BB60-1AA0	
- Spring-loaded terminals: 3SU1401-1BB00-3AA0, 3SU1401-1BB20-3AA0, 3SU1401-1BB30-3AA0, 3SU1401-1BB40-3AA0, 3SU1401-1BB50-3AA0, 3SU1401-1BB60-3AA0	
• LED modules for base mounting	5
- Screw terminals: 3SU1401-2BB00-1AA0, 3SU1401-2BB20-1AA0, 3SU1401-2BB30-1AA0, 3SU1401-2BB40-1AA0, 3SU1401-2BB50-1AA0, 3SU1401-2BB60-1AA0	
- Spring-loaded terminals: 3SU1401-2BB00-3AA0, 3SU1401-2BB20-3AA0, 3SU1401-2BB30-3AA0, 3SU1401-2BB40-3AA0, 3SU1401-2BB50-3AA0, 3SU1401-2BB60-3AA0	

When ordering products in multi-unit packaging for devices from the SIRIUS ACT range, the Article No. of the product concerned must be supplemented with **"-Z"** and, in addition, the order code **X05** must be specified.

Ordering example:  
3SU1500-0AA10-0AA0-Z X05;  
pack of 5 (1 pack = 5 units)

## Appendix

### Standards and approvals

#### Approvals, test certificates, characteristic curves

An overview of the certificates available for Industrial Control products along with more technical documentation can be consulted daily on the internet at:

[www.siemens.com/sirius/approvals](http://www.siemens.com/sirius/approvals)

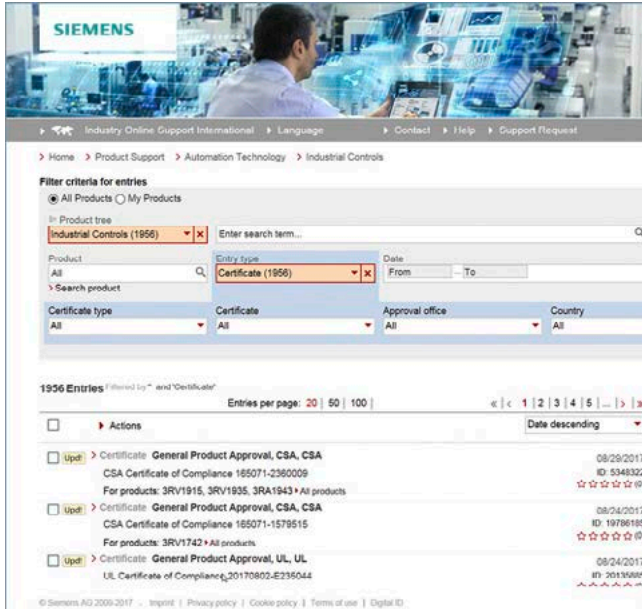

Product support: Approvals/certificates

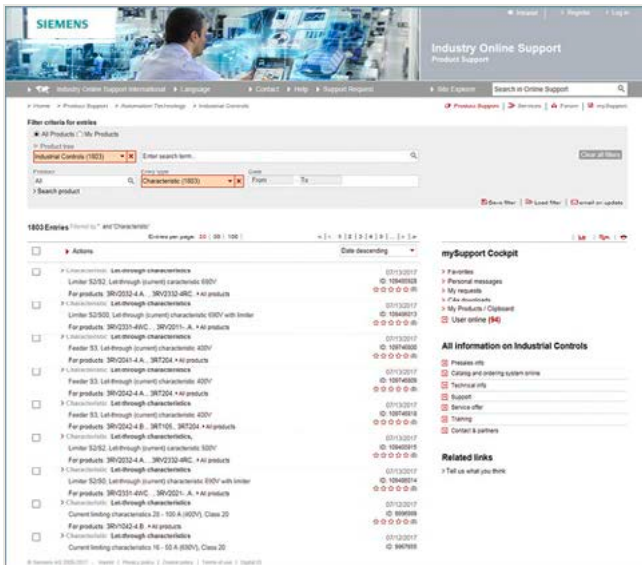

Product support: Characteristics

#### Safety characteristics

In the following standards, the so-called B10 values for calculating the safety integrity or safety integrity level (SIL) in functional safety at a high or continuous demand rate are required also for electromechanical switchgear:

- IEC 62061 "Safety of machines – Functional safety of safety-related electrical, electronic and programmable electronic control systems",
- ISO 13849-1 "Safety of machines – Safety-related components of controls – Part 1: General principles".

Failure rates of electromechanical components are required for calculating the safety integrity or safety integrity level (SIL) in functional safety:

- in the manufacturing industry at a high demand rate
- in the process industry at a low demand rate

Further requirements are laid down in IEC 61511-1 "Functional safety – Safety instrumented systems for the process industry sector – Part 1: Framework, definitions, system, hardware and software requirements".

The German versions of the above standards are:

- DIN EN 62061
- DIN EN ISO 13849
- DIN EN 61511-1

The Safety Evaluation in the TIA Selection Tool assists in calculating the safety functions as verification for the machine documentation. It is available free of charge at [www.siemens.com/safety-evaluation](http://www.siemens.com/safety-evaluation).

More information such as notes on trainings and Safety Consulting as well as application examples with calculations are available at [www.siemens.com/safety-integrated](http://www.siemens.com/safety-integrated).

#### Definitions

$\lambda(t) dt$  is the probability that a unit which has not failed by a certain time  $t$  will fail in the following interval  $(t; t + dt)$ . Failure rates have the dimension 1/time unit, e.g. 1/h. Failure rates for components are often specified in FIT (failures in time unit): 1 FIT equals  $10^{-9}/h$ . From the failure rate it is possible to derive a (mathematical) distribution function of the failure probability:

$F(t) = 1 - \exp(-\lambda t)$ , with  $\lambda$  as constant failure rate

- The mean value of this exponential distribution is also referred to as:
  - Mean Time To Failure (MTTF) in the case of irreparable components; 63.2% of components fail by the MTTF.
  - Mean Operating Time Between Failures (MTBF) in the case of repairable components.
- $MTTF = 1/\lambda$   
(MTTF is a statistical mean value but no guarantee for endurance).

Electromechanical components are often irreparable components. In general, the failure rate of monitored units changes with age.

The B10 value for devices subject to wear is expressed in number of operating cycles:

- It is the number of operating cycles after which 10% of the test specimens fail in the course of an endurance test (or: The number of operating cycles after which 10% of the devices have failed).

For low demand rates (mainly in the process industry), the failure rate and not the B10 value is used to determine the failure probability.

The safety characteristics of electromechanical SIRIUS products can be found at <https://support.industry.siemens.com/cs/ww/en/view/109739348> or in the SIEMENS Industry Online Support Portal ([www.siemens.com/online-support](http://www.siemens.com/online-support)) under the Entry ID: 109739348.



## Standards

IEC	EN/ EN IEC	Title
60947-1 60947-2 60947-3	60947-1 60947-2 60947-3	Low-voltage switchgear and controlgear: General rules • Circuit-breakers • Switches, disconnectors, switch-disconnectors and fuse-combination units
60947-4-1 60947-4-2 60947-4-3	60947-4-1 60947-4-2 60947-4-3	• Contactors and motor starters: Electromechanical contactors and motor starters • Contactors and motor starters: AC semiconductor motor controllers and starters, soft starters • AC semiconductor controllers and contactors for non-motor loads
60947-5-1 60947-5-2 60947-5-3 60947-5-5 60947-5-6 60947-5-7 60947-5-8 60947-5-9	60947-5-1 60947-5-2 60947-5-3 60947-5-5 60947-5-6 60947-5-7 60947-5-8 60947-5-9	• Control circuit devices and switching elements - Electromechanical control circuit devices • Control circuit devices and switching elements - Proximity switches • Requirements for proximity devices with defined behaviour under fault conditions • Electrical emergency stop device with mechanical latching function • Control devices and switching elements - DC interface for proximity sensors and switching amplifier (NAMUR) • Requirements for proximity devices with analogue output • Three-position enabling switches • Flow rate switches
60947-6-1 60947-6-2	60947-6-1 60947-6-2	• Multiple function equipment - Transfer switching equipment • Multiple function equipment - Control and protective switching devices (or equipment) (CPS)
60947-7-1 60947-7-2 60947-7-3 60947-7-4	60947-7-1 60947-7-2 60947-7-3 60947-7-4	• Ancillary equipment - Terminal blocks for copper conductors • Ancillary equipment - Protective conductor terminal blocks for copper conductors • Ancillary equipment - Safety requirements for fuse terminal blocks • Ancillary equipment - PCB terminal blocks for copper conductors
60947-8	60947-8	• Control units for built-in thermal protection (PTC) for rotating electrical machines
60947-9-1	60947-9-1	• Low-voltage switchgear and controlgear - Active arc-fault mitigation systems - Part 9-1: Arc quenching devices
62026-2	62026-2	• Actuator sensor interface (AS-i)
60269-1 60269-4	60269-1 60269-4	Low-voltage fuses: General requirements Low-voltage fuses: Supplementary requirements for fuse-links for the protection of semiconductor devices
60050-441	--	International Electrotechnical Vocabulary. Switchgear, controlgear and fuses
61439-1 61439-2 61439-3	61439-1 61439-2 61439-3	Low-voltage switchgear and controlgear assemblies: General rules Low-voltage switchgear and controlgear assemblies: Power switchgear and controlgear assemblies Low-voltage switchgear and controlgear assemblies: Distribution boards intended to be operated by ordinary persons (DBO)
61439-4	61439-4	Low-voltage switchgear and controlgear assemblies: Particular requirements for assemblies for construction sites (ACS)
61439-5 61439-6 61439-7	61439-5 61439-6 --	Low-voltage switchgear and controlgear assemblies: Assemblies for power distribution in public networks Low-voltage switchgear and controlgear assemblies - Part 6: Busbar trunking systems (busways) Low-voltage switchgear and controlgear assemblies - Part 7: Assemblies for specific applications such as marinas, camping sites, market squares, electric vehicle charging stations
--	50274	Low-voltage switchgear and controlgear assemblies - Protection against electric shock - Protection against unintentional direct contact with hazardous live parts
61140	61140	Protection against electric shock - Common aspects for installation and equipment
60664-1	60664-1	Insulation coordination for electrical equipment in low-voltage systems; Principles, requirements and tests
60204-1 60079-0 60079-14	60204-1 60079-0 60079-14	Electrical equipment of machines: General requirements Explosive atmospheres - Part 0: Equipment - General requirements Explosive atmospheres - Part 14: Electrical installations design, selection and erection
61810-1 61812-1	61810-1 61812-1	Electromechanical elementary relays; General requirements Time relays for industrial and residential use - Part 1: Requirements and tests
60999-1	60999-1	Connecting devices - Electrical copper conductors - Safety requirements for screw-type and screwless-type clamping units - Part 1: General requirements and particular requirements for clamping units for conductors from 0.2 mm <sup>2</sup> up to 35 mm <sup>2</sup> (included)
60999-2	60999-2	Connecting devices - Electrical copper conductors - Safety requirements for screw-type and screwless-type clamping units: Particular requirements for clamping units for conductors above 35 mm <sup>2</sup> up to 300 mm <sup>2</sup> (included)
IEC/TR 61000-4-1	61000-4-1	Electromagnetic compatibility (EMC) - Part 4-1: Testing and measuring techniques - Overview of IEC 61000-4 series
61000-6-2 61000-6-3	61000-6-2 61000-6-3	Electromagnetic compatibility (EMC); Generic standards - Immunity for industrial environments Electromagnetic compatibility (EMC); Generic standards - Emission standard for residential, commercial and light-industrial environments
61000-6-4	61000-6-4	Electromagnetic compatibility (EMC); Generic standards - Emission standard for industrial environments
61869-1	61869-1	Instrument transformers: General requirements
61869-2	61869-2	Instrument transformers: Additional requirements for current transformers

## Appendix

### Standards and approvals

UL	CSA C22.2	ASME	JIS	Title
508	--	--	--	Industrial control equipment
60947-1	No. 60947-1	--	--	Low-voltage switchgear and controlgear - Part 1: General rules
60947-4-1	No. 60947-4-1	--	--	Low-voltage switchgear and controlgear - Part 4-1: Contactor and motor starters - Electromechanical contactors and motor starters
60947-4-2	No. 60947-4-2	--	--	Low-voltage switchgear and controlgear - Part 4-2: Contactors and motor-starters - AC semiconductor motor controllers and starters
60947-5-1	No. 60947-5-1	--	--	Low-voltage switchgear and controlgear - Part 5-1: Control circuit devices and switching elements - Electromechanical control circuit devices
60947-5-5	60947-5-5	--	--	Low-voltage switchgear and controlgear - Part 5-5: Control circuit devices and switching elements - Electrical emergency stop device with mechanical latching function
489	No. 5	--	--	Molded case circuit breakers, molded case switches, and circuit breaker enclosures
1012	--	--	--	Power units other than CLASS 2
1059	--	--	--	Terminal blocks
486A-486B	No. 65	--	--	Wire connectors
486E	--	--	--	Equipment wiring terminals for use with aluminum and/or copper conductors
50	No. 94.1	--	--	Enclosures for electrical equipment - Non-environmental considerations
50E	No. 94.2	--	--	Enclosures for electrical equipment - Environmental considerations
--	No. 14	--	--	Industrial control equipment
--	No. 107.1	--	--	General use power supplies
--	--	A17.5 / CSA B 44.1	--	Elevator and escalator electrical equipment
--	--	--	C 8201-4-1	Low-voltage switchgear and controlgear; Contactors and motor-starters

#### Approval requirements valid in different countries

Siemens low-voltage switchgear and controlgear are designed, manufactured and tested according to the relevant German standards (DIN and VDE), IEC publications and European standards (EN) as well as CSA and UL standards. The standards assigned to the single devices are stated in the relevant parts of this catalog.

As far as is economically viable, the requirements of the various standards valid in other countries are also taken into account in the design of the equipment.

In some countries an approval is required for certain low-voltage switchgear and controlgear components (see table below).

Depending on the market requirements, these components have been submitted for approval to the authorized testing institutes.

In some cases, CSA for Canada and UL for the USA only approve special switchgear versions. Such special versions are listed separately from the standard versions in the individual parts of this catalog.





For this equipment, partial limitations of the maximum permissible voltages, currents and ratings can be imposed, or special approval and, in some cases, special identification is required.

For use on board ship, the specifications of the marine classification societies must be observed (see table on page 11/11). In some cases, they require type tests of the components to be approved.

The Chinese certification system has changed. As of November 1, 2020, the self-declaration by Siemens (Self-Declaration of Compliance (SDOC)) forms the basis of CCC and the import to China. The CCC scope, product labeling, certification procedures, implementation rules in manufacturing and regulations regarding the import to China have remained unchanged. All CCC certificates issued by CQC have been transferred to SDOCs and all CCC certificates issued by CQC are invalid as of November 1, 2020.

UKCA: As of January 1, 2023, all devices to be marketed in Great Britain require a manufacturer's declaration (UK Declaration of Conformity) and must be supplied with a UKCA mark. The declaration is based on UK regulations and the underlying British standards (BS). Alternatively, EN standards can also be applied. Otherwise, the same requirements apply as for the EU Declaration of Conformity.

#### Testing bodies, approval identification and approval requirements

Country	Canada	USA	China	Russia/Belarus/Kazakhstan/...
<b>Government-appointed or private, officially recognized testing bodies</b>	CSA UL (USA)	UL	Self-Declaration of Compliance (Siemens)	Official national regulation/TR
<b>Mark of conformity</b>				
<b>Approval requirement</b>	+	+	+	+
<b>Remarks</b>	UL and CSA are authorized to grant approval certificates in accordance with Canadian and North American regulations. Please note: These approvals are not recognized in many cases and must be covered by additional approvals issued by the national testing agency.		--	Eurasian customs union

For more information about the approval marks, see page 11/13.



**Marine classification societies**

Country	Germany Norway	United Kingdom	France	CIS	Italy	Poland	USA
<b>Name</b>	DNV	Lloyds Register of Shipping	Bureau Veritas	Russian Maritime Register of Shipping	Registro Italiano Navale	Polski Rejestr Statków	American Bureau of Shipping
<b>Codes</b>	DNV	LR	BV	RS	RINA	PRS	ABS

**CE marking**

Manufacturers of products which fall within the subject area to which EU directives apply must identify their products, operating instructions or packaging with a CE mark of conformity.

By attaching the CE marking, the manufacturer confirms that the product conforms to the relevant basic requirements of all directives applicable to the product. The mark of conformity is a mandatory requirement for putting products into circulation throughout the EU.

All the products in this catalog are in conformance with the relevant specific EU directives and bear the CE mark of conformity **CE**.

- Low-voltage directive
- EMC directive
- Machinery directive
- ATEX directive
- RED directive
- RoHS directive

**Accident prevention**

Test certificates and approvals from DGUV, SUVA (Swiss institute for accident prevention), TÜV or VDE are available for some devices in safety control systems. For details, [see the respective product descriptions](#).

## Appendix

### Standards and approvals

#### Ex protection certificates for SIRIUS controls

Controls that are installed in a potentially explosive atmosphere or motor protection devices that protect a motor installed in a potentially explosive atmosphere against overloading or a pump in said atmosphere from dry running must comply with certain special requirements. These requirements are laid down in the following standards:

- EN 50495
- EN 60079-0
- EN 60079-1
- EN 60079-7
- EN 60079-11
- EN 60079-14
- EN 60079-17
- EN 60079-31
- EN 60947-1
- EN 60947-4-1
- EN 60947-4-2
- EN 60947-5-1
- EN 60947-8
- EN ISO/IEC 80079-34
- EN ISO 80079-36
- EN ISO 80079-37

#### Certification

Controls and motor protection devices that are brought into circulation within the member states of the EU in accordance with EU directive 2014/34/EU must have been constructed and tested according to the above-mentioned standards and must have a declaration of conformity from the manufacturer based on a prototype test certificate.

The quality management (QM) system of the manufacturer is subject to certain requirements and a "QM certificate" must be obtained for the manufacturer from a recognized authority.

#### Certification of the QM system

A certificate of approval for quality assurance production has been issued by DEKRA Testing and Certification GmbH<sup>1)</sup> under the number BVS 20 ATEX ZQS/E111 according to Directive 2014/34/EU. The quality management (QM) system is also checked within the scope of the IECEx Scheme. Conformity with the requirements is confirmed using document DE/BVS/QAR15.0002/08.

These certificates are valid for equipment groups I and II and categories M2 and 2: Safety and control devices for electrical equipment.

#### Certificates

Declarations of conformity and prototype test certificates are available at [www.siemens.com/online-support](http://www.siemens.com/online-support) for viewing and downloading. As far as explosion protection is concerned, these are available for the following products:

- 3RB, 3RM, 3RN, 3RU, 3RV, 3RW, 3UF motor protection devices
- 3RS2 temperature monitoring relays
- 3SU1 LED modules

You can find more information about industrial controls for applications in explosion-protected areas at [www.siemens.com/sirius/atex](http://www.siemens.com/sirius/atex).

<sup>1)</sup> DEKRA Testing and Certification GmbH  
The certification authority of "DEKRA Testing and Certification GmbH" with authority number 0158 according to Article 13 of Directive 2014/34/EU of the European Parliament and Council certifies that Siemens Amberg, Cham, Suzhou and Trutnov maintains a quality assurance system for production that satisfies Appendices IV and VII of this Directive.

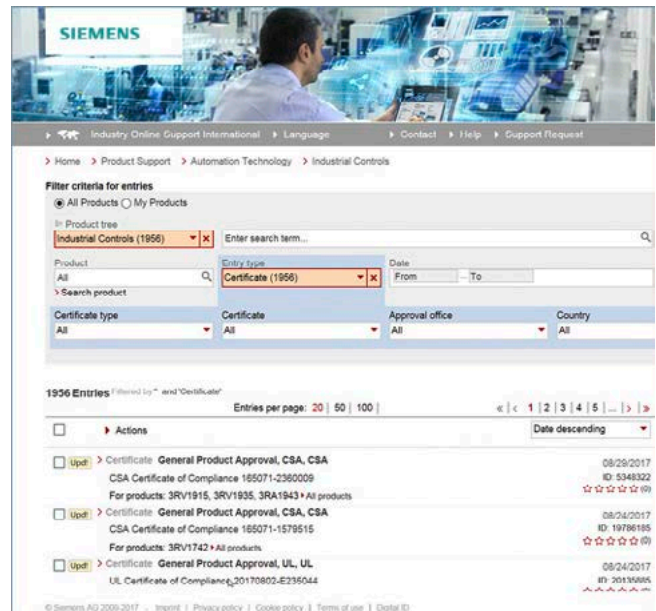

Selection box

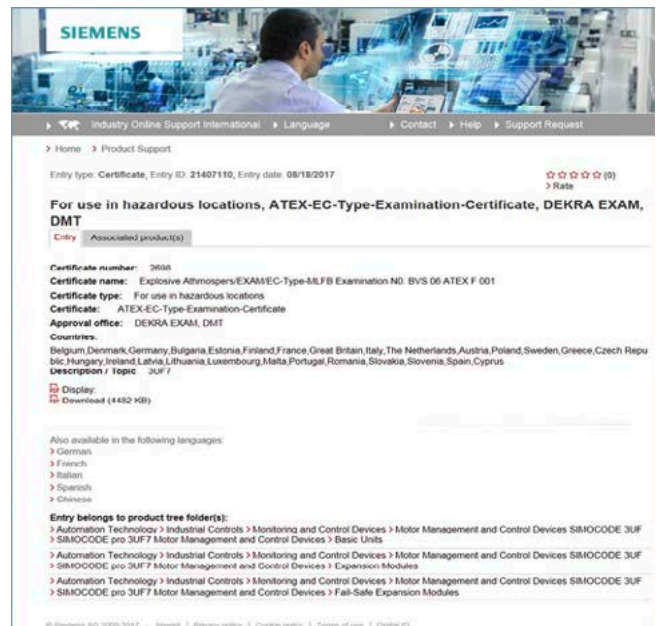

Description of certificate with view and download option

#### Identifying markings

All equipment must be marked according to the ATEX guideline. The ATEX identification code contains the equipment group, the approved environment, the number of the certification authority and other technical data that was determined from the type test.

### Certificate of the AS-International Association for AS-Interface products

AS-Interface products are tested and certified by the AS-International Association. The products have been tested in an accredited test laboratory according to testing guidelines.

### Special standards for the USA and Canada

In the USA and Canada, for machine tools and processing machines in particular, supply lines are laid using rubber insulated cable enclosed in heavy-duty steel piping similar to that used for gas or water pipe systems.











The tubing system must be completely watertight and electrically conductive (especially sleeving and elbows). Since the tubing system can also be grounded, the cable entries of enclosed units equipped with heavy-gauge or metric threads must be fitted with metal adapters between these threads and the tube thread. The necessary adapters are specified for the switchgear as accessories; they should be ordered separately unless otherwise specified.

Low-voltage switchgear and controlgear for auxiliary circuits (e.g. contactor relays, commanding and signaling devices and auxiliary switches/auxiliary contacts in general) are generally only approved by CSA and UL for "**Heavy Duty**" or "**Standard Duty**" and are identified either with these specifications in addition to the maximum permissible voltage or by using an abbreviation.

The abbreviations are harmonized with IEC 60947-5-1 Annex 1 Table A.1 and correspond to the stated utilization categories.

For various switching devices detailed in the catalog, a note has been included to the effect that, above a certain voltage, the auxiliary switches/auxiliary contacts can only be used if they have the same polarity. This means that the input terminals can only be connected to the same pole of the control voltage, e.g. "600 V AC above 300 V AC same polarity".

### Distinguishing features of UL approvals (for USA and Canada)

Recognized Component	Listed Product
Devices are identified on the rating plate using the "UL recognition mark": USA:  c  us Canada: c   us	Devices are identified using the "UL listing mark" on the rating plate e.g. USA:  LISTED XXX      Canada: c  LISTED XXX IND. CONT. EQ.      IND. CONT. EQ. (XXX stands for: UL Code Classification Number)
Devices are approved as modules for "factory wiring" or other conditions of acceptability, i.e.: As devices for installation in control systems, which are selected, installed, wired and tested entirely by trained personnel in factories, workshops or elsewhere, <b>according to the operating conditions</b> .	Devices are approved for "field wiring", i.e.: <ul style="list-style-type: none"> <li>As devices for installation in control systems, which are completely wired by trained personnel in factories, workshops or elsewhere.</li> <li>As single devices for sale in retail outlets in the USA/Canada.</li> </ul>
If devices are  or c  approved as "listed products", they are also approved as  or c  "recognized components".	

For more information about UL and CSA, [see page 11/10](#).

### Special standards for Russia, Australia and China

#### EAC approval for Russia/Belarus/Kazakhstan/...



EAC mark

Since February 15, 2013, Russia, Kazakhstan, Belarus and other countries have been united in the Eurasian EAC customs union. An EAC approval as replacement for the GOST mark is required for all products that are to be sold in Russia.

All devices delivered to the customs union must have these customs certifications.

#### RCM approval for Australia



RCM mark

The RCM mark is required for marketing Siemens electronic devices in Australia. Electronic devices must provide proof of EMC clearance in Australia, similar to the CE mark of conformity laid down by the EMC directive applicable in the EU and bear the "RCM" mark.

# Appendix

## Quality management

### Quality management

The quality management system of our "Electrical Products" Business Unit in the "Smart Infrastructure" business complies with the international standard EN ISO 9001.

The products and systems described in this catalog are developed, manufactured and sold under application of a certified quality management system according to ISO 9001.

### Certificates

For information about available certifications of the quality management system for Industrial Controls products, please visit website address:

<https://new.siemens.com/global/en/general/system-certificates/si-ep.html>

System	Certifier	Basic	Valid until	Location	Language
Quality Management	DQS	ISO 9001	Aug 11, 2017	Amberg Cham Purni	DE EN
Quality Management	TÜV Rheinland	ISO 9001	Oct 12, 2017	Cabrúria	EN PT
Quality Management	TÜV Rheinland	ISO 9001	Dec 18, 2017	Overhagen	EN ES
Quality Management	AIB Vireoite	ISO 9001	Mar 9, 2018	Hüllingen	EN
Quality Management	BSI	ISO 9001	Jul 29, 2018	Kalva	EN
Quality Management	TSE	ISO 9001	May 21, 2018	Kartal	EN
Quality Management	TÜV Rheinland	ISO 9001	Oct 12, 2017	Mansau	EN PT
Quality Management	TÜV Rheinland	ISO 9001	Oct 31, 2016	Suzhou	EN CN
Quality Management	TÜV Rheinland	ISO 9001	Sep 14, 2018	Tianlai	EN CN
Quality Management	DQS	ISO 9001	Jul 6, 2017	Tulshov	EN CZ
Quality Management	DQS	ISO 9001	Sep 14, 2018	West Chicago	EN
Environment Management	DQS	ISO 14001	Oct 22, 2018	Amberg Cham	DE EN
Environment Management	TÜV Rheinland	ISO 14001	Oct 12, 2017	Cabrúria	EN PT
Environment Management	Global Standards	ISO 14001	Sep 14, 2018	Overhagen	EN ES
Environment Management	BSI	ISO 14001	Jun 27, 2018	Kalva	EN
Environment Management	TSE	ISO 14001	Oct 9, 2017	Kartal	EN
Environment Management	TÜV Rheinland	ISO 14001	Oct 12, 2017	Mansau	EN PT
Environment Management	CEC	ISO 14001	May 11, 2018	Suzhou	EN CN
Environment Management	DQS	ISO 14001	Jul 6, 2017	Tulshov	EN CZ
Environment Management	DQS	ISO 14001	Nov 29, 2016	West Chicago	EN
Health and Safety	DQS	OHSAS 18001	Oct 17, 2018	Amberg Cham	DE EN
Health and Safety	TÜV Rheinland	OHSAS 18001	Oct 12, 2017	Cabrúria	EN PT
Health and Safety	Global Standards	OHSAS 18001	Mar 14, 2019	Overhagen	EN ES
Health and Safety	BSI	OHSAS 18001	Jun 27, 2018	Kalva	EN
Health and Safety	TSE	OHSAS 18001	Jun 8, 2018	Kartal	EN
Health and Safety	TÜV Rheinland	OHSAS 18001	Oct 12, 2017	Mansau	EN PT
Health and Safety	CVC	OHSAS 18001	May 16, 2017	Suzhou	EN CN
Health and Safety	DQS	OHSAS 18001	Jul 1, 2017	Tulshov	EN CZ
Health and Safety	DQS	OHSAS 18001	Nov 29, 2016	West Chicago	EN
Integrated Management System	DQS	ISO 9001 ISO 14001 OHSAS 18001	Jul 1, 2017	Tulshov	EN CZ
Special Systems	Certifier	Basic	Valid until	Location	Language
Contractor Assessment	E.ON Kernkraft	KTA 1401	Jul 10, 2018	Amberg Cham Tulshov	DE EN
Production Quality Assessment Notification	DEKRA EXAM	ATEX	Apr 4, 2017	Amberg Cham Tulshov	DE EN
Particle Size Testing Laboratory	FLUKA	PLN 11004	Jun 14, 2018	Amberg	DE

## Overview

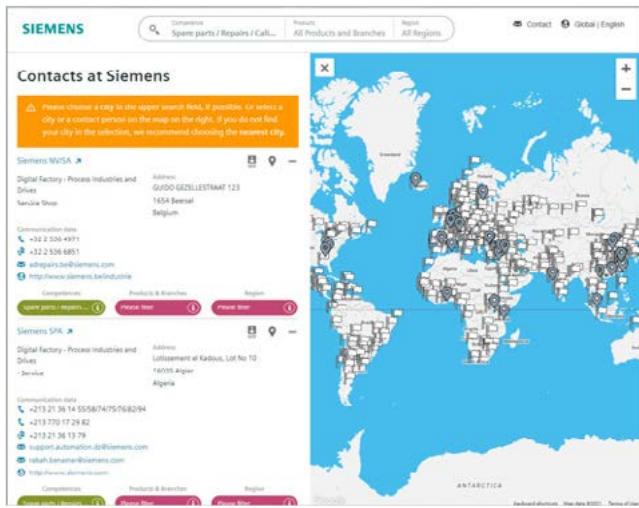

At your service locally, around the globe for consulting, sales, training, service, support, spare parts on the entire portfolio of Siemens.

Your partner can be found in our Personal Contacts Database at: [www.siemens.com/automation-contact](http://www.siemens.com/automation-contact)

You start by selecting

- the required competence,
- products and branches,
- a country and a city

or by a

- location search or free text search.

## Appendix

### Partners at Siemens

#### Siemens Partner Program

##### Overview

##### **Siemens Solution and Approved Partner – Partners for your success**



##### Highest competence in automation and drive technology

Siemens works closely together with selected partner companies around the world in order to ensure that customer requirements for all aspects of automation and drives are fulfilled as best as possible – wherever you are, and whatever the time.

We place great value on our customers acting in accordance with the same ideals which characterize Siemens as a whole: Competence, professionalism and quality. That is why continuous development through qualification and certification measures in line with global standards is a central aspect of our Partner Program. This means that with our partners, you benefit from the same high quality standards all over the world. The partner emblem is the symbol for tried and tested quality.

##### The partner network for industry

The Siemens Partner Program offers you expertise and experience close at hand.

Within our global network, we distinguish between Solution Partners and Approved Partners. We currently work with more than 1,500 Solution Partners around the world. Our network of over 150 Approved Partners continues to grow. In more than 80 countries worldwide.

##### Siemens Solution Partner – Automation Drives



At present we are working with more than 1,500 Solution Partners worldwide. They are characterized by extensive application, system and sector knowledge, as well as proven project experience, and are able to implement future-proof tailored solutions of the highest quality, based on our product and system portfolio.

##### Siemens Approved Partner – Value Added Reseller



With their detailed technical knowledge, Siemens Approved Partners – Value Added Resellers offer a combination of products and services that range from specialist technologies and customized modifications to the provision of high-quality system and product packages. They also provide qualified technical support and assistance.

##### Siemens Approved Partner – Industry Services



Siemens Approved Partner – Industry Services put their unique expertise entirely at the service of enhancing your productivity and can be instrumental in ensuring the availability of your plants.

##### **Partner Finder**

The ideal partner for your task is just a mouse click away!

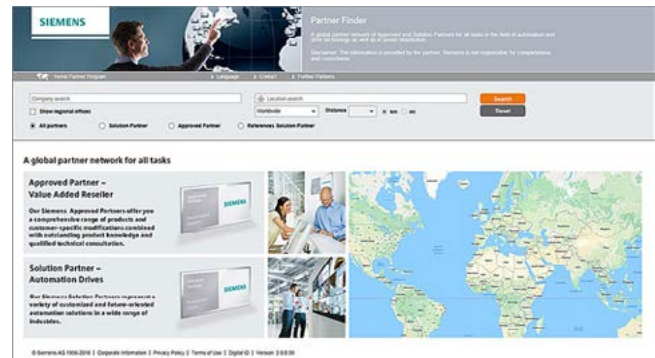

In the Siemens global Solution Partner Program, customers are certain to find the optimum partner for their specific requirements – with no great effort. The Partner Finder is basically a comprehensive database that showcases the profiles of all our partners.

##### Easy selection:

Set filters in the search screen form according to the criteria that are relevant to you. You can also directly enter the name of an existing partner.

##### Skills at a glance:

Gain a quick insight into the specific competencies of any particular partner with the reference reports.

##### Direct contact option:

Use our electronic query form:

[www.siemens.com/partnerfinder](http://www.siemens.com/partnerfinder)

Additional information of the Siemens Partners for industry is available online at:

[www.siemens.com/partnerprogram](http://www.siemens.com/partnerprogram)

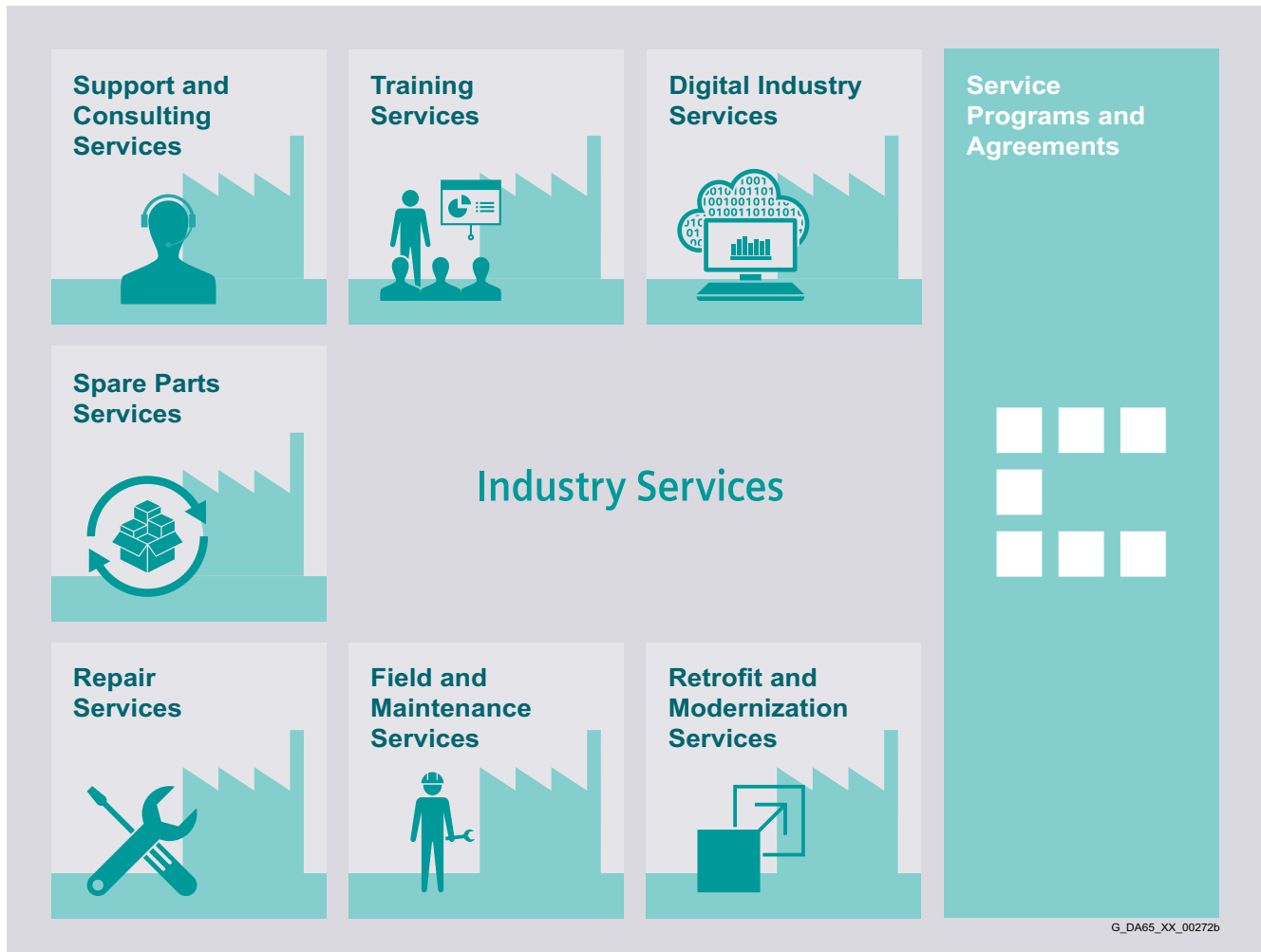

## Overview

**Keep your business running and shaping your digital future – with Industry Services**

Optimizing the productivity of your equipment and operations can be a challenge, especially with constantly changing market conditions. Working with our service experts makes it easier. We understand your industry's unique processes and provide the services needed so that you can better achieve your business goals.

You can count on us to maximize your uptime and minimize your downtime, increasing your operations' productivity and reliability. When your operations have to be changed quickly to meet a new demand or business opportunity, our services give you the flexibility to adapt. Of course, we take care that your production is protected against cyber threats. We assist in keeping your operations as energy and resource efficient as possible and reducing your total cost of ownership. As a trendsetter, we ensure that you can capitalize on the opportunities of digitalization and by applying data analytics to enhance decision making: You can be sure that your plant reaches its full potential and retains this over the longer lifespan.

You can rely on our highly dedicated team of engineers, technicians and specialists to deliver the services you need – safely, professionally and in compliance with all regulations. We are there for you, where you need us, when you need us.

[www.siemens.com/industryservices](http://www.siemens.com/industryservices)

## Appendix

### Industry Services – Portfolio overview

#### Overview



#### Digital Industry Services

Digital Industry Services make your industrial processes transparent to gain improvements in productivity, asset availability, and energy efficiency.

Production data is generated, filtered and translated with intelligent analytics to enhance decision-making.

This is done whilst taking data security into consideration and with continuous protection against cyber-attack threats.

[www.siemens.com/global/en/products/services/industry/digital-industry-services.html](https://www.siemens.com/global/en/products/services/industry/digital-industry-services.html)

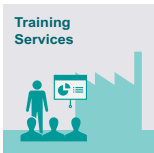

#### Training Services

From the basics and advanced to specialist skills, SITRAIN courses provide expertise right from the manufacturer – and encompass the entire spectrum of Siemens products and systems for the industry.

Worldwide, SITRAIN courses are available wherever you need a training course in more than 170 locations in over 60 countries.

<https://support.industry.siemens.com/cs/ww/en/sc/2226>



#### Support and Consulting Services

**Industry Online Support** site for comprehensive information, application examples, FAQs and support requests.

**Technical and Engineering Support** for advice and answers for all inquiries about functionality, handling, and fault clearance. The Service Card as prepaid support for value added services such as Priority Call Back or Extended Support offers the clear advantage of quick and easy purchasing.

**Information & Consulting Services**, e.g. SIMATIC System Audit; clarity about the state and service capability of your automation system or Lifecycle Information Services; transparency on the lifecycle of the products in your plants.

<https://support.industry.siemens.com/cs/ww/en/sc/2235>



#### Spare Parts

Spare Parts Services are available worldwide for smooth and fast supply of spare parts – and thus optimal plant availability. Genuine spare parts are available for up to ten years. Logistic experts take care of procurement, transport, custom clearance, storage and order management.

Reliable logistics processes ensure that components reach their destination as needed.

Since not all spare parts can be kept in stock at all times, Siemens offers a preventive measure for spare parts provisioning on the customer's premises with optimized **Spare Parts Packages** for individual products, custom-assembled drive components and entire integrated drive trains – including risk consulting.

**Asset Optimization Services** help you design a strategy for parts supply where your investment and carrying costs are reduced and the risk of obsolescence is avoided.

<https://support.industry.siemens.com/cs/ww/en/sc/2110>



#### Repair Services

Repair Services are offered on-site and in regional repair centers for fast restoration of faulty devices' functionality.

Also available are extended repair services, which include additional diagnostic and repair measures, as well as emergency services.

<https://support.industry.siemens.com/cs/ww/en/sc/2154>



#### Field and Maintenance Services

Siemens specialists are available globally to provide expert field and maintenance services, including commissioning, functional testing, preventive maintenance and fault clearance.

All services can be included in customized service agreements with defined reaction times or fixed maintenance intervals.

<https://support.industry.siemens.com/cs/ww/en/sc/2265>



#### Retrofit and Modernization Services

Provide a cost-effective solution for the expansion of entire plants, optimization of systems or upgrading existing products to the latest technology and software, e.g. migration services for automation systems.

Service experts support projects from planning through commissioning and, if desired over the entire extended lifespan, e.g. Retrofit for Integrated Drive Systems for an extended lifetime of your machines and plants.

<https://support.industry.siemens.com/cs/ww/en/sc/2286>



#### Service Programs and Agreements

A technical Service Program or Agreement enables you to easily bundle a wide range of services into a single annual or multi-year agreement.

You pick the services you need to match your unique requirements or fill gaps in your organization's maintenance capabilities.

Programs and agreements can be customized as KPI-based and/or performance-based contracts.

<https://support.industry.siemens.com/cs/ww/en/sc/2275>



## Overview

Online Support – fast, intuitive, whenever you want, wherever you need



**Web**  
support.industry.siemens.com

**App**

GET IT ON Google Play | GET IT ON App Store | Microsoft

Scan the QR code for information on our Online Support app.

**FAQ / Application examples**  
Information about industrial products, programming and configuration as well as application examples

**Technical Information**  
Videos, documentation, manuals, updates, product notes, compatibility tool, certificates, planning data such as dimensional drawings, product data, 3D models

**Forum**  
Exchange information and experience with other users and experts

## Online Support for Siemens Products for Industry

Siemens Industry and Online Support with some 1.7 million visitors per month is one of the most popular web services provided by Siemens. It is the central access point for comprehensive technical know-how about products, systems and services for automation and drives applications as well as for process industries.

In connection with the challenges and opportunities related to digitalization you can look forward to continued support with innovative offerings.

## Appendix

### Software licenses

#### Overview

##### Software types

Software requiring a license is categorized into types. The following software types have been defined:

- Engineering software
- Runtime software

##### Engineering software

This includes all software products for creating (engineering) user software, e.g. for configuring, programming, parameterizing, testing, commissioning or servicing.

Data generated with engineering software and executable programs can be duplicated for your own use or for use by third-parties free-of-charge.

##### Runtime software

This includes all software products required for plant/machine operation, e.g. operating system, basic system, system expansions, drivers, etc.

The duplication of the runtime software and executable programs created with the runtime software for your own use or for use by third-parties is subject to a charge.

You can find information about license fees according to use in the ordering data (e.g. in the catalog). Examples of categories of use include per CPU, per installation, per channel, per instance, per axis, per control loop, per variable, etc.

Information about extended rights of use for parameterization/configuration tools supplied as integral components of the scope of supply can be found in the readme file supplied with the relevant product(s).

##### License types

Siemens Industry Automation & Drive Technologies offers various types of software license:

- Floating license
- Single license
- Rental license
- Rental floating license
- Trial license
- Demo license
- Demo floating license

##### Floating license

The software may be installed for internal use on any number of devices by the licensee. Only the concurrent user is licensed. The concurrent user is the person using the program. Use begins when the software is started. A license is required for each concurrent user.

##### Single license

Unlike the floating license, a single license permits only one installation of the software per license.

The type of use licensed is specified in the ordering data and in the Certificate of License (CoL). Types of use include for example per instance, per axis, per channel, etc.

One single license is required for each type of use defined.

##### Rental license

A rental license supports the "sporadic use" of engineering software. Once the license key has been installed, the software can be used for a specific period of time (the operating hours do not have to be consecutive).

One license is required for each installation of the software.

##### Rental floating license

The rental floating license corresponds to the rental license, except that a license is not required for each installation of the software. Rather, one license is required per object (for example, user or device).

##### Trial license

A trial license supports "short-term use" of the software in a non-productive context, e.g. for testing and evaluation purposes. It can be transferred to another license.

##### Demo license

The demo license support the "sporadic use" of engineering software in a non-productive context, for example, use for testing and evaluation purposes. It can be transferred to another license. After the installation of the license key, the software can be operated for a specific period of time, whereby usage can be interrupted as often as required.

One license is required per installation of the software.

##### Demo floating license

The demo floating license corresponds to the demo license, except that a license is not required for each installation of the software. Rather, one license is required per object (for example, user or device).

##### Certificate of License (CoL)

The CoL is the licensee's proof that the use of the software has been licensed by Siemens. A CoL is required for every type of use and must be kept in a safe place.

##### Downgrading

The licensee is permitted to use the software or an earlier version/release of the software, provided that the licensee owns such a version/release and its use is technically feasible.

##### Delivery versions

Software is constantly being updated. The following delivery versions

- PowerPack
- Upgrade

can be used to access updates.

Existing bug fixes are supplied with the ServicePack version.

##### PowerPack

PowerPacks can be used to upgrade to more powerful software. The licensee receives a new license agreement and CoL (Certificate of License) with the PowerPack. This CoL, together with the CoL for the original product, proves that the new software is licensed.

A separate PowerPack must be purchased for each original license of the software to be replaced.

##### Upgrade

An upgrade permits the use of a new version of the software on the condition that a license for a previous version of the product is already held.

The licensee receives a new license agreement and CoL with the upgrade. This CoL, together with the CoL for the previous product, proves that the new version is licensed.

A separate upgrade must be purchased for each original license of the software to be upgraded.

**Overview****ServicePack**

ServicePacks are used to debug existing products. ServicePacks may be duplicated for use as prescribed according to the number of existing original licenses.

**License key**

Siemens Industry Automation & Drive Technologies supplies software products with and without license keys.

The license key serves as an electronic license stamp and is also the "switch" for activating the software (floating license, rental license, etc.).

The complete installation of software products requiring license keys includes the program to be licensed (the software) and the license key (which represents the license).

**Software Update Service (SUS)**

As part of the SUS contract, all software updates for the respective product are made available to you free of charge for a period of one year from the invoice date. The contract will automatically be extended for one year if it is not canceled three months before it expires.

The possession of the current version of the respective software is a basic condition for entering into an SUS contract.

You can download explanations concerning license conditions from [https://mall.industry.siemens.com/legal/ww/en/terms\\_of\\_trade\\_en.pdf](https://mall.industry.siemens.com/legal/ww/en/terms_of_trade_en.pdf)

## Appendix

### Conditions of sale and delivery

#### 1. General Provisions

By using this catalog you can purchase products (hardware, software and services) described therein from Siemens Aktiengesellschaft subject to the following Terms and Conditions of Sale and Delivery (hereinafter referred to as "T&C"). Please note that the scope, the quality and the conditions for supplies and services, including software products, by any Siemens entity having a registered office outside Germany, shall be subject exclusively to the General Terms and Conditions of the respective Siemens entity. The following T&C apply exclusively for orders placed with Siemens Aktiengesellschaft, Germany.

##### 1.1 For customers with a seat or registered office in European Union

For customers with a seat or registered office in European Union, the following terms and conditions apply subordinate to T&C:

- for products, which include specific terms and conditions in the description text, these specific terms and conditions shall apply and subordinate thereto,
- for stand-alone software products and software products forming a part of a product or project, the "General License Conditions for Software Products for Automation and Drives for Customers with a Seat or registered Office in Germany"<sup>1)</sup> and/or
- for consulting services the "Allgemeine Geschäftsbedingungen für Beratungsleistungen der Division DF – Deutschland" (available only in German) and/or
- for other services, the „Supplementary Terms and Conditions for Services ("BL")"<sup>1)</sup> and/or
- for other supplies the "General Conditions for the Supply of Products and Services of the Electrical and Electronics Industry"<sup>1)</sup>.

In case such supplies should contain Open Source Software, the conditions of which shall prevail over the "General Conditions for the Supply of Products and Services of the Electrical and Electronics Industry"<sup>1)</sup>, a notice will be contained in the scope of delivery in which the applicable conditions for Open Source Software are specified. This shall apply mutatis mutandis for notices referring to other third party software components.

##### 1.2 For customers with a seat or registered office outside European Union

For customers with a seat or registered office outside European Union, the following terms and conditions apply subordinate to T&C:

- for products, which include specific terms and conditions in the description text, these specific terms and conditions shall apply and subordinate thereto,
- for consulting services the "Standard Terms and Conditions for Consulting Services of the Division DF for Customers with a Seat or Registered Office Outside of Germany"<sup>1)</sup> and/or
- for other services the "International Terms & Conditions for Services"<sup>1)</sup> supplemented by "Software Licensing Conditions"<sup>1)</sup> and/or
- for other supplies of hard- and software the "International Terms & Conditions for Products"<sup>1)</sup> supplemented by "Software Licensing Conditions"<sup>1)</sup>

##### 1.3 For customers with master or framework agreement

To the extent our supplies and/or services offered are covered by an existing master or framework agreement, the terms and conditions of that agreement shall apply instead of T&C.

#### 2. Prices

The prices are in € (Euro) ex point of delivery, exclusive of packaging.

The sales tax (value added tax) is not included in the prices. It shall be charged separately at the respective rate according to the applicable statutory legal regulations.

Prices are subject to change without prior notice. We will charge the prices valid at the time of delivery.

To compensate for variations in the price of raw materials (e.g. silver, copper, aluminum, lead, gold, dysprosium and neodym), surcharges are calculated on a daily basis using the so-called metal factor for products containing these raw materials.

A surcharge for the respective raw material is calculated as a supplement to the price of a product if the basic official price of the raw material in question is exceeded.

The metal factor of a product indicates the basic official price (for those raw materials concerned) as of which the surcharges on the price of the product are applied, and with what method of calculation.

An exact explanation of the metal factor can be downloaded at: [https://mall.industry.siemens.com/legal/ww/en/terms\\_of\\_trade\\_en.pdf](https://mall.industry.siemens.com/legal/ww/en/terms_of_trade_en.pdf)

To calculate the surcharge (except in the cases of dysprosium and neodym), the official price from the day prior to that on which the order was received or the release order was effected is used.

To calculate the surcharge applicable to dysprosium and neodym ("rare earths"), the corresponding three-month basic average price in the quarter prior to that in which the order was received or the release order was effected is used with a one-month buffer (details on the calculation can be found in the explanation of the metal factor).

#### 3. Additional Terms and Conditions

The dimensions are in mm. In Germany, according to the German law on units in measuring technology, data in inches apply only to devices for export.

Illustrations are not binding.

Insofar as there are no remarks on the individual pages of this catalog – especially with regard to data, dimensions and weights given – these are subject to change without prior notice.

<sup>1)</sup> The text of the Terms and Conditions of Siemens AG can be downloaded at [https://mall.industry.siemens.com/legal/ww/en/terms\\_of\\_trade\\_en.pdf](https://mall.industry.siemens.com/legal/ww/en/terms_of_trade_en.pdf)

#### 4. Export Regulations

We shall not be obligated to fulfill any agreement if such fulfillment is prevented by any impediments arising out of national or international foreign trade or customs requirements or any embargoes and/or other sanctions.

Export may be subject to license. We shall indicate in the delivery details whether licenses are required under German, European and US export lists.

Our products are controlled by the U.S. Government (when labeled with "ECCN" unequal "N") and authorized for export only to the country of ultimate destination for use by the ultimate consignee or end-user(s) herein identified. They may not be resold, transferred, or otherwise disposed of, to any other country or to any person other than the authorized ultimate consignee or end-user(s), either in their original form or after being incorporated into other items, without first obtaining approval from the U.S. Government or as otherwise authorized by U.S. law and regulations. Products labeled with "AL" unequal "N" are subject to European / national export authorization.

The export indications can be viewed in advance in the description of the respective goods on the Industry Mall, our online catalog system. Only the export labels "AL" and "ECCN" indicated on order confirmations, delivery notes and invoices are authoritative.

Products without label, with label "AL:N" / "ECCN:N", or label "AL:9X9999" / "ECCN: 9X9999" may require authorization from responsible authorities depending on the final end-use, or the destination.

If you transfer goods (hardware and/or software and/or technology as well as corresponding documentation, regardless of the mode of provision) delivered by us or works and services (including all kinds of technical support) performed by us to a third party worldwide, you shall comply with all applicable national and international (re-)export control regulations. In any event of such transfer of goods, works and services you shall comply with the (re-) export control regulations of the Federal Republic of Germany, of the European Union and of the United States of America.

Prior to any transfer of goods, works and services provided by us to a third party you shall in particular check and guarantee by appropriate measures that

- there will be no infringement of an embargo imposed by the European Union, by the United States of America and/ or by the United Nations by such transfer, by brokering of contracts concerning those goods, works and services or by provision of other economic resources in connection with those goods, works and services, also considering the limitations of domestic business and prohibitions of by-passing those embargoes;
- such goods, works and services are not intended for use in connection with armaments, nuclear technology or weapons, if and to the extent such use is subject to prohibition or authorization, unless required authorization is provided;
- the regulations of all applicable Sanctioned Party Lists of the European Union and the United States of America concerning the trading with entities, persons and organizations listed therein are considered.

If required to enable authorities or us to conduct export control checks, you, upon request by us, shall promptly provide us with all information pertaining to the particular end customer, the particular destination and the particular intended use of goods, works and services provided by us, as well as any export control restrictions existing.

You acknowledge that under the EU embargo regulations against Iran, Syria and Russia respectively the sale of certain listed goods and related services is subject to authorization by the competent export control authorities of the European Union. If (i) the goods or services ordered by you are destined for Iran, Syria or Russia, and (ii) the contract for our supplies and/or services is subject to prior authorization of the competent export control authorities of the European Union, the contract between you and us shall come into force in this respect only upon granting of such authorization.

The products listed in this catalog may be subject to European/German and/or US export regulations. Any export requiring approval is therefore subject to authorization by the relevant authorities.

Errors excepted and subject to change without prior notice.

## Appendix

### Notes



## Selection and ordering at Siemens Industry Mall, downloading and ordering catalogs

### Easy product selection and ordering: Industry Mall

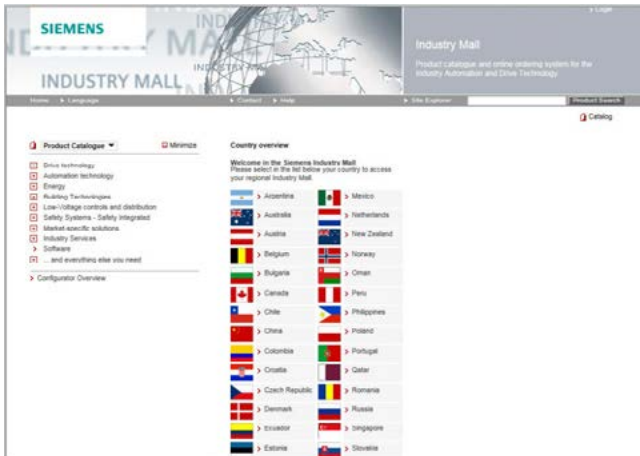

### Industry Mall

The Industry Mall is a Siemens AG Internet ordering platform. It provides you with online access to a comprehensive product spectrum that is presented in an informative, well-organized way.

Powerful search functions help you select the required products, while configurators enable you to configure complex product and system components quickly and easily. CAX data are also available for you to use.

Data transfer allows the entire procedure, from selection through ordering to tracking and tracing, to be carried out online. Availability checks, individual customer discounting, and quotation preparation are also possible.

[www.siemens.com/industrymall](http://www.siemens.com/industrymall)

### Downloading catalogs

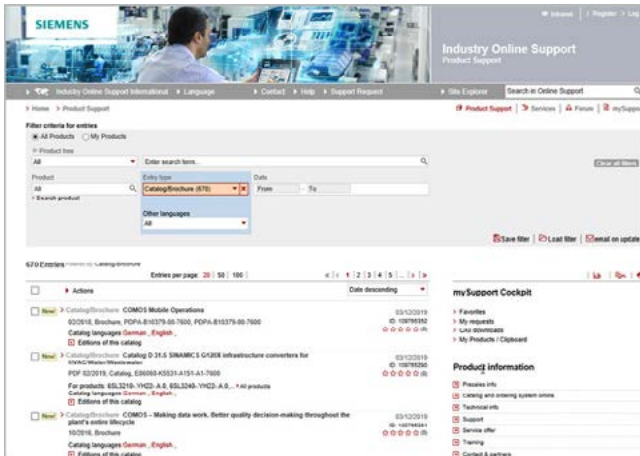

### Siemens Industry Online Support

You can download catalogs and brochures in PDF format from Siemens Industry Online Support without having to register.

The filter box makes it possible to perform targeted searches.

[www.siemens.com/industry-catalogs](http://www.siemens.com/industry-catalogs)

### Ordering printed catalogs



Please contact your local Siemens branch if you are interested in ordering printed catalogs.

Addresses can be found at [www.siemens.com/automation-contact](http://www.siemens.com/automation-contact)

#### Get more information

[www.siemens.com/railway-component](http://www.siemens.com/railway-component)

Published by  
Siemens AG

Smart Infrastructure  
Electrical Products  
Siemensstrasse 10  
93055 Regensburg, Germany

For the U.S. published by  
Siemens Industry Inc.

100 Technology Drive  
Alpharetta, GA 30005  
United States

PDF (E86060-K1012-A101-A3-7600)  
KG 1022 1030 En  
Produced in Germany  
© Siemens 2022

#### Security information

Siemens provides products and solutions with industrial security functions that support the secure operation of plants, systems, machines and networks.

In order to protect plants, systems, machines and networks against cyber threats, it is necessary to implement – and continuously maintain – a holistic, state-of-the-art industrial security concept. Siemens' products and solutions constitute one element of such a concept.

Customers are responsible for preventing unauthorized access to their plants, systems, machines and networks. Such systems, machines and components should only be connected to an enterprise network or the internet if and to the extent such a connection is necessary and only when appropriate security measures (e.g. firewalls and/or network segmentation) are in place.

For additional information on industrial security measures that may be implemented, please visit <https://www.siemens.com/industrialsecurity>.

Siemens' products and solutions undergo continuous development to make them more secure. Siemens strongly recommends that product updates are applied as soon as they are available and that the latest product versions are used. Use of product versions that are no longer supported, and failure to apply the latest updates may increase customer's exposure to cyber threats.

To stay informed about product updates, subscribe to the Siemens Industrial Security RSS Feed under <https://www.siemens.com/cert>.

Subject to changes and errors. The information given in this document only contains general descriptions and/or performance features which may not always specifically reflect those described, or which may undergo modification in the course of further development of the products. The requested performance features are binding only when they are expressly agreed upon in the concluded contract.

All product designations may be trademarks or other rights of Siemens AG, its affiliated companies or other companies whose use by third parties for their own purposes could violate the rights of the respective owner.