

SC Type Fiber Optic Connectors

HSC Series

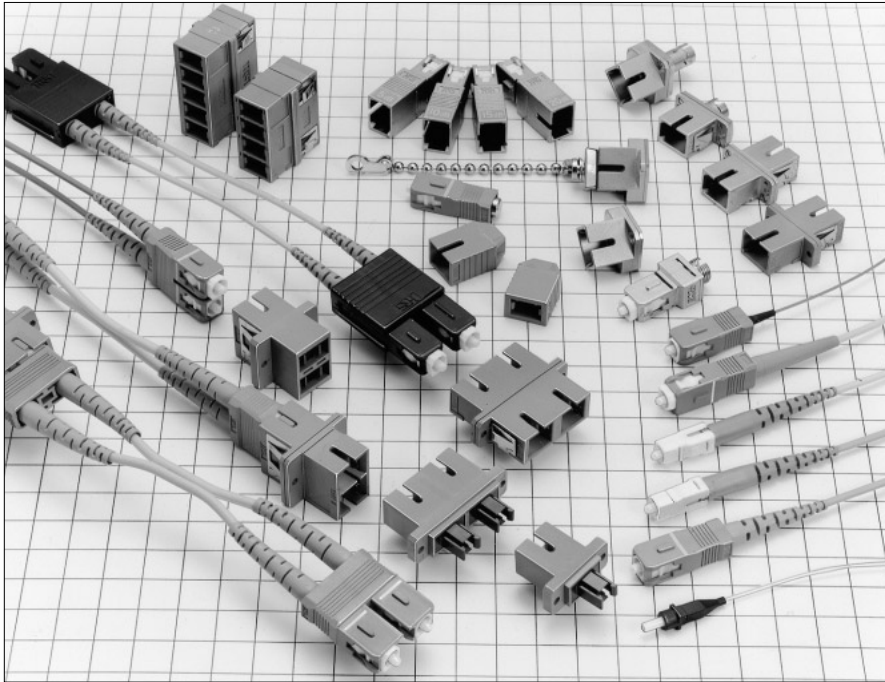

■ Features

1. JIS, IEC standards compliant and fully intermateable with NTT's SC products.

JIS C 5973 (F04 type fiber optic connectors)
IEC 61754-4

2. Plugs with strain relief boot

Long strain relief boot assures that there are no performance losses when a pull force is applied in a vertical bend direction.

The color of the boot identify the type of polishing:

Blue: PC polishing

Green: Angled PC polishing (APC)

Light purple: Advanced PC (AdPC) polishing

Other colors are also possible.

3. Zirconia Split Sleeve Adapter

Reduces the possibility of powdering caused by the repeated insertion and withdrawal of ferrule.

4. Duplex SC Type: Rigid Type

Available in following types;

H type – 8.5 mm spacing between the fibers, for high density applications.

F type – 12.7 mm spacing between the fibers, low profile, for LAN applications.

Refer to page 39 for further information.

5. Duplex SC Type: Adjustable Type – Comply With ANSI Standards

Floating mechanism with Duplex SC plug.

It is also fully compatible with the HSCF fixed type.

6. Simplified Plugs and Receptacles.

Small size (23.8mm plug length) simplified SC plug is designed for equipments inside connection.

Refer to page 43 for further information.

■ Applications

LAN, public communications lines, CableTV, computer transmission systems, test equipment, and other applications requiring reliable fiber optic connections.

Product Specifications

| Ratings | | Operating temperature range | | -25°C to +70°C | | Storage temperature range | | -25°C to +70°C | | |
|-------------------------------|--|-----------------------------|--|----------------|--|---|--|------------------|--|--|
| Item | | | Test Method (IEC 61300) | | | Specifications | | | | |
| Optical Characteristics | Insertion Loss | (SM) | Wavelength 1310nm (LD) | | | 0.5dB max. (PC, AdPC, APC) | | | | |
| | | (GI) | Wavelength 1310nm (LED) | | | 0.3dB max. (PC) | | | | |
| | Return Loss | (SM) | Wavelength 1310nm (LD) | | | 22dB min. (PC) | | 40dB min. (AdPC) | | |
| | | (GI) | | | | 60dB min. (APC) | | 22dB min. (PC) | | |
| Mechanical Characteristics | Engagement and Separation /force | | Measured with corresponding connector. | | | Simplex plug Engagement force: 19.6 N max. Separation force: 19.6 N max. Duplex plug Engagement force: 39 N max. Separation force: 39 N max. | | | | |
| | Ferrule withdrawal force | | Extract zirconia gauge 2.499 ±0.0005 mm dia from split sleeve. | | | Copper alloy split sleeve | | 2N to 5.9N | | |
| | Cable retention (Straight pull) | | 89N tensile load for one minute. | | | 1) Insertion loss fluctuation after test: 0.2dB max. 2) No visible damage, dislocation of clamp or cable. | | | | |
| | Durability (cycles, mating/un-mating) | | 1000 times | | | 1) Insertion loss fluctuation after test: 0.2dB max. 2) No visible damage, cracks or part dislocation. | | | | |
| | Vibration | | Frequency: 10 to 55 Hz, single amplitude of 0.75 mm, 2 hours in each of the 3 axis. | | | | | | | |
| | Shock | | Acceleration of 981 m/s ² , 6 ms duration, sin half-wave waveform, 10 cycles in each of the 3 axis. | | | | | | | |
| Environmental Characteristics | Humidity (Temperature/ humidity- cycles) | | -10°C to 65°C, humidity: 90% to 96% 20 cycles | | | No significant corrosion. | | | | |
| | Change of temperature | | -40°C to +75°C 42 cycles (Complies with Telcordia standard GR-326-CORE) | | | | | | | |
| | Dry heat | | 960 hours at 85°C | | | | | | | |
| | Cold | | 960 hours at -25°C | | | | | | | |
| | Salt mist | | 48 hours in a 5% concentration of salt mist | | | | | | | |

Materials

| Part | Material |
|----------------------------|-------------------------------|
| Simplex plug housing | Synthetic resin |
| Spring | Stainless steel |
| Ferrule | Zirconia |
| Simplex adapter housing | Synthetic resin or Zinc alloy |
| 4-position adapter housing | Synthetic resin |
| 5-position adapter housing | Synthetic resin |
| Receptacle housing | Zinc alloy |
| Attenuator housing | Zinc alloy |
| Split sleeve | Zirconia or Copper alloy |
| Dust cap | Synthetic resin |

Function diagram

Simplex type

SC type plug housing

Strain relief type

(For Cable Diameter: 2 mm & 3mm)



HSC-PH2-E1,E2,E5
HSC-PH3-B1,B2,B5

0.9 mm fiber

Light weight type



HSC-PH0.9-E1,E2,E5

Short length type

(For Cable Diameter: 2mm)



HSC-PH2-E1-A

Short length type

(For Cable Diameter: 3mm)



HSC-PH3-A4

Conversion adapter

- FC jack to SC Plug



HSCP-HRFCJ-1, 2
HSCP-HRFCJ-1AS, 2AS

Adapter-Panel Mounting

Plastic Housing Products

HSC-A3
HSC-A3-D1
HSC-A3-D2

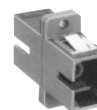

Die Cast Housing Products

HSC-A2
HSC-A2-D1



Conversion adapter

FC to SC - Screw Mounting

HSCJ-HRFCJ-B



FC to SC - Panel Mounting

HSCJ-HRFCJ-C



ST to SC - Screw Mounting

HSCJ-HSTJ-B



Receptacle

HSC-R1-B,R2-B



Simplified receptacle

HSC-SR-1,D1
HSC-SR-2,D2



<Tool Insertion/Extraction Connectors>

SC2 type plug housing

Strain relief

(For Cable Diameter: 2 mm & 3mm)



HSC2-PH2-E1,E2,E5
HSC2-PH3-B1,B2,B5

0.9 mm fiber Type



HSC2-PH0.9-E1,E2

Short length type

(For Cable Diameter: 2 mm)



HSC2-PH2-E1-A

Short length type

(For Cable Diameter: 3mm)



HSC2-PH3-A

Adapter

4-Position Adapter
Panel Mounting type

HSC2-4A
HSC2-4A-D1



5-Position Adapter
Panel Mounting type

HSC2-5A



Simplified receptacle

HSC2-8SR-1
HSC2-8SR-D1



Duplex type

<Plug Housings>

F type

Plug Housing
 (For Cable Diameter: 2mm&3mm)

HSCF-2PH2-E1,E2
 HSCF-2PH3-B1,B2



<Complies with ANSI Standard for adjustable Type>

For Single mode
 (For Cable Diameter: 2mm&3mm)

HSCM-2SPH2-B1,B2
 HSCM-2SPH3-B1,B2



For Multi mode
 (For Cable Diameter: 2 mm & 3mm)

HSCM-2GPH2-B1
 HSCM-2GPH3-B1



H type

Plug Housing
 (For Cable Diameter: 2 mm & 3mm)

HSCH-2PH2-B1,B2
 HSCH-2PH3-B1,B2



<Adapters>

F type

Panel Mounting

HSCF-2A(P)
 HSCF-2A-D(P)



H type

Snap - in

HSCH-2A1(P)
 HSCH-2A1-D(P)



Screw Mounting

HSCH-2A(P)
 HSCH-2A-D(P)



Fixed attenuators

For single mode

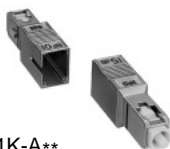

HSC-AT 11K-A**

See Page 85 for details.

For GI



HSC-AT5S-B**A

Terminators

Plug type



HSC-TM-P1

Tool- Insertion/Removal



HSC2-TM-P1

Receptacle type



HSC-TM-R1

See Page 89 for details.

Tool Insertion/Removal



HSC2-TM-R1

Simplex type

●Strain relief type

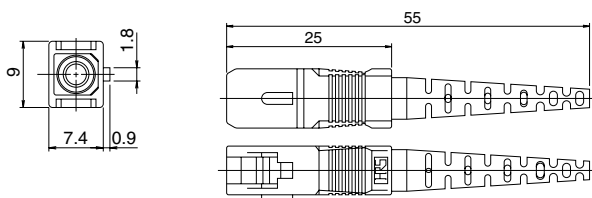

| Part Number | CL No. | Fiber cable type | Boot color | Polishing type | Outer jacket fixing |
|----------------|---------------|------------------|--------------|----------------|---------------------|
| HSC-PH2-E1(31) | 704-0327-3-31 | φ2mm | Blue | PC | Glue |
| HSC-PH2-E2(31) | 704-0328-6-31 | | Light purple | AdPC | |
| HSC-PH2-E5(31) | 704-3108-6-31 | | Green | APC | |
| HSC-PH3-B1(31) | 704-0222-5-31 | φ3mm | Blue | PC | Crimp |
| HSC-PH3-B2(31) | 704-0223-8-31 | | Light purple | AdPC | |
| HSC-PH3-B5(31) | 704-3020-7-31 | | Green | APC | |

●Light weight type (For 0.9mm fiber)

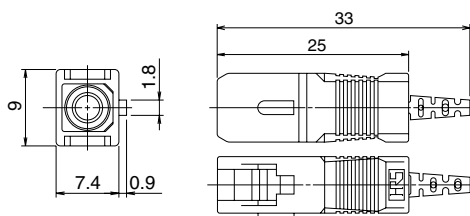

| Part Number | CL No. | Boot color | Polishing type |
|------------------|---------------|--------------|----------------|
| HSC-PH0.9-E1(06) | 704-0339-2-06 | Blue | PC |
| HSC-PH0.9-E2(31) | 704-0354-6-31 | Light purple | AdPC |
| HSC-PH0.9-E5(31) | 704-3104-5-31 | Green | APC |

●Short length type (For 2mm Cable)

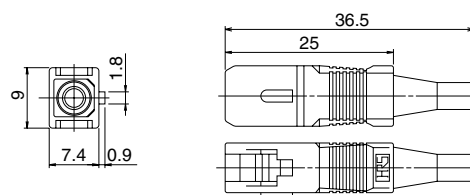

| Part Number | CL No. | Boot color | Polishing type | Outer jacket fixing |
|------------------|---------------|--------------|----------------|---------------------|
| HSC-PH2-E1-A(31) | 704-0464-4-31 | Blue | PC | Glue |
| HSC-PH2-E2-A(31) | 704-0480-0-31 | Light purple | AdPC | |
| HSC-PH2-E5-A | 704-3124-2 | Green | APC | |

●Short length type (For 3mm Cable)

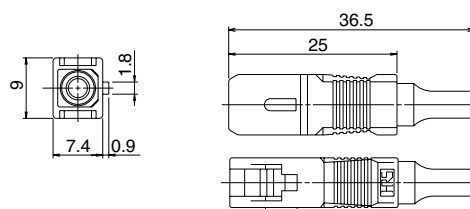

| Part Number | CL No. | Boot color | Polishing type | Outer jacket fixing |
|----------------|---------------|--------------|----------------|---------------------|
| HSC-PH3-A4(31) | 704-0245-0-31 | Blue | PC | Crimp |
| HSC-PH3-A4(32) | 704-0245-0-32 | Light purple | AdPC | |

■ Tool Insertion/Extraction Plug Housings

● Strain relief type

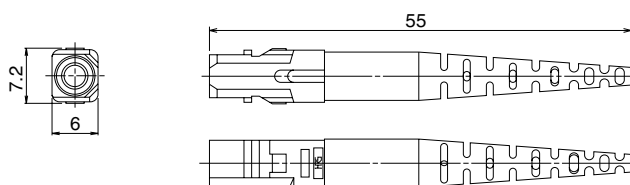

| Part Number | CL No. | Fiber cable type | Boot color | Polishing type | Outer jacket fixing |
|-----------------|---------------|------------------|--------------|----------------|---------------------|
| HSC2-PH2-E1(31) | 704-0329-9-31 | φ2mm | Blue | PC | Glue |
| HSC2-PH2-E2(31) | 704-0330-8-31 | | Light purple | AdPC | |
| HSC2-PH2-E5(31) | 704-3109-9-31 | | Green | APC | |
| HSC2-PH3-B1(31) | 704-0226-6-31 | φ3mm | Blue | PC | Crimp |
| HSC2-PH3-B2(31) | 704-0227-9-31 | | Light purple | AdPC | |
| HSC2-PH3-B5 | 704-3123-0 | | Green | APC | |

● Light weight type (For 0.9mm fiber)

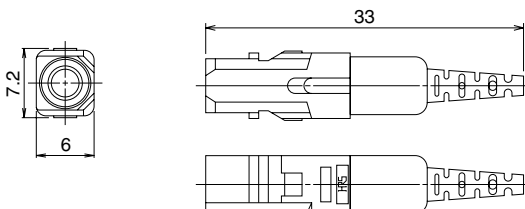

| Part Number | CL No. | Boot color | Polishing type |
|-------------------|---------------|--------------|----------------|
| HSC2-PH0.9-E1(31) | 704-0421-1-31 | Blue | PC |
| HSC2-PH0.9-E2(31) | 704-0422-4-31 | Light purple | AdPC |

● Short length type (For 2mm Cable)

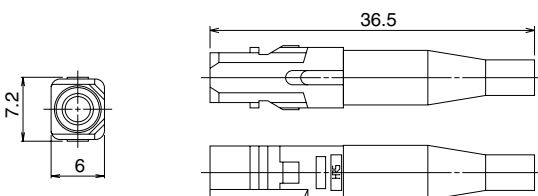

| Part Number | CL No. | Boot color | Polishing type | Outer jacket fixing |
|---------------|------------|--------------|----------------|---------------------|
| HSC2-PH2-E1-A | 704-0482-6 | Blue | PC | Glue |
| HSC2-PH2-E2-A | 704-0481-3 | Light purple | AdPC | |

● Short length type (For 3mm Cable)

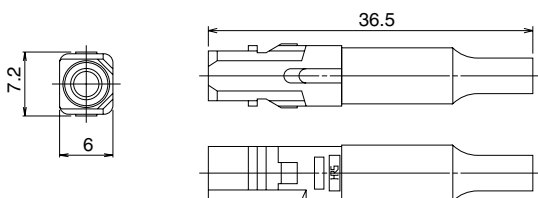

| Part Number | CL No. | Boot color | Polishing type | Outer jacket attachment |
|----------------|---------------|------------|----------------|-------------------------|
| HSC2-PH3-A(31) | 704-0015-0-31 | Blue | PC | Crimp |

Note : Please contact HIROSE for other variations.

■ Receptacles

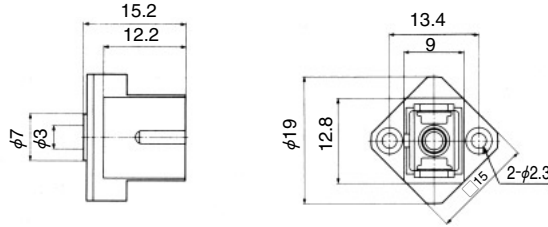

Note: Designed for power meter sensors

| Part Number | CL No. | Remarks |
|--------------|---------------|---------|
| HSC-R1-B(05) | 704-0022-6-05 | For MM |
| HSC-R2-B(05) | 704-0023-9-05 | For SM |

■ Ferrules

● For PC, AdPC and UPC

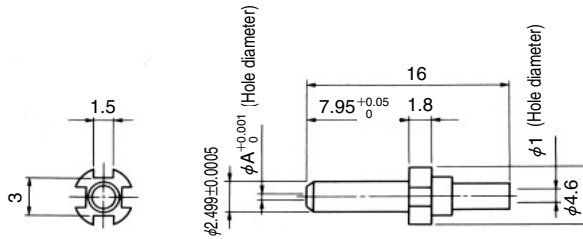

| Part Number | CL No. | A dimension | Applicable Fiber cable |
|--------------------|---------------|-------------|------------------------|
| HSC-F321-A125(10) | 704-0070-9-10 | 0.125 | SM,MM |
| HSC-F321-A1255(10) | 704-0200-2-10 | 0.1255 | |
| HSC-F321-A126(10) | 704-0071-1-10 | 0.126 | |

● For APC

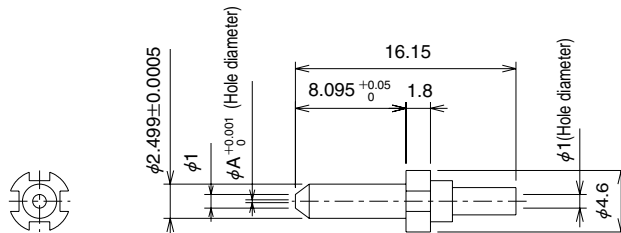

| Part Number | CL No. | A dimension | Applicable Fiber cable |
|---------------|------------|-------------|------------------------|
| HSC-F391-A125 | 704-3101-7 | 0.125 | SM |
| HSC-F391-A126 | 704-3102-0 | 0.126 | |
| HSC-F391-A127 | 704-3103-2 | 0.127 | |

- (1) No gap design.
- (2) The entrance angle of the fiber has been set at 60° for easy fiber insertion.

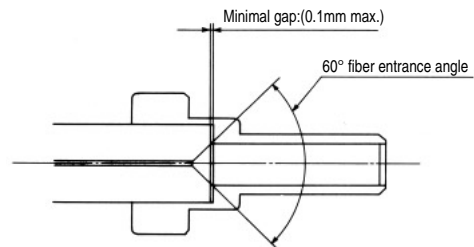

Adapters - Panel Mounting

SC adapters

SC/SC Plastic Housing

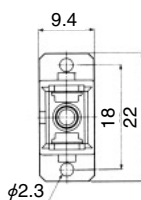
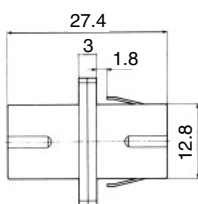

Panel cutout

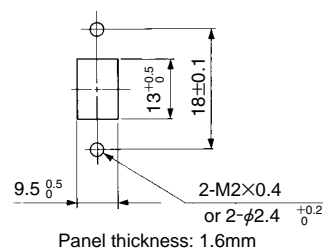

| Part Number | CL No. | Split sleeve | Remarks |
|---------------|---------------|--------------|---------------|
| HSC-A3(51) | 704-0092-1-51 | Copper alloy | PC,AdPC(Blue) |
| HSC-A3-D1(02) | 704-0217-5-02 | Zirconia | |
| HSC-A3-D2(06) | 704-3007-9-06 | Zirconia | APC(Green) |

SC/SC Die Cast Metal Housing

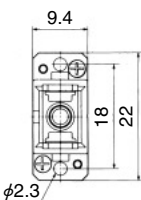
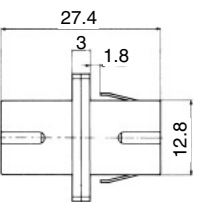

Panel cutout

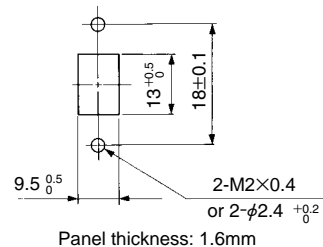

| Part Number | CL No. | Split sleeve |
|---------------|---------------|--------------|
| HSC-A2(51) | 704-0020-0-51 | Copper alloy |
| HSC-A2-D1(01) | 704-0258-2-01 | Zirconia |

SC2 adapters

SC/SC2 4-way adapter

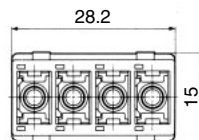
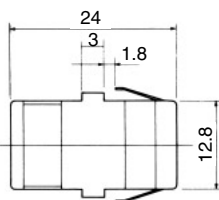

Panel cutout

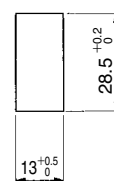

Panel thickness: 1.6mm

| Part Number | CL No. | Split sleeve |
|----------------|---------------|--------------|
| HSC2-4A(51) | 704-0024-1-51 | Copper alloy |
| HSC2-4A-D1(01) | 704-0290-5-01 | Zirconia |

SC/SC2 5-way adapter (for Multi-mode fiber)

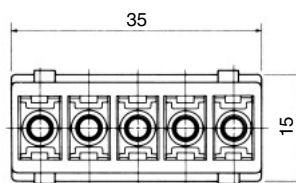
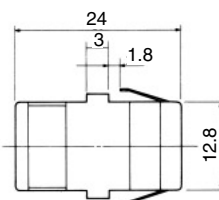

Panel cutout

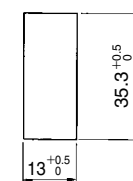

Panel thickness: 1.6mm

| Part Number | CL No. | Split sleeve |
|-------------|---------------|--------------|
| HSC2-5A(51) | 704-0025-4-51 | Copper alloy |

■ Conversion adapters

● FC / SC Screw Mounting

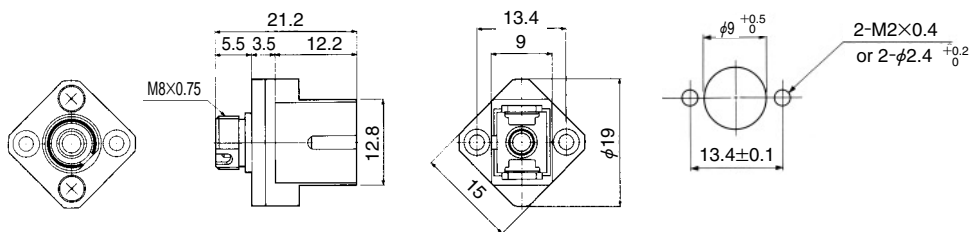

| Part Number | CL No. | Split sleeve |
|------------------|---------------|--------------|
| HSCJ-HRFCJ-B(51) | 704-0021-3-51 | Copper alloy |

◆ Panel cutout

● FC / SC Snap-in and/or Screw Mounting

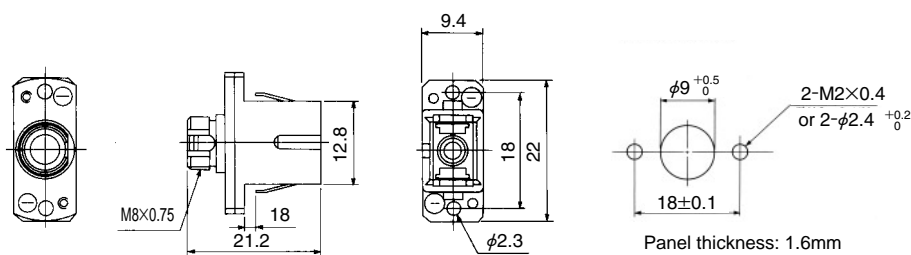
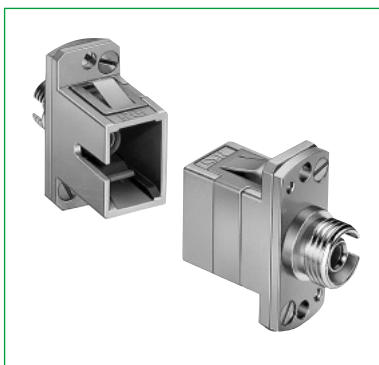

| Part Number | CL No. | Split sleeve |
|------------------|---------------|--------------|
| HSCJ-HRFCJ-C(51) | 704-0206-9-51 | Copper alloy |

◆ Panel cutout

● ST / SC Screw Mounting

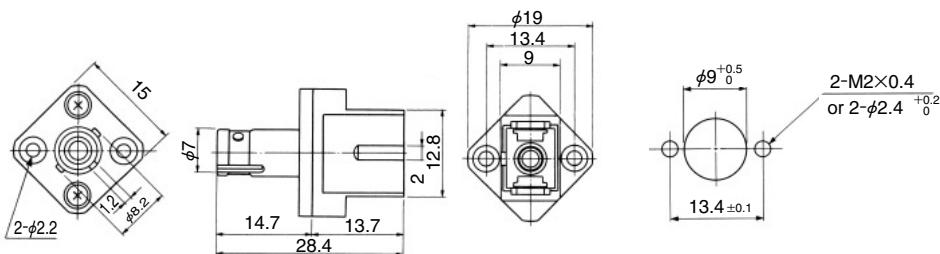

| Part Number | CL No. | Split sleeve |
|-----------------|---------------|--------------|
| HSCJ-HSTJ-B(51) | 704-0102-3-51 | Copper alloy |

◆ Panel cutout

MU

SC

FC

Harsh Environment

Attenuators

Terminators

●FC / SC

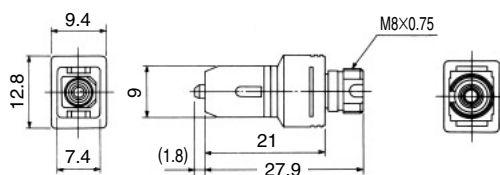

| Part Number | CL No. | Split sleeve | Polishing type | Applicable Fiber cable |
|--------------------|---------------|--------------|----------------|------------------------|
| HSCP-HRFCJ-1(51) | 704-0203-0-51 | Copper alloy | PC | GI-50/125 |
| HSCP-HRFCJ-1AS(51) | 704-0288-3-51 | | AdPC | |
| HSCP-HRFCJ-2(51) | 704-0204-3-51 | | PC | SM-9.5/125 |
| HSCP-HRFCJ-2AS(51) | 704-0289-6-51 | | AdPC | |

●The positions of SC guide key and FC guide slot will not be always aligned.

●FC / SC

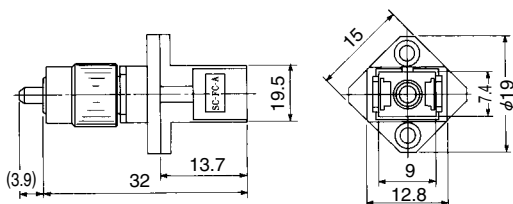

| Part Number | CL No. | Split sleeve | Polishing type | Applicable Fiber cable |
|--------------------|---------------|--------------|----------------|------------------------|
| HRFCP-HSCJ-1(51) | 701-0065-0-51 | Copper alloy | PC | GI-50/125 |
| HRFCP-HSCJ-1AS(51) | 701-0108-0-51 | | AdPC | |
| HRFCP-HSCJ-2(51) | 701-0085-7-51 | | PC | SM-9.5/125 |
| HRFCP-HSCJ-2AS(51) | 701-0109-3-51 | | AdPC | |

●The positions of SC guide slot and FC guide key will not be always aligned.

■Cap

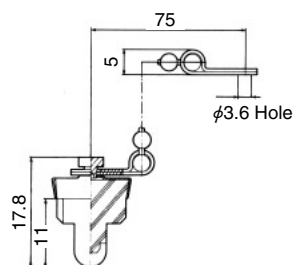

| Part Number | CL No. | Applicable products |
|-------------|------------|--|
| HSC-C2 | 704-0061-8 | HSC-A2 , HSC-A3 , HSCJ-HRFCJ-B , CHSCJ-HSTJ-B , HSC-R1-B , HSC-R2-B |

◆ Mounting Dimensions

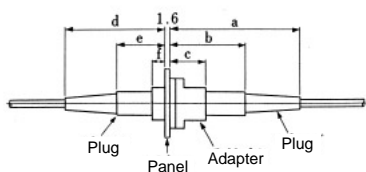

Unit: mm

| Combination | | Dimensions | | | | | |
|--|--------------|------------|------|------|------|------|------|
| Adapter | Housing | a | b | c | d | e | f |
| HSC-A2 HSC-A2-D1 HSC-A3 HSC-A3-D1 | HSC-PH2-E1 | 58 | 28 | 15.2 | 53.4 | 23.4 | 10.6 |
| | HSC-PH2-E2 | | | | | | |
| | HSC-PH3-B1 | | | | | | |
| | HSC-PH3-B2 | 39.5 | 28 | 15.2 | 34.9 | 23.4 | 10.6 |
| | HSC-PH2-E1-A | | | | | | |
| | HSC-PH3-A4 | | | | | | |
| HSC-PH0.9-E1 | 36 | 26 | 15.2 | 31.4 | 21.4 | 10.6 | |
| HSC2-4A HSC2-4A-D1 HSC2-5A HSC2-5A-D1 | HSC2-PH2-E1 | 58 | — | 13.5 | 53.4 | — | 8.9 |
| | HSC2-PH2-E2 | | | | | | |
| | HSC2-PH3-B1 | | | | | | |
| | HSC2-PH3-B2 | 39.5 | — | 13.5 | 34.9 | — | 8.9 |
| | HSC2-PH3-A | | | | | | |
| | HSC-PH2-E1-A | | | | | | |
| HSC2-PH0.9-E1 | 36 | — | 13.5 | 31.4 | — | 8.9 | |
| HSC-R1-B HSC-R2-B | HSC-PH2-E1 | 57.5 | 27.5 | 14.7 | — | — | — |
| | HSC-PH2-E1 | | | | | | |
| | HSC-PH3-B1 | | | | | | |
| | HSC-PH3-B2 | | | | | | |

Note: Panel thickness: 1.6mm

MU

SC

FC

Harsh
Environment

Attenuators

Terminators

Tools

●Crimp Tool

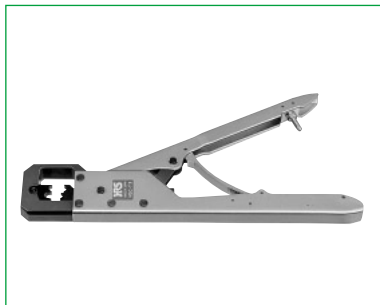

| Part Number | CL No. | Applicable connector |
|-------------|------------|-----------------------------|
| HSC-T3 | 704-0287-0 | SC plug for 2mm, 3mm cable. |

<Locations>

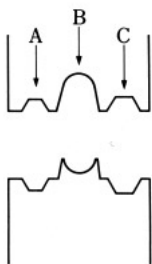

- (1) 2mm Jacket crimping: section A
- 3mm Jacket crimping: section C
- (2) Kevlar™ crimping: section B

●HSC2 Insertion/Extraction Tool



| Part Number | CL No. | Applicable Products |
|-------------|------------|---------------------|
| HSC-T1-L | 704-0286-8 | HSC2 series. |

<How to operate>

1. Open the tip of tool by compressing levers as shown below.

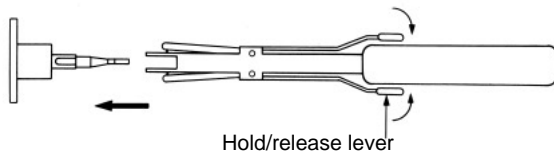

2. Insert the tool (with opening the tips) into adapter.

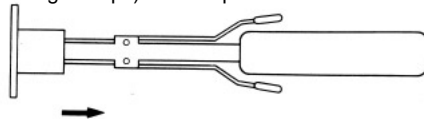

3. Release the levers (then the tool catch HSC2 plug) and you can release the connector.

●Plug assemble Tool



| Part Number | CL No. |
|---------------|------------|
| HSC2-PH2/CVMD | 902-6029-1 |

SC Duplex

◆Notes

SC duplex adapters can be also connected with Simplex SC plugs.
 SC type attenuators (HSC-AT11K-A※-※) can be connected only with F type adapters.

■Plug Housing

●F Type

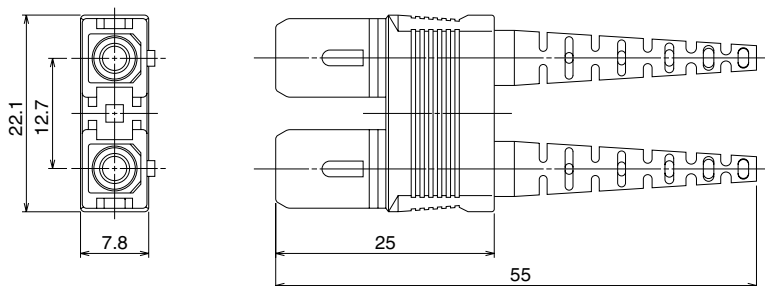

| Part Number | CL No. | Applicable Cable Diameter | Boot Color | Polishing type |
|---------------------|---------------|---------------------------|--------------|----------------|
| HSCF-2PH2-E1(P)(31) | 704-2109-3-31 | φ2mm | Blue | PC |
| HSCF-2PH2-E2(P)(31) | 704-2120-6-31 | | Light purple | AdPC |
| HSCF-2PH3-B1(P)(31) | 704-2032-0-31 | φ3mm | Blue | PC |
| HSCF-2PH3-B2(P)(31) | 704-2036-1-31 | | Light purple | AdPC |

●H Type

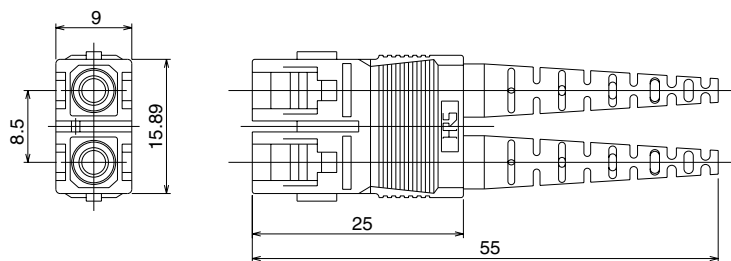

| Part Number | CL No. | Applicable Cable Diameter | Boot Color | Polishing type |
|---------------------|---------------|---------------------------|--------------|----------------|
| HSCH-2PH2-B1(P)(31) | 704-2046-5-31 | φ2mm | Blue | PC |
| HSCH-2PH2-B2(P)(31) | 704-2058-4-31 | | Light purple | AdPC |
| HSCH-2PH3-B1(P)(31) | 704-2054-3-31 | φ3mm | Blue | PC |
| HSCH-2PH3-B2(P)(31) | 704-2050-2-31 | | Light purple | AdPC |

Adapters

F type Snap-in and/or Screw Mounting

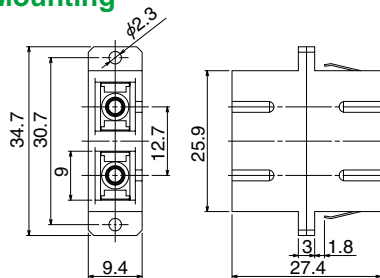
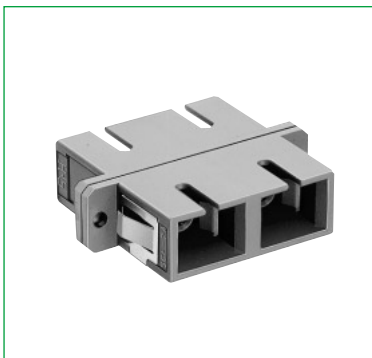

Panel cutout

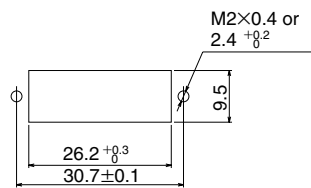

Panel thickness: 1.6mm

| Part Number | CL No. | Split sleeve | Color |
|-------------------|---------------|--------------|-------|
| HSCF-2A(P)(51) | 704-2008-6-51 | Copper alloy | Blue |
| HSCF-2A-D(P)(06) | 704-2040-9-06 | Zirconia | Green |
| HSCF-2A-D2(P)(06) | 704-2112-8-06 | | |

H type Snap-in

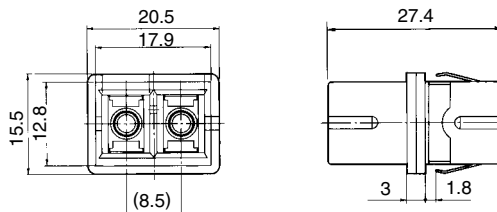

Panel cutout

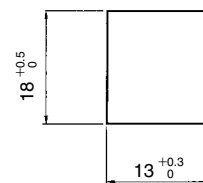

Panel thickness: 1.6mm

| Part Number | CL No. | Split sleeve | Color |
|-------------------|---------------|--------------|-------|
| HSCH-2A1(P)(51) | 704-2066-2-51 | Copper alloy | Blue |
| HSCH-2A1-D(P)(02) | 704-2117-1-02 | Zirconia | Green |
| HSCH-2A1-D2(P) | 704-2137-9 | | |

H type Snap-in and/or Screw Mounting

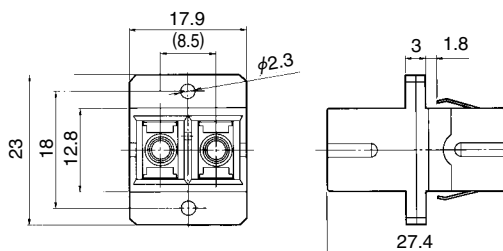

Panel cutout

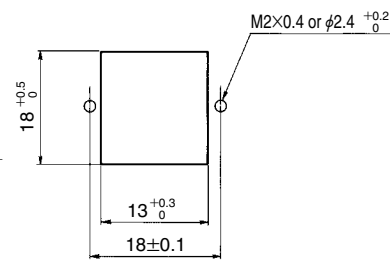

Panel thickness: 1.6mm

| Part Number | CL No. | Split sleeve | Color |
|-------------------|---------------|--------------|-------|
| HSCH-2A(P)(51) | 704-2020-1-51 | Copper alloy | Blue |
| HSCH-2A-D(P)(02) | 704-2062-1-02 | Zirconia | Green |
| HSCH-2A-D2(P)(03) | 704-2108-0-03 | | |

◆ Mounting Dimensions

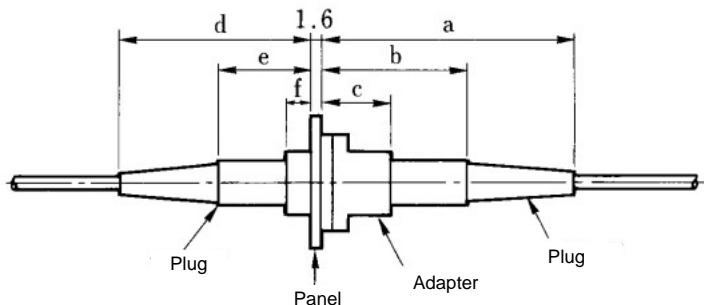

<F Type>

Unit: mm

| Combination | | Dimensions | | | | | |
|----------------------------|------------------------------|------------|----|------|------|------|------|
| Adapter | Housing | a | b | c | d | e | f |
| HSCF-2A(P) HSCF-2A-D(P) | HSC-PH*-E# HSCF-PH*-B#(P) | 58 | 28 | 15.2 | 53.4 | 23.4 | 10.6 |
| | HSC-PH*-A4 | 39.5 | 28 | 15.2 | 34.9 | 23.4 | 10.6 |
| | HSC-PH0.9-E# | 36 | 26 | 15.2 | 31.4 | 21.4 | 10.6 |

<H Type>

| Combination | | Dimensions | | | | | |
|---|-------------------------------|------------|----|------|------|------|------|
| Adapter | Housing | a | b | c | d | e | f |
| HSCH-2A(P) HSCH-2A-D(P) HSCH-2A1(P) | HSC-PH*-E# HSCH-2PH*-B#(P) | 58 | 28 | 15.2 | 53.4 | 23.4 | 10.6 |
| | HSC-PH*-A4 | 39.5 | 28 | 15.2 | 34.9 | 23.4 | 10.6 |
| | HSC-PH0.9-E# | 36 | 26 | 15.2 | 31.4 | 21.4 | 10.6 |

Note 1: * indicates cable diameter: 2= ϕ 2mm diameter

3= ϕ 3mm diameter

Note 2: # indicates polishing type:

1= PC polishing

2= AdPC polishing

Complies with ANSI Standard

ANSI X3T9.3 Fibre Channel Physical and Signaling Interface

■ Plug Housings

● For Single Mode

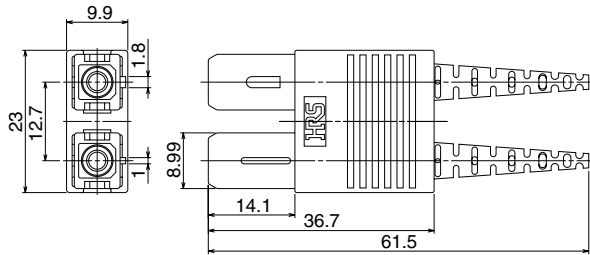
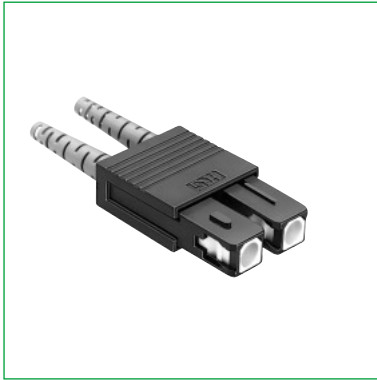

| Part Number | CL No. | Applicable cable | Boot color | Polishing type |
|---------------|------------|--|--------------|----------------|
| HSCM-2SPH2-B1 | 704-2100-9 | Simplex-2mm dia. cable or dual fiber zip cable | Blue | PC |
| HSCM-2SPH3-B1 | 704-2102-4 | Simplex-3mm dia. cable or dual fiber zip cable | | |
| HSCM-2SPH2-B2 | 704-2133-8 | Simplex-2mm dia. cable or dual fiber zip cable | Light purple | AdPC |
| HSCM-2SPH3-B2 | — | Simplex-3mm dia. cable or dual fiber zip cable | | |

● For Multi-mode

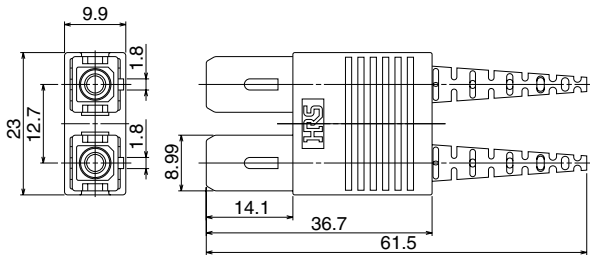

| Part Number | CL No. | Applicable cable | Boot color | Polishing type |
|---------------|------------|--|------------|----------------|
| HSCM-2GPH2-B1 | 704-2104-0 | Simplex-2mm dia. cable or dual fiber zip cable | Blue | PC |
| HSCM-2GPH3-B1 | 704-2106-5 | Simplex-3mm dia. cable or dual fiber zip cable | | |

■ Ferrules

Conventional SC ferrules.
 Refer to page 33 for details.

■ Adapters

F type SC adapters.
 Refer to page 40 for details.

MU

SC

FC

Harsh Environment

Attenuators

Terminators