



# NetScaler MPX

## Contents

<b>Common hardware components</b>	<b>5</b>
<b>Data sheets</b>	<b>24</b>
<b>NetScaler MPX hardware-software compatibility matrix</b>	<b>24</b>
<b>Hardware platforms</b>	<b>26</b>
<b>NetScaler MPX 5500</b>	<b>26</b>
<b>NetScaler MPX 5550 and MPX 5650</b>	<b>28</b>
<b>NetScaler MPX 5900</b>	<b>29</b>
<b>NetScaler MPX 7500 and MPX 9500</b>	<b>31</b>
<b>NetScaler MPX 8005, MPX 8015, MPX 8200, MPX 8400, MPX 8600, and MPX 8800</b>	<b>34</b>
<b>NetScaler MPX 8900</b>	<b>36</b>
<b>NetScaler MPX 8900 FIPS certified appliance</b>	<b>39</b>
<b>NetScaler MPX 9100</b>	<b>41</b>
<b>NetScaler MPX 9100 FIPS</b>	<b>43</b>
<b>NetScaler MPX 9700, MPX 10500, MPX 12500, and MPX 15500</b>	<b>45</b>
<b>NetScaler MPX 11500, MPX 13500, MPX 14500, MPX 16500, MPX 18500, and MPX 20500</b>	<b>48</b>
<b>NetScaler MPX 11500</b>	<b>51</b>
<b>NetScaler MPX 14000</b>	<b>53</b>
<b>NetScaler MPX 14000-40C</b>	<b>55</b>
<b>NetScaler MPX 14000-40G</b>	<b>57</b>
<b>NetScaler MPX 14000-40S</b>	<b>59</b>
<b>NetScaler MPX 14000 FIPS</b>	<b>61</b>
<b>NetScaler MPX 15000</b>	<b>63</b>
<b>NetScaler MPX 15000-50G</b>	<b>65</b>

<b>NetScaler MPX 15000-50G FIPS certified appliance</b>	<b>68</b>
<b>NetScaler MPX 16000</b>	<b>71</b>
<b>NetScaler MPX 17500, MPX 19500, and MPX 21500</b>	<b>74</b>
<b>NetScaler MPX 17550, MPX 19550, MPX 20550, and MPX 21550</b>	<b>76</b>
<b>NetScaler MPX 22000</b>	<b>78</b>
<b>NetScaler MPX 24100</b>	<b>81</b>
<b>NetScaler MPX 25000A</b>	<b>83</b>
<b>NetScaler MPX 25100T</b>	<b>85</b>
<b>NetScaler MPX 25000TA</b>	<b>87</b>
<b>NetScaler MPX 25000-40G</b>	<b>89</b>
<b>NetScaler MPX 26000</b>	<b>91</b>
<b>NetScaler MPX 26000-50S</b>	<b>93</b>
<b>NetScaler MPX 26000-100G</b>	<b>96</b>
<b>NetScaler T1010</b>	<b>98</b>
<b>NetScaler T1100</b>	<b>100</b>
<b>NetScaler T1120</b>	<b>102</b>
<b>NetScaler T1200</b>	<b>104</b>
<b>NetScaler T1300</b>	<b>105</b>
<b>NetScaler T1310</b>	<b>107</b>
<b>Field replaceable units</b>	<b>110</b>
<b>Safety, cautions, warnings, and other information</b>	<b>127</b>
<b>Taiwan BSMI RoHS statement</b>	<b>132</b>
<b>FCC compliance statement</b>	<b>134</b>
<b>Prepare for installation</b>	<b>135</b>

<b>Install the hardware</b>	<b>137</b>
<b>Initial configuration</b>	<b>147</b>
<b>Lights out management port of the NetScaler MPX appliance</b>	<b>160</b>
<b>Set the LOM password length using the IPMI tool</b>	<b>162</b>
<b>Configure the network settings on the LOM port</b>	<b>163</b>
<b>Install a certificate and key on the LOM GUI</b>	<b>168</b>
<b>Obtain the MAC address, serial number, and host properties of the appliance</b>	<b>174</b>
<b>Perform power control operations by using the LOM port</b>	<b>175</b>
<b>Restore the BMC configuration to factory defaults</b>	<b>177</b>
<b>Use the BIOS POST code to detect errors</b>	<b>178</b>
<b>Upgrade the LOM firmware on a NetScaler MPX appliance</b>	<b>178</b>
<b>Enable RADIUS authentication in the LOM GUI</b>	<b>180</b>
<b>RAKP topology on NetScaler appliances</b>	<b>182</b>
<b>Configure Active Directory in LOM</b>	<b>183</b>
<b>Change the BMC host name</b>	<b>186</b>
<b>Hardware health attributes for the MPX 16000 platform</b>	<b>187</b>
<b>Hardware health attributes for the MPX 9100 platform</b>	<b>192</b>
<b>Legacy hardware health attributes</b>	<b>197</b>
<b>Configure the ring size on Mellanox and Fortville interfaces</b>	<b>206</b>
<b>Fortville NICs firmware upgrade on NetScaler MPX appliances</b>	<b>210</b>
<b>Mellanox NIC firmware upgrade on NetScaler MPX</b>	<b>213</b>
<b>Wiping the data from your NetScaler</b>	<b>217</b>
<b>How to verify the file system integrity of your NetScaler MPX appliance</b>	<b>221</b>
<b>Migrate the configuration of an existing NetScaler appliance to another NetScaler appliance</b>	<b>224</b>

<b>Troubleshooting</b>	<b>227</b>
<b>Hardware FAQs</b>	<b>229</b>

## Common hardware components

March 8, 2024

Each platform has front panel and back panel hardware components. The front panel on most appliances has an LCD display and an RS232 serial console port. The number, type, and location of ports vary by hardware platform for the following transceivers: copper Ethernet, copper and fiber 1G SFP, copper 10G Base-T, 10G SFP+, 40G QSFP+, 50G QSFP28, and 100G QSFP28. The back panel provides access to the field replaceable units (power supplies and solid-state drives).

### LCD display and LED status indicators

#### Note

This section does not apply to MPX 9100 and MPX 16000.

The LCD display on the front of every appliance displays messages about the current operating status of the appliance. These messages communicate whether your appliance has started and is operating normally. If the appliance is not operating normally, the LCD displays troubleshooting messages.

The LCD displays live statistics, diagnostic information, and active alerts. The dimensions of the LCD limit the display to two lines of 16 characters each. As the result, the displayed information flows through a sequence of screens. Each screen shows information about a specific function.

The LCD has an LED backlight. Normally, the backlight glows steadily. When there is an active alert, it blinks rapidly. If the alert information exceeds the LCD screen size, the backlight blinks at the beginning of each display screen. After the appliance shuts down, the backlight remains on for one minute and then automatically turns off.

### System status LEDs

On the MPX 22000 and MPX 24000 appliance back panel, system status LEDs indicate the overall status of the appliance. The following table describes the indicators of the system status LED.

**Note:** System status LEDs are available on only some NetScaler appliances.

---

LED Color	LED Indicates
OFF	No power.
Green	Appliance is receiving power.
Red	Appliance has detected an error.

---

The port LEDs show whether a link is established and traffic is flowing through the port. The following table describes the LED indicators for each port. There are two LED indicators for each port type.

**Note:** This section applies to all the appliances.

**LED port-status indicators**

Port Type	LED Color	LED Indicates
50 Gbps	Off	A link has not been established.
	Blinking amber	Indicates a problem with the link
	Solid green	Indicates a valid link with no active traffic.
	Blinking green	Indicates a valid link with active traffic.

Port Type	LED	LED	LED Color	LED Indicates
10 Gbps	Top	Speed	Off	No connection.
			Solid blue or solid green	Traffic rate of 10 gigabits per second.
		Bottom	Link/Activity	Off
1G SFP (1 Gbps)	Left	Link/Activity	Solid green	Traffic is passing through the port.
			Blinking green	No link.
	Right	Speed	Off	Traffic is passing through the port.
			Blinking green	Off

Port Type	LED	LED	LED Color	LED Indicates
Ethernet (RJ45)	Left (Right on MPX 5900 platform)	Speed	Yellow	Traffic rate of 1 gigabit per second.
			Off	No connection, or a traffic rate of 10 megabits per second (Mbps).
			Green	Traffic rate of 100 Mbps.
			Yellow	Traffic rate of 1 gigabit per second.
Management (RJ45)	Left	Speed	Link/Activity	Off
			Right (Left on MPX 5900 platform)	Blinking green
			Off	No connection, or a traffic rate of 10 megabits per second (Mbps).
			Green	Green
	Right	Link/Activity	Off	Amber
			Solid yellow	No link.
				Link is established but no traffic is passing through the port.

On each power supply, a bicolor LED indicator shows the condition of the power supply.

### 3Y power supply

The 3Y power supply is used on the following platforms:

- 450 W AC/DC



- MPX 8005/8010/8015
- MPX 8200/8400/8600/8800
- 850 W AC
  - MPX 16000
- 1000 W AC/DC
  - MPX 14000
  - MPX 25000
  - T1300
  - MPX 15000
  - MPX 15000-50G
  - MPX 26000
  - MPX 26000-100G
- 1200 W AC/DC
  - MPX 26000-50S

### 3Y power supply LED behavior

Power Supply	450 W AC	450 W DC	850 W AC	1000 W AC	1000 W DC	1200 W AC
LED behavior when No Power to any power supply	YM-2451CAR	YM-2451DBR	YSEF0850EM	YM-2102NA01R	YM-2102JA01R	YM-2122CA01R
No power to this power supply	Off	Off	Off	Off	Off	Off
Power supply is in standby mode	Flashing GREEN	Flashing BLUE	Flashing GREEN	Flashing GREEN	Flashing GREEN	Flashing GREEN

Power Supply	450 W AC	450 W DC	850 W AC	1000 W AC	1000 W DC	1200 W AC
Power supply is functional	GREEN	BLUE	GREEN	GREEN	GREEN	GREEN
Power supply failure	RED	RED	AMBER	RED	RED	RED
Warning (OVP/U-VP/OCP/OT-P/Fan)	-	-	Flashing AMBER	-	Flashing RED/GREEN	-

**Note**

The following legacy platforms use the 300W 3Y power supply: 5850/5750/5650/5550/5500/5600.

**AcBel power supply**

The AcBel power supply is used on the following platforms. The power supply model number is added for each platform.

- 450 W AC
  - MPX 5900/8900 (R1BA2451B)
- 450 W DC
  - MPX 5900/8900 (R1BD2451A)
- 450 W AC
  - MPX 9100 (R1BA2451D)

**MPX 9100 AcBel 450 W power supply LED behavior**

Power Supply	450 W AC (100–240 VAC)
LED behavior when	
No Power to any power supply	Off
No power to this power supply	ORANGE

Power Supply	450 W AC (100–240 VAC)
Power supply is in standby mode	Flashing GREEN
Power supply is functional	GREEN
Power supply failure	ORANGE
Power supply failure warning (OVP/UVP/OCP/OTP/Fan)	Flashing ORANGE

### MPX 5900/8900 AcBel 450 W power supply LED behavior

Power Supply	450 W AC (100–240 VAC)	450 W DC (-40 VDC to -72 VDC)
LED behavior when		
No Power to any power supply	Off	Off
No power to this power supply	RED	AMBER
Power supply is in standby mode	Flashing GREEN	Flashing BLUE
Power supply is functional	GREEN	BLUE
Power supply failure	RED	AMBER
Power supply failure warning (OVP/UVP/OCP/OTP/Fan)	Flashing RED/GREEN	Flashing AMBER

#### Note

AC power supplies use green LEDs and DC power supplies use blue LEDs.

### Zippy power supply

The Zippy power supply is used on the following platforms:

- 960 W AC/DC
  - MPX 11515/11520/11530/11540/11542
  - MPX 11500/13500/14500/16500/18500/20500

### Zippy 960 W power supply LED behavior

Power Supply	960 W AC	960 W DC
LED behavior when	G1W2-5960V3V Rev.5	DG1W-3960 V
No Power to any power supply	Off	Off
No power to this power supply	Continuous beep sound	Continuous beep sound
Power supply is in standby mode	-	-
Power supply is functional (Power ON)	GREEN	GREEN
Power supply failure	-	-
Warning (OVP/UVP/OCP/OTP/Fan)	-	-

**Note**

Power Supply Unit **ON**-Green

Power Supply Unit **OFF**- No Color

There is no other function other than ON or OFF for the module LEDs. A continuous beep sound occurs if a cable or module is unplugged.

**Flex power supply**

The Flex power supply is used on the following platforms:

- 750 W AC/DC
  - MPX 24000
  - MPX 22000
  - T1200

**Flex (750 W) power supply LED behavior**

Power Supply	750 W AC	750 W DC
LED behavior when	F750E-XX A00	
No Power to any power supply	Off	Off
No power to this power supply	LED goes off	LED goes off

Power Supply	750 W AC	750 W DC
Power supply is in standby mode	-	-
Power supply is functional (Power On)	GREEN	GREEN
Power supply failure	-	-
Warning (OVP/UVP/OCP/OTP/Fan)	-	-

**Note**

Power Supply Unit **ON**-Green

Power Supply Unit **OFF**- No Color

There is no other function other than ON or OFF for the module LEDs. A continuous beep sound occurs if a cable or module is unplugged.

**Ports**

Ports are used to connect the appliance to external devices. NetScaler appliances support the following ports:

- RS232 serial ports
- 10/100/1000Base-T copper Ethernet ports
- 1 GB copper and fiber SFP ports
- 10 GB fiber SFP+
- 25 GB SFP 28
- 40G QSFP+
- 50 GB QSFP28
- 100 GB QSFP28

All NetScaler appliances have a combination of some or all of these ports. Cards might be vertical or horizontal depending on the platform. The number of ports per card varies across platforms. For better fault tolerance, create link aggregated groups (LAGs) on independent cards. Typically, cards are vertical on 2U appliances and horizontal on 1U appliances as seen in the following sample illustrations.



For more information about LAGs, see [Configuring Link Aggregation](#). For details on the type and number of ports available on your appliance, see the section describing that platform.

**Note**

NetScaler appliances use the Receive Side Scaling (RSS) feature to optimally distribute and process traffic. The RSS implementation is based on [ToepLitz](#) hashing which distributes the packet among its queues based on the 5-tuple: TCP/IP protocol, source IP address, destination IP address, source port, and destination port.

**RS232 serial port**

The RS232 serial console port provides a connection between the appliance and a computer, allowing direct access to the appliance for initial configuration and troubleshooting.

All hardware platforms ship with an appropriate serial cable used to connect your computer to the appliance. For instructions on connecting your computer to the appliance, see [Install the Hardware](#).

**Copper Ethernet ports**

The copper Ethernet ports installed on many models of the appliance are standard RJ45 ports.

There are two types of copper Ethernet ports that can be installed on your appliance:

- 10/100BASE-T port
 

The 10/100BASE-T port has a maximum transmission speed of 100 megabits per second (Mbps). Most platforms have at least one 10/100BASE-T port.
- 10/100/1000BASE-T port
 

The 10/100/1000BASE-T port has a maximum transmission speed of 1 gigabit per second, 10 times faster than the other type of copper Ethernet port. Most platforms have at least one 10/100/1000Base-T port.

To connect any of these ports to your network, plug one end of a standard Ethernet cable into the port. Plug the other end into the appropriate network connector.

### Management ports

Management ports are standard copper Ethernet ports (RJ45). They are used for direct access to the appliance for system administration functions.

### 1G SFP and 10G SFP+ ports

A 1G SFP port can operate at a speed of 1 Gbps. It accepts either a copper 1G SFP transceiver for operation as a copper Ethernet port, or a fiber 1G SFP transceiver for operation as a fiber optic port.

The 10G SFP+ modules are dual-speed capable and support both 1 Gbps and 10 Gbps, depending on the peer switch that the model connects to. You need a fiber optic cable to connect to a port. If the other end of the fiber optic cable is attached to a 1G SFP port, the 10G SFP+ port automatically negotiates to 1G speed.

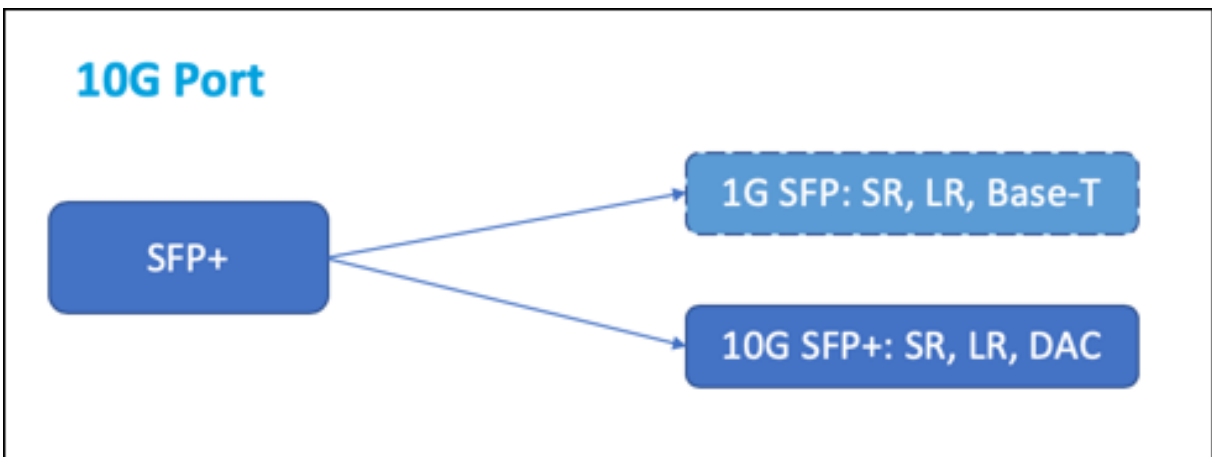

### Ports compatibility:

On some appliances, the 10G slot supports copper 1G transceivers, which can operate at up to 1 Gbps in a 10 Gbps slot.

### Notes:

- Certain platforms have 10G slots that do not support copper transceivers. Check with your account representative for support details.
- You cannot insert a fiber 1G transceiver into a 10G slot.
- You cannot insert a 10G transceiver into a 1G slot.

## 25G, 40G, 50G, and 100G ports

A 100G port can support five speeds: 10G, 25G, 40G, 50G, and 100G. 1G speed is not supported on the 100G port. 50G and 100G ports use the same transceiver. 40G QSFP+ are high-speed ports that can operate at speeds of up to 40 Gbps. The appliance determines the speed, and not the port.

Only 50G/100G (QSFP28) transceivers can be directly used on a QSFP28 interface. Use a QSA28 adapter on a QSFP28 interface to use 10G (SFP+) and 25G (SFP28) transceivers. Use a 40G QSFP+ transceiver in the 50G/100G port if the peer is 40G.

The following diagram shows the transceiver compatibility.

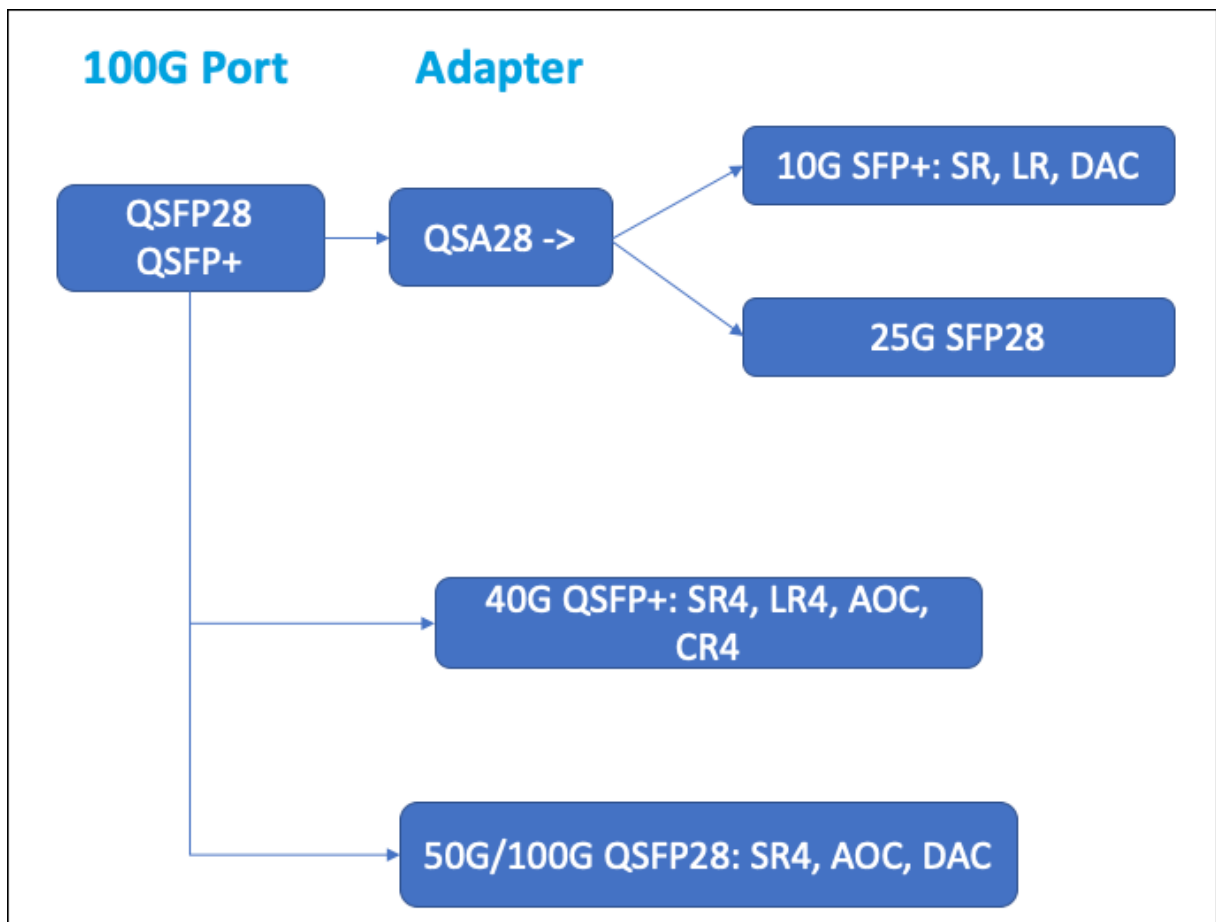



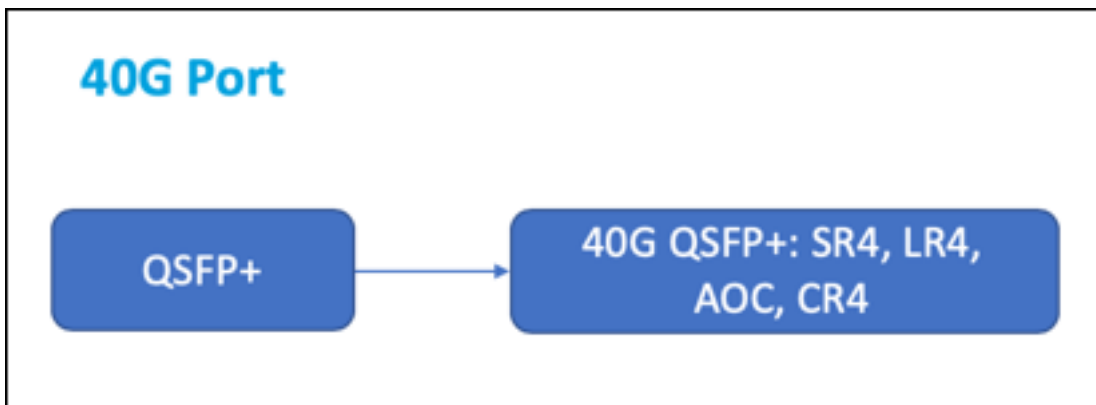
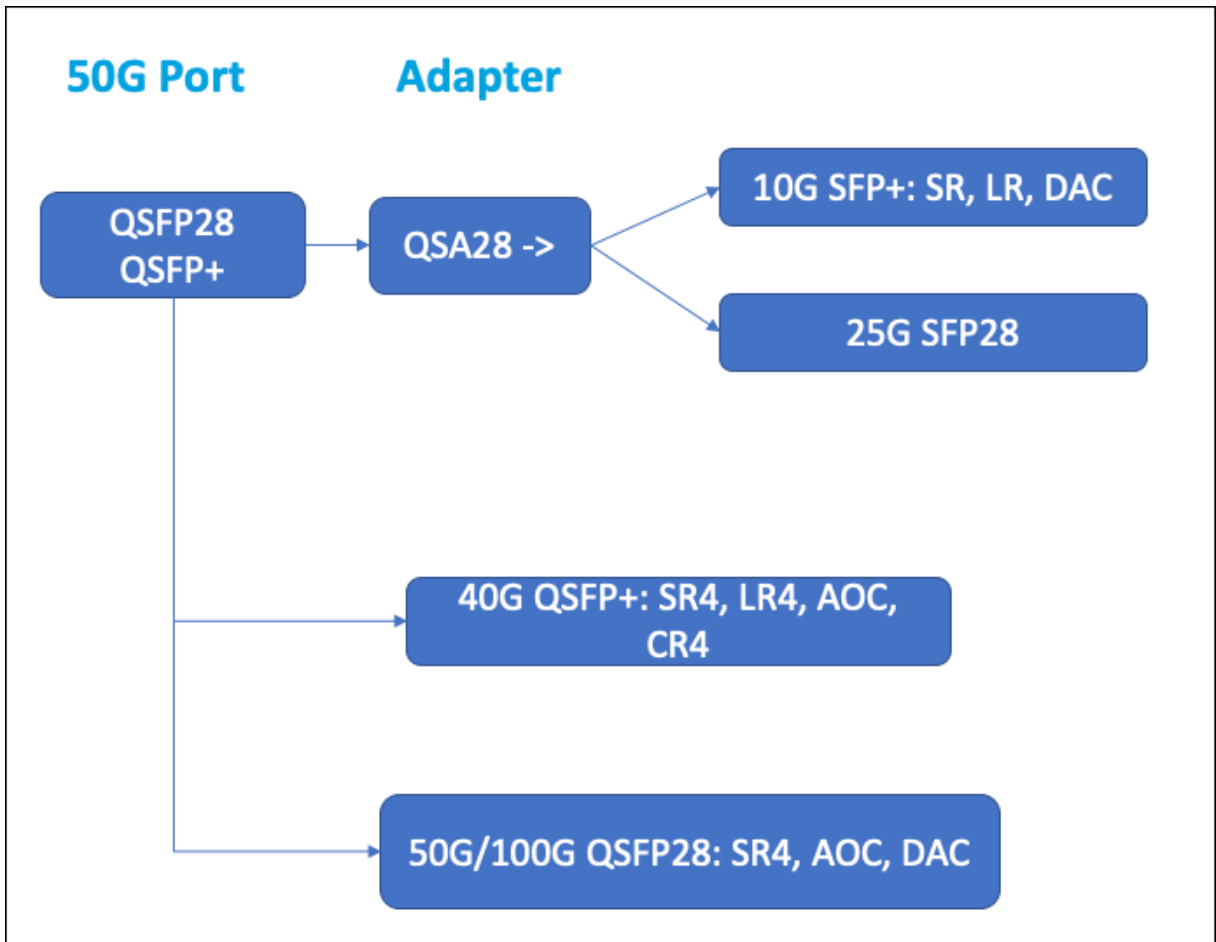

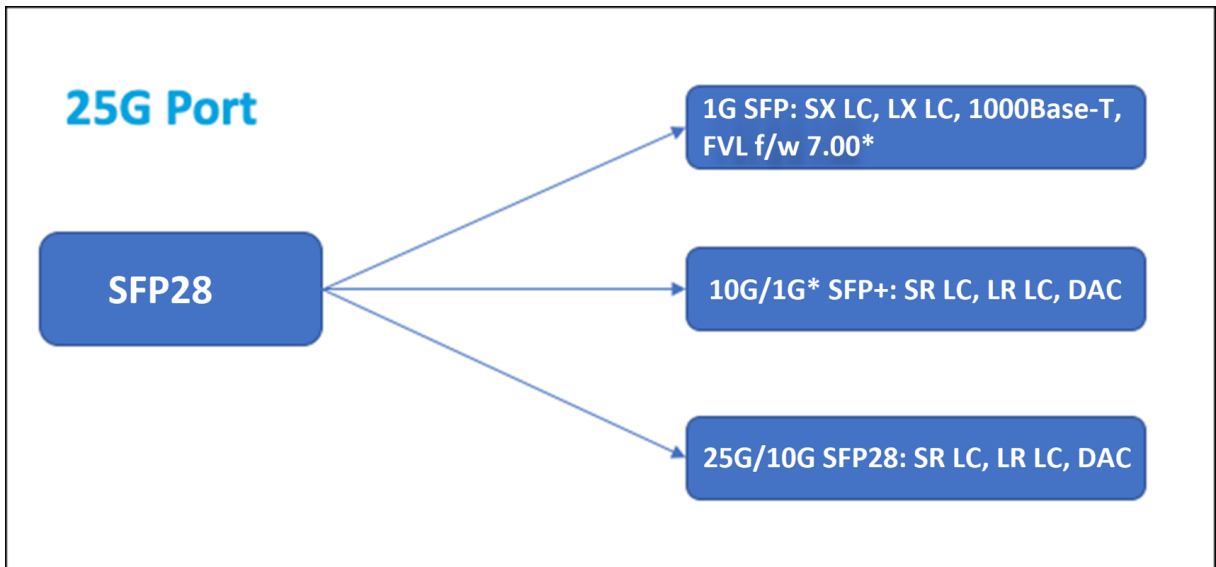

**Note:**

FVL firmware 8.70 does not support 1G connectivity.

Dual speed 10G/1G SFP+ (both SR LC & LR LC) will not operate at 1G, if FVL firmware 8.70 is used.

**1G pluggable media**

The following information is provided for 1G transceivers:

- Description: The price list description of the part.
- Transmit Wavelength: The nominal transmit wavelength.
- Cable/Fiber Type: Fiber characteristics affect the maximum transmit distance achievable. With 10G on multi-mode fiber (MMF) various dispersion components become dominant. For more information, see <http://www.thefoa.org/tech/ref/basic/fiber.html>.
- Typical Reach: Maximum transmit distance.
- Applicable platforms: Some chassis are available with different media options. Use the appropriate data sheet to confirm that your particular chassis type supports the media.

**Copper 1G SFP distance specifications**

**Description:** NetScaler 1G SFP Ethernet copper (100 m) - 4 pack

**Transmitter wavelength (nm):** Not applicable

**Cable type:** Category 5 (Cat-5) copper cable

**Typical reach (m):** 100 m

**Applicable platforms:**

- MPX 5900/5905/5910
- MPX 8005/8015/8200/8400/8600/8800
- MPX 14000
- MPX 22000
- MPX 24000

### **Short reach fiber 1G SFP distance specifications**

**Description:** NetScaler 1G SFP Ethernet SX (300 m) - 4 pack

**Transmitter wavelength (nm):** 850 nm (nominal)

**Fiber type:** 50/125um MMF, 2000MHz-km (OM3)

**Typical Reach (m):** 550 m

**Fiber type:** 50/125um MMF, 500MHz-km (OM2)

**Typical Reach (m):** 550 m

**Fiber type:** 50/125um MMF, 400MHz-km

**Typical Reach (m):** 550 m

**Fiber type:** 62.5/125um MMF, 200MHz-km (OM1)

**Typical Reach (m):** 300 m

**Fiber type:** 62.5/125um MMF, 160MHz-km

**Typical Reach (m):** 300 m

#### **Applicable platforms:**

- MPX 5900/5905/5910
- MPX 8005/8015/8200/8400/8600/8800
- MPX 22000
- MPX 24000

### **Short reach fiber 1G SFP distance specifications**

**Description:** NetScaler 1G SFP Ethernet short range (300 m) - Single

**Transmitter wavelength (nm):** 850 nm (nominal)

**Fiber type:** 50/125um MMF, 2000MHz-km (OM3)

**Typical Reach (m):** 550 m

**Fiber type:** 50/125um MMF, 500MHz-km (OM2)

**Typical Reach (m):** 550 m

**Fiber type:** 50/125um MMF, 400MHz-km

**Typical Reach (m):** 550 m

**Fiber type:** 62.5/125um MMF, 200MHz-km (OM1)

**Typical Reach (m):** 275 m

**Fiber type:** 62.5/125um MMF, 160MHz-km

**Typical Reach (m):** 220 m

**Applicable platforms:**

- MPX 5900/5905/5910
- MPX 8005/8015/8200/8400/8600/8800
- MPX 22000
- MPX 24000

**Long reach fiber 1G SFP distance specifications**

**Description:** NetScaler 1G SFP Ethernet LX - Single

**Transmitter wavelength (nm):** 1310 nm (nominal)

**Fiber type:** 9/125um SMF

**Typical reach (m):** 10 km

**Applicable platforms:**

- MPX 5900/5905/5910
- MPX 8005/8015/8200/8400/8600/8800
- MPX 22000
- MPX 24000

**Long reach fiber 1G SFP distance specifications**

**Description:** NetScaler 1G SFP Ethernet long range (10 km) - Single

**Transmitter wavelength (nm):** 1310 nm (nominal)

**Fiber type:** 9/125um SMF

**Typical reach (m):** 10 km

**Applicable platforms:**

- MPX 5900/5905/5910
- MPX 8005/8015/8200/8400/8600/8800
- MPX 9700/10500/12500/15500

- MPX 22000
- MPX 24000

## 10 GE pluggable media

The following information is provided for 10G transceivers:

- Description: The price list description of the part.
- Transmit Wavelength: The nominal transmit wavelength.
- Cable/Fiber Type: Fiber characteristics affect the maximum transmit distance achievable. With 10G on multi-mode fiber (MMF), various dispersion components become dominant. For more information, see <http://www.thefoa.org/tech/ref/basic/fiber.html>.
- Typical Reach: Maximum transmit distance.
- Applicable platforms: Some chassis are available with different media options. Use the appropriate data sheet to confirm that your particular chassis type supports the media.

### Short reach fiber 10G SFP+ distance specifications

#### Applicable platforms:

- MPX 5900/5905/5910
- MPX 8005/8015/8200/8400/8600/8800/8900
- MPX 9100
- MPX 22000
- MPX 24000
- MPX 25000T
- MPX 25100 40G, MPX 25160 40G
- MPX 14000
- MPX 14000-40G
- MPX 14000-40S
- MPX 14000 FIPS
- MPX 15000
- MPX 15000-50G (adapter required to connect 50G ports to 10G transceiver)
- MPX 16000 (adapter required to connect 100G ports to 10G transceiver)
- MPX 26000 (adapter required to connect 50G ports to 10G transceiver)
- MPX 26000-50S (adapter required to connect 50G ports to 10G transceiver)
- MPX 26000-100G (adapter required to connect 100G ports to 10G transceiver)

Description	Transmitter		
	Wavelength (nm)	Fiber Type	Typical Reach (m)
NetScaler 10G SFP+, Ethernet Short Range (300 m) - Single	850 nm (nominal)	50/125um MMF, 2000MHz-km (OM3)	300 m
		50/125um MMF, 500MHz-km (OM2)	82 m
		50/125um MMF, 400MHz-km	66 m
		62.5/125um MMF, 200MHz-km (OM1)	33 m
		62.5/125um MMF, 160MHz-km	26 m

### Long reach fiber 10G SFP+ distance specifications

**Description:** NetScaler 10G SFP+ Ethernet long range (10 km) - Single

**Transmitter wavelength (nm):** 1310 nm (nominal)

**Fiber type:** 9/125um SMF

**Typical reach (m):** 10 km

**Applicable platforms:**

- MPX 5900/5905/5910
- MPX 8005/8015/8200/8400/8600/8800/8900
- MPX 9100
- MPX 22000
- MPX 24000
- MPX 25000T
- MPX 25000-40G
- MPX 14000
- MPX 14000-40G
- MPX 14000-40S
- MPX 14000 FIPS
- MPX 15000
- MPX 15000-50G (adapter required to connect 50G ports to 10G transceiver)
- MPX 16000 (adapter required to connect 100G ports to 10G transceiver)
- MPX 26000 (adapter required to connect 50G ports to 10G transceiver)

- MPX 26000-50S (adapter required to connect 50G ports to 10G transceiver)
- MPX 26000-100G (adapter required to connect 100G ports to 10G transceiver)

### **Citrix direct-attached (DAC) copper TwinAx 10G SFP+ passive cables specifications**

**Description:** NetScaler 1 m DAC SFP+ cable for up to 1 m distance

**Applicable platforms:**

- MPX 5901/5905/5910
- MPX 8005/8015/8200/8400/8600/8800
- MPX 8905/8910/8920/8930
- MPX 9100
- MPX 16000
- MPX 22000
- MPX 24000
- MPX 14000
- MPX 14000-40G
- MPX 14000-40S
- MPX 14000 FIPS
- MPX 25000TA
- MPX 25000A
- MPX 25000T
- MPX 25000-40G

**Description:** NetScaler 3 m DAC SFP+ cable for up to 3 m distance

**Applicable platforms:**

- MPX 5901/5905/5910
- MPX 8005/8015/8200/8400/8600/8800
- MPX 8905/8910/8920/8930
- MPX 9100
- MPX 16000
- MPX 22000
- MPX 24000
- MPX 14000
- MPX 14000-40G
- MPX 14000-40S
- MPX 14000 FIPS
- MPX 25000TA
- MPX 25000A

- MPX 25000T
- MPX 25000-40G

**Description:** NetScaler 5 m DAC SFP+ cable for up to 5 m distance

**Applicable platforms:**

- MPX 8005/8015/8200/8400/8600/8800
- MPX 9100
- MPX 14000
- MPX 14000-40G
- MPX 14000-40S
- MPX 14000 FIPS
- MPX 16000
- MPX 17500/19500/21500
- MPX 22000
- MPX 24000
- MPX 25000TA
- MPX 25000A
- MPX 25000T
- MPX 25000-40G

**Cisco 40G QSFP+ breakout cable specifications**

**Cisco part number:** L45593-D178-C30

**Description:** 40GBASE-CR4 QSFP+ to four 10GBASE-CU SFP+ direct attach breakout cable assembly, 3 meters passive

**Applicable platforms:**

- MPX 14000-40G
- MPX 14000-40C
- MPX 14000-40S
- MPX 14000 FIPS
- MPX 16000
- MPX 22000
- MPX 24000
- MPX 25000T
- MPX 25000-40G
- MPX 25000TA
- MPX 25000A



**Notes:**

- The peer switch must be 40G. You connect 4x10G ports on the NetScaler appliance. The reverse is not supported. That is, 40G on the NetScaler appliance and 4x10G on the peer switch is not supported.
- To obtain these cables, contact Cisco partner representatives.

**Data sheets**

December 31, 2023

The data sheet is available on [www.netscaler.com](http://www.netscaler.com). Navigate to **Platform > Form Factors > Hardware**.

**NetScaler MPX hardware-software compatibility matrix**

December 31, 2023

The following table lists the compatibility matrix for all NetScaler hardware platforms and the software releases supported on these platforms. The base platform is listed. For information about the models for each platform, check the [data sheet](#).

**Note:** For details of the builds containing the security fix (CVE-2019-19781), see <https://support.citrix.com/article/CTX267027>.

**IMPORTANT:** The first supported build for each hardware platform and software release are listed in the following table. **All subsequent builds are supported unless the word “only” follows the build number. When it does, only the specified build is supported on that platform.**

Hardware platforms/ Software releases	11.1	12.1	13.0	13.1	14.1
MPX 5500	11.1–47.14	12.1–48.13	13.0–36.27	13.1–4.x	X
MPX 5550	11.1–47.14	12.1–48.13	13.0–36.27	13.1–4.x	14.1–4.x
MPX 5900	11.1–56.15	12.1–48.13	13.0–36.27	13.1–4.x	14.1–4.x
MPX 7500	11.1–47.14	12.1–48.13	13.0–36.27	13.1–4.x	X

Hardware platforms/ Software releases	11.1	12.1	13.0	13.1	14.1
MPX 8000	11.1–47.14	12.1–48.13	13.0–36.27	13.1–4.x	14.1–4.x
MPX 8900	11.1–56.15	12.1–48.13	13.0–36.27	13.1–4.x	14.1–4.x
MPX 8900 FIPS certified <a href="#">Cert #4043</a>	X	12.1–55.X FIPS	X	13.1–37.x FIPS	X
MPX 9100	X	X	X	13.1–21.x	14.1–4.x
MPX 9100 FIPS (in process for certification)	X	X	X	13.1–37.x FIPS	X
MPX 9700	11.1–47.14	12.1–48.13	13.0–36.27	13.1–4.x	X
MPX 11500	11.1–47.14	12.1–48.13	13.0–36.27	13.1–4.x	X
MPX 14000	11.1–47.14	12.1–48.13	13.0–36.27	13.1–4.x	14.1–4.x
MPX 14000-40C	11.1–47.14	12.1–48.13	13.0–36.27	13.1–4.x	14.1–4.x
MPX 14000-40G	11.1–47.14	12.1–48.13	13.0–36.27	13.1–4.x	14.1–4.x
MPX 14000-40S	11.1–47.14	12.1–48.13	13.0–36.27	13.1–4.x	14.1–4.x
MPX 14000 FIPS	11.1–51.21	12.1–48.13	13.0–36.27	13.1–4.x	14.1–4.x
MPX 15000-25G	11.1–60.13	12.1–50.31	13.0–36.27	13.1–4.x	14.1–4.x
MPX 15000-50G	11.1–60.13	12.1–50.31	13.0–36.27	13.1–4.x	14.1–4.x
MPX 15000-50G FIPS certified <a href="#">Cert #4043</a>	X	12.1–55.X FIPS	X	13.1–37.x FIPS	X
MPX 16000	X	X	X	13.1–37.x	14.1–4.x
MPX 22000	11.1–47.14	12.1–48.13	13.0–36.27	13.1–4.x	14.1–4.x
MPX 24100	11.1–47.14	12.1–48.13	13.0–36.27	13.1–4.x	14.1–4.x
MPX 25100-40G	11.1–47.14	12.1–48.13	13.0–36.27	13.1–4.x	14.1–4.x

Hardware platforms/ Software releases	11.1	12.1	13.0	13.1	14.1
MPX 26100	11.1–60.13	12.1–50.31	13.0–36.27	13.1–4.x	14.1–4.x
MPX 26100-50S	11.1–60.13	12.1–50.31	13.0–36.27	13.1–4.x	14.1–4.x
MPX 26000-100G	11.1–56.15	12.1–50.31	13.0–36.27	13.1–4.x	14.1–4.x

## Hardware platforms

December 31, 2023

The various NetScaler hardware platforms offer a wide range of features, communication ports, and processing capacities. All the MPX platforms have multicore processors.

The NetScaler hardware platforms range from the single 10-core processor MPX 9100 to the high-capacity MPX two 16-core processor MPX 16000. The various NetScaler hardware platforms are similar in that they use the same types of components, but different models provide different hardware capabilities. All NetScaler hardware platforms support the NetScaler software. All NetScaler appliances have front to rear airflow.

For information on the software releases supported on the NetScaler hardware platforms, see [Hardware Software Release Matrix](#).

## NetScaler MPX 5500

December 31, 2023

**Note:**

This platform has reached its end of life.

The NetScaler MPX 5500 is a 1U appliance, with 1 dual-core processor, and 4 GB of memory.

The following figure shows the front panel of the MPX 5500.

Figure 1. NetScaler MPX 5500, front panel

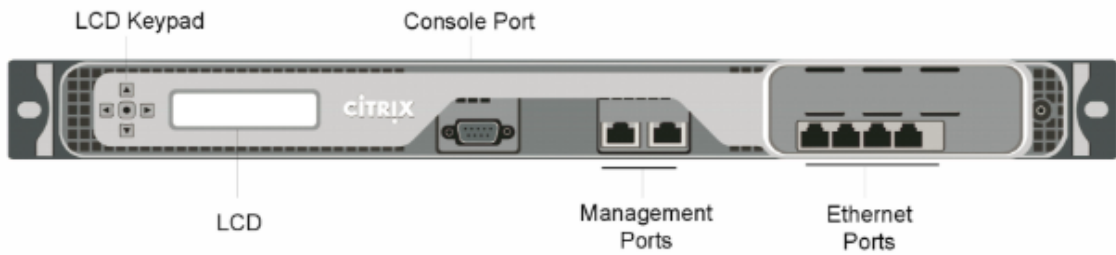

The MPX 5500 has the following ports:

- RS232 serial console port.
- Two 10/100/1000Base-T copper Ethernet management ports, numbered 0/1 and 0/2 from left to right. You can use these ports to connect directly to the appliance for system administration functions.
- Four 10/100/1000Base-T copper Ethernet ports numbered 1/1, 1/2, 1/3, and 1/4 from left to right.

Note: The network port numbers on all appliances consist of two numbers separated by a forward slash. The first number is the port adapter slot number. The second number is the interface port number. Ports on appliances are numbered sequentially starting with 1.

The following figure shows the back panel of the MPX 5500.

Figure 2. NetScaler MPX 5500, back panel

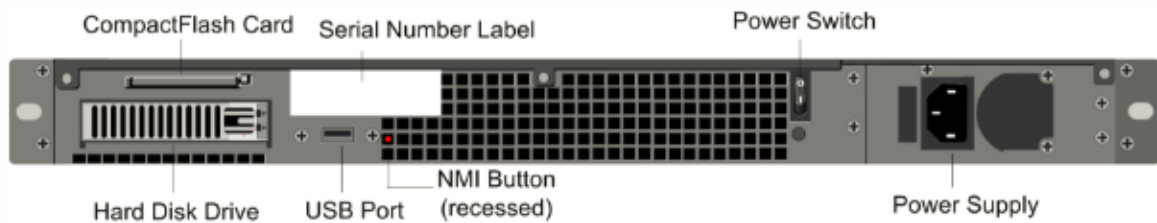

The following components are visible on the back panel of the MPX 5500:

- Four GB removable CompactFlash card that is used to store the NetScaler software.
- Power switch, which turns off power to the MPX 5500, as if you were to unplug the power supply. Press the switch for five seconds to shut off the power.
- Removable hard-disk drive (HDD) that is used to store user data. Appliances shipped before February 2012 store user data on an HDD. In appliances shipped after February 2012, a solid-state drive replaces the HDD. Both types of drive have the same functionality and support the same software releases.

**Note:** Drive densities might increase as components become EOL but its size is never smaller than the original.

- USB port (reserved for a future release).
- Non-maskable interrupt (NMI) Button that is used at the request of Technical Support and produces a core dump on the appliance. Use a pen, pencil, or other pointed object to press this red button, which is recessed to prevent unintentional activation.
- Power supply rated at 300 watts, 110–220 volts. The power-supply fan is designed to turn on only when the internal temperature of the power supply reaches a certain value. You cannot see the fan turning on the back panel. What you can see is the fixed part of the fan that holds the spinning motor.

For information about installing the rails, rack mounting the hardware, and connecting the cables, see [Installing the hardware](#).

For information about performing the initial configuration of your appliance, see [Initial Configuration](#).

## NetScaler MPX 5550 and MPX 5650

December 31, 2023

The the NetScaler models MPX 5550 and MPX 5650 are 1U appliances. Each model has 1 quad-core processor and 8 GB of memory.

The following figure shows the front panel of the MPX 5550/5650 appliance.

Figure 1. NetScaler MPX 5550/5650, front panel

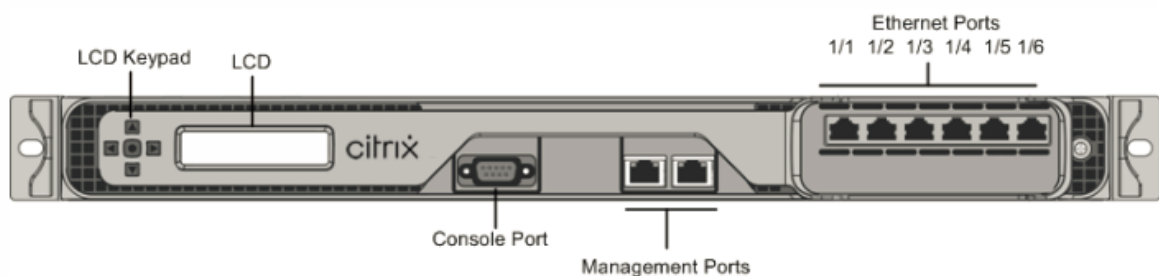

Depending on the model, the appliance has the following ports:

- RS232 serial console port.
- Two 10/100/1000Base-T copper Ethernet management ports (RJ45), numbered 0/1 and 0/2 from left to right. The management port is used to connect directly to the appliance for system administration functions.

- Six 10/100/1000Base-T copper Ethernet ports numbered 1/1, 1/2, 1/3, 1/4, 1/5, and 1/6 from left to right.

The following figure shows the back panel of the MPX 5550/5650 appliance.

Figure 2. NetScaler MPX 5550/5650 appliance, back panel

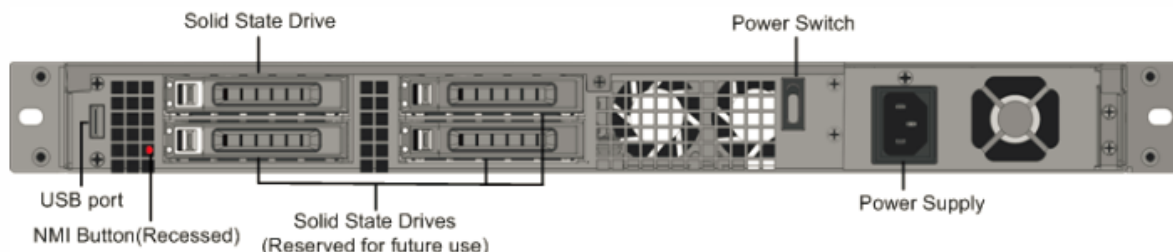

The following components are visible on the back panel of the MPX 5550/5650 appliance:

- 160 GB or larger removable solid-state drive (SSD).  
**Note:** Drive densities might increase as components become EOL but its size is never smaller than the original.
- Power switch, which turns off power to the appliance, as if you were to unplug the power supply. Press the switch for five seconds to shut off the power.
- USB port (reserved for a future release).
- Non-maskable interrupt (NMI) button, which is used at the request of Technical Support to produce a NetScaler core dump. Use a pen, pencil, or other pointed object to press this red button, which is recessed to prevent unintentional activation.
- Single power supply, rated at 300 watts, 110–220 volts.

For information about installing the rails, rack mounting the hardware, and connecting the cables, see [Installing the Hardware](#).

For information about performing the initial configuration of your appliance, see [Initial Configuration](#).

## NetScaler MPX 5900

December 31, 2023

The NetScaler MPX 5900 appliance is a 1U appliance. This platform has a single 8-core processor and 16 GB of memory. The appliance provides a total of eight network ports:

- Six 10/100/1000Base-T RJ45 copper Ethernet Ports.

- Two 10G/1G SFP+ Ethernet Ports.

For information on the software releases supported on the NetScaler hardware platforms, see [Hardware Software Release Matrix](#).

The following figure shows the front panel of the MPX 5900 appliance.

Figure 1. NetScaler MPX 5900, front panel

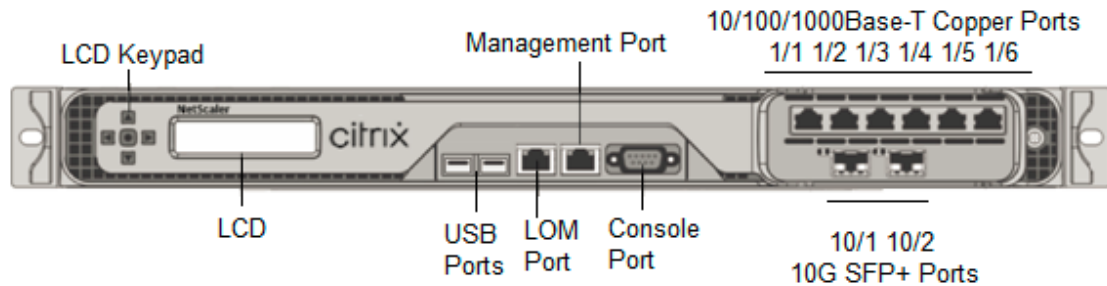

The NetScaler MPX 5900 appliances have the following ports:

- RS232 serial Console Port.
- One 10/100/1000Base-T RJ45 copper Ethernet LOM Port. Use this port to remotely monitor and manage the appliance independently of the NetScaler software.
- One 10/100/1000Base-T RJ45 copper Ethernet Management Port, numbered 0/1. This port is used to connect directly to the appliance for NetScaler administration functions.
- Six 10/100/1000Base-T RJ45 copper Ethernet Ports, numbered 1/1 to 1/6 from left to right.
- Two 10G/1G SFP+ Ethernet Ports, numbered 10/1 to 10/2 from left to right.
- USB port (reserved for a future release).

The following figure shows the back panel of the MPX 5900 appliance.

Figure 2. NetScaler MPX 5900, back panel

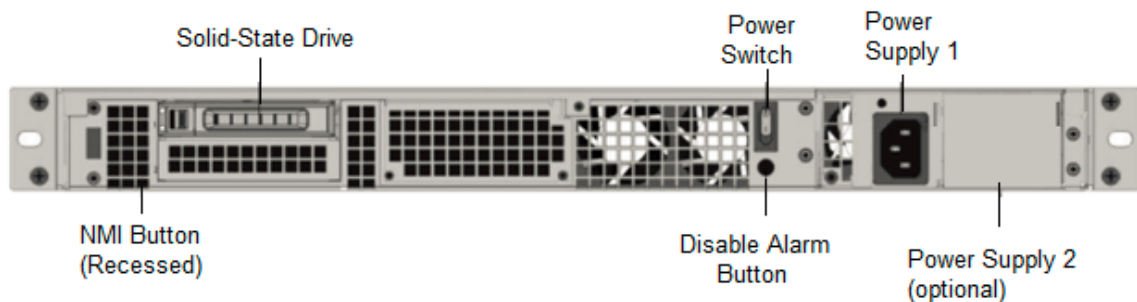

The following components are visible on the back panel of the MPX 5900 appliances:

- One 240 GB or larger removable solid-state drive (SSD).

**Note:** Drive densities might increase as components become EOL but its size is never smaller than the original.

- Power switch, which turns power to the appliance on or off.
  - If the OS is functional, press the switch for less than two seconds to power down the system with a graceful shutdown.
  - If the OS is not responsive, press the power switch for more than 4 seconds to force the power off.
- One power supply, rated at 450 watts, 100–240 VAC (second power supply for redundancy is a customer installable option). Maximum power consumption is under 180-190 watts and typical power consumption is 150-160 watts. Each power supply has an LED indicating its status, as follows:

LED Color	LED Indicates
OFF	No power to any power supply in the appliance.
Flashing RED	No power to this power supply.
Flashing GREEN	Power supply is in standby mode.
GREEN	Power supply is functional.
RED	Power supply failure.

- **Disable alarm button**, which is functional only when the appliance has two power supplies. Press this button to silence the power alarm when one of two power supplies loses input power (second power supply optional) or when a power supply is malfunctioning.
- Non-Maskable Interrupt (NMI) Button, used at the request of Technical Support to initiate a core dump. To press this red button, which is recessed to prevent unintentional activation, use a pen, pencil, or other pointed object. The NMI Button is also available remotely over the network in the LOM GUI, in the Remote Control menu. For more information about the lights out management port of the appliance, see [Lights out management port of the NetScaler MPX appliance](#).

## NetScaler MPX 7500 and MPX 9500

December 31, 2023

**Note:**

This platform has reached its end of life.

The NetScaler MPX 7500/9500 are 1U appliances, each with 1 quad-core processor, and 8 GB of memory. The MPX 7500/9500 appliances are available in two port configurations: 8x10/100/1000Base-T copper Ethernet ports and 4x1G SFP + 4x10/100/1000Base-T copper Ethernet ports.



The following figure shows the front panel of the MPX 7500/9500 (8x10/100/1000Base-T copper Ethernet ports) appliances.

Figure 1. NetScaler MPX 7500/9500 (8x10/100/1000Base-T copper Ethernet ports), front panel

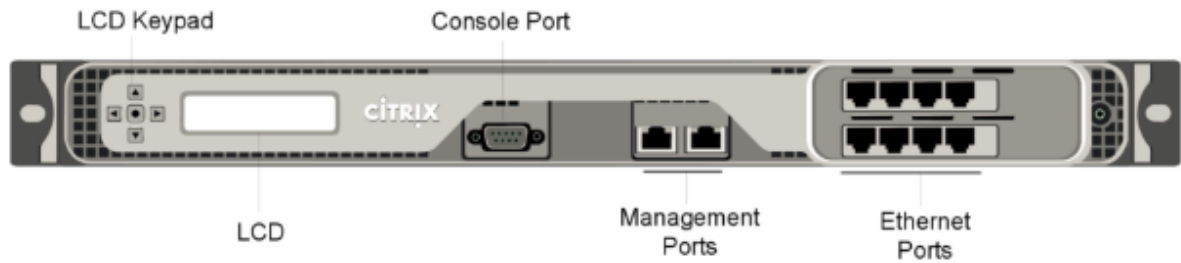

The following figure shows the front panel of the MPX 7500/9500 (4x1G SFP + 4x10/100/1000Base-T copper Ethernet ports) appliances.

Figure 2. NetScaler MPX 7500/9500 (4x1G SFP + 4x10/100/1000Base-T copper Ethernet ports), front panel

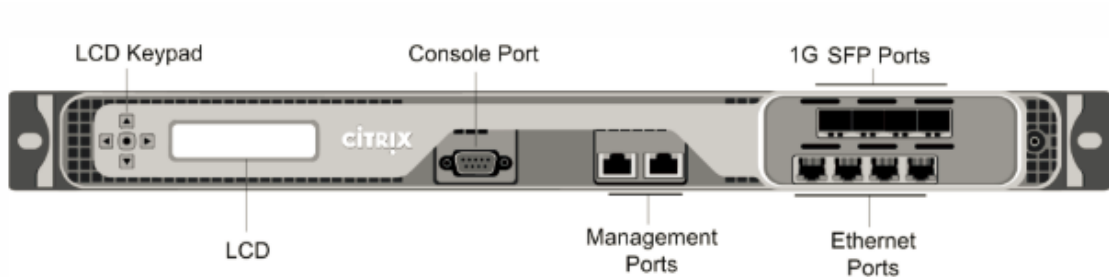

Depending on the model, the appliance has the following ports:

- RS232 serial console port.
- Two 10/100/1000Base-T copper Ethernet management ports, numbered 0/1 and 0/2 from left to right. These ports are used to connect directly to the appliance for system administration functions.
- Network Ports
  - MPX 7500/9500 (8x10/100/1000Base-T copper Ethernet ports). Eight 10/100/1000Base-T copper Ethernet ports. Four ports numbered 1/1, 1/2, 1/3, and 1/4 on the top row from left to right. Four ports numbered 1/5, 1/6, 1/7, and 1/8 on the bottom row from left to right.
  - MPX 7500/9500 (4x1G SFP + 4x10/100/1000Base-T copper Ethernet ports). Four 1-gigabit copper or fiber 1G SFP ports numbered 1/1, 1/2, 1/3, and 1/4 on the top row from left to right. Four 10/100/1000BASE-T copper Ethernet ports (RJ45) numbered 1/5, 1/6, 1/7, and 1/8 on the bottom row from left to right.

The following figure shows the back panel of the MPX 7500/9500 appliance.

Figure 3. NetScaler MPX 7500/9500, back panel

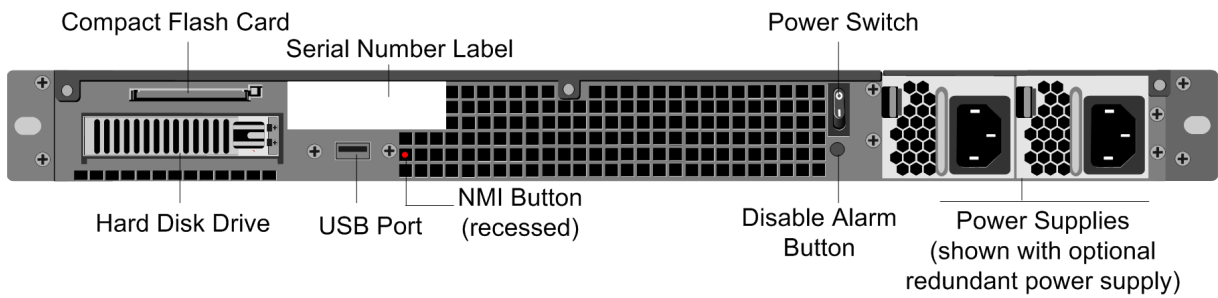

The following components are visible on the back panel of the MPX 7500 /9500:

- 4 GB removable CompactFlash card that is used to store the NetScaler software.
- Power switch, which turns off power to the MPX 7500/9500, as if you were to unplug the power supply. Press the switch for five seconds to shut off the power.
- Removable hard-disk drive (HDD) that is used to store user data. Appliances shipped before February 2012 store user data on an HDD. In appliances shipped after February 2012, a solid-state drive replaces the HDD. Both types of drive have the same functionality and support the same software releases.
- USB port (reserved for a future release).
- Non-maskable interrupt (NMI) button that is used at the request of Technical Support and produces a core dump on the appliance. Use a pen, pencil, or other pointed object to press this red button, which is recessed to prevent unintentional activation.
- **Disable alarm button.** This button is functional only when the appliance has two power supplies.

Press this button to stop the power alarm from sounding when one of the following conditions is true:

- You have plugged the MPX 7500/9500 into only one power outlet.
- One power supply is malfunctioning and you want to continue operating the MPX 7500/9500 until it is repaired.

For information about installing the rails, rack mounting the hardware, and connecting the cables, see [Installing the hardware](#).

For information about performing the initial configuration of your appliance, see [Initial Configuration](#).

## NetScaler MPX 8005, MPX 8015, MPX 8200, MPX 8400, MPX 8600, and MPX 8800

December 31, 2023

The NetScaler models

MPX 8005, MPX 8015, MPX 8200, MPX 8400,

MPX 8600, and MPX 8800 are 1U appliances. Each model has one quad-core processor and 32 GB of memory. The

MPX

8005/8015/8200/8400/8600

/8800 appliances are available in two port configurations:

- Six 10/100/1000Base-T copper Ethernet ports and six 1G SFP ports (6x10/100/1000Base-T copper Ethernet ports + 6x1G SFP)
- Six 10/100/1000Base-T copper Ethernet ports and two 10G SFP+ ports (6x10/100/1000Base-T copper Ethernet ports + 2x10G SFP+)

The following figure shows the front panel of the MPX 8005/8015/8200/8400/8600/8800 (6x10/100/1000Base-T copper Ethernet ports + 6x1G SFP) appliance.

Figure 1. NetScaler MPX 8005/8015/8200/8400/8600/8800 (6x10/100/1000Base-T copper Ethernet ports + 6x1G SFP), front panel

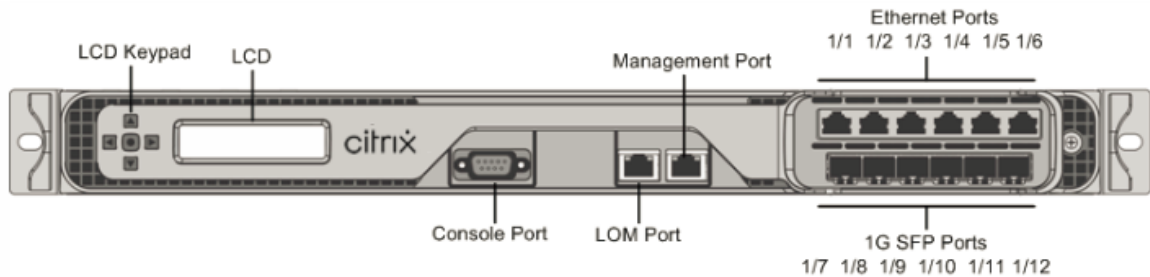

The following figure shows the front panel of the MPX 8005/8015/8200/8400/8600/8800 (6x10/100/1000Base-T copper Ethernet ports + 2x10G SFP+) appliance.

Figure 2. NetScaler MPX 8005/8015/8200/8400/8600/8800 (6x10/100/1000Base-T copper Ethernet ports + 2x10G SFP+), front panel

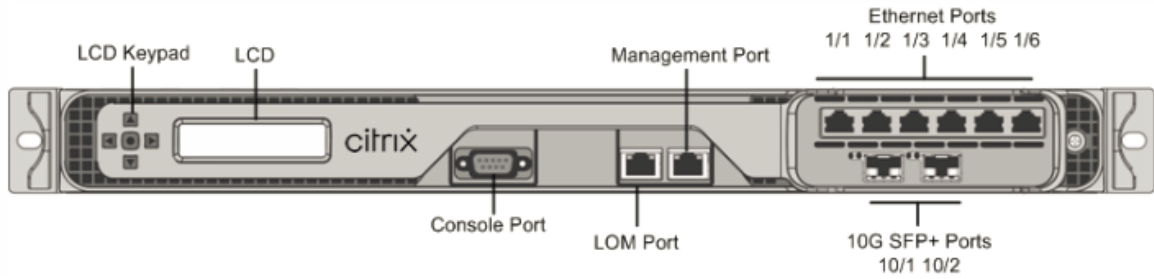

Depending on the model, the appliance has the following ports:

- RS232 serial console port.
- One 10/100Base-T copper Ethernet Port (RJ45), also called LOM port. You can use this port to remotely monitor and manage the appliance independently of the NetScaler software.
- One 10/100/1000Base-T copper Ethernet management port (RJ45), numbered 0/1. The management port is used to connect directly to the appliance for system administration functions.
- Network Ports
  - MPX 8005/8015/8200/8400/8600/8800 (6x10/100/1000Base-T copper Ethernet ports + 6x1G SFP). Six 10/100/1000BASE-T copper Ethernet ports (RJ45) numbered 1/1, 1/2, 1/3, 1/4, 1/5, and 1/6 on the top row from left to right, and six 1-gigabit copper or fiber 1G SFP ports numbered 1/7, 1/8, 1/9, 1/10, 1/11, and 1/12 on the bottom row from left to right.
  - MPX 8005/8015/8200/8400/8600/8800 (6x10/100/1000Base-T copper Ethernet ports + 2x10G SFP+). Six 10/100/1000BASE-T copper Ethernet ports (RJ45) numbered 1/1, 1/2, 1/3, 1/4, 1/5, and 1/6 on the top row from left to right and two 10-gigabit SFP+ ports numbered 10/1 and 10/2 on the bottom row from left to right.

The following figure shows the back panel of the MPX 8005/8015/8200/8400/8600/8800 appliance.

Figure 3. NetScaler MPX 8005/8015/8200/8400/8600/8800 appliance, back panel

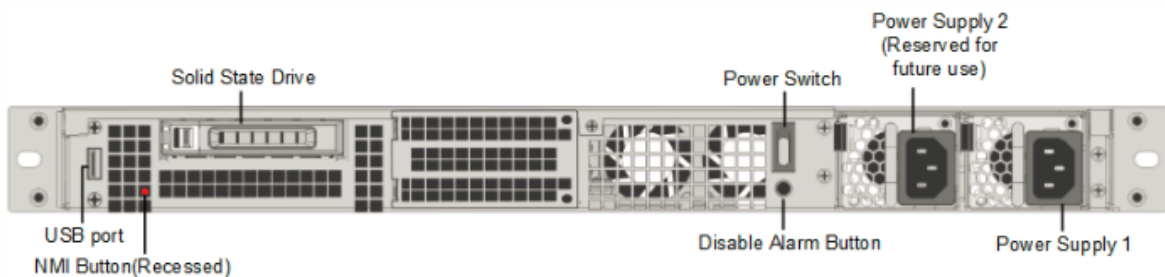

The following components are visible on the back panel of the MPX 8005/8015/8200/8400/8600/8800 appliance:

- One 256 GB or larger removable solid-state drive (SSD).
 

**Note:** Drive densities might increase as components become EOL but its size is never smaller than the original.

**Note:** Earlier MPX 8005/8015/8200/8400/8600/8800 appliances had three extra SSD slots for future use. Current NetScaler MPX 8005/8015/8200/8400/8600/8800 appliances do not have any additional SSD slots for future use.

- Power switch, which turns off power to the appliance, as if you were to unplug the power supply. Press the switch for five seconds to shut off the power.
- USB port (reserved for a future release).
- Non-maskable interrupt (NMI) button, which is used at the request of Technical Support to produce a NetScaler core dump. Use a pen, pencil, or other pointed object to press this red button, which is recessed to prevent unintentional activation.
- **Disable alarm button**, which is nonfunctional. This button is functional only if you install a second power supply.

Press this button to stop the power alarm from sounding when either of the following conditions is true:

- You have plugged the appliance into only one power outlet.
  - One power supply is malfunctioning, and you want to continue operating the appliance until it is repaired.
- Single power supply, rated at 450 watts, 110–220 volts. Maximum power consumption is 250 watts and typical power consumption is 185 watts.

**Note:** The MPX 8005/8015/8200/8400/8600/8800 appliance supports dual power supplies, but ships with one power supply. Contact your NetScaler sales representative to order a second power supply.

For information about installing the rails, rack mounting the hardware, and connecting the cables, see [Hardware installation](#).

For information about performing the initial configuration of your appliance, see [NetScaler initial configuration](#).

## NetScaler MPX 8900

December 31, 2023

The NetScaler MPX 8900 appliance is a 1U appliance. This platform has a single 8-core processor and 32 GB of memory. The appliance provides a total of 10 network ports:

- Six 10/100/1000Base-T RJ45 copper Ethernet Ports.

- Four 10G/1G SFP+ Ethernet Ports.

For information on the software releases supported on the NetScaler hardware platforms, see [Hardware-Software Release Matrix](#).

The following figure shows the front panel of the MPX 8900 series appliances.

Figure 1. NetScaler MPX 8900, front panel

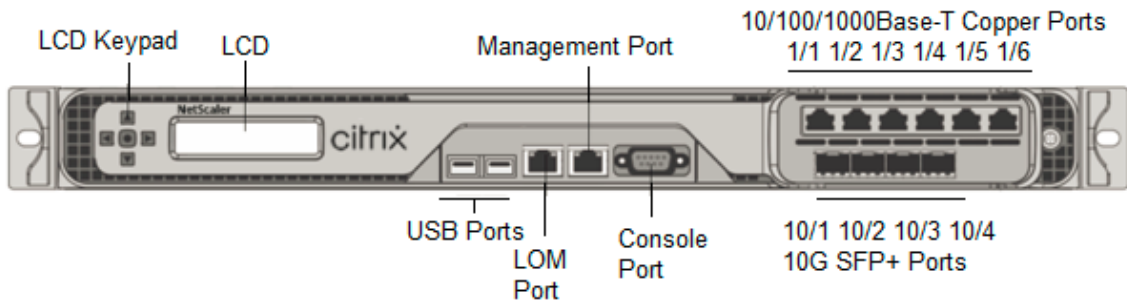

The NetScaler MPX 8900 series appliances have the following ports:

- RS232 serial Console Port.
- One 10/100/1000Base-T RJ45 copper Ethernet LOM Port. Use this port to remotely monitor and manage the appliance independently of the NetScaler software.
- One 10/100/1000Base-T RJ45 copper Ethernet Management Port, numbered 0/1. This port is used to connect directly to the appliance for NetScaler administration functions.
- Six 10/100/1000Base-T RJ45 copper Ethernet Ports, numbered 1/1 to 1/6 from left to right.
- Four 10G/1G SFP+ Ethernet Ports, numbered 10/1 to 10/4 from left to right.
- USB port (reserved for a future release).

The following table indicates the LED status for the Management and LOM ports:

LED Color	LED Indicates
OFF	No connection or 10 Mbps speed
Flashing YELLOW	Active
Flashing GREEN	100 Mbps speed
AMBER	1 Gbps speed

The following figure shows the back panel of the MPX 8900 appliance.

Figure 2. NetScaler MPX 8900, back panel

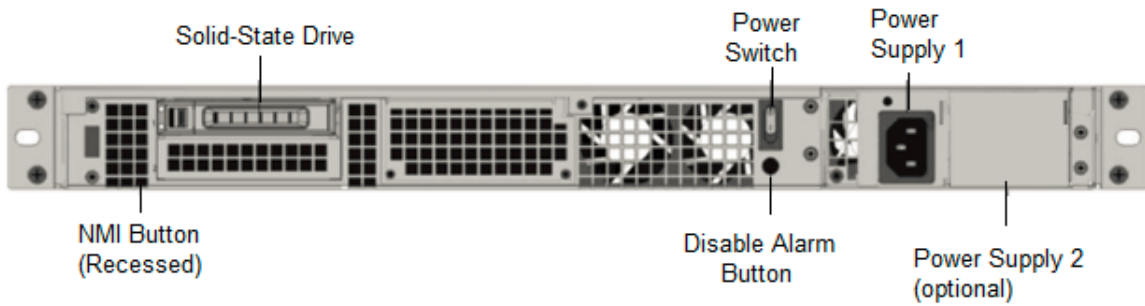

The following components are visible on the back panel of the MPX 8900 appliance:

- One 240 GB or larger removable solid-state drive (SSD).
  - Note:** Drive densities might increase as components become EOL but its size is never smaller than the original.
- Power switch, which turns power to the appliance on or off.
  - If the OS is functional, press the switch for less than two seconds to power down the system with a graceful shutdown.
  - If the OS is not responsive, press the power switch for more than 4 seconds to force the power off.
- One power supply, rated at 450 watts, 100–240 VAC (second power supply for redundancy is a customer installable option). Maximum power consumption is 196 watts and typical power consumption is 163 watts. The following table indicates the LED status of each power supply:

LED Color	LED Indicates
OFF	No power to any power supply in the appliance.
Flashing RED	No power to this power supply.
Flashing GREEN	Power supply is in standby mode.
GREEN	Power supply is functional.
RED	Power supply failure.

- **Disable alarm button**, which is functional only when the appliance has two power supplies. Press this button to silence the power alarm when one of two power supplies loses input power (second power supply optional) or when a power supply is malfunctioning.
- Non-Maskable Interrupt (NMI) Button, used at the request of Technical Support to initiate a core dump. To press this red button, which is recessed to prevent unintentional activation, use a pen, pencil, or other pointed object. The NMI Button is also available remotely over the network in

the LOM GUI, in the **Remote Control** menu. For more information about the lights out management port of the appliance, see [Lights out management port of the NetScaler MPX appliance](#).

## NetScaler MPX 8900 FIPS certified appliance

December 31, 2023

The NetScaler MPX 8900 FIPS certified appliance is a 1U appliance. This platform has a single 8-core processor and 32 GB of memory.

**Note:** On all sides of the appliance, you see FIPS tamper seals. Tampering with the seals breaks the FIPS requirement.

The appliance provides a total of 10 network ports:

- Six 10/100/1000Base-T RJ45 copper Ethernet Ports.
- Four 10G/1G SFP+ Ethernet Ports.

For information on the software releases supported on the NetScaler hardware platforms, see [Hardware-Software Release Matrix](#).

The following figure shows the front panel of the MPX 8900 FIPS certified appliance.

Figure 1. NetScaler MPX 8900 FIPS certified appliance, front panel

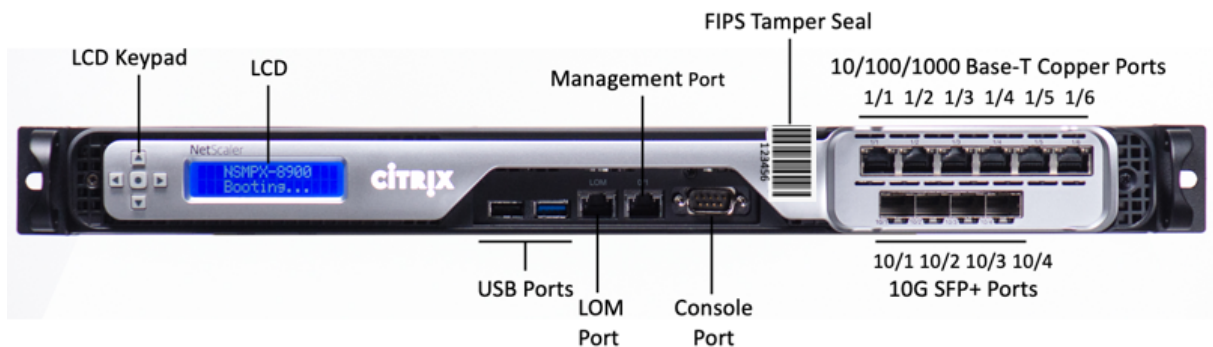

The NetScaler MPX 8900 FIPS certified appliance has the following ports:

- RS232 serial Console Port.
- One 10/100/1000Base-T RJ45 copper Ethernet LOM Port. Use this port to remotely monitor and manage the appliance independently of the NetScaler software.
- One 10/100/1000Base-T RJ45 copper Ethernet Management Port, numbered 0/1. This port is used to connect directly to the appliance for NetScaler administration functions.
- Six 10/100/1000Base-T RJ45 copper Ethernet Ports, numbered 1/1 to 1/6 from left to right.
- Four 10G/1G SFP+ Ethernet Ports, numbered 10/1 to 10/4 from left to right.



- USB port (reserved for a future release).

The following table indicates the LED status for the Management and LOM ports:

LED Color	LED Indicates
OFF	No connection or 10 Mbps speed
Flashing YELLOW	Active
Flashing GREEN	100 Mbps speed
AMBER	1 Gbps speed

The following figure shows the back panel of the MPX 8900 FIPS certified appliance.

Figure 2. NetScaler MPX 8900 FIPS certified appliance, back panel

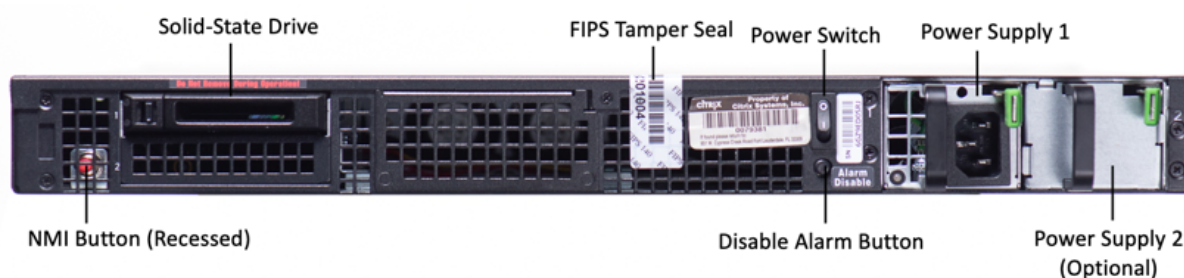

The following components are visible on the back panel of the MPX 8900 FIPS certified appliance:

- One 240 GB or larger removable solid-state drive (SSD).
  - Note:** Drive densities might increase as components become EOL but its size is never smaller than the original.
- Power switch, which turns power to the appliance on or off.
  - If the OS is functional, press the switch for less than two seconds to power down the system with a graceful shutdown.
  - If the OS is not responsive, press the power switch for more than 4 seconds to force the power off.
- One power supply, rated at 450 watts, 100–240 VAC (second power supply for redundancy is a customer installable option). Maximum power consumption is 275 watts and typical power consumption is 225 watts. The following table indicates the LED status of each power supply:

LED Color	LED Indicates
OFF	No power to any power supply in the appliance.
Flashing RED	No power to this power supply.
Flashing GREEN	Power supply is in standby mode.
GREEN	Power supply is functional.
RED	Power supply failure.

---

- **\*\*Disable alarm button\*\***, which is functional only when the appliance has two power supplies. Press this button to silence the power alarm when one of two power supplies loses input power (second power supply optional) or when a power supply is malfunctioning.
- Non-Maskable Interrupt (NMI) Button, used at the request of Technical Support to initiate a core dump. To press this red button, which is recessed to prevent unintentional activation, use a pen, pencil, or other pointed object. The NMI Button is also available remotely over the network in the LOM GUI, in the **Remote Control** menu. For more information about the lights out management port of the appliance, see [Lights out management port of the NetScaler MPX appliance](#).

For information about configuring this appliance see [NetScaler MPX FIPS certified appliances](#).

## NetScaler MPX 9100

January 12, 2024

The NetScaler MPX 9100 appliance is a 1U appliance. This platform has a single 10-core processor and 64 GB of memory. The appliance provides a total of eight 25G SFP28 ports.

For information on the software releases supported on the ADC hardware platforms, see [Hardware-Software Release Matrix](#).

The following figure shows the front panel of the MPX 9100 appliance.

Figure 1. NetScaler MPX 9100, front panel

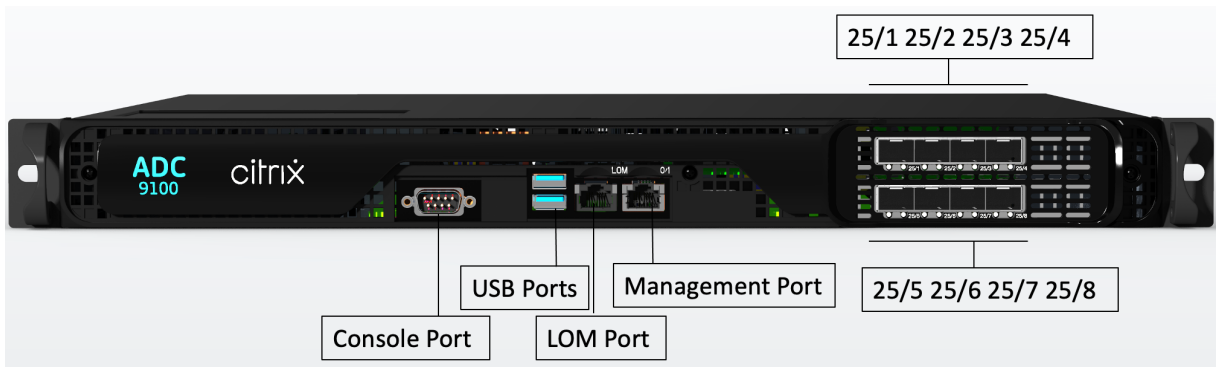

The NetScaler MPX 9100 series appliances have the following ports:

- RS232 serial Console port.
- One 10/100/1000Base-T RJ45 copper Ethernet LOM port. Use this port to remotely monitor and manage the appliance independently of the ADC software.
- One 10/100/1000Base-T RJ45 copper Ethernet management port, numbered 0/1. This port is used to connect directly to the appliance for ADC administration functions.
- Two USB ports (reserved for a future release).
- Eight 25G SFP28 ports, numbered 25/1 to 25/8. For information about supported transceivers per port, see [25G, 40G, 50G, and 100G ports](#).

The following figure shows the back panel of the MPX 9100 appliance.

Figure 2. NetScaler MPX 9100, back panel

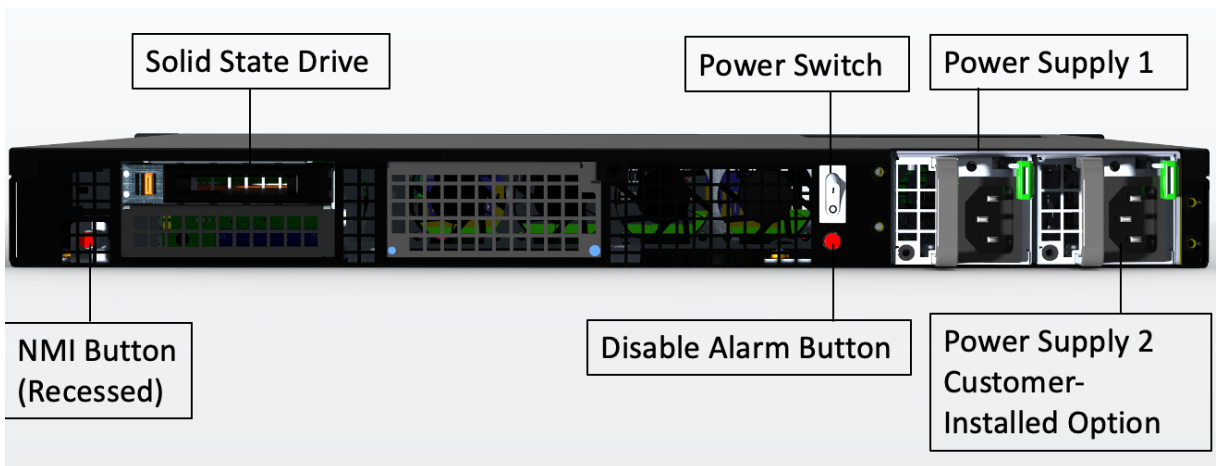

The following components are visible on the back panel of the MPX 9100 appliance:

- One 480 GB removable solid-state drive (SSD).  
**Note:** Drive densities might increase as components become EOL but its size is never smaller than the original.
- Power switch, which turns power to the appliance on or off.

- If the OS is functional, press the switch for less than two seconds to power down the system with a graceful shutdown.
  - If the OS is not responsive, press the power switch for more than 4 seconds to force the power off.
- Two power supplies (for hardware shipped after 13th Dec, 2023), rated at 450 watts, 100–240 VAC. Maximum power consumption is 275 watts and typical power consumption is 225 watts. The following table indicates the LED status of each power supply:

LED Color	LED Indicates
OFF	No power to any power supply in the appliance.
Flashing RED	No power to this power supply.
Flashing GREEN	Power supply is in standby mode.
GREEN	Power supply is functional.
RED	Power supply failure.

- **Disable alarm button**, which is functional only when the appliance has two power supplies. Press this button to silence the power alarm when one of two power supplies loses input power (second power supply optional) or when a power supply is malfunctioning.
- **Non-Maskable Interrupt (NMI) Button**, used at the request of Technical Support to initiate a core dump. To press this red button, which is recessed to prevent unintentional activation, use a pen, pencil, or other pointed object. The NMI Button is also available remotely over the network in the LOM GUI, in the **Remote Control** menu. For more information about the lights out management port of the appliance, see [Lights out management port of the NetScaler MPX appliance](#).

## NetScaler MPX 9100 FIPS

December 31, 2023

The NetScaler MPX 9100 FIPS appliance is a 1U appliance. This platform has a single 10-core processor and 64 GB of memory. The appliance provides a total of eight 25G SFP28 ports.

For information on the software releases supported on the ADC hardware platforms, see [Hardware-Software Release Matrix](#).

The following figure shows the front panel of the MPX 9100 FIPS appliance.

Figure 1. NetScaler MPX 9100 FIPS, front panel

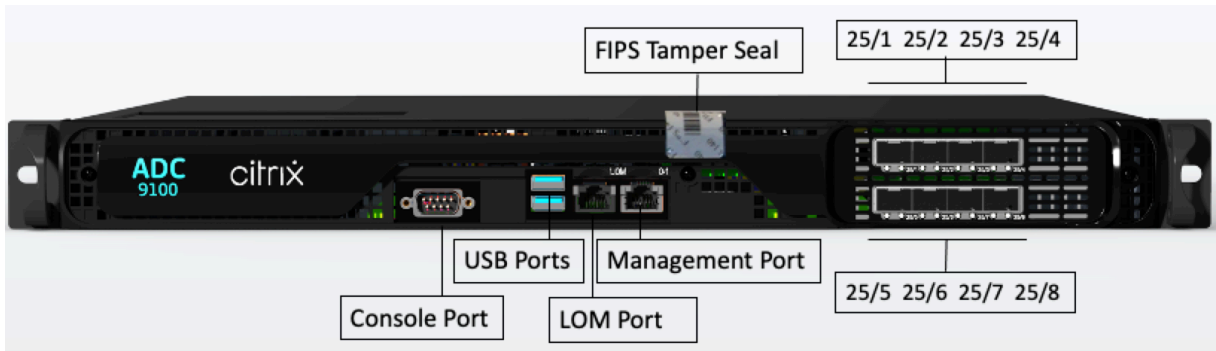

The NetScaler MPX 9100 FIPS series appliances have the following ports:

- RS232 serial Console port.
- One 10/100/1000Base-T RJ45 copper Ethernet LOM port. Use this port to remotely monitor and manage the appliance independently of the ADC software.
- One 10/100/1000Base-T RJ45 copper Ethernet management port, numbered 0/1. This port is used to connect directly to the appliance for ADC administration functions.
- Two USB ports (reserved for a future release).
- Eight 25G SFP28 ports, numbered 25/1 to 25/8. For information about supported transceivers per port, see [25G](#), [40G](#), [50G](#), and [100G ports](#).

The following figure shows the back panel of the MPX 9100 FIPS appliance.

Figure 2. NetScaler MPX 9100 FIPS, back panel

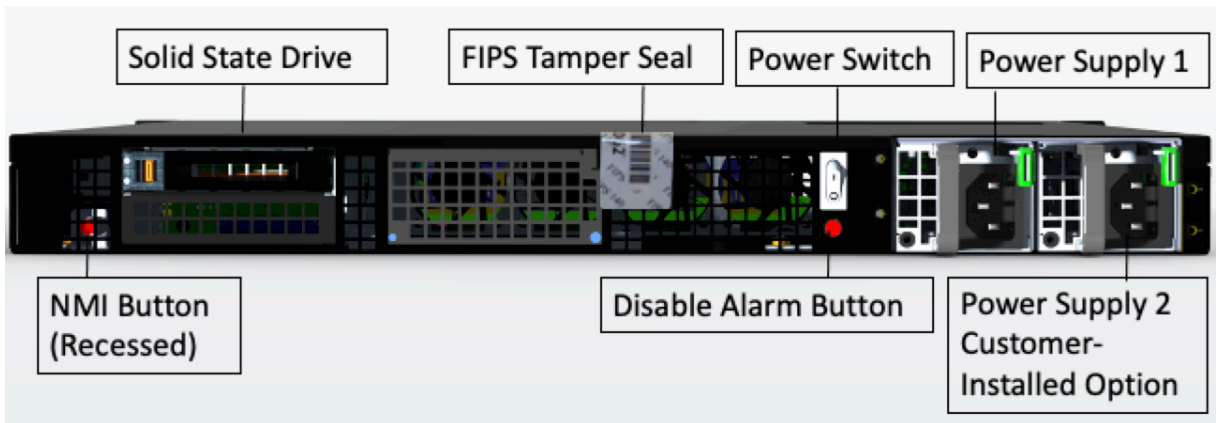

The following components are visible on the back panel of the MPX 9100 FIPS appliance:

- One 480 GB removable solid-state drive (SSD).  
**Note:** Drive densities might increase as components become EOL but its size is never smaller than the original.
- Power switch, which turns power to the appliance on or off.

- If the OS is functional, press the switch for less than two seconds to power down the system with a graceful shutdown.
  - If the OS is not responsive, press the power switch for more than 4 seconds to force the power off.
- One power supply, rated at 450 watts, 100–240 VAC (second power supply for redundancy is a customer-installable option). Maximum power consumption is 275 watts and typical power consumption is 225 watts. The following table indicates the LED status of each power supply:

LED Color	LED Indicates
OFF	No power to any power supply in the appliance.
Flashing RED	No power to this power supply.
Flashing GREEN	Power supply is in standby mode.
GREEN	Power supply is functional.
RED	Power supply failure.

- **Disable alarm button**, which is functional only when the appliance has two power supplies. Press this button to silence the power alarm when one of two power supplies loses input power (second power supply optional) or when a power supply is malfunctioning.
- **Non-Maskable Interrupt (NMI) Button**, used at the request of Technical Support to initiate a core dump. To press this red button, which is recessed to prevent unintentional activation, use a pen, pencil, or other pointed object. The NMI Button is also available remotely over the network in the LOM GUI, in the **Remote Control** menu. For more information about the lights out management port of the appliance, see [Lights out management port of the NetScaler MPX appliance](#).

For information about configuring this appliance see [MPX FIPS appliances](#).

## NetScaler MPX 9700, MPX 10500, MPX 12500, and MPX 15500

December 31, 2023

**Note:**

This platform has reached its end of life.

The NetScaler MPX 9700/10500/12500/15500 are 2U appliances, each with 2 quad-core processors, and 16 GB of memory. All these appliances are also available in a 10G model and a FIPS model.

The following figure shows the front panel of the MPX 9700/10500/12500/15500.

Figure 1. NetScaler MPX 9700/10500/12500/15500, front panel

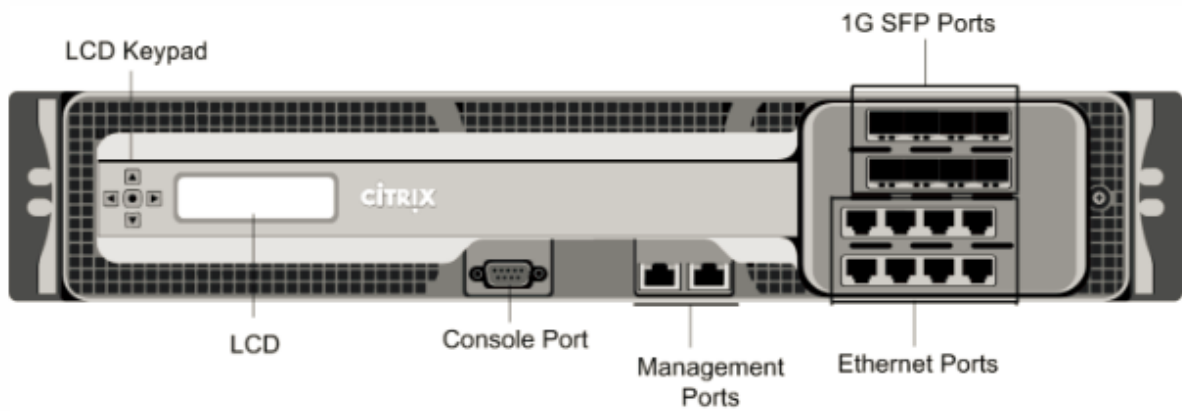

The following figure shows the front panel of the MPX 9700/10500/12500/15500 10G.

Figure 2. NetScaler MPX 9700/10500/12500/15500 10G, front panel

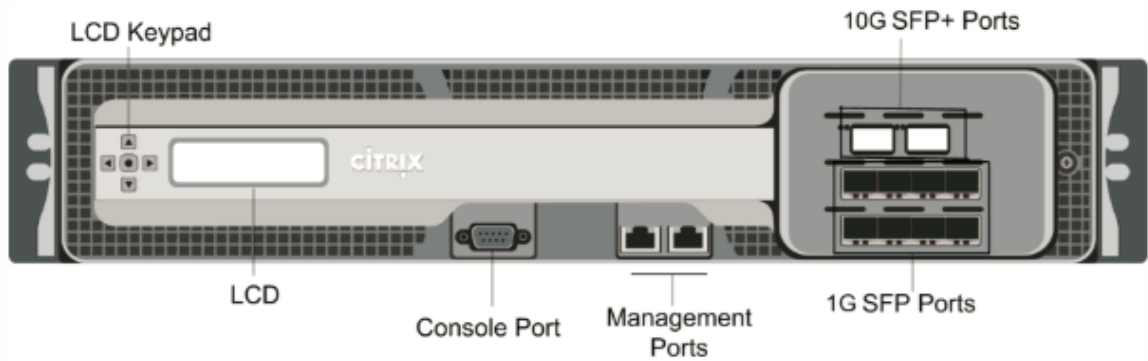

The following figure shows the front panel of the MPX 9700/10500/12500/15500 FIPS.

Figure 3. NetScaler MPX 9700/10500/12500/15500 FIPS, front panel

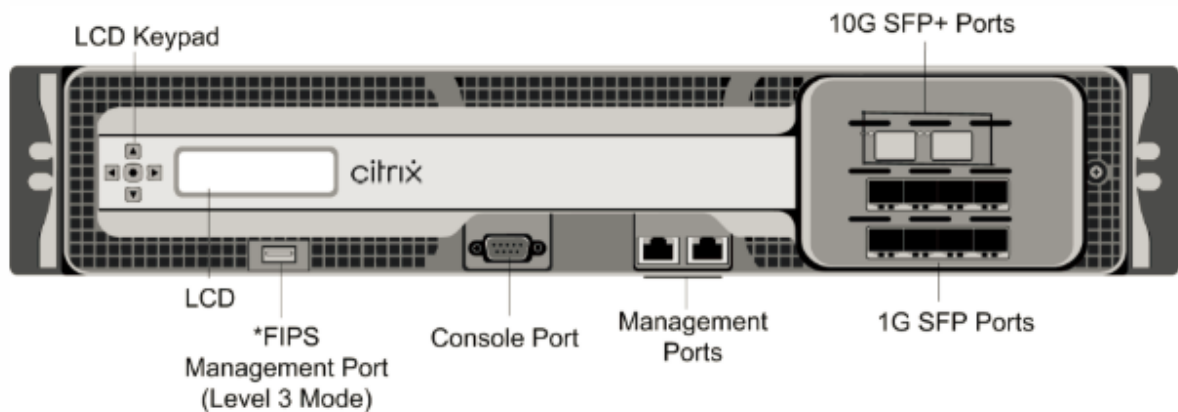

\*The FIPS Management Port (Level 3 Mode) is reserved for a future release.

Caution: Do not insert a USB device into the FIPS Management Port. Doing so causes the FIPS card to fail.

Depending on the model, the appliance has the following ports:

- FIPS Management Port (reserved for a future release).
- RS232 serial Console Port.
- Two 10/100/1000Base-T copper Ethernet Management Ports (RJ45), numbered 0/1 and 0/2 from left to right. These ports are used to connect directly to the appliance for system administration functions.
- Network Ports
  - MPX 9700/10500/12500/15500. Eight copper or fiber 1G SFP ports numbered 1/1, 1/2, 1/3, and 1/4 on the first row from left to right. Ports are numbered 1/5, 1/6, 1/7, and 1/8 on the second row from left to right. Eight 10/100/1000BASE-T copper Ethernet Ports (RJ45) numbered 1/9, 1/10, 1/11, and 1/12 on the third row from left to right. Ports are numbered 1/13, 1/14, 1/15, and 1/16 on the fourth row from left to right.
  - MPX 9700/10500/12500/15500 10G and MPX 9700/10500/12500/15000 FIPS. Two 10G SFP+ Ports numbered 10/1 and 10/2 on the top row. Eight 1-gigabit copper or fiber 1G SFP Ports numbered 1/1, 1/2, 1/3, and 1/4 on the middle row from left to right. Ports are numbered 1/5, 1/6, 1/7, and 1/8 on the bottom row from left to right.

**Important:** The 10-gigabit ports on this appliance are labeled 10/1 and 10/2.

The following figure shows the back panel of the MPX 9700/10500/12500/15500 appliances, including the 10G model and FIPS model.

Figure 4. NetScaler MPX 9700/10500/12500/15500, MPX 9700/10500/12500/15500 FIPS, and MPX 9700/10500/12500/15500 10G, back panel

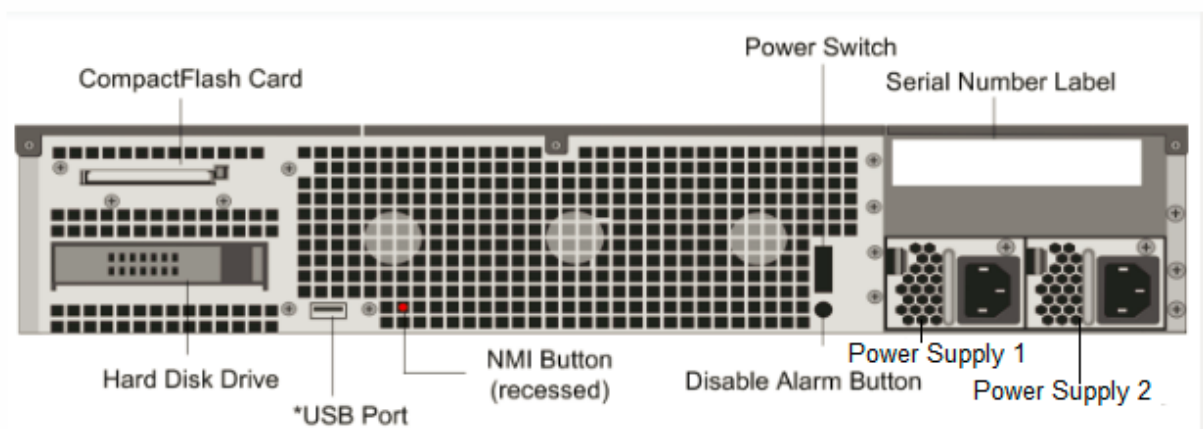



**Note:** The USB Port is reserved for a future release.

The following components are visible on the back panel of the MPX 9700/10500/12500/15500, including the 10G model and FIPS model:

- Four GB removable CompactFlash Card that is used to store the NetScaler software.
- Power Switch, which turns off power to the appliance, as if you were to unplug the power supply. Press the switch for five seconds to shut off the power.
- Removable Hard Disk Drive that is used to store user data.
- USB Port (reserved for a future release).
- Non-maskable interrupt (NMI) Button that is used at the request of Technical Support and produces a core dump on the appliance. Use a pen, pencil, or other pointed object to press this red button, which is recessed to prevent unintentional activation.
- **Disable alarm button.** This button is functional only when the appliance has two power supplies.

Press this button to stop the power alarm from sounding when either of the following conditions is true:

- You have plugged the appliance into only one power outlet.
  - One power supply is malfunctioning, and you want to continue operating the appliance until it is repaired.
- Two power supplies, each rated at 450 watts, 110–220 volts. Maximum power consumption is 360 watts.

For information about installing the rails, rack mounting the hardware, and connecting the cables, see “[Installing the Hardware](#).”

For information about performing the initial configuration of your appliance, see “[Initial Configuration](#).”

## **NetScaler MPX 11500, MPX 13500, MPX 14500, MPX 16500, MPX 18500, and MPX 20500**

December 31, 2023

**Note:**

This platform has reached its end of life.

The NetScaler models MPX 11500/13500/14500/16500/18500/20500 are 2U appliances. Each model has two 6-core processors for a total of 12 physical cores (24 cores with hyper-threading), and 48 GB of memory.

The following figure shows the front panel of the MPX 11500/13500/14500/16500/18500/20500 appliance.

Figure 1. NetScaler MPX 11500/13500/14500/16500/18500/20500 appliance, front panel

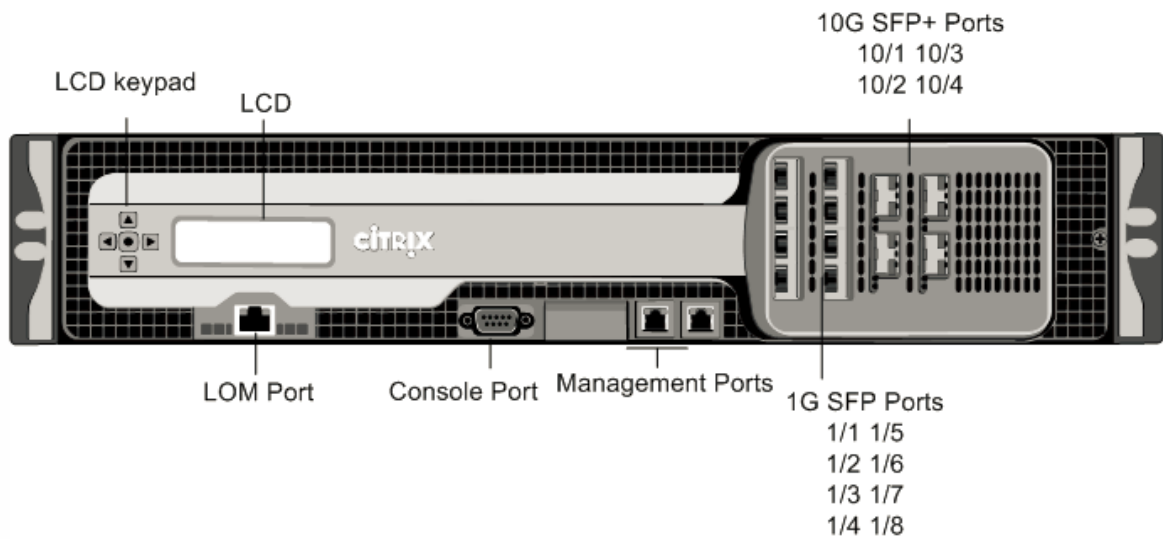

The MPX 11500/13500/14500/16500/18500/20500 appliances have the following ports:

- 10/100Base-T copper Ethernet Port (RJ45), also called LOM port. You can use this port to remotely monitor and manage the appliance independently of the NetScaler software.  
Note: The LEDs on the LOM port are not operational by design.
- RS232 serial console port.
- Two 10/100/1000Base-T copper Ethernet management ports (RJ45), numbered 0/1 and 0/2 from left to right. These ports are used to connect directly to the appliance for system administration functions.
- Eight 1G SFP ports numbered 1/1, 1/2, 1/3, 1/4 from top to bottom in the first column. Ports are numbered 1/5, 1/6, 1/7, and 1/8 from top to bottom in the second column.
- Four 10G SFP+ ports numbered 10/1 and 10/2 from top to bottom in the first column, and 10/3 and 10/4 from top to bottom in the second column.

The following figure shows the back panel of the MPX 11500/13500/14500/16500/18500/20500 appliance.

Figure 2. NetScaler MPX 11500/13500/14500/16500/18500/20500 appliance, back panel

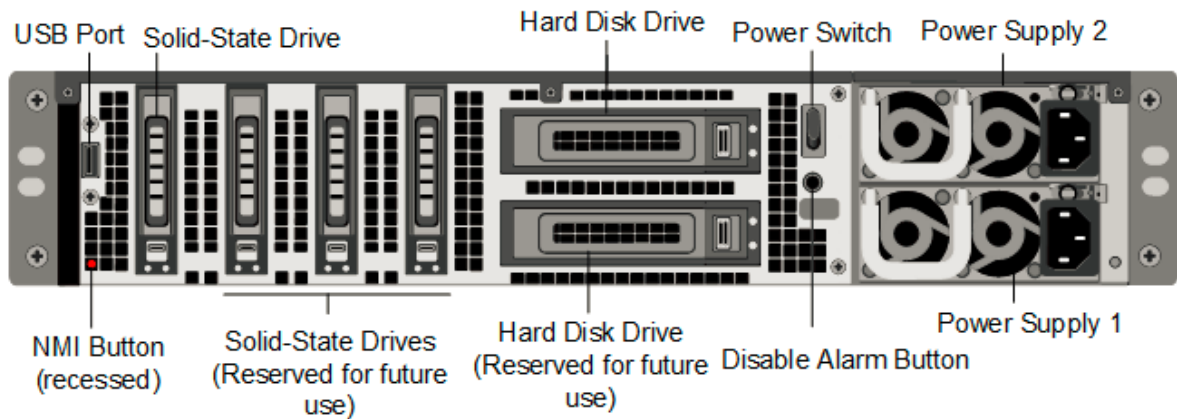

The following components are visible on the back panel of the MPX 11500/13500/14500/16500/18500/20500 appliance:

- 160 GB or larger removable solid-state drive.
  - Note:** Drive densities might increase as components become EOL but its size is never smaller than the original.
- USB port (reserved for a future release).
- Power switch, which turns off power to the appliance, as if you were to unplug the power supply. Press the switch for five seconds to shut off the power.
- Non-maskable interrupt (NMI) Button that is used at the request of Technical Support and produces a core dump on the appliance. Use a pen, pencil, or other pointed object to press this red button, which is recessed to prevent unintentional activation.
- Two removable hard-disk drives that are used to store user data.
- **Disable alarm button.** This button is functional only when the appliance has two power supplies.

Press this button to stop the power alarm from sounding when either of the following conditions is true:

- 1 - You have plugged the appliance into only one power outlet.
- 2 - One power supply is malfunctioning, and you want to **continue** operating the appliance until it is repaired.

- Two power supplies, each rated at 960 watts, 110–220 volts. Maximum power consumption is 650 watts. Typical power consumption is 500 watts.

For information about installing the rails, rack mounting the hardware, and connecting the cables, see [Installing the Hardware](#).

For information about performing the initial configuration of your appliance, see [Initial Configuration](#).

## NetScaler MPX 11500

December 31, 2023

**Note:**

This platform has reached its end of life.

The NetScaler models

MPX 11515/11520/11530/11540/11542 are 2U appliances. Each model has two 6-core processors for a total of 12 physical cores (24 cores with hyper-threading), and 48 GB of memory. The following figure shows the front panel of the MPX 11515/11520/11530/11540/11542 appliance.

Figure 1. NetScaler MPX 11515/11520/11530/11540/11542 appliance, front panel

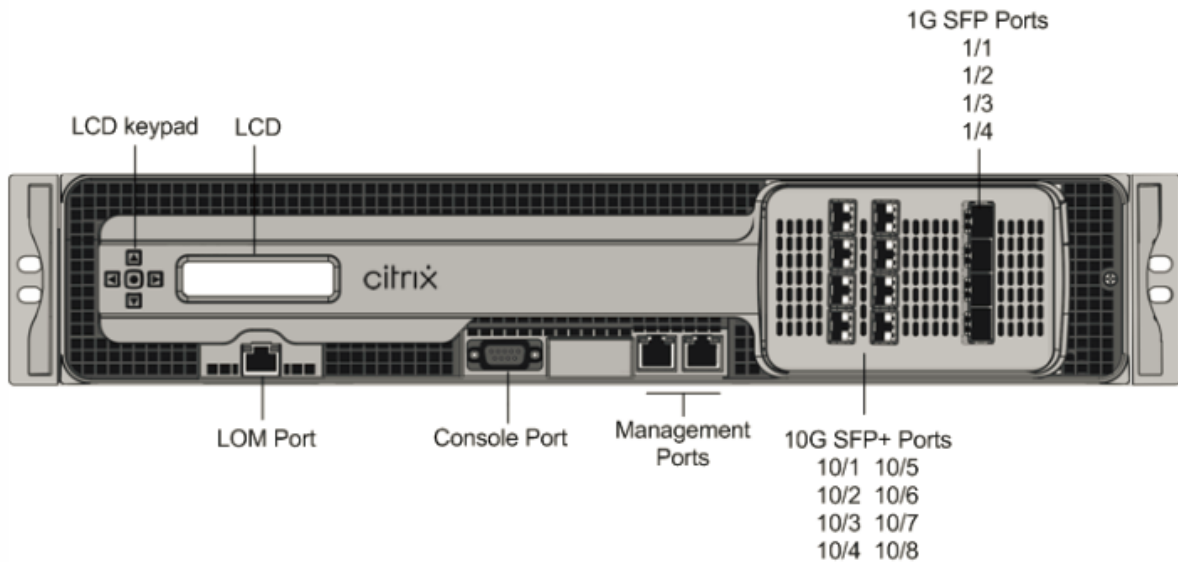

The MPX 11515/11520/11530/11540/11542 appliances have the following ports:

- RS232 serial console port.
- 10/100Base-T copper Ethernet Port (RJ45), also called LOM port. You can use this port to remotely monitor and manage the appliance independently of the NetScaler software.  
Note: The LEDs on the LOM port are not operational by design.
- Two 10/100/1000Base-T copper Ethernet management ports (RJ45), numbered 0/1 and 0/2 from left to right. These ports are used to connect directly to the appliance for system administration functions.
- Eight 10G SFP+ ports and four copper or fiber 1G SFP ports.

The following figure shows the back panel of the MPX 11515/11520/11530/11540/11542 appliance.

Figure 2. NetScaler MPX11515/11520/11530/11540/11542 appliance, back panel

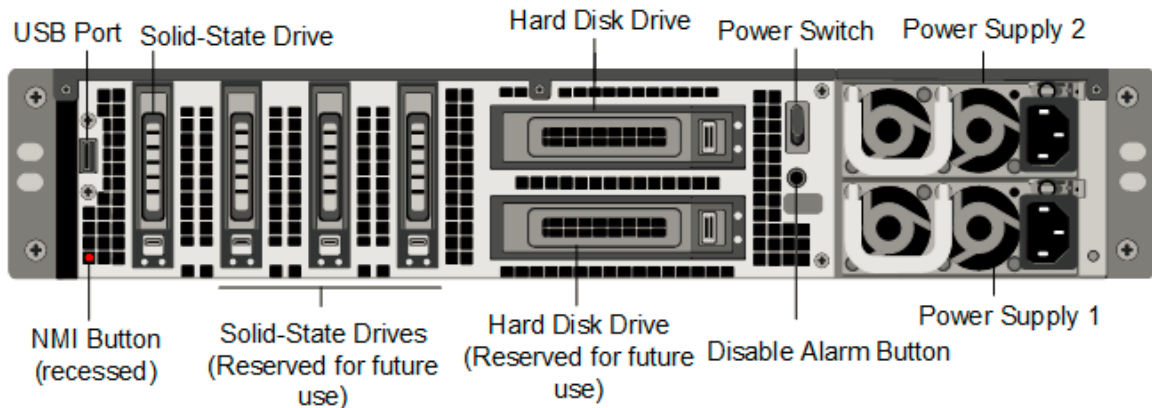

The following components are visible on the back panel of the MPX 11515/11520/11530/11540/11542 appliance:

- 256 GB or larger removable solid-state drive.
  - Note:** Drive densities might increase as components become EOL but its size is never smaller than the original.
- USB port (reserved for a future release).
- Power switch, which turns off power to the appliance, as if you were to unplug the power supply. Press the switch for five seconds to shut off the power.
- Non-maskable interrupt (NMI) Button that is used at the request of Technical Support and produces a core dump on the appliance. Use a pen, pencil, or other pointed object to press this red button, which is recessed to prevent unintentional activation.
- Two removable hard-disk drives that are used to store user data.
- **Disable alarm button.** This button is functional only when the appliance has two power supplies.
  - Press this button to stop the power alarm from sounding when either of the following conditions is true:
    - You have plugged the appliance into only one power outlet.
    - One power supply is malfunctioning, and you want to continue operating the appliance until it is repaired.
- Two power supplies, each rated at 960 watts, 110–220 volts. Maximum power consumption is 650 watts and typical power consumption is 500 watts, except on the MPX 11540T appliance which has a maximum power consumption of 365 watts and typical power consumption of 300 watts.

For information about installing the rails, rack mounting the hardware, and connecting the cables, see “[Installing the Hardware.](#)”

For information about performing initial configuration of your appliance, see “[Initial Configuration.](#)”

## NetScaler MPX 14000

December 31, 2023

The NetScaler MPX 14020/14030/14040/14060/14080/14100 are 2U appliances. Each model has two 6-core processors and 64 GB of memory and sixteen 10G SFP+ ports (16x10G SFP+).

For information about the software releases supported on the NetScaler hardware platforms, see [NetScaler hardware software support matrix](#).

The following figure shows the front panel of the MPX 14020/14030/14040/14060/14080 (16x10G SFP+) appliance.

Figure 1. NetScaler MPX 14020/14030/14040/14060/14080/14100 (16x10G SFP+), front panel

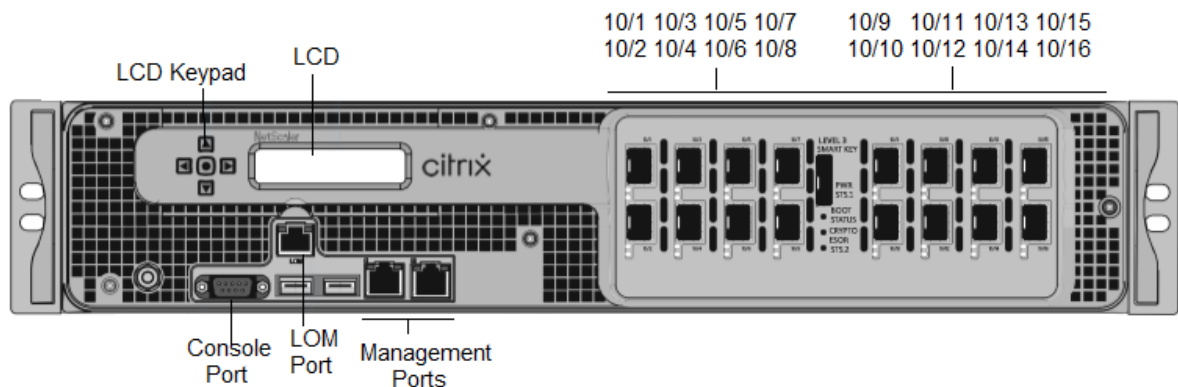

The NetScaler MPX 14020/14030/14040/14060/14080/14100 appliances have the following ports:

- RS232 serial Console Port.
- 10/100Base-T copper Ethernet Port (RJ45), also called the LOM port. You can use this port to remotely monitor and manage the appliance independently of the NetScaler software.
- Two 10/100/1000Base-T copper Ethernet Management Ports (RJ45), numbered 0/1 and 0/2 from left to right. These ports are used to connect directly to the appliance for system administration functions.
- Network Ports, sixteen 10G SFP+ ports (16x10G SFP+).
- USB port (reserved for a future release).

**Note:** The 10G SFP+ ports on these appliances support copper 1G SFP transceivers.

The following figure shows the back panel of the MPX 14020/14030/14040/14060/14080/ 14100 appliance.

Figure 2. NetScaler MPX 14020/14030/14040/14060/14080/14100, back panel

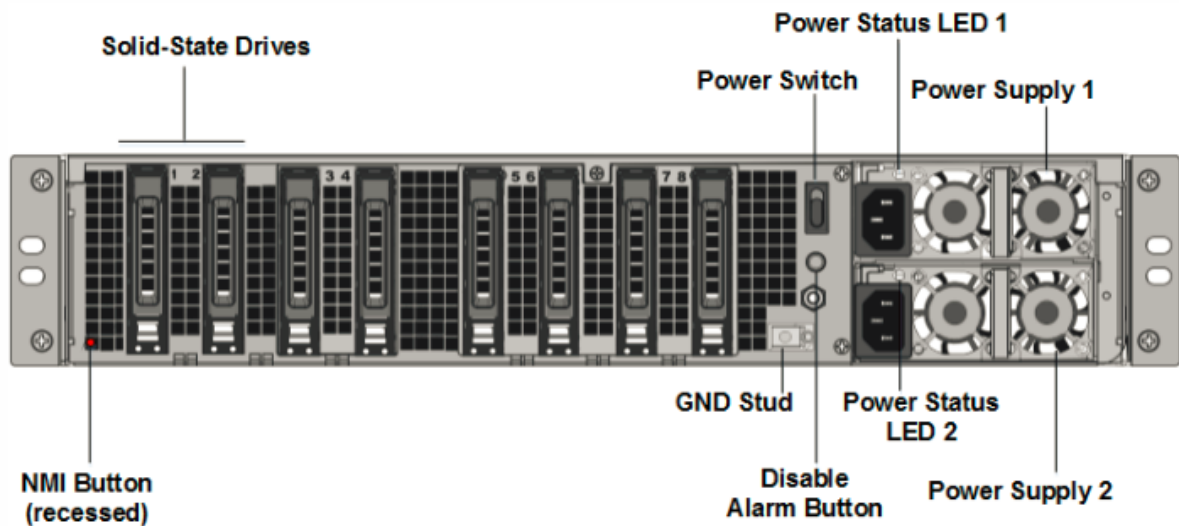

The following components are visible on the back panel of the MPX 14020/14030/14040/14060/14080/14100 appliance:

- Two 240 GB or larger removable solid-state drives in a redundant array of independent disks (RAID) configuration. In a RAID configuration, the same data is stored on multiple drives to improve performance, increase storage capacity, lower the risk of data loss, and provide fault tolerance. The two SSDs store the same data. If one fails and you replace it, the new SSD mirrors the other one.

**Note:** Drive densities might increase as components become EOL but its size is never smaller than the original.

- Power switch, which turns power to the appliance on or off. Press the switch for less than two seconds to shut off the power.
- Two power supplies, each rated at 1000 watts, 100–240 volts. Each power supply has an LED that indicates the status of the power supply, as described in [Common hardware components](#).
- **Disable alarm button**, which is functional only when the appliance has two power supplies. Press this button to stop the power alarm from sounding when:
  - You have plugged the appliance into only one power outlet
  - One power supply is malfunctioning and you want to continue operating the appliance until it is repaired.

- Non-maskable interrupt (NMI) Button, used at the request of Technical Support to initiate a core dump. To press this red button, which is recessed to prevent unintentional activation, use a pen, pencil, or other pointed object. The NMI button is also available remotely over the network in the LOM GUI, in the Remote Control menu.

For information about installing the rails, rack mounting the hardware, and connecting the cables, see [Installing the Hardware](#).

For information about performing initial configuration of your appliance, see [Initial Configuration](#).

## NetScaler MPX 14000-40C

December 31, 2023

The NetScaler MPX 14000-40C are 2U appliances. Each model has 2 six-core processors, 64 GB of memory, and sixteen 10G SFP+ ports.

The following figure shows the front panel of the 14000-40C appliance.

Figure 1. NetScaler MPX 14020/14040/14060/14080/14100-40C (16x10G SFP+ ports), front panel

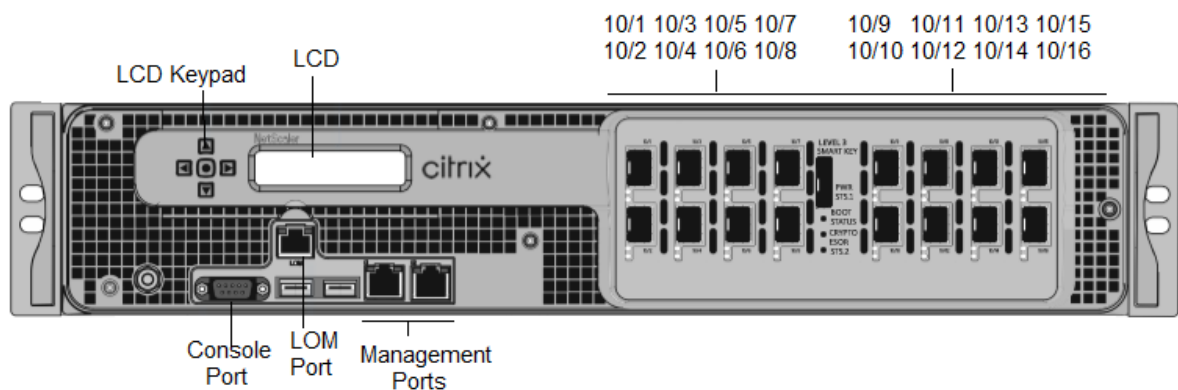

The NetScaler MPX14000-40C appliances have the following ports:

- RS232 serial Console Port.
- 10/100Base-T copper Ethernet Port (RJ45), also called the LOM port. You can use this port to remotely monitor and manage the appliance independently of the NetScaler software.
- Two 10/100/1000Base-T copper Ethernet management ports (RJ45), also called Management ports, numbered 0/1 and 0/2 from left to right. These ports are used to connect directly to the appliance for system administration functions.
- Network Ports: Sixteen 10G SFP+ ports.
- USB port (reserved for a future release).



The following figure shows the back panel of the MPX14000-40C appliances.

Figure 2. NetScaler MPX 14020/14040/14060/14080/14100-40C (16x10G SFP+), back panel

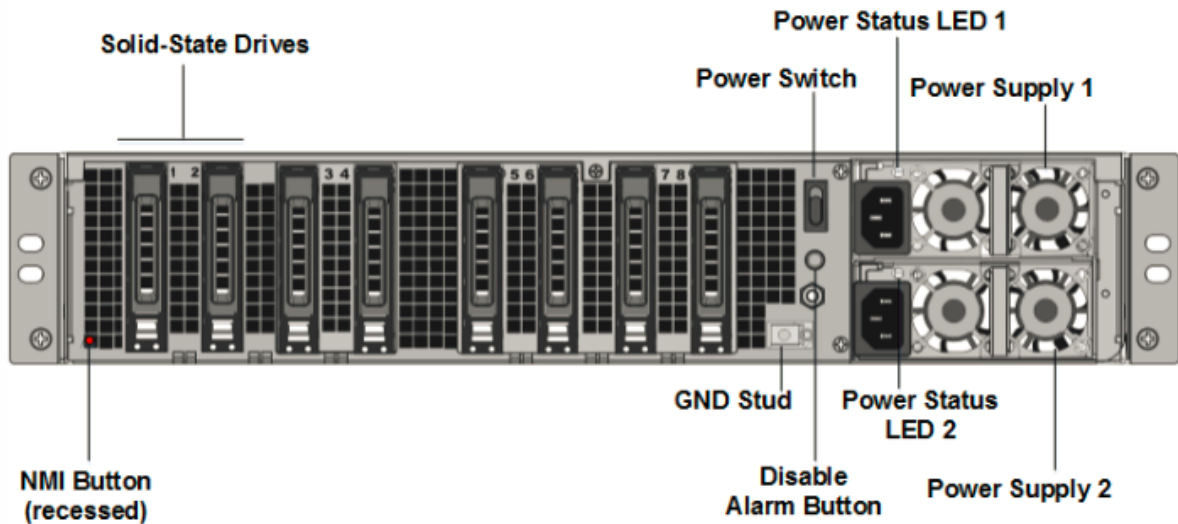

The following components are visible on the back panel of the MPX 14000-40C appliances:

- Two 300 GB or larger removable solid-state drives in a redundant array of independent disks (RAID) devices. In a RAID configuration, the same data is stored on multiple drives to improve performance, increase storage capacity, lower the risk of data loss, and provide fault tolerance. The two SSDs store the same data. If one fails and you replace it, the new SSD mirrors the other one.
 

**Note:** Drive densities might increase as components become EOL but its size is never smaller than the original.
- Power switch, which turns power to the appliance on or off. Press the switch for less than two seconds to shut off the power. For more information, see [Common Hardware Components](#)
- Two power supplies, each power supply is rated at 1000 watts, 100–240 volts. Each power supply has an LED that indicates the status of the power supply, as described [Common hardware components](#).
- **Disable alarm button.** This button is functional when the appliance has two power supplies. Press this button to stop the power alarm from sounding when one of the following conditions is true:
  - You have plugged the appliance into only one power outlet.
  - One power supply is malfunctioning and you want to continue operating the appliance until it is repaired.
- Non-maskable interrupt (NMI) Button that is used at the request of Technical Support to initiate a core dump. To press this red button, which is recessed to prevent unintentional activation,

use a pen, pencil, or other pointed object. The NMI Button is also available remotely over the network in the LOM GUI, in the Remote Control menu. For more information about lights out management port of the appliance, see [Lights out management port of the NetScaler MPX appliance](#).

## NetScaler MPX 14000-40G

December 31, 2023

The NetScaler MPX 14020-40G, MPX 14040-40G, MPX 14060-40G, MPX 14080-40G, MPX 14100-40G are 2U appliances. Each model has two 6-core processors, 64 GB of memory, four 40G QSFP+ ports, and sixteen 10G SFP+ ports (4x40G QSFP+ + 16x10G SFP+).

The following figure shows the front panel of the 14000-40G appliance.

Figure 1. NetScaler MPX 14020/14040/14060/14080/14100-40G (4x40G QSFP+, 16x10G SFP+), front panel

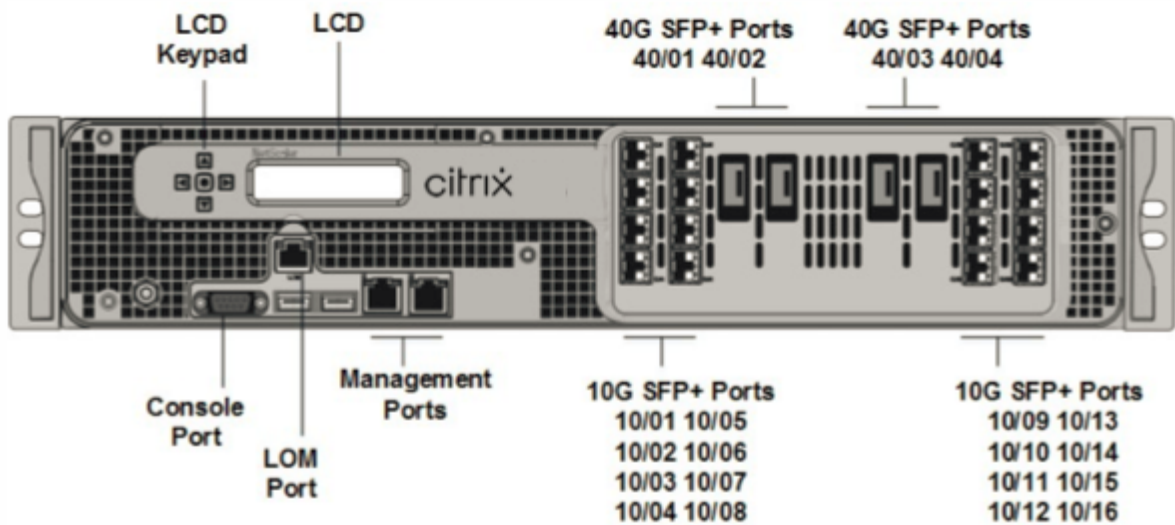

- RS232 serial Console Port.
- 10/100Base-T copper Ethernet Port (RJ45), also called the LOM port. You can use this port to remotely monitor and manage the appliance independently of the NetScaler software.
- Two 10/100/1000Base-T copper Ethernet Management Ports (RJ45), numbered 0/1 and 0/2 from left to right. These ports are used to connect directly to the appliance for system administration functions.
- Network Ports, sixteen 10G SFP+ ports (16x10G SFP+), four 40G QSFP+ ports (4x40G QSFP+). For information about supported transceivers per port, see [25G, 40G, 50G, and 100G ports](#).

- USB port (reserved for a future release).

**Note:** the following points regarding the network ports on 14000 FIPS appliances:

- 10G ports do not support 1G copper or 1G fiber transceivers.
- 40G ports do not support 10G and 1G transceivers.

The following figure shows the back panel of the 14000-40G appliance.

Figure 2. NetScaler MPX 14020/14040/14060/14080/14100-40G (4x40G QSFP+, 16x10G SFP+), back panel

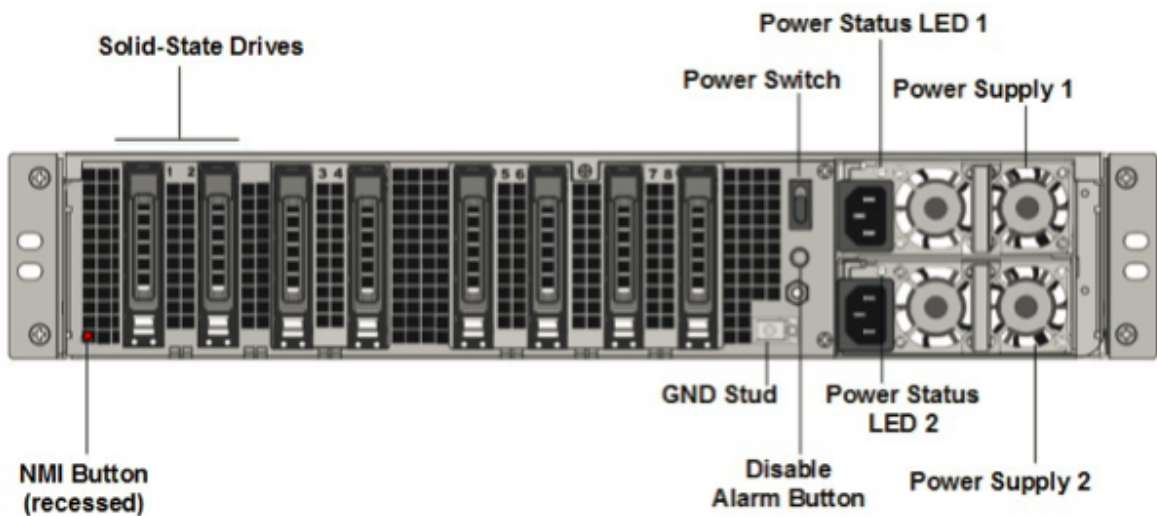

The following components are visible on the back panel of the MPX 14000-40G appliance:

- Two 300 GB or larger removable solid-state drives in a redundant array of independent disks (RAID) devices. In a RAID configuration, the same data is stored on multiple drives to improve performance, increase storage capacity, lower the risk of data loss, and provide fault tolerance. The two SSDs store the same data. If one fails and you replace it, the new SSD mirrors the other one.

**Note:** Drive densities might increase as components become EOL but its size is never smaller than the original.

- **Power switch.** This switch turns the power to the appliance on or off. Press the switch for less than two seconds to shut off the power.
- **Two power supplies.** Each power supply is rated at 1000 watts, 100–240 volts. Each power supply has an LED that indicates the status of the power supply, as described in [Common hardware components](#).
- **Disable alarm button.** This button is functional only when the appliance has two power supplies. Press this button to stop the power alarm from sounding when one of the following conditions is true:

- You have plugged the appliance into only one power outlet.
- One power supply is malfunctioning and you want to continue operating the appliance until it is repaired.
- Non-maskable interrupt (NMI) button. This button is used at the request of Technical Support to initiate a core dump. To press this red button, which is recessed to prevent unintentional activation, use a pen, pencil, or other pointed object. The NMI Button is also available remotely over the network in the LOM GUI, in the Remote Control menu. For more information about the lights out management port of the appliance, see [Lights out management port of the NetScaler MPX appliance](#) topic.

## NetScaler MPX 14000-40S

December 31, 2023

The NetScaler MPX 14040-40S, MPX 14060-40S, MPX 14080-40S, MPX 14100-40S are 2U appliances. Each model has two 6-core processors, 64 GB of memory, four 40G QSFP+ ports, and eight 10G SFP+ ports.

The following figure shows the front panel of the 14000-40S appliance.

Figure 1. NetScaler MPX 14040/14060/14080/14100-40S (4x40G QSFP+, 8x10G SFP+), front panel

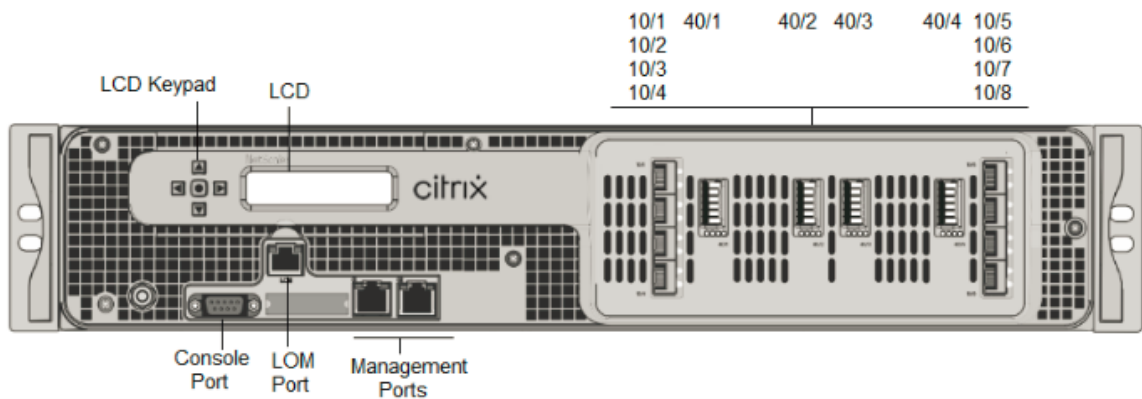

The NetScaler MPX 14000-40S appliances have the following ports:

- RS232 serial Console Port.
- 10/100Base-T copper Ethernet Port (RJ45), also called the LOM port. You can use this port to remotely monitor and manage the appliance independently of the NetScaler software.
- Two 10/100/1000Base-T copper Ethernet management ports (RJ45), also called Management ports, numbered 0/1 and 0/2 from left to right. These ports are used to connect directly to the appliance for system administration functions.

- Network Ports, four 40G QSFP+, eight 10G SFP+ ports. For information about supported transceivers per port, see [25G, 40G, 50G, and 100G ports](#).

The following figure shows the back panel of the 14000-40S appliance.

Figure 2. NetScaler MPX 14020/14040/14060/14080/14100-40S (4x40G QSFP+, 8x10G SFP+), back panel

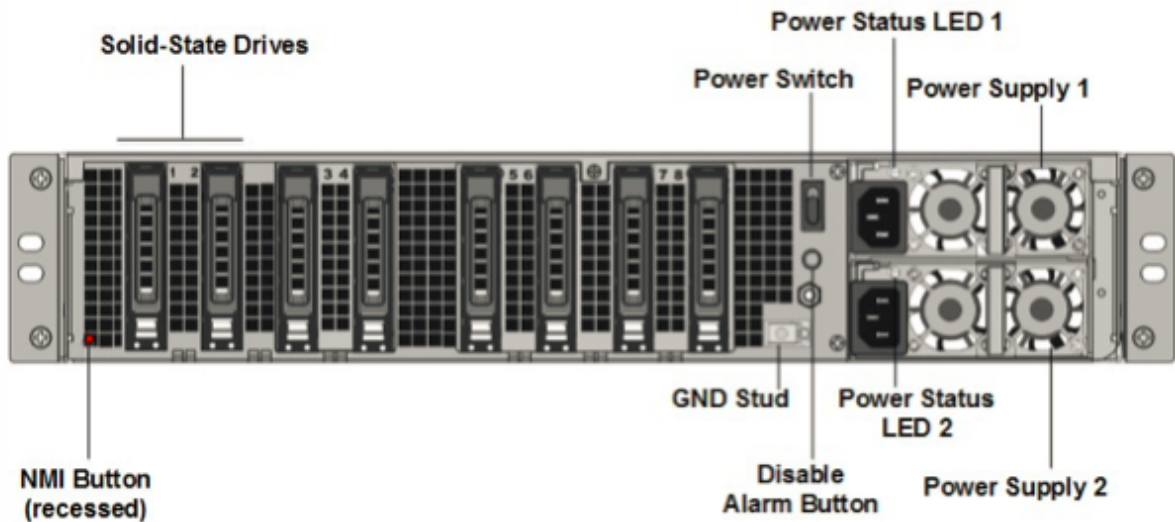

The following components are visible on the back panel of the MPX 14000-40S appliance:

- Two 300 GB or larger removable solid-state drives in a redundant array of independent disks (RAID) devices. In a RAID configuration, the same data is stored on multiple drives to improve performance, increase storage capacity, lower the risk of data loss, and provide fault tolerance. The two SSDs store the same data. If one fails and you replace it, the new SSD mirrors the other one.  
**Note:** Drive densities might increase as components become EOL but its size is never smaller than the original.
- Power switch, which turns the power to the appliance on or off. Press the switch for less than two seconds to shut off the power.
- Two power supplies, each power supply is rated at 1000 watts, 100–240 volts. Each power supply has an LED that indicates the status of the power supply, as described in [Common Hardware Components](#).
- **Disable alarm button.** This button is functional only when the appliance has two power supplies. Press this button to stop the power alarm from sounding when one of the following conditions is true:
  - You have plugged the appliance into only one power outlet.
  - One power supply is malfunctioning and you want to continue operating the appliance until it is repaired.

- Non-maskable interrupt (NMI) button that is used at the request of Technical Support to initiate a core dump. To press this red button, which is recessed to prevent unintentional activation, use a pen, pencil, or other pointed object. The NMI Button is also available remotely over the network in the LOM GUI, in the Remote Control menu. For more information about the lights out management port of the appliance, see [Lights out management port of the NetScaler MPX appliance](#).

## NetScaler MPX 14000 FIPS

December 31, 2023

### Note

For information about configuring a NetScaler MPX 14030/14060/14080 FIPS appliance, see [MPX 14000 FIPS appliance](#).

The NetScaler models MPX 14030 FIPS, MPX 14060 FIPS, and MPX 14080 FIPS are 2U appliances. Each model has two 6-core processors, 64 GB of memory, sixteen 10G SFP+ ports (16x10G SFP+).

The following figure shows the front panel of the MPX 14030/14060/14080 FIPS appliances.

Figure 1. NetScaler MPX 14030/14060/14080 FIPS, front panel

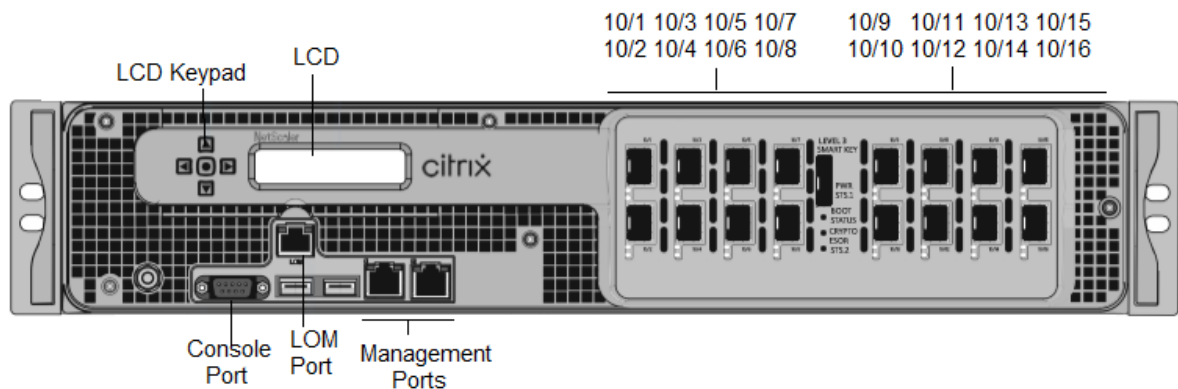

The NetScaler MPX 14030/14060/14080 FIPS appliances have the following ports:

- RS232 serial Console Port.
- 10/100Base-T copper Ethernet Port (RJ45), also called the LOM port. You can use this port to remotely monitor and manage the appliance independently of the NetScaler software.
- Two 10/100/1000Base-T copper Ethernet Management Ports (RJ45), numbered 0/1 and 0/2 from left to right. These ports are used to connect directly to the appliance for system administration functions.
- Sixteen 10G SFP+ ports.

- USB port (reserved for a future release).

**Notes:**

- 10G ports do not support 1G copper or 1G fiber transceivers.
- 40G ports do not support 10G and 1G transceivers.

The following figure shows the back panel of the MPX 14030/14060/14080 FIPS appliances.

Figure 2. NetScaler MPX 14030/14060/14080 FIPS appliance, back panel

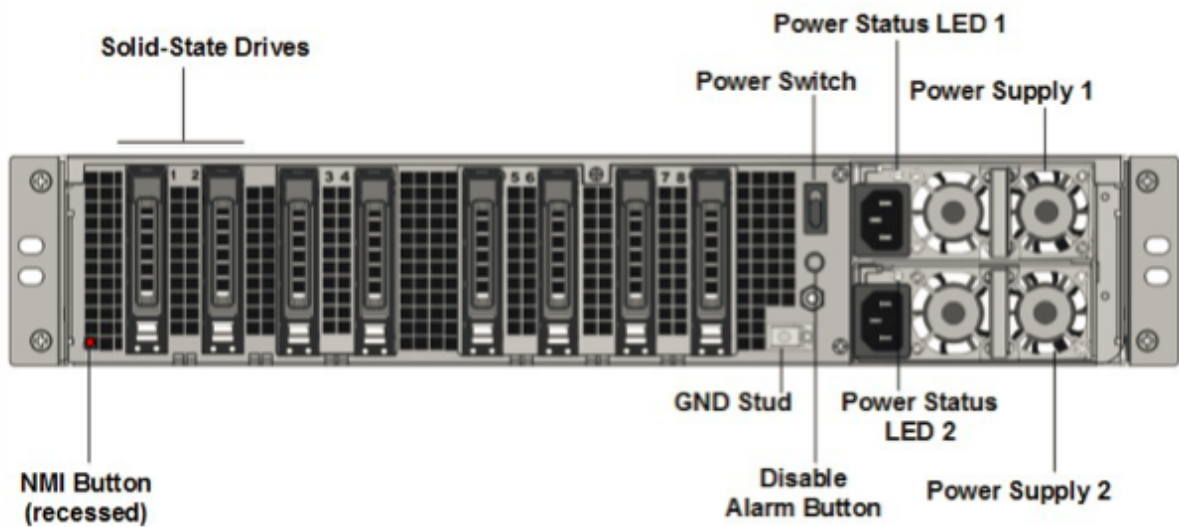

The following components are visible on the back panel of the MPX 14000 FIPS appliance:

- Two 300 GB or larger removable solid-state drives in a redundant array of independent disks (RAID) devices. In a RAID configuration, the same data is stored on multiple drives to improve performance, increase storage capacity, lower the risk of data loss, and provide fault tolerance. The two SSDs store the same data. If one fails and you replace it, the new SSD mirrors the other one.

**Note:** Drive densities might increase as components become EOL but its size is never smaller than the original.

- **Power switch.** This switch turns the power to the appliance on or off. Press the switch for less than two seconds to shut off the power.
- **Two power supplies.** Each power supply is rated at 1000 watts, 100–240 volts. Each power supply has an LED that indicates the status of the power supply, as described in [Common hardware components](#).
- **Disable alarm button.** This button is functional only when the appliance has two power supplies. Press this button to stop the power alarm from sounding when:
  - You have plugged the appliance into only one power outlet

- One power supply is malfunctioning and you want to continue operating the appliance until it is repaired.
- Non-maskable interrupt (NMI) button. This button is used at the request of Technical Support to initiate a core dump. To press this red button, which is recessed to prevent unintentional activation, use a pen, pencil, or other pointed object. The NMI Button is also available remotely over the network in the LOM GUI, in the Remote Control menu. For more information about the lights out management port of the appliance, see [Lights out management port of the NetScaler MPX appliance](#).

## NetScaler MPX 15000

January 12, 2024

The NetScaler MPX 15000 appliance is a 2U appliance. This platform has two 8-core processors and 128 GB of memory. The appliance provides a total of 16 Ethernet 25G ports.

For information on the software releases supported on the NetScaler hardware platforms, see [Hardware-Software Release Matrix](#).

The following figure shows the front panel of the MPX 15000 series appliances.

Figure 1. NetScaler MPX 15000, front panel

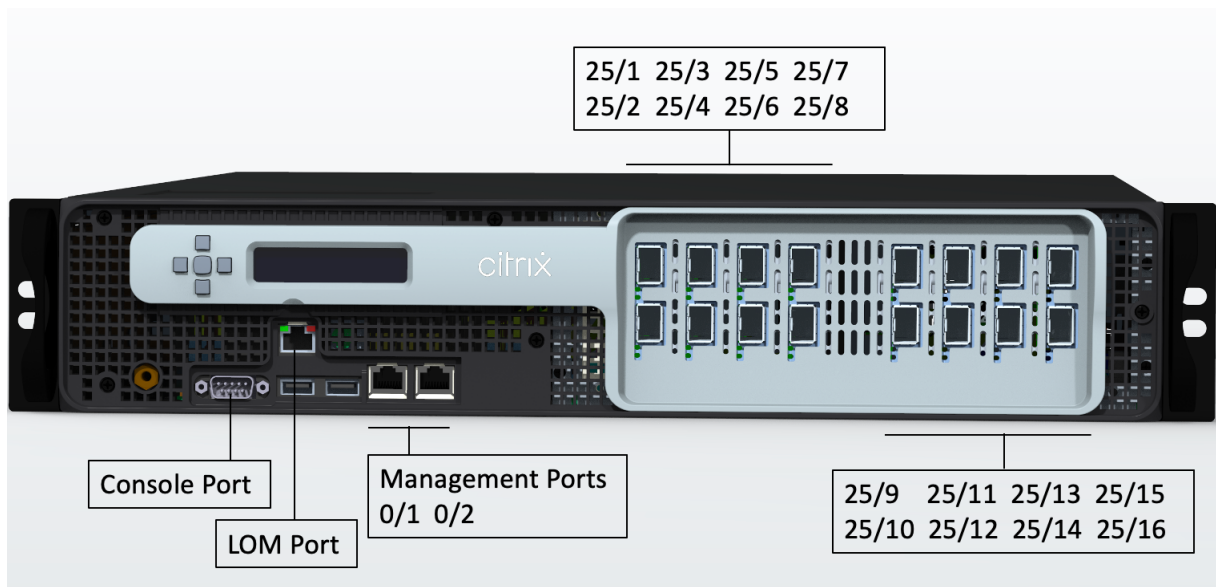

The NetScaler MPX 15000 series appliances have the following ports:

- RS232 serial console port.



- Two 10/100/1000Base-T RJ45 copper Ethernet Management ports, numbered 0/1 and 0/2. This port is used to connect directly to the appliance for NetScaler administration functions.
- One 10/100/1000Base-T RJ45 copper Ethernet Management Port, numbered 0/1. This port is used to connect directly to the appliance for NetScaler administration functions.
- Sixteen 25G Ethernet ports numbered 25/1 to 25/16. For information about supported transceivers per port, see [25G, 40G, 50G, and 100G ports](#).

The following figure shows the back panel of the MPX 15000 appliance.

Figure 2. NetScaler MPX 15000, back panel

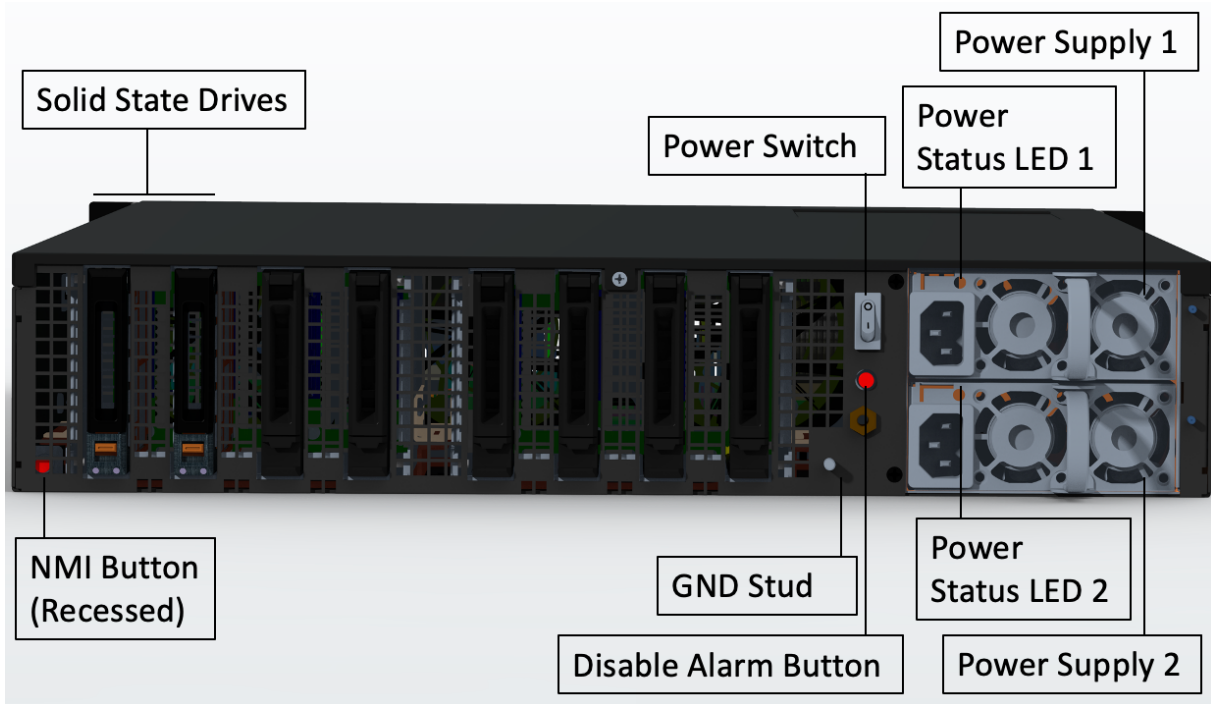

The following components are visible on the back panel of the MPX 15000 appliance:

- Two 480 GB or larger removable solid-state drives in a redundant array of independent disks (RAID) configuration. In a RAID configuration, the same data is stored on multiple drives to improve performance, increase storage capacity, lower the risk of data loss, and provide fault tolerance. The two SSDs store the same data. If one fails and you replace it, the new SSD mirrors the other one.  
**Note:** Drive densities might increase as components become EOL but its size is never smaller than the original.
- Power switch, which turns power to the appliance on or off.
  - If the OS is functional, press the switch for less than two seconds to power down the system with a graceful shutdown.

- If the OS is not responsive, press the power switch for more than 4 seconds to force the power off.
- Two hot-swappable, 100–240 VAC input power supply modules, rated at 1000 watts each. Maximum power consumption is 520 watts and typical power consumption is 395 watts. Each power supply has an LED indicating its status:

LED Color	LED Indicates
OFF	No power to any power supply in the appliance.
Flashing RED	No power to this power supply.
Flashing GREEN	Power supply is in standby mode.
GREEN	Power supply is functional.
RED	Power supply failure.
Flashing RED and GREEN	Warning (OVP/UVP/OCP/OTP/Fan); OVP = Over Voltage Protection; UVP = Under Voltage Protection; OCP = Over Current Protection; OTP = Over Temperature Protection

- **Disable alarm button**, which is functional only when the appliance has two power supplies. Press this button to silence the power alarm when one of two power supplies loses input power (second power supply optional) or when a power supply is malfunctioning.
- Non-Maskable Interrupt (NMI) Button, used at the request of Technical Support to initiate a core dump. To press this red button, which is recessed to prevent unintentional activation, use a pen, pencil, or other pointed object. The NMI Button is also available remotely over the network in the LOM GUI, in the Remote Control menu. For more information about the lights out management port of the appliance, see [Lights out management port of the NetScaler MPX appliance](#) topic.

## NetScaler MPX 15000-50G

December 31, 2023

The NetScaler MPX 15000-50G appliance is a 2U appliance. This platform has two 8-core processors and 128 GB of memory. The MPX 15000-50G appliance provides a total of 12 network ports:

- Eight 10G SFP+ Ethernet Ports
- Four 50G Ethernet Ports

For information about the software releases supported on the NetScaler hardware platforms, see [NetScaler MPX hardware software compatibility matrix](#).

The following figure shows the front panel of the NetScaler MPX 15000-50G appliance.

Figure 1. NetScaler MPX 15000-50G, front panel

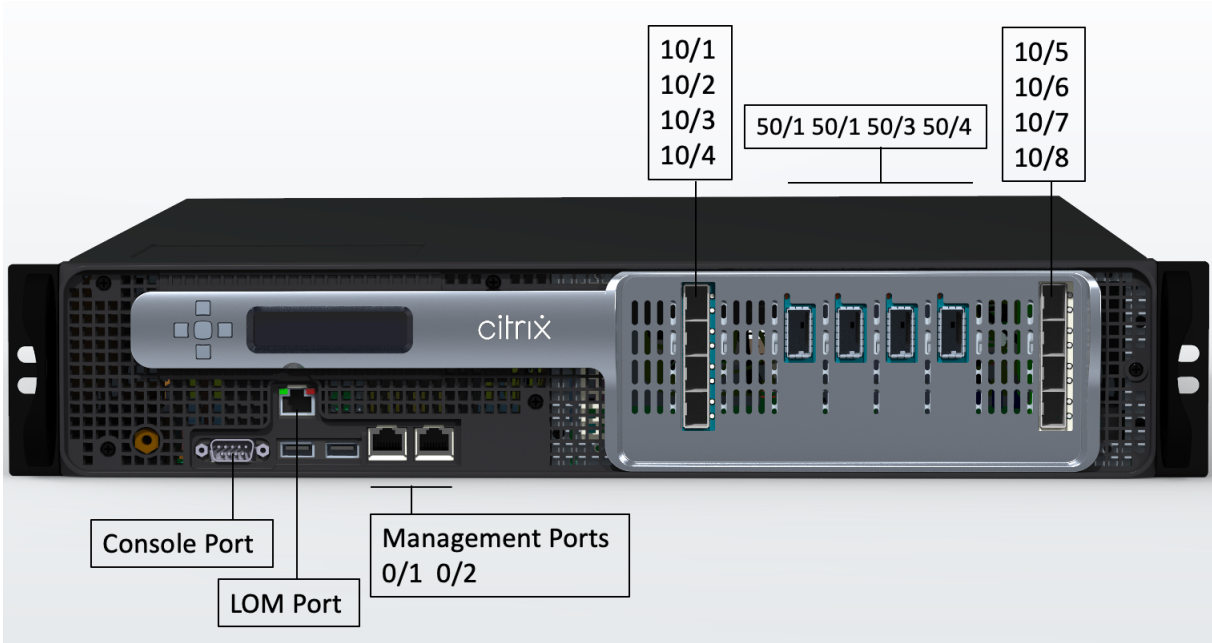

The NetScaler MPX 15000-50G appliances have the following ports:

- RS232 serial console port.
- One 10/100/1000Base-T RJ45 copper Ethernet LOM port. Use this port to remotely monitor and manage the appliance independently of the NetScaler software.
- Two 10/100/1000Base-T RJ45 copper Ethernet Management ports, numbered 0/1 and 0/2. This port is used to connect directly to the appliance for NetScaler administration functions.
- Eight 10G SFP+ Ethernet ports, numbered 10/1 to 10/8.
- Four 50G ports, numbered 50/1 to 50/4. For information about supported transceivers per port, see [25G, 40G, 50G, and 100G ports](#).

The following figure shows the back panel of the NetScaler MPX 15000-50G appliance.

Figure 2. NetScaler MPX 15000-50G, back panel

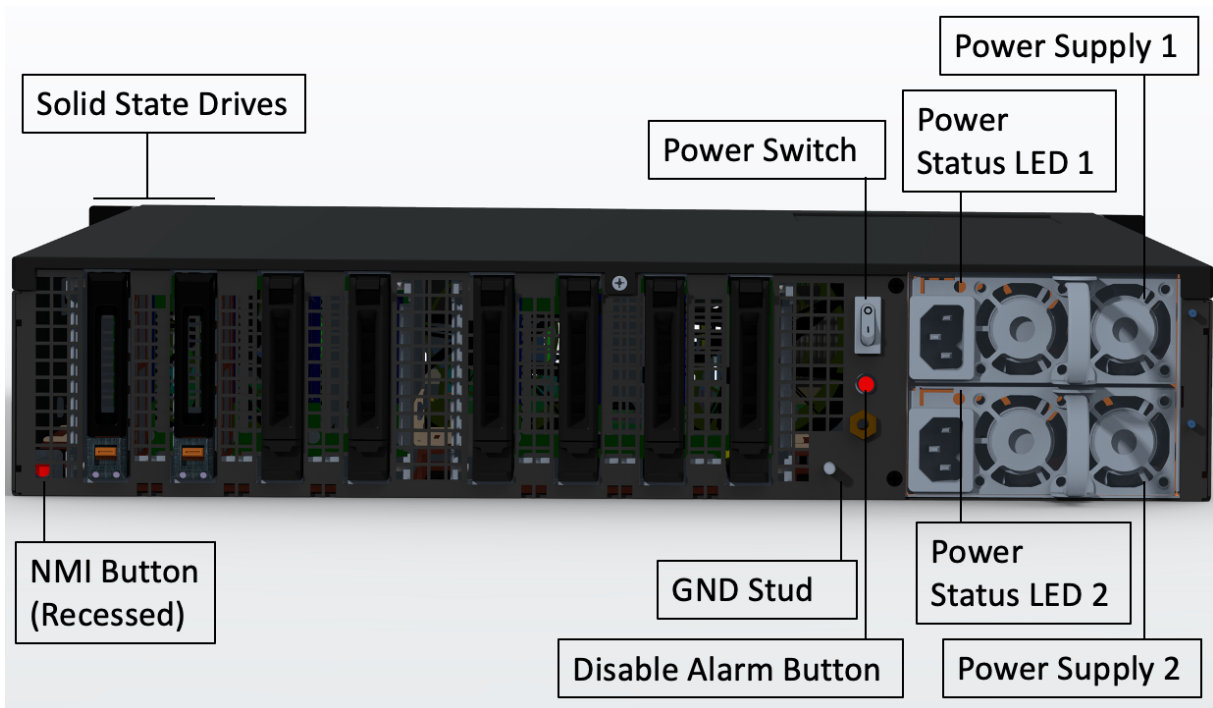

The following components are visible on the back panel of the MPX 15000-50G appliances:

- Two 480 GB or larger removable solid-state drives in a redundant array of independent disks (RAID) configuration. In a RAID configuration, the same data is stored on multiple drives to improve performance, increase storage capacity, lower the risk of data loss, and provide fault tolerance. The two SSDs store the same data. If one fails and you replace it, the new SSD mirrors the other one.
 

**Note:** Drive densities might increase as components become EOL but its size is never smaller than the original.
- Power switch, which turns power to the appliance on or off.
  - If the OS is functional, press the switch for less than two seconds to power down the system with a graceful shutdown.
  - If the OS is not responsive, press the power switch for more than 4 seconds to force the power off.
- Two hot-swappable 100–240 VAC input power supply modules, rated at 1000 watts each. Maximum power consumption is 522 watts and typical power consumption is 300 watts. The following table indicates the LED status of each power supply:

LED Color	LED Indicates
OFF	No power to any power supply on the appliance.

LED Color	LED Indicates
Flashing RED	No power to this power supply.
Flashing GREEN	Power supply is in standby mode.
GREEN	Power supply is functional.
RED	Power supply failure.
Flashing RED and GREEN	Warning (OVP/UVP/OCP/OTP/Fan); OVP = Over Voltage Protection; UVP = Under Voltage Protection; OCP = Over Current Protection; OTP = Over Temperature Protection

- **Disable alarm button.** Press this button to silence the power alarm when one of two power supplies loses input power or when a power supply is malfunctioning.
- **Non-Maskable Interrupt (NMI) Button,** used at the request of Technical Support to initiate a core dump. To press this red button, which is recessed to prevent unintentional activation, use a pen, pencil, or other pointed object. The NMI Button is also available remotely over the network in the LOM GUI, in the Remote Control menu. For more information about the lights out management port of the appliance, see [NetScaler MPX hardware-software compatibility matrix](#).

## NetScaler MPX 15000-50G FIPS certified appliance

December 31, 2023

The NetScaler MPX 15000-50G FIPS certified appliance is a 2U appliance. This platform has two 8-core processors and 128 GB of memory.

**Note:** There are FIPS tamper seals on all sides of the appliance. Tampering with the seals breaks the FIPS requirement.

The MPX 15000-50G FIPS certified appliance provides a total of 12 network ports:

- Eight 10G SFP+ Ethernet Ports
- Four 50G Ethernet Ports

For information about the software releases supported on the NetScaler hardware platforms, see [NetScaler MPX hardware software compatibility matrix](#).

The following figure shows the front panel of the NetScaler MPX 15000-50G FIPS certified appliance.

Figure 1. NetScaler MPX 15000-50G FIPS certified appliance, front panel

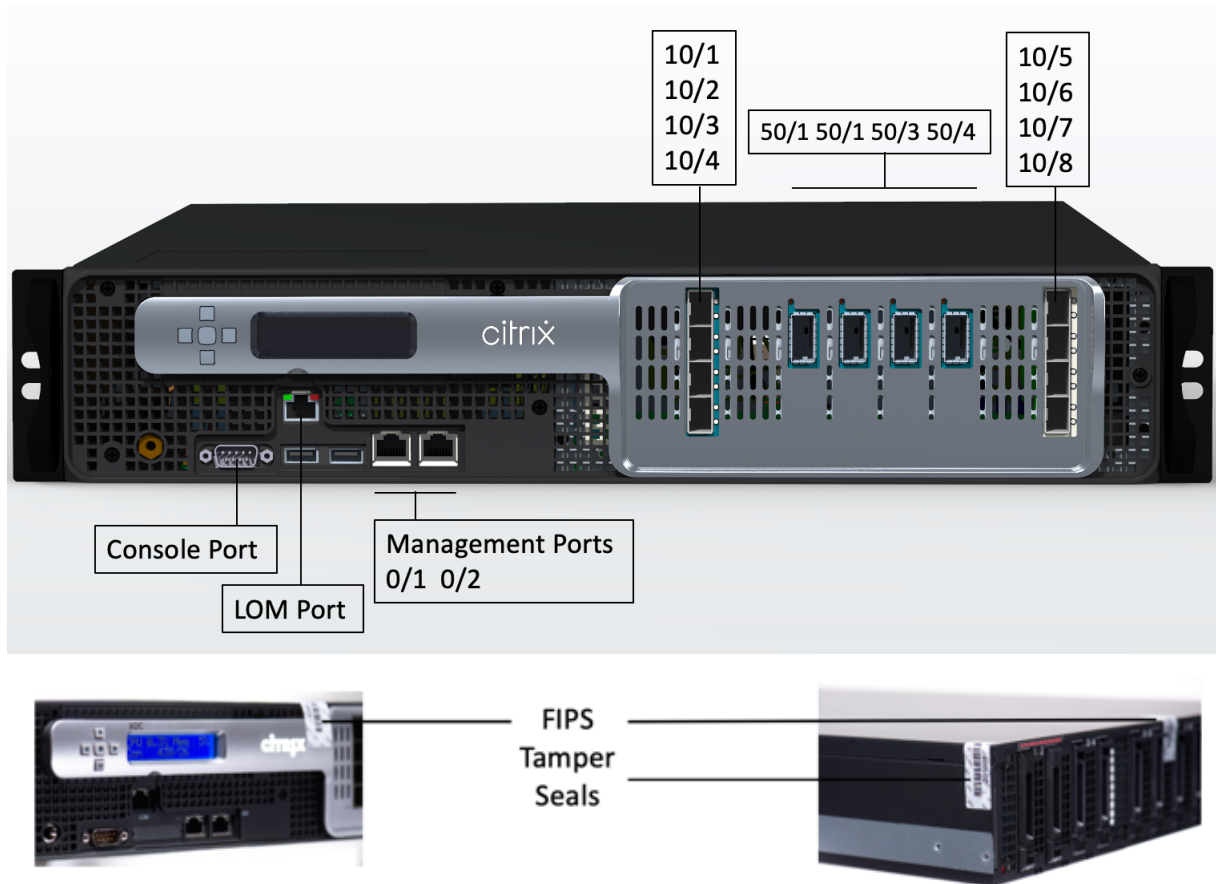

The NetScaler MPX 15000-50G FIPS certified appliance has the following ports:

- RS232 serial console port.
- One 10/100/1000Base-T RJ45 copper Ethernet LOM port. Use this port to remotely monitor and manage the appliance independently of the NetScaler software.
- Two 10/100/1000Base-T RJ45 copper Ethernet Management ports, numbered 0/1 and 0/2. This port is used to connect directly to the appliance for NetScaler administration functions.
- Eight 10G SFP+ Ethernet ports, numbered 10/1 to 10/8.
- Four 50G ports, numbered 50/1 to 50/4. For information about supported transceivers per port, see [25G](#), [40G](#), [50G](#), and [100G](#) ports.

The following figure shows the back panel of the NetScaler MPX 15000-50G FIPS certified appliance.

Figure 2. NetScaler MPX 15000-50G FIPS certified appliance, back panel

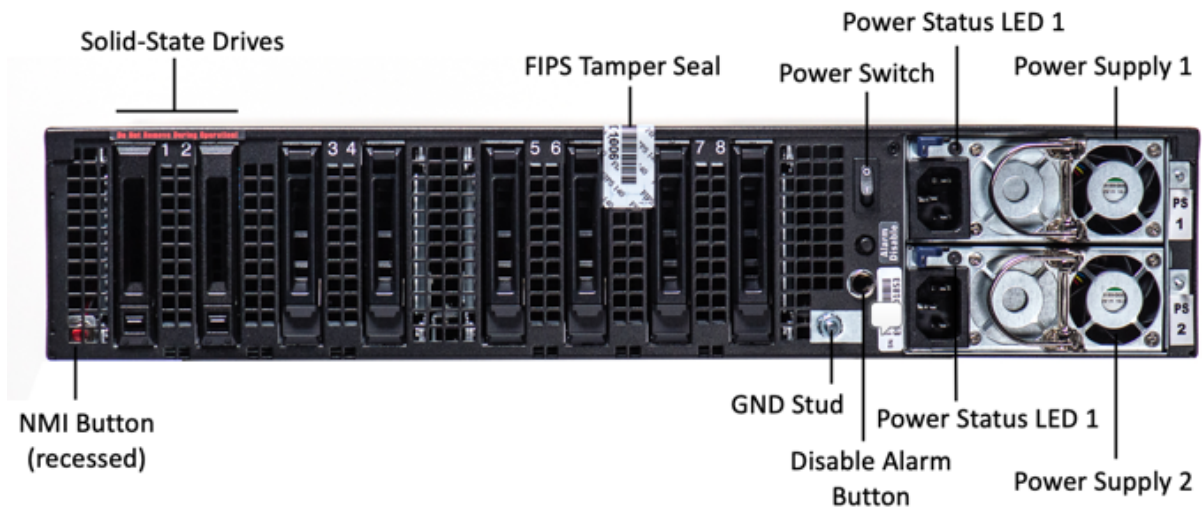

The following components are visible on the back panel of the MPX 15000-50G FIPS certified appliance:

- Two 480 GB or larger removable solid-state drives in a redundant array of independent disks (RAID) configuration. In a RAID configuration, the same data is stored on multiple drives to improve performance, increase storage capacity, lower the risk of data loss, and provide fault tolerance. The two SSDs store the same data. If one fails and you replace it, the new SSD mirrors the other one.
 

**Note:** Drive densities might increase as components become EOL but its size is never smaller than the original.
- Power switch, which turns power to the appliance on or off.
  - If the OS is functional, press the switch for less than two seconds to power down the system with a graceful shutdown.
  - If the OS is not responsive, press the power switch for more than 4 seconds to force the power off.
- Two hot-swappable 100–240 VAC input power supply modules, rated at 1000 watts each. Maximum power consumption is 522 watts and typical power consumption is 300 watts. The following table indicates the LED status of each power supply:

LED Color	LED Indicates
OFF	No power to any power supply on the appliance.
Flashing RED	No power to this power supply.
Flashing GREEN	Power supply is in standby mode.

LED Color	LED Indicates
GREEN	Power supply is functional.
RED	Power supply failure.
Flashing RED and GREEN	Warning (OVP/UVP/OCP/OTP/Fan); OVP = Over Voltage Protection; UVP = Under Voltage Protection; OCP = Over Current Protection; OTP = Over Temperature Protection

- **Disable alarm button.** Press this button to silence the power alarm when one of two power supplies loses input power or when a power supply is malfunctioning.
- **Non-Maskable Interrupt (NMI) Button,** used at the request of Technical Support to initiate a core dump. To press this red button, which is recessed to prevent unintentional activation, use a pen, pencil, or other pointed object. The NMI Button is also available remotely over the network in the LOM GUI, in the Remote Control menu. For more information about the lights out management port of the appliance, see [NetScaler MPX hardware-software compatibility matrix](#).

For information about configuring this appliance see [NetScaler MPX FIPS certified appliances](#).

## NetScaler MPX 16000

December 31, 2023

The NetScaler MPX 16000 appliance is a 2U appliance. This platform has two 16-core processors and 128 GB (16 x 8 GB DIMM) of memory. The appliance provides a total of eight 25G SFP28 ports and four 100G QSFP28 Ethernet ports.

For information on the software releases supported on the ADC hardware platforms, see [Hardware-Software Release Matrix](#).

The following figure shows the front panel of the MPX 16000 appliance.

Figure 1. NetScaler MPX 16000, front panel



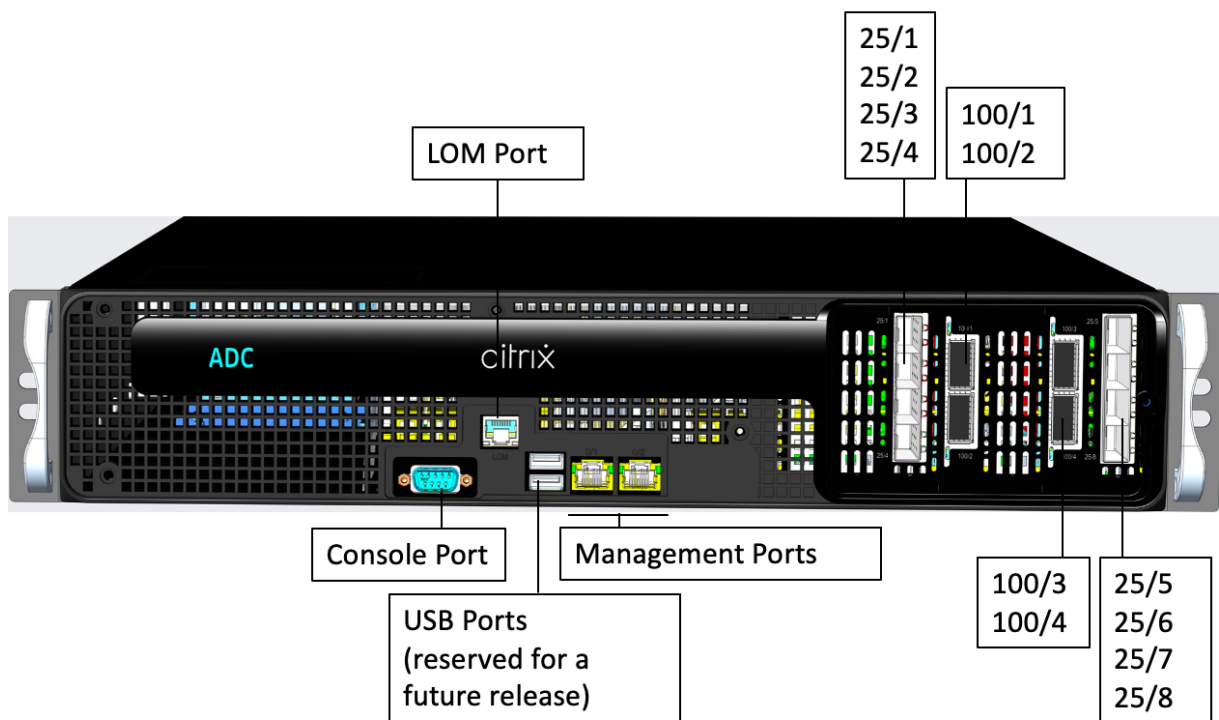

The NetScaler MPX 16000 series appliances have the following ports:

- RS232 serial Console port.
- One 10/100/1000Base-T RJ45 copper Ethernet LOM port. Use this port to remotely monitor and manage the appliance independently of the ADC software.
- Two 10/100/1000Base-T RJ45 copper Ethernet management ports, numbered 0/1 and 0/2. These ports are used to connect directly to the appliance for ADC administration functions.
- Two USB ports (reserved for a future release).
- Eight 25G SFP28 ports, numbered 25/1 to 25/8. Four 100G QSFP28 ports, numbered 100/1 to 100/4. For information about supported transceivers per port, see [25G](#), [40G](#), [50G](#), and [100G ports](#).

The following figure shows the back panel of the MPX 16000 appliance.

Figure 2. NetScaler MPX 16000, back panel

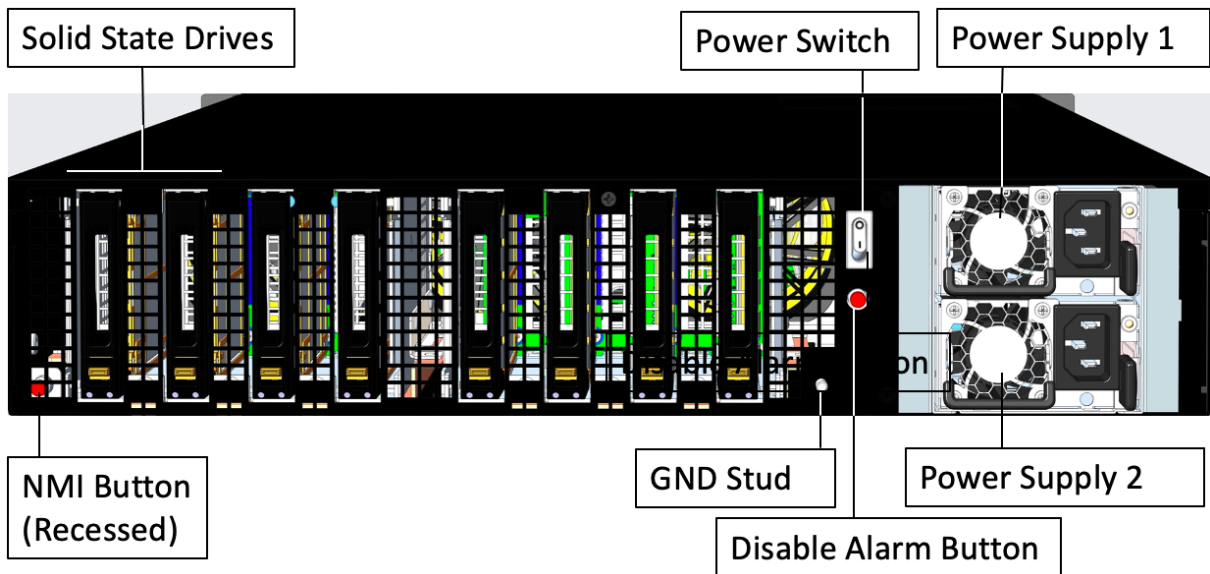

The following components are visible on the back panel of the MPX 16000 appliance:

- Two 960 GB removable solid-state drives (SSD).
  - Note:** Drive densities might increase as components become EOL but its size is never smaller than the original.
- Power switch, which turns power to the appliance on or off.
  - If the OS is functional, press the switch for less than two seconds to power down the system with a graceful shutdown.
  - If the OS is not responsive, press the power switch for more than 4 seconds to force the power off.
- Two power supplies, rated at 850 watts, 100–240 VAC. Maximum power consumption is 584 watts and typical power consumption is 465 watts. The following table indicates the LED status of each power supply:

LED Color	LED Indicates
OFF	No power to any power supply in the appliance.
Flashing RED	No power to this power supply.
Flashing GREEN	Power supply is in standby mode.
GREEN	Power supply is functional.
RED	Power supply failure.

- **Disable alarm button**, which is functional only when the appliance has two power supplies.

Press this button to silence the power alarm when one of two power supplies loses input power (second power supply optional) or when a power supply is malfunctioning.

- **Non-Maskable Interrupt (NMI) Button**, used at the request of Technical Support to initiate a core dump. To press this red button, which is recessed to prevent unintentional activation, use a pen, pencil, or other pointed object. The NMI Button is also available remotely over the network in the LOM GUI, in the **Remote Control** menu. For more information about the lights out management port of the appliance, see [Lights out management port of the NetScaler MPX appliance](#).

## NetScaler MPX 17500, MPX 19500, and MPX 21500

December 31, 2023

**Note:** This platform has reached its end of life.

The NetScaler models MPX 17500/19500/21500 are 2U appliances. Each model has two 6-core processors and 48 GB of memory.

The following figure shows the front panel of the MPX 17500/19500/21500 appliance.

Figure 1. NetScaler MPX 17500/19500/21500 appliance, front panel

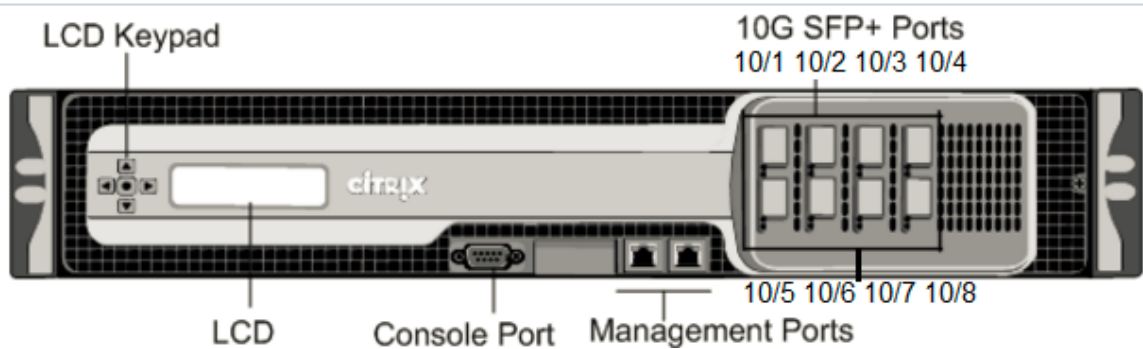

The MPX 17500/19500/21500 appliances have the following ports:

- RS232 serial console port.
- Two 10/100/1000Base-T copper Ethernet management ports (RJ45), numbered 0/1 and 0/2 from left to right. These ports are used to connect directly to the appliance for system administration functions.
- Eight 10G SFP+ ports numbered 10/1, 10/2, 10/3, and 10/4 on the top row from left to right. Ports are numbered 10/5, 10/6, 10/7, and 10/8 on the bottom row from left to right.

The following figure shows the back panel of the MPX 17500/19500/21500 appliance.

Figure 2. NetScaler MPX 17500/19500/21500 appliance, back panel

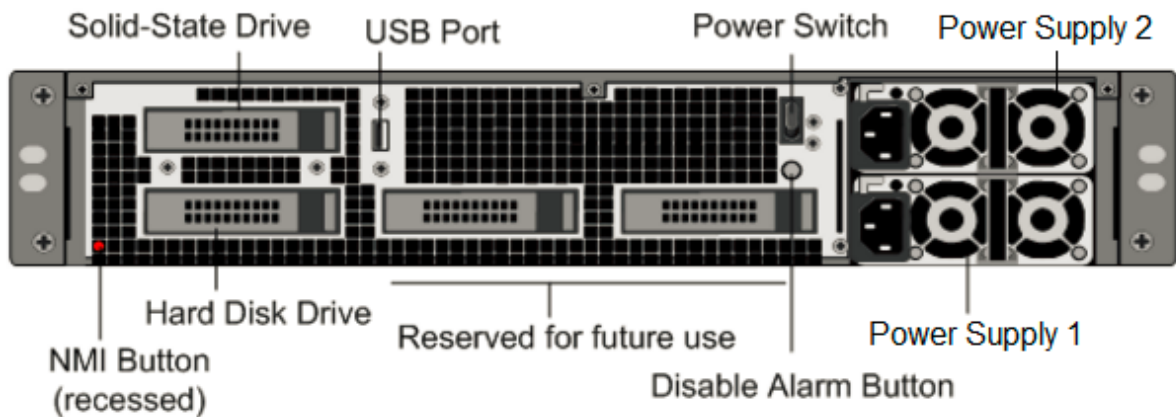

The following components are visible on the back panel of the MPX 17500/19500/21500 appliance:

- 160 GB or larger removable solid-state drive.  
**Note:** Drive densities might increase as components become EOL but its size is never smaller than the original.
- USB port (reserved for a future release).
- Power switch, which turns off power to the appliance, as if you were to unplug the power supply. Press the switch for five seconds to shut off the power.
- Non-maskable interrupt (NMI) button that is used at the request of Technical Support and produces a core dump on the appliance. Use a pen, pencil, or other pointed object to press this red button, which is recessed to prevent unintentional activation.
- Removable hard-disk drive that stores user data.
- **Disable alarm button.** This button is functional only when the appliance has two power supplies.

Press this button to stop the power alarm from sounding when either of the following conditions is true:

- You have plugged the appliance into only one power outlet.
  - One power supply is malfunctioning, and you want to continue operating the appliance until it is repaired.
- Two power supplies, each rated at 1000 watts, 110–220 volts. Maximum power consumption is 500 watts.

For information about installing the rails, rack mounting the hardware, and connecting the cables, see [Installing the Hardware](#).

For information about performing the initial configuration of your appliance, see [Initial Configuration](#).

## NetScaler MPX 17550, MPX 19550, MPX 20550, and MPX 21550

December 31, 2023

**Note:** This platform has reached its end of life.

The NetScaler models MPX 17550, MPX 19550, MPX 20550, and MPX 21550 are 2U appliances. Each model has two 6-core processors for a total of 12 physical cores (24 cores with hyper-threading), and 96 GB of memory.

The following figure shows the front panel of the MPX 17550/19550/20550/21550 appliance.

Figure 1. NetScaler MPX 17550/19550/20550/21550 appliance, front panel

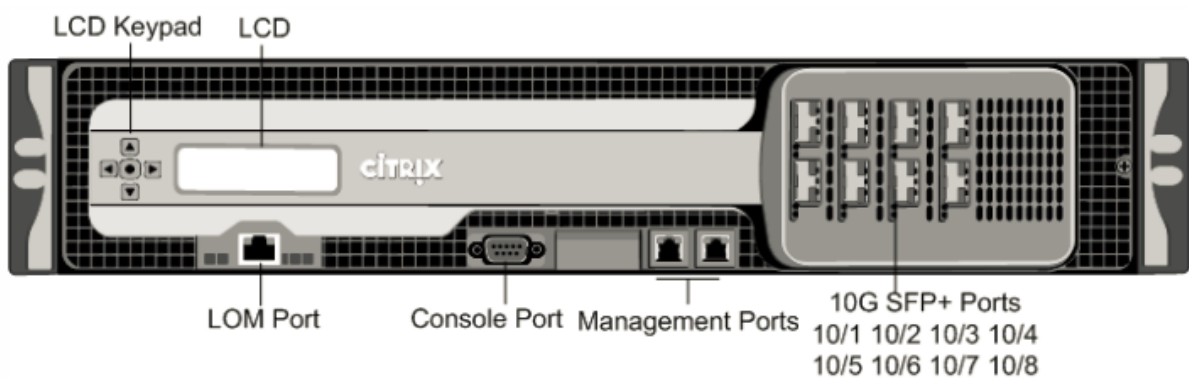

The MPX 17550/19550/20550/21550 appliance has the following ports:

- 10/100Base-T copper Ethernet Port (RJ45), also called LOM port. You can use this port to remotely monitor and manage the appliance independently of the NetScaler software.  
Note: The LEDs on the LOM port are not operational by design.
- RS232 serial console port.
- Two 10/100/1000Base-T copper Ethernet management ports (RJ45), numbered 0/1 and 0/2 from left to right. These ports are used to connect directly to the appliance for system administration functions.
- Eight 10G SFP+ ports numbered 10/1, 10/2, 10/3, and 10/4 on the top row from left to right. Ports are numbered 10/5, 10/6, 10/7, and 10/8 on the bottom row from left to right.

The following figure shows the back panel of the MPX 17550/19550/20550/21550 appliance.

Figure 2. NetScaler MPX 17550/19550/20550/21550 appliance, back panel

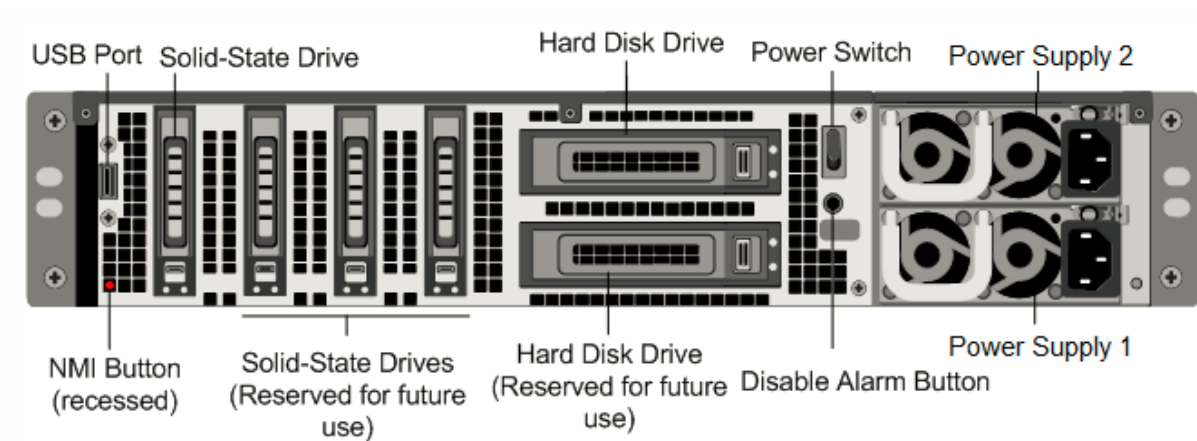

The following components are visible on the back panel of the MPX 17550/19550/20550/21550 appliance:

- 160 GB or larger removable solid-state drive that is used to store the NetScaler software.  
**Note:** Drive densities might increase as components become EOL but its size is never smaller than the original.
- USB port (reserved for a future release).
- Power switch, which turns off power to the appliance, as if you were to unplug the power supply. Press the switch for five seconds to shut off the power.
- Non-maskable interrupt (NMI) button that is used at the request of Technical Support and produces a core dump on the appliance. Use a pen, pencil, or other pointed object to press this red button, which is recessed to prevent unintentional activation.
- Two removable hard-disk drives that store user data.
- **Disable alarm button.** This button is functional only when the appliance has two power supplies.

Press this button to stop the power alarm from sounding when either of the following conditions is true:

- You have plugged the appliance into only one power outlet.
  - One power supply is malfunctioning, and you want to continue operating the appliance until it is repaired.
- Two power supplies, each rated at 960 watts, 110–220 volts. Maximum power consumption is 850 watts. Typical power consumption is 570 watts.

For information about installing the rails, rack mounting the hardware, and connecting the cables, see [Installing the Hardware](#).

For information about performing the initial configuration of your appliance, see [Initial Configuration](#).

## NetScaler MPX 22000

December 31, 2023

The NetScaler

MPX 22040/22060/22080/22100/22120 are 2U appliances. Each model has two 8-core processors and 256 GB of memory. The

MPX 22040/22060/22080/22100/22120 appliances are available in two port configurations:

- Twelve 1G SFP ports and twenty-four 10G SFP+ ports (12x1G SFP + 24x10G SFP+)
- Twenty-four 10G SFP+ ports (24x10G SFP+)

The following figure shows the front panel of the MPX 22040/22060/22080/22100/22120 (12x1G SFP + 24x10G SFP+) appliance.

Figure 1. NetScaler MPX 22040/22060/22080/22100/22120 (12x1G SFP + 24x10G SFP+), front panel

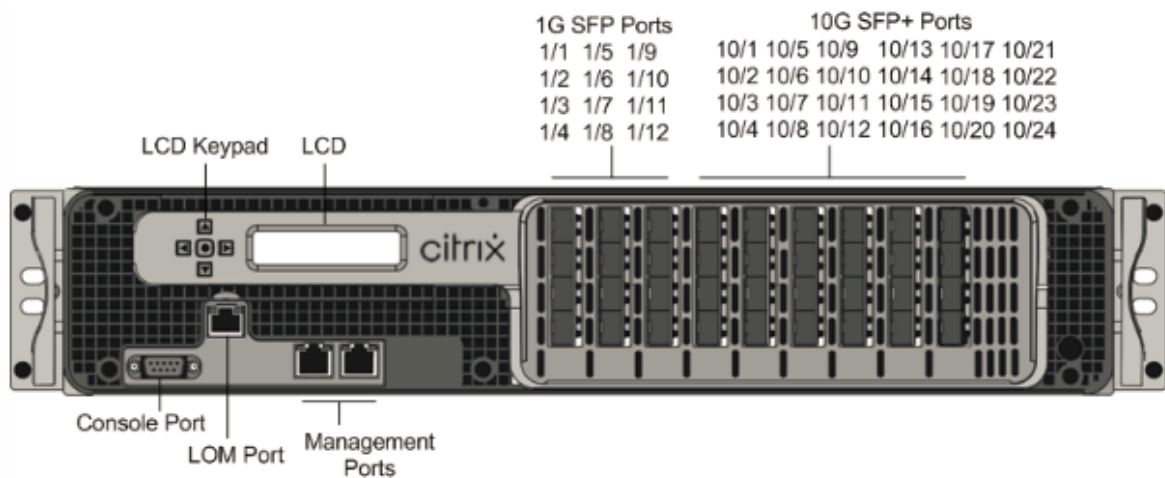

The following figure shows the front panel of the MPX 22040/22060/22080/22100/22120 (24x10G SFP+) appliance.

Figure 2. NetScaler MPX 22040/22060/22080/22100/22120 (24x10G SFP+), front panel

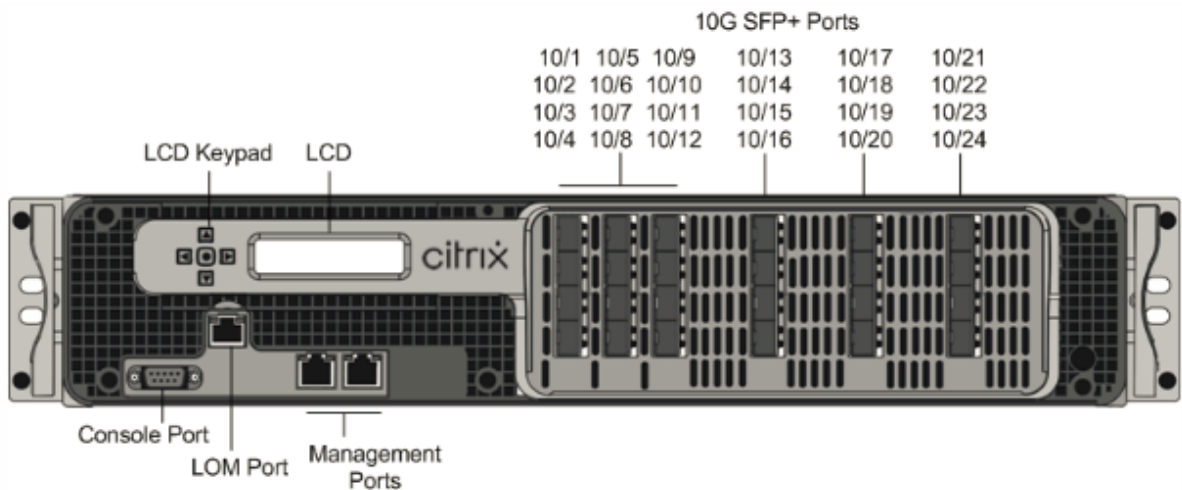

Depending on the model, the appliance has the following ports:

- RS232 serial Console Port.
- 10/100Base-T copper Ethernet Port (RJ45), also called the LOM port. You can use this port to remotely monitor and manage the appliance independently of the NetScaler software.
- Two 10/100/1000Base-T copper Ethernet Management Ports (RJ45), numbered 0/1 and 0/2 from left to right. These ports are used to connect directly to the appliance for system administration functions.
- Network Ports
  - MPX 22040/22060/22080/22100/22120 (12x1G SFP + 24x10G SFP+). Twelve copper or fiber 1G SFP ports and twenty-four 10G SFP+ ports.
  - MPX 22040/22060/22080/22100/22120 (24x10G SFP+). Twenty-four 10G SFP+ ports.

The following figure shows the back panel of the MPX 22040/22060/22080/22100/22120 appliances.

Figure 3. NetScaler MPX 22040/22060/22080/22100/22120, back panel



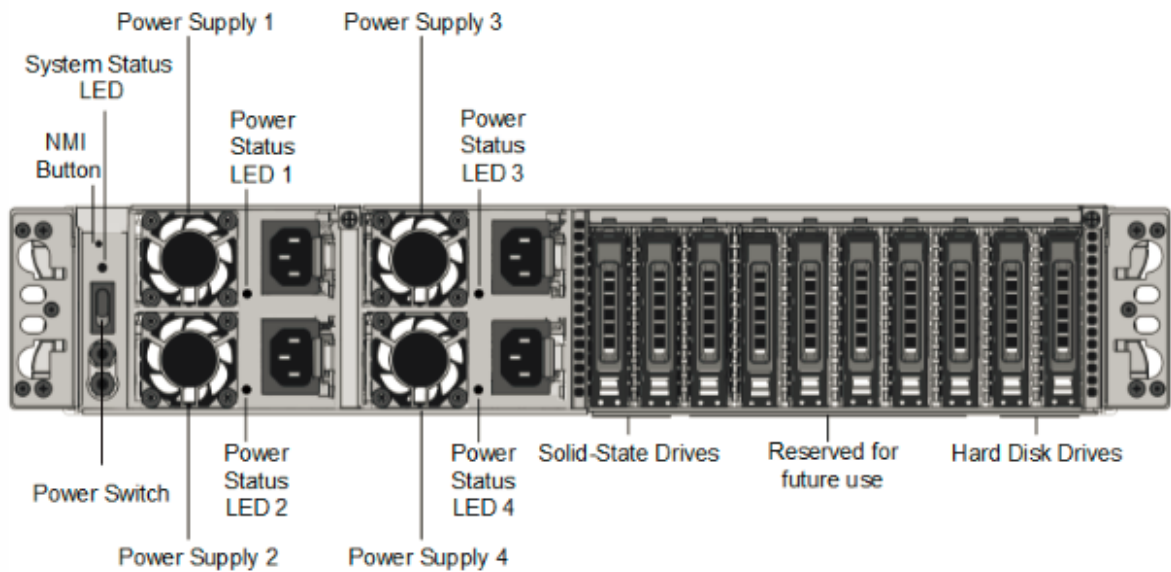

The following components are visible on the back panel of the MPX 22040/22060/22080/22100/22120 appliance:

- Non-maskable interrupt (NMI) Button, used at the request of Technical Support to initiate a core dump. To press this red button, which is recessed to prevent unintentional activation, use a pen, pencil, or other pointed object. The NMI Button is also available remotely over the network in the LOM GUI, in the Remote Control menu. For more information, see [Lights out management port of the appliance](#) topic.
  - System status LED, which indicates the status of the appliance, as described in [Common hardware components](#).
- Note:** On an MPX 22040/22060/22080/22100/22120 appliance running LOM firmware version 3.22, the system status LED indicates an error (continuously glows RED) even though the appliance is functioning properly.
- Four power supplies, each rated at 750 watts, 100–240 volts. A minimum of two power supplies are required for proper operation. The extra power supplies act as backup. Each power supply has an LED that indicates the status of the power supply, as described in [Common hardware components](#).
  - Power switch, which turns off power to the appliance. Press the switch for less than two seconds to shut off the power.
  - Two 128 or larger GB removable solid-state drives.
  - One 500 GB or larger removable hard disk drive that is used to store user data.

**Note:** Drive densities might increase as components become EOL but its size is never smaller than the original.

For information about installing the rails, rack mounting the hardware, and connecting the cables, see [Installing the Hardware](#).

For information about performing initial configuration of your appliance, see [Initial Configuration](#).

## NetScaler MPX 24100

December 31, 2023

The NetScaler MPX 24100/24150 are 2U appliances. Each model has two 8-core processors and 256 GB of memory. The MPX 24100/24150 appliances are available in the twelve 1G SFP ports and twenty-four 10G SFP+ ports (12x1G SFP + 24x10G SFP+) configuration.

The following figure shows the front panel of the MPX 24100/24150 (12x1G SFP + 24x10G SFP+) appliance.

Figure 1. NetScaler MPX 24100/24150 (12x1G SFP + 24x10G SFP+), front panel

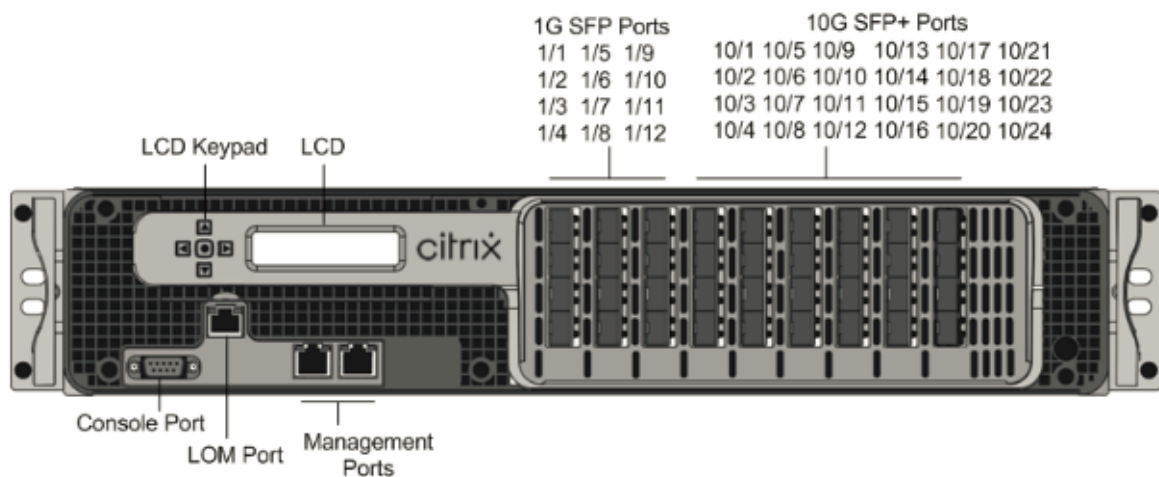

The NetScaler MPX 24xxx appliances have the following ports:

- RS232 serial Console Port.
- 10/100Base-T copper Ethernet Port (RJ45), also called the LOM port. You can use this port to remotely monitor and manage the appliance independently of the NetScaler software.
- Two 10/100/1000Base-T copper Ethernet Management Ports (RJ45), numbered 0/1 and 0/2 from left to right. These ports are used to connect directly to the appliance for system administration functions.
- Network Ports. Twelve copper or fiber 1G SFP ports and twenty-four 10G SFP+ ports.

The following figure shows the back panel of the MPX 24100/24150 appliances.

Figure 2. NetScaler MPX 24100/24150, back panel

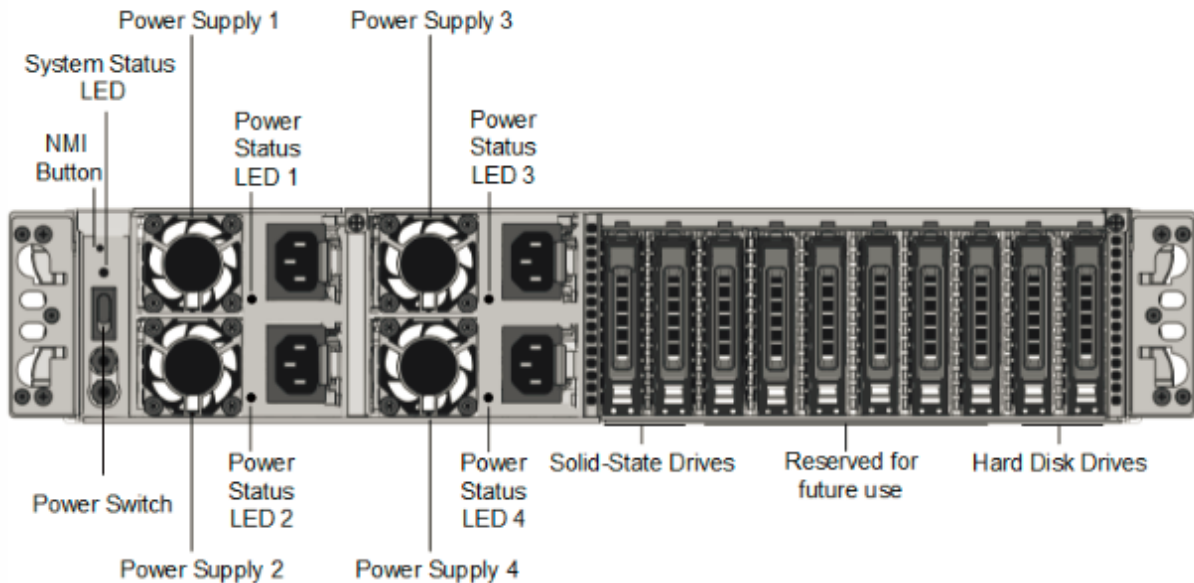

The following components are visible on the back panel of the MPX 24xxx appliances:

- Non-maskable interrupt (NMI) Button, used at the request of Technical Support to initiate a core dump. To press this red button, which is recessed to prevent unintentional activation, use a pen, pencil, or other pointed object. The NMI Button is also available remotely over the network in the LOM GUI, in the Remote Control menu.
- System status LED, which indicates the status of the appliance, as described in [Common hardware components](#).

**Note:** On an

MPX 24100/24150 appliance running LOM firmware version 3.22, the system status LED indicates an error (continuously glows RED) even though the appliance is functioning properly.

- Four power supplies, each rated at 750 watts, 100–240 volts. A minimum of two power supplies are required for proper operation. The extra power supplies act as backup. Each power supply has an LED that indicates the status of the power supply, as described in [Common hardware components](#).
- Power switch, which turns off power to the appliance. Press the switch for less than two seconds to shut off the power.
- Two 128 GB or larger removable solid-state drives.  
**Note:** Drive densities might increase as components become EOL but its size is never smaller than the original.
- One 500 GB or larger removable hard disk drive that is used to store user data.

For information about installing the rails, rack mounting the hardware, and connecting the cables, see [Installing the Hardware](#).

For information about performing initial configuration of your appliance, see [Initial Configuration](#).

## NetScaler MPX 25000A

December 31, 2023

The NetScaler MPX 25100A, MPX 25160A, and MPX 25200A are 2U appliances. Each model has two eight-core processors, 256 GB of memory, eight 40G QSFP+ ports (8x40G QSFP+).

The front panel of the MPX 25100A, MPX 25160A, and MPX 25200A appliances has a (8x40G QSFP+) port configuration.

Figure 1. NetScaler MPX 25100A, MPX 25160A, and MPX 25200A, front panel

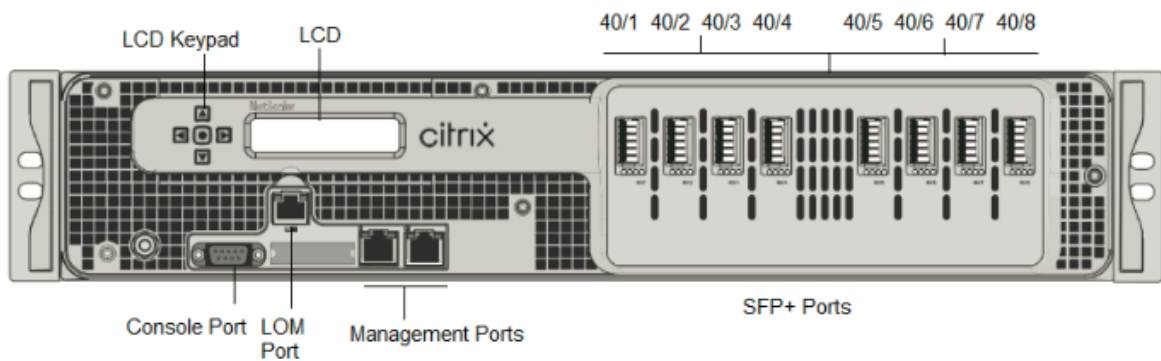

The NetScaler MPX 25100A, MPX 25160A, and MPX 25200A appliances have the following ports:

- RS232 serial Console Port.
- 10/100Base-T copper Ethernet Port (RJ45), also called the LOM port. You can use this port to remotely monitor and manage the appliance independently of the NetScaler software.
- Network Ports, eight 40G QSFP+ ports. For information about supported transceivers per port, see [25G, 40G, 50G, and 100G ports](#).

**Note:** 40G ports do not support 10G and 1G transceivers.

The following figure shows the back panel of the MPX 25100A, MPX 25160A, and MPX 25200A appliances.

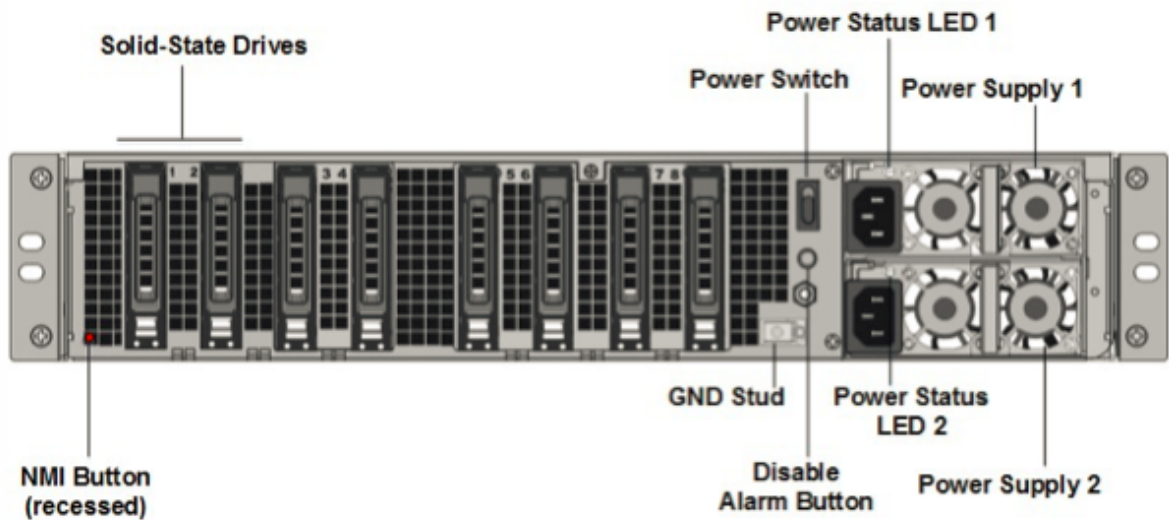

The following components are visible on the back panel of the MPX 25100A, MPX 25160A, and MPX 25200A:

- Two 300 GB or larger removable solid-state drives in a redundant array of independent disks (RAID) devices. In a RAID configuration, the same data is stored on multiple drives to improve performance, increase storage capacity, lower the risk of data loss, and provide fault tolerance. The two SSDs store the same data. If one fails and you replace it, the new SSD mirrors the other one.  
**Note:** Drive densities might increase as components become EOL but its size is never smaller than the original.
- Power switch. This switch turns the power to the appliance on or off. Press the switch for less than two seconds to shut off the power.
- Two power supplies. Each power supply is rated at 1000 watts, 100–240 volts. Each power supply has an LED that indicates the status of the power supply, as described in [Common hardware components](#).
- **Disable alarm button.** This button is functional only when the appliance has two power supplies. Press this button to stop the power alarm from sounding when you have plugged the appliance into only one power outlet, or when one power supply is malfunctioning and you want to continue operating the appliance until it is repaired.
- Non-maskable interrupt (NMI) button. This button is used at the request of Technical Support to initiate a core dump. To press this red button, which is recessed to prevent unintentional activation, use a pen, pencil, or other pointed object. The NMI Button is also available remotely over the network in the LOM GUI, in the Remote Control menu. For more information about the lights out management port of the appliance, see [Lights out management port of the NetScaler MPX appliance](#).

## NetScaler MPX 25100T

December 31, 2023

The NetScaler MPX 25100T and 25160T are 2U appliances. Each model has two 10-core processors and 128 GB of memory. The MPX 25100T/25160T appliances are available in the thirty-two 10G SFP+ ports (32x10G SFP+) configuration.

**Note:** The MPX 25000T appliances are not RAID (redundant array of independent disks) devices.

The following figure shows the front panel of the MPX 25100T/25160T (32x10G SFP+) appliance.

Figure 1. NetScaler MPX 25100T/25160T (32x10G SFP+), front panel

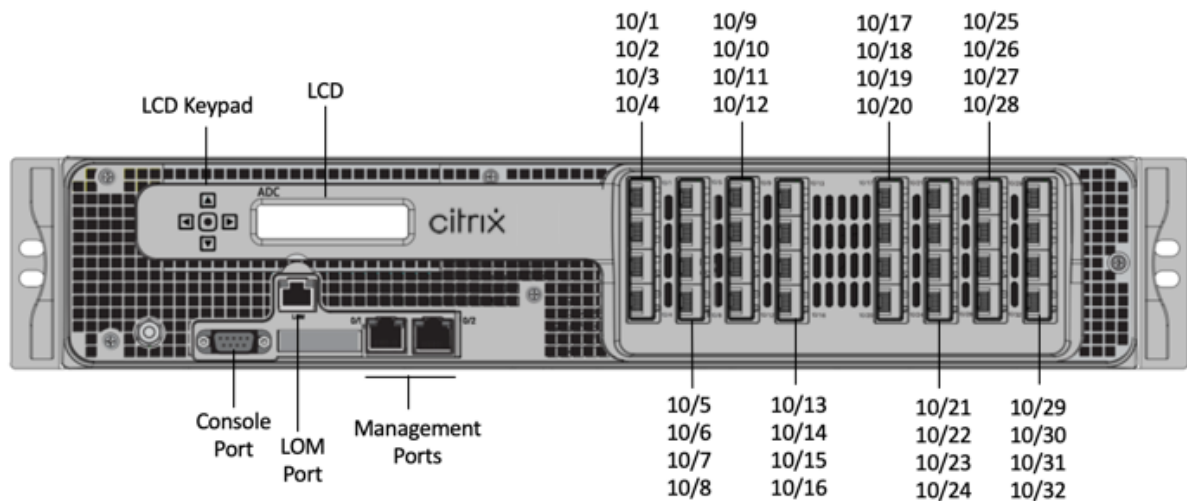

Depending on the model, the appliance has the following ports:

- RS232 serial Console Port.
- 10/100Base-T copper Ethernet Port (RJ45), also called the LOM port. You can use this port to remotely monitor and manage the appliance independently of the NetScaler software.
- Two 10/100/1000Base-T copper Ethernet Management Ports (RJ45), numbered 0/1 and 0/2 from left to right. These ports are used to connect directly to the appliance for system administration functions.
- Network Ports, thirty-two 10G SFP+ ports (32x10G SFP+).

**Note:** The 10G SFP+ ports on these appliances support copper 1G SFP transceivers.

The following figure shows the back panel of the MPX 25100T/25160T appliance.

Figure 2. NetScaler MPX 25100T/25160T, back panel

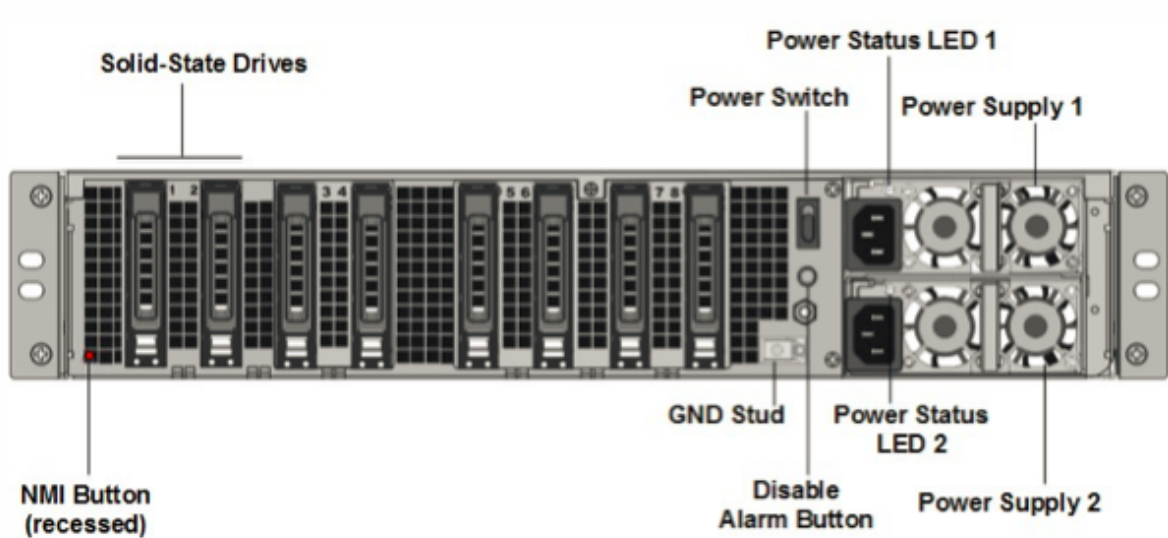

The following components are visible on the back panel of the MPX 25100T/25160T appliance:

- One 300 GB or larger removable solid-state drive.  
**Note:** Drive densities might increase as components become EOL but its size is never smaller than the original.
- Power switch, which turns power to the appliance on or off. Press the switch for less than two seconds to shut off the power.
- Two power supplies, each rated at 1000 watts, 100–240 volts. Max power consumption is 717 W. Typical power consumption is 594 W. Each power supply has an LED that indicates the status of the power supply, as described in [Common hardware components](#).
- **Disable alarm button**, which is functional only when the appliance has two power supplies. Press this button to stop the power alarm from sounding when either of the following conditions is true:
  - You have plugged the appliance into only one power outlet.
  - One power supply is malfunctioning, and you want to continue operating the appliance until it is repaired.
- Non-maskable interrupt (NMI) Button, used at the request of Technical Support to initiate a core dump. To press this red button, which is recessed to prevent unintentional activation, use a pen, pencil, or other pointed object. The NMI Button is also available remotely over the network in the LOM GUI, in the Remote Control menu. For more information about the lights out management port of the appliance, see [Lights out management port of the NetScaler MPX appliance](#).

For information about installing the rails, rack mounting the hardware, and connecting the cables, see [Installing the Hardware](#).

For information about performing initial configuration of your appliance, see [Initial Configuration](#).

## NetScaler MPX 2500TA

December 31, 2023

The NetScaler MPX 25100TA, MPX 25160TA, and MPX 25200TA are 2U appliances. Each model has two 8-core processors, 128 GB of memory, 8X40GE (QSFP+) ports.

The front panel of the MPX 25100TA, MPX 25160TA, and MPX 25200TA have (8X40GE QSFP+) ports.

Figure 1. NetScaler MPX 25100TA, MPX 25160TA, and MPX 25200TA, front panel

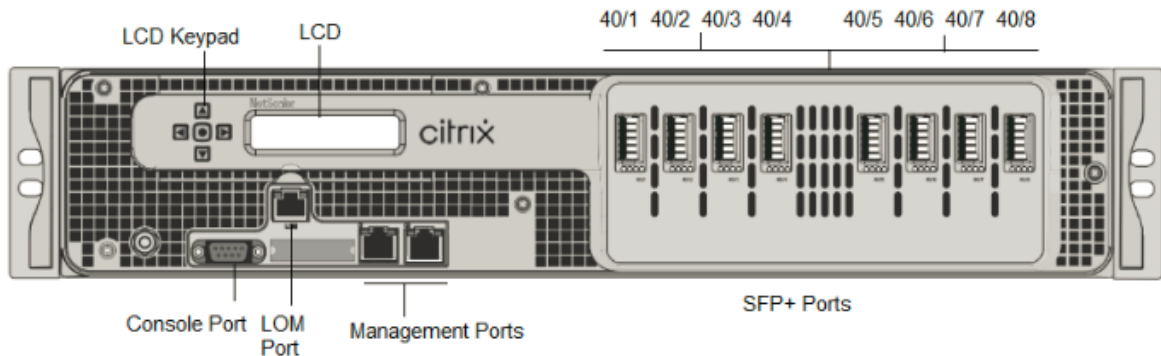

The NetScaler MPX 25100TA, MPX 25160TA, and MPX 25200TA appliances have the following ports:

- RS232 serial Console Port.
- 10/100Base-T copper Ethernet Port (RJ45), also called the LOM port. You can use this port to remotely monitor and manage the appliance independently of the NetScaler software.
- Two 10/100/1000Base-T copper Ethernet Management Ports (RJ45), numbered 0/1 and 0/2 from left to right. These ports are used to connect directly to the appliance for system administration functions.
- Network Ports, 8 X 40GE QSFP+ ports. For information about supported transceivers per port, see [25G, 40G, 50G, and 100G ports](#).

Note the following points regarding the network ports on MPX 25100TA appliances:

- 10G ports do not support 1G copper or 1G fiber transceivers.
- 40G ports do not support 10G and 1G transceivers.

Figure 2. NetScaler MPX 25100TA, MPX 25160TA, back panel.



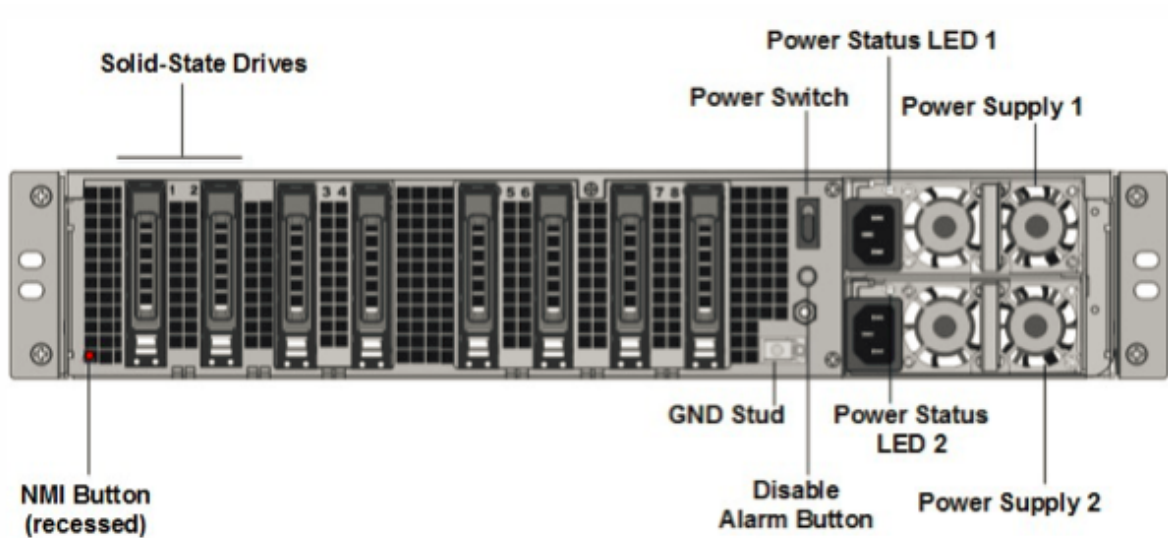

The following components are visible on the back panel of the MPX 25100TA, MPX 25160TA, and MPX 25200TA appliance:

- One 300 GB or larger removable solid-state drives in a redundant array of independent disks (RAID) devices. In a RAID configuration, the same data is stored on multiple drives to improve performance, increase storage capacity, lower the risk of data loss, and provide fault tolerance. The two SSDs store the same data. If one fails and you replace it, the new SSD mirrors the other one.
 

**Note:** Drive densities might increase as components become EOL but its size is never smaller than the original.
- Power switch, which turns power to the appliance on or off. Press the switch for less than two seconds to shut off the power.
- Two power supplies, each rated at 1000 watts, 100–240 volts. Max power consumption is 717 W. Typical power consumption is 594 W. Each power supply has an LED that indicates the status of the power supply, as described in [Common hardware components](#).
- **Disable alarm button**, which is functional only when the appliance has two power supplies. Press this button to stop the power alarm from sounding when one of the following conditions is true:
  - You have plugged the appliance into only one power outlet
  - One power supply is malfunctioning and you want to continue operating the appliance until it is repaired.
- Non-maskable interrupt (NMI) Button, used at the request of Technical Support to initiate a core dump. To press this red button, which is recessed to prevent unintentional activation, use a pen, pencil, or other pointed object. The NMI Button is also available remotely over the network in

the LOM GUI, in the Remote Control menu. For more information about the lights out management port of the appliance, see [Lights out management port of the NetScaler MPX appliance](#).

## NetScaler MPX 25000-40G

December 31, 2023

The NetScaler MPX 25000-40G are 2U appliances. Each model has two 10-core processors, 256 GB of memory, four 40G QSFP+ ports, and sixteen 10G SFP+ ports (4x40G QSFP+ 16x10G SFP+).

The following figure shows the front panel of the MPX 25100/MPX 25160/25200 40G appliances.

Figure 1. NetScaler MPX 25100 40G, MPX 25160 40G, MPX 25200 40G, front panel

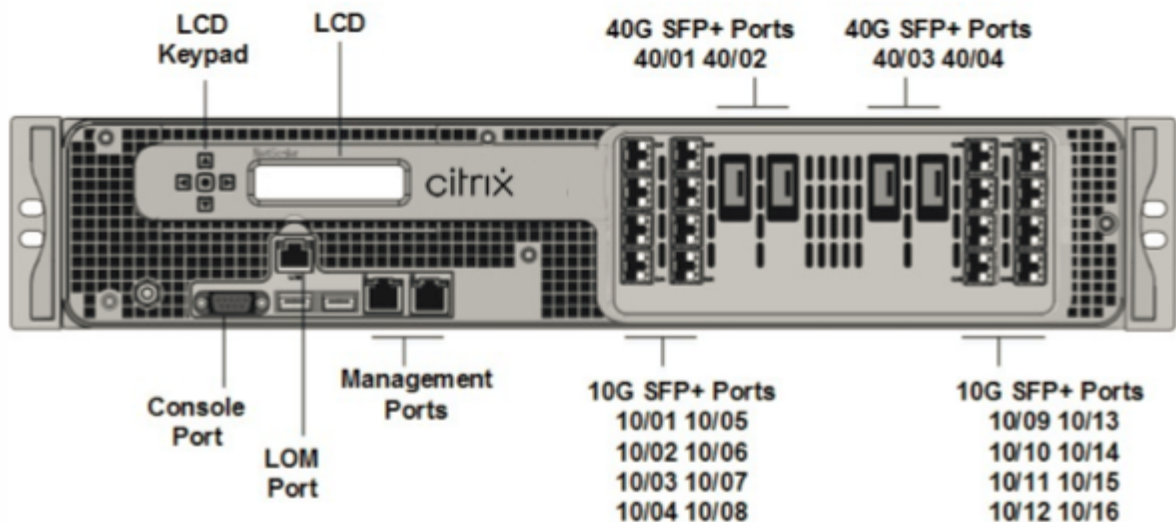

- RS232 serial Console Port.
- 10/100Base-T copper Ethernet Port (RJ45), also called the LOM port. You can use this port to remotely monitor and manage the appliance independently of the NetScaler software.
- Network Ports. Four 40G QSFP+ ports and sixteen 10G SFP+ ports (4x40G QSFP+, 4x10G SFP+, 4x10G Base-T). For information about supported transceivers per port, see [25G, 40G, 50G, and 100G ports](#).
- USB ports (reserved for a future release).

Note the following points regarding the network ports on MPX 25100 40G and MPX 25160 40G appliances:

- 10G ports do not support 1G copper or 1G fiber transceivers.
- 40G ports do not support 10G and 1G transceivers.

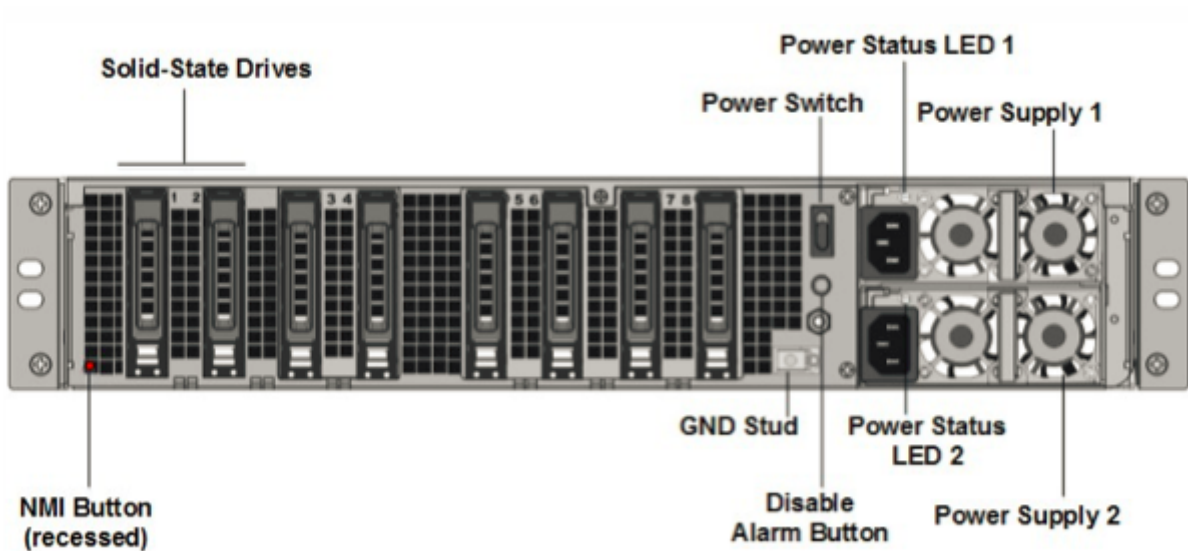

The following components are visible on the back panel of the MPX 25100/25160/25200 40G appliances:

- Two 300 GB or larger removable solid-state drives in a redundant array of independent disks (RAID) devices. In a RAID configuration, the same data is stored on multiple drives to improve performance, increase storage capacity, lower the risk of data loss, and provide fault tolerance. The two SSDs store the same data. If one fails and you replace it, the new SSD mirrors the other one.

**Note:** Drive densities might increase as components become EOL but its size is never smaller than the original.

- **Power switch**  
This switch turns the power to the appliance on or off. Press the switch for less than two seconds to shut off the power.
- **Two power supplies.**  
Each power supply is rated at 1000 watts, 100–240 volts. Each power supply has an LED that indicates the status of the power supply, as described in [Common hardware components](#).
- **Disable alarm button.** This button is functional only when the appliance has two power supplies. Press this button to stop the power alarm from sounding when one of the following conditions is true:
  - You have plugged the appliance into only one power outlet.
  - One power supply is malfunctioning and you want to continue operating the appliance until it is repaired.
 For more information, see [Lights out management port of the NetScaler MPX appliance](#) topic.

- Non-maskable interrupt (NMI) button

This button is used at the request of Technical Support to initiate a core dump. To press this red button, which is recessed to prevent unintentional activation, use a pen, pencil, or other pointed object. The NMI Button is also available remotely over the network in the LOM GUI, in the Remote Control menu. For more information about the lights out management port of the appliance, see [Lights out management port of the NetScaler MPX appliance](#) topic.

## NetScaler MPX 26000

December 31, 2023

The NetScaler MPX 26100/26160/26200 appliances are 2U appliances. These appliances have two 14-core processors and 256 GB of memory. The appliance has eight 50G and sixteen 25G network ports.

For information about the software releases supported on the NetScaler hardware platforms, see [NetScaler MPX hardware software compatibility matrix](#).

The following figure shows the front panel of the NetScaler MPX 26000 appliances.

Figure 1. NetScaler MPX 26000, front panel

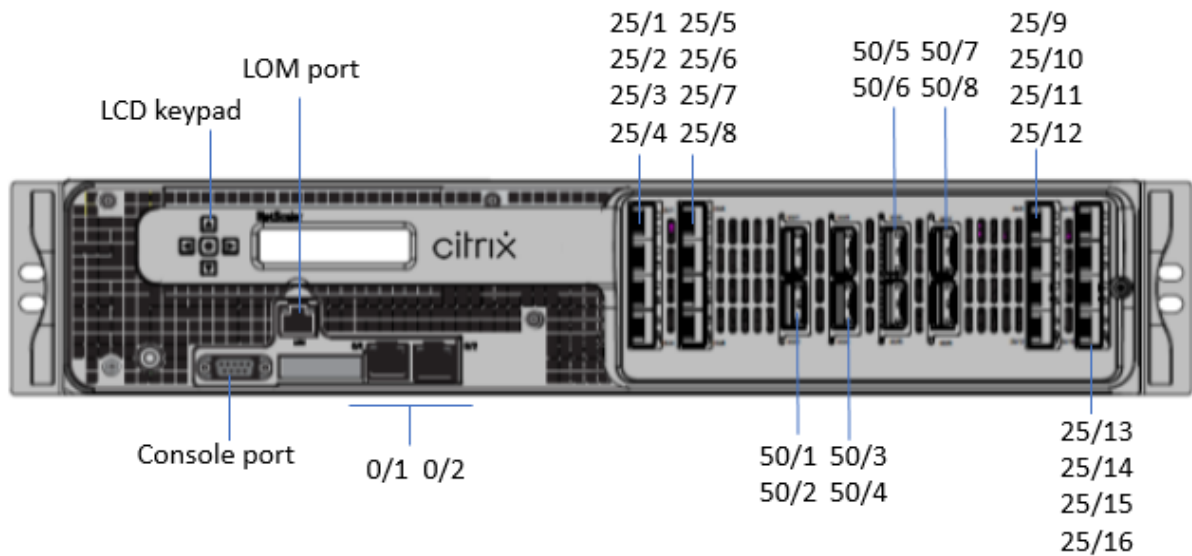

The NetScaler MPX 26000 appliances have the following ports:

- RS232 serial console port.
- One 10/100/1000Base-T RJ45 copper Ethernet LOM Port. Use this port to remotely monitor and manage the appliance independently of the NetScaler software.

- Two 10/100/1000Base-T RJ45 copper Ethernet Management Ports, numbered 0/1 and 0/2. These ports are used to connect directly to the appliance for NetScaler administration functions.
- Eight 50G ports, numbered 50/1 to 50/8.
- Sixteen 25G ports, numbered 25/1 through 25/16. For information about supported transceivers per port, see [25G, 40G, 50G, and 100G ports](#).

The following figure shows the back panel of the MPX 26000 appliances.

Figure 2. NetScaler MPX 26000, back panel

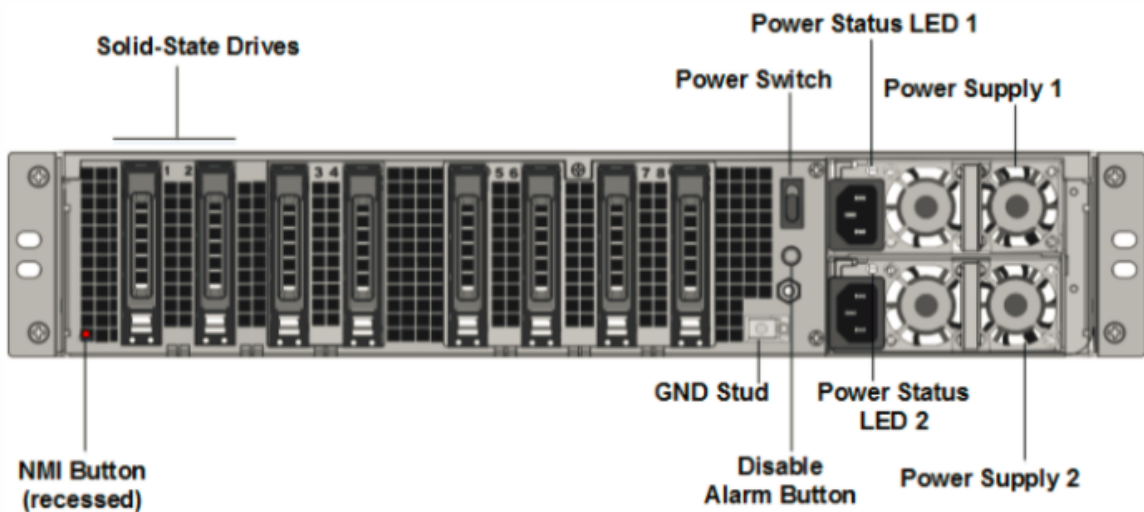

The following components are visible on the back panel of the NetScaler MPX 26000 appliances:

- Two 480 GB or larger removable solid-state drives in a redundant array of independent disks (RAID) configuration. In a RAID configuration, the same data is stored on multiple drives to improve performance, increase storage capacity, lower the risk of data loss, and provide fault tolerance. The two SSDs store the same data. If one fails and you replace it, the new SSD mirrors the other one.  
**Note:** Drive densities might increase as components become EOL but its size is never smaller than the original.
- Power switch, which turns power to the appliance on or off.
  - If the OS is functional, press the switch for less than two seconds to power down the system with a graceful shutdown.
  - If the OS is not responsive, press the power switch for more than 4 seconds to force the power off.
- Two hot-swappable 100–240 VAC, 1000 W power supply modules. Max power consumption is 672 W. Typical power consumption is 540 W. Each power supply has an LED indicating its status

as follows:

LED Color	LED Indicates
OFF	No power to any power supply on the appliance.
Flashing RED	No power to this power supply.
Flashing GREEN	Power supply is in standby mode.
GREEN	Power supply is functional.
RED	Power supply failure.
Flashing RED and GREEN	Warning (OVP/UVP/OCP/OTP/Fan); OVP = Over Voltage Protection; UVP = Under Voltage Protection; OCP = Over Current Protection; OTP = Over Temperature Protection

- **Disable alarm button.** Press this button to silence the power alarm when one of two power supplies loses input power or when a power supply is malfunctioning.
- **Non-Maskable Interrupt (NMI) Button,** used at the request of Technical Support to initiate a core dump. To press this red button, which is recessed to prevent unintentional activation, use a pen, pencil, or other pointed object. The NMI Button is also available remotely over the network in the LOM GUI, in the Remote Control menu. For more information about the lights out management port of the appliance, see [Lights out management port of the NetScaler MPX appliance](#).

## NetScaler MPX 26000-50S

December 31, 2023

The NetScaler MPX 26000-50S appliances are 2U appliances. These appliances have two 14-core processors and 256 GB of memory. The appliances have four 50G and 16 25G network ports.

For information about the software releases supported on the NetScaler hardware platforms, see [NetScaler MPX hardware software compatibility matrix](#).

The following figure shows the front panel of the NetScaler MPX 26000-50S appliances.

Figure 1. NetScaler MPX 26000-50S, front panel

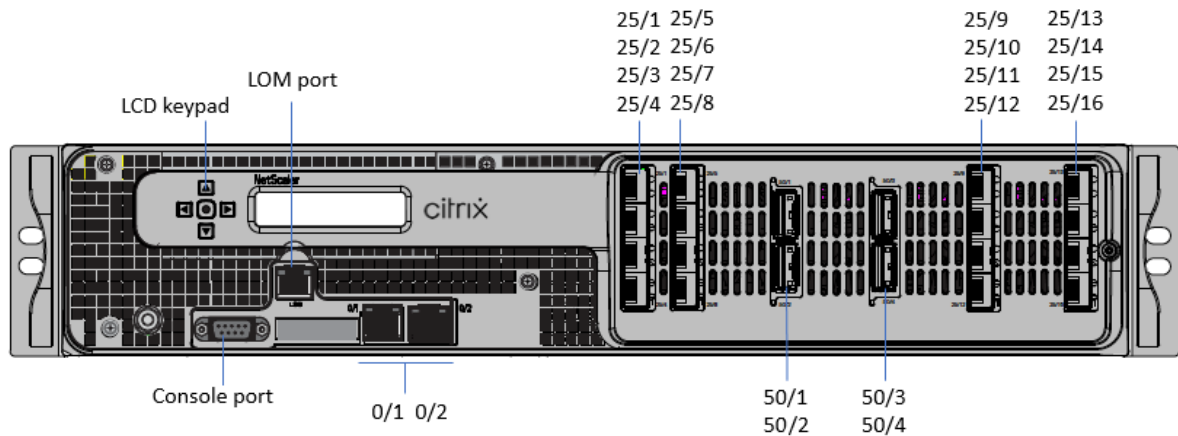

The NetScaler MPX 26000-50S appliances have the following ports:

- RS232 serial console port.
- One 10/100/1000Base-T RJ45 copper Ethernet LOM Port. Use this port to remotely monitor and manage the appliance independently of the NetScaler software.
- Two 10/100/1000Base-T RJ45 copper Ethernet Management Ports, numbered 0/1 and 0/2. These ports are used to connect directly to the appliance for NetScaler administration functions.
- Four 50G ports, numbered 50/1 to 50/4.
- Sixteen 25G ports, numbered 25/1 through 25/16. For information about supported transceivers per port, see [25G, 40G, 50G, and 100G ports](#).

The following figure shows the back panel of the MPX 26000-50S appliances.

Figure 2. NetScaler MPX 26000-50S, back panel

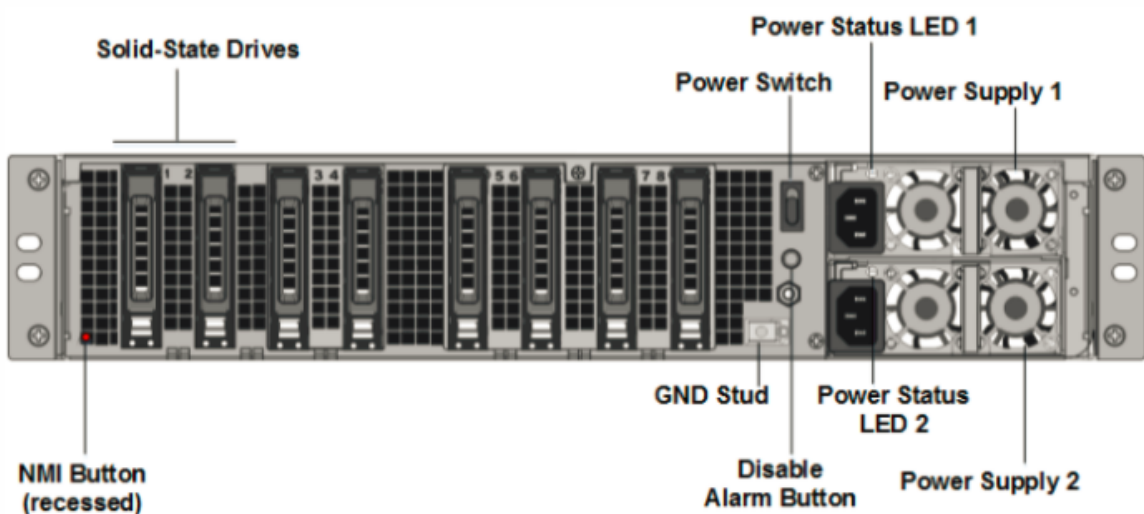

The following components are visible on the back panel of the NetScaler MPX 26000-50S appliances:

- Two 480 GB or larger removable solid-state drives in a redundant array of independent disks (RAID) configuration. In a RAID configuration, the same data is stored on multiple drives to improve performance, increase storage capacity, lower the risk of data loss, and provide fault tolerance. The two SSDs store the same data. If one fails and you replace it, the new SSD mirrors the other one.

**Note:** Drive densities might increase as components become EOL but its size is never smaller than the original.

- Power switch, which turns power to the appliance on or off.
  - If the OS is functional, press the switch for less than two seconds to power down the system with a graceful shutdown.
  - If the OS is not responsive, press the power switch for more than 4 seconds to force the power off.
- Two hot-swappable 100–240 VAC, 1200 W power supply modules. Max power consumption is 764 W. Typical power consumption is 628 W. Each power supply has an LED indicating its status:

LED Color	LED Indicates
OFF	No power to any power supply on the appliance.
Flashing RED	No power to this power supply.
Flashing GREEN	Power supply is in standby mode.
GREEN	Power supply is functional.
RED	Power supply failure.
Flashing RED and GREEN	Warning; (OVP/UVP/OCP/OTP/Fan); OVP = Over Voltage Protection; UVP = Under Voltage Protection; OCP = Over Current Protection; OTP = Over Temperature Protection; OTP = Over Temperature Protection

- **Disable alarm button.** Press this button to silence the power alarm when one of two power supplies loses input power or when a power supply is malfunctioning.
- Non-Maskable Interrupt (NMI) Button, used at the request of Technical Support to initiate a core dump. To press this red button, which is recessed to prevent unintentional activation, use a pen, pencil, or other pointed object. The NMI Button is also available remotely over the network in the LOM GUI, in the Remote Control menu. For more information about the lights out management port of the appliance, see [Lights out management port of the NetScaler MPX appliance](#).



## NetScaler MPX 26000-100G

December 31, 2023

The NetScaler MPX 26000-100G and MPX 26000T-100G appliances are 2U appliance. These appliances have two 14-core processors and 256 GB of memory. The appliances provide a total of 8 network ports: Four cards with dual 100G SFP+ Ethernet Ports.

For information about the software releases supported on the NetScaler hardware platforms, see [NetScaler MPX hardware software compatibility matrix](#).

The following figure shows the front panel of the NetScaler MPX 26000-100G and NetScaler MPX 26000T-100G appliances.

Figure 1. NetScaler MPX 26000-100G and NetScaler MPX 26000T-100G, front panel

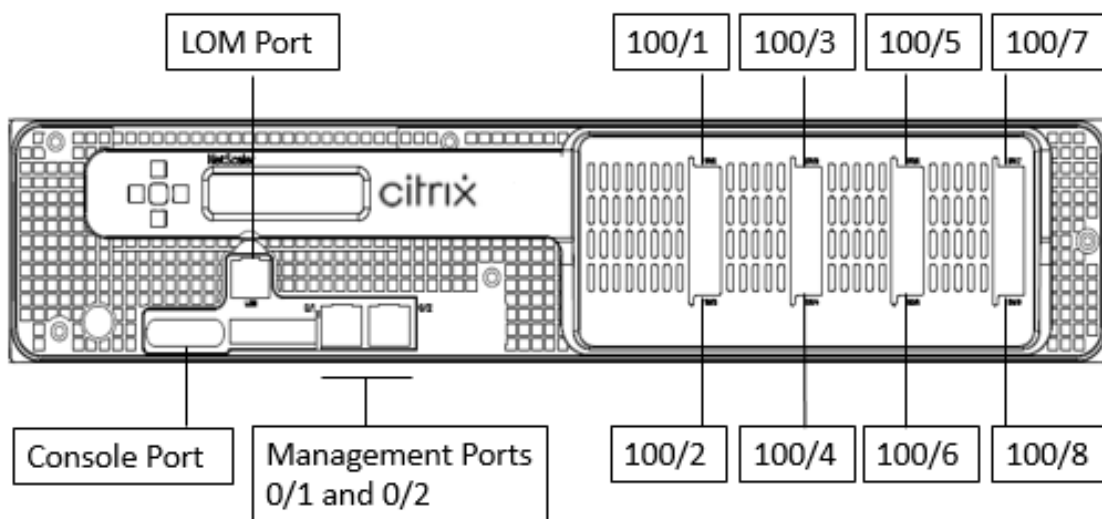

The NetScaler MPX 26000-100G and NetScaler MPX 26000T-100G appliances have the following ports:

- RS232 serial Console Port.
- One 10/100/1000Base-T RJ45 copper Ethernet LOM Port. Use this port to remotely monitor and manage the appliance independently of the NetScaler software.
- Two 10/100/1000Base-T RJ45 copper Ethernet Management Ports, numbered 0/1 and 0/2. These ports are used to connect directly to the appliance for NetScaler administration functions.
- Eight 100G Ethernet Ports, numbered 100/1 to 100/8. For information about supported transceivers per port, see [25G, 40G, 50G, and 100G ports](#).

**Note**

There are no native 10G ports on 26000-100G. The 100G ports support native 40G/50G/100G transceivers, DAC and AoCs. To support native 10G and 25G transceivers, DAC and AoCs, use an SFP+ to QSFP+ adapter.

The following figure shows the back panel of the NetScaler MPX 26000-100G and NetScaler MPX 26000T-100G appliances.

Figure 2. NetScaler MPX 26000-100G and NetScaler MPX 26000T-100G, back panel

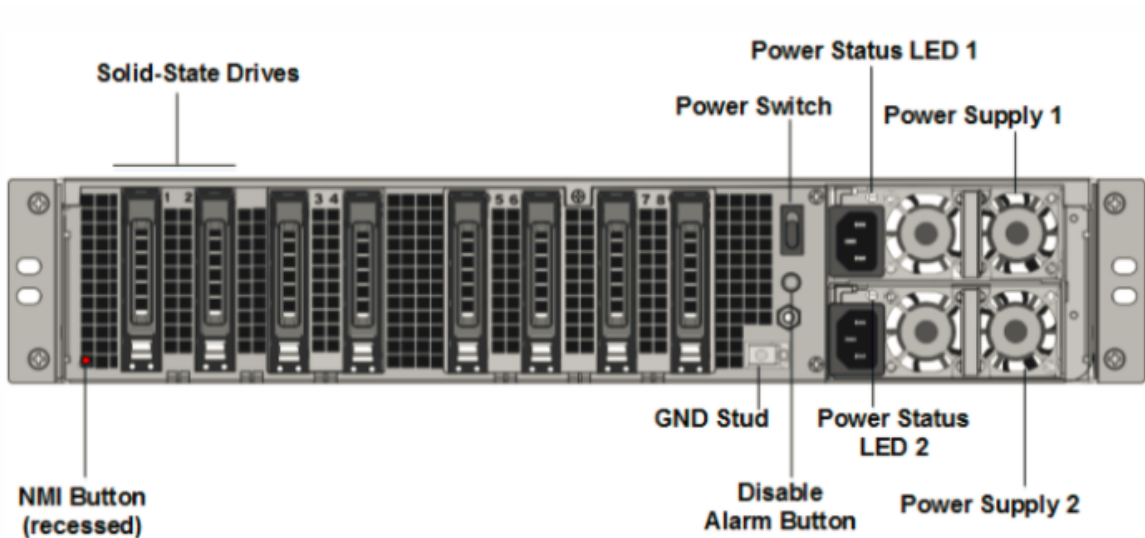

The following components are visible on the back panel of the NetScaler MPX 26000-100G and NetScaler MPX 26000T-100G appliances:

- Two 480 GB or larger removable solid-state drives in a redundant array of independent disks (RAID) configuration. In a RAID configuration, the same data is stored on multiple drives to improve performance, increase storage capacity, lower the risk of data loss, and provide fault tolerance. The two SSDs store the same data. If one fails and you replace it, the new SSD mirrors the other one.

**Note:** Drive densities might increase as components become EOL but its size is never smaller than the original.

- Power switch, which turns power to the appliance on or off.
  - If the OS is functional, press the switch for less than two seconds to power down the system with a graceful shutdown.
  - If the OS is not responsive, press the power switch for more than 4 seconds to force the power off.

- Two hot-swappable 100–240 VAC input power supply modules. Each power supply has an LED indicating its status:

LED Color	LED Indicates
OFF	No power to any power supply on the appliance.
Flashing RED	No power to this power supply.
Flashing GREEN	Power supply is in standby mode.
GREEN	Power supply is functional.
RED	Power supply failure.
Flashing RED and GREEN	Warning; (OVP/UVP/OCP/OTP/Fan); OVP = Over Voltage Protection; UVP = Under Voltage Protection; OCP = Over Current Protection; OTP = Over Temperature Protection

- **Disable alarm button.** Press this button to silence the power alarm when one of two power supplies loses input power or when a power supply is malfunctioning.
- Non-Maskable Interrupt (NMI) Button, used at the request of Technical Support to initiate a core dump. To press this red button, which is recessed to prevent unintentional activation, use a pen, pencil, or other pointed object. The NMI Button is also available remotely over the network in the LOM GUI, in the Remote Control menu. For more information about the lights out management port of the appliance, see [Lights out management port of the NetScaler MPX appliance](#).

## NetScaler T1010

December 31, 2023

The NetScaler T1010 is a 1U appliance, with a single-core processor, and 32 GB of memory.

The following figure shows the front panel of the T1010 appliance.

Figure 1. NetScaler T1010 front panel

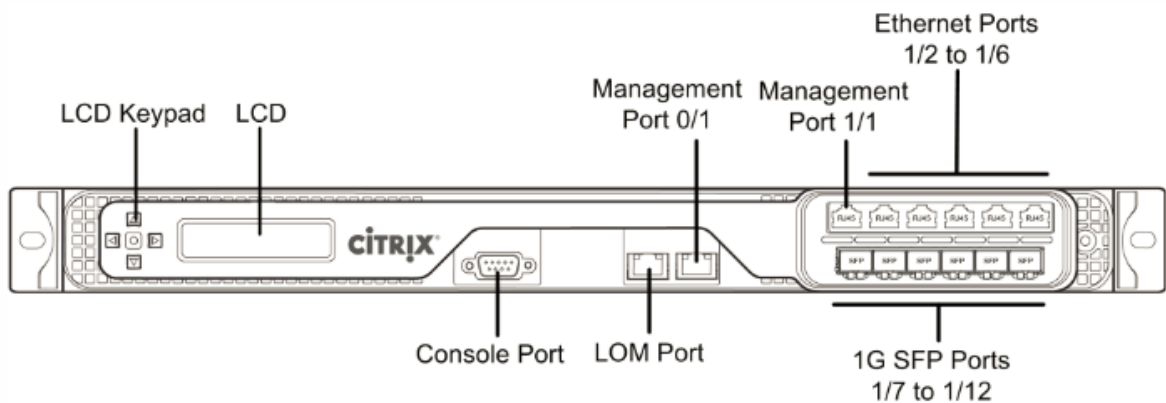

The T1010 appliance has the following ports:

- Six 1000BASE-X SFP data plane ports
- Five 1GB RJ-45 data plane ports
- Two 10/100/1000BASE-T, RJ45 management plane ports
- One 10/100BASE-T, RJ-45 Lights-Out Management (LOM) ports

The following figure shows the rear panel of the T1010 appliance.

Figure 2. NetScaler T1010 rear panel

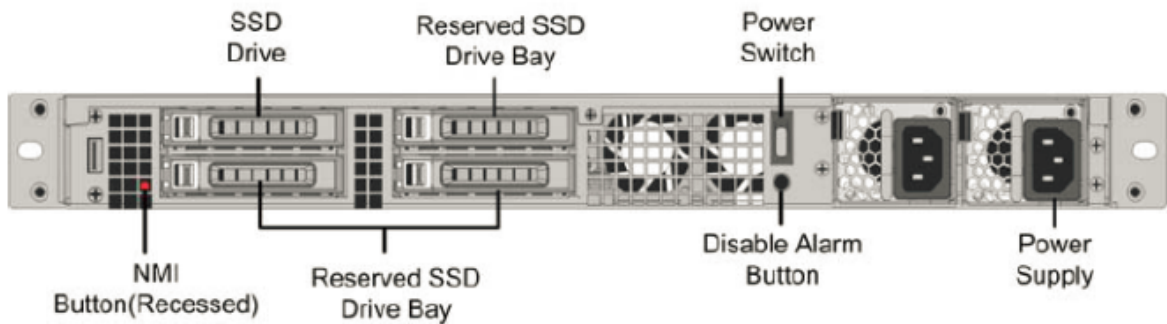

The following components are visible on the back panel of the T1010 appliance:

- One 256 GB or larger removable solid-state drive.
  - Note:** Drive densities might increase as components become EOL but its size is never smaller than the original.
- Non-maskable interrupt (NMI) button, which is used at the request of Technical Support to produce a NetScaler core dump. Use a pen, pencil, or other pointed object to press this red button, which is recessed to prevent unintentional activation.
- Power switch, which turns off power to the appliance, as if you were to unplug the power supply. Press the switch for five seconds to shut off the power.

- **Disable alarm button**, which is nonfunctional. This button is functional only if you install a second power supply.
- Press this button to stop the power alarm from sounding when either of the following conditions is true:
  - You have plugged the appliance into only one power outlet.
  - One power supply is malfunctioning, and you want to continue operating the appliance until it is repaired.
- Single power supply, rated at 450 watts, 110–220 volts.

For information about installing the rails, rack mounting the hardware, and connecting the cables, see [Installing the Hardware](#).

For information about performing initial configuration of your appliance, see [Initial Configuration](#).

## NetScaler T1100

December 31, 2023

The NetScaler T1100 is a 2U appliance, with 1 dual-core processor, and 42 GB memory.

The following figure shows the front panels of the two models T1100 appliance, T1100 (Gen1) and T1100 (16).

Figure 1. NetScaler T1100 (Gen1) and T1100 (16) front panels

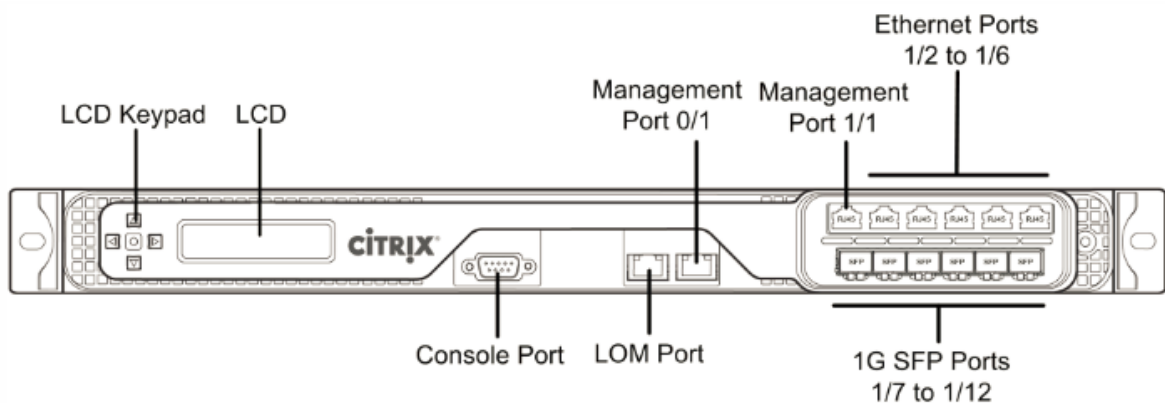

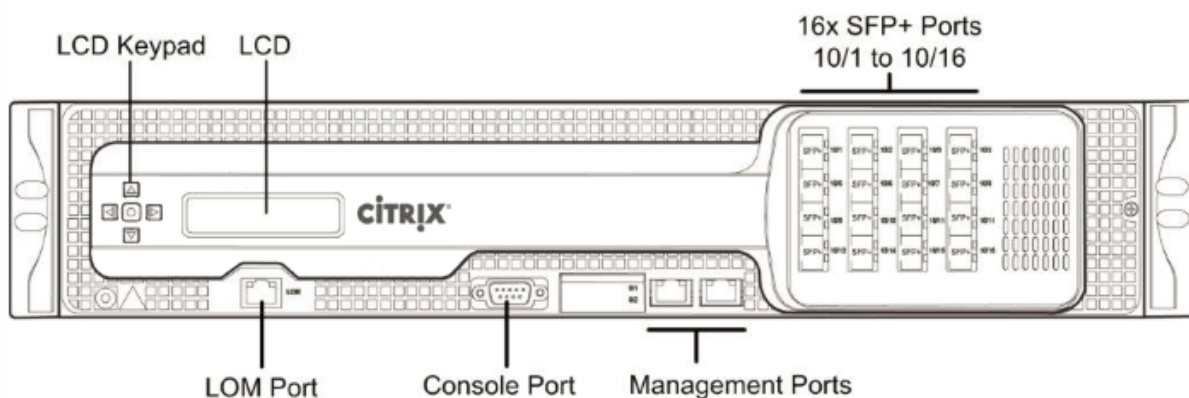

The T1100 appliance has the following ports:

- Eight 10GBASE-X SFP+ data plane ports [T1100 (Gen1)]
- 16 10GBASE-X SFP+ data plane ports [T1100 (16)]
- Two 10/100/1000BASE-T, RJ45 management plane ports
- One 10/100BASE-T, RJ-45 LOM ports

The following figure shows the back panel of the T1100.

Figure 2. NetScaler T1100 back panel

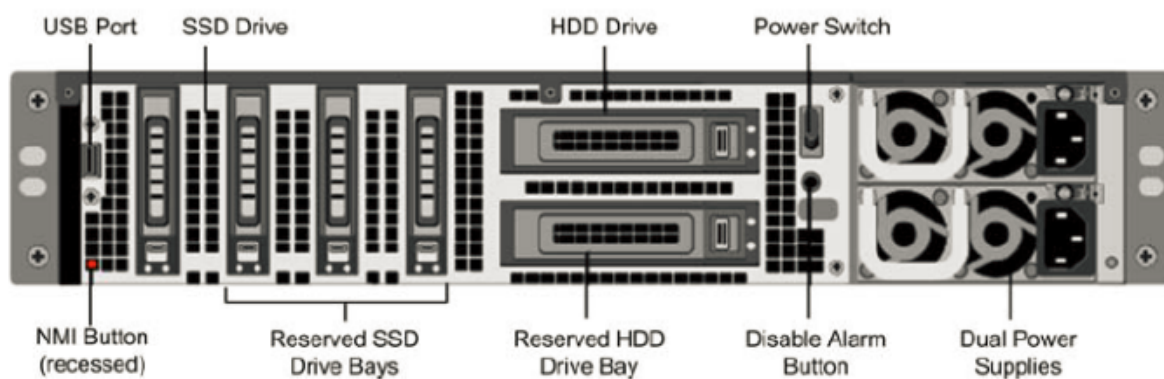

The following components are visible on the back panel of the T1100:

- USB port (reserved for a future release).
- 160 GB removable solid-state drive.
- **Note:** Drive densities might increase as components become EOL but its size is never smaller than the original.
- Removable hard-disk drive that stores user data.
- Power switch, which turns off power to the appliance, as if you were to unplug the power supply. Press the switch for five seconds to shut off the power.

- Non-maskable interrupt (NMI) button that is used at the request of Technical Support and produces a core dump on the appliance. Use a pen, pencil, or other pointed object to press this red button, which is recessed to prevent unintentional activation.
- **Disable alarm button.** This button is functional only when the appliance has two power supplies. Press this button to stop the power alarm from sounding when either of the following conditions is true:
  - You have plugged the appliance into only one power outlet.
  - One power supply is malfunctioning, and you want to continue operating the appliance until it is repaired.
- Dual power supplies, each rated at 650 watts, 110–220 volts.

For information about installing the rails, rack mounting the hardware, and connecting the cables, see [Installing the Hardware](#).

For information about performing initial configuration of your appliance, see [Initial Configuration](#).

## NetScaler T1120

December 31, 2023

The NetScaler T1120 appliance is a 2U appliance, with a dual-core processor and 128 GB memory.

The following figure shows the front panel of the T1120 appliance.

Figure 1. NetScaler T1120 appliance front panel

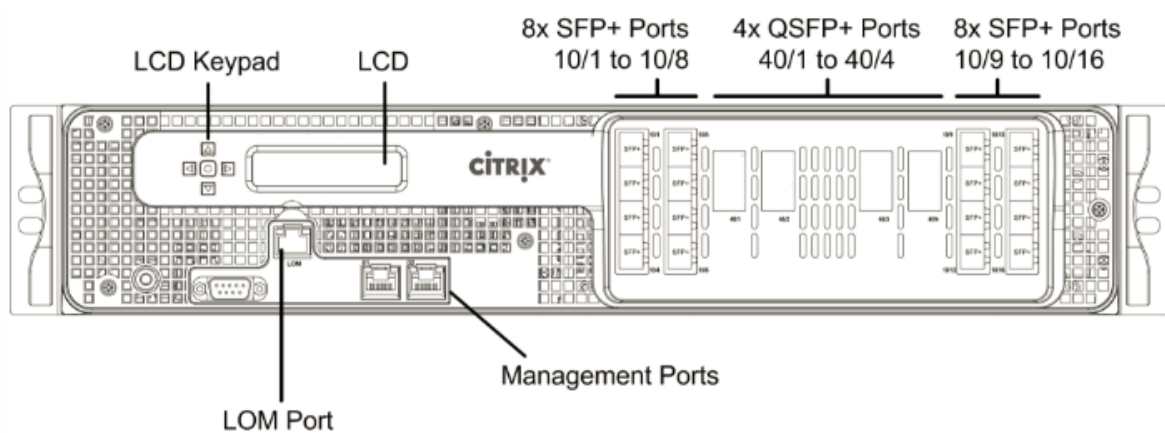

The T1120 appliance has the following ports:

- Four 40G QSFP+ ports
- 16 10GBASE-X SFP+ ports

- Two 10/100/1000BASE-T, RJ45 ports
- One 10/100BASE-T RJ-45 LOM port

The following figure shows the back panel of the T1120 appliance.

Figure 2. NetScaler T1120 back panel

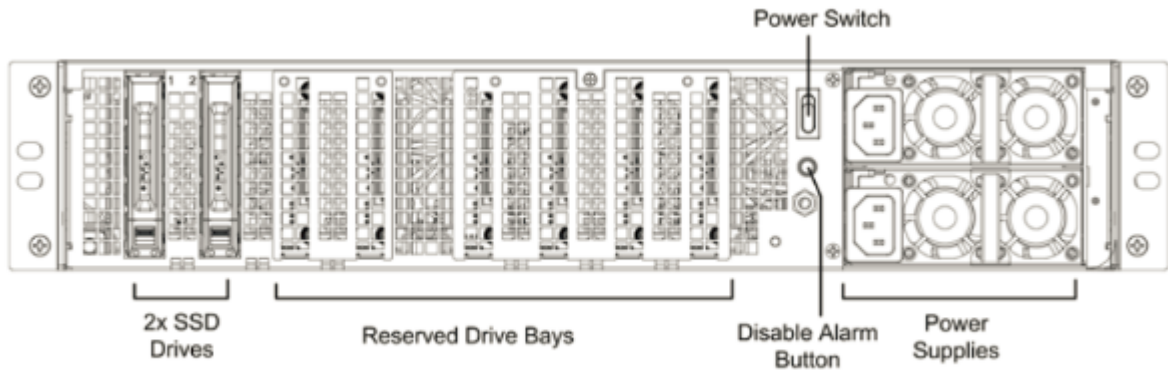

The following components are visible on the back panel of the T1120 appliance:

- 240 GB removable solid-state drive.  
**Note:** Drive densities might increase as components become EOL but its size is never smaller than the original.
- Power switch, which turns off power to the appliance, as if you were to unplug the power supply. Press the switch for less than two seconds to shut off the power.
- **Disable alarm button.** This button is functional only when the appliance has two power supplies. Press this button to stop the power alarm from sounding when either of the following conditions is true:
  - You have plugged the appliance into only one power outlet.
  - One power supply is malfunctioning, and you want to continue operating the appliance until it is repaired.
- Two power supplies, each rated at 1000 watts, 100–240 volts. Each power supply has an LED that indicates the status of the power supply.

For information about installing the rails, rack mounting the hardware, and connecting the cables, see [Installing the Hardware](#).

For information about performing initial configuration of your appliance, see [Initial Configuration](#).



## NetScaler T1200

December 31, 2023

The NetScaler T1200 is a 2U appliance, with a dual-core processor and 256 GB memory.

The following figure shows the front panel of the T1200 appliance.

Figure 1. NetScaler T1200 front panel

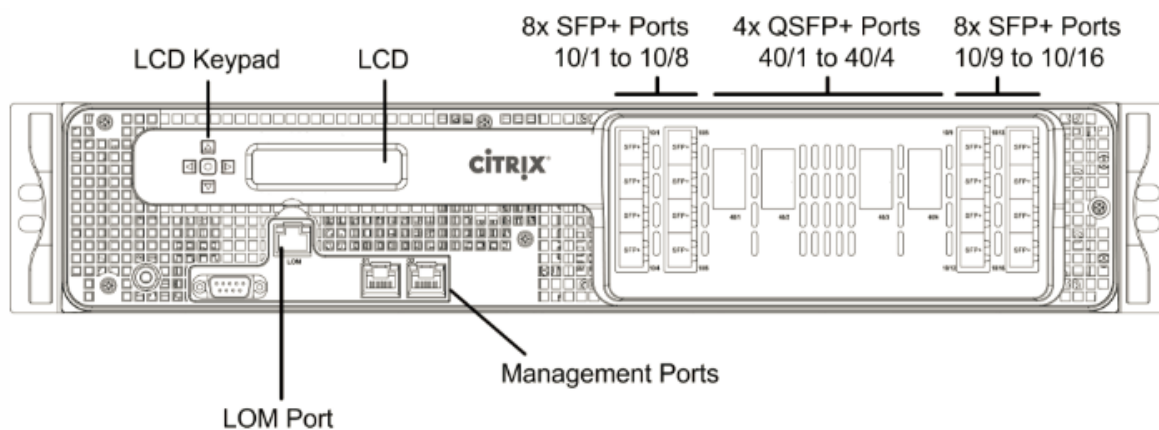

The T1200 appliance has the following ports:

- 24 10GBASE-X SFP+ data plane ports
- 12 1000BASE-X SFP data plane ports
- Two 10/100/1000BASE-T, RJ45 management ports
- One 10/100BASE-T, RJ-45 LOM port

The following figure shows the back panel of the T1200 appliance.

Figure 2. NetScaler T1200 back panel

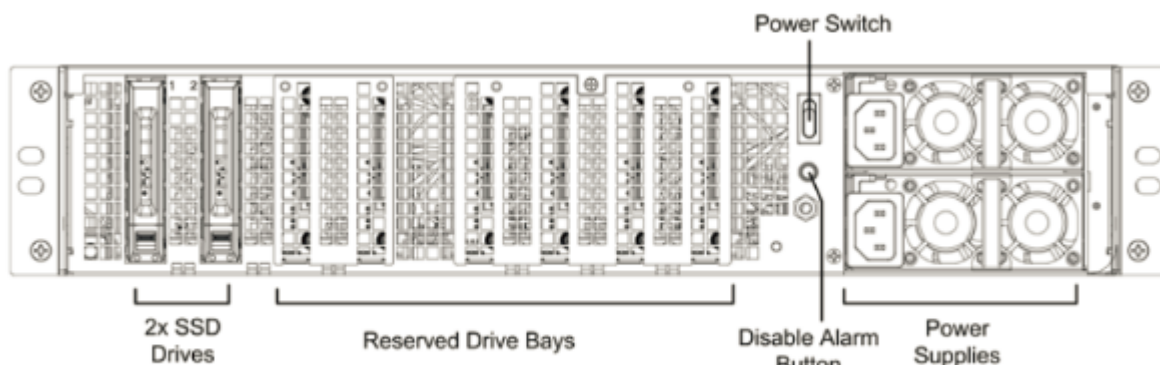

The following components are visible on the back panel of the T1200 appliance:

- System status LED, which indicates the status of the appliance, as described in the LCD Display and LED Status Indicators.
- Four power supplies, each rated at 750 watts, 100–240 volts. A minimum of two power supplies are required for proper operation. The extra power supplies act as backup. Each power supply has an LED that indicates the status of the power supply, as described in the LCD Display and LED Status Indicators.
- Power switch, which turns off power to the appliance. Press the switch for less than two seconds to shut off the power.
- Two 256 GB removable solid-state drives.  
**Note:** Drive densities might increase as components become EOL but its size is never smaller than the original.
- Two 1TB removable hard disk drives that are used to store user data.

For information about installing the rails, rack mounting the hardware, and connecting the cables, see [Installing the Hardware](#).

For information about performing the initial configuration of your appliance, see [Initial Configuration](#).

## NetScaler T1300

December 31, 2023

The NetScaler T1300 is a 2U appliance, with a dual-core processor and 128 GB memory.

The following figure shows the front panels of the T1300-10GE and T1300-40GE appliances.

Figure 1. NetScaler T1300-10GE and T1300-40GE front panels

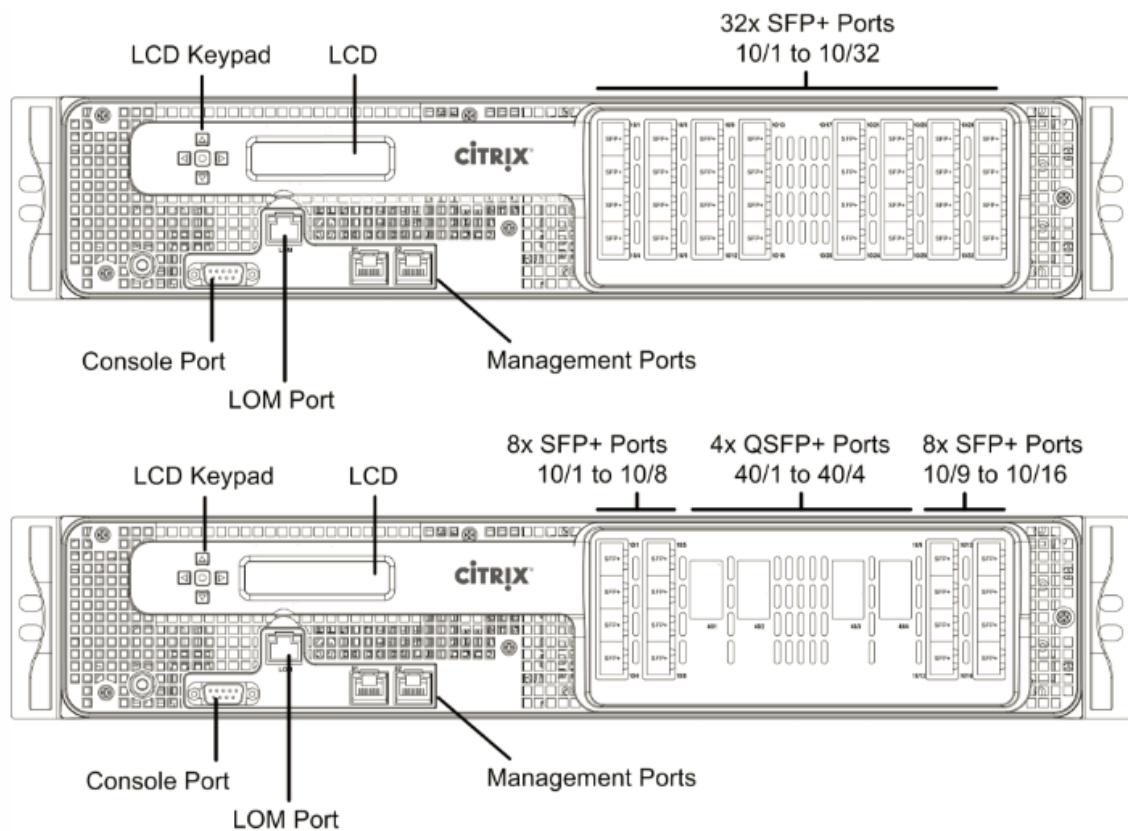

The T1300 appliance has the following ports:

- Two 10/100/1000BASE-T, RJ45 management plane ports
- One 10/100BASE-T, RJ-45 LOM port
- 32 10GBASE-X SFP+ data plane ports (T1300-10GE)
- Four 40G QSFP+ data plane ports (T1300-40GE)
- 16 10GBASE-X SFP+ data plane ports (T1300-40GE)

The following figure shows the back panel of the T1300 appliance.

Figure 2. NetScaler T1300 back panel

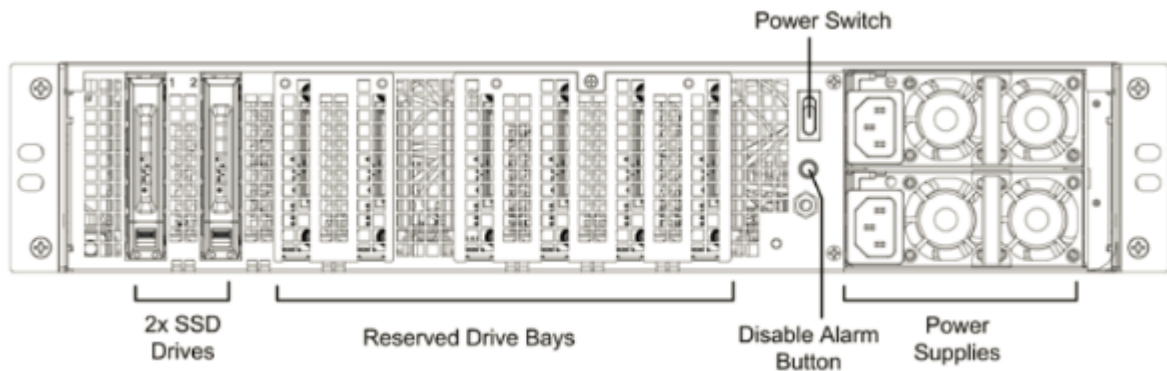

The following components are visible on the back panel of the T1300 appliance:

- One 300 GB removable solid-state drive on the T1300-10GE appliance and two 300 GB removable solid-state drives on the T1300-40GE appliance.

**Note:** Drive densities might increase as components become EOL but its size is smaller than the original.

- Power switch, which turns power to the appliance on or off. Press the switch for less than two seconds to shut off the power.
- Two power supplies, each rated at 1000 watts, 100–240 volts.
- **\*\*Disable alarm button\*\***, which is functional only when the appliance has two power supplies. Press this button to stop the power alarm from sounding when one of the following conditions is true:
  - You have plugged the appliance into only one power outlet.
  - One power supply is malfunctioning, and you want to continue operating the appliance until it is repaired.

For information about installing the rails, rack mounting the hardware, and connecting the cables, see [Installing the Hardware](#).

For information about performing the initial configuration of your appliance, see [Initial Configuration](#).

## NetScaler T1310

December 31, 2023

The NetScaler T1310 is a 2U appliance. It has two 10-core processors and 256 GB memory. The T1310 appliance is available in the eight 40G QSFP+ ports (8x40G QSFP+) configuration.

**Note:** The T1310 appliance is not a RAID device.

The following figure shows the front panel of the T1310 appliance.

Figure 1. NetScaler T1310 front panel

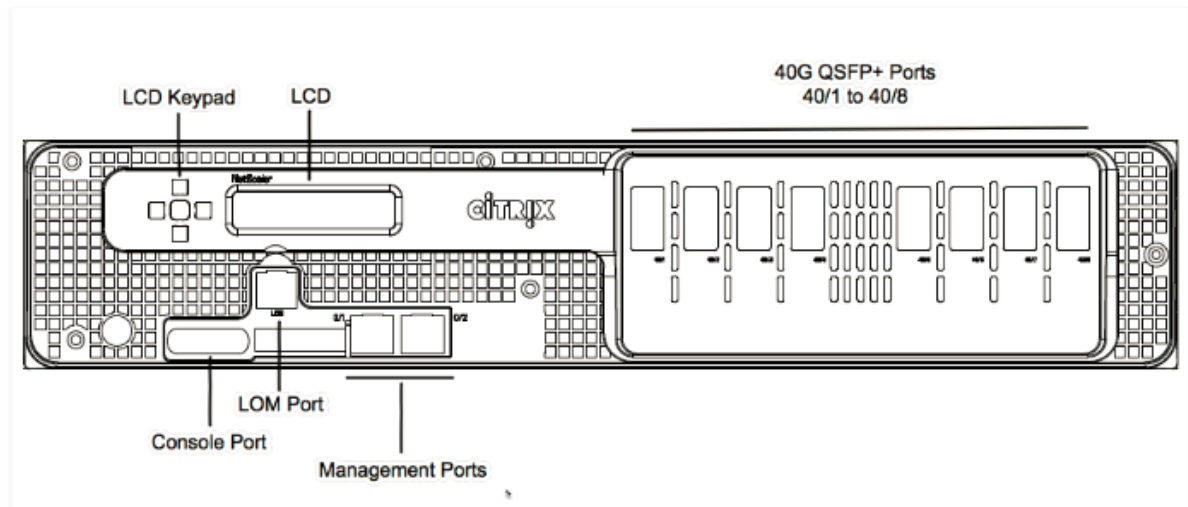

The T1310 appliance has the following ports:

- RS232 serial Console Port.
- 10/100Base-T copper Ethernet Port (RJ45), also called the LOM port. You can use this port to remotely monitor and manage the appliance independently of the NetScaler software.
- Two 10/100/1000Base-T copper Ethernet Management Ports (RJ45), numbered 0/1 and 0/2 from left to right. These ports are used to connect directly to the appliance for system administration functions.
- Network Ports: eight 40G QSFP+ ports (8x40G QSFP+).

**Note:** 40G QSFP+ transceivers are sold separately. 40G ports do not support 10G and 1G transceivers. Contact your NetScaler sales representative to order transceivers for your appliance.

The following figure shows the back panel of the T1310 appliance.

Figure 2. NetScaler T1310 back panel

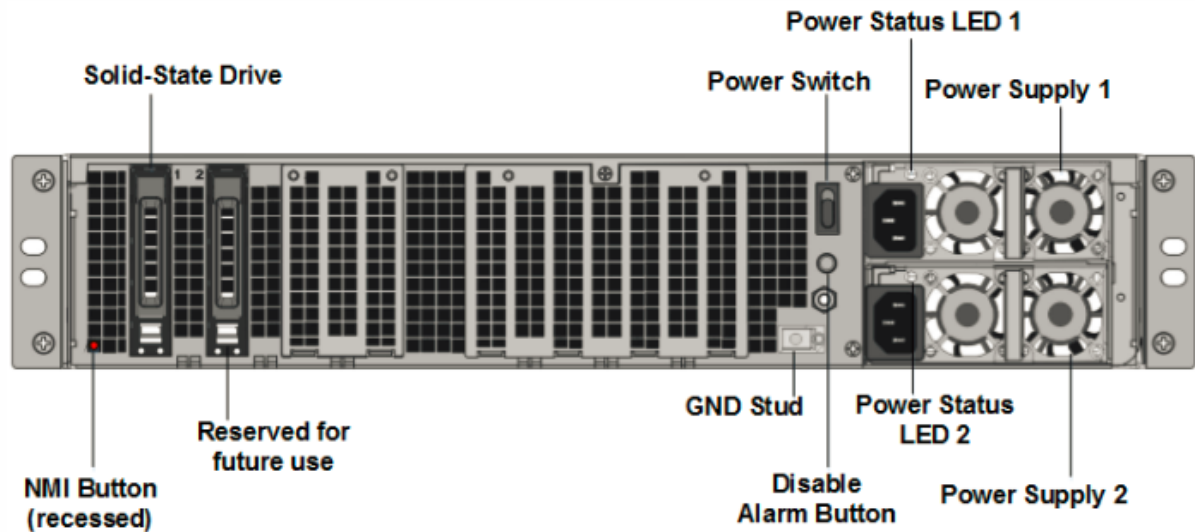

The following components are visible on the back panel of the T1310 appliance:

- One 300 GB removable solid-state drive.
  - Note:** Drive densities might increase as components become EOL but its size is never smaller than the original.
- Power switch, which turns power to the appliance on or off. Press the switch for less than two seconds to shut off the power.
- Two power supplies, each rated at 1000 watts, 100–240 volts. Each power supply has an LED that indicates the status of the power supply, as described in LCD Display and LED Status Indicators.
- **Disable alarm button**, which is functional only when the appliance has two power supplies.
- Press this button to stop the power alarm from sounding when either of the following conditions is true:
  - You have plugged the appliance into only one power outlet.
  - One power supply is malfunctioning, and you want to continue operating the appliance until it is repaired.
- Non-maskable interrupt (NMI) Button, used at the request of Technical Support to initiate a core dump. To press this red button, which is recessed to prevent unintentional activation, use a pen, pencil, or other pointed object. The NMI Button is also available remotely over the network in the LOM GUI, in the Remote Control menu. For more information on the lights out management Port of the appliance, see [Lights out management port of the NetScaler MPX appliance](#).

For information about installing the rails, rack mounting the hardware, and connecting the cables, see [Installing the Hardware](#).

For information about performing the initial configuration of your appliance, see [Initial Configuration](#).

## Field replaceable units

December 31, 2023

NetScaler field replaceable units (FRU) are ADC components that a user or a technician can replace at the user's site. The FRUs for a NetScaler appliance include DC or AC power supplies, solid-state (SSD) or hard-disk drives (HDD), direct attach cable (DAC), the bezel of the appliance, transceivers, and rail kits.

### Notes:

- The SSD or HDD stores your configuration information, and it must be restored from a backup after the unit is replaced.
- All NetScaler FRUs must be purchased from Citrix. Components not provided by NetScaler are not supported on NetScaler appliances. Contact your NetScaler sales representative to buy FRUs for your appliance.

## Power supply

For appliances containing two power supplies, the second power supply is optional but recommended. Some appliances can accommodate four power supplies, and require two power supplies as a bare minimum for proper operation. As a best practice, plug in all the power supplies for redundancy.

The appliance ships with a standard power cord that plugs into the appliance's power supply. It has a NEMA 5–15 plug on the other end for connecting to the power outlet on the rack or in the wall.

For power-supply specifications, see [Common Components](#).

### Note:

If you suspect that a power-supply fan is not working, see the description of your platform. On some platforms, what appears to be the fan does not turn, and the actual fan turns only when necessary.

On each power supply, a bicolor LED indicator shows the condition of the power supply.

## Electrical safety precautions for power supply replacement

- Make sure that the appliance has a direct physical connection to earth ground during normal use. When installing or repairing an appliance, always connect the ground circuit first and disconnect it last.
- Never touch a power supply when the power cord is plugged in. As long as the power cord is plugged in, line voltages are present in the power supply even if the power switch is turned off.

For the complete list of safety precautions, see [Safety, Cautions, Warnings, and Other Information](#).

## Replace an AC power supply

Most NetScaler MPX platforms accommodate two power supplies. Some platforms accommodate four power supplies. All NetScaler appliances function properly with a single power supply, except the appliances that accommodate four power supplies. These appliances need two power supplies for proper operation. The other power supply serves as a backup. All power supplies must be of the same type (AC or DC).

### Note:

If the appliance has only one power supply, you have to shut down the appliance before replacing the power supply. With two power supplies, you can replace one power supply without shutting down the appliance, provided the other power supply is working. With four power supplies, you can replace one or two power supplies without shutting down the appliance, provided the other two power supplies are working.

To install or replace an AC power supply on a NetScaler appliance:

1. Align the handle perpendicular to the power supply. Loosen the thumbscrew (if it is screwed) and press the lever toward the handle and pull out the existing power supply.

### Note

The illustration in the following figures might not represent the actual NetScaler appliance.

Figure 1. Remove the existing AC power supply



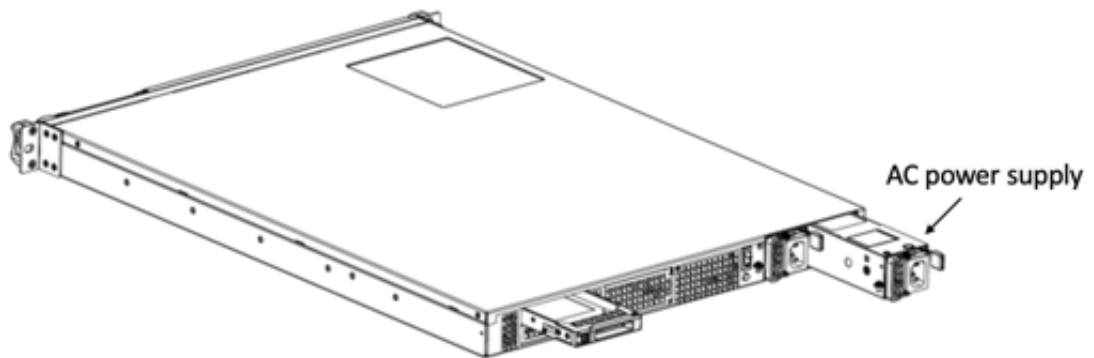

2. Carefully remove the new power supply from its box.
3. On the back of the appliance, align the power supply with the power supply slot.
4. Insert the power supply into the slot and press against the semicircular handle until you hear the power supply snap into place.
5. Connect the power supply to a power source. If connecting all power supplies, plug separate power cords into the power supplies and connect them to separate wall sockets.

**Note:**

NetScaler appliances emit a high-pitched alert in the following scenarios:

- One power supply fails
- You connect only one power cable to an appliance in which two power supplies are installed.

To silence the alarm, press the small red button on the back panel of the appliance. The **Disable alarm button** is functional only when the appliance has two power supplies.

### Replace a DC power supply

Most NetScaler MPX platforms can accommodate two power supplies. Some platforms can accommodate four power supplies. All NetScaler appliances function properly with a single power supply, except the appliances that can accommodate four power supplies. These appliances need two power supplies for proper operation. The other power supply serves as a backup. All power supplies must be of the same type (AC or DC).

**Note:**

If the appliance has only one power supply, you have to shut down the appliance before replacing the power supply. With two power supplies, you can replace one power supply without shutting

down the appliance, provided the other power supply is working. With four power supplies, you can replace one or two power supplies without shutting down the appliance, provided the other two power supplies are working.

To install or replace a DC power supply on a NetScaler appliance:

1. Loosen the thumbscrew and press the lever towards the handle and pull out the existing power supply, as shown in the following figure.

**Note:**

The illustration in the following figures might not represent the actual NetScaler appliance.

Figure 2. Remove the existing DC power supply



2. Carefully remove the new power supply from its box.
3. On the back of the appliance, align the power supply with the power supply slot.
4. Insert the power supply into the slot while pressing the lever towards the handle. Apply firm pressure to insert the power supply firmly into the slot.

Figure 3. Inserting the Replacement DC Power Supply



5. When the power supply is inserted into its slot, release the lever.
6. Connect the power supply to a power source. If connecting all power supplies, plug separate power cords into the power supplies and connect them to separate wall sockets.

**Note:**

NetScaler appliances emit a high-pitched alert in the following scenarios:

- One power supply fails

- You connect only one power cable to an appliance in which two power supplies are installed.

To silence the alarm, press the small red button on the back panel of the appliance. The **Disable alarm button** is functional only when the appliance has two power supplies.

## Solid-state drive

An SSD is a high-performance device that stores data in solid-state flash memory. The MPX SSDs contain the boot loader configuration file, configuration file (ns.conf), licenses, and for some models, the NetScaler software and the user data.

All MPX platforms store the NetScaler software on the SSD. The SSD is mounted as /flash.

### Note:

On the MPX 5550/5650 and MPX 8005/8015/8200/8400/8600/8800 appliances, both /flash and /var are mounted from different partitions of the same SSD drive.

## Replace a RAID-supported SSD by using the CLI

### Note:

This section is application to NetScaler versions 12.1 and 13.0. For later versions, please get in touch with NetScaler Support.

In the ADC GUI, navigate to **Configuration > System > Diagnostic > Utility > Command line interface**.

You can also access the CLI from the serial console port or the management port (0/1 or 0/2).

### Note:

The RAID status can take READY or DEGRADED values. The drive status can take ONLINE or MISSING values.

To check the status of your SSDs in RAID, at the CLI type:

Command:

```
1 sh raid
2 <!--NeedCopy-->
```

Output:

```
1 RAID1 status: READY
2 Drive:
3      1  ONLINE
```

```
4      2  ONLINE
5 Done
6 <!--NeedCopy-->
```

If both the SSDs show ONLINE and the RAID status shows READY, no action is required.

In the following table, the values in the first column show the drive number on the back panel of the appliance. The drive number in the other columns refers to the number that must be used in the command or as it appears in the output of the CLI and shell.

Chassis	CLI command	Shell command	Shell command	Shell command
Slot in chassis	<code>sh raid</code>	<code>atacontrol status ar0</code>	<code>atacontrol detach/ atacontrol attach</code>	<code>atacontrol addspare ar0</code>
SSD 1	drive 1	drive 0	ata2	ad4
SSD 2	drive 2	drive 1	ata3	ad6

The following output indicates SSD 2 has failed and must be replaced.

Command:

```
1 sh raid
2 <!--NeedCopy-->
```

Output:

```
1 RAID1 status: DEGRADED
2 Drive:
3      1  ONLINE
4      2  MISSING
5 Done
6 <!--NeedCopy-->
```

Sometimes, the failed drive/SSD might not be reported.

Command:

```
1 sh raid
2 <!--NeedCopy-->
```

Output:

```
1 RAID1 status: DEGRADED
2 Drive:
3      1  ONLINE
4 Done
```

```
5 <!--NeedCopy-->
```

From the shell, confirm that drive 1/SSD 2 has failed, RAID status reports DEGRADED and drive 1/SSD 2 reports MISSING, or not present in the output.

1. At the NetScaler command prompt, switch to the shell prompt. Type: `shell`
2. Check the status of the RAID array. SSD2 shows missing or is not present in the output.

Command:

```
1 root@ns# atacontrol status ar0
2 <!--NeedCopy-->
```

Output:

```
1 ar0: ATA RAID1 status: DEGRADED
2 subdisks:
3     0 ad4 ONLINE
4     1 ---- MISSING
5 <!--NeedCopy-->
```

OR

```
1 ar0: ATA RAID1 status: DEGRADED
2 subdisks:
3     0 ad4 ONLINE
4 <!--NeedCopy-->
```

**Note:**

Drive numbering changes in the shell: SSD 1 reports as drive 0 and SSD 2 as drive 1.

Perform the following steps to restore the RAID array to health by using the `atacontrol` utility.

1. Detach a failed drive. The failed drive is replaced with a new FRU drive.
2. Attach the FRU drive.
3. Add the FRU drive to the RAID array.
4. Verify that the replacement drive is recognized.
5. Start the rebuild process.
6. Monitor the rebuild process.
7. Verify that the rebuild is successful.
8. Exit the bash shell and verify from the NetScaler CLI.

**Example when SSD 2 fails** In the following example, SSD 2/drive 1/ata3 has failed.

1. Detach a failed drive.

```
1 root@ns# atacontrol detach ata3
2 <!--NeedCopy-->
```

2. Physically, remove SSD 2/drive 1 and replace it with a new FRU drive in slot 2.
3. Attach the FRU drive.

```
1 root@ns# atacontrol attach ata3
2 <!--NeedCopy-->
```

4. Add the FRU drive to the RAID array.

```
1 root@ns# atacontrol addspare ar0 ad6
2 <!--NeedCopy-->
```

5. Verify that the replacement drive is recognized.

```
1 root@ns# atacontrol status ar0
2 <!--NeedCopy-->
```

Output:

```
1 ar0: ATA RAID1 status: DEGRADED
2 subdisks:
3   0 ad4 ONLINE
4   1 ad6 SPARE
5 <!--NeedCopy-->
```

6. Start the rebuild process.

```
1 root@ns# atacontrol rebuild ar0
2 <!--NeedCopy-->
```

7. Monitor the rebuild process.

```
1 root@ns# atacontrol status ar0
2 <!--NeedCopy-->
```

Output:

```
1 ar0: ATA RAID1 status: REBUILDING 10% completed
2 subdisks:
3   0 ad4 ONLINE
4   1 ad6 SPARE
5 <!--NeedCopy-->
```

**Note:**

Rebuilding the RAID array takes some time.

8. Verify that the REBUILD is successful.

```
1 root@ns# atacontrol status ar0
2 <!--NeedCopy-->
```

**Output:**

```
1 ar0: ATA RAID1 status: READY
2 subdisks:
3   0 ad4 ONLINE
4   1 ad6 ONLINE
5 <!--NeedCopy-->
```

**Note:**

After the rebuild operation completes, the subdisks status shows ONLINE, and the RAID status shows READY.

9. Exit the shell and verify the status of the RAID array from the NetScaler CLI.

```
1 root@ns# exit
2 >sh raid
3 <!--NeedCopy-->
```

**Output:**

```
1 RAID1 status: READY
2 Drive:
3       1 ONLINE
4       2 ONLINE
5 Done
6 <!--NeedCopy-->
```

**Example when SSD 1 fails** In the following example, SSD 1/drive 0/ata2 has failed.

1. Detach a failed drive.

```
1 root@ns# atacontrol detach ata2
2 <!--NeedCopy-->
```

2. Physically, remove SSD 1/drive 0 and replace it with a new FRU drive in slot 1.

3. Attach the FRU drive.

```
1 root@ns# atacontrol attach ata2
2 <!--NeedCopy-->
```

4. Add the FRU drive to the RAID array.

```
1 root@ns# atacontrol addspare ar0 ad4
2 <!--NeedCopy-->
```

5. Verify that the replacement drive is recognized.

```
1 root@ns# atacontrol status ar0
2 <!--NeedCopy-->
```

Output:

```
1 ar0: ATA RAID1 status: DEGRADED
2 subdisks:
3   0 ad4 SPARE
4   1 ad6 ONLINE
5 <!--NeedCopy-->
```

6. Start the rebuild process.

```
1 root@ns# atacontrol rebuild ar0
2 <!--NeedCopy-->
```

7. Monitor the rebuild process.

```
1 root@ns# atacontrol status ar0
2 <!--NeedCopy-->
```

Output:

```
1 ar0: ATA RAID1 status: REBUILDING 10% completed
2 subdisks:
3   0 ad4 SPARE
4   1 ad6 ONLINE
5 <!--NeedCopy-->
```

**Note:**

Rebuilding the RAID array takes some time.

8. Verify that the REBUILD is successful.

```
1 root@ns# atacontrol status ar0
2 <!--NeedCopy-->
```

Output:

```
1 ar0: ATA RAID1 status: READY
2 subdisks:
3   0 ad4 ONLINE
4   1 ad6 ONLINE
5 <!--NeedCopy-->
```



**Note:**

After the rebuild operation completes, the subdisks status shows ONLINE, and the RAID status shows READY.

9. Exit the shell and verify the status of the RAID array from the NetScaler CLI.

```
1 root@ns# exit
2 >sh raid
3 <!--NeedCopy-->
```

**Output:**

```
1 RAID1 status: READY
2 Drive:
3 1 ONLINE
4 2 ONLINE
5 Done
6 <!--NeedCopy-->
```

**Replace a solid-state drive**

Replacement SSDs contain a pre-installed version of the NetScaler software and a generic configuration file (ns.conf). However, it does not contain SSL-related certificates and keys, or custom boot settings. Configuration files and customized settings must be restored to a replacement drive from a backup storage location at the customer site, if available. The files to be restored might include:

- /flash/nsconfig/ns.conf: The current configuration file.
- /flash/nsconfig/ZebOS.conf: The ZebOS configuration file.
- /flash/nsconfig/license: The licenses for the NetScaler features.
- /flash/nsconfig/ssl: The SSL certificates and keys required for encrypting data to clients or to back-end servers.
- /nsconfig/rc.netscaler: Customer-specific boot operations (optional).

To replace a solid-state drive:

1. At the NetScaler command prompt, exit to the shell prompt. Type:  
`shell`
2. Shut down the NetScaler appliance by typing the following command at the shell prompt:  
`shutdown -p now`
3. Locate the SSD on the back panel of the appliance. Push the safety latch of the drive cover to the right or down, depending on the platform, while pulling out on the drive handle to disengage. Pull out the faulty drive.

**Note:**

The illustration in the following figures might not represent the actual NetScaler appliance.

Figure 4. Remove the existing solid-state drive

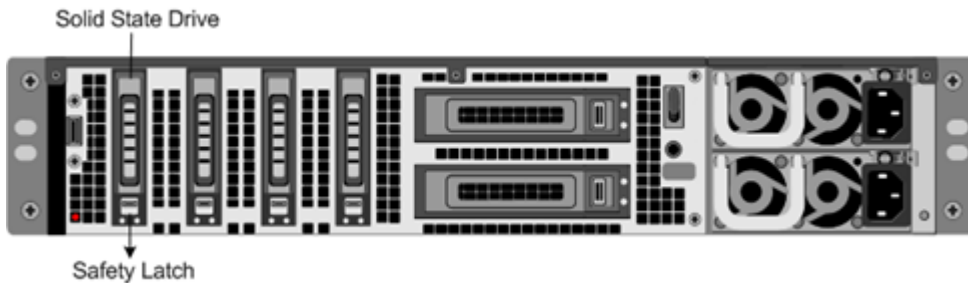

4. Verify that the replacement SSD is the correct type for the platform.
5. Pick up the new SSD, open the drive handle fully to the left or up, and insert the drive into the slot as far as possible. To seat the drive, close the handle flush with the rear of the appliance so that the drive locks securely into the slot.

**Important:** When you insert the drive, make sure that the NetScaler product label is at the top if the drive is inserted horizontally. The label must be at the right if the drive is inserted vertically.

Figure 5. Insert the replacement solid-state drive



6. Turn on the NetScaler appliance. When the appliance starts, it no longer has the previous working configuration. Therefore, the appliance is reachable only through the default IP address of 192.168.100.1/16, or through the console port.
7. Perform the initial configuration of the appliance, as described in [Initial Configuration](#). Log on to the default IP address by using a web browser, or connect to the serial console by using a console cable, to perform the initial configuration.
8. Upload a platform license and any optional feature licenses, including universal licenses, to the NetScaler appliance. For more information, see [Licensing](#).
9. Once the correct NetScaler software version is loaded, you can restore the working configuration. Copy a previous version of the `ns.conf` file to the `/nsconfig` directory by using an SCP utility. Alternately, paste the previous configuration into the `/nsconfig/ns.conf` file from the NetScaler command prompt. To load the new `ns.conf` file, you must restart the NetScaler appliance by entering the `reboot` command at the NetScaler command prompt.

## Hard disk drive

A hard disk drive (HDD) stores logs and other data files. Files stored on the HDD include the `newslog` files, `dmesg` and messages files, and any core/crash files. The HDD comes in various capacities, depending on the NetScaler platform. Hard drives are used for storing files required at runtime. An HDD is mounted as `/var`.

## Replace a hard disk drive

A hard disk drive (HDD) stores log files and other user files. Collection of new log files begins upon boot-up with the new HDD.

To install a hard disk drive:

1. At the NetScaler command prompt, exit to the shell prompt. Type:

```
shell
```

2. Shut down the NetScaler appliance by typing one of the following commands at the shell prompt.

- On an MPX appliance, type:

```
shutdown -p now
```

- On a non-MPX appliance, type:

```
shutdown
```

3. Locate the hard disk drive on the back panel of the appliance.
4. Verify that the replacement hard disk drive is the correct type for the NetScaler platform.
5. Disengage the hard disk drive by pushing the safety latch of the drive cover to the right or down, depending on the platform, while pulling out on the drive handle. Pull out the faulty drive.

### Note:

The illustration in the following figures might not represent the actual NetScaler appliance.

Figure 6. Removing the existing hard disk drive

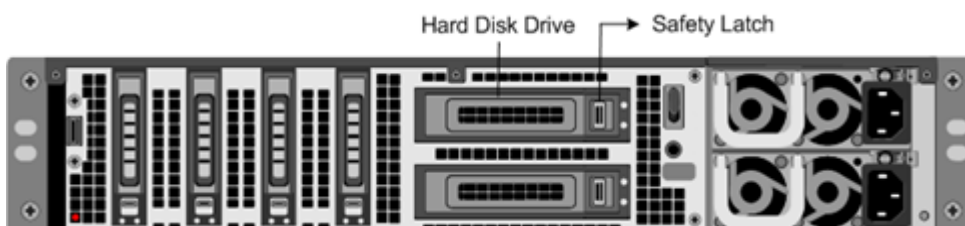

6. Pick up the new disk drive, open the drive handle fully to the left, and insert the new drive into the slot as far as possible. To seat the drive, close the handle flush with the rear of the appliance so that the hard drive locks securely into the slot.

**Important:**

When you insert the drive, make sure that the NetScaler product label is at the top.

Figure 7. Insert the replacement hard disk drive



7. Turn on the NetScaler appliance. The appliance starts the NetScaler software and reads the configuration file from the CompactFlash card.

## Direct attach cable

A direct attach cable (DAC) assembly is a high performance integrated duplex data link for bi-directional communication. The cable is compliant with the IPF MSA (SFF-8432) for mechanical form factor and SFP+ MSA for direct attach cables. The cable, which can be up to 5 meters long, is data-rate agnostic. Supporting speeds more than 10 Gbps, it is a cost-effective alternative to optical links (SFP+ transceivers and fiber optic cables.)

The transceiver with DAC is hot-swappable. You can insert and remove the transceiver with the attached cable without shutting down the appliance. The NetScaler appliance supports only a passive DAC.

**Important:**

- DAC is supported only on 10G ports. Do not insert a DAC into a 1G port.
- Do not attempt to unplug the integrated copper cable from the transceiver and insert a fiber cable into the transceiver.

## Install a direct attach cable

**Note:**

The illustrations in the following figures are only for reference and might not represent the actual NetScaler appliance.

To install or remove a direct attach cable:

1. To install the DAC, slide it into the 10G port on the appliance, as shown in the following figure. You hear a click when the DAC properly fits into the port.

Figure 8. Insert a DAC into the 10G port

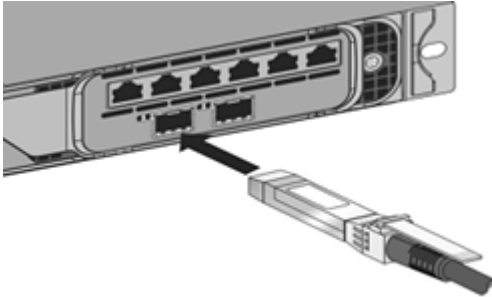

2. To remove the DAC, pull the tab on the top of the DAC, and then pull the DAC out of the port, as shown in the following figure.

Figure 9. Remove a DAC from the 10G port

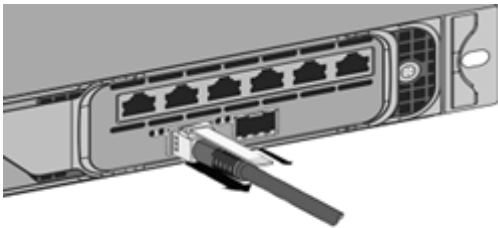

## Bezel

The bezel of a NetScaler appliance is now available as a FRU and can be replaced in the field.

**Note:**

The bezel FRU is supported only on the MPX/SDX 9100 platform.

### To replace the bezel

1. Remove the five screws that attach the bezel to the chassis front.
2. Disconnect the cable (see image).
3. Discard the old bezel.
4. Reconnect the cable to the new bezel.

5. Attach the new bezel to the chassis front using screws.

Figure 1: Replacing the 2U bezel

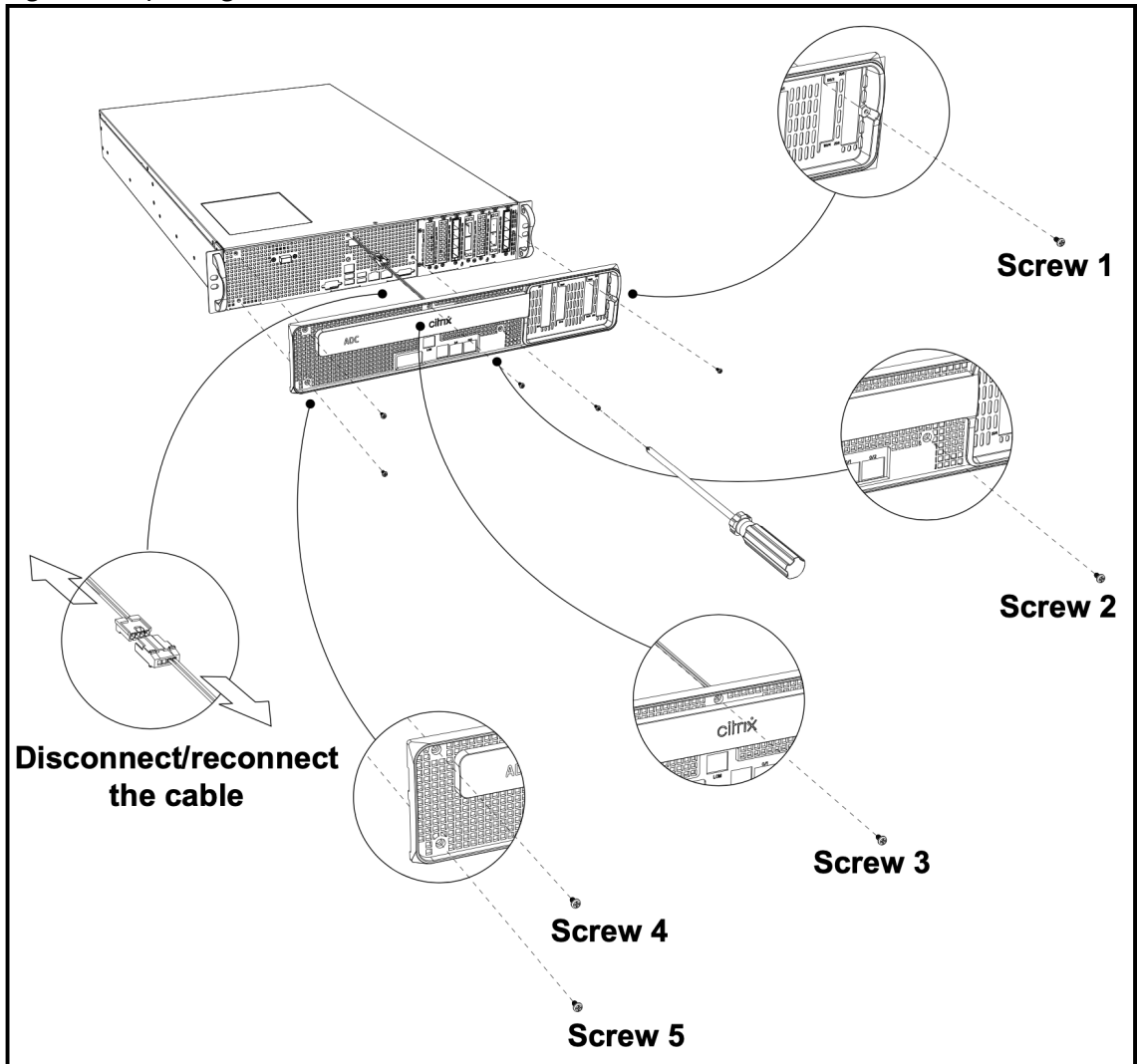
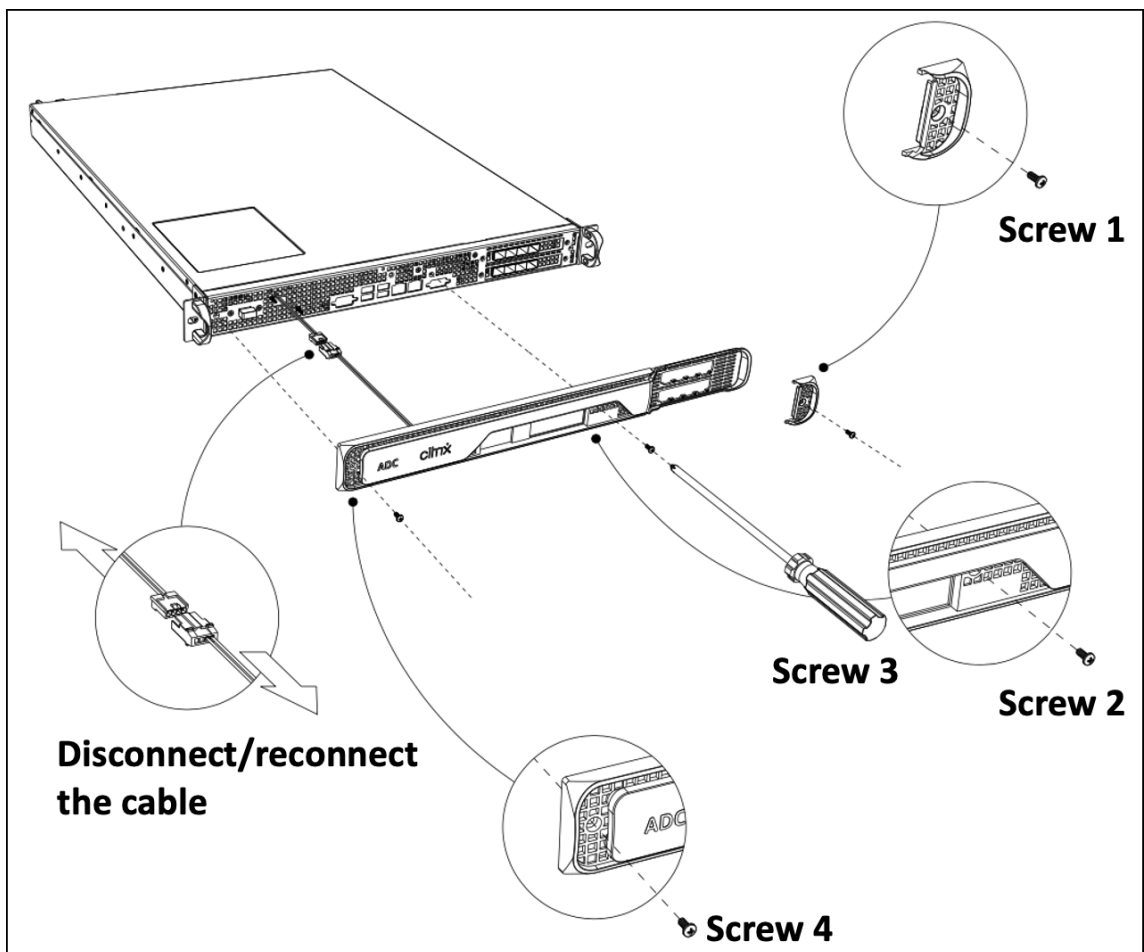

Figure 2: Replacing the 1U bezel



## Transceivers

Transceivers, in different speeds, are available as a FRU. Reach out to your NetScaler sales contact or partner to order transceivers.

For information about removing and installing transceivers, see [Install and remove 1G SFP transceivers](#).

## Rail kits

Rail kits are available as a FRU. Rail kits are available in 28 inches (38 inches extended) and 23 inches (33 inches extended). Reach out to your NetScaler sales contact or partner to order rail kits.

For information about attaching the rail kits to the appliance, see [Rack-mount the appliance](#).

## Safety, cautions, warnings, and other information

December 31, 2023

**Note:** For the list of safety certifications, standards, and ROHS compliance for each model, see the data sheet. The data sheet is available on [www.netscaler.com](http://www.netscaler.com). Navigate to **Platform > Form Factors > Hardware**.

### Safety statements

The following safety statements provide the caution and danger information you need to know, before installing the product.

#### Statement 1:

Danger: Electrical current from power, telephone, and communication cables is hazardous.

To avoid a shock hazard:

- Do not connect or disconnect any cables or perform installation, maintenance, or reconfiguration of this product during an electrical storm.
- Connect all power cords to a properly wired and grounded electrical outlet.
- Connect to properly wired outlets any equipment that is attached to this product.
- When possible, use one hand only to connect or disconnect signal cables.
- Never turn on any equipment when there is evidence of fire, water, or structural damage.
- Disconnect the attached power cords, telecommunications systems, networks, and modems before you open the device covers, unless instructed otherwise in the installation and configuration procedures.
- Connect and disconnect cables as described in the following table when installing, moving, or opening covers on this product or attached devices.

### Connect cables

- Shut OFF all power sources and equipment to be attached to this product.
- Attach all cables to the devices.
- Attach signal cables to the connectors.
- Attach power cords to power sources. For DC systems, ensure correct polarity of -48 VDC connections: RTN is (+) and -48 VDC is (-). Earth ground must use a two-hole lug for safety.
- Turn ON all the power sources.



### **Disconnect cables**

- Shut OFF all power sources and equipment to be attached to this product.
- For AC systems, remove all power cords from the shelf power receptacles or interrupt power at the ac power distribution unit.
- For DC systems, disconnect DC power sources at the breaker panel or by turning off the power source, then remove the DC cables.
- Remove the signal cables from the connectors.
- Remove all cables from the devices

### **Statement 2:**

Caution: When laser products (such as CD-ROMs, DVD drives, fiber optic devices, or transmitters) are installed, note the following:

- Do not remove the covers. Removing the covers of the laser product might result in exposure to hazardous laser radiation. There are no serviceable parts inside the device.
- Use of controls or adjustments or performance of procedures other than the ones specified here might result in hazardous radiation exposure.

Danger: Some laser products contain an embedded Class 3A or Class 3B laser diode. Note the following:

- Laser radiation when open. Do not stare into the beam, do not view directly with optical instruments, and avoid direct exposure to the beam.

### **Statement 3:**

Caution:

Never remove the cover on a power supply or any part that has the following label attached.



Hazardous voltage, current, and energy levels are present inside any component that has this label attached. There are no serviceable parts inside these components. If you suspect a problem with one of these parts, contact a service technician.

### **Statement 4:**

**Danger:** Overloading a branch circuit is potentially a fire hazard and a shock hazard under certain conditions. To avoid these hazards, ensure that your system electrical requirements do not exceed branch circuit protection requirements. See the information that is provided with your device for electrical specifications.

**Statement 5 (applies to NetScaler ADC appliances with -48 VDC input):**

**Caution:** This equipment is designed to permit the connection between the earthed conductor of the DC supply circuit and the earthing conductor at the equipment. If this connection is made, the following conditions must be met:

- This equipment must be connected directly to the DC supply system earthing electrode conductor or to a bonding jumper from an earthing terminal bar or bus to which the DC supply system earthing electrode conductor is connected.
- This equipment must be located in the same immediate area (such as, adjacent cabinets) as any other equipment that has a connection between the earthed conductor of the same DC supply circuit and the earthing conductor, and also the point of earthing of the DC system. The DC system must not be earthed elsewhere.
- The DC supply source must be located within the same premises as this equipment.
- Switching or disconnecting devices must not be in the earthed circuit conductor between the DC source and the point of connection of the earthing electrode conductor.

**Statement 6:**

**Caution:** To reduce the risk of electric shock or energy hazards:

- This equipment must be installed by trained service personnel in a restricted-access location, as defined by the NEC and IEC/UL/CSA 60950-1 and 62368-1, the Standard for Safety of IT Equipment.
- Connect the equipment to a properly grounded safety extra low voltage (SELV) source. A SELV source is a secondary circuit that is designed so that normal and single fault conditions do not cause the voltages to exceed a safe level (60 V direct current).
- Incorporate a readily available approved and rated disconnect device in the field wiring.
- See the specifications in the product documentation for the required circuit-breaker rating for branch circuit overcurrent protection.
- Use copper wire conductors only. See the specifications in the product documentation for the required wire size.
- See the specifications in the product documentation for the required torque values for the wiring-terminal nuts.

**Statement 7:**

**Caution:** Shock hazard. Equipment might be powered by multiple sources.



**Statement 8:**

Caution: During installation or maintenance procedures, wear a grounding wrist strap to avoid ESD damage to the electronics of the appliance. Use a conductive wrist strap attached to a good earth ground or to the appliance. You can attach it to the connector beside the ESD symbol on the back.



**Statement 9:**

Warning: Hazardous moving parts. Keep away from moving fan blades.



**Fiber optic safety information**

Danger: Hazardous Radiation

Fiber optic products use laser radiation with the potential to cause injury. Uncovered ports might release this radiation. Avoid direct exposure to laser radiation. Do not stare into the beam, and do not view directly with optical instruments. Do not remove any protective shields on fiber optic transceiver modules.

**Cautions, warnings, and other information**

**Electrical safety precautions:**

Follow basic electrical safety precautions to protect yourself from harm and the appliance from damage.

- Be aware of the location of the emergency power off (EPO) switch, so that you can quickly remove power to the appliance if an electrical accident occurs.

- Remove all jewelry and other metal objects that might come into contact with power sources or wires before installing or repairing the appliance. When you touch both a live power source or wire and ground, any metal objects can heat up rapidly and might cause burns, set clothing on fire, or fuse the metal object to an exposed terminal.
- Use a regulating, uninterruptible power supply to protect the appliance from power surges and voltage spikes, and to keep the appliance operating if power fails.
- Never stack the appliance on top of any other server or electronic equipment.
- All appliances are designed to be installed on power systems that use TN earthing. Do not install your device on a power system that uses either TT or IT earthing.
- Ensure that the appliance has a direct physical connection to the earth during normal use. When installing or repairing an appliance, always ensure that the ground circuit is connected first and disconnected last.
- Ensure that a fuse or circuit breaker no larger than 120 VAC, 15 A U.S. (240 VAC, 16 A international) is used on all current-carrying conductors on the power system to which your appliances are connected.
- Do not work alone when working with high voltage components.
- Always disconnect the appliance from power before removing or installing any component, unless the component is hot-swappable. When disconnecting power, first shut down the appliance, and then unplug the power cords of all the power supply units connected to the appliance. As long as the power cord is plugged in, line voltages can be present in the power supply, even when the power switch is OFF.
- Do not use mats designed to decrease static electrical discharge as protection from electrical shock. Instead, use rubber mats that have been designed as electrical insulators.
- Ensure that the power source can handle the appliance's maximum power consumption rating with no danger of an overload. Always unplug any appliance before performing repairs or upgrades.
- Do not overload the wiring in your server cabinet or on your server room rack.
- During thunderstorms, or anticipated thunderstorms, avoid performing any hardware repairs or upgrades until the danger of lightning has passed.
- When you dispose of an old appliance or any components, follow any local and national laws on the disposal of electronic waste.
- To prevent possible explosions, replace expired batteries with the same model or a manufacturer-recommended substitute and follow the manufacturer's instructions for battery replacement and disposal.

- This product is also designed for an IT power distribution system with phase-to-phase voltage 230 V.
- Never remove a power supply cover or any sealed part that has the following label:

Hazardous voltage, current, and energy levels are present inside any component that has this label attached. There are no user-serviceable parts inside these components. If you suspect a problem with one of these parts, contact Citrix Technical Support.

### **Appliance precautions:**

- Determine the placement of each component in the rack before you install the rails.
- Install the heaviest appliance first, at the bottom of the rack, and then work upward. Distribute the load on the rack evenly. An unbalanced rack is hazardous.
- Allow the power supply units and hard drives to cool before touching them.
- Install the equipment near an electrical outlet for easy access.
- Mount equipment in a rack with sufficient airflow for safe operation.
- For a closed or multiple-unit rack assembly, the ambient operating temperature of the rack environment might be greater than the ambient temperature of the room. Therefore, consider the lowest and highest operating temperatures of the equipment when making a decision about where to install the appliance in the rack.

### **Rack precautions:**

- Ensure that the leveling jacks on the bottom of the rack are fully extended to the floor, with the full weight of the rack resting on them.
- For a single-rack installation, attach a stabilizer to the rack.
- For a multiple-rack installation, couple (attach) the racks together.
- Always ensure that the rack is stable before extending a component from the rack.
- Extend only one component at a time. Extending two or more simultaneously might cause the rack to become unstable.
- The handles on the left and right of the front panel of the appliance must be used only for extending the appliance out of the rack. Do not use these handles for mounting the appliance on the rack. Use the rack-rail hardware, described later, instead.

## **Taiwan BSMI RoHS statement**

December 31, 2023

The following tables are a declaration of the presence condition of restricted substances in NetScaler MPX and SDX hardware appliances.

## 限用物質含有情況標示聲明書

## Declaration of the Presence Condition of Restricted Substances

設備名稱：網路負載均衡設備(服務器)						
單元 Unit	限用物質及其化學符號 Restricted substances and its chemical symbols					
	鉛Lead (Pb)	汞Mercury (Hg)	鎘Cadmium (Cd)	六價鉻 Hexavalent chromium (Cr <sup>+6</sup> )	多溴聯苯 Polybrominated biphenyls (PBB)	多溴二苯醚 Polybrominated diphenyl ethers (PBDE)
金屬外殼	○	○	○	○	○	○
印刷電路板	○	○	○	○	○	○
電源供應器	○	○	○	○	○	○
風扇	○	○	○	○	○	○
外殼前面板	○	○	○	○	○	○
配件(電源線、傳輸線)	○	○	○	○	○	○
<p>備考1. “超出0.1 wt %”及“超出0.01 wt %”係指限用物質之百分比含量超出百分比含量基準值。            Note 1: “Exceeding 0.1 wt %” and “exceeding 0.01 wt %” indicate that the percentage content of the restricted substance exceeds the reference percentage value of presence condition.</p> <p>備考2. “○”係指該項限用物質之百分比含量未超出百分比含量基準值。            Note 2: “○” indicates that the percentage content of the restricted substance does not exceed the percentage of reference value of presence.</p> <p>備考3. “—”係指該項限用物質為排除項目。            Note 3: The “—” indicates that the restricted substance corresponds to the exemption.</p>						

## 限用物質含有情況標示聲明書

### Declaration of the Presence Condition of Restricted Substances

設備名稱：網路負載均衡設備						
單元 Unit	限用物質及其化學符號 Restricted substances and its chemical symbols					
	鉛Lead (Pb)	汞Mercury (Hg)	鎘Cadmium (Cd)	六價鉻 Hexavalent chromium (Cr <sup>+6</sup> )	多溴聯苯 Polybrominated biphenyls (PBB)	多溴二苯醚 Polybrominated diphenyl ethers (PBDE)
金屬外殼	○	○	○	○	○	○
印刷電路板	○	○	○	○	○	○
電源供應器	○	○	○	○	○	○
風扇	○	○	○	○	○	○
外殼前面板	○	○	○	○	○	○
配件(電源線、傳輸線)	○	○	○	○	○	○
<p>備考1. “超出0.1 wt %”及“超出0.01 wt %”係指限用物質之百分比含量超出百分比含量基準值。                      Note 1 : “Exceeding 0.1 wt %” and “exceeding 0.01 wt %” indicate that the percentage content of the restricted substance exceeds the reference percentage value of presence condition.</p> <p>備考2. “○”係指該項限用物質之百分比含量未超出百分比含量基準值。                      Note 2 : “○” indicates that the percentage content of the restricted substance does not exceed the percentage of reference value of presence.</p> <p>備考3. “-”係指該項限用物質為排除項目。                      Note 3 : The “-” indicates that the restricted substance corresponds to the exemption.</p>						

## FCC compliance statement

December 31, 2023

### Supplier’s declaration of conformity

The FCC Compliance Statements listed on this page apply to all NetScaler MPX and SDX hardware models.

Responsible Party –U.S. Contact Information:

Citrix Systems, Inc.  
4988 Great America Parkway  
Santa Clara, CA  
95054 USA

compliance.prime@cloud.com

This device complies with part 15 of the FCC Rules. Operation is subject to the following two conditions: (1) This device might not cause harmful interference, and (2) this device must accept any interference received, including interference that might cause undesired operation.

**Note:** This equipment has been tested and found to comply with the limits for a Class A digital device, according to part 15 of the FCC Rules. These limits are designed to provide reasonable protection against harmful interference when the equipment is operated in a commercial environment. This equipment generates, uses, and can radiate radio frequency energy and, if not installed and used in accordance with the instruction manual, might cause harmful interference to radio communications. Operation of this equipment in a residential area is likely to cause harmful interference in which case the user is required to correct the interference at their own expense.

## Prepare for installation

December 31, 2023

Before you install your new appliance, carefully unpack your appliance and make sure that all parts were delivered. Verify that the location where the appliance is to be installed meets temperature and power requirements. Also verify that the server cabinet or floor-to-ceiling cabinet is securely bolted to the floor and has sufficient airflow.

**Note:** On all appliances, the air flows from front to rear.

Only trained and qualified personnel must install, maintain, or replace the appliance. Ensure that all cautions and warnings are followed.

## Unpack the appliance

The hardware accessories for your particular appliance, such as cables, adapters, and rail kit, vary depending on the hardware platform you ordered. Unpack the box that contains your new appliance on a sturdy table with plenty of space, and inspect the contents.

Verify that you received the cables, adapter, and rail kits specified for your appliance.



**Note**

Make sure that a power outlet is available for each cable.

If the kit that you received does not fit your rack, contact your NetScaler sales representative to order the appropriate kit.

Transceiver modules are sold separately. Contact your NetScaler sales representative to order transceiver modules for your appliance. Only transceivers supplied by Citrix are supported on the appliance.

**Important**

For Brazilian customers, NetScaler does not ship a power cable. Use a cable that conforms to the ABNT NBR 14136:2002 standard.

In addition to the items included in the box with your new appliance, you need the following items to complete the installation and initial configuration process.

- Ethernet cables for each additional Ethernet port that you connect to your network.
- One available Ethernet port on your network switch or hub for each NetScaler Ethernet port you want to connect to your network.
- A computer to serve as a management workstation.

## **Prepare the site and rack**

There are specific site and rack requirements for the NetScaler appliance. Make sure that adequate environmental control and power density are available. Racks must be bolted to the ground, have sufficient airflow, and have adequate power and network connections. Preparing the site and rack are important steps in the installation process and help ensure a smooth installation.

### **Site requirements**

The appliance must be installed in a server room or server cabinet with the following features:

- Environment control

An air conditioner, preferably a dedicated computer room air conditioner (CRAC), capable of maintaining the cabinet or server room at a temperature of no more than 27 degrees C/80.6 degrees F at altitudes of up to 2100 m/7000 ft, or 18 degrees C/64.4 degrees F at higher altitudes, a humidity level no greater than 45 percent, and a dust-free environment.

- Power density

Wiring capable of handling at least 4000 watts per rack unit in addition to power needs **for** the CRAC.

## Rack requirements

The rack on which you install your appliance must meet the following criteria:

- **Rack characteristics:**

Racks must be either integrated into a purpose-designed server cabinet or be the floor-to-ceiling type, bolted down at both top and bottom to ensure stability. If you have a cabinet, it must be installed perpendicular to a load-bearing wall for stability and sufficient airflow. If you have a server room, your racks must be installed in rows spaced at least 1 meter/3 feet apart for sufficient airflow. Your rack must allow your IT personnel unfettered access to the front and back of each server and to all power and network connections.

- **Power connections:**

At minimum, two standard power outlets per unit.

- **Network connections:**

At minimum, four Ethernet connections per rack unit.

- **Space requirements:**

One empty for the 1U models and two consecutive empty rack units for all other appliance models.

**Note:** You can order the following rail kits separately.

- Compact 4-post rail kit, which fits racks of 23–33 inches.
- 2-post rail kit, which fits 2-post racks.

Important:

See [Safety, cautions, warnings, and other information](#) for detailed electrical, appliance, and rack safety precautions.

## Install the hardware

December 31, 2023

You are ready to install the hardware after you determine that the location meets the environmental standards and the server rack is in place according to the instructions. After you mount the appliance, you are ready to connect it to the network, to a power source, and to the console terminal. The console terminal can be used for initial configuration. To complete the installation, you turn on the appliance. Be sure to observe the cautions and warnings listed with the installation instructions.

**Note:** Keep the serial number handy before mounting the appliance on the rack. The serial number is the password for the first time logon to the appliance and can be found at the back of the appliance.

Watch this quick video about [How to rack mount a NetScaler hardware appliance](#).

## Mount the appliance on a rack

Most appliances can be installed in standard server racks that conform to the EIA-310-D specification. The appliances ship with a set of rails, which you must install before you mount the appliance. The only tools that you need for installing an appliance are a Phillips screwdriver and a flathead screwdriver.

### Warning:

If you are installing the appliance as the only unit in the rack, mount it at the bottom. Make sure that the heaviest unit is at the bottom if the rack contains other units. Install stabilizing devices, if available, in the rack before mounting the appliance.

Your appliance requires one or two rack units depending on the height of the appliance.

## Remove the inner rails from the rail assembly

1. Place the rail assembly on a flat surface.
2. Slide out the inner rail toward the front of the assembly.
3. Press the latch until the inner rail comes all the way out of the rail assembly.
4. Repeat steps 1 through 3 to remove the second inner rail.

## Attach the inner rails to the appliance

1. Position the right inner rail behind the handle on the right side of the appliance.
2. Align the holes on the rail with the corresponding holes on the side of the appliance.
3. Attach the rail to the appliance with the provided screws: 4 per side for a 1U appliance and 5 per side for a 2U appliance, as shown in the following figure.

Figure 1. Attach inner rails



4. Repeat steps 1 through 3 to install the left inner rail on the other side of the appliance.

### Install the rack rails on the rack

1. If you have a round-hole, threaded rack, skip to step 3.
2. Install square nut retainers into the front post and back post of the rack as shown in the following figures. Before inserting a screw, be sure to align the square nut with the correct hole for your 1U or 2U appliance. The three holes are not evenly spaced.

Figure 2. Install retainers into the front rack posts

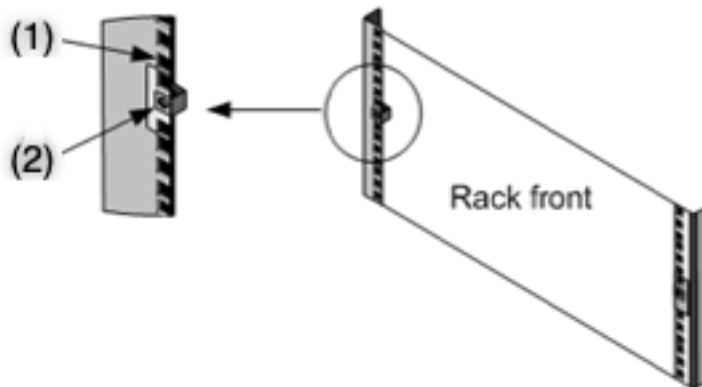

- (1)-Install in this hole for a 2U appliance.
- (2)-Install in center hole for a 1U appliance.

Figure 3. Install retainers into the rear rack posts

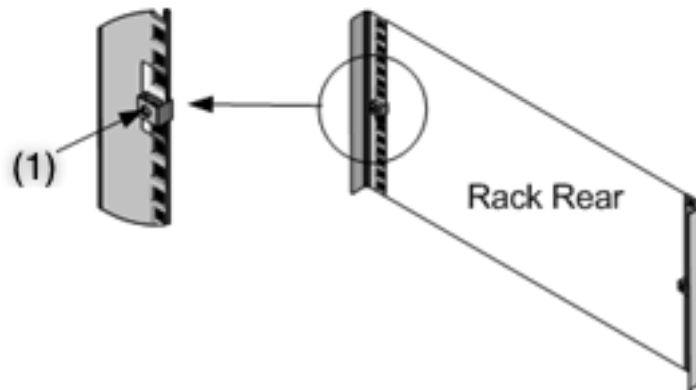

(1)-Install in the center hole for a 1U or a 2U appliance.

3. Install the adjustable rail assembly into the rack as shown in the following figures. Use a screw to lock the rear rail flange into the rack. With the screw securing the rail in place, you can optionally remove the latching spring.

Figure 4. Install the rail assembly to the rack

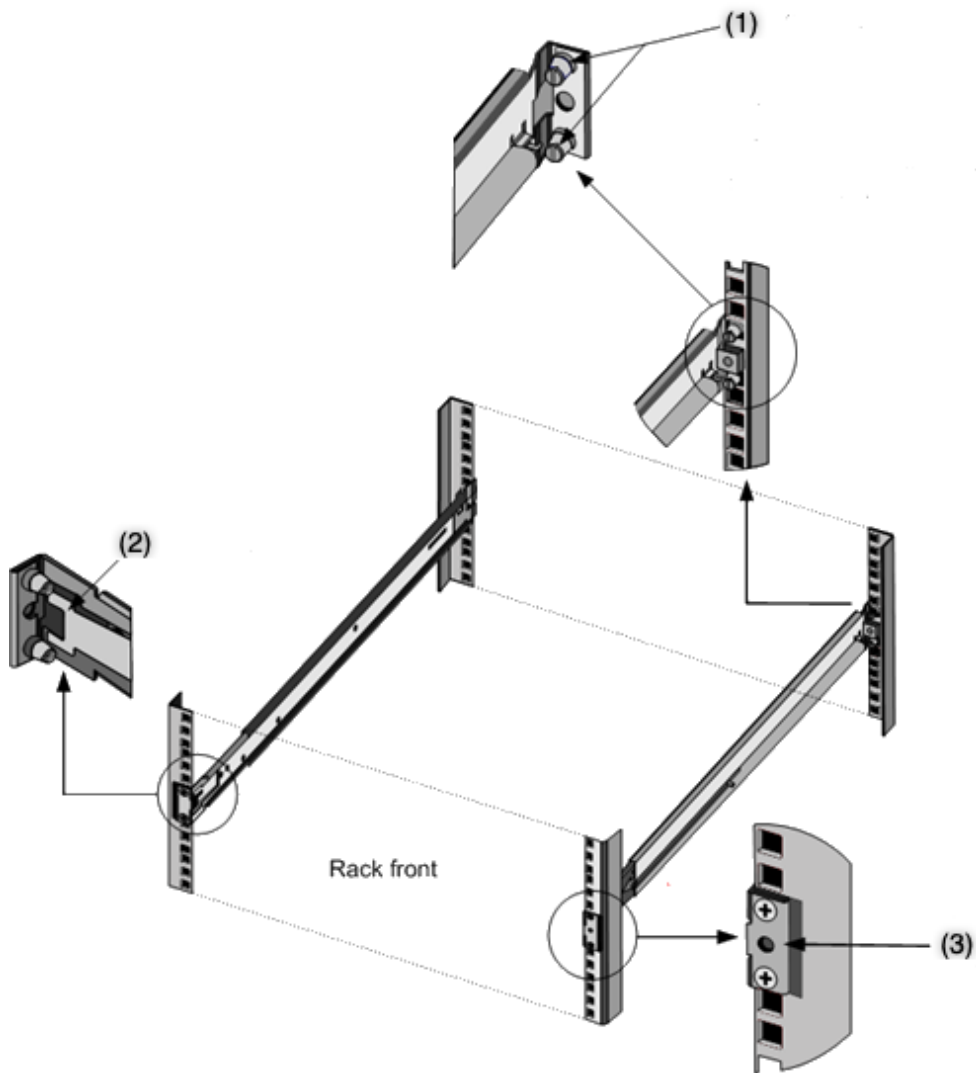

(1)-For round-hole threaded racks, remove the stud, and discard. Secure the rail to the rack by using the flat head screws that were holding the studs in place. For square-hole and round-hole non-threaded racks, insert studs into the hole in the rear of the rack.

(2)-Latching spring.

(3)-Don't insert the screw into this hole until you have installed the appliance into the rack.

### Install the appliance in the rack

1. Align the inner rails, attached to the appliance, with the rack rails.
2. Slide the appliance into the rack rails, keeping the pressure even on both sides.
3. Verify that the appliance is locked in place by pulling it all the way out from the rack.

Figure 5. Mount the appliance on a rack

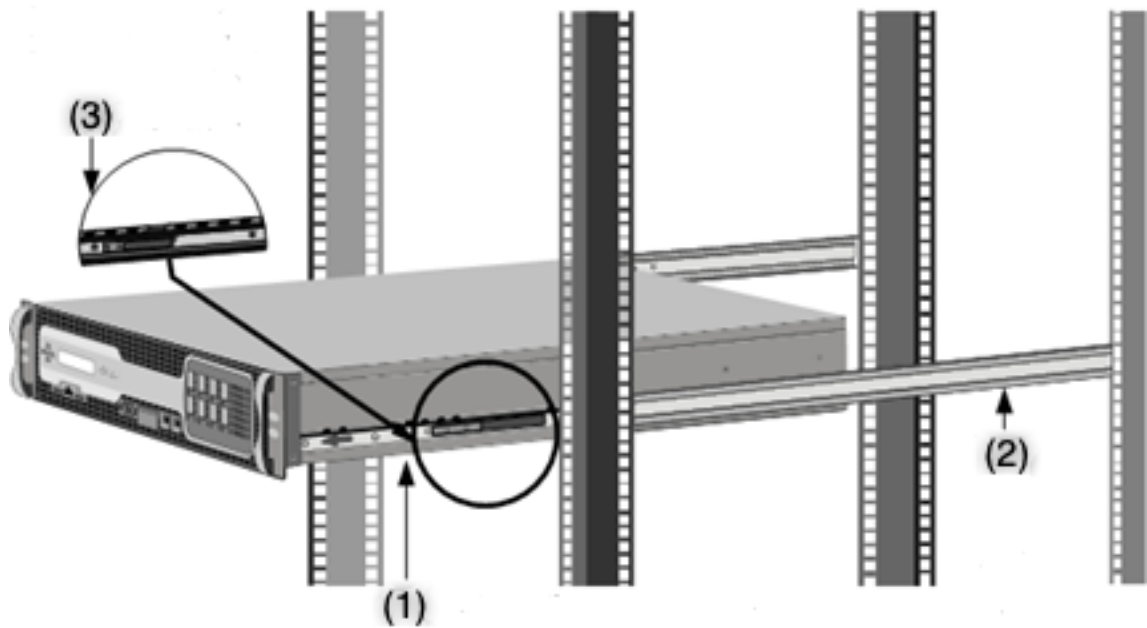

(1)-Attach the inner rails to the appliance by using the screws provided.

(2)-Attach the outer rails to the tack.

(3)-Press the latch to slide the appliance in or out of the rack.

A Small Form-Factor Pluggable (SFP) is a compact transceiver that can operate at speeds of up to 1 gigabit per second. It is available in both copper and fiber types. Inserting a 1G SFP copper transceiver converts the 1G SFP port to a 1000BASE-T port. Inserting a 1G SFP fiber transceiver converts the 1G SFP port to a 1000BASE-X port.

Auto-negotiation is enabled by default on the ports into which you insert your transceiver. When a link between the port and the network is established, the mode is matched on both ends of the cable for the transceivers. The speed is also auto-negotiated.

## Install and remove transceivers

### Notes

The 1G SFP transceiver is hot-swappable. The 40G QSFP+/10G SFP+ transceivers are hot-swappable on the NetScaler appliances that use the `ixgbe` (ix) interface. >

The 100G ports support native 40G/50G/100G transceivers, direct attach copper cables (DAC) and active optical cables (AOC).

Native 10G and 25G transceivers are supported on appliances that do not have 10G and 25G ports, but require the use of an SFP+ to QSFP+ adapter. Contact your NetScaler representative to pur-

chase this adapter.

NetScaler appliances do not support transceivers from vendors other than Citrix Systems. Attempting to install third-party transceivers on your NetScaler appliance voids the warranty.

Do not install the transceivers with the cables attached. Doing so can damage the cable, the connector, or the optical interface of the transceiver.

Frequent installation and removal of transceivers shortens their life span. Follow the removal procedure carefully to avoid damaging the transceiver or the appliance.

### Install a transceiver

1. Remove the transceiver carefully from its box.  
Danger: Do not look directly into fiber optic transceivers or cables. They emit laser beams that can damage your eyes.
2. Align the transceiver to the front of the appropriate transceiver port on the front panel of the appliance.  
Note: The illustration in the following figures might not represent your actual appliance.

Figure 6. Install a transceiver

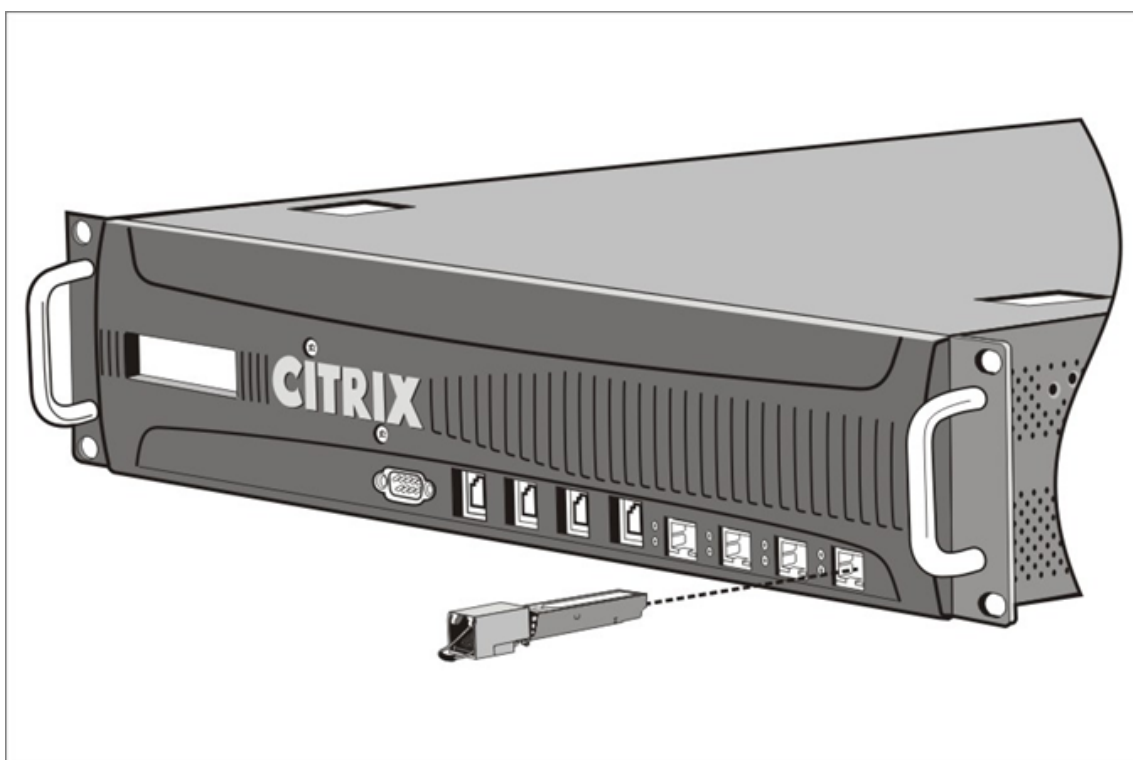

3. Hold the transceiver between your thumb and index finger and insert it into the transceiver port. Press it in until you hear the transceiver snap into place.



4. Lock the transceiver.
5. Verify that the LED is green and blinks twice, which indicates that the transceiver is functioning correctly.
6. If you are using a fiber transceiver, do not remove the dust caps attached to the transceiver and the cable until you are ready to insert the cable.

### Remove a transceiver

1. Disconnect the cable from the transceiver. If you are using a fiber optic cable, replace the dust cap on the cable before putting it away.  
Danger: Do not look directly into fiber optic transceivers or cables. They emit laser beams that can damage your eyes.
2. Unlock the transceiver.
3. Hold the transceiver between your thumb and index finger and slowly pull it out of the port.
4. If you are removing a fiber transceiver, replace the dust cap before putting it away.
5. Put the transceiver into its original box or another appropriate container.

To know which transceivers are supported on your appliance, look for your platform details in [Hardware Platforms](#).

### Connect the cables

When the appliance is securely mounted on the rack, you are ready to connect the cables. Ethernet cables and the optional console cable are connected first. Connect the power cable last.

**Danger:** Before installing or repairing the appliance, remove all jewelry and other metal objects that might come in contact with power sources or wires. Touching both a live power source or wire and ground, can cause any metal objects to heat up rapidly. It can also cause burns, set clothing on fire, or fuse the metal object to an exposed terminal.

### Connect the Ethernet cables

Ethernet cables connect your appliance to the network. The type of cable you need depends on the type of port used to connect to the network. Use a category 5e or category 6 Ethernet cable with a standard RJ-45 connector on a 10/100/1000BASE-T port or 1G SFP copper transceiver. Use a fiber optic cable with an LC duplex connector with a 1G SFP fiber transceiver, 10G SFP+, or 40G QSFP+ transceiver. The type of connector at the other end of the fiber optic cable depends on the port of the device that you are connecting.

### To connect an Ethernet cable to a 10/100/1000BASE-T port or 1G SFP copper transceiver

1. Insert the RJ-45 connector on the Ethernet cable into an appropriate port on the front panel of the appliance, as shown in the following figure.

Figure 8. Insert an Ethernet cable



2. Insert the RJ-45 connector on the other end into the target device, such as a router or switch.
3. Verify that the LED glows amber when the connection is established.

### To connect the Ethernet cable to a 1G SFP fiber, 10G SFP+, or 40G QSFP+ transceiver

1. Remove the dust caps from the transceiver and cable.
2. Insert the LC connector on the fiber optic cable into the appropriate port on the front panel of the appliance.
3. Insert the connector on the other end into the target device, such as a router or switch.
4. Verify that the LED glows amber when the connection is established.

### Connect the console cable

Use the console cable to connect your appliance to a computer or terminal, from which you can configure the appliance.

Alternatively, you can use a computer connected to the network. Before connecting the console cable, configure the computer or terminal to support VT100 terminal emulation as follows:

- 9600 baud
- 8 data bits
- 1 stop bit, parity, and flow control set to NONE.

Then connect one end of the console cable to the RS232 serial port on the appliance and the other end to the computer or terminal.

### To connect the console cable to a computer or terminal

1. Insert the DB-9 connector of the cable into the console port on the front panel of the appliance.

Figure 9. Insert a console cable



Note: To use a cable with an RJ-45 converter, insert the optional converter provided into the console port and attach the cable to it.

2. Insert the RJ-45 connector into the serial port of the computer or terminal.

### Connect the power cable

The number of power cables shipped with an appliance depends on the number of power supplies on the appliance. Appliances that come with two power cables can also operate if only one power cable is connected. Appliances that come with four power cables can also operate if only two power cables are connected. A separate ground cable might not be required, because the three-prong plug provides grounding.

### To connect the appliance to the power source

1. Connect the power cable to one of the inlet receptacles on the back of the appliance. Connect the other end of the power cable to a power outlet.

Figure 10. Insert a power cable



2. If your appliance has more than one power supply, repeat this process. The additional power supply is a redundant, hot-swappable power supply.
3. The NetScaler logo and the LCD on the front of the appliance illuminate after the appliance starts, and the LCD indicates the operational status of the appliance.

#### Note

Appliances with two power supplies emit a high-pitched alert if one power supply fails or if you connect only one power cable to the appliance. Press the small red button on the back panel of the appliance to silence the alarm.

## Switch on the appliance

After you have installed the appliance in a rack and connected the cables, verify that the power cable is properly connected. If you have installed more than one power supply, make sure the other cable is connected to an outlet for a different circuit than the first. After verifying the connections, you are ready to switch on the appliance.

### To switch on the appliance

1. Verify that the appliance is connected through a console or Ethernet port. This connection ensures that you can configure the appliance after it is switched on.
2. Press the ON/OFF toggle power switch on the back panel of the appliance.

Figure 11. Power switch on back panel

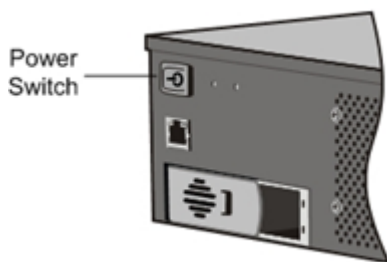
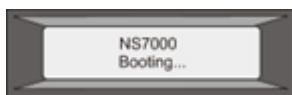

Figure 12. LCD startup screen



**Caution:** Be aware of the location of the emergency power off (EPO) switch, so that if an electrical accident occurs you can quickly remove power from the appliance.

## Initial configuration

December 31, 2023

After you have installed your appliance in a rack, you are ready to perform the initial configuration. Once the initial configuration is complete, refer to the specific configuration guides for the features you are using.

Initial configuration is the same for the multifunction NetScaler, NetScaler Gateway, and the dedicated NetScaler Web App Firewall appliances. You can use any of the following interfaces for the initial configuration of your appliance:

- **First-time use wizard:** If you use a web browser to connect to the appliance, you are prompted to enter the network configuration and licensing information, if it is not already specified.
- **LCD keypad:** You can specify the network settings, but you must use a different interface to upload your licenses.
- **Serial console:** After connecting to the serial console, you can use the NetScaler command line to specify the network settings and upload your licenses,
- **Dynamic Host Configuration Protocol (DHCP):** To configure an appliance from a remote network, use DHCP to assign each new appliance an IP address at which you can access the appliance for remote configuration. You can also use DHCP to install multiple NetScaler appliances and then configure them without using the console port.

For initial configuration, use the default password as both the administrative user name and the password. For subsequent access, use the password assigned during initial configuration.

After you complete the initial configuration of the appliance, you can configure secure access to your appliance. As a result, you are no longer prompted for a password when logging on. This configuration is especially helpful in environments for which you would otherwise have to keep track of many passwords.

### **Using the first-time setup wizard**

To configure a NetScaler appliance (or NetScaler virtual appliance) for the first time, you need an administrative computer configured on the same network as the appliance.

Assign a NetScaler IP (NSIP) address as the management IP address of your NetScaler appliance. You access the appliance for configuration, monitoring, and other management tasks at this address. Assign a subnet IP (SNIP) address for your NetScaler to communicate with the back-end servers. Specify a host name to identify your appliance, an IP address for a DNS server to resolve domain names, and the time zone in which your appliance is located.

The wizard automatically appears if any of the following conditions are met:

- The appliance is configured with the default IP address.
- A subnet IP address is not configured.
- Licenses are not present on the appliance.

### **Perform first-time configuration of your appliance**

1. In a web browser, type:

```
1 http://192.168.100.1
2 <!--NeedCopy-->
```

**Note:** The NetScaler software is preconfigured with this default IP address.

If you have already assigned as NSIP address, type that address in a web browser.

2. In **User Name**, type `nsroot`. In **Password**, if the earlier default password does not work, try typing the serial number of the appliance. The serial number bar code is available at the back of the appliance. Citrix recommends that you change the password after the first logon. For information about changing the password, see [Change the administrative password](#).

The following screen appears.

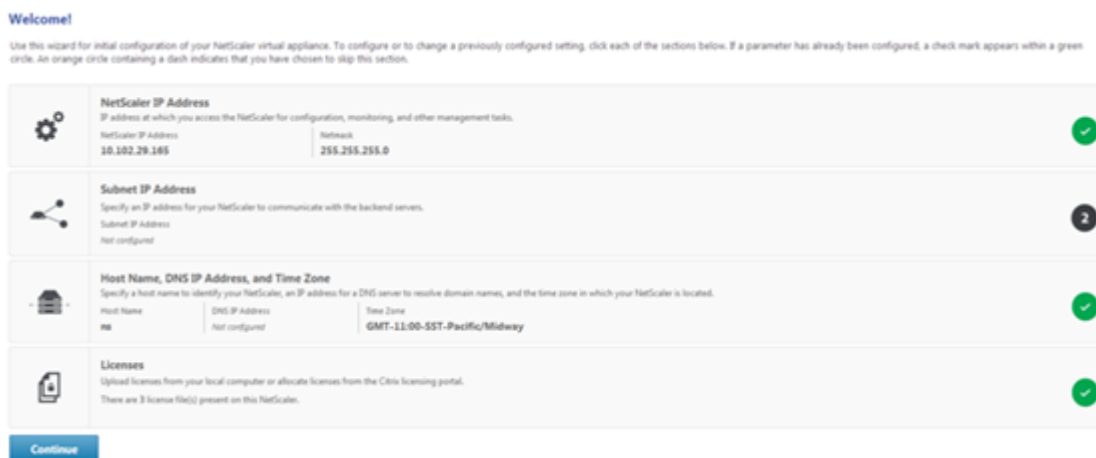

3. To configure or to change a previously configured setting, click inside each section. When done, click **Continue**.
4. When prompted, select **Reboot**.

## Using the LCD keypad

When you first install the appliance, you can configure the initial settings by using the LCD keypad on the front panel of the appliance. The keypad interacts with the LCD display module, which is also on the front panel of these appliances.

**Note:** You can use the LCD keypad for initial configuration on a new appliance with the default configuration. The configuration file (`ns.conf`) must contain the following command and default values.

```
1 set ns config -IPAddress 192.168.100.1 -netmask 255.255.0.0
2 <!--NeedCopy-->
```

The functions of the different keys are explained in the following table.

Table 1. LCD key functions

Key	Function
<	Moves the cursor one digit to the left.
	Moves the cursor one digit to the right.
v	Increments the digit under the cursor.
.	Decrements the digit under the cursor.
.	Processes the information, or terminates the configuration, if none of the values are changed. This key is also known as the <b>ENTER</b> key.

To perform the initial configuration by using the LCD keypad press the “<” key.

You are prompted to enter the subnet mask, NetScaler IP address (NSIP), and gateway in that order respectively. The subnet mask is associated with both the NSIP and default gateway IP address. The NSIP is the IPv4 address of the NetScaler appliance. The default gateway is the IPv4 address for the router, which handles the external IP traffic that the appliance cannot otherwise route. The NSIP address and the default gateway must be on the same subnet.

If you enter a valid value for the subnet mask, such as 255.255.255.224, you are prompted to enter the IP address. Similarly, if you enter a valid value for the IP address, you are prompted to enter the gateway address. If the value you entered is invalid, the following error message appears for three seconds. Here `xxx.xxx.xxx.xxx` is the IP address you entered, followed by a request to reenter the value.

```
1 Invalid addr!
2 xxx.xxx.xxx.xxx
3 <!--NeedCopy-->
```

If you press the ENTER (.) key without changing any of the digits, the software interprets it as a user exit request. The following message is displayed for three seconds.

```
1 Exiting menu...
2 xxx.xxx.xxx.xxx
3 <!--NeedCopy-->
```

If all the values entered are valid, when you press the **ENTER** key, the following message appears.

```
1 Values accepted,
2 Rebooting...
3 <!--NeedCopy-->
```

The subnet mask, NSIP, and gateway values are saved in the configuration file.

Note: For information about deploying a high availability (HA) pair, see [High Availability](#).

## Using the NetScaler serial console

When you first install the appliance, you can configure the initial settings by using the serial console. With the serial console, you can change the system IP address, create a subnet or mapped IP address, configure advanced network settings, and change the time zone.

**Note:** To locate the serial console port on your appliance, see the front panel illustration of your specific appliance.

### Configure initial settings by using a serial console

1. Connect the console cable into your appliance. For more information, see “Connecting the Console Cable” in [“Installing the Hardware”](#).
2. Run the vt100 terminal emulation program of your choice on your computer to connect to the appliance and configure the following settings: 9600 baud, 8 data bits, 1 stop bit, parity, and flow control set to NONE.
3. Press ENTER. The terminal screen displays the Logon prompt.

**Note:** You might have to press ENTER two or three times, depending on which terminal program you are using.

4. Log on to the appliance with the administrator credentials. In **User Name**, type `nsroot`. In **Password**, if the earlier default password does not work, try typing the serial number of the appliance. The serial number bar code is available at the back of the appliance. Citrix recommends that you change the password after the first logon. For information about changing the password, see [Change the administrative password](#).
5. At the prompt, type `config ns` to run the NetScaler configuration script.
6. To complete the initial configuration of your appliance, follow the prompts.

**Note:** To prevent an attacker from breaching your ability to send packets to the appliance, choose a non-routable IP address on your organization’s LAN as your appliance IP address.

You can replace steps 5 and 6 with the following commands. At the NetScaler command prompt, type:

```
1 set ns config -ipaddress<IPAddress> -netmask<subnetMask>
2 add ns ip<IPAddress> <subnetMask> -type<type>
3 add route<network> <netmask> <gateway>
4 set system user <userName> -password
5 save ns config
6 reboot
7 <!--NeedCopy-->
```

### Example:



```
1 set ns config -ipaddress 10.102.29.60 -netmask 255.255.255.0
2 add ns ip 10.102.29.61 255.255.255.0 -type snip
3 add route 0.0.0.0 0.0.0.0 10.102.29.1
4 set system user nsroot -password
5 Enter password: *****
6 Confirm password: *****
7 save ns config
8 reboot
9 <!--NeedCopy-->
```

You have now completed the initial configuration of your appliance.

## Using DHCP for initial access

Note: The terms NetScaler appliance and appliance are used interchangeably.

For initial configuration of a NetScaler appliance, the Dynamic Host Configuration Protocol (DHCP) can eliminate dependency on the console. DHCP provides a subnet IP (SNIP) address at which you can access the appliance to configure it remotely. You can also use DHCP after initial configuration if, for example, you want to move an appliance to a different subnet.

To use DHCP, you must first specify the appliance vendor class identifier on a DHCP server. Optionally, you can also specify the pool of IP addresses from which your NetScaler appliance can acquire an IP address. If a pool is not specified, the address is acquired from the general pool.

A new NetScaler appliance does not have a configuration file. When you connect an appliance without a configuration file to the network, its DHCP client automatically polls the DHCP server for an IP address. If you have specified the appliance vendor class identifier on the DHCP server, the server returns an address. You can also enable the DHCP client on a previously configured appliance.

## Prerequisites

To use DHCP, you must:

1. Note the system ID (`sysid`) on the serial number sticker on the back panel of the appliance. On an older appliance, the system ID might not be available. In this case, use the MAC address instead of the system ID.
2. Set up a DHCP server and configure it with the appliance vendor class identifier.

## Configure a Linux/UNIX DHCP server for the NetScaler appliance

1. Specify “citrix-NS” as the vendor class identifier for the NetScaler appliance by adding the following configuration to the server’s `dhcpd.conf` file. The subclass declaration must be inside

the subnet declaration.

```

1 option space auto;
2   option auto.key code 1 = text;
3
4   class "citrix-1" {
5
6       match option vendor-class-identifier;
7   }
8
9
10  subclass "citrix-1" "citrix-NS"{
11
12      vendor-option-space auto;
13      option auto.key "citrix-NS";
14  <!--NeedCopy-->

```

**Note:** The location of the `dhcpd.conf` file can be different in different versions and flavors of the Linux/UNIX-based operating system. For example, in FreeBSD 6.3 the file is present in the `/etc` folder. For the location, see the [dhcpd manpage](#) of the DHCP server.

1. If you do not want NetScaler appliances to use IP addresses from the general pool, specify a pool of addresses for the appliance. Include this pool declaration inside the subnet declaration. For example, adding the following configuration to the `dhcpd.conf` file specifies a pool of IP addresses ranging from 192.168.2.120 to 192.168.2.127.

```

1 pool {
2
3   allow members of "citrix-1";
4   range 192.168.2.120 192.168.2.127;
5   option subnet-mask 255.255.255.0;
6   }
7
8  <!--NeedCopy-->

```

1. Terminate the DHCP process and restart it to reflect the change to the configuration file. At the shell prompt, type:

```

1 killall dhcpd
2 dhcpd&
3 <!--NeedCopy-->

```

#### Sample DHCP configuration (dhcpd.conf)

```

1 option space auto;
2 option auto.key code 1 = text;
3
4 class "citrix-1" {
5
6     match option vendor-class-identifier;

```

```
7 }
8
9
10 subnet 192.168.2.0 netmask 255.255.255.0 {
11
12 option routers10.217.242.1;
13 option domain-name"jeffbr.local";
14 option domain-name-servers8.8.8.8;
15 default-lease-time 21600;
16 max-lease-time 43200;
17 subclass "citrix-1" "citrix-NS" {
18
19 vendor-option-space auto;
20 option auto.key "citrix-NS";
21 }
22
23 pool {
24
25 allow members of "citrix-1";
26 range 192.168.2.120 192.168.2.127;
27 option subnet-mask 255.255.255.0;
28 }
29
30 }
31
32 <!--NeedCopy-->
```

1. Open Server Manager and make sure DHCP service is running.
2. Open **DHCP Manager**, click **DHCP**, and select **IPv4**.
3. To configure Vendor Class as `..citrix-NS` right click **IPv4** and select **Define Vendor Classes**. Add a new class by specifying a display name, description, and “.citrix-NS” as the ASCII value. Click **OK**.
4. Create a scope to configure IP range, subnetwork, DNS server, WIN server, default Gateway, and excluded IP address range. To create a scope, in the **IPv4** list, right-click **Scope Options** and enter a name and description. Click **Next**.
5. Provide an IP address range and subnet mask corresponding to the interface IP address bound to the Server. Click **Next**.
6. To exclude an IP address, add it in **Add Exclusion and Delay**. Click **Next**.
7. Add a lease duration and click **Next**.
8. Select “Yes, I want to configure these options now” and click **Next**.
9. Optionally, provide a default gateway and click **Next**.
10. Optionally, provide a domain name and a DNS server, and click **Next**.
11. Optionally, provide a WINS server, and click **Next**.

12. Activate scope by selecting “Yes, I want to activate this scope now,” and click **Next**.
13. Click **Finish**. You can view the configured scope in the IPv4 tab.

### Implementing an initial NetScaler configuration from a remote computer

When a new NetScaler appliance starts, it automatically polls the DHCP server for an IP address and provides the DHCP server with its `sysid`. This action is also true for any appliance that does not have a configuration file. The DHCP server selects one IP address from its pool and assigns it as a subnet IP (SNIP) address to the appliance. The DHCP server includes the `sysid` of the appliance and the IP address that it assigns to the appliance in the server’s `dhcpd.leases` file. To find the IP address of your appliance, look in the `dhcpd.leases` file for the last entry with the `sysid` of your appliance in the `uid` or `client-hostname` field. Verify that the binding state in this entry is active. If the binding state is not active but free, the IP address is not yet associated with the appliance.

You can use this address to connect to the appliance and remotely configure the initial settings. For example, you can change the IP address, subnet mask, and gateway settings that were fetched from the DHCP server. After completing the initial configuration, you can manually return the DHCP IP address to the server pool. Alternatively, restarting the appliance automatically releases the DHCP IP address back to the server pool.

You can find out the SNIP address assigned to the appliance from the NetScaler console or from the DHCP server.

**Find the SNIP address from the NetScaler console** At the console prompt, type:

```
1 sh dhcpParams
2 DHCP Client on next reboot is ON
3 DHCP Client Current State: Active
4 DHCP Client Default route save: OFF
5 DHCP acquired IP:192.168.2.127
6 DHCP acquired Netmask:255.255.255.0
7 DHCP acquired Gateway:192.168.2.1
8 Done
9 <!--NeedCopy-->
```

**Find the SNIP address from the DHCP server** Look in the `dhcpd.leases` file for the last entry with the `sysid` of your appliance in the `uid` or `client-hostname` field.

#### Example:

The following entry in a DHCP server’s `dhcpd.leases` file verifies the binding state of the appliance whose `sysid` is `45eae1a8157e89b9314f`.

```

1 lease 192.168.2.127 {
2
3   starts 3 2013/08/19 00:40:37;
4   ends 3 2013/08/19 06:40:37;
5   cltt 3 2013/08/19 00:40:37;
6   binding state active;
7   next binding state free;
8   hardware ethernet 00:d0:68:11:f4:d6;
9   uid "45eae1a8157e89b9314f";
10  client-hostname "45eae1a8157e89b9314f";
11 <!--NeedCopy-->

```

In the preceding example, the binding state is ACTIVE and the IP address assigned to the appliance is 192.168.2.127.

The following table describes DHCP-related CLI commands that you might want to use when configuring a new NetScaler appliance.

Table 2. NetScaler CLI commands for using DHCP with a new NetScaler appliance

Task	At the command prompt, type
To verify the DHCP fetched details, such as IP address, subnet mask, and gateway on the appliance	sh dhcpParams
To release the DHCP IP address and return it to the IP address pool on the DHCP server when the NetScaler configuration is complete	release dhcpIP

**Using DHCP when a configuration file is present**

If you need to move a NetScaler appliance to a different subnet, you can use DHCP to access an appliance that already has a configuration file. Before moving the appliance, enable its DHCP client and save the configuration. As a result, when the appliance restarts, it automatically polls the DHCP server for an IP address. Enable the DHCP client and save the configuration before shutting down the appliance. If you did not enable, you need to connect to the appliance through the console and dynamically run the DHCP client on the appliance. The DHCP server provides an IP address, a gateway, and a subnet mask. You can use the IP address to access the appliance and configure the other settings remotely.

If the DHCP client is enabled in the configuration file, disable it and then save the configuration file. If the DHCP client is enabled, the appliance polls the DHCP server again for an IP address when it restarts.

The CLI commands associated with each task are listed:

- To dynamically run the DHCP client to fetch an IP address from the DHCP server

```
set dhcpParams dhcpClient on
```

- To configure the DHCP client to run when the appliance restarts

```
set dhcpParams dhcpClient on  
save config
```

- To prevent the DHCP client from running when the appliance restarts

```
set dhcpParams dhcpClient off  
save config
```

**Note:** This command is required only if the ON setting was saved.

- To save the DHCP acquired route so that it is available when the appliance restarts

```
> set dhcpParams -dhcpclient on -saveroute on  
> save config
```

- To prevent saving the DHCP acquired route (default behavior)

```
set dhcpParams -dhcpclient on -saveroute off  
save config
```

**Note:** This command is required only if the ON setting was saved.

## Access a NetScaler appliance by using SSH keys and no password

If you administer many NetScaler appliances, storing and looking up passwords for logging on to individual appliances can be cumbersome. To avoid being prompted for passwords, you can set up secure shell access with public key encryption on each appliance.

NetScaler features can also use SSH key based authentication for internal communication when the internal user is disabled (by using the `set ns param -internaluserlogin disabled` command). In such cases, the key name must be set as `ns_comm_key`.

To set up access using SSH keys, you must generate the public-private key pair on a client and copy the public key to the remote NetScaler appliance.

## Generate the keys and connect to a remote NetScaler appliance by using SSH keys

1. On a client (Linux client or a NetScaler) change the directory to `/root/.ssh`.

```
cd /root/.ssh
```

2. Generate the public-private key pair.

```
ssh-keygen -t <key_type> -f <optional_key_file_name>
```

**Example:**

To create an RSA key with default file name.

```
ssh-keygen -t rsa
```

3. Press ENTER when prompted for a file name for the key pair.

**Note:**

- If you update the default file name for the key pair, use the new name instead of the default name in the rest of this procedure.
- If you want to disable the internal user login, use “ns\_comm\_key” as the file name for the public-private key pair.

4. Press ENTER two times when prompted for a passphrase.

Note: If the client is a NetScaler appliance, move the private key file to a persistent location such as the subdirectories of the /flash and /var directories.

5. Log on to the remote NetScaler appliance from the client by using FTP, and perform the following:

- a) Change directory to /nsconfig/ssh. At the prompt, type:

```
cd /nsconfig/ssh
```

- b) Use the binary transfer mode to copy the public key to this directory.

```
bin  
put id_rsa.pub
```

6. Open a connection to the remote NetScaler appliance by using an SSH client, such as PuTTY, and perform the following:

- a) Log on to the remote appliance using the administrator credentials.

- b) Go to the NetScaler shell.

```
shell
```

- c) At the shell prompt, change the directory to /nsconfig/ssh.

```
root@ns# cd /nsconfig/ssh
```

- d) Append the public key to the authorized\_keys file. At the shell prompt, type:

```
root@ns# cat id_rsa.pub >> authorized_keys
```

**Note:** If the `authorized_keys` file does not exist on the appliance, you must first create the file and then append the contents.

- e) Change the permission of the `/flash`, `nsconfig`, and `ssh` directories to 755.

```
root@ns# chmod 755 /flash
root@ns# chmod 755 /flash/nsconfig
root@ns# chmod 755 /flash/nsconfig/ssh
```

- f) Change the permission of the `authorized_keys` file to 744.

```
root@ns# chmod 744 authorized_keys
```

- g) Optionally, remove the public key.

```
root@ns# rm id_rsa.pub
```

7. On the client, verify that you can connect to the remote NetScaler appliance by using SSH, without entering the password.

If using the default file name for the public-private key pair.

```
ssh <user_name>@<CitrixADCIPAddress>
```

If using “`ns_comm_key`” (when internal user is disabled) for the public-private key pair.

```
ssh -i /nsconfig/ssh/ns_comm_key <user_name>@<CitrixADCIPAddress>
```

If using any other name for the public-private key pair.

```
ssh -i <path_to_client_private_key> <user_name>@<CitrixADCIPAddress>
>
```

## Change the administrative password

The default user account is the administrative account, which provides complete access to all features of the NetScaler appliance. To preserve security, the administrative account must be used only when necessary. Only individuals whose duties require full access must know the password for the administrative account.

**Note:** Citrix recommends changing the administrative password frequently.

### Change the administrative password by using the GUI

1. Log on to the appliance by using the administrative credentials.
2. Navigate to **System > User Administration > Users**.
3. In the **Users** pane, click the default user account, and then click **Change Password**.



4. In the **Change Password** dialog box, in **Password** and **Confirm Password**, type the password of your choice.
5. Click **OK**.

### Change the administrative password by using the CLI

At the command prompt, type:

```
1 set system user <userName> -password
2 <!--NeedCopy-->
```

#### Example:

```
1 set system user nsroot -password
2 Enter password: *****
3 Confirm password: *****
4 Done
5 <!--NeedCopy-->
```

## Lights out management port of the NetScaler MPX appliance

December 31, 2023

Some NetScaler appliances have an Intelligent Platform Management Interface (IPMI), also known as the lights out management (LOM) port, on the front panel of the appliance. You can use the LOM port to remotely monitor and manage the appliance, independently of the NetScaler software.

Connect the LOM port to a dedicated channel that is separate from the data channel, to maintain connectivity to the appliance even if the data network is down. You eliminate the data cable and data network as a single point of failure.

You can access the LOM port through a browser and use the GUI (GUI) for most tasks. All tasks can be performed through the NetScaler shell.

You can use either the GUI or a shell for the following tasks:

- Configuring the network settings
- Health monitoring
- Power control operations
- Factory reset
- Enable or disable RAKP

Different NetScaler ADC appliances support different shells:

- For FreeBSD based NetScaler MPX appliances, use the `bash nsroot` shell (also known as NS Shell).
- For Linux based appliances, use the Linux bash root shell.

**Note**

The terms LOM and Baseboard Management Controller (BMC) are used interchangeably.

**LOM support matrix**

The LOM support matrix shows the recommended LOM firmware version for different platforms.

Platform	Recommended Version
MPX 5900	4.61
MPX 8015	3.21
MPX 8900	4.61
MPX 9100	2.13.12
MPX 11500	3.39
MPX 11500 NEBS	3.39
MPX 11515	3.39
MPX 14000	4.14
MPX 14000-40S	4.14
MPX 14000 FIPS	4.14
MPX 14000-40G	4.14
MPX 15000	5.56
MPX 15000-50G	5.56
MPX 16000	2.13.12
MPX 17500	3.39
MPX 17550	3.39
MPX 22000	3.24
MPX 24000	3.24
MPX 25000A	4.14
MPX 25000TA	4.14

---

Platform	Recommended Version
MPX 25000-40G	4.14
MPX 26000	5.56
MPX 26000-50S	5.56
MPX 26000-100G	5.56

---

## Set the LOM password length using the IPMI tool

December 31, 2023

On NetScaler MPX, you can set different lengths (between 16 and 20 characters) for the LOM password using the IPMI tool. There are no restrictions to changing or creating the LOM password using the LOM GUI. However, there are some restrictions while using the IPMI tool for this task.

### To set the LOM password length using the IPMI tool

1. Log in to the NetScaler shell.
2. Type `ipmitool user set password <userid> <password> <20>`

If you don't type 20 at the end, you cannot log in to the LOM GUI with a password of length greater than 16 characters. You don't need to type 20 if your password length is fewer than 16 characters. To include special characters in your password, enclose it within double quotation marks.

### Examples

Here are some sample commands with output by varying the LOM password length starting with 19 characters and decreasing to 17 characters, which require <20> at the end of the command.

Example#1 - LOM password length = 19

```
root@ns# ipmitool user set password 2 examplelompassword1 20
```

Set user password command successful (user 2)

Example#2 - LOM password length = 18

```
root@ns# ipmitool user set password 2 examplelompassword 20
```

Set user password command successful (user 2)

Example#3 - LOM password length = 17

```
root@ns# ipmitool user set password 2 examplelompasswor 20
```

Set user password command successful (user 2)

### Points to note

- For MPX 5900, MPX 8900, MPX 14000, and MPX 15000 platforms, the LOM firmware supports a password length of up to 19 characters.
- For MPX 9100 and MPX 16000 platforms, the LOM firmware supports a password length of up to 20 characters.

## Configure the network settings on the LOM port

December 31, 2023

The default IP address for initial access to the LOM port is 192.168.1.3. Change the default credentials and IP address the first time you log on. All LOM GUI operations require you to connect to the appliance by typing the LOM IP address in a web browser and then entering the administrator credentials. Alternatively, you can access LOM functionality through the command line by using the `ipmitool` utility. Using the `ipmitool` utility remotely, you can:

- Determine the LOM firmware version number.
- Perform warm and cold restarts.
- Configure LOM network settings.
- Monitor the health of the appliance.
- Perform power control operations.

The utility is available for download at <http://ipmitool.sourceforge.net/>. The `ipmitool` utility is also included in NetScaler MPX and CloudBridge/SDX (dom0) appliances for initial LOM port network configuration. When using the shell, you can choose to use DHCP or static IP settings for initial network configuration. After configuring the network settings, you can use the `ipmitool` commands over the network. For example, the BMC firmware revision command would need the same user name, password, and IP address that is used to access the BMC/LOM GUI port.

For initial configuration, connect the network port on your laptop or workstation directly to the LOM port with a crossover cable. Or connect to a switch in the same local subnet(192.168.1.x) as the LOM port. Assign a network-reachable IP address and change the default credentials. After saving the new settings, the LOM restarts and the changes take effect. After the restart, you must use the new address to access to the LOM.

If you make a mistake that results in losing network connectivity at both the old and new IP addresses, you must use the local shell method to recover.

See the [Secure Deployment Guide](#) for best practices for managing administrative credentials and configuring your network for a secure LOM deployment.

**Tip:** For first-time setup in a network, to facilitate troubleshooting, make sure that a laptop/PC is connected directly to the LOM port. Do the following if you can ping and access the LOM GUI at the default IP address (192.168.1.3) by using static addressing on the laptop/PC, but remote access does not work.

- Take a closer look at network firewall settings and access control list (ACL) policies of all network devices along the network path.

**Tip:** If some LOM GUI features work but others do not (for example, normal ADC console output is visible in the ADC console window in the LOM GUI, but typing in the console does not work), try the preceding method to isolate the cause to the specific BMC protocol being blocked by the network.

**Tip:** Use the iKVM (HTML5) feature to access the LOM GUI. Alternately, use Java. Ensure that the latest Java updates are installed on your computer.

### Configure the NetScaler LOM port by using the GUI

1. In a web browser, type <http://192.168.1.3> and enter the default user credentials.  
Note: The NetScaler LOM port is preconfigured with IP address 192.168.1.3 and subnet mask 255.255.255.0.
2. On the Configuration tab, click Network and type new values for the following parameters:
  - IP Address—IP address of the LOM port
  - Subnet Mask—Subnet mask used to define the subnet of the LOM port
  - Default Gateway—IP address of the router that connects the LOM port to the network
3. Click Save.
4. If you want to change the user credentials, navigate to **Configuration > Users**, select the user, click **Modify User**, and change the credentials.

### Configure the NetScaler LOM port by using the shell

**Note:** You need superuser (admin) credentials to access the shell.

1. Configure the IP addressing mode:
  - To use DHCP, at the shell prompt, type:  

```
ipmitool lan set 1 ipsrc dhcp
```

No further IP-level configuration is required.

- To use static addressing, at the shell prompt type:
  - a) `ipmitool lan set 1 ipsrc static`
  - b) `ipmitool lan set 1 ipaddr <LOM IP address>`
  - c) `ipmitool lan set 1 netmask <netmask IP address>`
  - d) `ipmitool lan set 1 defgw ipaddr <default gateway IP address >`

The BMC reboots to apply the changes. Pings to the BMC succeed after approximately 60 seconds.

2. Optionally, to configure Ethernet VLAN ID and priority, at the NetScaler shell prompt type:

- `ipmitool lan set 1 vlan id <off|<ID>>`
- `ipmitool lan set 1 vlan priority <priority>`

You can either disable or enable the VLAN. Set the VLAN ID to a value from 1 to 4094, and the VLAN priority to a value from 0 to 7. After the network settings have been correctly applied, you can access the `ipmitool` remotely from a physically separate machine over the network. For remote access, enter the BMC user name, BMC password, and the BMC IP address. For example, to run the `ipmitool mc info` command, at the shell prompt on a remote machine, type:

```
ipmitool -U <username> -P <password> -H <bmc IP address> mc info
```

## Obtain health monitoring information

There are two ADC MIBs: the NetScaler software management MIB and the ADC IPMI LOM hardware management MIB. The software management MIB is primarily used for monitoring the application software and the application software's utilization of hardware resources, such as CPU % and memory %. It provides a high level view of the appliance and is therefore suitable for the application monitoring function carried out by an application group within an organization. The LOM MIB is used for monitoring the hardware health and therefore provides a lower level view of the appliance. It is more applicable to the network monitoring function carried out by a network monitoring group.

The LOM SNMP traps in the LOM MIB report hardware failures. The ADC SNMP traps in the ADC MIB report software failures and hardware load issues.

The ADC MIB has a small subset of hardware sensors. It does not cover any BIOS level failures, because the BIOS checks the hardware primarily during boot time, before the NetScaler software starts. If the BIOS detects a failure, it does not load the boot loader. If the boot loader does not load, the operating system does not load, and therefore the ADC SNMP software service responsible for sending the traps does not load.

The NetScaler software Management MIB issues a warning under the following conditions only:

1. If the failure is gradual enough for the main CPU to issue an SNMP alert. An electrical failure close to the CPU, such as a failed electrical capacitor, occurs too quickly for the CPU to issue an alert.
2. If the failure happens after the BIOS, Operating System, and SNMP service have started and normal boot-up has been successful.
3. If the failure happens while the operating system and other system software are in a stable enough state for the SNMP software service to run.

Whenever the ADC MIB is unable to report these warnings, because of hardware or software failure, the LOM MIB monitors and reports the warnings. The LOM microcontroller operates independently of the NetScaler software. To monitor the hardware and software of the NetScaler appliance, you must use both the ADC MIB and the LOM MIB.

The ADC IPMI LOM hardware management MIB SNMP firmware runs on the BMC microcontroller chip. The BMC chip CPU sends a warning in the case of a hardware failure, regardless of whether any of the preceding conditions occur. For example, if the BIOS halts the system during boot-up because of a memory DIMM failure, the BMC chip uses the BIOS POST code snooping mechanism to detect the failure. And then sends a bad DIMM SNMP alert.

You can log on to the LOM port to view the health information about the appliance. All system sensor information, such as system temperature, CPU temperature, and status of fans and power supplies, appears on the sensor readings page. The Event Log records time stamps of routine events such as a power cycle, in addition to recording hardware-failure events. If SNMP traps are enabled, these events can be sent to your SNMP Network Monitoring software. For more information about how to set up an SNMP alert, see [Configuring SNMP Alerts](#).

1. In the **Menu** bar, click **System Health**.
2. Under **Options**, click **Sensor Readings**.

## Install the MIB

Download the IPMI SNMP management information base (MIB) for your LOM firmware version, and import it into the SNMP monitoring software.

For a sample configuration, see <http://www.net-snmp.org/tutorial/tutorial-5/commands/snmptrap.html>. For the exact steps of this procedure specific to your environment, contact your SNMP network monitoring software provider.

## Configure SNMP alerts

You can configure SNMP alerts on the LOM. Optionally, you can configure an alert to send emails.

To configure the alerts, you can use the LOM GUI or the NetScaler shell.

### Configure SNMP alerts on the LOM by using the GUI

1. Download the IPMI View utility from <ftp://ftp.supermicro.com/utility/IPMIView/> and install it on your computer. Use this utility to test the configuration. For more information, see the section about configuring the alert settings in the IPMI View User Guide at <http://supermicro.com>.
2. Open the IPMI View utility.
3. In the LOM GUI, navigate to **Configuration > Alerts**, click Alert No 1, and then click **Modify**.
4. Select the severity level of the events for which to generate alerts.
5. Set Destination IP to the IP address at which you installed the IPMI View utility.
6. Optionally, to receive alerts by email, specify an email address. To avoid receiving email for routine alerts, specify a severity higher than Informational.
7. Click **Save**.
8. The LOM starts sending alerts to the IPMI View utility within in a minute or two. After the IPMI View utility starts receiving alerts from the LOM, reconfigure the destination IP address to point to your SNMP Network Management Software, such as HP OpenView.

### Set up SNMP alerts on the LOM by using the NetScaler shell

To customize your filter and policy settings, see the IPMI Specification 2.0 rev. 1.1 documentation.

The latest IPMI specifications are available from the IPMI section of the Intel website:

<http://www.intel.com/content/www/us/en/servers/ipmi/ipmi-specifications.html>

Usually, customization in the SNMP Network Management Software is the preferred method, because it can be done one time at a central location. Therefore, the following settings send all events for all sensors to the SNMP network management software. These events are low traffic events and therefore do not result in any significant network usage.

**Set up SNMP filters** The following commands set up SNMP to allow all events:

```
ipmitool raw 4 0x12 0x6 0x10 0x80 1 1 0 0xff 0xff 0xff 0xff 0xff 0xff  
0xff 0 0xff 0 0 0xff 0 0 0xff 0
```

**Set up a policy list** The following command creates a policy list for all sensors and events:

```
ipmitool raw 4 0x12 9 0x10 0x18 0x11 0x81
```

**Set up the destination address for SNMP events** The following command sets up a destination IP address for an SNMP event:

```
ipmitool lan alert set 1 1 ipaddr <x.x.x.x>
```



Where, <x.x.x.x> is the IP address to which the SNMP event is sent.

**Specify an SNMP community string name** At the prompt, type:

```
ipmitool lan set 1 snmp <community string>
```

## Install a certificate and key on the LOM GUI

December 31, 2023

Citrix recommends using HTTPS to access the LOM GUI. To use HTTPS, you must replace the default SSL certificate with one from a trusted certificate authority and upload a private key to the LOM GUI.

To encrypt SNMP alerts, set up an SSL certificate and private key. In the GUI, navigate to **Configuration > SSL Certification** and apply the SSL certificate and private key. See the NetScaler Secure Deployment Guide for more information about how to securely deploy the LOM in your network. To enable encryption and learn the security measures for LOM, see [NetScaler Secure Deployment Guide](#).

If you make a mistake, you must restore the BMC to the factory defaults to erase the certificate and key. Use the following shell command:

```
1 ipmitool raw 0x30 0x40
2 <!--NeedCopy-->
```

**Note:** The certificate file must contain only the certificate. The certificate and key must not be in the same file. Make sure that the certificate contains only the certificate and that the key file contains only the key.

### Upload a trusted certificate and private key by using the LOM GUI

1. Navigate to **Configuration > SSL Certification**.

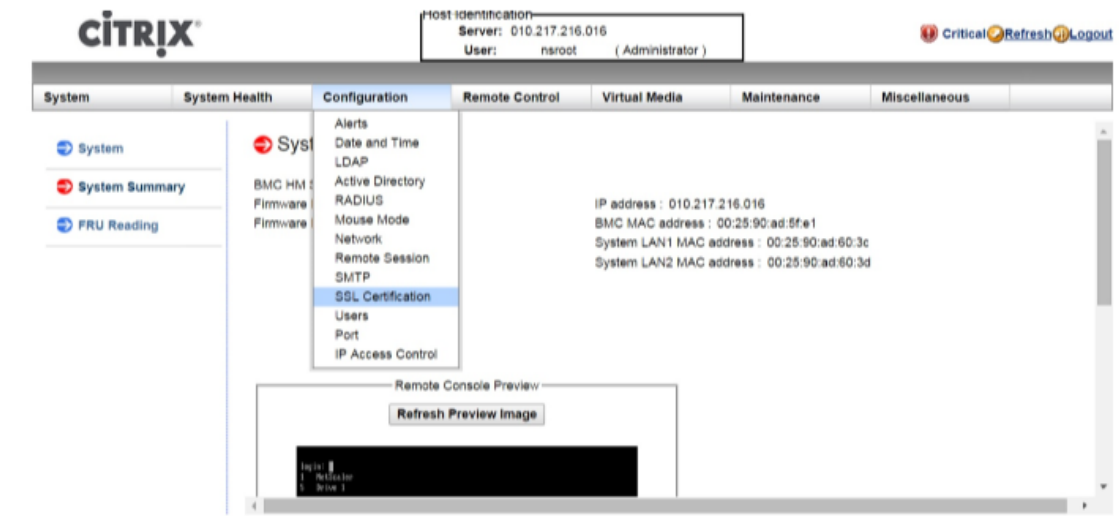

2. In the right pane, click the **Choose File** buttons to select a new SSL certificate and a new private key.

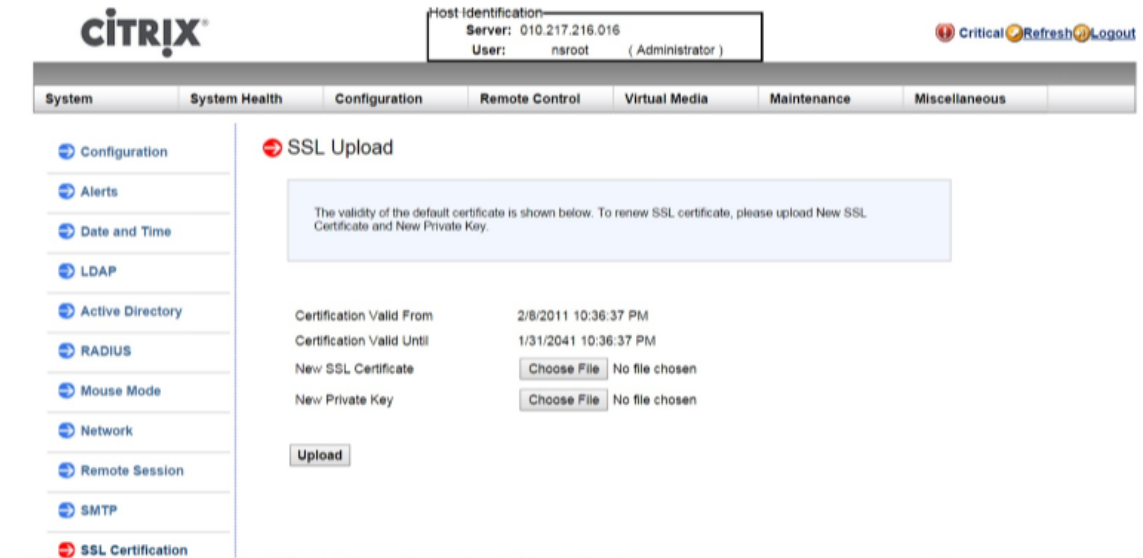

3. To verify that you have selected the correct certificate and private key, check the file names of the certificate and key, which appear next to the **Choose File** buttons.

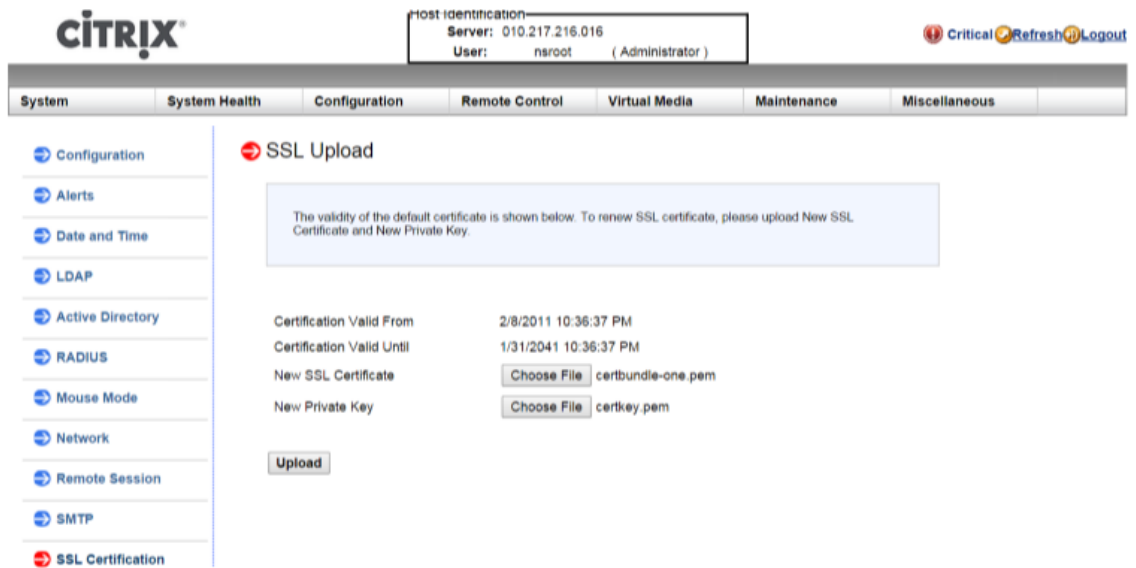

4. Click **Upload**. A message informs you that uploading a new SSL certificate replaces the existing (default) certificate.
5. Click **OK**.

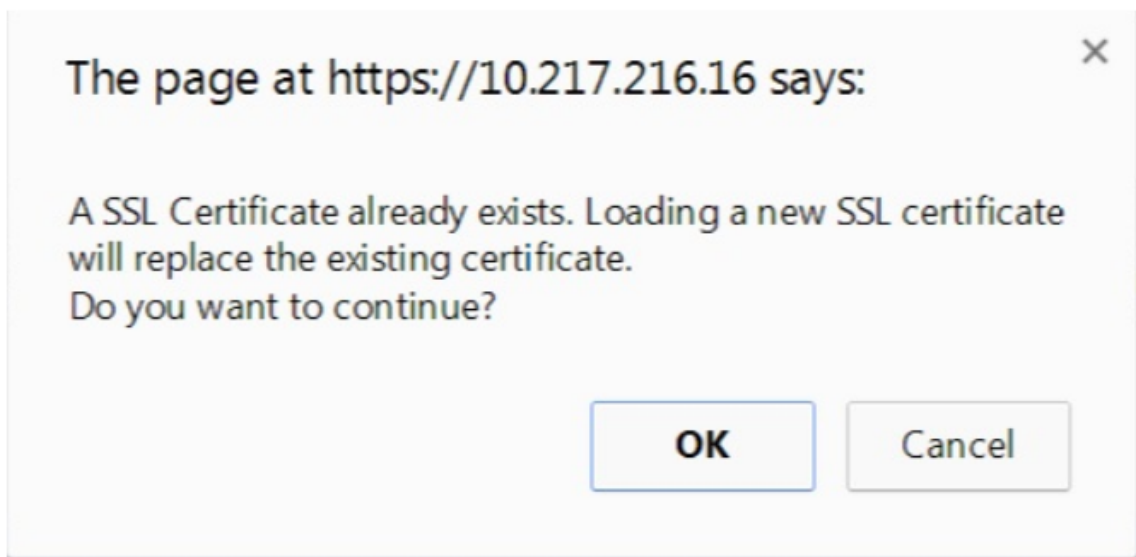

6. When a message informs you that the certificate and key have been uploaded successfully, click **OK** to reset the device.

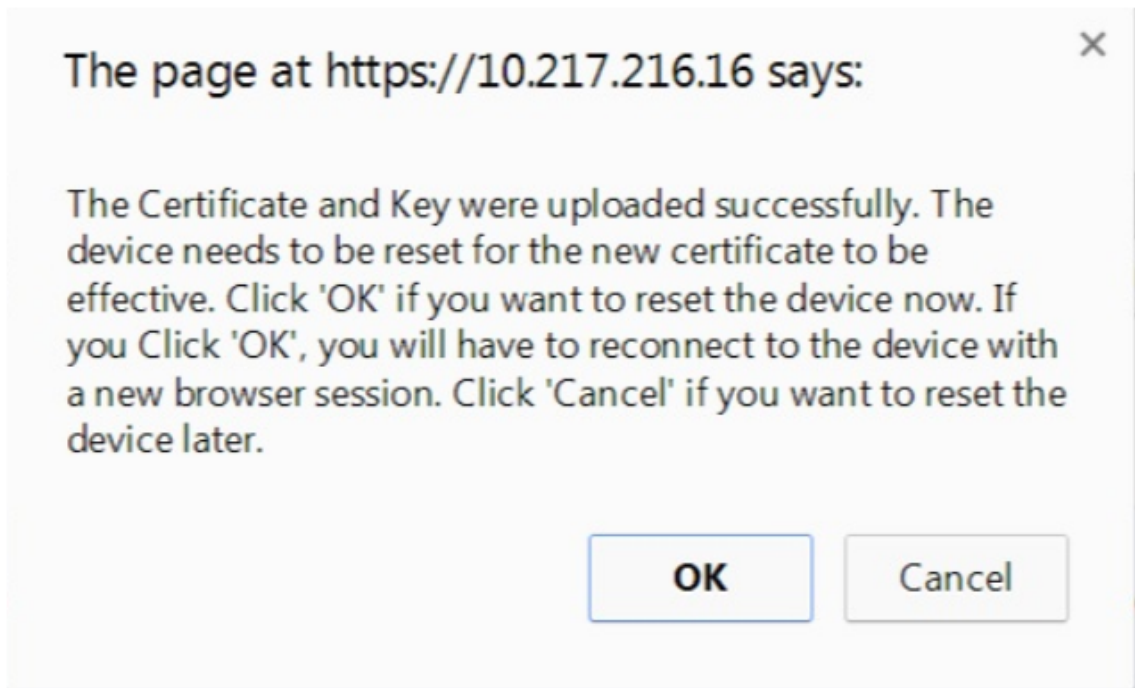

The reset takes approximately 60 seconds. You are then redirected to the logon page.

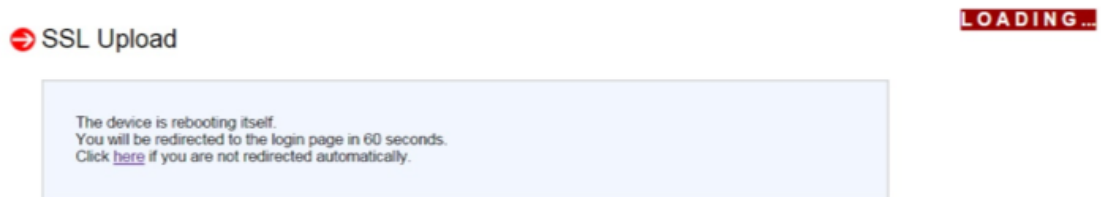

7. Log on to the LOM GUI by using your default credentials.  
Note: If the certificate or key is invalid, the BMC reboots, tries the new settings, and reverts to using the previous settings.
8. In the address bar, click the lock icon to display the connection tab, as shown in the following screenshot.

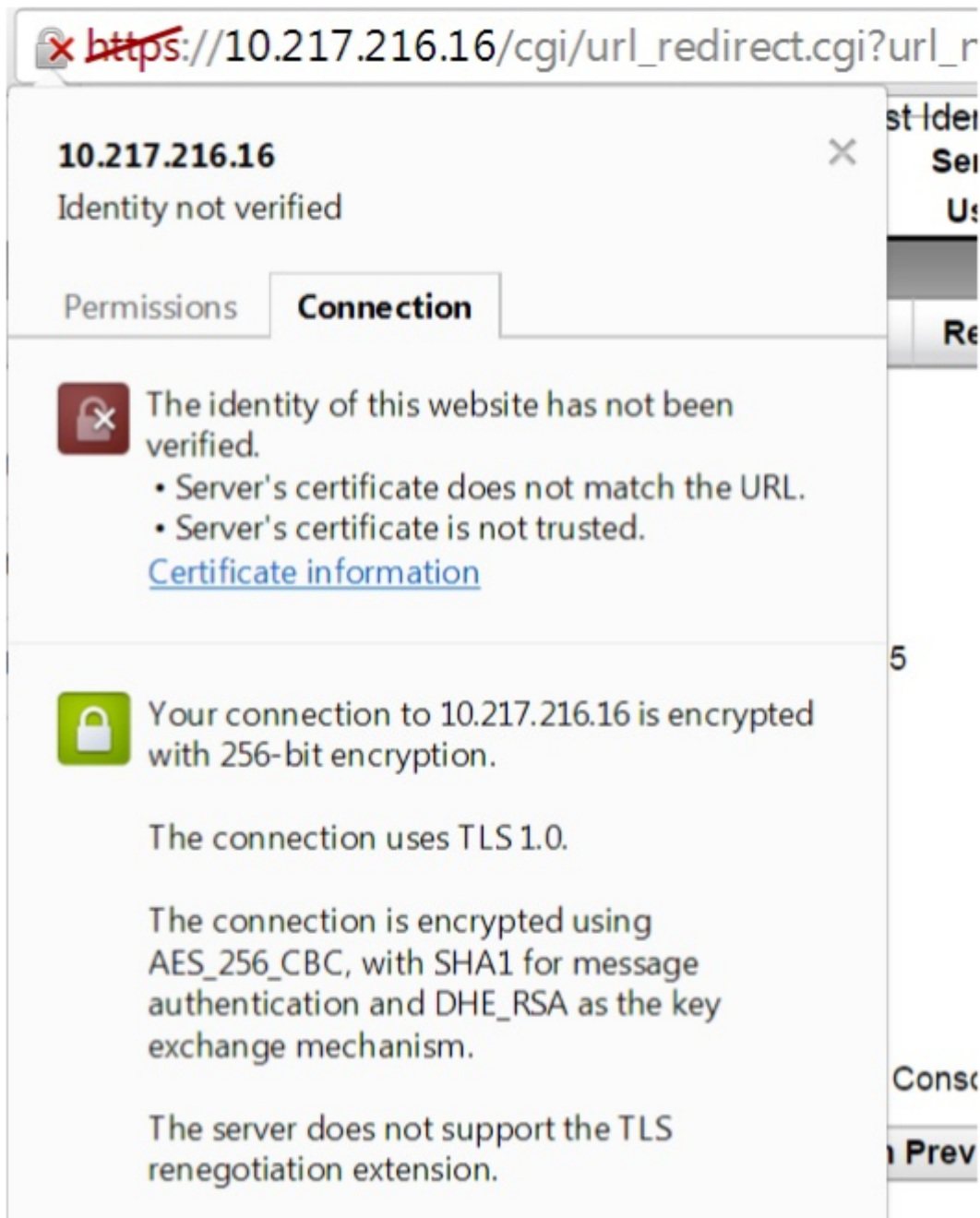

9. Click Certificate information to display details about the certificate that you uploaded.

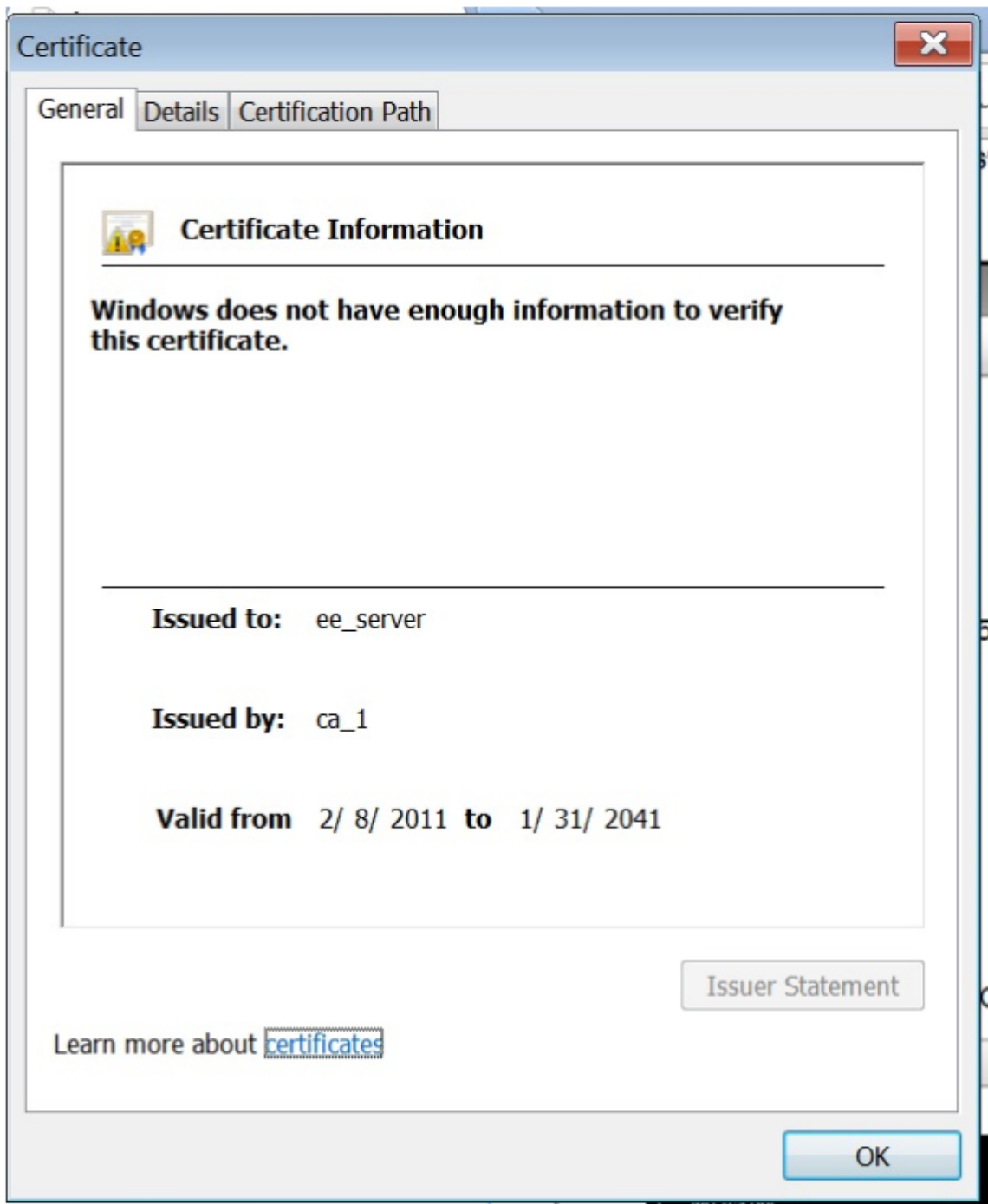

**Note:** Best practices for LOM and ADC security are covered in [NetScaler Secure Deployment Guide](#).

## Obtain the MAC address, serial number, and host properties of the appliance

December 31, 2023

A Media Access Control address (MAC address) is a unique identifier assigned to network interfaces for communication on the physical network segment. The serial number is on the back panel of the appliance. If you do not have easy access to the back panel, you can get the appliance's serial number by logging on to the LOM port. You can also retrieve the parameter settings assigned to the IP addresses, such as the state of ARP, ICMP, telnet, secure shell access, and dynamic routing.

### To obtain the MAC address, serial number, and host properties of the appliance by using the LOM GUI

1. In the **Menu** bar, click **Remote Control**.
2. Under **Options**, click **Console Redirection**.
3. Click **Launch Console**, and then click **Yes**.
4. Type the administrator credentials.
5. Type `show interface <management_interface_id>` to display the MAC address.
6. Type `show hardware` to display the serial number of the appliance.
7. Type `sh nsip` to display the host properties of the appliance.

### Obtain the MAC address and host properties of the BMC by using the appliance shell

At the shell prompt, type:

```
ipmitool lan print
```

#### Example:

```
1 Set in Progress      : Set Complete
2 Auth Type Support    : MD2 MD5 OEM
3 Auth Type Enable     : Callback : MD2 MD5 OEM
4                      : User      : MD2 MD5 OEM
5                      : Operator  : MD2 MD5 OEM
6                      : Admin    : MD2 MD5 OEM
7                      : OEM      :
8 IP Address Source    : Static Address
9 IP Address           : 192.168.1.3
10 Subnet Mask         : 255.255.255.0
11 MAC Address         : 00:25:90:3f:5e:d0
12 SNMP Community String : public
13 IP Header           : TTL=0x00 Flags=0x00 Precedence=0x00 TOS=0x00
```

```
14 BMC ARP Control      : ARP Responses Enabled, Gratuitous ARP
    Disabled
15 Gratuitous ARP Intrvl : 0.0 seconds
16 Default Gateway IP   : 0.0.0.0
17 Default Gateway MAC  : 00:00:00:00:00:00
18 Backup Gateway IP    : 0.0.0.0
19 Backup Gateway MAC   : 00:00:00:00:00:00
20 802.1q VLAN ID      : Disabled
21 802.1q VLAN Priority : 0
22 RMCP+ Cipher Suites  : 1,2,3,6,7,8,11,12,0
23 Cipher Suite Priv Max : aaaaXXaaaXXaaXX
24                       : X=Cipher Suite Unused
25                       : c=CALLBACK
26                       : u=USER
27                       : o=OPERATOR
28                       : a=ADMIN
29                       : O=OEM
30 <!--NeedCopy-->
```

## Perform power control operations by using the LOM port

December 31, 2023

Through the LOM port, you can remotely perform power control operations, such as graceful shutdown and restart, power cycling the appliance, and restarting the BMC microcontroller. A cold restart takes longer than a warm restart. In a cold restart, you switch off power to the appliance and then switch it back on.

### Perform power control operations by using the GUI

1. In the **Menu** bar, click **Remote Control**.
2. Under **Options**, click **Power Control**, and then select one of the following options:
  - **Reset System**—Gracefully restart the appliance. All operations on the appliance are stopped, no new connections to the client or server are accepted, and all existing connections are closed. This option is similar to a warm restart, such as by entering the reboot command. The BMC does not reboot itself during this operation.
  - **Power Off System –Immediate**—Disconnect power to the appliance immediately, without gracefully shutting down the appliance. The BMC continues to operate normally in this mode to allow the user to remotely power on the appliance. This option is the same as pushing the power button until the unit powers off.
  - **Power Off System –Orderly Shutdown**—Gracefully shut down the appliance, and then disconnect power to the appliance. This option has the same effect as pressing the power



button on the back panel of the appliance for less than four seconds. All operations on the appliance are stopped, no new connections to the client or server are accepted, and all existing connections are closed before the appliance shuts down. The BMC continues to operate normally in this mode to allow the user to remotely power on the appliance. This option is the same as entering the shutdown command in the appliance shell.

- **Power On System**—Switch on the appliance. The BMC does not reboot itself during this operation. This option is the same as pushing the power button.
- **Power Cycle System**—Switch off the appliance, and then switch it back on. The BMC does not reboot itself during this operation. This option is the same as pushing the power button until the unit powers off, and then pushing the power button to power on the unit.

3. Click **Perform Action**.

### **Perform a power cycle of the BMC**

A warm restart, cold restart, or a power cycle of the appliance, using the power button, does not include power cycling the BMC. The BMC runs on standby power directly from the power supply. Therefore, the state of the power button on the appliance does not affect the BMC. The only way to power cycle the BMC is to remove all power cords from the appliance for 60 seconds.

### **Perform power control operations on the BMC by using the appliance shell**

When performing either a warm or cold restart of the BMC microcontroller, you cannot communicate with the LOM port. Both actions restart the BMC but not the main CPU. To perform a warm restart of LOM from the appliance, type:

```
ipmitool mc reset warm
```

### **Perform a warm restart remotely from another computer on the network**

```
ipmitool -U <bmc_gui_username> -P <bmc_gui_password> -H <bmc IP address> mc reset warm
```

### **Perform a cold restart of the LOM from the appliance**

```
ipmitool mc reset cold
```

### **Perform a warm restart remotely from another computer on the network**

```
ipmitool -U <bmc_gui_username> -P <bmc_gui_password> -H <bmc IP  
address> mc reset cold
```

### **Perform a core dump**

If the appliance fails or becomes unresponsive, you can remotely perform a core dump. This procedure has the same effect as pressing the **NMI** button on the back panel of the appliance.

### **Perform a core dump by using the GUI**

1. In the **Menu** bar, click **Remote Control**.
2. Under **Options**, click **NMI**, and then click **Initiate NMI**.

### **Perform a core dump remotely from another computer on the network by using the shell**

At the shell prompt, type:

```
ipmitool -U <bmc_gui_username> -P <bmc_gui_password> -H <bmc IP  
address> chassis power diag
```

## **Restore the BMC configuration to factory defaults**

December 31, 2023

You can restore the BMC to its factory-default settings, including deleting the SSL Certificate and SSL key.

### **Reset the configuration to factory defaults by using the GUI**

1. Navigate to **Maintenance > Factory Default**.
2. Click **Restore**.

### **Reset the configuration to factory defaults by using the shell**

At the shell prompt, type:

```
ipmitool raw 0x30 0x40
```

## Use the BIOS POST code to detect errors

December 31, 2023

You can read the BIOS POST code by using the LOM GUI or the shell. To interpret the BIOS Beep codes, see [https://www.supermicro.com/manuals/other/AMI\\_AptioV\\_BIOS\\_POST\\_Codes\\_for\\_SM\\_Motherboards.pdf](https://www.supermicro.com/manuals/other/AMI_AptioV_BIOS_POST_Codes_for_SM_Motherboards.pdf).

### Read the BIOS post code by using the LOM GUI

Navigate to **Miscellaneous > BIOS Post Snooping**.

### Read the BIOS post code by using the shell

At the prompt, type:

```
ipmitool raw 0x30 0x2a
```

## Upgrade the LOM firmware on a NetScaler MPX appliance

December 31, 2023

Citrix has automated the upgrade of LOM firmware within NetScaler MPX software. It is no longer necessary to know your hardware platform or download any LOM firmware.

#### Note

This procedure requires two reboots to complete and therefore a disruption in production traffic is expected. Citrix recommends that you perform the upgrade during a maintenance window. In a high availability setup, perform the upgrade on the secondary node to minimize disruption to production traffic. Run the `upgrade_bmc.sh` script on the following supported platforms. The script is available in the `/netscaler` folder.

- MPX 5900
- MPX 8005
- MPX 8900
- MPX 9100
- MPX 11500
- MPX 11515

- MPX 14000
- MPX 15000
- MPX 16000
- MPX 22000
- MPX 25000
- MPX 26000

For information about upgrading the NetScaler appliance, see [Upgrade and downgrade a NetScaler appliance](#)

**Note**

If you cannot log into the LOM GUI on the MPX 5900, MPX 8900, MPX 15000, or MPX 26000, reset the LOM password by typing `shell` in the command prompt and then `ipmitool user set password 2 <your preferred password>` after upgrade to 5.56 or 4.61.

**Troubleshooting**

- Console redirection fails after upgrading the LOM to 4.61 on the MPX 5900 and MPX 8900 platforms or 5.56 on the MPX 15000 and MPX 26000 platforms.

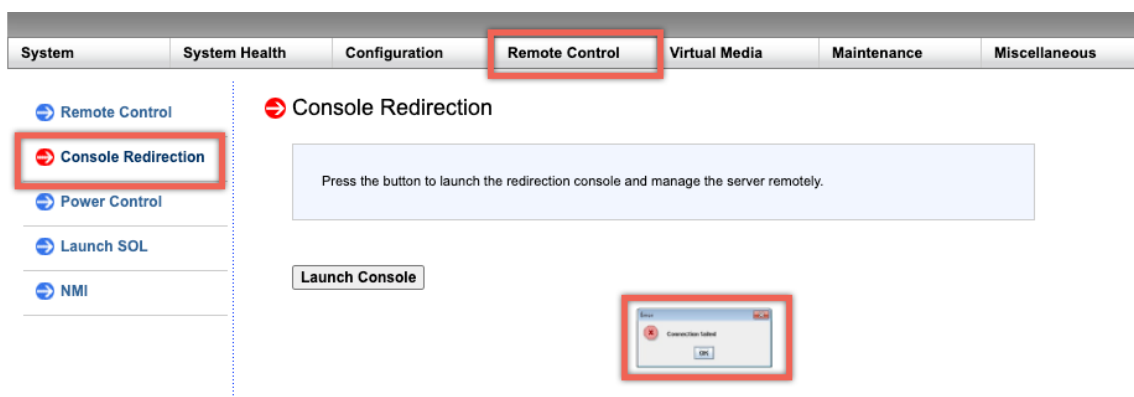

Perform a unit reset from the Maintenance tab, which resets the BMC.

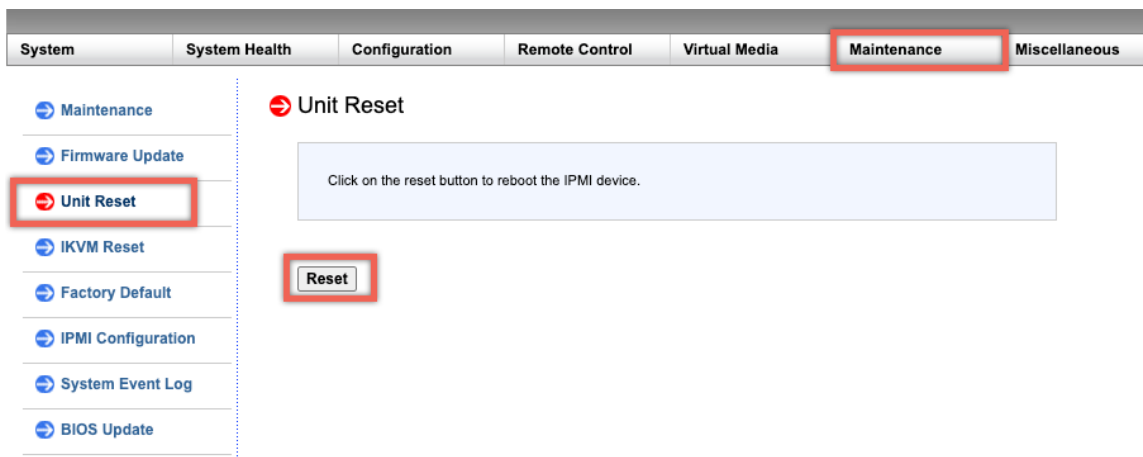

## Enable RADIUS authentication in the LOM GUI

December 31, 2023

RADIUS (Remote Authentication Dial-In User Service) is a network protocol that allows you to manage remote user authentication, authorization, and auditing.

### Configure RADIUS authentication in the LOM GUI

1. Log on to the LOM GUI.
2. Navigate to **Configuration > Radius**.
3. Select **Enable RADIUS**.
4. Specify the port and IP address of the RADIUS server.
5. Specify the secret (password) for the user to access the RADIUS server.
6. Click **Save**.

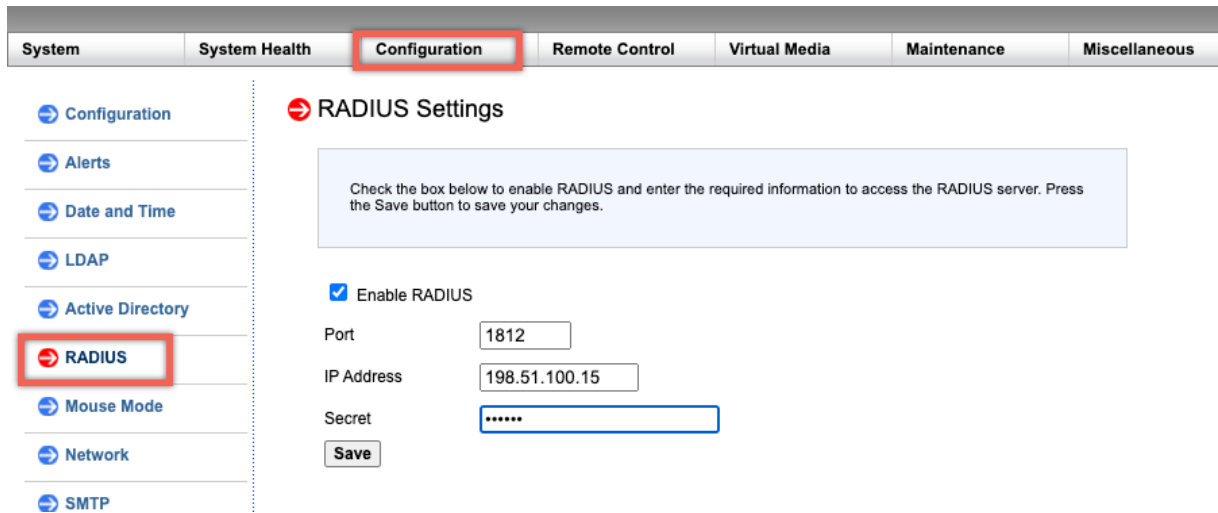

**Parameters:**

**RADIUS username and password:**

The RADIUS server determines the supported characters and lengths. BMC does not limit or filter any character.

On the MPX 8000/8600, MPX 14000, and MPX 25000 series platforms, BMC password length support: 1 character minimum, 16 character maximum.

On the MPX 8900, MPX 15000, and MPX 26000 series platforms, BMC password length: 1 character minimum, 64 character maximum.

**RADIUS secret:**

BMC valid characters are 0–9, a–z, A–Z, ! @, +, -, /, : and \_.

On the MPX 8000/8600, MPX 14000, and MPX 25000 series platforms, BMC secret length support: 1 character minimum, 31 character maximum.

On the MPX 8900, MPX 15000, and MPX 26000 series platforms, BMC secret length: 1 character minimum, 128 character maximum.

**Configure an external computer running Windows or Ubuntu OS to access the LOM using RADIUS’network protocol**

RADIUS is an application that runs on an external computer to access the Citrix LOM. Before you run RADIUS, you need to configure the user account and client information.

Perform the following actions:

1. Configure a user account in Ubuntu.
2. Configure client information in Ubuntu.

3. Start the RADIUS server in Ubuntu.
4. Add roles in Windows server.
5. Add an object –Group.
6. Add an object –User.
7. Add a network policy.
8. Add a vendor specific attribute.
9. Configure a RADIUS client.

For more information, see the documentation for Ubuntu.

## RAKP topology on NetScaler appliances

December 31, 2023

Remote Authenticated Key-Exchange Protocol (RAKP) is used with the IPMI tool for remote authentication. On NetScaler appliances that support RAKP, it is disabled by default. You can enable or disable it using one of the following methods:

1. LOM GUI
2. ADC shell

### Enable or disable RAKP using the LOM GUI

1. In a web browser, log on to the LOM GUI.
2. Navigate to **Miscellaneous > SMC RAKP**. The current RAKP status is displayed.
3. Select **Enable** or **Disable**.
4. Click **Save**.

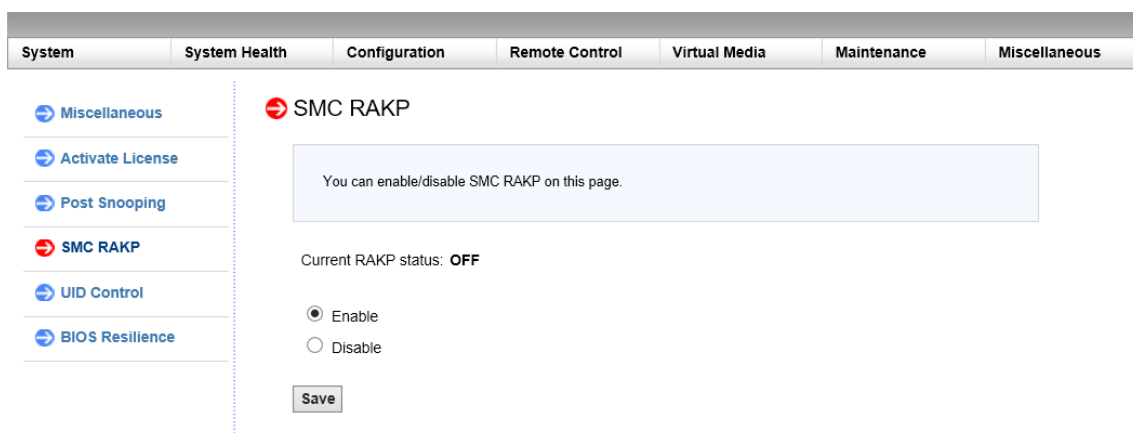

## Enable or disable RAKP using the ADC bash shell

- To enable RAKP, type: `ipmitool raw 0x30 0x72 0x01 0x01`
- To disable RAKP, type: `ipmitool raw 0x30 0x72 0x01 0x00`

## Configure Active Directory in LOM

December 31, 2023

Add an active directory in LOM to use LDAP authentication with LOM.

Follow these steps to add an Active Directory in LOM.

1. Log on to the LOM GUI.
2. Navigate to **Configuration > Active Directory**.

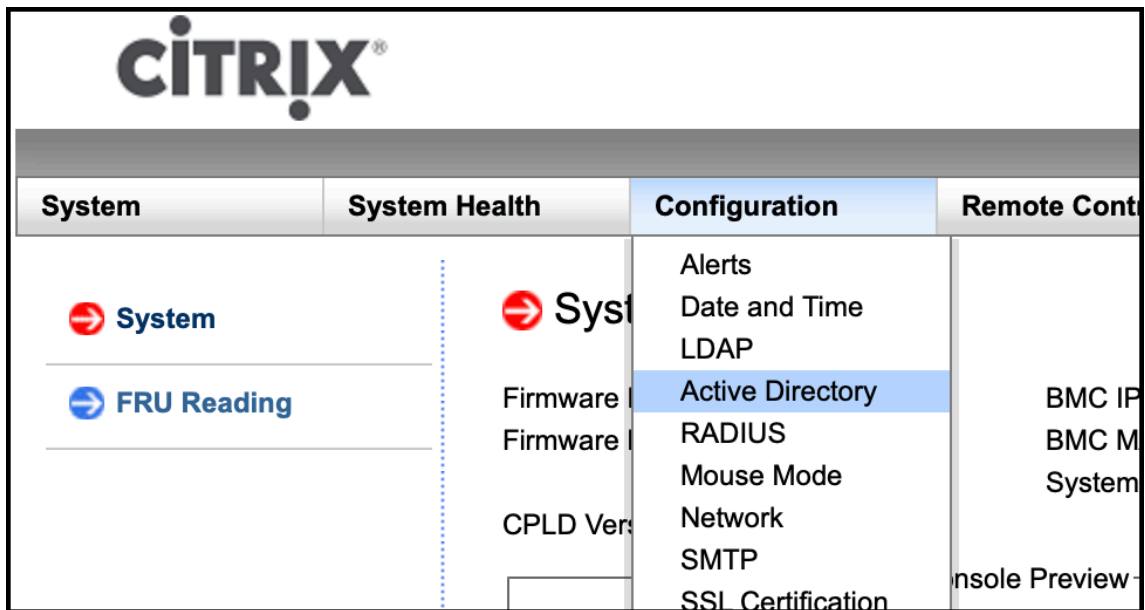

3. Click the link to configure or edit active directory settings.

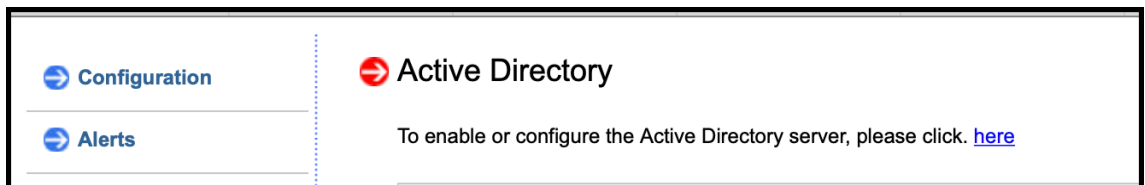

4. Type values for the different parameters and click **Save**.



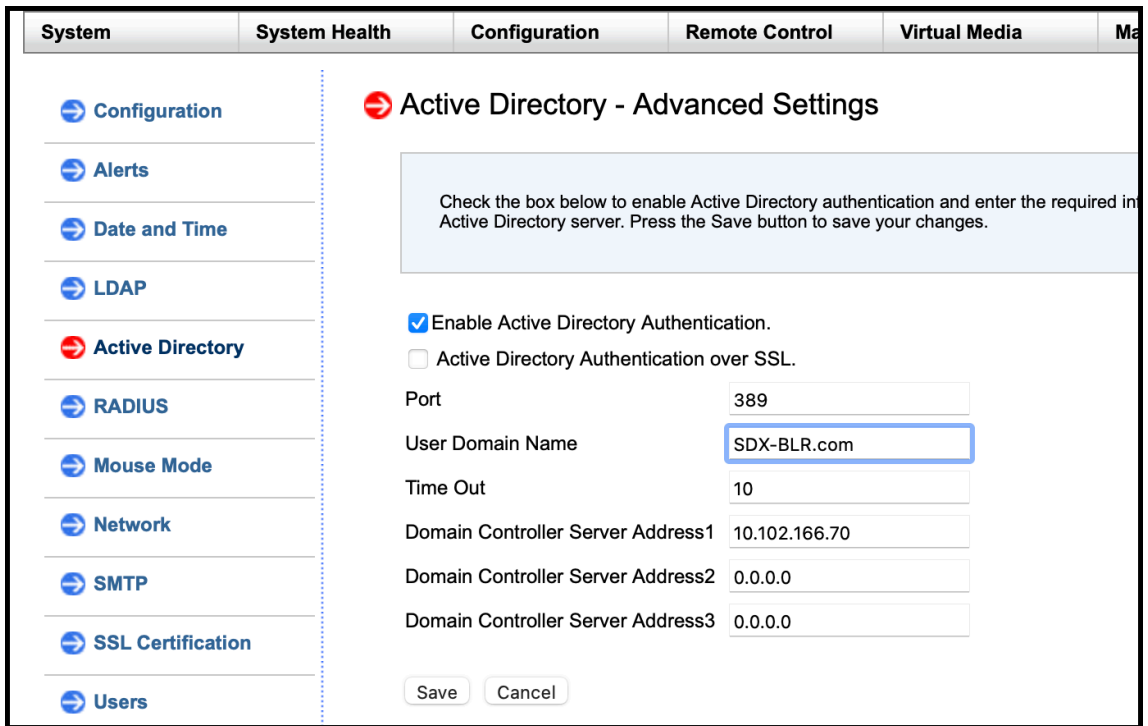

The following message appears after a successful save.

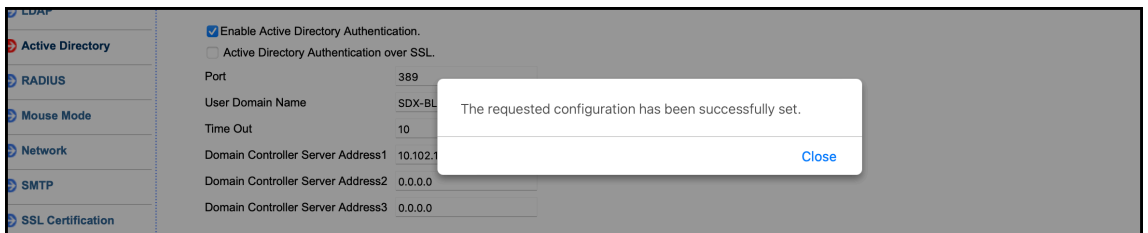

5. Click **Active Directory** and add a role group. A role group is required to give an Active Directory user a specific type of privilege on LOM.

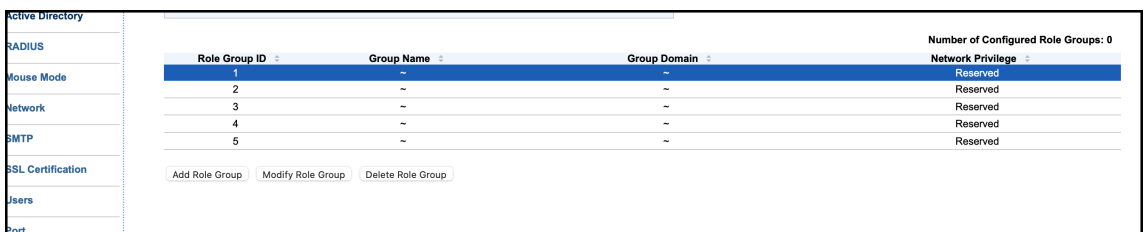

6. Select **Administrator** to give admin privileges to the role group and click **Save**.

Alerts

Date and Time

DAP

Active Directory

RADIUS

Mouse Mode

Network

Enter the information for the new role group below and press Add. Press Cancel

Role Group Name:

Role Group Domain:

Role Group Privilege:

- Administrator
- Operator
- User
- No Access

The role group appears in the table.

Role Group ID	Group Name	Group Domain	Network Privilege
1	SDXgroup1	SDX-BLR.com	Administrator
2	~	~	Reserved
3	~	~	Reserved

Number of Configured Role Groups: 1

7. Log on as an Active Directory user.



Please Login

Username

Password

You have completed the steps to add an Active Directory.

## Change the BMC host name

December 31, 2023

When changing the host name for BMC version 2.12, you must enter an IP address in the **DNS Server IP** field. Leaving this field blank results in the following error.

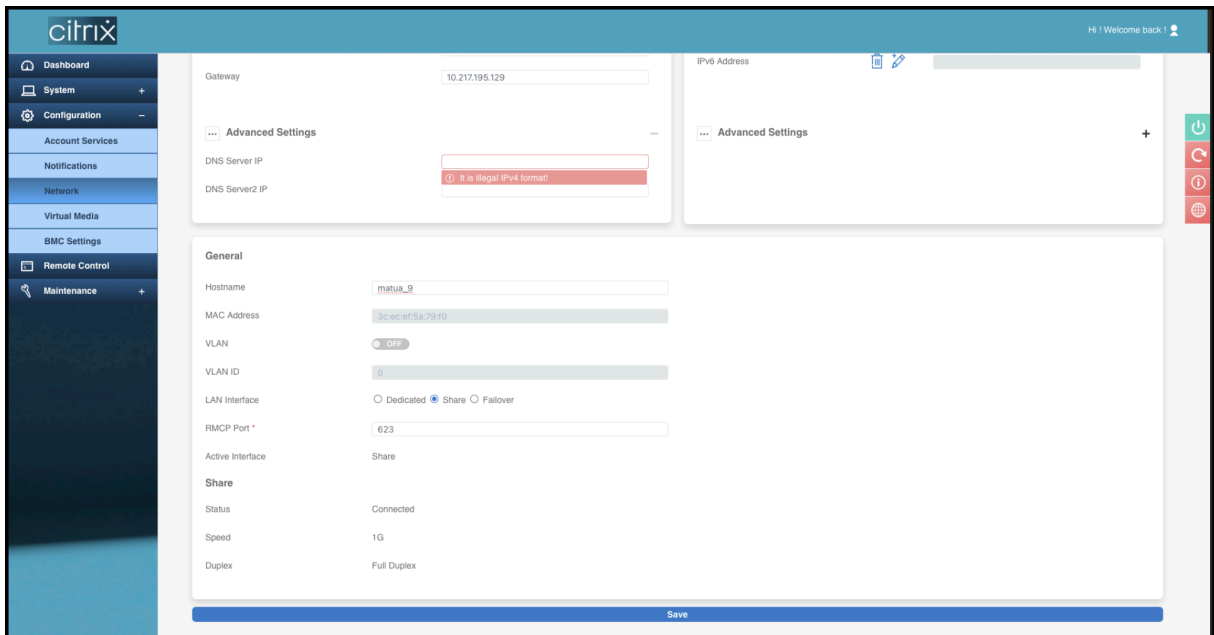

Entering a dummy IP address, such as 0.0.0.0 is supported.

Perform the following steps to change the host name for BMC version 2.12 using the LOM GUI.

1. Log on to the LOM GUI.
2. Navigate to **Configuration > Network**.
3. In the **DNS Server IP** field, type an IP address. Type 0.0.0.0 if you don't have an IP address.
4. Type a host name.
5. Click **Save**.

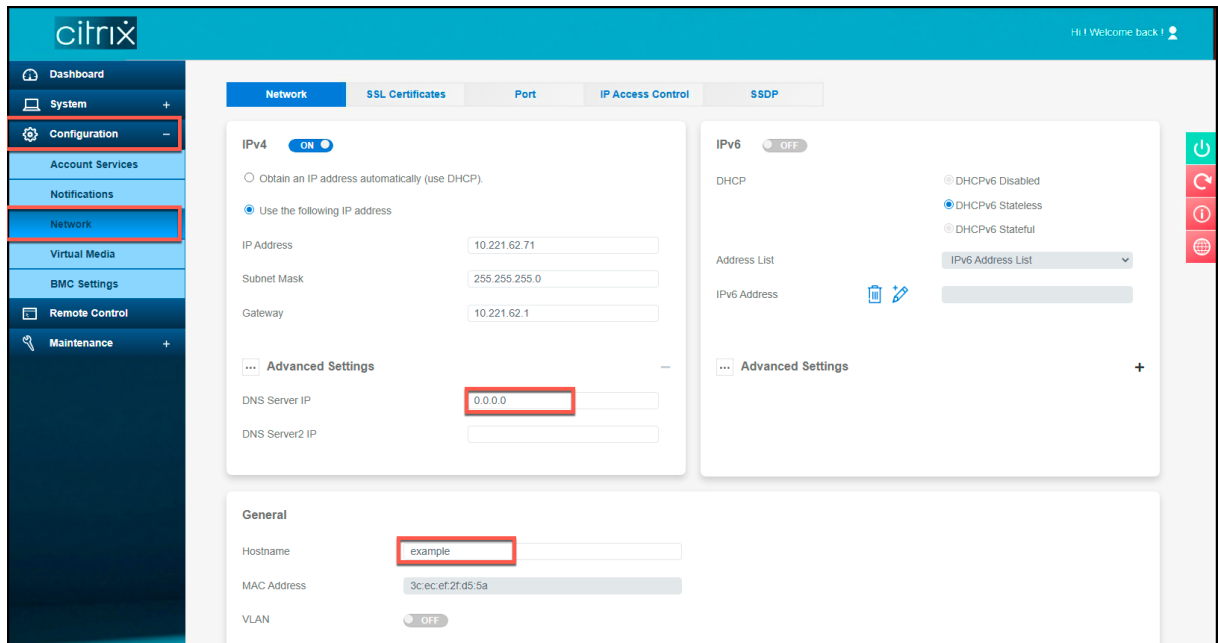

## Hardware health attributes for the MPX 16000 platform

December 31, 2023

The following table lists the recommended ranges for the health attributes on the MPX 16000 platform.

Run the `ipmitool sdr list` command from the shell. This command lists the sensory parameters data in detail.

Run the `stat system -detail` command from the CLI. This command lists a subset of the parameters.

Health Attribute (shell)	Health Attribute (CLI)	Recommended Range
CPU1 Temp	CPU 0 Temperature (Celsius)	10–95
CPU2 Temp	CPU 1 Temperature (Celsius)	10–95
PCH Temp	Temperature 1 (Celsius)	10–85
System Temp	Internal Temperature (Celsius)	10–80
Peripheral Temp	Temperature 0 (Celsius)	10–80
Fan 1	CPU Fan 0 Speed (RPM)	1260–8260
Fan 2	CPU Fan 1 Speed (RPM)	1260–8260

Health Attribute (shell)	Health Attribute (CLI)	Recommended Range
Fan 3	System Fan Speed (RPM)	1260–8260
Fan 4	System Fan 1 Speed (RPM)	1260–8260
Fan 5	System Fan 2 Speed (RPM)	1260–8260
Fan 6	Fan 0 Speed (RPM)	1260–8260
12V	+12.0 V Supply Voltage	11.330–12.520
5VCC	+5.0 V Supply Voltage	4.713–5.217
3.3VCC	Main 3.3 V Supply Voltage	3.134–3.464
VBAT	Battery Voltage (Volts)	2.591–3.464
Vcpu1VCCIN	CPU 0 Core Voltage (Volts)	1.616–2.016
Vcpu2VCCIN	CPU 1 Core Voltage (Volts)	1.616–2.016
Vcpu1VDDQABCD	Voltage 0 (Volts)	1.096–1.344
Vcpu1VDDQEFGH	Voltage 1 (Volts)	1.096–1.344
Vcpu2VDDQABCD	Voltage 2 (Volts)	1.096–1.344
Vcpu2VDDQEFGH	Voltage 3 (Volts)	1.096–1.344
5VSB	5V Standby Voltage (Volts)	4.745–5.249
3.3VSB	Standby 3.3 V Supply Voltage	3.117–3.447
1.8V PCH	Voltage 4 (Volts)	1.698–1.883
PS1 Status	Power supply 1 status	• not applicable -
PS2 Status	Power supply 2 status	• not applicable -

## Sample output

The following sections list the different ways to view the system sensor health attributes. The data is a sample representation only. The output from your appliance might be different. For the acceptable ranges, see the previous table.

- From the CLI
- From the shell
- From the LOM GUI

## CLI

At the command line, type: `stat system -detail`

```
1 >stat system -detail
2
3 NetScaler Executive View
4
5 System Information:
6 Up since          Tue Nov 15 13:50:59 2022
7 Up since(Local)  Tue Nov 15 13:50:59 2022
8 Memory usage (MB)          3562
9 InUse Memory (%)          6.24
10 Number of CPUs           9
11
12 System Health Statistics (Standard):
13 CPU 0 Core Voltage (Volts)          1.77
14 CPU 1 Core Voltage (Volts)          1.77
15 Main 3.3 V Supply Voltage          3.49
16 Standby 3.3 V Supply Voltage        3.45
17 +5.0 V Supply Voltage               5.26
18 +12.0 V Supply Voltage              12.44
19 Battery Voltage (Volts)             3.11
20 Intel CPU Vtt Power(Volts)          0.00
21 5V Standby Voltage(Volts)           5.04
22 Voltage Sensor2(Volts)              0.00
23 CPU Fan 0 Speed (RPM)               3360
24 CPU Fan 1 Speed (RPM)               3360
25 System Fan Speed (RPM)              3360
26 System Fan 1 Speed (RPM)            3360
27 System Fan 2 Speed (RPM)            3360
28 CPU 0 Temperature (Celsius)         54
29 CPU 1 Temperature (Celsius)         53
30 Internal Temperature (Celsius)      33
31 Power supply 1 status                NORMAL
32 Power supply 2 status                NORMAL
33 Power supply 3 status                NOT SUPPORTED
34 Power supply 4 status                NOT SUPPORTED
35
36 System Disk Statistics:
37 /flash Size (MB)                    29748
38 /flash Used (MB)                    3927
39 /flash Available (MB)                23441
40 /flash Used (%)                      14
41 /var Size (MB)                       800856
42 /var Used (MB)                       20127
43 /var Available (MB)                  716660
44 /var Used (%)                         2
45
46 System Health Statistics(Auxiliary):
47 Voltage 0 (Volts)                    1.20
48 Voltage 1 (Volts)                    1.20
49 Voltage 2 (Volts)                    1.20
```

```
50 Voltage 3 (Volts) 1.20
51 Voltage 4 (Volts) 1.88
52 Voltage 5 (Volts) 0.00
53 Voltage 6 (Volts) 0.00
54 Voltage 7 (Volts) 0.00
55 Fan 0 Speed (RPM) 3360
56 Fan 1 Speed (RPM) 0
57 Fan 2 Speed (RPM) 0
58 Fan 3 Speed (RPM) 0
59 Temperature 0 (Celsius) 28
60 Temperature 1 (Celsius) 34
61 Temperature 2 (Celsius) 0
62 Temperature 3 (Celsius) 0
63 Done
64 >
65 <!--NeedCopy-->
```

## Shell

At the command line, type: `shell`

```
1 > shell
2 root@ns# ipmitool sdr list
3
4 CPU1 Temp | 54 degrees C | ok
5 CPU2 Temp | 53 degrees C | ok
6 PCH Temp | 34 degrees C | ok
7 System Temp | 33 degrees C | ok
8 Peripheral Temp | 28 degrees C | ok
9 CPU1_VRMIN Temp | 65 degrees C | ok
10 CPU1_VRMIO Temp | 44 degrees C | ok
11 CPU2_VRMIN Temp | 46 degrees C | ok
12 CPU2_VRMIO Temp | 47 degrees C | ok
13 P1_VRMABCD Temp | 38 degrees C | ok
14 P1_VRMEFGH Temp | 43 degrees C | ok
15 P2_VRMABCD Temp | 42 degrees C | ok
16 P2_VRMEFGH Temp | 45 degrees C | ok
17 FAN1 | 3360 RPM | ok
18 FAN2 | 3360 RPM | ok
19 FAN3 | 3360 RPM | ok
20 FAN4 | 3360 RPM | ok
21 FAN5 | 3360 RPM | ok
22 FAN6 | 3360 RPM | ok
23 P1_DIMMA~D Temp | 38 degrees C | ok
24 P1_DIMME~H Temp | 33 degrees C | ok
25 P2_DIMMA~D Temp | 30 degrees C | ok
26 P2_DIMME~H Temp | 30 degrees C | ok
27 12V | 12.44 Volts | ok
28 5VCC | 5.26 Volts | ok
29 3.3VCC | 3.49 Volts | ok
30 VBAT | 3.11 Volts | ok
31 Vcpu1VCCIN | 1.77 Volts | ok
```

```

32 Vcpu1VCCIO      | 1.00 Volts      | ok
33 Vcpu2VCCIN     | 1.77 Volts      | ok
34 Vcpu2VCCIO     | 1.00 Volts      | ok
35 Vcpu1VDDQABCD  | 1.20 Volts      | ok
36 Vcpu1VDDQEFGH  | 1.20 Volts      | ok
37 Vcpu2VDDQABCD  | 1.20 Volts      | ok
38 Vcpu2VDDQEFGH  | 1.20 Volts      | ok
39 5VSB           | 5.04 Volts      | ok
40 3.3VSB         | 3.45 Volts      | ok
41 2.5V BMC       | 2.56 Volts      | ok
42 1.8V BMC       | 1.83 Volts      | ok
43 1.2V BMC       | 1.20 Volts      | ok
44 1.0V BMC       | 1.02 Volts      | ok
45 1.8V PCH       | 1.88 Volts      | ok
46 PVNN PCH       | 1.06 Volts      | ok
47 1.05V PCH      | 1.06 Volts      | ok
48 PS1 Status     | 0x01            | ok
49 PS2 Status     | 0x01            | ok
50 AOC_NIC2 Temp  | 51 degrees C    | ok
51 AOC_NIC4 Temp  | 51 degrees C    | ok
52 root@ns#
53 <!--NeedCopy-->

```

## LOM GUI

1. Log on to the LOM GUI.
2. On the Dashboard, click **Sensor** for temperature and voltage values. Click **Fan** for fan values.



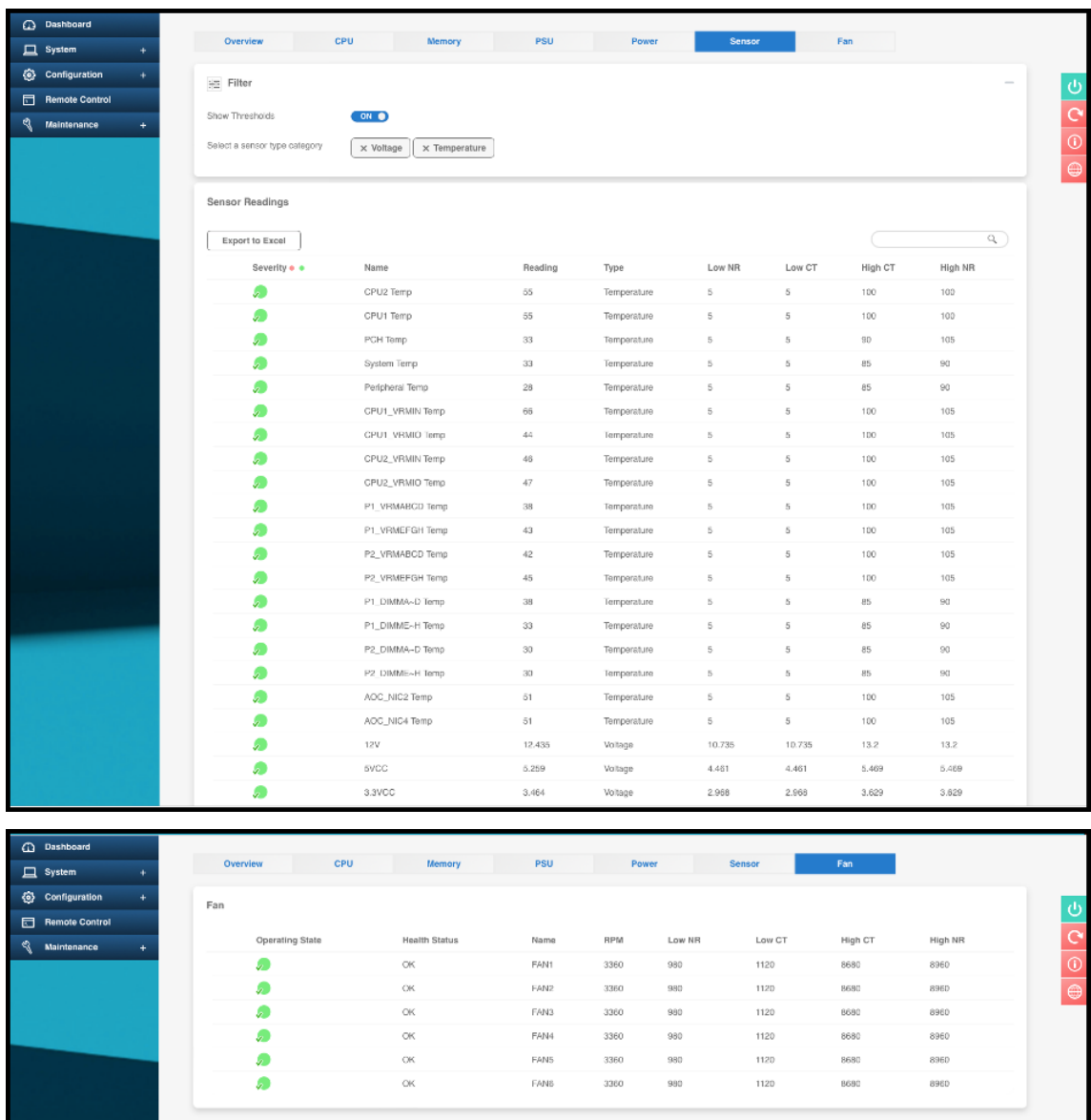

## Hardware health attributes for the MPX 9100 platform

December 31, 2023

The following table lists the recommended ranges for the health attributes on the MPX 9100 platform.

Run the `ipmitool sdr list` command from the shell. This command lists the sensory parameters data in detail.

Run the `stat system -detail` command from the CLI. This command lists a subset of the para-

meters.

Health Attribute (shell)	Health Attribute (CLI)	Recommended Range
CPU Temp	CPU 0 Temperature (Celsius)	10–95
PCH Temp	Temperature 1 (Celsius)	10–85
System Temp	Internal Temperature (Celsius)	10–80
Peripheral Temp	Temperature 0 (Celsius)	10–80
CPU_VRMIN Temp	• nl -	10–95
VRMABCD Temp	• nl -	10–95
VRMEFGH Temp	• nl -	10–95
DIMMABCD Temp	• nl -	10–80
DIMMEFGH Temp	• nl -	10–80
Fan 1	CPU Fan 0 Speed (RPM)	1260–18060
Fan 2	CPU Fan 1 Speed (RPM)	1260–18060
Fan 3	System Fan Speed (RPM)	1260–18060
Fan 4	System Fan 1 Speed (RPM)	1260–18060
Fan 5	System Fan 2 Speed (RPM)	1260–18060
Fan 6	Fan 0 Speed (RPM)	1260–18060
12V	+12.0 V Supply Voltage	10.704–13.812
5VCC	+5.0 V Supply Voltage	4.466–5.737
3.3VCC	Main 3.3 V Supply Voltage	2.885–3.690
VBAT	Battery Voltage (Volts)	2.591–3.464
5VSB	5V Standby Voltage (Volts)	4.496–5.378
3.3VSB	Standby 3.3 V Supply Voltage	2.954–3.552
1.8V PCH	Voltage 2 (Volts)	1.618–1.943
PVNN PCH	• nl -	0.892–1.072
1.05V PCH	• nl -	0.915–1.176
2.5V BMC	• nl -	2.177–2.804
1.8V BMC	• nl -	1.620–1.944
1.2V BMC	• nl -	1.074–1.290
1.0V BMC	• nl -	0.892–1.072

Health Attribute (shell)	Health Attribute (CLI)	Recommended Range
VcpuVRM	• nl -	1.616–1.944
Vcpu	CPU 0 Core Voltage (Volts)	0.931–1.195
VDimmABCD (Volts)	Voltage 0 (Volts)	1.096–1.344
VDimmEFGH (Volts)	Voltage 1 (Volts)	1.096–1.344
PS1 Status	Power supply 1 status	• na -
PS2 Status	Power supply 2 status	• na -

### Notes

- nl- Parameter not listed in the output of the `stat system -detail` command.
- na- Not applicable.

### Sample output

The following sections list the different ways to view the system sensor health attributes. The data is a sample representation only. The output from your appliance might be different. For the acceptable ranges, see the previous table.

- From the CLI
- From the shell
- From the LOM GUI

### CLI

At the command line, type: `stat system -detail`

```

1 >stat system -detail
2
3 NetScaler Executive View
4
5 System Information:
6 Up since      Tue Nov 15 13:50:59 2022
7 Up since(Local) Tue Nov 15 13:50:59 2022
8 Memory usage (MB)          3562
9 InUse Memory (%)           6.24
10 Number of CPUs             9
11
12 System Health Statistics (Standard):
13 CPU 0 Core Voltage (Volts)          1.07

```

```
14 CPU 1 Core Voltage (Volts) 0.00
15 Main 3.3 V Supply Voltage 3.32
16 Standby 3.3 V Supply Voltage 3.39
17 +5.0 V Supply Voltage 5.12
18 +12.0 V Supply Voltage 12.38
19 Battery Voltage (Volts) 3.06
20 Intel CPU Vtt Power(Volts) 0.00
21 5V Standby Voltage(Volts) 5.13
22 Voltage Sensor2(Volts) 0.00
23 CPU Fan 0 Speed (RPM) 9240
24 CPU Fan 1 Speed (RPM) 9380
25 System Fan Speed (RPM) 9380
26 System Fan 1 Speed (RPM) 9100
27 System Fan 2 Speed (RPM) 9520
28 CPU 0 Temperature (Celsius) 58
29 CPU 1 Temperature (Celsius) 0
30 Internal Temperature (Celsius) 42
31 Power supply 1 status NORMAL
32 Power supply 2 status NOT PRESENT
33 Power supply 3 status NOT SUPPORTED
34 Power supply 4 status NOT SUPPORTED
35
36 System Disk Statistics:
37 /flash Size (MB) 23801
38 /flash Used (MB) 3392
39 /flash Available (MB) 18504
40 /flash Used (%) 15
41 /var Size (MB) 341189
42 /var Used (MB) 12637
43 /var Available (MB) 301257
44 /var Used (%) 4
45
46 System Health Statistics(Auxiliary):
47 Voltage 0 (Volts) 1.22
48 Voltage 1 (Volts) 1.22
49 Voltage 2 (Volts) 1.85
50 Voltage 3 (Volts) 0.00
51 Voltage 4 (Volts) 0.00
52 Voltage 5 (Volts) 0.00
53 Voltage 6 (Volts) 0.00
54 Voltage 7 (Volts) 0.00
55 Fan 0 Speed (RPM) 9240
56 Fan 1 Speed (RPM) 0
57 Fan 2 Speed (RPM) 0
58 Fan 3 Speed (RPM) 0
59 Temperature 0 (Celsius) 23
60 Temperature 1 (Celsius) 33
61 Temperature 2 (Celsius) 0
62 Temperature 3 (Celsius) 0
63 Done
64 >
65 <!--NeedCopy-->
```

## Shell

At the command line, type: `shell`

```
1 > shell
2 root@ns# ipmitool sdr list
3
4 CPU Temp           | 59 degrees C       | ok
5 PCH Temp           | 32 degrees C       | ok
6 System Temp       | 42 degrees C       | ok
7 Peripheral Temp   | 23 degrees C       | ok
8 CPU_VRMIN Temp    | 51 degrees C       | ok
9 VRMABCD Temp      | 38 degrees C       | ok
10 VRMEFGH Temp     | 40 degrees C       | ok
11 DIMMABCD Temp    | 27 degrees C       | ok
12 DIMMEFGH Temp    | 30 degrees C       | ok
13 FAN1              | 9380 RPM           | ok
14 FAN2              | 9380 RPM           | ok
15 FAN3              | 9380 RPM           | ok
16 FAN4              | 9240 RPM           | ok
17 FAN5              | 9240 RPM           | ok
18 FAN6              | 9240 RPM           | ok
19 12V               | 12.38 Volts        | ok
20 5VCC              | 5.12 Volts         | ok
21 3.3VCC            | 3.32 Volts         | ok
22 VBAT              | 3.06 Volts         | ok
23 5VSB              | 5.13 Volts         | ok
24 3.3VSB            | 3.39 Volts         | ok
25 1.8V PCH          | 1.85 Volts         | ok
26 PVNN PCH          | 1.03 Volts         | ok
27 1.05V PCH         | 1.06 Volts         | ok
28 2.5V BMC          | 2.56 Volts         | ok
29 1.8V BMC          | 1.78 Volts         | ok
30 1.2V BMC          | 1.18 Volts         | ok
31 1.0V BMC          | 0.99 Volts         | ok
32 VcpuVRM           | 1.78 Volts         | ok
33 Vcpu              | 1.07 Volts         | ok
34 VDimmABCD         | 1.22 Volts         | ok
35 VDimmEFGH         | 1.22 Volts         | ok
36 PS1 Status        | 0x01               | ok
37 PS2 Status        | 0x00               | ok
38 root@ns#
39 <!--NeedCopy-->
```

## LOM GUI

1. Log on to the LOM GUI.
2. On the Dashboard, click **Sensor** for temperature and voltage values. Click **Fan** for fan values.

Severity	Name	Reading	Type	Low NR	Low CT	High CT	High NR
OK	PCH Temp	35	Temperature	5	5	90	105
OK	CPU Temp	61	Temperature	5	5	100	100
OK	System Temp	43	Temperature	5	5	85	90
OK	Peripheral Temp	25	Temperature	5	5	85	90
OK	CPU_VRMIN Temp	52	Temperature	5	5	100	105
OK	VRMABCD Temp	38	Temperature	5	5	100	105
OK	VRMEFGH Temp	40	Temperature	5	5	100	105
OK	DIMMABCD Temp	31	Temperature	5	5	85	90
OK	DIMMEFGH Temp	33	Temperature	5	5	85	90

Operating State	Health Status	Name	RPM	Low NR	Low CT	High CT	High NR
OK	OK	FAN1	9240	980	1120	19740	21560
OK	OK	FAN2	9380	980	1120	19740	21560
OK	OK	FAN3	9380	980	1120	19740	21560
OK	OK	FAN4	9100	980	1120	19740	21560
OK	OK	FAN5	9100	980	1120	19740	21560
OK	OK	FAN6	9240	980	1120	19740	21560

## Legacy hardware health attributes

March 22, 2024

Operating ranges for NetScaler hardware platforms vary for different attributes.

### Note

Use the `stat system -detail` command to display the current values of the attributes.

**Health attributes for the MPX 5900 platform**

The following table lists the health attributes for the MPX 5900 platform.

---

Health Attribute	Recommended Range
CPU 0 Temperature (Celsius)	0 to 85
Temperature 1 (Celsius) under Auxiliary	-5 to 90
Internal Temperature (Celsius)	-5 to 80
Temperature 0 (Celsius) under Auxiliary	-5 to 80
CPU Fan 0 Speed (RPM)	1500 to 18000
CPU Fan 1 Speed (RPM)	1500 to 18000
System Fan Speed (RPM)	1500 to 18000
System Fan 1 Speed (RPM)	1500 to 18000
System Fan 2 Speed (RPM)	1500 to 18000
Fan 0 Speed (RPM) under Auxiliary	1500 to 18000
+12.0 V Supply Voltage (Volts)	10.74 to 12.945
+5.0 V Supply Voltage (Volts)	4.48 to 5.39
Main 3.3 V Supply Voltage (Volts)	2.959 to 3.554
Battery Voltage (Volts)	2.599 to 3.775
CPU 0 Core Voltage (Volts)	1.395 to 1.899
Voltage 0 (Volts) under Auxiliary	1.047 to 1.344
Voltage 1 (Volts) under Auxiliary	1.047 to 1.344
5 V Standby Voltage(Volts)	4.48 to 5.39
Standby 3.3 V Supply Voltage (Volts)	2.959 to 3.544
Power Supply 1 Status	NORMAL
Power Supply 2 Status	NOT PRESENT–NORMAL

---

**Health attributes for the MPX 8900 platform**

The following table lists the health attributes for the MPX 8900 platform.

Health Attribute	Recommended Range
CPU 0 core (Volts)	1.395 to 1.899
Main 3.3 V Supply (Volts)	2.959 to 3.554
Standby 3.3 V Supply (Volts)	2.959 to 3.554
+5.0 V Supply (Volts)	4.48 to 5.39
+12.0 V Supply (Volts)	10.74 to 12.945
Battery (Volts)	2.599 to 3.775
5 V Standby (Volts)	4.48 to 5.39
CPU Fan 0 Speed (RPM)	1500 to 18000
CPU Fan 1 Speed (RPM)	1500 to 18000
System Fan Speed (RPM)	1500 to 18000
System Fan 1 Speed (RPM)	1500 to 18000
System Fan 2 Speed (RPM)	1500 to 18000
CPU 0 Temperature (Celsius)	0 to 85
Internal Temperature (Celsius)	-5 to 80
Power Supply 1 Status	NORMAL
Power Supply 2 Status	NOT PRESENT–NORMAL

### Health attributes for the MPX 15000 and MPX 26000 platforms

The following table lists the health attributes for the MPX 15000 and MPX 26000 platforms.

Health Attribute	Unit	Minimum value	Nominal value	Maximum value
CPU 0 Core Voltage	Volt	1.47	1.82	1.835
CPU 1 Core Voltage	Volt	1.47	1.82	1.835
3_3VCC	Volt	3.12	3.30	3.48
3_3VSB	Volt	3.12	3.30	3.48
5VCC	Volt	4.72	5.00	5.28
p12V	Volt	11.33	12.00	12.67



Health Attribute	Unit	Minimum value	Nominal value	Maximum value
VBAT	Volt	2.75	3.00	3.200
Vtt	-NA-	-NA-	-NA-	-NA-
5VSB	Volt	4.72	5.00	5.28
Voltage Sensor 2	-NA-	-NA-	-NA-	-NA-
CPU Fan 0 Speed	RPM	1500	-NA-	7500
CPU Fan 1 Speed	RPM	1500	-NA-	7500
System Fan Speed	RPM	1500	-NA-	7500
System Fan 1 Speed	RPM	1500	-NA-	7500
System Fan 2 Speed	RPM	1500	-NA-	7500
Fan 0 Speed	RPM	1500	-NA-	7500
CPU 0 Temp	Celsius	0	-NA-	85
CPU 1 Temp	Celsius	0	-NA-	85
Internal Temp	Celsius	0	-NA-	80

### Health attributes for the MPX 14000 platform

The following table lists the health attributes for the MPX 14000 platform.

Health Attribute	Recommended Range
CPU 0 core (Volts)	0.85–0.91
CPU 1 core Volt	0.85–0.93
Main 3.3 V Supply (Volts)	3.31–3.36
Standby 3.3 V Supply (Volts)	3.26–3.31
+5.0 V Supply (Volts)	4.99–5.06
+12.0 V Supply (Volts)	11.98–12.08
Battery Voltage	3.02–3.12
Internal CPU Vtt Power	0.99–1.01

Health Attribute	Recommended Range
CPU Fan 0 Speed (RPM)	1875–4350
CPU Fan 1 Speed (RPM)	1875–4200
System Fan Speed (RPM)	1875–4350
System Fan 1 Speed (RPM)	1875–4275
System Fan 2 Speed (RPM)	1875–4200
CPU 0 Temperature (Celsius)	33–43
CPU 1 Temperature (Celsius)	35–45
Internal Temperature (Celsius)	28–38
Power Supply 1 Status	NORMAL
Power Supply 2 Status	NORMAL

### Health attributes for the MPX 22040 platform

The following table lists the health attributes for the MPX 22040 platform.

Health attribute	Unit	Lower	Lower	Lower	Upper	Upper	Upper
		Non-Recoverable	Critical	Non-Critical	Non-Critical	Critical	Non-Recoverable
CPU1 Temp	degrees C	0.000	0.000	0.000	90.000	93.000	95.000
CPU2 Temp	degrees C	0.000	0.000	0.000	90.000	93.000	95.000
System Temp	degrees C	-9.000	-7.000	-5.000	80.000	85.000	90.000
Peripheral Temp	degrees C	-9.000	-7.000	-5.000	80.000	85.000	90.000
PCH Temp	degrees C	-11.000	-8.000	-5.000	90.000	95.000	100.000
FPC_Temp 1	degrees C	• NA -	• NA -	• NA -	66.000	70.000	75.000
FPC_Temp 2	degrees C	• NA -	• NA -	• NA -	72.000	76.000	82.000
FPC_Temp 3	degrees C	• NA -	• NA -	• NA -	72.000	76.000	82.000

Health attribute	Unit	Lower Non-Recoverable	Lower Critical	Lower Non-Critical	Upper Non-Critical	Upper Critical	Upper Non-Recoverable
HDDBP_Temp1	degrees C	• NA -	• NA -	• NA -	72.000	76.000	82.000
HDDBP_Temp2	degrees C	• NA -	• NA -	• NA -	72.000	76.000	82.000
FAN 1	RPM	• NA -	1980.000	• NA -	• NA -	• NA -	• NA -
FAN 2	RPM	• NA -	1980.000	• NA -	• NA -	• NA -	• NA -
FAN 3	RPM	• NA -	1980.000	• NA -	• NA -	• NA -	• NA -
FAN 4	RPM	• NA -	1980.000	• NA -	• NA -	• NA -	• NA -
FAN 5	RPM	• NA -	1980.000	• NA -	• NA -	• NA -	• NA -
FAN 6	RPM	• NA -	1980.000	• NA -	• NA -	• NA -	• NA -
FAN 7	RPM	• NA -	1980.000	• NA -	• NA -	• NA -	• NA -
FAN 8	RPM	• NA -	1980.000	• NA -	• NA -	• NA -	• NA -
PS_1 Status	discrete	• NA -	• NA -	• NA -	• NA -	• NA -	• NA -
PS_1 FAN	RPM	• NA -	• NA -	• NA -	• NA -	• NA -	• NA -
PS_1 Temp	degrees C	• NA -	• NA -	• NA -	• NA -	• NA -	• NA -
PS_2 Status	discrete	• NA -	• NA -	• NA -	• NA -	• NA -	• NA -
PS_2 FAN	RPM	• NA -	• NA -	• NA -	• NA -	• NA -	• NA -
PS_2 Temp	degrees C	• NA -	• NA -	• NA -	• NA -	• NA -	• NA -
PS_3 Status	discrete	• NA -	• NA -	• NA -	• NA -	• NA -	• NA -
PS_3 FAN	RPM	• NA -	1980.000	• NA -	• NA -	• NA -	• NA -
PS_3 Temp	degrees C	• NA -	• NA -	• NA -	72.000	76.000	82.000
PS_4 Status	discrete	• NA -	• NA -	• NA -	• NA -	• NA -	• NA -
PS_4 FAN	RPM	• NA -	1980.000	• NA -	• NA -	• NA -	• NA -
PS_4 Temp	degrees C	• NA -	• NA -	• NA -	72.000	76.000	82.000

Health attribute	Unit	Lower Non-Recoverable	Lower Critical	Lower Non-Critical	Upper Non-Critical	Upper Critical	Upper Non-Recoverable
FPC Status	discrete	• NA -	• NA -	• NA -	• NA -	• NA -	• NA -
VTT	Volts	0.816	0.864	0.912	1.344	1.392	1.440
CPU1 Vcore	Volts	0.480	0.512	0.544	1.488	1.520	1.552
CPU2 Vcore	Volts	0.480	0.512	0.544	1.488	1.520	1.552
VDIMM AB	Volts	1.104	1.152	1.200	1.648	1.696	1.744
VDIMM CD	Volts	1.104	1.152	1.200	1.648	1.696	1.744
VDIMM EF	Volts	1.104	1.152	1.200	1.648	1.696	1.744
VDIMM GH	Volts	1.104	1.152	1.200	1.648	1.696	1.744
+1.5 V	Volts	1.248	1.296	1.344	1.648	1.696	1.744
3.3 V	Volts	2.640	2.784	2.928	3.648	3.792	3.936
+3.3VSB	Volts	2.640	2.784	2.928	3.648	3.792	3.936
5 V	Volts	4.096	4.288	4.480	5.504	5.696	6.912
12 V	Volts	10.176	10.494	10.812	13.250	13.568	13.886
VBAT	Volts	2.400	2.544	2.688	3.312	3.456	3.600

### Health attributes for MPX 24100 platform

The following table lists the health attributes for MPX 24100/24150.

Health attribute	Unit	Lower Non-Recoverable	Lower Critical	Lower Non-Critical	Upper Non-Critical	Upper Critical	Upper Non-Recoverable
CPU1 Temp	degrees C	0.000	0.000	0.000	90.000	93.000	95.000
CPU2 Temp	degrees C	0.000	0.000	0.000	90.000	93.000	95.000
System Temp	degrees C	-9.000	-7.000	-5.000	80.000	85.000	90.000

Health attribute	Unit	Lower		Upper		Upper	
		Non-Recoverable	Lower Critical	Non-Critical	Non-Critical	Upper Critical	Non-Recoverable
Peripheral Temp	degrees C	-9.000	-7.000	-5.000	80.000	85.000	90.000
PCH Temp	degrees C	-11.000	-8.000	-5.000	90.000	95.000	100.000
FPC_Temp 1	degrees C	• NA -	• NA -	• NA -	66.000	70.000	75.000
FPC_Temp 2	degrees C	• NA -	• NA -	• NA -	72.000	76.000	82.000
FPC_Temp 3	degrees C	• NA -	• NA -	• NA -	72.000	76.000	82.000
HDDBP_Temp 1	degrees C	• NA -	• NA -	• NA -	72.000	76.000	82.000
HDDBP_Temp 2	degrees C	• NA -	• NA -	• NA -	72.000	76.000	82.000
FAN 1	RPM	• NA -	1980.000	• NA -	• NA -	• NA -	• NA -
FAN 2	RPM	• NA -	1980.000	• NA -	• NA -	• NA -	• NA -
FAN 3	RPM	• NA -	1980.000	• NA -	• NA -	• NA -	• NA -
FAN 4	RPM	• NA -	1980.000	• NA -	• NA -	• NA -	• NA -
FAN 5	RPM	• NA -	1980.000	• NA -	• NA -	• NA -	• NA -
FAN 6	RPM	• NA -	1980.000	• NA -	• NA -	• NA -	• NA -
FAN 7	RPM	• NA -	1980.000	• NA -	• NA -	• NA -	• NA -
FAN 8	RPM	• NA -	1980.000	• NA -	• NA -	• NA -	• NA -
PS_1 Status	discrete	• NA -	• NA -	• NA -	• NA -	• NA -	• NA -
PS_1 FAN	RPM	• NA -	1980.000	• NA -	• NA -	• NA -	• NA -
PS_1 Temp	degrees C	• NA -	• NA -	• NA -	72.000	76.000	82.000
PS_2 Status	discrete	• NA -	• NA -	• NA -	• NA -	• NA -	• NA -
PS_2 FAN	RPM	• NA -	• NA -	• NA -	• NA -	• NA -	• NA -
PS_2 Temp	degrees C	• NA -	• NA -	• NA -	• NA -	• NA -	• NA -

Health attribute	Unit	Lower		Upper		Upper	
		Non-Recoverable	Lower Critical	Non-Critical	Non-Critical	Upper Critical	Non-Recoverable
PS_3 Status	discrete	• NA -	• NA -	• NA -	• NA -	• NA -	• NA -
PS_3 FAN	RPM	• NA -	• NA -	• NA -	• NA -	• NA -	• NA -
PS_3 Temp	degrees C	• NA -	• NA -	• NA -	• NA -	• NA -	• NA -
PS_4 Status	discrete	• NA -	• NA -	• NA -	• NA -	• NA -	• NA -
PS_4 FAN	RPM	• NA -	• NA -	• NA -	• NA -	• NA -	• NA -
PS_4 Temp	degrees C	• NA -	• NA -	• NA -	• NA -	• NA -	• NA -
FPC Status	discrete	• NA -	• NA -	• NA -	• NA -	• NA -	• NA -
VTT	Volts	0.816	0.864	0.912	1.344	1.392	1.440
CPU1 Vcore	Volts	0.480	0.512	0.544	1.488	1.520	1.552
CPU2 Vcore	Volts	0.480	0.512	0.544	1.488	1.520	1.552
VDIMM AB	Volts	1.104	1.152	1.200	1.648	1.696	1.744
VDIMM CD	Volts	1.104	1.152	1.200	1.648	1.696	1.744
VDIMM EF	Volts	1.104	1.152	1.200	1.648	1.696	1.744
VDIMM GH	Volts	1.104	1.152	1.200	1.648	1.696	1.744
+1.5 V	Volts	1.248	1.296	1.344	1.648	1.696	1.744
3.3 V	Volts	2.640	2.784	2.928	3.648	3.792	3.936
+3.3VSB	Volts	2.640	2.784	2.928	3.648	3.792	3.936
5 V	Volts	4.096	4.288	4.480	5.504	5.696	6.912
12 V	Volts	10.176	10.494	10.812	13.250	13.568	13.886
VBAT	Volts	2.400	2.544	2.688	3.312	3.456	3.600

## Configure the ring size on Mellanox and Fortville interfaces

April 10, 2024

NetScaler platforms support Mellanox and Fortville interfaces. The ring size on these interfaces is configurable. A higher ring size reduces the packet drops when there is a sudden burst in traffic.

### Prerequisite

The interface for which you're configuring the ring size must be UP when applying these changes.

### Configure the ring size on Mellanox NICs

**Note:**

This feature is available in release 14.1 build 21.x and later.

50 G and 100 G interfaces on NetScaler platforms are Mellanox NICs. The following platforms contain Mellanox NICs:

- MPX 9100
- MPX 15000-50G
- MPX 15000-50G FIPS certified appliance
- MPX 16000
- MPX 26000
- MPX 26000-50S
- MPX 26000-100G
- MPX 26000T-100G

The maximum ring size that you can set on a Mellanox interface is 16384 bits. Only the fixed ring type is supported. You must do a full reboot of the appliance for the settings to take effect.

### To set the ring size on a Mellanox NIC

At the command prompt, type:

```
set interface <id> [-ringsize <positive_integer>] [-ringtype ( Elastic | Fixed )]
```

### Example:

```
1 >set int 100/1 ringsize 16384 ringtype fixed
2 >reboot
3 > sh int 100/1
4
5 1)      Interface 100/1 (100G Ethernet, CR4, 100 Gbit) #2
6         flags=0xc020 <ENABLED, UP, UP, autoneg, HAMON, HEARTBEAT, 802.1
           q>
7         MTU=1500, native vlan=1, MAC=0c:42:a1:eb:f3:a3, uptime 101
           h45m50s
8         Requested: media AUTO, speed AUTO, duplex AUTO, fctl OFF,
9             throughput 0
10        Actual: media UTP, speed 100000, duplex FULL, fctl OFF,
           throughput 100000
11        LLDP Mode: NONE,                LR Priority: 1024
12
13        RX: Pkts(205951) Bytes(15819732) Errs(0) Drops(204858) Stalls
           (0)
14        TX: Pkts(720) Bytes(828600) Errs(0) Drops(0) Stalls(0)
15        NIC: InDisc(0) OutDisc(0) Fctls(0) Stalls(0) Hangs(0) Muted(0)
16        Bandwidth thresholds are not set.
17        Rx Ring: Configured size=16384, Actual size=16384, Type: Fixed
18 <!--NeedCopy-->
```

### To unset the ring size on a Mellanox NIC

You cannot unset the ring size on a Mellanox NIC. You must set it to the default value.

#### Example:

```
1 >set int 100/1 ringsize 2048 ringtype fixed
2 >reboot
3 > sh int 100/1
4
5 1)      Interface 100/1 (100G Ethernet, CR4, 100 Gbit) #2
6         flags=0xc020 <ENABLED, UP, UP, autoneg, HAMON, HEARTBEAT, 802.1
           q>
7         MTU=1500, native vlan=1, MAC=0c:42:a1:eb:f3:a3, uptime 101
           h45m50s
8         Requested: media AUTO, speed AUTO, duplex AUTO, fctl OFF,
9             throughput 0
10        Actual: media UTP, speed 100000, duplex FULL, fctl OFF,
           throughput 100000
11        LLDP Mode: NONE,                LR Priority: 1024
12
13        RX: Pkts(205951) Bytes(15819732) Errs(0) Drops(204858) Stalls
           (0)
14        TX: Pkts(720) Bytes(828600) Errs(0) Drops(0) Stalls(0)
15        NIC: InDisc(0) OutDisc(0) Fctls(0) Stalls(0) Hangs(0) Muted(0)
16        Bandwidth thresholds are not set.
17        Rx Ring: Configured size=2048, Actual size=2048, Type: Fixed
18 <!--NeedCopy-->
```



## Configure the ring size on Fortville NICs

### Note:

This feature is available in release 13.0 build 90.x and later.

10 G, 25 G, and 40 G interfaces on NetScaler platforms are Fortville interfaces. The following MPX appliances and corresponding zero-capacity appliances contain Fortville NICs:

- MPX 8900
- MPX 8900 FIPS certified appliance
- MPX 9100
- MPX 14000-40C
- MPX 14000-40S
- MPX 14000-40G
- MPX 15000
- MPX 15000-50G
- MPX 15000-50G FIPS certified appliance
- MPX 16000
- MPX 25000-40G
- MPX 25000T
- MPX 25000TA
- MPX 25000-40G
- MPX 26000
- MPX 26000-50S

The maximum ring size that you can set on a Fortville interface is 4096 bits. You can set the ring type as fixed or elastic. An elastic ring type allows the interface to accept a burst in traffic.

### Prerequisite

Interface must be UP when applying these changes.

### To set the ring size on a Fortville NIC

At the command prompt, type:

```
set interface <id> [-ringsize <positive_integer>] [-ringtype ( Elastic | Fixed )]
```

### Example:

```
1 > set int 25/1 ringsize 4096 ringtype elastic
2 Done
3 > sh int 25/1
4
5 1) Interface 25/1 (25G Ethernet, CR, 25 Gbit) #8
6 flags=0xc020 <ENABLED, UP, UP, autoneg, HAMON, HEARTBEAT, 802.1
7 q>
8 MTU=1500, native vlan=1, MAC=00:e0:ed:dc:11:bf, uptime 101
9 h17m10s
10 Requested: media AUTO, speed AUTO, duplex AUTO, fctl OFF,
11 throughput 0
12 Actual: media UTP, speed 25000, duplex FULL, fctl OFF,
13 throughput 25000
14 LLDP Mode: NONE, LR Priority: 1024
15
16 RX: Pkts(257620) Bytes(21778920) Errs(0) Drops(186380) Stalls
17 (0)
18 TX: Pkts(417) Bytes(17514) Errs(0) Drops(0) Stalls(0)
19 NIC: InDisc(0) OutDisc(0) Fctls(0) Stalls(0) Hangs(0) Muted(0)
20 Bandwidth thresholds are not set.
21 Rx Ring: Configured size=4096, Actual size=512, Type: Elastic
22 Done
23
24
25 > set int 25/1 ringsize 4096 ringtype fixed
26 Done
27 > sh int 25/1
28
29 1) Interface 25/1 (25G Ethernet, CR, 25 Gbit) #8
30 flags=0xc020 <ENABLED, UP, UP, autoneg, HAMON, HEARTBEAT, 802.1
31 q>
32 MTU=1500, native vlan=1, MAC=00:e0:ed:dc:11:bf, uptime 101
33 h17m10s
34 Requested: media AUTO, speed AUTO, duplex AUTO, fctl OFF,
35 throughput 0
36 Actual: media UTP, speed 25000, duplex FULL, fctl OFF,
37 throughput 25000
38 LLDP Mode: NONE, LR Priority: 1024
39
40 RX: Pkts(257620) Bytes(21778920) Errs(0) Drops(186380) Stalls
41 (0)
42 TX: Pkts(417) Bytes(17514) Errs(0) Drops(0) Stalls(0)
43 NIC: InDisc(0) OutDisc(0) Fctls(0) Stalls(0) Hangs(0) Muted(0)
44 Bandwidth thresholds are not set.
45 Rx Ring: Configured size=4096, Actual size=4096, Type: Fixed
46 Done
47 <!--NeedCopy-->
```

## To unset the ring size on a Fortville NIC

At the command prompt, type:

```
unset interface <id> ringsize ringtype
```

### Example:

```
1 > unset int 25/1 ringsize ringtype
2 Done
3 > sh int 25/1
4
5 1)      Interface 25/1 (25G Ethernet, CR, 25 Gbit) #7
6         flags=0xc020 <ENABLED, UP, UP, autoneg, HAMON, HEARTBEAT, 802.1
7         q>
8         MTU=1500, native vlan=1, MAC=00:e0:ed:dc:11:be, uptime 0h00m02s
9         Requested: media AUTO, speed AUTO, duplex AUTO, fctl OFF,
10        throughput 0
11        Actual: media UTP, speed 25000, duplex FULL, fctl OFF,
12        throughput 25000
13        LLDP Mode: NONE,                LRPriority: 1024
14
15        RX: Pkts(11560) Bytes(971823) Errs(0) Drops(8330) Stalls(0)
16        TX: Pkts(69) Bytes(2898) Errs(0) Drops(0) Stalls(0)
17        NIC: InDisc(0) OutDisc(0) Fctls(0) Stalls(0) Hangs(0) Muted(0)
18        Bandwidth thresholds are not set.
19        Rx Ring: Configured size=2048, Actual size=512, Type: Elastic
20
21 Done
22 >
23 <!--NeedCopy-->
```

## Fortville NICs firmware upgrade on NetScaler MPX appliances

December 31, 2023

### Note

Firmware version 8.70 is supported on software version 13.1 and later. The default firmware version is 7.00. To upgrade to firmware version 8.70, run the following commands:

```
1 shell
2 cd /netscaler
3 sh upgrade_fortville_nics.sh 8.70
4 <!--NeedCopy-->
```

Upgrade the firmware on NetScaler MPX appliances containing Fortville NICs to remediate <https://su>

[port.citrix.com/article/CTX263807](http://port.citrix.com/article/CTX263807).

## Prerequisites

1. Before upgrading the NIC firmware to version 7.00, you must upgrade the NetScaler MPX appliance to a software version that supports the new firmware. The following versions support firmware version 7.00.

- 11.1 build 64.x and later
- 12.1 build 56.x and later
- 13.0 build 58.x and later

**Important:** Do not downgrade the software version to a build earlier to these builds.

2. The following script must be present in the `/netscaler` directory:

`upgrade_fortville_nics.sh`

If the script is not present, the installed ADC software image does not support the firmware upgrade.

3. The following scripts must be present in the `/var/tmp/Fortville_Silicom_Intel/scripts` directory:

- `fortville_fw_update`
- `fortville_fw_update_intel_1`
- `fortville_fw_update_silicom_1`
- `fortville_fw_update_state_machine`
- `fortville_fw_update_subr`

If these scripts are not present, at the command prompt, run `installns` to install these files. The files are included with all ADC software that supports this firmware upgrade.

## Supported Platforms

The firmware upgrade scripts are supported on all NetScaler MPX platforms containing Fortville NICs. The scripts verify if the appliance contains Fortville NICs and exit if none is found.

**Note:** These firmware upgrade scripts are not supported on the NetScaler SDX platform.

The following MPX appliances and corresponding zero-capacity appliances contain Fortville NICs:

- MPX 8900
- MPX 8900 FIPS certified appliance

- MPX 9100
- MPX 14000-40C
- MPX 14000-40S
- MPX 14000-40G
- MPX 15000
- MPX 15000-50G
- MPX 15000-50G FIPS certified appliance
- MPX 16000
- MPX 25000-40G
- MPX 25000T
- MPX 25000TA
- MPX 25000-40G
- MPX 26000
- MPX 26000-50S
- T1300
- T1310

### Upgrade the firmware

#### Important:

- The upgrade script takes the appliance off the network. The time taken to complete the offline NIC firmware upgrade varies by platform. For example, on an MPX 14000 platform with 6 Fortville NICs, the total time to upgrade is around 30 min.
- After updating the firmware, ensure that the software version on the appliance supports the new firmware.

The firmware upgrade scripts upgrade the NIC firmware to version 7.00. This upgrade is performed on Fortville 10G and 40G NICs manufactured by Silicom or Intel, and Fortville 25G NICs manufactured by Silicom.

#### Notes:

- After updating the firmware version on the NIC to 7.00 you cannot downgrade the NIC to an earlier version.
- Upgrading some Fortville NICs might take multiple attempts. For example, updating some NICs to firmware version 7.00 might take up to three attempts.

To upgrade the firmware, at the command prompt type:

```
1 > shell
2 root@ns# cd /netscaler
3 root@ns# sh upgrade_fortville_nics.sh
```

```
4 <!--NeedCopy-->
```

By default, the firmware is upgraded to version 7.00.

## Post upgrade

After `fortville_fw_update_state_machine` has run, it deletes the `/nsconfig/.developer` and `/nsconfig/rc.local` files and exits.

- By deleting the `/nsconfig/.developer` file, the NetScaler software comes up on reboot.
- By deleting the `/nsconfig/rc.local` file the `fortville_fw_update_state_machine` script is not invoked on reboot.

After reboot, NetScaler software is up and the firmware upgrade process is complete.

After firmware upgrade, the log file `upgrade_fortville_nic_fw.log` in the `/var/log` directory, contains a detailed record of the firmware upgrade activities. Among other information, it records the duration of the firmware update process.

Also, the file `.fortville_firmware_upgrade_parm_file`, in the directory `/var/tmp/Fortville_Silicom_Intel/scripts`, is not deleted. You can examine it for information about the firmware upgrade.

The `fortville_nic_info` script can be invoked to print an informational summary about the Fortville NICs in the host ADC appliance. The information is recorded in the log file.

To run the script, at the command prompt, type:

```
1 > shell
2 root@ns# cd /var/tmp/Fortville_Silicom_Intel/scripts
3 root@ns# sh fortville_nic_info
4
5 <!--NeedCopy-->
```

## Mellanox NIC firmware upgrade on NetScaler MPX

April 2, 2024

### Note

Firmware upgrade on Mellanox NICs is supported on NetScaler software version 13.0 build 90.x and later.

You must run the upgrade script from the console. Otherwise, you get the following message:

```
1 The NIC firmware upgrade process will disable all NIC ports during the
  upgrade.
2
3 All active SSH sessions will be terminated, including this one.
4
5 This NIC upgrade must be run while logged in from the serial console
6 Please restart the upgrade from the serial console.
7 <!--NeedCopy-->
```

To upgrade the firmware, run the following commands:

```
1 shell
2 cd /netscaler
3 sh upgrade_mellanox_nics.sh <firmware_version>
4 <!--NeedCopy-->
```

Supported versions of Mellanox firmware on different 50 G and 100 G NICs are:

- 12.20.1010
- 12.21.2010
- 12.28.2006
- 20.27.2008
- 20.31.1014
- 20.32.1010
- 22.32.2004
- 22.34.4000
- 22.35.1012

**Example:**

```
sh upgrade_mellanox_nic.sh 22.35.1012
```

To force an upgrade, type:

```
sh upgrade_mellanox_nic.sh 22.35.1012 -f
```

**Prerequisites**

1. Before upgrading the NIC firmware, you must upgrade the build on NetScaler MPX to a software version that supports the new firmware. The following NetScaler versions support Mellanox firmware upgrade:
  - 13.0 build 90.x and later
  - 13.1 all builds
  - 14.1 all builds

**Important:**

Do not downgrade the software version to a build earlier than these builds.

2. The following script must be present in the `/netscaler` directory: `upgrade_mellanox_nic.sh`

If the script is not present, the installed NetScaler software image does not support the firmware upgrade.

3. The following scripts must be present in the `/var/tmp/Mellanox/scripts` directory:

- `mellanox_fw_update_pwr_cycle_mgr`
- `mellanox_fw_update_subr`
- `mellanox_fw_update_state_machine`
- `mellanox_nic_info`

If these scripts are not present, at the command prompt, run `installns` to install these files. The files are included with all NetScaler software that supports this firmware upgrade.

## Supported platforms

**Note:** The Mellanox firmware upgrade script is not supported on NetScaler SDX.

The following platforms contain Mellanox NICs:

- MPX 9100
- MPX 15000-50G
- MPX 15000-50G FIPS certified appliance
- MPX 16000
- MPX 26000
- MPX 26000-50S
- MPX 26000-100G
- MPX 26000T-100G

## Upgrade the firmware

**Important:**

The upgrade script takes the appliance off the network. The time taken to complete the offline NIC firmware upgrade varies by platform. For example, on an MPX 26000 platform with 8 Mellanox NICs, the upgrade can take up to an hour.

This upgrade is performed only on Mellanox 50 G and 100 G NICs.

You can check the current firmware version by running the following command at the shell prompt.



```

1 > shell
2 root@ns# cd /var/nslog/
3 root@ns# vi dmesg.boot
4 <!--NeedCopy-->

```

Look for an entry similar to the following

```

1 ...
2
3 mce0: INFO: firmware version: 12.28.2006
4
5 ...
6 <!--NeedCopy-->

```

### Post upgrade

After `upgrade_mellanox_nic.sh` has run, it deletes the `/nsconfig/.developer` and `/nsconfig/rc.local` files and exits. By deleting the `/nsconfig/.developer` file, NetScaler comes up on reboot.

After reboot, NetScaler is up and the firmware upgrade process is complete.

After firmware upgrade, the log file `mellanoxFw.log` in the `/var/log` directory, contains a detailed record of the firmware upgrade activities. Among other information, it records the duration of the firmware update process.

Run the `mellanox_nic_info` script to print an informational summary about the Mellanox NICs in the host NetScaler. The information is recorded in the log file.

To run the script, at the command prompt, type:

```

1 > shell
2 >root@ns# cd /var/tmp/Mellanox/scripts
3 >root@ns# sh mellanox_nic_info
4 >>> =====
5 >>> Invoking mellanox_nic_info informational script Mon Apr  1 09:57:48
   UTC 2024
6 >>> NetScaler has at least one Mellanox NIC
7 mce#  NS if#      FW ver    PCI DBSF      PSID          Name
8 -----
   Type
9 mce0 (100/2)    20.32.1010 pci0:138:0:0  MT_0000000224 MCX653106A-
   ECA_Ax CX_6
10 <!--NeedCopy-->

```

## Wiping the data from your NetScaler

January 12, 2024

There are two scenarios when you are likely to wipe the data from your NetScaler:

- You are decommissioning or returning the NetScaler and want to remove all of your configuration and files before you return it.
- You are redeploying the NetScaler and want to start with a factory default configuration.

The configuration-wipe scripts remove all customer proprietary information from a NetScaler.

**Caution:** Running these scripts is dangerous. If something goes wrong during execution, the NetScaler might be rendered unbootable, and we might have to reinstall the software image. The config wipe scripts remove everything on the box, including licenses, configuration, images, and scripts and the configuration is not preserved without a valid backup. Run these scripts only after understanding the consequences. We recommend that you reach out to NetScaler support and open a support case to engage the relevant team.

### Points to note

1. The new configuration-wipe scripts are distributed in the official NetScaler software bundle. For example, the tar file for 14.1-4.42 (build-14.1-4.42\_nc\_64.tgz) contains the scripts.
2. The scripts in the recovery folder (`/flash/.recovery`) must be replaced with these scripts before running the command to wipe out the data.

**Important!**

If the `/flash/.recovery` folder does not exist, the SSD must be replaced.

3. Ensure that the config wipe scripts match the build number. For example, if you plan to upgrade to 14.1-4.42, download the scripts for this build.
4. The number in the script is the date and not the software version. That is, `config_wipe_01_10_23.tgz` refers to 10 January 2023. If you see multiple files in the installation package, use the file with the later date.
5. Run the config wipe script only after upgrading to the matching build.

### Supported Platforms

The script is supported on all NetScaler MPX appliances. The script is not supported on NetScaler SDX appliances.

## Commands to wipe the config

1. Create a folder for the build, download the tarball, and extract the contents into this folder. The following code sample is for the 14.1-4.42 build.

At the command line, type:

```
1 > shell
2 root@ns# mkdir -p /var/nsinstall/14.1-4.42
3
4 root@ns# cd /var/nsinstall/14.1-4.42/
5
6 root@ns# pwd
7
8 /var/nsinstall/14.1-4.42
9
10 root@ns# tar xvzf /var/build-14.1-4.42_nc_64.tgz
11
12 x .ns.version
13
14 x OTP_tool.tgz
15
16 x installns
17
18 x invalid_config_check_files.tgz
19
20 x nsconfig
21
22 x skf
23
24 x schema.json
25
26 x licserververify
27
28 x reference_schema.json
29
30 x bootloader.tgz
31
32 x python.tgz
33 <!--NeedCopy-->
```

2. Verify that the scripts are part of the tarball.

At the command line, type:

```
1 > shell
2 root@ns# ls -l config_wipe*
3
4 -rw-r--r-- 1 root 1001 136782 Jul 26 04:29 config_wipe_01_10_23
5 .tgz
6 <!--NeedCopy-->
```

3. Run `installns` to install the fresh build.

4. Reboot the NetScaler.
5. Switch to the `/flash/.recovery` folder and extract the contents. If the folder does not exist, the SSD must be replaced.

```
1 root@ns# cd /flash/.recovery
2
3 root@ns# tar xvzf /var/nsinstall/14.1-4.42/config_wipe_01_10_23.
  tgz
4
5 x rc.conf_wipe_subr
6
7 x rc.disk_wipe_and_reset
8
9 x rc.flash_wipe_recover
10
11 x rc.local_disk_wipe_2
12
13 x rc.local_flash_wipe_1
14
15 x rc.main_disk_wipe
16
17 x rc.main_flash_wipe
18
19 x rc.system_wipe_and_reset
20
21 x loader
22
23 x .new_loader_version
24
25 root@ns#
26 <!--NeedCopy-->
```

6. Wipe the configuration. At the command line, type:

```
1 sh rc.system_wipe_and_reset
2 <!--NeedCopy-->
```

Two optional parameters are available to zero the flash and the disk one or more times.

```
1 sh rc.system_wipe_and_reset [num_flash_loops [num_disk_loops]]
2 <!--NeedCopy-->
```

**Parameters:**

**num\_flash\_loops** - Number of times to loop through the flash, zeroing all sectors. The default is 0. Acceptable values are from 0 through 16.

**num\_disk\_loops** - Number of times to loop through the hard drive, zeroing all sectors. The default is 0. Acceptable values are from 0 through 16.

**Note:**

You can specify num\_disk\_loops only after you provide num\_flash\_loops. To zero the disk without zeroing the flash, set the flash parameter to 0.

**Examples**

The following command is used to zero the flash once and zero the hard drive twice.

```
1 sh rc.system_wipe_and_reset 1 2
2 <!--NeedCopy-->
```

The following command is used to zero only the hard drive once.

```
1 sh rc.system_wipe_and_reset 0 1
2 <!--NeedCopy-->
```

Use any of the following commands to zero the flash four times.

```
1 sh rc.system_wipe_and_reset 4 0
2 <!--NeedCopy-->
```

OR

```
1 sh rc.system_wipe_and_reset 4
2 <!--NeedCopy-->
```

**Script running time**

The appliance might reboot one or more times. The time taken for some sample configuration is as follows:

- Without parameters, the script completes in five minutes. That is, the disk is only reformatted and not zeroed. Zeroing adds extra security so that the data cannot be recovered.
- When you zero the flash:
  - On appliances with 256 MB flash, slightly more than one minute is added per pass.
  - On MPX appliances with 4 GB flash, approximately 17 minutes are added per pass.
- When you zero the disk:
  - On appliances with 80 GB hard drives, approximately 52 minutes are added per pass.
  - On MPX appliances with 250 GB hard drives, approximately 163 minutes are added per pass.

## Appliances with one SSD

A config wipe deletes and rebuilds all the data from the /flash and /var partitions irrespective of whether it is a single SSD system or a system with separate flash and hard drive.

On single SSD systems, there is only one physical storage device. Therefore, you cannot reformat and optionally zero the entire device.

Instead of reformatting the entire flash, only the flash partition is reformatted. Instead of zeroing the entire flash, only the flash partition is zeroed.

Since there is a hard drive partition instead of a physical hard drive, reformatting and optionally zeroing is limited to the hard drive partition.

## How to verify the file system integrity of your NetScaler MPX appliance

December 31, 2023

Complete the following procedure to verify the file system integrity of the NetScaler MPX appliance.

1. Connect a console cable to the serial console of the ADC appliance, which is 9600 baud, 8 bits, 1 stop bit, and No parity.
2. Restart the appliance.
3. Press **Ctrl+C** keys simultaneously when you see the message `Booting [/ns-12.1-60.19] counting down from 2 to 1 second`. At the OK prompt, type `?` to show available commands.

```

BTX loader 1.00  BTX version is 1.01
Booting [/ns-12.1-60.19] in 1 second...
Type '?' for a list of commands, 'help' for more detailed help.
OK ?
Available commands:
heap          show heap usage
reboot        reboot the system
bcachestat   get disk block cache stats
autoboot     boot automatically after a delay
boot         boot a file or loaded kernel
lsdev        list all devices
more         show contents of a file
read         read input from the terminal
echo         echo arguments
unset        unset a variable
set          set a variable
show         show variable(s)
?           list commands
help         detailed help
include      read commands from a file
ls           list files
lsmod        list loaded modules
unload       unload all modules
load         load a kernel or module
pnpscan     scan for PnP devices
snap        show BIOS SMAP
boot-conf   load kernel and modules, then autoboot
read-conf   read a configuration file
enable-module enable loading of a module
disable-module disable loading of a module
toggle-module toggle loading of a module
show-module show module load data
OK ?

```

4. Type `boot -s` to start the kernel in single user mode.

```

OK boot -s
GDB: debug ports: uart
GDB: current port: uart
KDB: debugger backends: ddb gdb
KDB: current backend: ddb
SMAP type=01 base=0000000000000000 len=0000000000009b000
SMAP type=02 base=0000000000009b000 len=0000000000005000
SMAP type=02 base=000000000000e0000 len=00000000000020000
SMAP type=01 base=00000000000100000 len=00000000078e93000
SMAP type=02 base=00000000078f93000 len=0000000000091b000
SMAP type=04 base=00000000798ae000 len=0000000000049f000
SMAP type=02 base=0000000079d4d000 len=000000000022b3000
SMAP type=01 base=00000000100000000 len=00000000f80000000
SMAP type=02 base=000000007c0000000 len=00000000014000000
SMAP type=02 base=00000000fed1c000 len=00000000000029000
SMAP type=02 base=00000000fff000000 len=00000000001000000
Copyright (c) 1992-2013 The FreeBSD Project.

```

5. Press **Enter** after the following message is displayed:  
Enter full pathname of shell or RETURN **for** /bin/sh.  
**Note:** The prompt of the appliance changes to `\u@`.
6. Type `fsck_ufs -y /dev/ad0s1a` to verify the disk consistency of the `/flash` partition:

```

\nu@fsck_ufs -y /dev/ad0s1a
** /dev/ad0s1a
** Last Mounted on /flash
** Phase 1 - Check Blocks and Sizes
** Phase 2 - Check Pathnames
** Phase 3 - Check Connectivity
** Phase 4 - Check Reference Counts
** Phase 5 - Check Cyl groups
304 files, 391432 used, 8240223 free (63 frags, 1030020 blocks, 0.0% fragmentation)
***** FILE SYSTEM IS CLEAN *****
\nu@

```

7. Type `df` to display the currently mounted partitions.

```

\nu@df
Filesystem 1K-blocks    Used Avail Capacity  Mounted on
/dev/md0    422318 395666 18206    96%    /
devfs       1         1      0    100%   /dev

```

8. If the device name `s1a` is not mounted, type `/sbin/mount /dev/ad0s1a /flash` to mount the disk name `s1a` on the `/flash` partition. Type `df` to display the updated partitions.

```

\nu@/sbin/mount /dev/ad0s1a /flash
\nu@df
Filesystem 1K-blocks    Used    Avail Capacity  Mounted on
/dev/md0    422318 395666  18206    96%    /
devfs       1         1      0    100%   /dev
/dev/ad0s1a 17263310 782864 15099382  5%    /flash

```

9. Type `fsck_ufs -y /dev/ad0s1e` to verify the disk consistency of the `/var` partition.

```

\nu@fsck_ufs -y /dev/ad0s1e
** /dev/ad0s1e
** Last Mounted on /var
** Phase 1 - Check Blocks and Sizes
** Phase 2 - Check Pathnames
** Phase 3 - Check Connectivity
** Phase 4 - Check Reference Counts
** Phase 5 - Check Cyl groups
109777 files, 8193132 used, 65433941 free (957 frags, 8179123 blocks, 0.0% fragmentation)
***** FILE SYSTEM IS CLEAN *****
\nu@

```

10. If the device name `s1e` is not mounted, type `/sbin/mount /dev/ad0s1e /var` to mount the disk drive on the `/var` partition. Type `df` to display the mounted partitions.

```

\nu@/sbin/mount /dev/ad0s1e /var
\nu@df
Filesystem 1K-blocks    Used    Avail Capacity  Mounted on
/dev/md0    422318 395666  18206    96%    /
devfs       1         1      0    100%   /dev
/dev/ad0s1a 17263310 782864 15099382  5%    /flash
/dev/ad0s1e 147254146 16386264 119087552 12%   /var

```

If the output does not appear to be normal or an error is displayed, reset the hard disk drive, and repeat the procedure again. If the error is displayed again, contact NetScaler support for further investigation.



## Migrate the configuration of an existing NetScaler appliance to another NetScaler appliance

December 31, 2023

Before migrating to a new appliance, you must make some changes to the configuration of the old appliance before you copy the configuration to the new appliance.

Note: The following procedure does not apply to NetScaler FIPS appliances.

### Migrate a configuration

1. On the old appliance, create a backup copy of the configuration file (ns.conf).
2. Use a vi editor to edit the configuration file that you backed up. For example, you might want to change the user name, host name, and password.  
**Note:** Remove all interface-related configuration, such as `set interface`, `bind vlan`, `add channel`, `bind channel`, and `set channel`.
3. Shut down the old appliance.
4. Perform initial configuration on the new appliance. Connect to the serial console, and at the command prompt type **config ns** to run the NetScaler configuration script. Enter parameter values, such as NetScaler IP address (NSIP) and subnet mask. For information about performing initial configuration by using the configuration utility (GUI) or the LCD keypad, see [Initial Configuration](#).
5. Restart the new appliance.
6. Add a route on the new appliance. At the command prompt, type: `add route <network> <netmask> <gateway>`
7. Copy the edited configuration file to the new appliance.
8. Copy other relevant files, such as bookmarks, SSL certificates, CRLs, Web App Firewall profiles, login schemas, and portal themes to the new appliance. For more information about exporting a Web App Firewall profile, see [Exporting and importing a Web App Firewall profile](#). If you have added any login schemas, copy them from `/nsconfig/loginschema/*.xml` to the new appliance before copying the config file. After applying the config file, copy the portal theme files from the `/var/netscaler/logon/themes/` and `/var/netscaler/logon/LogonPoint/custom` folders to the new appliance. Return your feature license to the Citrix licensing portal and reallocate it on the new appliance.  
**Note:** The platform license is different for a new appliance.
9. Restart the new appliance.
10. Add the interface-related configuration specific to your new appliance, switch, and router, and save the configuration.

If you have a high-availability setup, you must perform the preceding procedure on both the nodes.

## Migrate the configuration of a FIPS appliance

In the following steps, appliance A is the source appliance and appliance B is the target appliance.

1. Initialize the FIPS card on appliance B. At the command prompt, type the following commands:

```
1 reset fips
2 Done
3
4 reboot
5
6 set fips -initHSM Level-2 so12345 so12345 user123 -hsmLabel NSFIPS
7
8 This command will erase all data on the FIPS card. You must save
  the configuration (saveconfig) after executing this command. Do
  you want to continue?(Y/N)y
9
10 Done
11 <!--NeedCopy-->
```

**Note:** The following message appears when you run the `set fips` command:

```
1 This command will erase all data on the FIPS card. You must save
  the configuration (saveconfig) after executing this command. [
  Note: On MPX/SDX 14xxx FIPS platform, the FIPS security is at
  Level-3 by default, and the -initHSM Level-2 option is
  internally converted to Level-3] Do you want to continue?(Y/N)
  y
2
3 saveconfig
4 Done
5
6 reboot
7
8 reboot
9 <!--NeedCopy-->
```

2. **On appliance A**, open an SSH connection to the appliance by using an SSH client, such as PuTTY.
3. Log on to the appliance, using the administrator credentials.
4. Initialize appliance A as the source appliance. At the command prompt, type:

```
1 init ssl fipsSIMsource <certFile>
2 <!--NeedCopy-->
```

**Example:**

```
init fipsSIMsource /nsconfig/ssl/nodeA.cert
```

- Copy this `<certFile>` file to appliance B, in the `/nconfig/ssl` folder.

**Example:**

```
scp /nconfig/ssl/nodeA.cert nsroot@198.51.100.10:/nconfig/ssl
```

- On appliance B**, open an SSH connection to the appliance by using an SSH client, such as PuTTY.
- Log on to the appliance, using the administrator credentials.
- Initialize appliance B as the target appliance. At the command prompt, type:

```
1 init ssl fipsSIMtarget <certFile> <keyVector> <targetSecret>
2 <!--NeedCopy-->
```

**Example:**

```
init fipsSIMtarget /nconfig/ssl/nodeA.cert /nconfig/ssl/nodeB.
key /nconfig/ssl/nodeB.secret
```

- Copy this `<targetSecret>` file to appliance A.

**Example:**

```
scp /nconfig/ssl/fipslbdal0801b.secret nsroot@198.51.100.20:/
nconfig/ssl
```

- On appliance A**, enable appliance A as the source appliance. At the command prompt, type:

```
1 enable ssl fipsSIMsource <targetSecret> <sourceSecret>
2 <!--NeedCopy-->
```

**Example:**

```
enable fipsSIMsource /nconfig/ssl/nodeB.secret /nconfig/ssl/
nodeA.secret
```

- Copy this `<sourceSecret>` file to appliance B.

**Example:**

```
scp /nconfig/ssl/fipslbdal0801b.secret nsroot@198.51.100.10:/
nconfig/ssl
```

- On appliance B**, enable appliance B as the target appliance. At the command prompt, type:

```
1 enable ssl fipsSIMtarget <keyVector> <sourceSecret>
2 <!--NeedCopy-->
```

**Example:**

```
enable fipsSIMtarget /nconfig/ssl/nodeB.key /nconfig/ssl/nodeA.
secret
```

- Export the FIPS keys on appliance A.

**Example:**

```
export fipskey Key-FIPS-1 -key Key-FIPS-1.key
```

14. Copy the key file to appliance B, in the `/nconfig/ssl` folder.

**Example:**

```
scp /nconfig/ssl/nodeA.key nsroot@198.51.100.10:/nconfig/ssl
```

15. Import the FIPS keys on appliance B.

**Example:**

```
import fipskey Key-FIPS-2 -key Key-FIPS-2.key -inform SIM -  
exponent F4
```

16. Copy the certificate files to appliance B, in the `/nconfig/ssl` folder.

**Example:**

```
scp /nconfig/ssl/nodeA.cert nsroot@198.51.100.10:/nconfig/ssl
```

17. Copy the rest of the configuration from appliance A to appliance B.

## Troubleshooting

December 31, 2023

### **I cannot access the NetScaler appliance after it is restarted. The NetScaler IP address (NSIP) is not accessible and does not respond to a ping request**

NetScaler MPX 8005/8015/8200/8400/8600/8800, MPX 11500/13500/14500/16500/18500/20500, MPX 11515/11520/11530/11540/11542, MPX 17550/19550/20550/21550, MPX 22040/22060/22080/22100/22120, MPX 24100/24150, MPX 25100T/25160T, T1010, T1100, T1200, T1300, and T1310 appliances support LOM. Depending on the state of the LOM configuration, start with one of the steps in the following procedure. To configure the LOM port, see [Lights out management port of the NetScaler appliance](#).

1. If the LOM port is configured and known to have been working previously, log on to the LOM GUI, and perform the following steps:
  - a) Navigate to **Remote Control > Console Redirection**, and then click **Launch Console**.
  - b) On the Java iKVM Viewer screen, check the VGA console window for boot errors, such as bad or missing boot media (boot drive/Compact Flash card). Reseat any unconnected boot

- media. If the appliance boots up, try to log on and run the `show techsupport` command from the NetScaler command line. Complete the Check Network Interfaces steps to find a working interface on which to transfer the support bundle file.
- c) Navigate to **System Health > Sensor Readings** to check the status of the hardware components (for example, CPU temperature, system temperature, and power supply status). You might have to scroll down. Green indicates that the hardware component is functioning properly. Red indicates that it has failed. Contact NetScaler support if you observe red indicators.
  - d) Navigate to **Miscellaneous > Post Snooping** and check for BIOS POST initialization codes. If the value of Post Snooping is “00” or “AC,” and the AC power supply LED light is green, the BIOS booted up normally. If not, check the Java iKVM Viewer screen to see if the appliance stopped responding during BIOS POST initialization. Perform substeps a through f of Step 2 to recover the appliance. If these steps fail, contact NetScaler support.
2. If the LOM port is configured and the LOM GUI is not accessible, try pinging the LOM IP address. The baseboard management controller (BMC, also known as LOM) runs on standby power. Even if the appliance is powered off by pressing the power button, the BMC is still working. If you are unable to ping the LOM IP address, connect to the COM1 console port through a serial cable. You can also try pinging the NetScaler IP address (NSIP). The serial cable can be connected to a network serial terminal/console server for remote access. On the appliance, do the following:
    - a) Verify that the appliance is receiving power.
    - b) If the appliance is not receiving power, change the power cable and connect the cable to another socket.
    - c) Verify that the power supply is properly seated in the power supply slot.
    - d) Remove all AC power supply cords for 30 seconds to completely remove power from the appliance.
    - e) Reinsert the AC power supply cords and check the LEDs indicating the status of the AC power supplies. If a power-supply LED is not green, troubleshoot the power supply.
    - f) Try pinging the LOM IP again. If successful, go to Step 1.
  3. If the appliance does not support the LOM port or the LOM port is not configured, do the following:
    - a) Connect the serial console cable to the appliance.
    - b) Perform the substeps a through e of Step 2.
    - c) On the serial console port window, check for any boot failure errors, such as bad or missing boot media (boot drive/Compact Flash card). Reseat any unconnected boot media. If the appliance boots up, try to log on and run the `show techsupport` command from the NetScaler command line. Complete the Check Network Interfaces steps to find a working interface on which to transfer the support bundle file.

## Check network interfaces

1. If management interface 0/1 is not operational, use the Java iKVM Viewer, described previously, to set up management interface 0/2, and connect a network cable to port 0/2. Use the serial console port for appliances that do not support the LOM port.
2. Make sure that the LED port status indicators are green for all interfaces. For more information about LED port status indicators, see “LED Port-Status Indicators” in [Ports](#).
3. Verify that NetScaler supports the SFP/SFP+/XFP transceivers that you are using.

## Hardware FAQs

December 31, 2023

### Transceivers

- Are transceivers shipped with the appliance?

No. Transceivers are available for purchase separately. Contact your NetScaler sales representative to buy transceivers for your appliance.

- Why does the 10G SFP+ transceiver autonegotiate to 1G speed?

Autonegotiation is enabled by default on the 10G SFP+ ports into which you insert your 10G SFP+ transceiver. When a link is established between the port and the network, the speed is autonegotiated. For example, if you connect the port to a 1G network, the speed is autonegotiated to 1G.

- Can I insert a 1G transceiver into a 10G slot?

- Only MPX 14000 and MPX 25000 appliances support copper transceivers.
- The 10G slot supports copper 1G transceivers, which can operate at up to 1 Gbps in a 10 Gbps slot.

**Note: 10G transceivers are not supported in 1G slots.**

The following table shows the compatibility matrix of transceivers and ports available on the NetScaler appliance.

Ports/Transceivers	10G transceiver	1G fiber transceiver	1G copper transceiver
10G port	Supported	Supported with exceptions (see note)	Supported
1G fiber port	Not Supported	Supported	Not Supported
1G copper port	Not Supported	Not Supported	Supported

**Note:**

The following appliances do not support the 1G fiber transceiver in a 10G port.

- MPX/SDX 89xx
- MPX/SDX 89xxT
- MPX/SDX 15xxx-50G
- MPX/SDX 14xxx-40G
- MPX/SDX 14xxx-40S
- MPX/SDX 25xxx-40G

Workaround: Use a 10G/1G dual speed transceiver to obtain 1G speeds.

For more information about supported transceivers per port, see [25G](#), [40G](#), [50G](#), and [100G ports](#).

**Ports**

- What is QSFP+?

QSFP+ stands for Quad Small Form-factor Pluggable, which is a small, hot-pluggable transceiver for connecting data devices. This transceiver is used for 40G interfaces.

**QSFP+ to four SFP+ Copper Breakout Cables:** These cables connect to four SFP+ 10GE ports of an ADC appliance on one end and to a QSFP+ 40G port of a Cisco switch on the other end.

**Support for 40G connectivity:** NetScaler models that have at least four 10G SFP+ ports connect to Cisco 40G interfaces by aggregating four of the 10G SFP+ ports to form a 40G link aggregation channel. QSFP to Four port SFP+ Copper Breakout Cable **QSFP-4SFP10G-CU3M (reports as L45593-D178-C30)** is used. The reverse is not supported. That is, connectivity from a 40G port on a NetScaler appliance and 4x10G ports on the peer switch is not supported.

- Which NetScaler appliances support the **QSFP-4SFP10G-CU3M (reports as L45593-D178-C30)** Breakout Cable?

NetScaler appliances that have at least four 10G SFP+ ports support the QSFP Breakout Cable.

- What is QSFP28?

QSFP28 is a hot-pluggable transceiver module designed for 100G data rate. QSFP28 integrates 4 transmit and 4 receiver channels. “28” means that each lane carries up to 28G data rate. QSFP28 can do 4x25G breakout connection, 2x50G breakout, or 1x100G depending on the transceiver used.

## Power supplies

- Is the power supply on the NetScaler MPX 5500 and MPX 5550/5650 appliances field replaceable?

No. The power supply on the NetScaler MPX 5500 and MPX 5550/5650 appliances is fixed.

- Do the MPX 8005, 8015, 8200, 8400, 8600, 8800 and T1010 appliances ship with two power supplies?

No. The MPX 8005, 8015, 8200, 8400, 8600, 8800 and T1010 appliances support dual power supplies but ship with one power supply. Contact your NetScaler sales representative to order a second power supply.

- How many power supplies are shipped with each platform?

Some platforms support two power supplies; some platforms support four power supplies. The number of power supplies shipped with the appliance might be less than the number of power supplies supported. More power supplies are available for purchase.

- Are power supplies hot-swappable?

Yes. If the appliance has two power supplies, you can replace one power supply without shutting down the appliance, provided the other power supply is working.

## Rack and rail

- Do you have different rail kits for 1U and 2U appliances?

No. All MPX and SDX appliances use the same rail kit. The kit contains two pairs of slide rails, of different lengths, for a 1U and a 2U appliance.

- Which rail kit must I buy?

The appliance ships with the standard 4-post rail kit that fits racks 28–38 inches.

The compact 4-post rail kit for racks 23–33 inches, or the 2-post rail kit for 2-post racks, has to be purchased separately. Contact your NetScaler sales representative to order the appropriate kit.



- What are the maximum and the minimum lengths of the outer rack rails?

The length of a standard outer rack rail is from 28 inches to 38 inches. The length of a shorter outer rack rail is from 23 inches to 33 inches.

- What is the space required between the front post and rear post of the rack?

Standard racks require 28–38 inches between the front and rear posts. Shorter racks require from 23 inches to 33 inches.

- How far can an appliance extend from the front post of the rack?

The chassis can extend up to 1.25 inches from the front post for all NetScaler MPX and SDX appliances.

- How much space is required for maintaining the front and rear area of an appliance?

Minimum clearance areas of 36 inches for the front area and 24 inches for the rear area are required for maintenance of all NetScaler appliances.

## Lights out management (LOM) port

- Which LOM features are supported on the NetScaler MPX Appliance?

Some platforms have an Intelligent Platform Management Interface (IPMI), also known as the Lights out management (LOM) port, on the front panel of the appliance. The following three LOM features are supported on those platforms:

- Configure the LOM port
- Power cycle the appliance
- Perform a core dump

- Can the LOM interface be configured to accept only encrypted Virtual Network Computer (VNC) sessions on TCP port 5900?

Yes, customers who enable Transport Layer Security (TLS) on their LOM interface will have their VNC connections delivered over TLS as well.

For more information on LOM security guidelines, see [Secure Deployment Guide for NetScaler MPX, VPX, and SDX Appliances](#).

- Can the version of SSH used on the LOM interface be upgraded? Is there a patch available?

Individual components of the LOM cannot be upgraded independently. You must upgrade the entire LOM firmware as a package. On the MPX appliances, the LOM upgrade is performed explicitly by going out to the shell and running the `upgrade_bmc . sh` script.

- Is it possible to add a third-party or self-signed SSL certificate to the LOM interface?

Yes, you can enable SSL on the latest binaries for third-party and self-signed SSL certificates, except on the 88XX models. On those models, the current LOM release does not support third-party certificates.

## General

- What is the recommended terminal emulator?

PuTTY.

- Which platforms support Pay-As-You-Grow licenses?

Check the NetScaler data sheet for the updated list of platforms that support Pay-As-You-Grow licenses.

Some of the platforms that support Pay-As-You-Grow licenses are listed here:

- MPX 5550 to MPX 5650
  - MPX 5901 to MPX 5905 to MPX 5910
  - MPX 8005 to MPX 8015
  - MPX 8905 to MPX 8910 to MPX 8920 to MPX 8930
  - MPX 14020 to MPX 14030 MPX 14040 MPX 14060 MPX 14080 MPX 14100
  - MPX 14020-40G to MPX 14030-40G MPX 14040-40G MPX 14060-40G MPX 14080-40G MPX 14100-40G
  - MPX 14040-40S MPX 14060-40S MPX 14080-40S MPX 14100-40S
  - MPX 14030 FIPS to 14060 FIPS to 14080 FIPS
  - MPX 15020 to MPX 15030 to MPX 15040 to MPX 15060 to MPX 15080 to MPX 15100
  - MPX 15020-50G to MPX 15030-50G to MPX 15040-50G to MPX 15060-50G to MPX 15080-50G to MPX 15100-50G
  - MPX 22040 to MPX 22060 to MPX 22080 to MPX 22100 to MPX 22120
  - MPX 25100-40G to MPX 25160-40G to MPX 25200-40G
  - T-series platform
- Do NetScaler appliances support direct attach cable (DAC)?  
Yes, NetScaler appliances support a passive DAC in release 10.5 and later.
  - Which port must I insert the DAC into?  
DAC is inserted into the 10G port on the appliance.
  - Does the 1G port support a DAC?  
No. The DAC might fit into a 1G port but is not supported.
  - How can I order a DAC?  
Contact your NetScaler sales representative to order a DAC.

- Can I mix DAC and fiber transceivers on the same appliance?

Yes. You can mix DAC and fiber transceivers on the same appliance. Each 10G port supports both options.

- Can I mix SFP+ fiber and DAC in ports that are part of the same link aggregation channel?

No. There must be symmetry between all elements in the same link aggregation channel.

- Which transceivers use the MPO type connector?

Only 40G QSFP+ SR4 transceiver and 100G QSFP28 SR4 transceivers use the MPO type connector. All other fiber transceivers use the LC type connector.

- Are special adapters required for 25G, 50G, and 100G ports?

A 100G port can support five speeds: 10G, 25G, 40G, 50G, and 100G. 1G speed is not supported on the 100G port. 50G and 100G ports use the same transceiver. The appliance determines the speed, and not the port.

Only 50G/100G (QSFP28) and 40G (QSFP+) transceivers can be directly used on a QSFP28 interface. Use a QSA28 adapter on a QSFP28 interface to use 10G (SFP+) and 25G (SFP28) transceivers.

The following diagram shows the transceiver compatibility.

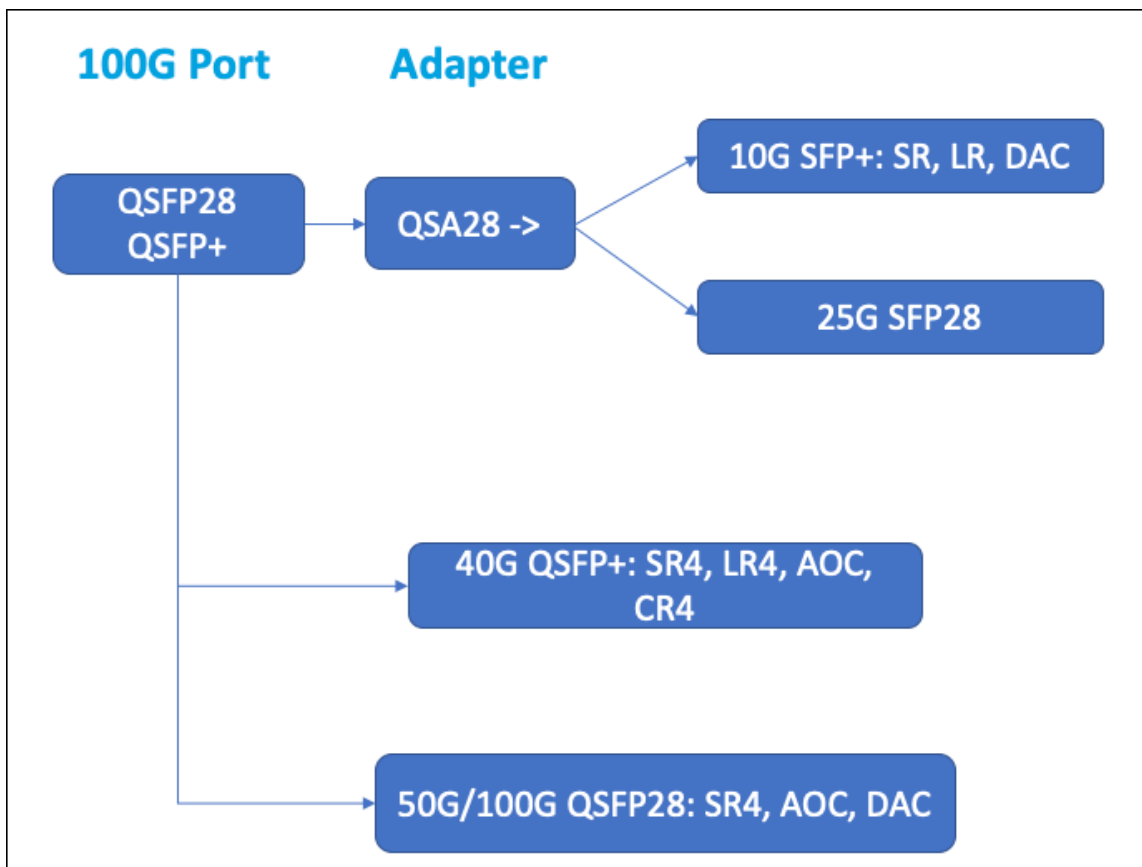

- Is the 40G SR4 QSFP (also known as BiDi) transceiver supported?

Yes. The following platforms support BiDi transceivers:

- MPX/SDX 14000 40C
- MPX/SDX 14000 40S
- MPX/SDX 14000 40G
- MPX/SDX 15000 50G
- MPX 15041T 50G
- MPX 15081T 50G
- MPX 25000TA
- MPX/SDX 25000 40G
- MPX/SDX 26000
- MPX/SDX 26000 50S
- MPX/SDX 26000 100G



© 2024 Cloud Software Group, Inc. All rights reserved. Cloud Software Group, the Cloud Software Group logo, and other marks appearing herein are property of Cloud Software Group, Inc. and/or one or more of its subsidiaries, and may be registered with the U.S. Patent and Trademark Office and in other countries. All other marks are the property of their respective owner(s).

---