



User Manual

JustConnect 16-Channel PoE Network Video Recorder

Preface

D-Link reserves the right to revise this publication and to make changes in the content hereof without obligation to notify any person or organization of such revisions or changes. Information in this document may become obsolete as our services and websites develop and change.

Manual Revision

Revision	Date	Description
1.00	April 27, 2016	• A1 Initial version
1.10	November 29, 2016	• Modified Remote Live View Control specification

Trademarks

D-Link and the D-Link logo are trademarks or registered trademarks of D-Link Corporation or its subsidiaries in the United States or other countries. All other company or product names mentioned herein are trademarks or registered trademarks of their respective companies.

Copyright © 2016 by D-Link Corporation, Inc.

All rights reserved. This publication may not be reproduced, in whole or in part, without prior expressed written permission from D-Link Corporation, Inc.

Apple®, Apple logo®, Safari®, iPhone®, iPad®, iPod touch® and Macintosh® are trademarks of Apple Inc., registered in the U.S. and other countries. App StoreSM is a service mark of Apple Inc. Google Play™ and Android™ are trademarks of Google Inc. Internet Explorer®, Windows® and the Windows logo are trademarks of the Microsoft group of companies.

ErP Power Usage

This device is an Energy Related Product (ErP) designed to be always on. It can be turned off via a power switch to save energy when it is not needed.

Switched Off: 0.35 watts

Table of Contents

Product Overview	1	Schedule	34
Package Contents.....	1	Recording Schedule.....	34
System Requirements	2	Event.....	36
Introduction	3	E-Mail Settings	36
Features.....	4	E-Map Settings.....	37
Hardware Overview	7	DI and DO	38
Front View.....	7	Event Settings	39
Rear Panel (Connections).....	8	Log	41
Installation	9	Maintenance.....	42
Hard Drive Installation.....	9	Display and Language	42
Connect Your Network Camera(s)	12	User Account	43
Configuring Your DNR-2020-04P	13	System	44
Configuration	14	Time and Date.....	45
Live Video	15	Firmware Upgrade.....	46
Playback.....	19	Hard Drive.....	47
Smart Search	21	PoE Status	48
Menu Bar	24	Camera Search.....	49
Setup Wizard	25	Album	50
Setup.....	26	Backup.....	51
Network.....	26	Help	53
Network Setup.....	26	Applications	54
Dynamic DNS Settings.....	28	D-Link NVR Search Utility - Windows	54
IP Filter	29	D-Link NVR Search Utility - Mac	56
SNMP	30	Playback Manager	57
Camera	31	Remote Backup	59
Audio and Video.....	31	Verification Tool.....	61

Troubleshooting 62

Technical Specifications 63

Regulatory Information..... 66

Product Overview

Package Contents

- D-Link DNR-2020-04P JustConnect 16-Channel PoE Network Video Recorder
- Hard disk screw x 8
- Rack-mount bracket x 2
- Rack-mount bracket screw x 8
- Power adapter x 1
- Power adapter cable
- Ethernet cable
- Quick Install Guide
- CD-ROM with applications and product documentation



Note: Using a power supply with a different voltage than the one included with your product will cause damage and void the warranty for this product.

If any of the above items are missing, please contact your reseller.

System Requirements

<p>Hardware Requirements</p>	<ul style="list-style-type: none"> • Two 3.5" SATA hard disk drives (not included)
<p>Network Requirements</p>	<ul style="list-style-type: none"> • Broadband Internet connection (for remote access) • Network camera(s) (refer to the D-Link website for a list of supported cameras) • 10/100/1000 Mbps Ethernet switch or router
<p>Web-based Configuration Utility / Remote PC Minimum Requirements</p>	<p>Computer with the following:</p> <ul style="list-style-type: none"> • Microsoft Windows 10, 8, 7, Vista, or XP (with Service Pack 3); Mac OS X (10.7 or above) • PC with Pentium 4 – 2.4 GHz or above; at least 512 MB RAM • Internet Explorer 8, Firefox 20, or Safari 6 or higher • Existing 10/100/1000 Mbps Ethernet-based network <p><i>Note: Make sure you have the latest version of Java installed. Visit www.java.com to download the latest version.</i></p>

Introduction

Congratulations on your purchase of the DNR-2020-04P JustConnect 16-Channel PoE Network Video Recorder.

The DNR-2020-04P is a standalone Network Video Recorder (NVR) designed to meet the surveillance requirements of small and medium businesses. Thanks to its support for Power over Ethernet (PoE), it is easy to deploy without further investment in electrical cabling. It features gigabit LAN speeds for high performance monitoring and recording of up to 16 channels simultaneously in mission-critical applications. Added support for multi-channel network cameras using M-JPEG, MPEG4, or H.264 codecs, and two 3.5-inch SATA hard disks with RAID to provide versatility, efficiency, and redundancy to meet enterprise needs.

Featuring a powerful embedded system, the DNR-2020-04P can record, monitor, and play back video simultaneously from network cameras located in local or remote sites without keeping your PC powered on. Simply connect a USB mouse and an HDMI or VGA display to the device for instant access. Also, the DNR-2020-04P can be easily set up for remote access and supports real-time monitoring and playback from anywhere via a web browser. Surveillance can be automated using versatile recording modes that can be set independently for each channel, and support for audio in /out, DI/DO triggering, and external USB 3.0 storage fills the needs of small businesses. Completing the package is the bundled video management software and support for mobile app management, making the DNR-2020-04P a comprehensive monitoring and storage solution for all your video recording needs.

Features

Comprehensive IP Surveillance Solution

- **Total Solution:** The DNR-2020-04P is a standalone network video recorder capable of 24/7 recording without a PC. The NVR can manage multiple network cameras, provide access to view live video, and play recorded data through the Internet from anywhere, anytime.
- **Convenient and Easy to Use:** Power over Ethernet (PoE) saves on infrastructure costs and makes setting up network cameras easy. A user-friendly GUI simplifies network and camera setup, allowing you to easily access multiple cameras for configuration and viewing, recording and playback of video.
- **Centralized Interface for Configuration:** The DNR-2020-04P provides a flexible and economic alternative to manage and configure multiple network cameras on a centralized device.
- **Megapixel Resolution Support:** The DNR-2020-04P supports high-resolution recording for vivid videos with high clarity.

Complete Network Functionality

- **PPPoE Support:** The NVR can connect to the Internet via an ADSL modem over Ethernet.
- **DDNS Support:** Dynamic DNS is a solution for users without a fixed IP address. With the DDNS service, you can connect to the NVR over the Internet using an easy-to-remember domain name.
- **NTP Support:** Maintaining an accurate record of time is essential if recorded data is to be used as evidence. To ensure that the time recording is always accurate, the NVR can update the system clock from a time server on the Internet using the Network Time Protocol (NTP).
- **DHCP Server:** The NVR can act as a DHCP server for easy deployment of network cameras when placed in a network that has no existing DHCP server.
- **Quality of Service (QoS):** The NVR can be customized to prioritize specific types of traffic via queues so that streams are smooth and reliable for mission-critical applications.
- **SNMP:** The Simple Network Management Protocol (SNMP) is an application layer protocol that facilitates the exchange of management information between network devices. It helps network administrators remotely manage network devices and find and solve network problems with ease. The SNMP consists of the following three key components:
 - **Manager:** Network-management station (NMS), a server that executes applications that monitor and control

managed devices.

- **Agent:** A network-management software module on a managed device which transfers the status of managed devices to the NMS.
- **Managed device:** A network node on a managed network. For example: routers, switches, bridges, hubs, computer hosts, printers, IP telephones, network cameras, web servers, and databases.

Full-featured Recording

- **Flexible Recording Schedule:** Once cameras have been set up, a highly configurable scheduling system allows for continuous recording, set recording during specific time frames, or recording only on motion detection. Each camera can be set to record independently in their own modes. Event recording based on specific triggers is also supported.
- **Recording Automatic Overwrite:** The NVR can be configured to overwrite the oldest data automatically when hard disk space runs out, allowing for continuous and uninterrupted recording.
- **Recording Stop Alert:** The NVR also provides the option to stop recording when the hard disk is full. When the disk reaches capacity, a notification can be sent via e-mail and an audible alarm can be sounded.

Comprehensive Data and Security

- **Auto Boot after Power Recovery:** The NVR will boot up automatically once power is restored after a power outage.
- **Access List Control:** Users can specify safe and blocked IP addresses to filter external connections, increasing data security.
- **Multiple User Privilege Control:** Administrators may also choose access privileges for users by specifying the cameras they may have access to for live view, playback, audio, and PTZ functions.
- **Backup Recording Data:** Recorded data is stored in a secure database. This recorded data can be backed up to additional storage locations periodically or whenever needed.
- **RAID Mirroring:** RAID 1 hard disk configuration mirrors recorded data onto two separate hard drives. In the event of HDD failure, data integrity is maintained on the secondary HDD.

Flexible Event Management

- **Audio In/Out:** Connect a microphone and a speaker to allow two-way communication (if supported by the camera).
- **DI/DO triggering:** Connect to devices such as door sensors or point-of-sale systems to allow for easy event-based recording and action triggering. The NVR can monitor trigger events from all cameras, such as motion detection. These can be used to trigger e-mail notifications and recordings, all centrally handled by the NVR.

Instant Live View

- **Full Screen:** Enlarge the display to view full-screen live and recorded video views.
- **Drag and Drop GUI:** With multiple channels enabled, users can drag and drop channels to preferred locations.
- **Camera Name and Status on OSD:** Camera name and recording status are displayed on the OSD (On Screen Display) to help identify the current camera.
- **PTZ:** Users can control Pan/Tilt/Zoom (PTZ) functions for supported cameras from within the interface using the provided buttons, or by directly clicking on the video.
- **Audio Support:** Audio picked up by a supported camera can be recorded and played back.
- **Preset Point:** Camera position presets allow you to instantly restore a previously saved view.
- **Digital Zoom:** Videos can be enlarged by digital zoom.

Intelligent Playback

- **AVI Outputs:** Raw video can be exported to AVI format.
- **Playback Speed Control:** Playback speed control allows for fast forward or fast rewind, and step playback can display video one frame at a time.
- **Smart Search:** Users can search through footage by setting specific criteria such as motion detection.

Hardware Overview

Front View

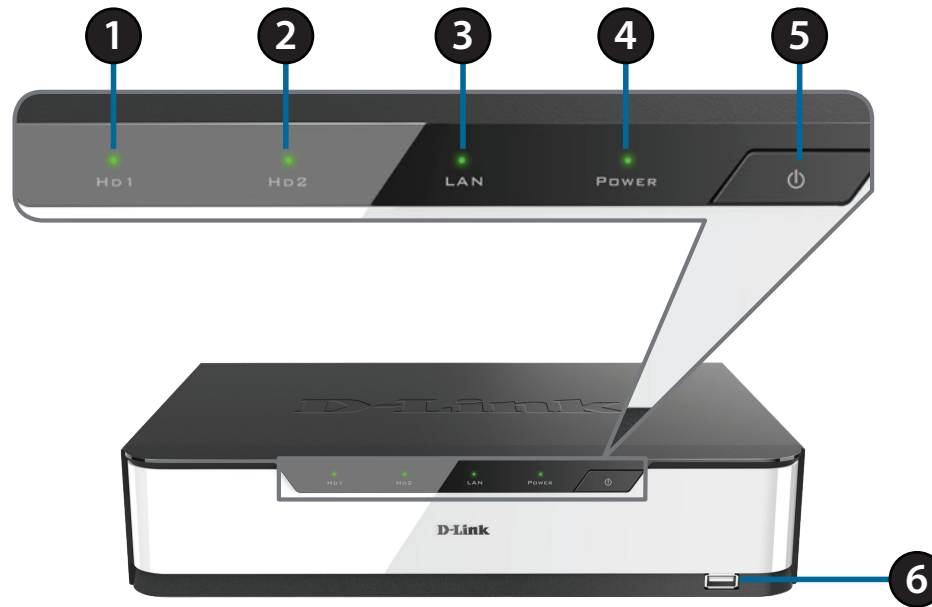

1	HD1 LED	A solid green light indicates that the hard drive is installed properly. This light will blink during the read/write process. If the light is red, the hard drive is installed but has failed.
2	HD2 LED	A solid green light indicates that the hard drive is installed properly. This light will blink during the read/write process. If the light is red, the hard drive is installed but has failed.
3	LAN LED	A solid green light indicates that the device is connected to your network. This light will blink during data transfer. If the light is off, the device is not connected to your network.
4	Power LED	A solid green light indicates the device is powered on. This light will blink during bootup. If the power LED is off, the device is not powered on.
5	Power Button	Push this button for one second to power on the device or for 5 seconds or more to power off.
6	USB 2.0 Port	Connect a mouse to control the management UI when a monitor is connected via HDMI or VGA. This port is used for firmware updates, video exports to USB drives, and backups. Connection to a USB mouse/keyboard is supported.

Rear Panel (Connections)

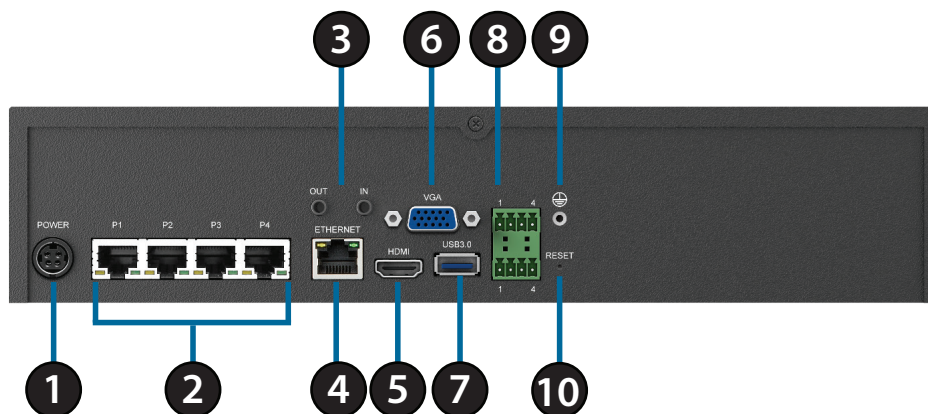

1	Power Input	Connect the supplied power cord to the input port.
2	PoE Ports 1-4	Connect PoE devices to these ports for power to be supplied via Ethernet. Non-PoE devices will only have Ethernet functionality. Green: A solid LED indicates that LAN is connected. The LED will blink during data transfer. An unlit LED indicates there is no network connection. Orange: A solid LED indicates that power via PoE is normal. An unlit LED indicates there is no power.
3	Audio In/Out	Connect a microphone to the Audio In port to use 2-way communication with your camera(s). Connect external speakers to the Audio Out port for audio playback. Please note that your camera(s) must support this feature.
4	Gigabit Ethernet Port	Connect the device to your router or switch using an Ethernet cable. Yellow: Solid indicates Link status (connected to LAN). Blinking indicates data is being transferred. Green: Solid Indicates an active Gigabit Ethernet connection. Off indicates Fast Ethernet connection.
5	HDMI Output	Connect to your TV or monitor using an HDMI cable.
6	VGA Output	Connect a monitor using a D-sub cable.
7	USB 3.0 Port	Connect an external USB hard disk for more storage.
8	DI/DO	Connect four Digital Input devices and one Digital Output device to these ports.
9	Grounding Port	Connect a grounding wire to ground the NVR.
10	Reset Button	Press and hold the reset button for 10 seconds to reset to factory default settings.

Installation

Hard Drive Installation

1. First, make sure the power cable is not plugged into a power outlet. Access the DNR-2020-04P's hard drive bays by removing the screws from the sides and back of the device.

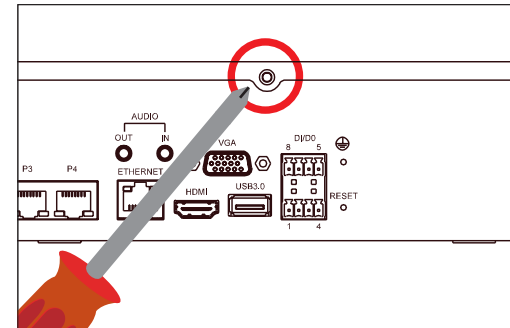
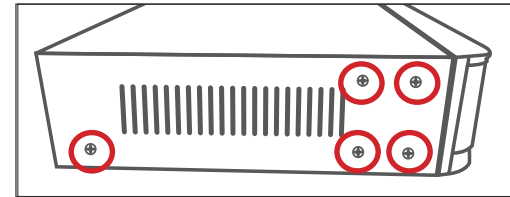

2. Once the cover is removed, slide it rearward to remove it from the device.

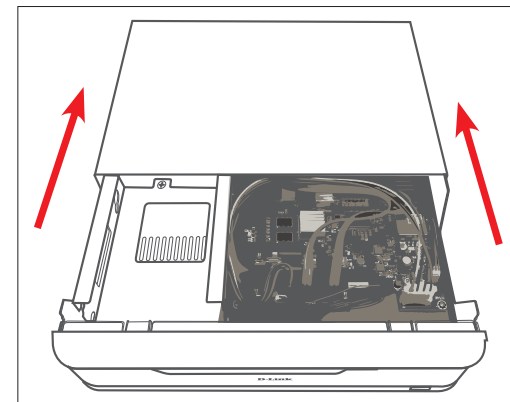

3. Detach the HDD bay bracket, then insert one or two 3.5" SATA hard drives into the drive bays and use the provided screws to secure the drives in the bracket.

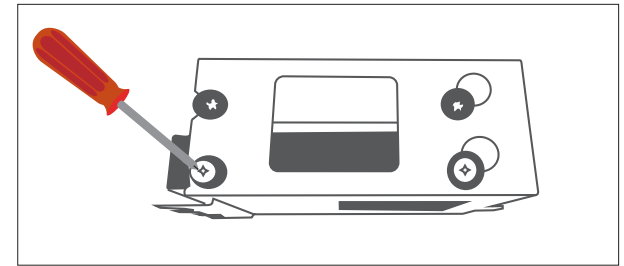

4. Connect the power and SATA cables from the device to each HDD. If a drive has been inserted correctly, the HDD LED will light up.

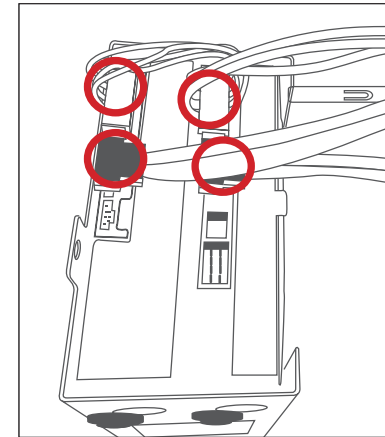

5. Re-attach the drive bay bracket to the device enclosure by sliding the tabs into the holes and using the screws provided to secure it.

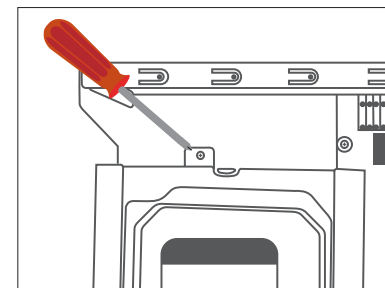

6. Re-attach the top cover by sliding it over the device. Re-insert the screw in rear of the cover to secure it.

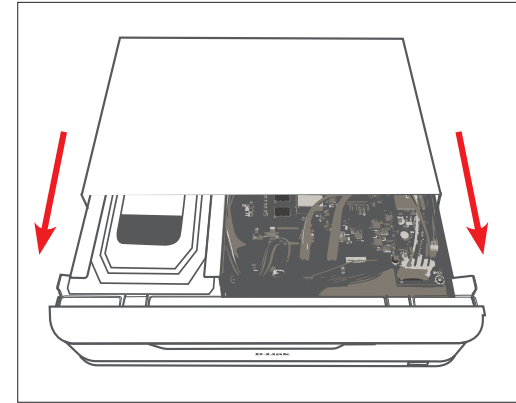

Connect Your Network Camera(s)

You can connect PoE network cameras directly to your DNR-2020-04P. For non-PoE network cameras, you will need to locate power outlets in the on-site environment then run a CAT5 UTP cable to the P1-4 ports on the NVR.

1. Connect a CAT5 UTP cable to a port marked either P1, P2, P3, or P4.

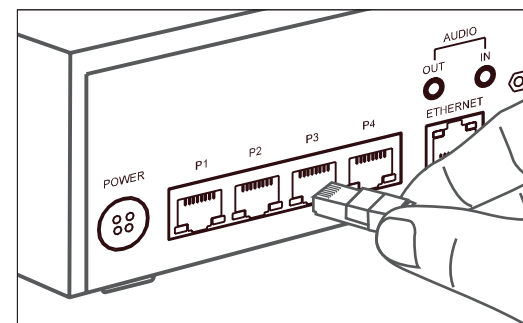

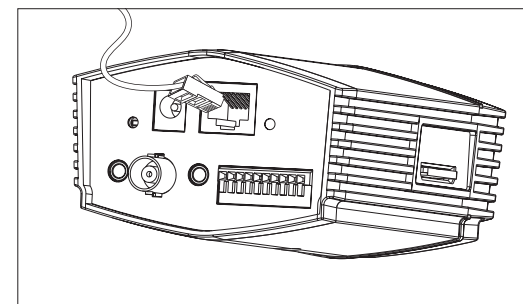

2. Connect the other end of the cable to your PoE Camera.

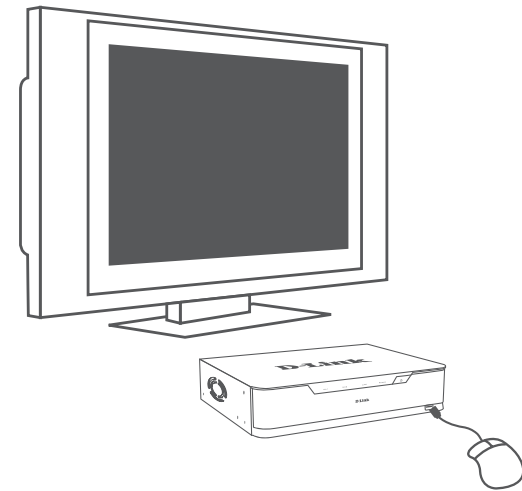

Configuring Your DNR-2020-04P

You can setup your NVR without using a PC by connecting a VGA or HDMI display to the respective ports on the back of the device. To control the Graphical User Interface (GUI), connect a USB mouse to the USB port on the front panel.



The default username of the NVR is **admin** and the default password is blank. You can customize the password and configure NVR settings by clicking on the setup wizard icon  and following the on-screen instructions.







Configuration

You can access the configuration interface for the NVR on your PC by running the **NVR Search Utility** or manually opening a web browser and entering the IP address of your NVR. Enter **admin** as the username and enter the password you created during installation.

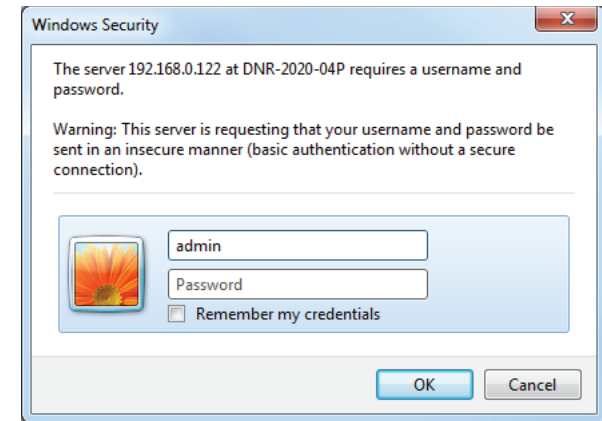
You can also control and manage the NVR locally by connecting it to a TV or external VGA/HDMI monitor and plugging in a USB mouse to control the interface.

This section will enable you to configure and view the live video from your network cameras.



	Live Video	Shows the live video of network cameras and controls PTZ functions.
	Playback	Displays recorded video and exports snapshots or video.
	Log Out	Logs out of the NVR.
	Shut Down	Shuts down the NVR.

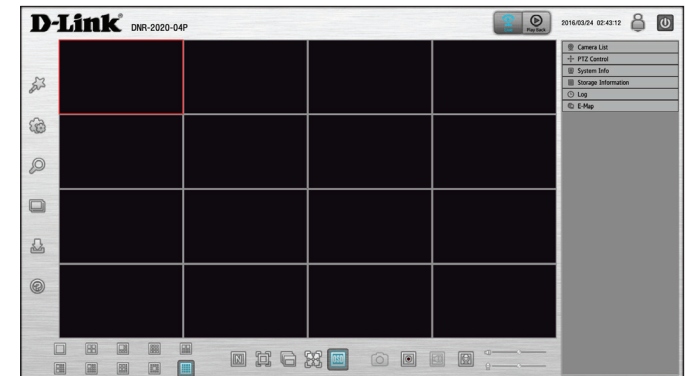

Live Video

This section describes the configuring and viewing of live video from your network cameras, the functions of the live video screen, and the PTZ functions. To monitor live video:

Step 1: Click the  button at the top of the screen.





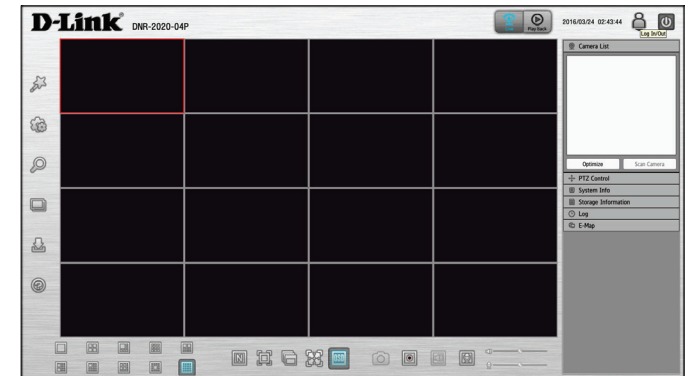









Step 2: Select a camera(s) from the camera list on the right and then drag it to the location to where you want it to be displayed.

Optional: You can change the video display position by dragging it to another position.





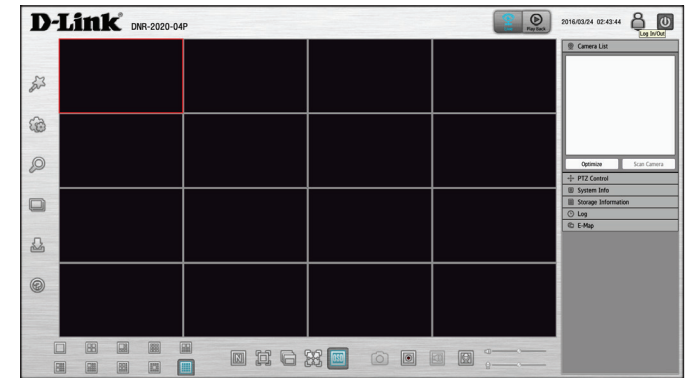

Notes:

1. The selected video will be marked with a red line.
2. Enable EPTZ: Right-click on the video and click on **EPTZ**. Click the + or – button to zoom in or zoom out. The flashing square at the lower right of the video grid indicates the corresponding view of the camera.
3. If the camera supports PTZ, you can control the selected camera from the PTZ panel.
4. If the camera supports audio, you can check **Enable Audio** from the right-click menu and listen to the channel's audio.
5. Snapshot: Right-click on the video and select the snapshot function to capture a specific video image immediately.
6. Right-clicking on the video will show the option as **Full Screen**. Press the **ESC** button on the keyboard to return to normal display.
7. Swap: Right-click on the video and select **Swap** to display a different video channel.

	Display Single feed	Use this button to switch to a single camera feed in the live video display area.
	Display 2 x 2 feeds	Use this button to switch to view four cameras in the live video display area.
	Display 1 + 5 feeds	Use this button to switch to view one large and five small streams in the live video display area.
	Display 3 x 3 feeds	Use this button to switch to view nine cameras in the live video display area.
	Display 2 + 8 feeds	Enlarge two channels in the top row.
	Display 2 + 8 feeds	Enlarge two channels in the left column.
	Display 1 + 12 feeds	Enlarge one channel and show 12 additional streams.
	Display 4 + 9 feeds	Enlarge 4 channels and display 9 feeds.
	Display 1 center + 12 feeds	Enlarge one channel in the center and display 12 feeds.
	Display 16 feeds	Show all 16 feeds simultaneously.
	Switch between feeds	Click to cycle between 2x2, 3x3, 4x4 views.
	Full Screen	Select to display the video with full screen. Press the ESC button on the keyboard to return to normal display.
	Glance	Activate auto scan to rotate the channels/cameras on the display screen.
	Actual Size	Use this button to display the recording in its original resolution.
	OSD	Display video stream information in the window.



	Snapshot	Click to take a still image and save it to a folder.
	Manual Record	Click to enable or disable manual recording.
	Speaker On/Off	Turn the speaker on or off.
	Mic On/Off	Turn the microphone on or off.
	PTZ Control	You can control the camera view by utilizing the PTZ (pan, tilt, and zoom) camera control panel to adjust the camera angle. This function is only available with cameras that support the PTZ function.

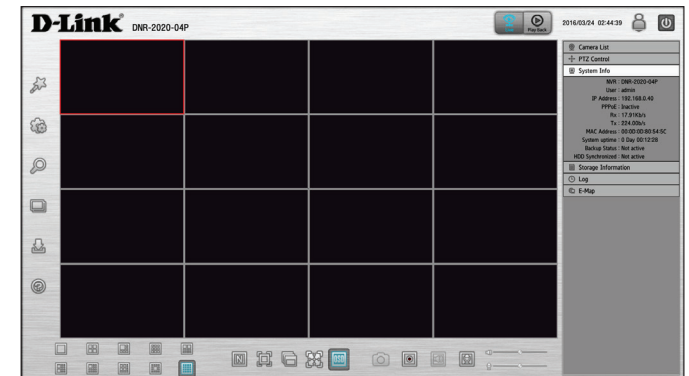
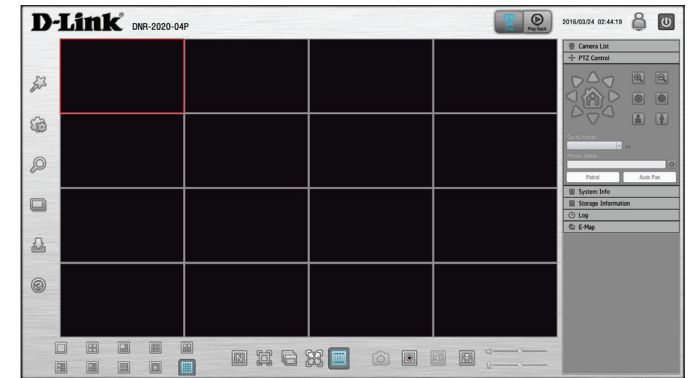

Information panel on the right side of the GUI:

- Camera List:** Displays the cameras connected to the NVR and their respective IP addresses.
- Optimize:** Click **Optimize** to fine tune your camera settings for smoother live viewing and video recording.
- Scan Camera:** Click **Scan Camera** and the NVR will use Admin as the user name and a blank password to automatically add any network cameras from the same local area network.

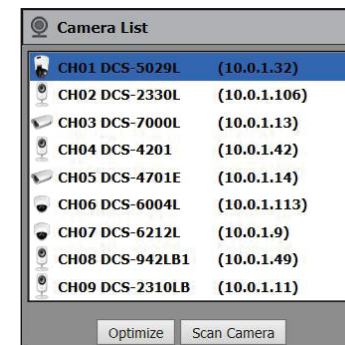

System Info: Displays the NVR's network information such as the NVR's IP address, MAC address, and transfer rates.

System Info

NVR : DNR-2020-04P
 User : admin
 IP Address : 192.168.0.102
 PPPoE : Inactive
 Rx : 2.67 Mb/s
 Tx : 617.01 Kb/s
 MAC Address : 00:00:0D:80:54:12
 System uptime : 1 Day 16 : 53 : 18
 Backup Status : Not active

Storage Information

Total Hard Drive Capacity: 2.7 TB

Device	Free	Used	Total
HDD	4.7 GB	2.7 TB	2.7 TB
Device	Free	Used	Total
USB	921.5 GB	9.5 GB	931.0 GB

Storage Information: Displays a pie chart and table of used and free space as well as any attached storage devices.

Log: Displays the System, NVR, and Event logs.

Log

System NVR Event

Date	Time	Info
2015/11/24	09:29:58	admin login Ok from 10.0.1
2015/11/24	04:46:21	camera device 10.0.1.42 ad
2015/11/23	19:18:09	camera device 10.0.1.9 add
2015/11/23	18:23:05	admin login Ok from 10.0.1
2015/11/23	17:47:55	admin login Ok from 10.0.1
2015/11/23	16:03:28	admin login Ok from 10.0.1
2015/11/23	15:16:01	admin login Ok from 10.0.1
2015/11/23	14:37:17	camera device 10.0.1.113 a
2015/11/23	14:08:50	admin login Ok from 10.0.1
2015/11/23	13:49:53	admin login.

Previous 1/10 Next

E-Map: Check E-map to see camera(s) location and connection status.













E-Map

E-Map E-Map1 E-Map2







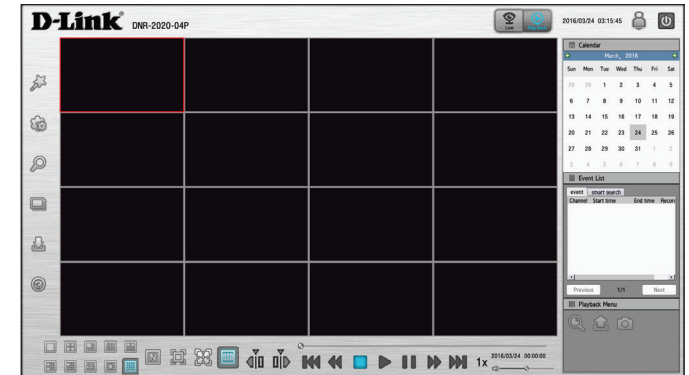

The image shows a floor plan with several camera icons placed at various locations within the room layout.

Playback

This section shows the NVR's recorded video feeds. You may select any of the available icons listed below to playback, adjust, and export the recorded video streams.

	Display Single feed	Use this button to switch to a single camera feed in the live video display area.
	Display 2 x 2 feeds	Use this button to switch to view four cameras in the live video display area.
	Display 1 + 5 feeds	Use this button to switch to view one large and five small streams in the live video display area.
	Display 3 x 3 feeds	Use this button to switch to view nine cameras in the live video display area.
	Display 2 + 8 feeds	Enlarge two channels in the top row.
	Switch between feeds	Click to cycle between 2x2, 3x3, 4x4 views.
	Full Screen	Use this button to switch to a full screen view of the live video feed.
	Display 2 + 8 feeds	Enlarge two channels in the left column.
	Display 1 + 12 feeds	Enlarge one channel and show 12 additional streams.
	Display 4 + 9 feeds	Enlarge 4 channels and display 9 feeds.
	Display 1 center + 12 feeds	Enlarge one channel in the center and display 12 feeds.
	Display 16 feeds	Show all 16 feeds simultaneously.
	Actual Size	Use this button to display the recording in its original resolution.



	On Screen Display Settings	Use this button to configure the various settings for the on screen display.
	Cue in/Cue Out	Click the Cue In or Cue Out button to set the period for saving a video.
	Play/Stop/Pause	Select a camera/video and click this button to play/stop/pause a particular channel.
	Speed	Click to increase or decrease the playback speed.
	Reverse/Step Forward	Click to pause the playback and move to next frame or last frame.
	Smart Search Button	Click to start the smart search.
	Export	Use the button to export a video stream.
	Snapshot	Click this button to take a still image of the selected video stream.

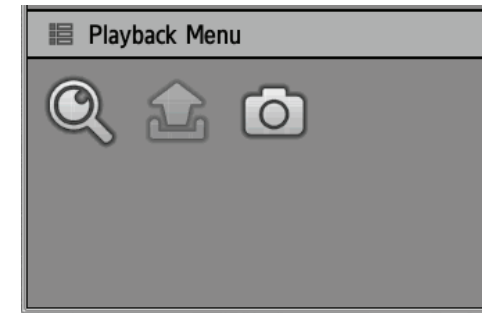

Smart Search

Smart Search lets you find specific events for review. You may select any of the available icons under playback to control, adjust, and export the recorded video streams.

Step 1:

Click on the Playback icon to enter playback mode.

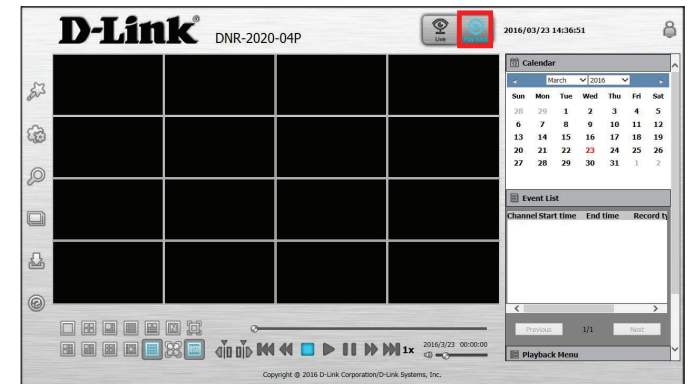

Step 2:

Select the time and date of your specific event in the Calendar in the right column to begin playback from.



Step 3:

Select the time period of the event that you wish to search for and press **OK** in the pop-up window. This will show the channels available for the time period.

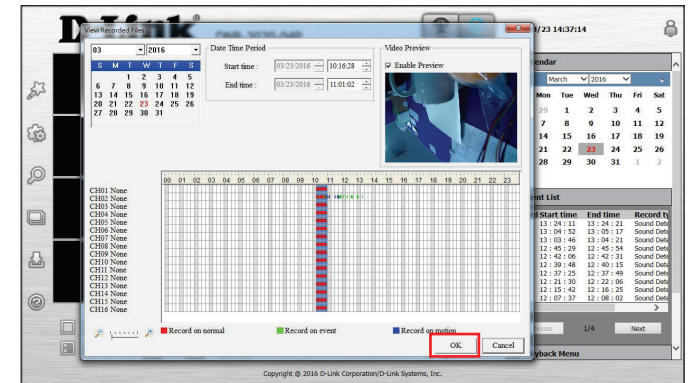

Step 4:

In the available channels, select the channel that you wish to review.

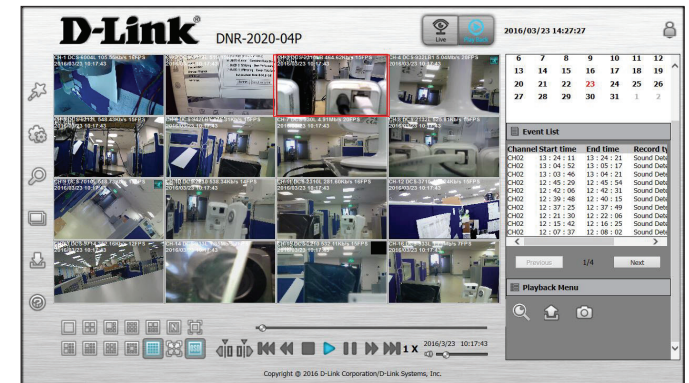

Step 5:

Click on the Smart Search button to search the selected channel for the specified time period.

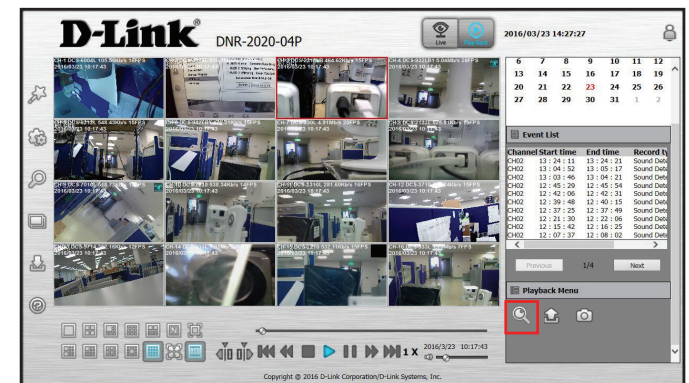

Step 6:

If necessary, in the Smart Search window, select the area you wish to detect for abnormal events.

Step 7:

Select the sensitivity level from the drop-down menu.

Step 8:

Click **OK** when you are done specifying the selected area in the channel for abnormal events during the specified time period.









Step 9:

Click a channel event under the Smart Search tab in the Event List window to play back the recorded event.

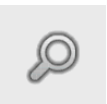

Menu Bar

The Menu bar resides on the left side of the screen. You can click the icons in this bar to access different sections, which are described in the following pages.

	Setup Wizard	This will start the Setup Wizard, which will help you set up and configure the basic settings of the NVR. Refer to Setup Wizard on page 25.
	Settings	This will open the settings page of the NVR, where you can manually configure the different settings and features of the device. Refer to Setup on page 26.
	Camera Search	This will let you automatically search for new cameras to add to the NVR. Refer to Camera Search on page 49.
	Album	This will open the album, where you can see all the snapshots taken by the NVR. Refer to Album on page 50.
	Backup	This will let you back up the recordings stored on the NVR to a USB drive, Samba server, or FTP server. Refer to Backup on page 51.
	Help	This shows more information about using the NVR. Refer to Help on page 53.

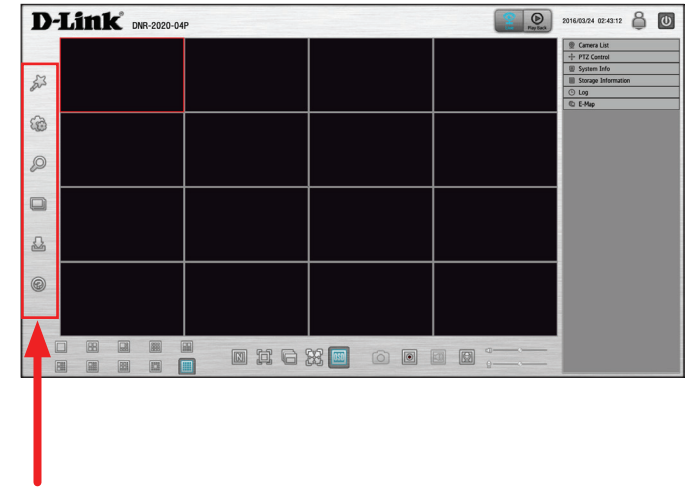

Setup Wizard

The Setup Wizard, helps you set up and configure the basic settings of the NVR. Select the language you want to use, then click the **Next** button to start the wizard.



Setup

Network

Network Setup

Network Setup lets you configure how you connect the NVR to the Internet or local network.

DHCP: Select this connection if you have a DHCP server running on your network and would like a dynamic IP address to be automatically updated to your NVR.

Static IP: You may obtain a static or fixed IP address and other network information from your network administrator. A static IP address will simplify access to your NVR in the future.

IP Address: Enter the fixed IP address of the NVR and the port that is used to access the web interface.

Subnet Mask: Set this to match the subnet mask of the provided IP address. The default value **255.255.255**.

Gateway: Set this to the default gateway on your router or local subnet for proper network routing.

DNS1: Primary domain name server that translates names to IP addresses.

DNS2: Secondary domain name server to back up the primary domain name server.

Enable PPPoE: Enable this setting if your ISP is using PPPoE. You may already have a Username and Password provided by your ISP, or you may need to contact your ISP. The connection status will be determined automatically by the system.

DHCP Server: Enable or disable the DHCP server. If your network doesn't have a DHCP server, enable this feature for easier local network setup. You can specify the IP address range and lease time that DHCP uses to provide IP addresses to clients.

Enable Bonjour: Enable the Bonjour service to allow users to discover the DNR-2020-04P with Apple devices.

The screenshot shows the 'Network Setup' configuration window. The left sidebar lists various settings categories: Network Setup, Dynamic DNS Settings, IP Filter, SNMP, Camera, Audio and Video, Schedule, Recording Schedule, Event, E-Mail Settings, E-Map Settings, DI and DO, Event Settings, Logs, Maintenance, Display and Language, User Account, System, Time and Date, Firmware Upgrade, Hard Drive, and PoE Status. The main area is titled 'Network Setup' and contains the following options:

- DHCP:** Selected with a radio button.
 - IP Address: 192.168.0.129
 - Subnet Mask: 255.255.252.0
 - Gateway: 192.168.1.254
 - DNS1: 193.95.1.1
 - DNS2: 8.8.8.8
 - Http Port: 80
- Static IP:** Unselected with a radio button.
- Enable PPPoE:** Unchecked checkbox.
 - User Name: []
 - Password: []
 - Confirm Password: []
 - Status: Inactive
- DHCP Server:**
 - Enable DHCP server: Unchecked checkbox.
 - DHCP IP address range: 0.0.0.0 to 0.0.0.0
 - DHCP lease time: 24 (hour)
- Apple:**
 - Enable Bonjour: Checked checkbox.
 - Bonjour Name: DNR-2020-04P

Buttons for 'Save' and 'Cancel' are located at the bottom right of the window.

Bonjour

Name: Enter the name of the device that will be used to identify the DNR-2020-04P when using Apple devices.

Dynamic DNS Settings

Enable this option only if you have registered a domain name with a dynamic DNS service provider. The following parameters are displayed when the option is enabled.

Server Address: Select a dynamic DNS service provider from the pull-down list or input a custom DDNS server IP address.

Host Name: Enter your host name. For example: myhost.mydomain.net.

Username: Enter the username for your dynamic DNS account.

Password: Enter the password for your dynamic DNS account. Confirm it in the next text box.

Timeout: Type in the number of hours between updates to your DDNS provider.

Status: Displays the status of your DDNS connection.

The screenshot shows a 'Setup' window with a sidebar on the left containing various configuration categories: Network, Network Setup, Dynamic DNS Settings (highlighted), IP Filter, SNMP, Camera, Audio and Video, Schedule, Recording Schedule, Event, E-Mail Settings, DI and DD, Event Settings, Logs, Maintenance, Display and Language, User Account, System, Time and Date, Firmware Upgrade, Hard Drive, and PoE Status. The main area is titled 'Dynamic DNS' and features a radio button to 'Enable' (selected) and a 'Disable' option. Below this are several input fields: 'Server address' (containing 'www.dlinkddns.com'), 'Host Name', 'User Name', and 'Password'. A 'Confirm Password' field is also present. A 'Timeout' field is set to '24' (Hour). The 'Status' is displayed as 'Inactive'. At the bottom right, there are 'Save' and 'Cancel' buttons.

IP Filter

By enabling IP filtering you can allow or block visitors from accessing the NVR. To add IP addresses to the Allowed or Blocked lists, enter the IP address range you want to allow or block into the text boxes, then click on **Add to Allowed List** or **Add to Blocked List**.

Enable Allowed List: Enabling this will allow only the IP addresses in the allowed list to access your NVR.

Note: Make sure you enter the IP address of the PC you use to access the NVR before enabling this option, or you may not be able to access it afterwards.

Enable Blocked List: Enabling this will block all IP addresses in the blocked list from accessing your NVR.

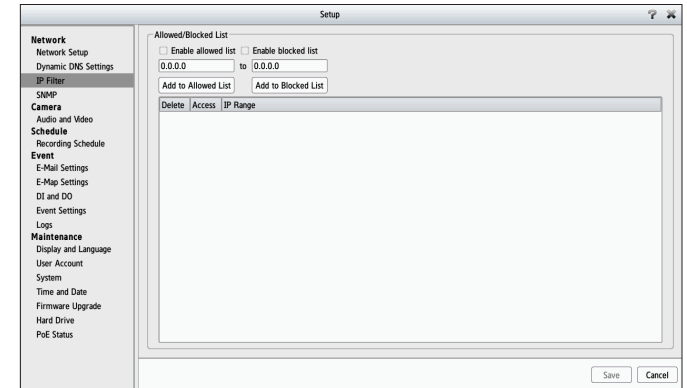

SNMP

If you have SNMP agents that you wish to send traps such as alarms and syslog messages to your NVR, you can enable and configure your SNMP settings on this page.

Enable SNMPv1, SNMPv2c: Enable and enter a password for the Read/Write and Read-Only community strings here. Change the community string to keep intruders from getting information about the network setup.

Enable SNMPv3: This SNMP version adds encryption and authentication to the service for better security. You can specify separate Read/Write versus Read-only name and passwords as well as the type of encryption to use.

The screenshot shows the 'Setup' window for SNMP configuration. The left sidebar lists various settings categories, with 'SNMP' selected. The main area contains the following fields:

- Enable SNMPv1, SNMPv2c
- Read/Write community: private
- Read only community: public
- Enable SNMPv3
- Read/Write Security name: private
- Authentication type: MD5
- Authentication password: [empty]
- Encryption password: [empty]
- Read only security name: public
- Authentication type: MD5
- Authentication password: [empty]
- Encryption password: [empty]

At the bottom right, there are 'Save' and 'Cancel' buttons.

Camera

Audio and Video

This section will allow you to configure and modify video, audio, and image settings for each camera. Click on the camera name in the top section and configure the parameters in the bottom section.

The Video tab has the following settings:

- Camera Name:** The name of the camera is displayed here.
- Main Profile:** Choose from preset video profiles to apply as the main profile for this camera.
- Video Format:** Select from the video formats supported by the camera. Options include MJPEG, MPEG4, and H.264.
- Frame Rate:** Select the frame rate for the camera. The default rate is 15 fps.
Note: *The system will adjust the frame rate automatically based on the maximum frame rate that the camera can support.*
- Resolution:** Select the resolution for the selected camera.
- Bit Rate:** Select the preferred bit rate for small or large file sizes.
- Quality:** Select the quality of the video for the camera.
- Sub Profile:** Choose from preset video profiles to apply as the sub profile for this camera. Select alternate settings for the above fields for this profile.

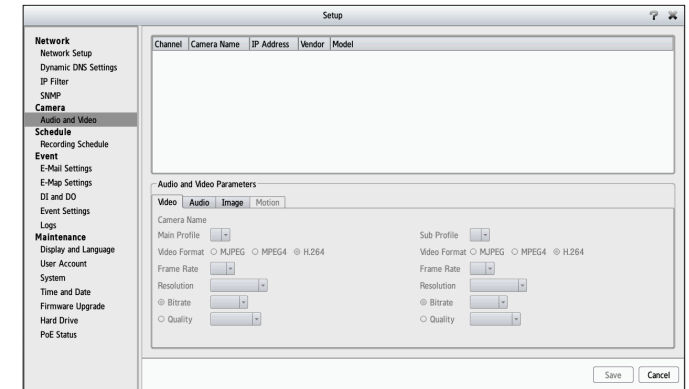

The Audio tab has the following settings:

Audio Format: Select from supported audio formats (G.711, G.726, AAC).

Enable Microphone: Turn on/off the microphone on the camera (if supported).

Audio-in Gain Level: Select the audio-in gain level for the microphone.

Enable Speaker: Enable audio out on the camera (if supported).

Audio Out Volume Level: Adjust the volume of the camera's speaker.

The Image tab has the following settings:

Brightness: Adjust the brightness.

Contrast: Adjust the contrast.

Saturation: Adjust the saturation.

Sharpness: Adjust the sharpness.

Note: For some IP cameras, the NVR supports motion detection.

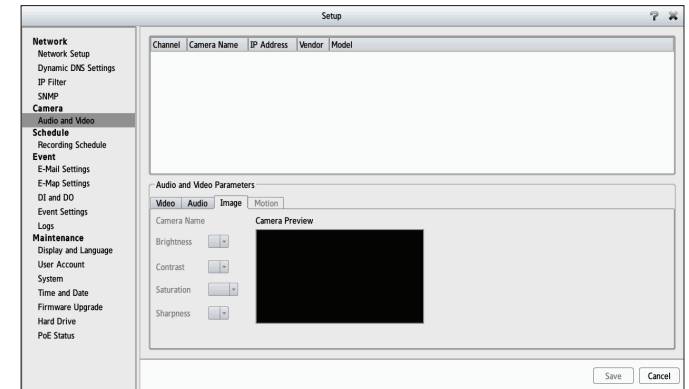
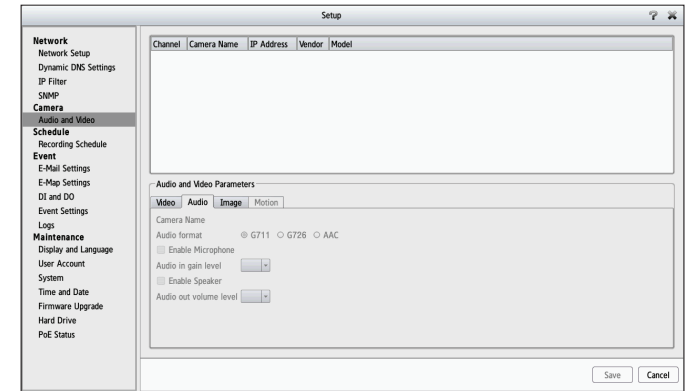

The Motion tab has the following settings:

- Enable Video Motion:** Click on the check box to enable or disable motion detection settings.
- Clear:** Clear all motion detection area selections on this channel.
- Restore:** Restore previous motion detection area selections on this channel.
- Select All:** Click on the check box to select all motion detection area selections on this channel.
- Sensitivity:** Set the sensitivity of the motion detection from 0-100 in this text box.

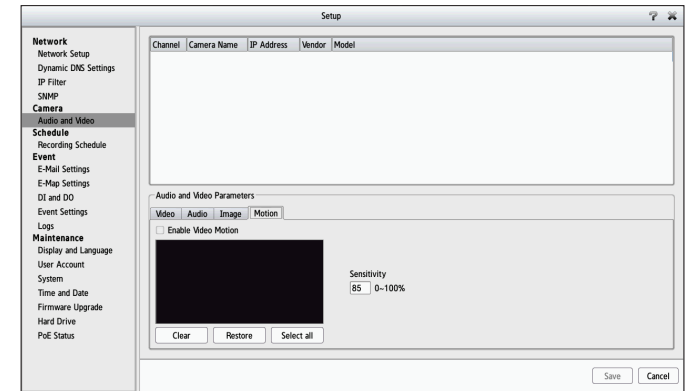

Schedule

Recording Schedule

Once the cameras have been set up, a highly configurable scheduling system allows for either continuous recording or scheduled recording. Each camera can be set to record independently at preset intervals and provide event recording based on specific triggers. The NVR can be configured to overwrite the oldest data automatically when hard disk space runs out, allowing for continuous and uninterrupted recording. It is possible to specify the number of days the recording should be kept for (within the limits of the hard disk capacity).

Set Recording Mode

Enable Schedule Recording: Record according to a schedule set below.

Enable Automatic Overwrite: Select this option to automatically empty disk space when the disk space is full. This will overwrite the earliest recorded video with the latest video one day at a time.

Enable Audio Recording: Set the duration to store recorded video clips. After the duration, the clips will be purged.

Keep [x] Day(s) Video: Keep at least [x] days of video footage on hard disk when the video recycles.

Set Recording Schedule

Always Record: Click this button to enable always-on recording for all IP cameras.

Add/Edit Schedule: Select a camera from the camera list, and click **Add/Edit Schedule** to create a new schedule for the selected camera.

Delete Schedule: Select a camera from the camera list, and click **Delete Schedule** to delete the schedule for the selected camera.

Copy Schedule: Select a camera from the camera list, and click **Copy Schedule** to create a duplicate schedule.

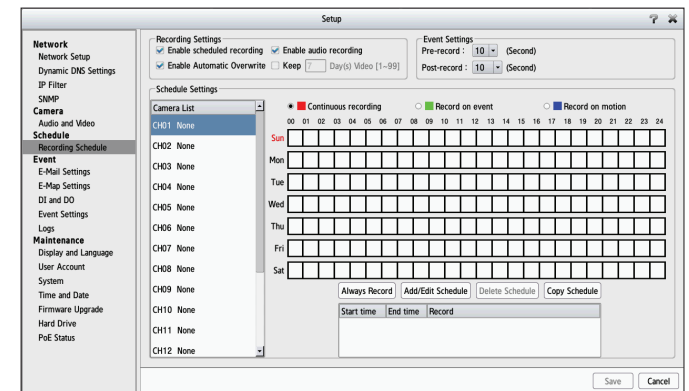

Set Recording Schedule Configuration

1. Select one of the cameras from the list and click on **Add/Edit Schedule**.
2. Choose a recording mode. The available options are: **Continuous Recording**, **Record on event**, and **Record on motion**.
3. Enter the desired **Start time** and **End time**, and choose a day of the week that the recording function will be active.
4. Press the **OK** button to save the new schedule.

Note:

- When configuring the motion detection event, be sure to set up the motion detection function on your camera first.
- After changing the motion detection settings of your camera, be sure to disconnect the camera from the NVR and then re-connect it to update any new changes.
- You can drag the time bar to change the recording period. Select the red bar for **Continuous recording** feature, the green bar for **Record on event** and the blue bar for **Record on motion** feature.

Schedule Settings

Mode

- Continuous recording
- Record on event
- Record on motion

Time

Start time : 00 : 00

End time : 23 : 59

- Sun Mon Tue Wed
- Thu Fri Sat

OK Cancel

Event E-Mail Settings

If an event occurs, such as motion detection, or a hard disk failure, the NVR can be configured to send an email notification to one or more email addresses. Here you can configure the e-mail notification settings.

Sender Email Address: Input the sender's e-mail address.

Server Address: Enter the SMTP (Simple Mail Transport Protocol) server IP address.

User Name: Enter the user name for your SMTP account.

Password: Enter the password for your SMTP account.

Port: Enter the port used by your SMTP server. Tick the checkbox here if the e-mail server uses the SSL protocol.

Test: Click this button to send a test email and verify whether the settings are correct.

Adding Contacts

Step 1: Insert the name of a new contact to receive notifications.

Step 2: Insert the e-mail address of this contact.

Step 3: Click **Add**.

The screenshot shows the 'Setup' window with the 'E-Mail Settings' tab selected. The 'SMTP Settings' section includes fields for 'Sender email address', 'Server address', 'User Name', and 'Password'. The 'Port' is set to 25, and there is a checkbox for 'This server requires a secure connection (StartTLS)'. A 'Test' button is located below these fields. The 'Contact' section below has 'User Name' and 'Email Address' input fields, an 'Add' button, and a table with columns for 'Delete', 'User Name', and 'Email Address'. 'Save' and 'Cancel' buttons are at the bottom right.

E-Map Settings

The E-Map lets you view where cameras are placed via a blueprint of your home or business. When an event occurs, the E-map event indicator will show the location of the event.

You can upload your E-Map to the NVR. The maximum file size is 20 KBytes in BMP and JPG file format. You can then drag and drop camera icons onto the E-Map indicating camera placement.

Click **Save Settings** once you are done configuring your map.

Edit: Upload an image to be used as your map.

Delete: Delete a camera icon from the map.

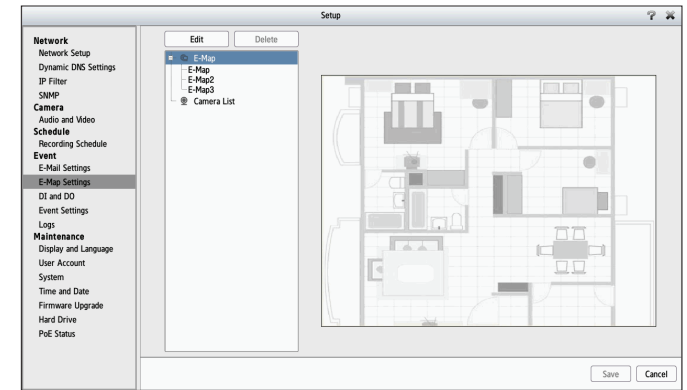

DI and DO

The DI and DO page lets you manage four Digital Input (DI) and one Digital Output (DO) devices connected to your NVR. It shows you the DI/DO mapping and the current state of the device (Normally Closed (NC), Normally Open(NO), or OFF).

For Digital Inputs 1-4:

When a DI is set to Normally Closed (N.C.), the normal state of the circuit is closed to ground. In this scenario, events are triggered when the circuit is opened, which then changes the status of the device to Open.

Example: The magnetic contacts on a window sensor that are broken during a break-in will trigger an event.

When a DI is set to Normally Open (N.O.), the normal state of the circuit is open. In this status, events are triggered when the circuit is closed to ground, which then changes the status to Closed.

Example: A DI light switch that is turned on during off hours may close the circuit and trigger an event.

For Digital Output:

- **OFF** indicates that the device is inactive and has not been triggered.
- **ON** indicates that the device is currently triggered.

Please go to the **Event Settings** on page 39 to select Digital Output as the action and select the events that can act as triggers.

Click **Save** once you are done configuring your devices.

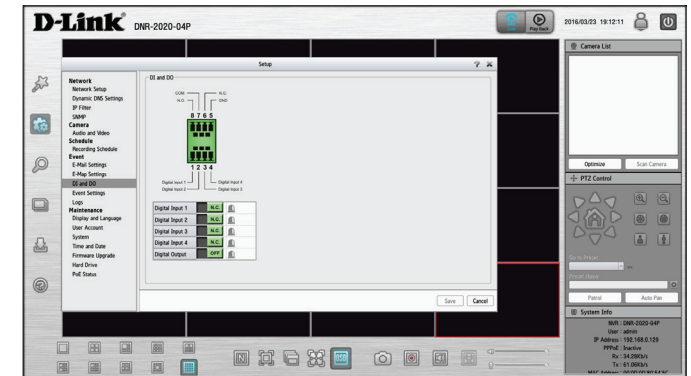

Event Settings

This page lets you configure what to do when an event is triggered by a camera, such as when motion is detected. The NVR can then perform an action, such as sending an e-mail notification.

For **Camera Event Settings** and **System Event Settings**:

Step 1: Select an event to listen for:

- Connection Lost:** An action is executed when connection is lost.
- Motion Detected:** An action is executed when motion is detected.
- Passive Infrared:** An action is executed when the PIR sensor is activated.

Digital Input: An action is executed when the signal voltage is above or below a specific threshold.

Sound Detection: An action is executed when the camera microphone detects audio.

Hard Disk Space Full: When the Overwrite function is not enabled, the NVR will stop recording when the HDD is full and will send an alert.

Hard Disk Error: An alert will be sent if there is an error with the hard disk.

Fan Error: An alert will be sent if there is a fan error.

Network Disconnected: An action is executed when the NVR is disconnected from its network.

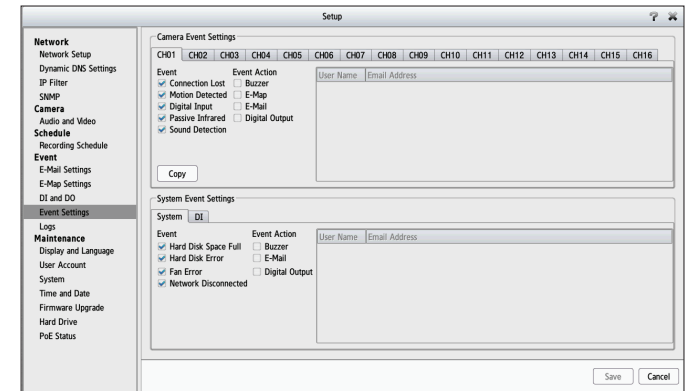

Step 2: Select an event action:

Buzzer: The buzzer will sound as an alert.

E-Map: Select this option to update the camera status on the E-Map.

E-Mail: Select this option to have e-mail sent to a specified SMTP account after receiving a camera event.

Digital Output: If you have connected a device to the NVR's digital output, selecting this option will trigger the output when a selected event occurs.

Log

This section displays the event log information including System, NVR, and event logs. It allows you to check the details of each log and download them to an external USB drive for backup. Click **Clear** to reset the logs.

- System Log:** Displays the system log information.
- NVR Log:** Displays the NVR log information, such as when recording stops or the NVR system starts.
- NVR Event Log:** Displays the event log information, such as motion detection or if a camera is disconnected.

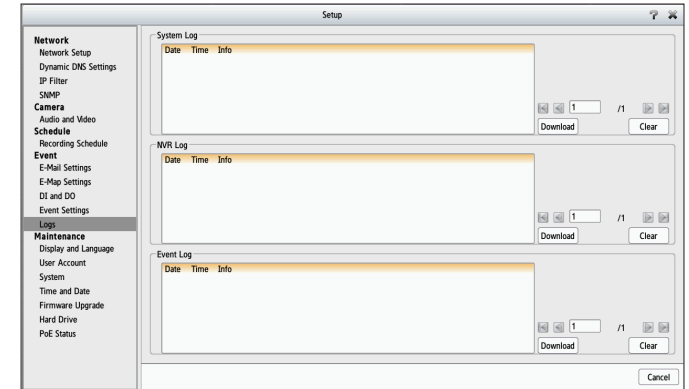

Maintenance

Display and Language

This section will let you manage language, display, and On-Screen Display (OSD) settings for your NVR.

Language: Select the language.

Device Name: Change the device name of the NVR.

Auto Scan Interval: The auto scan feature allows you to monitor and scan the activity on all attached cameras for a specific time.

Enable Camera OSD: Enables or disables the camera's OSD.

Camera Name: Displays the name of the camera on the OSD.

Date: Displays the date.

Bitrate: Displays the bitrate.

Camera Number: Displays the camera number.

Time: Displays the time.

Frame Rate: Displays the frame rate.

Size: Displays the size in pixels.

Color: Change the color of camera's OSD.

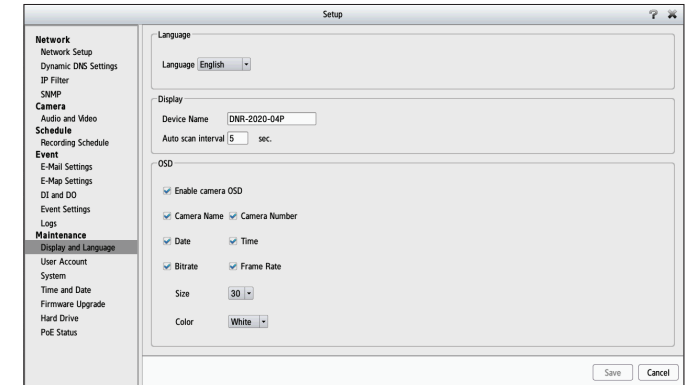

User Account

The User Account page enables you to create and delete user accounts for accessing your NVR device and set user privileges for them.

Adding a New User

Follow the steps to manage existing user accounts and give new users access to the NVR. Management options include adding and deleting users, and allowing access rights to users. You can also change admin and user passwords. You can also change admin and user passwords.

Step 1: Click **Add** to input the new user account.

Step 2: Input the password. Type the password again to confirm.

Step 3: Select the channel of the cameras and **PTZ/Microphone** functions that this user can access.

Step 4: Select the playback channels and Miscellaneous functions that this user can access.

Step 5: Click **Save Settings** to apply.

The Administrator account can configure all functions of the NVR. This account cannot be deleted. The default password for **admin** is blank. Setting a password after the first login is strongly recommended. Hold the reset button on the rear panel of the device to reset the NVR password to the factory default.

Note: *Resetting the device will erase all previously saved settings.*

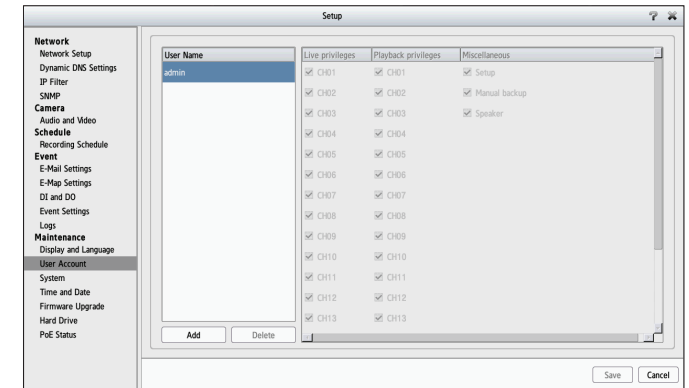

Create Account
✕

User Name

New Password

Retype Password

System

On this page, you can save the NVR configuration to a file and restore it when necessary, such as restarting the NVR in the event of a crash. Reset the NVR to restore all configurations to factory default. Click **Save** to apply your changes.

System Restart: If the NVR is malfunctioning or crashes unexpectedly, click **Restart** on the NVR. Restarting the NVR will take about ninety seconds.

Restore to Factory Default Settings: This will reset all settings back to the factory defaults.

Save Configuration Settings: All the configurations can be saved as a file to the specified location. Click **Save** to save the file.

Load Configuration Settings: You can restore the configuration file after resetting to factory default file. Click **Browse** to select the configuration file and restore it by clicking **Load**.

Idle Time (Minutes): When the administrator enters all the Setup pages (except the Live Video and Playback Page), the NVR will keep track of the idle time when the user is not active. If this inactive period exceeds the specified limit, the user will be logged out and will have to log in again for security purposes. You can change the idle time limit here.

Buzzer: Enable or disable the buzzer. This is an audible alarm that sounds when an event is triggered.

Enable Auto Plugin: Enable or disable auto plugin. Enabling auto plugin allows the NVR to automatically detect any connected cameras on the LAN. The NVR will automatically change the secondary video profile of IP cameras once this option is enabled.

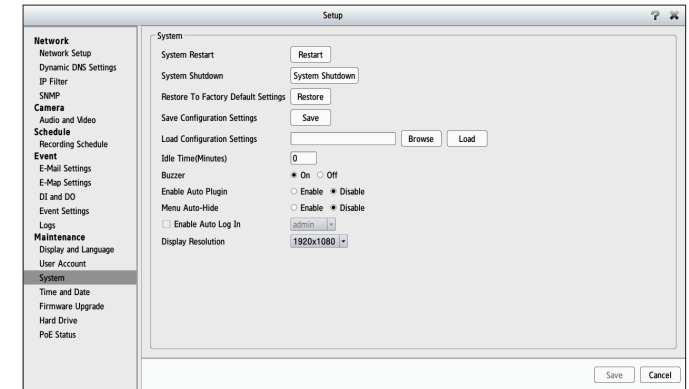

Time and Date

Configure time and date settings here. Click **Save Settings** to apply your changes.

Manually Set the Time and Date:

Enter the complete time and date settings manually.

Synchronize with NTP Server:

Select or enter an NTP Server here. An NTP Server is a server on the Internet that maintains time. The NVR will contact the server you entered and update to the correct time.

Time Zone:

Select your time zone from the pull-down list. There are three choices for setting the time.

Enable Daylight Saving:

Check the box to enable daylight savings time (DST). You can enable automatic daylight savings time, or enter daylight saving time start and end dates manually. You can enter the month, week, day, hour and minute when daylight savings time starts and ends, and also enter the timezone offset from GMT/UTC.

The screenshot shows the 'Setup' window for 'Time and Date' configuration. The left sidebar lists various settings categories, with 'Time and Date' selected. The main content area is divided into several sections:

- Time and Date:** Includes a 'Set date and time manually' section with fields for Date (2016/03/24) and Time (02:27:21).
- NTP Server:** A section with a checked 'Synchronize with NTP Server' option and a dropdown menu for 'NTP Server' set to 'ntp1.dlink.com'.
- Time Zone:** A dropdown menu currently set to '(GMT) Coordinated Universal Time'.
- Daylight Saving Time:** A section with an unchecked 'Enable Daylight Saving' checkbox. Below it, there is a radio button for 'Auto Daylight Saving' and a note 'Daylight Saving Time has been manually set'. A table for manual settings is visible:

Start time	Month	Week	Day of week	Hour	Minute
1:00	1	1	Sunday	00	00
1:00	1	1	Sunday	00	00

At the bottom right of the window are 'Save' and 'Cancel' buttons.

Firmware Upgrade

The device firmware and device pack can be upgraded from this page. To update the firmware, you must save the updated firmware file to a USB drive, then connect it to the NVR's USB port. Click **Browse** to search the USB drive for the firmware update file. Click **Load** to upgrade. The new version number will be displayed. Firmware updates are available on the D-Link Support page at <http://www.dlink.com/support>

Note: You may need to reformat your USB drive to NTFS format in order for the DNR-2020-04P to recognize it.

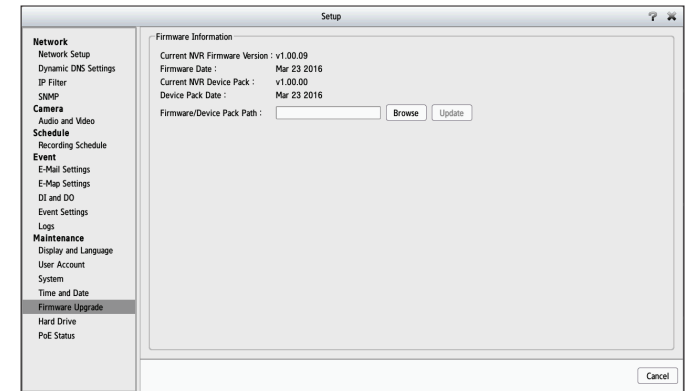

Hard Drive

You can format the HDD and USB drives in this section, as well as eject the USB drive. Formatting the HDD and USB drive will erase all data on the drive.

Note: Do not unplug the USB drive without clicking eject first, or the files on the USB drive may become damaged.

- HDD format Standard (Individual Disks):** Only supports one hard drive to create the volume.
- HDD format JBOD (Linear - Combines Both Disks):** Combines both hard drives in a linear fashion to create one large volume geared towards maximum available space. This mode does not provide any redundancy.
- HDD format RAID 0 (Striping - Best Performance):** Combines both hard drives in a striped fashion to create one large volume geared towards maximum performance. All data will be lost if one disk fails.
- HDD format RAID 1 (Mirroring - Keeps Data Safe):** Mirrors the hard drives for redundancy. If one hard drive fails, the other still has all the data. Replace the failed hard drive and the volume will rebuild, providing maximum data protection.
- Estimated Size:** Displays the total capacity available for use.
- HDD Used:** Displays the used space and total space of the volume.
- Synchronization:** In RAID 1 Mode, use this function to rebuild your data to a new disk when one of the hard drives has been replaced.

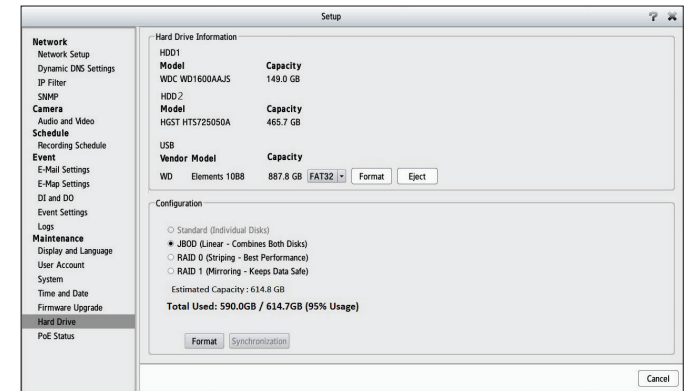

PoE Status

You can check the status of the PoE ports (P1-P4) on the NVR from this page.

Link Status: Displays the status of the Ethernet connection

Link	A network connection is established.
Unlink	There is no network connection.

PoE Consumption: Displays the status of the PoE port

15W	The camera's maximum power consumption is 15 watts.
7W	The camera's maximum power consumption is 7 watts.
4W	The camera's maximum power consumption is 4 watts.
0W	PoE is not actively providing power.
N/A	PoE is not supported.
Overload	The total PoE power consumption is above 45 watts. Power provision has stopped.
Overcurrent	The camera's power consumption is beyond the PoE class limit. Power provision has stopped.
Total PoE Power Consumption	The NVR can supply a total of 45 watts via PoE.

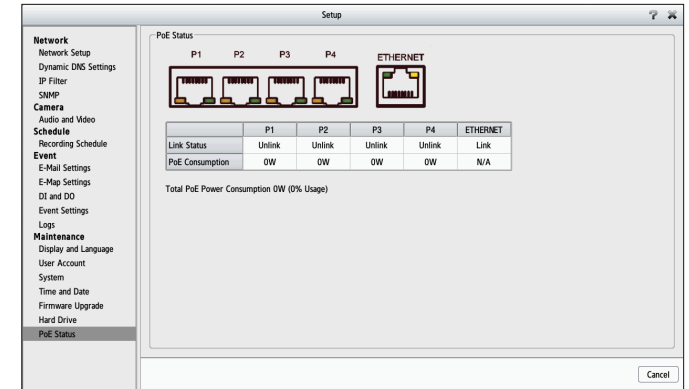

Camera Search

The Camera Search function lets you automatically add cameras to the NVR. You can then view camera information and preview the camera's feed. To add cameras follow the steps below.

Step 1: Click either **D-link** for D-link brand cameras or **Onvif** for cameras with Onvif certification. Click **Search** to search for network cameras. The system will list all the available cameras at that point in time.

Step 2: Highlight the camera by clicking on it. You can enter the camera name, user name, and password of the camera at the bottom.

Step 3: Then click the **Add** button to add a camera to your camera list. If the cameras are already added, they will be marked red.

Notes:

- Some cameras will limit the logins to the administrator only.
- To add cameras without the UPnP function, please go to the camera Setup menu and enter the IP address manually.
- You may not be able to see all the cameras on your first search. It may take a moment for the devices to respond to the UPnP request. Please click **Search** again if the cameras are not immediately displayed.

Step 4: Click **Save** to add the selected camera to the NVR.

Step 5: Click **OK** in the pop-up window to confirm. Repeat steps 2 through 5 to add other cameras to your list.

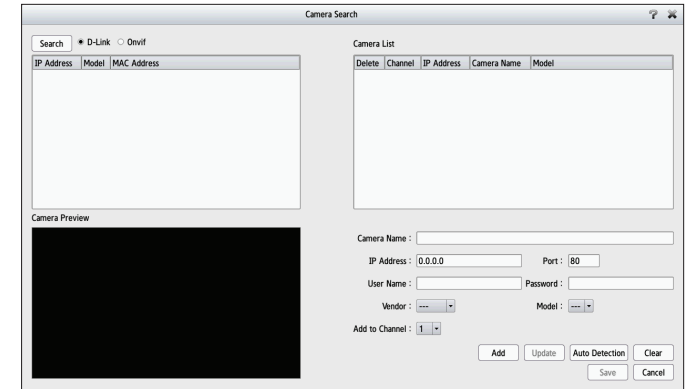

Album

If you have taken screenshots from the live page, you can view them in the Album. You can also export or delete screenshots from this page.

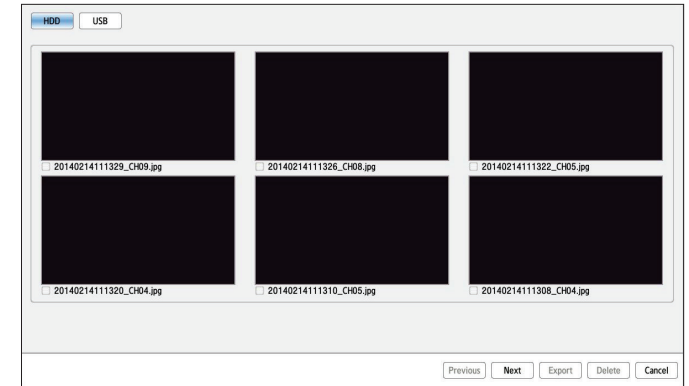

Backup

Unlike the Save Video function, the Backup function will save all the recorded videos during the time period you select, instead of a single video clip. You can set the NVR to make daily backups by using Auto Backup, or you can make a single backup immediately by using Manual Backup.

Enable auto backup: Check the **Enable** option to back up your recording data according to a daily schedule.

Daily backup time: The daily scheduled time to start the backup process.

Start/End time: Select a time period of recordings to back up.

Camera: Select the camera channels that you want to back up the recordings of.

Backup Type: You can select whether to back up to a USB drive, a Samba server, or an FTP site. Click **Stop** to stop the backup process.

If you choose **Manual Backup**, you will see the following settings:

Date: Select a date to start the backup process.

Start/End time: Select a time period of recordings to back up.

Camera: Select the cameras that you want to back up the recordings of.

Backup Type: You can select whether to back up to a USB drive, a Samba server, or an FTP site.

Start/Stop: Click **Start** to start a manual backup using the settings specified, or click **Stop** to stop a currently running backup.

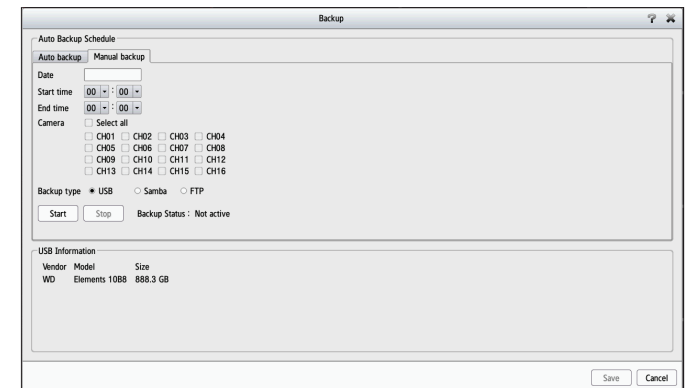
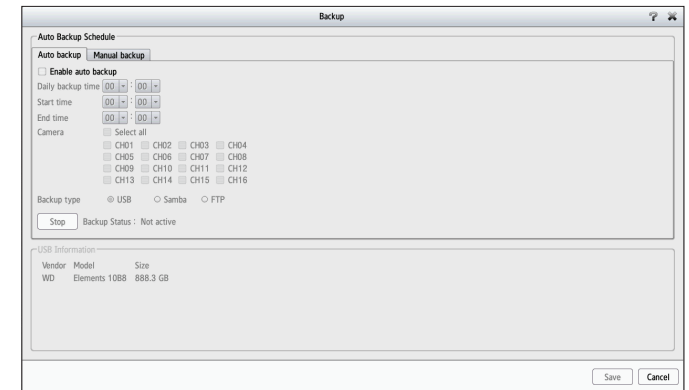

If you choose **Samba as the backup type**, you will see the following settings:

Samba server: Enter the address of your Samba server.

Samba entry: Enter the folder path for the Samba server that you want to back up your recordings to.

User Name: Enter the username for your Samba server account.

Password: Enter the password for your Samba server account.

The screenshot shows the 'Backup' configuration window with the 'Auto Backup Schedule' tab selected. Under 'Auto backup', the 'Enable auto backup' checkbox is checked. The 'Daily backup time' is set to 00:00. The 'Start time' and 'End time' are also set to 00:00. Under 'Camera', the 'Select all' checkbox is checked, and all camera channels (CH01 through CH09) are selected. The 'Backup type' is set to 'Samba'. A 'Stop' button is visible. Below this, the 'Samba Settings' section includes fields for 'Server address' (with an example of 192.168.0.240), 'Samba entry' (with an example of folder1/folder2/folder3), 'User Name', and 'Password'. A 'Test' button is located below the password field. At the bottom right, there are 'Save Settings' and 'Don't Save Settings' buttons.

If you choose **FTP as the backup type**, you will see the following settings:

FTP server: Enter the address of your FTP server.

FTP port: Enter the port used by your FTP server.

Folder: Enter the folder path for the FTP server that you want to back up your recordings to.

User Name: Enter the username for your FTP server account.

Password: Enter the password for your FTP server account.

The screenshot shows the 'Backup' configuration window with the 'Auto Backup Schedule' tab selected. Under 'Auto backup', the 'Enable auto backup' checkbox is checked. The 'Daily backup time' is set to 00:00. The 'Start time' and 'End time' are also set to 00:00. Under 'Camera', the 'Select all' checkbox is checked, and all camera channels (CH01 through CH09) are selected. The 'Backup type' is set to 'FTP'. A 'Stop' button is visible. Below this, the 'FTP Settings' section includes fields for 'Server address' (with an example of 192.168.0.240), 'Port' (set to 21), 'Folder' (with an example of folder1/folder2/folder3), 'User Name', and 'Password'. A 'Test' button is located below the password field. At the bottom right, there are 'Save Settings' and 'Don't Save Settings' buttons.

Help

The NVR Help page provides a list of support topics. Click on any of the topics in the left-hand bar to access the manual for that specific feature.

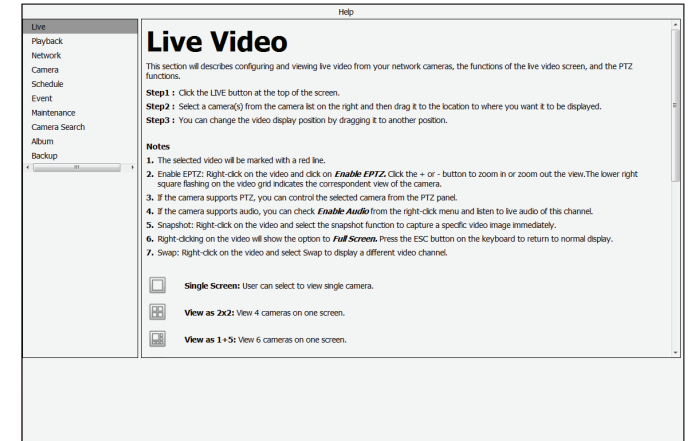

Applications

D-Link NVR Search Utility - Windows

In Windows, you can run the D-Link NVR Search Utility from the CD to search for the NVR on the local network. When powered on, during the initial boot sequence, the device will wait to be assigned an IP address via DHCP by default. If it does not receive a DHCP-assigned IP address, the Auto-IP process will assign a 169.254.xxx.xxx address to the device. If you want to change the IP address before logging in, or are unable to connect to the NVR IP address, you can use the NVR Search Utility provided on the product CD to locate the device on your network and make any changes that are needed.

Network Video Recorder: The D-Link NVR Search Utility displays any NVR devices it detects on the network.

Refresh: Click to refresh the device list.

Configuration: Click Configuration to access the Web-based configuration of the NVR.

LAN: Configure the LAN Settings for the NVR.

Receive DHCP: Select **Enable** to use DHCP for your LAN IP settings, or **Disable** to use static IP.

Apply: Click **Apply** to save and activate the changes to the LAN Settings.

About: Click **About** to view the software version of the NVR Search Utility.

Exit: Click **Exit** to close the utility.

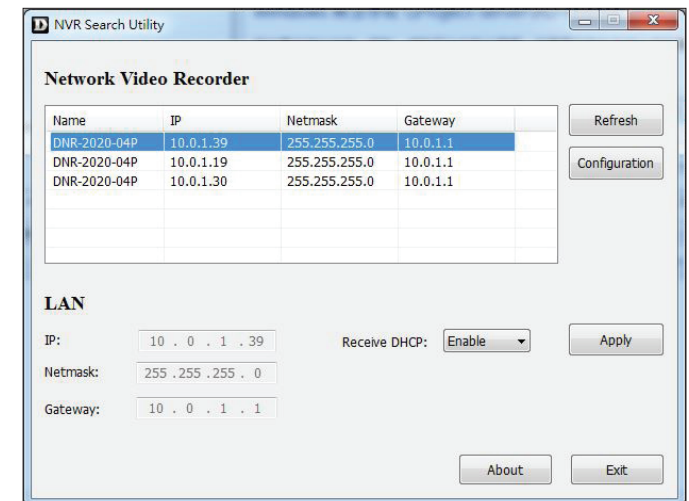

Select a device from the list and click **Configuration**. This will launch the computer's default web browser and direct it to the IP address listed for the device.

Note: *The computer used to access the NVR web-based configuration manager must be on the same subnet as the NVR. If your network is using a DHCP server and the computer receives IP settings from the same DHCP server, the NVR will automatically be in the same subnet.*

If you have any problems accessing the Internet, make sure the browser is not configured to use a proxy server.

D-Link NVR Search Utility - Mac

Insert the CD, go to the CD directory, then enter the Mac Utility folder. Click the NVR Search Utility file to run the setup tool. When first powered on, during the initial boot sequence the device will wait to be assigned an IP address via DHCP. If it does not receive a DHCP-assigned IP address the Auto-IP process will assign a 169.254.xxx.xxx address to the device. If you want to change the IP address before logging in or are unable to connect to the NVR IP address, you can use the NVR Search Utility provided on the product CD to locate the device on your network and make any changes that are needed.

Network Video Recorder: The D-Link NVR Search Utility displays any NVR devices it detects on the network.

Refresh: Click to refresh the device list.

Configuration: Click **Configuration** to access the Web-based configuration of the NVR.

LAN: Configure the LAN Settings for the NVR.

Receive DHCP: Select **Enable** to use DHCP for your LAN IP settings, or **Disable** to use static IP.

Apply: Click **Apply** to save and activate the changes to the LAN Settings.

About: Click **About** to view the software version of the NVR Search Utility.

Exit: Click **Exit** to close the utility.

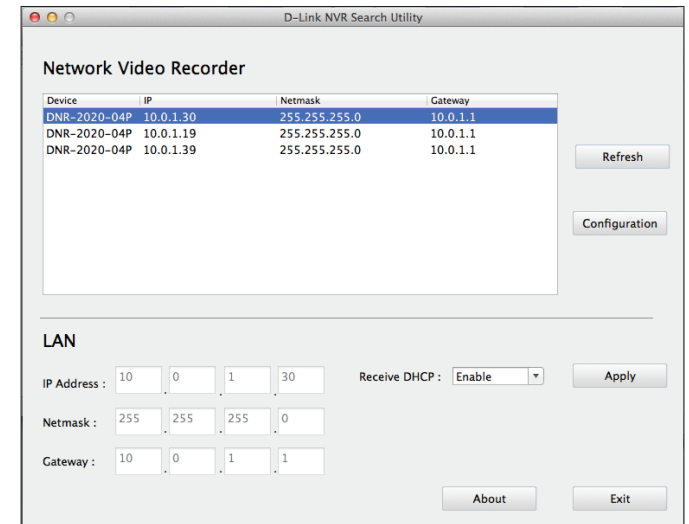

Playback Manager

This feature allows you to search and play back recorded video.

Play Recorded Video

Step 1: Click the **Playback** tab at the top of the window.





Step 2: Click the day highlighted in red on the calendar. The **View Recorded Files Window** will show information about the available video clips.



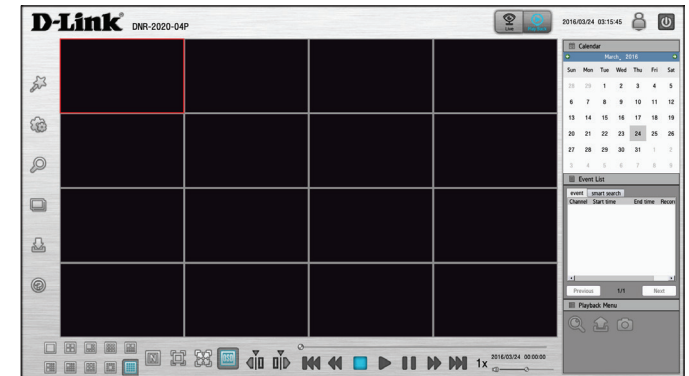

Step 3: Select the date you would like to play back video records for.

Step 4: Highlight the video records that you would like to review.

Click the **OK** button.



	Play
	Stop
	Select a camera/video and click this button to play/stop/pause a particular channel.
	Step forward
	Step backward

	Fast forward
	Rewind
	Set the start point of the export file
	Set the end point of the export file

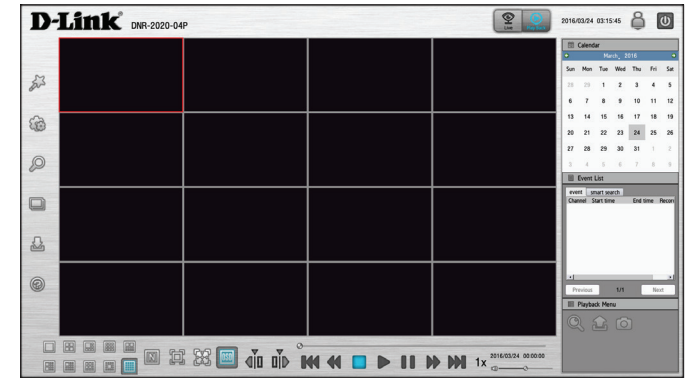

Remote Backup

You can run the Remote Backup application to back up your files. Run the application by going to **Start > Programs > D-Link > DNR-2020-04P > Remote Backup**. You can Add, Delete, and Edit multiple NVR devices here.

Step 1: Input the IP address of the NVR.

Step 2: Input the user name.

Step 3: Input the password and click **OK**.

Step 4: Click **New Period**.

Step 5: Select the date that the video was recorded.

Step 6: Set the **Start Time** and **End Time** you would like to back up (or highlight the video records that you would like to back up). The time period specified cannot exceed 24 hours.

Step 7: Select the cameras you would like to back up and click **OK**.

Step 8: Select the time slot which you would like to back up.

Step 9: Click **Backup**.

Step 10: Select the location where you would like to save the backup data.

Step 11: Check the **Include the Backup Program** option, which will add a playback application into the backup folder.

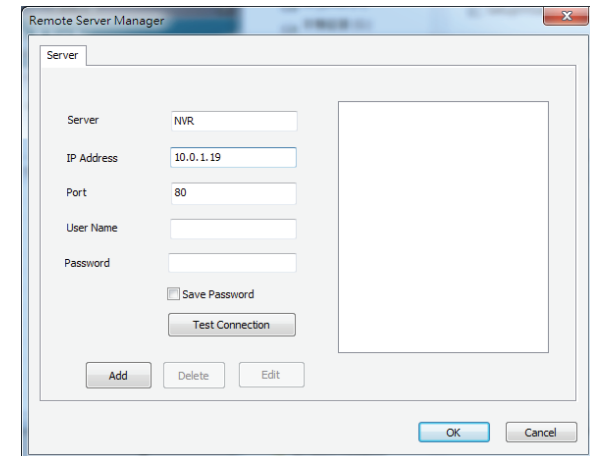

Start Time	End Time	Camera	Disk Size
2014/03/05 08:25:54	2014/03/05 08:26:34	4	0.48 MB

Date Time Period

Start Time : 2014/03/04 00:00:00

End Time : 2014/03/04 00:00:00

Video Preview

Enable Preview

Camera	00	01	02	03	04	05	06	07	08	09	10	11	12	13	14	15	16	17	18	19	20	21	22	23
CH01 DCS-2132...																								
CH02 DCS-6511																								
CH03 DCS-5020L																								
CH04 DCS-2230																								
CH05 DCS-2132...																								
CH06 DCS-5222...																								
CH07 DCS-3716																								
CH08 DCS-5222...																								
CH09 DCS-2330L																								

Record on Event
 Record on Normal
 Record on Motion

Step 12: Click **OK**.

Select the device from the list and click **Configuration**. This will launch the computer's default web browser and direct it to the IP address listed for the NVR. If you encounter a problem, make sure the browser is not configured to use a proxy server.

Note: *The computer used to access the remote backup application must be on the same subnet as the NVR. If your network is using a DHCP server and the computer receives IP settings from the DHCP server, the NVR will automatically be in the same subnet.*

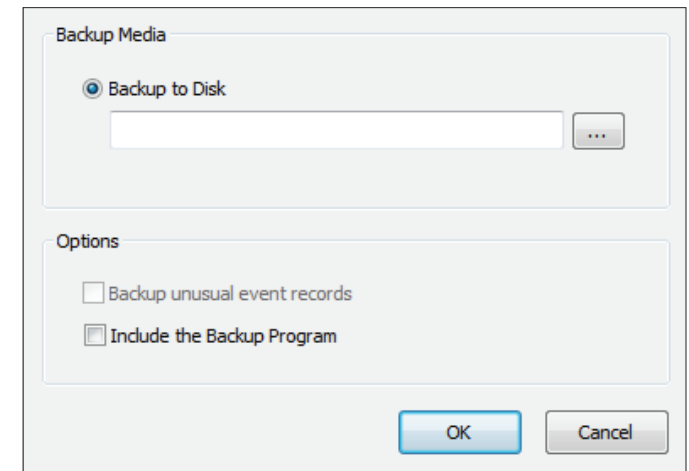

Verification Tool

The Verification Tool verifies whether the data created by the system has been tampered with. It's the process by which a digital watermark (a digital signature) is added to each recorded video frame to ensure its authenticity.

There are two types of data that can be verified by the Verification Tool:

1. Video files (.avi, .asf)
2. Image files (.bmp, .jpg)

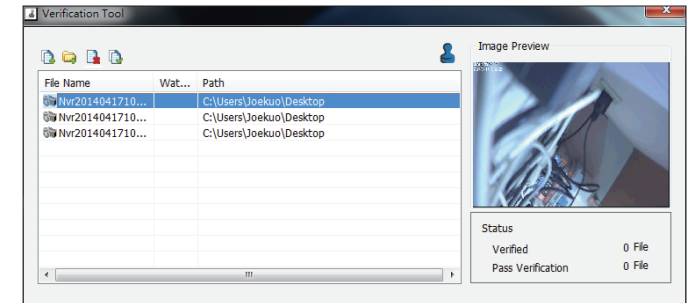

Add File: Add a single file to the list for verification.

Add Folder: Choose a folder with multiple files to list for verification.

Remove File: Remove indicated file(s) from list.

Select All: Select all files in the list for verification.

Note: Choose the file type first before selecting files.

Troubleshooting

Replacing a failed disk drive

If a disk drive fails, the Disk Status LED will turn red. When replacing a failed disk drive, be sure to use a new drive of the same or slightly greater capacity.

Step 1: Power off the NVR.

Step 2: Open the unit's cover.

Step 3: Pull out the failed disk drive.

Step 4: Install a new disk drive into the slot. Please refer to **Hard Drive Installation** on page 9.

If you forget the admin password for the device

If you forget the password, you can reset the device, which will reset the password for the **admin** account to its default (blank). Please note that this will reset all settings on the device back to the factory defaults, and it may cause data to become inaccessible; it is highly recommended that you back up your recorded data before resetting your device. To reset the device, make sure it is turned on then press and hold the reset button for 10 seconds until the Power LED flashes three times. The administrator password will now be blank.

If you cannot log in to the NVR using your web browser

Check the settings of your anti-virus software to make sure it isn't blocking access to the NVR web interface.

If you cannot see the complete web interface in your web browser

If you cannot see the complete page of the system, the ActiveX installation process may not be complete.

Step 1: Open your web browser and connect to your NVR.

Step 2: The browser will ask whether to install ActiveX.

Step 3: Click the upper bar to begin the installation process.

Step 4: Click **Install** to complete the process.

Technical Specifications

Firmware Specifications

OS

- Linux

CAMERAS SUPPORT

- Supports all D-Link network cameras. Includes support for auto-discovery and up to 3 megapixel resolution.

RECORDING PERFORMANCE

- Max recording bitrate: 80 Mbit
- Primary video profile:
 - H.264 at 1080p at 480 fps
- Secondary video profile:
 - H.264 at VGA at 240 fps

CAMERA SEARCH

- UPnP

AUDIO & VIDEO RECORDING

- Synchronized audio & video recording.

COMPRESSION FORMAT

- H.264, MPEG-4, M-JPEG (depending on the network camera)

VIDEO SETTING

- Resolution, quality, frame rate, enable audio, image parameters

RECORDING TYPE

- Record by schedule, manual record and event recording (motion detection from camera)

REMOTE LIVE VIEW

- Supported via IE browser (Max. 16 simultaneous channels)

REMOTE LIVE VIEW CONTROL

- Live view, preset/go, patrol, focus, PTZ functions, snapshot, full screen, digital zoom, e-map, multiple views (1/4/9/16)

REMOTE PLAYBACK

- Supported via IE and NVR client
- Playback system with timeline GUI, search by event, area, cameras, date and time
- IE & NVR client support 16 channel playback
- Digital zoom in to specific area

REMOTE PLAYBACK CONTROL

- Playback with normal, fast forward/rewind, and step forward/rewind

OVERWRITE RECORDING

- Auto recycling when disk storage is full

FILE EXPORT

- Export videos to AVI or ASF file
- Export images to BMP or JPG file (only support ASF export in remote mode)

USER ACCOUNT

- Additional accounts can be created to allow user access to the system, and specify authorization for the camera channels, PTZ, etc.

DDNS

- D-Link DDNS and DynDns server support
- Manual DDNS

SYSTEM TIME

- Set the system time (D-Link NTP, manual input)

REMOTE BACKUP

- Remote software can back up raw data to redundant storage
- Auto back up video from the previous day to the FTP server

SYSTEM STATUS

- System status
- EMAP support

NETWORK SERVICE PROTOCOLS

- IPV4, ARP, TCP, UDP, ICMP
- DHCP Server/Client

- NTP Client
- DNS Client
- DDNS Client (D-Link)
- SMTP Client
- FTP Client
- HTTP Server
- RTP
- RTCP
- RTSP
- IP filtering
- UPnP
- CoS
- QoS/DSCP
- HTTPS
- Samba
- Bonjour
- SNMP v1/v2c/v3
- PPPoE
- DDP

USER INTERFACE

- HTTP Web browser - Internet Explorer® 8, Firefox® 20, or Safari® 6 or above
- NVR Search Utility

Hardware Specifications

STANDARDS

- IEEE 802.3u/x/z
- IEEE 802.3af
- Auto MDI/MDI-X

HARD DISK

- SATA I, II, III
- Reformat Disk

TWO RESET MODES

- Reset firmware GUI button
- HW reset button (press for 10 seconds)

FLASH ROM

- 128 MB

RAM

- 1024 MB DDRIII

NIC

- Gigabit Ethernet LAN port (10/100/1000 Mbps)

I/O PORTS

- 1 x 10/100/1000BASE-T RJ-45 port
- 4 x 10/100BASE-T PoE port (802.3af)
- HDMI (supports 720p and 1080p resolution with 16:9 display ratio)
- D-sub for VGA output
- 3.5 mm audio in/out ports
- 1 x USB 3.0 port
- 1 x USB 2.0 port
- 3.5 mm audio input x 1, output x 1
- 4 x DI, 1 x DO

POWER ADAPTER

- 48 V DC, 1.85 A

RESET BUTTON

- Reset to factory default

POWER CONSUMPTION

- Max. power consumption: 90 W

DIMENSIONS (W x D x H)

- 300 x 225 x 63 (W x D x H) mm (11.81 x 8.86 x 2.48 inches)

WEIGHT

- 2.1 kg (4.63 lbs)

OPERATING TEMPERATURE

- Operating: 0 to 40 °C (32 to 104 °F)
- Storage: -20 to 70 °C (-4 to 158 °F)

HUMIDITY

- Operating: 5% to 90% (non-condensing)

PACKAGE CONTENTS

- Network Video Recorder
- Hard disk screw x 8

- Rack-mount bracket x 2
- Rack-mount bracket screw x 8
- Power adapter x 1
- Power adapter cable
- Ethernet cable
- Quick Install Guide
- CD-ROM with applications and product documentation

Regulatory Information

Federal Communication Commission Interference Statement

This equipment has been tested and found to comply with the limits for a Class A digital device, pursuant to part 15 of the FCC Rules. These limits are designed to provide reasonable protection against harmful interference when the equipment is operated in a commercial environment. This equipment generates, uses, and can radiate radio frequency energy and, if not installed and used in accordance with the instruction manual, may cause harmful interference to radio communications. Operation of this equipment in a residential area is likely to cause harmful interference in which case the user will be required to correct the interference at his own expense.

Non-modification Statement

Any changes or modifications not expressly approved by the party responsible for compliance could void the user's authority to operate the equipment.

Caution

This device complies with Part 15 of the FCC Rules. Operation is subject to the following two conditions:

(1) This device may not cause harmful interference, and (2) this device must accept any interference received, including interference that may cause undesired operation.

Innovation, Science and Economic Development Canada (ISED) Statement:

This Class A digital apparatus complies with Canadian ICES-003.

Cet appareil numérique de la classe A est conforme à la norme NMB-003 du Canada.

CE EMI Class A Warning

This equipment is compliant with Class A of CISPR 32. In a residential environment this equipment may cause radio interference.

SAFETY INSTRUCTIONS

The following general safety guidelines are provided to help ensure your own personal safety and protect your product from potential damage. Remember to consult the product user instructions for more details.

- Static electricity can be harmful to electronic components. Discharge static electricity from your body (i.e. touching grounded bare metal) before touching the product.
- Do not attempt to service the product and never disassemble the product. For some products with a user replaceable battery, please read and follow the instructions in the user manual.
- Do not spill food or liquid on your product and never push any objects into the openings of your product.
- Do not use this product near water, areas with high humidity, or condensation unless the product is specifically rated for outdoor application.
- Keep the product away from radiators and other heat sources.
- Always unplug the product from mains power before cleaning and use a dry lint free cloth only.

SICHERHEITSVORSCHRIFTEN

Die folgenden allgemeinen Sicherheitsvorschriften dienen als Hilfe zur Gewährleistung Ihrer eigenen Sicherheit und zum Schutz Ihres Produkts. Weitere Details finden Sie in den Benutzeranleitungen zum Produkt.

- Statische Elektrizität kann elektronischen Komponenten schaden. Um Schäden durch statische Aufladung zu vermeiden, leiten Sie elektrostatische Ladungen von Ihrem Körper ab, (z. B. durch Berühren eines geerdeten blanken Metallteils), bevor Sie das Produkt berühren.
- Unterlassen Sie jeden Versuch, das Produkt zu warten, und versuchen Sie nicht, es in seine Bestandteile zu zerlegen. Für einige Produkte mit austauschbaren Akkus lesen Sie bitte das Benutzerhandbuch und befolgen Sie die dort beschriebenen Anleitungen.
- Vermeiden Sie, dass Speisen oder Flüssigkeiten auf Ihr Produkt gelangen, und stecken Sie keine Gegenstände in die Gehäuseschlitze oder -öffnungen Ihres Produkts.
- Verwenden Sie dieses Produkt nicht in unmittelbarer Nähe von Wasser und nicht in Bereichen mit hoher Luftfeuchtigkeit oder Kondensation, es sei denn, es ist speziell zur Nutzung in Außenbereichen vorgesehen und eingestuft.
- Halten Sie das Produkt von Heizkörpern und anderen Quellen fern, die Wärme erzeugen.
- Trennen Sie das Produkt immer von der Stromzufuhr, bevor Sie es reinigen und verwenden Sie dazu ausschließlich ein trockenes fusselfreies Tuch.

CONSIGNES DE SÉCURITÉ

Les consignes générales de sécurité ci-après sont fournies afin d'assurer votre sécurité personnelle et de protéger le produit d'éventuels dommages. Veuillez consulter les consignes d'utilisation du produit pour plus de détails.

- L'électricité statique peut endommager les composants électroniques. Déchargez l'électricité statique de votre corps (en touchant un objet en métal relié à la terre par exemple) avant de toucher le produit.
- N'essayez pas d'intervenir sur le produit et ne le démontez jamais. Pour certains produits contenant une batterie remplaçable par l'utilisateur,

- veuillez lire et suivre les consignes contenues dans le manuel d'utilisation.
- Ne renversez pas d'aliments ou de liquide sur le produit et n'insérez jamais d'objets dans les orifices.
- N'utilisez pas ce produit à proximité d'un point d'eau, de zones très humides ou de condensation sauf si le produit a été spécifiquement conçu pour une application extérieure.
- Éloignez le produit des radiateurs et autres sources de chaleur.
- Débranchez toujours le produit de l'alimentation avant de le nettoyer et utilisez uniquement un chiffon sec non pelucheux.

INSTRUCCIONES DE SEGURIDAD

Las siguientes directrices de seguridad general se facilitan para ayudarle a garantizar su propia seguridad personal y para proteger el producto frente a posibles daños. No olvide consultar las instrucciones del usuario del producto para obtener más información.

- La electricidad estática puede resultar nociva para los componentes electrónicos. Descargue la electricidad estática de su cuerpo (p. ej., tocando algún metal sin revestimiento conectado a tierra) antes de tocar el producto.
- No intente realizar el mantenimiento del producto ni lo desmonte nunca. Para algunos productos con batería reemplazable por el usuario, lea y siga las instrucciones del manual de usuario.
- No derrame comida o líquidos sobre el producto y nunca deje que caigan objetos en las aberturas del mismo.
- No utilice este producto cerca del agua, en zonas con humedad o condensación elevadas a menos que el producto esté clasificado específicamente para aplicación en exteriores.
- Mantenga el producto alejado de los radiadores y de otras fuentes de calor.
- Desenchufe siempre el producto de la alimentación de red antes de limpiarlo y utilice solo un paño seco sin pelusa"

ISTRUZIONI PER LA SICUREZZA

Las siguientes directrices de seguridad general se facilitan para ayudarle a garantizar su propia seguridad personal y para proteger el producto frente a posibles daños. No olvide consultar las instrucciones del usuario del producto para obtener más información.

- La electricidad estática puede resultar nociva para los componentes electrónicos. Descargue la electricidad estática de su cuerpo (p. ej., tocando algún metal sin revestimiento conectado a tierra) antes de tocar el producto.
- No intente realizar el mantenimiento del producto ni lo desmonte nunca. Para algunos productos con batería reemplazable por el usuario, lea y siga las instrucciones del manual de usuario.
- No derrame comida o líquidos sobre el producto y nunca deje que caigan objetos en las aberturas del mismo.
- No utilice este producto cerca del agua, en zonas con humedad o condensación elevadas a menos que el producto esté clasificado específicamente para aplicación en exteriores.
- Mantenga el producto alejado de los radiadores y de otras fuentes de calor.
- Desenchufe siempre el producto de la alimentación de red antes de limpiarlo y utilice solo un paño seco sin pelusa"

VEILIGHEIDSINFORMATIE

De volgende algemene veiligheidsinformatie werd verstrekt om uw eigen persoonlijke veiligheid te waarborgen en uw product te beschermen tegen mogelijke schade. Denk eraan om de gebruikersinstructies van het product te raadplegen voor meer informatie.

- Statische elektriciteit kan schadelijk zijn voor elektronische componenten. Ontlaad de statische elektriciteit van uw lichaam (d.w.z. het aanraken van geaard bloot metaal) voordat u het product aanraakt.
- U mag nooit proberen het product te onderhouden en u mag het product nooit demonteren. Voor sommige producten met door de gebruiker te vervangen batterij, dient u de instructies in de gebruikershandleiding te lezen en te volgen.
- Mors geen voedsel of vloeistof op uw product en u mag nooit voorwerpen in de openingen van uw product duwen.
- Gebruik dit product niet in de buurt van water, gebieden met hoge vochtigheid of condensatie, tenzij het product specifiek geclassificeerd is voor gebruik buitenshuis.
- Houd het product uit de buurt van radiators en andere warmtebronnen.
- U dient het product steeds los te koppelen van de stroom voordat u het reinigt en gebruik uitsluitend een droge pluisvrije doek"

Disposing and Recycling Your Product

ENGLISH

EN



This symbol on the product or packaging means that according to local laws and regulations this product should not be disposed of in household waste but sent for recycling. Please take it to a collection point designated by your local authorities once it has reached the end of its life, some will accept products for free. By recycling the product and its packaging in this manner you help to conserve the environment and protect human health.

D-Link and the Environment

At D-Link, we understand and are committed to reducing any impact our operations and products may have on the environment. To minimise this impact D-Link designs and builds its products to be as environmentally friendly as possible, by using recyclable, low toxic materials in both products and packaging.

D-Link recommends that you always switch off or unplug your D-Link products when they are not in use. By doing so you will help to save energy and reduce CO2 emissions.

To learn more about our environmentally responsible products and packaging please visit www.dlinkgreen.com.

DEUTSCH

DE



Dieses Symbol auf dem Produkt oder der Verpackung weist darauf hin, dass dieses Produkt gemäß bestehender örtlicher Gesetze und Vorschriften nicht über den normalen Hausmüll entsorgt werden sollte, sondern einer Wiederverwertung zuzuführen ist. Bringen Sie es bitte zu einer von Ihrer Kommunalbehörde entsprechend amtlich ausgewiesenen Sammelstelle, sobald das Produkt das Ende seiner Nutzungsdauer erreicht hat. Für die Annahme solcher Produkte erheben einige dieser Stellen keine Gebühren. Durch ein auf diese Weise durchgeführtes Recycling des Produkts und seiner Verpackung helfen Sie, die Umwelt zu schonen und die menschliche Gesundheit zu schützen.

D-Link und die Umwelt

D-Link ist sich den möglichen Auswirkungen seiner Geschäftstätigkeiten und seiner Produkte auf die Umwelt bewusst und fühlt sich verpflichtet, diese entsprechend zu mindern. Zu diesem Zweck entwickelt und stellt D-Link seine Produkte mit dem Ziel größtmöglicher Umweltfreundlichkeit her und verwendet wiederverwertbare, schadstoffarme Materialien bei Produktherstellung und Verpackung.

D-Link empfiehlt, Ihre Produkte von D-Link, wenn nicht in Gebrauch, immer auszuschalten oder vom Netz zu nehmen. Auf diese Weise helfen Sie, Energie zu sparen und CO2-Emissionen zu reduzieren.

Wenn Sie mehr über unsere umweltgerechten Produkte und Verpackungen wissen möchten, finden Sie entsprechende Informationen im Internet unter www.dlinkgreen.com.

FRANÇAIS**FR**

Ce symbole apposé sur le produit ou son emballage signifie que, conformément aux lois et réglementations locales, ce produit ne doit pas être éliminé avec les déchets domestiques mais recyclé. Veuillez le rapporter à un point de collecte prévu à cet effet par les autorités locales; certains accepteront vos produits gratuitement. En recyclant le produit et son emballage de cette manière, vous aidez à préserver l'environnement et à protéger la santé de l'homme.

D-Link et l'environnement

Chez D-Link, nous sommes conscients de l'impact de nos opérations et produits sur l'environnement et nous engageons à le réduire. Pour limiter cet impact, D-Link conçoit et fabrique ses produits de manière aussi écologique que possible, en utilisant des matériaux recyclables et faiblement toxiques, tant dans ses produits que ses emballages.

D-Link recommande de toujours éteindre ou débrancher vos produits D-Link lorsque vous ne les utilisez pas. Vous réaliserez ainsi des économies d'énergie et réduirez vos émissions de CO₂.

Pour en savoir plus sur les produits et emballages respectueux de l'environnement, veuillez consulter le www.dlinkgreen.com.

ESPAÑOL**ES**

Este símbolo en el producto o el embalaje significa que, de acuerdo con la legislación y la normativa local, este producto no se debe desechar en la basura doméstica sino que se debe reciclar. Llévelo a un punto de recogida designado por las autoridades locales una vez que ha llegado al fin de su vida útil; algunos de ellos aceptan recogerlos de forma gratuita. Al reciclar el producto y su embalaje de esta forma, contribuye a preservar el medio ambiente y a proteger la salud de los seres humanos.

D-Link y el medio ambiente

En D-Link, comprendemos y estamos comprometidos con la reducción del impacto que puedan tener nuestras actividades y nuestros productos en el medio ambiente. Para reducir este impacto, D-Link diseña y fabrica sus productos para que sean lo más ecológicos posible, utilizando materiales reciclables y de baja toxicidad tanto en los productos como en el embalaje.

D-Link recomienda apagar o desenchufar los productos D-Link cuando no se estén utilizando. Al hacerlo, contribuirá a ahorrar energía y a reducir las emisiones de CO₂.

Para obtener más información acerca de nuestros productos y embalajes ecológicos, visite el sitio www.dlinkgreen.com.

ITALIANO**IT**

La presenza di questo simbolo sul prodotto o sulla confezione del prodotto indica che, in conformità alle leggi e alle normative locali, questo prodotto non deve essere smaltito nei rifiuti domestici, ma avviato al riciclo. Una volta terminato il ciclo di vita utile, portare il prodotto presso un punto di raccolta indicato dalle autorità locali. Alcuni questi punti di raccolta accettano gratuitamente i prodotti da riciclare. Scegliendo di riciclare il prodotto e il relativo imballaggio, si contribuirà a preservare l'ambiente e a salvaguardare la salute umana.

D-Link e l'ambiente

D-Link cerca da sempre di ridurre l'impatto ambientale dei propri stabilimenti e dei propri prodotti. Allo scopo di ridurre al minimo tale impatto, D-Link progetta e realizza i propri prodotti in modo che rispettino il più possibile l'ambiente, utilizzando materiali riciclabili a basso tasso di tossicità sia per i prodotti che per gli imballaggi.

D-Link raccomanda di spegnere sempre i prodotti D-Link o di scollegarne la spina quando non vengono utilizzati. In questo modo si contribuirà a risparmiare energia e a ridurre le emissioni di anidride carbonica.

Per ulteriori informazioni sui prodotti e sugli imballaggi D-Link a ridotto impatto ambientale, visitate il sito all'indirizzo www.dlinkgreen.com.

NEDERLANDS**NL**

Dit symbool op het product of de verpakking betekent dat dit product volgens de plaatselijke wetgeving niet mag worden weggegooid met het huishoudelijk afval, maar voor recyclage moeten worden ingeleverd. Zodra het product het einde van de levensduur heeft bereikt, dient u het naar een inzamelpunt te brengen dat hiertoe werd aangeduid door uw plaatselijke autoriteiten, sommige autoriteiten accepteren producten zonder dat u hiervoor dient te betalen. Door het product en de verpakking op deze manier te recyclen helpt u het milieu en de gezondheid van de mens te beschermen.

D-Link en het milieu

Bij D-Link spannen we ons in om de impact van onze handelingen en producten op het milieu te beperken. Om deze impact te beperken, ontwerpt en bouwt D-Link zijn producten zo milieuvriendelijk mogelijk, door het gebruik van recycleerbare producten met lage toxiciteit in product en verpakking.

D-Link raadt aan om steeds uw D-Link producten uit te schakelen of uit de stekker te halen wanneer u ze niet gebruikt. Door dit te doen bespaart u energie en beperkt u de CO₂-emissies.

Breng een bezoek aan www.dlinkgreen.com voor meer informatie over onze milieuverantwoorde producten en verpakkingen.

POLSKI**PL**

Ten symbol umieszczony na produkcie lub opakowaniu oznacza, że zgodnie z miejscowym prawem i lokalnymi przepisami niniejszego produktu nie wolno wyrzucać jak odpady czy śmieci z gospodarstwa domowego, lecz należy go poddać procesowi recyklingu. Po zakończeniu użytkowania produktu, niektóre odpowiednie do tego celu podmioty przyjmą takie produkty nieodpłatnie, dlatego prosimy dostarczyć go do punktu zbiórki wskazanego przez lokalne władze. Poprzez proces recyklingu i dzięki takiemu postępowaniu z produktem oraz jego opakowaniem, pomogą Państwo chronić środowisko naturalne i dbać o ludzkie zdrowie.

D-Link i środowisko

D-Link podchodzimy w sposób świadomy do ochrony otoczenia oraz jesteśmy zaangażowani w zmniejszanie wpływu naszych działań i produktów na środowisko naturalne. W celu zminimalizowania takiego wpływu firma D-Link konstruuje i wytwarza swoje produkty w taki sposób, aby były one jak najbardziej przyjazne środowisku, stosując do tych celów materiały nadające się do powtórnego wykorzystania, charakteryzujące się małą toksycznością zarówno w przypadku samych produktów jak i opakowań.

Firma D-Link zaleca, aby Państwo zawsze prawidłowo wyłączali z użytku swoje produkty D-Link, gdy nie są one wykorzystywane. Postępując w ten sposób pozwalają Państwo oszczędzać energię i zmniejszać emisje CO₂.

Aby dowiedzieć się więcej na temat produktów i opakowań mających wpływ na środowisko prosimy zapoznać się ze stroną Internetową www.dlinkgreen.com.

ČESKY**CZ**

Tento symbol na výrobku nebo jeho obalu znamená, že podle místně platných předpisů se výrobek nesmí vyhazovat do komunálního odpadu, ale odeslat k recyklaci. Až výrobek doslouží, odneste jej prosím na sběrné místo určené místními úřady k tomuto účelu. Někteří sběrná místa přijímají výrobky zdarma. Recyklací výrobku i obalu pomáháte chránit životní prostředí i lidské zdraví.

D-Link a životní prostředí

Ve společnosti D-Link jsme si vědomi vlivu našich provozů a výrobků na životní prostředí a snažíme se o minimalizaci těchto vlivů. Proto své výrobky navrhujeme a vyrábíme tak, aby byly co nejekologičtější, a ve výrobcích i obalech používáme recyklovatelné a nízkotoxické materiály.

Společnost D-Link doporučuje, abyste své výrobky značky D-Link vypnuli nebo vytáhli ze zásuvky vždy, když je nepoužíváte. Pomůžete tak šetřit energii a snížit emise CO₂.

Více informací o našich ekologických výrobcích a obalech najdete na adrese www.dlinkgreen.com.

MAGYAR**HU**

Ez a szimbólum a terméken vagy a csomagoláson azt jelenti, hogy a helyi törvényeknek és szabályoknak megfelelően ez a termék nem semmisíthető meg a háztartási hulladékkal együtt, hanem újrahasznosításra kell küldeni. Kérjük, hogy a termék élettartamának elteltét követően vigye azt a helyi hatóság által kijelölt gyűjtőhelyre. A termékek egyes helyeken ingyen elhelyezhetők. A termék és a csomagolás újrahasznosításával segíti védeni a környezetet és az emberek egészségét.

A D-Link és a környezet

A D-Linknél megértjük és elkötelezettek vagyunk a műveleteink és termékeink környezetre gyakorolt hatásainak csökkentésére. Az ezen hatás csökkentése érdekében a D-Link a lehető leginkább környezetbarát termékeket tervez és gyárt azáltal, hogy újrahasznosítható, alacsony károsanyag-tartalmú termékeket gyárt és csomagolásokat alkalmaz.

A D-Link azt javasolja, hogy mindig kapcsolja ki vagy húzza ki a D-Link termékeket a tápforrásból, ha nem használja azokat. Ezzel segít az energia megtakarításában és a széndioxid kibocsátásának csökkentésében.

Környezetbarát termékeinkről és csomagolásainkról további információkat a www.dlinkgreen.com weboldalon tudhat meg.

NORSK**NO**

Dette symbolet på produktet eller forpakningen betyr at dette produktet ifølge lokale lover og forskrifter ikke skal kastes sammen med husholdningsavfall, men leveres inn til gjenvinning. Vennligst ta det til et innsamlingssted anvist av lokale myndigheter når det er kommet til slutten av levetiden. Noen steder aksepteres produkter uten avgift. Ved på denne måten å gjenvinne produktet og forpakningen hjelper du å verne miljøet og beskytte folks helse.

D-Link og miljøet

Hos D-Link forstår vi oss på og er forpliktet til å minske innvirkningen som vår drift og våre produkter kan ha på miljøet. For å minimalisere denne innvirkningen designer og lager D-Link produkter som er så miljøvennlig som mulig, ved å bruke resirkulerbare, lav-toksiske materialer både i produktene og forpakningen.

D-Link anbefaler at du alltid slår av eller frakobler D-Link-produkter når de ikke er i bruk. Ved å gjøre dette hjelper du å spare energi og å redusere CO2-utslipp.

For mer informasjon angående våre miljøansvarlige produkter og forpakninger kan du gå til www.dlinkgreen.com.

DANSK**DK**

Dette symbol på produktet eller emballagen betyder, at dette produkt i henhold til lokale love og regler ikke må bortskaffes som husholdningsaffald, mens skal sendes til genbrug. Indlever produktet til et indsamlingssted som angivet af de lokale myndigheder, når det er nået til slutningen af dets levetid. I nogle tilfælde vil produktet blive modtaget gratis. Ved at indlevere produktet og dets emballage til genbrug på denne måde bidrager du til at beskytte miljøet og den menneskelige sundhed.

D-Link og miljøet

Hos D-Link forstår vi og bestræber os på at reducere enhver indvirkning, som vores aktiviteter og produkter kan have på miljøet. For at minimere denne indvirkning designer og producerer D-Link sine produkter, så de er så miljøvenlige som muligt, ved at bruge genanvendelige materialer med lavt giftighedsniveau i både produkter og emballage.

D-Link anbefaler, at du altid slukker eller frakobler dine D-Link-produkter, når de ikke er i brug. Ved at gøre det bidrager du til at spare energi og reducere CO₂-udledningerne.

Du kan finde flere oplysninger om vores miljømæssigt ansvarlige produkter og emballage på www.dlinkgreen.com.

SUOMI**FI**

Tämä symboli tuotteen pakkauksessa tarkoittaa, että paikallisten lakien ja säännösten mukaisesti tätä tuotetta ei pidä hävittää yleisen kotitalousjätteen seassa vaan se tulee toimittaa kierrätettäväksi. Kun tuote on elinkaarensa päässä, toimita se lähimpään viranomaisten hyväksymään kierrätyspisteeseen. Kierrättämällä käytetyn tuotteen ja sen pakkauksen autat tukemaan sekä ympäristön että ihmisten terveyttä ja hyvinvointia.

D-Link ja ympäristö

D-Link ymmärtää ympäristönsuojelun tärkeyden ja on sitoutunut vähentämään tuotteistaan ja niiden valmistuksesta ympäristölle mahdollisesti aiheutuvia haittavaikutuksia. Nämä negatiiviset vaikutukset minimoidakseen D-Link suunnittelee ja valmistaa tuotteensa mahdollisimman ympäristöystävällisiksi käyttämällä kierrätettäviä, alhaisia pitoisuuksia haitallisia aineita sisältäviä materiaaleja sekä tuotteissaan että niiden pakkauksissa.

Suosittellemme, että irrotat D-Link-tuotteesi virtalähteestä tai sammutat ne aina, kun ne eivät ole käytössä. Toimimalla näin autat säästämään energiaa ja vähentämään hiilidioksiidipäästöjä.

Lue lisää ympäristöystävällisistä D-Link-tuotteista ja pakkauksistamme osoitteesta www.dlinkgreen.com.

SVENSKA**SE**

Den här symbolen på produkten eller förpackningen betyder att produkten enligt lokala lagar och föreskrifter inte skall kastas i hushållssoporna utan i stället återvinnas. Ta den vid slutet av dess livslängd till en av din lokala myndighet utsedd uppsamlingsplats, vissa accepterar produkter utan kostnad. Genom att på detta sätt återvinna produkten och förpackningen hjälper du till att bevara miljön och skydda människors hälsa.

D-Link och miljön

På D-Link förstår vi och är fast beslutna att minska den påverkan våra verksamheter och produkter kan ha på miljön. För att minska denna påverkan utformar och bygger D-Link sina produkter för att de ska vara så miljövänliga som möjligt, genom att använda återvinningsbara material med låg gifthalt i både produkter och förpackningar.

D-Link rekommenderar att du alltid stänger av eller kopplar ur dina D-Link produkter när du inte använder dem. Genom att göra detta hjälper du till att spara energi och minska utsläpp av koldioxid.

För mer information om våra miljöansvariga produkter och förpackningar www.dlinkgreen.com.

PORTUGUÊS**PT**

Este símbolo no produto ou embalagem significa que, de acordo com as leis e regulamentações locais, este produto não deverá ser eliminado juntamente com o lixo doméstico mas enviado para a reciclagem. Transporte-o para um ponto de recolha designado pelas suas autoridades locais quando este tiver atingido o fim da sua vida útil, alguns destes pontos aceitam produtos gratuitamente. Ao reciclar o produto e respectiva embalagem desta forma, ajuda a preservar o ambiente e protege a saúde humana.

A D-Link e o ambiente

Na D-Link compreendemos e comprometemo-nos com a redução do impacto que as nossas operações e produtos possam ter no ambiente. Para minimizar este impacto a D-Link concebe e constrói os seus produtos para que estes sejam o mais inofensivos para o ambiente possível, utilizando materiais recicláveis e não tóxicos tanto nos produtos como nas embalagens.

A D-Link recomenda que desligue os seus produtos D-Link quando estes não se encontrarem em utilização. Com esta acção ajudará a poupar energia e reduzir as emissões de CO₂.

Para saber mais sobre os nossos produtos e embalagens responsáveis a nível ambiental visite www.dlinkgreen.com.