



SOME MECHANISTIC, STEREOCHEMICAL AND STRUCTURAL PROBLEMS

IN TERPENOID CHEMISTRY

A THESIS

PRESENTED FOR THE DEGREE OF

DOCTOR OF PHILOSOPHY

in

The University of Adelaide

by

ANDREW DAVID ABELL, B.Sc. (Hons)

Department of Organic Chemistry

1985

Approved 7-5-1985

TABLE OF CONTENTS

	Page
SUMMARY	i
STATEMENT	iii
ACKNOWLEDGEMENTS	iv
INTRODUCTION	1
 CHAPTER I	
Stereospecific Formation of Tetrahydrofurans from Substituted 2,8-Dioxabicyclo{3.2.1}oct-3-ylmethanols.	
- Part 1.0 Introduction.	8
- Part 1.1 Reaction mechanism.	9
 CHAPTER II	
Lithium in Ammonia Reduction of the 3-Substituted Furans.	
- Part 2.0 Introduction.	25
- Part 2.1 2,8-Dioxabicyclo{3.2.1}oct-3-yl derivatives.	27
- Part 2.2 Model 3-substituted furans.	38
- Part 2.3 Model 3-substituted furans.	49
 CHAPTER III	
Synthesis of the Reduction Substrates.	
- Part 3.0 2,8-Dioxabicyclo{3.2.1}oct-3-yl derivatives.	53
- Part 3.1 3-Substituted furans.	55
- Part 3.2 Tertiary alcohol (70): The stereo- chemistry of acetal cleavage with methylmagnesium iodide.	60

	Page
CHAPTER IV	
Diterpenes from <i>Eremophila rotundifolia</i> .	
- Part 4.0 (13S,18R)-5,18:13,18-Diepoxysecurulic-14-en-8-ol (150a).	74
- Part 4.1 5,8-Dihydroxysecurulic-14-en-18-al (158).	97
- Part 4.2 X-ray crystallography.	103
- Part 4.3 Interrelation of (150a) and (158).	107
CHAPTER V	
Sesquiterpenes from <i>Eremophila rotundifolia</i> .	
- Part 5.0 Base catalysed rearrangement of freelingyne (2).	109
- Part 5.1 Eremophila-10,11(13)-diene-9,12-dione (168).	113
EXPERIMENTAL	
General	123
Work described in Chapter I.	
- Part 1.1	125
Work described in Chapter II.	
- Part 2.1	134
- Part 2.2	140
- Part 2.3	150
Work described in Chapter III.	
- Part 3.0	152
- Part 3.1	154
- Part 3.2	167
Isolation of the Terpenes from <i>Eremophila rotundifolia</i> .	173

	Page
Work described in Chapter IV.	
- Part 4.0	175
- Part 4.1	180
- Part 4.2	183
- Part 4.3	184
Work described in Chapter V.	
- Part 5.0	185
- Part 5.1	186
APPENDIX	188
REFERENCES	202

SUMMARY

Eremophila rotundifolia has yielded a number of interesting sesquiterpenes and diterpenes including the novel eremacetal (6). The 2,8-dioxabicyclooctane ring skeleton of eremacetal and its derivatives has been reported to undergo a number of interesting reactions some of which have been considered in detail in this thesis.

Chapter I deals with the formation of tetrahydrofurans from some substituted 2,8-dioxabicyclo{3.2.1}oct-3-ylmethanols with oxalic acid in aqueous methanol solution. The reactions were shown to occur stereospecifically with inversion of configuration at a tertiary carbon and are considered to proceed by a mechanism involving the carbonyl group generated by hydrolysis of the acetal function.

Chapter II describes the lithium in ammonia fission of the acetal of some 2,8-dioxabicyclo{3.2.1}oct-3-yl derivatives to yield both monofission and difission products. The mode of initial carbon-oxygen bond fission, either C1-O2 or C1-O8, would appear to be dependant on the nature of the C3 substituent. The lithium in ammonia reductions of some simpler model 3-substituted furan compounds with a benzylic* type oxygen substituent have also been studied. The synthetic models include series of benzylic cyclic ethers and hydroxy and benzyloxy benzylic acetals. The ease of the reduction and the product composition were shown to be dependant on the cyclic ether ring size and also on the ability of lithium cation to chelate between the acetal oxygen and the oxygen substituent of the side chain.

Chapter III describes the synthesis of the reduction substrates. The reaction of methylmagnesium iodide with methyl (1_R,3_S,5_R)-1-(furan-3'-yl)-5-methyl-2,8-dioxabicyclo{3.2.1}octane-3-carboxylate (138)

* Refers to a substituent adjacent to a furan ring.

was observed to give acetal cleavage products, in addition to the usual tertiary alcohol. The cleavage products arose from regioselective carbon-oxygen bond fission and intermolecular transfer of the methyl group of the Grignard reagent to the intermediate oxocarbenium ion.

Chapters IV and V deal with the isolation and characterisation of a number of new terpenes isolated from the wood extracts of *E. rotundifolia*. Two related diterpenes, (18R,13S)-5,18:13,18-diepoxyseerrulat-14-en-8-ol (150a) and 5,8-dihydroxyseerrulat-14-en-18-al (158) were isolated. The structures were deduced from chemical and spectroscopic data. The structure of (150a) was confirmed and the absolute configuration determined by a single-crystal X-ray analysis of its *p*-bromobenzoate. A chemical interrelation of the two diterpenes established the absolute structure and configuration of (158). The known sesquiterpene freelingyne (2) was also isolated and was shown to undergo a novel base catalysed rearrangement. Finally, the eremophilane, eremophila-10,11(13)-diene-9,12-dione (168), was isolated and subsequently characterised by its conversion to the known eremophilone (1a).

STATEMENT

This thesis contains no material previously submitted for a degree or diploma in any University, and to the best of my knowledge and belief, contains no material previously published or written by another person except where due reference is made in the text.

A.D. Abell

ACKNOWLEDGEMENTS

I wish to extend my sincere thanks to Dr. R.A. Massy-Westropp for his guidance, encouragement and enthusiasm during his supervision of this work.

I would also like to express my appreciation to Dr. E.H. Williams (University of Adelaide) and Dr. R. Riccio (University of Naples) for recording the 2D n.m.r. spectra and to Dr. E. Horn for performing the X-ray Crystallography.

The financial assistance of a Commonwealth Post-Graduate Research Award is gratefully acknowledged.

My thanks also go to my mother, Diane Abell, for her patience and diligence in the typing of this thesis.

Finally, I wish to thank my family for their understanding and support. In particular, I am indebted to my wife, Tessa, for her continual encouragement and understanding.

INTRODUCTION

Eremophila is a large indigenous Australian genus of predominantly desert adapted shrubs containing upwards of two hundred species.¹ Since the isolation from *E. mitchelli* of the biologically aberrant sesquiterpene eremophilones (1a)^{2a} and (1b)^{2b} about twenty species of the genus have been studied by chemists.¹⁻¹³ It is interesting that no other *Eremophila* species has yielded eremophilane sesquiterpenes although several other examples have been isolated from *E. mitchelli* and from other genera.

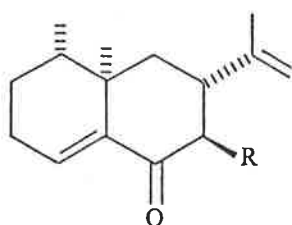

(1a) R=H

(1b) R=OH

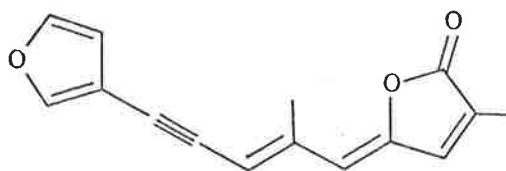

(2)

The essential oils of *Eremophila* are rich in sesquiterpenes and many of those isolated exhibit interesting structural features. The most common type are the acyclic furans, typified by the highly unsaturated and biogenetically obscure freelingyne (2), isolated from *E. freelingii*.³ Recently, sesquiterpenes with the (R,R)-calamenene⁴ {e.g. (3a) and (3b)}, eudesmane {e.g. (4)}⁵ and prezizaene {e.g. (5)}⁶ skeletons have been isolated from *Eremophila* species. *E. rotundifolia* has provided a number of 3-furano-sesquiterpenes including a novel bicyclic acetal named eremoacetal (6). Eremoacetal and its derivatives form the subject of some of the chemistry discussed in this thesis.

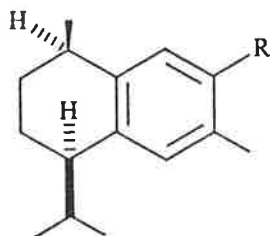

(3a) R=H

(3b) R=OH

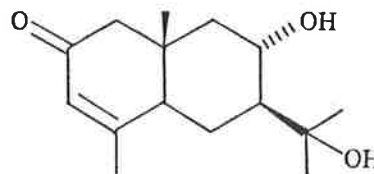

(4)

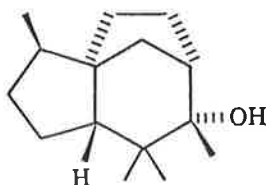

(5)

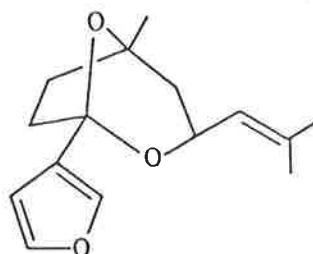

(6)

The genus *Eremophila* has also yielded a number of unusual diterpenes which can be divided into a few main groups. The first group includes a number of acyclic diterpenes, unique in that they contain two internal double bonds which are cis with respect to the carbon chain {e.g. (7)}¹. Some macrocyclic cembrane diterpenes {e.g. (8)}⁸ have also been isolated. Another group of which eremolactone (9)⁹ is the prototypical example, possess the non-isoprenoid eremane skeleton. A further group includes some apparently biogenetically related compounds typified by the decipiane diterpenes {e.g. (10)}¹⁰ and the serrulatane diterpenes, for example, dihydroxyserrulatic acid (11).¹¹ Recently, examples of a new class of diterpenes, named viscidane {e.g. (12)},¹² have been isolated from *E. viscida*.¹²

The only examples of C_{30} compounds to be isolated from *Eremophila* species are two related eremophilone sesquiterpene dimers (13a) and (13b).¹³

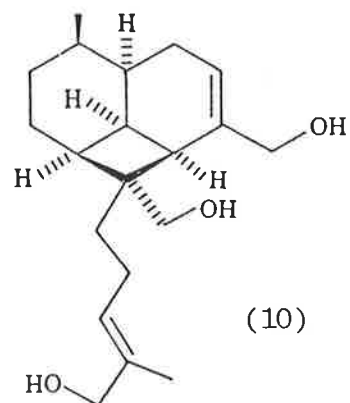
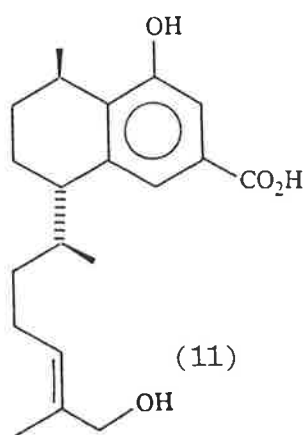
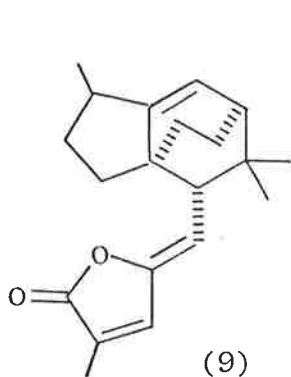
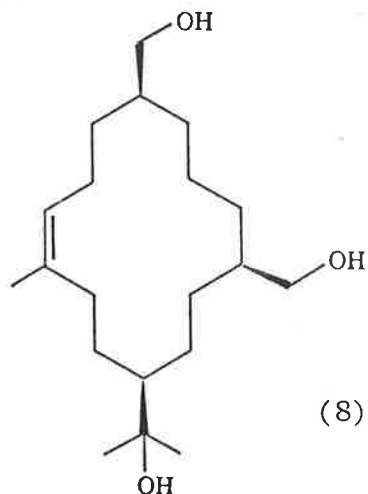
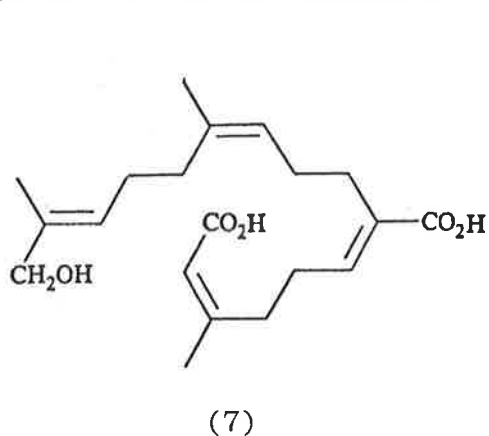

No triterpenes have been reported. In this thesis a number of new terpenes, with the known eremophilane and serrulatane skeletons, have been isolated from *E. rotundifolia*.

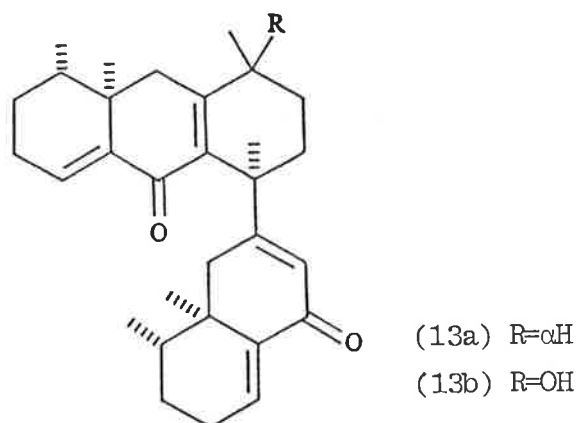
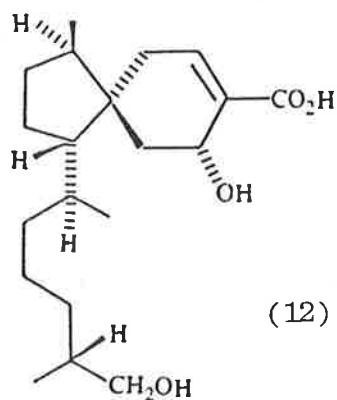

Several stable dioxabicyclooctane systems, e.g. the pheromones brevicomin¹⁴ and multistriatin^{15,16}, have been reported. Eremoacetal (6), a sesquiterpene of interest in this thesis, also possesses a stable dioxabicyclooctane acetal where the equilibrium under mildly acidic conditions strongly favours the acetal form.^{7,17,18} However, extended acid catalysed hydrolysis of eremoacetal (6) yields a mixture of diene (14) and rearranged allylic alcohol (15) possibly formed via the dihydroxy ketone (16).^{7,17} Alternatively, (14) and (15) may have formed by a concerted opening of the acetal followed by either loss of a proton or reaction with water. Mild treatment of eremoacetal (6) with acid in D₂O gave deuterium incorporation at C7, presumably by acid catalysed exchange α to the carbonyl group of (16).¹⁷

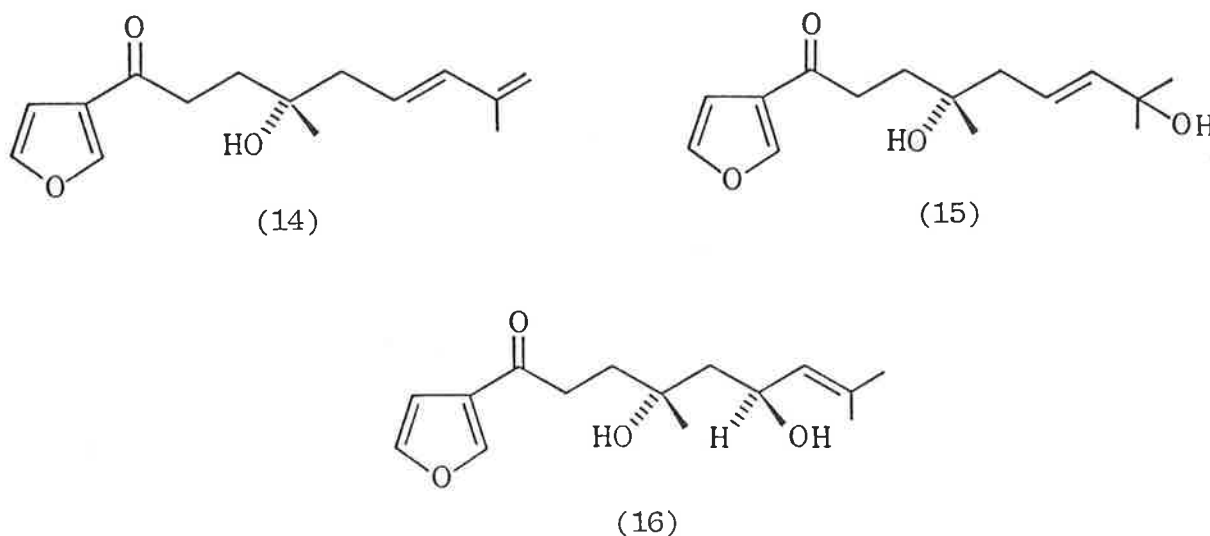

The 2,8-dioxabicyclooctane ring skeleton of eremoacetal (6) and its derivatives has been reported to undergo a number of interesting reactions. Although the acid catalysed ring opening yielded (14) and (15), it was found that solvolysis of eremoacetal (6), by heating it in aqueous pyridine,⁷ gave dihydroxy ketone (16) in 30% isolated yield.

Mesylates (40c) and (23b) undergo what is formally a two step reduction with lithium aluminium hydride to yield tetrahydrofurans.¹⁹

Mesylate (40c) gave alcohol (17) while mesylate (23b) gave two products characterised as alcohols (18) and (19) in the ratio of 1:2. The reduction of the C1-O2 bond of the acetal has been shown to occur with retention of

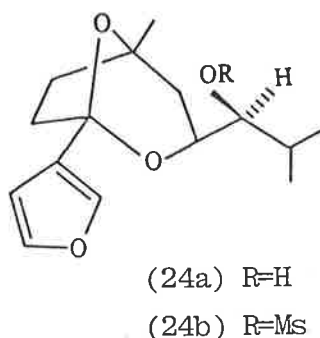
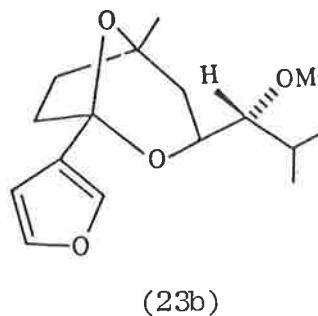
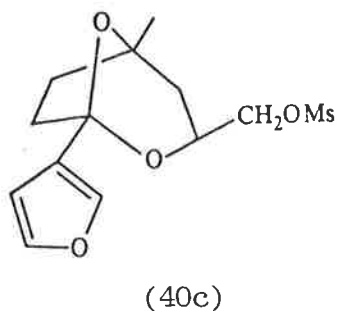

configuration to yield an intermediate epoxide {e.g. (20)} which is further reduced under the reaction conditions. A similar lithium aluminium hydride reduction of mesylate (24b) gave the parent alcohol (24a) as the only product, a result which presumably reflects a strong conformational dependence for the intermediate epoxide formation. On this basis it is apparent that the reaction requires a *trans* antiperiplanar arrangement of the C1-O2 and mesylate bonds.¹⁹

The reaction of some substituted hydroxy acetals {e.g. (21)} with oxalic acid in aqueous methanol solution has been observed to yield tetrahydrofurans {e.g. (25a)} stereospecifically and in good yield,¹⁸ a reaction which is discussed in detail in chapter one.

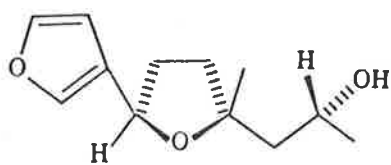

(17)

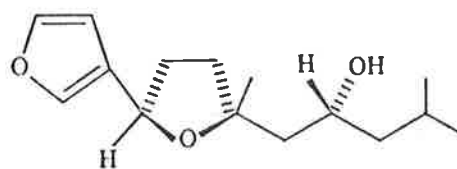

(18)

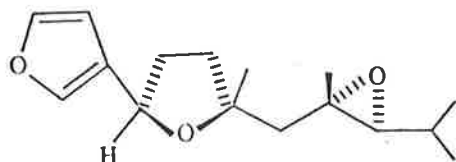

(20)

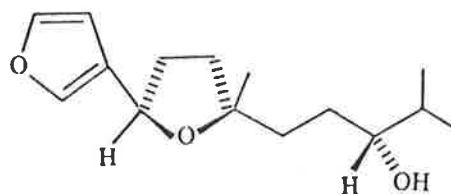

(19)

The lithium in ammonia reduction of eremoacetal (6), a molecule containing both benzylic and allylic type ether oxygens, both with and without a proton source, gave products in which the furan ring had been

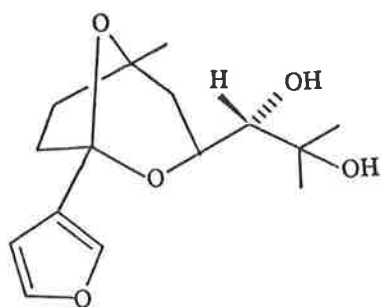

(21)

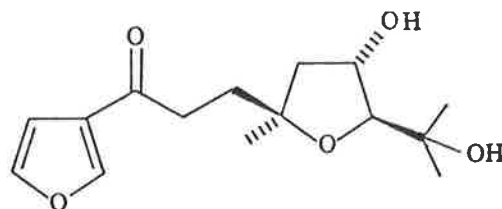

(25a)

reduced.¹⁷ Subsequently, an extensive study of the reduction of simpler synthetic 2-²⁰ and 3-²¹ substituted furan derivatives with a benzylic type oxygen substituent* was undertaken.²² The lithium in ammonia reduction of the 3-substituted furan derivatives {e.g. (60b), (60c) and (62)} in the absence of an external proton source gave products derived from benzylic type cleavage. When ethanol was present during the reduction extensive

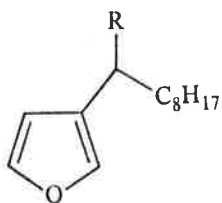

(60b) R=OAc

(60c) R=OMe

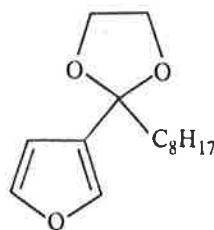

(62)

saturation and fission of the furan ring occurred.²¹ The reductions of a number of other synthetic 3-substituted furan derivatives have been studied in this thesis and the results obtained are discussed in chapter two.

*Benzylic type oxygen substituent refers throughout the thesis to an oxygen substituent adjacent to the furan ring.

CHAPTER I



Stereospecific Formation of Tetrahydrofurans from Substituted
2,8-Dioxabicyclo[3.2.1]oct-3-ylmethanols

1.0 It has been found that a number of derivatives of eremoacetal (6) bearing an hydroxyl substituent at C1 gave tetrahydrofuran formation under mild acidic conditions. The experimental conditions were not expected to yield such derivatives from the 1,4-diol function of the presumed acyclic keto alcohol intermediates (discussed later). Diol (21), the major isomer from the oxidation of eremoacetal with osmium tetroxide¹⁹, gave tetrahydrofuran (25a) on heating at 50° in aqueous methanol containing 5% oxalic acid. Similarly, the epimeric diol (22) gave an epimeric product (26a).

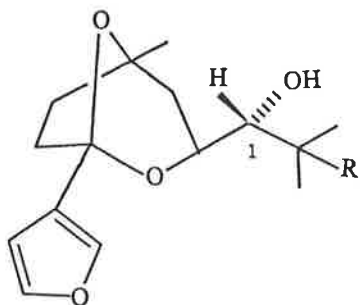

(21) R=OH
(23a) R=H

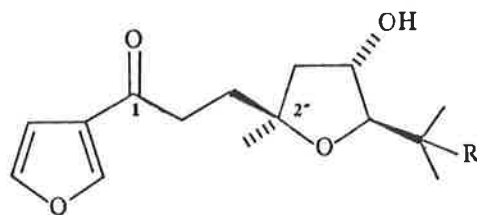

(25a) R=OH
(27) R=H

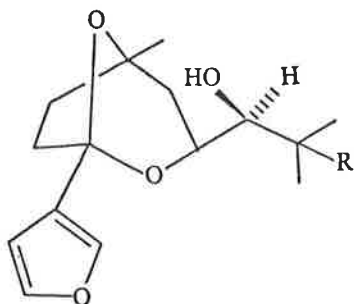

(22) R=OH
(24a) R=H

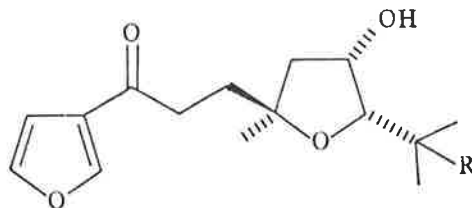

(26a) R=OH
(28) R=H

Under identical reaction conditions epimeric alcohols (23a) and (24a), made by hydroboration/oxidation of erempacetal¹⁹, gave a single product, (27) and (28) respectively. That (25a) and (26a) were tetrahydrofurans and not tetrahydropyrans was clear since both formed monoacetates on acetylation¹⁷. The infrared, ¹H n.m.r., and ¹³C n.m.r. spectra were in accord with the structures (25a), (26a), (27) and (28)¹⁷.

1.1 Since the tetrahydrofuran products (25a), (26a), (27) and (28) obtained were isomerically pure, and since diols (21) and (22) and alcohols (23a) and (24a) had known configurations,^{17,19} then the determination of the tetrahydrofuran product configurations should elucidate the mechanism of their formation. Further, since it was anticipated that all the tetrahydrofuran products would form via a common mechanism, the determination of the configuration of one product should reveal that of the others. Indeed, tetrahydrofuran (27) has been synthesized from (25a) by protecting the secondary hydroxy group as the acetate, followed by dehydration with thionyl chloride, deprotection and finally hydrogenation of the isolated double bond in the presence of P2 nickel catalyst.^{17,23} This interconversion demonstrates that the two series of compounds, starting from either the alcohol (23a) or the diol (21), have the same stereochemistry and excludes any change in configuration caused by an extra tertiary hydroxy group in diol (21).

Evidence for the relative configuration at C4'' and C5'' of (25a), (26a), (27) and (28) is available. Firstly, on attempted conversion of diols (25a) and (26a) into their acetonides only (26a) reacted, (25a) could not be induced to form the derivative¹⁷. An inspection of molecular models reveals that in a *trans* relative configuration at C4'' and C5'' the two

hydroxyl groups are more remote and hence less likely to form an acetonide. This result is consistent with a *trans* relative configuration at C4'' and C5'' for (25a).

Further evidence for the relative configurations at C4'' and C5'' can be found from the value of $J_{4'',5''}$. Literature values of approximately 6-7 Hz for *trans* coupling and 3-4 Hz for *cis* coupling have been reported for 2-substituted furan-3-ols.^{24,25,26} $J_{4'',5''}$ coupling constants of 5.0 and 2.6 Hz for tetrahydrofurans (25a) and (26a) respectively, are consistent with the assigned *trans* and *cis* stereochemistries. Similarly, tetrahydrofurans (27) and (28) have $J_{4'',5''}$ coupling constants of 7.0 and 2.4 Hz.

It is clear from the above evidence that the relative stereochemistry at C4'' and C5'' in the tetrahydrofuran products corresponds to the relative stereochemistry at the corresponding centres in the starting alcohols and diols, a result that is consistent with either retention or inversion of configuration at both centres. It would also be expected that the configuration at C2'' for each of the tetrahydrofuran products would be identical, the result of either inversion or retention. Hence, the determination of the configurations at C2'' and C4'' in the tetrahydrofurans would reveal the absolute stereochemistry and consequently the stereochemical transformations involved in their formation.

The determination of the configuration at C2'' and C4'' in tetrahydrofuran (25a) was achieved by degrading it to lactone (29) (corresponding centres C5 and C3, respectively) by reactions unlikely to alter the configuration at C2'' and C4'' of (25a) (Scheme 1.1). Although unknown, the absolute stereochemistry of lactone (29) was determined by

Scheme 1.1

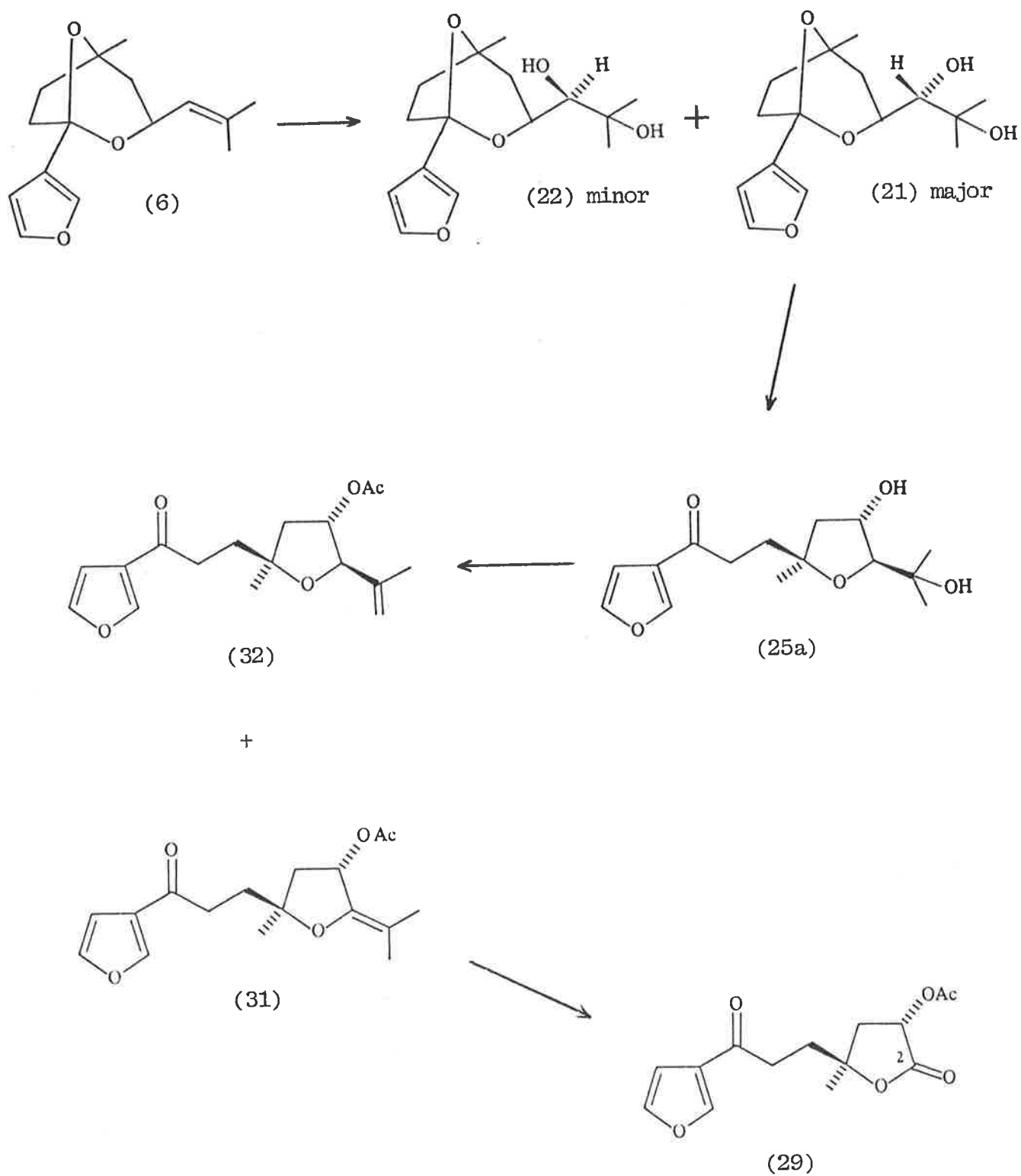

comparison with lactone (30b) of known absolute stereochemistry.

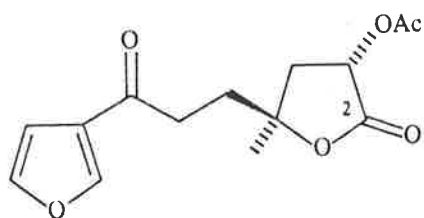

(29)

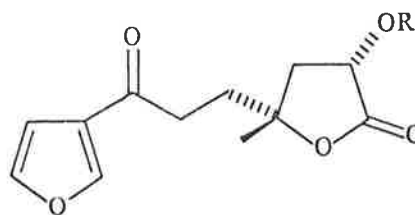

(30a) R=H

(30b) R=Ac

Treatment of eremoacetal (6) with osmium tetroxide and N-methyl morpholine N-oxide^{19,27} gave epimeric diols (21) and (22) which were separated by fractional crystallization. Reaction of major diol (21) with oxalic acid in aqueous methanol solution gave the required tetrahydrofuran (25a). Protection of the secondary hydroxyl group as the acetate followed by dehydration with phosphorus oxychloride in pyridine yielded a mixture of the required enol ether (31) and minor alkene (32) in a ratio of 3:1. A similar reaction with thionyl chloride in pyridine gave (31) and (32) in a ratio of 1:1. Ozonolysis of the crude mixture of (31) and (32), obtained from the phosphorus oxychloride reaction, in methanol/dimethyl sulphide at -78° , with a single equivalent of ozone, gave selective ozonolysis of the electron rich enol ether double bond to yield lactone (29) and recovered alkene (32). Although furans are attacked readily by ozone the furan ring in (31) and (32) is deactivated by conjugation with the carbonyl group.

Isomeric lactone (30b) was also prepared from eremoacetal (6) (Scheme 1.2). Oxidative cleavage of diol (21) with lead tetraacetate gave aldehyde (33) of known stereochemistry¹⁹. *In situ* silver oxide oxidation²⁸ of aldehyde (33) followed by acidification with dilute acid and acetylation gave lactone (30b). It was expected that the acid (34) from the oxidation would be in equilibrium with the ring-opened

Scheme 1.2

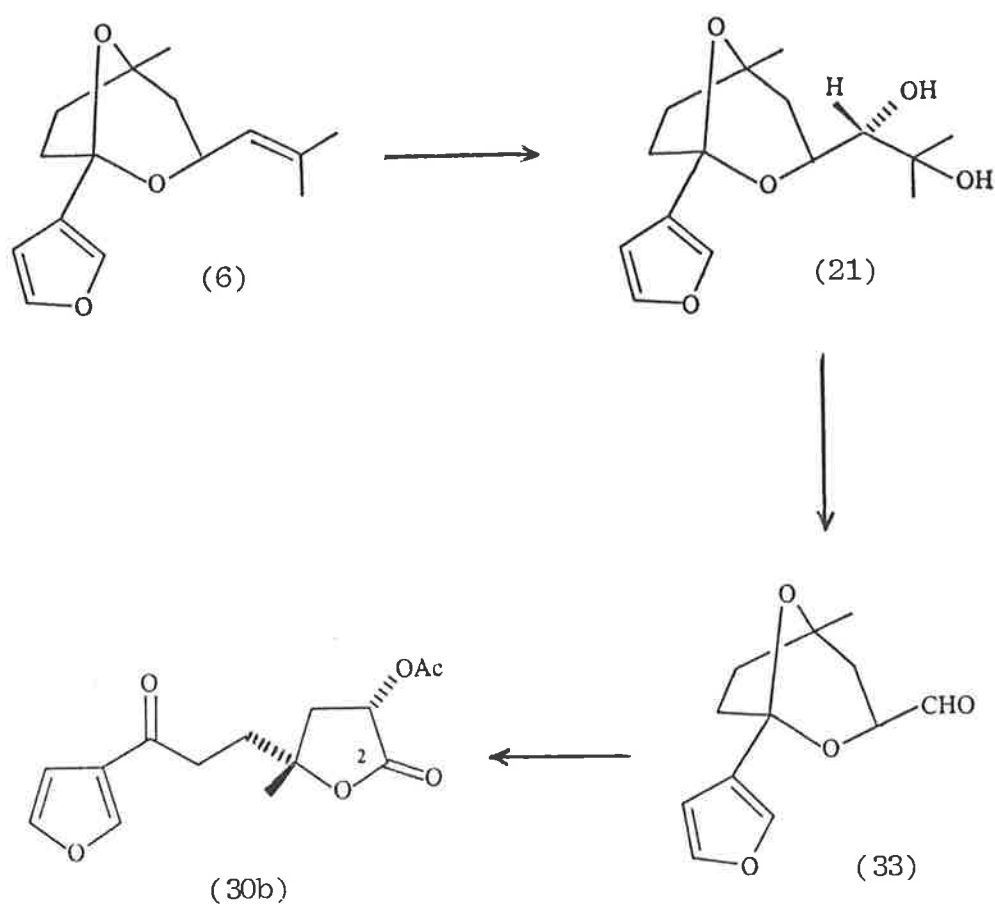

acid (34) under the acidic work-up conditions (Scheme 1.3). Lactonization

would then yield (30a). Immediately after acidification and extraction more than 50% of the acid (34) could be detected by ^1H n.m.r., however, intermediate acid (35) was not evident. Again the stability of the dioxabicyclooctane system is demonstrated.

Scheme 1.3

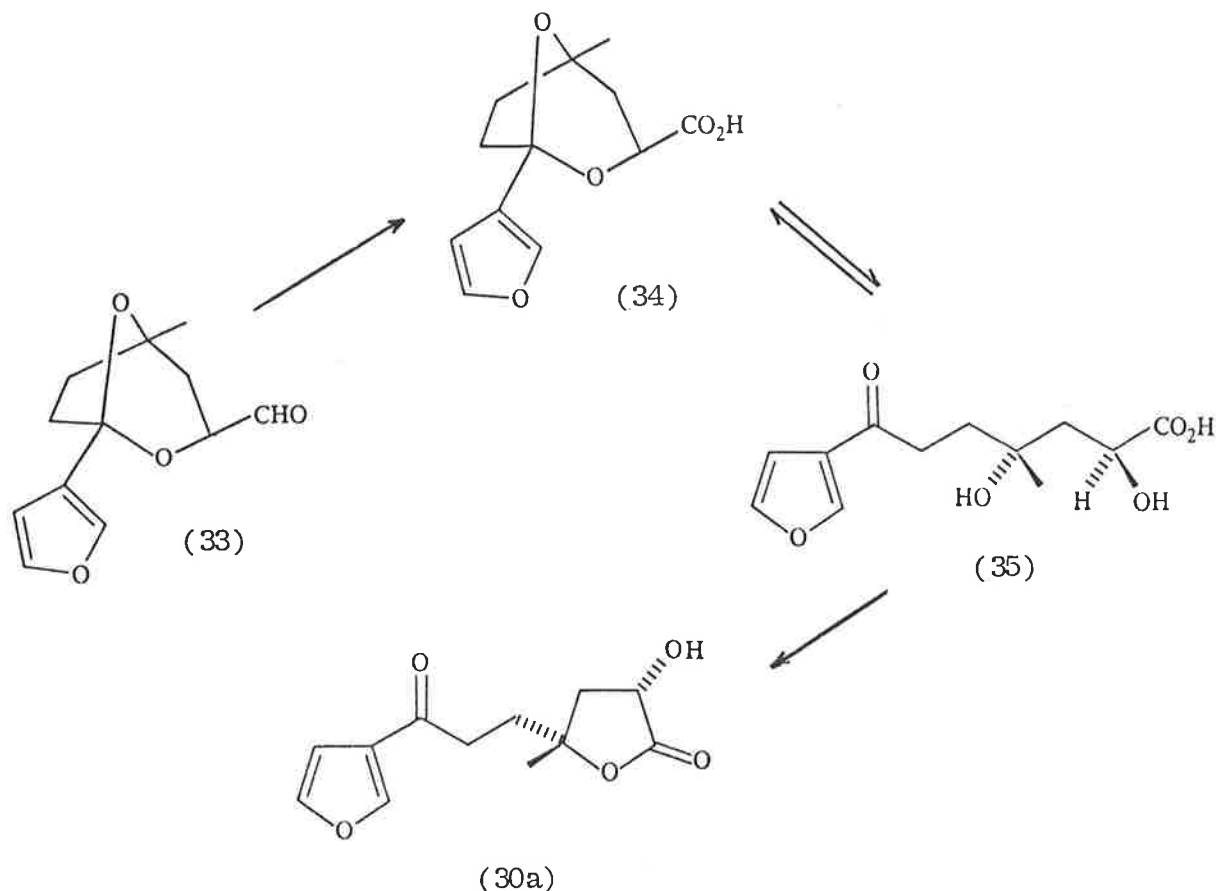

The absolute stereochemistry assigned to lactone (30b) assumes that its formation occurred with retention of configuration and also that (30a) is optically stable at low pH. This is consistent with the isolation of a single lactone isomer and with the findings of Sandberg that lactonization of optically active 4-hydroxy-4-methylhexanoic acid (36) occurs with retention of configuration²⁹.

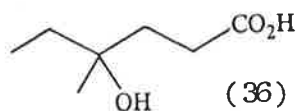

Scheme 1.4

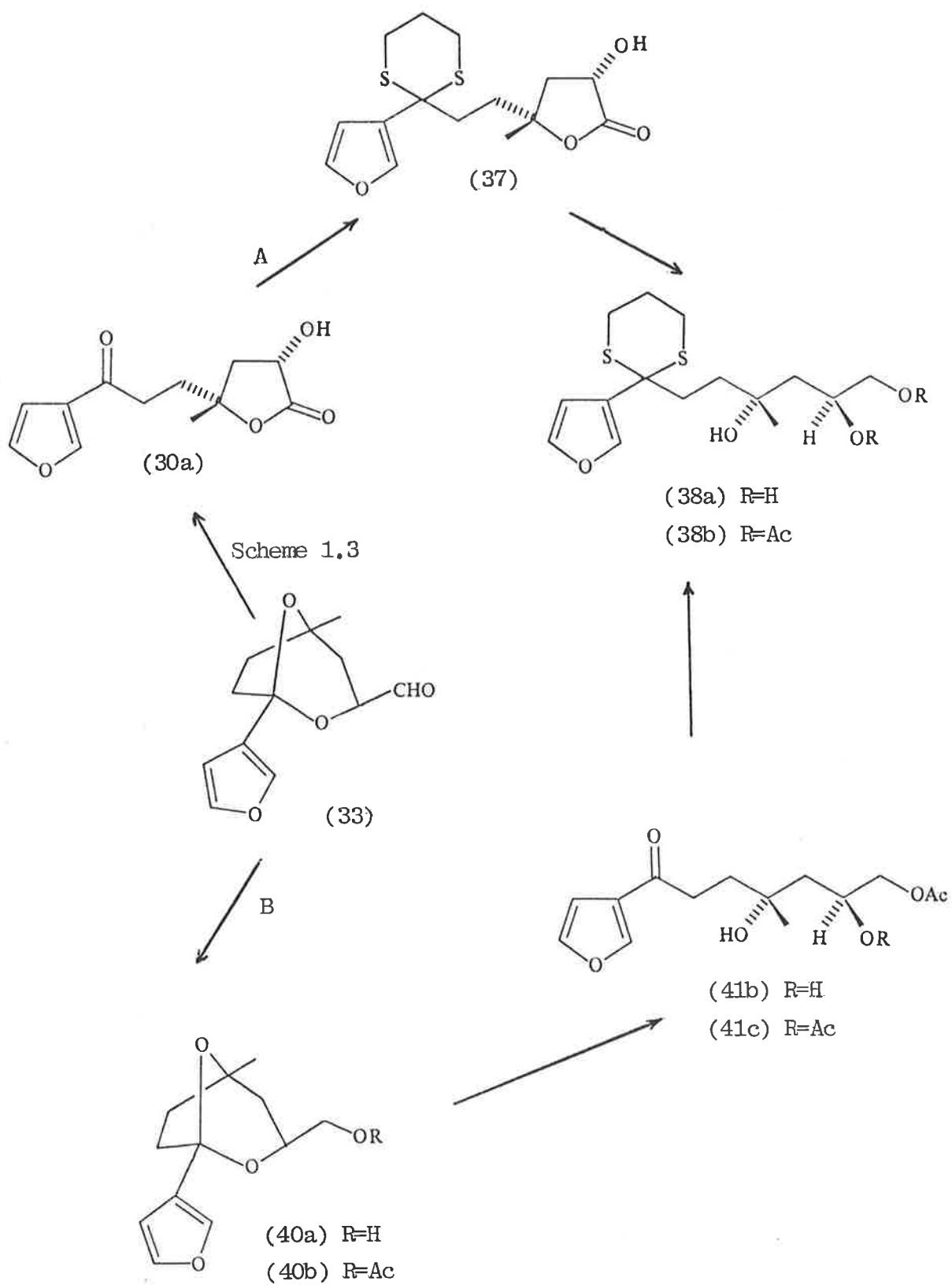

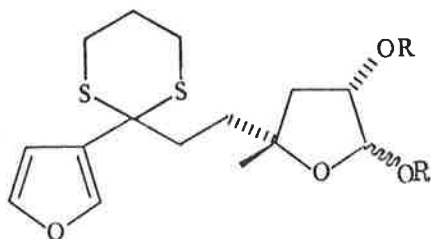

(42a) and (43a) R=H
(42b) and (43b) R=Ac

A confirmation of the stereochemistry of lactone (30b), deemed necessary due to the presence of the carbonyl group in (35) and also since tetrahydrofuran formation had been observed under acidic conditions in the previous examples, was achieved by preparation of the diacetate (38b) from both lactone (30a) and alcohol (40a). It was expected that all the reactions involved would ^{NOT} alter the stereochemistry (Scheme 1.4).

Lithium aluminium hydride reduction of the thioacetal of lactone (30a) followed by chromatography gave the triol (38a) and an inseparable mixture of epimeric hemiacetals (42a) and (43a). Acetylation of (38a) gave the required diacetate (38b). Acetylation of (42a) and (43a) gave an inseparable mixture of epimeric diacetates (42b) and (43b). The diacetates revealed characteristic downfield shifts (1 p.p.m.) for the two proton resonances geminal to the hydroxyl groups. Further lithium aluminium hydride reduction of epimeric hemiacetals (42a) and (43a) gave triol (38a) which on acetylation give diacetate (38b) identical to that previously synthesized.

Lithium aluminium hydride reduction of aldehyde (33) and acetylation of resultant alcohol (40a) gave acetate (40b) (route B, Scheme 1.4). It had been established earlier⁷ that eremoacetal (6) could be equilibrated with the dihydroxy ketone (16) by heating in aqueous pyridine (Scheme 1.5).

Scheme 1.5

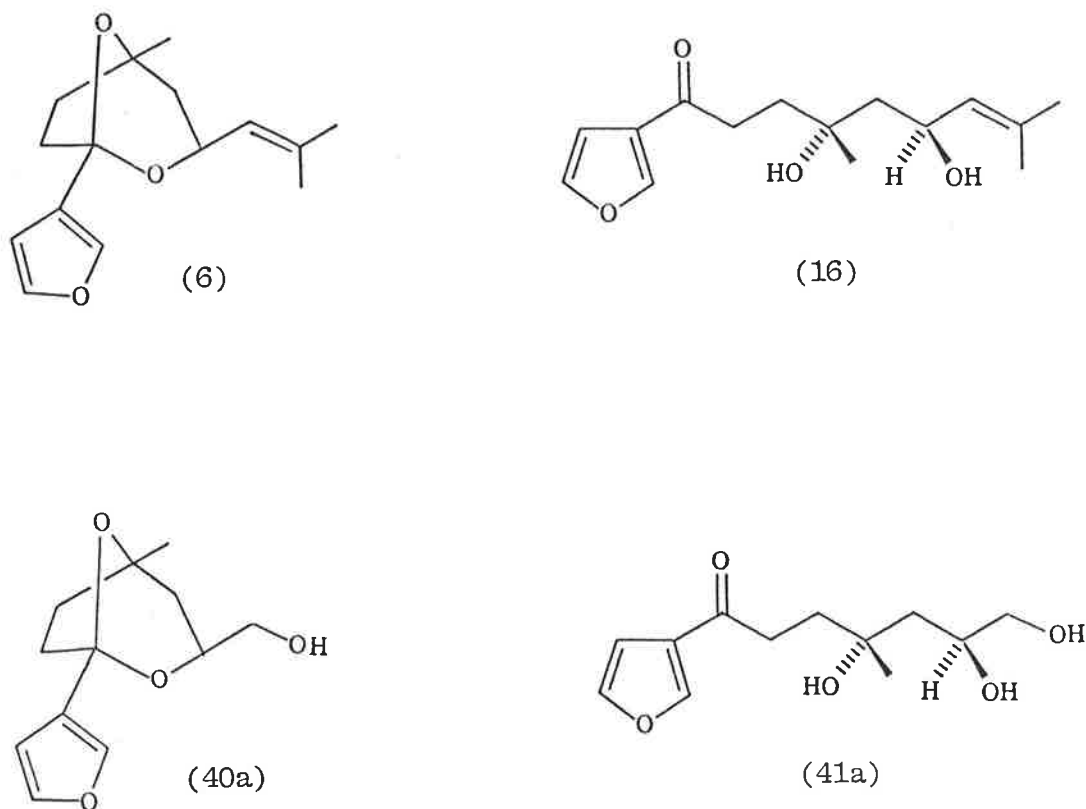

A similar solvolysis of alcohol (40a) gave an equilibrium mixture, by ^1H n.m.r., containing ring opened trihydroxy ketone (41a) (Scheme 1.5) which was not possible to isolate. Neither could it be reduced in the crude mixture with sodium borohydride. However, acetate (40b) on solvolysis in aqueous pyridine gave an equilibrium mixture containing dihydroxy acetate (41b) (45% by ^1H n.m.r.) and starting material (55% by ^1H n.m.r.). Again it was not possible to isolate (41b) but acetylation of the mixture gave the diacetate (41c) which on formation of the thioacetal gave a product identical with (38b) (Scheme 1.4). The compounds obtained from both routes gave identical ^1H n.m.r., ^{13}C n.m.r.,

Table 1.1 ^{13}C n.m.r. (20.1 MHz) and ^1H n.m.r. (80 MHz) (Both in CDCl_3) Spectral Data for Lactones (29) and (30b) in p.p.m. rel. to TMS.

C-Number	(29)		(30b)	
	^1H n.m.r.	^{13}C n.m.r.	^1H n.m.r.	^{13}C n.m.r.
2		176.6 (s)		174.2 (s)
3	5.50 (t)	69.1 (d)	5.48 (t)	69.0 (d)
4		40.6 (t)		39.8 (t)
5		83.9 (s)		83.6 (s)
5-Me	1.50 (s)	25.1 (q)	1.40 (s)	20.5 (q)
1'		34.6 (t)		35.0 (t)
2'	2.90 (m)	34.3 (t)	2.90 (m)	34.4 (t)
3'		193.4 (s)		193.6 (s)
2''	7.97 (m)	147.6 (d)	7.98 (m)	147.7 (d)
3''		127.5 (s)		127.5 (s)
4''	6.70 (m)	108.7 (d)	6.70 (m)	108.7 (d)
5''	7.40 (m)	144.7 (d)	7.35 (m)	144.7 (d)
OCO <u>Me</u>	2.16 (s)	26.6 (q)	2.10 (s)	25.9 (q)
<u>OCO</u> Me		169.9 (s)		170.0 (s)

infrared spectra, mass spectra and optical rotations ($[\alpha]_{577.3}^{20} = +4.4^{\circ}$, $[\alpha]_{546.4}^{20} = +5.4^{\circ}$). The configuration previously assigned to lactone (30b) is supported by the above correlation.

Lactone (30b) had physical data, Table 1.1, demonstrating that it was diastereomeric with lactone (29). In order to determine whether the two lactones (30b) and (29) were epimeric at C3 or C5 it was decided to prepare the unsaturated lactones (44) and (45). Attempted dehydration of alcohol (30a) with thionyl chloride in pyridine gave only chlorolactone (46). However, pyrolysis of (29) and (30b) at $600^{\circ}/0.1$ mm gave (44) and (45), respectively, by elimination of acetic acid. Both unsaturated

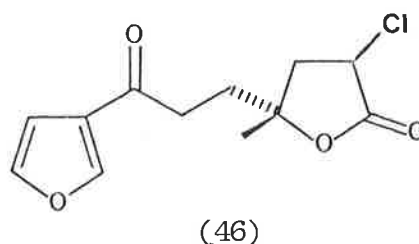
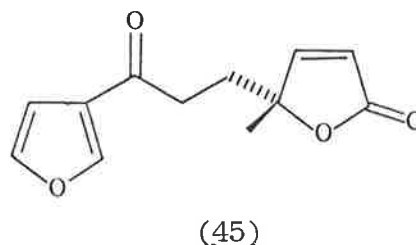
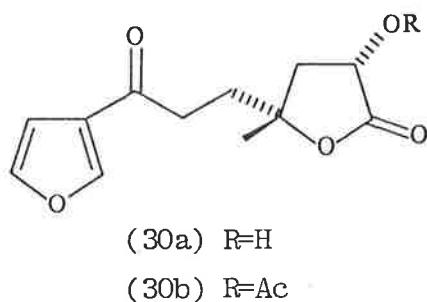
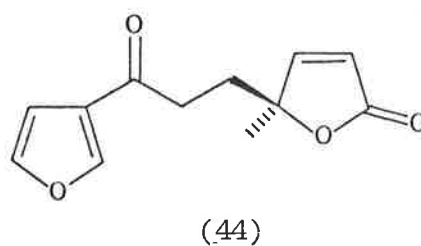
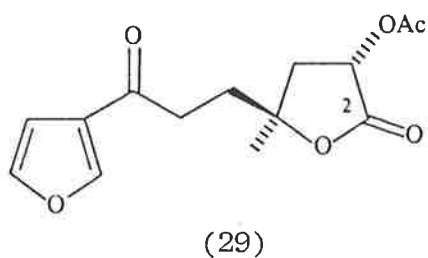

lactones gave identical spectral data but opposite optical rotations (Table 1.2). The lactones (29) and (30b) are therefore epimeric at C5. Consequently, during the formation of the tetrahydrofurans under acidic conditions

Table 1.2

	(44)	(45)
$\{\alpha\}_{577.3}^{20}$	-47°	$+49^{\circ}$
$\{\alpha\}_{546.4}^{20}$	-54°	$+58^{\circ}$

the tertiary carbon (C2'') has undergone an inversion of configuration, but the other two chiral carbons (C4'' and C5'') retain their configurations.

The direct formation of tetrahydrofurans from, e.g. (21), via intramolecular displacement by the hydroxyl group seems unlikely on steric grounds. Therefore, it is likely that the acyclic 1,4-diols, e.g. (48) are involved in the mechanism. Indeed, ready ring opening at room temperature under mildly acidic conditions was observed for eremoacetal (6),

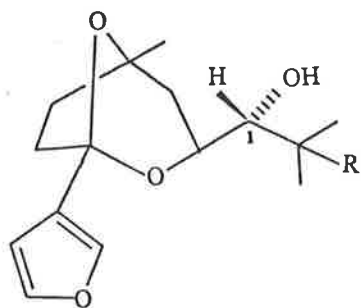

(23a) R=H
(21) R=OH

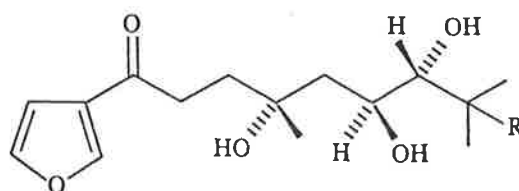

(47) R=H
(48) R=OH

dihydroeremoacetal (39) and diol (21) as evidenced in each case by deuterium exchange in the region around δ 2.4 corresponding to exchange

α to the carbonyl group in, e.g. (48). The diol (21) did not yield tetrahydrofuran (25a) until the mixture was warmed. Commonly used methods for the conversion of 1,4-diols to tetrahydrofurans require the presence of a strong acid, e.g. sulfuric and *p*-toluenesulfonic, and invariably involve an intermediate carbonium ion. For example, racemic 2-ethyl-2-methyltetrahydrofuran (50) was obtained from *p*-toluenesulfonic acid treatment of (-)-(S)-4-methylhexane-1,4-diol (49)³⁰. This result is consistent with a mechanism involving loss of the tertiary hydroxyl group to yield an intermediate carbonium ion with subsequent cyclization to the tetrahydrofuran. Similarly, loss of the secondary hydroxyl group from either (\pm) or *meso*-hexane-2,5-diol with sulfuric acid would account for the observed mixture of *cis*- and *trans*-2,5-dimethyltetrahydrofuran products³¹. Therefore, in order to explain the observed stereospecific

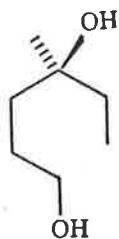

(49)



(50)

formation of tetrahydrofurans from, e.g. 1,4-diol intermediates (47) and (48), under unusually mild acidic conditions, it seems necessary to involve the carbonyl group in the mechanism.

Indeed, tetrahydrofurans were not observed on the treatment of 1,4-diols (51), (76) and (38a) with oxalic acid under identical reaction

conditions to those employed earlier. These results exclude the possibility of a mechanism involving protonation of the tertiary hydroxyl in e.g. (48) with synchronous ring closure and elimination of water.

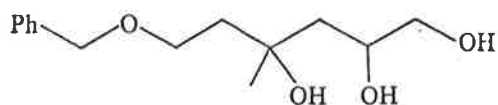

(51)

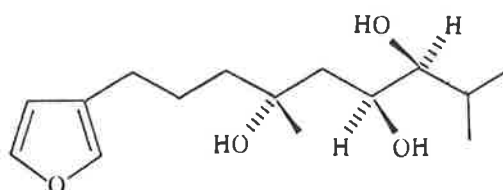

(76)

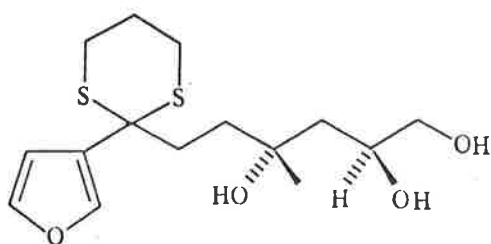

(38a)

A mechanism which is consistent with the stereochemistry of the tetrahydrofuran products and which involves the carbonyl group is outlined in Scheme 1.6. Acetal hydrolysis of diol (21) under acidic conditions would establish an equilibrium mixture of (48) and hemiacetals (53) and (54), presumably via a carbonium ion stabilized by an oxygen atom and the furan ring. Subsequent concomitant intramolecular attack by the hydroxyl group of (54) and formation of the carbonyl group would yield the tetrahydrofuran (25a).

Scheme 1.6

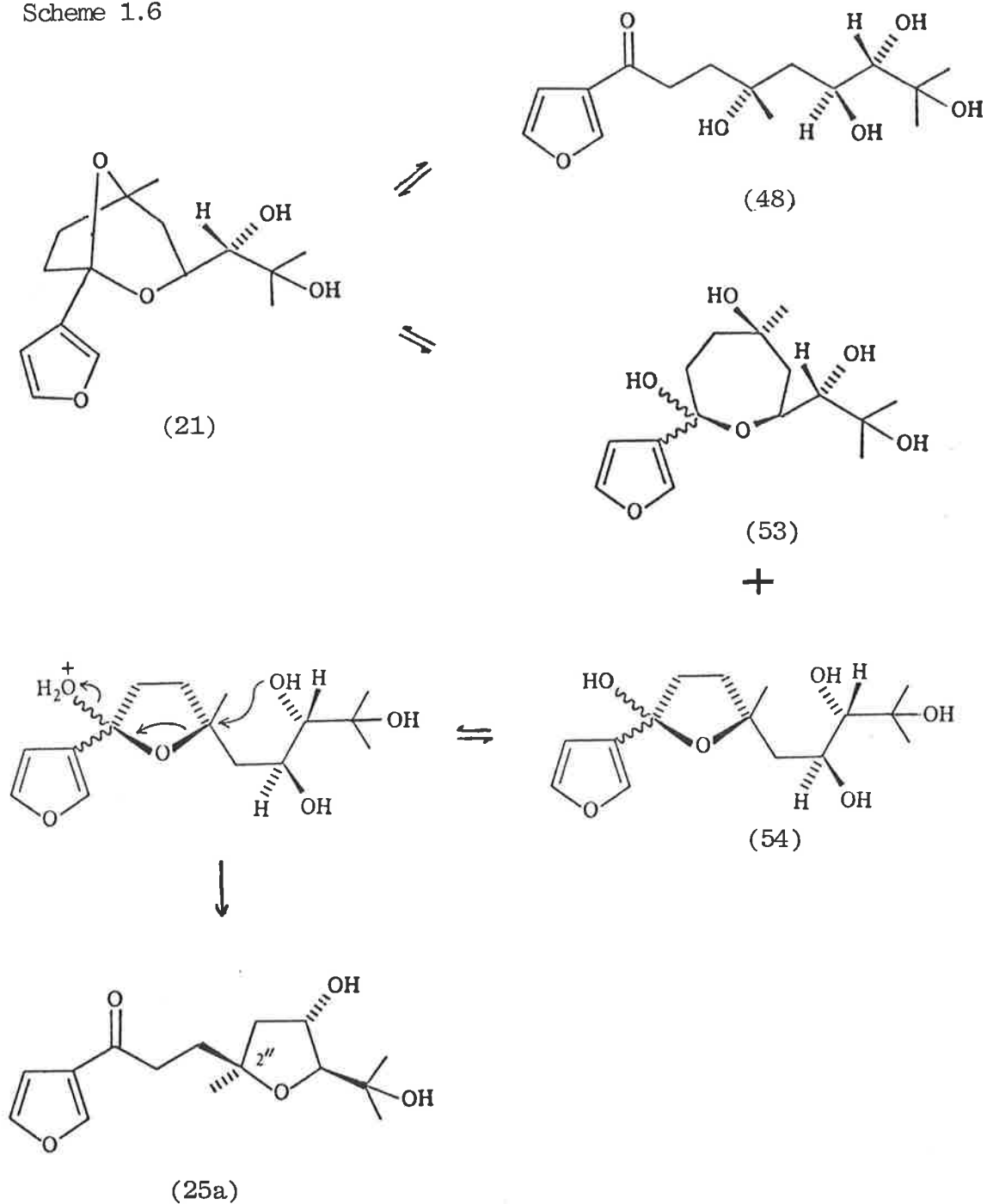

Interestingly, tertiary alcohol (70) gave tetrahydrofuran (55) on heating at 50° in aqueous methanol containing 5% oxalic acid. The mechanism indicated in Scheme 1.6, if applicable in this example,

necessitates that the tetrahydrofuran (55) is formed via an intramolecular attack by a tertiary hydroxy group on a tertiary centre with inversion of configuration.

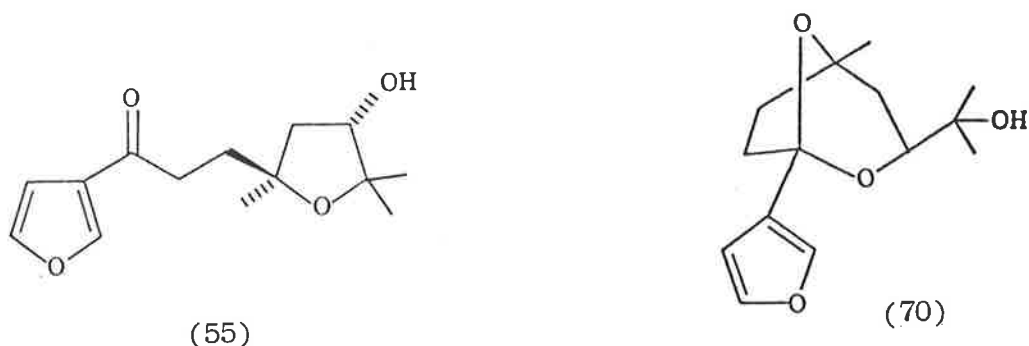

An intermediate 1,3-dioxolenium ion (57), stabilized by two oxygen atoms rather than an oxygen atom and a furan ring as in the present study, has been proposed for the rearrangement of acetoxy epoxide (56) to yield tetrahydrofuran (58)^{32,33}. In an analogous manner to the present study attack by the oxygen of intermediate (57), as shown, results in the formation of the tetrahydrofuran.

Scheme 1.7

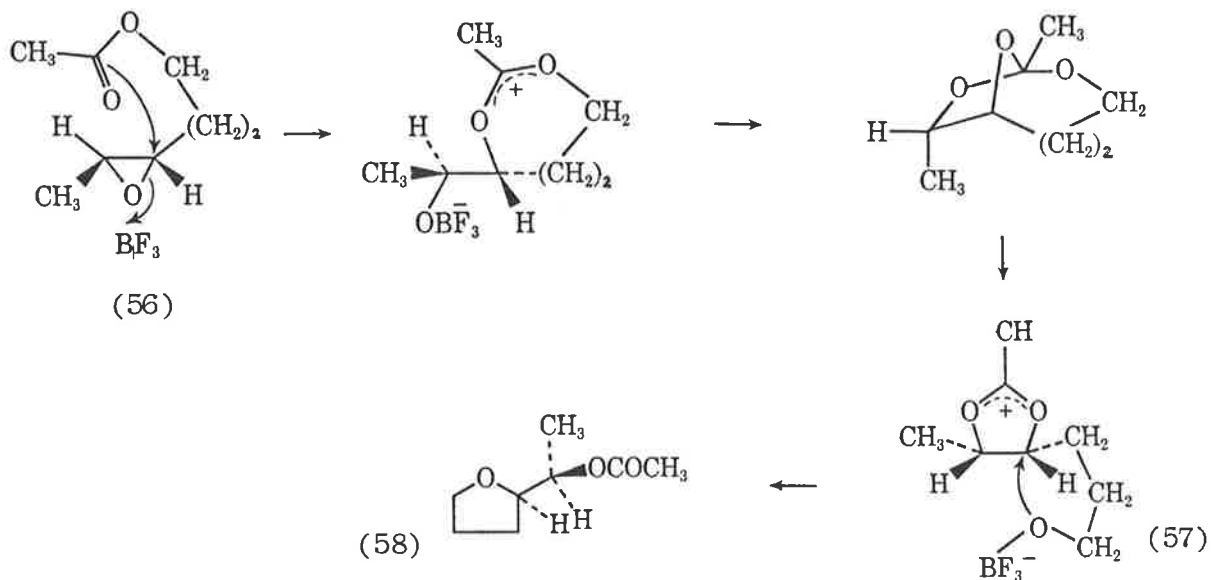

CHAPTER II

Lithium in Ammonia Reduction of 3-Substituted Furans

2.0 A variety of organic molecules are reduced with a metal in ammonia, either in the presence of a proton donor or followed by treatment with a proton donor.³⁵ The alkali metals and calcium are most commonly employed and generally in solutions in liquid ammonia or less frequently in low molecular weight amines. The metals dissolve in liquid ammonia to give solutions which behave as if they contain metal cations and "solvated electrons".^{34, 36}

Although many organic compounds are soluble to a useful extent in liquid ammonia, solubility usually can be enhanced by using a co-solvent often tetrahydrofuran. A number of reduction variables are therefore evident for dissolving metal reductions. Firstly, the solubility of the organic substrate in liquid ammonia influences whether or not a co-solvent is employed. Solubility and also stability of reaction intermediates is dependent on whether the ammonia is at boiling point (-33°) or at a lower temperature. The purity of the ammonia is known to affect the reduction potential of the metal in solution, for example iron impurities lower the reducing ability of the metal ammonia solution.³⁵ Reaction time and whether air is rigorously excluded from the reduction system are also important. Lithium is usually the metal of choice for the reductions due to its high solubility in liquid ammonia.

It is well documented that allylic and benzylic ethers^{35, 37}, acetals^{35, 37, 38} and to a lesser extent alcohols^{35, 37-45} are reductively cleaved in metal ammonia solutions. Attempted reductive cleavage of eremoacetal (6), which contains both allylic and benzylic acetal oxygens, in solutions of lithium, sodium or calcium in liquid ammonia, both with and without an external proton source, gave complex mixtures¹⁷. The furan

ring clearly underwent reduction since the crude mixture revealed no furan resonances by ^1H n.m.r. As a result of these observations the lithium in ammonia reduction of both 2-²⁰ and 3-²¹ substituted furans was extensively studied.

Reduction of acetate (60b) with lithium in ammonia for 15 min gave alkylfuran (59) (75%) and alcohol (60a) (25%) due to hydrogenolysis and acetate reduction respectively. An identical reduction of ether (60c)

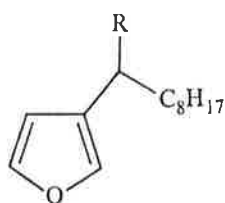

(59) R=H

(60a) R=OH

(60b) R=OAc

(60c) R=OMe

(61) R=OCH₂CH₂OH

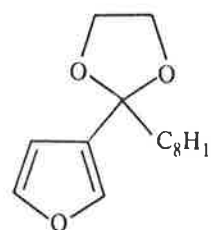

(62)

gave a mixture of alkylfuran (59) (12%) and recovered starting material (88%). Similarly, the acetal (62) on treatment with lithium in ammonia for 15 min gave alkylfuran (59) (23%), alcohol (61) (58%) and starting material (19%). Therefore, hydrogenolysis of the first acetal oxygen is faster than hydrogenolysis of the second acetal oxygen {to give (59)} and is also faster than hydrogenolysis of the methoxyl group in the ether (60c). It would also appear that the rate of reductive fission of the carbon-oxygen bond in (61) and that of the methoxy group in (60c) are similar. Consequently, the lithium alkoxide derived from (61) must have little influence on its subsequent reductive cleavage.

Reduction of acetal (62) with lithium and ammonia in the presence of ethanol gave extensive reduction and cleavage of the furan ring.²¹ In contrast with the reduction of the 3-substituted compounds the following observations were made with the 2-substituted series. Lithium in ammonia

reduction of acetate (64), both with and without an external proton source, gave 2-alkylfuran (63) as the exclusive product.²⁰ A similar reduction of the acetal (65) for 1 h gave 2-alkylfuran (63) in quantitative yield.

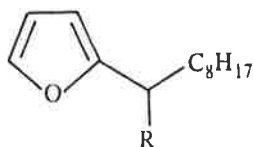

(63) R=H

(64) R=OAc

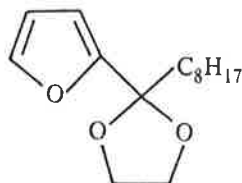

(65)

With an added proton source acetal (65) gave 2-alkylfuran (63) as the predominant product (95%) and a small amount of furan reduction (5%).

The 3-substituted furan examples discussed above undergo benzylic hydrogenolysis much more slowly than the 2-substituted furans; consequently with an external proton source present, proton addition to the furan ring can compete favourably with hydrogenolysis.²¹ Within the 3-substituted furan series the rate of substituent removal appears to parallel the stability of the leaving group.²¹

2.1 Eremoacetal (6) and its derivatives provide suitable models for the investigation of the metal in ammonia cleavage of the dioxabicyclo-[3.2.1]octane system.¹⁷ In particular, these compounds have a clearly defined stereochemistry and allow a study to be made involving the selectivity of bond cleavage. Also, the possible influence of lithium chelation

Table 2.1. Lithium in Ammonia Reductions of the Dioxabicyclooctane

Derivatives

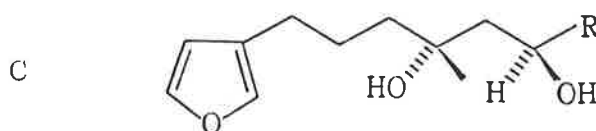
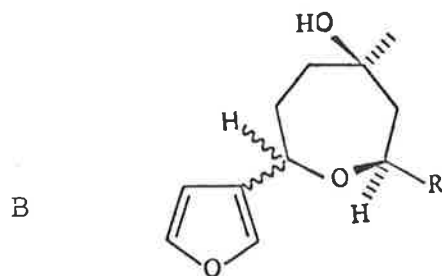
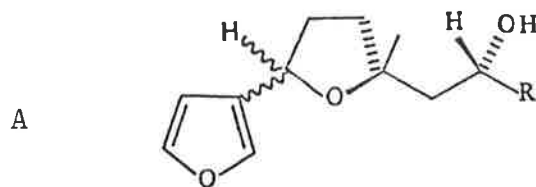
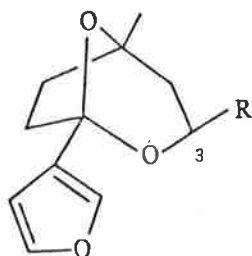

R	(h) Time	S.M.	Isolated Products (Compound No.)	
			monocleavage	dicleavage
-CH ₂ CH(CH ₃) ₂ (39)	3 ¹ 7 7 ¹ 7	63% 30%	17% B (71) 20% B (71)	7% (73) 40% (73)
-CH ₂ OH (40a)	5.5	42%	3-4% B	41% (74a)
-CH ₂ OCH ₂ OCH ₃ (40d)	5.5	9%	2% B	68% (75)
 (66a)	3	40%	-	37% (76)
 (67a)	3	a	-	90% (77)
 (68a)	3	a	-	79% (78)
-CH ₂ COH(CH ₃) ₂ (69)	3	19%	-	60% (79)
-COH(CH ₃) ₂ (70)	3	18%	-	62% (80)

a 1-2% detected by ¹H n.m.r. in the crude mixture.

can be assessed because of the ease of synthesis of a variety of alcohols with the hydroxyl group in the side chain at C3. In preliminary studies, significant differences were observed in the reduction rate and product composition for the lithium in ammonia reduction of eremoacetal, dihydroeremoacetal (39) and alcohol (40a). As a consequence, a number of other examples were studied in detail (Table 2.1). The lithium in ammonia reductions were performed at -33° under standardized conditions (see Exp. Section) with no added proton source unless specified. Treatment of dihydroeremoacetal (39), prepared by hydrogenation of eremoacetal (6)⁷, with lithium in ammonia for 15 min returned 99% starting material. A similar reduction of (39) for 3 h afforded starting material (63%), oxepanes (71)^{*}(17%) and diol (73) (7%), but after 7 h reduction, 30% starting material was recovered in addition to oxepanes (71) (20%) and diol (73) (40%). The cleavage of the acetal was quite slow and, interestingly, none of the tetrahydrofuran isomers (72) were detected.

A 5.5 h lithium in ammonia reduction of primary alcohol (40a) gave starting material (42%), triol (74a) (41%) and 3-4% of material tentatively assigned as oxepane monocleavage product. Triol (74a) was characterized as its diacetate (74b). In comparison, reduction of the protected alcohol (40d) with lithium in ammonia for 5.5 h gave dicleavage product (75) (68%) and only 9% starting material.

Lithium in ammonia reduction for 3 h of the secondary alcohol (66a), prepared from aldehyde (33),^{17,19} gave starting material (40%) and triol (76) (37%). By comparison, the epimeric secondary alcohols (67a) and (68a), prepared from aldehyde (33),¹⁷ were rapidly reduced after 3 h. A 3 h

* diastereomers were separable¹⁷

lithium in ammonia reduction of tertiary alcohols (69) and (70) revealed the following; (69) gave starting material (19%) and triol (79) (60%) while (70) gave starting material (18%) and triol (80) (62%).

No tetrahydrofuran monocleavage products were detected in any of the lithium in ammonia reductions. Consequently, it was not clear whether the reduction of tetrahydrofuran monocleavage products {e.g. (72)}, if formed, occurred rapidly relative to the oxepanes {e.g. (71)}, or whether preferential cleavage of the C1-08 bond had occurred.

The relative rate of cleavage of tetrahydrofuran (72a) and oxepane (71a) was established by a competitive reduction.¹⁷ A mixture of oxepane (71a) and independently synthesized tetrahydrofuran (72a)¹⁹ (1:1) was reduced with lithium in ammonia for 1 h. Isolation and characterisation of the products revealed the following; tetrahydrofuran (72a) had been >95% reduced, whereas oxepane (71a) appeared inert (90% recovered). Diol (73) was also isolated (50% yield).

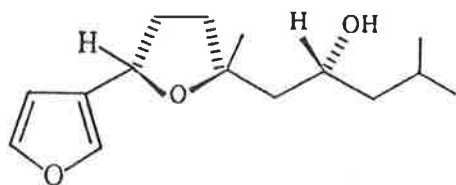

(72a)

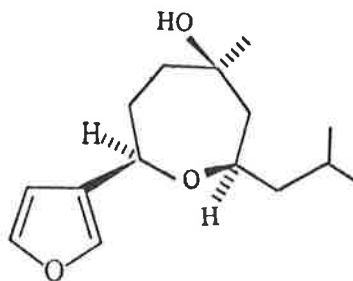

(71a)

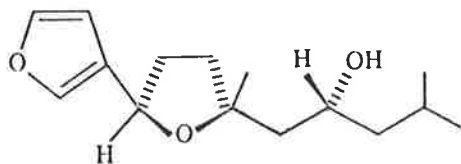

(72b)

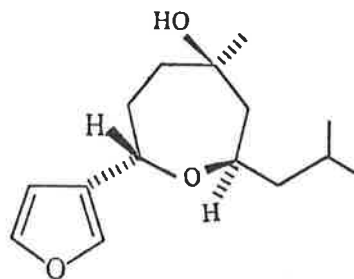

(71b)

Clearly, the tetrahydrofuran (72a) had been rapidly reduced to diol (73). These observations have been confirmed with other model compounds that will be discussed later. Therefore, if tetrahydrofuran (72a) had been formed in the initial reduction of (39) it would have been rapidly reduced to diol (73).

It has been postulated that the hydrogenolysis of a benzylic leaving group with lithium in ammonia proceeds via the addition of two electrons to produce a dianion species.^{35,37,46,47} The addition of a second electron to a system already negatively charged is presumably slow, although solvation by ammonia may stabilize the dianion. Regardless of whether the transition state for the reductive fission involves a dianion or an anion radical the benzylic cleavage will ultimately yield either of two dianion species {(83) and (84) Scheme 2.1} a process facilitated by the ability of the aromatic nucleus to stabilize a negative charge and by the high affinity for electrons of the oxygen atoms present in the dioxolane ring.

C1-02 cleavage yields the tetrahydrofuran dianion (84) while C1-08 cleavage yields the oxepane dianion (83), both of which must be sufficiently basic to suffer protonation by ammonia. A further electron addition with subsequent benzylic cleavage would yield a common diol (87) (Scheme 2.1).

The electron addition is usually reversible and the equilibrium position is affected by solvation, a probable reason for the favourable effect of ammonia on ion production, and also by the structure of the organic substrate.^{35,46} The greater the degree of unsaturation, the higher the electron affinity of the system, and the greater the ground state strain, the more the equilibrium will favour addition.³⁵ The

Scheme 2.1.

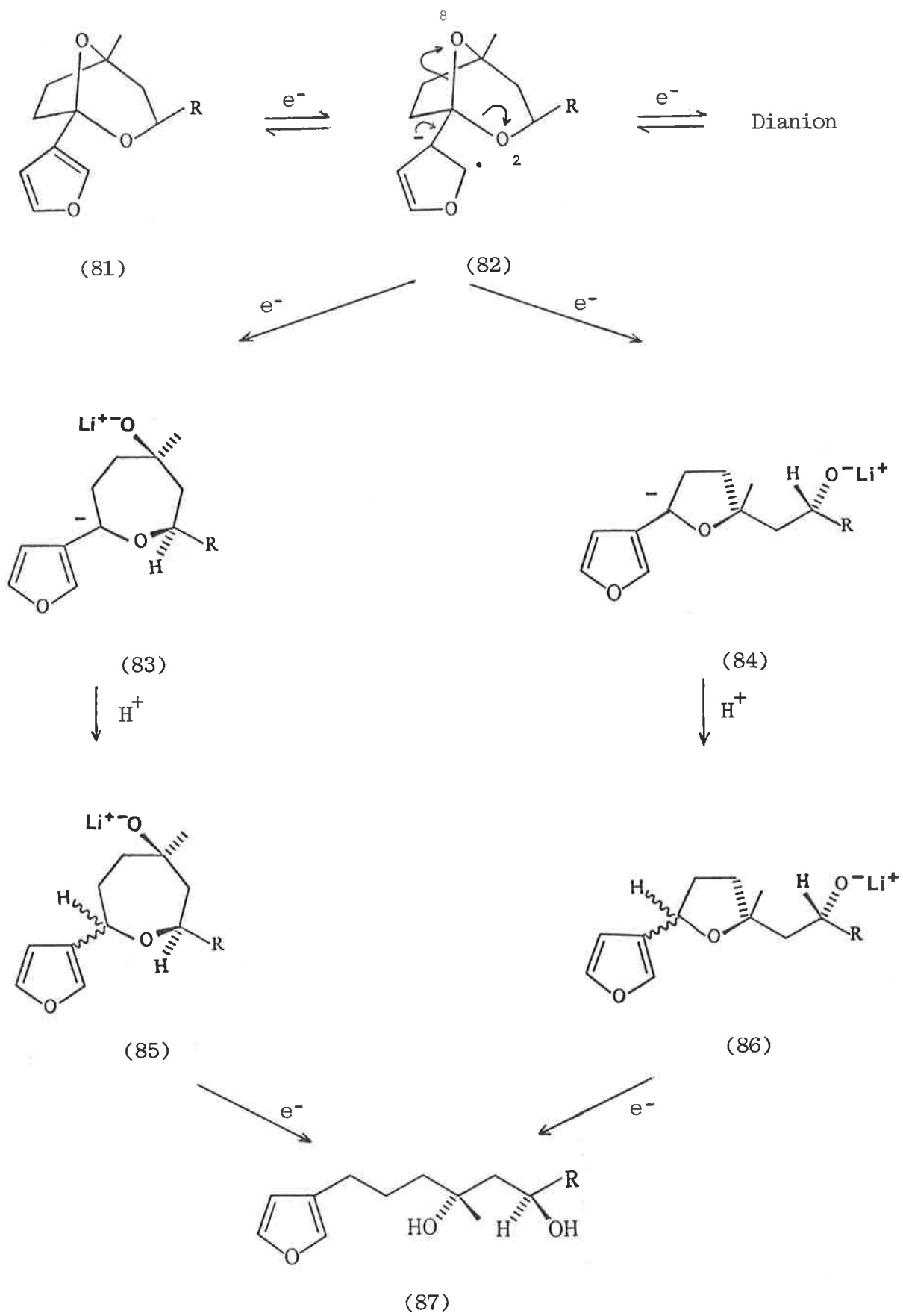

reducibility of the system depends on whether it adds an electron and also on whether the resulting anion radical can be irreversibly transformed. Also, despite uncertainties about the reaction kinetics, it is probable that the rate of reduction is dependent, as one factor at least, on the equilibrium position of the electron addition and hence the initially formed anion radical concentration.

The reduction rate and product composition are clearly dependent on the nature of the group R in (81) (Scheme 2.1). When R does not contain an oxygenated substituent, e.g. (39), the reduction rate is slow and oxepane, e.g. (71), was isolated. However, when R contains an oxygenated substituent (Table 2.1) the reduction rate is significantly enhanced and small quantities, if any, of the oxepane products were isolated.

Either the reduction proceeds exclusively via one of the two alternative pathways of Scheme 2.1, irrespective of R, where the nature of R in (81) governs the rate of that pathway, or alternatively, the nature of R determines whether C1-02 or C1-08 cleavage is observed and possibly the rate of subsequent reduction of (83) and (84) {c.f. (71a) and (72) competitive reduction}.

The reduction of dihydroeremoacetal (39) with lithium in ammonia for 7 h gave epimeric oxepanes (71a) and (71b) in the ratio of 20:1. A competitive reduction of a mixture of (71a) and (71b) for 3 h gave approximately equal reduction of each component. Consequently, the difference in rates of reduction of these epimers is insignificant and the implication is that (71a) is formed more rapidly by a preferential protonation from the relevant face of the common oxepane intermediate {e.g. (83)}. Interestingly the competitive reduction of (71a) and (71b) for 3 h gave diol (73) in 10% yield, a figure which is similar to that obtained for the 3 h reduction of dihydroeremoacetal (39) which yielded diol (73) (7%). The

reduction of dihydroeremacetal (39), at least, would therefore appear to proceed predominantly, if not exclusively, via the oxepanes (71).

It is likely, therefore, that when R in (81) (Scheme 2.1) is oxygenated the reduction proceeds significantly and in some cases exclusively via the tetrahydrofuran intermediate (84) which, on the basis of the competitive reduction of (71a) and (72a) and on the study of model compounds (see later), would cleave rapidly.

A preference for oxepane formation (C1-O8 cleavage) with dihydroeremacetal (39) is difficult to rationalize. The reaction pathway taken by anion radical (82) will clearly be that which is energetically most favourable. It is likely that the conformation of the furan ring is crucial for the required overlap of the orbitals necessary for the preferential formation of the oxepane (83).

The presence of an additional oxygenated substituent in the C3 side chain of the reduction substrate {e.g. in (40a), (40d), (66a), (67a), (68a), (69) and (70)} may enhance the coordination of a solvated lithium cation to the benzylic type oxygen, a process that would be expected to assist electron addition to the aromatic system. Lithium cation is known to coordinate via 4,5 (most favourable) and 6-membered intermediates.^{48,49} Eremacetal derivatives (40a), (40d), (66a), (67a), (68a) and (70) have the potential to coordinate lithium to O2 and OR' in the C3 side chain via a five membered ring; the chelation might be expected to predominate between the oxygenated substituent (OR') and O2 (5 membered system) rather

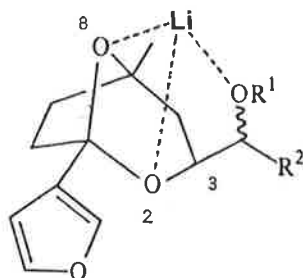

than with 08 (7 membered system). Preferential chelation may, therefore, stabilize the transition state for C1-02 cleavage relative to C1-08, such that C1-02 cleavage would predominate to yield tetrahydrofuran (84) (Scheme 2.1). It has been reported¹⁹ that mesylate (40c) undergoes a two step stereospecific reduction with lithium aluminium hydride to yield tetrahydrofuran (17), a reaction probably involving coordination. Similarly, the reaction of methyl ester (138) with methylmagnesium iodide gave, as

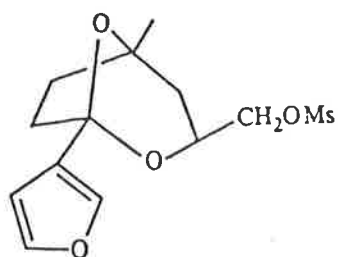

(40c)

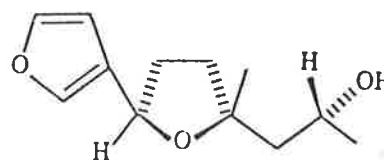

(17)

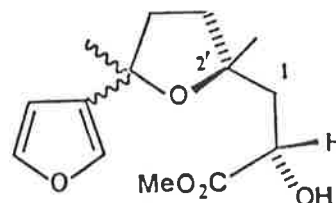

(139a) and (140a)

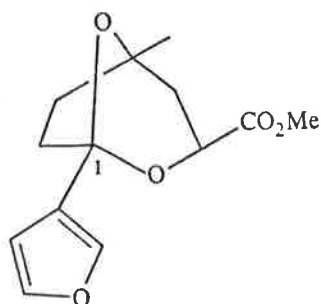

(138)

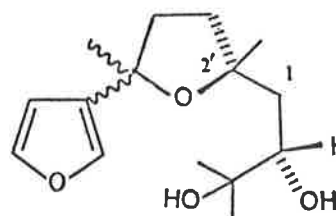

(141a) and (142a)

cleavage products, tetrahydrofurans (139a) to (142a) with no detected oxepane.⁵⁰ This reaction, which is discussed later, is assumed to be directed by a selective coordination of the Grignard reagent.

The result of preferential C1-02 cleavage would be tetrahydrofuran

formation which, on the basis of the competitive reduction of (71a) and (72a), would rapidly reduce to the dicleavage product. Indeed, (40a), (40d), (66a), (67a), (68a) and (70) were all reduced more readily than dihydroeremoacetal (39) and gave little or no detected oxepane product. These observations can also be explained by an enhanced rate of oxepane intermediate cleavage due to a similar lithium coordination involving OR and the benzylic oxygen of the oxepane dianion (83) (Scheme 2.1).

Interestingly, the protected primary alcohol (40d) was cleaved with lithium in ammonia substantially faster than the parent alcohol (40a). In the reduction medium an hydroxyl substituent would readily deprotonate. Although the alkoxide would form a stable metal alkoxide, further addition of an electron to a system that is already negatively charged may be inhibited,^{35, 46} a probable reason for the slow reduction of benzylic alcohols. Although the protected alcohol (40d) does not possess the free hydroxyl group it would still permit favourable lithium coordination. The inhibition of electron addition to the negatively charged alkoxide would be offset somewhat by the formation of the metal alkoxide and by ammonia solvation.

The lithium alkoxide derived from (61) and the methoxy group of (60c) are cleaved at similar rates by lithium in ammonia,²¹ thus indicating

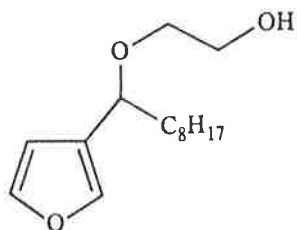

(61)

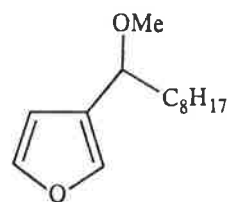

(60c)

that the lithium alkoxide of (61) has little influence on the reduction in this case.

The secondary alcohols (67a) and (68a) show a substantial enhancement in the rate of reduction as compared to primary alcohol (40a). A secondary hydroxyl substituent is less acidic than a primary presumably due to a decrease in solvation of the corresponding alkoxide by the solvent, in this case ammonia, which tends to stabilize the anion. However, a decrease in solvation and hence a decrease in acidity may enhance lithium chelation and hence the reduction rate. A delicate balance between anion solvation and lithium chelation would appear to exist.

The secondary alcohol (66a) was reduced substantially slower than either (67a) or (68a). Presumably, both lithium chelation and ammonia solvation are sterically hindered by the bulk of the isopropyl group. The results obtained for the tertiary alcohol (70) appear to support these conclusions (Table 2.1).

Tertiary alcohol (69), which can form a lithium chelate between the C3 side chain hydroxyl group and O2 via a 6-membered ring system was observed to reductively cleave at a rate comparable to (70).

The rate of lithium in ammonia cleavage of the benzylic dioxabicyclooctane system would appear to be dependent on the position and nature (primary, secondary or tertiary) of the oxygen substituent in (40a), (40d), (66a), (67a), (68a), (69) and (70). Only in the absence of the oxygen substituent, e.g. dihydroeremoacetal (39), was a significant amount of monocleavage product oxepane, e.g. (71), observed. In accord with this observation it has been reported¹⁷ that a 9 h lithium in ammonia reduction of acetal (88) returned starting material (30%), diols

(89) (22%) and a mixture of oxepanes (90) (35%). Again none of the tetrahydrofuran monocleavage product was observed.

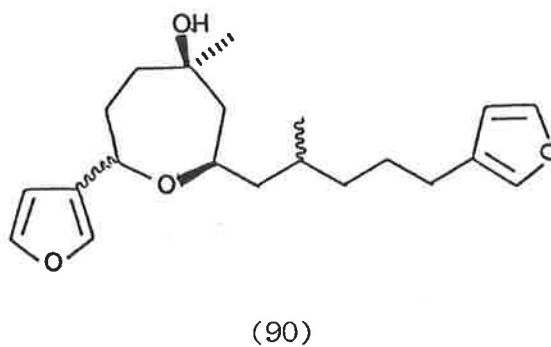
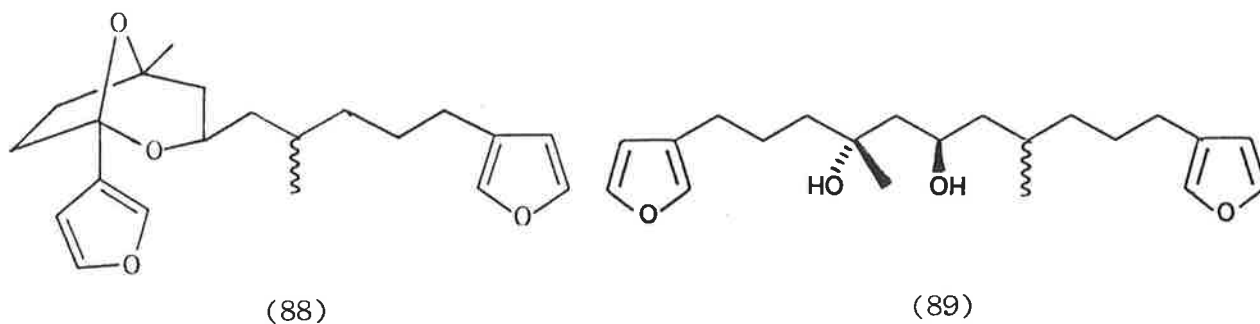

2.2 Both the position of the oxygen substituent in the C3 side chain of the reduction substrate and also the reasons for the vast differences in the observed rate of reduction of oxepane (71a) and tetrahydrofuran (72a) and indeed acetal (62) would appear to be significant in controlling the outcome of the reduction. A systematic study of the lithium in ammonia reduction of simpler synthetic 3-substituted furan derivatives was undertaken in an attempt to rationalize the results obtained. It was decided to study the reduction of benzylic cyclic ethers of varying ring size (5,6,7) and also examples with an hydroxyl group at varying carbon chain lengths from the benzylic dioxolane ring.

Table 2.2. Lithium in Ammonia Reductions of the Benzylic Cyclic Ethers

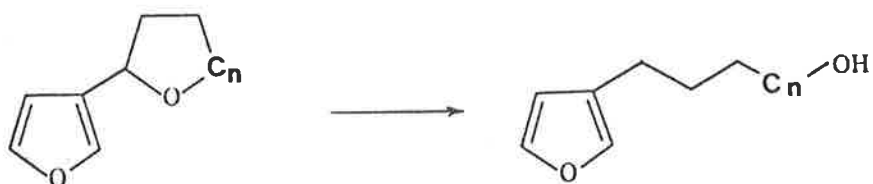

Substrate	Time (min)	Product		S.M.	
		G.C.	Isolated	G.C.	Isolated
(91) n = 1	15	(94) 93%	90%	<1%	-
(92) n = 2	15	(95) 18%	17%	76%	65%
(93) n = 3	15	(96) 13%	13%	85%	74%

Competitive Experiments

Substrates	Time (min)	% Reduced (G.C.)
(91) n = 1		100%
(92) n = 2	11	10%
(93) n = 3		8%
(92) n = 2	17	30%
(60c)		15%

All the reductions were carried out by use of a solution of lithium metal in a refluxing (-33°) mixture of liquid ammonia and tetrahydrofuran (co-solvent). The reductions were performed without an external proton source unless otherwise stated. The crude ether extracts from the reductions were analysed directly by g.l.c. and the products were subsequently isolated and characterized. A number of substrates were reduced under competitive conditions in order to accurately assess their relative rates of reduction. All the reductions were carried out under carefully standardized conditions (see Experimental Section).

An examination of the results summarized in Table 2.2 reveals that after 15 min reduction, with lithium in ammonia, the tetrahydrofuran derivative (91) was reductively cleaved substantially quicker (93% reduced) than either the tetrahydropyran (92) (18% reduced) or the oxepane (93) (13% reduced). The competitive reduction of (91), (92) and (93) supports this observation. The rates of reductive fission of the carbon-oxygen bonds in tetrahydropyran (92) and methyl ether (60c) are comparable.

It is documented that the ring-opening rates of cyclic ethers normally follow the order 3- > 4- > 5- > 6- membered ring.⁵³ The ease of ring opening of the cyclic ethers can be related directly to their thermodynamic properties.⁵⁴ The results of Pell and Pilcher,^{54c} who measured the heats of combustion of the cyclic ethers and subsequently the strain energies, are tabulated in Table 2.3. Cox^{54b} considered the slight strain in the six-membered ether ring to be angular in origin, since a carbon-oxygen bond is slightly shorter than a carbon-carbon bond.

Table 2.3. Strain Energies in Cyclic Ethers (Kcal/mole) ^{54c}

Ring Size	Alkane	Ether
3	27.43	27.28
4	26.04	25.51
5	6.05	5.63
6	-0.02	1.16

It is evident that the five-membered cyclic ether possesses approximately five times the strain energy of the 6-membered cyclic ether, a result reflected by the lithium in ammonia reduction rates of (91) and (92), (Table 2.2). Presumably, the 6- and 7- membered cyclic ethers, (92) and (93) respectively, possess little strain energy and hence are cleaved at a rate comparable to methyl ether (60c).

Attempts to rank the basicities of the cyclic ethers have been somewhat conflicting.⁵⁵ Consequently, any attempts to rationalize the differences in the rate of carbon-oxygen bond cleavage of (91), (92) and (93) on the basis of electron sharing capacities and hence ability to coordinate lithium cation must be treated with caution.

Reduction of acetal alcohol (97a) with lithium in ammonia for 15 min gave a mixture of alkylfuran (103) (55%), diol (100) (13%),

Table 2.4. Lithium in Ammonia Reductions of the Alcohols

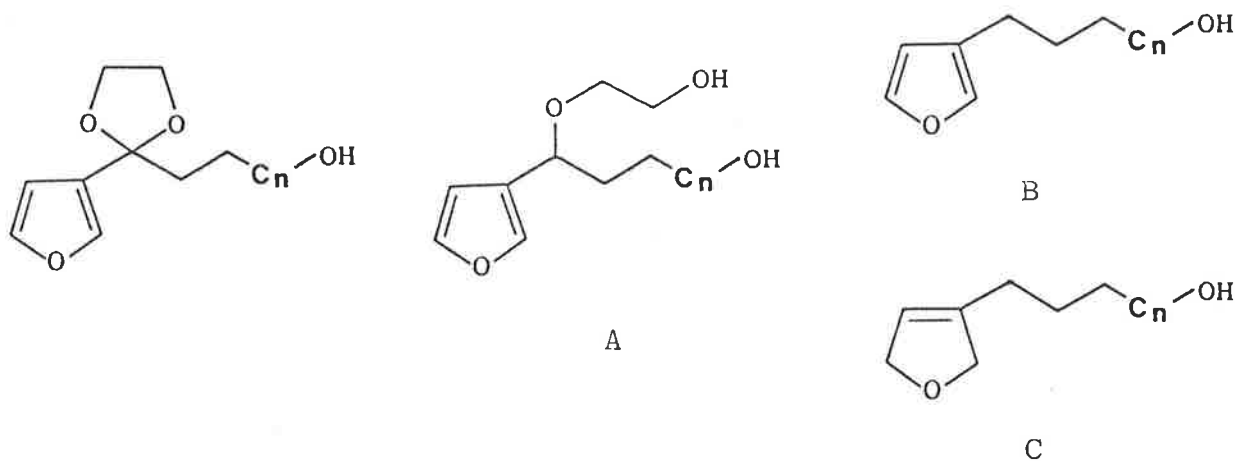

Substrate	Time (min)	Products (G.C. yields)			
		S.M.	(A) mono- cleavage	(B) di- cleavage	(C) furan reduction
(97a) n=0	15	3%	(100) 13%	(103) 55%	(104) 10%
(98a) n=1	15	28%	(101) 10%	(94) 48%	(105) 5%

Competitive Reductions

(97a) n=0	15	3%	(100) 12%	(103) 47%	(104) 18%
(98a) n=1		33%	(101) 12%	(94) 50%	(105) 2%
(97a) n=0	15	2%	(100) 12%	(103) 52%	(104) 14%
(99a) n=3		43%	(102) 13%	(96) 41%	a

a Furan reduction product not observed

starting material (3%) and furan reduction product (104)(10%) (Table 2.4). The 2,5-dihydrofuran (104) was isolated and subsequently distinguished from the isomeric alkenes (106) and (107) (Scheme 2.3) by ^1H n.m.r. spectroscopy (δ 5.50, 1H, bs, H4') and ^{13}C n.m.r. (δ 23.7, t, C2; 30.9, t, C3; 62.7, t, C1; 76.3, t, C2', C5'; 119.6, d, C4'). In comparison, the lithium in ammonia reduction of acetal (62), with an added proton source, gave the 2,5-dihydrofuran (108) (6.4%) as the major furan reduction product.²¹

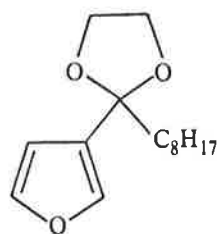

(62)

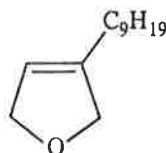

(108)

The acetal alcohol (98a), when submitted to reduction with lithium in ammonia for 15 min, afforded the alkylfuran (94) (48%), diol (101) (10%), starting material (28%) and 2,5-dihydrofuran (105) (5%). Significantly less reduction of (98a) relative to (97a) was therefore evident, a result confirmed by a competitive lithium in ammonia reduction of (97a) and (98a) (Table 2.4).

The reduction of acetal alcohol (99a) with lithium in ammonia for 15 min was also significantly slower than the reduction of (97a). A competitive reduction of the acetal alcohols (97a) and (99a) for 15 min gave alcohol (96) (41%), diol (102) (13%) and starting material (99a) (43%) for (99a) (Table 2.4).

A number of trends emerge from the above examples. Firstly, the rate of benzylic acetal cleavage is dependent on the position of the non-benzylic hydroxyl group. It is clear from previous work²¹ that furan

Table 2.5. Lithium in Ammonia Reductions of the Benzyloxy Acetals

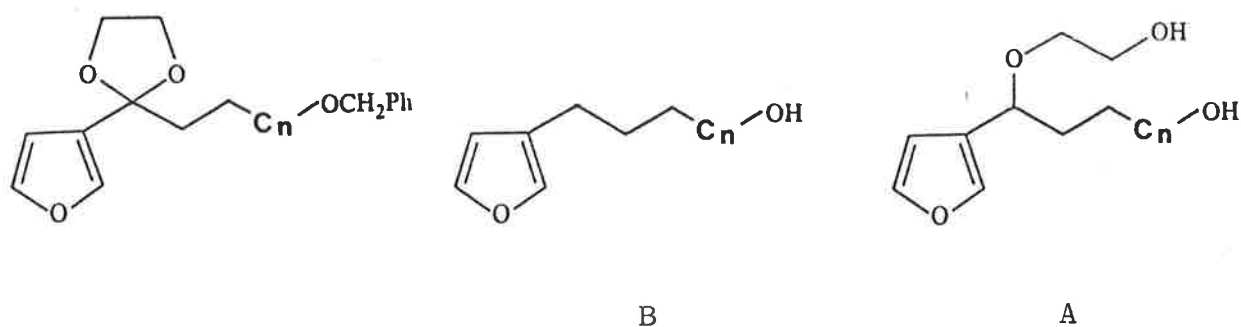

Substrate	Time (min)	Products		
		parent alcohol	(A) mono- cleavage	(B) di- cleavage
(98b) n=1	15	(98a) 43%	(101) 1%	(94) 41%
(99b) n=3	15	(99a) 54%	(102) 16%	(96) 29%
Competitive Reduction				
(97b) n=0	15	(97a) 4%	(100) 13%	(103) 70%
(99b) n=3		(99a) 49%	(102) 17%	(96) 29%

reduction occurs rapidly in the presence of an added proton source. However, it is unlikely that the enhanced rate of reduction of (97a) relative to both (98a) and (99a) is attributable to the amount of furan reduction. A competitive reduction of benzyloxy acetals (97b) and (99b) (Table 2.5) under the same conditions as those used above gave the parent alcohol (97a) (4%), monocleavage product (100) (13%) and alkylfuran (103) (70%). Significantly, rapid hydrogenolysis of the benzyloxy acetal (97b) was observed with no furan reduction. The furan reduction observed for (97a) is accompanied by a corresponding decrease in the amount of acetal cleavage {c.f. (97a) and (97b)}. This would suggest that a competition exists between the protonation and acetal cleavage of a common intermediate where the formation of the intermediate must be rate determining.

The lithium in ammonia reduction of a benzylic ether is known to occur rapidly, e.g. a benzylic ether can be selectively reduced with lithium in ammonia at -78° in the presence of a benzylic acetal.⁵¹ Consequently, it was assumed that (97b) would initially form the metal alkoxide which would subsequently reduce to (100) and (103). Bibenzyl⁵² was also detected in the crude product mixture obtained from the lithium in ammonia reduction of (97b) presumably as a result of benzyl radical coupling.

It is unclear whether the effect of the hydroxyl group is to alter the ease with which an electron is added to the system or whether it alters the rate of cleavage of one of the reduction intermediates. Perhaps the hydroxyl group of (97a) can intramolecularly protonate a reduction intermediate and hence facilitate that pathway or, perhaps lithium cation can coordinate between a benzylic oxygen, O3, and the hydroxyl group via a favourable 6-membered ring (Scheme 2.2) such that electron addition to the aromatic system is facilitated. The latter is

more likely to be the case since the rate of acetal cleavage is also dramatically affected by the position of the benzylic ether moiety in (97b), (98b) and (99b) (Table 2.5).

Scheme 2.2

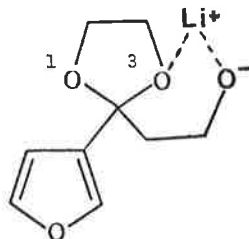

The reductive fission of benzylic alcohols is commonly inhibited by placing a negative charge on the oxygen through salt formation.^{35, 36} However, such examples invariably involve sodium and since the above examples {e.g. (97a), (98a), (99a)} were cleaved efficiently by lithium in ammonia, further support for a lithium coordination facilitated mechanism is evident.

The hydrogenolysis of hydroxy acetals (97a), (98a) and (99a) gave some furan reduction, the extent of which was dependent on the position of the hydroxyl group. Hydroxy acetal (97a) gave 10% of the 2,5-dihydrofuran (104), (98a) gave only 5% of the 2,5-dihydrofuran (105) while (99a) gave little or no furan reduction.

The proposed mechanism for the formation of the 2,5-dihydrofurans is outlined in Scheme 2.3. Electron addition to the acetal {e.g. (97a)} would produce either of two anion radicals (109) and (110). The aromatic system of an alkylfuran possessing a σ -electron withdrawing benzylic substituent is destabilized relative to the alkylfuran.^{21, 56} This

Scheme 2.3

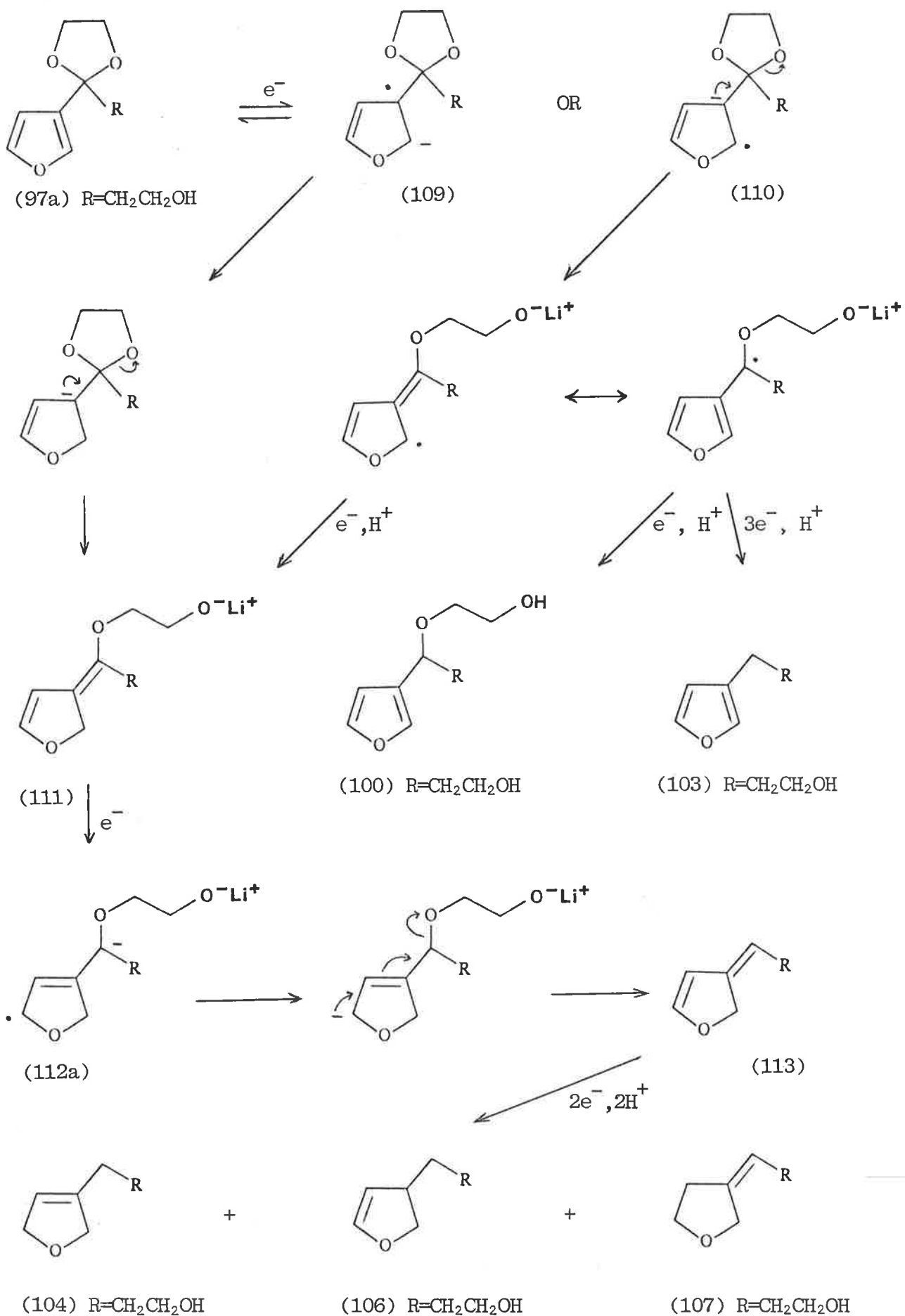

would lead to a higher concentration of anion radical during reduction with lithium in ammonia and enable these derivatives to reduce, even though the alkylfurans are inert to the reduction conditions.²¹ Acetal cleavage of (110) ultimately yields the acetal hydrogenolysis products {e.g. (100) and (103)}. Protonation of (109) at carbon 2, either by an external proton source or via the hydroxyl group, followed by elimination of one acetal oxygen would yield the diene (111). Dienes are known to be reduced rapidly by lithium in ammonia.³⁵ Electron addition to diene (111) would give an anion radical of which one resonance contributor is shown (112a). Subsequent protonation of (112a) and elimination of the second acetal oxygen would give diene (113). The diene (113) would not be isolated, but would rapidly reduce under the reaction conditions to yield predominantly the 2,5-dihydrofuran {e.g. (104)}.

The lithium in ammonia reduction of both dihydroacetal (39) and benzyloxy acetal (97b) in the presence of an equivalent of *t*-butyl alcohol gave no furan reduction. It is therefore likely that the furan reduction observed, particularly with (97a), is due to an intramolecular proton transfer. In support, it was noted that the amount of furan reduction product obtained decreased in the order (97a) > (98a) > (99a) (Table 2.4), as a function of the hydroxyl group position. The ease of intramolecular proton transfer would be expected to be greatest when $n=1$ (Scheme 2.4) {e.g. for (97a)}; this was the observed result. No furan reduction products were detected for the lithium in ammonia reductions of the benzyloxy acetals (97b), (98b) and (99b), or for the acetal (62).

All the acetal substrates bearing a non benzylic oxygen substituent {e.g. (97a), (98a), (99a), (97b), (98b), (99b)} gave significantly less monofission product than, for example, acetal (62) (38%). This trend

was also observed for the dioxabicyclooctane examples, (Table 2.1), where only dihydroeremacetal (39) gave monocleavage products. It is also

Scheme 2.4

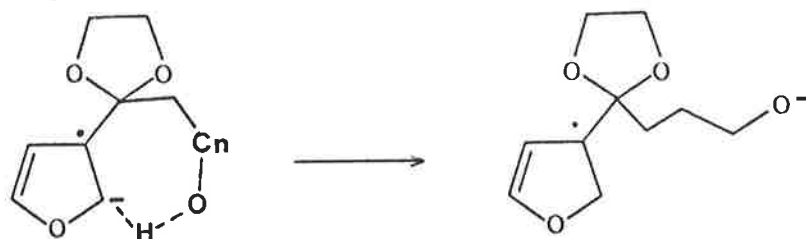

noteworthy that the reduction of 2-methyl-2-phenyl-1,3-dioxolane with only two equivalents of sodium in methanol and ammonia gave ethylbenzene (39%) together with starting material, but none of the monofission product.³⁷ If a two-stage mechanism is in fact involved in the removal of the acetal oxygens, then the second stage must be easier in this case.

2.3 The lithium in ammonia reductions of two 4-substituted dioxolanes were also investigated and the results are summarized in Table 2.6. G.l.c. analysis of the crude reaction product revealed the nature and percentage yield of each component.

The 4-substituted dioxolane systems were of interest for two reasons. Firstly, as indicated in Scheme 2.5, either of two modes of initial acetal cleavage are feasible, both of which would subsequently yield 3-nonylfuran (59). The monocleavage product (116a), isolated from the lithium in ammonia reduction of (114) was characterised as its diacetate (116b). Acetylation produced a characteristic downfield shift of 0.5 p.p.m. for three proton resonances, a result which is consistent only with structure (116a). The absence of products derived from pathway 1 in Scheme 2.5

Table 2.6. Lithium in Ammonia Reduction of the 4-Substituted Dioxolanes

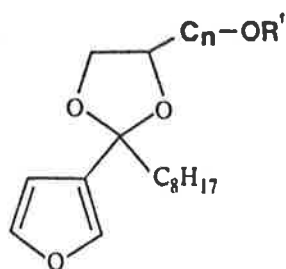

Substrate	Time	Products		
		parent alcohol	mono-cleavage	di-cleavage
(114, R'=H)n=1	15 min	(114) 95%	a	a
	3 h	(114) 73%	(116a) 8%	(59) 10%
(115b, R'=CH ₂ Ph)n=3	15 min	(115a, R'=H) 90%	10% ^b	a

a Not observed
 b Uncharacterized

supports the notion that lithium chelation plays an important role in controlling these reductions. According to the ideas discussed previously, lithium chelation might be expected to predominate between the hydroxyl

Scheme 2.5. 4-Substituted Dioxolane System Cleavage

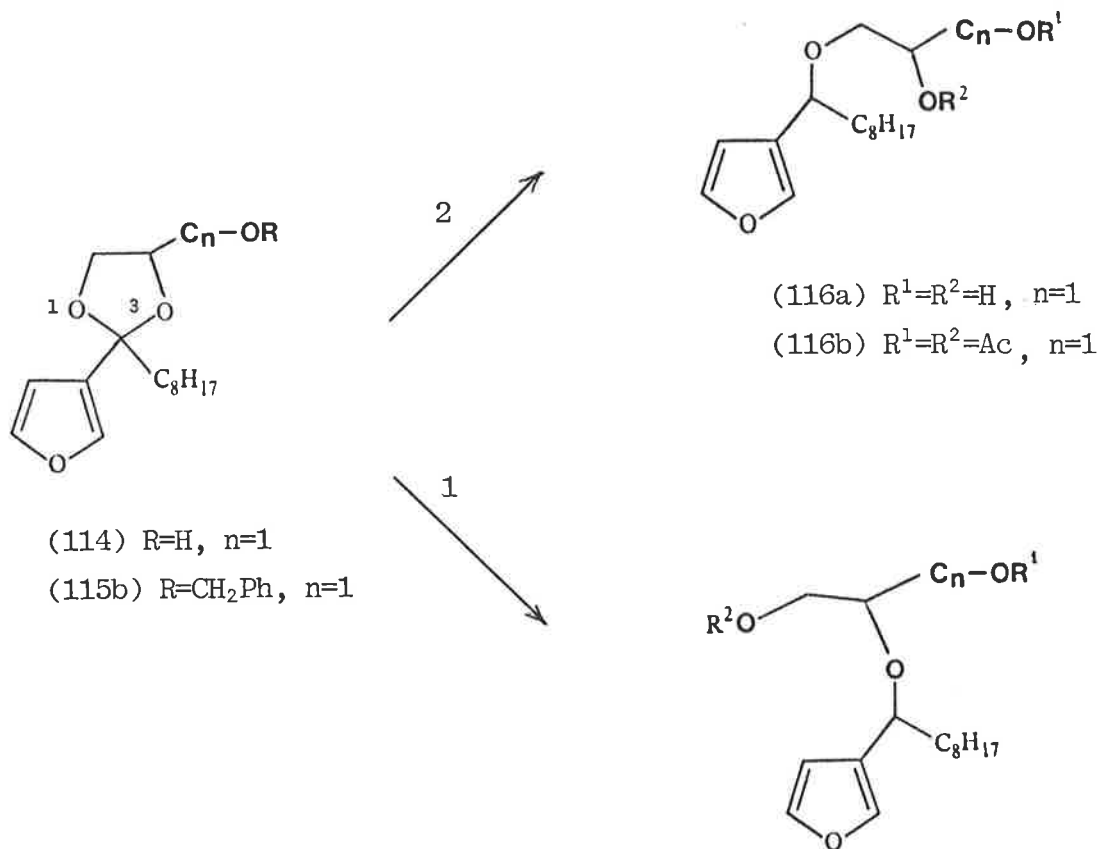

group and O3 rather than with O1 (Scheme 2.6), such that regioselective C2-O3 acetal cleavage would occur.

Scheme 2.6

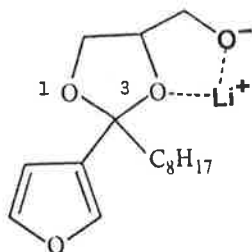

The second reason for studying the 4-substituted dioxolane systems was that they more closely resemble the substitution pattern of the dioxabicyclooctane examples {e.g. (68a)} studied earlier. However, the reasons for the slow rate of reduction in both instances remain unclear and deserve further investigation.

CHAPTER III

Synthesis of the Reduction Substrates

3.0 Dioxabicyclooctane Derivatives

Treatment of aldehyde (33) with methylmagnesium iodide at -70° gave an inseparable mixture of epimeric alcohols (67a) and (68a) (50:28).¹⁹ The corresponding acetates (67b) and (68b), however, were readily separated and gave the alcohols on lithium aluminium hydride reduction.

Alcohol (40a), obtained by lithium aluminium hydride reduction of aldehyde (33)¹⁹, readily formed the methoxymethyl ether (40d) on treatment with chloromethyl methyl ether and ethyldiisopropylamine.

Samples of dihydroeremoacetal (39) and tertiary alcohol (69), synthesized by Dimitriadis from eremoacetal (6) via P2 nickel catalysed hydrogenation⁷ and oxymercuration¹⁷ respectively, were available.

Alcohol (66a) was readily prepared by hydroboration of eremoacetal (6).¹⁹

Scheme 3.1

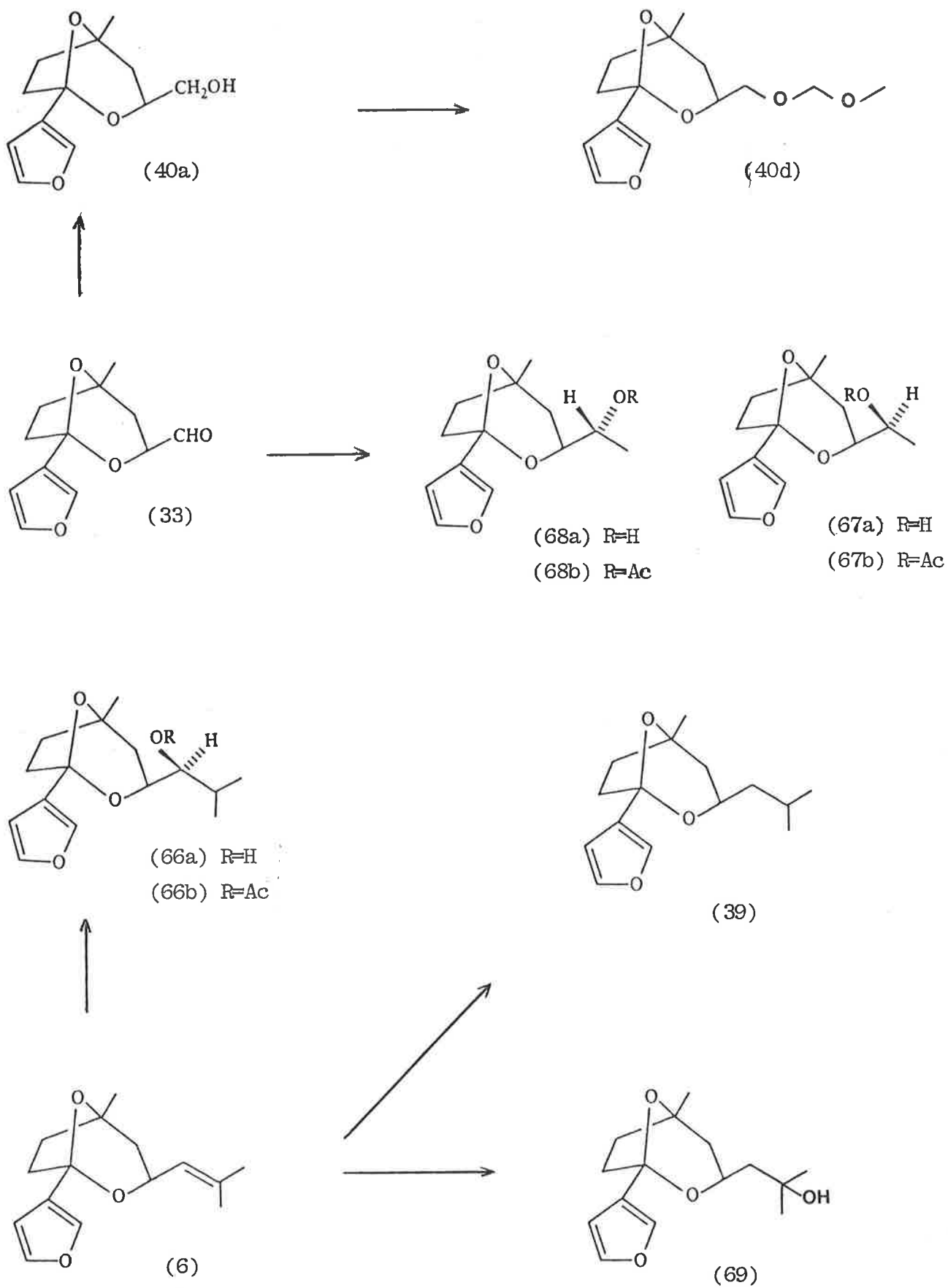

3.1 3-Substituted Furans

The reaction of alkyllithium reagents with furancarboxylic acids to give furyl ketones has been reported.^{58,59,60} Ketone (121) has been synthesized by preparing the alkyllithium reagent from benzyloxy chloride (117b) in the presence of lithium furan-3-carboxylate.⁶⁰ In addition to the desired ketone (121) (68%) small quantities of diketone (130) (4.5%) and ketone (131) (2%) were isolated. When the alkyllithium

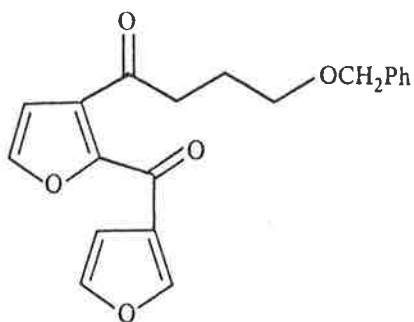

(130)

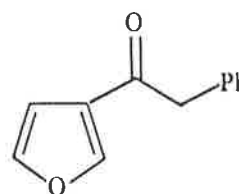

(131)

was prepared separately, only a low yield of the required ketone (121) was obtained. The product consisted mainly of protonated alkyllithium and furan-3-carboxylic acid.

Despite the literature precedence, the preparation^a of (121), and similarly of (122) and (123), was only achieved after considerable effort. Reasonable yields of the desired ketones were only obtained when sodium doped lithium (2% sodium) was used.^{61,62} The attempted preparation of ketone (122) with commercially available methyllithium-lithium bromide complex or with *n*-butyllithium gave a low yield of the desired ketone (122). When tetrahydrofuran was used as solvent, instead of diethyl ether, the

Scheme 3.2

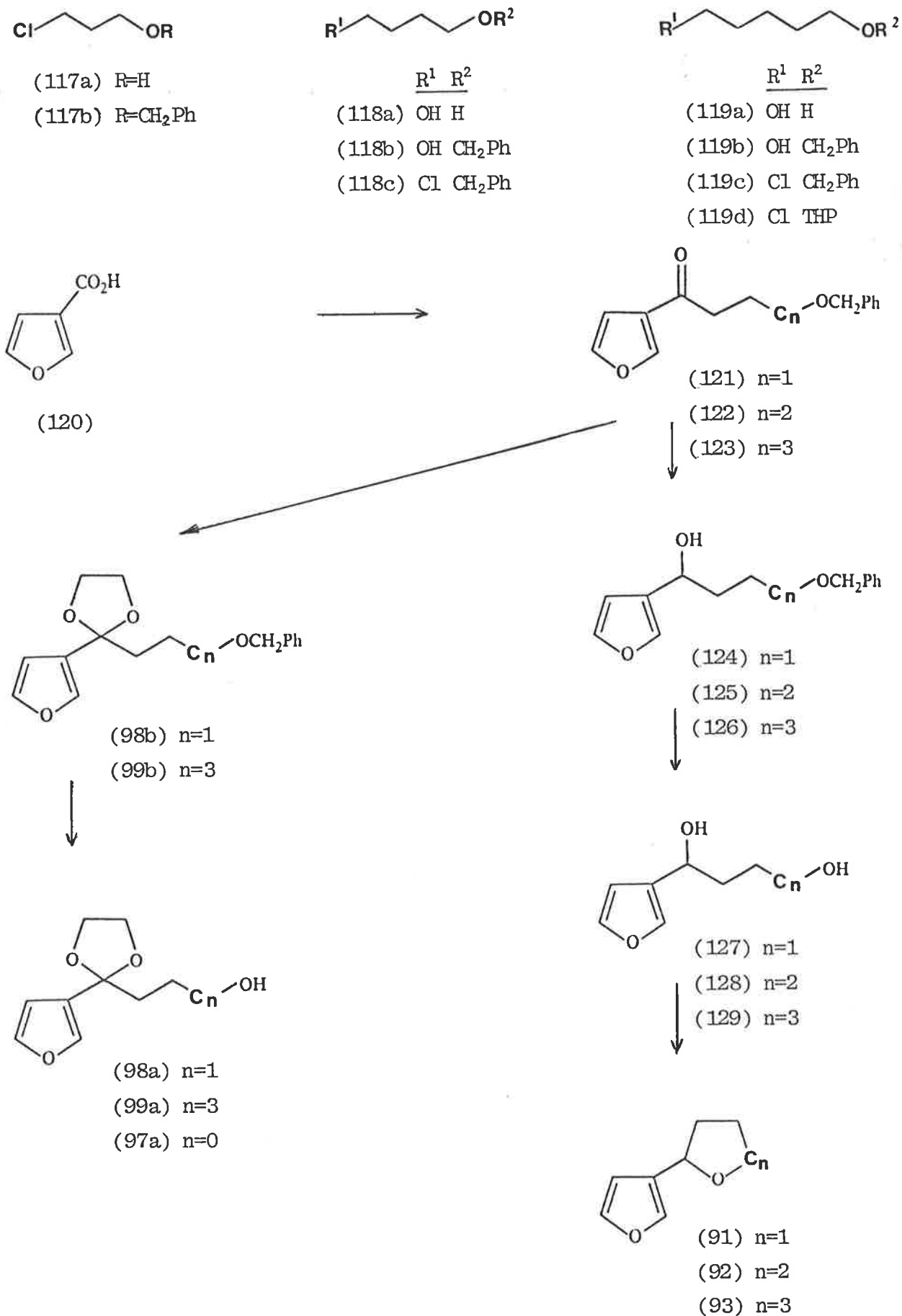

reaction of the metal was faster and the resultant alkyllithium more reactive. Instead of the desired ketone (122) the reaction gave 5-phenylpentan-1-ol (133) and benzyl ether (132) by intramolecular and intermolecular alkyllithium reactions, respectively (Scheme 3.3). The

Scheme 3.3

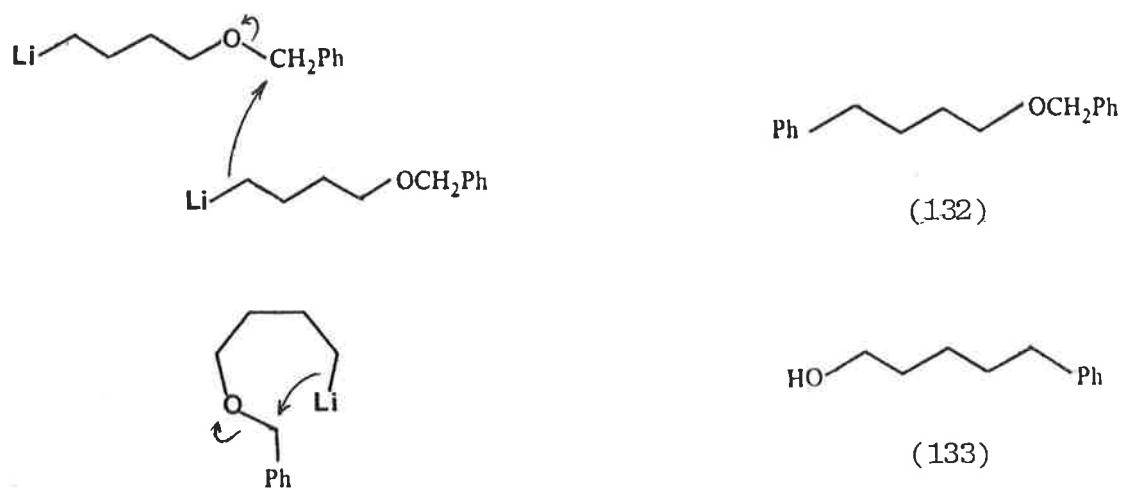

enhanced reactivity of alkyllithium reagent in tetrahydrofuran has been noted in the literature.^{60,63} When the tetrahydropyranyl halide (119d) was used, instead of benzyloxy chloride (119c), only 10-15% of the desired ketone was obtained.

Thus, ketones (121), (122) and (123) were best synthesized in diethyl ether by the method of Dimitriadis⁶⁰ with methyl lithium prepared from methyl iodide,⁶⁴ and sodium doped lithium (2% sodium).^{61,62} In addition, the benzyl ether and not the tetrahydropyranyl ether protecting group gave the highest yield of the desired ketone.

Benzyloxy chloride (117b) was readily prepared from 3-chloropropan-1-ol (117a) by treatment with sodium hydride and benzyl bromide. The benzyloxy chloride (118c) was prepared by the following route. The mono-benzyl ether (118b), prepared from 1,4-butanediol (118a), was converted

into the chloride (118c) by using the triphenylphosphine and carbon tetrachloride procedure.⁶⁵ Hydroboration of 5-benzoyloxypent-1-ene gave the monobenzyl ether (119b) which was converted into the chloride (119c) using triphenylphosphine and carbon tetrachloride.

Formation of the acetal (98b) from ketone (121) followed by selective lithium in ammonia reduction at -78° gave the acetal alcohol (98a) in good yield. In order to form the cyclic ether (91) the carbonyl group of ketone (121) was reduced with sodium borohydride. Lithium in ammonia reduction of the resultant alcohol (124) at -78° gave the 1,4-diol (127) which readily cyclized to (91) in dichloromethane containing a trace of *p*-toluenesulfonic acid.

A sequence of reactions similar to that used for the synthesis of (91) and (98a) was employed for the preparation of (92), (93) and (99a).

Formation of the acetal (135) from the β -keto ester (134)⁶⁶ with subsequent lithium aluminium hydride reduction of the ester moiety gave the acetal alcohol (97a) (Scheme 3.4).

Scheme 3.4

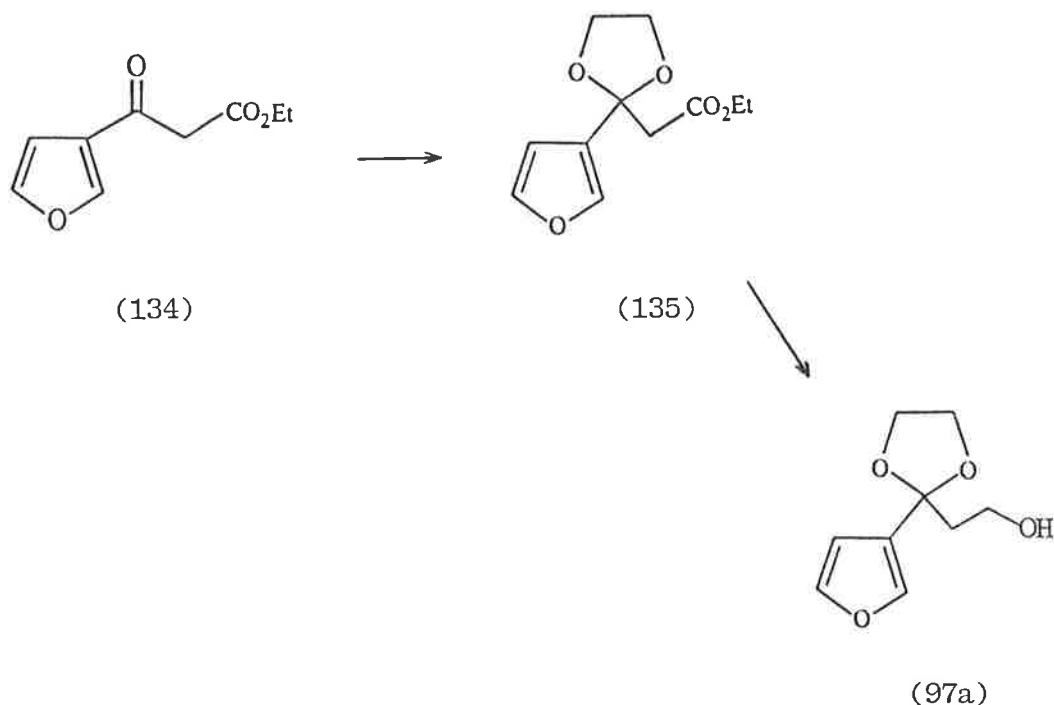

Alcohol (114) and dioxolane (115b) were prepared from ketone (136) by reaction with glycerol and 5-benzyloxypentane-1,2-diol (137),^{115,117} respectively.

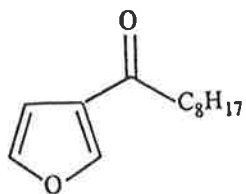

(136)

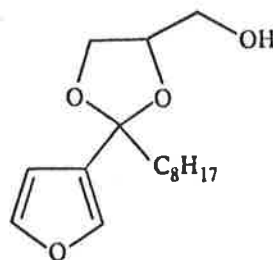

(114)

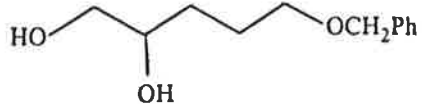

(137)

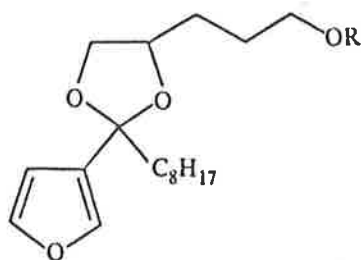

(115a) R=H

(115b) R=CH₂Ph

3.2 Tertiary Alcohol (70) : The Stereochemistry of Acetal Cleavage with Methylmagnesium Iodide

The ester (138) was prepared from the corresponding aldehyde (33)¹⁹ by an *in situ* silver oxide oxidation followed by methylation with diazomethane. The bicyclic acid (34) is known to be unstable at low pH and exists in equilibrium with the acyclic acid (35) which can subsequently undergo ring closure to lactone (30a) (Scheme 3.5). Nevertheless, with careful acidification at 0° the equilibrium is strongly in favour of the bicyclic acid (34) such that diazomethane methylation of the crude material afforded ester (138) in 42% yield.

Scheme 3.5

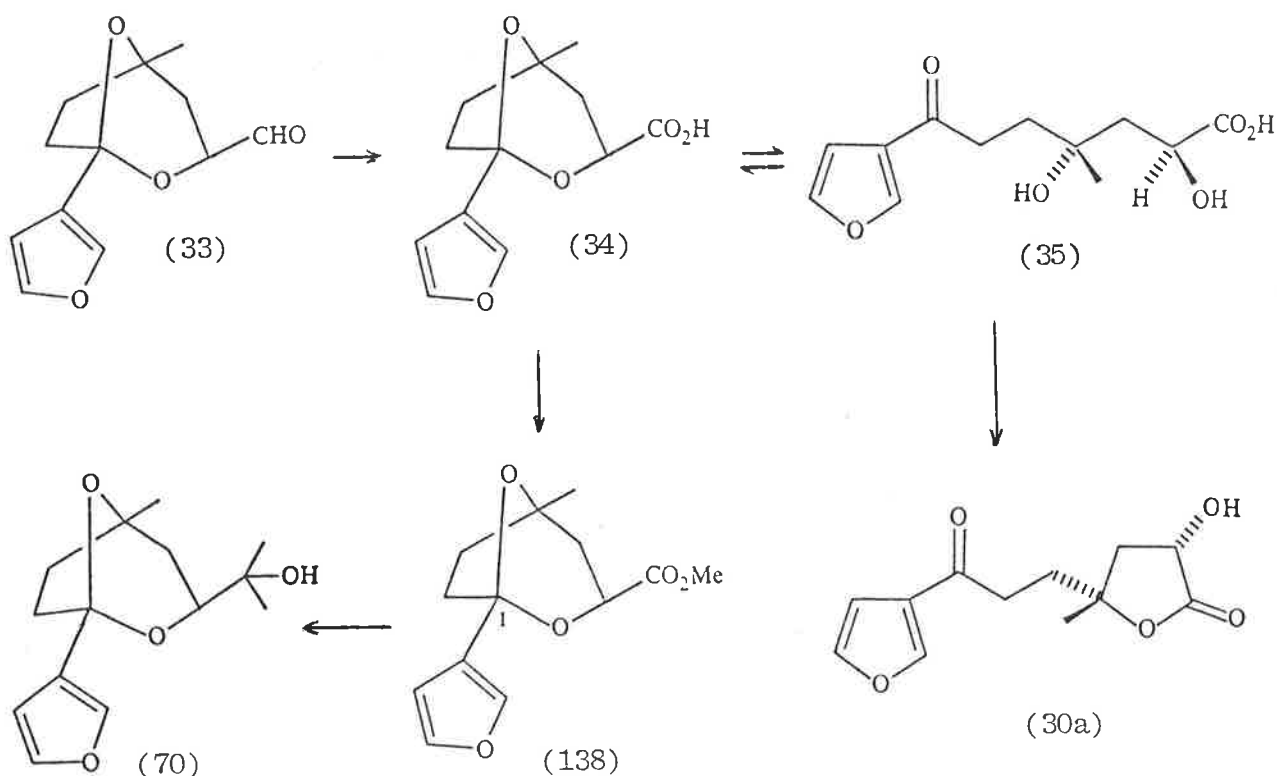

Reaction of ester (138) with methylmagnesium iodide in diethyl ether for 2h at 25° gave the tertiary alcohol (70) (41%) and an unexpected mixture of acetal cleavage products (139 - 142; R=H) (33%).

Chromatography of the product mixture gave a fraction containing (139a), (140a) and (70) and another containing (141a) and (142a). Acetylation of the first fraction, followed by chromatography permitted separation of the epimeric acetates (139b) and (140b) (11%) from the tertiary alcohol (70) (41%). Further chromatography of the second fraction gave (141a) (13%) and (142a) (9%) as pure compounds.

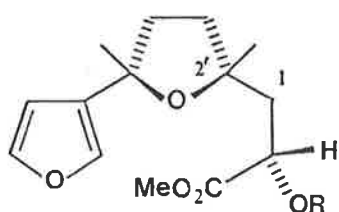

(139a) R=H
(139b) R=Ac

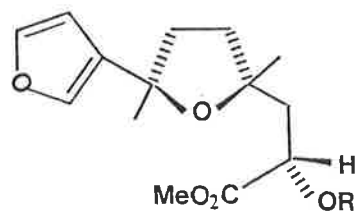

(140a) R=H
(140b) R=Ac

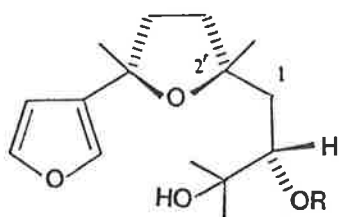

(141a) R=H
(141b) R=Ac

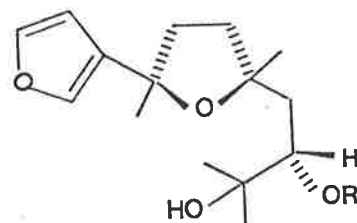

(142a) R=H
(142b) R=Ac

Neither the mixture of (139a) and (140a) nor their corresponding acetates (139b) and (140b) could be separated by chromatography. However, the spectral data for (139a) and (140a) and their acetates were consistent with the assigned structure. In particular, the resonances of the two

Figure 3.1. ^1H n.m.r. Spectrum (80 MHz) of Diol (141a) in CDCl_3

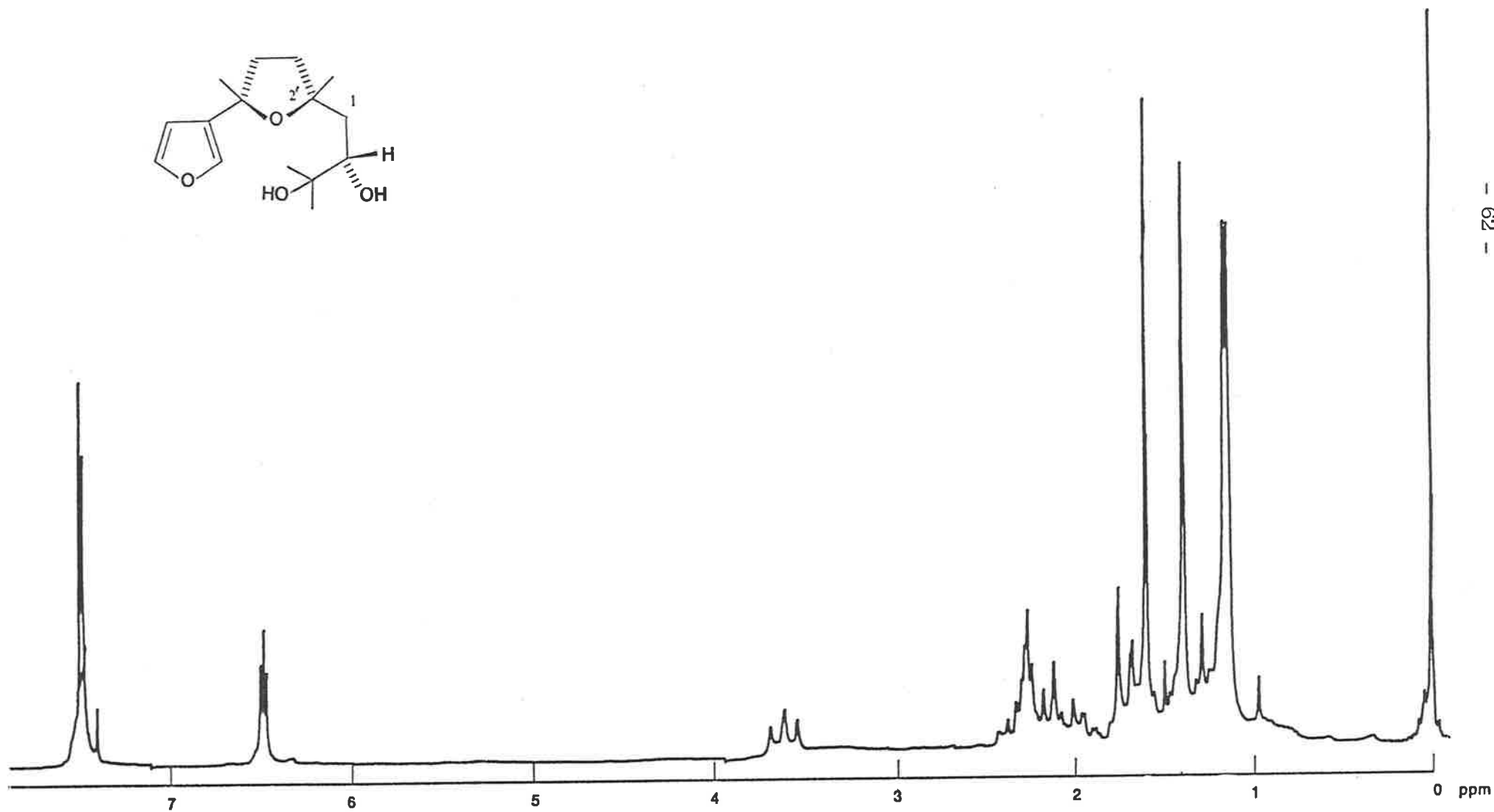
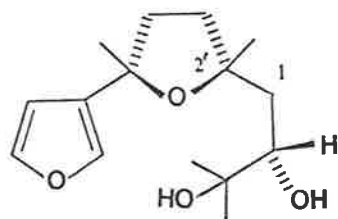

Figure 3.2. ^1H n.m.r. Spectrum (80 MHz) of Diol (142a) in CDCl_3

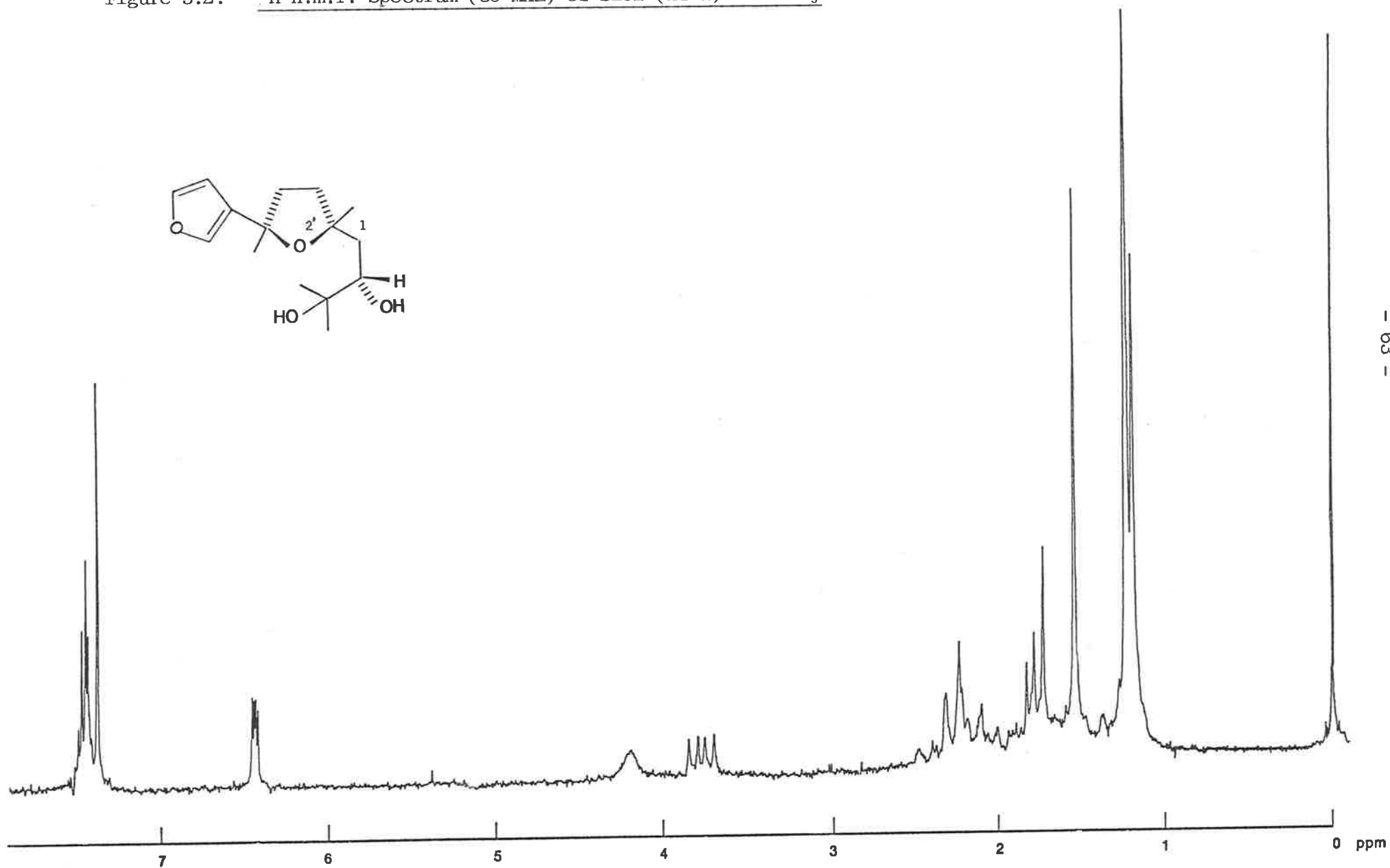

Figure 3.3. ^1H n.m.r. Spectrum (300 MHz) of Propanoates (139a) and (140a) in C_6D_6

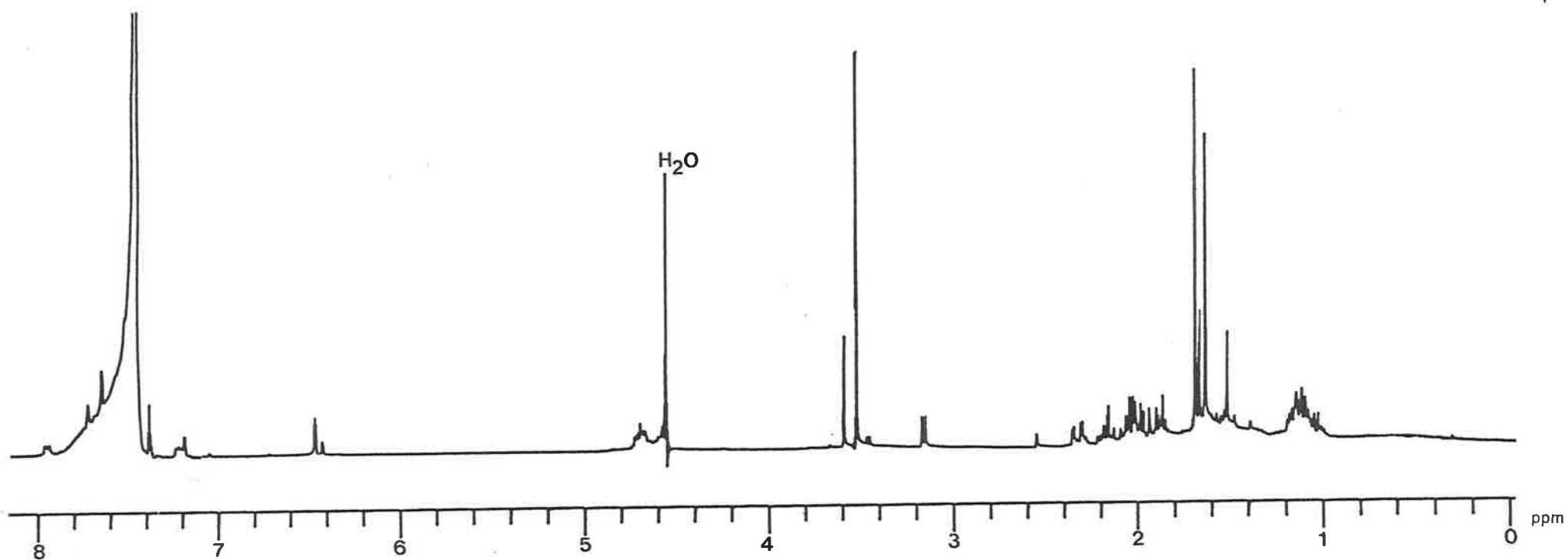
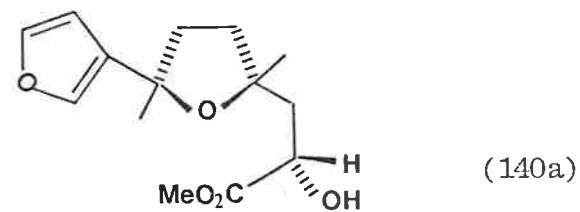
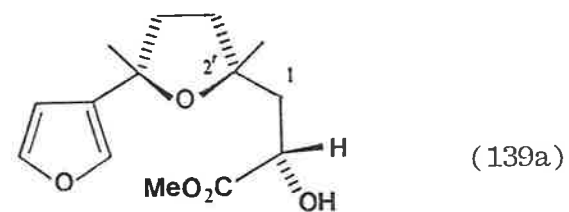

Figure 3.4. ^1H n.m.r. Spectrum (80 MHz) of Ketone (143) in CDCl_3

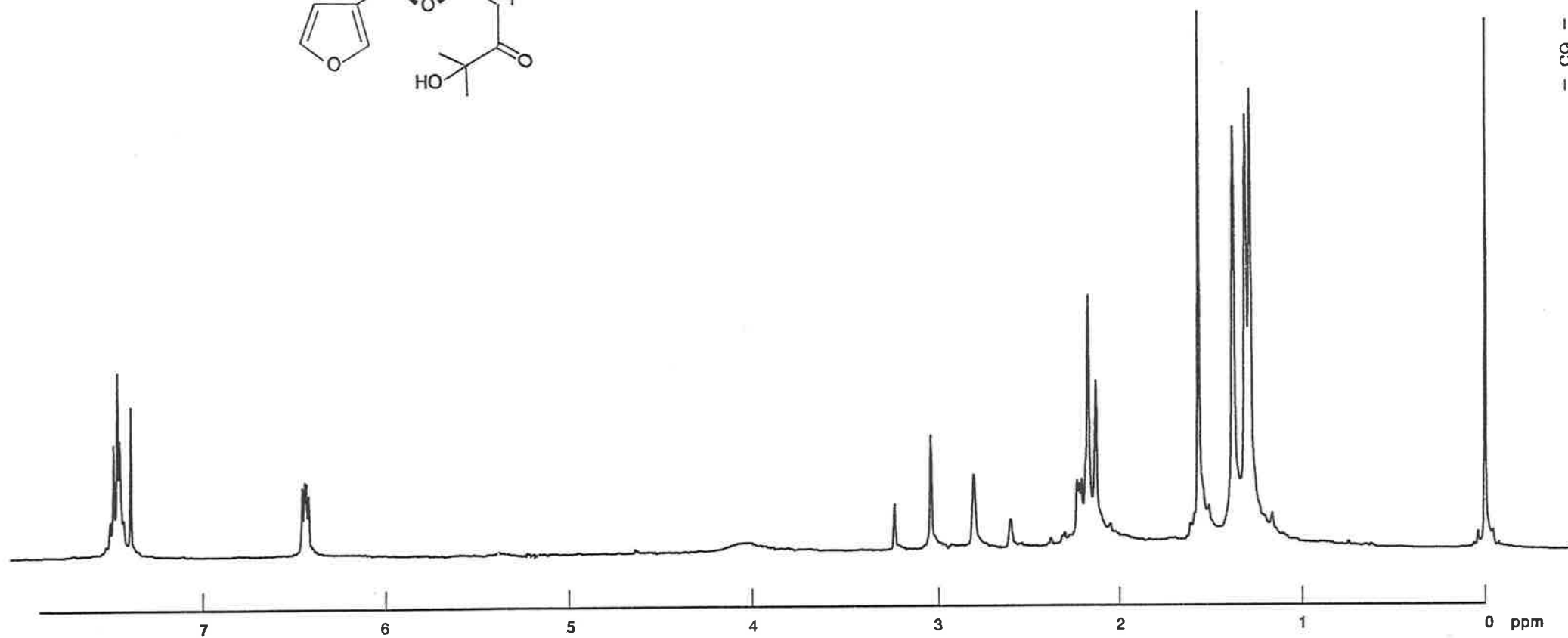
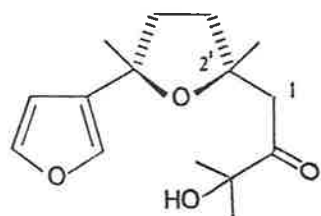
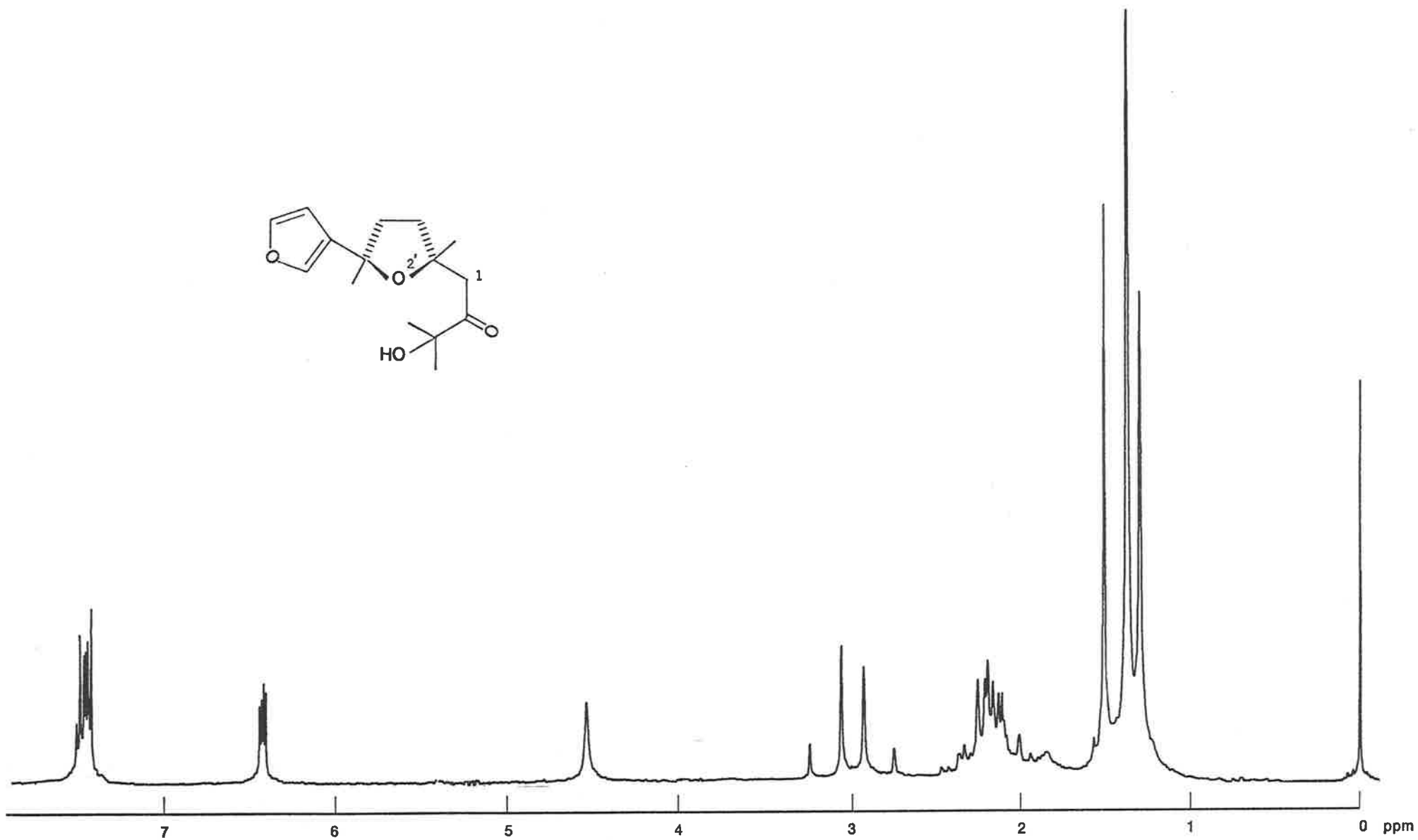

Figure 3.5. ^1H n.m.r. Spectrum (80 MHz) of Ketone (144) in CDCl_3



furan protons H2'' and H5'' overlapped at δ 7.13 which is consistent with a single oxygen substituent on the carbon benzylic to the furan ring. The methyl ester group of (139b) and (140b) was evident by ^1H n.m.r. as a three proton singlet at δ 3.61 and by mass spectroscopy, m/z 279 ($\text{M}-\text{CH}_3\text{O}$). Twinning of the acetate methyl proton resonance of (139b) and (140b) was consistent with a diastereomeric mixture and the ability of (139a) and (140a) to form acetates excluded the alternative oxepane structure which would be the result of C1-O8 bond cleavage.

The spectral data for (141a) and (142a) were consistent with the proposed tetrahydrofuran structures. Again, the chemical shift of the H2'' and H5'' furan protons overlap for both isomers. H2 appears at δ 3.54 in (141a) as a triplet and at δ 3.70 as a doublet of doublets in (142a), and in addition, each isomer gave a monoacetate in which these n.m.r. resonances shifted downfield by approximately 1.2 p.p.m. The ^{13}C n.m.r. (Table 3.1) and mass spectra $\{m/z$ 268(M), 253(M-Me) $\}$ are also in full accord with the structures (141a) and (142a). In particular, a comparison of the ^{13}C chemical shifts obtained for (141a) and (142a) indicates that the two compounds are probably diastereomers.

The structures of (139b) and (140b) were related directly to those of (141a) and (142a). Treatment of the isolated mixture of acetates (139b) and (140b) with methylmagnesium iodide gave diols (141a) and (142a), identical by mass spectroscopy and ^1H n.m.r. to the compounds previously described, and an inseparable mixture of epimeric hydroxy esters (139a) and (140a). Both the epimers (139a) and (140a) were clearly evident from the twinning observed in the ^1H n.m.r. of the mixture (Figure 3.3). In particular, resonances for the furan proton H4'' were evident at δ 6.42, 6.45, methyl ester at δ 3.50, 3.60, hydroxyl group at δ 3.45, 3.15, 5'-Me at δ 1.68, 1.65 and for 2'-Me at δ 1.61, 1.50.

Table 3.1. ^{13}C n.m.r. of (141a), (142a), (143) and (144) in CDCl_3

C-Number	(141a)	(142a)	(143)	(144)
1	42.5 t	41.4 t	48.3 t	48.5 t
2	75.2 d	75.3 d	a	a
3	72.8 s	72.5 s	76.9 s	77.0 s
4	30.6 q	30.0 q	30.5 q	29.8 q
3-Me	29.4 q	29.4 q	27.6 q	27.3 q
2'	80.7 s	81.0 s	80.9 s	81.9 s
3'	36.8 t	35.5 t	38.6 t	38.6 t
4'	38.6 t	38.9 t	38.0 t	37.5 t
5'	84.4 s	85.1 s	82.8 s	83.3 s
2'-Me	26.0 q	26.0 q	26.5 q	26.5 q
5'-Me	23.8 q	24.2 q	26.7 q	26.7 q
2''	137.9 d	137.9 d	138.0 d	137.9 d
3''	133.1 s	134.1 s	a	a
4''	108.8 d	109.1 d	109.0 d	109.0 d
5''	143.7 d	143.3 d	143.6 d	143.5 d

a not observed.

It is likely that only one asymmetric carbon centre is involved in the reaction of (138) with methylmagnesium iodide since only two of the possible diol isomers and the corresponding hydroxy ester isomers were formed. Methylmagnesium iodide cleavage must involve C1 in (138) but would clearly unalter the configuration at C5 in (138). However, in order to confirm that the isomeric products were not epimeric at C2 (in 139-142) it was decided to oxidize the diols, (141a) and (142a), to the corresponding ketones, (143) and (144). The two ketones were clearly different by ^1H n.m.r. (Figures 3.4 and 3.5) and ^{13}C n.m.r. (Table 3.1). Consequently, the two ketones and the corresponding diols are epimeric at C5' as a result of attack by methylmagnesium iodide from both faces of an intermediate oxocarbenium ion.

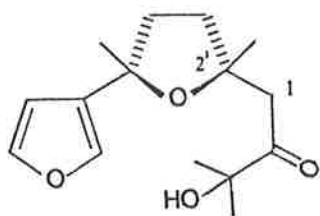

(143)

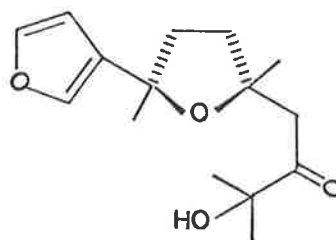

(144)

Each of the diols, (141a) and (142a), revealed four distinct quaternary methyl group proton resonances and the chemical shifts of which permitted a tentative assignment of configuration (Figures 3.1 and 3.2). The furan ring is known to produce a shielding effect on neighbouring substituents which approach the ring face,^{6 7-69} and this effect has been observed with (-)-ngaione (145) which exhibits a small upfield shift for the isopropyl doublet relative to its C2' epimer, (-)-epingaione (146).⁷⁰ The 5'-methyl group at the benzylic position of both (141a) and (142a) is assigned as the lowest field methyl resonances at δ 1.57 and 1.52, respectively (Figures 3.1 and 3.2). The isopropyl methyl

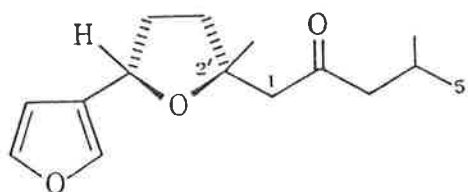

(145)

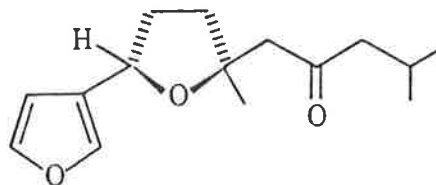

(146)

resonances of diol (141a) are 0.06-0.10 p.p.m. upfield relative to those of diol (142a) and the 2'-methyl of (142a) is shielded by 0.15-0.19 p.p.m. relative to (141a). The chemical shifts observed for

the four quaternary methyl groups of diols (141a) and (142a) are consistent with the assigned stereochemistries. A similar, but smaller upfield shift of 0.11 p.p.m. for the 2'-methyl was observed in the spectrum of the mixture of epimers (139a) and (140a); the 2'-methyl resonance appeared at δ 1.50 in (140a) and at δ 1.61 in (139a). The chemical shifts for the four quaternary methyl groups of ketones (143) and (144) further support the assigned stereochemistries of the cleavage products. In particular, the ^1H n.m.r. spectra of the ketones (143) and (144) (Figures 3.4 and 3.5) closely parallel those obtained for the respective diol precursors (Figures 3.1 and 3.2). The 3-methyl and $(\text{H}_4)_3$ resonances of diol (141a) and the corresponding ketone (143) occur at distinct chemical shifts whereas the same resonances in diol (142a) and ketone (144) overlap. As a consequence of the shielding influence of the furan ring the 2'-methyl of ketone (144) is shielded by 0.07 p.p.m. relative to (143) and the isopropyl methyl resonances of (143) are upfield by 0.06-0.08 p.p.m. relative to (144), shifts which are comparable to those obtained for diols (141a) and (142a). The 5'-methyl resonance of ketone (143) appeared at δ 1.54 and at 1.57 for the precursor diol (141a). Similarly, the 5'-methyl resonance of ketone (144) and diol (142a) appeared at δ 1.48 and 1.52 respectively. It is also noteworthy that the 2'-methyl resonance for ketone (144) and (-)-epingaione (146),⁷⁰ compounds which have the same relative stereochemistry, occur at similar chemical shifts (δ 1.28 and 1.27 respectively). In comparison the 2'-methyl resonance of ketone (143) appeared at δ 1.35.

Treatment of tertiary alcohol (70) with methylmagnesium iodide gave no acetal fission products as revealed by ^1H n.m.r. spectroscopy. Therefore, the diols (141a) and (142a) are considered to have arisen from the intermediate magnesium derivatives of the hydroxy esters (139a) and (140a). The reaction of methylmagnesium iodide with ester (138) in ether solution

is summarized in Scheme 3.6. A competition exists between addition to the ester function to give tertiary alcohol (70) (41%) and cleavage of the acetal (33%). Selectivity for cleavage of the C1-O2 bond of ester (138) was evident with no detected oxepane derivatives. The preference

Scheme 3.6. Reaction of Methylmagnesium Iodide with Ester (138)

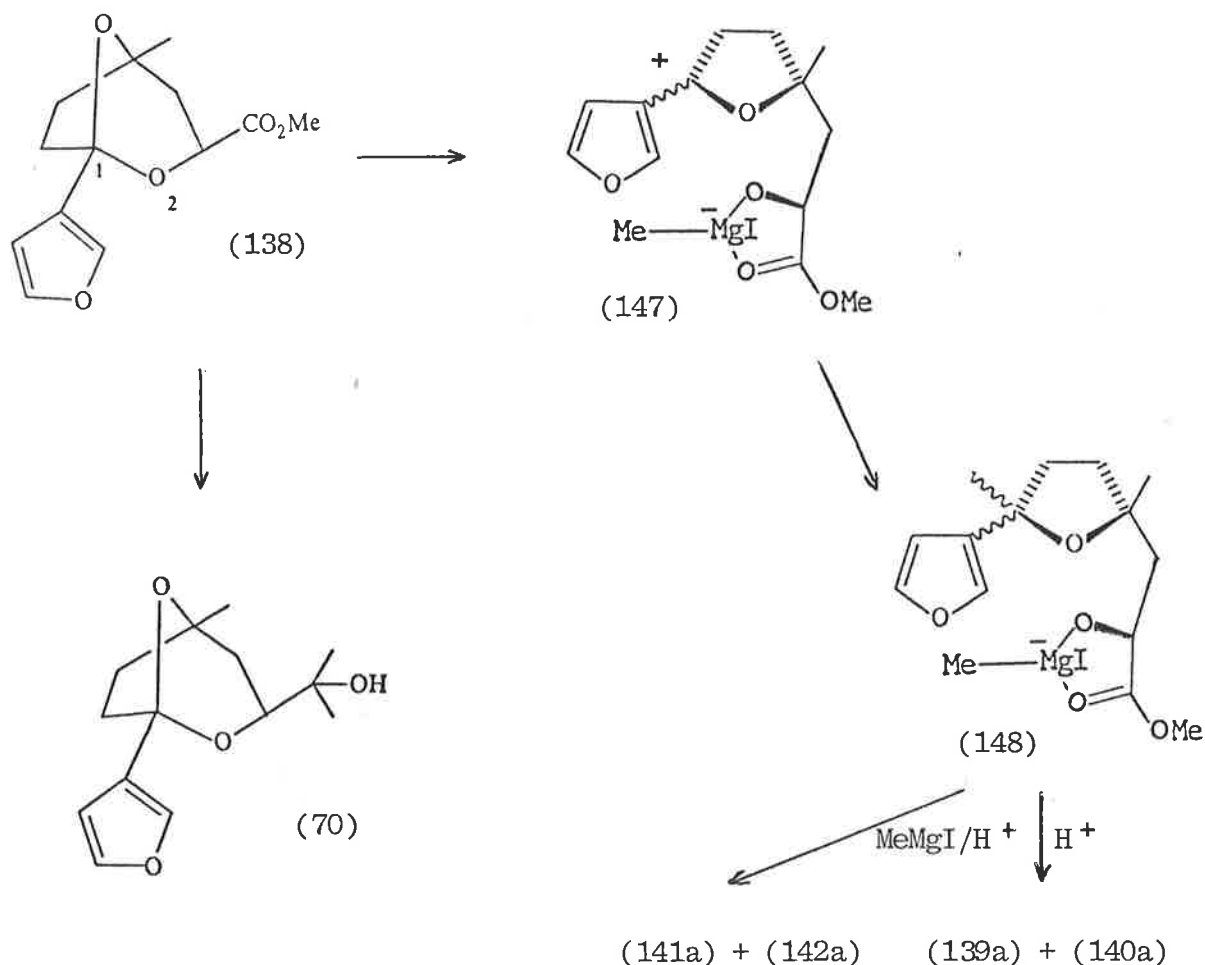

for C1-O2 bond cleavage over C1-O8 bond cleavage presumably reflects the preferential chelation between methylmagnesium iodide, O2 and the ester function. A similar selectivity for C1-O2 bond cleavage was observed in the lithium aluminium hydride reduction of some 2,8-dioxabicyclo-{3.2.1}oct-3-yl methanesulphonates¹⁹ and may in fact account for the

observed differences in the rate of the lithium in ammonia reduction of some benzylic 2,8-dioxabicyclo{3.2.1}oct-3-yl derivatives (Chpt. 2). The chelation of methylmagnesium iodide with ester (138) would facilitate acetal cleavage to yield the oxocarbenium ion (147) which is stabilized by both the oxygen substituent and the furan ring. Subsequent reaction of methylmagnesium iodide from both faces of (147) would account for the epimeric cleavage products observed.

The major cleavage product isomers isolated, (139a) and (141a), are the result of methyl transfer from the face of oxocarbenium ion (147) flanked by the 2'-methyl group. Such an attack is not possible by an intramolecular transfer of the methyl group of the intermediate oxocarbenium ion (147) and consequently the magnesium derivative of (139a), at least, must arise by the reaction of further Grignard reagent on the ion (147).

Several reports have appeared concerning reactions of Grignard reagents with acetals in which one of the carbon-oxygen bonds undergoes replacement with an alkyl group. Acetals of α,β -unsaturated aldehydes,^{71, 73} aryl ethyl acetals,⁷⁴ 1,3-dioxolanes⁷⁵ and orthoesters⁷⁶⁻⁷⁸ have been studied. Although much of the work has been oriented towards synthesis, e.g. the preparation of acetals from orthoesters, some studies have been concerned mainly with mechanistic aspects.

The reaction of 2-methoxy-1,3-dioxanes with Grignard reagents has been reported to proceed with retention of configuration,⁷⁷ however, it has been suggested that the reaction of ethylmagnesium bromide with aryl ethyl acetals is S_N2 like.⁷⁴ It is therefore evident that it is difficult to draw mechanistic generalizations concerning the reaction of Grignard reagents with acetals.

The reaction of Grignard reagents with 2-substituted 1,3-dioxolanes have been reported to give ring cleavage products, formed from attack of Grignard reagent at C2, or enol ethers arising from attack on the β -hydrogen, depending on conditions.⁷⁵ In this instance, it was considered that complexation of the dioxolane with $(\text{EtMgBr} \cdot \text{Et}_3\text{N})_2$ would give a complex with oxonium ion character. This complex could be converted to products, via

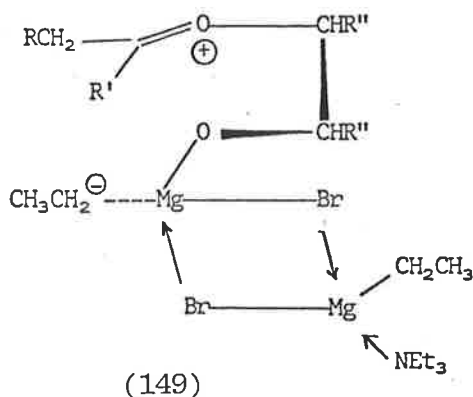

species (149) or via a second order reaction with another Grignard entity. (149) was considered to exist as a discrete, but unstable, intermediate from which the product would arise intramolecularly via a four centre transition state.⁷⁵

The present study, using the bicyclic acetal (138), supports the presence of a relatively long-lived oxocarbenium ion, but does not support the formation of products exclusively via an intermediate four centre transition state.

CHAPTER IV

Diterpenes from *Eremophila rotundifolia*

4.0 The wood of *E. rotundifolia* contained a number of interesting diterpenes. Chromatography of the wood extract allowed the isolation of the major constituent, serrulatenol (150a), as a colourless crystalline solid. The nomenclature of this compound and its derivatives, is based on the known serrulatane skeleton for which the absolute configuration has been defined.¹¹

The molecular formula $C_{20}H_{26}O_3$ was established for (150a) by elemental analysis and high-resolution mass measurements. The ultraviolet spectrum

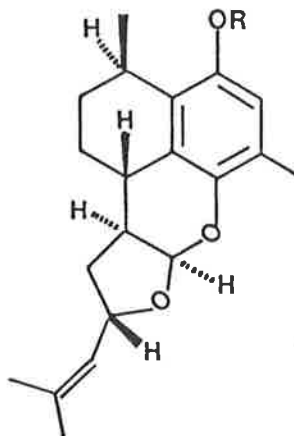

- (150a) R=H
- (150b) R=Ac
- (150c) R=*p*-COPhBr

of (150a) showed an absorption band at λ_{\max} 289 nm (3500) which shifted to a longer wavelength (λ_{\max} 302) on passing from neutral to alkaline conditions. The observed shift to longer wavelength⁷⁹ indicated the presence of a phenolic group which was supported by strong infrared absorptions at 3560 and 3440 cm^{-1} . Acetylation of (150a) with acetic anhydride in pyridine

Table 4.1. ^{13}C n.m.r. Spectral Data and C-H Chemical Shift
 Correlation for (150a) (CDCl_3). P.p.m. rel. to TMS

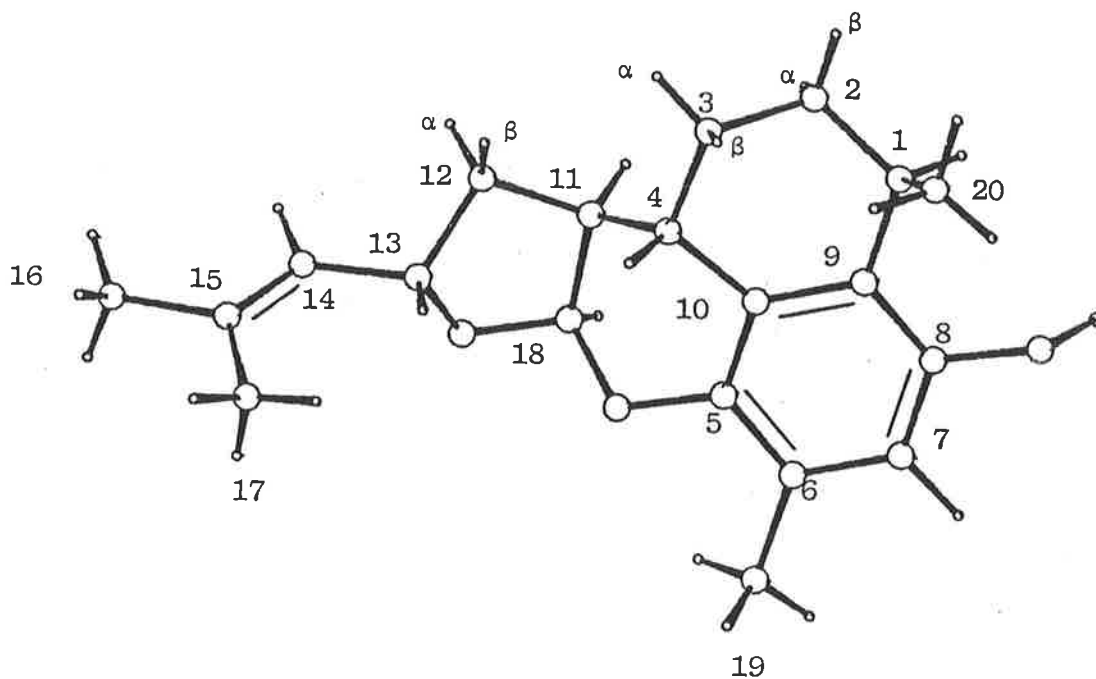

C-Number	Chem. Shift	Multi- plicity	Proton Correlation (δ)	
			Single Bond	Long Range
1	27.3	d	3.07	1.23 (H20) ₃
2	28.2	t	1.55; 1.80	1.23 (H20) ₃
3	23.3	t	1.55; 2.20	
4	32.9	d	2.56	
5	144.3	s		2.18 (H19) ₃
6	125.4	s		2.18 (H19) ₃
7	115.0	d	6.44	2.18 (H19) ₃
8	148.7	s		6.44 H7
9	126.2	s		1.23 (H20) ₃
10	129.1	s		2.20 H3 β
11	48.8	d	2.30	
12	38.0	t	1.87; 2.02	
13	75.7	d	5.15	5.30 H18
14	124.1	d	5.20	1.74 (H16) ₃ (H17) ₃
15	137.9	s		1.74 (H16) ₃ (H17) ₃
16	25.8	q	1.74	
17	18.5	q	1.74	
18	105.1	d	5.30	2.02 H12 β
19	15.2	q	2.18	
20	19.6	q	1.23	

Table 4.2. ^1H n.m.r. Spectral Data (300 MHz) for (150a) in CDCl_3

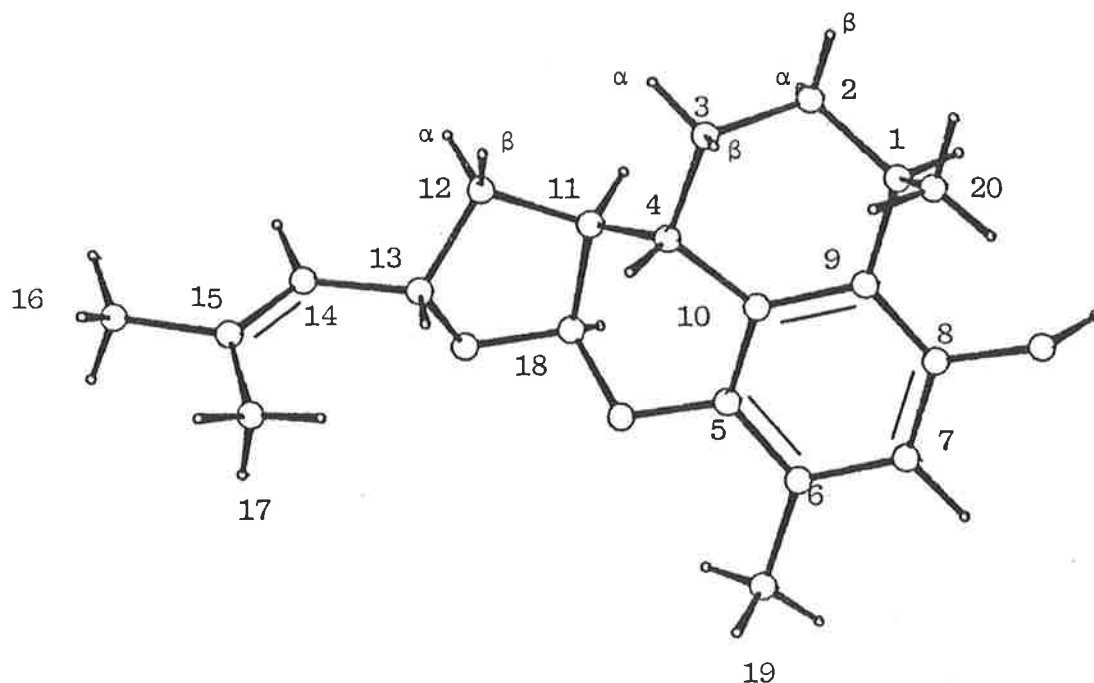

Proton	Chem. Shift ^d	Multi- plicity	J ^e (Hz)	Proton	Chem. Shift	Multi- plicity	J (Hz)
H1	3.02	tq	6,7	H11	2.30	ddt	1.2, 5.6, 10
H2 β	1.55	a		H12 β	2.02	ddd	1.2, 5, 13
H2 α	1.80	a		H12 α	1.87	dt	13, 10
H3 β	2.20	a		H13	5.15	ddd	5, 9, 10
	1.94 ^b	ddt	3,7,11	H14	5.20	dqq	9, 1.2, 1.2
H3 α	1.55	a		(H16) ₃	1.74	d ^f	1.2
	1.27 ^b	9 lines		(H17) ₃	1.74	d ^f	1.2
H4	2.56	ddd	3,7,10	H18	5.30	d	5.6
H7	6.44	s		(H19) ₃	2.18	s	
8-OH	4.50 ^b			(H20) ₃	1.23	d	7

- a Resonance obscured.
 b Data obtained in (D₆) Benzene.
 c Chemical shift is concentration dependent.
 d Chemical shift values represent the centre of each resonance.
 e Coupling constants have been determined on first order principles and hence are approximate.
 f Only observed on resolution enhancement

Figure 4.1. ^1H n.m.r. Spectrum (300 MHz) of the Serrulatenol (150a) in CDCl_3

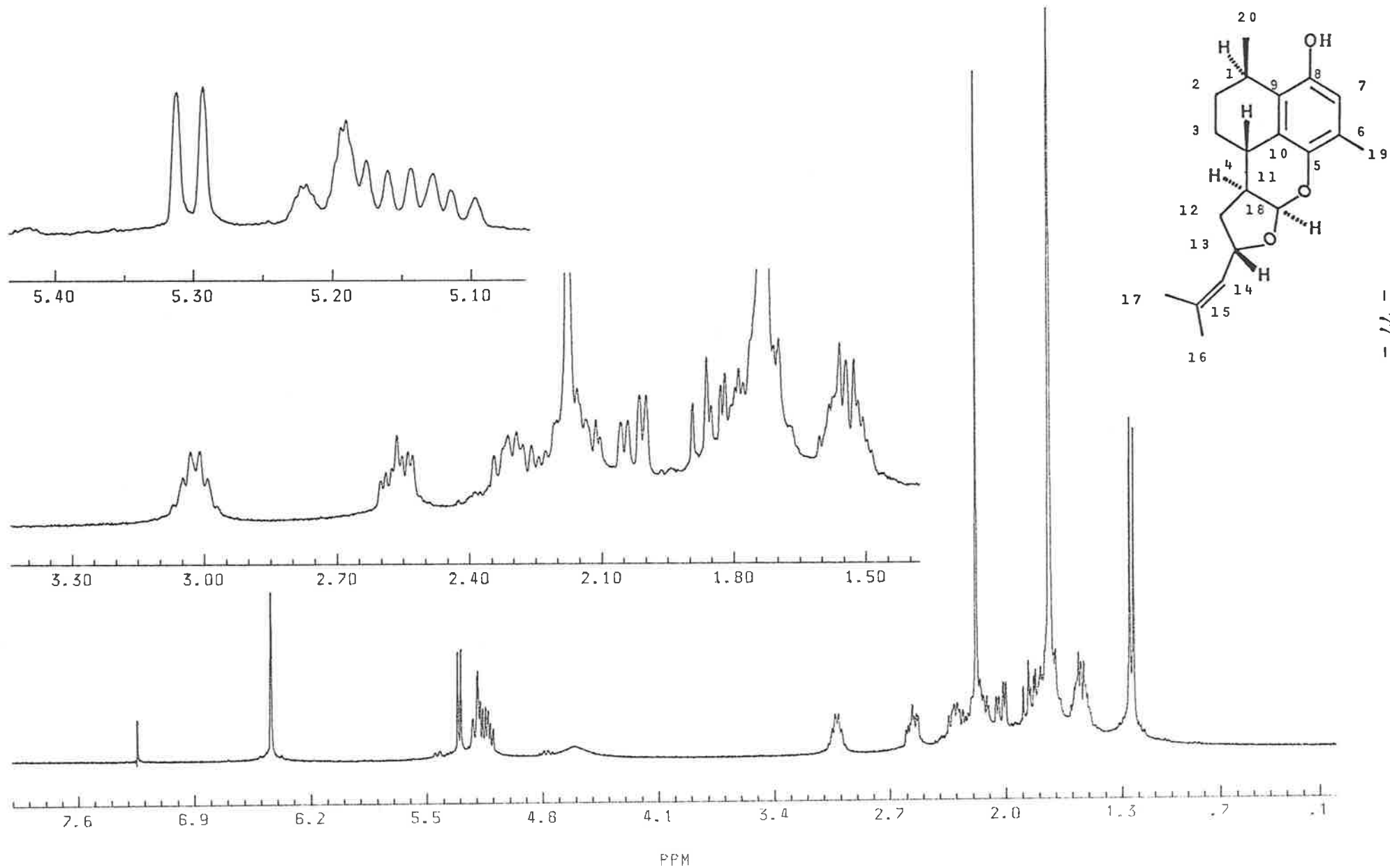
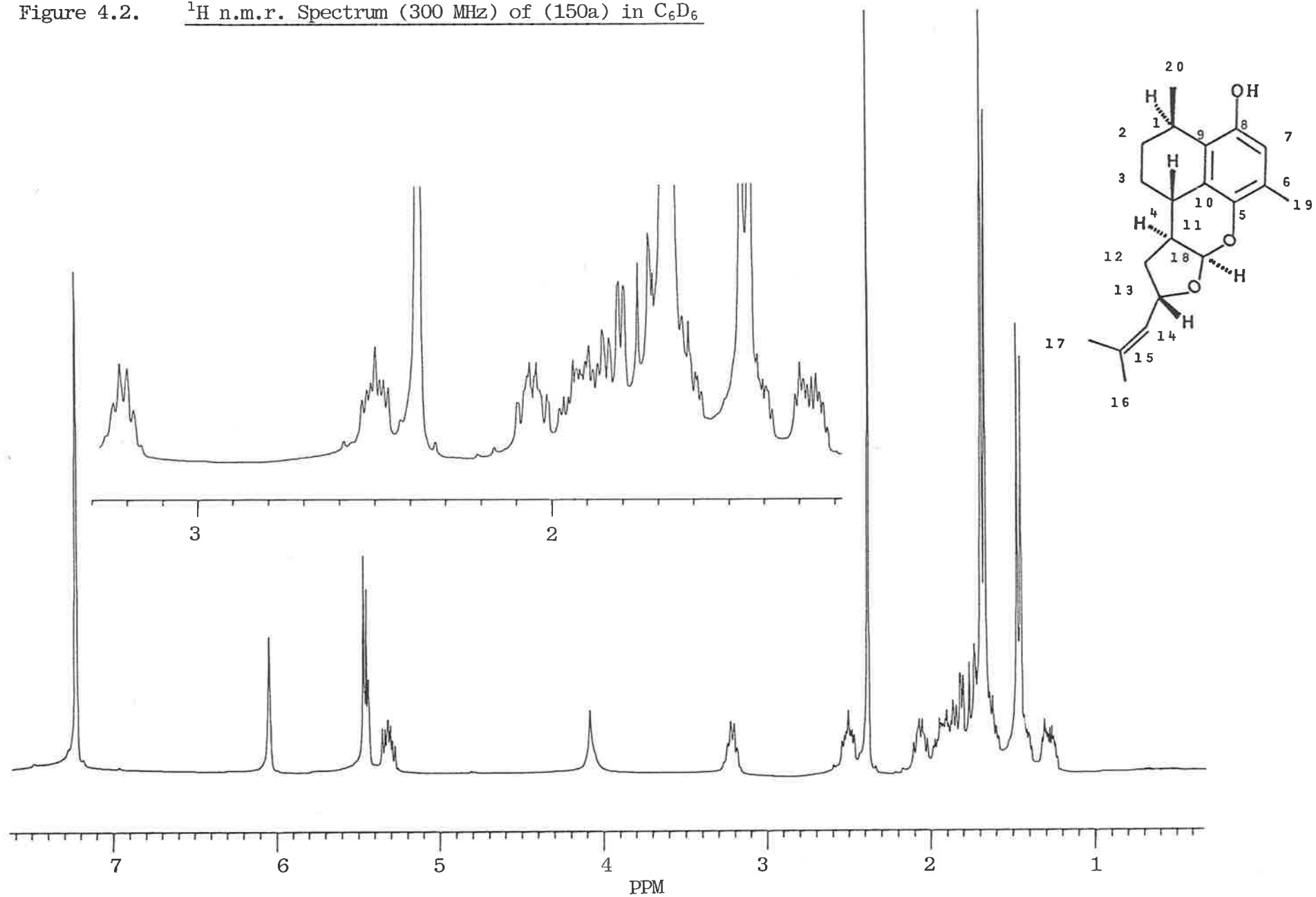

Figure 4.2. ^1H n.m.r. Spectrum (300 MHz) of (150a) in C_6D_6



gave a phenolic monoacetate (150b) which showed a characteristic infrared absorption at 1760 cm^{-1} .

Examination of the ^{13}C n.m.r. spectrum of (150a) (Table 4.1) revealed all 20 carbon resonances. The low field resonances at δ 115.0 (d), 125.4 (s), 126.2 (s) 129.1 (s) 144.3 (s) and 148.7 (s) were consistent with a pentasubstituted phenolic ring and those at δ 124.1 (d) and 137.9 (s) were assigned to the carbon atoms of a trisubstituted double bond. These assignments were supported by the formation of two diastereomeric monoepoxides (151) and (152) from (150b) and by the appearance of a single aromatic proton resonance at δ 6.44 for (150a) (Figure 4.1, Table 4.2)

The ^{13}C resonance at δ 105.1 (d) was assigned to the acetal carbon,⁸⁰ C18. Therefore, the nature of all three oxygen atoms present in the molecule was established. Furthermore, the ^{13}C resonances at δ 148.7 (s) and 144.3 (s) suggested that the phenolic ring bore a second oxygen substituent. A resonance at δ 75.7 (d) was consistent with an allylic ether carbon bearing a methine proton and consequently, the structural unit (153a) was established.

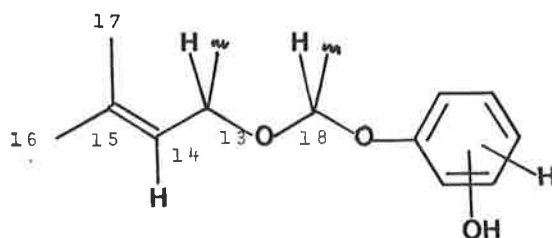

(153a)

The vinylic methyl groups, C16 and C17, were assigned to the ^{13}C resonances at δ 25.8 and 18.5 respectively.⁸¹ An examination of the olefin proton resonance, H14, confirmed the existence of the vinylic methyl groups. At first sight the olefin proton resonance at δ 5.20 appeared as a doublet

Figure 4.3. Contour Plot of the Proton Correlation
Spectrum (COSY) of (150a) in CDCl₃

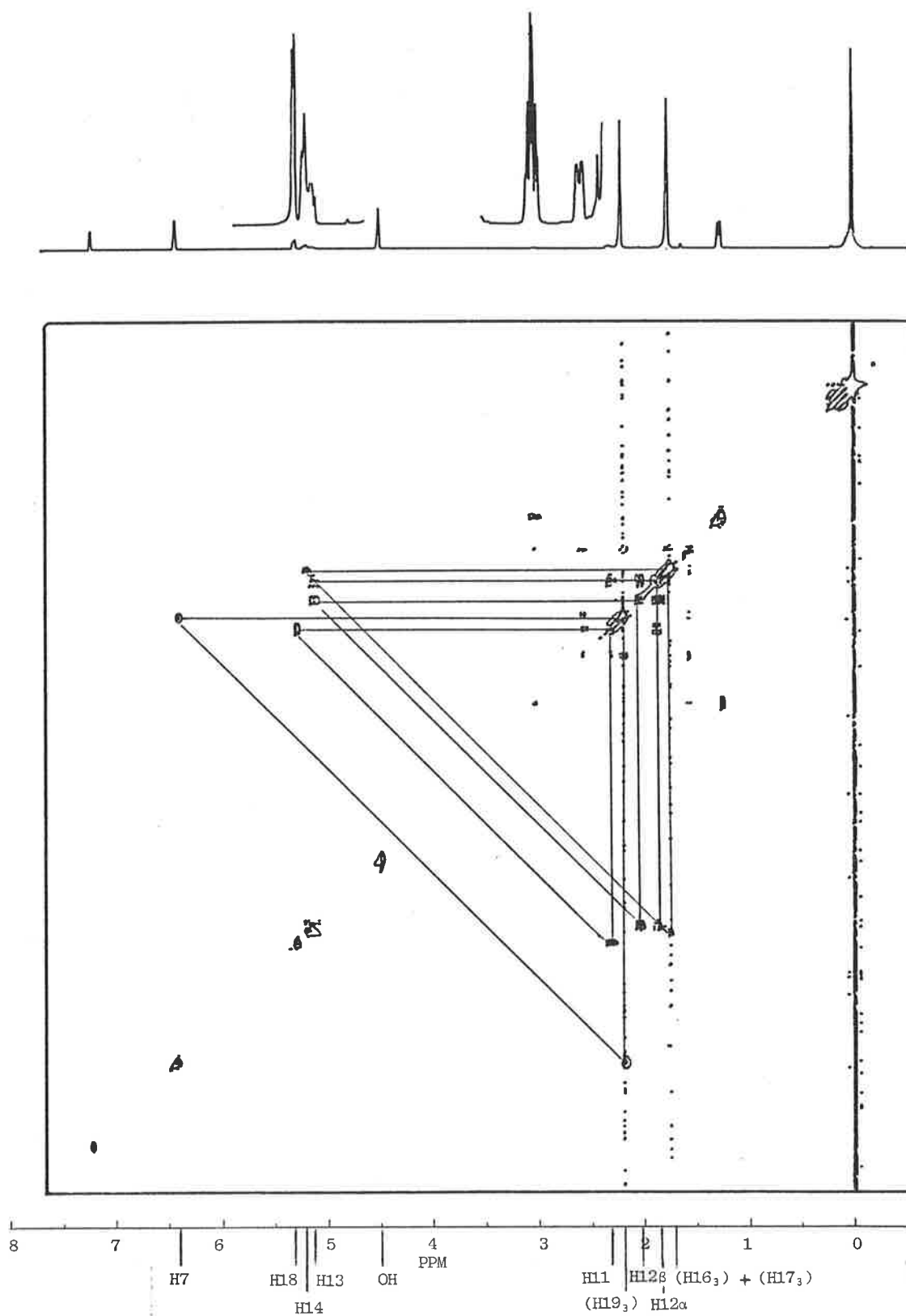
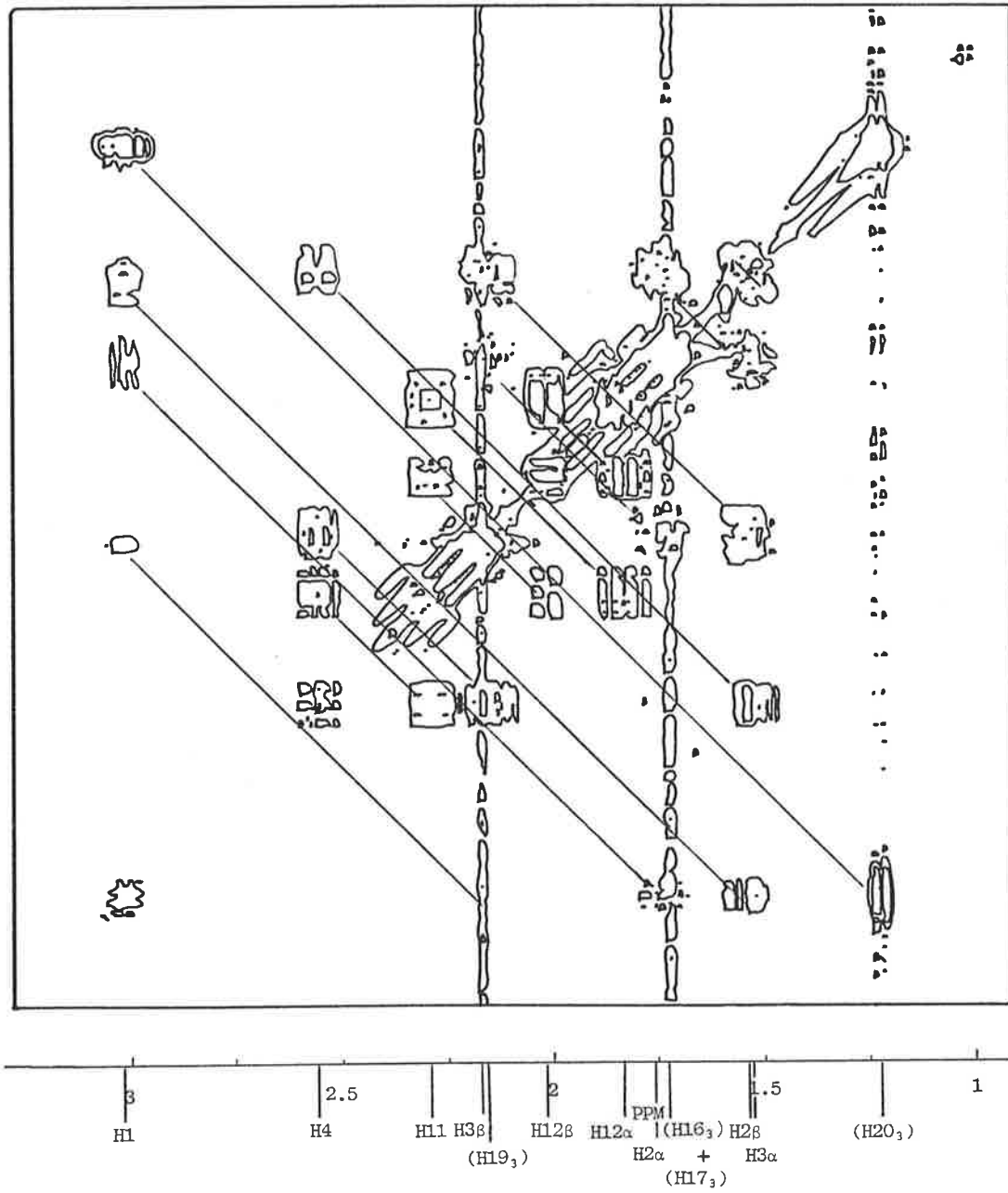
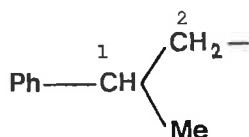

Figure 4.4. Contour Plot of the Proton Correlation Spectrum
(COSY, High Field Expansion) of (150a) in CDCl₃



(Figure 4.1, Table 4.2) with two off-diagonal COSY* cross peaks to the H13 resonance (Figures 4.3, 4.4). A closer examination revealed H14 to be allylically coupled (J 1.2 Hz) to the six proton resonance centred at δ 1.74 (COSY off-diagonal cross peaks were also evident between the H14 and vinylic methyl resonances, Figure 4.3)

The ^1H n.m.r. spectrum of (150a) revealed benzylic methine resonances at δ 3.02 and 2.56. The resonance centred at δ 3.02, H1, with corresponding ^{13}C resonance at δ 27.3 {as shown by ^{13}C - ^1H chemical shift correlation (Table 4.1)} appeared as a triplet of quartets. H1 was coupled to the methyl doublet resonance at δ 1.23 (J 7.0 Hz) and to the two resonances at δ 1.55 and 1.80, (H2)₂. The proton resonances at δ 1.55 and 1.80 were confirmed as a methylene pair by chemical shift correlation with the ^{13}C resonance at δ 28.2 (t). Double irradiation at the H20 methyl resonance collapsed the H1 signal to an apparent triplet (J 6 Hz). Off-diagonal COSY cross peaks between the H1, (H20)₃ and (H2)₂ resonances confirmed the interrelation. The above ^1H n.m.r. data firmly established the partial structure (153b).



(153b)

A complex resonance at δ 2.56 (ddd), assigned to the benzylic proton H4, was simplified to a dd by irradiation at δ 2.30, H11. H4 was, therefore, coupled to H11 and to a further two protons identified as the methylene pair (H3)₂. Again, ^{13}C - ^1H chemical shift correlation permitted the methylene protons (H3)₂ and the methine protons H4 and H11 to be assigned to ^{13}C resonances at δ 23.3 (t), 32.9 (d) and 48.8 (d), respectively. COSY

*COSY refers throughout this thesis to proton correlation spectroscopy¹¹⁹

Table 4.3. COSY Coupling Data for (150a)

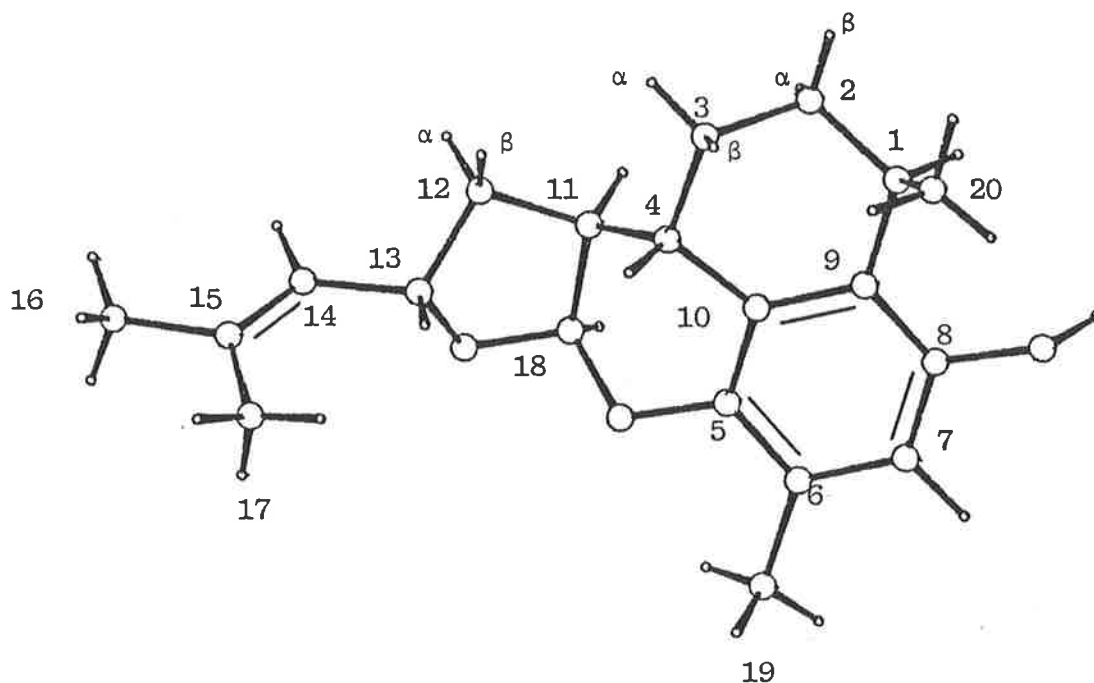

Proton	1	2 β	2 α	3 β	3 α	4	7	11	12 β	12 α	13	14	16	17	18	19	20
H1		X	X		L												X
2 β	X		X	X	X												
2 α	X	X		X	X												
3 β		X	X		X	X											
3 α		X	X	X		X											
4				X	X			X									
7																	X
11						X			X	X					X		
12 β								X		X							
12 α								X	X								
13									X	X							
14											X			X	X		
16												X					
17												X					
18								X									
19						X											
20	X																

L Refers to long range.

off-diagonal cross peaks also interrelated the proton resonances. The structural unit (153c) is therefore established, where the methylene in this case is distinct from that shown in (153b) (each methylene was correlated with a different ^{13}C resonance, Table 4.1).

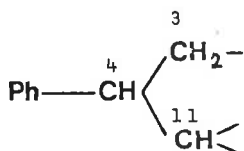

(153c)

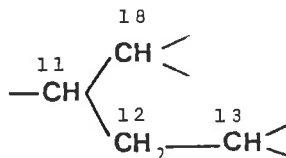

(153d)

The partial structure (153c) can be extended on the basis of the following data {partial structure (153d)}. H11, δ 2.30 (ddt), was further coupled to H18, δ 5.30 (d), and unequally to a third methylene (H12)₂, δ 1.87 (dt) and 2.02 (ddd). The protons H11, H18 and (H12)₂ were correlated with ^{13}C resonances (Table 4.1) and were interrelated by double irradiation studies and by COSY n.m.r. (Figure 4.3 and Table 4.3). The methylene protons (H12)₂ revealed geminal coupling (J 13 Hz) and vicinal coupling to both H11 and H13.

By elimination of the above ^1H n.m.r. data {partial structures (153a)-(153d)} gives the isoprenoid skeleton of (150a), where the indicated aromatic substitution is consistent with an isoprenoid origin.

The most difficult assignment in the ^1H n.m.r. spectrum of (150a) was that of the methylene protons (H2)₂, (H3)₂ and (H12)₂. Each methylene proton was chemically distinct, presumably due to the close proximity of the aromatic ring, and the resonances were partly, and in some cases totally obscured (Figure 4.1). An identification of the methylene proton resonances and indeed all the proton resonances, was only possible when the protons

were correlated with ^{13}C resonances of known multiplicity. The ^1H n.m.r. spectrum of (150a) in (D6) benzene (Figure 4.2) did, however, unravel a number of otherwise obscured resonances. The individual protons of each of the three methylenes were only assigned to a particular resonance when the configuration of (150a) was confirmed (Section 4.2). It was then possible to make assignments on the basis of coupling constants (Section 4.2).

It is important to realize that the ^1H n.m.r. spectrum of (150a) has been analysed purely on first order principles. This was performed partly because of the complexity of the spin systems involved in (150a) but also because it was felt that the high field spectrometer used (300 MHz) gave sufficient dispersion of the resonances to permit a reasonable analysis. Similar approaches to the analysis of the ^1H n.m.r. high field spectra of natural products have been reported.⁸² The structure of (150a) was confirmed by a single-crystal X-ray analysis which also established the absolute configuration (Section 4.2).

A close examination of the Long Range ^1H - ^{13}C correlation (Table 4.1) and COSY (Figures 4.3, 4.4) data further supports the structure assigned to (150a). In particular, the aromatic ring substitution pattern was confirmed. The aromatic methyl group (H19)₃, δ 2.18, was correlated to the aromatic carbons C5, C6 and C7. Similarly, a prominent COSY off-diagonal cross peak was evident between the H7 and (H19)₃ resonances. H7 was also correlated with the carbon bearing the phenolic group, C8. Other significant ^1H - ^{13}C correlations existed between C9 and the methyl group, (H20)₃ and another, although weak, between C10 and H3 β .

The ortho relationship between the phenolic group and the aromatic proton, H7, was confirmed on examination of the ^1H n.m.r. and ^{13}C n.m.r. spectra of the acetate (150b). The resonance for H7 in the acetate (150b)

was shifted to lower field by 0.27 p.p.m. which is in line with previously reported examples.⁸³ A comparison of the aromatic ¹³C chemical shifts for (150a) and (150b) is given in Table 4.4. The observed chemical shift

Table 4.4. Comparison of the Aromatic ¹³C Chemical Shifts of (150a) and (150b) (in CDCl₃)

Aromatic C-Number	(150a)	(150b)	Shift	Expected ⁸⁴ Shift
5	144.3 (s)	148.8 (s)	+ 4.5	+ 5.3
6	124.4 (s)	125.6 (s)	+ 0.2	- 0.4
7	115.0 (d)	121.7 (d)	+ 6.7	+ 6.7
8	148.7 (s)	143.1 (s)	- 5.6	- 3.9
9	126.2 (s)	131.2 (s)	+ 5.0	+ 6.7
10	129.1 (s)	128.4 (s)	+ 0.7	- 0.4

changes are in close agreement with the published figures.⁸⁴ For example, acetylation shifted the resonance for C8 to higher field by 5.6 p.p.m. (lit.⁸³ - 3.9 p.p.m.) and the resonances for C7 and C9 to lower field by 6.7 and 5.0 p.p.m., respectively (lit.⁸³ + 6.7 p.p.m.).

A number of other informative long range ¹H - ¹³C correlations were evident (Table 4.1). A long range ¹H - ¹³C correlation existed between the methyl group protons (H20)₃ and both C1 and C2 and similarly, between the acetal methine proton H18 and both C13 and C12. The above information is in full accord with the structure assigned to (150a).

Some of the functionalities associated with (150a) were confirmed by the synthesis of a number of simple derivatives. The isomeric epoxides (151) and (152) prepared from (150b) with *m*-chloroperoxybenzoic acid, gave

Figure 4.5. ^1H n.m.r. Spectrum (300 MHz) of the Epoxide (152) in CDCl_3

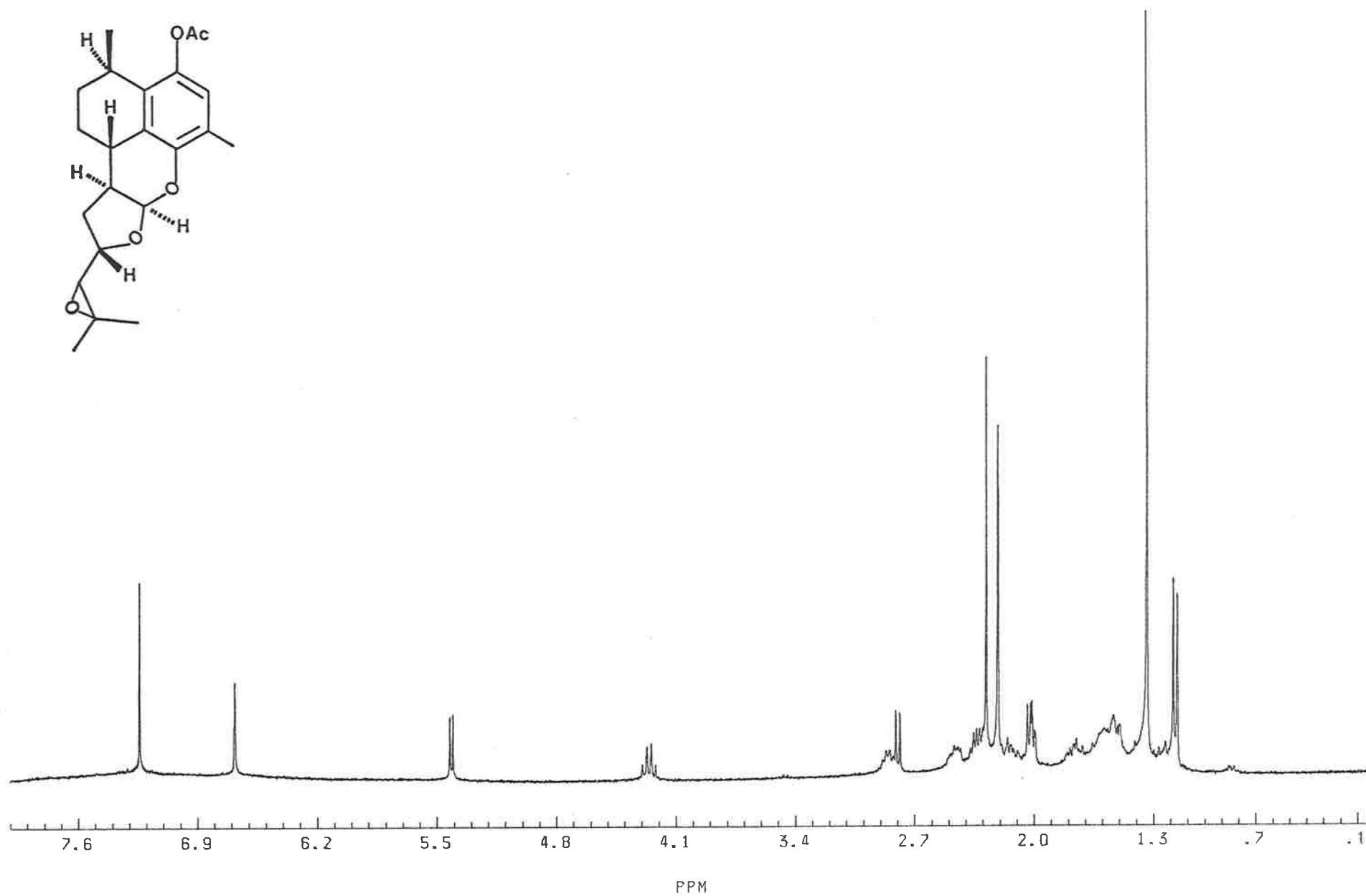
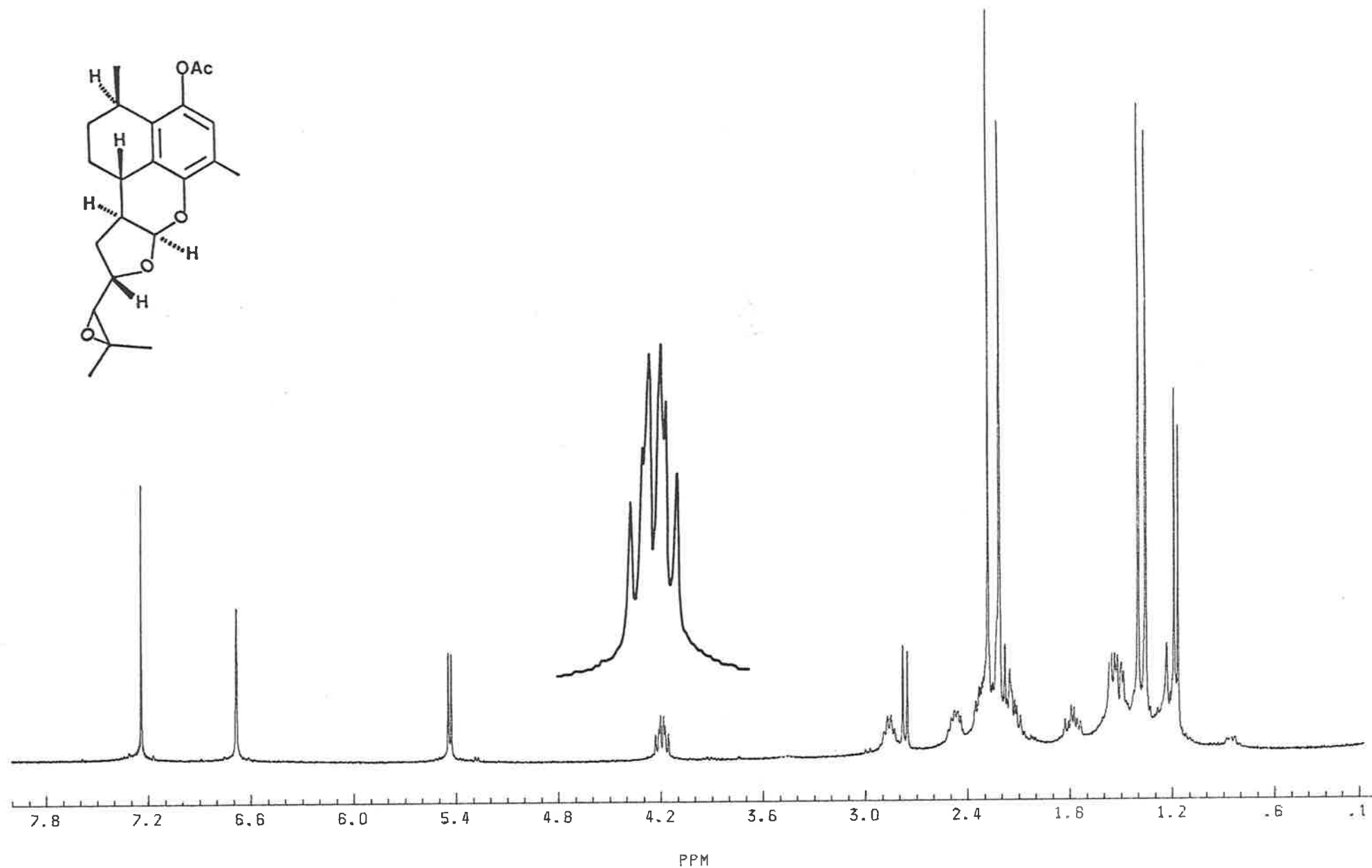
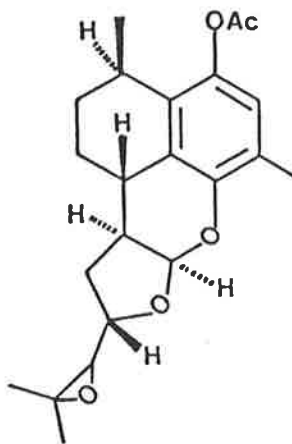

Figure 4.6. ^1H n.m.r. Spectrum (300 MHz) of the Epoxide (151) in CDCl_3



spectroscopic properties similar to those observed for the parent (150a) except for a few noticeable shifts. The 300 MHz ^1H n.m.r. spectra of both isomeric epoxides (Figures 4.5, 4.6) revealed a new doublet resonance for H14, δ 2.79 (H R_f isomer), 2.82 (L R_f isomer), which was shown by double resonance studies to be coupled to the ether proton H13, δ 4.21 (H R_f isomer), 4.29 (L R_f isomer). The methyl resonances for (H16)₃ and (H17)₃ of both



(151) and (152)

epoxides gave characteristic shifts to higher field. ^{13}C resonances at δ 65.1 (d) and 59.3 (s) (H R_f isomer) and at δ 65.3 (d) and 57.4 (s) (L R_f isomer) (Table 4.5) were at positions typical of a trisubstituted epoxide.^{82, 84}

Serrulatenol (150a) was reduced by catalytic hydrogenation with 10% palladium-on-carbon for 40 min. The products isolated, (154a) and (155a), indicated that an initial competition existed between saturation of the double bond and allylic hydrogenolysis. The major product isolated was the serrulatanol (154a). Catalytic hydrogenolysis is commonly found in molecules with an allylic or benzylic leaving group.⁸⁵ However, the hydrogenolysis product (155a) in this case was a hemiacetal, which on

Table 4.5. ^{13}C n.m.r. (20.1 MHz) Spectral Data of (150a) and its Derivatives (CDCl_3). P.p.m. rel. to TMS

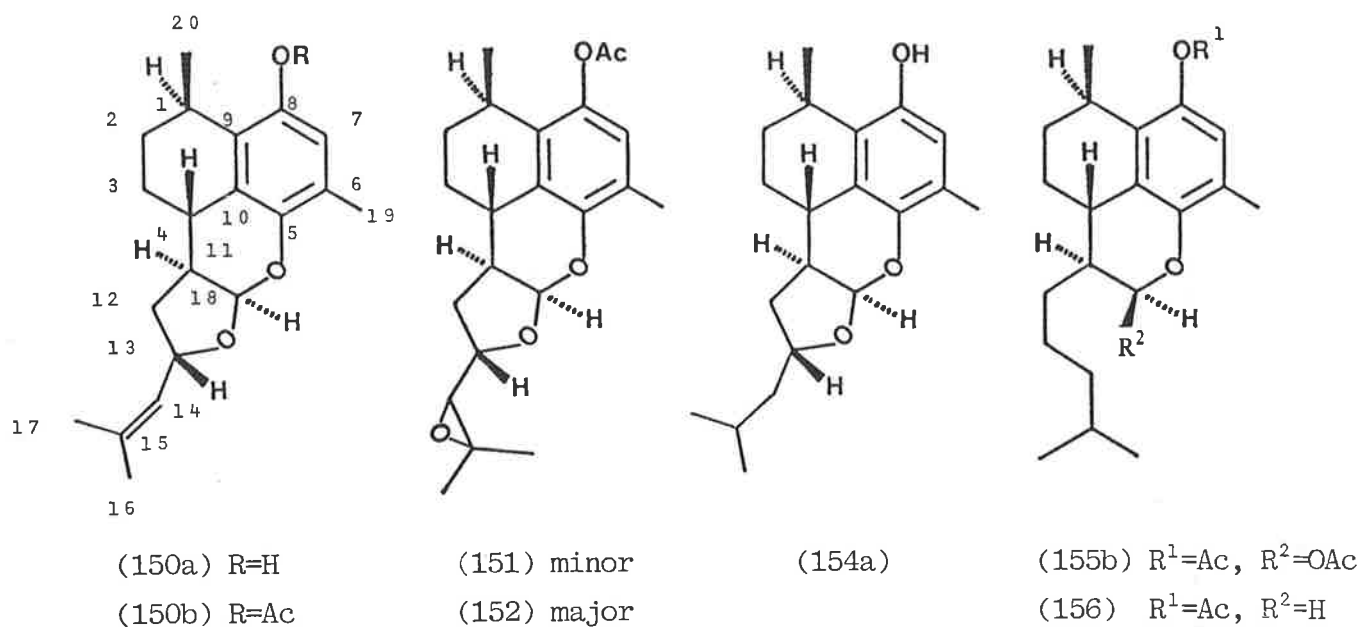

C-Number	(150a)	(150b) ^a	(151) ^a	(152) ^a	(154a) ^a	(155b) ^a	(156) ^a
1	27.3 d	27.8 d	28.0 d	28.0	27.2 d	28.6 d	b
2	28.2 t	28.2 t	28.6 t	28.5	28.1 t	28.6 t	b
3	23.3 t	23.3 t	24.0 t	23.8	23.0 t	b	b
4	32.9 d	32.6 d	32.5 d	33.0	32.9 d	32.6 d	37.5 d
5	144.3 s	148.8 s	148.5 s	148.8	148.4 s	145.9 s	149.4 s
6	125.4 s	125.6 s	125.7 s	126.0	125.1 s	124.0 s	123.3 s
7	115.0 d	121.7 d	122.0 d	122.1	114.7 d	122.7 d	122.2 d
8	148.7 s	143.1 s	143.3 s	143.3	144.0 s	142.7 s	141.5 s
9	126.2 s	131.2 s	131.4 s	131.4	128.9 s	131.2 s	131.7 s
10	129.1 s	128.4 s	127.9 s	128.2	126.0 s	c	124.2 s
11	48.8 d	48.5 d	47.8 d	47.8	48.4 d	39.8 d	38.7 d
12	38.0 t	37.9 t	35.4 t	34.0	37.5 t	b	b
13	75.7 d	75.3 d	76.4 d	78.6	77.6 d	b	b
14	124.1 d	124.0 d	65.1 d	65.3	44.1 t	39.3 t	39.4 t
15	137.9 s	137.1 s	59.3 s	57.4	23.0 d	22.9 d	b
16	25.8 q	25.7 q	24.6 q	25.1	25.6 q	28.0 q	26.7 q
17	18.5 q	18.5 q	19.0 q	19.8	23.3 q	b	b
18	105.1 d	104.7 d	104.9 d	105.5	105.0 d	90.5 d	70.0 t
19	15.2 q	15.4 q	15.5 q	15.7	15.2 q	16.0 q	16.2 q
20	19.6 q	19.8 q	20.2 q	20.2	19.5 q	b	b
OCOMe		20.9 q	21.1 q	21.2		21.4 2xq	21.2 q
OCOMe		169.7 s	170.0 s	170.1		170.2 2xs	170.2 s

a Assignments are based on the chemical shifts of (150a) and hence are only tentative.
 b Difficult to assign.
 c Not observed.

acetylation gave a diacetate which underwent further catalytic hydrogenolysis. Catalytic hydrogenolysis of (155b) in ethyl acetate for 2 h gave (156) which,

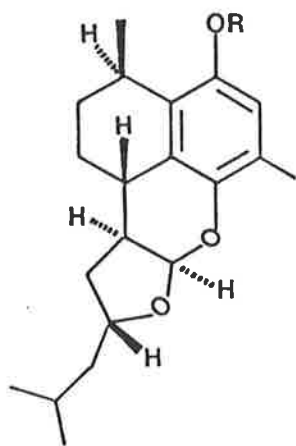

(154a) R=H
(154b) R=Ac

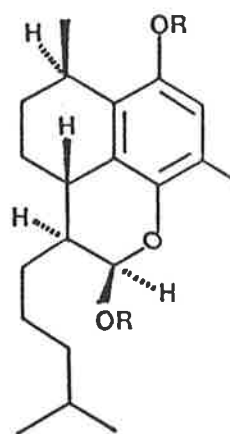

(155a) R=H
(155b) R=Ac

in comparison to (150b), had lost one oxygen atom. An extended reaction of (150a) in ethyl acetate for 48 h with 10% palladium-on-carbon gave the

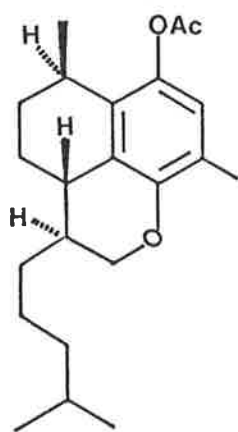

(156)

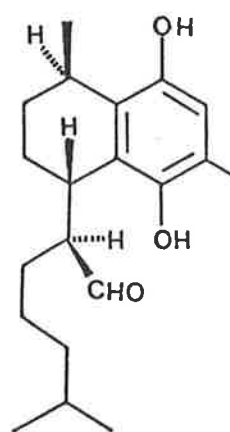

(157)

Figure 4.7. ^1H n.m.r. Spectrum (300 MHz) of (154a) in CDCl_3

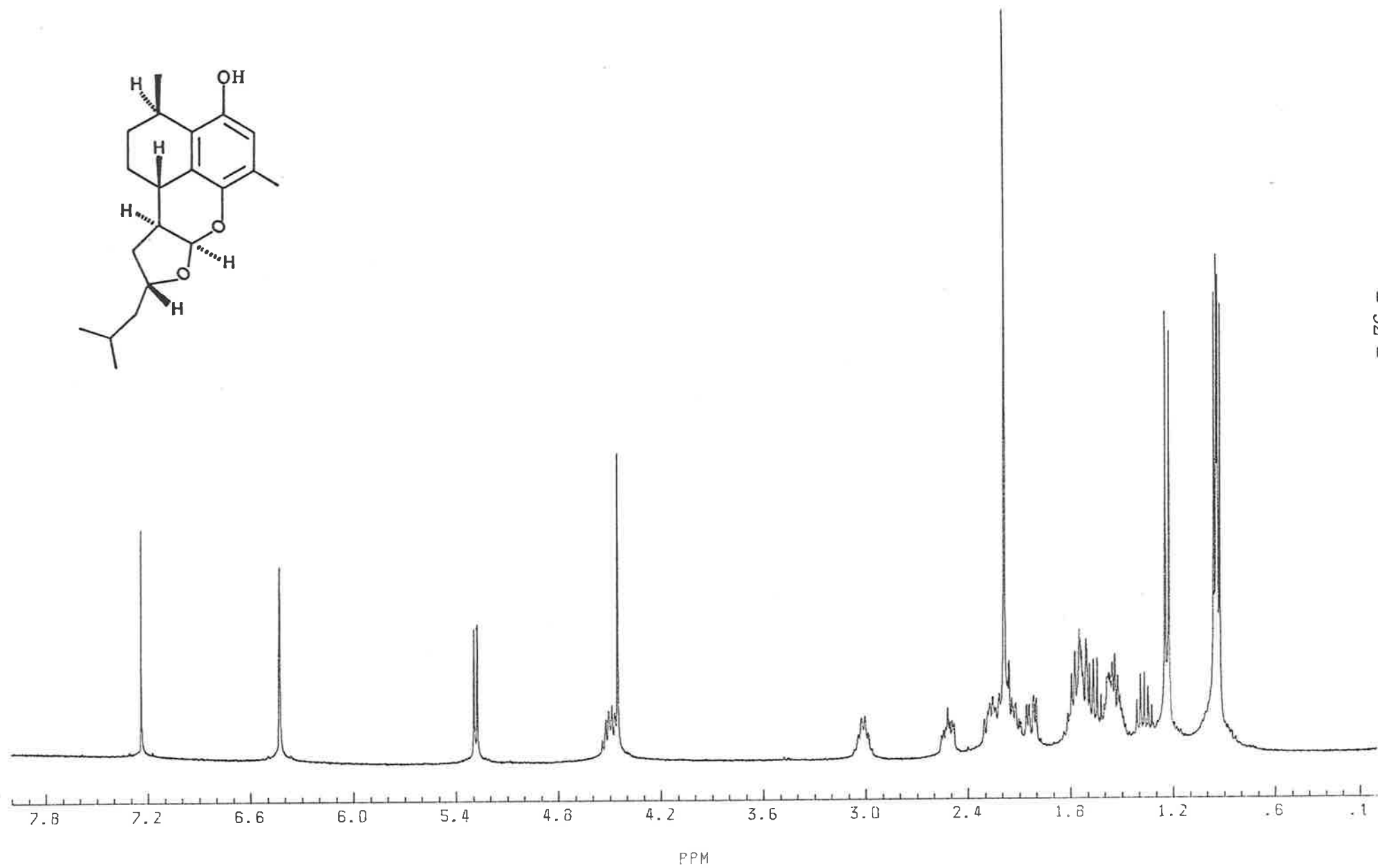
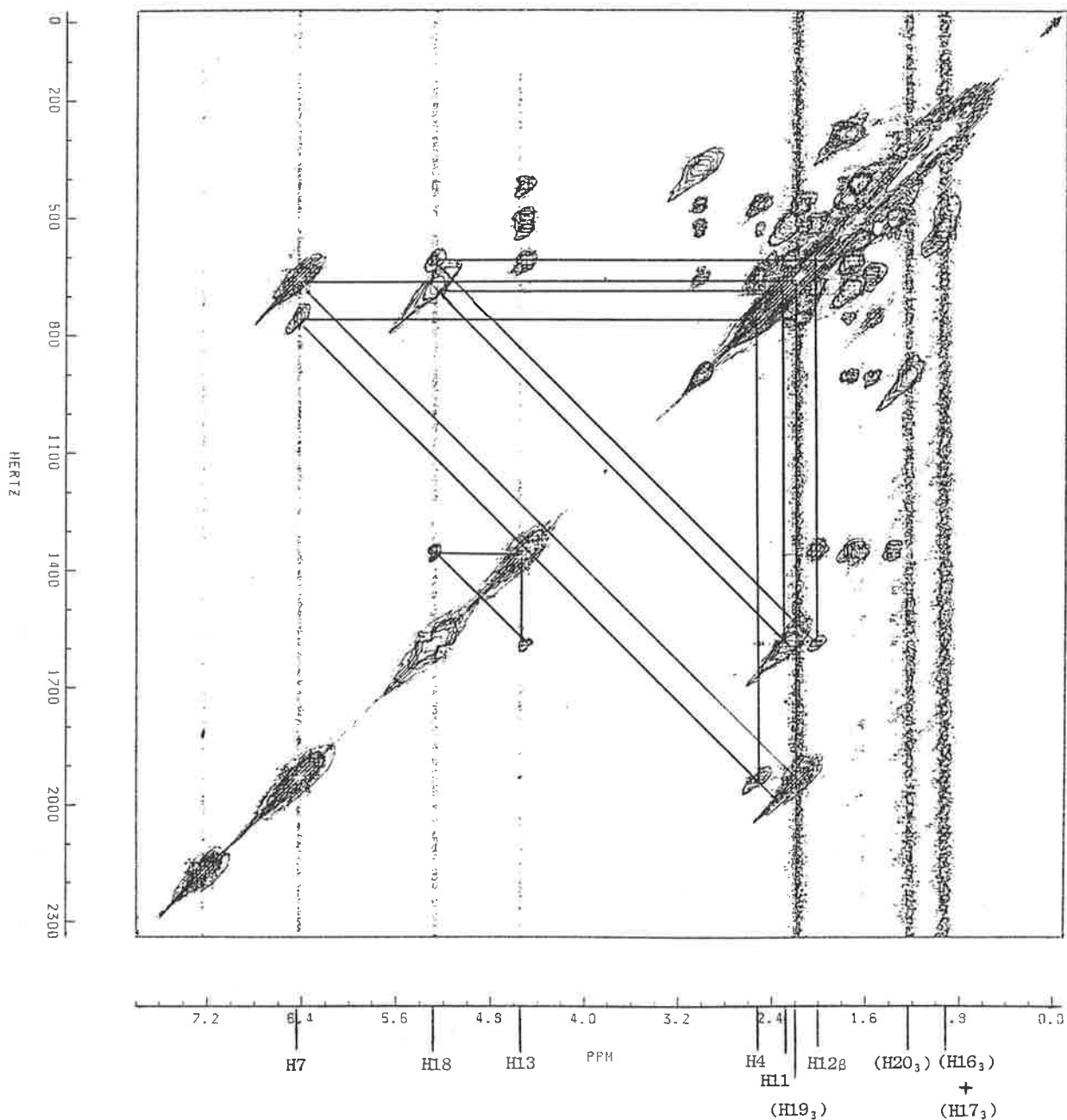
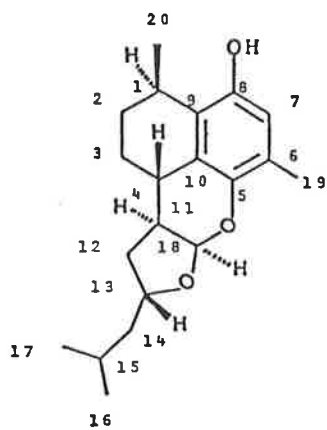

Figure 4.8. Contour Plot of the Proton Correlation Spectrum (COSY) of (154a) in CDCl₃



expected product (154a), however, (155a) was not obtained. The cyclic hemiacetal had instead ring opened to give the serrulatanal (157) which closely resembled a second serrulatane diterpene (158) (discussed in Section 4.1).

The spectroscopic data obtained for serrulatanol (154a) provided further proof for the proposed structure. The only point of note from the ^{13}C n.m.r. spectrum of (154a) was the appearance of the new resonances at δ 44.1 (t) and 23.0 (d), assigned to C14 and C15 respectively and the absence of the corresponding olefinic resonances of (150a) (Table 4.5). A comparison of both the ^1H n.m.r. (Fig. 4.7) and COSY (Fig. 4.8) spectra of (154a) reveals a number of interesting proton couplings. The high field region of the ^1H n.m.r. spectrum is complex and in any case the couplings are similar to those previously reported for (150a). More interesting are a number of long-range couplings clearly evident in the low field region of the COSY spectrum (the off-diagonal cross peaks for the couplings discussed below have been highlighted in Fig. 4.8).

Apart from being coupled to the aromatic methyl group $(\text{H19})_3$, H7 is also weakly coupled to H4 as evidenced by an off-diagonal COSY cross peak between the two resonances. Benzylic coupling of this type is well known.⁸⁶ Another well documented type of long-range coupling is the so called "W-coupling"⁸⁶ and examples of this are clearly evident between protons H18/H13 and H18/H12 β (Figure 4.8).

The H18 resonance for hemiacetal (155a) occurred at δ 5.48 (apparent doublet) and was observed to shift to a lower field by 1.03 p.p.m. on forming the diacetate (155b) (δ 6.51, d, J 1.9 Hz, Figure 4.9). A number of other proton resonances of (155b) were readily assigned (Figure 4.9): H7 appeared at δ 6.68 (s), H1 and H4 were evident at δ 2.95 (sex.) and

Figure 4.9. ^1H n.m.r. Spectrum (300 MHz) of (155b) in CDCl_3

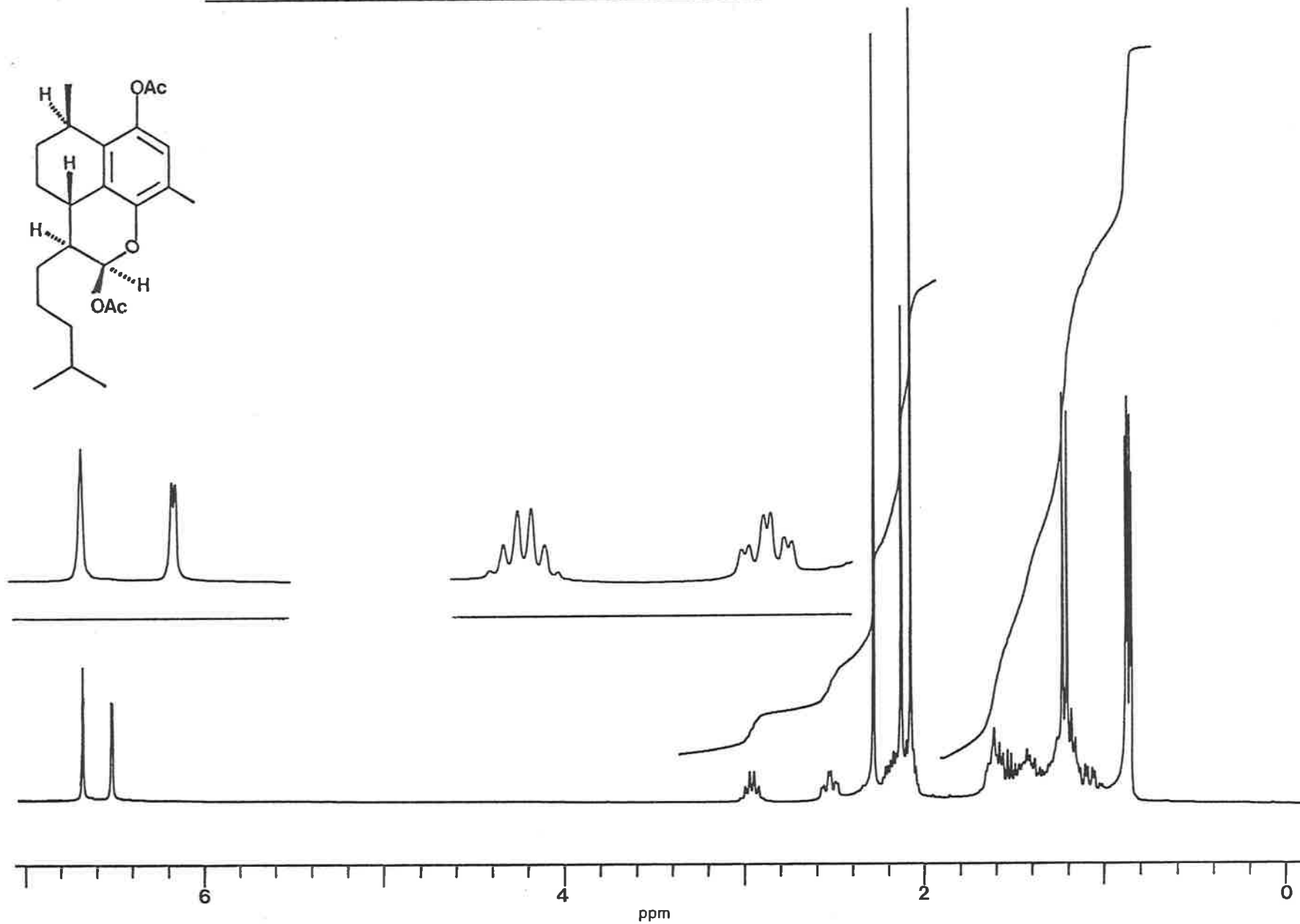
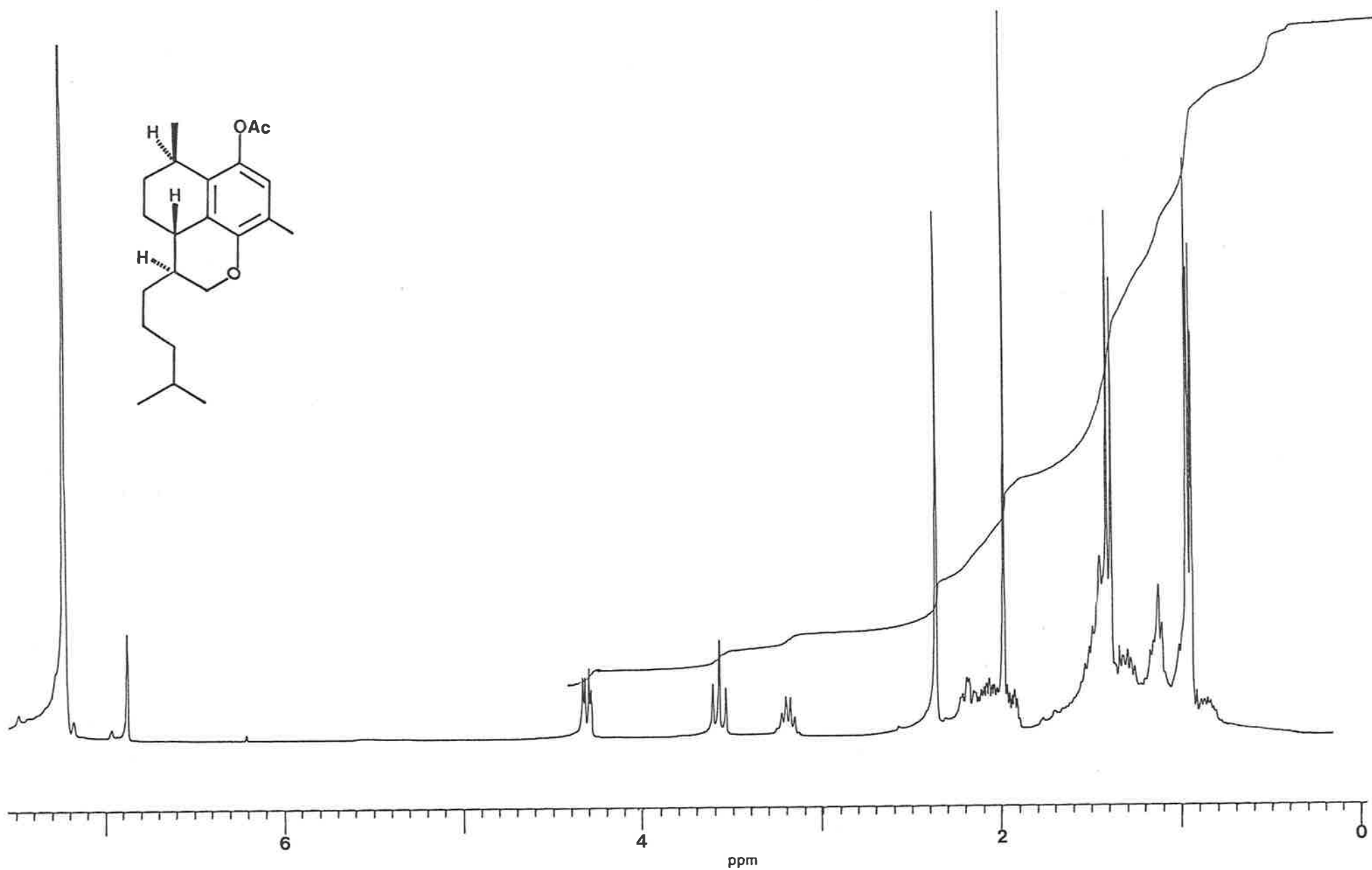

Figure 4.10. ^1H n.m.r. Spectrum (300 MHz) of (156) in C_6D_6



2.55 (dt) respectively and the methyl groups 8-acetate (δ 2.28), (H19)₃ (δ 2.13), 18-acetate (δ 2.07), (H20)₃ (1.21, d, J 6.8 Hz), and (H16)₃/(H17)₃ (0.87, 0.85, each 3H, d).

The C18 resonance for (155b) appeared at δ 90.5 (d) (Table 4.5) which is 14.6 p.p.m. upfield relative to the parent (150a). On the other hand, the resonance for C18 appeared at δ 70.0 as a triplet for (156), some 20.5 p.p.m. further upfield. (156) gave two proton resonances of an AMX system at δ_A 4.32 (dd, J 3, 10 Hz) and δ_M 3.58 (t, J 10 Hz) which were assigned to (H18)₂ (Figure 4.10). Double irradiation at either of the methylene protons (H18)₂ collapsed the other to a doublet and therefore both were vicinally coupled to H11. The remainder of the ¹H n.m.r. spectrum of (156) (Figure 4.10) compares favourably with that of (155b) (Figure 4.9).

4.1 A second biogenetically related serrulatane diterpene, serrulatenal (158), was also isolated from the wood extract of *E. rotundifolia*. (158) proved difficult to purify and hence was characterized as the triacetate (159b).

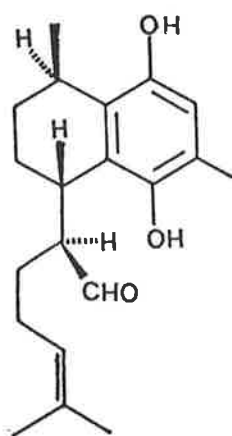

(158)

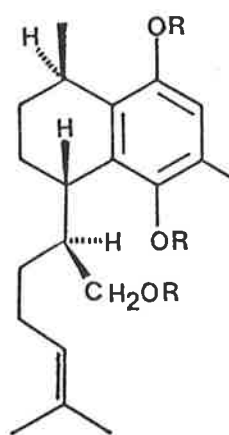

(159a) R=H

(159b) R=Ac

Table 4.6. ^{13}C n.m.r. (20.1 MHz) Spectral Data of the Serrulatenyl Acetate (159b) and the Dihydro Derivative (162) (Both in CDCl_3)

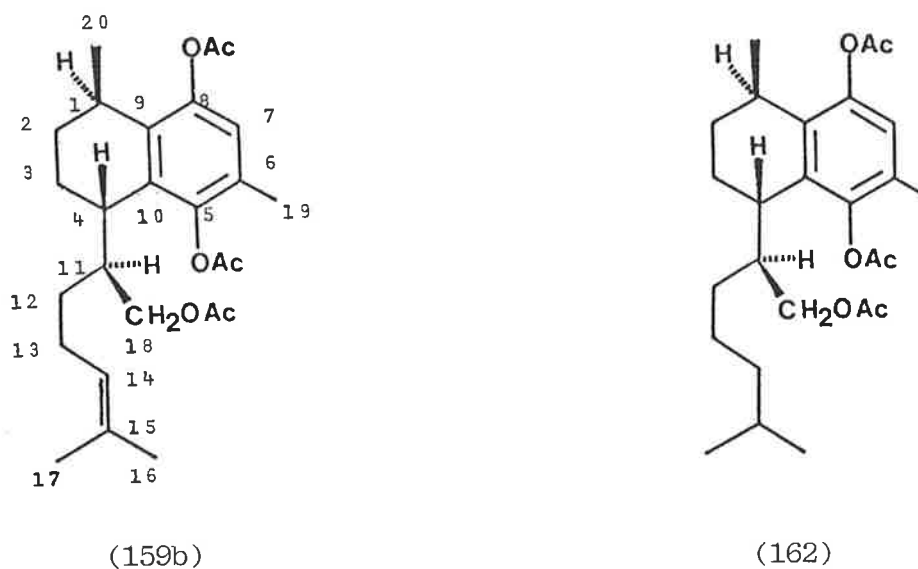

C-Number	(159b)	(162)
1	27.4 (d)	27.8 b
2	30.8 (t)	30.7 (t)
3	25.6 b	25.5 b
4	33.9 (d)	33.7 (d)
5	146.6 (s) ^a	146.6 (s) ^a
6	128.5 (s) ^a	128.4 (s) ^a
7	122.6 (d)	122.6 (d)
8	145.6 (s) ^a	145.6 (s) ^a
9	132.0 (s) ^a	132.1 (s) ^a
10	134.0 (s) ^a	134.0 (s) ^a
11	41.4 (d)	41.8 (d)
12	26.6 b	25.8 b
13	17.8 b	22.0 b
14	124.2 (d)	39.1 (t)
15	c	22.7 b
16	25.8 b	27.3 b
17	19.6 b	22.5 b
18	66.2 (t)	66.3 (t)
8-Me	16.5 (q)	16.4 (q)
1-Me	20.9 b	21.0 b
OCOMe	21.0, 21.2, 22.2 b	19.6, 20.8, 20.9 b
OCOMe	171.2, 169.5, 168.7 (3xs)	171.2, 169.5, 168.8 (3xs)

a May be interchanged with each column.
 b Difficult to assign multiplicity and assignments are therefore tentative.
 c Not observed.

Figure 4.11. ^1H n.m.r. Spectrum (300 MHz) of the Triacetate (159b) in CDCl_3

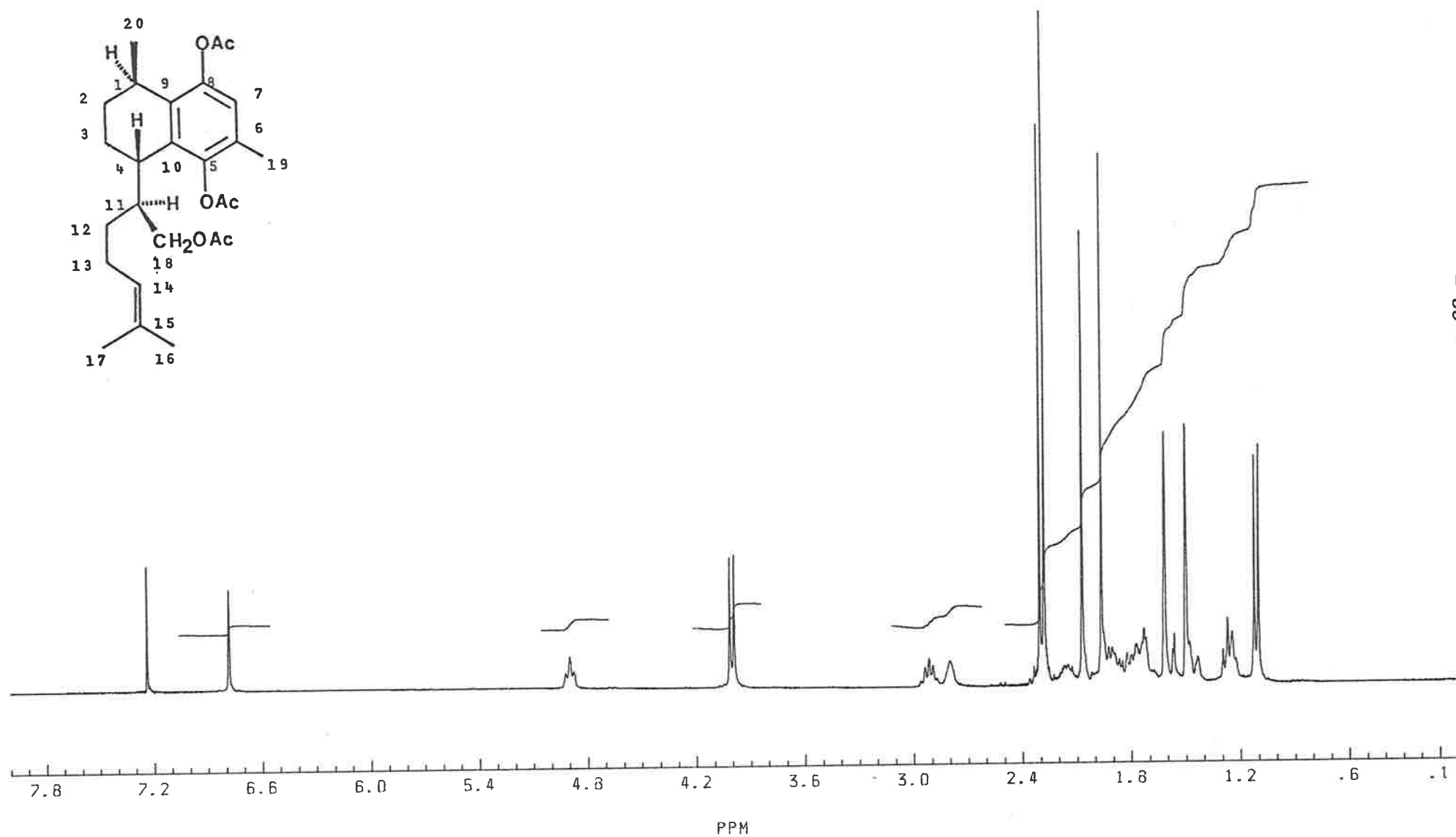

A comparison of the ^{13}C n.m.r. spectrum of the triacetate (159a) (Table 4.6) with that of (150a) (Table 4.5) reveals a similar distribution of resonances. Noticeable exceptions are the disappearances of the acetal C18 resonance of (150a) {now evident as a primary acetate carbon resonance at δ 66.2 (t)} and also the allylic ether carbon resonance, C13.

The ^1H n.m.r. spectrum of (159b) (Figure 4.11) reveals a single aromatic resonance at δ 6.79. Also present is a broad triplet resonance centred at δ 4.89 (H14) which is coupled to the vicinal protons H13 and also weakly to the allylic methyl groups (H16)₃ and (H17)₃. A two proton doublet resonance for the methylene at C18 was assigned as the A₂ part of an A₂X system (δ_{A} 4.00, d, \underline{J} 7.2 Hz; δ_{X} 2.15, m, H11). The ^1H n.m.r. spectrum (60 MHz) of the corresponding primary alcohol (159a) showed the (H18)₂ resonance to be 0.4 p.p.m. upfield relative to the acetate (159b) as a partly obscured multiplet (probably the AB part of an ABX system).

Two multiplets at δ 2.80 and 2.92 for (159b) (Figure 4.11), the latter showing coupling (7 Hz) to the secondary methyl at δ 1.11, were assigned to the benzylic protons H4 and H1, respectively. Both the phenolic acetate methyl resonances of (159b) were clearly evident at δ 2.31 and 2.28 as was the primary acetate methyl resonance at δ 1.96. The infrared spectrum of (159b) confirmed the presence of both the phenolic and primary acetates with absorptions at 1760 and 1735 cm^{-1} .

The structure of (158) and indeed that of (150a), was further supported by the conversion of (158) into the ketone (160) and the 1,4-benzoquinone (161b). Catalytic hydrogenation of the triacetate (159b) with 10% palladium-on-carbon gave the dihydro compound (162). Pyrolysis of (162) at 650^o/0.05 mm gave (163). Ozonolysis of (163) in methanol/dimethyl sulfide at -78^o gave the required ketone (160). The distinguishing features

Figure 4.12. ^1H n.m.r. Spectrum (300 MHz) of the Ketone (160) in CDCl_3

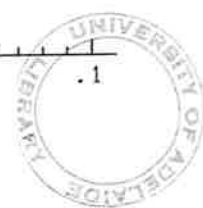
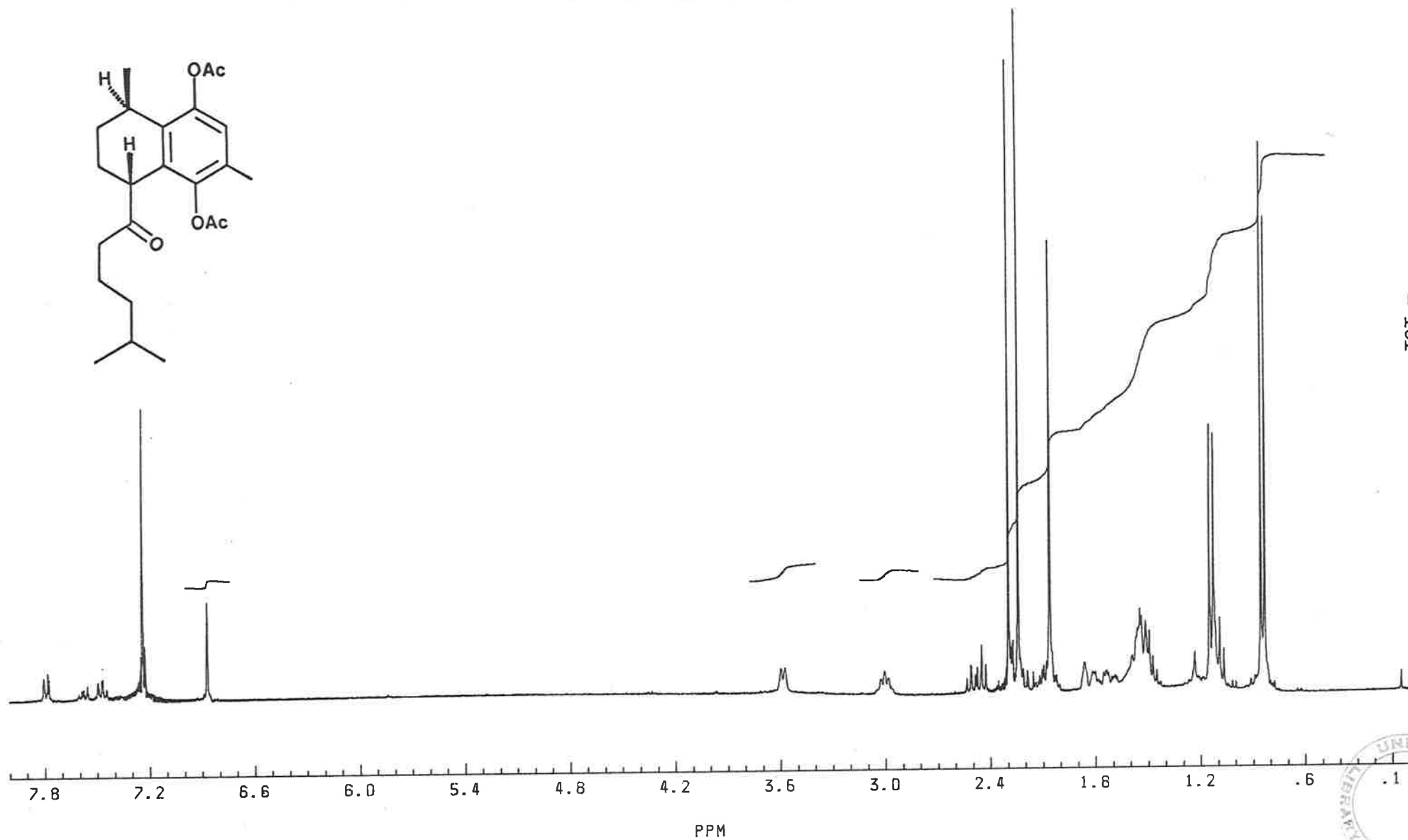

of the ^1H n.m.r. spectrum of (160) (Fig. 4.12) were resonances at δ 3.57 (an apparent doublet, H4) and 2.48 (dt, one of the H12 methylene protons).

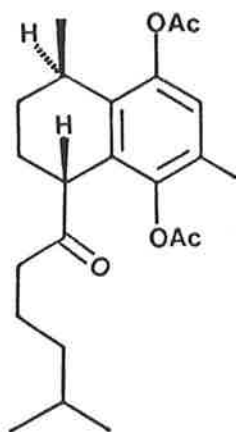

(160)

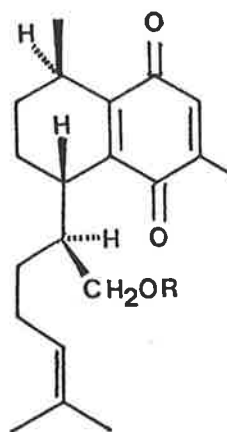

(161a) R=H

(161b) R=Ac

The second H12 methylene resonance was obscured presumably under the aromatic methyl resonance. The resonance at δ 3.57 was at an unusually low field

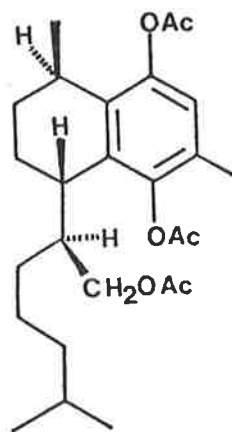

(162)

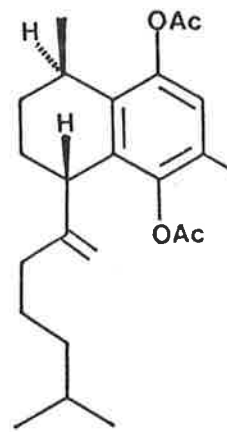

(163)

for a methine proton α to a ketone. In comparison, the resonance for H4 in (163) occurred at δ 3.34 (bd) also at a low field position. Two resonances were observed for the exocyclic methylene pair of (163) at δ 4.82 (apparent dt, \underline{J} 1.2, 1.5 Hz) and 4.05 (apparent dd) ($\underline{J}_{\text{gem.}} = 1.5$ Hz). Resonances for C4 and C11 were present at δ 47.4 (d) and 41.4 (t), respectively, for ketone (160) and at δ 39.9 (d) and 39.3 (t) for (163).

The 1,4-hydroquinone moiety of (159a) was confirmed by its ready oxidation with Jones reagent¹²⁰ at 0° to the corresponding 1,4-benzoquinone (161a). (161a) readily formed the monoacetate (161b) which had spectroscopic data consistent with a 1,4-benzoquinone functionality.⁸⁷ The ¹H n.m.r. spectrum revealed a quartet at δ 6.50 (quinoid proton H7) which was allylically coupled to the methyl doublet at δ 1.99 (\underline{J} 1.6 Hz). Infrared absorptions at 1640 cm⁻¹ (C=O vibration) and at 1600 cm⁻¹ (weak C=C vibration) were also consistent with literature figures.⁸⁷ 1,2-Benzoquinones generally absorb at higher wave numbers between 1660 and 1690 cm⁻¹.⁸⁷ 1,4-Benzoquinone (161b) was isolated as a yellow oil with ultraviolet absorptions λ_{max} at 347 (1030), 285 (2200) and 259 (15000) nm.

The ¹H n.m.r. spectrum of (161b) at 80 MHz showed 8 lines for the methylene (H18)₂ as the AB part of an ABX system. However, at 300 MHz the ABX system clearly simplified to an AMX system (δ_{A} 4.07, $\underline{J}_{\text{AM}}$ 11.4 Hz, $\underline{J}_{\text{AX}}$ 4.7 Hz; δ_{M} 3.84, dd, $\underline{J}_{\text{MX}}$ 9.0 Hz).

4.2 The structure of (150a) was confirmed and the absolute configuration determined by a single-crystal X-ray analysis of the *p*-bromobenzoate derivative (150c). The final atomic coordinates, thermal parameters, bond lengths and bond angles are given in Tables 4.7 - 4.10 and the tabulated structural factors can be found in Appendix 1. Figure 4.13 is a PLUTO plot

Table 4.7. Final Atomic Coordinates and Thermal Parameters for C₂₇H₂₉BrO₄

Atom [*]	x	y	z	U(11)	U(22)	U(33)	U(23)	U(13)	U(12)
Br(1)	-17205(5)	-25010(14)	-22077(4)	391(3)	687(3)	785(4)	-11(3)	-144(2)	90(3)
O(1)	4368(4)	-5735(4)	802(3)	55(2)	45(2)	70(2)	1(2)	-15(2)	7(2)
O(2)	4664(3)	-3530(4)	1277(2)	37(2)	43(2)	52(2)	-8(2)	-10(1)	6(1)
O(3)	10109(3)	-4200(4)	3827(2)	23(1)	49(2)	48(2)	3(2)	5(1)	0(1)
O(4)	11562(3)	-5403(4)	5163(2)	27(1)	74(2)	50(2)	12(2)	6(1)	10(2)
C(1)	24(5)	-3163(6)	-1310(3)	34(2)	51(3)	37(2)	1(2)	0(2)	1(2)
C(2)	1154(5)	-2240(6)	-926(4)	42(2)	43(3)	67(3)	12(3)	-8(2)	-3(2)
C(3)	2425(5)	-2689(6)	-258(4)	38(2)	49(3)	65(3)	8(3)	-6(2)	-6(2)
C(4)	2585(4)	-4061(5)	8(3)	32(2)	41(2)	33(2)	-1(2)	7(2)	1(2)
C(5)	1463(5)	-4976(5)	-416(3)	46(3)	39(3)	41(2)	0(2)	-2(2)	2(2)
C(6)	171(5)	-4528(5)	-1067(4)	40(2)	46(3)	48(3)	-4(2)	0(2)	-8(2)
C(7)	3948(5)	-4574(5)	724(3)	37(2)	42(3)	32(2)	2(2)	3(2)	0(2)
C(8)	6061(5)	-3771(5)	1941(3)	34(2)	37(2)	41(2)	-3(2)	-3(2)	4(2)
C(9)	7320(5)	-3619(5)	1526(3)	43(2)	38(2)	35(2)	-2(2)	5(2)	3(2)
C(10)	8757(5)	-3751(5)	2160(3)	35(2)	34(2)	41(2)	-4(2)	8(2)	0(2)
C(11)	10148(5)	-3563(6)	1739(4)	42(3)	58(3)	45(3)	2(2)	20(2)	1(2)
C(12)	8821(4)	-4029(4)	3162(3)	27(2)	31(2)	39(2)	3(2)	4(2)	0(2)
C(13)	7544(4)	-4094(4)	3592(3)	27(2)	28(2)	40(2)	-6(2)	4(2)	-1(2)
C(14)	6122(4)	-3999(5)	2954(3)	26(2)	33(2)	40(2)	-5(2)	4(2)	0(2)
C(15)	4727(4)	-4145(5)	3411(4)	21(2)	51(3)	56(3)	-9(2)	7(2)	0(2)
C(16)	4007(6)	-2752(6)	3506(4)	43(3)	65(4)	70(3)	-8(3)	11(2)	18(3)
C(17)	5118(5)	-4922(6)	4406(4)	32(2)	54(3)	55(3)	-1(2)	18(2)	-2(2)
C(18)	6431(5)	-4282(6)	5159(3)	33(2)	53(3)	47(3)	-3(2)	13(2)	3(2)
C(19)	7066(4)	-4226(5)	4731(3)	28(2)	33(2)	36(2)	-1(2)	6(2)	-1(2)
C(20)	8950(4)	-5446(5)	5050(3)	29(2)	29(2)	48(3)	-3(2)	8(2)	-1(2)
C(21)	10232(5)	-5415(5)	4454(3)	30(2)	40(2)	43(2)	4(2)	5(2)	4(2)
C(22)	9777(5)	-5405(6)	6154(5)	34(2)	51(3)	38(2)	10(2)	5(2)	5(2)
C(23)	11300(5)	-4804(5)	6101(4)	36(2)	36(2)	55(3)	6(2)	-6(2)	0(2)
C(24)	12576(5)	-5177(6)	6951(4)	40(3)	41(3)	54(3)	14(2)	-7(2)	-3(2)
C(25)	13666(5)	-4355(5)	7408(4)	36(2)	44(3)	44(2)	5(2)	5(2)	3(2)
C(26)	14907(6)	-4065(7)	-1743(4)	41(3)	67(4)	53(3)	9(3)	-5(2)	-1(3)
C(27)	13799(7)	-2891(6)	7120(6)	56(3)	59(4)	95(5)	27(3)	-17(3)	-13(3)

*Br coordinates x 10⁵, others x 10⁴
 Br thermal parameters x 10⁴, others x 10³

Table 4.8. Hydrogen Parameters for C₂₇H₂₉BrO₄

Atom	x	y	z	U(11)
H(1)	1017(5)	-1178(6)	-1160(4)	42(6)
H(2)	3311(5)	-1986(6)	77(4)	42(6)
H(3)	1575(5)	-6048(5)	-207(3)	42(6)
H(4)	-723(5)	-5228(5)	-1390(4)	42(6)
H(5)	7196(5)	-3414(5)	722(3)	42(6)
H(6)	9890(5)	-3611(6)	1000(4)	81(11)
H(7)	10809(5)	-4320(6)	2003(4)	81(11)
H(8)	10652(5)	-2700(6)	1947(4)	81(11)
H(9)	3962(4)	-4670(5)	2953(4)	42(5)
H(10)	3128(6)	-2991(6)	3769(4)	81(8)
H(11)	3699(6)	-2251(6)	2871(4)	81(8)
H(12)	4673(6)	-2182(6)	3998(4)	81(8)
H(13)	4242(5)	-4944(6)	4709(4)	42(5)
H(14)	5393(5)	-5853(6)	4262(4)	42(5)
H(15)	6152(5)	-3356(6)	5313(3)	42(5)
H(16)	6625(5)	-4827(6)	5779(3)	42(5)
H(17)	8372(4)	-3409(5)	5047(3)	42(5)
H(18)	8297(4)	-6241(5)	4906(3)	42(5)
H(19)	10122(5)	-6211(5)	4009(3)	42(5)
H(20)	9254(5)	-4832(6)	6557(3)	42(5)
H(21)	9896(5)	-6323(6)	6443(3)	42(5)
H(22)	11267(5)	-3809(5)	6138(4)	42(5)
H(23)	12610(5)	-6226(6)	7218(4)	42(5)
H(24)	15105(6)	-4190(7)	-1200(4)	81(8)
H(25)	15791(6)	-4972(7)	-2030(4)	81(8)
H(26)	14660(6)	-5739(7)	-1472(4)	81(8)
H(27)	14158(7)	-2260(6)	7678(6)	81(8)
H(28)	13017(7)	-2451(6)	6618(6)	81(8)
H(29)	14625(7)	-3146(6)	6804(6)	81(8)

Table 4.9. Bond Lengths (Å) for C₂₇H₂₉BrO₄

C(1)	--- Br(1)	1.891(4)			
C(7)	---- O(1)	1.190(6)	C(7)	---- O(2)	1.342(6)
C(8)	---- O(2)	1.409(5)	C(12)	---- O(3)	1.379(4)
C(21)	---- O(3)	1.446(6)	C(21)	---- O(4)	1.373(5)
C(23)	---- O(4)	1.451(6)	C(2)	---- C(1)	1.380(7)
C(6)	---- C(1)	1.367(8)	C(3)	---- C(2)	1.376(6)
C(4)	---- C(3)	1.381(8)	C(5)	---- C(4)	1.384(6)
C(7)	---- C(4)	1.486(6)	C(6)	---- C(5)	1.378(6)
C(9)	---- C(8)	1.385(7)	C(14)	---- C(8)	1.367(6)
C(10)	---- C(9)	1.407(6)	C(11)	---- C(10)	1.504(7)
C(12)	---- C(10)	1.361(6)	C(13)	---- C(12)	1.405(6)
C(14)	---- C(13)	1.395(5)	C(19)	---- C(13)	1.500(6)
C(15)	---- C(14)	1.530(6)	C(16)	---- C(15)	1.522(8)
C(17)	---- C(15)	1.510(7)	C(18)	---- C(17)	1.525(6)
C(19)	---- C(18)	1.536(6)	C(20)	---- C(19)	1.546(6)
C(21)	---- C(20)	1.549(7)	C(22)	---- C(20)	1.514(6)
C(23)	---- C(22)	1.522(7)	C(24)	---- C(23)	1.489(6)
C(25)	---- C(24)	1.320(7)	C(26)	---- C(25)	1.508(7)
C(27)	---- C(25)	1.487(8)			

Table 4.10. Bond Angles (°) for C₂₇H₂₉BrO₄

C(8)	- O(2)	- C(7)	119.4(4)	C(21)	- O(3)	- C(12)	112.5(3)
C(23)	- O(4)	- C(21)	108.7(3)	C(2)	- C(1)	- Br(1)	118.4(4)
C(6)	- C(1)	- Br(1)	120.6(4)	C(6)	- C(1)	- C(2)	121.0(4)
C(3)	- C(2)	- C(1)	119.6(5)	C(4)	- C(3)	- C(2)	120.2(5)
C(5)	- C(4)	- C(3)	119.1(4)	C(7)	- C(4)	- C(3)	121.3(4)
C(7)	- C(4)	- C(5)	119.5(4)	C(6)	- C(5)	- C(4)	120.9(5)
C(5)	- C(6)	- C(1)	119.0(4)	O(2)	- C(7)	- O(1)	124.1(4)
C(4)	- C(7)	- O(1)	125.8(4)	C(4)	- C(7)	- O(2)	110.1(4)
C(9)	- C(8)	- O(2)	116.2(4)	C(14)	- C(8)	- O(2)	119.8(4)
C(14)	- C(8)	- C(9)	123.7(4)	C(10)	- C(9)	- C(8)	119.4(4)
C(11)	- C(10)	- C(9)	120.8(4)	C(12)	- C(10)	- C(9)	117.0(4)
C(12)	- C(10)	- C(11)	122.1(4)	C(10)	- C(12)	- O(3)	120.4(4)
C(13)	- C(12)	- O(3)	116.2(4)	C(13)	- C(12)	- C(10)	123.3(4)
C(14)	- C(13)	- C(12)	119.2(4)	C(19)	- C(13)	- C(12)	115.0(3)
C(19)	- C(13)	- C(14)	125.8(4)	C(13)	- C(14)	- C(8)	117.2(4)
C(15)	- C(14)	- C(8)	123.5(4)	C(15)	- C(14)	- C(13)	119.4(4)
C(16)	- C(15)	- C(14)	111.1(4)	C(17)	- C(15)	- C(14)	109.9(3)
C(17)	- C(15)	- C(16)	113.4(5)	C(18)	- C(17)	- C(15)	112.7(4)
C(19)	- C(18)	- C(17)	112.1(4)	C(18)	- C(19)	- C(13)	112.7(3)
C(20)	- C(19)	- C(13)	108.8(4)	C(20)	- C(19)	- C(18)	114.5(4)
C(21)	- C(20)	- C(19)	110.5(4)	C(22)	- C(20)	- C(19)	114.0(4)
C(22)	- C(20)	- C(21)	103.4(3)	O(4)	- C(21)	- O(3)	107.9(4)
C(20)	- C(21)	- O(3)	112.7(4)	C(20)	- C(21)	- O(4)	107.0(4)
C(23)	- C(22)	- C(20)	103.5(4)	C(22)	- C(23)	- O(4)	101.9(4)
C(24)	- C(23)	- O(4)	108.7(4)	C(24)	- C(23)	- C(22)	116.1(4)
C(25)	- C(24)	- C(23)	126.6(5)	C(26)	- C(25)	- C(24)	121.4(5)
C(27)	- C(25)	- C(24)	123.6(5)	C(27)	- C(25)	- C(26)	115.0(5)

Figure 4.13.

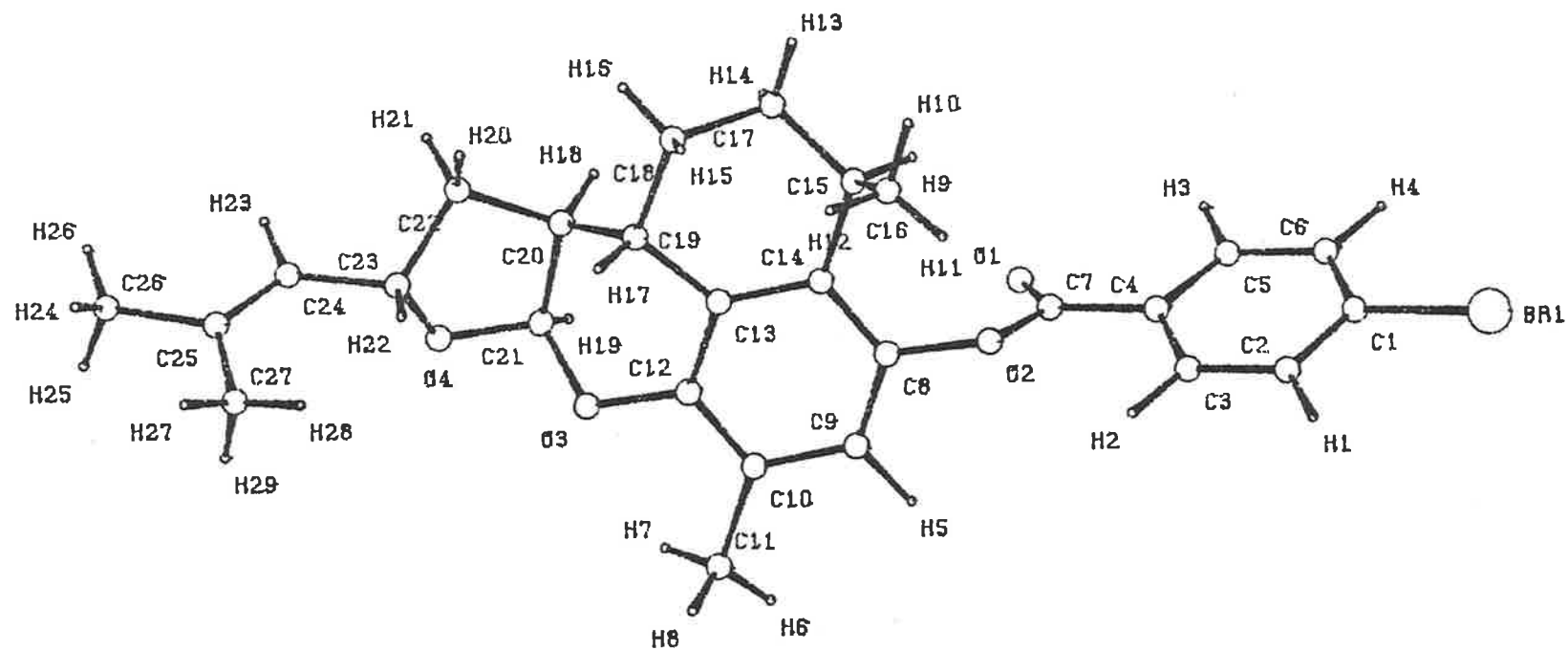

of the molecule showing the absolute configuration and the atomic numbering scheme employed.

A subsequent detailed analysis of the proton-proton couplings of (150a) (Table 4.2) was consistent with the assigned stereochemistry and also permitted the assignment of each proton of the three methylenes to a particular resonance in the ^1H n.m.r. spectrum.

The resonance due to H1 (Table 4.2, Figure 4.1) collapsed on irradiation at the C1-Me resonance to a triplet of 6 Hz coupling. This was consistent with the C1-Me group being axial and H1 equatorial. Consequently, H1 is coupled equally to both the protons $(\text{H2})_2$. The protons associated with the resonances at δ 1.80 ($\text{H2}\alpha$) and 2.20 ($\text{H3}\beta$) were coupled with \underline{J} 11 Hz, a value consistent with axial-axial coupling.⁸⁸ The coupling between $\text{H3}\beta$ (axial) and H4 was 7 Hz, a value which is consistent with a small dihedral angle.⁸⁸ H4 was further coupled to $\text{H3}\alpha$ (equatorial) (J_{ae} 3 Hz) and to H11 (J_{aa} 10 Hz, a value consistent with a 1,2-diaxial type arrangement⁸⁸). H11 was coupled unequally to the $(\text{H12})_2$ methylene protons ($\underline{J}_{11,12\beta}$ 1.2 Hz, dihedral angle is approaching 90° , $\underline{J}_{11,12\alpha}$ 10 Hz).

4.3 The second serrulatane isolated, serrulatenal (158), was inter-related with serrulatenol (150a) in order to confirm the assigned structure and to establish its absolute configuration. The dihydro compound (162) had been previously prepared from (158) by lithium aluminium hydride reduction, acetylation and finally catalytic reduction (Section 4.1). Reduction of the diacetate (155b), obtained from (150a) via catalytic hydrogenolysis, with lithium aluminium hydride followed by acetylation gave (162). It had spectral data $\{^1\text{H}$ n.m.r. (Table 4.6) ^1H n.m.r., and I.R.} and optical rotation ($\{ \alpha \}_{577}^{20} -18^\circ$) identical with those of the sample previously described.

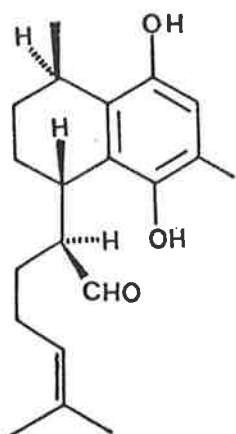

(158)

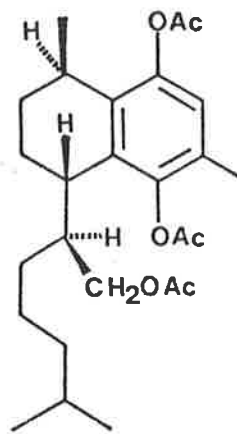

(162)

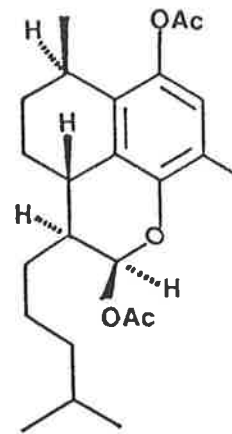

(155b)

It is therefore evident that the serrulatanes (150a) and (158) have the same absolute configuration and it is probable that (158) is in fact a biogenetic precursor of (150a). The serrulatanes isolated from different *Eremophila* species¹¹ have the same absolute configuration at C1, C4 and C11.

CHAPTER V

Sesquiterpenes from *Eremophila rotundifolia*

5.0 The wood of *E. rotundifolia* also yielded a number of interesting sesquiterpenes including freelingyne (2) which had previously only been isolated from *E. freelingii*.³ It was noted during the structural elucidation of freelingyne (2) that the reaction of (2) with refluxing aqueous methanolic sodium hydroxide for 7 h, afforded a rearranged acid for which structure (164a) was tentatively assigned.^{8,9} The reaction of freelingyne (2), isolated from *E. rotundifolia* in the current work, under

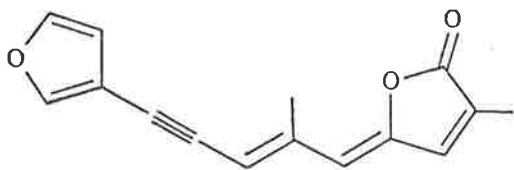

(2)

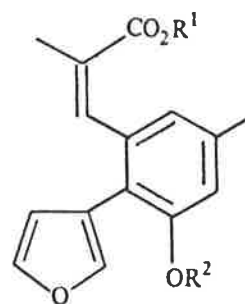

(164a) R¹=R²=H

(164b) R¹=Me, R²=H

milder conditions, aqueous methanolic sodium hydroxide at 20° for 48 h, gave the acid (164a) which was methylated with diazomethane to yield the corresponding methyl ester (164b). Consequently, a detailed structural analysis of (164b) was undertaken.

The molecular formula C₁₆H₁₆O₄ was established for compound (164b) by elemental analysis and high resolution mass measurements. The ¹³C n.m.r.

Figure 5.1. ^1H n.m.r. Spectrum (300 MHz) of the Methyl Ester (164b) in CDCl_3

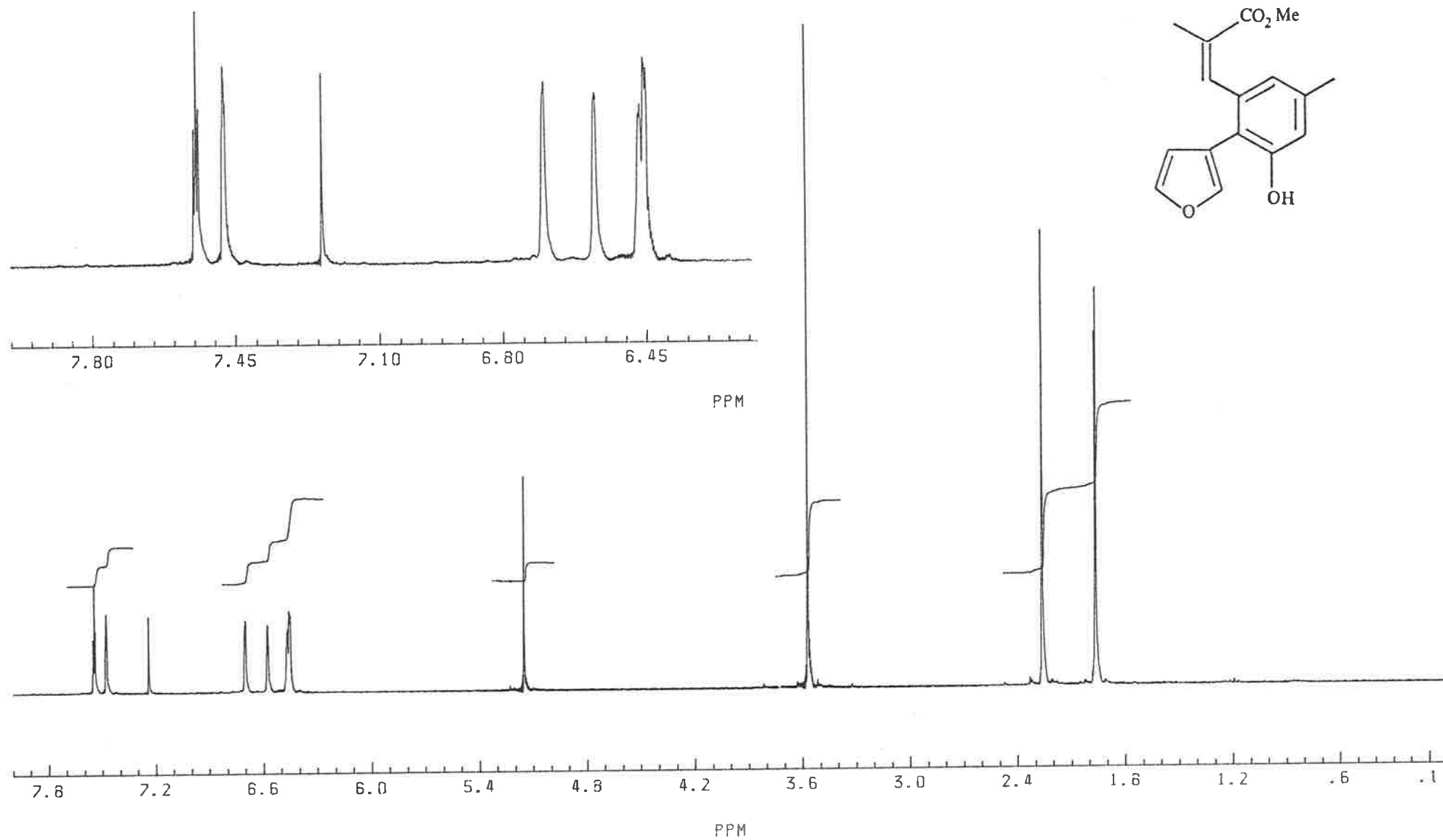

spectrum of (164b) revealed the presence of an ester δ 170.4 (s), a furan ring { δ 143.8 (d), 142.1 (d), 130.2 (s), 112.7 (d)}, a trisubstituted phenol { δ 153.4 (s), 138.6 (s), 137.6 (s), 121.7 (d), 118.8 (s), 115.5 (d)} and an olefin conjugated with both the aromatic ring and the methyl ester { δ 135.8 (d), 114.9 (s)}. Three methyl ^{13}C resonances were also evident at δ 51.6 (methyl ester), 21.3 and 20.8.

The solution infrared spectrum of (164b) revealed a sharp phenolic hydroxyl stretch (3510 cm^{-1}), an unsaturated ester (1700 cm^{-1}) and a furan ring (870 cm^{-1}).

The assigned isoprenoid structure of (164b), and in particular the meta relationship of the two aromatic protons, was confirmed by 300 MHz ^1H n.m.r. (Fig. 5.1). The ^1H n.m.r. spectrum revealed all the proton resonances which were interrelated by double irradiation studies. A doublet resonance at δ 1.96 was assigned as the vinylic methyl group (coupled to the olefinic proton resonance at δ 6.47 with a coupling constant of 1.6 Hz). It is difficult to assign the stereochemistry of the conjugated double bond on the basis of the magnitude of the allylic coupling constant unless both geometric isomers can be compared.⁸⁶ Attempts to isomerize (164a) both photochemically and with iodine proved fruitless.

The singlet resonances at δ 2.26, 3.57 and 5.15 (D_2O exchanged) were assigned to the aromatic methyl, methyl ester and phenolic hydroxyl groups, respectively. The furan proton resonances were clearly evident at δ 7.55 (H5"), 7.48 (H2") and 6.46 (H4"). Broad singlet resonances at δ 6.70 and 6.58 were observed for the meta substituted aromatic protons. Irradiation at δ 2.26 (aromatic methyl resonance) simplified both the broad singlets to an AB quartet. The A and B resonances were mutually coupled with a coupling constant of 1.5 Hz, where literature values of 1-3 Hz have been reported for meta proton couplings.^{86, 88}

Scheme 5.1. Hydrolysis of Freelingyne (2) with Sodium Hydroxide

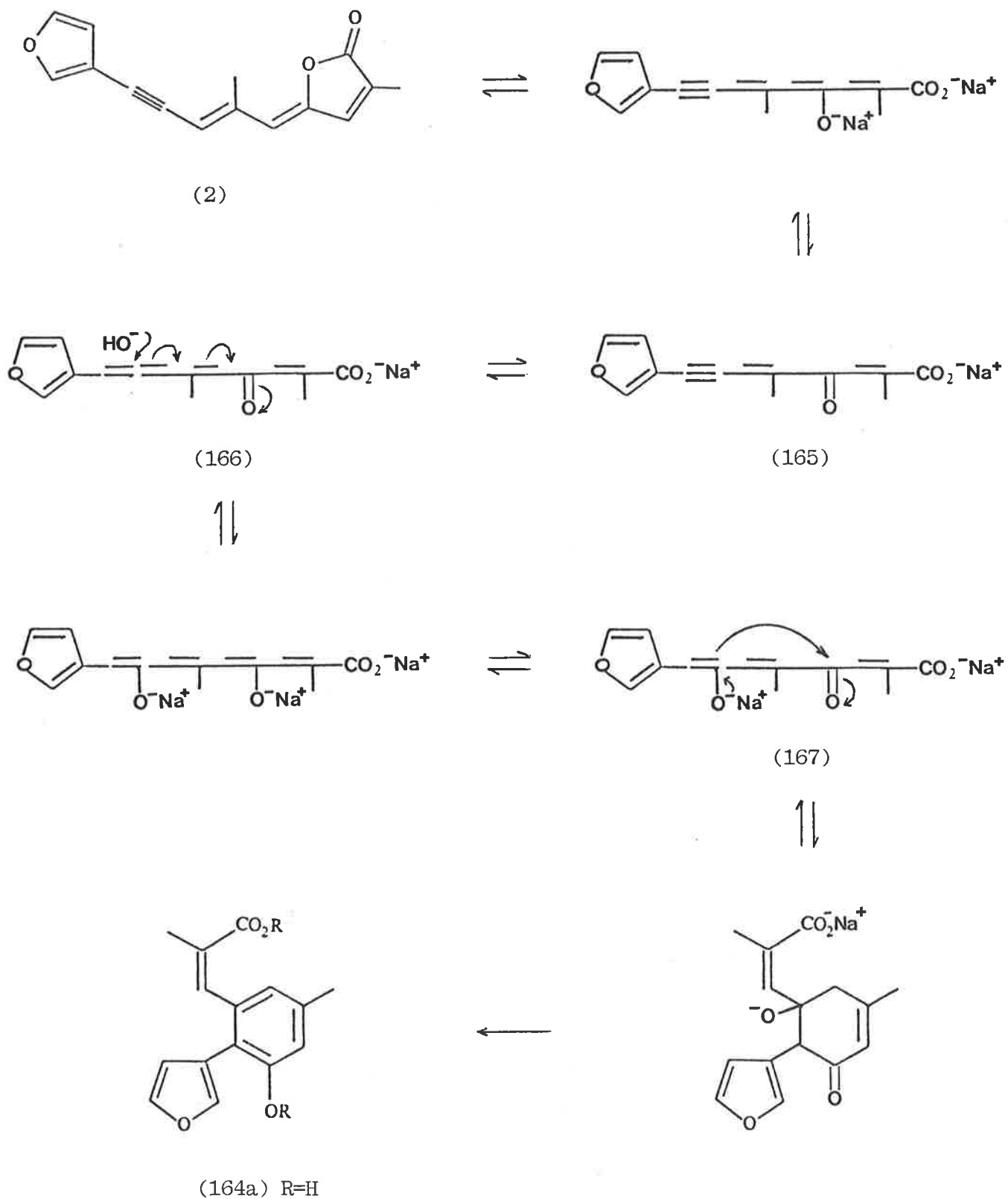

A possible mechanism for the formation of (164a) from freelingyne (2) is outlined in Scheme 5.1. The lactone moiety of freelingyne would readily hydrolyse under the conditions to yield an intermediate keto-acid (165). Isomerism of the keto-acid (165) would yield allene (166) which would undergo further nucleophilic attack by hydroxyl ion as indicated. Subsequent enolate protonation, cyclization and dehydration would yield the acid (164a). The stereochemistry of the conjugated double bond in (164a) has been drawn as in freelingyne (2), however, it is plausible that isomerization has occurred.

5.1 Dione (168), an eremophilane sesquiterpene, was isolated from the wood of *E. rotundifolia*. In recent years many sesquiterpenes possessing the nonisoprenoid decalin nucleus of eremophilone have been isolated.⁹⁰ The eremophilanes, e.g. eremophilone (1a),^{2a} are distinguished from the valencanes, e.g. valencene (169),⁹² by the all *cis* relative stereochemistry of the two methyl substituents and the isopropenyl group.⁹³

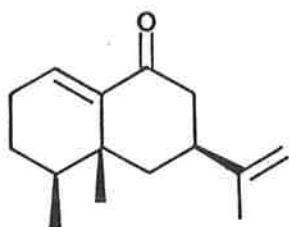

(1a)

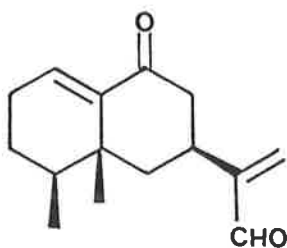

(168)

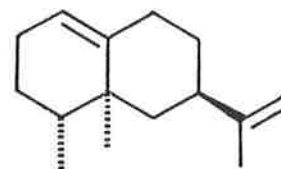

(169)

Eremophilone (1a) was first isolated in 1932 from the wood of *E. mitchelli*,⁹¹ which until now was the only *Eremophila* species to yield eremophilane sesquiterpenes. After considerable deliberation, the correct

structure for eremophilone (1a) was proposed⁹⁴ and subsequently validated in the decades to follow.⁹⁵ In 1959 the relative and absolute configuration of eremophilone (1a) was determined.⁹⁶ In addition to the interesting biogenetic and stereochemical aspects the eremophilane-valencane sesquiterpenes have also been of considerable interest to the synthetic chemist with a number of syntheses of eremophilone (1a) having been reported.⁹⁷

The structure of dione (168) was established by spectroscopic methods and via an interrelation with eremophilone (1a) of known absolute configuration. The ¹H n.m.r. (Fig. 5.2 and Table 5.1) and ¹³C n.m.r. (Table 5.1) spectra are consistent with the assigned structure. ¹³C resonances at δ 194.0 (d), 144.4 (s) and 133.8 (t) suggested the presence of an α,β -unsaturated aldehyde carrying two protons on the carbon β to the aldehyde group. ¹H resonances at δ 9.48 (1H,s), 6.01, 6.21 (each, 1H, s) were consistent with the α,β -unsaturated aldehyde. The ¹³C n.m.r. spectrum of (168) also revealed the presence of an α,β -unsaturated ketone with resonances at δ 203.2 (s), 152.8 (s), 135.9 (d). Again, this was confirmed by the apparent triplet proton resonance at δ 6.50 (X part of an A₂X system). The infrared spectrum of (168) confirmed the presence of the α,β -unsaturated aldehyde and ketone functionalities with stretches at 1685 and 1620 cm⁻¹. The high field ¹³C resonance at δ 36.3 (s) was assigned as the tetra-substituted ring junction carbon C5.

The 300 MHz ¹H n.m.r. spectrum of dione (168) (Fig. 5.2 and Table 5.1) supported the above structural assignments and, in addition, revealed the presence of two methyl groups with resonances at δ 0.86 (3H, d) and 0.88 (3H, s). A number of the ¹H resonances of (168) were interrelated by double resonance studies.

Figure 5.2. ^1H n.m.r. Spectrum (300 MHz) of the Dione (168) in CDCl_3

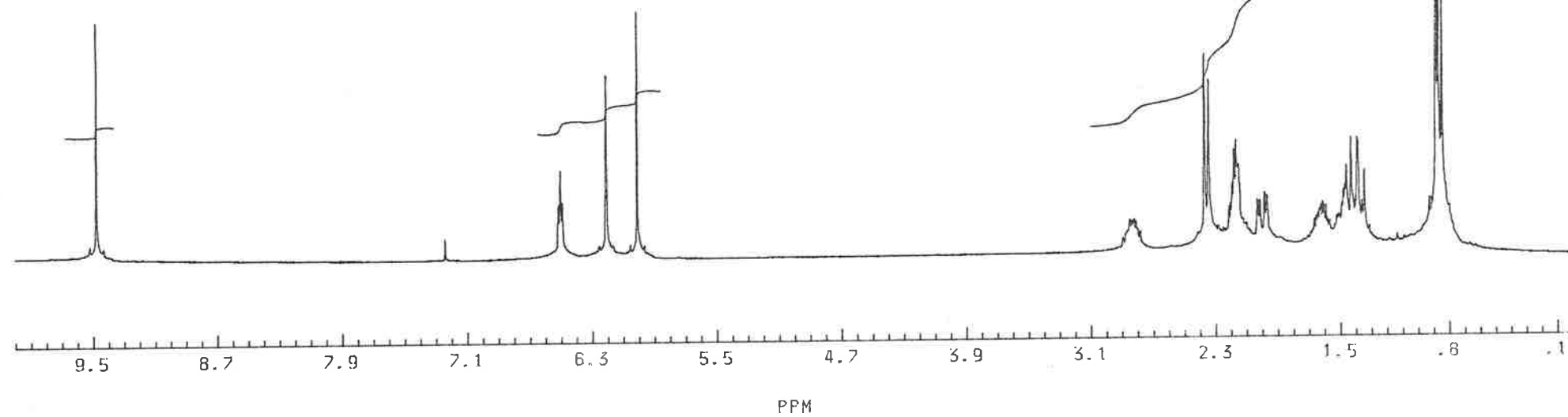
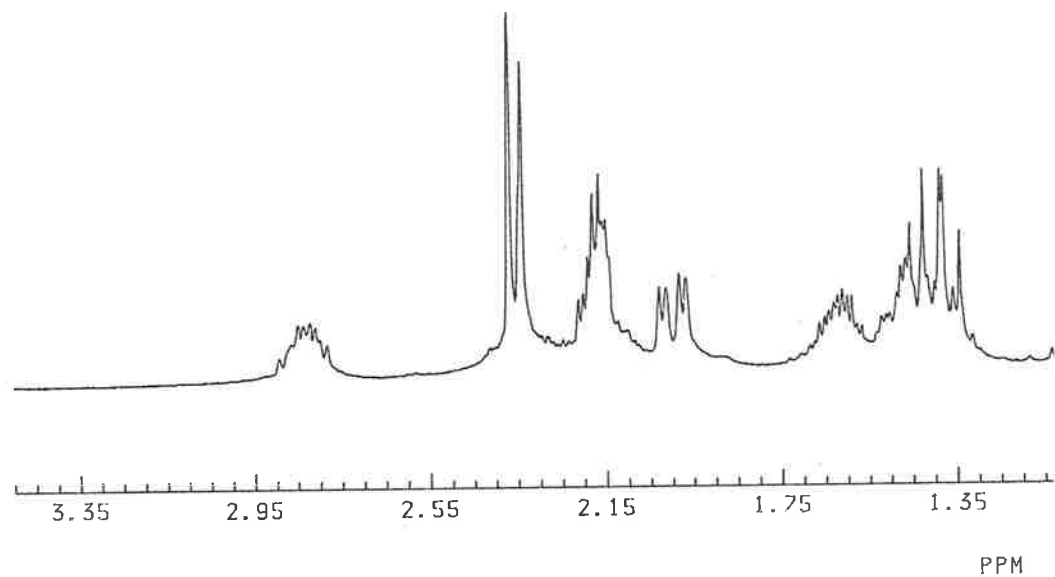
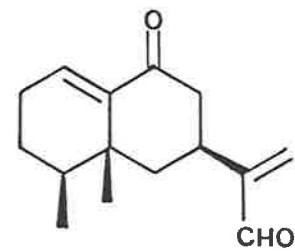
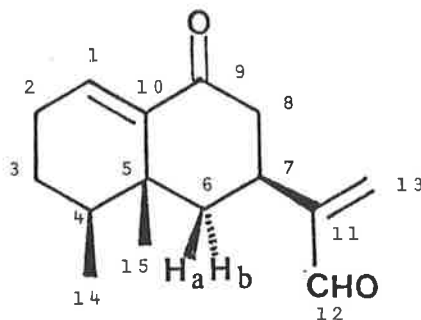

Table 5.1. ^1H n.m.r. (300 MHz) and ^{13}C n.m.r. (20.1 MHz) Chemical Shifts of Dione (168) (CDCl_3) in p.p.m. rel. to TMS



C-Number		^1H n.m.r. ^c	^{13}C n.m.r.
1		6.50 (1H, t, \underline{J} 3.9 Hz)	135.9 (d)
2		2.17 (2H, m)	41.5 (t) ^a
3		1.42 (2H, m)	25.6 (t) ^b
4		1.62 (1H, m)	30.7 (d)
5			36.3 (s)
6 ^d	Ha	2.00 (1H, dd, \underline{J} 4.9, 13.7 Hz)	26.5 (t) ^b
	Hb	1.42 (1H, m)	
7 ^d		2.83 (1H, m)	38.3 (d)
8		2.35 (2H, d, \underline{J} 8.8 Hz)	42.8 (t) ^a
9			203.2 (s)
10			152.8 (s)
11			144.4 (s)
12		9.48 (1H, s)	194.0 (d)
13		6.01, 6.21 (each 1H, s)	133.8 (t)
14		0.86 (3H, d, \underline{J} 6.3 Hz)	16.0 (q)
15		0.88 (3H, s)	25.0 (q)

a, b Similar values may be inverted

c Chemical shift values represent the centre of each resonance.

d (H6)₂ and H7 can be considered as an AMX spin system.

Irradiation of the one-proton multiplet centred at δ 2.83 (H7) resulted in the simplification of a number of other resonances. The apparent two-proton doublet centred at δ 2.35, assigned to (H8)₂, collapsed to a singlet thus confirming (H8)₂ as the A₂ part of an A₂X system. Similarly, the (H6)₂ methylene resonances centred at δ 2.00 and 1.42 collapsed to an AB quartet (δ_A 2.01, δ_B 1.40, J_{AB} 14.7 Hz). Irradiation of the one-proton multiplet at δ 1.62 (H4) resulted in the collapse of the methyl doublet at δ 0.86 to a singlet.

An analysis of the proton-proton couplings of (168) supported the proposed structure and revealed an interesting inherent conformational feature of the molecule. Firstly, the one-proton apparent triplet resonance at δ 6.50 (H1) was coupled to the methylene protons (H2)₂ with a coupling constant of 3.9 Hz* (A₂X system), a value which is consistent with the six-membered ring system.⁸⁸

The *cis* relationship between the three alkyl groups of the eremophilanes forces the system either to have the methyl and isopropenyl groups on the cyclohexanone ring 1,3 diaxial or to distort the cyclohexanone ring toward a boat conformation. With dione (168), at least, the former would appear to be the favoured conformation as vindicated by the appearance of the two methylene protons (H8)₂ as a doublet (A₂ part of an A₂X system). In the all chair form, H7 is equatorial and hence would be coupled to both (H8)₂ methylene protons equally, as was the observed case. If on the other hand the isopropenyl group was equatorial, then each methylene proton (H8)₂ would be unequally coupled to H7.

The retro-Diels-Alder fragmentation observed in the mass spectrum of dione (168) (M-C₃H₆, base peak) confirmed the positions of the ring double bond and the two methyl groups.

* Coupling constant is based on first order analysis.

Table 5.2. ^1H n.m.r. (80 MHz) Chemical Shifts of (170a) (170b) and (171) (CDCl_3) in p.p.m. rel. to TMS

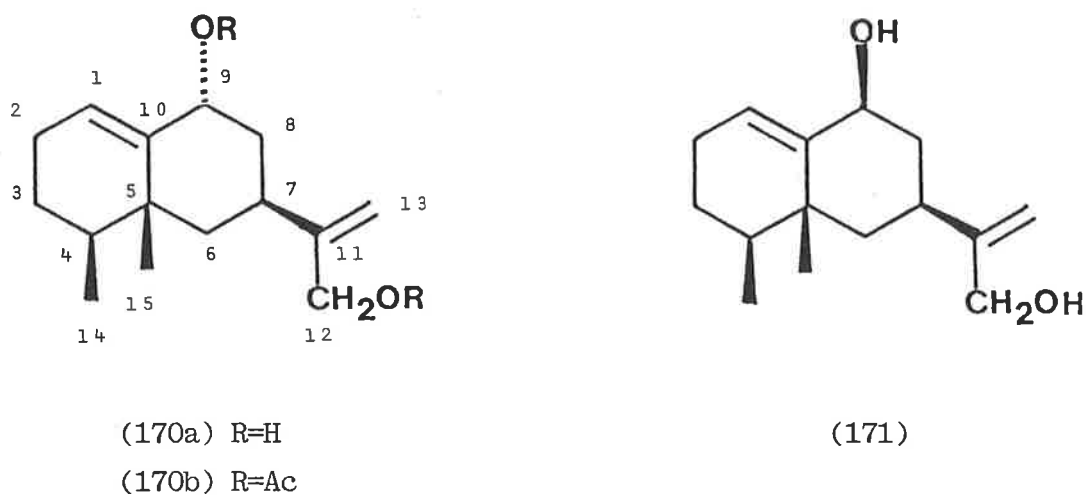

Proton	(170a)	(170b)	(171)
H1	5.70 (bs)	5.55 (bs)	5.64 (t, \underline{J} 3.4 Hz) ^d
(H2) ₂	a	b	c
(H3) ₂	a	b	c
H4	a	b	c
(H6) ₂	a	b	c
(H7)	a	b	c
(H8) ₂	a	b	c
(H9)	4.50 (b)	5.45 (b)	4.34 (dd, \underline{J} 3.9, 7.6 Hz) ^d
(H12) ₂	4.08 (s)	4.50 (s)	4.08 (s)
(H13) ₂	4.92, 5.03 (2xs)	5.00, 5.02 (2xs)	4.91, 5.01 (2xs)
(H14) ₃	0.84 (d)	0.85 (d)	0.85 (d, \underline{J} 4.9 Hz)
(H15) ₃	0.88 (s)	0.88 (s)	1.09 (s)
OCOMe		2.01, 2.03 (2xs)	

a, b, c Overlapping resonances

d 1st Order analysis.

Table 5.3. ^{13}C n.m.r. (20.1 MHz) Chemical Shifts of (170a), (170b) and (171) (CDCl_3) in p.p.m. rel. to TMS

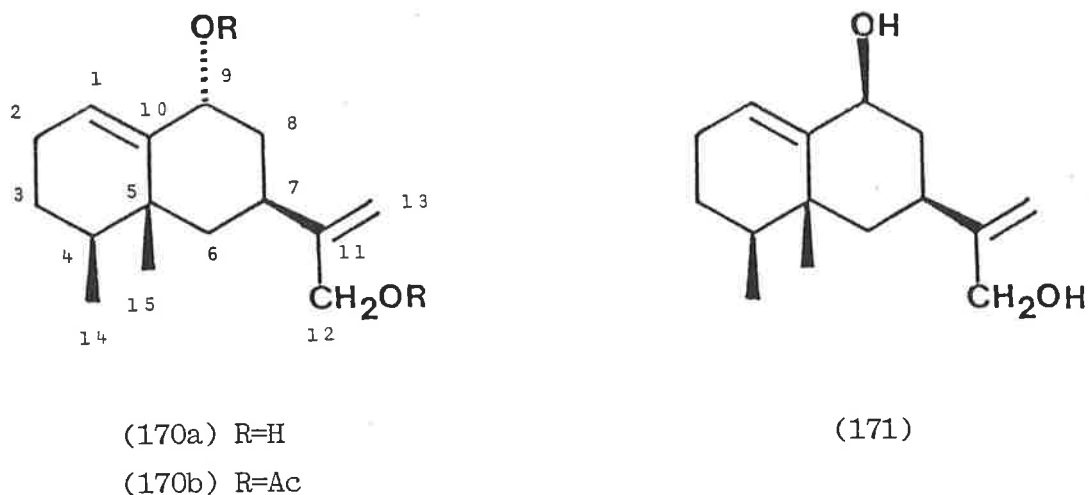

C-Number	(170a)	(170b)	(171)
1	117.1 (d)	118.0 (d)	127.5 (d)
2	37.0 (t) ^a	37.0 (t) ^a	37.5 (t) ^a
3	27.1 (t) ^b	26.8 (t) ^b	27.0 (t) ^b
4	34.2 (d)	34.6 (d)	34.3 (d)
5	38.1 (s)	37.5 (s)	37.2 (s)
6	25.0 (t) ^b	25.1 (t) ^b	25.6 (t) ^b
7	39.1 (d)	38.3 (d)	38.6 (d)
8	40.7 (t) ^a	39.2 (t) ^a	40.5 (t) ^a
9	66.9 (d)	69.2 (d)	c
10	152.9 (s)	146.9 (s)	c
11	146.4 (s)	141.4 (s)	c
12	65.4 (t)	66.6 (t)	65.4 (t)
13	108.4 (t)	112.1 (t)	108.8 (t)
14	16.2 (q)	16.2 (q)	15.8 (q)
15	21.0 (q)	20.6 (q)	23.8 (q)
OCOMe		170.4, 172.0 (2xs)	
OCOMe		21.1, 21.4 (2xq)	

a, b Values in the same column may be interchanged.

c Not observed.

Dione (168) was reduced with sodium borohydride in the presence of cerium trichloride⁹⁸ to yield two separable epimeric diols (170a) and (171). The major diol (170a) readily formed a diacetate (170b) which gave a characteristic downfield shift for the H9 and (H12)₂ resonances (Table 5.2). ¹³C resonances at δ 65.4 (t) and 66.9 (d) for diol (170a) were assigned to the carbons of a primary and secondary allylic alcohol, respectively (Table 5.3). Accordingly, the ¹³C resonances at δ 194.0 (d) and 203.2 (s) associated with dione (168) are missing. Similar shifts were observed for the minor diol (171).

A number of the proton resonances of the major diol (170a) were interrelated by double resonance studies. For example, irradiation of the proton resonance at δ 4.50 (H9) simplified the broad resonance at δ 5.70 to an apparent triplet (X part of an A₂X system). This evidence suggested that H9 and H1 were allylically coupled. No such allylic coupling was evident for the minor diol (171) where H1 appeared as an apparent triplet resonance (X part of an A₂X system) (J 3.4 Hz).

Allylic coupling has been found to be dependent on the dihedral angle σ between C-H_a and C-H_c (Fig. 5.3).^{99,100,101} J_{ac} is a maximum value* when σ approaches 90°. In many cases the allylic coupling causes broadening rather than the expected secondary coupling.¹⁰¹ For example,

Figure 5.3

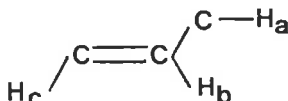

*Maximum value denotes absolute magnitude. Allylic coupling constants are generally negative.¹⁰⁰

it was found that the vinylic proton H6 in (172) gave a broader doublet than in (173), presumably due to additional coupling with H4^{101,102}

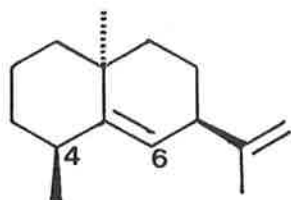

(172)

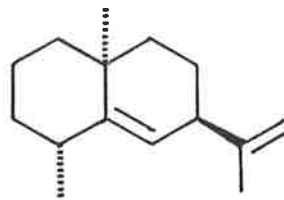

(173)

{ $\sigma \approx 90^\circ$ for (172), $\sigma \approx 0^\circ$ for (173)}. A similar steric restriction on allylic coupling has been observed in a series of 6-substituted cholest-4-en-3-ones¹⁰³ and in numerous other complex natural products.¹⁰¹

Only the major diol (170a) gave significant allylic coupling between H1 and H9, as indicated by the broadening of the resonance for H1. On the basis of the above examples a tentative assignment of the configuration of (170a) was made where H9 is axial and the 9-hydroxyl group is equatorial. The configuration assigned to the major diol (170a) infers that the reduction of the α,β -unsaturated ketone must have occurred via an intramolecular transfer of hydride from the sterically hindered β face. The H9 resonance observed for the minor allylic alcohol (171) appeared as a doublet of doublets rather than a triplet which infers that the ring system is distorted from the all chair form.

Dione (168) was interrelated with two known sesquiterpenes, eremophilone (1a)^{2a} and eremophilene (174)¹⁰⁴, in order to confirm the assigned structure and establish the absolute configuration. The interrelation excluded the possibility of (168) possessing the valencane skeleton, e.g. valencene (169)⁹².

It was anticipated that the reduction of the diacetate (170b) with lithium in ammonia would yield eremophilene (174), based on the known reduction of 11,12-dihydroeremophilan-9-yl acetate (175) to the corresponding

hydrocarbon (176)¹⁰⁵ The reduction, however, gave mainly the allylic alcohol (177) in addition to an inseparable mixture of eremophilene (174) and its isomer (178). The ¹H n.m.r. spectrum of the mixture of (174) and (178) was consistent with that reported for eremophilene (174)^{104c},

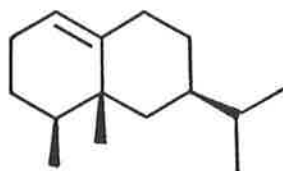

(176)

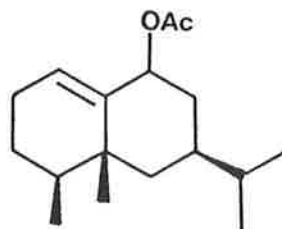

(175)

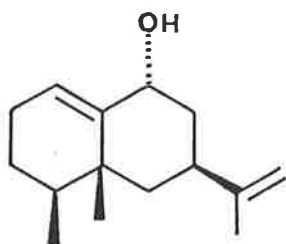

(177)

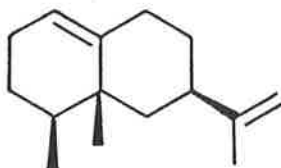

(174)

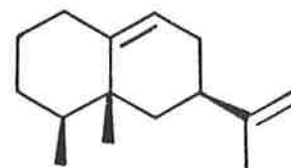

(178)

however, the ¹³C n.m.r. spectrum clearly revealed the presence of both isomers. The ¹³C n.m.r. resonances reported for eremophilene (174)¹⁰⁶ were evident in the mixture.

Oxidation of the allylic alcohol (177)^{97a} with Collins reagent¹⁰⁷ gave eremophilone (1a) which gave an optical rotation^{2a} and ¹H n.m.r. spectrum¹⁰⁸ identical with those of the naturally isolated material. The isolation of dione (168) from *E. rotundifolia* provides only the second example of an *Eremophila* species yielding an eremophilane sesquiterpene. Until now, eremophilanes had only been isolated from *E. mitchelli*.

EXPERIMENTAL

GENERAL

Melting points were determined using a Kofler hot-stage melting point apparatus under a Reichert microscope and are uncorrected.

Microanalyses were performed by the Australian Microanalytical Service, Melbourne.

Infrared spectra were recorded either on a Jasco IRA-1 or Jasco A-102 infrared spectrophotometer. The 1603 cm^{-1} band of polystyrene was used as a reference. Chloroform was used as the solvent for solution infrared samples.

Ultraviolet spectra were recorded on a Pye-Unicam SP8-100 ultraviolet spectrophotometer.

Optical rotations were determined on a Perkin-Elmer 141 MC polarimeter.

Mass spectra were recorded on either a Hitachi Perkin-Elmer RMU-7D double focussing mass spectrometer or an AEI MS-30 mass spectrometer. The mass spectra of gas-liquid chromatography elutants were recorded on an AEI MS-30 mass spectrometer coupled to a Pye-Unicam 104 gas chromatograph.

Analytical gas-liquid chromatography (g.l.c.) was carried out on a Perkin-Elmer Sigma 3B gas chromatograph. Nitrogen carrier gas was used for all the g.l.c. work. The Perkin-Elmer Sigma 3B gas chromatograph was equipped with a flame ionization detector and was coupled to a Perkin-Elmer M-2 printing integrator. The following columns were used:

- A. 5% OV17 on Varaport (80/100), 4.5 m x 8 mm, glass.
- B. 2% carbowax 20M on Varaport (30), 1.5 m x 8 mm, glass.
- C. 5% carbowax 20M on Varaport (30), 1.5 m x 4 mm, glass.

The carrier gas flow rate was 40 ml/min for columns A and C and 25 ml/min for column B.

^1H nuclear magnetic resonance (n.m.r.) spectra were recorded on either a Varian T60 spectrometer operating at 60 MHz, a Jeol HNM-PMX60 spectrometer operating at 60 MHz, a Bruker WP 80 DS Fourier Transform spectrometer operating at 80 MHz, or a Bruker CXP 300 Fourier Transform spectrometer operating at 300.13 MHz. The ^1H n.m.r. spectra were recorded at 60 MHz unless otherwise indicated. The ^{13}C n.m.r. spectra were recorded on a Bruker WP 80 DS Fourier Transform spectrometer operating at 20.1 MHz. Chemical shifts are in p.p.m. downfield from the internal standard, tetramethylsilane; multiplicities are abbreviated to: s, singlet; d, doublet; t, triplet; q, quartet; quin., quintet; sex., sextet; m, multiplet; b, broad; D_2O exchange implies that the signal exchanges on the addition of D_2O to the sample.

2-D correlation spectra were recorded on either a Bruker CXP 300 Fourier Transform spectrometer using DISCXP version 820601.1, or a Bruker WM 250 Fourier Transform spectrometer.

All preparative thin layer chromatography (t.l.c.) plates were prepared from 50% Merck Kieselgel G and 50% HF254 applied to glass plates as a suspension in water. Flash chromatography¹⁰⁹ refers to nitrogen pressure driven rapid chromatography using Merck Kieselgel 60 (230-400 mesh ASTM).

Light petroleum refers to the hydrocarbon fraction b.p. 60-70 $^{\circ}$. Magnesium sulphate (anhydrous) was used as the drying agent for non aqueous solutions. All solvents and chemicals were purified by standard procedures¹¹⁰. Lithium aluminium hydride reductions were worked up according to the method of D.A. Evans *et al*¹¹¹ unless otherwise stated.

Work Described in Chapter 1

Part 1.1

Catalytic Osmium Tetroxide Oxidation of Ereboacetal (6)

Ereboacetal (6) (5g) was oxidized with osmium tetroxide (25mg) as described¹⁹ to yield the crude mixture of partly crystalline epimeric diols. Crystallisation from dichloromethane/hexane gave major diol (21) (3.50g, 62%), m.p. 115-116^o (lit.¹⁹ 117-118^o).

The mother liquor from the crystallisation was a mixture of major diol (21) and minor diol (22) (1.78g, 31%).

Preparation of Tetrahydrofuran (25a) from Hydroxy Acetal (21)

The diol (21) (8g) was hydrolysed in methanol/dilute oxalic acid (5% aqueous) (1:1) as described^{7,18} to yield (2''S,4''S,5''S)-1-(furan-3'-yl)-4''-hydroxy-3-{5''-(1'''-hydroxy-1'''-methylethyl)-2''-methyltetrahydrofuran-2''-yl}propan-1-one (25a) (6.76g, 90%), m.p. 74-75^o (lit.¹⁸ 74-75^o).

Conversion of Diol (25a) to the Lactone (29)

1. The diol (25a) (4.0g, 14.2 mmole) was acetylated with acetic anhydride (10 ml) in pyridine (20 ml) at 20^o for 18 h. Dichloromethane (50 ml) was added and the solution was washed with dilute hydrochloric acid (10% aqueous, 3 times) dilute sodium hydroxide (10% aqueous) and water. The solution was dried, evaporated under reduced pressure and the residue chromatographed on silica gel (dichloromethane/ether 4:1). (2S,3S,5S)-5-{3'-(Furan-3'-yl)-3'-oxopropyl}-2-(1''-hydroxy-1''-methylethyl)-5-methyltetrahydrofuran-3-yl acetate (25b) was recrystallised from chloroform/light petroleum to yield colourless crystals, m.p. 67.5-68.5^o. (Found: C, 62.9; H, 7.5. C₁H₂₄O₆ requires C, 63.0; H, 7.5%). ν_{\max} (Nujol) 3500, 1730, 1670 cm⁻¹.

^1H n.m.r. δ (CDCl_3) 1.15, 6H, s, 1'''-Me, ($\text{H}2'''$)₃; 1.25, 3H, s, 5-Me; 2.05, 3H, s, OCOMe; 2.90, 2H, m, ($\text{H}2'$)₂; 3.73, 1H, d, \underline{J} 4 Hz, H2; 5.20, 1H, m, H3; 6.70, 1H, m, H4''; 7.35, 1H, m, H5''; 7.93, 1H, m, H2''.

2. The acetate (25b) (400 mg) was dissolved in pyridine (3 ml) and cooled to 0°. Phosphorus oxychloride (0.8 ml) was added dropwise with stirring. After 30 min the mixture was warmed to 50° and maintained at this temperature for 3 h with stirring. The reaction was quenched with ice and extracted with dichloromethane. The organic phase was washed with water, dried and evaporated under reduced pressure to yield a pale yellow oil (312 mg, 85%). The ^1H n.m.r. spectrum revealed a mixture of enol ether (31) and alkene (32) in a ratio of 3:1.

Dehydration of acetate (25b) with thionyl chloride in pyridine at 0° for 10 min gave (31) and (32) in a ratio of 1:1.

3. The crude mixture of (31) and (32) (312 mg) was dissolved in methanol (10 ml) containing dimethyl sulphide (2 ml) at -78°. One molar equivalent {based on enol ether (31)} of ozone was bubbled through the solution. The reaction mixture was stirred for 1 h at -78° then at 0° for 1 h and finally at 25° for 18 h (under nitrogen). Water (30 ml) was added and the solution was extracted with dichloromethane (3 x 10 ml), dried and evaporated under reduced pressure. The yellow oil, on preparative t.l.c. (ether/light petroleum, 4:1), yielded (3S,5S)-3-acetoxy-5-{3'-(furan-3''-yl)-3'-oxopropyl}-5-methyldihydrofuran-2(3H)-one (29) (195 mg, 56%), m.p. 75-76° from ether/light petroleum. (Found: C, 60.1; H, 5.8. $\text{C}_{14}\text{H}_{16}\text{O}_6$ requires C, 60.0; H, 5.8%). ν_{max} (Nujol) 3160, 3140, 1780, 1740, 1690, 1560, 1510, 1210, 870 cm^{-1} . ^1H n.m.r. δ (CDCl_3) 1.50, 3H, s, 5-Me; 2.15, 3H, s, OCOMe; 2.90, 2H, m, ($\text{H}2'$)₂; 5.50, 1H, t, \underline{J} 8 Hz, H3; 6.70, 1H, m, H4''; 7.40, 1H, m, H5''; 7.96, 1H, m, H2''. ^{13}C n.m.r. δ (CDCl_3) 25.1 (q), 26.6 (q), 34.3 (t), 34.6 (t), 40.6 (t), 69.1 (d), 83.9 (s), 108.7 (d), 127.5 (s), 144.7 (d), 147.6 (d), 169.9 (s), 176.6 (s), 193.4 (s).

The lower R_f fraction was (2R,3S,5S)-5-{3'-(furan-3'-yl)-3'-oxopropyl}-2-isopropenyl-5-methyltetrahydrofuran-3-yl acetate (32) (80 mg, 22%), m.p. 36-40^o. ν_{\max} (Nujol) 3160, 3120, 3080, 1740, 1670, 1610, 1570, 1520, 1240, 880 cm^{-1} . ^1H n.m.r. δ (CDCl_3) 1.33, 3H, s, 5-Me; 1.73, 3H, s, Me; 2.03, 3H, s, OCOMe; 2.86, 2H, m, (H2')₂; 4.30, 1H, d, J 5 Hz, H2; 5.00, 3H, m, =CH₂, H3; 6.66, 1H, m, H4''; 7.30, 1H, m, H5''; 7.90, 1H, m, H2''. This by-product was not characterised further.

Preparation of Lactone (30b) from Aldehyde (33)

1. Aldehyde (33) was prepared from diol (21) by the literature method¹⁹ (80%), b.p. 112^o/0.1 mm (lit.¹⁹ 110^o/0.1 mm).
2. The aldehyde (33) (1.5g, 6.76 mmol) was oxidized²⁸ by adding a solution of sodium hydroxide (1.13 g) in water (50 ml) dropwise over 1.5 h to a rapidly stirred solution of the aldehyde and silver nitrate (1.15 g, 6.79 mmol) in methanol/water (2:1, 50 ml). Stirring was continued for a further 2 h after which the mixture was filtered through celite and the filtrate concentrated under reduced pressure. The residue was cooled and acidified with dilute hydrochloric acid (10% aqueous) to pH 2-3. The aqueous phase was saturated with salt, extracted with dichloromethane (3 x 20 ml), the extract dried and concentrated under reduced pressure to yield a brown oil which was allowed to stand at 20^o for 3 days. Flash chromatography with ether/light petroleum (9:1) gave (3S,5R)-5-{3'-(furan-3'-yl)-3'-oxopropyl}-3-hydroxy-5-methyldihydrofuran-2(3H)-one (30a) (490 mg, 31%), m.p. 101-102.5^o (lit.¹⁷ 101-102.5^o).

Acetylation with acetic anhydride in pyridine, followed by crystallisation of the product from ether/light petroleum gave (3S,5R)-3-acetoxy-5-{3'-(furan-3'-yl)-3'-oxopropyl}-5-methyldihydrofuran-2(3H)-one (30b), m.p. 75.5-76^o {m.m.p. with (29) depressed}. (Found: C, 60.2; H, 6.0. $\text{C}_{14}\text{H}_{16}\text{O}_6$

requires C, 60.0; H, 5.8%). ν_{\max} (Nujol) 3160, 3140, 1795, 1745, 1660, 1560, 1520, 875 cm^{-1} . ^1H n.m.r. δ (CDCl_3) 1.40, 3H, s, 5-Me; 2.10, 3H, s, OCOMe; 2.90, 2H, m, $(\text{H}2')$ ₂; 5.48, 1H, t, \underline{J} 8 Hz, H3; 6.70, 1H, m, H4''; 7.35, 1H, m, H5''; 7.98, 1H, m, H2''. ^{13}C n.m.r. δ (CDCl_3) 20.5 (q), 25.9 (q), 34.4 (t), 35.0 (t), 39.8 (t), 69.0 (d), 83.6 (s), 108.7 (d), 127.5 (s), 144.7 (d), 147.7 (d), 170.0 (s), 174.2 (s), 193.6 (s).

Preparation of Diacetate (38b) from the Lactone (30b)

1. A solution of the lactone (30b) (550 mg, 2.30 mmol) and propane-1,3-dithiol (250 mg, 2.31 mmol) in dichloromethane (10 ml) was stirred and cooled to 0°. Boron trifluoride etherate (10 drops) was added and the solution was allowed to warm to room temperature. After stirring for 12 h dichloromethane (20 ml) was added and the solution was washed with water, sodium hydroxide solution (10%) and water. After drying, concentration gave the thioacetal as a yellow oil (780 mg, 92%). ^1H n.m.r. δ (CDCl_3) 1.30, 3H, s, 5-Me; 2.90, 4H, m, S-CH₂-; 4.50, 1H, t, \underline{J} 9 Hz, H3; 6.33, 1H, m, H4''; 7.26, 1H, m, H5''; 7.36, 1H, m, H2''.

The crude thioacetal (780 mg) was reduced with an excess of lithium aluminium hydride (100 mg) in tetrahydrofuran (5 ml) at 25° for 0.5 h. Work-up with saturated sodium sulphate gave a yellow oil which on preparative t.l.c. (ethyl acetate/light petroleum, 7:3) gave, as the higher R_f fraction, (2S,4R)-7-(furan-3'-yl)-4-methyl-7,7-(propylenedithio)heptane-1,2,4-triol (38a) as a colourless oil (139 mg, 18%). ^1H n.m.r. δ (CDCl_3) 1.13, 3H, s, 4-Me; 2.85, 4H, m, S-CH₂-; 3.10, 2H, m, $(\text{H}1)$ ₂; 4.05, 1H, m, H2; 6.40, 1H, m, H4'; 7.33, 1H, m, H5'; 7.45, 1H, m, H2'. The lower R_f fraction was a mixture of epimeric hemiacetals (42a) and (43a) (555 mg, 58%). Further reduction of (42a) and (43a) with lithium aluminium hydride gave triol (38a).

2. Triol (38a) (100 mg, 0.3 mmole) was acetylated with acetic anhydride in pyridine at 20° for 18 h. Isolation and preparative t.l.c. (ethyl acetate/light petroleum 2:3) gave (2S,4R)-2-acetoxy-7-(furan-3'-yl)-4-hydroxy-4-methyl-7,7-(propylenedithio)hept-1-yl acetate (38b) as a colourless oil (105 mg, 84%). (Found: $\underline{m/z}$ 416.1312. $C_{19}H_{28}O_6S_2$ requires 416.1327). $[\alpha]_{577.3}^{20} +4.6^\circ$; $[\alpha]_{546.4}^{20} +5.4^\circ$ (0.725% in $CHCl_3$). ν_{max} (film) 3520, 1745, 1735, 1370, 1220, 870 cm^{-1} . 1H n.m.r. δ ($CDCl_3$) 1.26, 3H, s, 4-Me; 2.01, 2.03, each 3H, s, OCOme; 2.80, 4H, m, S-CH₂-; 4.20, 2H, m, (H1)₂; 5.18, 1H, m, H2; 6.36, 1H, m, H4'; 7.26, 1H, m, H5'; 7.36, 1H, m, H2'. $\underline{m/z}$ 417 (M+1), 416 (M), 310, 309, 189, 185, 95, 83, 43 (100).

Preparation of Diacetate (41c) from Alcohol (40a)

The alcohol (40a) (500 mg, 2.24 mmole), prepared by the literature method from aldehyde (33),⁹ was acetylated with acetic anhydride in pyridine to give the crude acetate (40b) which crystallised with difficulty from chloroform/light petroleum, m.p. 80-85°. ν_{max} (Nujol) 3160, 3130, 1730, 1600, 1500 cm^{-1} . 1H n.m.r. δ ($CDCl_3$) 1.40, 3H, s, 5-Me; 2.03, 3H, s, OCOme; 4.10, 3H, m, H3, CH₂OAc; 6.36, 1H, m, H4'; 7.25, 1H, m, H5'; 7.40, 1H, m, H2'. $\underline{m/z}$ 266 (M), 207, 193, 95, 79, 43 (100). The acetate (40b) (450 mg) was dissolved in pyridine (10 ml) and water (10 ml) and the solution was stirred at 70° under nitrogen for 18 h. Dichloromethane (30 ml) was added. The organic phase was separated, dried and evaporated under reduced pressure to yield a yellow oil (450 mg). 1H n.m.r. spectroscopy revealed the presence of acetate (40b) (55%) and acyclic monoacetate (41b) (45%), δ ($CDCl_3$) 1.23, 3H, s, 4-Me; 6.70, 1H, m, H4'; 8.00, 1H, m, H2'. The mixture was acetylated with acetic anhydride in pyridine at 20° for 18 h to yield an oil. Flash chromatography (ethyl acetate/light petroleum, 1:1)

gave acetate (40b) (288 mg, 64% recovery), m.p. 80-85^o and the required diacetate (41c) (183 mg, 33%). ν_{\max} (film) 3500, 3160, 3080, 1740, 875 cm^{-1} . ¹H n.m.r. δ (CDCl_3) 1.22, 3H, s, 4-Me; 2.03, 6H, s, OCOMe; 2.86, 2H, t, J 7 Hz, (H6)₂; 4.15, 2H, m, (H1)₂; 5.23, 1H, m, H2; 6.66, 1H, m, H4'; 7.30, 1H, m, H5'; 7.93, 1H, m, H2'. Finally, formation of the thioacetal of (41c) (180 mg, 0.55 mmol) for comparison with (38b) was achieved with propane-1,3-dithiol (60 mg, 0.56 mmole) as described above with a reaction time of 0.5 h at 0^o followed by 6 h at 20^o. Isolation gave a product (115 mg, 50%) which was identical with (2S,4R)-2-acetoxy-7-(furan-3'-yl)-4-hydroxy-4-methyl-7,7-(propylenedithio)hept-1-yl acetate (38b), isolated from the other sequence of reactions. $[\alpha]_{577.3}^{20} + 4.4^{\circ}$; $[\alpha]_{546.4}^{20} + 5.4^{\circ}$ (0.97% in CHCl_3).

When the alcohol (40a) (50 mg) was heated at 70^o in (D5) pyridine (0.4 ml) and D₂O (0.4 ml) for 20 h the ¹H n.m.r. spectrum showed the presence of alcohol (40a) and the corresponding trihydroxy ketone (41a) in ratio of 5:4. However, extraction with dichloromethane resulted only in recovery of the starting material (40a) as did sodium borohydride reduction of the crude mixture.

Preparation of Lactones (44) and (45)

1. Pyrolysis of the acetoxy lactone (30b) (80 mg) through a quartz glass column (35 cm x 3 cm) at 600^o/0.1 mm gave (5R)-5-{3'-(furan-3'-yl)-3'-oxopropyl}-5-methylfuran-2(5H)-one (45). Preparative t.l.c. (ether/light petroleum, 4:1) gave a sample m.p. 65-67^o (from carbon tetrachloride/light petroleum) (51 mg, 80%), b.p. 90^o/10⁻³ mm (block). (Found: m/z 220.073. $\text{C}_{12}\text{H}_{12}\text{O}_4$ requires 220.074). $[\alpha]_{577.3}^{20} + 49^{\circ}$; $[\alpha]_{546.4}^{20} + 58^{\circ}$ (0.45% in CHCl_3). ν_{\max} (film) 3160, 3140, 3020, 2980, 1765, 1690, 1575, 1520, 1155, 880 cm^{-1} .

^1H n.m.r. δ (CDCl_3) 1.50, 3H, s, 5-Me; 2.22, 2H, m, ($\text{H}1'$)₂; 2.70, 2H, m, ($\text{H}2'$)₂; 5.90, 1H, d, J 5 Hz, H3; 6.63, 1H, m, $\text{H}4''$; 7.25, 1H, d, J 5 Hz, H4; 7.35, 1H, m, $\text{H}5''$; 7.90, 1H, m, $\text{H}2''$. m/z 220 (M), 192, 110, 97, 95 (100).

Similarly, pyrolysis of the acetoxy lactone (29) gave (5S)-5-{3'-(furan-3'-yl)-3'-oxopropyl}-5-methylfuran-2(5H)-one (44) (75%), m.p. 64-66°. This compound was identical with lactone (45), except that the optical rotation was of opposite sign: $[\alpha]_{577.3}^{20} -47^\circ$; $[\alpha]_{546.4}^{20} -54^\circ$ (1.1% in CHCl_3).

2. Thionyl chloride (0.1 ml) was added dropwise to a solution of hydroxy lactone (30a) in pyridine at 0°. Stirring was continued for 30 min at 0° and for a further 4 h at 15°. The reaction mixture was extracted with dichloromethane (3 times). The organic phase was washed with hydrochloric acid (10% aqueous, 3 times), water, dried and evaporated under reduced pressure. Preparative chromatography on silica (ether/light petroleum, 4:1) gave starting material (50 mg, 33%) and 3-chloro-5-{3'-(furan-3'-yl)-3'-oxopropyl}-5-methyldihydrofuran-2(3H)-one (46) (102 mg, 63%), m.p. 43.5-46.5°, b.p. 135°/0.5 mm (block). (Found: C, 56.4; H, 4.8. $\text{C}_{12}\text{H}_{13}\text{O}_4\text{Cl}$ requires C, 56.2; H, 5.1%). ν_{max} (film) 3160, 3000, 2960, 1780, 1680, 1560, 1150, 870 cm^{-1} . ^1H n.m.r. δ (CDCl_3) 1.53, 3H, s, 5-Me; 2.95, 2H, m, ($\text{H}2'$)₂; 4.63, 1H, t, J 8 Hz, H3; 6.70, 1H, m, $\text{H}4''$; 7.35, 1H, m, $\text{H}5''$; 8.00, 1H, m, $\text{H}2''$.

Reaction of the Triols (38a), (51) and (76) Under Acidic Conditions

Each of the triols, (2S,4R)-7-(furan-3'-yl)-4-methyl-7,7-(propylene-dithio)heptane-1,2,4-triol (38a), 6-benzyloxy-4-methylhexane-1,2,4-triol (51) and (3S,4S,6R)-9-(furan-3'-yl)-2,6-dimethylnonane-3,4,6-triol (76) was treated with (D_2) oxalic acid (10 mg) in CD_3OD (0.4 ml)/(D_2O (0.4 ml) at 70°. The reactions were followed by ^1H n.m.r. spectroscopy. No tetrahydrofuran or other products were observed within 72 h.

¹H n.m.r. Experiments

1. Diol (21) (50 mg) in CD₃OD (0.5 ml)/D₂O (0.5 ml)/(D₂) oxalic acid (10 mg) at 25^o, by ¹H n.m.r., exchanged in the region of δ 2.4, corresponding to exchange α to the carbonyl group of (48). When the reaction was maintained at 50^o complete conversion into the tetrahydrofuran (25a) occurred within 17 h.

2. A similar treatment of eremoacetal (6) revealed deuterium exchange of (H7)₂ after 1 h at 25^o. (H6)₂ collapsed to a two proton singlet at δ 2.0.

3. A similar deuterium exchange in the region of δ 2.4 was also evident for dihydroeremoacetal (39) after 48 h at 30^o under identical conditions to those used for diol (21).

4. A similar treatment of tertiary alcohol (70) (20 mg) for 48 h at 70^o gave (2''S,4''S)-1-(furan-3'-yl)-3-{4''-hydroxy-2'',5'',5''-trimethyltetrahydrofuran-2''-yl}propan-1-one (55). ¹H n.m.r. δ (CD₃OD/D₂O, 1:1) 6.6, 1H, m, H4'; 7.3, 1H, m, H5'; 8.0, 1H, m, H2'.

Work Described in Chapter II

Lithium in Ammonia Reductions: Reagents and Equipment^{5 7}

Lithium wire (3.2 mm diameter, 0.02% sodium) was stored under liquid paraffin. Immediately prior to use, a small section was cut off with a new stainless-steel spatula blade and washed with light petroleum. The required amount of lithium was weighed and added in small pieces to the liquid ammonia under a positive nitrogen pressure. Tetrahydrofuran was refluxed over sodium and benzophenone until the blue colour of the ketyl was well established. The anhydrous tetrahydrofuran was collected under nitrogen and transferred to the reaction mixture with a syringe.

Commercial anhydrous ammonia was purified prior to use in the following way: ammonia (100 ml) was distilled from the tank into a flask containing sodium metal (c. 4g) and anhydrous ferric chloride (c. 100 mg). The ammonia was refluxed for 0.5 h and subsequently distilled into the reduction flask under a positive pressure of nitrogen.

All the reductions were carried out in a graduated multi-necked Erlenmeyer flask fitted with a acetone/dry-ice-charged condenser and suba seal. The reagents were added in turn with a syringe through the suba seal. The reaction flask contained a glass-encapsulated magnetic stirring bar and was maintained under a positive pressure of nitrogen throughout the reaction.

Prior to carrying out a reduction, all glassware was cleansed by washing with copious quantities of c. 1% aqueous triethylamine and finally washing with distilled water. The glassware was dried overnight in an oven at 130°. The assembled apparatus was flame-dried prior to use and teflon tape was employed to seal all joints.

Part 2.1

General Reduction Procedure

A solution of the reduction substrate in tetrahydrofuran was added over 5 min to a solution of lithium in ammonia which had been stirred for 15 min prior to the addition. The mixture was stirred under reflux and after the required period isoprene was added to remove the excess of metal. Solid ammonium chloride was added and the ammonia was allowed to evaporate. Water was added and the solution was extracted with dichloromethane (4 times). The combined organic extracts were dried and evaporated under reduced pressure. The crude product was analysed directly by ^1H n.m.r. (comparison of H_4' integrals) and, where specified, the individual components were isolated by preparative t.l.c.

Reduction of Dihydroeremoacetal (39)

A solution of dihydroeremoacetal (39) (110 mg, 0.4 mmole) in tetrahydrofuran (1 ml) was reduced with lithium (40 mg, 5.7 mmole) in ammonia (10 ml) for 3 h. Purification by preparative t.l.c. (ether/light petroleum, 1:2) gave starting material (63%), oxepanes (71) (17%) and diol (73) (7%). The products were identified by the ^1H n.m.r. comparison with authentic samples.¹⁷

Competitive Reduction of Oxepanes (71a) and (71b)

A solution of (71a) (49 mg, 0.19 mmole) and (71b) (50 mg, 0.2 mmole) in tetrahydrofuran (1 ml) was reduced with lithium (40 mg, 5.7 mmole) in ammonia (10 ml) for 3 h. ^1H n.m.r. of the crude product revealed oxepanes (86%) and diol (73) (14%). Preparative t.l.c. (ether/light petroleum, 1:1) gave (71a) (43 mg, 88% recovery), (71b) (40 mg, 80% recovery) and diol (73) (9.5 mg, 9% based on both oxepanes).

Reduction of Dihydroeremoacetal (39) in the presence of *tert*-Butyl Alcohol

A solution of dihydroeremoacetal (39) (500 mg, 2 mmole) and *tert*-butyl alcohol (148 mg, 2 mmole) in tetrahydrofuran (3.9 ml) was reduced with lithium (85 mg, 12.25 mmole) in ammonia (30 ml) for 3 h. ¹H n.m.r. of the crude product revealed cleavage products {(71), (73)} and starting material in the ratio of 1:4. Preparative t.l.c. (ether/light petroleum, 1:2) gave starting material (330 mg, 66%) and a fraction containing oxepanes (71) and diol (73) (121 mg total, 24%, 7:3 by ¹H n.m.r.).

Reduction of Primary Alcohol (40a)

A solution of the alcohol (40a) (200 mg, 0.89 mmole) in tetrahydrofuran (2 ml) was reduced with lithium (70 mg, 10.09 mmole) in ammonia (20 ml) for 5.5 h. ¹H n.m.r. of the crude product revealed starting material and triol (74) in a ratio of 1:1. Preparative t.l.c. (ether/methanol, 99:1) gave starting material (83 mg, 42%) and a fraction tentatively assigned as oxepanol monocleavage product (3-4%). ¹H n.m.r. δ (CDCl₃) 1.16, 3H, s; 3.50, 2H, m; 4.00, 1H, m; 4.80, 1H, m; 6.30, 1H, m; 7.25, 2H, m.

The lowest R_f fraction was (2S,4R)-7-(furan-3'-yl)-4-methylheptane-1,2,4-triol (74a) (83 mg, 41%). ¹H n.m.r. δ (CDCl₃) 1.16, 3H, s, 4-Me; 1.62, 6H, m, (H3)₂, (H5)₂, (H6)₂; 2.43, 2H, m, (H7)₂; 3.50-4.00, 6H, m, (H1)₂, H2, 3xOH; 6.22, 1H, m, H4'; 7.16, 1H, m, H2'; 7.25, 1H, m, H5'. ¹³C n.m.r. δ (CDCl₃) 25.0, t, C6; 25.3, t, C7; 28.1, q, 4-Me; 40.7, t, C5; 42.4, t, C3; 67.2, t, C1; 69.7, d, C2; 73.2, s, C4; 111.1, d, C4'; 125.1, s, C3'; 139.1, d, C2'; 143.0, d, C5'.

Triol (74) was characterised as its diacetate, (2S,4R)-2-acetoxy-7-(furan-3'-yl)-4-hydroxy-4-methylheptyl acetate (74b). (Found: m/z 312.1582. C₁₆H₂₄O₆ requires 312.1572). ν_{\max} (film) 3400, 2950, 1740, 1370,

1230, 875 cm^{-1} . ^1H n.m.r. δ (CDCl_3) 1.20, 3H, s, 4-Me; 1.30-1.85, 6H, m, (H3)₂, (H5)₂, (H6)₂; 2.03, 6H, s, 2xOCOMe; 2.40, 2H, m, (H7)₂; 4.10, 2H, m, (H1)₂; 5.25, 1H, m, H2; 6.20, 1H, m, H4'; 7.15, 1H, m, H2'; 7.25, 1H, m, H5'. ^{13}C n.m.r. δ (CDCl_3) 20.9, q, OCOMe; 21.3, q, OCOMe; 24.2, t, C6; 25.1, t, C7; 26.7, q, 4-Me; 42.0, t, C5; 42.8, t, C3; 66.2, t, C1; 69.2, d, C2; 71.5, s, C4; 111.1, d, C4'; 125.0, s, C3'; 139.1, d, C2'; 143.1, d, C5'; 171.1, s, OCOMe. m/z 312 (M), 294 (M-H₂O), 143, 135, 100, 95, 94 (100), 83, 43.

Reduction of Methoxymethyl Ether (40d)

A solution of the methoxymethyl ether (40d) (400 mg, 1.49 mmole) in tetrahydrofuran (3.5 ml) was reduced with lithium (120 mg, 17.29) in ammonia (35 ml) for 5.5 h. ^1H n.m.r. of the crude product revealed starting material and diol (75) in the ratio of 1:8. Preparative t.l.c. (ether/light petroleum, 9:1) gave starting material (36 mg, 9%) and (2S,3R)-7-(furan-3'-yl)-1-(methoxymethoxy)-4-methylheptane-2,4-diol (75) (272 mg, 68%), b.p.

$115^{\circ}/1 \times 10^{-3}$ mm (block). (Found: C, 62.0; H, 8.9. $\text{C}_{14}\text{H}_{24}\text{O}_5$ requires C, 61.7; H, 8.9%). ν_{max} (film) 3400, 2960, 1500, 1460, 1440, 1370, 1140, 1100, 1030, 915, 870, 770 cm^{-1} . ^1H n.m.r. δ (CDCl_3) 1.16, 3H, s, (H4)₃; 1.65, 6H, m, (H3)₂, (H5)₂, (H6)₂; 2.40, 2H, m, (H7)₂; 3.30, 3H, s, OMe; 3.40, 2H, d, (H1)₂; 3.95, 1H, m, H2; 4.56, 2H, s, OCH₂O; 6.20, 1H, m, H4'; 7.13, 1H, m, H2'; 7.23, 1H, m, H5'. ^{13}C n.m.r. δ (CDCl_3) 24.9, t, C6; 25.1, t, C7; 28.0, q, 4-Me; 40.3, t, C5; 42.5, t, C3; 55.2, q, OMe; 68.0, d, C2; 72.7, s, C4; 73.2, t, C1; 96.9, t, OCH₂O; 111.0, d, C4'; 124.9, s, C3'; 138.9, d, C2'; 142.8, d, C5'. m/z 272 (M), 270, 254(M-H₂O), 193, 179, 135, 95, 94, 83, 81, 45 (100), 42.

The lowest R_f fraction was tentatively assigned as oxepanol monocleavage product (<2%). ^1H n.m.r. δ (CDCl_3) 6.28, 1H, m; 7.26, 2H, m.

Reduction of Secondary Alcohol (66a)

A solution of the alcohol (66a) (150 mg, 0.56 mmole) in tetrahydrofuran (1 ml) was reduced with lithium (40 mg, 5.76 mmole) in ammonia (15 ml) for 3 h. ^1H n.m.r. of the crude product revealed starting material and triol (76) in a ratio of 1.15 : 1. Preparative t.l.c. (ether) gave starting material (60 mg, 40%), and (3S,4S,6R)-9-(furan-3'-yl)-2,6-dimethylnonane-3,4,6-triol (76) (55 mg, 37%), b.p. $85^\circ/1 \times 10^{-3}$ mm (block). (Found; C, 67.0; H, 9.7. $\text{C}_{15}\text{H}_{26}\text{O}_4$ requires C, 66.7; H, 9.7%). ν_{max} (film) 3400, 2980, 2940, 1510, 1475, 1030, 880 cm^{-1} . ^1H n.m.r. δ (CDCl_3) 0.93, 0.96, each 3H, d, $(\text{H}1)_3$, 2-Me; 1.16, 3H, s, 6-Me; 1.56, 6H, m, $(\text{H}5)_2$, $(\text{H}7)_2$, $(\text{H}8)_2$; 2.45, 2H, m, $(\text{H}9)_2$; 2.65, 3.00, 3.50, each 1H, b, OH; 3.82, 2H, m, H3, H4; 6.15, 1H, m, H4'; 7.10, 1H, m, H2'; 7.20, 1H, m, H5'. ^{13}C n.m.r. δ (CDCl_3) 17.0, q, C1; 19.6, q, 2-Me; 25.0, t, C8; 25.0, t, C9; 28.3, q, 6-Me; 29.8, d, C2; 39.9, t, C7; 42.7, t, C5; 69.3, d, C4; 73.2, s, C6; 79.5, d, C3; 110.9, d, C4'; 124.8, s, C3'; 138.8, d, C2'; 142.8, d, C5'. $\underline{m/z}$ 270 (M), 252 (M-H₂O), 197, 135, 95, 94 (100), 43.

The lowest R_f fraction (5%) gave no furan proton resonances by ^1H n.m.r.

Reduction of Secondary Alcohol (67a)

A solution of the alcohol (67a) (60 mg, 0.25 mmole) in tetrahydrofuran (1 ml) was reduced with lithium (40 mg, 5.76 mmole) in ammonia (15 ml) for 3 h. ^1H n.m.r. of the crude product revealed starting material and triol (77) in the ratio of 1 : 99. Preparative t.l.c. (ether) gave (2S,3S,5R)-8-(furan-3'-yl)-5-methyloctane-2,3,5-triol(77) (55 mg, 90%). ν_{max} (film) 3400, 2990, 2960, 1505, 1370, 1120, 1050, 1020, 870 cm^{-1} . ^1H n.m.r. δ (CDCl_3) 1.15, 3H, d, \underline{J} 5 Hz, $(\text{H}1)_3$; 1.18, 3H, s, 5-Me; 1.58, 6H, bs, $(\text{H}4)_2$, $(\text{H}6)_2$, $(\text{H}7)_2$; 2.42, 2H, m, $(\text{H}8)_2$; 3.25-3.85, 5H, m, H2, H3, 3xOH;

6.19, 1H, m, H4'; 7.13, 1H, m, H2'; 7.22, 1H, m, H5'. ^{13}C n.m.r. (CDCl_3) 18.2, q, C1; 19.2, t, C7; 25.3, t, C8; 28.5, q, 5-Me; 40.1, t, C6; 42.3, t, C4; 71.4, d, C2; 73.6, s, C5; 73.6, d, C3; 111.1, d, C4'; 125.0, s, C3'; 139.2, d, C2'; 143.1, d, C5'.

Reduction of Secondary Alcohol (68a)

A solution of the alcohol (68a) (50 mg, 0.21 mmole) in tetrahydrofuran (1 ml) was reduced with lithium (30 mg, 4.32 mmole) in ammonia (10 ml) for 3 h. ^1H n.m.r. of the crude product revealed starting material and triol (78) in the ratio of 1 : 49. Preparative t.l.c. (ether) gave (2R,3S,5R)-8-(furan-3'-yl)-5-methyloctane-2,3,5-triol (78) (40 mg, 79%). ν_{max} (film) 3400, 2990, 2960, 1500, 1370, 1160, 1120, 870 cm^{-1} . ^1H n.m.r. δ (CDCl_3) 1.14, 3H, d, (H1)₃; 1.20, 3H, s, 5-Me; 1.60, 6H, bs, (H4)₂, (H6)₂, (H7)₂; 2.40 2H, m, (H8)₂; 3.50-4.00, 5H, m, H2, H3, 3xOH; 6.17, 1H, m, H4'; 7.15, 1H, m, H2'; 7.23, 1H, m, H5'.

Reduction of Tertiary Alcohol (69)

A solution of the alcohol (69) (100 mg, 0.38 mmole) in tetrahydrofuran (1 ml) was reduced with lithium (40 mg, 5.76 mmole) in ammonia (10 ml) for 3 h. ^1H n.m.r. of the crude product revealed starting material and triol (79) in the ratio of 22 : 78. Preparative t.l.c. (ether/light petroleum, 4:1) gave starting material (19 mg, 19%) and triol (79)¹⁷ (61 mg, 60%). The triol (79) gave an identical ^1H n.m.r. spectrum to that reported.¹⁷

Reduction of Tertiary Alcohol (70)

A solution of the alcohol (70) (100 mg, 0.40 mmole) in tetrahydrofuran (1 ml) was reduced with lithium (35 mg, 5.04 mmole) in ammonia (10 ml) for 3 h. ^1H n.m.r. of the crude product revealed starting material and

triol (80) in the ratio of 27 : 73. Preparative t.l.c. (ether) gave starting material (18 mg, 18%), and (3S,5R)-8-(furan-3'-yl)-2,5-dimethyloctane-2,3,5-triol (80) (63 mg, 62%), m.p. 79-82^o, sublimed 75^o/1x10⁻³ mm. (Found: C, 65.7; H, 9.7. C₁₄H₂₄O₄ requires C, 65.6; H, 9.5%). (Found: m/z 256.1680. C₁₄H₂₄O₄ requires 256.1675). ν_{\max} (Solution) 3650, 3400, 2925, 1600, 1495, 1455, 1370, 1150, 1100, 1015, 945, 895, 870 cm⁻¹. ¹H n.m.r. δ (CDCl₃) 1.10, 1.13, 1.16, each 3H, s, (H1)₃, 2-Me, 5-Me; 1.35-1.60, 6H, m, (H4)₂, (H6)₂, (H7)₂; 2.40, 2H, m, (H8)₂; 3.60, 1H, t, J 6 Hz; 6.15, 1H, m, H4'; 7.10, 1H, m, H2'; 7.22, 1H, m, H5'. ¹³C n.m.r. δ (CDCl₃) 23.6, q, C1; 25.3, t, C7 C8; 26.5, q, 2-Me; 29.1, q, 5-Me; 40.0, t, C6; 40.5, t, C4; 72.9, d, C3; 73.6, s, C5; 111.1, d, C4'; 125.0, s, C3'; 139.2, s, C2'; 143.1, s, C5'. m/z 256 (M), 238 (M-H₂O), 153, 152, 135, 129, 95, 94, 91, 82, 81, 71, 43 (100).

The lowest R_f fraction (5%) revealed no furan proton resonances by ¹H n.m.r.

Part 2.2

General Reduction Procedure

The g.l.c. response ratios of the reduction substrates and the reduction products were predetermined. A solution of the reduction substrate, butyl nonyl ether (g.l.c. standard) and, where indicated, an external proton source in tetrahydrofuran was analysed by g.l.c. on the specified column. The above solution was added over the specified period to a solution of lithium in ammonia which had been stirred for 10 min prior to the addition. The mixture was stirred under reflux and after the required period isoprene was added to remove the excess of metal. Solid ammonium chloride was added and the ammonia was allowed to evaporate. Water followed by ether (unless otherwise stated) was introduced and the layers were separated after shaking. The aqueous phase was further extracted with ether (3 times) and the combined organic extracts were analysed by g.l.c. on the specified column, dried and evaporated under reduced pressure.

The products were identified by g.l.c. retention time comparison with authentic samples and, where indicated, the products were isolated by preparative t.l.c. A comparison of the g.l.c. data from before and after the reduction gave the percentage yield of each component present in the crude product mixture. The individual components of the product mixture are quoted in the order of elution.

The reduction substrates and products do not appear to be volatile during the evaporation of ammonia. For example, the evaporation of ammonia from a mixture of butyl nonyl ether and the alcohols (97a) and (103) (18 mg) returned the same mixture (18 mg).

Reduction of Tetrahydrofuran (91)

A solution of the tetrahydrofuran (91) (105 mg, 0.76 mmole) and butyl nonyl ether (60 mg, 0.30 mmole) in tetrahydrofuran (3 ml) was submitted to g.l.c. analysis (Column A, 120°-200° at 5°/min). The above solution was added over 1 min to a stirred solution of lithium (90 mg, 12.97 mmole) in ammonia (40 ml). The reduction was terminated after a further 14 min and the crude product ether extract was submitted to g.l.c. analysis (Column A, 120°-200° at 5°/min). The g.l.c. data revealed starting material (91) (<1%) and alcohol (94) (93%). Preparative t.l.c. (ether/light petroleum, 1:1) gave 4-(furan-3'-yl)butan-1-ol (94) (94 mg, 90%), b.p. 35°/2x10⁻³ mm (block). (Found: C, 68.6, H, 8.6. C₈H₁₂O₂ requires C, 68.6; H, 8.6%). (Found: m/z 140.0784. C₈H₁₂O₂ requires 140.0837). ν_{\max} (film) 3400, 2970, 2890, 1505, 1160, 1065, 1030, 880 cm⁻¹. ¹H n.m.r. δ (CCl₄) 1.30-1.80, 4H, m, (H2)₂, (H3)₂; 2.37, 2H, m, (H4)₂; 3.64, 1H, b, OH; 3.48, 2H, m, (H1)₂; 6.10, 1H, m, H4'; 7.03, 1H, m, H2'; 7.16, 1H, m, H5'. m/z 140 (M), 95, 94, 82, 81, 69, 53, 41.

Reduction of Tetrahydropyran (92)

A solution of the tetrahydropyran (92) (150 mg, 0.99 mmole) and butyl nonyl ether (71 mg, 0.36 mmole) in tetrahydrofuran (3.9 ml) was submitted to g.l.c. analysis (Column B, 75° (isothermal 5 min) - 150° at 6°/min). The above solution was added over 1 min to a stirred solution of lithium (120 mg, 17.3 mmole) in ammonia (50 ml). The reduction was terminated after a further 14 min and the crude product ether extract was submitted to g.l.c. analysis (Column B, 75° (isothermal 5 min) - 150° at 6°/min). The g.l.c. data revealed starting material (76%) and alcohol (95) (18%). Preparative t.l.c. (ether/light petroleum, 1:3) gave starting material (97 mg, 65%)

and 5-(furan-3'-yl)pentan-1-ol (95) (26 mg, 17%), b.p. $45^{\circ}/2 \times 10^{-3}$ mm (block). (Found: C, 70.5; H, 8.8. $C_9H_{14}O_2$ requires C, 70.1; H, 9.2%). (Found: m/z 154.0983. $C_9H_{14}O_2$ requires 154.0994). ν_{max} (film) 3350, 2925, 2850, 1505, 1460, 1380, 1160, 1065, 1025, 870, 780 cm^{-1} . 1H n.m.r. δ ($CDCl_3$) 1.20-1.90, 7H, m, (H2)₂, (H3)₂, (H4)₂, OH; 2.36, 2H, m, (H5)₂; 3.51, 2H, t, J 6 Hz, (H1)₂; 6.11, 1H, m, H4'; 7.05, 1H, m, H2'; 7.17, 1H, m, H5'. m/z 154 (M), 95, 94, 82, 81 (100), 69, 67, 53, 40, 38, 31.

Reduction of Oxepane (93)

A solution of the oxepane (93) (125 mg, 0.75 mmole) and butyl nonyl ether (62 mg, 0.31 mmole) in tetrahydrofuran (3 ml) was submitted to g.l.c. analysis (Column B, 75° (isothermal 4 min) -150° at $6^{\circ}/min$). The above solution was added over 1 min to a stirred solution of lithium (92 mg, 13.3 mmole) in ammonia (40 ml). The reduction was terminated after a further 14 min and the crude product ether extract was submitted to g.l.c. analysis (Column B, 75° (isothermal 4 min) -150° at $6^{\circ}/min$). The g.l.c. data revealed starting material (85%) and alcohol (96) (13%). Preparative t.l.c. (ether/light petroleum, 1:3) gave starting material (93 mg, 74%) and 6-(furan-3'-yl)hexan-1-ol (96) (17 mg, 13%), b.p. $45^{\circ}/8 \times 10^{-3}$ mm (block). (Found: C, 71.1; H, 9.4. $C_{10}H_{16}O_2$ requires C, 71.4; H, 9.6%). (Found: m/z 168.1147. $C_{10}H_{16}O_2$ requires 168.1150). ν_{max} (film) 3350, 2925, 2820, 1500, 1460, 1380, 1160, 1020, 870, 775 cm^{-1} . 1H n.m.r. δ ($CDCl_3$) 1.15-1.65, 8H, m, (H2)₂, (H3)₂, (H4)₂, (H5)₂; 1.85, 1H, bs, OH; 2.32, 2H, m, (H6)₂; 3.50, 2H, t, J 6 Hz, (H1)₂; 6.12, 1H, m, H4'; 7.05, 1H, m, H2'; 7.20, 1H, m, H5'. m/z 168 (M), 95, 94, 82 (100), 81, 67, 53, 41, 39, 31.

Competitive Reduction of (91), (92) and (93)

A solution of (91), (92), (93) (170 mg total) and butyl nonyl ether in tetrahydrofuran (4 ml) was submitted to g.l.c. analysis (Column A,

100^o-200^o at 6^o/min). The four components were observed in a ratio of 1.02 : 1.3 : 1.3 : 1 respectively. The above solution was added over 1 min to a stirred solution of lithium (105 mg, 15.1 mmole) in ammonia (50 ml). The reduction was terminated after a further 11 min and the crude product ether extract was submitted to g.l.c. analysis (Column B, 75^o (isothermal 4 min) -150^o at 6^o/min and Column A for the detection of (91) only, 100^o-200^o at 6^o/min). The g.l.c. data revealed (91) (<1%), (92) (88%), (93) (87%) and the corresponding cleavage products (94) (98%), (95) (10%) and (96) (8%) respectively.

Competitive Reduction of Tetrahydropyran (92) and Methyl Ether (60c)

A solution of the tetrahydropyran (92) (13.5 mg, 0.10 mmole), methyl ether (60c) (18 mg, 0.08 mmole) and butyl nonyl ether (8.8 mg, 0.04 mmole) in tetrahydrofuran (0.5 ml) was submitted to g.l.c. analysis (Column B, 75^o (isothermal 5 min) -200^o at 6^o/min). The above solution was added over 0.5 min to a stirred solution of lithium (20 mg, 2.88 mmole) in ammonia (10 ml). The reduction was terminated after a further 16.5 min and the crude product ether extract was submitted to g.l.c. analysis (Column B, 75^o (isothermal 5 min) -200^o at 6^o/min). The g.l.c. data revealed (92) (68%), (60c) (78%) and the corresponding cleavage products (94) (30%) and (59) (15%), respectively.

Reduction of Acetal Alcohol (97a)

1. A solution of the alcohol (97a) (58.5 mg, 0.32 mmole) and butyl nonyl ether (16.5 mg, 0.08 mmole) in tetrahydrofuran (0.75 ml) was submitted to g.l.c. analysis (Column B, 75^o (isothermal 3 min) -190^o at 6^o/min). The above solution was added over 1 min to a stirred solution of lithium (22 mg, 3.17 mmole) in ammonia (10 ml). The reduction was terminated after a

further 14 min and the crude product ether extract was submitted to g.l.c. analysis (Column B, 75^o (isothermal 3 min) -190^o at 6^o/min). The g.l.c. data revealed alcohol (103) (55%), 2,5-dihydrofuran (104) (10%), starting material (97a) (3%) and diol (100) (13%). G.c.m.s. data (Column C, 160^o (isothermal 5 min) -230^o at 5^o/min) on component (104) revealed $\underline{m/z}$ 128 (M).

Preparative t.l.c. (ether/light petroleum, 4:1) gave 2,5-dihydrofuran (104) (5 mg, 8%). ¹H n.m.r. δ (CDCl₃) 1.10, 1H, s, OH; 1.50, 2H, m, (H2)₂; 2.15, 2H, m, (H3)₂; 3.60, 2H, t, \underline{J} 5 Hz, (H1)₂; 4.50, 4H, bs, (H2')₂, (H5')₂; 5.50, 1H, bs, H4'. ¹³C n.m.r. δ (CDCl₃) 23.7, t, C2; 30.9, t, C3; 62.7, t, C1; 76.3, t, C2', C5'; 119.6, d, H4'.

2. A solution of the alcohol (97a) (300 mg, 1.63 mmole) in tetrahydrofuran (4.8 ml) was added dropwise over 5 min to a stirred solution of lithium (115 mg, 16.57 mmole) in ammonia (50 ml). The reduction was terminated after a further 13 min. Preparative t.l.c. (ether/light petroleum, 4:1) of the crude material (210 mg) gave starting material (7 mg, 2%) and 3-(furan-3'-yl)propan-1-ol (103) (113 mg, 55%), b.p. 45^o/0.5 mm (block). (Found: C, 66.1; H, 8.0. C₇H₁₀O₂ requires C, 66.6; H, 8.0%). (Found: $\underline{m/z}$ 126.0632. C₇H₁₀O₂ requires 126.0681). ν_{\max} (film) 3360, 2960, 2890 1500m 1150, 1050, 1020, 870 cm⁻¹. ¹H n.m.r. δ (CDCl₃) 1.80, 2H, m, (H2)₂; 2.45, 2H, t, \underline{J} 7 Hz, (H3)₂; 3.06, 1H, s, OH; 3.52, 2H, t, \underline{J} 6 Hz, (H1)₂; 6.10, 1H, m, H4'; 7.05, 1H, m, H2'; 7.16, 1H, m, H5'. $\underline{m/z}$ 126 (M), 82, 81, 44, 40, 34, 32.

The low R_f fraction was 3-(furan-3'-yl)-3-(2''-hydroxyethoxy)propan-1-ol (100) (59 mg, 19%), b.p. 80^o/2x10⁻³ mm (block). (Found: C, 57.7; H, 7.2. C₉H₁₄O₄ requires C, 58.0; H, 7.6%). (Found: $\underline{m/z}$ 186.0893. C₉H₁₄O₄ requires 186.0892). ν_{\max} (film) 3400, 2960, 2880, 1500, 1150, 1100, 1050, 1020, 870 cm⁻¹. ¹H n.m.r. δ (CDCl₃) 2.02, 2H, m, (H2)₂; 3.40-3.90, 8H, m,

(H1)₂, (H1'')₂, (H2'')₂, 2xOH; 4.50, 1H, dd, J 5, 7 Hz, H3; 6.30, 1H, m, H4'; 7.26, 2H, m, H2', H5'. m/z 186 (M), 141, 122, 97, 95, 94, 66, 65, 43, 41.

Reduction of Acetal Alcohol (98a)

1. A solution of the alcohol (98a) (56.5 mg, 0.29 mmole) and butyl nonyl ether (11.2 mg, 0.06 mmole) in tetrahydrofuran (0.75 ml) was submitted to g.l.c. analysis (Column B, 75° (isothermal 3 min) -190° at 6°/min). The above solution was added over 1 min to a stirred solution of lithium (24 mg, 3.46 mmole) in ammonia (10 ml). The reduction was terminated after a further 14 min and the crude product ether extract was submitted to g.l.c. analysis (Column B, 75° (isothermal 3 min) -190° at 6°/min). The g.l.c. data revealed alcohol (94) (48%), 2,5-dihydrofuran (105) (5%), starting material (28%) and diol (101) (10%). G.c.m.s. data (Column C, 160° (isothermal 5 min) -230° at 5°/min) on component (105) revealed m/z 142 (M).

2. A solution of the alcohol (98a) (200 mg, 1.01 mmole) in tetrahydrofuran (3 ml) was added dropwise over 5 min to a stirred solution of lithium (70 mg, 10.09 mmole) in ammonia (30 ml). The reduction was terminated after a further 13 min. Preparative t.l.c. (ether/light petroleum, 4:1) gave starting material (68 mg, 34%) and 4-(furan-3'-yl)butan-1-ol (94) (59 mg, 42%) identical spectroscopic data to that obtained for the same compound isolated from the lithium in ammonia reduction of tetrahydrofuran (91).

The low R_f fraction was 4-(furan-3'-yl)-4-(2''-hydroxyethoxy)butan-1-ol (101) (30 mg, 15%), b.p. 85°/2x10⁻³ mm (block). (Found: C, 58.7; H, 8.2. C₁₀H₁₆O₄· $\frac{1}{4}$ H₂O requires C, 58.7; H, 8.1%). (Found: m/z 200.1060. C₁₀H₁₆O₄ requires 200.1049). ν_{\max} (film) 3400, 2960, 2890, 1500, 1150, 1100, 1055, 1020, 870 cm⁻¹. ¹H n.m.r. δ (CDCl₃) 1.40-1.90, 4H, m, (H2)₂, (H3)₂; 2.76 2H, bs, 2xOH; 3.30-3.77, 6H, m, (H1)₂, (H1'')₂, (H2'')₂; 4.30, 1H, t; J 7 Hz,

H4; 6.29, 1H, m, H4'; 7.30, 2H, m, H2', H5'. m/z 200 (M), 155, 141, 97 (100), 95, 79, 77, 45, 44, 39, 32.

Competitive Reduction of Acetal Alcohols (97a) and (98a)

A solution of (97a) (53.7 mg, 0.29 mmole), (98a) 52 mg, 0.26 mmole) and butyl nonyl ether (13.9 mg, 0.07 mmole) in tetrahydrofuran (1.5 ml) was submitted to g.l.c. analysis (Column B, 75^o (isothermal 3 min) -190^o at 6^o/min). The above solution was added over 1 min to a stirred solution of lithium (40 mg, 5.76 mmole) in ammonia (20 ml). The reduction was terminated after a further 14 min and the crude product ether extract was submitted to g.l.c. analysis (Column B, 75^o (isothermal 3 min) -190^o at 6^o/min). The g.l.c. data revealed alcohol (103) (52%), 2,5-dihydrofuran (104) (18%), starting material (97a) (3%) and diol (100) (12%) for (97a) and alcohol (94) (50%), 2,5-dihydrofuran (105) (2%), starting material (98a) (33%) and diol (101) (12%) for (98a).

Competitive Reduction of (97a) and (99a)

A solution of (97a), (99a) (160 mg total) and butyl nonyl ether in tetrahydrofuran (2.2 ml) was submitted to g.l.c. analysis (Column B, 75^o (isothermal 4 min) -200^o at 6^o/min), The three components were observed in a ratio of 5.34 : 5.89 : 1 respectively. The above solution was added over 1 min to a stirred solution of lithium (80 mg, 11.53 mmole) in ammonia (30 ml). The reduction was terminated after a further 14 min and the crude product ether extract was submitted to g.l.c. analysis (Column B, 75^o (isothermal 4 min) -200^o at 6^o/min). The g.l.c. data revealed alcohol (103) (38%), 2,5-dihydrofuran (104) (18%), starting material (97a) (2%) and diol (100) (16%) for (97a) and alcohol (96) (41%), starting material (99a) (43%) and diol (102) (13%) for (99a).

Reduction of Benzyloxy Acetal (98b)

A solution of benzyloxy acetal (98b) (84 mg, 0.30 mmole) and butyl nonyl ether (22 mg, 0.11 mmole) in tetrahydrofuran (0.75 ml) was submitted to g.l.c. analysis (Column B, 75° (isothermal 3 min) -190° at 6°/min). The above solution was added over 1 min to a stirred solution of lithium (20 mg, 2.88 mmole) in ammonia (10 ml). The reduction was terminated after a further 14 min and the crude product ether extract was submitted to g.l.c. analysis (Column B, 75° (isothermal 3 min) -190° at 6°/min). The g.l.c. data revealed alcohol (94) (41%), bibenzyl,⁵² parent alcohol (98a) (43%) and diol (101) (c. 1%).

Reduction of Benzyloxy Acetal (99b)

A solution of benzyloxy acetal (99b) (220 mg, 0.70 mmole) and butyl nonyl ether (55 mg, 0.28 mmole) in tetrahydrofuran (1.75 ml) was submitted to g.l.c. analysis (Column B, 75° (isothermal 3 min) -220° at 6/min). The above solution was added over 1 min to a stirred solution of lithium (55 mg, 7.93 mmole) in ammonia (20 ml). The reduction was terminated after a further 14 min and the crude product ether extract was submitted to g.l.c. analysis (Column B, 75° (isothermal 3 min) -220° at 6°/min). The g.l.c. data revealed alcohol (96) (29%), bibenzyl,⁵² parent alcohol (99a) (54%) and diol (102) (16%). Preparative t.l.c. (ether/light petroleum, 4:1) gave alcohols (96) (37 mg, 31%) and (99a) (79 mg, 50%) (identical spectroscopic data to those obtained for the same compounds described previously).

The low R_f fraction was 6-(furan-3'-yl)-6-(2''-hydroxyethoxy)hexan-1-ol (102) (26 mg, 16%). (Found: $\underline{m/z}$ 228.1357. C₁₂H₂₀O₄ requires 228.1362).
 ν_{\max} (film) 3400, 2940, 2860, 1505, 1460, 1160, 1110, 1060, 1020, 910, 870 cm⁻¹.
¹H n.m.r. δ (CDCl₃) 1.25-1.85, 8H, m, (H2)₂, (H3)₂, (H4)₂, (H5)₂; 2.00, 2H, bs,

2xOH; 3.30-3.70, 6H, m, (H1)₂, (H1'')₂, (H2'')₂; 4.25, 1H, t, J 6 Hz, H6;
6.30, 1H, m, H4'; 7.31, 2H, m, H2', H5'.

Competitive Reduction of Benzyloxy Acetals (97b) and (99b)

A solution of (97b) (40.5 mg, 0.15 mmole), (99b), (37 mg, 0.12 mmole) and butyl nonyl ether (15 mg, 0.08 mmole) in tetrahydrofuran (0.75 ml) was submitted to g.l.c. analysis (Column B, 75^o (isothermal 4 min) -220^o at 6^o/min). The above solution was added over 1 min to a stirred solution of lithium (23 mg, 3.31 mmole) in ammonia (10 ml). The reduction was terminated after a further 14 min and the crude product ether extract was submitted to g.l.c. analysis (Column B, 75^o (isothermal 4 min) -220^o at 6^o/min). The g.l.c. data revealed alcohol (103) (70%), parent alcohol (97a) (4%) and diol (100) (12%) for (97b) and alcohol (96) (29%), parent alcohol (99a) (49%) and diol (102) (17%) for (99b). Bibenzyl was also evident by g.l.c.

Reduction of Acetal (62)

A solution of acetal (62) (63 mg, 0.25 mmole) and butyl nonyl ether (10 mg, 0.05 mmole) in tetrahydrofuran (0.75 ml) was submitted to g.l.c. analysis (Column B, 75^o (isothermal 3 min) - 200^o at 6^o/min). The above solution was added over 0.5 min to a stirred solution of lithium (34 mg, 4.90 mmole) in ammonia (15 ml). The reduction was terminated after a further 14.5 min and the crude product ether extract was submitted to g.l.c. analysis (Column B, 75^o (isothermal 3 min) - 200^o at 6^o/min). The g.l.c. data revealed 3-nonylfuran (59) (10%), starting material (41%) and alcohol (61) (35%) which were identified by comparison with authentic samples.²¹

Reduction of Benzyloxy Acetal (97b) in the presence of *tert*-Butyl Alcohol

A solution of benzyloxy acetal (97b) (50 mg, 0.18 mmole), *tert*-butyl alcohol (14.5 mg, 0.20 mmole) and butyl nonyl ether (10 mg, 0.05 mmole) in tetrahydrofuran (0.75 ml) was submitted to g.l.c. analysis (Column B, 75^o (isothermal 4 min) -220^o at 6^o/min). The above solution was added over 0.5 min to a stirred solution of lithium (25 mg, 3.60 mmole) in ammonia (10 ml). The reduction was terminated after a further 14.5 min and the crude product ether extract was submitted to g.l.c. analysis (Column B, 75^o (isothermal 4 min) -220^o at 6^o/min). The g.l.c. data revealed alcohol (103) (80%), parent alcohol (97a) (2%) and diol (100) (10%).

Part 2.3

Reduction of Acetal Alcohol (114)

1. A solution of the acetal alcohol (114) (80.5 mg, 0.29 mmole) and butyl nonyl ether (19 mg, 0.10 mmole) in tetrahydrofuran (0.75 ml) was submitted to g.l.c. analysis (Column B, 75° (isothermal 3 min) -220° at 6°/min). The above solution was added over 1 min to a stirred solution of lithium (24 mg, 3.46 mmole) in ammonia (10 ml). The reduction was terminated after a further 14 min and the crude product ether extract was submitted to g.l.c. analysis (Column B, 75° (isothermal 3 min) -220° at 6°/min). The g.l.c. data revealed starting material (95%).

2. A similar reduction of acetal alcohol (114) (255 mg, 0.90 mmole) and butyl nonyl ether (42 mg, 0.21 mmole) in tetrahydrofuran (2.4 ml) with lithium (75 mg, 10.81 mmole) in ammonia (30 ml) gave, by g.l.c., 3-nonylfuran (59) (10%), starting material (73%) and diol (116a) (8%).

Preparative t.l.c. (ether) gave 3-nonylfuran (59) (21 mg, 12%) and starting material (114) (165 mg, 65%). The low R_f fraction was 3-{1'-(furan-3''-yl)nonoxy}propane-1,2-diol (116a) (18 mg, 7%), which was acetylated with acetic anhydride in pyridine. Isolation gave 2-acetoxy-3-{1'-(furan-3''-yl)nonoxy}prop-1-yl acetate (116b) (15 mg). (Found: m/z 368.2191. $C_{20}H_{32}O_6$ requires 368.2199). ν_{max} (film) 2925, 2850, 1740, 1500, 1365, 1220, 1155, 1090, 1045, 1020, 870 cm^{-1} . 1H n.m.r. δ ($CDCl_3$) 0.95, 3H, bt, (H9')₃; 1.15-1.70, 14H, m, (H2')₂-(H8')₂; 1.93, 1.95, each 3H, s, OCOMe; 3.28, 2H, d, J 5 Hz, (H3)₂; 4.10, 3H, m, (H1)₂, H2; 4.90, 1H, m, H1'; 6.25 1H, m, H4''; 7.20, 7.22, each 1H, m, H2'', H5''. m/z 368 (M), 308, 255, 209, 193, 160, 159 (100), 117, 100, 99, 95, 94, 81, 57, 55, 43, 41.

Reduction of Benzyloxy Acetal (115b)

A solution of the benzyloxy acetal (115b) (120 mg, 0.30 mmole) and butyl nonyl ether (12.5 mg, 0.06 mmole) in tetrahydrofuran (0.75 ml) was submitted to g.l.c. analysis (Column B, 75° (isothermal 3 min) -220° at 10°/min). The above solution was added over 1 min to a stirred solution of lithium (25 mg, 3.60 mmole) in ammonia (10 ml). The reduction was terminated after a further 14 min and the crude product ether extract was submitted to g.l.c. analysis (Column B, 75° (isothermal 3 min) -220° at 10°/min). The g.l.c. data revealed parent alcohol (115a) (90%) and uncharacterised monocleavage material (10%).

Work Described in Chapter III

Part 3.0

Reaction of Methylmagnesium Iodide with Aldehyde (33)

Aldehyde (33) (300 mg), on reaction with methylmagnesium iodide as described¹⁹, gave a crude mixture of inseparable epimeric alcohols. Acetylation of the mixture with acetic anhydride in pyridine, as previously described, permitted separation of the epimers¹⁹ which on reduction with lithium aluminium hydride in ether gave the major alcohol (1R,1'R,3'S,5'R)-1-{1'-(furan-3'-yl)-5'-methyl-2',8'-dioxabicyclo{3.2.1}oct-3'-yl}ethan-1-ol (68a) (50%). ¹H n.m.r. δ (CDCl₃) 1.16, 3H, d, J 6 Hz, (H₂)₃; 1.30, 3H, s, 5'-Me; 1.50-2.30, 7H, m, (H_{4'})₂, (H_{6'})₂, (H_{7'})₂, OH; 3.74, 2H, m, H₁, H_{3'}; 6.32, 1H, m, H_{4''}; 7.20, 1H, m, H_{5''}; 7.32, 1H, m, H_{2''}. The other fraction was the minor alcohol (1S,1'R,3'S,5'R)-1-{1'-(furan-3'-yl)-5'-methyl-2',8'-dioxabicyclo{3.2.1}oct-3'-yl}ethan-1-ol (67a) (28%). ¹H n.m.r. δ (CDCl₃) 1.14, 3H, d, J 6 Hz, (H₂)₃; 1.30, 3H, s, 5'-Me; 1.60-2.56, 7H, m, (H_{4'})₂; (H_{6'})₂, (H_{7'})₂, OH; 3.68, 2H, m, H₁, H_{3'}; 6.40, 1H, m, H_{4''}; 7.25, 1H, m, H_{5''}; 7.40, 1H, m, H_{2''}.

Preparation of Methoxymethyl Ether (40d)

To a stirred solution of alcohol (40a) (520 mg, 2.36 mmole) in dry dichloromethane (5 ml) under nitrogen at 0^o was added ethyldiisopropylamine (3.1 g, 23.9 mmole) and chloromethyl methyl ether (4.4 g, 54.7 mmole). The solution was stirred at 10-15^o for 24 h. Dichloromethane (20 ml) was added and the solution was washed with water (4x15 ml), dried and evaporated to dryness under reduced pressure to yield (1R,3S,5R)-1-(furan-3'-yl)-3-methoxymethyloxymethyl)-5-methyl-2,8-dioxabicyclo{3.2.1}octane (40d) (520 mg, 84%). (Found: m/z 268.1308 C₁₄H₂₀O₅ requires 268.1311). ν_{max} (film) 3125, 2910, 2860, 1600, 1500, 1370, 1340, 1145, 1030, 930, 870, 790 cm⁻¹.

^1H n.m.r. δ (CDCl_3) 1.42, 3H, s, 5-Me; 1.50-2.40, 6H, m, (H4) $_2$, (H6) $_2$, (H7) $_2$;
3.20, 3H, s, OMe; 3.54, 2H, m, CH $_2$ O; 4.15, 1H, m, OCH; 4.58, 2H, s,
OCH $_2$ O; 6.35, 1H, m, H4'; 7.20, 1H, m, H5'; 7.40, 1H, m, H2'. m/z 269 (M+1),
268 (M), 193, 165, 147, 113, 95 (100), 45, 43, 41, 39.

Part 3.1

Preparation of 1-Benzyloxy-3-chloropropane (117b)

1-Benzyloxy-3-chloropropane (117b) was prepared from 3-chloropropan-1-ol (28.5 g, 0.3 mole) and sodium hydride (7.5 g, 0.313 mole; washed free of oil with light petroleum) by the method described.⁶⁰ Distillation gave pure 1-benzyloxy-3-chloropropane (117b) (50.5 g, 92%), b.p. 58-60°/0.02 mm (lit.¹¹² b.p. 95-100°/1 mm).

Preparation of 1-Benzyloxy-4-chlorobutane (118c)

1. To a suspension of sodium hydride (7.5 g, 0.31 mole; washed free of oil with light petroleum) in dry tetrahydrofuran (100 ml) was added 1,4-butanediol (27 g, 0.30 mole) in dimethylformamide (20 ml). After stirring for 1 h a solution of benzyl bromide (51 g, 0.30 mole) in dimethylformamide (20 ml) was added over 1 h. The mixture was stirred at 25° for 18 h. Water (150 ml) was added and the mixture was extracted with ether (3 times). The combined ether extracts were washed with water, dried and evaporated under reduced pressure to give 4-benzyloxybutan-1-ol (118b) (52.5 g, 90%), b.p. 100-105°/0.5 mm (lit.¹¹³ 95-105°/0.5 mm).

2. 4-Benzyloxybutan-1-ol (118b) (52 g, 0.29 mole) was converted to 1-benzyloxy-4-chlorobutane (118c) using triphenylphosphine (98.5 g) and carbon tetrachloride (260 ml) according to the general method described.⁶⁵ Isolation gave a pale yellow oil which was chromatographed on alumina (light petroleum) and distilled (49.3 g, 86%), b.p. 78-80°/0.5 mm (lit.¹¹⁴ 75°/0.7 mm).

Preparation of 1-Benzyloxy-5-chloropentane (119c)

1. 5-Benzyloxy-pent-1-ene¹¹⁷ (30 g 170 mmole) in dry tetrahydrofuran (60 ml) was added to sodium borohydride (1.58 g, 41.6 mmole) under a nitrogen

atmosphere. The mixture was stirred at 25^o and hydroboration was initiated by dropwise addition of boron trifluoride etherate (7.3 ml) over 1 h. Stirring was continued at 25^o for a further 1.5 h, followed by the addition of water (11 ml). The organoborane was oxidized at 30-40^o by the slow addition of sodium hydroxide (10% aqueous, 15 ml) followed by hydrogen peroxide (30% aqueous, 15 ml). Stirring was continued for a further 30 min. The mixture was saturated with sodium chloride and the organic phase was washed with brine, dried and evaporated under reduced pressure to yield 5-benzyloxypentan-1-ol (119b) (29.3 g, 97%). ¹H n.m.r. spectrum was identical with that reported.¹¹³

2. 5-Benzyloxypentan-1-ol (119b) (29.3 g, 151 mmole) was converted to 1-benzyloxy-5-chloropentane (119c) using triphenylphosphine (51.5 g) and carbon tetrachloride (136 ml) according to the general method described.⁶⁵ Chromatography on alumina (light petroleum) gave 1-benzyloxy-5-chloropentane (119c) (23.2 g, 73%), b.p. 67-69^o/0.005 mm (lit.¹¹⁴ 86^o/0.1 mm). ¹H n.m.r. δ (CDCl₃) 1.56, 6H, m, (H2)₂, (H3)₂, (H4)₂; 3.46, 4H, m, (H1)₂, (H5)₂; 4.47, 2H, s, OCH₂Ph; 7.32, 5H, s, arom. ¹³C n.m.r. δ (CDCl₃) 23.9 (t), 29.2 (t), 32.6 (t), 70.3 (t), 73.1 (t), 127.8 (d), 128.5 (d), 138.8 (s) 142.4 (s).

Preparation of 4-Benzyloxy-1-(furan-3'-yl)butan-1-one (121)

1. 4-Benzyloxy-1-(furan-3'-yl)butan-1-one (121) was prepared from furan-3-carboxylic acid (4.48 g, 40 mmole), methyllithium (40 mmole, prepared from iodomethane⁶⁴), 1-benzyloxy-3-chloropropane (117b) (9.25 g, 50 mmole) and lithium alloy (2% sodium, 0.75 g) by the method of Dimitriadis⁶⁰ (3.55 g, 37%), b.p. 120-125^o/0.5 mm (lit.⁶⁰ 130^o/0.4 mm {block}).

2. A similar reaction using *n*-butyllithium yielded only starting material.

Reduction of Ketone (121) to 4-Benzyloxy-1-(furan-3'-yl)butan-1-ol (124)

Sodium borohydride (180 mg) was added to a stirred solution of ketone (121) (2.3 g, 9.43 mmole) in methanol (50 ml) at 0° and the reaction mixture was stirred for 45 min at 0°. The methanol was removed under reduced pressure and to the residue was added water (5 ml). The mixture was extracted with ether (4 times), dried and evaporated under reduced pressure to yield 4-benzyloxy-1-(furan-3'-yl)butan-1-ol (124) as a colourless oil (2.29 g, 99%). The ¹H n.m.r. spectrum was identical with that previously reported.⁶⁰

Reduction of Alcohol (124) to 1-(Furan-3'-yl)butane-1,4-diol (127)

Alcohol (124) (2.13 g, 8.66 mmole) in dry tetrahydrofuran (25 ml) was added to a stirred solution of liquid ammonia (300 ml, distilled) and lithium (1 g, 0.2% sodium) at -78°. The blue solution was stirred at -78° for 30 min at which time isoprene was added to discharge the blue colour. The ammonia was allowed to evaporate overnight. Water (20 ml) was added and the mixture was extracted with dichloromethane (5 times), dried and evaporated under reduced pressure to yield a pale yellow oil. Flash chromatography (ether/light petroleum, 1:1 to 1:0) gave 1-(furan-3'-yl)-butane-1,4-diol (127) (1.15 g, 85%). (Found: m/z 156.0784. C₈H₁₂O₃ requires 156.0786). ν_{\max} (film) 2350, 2925, 2850, 1500, 1155, 1040, 1020, 870 cm⁻¹. ¹H n.m.r. δ (CDCl₃) 1.75, 4H, m, (H₂)₂, (H₃)₂; 3.30, 2H, b, 2xOH; 3.58, 2H, m, (H₄)₂; 4.60, 1H, m, H₁; 6.30, 1H, m, H₄'; 7.26, 2H, m, H₂', H₅'. m/z 156 (M), 138, 110, 97 (100), 69, 41, 39. This sample was used subsequently without further purification.

Cyclization of Diol (127) to Tetrahydrofuran (91)

Diol (127) (1.12g, 7.18 mmole), *p*-toluenesulfonic acid (80 mg) in dichloromethane (250 ml) containing 4Å sieves, was stirred at 0° under nitrogen for 2 h. The solution was stirred at 25° for a further 24 h, washed with sodium bicarbonate (10% aqueous, 50 ml), dried and evaporated under reduced pressure to yield 3-(tetrahydrofuran-2'-yl)furan (91) (975 mg, 98%), b.p. 92-96°/22 mm (block) (some loss on distillation). (Found: C, 69.8; H, 7.5. C₈H₁₀O₂ requires C, 69.6; H, 7.3%). (Found: $\frac{m}{z}$ 138.0685. C₈H₁₀O₂ requires 138.0681). ν_{\max} (film) 2975, 2860, 1600, 1500, 1155, 1050, 1020, 875 cm⁻¹. ¹H n.m.r. 80 MHz, δ (CDCl₃) 2.00, 4H, m, (H3')₂, (H4')₂; 3.95, 2H, m, (H5')₂; 4.85, 1H, m, H2'; 6.40, 1H, m, H4; 7.38, 2H, m, H2, H5. ¹³C n.m.r. δ (CDCl₃) 26.0 (t); 32.8 (t), 68.1 (t), 73.7 (d), 109.1 (d), 127.5 (s), 139.4 (d), 143.5 (d).

Preparation of 5-Benzyloxy-1-(furan-3'-yl)pentan-1-one (122)

1. The reaction was done using 3-furoic acid (4.48 g, 40 mmole), methyl-lithium (40 mmole, prepared from MeI⁶⁴), 1-benzyloxy-4-chlorobutane (118c) (9.9 g, 50 mmole) and lithium alloy (2% sodium, 750 mg) according to the literature method.⁶⁰ After 1 h at -45° and 8 h at -30° to -20°, isolation gave a yellow oil. Chromatography on alumina (ether/light petroleum, 1:1 to 1:0) gave non furan containing material (7 g) and 4-benzyloxy-1-(furan-3'-yl)-pentan-1-one (122) (2.85 g, 27 %), b.p. 88-90°/5x10⁻³ mm (block). (Found: C, 74.5; H, 7.2. C₁₆H₁₈O₃ requires C, 74.4; H, 7.0%). (Found: $\frac{m}{z}$ 258.1263. C₁₆H₁₈O₃ requires 258.1256). ν_{\max} (film) 3120, 3050, 3020, 2925, 2850, 2750, 1675, 1600, 1560, 1505, 1450, 1150, 1100, 870, 735, 700 cm⁻¹. ¹H n.m.r. δ (CDCl₃) 1.72, 4H, m, (H3)₂, (H4)₂; 2.75, 2H, m, (H2)₂; 3.48, 2H, m, (H5)₂; 4.48, 2H, s, OCH₂Ph; 6.75, 1H, m, H4'; 7.35, 5H, s, arom; 7.39, 1H, m, H5'; 8.00, 1H, m, H2'. $\frac{m}{z}$ 258 (M), 215, 167, 152, 123, 95 (100), 91.

2. A similar reaction using methyllithium-lithium bromide complex (commercially available)* yielded ketone (122) (2% by ^1H n.m.r.) and starting material.

3. A similar reaction at -30° to -40° for 2.5 h using 3-furoic acid (500 mg, 4.46 mmole) methyllithium-lithium bromide complex (4.46 mmole), 1-benzyloxy-4-chlorobutane (118c) (1.1 g, 5.5 mmole) and lithium alloy (2% sodium, 85 mg) in tetrahydrofuran gave, after preparative t.l.c. (ether/light petroleum, 1:9) 1-benzyloxy-5-phenylpentane (132) (250 mg, 22 %). (Found: $\underline{m/z}$ 254.1662. $\text{C}_{18}\text{H}_{22}\text{O}$ requires 254.1670). ν_{max} (film) 3100, 3070, 3030, 2940, 2855, 1605, 1500, 1450, 1360, 1100, 1025, 740, 700 cm^{-1} . ^1H n.m.r. δ (CDCl_3) 1.50, 6H, m, (H2)₂, (H3)₂, (H4)₂; 2.60, 2H, m, (H5)₂; 3.40, 2H, m, (H1)₂; 4.43, 2H, s, OCH_2Ph ; 7.10, 7.20, each 5H, s, arom. $\underline{m/z}$ 254 (M), 163, 146, 145, 117, 92 (100), 91.

The more polar material was 5-phenylpentan-1-ol (133) (175 mg, 23 %). Identical by ^1H n.m.r. and t.l.c. to commercially available material.*

Reduction of Ketone (122) to Alcohol (125)

Ketone (122) (2.5 g, 9.69 mmole) was reduced with sodium borohydride (200 mg) in methanol (50 ml). Work-up as before gave 5-benzyloxy-1-(furan-3'-yl)-pentan-1-ol (125) (2.5 g, 99%). (Found: $\underline{m/z}$ 260.1414. $\text{C}_{16}\text{H}_{20}\text{O}_3$ requires 260.1412). ν_{max} (film) 3400, 3075, 3050, 3025, 2925, 2850, 1600, 1500, 1450, 1360, 1155, 1100, 1020, 870, 730, 700 cm^{-1} . ^1H n.m.r. δ (CDCl_3) 1.60-1.90, 7H, m, (H2)₂, (H3)₂, (H4)₂, OH; 3.45, 2H, m, (H5)₂; 4.42, 2H, s, OCH_2Ph ; 4.60, 1H, m, H1; 6.34, 1H, m, H4'; 7.25, 7H, s, H2', H5', arom. $\underline{m/z}$ 260 (M), 188, 151, 97 (100), 92, 91. This sample was used subsequently without further purification.

* Aldrich Chemical Company

Reduction of Alcohol (125) to give Diol (128)

Alcohol (125) (2.45 g, 9.42 mmole) was reduced with distilled liquid ammonia (400 ml), lithium alloy (0.2% sodium, 1 g) and dry tetrahydrofuran (50 ml) at -78° for 1 h. Work-up as above and flash chromatography (ether/light petroleum, 1:1 to 1:0) gave 1-(furan-3'-yl)pentane-1,5-diol (128) (1.12 g, 70%). ν_{\max} (film) 3350, 2940, 2855, 1500, 1160, 1060, 1020, 875 cm^{-1} . ^1H n.m.r. δ (CDCl_3) 1.38-1.88, 6H, m, $(\text{H}_2)_2$, $(\text{H}_3)_2$, $(\text{H}_4)_2$; 3.15, 2H, b, 2xOH; 3.63, 2H, m, $(\text{H}_5)_2$; 4.60, 1H, t, J 5 Hz, H1; 6.35, 1H, m, H4'; 7.35, 2H, m, H2', H5'. m/z 170 (M), 151, 97 (100), 95.

Cyclization of Diol (128) to Tetrahydropyran (92)

Diol (128) (1.10 g, 6.47 mmole) in dichloromethane (250 ml) containing *p*-toluenesulfonic acid (100 mg) and 4 \AA sieves was stirred under nitrogen for 6 h at 0° and 12 h at 20° . Work-up as previously described gave 2-(furan-3'-yl)tetrahydropyran (92) (895 mg, 91%), b.p. 130-133 $^{\circ}$ /20 mm (block) (some loss on distillation). (Found: C, 70.9; H, 8.1. $\text{C}_9\text{H}_{12}\text{O}_2$ requires C, 71.0; H, 8.0%). ν_{\max} (film) 3140, 2930, 2850, 1600, 1505, 1440, 1270, 1205, 1160, 1090, 905, 875, 790, 760 cm^{-1} . ^1H n.m.r. 80 MHz, δ (CDCl_3) 1.38-1.85, 6H, m, $(\text{H}_3)_2$, $(\text{H}_4)_2$, $(\text{H}_5)_2$; 3.55, 1H, m, H6; 4.05 1H, m, H6; 4.25, 1H, m, H2; 6.38, 1H, m, H4'; 7.36, 2H, m, H2', H5'. m/z 152 (M), 151 (M-1), 95 (100).

Preparation of 6-Benzyloxy-1-(furan-3'-yl)hexan-1-one (123)

The reaction was done using 3-furoic acid (4.48 g, 40 mmole), methyl-lithium (40 mmole, prepared from MeI^{64}), 1-benzyloxy-5-chloropentane (119c) (10.5 g, 49.5 mmole) and lithium alloy (2% sodium, 750 mg) according to the literature method.⁶⁰ After 3.5 h at -30° to -40° and 12 h at 20° , work-up gave a yellow oil. Chromatography on alumina (ether/light petroleum, 2:3 to 1:0) gave 1-benzyloxy-1-(furan-3'-yl)hexan-1-one (6 g). ν_{\max} (film) 3075, 3050, 3010, 2940,

2915, 2840, 1495, 1450, 1360, 1200, 1100, 1025, 910, 830, 795 cm^{-1} . ^1H n.m.r. δ (CDCl_3) 1.88, 3H, bt, $(\text{H}_5)_3$; 1.10-1.80, 6H, m, $(\text{H}_2)_2$, $(\text{H}_3)_2$, $(\text{H}_4)_2$; 3.40 2H, bt, $(\text{H}_1)_2$; 4.30, 2H, s, OCH_2Ph ; 7.20, 5H, s, arom. The low R_f material was 6-benzyloxy-1-(furan-3'-yl) hexan-1-one (123) (2.85 g, 26. %), b.p. $130-133^\circ/6 \times 10^{-3}$ mm (block). (Found: C, 75.0; H, 7.3. $\text{C}_{17}\text{H}_{20}\text{O}_3$ requires C, 75.0; H, 7.4%). (Found: m/z 272.1405. $\text{C}_{17}\text{H}_{20}\text{O}_3$ requires 272.1412). ν_{max} (film) 3110, 3050, 3010, 2920, 2840, 1675, 1560, 1510, 1450, 1150, 1100, 870, 735, 695 cm^{-1} . ^1H n.m.r. δ (CDCl_3) 1.50-1.85, 6H, m, $(\text{H}_3)_2$, $(\text{H}_4)_2$, $(\text{H}_5)_2$; 2.72, 2H, bt, $(\text{H}_2)_2$; 3.48, 2H, bt, $(\text{H}_6)_2$; 4.48, 2H, s, OCH_2Ph ; 6.70, 1H, m, H_4' ; 7.26, 5H, s, arom; 7.36, 1H, m, H_5' ; 7.95, 1H, m, H_2' . m/z 272 (M), 222, 186, 95 (100), 91, 65, 39.

Reduction of Ketone (123) to Alcohol (126)

Ketone (123) (2.5 g, 9.19 mmole) was reduced with sodium borohydride (250 mg) in methanol (50 ml). Work-up gave 6-benzyloxy-1-(furan-3'-yl)hexan-1-ol (126) which was not purified further (2.5 g, 99%). (Found: m/z 274.1565. $\text{C}_{17}\text{H}_{22}\text{O}_3$ requires 274.1569). ν_{max} (film) 3400, 3090, 3060, 3030, 2940, 2850, 1600, 1505, 1495, 1450, 1365, 1160, 1100, 1025, 875, 795, 740, 700 cm^{-1} . ^1H n.m.r. δ (CDCl_3) 1.18-1.85, 9H, m, $(\text{H}_2)_2$, $(\text{H}_3)_2$, $(\text{H}_4)_2$, $(\text{H}_5)_2$, OH; 3.40, 2H, bt, $(\text{H}_6)_2$; 4.42, 2H, s, OCH_2Ph ; 4.50, 1H, m, H_1 ; 6.26, 1H, m, H_4' ; 7.20, 7H, s, H_2' , H_5' , arom. m/z 274 (M), 183, 165, 97 (100), 92, 91, 41.

Reduction of Alcohol (126) to Diol (129)

Alcohol (126) (2.48 g, 9.05 mmole) was reduced with distilled liquid ammonia (400 ml) and lithium alloy (0.2% sodium, 1.5 g) at -78° for 1 h. Isolation and preparative t.l.c. (ether) gave 1-(furan-3'-yl)-hexane-1,6-diol (129) (1.35 g, 81%). (Found: m/z 184.1098. $\text{C}_{10}\text{H}_{16}\text{O}_3$ requires 184.1099). ν_{max} (film) 3350, 2940, 2850, 1505, 1160, 1055, 1025, 910, 875 cm^{-1} . ^1H n.m.r.

δ (CDCl_3) 1.35-1.85, 8H, m, $(\text{H}_2)_2$, $(\text{H}_3)_2$, $(\text{H}_4)_2$, $(\text{H}_5)_2$; 2.65, 2H, b, 2xOH; 3.59, 2H, bt, $(\text{H}_6)_2$; 4.62, 1H, t, J 6 Hz, H1; 6.37, 1H, m, H4', 7.33, 2H, m, H2', H5'. m/z 184 (M), 167, 97 (100), 95, 81, 41.

Cyclization of Diol (129) to Oxepane (93)

Diol (129) (1.2 g, 6.52 mmole) in dichloromethane (250 ml) containing *p*-toluenesulfonic acid (100 mg) and 4Å sieves was stirred under nitrogen for 5 h at 0° and at 15° for 36 h. Work-up as previously described followed by preparative t.l.c. (ether/light petroleum, 1:9) gave 2-(furan-3'-yl)oxepane (93) (685 mg, 63%), b.p. 135°/18 mm (block). (Found: m/z 166.0995. $\text{C}_{10}\text{H}_{14}\text{O}_2$ requires 166.0994). (Found: C, 72.3; H, 8.5. $\text{C}_{10}\text{H}_{14}\text{O}_2$ requires C, 72.3; H, 8.5%). ν_{max} (film) 3140, 2945, 2850, 1600, 1505, 1165, 1120, 1040, 1025, 880 cm^{-1} . ^1H n.m.r. 80 MHz, δ (CDCl_3) 1.40-1.85, 8H, m, $(\text{H}_3)_2$, $(\text{H}_4)_2$, $(\text{H}_5)_2$, $(\text{H}_6)_2$; 3.62, 2H, m, $(\text{H}_7)_2$; 4.50, 1H, m, H2; 6.35, 1H, m, H4'; 7.34, 2H, m, H2', H5'. m/z 166 (M), 97, 96, 95 (100).

Preparation of 3,3-Ethylenedioxy-3-(furan-3'-yl)propan-1-ol (97a)

1. The β -keto ester (134) was prepared from monoethyl malonate¹¹⁶ and 3-furoyl chloride by the general method.⁶⁶ Its ^1H n.m.r. spectrum was identical with that reported.⁶⁶
2. Under a nitrogen atmosphere, a mixture of β -keto ester (134) (3 g, 16.48 mmole), ethylene glycol (8.91 g, 8.1 ml, 142.8 mmole) and *p*-toluenesulfonic acid (120 mg) in 1,2-dichloroethane (60 ml) was heated under reflux for 15 h in a system equipped with a modified Dean and Stark apparatus in which the solvent passed through a short column of 4Å sieves before returning to the reaction flask. After cooling to 20°, triethylamine (0.75 ml) was added, the mixture poured into ammonia (10% aqueous, 50 ml), the layers separated, and the aqueous phase extracted with dichloromethane

(3 times). The combined organic phases were dried and evaporated under reduced pressure to yield a mixture of ethyl 3,3-ethylenedioxy-3-(furan-3'-yl)-propanoate (135) and starting material (3.38 g, 19:1 by ^1H n.m.r.). Because this mixture was difficult to purify it was reduced directly.

3. The crude acetal ester (135) (3.38 g) was reduced with lithium aluminium hydride (600 mg) at 25° for 2 h. Work-up gave a yellow oil which on flash chromatography (ether/light petroleum, 1:1) gave 3,3-ethylenedioxy-3-(furan-3'-yl)propan-1-ol (97a) (2.16 g, 71 %), b.p. $50-52^\circ/10^{-2}$ mm (block) (Found: C, 58.8; H, 6.7. $\text{C}_9\text{H}_{12}\text{O}_4$ requires C, 58.7; H, 6.6%). (Found: m/z 184.0727. $\text{C}_9\text{H}_{12}\text{O}_4$ requires 184.0736). ν_{max} (film) 3440, 3160, 2980, 2920, 1590, 1500, 1050, 1030, 945, 870 cm^{-1} . ^1H n.m.r. δ (CDCl_3) 2.10, 2H, t, J 5.5 Hz, $(\text{H}_2)_2$; 2.30, 1H, s, OH; 3.62, 2H, t, J 5.5 Hz, $(\text{H}_1)_2$; 3.95, 4H, m, $\text{O}-\text{CH}_2-$; 6.31, 1H, m, H_4' ; 7.36, 2H, m, H_2' , H_5' . m/z 184 (M), 166, 154, 139 (100), 95.

Preparation of 4,4-Ethylenedioxy-4-(furan-3'-yl)butan-1-ol (98a)

1. The acetal (98b) was prepared from ketone (121) (3.5 g, 14.3 mmole), ethylene glycol (8.8 g, 8 ml, 141 mmole) and *p*-toluenesulfonic acid (120 mg) in 1,2-dichloroethane (60 ml) by the method previously described. Work-up after 15 h reflux gave a brown mobile oil. The residue was purified by flash chromatography (ether/light petroleum, 1:4) to afford 2-(3'-benzyloxypropyl)-2-(furan-3'-yl)-1,3-dioxolane (98b) (3.78 g, 92%), b.p. $77-80^\circ/5 \times 10^{-3}$ mm (block). (Found: C, 71.1; H, 7.2. $\text{C}_{17}\text{H}_{20}\text{O}_4$ requires C, 70.8; H, 7.0%). ν_{max} (film) 3150, 3090, 3060, 3040, 2960, 2900, 1595, 1500, 1450, 1150, 1100, 1140, 1020, 870, 795, 725, 680 cm^{-1} . ^1H n.m.r. δ (CDCl_3) 1.50-2.00, 4H, m, $(\text{H}_1'')_2$, $(\text{H}_2'')_2$; 3.40, 2H, t, J 6 Hz, $(\text{H}_3'')_2$; 3.86, 4H, m, $\text{O}-\text{CH}_2-$; 4.47, 2H, s, OCH_2Ph ; 6.38, 1H, m, H_4'' ; 7.35, 5H, s, arom; 7.40, 2H, m, H_2'' , H_5'' . m/z 288 (M), 158, 139 (100), 95, 91.

2. Acetal (98b) (3.2 g, 11.1 mmole) in dry tetrahydrofuran (40 ml) was added to a stirred solution of lithium alloy (0.02% sodium, 850 mg) in distilled ammonia (400 ml) at -78° . Work-up as previously described (isoprene and ammonium chloride) and flash chromatography (dichloromethane/methanol, 99:1) gave 4,4-ethylenedioxy-4-(furan-3'-yl)butan-1-ol (98a) (1.88 g, 85%), b.p. $60^{\circ}/2 \times 10^{-3}$ mm (block). (Found: C, 60.7; H, 7.1. $C_{10}H_{14}O_4$ requires C, 60.6; H, 7.1%). (Found: m/z 198.0886. $C_{10}H_{14}O_4$ requires 198.0892). ν_{\max} (film) 3400, 2960, 2910, 1500, 1185, 1150, 1040, 875 cm^{-1} . 1H n.m.r. δ ($CDCl_3$) 1.37-2.01, 4H, m, (H2)₂, (H3)₂; 2.20, 1H, s, OH; 3.51, 2H, t, J 5.5 Hz, (H1)₂; 3.84, 4H, m, O-CH₂-; 6.21, 1H, m, H4'; 7.22, 2H, m, H2', H5'. m/z 198 (M), 181, 167, 154, 137, 95 (100).

The high R_f fraction was 4-(furan-3'-yl)butan-1-ol (94) (150 mg, 10%), identical 1H n.m.r. spectrum with that reported in Chapter 2 Part 2.2.

Preparation of 6,6-Ethylenedioxy-6-(furan-3'-yl)hexan-1-ol (99a)

1. The acetal (99b) was prepared from ketone (123) (1.0 g, 3.68 mmole), ethylene glycol (4 ml) and *p*-toluenesulfonic acid (100 mg) in 1,2-dichloroethane (50 ml) by the method previously described. Flash chromatography (ether/light petroleum, 1:4) gave 2-(5'-benzyloxypentyl)-2-(furan-3''-yl)-1,3-dioxolane (99b) (1.03 g, 89%), b.p. $125^{\circ}/5 \times 10^{-3}$ mm (block). (Found: C, 72.5; H, 7.4. $C_{19}H_{24}O_4$ requires C, 72.2; H, 7.7%). (Found: m/z 316.1669. $C_{19}H_{24}O_4$ requires 316.1675). ν_{\max} (film) 3150, 3075, 3050, 2960, 2875, 1595, 1510, 1455, 1370, 1190, 1160, 1100, 1050, 1030, 875, 800, 735, 700 cm^{-1} . 1H n.m.r. δ (CCl_4) 1.23-2.00, 8H, m, (H1')₂, (H2')₂, (H3')₂, (H4')₂; 3.30, 2H, t, J 5 Hz, (H5')₂; 3.75, 4H, m, O-CH₂-; 4.35, 2H, s, OCH₂Ph; 6.15, 1H, m, H4'; 7.15, 5H, s, arom; 7.20, 2H, m, H2'', H5''. m/z 316 (M), 139 (100), 95, 91, 63, 38.

2. Acetal (99b) (200 mg, 0.64 mmole) in tetrahydrofuran (3 ml) was reduced with lithium (0.02% sodium, 60 mg) in ammonia (30 ml) at -78° for 0.5 h as previously described. Preparative t.l.c. (ether/light petroleum, 8:1) gave 6,6-ethylenedioxy-6-(furan-3'-yl)hexan-1-ol (99a) (110 mg, 76%), b.p. $65-68^{\circ}/1 \times 10^{-3}$ mm (block). (Found: C, 63.7; H 8.0. $C_{12}H_{18}O_4$ requires C, 63.7; H, 7.7%). ν_{\max} (film) 3400, 3150, 2950, 2900, 1595, 1505, 1190, 1160, 1070, 1050, 1020, 945 870, 800, 730 cm^{-1} . 1H n.m.r. δ ($CDCl_3$) 1.20-2.00, 8H, m, (H2)₂, (H3)₂, (H4)₂, (H5)₂; 2.20, 1H, s, OH; 3.60, 2H, t, \underline{J} 5 Hz, (H1)₂; 3.85, 4H, m, O-CH₂-; 6.23, 1H, m, H4'; 7.28, 2H, m, H2', H5'. $\underline{m/z}$ 226 (M), 139 (100), 110, 95.

Preparation of 2-(2'-Benzyloxyethyl)-2-(furan-3'-yl)-1,3-dioxolane (97b)

The alcohol (97a) in dimethylformamide (0.5 ml) and tetrahydrofuran (1 ml) was added to a suspension of NaH (50 mg, washed free of oil with light petroleum) over 45 min. Benzyl bromide (204 mg, 1.19 mmole) was added and the solution was stirred for 18 h at 15° . Water (5 ml) was added and the mixture was extracted with ether (4x10 ml). The organic phase was dried, evaporated under reduced pressure and chromatographed by preparative t.l.c. to yield 2-(2'-benzyloxyethyl)-2-(furan-3'-yl)-1,3-dioxolane (97b). (209 mg, 64%), b.p. $65-70^{\circ}/5 \times 10^{-3}$ (block). (Found: $\underline{m/z}$ 274.1211. $C_{16}H_{18}O_4$ requires 274.1205). ν_{\max} (film) 3130, 3050, 3025, 2950, 2875, 1590, 1500, 1450, 1365, 1180, 1155, 1100, 1045, 870, 800, 735, 695 cm^{-1} . 1H n.m.r. δ (CCl_4) 2.16, 2H, t, \underline{J} 7 Hz, (H1')₂; 3.45, 2H, t, \underline{J} 7 Hz, (H2')₂; 3.80, 4H, m, O-CH₂-; 4.32, 2H, s, OCH₂Ph; 3.16, 1H, m, H4''; 7.10, 5H, s, arom; 7.16, 2H, m, H2'', H5''. $\underline{m/z}$ 274 (M), 158, 139 (100), 95, 91.

Preparation of 2-(Furan-3'-yl)-2-octyl-1,3-dioxolan-4-ylmethanol (114)

The reaction was done using ketone²² (136) (1.99 g, 9.57 mmole), glycerol (7 ml, 95.8 mmole) and *p*-toluenesulfonic acid (80 mg) in 1,2-dichloro-

ethane (40 ml) according to the method previously described. After 15 h, isolation gave an oil which was chromatographed on alumina (ether/light petroleum, 0:1 to 1:1). The high R_f product was ketone (136) (100 mg, 5%).

The low R_f material was 2-(furan-3'-yl)-2-octyl-1,3-dioxolan-4-ylmethanol (114) (1.95 g, 72%), b.p. 95-100^o/0.02 mm (block). (Found: C, 68.1; H, 9.5. $C_{16}H_{26}O_4$ requires C, 68.1; H, 9.3%). ν_{max} (film) 3450, 2960, 2880, 1595, 1500, 1460, 1180, 1150, 1045, 875 cm^{-1} . 1H n.m.r. δ ($CDCl_3$) 0.80-1.82, 18H, m; 3.40-4.20, 5H, m, (H5)₂, H4, $\underline{CH_2OH}$; 6.18, 1H, m, H4'; 7.38, 2H, m, H2', H5'. m/z 283 (M+1), 251, 169 (100), 95.

Preparation of 4-(3'-Benzyloxypropyl)-2-(furan-3''-yl)-2-octyl-1,3-dioxolane (115b)

1. 5-Benzyloxy-pentane-1,2-diol (137) was prepared from 5-benzyloxy-pent-1-ene^{115,117} by the method of Price¹¹⁷ (50%), b.p. 129-130^o/0.02 mm (lit.¹¹⁷ 173^o/0.25 mm). Its 1H n.m.r. spectrum was identical with that reported.¹¹⁷

2. The reaction of ketone (136)²² (1 g, 4.81 mmole), 5-benzyloxy-pentane-1,2-diol (137) (1.20 g, 5.71 mmole) and *p*-toluenesulfonic acid (40 mg) in 1,2-dichloroethane (30 ml) for 26 h according to the method previously described gave a mixture of ketone (136) and the required dioxolane (115b). To facilitate purification, the crude mixture (1 g) was reduced with an excess of lithium aluminium hydride in ether (10 ml) at 0^o. Work-up and flash chromatography (ether/light petroleum, 1:4) gave 4-(3'-benzyloxypropyl)-2-(furan-3''-yl)-2-octyl-1,3-dioxolane (115b) (480 mg, 25%), b.p.

142-148^o/5x10⁻³ (block). (Found: C, 75.0; H, 9.1. $C_{25}H_{36}O_4$ requires C, 75.0; H, 9.1%). (Found: m/z 400.2623. $C_{25}H_{36}O_4$ requires 400.2614).

ν_{max} (film) 3010, 2900, 2830, 1585, 1495, 1460, 1450, 1090, 1050, 1020, 870 cm^{-1} . 1H n.m.r. 80 MHz, ($CDCl_3$) 0.85-1.64, 21H, m, octyl, (H1')₂, (H2')₂; 3.47, 3H, m, H4, (H5)₂; 3.99, 2H, m, (H3')₂; 4.48, 2H, s, OCH_2Ph ; 6.30, 1H, m,

H4'; 7.30, 2H, m, H2', H5'. $\underline{m/z}$ 400 (M), 287, 208, 185, 110 (100), 95, 91.

The low R_f fraction was 1-(furan-3'-yl)nonan-1-ol (60a) (495 mg, 49%), identical ^1H n.m.r. spectrum with that reported.²²

Part 3.2

Synthesis of Ester (138)

The aldehyde (33) (800 mg, 3.6 mmole) was oxidized²⁸ by adding a solution of sodium hydroxide (600 mg) in methanol/water (2:3, 50 ml) dropwise over 45 min to a rapidly stirred solution of the aldehyde (33) and silver nitrate (650 mg) in methanol/water (3:1, 40 ml). The black suspension was stirred for a further 2 h at 20^o, filtered through celite and the methanol removed under reduced pressure. The alkaline solution was extracted with dichloromethane, acidified at 0^o with dilute hydrochloric acid (10% aqueous) to pH 3-4 and extracted with ether (5 times). The crude ether extract was treated with an excess of diazomethane, dried and evaporated under reduced pressure. Flash chromatography (ether/light petroleum, 1:1) gave (3S,5R)-5-{3'-(furan-3'-yl)-3'-oxopropyl}-3-hydroxy-5-methyldihydrofuran-2(3H)-one (30a) (130 mg, 15.2%), m.p. 101-102^o (lit.^{17,18} 101-102.5^o) and methyl (1R,3S,5R)-1-(furan-3'-yl)-5-methyl-2,8-dioxabicyclo[3.2.1]octane-3-carboxylate (138) (380 mg, 42%), m.p. 87-88^o from light petroleum. (Found: C, 62.3; H, 6.5. C₁₃H₁₆O₅ requires C, 61.9; H, 6.4%). ν_{\max} (Nujol) 3160, 3130, 1735, 1620, 1600, 1510, 1030, 810 cm⁻¹. ¹H n.m.r. δ (CDCl₃) 1.40, 3H, s, 5-Me; 1.70-2.50, 6H, m, (H4)₂, (H6)₂, (H7)₂; 3.70, 3H, s, CO₂Me; 4.55, 1H, dd, J 6, 9 Hz, H3; 6.42, 1H, m, H4'; 7.26, 1H, m, H5'; 7.45, 1H, m, H2'. m/z 252 (M), 220 (M-CH₃O), 193, 157, 125, 95 (100), 81.

Reaction of Methylmagnesium Iodide with Ester (138)

Methyl ester (138) (280 mg, 1.11 mmole) in dry ether (5 ml) was added dropwise to a stirred solution of methylmagnesium iodide (prepared from 8.03 mmole iodomethane and 8.22 mmole magnesium) in dry ether (10 ml)

at 0° under nitrogen. The mixture was stirred at 0° for 15 min and for a further 2 h at 25°. Ammonium chloride (saturated, 10 ml) was added and the mixture was extracted with ether (5 times) dried and evaporated under reduced pressure to yield a pale yellow oil (260 mg). Preparative chromatography (ether/light petroleum, 4:1) gave two main fractions. Fraction one (180 mg) was acetylated with acetic anhydride (1 ml) in pyridine (2 ml) at 20° for 18 h. Dichloromethane (10 ml) was added and the solution was washed with dilute hydrochloric acid (10% aqueous, 3 times), dilute sodium hydroxide (10% aqueous) and water. The solution was dried, evaporated under reduced pressure and the residue chromatographed by preparative t.l.c. (ether/light petroleum 1:1) to yield methyl (2S,2'R,5'R)- and (2S,2'R,5'S)-2-acetoxy-3-[5'-(furan-3'-yl)-2',5'-dimethyltetrahydrofuran-2'-yl]propanoates (140b) and (139b) (39 mg, 11. %). (Found: $\underline{m/z}$ 295.1182 (M-Me). $C_{15}H_{19}O_6$ requires $\underline{m/z}$ 295.1187). ν_{\max} (film) 2975, 1740, 1500, 1380, 875 cm^{-1} . 1H n.m.r. δ ($CDCl_3$) 1.23, 3H, bs, 2'-Me; 1.41, 3H, s, 5'-Me; 1.60-2.00, 6H, m, (H3')₂, (H4')₂, (H3)₂; 2.01, m, 3H, bs, OCOMe; 3.61, 3H, s, CO₂Me; 5.00, 1H, m, H2; 6.10, 1H, m, H4''; 7.13, 2H, m, H2'', H5''. $\underline{m/z}$ 295 (M-Me), 279, 253, 235, 203, 165, 95, 43 (100). The lower R_f component of fraction one was (1'R,3'S,5'R)-2-[1'-(furan-3'-yl)-5'-methyl-2'8'-dioxabicyclo{3.2.1}oct-3'-yl]propan-2-ol (70) (115 mg, 41 %), m.p. 79.5-80.5°, sublimed 70°/1x10⁻²mm. (Found: C, 66.40; H, 7.78. $C_{14}H_{20}O_4$ requires C, 66.65; H, 7.99%). (Found: $\underline{m/z}$ 252.1362. $C_{14}H_{20}O_4$ requires $\underline{m/z}$ 252.1382). ν_{\max} (film) 3440, 2975, 2925, 2875, 1600, 1500, 935, 875, 790 cm^{-1} . 1H n.m.r. δ ($CDCl_3$) 1.06, 1.13, each 3H, s, (H1)₃, (H3)₃; 1.36, 3H, s, 5'-Me; 1.60-2.40, 6H, m, (H4')₂, (H6')₂, (H7')₂; 3.63, 1H, dd, J 4, 7 Hz, H3'; 4.40, 1H, b, OH;

6.26, 1H, m, H4''; 7.25, 1H, m, H5''; 7.30, 1H, m, H2''. m/z 252 (M), 237, 194, 193, 147, 95 (100), 59, 43.

Fraction two (78 mg) was acetylated with acetic anhydride (0.5 ml) in pyridine (1 ml) at 20° for 18 h. Workup as above gave an inseparable mixture of (2S,2'R,5'R)- and (2S,2'R,5'S)-1-{5'-(furan-3'-yl)-2',5'-dimethyltetrahydrofuran-2'-yl}-3-hydroxy-3-methylbut-2-yl acetates (142b) and (141b) respectively. Reduction of the diastereomeric mixture of (142b) and (141b) with lithium aluminium hydride in dry ether and preparative t.l.c. (dichloromethane/ether, 7:3, run twice) yielded a high R_f fraction of (2S,2'R,5'R)-1-{5'-(furan-3'-yl)-2',5'-dimethyltetrahydrofuran-2'-yl}-3-methylbutane-2,3-diol (142a) (27 mg, 9 %) as a colourless oil. (Found: m/z 253.1450 (M-Me). $C_{14}H_{21}O_4$ requires 253.1440). ν_{max} (film) 3440, 3000, 2960, 2900, 1500, 1370, 870, cm^{-1} . 1H n.m.r. 80 MHz, δ ($CDCl_3$) 1.18, 3H, s, 2'-Me; 1.22, 6H, s, 3-Me, (H4)₃; 1.52, 3H, s, 5'-Me; 1.69-2.40, 7H, m, (H3')₂, (H4')₂, (H1)₂, OH; 3.70, 1H, dd, J 4.4, 7.5 Hz, H2; 4.16, 1H, b, OH; 6.35, 1H, m, H4''; 7.34, 2H, m, H2'', H5''. ^{13}C n.m.r. δ ($CDCl_3$) 24.2 (q), 26.0 (q), 29.4 (q), 30.0 (q), 35.5 (t), 38.9 (t), 41.4 (t), 72.5 (s), 75.3 (d), 81.0 (s), 85.1 (s), 109.1 (d), 134.1 (s), 137.9 (d), 143.3 (d). m/z 253 (M-Me), 235, 165 (100), 147, 108, 95, 43. The low R_f isomer (2S,2'R,5'S)-1-{5'-(furan-3'-yl)-2',5'-dimethyltetrahydrofuran-2'-yl}-3-methylbutane-2,3-diol (141a) (38 mg, 12 %) was isolated as an oil. (Found: m/z 268.1685. $C_{15}H_{24}O_4$ requires 268.1674). ν_{max} (film) 3450, 3000, 2960, 2900, 1505, 1380, 1020, 875 cm^{-1} . 1H n.m.r. 80 MHz, δ ($CDCl_3$) 1.12, 1.14, each 3H, s, 3-Me, (H4)₃; 1.37, 3H, s, 2'-Me; 1.57, 3H, 5'-Me; 1.30-2.30, 8H, m, (H3')₂, (H4')₂, (H1)₂, 2xOH; 3.54, 1H, t, J 5.6 Hz, H2; 6.38, 1H, m, H4''; 7.36, 2H, m, H2'', H5'', ^{13}C n.m.r. δ

(CDCl₃) 23.8 (q), 26.0 (q), 29.4 (q), 30.6 (q), 36.8 (t), 38.6 (t), 42.5 (t), 72.8 (s), 75.2 (d), 80.7 (s), 84.4 (s), 108.8 (d), 133.1 (s), 137.9 (d), 143.7 (d). m/z 268 (m), 253, 235, 191, 165, 147, 108 (100), 95, 43.

Reaction of Diastereomers (139b) and (140b) with Methylmagnesium Iodide

A mixture of diastereomers (139b) and (140b) (30 mg, 0.10 mmole) in dry ether (2 ml) was treated with an excess of methylmagnesium iodide (prepared from 1 mmole iodomethane and 1 mmole magnesium). The mixture was stirred at 0° for 30 min and for a further 3 h at 25°. Workup as before and preparative t.l.c. (dichloromethane/ether, 7:3) yielded diols (141a) (8 mg) and (142a) (5 mg) identical with previously isolated samples (t.l.c., m.s. and ¹H n.m.r.) The highest R_f fraction was a mixture of methyl (2S,2'R,5'R)-3-{5'-(furan-3'-yl)-2',5'-dimethyltetrahydrofuran-2'-yl}-2-hydroxypropanoate (140a). {¹H n.m.r. 300 MHz, δ (C₆D₆) 1.50, 3H, s, 2'-Me; 1.65, 3H, s, 5'-Me; 3.60, 3H, s, CO₂Me; 4.55, 1H, m, H₂; 6.42, 1H, m, H₄'} and methyl (2S,2'R,5'S)-3-{5'-(furan-3'-yl)-2',5'-dimethyltetrahydrofuran-2'-yl}-2-hydroxypropanoate (139a) {¹H n.m.r. 300 MHz, δ (C₆D₆) 1.61, 3H, s, 2'-Me; 1.68, 3H, s, 5'-Me; 3.50, 3H, s, CO₂Me; 4.70, 1H, m, H₂; 6.45, 1H, m, H₄'} in a ratio of 2:5 (combined yield 15 mg, 60%).

Reaction of Tertiary Alcohol (70) with Methylmagnesium Iodide

Tertiary alcohol (70) (15 mg, 0.06 mmole) was treated with an excess of methylmagnesium iodide for 15 min at 0° and then for 2.5 h at 25°. Workup revealed no cleavage products by ¹H n.m.r.

Oxidation¹¹⁸ of Diols (141a) and (142a)

Diol (141a) (40 mg, 0.15 mmole) in dichloromethane (2 ml) was added to a mixture of dimethyl sulphoxide (170 μ l) and oxalyl chloride (100 μ l) in dichloromethane at -78° with stirring. After 30 min triethylamine (550 μ l) was added and the mixture was allowed to warm to 25° . Water (5 ml) was added, the organic layer was separated and the aqueous layer was extracted with dichloromethane (3 x 10 ml). The combined extracts were dried and evaporated under reduced pressure. Preparative t.l.c. (dichloromethane/ether, 9:1) gave starting material (8 mg, 20%) and the higher R_f , major product (2'R,5'S)-1-[5'-(furan-3'-yl)-2',5'-dimethyltetrahydrofuran-2'-yl]-3-hydroxy-3-methylbutan-2-one (143) (22 mg, 55%). (Found: m/z 251.1282 (M-Me). $C_{15}H_{22}O_4$ requires 251.1283). ν_{max} (film) 3400, 2950, 2900, 2850, 1700, 1495, 1360, 1155, 1050, 870 cm^{-1} . 1H n.m.r. 80MHz, δ ($CDCl_3$) 1.27, 1.29, each 3H, s, 3-Me, (H4)₃; 1.35, 3H, s, 2'-Me; 1.54, 3H, s, 5'-Me; 2.10-2.18, 4H, m, (H3')₂, (H4')₂; 2.67, 3.04, 2H, ABq, J 15.6 Hz; (H1)₂; 4.00, 1H, b. OH; 6.33, 1H, m, H4''; 7.34, 2H, m, H2'', H5''. ^{13}C n.m.r. δ ($CDCl_3$) 25.5 (q), 26.7 (q), 27.6 (q), 30.5 (q), 38.0 (t), 38.6 (t), 48.3 (t), 76.9 (s), 80.9 (s), 82.8 (s), 109.0 (d), 138.0 (d), 143.6 (d). m/z 251 (M-Me), 208, 180, 165, 147, 122, 111, 108, 95 (100), 59.

Similarly, oxidation of diol (142a) (40 mg, 0.15 mmole) gave starting material (8 mg, 20%) and higher R_f major product (2'R,5'R)-1-[5'-furan-3'-yl)-2',5'-dimethyltetrahydrofuran-2'-yl]-3-hydroxy-3-methylbutan-2-one (144) (27 mg, 68%). (Found: m/z 251.1284 (M-Me). $C_{15}H_{22}O_4$ requires 251.1283). ν_{max} (film) 3400, 2950, 2910, 2850, 1700 1500, 1365, 1155, 1055, 1015, 870 cm^{-1} . 1H n.m.r. 80 MHz, δ ($CDCl_3$) 1.28

3H, s, 2'-Me; 1.35, 6H, s, 3-Me, (H4)₃; 1.48, 3H, s, 5'-Me; 1.82-2.30, 4H, m, (H3')₂, (H4')₂; 2.82, 3.04, 2H, ABq, J 14.2 Hz, (H1)₂; 4.45, 1H, b, OH; 6.31, 1H, m, H4''; 7.32, 2H, m, H2'', H5''. ¹³C n.m.r. δ (CDCl₃) 26.5 (q), 26.7 (q), 27.3 (q), 29.8 (q), 37.5 (t), 38.6 (t), 48.5 (t), 77.0 (s), 81.9 (s), 83.3 (s), 109.0 (d), 137.9 (d), 143.5 (d). m/z 251 (M-Me), 233, 208, 180, 165, 147, 122, 111, 108, 95 (100).

Isolation of the Terpenes from *Eremophila rotundifolia*

The finely ground wood of *E. rotundifolia* (16 kg) was extracted with dichloromethane (3 x 30 l). Removal of the solvent under reduced pressure gave a crude dark red oil (1.4 kg). A sample of the crude extract (230 g) was chromatographed on silica (2 kg) (ether/light petroleum mixtures) to give a number of crude fractions. Re-chromatography of the thus obtained fractions on silica (ether/light petroleum mixtures) gave 5,8-dihydroxyserrulat-14-en-18-al (158) (350 mg, 0.15%), which proved difficult to purify. ^1H n.m.r. δ (CDCl_3) 5.00, 1H, m, H14; 6.35, 1H, bs, H7; 9.28, 1H, d, \underline{J} 2.5 Hz, H18. The characterisation of (158) is reported later.

The known sesquiterpene freelingyne (2)³ was also isolated (450 mg, 0.2%). Its ^1H n.m.r. was identical with that reported.³

The major constituent isolated was (13S,18R)-5,18:13,18-diepoxy-serrulat-14-en-8-ol (150a) (1.65 g, 0.72%), as colourless crystals from chloroform/light petroleum, m.p. 176-178^o, sublimed 160^o/1x10⁻³mm. (Found: C, 76.5; H, 8.4; $\underline{m/z}$ 314.1888. $\text{C}_{20}\text{H}_{26}\text{O}_3$ requires C, 76.4; H, 8.3%; $\underline{m/z}$ 314.1882). $\{\alpha\}_{577}^{20}$ -24.2 (1% in CHCl_3). ν_{max} (Nujol) 3560, 3440, 1620, 1175, 1100, 1050, 1000, 970, 940, 860, 855 cm^{-1} . λ_{max} (EtOH) 204 (53600), 289 (3500) nm. ^1H n.m.r. 300 MHz (Figure 4.1, Table 4.2) δ (CDCl_3) 1.23, 3H, d, \underline{J} 7, Hz, $(\text{H}20)_3$; 1.55, 2H, m, H2 β , H3 α ; 1.74, 6H, s, $(\text{H}16)_3$, $(\text{H}17)_3$; 1.80, 1H, obscured, H2 α ; 1.87, 1H, dt, \underline{J} 13, 10 Hz, H12 α ; 2.02, 1H, ddd, \underline{J} 1.2, 5, 13, Hz, H12 β ; 2.18, 3H, s, $(\text{H}19)_3$; 2.20, 1H, obscured, H3 β ; 2.30, 1H, ddt, \underline{J} 1.2, 5.6, 10 Hz, H11; 2.56, 1H, ddd, \underline{J} 3, 7, 10 Hz, H4; 3.02, 1H, tq, \underline{J} 6, 7 Hz, H1; 4.50, 1H, s, OH; 5.15, 1H, ddd, \underline{J} 5, 9, 10 Hz, H13; 5.20, 1H, dq, \underline{J} 9, 1.2, 1.2 Hz, H14; 5.30, 1H, d, \underline{J} 5.6 Hz, H18; 6.44, 1H, s, H7. ^{13}C n.m.r. (Table 4.1) δ (CDCl_3) 15.2 (q), 18.5 (q), 19.6 (q),

23.3 (t), 25.8 (q), 27.3 (d), 28.2 (t), 32.9 (d), 38.0 (t), 48.8 (d),
75.7 (d), 105.1 (d), 115.0 (d), 124.1 (d), 125.4 (s), 126.2 (s), 129.1 (s),
137.9 (s), 144.3 (s), 148.7 (s). $\underline{m/z}$ 314 (M), 254, 192, 191, 124, 44 (100).

The lowest R_f component isolated was eremophila-10,11 (13)-diene-9,12-dione (168) (200 mg, 0.1%) which proved difficult to purify, b.p. 95-105^o/0.002 mm (block). (Found: $\underline{m/z}$ 232.1466. $C_{15}H_{20}O_2$ requires 232.1463). ν_{\max} (film) 2950, 2910, 2860, 2810, 1685, 1620, 1460, 1370, 1300, 1260, 1220, 965, 940 cm^{-1} . 1H n.m.r. 300 MHz (Table 5.1) δ ($CDCl_3$) 0.86, 3H, d, \underline{J} 6.3 Hz, (H14)₃; 0.88, 3H, s, (H15)₃; 1.35-1.55, 3H, m, (H3)₂, H6 ; 1.62, 1H, m, H4; 2.00, 1H, dd, \underline{J} 4.9, 13.7 Hz, H6 ; 2.17, 2H, m, (H2)₂; 2.35, 2H, d, \underline{J} 8.8 Hz, (H8)₂; 2.83, 1H, m, H7; 6.01, 6.21, each 1H, s, (H13)₂; 6.50, 1H, t, \underline{J} 3.9 Hz, H1. ^{13}C n.m.r. (Table 5.1) δ ($CDCl_3$) 16.0 (q), 25.0 (q), 25.6 (t), 26.5 (t), 30.7 (d), 36.3 (s), 38.3 (d), 41.5 (t), 42.8 (t), 133.8 (t), 135.9 (d), 144.4 (s), 152.8 (s), 194.0 (d), 203.2 (s). $\underline{m/z}$ 232 (M), 217 (M-Me), 190 (M-C₃H₆, 100), 175, 161, 147, 134, 121, 91.

Work Described in Chapter IV

Part 4.0

Acetylation of the Serrulatenol (150a)

1. The Serrulatenol (150a) (150 mg, 0.48 mmole) was acetylated with acetic anhydride (1 ml) in pyridine (2 ml) at 20^o for 20 h. Dichloromethane (10 ml) was added and the solution was washed with dilute hydrochloric acid (10% aqueous, 3 times), dilute sodium hydroxide and water. The solution was dried and evaporated under reduced pressure; the residue was chromatographed by preparative t.l.c. (ether/light petroleum, 2:5). (13S,18R)-5,18:13,18-diepoxy-serrulat-14-en-8-yl acetate (150b) was recrystallized from methanol/water to yield colourless needles, m.p. 105-107^o. (Found: C, 74.2; H, 8.1; m/z 356.1963. C₂₂H₂₈O₄ requires C, 74.1; H, 7.9%; m/z 356.1987). ν_{\max} (Nujol) 2970, 2950, 2870, 1760, 1202, 1195, 1100, 960 cm⁻¹. ¹H n.m.r. 300 MHz, δ (CDCl₃) 1.22, 3H, d, J 7 Hz, (H20)₃; 1.75, 6H, s, (H16)₃, (H17)₃; 2.22, 3H, s, (H19)₃; 2.28, 3H, s, OCOMe; 2.58, 1H, ddd, H4; 2.88, 1H, sex., H1; 5.19, 2H, m, H13, H14; 5.39, 1H, d, J 5 Hz, H18; 6.71, 1H, s, H7. ¹³C n.m.r. (Table 4.5) δ (CDCl₃) 15.4 (q), 18.5 (q), 19.8 (q) 20.9 (q), 23.3 (t), 25.7 (q), 27.8 (d), 28.2 (t), 32.6 (d), 37.9 (t), 48.5 (d), 75.3 (d), 104.7 (d), 121.7 (d), 124.0 (d), 125.6 (s), 128.4 (s) 131.2 (s), 137.1 (s), 143.1 (s), 148.8 (s), 169.7 (s). m/z 356 (M), 314, 233, 191 (100), 175, 124.
2. The acetate (150b) was reduced with an excess of lithium aluminium hydride to give (150a) which gave an indentical ¹H n.m.r. to that previously recorded.

Catalytic Reduction of the Serrulatenol (150a)

1. Serrulatenol (150a) (600 mg, 1.91 mmole) was hydrogenated in ethyl acetate solution in the presence of 10% palladium-on-carbon for 40 min at 15^o. The reaction mixture was filtered through celite and the filtrate was evaporated under reduced pressure. Preparative t.l.c. (ether/light petroleum, 1:4, run twice) gave (13R,18R)-5,18:13,18-diepoxy-serrulatan-8-ol (154a) (398 mg, 66%), m.p. 124-126^o from light petroleum. (Found: C, 76.2; H, 8.9; m/z 316.2046. C₂₀H₂₈O₃ requires C, 75.9; H, 8.9%; m/z 316.2038). ν_{\max} (CHCl₃) 3630, 3400, 3010, 2980, 2955, 2890, 1600, 1460, 1440, 1410, 1100, 1030, 970 cm⁻¹. ¹H n.m.r. 300 MHz (Figure 4.7) δ (CDCl₃) 0.96, 0.98, each 3H, d, J 4.3 Hz, (H16)₃, (H17)₃; 1.26, 3H, d, J 6.9 Hz, (H20)₃; 2.22, 3H, s, (H19)₃; 2.27, 1H, m, H11; 2.55, 1H, ddd, H4; 3.03, 1H, sex., H1; 4.40, 1H, s, OH; 4.51, 1H, m, H13; 5.32, 1H, d, J 5 Hz, H18; 6.46, 1H, s, H7. ¹³C n.m.r. (Table 4.5) δ (CDCl₃) 15.2 (q), 19.5 (q), 23.0 (d,t), 23.3 (q), 25.6 (q), 27.2 (d), 28.1 (t), 32.9 (d), 37.5 (t), 44.1 (t), 48.4 (d), 77.6 (d), 105.0 (d), 114.7 (d), 125.1 (s), 126.0 (s), 128.9 (s), 144.0 (s), 148.4 (s). m/z 316 (M), 191, 190 (100), 175, 86, 84.

The lower R_f fraction was rechromatographed by preparative t.l.c. (ether/light petroleum, 1:4, run twice) to give (18R)-5,18-epoxy-serrulatan-8,18-diol (155a) (120 mg, 20%). ¹H n.m.r. δ (CDCl₃) 5.48, 1H, d, J 3 Hz, H18. m/z 318 (M), 215, 191, 190 (100), 175. (155a) was acetylated with acetic anhydride in pyridine to give (18S)-18-acetoxy-5,18-epoxy-serrulatan-8-yl acetate (155b). (Found: m/z 402.2398. C₂₄O₃4O₅ requires 402.2406). ν_{\max} (film) 2980, 2950, 2890, 1755, 1460, 1360, 1190, 1005, 905 cm⁻¹. ¹H n.m.r. 300 MHz (Figure 4.9) δ (CDCl₃) 0.85, 0.87, each 3H, d, J 2.6 Hz, (H16)₃, (H17)₃; 1.21, 3H, d, J 6.8 Hz, (H20)₃; 2.07, 3H, s, 18-OCOMe; 2.13,

3H, s, (H19)₃; 2.28, 3H, s, 8-OCOMe; 2.55, 1H, dt, H4; 2.95, 1H, sex., H1; 6.51, 1H, d, J 1.9 Hz, H18; 6.68, 1H, s, H7. ¹³C n.m.r. (Table 4.5) δ (CDCl₃) 16.0 (q), 21.4 (q), 22.6, 22.9 (d), 24.8, 26.6, 28.0 (q), 28.6 (d,t), 31.7, 32.6 (d), 39.3 (t), 39.8 (d), 90.5 (d), 122.7 (d), 124.0 (s), 131.2 (s), 142.7 (s), 145.9 (s), 170.2 (s). m/z 402 (M), 360, 343, 300, 257, 215 (100), 191, 190.

2. An extended hydrogenation of (150a) in ethyl acetate solution in the presence of 10% palladium-on-carbon for 48 h gave (154a) as above and serrulatanal (157) which was not purified. ¹H n.m.r. (crude) δ (CDCl₃) 9.32, 1H, d, J 2.5 Hz, H18.

3. Hydrogenation of (150a) (100 mg, 0.32 mmole) in ethyl acetate solution in the presence of 10% palladium-on-carbon for 1 h gave a mixture of (154a) and (155a) (2:1 by ¹H n.m.r.). The mixture was acetylated with acetic anhydride in pyridine and the thus obtained mixture of (154b) and (155b) was re-hydrogenated for a further 2.5 h. Preparative t.l.c. (ether/light petroleum 1:5) gave 5,18-epoxyserrulatan-8-yl acetate (156) (23 mg, 21%), m.p. 66-68^o from methanol/water. (Found: m/z 344.2355. C₂₂H₃₂O₃ requires 344.2351). v_{max} (CDCl₃) 2980, 2960, 2890, 1760, 1480, 1365, 1200, 1035, 910 cm⁻¹. ¹H n.m.r. 300 MHz (Figure 4.10) δ (C₆D₆) 0.94, 0.96, each 3H, d, (H16)₃, (H17)₃; 1.39, 3H, d, J 6.9 Hz, (H20)₃; 1.99, 3H, s, (H19)₃; 2.18, 1H, dt, H4; 3.19, 1H, sex., H1; 3.58, t, M part of an AMX, J 10 Hz, H18; 4.32, dd, A part of an AMX, J 3, 10 Hz, H18; 6.88, 1H, s, H7. ¹³C n.m.r. (Table 4.5) δ (CDCl₃) 16.2 (q), 21.2 (q), 22.7, 22.9, 23.3, 24.9, 26.7 (q), 28.1, 30.2, 31.2, 37.5 (d), 38.7 (d), 39.4 (t), 70.0 (t), 122.2 (d), 123.3 (s), 124.2 (s), 131.7 (s), 141.5 (s), 149.4 (s), 170.2 (s). m/z 344 (M), 302 (100), 287, 191, 190, 175, 161.

The lower R_f fraction was the acetate (154b) (45 mg, 39%) ^1H n.m.r. δ (CDCl_3) 0.95, 1.02, each 3H, s, (H16)₃, (H17)₃; 1.14, 3H, d, J 7 Hz, (H20)₃; 2.21, 3H, s, (H19)₃; 2.26, 3H, s, OCOMe; 2.95, 1H, m, H1; 4.50, 1H, m, H13; 5.31, 1H, d, J 5 Hz, H18; 6.61, 1H, s, H7.

Epoxidation of the Phenolic Acetate (150b)

m-Chloroperoxybenzoic acid (100 mg, 80% puris) was added to the phenolic acetate (150mg, 0.42 mmole) in dry dichloromethane (15 ml). After stirring at 0° for 3 h starting material could not be detected by t.l.c. The excess of *m*-chloroperoxybenzoic acid was destroyed with aqueous sodium bisulfite and the acid was then removed by washing with potassium carbonate solution. Removal of the solvent and preparative chromatography (ether/light petroleum, 1:2) gave the two epoxides, (13S,14S,18R)- and (13S,14R,18R)- 5,18:13,18:14,15-triepoxysecurulatan-8-yl acetates. The higher R_f fraction was the minor epoxide (151) (58 mg, 37%), m.p. 107-110° from dichloromethane/light petroleum. (Found: C, 70.6; H, 7.8; m/z 372.1936. $\text{C}_{22}\text{H}_{28}\text{O}_5$ requires C, 70.9; H, 7.6%; m/z 372.1937). ν_{max} (CDCl_3) 2960, 2880, 1755, 1600, 1480, 1450, 1380, 1365, 1220, 1185, 1030, 980, 910 cm^{-1} . ^1H n.m.r. 300 Hz (Figure 4.6) δ (CDCl_3) 1.21, 3H, d, J 6.8 Hz, (H20)₃; 1.38, 1.42, each 3H, s, (H16)₃, (H17)₃; 2.24, 3H, s, (H19)₃; 2.30, 3H, s, OCOMe; 2.50, 1H, m, H4; 2.79, 1H, d, J 7.9 Hz, H14; 2.87, 1H, sex., H1; 4.21, 1H, dt, J 6, 8 Hz, H13; 5.46, 1H, d, J 5.6 Hz, H18; 6.71, 1H, s, H7. ^{13}C n.m.r. (Table 4.5) δ (CDCl_3) 15.5 (q), 19.0 (q), 20.2 (q), 21.1 (q), 24.0 (t), 24.6 (q), 28.0 (d), 28.6 (t), 32.5 (d), 35.4 (t), 47.8 (d), 59.3 (s), 65.1 (d), 76.4 (d), 104.9 (d), 122.0 (d), 125.7 (s), 127.9 (s), 131.4 (s), 143.3 (s), 148.5 (s), 170.0 (s). m/z 372 (M), 330, 258, 191, 190, 156, 139, 111, 105, 57, 55, 44 (100).

The lower R_f fraction was the major epoxide (152) (78 mg, 50%), m.p. 149-151^o from dichloromethane/light petroleum. (Found: C, 70.6; H, 7.7; m/z 372.1929. $C_{22}H_{28}O_4$ requires C, 70.9; H, 7.6%; m/z 372.1937). ν_{max} ($CDCl_3$) 2960, 2880, 1755, 1480, 1450, 1380, 1365, 1190, 1105, 1060, 995, 870 cm^{-1} . 1H n.m.r. 300 MHz (Figure 4.5) δ ($CDCl_3$) 1.21, 3H, d, J 6.9 Hz, (H20)₃; 1.37, 6H, s, (H16)₃, (H17)₃; 2.25, 3H, s, (H19)₃; 2.31, 3H, s, OCOMe; 2.45, 1H, m, H4; 2.82, 1H, d, J 7.3 Hz, H14; 2.87 1H, sex., H1; 4.29, 1H, q, J 8 Hz, H13; 5.45, 1H, d, J 5.2 Hz, H18; 6.72, 1H, s, H7. ^{13}C n.m.r. (Table 4.5) δ ($CDCl_3$) 15.7, 19.8, 20.2, 21.2, 38.8, 25.1, 28.0, 28.5, 33.0, 34.0, 47.8, 57.4, 65.3, 78.6, 105.5, 122.1, 126.0, 128.2, 131.4, 143.3, 148.8, 170.1. m/z 272 (M), 330, 258, 222, 215, 191, 190 (100), 175.

Part 4.1

Reduction of the Serrulatenal (158)

1. Serrulatenal (158) (300mg crude) in ether was reduced with lithium aluminium hydride at 15° for 40 min. Preparative t.l.c. (ether/light petroleum, 1:1) gave serrulat-14-ene-5,8,18-triol (159a). (Found: $\underline{m/z}$ 318.2187. $C_{20}H_{30}O_3$ requires 318.2195). 1H n.m.r. δ ($CDCl_3$) 1.13, 3H, d, \underline{J} 7 Hz, (H20)₃; 1.56, 1.63, each 3H, s, (H16)₃, (H17)₃; 2.12, 3H, s, (H19)₃; 3.00, 2H, m, H1, H4; 3.30-3.90, 3H, m, (H18)₂, OH; 5.02, 1H, bt, H14; 6.35, 1H, s, H7. $\underline{m/z}$ 318 (M), 300 (M-H₂O), 215, 191 (100).

2. The triol (159a) was acetylated with acetic anhydride in pyridine to give 8,18-diacetoxyserrulat-14-en-5-yl acetate (159b) (200 mg), b.p. 160°/5x10⁻³ mm (block). (Found: C, 70.2; H, 8.4; $\underline{m/z}$ 444.2498. $C_{26}H_{36}O_6$ requires C, 70.2; H, 8.2%; $\underline{m/z}$ 444.2512). $\{\alpha\}_{577}^{20} -17^\circ$ (6.18% in $CHCl_3$). ν_{max} (film) 2950, 2915, 2850, 1760, 1735, 1465, 1445, 1365, 1235, 1210, 1180, 1040, 1030, 915 cm^{-1} . 1H n.m.r. 300 MHz (Figure 4.11) δ ($CDCl_3$) 1.11, 3H, d, \underline{J} 7.0 Hz, (H20)₃; 1.50, 1.62, each 3H, s, (H16)₃, (H17)₃; 1.96, 3H, s, 18-OCOMe; 2.07, 3H, s, (H19)₃; 2.28, 2.31, each 3H, s, 2xOCOMe; 2.80, 1H, b, H4; 2.92, 1H, quin., H1; 4.00, 2H, d, \underline{J} 7.2 Hz, (H18)₂; 4.89, 1H, bt, H14; 6.79, 1H, s, H7. ^{13}C n.m.r. (Table 4.6) 16.5, 17.8, 19.6, 20.9, 21.0, 21.2, 22.2, 25.6, 25.8, 26.6, 27.4, 30.8, 33.9, 41.4, 66.2, 122.6, 124.2, 128.5, 132.0, 134.0, 145.6, 146.6, 168.7, 169.5, 171.2. $\underline{m/z}$ 444 (M), 402, 360, 300, 275, 233, 215, 191 (100), 155, 91.

Preparation of the Ketone (160)

1. Triacetate (159b) (80 mg, 0.18 mmole) was hydrogenated in ethyl acetate (8 ml) solution in the presence of 10% palladium-on-carbon to give 8,18-diacetoxyserrulatan-5-yl acetate (162) (quant.). (Found: $\underline{m/z}$

446.2672. $C_{26}H_{38}O_6$ requires 446.2668). ν_{\max} (film) 2960, 2925, 2870, 1760, 1735, 1465, 1365, 1240, 1210, 1180, 1040, 915, 730 cm^{-1} . 1H n.m.r. 80 MHz, δ ($CDCl_3$) 0.74, 0.82, each 3H, s, (H16)₃, (H17)₃; 1.11, 3H, d, \underline{J} 6.8 Hz, (H20)₃; 1.94, 3H, s, 18-OCOMe; 2.06, 3H, s, (H19)₃; 2.26, 2.30, each 3H, s, 2xOCOMe; 2.85, 2H, m, H1, H4; 3.98, 2H, d, \underline{J} 7.1 Hz, (H18)₂; 6.77, 1H, s, H7. ^{13}C n.m.r. (Table 4.6) δ ($CDCl_3$) 16.4, 19.6, 20.9, 21.0, 22.0, 22.5, 22.6, 25.5, 25.8, 27.3, 27.8, 30.7, 33.7, 39.1, 41.8, 66.3, 122.6, 128.4, 132.1, 134.0, 145.6, 146.6, 168.8, 169.5, 171.2. m/z 446 (M), 404, 363, 344, 302, 233, 191 (100), 183, 175, 108, 43.

2. Pyrolysis of the triacetate (162) (80 mg) through a quartz glass column (35 cm x 3 cm) at 650^o/0.05 mm gave, after preparative t.l.c. (ether/light petroleum, 1:1), 8-acetoxyserrulat-11(18)-en-5-yl acetate (163).

1H n.m.r. 80 MHz, δ ($CDCl_3$) 0.87, 0.94, each 3H, s, (H16)₃, (H17)₃; 1.14, 3H, d, \underline{J} 7 Hz, (H20)₃; 2.07, 3H, s, (H19)₃; 2.25, 2.30, each 3H, s, 2xOCOMe; 2.85, 1H, m, H1; 3.34, 1H, bd, H4; 4.05, 1H, d, \underline{J} 7.1 Hz, H18; 4.82, 1H, dt, \underline{J} 1.2, 1.5 Hz, H18; 6.83, 1H, s, H7. ^{13}C n.m.r. δ ($CDCl_3$) 16.6, 20.8, 21.2, 21.4, 22.8, 24.1, 26.2, 27.5, 28.2, 36.2, 39.3, 39.9, 111.9, 122.6, 128.5, 130.3, 132.6.

3. The diacetate (163) (20 mg) was dissolved in methanol (5 ml) containing dimethyl sulfide (0.25 ml) and an excess of ozone was bubbled through the solution. The reaction mixture was stirred for 1 h at -78^o then at 0^o for 1 h and finally at 15^o for 18 h. Water was added and the solution was extracted with dichloromethane (3 times), dried and evaporated under reduced pressure. Preparative t.l.c (ether/light petroleum, 1:1) gave (4R)-8-acetoxy-11-oxo-18-norserrulatan-5-yl acetate (160) (Found; m/z 388.2239. $C_{23}H_{32}O_5$ requires 388.2250). ν_{\max} ($CHCl_3$) 2925, 2850, 1755, 1700, 1365, 1170 900 cm^{-1} . 1H n.m.r. 300 MHz, (Figure 4.12) δ ($CDCl_3$) 0.83,

0.85, each 3H, s, (H16)₃, (H17)₃; 1.14, 3H, d, \underline{J} 6.8 Hz, 1-Me; 2.06, 3H, s, 6-Me; 2.24, 2.29, each 3H, s, 2xOCOMe; 2.48, 1H, dt, \underline{J} 18.1, 7.3 Hz, H12; 3.00, 1H, quin., H1; 3.57, 1H, d, \underline{J} 7.8 Hz, H4; 6.86, 1H, s, H7. ¹³C n.m.r. δ (CDCl₃) 20.4, 20.6, 20.9, 21.2, 21.7, 25.7, 27.2, 41.4, 123.4. $\underline{m/z}$ 388 (M), 346, 328, 304, 286, 275, 233, 191 (100), 119, 117, 36, 32.

Preparation of the 1,4-Benzoquinone (161b)

A sample of the triol (159a) (50 mg) was oxidized with Jones reagent¹²⁰ in acetone (5 ml) at 0°. The mixture was stirred at 0° for 15 min, diluted with water and extracted with dichloromethane (10 ml). The solvent was removed under reduced pressure and the resultant yellow oil was chromatographed by preparative t.l.c. (ether/light petroleum, 1:1). The main fraction was acetylated with acetic anhydride in pyridine to give 18-acetoxy-5,8-dihydroserrulat-14-ene-5,8-dione (161b) (30 mg). ν_{\max} (film) 2960, 2940, 2870, 1740, 1640, 1600, 1450, 1370, 1360, 1280, 1030, 910 cm⁻¹. λ_{\max} (EtOH) 259 (15000), 285 (2200), 347 (1030) nm. ¹H n.m.r. 300 MHz, δ (CDCl₃) 1.06, 3H, d, \underline{J} 7 Hz, (H20)₃; 1.41, 1.53, each 3H, s, (H16)₃, (H17)₃; 1.94, 1H, s, OCOMe; 1.99, 3H, d, \underline{J} 1.6 Hz, (H19)₃; 2.91, 1H, m, H1; 3.84, 1H, dd, M part of an AMX, \underline{J} 11.4, 9.0 Hz, H18; 4.07, 1H, dd, A part of an AMX, \underline{J} 4.7, 11.4 Hz, H18; 5.0, 1H, bt, \underline{J} 6 Hz, H14; 6.50, 1H, q, \underline{J} 1.6 Hz, H7.

Part 4.2

Preparation of the p-Bromobenzoate (150c)

The phenol (150a) (50 mg, 0.16 mmole) in pyridine (0.5 ml) and dichloromethane (15 ml) was refluxed for 24 h[†] ^{with p-bromobenzoyl chloride}. The solution was washed with dilute hydrochloric acid (10% aqueous, 2 times), aqueous sodium bicarbonate (5%) and evaporated under reduced pressure to give the p-bromobenzoate (150c), m.p. 217-220^o. (Found: C, 64.8; H, 5.9. C₂₇H₂₉BrO₄ requires C, 65.2; H, 5.9%). ν_{\max} (Nujol) 2960, 2930, 2850, 1740, 1600, 1095, 965 cm⁻¹. ¹H n.m.r. δ (CDCl₃) 1.20, 3H, d, J 7 Hz, (H20)₃; 1.72, 6H, s, (H16)₃, (H17)₃; 2.22, 3H, s, (H19)₃; 5.13, 2H, m, H13, H14; 5.32, 1H, d, J 5 Hz, H18; 6.70, 1H, s, H7; 7.50, 7.90, AA'BB' system, arom. m/z 498/496 (M), 375/373, 185/183 (100), 173, 157/155.

Part 4.3

Interconversion of the Serrulatane Diterpenes (150a) and (158)

A mixture of the dihydroserrulatane (154a) and the diacetate (155b) (60 mg, 9:1 by ^1H n.m.r.) in ether (5 ml) was reduced with an excess of lithium aluminium hydride at 25° for 45 min. Workup gave a crude sample which was acetylated with acetic anhydride in pyridine. Preparative t.l.c. (ether/light petroleum, 1:3, run twice) gave 8,18-diacetoxyserrulatan-5-yl acetate (162). $[\alpha]_D^{20} -18^\circ$ (0.25% in CHCl_3). This compound was identical (optical rotation, t.l.c., ^1H n.m.r. and ^{13}C n.m.r.) to that previously described (Part 4.1).

Part 5.0

Hydrolysis of Freelingyne (2)

1. A mixture of freelingyne (2) (400 mg, 1.67 mmole), sodium hydroxide (300 mg, 7.5 mmole) and water (25 ml) containing methanol (20 ml) was refluxed under a nitrogen atmosphere for 7 h. Isolation according to the method described⁸⁹ gave the crude phenol (164a) which was methylated with diazomethane. Methyl 3-{2'-(furan-3''-yl)-3'-hydroxy-5'-methylphenyl}-2-methylpropenoate (164b) (292 mg, 64%) crystallized from ether/light petroleum as colourless rhombic crystals, m.p. 86-86.5^o (lit.⁸⁹ 96^o). ν_{\max} (CHCl₃) 3510, 2975, 2940, 2900, 2820, 1700, 1300, 1120, 1010, 870 cm⁻¹. ¹H n.m.r. 300 MHz (Figure 5.1) δ (CDCl₃) 1.96, 3H, d, J 1.6 Hz, 2-Me; 2.26, 3H, s, 5'-Me; 3.57, 3H, s, CO₂Me; 5.15, 1H, s, OH; 6.46, 1H m, H4''; 6.47, 1H, m, H3; 6.58, 6.70, each 1H, s, H4', H6'; 7.48, 1H, m, H2''; 7.55, 1H, m, H5''.
¹³C n.m.r. δ (CDCl₃) 20.8 (q), 21.3 (q), 51.6 (q), 112.7 (d), 114.9 (s), 115.5 (d), 118.8 (s), 121.7 (d), 130.2 (s), 135.8 (d), 137.6 (s), 138.6 (s), 142.1 (d), 143.8 (d), 153.4 (s), 170.4 (s). m/z 272 (M), 244, 213, 214 (100), 185, 184, 183, 169, 155, 141, 115, 45.
2. A similar reaction at 20^o gave (164a) after 48 h with no starting material detected by t.l.c. or ¹H n.m.r.

Part 5.1

Reduction of Eremophila-10,11(13)-diene-9,12-dione (168)

1. The dione (168) (25 mg, 0.11 mmole) in ethanol (2 ml) was reduced with sodium borohydride in the presence of cerium trichloride according to the method of Luche *et al.*⁹⁸ Preparative t.l.c. (ether/light petroleum, 3:7) gave the major diol, (9R)-eremophila-10,11(13)-diene-9,12-diol (170a) (13 mg, 51%). ¹H n.m.r. 80 MHz (Table 5.2) δ (CDCl₃) 0.84, 3H, d, (H14)₃; 0.88, 3H, s, (H15)₃; 1.30-2.30, 12H, m; 4.08, 2H, s, (H12)₂; 4.50, 1H, b, H9; 4.92, 5.03, each 1H, s, (H13)₂; 5.70, 1H, bs, H1. ¹³C n.m.r. (Table 5.2) δ (CDCl₃) 16.2 (q), 21.0 (q), 25.0 (t), 27.1 (t), 34.2 (d), 37.0 (t), 38.1 (s), 39.1 (d), 40.7 (t), 65.4 (t), 66.9 (d), 108.4 (t), 117.1 (d), 146.4 (s), 152.9 (s). m/z 236 (M), 221 (M-Me), 218 (M-H₂O), 167, 149, 40, 32 (100).

The lower R_f fraction was (9S)-eremophila-10,11(13)-diene-9,12-diol (171) (8 mg, 31%). ν_{\max} (CDCl₃) 3400, 2925, 2860, 1460, 1370, 1010, 905 cm⁻¹. ¹H n.m.r. 80 MHz (Table 5.2) δ (CDCl₃) 0.85, 3H, d, J 4.9 Hz, (H14)₃; 1.09, 3H, s, (H15)₃; 1.30-2.20, 12H, m; 4.08, 2H, s, (H12)₂; 4.34, 1H, dd, J 3.9, 7.6 Hz, H9; 4.91, 5.01, each 1H, s, (H13)₂; 5.64, 1H, t, J 3.4 Hz, H1. ¹³C n.m.r. (Table 5.2) δ (CDCl₃) 15.8 (q), 23.8 (q), 25.6 (t), 27.0 (t), 34.3 (d), 37.2 (s), 37.5 (t), 38.6 (d), 40.5 (t), 65.4 (t), 108.8 (t), 127.5 (d).

2. Acetylation of diol (170a) with acetic anhydride in pyridine for 18 h gave (9R)-eremophila-12-acetoxy-10,11(13)-dien-9-yl acetate (170b), b.p. 90^o/5x10⁻³ mm (block). (Found: C, 70.9; H, 9.4. C₁₉H₂₈O₄ requires C, 71.2; H, 8.8%). ν_{\max} (film) 2950, 2920, 2870, 1740, 1645, 1460, 1430, 1365, 1240, 1040 cm⁻¹. ¹H n.m.r. 80 MHz, (Table 5.2) δ (CDCl₃) 0.85, 3H, d, (H14)₃;

0.88, 3H, s, (H15)₃; 1.30-2.30, 12H, m: 2.01, 2.03, each 3H, s, 2xOCOMe; 4.50, 2H, s, (H12)₂; 5.00, 5.02, each 1H, s, (H13)₂; 5.45, 1H, b, H9 ; 5.55, 1H, bs, H1. ¹³C n.m.r. δ (CDCl₃) 16.2 (q), 20.6 (q), 21.1 (q), 21.4 (q), 25.1 (t), 26.8 (t), 34.6 (d), 37.0 (t), 37.5 (s), 38.3 (d), 39.2 (t), 66.6 (t), 69.2 (d), 112.1 (t), 118.0 (d), 141.4 (s), 146.9 (s), 170.4 (s), 172.0 (s).

Conversion of Dione (168) to Eremophilone (1a)

1. The diacetate (170b) (60 mg, 0.19 mmole) in tetrahydrofuran (1 ml) was reduced with lithium (30 mg, 4.32 mmole) and ammonia (15 ml). After 0.5 h solid ammonium chloride was added to discharge the blue colour. Water was added and the solution was extracted with ether (3 times). The combined organic extracts were dried and evaporated under reduced pressure. Preparative t.l.c. (ether/light petroleum, 1:9) gave an inseparable mixture of eremophilene (174) and the isomeric diene (178) (10 mg combined, 26%). The ¹H n.m.r. was identical with that reported in the literature for eremophilene.^{15c} ¹³C n.m.r. (CDCl₃) 16.0, 16.2, 20.5, 21.0, 21.3, 21.7, 25.7, 24.4, 28.7, 29.5, 30.0, 30.3, 31.8, 32.5, 37.2, 38.0, 38.7, 39.0, 40.1, 108.6, 118.2, 120.8, 143.8, 146.7, 150.2, 150.6.

The lowest R_f fraction was (9R)-eremophila-10,11(13)-dien-9-ol (177) (30 mg, 72%). ¹H n.m.r. δ (CDCl₃) 1.0, 6H, bs, (H14)₃, (H15)₃; 1.80, 3H, s, (H12)₃; 4.50, 1H, m, H9; 4.78, 2H, bs, (H13)₂; 5.72, 1H, m, H1. The allylic alcohol (177) was subsequently used without further purification for the oxidation.

2. The allylic alcohol (177) (30 mg, 0.14 mmole) was oxidized with Collins reagent, according to the method of Ratcliffe,¹⁰⁷ to give eremophilone (1a) (quantit.) which gave an optical rotation^{2a} and ¹H n.m.r. spectrum¹⁰⁸ identical with those of the natural material isolated from *E. mitchelli*.

APPENDIX

Solution and Refinement

The structure was solved by the heavy atom technique. The bromine position was determined by the analysis of a three dimensional Patterson synthesis calculated by the SHELX¹ program. All other non-hydrogen atoms were located in the Fourier difference maps of successive full-matrix least-square refinements using the SHELX program. Hydrogen atoms were included at calculated positions (C-H 0.97Å; =C-H 1.08) and their thermal parameters were refined as common group factors. A full-matrix least-square calculation with the bromine, all oxygens and nine carbon atoms modelled anisotropically converged with $R^* = 0.057$ and $R_w^* = 0.062$. When the calculation was repeated with the signs of all the atomic coordinates changed the refinement converged with $R = 0.050$ and $R_w = 0.055$. These significantly lower r values thus determine the absolute configuration of the structure^{2,3}. In the final blocked-matrix least-squares calculation all non-hydrogen atoms were modelled anisotropically, R and R_w converged at 0.038 and 0.041, respectively. While the weighting scheme employed converged at $w=8.09/(\sigma^2 F_o + 0.0002 F_o \times F_o)$. The largest peak remaining in the final difference map was associated with the bromine atom and 0.6 eÅ^{-3} in height. The final least-square positional parameters, hydrogen atom parameters and thermal parameters are given in Tables 4.7 and 4.8. The structure factor amplitudes are supplied in the Appendix Tables. All the above calculations were performed using the scattering factors for the respective neutral atoms as tabulated in the International Tables for X-ray Crystallography.⁴

Description of Structures

- (a) Figure 4.13 is a PLUTO⁵ plot showing the absolute configuration of the compound and the atomic numbering scheme employed.

Crystallography on $C_2H_29BrO_4$

The title compound crystallizes as clear prisms in the monoclinic space group $P2_1$ with $a = 9.112(1)$ $b = 9.743(2)$, $c = 13.423(3)$ and $Z = 2$. The structural final refinement of a blocked-matrix least-squares calculation converged with $R = 0.038$ and $R_w = 0.041$.

Crystal Data.

An clear crystal of dimensions $0.11 \times 0.14 \times 0.32 \text{ mm}^3$ was mounted on a glass fibre and coated with cyano-acrylate super glue. Lattice parameters at 22° were determined by a least-squares fit to the setting angles of 25 independent reflections, measured and refined by scans performed on an Enraf-Nonius CAD4 four-circle diffractometer employing graphite monochromated MoK_{α} radiation. The density was determined by flotation using a solution mixture of petroleum spirit (120-160) $C_2H_29BrO_4$, form. wt. 417.50, spacegroup $P2_1$, a 9.112(1), b 9.743(2), c 13.423(3)Å; D_o 1.413, D_c 1.418 g cm^{-3} ; U 1164.5 \AA^3 ; Z 2; $(Mo K)$ 17.8 cm^{-1} ; (MoK) 0.7107Å; $F(000)$ 516 electrons.

Intensity data (+h,+k,+l) were collected in the range $1.4 < \theta < 25$ deg using an omega - $n/3$ theta scan, where $n(=3)$ was optimized by profile analysis of a typical reflection. The omega scan angles and horizontal counter apertures employed were $\{1.65+0.35\tan(\theta)\}$ deg. and $\{2.40+0.5\tan(\theta)\}$ mm, respectively. Three standard reflections, monitored after every 58 min of data collection indicated that by completion of the data collection no decomposition had occurred. Data reduction and application of Lorentz and polarization corrections were performed using program SUSCAD.¹ Of the 2289 reflections collected, 1908 with $I > 2.5\sigma(I)$ were considered observed and used in the calculations.

(b) The bond lengths and angles are given in Tables 4.9 and 4.10.

*

$$R = \frac{\sum (|F_o| - |F_c|)}{\sum F_o} ,$$

$$R_w = \frac{\sum (|F_o| - |F_c|) \cdot \sqrt{w}}{\sum (|F_o| \sqrt{w})} .$$

References

1. SUSCAD "Data reduction programs for the CAD 4 diffractometer", University of Sydney, 1976; SHELX, "Program for crystal structure determination", G.M. Sheldrick, 1976.
2. Bijvoet, J.M., Peerdeman, A.F., and Van Bommel, A.J., Nature, 1951, 168, 271.
3. Karle, J., and Hauptmann, H., Acta Cryst., 1956, 9, 635.
4. "International Tables for Crystallography", Vol. 4, pp.99, 149 (Kynoch Press; Birmingham 1974).
5. PLUTO: "Plotting program for molecular structures", by W.D.S. Motherwell.

Supplementary Table. Tabulated Structural Factors for C₂₇H₂₉BrO₄

OBSERVED AND CALCULATED STRUCTURE FACTORS FOR										C20H DIFFERENCE SYNTHESIS										PAGE 1				
H	K	L	10FO	10FC	H	K	L	10FO	10FC	H	K	L	10FO	10FC	H	K	L	10FO	10FC	H	K	L	10FO	10FC
1	0	0	372	347	7	3	0	380	380	5	7	0	158	164	4	0	1	568	525	-1	2	1	972	953
2	0	0	329	322	8	3	0	140	143	6	7	0	51	48	5	0	1	88	92	0	2	1	631	646
3	0	0	537	511	9	3	0	33	30	8	7	0	99	98	6	0	1	200	190	1	2	1	574	584
4	0	0	68	70	10	3	0	133	139	0	8	0	190	195	7	0	1	411	410	2	2	1	520	512
5	0	0	459	430	0	4	0	416	428	1	8	0	64	66	8	0	1	186	192	3	2	1	156	149
6	0	0	375	365	1	4	0	241	247	2	8	0	161	168	9	0	1	59	55	4	2	1	532	499
7	0	0	219	226	2	4	0	255	254	3	8	0	251	261	10	0	1	92	93	5	2	1	391	325
8	0	0	225	228	3	4	0	454	453	4	8	0	80	80	-9	1	1	60	67	6	2	1	117	116
9	0	0	132	133	4	4	0	213	212	5	8	0	60	59	-8	1	1	261	262	7	2	1	191	194
1	1	0	511	494	5	4	0	134	130	6	8	0	86	87	-7	1	1	119	112	8	2	1	111	121
2	1	0	603	574	6	4	0	290	284	7	8	0	52	56	-6	1	1	339	334	9	2	1	65	61
3	1	0	316	295	7	4	0	87	86	1	9	0	73	77	-5	1	1	326	299	10	2	1	117	123
4	1	0	512	480	8	4	0	130	131	2	9	0	87	88	-4	1	1	184	163	-10	3	1	56	53
5	1	0	413	398	9	4	0	146	149	3	9	0	89	95	-3	1	1	636	582	-9	3	1	126	135
6	1	0	82	77	1	5	0	329	341	4	9	0	46	45	-2	1	1	483	438	-8	3	1	78	77
7	1	0	272	271	2	5	0	276	281	5	9	0	63	64	-1	1	1	685	610	-7	3	1	78	82
8	1	0	217	223	3	5	0	141	136	0	10	0	81	79	0	1	1	402	393	-6	3	1	111	107
9	1	0	140	145	4	5	0	369	360	1	10	0	106	105	1	1	1	310	306	-5	3	1	393	318
10	1	0	118	120	5	5	0	205	205	3	10	0	40	39	2	1	1	448	427	-4	3	1	57	50
0	2	0	947	1002	6	5	0	40	35	4	10	0	63	63	3	1	1	349	345	-3	3	1	296	276
1	2	0	236	246	7	5	0	309	313	5	10	0	63	63	4	1	1	337	324	-2	3	1	206	207
2	2	0	576	561	8	5	0	87	86	1	11	0	52	51	5	1	1	229	227	-1	3	1	132	139
3	2	0	392	377	9	5	0	55	53	2	11	0	64	63	6	1	1	353	346	0	3	1	976	1013
4	2	0	260	253	0	6	0	491	496	-10	0	1	113	111	7	1	1	105	112	1	3	1	566	563
5	2	0	255	250	1	6	0	155	166	-9	0	1	129	122	8	1	1	142	140	2	3	1	268	260
6	2	0	161	159	2	6	0	207	210	-8	0	1	78	83	9	1	1	183	189	3	3	1	565	563
7	2	0	48	50	3	6	0	186	195	-7	0	1	571	575	10	1	1	57	65	4	3	1	180	187
8	2	0	311	316	4	6	0	124	129	-6	0	1	20	18	-10	2	1	129	131	5	3	1	112	106
9	2	0	117	124	5	6	0	238	238	-5	0	1	68	61	-9	2	1	40	42	6	3	1	333	332
10	2	0	36	39	6	6	0	56	57	-4	0	1	328	322	-8	2	1	178	186	7	3	1	188	155
1	3	0	329	319	7	6	0	108	107	-3	0	1	21	17	-7	2	1	297	287	8	3	1	84	87
2	3	0	498	467	8	6	0	61	57	-2	0	1	273	268	-6	2	1	165	158	9	3	1	113	118
3	3	0	62	59	1	7	0	239	248	-1	0	1	312	302	-5	2	1	335	324	10	3	1	36	49
4	3	0	180	180	2	7	0	188	191	1	0	1	83	86	-4	2	1	398	373	-10	4	1	80	84
5	3	0	180	188	3	7	0	125	125	2	0	1	464	440	-3	2	1	291	262	-9	4	1	95	96
6	3	0	68	60	4	7	0	150	155	3	0	1	169	156	-2	2	1	434	413	-8	4	1	132	139

OBSERVED AND CALCULATED STRUCTURE FACTORS FOR

C20H DIFFERENCE SYNTHESIS

PAGE 2

H	K	L	10FO	10FC	H	K	L	10FO	10FC	H	K	L	10FO	10FC	H	K	L	10FO	10FC	H	K	L	10FO	10FC
-7	4	1	102	100	-9	6	1	71	72	-6	8	1	80	82	-1	11	1	50	47	2	1	2	625	606
-6	4	1	149	133	-8	6	1	59	63	-5	8	1	76	78	0	11	1	79	50	3	1	2	116	108
-5	4	1	208	195	-7	6	1	217	218	-4	8	1	129	141	2	11	1	52	47	4	1	2	456	426
-4	4	1	376	359	-6	6	1	39	42	-3	8	1	75	77	3	11	1	31	32	5	1	2	367	361
-3	4	1	87	82	-5	6	1	125	122	-2	8	1	67	66	-10	0	2	94	96	6	1	2	203	203
-2	4	1	134	136	-4	6	1	238	241	-1	8	1	172	177	-9	0	2	106	120	7	1	2	67	66
-1	4	1	551	598	-3	6	1	127	132	0	8	1	239	241	-8	0	2	53	46	8	1	2	169	172
0	4	1	74	74	-2	6	1	138	151	2	8	1	201	196	-7	0	2	18	29	9	1	2	35	26
1	4	1	414	414	-1	6	2	270	275	4	8	1	89	87	-6	0	2	268	269	10	1	2	116	116
2	4	1	405	407	0	6	1	66	63	5	8	1	129	126	-5	0	2	339	325	-9	2	2	148	155
3	4	1	132	117	1	8	1	247	252	6	8	1	41	44	-4	0	2	155	142	-8	2	2	211	211
4	4	1	252	240	2	8	1	298	293	7	8	1	129	137	-3	0	2	129	136	-7	2	2	175	167
5	4	1	337	332	3	8	1	75	68	-6	9	1	84	81	-2	0	2	170	166	-6	2	2	244	231
6	4	1	75	69	4	6	1	171	179	-5	9	1	64	70	-1	0	2	366	377	-5	2	2	325	308
7	4	1	99	101	5	6	1	93	87	-4	9	1	71	81	1	0	2	186	159	-4	2	2	367	343
8	4	1	167	172	6	6	1	49	46	-3	9	1	100	108	2	0	2	73	65	-3	2	2	487	447
9	4	1	97	99	7	6	1	203	207	-2	9	1	107	115	3	0	2	272	270	-2	2	2	365	343
-9	5	1	71	70	8	6	1	132	132	-1	9	1	39	36	4	0	2	636	600	-1	2	2	463	462
-8	5	1	115	115	-8	7	1	180	179	0	9	1	104	106	5	0	2	107	104	0	2	2	901	902
-7	5	1	102	96	-7	7	1	135	138	1	9	1	144	148	6	0	2	144	142	1	2	2	253	246
-6	5	1	281	277	-6	7	1	89	89	2	9	1	45	42	7	0	2	47	48	2	2	2	396	387
-5	5	1	100	93	-5	7	1	119	116	3	9	1	195	197	8	0	2	135	130	3	2	2	507	490
-4	5	1	122	121	-4	7	1	42	39	4	9	1	81	79	9	0	2	232	237	4	2	2	371	341
-3	5	1	426	418	-3	7	1	226	236	5	9	1	85	85	10	0	2	48	60	5	2	2	233	233
-2	5	1	179	189	-2	7	1	130	143	6	9	1	65	70	-10	1	2	102	106	6	2	2	446	443
-1	5	1	240	258	-1	7	1	90	96	-5	10	1	60	64	-9	1	2	54	51	7	2	2	350	351
0	5	1	635	640	0	7	1	62	65	-4	10	1	60	62	-8	1	2	240	246	8	2	2	72	72
1	5	1	183	155	1	7	1	170	169	-3	10	1	60	62	-7	1	2	188	192	9	2	2	132	129
2	5	1	130	135	2	7	1	189	188	0	10	1	87	95	-6	1	2	91	82	10	2	2	67	75
3	5	1	180	179	3	7	1	204	205	1	10	1	163	163	-5	1	2	35	35	-10	3	2	75	76
4	5	1	190	190	4	7	1	86	88	2	10	1	66	66	-4	1	2	405	383	-9	3	2	91	83
5	5	1	135	137	5	7	1	43	41	3	10	1	62	62	-3	1	2	349	329	-8	3	2	103	104
6	5	1	149	149	6	7	1	164	163	4	10	1	116	114	-2	1	2	743	690	-7	3	2	348	348
7	5	1	127	130	7	7	1	99	102	5	10	1	55	55	-1	1	2	854	809	-6	3	2	171	161
8	5	1	109	112	8	7	1	56	57	6	11	1	54	54	0	1	2	443	441	-5	3	2	291	273
9	5	1	118	124	-7	8	1	100	99	-2	11	1	50	52	1	1	2	317	317	-4	3	2	655	604

OBSERVED AND CALCULATED STRUCTURE FACTORS FOR C20H DIFFERENCE SYNTHESIS PAGE 3

H	K	L	10FO	10FC	H	K	L	10FO	10FC	H	K	L	10FO	10FC	H	K	L	10FO	10FC					
-3	3	2	300	276	-8	5	2	109	108	-4	7	2	269	273	3	9	2	56	54	-5	1	3	128	141
-2	3	2	347	343	-4	5	2	33	30	-3	7	2	114	123	4	9	2	69	68	-8	1	3	239	240
-1	3	2	374	408	-3	5	2	240	233	-3	7	2	79	89	5	9	2	68	59	-7	1	3	66	67
0	3	2	220	223	-2	5	2	385	405	-2	7	2	225	236	-5	10	2	49	52	-6	1	3	167	169
1	3	2	363	380	-1	5	2	282	296	0	7	2	187	201	-4	10	2	54	63	-7	1	3	349	340
2	3	2	556	549	0	5	2	494	494	1	7	2	284	285	-3	10	2	90	99	-4	1	3	342	314
3	3	2	226	217	1	5	2	155	162	2	7	2	232	225	-2	10	2	62	64	-3	1	3	279	287
4	3	2	237	239	2	5	2	246	243	3	7	2	167	172	-1	10	2	53	57	-2	1	3	368	353
5	3	2	254	257	3	5	2	111	104	4	7	2	133	124	0	10	2	38	43	-1	1	3	875	906
6	3	2	65	62	4	5	2	289	292	5	7	2	166	161	2	10	2	57	63	0	1	3	390	426
7	3	2	325	328	5	5	2	153	153	6	7	2	40	45	3	10	2	89	84	1	1	3	546	549
8	3	2	144	149	6	5	2	71	79	7	7	2	81	83	4	10	2	44	43	2	1	3	227	224
9	3	2	60	66	7	5	2	104	98	8	7	2	108	110	-3	11	2	44	44	3	1	3	433	418
-10	4	2	44	45	8	5	2	77	79	-7	6	2	69	71	-2	11	2	60	64	4	1	3	387	379
-9	4	2	76	79	-9	6	2	68	69	-6	6	2	47	47	0	11	2	105	108	5	1	3	92	89
-8	4	2	221	210	-8	6	2	100	100	-5	8	2	96	94	2	11	2	57	59	6	1	3	376	375
-7	4	2	179	179	-7	6	2	65	62	-4	8	2	101	102	-10	0	3	43	42	7	1	3	201	188
-6	4	2	161	161	-6	6	2	163	153	-3	8	2	137	145	-9	0	3	103	105	8	1	3	65	65
-5	4	2	295	286	-5	6	2	154	154	-2	8	2	138	140	-8	0	3	61	59	9	1	3	170	176
-4	4	2	180	167	-4	6	2	125	125	-1	8	2	139	147	-7	0	3	180	179	-10	2	3	106	111
-3	4	2	119	122	-3	6	2	173	168	0	8	2	242	243	-6	0	3	256	247	-9	2	3	53	60
-2	4	2	372	378	-2	6	2	99	111	1	8	2	103	102	-5	0	3	200	216	-8	2	3	85	80
-1	4	2	78	74	-1	6	2	34	36	2	8	2	77	77	-4	0	3	379	266	-7	2	3	245	250
0	4	2	161	170	0	6	2	202	210	3	8	2	138	137	-3	0	3	808	736	-6	2	3	247	229
1	4	2	211	222	1	6	2	224	224	4	8	2	69	82	-2	0	3	1062	1033	-5	2	3	259	243
2	4	2	232	220	2	6	2	61	57	5	8	2	70	72	-1	0	3	506	555	-4	2	3	232	222
3	4	2	403	403	3	6	2	307	308	6	8	2	81	89	0	0	3	357	401	-3	2	3	141	126
4	4	2	88	87	4	6	2	288	281	7	8	2	139	146	1	0	3	48	51	-2	2	3	224	200
5	4	2	122	125	5	6	2	59	59	-6	8	2	53	56	2	0	3	731	728	-1	2	3	785	754
6	4	2	224	224	6	6	2	222	222	-5	9	2	66	64	3	0	3	39	35	0	2	3	150	135
7	4	2	54	51	7	6	2	72	75	-4	9	2	126	131	4	0	3	211	212	1	2	3	134	142
8	4	2	112	115	8	6	2	43	43	-3	9	2	34	39	5	0	3	402	401	2	2	3	374	367
9	4	2	133	140	-7	7	2	94	98	-1	9	2	155	155	6	0	3	394	389	3	2	3	390	368
-9	5	2	85	83	-7	7	2	81	77	0	9	2	103	110	7	0	3	184	181	4	2	3	227	223
-8	5	2	115	116	-6	7	2	37	33	1	9	2	176	189	8	0	3	192	202	5	2	3	254	253
-7	5	2	167	171	-5	7	2	187	192	2	9	2	125	121	-10	1	3	52	49	6	2	3	50	51

OBSERVED AND CALCULATED STRUCTURE FACTORS FOR

C20H DIFFERENCE SYNTHESIS

H	K	L	10FO	10FC	H	K	L	10FO	10FC	H	K	L	10FO	10FC	H	K	L	10FO	10FC	H	K	L	10FO	10FC
7	2	3	62	63	3	4	3	371	356	3	6	3	93	39	-6	9	3	46	47	3	0	4	551	538
8	2	3	177	177	4	4	3	262	261	4	6	3	98	54	-5	9	3	100	132	4	0	4	494	477
9	2	3	60	62	5	4	3	242	237	5	6	3	171	172	-4	9	3	74	79	5	0	4	57	51
-10	3	3	31	26	6	4	3	202	207	6	6	3	62	63	-3	9	3	92	96	6	0	4	242	245
-9	3	3	58	55	7	4	3	189	196	7	6	3	113	122	-2	9	3	78	81	7	0	4	52	52
-8	3	3	167	166	8	4	3	153	159	8	6	3	127	127	-1	9	3	91	89	8	0	4	137	136
-7	3	3	107	106	9	4	3	73	80	-8	7	3	88	82	0	9	3	88	86	-10	1	4	67	69
-6	3	3	172	164	-9	5	3	132	137	-7	7	3	28	35	1	9	3	57	56	-9	1	4	103	105
-5	3	3	237	229	-8	5	3	100	96	-6	7	3	160	157	2	9	3	55	53	-8	1	4	105	109
-4	3	3	88	85	-7	5	3	171	168	-5	7	3	65	64	3	9	3	105	101	-7	1	4	242	238
-3	3	3	372	349	-6	5	3	80	80	-4	7	3	132	129	4	9	3	89	90	-6	1	4	214	205
-2	3	3	266	265	-5	5	3	266	258	-3	7	3	48	52	-3	10	3	35	38	-5	1	4	67	60
-1	3	3	163	169	-4	5	3	86	79	-2	7	3	145	154	-4	10	3	101	105	-4	1	4	482	474
0	3	3	387	384	-3	5	3	181	181	-1	7	3	74	75	-3	10	3	65	71	-3	1	4	212	198
1	3	3	266	260	-2	5	3	225	248	0	7	3	154	157	-2	10	3	27	19	-2	1	4	184	188
2	3	3	103	97	-1	5	3	178	173	1	7	3	257	255	-1	10	3	93	101	-1	1	4	497	546
3	3	3	347	340	0	5	3	276	276	2	7	3	80	80	0	10	3	161	164	0	1	4	144	160
4	3	3	380	367	1	5	3	349	341	3	7	3	162	164	1	10	3	83	83	1	1	4	296	318
5	3	3	84	88	2	5	3	80	80	4	7	3	105	104	2	10	3	47	46	2	1	4	518	529
6	3	3	196	195	3	5	3	149	152	5	7	3	141	147	-2	11	3	54	53	3	1	4	802	800
7	3	3	104	105	4	5	3	350	348	6	7	3	132	133	-1	11	3	41	42	4	1	4	253	243
8	3	3	90	98	5	5	3	125	133	7	7	3	85	86	0	11	3	85	88	5	1	4	352	352
9	3	3	172	179	5	5	3	249	251	-7	8	3	88	89	1	11	3	86	81	6	1	4	182	183
-10	4	3	56	59	6	5	3	234	239	-6	8	3	71	69	-10	0	4	56	83	7	1	4	223	223
-9	4	3	52	50	7	5	3	79	78	-5	8	3	72	66	-9	0	4	177	188	8	1	4	231	219
-8	4	3	52	53	-8	6	3	88	91	-4	8	3	164	172	-8	0	4	208	213	9	1	4	81	66
-7	4	3	118	115	-7	6	3	75	72	-3	8	3	89	91	-7	0	4	191	189	-10	2	4	77	77
-6	4	3	126	113	-6	6	3	100	98	-2	8	3	113	119	-6	0	4	43	33	-9	2	4	68	87
-5	4	3	260	249	-5	6	3	80	86	-1	8	3	99	96	-5	0	4	271	278	-8	2	4	142	138
-4	4	3	344	329	-4	6	3	333	332	0	8	3	170	172	-4	0	4	647	626	-7	2	4	226	225
-3	4	3	134	141	-3	6	3	260	264	1	8	3	190	151	-3	0	4	364	364	-6	2	4	213	279
-2	4	3	339	341	-2	6	3	49	47	2	8	3	85	85	-2	0	4	1175	1163	-5	2	4	533	490
-1	4	3	452	496	-1	6	3	245	263	3	8	3	108	109	-1	0	4	358	395	-4	2	4	218	218
0	4	3	257	248	0	6	3	183	181	4	8	3	108	107	0	0	4	128	148	-3	2	4	259	249
1	4	3	324	330	1	6	3	29	31	5	8	3	108	106	1	0	4	398	435	-2	2	4	158	160
2	4	3	433	429	2	6	3	385	380	6	8	3	41	36	2	0	4	369	358	0	2	4	319	333

OBSERVED AND CALCULATED STRUCTURE FACTORS FOR

C20H DIFFERENCE SYNTHESIS

PAGE 5

H	K	L	10FO	10FC	H	K	L	10FO	10FC	H	K	L	10FO	10FC	H	K	L	10FO	10FC	H	K	L	10FO	10FC
1	2	4	514	507	-1	4	4	315	313	1	6	4	218	214	-4	9	4	79	77	7	0	5	25	19
2	2	4	307	285	0	4	4	352	345	2	6	4	68	69	-3	9	4	52	52	8	0	5	197	199
3	2	4	201	206	1	4	4	425	412	3	6	4	144	146	-1	9	4	94	98	9	2	5	61	66
4	2	4	318	311	2	4	4	108	100	4	6	4	152	143	0	9	4	53	53	-10	1	5	63	67
5	2	4	40	39	3	4	4	363	347	5	6	4	51	53	1	9	4	108	107	-8	1	5	63	60
6	2	4	204	202	4	4	4	124	123	6	6	4	143	143	2	9	4	117	115	-7	1	5	75	77
7	2	4	216	217	5	4	4	184	154	7	6	4	73	72	3	9	4	74	69	-6	1	5	87	93
8	2	4	66	67	6	4	4	131	132	8	6	4	45	43	4	9	4	71	74	-5	1	5	359	361
9	2	4	130	136	-9	5	4	78	77	-8	7	4	56	58	5	9	4	96	94	-4	1	5	258	249
10	3	4	77	87	-8	5	4	132	134	-7	7	4	67	68	-4	10	4	46	54	-3	1	5	254	267
11	3	4	139	142	-7	5	4	207	206	-6	7	4	85	85	-3	10	4	78	83	-2	1	5	317	324
12	3	4	86	83	-6	5	4	172	163	-5	7	4	82	80	-2	10	4	79	85	-1	1	5	256	275
13	3	4	72	69	-5	5	4	75	72	-4	7	4	145	144	-1	10	4	93	94	0	1	5	526	584
14	3	4	108	101	-4	5	4	193	183	-3	7	4	76	85	0	10	4	47	43	1	1	5	198	216
15	3	4	92	89	-3	5	4	134	138	-2	7	4	133	138	1	10	4	55	48	2	1	5	424	417
16	3	4	211	208	-2	5	4	166	170	0	7	4	169	165	2	10	4	42	38	3	1	5	112	129
17	3	4	363	358	-1	5	4	247	252	2	7	4	161	159	3	10	4	81	78	4	1	5	331	326
18	3	4	101	99	0	5	4	288	284	3	7	4	189	188	4	10	4	89	84	5	1	5	124	117
19	3	4	341	374	1	5	4	171	171	4	7	4	51	55	-1	11	4	30	30	6	1	5	115	111
20	3	4	220	218	2	5	4	321	318	5	7	4	159	161	0	11	4	47	46	7	1	5	187	185
21	3	4	133	129	3	5	4	157	150	6	7	4	117	121	-10	0	5	49	48	8	1	5	71	70
22	3	4	270	267	4	5	4	78	78	-7	7	4	46	49	-9	0	5	149	154	9	1	5	127	135
23	3	4	157	149	5	5	4	249	249	-6	8	4	43	44	-8	0	5	23	30	-10	2	5	93	100
24	3	4	193	180	6	5	4	42	39	-5	8	4	83	80	-7	0	5	79	85	-9	2	5	75	79
25	3	4	330	321	7	5	4	113	116	-4	8	4	119	125	-6	0	5	233	230	-8	2	5	73	78
26	3	4	202	204	8	5	4	161	161	-3	8	4	125	135	-4	0	5	163	145	-7	2	5	191	194
27	3	4	80	89	-9	6	4	60	56	-2	8	4	51	55	-3	0	5	317	324	-6	2	5	123	118
28	3	4	203	214	-8	6	4	44	40	-1	8	4	75	87	-2	0	5	43	42	-5	2	5	104	104
29	4	4	56	54	-7	6	4	81	80	-1	8	4	74	73	-1	0	5	444	509	-4	2	2	346	338
30	4	4	139	134	-6	6	4	76	71	0	8	4	137	143	0	0	5	65	79	-3	2	2	384	381
31	4	4	48	44	-5	6	4	186	190	1	8	4	186	183	0	0	5	207	206	-2	2	2	48	43
32	4	4	167	161	-4	6	4	106	111	2	8	4	107	101	2	0	5	298	307	-1	2	2	261	298
33	4	4	239	229	-3	6	4	134	136	3	8	4	99	99	3	0	5	93	100	0	2	2	380	389
34	4	4	240	216	-2	6	4	280	300	4	8	4	78	76	4	0	5	198	202	1	2	2	152	150
35	4	4	172	166	-1	6	4	163	156	5	8	4	48	53	5	0	5	245	236	2	2	2	639	622
36	4	4	322	316	0	6	4	236	240	6	8	4	85	85	6	0	5	208	210	3	2	2	250	239

OBSERVED AND CALCULATED STRUCTURE FACTORS FOR

C20H DIFFERENCE SYNTHESIS

PAGE 5

H	K	L	10FO	10FC	H	K	L	10FO	10FC	H	K	L	10FO	10FC	H	K	L	10FO	10FC	H	K	L	10FO	10FC
4	2	5	68	68	3	4	5	372	355	5	6	5	203	202	-2	9	5	71	67	-3	1	5	560	570
5	2	5	380	385	4	4	5	95	93	6	6	5	109	113	-1	9	5	58	62	-2	1	5	266	281
6	2	5	134	132	5	4	5	162	160	7	6	5	55	51	0	9	5	54	53	-1	1	5	212	230
7	2	5	201	212	6	4	5	188	165	-8	7	5	57	54	1	9	5	161	160	0	1	5	174	199
8	2	5	185	188	7	4	5	185	194	-8	7	5	117	119	2	9	5	41	38	1	1	5	93	103
9	2	5	82	94	8	4	5	132	135	-6	7	5	52	50	4	9	5	48	40	2	1	5	365	375
-10	3	5	71	70	-9	5	5	47	47	-5	7	5	140	134	5	9	5	52	51	3	1	5	408	415
-19	3	5	101	108	-8	5	5	88	90	-4	7	5	86	81	-4	10	5	58	53	4	1	5	92	93
-18	3	5	221	221	-6	5	5	165	151	-3	7	5	86	85	-2	10	5	41	40	5	1	5	147	144
-17	3	5	126	123	-5	5	5	234	229	-2	7	5	177	181	-1	10	5	64	66	6	1	5	187	165
-15	3	5	242	234	-4	5	5	167	159	-1	7	5	91	93	0	10	5	55	66	7	1	5	133	134
-14	3	5	205	193	-3	5	5	44	36	0	7	5	181	175	2	10	5	70	66	8	1	5	187	192
-13	3	5	336	323	-2	5	5	187	196	1	7	5	172	167	3	10	5	49	43	-8	2	2	125	123
-12	3	5	531	513	-1	5	5	76	68	2	7	5	86	95	-10	0	5	80	82	-7	2	2	94	94
-11	3	5	317	327	0	5	5	239	230	3	7	5	160	158	-8	0	5	230	236	-6	2	2	95	95
0	3	5	213	211	1	5	5	205	195	4	7	5	141	144	-7	0	5	131	132	-5	2	2	165	164
1	3	5	564	556	2	5	5	212	198	5	7	5	62	57	-6	0	5	35	38	-4	2	2	251	243
2	3	5	105	99	3	5	5	99	98	6	7	5	131	127	-5	0	5	218	220	-3	2	2	361	356
3	3	5	283	281	4	5	5	145	149	-7	8	5	47	43	-4	0	5	34	33	-2	2	2	433	444
4	3	5	427	427	5	5	5	96	84	-7	8	5	96	95	-3	0	5	20	17	-1	2	2	160	176
5	3	5	76	74	6	5	5	152	155	-5	8	5	55	56	-2	0	5	41	50	0	2	2	305	315
6	3	5	156	161	7	5	5	111	108	-4	8	5	172	176	-1	0	5	245	277	1	2	2	362	374
7	3	5	167	168	8	5	5	54	54	-3	8	5	148	156	0	0	5	117	110	2	2	2	101	95
-10	4	5	52	47	-9	6	5	56	57	-2	8	5	60	65	1	0	5	372	407	3	2	2	242	248
-9	4	5	67	68	-8	6	5	42	41	-1	8	5	99	96	2	0	5	311	313	4	2	2	268	295
-8	4	5	79	74	-7	6	5	102	103	0	8	5	216	216	4	0	5	348	346	5	2	2	316	317
-7	4	5	127	123	-6	6	5	65	60	1	8	5	43	40	6	0	5	280	290	6	2	2	171	170
-6	4	5	209	197	-5	6	5	140	134	2	8	5	80	80	7	0	5	236	234	7	2	2	125	126
-5	4	5	125	123	-4	6	5	44	44	3	8	5	102	100	8	0	5	63	54	8	2	2	63	62
-4	4	5	172	162	-3	6	5	117	115	4	8	5	77	77	-10	1	5	64	65	-10	3	2	53	50
-3	4	5	296	290	-2	6	5	229	236	5	8	5	113	112	-9	1	5	106	111	-9	3	2	37	37
-2	4	5	60	57	-1	6	5	109	107	6	8	5	44	42	-8	1	5	78	84	-8	3	2	76	79
-1	4	5	60	62	0	6	5	52	51	7	8	5	50	49	-7	1	5	103	106	-7	3	2	110	99
0	4	5	217	226	1	6	5	271	272	-6	9	5	93	95	-6	1	5	143	138	-6	3	2	326	321
1	4	5	72	76	2	6	5	202	197	-5	9	5	84	80	-5	1	5	56	54	-5	3	2	46	39
2	4	5	197	195	3	6	5	193	195	-4	9	5	77	75	-4	1	5	190	191	-4	3	2	118	104

OBSERVED AND CALCULATED STRUCTURE FACTORS FOR

C20H DIFFERENCE SYNTHESIS

PAGE 7

H	K	L	10FO	10FC	H	K	L	10FO	10FC	H	K	L	10FO	10FC	H	K	L	10FO	10FC	H	K	L	10FO	10FC
-3	3	6	133	138	-2	5	6	171	176	3	7	6	60	59	-3	0	7	424	450	-3	2	7	227	243
-2	3	6	121	111	-1	5	6	195	188	4	7	6	75	76	-2	0	7	25	27	-2	2	7	121	190
-1	3	6	479	513	0	5	6	148	143	5	7	6	159	158	-1	0	7	411	455	-1	2	7	109	114
0	3	6	352	349	1	5	6	85	84	6	7	6	95	92	0	0	7	383	408	0	2	7	154	175
1	3	6	114	102	2	5	6	317	311	-7	8	6	57	55	2	0	7	236	252	1	2	7	78	71
2	3	6	166	168	3	5	6	254	249	-6	8	6	57	54	3	0	7	307	311	2	2	7	153	158
3	3	6	128	126	4	5	6	81	78	-5	8	6	31	42	4	0	7	129	122	3	2	7	227	227
4	3	6	125	128	5	5	6	83	81	-4	8	6	79	78	5	0	7	148	152	4	2	7	38	26
5	3	6	343	339	6	5	6	139	134	-3	8	6	32	34	6	0	7	179	174	5	2	7	127	128
6	3	6	140	133	7	5	6	35	38	-2	8	6	95	107	7	0	7	32	30	6	2	7	143	138
8	3	6	141	145	-8	6	6	109	109	-1	8	6	26	19	8	0	7	184	183	8	2	7	100	103
-9	4	6	31	37	-7	6	6	56	55	0	8	6	134	134	-10	1	7	75	78	-10	3	7	41	47
-8	4	6	30	36	-6	6	6	88	82	1	8	6	113	107	-9	1	7	103	103	-9	3	7	30	37
-7	4	6	64	66	-5	6	6	196	189	2	8	6	182	177	-7	1	7	103	101	-8	3	7	113	115
-6	4	6	64	65	-4	6	6	123	121	3	8	6	104	99	-6	1	7	44	40	-7	3	7	96	101
-5	4	6	140	142	-3	6	6	127	121	4	8	6	60	58	-5	1	7	182	186	-6	3	7	45	43
-4	4	6	238	227	-2	6	6	121	122	-6	9	6	76	78	-4	1	7	165	159	-5	3	7	153	152
-3	4	6	83	83	-1	6	6	120	124	-5	9	6	37	31	-3	1	7	207	223	-4	3	7	146	143
-2	4	6	169	168	0	6	6	122	115	-4	9	6	60	63	-2	1	7	209	221	-3	3	7	97	94
-1	4	6	187	179	1	6	6	216	212	-3	9	6	26	17	-1	1	7	211	215	-2	3	7	140	143
0	4	6	266	258	2	6	6	221	223	-1	9	6	50	51	0	1	7	207	217	-1	3	7	27	29
1	4	6	332	327	3	6	6	112	111	0	9	6	108	110	1	1	7	405	434	0	3	7	86	73
2	4	6	72	69	4	6	6	192	191	2	9	6	116	114	2	1	7	197	200	1	3	7	236	237
3	4	6	92	91	5	6	6	66	68	3	9	6	87	85	3	1	7	119	124	2	3	7	272	266
4	4	6	271	270	6	6	6	92	90	-4	10	6	35	37	4	1	7	389	392	3	3	7	52	54
5	4	6	69	64	7	6	6	157	153	-2	10	6	83	85	5	1	7	155	157	4	3	7	144	136
6	4	6	95	102	-7	7	6	76	73	-1	10	6	63	62	6	1	7	89	85	5	3	7	126	123
7	4	6	176	182	-6	7	6	150	145	0	10	6	54	55	7	1	7	214	215	6	3	7	157	171
8	4	6	75	74	-5	7	6	108	112	1	10	6	73	66	8	1	7	76	73	7	3	7	175	176
-9	5	6	96	95	-4	7	6	82	75	2	10	6	77	77	-10	2	7	32	32	8	3	7	48	51
-8	5	6	58	59	-3	7	6	36	45	-9	0	7	39	32	-9	2	7	97	102	-9	4	7	55	58
-7	5	6	54	52	-2	7	6	46	52	-8	0	7	39	40	-8	2	7	87	87	-8	4	7	69	70
-6	5	6	62	64	-1	7	6	165	162	-7	0	7	107	107	-7	2	7	104	106	-7	4	7	144	141
-5	5	6	98	95	0	7	6	180	179	-6	0	7	97	98	-6	2	7	152	148	-6	4	7	119	106
-4	5	6	228	222	1	7	6	52	52	-5	0	7	180	192	-5	2	7	64	65	-5	4	7	110	108
-3	5	6	324	314	2	7	6	119	116	-4	0	7	500	525	-4	2	7	53	49	-4	4	7	187	172

OBSERVED AND CALCULATED STRUCTURE FACTORS FOR

C20H DIFFERENCE SYNTHESIS

PAGE 2

H	K	L	10FO	10FC	H	K	L	10FO	10FC	H	K	L	10FO	10FC	H	K	L	10FO	10FC
-3	4	7	276	262	3	6	7	198	185	0	10	7	75	70	7	1	8	54	47
-2	4	7	109	114	4	6	7	75	76	1	10	7	27	27	-10	2	8	54	59
-1	4	7	132	139	5	6	7	79	83	-10	0	8	60	64	-8	2	8	65	63
0	4	7	255	251	6	6	7	81	78	-8	0	8	56	64	-7	2	8	111	104
1	4	7	110	111	-5	7	7	43	31	-8	0	8	39	40	-6	2	8	81	90
2	4	7	182	186	-4	7	7	60	55	-6	0	8	49	44	-5	2	8	74	80
3	4	7	130	123	-3	7	7	38	40	-5	0	8	152	150	-4	2	8	270	271
4	4	7	75	71	-2	7	7	79	86	-4	0	8	271	280	-3	2	8	53	55
5	4	7	139	143	-1	7	7	180	178	-2	0	8	24	31	-2	2	8	167	183
6	4	7	128	126	0	7	7	65	60	-1	0	8	76	89	-1	2	8	334	354
-8	5	7	64	66	1	7	7	141	134	0	0	8	135	143	0	2	8	90	91
-7	5	7	85	93	2	7	7	137	132	1	0	8	454	493	1	2	8	74	50
-6	5	7	36	43	3	7	7	129	130	2	0	8	35	40	2	2	8	243	245
-5	5	7	80	77	4	7	7	131	131	3	0	8	50	58	3	2	8	175	185
-4	5	7	49	45	6	7	7	64	63	4	0	8	171	160	4	2	8	242	241
-3	5	7	65	56	-7	8	7	59	55	5	0	8	121	117	5	2	8	117	110
-2	5	7	222	212	-6	8	7	69	72	6	0	8	87	98	6	2	8	105	112
-1	5	7	244	239	-5	8	7	37	40	7	0	8	130	135	7	2	8	145	142
0	5	7	137	136	-4	8	7	105	102	8	0	8	115	102	-6	3	8	106	106
1	5	7	151	144	-3	8	7	49	54	-10	1	8	36	31	-5	3	8	58	60
2	5	7	78	75	-2	8	7	82	88	-9	1	8	92	89	-4	3	8	115	106
3	5	7	309	306	-1	8	7	149	149	-8	1	8	75	82	-3	3	8	237	234
4	5	7	257	253	0	8	7	37	36	-7	1	8	78	84	-2	3	8	144	146
5	5	7	153	149	1	8	7	63	65	-6	1	8	179	179	-1	3	8	224	236
6	5	7	75	76	2	8	7	51	49	-5	1	8	87	93	0	3	8	195	207
7	5	7	118	114	3	8	7	67	65	-4	1	8	70	74	1	3	8	57	57
-8	6	7	46	46	4	8	7	54	56	-3	1	8	244	255	2	3	8	203	206
-6	6	7	139	141	5	8	7	94	94	-2	1	8	27	37	3	3	8	444	439
-5	6	7	102	96	-5	8	7	100	88	-1	1	8	59	100	4	3	8	144	139
-4	6	7	97	88	-4	9	7	56	54	0	1	8	259	267	5	3	8	159	160
-3	6	7	156	159	-2	9	7	87	88	1	1	8	195	198	6	3	8	30	27
-2	6	7	70	71	-1	9	7	70	71	2	1	8	141	150	-8	4	8	64	61
-1	6	7	155	147	1	9	7	63	57	3	1	8	207	212	-7	4	8	55	51
0	6	7	271	268	2	9	7	49	46	-6	4	8	67	62	-6	4	8	43	46
1	6	7	21	14	3	9	7	53	52	-5	4	8	156	162	-5	4	8	208	193
2	6	7	116	110	-3	10	7	69	68	6	1	8	172	171	-4	4	8	98	82

OBSERVED AND CALCULATED STRUCTURE FACTORS FOR

G20H DIFFERENCE SYNTHESIS

PAGE 8

H	K	L	10FO	10FC	H	K	L	10FO	10FC	H	K	L	10FO	10FC	H	K	L	10FO	10FC	H	K	L	10FO	10FC
-7	7	8	63	60	2	0	9	38	40	5	2	9	138	149	-7	5	9	91	88	-2	8	9	63	61
-6	7	8	67	64	3	0	9	365	373	6	2	9	151	156	-6	5	9	65	66	-2	8	9	60	69
-5	7	8	72	71	4	0	9	49	44	7	2	9	73	67	-4	5	9	141	142	-1	8	9	52	41
-4	7	8	85	83	5	0	9	58	60	-9	3	9	64	67	-2	5	9	117	117	0	8	9	55	41
-3	7	8	117	118	6	0	9	162	157	-8	3	9	53	51	-1	5	9	212	217	3	8	9	119	114
0	7	8	125	119	7	0	9	66	57	-7	3	9	66	63	0	0	9	36	37	-4	9	9	61	60
1	7	8	56	56	-9	1	9	30	31	-6	3	9	60	57	1	5	9	140	138	-3	9	9	54	55
2	7	8	122	117	-8	1	9	41	32	-5	3	9	65	58	2	5	9	116	103	-2	9	9	79	82
3	7	8	90	89	-7	1	9	98	103	-4	3	9	362	368	3	5	9	68	67	-1	9	9	69	73
4	7	8	113	110	-6	1	9	78	90	-3	3	9	63	59	4	5	9	106	103	1	9	9	60	59
5	7	8	48	47	-5	1	9	200	206	-2	3	9	95	98	5	5	9	95	90	-9	0	10	21	25
-6	8	8	48	55	-4	1	9	191	193	-1	3	9	165	165	-7	5	9	66	64	-7	0	10	125	121
-4	8	8	47	48	-3	1	9	71	77	1	3	9	193	197	-5	6	9	64	56	-5	0	10	68	62
-2	8	8	117	119	-2	1	9	185	204	2	3	9	53	57	-4	6	9	60	56	-4	0	10	301	306
-1	8	8	120	109	-1	1	9	104	111	3	3	9	153	150	-3	6	9	82	76	-3	0	10	96	113
0	8	8	83	79	0	1	9	108	123	4	3	9	126	124	-2	6	9	89	94	-2	0	10	89	84
1	8	8	75	74	1	1	9	184	188	5	3	9	112	114	-1	6	9	46	36	-1	0	10	247	252
2	8	8	88	85	2	1	9	230	254	6	3	9	45	45	0	6	9	148	139	0	0	10	144	147
3	8	8	108	104	3	1	9	124	120	7	3	9	128	128	1	6	9	136	134	1	0	10	46	45
4	8	8	84	85	4	1	9	258	269	-9	4	9	61	60	1	6	9	120	121	2	0	10	157	159
-4	9	8	54	54	5	1	9	138	135	-8	4	9	62	62	3	6	9	229	219	3	0	10	38	44
-3	9	8	28	31	6	1	9	54	59	-7	4	9	74	63	4	6	9	87	84	4	0	10	25	25
-2	9	8	53	56	7	1	9	118	118	-6	4	9	114	112	5	6	9	88	83	5	0	10	154	152
-1	9	8	65	64	-9	2	9	71	65	-5	4	9	217	215	-7	7	9	56	55	-9	1	10	30	28
0	9	8	94	96	-7	2	9	43	42	-4	4	9	80	84	-5	7	9	81	76	-8	1	10	25	25
1	9	8	50	48	-6	2	9	128	126	-4	4	9	109	102	-4	7	9	31	29	-7	1	10	42	41
2	9	8	43	43	-5	2	9	161	158	-3	4	9	42	46	-4	7	9	94	88	-6	1	10	128	123
3	9	8	58	56	-4	2	9	243	238	-2	4	9	58	57	-2	7	9	42	40	-5	1	10	300	315
4	9	8	31	25	-3	2	9	129	129	-1	4	9	109	114	-1	7	9	39	33	-4	1	10	144	159
-8	0	9	75	81	-2	2	9	109	123	0	4	9	109	114	0	7	9	82	72	-3	1	10	119	115
-6	0	9	33	30	-1	2	9	166	165	1	4	9	129	123	1	7	9	116	112	-2	1	10	57	58
-4	0	9	108	116	0	2	9	282	312	2	4	9	96	100	2	7	9	42	40	-1	1	10	135	141
-3	0	9	107	99	1	2	9	96	95	3	4	9	167	160	3	7	9	125	126	0	1	10	185	197
-2	0	9	151	145	2	2	9	109	107	4	4	9	61	52	4	7	9	46	40	1	1	10	167	169
0	0	9	113	129	3	2	9	368	370	5	4	9	63	63	-6	8	9	46	40	1	1	10	129	131
1	0	9	122	119	4	2	9	123	119	-8	5	9	42	29	-5	8	9	37	31	2	1	10	229	231

OBSERVED AND CALCULATED STRUCTURE FACTORS FOR

C20H DIFFERENCE SYNTHESIS

PAGE 10

H	K	L	10FD	10FC	H	K	L	10FD	10FC	H	K	L	10FD	10FC	H	K	L	10FD	10FC	H	K	L	10FD	10FC
4	1	10	77	78	3	4	10	106	102	1	8	10	46	41	1	2	11	96	96	2	5	11	71	67
5	1	10	96	102	4	4	10	129	125	-6	0	11	75	75	2	2	11	81	85	3	5	11	73	76
8	1	10	148	149	5	4	10	112	110	-5	0	11	49	50	3	2	11	97	95	4	5	11	39	36
-9	2	10	37	40	-6	5	10	52	50	-4	0	11	204	195	4	2	11	28	24	-5	6	11	46	43
-8	2	10	48	43	-5	5	10	124	121	-3	0	11	124	124	5	2	11	51	55	-5	6	11	92	90
-6	2	10	74	75	-4	5	10	78	78	-2	0	11	93	94	-7	3	11	70	66	-4	6	11	98	90
-5	2	10	147	142	-3	5	10	114	115	-1	0	11	163	163	-6	3	11	59	57	-3	6	11	70	59
-4	2	10	130	134	-2	5	10	49	50	0	0	11	92	86	-5	3	11	70	75	-2	6	11	37	35
-3	2	10	20	17	-1	5	10	54	50	1	0	11	88	85	-4	3	11	130	128	0	6	11	44	36
-2	2	10	86	85	0	5	10	153	153	2	0	11	70	70	-2	3	11	57	51	1	6	11	53	50
-1	2	10	89	92	1	5	10	119	120	3	0	11	244	246	-1	3	11	127	128	2	6	11	39	43
1	2	10	148	150	2	5	10	107	98	4	0	11	85	78	0	3	11	169	177	-3	6	11	97	91
2	2	10	151	148	3	5	10	181	178	5	0	11	119	116	2	3	11	103	106	-2	7	11	57	50
3	2	10	144	146	4	5	10	62	64	-8	1	11	54	52	3	3	11	89	90	-4	7	11	42	47
4	2	10	100	91	5	5	10	47	45	-7	1	11	35	35	4	3	11	91	90	-3	7	11	44	43
5	2	10	112	105	-7	6	10	48	48	-6	1	11	35	43	5	3	11	134	127	-2	7	11	55	55
6	2	10	34	31	-6	6	10	57	63	-5	1	11	81	70	-8	4	11	51	49	-1	7	11	83	80
-8	3	10	78	82	-5	6	10	40	28	-4	1	11	108	108	-5	4	11	117	118	1	7	11	59	52
-6	3	10	74	75	-4	6	10	141	134	-3	1	11	50	55	-4	4	11	71	77	2	7	11	133	130
-5	3	10	138	134	-3	6	10	59	58	-2	1	11	60	61	-3	4	11	83	82	-3	8	11	29	31
-4	3	10	157	151	-2	6	10	85	80	-1	1	11	145	137	-2	4	11	126	133	-2	8	11	47	48
-3	3	10	84	76	-1	6	10	104	111	0	1	11	109	113	-1	4	11	86	72	-1	8	11	46	41
-2	3	10	152	166	0	6	10	88	89	1	1	11	123	117	0	4	11	92	89	0	8	11	60	52
-1	3	10	62	65	1	6	10	60	52	2	1	11	195	187	1	4	11	66	64	-7	0	12	65	59
0	3	10	124	122	2	6	10	74	70	3	1	11	56	57	2	4	11	102	94	-5	0	12	114	126
1	3	10	51	55	3	6	10	45	45	4	1	11	85	83	3	4	11	37	34	-5	0	12	55	67
3	3	10	283	284	4	6	10	73	64	5	1	11	139	141	4	4	11	89	85	-1	0	12	149	143
4	3	10	82	70	-5	7	10	41	40	-8	2	11	44	48	5	4	11	45	42	0	0	12	85	84
5	3	10	52	56	-4	7	10	51	48	-7	2	11	27	30	-6	5	11	46	47	3	0	12	56	57
6	3	10	109	108	-3	7	10	163	158	-6	2	11	107	105	-5	5	11	111	101	4	0	12	71	66
-7	4	10	70	65	-2	7	10	97	93	-5	2	11	127	133	-4	5	11	143	139	5	0	12	133	128
-5	4	10	162	158	0	7	10	54	51	-4	2	11	173	162	-3	5	11	35	45	-6	1	12	35	32
-2	4	10	107	102	2	7	10	66	63	-3	2	11	55	48	-2	5	11	51	51	-5	1	12	101	103
-1	4	10	145	154	-4	8	10	60	61	-2	2	11	100	100	-1	5	11	44	35	-4	1	12	55	57
1	4	10	63	54	-2	8	10	60	67	-1	2	11	64	77	0	5	11	91	95	-3	1	12	52	47
2	4	10	220	218	-1	8	10	37	32	0	2	11	135	131	1	5	11	147	145	-2	1	12	106	107

OBSERVED AND CALCULATED STRUCTURE FACTORS FOR

G20H DIFFERENCE SYNTHESIS

PAGE 11

H	K	L	10FO	10FC	H	K	L	10FO	10FC	H	K	L	10FO	10FC	H	K	L	10FO	10FC	H	K	L	10FO	10FC
0	1	12	57	51	-1	3	12	107	104	3	5	12	103	98	1	1	13	51	47	2	3	13	79	72
1	1	12	84	83	0	3	12	146	144	-4	6	12	38	40	2	1	13	73	73	-6	4	13	24	21
2	1	12	80	75	1	3	12	86	96	-1	6	12	116	112	3	1	13	45	39	-5	4	13	55	55
3	1	12	71	65	2	3	12	89	98	1	6	12	38	38	4	1	13	66	57	-3	4	13	61	51
4	1	12	90	82	3	3	12	74	69	2	6	12	61	57	-6	2	13	70	67	-2	4	13	48	45
-6	2	12	41	47	4	3	12	72	70	-4	7	12	50	53	-5	2	13	37	43	-1	4	13	69	78
-5	2	12	63	53	-7	4	12	55	49	-1	7	12	47	52	-3	2	13	60	53	0	4	13	46	38
-4	2	12	113	107	-2	4	12	48	50	0	7	12	68	61	-2	2	13	66	67	1	4	13	77	72
-3	2	12	93	105	-1	4	12	132	132	1	7	12	50	55	-1	2	13	67	72	2	4	13	41	45
-2	2	12	116	112	0	4	12	59	55	-5	0	13	63	63	1	2	13	82	76	3	4	13	37	28
-1	2	12	53	44	2	4	12	134	129	-4	0	13	83	87	2	2	13	54	51	-5	5	13	65	55
0	2	12	72	74	3	4	12	43	43	-2	0	13	128	137	3	2	13	100	96	-4	5	13	59	59
1	2	12	144	138	4	4	12	70	65	0	0	13	97	95	-7	3	13	25	26	-3	5	13	74	76
2	2	12	188	184	-5	5	12	44	43	1	0	13	130	124	-6	3	13	61	66	-2	5	13	34	30
3	2	12	36	33	-4	5	12	28	31	-4	0	13	62	59	-5	3	13	42	47	-1	5	13	62	55
4	2	12	57	62	-3	5	12	76	71	-7	1	13	57	63	-4	3	13	76	69	2	5	13	56	54
5	2	12	87	87	-2	5	12	72	70	-6	1	13	52	55	-3	3	13	39	33	-4	6	13	41	41
-6	3	12	64	59	-1	5	12	129	140	-4	1	13	42	35	-2	3	13	51	46	-3	6	13	31	32
-5	3	12	113	115	0	5	12	40	48	-2	1	13	44	35	-1	3	13	49	53	-2	6	13	56	52
-4	3	12	67	64	1	5	12	52	47	-1	1	13	140	134	0	3	13	79	82	0	6	13	61	57
-3	3	12	69	68	2	5	12	48	45	0	1	13	104	106	1	3	13	77	71					

REFERENCES

References

1. Ghisalberti, E.L., Jefferies, P.R., and Proudfoot, G.M.,
Aust. J. Chem., 1981, 34, 1491.
2. (a) Simonsen, J., and Barton, D.H.R., "The Terpenes", Vol.III
p. 212 (Cambridge University Press : London 1952); (b)
Massy-Westropp, R.A., and Reynolds, G.D., Aust. J. Chem., 1966, 19, 303.
3. Massy-Westropp, R.A., Reynolds, G.D., and Spotswood, T.M.,
Tetrahedron Lett., 1966, 1939; Ingham, C.F., and Massy-Westropp, R.A.,
Aust. J. Chem., 1974, 27, 1491.
4. Croft, K.D., Ghisalberti, E.L., Hocart, C.H., Jefferies, P.R.,
Raston, C.L., and White, A.H., J. Chem. Soc. Perkin Trans. I, 1978,
1267.
5. Babidge, P.J., and Massy-Westropp, R.A., Aust. J. Chem., 1984,
37, 629.
6. Carrol, P.J., Ghisalberti, E.L., and Ralph, D.E., Phytochemistry,
1976, 15, 777.
7. Dimitriadis, E., and Massy-Westropp, R.A., Aust. J. Chem., 1979,
32, 2003.
8. Coates, P., Ghisalberti, E.L., and Jefferies, P.R., Aust. J. Chem.,
1977, 30, 2717; Maslen, E.N., Raston, C.L., and White, A.H.,
Aust. J. Chem., 1977, 30, 2723; Ghisalberti, E.L., Jefferies, P.R.,
Mori, T.A., Patrick, V.A., and White, A.H., Aust. J. Chem., 1983, 36,
1187.
9. Jefferies, P.R., Knox, J.R., and Middleton, E.J., Aust. J. Chem.,
1962, 15, 532; Oh, Y.L., and Maslen, E.N., Acta Crystallogr.,
Sect. B, 1968, 24, 883; Birch, A.J., Grimshaw, J., and Turnbull,
J.P., J. Chem. Soc., 1963, 2412; Croft, K.D., Ghisalberti, E.L.,
Jefferies, P.R., Mori, T.A., Skelton, B.W., and White, A.H.,
Aust. J. Chem., 1984, 37, 785.

10. Ghisalberti, E.L., Jefferies, P.R., and Sheppard, P., Tetrahedron Lett., 1975, 1775; Maslen, E.N., Sheppard, P.N., White, A.H., and Willis, A.C., J. Chem. Soc. Perkin Trans. II, 1976, 263; Croft, K.D., Ghisalberti, E.L., Jefferies, P.R., and Stuart, A.D., Tetrahedron, 1981, 37, 383.
11. Croft, K.D., Ghisalberti, E.L., Jefferies, P.R., Raston, C.L., **Hall, S.R.**, and White, A.H., Tetrahedron, 1977, 33, 1475; Croft, K.D., Ghisalberti, E.L., Jefferies, P.R., Stuart, A.D., Aust. J. Chem., 1979, 32, 2079; Croft, K.D., Ghisalberti, E.L., Jefferies, P.R., and Proudfoot, G.M., Aust. J. Chem., 1981, 34, 1951.
12. Ghisalberti, E.L., Hocart, C.H., Jefferies, P.R., Proudfoot, G.M., Skelton, B.W., and White, A.H., Aust. J. Chem., 1983, 36, 993; Ghisalberti, E.L., Jefferies, P.R., and Mori, T.A., Aust. J. Chem., 1984, 37, 635.
13. Lewis, D.E., Massy-Westropp, R.A., and Snow, M.R., Acta Crystallogr., Sect. B, 1979, 35, 2253; Lewis, D.E., Massy-Westropp, R.A., Ingham, C.F., and Wells, R.J., Aust. J. Chem., 1982, 35, 809.
14. Lipkowitz, K.B., Scarpone, S., Mundy, B.P., and Bornmann, W.G., J. Org. Chem., 1979, 44, 486.
15. Mori, K., Tetrahedron, 1976, 32, 1979.
16. Gore, W.E., Pearce, G.T., and Silverstein, R.M., J. Org. Chem., 1976, 41, 603.
17. Dimitriadis, E., Ph.D. Thesis, The University of Adelaide, 1980.
18. Abell, A.D., Dimitriadis, E., Massy-Westropp, R.A., Aust. J. Chem., 1984, 37, 395.
19. Dimitriadis, E., Massy-Westropp, R.A., Aust. J. Chem., 1982, 35, 1895.
20. Massy-Westropp, R.A., and Warren, R.F.O., Aust. J. Chem., 1984, 37, 1303.

21. Massy-Westropp, R.A., and Warren, R.F.O., Aust. J. Chem., 1984, 37, 1023.
22. Warren, R.F.O., A Ph.D. Thesis, The University of Adelaide, 1982.
23. Brown, C.A., and Ahuja, V.K., J. Org. Chem., 1973, 38, 2226.
24. Krüger, H.-R., Marschall, H., Weyerstahl, P., and Nerdel, F., Chem. Ber., 1973, 106, 91.
25. Krüger, H.-R., Weyerstahl, P., Marschall, H., and Nerdel, F., Chem. Ber., 1972, 105, 3553.
26. Zalkow, L.H., and Ghosal, M., J. Chem. Soc., Chem., Commun., 1967, 922.
27. VanRheenen, V., Kelly, R.C., and Cha, D.Y., Tetrahedron Lett., 1976, 1973.
28. Marshall, J.A., and Cohen, N., J. Org. Chem., 1965, 30, 3475.
29. Sandberg, R., Acta Chem. Scand., 1962, 16, 1124.
30. Jacobus, J., J. Org. Chem., 1973, 38, 402.
31. Molnár, A., Felföldi, K., and Bartók, M., Tetrahedron, 1981, 37, 2149.
32. Coxon, J.M., Hartshorn, M.P., and Swallow, W.H., J. Chem. Soc. Chem. Commun., 1973, 261.
33. Coxon, J.M., Hartshorn, M.P., and Swallow, W.H., J. Org. Chem., 1974, 39, 1142.
34. March, J., "Advanced Organic Chemistry: Reactions, Mechanisms, and Structure" (McGraw-Hill : London 1977).
35. Birch, A.J., and Subba Rao, G., Adv. Org. Chem., 1972, 8, 1.
36. Schindewolf, U., Angew Chem. Intern. Ed. Engl., 1968, 7, 190.
37. Pinder, A.R., and Smith, H., J. Chem. Soc., 1954, 113.
38. Kaiser, E.M., Synthesis, 1972, 391.
39. Watt, G.W., Chem. Rev., 1950, 46, 317.

40. Van Der Zanden, J.M., and Borg, A.P., Rec. Trav. Chim., 1956, 75, 1115.
41. Birch, A.J., J. Chem. Soc., 1945, 809.
42. Small, G.H., Minella, A.E., and Hall, S.S., J. Org. Chem., 1975, 40, 3151.
43. Hall, S.S. Lipsky, S.D., McEnroe, F.J., and Bartels, A.P., J. Org. Chem., 1971, 36, 2588.
44. Hall, S.S., Lipsky, S.D., and Small, G.H., Tetrahedron Lett., 1971, 1853.
45. Hall, S.S., Bartels, A.P., and Engman, A.M., J. Org. Chem., 1972, 37, 760.
46. Birch, A.J., Quart. Rev., 1950, 4, 69.
47. Stapleford, K.S.J., Synth. Commun., 1982, 12, 651.
48. Snieckus, V., Heterocycles, 1980, 14, 1649.
49. Gschwend, H.W. and Rodriguez, H.R., Org. Reactions, 1979, 26, 1.
50. Abell, A.D., and Massy-Westropp, R.A., Aust. J. Chem., in preparation.
(See Chapter 3.2)
51. Examples discussed in Chapter 3.1.
52. Kleiderer, E.C., and Kornfeld, E.C., J. Org. Chem., 1948, 13, 455.
53. Gritter, R.J., in "The Chemistry of the Ether Linkage" (Ed. Patai, S.) Chapter 9 (Interscience : New York 1967).
54. (a) Gray, P., and Williams, A., Trans. Faraday Soc., 1959, 55, 760;
(b) Cox, J.D., Tetrahedron, 1963, 19, 1175; (c) Pell, A.S.,
and Pilcher, G., Trans. Farady Soc., 1965, 61, 71.
55. Rosowsky, A., in "The Chemistry of Heterocyclic Compounds" (Ed. A. Weissberger and E.C. Taylor) Vol. 26, p. 38 (Wiley-Interscience : New York 1972).
56. John, I.G., and Radom, L., J. Am. Chem. Soc., 1978, 100, 3981.
57. Paddon-Row, M.N., and Hartcher, R., Aust. J. Chem., 1980, 33, 785.

58. Gronowitz, S., and Sörlin, G., Ark. Kemi, 1962, 19, 515.
59. Cantrell, T.S., J. Org. Chem., 1977, 42, 3774.
60. Dimitriadis, E., and Massy-Westropp, R.A. Aust. J. Chem., 1984, 37, 619.
61. Kamiensky, C.W., and Esmay, D.L., J. Org. Chem., 1960, 25, 1807;
Beel, J.A., Koch, W.G., Tomasi, G.E., Hermansen, D.E., and
Fleetwood, P., J. Org. Chem., 1959, 24, 2036; West, R., and
Glaze, W.H., J. Org. Chem., 1961, 26, 2096; Beel, J.A., Clark, H.C.,
and Whyman, D., J. Chem. Soc., 1962, 4423.
62. Fieser, L.F., and Fieser, M., "Reagents for Organic Synthesis",
Vol. 1, pp. 571 and 618 (Wiley : New York 1967).
63. Wakefield, B.J., "The Chemistry of Organolithium Compounds" (Pergamon
Press : Oxford 1974).
64. Schölikopf, U., Paust, J., and Patsch, M.R., Org. Synth., 1973,
Col. Vol. 5, 859.
65. Calzada, J.G., and Hooz, J., Org. Synth., 1974, 54, 63.
66. Wierenga, W., and Skulnick, H.I., J. Org. Chem., 1979, 44, 310.
67. Pople, J.A., Schneider, W.G., and Bernstein, H.J., "High Resolution
Nuclear Magnetic Resonance", p. 180 (McGraw-Hill : London 1959).
68. Becker, E.D., "High Resolution NMR, Theory and Chemical Applications",
p. 73 (Academic Press : London 1980).
69. Elvidge, J.A. in "Nuclear Magnetic Resonance for Organic Chemists"
(Ed. D.W. Mathieson) p. 33 (Academic Press : London 1967).
70. Hegarty, B.F., Kelly, J.R., Park, R.J., and Sutherland, M.D.,
Aust. J. Chem., 1970, 23, 107; Hamilton, W.D., Park, R.J. Perry, G.J.,
and Sutherland, M.D., Aust. J. Chem., 1973, 26, 375.
71. Normant, J.F., Commercon, A., Bourgain, M., and Villieras, J.,
Tetrahedron Lett., 1975, 3833.

72. Wenkert, E., and Ferreira, T.W., Organometallics, 1982, 1, 1670.
73. Ishikawa, H., Mukaiyama, T., and Ikeda, S., Bull. Chem. Soc. Jpn., 1981, 54, 776.
74. Beltrame, P., Gelli, G., and Loi, A., J. Chem. Soc. Perkin Trans. II, 1976, 1001.
75. Westera, G., Blomberg, C., and Bickelhaupt, F., J. Organometal. Chem., 1978, 144, 291.
76. Gendreau, Y., and Normant, J.F., Bull. Soc. Chim. Fr., 1979, Part 2, 305.
77. Eliel, E.L., and Nader, F.W., J. Amer. Chem. Soc., 1970, 92, 584.
78. Barbot, F., Poncini, L., Randrianoelina, B., and Miginiac, P., J. Chem. Research (S), 1981, 343.
79. Scott, A.I., "Interpretation of the Ultraviolet Spectra of Natural Products" (Pergamon Press : Oxford 1964).
80. Johnson, L.F., and Jankowski, W.C., "Carbon-13 NMR Spectra" (Wiley : New York 1972).
81. Minale, L., and Riccio, R., Tetrahedron Lett., 1976, 2711, and ref. 5 cited therein.
82. Burns, K.P., Englert, G., Kazlauskas, R., Murphy, P.T., Schönholzer, P., and Wells, R.J., Aust. J. Chem., 1983, 36, 171, and refs. cited therein.
83. Capon, R.J. Ghisalberti, E.L., and Jefferies, P.R., Aust. J. Chem., 1982, 35, 2583.
84. Wehrli, F.W., and Wirthlin, T., "Interpretation of Carbon-13 NMR Spectra" (Wiley Heyden : New York 1983).
85. House, H.O., "Modern Synthetic Reactions" (Benjamin : London 1972).
86. Jackman, L.M., and Sternhell, S., "Application of Nuclear Magnetic Resonance Spectroscopy in Organic Chemistry" (Pergamon Press : London 1969).

87. Berger, St., and Rieker, A., in "The Chemistry of the Quinonoid Compounds" (Ed. S. Patai) Part 1, Chapter 4 (Wiley : New York 1974).
88. Williams, D.H., and Fleming, I., "Spectroscopic Methods in Organic Chemistry" (McGraw-Hill : London 1973).
89. Reynolds, G.D., Ph.D. Thesis, The University of Adelaide, 1967.
90. Pinder, A.R., Perfum. Essent. Oil Rec., 1968, 59, 280, 645.
91. Bradfield, A.E., Penfold, A.R., and Simonsen, J.L., J. Chem. Soc., 1932, 2744.
92. Hunter, G.L.K., and Brogden, W.B., J. Food Sci., 1963, 30, 1; MacLeod, Jr., W.D., Tetrahedron Lett., 1965, 4779.
93. The definition of the valencane and eremophilane skeletons used in this thesis is in accord with Marshall, J.A., and Warne, Jr., T.M., J. Org. Chem., 1971, 36, 178; Rigaudy, J., and Klesney, S.P., "IUPAC Nomenclature of Organic Chemistry", p. 504 (Pergamon Press : New York 1979).
94. Penfold, A.R., and Simonsen, J.L., J. Chem. Soc., 1939, 87.
95. Copp, F.C., and Simonsen, J.L., J. Chem. Soc., 1940, 415; Gillam, A.E., Lynas-Gray, J.I., Penfold, A.R., and Simonsen, J.L., J. Chem. Soc., 1941, 60; Geissman, T.A., J. Am. Chem. Soc., 1953, 75, 4008.
96. Djerassi, C., Mauli, R., and Zalkow, L.H., J. Am. Chem. Soc., 1959, 81, 3424; Zalkow, L.H., Markley, F.X., and Djerassi, C., J. Am. Chem. Soc., 1959, 81, 2914; Zalkow, L.H., Markley, F.X., and Djerassi, C., J. Am. Chem. Soc., 1960, 82, 6354; Zalkow, L.H., Shaligram, A.M., Hu, S-E., and Djerassi, C., Tetrahedron, 1966, 22, 337.
97. (a) Ziegler, F.E., and Wender, P.A., Tetrahedron Lett., 1974, 449; (b) Mc Murry, J.E., Musser, J.H., Ahmad, M.S., and Blaszcak, L.C., J. Org. Chem., 1975, 40, 1829; (c) Ficini, J., and Touzin, A.M., Tetrahedron Lett., 1977, 1081.

98. Luche, J-L., Rodriguez-Hahn, L., and Crabbé, P., J. Chem. Soc. Chem. Commun., 1978, 601; Gemal, A.L., and Luche, J-L., J. Am. Chem. Soc., 1981, 103, 5454.
99. Becker, E.D., "High Resolution NMR, Theory and Chemical Applications", p. 104 (Academic Press : London 1980).
100. Newsoroff, G.P., and Sternhell, S., Aust. J. Chem., 1972, 25, 1669, and refs. cited therein.
101. Sternhell, S., Rev. Pure and Appl. Chem., 1964, 14, 15, and refs. cited therein.
102. Büchi, G., Greuter, F., and Tokoroyama, T., Tetrahedron Lett., 1962, 827.
103. Collins, D.J., Hobbs, J.J., and Sternhell, S., Aust. J. Chem., 1963, 16, 1030; Collins, D.J., Hobbs, J.J., and Sternhell, S., Tetrahedron Lett., 1963, 197.
104. (a) Hochmannová, J., and Herout, V., Collect. Czech. Chem. Commun., 1964, 29, 2369; (b) Piers, E., and Keziere, R.J., Tetrahedron Lett., 1968, 583; (c) Křepinský, J., Motly, O., Dolejš, L., Novotný, L., Herout, V., and Bates, R.B., Tetrahedron Lett., 1968, 3315.
105. Saunders, W.D., and Pinder, A.R., Tetrahedron Lett., 1977, 1687.
106. Näf, F., Decorzant, R., and Thommen, W., Helv. Chim. Acta, 1982, 65, 2212.
107. Ratcliffe, R., and Rodehorst, R., J. Org. Chem., 1970, 35, 4000.
108. A copy of the ¹H n.m.r. spectrum of natural eremophilone was obtained from Dr. R.A. Massy-Westropp, University of Adelaide.
109. Still, W.C., Kahn, M., and Mitra, A., J. Org. Chem., 1978, 43, 2923.
110. Perrin, D.D., Armarego, W.L.F., and Perrin, D.R., "Purification of Laboratory Chemicals" (Pergamon Press : New York 1980).

111. Evans, D.A., Carroll, G.L., and Truesdale, L.K., J. Org. Chem., 1974, 39, 914.
112. Kutney, J.P., Abdurahman, N., Gletsos, C., Le Quesne, P., Piers, E., and Vlattas, I., J. Am. Chem. Soc., 1970, 92, 1727.
113. Sheehan, M., Spangler, R.J., and Djerassi, C., J. Org. Chem., 1971, 36, 3526.
114. Genzer, J.D., Huttner, C.P., and Van Wessen, G.C., J. Am. Chem. Soc., 1951, 73, 3159.
115. Brooks, L.A., and Synder, H.R., Org. Syn., 1955, Coll. Vol. 3, 698.
116. Strube, R.E., Org. Syn., 1963, Coll. Vol. 4, 417.
117. Price, M.F., A Ph.D. Thesis, University of Adelaide, 1980, and refs. cited therein.
118. Omura, K., and Swern, D., Tetrahedron, 1978, 34, 1651.
119. Bax, A., and Freeman, R., J. Magn. Reson., 1981, 42, 164, and refs. cited therein; Bax, A., and Freeman, R., J. Magn. Res., 1981, 44, 542, and refs. cited therein.
120. Bowers, A., Halsall, T.G., Jones, E.R.H., and Lemin, A.J., J. Chem. Soc., 1953, 2548.