

AV Amplifier

DSP-Z11

Front panel

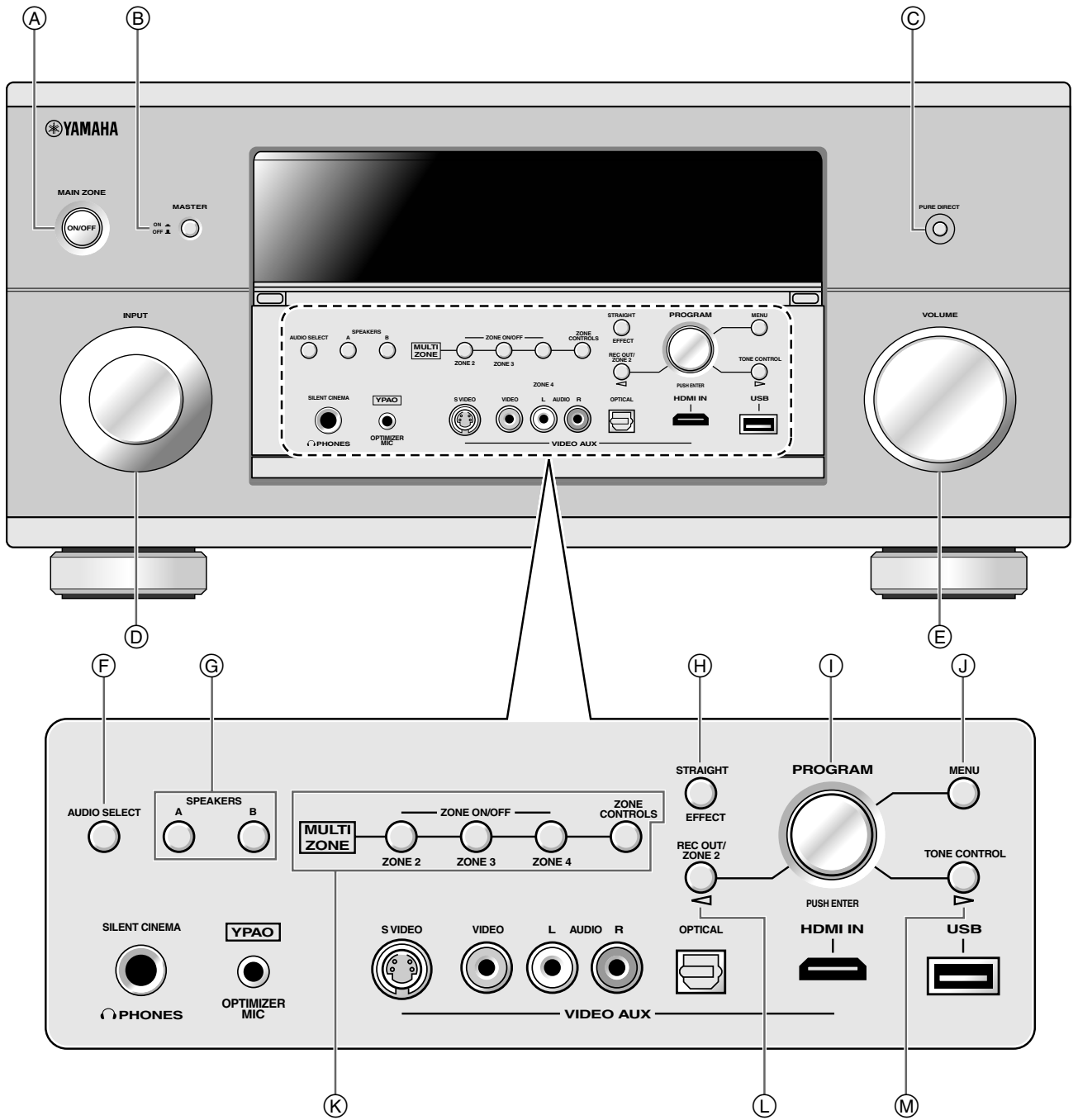

Remote control

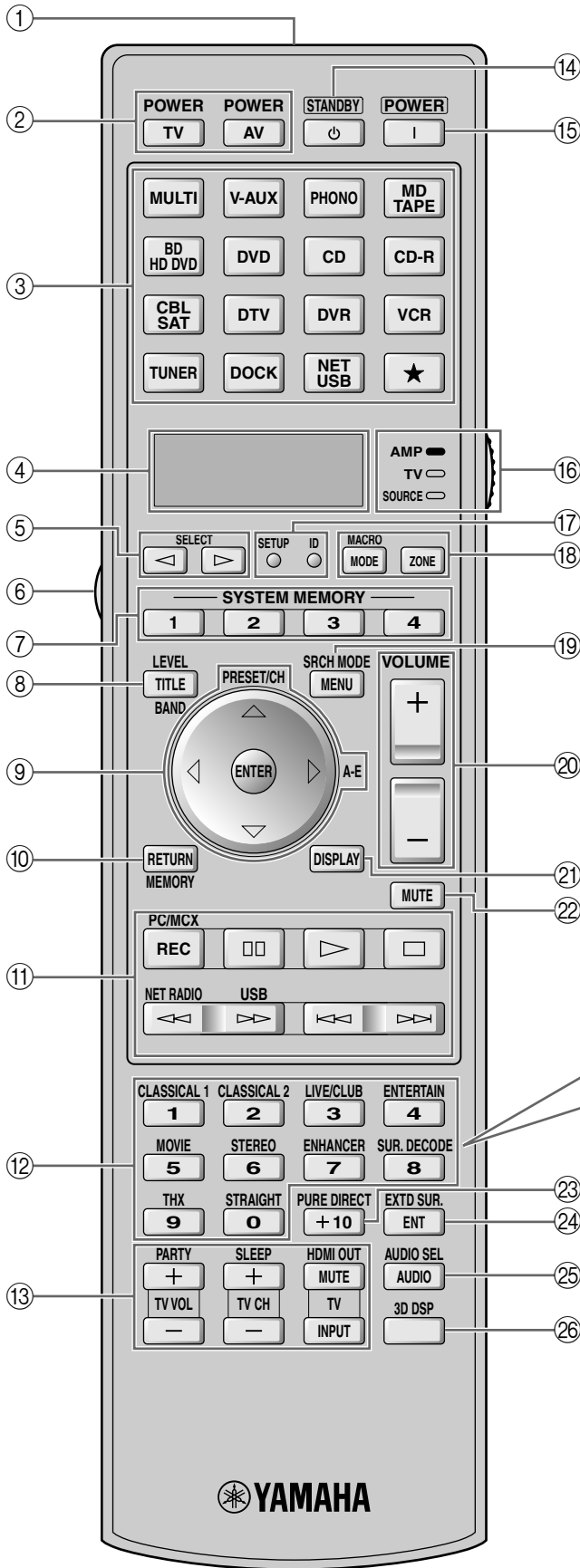

Backlight mode
 The remote control is equipped with the motion sensor and the remote control lights up the backlight corresponding to the motions or operation. If you do not want to lights up the backlight when this unit detects motions, change the backlight mode (see page 104).

Simplified remote control
 This products is supplied with the simplified remote control. Refer to “Simplified remote control” on page 110.

Optional component control area button (☆)
 You can control the desired component without changing the input source of this unit (see page 102).

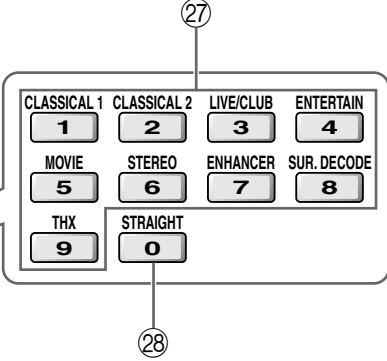

Limited Guarantee for European Economic Area (EEA) and Switzerland

Thank you for having chosen a Yamaha product. In the unlikely event that your Yamaha product needs guarantee service, please contact the dealer from whom it was purchased. If you experience any difficulty, please contact Yamaha representative office in your country. You can find full details on our website (<http://www.yamaha-hifi.com/> or <http://www.yamaha-uk.com/> for U.K. resident).

The product is guaranteed to be free from defects in workmanship or materials for a period of two years from the date of the original purchase. Yamaha undertakes, subject to the conditions listed below, to have the faulty product or any part(s) repaired, or replaced at Yamaha's discretion, without any charge for parts or labour. Yamaha reserves the right to replace a product with that of a similar kind and/or value and condition, where a model has been discontinued or is considered uneconomic to repair.

Conditions

1. The original invoice or sales receipt (showing date of purchase, product code and dealer's name) MUST accompany the defective product, along with a statement detailing the fault. In the absence of this clear proof of purchase, Yamaha reserves the right to refuse to provide free of charge service and the product may be returned at the customer's expense.
2. The product MUST have been purchased from an AUTHORISED Yamaha dealer within the European Economic Area (EEA) or Switzerland.
3. The product must not have been the subject of any modifications or alterations, unless authorised in writing by Yamaha.
4. The following are excluded from this guarantee:
 - a. Periodic maintenance and repair or replacement of parts due to normal wear and tear.
 - b. Damage resulting from:
 - (1) Repairs performed by the customer himself or by an unauthorised third party.
 - (2) Inadequate packaging or mishandling, when the product is in transit from the customer. Please note that it is the customer's responsibility to ensure the product is adequately packaged when returning the product for repair.
 - (3) Misuse, including but not limited to (a) failure to use the product for its normal purpose or in accordance with Yamaha's instructions on the proper use, maintenance and storage, and (b) installation or use of the product in a manner inconsistent with the technical or safety standards in force in the country where it is used.
 - (4) Accidents, lightning, water, fire, improper ventilation, battery leakage or any cause beyond Yamaha's control.
 - (5) Defects of the system into which this product is incorporated and/or incompatibility with third party products.
 - (6) Use of a product imported into the EEA and/or Switzerland, not by Yamaha, where that product does not conform to the technical or safety standards of the country of use and/or to the standard specification of a product sold by Yamaha in the EEA and/or Switzerland.
 - (7) Non AV (Audio Visual) related products.
(Products subject to "Yamaha AV Guarantee Statement" are defined in our website at <http://www.yamaha-hifi.com/> or <http://www.yamaha-uk.com/> for U.K. resident.)
5. Where the guarantee differs between the country of purchase and the country of use of the product, the guarantee of the country of use shall apply.
6. Yamaha may not be held responsible for any losses or damages, whether direct, consequential or otherwise, save for the repair or replacement of the product.
7. Please backup any custom settings or data, as Yamaha may not be held responsible for any alteration or loss to such settings or data.
8. This guarantee does not affect the consumer's statutory rights under applicable national laws in force or the consumer's rights against the dealer arising from their sales/purchase contract.

Caution: Read this before operating your unit.

- 1 To assure the finest performance, please read this manual carefully. Keep it in a safe place for future reference.
- 2 Install this sound system in a well ventilated, cool, dry, clean place – away from direct sunlight, heat sources, vibration, dust, moisture, and/or cold. Allow ventilation space of at least 30 cm on the top, 20 cm on the left and right, and 20 cm on the back of this unit.
- 3 Locate this unit away from other electrical appliances, motors, or transformers to avoid humming sounds.
- 4 Do not expose this unit to sudden temperature changes from cold to hot, and do not locate this unit in an environment with high humidity (i.e. a room with a humidifier) to prevent condensation inside this unit, which may cause an electrical shock, fire, damage to this unit, and/or personal injury.
- 5 Avoid installing this unit where foreign objects may fall onto this unit and/or this unit may be exposed to liquid dripping or splashing. On the top of this unit, do not place:
 - Other components, as they may cause damage and/or discoloration on the surface of this unit.
 - Burning objects (i.e. candles), as they may cause fire, damage to this unit, and/or personal injury.
 - Containers with liquid in them, as they may fall and liquid may cause electrical shock to the user and/or damage to this unit.
- 6 Do not cover this unit with a newspaper, tablecloth, curtain, etc. in order not to obstruct heat radiation. If the temperature inside this unit rises, it may cause fire, damage to this unit, and/or personal injury.
- 7 Do not plug in this unit to a wall outlet until all connections are complete.
- 8 Do not operate this unit upside-down. It may overheat, possibly causing damage.
- 9 Do not use force on switches, knobs and/or cords.
- 10 When disconnecting the power cable from the wall outlet, grasp the plug; do not pull the cable.
- 11 Do not clean this unit with chemical solvents; this might damage the finish. Use a clean, dry cloth.
- 12 Only voltage specified on this unit must be used. Using this unit with a higher voltage than specified is dangerous and may cause fire, damage to this unit, and/or personal injury. Yamaha will not be held responsible for any damage resulting from use of this unit with a voltage other than specified.
- 13 To prevent damage by lightning, keep the power cord and outdoor antennas disconnected from a wall outlet or the unit during a lightning storm.
- 14 Do not attempt to modify or fix this unit. Contact qualified Yamaha service personnel when any service is needed. The cabinet should never be opened for any reasons.
- 15 When not planning to use this unit for long periods of time (i.e. vacation), disconnect the AC power plug from the wall outlet.
- 16 Install this unit near the AC outlet and where the AC power plug can be reached easily.
- 17 Be sure to read the “Troubleshooting” section on common operating errors before concluding that this unit is faulty.
- 18 Before moving this unit, press **ⓂMASTER ON/OFF** to release it outward to the OFF position to turn off this unit, the main room, Zone 2, Zone 3, and Zone 4 and then disconnect the AC power plug from the AC wall outlet.
- 19 **VOLTAGE SELECTOR** (Asia and General models only)
The **VOLTAGE SELECTOR** on the rear panel of this unit must be set for your local main voltage **BEFORE** plugging into the AC wall outlet. Voltages are as follows:
..... 110/120/220/230–240 V AC, 50/60 Hz
- 20 The batteries shall not be exposed to excessive heat such as sunshine, fire or like.
- 21 Excessive sound pressure from earphones and headphones can cause hearing loss.

WARNING

TO REDUCE THE RISK OF FIRE OR ELECTRIC SHOCK,
DO NOT EXPOSE THIS UNIT TO RAIN OR MOISTURE.

As long as this unit is connected to the AC wall outlet, it is not disconnected from the AC power source even if you turn off this unit by **ⓂMASTER ON/OFF**. In this state, this unit is designed to consume a very small quantity of power.

■ For U.K. customers

If the socket outlets in the home are not suitable for the plug supplied with this appliance, it should be cut off and an appropriate 3 pin plug fitted. For details, refer to the instructions described below.

Note

The plug severed from the mains lead must be destroyed, as a plug with bared flexible cord is hazardous if engaged in a live socket outlet.

■ Special Instructions for U.K. Model

IMPORTANT

THE WIRES IN MAINS LEAD ARE COLOURED IN ACCORDANCE WITH THE FOLLOWING CODE:

Blue: NEUTRAL

Brown: LIVE

As the colours of the wires in the mains lead of this apparatus may not correspond with the coloured markings identifying the terminals in your plug, proceed as follows:

The wire which is coloured BLUE must be connected to the terminal which is marked with the letter N or coloured BLACK. The wire which is coloured BROWN must be connected to the terminal which is marked with the letter L or coloured RED.

Making sure that neither core is connected to the earth terminal of the three pin plug.



This symbol mark is according to the EU directive 2002/96/EC.

This symbol mark means that electrical and electronic equipment, at their end-of-life, should be disposed of separately from your household waste.

Please act according to your local rules and do not dispose of your old products with your normal household waste.

Contents

Introduction

Notices	8
Features.....	10
Getting started.....	11
Quick start guide.....	13

Preparation

Connections	20
Optimizing the speaker setting for your listening room (YPAO)	42
Before starting the automatic setup	42
Using the quick automatic setup.....	43
Using the basic automatic setup	44
Reviewing the result of the automatic setup	45
Using advanced automatic setup	46

Basic Operation

Playback.....	50
Basic procedure	50
Selecting the MULTI CH INPUT component.....	50
Selecting the HDMI OUT jack	51
Selecting the front speaker set.....	51
Using the Zone B feature.....	51
Using your headphones	51
Playing video sources in the background of an audio source.....	51
Selecting audio input jacks	
(AUDIO SELECT).....	52
Muting the audio output	52
Using the sleep timer	52
Canceling the sleep timer	52
Operating this unit	
by using the graphical user interface (GUI) menu	53
Items in GUI menu	53
Basic controls in the GUI menu	53
Basic operation of the GUI menu	
by using the front panel controls.....	53
Sound field programs	54
Selecting sound field programs	54
Sound field program descriptions.....	54
For audio music sources.....	55
For various sources.....	57
For visual sources of music	57
For parties.....	58
For game programs.....	58
For movie sources	58
Stereo playback	59
For compression artifacts	
(Compressed Music Enhancer mode)	59
Surround decoder mode.....	59
THX Surround mode.....	59
Using sound field programs without surround speakers	
(Virtual CINEMA DSP).....	60
Enjoying multi-channel sources and sound field programs with headphones (SILENT CINEMA).....	60
Using CINEMA DSP HD ³ mode.....	60
Enjoying unprocessed input sources.....	60
Deactivating the "STRAIGHT" mode	60
Using audio features	61
Enjoying pure hi-fi sound	61
Adjusting the tonal quality	61
Adjusting the speaker level.....	61
Recording.....	62

Internal Source Operation

Using iPod™	64
Controlling iPod™.....	64
Remote control operation	64
Controlling iPod in the simple remote mode.....	64
Controlling iPod in the menu browse mode	64
The functions of the play information display.....	65
Using Network/USB features.....	66
Navigating the network and USB menus.....	66
Remote control operation	67
Using a PC server or Yamaha MCX-2000	68
Installing Windows Media Player 11 on your PC	68
Registering this unit on the Yamaha MCX-2000	68
Using the Internet Radio	69
Storing your favorite Internet Radio stations	
with bookmarks.....	69
Using a USB storage device or a USB portable audio player	69
Using shortcut buttons	70
Assigning the items to the numeric button (1-8).....	70
Select an item by using numeric buttons (1-8).....	70



Advanced Operation

Advanced sound configurations	72
Selecting decoders	72
Selecting decoders for 2-channel sources	
(surround decode mode).....	72
Decoder descriptions	72
Selecting decoders used with sound field programs.....	72
Selecting decoders for multi-channel sources	72
Playing back sources with the THX Surround modes	73
For 2-channel sources.....	73
For multi-channel sources	73
Graphical user interface (GUI) menu.....	74
GUI menu overview.....	76
Stereo/Surround (Stereo/Surround menu)	77
Input Select	81
Manual Setup (Basic).....	83
Manual Setup (Volume).....	86
Manual Setup (Sound)	86
Manual Setup (Video).....	89
Manual Setup (Multi Zone)	91
Manual Setup (Network)	92
Manual Setup (Option)	93
Signal Info. (Input signal information).....	95
Language.....	95
Saving and recalling the system settings	
(System Memory).....	96
Saving the current system settings.....	96
Saving by the SYSTEM MEMORY buttons.....	96
Saving by the GUI menu operation	96
Renaming the stored settings.....	97
Saved parameters for the main zone.....	98
Saved parameters for Zone 2, Zone 3, or Zone 4	98
Loading the stored system settings	98
Loading by the SYSTEM MEMORY buttons	98
Loading by the GUI menu operation.....	98
Using examples	99
Example 1: Switching the settings	
of this unit according to the using situations.....	99
Example 2: Switching the setting of this unit according to the environment of the listening room	100
Controlling this unit by using the Web browser (Web Control Center).....	101

Remote control features	102
Controlling this unit, a TV, or other components.....	102
Controlling this unit	102
Controlling a TV	102
Controlling other components.....	103
Selecting a component to be controlled	103
Controlling optional components (Option mode)	103
Customizing the remote control	104
Setting the backlight mode of the remote control (LIGHT).....	104
Setting remote control codes (P-SET)	104
Programming codes from other remote controls (LEARN)	105
Changing source names in the display window (RNAME)	106
Macro programming features	107
Recalling programmed macro-operations	107
Default macro functions	108
Programming macro operations (MACRO).....	108
Clearing configurations	109
Clearing function sets (CLEAR).....	109
Clearing a learned function (ERASE).....	109
Simplified remote control.....	110
Setting the controlling zone of the simplified remote control	110
Replacing the battery in the simplified remote control.....	110
Using multi-zone configuration	111
Step1: Planning the multi-zone system	111
Step2: Connecting the speakers, external amplifiers, and/or other components	112
Using the internal amplifier of this unit	112
Using external amplifiers	113
Using the ZONE DIGITAL OUT (COAXIAL) jack	113
Connecting Zone video monitor.....	114
Video signal up-conversion to the zone component video signals	114
Using REMOTE IN/OUT and TRIGGER OUT jacks for Zone 2, Zone 3, and Zone 4	115
Step3: Setting the zone parameter	116
Assigning the zone speakers	116
Controlling Zone 2, Zone 3, or Zone 4.....	116
Basic operation.....	116
Selecting the input source Zone 2, Zone 3, or Zone 4	117
Adjusting the volume level of Zone 2, Zone 3, or Zone 4.....	117
Setting the sleep timer for Zone 2, Zone 3, or Zone 4	117
Adjusting the tonal quality of Zone 2, Zone 3, or Zone 4	118
Using the Zone OSD	118
Using the party mode	118
Advanced setup	119
Using the advanced setup menu	119



Additional Information

Troubleshooting	122
Glossary	128
Parametric equalizer information	135
Block diagrams	136
Specifications	138
Index	140
List of remote control codes	144

“MASTER ON/OFF” or “DVD” (example) indicates the name of the parts on the front panel or the remote control. Refer to the cover pages at the top of this manual for the information about each position of the parts.

Notices

About this manual

-  indicates a tip for your operation.
- Some operations can be performed by using either the buttons on the front panel or the ones on the remote control. In case the button names differ between the front panel and the remote control, the button name on the remote control is given in parentheses.
- This manual is printed prior to production. Design and specifications are subject to change in part as a result of improvements, etc. In case of differences between the manual and product, the product has priority.
- This unit is equipped with GUI language switching capability. In this manual, the illustrations of the GUI are examples when you set the GUI language to English.
- “**A MAIN ZONE ON/OFF**” or “**3 DVD**” (example) indicates the name of the parts on the front panel or the remote control. Refer to the cover pages at the top of this manual for the information about each position of the parts.
- The symbol “” with page number(s) indicates the corresponding reference page(s).



Manufactured under license from Dolby Laboratories.

“Dolby”, “Pro Logic”, and the double-D symbol are trademarks of Dolby Laboratories.



Manufactured under license under U.S. Patent No's:

5,451,942;5,956,674;5,974,380;5,978,762;6,226,616;6,487,535 & other U.S. and worldwide patents issued & pending. DTS is a registered trademark and the DTS logos, Symbol, DTS-HD and DTS-HD Master Audio are trademark of DTS, Inc. © 1996-2007 DTS, Inc. All Rights Reserved.



THX, the THX logo and Ultra2 Plus are trademarks of THX Ltd. which may be registered in some jurisdictions. All rights reserved. All other trademarks are the property of their respective owners.

iPod™

“iPod” is a trademark of Apple Inc., registered in the U.S. and other countries.



Fraunhofer Institut
Integrierte Schaltungen

MPEG Layer-3 audio coding technology licensed from Fraunhofer IIS and Thomson.



This amplifier supports network connections.

HDMI

“HDMI”, the “HDMI” logo, and “High-Definition Multimedia Interface” are trademarks or registered trademarks of HDMI Licensing LLC.

SILENT™
CINEMA

“SILENT CINEMA” is a trademark of Yamaha Corporation.

Windows XP, Windows Vista, Windows Internet Explorer, Windows Media Audio, Windows Media Connect, and Windows Media Player are either registered trademarks or trademarks of Microsoft corporation in the United States and/or other countries.

The PlaysForSure logo, Windows Media and the Windows logo are trademarks or registered trademarks of Microsoft Corporation in the United States and/or other countries.

Content providers are using the digital rights management technology for Windows Media contained in this device (WM-DRM) to protect the integrity of their content (Secure Content) so that their intellectual property, including copyright, in such content is not misappropriated.

This device uses WM-DRM software to play Secure Content (WM-DRM Software).

If the security of the WM-DRM Software in this device has been compromised, owners of Secure Content (Secure Content Owners) may request that Microsoft revoke the WM-DRM Software's right to acquire new licenses to copy, display and/or play Secure Content. Revocation does not alter the WM-DRM Software's ability to play unprotected content. A list of revoked WM-DRM Software is sent to your device whenever you download a license for Secure Content from the Internet or from a PC. Microsoft may, in conjunction with such license, also download revocation list onto your device on behalf of Secure Content Owners.

Introduction

Features	10
Getting started	11
Supplied accessories	11
Using the remote control	12
Opening and closing the front panel door	12
VOLTAGE SELECTOR (Asia and General models only)	12
Quick start guide	13
Preparation: Check the items	13
Step 1: Set up your speakers	14
Step 2: Connect your Blu-ray Disc/HD DVD player and other components	16
Step 3: Turn on the power and start playback	17
What do you want to do with this unit?	18

Features

Built-in 11-channel power amplifier

- ◆ Minimum RMS output power (20 Hz to 20 kHz, 0.04% THD, 8 Ω)
Front: 140 W + 140 W
Center: 140 W
Surround: 140 W + 140 W
Surround back: 140 W + 140 W
Front presence: 50 W + 50 W
Rear presence: 50 W + 50 W

Sound field programs ☞ P. 54

- ◆ Proprietary Yamaha technology for the creation of sound fields
- ◆ THX Ultra2 Plus surround modes ☞ P. 73
- ◆ CINEMA DSP HD³ mode for creating intensive and accurate stereoscopic sound field ☞ P. 60
- ◆ Compressed Music Enhancer mode to improve the sound quality of compression artifacts (such as the MP3 format) to that of a high-quality multi-channel source playback ☞ P. 59
- ◆ Virtual CINEMA DSP ☞ P. 60
- ◆ SILENT CINEMA ☞ P. 60

Digital audio decoders

- ◆ Dolby TrueHD, Dolby Digital Plus decoder
- ◆ DTS-HD Master Audio, DTS-HD High Resolution Audio decoder
- ◆ Dolby Digital/Dolby Digital EX decoder
- ◆ DTS/DTS-ES Matrix 6.1, Discrete 6.1, DTS 96/24 decoder
- ◆ Dolby Pro Logic/Dolby Pro Logic II/Dolby Pro Logic IIX decoder
- ◆ DTS NEO:6 decoder

HDMI™ (High-Definition Multimedia Interface) ☞ P. 28

- ◆ HDMI interface for standard, enhanced or high-definition video as well as multi-channel digital audio based on HDMI version 1.3a
- ◆ Automatic audio and video synchronization (lip sync) information capability
- ◆ Deep Color (30/36 bit) and xvYCC color video signal transmission capability
- ◆ High refresh rate and high resolution video signals capability
- ◆ High definition digital audio format signals capability
- ◆ Analog video to HDMI digital video up-conversion (composite video ↔ S-video ↔ component video → HDMI digital video) capability for monitor out
- ◆ Analog and HDMI video signal up-scaling ☞ P. 89

iPod controlling capability ☞ P. 64

- ◆ DOCK terminal to connect a Yamaha iPod universal dock (such as the YDS-10, sold separately), which supports iPod (Click and Wheel), iPod nano, and iPod mini

Network features ☞ P. 66

- ◆ NETWORK port to connect a PC and Yamaha MCX-2000 or access the Internet Radio via LAN
- ◆ DHCP automatic or manual network configuration

USB features ☞ P. 69

- ◆ USB ports to connect a USB storage device, USB Hard disc drive, or a USB portable audio player

Web control feature

- ◆ Web control capability of this unit by using a Web browser ☞ P. 101

Automatic speaker setup features

- ◆ Advanced YPAO (Yamaha Parametric Room Acoustic Optimizer) for automatic speaker setup ☞ P. 42
- ◆ Specialized parametric equalizer for the standing wave reduction ☞ P. 44
- ◆ Multiple point measurement feature for multiple listening positions ☞ P. 46
- ◆ Speaker angle measurement feature for the optimized CINEMA DSP effect ☞ P. 60

Other features

- ◆ 192-kHz/24-bit D/A converter
- ◆ GUI (graphical user interface) menus that allow you to optimize this unit to suit your individual audio/video system ☞ P. 74
- ◆ GUI display menu language switching capability (English, Japanese, French, German, Spanish and Russian) ☞ P. 95
- ◆ 6 or 8-channel additional input jacks for discrete multi-channel input ☞ P. 35
- ◆ Multiple subwoofers connection capability ☞ P. 25
- ◆ Analog video interlace/progressive conversion from 480i (NTSC)/576i (PAL) to 480p/576p
- ◆ S-video signal input/output capability ☞ P. 29
- ◆ Component video input/output capability includes (4 COMPONENT VIDEO INs and 2 MONITOR OUTs) ☞ P. 28
- ◆ Optical and coaxial digital audio signal jacks ☞ P. 28
- ◆ Pure Direct mode for pure hi-fi sound for all sources ☞ P. 61
- ◆ Adaptive dynamic range controlling capability ☞ P. 86
- ◆ Adaptive DSP effect level controlling capability ☞ P. 86
- ◆ Remote control with preset remote control codes, learning, macro and buttons and display backlight capability ☞ P. 102
- ◆ Simplified remote control ☞ P. 110
- ◆ Advanced amplifier assign capability ☞ P. 119
- ◆ Flexible assignable trigger out jack ☞ P. 94
- ◆ Zone switching capability between the main zone and Zone 2/Zone 3/Zone 4 using ZONE CONTROLS ☞ P. 91
- ◆ Zone 2 video output (composite and component) and displaying OSD (on-screen display) capability ☞ P. 114
- ◆ System Memory capability for saving and recalling multiple system parameter settings ☞ P. 96
- ◆ Sleep timer ☞ P. 52

Getting started

Supplied accessories

Check that you received all of the following parts.

Remote control

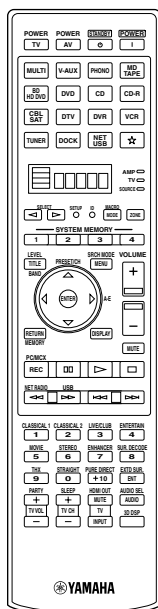

Simplified remote control

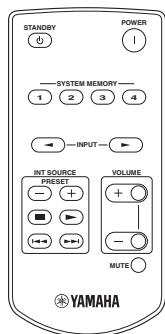

Batteries (4)
(AAA, LR03)

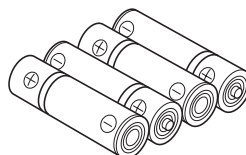

Microphone base

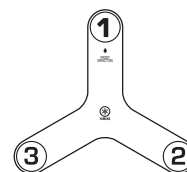

Optimizer microphone

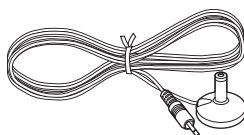

Power cable
(Two for Asia model)

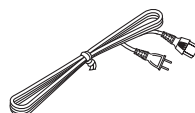

Note

The form of the supplied accessories varies depending on the models.

■ Installing batteries in the remote control

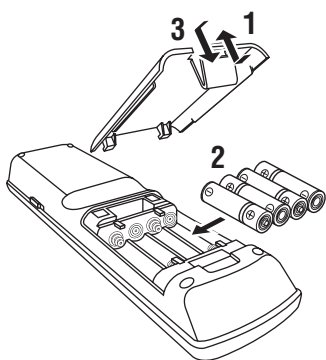

- 1** Take off the battery compartment cover.
- 2** Insert the four supplied batteries (AAA, LR03) according to the polarity markings (+ and -) on the inside of the battery compartment.
- 3** Snap the battery compartment cover back into place.

Notes

- Change all of the batteries if you notice the operation range of the remote control decreases.
- Do not use old batteries together with new ones.
- Do not use different types of batteries (such as alkaline and manganese batteries) together. Read the packaging carefully as these different types of batteries may have the same shape and color.
- We strongly recommend that you use alkaline batteries.
- If the batteries have leaked, dispose of them immediately. Avoid touching the leaked material or letting it come into contact with clothing, etc. Clean the battery compartment thoroughly before installing new batteries.
- Do not throw away batteries with general house waste; dispose of them correctly in accordance with your local regulations.
- If the remote control is without batteries for more than 2 minutes, or if exhausted batteries remain in the remote control, the contents of the memory may be cleared. When the memory is cleared, insert new batteries, set up the remote control code and program any acquired functions that may have been cleared.

Using the remote control

The remote control transmits a directional infrared ray. Be sure to aim the remote control directly at the remote control sensor on this unit during operation.

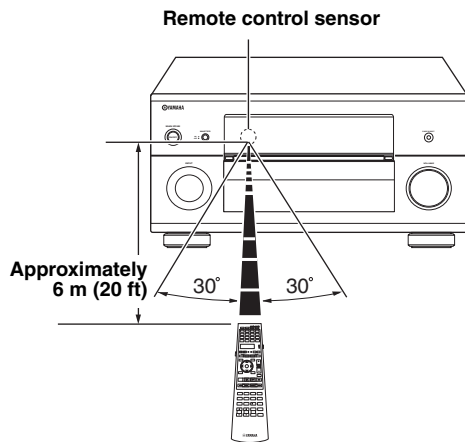

⑥ LIGHT

Lights up the remote control buttons and the display window (④).

Display window (④)

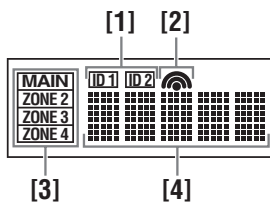

[1] ID1/ID2 indicator

Indicates the currently selected remote control ID (see page 119).

[2] Transmit indicator

Appears while the remote control is sending infrared signals.

[3] Zone indicators

Indicates the currently controlling zone (see page 116).

[4] Information display

Shows the name of the selected input source that you can control.

Infrared window (①)

Outputs infrared control signals. Aim this window at the component you want to operate.

Operation mode selector (⑩)

The function of some buttons depends on the operation mode selector position.

AMP

Operates the amplifier function of this unit.

SOURCE

Operates the component selected with an input selector button (see page 103).

TV

Operates the TV (see page 102).

Notes

- Do not spill water or other liquids on the remote control.
- Do not drop the remote control.
- Do not leave or store the remote control in the following types of conditions:
 - places of high humidity, such as near a bath
 - places of high temperatures, such as near a heater or stove
 - places of extremely low temperatures
 - dusty places

Backlight mode

The remote control is equipped with the motion sensor and the remote control lights up the backlight corresponding to the motions or operation. If you do not want to lights up the backlight when this unit detects motions, change the backlight mode (see page 104).

Opening and closing the front panel door

When you want to use the controls behind the front panel door, open the door by gently pressing on the lower part of the panel. Keep the door closed when not using these controls.

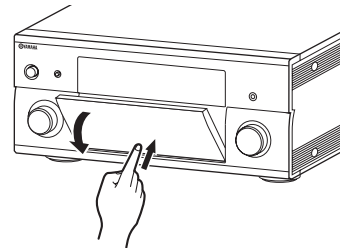

To open, press gently on the lower part of the panel.

VOLTAGE SELECTOR (Asia and General models only)

Caution

The VOLTAGE SELECTOR on the rear panel of this unit must be set for your local voltage BEFORE plugging the power cable into the AC wall outlet. Improper setting of the VOLTAGE SELECTOR may cause damage to this unit and create a potential fire hazard.

Rotate the VOLTAGE SELECTOR clockwise or counterclockwise to the correct position using a straight slot screwdriver.

Voltages are as follows:

..... AC 110/120/220/230–240 V, 50/60 Hz

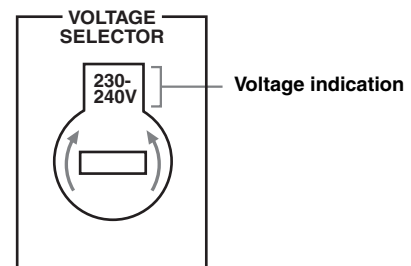

Quick start guide

The following steps describe the easiest way to enjoy Blu-ray Disc/HD DVD movie playback in your home theater. See pages 21 to 24 for details of the speaker placement.

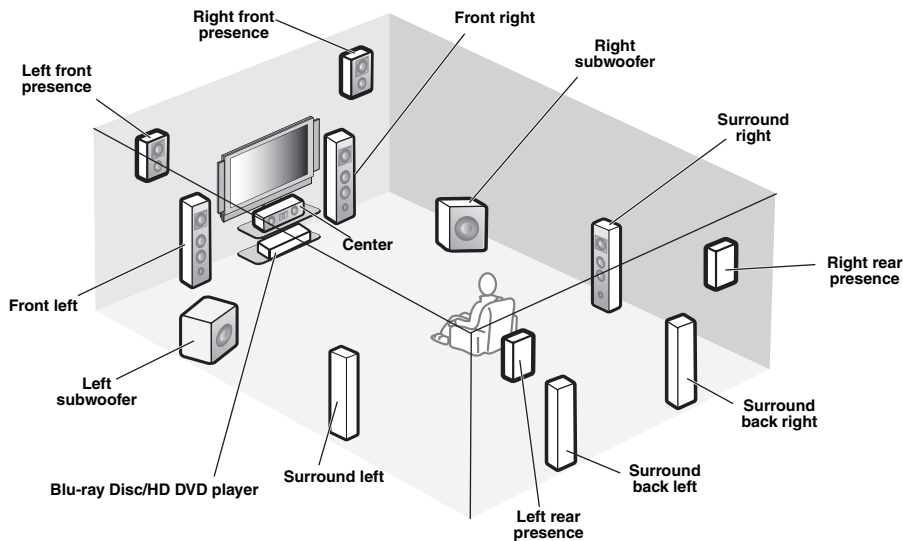

Step 1: Set up your speakers

➔ P. 14

Step 2: Connect your Blu-ray Disc/HD DVD player and other components

➔ P. 16

Step 3: Turn on the power and start playback

➔ P. 17

Enjoy Blu-ray Disc/HD DVD playback!

Preparation: Check the items

In these steps, you need the following supplied accessory.

- Power cable

The following items are not included in the package of this unit.

- Speakers
 - Front speaker x 2
 - Center speaker x 1
 - Surround speaker x 4
 - Front presence speaker x 2
 - Rear presence speaker x 2

Select magnetically shielded speakers. The minimum required speakers are two front speakers. The priority of the requirement of other speakers is as follows:

 1. Two surround speakers
 2. One center speaker
 3. One (or two) surround back speaker(s)
 4. Two front presence speakers
 5. Two rear presence speakers
- Active subwoofers x 2
Select active subwoofers equipped with an RCA input jack.
- Speaker cable x 11
- Subwoofer cables x 2
Select monaural RCA cables.
- HDMI cables x 2
Select HDMI cables shorter than 5 meters (16 feet) with the HDMI logo printed on it.
- Blu-ray Disc/HD DVD player x 1
Select Blu-ray Disc/HD DVD player equipped with an HDMI output jack.
- Video monitor..... x 1
Select a TV monitor, video monitor or projector equipped with an HDMI input jack.

Step 1: Set up your speakers

Place your speakers in the room and connect them to this unit.

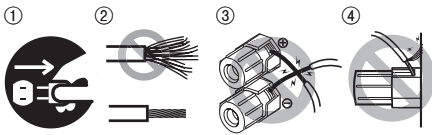

- ① Make sure that this unit and the subwoofers are unplugged from the AC wall outlets.
- ② Twist the exposed wires of the speaker cables together to prevent short circuits.
- ③ Do not let the bare speaker wires touch each other.
- ④ Do not let the bare speaker wires touch any metal part of this unit.

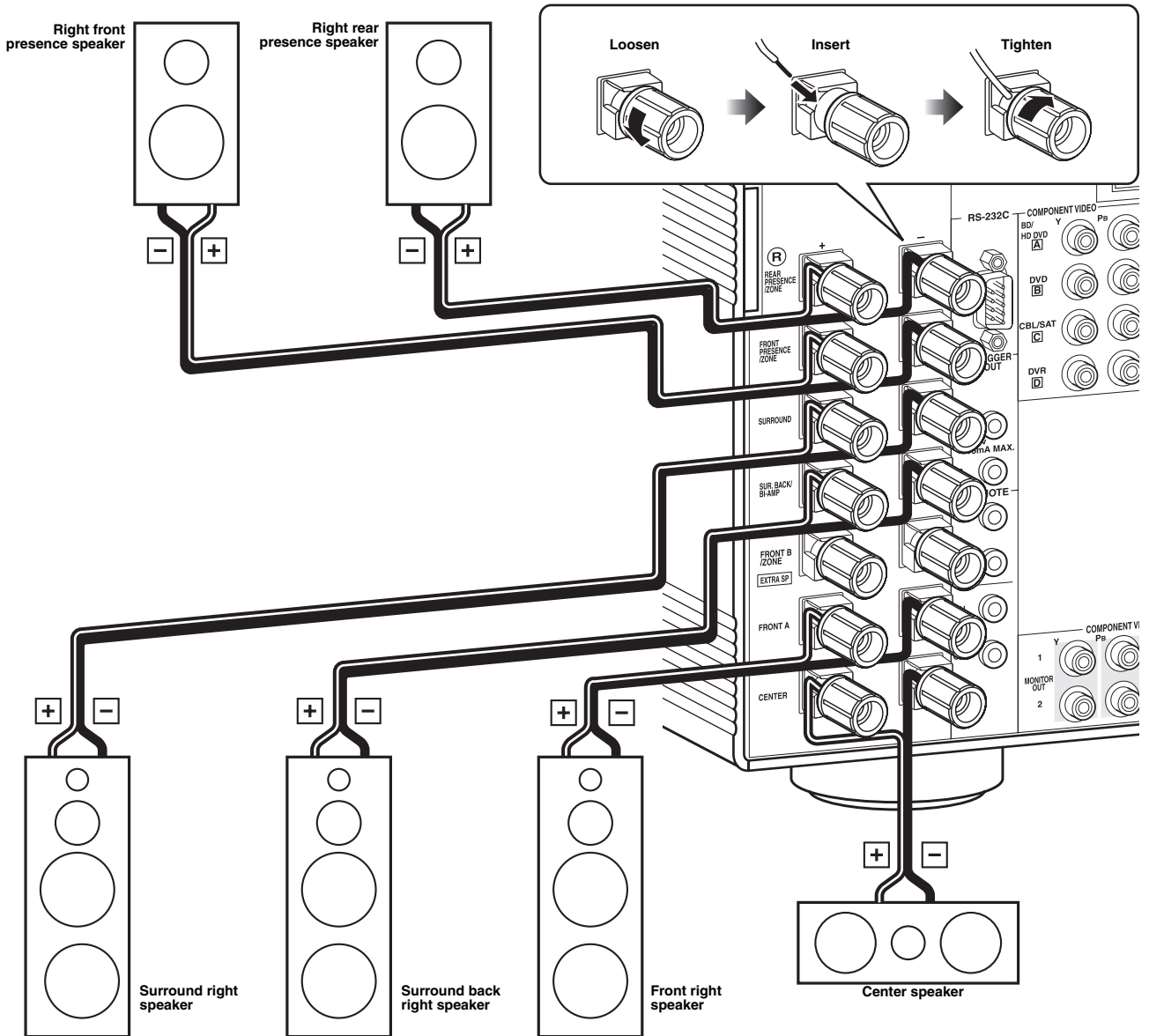

For other speaker configurations

If you want to connect less than 11 speakers and 2 subwoofers, connect the speakers as follows.

	Front left	Front right	Center	Surround left	Surround right	Surround back left	Surround back right	Front presence left	Front presence right	Rear presence left	Rear presence right	Subwoofer left	Subwoofer right
11.2/11.1	●	●	●	●	●	●	●	●	●	●	●	●	●
9.2/9.1	●	●	●	●	●	●	●	●	●	●	●	●	●
7.2/7.1	●	●	●	●	●	●	●	●	●	●	●	●	●
6.2/6.1	●	●	●	●	●	●	●	●	●	●	●	●	●
5.2/5.1	●	●	●	●	●	●	●	●	●	●	●	●	●
3.2/3.1	●	●	●	●	●	●	●	●	●	●	●	●	●
2.2/2.1	●	●	●	●	●	●	●	●	●	●	●	●	●

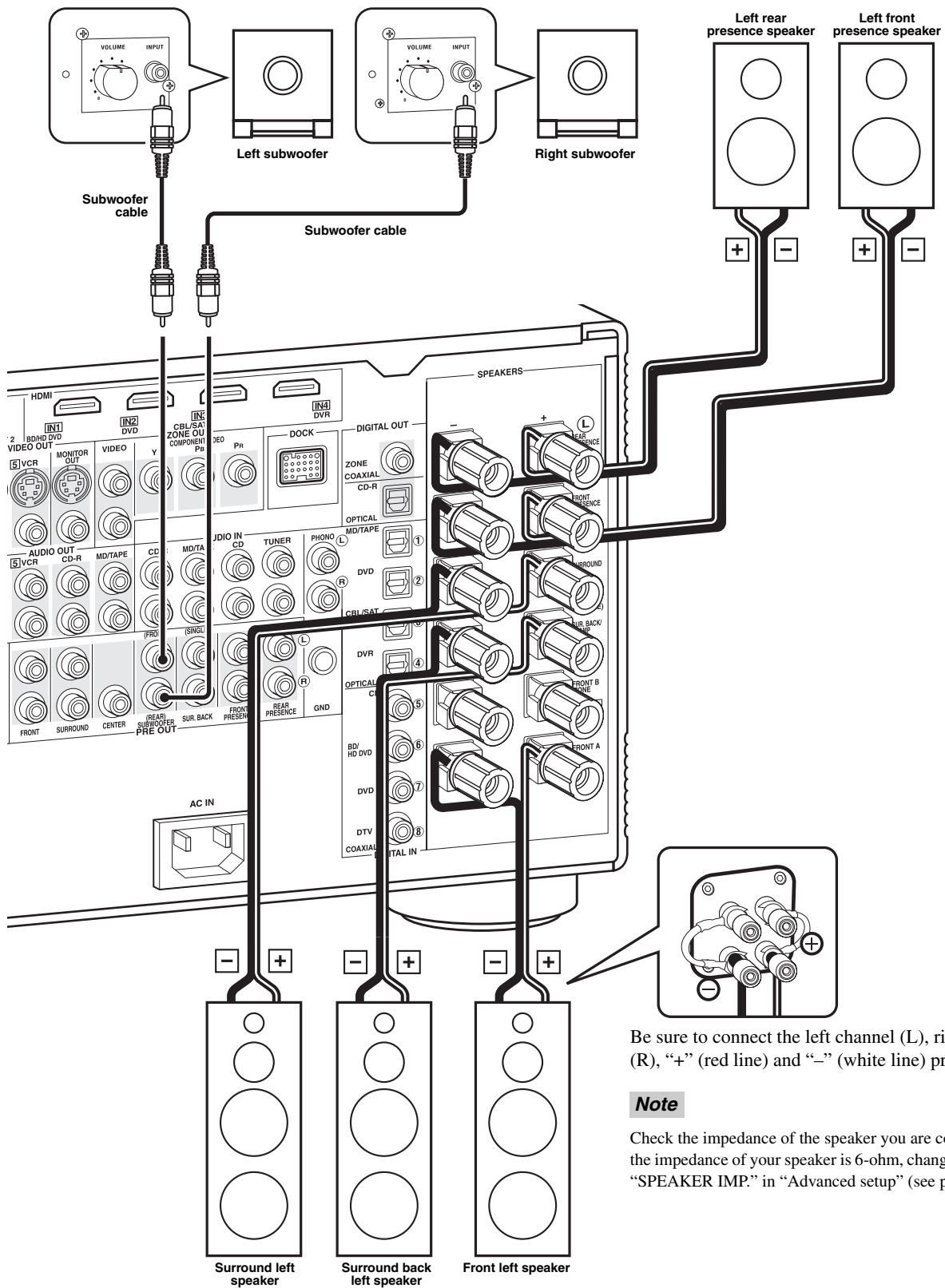



Be sure to connect the left channel (L), right channel (R), “+” (red line) and “-” (white line) properly.

Note

Check the impedance of the speaker you are connecting. If the impedance of your speaker is 6-ohm, change the setting of “SPEAKER IMP.” in “Advanced setup” (see page 119).

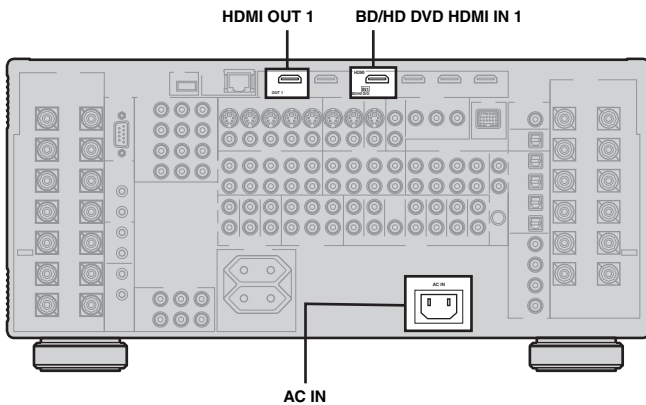
Step 2: Connect your Blu-ray Disc/HD DVD player and other components



 Make sure that this unit and the Blu-ray Disc/HD DVD player are unplugged from the AC wall outlets.

1 Connect an HDMI cable to the HDMI output jack on your Blu-ray Disc/HD DVD player and the BD/HD DVD HDMI IN 1 jack of this unit.

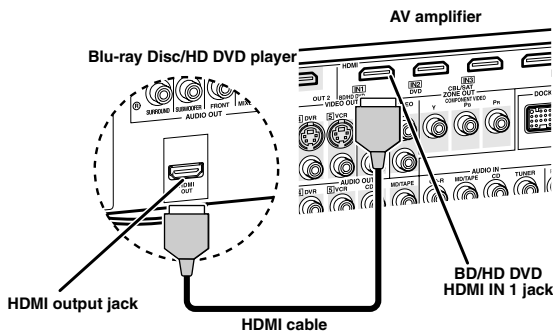

2 Connect an HDMI cable to the HDMI OUT 1 jack on this unit and the HDMI input jack on your video monitor.

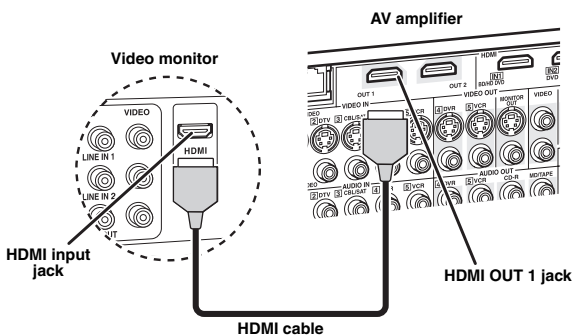

3 Connect the supplied power cable to AC IN on this unit and then plug the power cable and other components into the AC wall outlet.



This unit is equipped with AC OUTLET(S) that provide(s) power to other components. See page 38 for details.

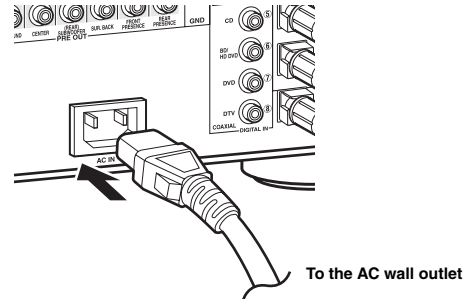

General connection information

- General information on jacks and cable plugs [P. 28](#)
- General information on HDMI [P. 28](#)
- Speaker impedance setting [P. 39](#)

For further connections

- Using other kinds of speaker combinations [P. 21](#)
- Connecting a video monitor via various ways of connection [P. 30](#)
- Connecting a Blu-ray Disc/HD DVD player via various ways of connection [P. 31](#)
- Connecting a DVD player via various ways of connection [P. 32](#)
- Connecting a DVD recorder or a digital video recorder [P. 33](#)
- Connecting a set-top box [P. 32](#)
- Connecting a CD player, an MD recorder, or a turntable [P. 34](#)
- Connecting an external amplifier [P. 35](#)
- Connecting a DVD player via multi-channel analog audio connection [P. 35](#)
- Connecting a Yamaha iPod universal dock [P. 36](#)
- Using the REMOTE IN/OUT jacks [P. 36](#)
- Using the TRIGGER OUT jacks [P. 36](#)
- Using the VIDEO AUX jacks on the front panel [P. 38](#)
- Connecting this unit to your network [P. 37](#)
- Connecting a USB device [P. 37](#)

Step 3: Turn on the power and start playback

Check the type of the connected speakers.

If the speakers are 6-ohm speakers, set "SPEAKER IMP." to "6Ω MIN" before using this unit (see page 119).

1 Turn on the video monitor connected to this unit.

2 Press **Ⓜ** **MASTER ON/OFF** inward to the ON position on the front panel.

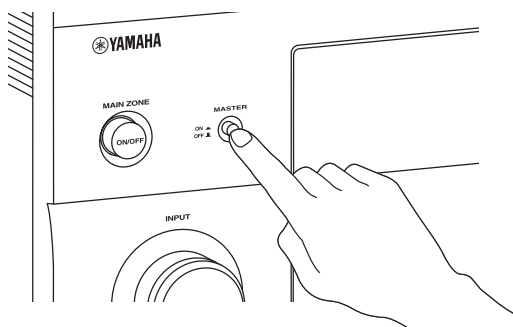

Note

After this unit is turned on, it takes approximately 20 seconds until this unit produces sounds, and while "Please wait" appears in the front panel display, this unit does not accept the front panel operations and stores the remote control operations. This unit performs the stored remote control operations after "Please wait" disappears.

3 Rotate the **Ⓜ** **INPUT** selector to set the input source to "BD/HD DVD".



The recommended sound field program is set for each input source (BD/HD DVD, etc.). You can also use various sound field programs and other sound modes for playback. Refer to the following pages for details:

- see pages 60 and 72 to use various sound field programs
- see page 60 to turn on or off the sound effect
- see page 61 to use the pure direct mode for high fidelity sound

4 Start playback of the desired Blu-ray Disc/HD DVD source on your player.

5 Rotate **Ⓜ** **VOLUME** to adjust the volume.

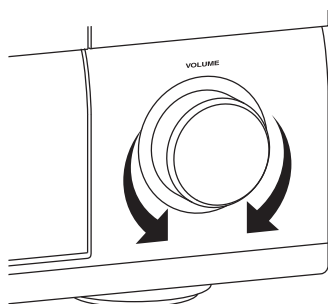

After using this unit...

Press **Ⓜ** **MAIN ZONE ON/OFF** to set this unit to the standby mode.

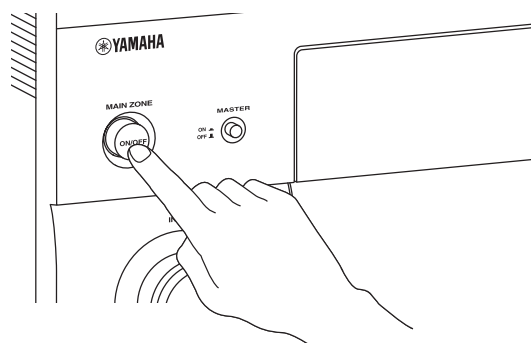

This unit is set to the standby mode and consumes a small amount of power in order to receive infrared signals from the remote control. To turn on this unit from the standby mode, press **Ⓜ** **MAIN ZONE ON/OFF** on the front panel (or **Ⓜ** **POWER** on the remote control). See page 39 for details.

Automatic setup feature

To optimize the speaker settings for your listening room, use the automatic setup feature. See pages 43 to 48 for details.

Are you enjoying playback?

If there are some troubles with playback, check the settings as follows.

No sound is output.

Are the speakers connected correctly?

➔ Check the speaker connection.

Are Your Blu-ray Disc/HD DVD player connected correctly?

➔ Check the connection of the Blu-ray Disc/HD DVD player.

Are the front speakers selected correctly?

➔ Press **Ⓜ** **SPEAKERS A** or **Ⓜ** **SPEAKERS B**.

Is volume setting correct?

➔ Adjust the volume level.

Does the Blu-ray Disc/HD DVD player play back correctly?

➔ Check the setting of the Blu-ray Disc/HD DVD player.

No picture.

Is the video monitor connected correctly?

➔ Check the connection of the video monitor.

If the video monitor is connected to the HDMI OUT 1 jack of this unit, is the "HDMI OUT SEL" setting correct?

➔ Set the operation mode selector to **Ⓜ** **AMP** and then press **Ⓜ** **HDMI OUT** repeatedly to set "HDMI OUT SEL" to "OUT 1".

Is Blu-ray Disc/HD DVD player connected correctly?

➔ Check the connection of the video monitor.

Is the input source setting of the video monitor correct?

➔ Check the setting of the input source of the video monitor.

Any other troubles?

Refer to "Troubleshooting" on pages 122 to 127 for other troubles.

What do you want to do with this unit?

Using various input sources

- Basic operations of this unit ☞ P. 50
- Using your iPod with this unit ☞ P. 64
- Enjoying the contents stored on your PC ☞ P. 66
- Enjoying Internet radio programs and Podcasts ☞ P. 69
- Using USB devices with this unit ☞ P. 69

Using various sound features

- Using various sound field programs ☞ P. 54
- Using the Pure Direct mode for high fidelity sound ☞ P. 61
- Adjusting the tonal quality of the speakers ☞ P. 61
- Customizing the sound field programs ☞ P. 72

Additional features

- Setting the remote control ☞ P. 102
- Displaying the current input source signal information in the GUI ☞ P. 95
- Saving and recalling the system settings of this unit (System Memory) ☞ P. 96
- Controlling this unit using a Web browser ☞ P. 101
- Using headphones ☞ P. 51
- Using this unit in multiple rooms simultaneously (multi-zone configuration) ☞ P. 111
- Automatically turning off this unit ☞ P. 52

Manually adjusting various parameters of this unit

- Setting the language of the GUI menu ☞ P. 95
- Assigning the input/output jacks on this unit ☞ P. 81
- Setting the parameters for each input source ☞ P. 81
- Setting the parameters related to the volume level ☞ P. 86
- Adjusting the tonal quality of each channel manually by using the parametric equalizer ☞ P. 87
- Adjusting the audio and video synchronization ☞ P. 88
- Muting the selected speaker channel ☞ P. 89
- Setting the parameters related to the video signals ☞ P. 89
- Setting the basic speaker configuration ☞ P. 83
- Setting the network parameters ☞ P. 92
- Setting the parameters of the multi-zone feature ☞ P. 92
- Protecting the various settings ☞ P. 94

Adjusting the advanced parameters

- Setting the speaker impedance of the connected speakers ☞ P. 119
- Setting the language of the GUI menu ☞ P. 120
- Setting the video format of the connected video monitor ☞ P. 120
- Setting the parameters of this unit to default values ☞ P. 127

Preparation

Connections	20
Rear panel	20
Placing speakers	21
Connecting speakers	23
Using subwoofers	25
Using presence speakers	26
Connecting the speaker cable	27
Information on jacks and cable plugs	28
Information on HDMI™	28
Audio and video signal flow	29
Connecting a TV monitor or projector	30
Connecting other components	31
Connecting the network	37
Connecting the USB storage devices to the USB ports	37
Connecting the power cable	38
Using the VIDEO AUX jacks on the front panel	38
Setting the speaker impedance and language	39
Turning this unit on and off	39
Front panel display	40
Optimizing the speaker setting for your listening room (YPAO).....	42
Before starting the automatic setup	42
Using the quick automatic setup	43
Using the basic automatic setup	44
Using advanced automatic setup	46

Connections

Rear panel

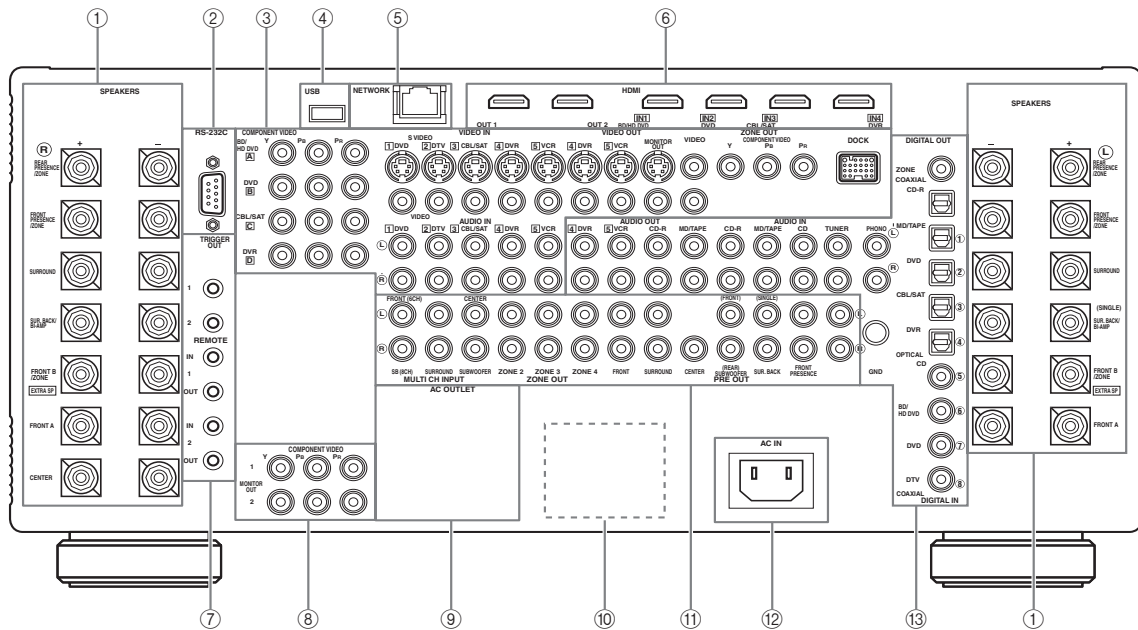

Name	Page
① Speaker terminals	23
③ COMPONENT VIDEO jacks	28 – 33
Video component jacks	28 – 33
Zone video out jacks	114
DOCK terminal	36
④ USB port	37
⑤ NETWORK port	37
⑥ HDMI jacks	28
⑦ TRIGGER OUT jack	36
REMOTE IN/OUT jacks	36
⑧ COMPONENT VIDEO MONITOR OUT jacks	30
⑨ AC OUTLET(S)	38
⑩ VOLTAGE SELECTOR (Asia and General models only)	12
⑪ MULTI CH INPUT jacks	35
ZONE OUT jacks	112
PRE OUT jacks	35
⑫ AC IN	38
⑬ Audio component jacks	34
Digital audio jacks	31
ZONE DIGITAL OUT jack	113

② RS-232C terminal

This is a control expansion terminal for custom installation. Consult your dealer for details.

Placing speakers

The speaker layout below shows the speaker setting we recommend. You can use it to enjoy the CINEMA DSP and multi-channel audio sources.

11.2/11.1 -channel speaker layout

11.2/11.1-channel speaker layout is highly recommended for playback the sound of high definition audio formats (Dolby TrueHD, DTS-HD Master Audio, etc.) as well as the conventional audio sources with sound field programs. See page 23 for connection information.

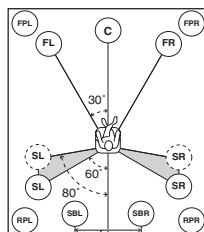
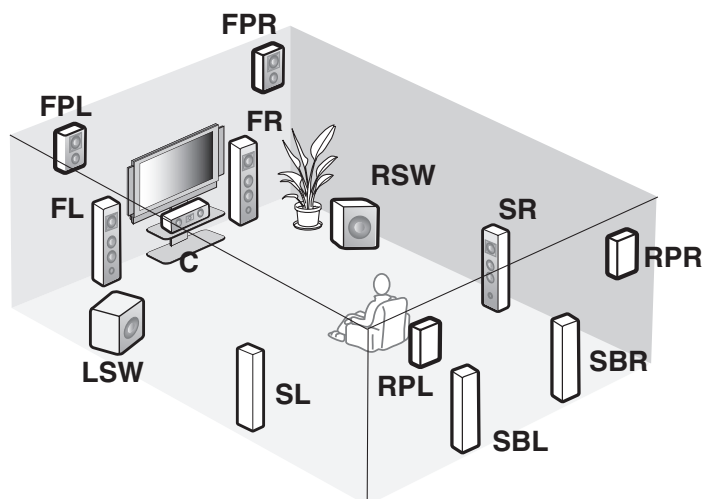

30 cm (12 in) or more

Speaker indications

FL/FR: Front left/right

C: Center

SL/SR: Surround left/right

SBL/SBR: Surround back left/right

FPL/FPR: Front presence left/right

RPL/RPR: Rear presence left/right

LSW/RSW: Left/right subwoofer

Front left and right speakers

The front speakers are used for the main source sound plus effect sounds. Place these speakers at an equal distance from the ideal listening position. The distance of each speaker from each side of the video monitor should be the same.

Center speaker

The center speaker is for the center channel sounds (dialog, vocals, etc.). If for some reason it is not practical to use a center speaker, you can do without it. Best results, however, are obtained with the full system.

Surround left and right speakers

The surround speakers are used for effect and surround sounds.

Surround back left and right speakers

The surround back speakers supplement the surround speakers and provide more realistic front-to-back transitions.

Front and rear presence left and right speakers

See page 26 for details.

Left and right subwoofers

See page 25 for details.

Using di-pole speakers

It is recommended that you use di-pole speakers for surround left and right channels for the accurate playback with the THX surround modes. When you use di-pole speakers, place the surround and surround back speakers as below. Set the distance between surround back speakers rather narrow compared with the conventional speaker layout.

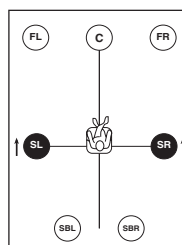

● : Di-pole speaker

↑ : Direction of the di-pole speaker phase

■ **7.2/7.1 (or 6.2/6.1) -channel speaker layout**

See page 23 for connection information.

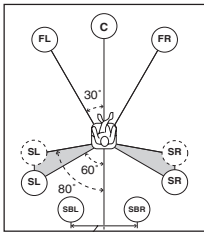
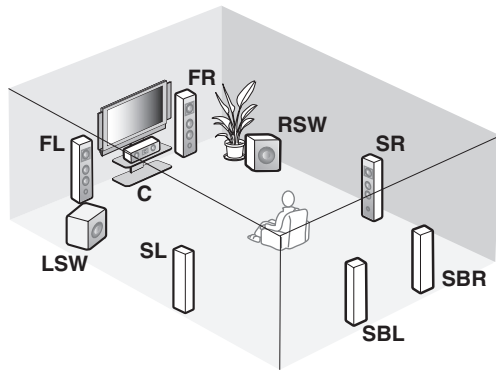

30 cm (12 in) or more

Speaker indications

- FL/FR:** Front left/right
- C:** Center
- SL/SR:** Surround left/right
- SBL/SBR:** Surround back left/right
- LSW/RSW:** Left/right subwoofer

Front left and right speakers

Center speaker

Surround left and right speakers

The functions and settings of each speaker are the same as those for the 11.2/11.1-channel speaker layout (see page 21).

Surround back left and right speakers

The surround back speakers supplement the surround speakers and provide more realistic front-to-back transitions.

If you use a single surround back speaker, connect the single surround back speaker to the SUR.BACK/BI-AMP (SINGLE) speaker terminal and place the speaker behind the listening position. The surround back left and right channel signals are mixed down and output at the single surround back speaker when you set “Surround Back” to “Small x1” or “Large x1” (see page 84).

Subwoofer

See page 25 for details.



You can also use the front presence speakers (see page 26) instead of the surround back speakers.

For other speaker combinations

You can enjoy multi-channel sources with sound field programs by using a speaker combination other than the speaker combinations shown above.

Use the automatic setup feature (see page 42) or set the “Speaker Set” parameters in “Manual Setup” (see page 84) to output the surround sounds at the connected speakers.

■ **5.2/5.1 -channel speaker layout**

See page 23 for connection information.

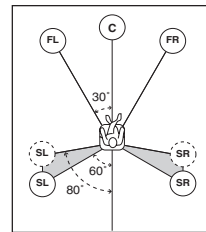
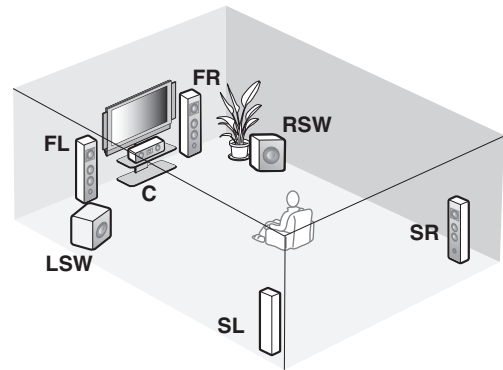

Speaker indications

- FL/FR:** Front left/right
- C:** Center
- SL/SR:** Surround left/right
- LSW/RSW:** Left/right subwoofer

Front left and right speakers

Center speaker

Subwoofer

The functions and settings of each speaker are the same as those for the 11.2/11.1-channel speaker layout (see page 21).

Surround left and right speakers

Connect the surround speakers to the SURROUND speaker terminals even if you place the surround speakers behind the listening position. For the smooth and unbroken sound field behind the listening position, place the surround left and right speakers farther back compared with the placement in the 11.2/11.1-channel speaker layout. The surround back channel signals are directed to the surround left and right speakers when “Surround Back” is set to “None” (see page 84).

Subwoofer

See page 25 for details.

Connecting speakers

Be sure to connect the left channel (L), right channel (R), “+” (red line) and “-” (white line) properly. If the connections are faulty, this unit cannot reproduce the input sources accurately.

Caution

- Before connecting the speakers, make sure that this unit is turned off (see page 39).
- Do not let the bare speaker wires touch each other or do not let them touch any metal part of this unit. This could damage this unit and/or speakers.
- Use magnetically shielded speakers. If this type of speaker still creates interference with the monitor, place the speakers away from the monitor.
- If you are to use 6-ohm speakers, be sure to set “SPEAKER IMP.” to “6ΩMIN” before using this unit (see page 39).

Notes

- A speaker cord is actually a pair of insulated cables running side by side. Cables are colored or shaped differently, perhaps with a stripe, groove or ridge. Connect the striped (grooved, etc.) cable to the “+” (red line) terminals on this unit and your speaker. Connect the plain cable to the “-” (white line) terminals.
- You can use the REAR ZONE/PRESENCE, FRONT ZONE/PRESENCE, and/or EXTRA SP speaker terminals for the Zone 2, Zone 3, and/or Zone 4 speakers (see page 116). You can also use all speaker terminals on this unit for the Zone 2, Zone 3, and/or Zone 4 speakers (see page 120).

■ For the 11.2/11.1 (or 9.2/9.1) -channel speaker setting

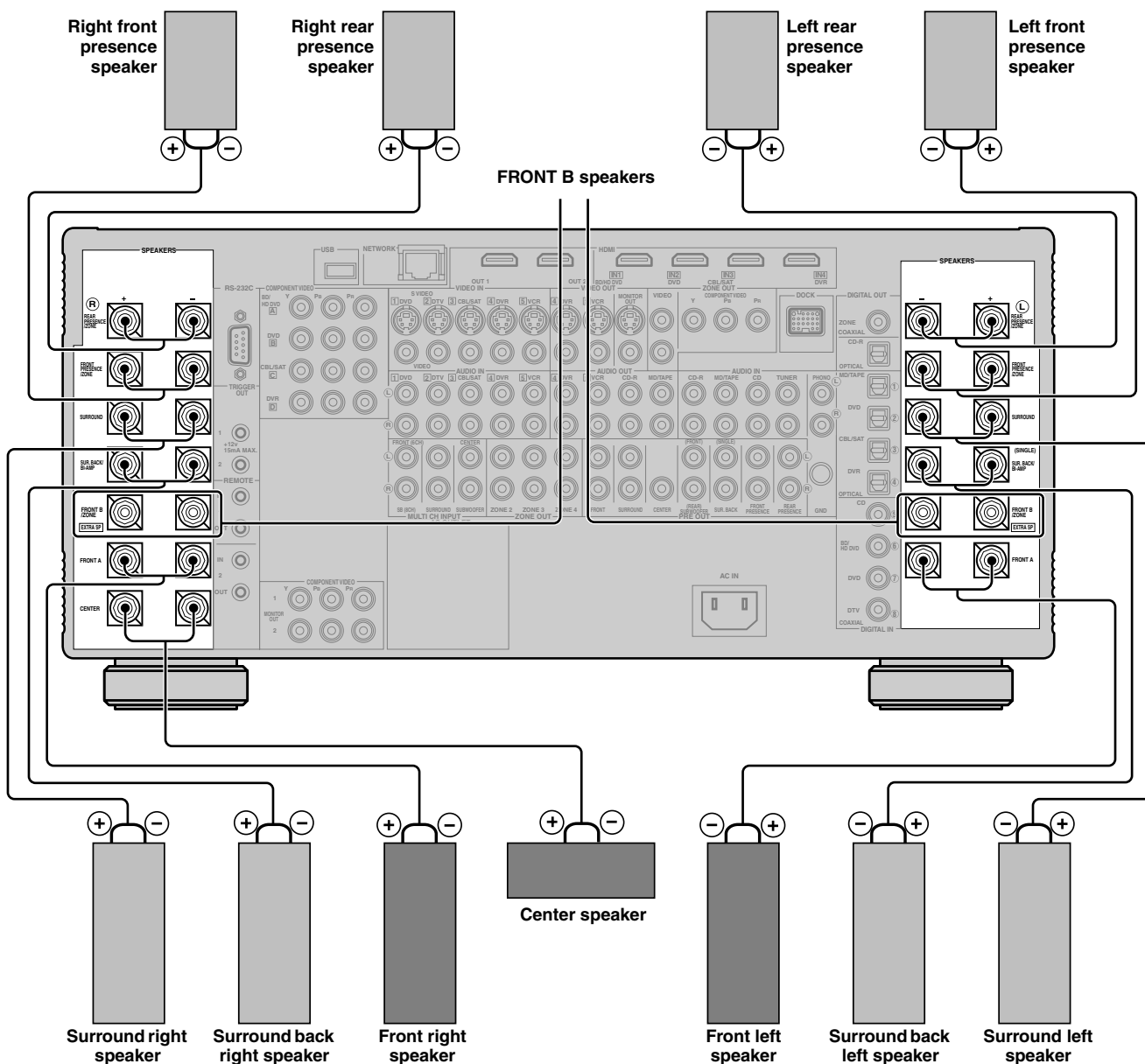

■ For the 7.2/7.1 (or 6.2/6.1) -channel speaker setting

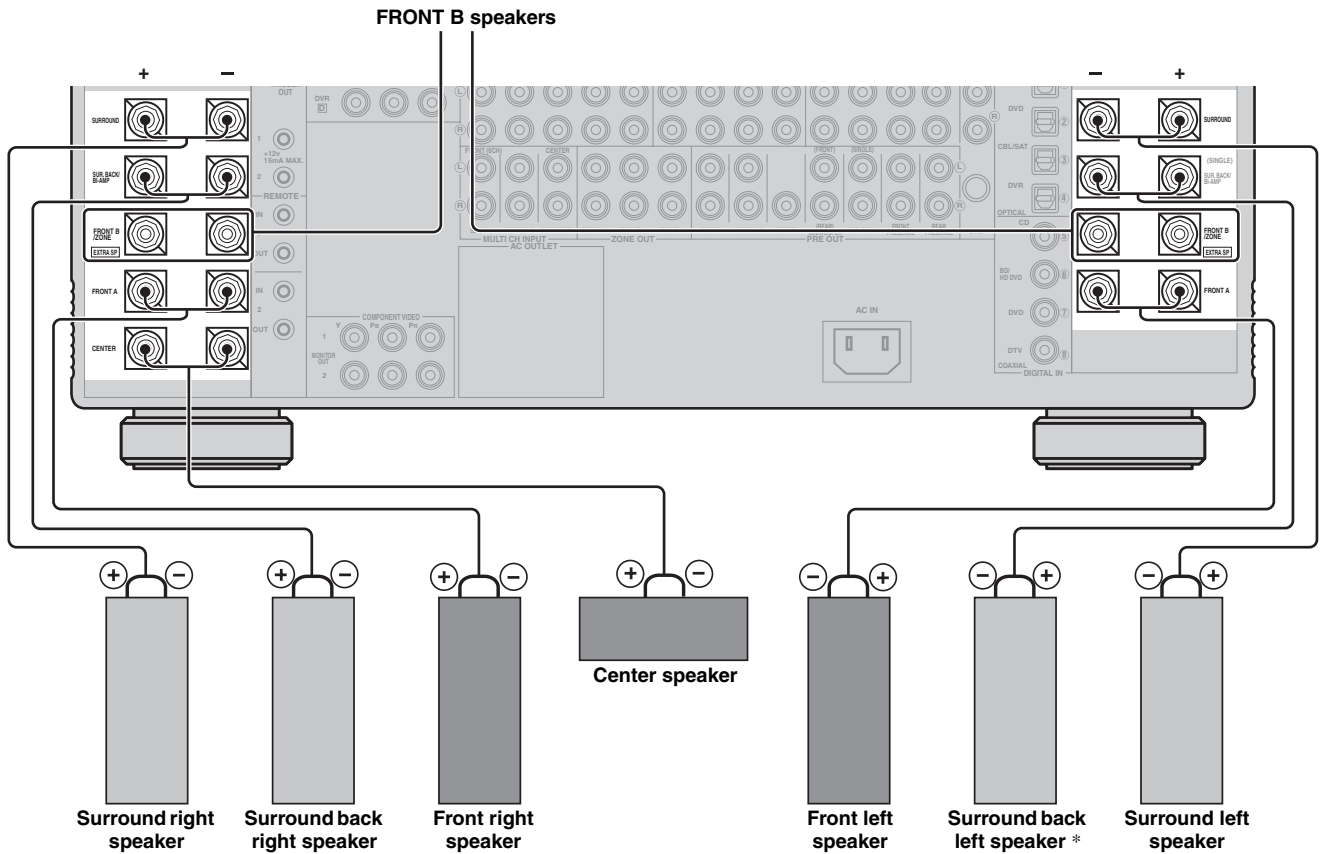

* If you use a single surround back speaker, connect the speaker to the SUR.BACK/BI-AMP (SINGLE) speaker terminal.

■ For the 5.2/5.1 -channel speaker setting

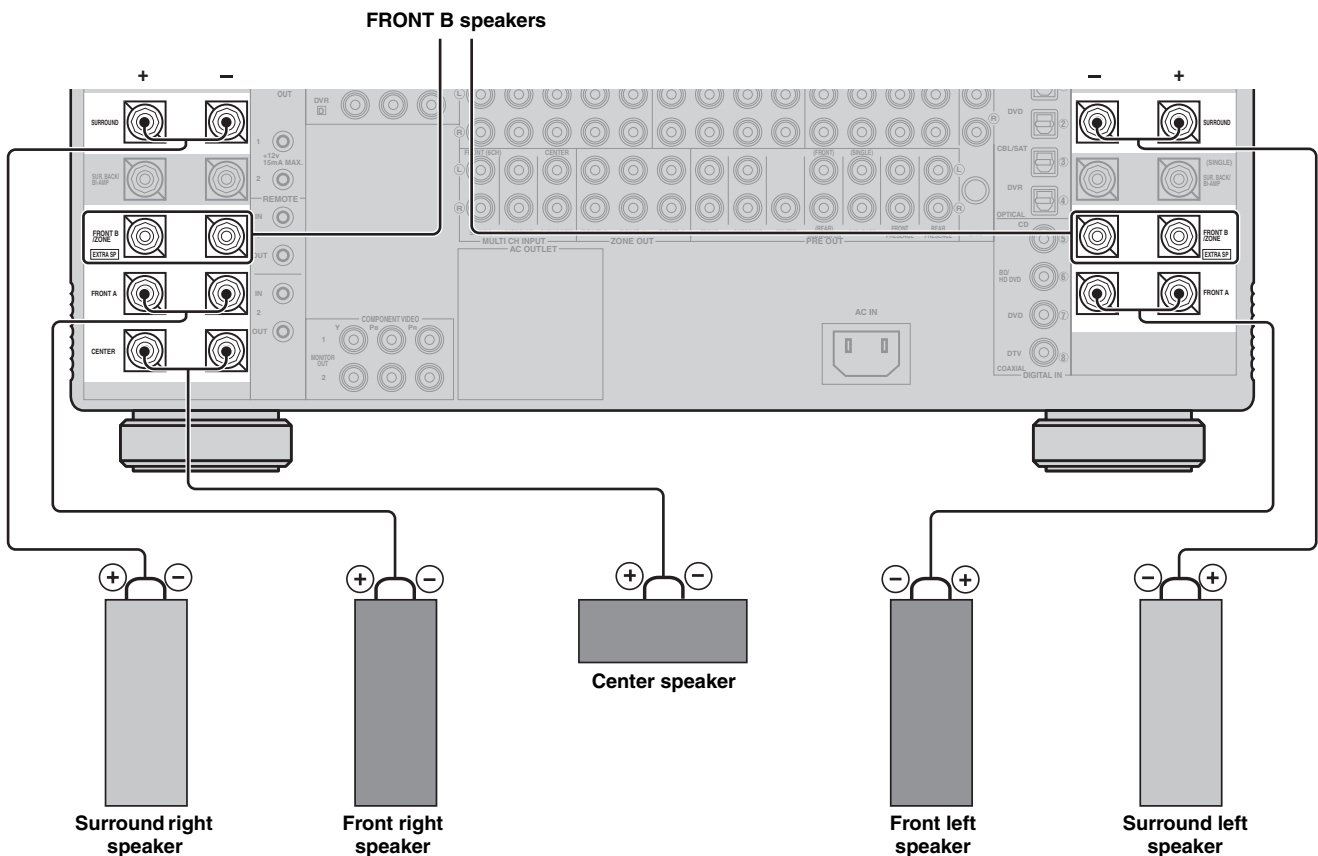

Using subwoofers

The use of subwoofers with built-in amplifiers, such as the Yamaha Active Servo Processing Subwoofer System, is effective not only for reinforcing bass frequencies from any or all channels, but also for reproducing the high fidelity sound of the LFE (low-frequency effect) channel included in digital audio signals. Turn it slightly toward the center of the room to reduce wall reflections.

You can use one or two subwoofers and select various positions of the subwoofers.

■ Configuration 1: Front left and right

Set "Configuration" in "Subwoofer" to "Stereo" (see page 85).

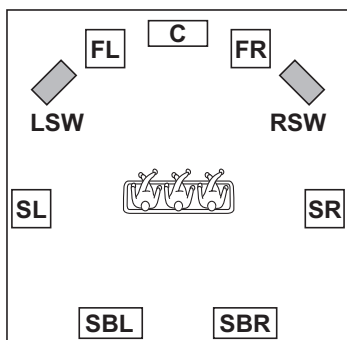

Speaker indications

- FL/FR:** Front left/right
- C:** Center
- SL/SR:** Surround left/right
- SBL/SBR:** Surround back left/right
- LSW/RSW:** Left/right subwoofer

■ Configuration 2: Front and rear

Set "Configuration" in "Subwoofer" to "Front & Rear" (see page 85).

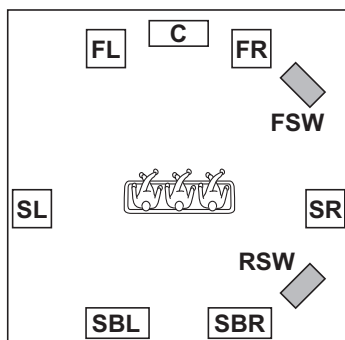

Speaker indications

- FL/FR:** Front left/right
- C:** Center
- SL/SR:** Surround left/right
- SBL/SBR:** Surround back left/right
- FSW/RSW:** Front/rear subwoofer

■ Configuration 3: A single subwoofer

Set "Configuration" in "Subwoofer" to "Monaural" (see page 85).

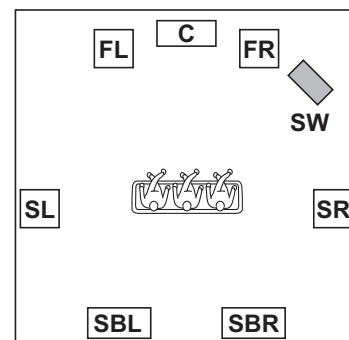

Speaker indications

- FL/FR:** Front left/right
- C:** Center
- SL/SR:** Surround left/right
- SBL/SBR:** Surround back left/right
- SW:** Subwoofer

■ Connecting subwoofers

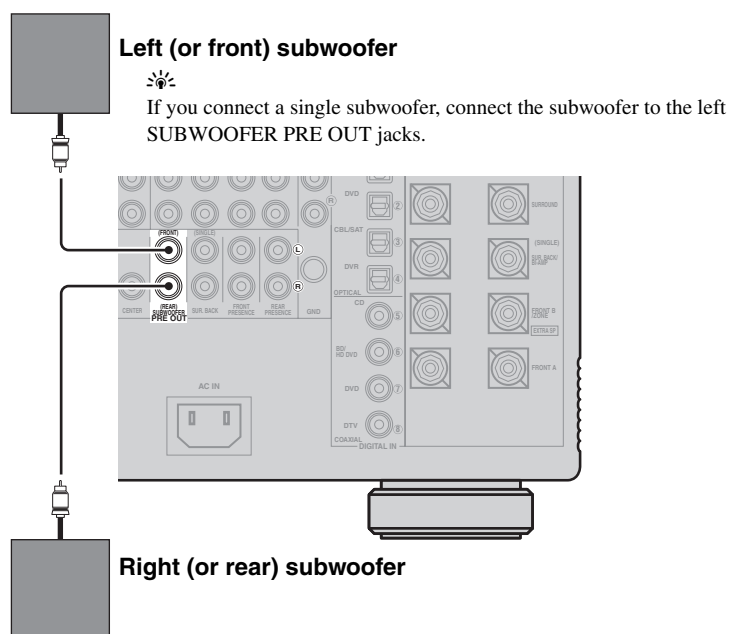

Using presence speakers

The presence speakers supplement the sound from the front and surround back speakers with extra ambient effects produced by the sound field programs (see page 54). Presence speakers function more effectively when the CINEMA DSP HD³ mode is active (see page 60). You can adjust the vertical position of dialogues with using the front presence speakers (see page 77).

Note

If “Front Presence” is set to “None”, the rear presence speakers also do not function and you cannot activate the CINEMA DSP HD³ mode.

Front presence speakers

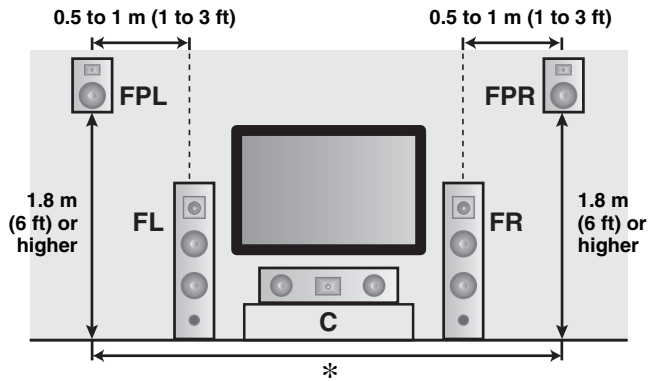

Speaker indications

- FL:** Front left
- FR:** Front right
- C:** Center
- FPL:** Front presence left
- FPR:** Front presence right

Rear presence speakers

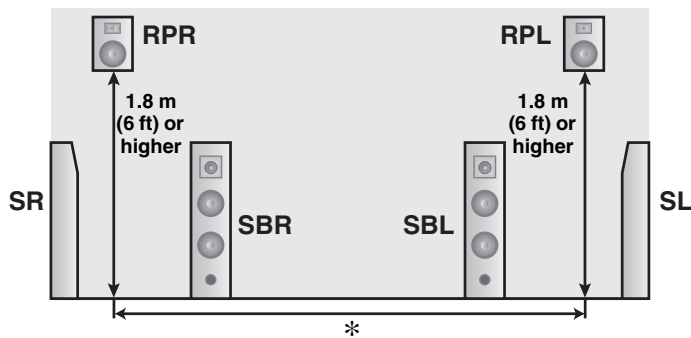

Speaker indications

- SL:** Surround left
- SR:** Surround right
- SBL:** Surround back left
- SBR:** Surround back right
- RPL:** Rear presence left
- RPR:** Rear presence right

* Place the rear presence left and right speakers so that the distance between the rear presence left and right speakers is same as the distance between front presence left and right speakers.

Connecting the speaker cable

- 1 Remove approximately 10 mm (0.4 in) of insulation from the end of each speaker cable and then twist the exposed wires of the cable together to prevent short circuits.

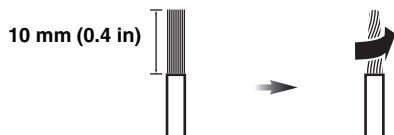

- 2 Loosen the knob.

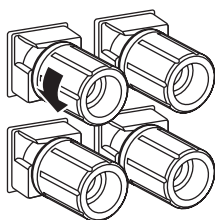

Red line: positive (+)
White line: negative (-)

- 3 Insert one bare wire into the hole on the side of each terminal.

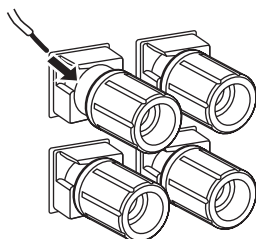

- 4 Tighten the knob to secure the wire.

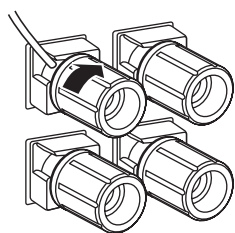

Connecting the banana plug (China and General models only)

Tighten the knob and then insert the banana plug connector into the end of the corresponding terminal.

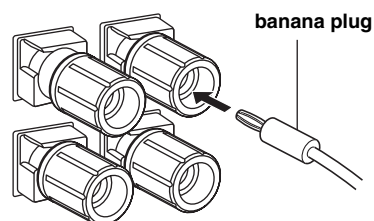

Red line: positive (+)
White line: negative (-)

Using bi-amplification connections

Caution

Remove the shorting bars or bridges of your speakers to separate the LPF (low pass filter) and HPF (high pass filter) crossovers.

This unit allows you to make bi-amplification connections to one speaker system. Check if your speakers support bi-amplification. To make the bi-amplification connections, use the FRONT A and SUR.BACK/BI-AMP terminals as shown below. To activate the bi-amplification connections, set "BI-AMP" to "ON" in "Advanced setup" (see page 120).

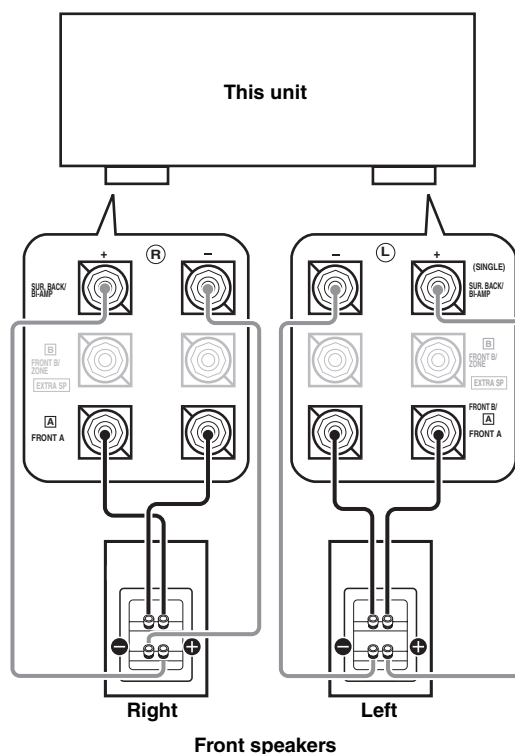

Note

When you make the conventional connection, make sure that the shorting bars are put into the terminals of the speakers appropriately. Refer to the instruction manuals of the speakers for details.

Information on jacks and cable plugs

Audio jacks and cable plugs

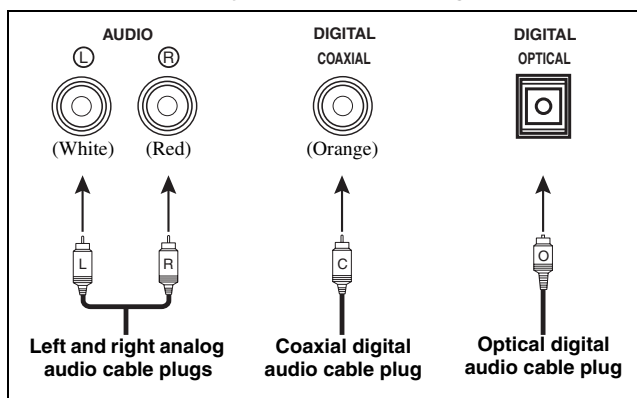

■ Audio jacks

This unit has three types of audio jacks. Connection depends on the availability of audio jacks on your other components.

AUDIO jacks

For conventional analog audio signals transmitted via left and right analog audio cables. Connect red plugs to the right jacks and white plugs to the left jacks.

DIGITAL COAXIAL jacks

For digital audio signals transmitted via coaxial digital audio cables.

DIGITAL OPTICAL jacks

For digital audio signals transmitted via optical digital audio cables.

Note

You can use the digital jacks to input PCM, Dolby Digital and DTS bitstreams. When you connect components to both the COAXIAL and OPTICAL jacks, priority is given to the signals input at the COAXIAL jack. All digital input jacks are compatible with 96-kHz sampling digital signals.

Video jacks and cable plugs

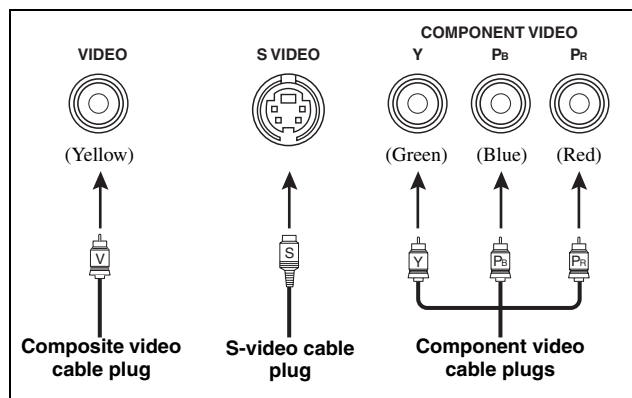

■ Video jacks

This unit has three types of video jacks. Connect the video input jacks on this unit to the video output jacks of the input source components to switch the audio and video sources simultaneously. Connection depends on the availability of input jacks on your video monitor.

VIDEO jacks

For conventional composite video signals transmitted via composite video cables.

S VIDEO jacks

For S-video signals, separated into the luminance (Y) and chrominance (C) video signals transmitted on separate wires of S-video cables.

COMPONENT VIDEO jacks

For component video signals, separated into the luminance (Y) and chrominance (Pb, Pr) video signals transmitted on separate wires of component video cables.



This unit is equipped with the video conversion function. See pages 29 and 89 for details.

Information on HDMI™

■ HDMI jack and cable plug

This unit has five HDMI input jacks and two HDMI output jacks for digital audio and video signal input/output.

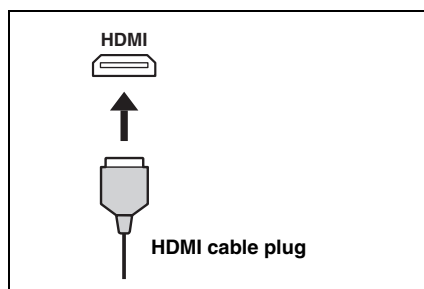

- We recommend that you use a commercially available HDMI cable shorter than 5 meters (16 feet) with the HDMI logo printed on it.
- Use a conversion cable (HDMI jack ↔ DVI-D jack) to connect this unit to other DVI components.
- You can check the potential problem about the HDMI connection (see page 95).

- See page 139 for the information on the input signal capability of this unit for the HDMI connection.
- When you set “Standby Through” in “Manual Setup” to “On”, this unit allows the HDMI signals input at an HDMI IN jack to pass through this unit and output at an HDMI OUT jack (see page 94).

Notes

- Do not disconnect or connect the cable or turn off the power of the HDMI components connected to the HDMI OUT jacks on this unit while data is being transferred. Doing so may disrupt playback or cause noise.
- The HDMI OUT jacks output the audio signals input at the HDMI input jacks only when “Support Audio” is set to “Other” (see page 94).
- If you turn off the power of the video monitor connected to the HDMI OUT jacks via a DVI connection, this unit may fail to establish the connection to the component.
- The analog video signals input at the composite video, S-video and component video jacks can be digitally up-converted to be output at the HDMI OUT jacks. Set “Conversion” to “On” in “Manual Setup” (see page 89) to activate this feature.
- This unit is equipped with two HDMI OUT jacks, however cannot output the video signals to the both HDMI OUT jacks simultaneously. You can select the active HDMI OUT jack. See page 50 for details.

Audio and video signal flow

Audio signal flow

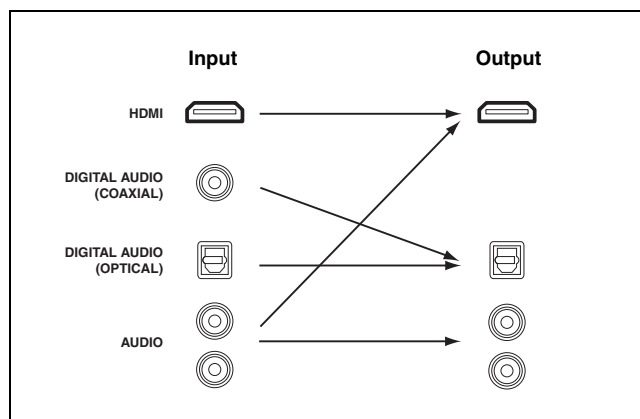

Notes

- 2-channel as well as multi-channel PCM, Dolby Digital and DTS signals input at the HDMI input jacks can be output at the HDMI OUT jacks only when “Support Audio” is set to “Other” (see page 94).
- The following types of audio signals can be only input at HDMI input jacks:
 - DSD
 - Dolby TrueHD
 - Dolby Digital Plus
 - DTS-HD Master Audio
 - DTS-HD High Resolution Audio

Video signal flow

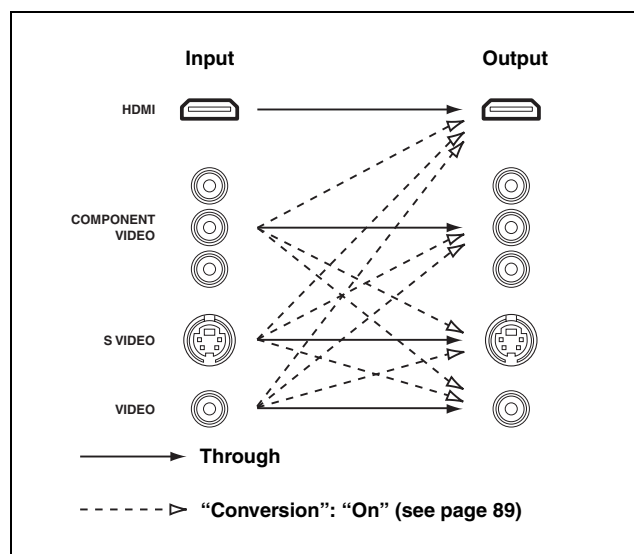

You can deinterlace and convert the resolution of the video signals by using “Video” parameters. See page 89 for details.

Notes

- When the analog video signals are input at the COMPONENT VIDEO, S VIDEO and VIDEO jacks, the priority order of the input signals is as follows:
 1. COMPONENT VIDEO
 2. S VIDEO
 3. VIDEO
- This unit is equipped with the two COMPONENT VIDEO MONITOR OUT jacks and HDMI OUT jacks. The COMPONENT VIDEO MONITOR OUT 1 and 2 outputs the same video signals and you can use both COMPONENT VIDEO OUT jacks simultaneously.
- Digital video signals input at the HDMI input jacks cannot be output from analog video output jacks.
- The analog component video signals (with 480i (NTSC)/576i (PAL) of resolution only) are converted to the S-video or composite video signals and output at the VIDEO or S VIDEO MONITOR OUT jacks.
- The GUI signal is not output at the DVR OUT and VCR OUT jacks and is not recorded.

Connecting a TV monitor or projector

Connect your TV (or projector) to one of the HDMI OUT jacks, the COMPONENT VIDEO MONITOR OUT jacks, the S VIDEO MONITOR OUT jack or the VIDEO MONITOR OUT jack of this unit.



Make sure that this unit and other components are unplugged from the AC wall outlets.



You can select to play back HDMI audio signals on this unit or on another HDMI component connected to the HDMI OUT jacks on the rear panel of this unit. Use the "Support Audio" parameter in "Option" to select the component to play back HDMI audio signals (see page 94).

Notes

- This unit is equipped with two HDMI OUT jacks, however cannot output the video signals to the both HDMI OUT jacks simultaneously. You can select the active HDMI OUT jack. Set the operation mode selector to **AMP** and then press **HDMI OUT** repeatedly.
- If you connect a video monitor or projector to one of the HDMI OUT jack, connect the component to the HDMI OUT 1 jack.
- Some video monitors connected to this unit via a DVI connection fail to recognize the HDMI audio/video signals being input if they are in the standby mode. In this case, the HDMI indicator flashes irregularly.
- The GUI menu is not overlaid on the input video image depending on the input video signal format and the setting of the parameters in "Wall Paper" (see page 91). In this case, the GUI menu appears with the wall paper or gray background.
- If the connected video monitor is compatible with the automatic audio and video synchronization feature (automatic lip sync feature), this unit adjusts the audio and video timing automatically (see page 88). Connect the video monitor to the HDMI OUT jacks on this unit to use the feature.

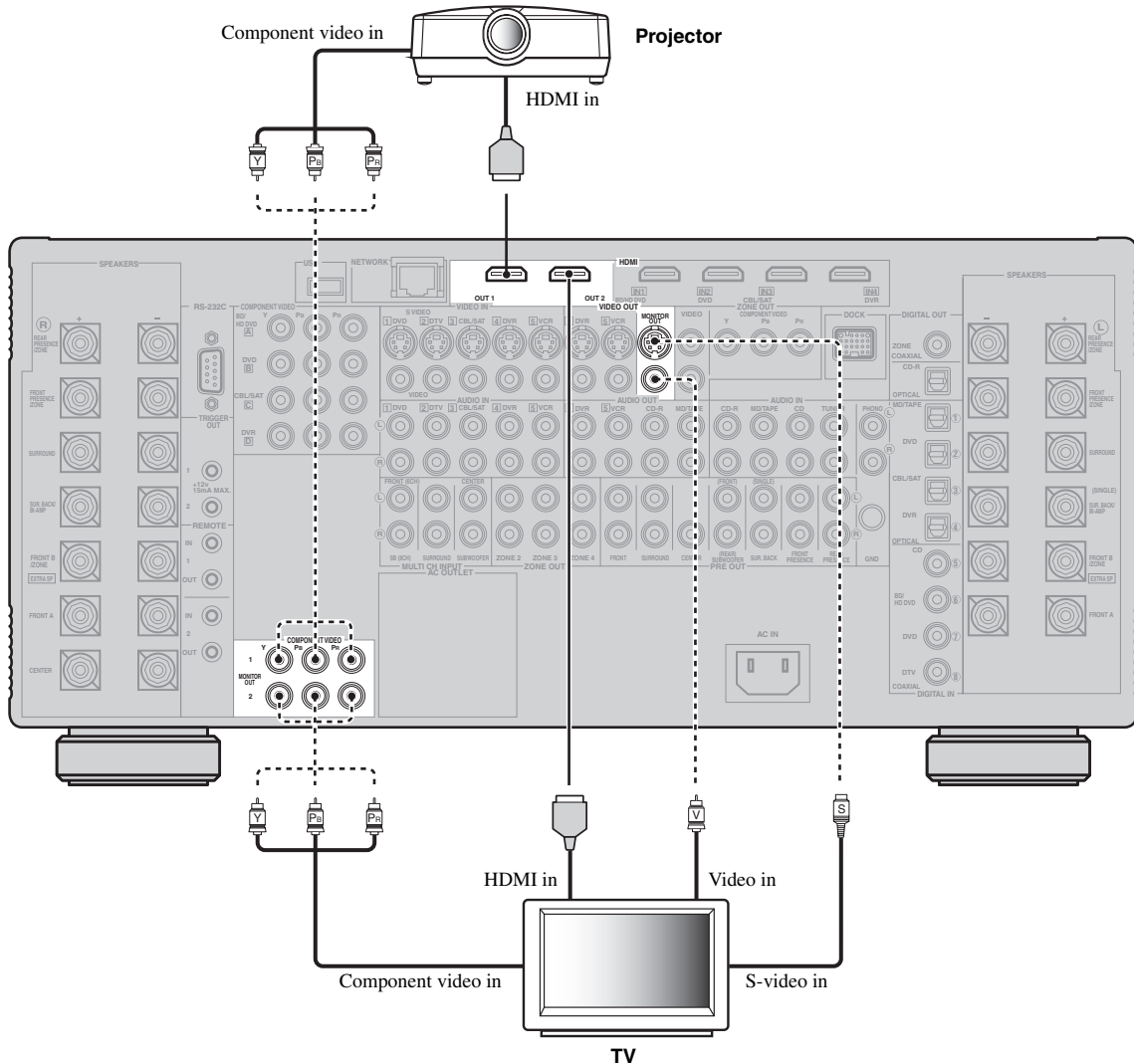

———— indicates recommended connections
 - - - - - indicates alternative connections

Connecting other components



Make sure that this unit and other components are unplugged from the AC wall outlets.

Notes

- When “Conversion” is set to “Off” (see page 89), be sure to make the same type of video connections as those made for your TV (see page 30). For example, if you connected your TV to the VIDEO MONITOR OUT jack on this unit, connect your other components to the VIDEO jacks.

■ Connecting a Blu-ray Disc or HD DVD player

Connect your Blu-ray Disc or HD DVD player to the HDMI IN1 jack on this unit to perform the features of the Blu-ray Disc or HD DVD completely.

- When “Conversion” is set to “On” (see page 89), the converted video signals are output only at the MONITOR OUT jacks. When recording a source, you must make the same type of video connections between each component.
- To make a digital connection to a component other than the default component assigned to each DIGITAL INPUT or DIGITAL OUTPUT jack, select the corresponding setting for “Optical Input”, “Optical Output”, or “Coaxial Input” in “I/O Assignment” (see page 81).
- If you connect your DVD player to both the DIGITAL INPUT (OPTICAL) and the DIGITAL INPUT (COAXIAL) jacks, priority is given to the signals input at the DIGITAL INPUT (COAXIAL) jack.

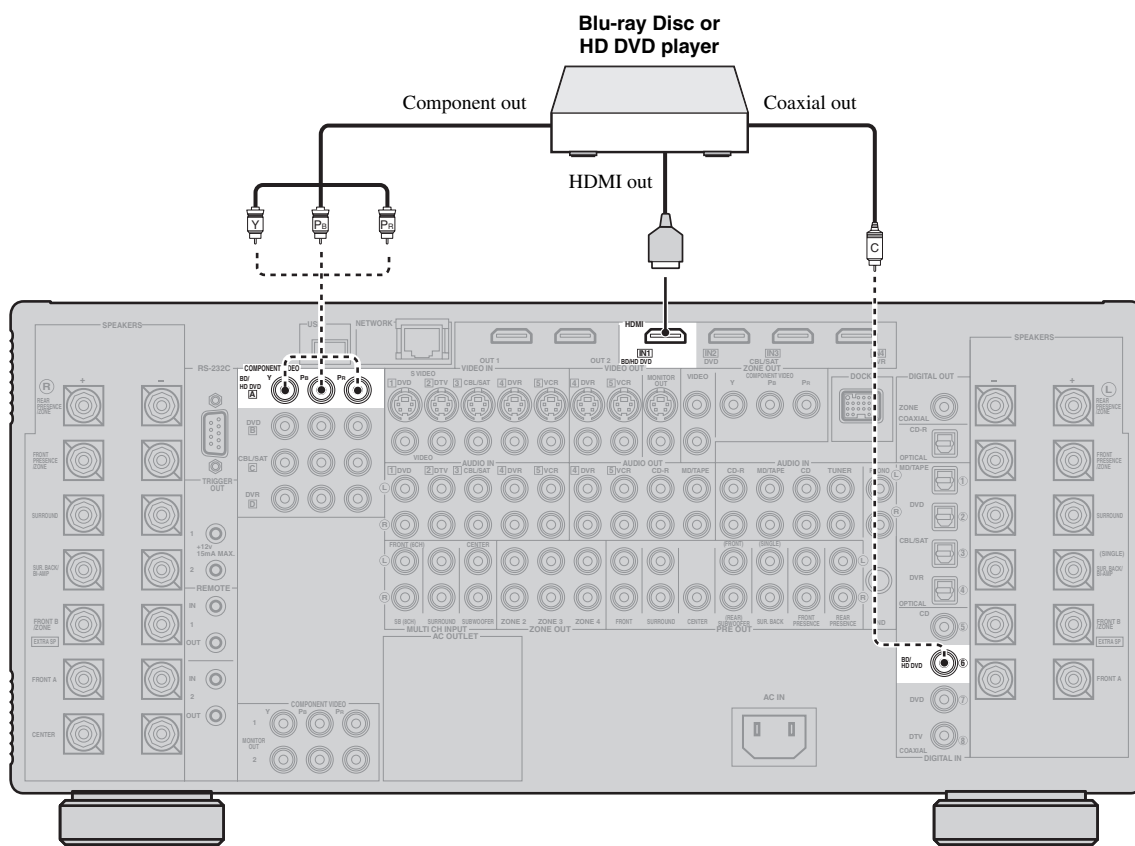

———— indicates recommended connections
 - - - - - indicates alternative connections

■ Connecting a DVD player

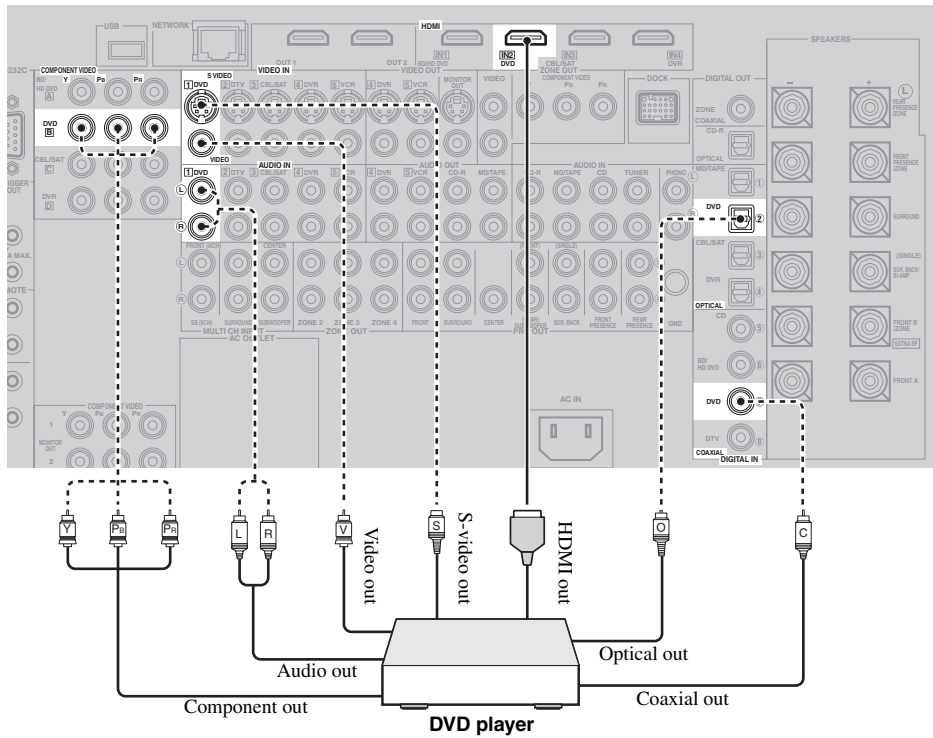

■ Connecting set-top boxes

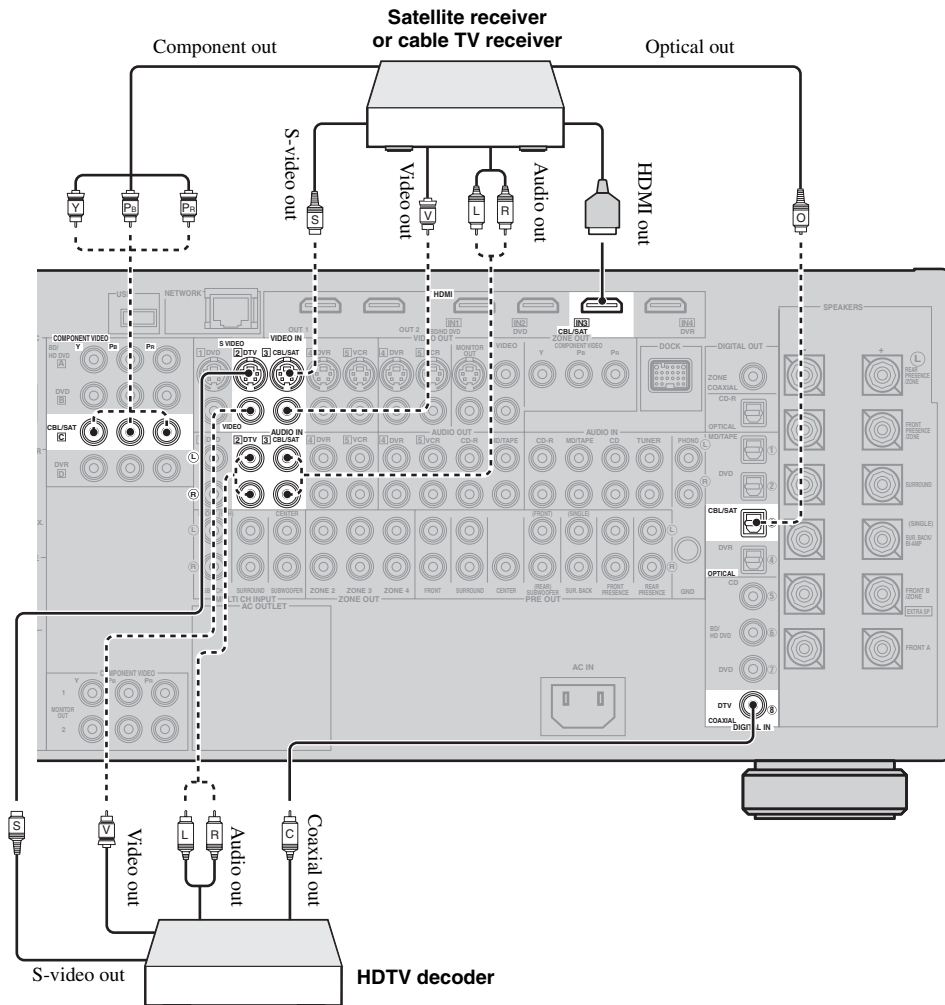

■ Connecting a DVD recorder

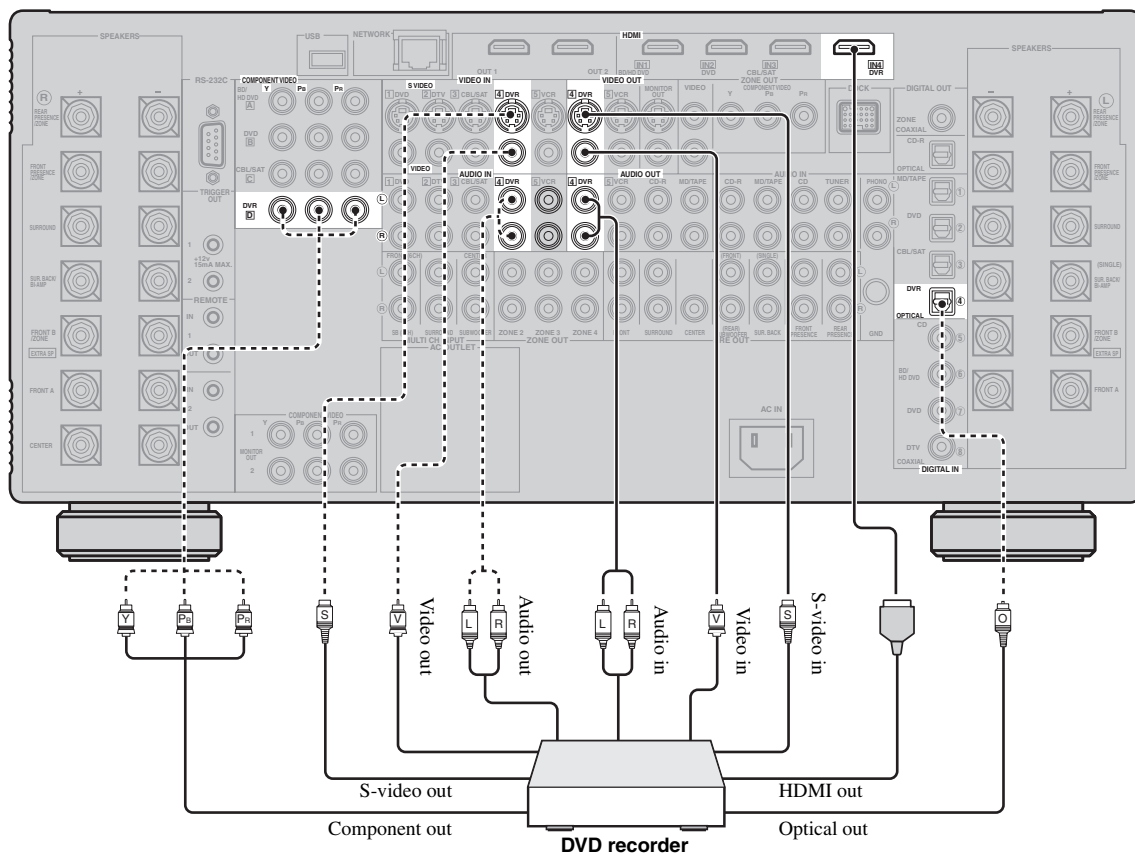

Preparation

■ Connecting a VCR

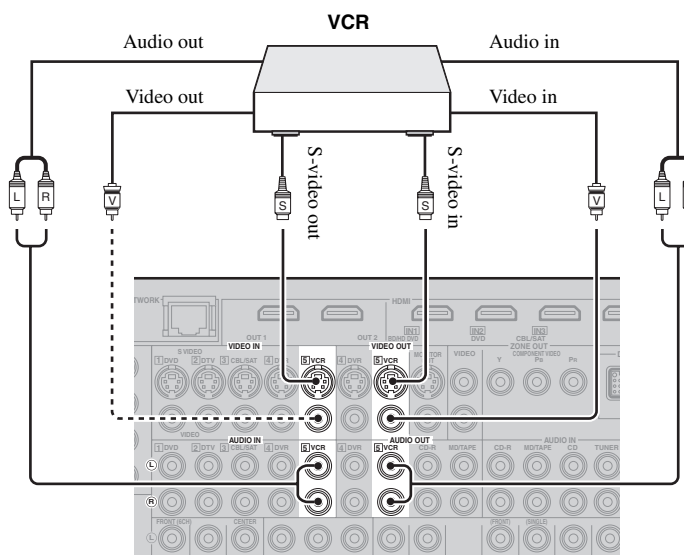

— indicates recommended connections
 - - - indicates alternative connections

■ Connecting audio components

Notes

- Connect your turntable to the GND terminal on this unit to reduce noise in the signal. However, you may hear less noise without the connection to the GND terminal for some turntables.
- The PHONO jacks are only compatible with a turntable with an MM or a high-output MC cartridge. To connect a turntable with a low-output MC cartridge to the PHONO jacks, use an in-line boosting transformer or an MC-head amplifier.
- When you connect both the DIGITAL INPUT (OPTICAL) jack and the DIGITAL INPUT (COAXIAL) jack to an audio component, the priority is given to the DIGITAL INPUT (COAXIAL) jack.

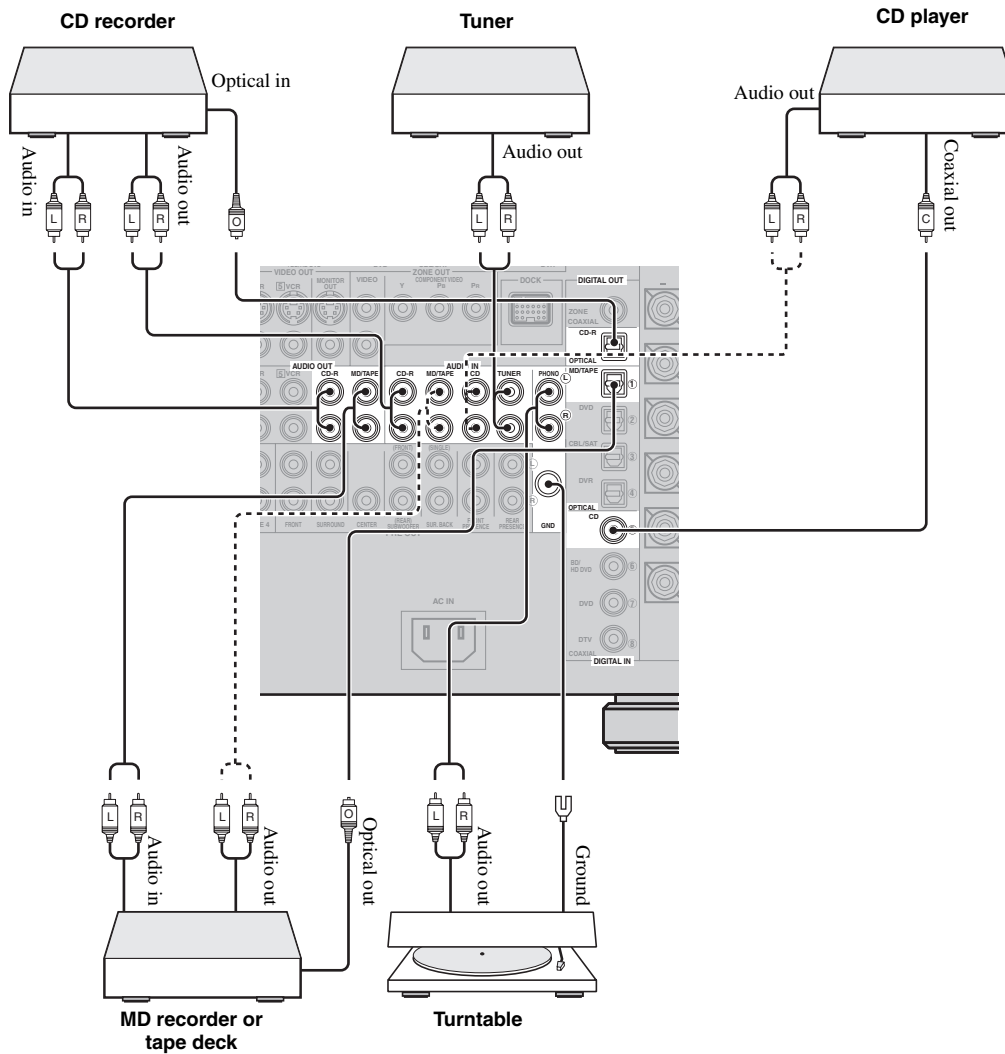

———— indicates recommended connections
 - - - - - indicates alternative connections

■ Connecting external amplifiers

This unit has more than enough power for any home use. However, if you want to use external amplifiers, connect the external amplifiers to the PRE OUT jacks. Each PRE OUT jack outputs the same channel signals as the corresponding SPEAKERS terminals.



Use the external amplifiers in the following cases:

- when you want to add more power to the speaker output
- when you want to use another amplifier for your presence of sounds
- when you want to enjoy the 11.2-channel surround sound in the main zone with activating the other zones (see page 111)

Pre-amplifier mode

If you want use the external amplifiers for the all channels in the main zone, set "PREAMP MODE" to "ON" in the advanced setup (see page 120). When "PREAMP MODE" is set to "ON", the power consumption is reduced.

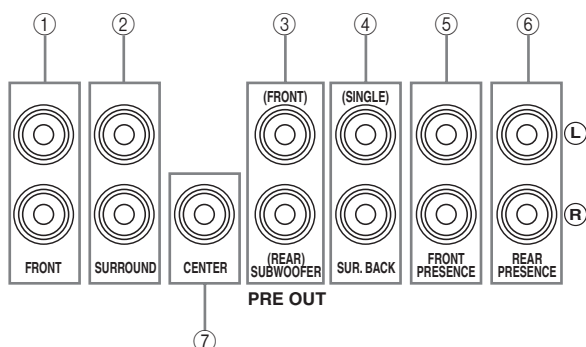

PRE OUT jack	Output audio channel
① FRONT	Front left/right
② SURROUND	Surround left/right
③ SUBWOOFER	Subwoofer left/right (see page 25)
④ SUR.BACK	Surround back left/right *
⑤ FRONT PRESENCE	Front presence left/right
⑥ REAR PRESENCE	Rear presence left/right
⑦ CENTER	Center

Note

* When you only connect one external amplifier for the surround back channel, connect it to the SINGLE jack.

■ Connecting a multi-format player or an external decoder

This unit is equipped with 6 additional input jacks (left and right FRONT, CENTER, left and right SURROUND and SUBWOOFER) for discrete multi-channel input from a multi-format player, external decoder, sound processor or pre-amplifier. If you set "Input Channels" to "8ch" in "Multi CH Assign" (see page 83), you can use the input jacks assigned as "Front Input" in "Multi CH Assign" (see page 83) together with the MULTI CH INPUT jacks to input 8-channel signals.

Connect the output jacks on your multi-format player or external decoder to the MULTI CH INPUT jacks. Be sure to match the left and right outputs to the left and right input jacks for the front and surround channels.

Notes

- When you select the component connected to the MULTI CH INPUT jacks as the input source (see page 50), this unit automatically turns off the digital sound field processor, and you cannot select sound field programs.
- The audio signals input at the CENTER and SUBWOOFER MULTI CH INPUT jacks are mixed down to the left and right headphone channels.
- This unit redirects the audio signals input at the CENTER and/or SUBWOOFER MULTI CH INPUT jacks to the front left and right speaker channels when you set "Center" and/or "Configuration" in "Speaker Set" to "None" (see page 84). We recommend that you connect at least a 5.1-channel speaker system before using this feature.

For 6-channel input

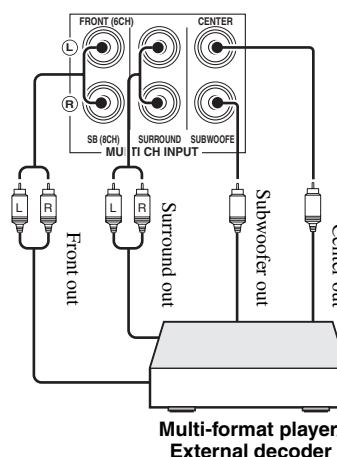

For 8-channel input

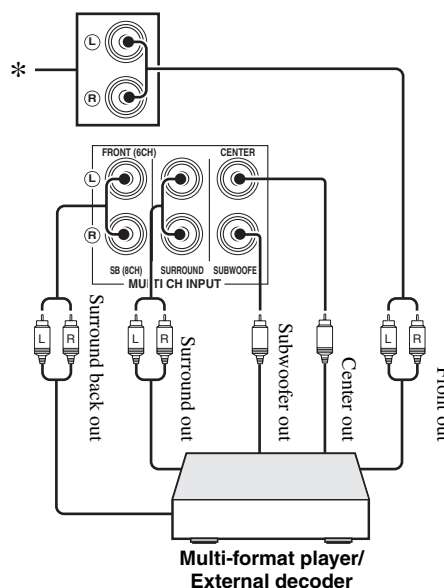

Note

* The analog audio input jacks assigned as "Front Input" in "Multi CH Assign" (see page 83).

■ Connecting a Yamaha iPod universal dock

This unit is equipped with the DOCK terminal on the rear panel that allows you to connect a Yamaha iPod universal dock (such as the YDS-10, sold separately) where you can station your iPod and control playback of your iPod using the supplied remote control. Connect a Yamaha iPod universal dock (such as the YDS-10, sold separately) to the DOCK terminal on the rear panel of this unit using its dedicated cable.

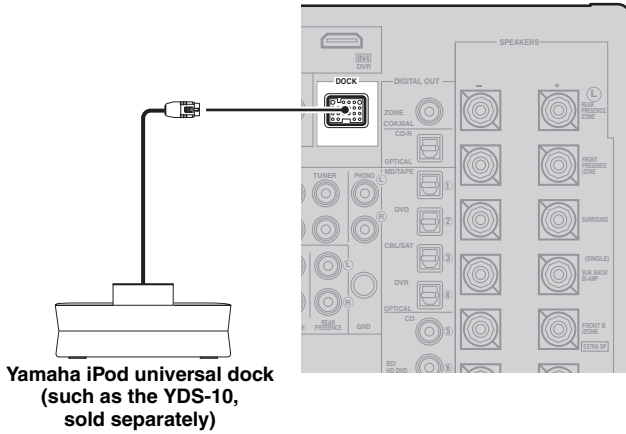

■ Using REMOTE IN/OUT jacks

When the components have the capability of the transmission of the remote control signals, connect the REMOTE IN and REMOTE OUT jacks to the remote control input and output jacks with the monaural analog mini cable as follows.

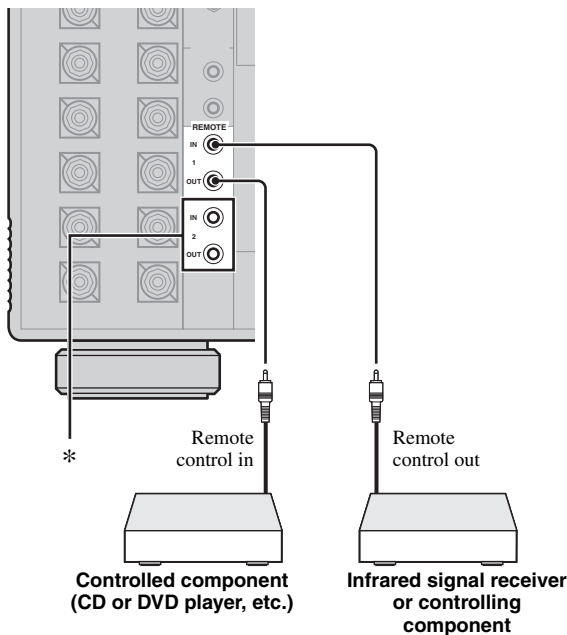

* You can connect another set of infrared signal receiver and Yamaha component to the REMOTE IN 2 and OUT 2 jacks same as the REMOTE IN 1 and OUT 1 jacks.

■ Using the TRIGGER OUT jacks

This unit can control the components (for example, the electric screen, projector, etc.) corresponding to the selected input source and activating/deactivating the desired zone. This unit sends the 12 V/15 mA direct electric current at the TRIGGER OUT jacks according to the settings of "Trigger Output" in "Manual Setup" (see page 94). Connect one of the TRIGGER OUT jack on this unit and the trigger input jack (or control input jack) of the components with the monaural analog mini cable as follows.

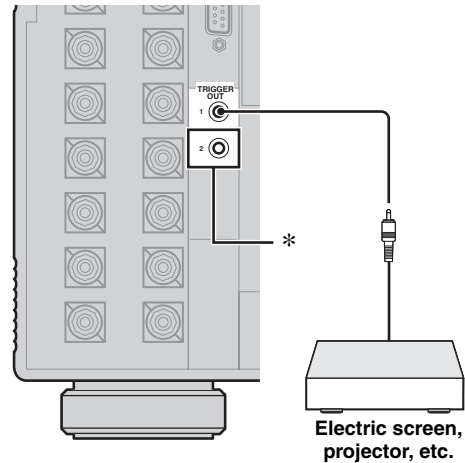

* You can connect another component to the TRIGGER OUT 2 jack same as the TRIGGER OUT 1 jack.

Note

The function when you use this feature with the components may vary depending on the components. Refer to the instruction manuals of the connected components.

Connecting the network

To connect this unit to your network, plug one end of a network cable (CAT-5 or higher straight cable) into the NETWORK port on this unit, and plug the other end into one of the LAN ports on your router that supports the DHCP (Dynamic Host Configuration Protocol) server function. The following diagram shows a connection example where this unit is connected to one of the LAN ports on a 4-port router. To enjoy music files saved on your PC and Yamaha MCX-2000, access the Internet Radio, or control this unit by using your PC, each device must be connected properly in the network.

Notes

- You must use an STP (shielded twisted pair) cable (commercially available) to connect a network hub or router and this unit.
- If the DHCP server function on your router is disabled, you need to configure the network settings manually (see page 92).
- Yamaha MCX-2000, MCX-A10 and MCX-C15 may not be for sale in some locations.

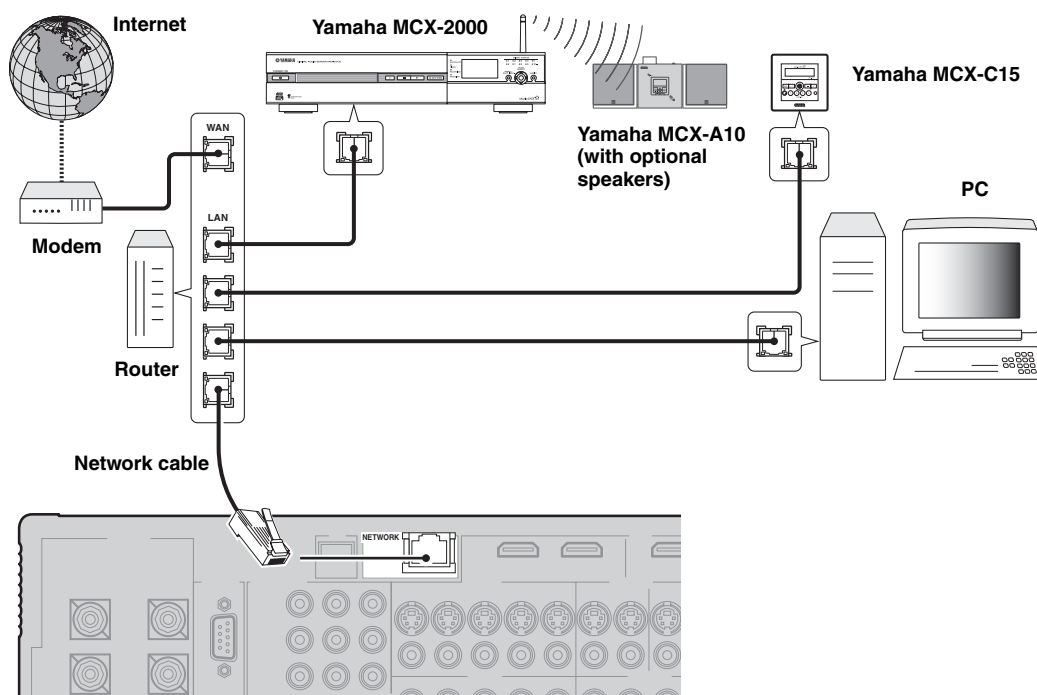

Connecting the USB storage devices to the USB ports

This unit is equipped with both the front and rear USB ports. Connect the USB storage device (for example, a high capacity USB hard disk drive) to the front or rear USB port on this unit. Set "USB Select" in "Input Select" to "Front" or "Rear" to select the active USB port (see page 83). The initial setting of "USB Select" is "Front".

(Rear panel)

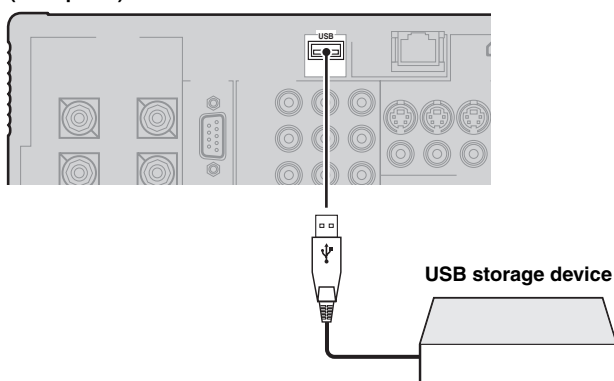

(Front panel)

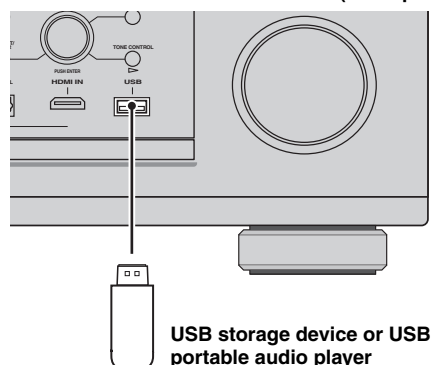

Notes

- We do not guarantee the power supply and operation of all the connected USB devices.
- See page 69 for more information about the USB storage devices that this unit is supported to.

Connecting the power cable

■ Connecting the AC power cable

Plug the supplied AC power cable into the AC inlet (AC IN) after all other connections are complete, and then plug the AC power cable into an AC wall outlet.

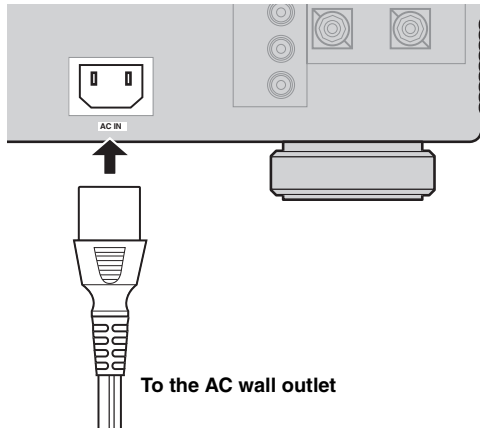

■ AC OUTLET(S) (SWITCHED)

U.K. model 1 outlet
 Korea model None
 Other models 2 outlets

Use these outlet(s) to supply power to any connected components. Connect the power cable of your other components to these outlet(s). Power to these outlet(s) is supplied when this unit is turned on. However, power to these outlet(s) is cut off when this unit is turned off. For information on the maximum power or the total power consumption of the components that can be connected to these outlet(s), see "Specifications" on page 138.

Using the VIDEO AUX jacks on the front panel

Use the VIDEO AUX jacks on the front panel to connect a game console or a video camera to this unit.

Caution

Be sure to turn down the volume of this unit and other components before making connections.

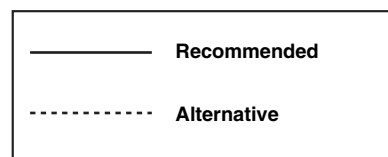
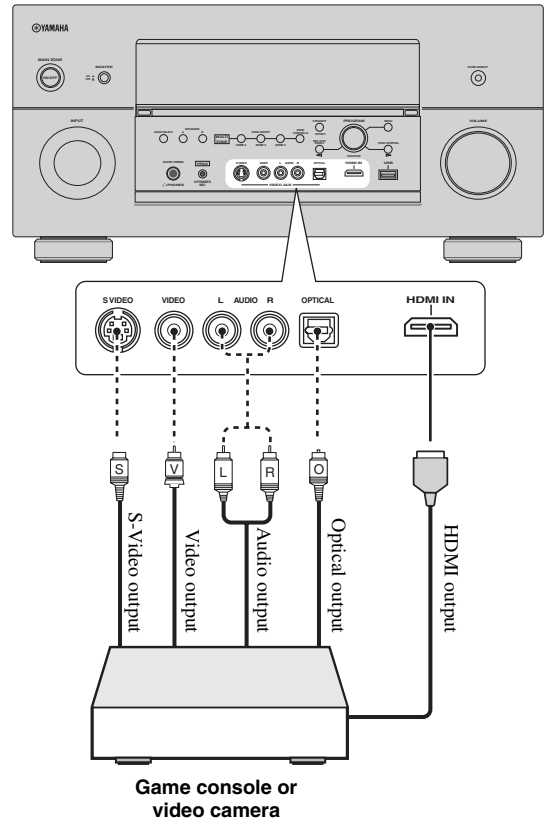

Setting the speaker impedance and language

Caution

If you are to use 6-ohm speakers, set “SPEAKER IMP.” to “6ΩMIN” as follows BEFORE using this unit.

Before using this unit, set the speaker impedance of the connected speakers and the language of the menu items and messages.

1 Make sure this unit is turned off.

2 Press and hold **PROGRAM** on the front panel and then press **MASTER ON/OFF** inward to the ON position to turn on this unit.

Press and hold **PROGRAM** until “ADVANCED SETUP” appears in the front panel display.

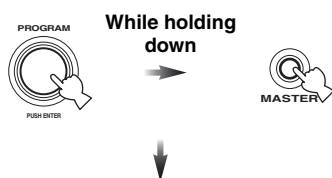

3 Rotate **PROGRAM** to select “SPEAKER IMP.”.

4 Press **PROGRAM** repeatedly to select “8ΩMIN” or “6ΩMIN”.

5 Rotate **PROGRAM** to select “LANGUAGE”.

6 Press **PROGRAM** repeatedly to select the desired language setting.

Choices: **ENGLISH** (English), **JAPANESE** (Japanese), **FRENCH** (French), **GERMAN** (German), **SPANISH** (Spanish), **RUSSIAN** (Russian)

Notes

- You can also select the language setting by using GUI menu. See page 95 for details.
- Some languages are not displayed in the front panel display or Zone OSD.

LANGUAGE	GUI menu	Front panel display	Zone OSD
RUSSIAN	○	○	—
JAPANESE	○	—	—
Other languages	○	○	○

○ ... The selected language is displayed.

— ... The selected language is not displayed. The menu items and messages are displayed in English.

7 Press **MASTER ON/OFF** to release it outward to the OFF position to save the new setting and turn off this unit.

The setting you made is reflected next time you turn on this unit.

Turning this unit on and off

Turning on this unit

Press **MASTER ON/OFF** on the front panel inward to the ON position to turn on this unit.

When you turn on this unit by pressing **MASTER ON/OFF**, the main zone is turned on.

Note

After this unit is turned on, it takes approximately 20 seconds until this unit produces sounds, and while “Please wait” appears in the front panel display, this unit does not accept the front panel operations and stores the remote control operations. This unit performs the stored remote control operations after “Please wait” disappears.

Turning off this unit

Press **MASTER ON/OFF** on the front panel again to release it outward to the OFF position to turn off this unit.

Notes

- MAIN ZONE ON/OFF** on the front panel as well as **POWER** and **STANDBY** on the remote control are operational only when **MASTER ON/OFF** is pressed inward to the ON position.
- Basically, we recommend that you use the standby mode to turn off this unit.

Set the main zone to the standby mode

Press **MAIN ZONE ON/OFF** (or **STANDBY**) to set the main zone to the standby mode.

In the standby mode, this unit consumes a small amount of power in order to receive infrared signals from the remote control.

Turning on the main zone from the standby mode

Press **MAIN ZONE ON/OFF** (or **POWER**) to turn on the main zone.



- When you turn on this unit, there will be a delay for a few seconds before this unit can reproduce sound.
- These buttons are operational only when **MASTER ON/OFF** is pressed inward to the ON position.

If there are some problems...

- First, turn off and then turn on this unit again.
- If problems persist, initialize the parameters of this unit. See page 127 for details.

Front panel display

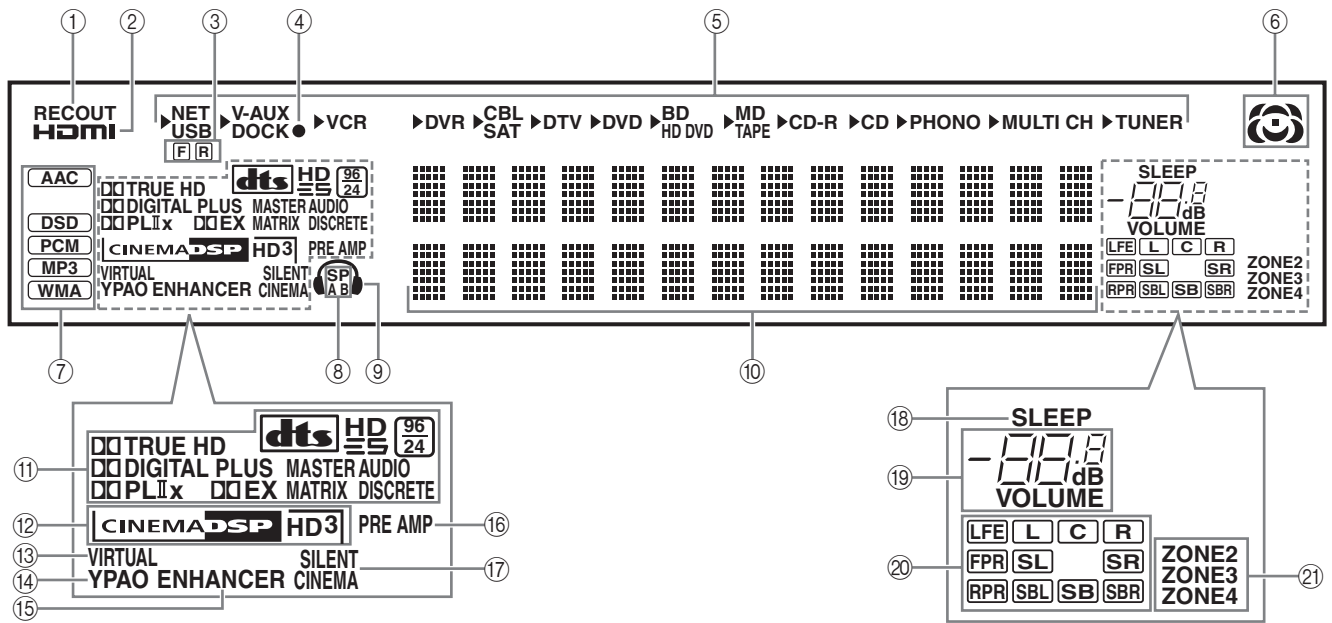

① RECOUT indicator

Lights up when this unit is in the recording input source selecting mode (see page 62).

② HDMI indicator

Lights up when the signal of the selected input source is input at one of the HDMI input jacks (see page 28).
HDMI indicator also lights up when “Standby Through” is set to “On” and this unit is in the standby mode (see page 94).

③ Front/rear USB port indicator

Lights up according to the setting of “USB Select” (see page 83).
F: Front USB port is selected.
R: Rear USB port is selected.

④ Battery charge indicator

Lights up when this unit charges the battery of the stationed iPod in the standby mode of this unit (see page 64).

⑤ Input source indicators

The corresponding cursor lights up to show the currently selected input source.

Note

NET indicator also lights up when “NET STANDBY” in “Advanced setup” is set to “YES” and this unit is in the standby mode (see page 119).

⑥ Sound field indicators

Light up to indicate the active sound fields (see page 54).

⑦ Input signal indicators

The respective indicator lights up when this unit is reproducing DSD (Direct Stream Digital), PCM (Pulse Code Modulation), WMA (Windows Media Audio), MP3 (MPEG-1 Audio Layer-3), or AAC (MPEG-4 AAC) audio signals.

⑧ SP A B indicators

Lights up according to the set of front speakers activated (see page 51).

SP A: The FRONT A speakers are activated.

SP B: The FRONT B speakers are activated.

SP A B: The FRONT A and B speakers are activated.

⑨ Headphones indicator

Lights up when headphones are connected (see page 51).

⑩ Multi-information display

Shows the name of the current sound field settings and other information when adjusting or changing settings.

⑪ Decoder indicators

The respective indicator lights up when any of the decoders of this unit function.

⑫ DSP indicators

The respective indicator lights up when any of the sound field programs are selected.

CINEMA DSP HD indicator

Lights up when you select a CINEMA DSP or HiFi DSP sound field program (see page 54).

HD³ indicator

Lights up when the CINEMA DSP HD³ mode is active (see page 60).

⑬ VIRTUAL indicator

Lights up when the Virtual CINEMA DSP mode is active (see page 60).

⑭ YPAO indicator

Lights up when you run “Auto Setup” and when the speaker settings set in “Auto Setup” are used without any modifications (see page 42).

⑮ ENHANCER indicator

Lights up when the Compressed Music Enhancer mode is selected (see page 59).

⑯ PRE AMP indicator

Lights up when this unit is in the pre-amplifier mode (see page 120).

⑰ SILENT CINEMA indicator

Lights up when headphones are connected and a sound field program is selected (see page 60).

⑱ SLEEP indicator

Lights up while the sleep timer is on (see page 52).

⑲ VOLUME level indicator

Indicates the current volume level.

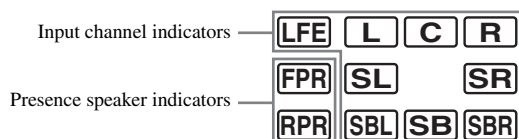

When the audio output is muted, the VOLUME level indicator flashes (see page 50).

⑳ Input channel and speaker indicators**Input channel indicators**

- Indicate the channel components of the current digital input signal.
- Light up or flash according to the settings of the speakers when this unit is in the auto setup procedure (see page 42) or the speaker level setting procedure in the “Speaker Level” (see page 86).

Presence speaker indicators

Light up according to setting for “Front Presence” and “Rear Presence” (see page 84) in “Speaker Set” when this unit is in the auto setup procedure (see page 42) or the speaker level setting procedure in the “Speaker Level” (see page 86).



You can make settings for the presence and surround back speakers automatically by running “Auto Setup” (see page 42) or manually by adjusting settings for “Front Presence”, “Rear Presence” (see page 84), and “Surround Back” (see page 84) in “Speaker Set”.

㉑ ZONE2/ZONE3/ZONE4 indicators

Lights up when Zone 2, Zone 3, or Zone 4 is turned on (see page 111).

Optimizing the speaker setting for your listening room (YPAO)

This unit employs the YPAO (Yamaha Parametric Room Acoustic Optimizer) technology which lets you avoid troublesome listening-based speaker setup and achieves highly accurate sound adjustments automatically. The supplied optimizer microphone collects and this unit analyzes the sound your speakers produce in your actual listening environment.

This unit is equipped with various automatic setup features. You can select the automatic setup features according to your preference.

Quick automatic setup

Use this feature to carry out the automatic setup quickly. You can optimize the basic parameters of the sound in the listening room automatically.

 P. 43

Basic automatic setup

Use this feature to customize the automatic setup and review the result of the measurements. You can set the parameters that this unit sets in the automatic setup procedure and review the results of the measurements.

 P. 44

Advanced automatic setup

Use this feature to make fine-adjustments of the sound. You can optimize the setup of this unit for multiple listening positions in a listening room, and/or for the effect of the sound field programs.

 P. 46

Notes

- Sometimes due to interaction with the room, you may notice irregular results when setting the level and/or distance of the main speakers. If this happens, THX Ltd. recommends setting them manually.
- Sometimes due to the electrical complexities of subwoofers and the interaction with the room, THX Ltd. recommends setting the level and the distance of the subwoofer manually.

Before starting the automatic setup

Make sure of the following check points before starting the automatic setup operations.

- Speakers are connected appropriately.
- Headphones are disconnected from this unit.
- This unit is turned on.
- The connected subwoofer is turned on and the volume level is set to about half way (or slightly less).
- The crossover frequency controls of the connected subwoofer is set to the maximum.

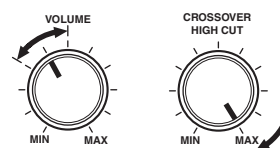

Controls of a subwoofer (example)

- If you use the external amplifiers (see page 35), the amplifiers are turned on and the settings are appropriate.
- The room is sufficiently quiet.
- Set the operation mode selector on the remote control to **AMP**.

Notes

- Be advised that it is normal for loud test tones to be output during the automatic setup procedure.
- To achieve the best results, make sure the room is as quiet as possible while the automatic setup procedure is in progress. If there is too much ambient noise, the results may not be satisfactory.

Using the quick automatic setup

Use this feature to optimize the sound of this unit to the listening room quickly.

1 Connect the supplied optimizer microphone to the OPTIMIZER MIC jack on the front panel.

“MIC ON” appears in the front panel display.

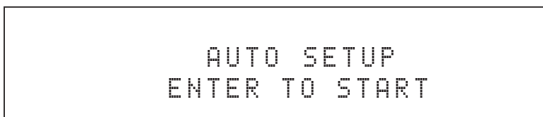
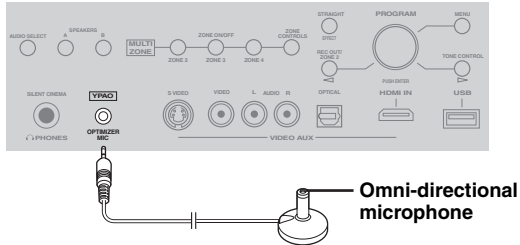

Note

If “GUI” appears in the front panel display as follows, the menu screen (GUI) is displayed in the video monitor and you cannot proceed the quick automatic setup. In such a case, press **MENU** to turn off the GUI or use the basic automatic setup procedure (see page 44).

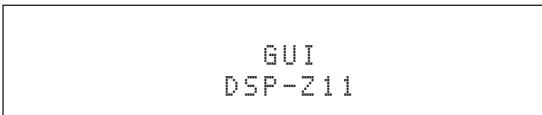

2 Place the optimizer microphone at your normal listening position on a flat level surface with the omni-directional microphone heading upward.

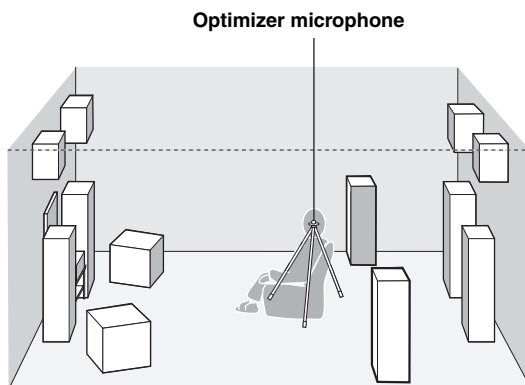

It is recommended that you use a tripod (etc.) to affix the optimizer microphone at the same height as your ears would be when you are seated in your listening position. You can use the attached screw of a tripod (etc.) to fix the optimizer microphone to the tripod (etc.).

Before proceeding next operation

Once you perform the next operation, this unit starts the automatic setup procedure immediately. For more accurate measurements, we recommend that you move to the wall where speakers are not around.

3 Press **PROGRAM** on the front panel to start the measurements.

This unit starts the measurements immediately. Loud test tones are output from each speaker during the automatic setup procedure. During the setup procedure, following messages appear in the front panel display.

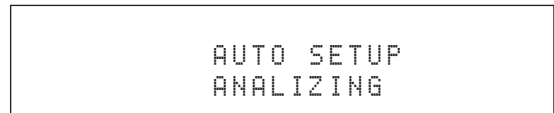
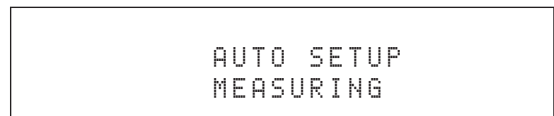
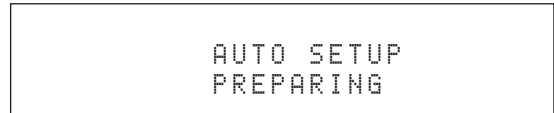

To cancel the automatic setup procedure, rotate **VOLUME**.

Notes

- During the automatic setup procedure, do not perform any operation on this unit.
- Keep quiet when you leave the room. The necessary time for the automatic setup procedure may differ depending on the environment of the listening room and connected speakers (from 30 seconds to 5 minutes).

4 Once this unit completes all measurements and adjustments successfully, following message appears in the front panel display.

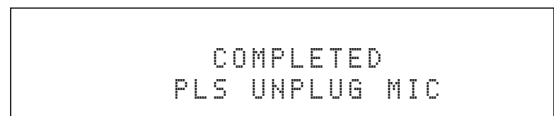

If error or warning message appears...

Error message appears in the front panel display. See the “Auto Setup” section in “Troubleshooting” on page 126 for a complete list of error messages and proper remedies.

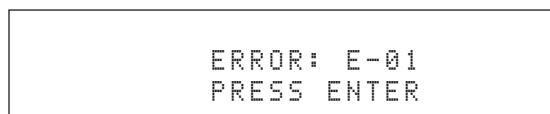

You can check the detailed results of the measurements by using the video monitor. See page 45 for details.

5 Disconnect the optimizer microphone to exit from the automatic setup mode.

The optimizer microphone is sensitive to heat. Keep it away from direct sunlight and do not place it on top of this unit.

Using the basic automatic setup

Use this feature to customize the measurements and the settings of the automatic setup using the connected video monitor.

1 Turn on the connected video monitor.

2 Connect the supplied optimizer microphone to this unit and then place the microphone appropriately.

Refer to the steps 1 and 2 of “Using the quick automatic setup” on page 43.

3 Press MENU on the remote control.

Following menu screen appears in the video monitor.

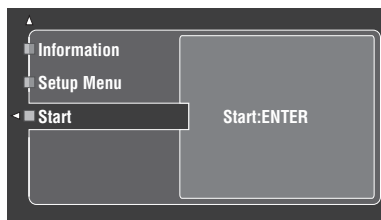

4 Press Setup Menu to select “Setup Menu” and then Right Arrow .

The list of the measurements in the automatic setup appears in the screen.

5 Press Up Arrow / Down Arrow repeatedly to select the desired measurement item and then press ENTER repeatedly to select whether the selected measurement is carried out.

Check mark appears in the check box of the measurement that this unit carries out.

Measurement	Descriptions
Multi Measure (Multiple point measurement)	You can make adjustments of this unit for multiple listening positions. For details, refer to “Using advanced automatic setup” on page 46. In the basic automatic setup, leave the setting to the default.
Wiring (Speaker wiring)	This unit checks and adjusts which speakers are connected and the polarity of each speaker.
Distance (Speaker distance)	This unit checks and adjusts the distance of each speaker from the listening position and adjusts the timing of each channel.
Size (Speaker size)	This unit checks and adjusts the frequency response of each speaker and sets the appropriate low-frequency crossover for each channel.
Equalizing (Speaker equalizing)	Parametric equalizer adjusts the level of the specified frequency bands. This unit automatically selects the crucial frequency bands for the listening room and adjusts the level of the selected frequency bands to create a cohesive sound field in the room.
Level (Speaker level)	This unit checks and adjusts the volume level of each speaker.
Standing Wave (Standing wave cancelling)	Standing waves are the sound waves generated in a room due to the acoustic characteristics of the room and audio system, etc., and the acoustic standing waves may interrupt the accurate reproduction of the source sound and distort the characteristics of the sound produced by this unit. This unit reduces the effects of the standing waves in the listening with the specially customized parametric equalizer.
Angle (Speaker angle)	For details, refer to “Using advanced automatic setup” on page 46. In the basic automatic setup, clear the check mark.

Note

When you use THX speakers, clear the check mark of “Size” and then make sure that “Small” or “Small x2” are selected in “Speaker Set” (see page 84).

6 Once you have finished the settings, press Left Arrow to return to the previous menu level and then press Down Arrow to select “Start”.

7 Press ENTER to start the measurements.

This unit starts the measurements immediately. Loud test tones are output from each speaker during the automatic setup procedure.

Notes

- During the automatic setup procedure, do not perform any operation on this unit.
- Keep quiet when you leave the room. The necessary time for the automatic setup procedure may differ depending on the environment of the listening room and connected speakers (from 30 seconds to 5 minutes).



To cancel the automatic setup procedure, press RETURN . The error message “E09:User Cancel” appears in the menu screen and this unit stops the measurement immediately (see page 45).

8 Once all measurement items are set successfully, following display appears in the menu screen.

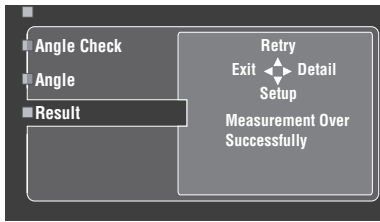

- In this menu, you can perform the following operations:
- Press F9 ∇ and select “Setup” to set the measured values.
 - Press F9 Δ and select “Retry” to retry the automatic setup procedure. This unit starts the automatic setup procedure immediately again.
 - Press F9 \triangleright and select “Detail” to view information about measurement results and warning messages. In the information display, press F9 Δ / ∇ repeatedly to toggle between the parameters. See page 46 for details.
 - Press F9 \triangleleft to cancel the measurement results and exit from the automatic setup menu.

If error or warning messages appear...

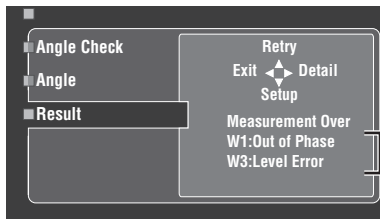

Error or warning messages

When this unit detects potential problems during the automatic setup procedure, error or warning messages appears in the result display. See the “Auto Setup” section in “Troubleshooting” on page 126 for a complete list of error or warning messages and proper remedies. Press F9 \triangleleft to view the detailed information of the error or warning messages.

9 Press F9 **MENU** to turn off the GUI menu.

Notes

- After you have completed the automatic setup procedure, be sure to disconnect the optimizer microphone.
- The optimizer microphone is sensitive to heat. Keep it away from direct sunlight and do not place it on top of this unit.

■ Reviewing the result of the automatic setup

Use this feature to review the result of the automatic setup.

1 Set the operation mode selector to F16 **AMP** and then press F19 **MENU** to turn on the GUI screen.

2 Press F9 Δ / ∇ repeatedly and then F9 \triangleright to select “Auto Setup”.

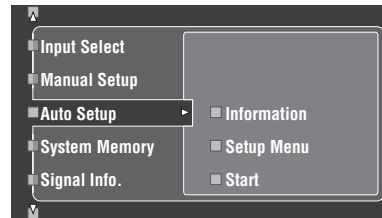

3 Press F9 Δ to select “Information”.



4 Press F9 \triangleright and then F9 Δ / ∇ repeatedly to select the desired check items.

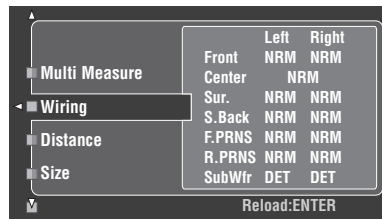

Measurement	Descriptions
Multi Measure (Multiple point measurement)	Displays the number of the points the measurements are carried out at. For details, refer to "Using advanced automatic setup" on this page.
Wiring (Speaker wiring)	Displays the polarity of each connected speaker. – "NRM" appears when the polarity of the connected speaker is normal. – "REV" appears when the polarity of the connected speaker is reversed. – "DET" appears when this unit detects the subwoofer(s) is connected. – "----" appears when no speaker is connected to the corresponding speaker channel.
Distance (Speaker distance)	Displays the speaker distance from the listening position. Press ⏪ repeatedly to switch the unit to display the value of the each speaker distance.
Size (Speaker size)	Displays the size of the connected speakers and the bass cross over frequency ("Cross"). – "LRG" appears when the connected speaker has the ability to reproduce the low-frequency signals effectively. – "SML" appears when the connected speaker does not have the ability to reproduce the low-frequency signals effectively.
Equalizing (Speaker equalizing)	Displays the result of the adjustment of the frequency responses of each connected speaker. You can switch the parametric equalizer type that appears in the result display by pressing ⏪ repeatedly in the "Equalizing" result display. To apply the result that is displayed in the display, press ⏵ENTER . Choices: Natural , Flat, Front – Select "Natural" to average out the frequency response of all speakers with higher frequencies being less emphasized. Recommended if the "Flat" setting sounds a little harsh. – Select "Flat" to average the frequency response of all speakers. Recommended if all of your speakers are of similar quality. – Select "Front" to adjust the frequency response of each speaker in accordance with the sound of your front speakers. Recommended if your front speakers are of much higher quality than your other speakers.
Level (Speaker level)	Displays the result of the adjustment of each connected speaker output level. You can display the result of the adjustment of the speaker level for each parametric equalizer type (see above) by pressing ⏪ repeatedly. Select "Through" to display the result when this unit does not use the parametric equalizer.
Standing Wave (Standing wave cancelling)	Displays the active band frequencies of the special parametric equalizer for each speaker. Press ⏪ repeatedly to switch the result of the front and rear speaker.
Angle (Speaker angle)	Displays the angles of the front speakers, surround speakers, front presence speakers and rear presence speakers at the measured point.



- You can reload the displayed result of the automatic setup by pressing **⏵ENTER**.
- The results of the measurement that are the causes of the warning message(s) appear in red.

Notes

- "----" appears when no speaker is connected to the corresponding speaker channel or this unit does not measure the corresponding speaker channel yet.
- If you change speakers, speaker positions, or the layout of your listening environment, run "Auto Setup" again to recalibrate your system.
- The distances displayed in the "Distance" results may be longer than the actual distance depending on the characteristics of your subwoofer or external amplifiers if you connect them.
- In the "Equalizing" results, different values may be set for the same band to provide finer adjustments.
- Even if you change the setting of "PEQ Select", the equalizer type that is displayed in "Equalizing" is not changed.

5 Once you finish the review of the result of the automatic setup, press **⏵** repeatedly to exit from the automatic setup menu.



- You can also set the parametric equalizer type by using "Parametric EQ" in "Manual Setup" (see page 87).
- You can set the connected subwoofer phases by using "Phase" in "Manual Setup" (see page 85).

Using advanced automatic setup

You can use the multiple-point measurement feature to optimize up to eight listening positions in a listening room and speaker angle measurement feature to optimize the speakers for the effects of the sound field programs.

Notes

- Before starting the operations, prepare the supplied microphone base.
- You can make fine adjustments of this unit by using the multiple-point measurement and speaker angle measurement features, however it takes from 30 seconds to 3 minutes to make the measurements at each listening point.

The following listening room is set as the example in the following instructions.

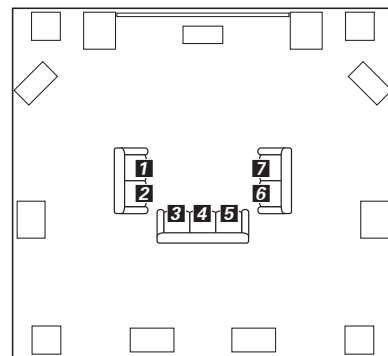

1/2/3/4/5/6/7: Listening positions

1 Turn on the connected video monitor.

- 2 **Connect the supplied optimizer microphone to this unit and then place the microphone appropriately.** Refer to the steps 1 and 2 of "Using the quick automatic setup" on page 43. First, place the optimizer microphone to the listening position **1**.

- 3 Press MENU on the remote control.**
Following menu screen appears in the video monitor.

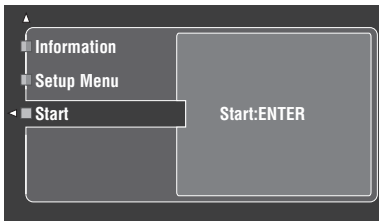

- 4 Press UP to select "Setup Menu" and then RIGHT .**
The list of the measurements in the automatic setup appears in the screen.

- 5 Press UP repeatedly to select "Multi Measure".**

- 6 Press RIGHT and then UP / DOWN repeatedly to set the number of the listening positions you want to make the measurement at.**
Choices: 1, 2, 3, 4, 5, 6, 7, 8

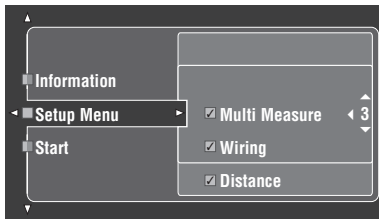

- 7 Press LEFT to return to the previous menu level and then press DOWN repeatedly to select "Angle".**

- 8 Make sure that a check mark appears in the check box of "Angle".**
If the check mark does not appear, press ENTER to select the check box.

- 9 Once you have finished the settings, press LEFT to return to the previous menu level and then press DOWN to select "Start".**
This unit starts the measurement procedure. See page 44 for details.

- 10 Once this unit pauses the automatic measurement procedure and then "Put the microphone at 2nd listening position" appears in the display, move the optimizer microphone to the listening position 2 .**

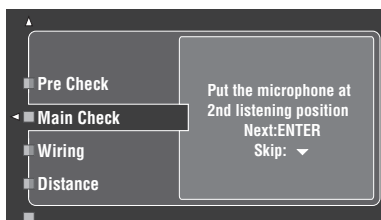

- 11 Press ENTER to start the measurement at the next listening position.**

To skip the measurements at the remaining listening positions, press DOWN .

- 12 Repeat steps 10 and 11 until the measurements at all listening points are completed.**

- 13 Once following display appears in the video monitor, place the supplied microphone base at the listening point you want to be seated most frequently as follows.**

Make sure that the arrow mark on the microphone base points the center speaker or between the front left and right speakers.

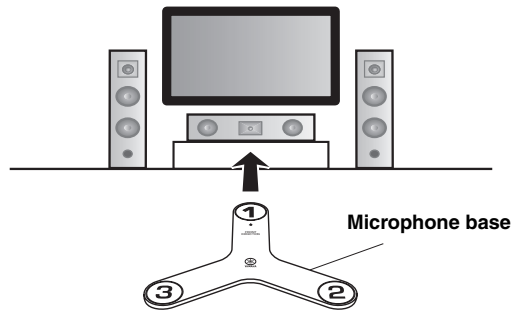
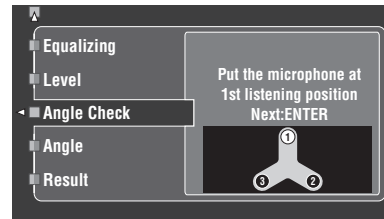

Note

For the accurate measurements of the speaker angles, we strongly recommend that you use a tripod (etc.) to affix the microphone base at the same height as your ears would be when you are seated in your listening position. You can use the attached screw of a tripod (etc.) to fix the microphone base to the tripod (etc.).

- 14 Place the optimizer microphone to the "(1)" position on the microphone base.**

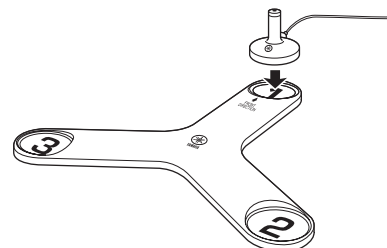

- 15** Once the setting has been completed, press **ENTER**.

This unit starts the measurements of the speaker angles.

- 16** Once the following display appears in the video monitor, move the optimizer microphone to the “(2)” position on the microphone base.

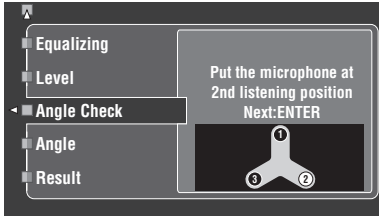

- 17** Press **ENTER** to resume the measurements.

- 18** Once the following display appears in the video monitor, move the optimizer microphone to the “(3)” position on the microphone base.

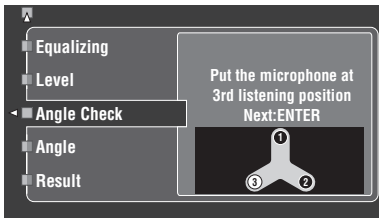

- 19** Press **ENTER** to resume the measurements.

- 20** Once the measurement procedure has been complete, following display appears in the video monitor.

See page 45 for details.

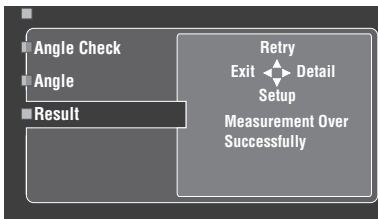

For other configuration of the listening position

The following examples indicate the measurement points when there is a listening position or are two listening positions.

Example 1: Two listening positions

We recommend that you make measurements in front of and behind the listening positions as well as the listening positions.

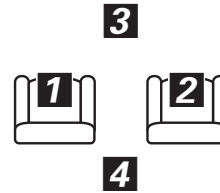

Example 2: One listening position

We recommend that you make measurements around the listening position as well as the listening position.

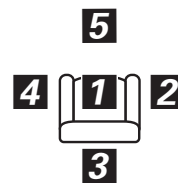

Basic Operation

Playback	50
Basic procedure	50
Selecting the MULTI CH INPUT component	50
Selecting the HDMI OUT jack	51
Selecting the front speaker set	51
Using your headphones	51
Playing video sources in the background of an audio source	51
Selecting audio input jacks (AUDIO SELECT)	52
Muting the audio output	52
Using the sleep timer	52
Operating this unit by using the graphical user interface (GUI) menu	53
Sound field programs	54
Selecting sound field programs	54
Sound field program descriptions	54
Using CINEMA DSP HD ³ mode	60
Enjoying unprocessed input sources	60
Using audio features	61
Enjoying pure hi-fi sound	61
Adjusting the tonal quality	61
Adjusting the speaker level	61
Recording	62

Playback

Caution

Extreme caution should be exercised when you play back CDs encoded in DTS. If you play back a CD encoded in DTS on a DTS-incompatible CD player, you will only hear some unwanted noise that may damage your speakers. Check whether your CD player supports CDs encoded in DTS. Also, check the sound output level of your CD player before you play back a CD encoded in DTS.



To play DTS-encoded CDs when using a digital audio connection, set "Decoder Mode" in "Input Select" to "DTS" before playback (see page 82).

Before performing the following operations, set the operation mode selector on the remote control to **AMP**.

Basic procedure

1 Turn on the video monitor connected to this unit.



- If you connect two video monitors to the HDMI OUT jacks of this unit, press **HDMI OUT** repeatedly to select the active video monitor.
- You can control this unit by using the graphical user interface (GUI) screen. See page 53 for details.
- You can turn on or off the short message displays in the video monitor. See page 90 for details.

2 Rotate the **INPUT** selector (or press one of the input selector buttons (3)) to select the desired input source.

The name of the currently selected input source appears in the front panel display and in the short message display for a few seconds.

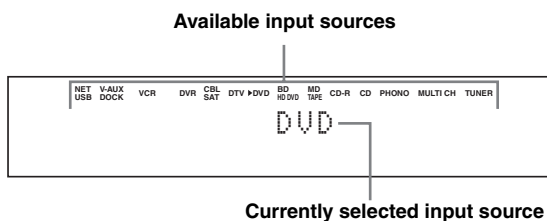

3 Start playback on the selected source component or select a broadcast station.

- Refer to the instruction manuals for the source component.
- See page 66 for details about playback of Internet Radio programs and the music contents in the PC or USB storage devices.

4 Rotate **VOLUME** (or press **VOLUME +/-**) to adjust the volume to the desired output level.

Control range: Mute, -80.0 dB (minimum) to +16.5 dB (maximum)



See page 61 to adjust the level of each speaker.

5 Rotate the **PROGRAM** selector (or press one of the sound field program selector buttons (2)) repeatedly to select the desired sound field program.

The name of the selected sound field program appears in the front panel display and in the short message display. See page 54 for details about sound field programs.

Currently selected sound field program category

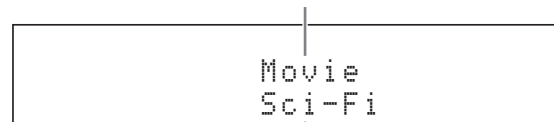

Currently selected sound field program

Note

Sound field programs cannot be selected when the component connected to the MULTI CH INPUT jacks is selected as the input source (see page 50).



- Choose a sound field program based on your listening preference, not merely on the name of the program.
- When you select an input source, this unit automatically selects the last sound field program used with the corresponding input source.

Selecting the MULTI CH INPUT component

Use this feature to select the component connected to the MULTI CH INPUT jacks (see page 35) as the input source.

Rotate the **INPUT** selector (or press **MULTI**) to select "MULTI CH".



Use "MULTI CH" menu in "Input Select" to set the parameters for MULTI CH (see page 83).

Note

Sound field programs cannot be selected when the component connected to the MULTI CH INPUT jacks is selected as the input source (see page 54).

Selecting the HDMI OUT jack

Use this feature to select the HDMI OUT jack to output the input signals.

Press **ⓂHDMI OUT** on the remote control repeatedly to select the desired setting of “HDMI OUT SEL”.

Each time you press **ⓂHDMI OUT**, the front panel display changes as shown below.



Choice	Functions
OUT 1	Outputs the signals at the HDMI OUT 1 jack.
OUT 2	Outputs the signals at the HDMI OUT 2 jack.
OFF	Does not output any signals at the HDMI OUT 1 and 2 jacks. Select this setting when you do not use the video monitor connected to one of the HDMI OUT jacks.

Selecting the front speaker set

Use this feature to turn the front speaker system (FRONT A and/or FRONT B) on or off.

Press **ⓂSPEAKERS A** and/or **ⓂSPEAKERS B** on the front panel to turn on or off the set of front speakers connected to the FRONT A and/or EXTRA SP speaker terminals.

Note

Turn off the volume level of this unit when you switch the front speaker setting.

■ Using the Zone B feature

When you set “Speaker B” to “ZoneB” (see page 91), you can use the speakers connected to the EXTRA SP speaker terminals in another room (Zone B).

Press **ⓂSPEAKERS B** on the front panel repeatedly to turn on or off the Zone B speakers.

When you activate the Zone B speakers, all the speakers in the main room are muted.

Note

You cannot activate both the main room and Zone B speakers simultaneously.

Using your headphones

Connect a pair of headphones with a stereo analog audio cable plug to the PHONES jack on the front panel.

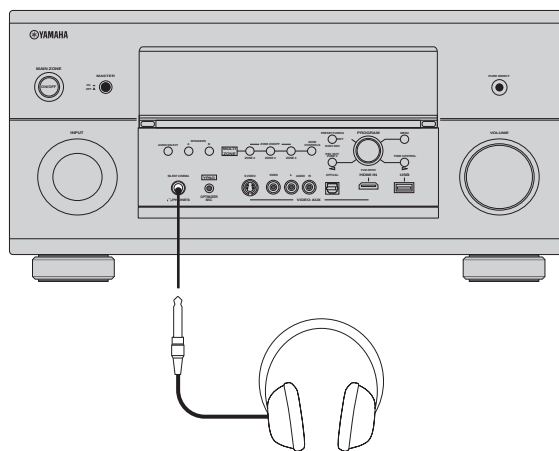

When you select a sound field program, the SILENT CINEMA mode activates automatically (see page 60).

Notes

- When you connect headphones, no signals are output at the speaker terminals.
- All digital multi-channel audio signals (except DSD signals) are mixed down to the left and right headphone channels.
- If you connect or disconnect your headphones to or from this unit in the party mode, the sounds in the zones that join in the party mode are muted for a moment.
- The audio signals input at the CENTER and SUBWOOFER MULTI CH INPUT jacks are mixed down to the left and right headphone channels.

Playing video sources in the background of an audio source

You can combine a video image from a video source with sound from an audio source. For example, you can enjoy listening to classical music while viewing beautiful scenery from the video source in the video monitor.

Press the input selector buttons (Ⓜ) to select a video source and then an audio source.

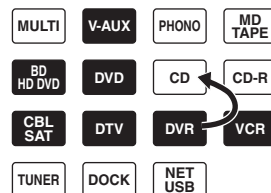

: Audio source buttons

: Video source buttons



Set the “BGV” parameter in the “MULTI CH” menu to the desired setting to select the default background video input source of the MULTI CH INPUT sources (see page 83).

Selecting audio input jacks (AUDIO SELECT)

This unit comes with a variety of input jacks. Use this feature (audio input jack select) to switch the input jack assigned to an input source when more than one jacks are assigned to an input source.



- We recommend setting the audio input jack select to “AUTO” in most cases.
- You can adjust the default the audio input jack select of this unit by using “Audio Select” in “Option” (see page 93).
- You can also set the audio input jack select setting in “Audio Select” in “Input Select” (see page 82).

1 Rotate the **ⓂINPUT selector (or press one of the input selector buttons **Ⓜ**) to select the desired input source.**

2 Press **ⓂAUDIO SELECT (or **Ⓜ**AUDIO SEL) repeatedly to select the desired Audio input jack select setting.**

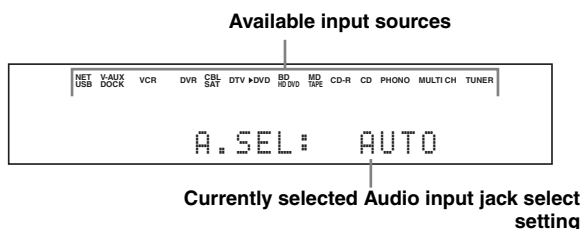

AUTO	Automatically selects input signals in the following order: (1) HDMI (2) Digital signals (3) Analog signals
HDMI	Selects only HDMI signals. When HDMI signals are not input, no sound is output.
COAX/OPT	Automatically selects input signals in the following order: (1) Digital signals input at the COAXIAL jack. (2) Digital signals input at the OPTICAL jack. When no signals are input, no sound is output.
ANALOG	Selects only analog signals. If no analog signals are input, no sound is output.

Note

This feature is not available when no digital input jack (OPTICAL, COAXIAL and HDMI) are assigned. Use “I/O Assignment” in “Input Select” to reassign the respective input jack (see page 81).

Muting the audio output

Press **ⓂMUTE on the remote control to mute the audio output. Press **Ⓜ**MUTE again to resume the audio output.** “VOLUME” flashes in the front panel display when the audio output is muted.



- You can also rotate **Ⓜ**VOLUME on the front panel or press **Ⓜ**VOLUME +/- on the remote control to resume the audio output.
- You can adjust the muting level by using the “Muting Type” parameter in “Volume” (see page 86).

Using the sleep timer

Use this feature to automatically set the main zone to the standby mode after a certain amount of time. The sleep timer is useful when you are going to sleep while this unit is playing or recording a source. The sleep timer also automatically turns off any external components connected to the AC OUTLET(S) (see page 38).

1 Press one of the input selector buttons **Ⓜ on the remote control to select the desired input source.**

2 Start playback on the selected source component or select a broadcast station.

Refer to the operating instructions for the source component.

3 Press **ⓂSLEEP repeatedly to set the amount of time.**

Each time you press **Ⓜ**SLEEP, the front panel display changes as shown below.

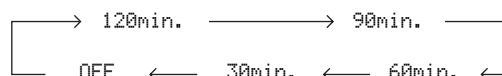

The SLEEP indicator flashes while you are switching the amount of time for the sleep timer. Once the sleep timer is set, the SLEEP indicator lights up in the front panel display, and the display returns to the selected sound field program.

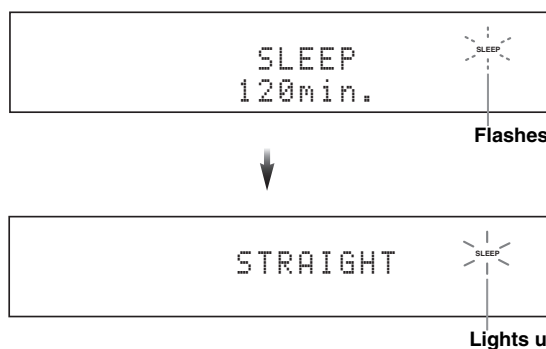

■ Canceling the sleep timer

Press **ⓂSLEEP repeatedly until “OFF” appears in the front panel display.**

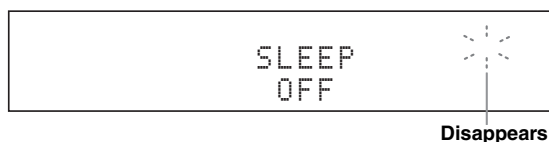

The SLEEP indicator turns off, and “OFF” disappears from the front panel display after a few seconds.



- The sleep timer setting can also be canceled by pressing **Ⓜ**MAIN ZONE ON/OFF (or **Ⓜ**STANDBY) to set the main zone to the standby mode.
- You can also set the sleep timer for Zone 2, Zone 3, or Zone 4. See page 117 for details.

Operating this unit by using the graphical user interface (GUI) menu

This unit features a sophisticated graphical user interface (GUI) menu that helps you to control the amplifier function of this unit. With the GUI menu, you can view the information of the signals being input and the status of this unit. You can also set up this unit using the GUI menu (see page 74).

Items in GUI menu

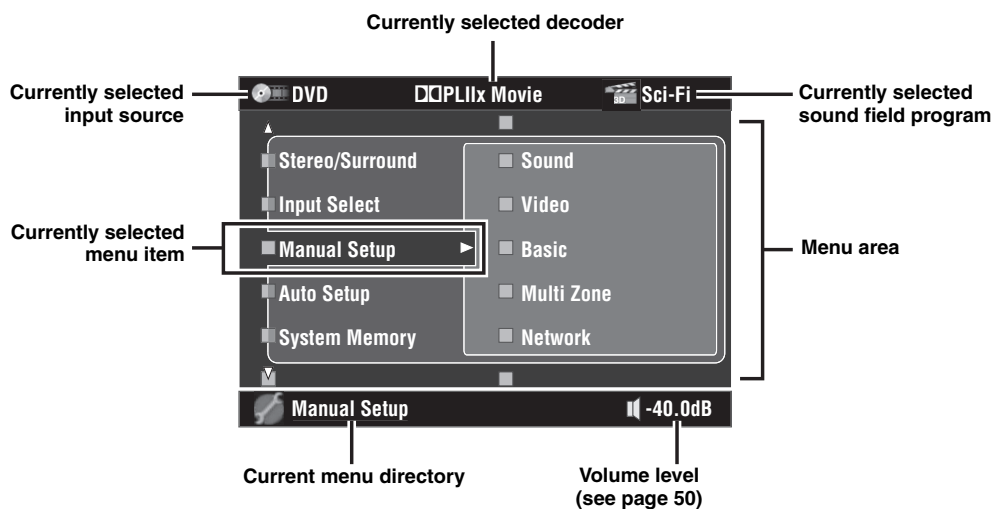

- Set the operation mode selector to **AMP** when you operate this unit by using GUI menu.
- See page 74 for details about the contents in the menu area.
- This unit reserves the previously selected GUI menu.

Basic controls in the GUI menu

Button	Function
Cursor Δ / ∇	Selects the item in the current menu level.
Cursor \triangleright	Selects the currently selected menu item and moves to the next menu level.
Cursor \triangleleft	Returns to the previous menu level.
ENTER	Selects the currently selected menu item and moves to the next menu level.
MENU	Turns on or off the GUI menu.

Basic operation of the GUI menu by using the front panel controls

PROGRAM	Function
Turn left/right	Selects the item in the current menu level.
Press	Selects the currently selected menu item and moves to the next menu level.

Button	Functions
MENU	Turns on or off the GUI menu.
\triangleleft	Returns to the previous menu level.
\triangleright	Selects the currently selected menu item and moves to the next menu level.

Sound field programs

This unit is equipped with a variety of precise digital decoders that allow you to enjoy multi-channel playback from almost any stereo or multi-channel sound source. This unit is also equipped with a Yamaha digital sound field processing (DSP) chip containing several sound field programs which you can use to enhance your playback experience.



- The Yamaha CINEMA DSP sound field program are compatible with all Dolby Digital, DTS, Dolby Surround, Dolby TrueHD, and DTS-HD sources.
- The Yamaha HiFi DSP sound field programs recreate real-world acoustic environments made from precise measurements taken in actual concert halls, music venues, movie theaters, etc. Thus, you may notice variations in the strength of the reflections coming from the front, back, left and right.

Selecting sound field programs

Rotate the ① **PROGRAM** selector (or set the operation mode selector to ⑩ **AMP** and then press one of the sound field selector buttons (⑫) repeatedly).

The name of the selected sound field program appears in the front panel display and in the short message display.

Notes

- When you select an input source, this unit automatically selects the last sound field program used with the corresponding input source.
- Sound field programs cannot be selected when the component connected to the MULTI CH INPUT jacks is selected as the input source (see page 50) or when this unit is in the Pure Direct mode (see page 61).
- Sampling frequencies higher than 96 kHz are sampled down to 96 kHz or lower and then sound field programs are applied.



You can select the desired sound field programs and setting the parameters by using GUI menu. See page 77 for details.

Sound field program descriptions



Select a sound field program based on your listening preference, not merely on the name of the program, etc.

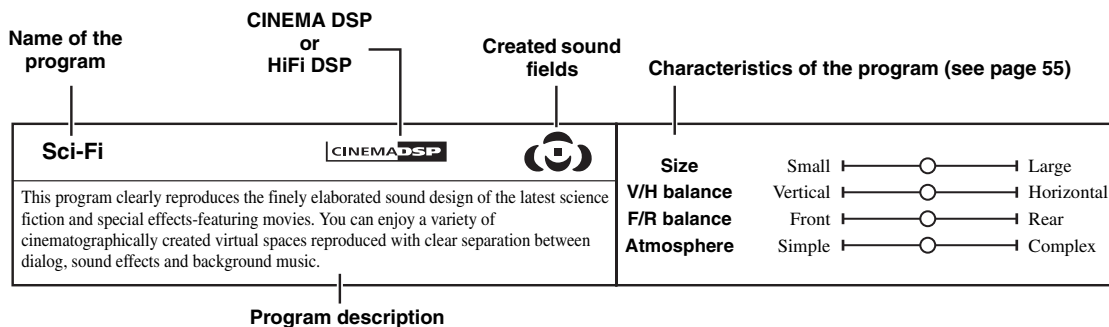

Sound field indicators

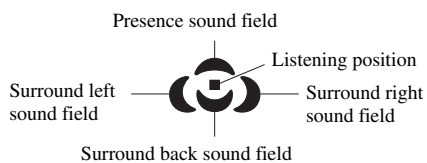

When the CINEMA DSP HD³ mode is active (see page 60), the HD³ sound field indicators light up.

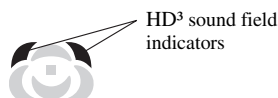

Note

The available sound field parameters and the created sound fields differ depending on the input sources and the settings of this unit.

Descriptions of the characteristics of the sound field programs

Following indexes indicates the characteristics and trends of each sound field program.

Note

The characteristics of the sound field programs may differ depending on the settings of the listening room, etc.

Size of sound field space (Size)

(For the HiFi DSP and CINEMA DSP programs)

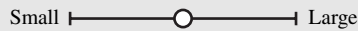

Indicates the size of the sound field to be generated. If the value for this item is small, the sound is that of a small space, while if the value is large, the sound is that of a vast space.

Vertical/horizontal balance (V/H balance)

(For the HiFi DSP and CINEMA DSP programs)

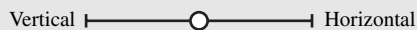

Indicates the balance of the vertical (height) and horizontal directions for the sound field to be generated. If this item is more in the horizontal direction, the sound is that of a space with strong reflections from the walls, while if it is more in the vertical direction, the sound is that of a space with strong reflections from the ceiling.

Front/rear balance (F/R balance)

(For the CINEMA DSP programs only)

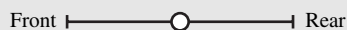

A CINEMA DSP sound field processing expressing whether the effect is stronger towards the front or rear. When the effect is stronger towards the front, the listener senses a feeling of openness and depth towards the screen, while when the effect is stronger towards the rear, the listener gets a sense of envelopment and movement. Suits basically all types of contents for programs with a good front/rear balance, and is effective when selected appropriately for programs in which the balance is more towards either the front or rear.

Sound field atmosphere (Atmosphere)

(For the HiFi DSP programs)

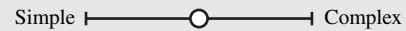

The sound field to be generated is evaluated according to whether it is nearer to one or the other of the following:

Simple: Sounds that fade straight-forwardly, with a light, gentle impression, depending on the program. This suits almost all contents relatively well, but provides little brilliance or powerfulness.

Complex: Sounds transform in complex ways as they fade out, with a rich, brilliant impression, depending on the program.

This is extremely effective for the right contents, but is suited for a smaller range of contents.

(For the CINEMA DSP programs)

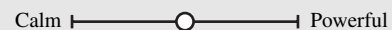

The sound field to be generated is evaluated according to whether it is nearer to one or the other of the following:

Calm: An overall composed, moderate effect, stressing the overall quality of the atmosphere without aiming at any extreme effects.

This suits almost all contents relatively well, but provides little showiness or powerfulness.

Powerful: Designed with specific contents in mind (expressing vast spaces, feverish excitement, etc.). This is extremely effective for the right contents, but is suited for a smaller range of contents.

■ For audio music sources





For audio music sources, we also recommend using the Pure Direct mode (see page 61), the “STRAIGHT” mode (see page 60), or surround decode mode (see page 72).

CLASSICAL 1 CLASSICAL 1

<p>Hall in Munich A HiFi DSP </p> <p>This sound field simulates a concert hall with approximately 2500 seats in Munich, using stylish wood for the interior finishing as normal standards for European concert halls. Fine, beautiful reverberations spread richly, creating a calming atmosphere. The listener's virtual seat is at the center left of the arena.</p>	<p>Size Small Large</p> <p>V/H balance Vertical Horizontal</p> <p>Atmosphere Simple Complex</p>
<p>Hall in Munich B HiFi DSP </p> <p>This hall is frequently used for recording orchestral music, and is a shoe-box type concert hall with around 1300 seats. The hall is constructed from marble, resulting in relatively flat resonance. Further, the high ceiling causes sound to reverberate for longer than usual.</p>	<p>Size Small Large</p> <p>V/H balance Vertical Horizontal</p> <p>Atmosphere Simple Complex</p>
<p>Hall in Frankfurt HiFi DSP </p> <p>This is a large shoe-box type concert hall with around 2400 seats located in Frankfurt. This hall has a very solid, powerful sound. The listener's virtual seat is in the center-right section on the first floor.</p>	<p>Size Small Large</p> <p>V/H balance Vertical Horizontal</p> <p>Atmosphere Simple Complex</p>

Sound field programs

Hall in Stuttgart	HiFi DSP		Size	Small <input type="range" value="75"/> Large
This is a large asymmetrical concert hall with around 2000 seats located in downtown Stuttgart. Sound reflected off the concrete wall located to the left of listeners has a powerful presence.			V/H balance	Vertical <input type="range" value="50"/> Horizontal
			Atmosphere	Simple <input type="range" value="25"/> Complex

Hall in Vienna	HiFi DSP		Size	Small <input type="range" value="75"/> Large
This is an approximately 1700-seated, middle-sized concert hall with a shoebox shape that is traditional in Vienna. Pillars and ornate carvings create extremely complex reflections from all around the audience, producing a very full, rich sound.			V/H balance	Vertical <input type="range" value="25"/> Horizontal
			Atmosphere	Simple <input type="range" value="75"/> Complex

Hall in Amsterdam	HiFi DSP		Size	Small <input type="range" value="75"/> Large
The large, shoe box shaped hall seats about 2200 around the circle stage. Reflections are rich and pleasing while the sound travels freely.			V/H balance	Vertical <input type="range" value="50"/> Horizontal
			Atmosphere	Simple <input type="range" value="25"/> Complex

CLASSICAL 2
2 CLASSICAL 2

Hall in USA A	HiFi DSP		Size	Small <input type="range" value="75"/> Large
This is a large 2600 seat concert hall in the United States which features a fairly traditional European design. The interior is relatively simple, in the American style. The middle and high frequencies are richly and beautifully reinforced.			V/H balance	Vertical <input type="range" value="75"/> Horizontal
			Atmosphere	Simple <input type="range" value="25"/> Complex

Hall in USA B	HiFi DSP		Size	Small <input type="range" value="75"/> Large
This spacious arch-shaped hall has a dome ceiling and can seat 2600. The ample resonance apparent in the sound is a feature brought about by longer than average period of reverberation. In addition to this, the reflector suspended above the stage allows listeners to experience rich sound from the direction of the stage.			V/H balance	Vertical <input type="range" value="50"/> Horizontal
			Atmosphere	Simple <input type="range" value="50"/> Complex

Chamber	HiFi DSP		Size	Small <input type="range" value="25"/> Large
This program creates a relatively wide space with a high ceiling like an audience hall in a palace. It offers pleasant reverberations that are suitable for courtly music and chamber music.			V/H balance	Vertical <input type="range" value="75"/> Horizontal
			Atmosphere	Simple <input type="range" value="25"/> Complex

Church in Tokyo	HiFi DSP		Size	Small <input type="range" value="50"/> Large
The acoustic environment of an ordinary church with moderate reverberations. The reverberation lasts 2.5 seconds. This is ideal for reproducing church organ and choral music.			V/H balance	Vertical <input type="range" value="10"/> Horizontal
			Atmosphere	Simple <input type="range" value="50"/> Complex

Church in Freiburg	HiFi DSP		Size	Small <input type="range" value="75"/> Large
Located in the south of Germany, this grand, stone-built church has a pointed tower at 120 meters in height. Its long and narrow shape and the high ceiling enable the elongated reverberation time and limited initial reflection time. Thus, the rich reverberation rather than the sound itself reproduces the atmosphere of the church.			V/H balance	Vertical <input type="range" value="50"/> Horizontal
			Atmosphere	Simple <input type="range" value="75"/> Complex

Church in Royaumont	HiFi DSP		Size	Small <input type="range" value="75"/> Large
This program features the sound field created by the refectory (dining hall) of a beautiful medieval Gothic monastery located in Royaumont on the outskirts of Paris.			V/H balance	Vertical <input type="range" value="25"/> Horizontal
			Atmosphere	Simple <input type="range" value="75"/> Complex

LIVE/CLUB
3 LIVE/CLUB

Village Gate	HiFi DSP		Size	Small <input type="range" value="50"/> Large
This is the sound field at a jazz club that was in New York. It is in a basement and has a relatively spacious floor area. The listener's virtual seat is at the center left of the hall.			V/H balance	Vertical <input type="range" value="50"/> Horizontal
			Atmosphere	Simple <input type="range" value="50"/> Complex

Village Vanguard	HiFi DSP		Size	Small <input type="range" value="25"/> Large
The Jazz club is on 7th Avenue, New York. This small club with the low ceiling makes the powerful reflections converge toward the stage located in the corner.			V/H balance	Vertical <input type="range" value="75"/> Horizontal
			Atmosphere	Simple <input type="range" value="25"/> Complex

The Bottom Line	HiFi DSP		Size	Small <input type="range" value="50"/> Large
This is the sound field at stage front in The Bottom Line, that was a famous New York jazz club once. The floor can seat 300 people to the left and right in a sound field offering real and vibrant sound.			V/H balance	Vertical <input type="range" value="50"/> Horizontal
			Atmosphere	Simple <input type="range" value="50"/> Complex

Cellar Club	HiFi DSP		Size	Small <input type="range" value="20"/> Large
This program simulates a live house with a low ceiling and homey atmosphere. A realistic, live sound field features powerful sound as if the listener is in a row in front of a small stage.			V/H balance	Vertical <input type="range" value="20"/> Horizontal
			Atmosphere	Simple <input type="range" value="50"/> Complex

The Roxy Theatre	HiFi DSP		Size	Small <input type="range" value="50"/> Large
This is the sound field of a rock music live house in Los Angeles, with approximately 460 seats. The listener's virtual seat is at the center left of the hall.			V/H balance	Vertical <input type="range" value="50"/> Horizontal
			Atmosphere	Simple <input type="range" value="50"/> Complex

Warehouse Loft	HiFi DSP		Size	Small <input type="range" value="30"/> Large
The warehouse resembles some lofts in Soho. Sound reflects off the concrete walls clearly with a lot of energy.			V/H balance	Vertical <input type="range" value="30"/> Horizontal
			Atmosphere	Simple <input type="range" value="80"/> Complex

Arena	HiFi DSP		Size	Small <input type="range" value="80"/> Large
This is the sound field of a large arena, with just the right sense of distance from the stage. A dynamic sound field reproduces the power of live performances.			V/H balance	Vertical <input type="range" value="80"/> Horizontal
			Atmosphere	Simple <input type="range" value="50"/> Complex

■ For various sources

 ENTERTAIN

Sports	CINEMA DSP		Size	Small <input type="range" value="50"/> Large
This program allows the listeners to enjoy stereo sport broadcasts and studio variety programs with enriched live feeling. In sports broadcasts, the voices of the commentator and sportscaster are positioned clearly on the center while the atmosphere of the stadium expands in an optimum space to offer the listeners with a feeling of presence in the stadium.			V/H balance	Vertical <input type="range" value="50"/> Horizontal
			F/R balance	Front <input type="range" value="50"/> Rear
			Atmosphere	Calm <input type="range" value="50"/> Powerful

■ For visual sources of music

 ENTERTAIN

Music Video	CINEMA DSP		Size	Small <input type="range" value="50"/> Large
This sound field offers an image of a concert hall for live performance of pop, rock and jazz music. The listener can indulge oneself in a hot live space thanks to the presence sound field that emphasizes the vividness of vocals and solo play and the beat of rhythm instruments, and to the surround sound field that reproduces the space of a big live hall.			V/H balance	Vertical <input type="range" value="50"/> Horizontal
			F/R balance	Front <input type="range" value="50"/> Rear
			Atmosphere	Calm <input type="range" value="50"/> Powerful

Recital/Opera	CINEMA DSP		Size	Small <input type="range" value="50"/> Large
This program controls the amount of reverberations at an optimum level and emphasizes the depth and clarity of human voices. "Recital/Opera" offers the reverberations of an orchestra box in front of the listener at the same time as providing the acoustic positioning and feeling of presence on the stage. The surround sound field is relatively moderate, but the data for concert hall effects are used to represent the inherent beauty of music. The listener will not be fatigued even after long hours of opera entertainment.			V/H balance	Vertical <input type="range" value="50"/> Horizontal
			F/R balance	Front <input type="range" value="50"/> Rear
			Atmosphere	Calm <input type="range" value="20"/> Powerful

Pavilion	CINEMA DSP		Size	Small <input type="range" value="80"/> Large
This program reproduces vocals clearly, letting you feel the spaciousness of a pavilion. Reverberation, which is somewhat delayed, reproduces the live acoustics unique to a pavilion, and helps to make concert scenes more exciting.			V/H balance	Vertical <input type="range" value="80"/> Horizontal
			F/R balance	Front <input type="range" value="50"/> Rear
			Atmosphere	Calm <input type="range" value="80"/> Powerful

■ For parties

ENTERTAIN
4 ENTERTAIN

Disco	HiFi DSP		Size	Small <input type="checkbox"/> <input type="checkbox"/> <input type="checkbox"/> <input type="checkbox"/> <input type="checkbox"/> Large
This program recreates the acoustic environment of a lively disco in the heart of a big city. The sound is dense and highly concentrated. It is also characterized by high-energy, "immediate" sound.			V/H balance	Vertical <input type="checkbox"/> <input type="checkbox"/> <input type="checkbox"/> <input type="checkbox"/> <input type="checkbox"/> Horizontal
			Atmosphere	Simple <input type="checkbox"/> <input type="checkbox"/> <input type="checkbox"/> <input type="checkbox"/> <input checked="" type="checkbox"/> Complex

■ For game programs

ENTERTAIN
4 ENTERTAIN

Action Game	CINEMA DSP		Size	Small <input type="checkbox"/> <input type="checkbox"/> <input type="checkbox"/> <input type="checkbox"/> <input type="checkbox"/> Large
This sound field is suitable for action games such as car racing and FPS games. It uses the reflection data that limits the effects range per channel in order to offer a powerful playing environment with a being-there feeling by enhancing various effects tones while maintaining a clear sense of directions.			V/H balance	Vertical <input type="checkbox"/> <input type="checkbox"/> <input type="checkbox"/> <input type="checkbox"/> <input type="checkbox"/> Horizontal
			F/R balance	Front <input type="checkbox"/> <input type="checkbox"/> <input type="checkbox"/> <input type="checkbox"/> <input type="checkbox"/> Rear
			Atmosphere	Calm <input type="checkbox"/> <input type="checkbox"/> <input type="checkbox"/> <input type="checkbox"/> <input type="checkbox"/> Powerful

Roleplaying Game	CINEMA DSP		Size	Small <input type="checkbox"/> <input type="checkbox"/> <input type="checkbox"/> <input type="checkbox"/> <input type="checkbox"/> Large
This sound field is suitable for role-playing and adventure games. It combines the sound field effects for movies and the sound field design used with "Action Game" to represent the depth and spatial feeling of the field during play, while offering movie-like surround effects in the movie scenes in the game.			V/H balance	Vertical <input type="checkbox"/> <input type="checkbox"/> <input type="checkbox"/> <input type="checkbox"/> <input type="checkbox"/> Horizontal
			F/R balance	Front <input type="checkbox"/> <input type="checkbox"/> <input type="checkbox"/> <input type="checkbox"/> <input type="checkbox"/> Rear
			Atmosphere	Calm <input type="checkbox"/> <input type="checkbox"/> <input type="checkbox"/> <input type="checkbox"/> <input type="checkbox"/> Powerful

■ For movie sources





You can select the desired decoder used with following sound field program (except "Mono Movie"). See page 72 for details.

MOVIE
5 MOVIE





Standard	CINEMA DSP		Size	Small <input type="checkbox"/> <input type="checkbox"/> <input type="checkbox"/> <input type="checkbox"/> <input type="checkbox"/> Large
This program create a sound field emphasizing the surrounding feeling without disturbing the original acoustic positioning of multi-channel audio such as Dolby Digital and DTS. It has been designed with the concept of "an ideal movie theater", in which the audience is surrounded by beautiful reverberations from the left, right and rear.			V/H balance	Vertical <input type="checkbox"/> <input type="checkbox"/> <input type="checkbox"/> <input type="checkbox"/> <input type="checkbox"/> Horizontal
			F/R balance	Front <input type="checkbox"/> <input type="checkbox"/> <input type="checkbox"/> <input type="checkbox"/> <input checked="" type="checkbox"/> Rear
			Atmosphere	Calm <input type="checkbox"/> <input type="checkbox"/> <input type="checkbox"/> <input type="checkbox"/> <input type="checkbox"/> Powerful

Spectacle	CINEMA DSP		Size	Small <input type="checkbox"/> <input type="checkbox"/> <input type="checkbox"/> <input type="checkbox"/> <input type="checkbox"/> Large
This program represents the spectacular feeling of large-scale movie productions. It reproduces a broad theater sound field matching the cinemascope and wider-screen movies with an excellent dynamic range from very small to extremely large sound.			V/H balance	Vertical <input type="checkbox"/> <input type="checkbox"/> <input type="checkbox"/> <input type="checkbox"/> <input type="checkbox"/> Horizontal
			F/R balance	Front <input type="checkbox"/> <input type="checkbox"/> <input type="checkbox"/> <input type="checkbox"/> <input type="checkbox"/> Rear
			Atmosphere	Calm <input type="checkbox"/> <input type="checkbox"/> <input type="checkbox"/> <input type="checkbox"/> <input type="checkbox"/> Powerful

Sci-Fi	CINEMA DSP		Size	Small <input type="checkbox"/> <input type="checkbox"/> <input type="checkbox"/> <input type="checkbox"/> <input type="checkbox"/> Large
This program clearly reproduces the finely elaborated sound design of the latest science fiction and special effects-featuring movies. You can enjoy a variety of cinematographically created virtual spaces reproduced with clear separation between dialog, sound effects and background music.			V/H balance	Vertical <input type="checkbox"/> <input type="checkbox"/> <input type="checkbox"/> <input type="checkbox"/> <input type="checkbox"/> Horizontal
			F/R balance	Front <input type="checkbox"/> <input type="checkbox"/> <input type="checkbox"/> <input type="checkbox"/> <input type="checkbox"/> Rear
			Atmosphere	Calm <input type="checkbox"/> <input type="checkbox"/> <input type="checkbox"/> <input type="checkbox"/> <input type="checkbox"/> Powerful

Adventure	CINEMA DSP		Size	Small <input type="checkbox"/> <input type="checkbox"/> <input type="checkbox"/> <input type="checkbox"/> <input type="checkbox"/> Large
This program is ideal for precisely reproducing the sound design of action and adventure movies. The sound field restrains reverberations but puts emphasis on reproducing a powerful space expanded widely to the left and right. The reproduced depth is also restrained relatively to ensure the separation between audio channels and the clarity of the sound.			V/H balance	Vertical <input type="checkbox"/> <input type="checkbox"/> <input type="checkbox"/> <input type="checkbox"/> <input type="checkbox"/> Horizontal
			F/R balance	Front <input type="checkbox"/> <input type="checkbox"/> <input type="checkbox"/> <input type="checkbox"/> <input type="checkbox"/> Rear
			Atmosphere	Calm <input type="checkbox"/> <input type="checkbox"/> <input type="checkbox"/> <input type="checkbox"/> <input type="checkbox"/> Powerful

Drama	CINEMA DSP		Size	Small <input type="checkbox"/> <input type="checkbox"/> <input type="checkbox"/> <input type="checkbox"/> <input type="checkbox"/> Large
This sound field features stable reverberations that match a wide range of movie genres from serious dramas to musicals and comedies. The reverberations are modest but offer an optimum spatial feeling, reproducing effects tones and background music softly but cubically around clear words and center positioning in a way that does not fatigue the listener even after long hours of viewing.			V/H balance	Vertical <input type="checkbox"/> <input type="checkbox"/> <input type="checkbox"/> <input type="checkbox"/> <input type="checkbox"/> Horizontal
			F/R balance	Front <input type="checkbox"/> <input type="checkbox"/> <input type="checkbox"/> <input type="checkbox"/> <input type="checkbox"/> Rear
			Atmosphere	Calm <input type="checkbox"/> <input type="checkbox"/> <input type="checkbox"/> <input type="checkbox"/> <input type="checkbox"/> Powerful

Mono Movie CINEMA DSP 	Size Small  Large
	V/H balance Vertical  Horizontal
This program is provided for reproducing monaural video sources such as a classic movie in an atmosphere of a good old movie theater. The program produces the optimum expansion and reverberation to the original audio to create a comfortable space with a certain sound depth.	F/R balance Front  Rear
	Atmosphere Calm  Powerful

■ Stereo playback

STEREO
6 **STEREO**

2ch Stereo
Use this program to mix down multi-channel sources to 2 channels.

11ch Stereo HiFi DSP
Use this program to output sound from all speakers. When you play back multi-channel sources, this unit downmixes the source to 2 channels, and then output the sound from all speakers. This program creates a larger sound field and is ideal for background music at parties, etc.

■ For compression artifacts
(Compressed Music Enhancer mode)

ENHANCER
7 **ENHANCER**

Straight Enhancer
Use this program to improve the sound enhancer nearest to the original depth and width of the 2-channel or multi-channel compression artifacts.

11ch Enhancer
Use this program to play back compression artifacts in 11-channel stereo.

■ Surround decoder mode

SUR_DECODE
8 **SUR. DECODE**

Surround Decode
Use this program to play back sources with using the desired surround decoders.

■ THX Surround mode

THX
9 **THX**

Use this feature to play back sources with the accurate surround processing programs compliant with the THX specifications. See page 72 for details.

■ Using sound field programs without surround speakers (Virtual CINEMA DSP)

Virtual CINEMA DSP allows you to enjoy the CINEMA DSP or HiFi DSP sound field programs without surround speakers. It creates virtual speakers to reproduce the natural sound field. When you set “Surround” to “None” (see page 84), Virtual CINEMA DSP activates automatically whenever you select a CINEMA DSP or HiFi DSP sound field program (see page 54).

Note

Virtual CINEMA DSP will not activate even when “Surround” is set to “None” (see page 84) and you select a CINEMA DSP or HiFi DSP sound field program in the following cases:

- when the component connected to the MULTI CH INPUT jacks is selected as the input source (see page 50).
- when headphones are connected to the PHONES jack.
- when this unit is in the “11ch Stereo” mode.

■ Enjoying multi-channel sources and sound field programs with headphones (SILENT CINEMA)

SILENT CINEMA allows you to enjoy multi-channel music or movie sound through ordinary headphones. SILENT CINEMA activates automatically whenever you connect headphones to the PHONES jack while listening to CINEMA DSP or HiFi DSP sound field programs (see page 54). When activated, the SILENT CINEMA indicator lights up in the front panel display.

Notes

- SILENT CINEMA does not activate when the component connected to the MULTI CH INPUT jacks is selected as the input source (see page 50).
- SILENT CINEMA is not effective when the Pure Direct (see page 61) or “2ch Stereo” mode (see page 59) is selected, or when this unit is in the “STRAIGHT” mode.

Before performing the following operation, set the operation mode selector on the remote control to **AMP**.

Using CINEMA DSP HD³ mode

CINEMA DSP HD³ mode creates the intensive and accurate stereoscopic sound field in the listening room. You can activate and deactivate the CINEMA DSP HD³ mode.

Press **3D DSP repeatedly to turn on and off the CINEMA DSP HD³ mode.**

- “HD CUBIC:ON” appears in the front panel display and the HD³ indicator (see page 40) and HD³ sound field indicators light up while this unit is in the CINEMA DSP HD³ mode. CINEMA DSP HD³ mode creates the intensive and stereoscopic sound field in the listening room.
- “HD CUBIC:OFF” appears in the front panel display and the HD³ indicator disappears when the CINEMA DSP HD³ mode is turned off. Conventional CINEMA DSP mode creates the large and expanding sound field in the listening room.

Notes

- “HD CUBIC:—” appears when the CINEMA DSP HD³ mode is not available.
- If you set “Front Presence” to “None”, this unit cannot activate the CINEMA DSP HD³ mode.
- This unit activates the CINEMA DSP HD³ mode only when you select one of the CINEMA DSP or HiFi DSP sound field programs (except the “11ch Stereo” mode).
- When your headphones are connected to this unit, this unit cannot activate the CINEMA DSP HD³ mode.

Enjoying unprocessed input sources

When this unit is in the “STRAIGHT” mode, 2-channel stereo sources are output from only the front left and right speakers and multi-channel sources are decoded straight into the appropriate channels without any additional effect processing.



You can also select the “STRAIGHT” mode by using GUI menu. See page 78 for details.

Press **STRAIGHT (or **STRAIGHT**) to select “STRAIGHT”.**

STRAIGHT



- The names of the audio signal format of the input source and the active decoder appear in the front panel display.
- You can select the extended surround mode used with the “STRAIGHT” mode by pressing **EXTD SUR**. (see page 72).

■ Deactivating the “STRAIGHT” mode

Press **STRAIGHT (or **STRAIGHT**) so that “STRAIGHT” disappears from the front panel display.**

The sound effect is turned back on.



You can also select desired sound field program by rotating **PROGRAM** (or press one of the desired sound field program buttons (**SP**)) repeatedly.

Using audio features

Before performing the following operation, set the operation mode selector on the remote control to **AMP**.

Enjoying pure hi-fi sound

Use the Pure Direct mode to enjoy the pure fidelity sound of the selected source. When the Pure Direct mode is activated, this unit plays back the selected source with the least circuitry.

Press **PURE DIRECT** (or **PURE DIRECT**) to turn on or off the Pure Direct mode.

The **PURE DIRECT** button on the front panel lights up and the front panel display automatically turns off while this unit is in the Pure Direct mode.

Notes

- When you set Audio input jack selects to “Auto”, “HDMI”, or “Coax/Opt” (see page 52) and play back the bitstreams or multi-channel PCM sources, this unit activates the corresponding decoder.
- The following operations are not possible when this unit is in the Pure Direct mode:
 - switching the sound field program
 - displaying the GUI menu
 - operating video functions (video conversion, etc.)
- The Pure Direct mode is automatically canceled whenever this unit is turned off.
- When you set “Pure Direct” in “Manual Setup” to “Video On”, you can display the video images of the current input source (see page 89). You cannot use the GUI menu while this unit is in the Pure Direct mode even if “Pure Direct” in “Manual Setup” to “Video On”.
- While this unit is in the Pure Direct mode, you cannot activate Zone 2, Zone 3, and Zone 4, and when this unit is in the Pure Direct mode, Zone 2, Zone 3, and Zone 4 are automatically tuned off.



The front panel display turns on momentarily when an operation is performed.

Adjusting the tonal quality

Use this feature to adjust the balance of bass and treble for the front L/R and center speaker channels and the subwoofer channel.

- 1 Press **TONE CONTROL** on the front panel.
- 2 Press **PROGRAM** repeatedly to select the high-frequency response (TREBLE), or the low-frequency response (BASS).
- 3 Rotate **PROGRAM** to adjust the high-frequency response (TREBLE), or the low-frequency response (BASS).

Control range: -6.0 dB to +6.0 dB

Notes

- If you increase or decrease the high-frequency or the low-frequency sound to an extreme level, the tonal quality of the surround speakers may not match that of the front L/R and center speakers and the subwoofer.
- TONE CONTROL is not effective when PURE DIRECT or the THX Surround mode is selected, or when MULTI CH is selected as the input source.



Use “Tone Control” parameter in “Sound” menu to adjust the balance of bass and treble output to your speakers or headphones by using GUI menu. See page 88 for details.

Adjusting the speaker level

You can adjust the output level of each speaker while listening to a music source. This is also possible when playing sources input at the MULTI CH INPUT jacks.

Note

This operation will override the level adjustments made in “Auto Setup” (see page 42) and “Speaker Level” (see page 86).

- 1 Press **LEVEL** on the remote control repeatedly to select the speaker you want to adjust.

Display	Adjusted speaker
FRONT L	Front left speaker
FRONT R	Front right speaker
CENTER	Center speaker
SUR. L	Surround left speaker
SUR. R	Surround right speaker
SB L	Surround back left speaker
SB R	Surround back right speaker
SWFR L	Subwoofer left
SWFR R	Subwoofer right
FP L	Front presence left speaker
FP R	Front presence right speaker
RP L	Rear presence left speaker
RP R	Rear presence right speaker



Once you press **LEVEL** on the remote control, you can also select the speaker by pressing **△ / ▽**.

- 2 Press **◀ / ▶** to adjust the speaker output level.
 - Press **▶** to increase the value.
 - Press **◀** to decrease the value.
 Control range: -10.0 dB to +10.0 dB

Recording

Recording adjustments and other operations are performed from the recording components. Refer to the operating instructions for those components.

Caution

The DTS signal is a digital bitstream. Attempting to digitally record the DTS bitstream will result in noise being recorded. Therefore, if you want to use this unit to record sources encoded in DTS, the following considerations and adjustments need to be made. To play DTS-encoded DVDs and CDs (when using a digital audio connection) on your DTS-compatible player, follow its operating instructions to make a setting so that the analog signal will be output from the player.

Notes

- When this unit is set to the standby mode, you cannot record between other components connected to this unit.
- TONE CONTROL (see page 61) and the volume settings, the speaker level (see page 86) and the sound field programs (see page 54) do not affect recorded material.
- When this unit is in the Pure Direct mode, no signals output at the AUDIO OUT jacks.
- The source connected to the MULTI CH INPUT jacks on this unit cannot be recorded.
- The Internet Radio, PC or MCX audio signals are only output at the analog AUDIO OUT jacks.
- Digital signals input at the DIGITAL INPUT jacks are not output at the analog AUDIO OUT jacks for recording. Likewise, analog signals input at the AUDIO IN jacks are not output at the DIGITAL OUTPUT jack. Therefore, if your source component is connected to provide only digital or analog signals, you can only record digital or analog signals.
- A given input source is not output on the same AUDIO OUT channel.
- S-video and composite video signals pass independently through the video circuits of this unit. Therefore, when recording or dubbing video signals input from a video source component that provides only an S-video or a composite video signal, you can record only an S-video or a composite video signal on your VCR.
- The analog audio and video signals input at the DOCK terminal can be output at the analog AUDIO OUT jacks and DVR or VCR OUT jacks for recording.
- Check the copyright laws in your country to record from CDs, radio, etc. Recording of copyrighted material may infringe copyright laws.



Do a test recording before you start an actual recording.

If you play back a video source that uses scrambled or encoded signals to prevent it from being dubbed, the picture itself may be disturbed due to those signals.

1 Turn on all the connected components.

2 Press **REC OUT/ZONE2** until the **RECOU** indicator lights up in the front panel display.

This unit in the recording source selecting mode.



3 Rotate **PROGRAM** to select the source component you want to record from.

Carry out the operation while the RECOU indicator is lit.



Select "SOURCE" to record the currently selected input source.

4 Start playback on the selected source component or select a broadcast station.

5 Start recording on the recording component.

Internal Source Operation

Using iPod™	64
Controlling iPod™	64
Using Network/USB features	66
Navigating the network and USB menus	66
Using a PC server or Yamaha MCX-2000	68
Using the Internet Radio	69
Using a USB storage device or a USB portable audio player	69
Using shortcut buttons	70

Using iPod™

Once you have stationed your iPod in a Yamaha iPod universal dock (such as the YDS-10, sold separately) connected to the DOCK terminal on this unit (see page 36), you can enjoy playback of your iPod using the supplied remote control. You can also use the Compressed Music Enhancer mode of this unit to enhance the sound quality of the compression artifacts (such as the MP3 format) stored on your iPod (see page 59).

Notes

- Only iPod (Click and Wheel), iPod nano, and iPod mini are supported.
- Some features may not be compatible depending on the model or the software version of your iPod.



- For a complete list of status messages that appear in the front panel display and video monitor, see the “iPod” section in “Troubleshooting” on page 126.
- Once your iPod is stationed in a Yamaha iPod universal dock (such as the YDS-10, sold separately) connected to the DOCK terminal on this unit, this unit begins signal transmission with your iPod.
- Once the connection between your iPod and this unit is complete, “iPod connected” appears in the front panel display.
- Your iPod battery is automatically charged when your iPod is stationed in a Yamaha iPod universal dock (such as the YDS-10, sold separately) connected to the DOCK terminal on this unit as long as this unit is turned on. You can also select whether this unit charges the battery of the stationed iPod or not when this unit is in the standby mode by selecting the “Standby Charge” parameter in “iPod” (see page 93).
- While the stationed iPod is being charged in the standby mode of this unit, the battery charge indicator (see page 40) appears in the front panel display. Once the charge is complete (or after 4 hours from the start of the charge), the indicator disappears.

Controlling iPod™

You can control your iPod when “DOCK” is selected as the input source. The operations of your iPod can be done with the aid of the GUI screen of this unit (menu browse mode) or without it (simple remote mode).

■ Remote control operation

Before performing the following operations, set the operation mode selector on the remote control to **⑮SOURCE** and then press **③DOCK**.

Button	Function
③ ENTER	Subsequent menu
△	Menu up
▽	Menu down
◀	Previous menu
▶	Subsequent menu
⑩ ◀◀	Search backward (Press and hold)
▶▶	Search forward (Press and hold)
▶▶▶	Skip forward
◀◀◀	Skip backward
□	Stop
⏸	Pause (Menu browse mode) Play/Pause (Simple remote mode)
▶	Play (Menu browse mode) Play/Pause (Simple remote mode)
⑮ MENU	Previous menu
⑳ DISPLAY	Display

■ Controlling iPod in the simple remote mode

You can perform the basic operations of your iPod (play, stop, skip, etc.) using the supplied remote control without the aid of the video monitor.



- You can view the photos or video clips stored on your iPod (some models only).
- Operations can be also done with the controls on your iPod.

■ Controlling iPod in the menu browse mode

You can perform the advanced operations of your iPod using the supplied remote control with the aid of the video monitor. The name of the song being played appears in the front panel display according to the “Scroll” parameter in “Front Panel Disp.” (see page 93). You can also browse the songs stored on your iPod in the by using your video monitor. Further, you can change or adjust settings for your iPod to suit your personal preferences.

Notes

- Operations cannot be done with the controls on your iPod.
- There are some characters that cannot be displayed in the front panel display or in the GUI screen of this unit. Those characters are replaced with underscores “_”.
- You cannot browse the photos or video clips stored on your iPod in the GUI screen. Use the simple remote mode to enjoy watching the photos or video clips stored on your iPod.
- You can set the time for which the GUI screen of iPod is displayed in the video monitor by using the “On Screen” parameter in “Manual Setup” (see page 90).

Before performing the following operations, set the operation mode selector on the remote control to **⑮SOURCE** and then press **③DOCK**.

1 Press **⑳DISPLAY** on the remote control.

The following display appears in the video monitor.

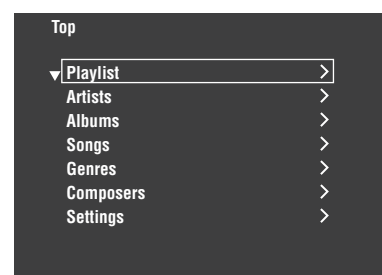

2 Press **Ⓢ** / **⓪** / **Ⓛ** / **Ⓜ** / **Ⓡ** to navigate the iPod menu and then press **Ⓢ** **ENTER** to begin playback of the selected song.

Choices: Playlist (playlists), Artists (artists), Albums (albums), Songs (songs), Genres (genres), Composers (composers), Settings (settings)

- Playlist > Songs
- Artists > Albums > Songs
- Albums > Songs
- Songs
- Genres > Artists > Albums > Songs
- Composers > Albums > Songs
- Settings > Shuffle, Repeat

Shuffle (Shuffle)

Use this feature to set this unit to play songs or albums in random order.

Choices: Off, Songs, Albums

- Select “Off” to deactivate this feature.
- Select “Songs” to set this unit to play songs in random order.
- Select “Albums” to set this unit to play albums in random order.

Notes

- When “Shuffle” is set to a setting other than “Off”, “” appears in the top right corner while songs or albums are being shuffled.
- Press **Ⓢ** **ENTER** repeatedly to toggle between the settings of “Shuffle”.



Repeat (Repeat)

Use this feature to set this unit to repeat one song or a sequence of songs.

Choices: Off, One, All

- Select “Off” to deactivate this feature.
- Select “One” to set this unit to repeat one song.
- Select “All” to set this unit to repeat a sequence of songs.

Notes

- When “Repeat” is set to a setting other than “Off”, “” or “” appears in the top right corner while one song or a sequence of songs are being repeated.
- Press **Ⓢ** **ENTER** repeatedly to toggle between the settings of “Repeat”.







Press **Ⓢ** **DISPLAY** again to turn off the iPod menu.

iPod menu in the Zone OSD

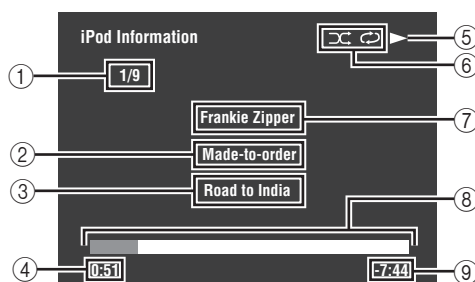
You can control your iPod by using the Zone OSD. The design and functions may be different from the iPod menu displayed in the video monitor in the main zone.

■ The functions of the play information display



- ① Track number/total tracks
- ② Name of the album
- ③ Name of the song
- ④ Elapsed time
- ⑤  (playback),  (pausing),  (search forward) or  (search backward)
- ⑥ Shuffle and repeat icons
- ⑦ Name of the artist
- ⑧ Progress bar
- ⑨ Remaining time

Using Network/USB features

This unit is equipped with network and USB features that allow you to enjoy WAV (PCM format only), MP3, MPEG-4 AAC, and WMA files saved on your PC, Yamaha MCX-2000, USB storage device and USB portable audio player or access the Internet Radio.

Notes

- Yamaha MCX-2000 may not be for sale in some locations.
- For further details about networking, refer to the operation manuals supplied with your network devices. Also refer to technical reference books, if needed.
- Some WAV, MP3, MPEG-4 AAC, and WMA files may not be playable or may be noisy when played.



For a complete list of status messages that appear in the front panel display and video monitor, see the “Network and USB” section in “Troubleshooting” on page 124.

Navigating the network and USB menus

The following diagram shows the construction of the network and USB menu.

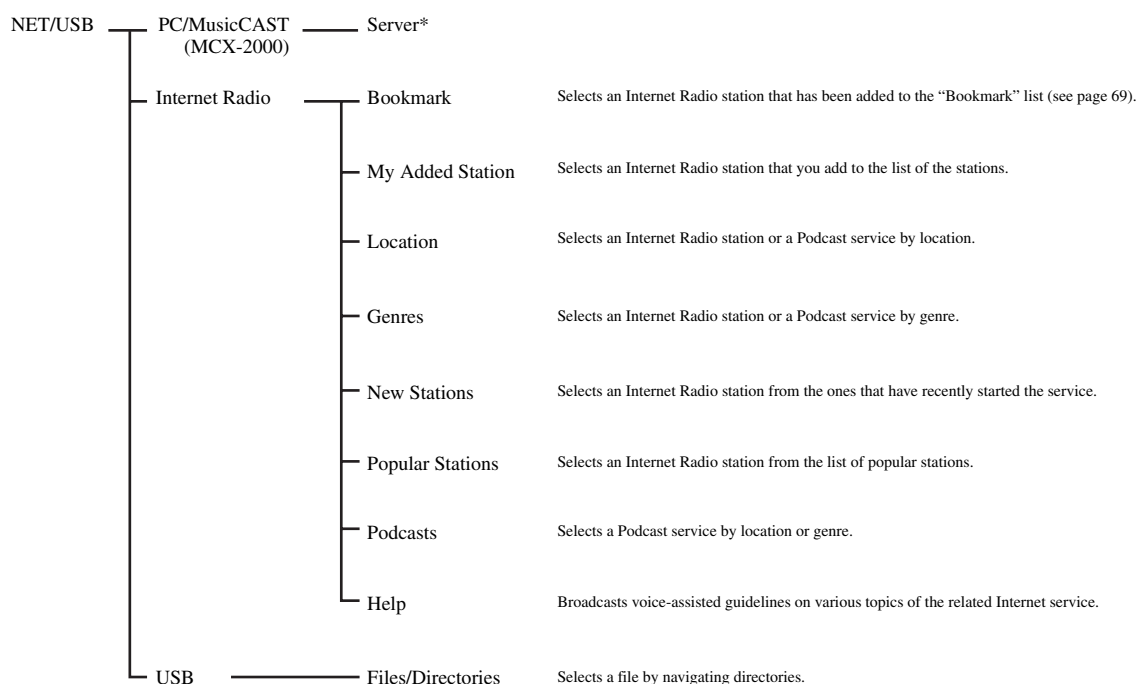

Note

* Only the available PC servers and MCX-2000 are displayed.



You can also browse and select the desired contents by using your PC. See page 101 for details.

The following procedure shows the basic steps to navigate the network and USB menus. See pages 68 to 70 for details about each sub input source.

Before performing the following operations, set the operation mode selector on the remote control to **ⓂSOURCE**.

1 Press **ⓂNET/USB** on the remote control to select “NET/USB” as the input source.

The cursor on the left of the NET/USB indicator lights up in the front panel display, and the contents previously played for the corresponding sub input source of NET/USB is automatically played.

Lights up

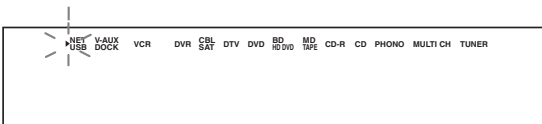

2 Press **ⓂDISPLAY** to display the top NET/USB menu.

The following display appears in the video monitor. If any other screen appears in the video monitor, press **ⓂMENU** on the remote control repeatedly until the top NET/USB menu appears.

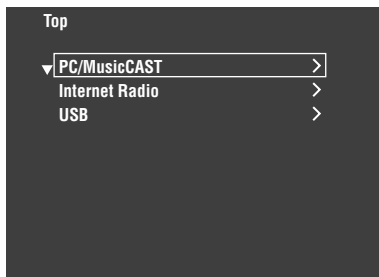

3 Press **ⓂΔ / ▽** to select the desired sub input source and then press **Ⓜ▷** or **ⓂENTER**.



You can also select the desired sub input source by pressing **ⓂPC/MCX**, **ⓂNET RADIO**, or **ⓂUSB** when “NET/USB” is selected as the input source. This unit automatically starts playback of the last selected music file, Internet Radio station, or Podcast when you press **ⓂPC/MCX**, **ⓂNET RADIO**, or **ⓂUSB**.

4 Press **ⓂΔ / ▽ / < / >** to select the desired song or Internet Radio station.

- Press **ⓂΔ / ▽** to select the desired menu.
- Press **Ⓜ▷** to enter the selected menu.
- Press **Ⓜ<** to return to the previous menu level.



- “>” in the right corner of each menu line indicates that there is a submenu available in the next menu level.
- You can also press **ⓂENTER** or **ⓂMENU** to enter the selected menu or to return to the previous menu level.

5 Press **ⓂENTER** to play the selected song or to listen to the selected station.



- See page 65 for details about the functions of the play information display.
- Some items do not appear in the play information display depending on the selected sub input source.
- You can set the time for which the GUI screen of the network/USB is displayed in the video monitor by using “On Screen” in “Manual Setup” (see page 90).
- Press **ⓂDISPLAY** again to turn off the Network/USB menu.

Remote control operation

Before performing the following operations, set the operation mode selector on the remote control to **ⓂSOURCE** and then press **ⓂNET/USB**.

Button	Function
ⓂTITLE	Bookmark *1
ⓂΔ	Up
Ⓜ▽	Down
Ⓜ<	Previous menu
Ⓜ▷	Subsequent menu
ⓂENTER	Subsequent menu
ⓂMEMORY	Memory
ⓂNET RADIO	Select “NET RADIO”
ⓂUSB	Select “USB”
Ⓜ⏮	Skip backward (“PC/MCX” and “USB” only)
Ⓜ⏭	Skip forward (“PC/MCX” and “USB” only)
ⓂPC/MCX	Select “PC/MCX”
Ⓜ□	Stop
Ⓜ▷	Play
Ⓜ1 – 8	Numeric buttons (1-8) *2
ⓂMENU	Previous menu
ⓂDISPLAY	Display

*1 Press and hold to store your favorite Internet Radio stations with bookmarks (see page 69).

*2 Press to assign or recall the preset items (see page 70).

Network/USB menu in the Zone OSD

You can use the network/USB feature with the Zone OSD. The design and functions may be different from the network/USB menu displayed in the video monitor in the main zone.

Using a PC server or Yamaha MCX-2000

Use this feature to enjoy music files saved on your PC or Yamaha MCX-2000. MCX-2000 is a music server that enhances the concept of Yamaha exclusive MusicCAST, a digital music delivery method over a personal network.

1 Install Windows Media Player 11 on your PC, or register this unit on your Yamaha MCX-2000.

- Refer to “Installing Windows Media Player 11 on your PC” and “Registering this unit on the Yamaha MCX-2000” on page 68.
- This procedure is needed only the first time.
- (PC only) You may need to make some setting of Windows Media Player 11 to start the contents sharing. Refer to the attached documents of Windows Media Player 11.

2 Turn on your PC or MCX-2000.

The PC server or MCX-2000 is added to the server list on the submenu of PC/MusicCAST.

3 Select a desired server or MusicCAST to begin playback.

Notes

- Yamaha MCX-2000 may not be for sale in some locations.
- You can connect this unit to up to 15 PC servers and 1 MCX-2000, and each server must be connected to the same subnet as this unit.
- Some WAV, MP3, MPEG-4 AAC, and WMA files on your PC may not be playable or may be noisy when played.
- (MCX-2000 only) Files marked with an asterisk (*) have not been converted to MP3 format. You cannot play back such files immediately unless you set the “Receive PCM Stream” setting of this unit to “ON” on MCX-2000. For details, refer to the instruction manual of MCX-2000.



- While a song is being played, the time elapsed is displayed at the bottom of the playback information screen.
- You can use / to skip backward/forward and / to start/stop playback independently from the menu in the video monitor.
- You can set the settings for repeat and shuffle mode by using the “Play Style” parameters in “NET/USB” (see page 83).
- You can set the front panel display mode by using the “Scroll” parameter in “Front Panel Disp.” (see page 93).

■ Installing Windows Media Player 11 on your PC

With Windows Media Player 11, you can play back the audio files on your PC. For details refer to the documents of Windows Media Player 11.



You can also play back the audio files on your PC with Windows Media Connect 2.0 installed.

1 Install Windows Media Player 11 on your PC.

You can download the installer of Windows Media Player 11 from the Microsoft website, or use the upgrade function of the installed Microsoft Windows Media Player.

2 Turn on your PC and then share a folder on the PC.

The Shared folder is added to the server list on the submenu of PC/MusicCAST.

Notes

- If the operating system (OS) of your PC is Windows Vista, Windows Media Player 11 is pre-installed (except some products).
- Some security software installed on your PC (anti-virus software, firewall software, etc.) may block the access of this unit to your PC. In such cases, configure the security software appropriately.

■ Registering this unit on the Yamaha MCX-2000

You must register this unit on your Yamaha MCX-2000 so that this unit can be recognized by your Yamaha MCX-2000. For details, refer to the operation manual supplied with your Yamaha MCX-2000.

1 Turn off this unit.

2 Set your Yamaha MCX-2000 to the “Auto Config” mode.

3 Turn on this unit.

- MCX-2000 is added to the server list on the submenu of PC/MCX.
- The client ID of this unit appears in the OSD of your Yamaha MCX-2000 (shown as CL-XXXXX), and this completes the automatic configuration procedure.

Notes

- The latter part of the client ID of this unit is same as the last 5 digits of the MAC address of this unit. For details about MAC address, see page 93.
- To clear the registered client ID of this unit, use the “Manual Config” mode of your Yamaha MCX-2000 (refer to the instruction manual of MCX-2000) and then set “INITIALIZE” in the advanced setup menu of this unit to “NETWORK” (see page 119).
- The client control functions of MusicCAST over this unit other than “View Play Info”, “Receive PCM Stream” and “Edit Client title” are not available. Avoid using these functions as it will stop the playback on this unit.

Using the Internet Radio

Use this feature to listen to Internet Radio stations. This unit uses the vTuner Internet Radio station database service particularly customized for this unit, providing over 2000 radio station database. Further, you can store your favorite stations with bookmarks.

Notes

- This service may be discontinued without notice.
- Some Internet Radio stations may not be played even if they are selected in the NET RADIO menu.
- To listen to the Internet Radio, connect this unit to your network (see page 37).
- A narrowband Internet connection (i.e. 56K modem, ISDN) will not provide satisfactory results, and a broadband connection is strongly recommended (i.e. a cable modem, an xDSL modem, etc.). For detailed information, consult with your ISP.



- You can use **⏮** / **⏹** to start/stop playback independently from the menu in the video monitor.
- “Podcast” is a type of the Internet Radio service, and there are a number of Podcast services available on the Internet. The Podcast is not a continuous service. That is, this unit stops playback when an episode of the Podcast ends.
- Some security devices (such as firewall) may block the access of this unit to Internet Radio stations. In such cases, configure the security settings appropriately.

■ Storing your favorite Internet Radio stations with bookmarks

Use this feature to select your favorite Internet Radio stations quickly.

Press and hold **Ⓢ TITLE on the remote control while the selected Internet Radio station service is being broadcast.**

The stored Internet Radio station is added to the “Bookmark” list (see page 66).



- To remove the stored station from the list, select the item in the first level of the “Bookmark” list and then press and hold **Ⓢ** TITLE on the remote control.
- You can also register your favorite Internet Radio stations to this unit by accessing the following website with the web browser on your PC. To use this feature, you need the MAC address of this unit as the ID number and your e-mail address to create your personal account. Use “Information” in the “Network” menu to display the MAC address of this unit (see page 92). For details, refer to the help information on the website.
URL: <http://radio.vtuner.com/>

Using a USB storage device or a USB portable audio player

Use this feature to enjoy WAV (PCM format only), MP3, WMA and MPEG-4 AAC files saved on your USB storage device or USB portable audio player connected to the USB port on the front panel of this unit.

This unit is equipped with the front and rear USB ports. Set “USB Select” in “Input Select” to “Front” or “Rear” to select the active USB port (see page 83).

Notes

- This unit supports USB mass storage class or USB MTP devices using FAT 16 or FAT 32.
- Only the first partition is displayed in the GUI menu. You cannot select files in other partitions.
- Up to 8 levels of directory hierarchy and 500 music files per directory are recognized.
- Some devices may not work properly even if they meet the requirements.
- Some WAV, MP3, WMA and MPEG-4 AAC files may not be playable or may be noisy when played.
- When you connect your USB storage device or USB portable audio player, there may be an about 10 seconds delay.



- While a song is being played, the time elapsed is displayed at the bottom of the playback information screen.
- You can use **⏮** / **⏭** to skip backward/forward and **⏮** / **⏹** to start/stop playback independently from the menu in the video monitor.
- You can set the settings for repeat and shuffle mode by using the “Play Style” parameters in “NET/USB” (see page 83).
- You can set the front panel display mode by using the “Scroll” parameter in “Front Panel Disp.” (see page 93).

Using shortcut buttons

Use this feature to access the desired music sources (WAV, MP3 and WMA files on the connected PC, MCX-2000 or USB storage devices and Internet Radio stations) directly. You can preset 8 items in each sub input sources.

■ Assigning the items to the numeric button (1-8)

Before performing the following operations, set the operation mode selector on the remote control to **ⓂSOURCE**.

1 Press **ⓂNET/USB** to select “NET/USB” as the input source.

2 Select a desired music source you want to assign to the numeric button (1-8) (Ⓜ), and then play back the source.

See page 67 for details.

3 Press **ⓂMEMORY**.

This unit in the memory preset mode. The MEMORY indicator flashes and following message appears in the video monitor and front panel display.

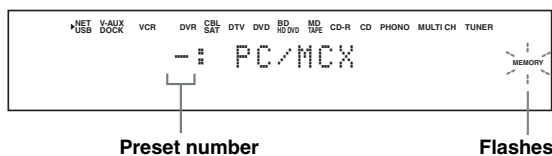

When you do not complete each of the following steps within 10 seconds, the memory preset mode is automatically canceled. In this case, start over from step 3.

4 Press desired numeric buttons (1-8) (Ⓜ).

The number of the selected numeric button appears in the video monitor or front panel display.

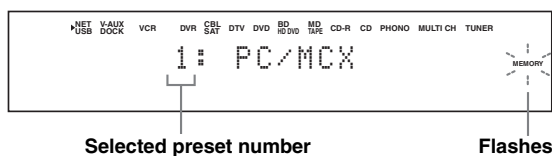

5 Press **ⓂENTER** or **ⓂMEMORY** to confirm the preset.

■ Select an item by using numeric buttons (1-8) (Ⓜ)

Before performing the following operations, set the operation mode selector on the remote control to **ⓂSOURCE**.

1 Press **ⓂNET/USB** to select “NET/USB” as the input source.

2 Select the desired sub input source.

3 Press one of the numeric button (1-8) (Ⓜ) which the desired item is assigned to select the item as the input source.

The selected preset number appears in the front panel display, and this unit starts the playback of the source assigned to the selected numeric button.

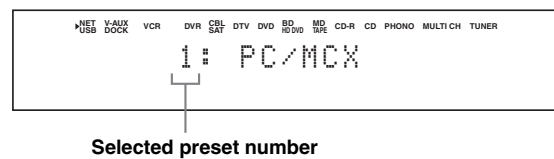

Notes

- “Empty Memory!” appears in the front panel display and the short message display when you press the numeric button (1-8) (Ⓜ) to which no items are assigned.
- This unit does not recall the correct item assigned to the selected numeric button (1-8) (Ⓜ) in the following cases:
 - the connected USB device is incorrect.
 - the PC or MCX-2000 which stores the selected item is turned off or disconnected from the network.
 - the selected Internet Radio station is temporary unavailable or out of service.
 - the directory of the selected item has been changed.



This unit stores the relative position of the preset items in a directory or playlist, and does not recall the correct item by using numeric buttons (1-8) (Ⓜ) if you add or delete music files to or from the same directory or playlist as the preset items. In such cases, preset the desired item to the numeric buttons (1-8) (Ⓜ) again.

We recommend the following methods:

PC server/MCX-2000

Create eight playlists which contain the desired items, and then preset the top item of each playlist to the numeric buttons (1-8) (Ⓜ). When you change the items which are preset to the numeric buttons (1-8) (Ⓜ), replace the registered items in the playlist with the desired items without deleting the playlist.

USB storage devices

Create eight directories which contain the desired items in a directory beside the directory which contains all music files, and then preset the top item of each directory to the numeric buttons (1-8) (Ⓜ). When you change the items which are preset to the numeric buttons (1-8) (Ⓜ), replace the items in the directory to the desired items without deleting the directory.

Advanced Operation

Advanced sound configurations	72
Selecting decoders	72
Playing back sources with the THX Surround modes	73
Graphical user interface (GUI) menu	74
GUI menu overview	76
Stereo/Surround (Stereo/Surround menu)	77
Input Select	81
Manual Setup (Basic)	83
Manual Setup (Volume)	86
Manual Setup (Sound)	86
Manual Setup (Video)	89
Manual Setup (Multi Zone)	91
Manual Setup (Network)	92
Manual Setup (Option)	93
Signal Info. (Input signal information)	95
Language	95
Saving and recalling the system settings (System Memory)	96
Saving the current system settings	96
Loading the stored system settings	98
Using examples	99
Controlling this unit by using the Web browser (Web Control Center)	101
Remote control features	102
Controlling this unit, a TV, or other components	102
Customizing the remote control	104
Setting the backlight mode of the remote control (LIGHT)	104
Setting remote control codes (P-SET)	104
Programming codes from other remote controls (LEARN)	105
Changing source names in the display window (RNAME)	106
Macro programming features	107
Clearing configurations	109
Simplified remote control	110
Using multi-zone configuration	111
Step1: Planning the multi-zone system	111
Step2: Connecting the speakers, external amplifiers, and/or other components	112
Step3: Setting the zone parameter	116
Controlling Zone 2, Zone 3, or Zone 4	116
Using the party mode	118
Advanced setup	119
Using the advanced setup menu	119

Advanced sound configurations

Selecting decoders

Selecting decoders for 2-channel sources (surround decode mode)

Use this feature to play back sources with selected decoders. You can play back 2-channel sources on multi-channels.

Set the operation mode selector to **AMP** and then press **SUR. DECODE** repeatedly on the remote control to select the surround decode mode.

You can select desired surround decoder modes depending on the type of source you are playing and your personal preference.



You can select the desired decoder and adjust the decoder parameter settings by using GUI menu. See page 78 for details.

Decoder descriptions

Name of the decoder (Decoder Type)	Decoder description
PLIIX Music PLII Music	Dolby Pro Logic IIX (or Dolby Pro Logic II) processing for music sources. The Pro Logic IIX decoder is not available when "Surround Back" is set to "None" or using headphones (see page 84).

Pro Logic
Dolby Pro Logic processing for any sources.

PLIIX Movie PLII Movie
Dolby Pro Logic IIX (or Dolby Pro Logic II) processing for movie sources. The Pro Logic IIX decoder is not available when "Surround Back" is set to "None" or using headphones (see page 84).

PLIIX Music PLII Music
Dolby Pro Logic IIX (or Dolby Pro Logic II) processing for music sources. The Pro Logic IIX decoder is not available when "Surround Back" is set to "None" or using headphones (see page 84).

PLIIX Game PLII Game
Dolby Pro Logic IIX (or Dolby Pro Logic II) processing for game sources. The Pro Logic IIX decoder is not available when "Surround Back" is set to "None" or using headphones (see page 84).

Neo:6 Music
DTS processing for music sources.

Neo:6 Cinema
DTS processing for movie sources.



When you select the surround decode mode for the multi-channel digital sources, this unit automatically selects the corresponding decoder for each source.

Selecting decoders used with sound field programs

Use this feature to select the desired decoder used with MOVIE sound field programs (except "Mono Movie") or THX Surround mode. Use "Decoder Type" parameter in "Stereo/Surround" to set the desired decoder (see page 78).

Available decoders (Decoder Type)

For MOVIE sound field programs (see page 58)

Choices: PLIIX Movie (PLII Movie), Neo:6 Cinema

For THX Cinema mode

Choices: Pro Logic, PLIIX Movie (PL II Movie), Neo:6 Cinema, Off

For THX Music mode

Choices: Pro Logic, PLIIX Music (PL II Music), Neo:6 Music, Off

For THX Games mode

Choices: Pro Logic, PL II Game, Neo:6 Cinema, Off

Notes

When you select "Decoder Type" to "Off" in the THX Surround mode, this unit activates the decoder corresponding to the input source.

Selecting decoders for multi-channel sources

If you connected surround back speakers, use this feature to enjoy 6.1/7.1-channel playback for multi-channel sources using the Dolby Pro Logic IIX, Dolby Digital EX, or DTS-ES decoders.

1 Set the operation mode selector to **AMP** and then press **EXTD SUR.** on the remote control repeatedly to switch between 5.1 and 6.1/7.1-channel playback.

Choice	Functions
AUTO	Activates the optimum decoder to play back signals in 6.1/7.1 channels when this unit recognizes a signal flag being input.
Decoders (PLIIX Movie, PLIIX Music, EX/ES, EX)	Use this feature to activate the desired decoders for the playback of multi-channel sources manually.
OFF	Does not use any decoders to create 6.1/7.1 channels.

2 Press **◀ / ▶** repeatedly to select a decoder while the name of the decoder is displayed when you select other than "AUTO" or "OFF".



Use this feature to activate the desired decoder manually when this unit cannot detect the signal flag encoded to the input sources correctly.

Notes

- The available decoders vary depending on the setting of the speakers and the input sources.
- 6.1/7.1-channel playback is not possible in the following cases:
 - when “Surround” (see page 84) or “Surround Back” (see page 84) is set to “None”.
 - when the component connected to the MULTI CH INPUT jacks is being played.
 - when the source being played does not contain surround left and right channel signals.
 - when a Dolby Digital KARAOKE source is being played.
 - when this unit is in the stereo playback, 11ch Enhancer (see page 59) or Pure Direct (see page 61) mode.
 - when “BI-AMP” is set to “ON” (see page 120).

Playing back sources with the THX Surround modes

Use this feature to play back sources with the accurate surround processing programs compliant with the THX specifications.

Rotate **① PROGRAM** (or set the operation mode selector to **⑩ AMP** and then press **⑳ THX** repeatedly) to select the desired THX Surround mode.

You can select the THX Surround mode for movies, music, or games.

■ For 2-channel sources

You can select the following THX Surround programs.

Cinema

THX Surround mode for the 2-channel movie sources. This unit decodes the sources by the selected decoder.

Music

THX Surround mode for the 2-channel music sources. This unit decodes the sources by the selected decoder before THX processing.

Games

THX Surround mode for the 2-channel game audio. This unit decodes the sources by the selected decoder before THX processing.



When this unit is in the THX Cinema, THX Music, or THX Games mode, you can select the desired surround decoder (see page 72).

■ For multi-channel sources

You can select the following THX Surround programs.

Ultra2 Cinema Surround EX Cinema

THX Surround modes for the multi-channel movie sources. When this unit activates the Dolby Digital EX decoder (see left), this unit automatically selects the THX Surround EX mode, and when this unit activates the decoders for 6.1/7.1-channel playback or when “Surround Back” is set to “Large x1”, “Small x1”, or “None” (see page 84), this unit automatically selects the THX Cinema mode.

Ultra2 Music Music

THX Surround mode for the multi-channel music sources. When “Surround Back” is set to “Large x1”, “Small x1”, or “None” (see page 84), this unit automatically selects the THX Music mode.

Ultra2 Games Games

THX Surround mode for the multi-channel game audio. When “Surround Back” is set to “Large x1”, “Small x1”, or “None” (see page 84), this unit automatically selects the THX Games mode.



To optimize the speaker settings for the THX Surround modes, set the parameters in “THX Set” (see page 83) appropriately.

System Memory

You can store the settings of this unit optimized for the THX Surround modes and recall them easily by using the system memory feature. See page 96 for details.

Graphical user interface (GUI) menu

DSP-Z11 GUI menu tree

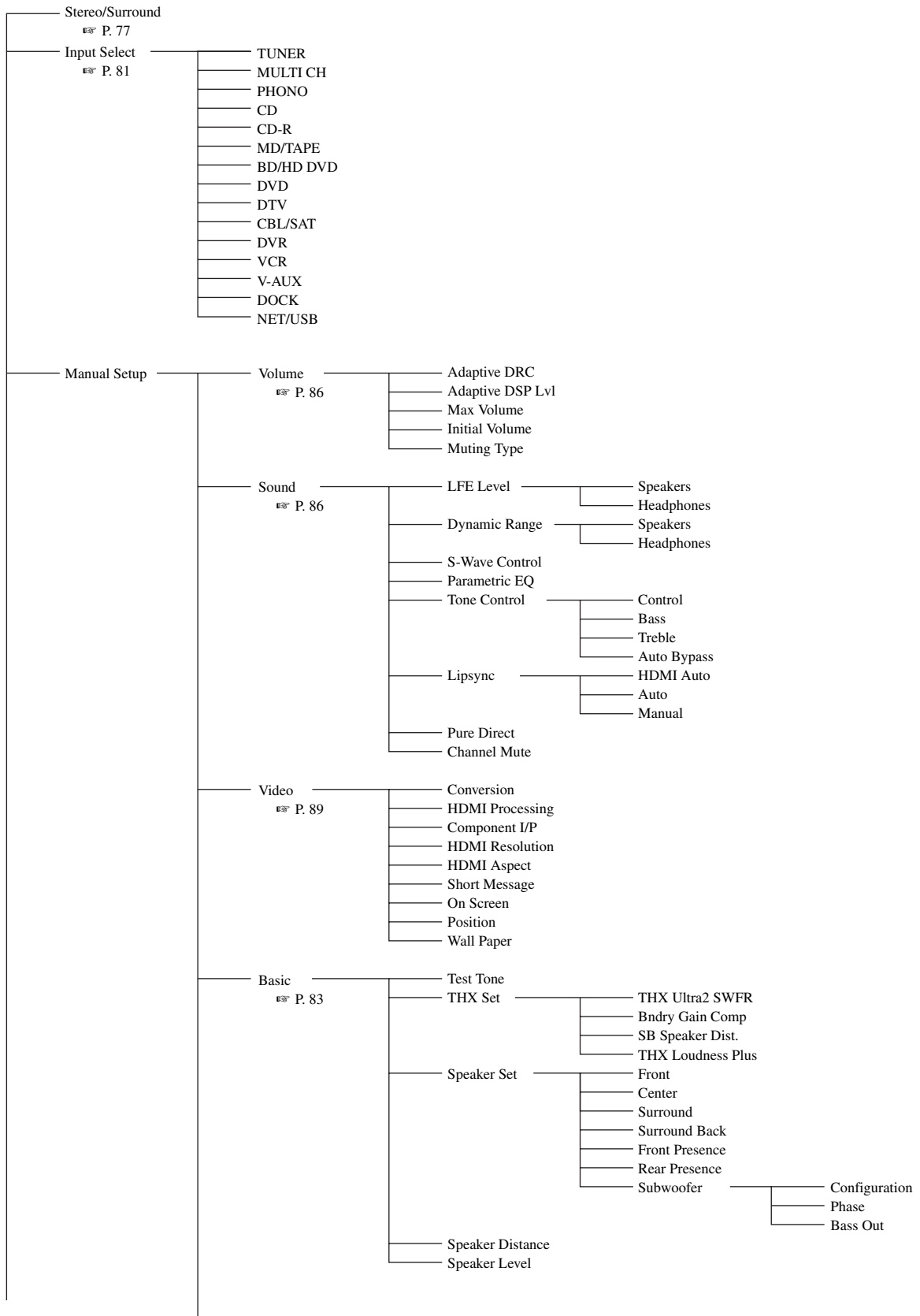

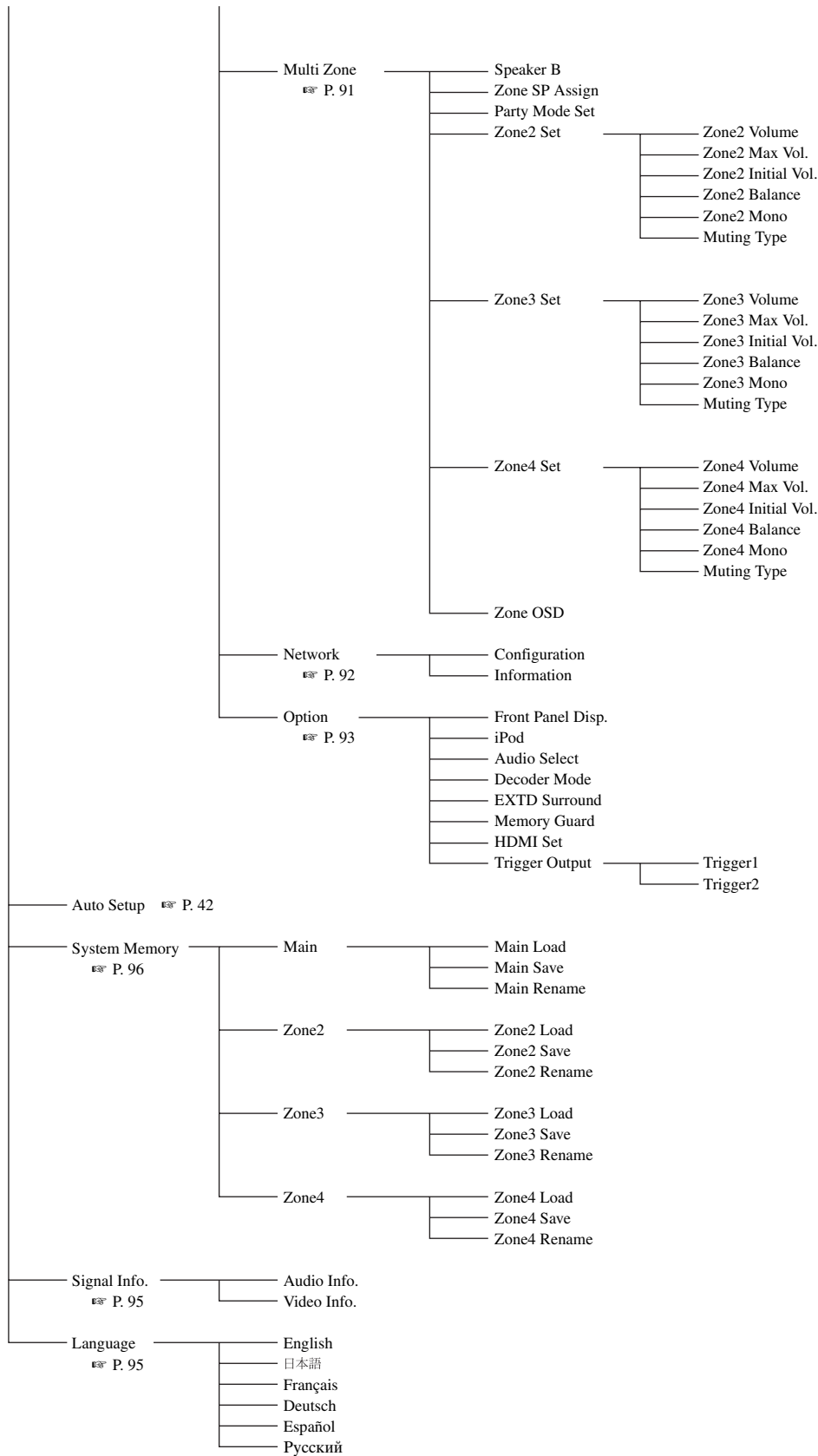

GUI menu overview

This unit features a sophisticated graphical user interface (GUI) menu that helps you to control the amplifier function of this unit. With the GUI menu, you can view the information of the signals being input and the status of this unit.

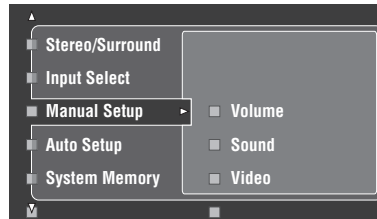

■ Stereo/Surround (Stereo/Surround menu)

Use this feature to select the sound field programs and customize the program parameter settings (see page 77).

■ Input Select (Input select menu)

Use this feature to select the input source and customize the parameters of each input source (see page 81).

■ Manual Setup (Manual setup menu)

Use this feature to manually adjust speaker and system parameters.

Volume (Volume menu)

See page 86 for details.

Sound (Sound menu)

See page 86 for details.

Video (Video menu)

See page 89 for details.

Basic (Basic menu)

See page 83 for details.

Multi Zone (Multi-zone menu)

See page 91 for details.

Network (Network and USB menu)

See page 92 for details.

Option (Option menu)

See page 93 for details.

■ Auto Setup (Automatic setup menu)

Use this feature to run the automatic setup and specify which speaker parameters to be adjusted (see page 42).

■ System Memory (System memory menu)

Use this feature to store and recall various settings of this unit (see page 96).

■ Signal Info. (Signal information)

Use this feature to check audio and video signal information (see page 95).

■ Language (GUI language menu)

Use this feature to select the language of your choice that appears in the GUI menu of this unit (see page 95).



- You can also select the GUI language using "LANGUAGE" parameter in "Advanced setup" in the front panel display (see page 120).
- See page 53 for details about the basic operations in GUI menu.
- Refer to the "Graphical user interface (GUI) menu" on page 74 for the complete menu structure.

Stereo/Surround (Stereo/Surround menu)

Use this feature to select the sound field programs (see page 54), the surround decode mode, the THX Surround mode, or the "STRAIGHT" mode (see page 60), and adjust the parameters of each program.

Basic configuration of sound field programs

Each sound field program has some parameters defining the characteristics of the program. To customize the selected sound field program, adjust "DSP Level" and/or "Dialogue Lift" first, and then try other parameters.

Adjusting the effect sound level of the sound field programs (DSP Level)

Sound field programs add effect sounds (DSP effect sounds) to the original source sound to create sound field in the listening room. Use the "DSP Level" parameter to adjust the level of the effect sounds.

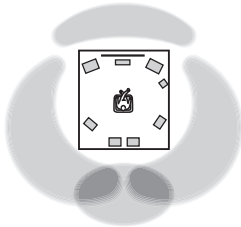

The DSP effect sound level is low

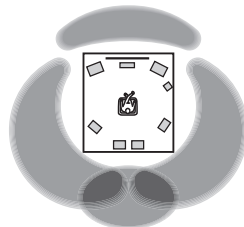

The DSP effect sound level is high

Adjust "DSP Level" as follows:

Increase the value of "DSP Level" when

- the effect sound of the selected sound field program is too weak.
- you cannot recognize any difference between the sound field programs.

Decrease the value of "DSP Level" when

- the sound is vague.
- you feel that the additional sound effect is excessive.

Control range: -6 dB to +3 dB

Adjusting the vertical dialogue position (Dialogue Lift)

Use this feature to adjust the vertical position of the dialogues in movies. The ideal position of the dialogues is at the center of the video monitor screen.

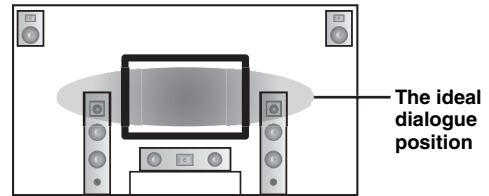

If the dialogues are heard at the lower position of the video monitor screen, increase the value of "Dialogue Lift".

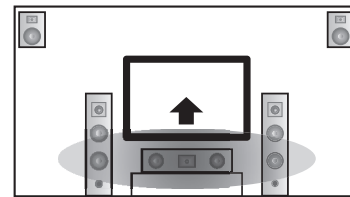

Move up to the ideal dialogue position

Choices: 0, 1, 2, 3, 4, 5

"0" (initial setting) is the lowest position, and "5" is the highest position.

Notes

- "Dialogue Lift" is available when "Front Presence" is set to "Yes" (see page 84) and headphones are not connected.
- You cannot move the dialogue position down from the initial dialogue position.

■ Sound field parameter descriptions

You can adjust the values of certain digital sound field parameters so that the sound fields are recreated accurately in your listening room. Not all of the following parameters are found in every program.

Sound field parameter	Features
Decoder Type	Decoder type. Selects the decoder used with the SUR, DECODE, THX, or MOVIE programs. See page 72 for details.
Init. Delay Sur. Init. Delay SB. Init. Delay	<p>Initial delay. Presence, surround, and surround back sound field initial delay. Changes the apparent size of the sound field by adjusting the delay between the direct sound and the first reflection heard by the listener. The smaller the value, the smaller the sound field seems to the listener.</p> <p>☼ When you adjust the initial delay parameters, we also recommend that you adjust the corresponding room size parameters likewise. This adjustment is especially effective for the CINEMA DSP programs.</p> <p>Control range: 1 to 99 ms (Init. Delay) 1 to 49 ms (Sur. Init. Delay and SB Init. Delay)</p>

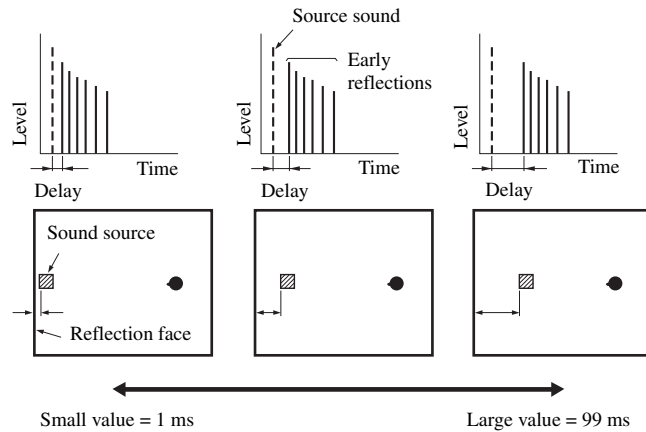

Room Size **Sur. Room Size** **SB. Room Size**

Room size. Presence, surround, and surround back room size. Adjusts the apparent size of the sound field. The larger the value, the larger the surround sound field becomes. As the sound is repeatedly reflected around a room, the larger the hall is, the longer the time between the original reflected sound and the subsequent reflections. By controlling the time between the reflected sounds, you can change the apparent size of the virtual venue. Changing this parameter from one to two doubles the apparent length of the room.

☼
When you adjust the room size parameters, we also recommend that you adjust the corresponding initial delay parameters likewise. This adjustment is especially effective for the CINEMA DSP programs.

Control range: 0.1 to 2.0

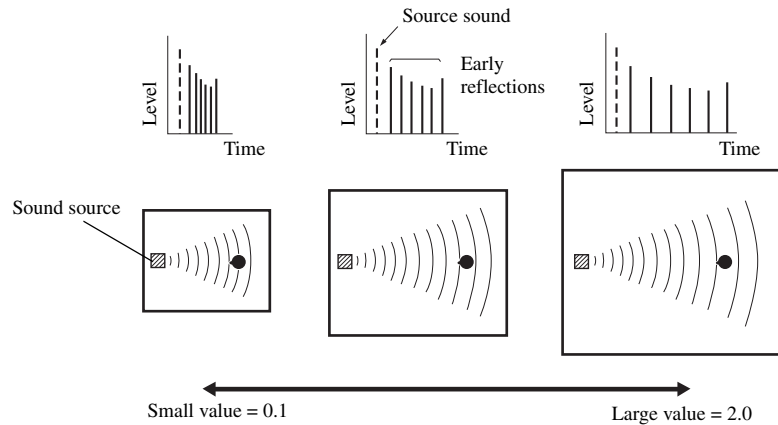

Sound field parameter	Features
Liveness Sur. Liveness SB. Liveness	Liveness, Surround and surround back liveness. Adjusts the reflectivity of the virtual walls in the hall by changing the rate at which the early reflections decay. The early reflections of a sound source decay much faster in a room with acoustically absorbent wall surfaces than in one which has highly reflective surfaces. A room with acoustically absorbent surfaces is referred to as “dead”, while a room with highly reflective surfaces is referred to as “live”. This parameter lets you adjust the early reflection decay rate and thus the “liveness” of the room. Control range: 0 to 10

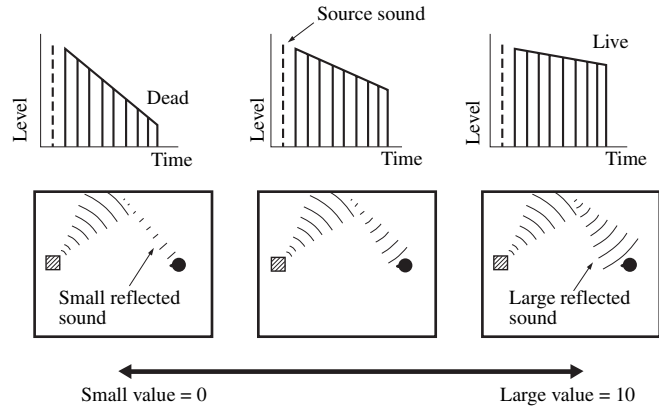

Rev. Time	Reverberation time. Adjusts the amount of time taken for the dense, subsequent reverberation sound to decay by 60 dB at 1 kHz. This changes the apparent size of the acoustic environment over an extremely wide range. Set a longer reverberation time to get more sustaining reverberation sound, and set a shorter time to get articulate sound. Control range: 1.0 to 5.0 s
------------------	--

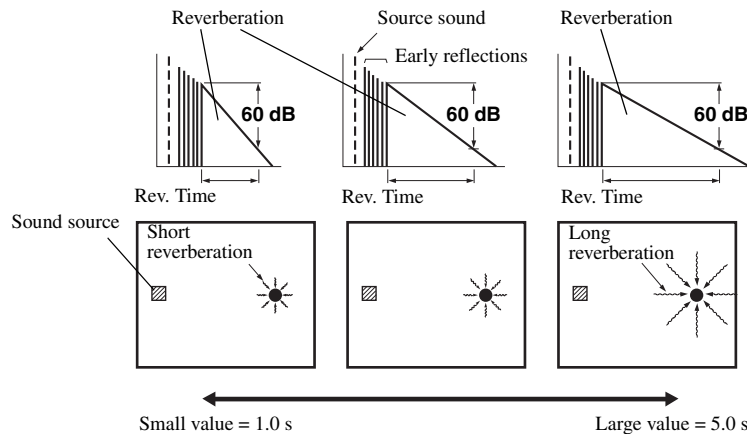

Rev. Delay	Reverberation delay. Adjusts the time difference between the beginning of the direct sound and the beginning of the reverberation sound. The larger the value, the later the reverberation sound begins. A later reverberation sound makes you feel as if you are in a larger acoustic environment. Control range: 0 to 250 ms
-------------------	---

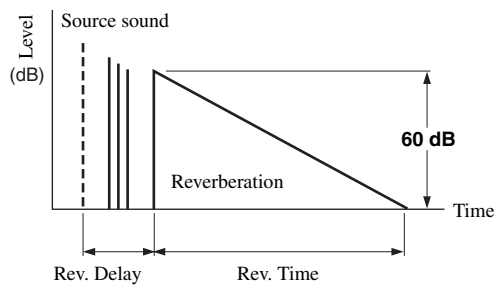

Sound field parameter	Features
Rev. Level	Reverberation level. Adjusts the volume of the reverberation sound. The larger the value, the stronger the reverberation becomes. Control range: 0 to 100%

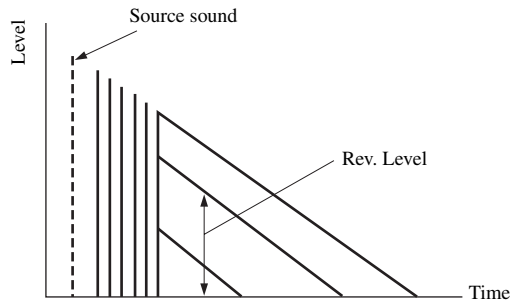

■ Stereo program parameter descriptions

Sound field parameter	Features
Direct ("2ch Stereo" only)	2-channel stereo direct. Bypasses the decoders and DSP processors of this unit for pure hi-fi stereo sound when playing 2-channel analog sources. Choices: Auto , Off <ul style="list-style-type: none"> Select "Auto" to bypass the decoders, DSP processors and the tone control circuitry only when "BASS" and "TREBLE" are set to "BYPASS" (see page 61). Select "Off" not to bypass the decoders, DSP processors and the tone control circuitry when "BASS" and "TREBLE" are set to "BYPASS". When multi-channel signals are input, they are downmixed to 2 channels and output from the front left and right speakers. The low-frequency signals of the front left and right channels are redirected to the subwoofer in the following cases: <ul style="list-style-type: none"> "Bass Out" is set to "Front & SWFR" (see page 85). "Front" is set to "Small" (see page 84) and "Bass Out" is set to "SWFR" (see page 85).
Center Level Surround L Level Surround R Level Sur.Back L Level Sur.Back R Level F.PRNS L Level F.PRNS R Level R.PRNS L Level R.PRNS R Level ("11ch Stereo" only)	11-channel stereo center, surround left, surround right, surround back, presence left and presence right levels. Adjusts the volume level of each channel in the 11-channel stereo mode. The available parameters differ depending on the speaker settings. Control range: 0 to 100%

■ Compressed Music Enhancer mode parameter descriptions

The Compressed Music Enhancer mode	Features
Level ("Straight Enhancer" and "11ch Enhancer" only)	Straight enhancer or 11-channel enhancer effect level. Select "High" or "Low" to adjust the effect for the high-frequency. Choices: High , Low

■ Decoder parameter descriptions

Decoder parameter	Features
Panorama ("PLI _x Music" and "PLII Music" only)	Pro Logic I _x Music and Pro Logic II Music panorama. Sends stereo signals to the surround speakers as well as the front speakers for a wraparound effect. Choices: Off , On
Center Width ("PLI _x Music" and "PLII Music" only)	Pro Logic I _x Music and Pro Logic II Music center width. Moves the center channel output completely towards the center speaker or towards the front left and right speakers. A larger value moves the center channel output towards the front left and right speakers. Control range: 0 (center channel sound is output only from the center speaker) to 7 (center channel sound is output only from the front left and right speakers) Initial setting: 3

Decoder parameter	Features
Dimension (“PLIIX Music” and “PLII Music” only)	Pro Logic IIX Music and Pro Logic II Music dimension. Adjusts the sound field either towards the front or towards the rear. Control range: -3 (towards the rear) to +3 (towards the front) Initial setting: STD (standard)
Center Image (“Neo:6 Music” only)	DTS Neo:6 Music center image. Adjusts the front left and right channel output relative to the center channel to make the center channel more or less dominant as necessary. Control range: 0.0 (center channel sound is output only from the front left and right speakers) to 1.0 (center channel sound output only from the center speaker) Initial setting: 0.3

Initialize (Program parameters initialization)

Use this feature to initialize the parameter of the selected sound field program.

Choices: **No**, **Yes**

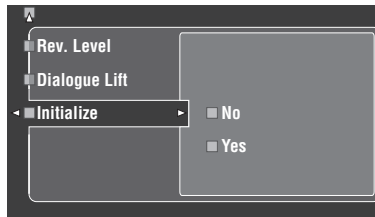

- Select “Yes” and then press **ENTER** to set the program parameters to the factory default settings.
- Select “No” (or press **◀**) to cancel the program parameter initialization.



Use “DSP PARAM” of “INITIALIZE” in “Advanced setup” to initialize the parameters of all sound field programs (see page 120).

Input Select

Use this feature to reassign digital input/outputs, select the input signal, rename the inputs, or adjust the level of the signal input at each input source.

Input source	Sub input source	Parameter
TUNER	—	Volume Trim Rename
MULTI CH	—	Volume Trim Rename Multi CH Assign BGV
PHONO		I/O Assignment
CD		Audio Select
CD-R		Decoder Mode
MD/TAPE		Volume Trim
BD/HD DVD		Rename
DVD	—	
DTV		
CBL/SAT		
DVR		
VCR		
V-AUX	—	I/O Assignment Audio Select Decoder Mode Volume Trim Rename
DOCK	—	Volume Trim Rename
NET/USB	PC/MCX	Volume Trim Play Style
	NET RADIO	Volume Trim
	USB	USB Select Volume Trim Play Style

Notes

- Some parameters described above may not be available for all input sources and some parameters are only available for specific input sources.
- You can set “Volume Trim” for each sub input source separately.
- The “Play Style” setting is effective to both “PC/MCX” and “USB”.

I/O Assignment (Input/output assignment)

Use this feature to assign the input/output jacks according to the component to be used if the initial settings of this unit do not correspond to your needs. Change the following parameters to reassign the respective jacks and effectively connect more components.

Once the input/output jacks are reassigned, you can select the corresponding component by using the **INPUT** selector (or the input selector buttons (3)).

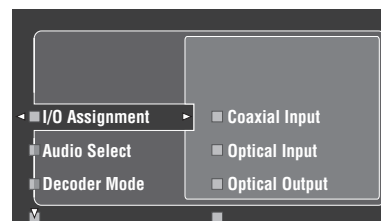

Example 1: Assigning the CD DIGITAL INPUT COAXIAL jack to “VCR”.

- 1** Select “Input Select” in the GUI menu and then select “VCR”.
- 2** Select “I/O Assignment” and then “Coaxial Input”.
- 3** Select “**CD**”.

Example 2: Clearing a jack assignment.

- 1** Select “Input Select” and then select the desired input source (“DVD”, etc.).
- 2** Select “I/O Assignment” and then select the desired jack assignment (“Coaxial Input”, “Optical Input”, “Optical Output”, “Analog I/O”, “Component Video”, or “HDMI”).
- 3** Select “None” and then press **ENTER** to clear the assignment.

Notes

- “None” appears in the GUI when any input source is not assigned to the input/output jack.
- You cannot select a specific item more than once for the same type of jack.
- When you connect a component to both the COAXIAL and OPTICAL jacks, priority is given to signals input at the COAXIAL jack.

Audio Select (Audio input jack select)

Use this feature to select the type of the input jack you want to use.

Choice	Functions
Auto	Automatically selects input signals in the following order: (1) HDMI (2) Digital signals (3) Analog signals
HDMI	Selects only HDMI signals. When HDMI signals are not input, no sound is output.
Coax/Opt	Automatically selects input signals in the following order: (1) Digital signals input at the COAXIAL jack. (2) Digital signals input at the OPTICAL jack. When no signals are input, no sound is output.
Analog	Selects only analog signals. If no analog signals are input, no sound is output.



- You can also select the audio input jack by pressing **AUDIO SELECT** (or **AUDIO SEL**). See page 52 for details.
- You can set the default audio input jack select of this unit by using “Audio Select” in “Option” (see page 93).

Note

This feature is not available when no digital input jack (OPTICAL, COAXIAL and HDMI) are assigned. In addition, “HDMI” is not available as an Audio input jack select setting when the HDMI input jacks are not used. Use “I/O Assignment” in “Input Select” to reassign the respective input jack.

Decoder Mode (Decoder mode)

Use this feature to switch the decoder mode. You can designate the reassigned digital input jacks (see page 81) for digital audio signals.

Choice	Functions
Auto	Automatically detects digital audio signal input types and selects the appropriate decoder.
DTS	Activates the DTS decoder when digital audio signals are input.

Volume Trim (Volume trimming)

Use this feature to adjust the level of the signal input at each input source. This feature is useful if you want to balance the level of each input source to avoid sudden changes in volume when switching between input sources.

Control range: -6.0 dB to +6.0 dB

Initial setting: 0.0 dB



This parameter also affects the signals output at the ZONE OUT jacks.

Note

You can only adjust the volume for the current input source using this setting.

Rename (Rename)

Use this feature to change the name of the inputs in the GUI menu or the front panel display menu. (“DVD” is used as the source component in the following example.)

- 1** Press **← / →** to place the **_** (underscore) under the space or character you want to edit.

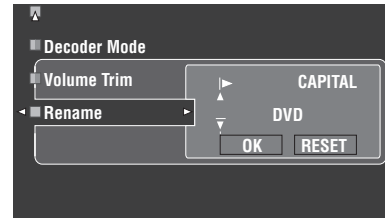

- 2** Press **ENTER** repeatedly to select a character type (**CAPITAL/SMALL/LATIN CAPITAL/LATIN SMALL/FIGURE/MARK**).

- 3** Press **↑ / ↓** to select the character you want to use and **← / →** to move to the next one.

- You can use up to 9 characters for each memory.
- Press **↓** to change the character in the following order, or press **↑** to go in the reverse order:
CAPITAL A to Z, space
SMALL a to z, space
LATIN CAPITAL Ä, Ö, Ü, etc., space
LATIN SMALL ä, ö, ü, etc., space
FIGURE 0 to 9, space
MARK !, #, %, &, etc., space
- Press **ENTER** to switch between character types.
- Press **→** repeatedly to select “RESET” to set the name of the input source to the initial name.

Notes

- The character types you can select differ depending on the setting in “Language” (see page 95).
- If you set “Language” to “日本語”, you can also select Japanese characters.

- 4** Press **← / →** repeatedly to select “OK” and press **ENTER** when complete.



- Repeat steps 1 to 4 to rename each input.
- You can also change the name of the input source that appears in the display window (④) on the remote control. Refer to “Changing source names in the display window (RNAME)” on page 106.

Note

You can only change the name of the current input source (except for multi channel input sources) using this setting.

■ Multi CH Assign (Multi channel assignment)

Use this feature to set the direction of the signals input into the center, subwoofer and surround channels when a source component is connected to the MULTI CH INPUT jacks.

Input Channels (Input channels)

Use this setting to select the number of channels input from an external decoder (see page 35).

Choice	Description
6ch	Select "6ch" the connected component outputs discrete 6-channel audio signals.
8ch	Select "8ch" the connected component outputs discrete 8-channel audio signals. Also set "Front Input" (see below) to the analog audio jacks at which the front left and right channel signals output from the connected component are input.

Note

Depending on the settings of the zone configuration, no sound is output at the surround back speakers even if you set "Input Channels" to "8ch". In this case, select "6ch" and set the audio output setting of the source component to 6 channels.

Front Input

(Front left and right channels input jacks)

If you selected "8ch" in "Input Channels", you can select analog jacks at which front left and right channel signals from an external decoder will be input.

Choices: CD, CD-R, MD/TAPE, BD/HD DVD, **DVD**, DTV, CBL/SAT, DVR, VCR, V-AUX

Note

If you have renamed an input source in "Rename" (see page 82), the name of the input source appears in the choices of this parameter.

■ BGV (Back ground video)

Use this feature to select the video source played in the background of the sources input at the MULTI CH INPUT jacks.

Choice	Functions
BD/HD DVD, DTV, CBL/SAT, DVD, DVR, VCR, V-AUX	Selects the corresponding input source as the background video source.
Last	Automatically selects the last selected video source as the background video source.
Off	Does not play the video source in the background.

Note

If you have renamed an input source in "Rename" (see page 82), the name of the input source appears in the choices of this parameter.

■ Play Style (Playback styles)

Use this feature to adjust the playback style according to your preference. You can shuffle songs in a random order or repeat one specific song or a sequence of songs.

Repeat (Repeat)

Use this feature to set this unit to repeat one song or a sequence of songs.

Choice	Functions
Off	Deactivates the repeat function.
Single	Repeats one song. "↺" appears in the top right corner of the playback status screen.
All	Repeats a sequence of songs. "🔁" appears in the top right corner of the playback status screen.

Notes

- If "Repeat" is set to "Single", the setting will be reset to "Off" when this unit is turned off.
- When you set "BGV" to "Last", you can select the background video source by using the remote control only.

Shuffle (Shuffle)

Use this feature to set this unit to play songs or albums in a random order.

Choice	Functions
Off	Deactivates the shuffle function.
On	Play songs or albums in a random order. "↻" appears in the top right corner of the playback status screen.

■ USB Select (USB port select)

Selects the component connected to the front or rear USB port as the input source (see page 37).

Choice	Functions
Front	Selects the component connected to the front USB port as the input source.
Rear	Selects the component connected to the rear USB port as the input source.

Manual Setup (Basic)

Use this menu to manually adjust any speaker setting.



- Most of the parameters described in the basic menu are set automatically when you run "Auto Setup". You can use the basic menu to make further adjustments, but we recommend running "Auto Setup" first.
- You can reset these parameters by performing the "Auto Setup" procedure (see page 42).
- If your subwoofer can adjust the output volume and the crossover frequency, set the volume to about half way (or slightly less) and set the crossover frequency to the maximum.

■ Test Tone (Test tone)

Turns the test tone output on or off for "Speaker Set", "Speaker Distance", and "Speaker Level" settings.

Choice	Functions
Off	This unit does not output the test tone for the "Speaker Set", "Speaker Level", and "Speaker Distance" settings.
On	This unit outputs the test tone for the "Speaker Set", "Speaker Level", and "Speaker Distance" settings. While "Test Tone" is set to "On", the volume level is automatically set to 0 dB.

Notes

- Loud test tones will be output when "On" is selected. In this case, make sure no children are present in the listening room.
- This function is automatically turned off if you exit "Basic".

■ THX Set (THX settings)

Use this feature to set the parameters to optimize the THX Surround modes (see page 73).

THX Ultra2 SWFR (THX Ultra2 subwoofer setting)

Use this feature to select whether the connected subwoofers are the THX Ultra2 certified subwoofers.

Choice	Descriptions
Yes	Select this setting when the connected subwoofers are the THX Ultra2 certified subwoofers.
No	Select this setting when the connected subwoofers are not the THX Ultra2 certified subwoofers.

Note

When “THX Ultra2 SWFR” is set to “No”, you cannot select “Bndry Gain Comp” is automatically set to “Off”.

Bndry Gain Comp (Boundary gain compensation)

Use this feature to improve boomy bass when the listening position is closer to the rear wall.

Choice	Descriptions
Off	Select this setting when you do not want to use the boundary gain compensation feature.
On	Select this setting to activate the boundary gain compensation feature.

SB Speaker Dist. (Surround back speaker distance)

Use this feature to set the distance between the left surround back speaker and right surround back speaker.

Choice	Descriptions
Under 1ft (Under 0.3m)	Select this setting when the distance between the two surround back speakers is less than 0.3 m (1 foot).
1 – 4ft (0.3-1.2m)	Select this setting when the distance between the two surround back speakers is 0.3 m to 1.2 m (1 foot to 4 feet).
Over 4ft (over 1.2m)	Select this setting when the distance between the two surround back speakers is over 1.2 m (4 feet).

Note

The unit used in this parameter differs depending on the setting of “Unit” in “Speaker Distance” (see page 85).

THX Loudness Plus (Loudness plus setting)

THX Loudness Plus function compensates for the total and spatial shifts that occur when the volume is reduced by intelligently adjusting ambient surround channel levels and frequency response. Use this feature to select whether this unit automatically activates the THX Loudness Plus function in the THX Surround modes.

Choice	Descriptions
Off	Deactivates the Loudness Plus function.
On	Activates the Loudness Plus function in the THX Surround modes.

■ Speaker Set (Speaker settings)

Use to manually adjust any speaker setting.



If you are not satisfied with the bass sounds from your speakers, you can change these settings according to your preference.

Measure for the speaker size

- The woofer section of a speaker is
- 16 cm (6.5 in) or larger: large
 - smaller than 16 cm (6.5 in): small



THX Ltd. recommends you that you set “Front”, “Center”, “Surround”, and “Surround Back” to “Small” and “Cross Over” to “80Hz (THX)”. To select the crossover frequency of the speaker(s) manually, select “Small” and then set “Cross Over” (see page 84).

Front (Front speakers)

Choice	Descriptions
Large	Select this setting when the front speakers are large.
Small	Select this setting when the front speakers are small.

Note

When “Bass Out” is set to “Front” (see page 85), you can select only “Large” in “Front”. If the value of “Front” is set to other than “Large” in advance, this unit change the value to “Large” automatically.

Center (Center speaker)

Choice	Descriptions
Large	Select this setting when the center speaker is large.
Small	Select this setting when the center speaker is small.
None	Select this setting when you do not use the center speaker. The center channel signals are directed to the front left and right speakers.

Surround (Surround left/right speakers)

Choice	Descriptions
Large	Select this setting when the surround speakers are large.
Small	Select this setting when the surround speakers are small.
None	Select this setting when you do not use the surround speakers. This unit is set to the Virtual CINEMA DSP mode (see page 60), and “Surround Back” is automatically set to “None”.



See page 23 for the connection information of the surround speakers.

Surround Back (Surround back left/right speakers)

Choice	Descriptions
Large x1	Select this setting when the single surround back speaker is large.
Large x2	Select this setting when the surround back left and right speakers are large.
Small x1	Select this setting when the single surround back speaker is small.
Small x2	Select this setting when the surround back left and right speakers are small.
None	Select this setting when you do not use the surround back speakers. The surround back channel signals are directed to the surround left and right speakers.



See page 23 for the connection information of the surround speakers.

Cross Over (Cross over)

Use this feature to select the crossover frequency of the speaker(s) that is set to “Small”. All frequencies below the selected frequency will be sent to the subwoofers or to the speakers set to “Large” in “Speaker Set” (see pages 84).

Choices: 40Hz, 60Hz, **80Hz (THX)**, 90Hz, 100Hz, 110Hz, 120Hz, 160Hz, 200Hz



If your subwoofers can adjust the output volume and the crossover frequency, set the volume to about half way (or slightly less) and set the crossover frequency to the maximum.

Front Presence (Front presence speakers)

Use this feature if you want to use the front presence speakers connected to this unit.

Choice	Descriptions
Yes	Select this setting when you use the front presence speakers.
None	Select this setting when you do not use the front presence speakers. “Rear Presence” is automatically set to “None”.

Notes

- If you set “Front Presence” to “None”, you cannot activate the CINEMA DSP HD³ mode (see page 60).
- “Dialogue Lift” is available when “Front Presence” is set to “Yes” and headphones are not connected.

Rear Presence (Rear presence speakers)

Use this feature if you want to use the rear presence speakers connected to this unit.

Choice	Descriptions
Yes	Select this setting when you use the rear presence speakers.
None	Select this setting when you do not use the rear presence speakers.

Subwoofer (Subwoofer)**Configuration (Subwoofer configuration)**

Use this feature to select the configuration of the subwoofers (see page 25).

Choice	Descriptions
Front & Rear	Select this setting when you place the subwoofers to the front and rear of the listening room.
Stereo	Select this setting when you place the subwoofers to the left and right of the listening room.
Monaural	Select this setting when you use a single subwoofer.
None	Select this setting when you do not use a subwoofer.



If your subwoofer can adjust the output volume and the crossover frequency, set the volume to about half way (or slightly less) and set the crossover frequency to the maximum.

Phase (Subwoofer phase)

Use this feature to switch the phase of your subwoofers if bass sounds are lacking or unclear.

Choice	Functions
Normal	Does not change the phase of your subwoofers.
L Reverse	Sets the phase of the left (or front) subwoofer to reverse.
R Reverse	Sets the phase of the right (or rear) subwoofer to reverse.
L&R Reverse	Sets the phase of the both subwoofers to reverse.

Bass Out (Bass out)

Use this feature to select the speakers that output the LFE (low-frequency effect) and the low-frequency signals. THX Ltd. recommends that “Bass Out” to “SWFR”.

LFE signals output

Choice	Subwoofers and speakers		
	Subwoofers	Front speakers	Other speakers
Front & SWFR	Output	No output	No output
SWFR	Output	No output	No output
Front	No output	Output	No output

Low-frequency signals output

Choice	Subwoofers and speakers		
	Subwoofers	Front speakers	Other speakers
Front & SWFR	*1	*2	*3
SWFR	*4	*3	*3
Front	No output	*1	*3

*1 Output(s) the low-frequency signals of the front channels and other speakers set to “Small”.

*2 Always output the low-frequency signals of the front channels.

*3 Output the low-frequency signals if the speakers are set to “Large”.

*4 Outputs the low-frequency signals of the speakers set to “Small” or “None”.

Speaker Distance (Speaker distance)

Use this feature to manually adjust the distance of each speaker and the delay applied to the respective channel. Ideally, each speaker should be the same distance from the main listening position. However, this is not possible in most home situations. Thus, a certain amount of delay must be applied to the sound from each speaker so that all sounds will arrive at the listening position at the same time.

Speaker distances

Control range: 0.30 to 24.00 m (1.0 to 80.0 ft)

Initial setting: 3.00 m (10.0 ft)

Control step: 0.05 m (0.2 ft)

Speaker Distance	Adjusted speaker
Front L	Front left speaker
Front R	Front right speaker
Center	Center speaker
Surround L	Surround left speaker
Surround R	Surround right speaker
Surround Back L	Surround back left speaker
Surround Back R	Surround back right speaker
Front Presence L	Front presence left speaker
Front Presence R	Front presence right speaker
Rear Presence L	Rear presence left speaker
Rear Presence R	Rear presence right speaker
Subwoofer L	Subwoofer left
Subwoofer R	Subwoofer right



If your subwoofer can adjust the output volume and the crossover frequency, set the volume to about half way (or slightly less) and set the crossover frequency to the maximum.

Notes

- The available speaker channels differ depending on the setting of the speakers.
- If you are only using one surround back speaker, connect it to the SUR.BACK SINGLE jack, and adjust the distance in “Surround Back L”.

Unit (Unit)

Selects the unit for displaying the values of “Speaker Distance” parameter.

Choice	Functions
Meter (m)	Adjusts speaker distances in meters.
Feet (ft)	Adjusts speaker distances in feet.

■ Speaker Level (Speaker level)

Use this feature to manually balance the speaker levels between the front left or surround left speakers and each speaker selected in “Speaker Set” (see page 84).

Control range: -10.0 dB to +10.0 dB

Initial setting: 0.0 dB

Control step: 0.5 dB

Speaker Level	Adjusted speaker
Front L	Front left speaker
Front R	Front right speaker
Center	Center speaker
Surround L	Surround left speaker
Surround R	Surround right speaker
Surround Back L	Surround back left speaker
Surround Back R	Surround back right speaker
Front Presence L	Front presence left speaker
Front Presence R	Front presence right speaker
Rear Presence L	Rear presence left speaker
Rear Presence R	Rear presence right speaker
Subwoofer L	Subwoofer left
Subwoofer R	Subwoofer right



- If your subwoofer can adjust the output volume and the crossover frequency, set the volume to about half way (or slightly less) and set the crossover frequency to the maximum.
- If you use a handheld sound pressure level meter, hold at arm’s length and point upwards so that the meter is in the listening position. With the meter set to the 70 dB scale and to C SLOW, calibrate each speaker to 75 dB.

Notes

- The available speaker channels differ depending on the setting of the speakers.
- If you are only using one surround back speaker, connect it to the SUR.BACK SINGLE jack, and adjust the balance in “Surround Back L”.
- The setting of “Speaker Level” changes depending on the setting of “PEQ Select” in “Manual Setup” (see page 87).

Manual Setup (Volume)

Use this menu to manually adjust the various volume settings.

Adaptive DRC (Adaptive dynamic range control)

Use this feature to adjust the dynamic range in conjunction with the volume level. This feature is useful when you are listening at lower volumes or at night. When “Adaptive DRC” is set to “Auto”, this unit controls the dynamic range as follows:

- If the VOLUME setting is low: the dynamic range is narrow
- If the VOLUME setting is high: the dynamic range is wide

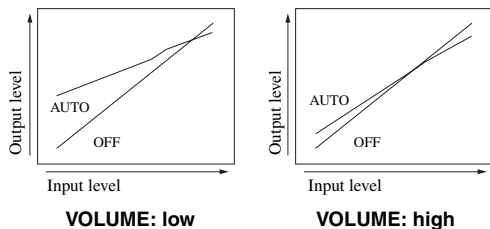

Choice	Functions
Auto	Adjusts the dynamic range automatically.
Off	Does not adjust the dynamic range automatically.



- You can also adjust the dynamic range of the bitstream signal sources by using “Dynamic Range” in “Sound” (see page 87).
- This function is also useful for listening with your headphones.

Notes

- The adaptive dynamic range control feature does not function when this unit is in the THX Surround modes (see page 73) or Pure Direct mode (see page 61).
- If you set “Direct” in “2ch Stereo” to “Auto” (see page 80) and this unit is in the 2ch Stereo mode, the adaptive dynamic range control feature does not function in some cases.

Adaptive DSP Lvl (Adaptive DSP effect level)

Use this feature to make fine adjustments of the DSP effect level (see page 77) automatically in conjunction with the volume level.

Choice	Functions
Auto	Adjusts the DSP effect level in conjunction with the volume level.
Off	Does not adjust the DSP effect level automatically.

Note

Even if you set “Adaptive DSP Lvl” to “Auto”, this unit does not change but fine-tunes the specified value of “DSP Level” (see page 77).

Max Volume (Maximum volume)

Use this feature to set the maximum volume level in the main zone. This feature is useful to avoid the unexpected loud sound by mistake.

For example, the original volume range is -80.0 dB to +16.5 dB.

However, when “Max Volume” is set to -5.0 dB, the volume range becomes -80.0 dB to -5.0 dB.

Control range: -30.0 dB to +15.0 dB, +16.5 dB

Control step: 5.0 dB

Initial Volume (Initial volume)

Use this feature to set the volume level of the main zone when the power of this unit is turned on.

Choices: Off, Mute, -80.0 dB to +16.5 dB

Control step: 0.5 dB

Notes

- When this unit is in the auto setup procedure, the volume level is automatically set to 0 dB regardless of the current “Max Volume” setting.
- The “Max Volume” setting takes priority over the initial volume setting. For example, if “Initial Volume” is set to -20.0 dB and “Max Volume” is set to -30.0 dB, the volume level is automatically set to -30.0 dB when you turn on the power of this unit next time.

Muting Type (Muting type)

Use this feature to adjust how much the mute function reduces the output volume (see page 52).

Choice	Functions
Full	Mutes all the audio output.
-20dB	Reduces the current volume by 20 dB.
-40dB	Reduces the current volume by 40 dB.

Manual Setup (Sound)

Use this menu to adjust the sound parameters.

■ LFE Level (Low-frequency effect level)

Use this feature to adjust the output level of the LFE (low-frequency effect) channel according to the capacity of your subwoofer or headphones. The LFE channel carries low-frequency special effects which are only added to certain scenes. This setting is effective only when this unit decodes bitstream signals.

Control range: -20.0 to 0.0 dB

Control step: 1.0 dB

Speakers (Speaker low-frequency effect level)

Select to adjust the speaker LFE level.

Headphones**(Headphone low-frequency effect level)**

Select to adjust the headphone LFE level.

Note

Depending on the settings of “Bass Out” (see page 85), some signals may not be output at the SUBWOOFER PRE OUT jacks.

Dynamic Range (Dynamic range)

Use this feature to select the amount of dynamic range compression to be applied to your speakers or headphones. This setting is effective only when the unit is decoding bitstream signals.

Speakers (Speaker dynamic range)

Adjusts the dynamic range compression for the speakers.

Headphones (Headphone dynamic range)

Adjusts the dynamic range compression for the headphones.

Choice	Functions
MAX	Preserves the greatest amount of dynamic range.
STD	Adjusts the dynamic range to medium. When this unit is decoding Dolby TrueHD signals, the dynamic range control is always active regardless of the instruction of the input source signals.
MIN/AUTO	<ul style="list-style-type: none"> • MIN: Adjusts the dynamic range to narrow when this unit is decoding bitstream signals (except Dolby TrueHD). • AUTO: Adjusts the dynamic range according to the instruction of the input source signals when this unit is decoding Dolby TrueHD signals.

S-Wave Control (Standing wave control)

Use this menu to activate or deactivate the specially customized parametric equalizer to reduce the effects of acoustic standing waves in the listening room. See page 44 for details.

Choice	Functions
On	Activates the parametric equalizer.
Off	Deactivates the parametric equalizer.

Parametric EQ (Parametric equalizer)

Use this feature to adjust the parametric equalizer of each speaker.

PEQ Data Copy (Parametric equalizer data copy)

Use this feature to copy the result data of the automatic setup to the manual configuration area. You can select the parametric equalizer type applied to the copied result data of the automatic setup. See page 46 for the descriptions of each parametric equalizer type.

Choice	Descriptions
Flat → Manual	Copies the result of the automatic setup that the “Flat” type parametric equalizer is applied to.
Front → Manual	Manual Copies the result of the automatic setup that the “Front” type parametric equalizer is applied to.
Natural → Manual	Copies the result of the automatic setup that the “Natural” type parametric equalizer is applied to.

PEQ Select (Parametric equalizer type select)

Use this feature to select the parametric equalizer type that applied to the results of the automatic setup. See page 46 for the descriptions of each parametric equalizer type.

Choice	Descriptions
Manual	Applies the manually configured parametric equalizer in “Manual Setup”.
Flat	Applies the “Flat” type parametric equalizer.
Front	Applies the “Front” type parametric equalizer.
Natural	Applies the “Natural” type parametric equalizer.
Through	Does not use the parametric equalizer.

Notes

- When you carry out the automatic setup, this unit automatically set “PEQ Select” to “Natural”.
- “Speaker Level” settings (see page 86) also changes corresponding to the setting of “PEQ Select”.
- This unit does not change the configurations of “Manual” even if you perform the automatic setup.

Manual parametric equalizer configuration of each speaker

Use this feature to adjust the tonal quality of each speaker. You can copy the results of the automatic setup for the base of the manual configuration by using “PEQ Data Copy”. Set “PEQ Select” to “Manual” in advanced.

1 Press $\text{Ⓢ}/\Delta/\nabla/◀/▶$ to select “Test Tone” or the speaker you want to adjust.

Choice	Adjusted speaker
Front L	Front left speaker
Front R	Front right speaker
Center	Center speaker
Surround L	Surround left speaker
Surround R	Surround right speaker
Surround Back L	Surround back left speaker
Surround Back R	Surround back right speaker
Front Presence L	Front presence left speaker
Front Presence R	Front presence right speaker
Rear Presence L	Rear presence left speaker
Rear Presence R	Rear presence right speaker
Subwoofer L	Subwoofer left
Subwoofer R	Subwoofer right

Test Tone

Use this feature to select whether to turn on or off the test tone output while you are adjusting the tonal quality of each speaker.

Choice	Functions
On	Outputs the test tone.
Off	Does not output the test tone.

2 Press **Ⓞ**➤ to access the settings window.

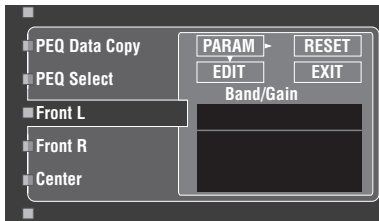

3 Press **Ⓞ**▲/▼/◀/▶ to select “PARAM” and then press **Ⓞ**ENTER to select a parameter from “Band” (band), “Freq.” (frequency) or “Q” (Q factor).



You can adjust “Gain” (gain) with any parameter.

4 Press **Ⓞ**▼ to select “EDIT” and press **Ⓞ**ENTER to access the edit window.

For more information on the parametric equalizer and each parameter, see page 131.

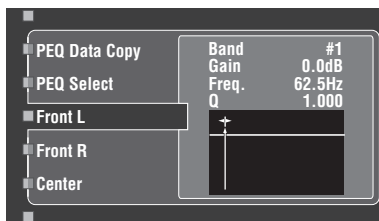

The parameter selected in “PARAM” is highlighted.

- Press **Ⓞ**◀/▶ to adjust the parameter.
- Press **Ⓞ**▲/▼ to adjust the “Gain”.
- Press **Ⓞ**ENTER to exit the edit window.



- When you select “Band” in step 3, you can use this menu as a graphic equalizer.
- “Band #4”, “Band #5”, “Band #6”, and “Band #7” can adjust the frequencies above of 500 Hz.
- When you select “Subwoofer L” or “Subwoofer R” in step 1 and “Band” in step 3, you can adjust “Band #1”, “Band #2”, and “Band #3” only. In this case, “Band #1”, “Band #2”, and “Band #3” can adjust the frequencies below of 250 Hz.

5 Repeat steps 3 and 4 until you are satisfied with the results.



If you want to reset all “Parametric EQ” parameter settings for the selected speaker, select “RESET” and press **Ⓞ**ENTER.

6 Select “EXIT” and press **Ⓞ**ENTER to exit from the settings window.

■ Tone Control (Tone control)

Use this feature to adjust the balance of bass and treble output to your speakers or headphones.

Note

Tone Control is not effective when:

- the Pure Direct mode (see page 61) is selected.
- one of the THX Surround mode is selected (see page 73).
- MULTI CH is selected as the input source.

Control (Tone control)

Choice	Functions
Speaker	Adjust the bass/treble balance of your speakers.
Headphone	Adjust the bass/treble balance of your headphones.



“Speaker” and “Headphone” adjustments are stored independently. The adjustments for “Speaker” affects the front left/right, center, presence left/right speaker channels and Subwoofer channel.

Bass (Bass control)

Use this feature to adjust low-frequencies output to your speakers or headphones.

Choices: 125 Hz, **350 Hz**, 500 Hz

Control range: –6.0 dB to +6.0 dB

Initial setting: 0.0 dB

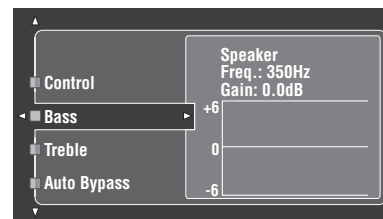

Treble (Treble control)

Use this feature to adjust high-frequencies output to your speakers or headphones.

Choices: 2.5 kHz, **3.5 kHz**, 8.0 kHz

Control range: –6.0 dB to +6.0 dB

Initial setting: 0.0 dB

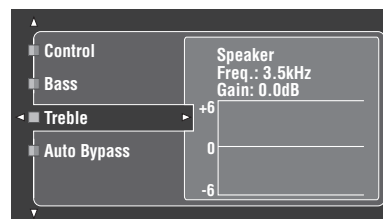

Auto Bypass (Auto bypass)

Use this feature to select whether the audio output bypasses the tone control circuitry when “Treble” and “Bass” are set to 0 dB (see page 61).

Choice	Functions
Auto	Automatically bypasses the tone control circuitry to provide the purest signal possible when “Treble” and “Bass” are set to 0 dB.
Off	Does not bypass the tone control circuitry.

■ Lipsync (Audio and video synchronization)

Use this feature to adjust the audio and video synchronization.

HDMI Auto (HDMI automatic lip sync mode)

If the connected video monitor is connected to the HDMI OUT jack on this unit and compatible with the automatic audio and video synchronization function (automatic lip sync), this unit adjusts the audio and video synchronization automatically. Use this feature to activate or deactivate the automatic lip sync.

Choice	Descriptions
Off	Select this setting if the connected video monitor is compatible with the automatic lip sync. Use “Auto” to make fine adjustments of the audio and video synchronization.
On	Select this setting if the video monitor is not compatible with the automatic lip sync or you do not want to use the automatic lip sync. Use “Manual” to adjustment the audio and video synchronization.

Auto (Automatic audio delay adjustment)

Use this feature to make fine adjustments of the audio and video synchronization when you set “HDMI Auto” to “On”.

Control range: 0 to 240 ms

Control step: 1 ms



“offset” indicates the difference between the value of the audio delay that this unit sets automatically and the value of the audio delay that you set in “HDMI Auto”. This unit stores the value of “Offset” and applies the value to other automatic lip sync compatible video monitors.

Manual (Manual audio delay adjustment)

Use this feature to adjust the delay of the sound output manually to synchronize audio with video images when you set “HDMI Auto” to “Off”.

Control range: 0 to 240 ms

Control step: 1 ms

■ Pure Direct (Pure Direct)

Use this feature to select whether this unit outputs the video signals when this unit is in the Pure Direct mode.

Choice	Functions
Video Off	Does not output video signals.
Video On	Outputs video signals. For the better sound quality, this unit only activates the limited video features.

Note

You cannot use the GUI menu while this unit is in the Pure Direct mode even if “Pure Direct” is set to “Video On”.

■ Channel Mute (Channel mute)

Use this feature to mute specific speaker channels.

Mode (Mode)

Use this feature to activate or deactivate the “Channel Mute” setting for each speaker.

Choice	Functions
Disable	Deactivates the “Channel Mute” function.
Enable	Activates the “Channel Mute” function.

Each speaker settings

Select whether this unit mutes each speaker channel when you set “Mode” to “Enable”.

Choice	Functions
Mute On	Mutes the selected speaker channel.
Mute Off	Does not mute the selected speaker channel.

Channel Mute	Speaker channel
Front L	Front left
Front R	Front right
Center	Center
Surround L	Surround left
Surround R	Surround right
Surround Back L	Surround back left
Surround Back R	Surround back right
Front Presence L	Front presence left speaker
Front Presence R	Front presence right speaker
Rear Presence L	Rear presence left speaker
Rear Presence R	Rear presence right speaker
Subwoofer L	Subwoofer left
Subwoofer R	Subwoofer right

Manual Setup (Video)

Use this menu to adjust the video parameters.

Note

Use the “VIDEO” in “INITIALIZE” to set the parameters in “Manual Setup (Video)” (except “Short Message” and “On Screen”) to the factory presets (see page 120).

■ Conversion (Video conversion)

Use this feature to activate or deactivate the video scaling as well as the HDMI up-conversion of the analog video signals input at the VIDEO, S VIDEO, and COMPONENT VIDEO jacks.

Choice	Functions
On	Converts composite, S-video, and component video signals interchangeably and up-converts composite, S-video, and component video signals to HDMI video signals.
Off	Does not convert any signals.

Notes

- For optimal video performance, THX Ltd. recommends that you set “Conversion” to “Off” to allow video signals to pass through the system without processing (e.g., video signals input at the COMPONENT VIDEO jacks are output at the COMPONENT VIDEO MONITOR OUT jacks without any processing).
- The converted video signals are only output at the MONITOR OUT jacks. When recording a video source, you must make the same type of video connections between each component.
- When composite video or S-video signals from a VCR are converted into component video signals, the picture quality may suffer depending on your VCR.
- If “Conversion” is set to “Off”, the “Component I/P”, “HDMI Resolution”, “HDMI Processing”, “HDMI Aspect”, and “Short Message” features are deactivated.
- Set “Conversion” to “On” to display the short message.
- This unit does not convert 480 line video signals and 576 line video signals interchangeably.
- The analog component video signals with 480i (NTSC)/576i (PAL) of resolution are converted into the S-video or composite video signals and output at the S VIDEO MONITOR OUT and VIDEO MONITOR OUT jacks.
- Even when “Conversion” is set to “On”, HDMI digital signals are not converted to analog video signals.
- This unit cannot convert the signals input at the VIDEO or S VIDEO jacks and displays the video images correctly depending on the input source component and the source played on the component. In such cases, set “Conversion” to “Off”.
- When non-standard video signals (such as video signals from a video game console) are input, this unit does not display short messages in the video monitor even if “Conversion” is set to “On”.
- When the analog component video signals with 480p/576p of resolution are input at the COMPONENT VIDEO jacks and the video monitor is connected to the VIDEO MONITOR OUT or S VIDEO MONITOR OUT jack on this unit, the GUI screen is not displayed in the video monitor.

■ HDMI Processing (HDMI video processing)

Use this feature to select whether this unit processes the video signals input at the HDMI IN jacks.

Choice	Functions
Off	Select this setting when you do not want this unit to process the video signals input at the HDMI IN jacks even if "Conversion" is set to "On".
On	Select this setting when you want this unit to process the video signals input at the HDMI IN jacks when "Conversion" is set to "On".

■ Component I/P (Component interlace/progressive conversion)

Use this feature to activate or deactivate the analog interlace/progressive conversion of the analog video signals input at the composite video, S-video and component video jacks so that the analog video signals deinterlaced from 480i (NTSC)/576i (PAL) to 480p/576p are output at the COMPONENT MONITOR OUT jacks.

Choice	Functions
On	Activates the analog interlace/progressive up-conversion of the analog video signals.
Off	Deactivates the analog interlace/progressive up-conversion of the analog video signals.

Notes

- If your video monitor does not support analog video signals with 480p/576p of resolution, the GUI screen may not be displayed on your video monitor when "Component I/P" is set to "On". In such a case, set "INITIALIZE" in "Advanced setup" parameter to "VIDEO" (see page 120).
- When you set "HDMI Processing" to "On", you may not set "Component I/P" in some cases.

■ HDMI Resolution (HDMI video signal resolution)

Use this feature to activate or deactivate the HDMI up-scaling of the analog and HDMI video signals input at the composite video, S-video and component video and HDMI IN jacks so that the up-scaled video signals are output at the HDMI OUT jacks.

This unit up-scales the analog video signals as follows:

- 480i (NTSC)/576i (PAL) → 480p/576p, 1080i, 720p, or 1080p
- 480p/576p → 1080i, 720p, or 1080p
- 1080i → 480p/576p, 720p, 1080p
- 720p → 480p/576p, 1080i, 1080p

Choice	Functions
Through	Does not up-scale any video signals.
480p (or 576p), 1080i, 720p, 1080p	Up-scales video signals to 480p or 576p, 1080i, 720p, or 1080p of resolution.

Note

The input video signals may be down-scaled depending on the setting of "HDMI Resolution".

■ HDMI Aspect (HDMI aspect ratio)

Use this feature to select whether this unit converts the aspect ratio of 4:3 video signals and outputs at the HDMI OUT jacks.

Choice	Functions
Through	Does not make any adjustments to the aspect ratio for the HDMI video signal sources.
16:9 Normal	Displays video images with the aspect ratio of 4:3 on your video monitor with the aspect ratio of 16:9. Black stripes appear on the right and left sides as a result.
Smart Zoom	Fits video images with the aspect ratio of 4:3 to your video monitor with the aspect ratio of 16:9. The signals are input with 720p, 1080i or 1080p of resolution, this setting does not affect the video signals output at the HDMI OUT jack.

Notes

- When "HDMI Resolution" is set to "Through", you cannot make any adjustments to "HDMI Aspect".
- If the aspect ratio of the input video source is other than 4:3, this unit automatically ignores the setting of "HDMI Aspect".
- When "HDMI Aspect" is set to "Smart Zoom", the video images of the edge of the video monitor are rather stretched.

■ Short Message (Short message display)

Use this feature to activate or deactivate the short message display displayed in the main zone video monitor function.

Choice	Functions
On	Activates the short message display function.
Off	Deactivates the short message display function.

Note

The short message display does not appear in the following cases:

- when the component video signals with 720p, 1080i or 1080p resolutions are input
- when HDMI video signals are input

■ On Screen (On-screen display time)

Use this feature to set the time for which the iPod menu, or NET/USB menu is displayed in the video monitor after you perform a certain operation.

Choice	Functions
Always	Displays the menu unceasingly during an operation.
10sec	Turns off the menu 10 seconds after you perform a certain operation.
30sec	Turns off the menu 30 seconds after you perform a certain operation.



This setting is applied to the GUI menu in the main zone and OSD in Zone 2, Zone 3, or Zone 4.

■ Position (GUI screen position)

Use this feature to adjust the vertical and horizontal position of the GUI screen.

Control range: -5 (downward/left) to +5 (upward/right)

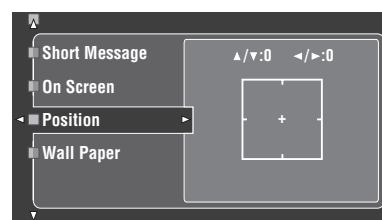

Button	Moving direction of the GUI display
Ⓢ ▲	Up
Ⓢ ▼	Down
Ⓢ ▷	Right
Ⓢ ◁	Left

■ Wall Paper (Wall paper)

Use this feature to display the wall paper or gray background in your video monitor when there is no video signal being input.

Choice	Functions
None	Does not display any background in your video monitor.
Piano	Displays a background image (the photograph of a piano) in your monitor when there is no video signal being input.
Horn	Displays a background image (the photograph of a horn) in your monitor when there is no video signal being input.
Electric Guitar	Displays a background image (the photograph of an electric guitar) in your monitor when there is no video signal being input.
Gray	Display a gray background in your monitor when there is no video signal being input.

Note

When "Conversion" is set to "Off", no background is displayed even if "Wall Paper" is set to other than "None".

Manual Setup (Multi Zone)

Use this menu to set the functions of the multi-zone configuration.

■ Speaker B (Speaker B setting)

Use this feature to select the location of the FRONT B speakers.

Choice	Descriptions
Main	Select this setting when you use the speakers connected to the EXTRA SP speaker terminals in the main room. This unit outputs the same audio signals at the EXTRA SP terminals as the FRONT A speaker terminals.
ZoneB	Select this setting when you use the speakers connected to the EXTRA SP speaker terminals in another room. When you turn off the FRONT A and FRONT B is turned on, all the speakers including the subwoofer in the main room are muted and this unit outputs sounds at the FRONT B terminals only.

Notes

- If you connect headphones to the PHONES jack on this unit, the sound is output from both the headphones and the speakers connected to the EXTRA SP terminals when "Speaker B" is set to "ZoneB".
- If a sound field program is selected when "Speaker B" is set to "ZoneB", this unit automatically enters the Virtual CINEMA DSP mode (see page 60).

■ Zone SP Assign (Zone speaker assignment)

Use this feature to assign the speaker terminals for Zone 2, Zone 3, and Zone 4. See page 116 for details.

■ Party Mode Set (Party mode settings)

The party mode enables you to play the same source in multiple zones simultaneously (see page 118). Use "Party Mode Set" menu to configure the functions of this unit when this unit is in the party mode.

Main 11ch Stereo (Main zone 11-channel stereo)

Use this feature to select whether the sound field program of the main zone is fixed to "11ch Stereo" when this unit is in the party mode.

Choice	Descriptions
Off	Select this setting to select the sound field program in the main zone as you like.
On	Select this setting to fix the sound field program of the main zone to "11ch Stereo" mode when this unit is in the party mode.

Target : Zone2/Target : Zone3/Target : Zone4 (Party mode target zone setting)

Use this feature to specify which zone joins to the party mode.

Choice	Descriptions
Disable	Select this setting not to join the selected zone to the party mode. You can select the input source of the selected zone independently even if this unit is in the party mode.
Enable	Select this setting to join the selected zone to the party mode. When this unit is in the party mode, the zone which this unit plays back the same source as the main zone in the zones join in the party mode.

■ Zone2 Set/Zone3 Set/Zone4 Set (Zone 2/Zone 3/Zone 4 settings)

Zone2 Volume/Zone3 Volume/Zone4 Volume (Zone 2/Zone 3/Zone 4 volume)

Use this menu to select whether this unit controls the volume level of the audio signals output at the ZONE OUT (ZONE2, ZONE3, or ZONE4) jacks.

Choice	Descriptions
Fixed	Select this setting when you want to control the volume level of the selected zone on the external amplifier. This unit fixes the ZONE OUT (ZONE 2 or ZONE 3) volume level to a standard line level.
Variable	Select this setting when you want to control the volume level of the selected zone on this unit. You can adjust the ZONE OUT (ZONE 2 or ZONE 3) volume level simultaneously with ⓈVOLUME +/- on the remote control.

Notes

- When "Zone2 Volume", "Zone3 Volume", or "Zone4 Volume" is set to "Fixed", you cannot select the following parameters:
 - Zone2 Max Vol./Zone3 Max Vol./Zone4 Max Vol.
 - Zone2 Initial Vol./Zone3 Initial Vol./Zone4 Initial Vol.
 - Zone2 Balance/Zone3 Balance/Zone4 Balance
- Even if you set "Zone2 Volume" to "Variable", the volume control on this unit does not function to the output level of the ZONE DIGITAL OUT (COAXIAL) jack (see page 113).

Zone2 Max Vol./Zone3 Max Vol./Zone4 Max Vol. (Zone 2/Zone 3/Zone 4 Maximum volume setting)

Use this feature to set the maximum volume level in the Zone 2, Zone 3, or Zone 4.

Control range: -30.0 dB to +15.0 dB, **+16.5 dB**

Control step: 5.0 dB

Note

The "Zone2 Max Vol.", "Zone3 Max Vol.", or "Zone4 Max Vol." setting takes priority over the "Zone2 Initial Vol.", "Zone3 Initial Vol.", or "Zone4 Initial Vol." setting. For example, "Zone2 Initial Vol." is set to -20.0 dB and then "Zone2 Max Vol." is set to -30.0 dB, the volume level is automatically set to -30.0 dB when you turn on the power of this unit next time.

**Zone2 Initial Vol./Zone3 Initial Vol./Zone4 Initial Vol.
(Zone 2/Zone 3/Zone 4 initial volume setting)**

Use this feature to set the volume level of Zone 2, Zone 3, or Zone 4 when the power of each zone is turned on.
Control range: **Off**, Mute, -80.0 dB to +16.5 dB
Control step: 0.5 dB

Note

The “Zone2 Max Vol.”, “Zone3 Max Vol.”, or “Zone4 Max Vol.” setting takes priority over the “Zone2 Initial Vol.”, “Zone3 Initial Vol.”, “Zone4 Initial Vol.” setting.

**Zone2 Balance/Zone3 Balance/Zone4 Balance
(Zone 2/Zone 3/Zone 4 balance)**

Use this feature to adjust the balance of the volume of the left and right channels in each zone.
Choices: L10 to L1, 0, R1 to R10

**Zone2 Mono/Zone3 Mono/Zone4 Mono
(Zone 2/Zone 3/Zone 4 monaural mode)**

Use this feature to select whether you play back sources monaurally in the selected zone.

Choice	Descriptions
Off	Turns off the monaural playback mode. This unit plays back sources in stereo.
On	Turns on the monaural playback mode. This unit mixes down the left and right channel signals and plays the sources monaurally.

**Muting Type
(Zone 2/Zone 3/Zone 4 muting type)**

Use this feature to adjust how much the mute function reduces the output volume of the selected zone.

Choice	Functions
Full	Mutes all the audio output.
-20dB	Reduces the current volume by 20 dB.
-40dB	Reduces the current volume by 40 dB.

■ Zone OSD (Zone on-screen display)

Use this feature to display the operational status of Zone 2, Zone 3, and Zone 4 on the Zone 2 video monitor connected to the ZONE VIDEO jacks on the rear panel of this unit. The Zone 2, Zone 3, and Zone 4 information to be displayed is listed as follows:

- The input source
- The volume level
- The audio mute status
- The tonal quality status
- iPod or network/USB menu when “DOCK” or “NET/USB” is selected as the input source of Zone 2, Zone 3, and/or Zone 4

Choice	Functions
Zone2	Displays the operational status of Zone 2 only.
Zone All	Displays the operational status of Zone 2, Zone 3, and Zone 4.

Notes

- You can connect up to two composite and one component video monitors to the ZONE OUT VIDEO jacks and ZONE OUT COMPONENT VIDEO jacks. If you connect multiple video monitors to the ZONE VIDEO and ZONE OUT COMPONENT VIDEO jacks, these video monitors display the same video images of the input source of Zone 2.
- When you set “Zone OSD” to “Zone All”, the operational status of Zone 3 and Zone 4 appears on the Zone 2 video monitor(s) even if Zone 2 is turned off.

Manual Setup (Network)

Use this menu to adjust the network and USB system parameters.

■ Configuration (Network configuration)

Use this feature to view the network parameters (IP address, etc.) or to change them manually.

DHCP (DHCP setting)

Use this feature to select whether this unit can obtain the network parameters (IP address, subnet mask, default gateway, primary DNS server and secondary DNS server) from the DHCP server of the connected network.

Choice	Descriptions
On	Select this setting when this unit can obtain the network parameters from the DHCP server of the connected network.
Off	Select this setting when you set the network parameters manually.

IP Address (IP address)

Use this parameter to specify an IP address assigned to this unit. This value must not duplicate the one used for other devices in the target network.

Subnet Mask (Subnet mask)

Use this parameter to specify the subnet mask value assigned to this unit.



For most of the cases, the subnet mask value can be set as “255.255.255.0”.

Default Gateway (Default gateway)

Use this parameter to specify the IP address of the default gateway.

DNS Server (P) (Primary DNS server)

DNS Server (S) (Secondary DNS server)

Use this parameter to specify the IP address of the primary and secondary DNS (Domain Name System) servers.

Note

If you have only one DNS address, enter the DNS address in “DNS Server (P)”. If you have two or more DNS addresses, enter one of them in “DNS Server (P)” and another in “DNS Server (S)”.

Setup (Setup)

Select “Setup” to confirm the settings of the “Configuration” parameters.

Procedure of the network configuration

- 1 From the top GUI menu, press $\textcircled{0}$ / Δ / ∇ on the remote control repeatedly and then $\textcircled{0}$ \triangleright to select “Configuration”.**
- 2 Press $\textcircled{0}$ / Δ / ∇ repeatedly and then $\textcircled{0}$ \triangleright to select “DHCP”.**

3 Press \odot Δ / ∇ to select “On” or “Off” and then \odot **ENTER** to confirm.

- If you select “On”, you do not have to set other network parameters. Refer to step 5 and finish the configuration.
- If you select “Off”, you need to set other network parameters. Refer to steps 4 through 6 to set the parameters.

Note

When “DHCP” is set to “On”, you cannot select and adjust any other network settings. To specify the other parameters, you need to first set “DHCP” to “Off”.

4 Press \odot Δ / ∇ to select the desired parameter and then \odot \triangleright .

5 Press \odot \triangleleft / \triangleright repeatedly to select the digit to change and then press \odot Δ / ∇ repeatedly to change the number.

6 Press \odot **ENTER** to confirm the setting of the parameter.

7 Repeat steps 4 through 6 to configure each network parameter.

8 Press \odot ∇ repeatedly to select “Setup” and then \odot **ENTER** to finish configuration.

Note

In case you have changed your network configuration, you may need to reconfigure the network settings again.



You can reset the network settings of this unit to the initial factory settings by using “NETWORK” or “INITIALIZE” in the advanced setup menu (see page 120).

Information (Network information)

Use this feature to display the network system information.

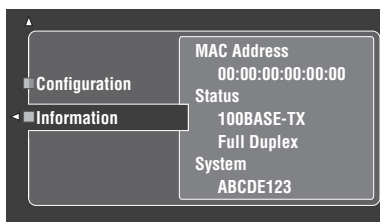

Note

The above display is an example.

MAC Address

(MAC (Media Access Control) address)

This information displays the MAC address that is assigned to this unit.

Status (Network status)

This information displays the current link status of the network.

Display status: 10BASE-T, 100BASE-TX, No Link, Full Duplex, Half Duplex

Note

“No Link” appears when network connection is not made.

System (System ID)

This information displays the system ID that is assigned to this unit.

Manual Setup (Option)

This menu adjusts the optional system settings.

Front Panel Disp. (Front panel display setting)

Dimmer (Dimmer)

Use this feature to adjust the brightness of the front panel display. Control range: -4 to 0

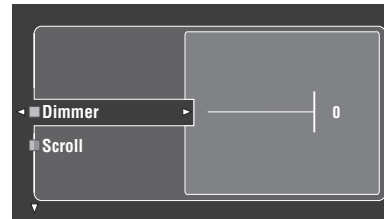

Scroll (Front panel display message scroll)

Use this feature to set whether to display the information (such as song title or channel name) in the front panel display in a continuous manner or by the first 14 alphanumeric characters after scrolling all characters once when “DOCK”, or “NET/USB” is selected as the input source.

Choice	Functions
Continue	Continuous mode. Select this to display the operation status in the front panel display in a continuous manner.
Once	Scroll-once mode. Select this to display the operation status in the front panel display by the first 14 alphanumeric characters after scrolling all characters once.

iPod (iPod settings)

Standby Charge

(iPod charge on the standby mode)

Use this feature to select whether this unit charges the battery of the stationed iPod or not when this unit is in the standby mode (see page 64).

Choice	Functions
Auto	Charges the battery of the stationed iPod when this unit is turned on and in the standby mode.
Off	Charges the battery of the stationed iPod only when this unit is turned on.

Audio Select (Default audio input jack select)

Use this feature to designate the default audio input jack select setting (see page 81) for the input sources connected to the DIGITAL INPUT jacks when you turn on the power of this unit.

Choice	Functions
Auto	Automatically detects the type of audio input signals and selects the appropriate audio input jack select setting.
Last	Automatically selects the last audio input jack select setting used for the connected input source.

Decoder Mode (Default decoder mode)

Use this feature to designate the default decoder mode (see page 82) for the input sources when you turn on the power of this unit.

Choice	Functions
Auto	Automatically detects the type of input signals and select the appropriate decoder mode setting.
Last	Automatically selects the last decoder mode setting used for the connected input source.

EXTD Surround (Default extended surround decoder mode setting)

Use this feature to designate the extended surround decoder mode (see page 72) for the input sources connected to the DIGITAL INPUT jacks when you turn on the power of this unit.

Choice	Functions
Auto	Automatically detects the input digital audio signals and activates the appropriate decoder.
Last	Selects the last selected extended surround decoder mode.

Memory Guard (Memory guard)

Use this feature to prevent accidental changes to sound field program parameter values and other system settings.

Choice	Functions
Off	Turns off the “Memory Guard” feature.
On	Protects the following parameters: <ul style="list-style-type: none"> – sound field program parameters – GUI menu parameters – speaker levels settings



When you select the protected parameter, “” appears at the bottom left of the GUI screen. You can adjust the parameters when you select the parameter and “” does not appear at the bottom left of the GUI menu even if “Memory Guard” is set to “On”.

HDMI Set (HDMI settings)

Use this feature to adjust the HDMI support audio.

Support Audio (Support audio)

Use this feature to select whether to play back HDMI audio signals on this unit or on another HDMI component connected to the HDMI OUT jacks on the rear panel of this unit.

Choice	Functions
DSP-Z11	Plays back HDMI audio signals on this unit. The HDMI audio signals input at the HDMI input jacks on this unit are not output to the HDMI component connected to the HDMI OUT jacks on the rear panel of this unit.
Other	Plays back HDMI audio signals on another HDMI component connected to the HDMI OUT jacks.

Note

Available audio/video signals depend on the specification of the connected video monitor. Refer to the instruction manual of each connected component.

Standby Through (Standby through)

Use this feature whether this unit allows the HDMI signals input at the HDMI IN jacks to pass through this unit when this unit is in the standby mode. You can also designate an HDMI IN jack and an HDMI OUT jack that accept the signals when “Standby Through” is set to “On” and this unit is in the standby mode.

Choice	Functions
Off	Does not accept the HDMI signals when this unit is in the standby mode.
On	Accepts the HDMI signals when this unit is in the standby mode.

Notes

- When “Standby Through” is set to “On” and this unit is in the standby mode, the audio signals are only output at the HDMI OUT 1 or HDMI OUT 2.
- When “Standby Through” is set to “On”, the amount of power consumption in the standby mode is increase. When not planning to use this unit for long periods of time, press **ⓂMASTER ON/OFF** to release it outward to the OFF position to turn off this unit.

Input/output jack select

When “Standby Through” is set to “On”, you can designate an HDMI IN jack and an HDMI OUT jack that accept the signals when this unit in the standby mode.

Input (HDMI IN jack select)

Use this feature to select an HDMI IN jack select that accepts HDMI signals when this unit is in the standby mode.

Choice	Selected HDMI IN jack
IN1	HDMI IN1
IN2	HDMI IN2
IN3	HDMI IN3
IN4	HDMI IN4
FRONT	Front HDMI IN

Output (HDMI OUT jack select)

Use this feature to select an HDMI OUT jack select that outputs HDMI signals when this unit is in the standby mode.

Choice	Selected HDMI OUT jack
OUT 1	HDMI OUT1
OUT 2	HDMI OUT2

Trigger Output (Trigger output)

Use this feature to select the functions of each TRIGGER OUT jack on this unit.

Choice	Function
Trigger1	Sets the functions for the TRIGGER OUT 1 jack.
Trigger2	Sets the functions for the TRIGGER OUT 2 jack.

Trigger operation mode

Choice	Descriptions
Power	Select this setting to send the voltage signals at the selected TRIGGER OUT jack while the selected zone is turned on.
Source	Select this setting to send the voltage signals at the selected TRIGGER OUT jack while the selected input source is selected.
Manual	Select this setting to send the voltage signals manually.

Source (Source)

After selecting the input source, you can set the function of the TRIGGER OUT jacks when the corresponding input source is selected.

Choice	Descriptions
Input High	Sends the voltage when you select the input source you set in "Source".
Input Low	Stops sending the voltage when you select the input source you set in "Source".

Manual (Manual)

Choice	Function
High	Sends the voltage signals.
Low	Stops sending the voltage signals.

Signal Info. (Input signal information)

You can display the format, sampling frequency, channel, bit rate and flag data of the current input signal.

■ Audio Info. (Audio information)

Format	Signal format. When this unit cannot detect a digital signal, it automatically switches to analog input.
Sampling	The number of samples per second taken from a continuous signal to make a discrete signal.
Channel	The number of source channels in the input signal (front/surround/LFE). For example, a multi-channel soundtrack with 3 front channels, 2 surround channels and LFE, is displayed as "3/2/0.1".
Bitrate	The number of bits passing a given point per second.
Dialogue	The dialogue normalization level preset to the current input bitstream signal (see page 131).
Flag1/Flag2	Flag data encoded in the bitstream, or PCM signals that cue this unit to automatically switch decoders ("Surround EX", etc.).

Notes

- "—" appears when this unit cannot display the corresponding information.
- Some high definition audio bitstream contents may not include the discrete surround back left and right channel signals but are encoded at the bitrate of 192 kHz.
- Even if you make settings to output bitstreams directly, some players convert the Dolby TrueHD or Dolby Digital Plus bitstreams to the Dolby Digital bitstreams, while converting the DTS-HD Master Audio or DTS-HD High Resolution Audio bitstreams to the DTS bitstreams.

■ Video Info. (Video information)

HDMI Signal	Type of the source video signals and the video signals output at the HDMI OUT jack on this unit.
HDMI Resolution	Resolution of the input signal (analog or HDMI) and the output signal (HDMI).
Analog Resolution	Resolution of the source video signals and the analog video signals output at the COMPONENT MONITOR OUT jacks of this unit.
HDMI Error (HDMI Message)	Error message for HDMI sources or connected HDMI devices. See page 124 for details.

HDMI error and message

Message	Cause
Device Over	The number of the connected HDMI components is over the limit. HDCP authentication failed.
Out of Resolution	The connected monitor is not compatible with the resolution of the input video signal.

Language

Use this feature to select the language of the menu items and messages.

Choices: **English** (English), 日本語 (Japanese), Français (French), Deutsch (German), Español (Spanish), Русский (Russian)



You can also select the language using the "LANGUAGE" parameter in "Advanced setup" in the front panel display (see page 120).

Language	GUI menu	Front panel display	Zone OSD
Русский (Russian)	<input type="radio"/>	<input type="radio"/>	—
日本語 (Japanese)	<input type="radio"/>	—	—
Other languages	<input type="radio"/>	<input type="radio"/>	<input type="radio"/>

... The selected language is displayed.

... The selected language is not displayed. The menu items and messages are displayed in English.

Saving and recalling the system settings (System Memory)

Use this feature to save and recall up to 10 of your favorite setting for the main zone. You can also save up to four of your favorite settings for Zone 2, Zone 3, or Zone 4.

Saving the current system settings

Before performing the following operations, set the operation mode selector on the remote control to **AMP**.

■ Saving by the **SYSTEM MEMORY** buttons

You can save the current system settings stored in “Memory1” to “Memory4” by pressing the corresponding **SYSTEM MEMORY** buttons.

Press and hold one of the SYSTEM MEMORY buttons on the remote control for 4 seconds.

“MEMORY 1 SAVE” (example) appears in the front panel display, and then this unit saves the current system setting to the corresponding memory number.

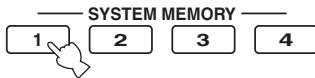

Notes

- If system settings are already saved in the selected memory number, this unit overwrites the old system settings.
- To save the system settings for Zone 2, Zone 3, or Zone 4, press **ZONE** on the remote control repeatedly to select the operation zone setting of the remote control and then press and hold the desired **SYSTEM MEMORY** button for 4 seconds. You can save the system settings for the selected Zone only when the zone is turned on.
- This unit saves the parameters in the groups you select by using the GUI menu when you save the parameters by using the **SYSTEM MEMORY** buttons.

■ Saving by the GUI menu operation

You can save the current system settings stored in “Memory1” to “Memory10” by using the “System Memory” menu in the GUI menu.

1 Press **MENU** on the remote control.

The top menu appears in the video monitor.

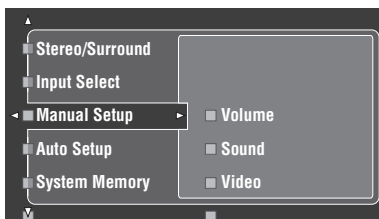

2 Press **UP/DOWN** repeatedly to select “System Memory” and then press **ENTER**.

The “System Memory” menu appears in the video monitor.

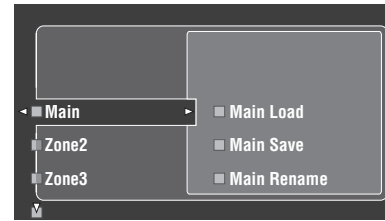

3 Press **UP/DOWN** repeatedly to select the desired zone and then press **ENTER**.

In the following example, you select “Main” (main zone). The list of the memory number appears in the video monitor.

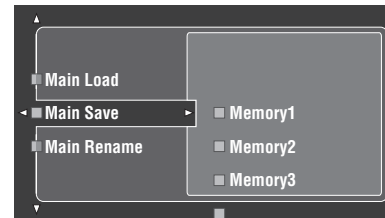

4 Press **UP/DOWN** repeatedly to select “Main Save” and then press **ENTER**.

The following menu appears in the video monitor.

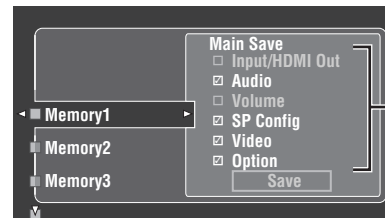

Group of the system parameters

5 Press **UP/DOWN** repeatedly to select the desired memory number (“Memory1” to “Memory10” or “Memory4”) and then press **ENTER**.

The list of the saved items appears in the video monitor.

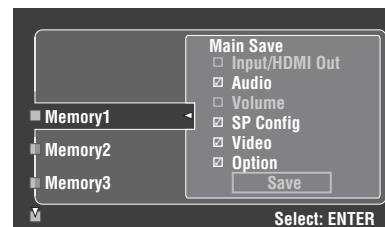



- If you select “Zone2”, “Zone3”, or “Zone4” in step 3, you can select “Memory1” to “Memory4”. You can save the parameters for the selected zone only when the zone is turned on.
- If system settings are already saved in the selected memory number, this unit overwrite to old system settings.
- If you save the system settings to “Memory1” to “Memory4”, you can load the stored settings by pressing the corresponding **SYSTEM MEMORY** buttons (see page 98).

6 Press $\odot\Delta / \nabla$ repeatedly to select the group of parameters and then press \odot ENTER to select or clear the check box of the group.

This unit saves the parameters in the checked groups. Refer to “Saved parameters for the main zone” on page 98.

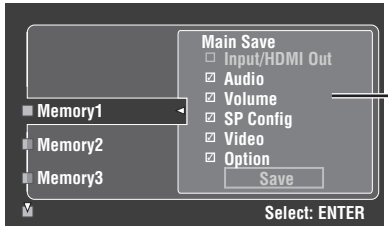

Current selected group of the parameters appears in red

Note

If the selected zone is other than “Main”, you can select “Input”, “Volume”, and “Tone Control”. See page 98 for details.

7 Press $\odot\nabla$ repeatedly to select “Save” and then \odot ENTER to save the current system settings to the selected memory number.

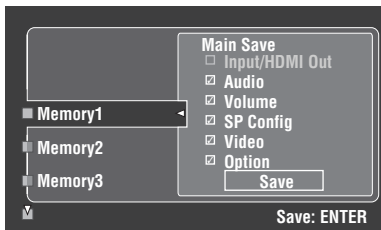

You can cancel the saving by pressing $\odot\triangleleft$.

8 Press \odot MENU again to exit from the GUI menu.

Renaming the stored settings

Use this feature to rename the stored settings. The name of each memory number appears in the GUI menu or front panel display.

1 Press \odot MENU on the remote control.

The top menu appears in the video monitor.

2 Press $\odot\Delta / \nabla$ repeatedly to select “System Memory” and then press $\odot\triangleright$.

The “System Memory” menu appears in the video monitor.

3 Press $\odot\Delta / \nabla$ repeatedly to select the desired zone and then press $\odot\triangleright$.

In the following example, “Main” is selected.

4 Press $\odot\Delta / \nabla$ repeatedly to select “Main Rename” (example) and then $\odot\triangleright$.

The list of the memory number appears in the video monitor.

5 Press $\odot\Delta / \nabla$ repeatedly to select the desired memory number and then $\odot\triangleright$.

The rename display appears in the video monitor.

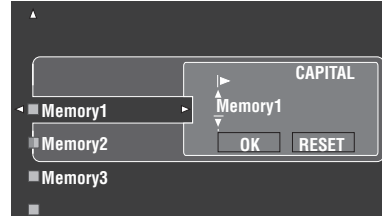

6 Press \odot ENTER repeatedly to select a character type (CAPITAL/SMALL/LATIN CAPITAL/LATIN SMALL/FIGURE/MARK).

7 Press $\odot\Delta / \nabla$ to select the character you want to use and $\odot\triangleleft / \triangleright$ to move to the next one.

- You can use up to 9 characters for each memory.
- Press $\odot\nabla$ to change the character in the following order, or press $\odot\Delta$ to go in the reverse order:
 CAPITAL A to Z, space
 SMALL a to z, space
 LATIN CAPITAL Ă, Ō, Ū, etc.
 LATIN SMALL ä, ö, ü, etc.
 FIGURE 0 to 9, space
 MARK !, #, %, &, etc.
- Press \odot ENTER to switch between character types.



Press $\odot\triangleright$ repeatedly to select “RESET” and then press \odot ENTER to set the name of the memory to the initial name.

Notes

- The character types you can select differ depending on the setting in “Language” (see page 95).
- If you set “Language” to “日本語”, you can also select Japanese characters.

8 Press $\odot\triangleright$ repeatedly to select “OK” and press \odot ENTER when complete.



Repeat steps 5 to 7 to rename each input.

9 Press \odot MENU again to exit from the GUI menu.

Note

If you change the setting of “Language” (see page 95) or “LANGUAGE” (see page 120), the name of each system memory are automatically set to the initial name of the selected language.

■ **Saved parameters for the main zone**

The groups of the system parameters indicated in bold are the groups that is saved in the initial setting.

Group	Parameters	Page
Input/HDMI Out *	Audio Select	82
	Decoder Mode	82
	Input source	50
	HDMI OUT SEL	—
Audio	Stereo/Surround	77
	Pure Direct on/off	61
	EXTD SUR. setting	72
	Adaptive DRC	86
	Adaptive DSP Lvl	86
	LFE Level	86
	Dynamic Range	87
	Tone Control	88
	Pure Direct	89
	CINEMA DSP HD ³ ON/OFF	60
Volume	Volume level	50
SP Config	S-Wave Control	87
	Parametric EQ	87
	THX Set	83
	Speaker Set	84
	Speaker Distance	85
	Speaker Level	86
	Speaker B	91
	Information (Auto Setup)	45
	Setup Menu (Auto Setup)	44
	Selected front speaker set (A and/or B)	51
Video	Conversion	89
	HDMI Processing	90
	Component I/P	90
	HDMI Resolution	90
	HDMI Aspect	90
	Short Message	90
	On Screen	90
	Position	90
	Wall Paper	91
	Option	Lipsync
Front Panel Disp.		93
Support Audio		94

Note

* The playing status of the network/USB sources (selected radio station, etc.) is also saved.

■ **Saved parameters for Zone 2, Zone 3, or Zone 4**

Parameter	Descriptions	Page
Input	Input source *	117
Volume	Volume level	117
Tone Control	Tone control settings	117

Note

* The playing status of the network/USB sources (selected radio station, etc.) is also saved.

Loading the stored system settings

- Before performing the following operations, set the operation mode selector on the remote control to **AMP**.
- This unit overwrites the stored settings to the current settings of this unit. If you do not want to erase the current settings, save the current settings to any System Memory number in advance.

■ **Loading by the **SYSTEM MEMORY** buttons**

You can recall the system settings stored in “Memory1” to “Memory4” by pressing the corresponding **SYSTEM MEMORY** buttons.



To recall the system settings for Zone 2, Zone 3, or Zone 4, press **ZONE** on the remote control repeatedly to select the operation zone setting of the remote control in advance. You can recall the system settings for the selected zone only when the zone is turned on.

1 Press one of the **SYSTEM MEMORY buttons on the remote control to select the desired memory number.**

“MEMORY 1 LOAD” (example) appears in the front panel display.



“EMPTY” appears in the menu screen if no system settings are stored in the selected memory number.

2 Press the selected **SYSTEM MEMORY button once more to confirm the selection.**

This unit loads the settings stored in the selected memory number.

■ **Loading by the GUI menu operation**

1 Press **MENU on the remote control.**

The top menu appears in the video monitor.

2 Press **UP / **DOWN** repeatedly to select “System Memory” and then press **RIGHT**.**

The “System Memory” menu appears in the video monitor.

3 Press **UP / **DOWN** repeatedly to select the desired zone and then press **RIGHT**.**

In the following example, you select “Main” (main zone). The list of the memory number appears in the video monitor.

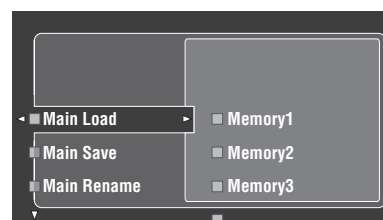

Note

You can recall the system settings for the selected zone only when the zone is turned on.

4 Press **Ⓣ** / **Ⓢ** / **Ⓤ** to select “Main Load” and then press **Ⓣ**.

The following menu appears in the video monitor.

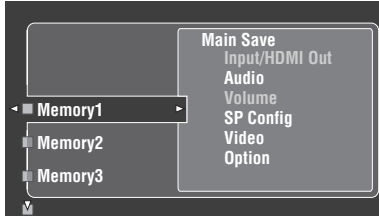

If system settings are already stored in the selected memory number, the stored system parameter settings appear in the menu screen. “Memory Empty” appears in the menu screen if no system settings are stored in the selected memory number.

5 Press **Ⓣ** / **Ⓢ** / **Ⓤ** repeatedly to select the desired memory number where the system settings are stored and then press **Ⓣ**.

Once “Load: ENTER” appears in the video monitor, press **Ⓣ** ENTER to confirm the loading.



You can cancel the loading by pressing **Ⓣ** <

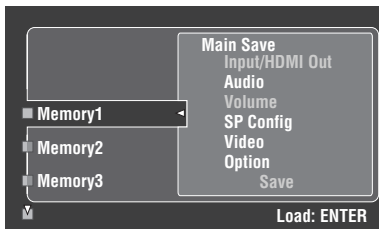

6 Press **Ⓣ** MENU to exit from the GUI menu.

Using examples

■ **Example 1: Switching the settings of this unit according to the using situations**

Use the following example to change the settings of this unit according to the using situations just by pressing the **Ⓣ** SYSTEM MEMORY buttons.

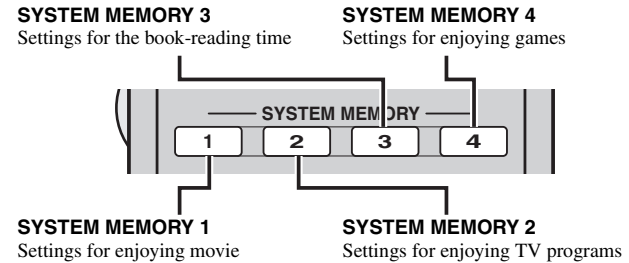

SYSTEM MEMORY 1: Settings for enjoying movie

Save the following settings to enjoy movies. You can switch the input source, sound field program, and the HDMI OUT jack simultaneously.

Recommended parameter settings

- Input source: BD/HD DVD (see page 50)
- “HDMI OUT SEL” setting: OUT 2 (see page 51)
- Sound field program: Sci-Fi (see page 54)
- “Dimmer”: -4 (see page 93)

Saved parameter groups

Input/HDMI Out, Audio, Option

SYSTEM MEMORY 2: Settings for enjoying TV programs

When you want to play back the audio signals input at the CBL/SAT HDMI IN 3 jack on the speakers of the TV connected to the HDMI OUT 1 jack to enjoy TV programs, use the following settings. You can set input source and output component of the audio signals simultaneously.

Recommended parameter settings

- Input source: CBL/SAT (see page 50)
- “HDMI OUT SEL” setting: OUT 1 (see page 51)
- “Support Audio” setting: Other (see page 94)

Saved parameter groups

Input/HDMI Out, Audio

SYSTEM MEMORY 3: Settings for the book-reading time

When you enjoy reading books with listening to your favorite Internet radio service, use the following settings. You can recall the desired input source, Internet radio service, and audio settings simultaneously.

Recommended parameter settings

- Input source: NET/USB (Net Radio) (see page 50)
- Sound field program: 11ch Enhancer (see page 54)
- Volume level: Slightly low (see page 50)



Before saving the settings, select the desired Internet radio service (see page 69).

Saved parameter groups

Input/HDMI Out, Audio, Volume

SYSTEM MEMORY 4: Settings for enjoying games

Save the following settings to enjoy roleplaying games. You can switch the input source, sound field program, and the HDMI OUT jack simultaneously.

Recommended parameter settings

Input source: V-AUX (see page 50)
Sound field program: Roleplaying Game (see page 54)
“HDMI OUT SEL” setting: OUT 2 (see page 51)

Saved parameter groups

Input/HDMI Out, Audio

■ Example 2: Switching the setting of this unit according to the environment of the listening room

Use the following example to change the speaker and audio settings according to the environment of the listening room and the situation.

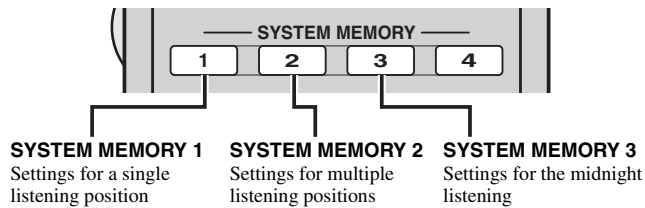

SYSTEM MEMORY 1: Settings for a single listening position

Save the result of the automatic setup for a single listening position.

Recommended parameter settings

Automatic setup: The result when you perform the measurement for the single listening position (see page 42).

Saved parameter group

SP Config

SYSTEM MEMORY 2: Settings for multiple listening positions

Save the result of the automatic setup for the multiple listening positions.

Recommended parameter settings

Automatic setup: The result when you perform the measurement for the multiple listening positions (see page 42).

Saved parameter group

SP Config

SYSTEM MEMORY 3: Settings for the midnight listening

The acoustic characteristics may change whether curtains are opened or closed. Use the following settings for the listening when you want to enjoy movies in midnight with low volume level.

Recommended parameter settings

Automatic setup: The result when you perform the measurement with the curtains are closed (see page 42).
“Adaptive DRC” setting: Auto (see page 86)
“Adaptive DSP Lvl” setting: Auto (see page 86)

Saved parameter groups

Audio, SP Config

Controlling this unit by using the Web browser (Web Control Center)

You can operate this unit by using a Web browser. You can select the input source and sound field program, browse the iPod or network/USB contents, select the preset items, and adjust the parameters of this unit by using the graphical user interface (Web Control Center) that appears in the Web browser. Check the IP address of this unit by using "IP Address" in "Network" menu (see page 92) in advance, and then enter the IP address to the Web browser to access this unit to control it.

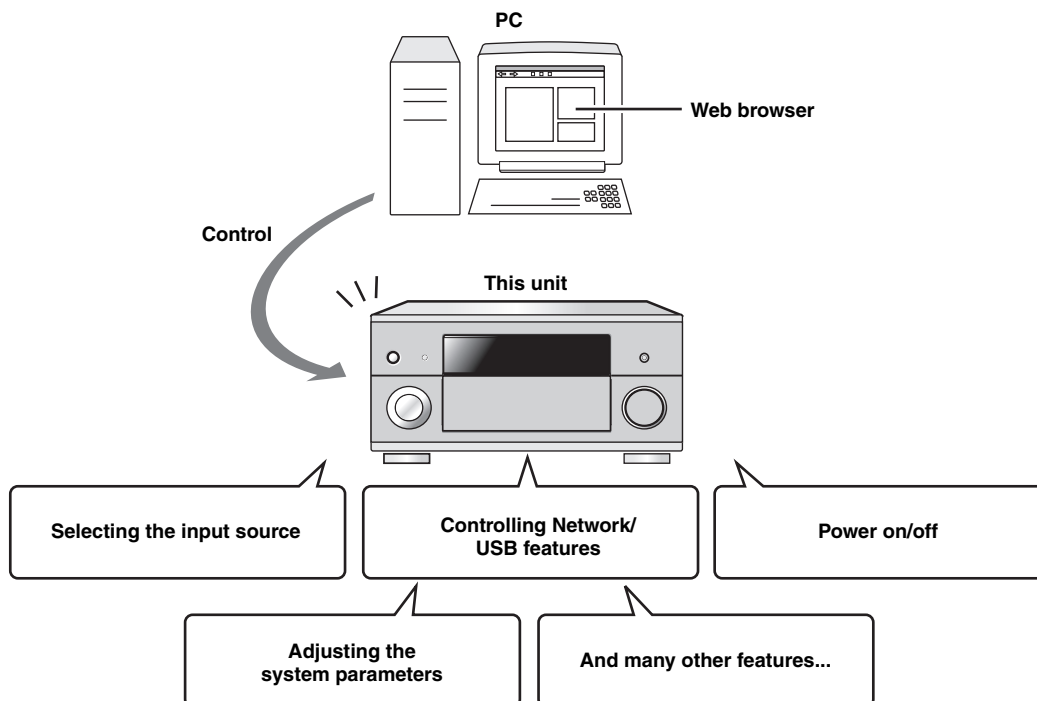

- To use this feature, this unit and your PC must be connected properly in the network. See page 37 for details of the connections.
- We recommend that you use Windows Internet Explorer 6 or 7 that is installed on Windows XP or Windows Vista PC to access this unit.
- You can select whether this unit accepts the controls by using the Web browser when this unit is in the standby mode. See page 119 for details.
- You can register the MAC address of the PCs you want to use to control this unit and limit the PCs that can control this unit by using the Web browser. You can select that this unit allows the access to this unit by the PCs whose MAC addresses are registered to this unit or allows the access by any PCs by using "MAC FILTER" in "Advanced setup" (see page 120).

Remote control features

In addition to controlling this unit, the remote control can also operate other audiovisual components made by Yamaha and other manufacturers. To control your TV or other components, you must set up the appropriate remote control code for each input source (see page 104).

Controlling this unit, a TV, or other components

Controlling this unit

Set the operation mode selector to **AMP** to control this unit.

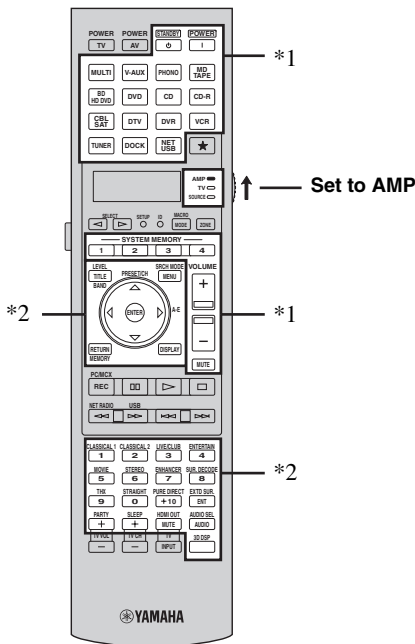

Controlling a TV

Set the operation mode selector to **TV** to control your TV. To control your TV, you must set the appropriate remote control code to the TV control area in advance (see page 104).

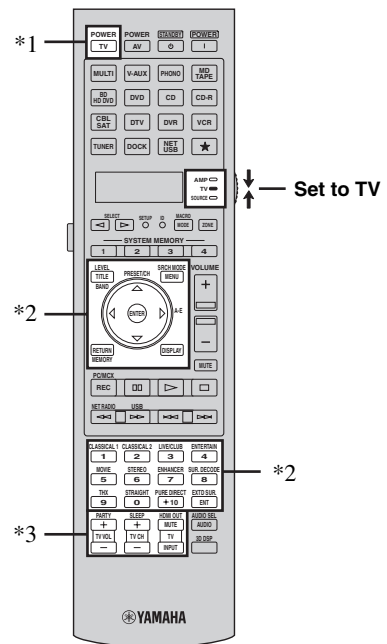

Notes

- *1 These buttons always control this unit regardless of the operation mode selector position.
- *2 These buttons control this unit only when the component operation mode selector is set to **AMP**.

Notes

- *1 **TV POWER** can always turn on or off the power of the TV regardless of the operation mode selector position.
- *2 These buttons control your TV only when the operation mode selector is set to **TV**. For details, see the “TV” column on page 103.
- *3 These buttons control your TV only when the operation mode selector is set to **TV** or **SOURCE**.

Remote control	Functions
TV VOL +/-	Increases or decreases the volume level.
TV CH +/-	Changes the currently selected channel.
TV MUTE	Mutes the audio output.
TV INPUT	Switches the input source.



If no code has been set to the “TV” area, the remote control operates the component that is set to the “DTV” area (see page 104).

Controlling other components

Set the operation mode selector to **16 SOURCE** to control other components selected with the input selector buttons or ☆ (3). You must set the appropriate remote control code for each input source in advance (see page 104). The following table shows the function of each control button used to control other components assigned to each input selector button or ☆ (3). Be advised that some buttons may not correctly operate the selected component.



The remote control has 16 modes (control areas) to control components so that the remote control can operate up to 16 different components.

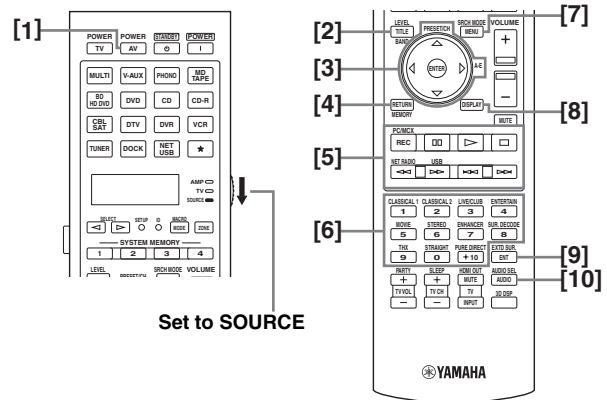

	Blu-ray Disc/ HD DVD player/ recorder	DVD player	LD player	DVD recorder/ Digital video recorder	VCR	TV	Cable TV/ Satellite tuner	CD player	MD recorder/ CD recorder	Tape deck	Tuner
[1] AV POWER	Power *1	Power *1	Power *1	Power *1	Power *1	DVR power *2	Power *1	Power *1	Power *1	Power *1	Power *1
[2] TITLE, BAND	Title	Title		Title		Title					Band
[3] PRESET/CH ▲	Menu up	Menu up		Menu up	Channel up	Menu up	Channel up				Menu up
PRESET/CH ▼	Menu down	Menu down		Menu down	Channel down	Menu down	Channel down				Menu down
A-E ◀	Menu left	Menu left		Menu left		Menu left					Menu left
A-E ▶	Menu right	Menu right		Menu right		Menu right				Direction A/B	Menu right
ENTER	Menu enter	Menu enter		Menu enter		Menu enter					Menu enter
[4] RETURN, MEMORY	Return	Return		Return		Return					Memory
[5] REC	Record (recorder)	Disc skip		Record	Record	DVR record *2	DVR record *2	Disc skip	Record	Record	
⏸	Pause	Pause	Pause	Pause	Pause	DVR pause *2	DVR pause *2	Pause	Pause	Pause	
▶	Play	Play	Play	Play	Play	DVR play *2	DVR play *2	Play	Play	Play	
⏹	Stop	Stop	Stop	Stop	Stop	DVR stop *2	DVR stop *2	Stop	Stop	Stop	
◀◀	Search backward	Search backward	Search backward	Search backward	Search backward	DVR search backward *2	DVR search backward *2	Search backward	Search backward	Search backward	
▶▶	Search forward	Search forward	Search forward	Search forward	Search forward	DVR search forward *2	DVR search forward *2	Search forward	Search forward	Search forward	
◀◀	Skip backward	Skip backward	Skip backward	Skip backward	Skip backward	DVR skip backward *2	DVR skip backward *2	Skip backward	Skip backward	Direction A	
▶▶	Skip forward	Skip forward	Skip forward	Skip forward	Skip forward	DVR skip forward *2	DVR skip forward *2	Skip forward	Skip forward	Direction B	
[6] 1-9, 0, +10	Numeric buttons	Numeric buttons	Numeric buttons	Numeric buttons	Numeric buttons	Numeric buttons	Numeric buttons	Numeric buttons	Numeric buttons		Numeric buttons
[7] MENU, SRCH MODE	Menu	Menu		Menu		Menu					Search mode
[8] DISPLAY	Display	Display	Display	Display	Display	Display	Display	Display	Display		Display
[9] ENT	Index	Index	Chapter/time	Index	Enter	Enter	Enter	Index	Index		Enter
[10] AUDIO	Audio	Audio	Audio	Audio							

Notes

*1 This button is operational only when the original remote control supplied with the component has a POWER button.

*2 These buttons operate your video recorder (DVD recorder etc.) only when you set the appropriate remote control code for DVR (see page 104).

Selecting a component to be controlled

You can select a component to be controlled independently of the input source selected with the input selector buttons or ☆.

Press **5 SELECT** ◀/▶ repeatedly to select the desired component.

The name of the component to be controlled appears in the display window (4) on the remote control.

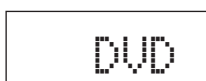

Controlling optional components (Option mode)

“OPTN1” and “OPTN2” are optional component control areas that can be programmed with remote control functions independently from any input source. This areas are useful for programming commands that are to be used only as a part of a macro function or for components that do not have a valid remote control code.

To select the option mode, press **5 SELECT** ◀/▶ repeatedly until “OPTN1” or “OPTN2” appears in the display window (4) on the remote control.

Note

You cannot set a remote control code for the optional component control areas. See page 105 to program buttons operated within these component control areas.

Customizing the remote control

Use the setup mode of the remote control to customize the remote control.

- 1 Press **⑰** **SETUP** on the remote control using a ballpoint pen or similar object.
“SETUP” appears in the display window on the remote control.

- 2 Press **⑨** **△** / **▽** repeatedly to select the desired setup mode.

Setup mode	Descriptions	Page
SETUP	Top setup mode menu.	—
LEARN	Learning mode. Use this feature to program codes from other remote controls.	105
P-SET	Preset mode. Use this feature to change the remote control code of each control area.	104
RNAME	Renaming mode. Use this feature to change the name of each control area.	106
MACRO	Macro programming mode. Use this feature to set the macro program.	108
CLEAR	Clearing mode. Use this feature to clear the configurations of this unit.	109
ERASE	Erase mode. Use this feature to erase the learned functions of each button.	109
EX-IR	Extended IR code mode. This feature is for the authorized custom installers only.	—
LIGHT	Backlight mode. Use this feature to set the light up mode of the remote control.	104

- 3 After the configurations, press **⑰** **SETUP** again to exit from the setup menu.

Note

If you do not complete each of the operations within 30 seconds, this unit automatically exits from the setup menu.

Setting the backlight mode of the remote control (LIGHT)

You can set the backlight mode of the remote control.

- 1 Press **⑰** **SETUP** on the remote control using a ballpoint pen or similar object.
“SETUP” appears in the display window (④) on the remote control.
- 2 Press **⑨** **△** / **▽** repeatedly to select “LIGHT” and then press **⑨** **ENTER**.
“LIGHT” and the current “LIGHT” setting appears in the display window (④) alternately.

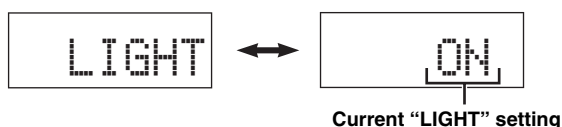

- 3 Press **⑨** **△** / **▽** to select the desired setting.

Choice	Descriptions
ON	Lights up the backlight when a button is pressed or the remote control detects a motion.
OFF	Lights up the backlight only when ⑥ LIGHT is pressed.

- 4 Press **⑨** **ENTER** to confirm the setting.
“OK” appears in the display window (④).

- 5 Press **⑰** **SETUP** again to exit from the setup mode.



You can light up the backlight by pressing **⑥** **LIGHT** anytime.

Setting remote control codes (P-SET)

You can control other components by setting the appropriate remote control codes. Codes can be set up for each control area. For a complete list of available remote control codes, refer to “List of remote control codes” at the end of this manual.

The following table shows the default component (Library: component category) and the remote control code for each control area.

Remote control code default settings

Control area	Library (component category)	Manufacturer	Default code
MULTI	DVD	Yamaha	04306
V-AUX	—	—	—
PHONO	—	—	—
MD TAPE	MD	Yamaha	00409
BD	DVD	Yamaha	04306
HD DVD	DVD	Yamaha	04306
DVD	DVD	Yamaha	04306
CD	CD	Yamaha	01105
CD-R	CD-R	Yamaha	01405
CBL	—	—	—
SAT	—	—	—
DTV	—	—	—
DVR	DVR	Yamaha	00707
VCR	—	—	—
TUNER	SOURCE	Yamaha	00012
DOCK	SOURCE	Yamaha	00012
NET	SOURCE	Yamaha	00012
USB	SOURCE	Yamaha	00012
☆ (TAPE)	TAPE	Yamaha	00311
TV	—	—	—

Note

You may not be able to operate your Yamaha component even if a Yamaha remote control code is preset as listed above. In this case, try setting another Yamaha remote control code.

1 Press **17** **SETUP** on the remote control using a ballpoint pen or similar object.

The remote control enters the setup menu. “SETUP” appears in the display window (4) on the remote control.

2 Press **9** **Δ** / **∇** repeatedly to select “P-SET” and then press **9** **ENTER**.

The remote control enters the preset mode. “P-SET” and name of the currently selected control area appears in the display window (4) alternately.

3 Set the operation mode selector to **17** **SOURCE** and then press an input selector button or **☆** (3) or **6** **SELECT** **<** / **>** repeatedly to select the control area you want to customize.

“P-SET” and name of the selected control area appears in the display window (4) alternately.



If you want to select “TV”, set the operation mode selector to **16** **TV**.

4 Press **9** **ENTER**.

The five-digit code set for the selected control area appears in the display window (4).



Note

“00000” appears in the display window (4) if no code has been set.

5 Press the numeric buttons (12) to enter the five-digit remote control code for the component you want to use.

For a complete list of available remote control codes, refer to “List of remote control codes” at the end of this manual.



You can also enter the desired number by pressing **9** **Δ** / **∇** / **<** / **>** repeatedly.

6 Press **9** **ENTER** to set the number.

“OK” appears in the display window (4) if setting was successful.

“NG” appears in the display window (4) if the setting was unsuccessful. In this case, start over from step 3.



If you continuously want to set up another code for another control area, repeat steps 3 through 6.

7 Press **17** **SETUP** again to exit from the setup mode.

8 Press **11** **>** or **2** **AV POWER** to confirm whether you can control your component using the remote control.



If operation is not possible and the manufacturer of your component has more than one code, try each of them until you find the correct one.

Notes

- “ERROR” appears in the display window (4) on the remote control if you press a button not indicated in the respective step, or when you press more than one button simultaneously.
- The supplied remote control does not contain all possible codes for commercially available audio and video components (including Yamaha components). If operation is not possible with any of the remote control codes, program the new remote control function using the learning feature (see “Programming codes from other remote controls (LEARN)” on page 105) or use the remote control supplied with the component.
- Functions programmed using the learning mode take priority over remote control code functions.
- If you set “00012” as the remote control code of the selected control area, you can operate the currently selected internal source (DOCK, or NET/USB).

Programming codes from other remote controls (LEARN)

You can program remote control codes from other remote controls. Use the learning feature if you want to program functions not included in the basic operations covered by the remote control codes, or an appropriate remote control code is not available. You can program the function of other remote control to the buttons in the highlighted areas in the following illustration. The buttons can be programmed independently for each control area.

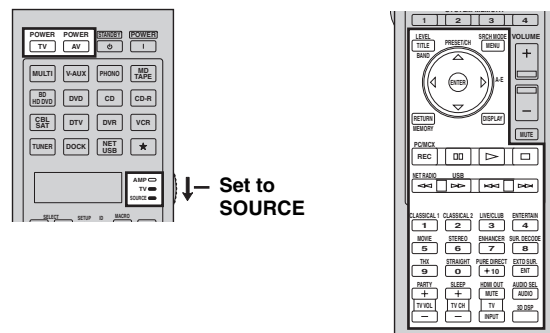

Notes

- The remote control transmits infrared rays. If the other remote control also uses infrared rays, this remote control can learn most of its functions. However, you may not be able to program some special signals or extremely long transmissions. Refer to the operating instructions for the other remote control.
- You cannot program the desired remote control code even if you select the buttons in the highlighted area in the above illustration depending on the selected control area and the assigned library.

1 Set the operation mode selector to **16** **SOURCE** and then press an input selector button or **☆** (3) to select the desired control area.

The name of the control area you want to customize appears in the display window (4) on the remote control.



- You can also select the desired control area by pressing **6** **SELECT** **<** / **>** repeatedly.
- If you want to select “TV”, set the operation mode selector to **16** **TV**.

Note

Make sure that the operation mode selector is set to **16** **SOURCE** or **16** **TV**. When you set the operation mode selector to **16** **AMP** and program a remote control codes from other remote controls, the programmed key cannot operate the amplifier function of this unit.

2 Press **17** **SETUP** using a ballpoint pen or similar object.

“SETUP” appears in the display window (4).

3 Press $\textcircled{9}$ Δ / ∇ repeatedly to select “LEARN” and then press $\textcircled{9}$ ENTER.

The remote control enters the learning mode. “LEARN” and the name of the selected control area appears in the display window $\textcircled{4}$ alternately.



4 Place this remote control about 5 to 10 cm (2 to 4 in) apart from the other remote control on a flat surface so that their infrared transmitters are aimed at each other and then press $\textcircled{9}$ ENTER.

“L-KEY” appears in the display window $\textcircled{4}$.

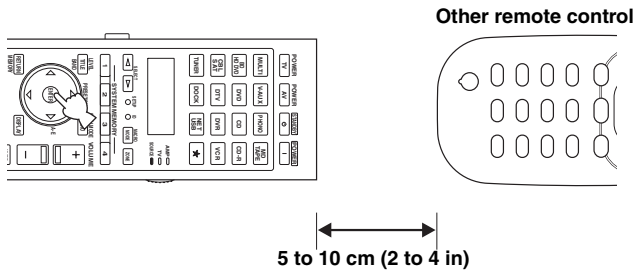

5 Press the button for which you want to program the new function.

“START” appears in the display window $\textcircled{4}$.

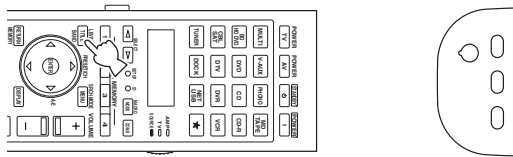

6 Press and hold the button you want to program on the other remote control until “OK” appears in the display window $\textcircled{4}$.

“NG” appears in the display window $\textcircled{4}$ if learning was unsuccessful. In this case, start over from step 4.

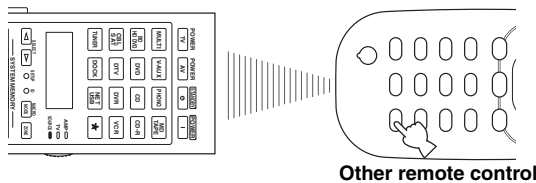

- When you want to program another function, repeat steps 4 and 6.
- When you continuously want to program another function for another control area, set the operation mode selector to $\textcircled{16}$ SOURCE and then press $\textcircled{5}$ SELECT \triangleleft / \triangleright repeatedly and then repeat steps 4 through 6. If you want to select “TV” as the control area, set the operation mode selector to $\textcircled{16}$ TV and then repeat steps 4 through 6.

7 Press $\textcircled{17}$ SETUP again to exit the setup menu.

Notes

- “ERROR” appears in the display window $\textcircled{4}$ on the remote control if you press a button not indicated in the respective step, or when you press more than one button simultaneously.
- This remote control can learn approximately 200 functions. However, depending on the signals learned, “FULL” may appear in the display before you program 200 functions. In this case, clear unnecessary programmed functions to make room for further learning.
- Learning may not be possible in the following cases:
 - when the batteries in the remote control for this unit or other components are weak.
 - when the distance between the two remote controls is too great or too small.
 - when the remote control infrared windows are not facing each other at the appropriate angle.
 - when the remote control is exposed to direct sunlight.
 - when the function to be programmed is continuous or uncommon.

Changing source names in the display window (RNAME)

You can change the name of the control area (input source) that appears in the display window $\textcircled{4}$ on the remote control if you want to use a different name than the factory preset. This feature is useful when you have set an control area to control a different component.

1 Set the operation mode selector to $\textcircled{16}$ SOURCE and then press an input selector button or \star $\textcircled{3}$ to select the desired control area.

The name of the control area you want to customize appears in the display window $\textcircled{4}$ on the remote control.



2 Press $\textcircled{17}$ SETUP using a ballpoint pen or similar object.

“SETUP” appears in the display window.

3 Press $\textcircled{9}$ Δ / ∇ repeatedly to select “RNAME” and then press $\textcircled{9}$ ENTER.

The remote control enters the renaming mode. “RNAME” and the name of the selected control area appears in the display window alternately.



You can change the renamed control area by pressing an input selector button or \star $\textcircled{3}$ or $\textcircled{6}$ SELECT \triangleleft / \triangleright repeatedly.

4 Press $\textcircled{9}$ Δ / ∇ repeatedly to select 3-letter name or 5-letter name you want to edit.

Each control area has both 3-letter name and 5-letter name. You can rename the 3-letter name and 5-letter name independently.

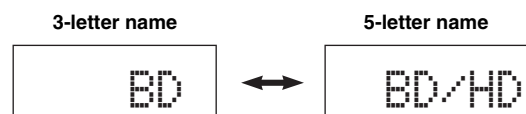

5 Press ⑨ ENTER.

The edit screen of the name of the currently selected control area appears in the display window (④).

**6 Press ⑨ </> repeatedly to move the cursor (|) to the position you want to edit.****7 Press ⑨ Δ / ▽ repeatedly to select and enter the desired character.**

Pressing ⑨ Δ changes the character as follows:

A to Z, a to z, 0, 1 to 9, space, - (minus), + (plus), / (slash) and : (colon).



Pressing ⑨ ▽ changes the characters in reverse order.

8 Repeat steps 6 and 7 until you change all the letters you want.**9 Press ⑨ ENTER to set the new name.**

“OK” appears in the display window (④) on the remote control if renaming was successful.



When you want to rename the another name of the selected control area, press the input selector button ☆ (③) or ⑥ SELECT </> repeatedly to select the desired control area and then press ⑨ ENTER and then carry out the operations of steps 4 through 9.

10 Press ⑰ SETUP again to exit the setup menu.

The new name of the control area appears in the display window (④).

**Note**

“ERROR” appears in the display window (④) on the remote control if you press a button not indicated in the respective step, or when you press more than one button simultaneously.

Macro programming features

The macro programming feature makes it possible to perform a series of operations with the press of a single button. For example, when you want to play a CD, normally you would turn on the components, select the CD input, and press the play button to start playback. The macro programming feature lets you perform all of these operations simply by pressing the CD macro button. The buttons listed as macro buttons below are factory set with macro programs. You can also program your own macros (see page 108).

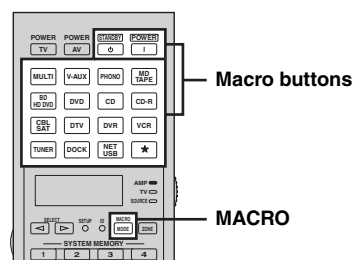
■ Recalling programmed macro-operations**1 Press ⑱ MACRO on the remote control.****2 Press the desired macro button.**

“M:the 3-letter name of the selected control area” (for example, “M:DVD”) appears in the display window (④), and this unit transmits the programmed functions. When you press ⑭ STANDBY or ⑮ POWER, “M:STB” or “M:PWR” appears in the display window (④), and this unit transmits the programmed functions.

3 Press ⑱ MACRO again to exit from the macro-operation mode.**Notes**

- While the remote control is running a macro program, it does not accept any other operation until it has completed running the program (the transmission indicator in the display stops flashing).
- Continue to aim the remote control at the component the macro is operating until the macro operation is complete.
- If you do not complete each of the operations within 30 seconds, this unit automatically exits from the macro-operation mode.

■ Default macro functions

Pressing macro	To automatically transmit these signals	
	First	Second
STANDBY	STANDBY	—
POWER	POWER	POWER (*1)
MULTI		MULTI
V-AUX		V-AUX
PHONO		PHONO
MD TAPE		MD TAPE
BD HD DVD		BD HD DVD
DVD		DVD
CD		CD
CD-R		CD-R
CBL SAT		CBL SAT
DTV		DTV
DVR		DVR
VCR		VCR
TUNER		TUNER
DOCK		DOCK
NET USB		NET USB (*2)
☆		☆

*1 Set the appropriate remote control code for TV in advance (see page 104).

*2 This unit plays the last received station or selected contents before the unit was set in the standby mode.

■ Programming macro operations (MACRO)

You can program your own macro and use the macro programming feature to transmit several remote control commands in sequence at the press of a button. Be sure to set up remote control codes or perform learning operations before programming the macro.

Notes

- The default macro is not cleared when a new macro is programmed for a button. The default macro can be used again when the programmed macro is cleared.
- It is not possible to add a new signal (macro step) to the default macro. Programming a macro changes all macro contents.
- We do not recommend that you program continuous operations (for example, volume control) in a macro.

1 Press **17** **SETUP** on the remote control using a ballpoint pen or similar object.

“SETUP” appears in the display window (4).

2 Press **9** **Δ** / **∇** repeatedly to select “MACRO” and then press **9** **ENTER**.

The remote control enters the macro-programming mode. “MACRO” and “M:the three-letter name of the selected control area” (for example, “M:DVD”) appears in the display window (4) alternately.



3 Press the desired macro button you want to assign the macro program to and then press **9** **ENTER**.

“M:the three-letter name of the selected macro button” (for example, “M:DVD”) and the name of the currently selected control area appears in the display window (4) alternately. When you press **14** **STANDBY** or **15** **POWER**, “M:STB” or “M:PWR” and the name of the currently selected control area appears in the display window (4) alternately.

4 Press the buttons for the functions you want to include in the macro operation in sequence.

Example

Set the input source to DVD → Turn on the DVD player → Turn on the video monitor

Step 1 (“MCR1”): Press DVD.

Step 2 (“MCR2”): Press AV POWER.

Step 3 (“MCR3”): Press TV POWER.

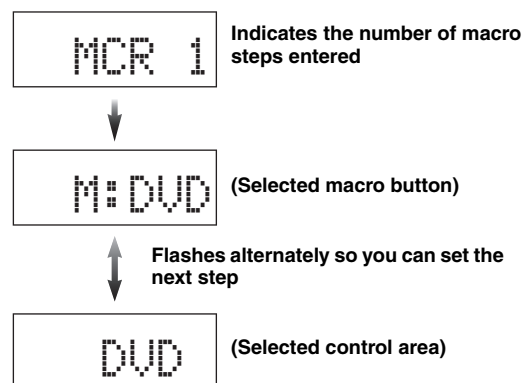
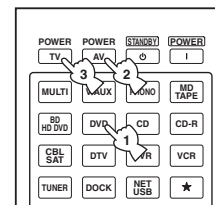

Notes

- To change the selected input area, press **5** **SELECT** **</>**. Pressing the input selector buttons or ☆ will program a macro step, whereas **5** **SELECT** **</>** only changes the selected input area.
- The position of the operation mode selector (AMP/TV/SOURCE) affects the assigned function. When the operation mode selector is set to **18** **AMP** or **19** **TV**, the input source selectors do not function.

5 Press **18** **MACRO** to confirm the program.

You can set up to 10 steps (10 functions). After you have set 10 steps, “FULL” appears and the remote control automatically exits from the macro programming mode.

6 Press **17** **SETUP** again to exit from the setup mode.

Note

“ERROR” appears in the display window (4) if you press more than one button simultaneously.

Clearing configurations

You can clear all changes made in each function set, such as learned functions, macros, renamed control area names and setup remote control ID.

■ Clearing function sets (CLEAR)

1 Press **17** **SETUP** on the remote control using a ballpoint pen or similar object.

“SETUP” appears in the display window (4).

2 Press **9** Δ / ∇ repeatedly to select “CLEAR” and then press **9** **ENTER**.

The remote control enters the clear mode. “CLEAR” and “L:the three-letter name of the selected control area” (for example, “L:DVD”) appears in the display window (4) alternately.



3 Press **9** Δ / ∇ repeatedly to select the desired clear mode.

Clear mode	Descriptions
L:DVD (etc.)	(L:Three-digit name of the selected control area) Clears all learned functions the respective control area. You can change the control area to be cleared by pressing the desired input selector button or ☆ (3) or 5 SELECT \triangleleft / \triangleright repeatedly.
L:AMP	Sets all learned functions for controlling the amplifier functions to the initial factory settings. Set the operation mode selector to 16 AMP to select this clear mode.
L:TV	Clears all learned functions for TV control area. Set the operation mode selector to 16 TV to select this clear mode.
L:ALL	Clears all learned functions.
M:DVD (etc.)	(M:Name of the selected macro button) Clears the macro programmed for the selected macro button (see page 108). The assigned macro to the selected macro button reverts to the initial factory macro. Press the desired macro button if you want to change the macro button you want to clear the programmed functions of.
M:ALL	Clears all programmed macros. The assigned macro to the selected macro button reverts to the initial factory macro.
RNAME	Set all the name of the control areas to the default settings.
FCTRY	Set all settings of the remote control to the initial factory settings.

4 Press and hold **9** **ENTER** for about 3 seconds.

When the clearing is successful, “OK” appears in the display window (4).

Notes

- “NG” appears in the display window (4) if clearing was unsuccessful.
- “ERROR” appears in the display window (4) if you press a button not indicated in the respective step, or if you press more than one button simultaneously.

5 Press **17** **SETUP** again to exit from the setup mode.

■ Clearing a learned function (ERASE)

1 Press **17** **SETUP** using a ballpoint pen or similar object.

“SETUP” appears in the display window (4).

2 Press **9** Δ / ∇ repeatedly to select “ERASE” and then press **9** **ENTER**.

The remote control enters the learning mode. “ERASE” and the name of the currently selected control area appears in the display window (4) alternately.



3 Set the operation mode selector to **16** **SOURCE** and then press an input selector button or ☆ (3).

“ERASE” and the name of the selected control area appears in the display window (4) alternately.



- You can also select the desired control area by pressing **6** **SELECT** \triangleleft / \triangleright repeatedly.
- If you want to erase the function learned in the AMP or TV control area, set the operation mode selector to **16** **AMP** or **16** **TV**.

4 Press **9** **ENTER**.

“E-KEY” appears in the display window (4).

5 Press and hold the button you want to clear for about 3 seconds.

If clearing is successful, “ERASE” and “OK” appears in the display window (4).



- If you continuously want to clear another function, repeat step 3.
- Once you clear a learned function, the button reverts to the factory setting (or to the manufacturer setting if you have set remote control codes).

6 Press **17** **SETUP** again to exit from the setup mode.

Notes

- “NG” appears in the display window (4) on the remote control if clearing was unsuccessful.
- “ERROR” appears in the display window (4) if you press more than one button simultaneously.

Simplified remote control

Use the supplied simplified remote control to make basic controls of this unit.

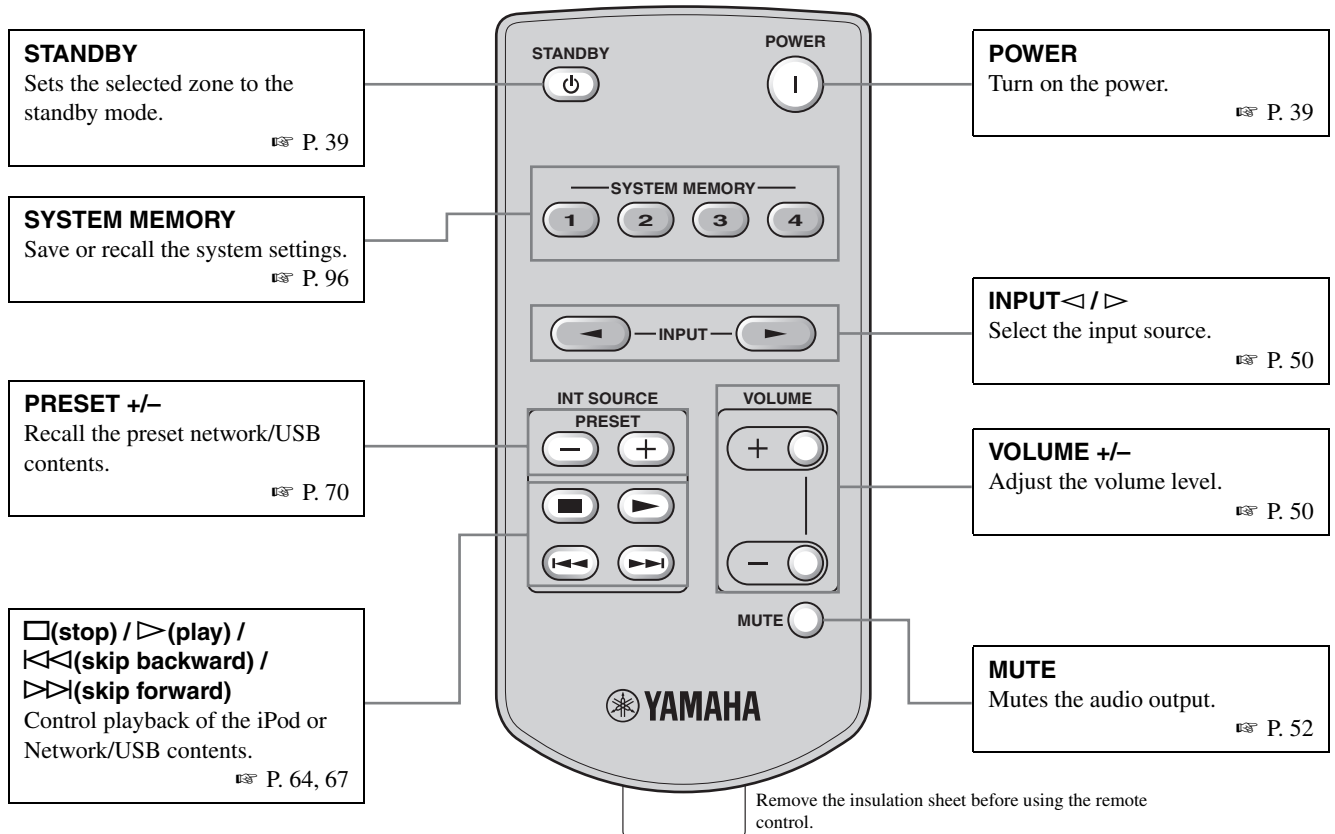

Note

When you select "NET/USB" as the input source, this unit activates the last selected sub input source (see page 67).

■ Setting the controlling zone of the simplified remote control

Use this feature to set the controlling zone (see page 116) and remote control ID (see page 119) of the simplified remote control.

Setting the remote control ID

Press and hold ◀◀ on the simplified remote control and then 1 or 2 for 3 seconds to select the desired remote control ID.

- ID1: Press and hold ◀◀ and 1.
- ID2: Press and hold ◀◀ and 2.

Setting the controlling zone

Press and hold ▶▶ on the simplified remote control and then 1, 2, 3, or 4 to select the desired zone.

- Main zone: Press and hold ▶▶ and then press 1.
- Zone 2: Press and hold ▶▶ and 2.
- Zone 3: Press and hold ▶▶ and 3.
- Zone 4: Press and hold ▶▶ and 4.

■ Replacing the battery in the simplified remote control

Change the battery when the operation range of the simplified remote control decreases.

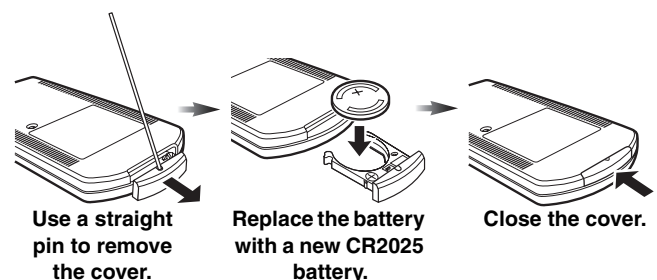

Notes

- Insert the battery according to the polarity markings (+ and -).
- If the batteries run out, immediately remove them from the simplified remote control to prevent an explosion or acid leak.
- If a battery starts leaking, dispose of it immediately. Be careful not to let the leaking battery acid touch your skin or clothing.
- Before inserting new batteries, wipe the compartment clean.
- Dispose of batteries according to your regional regulations.

Using multi-zone configuration

This unit allows you to configure a multi-zone audio/video system. The multi-zone configuration feature enables you to set this unit to reproduce separate input sources in the main zone, second zone (Zone 2), third zone (Zone 3), and fourth zone (Zone 4). You can control this unit from the second, third, or fourth zone using the supplied remote control.

Step 1: Planning the multi-zone system

First, plan the total multi-zone system with this unit carefully.

☞ P. 111

Step 2: Connecting the speakers and/or external amplifiers

Wire cables between rooms and connect the component and speakers to this unit.

☞ P. 112

Step 3: Set the zone parameters

Once you have finished the connections, turn on this unit and then set the parameters in "Multi Zone" menu (see page 91).

- Use "Zone SP Assign" to designate the speaker terminals on this unit to each zone.

☞ P. 116

- Use "Zone2 Set", "Zone3 Set", or "Zone4 Set" parameters to set the volume settings and other functions in each zone.

☞ P. 91

Step1: Planning the multi-zone system

This unit can control the audio and video system in the main zone and up to 3 optional zone (Zone 2, Zone 3, and Zone 4), and you can use the internal amplifiers or external amplifiers in Zone 2, Zone 3, or Zone 4.

The multi-zone system configuration differs depending on your requirements and equipment. Before connecting the speakers and/or external amplifiers for the multi-zone configuration, plan the total design of your multi-zone system.

When you plan the system, consider the following points:

1. Do you want to use the internal amplifiers of this unit or external amplifiers?
2. How many zones do you want to use this unit for?
3. How many channels do you want to use in the main zone?
4. If you use the internal amplifiers for the other zones, you cannot use some channels in the main zone in some cases.
5. How many speakers do you have?
6. Do you want to use the visual sources other than the main zone?



Since there are many possible ways to connect and use this unit in a multi-zone configuration, we recommend that you consult with your nearest authorized Yamaha dealer or service center for the planning and setup of the multi-zone system that best meet your requirements.

Pre-amplifier mode

If you want use the external amplifiers for the all channels in the main zone, you can use all the speaker terminals on this unit for Zone 2, Zone 3, and/or Zone 4 (Pre-amplifier mode). Set "PREAMP MODE" to "ON" in the advanced setup (see page 120).

In the following instruction, following system configuration is the example. When you use this system configuration, you can enjoy 7.2-channel playback in the main zone and 2-channel playback in the optional two zones. You can also enjoy 5.2-channel playback in the main zone and 2-channel playback in the optional three zones.

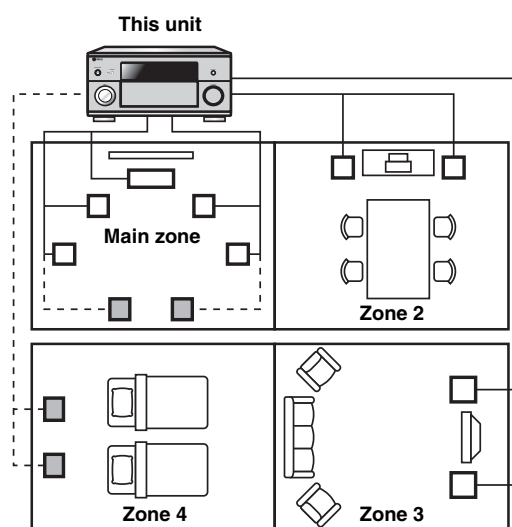

- Speakers you can use simultaneously
- - - Speakers you can use alternately. If you turn on Zone 4, the surround back speakers in the main zone do not output sounds.

Step2: Connecting the speakers, external amplifiers, and/or other components

You need the following additional equipment to use the multi-room functions of this unit:

- An infrared signal receiver in Zone 2, Zone 3, and/or Zone 4.
- An infrared emitter in the main room. This emitter transmits the infrared signals from the remote control in Zone 2, Zone 3, and/or Zone 4 to the main room (to a CD player or DVD player, for example).
- An amplifier and speakers for Zone 2, Zone 3, and/or Zone 4.
- A video monitor for the second room.

■ Using the internal amplifier of this unit

Important safety notice

The speaker terminals of this amplifier should not be connected to a Passive Loudspeaker Selector Box or more than one loudspeaker per channel.

Connection to a Passive Loudspeaker Selector Box or multiple speakers per channel could create an abnormally low impedance load resulting in amplifier damage. See this owner's manual for correct usage.

Compliance with minimum speaker impedance information for all channels must be maintained at all times. This information is found on the back panel of your amplifier.

To make the system of the example, connect the speakers in the main zone and other zones as follows:

You can assign the following speaker terminals to Zone 2, Zone 3, and/or Zone 4 freely.

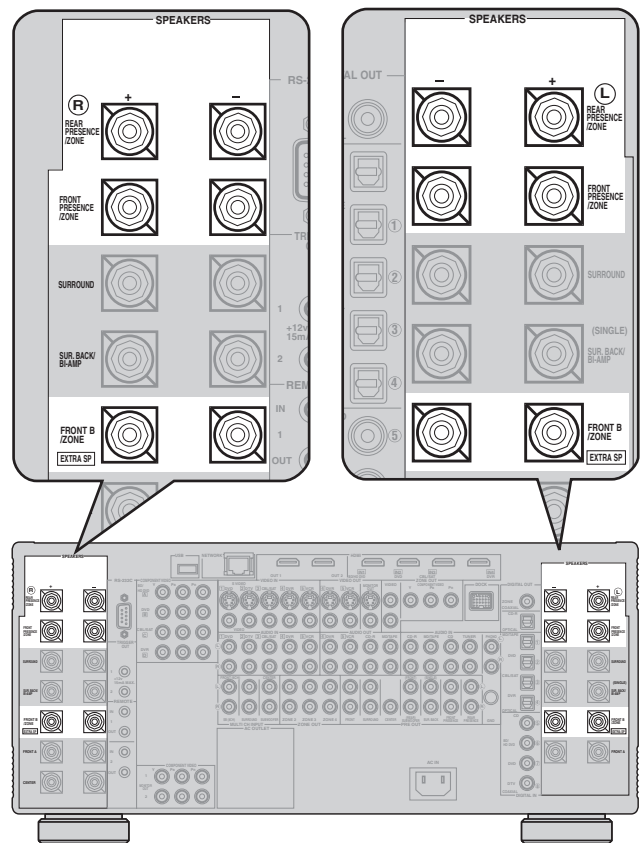
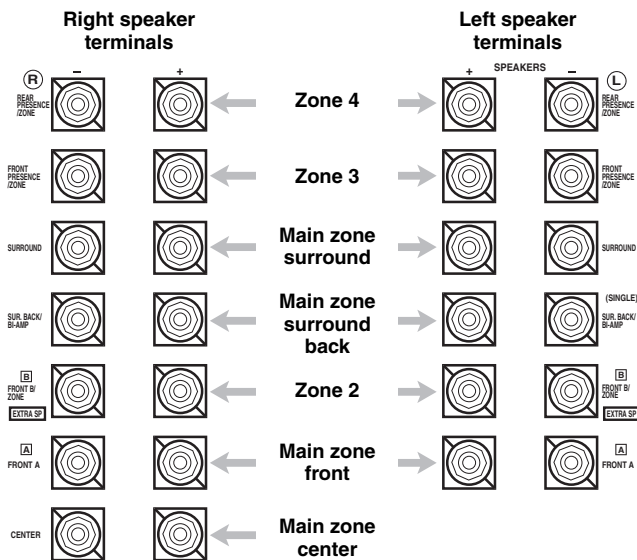

■ Using external amplifiers

When you use the external amplifiers in the Zone 2, Zone 3, and/or Zone 4, connect the external amplifiers to the ZONE OUT jacks of this unit with the analog audio cables.

Notes

- To avoid unexpected noise, DO NOT use the Zone 2/Zone 3 feature with CDs encoded in DTS.
- Adjust the Zone 2/Zone 3 volume by using the amplifier in the second/third room when “Zone2 Volume”, “Zone3 Volume”, or “Zone4 Volume” are set to “Fixed” (see page 91).

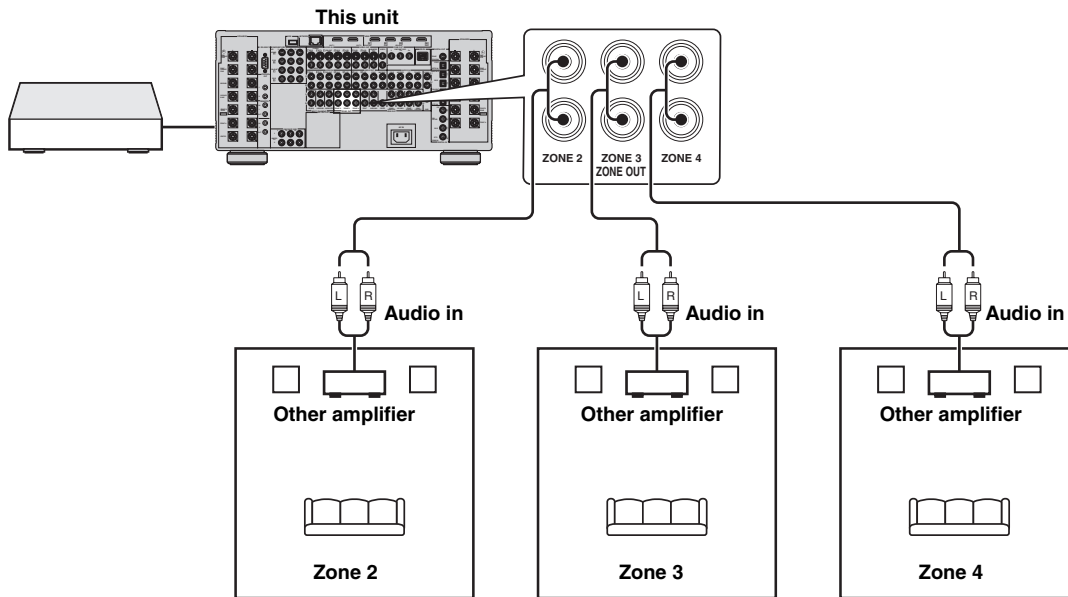

Compatible audio signals in the Zone 2, Zone 3, and/or Zone 4

When you connect the external amplifiers in Zone 2, Zone 3, and/or Zone 4 to the ZONE OUT jacks on this unit, this unit can transmit the analog audio signals only. In this setting, this unit cannot play back the digital audio sources input at the DIGITAL IN jacks and HDMI IN jacks in Zone 2, Zone 3, and/or Zone 4.



When this unit is in the party mode (see page 118), this unit can output the audio signals input at the HDMI IN jacks or DIGITAL IN jacks at the ZONE OUT jacks.

■ Using the ZONE DIGITAL OUT (COAXIAL) jack

When you connect an external amplifier in Zone 2 to the ZONE DIGITAL OUT (COAXIAL) jack, you can play back the digital and analog audio sources in Zone 2.

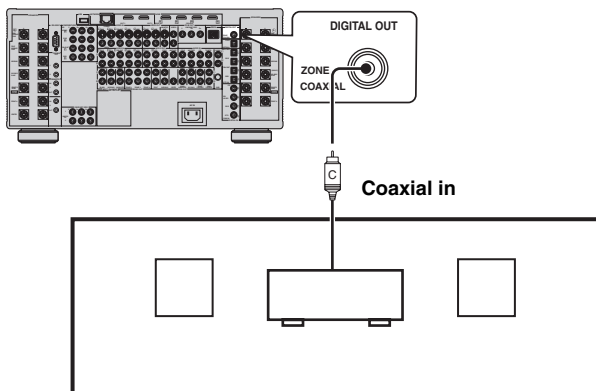

Audio signal flow for Zone 2

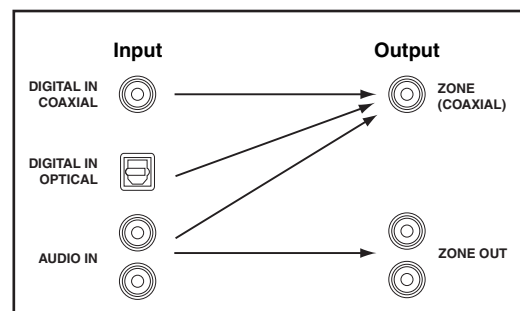

Notes

- Even if you set “Zone2 Volume” to “Variable” (see page 91), the volume control on this unit does not function to the output level of the ZONE DIGITAL OUT (COAXIAL) jack.
- When this unit plays back the copy-protected audio files, this unit does not output any audio signals at the ZONE DIGITAL OUT jack.

■ **Connecting Zone video monitor**

Connect the video monitor(s) in Zone 2 to the ZONE OUT VIDEO and/or ZONE OUT COMPONENT VIDEO jacks. If you connect the multiple zone video monitors to ZONE OUT VIDEO and/or ZONE OUT COMPONENT VIDEO jacks, the video monitors play back the same source simultaneously.

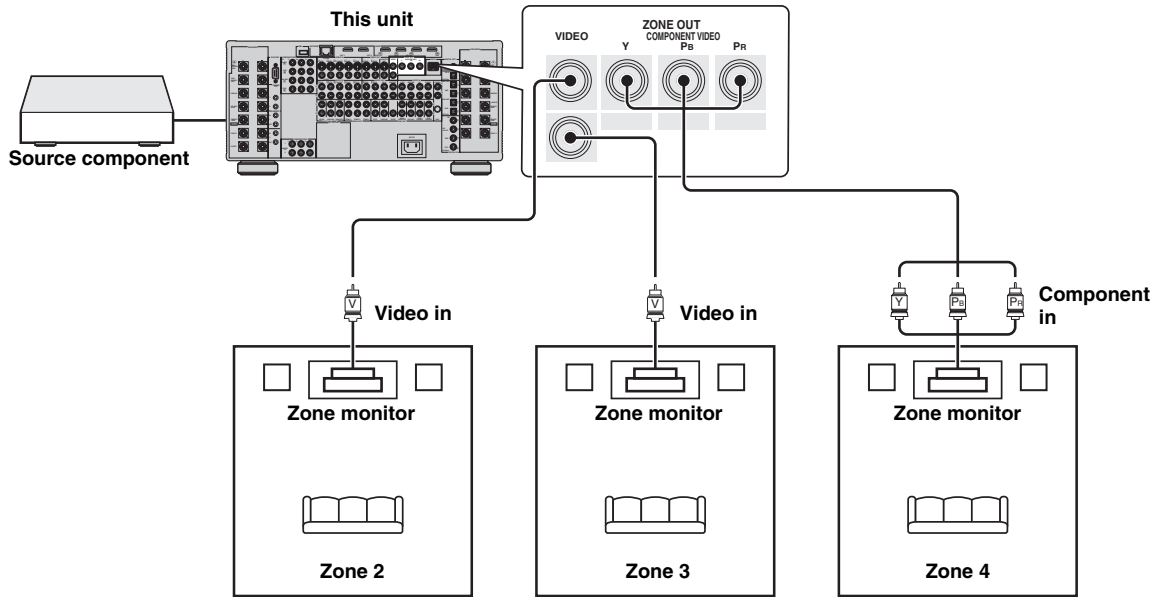

■ **Video signal up-conversion to the zone component video signals**

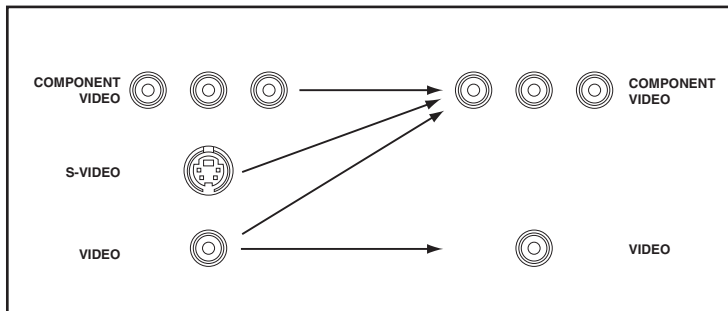

Note

Low-quality video signals input at the VIDEO or S VIDEO jacks may not be output at the ZONE OUT COMPONENT VIDEO jacks correctly.

■ Using REMOTE IN/OUT and TRIGGER OUT jacks for Zone 2, Zone 3, and Zone 4

You can use the REMOTE IN/OUT and TRIGGER OUT jacks on this unit for Zone 2, Zone 3, and Zone 4 as well as the main zone. Refer to “Using REMOTE IN/OUT jacks” and “Using the TRIGGER OUT jacks” on page 36 for more information.

REMOTE IN/OUT jacks

This unit is equipped with two REMOTE IN and REMOTE OUT jacks. You can use the REMOTE IN/OUT jacks to control this unit or other component from Zone 2, Zone 3, or Zone 4.

The following diagram shows an example of the connections.

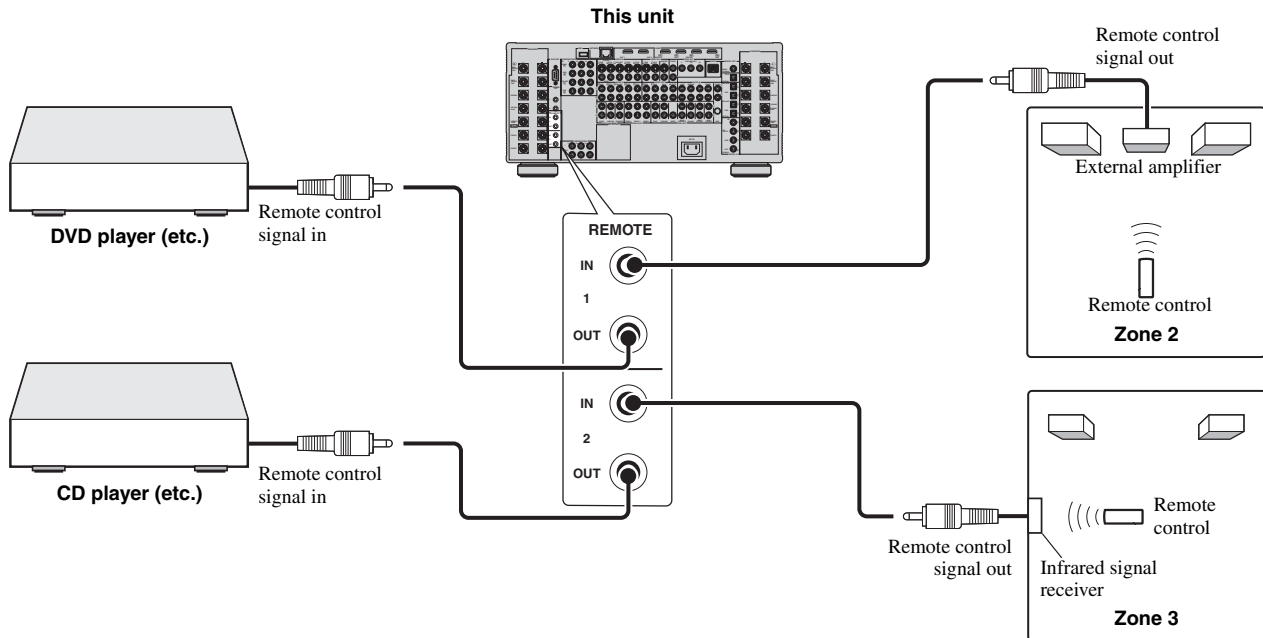

 Some Yamaha models are able to connect directly to the REMOTE OUT jack on this unit. If you own these products, you may not need to use an infrared emitter. Up to six Yamaha components can be connected as shown.

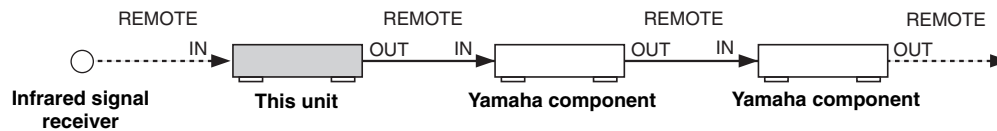

TRIGGER OUT jacks

This unit is equipped with two TRIGGER OUT jacks. You can turn on and off the component corresponding to the selection of the input source of the desired zone or turning on and off the desired zone. Use “Trigger Output” in “Manual Setup” to set the functions of the TRIGGER OUT jacks (see page 94).

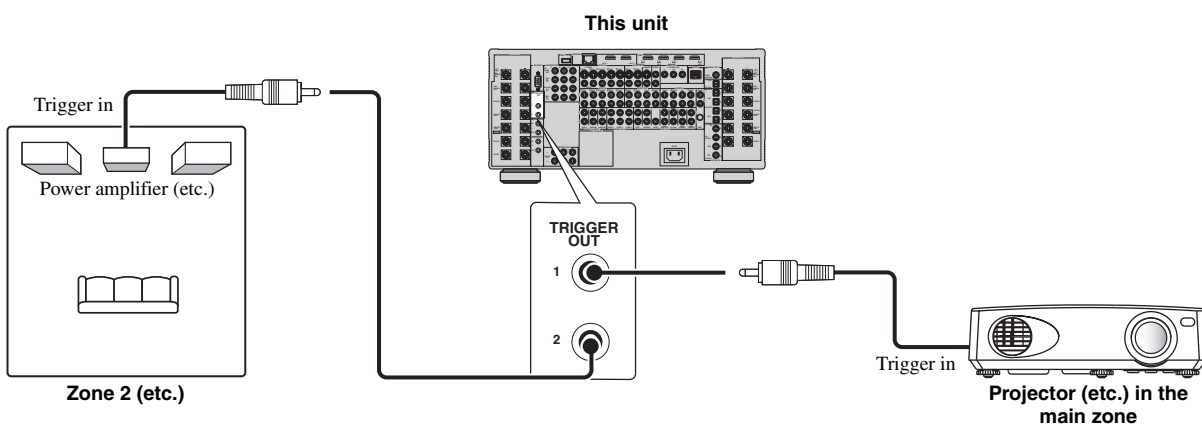

Step3: Setting the zone parameter

After the connection, turn on this unit and then set the assignment of the speaker terminals and other zone parameters.

■ Assigning the zone speakers

Use “Zone SP Assign” to set the zone that each speaker terminal are used for.

- 1 Press Ⓜ MENU on the remote control.**
The top GUI menu appears in the video monitor.
- 2 Press Ⓜ Δ / ∇ repeatedly to select “Manual Setup” and then Ⓜ \triangleright .**
- 3 Press Ⓜ Δ / ∇ repeatedly to select “Multi Zone” and then Ⓜ \triangleright .**
“Multi Zone” menu appears in the GUI screen.
- 4 Press Ⓜ Δ / ∇ repeatedly to select “Zone SP Assign” and then press Ⓜ \triangleright .**
Following display appears in the GUI screen.

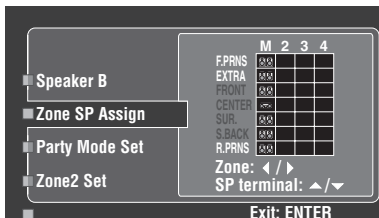

- 5 Press Ⓜ Δ / ∇ repeatedly to select the desired speaker terminals and then Ⓜ \triangleleft / \triangleright repeatedly to select the desired zone you want to use the speaker connected to the selected speaker terminals.**

When “PREAMP MODE” in the advanced setup is set to “OFF” (see page 120), “FRONT”, “CENTER”, “SUR.” and “S.BACK” are fixed to “M” (the main zone). To make the system of the example (see page 111), set “Zone SP Assign” as follows:

	M	2	3	4
F.PRNS			Ⓜ	Ⓜ
EXTRA		Ⓜ	Ⓜ	
FRONT	Ⓜ	Ⓜ		
CENTER	Ⓜ			
SUR.	Ⓜ	Ⓜ		
S.BACK	Ⓜ	Ⓜ		
R.PRNS				Ⓜ

Zone indications

- M: Main zone
- 2: Zone 2
- 3: Zone 3
- 4: Zone 4

Speaker terminal indications

- F.PRNS: FRONT PRESENCE speaker terminals
- EXTRA: EXTRA SP speaker terminals
- FRONT: FRONT A speaker terminals
- CENTER: CENTER speaker terminals
- SUR.: SURROUND speaker terminals
- S.BACK: SUR.BACK speaker terminals
- R.PRNS: REAR PRESENCE speaker terminals

PREAMP MODE

When “PREAMP MODE” in the advanced setup is set to “ON” (see page 120), you can assign all the speaker terminals of this unit to Zone 2, Zone 3, or Zone 4. The audio signals for the main zone are only output at the PRE OUT jacks.

- 6 Once you have finished the settings of all the speaker terminals, press Ⓜ ENTER to confirm the setting and exit from the “Zone SP Assign” screen.**
- 7 Set other zone parameters appropriately.**
See pages 91 and 92 for details.
- 8 Once you have finished the settings of the zone parameters, press Ⓜ MENU to exit the GUI menu.**

Controlling Zone 2, Zone 3, or Zone 4

You can select the zone you want to control by using the control buttons on the front panel or on the remote control.

■ Basic operation

Front panel operations

- 1 Press Ⓜ ZONE 2, Ⓜ ZONE 3, or Ⓜ ZONE 4 on the front panel to individually turn on or off Zone 2, Zone 3, or Zone 4.**
- 2 Press Ⓜ ZONE CONTROLS on the front panel repeatedly to select the zone you want to control.**
Each time you press Ⓜ ZONE CONTROLS, the front panel display changes as shown below, and the indicator for the currently selected zone flashes for approximately 10 seconds. However, no indicator flashes when the main zone is selected.



No indicator flashes when the main zone is selected.

ZONE2

Controls the Zone 2 functions.

ZONE3

Controls the Zone 3 functions.

ZONE4

Controls the Zone 4 functions.



- You must complete this step within 10 seconds while the selected zone flashes in the front panel display. Otherwise, the currently selected zone mode is automatically canceled. In this case, press Ⓜ ZONE CONTROLS again.
- The initial setting is ZONE2 when Zone 2, Zone 3, and Zone 4 are turned on.

3 Perform the operations in the selected zone.

For further operations, refer to the following pages:

Descriptions	Page
"Selecting the input source Zone 2, Zone 3, or Zone 4"	117
"Adjusting the volume level of Zone 2, Zone 3, or Zone 4"	117
"Adjusting the tonal quality of Zone 2, Zone 3, or Zone 4"	118



To turn off the desired zone, press **Ⓚ**ZONE 2, **Ⓚ**ZONE 3, or **Ⓚ**ZONE 4 again.

Remote control operations

1 Press **Ⓚ**ZONE repeatedly to select the zone you want to control.

"MAIN", "ZONE 2", "ZONE 3", or "ZONE 4" indicator appears in the display window (**④**) on the remote control.

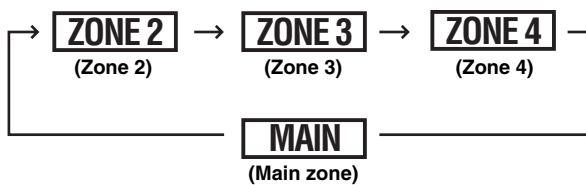

2 Press **Ⓚ**POWER to turn on the selected zone.

3 Perform the operations in the selected zone.

For further operations, refer to the following pages:

Descriptions	Page
"Selecting the input source Zone 2, Zone 3, or Zone 4"	117
"Adjusting the volume level of Zone 2, Zone 3, or Zone 4"	117
"Adjusting the tonal quality of Zone 2, Zone 3, or Zone 4"	118



To turn off the desired zone, press **Ⓚ**STANDBY.

Operate the following operations after activating the Zone 2, Zone 3, or Zone 4 operation mode.

■ Selecting the input source Zone 2, Zone 3, or Zone 4

Rotate the **Ⓚ**INPUT selector on the front panel (or set the operation mode selector to **Ⓚ**AMP and then press one of the input selector buttons (**Ⓚ**)) to select the input source of the selected zone.

- Select "DOCK" as the input source to use the iPod features in the selected zone. For details about the iPod operations, see "Using iPod™" on page 64.
- Select "NET/USB" as the input source to use the network/USB operations features in the selected zone. For details about the iPod operations, see "Using Network/USB features" on page 66.

Notes

- The selected input sources are shared across all zones.
- If you set the recording source other than "SOURCE" (see page 62), the input source of Zone 2 is fixed to the source you set as the recording source.

■ Adjusting the volume level of Zone 2, Zone 3, or Zone 4

Rotate **Ⓚ**VOLUME on the front panel (or press **Ⓚ**VOLUME +/-) to adjust the volume level of the selected zone.



Press **Ⓚ**MUTE on the remote control to mute the sound output to the selected zone.

Note

When you use the external amplifiers in Zone 2 or Zone 3, **Ⓚ**VOLUME +/- can be used only when "Zone2 Volume", "Zone3 Volume", or "Zone4 Volume" is set to "Variable" in "Zone2 Set", "Zone3 Set", or "Zone4 Set" (see page 91).

■ Setting the sleep timer for Zone 2, Zone 3, or Zone 4

Use this feature to turn off the desired zone to the standby mode after a certain amount of time.

Set the operation mode selector to **Ⓚ**AMP on the remote control and then press **Ⓚ**SLEEP repeatedly to set the amount of time.

Each time you press **Ⓚ**SLEEP, the sleep timer setting changes as shown below.

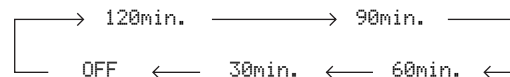

Operate the following operations after activating the Zone 2, Zone 3, or Zone 4 operation mode.

■ **Adjusting the tonal quality of Zone 2, Zone 3, or Zone 4**

- 1 Press **M TONE CONTROL** on the front panel.
- 2 Press **1 PROGRAM** repeatedly to select the high-frequency response (TREBLE), the low-frequency response (BASS).
- 3 Rotate **1 PROGRAM** to adjust the high-frequency response (BASS).
Control range: -10.0 dB to +10.0 dB

■ **Using the Zone OSD**

You can browse and select the iPod or network/USB contents by using the Zone OSD.

- 1 Set the operation mode selector to **16 SOURCE** and then press the desired input selector button (**3**).
- 2 Press **21 DISPLAY** on the remote control to turn on the Zone OSD.
- 3 Press **9** Δ / ∇ / \triangleleft / \triangleright and **9 ENTER** repeatedly to navigate the menu on the Zone OSD.

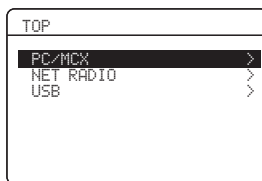

Notes

- The OSD menu appears in English even if you set “LANGUAGE” to “JAPANESE” or “RUSSIAN” (see page 120).
- There are some characters that cannot be displayed in the front panel display or in the OSD of this unit. Those characters are replaced with underscores “_”.
- You can set the time for which the Zone OSD is displayed in the Zone video monitor by using “On Screen” in “Manual Setup” (see page 90).



- Short message displays are also appears in the Zone video monitor. Use “Zone OSD” in “Manual Setup” to select that this unit displays the operational information of all zones or Zone 2 only (see page 92).
- You can display the status of the selected zone. Set the operation mode selector to **16 AMP** and then press **21 DISPLAY**.

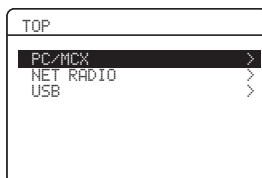

Using the party mode

Use this feature to play the main zone sources in the other zones simultaneously. This feature is useful to play back a background music in multiple zone in a home party.

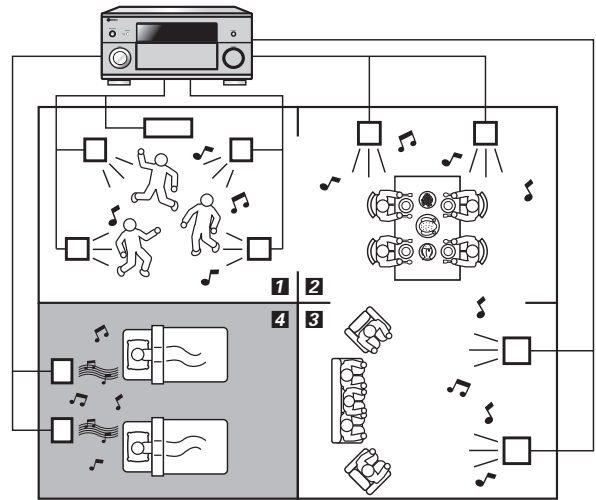

- 1, 2, 3 ... In the party mode, this unit distributes the same sources to the zones which join the party mode.
- 4 ... You can also operate the specific zone separately when this unit is in the party mode.

Turning on the party mode

Before performing the following operations, set the operation mode selector on the remote control to **16 AMP**.

Press 13 PARTY on the remote control to turn on the party mode.

“PARTY MODE ON” appears in the front panel display and then the main zone and the zones which join the party mode are turned on.

Turning off the party mode

Press 13 PARTY again to turn off the party mode.

“PARTY MODE OFF” appears in the front panel display and then the main zone and the zones that joins the party mode are turned off.



When this unit is in the party mode, the audio signals that is input at the HDMI IN jacks or DIGITAL IN jacks are output at the ZONE OUT jacks.

Notes

- If you select “MULTI CH” as the input source, this unit does not output any sounds when this unit is in the party mode.
- When you change the input source of the zone that joins the party mode, the input source of the main zone also changes same as the operated zone.
- When this unit is in the party mode, no signals are not output at the OUT (REC) jacks.

Selecting the zones joining the party mode

You can select the zone that joins the party mode by using the “Party Mode Set” parameters. If a zone does not join the party mode, you can play back a source in the zone independently from the main zone. See page 91 for details.

Advanced setup

This unit has additional menus that are displayed in the front panel display. The advanced setup menu offers additional operations to adjust and customize the way this unit operates. Change the initial settings (indicated in bold under each parameter) to reflect the needs of your listening environment.

Notes

- The settings you make are reflected next time you press **Ⓜ**MASTER ON/OFF inward to the ON position to turn on this unit (see page 39).
- Only **Ⓜ**MASTER ON/OFF and **Ⓟ**PROGRAM are effective while you are using the advanced setup menu.
- All the other operations cannot be made while you are using the advanced setup menu.
- The advanced setup menu is only available in the front panel display.

Using the advanced setup menu

- 1 Press **Ⓜ**MASTER ON/OFF on the front panel to release it outward to the OFF position to turn off this unit.**
- 2 Press and hold **Ⓟ**PROGRAM and then press **Ⓜ**MASTER ON/OFF inward to the ON position to turn on this unit.**
Press and hold **Ⓟ**PROGRAM until “ADVANCED SETUP” appears in the front panel display.
- 3 Rotate the **Ⓟ**PROGRAM to select the parameter you want to adjust.**
The name of the selected parameter appears in the front panel display.
- 4 Push **Ⓟ**PROGRAM repeatedly to change the selected parameter setting.**
- 5 Press **Ⓜ**MASTER ON/OFF to release it outward to the OFF position to save the new setting and turn off this unit.**



The settings you made are reflected next time you turn on this unit.

■ Speaker impedance **SPEAKER IMP.**

Use this feature to set the speaker impedance of this unit so that it matches that of your speakers.

Choice	Descriptions
8ΩMIN	Select this setting to set the speaker impedance to 8 Ω. The impedance of each speaker must be 8 Ω or higher.
6ΩMIN	Select this setting to set the speaker impedance to 6 Ω. The impedance of each speaker must be 6 Ω or higher.

■ Remote sensor **REMOTE SENSOR**

Use this feature to activate or deactivate the signal-receiving capability of the remote control sensor on the front panel of this unit.

Choice	Descriptions
ON	Select this setting if you want to activate the signal-receiving capability of the remote control sensor.
OFF	Select this setting if you want to deactivate the signal-receiving capability of the remote control sensor.

Note

We recommend setting the parameter to “ON” in most cases.

■ Wake on RS-232C access **RS-232C STANDBY**

Use this feature to set this unit to transmit data via the RS-232C interface when this unit is in the standby mode.

Choice	Functions
YES	Select this setting to set this unit to transmit data via the RS-232C interface.
NO	Select this setting to set this unit not to transmit data via the RS-232C interface.

■ Network standby **NET STANDBY**

Use this feature to select whether this unit accepts the commands via LAN network when this unit is in the standby mode (see page 101).

Choice	Functions
YES	Accepts the operations via LAN network when this unit is in the standby mode.
NO	Does not accept the operations via LAN network when this unit is in the standby mode.

Note

If you set “NET STANDBY” to “YES”, the amount of power consumption in the standby mode is increased.

■ Remote control ID setting **REMOTE CON AMP**

Use this feature to set the remote control ID of this unit for remote control recognition.

Choice	Descriptions
ID1	Select this setting when the ID of the remote control is set to “ID1”.
ID2	Select this setting when the ID of the remote control is set to “ID2”.

Setting remote control ID

Use this feature to set the remote control ID. This feature is useful when you control multiple Yamaha AV receiver or amplifier with using the remote control.

Press **ⓇID repeatedly using a ballpoint pen or similar object on the remote control to select the desired remote control ID.**

Each time you press **Ⓡ**ID, the remote control ID indicator changes as shown below.



To set the remote control ID of the simplified remote control, see page 110 for details.

See page 119 for the operation of the advanced setup.

■ Cooling fan operation mode FAN MODE

Use this feature to set the operation of the cooling fan of this unit.

Choice	Descriptions
AUTO	Select this setting to set the fan to operate automatically according to the temperature of this unit.
CONT.	Select this setting to set the fan to activate continuously regardless of the temperature of this unit.

■ Bi-amplifier mode BI-AMP

Use this feature to activate or deactivate the bi-amplifier function.

Choice	Descriptions
ON	Select this setting if you want to activate the bi-amplifier function.
OFF	Select this setting if you want to deactivate the bi-amplifier function.

Note

When “BI-AMP” is set to “ON”, the SUR.BACK/BI-AMP terminals cannot be used to connect surround back speakers in that the SUR.BACK/BI-AMP terminals are already used for the bi-amplifier connection (see page 27).

■ Pre-amplifier mode PREAMP MODE

Use this feature to select whether you use this unit as the pre-amplifier in the main zone and use all the internal amplifiers for the other zones.

Choice	Descriptions
ON	Select this setting when you use this unit as the pre-amplifier in the main zone. The audio signals for the main zone are only output at the PRE OUT jacks of this unit. You can assign all speaker terminals for the other zones.
OFF	Select this setting to use the internal amplifiers of this unit for the main zone, Zone 2, Zone 3, or Zone 4.

■ Recovery and backup of the system settings RECOV./BACKUP

Use this feature to save and restore the settings of this unit.

Choice	Select
RECOVERY	Restoring the saved setting of this unit.
BACKUP	Saves the current settings of this unit.
CANCEL	Cancels the recovery or backup of the settings of this unit.

Notes

- This unit does not save the preset network/USB items, and system memory settings.
- If no settings are saved, you cannot select “RECOVERY”.

■ Parameter initialization INITIALIZE

Use this feature to reset the parameters of this unit to the initial factory settings. You can select the category of parameters to be initialized.

Choice	Descriptions
DSP PARAM	Select this setting to initialize all the parameters of the sound field parameters (see page 77).
VIDEO	Select this setting except “Short Message” and “On Screen” (see page 90).
NETWORK	Select this setting except “Short Message” and “On Screen” (see page 90).
ALL	Select this setting to initialize all the parameters of this unit.
CANCEL	Select this setting to cancel the initialization procedure.

Notes

- Use “Initialize” in the sound field program menu to initialize the parameters of the desired program (see page 81).
- When the network settings are reset, “DHCP” in “Network” is automatically set to “On” (see page 92) and the registered client ID of this unit on your Yamaha MCX-2000 is cleared (see page 68).

■ MAC address filter MAC FILTER

Use this feature to filter the access to this unit via LAN to control this unit by the MAC address of the accessing PC (see page 101).

Choice	Descriptions
ON	Only allows to accept the access from the PC whose MAC address is registered to this unit.
OFF	Allows to accept the access from any PC.



You can register the MAC address that is allowed to access when “MAC FILTER” is set to “ON” by using the Web browser (see page 101).

■ TV format TV FORMAT

Use this feature to set the color encoding format of your television.

Choices: NTSC, PAL

Initial setting:

[General and Korea models]: NTSC

[Other models]: PAL

Note

This setting is applied to the video monitor in the main zone, Zone 2, Zone 3, and Zone 4.

■ HDMI monitor check MONITOR CHECK

Use this feature to activate or deactivate the monitor check function of this unit.

Choice	Descriptions
YES	This unit receives the information of the available video signal resolutions from the video monitor connected via HDMI and you can only select the resolutions supported by the video monitor in “HDMI Resolution” (see page 90).
SKIP	You can select any resolution in “HDMI Resolution”.

■ Language LANGUAGE

Use this feature to select the language of your choice that appears in the GUI (graphical user interface) menu, OSD display in the zone monitor and the messages that appear in the front panel display.

Choices: **ENGLISH** (English), **JAPANESE** (Japanese), **FRENCH** (French), **GERMAN** (German), **SPANISH** (Spanish), **RUSSIAN** (Russian)

Note

You can also select the language setting by using GUI menu. See page 95 for details.

LANGUAGE	GUI menu	Front panel display	Zone OSD
RUSSIAN	<input type="radio"/>	<input type="radio"/>	—
JAPANESE	<input type="radio"/>	—	—
Other languages	<input type="radio"/>	<input type="radio"/>	<input type="radio"/>

... The selected language is displayed.

— ... The selected language is not displayed. The menu items and messages are displayed in English.

Additional Information

Troubleshooting	122
Glossary	128
THX information	130
Sound field program information	131
Parametric equalizer information	135
Block diagrams	136
Specifications	138
Index	140
List of remote control codes	144

Troubleshooting

Refer to the table below when this unit does not function properly. If the problem you are experiencing is not listed below or if the instruction below does not help, turn off this unit, disconnect the power cable, and contact the nearest authorized Yamaha dealer or service center.

■ General

Problem	Cause	Remedy	See page	
This unit fails to turn on or enters the standby mode soon after the power is turned on.	The power cable is not connected or the plug is not completely inserted.	Connect the power cable firmly.	—	
	The speaker impedance setting is incorrect.	Set the speaker impedance to match your speakers.	39	
	The protection circuitry has been activated.	Make sure that all speaker wire connections on this unit and on all speakers are secure and that the wire for each connection does not touch anything other than its respective connection.	23	
	This unit has been exposed to a strong external electric shock (such as lightning or strong static electricity).	Set this unit to the standby mode, disconnect the power cable, plug it back in after 30 seconds and then use it normally.	—	
No sound.	Incorrect input or output cable connections.	Connect the cables properly. If the problem persists, the cables may be defective.	30-38	
	Audio input jack select is set to “HDMI”, “Coax/Opt” or “Analog”.	Set the audio input jack select to “Auto”.	52	
	Audio input jack select is set to “Analog” while the input source component outputs digital audio signals.	Set the audio input jack select to “Auto” or “Coax/Opt”.	52	
	No appropriate input source has been selected.	Select an appropriate input source with the Ⓢ INPUT selector on the front panel (or the input selector buttons Ⓢ) on the remote control).	50	
	Speaker connections are not secure.	Secure the connections.	23	
	The volume is turned down.	Turn up the volume.	—	
	The front speakers to be used have not been selected properly.	Select the front speakers by pressing Ⓢ SPEAKER A or Ⓢ SPEAKER B on the front panel.	51	
	The sound is muted.	Press Ⓢ MUTE or Ⓢ VOLUME +/- on the remote control to resume audio output and then adjust the volume.	52	
	Signals this unit cannot reproduce are being input from a source component, such as a CD-ROM.	Play a source whose signals can be reproduced by this unit.	—	
	The HDMI components connected to this unit do not support the HDCP copy protection standards.	Connect HDMI components that support the HDCP copy protection standards.	28	
	“Support Audio” is set to “Other” and HDMI audio signals are not being played back on this unit.	Set “Support Audio” in “Option” to “DSP-Z11”.	94	
	No picture.	The output and input for the picture are connected to different types of video jacks.	Set “Conversion” to “On” or connect your source components in the same way as you connect your video monitor to this unit.	89
		This unit outputs the video signals are not supported in the video monitor connected to the HDMI OUT jack.	Set the “INITIALIZE” to “VIDEO” to reset the video parameters.	120
Set “MONITOR CHECK” to “YES”.			120	
Input selector setting of the video monitor is incorrect.		Set the input source selector setting of the video monitor appropriately.	—	
Pure Direct mode is active.		Turn off the Pure Direct mode.	—	
		Set “Pure Direct” in “Sound” to “Video On”.	89	
Non-standard video signals are input.				
The HDMI OUT jack that the video monitor is connected is not selected.	Press Ⓢ HDMI OUT on the remote control repeatedly.	51		
Short message displays in the main zone do not appear in the video monitor.	“Short Message” is set to “Off”.	Set “Short Message” to “On”.	90	
	“Conversion” is set to “Off”.	Set “Conversion” to “On”.	89	
	The signals input at the HDMI input jacks are being output at the HDMI OUT jack.			
The sound suddenly goes off.	The protection circuitry has been activated because of a short circuit, etc.	Check that the speaker impedance setting is correct.	39, 119	
		Check that the speaker wires are not touching each other and then turn this unit back on.	—	
	The sleep timer has turned off this unit.	Turn on this unit, and play the source again.	—	
	The sound is muted.	Press Ⓢ MUTE or Ⓢ VOLUME +/- on the remote control to resume audio output.	52	

Problem	Cause	Remedy	See page
Sound is heard from the speaker on one side only.	Incorrect cable connections.	Connect the cables properly. If the problem persists, the cables may be defective.	23
	Incorrect settings in "Speaker Level".	Adjust the "Speaker Level" settings.	86
Only the center speaker outputs substantial sound.	When playing a monaural source with a CINEMA DSP program, the source signal is directed to the center channel, and the front and surround speakers output effect sounds.		
No sound is heard from the center speaker.	"Center" in "Speaker Set" is set to "None".	Set "Center" to "Small" or "Large".	84
	One of the HiFi DSP programs (except for "11ch Stereo") has been selected and analog 2-channel source is being input.	Try another sound field program if you want to output sound from the center speaker.	54
No sound is heard from the presence speakers.	The sound field programs are turned off.	Press Ⓢ STRAIGHT to turn them on.	60
	You are using a source or program combination that does not output sound from all channels.	Try another sound field program.	50
No sound is heard from the surround speakers.	"Surround" in "Speaker Set" is set to "None".	Set "Surround" to "Small" or "Large".	84
	This unit is in the "STRAIGHT" mode and a source which does not contain the surround channel signals is being played back.	Press Ⓢ STRAIGHT on the front panel so that "STRAIGHT" disappears from the front panel display.	60
No sound is heard from the subwoofer.	"Bass Out" in "Speaker Set" is set to "Front" when a Dolby Digital or DTS signal is being played.	Set "Bass Out" to "SWFR" or "Front & SWFR".	85
	"Bass Out" in "Speaker Set" is set to "SWFR" or "Front" when a 2-channel source is being played.	Set "Bass Out" to "Front & SWFR".	85
	The source does not contain low-frequency signals.		
No sound is heard from the surround back speakers.	"Surround" in "Speaker Set" is set to "None" and "Surround Back" is automatically set to "None".	Set "Surround" and "Surround Back" to a setting other than "None".	84
	"Surround Back" in "Speaker Set" is set to "None".	Set "Surround Back" to a setting other than "None".	84
The audio input sources cannot be played in the desired digital audio signal format. (Desired input source indicator or decoder indicator in the front panel display does not light up.)	The connected component is not set to output Dolby Digital or DTS digital signals.	Make an appropriate setting following the operating instructions for your component.	—
	Audio input jack select is set to "Analog".	Set the audio input jack select to "Auto".	52
A humming sound is heard.	Incorrect cable connections.	Connect the audio cables firmly. If the problem persists, the cables may be defective.	—
	No connection from the turntable to the GND terminal.	Connect the grounding cable of the turntable to the GND terminal on this unit.	34
The volume level is low while a record is being played.	The record is being played on a turntable with an MC cartridge.	Connect the turntable to this unit through an MC-head amplifier.	34
The volume level cannot be increased, or the sound is distorted.	The component connected to the AUDIO OUT jacks of this unit is turned off.	Turn on the power of the component.	—
The sound effect cannot be recorded.	It is not possible to record the sound effect with a recording component.		
A source cannot be recorded by a digital recording component connected to the DIGITAL OUTPUT jack.	The source component is not connected to the DIGITAL INPUT jacks on this unit.	Connect the source component to the DIGITAL INPUT jacks.	31, 34
	Some components cannot record Dolby Digital or DTS sources.		
A source cannot be recorded by an analog component connected to the AUDIO OUT jacks.	The source component is not connected to the analog AUDIO IN jacks on this unit.	Connect the source component to the analog AUDIO IN jacks.	34
The sound field parameters and some other settings of this unit cannot be changed.	"Memory Guard" in "Option" is set to "On".	Set "Memory Guard" to "Off".	94
This unit does not operate properly.	The internal microcomputer has been frozen by an external electric shock (such as lightning or excessive static electricity) or by a power supply with low voltage.	Disconnect the power cable from the AC wall outlet and then plug it in again after about 30 seconds.	—

Problem	Cause	Remedy	See page
“CHECK SP WIRES” appears in the front panel display.	Speaker cables are short-circuited.	Make sure all speaker cables are connected correctly.	23
There is noise interference from digital or radio frequency equipment.	This unit is too close to the digital or high-frequency equipment.	Move this unit further away from such equipment.	—
The picture is disturbed.	The video source uses scrambled or encoded signals to prevent dubbing.		
This unit suddenly enters the standby mode.	The internal temperature becomes too high and the overheat protection circuitry has been activated.	Wait about 1 hour for this unit to cool down and then turn it back on.	—

■ **Remote control**

Problem	Cause	Remedy	See page
The remote control does not work or function properly.	Wrong distance or angle.	The remote control will function within a maximum range of 6 m (20 ft) and no more than 30 degrees off-axis from the front panel.	12
	Direct sunlight or lighting (from an inverter type of fluorescent lamp, etc.) is striking the remote control sensor of this unit.	Reposition this unit.	—
	The batteries are weak.	Replace all batteries.	11
	The batteries do not last long and get quickly exhausted.	Using alkaline batteries is strongly recommended. Set the backlight mode to “OFF”.	— 104
	The operation mode selector is set incorrectly.	Set the operation mode selector correctly. When operating this unit, set it to the AMP position. When operating the component selected by the input selector button, set it to the SOURCE position. When operating the TV, set it to the TV position.	—
	The remote control code was not correctly set.	Set the remote control code correctly using “List of remote control codes” at the end of this manual.	104
		Try setting another code of the same manufacturer using “List of remote control codes” at the end of this manual.	104
The remote control ID of the remote control and this unit do not match.	Match the remote control ID of this unit and the remote control.	104	
The remote control does not work or function properly.	Even if the remote control code is correctly set, there are some models that do not respond to the remote control.	Program the necessary functions independently into the programmable buttons using the Learn feature.	105
The remote control does not learn new functions.	The batteries of this remote control and/or the other remote control are too weak.	Replace the batteries.	11
	The distance between the two remote controls is too much or too little.	Place the remote controls at the proper distance.	105
	The signal coding or modulation of the other remote control is not compatible with this remote control.	Learning is not possible.	—
	Memory capacity is full.	Delete other unnecessary functions to make room for the new functions.	109

■ **HDMI**

Problem	Cause	Remedy	See page
No picture or sound	The number of the connected HDMI components is over the limit.	Reduce the number of the connected HDMI components.	—
	HDCP authentication failed.	Check that the connected HDMI components support the HDCP copy protection standards.	—

■ **Network and USB**

Problem	Cause	Remedy	See page
The PC server/MCX-2000/Internet Radio does not function properly.	The IP address is not set properly.	Set the DHCP server function of the router to ON. Alternately, perform manual configuration according to the current operating environment.	92
	The network cable is not connected.	Connect it properly.	37

Problem	Cause	Remedy	See page
The music in the PC server cannot be played back.	The PC does not have Windows Media Player 11 or Windows Media Connect 2.0 installed in it.	Install Windows Media Player 11 or Windows Media Connect 2.0 in the PC.	—
	The music is recorded in a format that cannot be played on this unit. This unit cannot play music formats other than WMA, MP3, MPEG-4 AAC, and WAV (PCM format). Also note that it cannot play certain music files even if these are recorded in the WMA, MP3, MPEG-4 AAC, or WAV format.	Play music recorded in a format that this unit is compatible with.	—
The MusicCAST server cannot be connected.	You are attempting to connect to MCX-1000. The MusicCAST server that can be connected by this unit is MCX-2000.	Use MCX-2000 or the PC server.	—
	Auto Configuration is not executed.	Execute "Auto Configure".	68
"Disconnected" is displayed even when a USB device is present.	This unit recognized the USB storage device as an illegal device.	Turn this unit off then on again.	69
The Internet Radio cannot be played.	The firewall of the network device is activated. The Internet Radio can be played only when it passes through the port designated by each radio station. The port number is variable depending on radio station.	Check the firewall setting of the network device.	—
	Connection to the Internet is disconnected.	Check the configuration of the network device, and then contact the network connection provider.	—
The music files and directories in the USB device cannot be viewed.	The music files and directories are placed in locations other than the FAT area.	Place music files and directories in the FAT area.	—
	You are attempting to browse directory hierarchies of over 8 levels or a directory with more than 500 files.	Modify the data structure on your USB device.	—
The USB device cannot be recognized.	The connected USB device is USB portable audio player.	Some devices may become easier to recognize when they are inserted before turning this unit on.	69
This unit does not recall the correct item by using numeric buttons (1-8).	The connected USB device is incorrect.	Connect the USB device that stores the preset item.	69
	The directory that stores the selected item is changed.	Preset the desired item to the numeric button (1-8) again.	70
This unit does not recall the selected item by using numeric buttons (1-8).	The USB device is not connected correctly.	Connect the correct USB device properly.	37
	The PC or MCX-2000 that stores the selected item is turned off.	Turn on the PC or MCX-2000.	68
	The selected Internet Radio station is temporary unavailable or out of service.	Try again when the selected Internet Radio is providing the service. Preset other Internet Radio stations.	69 69
Status message	Cause	Remedy	See page
Please wait (Starting Server)	This unit is in the middle of waking up MCX-2000 that has been set to the standby mode.	Wait for approximately 20 seconds.	—
Connect error	There is a problem with the signal path from your network to this unit.	Check the connection between this unit and the LAN port on your router or hub.	37
		Make sure your router is properly connected and turned on. Also, make sure your modem is properly connected and turned on when you are attempting to listen to Internet Radio.	37
Disconnected	Your USB storage device or USB portable audio player has been disconnected from the USB port on this unit.	Check the connection between this unit and your USB storage device or USB portable audio player.	—
	The PC server or MCX-2000 previously connected to this unit no longer exists.	Connect this unit to the available PC server or MCX-2000.	68
	There is a problem with the signal path from your USB storage device or USB portable audio player to this unit.	Turn off this unit and reconnect your USB storage device or USB portable audio player to the USB port on this unit.	39
Try resetting your USB storage device or USB portable audio player.		—	
Access error	This unit cannot access your USB storage device or USB portable audio player.	Try another USB storage device or USB portable audio player.	—
	There is a problem with the signal path from your USB storage device or USB portable audio player to this unit.	Turn off this unit and reconnect your USB storage device or USB portable audio player to the USB port on this unit.	39
Try resetting your USB storage device or USB portable audio player.		—	

Status message	Cause	Remedy	See page
Unable to play	This unit cannot play back the songs currently stored on your PC.	Make sure Windows Media Player 11 or Windows Media Connect 2.0 is installed on your PC.	—
		Check that the songs currently stored on your PC are playable (MP3, WMA, MPEG-4 AAC, and WAV).	—
		Store some other playable music files (MP3, WMA, MPEG-4 AAC, and WAV) on your PC.	—
	The network may be overloaded with heavy traffic, and playback is interrupted.	Try preparing a network exclusively for use with this unit to separate it from general network traffic.	—
License Unavailable	This unit cannot find the license key of the file.	Acquire the license key of the file. For details, consult with the supplier of the file.	—
List updated	The list of the contents stored on your PC server or MCX-2000 has been updated.		
Bookmark ON (Bookmark OFF)	The desired Internet Radio station has been added (removed) to the “Bookmarks” list.		
Empty Memory!	No items are assigned to the selected numeric button.	Assign the desired item to the numeric button.	70
Not found!	This unit cannot find the assigned item for the selected numeric button.	Connect the USB device that stores the preset item.	—
		Turn on the PC or MCX-2000.	68
		Try again when the selected Internet Radio is providing the service.	69
		Preset the desired item to the numeric button (1-8) again.	70
USB Overloaded	Over current passes through the connected USB device.	Turn off this unit and then disconnect the USB device. If the message appears when you connect the USB device again, this unit may not compatible with the USB device.	—

■ iPod

Note

In case of a transmission error without a status message appearing in the front panel and in the video monitor, check the connection to your iPod (see page 36).

Status message	Cause	Remedy	See page
Loading...	This unit is in the middle of recognizing the connection with your iPod.		
	This unit is in the middle of acquiring song lists from your iPod.		
Connect error	There is a problem with the signal path from your iPod to this unit.	Turn off this unit and reconnect the Yamaha iPod universal dock to the DOCK terminal on this unit.	36
		Try resetting your iPod.	—
Unknown iPod	The iPod being used is not supported by this unit.	Only iPod (Click and Wheel), iPod nano, and iPod mini are supported.	—
iPod connected	Your iPod is properly stationed in a Yamaha iPod universal dock (such as the YDS-10, sold separately) connected to the DOCK terminal of this unit, and the connection between your iPod and this unit is complete.		
Disconnected	Your iPod was removed from a Yamaha iPod universal dock (such as YDS-10 sold separately) connected to the DOCK terminal of this unit.	Station your iPod back in a Yamaha iPod universal dock (such as YDS-10 sold separately) connected to the DOCK terminal on this unit.	36
Unable to play	This unit cannot play back the songs currently stored on your iPod.	Check that the songs currently stored on your iPod are playable.	—
		Store some other playable music files on your iPod.	—

■ Auto Setup

Before Auto Setup

Error message	Cause	Remedy	See page
Connect MIC!	Optimizer microphone is not connected.	Connect the supplied optimizer microphone to the OPTIMIZER MIC jack on the front panel.	43
Unplug Phones!	Headphones are connected.	Unplug the headphones.	—
No Setup Menu!	No check items are selected as the measurement items.	Select the desired check item.	44
Memory Guard!	“Memory Guard” is set to “On”.	Set “Memory Guard” to “Off”.	94

During Auto Setup

Error message	Cause	Remedy	See page
E01:No Front SP	Front L/R channel signals are not detected.	Check the front L/R speaker connections.	23
E02:No Sur. SP	A surround channel signal is not detected.	Check the surround speaker connections.	23
E03:No F. PRNS SP	A front presence channel signal is not detected.	Check the front presence speaker connections.	23
E04:SBR → SBL	Only right surround back channel signal is detected.	Connect the surround back speaker to the SUR.BACK/BI-AMP (SINGLE) terminal if you only have one surround back speaker.	23
E05:Noisy	Background noise is too loud.	Try running "Auto Setup" in a quiet environment.	—
		Turn off noisy electric equipment like air conditioners or move them away from the optimizer microphone.	—
E06:Check Sur.	Surround back speakers are connected, though surround L/R speakers are not.	Connect surround speakers when you use surround back speakers.	23
E07:No MIC	The optimizer microphone was unplugged during the "Auto Setup" procedure.	Connect the supplied optimizer microphone to the OPTIMIZER MIC jack on the front panel.	43
E08:No R.PRNS SP	A rear presence channel signal is not detected.	Check the rear presence speaker connections.	23
E09>User Cancel	The "Auto Setup" procedure was cancelled due to user activity.	Run "Auto Setup" again.	42
E10:Internal Err.	An internal error occurred.	Run "Auto Setup" again.	42

After Auto Setup

Warning message	Cause	Remedy	See page
W1:Out of Phase	Speaker polarity is not correct. This message may appear depending on the speakers even when the speakers are connected correctly.	Check the speaker connections for proper polarity (+ or -).	23
W2:Over Distance	The distance between the speaker and the listening position is over 24 m (80 ft).	Bring the speaker closer to the listening position.	—
W3:Level Error	The difference of volume level among speakers is excessive.	Readjust the speaker installation so that all speakers are set in locations with similar conditions.	—
		Check the speaker connections.	23
		Use speakers of similar quality.	—
		Adjust the output volume of the subwoofer.	42
W4:SP Mismatch	The result of the wiring check of "Auto Setup" is different from "Speaker Set" in "Manual Setup".	Use "Speaker Set" in "Manual Setup" to adjust the speaker settings manually.	84
	"Wiring" check procedure is skipped.	Select "Wiring" in "Setup Menu".	44

Notes

- If the "ERROR" or "WARNING" screens appears, check the cause of the problem, then run "Auto Setup" again.
- If warning "W2" or "W3" appears, the adjustment are made, however the adjustments may not be optimal.
- Depending on the speakers, warning "W1" may appears even if the speakers connections are correct.
- If error "E10" occurs repeatedly, please contact a qualified Yamaha service center.

Resetting the system

Use this feature to reset all the parameters of this unit to the initial factory settings.

Notes

- This procedure completely resets all the parameters of this unit including the GUI menu parameters.
- The initial factory settings are activated next time you turn on this unit.



To cancel the initialization procedure at any time without making any changes, press **ⓂMASTER ON/OFF** on the front panel to release it outward to the OFF position.

1 Press **ⓂMASTER ON/OFF** on the front panel to release it outward to the OFF position to turn off this unit.

2 Press and hold **ⓂPROGRAM** and then press **ⓂMASTER ON/OFF** inward to the ON position to turn on this unit.

Press and hold **ⓂPROGRAM** until "ADVANCED SETUP" appears in the front panel display (see page 119).

3 Rotate **ⓂPROGRAM** to select "INITIALIZE".

4 Press **ⓂPROGRAM** repeatedly to select "ALL".



- Select "CANCEL" to cancel the initialization procedure without making any changes.
- You can initialize the video parameters or sound field program parameters separately. See page 120 for details.

5 Press **ⓂMASTER ON/OFF** to release it outward to the OFF position to confirm your selection and turn off this unit.

Glossary

■ Audio and video synchronization (lip sync)

Lip sync, an abbreviation for lip synchronization, is a technical term that involves both a problem and a capability of maintaining audio and video signals synchronized during post-production and transmission. Whereas the audio and video latency requires complex end-user adjustments, HDMI version 1.3 incorporates an automatic audio and video syncing capability that allows devices to perform this synchronization automatically and accurately without user interaction.

■ Bi-amplification connection

A bi-amplification connection uses two amplifiers for a speaker. One amplifier is connected to the woofer section of a loudspeaker while the other is connected to the combined mid and tweeter section. With this arrangement each amplifier operates over a restricted frequency range. This restricted range presents each amplifier with a much simpler job and each amplifier is less likely to influence the sound in some way. The internal crossover of the speaker consists of a LPF (low pass filter) and a HPF (high pass filter). As its name implies, the LPF passes frequencies below a cutoff and rejects frequencies above the cutoff frequency. Likewise, the HPF passes frequencies above its cutoff.

■ Component video signal

With the component video signal system, the video signal is separated into the Y signal for the luminance and the PB and PR signals for the chrominance. Color can be reproduced more faithfully with this system because each of these signals is independent. The component signal is also called the "color difference signal" because the luminance signal is subtracted from the color signal. A monitor with component input jacks is required in order to output component signals.

■ Composite video signal

With the composite video signal system, the video signal is composed of three basic elements of a video picture: color, brightness and synchronization data. A composite video jack on a video component transmits these three elements combined.

■ Deep Color

Deep Color refers to the use of various color depths in displays, up from the 24-bit depths in previous versions of the HDMI specification. This extra bit depth allows HDTVs and other displays go from millions of colors to billions of colors and eliminate on-screen color banding for smooth tonal transitions and subtle gradations between colors. The increased contrast ratio can represent many times more shades of gray between black and white. Also Deep Color increases the number of available colors within the boundaries defined by the RGB or YCbCr color space.

■ Dolby Digital

Dolby Digital is a digital surround sound system that gives you completely independent multi-channel audio. With 3 front channels (front L/R and center), and 2 surround stereo channels, Dolby Digital provides 5 full-range audio channels. With an additional channel especially for bass effects, called LFE (Low Frequency Effect), the system has a total of 5.1-channels (LFE is counted as 0.1 channel). By using 2-channel stereo for the surround speakers, more accurate moving sound effects and surround sound environment are possible than with Dolby Surround. The wide dynamic range from maximum to minimum volume reproduced by the 5 full-range channels and the precise sound orientation generated using digital sound processing provide listeners with unprecedented excitement and realism. With this unit, any sound environment from monaural up to a 5.1-channel configuration can be freely selected for your enjoyment.

■ Dolby Digital EX

Dolby Digital EX creates 6 full-bandwidth output channels from 5.1-channel sources. This is done using a matrix decoder that derives 3 surround channels from the 2 in the original recording. For the best results, Dolby Digital EX should be used with movie sound tracks recorded with Dolby Digital Surround EX. With this additional channel, you can experience more dynamic and realistic moving sound especially with scenes with "fly-over" and "fly-around" effects.

■ Dolby Digital Plus

Dolby Digital Plus is an advanced audio technology developed for high-definition programming and media including HD broadcasts, HD DVD, and Blu-ray Disc. Selected as a mandatory audio standard for HD DVD and as an optional audio standard for Blu-ray Disc, this technology delivers multichannel sound with discrete channel output. Supporting bitrates up to 6.0 Mbps, Dolby Digital Plus can carry up to 7.1 discrete audio channels simultaneously. Supported by HDMI version 1.3 and designed for the optical disc players and AV receivers/amplifiers of the future, Dolby Digital Plus also remains fully compatible with the existing multichannel audio systems that incorporate Dolby Digital.

■ Dolby Pro Logic II

Dolby Pro Logic II is an improved technique used to decode vast numbers of existing Dolby Surround sources. This new technology enables a discrete 5-channel playback with 2 front left and right channels, 1 center channel, and 2 surround left and right channels instead of only 1 surround channel for conventional Pro Logic technology. There are three modes available: "Music mode" for music sources, "Movie mode" for movie sources and "Game mode" for game sources.

■ Dolby Pro Logic IIx

Dolby Pro Logic IIx is a new technology enabling discrete multi-channel playback from 2-channel or multi-channel sources. There are three modes available: "Music mode" for music sources, "Movie mode" for movie sources (for 2-channel sources only) and "Game mode" for game sources.

■ Dolby Surround

Dolby Surround uses a 4-channel analog recording system to reproduce realistic and dynamic sound effects: 2 front left and right channels (stereo), a center channel for dialog (monaural), and a surround channel for special sound effects (monaural). The surround channel reproduces sound within a narrow frequency range. Dolby Surround is widely used with nearly all video tapes and laser discs, and in many TV and cable broadcasts as well. The Dolby Pro Logic decoder built into this unit employs a digital signal processing system that automatically stabilizes the volume on each channel to enhance moving sound effects and directionality.

■ Dolby TrueHD

Dolby TrueHD is an advanced lossless audio technology developed for high-definition disc-based media including HD DVD and Blu-ray Disc. Selected as a mandatory audio standard for HD DVD and as an optional audio standard for Blu-ray Disc, this technology delivers sound that is bit-for-bit identical to the studio master, offering a high-definition home theater experience. Supporting bitrates up to 18.0 Mbps, Dolby TrueHD can carry up to 8 discrete channels of 24-bit/96 kHz audio simultaneously. Supported by HDMI version 1.3 and designed for the optical disc players and AV receivers/amplifiers of the future, Dolby TrueHD also remains fully compatible with the existing multichannel audio systems and retains the metadata capability of Dolby Digital, allowing dialog normalization and dynamic range control.

■ DSD

Direct Stream Digital (DSD) technology stores audio signals on digital storage media, such as Super Audio CDs. Using DSD, signals are stored as single bit values at a high-frequency sampling rate of 2.8224 MHz, while noise shaping and oversampling are used to reduce distortion, a common occurrence with very high quantization of audio signals. Due to the high sampling rate, better audio quality can be achieved than that offered by the PCM format used for normal audio CDs.

■ DTS 96/24

DTS 96/24 offers an unprecedented level of audio quality for multi-channel sound on DVD video, and is fully backward-compatible with all DTS decoders. "96" refers to a 96 kHz sampling rate compared to the typical 48 kHz sampling rate. "24" refers to 24-bit word length. DTS 96/24 offers sound quality transparent to the original 96/24 master, and 96/24 5.1-channel sound with full-quality full-motion video for music programs and motion picture soundtracks on DVD video.

■ DTS Digital Surround

DTS digital surround was developed to replace the analog soundtracks of movies with a 6.1-channel digital sound track, and is now rapidly gaining popularity in movie theaters around the world. DTS, Inc. has developed a home theater system so that you can enjoy the depth of sound and natural spatial representation of DTS digital surround in your home. This system produces practically distortion-free 6-channel sound (technically, front left and right, center, surround left and right, and LFE 0.1 (subwoofer) channels for a total of 5.1 channels). This unit incorporates a DTS-ES decoder that enables 6.1-channel reproduction by adding the surround back channel to the existing 5.1-channel format.

■ DTS Express

DTS Express is an advanced audio technology for the optional feature on Blu-ray Disc or HD DVD, which offers high-quality, low bit rate audio optimized for network streaming, and Internet applications. DTS Express is used for the Secondary Audio feature of Blu-ray Disc or the Sub Audio feature of HD DVD. These features deliver audio commentaries (for example, the additional commentaries made by the director of a film) on demand by the users via the Internet, etc. DTS Express signals are mixed down with the main audio stream on the player component, and the component sends the mixed audio stream to the AV receivers/amplifiers via digital coaxial, digital optical, or analog connections.

■ DTS-HD Master Audio

DTS-HD Master Audio is an advanced lossless audio technology developed for high-definition disc-based media including HD DVD and Blu-ray Disc. Selected as a mandatory audio standard for both HD DVD and Blu-ray Disc, this technology delivers sound that is bit-for-bit identical to the studio master, offering a high-definition home theater experience. Supporting bitrates up to 18.0 Mbps for HD DVD and up to 24.5 Mbps for Blu-ray Disc, DTS-HD Master Audio can carry up to 7.1 discrete channels of 24-bit/96 kHz audio simultaneously. Supported by HDMI version 1.3 and designed for the optical disc players and AV receivers/amplifiers of the future, DTS-HD Master Audio also remains fully compatible with the existing multichannel audio systems that incorporate DTS Digital Surround.

■ DTS-HD High Resolution Audio

DTS-HD High Resolution Audio is a high resolution audio technology developed for high-definition disc-based media including HD DVD and Blu-ray Disc. Selected as an optional audio standard for both HD DVD and Blu-ray Disc, this technology delivers sound that is virtually indistinguishable from the original, offering a high-definition home theater experience. Supporting bitrates up to 3.0 Mbps for HD DVD and 6.0 Mbps for Blu-ray Disc, DTS-HD High Resolution Audio can carry up to 7.1 discrete channels of 24-bit/96 kHz audio simultaneously. Supported by HDMI version 1.3 and designed for the optical disc players and AV receivers/amplifiers of the future, DTS-HD High Resolution Audio also remains fully compatible with the existing multichannel audio systems that incorporate DTS Digital Surround.

■ HDMI

HDMI (High-Definition Multimedia Interface) is the first industry-supported, uncompressed, all-digital audio/video interface. Providing an interface between any source (such as a set-top box or AV receiver) and an audio/video monitor (such as a digital television), HDMI supports standard, enhanced or high-definition video as well as multi-channel digital audio using a single cable. HDMI transmits all ATSC HDTV standards and supports 8-channel digital audio, with bandwidth to spare to accommodate future enhancements and requirements.

When used in combination with HDCP (High-bandwidth Digital Content Protection), HDMI provides a secure audio/video interface that meets the security requirements of content providers and system operators. For further information on HDMI, visit the HDMI website at "<http://www.hdmi.org/>".

■ LFE 0.1 channel

This channel reproduces low-frequency signals. The frequency range of this channel is from 20 Hz to 120 Hz. This channel is counted as 0.1 because it only enforces a low-frequency range compared to the full-range reproduced by the other 5/6 channels in Dolby Digital or DTS 5.1/6.1-channel systems.

■ MP3

One of the audio compression methods used by MPEG. It employs the irreversible compression method, which achieves a high compression rate by thinning out the data of hardly audible part to the human ears. It is said to be capable of compressing the data quantity by about 1/11 (128 kbps) while maintaining a similar audio quality to music CD.

■ MPEG-4 AAC

An MPEG-4 audio standard. As it allows compression of data at a bit rate lower than that of MPEG-2 AAC, it is used among others for mobile telephones, portable audio players and other low-capacity devices requiring high sound quality.

In addition to the above types of devices, MPEG-4 AAC is also used to distribute contents on the Internet, and as such is supported by computers, media servers and many other devices.

■ Neo:6

Neo:6 decodes the conventional 2-channel sources for 6-channel playback by the specific decoder. It enables playback with the full-range channels with higher separation just like digital discrete signal playback. There are two modes available: "Music mode" for music sources and "Cinema mode" for movie sources.

■ PCM (Linear PCM)

Linear PCM is a signal format under which an analog audio signal is digitized, recorded and transmitted without using any compression. This is used as a method of recording CDs and DVD audio. The PCM system uses a technique for sampling the size of the analog signal per very small unit of time. Standing for "Pulse Code Modulation", the analog signal is encoded as pulses and then modulated for recording.

■ Sampling frequency and number of quantized bits

When digitizing an analog audio signal, the number of times the signal is sampled per second is called the sampling frequency, while the degree of fineness when converting the sound level into a numeric value is called the number of quantized bits. The range of rates that can be played back is determined based on the sampling rate, while the dynamic range representing the sound level difference is determined by the number of quantized bits. In principle, the higher the sampling frequency, the wider the range of frequencies that can be played back, and the higher the number of quantized bits, the more finely the sound level can be reproduced.

■ S-video signal

With the S-video signal system, the video signal normally transmitted using a pin cable is separated and transmitted as the Y signal for the luminance and the C signal for the chrominance through the S-video cable. Using the S VIDEO jack eliminates video signal transmission loss and allows recording and playback of even more beautiful images.

■ WAV

Windows standard audio file format, which defines the method of recording the digital data obtained by converting audio signals. It does not specify the compression (coding) method so a desired compression method can be used with it. By default, it is compatible with the PCM method (no compression) and some compression methods including the ADPCM method.

■ WMA

An audio compression method developed by Microsoft Corporation. It employs the irreversible compression method, which achieves a high compression rate by thinning out the data of hardly audible part to the human ears. It is said to be capable of compressing the data quantity by about 1/22 (64 kbps) while maintaining a similar audio quality to music CD.

■ xvYCC

A color space standard supported by HDMI version 1.3. It is a more extensive color space than sRGB, and allows the expression of colors that could not be expressed before. While remaining compatible with the color gamut of sRGB standards, xvYCC expands the color space and can thus produce more vivid, natural images. It is particularly effective for still pictures and computer graphics.

THX information



THX
ULTRA 2™ PLUS
SURROUND EX™

RECOMMENDED USE

Larger Home Theater, Living Room, etc.

THX CERTIFICATION FEATURES

THX Loudness Plus featuring:

- Multichannel Spectral Balancing
- Dynamic Ambience Preservation

THX Cinema, Music, Games modes using:

- Re-Equalization
- Timbre Matching
- Adaptive Decorrelation
- ASA Technology

Boundary Gain Compensation

ADDITIONAL THX TECHNOLOGIES

Neural-THX Surround

THX PERFORMANCE

Capable of THX Reference Level at approx. 12 feet (4 meters) viewing/listening distance

Visit www.thx.com for further technical details.

■ THX Ultra2

Before any home theatre component can be THX Ultra2 certified, it must incorporate all the features above and also pass a rigorous series of quality and performance tests. Only then can a product feature the THX Ultra logo, which is your guarantee that the Home Theatre products you purchase will give you superb performance for many years to come. THX Ultra2 requirements cover every aspect of the product including pre-amplifier performance and operation, and hundreds of other parameters in both the digital and analog domain.

■ THX Cinema processing

THX is an exclusive set of standards and technologies established by the world-renowned film production company, Lucasfilm Ltd. THX grew from George Lucas' personal desire to make your experience of the film soundtrack, in both movie theatres and in your home theatre, as faithful as possible to what the director intended. Movie soundtracks are mixed in special movie theatres called dubbing stages and are designed to be played back in movie theatres with similar equipment and conditions. This same soundtrack is then transferred directly onto Laserdisc, VHS tape, DVD, etc., and is not changed for playback in a small home theatre environment. THX engineers developed patented technologies to accurately translate the sound from the movie theatre environment into the home, correcting the tonal and spatial errors that occur. On this product, when "THX" appears in the front panel display, THX features are automatically added in Cinema modes (e.g. THX Cinema, THX Surround EX).

THX Cinema mode

In this mode, THX Loudness Plus is designed around the industry-standard reference mixing level as well as adding other proprietary THX technologies such as Adaptive Decorrelation, Re-EQ, and Timbre Matching to recreate the theatrical experience at home.

■ THX Music mode

THX Music modes provide the appropriate THX processing to enhance music listening. THX Music applies a dedicated music profile of THX Loudness Plus, designed around the varying mix levels in music sources which are often very different than film or television sources. Additionally, THX Music applies Timbre Matching to the surround speaker channels.

■ THX Games mode

THX Games mode gives the benefit of THX Loudness Plus, as well as other THX proprietary features which provide the gamer with a more accurate listening experience at lower levels, while maintaining all of the directional cues critical to gameplay.

■ THX Surround EX

Dolby Digital Surround EX is a joint development of Dolby Laboratories and the THX Ltd.

In a movie theater, film soundtracks that have been encoded with Dolby Digital Surround EX technology are able to reproduce an extra channel which has been added during the mixing of the program. This channel, called Surround Back, places sounds behind the listener in addition to the currently available front left, front center, front right, surround right, surround left and subwoofer channels. This additional channel provides the opportunity for more detailed imaging behind the listener and brings more depth, spacious ambience and sound localization than ever before.

Movies that were created using the Dolby Digital Surround EX technology, when released into the home consumer market may exhibit wording to that effect on the packaging. A list of movies created using this technology can be found on the Dolby web site at www.dolby.com.

Only receiver and controller products bearing the THX Surround EX logo, when in the THX Surround EX mode, faithfully reproduce this new technology in the home.

This product may also engage the "THX Surround EX" mode during the playback of 5.1 channel material that is not Dolby Digital Surround EX encoded. In such case the information delivered to the Surround Back channel will be program dependent and may or may not be very pleasing depending on the particular soundtrack and the tastes of the individual listener.

■ THX Ultra2 Cinema mode

THX Ultra2 Cinema mode plays 5.1 movies using all 8 speakers giving you the best possible movie watching experience. In this mode, ASA processing blends the side surround speakers and back surround speakers providing the optimal mix of ambient and directional surround sounds. This mode permits the playback of a non Surround EX/ES encoded 5.1 movie to be played back over a 7.1 system. DTS-ES (Matrix and 6.1 Discrete) and Dolby Digital Surround EX encoded soundtracks will be automatically detected, if the appropriate flag has been encoded. Some Dolby Digital Surround EX soundtracks are missing the digital flag that allows automatic switching. If you know that the movie that you are watching is encoded in Surround EX, you can manually select the THX Surround EX playback mode, otherwise THX Ultra2 Cinema mode will apply ASA processing to provide optimum replay.

■ THX Ultra2 Music mode

For the playback of multi-channel music the THX Ultra2 Music mode should be selected. In this mode THX ASA processing is applied to the surround channels of all 5.1 encoded music sources such as DTS, Dolby Digital and DVD-Audio to provide a wide stable rear soundstage.

■ THX Ultra2 Games mode

For the playback of stereo and multi-channel game audio the THX Ultra2 Games mode should be selected. In this mode THX ASA processing is applied to the surround channels of all 5.1 and 2.0 encoded game sources such as analog, PCM, DTS and Dolby Digital. This accurately places all game audio surround information, providing a full 360 degree playback environment. THX Ultra2 Games mode is unique as it gives you a smooth transition of audio in all points of the surround field.

■ THX Loudness Plus

THX Loudness Plus is a new volume control technology featured in THX Ultra2 Plus™ and THX Select2 Plus™ Certified receivers. With THX Loudness Plus, home theater audiences can now experience the rich details in a surround mix at any volume level. A consequence of turning the volume below Reference Level is that certain sound elements can be lost or perceived differently by the listener. THX Loudness Plus compensates for the tonal and spatial shifts that occur when the volume is reduced by intelligently adjusting ambient surround channel levels and frequency response. This enables users to experience the true impact of soundtracks regardless of the volume setting. THX Loudness Plus is automatically applied when listening in any THX listening mode. The new THX Cinema, THX Music, and THX Games modes are tailored to apply the proper THX Loudness Plus settings for each type of content.

■ Re-Equalization

The tonal balance of a film soundtrack will be excessively bright and harsh when played back over audio equipment in the home because film soundtracks were designed to be played back in large movie theatres using very different professional equipment. Re-Equalization restores the correct tonal balance for watching a movie soundtrack in a small home environment.

■ Adaptive Decorrelation

In a movie theatre, a large number of surround speakers help create an enveloping surround sound experience, but in a home theatre there are usually only two speakers. This can make the surround speakers sound like headphones that lack spaciousness and envelopment. The surround sounds will also collapse into the closest speaker as you move away from the middle seating position. Adaptive Decorrelation slightly changes one surround channel's time and phase relationship with respect to the other surround channel. This expands the listening position and creates – with only two speakers – the same spacious surround experience as in a movie theatre.

■ Timbre Matching

The human ear changes our perception of a sound depending on the direction from which the sound is coming. In a movie theatre, there is an array of surround speakers so that the surround information is all around you. In a home theatre, you use only two speakers located to the side of your head. The Timbre Matching feature filters the information going to the surround speakers so that they more closely match the tonal characteristics of the sound coming from the front speakers. This ensures seamless panning between the front and surround speakers.

■ BGC (Boundary Gain Compensation)

If your chosen listening room layout (for practical or aesthetic reasons) results in the most of the listeners being close to the rear wall, the resulting bass level can be sufficiently reinforced by the boundary that the overall sound quality becomes “boomy”. THX Ultra2 receivers and controllers contain the BGC (Boundary Gain Compensation) feature to provide an improved bass balance. “Bndry Gain Comp” can be selected by setting “THX Ultra2 SWFR” to “Yes” in “THX Set” of “Manual Setup”.

■ ASA (Advanced Speaker Array)

ASA is a proprietary THX technology which processes the sound fed to 2 side and 2 back surround speakers to provide the optimal surround sound experience. When you set up your home theater system using all eight speaker outputs (Left, Center, Right, Surround Right, Surround Back Right, Surround Back Left, Surround Left and Subwoofer), be sure to go to the “THX Set” screen and choose the setting that most closely corresponds to the speaker spacing, which will re-optimize the surround sound-field.

ASA is used in three modes; THX Ultra2 Cinema, THX Ultra2 Music and THX Ultra2 Games.

■ Dialogue normalization

Dialogue Normalization (Dial Norm) is a feature of Dolby Digital, which is used to keep the programs at the same average listening level so the user does not have to change the volume control between Dolby Digital programs.

When playing back software which has been encoded in Dolby Digital, sometimes you may see a brief message in the front panel display which will read “Dial Norm X dB” (X being a numeric value). The display is showing how the program level relates with THX calibration level. If you want to play the program at calibrated theatrical levels, you may wish to adjust the volume. For example, if you see the following message: “Dial Norm + 4 dB” in the front panel display, to keep the overall output level at THX calibrated loudness, just turn down the volume control by 4 dB. However, unlike a movie theater where the playback loudness is preset, you can choose your preferred volume setting for best enjoyment.

Sound field program information

■ Elements of a sound field

What really creates the rich, full tones of a live instrument are the multiple reflections from the walls of the room. In addition to making the sound live, these reflections enable us to tell where the player is situated as well as the size and shape of the room in which we are sitting.

There are two distinct types of sound reflections that combine to make up the sound field in addition to the direct sound coming straight to our ears from the player's instrument.

■ Early reflections

Reflected sounds reach our ears extremely rapidly (50 ms to 100 ms after the direct sound), after reflecting from one surface only (for example, from a wall or the ceiling). Early reflections actually add clarity to the direct sound.

■ Reverberations

These are caused by reflections from more than one surface (for example, from the walls, and the ceiling) so numerous that they merge together to form a continuous sonic afterglow. They are non-directional and lessen the clarity of the direct sound.

Direct sound, early reflections and subsequent reverberations taken together help us to determine the subjective size and shape of the room, and it is this information that the digital sound field processor reproduces in order to create sound fields.

If you could create the appropriate early reflections and subsequent reverberations in your listening room, you would be able to create your own listening environment. The acoustics in your room could be changed to those of a concert hall, a dance floor, or a room with virtually any size at all. This ability to create sound fields at will is exactly what Yamaha has done with the digital sound field processor.

■ CINEMA DSP

Since the Dolby Surround and DTS systems were originally designed for use in movie theaters, their effect is best felt in a theater having many speakers designed for acoustic effects. Since home conditions, such as room size, wall material, number of speakers, and so on, can differ so widely, it is inevitable that there are differences in the sound heard. Based on a wealth of actually measured data, Yamaha CINEMA DSP provides the audiovisual experience of a movie theater in the listening room of your own home by using the Yamaha original sound field technology combined with various digital audio systems.

■ CINEMA DSP HD³

The actually measured sound field data contain the information of the height of the sound images. CINEMA DSP HD³ feature achieves the reproduction of the accurate height of the sound images so that it creates the accurate and intensive stereoscopic sound fields in a listening room.

■ SILENT CINEMA

Yamaha has developed a natural, realistic sound effect DSP algorithm for headphones. Parameters for headphones have been set for each sound field so that accurate representations of all the sound field programs can be enjoyed on headphones.

■ Virtual CINEMA DSP

Yamaha has developed a Virtual CINEMA DSP algorithm that allows you to enjoy DSP sound field surround effects even without any surround speakers by using virtual surround speakers. It is even possible to enjoy Virtual CINEMA DSP using a minimal two-speaker system that does not include a center speaker.

■ Compressed Music Enhancer

The Compressed Music Enhancer feature of this unit enhances your listening experience by regenerating the missing harmonics in a compression artifact. As a result, flattened complexity due to the loss of high-frequency fidelity as well as lack of bass due to the loss of low-frequency bass is compensated, providing improved performance of the overall sound system.

■ Sound output in each sound field program

Sound output from each speaker depends on the type of audio signals being input. Refer to the diagrams in the table below to understand the speaker layout for each sound field program.

Note

Be advised that there may be no or not enough sound output from speakers depending on the type of input source being played back. Furthermore, there may be some channels that can only be used partially when they are adjusted to specific aspects of movies, such as special sound effects, etc.

- L Front left speaker
- C Center speaker
- R Front right speaker
- SL Surround left speaker
- SR Surround right speaker
- SBL Surround back left speaker
- SBR Surround back right speaker
- FPL Front presence left speaker
- FPR Front presence right speaker
- RPL Rear presence left speaker
- RPR Rear presence right speaker
- Speaker from which sound is being output
- Speaker from which no sound is being output

Speaker settings	
11-channel	5-channel
①	—
②	—
③	—
④	—
⑤	—
⑥	—
⑦	—
⑧	—
⑨	—
⑩	—
⑪	—

*1 DOLBY DIGITAL / DOLBY DIGITAL / DOLBY DIGITAL : OFF

*2 DOLBY DIGITAL / DOLBY DIGITAL / DOLBY DIGITAL : ON or discrete 6.1/7.1-channel audio signals are input.

Program	HD ³	Input audio source			
		2-channel (monaural)	2-channel (stereo)	5.1-channel*1	6.1/7.1-channel*2
CLASSICAL1 Hall in Munich A Hall in Munich B Hall in Frankfurt Hall in Stuttgart Hall in Vienna Hall in Amsterdam	ON	①	①	③	④
CLASSICAL2 Hall in USA A Hall in USA B Chamber Church in Tokyo Church in Freiburg Church in Royaumont					
LIVE/CLUB Village Gate Village Vanguard The Bottom Line Cellar Club The Roxy Theatre Warehouse Loft Arena	OFF	②	②	③	④
ENTERTAINMENT Sports Music Video Recital/Opera Pavilion Disco Action Game Roleplaying Game	ON	③	④	③	④
MOVIE Standard Spectacle Sci-Fi Adventure Drama	OFF	⑤	④	③	④
MOVIE Mono Movie	ON	③	③	③	④
	OFF	⑤	⑥	③	④
STEREO 2ch Stereo	--	⑦	⑦	⑦	⑦
STEREO 11ch Stereo	--	④	④	④	④
MUSIC ENHANCER 11ch Enhancer	--	④	④	④	④
SUR.DECODE Surround Decoder (Pro Logic)	--	⑧	⑨	⑨	⑩
SUR.DECODE Surround Decoder (PLIIx Movie/PLII Movie) (PLIIx Game/PLII Game) (Neo:6 Cinema)	--	⑧	⑩	⑨	⑩
SUR.DECODE Surround Decoder (PLIIx Music/PLII Music) (Neo:6 Music)	--	⑪	⑩	⑨	⑩
THX Cinema (Pro Logic)	--	⑧	⑨	⑩	⑩
THX Cinema (PLIIx Movie/PLII Movie/ Neo: 6 Cinema)	--	⑧	⑩	⑩	⑩
THX Music	--	⑪	⑩	⑩	⑩
THX Games	--	⑧	⑩	⑩	⑩
STRAIGHT Pure Direct MUSIC ENHANCER Straight Enhancer	--	⑦	⑦	⑨	⑩

■ Available parameters for each sound field program

Note

Available sound field parameter may differ depending on the speaker settings.

	Dialogue Lift	Rev. Level	Rev. Delay	Rev. Time	SB. Liveness	SB. Room Size	SB. Init. Delay	Sur. Liveness	Sur. Room Size	Sur. Init. Delay	Liveness	Room Size	Init. Delay	DSP Level	Decoder Type
CLASSICAL1															
Hall in Munich A	●										●	●	●	●	
Hall in Munich B	●										●	●	●	●	
Hall in Frankfurt	●										●	●	●	●	
Hall in Stuttgart	●										●	●	●	●	
Hall in Vienna	●										●	●	●	●	
Hall in Amsterdam	●										●	●	●	●	
CLASSICAL2															
Hall in USA A	●										●	●	●	●	
Hall in USA B	●										●	●	●	●	
Chamber	●	●	●	●							●	●	●	●	
Church in Tokyo	●	●	●	●							●	●	●	●	
Church in Freiburg	●	●	●	●							●	●	●	●	
Church in Royaumont	●	●	●	●							●	●	●	●	
LIVE/CLUB															
Village Gate	●										●	●	●	●	
Village Vanguard	●										●	●	●	●	
The Bottom Line	●										●	●	●	●	
Cellar Club	●										●	●	●	●	
The Roxy Theatre	●	●	●	●							●	●	●	●	
Warehouse Loft	●	●	●	●							●	●	●	●	
Arena	●	●	●	●							●	●	●	●	
ENTERTAINMENT															
Sports	●	●	●	●					●	●					
Music Video	●	●	●	●					●	●					
Recital/Opera	●	●	●	●					●	●					
Pavilion	●	●	●	●					●	●					
Disco	●	●	●	●				●	●	●	●				
Action Game	●	●	●	●					●	●					
Roleplaying Game	●	●	●	●					●	●					
MOVIE															
Standard	●	●						●	●	●					
Spectacle	●	●	●	●					●	●					
Sci-Fi	●	●	●	●					●	●					
Adventure	●	●	●	●					●	●					
Drama	●	●	●	●					●	●					
Mono Movie	●	●	●	●					●	●	●				
	Dialogue Lift	Decoder Parameters	Level	Direct	R:P:RNS R Level	R:P:RNS L Level	F:P:RNS R Level	F:P:RNS L Level	Sur:Back R Level	Sur:Back L Level	Surround R Level	Surround L Level	Center Level	Decoder Type	
STEREO															
2ch Stereo				●											
11ch Stereo					●	●	●	●	●	●	●	●	●		
SUR. DECODE															
Surround Decoder	●	●													
THX															
Cinema/Ultra2 Cinema/Surround EX	●														
MUSIC ENHANCER															
Straight Enhancer/ 11ch Enhancer				●											

Parametric equalizer information

This unit employs Yamaha Parametric Room Acoustic Optimizer (YPAO) technology, together with the Parametric EQ settings (see page 87), to optimize the frequency characteristics of its parametric equalizer to match your listening environment. YPAO uses a combination of the following three parameters (Frequency, Gain and Q factor) to provide highly precise adjustment of the frequency characteristics.

■ Frequency

This parameter is adjustable in one-third octave increments between 32 Hz and 16 kHz.

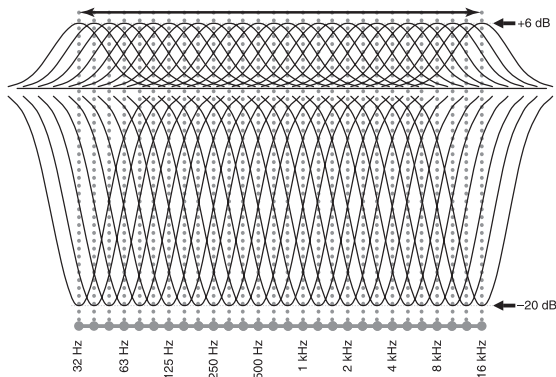

■ Gain

This parameter is adjustable in increments of 0.5 dB between -20 and +6 dB.

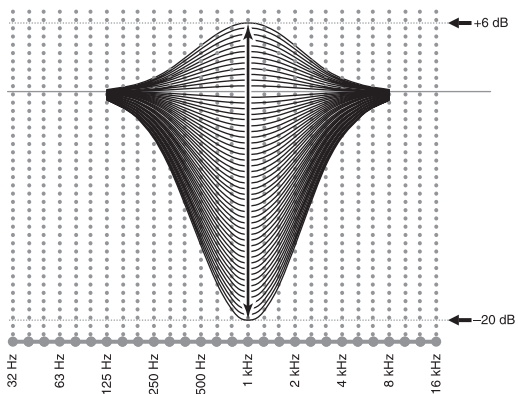

■ Q factor

The width of the specified frequency band is referred to as the Q factor. This parameter is adjustable between the values 0.5 and 10.

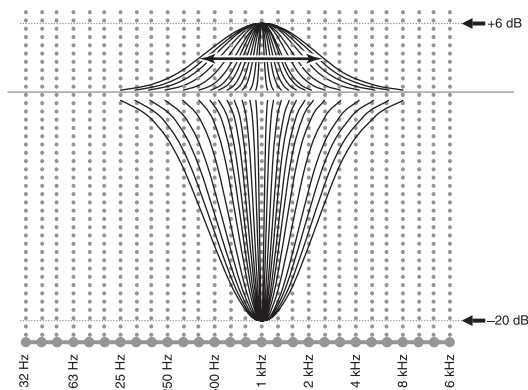

YPAO adjusts frequency characteristics to suit your listening requirements using a combination of the above three parameters (Frequency, Gain and Q factor) for each equalizer band in this unit's parametric equalizer. This unit has 7 equalizer bands for each channel.

The use of multiple equalizer bands enables more precise adjustments of frequency characteristics (as in Figure 2). This is not possible using only a single equalizer band (as in Figure 1).

Figure 1

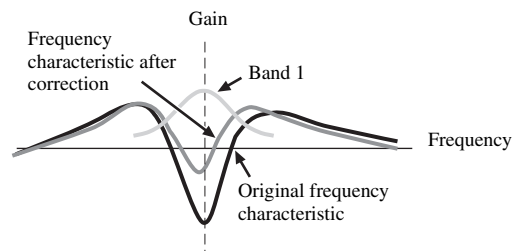
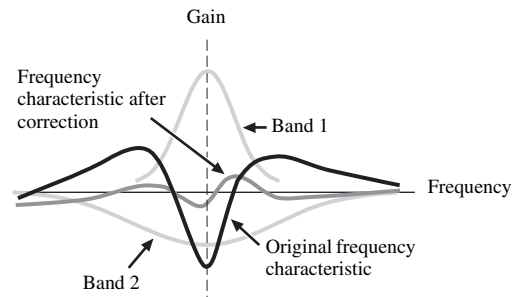

Figure 2



■ Standing wave

A wave generated when two waves of the same length, frequency and speed but traveling in opposite directions overlap. Standing waves appear to be stationary and simply oscillating in a fixed position without progressing.

Under certain conditions, the sound leaving a speaker and the sound reflecting off a wall, etc., in a room resonate. When this happens, it has a major effect on the frequency response in the room, and depending on the listening position sounds of specific frequencies may sound loud or inversely may be hard to hear. As a result, this hampers accurate reproduction of the sound source.

This unit is equipped with a parametric equalizer to reduce the effect of standing waves. The equalizer's settings can be optimized through automatic measurements. Even more accurate settings can be made by taking measurements at other positions.

Block diagrams

■ Audio section

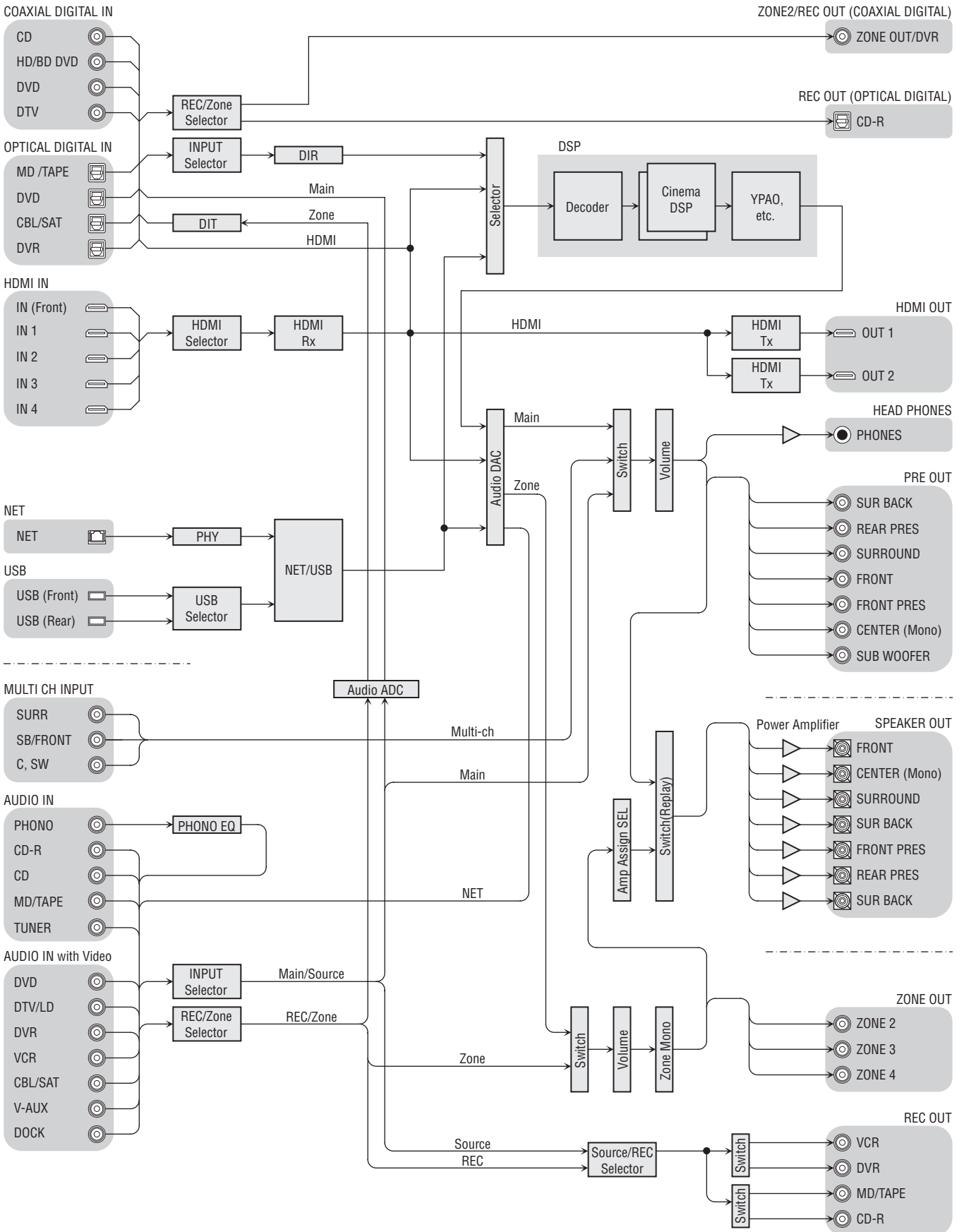

Video section

HDMI IN

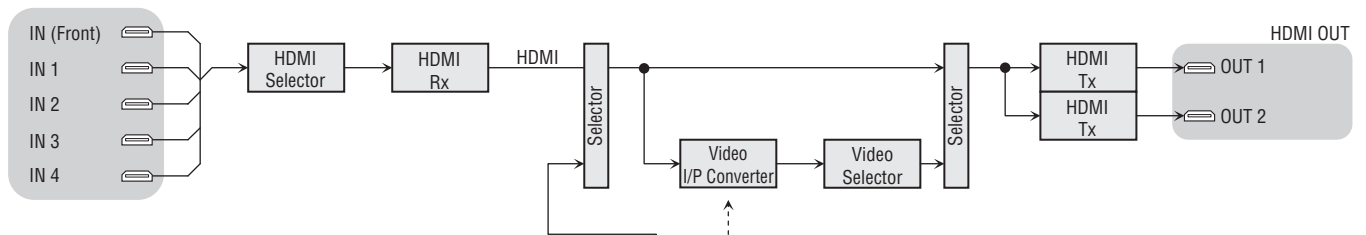

COMPONENT VIDEO IN

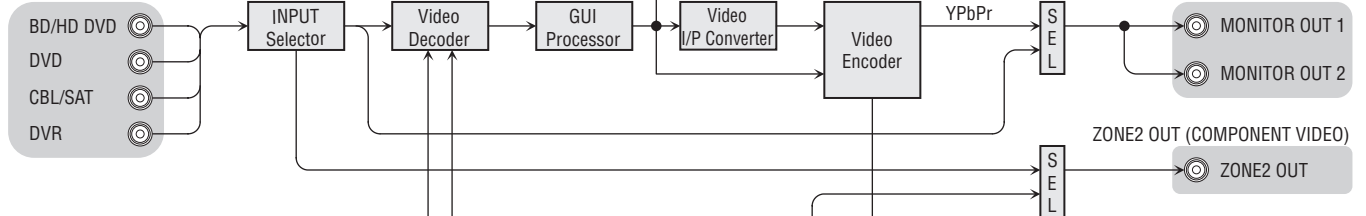

S VIDEO IN

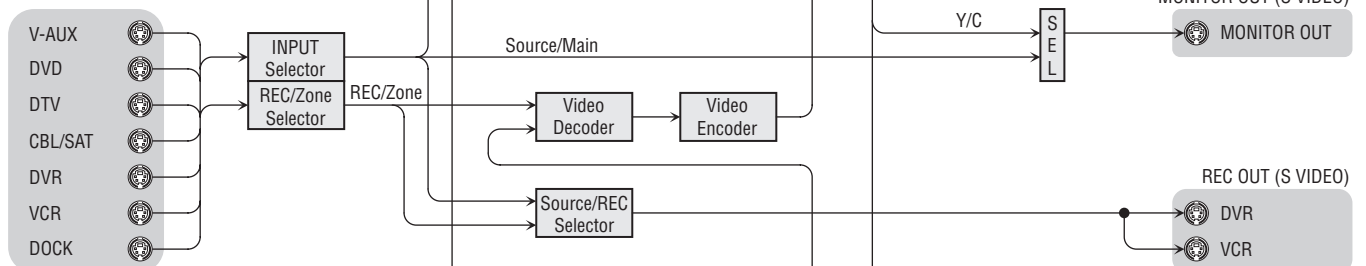

VIDEO IN

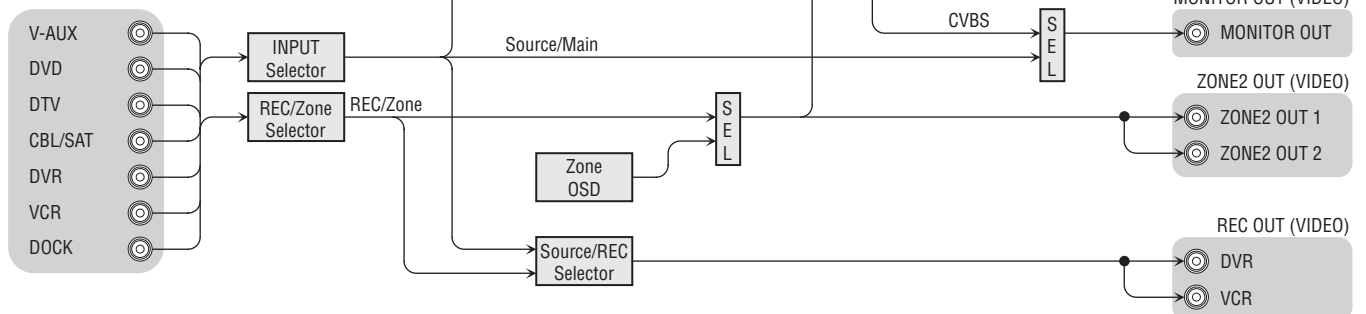

Additional Information

Specifications

AUDIO SECTION

- Minimum RMS Output Power (20 Hz to 20 kHz, 0.04% THD, 8 Ω)
 - Front, Center, Surround, Surround back 140 W
 - Front presence, Rear presence 50 W
- Dynamic Power (IHF)
 - [Asia, General, China and Korea models]
 - Front L/R 8/6/4/2 Ω 185/230/290/385 W
- Maximum Useful Output power (JEITA) (1 kHz, 10% THD, 8 Ω)
 - [Asia, General, China and Korea models]
 - Front, Center, Surround, Surround back 200 W
 - Front presence, Rear presence 75 W
- Maximum Output Power (1 kHz, 0.7% THD, 4 Ω)
 - [U.K. and Europe models]
 - Front, Center, Surround, Surround back 240 W
 - Front presence, Rear presence 90 W
- Dynamic Headroom
 - 8 Ω 1.2 dB
- IEC Output Power [U.K. and Europe models]
 - 1 kHz, 0.7% THD, 4 Ω 155 W
- Damping Factor (IHF)
 - Front L/R 1 kHz, 8 Ω 150 or more
- Input Sensitivity/Input Impedance
 - PHONO 3.5 mV/47 kΩ
 - CD, etc. 200 mV/47 kΩ
 - MULTI CH INPUT 200 mV/47 kΩ
- Maximum Input Voltage
 - PHONO (1 kHz, 0.1% THD) 60 mV or more
 - CD, etc. (1 kHz, 0.5% THD) 2.4 V or more
- Rated Output Voltage/Output Impedance
 - AUDIO OUT 200 mV/900 Ω
 - PRE OUT 1.0 V/500 Ω
 - SUBWOOFER 2.0 V/500 Ω
 - ZONE OUT 1.0 V/1.4 kΩ
- Headphone Jack Rated Output/Impedance
 - CD, etc. (1 kHz, 40 mV, 8 Ω) 150 mV/100 Ω
- Frequency Response
 - CD to Front L/R, Pure Direct 10 Hz to 100 kHz, +0/-3 dB
- RIAA Equalization Deviation
 - PHONO (20 Hz to 20 kHz) 0 ± 0.5 dB
- Total Harmonic Distortion
 - PHONO to AUDIO OUT (20 Hz to 20 kHz, 1 V) 0.02% or less
 - CD, etc. to Front L/R (20 Hz to 20 kHz, 70 W, 8 Ω) 0.02% or less
- Signal to Noise Ratio (IHF-A Network)
 - PHONO (5 mV) to Front L/R 81 dB or more
 - CD, etc. (250 mV) to Front L/R 100 dB or more
- Residual Noise (IHF-A Network)
 - Front L/R 70 μV or less
- Channel Separation (1 kHz/10 kHz)
 - PHONO (shortened) to Front L/R 70 dB/60 dB or more
 - CD, etc. (5.1 kΩ shortened) to Front L/R 70 dB/60 dB or more
- Tone Control (Front L/R, Center, Subwoofer)
 - BASS Boost/Cut ±6 dB/50 Hz
 - BASS Turnover Frequency 350 Hz
 - TREBLE Boost/Cut ±6 dB/20 kHz
 - TREBLE Turnover Frequency 3.5 kHz
- Zone 2/Zone 3 Tone Control
 - BASS Boost/Cut ±10 dB/100 Hz
 - BASS Turnover Frequency 380 Hz
 - TREBLE Boost/Cut ±10 dB/10 kHz
 - TREBLE Turnover Frequency 1.6 kHz
- Filter Characteristics (fc=40/60/80/90/100/110/120/160/200 Hz)
 - H.P.F. (Front, Center, Surround, Surround Back: Small) 12 dB/oct.
 - L.P.F. (Subwoofer) 24 dB/oct.

VIDEO SECTION

- Video Format [MONITOR OUT] (Wall Paper)
 - [Korea and General models] NTSC/PAL
 - [U.K., Europe, China and Asia models] PAL/NTSC
- Video Format (Video Conversion) NTSC/PAL
- Signal Level
 - Composite 1 V_{p-p}/75 Ω
 - S-video 1 V_{p-p}/75 Ω (Y), 0.286 or 0.3 V_{p-p}/75 Ω (C)
 - Component 1 V_{p-p}/75 Ω (Y), 0.7 V_{p-p}/75 Ω (Pb/Pb)
 - Maximum Input Level (Video Conversion Off) 1.5 V_{p-p} or more
- Signal to Noise Ratio (Video Conversion Off) 70 dB or more
- Frequency Response [MONITOR OUT]
 - Component (Video Conversion Off) 5 Hz to 100 MHz, ±3 dB
- Video Format [ZONE OUT] (Gray Back)
 - [Korea and General models] NTSC/PAL
 - [U.K., Europe, China and Asia models] PAL/NTSC
- Video signal type [ZONE COMPONENT OUT]
 - (Video conversion) NTSC/PAL

GENERAL

- Power Supply
 - [General and Asia models] AC 110/120/220/230-240 V, 50/60 Hz
 - [China model] AC 220 V, 50 Hz
 - [Korea model] AC 220 V, 60 Hz
 - [U.K. and Europe models] AC 230 V, 50 Hz
- Power Consumption 800 W/1000 VA
- Standby Power Consumption 0.1 W or less
- Maximum Power Consumption [General model only] 1500 W
- AC Outlets
 - [Asia, General and China models] 2 (Total 50 W maximum)
 - [U.K. model] 1 (100 W/0.4 A maximum)
 - [Europe model] 2 (Total 100 W/0.4 A maximum)
- Dimensions (W x H x D) 435 x 210 x 497 mm
(17-1/8 x 8-1/4 x 19-9/16 in)
- Weight 34.0 kg (74 lbs 15 oz)

* Specifications are subject to change without notice.

■ HDMI signal compatibility

Audio signals

Audio signal types	Audio signal formats	Compatible media
2ch Linear PCM	2ch, 32-192 kHz, 16/20/24 bit	CD, DVD-Video, DVD-Audio, etc.
Multi-ch Linear PCM	8ch, 32-192 kHz, 16/20/24 bit	DVD-Audio, etc.
DSD	2/5.1ch, 2.8224 MHz, 1 bit	SACD, etc.
Bitstream	Dolby Digital, DTS	DVD-Video, etc.
Bitstream (High definition audio)	Dolby TrueHD, Dolby Digital Plus, DTS-HD Master Audio, DTS-HD High Resolution Audio	Blu-ray Disc, HD DVD, etc.



- If the input source component can decode the bitstream audio signals of audio commentaries, you can play back the audio sources with the audio commentaries mixed down by using the following connections:
 - multi-channel analog audio input (see page 35)
 - DIGITAL INPUT OPTICAL (or COAXIAL)
- Refer to the supplied instruction manuals of the input source component, and set the component appropriately.

Notes

- When CPPM copy-protected DVD audio is played back, video and audio signals may not be output depending on the type of the DVD player.
- This unit is not compatible with HDCP-incompatible HDMI or DVI components.
- To decode audio bitstream signals on this unit, set the input source component appropriately so that the component outputs the bitstream audio signals directly (does not decode the bitstream signals on the component). Refer to the supplied instruction manuals for details.
- This unit is not compatible with the audio commentary features (for example, the special audio contents downloaded via Internet) of Blu-ray Disc or HD DVD. This unit does not play back the audio commentaries of the Blu-ray Disc or HD DVD contents.

Video signals

This unit is compatible with the video signals of the following resolutions:

Video signal format

- 480i/60 Hz
- 576i/50 Hz
- 480p/60 Hz
- 576p/50 Hz
- 720p/60 Hz, 50 Hz
- 1080i/60 Hz, 50 Hz
- 1080p/60 Hz, 50 Hz, 24 Hz

Compatibility with Deep Color and xvYCC video signals

This unit accepts 30 or 36 bit Deep Color video signals. Set “HDMI Resolution” to “Through” or “HDMI Processing” to “Off” (see page 90) to output the Deep Color and xvYCC video signals from the HDMI OUT jacks without any processing (see page 90). If you set “HDMI Processing” to “On” and “HDMI Resolution” to other than “Through”, this unit converts the Deep Color and xvYCC video signals to the video signals with normal color depth and color space. If the video monitor is not compatible with the Deep Color or xvYCC video signals, the video source may not play back correctly.

Default input assignment of HDMI input jacks

HDMI input jack	Assigned input source
IN1	BD/HD DVD
IN2	DVD
IN3	CBL/SAT
IN4	DVR
Front HDMI IN jack	V-AUX

The HDMI interface of this unit is based on the following standards:

- HDMI Version 1.3a (High-Definition Multimedia Interface Specification Version 1.3a) licensed by HDMI Licensing, LLC.
- HDCP (High-bandwidth Digital Content Protection System) licensed by Digital Content Protection, LLC.

Index

■ Numerics

11.1-channel speaker connection	23
11.1-channel speaker layout	21
11.2-channel speaker connection	23
11.2-channel speaker layout	21
11ch Enhancer	59
11ch Stereo	59
2ch Stereo	59
5.1-channel speaker connection	24
5.1-channel speaker layout	22
5.2-channel speaker connection	24
5.2-channel speaker layout	22
7.1-channel speaker connection	24
7.1-channel speaker layout	22
7.2-channel speaker connection	24
7.2-channel speaker layout	22

■ A

AC IN	20
AC OUTLET(S)	20, 38
Action Game	58
Adaptive DRC	86
Adaptive DSP effect level	86
Adaptive DSP Lvl	86
Adaptive dynamic range control	86
Adjusting speaker level	61
Adjusting tonal quality	61
Advanced automatic setup	46
Advanced setup	119
Advanced sound configurations	72
Adventure	58
AMP, Operation mode selector	12
Arena	57
Audio and video synchronization	88
Audio cable plugs	28
Audio component connection	34
Audio component jacks	20
Audio Info	95
Audio information	95
Audio input jack select	82
Audio input jack selection	52
AUDIO jacks	28
Audio jacks	28
AUDIO SELECT	52
Audio Select	82, 93
Audio signal flow	29
Auto	89
Auto Bypass	88
Auto bypass	88
Auto Setup, troubleshooting	126
Automatic audio delay adjustment	89

■ B

Back ground video	83
Background video source playback	51
Basic automatic setup	44
Basic, Manual Setup	83
Basic, Manual setup	83
Bass Cross Over	84
Bass cross over	84
Bass Out	85
Bass out	85
Battery charge indicator, Front panel display	40
BGV	83
BI-AMP	120
bi-amplification connections	27
Bi-amplifier mode	120

Blu-ray Disc player connection	31
Bndry Gain Comp	84
Bookmarks, network menu	66
Boundary gain compensation	84

■ C

Cable plugs	28
Cellar Club	57
Center	84
Center Image	81
Center Level	80
Center speaker	84
Center Width	80
Chamber	56
Channel Mute	89
Channel mute	89
Church in Freiburg	56
Church in Roayamont	56
Church in Tokyo	56
Cinema	73
CINEMA DSP HD ³ mode	60
CINEMA DSP indicator, Front panel display	40
CLASSICAL 1	55
CLASSICAL 2	56
Component I/P	90
Component interlace/progressive conversion	90
COMPONENT VIDEO jacks	20, 28
COMPONENT VIDEO MONITOR OUT jacks	20
Configuration	85
Connecting a DVD recorder	33
Connecting a multi-format player	35
Connecting a VCR	33
Connecting an external decoder	35
Connecting an iPod universal dock	36
Connecting audio components	34
Connecting external amplifiers	35
Connecting network	37
Connecting power cable	38
Connecting speaker cable	27
Connecting subwoofers	25
Connecting the USB memory devices	37
Connecting to the rear USB ports	37
Connection a Blu-ray Disc player	31
Connection an HD DVD player	31
Connection, DVD player	32
Connection, projector	30
Connection, set-top box	32
Connection, TV monitor	30
Controlling other components, remote control	103
Conversion	89
Cooling fan operation mode	120

■ D

Decoder descriptions	72
Decoder indicators, Front panel display	40
Decoder Mode	94
Decoder parameter descriptions	80
Decoder selection	72
Decoder Type	78
Default audio input jack select	93
Default decoder mode	94
Default Gateway	92
Default gateway	92
DHCP	92
DHCP setting	92

Dialogue Lift, Sound field parameter	77
Digital audio jacks	20
DIGITAL COAXIAL jacks	28
DIGITAL OPTICAL jacks	28
Dimension	81
Dimmer	93
Dimmer	93
Dipole speaker using	21
Direct	80
Disco	58
Display window, remote control	12
DNS Server (P)	92
DNS Server (S)	92
DOCK terminal	20
Drama	58
DSP indicators, Front panel display	40
DSP Level, Sound field parameter	77
DVD player connection	32
DVD recorder connection	33
Dynamic Range	87
Dynamic range	87

■ E

Effect sound level of the sound field parameter	77
ENHANCER	59
ENHANCER indicator, Front panel display	41
ENTERTAIN	57
External amplifier connection	35
External decoder connection	35

■ F

FAN MODE	120
Files/Directories, USB menu	66
Front	84
Front Panel Disp.	93
Front panel display	40
Front panel display message scroll	93
Front panel display setting	93
Front panel door	12
Front Presence	84
Front Presence L Level	80
Front Presence R Level	80
Front presence speakers	26, 84
Front speaker set selection	51
Front speakers	84
Front/rear USB port indicator, Front panel display	40

■ G

Genres, network menu	66
Graphic user interface (GUI) screen	74
Graphical user interface menu	53
GUI language setting	39
GUI menu	53
GUI screen position	90

■ H

Hall in Amsterdam	56
Hall in Frankfurt	55
Hall in Munich A	55
Hall in Munich B	55
Hall in Stuttgart	56
Hall in USA A	56
Hall in USA B	56
Hall in Vienna	56
HD Cubic indicator, Front panel display	40
HD DVD player connection	31
HDMI	28

- HDMI Aspect 90
 - HDMI aspect ratio 90
 - HDMI Auto 88
 - HDMI automatic lip sync mode 88
 - HDMI IN jack select 94
 - HDMI indicator, Front panel display 40
 - HDMI jack 28
 - HDMI jacks 20
 - HDMI monitor check 120
 - HDMI OUT jack select 94
 - HDMI Processing 90
 - HDMI Resolution 90
 - HDMI Set 94
 - HDMI settings 94
 - HDMI video processing 90
 - HDMI video signal resolution 90
 - HDMI, troubleshooting 124
 - Headphone using 51
 - Headphones indicator, Front panel display 40
 - Help, network menu 66
 - HiFi DSP 55
 - Hi-fi sound playback 61
- I**
- I/O Assignment 81
 - ID1/ID2 indicator, remote control 12
 - Information 93
 - Information display, remote control 12
 - Infrared window, remote control 12
 - Init. Delay 78
 - Initial Volume 86
 - Initial volume 86
 - INITIALIZE 120
 - Initialize, Sound field parameter 81
 - Input 94
 - Input channel indicators,
 - Front panel display 41
 - Input output jack select 94
 - Input Select 81
 - Input signal indicators,
 - Front panel display 40
 - Input signal information, GUI menu 95
 - Input source indicators,
 - Front panel display 40
 - Input/output assignment 81
 - Internet Radio using 69
 - Internet Radio, network menu 66
 - IP Address 92
 - IP address 92
 - iPod 93
 - iPod charge on the standby mode 93
 - iPod settings 93
 - iPod universal dock connection 36
 - iPod using 64
 - iPod, troubleshooting 126
- J**
- Jacks 28
- L**
- LAN STANDBY 119
 - LAN standby 119
 - LANGUAGE 120
 - Language 120
 - Language, GUI menu 95
 - Language, GUI menu 95
 - Level 80
 - LFE Level 86
 - LIGHT, remote control 12
 - Lipsync 88
 - LIVE/CLUB 56
 - Liveness 79
 - Loading system settings 98
- Locations, network menu 66
 - Loudness Plus 84
 - Loudness plus setting 84
 - Low-frequency effect level 86
- M**
- MAC Address 93
 - MAC address 93
 - MACRO 108
 - Macro programming, remote control 107
 - Main 11ch Stereo 91
 - Main zone 11-channel stereo 91
 - Manual 89, 95
 - Manual 95
 - Manual audio delay adjustment 89
 - Manual parametric equalizer configuration
 - of each speaker 87
 - Max Volume 86
 - Maximum volume 86
 - MCX-2000 using 68
 - Media Access Control address 93
 - Memory Guard 94
 - Memory guard 94
 - Microphone base 11
 - MONITOR CHECK 120
 - Mono Movie 59
 - MOVIE 58
 - Multi CH Assign 83
 - MULTI CH INPUT jacks 20
 - Multi channel assignment 83
 - Multi Zone, Manual Setup 91
 - Multi zone, Manual setup 91
 - Multi-channel sources playback
 - with headphones 60
 - Multi-format player connection 35
 - Multi-information display,
 - Front panel display 40
 - Multi-zone configuration 111
 - Music Video 57
 - Muting audio output 52
 - Muting Type 86, 92
 - Muting type 86
- N**
- Neo:6 Cinema 72
 - Neo:6 Music 72
 - NET/USB, Manual Setup 92
 - NET/USB, Manual setup 92
 - Network 92
 - Network connection 37
 - Network features
 - using USB features using 66
 - Network information 93
 - Network menu 66
 - NETWORK port 20
 - Network settings 92
 - Network status 93
 - Network, troubleshooting 124
 - New Stations, network menu 66
- O**
- On Screen 90
 - On-screen display time 90
 - Operation mode selector, remote control 12
 - OPTIMIZER MIC jack 43
 - Optimizing speaker setting 42
 - Option, Manual Setup 93
 - Option, Manual setup 93
 - Output 94
- P**
- Panorama 80
 - Parameter initialization 120
 - Parametric EQ 87
 - Parametric equalizer 87
 - Parametric equalizer data copy 87
 - Parametric equalizer information 135
 - Parametric equalizer type select 87
 - party mode 118
 - Party Mode Set 91
 - Party mode settings 91
 - Party mode target zone setting 91
 - Pavilion 57
 - PC server using 68
 - PC/MusicCAST, network feature 66
 - PEQ Data Copy 87
 - PEQ Select 87
 - Phase 85
 - Placing speakers 21
 - Play Style 83
 - Playback basic procedure 50
 - Playback styles 83
 - Playing video sources in the background 51
 - PLII Game 72
 - PLII Movie 72
 - PLII Music 72
 - PLIIX Game 72
 - PLIIX Movie 72
 - PLIIX Music 72
 - Podcasts, network menu 66
 - Popular Stations, network menu 66
 - Position 90
 - Power cable connection 38
 - PRE AMP indicator, Front panel display 41
 - PRE OUT jacks 20
 - PREAMP MODE 120
 - Pre-amplifier mode 120
 - Presence speaker indicators,
 - Front panel display 41
 - Presence speaker using 26
 - Primary DNS server 92
 - PRO LOGIC 72
 - Program parameters initialization 81
 - Programming macro operations 108
 - Projector connection 30
 - PURE DIRECT 61
 - Pure Direct 89
 - Pure Direct 89
- Q**
- Quick automatic setup 43
- R**
- Rear panel 20
 - Rear Presence 85
 - Rear Presence L Level 80
 - Rear Presence R Level 80
 - Rear presence speakers 26, 85
 - Rear USB port connection 37
 - Recital/Opera 57
 - RECOUT indicator, Front panel display 40
 - REMOTE CON AMP 119
 - Remote control code default settings 104
 - Remote control codes settings 104
 - Remote control ID setting 119
 - Remote control using 12
 - Remote control, troubleshooting 124
 - REMOTE IN jack 36
 - REMOTE IN/OUT jacks 20
 - REMOTE OUT jack 36
 - REMOTE SENSOR 119
 - Remote sensor 119
 - Rename 82
 - Rename 82
 - Repeat 65

- Repeat iPod playback 65
 Resetting the system 127
 Rev. Delay 79
 Rev. Level 80
 Rev. Time 79
 Roleplaying Game 58
 Room Size 78
 RS-232C STANDBY 119
 RS-232C terminal 20
- S**
- S VIDEO jacks 28
 Saving system settings 96
 SB Speaker Dist. 84
 SB. Init. Delay 78
 SB. Liveness 79
 SB. Room Size 78
 Sci-Fi 58
 Scroll 93
 Secondary DNS server 92
 Selecting audio input jacks 52
 Selecting decoders 72
 Selecting front speaker set 51
 Selecting sound field programs 54
 Selecting the
 MULTI CH INPUT component 50
 Server, network menu 66
 Set the main zone to the standby mode 39
 Setting GUI language 39
 Setting speaker impedance 39
 Set-top box connection 32
 Setup 92
 Setup 92
 Short Message 90
 Short message display 90
 Shortcut buttons, Network/USB features 70
 Shuffle 65
 Shuffle iPod playback 65
 Signal Info., GUI menu 95
 SILENT CINEMA 60
 SILENT CINEMA indicator,
 Front panel display 41
 SLEEP indicator, Front panel display 41
 Sleep timer 52
 Sound field indicators, Front panel display 40
 Sound field parameter descriptions 78
 Sound field program selection 54
 Sound field programs 54
 Sound field programs with headphones 60
 Sound field programs
 without surround speakers 60
 Sound, Manual Setup 86
 Sound, Manual setup 86
 SOURCE, Operation mode selector 12
 SP A B indicators, Front panel display 40
 Speaker B 91
 Speaker B setting 91
 Speaker cable connection 27
 Speaker Distance 85
 Speaker distance 85
 Speaker distances 85
 SPEAKER IMP. 119
 Speaker impedance 119
 Speaker impedance setting 39
 Speaker Level 86
 Speaker level 86
 Speaker level adjustment 61
 Speaker Set 84
 Speaker setting optimize 42
 Speaker settings 84
 Speaker terminals 20
 Speaker wiring, Auto setup parameter 44, 46
- Speakers, placement 21
 Specifications 138
 Spectacle 58
 Sports 57
 Standard 58
 Standby Charge 93
 Standby mode, Zone2, Zone3 116
 Standby Through 94
 Standby through 94
 Standing wave control 87
 Status 93
 STEREO 59
 Stereo program parameter descriptions 80
 Stereo/Surround menu, GUI menu 77
 Stereo/Surround, GUI menu 77
 STRAIGHT 60
 Straight Enhancer 59
 STRAIGHT mode 60
 Subnet Mask 92
 Subnet mask 92
 Subwoofer 85
 Subwoofer 25, 85
 Subwoofer configuration 85
 Subwoofer connection 25
 Subwoofer phase 85
 Subwoofer using 25
 Supplied accessories 11
 Support Audio 94
 Support audio 94
 Sur. Back L Level 80
 Sur. Back R Level 80
 SUR. DECODE 59
 Sur. Init. Delay 78
 Sur. Liveness 79
 Sur. Room Size 78
 Surround 84
 Surround Back 84
 Surround back left/right speakers 84
 Surround back speaker distance 84
 Surround Decode 59
 Surround decode mode 72
 Surround L Level 80
 Surround left/right speakers 84
 Surround R Level 80
 S-wave control 87
 System 93
 System ID 93
 System Memory 96
 System memory 96
 System reset 127
 System setting saving 96
 System settings loading 98
- T**
- Target:Zone2 91
 Target:Zone3 91
 Target:Zone4 91
 The Bottom Line 57
 The Roxy Theatre 57
 THX 59
 THX Set 83
 THX settings 83
 THX Ultra2 subwoofer setting 83
 THX Ultra2 SWFR 83
 Tonal quality adjustment 61
 Tone Control 88
 Tone control 88
 Transmit indicator, remote control 12
 Treble 88
 Treble control 88
 TRIGGER IN jacks 36
 Trigger operation mode 94
- TRIGGER OUT jack 20
 Trigger Output 94
 Trigger output 94
 Troubleshooting 122
 Tuner Select 92
 Turning off this unit 39
 Turning on the main zone
 from the standby mode 39
 Turning on this unit 39
 TV controlling by Remote control 102
 TV controlling, Remote control 102
 TV FORMAT 120
 TV format 120
 TV monitor connection 30
 TV, Operation mode selector 12
- U**
- Unit 85
 Unit 85
 Unprocessed input source playback 60
 USB memory device connection 37
 USB memory device using 69
 USB menu 66
 USB port 20
 USB port select 83
 USB portable audio player using 69
 USB Select 83
 USB, troubleshooting 124
 USB, USB menu 66
- V**
- VCR connection 33
 Vertical dialogue position 77
 VIDEO AUX jacks 38
 Video component jacks 20
 Video conversion 89
 Video Info. 95
 Video information 95
 VIDEO jacks 28
 Video jacks 28
 Video Manual setup 89
 Video signal flow 29
 Video source playback in background 51
 Video, Manual Setup 89
 Village Gate 56
 Village Vanguard 56
 Virtual CINEMA DSP 60
 VIRTUAL indicator, Front panel display 40
 VOLTAGE SELECTOR, Voltage selector 12
 VOLUME level indicator,
 Front panel display 41
 Volume Trim 82
 Volume trimming 82
 Volume, Manual Setup 86
 Volume, Manual setup 86
- W**
- Wake on RS-232C access 119
 Wall Paper 91
 Wall paper 91
 Warehouse Loft 57
 Wiring, Auto setup parameter 44, 46
- Y**
- YPAO 42
 YPAO indicator, Front panel display 41
- Z**
- Zone 2 balance 92
 Zone 2 initial volume setting 92
 Zone 2 Maximum volume setting 91
 Zone 2 monaural mode 92
 Zone 2 settings 91

Zone 2/3/4 muting type	92
Zone 2/3/4 tuner function select	92
Zone 3 balance	92
Zone 3 initial volume setting	92
Zone 3 Maximum volume setting	91
Zone 3 monaural mode	92
Zone 3 settings	91
Zone 4 balance	92
Zone 4 initial volume setting	92
Zone 4 Maximum volume setting	91
Zone 4 monaural mode	92
Zone 4 settings	91
Zone B feature	51
Zone indicators, remote control	12
Zone on-screen display	92
Zone OSD	92
ZONE OUT jacks	20
Zone SP Assign	91
Zone speaker assignment	91
Zone video monitor	114
Zone video out jacks	20
Zone video signal conversion	114
Zone2 Balance	92
Zone2 Initial Vol.	92
Zone2 Max Vol.	91
Zone2 Mono	92
Zone2 Set	91
ZONE2/ZONE3/ZONE4 indicators, Front panel display	41
Zone3 Balance	92
Zone3 Initial Vol.	92
Zone3 Max Vol.	91
Zone3 Mono	92
Zone3 Set	91
Zone4 Balance	92
Zone4 Initial Vol.	92
Zone4 Max Vol.	91
Zone4 Mono	92
Zone4 Set	91

“**Ⓐ** MAIN ZONE ON/OFF” or “**ⓓ** DVD” (example) indicates the name of the parts on the front panel or the remote control. Refer to the cover pages at the top of this manual for the information about each position of the parts.

List of remote control codes

TV		CURTIS MATHES		HELLO KITTY	05601	MITSUBISHI	00301,01301,01601,01901,02001,02601,02701,03101,03401,06701,11201,11901
ACURA	00101			HINARI	00101,00401		
ADDISON	01201,01601,08401			HISAWA	05701		
ADMIRAL	01301,02201,05801			HITACHI	00101,00301,01201,01501,01701,01801,02201,02601,03001,04501,06101,06901,07301,11701,12101	MIVAR	03901,04001,06801,07601
ADVENT	09601	CXC				MOTOROLA	01301
AGB	06801	DAEWOO	00101,00301,00401,01201,01601,02001,02401,02601,02701,04901,05601,07901,08201,13101	HUA TUN	00101	MTC	00301,00901,06701
AIKO	01201			HUANYU	04901	MULTITECH	00101,02701
AKAI	00101,00301,02901,04601,06801,08901,10501			HYPSON	00401,03701	MYRYAD	07001
AKURA	03701	DANSAI	00401	ICE	03701,04801	NAD	02101,02601,04601,11301
ALBA	00101,00401,04801,08501	DAYTON	00101	IMPERIAL	03301,04701,05201	NEC	00101,00301,00601,02001,02101,02401,02601,05701,06501,13201
AMERICA ACTION	02701,	DE GRAAF	02901,06901	INDIANA	00401		
AMPRO	09401	DECCA	00401,06801	INFINITY	00801	NECKERMANN	00401,07001
AMSTRAD	00101,00401,02501,04801,05101,05301,06801	DENON	01801	INGELEN	02201		
ANAM	00101,02701,03401	DIGATRON	00401	INNO HIT	06801	NEI	00401
ANAM NATIONAL		DIXI	00101,00401	INNOVA	00401	NETSAT	00401
	03401,08301	DUMONT	00201	INTEQ	00201	NEWAVE	00101,01201,01301,02601
ANITECH	00101	DWIN	09201,10101	INTERFUNK	00401,02201,03301,04601,06701		
AOC	00101,00301,00901,01201,01301,01601,02601,02701,05601	ECE	00401	INTERVISION	00401,03701,05001	NIKKAI	00401,03701
		ELBE	03501	ITS	04801	NIKKO	00301,01201,02601
APEX DIGITAL		ELECTROBAND	00001	ITT	02201,04601,06901	NOKIA	04601,05901,06001,06901,08101
ASA	01401			JBL	00801	NORCENT	09301,10801
AUDIOSONIC	00401,01701	ELIN	00401,06901	JCB	00001	NORDMENDE	01701,03801,07101
AWA	00101	ELITE	04101	JEAN	00101,00601,01201,02101,03101	NTC	01201
BANG & OLUFSEN		ELTA	00101	JENSEN	09601	OCEANIC	02201,04601
	07201	EMERSON	02001,02601,02701,03101,04601,05801,07901	JVC	00701,04801,05801,08401,08701	ONWA	02701,05301
BASIC	00101	ENVISION	00301,10601	KAISUI	00101	OPTIMUS	02001,02301,03401,08301
BAUR	00401,04601,06701	EPSON	11001	KAPSCH	02201	OPTONICA	01301
BAYSONIC	02701	ERRES	00401	KARCHER	07701	ORION	00401,03101,04101,05801,06801
BEAUMARK	02601	ETHER	00101,00301	KATHREIN	07001	OSAKI	03701,05101
BEKO	04701,06201,09001,09101	ETRON	00101	KEC	02701	OTTO VERSAND	00401,04101,06701,07001
		EUROPHON	06801	KENDO	00401		
BELL & HOWELL		FERGUSON	00401,01001,01701,03201,03801,04201,07101	KENWOOD	00301	PALLADIUM	04701,05201
	02001	FIDELITY	04601	KNEISSEL	03501,05401	PANAMA	03701
BEON	00401	FINLANDIA	02901,04401	KOLIN	00701,01601,02701	PANASONIC	00401,00601,00801,02201,03401,08301,12401
BLAUPUNKT	02801	FINLUX	00401,01401,01501,04401,0i6801	KORPEL	00401		
BLUE SKY	08501,11401	FIRSTAR	00101,03101	KOYODA	00101		
BONDSTEC	03301	FIRSTLINE	00101,03301,08501	KTV	00301,02701		
BRADFORD	02701	FISHER	01401,02001,02901,04701	&S ELECTRONIC	10301	PATHE CINEMA	03201,04101
BRANDT	01701,04201	FLINT	05701	LEYCO	00401,03701	PAUSA	00101
BROKSONIC	03101,05801	FORMENTI	00401,04101	LG	00301,00401,00901,01601,02601,09001	PENNEY	00301,00501,00601,00901,02101,02601,12201
BUSH	00101,00101,00401,04801,04901,08501,11401	FORTRESS	01301	LIESENK & TTER	00401		
BYDESIGN	14301,14401,14501,14601	FRONTECH	02201,03301,03701	LOEWE	06701	PERDIO	04101
		FUJITSU	08701,10401	LUXOR	04501,04601	PHILCO	00301,00401,00801,01801,02601,02701,03301,05801,13101
CANDLE	00301	FUNAI	02501,02701,03701	LXI	00501,00801,02001,02101,02601	PHILIPS	00001,00301,00401,00601,00801,01201,01601,02601,04901,07001,08801,12601
CARNIVALE	00301	FUTURETECH	02701	M ELECTRONIC		PHONOLA	00401
CARVER	00801,02401	GATEWAY	13301,13401		00101,00401,01401,01501,01701,02201,03801,04401,04901,06001	PILOT	00301
CASCADE	00101	GE	00301,00501,00601,01201,02601,02701,05601,07101,11801,12201,12601	MAGNADYNE	03301,06801	PIONEER	01701,02201,02301,03801,08601,09501,11301
CATHAY	00401	GEC	00401,06801	MAGNAFON	06801	PORTLAND	01201
CCE	00401	GELOSO	00101	MAGNAVOX	00301,00801,12001,12601	PRANDONI-PRINCE	06801
CELEBRITY	00001	GENEXXA	02201	MANESTH	03701,04101	PRIMA	09601
CELERA	09701	GIBRALTER	00201,00301	MARANTZ	00301,00401,00801,07001	PRISM	00601
CENTURION	00401	GOLDSTAR	00301,00401,01701,02001,02601,05001	MARK	00401	PROFEX	00101,04601
CGE	03301	GOODMANS	00401,04801,04901,08201	MATSUI	00101,00401,02901,04801,06301,06801	PROSCAN	00501
CHANGHONG	09701			MATSUSHITA	03401,08301	PROTECH	00101,00401,03301,03701,05201,08501
CHING TAI	00101,01201	GOREMJE	04701	MEDIATOR	00401	PROTON	00101,00301,02601
CHUN YUN	00001,00101,01201,02701	GRADIENTE	00701,02401	MEDION	08501,10301,11401	PULSAR	00201
		GRAETZ	02201,04601	MEGATRON	01801,02601	QUASAR	00601,03401,08301
CHUNG HSIN	00701,01601,02701	GRANADA	00401,02901,04301,06801	MEMOREX	00101,01901,02001,02601,03401,05801,11401	QUELLE	00401,01401,04601,06701
CIMLINE	00101	GRANDIN	07701			RADIOLA	00401
CINERAL	01201,05601	GRUNDIG	00401,02801,06301,07001,07401	METZ	05501	RADIOMARELLI	06801
CITIZEN	00301,00901,01201	GRUNPY	02701	MGA	00301,01901,02601		
CLARION	02701	HALLMARK	02601	MICROMAXX	10301		
CLARIVOX	00401	HANKOOK	00301,02601,02701	MICROSTAR	10301		
CLATRONIC	03301,04701	HANSEATIC	00401,04101,04601,05201,07001	MIDLAND	00201,00501,00601		
CONDOR	04101,04701	HANTAREX	06801	MINERVA	06301	RADIO SHACK	00301,00501,02001,02601,02701
CONRAC	10301	HARMAN/KARDON	00801	MINOKA	05101		
CONTEC	00101,02701	HARVARD	02701				
CRAIG	02701	HAVERMY	01301				
CROSLEY	00801	HCM	00101,05101				
CROWN	00101,00401,02701,04701,05201						
CTC	03301						

RCA	00001, 00301, 00501, 01101, 01201, 02601, 08601, 11501, 11801, 13901, 12201, 12501, 12601, 12801	TCM	10301	BASIC LINE	01402, 02102	IMPERIAL	00002
REALISTIC	00301, 02001, 02601, 02701	TEAC	00101, 00401, 03701, 05101, 05201, 05701, 08501, 11401	BEAUMARK	02002	INTERFUNK	01502
REDIFFUSION	04601	TEC	03301	BELL & HOWELL	01602	ITT	00602, 01602, 02002
REOC	09001	TECHNEMA	04101	BLAUPUNKT	01902	ITV	00402, 02102
REVOX	00401	TECHNICS	00601, 03401, 08301	BRANDT	02402	JENSEN	00602
REX	02201, 03501, 03701	TECHWOOD	00601	BRANDT ELECTRONIC	00602	JVC	00602, 00902, 01302
RFT	05201	TECO	00101, 00601, 01201, 01301, 02601, 03701, 08401	BROKSONIC	01702, 02602, 04402	KEC	00402, 02102
R-LINE	00401	TEKNIKA	00801, 00901, 01201, 01901, 02701	BUSH	01402, 02102, 02702	KENWOOD	00602, 01302
ROADSTAR	00101, 03701, 05201	TELEFUNKEN	01701, 03601, 04201, 08001, 08901	CALIX	00402	KLH	01402
RUNCO	00201, 00301, 06501, 07501	TELEMEISTER	04101	CANON	00302	KODAK	00302, 00402
SABA	01701, 02201, 03801, 04201	TELETECH	00101	CARVER	01502	KOLIN	00602, 00802
SACCS	03201	TENSAI	04101	CCE	01402, 02102	KORPEL	01402
SAGEM	07701	TERA	00301	CGE	00002	LENCO	02102
SAISHO	00101, 03701, 06801	THOMSON	01701, 03801, 07101, 08001, 12501	CIMLINE	01402	LEYCO	01402
SALORA	02201, 04601, 06901	THORN	00401, 01401, 04601, 06701	CINERAL	02102	LG	00402, 00702, 00902, 02902
SAMBERS	06801	TMK	02601	CITIZEN	00402, 02102, 04302	LLOYD'S	00002
SAMPO	00101, 00301, 01201, 01301, 02001, 02501, 02601, 08301, 13301	TNCI	00201	COLT	01402	LOEWE	00402, 01502, 04502
SAMSUNG	00101, 00301, 00401, 00901, 01101, 01201, 02001, 02601, 03701, 04701, 07001, 07401, 07801, 08901, 09801, 10501, 10701	TOSHIBA	00901, 02001, 02101, 06601, 07801, 08301, 10901, 12101, 12301, 13001, 13201	COMBITECH	02702	LOGIK	01402, 02002
SANSEI	05601	TRIUMPH	06801	CRAIG	00402, 01002, 01402, 02002	LUXOR	00802, 01102, 01602
SANSUI	05801	TUNTEX	00101, 00301, 01201	CROWN	01402, 02102	LXI	00402
SANYO	01401, 02001, 02701, 02901, 04301, 10201	TVS	05801	CURTIS MATHES	00302, 00602, 01202, 03702	M ELECTRONIC	00002
SBR	00401	UHER	04101	CYBERNEX	02002	MAGNASONIC	04302
SCHAUB LORENZ	04601	UNIVERSUM	00401, 01401, 01501, 03701, 04401, 04701, 06401	CYRUS	01502	MAGNAVOX	00002, 00302, 00502, 01502
SCHNEIDER	00401, 03301, 04801, 08501	VECTOR RESEARCH	00301	DAEWOO	00902, 01602, 02102, 03402, 04302	MAGNIN	02002
SCOTCH	02601	VESTEL	00401	DANSAI	01402	MANESTH	00902, 01402
SCOTT	02601, 02701, 03101	VICTOR	00701, 03401, 08301, 08401	DE GRAAF	00702	MARANTZ	00302, 01502
SEARS	00501, 00801, 02001, 02101, 02501, 02601	VIDEOSAT	03301	DECCA	00002, 01502	MARTA	00402
SEG	03701, 08501	VIDIKRON	00801	DENON	00702	MATSUI	02602, 02702
SEI	06801	VIDTECH	02601	DUAL	00602	MATSUSHITA	00302
SELECO	02201, 03501	VIEWSONIC	13301	DUMONT	00002, 01502, 01602	MEDION	02602
SEMIVOX	02701	VISION	04101	DYNATECH	00002	MEI	00302
SEMP	02101	VOXSON	02201	ELCATECH	01402	MEMOREX	00002, 00302, 00402, 00502, 01002, 01102, 01602, 02002, 02202, 02602, 04202
SHARP	00301, 01301, 08301	WALTHAM	04501	ELECTROHOME	00402	MEMPHIS	01402
SHEN YING	00101, 01201	WARDS	00301, 00801, 02601, 11301	ELECTROPHONIC	00402	METZ	00402, 02502, 04502
SHENG CHIA	00101, 01301, 03101	WATSON	00401, 04101	EMEREX	00102	MGA	00802, 02002
SIAREM	06801	WAYCON	02101	EMERSON	00002, 00302, 00402, 00802, 00902, 01702, 02002, 02102, 04302, 04402	MGN TECHNOLOGY	02002
SIEMENS	00401, 02801	WHITE WESTINGHOUSE	00401, 04101, 05801, 07901	ESC	02002, 02102	MINOLTA	00702
SINUDYNE	06801	Yamaha	00301, 01801, 08301, 10001, 11001, 13501, 13601, 13701, 13801, 14001, 14101, 14201	FERGUSON	00602, 02402	MITSUBISHI	00602, 00802, 01302, 01502, 03502
SKANTIC	04501	YAPSHE	03401	FIDELITY	00002	MOTOROLA	00302, 01102
SKY	00401	YOKO	00401, 03701	FINLANDIA	01502, 01602	MTC	00002, 02002
SKYGIANT	02701	ZENITH	00201, 01201, 02601, 05801	FINLUX	00002, 00702, 01502, 01602	MULTITECH	00002, 01402
SKYWORTH	00401			FIRSTLINE	00402, 00802, 00902, 01402	MURPHY	00002
SOLAVOX	02201			FISHER	01002, 01602	MYRYAD	01502
SONITRON	02901			FUJI	00202, 00302	NAD	01602
SONOKO	00101, 00401			FUJITSU	00002, 00902	NATIONAL	01902
SONOLOR	02201, 02901			FUNAI	00002	NEC	00302, 00402, 00602, 01102, 01302, 01602
SONTEC	00401			GARRARD	00002	NECKERMANN	01502
SONY	00001, 08301, 11101, 11601, 12701, 12901			GE	00302, 01202, 02002, 03502, 03702, 03802	NESCO	01402
SOUNDESIGN	02601, 02701			GEC	01502	NEWAVE	00402
SOUNDWAVE	00401, 05201			GENERAL	00902	NIKKO	00402
SOWA	00601, 00901, 01201, 02101, 02601			GO VIDEO	02802	NOBLEX	02002
SQUAREVIEW	02501			GOLDHAND	01402	NOKIA	00602, 01602, 02002
SSS	02701			GOLDSTAR	00402, 01802, 02902, 04202	NORDMENDE	00602, 02402
STANDARD	00101			GOODMANS	00002, 00402, 01402, 02102	OCEANIC	00002, 00602
STARLITE	02701			GRADIENTE	00002	OKANO	02302, 02602
STERN	02201, 03501			GRAETZ	00602, 01602, 02002	OLYMPUS	00302, 01902
SUPREME	00001			GRANADA	01502, 01602	OPTIMUS	00402, 01102, 01602, 02802
SYLVANIA	00301, 00801, 02501			GRANDIN	00002, 00402, 01402	ORION	01702, 02602, 02702, 04402
SYMPHONIC	02501, 02701			GRUNDIG	01402, 01502, 01902, 02502	OSAKI	00002, 00402, 01402
SYNCO	00001, 00901, 01201, 01301, 02601, 05601			HANSEATIC	00402	OTTO VERSAND	01502
SYSLINE	00401			HARLEY DAVIDSON	00002	PALLADIUM	00402, 00602, 01402
T + A	05501			HARMAN/KARDON	01502	PANASONIC	00302, 01802, 01902, 03102, 03702, 04502
TACICO	00101, 01201, 02601			HARWOOD	01402	PATHE MARCONI	00602
TAI YI	00101			HCM	01402	PENNEY	00302, 00402, 00702, 02002, 03702, 04202
TANDY	01301, 02201			HINARI	01402, 02002, 02702	PENTAX	00702
TASHIKO	01201, 08301			HI-Q	01002	PERDIO	00002
TATUNG	00101, 00401, 00601, 00801, 00901, 02001, 02101, 06801			HITACHI	00002, 00402, 00602, 00702, 02002	PHILCO	00302
				HUGHES NETWORK SYSTEMS	00702	PHILIPS	00302, 01502, 03202, 03902, 04002
				HYPSON	01402	PHONOLA	01502
						PILOT	00402
						PIONEER	00702, 01302, 01502
						POLK AUDIO	01502

List of remote control codes

PROFITRONIC	02002	VIDEO CONCEPTS	CANAL+	03104	SAGEM	02904, 04804, 05904
PROLINE	00002		CHAPARRAL	00804	SAMSUNG	03804, 04604, 06004, 06204
PROSCAN	01202, 03802	VIDEOMAGIC	CITYCOM	05304	SAT CONTROL	06404
PROTEC	01402	VIDEOSONIC	CONNEXIONS	01304	SATSTATION	04204
PULSAR	00502	VILLAIN	CROSSDIGITAL	04604	SCHWAIGER	04704
PYE	01502	WARDS	CYRUS	00704	SEEMANN	01304
QUASAR	00302, 03702		DAERYUNG	01304	SIEMENS	00604
QUELLE	01502		DAEWOO	06304	SKY	03004, 03304, 05204
RADIOLA	01502	WHITE WESTINGHOUSE	D-BOX	02104, 04904	SM ELECTRONIC	05404
RADIOSHACK	00002		DIGENIUS	01104	SONY	01704, 03004, 06704
RADIX	00402	XR-1000	DIRECTV	00904, 01204, 01504, 01704, 02204, 02304, 02804, 04104, 04604, 05104, 06904	STAR CHOICE	03504
RANDEX	00402	Yamaha			STRONG	06404
RCA	00302, 00702, 01202, 02002, 03502, 03702, 03802	YAMISHI			TANTEC	01404
REALISTIC	00002, 00302, 00402, 01002, 01102, 01602	YOKAN	DISH NETWORK SYSTEM	02604, 03704	TECHNISAT	04404, 04504
REOC	02602	YOKO	DISHPRO	02604, 03704	TELESTAR	04504
REPLAYTV	03002, 03102	ZENITH	DISTRATEL	00004	THOMSON	01404, 03104, 03904, 06104
REX	00602		DMT	04004	TOPFIELD	05504
ROADSTAR	00402, 01402, 02002, 02102	CABLE	DNT	00704, 01304	TOSHIBA	02304, 02704, 06904
RUNCO	00502	ABC	DREAM MULTIMEDIA	05804	TPS	02904, 05904
SABA	00602, 02402	AMERICAST	ECHOSTAR	00504, 01304, 01604, 02604, 03104, 03604, 03704, 04304	ULTIMATETV	01204, 01704
SALORA	00802	BELL SOUTH			UNIDEN	02004, 02204
SAMPO	00402, 01102	BIRMINGHAM CABLE COMMUNICATIONS	ENGEL	03804	UNIVERSUM	00604
SAMSUNG	00902, 02002, 02802		EXPRESSVU	02604	VENTANA	00704
SANKY	00502, 01102	BRITISH TELECOM	FINLUX	01404	WISI	00604, 01304, 01404
SANSUI	00002, 00602, 01302, 04402	DAERYUNG	FOXTEL	07004, 07104, 07204, 07304, 07404	XSAT	00104
SANYO	01002, 01602, 02002	DIRECTOR	FRACARRO	03604	ZEHNDER	04004
SAVILLE	02702	FILMNET	FTE	03404	ZENITH	03304
SBR	01502	GENERAL INSTRUMENT	FUBA	01304		
SCHAUB LORENZ			GALAXIS	03404, 04704	CD PLAYER	
	00002, 00602, 01602	GOLDSTAR	GE	01504	AIWA	00605
SCHNEIDER	00002, 01402, 01502	HAMLIN	GENERAL INSTRUMENT		ARCAM	00605
SCOTT	00802, 00902, 01702	JERROLD		03504	AUDIO RESEARCH	00605
SEARS	00002, 00302, 00402, 00702, 01002, 01602, 04202	LG	GOI	02604	AUDIO TON	00605
SEG	02002	MEMOREX	GOLD BOX	03104	AUDIOLAB	00605
SEI	01502	MNET	GRUNDIG	00604, 03004	AUDIOMECA	00605
SELECO	00602	MOTOROLA	HIRSCHMANN		CAIRN	00605
SEMP	00902			00604, 01304	CALIFORNIA AUDIO LABS	00205
SHARP	01102, 03502	NOOS	HITACHI	01404, 02804	CARVER	00605, 00805
SHINTOM	01402, 01602	PACE	HTS	02604	CYRUS	00605
SIEMENS	00402, 01502, 01602	PANASONIC	HUGHES NETWORK SYSTEM		DENON	01005
SILVA	00402	PARAGON		02304, 05104, 06904	DKK	00005
SINGER	00902, 01402	PHILIPS	HUMAX	03404, 05304	DMX ELECTRONICS	00605
SINUDYNE	01502	PIONEER	INVIDEO	03604	DYNAMIC BASS	00805
SONIC BLUE	03002, 03102	PULSAR	JVC	02604	EMERSON	00905
SONTEC	00402	PVP STEREO VISUAL MATRIX	KATHREIN	00104, 00604, 00704, 01004, 01804, 05604	FISHER	00805
SONY	00002, 00102, 00202, 00302, 03302, 04102		KREISELMEYER		GENEXXA	00305, 00905
STS	00702	QUASAR		00604	GOODMANS	00905
SUNKAI	02602	RCA	LABGEAR	06304	GRUNDIG	00605
SUNSTAR	00002	REGAL	LOGIX	03804	HARMAN/KARDON	00605, 00705
SUNTRONIC	00002	RUNCO	LORENZEN	01104	HITACHI	00305
SYLVANIA	00002, 00302, 00802, 01502	SAGEM	MAGNAVOX	02004, 02204	JVC	00505
		SAMSUNG	MANHATTAN	01404, 03804, 04204	KENWOOD	00105, 00405
SYMPHONIC	00002	SCIENTIFIC ATLANTA	MARANTZ	00704	KRELL	00605
TANDY	00002, 01602		MEDIASAT	03104	LINN	00605
TASHIKO	00002, 00402	SONY	MEMOREX	02204	LXI	00905
TATUNG	00002, 00602, 00902, 01302, 01502	STARCOM	METRONIC	00004	MAGNAVOX	00605, 00905
TEAC	00002, 00602, 02102, 02202, 03402	SUPERCABLE	MITSUBISHI	02304	MARANTZ	00205, 00605
TECHNICS	00302, 01902	TELE+1	MOTOROLA	03504	MATSUI	00605
TECO	00302, 00402, 00602, 01102	TORX	MYRYAD	00704	MCS	00205
TEKNIKA	00002, 00302, 00402	TOSHIBA	NEXT LEVEL	03504	MEMOREX	00905
TELEAVIA	00602	TRANS PX	NOKIA	01404, 02104, 02404, 04904, 05704, 06804	MERIDIAN	00605
TELEFUNKEN	00602, 02402	TS	OCTALTV	03704	MICROMEGA	00605
TENOSAL	01402	UNITED CABLE	ORBITECH	04504	MIRO	00005
TENSAI	00002	ZENITH	PACE	01404, 03004, 05204, 06604	MISSION	00605
THOMAS	00002		PANASONIC		MYRYAD	00605
THOMSON	00602, 01202, 01302, 02402	SATELLITE TUNER		00904, 01904, 03004, 06504	NAD	00005
THORN	00602, 01602	@SAT	PANDA	01404	NAIM	00605
TIVO	03202, 03302	ABSAT	PAYSAT	02204	NSM	00605
TMK	02002	ALBA	PHILIPS	00204, 00704, 01404, 02004, 02204, 02304, 03104, 04104, 05104, 06904	OPTIMUS	00005, 00305, 00405, 00805, 00905
TOSHIBA	00602, 00802, 00902, 01302, 01502, 03602	ALPHASTAR			PANASONIC	00205
TOTEVISION	00402, 02002	AMSTRAD	PIONEER	03104	PHILIPS	00605
UHER	02002	ASTON	PROMAX	01404	PIONEER	00305, 00905
UNITECH	02002	ASTRO	PROSCAN	01204, 01504	POLK AUDIO	00605
UNIVERSUM	00002, 00402, 01502, 02002	ATSAT	RADIOLA	00704	PROTON	00605
VECTOR	00902	AVALON	RADIOSHACK	03504	QED	00605
VICTOR	00602, 01302	BLAUPUNKT	RADIX	01304	QUAD	00605
		BRITISH SKY BROADCASTING	RCA	00404, 01204, 01504, 03204	QUASAR	00205
			RFT	00704	RCA	00305, 00805, 00905
		CANAL DIGITAL	SABRE	01404	REALISTIC	00805
					REVOX	00605

ROTEL	00605
SAE	00605
SANSUI	00605, 00905
SANYO	00805
SCOTT	00905
SEARS	00905
SHARP	00405
SIMAUDIO	00605
SONIC FRONTIERS	
	00605
SONY	00005
SYMPHONIC	00905
TAG MCLAREN	
	00605
TANDY	00305
TECHNICS	00205
THORENS	00605
THULE	00605
UNIVERSUM	00605
VICTOR	00505
WARDS	00605
Yamaha	01105, 01205

CD RECORDER

KENWOOD	01305
MARANTZ	01305
PHILIPS	01305
Yamaha	01405

DVD PLAYER

ACOUSTIC SOLUTIONS	
	02806
ALBA	02606
AMSTRAD	02306
APEX DIGITAL	
	02106, 02606, 03006,
	03506, 03606, 03706,
	04106
BLAUPINKT	02606
BLUE PARADE	01006
BUSH	02306
CENTREX	02106
CLATRONIC	03406
CYBERHOME	02406
DAEWOO	03206, 03306
DANSAI	03206
DECCA	03206
DENON	00006
DIAMOND	03106
DIGITREX	02106
DVD2000	00206
EMERSON	01206
ENTERPRISE	01206
FISHER	02006
GE	00306, 02606
GO VIDEO	02506
GOLDSTAR	02906
GRADIENTE	01806
GREENHILL	02606
GRUNDIG	00706
HITACHI	01106, 01906
HITEKER	02106
JVC	00906, 01306
KENWOOD	00006, 00606
KLH	02606
KOSS	01806
LG	02906
LIMIT	03106
MAGNAVOX	00106, 02206
MARANTZ	00706
MEMOREX	03806
MICO	02706
MICROSOFT	00306
MINTEK	02606
MITSUBISHI	00206
MUSTEK	02806
NESA	02606
ONKYO	00106
ORITRON	01806
PALSONIC	02106
PANASONIC	00006, 01606, 04206
PHILIPS	00106, 00706, 01706,
	03906
PIONEER	00406, 01006, 01506,
	01606
POLK AUDIO	00706
PROSCAN	00306
QWESTAR	01806

RCA	00306, 01006, 02606
ROTEL	01306
SAMSUNG	01106, 04506
SANYO	02006
SHARP	01406
SHERWOOD	03206
SHINSONIC	00506
SLIM ART	03306
SM ELECTRONIC	
	02806
SONY	00506, 04006
SYLVANIA	02206
TATUNG	03206
TEAC	01006, 02606
TECHNICS	00006
THETA DIGITAL	
	01006
THOMSON	00306
TOSHIBA	00106, 04606
URBAN CONCEPTS	
	00106
XBOX	00306
Yamaha	00006, 00706, 00806,
	04306, 04406
ZENITH	00106, 01206, 02906
ZEUS	03306

DVD RECORDER

HITACHI	01507
PANASONIC	00007, 00107, 00207
PHILIPS	00807
PIONEER	00407, 00507, 00607
SHARP	01207, 01307
SONY	00907, 01007, 01107
TOSHIBA	00307
VICTOR	01407
Yamaha	00707

LD PLAYER

CARVER	00108
DENON	00008
MARANTZ	00108
MITSUBISHI	00008
NAD	00008
NAGSMI	00008
OPTIMUS	00008
PHILIPS	00108
PIONEER	00008
SALORA	00108
SONY	00208
TELEFUNKEN	00008
Yamaha	00308

MD RECORDER

KENWOOD	00109
ONKYO	00309
SHARP	00209
SONY	00009
Yamaha	00409, 00509, 00609

RECEIVER (TUNER)

ADC	00710
AIWA	00410, 01210, 03610,
	03910, 04410
ALCO	03810
ANAM	04310
APEX DIGITAL	
	01810
AUDIOLAB	01510
AUDIOTRONIC	01510
AUDIOVOX	03810
BOSE	01610
CAMBRIDGE SOUNDWORKS	
	03310
CAPETRONIC	00710
CARVER	01210, 01510
CENTREX	01810
DENON	03210
FERGUSON	00710
FINE ARTS	01510
GRUNDIG	01510
HARMAN/KARDON	
	00210, 02610
INTEGRA	00310, 02510
JBL	00210, 02710

JVC	00110, 00710, 03410,
	04110
KENWOOD	01010, 03010
KLH	03810, 04010
MAGNAVOX	00710, 01210, 01510,
	02110
MARANTZ	00010, 01210, 01510,
	02410
MCS	00010
MICROMEGA	01510
MUSICMAGIC	01210
MYRYAD	01510
NAD	00610
NORCENT	03710
ONKYO	00310, 00810, 02510
OPTIMUS	00710, 00910
PANASONIC	00010, 02310, 04210,
	04710
PHILIPS	01210, 01510, 01910,
	02010, 02110, 02210,
	02410
PIONEER	00710, 00910, 03510
POLK AUDIO	02410
PROSCAN	01710
QUASAR	00010
RCA	00710, 00910, 01710,
	03810, 04310

SABA	00710
SANSUI	01210
SCHNEIDER	00710
SONY	00410, 01110, 01310,
	04510, 04610

STEREOPHONICS

	00910
SUNFIRE	03010
TEAC	03810
TECHNICS	00010, 02810, 02910,
	04210
TELEFUNKEN	00710
THOMSON	01710
THORENS	01510
UHER	00710
VENTURER	03810
VICTOR	00110
WARDS	00410
Yamaha	00510, 01410, 03110,
	04810, 05510, 05610,
	05710, 05810
Yamaha (iPod)	
	05310
Yamaha (NET)	
	05410

TAPE DECK

AIWA	00111
CARVER	00111
GRUNDIG	00111
HARMAN/KARDON	
	00111
MAGNAVOX	00111
MARANTZ	00111
MYRYAD	00111
OPTIMUS	00011
PHILIPS	00111
PIONEER	00011
POLK AUDIO	00111
RCA	00011
REVOX	00111
SANSUI	00111
SONY	00211
THORENS	00111
WARDS	00011
Yamaha	00311, 00411



© 2007 YAMAHA CORPORATION All rights reserved.

YAMAHA ELECTRONICS CORPORATION, USA 6660 ORANGETHORPE AVE., BUENA PARK, CALIF. 90620, U.S.A.
YAMAHA CANADA MUSIC LTD. 135 MILNER AVE., SCARBOROUGH, ONTARIO M1S 3R1, CANADA
YAMAHA ELECTRONIK EUROPA G.m.b.H. SIEMENSSTR. 22-34, 25462 RELLINGEN BEI HAMBURG, GERMANY
YAMAHA ELECTRONIQUE FRANCE S.A. RUE AMBROISE CROIZAT BP70 CROISSY-BEAUBOURG 77312 MARNE-LA-VALLEE CEDEX02, FRANCE
YAMAHA ELECTRONICS (UK) LTD. YAMAHA HOUSE, 200 RICKMANSWORTH ROAD WATFORD, HERTS WD18 7GQ, ENGLAND
YAMAHA SCANDINAVIA A.B. J A WETTERGRENS GATA 1, BOX 30053, 400 43 VÄSTRA FRÖLUNDA, SWEDEN
YAMAHA MUSIC AUSTRALIA PTY, LTD. 17-33 MARKET ST., SOUTH MELBOURNE, 3205 VIC., AUSTRALIA

YAMAHA CORPORATION
Printed in Malaysia ◀ WK97760