

## BCM957414M4142C

### Dual-Port 25 Gb/s or 10 Gb/s Ethernet PCI Express Gen3 x8 OCP Mezzanine Card

#### General Description

The Broadcom BCM957414M4142C is a dual-port 25 Gb/s or 10 Gb/s PCI Express Gen3 x8 Mezzanine Card designed to the Open Compute Project (OCP) Mezzanine Card specification with a SFP+ network connector. The adapter is designed to the OCP Mezzanine v2.0 specification as a Type 1 adapter, with the board outline adhering to a form factor called out in v0.5 of the specification. The adapter supports SFP+ optical modules and copper direct-attach cables. The card uses the Broadcom BCM57414 25GbE MAC controller with an integrated dual-channel 10GbE SFI transceiver.

#### Features

- Dual-port pluggable media interface, which may be equipped with 10G SFP+ optical transceiver or with copper direct-attach cable.
- Fully compliant with the SFF-8402 standard.
- x8 PCI Express v3.0 compliant.
- SR-IOV with up to 128 virtual functions (VFs).
- Function-Level Reset (FLR) support.
- TruFlow™ flow processing engine.
- Virtual Network Termination—XVXLAN, NVGRE, Geneve, GRE encaps/decap.
- Switch acceleration.
- Tunnel-aware stateless offloads.
- DCB support – PFC, ETS, QCN, DCBx.
- RDMA over Converged Ethernet (RoCE)
- Network Controller Sideband Interface (NCSI).
- SMBus 2.0.
- MCTP over SMBus.
- PCIe-based UART and KCS.
- Jumbo frames up to 9 KB.
- Advanced Congestion Avoidance.
- Multiqueue, NetQueue, and VMQ.
- IPv4 and IPv6 offloads.
- TCP, UDP, and IP checksum offloads.
- Large Send Offload (LSO).

- Large Receive Offload (LRO).
- TCP Segmentation Offload (TSO).
- Receive-side Scaling (RSS).
- Transmit-side Scaling (TSS).
- VLAN insertion/removal.
- Interrupt coalescing.
- Network boot—XPXE, UEFI.
- iSCSI boot.
- Wake-on-LAN (WOL).
- MSI and MSI.X.
- Conforms to the OCP Mezzanine Card Design Specification v2.0 Type 1.

#### Applications

Dual-Port 10-Gigabit Ethernet adapter for Open Compute Platform systems.

Figure 1: BCM957414M4142C OCP Mezzanine Card

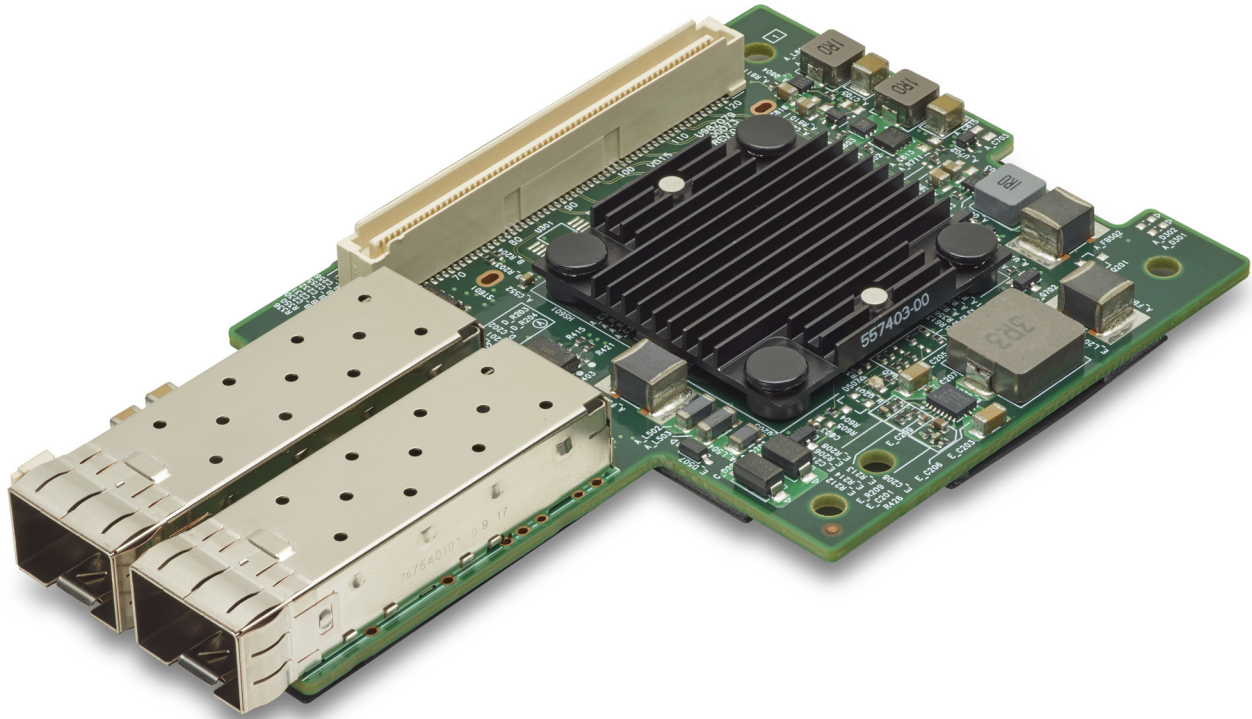

# Table of Contents

- 1 Functional Description** ..... 4
  - 1.1 Block Diagram..... 4
  - 1.2 Host Interface Connector ..... 4
  - 1.3 BCM57414 Ethernet Controller ..... 6
  - 1.4 Clock Requirements..... 6
  - 1.5 PCI Express Interface ..... 6
  - 1.6 NC-SI Interface ..... 6
  - 1.7 SMBus Interface ..... 6
  - 1.8 UART Interface ..... 6
  - 1.9 Nonvolatile RAM ..... 7
  - 1.10 Heat Sink ..... 7
  - 1.11 DC/DC Regulators ..... 7
  - 1.12 Power Supplies ..... 7
  - 1.13 LED Functions and Locations ..... 8
- 2 Regulatory and Safety Approvals**..... 9
  - 2.1 Regulatory..... 9
  - 2.2 Safety ..... 9
  - 2.3 Electromagnetic Compatibility (EMC) ..... 9
  - 2.4 Electrostatic Discharge (ESD) Compliance ..... 10
  - 2.5 FCC Statement ..... 10
- 3 Physical and Electrical Specifications** ..... 10
  - 3.1 Board Physical Dimensions ..... 10
  - 3.2 Environment Specifications..... 11
  - 3.3 Label Information ..... 12
    - 3.3.1 MAC Address Label..... 12
- 4 Ordering Information** ..... 13
- Revision History** ..... 14

# 1 Functional Description

This section provides the functional description of the BCM957414M4142C Network Interface Card.

## 1.1 Block Diagram

Figure 2 shows the main functional blocks on the BCM957414M4142C Network Interface Card.

Figure 2: BCM957414M4142C Block Diagram

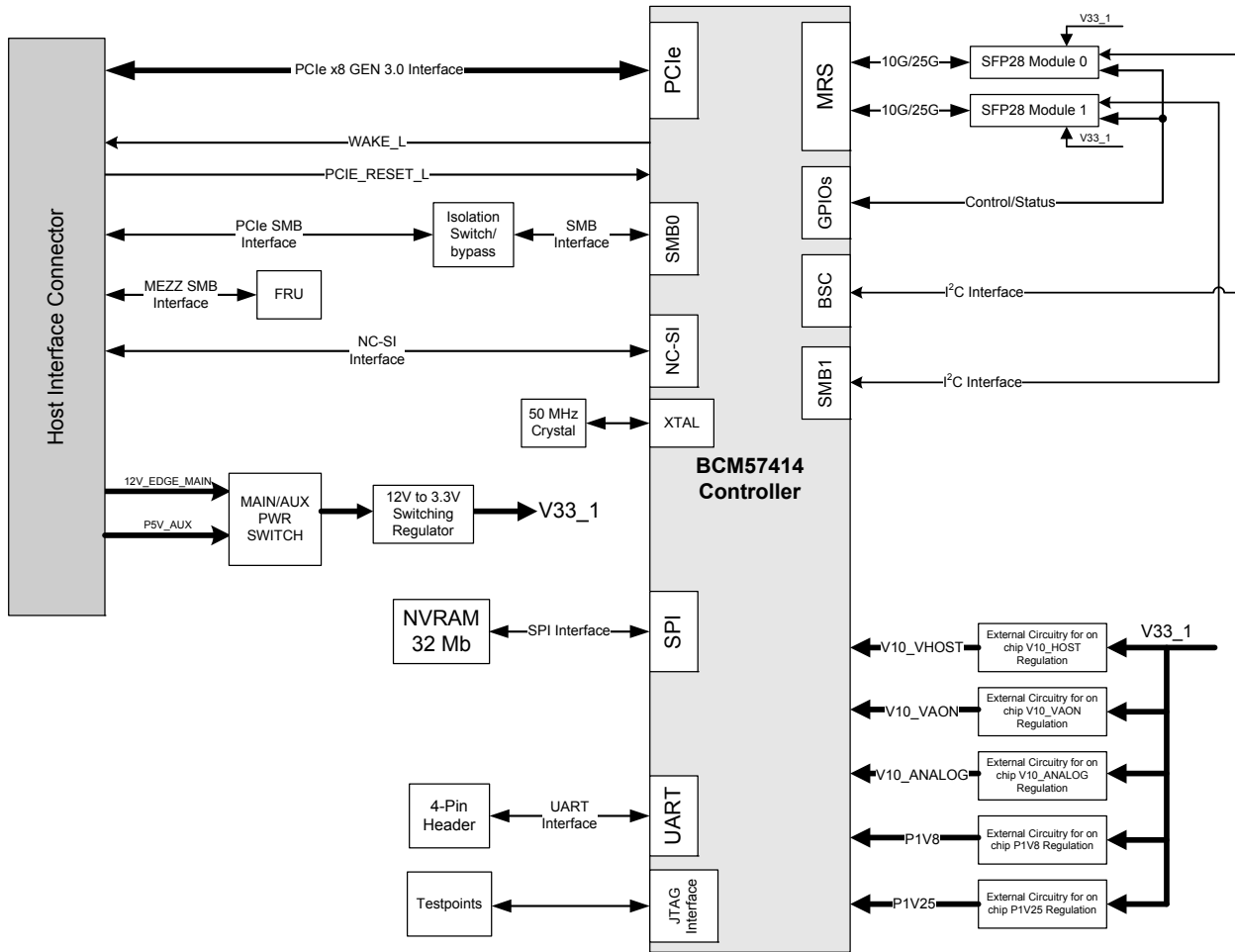

## 1.2 Host Interface Connector

The BCM957414M4142C OCP Mezzanine Card interfaces with the system baseboard via a vertical-stacked card-to-card connector, FCI/61083-124402LF. The PCIe bus, NC-SI bus, SMBus interface, various other sideband signals, and power are assigned to this connector. The connector pinout complies with that of Connector A as described in the OCP Mezzanine Card 2.0 Design Specification. Table 1 shows the signal pinout. Definitions of the signals at this connector are provided in the OCP Mezzanine Card Specification.

**Table 1: Host Interface Connector Signal Pinout**

Pin	Signal	Pin	Signal	Pin	Signal
A1	MEZZ_PRSNTA1_N/ BASEBOARD_A_ID	A41	GND	A81	NCSI_TXD1
A2	P5V_AUX	A42	MEZZ_RX_DP<3>	A82	GND
A3	P5V_AUX	A43	MEZZ_RX_DN<3>	A83	GND
A4	P5V_AUX	A44	GND	A84	CLK_100M_MEZZ0_D P
A5	GND	A45	GND	A85	CLK_100M_MEZZ0_D N
A6	GND	A46	MEZZ_RX_DP<4>	A86	GND
A7	P3V3_AUX	A47	MEZZ_RX_DN<4>	A87	GND
A8	GND	A48	GND	A88	MEZZ_TX_DP_C<0>
A9	GND	A49	GND	A89	MEZZ_TX_DN_C<0>
A10	P3V3	A50	MEZZ_RX_DP<5>	A90	GND
A11	P3V3	A51	MEZZ_RX_DN<5>	A91	GND
A12	P3V3	A52	GND	A92	MEZZ_TX_DP_C<1>
A13	P3V3	A53	GND	A93	MEZZ_TX_DN_C<1>
A14	NCSI_RCSDV	A54	MEZZ_RX_DP<6>	A94	GND
A15	NCSI_RCLK	A55	MEZZ_RX_DN<6>	A95	GND
A16	NCSI_TXEN	A56	GND	A96	MEZZ_TX_DP_C<2>
A17	PERST_N0	A57	GND	A97	MEZZ_TX_DN_C<2>
A18	MEZZ_SMCLK	A58	MEZZ_RX_DP<7>	A98	GND
A19	MEZZ_SMDATA	A59	MEZZ_RX_DN<7>	A99	GND
A20	GND	A60	GND	A100	MEZZ_TX_DP_C<3>
A21	GND	A61	P12V_AUX/P12V	A101	MEZZ_TX_DN_C<3>
A22	NCSI_RXD0	A62	P12V_AUX/P12V	A102	GND
A23	NCSI_RXD1	A63	P12V_AUX/P12V	A103	GND
A24	GND	A64	GND	A104	MEZZ_TX_DP_C<4>
A25	GND	A65	GND	A105	MEZZ_TX_DN_C<4>
A26	CLK_100M_MEZZ1_D P	A66	P3V3_AUX	A106	GND
A27	CLK_100M_MEZZ1_D N	A67	GND	A107	GND
A28	GND	A68	GND	A108	MEZZ_TX_DP_C<5>
A29	GND	A69	P3V3	A109	MEZZ_TX_DN_C<5>
A30	MEZZ_RX_DP<0>	A70	P3V3	A110	GND
A31	MEZZ_RX_DN<0>	A71	P3V3	A111	GND
A32	GND	A72	P3V3	A112	MEZZ_TX_DP_C<6>
A33	GND	A73	GND	A113	MEZZ_TX_DN_C<6>
A34	MEZZ_RX_DP<1>	A74	LAN_3V3STB_ALERT _N	A114	GND
A35	MEZZ_RX_DN<1>	A75	SMB_LAN_3V3STB_C LK	A115	GND
A36	GND	A76	SMB_LAN_3V3STB_D AT	A116	MEZZ_TX_DP_C<7>
A37	GND	A77	PCIE_WAKE_N	A117	MEZZ_TX_DN_C<7>
A38	MEZZ_RX_DP<2>	A78	NCSI_RXER	A118	GND
A39	MEZZ_RX_DN<2>	A79	GND	A119	GND
A40	GND	A80	NCSI_TXD0	A120	MEZZ_PRSNTA2_N

## 1.3 BCM57414 Ethernet Controller

The BCM57414 Ethernet Controller is configured as dual-port 10 Gb/s MAC with integrated SFP+ optical interface to the line side and x8 PCI Express v3.0 interface to the system host.

## 1.4 Clock Requirements

The BCM57414 has an integrated differential oscillator circuit that operates from an external 50 MHz crystal.

## 1.5 PCI Express Interface

PCIe is a high-bandwidth serial bus providing a low pin-count interface as an alternative to parallel PCI. It is part of the Host Interface Connector. The BCM57414 complies with the PCI Express Base Specification Revision 3.0, and supports an 8-lane PCIe v3.0 interface via the host interface connector.

## 1.6 NC-SI Interface

The BCM57414 Ethernet Controller supports the Network Controller Sideband Interface (NC-SI) Specification version 1.1.0. The NC-SI provides a standardized interface between the system Baseboard Management Controller (BMC) and the integrated NC-SI module of the BCM57414.

## 1.7 SMBus Interface

The BCM57414 Ethernet Controller SMB0 interface supports serial communications between BCM57414 and the system. The interface allows the Ethernet Controller to act as an SMBus master or a slave device.

## 1.8 UART Interface

The BCM57414 Ethernet Controller has an integrated UART interface that supports external access to its registers. The UART signals are brought out to the 4-pin header for connecting a remote access host. The UART debug connector is placed near the I/O connector to be accessible from outside, for ease of in-system debug.

**Table 2: UART Connector Pinout**

Pin	Signal
1	UART_TXD
2	UART_RXD
3	V33
4	GND

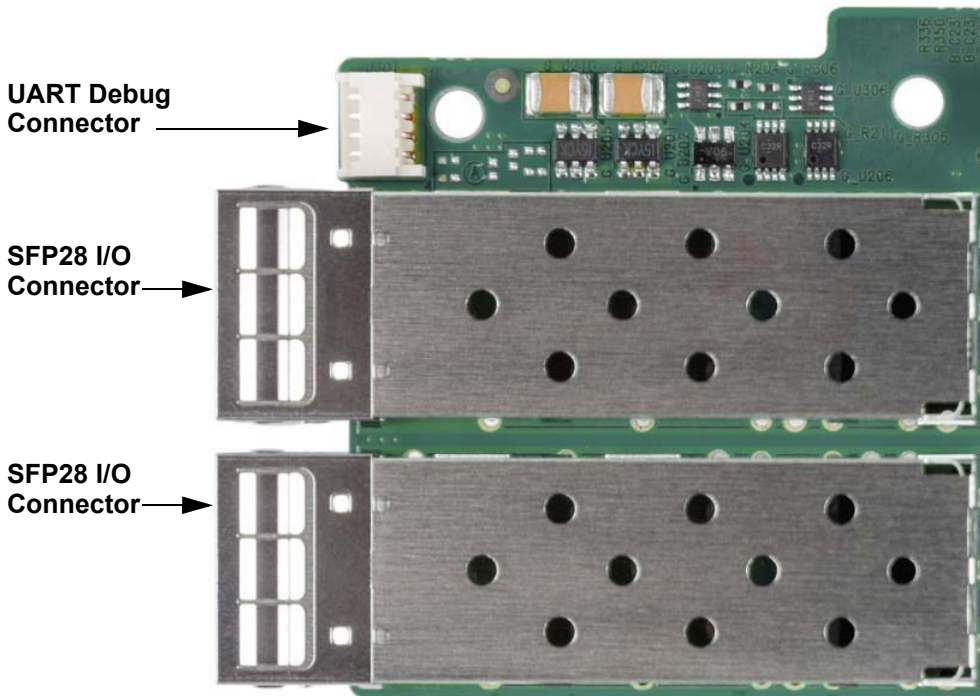
**Figure 3: UART Debug Connector**

## 1.9 Nonvolatile RAM

The BCM57414 Ethernet Controller requires a nonvolatile serial flash memory (NVRAM) to store the device firmware, PCI Configuration space settings (for example, Device ID, Vendor ID), MAC address, and so on. After power-up, the firmware is downloaded into the device memory and executed by the on-chip processor.

## 1.10 Heat Sink

The passive heat sink is attached to the Ethernet Controller using four spring-loaded push pins that insert into four mounting holes.

To prevent damage to the BCM57414 Ethernet Controller in the event of a missing heat sink, the Network Interface Card is not allowed to power up.

## 1.11 DC/DC Regulators

The on-board voltage regulators use the 12V edge main power from the host interface connector to derive the necessary power rails for different circuits and components on the board.

## 1.12 Power Supplies

All power is derived from the Mezzanine Card Host Interface Connector 12V/5V supply pins. These voltage supply pins feed on-board regulators that provide the necessary power to the various components on the card. The mezzanine card has six switching power supplies that power the card's various +1.0V, +1.25V, +1.8V, and +3.3V loads.

### 1.13 LED Functions and Locations

The SFP28 port supports two LEDs to indicate traffic activities and link speed. The LEDs are visible on the bottom side as shown in Figure 4. Its locations and form factors conform to the OCP Mezzanine Card Specification.

Figure 4: Activity and Link LED Locations

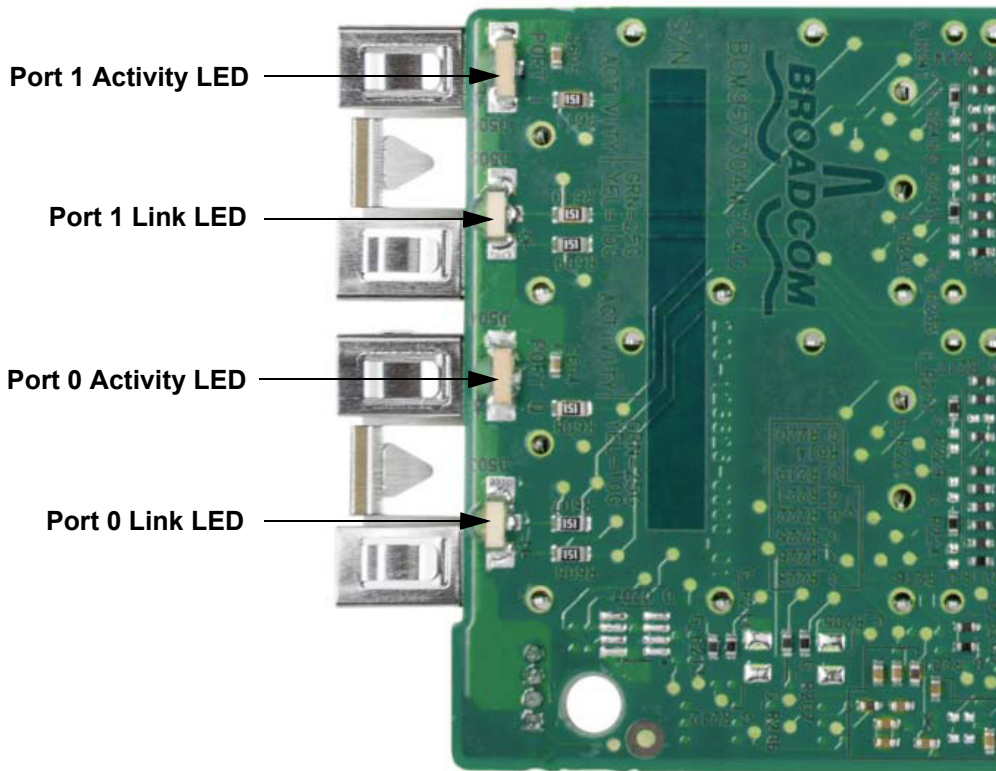

Table 3: LED Functions

LED Type	Color/Behavior	Note
Activity	Off	No Activity
	Green	Traffic Flowing Activity
Link	Off	No Link
	Green	Linked at 25 Gb/s
	Yellow	Linked at 10 Gb/s



## 2 Regulatory and Safety Approvals

The following sections detail the Regulatory, Safety, Electromagnetic Compatibility (EMC), and Electrostatic Discharge (ESD) standard compliance for the BCM957414M4142C Network Interface Card.

### 2.1 Regulatory

**Table 4: Regulatory Approvals**

Item	Applicable Standard	Approval (A)/Certificate (C)
CE/European Union	EN 62368-1:2014	CB report and certificate
UL/USA	IEC 62368-1 (ed. 2)	CB report and certificate

### 2.2 Safety

**Table 5: Safety Approvals**

Country	Certification Type/Standard	Compliance
International	CB Scheme ICES 003 – Digital Device UL 1977 (connector safety) UL 796 (PCB wiring safety) UL 94 (flammability of parts)	Yes

### 2.3 Electromagnetic Compatibility (EMC)

**Table 6: Electromagnetic Compatibility**

Standard/Country	Certification Type	Compliance
CE/EU	EN 55032:2012/AC:2013 Class A EN 55024:2010 EN 61000-3-2:2014 EN 61000-3-3:2013	CE report and CE DoC
FCC/USA	CFR47 Part 15 Subpart B Class A	FCC/IC DoC and EMC report referencing FCC and IC standards
IC/Canada	ICES-003 Class B	FCC/IC DoC and report referencing FCC and IC standards
ACA/Australia, New Zealand	AS/NZS CISPR 22:2009 +A1:2010	ACA certificate RCM mark
BSM/Taiwan	CNS 13438 (2006) Class A	BSMI certificate
BSMI/Taiwan	CNS 15663	BSMI certificate/RoHS table
MSIP/S. Korea	KN32 Class A KN35	Korea certificate MSIP mark
VCCI/Japan	VCCI-CISPR 32:2016	Copy of VCCI online certificate

## 2.4 Electrostatic Discharge (ESD) Compliance

Table 7: ESD Compliance Summary

Standard	Certification Type	Compliance
EN 55024:2010 (EN 61000-4-2)	Air/Direct discharge	Yes

## 2.5 FCC Statement

This equipment has been tested and found to comply with the limits for a Class A digital device, pursuant to Part 15 of the FCC Rules. These limits are designed to provide reasonable protection against harmful interference in a residential installation. This equipment generates uses and can radiate radio frequency energy and, if not installed and used in accordance with the instructions, may cause harmful interference to radio communications. However, there is no guarantee that interference will not occur in a particular installation. If this equipment does cause harmful interference to radio television reception, which can be determined by turning the equipment off and on, the user is encouraged to try to correct the interference by one or more of the following measures:

- Reorient or relocate the receiving antenna.
- Increase the separation between the equipment and receiver.
- Consult the dealer or an experienced radio/TV technician for help.

**NOTE:** Changes or modifications not expressly approved by the manufacture responsible for compliance could void the user's authority to operate the equipment.

## 3 Physical and Electrical Specifications

This section outlines the mechanicals of the BCM957414M4142C Network Interface Card as well as the environmental specifications.

### 3.1 Board Physical Dimensions

The BCM957414M4142C board dimensions are shown in [Figure 5](#). The dimensions are in inches with a tolerance of  $\pm 0.005$ .

**Figure 5: Board Physical Dimensions**

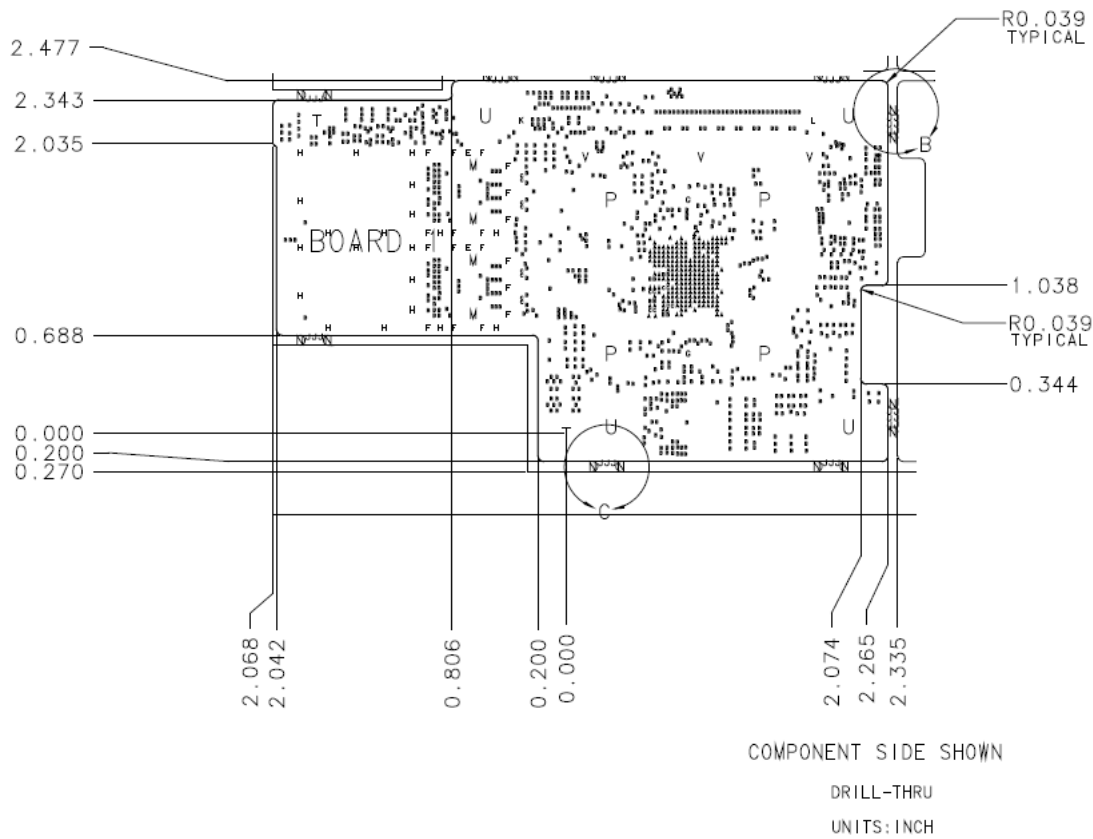

### 3.2 Environment Specifications

The mezzanine card meets the same environmental requirements specified in the OCP systems.

**Table 8: Environment Specifications**

Parameter	Condition
Storage Temperature	-40°C to +70°C
Storage Humidity	5% to 95% non-condensing
Vibration and Shock	IEC78-2-(*) and IEC721-3-(*)

### 3.3 Label Information

This section provides the label information of the BCM957414M4142C OCP Mezzanine Card. [Figure 6](#) outlines the label and corresponding locations.

**Figure 6: Labels Overview**

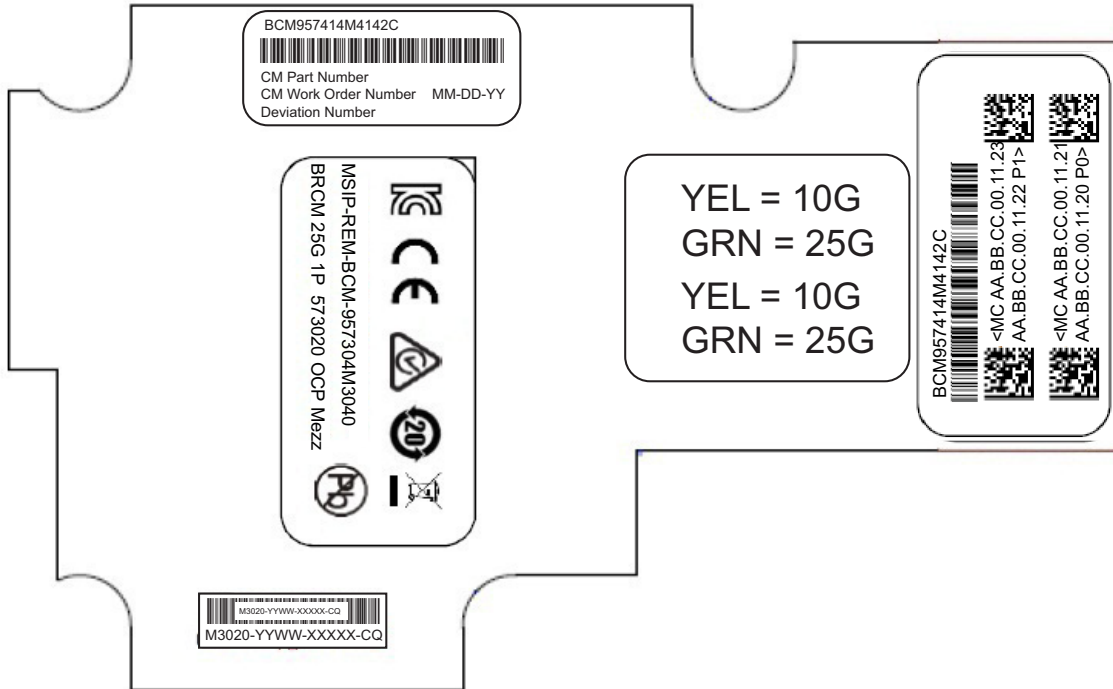

#### 3.3.1 MAC Address Label

In the example shown in [Figure 7 on page 12](#), BCM957414M4142C is the Part Number with 1D bar code, AA-BB-CC-00-11-20 is the MAC address of data network interface with 2D bar code for Port 0, and AA-BB-CC-00-11-21 is the MAC address of management network interface with 2D bar code for Port 0. AA-BB-CC-00-11-22 is the MAC address of data network interface with 2D bar code for Port 1, and AA-BB-CC-00-11-23 is the MAC address of management network interface with 2D bar code for Port 1.

**Figure 7: MAC Address Label**

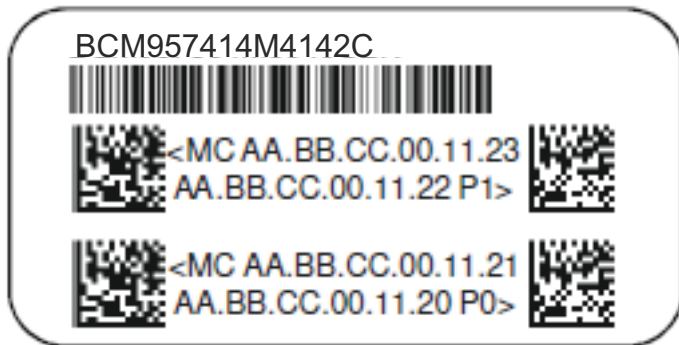

## 4 Ordering Information

**Table 9: Ordering Information**

Part Number	Description
BCM957414M4142C	Dual-Port 25 Gb/s or 10 Gb/s Ethernet PCI Express Gen3 x8 OCP Mezzanine Card

## Revision History

### **BCM957414M4142C-DS102; December 26, 2017**

**Updated:**

- [Regulatory and Safety Approvals](#)

### **BCM957414M4142C-DS101; September 22, 2017**

**Updated:**

- Labels Overview

### **BCM957414M4142C-DS100; August 22, 2017**

Initial release.

Broadcom, the pulse logo, Connecting everything, TruFlow, Avago Technologies, Avago, and the A logo are among the trademarks of Broadcom and/or its affiliates in the United States, certain other countries and/or the EU.

Copyright © 2017 by Broadcom. All Rights Reserved.

The term “Broadcom” refers to Broadcom Inc. and/or its subsidiaries. For more information, please visit [www.broadcom.com](http://www.broadcom.com).

Broadcom reserves the right to make changes without further notice to any products or data herein to improve reliability, function, or design. Information furnished by Broadcom is believed to be accurate and reliable. However, Broadcom does not assume any liability arising out of the application or use of this information, nor the application or use of any product or circuit described herein, neither does it convey any license under its patent rights nor the rights of others.

