



Industrial remote communication

Worldwide remote access to machines and systems



Industrial remote communication

Machines and systems are often distributed over wide areas. Securely connecting decentral stations with the control room is made possible with the versatile possibilities of remote communication. Remote communication enables access as well as continuous process data monitoring from the central station. Phoenix Contact provides a broad portfolio of products for wireless and wired remote access for this purpose.

Learn more:

phoenixcontact.com/remotecomunication



Remote maintenance

Maintenance and servicing work are performed quickly and efficiently with worldwide direct access to controllers and Ethernet networks.

More information starting on page 4



Remote control

The secure and continuous transmission of process data to the control center means that even remote stations and substations can be monitored and controlled.

More information starting on page 10

5G

Remote access via 5G

5G, the new cellular standard, significantly extends the possibilities of industrial communication. In addition to high data rates, higher numbers of devices and low latencies are possible with high reliability. Communication over long distances is often required in classic remote maintenance and remote control applications. This is where the public cellular network comes in, because it is available worldwide and provides Internet access even in remote locations.

With Industrial 5G, private networks that satisfy all of the prerequisites for flexible, sustainable network connections in mobile or highly flexible applications can also be established, for example. The advantages of a private network are that companies can track, analyze, and configure data traffic flexibly to suit their requirements. We will be happy to advise you on the new possibilities with 5G.



Remote control and remote monitoring

Errors are quickly eliminated and production downtimes minimized with proactive and precise early warning messages via SMS or e-mail.

More information starting on page 18

Contents

Remote maintenance	4
Remote maintenance via the cloud	6
Remote maintenance via in-house VPN infrastructure	9

Remote control	10
Remote control via the cellular network	12
Remote control via the cloud	13
Remote control via in-house cabling	14
Remote control via fiber optics	15
Remote control via wireless systems	16

Remote control and remote monitoring	18
--------------------------------------	----

Product overview	
Cloud-enabled products	20
Cloud-independent products	26

Remote maintenance

Secure remote maintenance via the Internet opens up huge potential for manufacturers of machines and production systems in terms of additional services. To safeguard your network connections against interference and manipulation, Phoenix Contact provides a large number of products and solutions featuring state-of-the-art security mechanisms such as Virtual Private Networks (VPN), Deep Packet Inspection (DPI), and self-learning firewalls. This ensures the confidentiality, integrity, and authenticity of your data.



Structure of the remote maintenance concept

Internet access

Depending on the wishes and possibilities on site, a remote maintenance connection is established via a wired Internet connection or with the help of a WLAN or cellular router. While the wired solution is simple and inexpensive to realize, a wireless solution features a high-level of flexibility, even in places where there is no Internet connection.

Data transmission

Either a self-hosted VPN server or turnkey solutions such as the mGuard Secure Cloud are used for data transmission. Both versions feature different advantages (see table).

VPN server	mGuard Secure Cloud
Description	
A secure, transparent communication channel is established between two devices over the Internet.	A secure, transparent communication channel is established over the Internet between the service personnel/field device and the mGuard Secure Cloud.
Internet connection	
Business Internet access required (fixed IP address)	Any Internet access can be used
Advantages	
<ul style="list-style-type: none"> • Freely definable routing, firewall, and VPN functionalities • Complete self-control of VPN tunnels 	<ul style="list-style-type: none"> • Turnkey VPN solution • Easy commissioning with configuration assistants • Customized routing, firewall, and VPN functionalities for cloud operation
Additional features	
<ul style="list-style-type: none"> • In-house encryption certificates necessary • Firewall rules switched on an event basis (conditional firewall) 	<ul style="list-style-type: none"> • Support for cellular devices such as iPad and iPhone • Logbook – all access is logged • Free basic account
IT expertise	
● ● ● ○ ○	● ○ ○ ○ ○

Ensuring data security

To make your remote connection secure, keep the following points in mind:

- Secure data transmission via VPN tunnel
- All access is traceable
- Connection only on demand (no permanent connection)
- Remote maintenance initiation via key switch, I/Os, API, SMS, or call
- No access to the superordinate network
- Use of state-of-the-art encryption standards (IPsec, OpenVPN)



Remote maintenance via the cloud

The mGuard Secure Cloud is a complete turnkey remote maintenance solution that connects service personnel and machines or systems securely, reliably, and without IT knowledge via the Internet. This reduces cost and time-intensive on-site service actions significantly. It provides operating companies, machine builders, and system manufacturers with a cost-effective alternative for realizing intelligent and sustainable service concepts.



Functional components of the mGuard Secure Cloud

Service personnel use an approved VPN client, such as the mGuard Secure VPN Client software or an iPad, and connect their workstations to the mGuard Secure Cloud.

The machines are also equipped with industrial-grade remote maintenance routers or PLCnext Control, and establish your VPN connection to the Secure Cloud as necessary. The VPN connections can be

established locally via hardware (key switch) or via software controlled by the system operator.

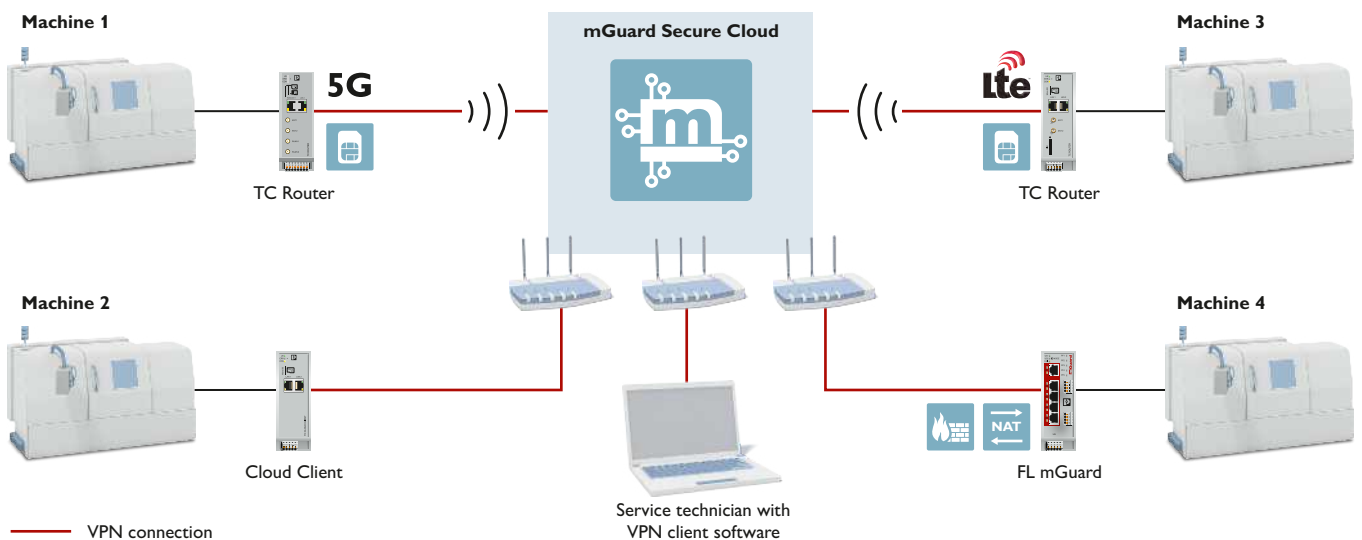

Simple – secure – reliable

The public cloud application based on the mGuard industry standard uses Virtual Private Networks (VPNs) with the proven IPsec security protocol. This ensures confidentiality, authenticity, and integrity. The remote monitoring solution, hosted in Germany, provides cloud computing in compliance with the stringent European data protection standard (GDPR).

This means that you do not need to invest in your own hardware, and you save on local administration costs. The hosted cloud is always up to the latest standard and always available. Thus, you benefit from regular updates and patch management, low latency times, and a high-availability computer center that is operated around the clock – a particularly convenient service offer, especially for small and medium-sized companies.

Your advantages

- ✓ Turnkey remote maintenance infrastructure
- ✓ Secure and scalable
- ✓ Risk-free and cost-free testing for 30 days possible
- ✓ Time and cost savings through remote services instead of expensive on-site service actions
- ✓ Easy commissioning with configuration assistants and intuitive-to-operate web interface
- ✓ Secure and reliable VPN connections, even to China



Register for free now and test the mGuard Secure Cloud:
<https://start.cloud.mguard.com>

mGuard Secure Cloud web interface

The mGuard Secure Cloud web interface clearly displays the availability of the service target and controls the service personnel access to assigned locations and machines.

New remote maintenance connections can be added conveniently via the assistant. You therefore have a good overview of all connected machines and systems.

The screenshot displays the mGuard Secure Cloud web interface. At the top, there is a navigation bar with tabs for 'Service Targets (Machines)', 'Service Workstations', 'Administration', and 'Logbook'. Below the navigation bar, a status bar indicates 'Service VPN tunnel online' and 'No secure connection initiated'. A search bar and a list of service targets are visible. The service targets are displayed in a grid format, each with a status indicator (red or green), a name, a serial number (sn.), and buttons for 'VPN Builder', 'Download file', and 'START'. The targets include 'Chris MarsBase II', 'DIRA', 'Eugene Field', 'IMA Engineering MGuard App', 'SpaceX Starship Tile Machino', 'TCR-4000-SR-Test', and 'VMM BU Shop Solar'. A 'New' button is also present in the top left of the grid. The interface is clean and professional, with a dark blue header and a light blue background for the content area.

Remote maintenance via the cloud

Compact, independent machines

The cloud clients from Phoenix Contact are ideally suited for the remote maintenance of individual, compact machines with a small IP network. They connect the machine to the mGuard Secure Cloud securely via VPN. The cellular network version is ideally suited for stand-alone machines without a network connection.

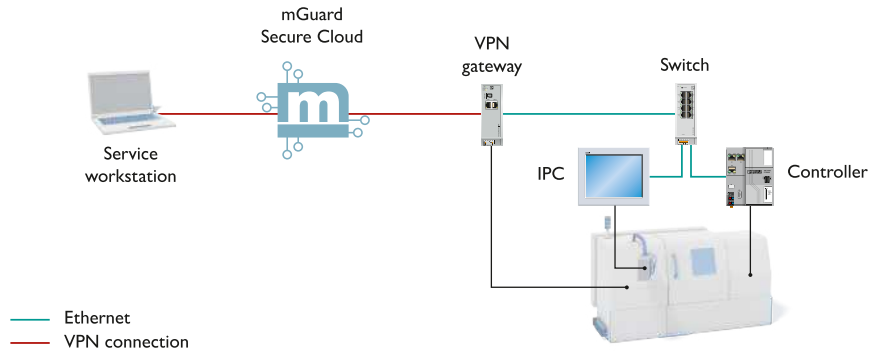

Integration into the production network

Protection against unauthorized access by people and malware is becoming increasingly more important for networked machines. The FL mGuard 2102 secures your machine network with a powerful, flexible, and easy-to-operate firewall. This enables the regulation of access to the machine in the production network, e.g. in ERP systems, and the secure connection of the machine to the mGuard Secure Cloud via VPN.

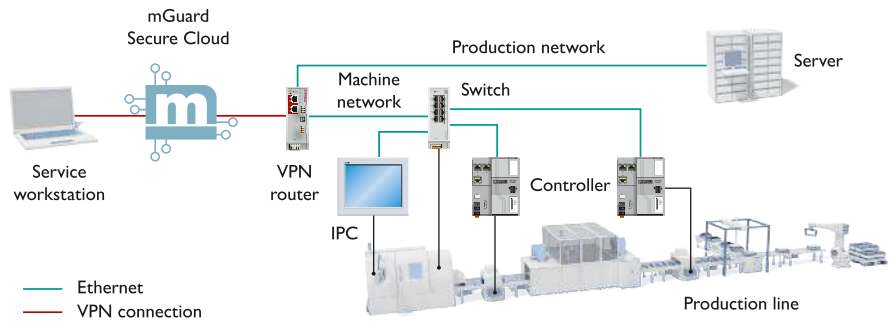

High network availability

When there is a high number of networked machines and systems, the availability of the machine network is of paramount importance.

Here, the FL mGuard secures the communication between the production and machine networks. A firewall monitors the incoming and outgoing data traffic at each port. Thus, the machine cannot be accessed in the production network during maintenance work.

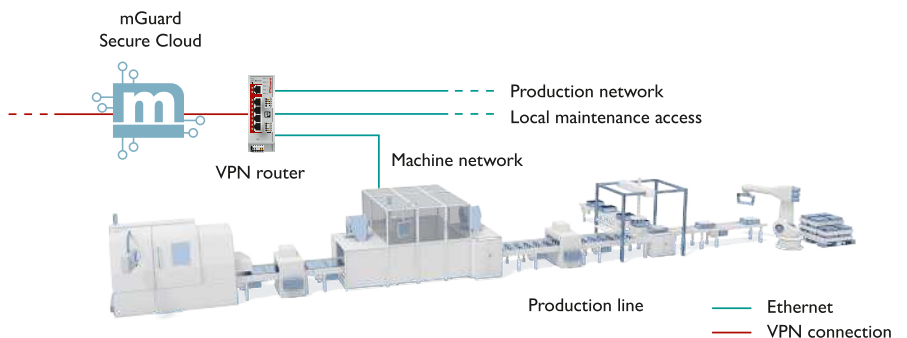

Remote maintenance via in-house VPN infrastructure

Would you like to freely define access rights and retain control over VPN connections yourself? Then operating your own on-premises VPN infrastructure is a good idea.

With your own VPN infrastructure, everything is yours – including your data, hardware, and software platforms. You decide on the configuration, the upgrades, and system changes yourself. Also, you do not always have to rely on Internet connectivity and external factors to access your machines and systems.

IT-savvy employees who take care of the on-premises infrastructure are indispensable. They have to take setup, operation, maintenance, back-up, and support into their own hands.

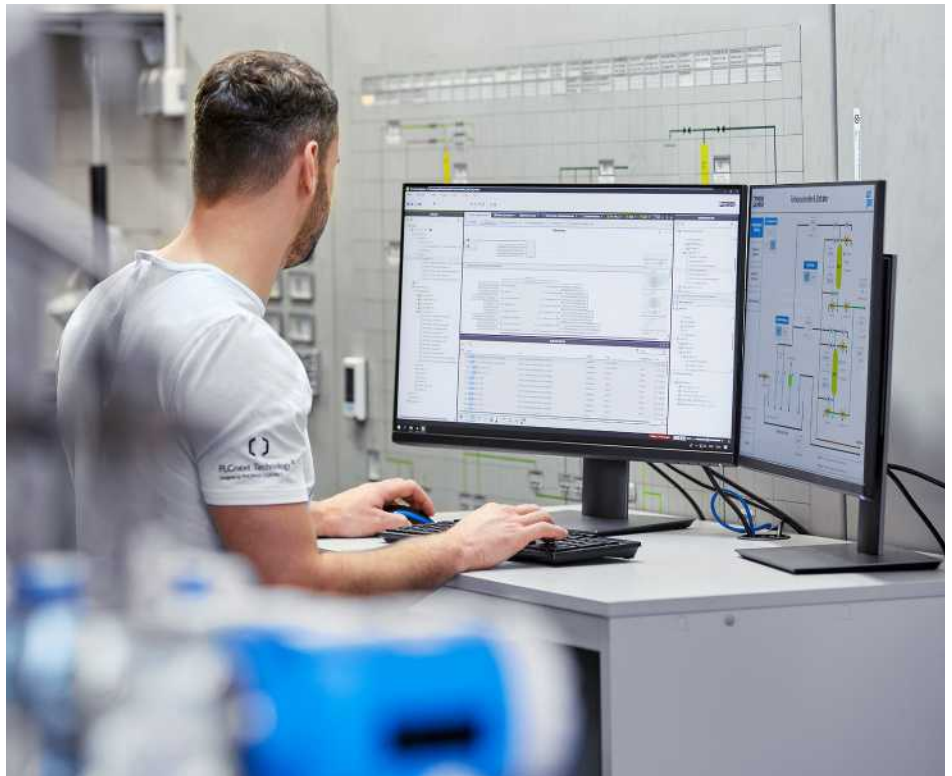

Typical structure of an in-house VPN infrastructure

All FL mGuard devices from Phoenix Contact can be connected to and operated on such a VPN infrastructure. The FL mGuard centerport in a 19"

design is recommended as the central VPN component. This guarantees perfect compatibility and high security standards.

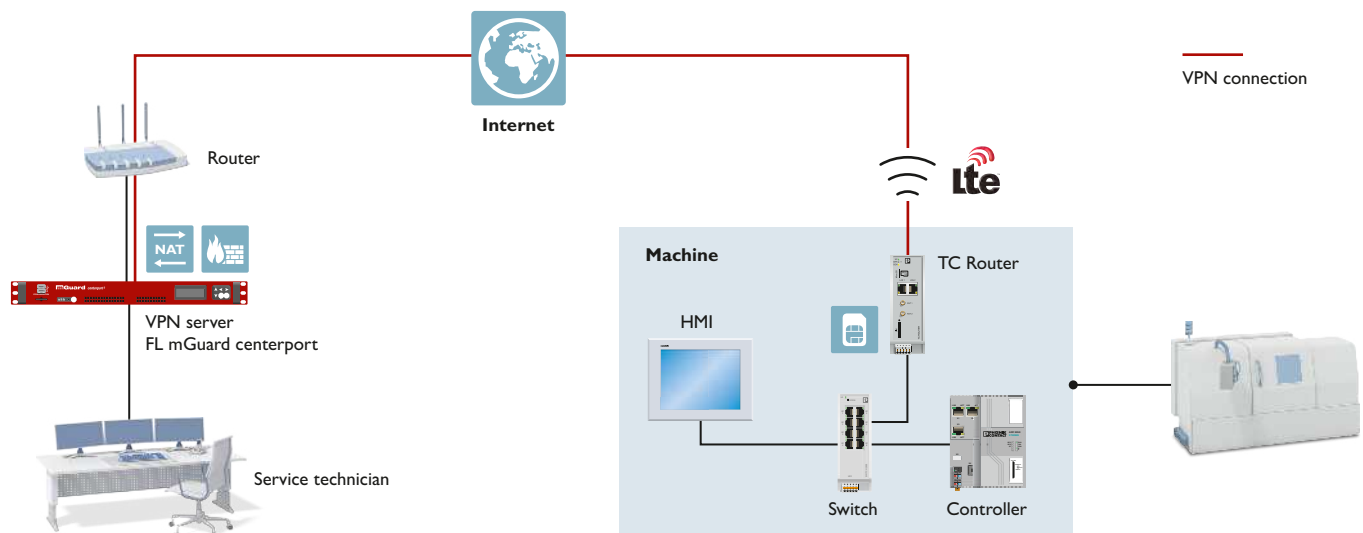

VPN connection

Remote control

Transfer your process data securely and continuously to the control center via company-owned lines or wirelessly (cellular communication). Phoenix Contact also provides modular remote control stations and application-specific systems for existing and new systems.



Remote control technology from the control system through to the field level

Remote control via various media

Which transmission medium is the right one for your application? If you want to cover long distances, fiber optics (FO) is recommended. If installing cables is expensive or impossible, wireless solutions are an option. If communication

cables are not available, existing cellular networks provide an excellent alternative. Phoenix Contact provides suitable components for every transmission medium: from media converters for converting to FO and (cellular) wireless modules through

to the appropriate connectors, cables, and antennas.

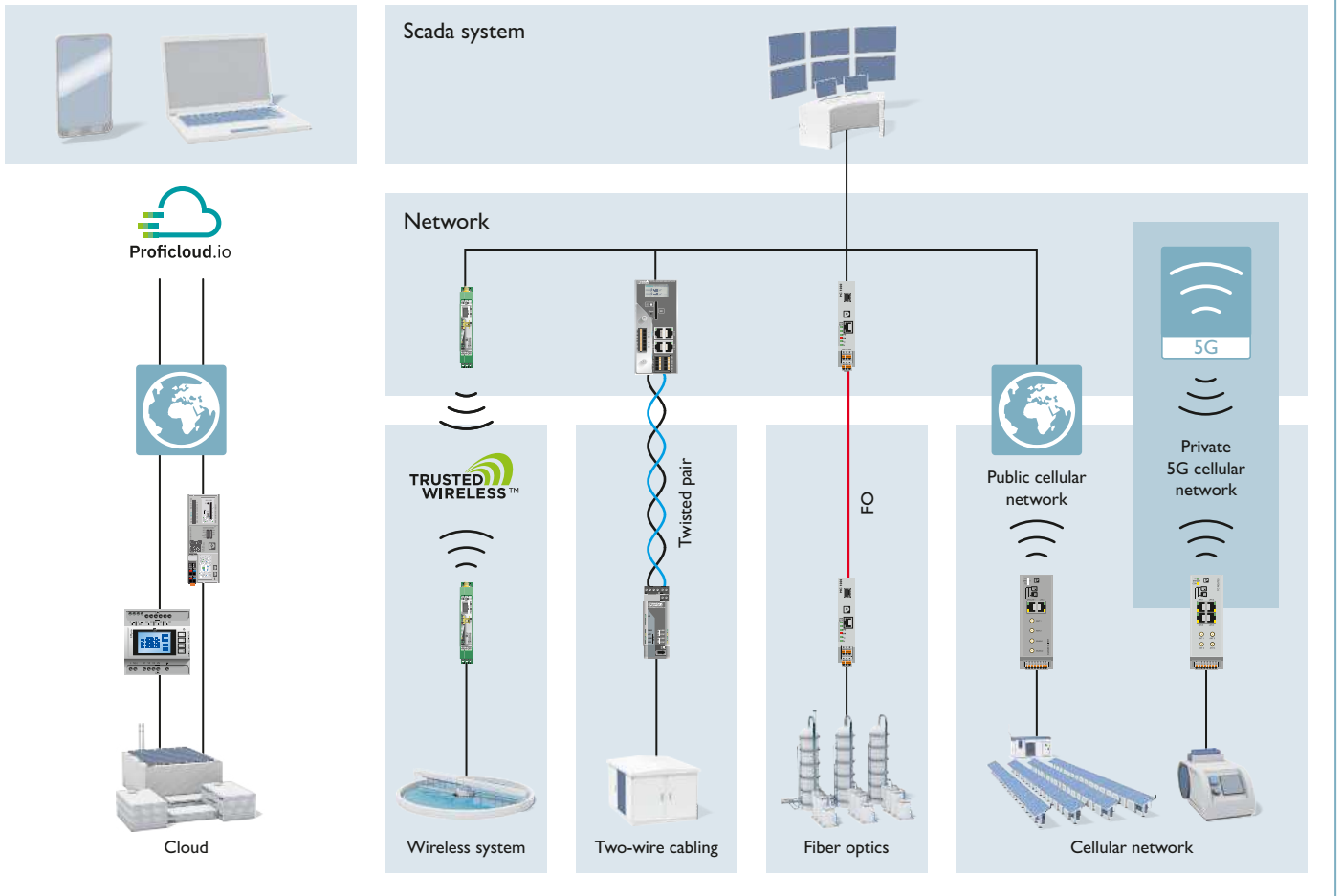

Properties of the transmission media

Proficloud	Wireless system	2-wire cable	Fiber optics	Cellular communication
Range				
Worldwide	Up to 32 km	Up to 20 km	Up to 80 km	Worldwide
Data throughput				
Depending on Internet access	Up to 250 kbps	Up to 1,000 Mbps	1,000 Mbps	150 Mbps (LTE) 1,000 Mbps (5G)
Latency				
● ● ● ○ ○	● ● ● ● ●	● ● ○ ○ ○	● ○ ○ ○ ○	● ● ● ○ ○

Remote control via the cellular network

For the continuous acquisition of your process data, Phoenix Contact provides cellular network devices that support all technology standards (5G, 4G, 3G, and 2G). With the globally available cellular network, the devices can communicate reliably, even in areas with a weak infrastructure.

The small remote stations and entire system parks, such as remote pumping stations, can be connected to the control center using methods ranging from text messaging, through remote control protocols at low data rates, all the way to broadband VPN connection, depending on the communication requirements.



Broadband connection for decentral systems

Cellular technology provides a secure communication solution for applications with a large data throughput. In 5G/4G networks, monitoring images and server functions are made available to the control center from around the world. The routers with VPN functionality enable closed communication over the Internet. The data traffic is transmitted directly to the control room via VPN. Thus, for example, it is possible to connect wind turbine generators via camera applications or to connect to the network of a sewage treatment plant.

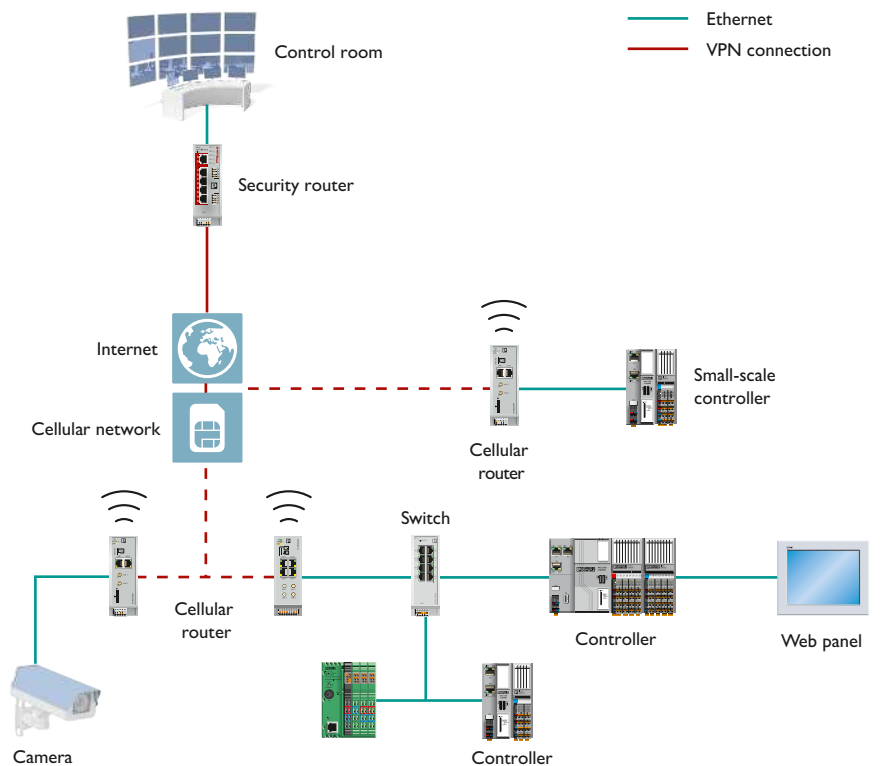

Remote control via the cloud

As an open, scalable IIoT platform, Proficloud.io provides you with intelligent communication, networked components, control technology, smart services, and comprehensive data analysis – all with the highest level of security. Take advantage of the unlimited possibilities of a cloud-based solution for the continuous transmission of data. With Proficloud.io, you can network your decentral devices in the field easily and securely over the Internet.

The advantages are:

- Access to component data at any time and from anywhere
- Access to data-based, future-oriented Smart Services such as the Device Management Service
- Secure and certified communication between the controller and Proficloud.io via TLS encryption



Future-oriented Smart Services

Smart, IIoT-capable components and controllers from Phoenix Contact allow data to be sent directly to Proficloud.io. The availability of component data is guaranteed, and users can access it at any time, anywhere.

Proficloud.io allows access to data-based, future-oriented Smart Services, with functions such as device management, state-of-health, and other interactions with the components. Smart Services also enable increased transparency of measurement and component data through advanced analytics, such as future machine learning. TLS encryption guarantees secure and certified communication between the controller, the components, and Proficloud.io.

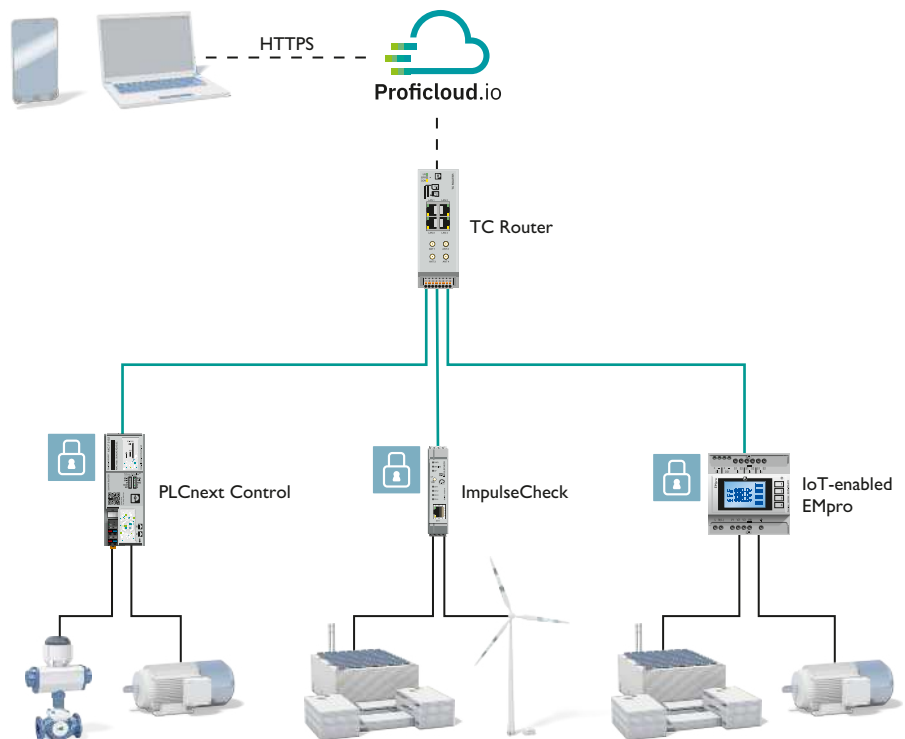

Remote control via in-house cabling

With extenders, you can connect Ethernet networks or serial fieldbuses economically over large distances.

In Gigabit applications, you can even achieve ranges of up to 20 km. Use existing cables for sophisticated network installations and minimize investment costs. Find the ideal extender for your application.



Serial fieldbus communication via any 2-wire cable system up to 20 km

Serial/PROFIBUS extender

With the PROFIBUS extender, you can reach remote PROFIBUS devices via existing copper cables. This means that data rates of up to 1.5 Mbps can be achieved over distances of up to 1.5 km without using special cables.

Ethernet extenders

With Ethernet extenders, you can connect Ethernet networks over distances up to 20 km via simple 2-wire cables. This allows data rates of up to 30 Mbps to be made a reality.

Gigabit Ethernet extenders

Gigabit Ethernet extenders enable broadband Ethernet applications up to 1 Gbps over distances up to 1 km. You can use both existing 2-wire cables and coaxial cables.

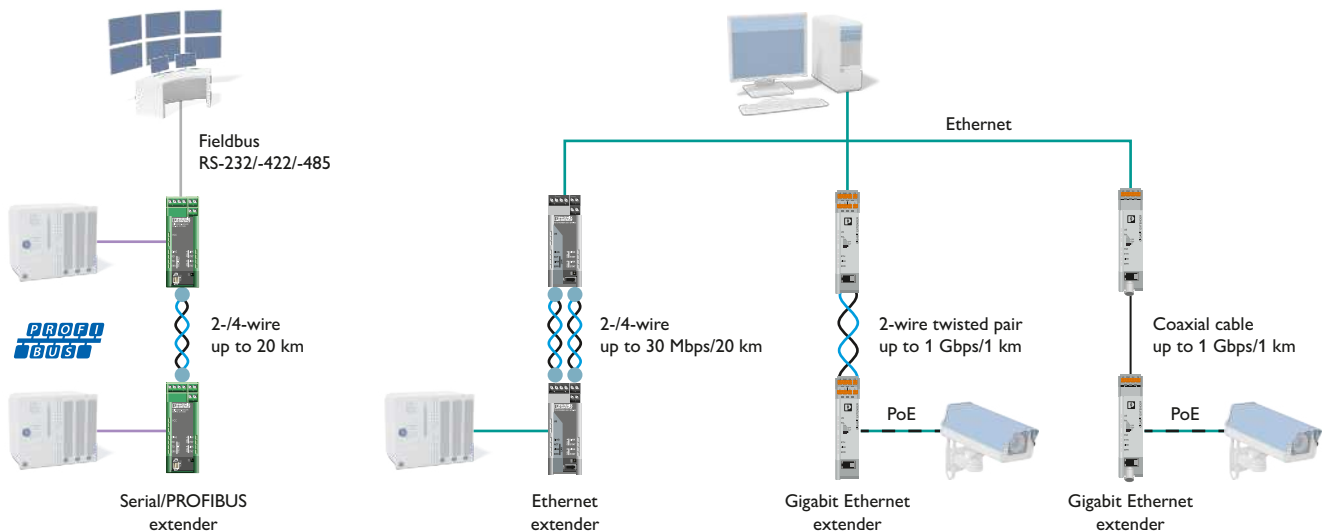

Remote control via fiber optics

FO media converters for Ethernet and fieldbus allow you to convert your copper interfaces to interference-free fiber optics without the need for complex surge protection, shielding, and equipotential bonding measures.

Another advantage of optical data transmission is the increase in the maximum range to up to 80 km in a point-to-point connection.



Communication to remote systems via fiber optics

Ethernet media converters

For high-level immunity to interference and long transmission ranges in industrial Ethernet applications, media converters transparently convert Ethernet data to fiber optics. Depending on the device and cable, they bridge distances of up to 80 km at data rates of up to 1 Gbps.

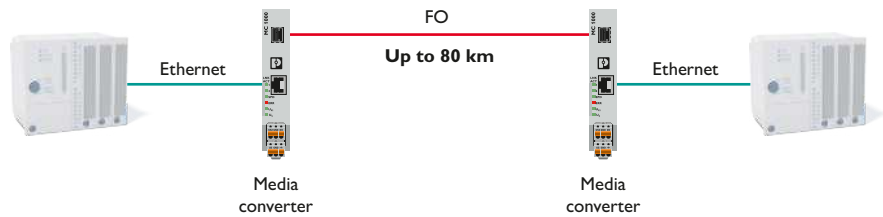

Media converters for fieldbuses

Media converters of the PSI-MOS product families convert copper-bound PROFIBUS interfaces to fiber optics. A transparent protocol is used to convert all data rates up to 12 Mbps.

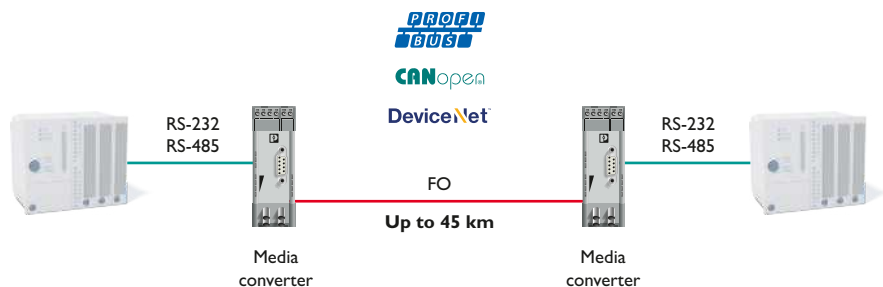

Remote control via wireless systems

With wireless systems, you simply record measuring data and system information from distant or poorly accessible areas and transfer it to central points.

Remote control technology is a reliable and inexpensive alternative to new cable paths, particularly if new system components are to be installed or defective communication cables replaced. The wireless modules have various interfaces and thus act as a gateway between local sensors and actuators of the process station and the control center.



Application example

Within the peripheral, highly branched system structures, measured values and other operating information must be transmitted securely, fill levels must be monitored, and pump performance and flow rates must be logged continuously.

Application

- In the event of damaged grounding cables and extensive repair work
- Networking of external buildings with the control system (no line of sight)
- Recording standby messages, pump delivery volume, flow, fill level

Advantages

- Easy commissioning
- Private wireless network – provider-independent
- Time and cost savings compared to laying cables

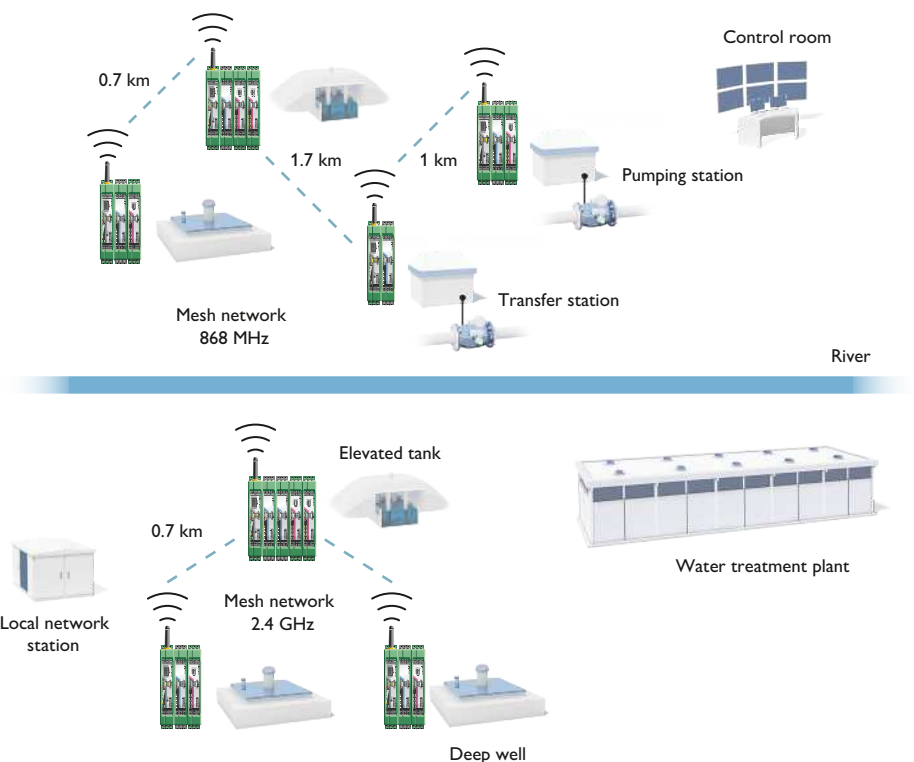

Remote control solutions in application

Power transmission and distribution

Application

Monitoring parameters is important for the efficient expansion and reliable operation of power grids. The increasing use of decentral generation systems and the rapidly increasing number of new electricity loads are creating new challenges. One such challenge is posed by the fluctuations in the amount of electricity generated, coupled with the simultaneous increase in loads such as heat pumps and e-mobility. The electrical power distribution network must therefore be optimized to ensure reliable and future-proof operation.

Solution

The smartRTU platform from Phoenix Contact is an easy-to-configure remote control and automation solution specially developed for monitoring and controlling distribution grids. The software enables complex applications to be configured in a clear web interface. The acquisition of operating data and remote control of the power grid enable operational optimization and investment planning.



Use of the remote control and automation system in a power grid

Solar power

Application

Decentral power generation plants make a key contribution to ensuring grid stability. The feed-in controller ensures that the setpoints and control procedures specified by the grid operator are maintained at the grid connection point. Control specifications from the grid operator are transmitted to the feed-in controller via remote control technology. The technical connection conditions of the grid operators specify how the systems are equipped. The grid operators are in turn subject to European and country-specific requirements.

Solution

The feed-in controller from Phoenix Contact – the Power Control Unit (PCU) – is certified for Germany, Poland, and Spain. The controller is a flexible solution based on PLCnext Technology. The PCU calculates the manipulated variables for the generating units based on the grid operator specifications and the permanently implemented control functions. The Resy10x function block library from Phoenix Contact extends the controller with remote control technology protocols and supports communication with the grid operator.



Grid connection with the feed-in controller from Phoenix Contact in a PV power station

Water and wastewater treatment

Application

Wastewater pumping stations play an important role in reliable wastewater disposal. Municipal wastewater companies have decentral wastewater pumping stations spread throughout their entire distribution grid. These must, when necessary, transport the wastewater to the higher-level sewage systems and function correctly around the clock. Current operating data is transmitted to the higher-level control system.

Solution

The turnkey Pump Control control cabinet solution with integrated remote control interface takes over the control and regulation of decentral wastewater pumping stations. Along with switching pumps selectively and recording measurement values, the controller transmits important messages to the higher-level control system via a common remote control protocol (IEC 60870-5-104, DNP3, OPC UA) and to the operating personnel via SMS.



Use of the Pump Control solution in a wastewater pumping station

Remote control and remote monitoring

Monitor analog and digital values easily and securely via the cellular network. The compact TC MOBILE I/O X200 remote control system keeps you up to date on the status or error state of your system, even in the field. You can send text messages via SMS or email and set switching outputs, e.g., for disconnecting the machine. Thus, you can prevent damage and downtimes and avoid costly on-site servicing.

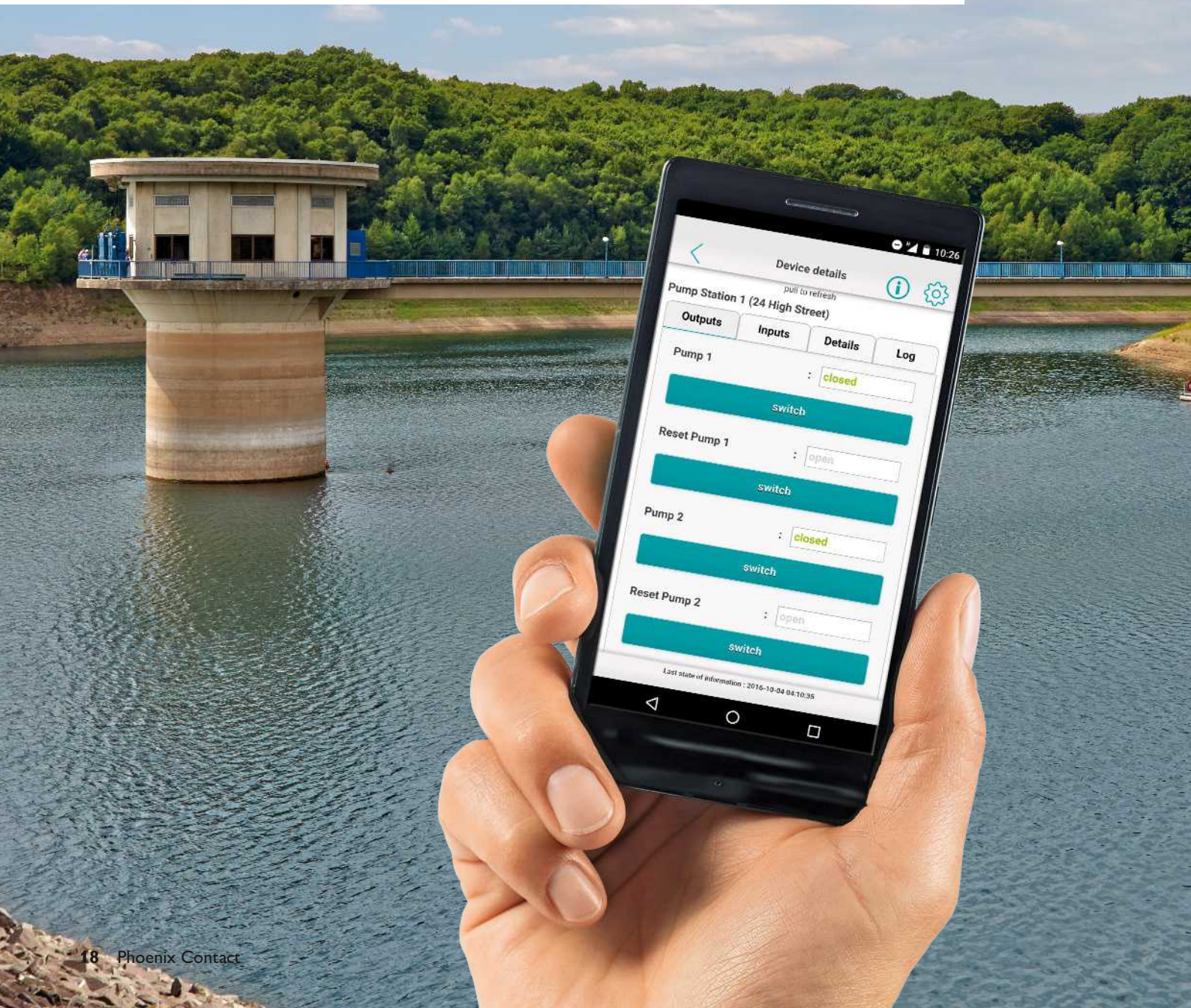

Remote control and monitoring via the cellular network

One network via SMS

In the case of autonomous remote stations, the few switching operations that are required and the system inspections are often still carried out by service personnel on site. Errors quickly lead to downtimes and high costs.

With automatic alerts, immediate remote error detection is possible – without requiring a complex and costly broadband connection. Monitor analog and digital values easily and securely via the cellular network with the compact TC MOBILE I/O X200 signaling system. This ensures that you are always kept up to date on the status and errors in your system.

You can send text messages via SMS or email, and set switching outputs, e.g., for disconnecting the machine. You can prevent damage and downtimes, and avoid costly on-site servicing.

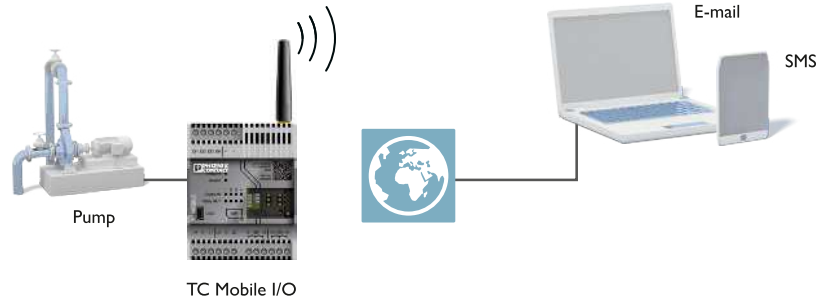

Your advantages

- ✓ Reduced machine and system downtimes with automatic alerts via SMS and email
- ✓ Decreased communication costs with event-driven alerts
- ✓ A conventional cellphone can serve as a peer
- ✓ Cellular networks are available worldwide
- ✓ Free switching by phone call

Free app for the TC MOBILE I/O X200 signaling system

The TC MOBILE I/O X200 also communicates with you via smartphone app (iOS and Android). The app allows you to switch your outputs conveniently and easily check the status of the device at any time.

The TC Mobile I/O app makes it even easier to use the device and saves you having to write a text message. You will receive alerts as usual via SMS and email. This ensures high-level accessibility in the field.

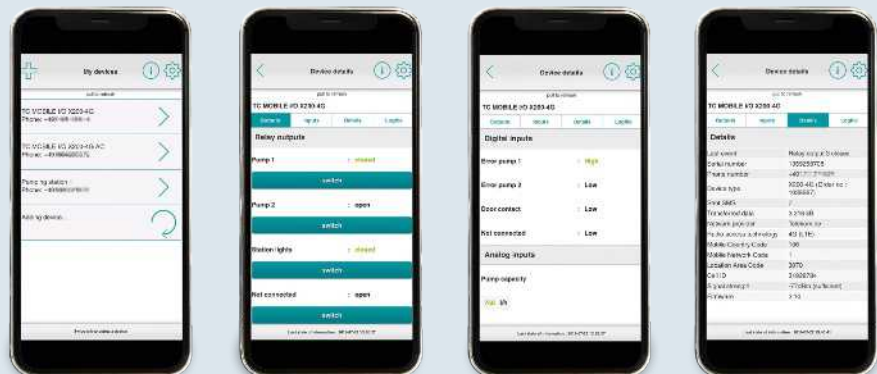

Cloud-enabled products

For remote communication with worldwide industrial systems, Phoenix Contact provides a broad portfolio for wired and wireless remote access. The range is supplemented by our cloud solutions for remote maintenance and the digitalization and analysis of process data.



Security routers

With the mGuard security routers, you can protect your machines and production cells from unauthorized access. A wide range of security functions as well as central management software help to easily increase the security level of your production facilities.

More information starting on page 24



Universal cellular routers

The TC ROUTER cellular routers enable robust data connections over 4G or 5G networks. This allows you to establish a mobile broadband connection even in demanding environments where a wired Internet connection is not available.

More information starting on page 24



Cloud services

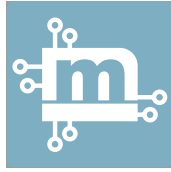

mGuard Secure Cloud

The complete turnkey VPN solution for easy remote maintenance.

More information starting on page 22



Proficloud.io

Unlimited possibilities of a cloud-based solution for the digitalization and analysis of process data.

More information starting on page 23

PLCnext Technology[®]

Designed by Phoenix Contact



Simple remote maintenance routers

Cloud clients connect machines securely to the mGuard Secure Cloud – wired, via WLAN, or via cellular communication. They are the inexpensive entry into scalable remote maintenance of machines, without the need for specific expertise in networking and VPN technology.

More information starting on page 24

Any Cloud: Open controllers

PLCnext Control, the controllers of the open ecosystem PLCnext Technology, can be connected to any cloud. Whether it's Phoenix Contact's Proficloud.io, Amazon's AWS, Microsoft's Azure, or your own cloud solution on site. Take advantage of individual cloud services to optimize your processes.





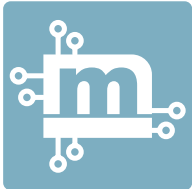
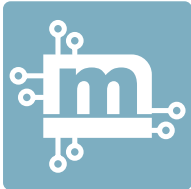

More information starting on page 25

Cloud-enabled products

mGuard Secure Cloud

Available editions and scope		
		
	mGuard Secure Cloud Basic	mGuard Secure Cloud Premium
Number of users	Unlimited	Unlimited
Number of machines	Unlimited	Unlimited
Number of service workstations	Unlimited	Unlimited
Concurrent service connections	1	3
Transfer volume per service connection	2 GB/month	4 GB/month
Total transfer volume	2 GB/month	12 GB/month
Guaranteed bandwidth	None	1 Mbps per service connection
Guaranteed availability (SLAs)	None	98% per year
Service VPN clients	mGuards, software VPN clients, macOS	mGuards, software VPN clients, macOS
Mobile service VPN clients	iPadOS, iOS (Apple iPad and iPhone)	iPadOS, iOS (Apple iPad and iPhone)
Machine VPN clients	mGuards, cloud clients, TC routers, PLCnext	mGuards, cloud clients, TC routers, PLCnext
Cloud support	Email	Phone, email
Additional service connection	No	Yes
Authorization model	Standard	Extended (location / machine / subnetworks)
Reporting	Yes	Yes
Report filter	No	Yes
Report export	No	Yes (CSV, Excel, PDF)
Two-factor authentication	Time-based one-time password (TOTP), email	Time-based one-time password (TOTP), email
Configuration blueprints	No	Yes
Machine networks	One private address space	Any number of private address spaces

Proficloud.io and Smart Services

Smart Services at a glance	
Smart Service	
 <p>Smart Services Powered by Proficloud.io</p> <p>Perfectly integrated cloud services for the smart route to industrial automation</p>	<ul style="list-style-type: none"> • Reduction of manual and redundant work steps with cross-location remote monitoring • Data visualization and analysis: Making decisions based on data • Increase in system availability with early error detection and automated warnings • Full transparency of the status of the systems – at any time, from anywhere.
All Smart Services in detail	
Device Management Service	
 <p>Device Management Service Powered by Proficloud.io</p> <p>The standard for all smart devices from Phoenix Contact</p>	<ul style="list-style-type: none"> • Overview of all devices • Health status of the devices • Firmware update from the cloud • Digital nameplate and device logs
User Management Service	
 <p>User Management Service Powered by Proficloud.io</p> <p>Invite users to Proficloud.io organizations and assign individual permissions</p>	<ul style="list-style-type: none"> • Inviting people to Proficloud.io organizations • Predefined roles such as admin, editor, and viewer • Create new organizations quickly and easily • Manage multiple location with one login
Time Series Data Service	
 <p>Time Series Data Service Powered by Proficloud.io</p> <p>All process data available centrally – at any time, anywhere</p>	<ul style="list-style-type: none"> • Access to process data from any location • Downtimes and workloads can be planned • Increased product quality through data • Warnings in the Smart Service or via email indicate impending problems • Expert knowledge accessible to every employee
Impulse Analytics Service	
 <p>Impulse Analytics Service Powered by Proficloud.io</p> <p>The world's first intelligent assistance system for surge protection in the field of mains protection</p>	<ul style="list-style-type: none"> • Improved workflows with remote monitoring • From reactive to proactive maintenance • Detailed information on overcurrent events (State-of-Health reports) and remaining service life of the surge protection device (SPD) • Higher availability and improved process stability
EMMA Service	
 <p>EMMA Service Powered by Proficloud.io</p> <p>Energy Monitoring, Management, Analytics: Smart energy management any time, anywhere</p>	<ul style="list-style-type: none"> • Visualization and analysis of energy data and uncovering potential savings • Draw conclusions about processes and energy consumption • External data sources can be integrated for additional data transparency • Export of data for further processing in other systems possible • Warning about limits that will be violated imminently • Visualization of the key indicator “Energy Performance Indicators (EnPI)” displayed with the reporting feature

Further information, connection of hardware and booking options at [Proficloud.io](https://www.proficloud.io)

Cloud-enabled products

Routers

	Internet access (WAN)	VPN tunnel	Ports	Special features	Type	Item no.
Security routers						
Integrated firewall for the protection of the machine network, Network Address Translation (NAT), VPN tunnel to the mGuard Secure Cloud, central device management						
	Operator network (RJ45)	2	2 x RJ45	–	FL MGuard 2102	1357828
		2	5 x RJ45	–	FL MGuard 2105	1153078*
		Up to 250	2 x RJ45	Extended firewall for complex security	FL MGuard 4302	1357840
		Up to 250	5 x RJ45		FL MGuard 4305	1357875*
Universal cellular routers						
Temperature range: -40°C ... +70°C, up to four DIs and two DOs and serial interface (depending on version), device and patch management (TC Router Online Manager)						
	4G LTE	3 VPN connections via IPsec or OpenVPN	2 x RJ45	European version	3002T-4G	2702528
	4G LTE			For Verizon Wireless cellular networks	3002T-4G VZW	2702532
				For AT&T cellular networks	3002T-4G ATT	2702533
	4G LTE + operator network (RJ45)	No limit, limited by system resources and available bandwidth	2 x RJ45 (2x LAN or 1x WAN 1x LAN)	European version	4002T-4G EU	1234352
	4G LTE + operator network (WLAN / RJ45)				4102T-4G EU WLAN	1234353
					4202T-4G EU WLAN	1234354
5G SA/NSA	3 VPN connections via IPsec or OpenVPN	4 x RJ45	European version	5004T-5G EU	1439475	
Simple remote maintenance routers						
Configuration and operation via mGuard Secure Cloud, simplified web interface, up to four DIs and two DOs (depending on variant)						
	Operator network (RJ45)	1 tunnel for mGuard Secure Cloud	2 x RJ45 (1 x LAN, 1 x WAN)	Worldwide	CLOUD CLIENT 1101T-TX/TX	1221706
	4G LTE EU			European version	CLOUD CLIENT 2002T-4G EU	1234355
	4G LTE EU + WLAN			European version	CLOUD CLIENT 2102T-4G EU WLAN	1234357
	WLAN			European version	CLOUD CLIENT 2002T-WLAN	1234360

* Item will be released in Q4 2023

Controllers

	Processor clock frequency	Main memory (RAM)	No. of tasks (min. cycle)	Security	Miscellaneous	Type	Item no.
Controllers							
PLC based on a Linux kernel. Real-time capable for IEC 61131-3 as well as for high-level languages such as C/C++ and Matlab® Simulink®							
	ARM Cortex A9, 2 x 800 MHz	0.5 GB	32 (1 ms)	IEC 62443-4-1 ML 3 Full		AXC F 2152	2404267
	Intel Atom E3930, 2 x 1.3 GHz	2 GB	32 (500 µs)	IEC 62443-4-1 ML 3 Full		AXC F 3152	1069208
	Intel Core i5-6300U, 2 x 2.4 GHz	8 GB	32 (500 µs)	IEC 62443-4-1 ML 3 Full	300 PROFI-safe devices	RFC 4072S	1051328
	Intel Core 5-6300U, 2x 2.4 GHz	8 GB	1 (10 ms recomm.)	–	Redundancy operation	RFC 4072R	1136419
	Intel Core i7-10700TE, 8 x 2 GHz	16 GB	128 (500 µs)	–	300 PROFI-safe devices	BPC 9102S	1246285
	Intel Celeron N3350, 2x 1.1 GHz	2 GB	32 (1 ms)	–	Preinstalled Edge software, Wi-Fi	EPC 1502	1185416
	Intel Celeron N3350, 2 x 1.1 GHz	4 GB	32 (1 ms)	–	Preinstalled Edge software, Wi-Fi	EPC 1522	1185423

	Description	Extension...	Type	Item no.
PLC extensions				
	Artificial intelligence	...to a machine learning module	AXC F XT ML1000	1259849
	Safety 1000	...to a safety-related controller	AXC F XT SPLC 1000	1159811
	Safety 3000	...to a safety-related controller	AXC F XT SPLC 3000	1160157*
	Ethernet	...with an additional Ethernet interface	AXC F XT ETH 1TX	2403115
	PROFIBUS	...for connecting a PROFIBUS network	AXC F XT PB	1091657
	Extension	...with up to three further PLCnext Control extensions	AXC F XT EXP	1139999
	INTERBUS	...for the connection of an INTERBUS remote bus	AXC F XT IB	2403018
	Extension Kit	...with a universal miniPCIe interface	AXC F XT KIT	1383116

* Item will be released mid 2023

Cloud-independent products

With our cloud-independent products, we enable the possibility of transmitting data securely and over long distances. End-to-end solutions for industrial remote communication – whether via cellular communication, Ethernet, or state-of-the-art wireless systems.



SMS relays

Monitor analog and digital values easily and securely via the cellular network. The TC MOBILE I/O X200 SMS relay keeps you up to date on the status or error state of your system, even in the field. You can send text messages via text message or email and set switching outputs, for example, to disconnect machines.

More information starting on page 28

Ethernet extenders

With Ethernet extenders, you can connect Ethernet networks economically over large distances. In Gigabit applications, you can even achieve ranges of up to 20 km. Use existing cables for sophisticated Ethernet installations to minimize investment costs.

More information starting on page 28



Wireless system

Radioline is the Phoenix Contact transmission system for extended systems and networks with up to 250 stations.

Special features include extremely easy assignment of inputs and outputs by simply turning the thumbwheel – without any programming.

More information starting on page 29





FO converters

For high-level immunity to interference and long transmission ranges in industrial applications, media converters transparently convert Ethernet data to fiber optics. The media converters allow you to bridge distances up to 80 kilometers depending on your choice of device and cable.



More information starting on page 30



Cloud-independent products

SMS relays









	Voltage supply	Analog inputs	Digital inputs	Relay outputs	Type	Item no.
Compact signaling system						
4G/LTE cellular interface, European version, switching via phone call and SMS, alerting via SMS and email, message in the event of power failure						
	DC supply (10 V DC ... 60 V DC)	2	4	4	TC MOBILE I/O X200-4G	1038567
	AC supply (93 V AC ... 250 V AC)	–	4	4	TC MOBILE I/O X200-4G AC	1038568

Extenders

	Managed/ unmanaged	Ports	On-site diagnostics	Topologies	Surge protection	Remote diagnostics	Type	Item no.
Ethernet extenders								
Overcome long ranges of up to 20 km with any 2-wire cables, plug-and-play commissioning								
	Managed	2 x SHDSL 4 x Ethernet	Display	Point-to-point, line, ring	SHDSL, integrated, can be replaced	Any location via IP	... 6004 ETH-2S	2702255
		1 x SHDSL 1 x Ethernet	LED	Point-to-point			... 4001 ETH-1S	2702253
	Unmanaged	2 x SHDSL 1 x Ethernet			Point-to-point, line, ring	–	Stationary connection via USB	... 2001 ETH-2S



	Range	Bandwidth	Cable type	Topologies	Connection	Supply function	Type	Item no.
Gigabit Ethernet extenders								
Realize Gigabit applications over any twisted pair/coaxial cable up to 1 km, plug-and-play commissioning								
	Up to 1 km	Up to 1 Gbps	Coaxial cable	Point-to-point, line, star, tree, ring	BNC female connector	PoL	... 1010 ETH COAX-G	1319319
						PoL and PoE	... 2010 ETH COAX-G	1319320
			Push-in terminal		PoL	... 1010 ETH TP-G	1319321	
					PoL and PoE	... 2010 ETH TP-G	1319322	

Wireless modules

	Function	Inputs	Outputs	Usage	Type	Item no.
Wireless modules, extension modules, and outdoor boxes						
Range up to 32 km, suitable for long distances with obstacles, transmission time typically 100 ms up to a few seconds, provider-independent						
	Outdoor box	Can be extended with up to three selectable I/O extension modules	Can be extended with up to three selectable I/O extension modules	Worldwide (wireless module selectable): 868 MHz, 900 MHz, or 2,400 MHz	RAD-RUGGED-BOX-CONF	1091638
		2 digital 1 analog	2 digital 1 analog	America 900 MHz	RAD-900-DAIO6	2702877
   	Wireless module	–	–	Europe 868 MHz	RAD-868-IFS	2904909
		–	–	North America 900 MHz	RAD-900-IFS	2901540
		–	–	Australia 900 MHz	RAD-900-IFS-AU	2702878
		–	–	Worldwide 2,400 MHz	RAD-2400-IFS	2901541
		–	–	Japan 2400 MHz	RAD-2400-IFS-JP	2702863
   	Extension module	4 digital	–	Can be combined with 2901536	RAD-DI4-IFS	2901535
		4 digital (NAMUR)	–	Can be combined with 2902811	RAD-NAM4-IFS	2316275
		8 digital	–	Can be combined with 2902811	RAD-DI8-IFS	2901539
		–	4 digital	Can be combined with 2901535	RAD-DOR4-IFS	2901536
		–	8 digital	Can be combined with 2316275 and 2901539	RAD-DO8-IFS	2902811
		2 digital 1 analog	2 digital 1 analog	Can be combined with 2901533	RAD-DAIO6-IFS	2901533
		4 analog (0/4...20 mA)	–	Can be combined with 2901538	RAD-AI4-IFS	2901537
		4 analog (0-5/10 V)	–	Can be combined with 2901538	RAD-AI4-U-IFS	2702290
		PT100 temperature module	–	Can be combined with 2901538	RAD-PT100-4-IFS	2904035
		–	4 analog	Can be combined with 2901537 , 2904035 , and 2702290	RAD-AO4-IFS	2901538

Cloud-independent products

Ethernet media converters

	FO port	Range	Data rate	Special features	Type	Item no.
Media converters for basic requirements						
Temperature range: -10°C ... +60°C, for an easy entry-level solution for converting to FO technology						
	MM SC	Up to 10 km	10/100 Mbps	<ul style="list-style-type: none"> • Store and Forward mode • Link Fault Pass-Through (LFPT) – can be activated via DIP switch 	MC 1000-MM SC	1329817*
	MM ST				MC 1000-MM ST	1329818*
	MM LC				MC 1000-MM LC	1329819*
	SM SC	Up to 20 km			MC 1000-SM20 SC	1329820*
	SM ST				MC 1000-SM20 ST	1329821*
	MM WDM A	Up to 10 km			MC 1000-MM WDM A	1329822*
	MM WDM B		MC 1000-MM WDM B		1329823*	
	MM SC	Dep. on module	10/100/1,000 Mbps		MC 1100-MM SC	1330888*
SFP	MC 1100-SFP		1330903*			
Media converters for standard requirements						
Temperature range: -40°C ... +75°C, robust metal housing, DNV-GL approval, redundant power supply						
	MM SC	Up to 10 km	10/100 Mbps	<ul style="list-style-type: none"> • Automode between Store-and-Forward and Cut-Through mode • Short latency time for real-time protocols • Link Fault Pass-Through (LFPT) – can be activated via DIP switch • Redundant power supply • Digital output for reading out alarm messages • Shipbuilding approval 	MC 1000T-MM10 SC	1329827*
	MM ST				MC 1000T-MM10 ST	1330244*
	MM LC				MC 1000T-MM10 LC	1330259*
	SM SC	Up to 20 km			MC 1000T-SM20 SC	1330262*
	SM SC	Up to 40 km			MC 1000T-SM40 SC	1330276*
	SM ST	Up to 20 km			MC 1000T-SM20 ST	1330282*
	SM WDM A	Up to 40 km			MC 1000T-SM40 WDM A	1330293*
	SM WDM B				MC 1000T-SM40 WDM B	1330296*
	MM WDM A	Up to 10 km			MC 1000T-MM10 WDM A	1330494*
	MM WDM B				MC 1000T-MM10 WDM B	1330509*
	SFP	Dep. on module			MC 1100T-SFP	1330902*
	MM SC	Up to 10 km			MC 1100T-MM10 SC	1330900*
	SM SC	Up to 20 km	MC 1100T-SM20 SC		1330898*	
Media converters for extended requirements						
Temperature range: -40°C...+75°C, rugged metal housing, DNV-GL approval, ATEX and IEC 61850-3 (IEEE 1613), redundant power supply						
	MM SC	Up to 10 km	10/100 Mbps	<ul style="list-style-type: none"> • Automode between Store-and-Forward and Cut-Through mode • Short latency time for real-time protocols • Link Fault Pass-Through (LFPT) – can be activated via DIP switch • Redundant power supply • Digital output for reading out alarm messages • Shipbuilding approval • Increased resistance to EMI • ATEX certification • IEC 61850 and IEEE 1613 for applications in the energy environment 	MC 1000E-MM10 SC	1330507*
	MM ST				MC 1000E-MM10 ST	1330504*
	MM LC				MC 1000E-MM10 LC	1330611*
	SM SC	Up to 20 km			MC 1000E-SM20 SC	1330728*
	SM SC	Up to 40 km			MC 1000E-SM40 SC	1330725*
	SM ST	Up to 20 km			MC 1000E-SM20 ST	1330723*
	SM LC	Up to 40 km			MC 1000E-SM40 LC	1330722*
	SM WDM A				MC 1000E-SM40 WDM A	1330885*
	SM WDM B	MC 1000E-SM40 WDM B			1330892*	
	MM WDM A	Up to 10 km			MC 1000E-MM10 WDM A	1330588*
	MM WDM B				MC 1000E-MM10 WDM B	1330890*
	SFP	Dep. on module			MC 1100E-SFP	1331375*
	MM SC	Up to 10 km	MC 1100E-MM10 SC		1330896*	
SM SC	Up to 20 km	MC 1100E-SM20 SC	1331377*			

** Item will be released in Q2 2023

Serial media converters

	Transmission	FO port	Range	Light wavelength	Type	Item no.
FO converters for PROFIBUS						
PROFIBUS applications up to 12 Mbps, bit retiming, bit oversampling, PROFIBUS Start Delimiter detection, redundant ring function, bar graph diagnostics of the optical link						
	Polymer / HCS	1 x FSMA	Up to 400 m	660 nm	PSI-MOS-PROFIB/FO 660 E	2708290
		2 x FSMA			PSI-MOS-PROFIB/FO 660 T	2708287
	Multimode fiberglass	1 x BFOC (ST)	Up to 3.3 km	850 nm	PSI-MOS-PROFIB/FO 850 E	2708274
		2 x BFOC (ST)			PSI-MOS-PROFIB/FO 850 T	2708261
	Singlemode fiberglass	1 x SC	Up to 45 km	1300 nm	PSI-MOS-PROFIB/FO 1300 E	2708559
		2 x SC			PSI-MOS-PROFIB/FO 1300 T	2708892
FO converters for RS-485						
RS-485 applications and Modbus, automatic data rate detection up to 500 Kbps, bar graph diagnostics of the optical link						
	Polymer / HCS	1 x FSMA	Up to 800 m	660 nm	PSI-MOS-RS485W2/FO 660 E	2708313
		2 x FSMA			PSI-MOS-RS485W2/FO 660 T	2708300
	Multimode fiberglass	1 ST port	Up to 4.2 km	850 nm	PSI-MOS-RS485W2/FO 850 E	2708339
		2 ST ports			PSI-MOS-RS485W2/FO 850 T	2708326
	Singlemode fiberglass	1 SC duplex	Up to 45 km	1300 nm	PSI-MOS-RS485W2/FO1300 E	2708562
FO converters for RS-232						
RS-232 applications, automatic data rate detection up to 115.2 Kbps, bar graph diagnostics of the optical link						
	Polymer/HCS	1 x FSMA	Up to 800 m	660 nm	PSI-MOS-RS232/FO 660 E	2708368
		2 x FSMA			PSI-MOS-RS232/FO 660 T	2708410
	Multimode fiberglass	1 ST port	Up to 4.8 km	850 nm	PSI-MOS-RS232/FO 850 E	2708371
		2 ST ports			PSI-MOS-RS232/FO 850 T	2708423
	Singlemode fiberglass	1 SC duplex	Up to 45 km	1300 nm	PSI-MOS-RS232/FO 1300 E	2708588

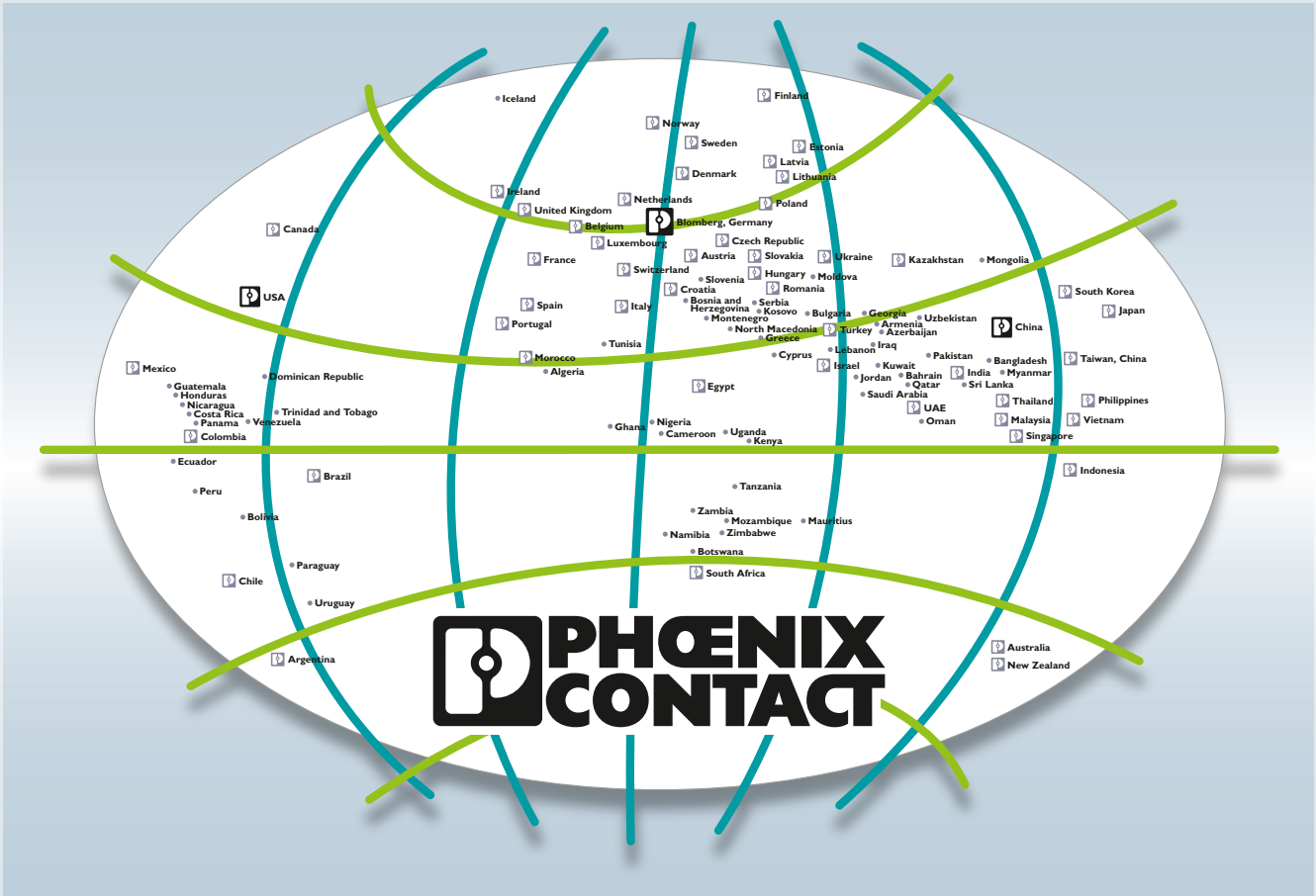

Open communication with customers and partners worldwide

Phoenix Contact is a global market leader based in Germany. We are known for producing future-oriented products and solutions for the electrification, networking, and automation of all sectors of the economy and infrastructure. With a global network reaching across more than 100 countries with over 20,000 employees, we maintain close relationships with our customers, something we believe is essential for our common success.

Our wide range of innovative products makes it easy for our customers to implement the latest technology in a variety of applications and industries. This especially applies to the target markets of energy, infrastructure, industry, and mobility.

You can find your local partner at
phoenixcontact.com