

*Knürr IT Special Catalog*  
*Networks and Data Centers*



*As at: March 2011*

# Contents

<b>Introduction</b>		Page 0.2	Content	
		Page 0.3	Complete solution from one source	
<b>Cabinets/Racks</b>		Page 1.1	Knürr DCM®	19" Heavy Duty Server Rack
		Page 1.11	Knürr Miracel®	19" Server Rack
		Page 1.23	Knürr Miracel®	19" Network Rack
		Page 1.49	Knürr SmartAisle™	Cold Aisle Containment - Knürr Miracel® as basis
		Page 1.61	Knürr CoolTherm®	19" server rack technology, water-cooled
		Page 1.65	Knürr CoolLoop®	Cooling unit for 19" rack, water-cooled
		Page 1.69	Knürr CoolAdd®	Cooling unit for 19" rack, water-cooled
		Page 1.73	Knürr CoolTrans®	Links building and server rack water circuit
		Page 1.77	Knürr Smaract®	19" Compact Rack
		Page 1.93	Knürr DoubleProRack®	19" Stand-Alone Enclosure
		Page 1.101	Knürr ConAct®	19" Network Wall Enclosure
<b>Accessories</b>	<b>Cooling</b>	Page 1.110	Knürr CoolBlast®	19" Rack Fan Unit
		Page 1.126	Knürr Filter Fan	Fan Units
<b>Cabling</b>		Page 1.128	Knürr Cable Management	
<b>System Accessories</b>		Page 1.128	Knürr System Accessories	
<b>Rack PDUs</b>		Page 2.1	Liebert MPX™	Adaptive Rack PDU
		Page 2.10	Liebert MPH™	Managed Rack PDU
		Page 2.13	Knürr DI-STRIP®	Basic Rack PDU – Overview
		Page 2.18	Knürr DI-STRIP® RM	Basic Rack PDU
		Page 2.19	Knürr DI-STRIP® M	Basic Rack PDU
		Page 2.20	Knürr DI-STRIP® HighPower®	Basic Rack PDU
		Page 2.22	Knürr DI-STRIP® TriplePower®	Basic Rack PDU
		Page 2.24	Knürr DI-STRIP® BladePower®	Basic Rack PDU
		Page 2.24	Knürr DI-STRIP® PizzaPower®	Basic Rack PDU
		Page 2.25	Knürr DI-STRIP®	Basic Rack PDU
<b>Power Supply</b>		Page 2.55	Knürr PowerTrans®	Power Distribution Rack
		Page 2.59	ENP UPS	Uninterruptible Power Supply
<b>Monitoring</b>		Page 2.75	Knürr RMS Compact II®	Checks and Controls
		Page 2.79	Liebert Nform™	Monitoring Software
		Page 2.83	Knürr @Lock®	Locking Systems
<b>Service</b>		Page 3.1	Glossary	
		Page 3.2	System Dimensioning	
		Page 3.3	Maintenance & Service	Power supply and additional equipment

For decades now **Emerson Network Power** has been a recognized global leader in the business-critical systems segment. The most successful companies in the world build on our solutions, technologies and services.



## Market-leading data center technologies for your company

**Business information is more important today than ever for companies of every size. Data centers form the backbone for business processes. And the same challenges appear in absolutely every data center. Increasing heat densities. Growing requirements for reliable power supply. Faster technological change. Cost pressure and lack of space.**

Knürr provides comprehensive products and services for all requirements – from compact racks and computer rooms, right through to global data centers.

On the basis of the specific requirements of different data centers, Emerson Network Power has developed a specific, ready-made solution – rack systems with integrated thermal management, power supply, cooling and monitoring. We also provide optional services and on-site expertise and support. We consequently ensure that you can easily order, configure, manage and implement your Knürr solution with no problems whatsoever.

### Integrated solutions. Integrated benefits. Integrated energy efficiency.

Together with Knürr and other divisions, only Emerson Network Power can provide the benefits of a fully integrated and prefabricated solution that covers all requirements – from the rack right through to the entire room. With us you get all your products and services from one single source. You can also rest assured that all components interact with one another perfectly.

- **Reliability** – Proven business-critical technologies that minimize failure sources (single points of failure) guarantee the greatest possible reliability for your IT systems. You can rest assured that your infrastructure is in good hands.
- **From one single source** – One central provider for the provision, configuration, installation and support of your products and technologies – a call is all it takes.
- **Integration** – From the rack through to the entire room – our products and services form one entirely integrated holistic system. All ready-to-use products that carry our name are configured for optimum interaction.
- **Technical support** – Where required on-site and factory-side support are provided by application specialists. In terms of numbers alone, Emerson Network Power has the world's strongest team of customer service specialists, trained directly in the factory. These people have the know-how and product knowledge to guarantee the highest possible availability and ensure fast recovery when things get serious.
- **Flexible configuration options** – Your IT requirements change continuously. Our products and technologies can be flexibly adjusted and provide you with a cost-effective option to support your growth – so the unexpected won't upset your course.
- **Energy efficiency** – This has always been one of our obligations for our customers, which is why we provide "Green IT" solutions that set standards on the ITC market. The result: a data center infrastructure that stays abreast of current and future requirements.





# Knürr DCM®

19" Server Rack System

19" Heavy Duty Rack

1.2 to 1.9



# Knürr DCM® conquers the world

## Standardization in the data center begins with the Knürr DCM®!

The Knürr DCM® is the modular building block for all “in row” applications of Emerson Network Power’s products. This means that linked racks in a rack suite work in perfect unison, as server racks, power racks, or as storage racks.

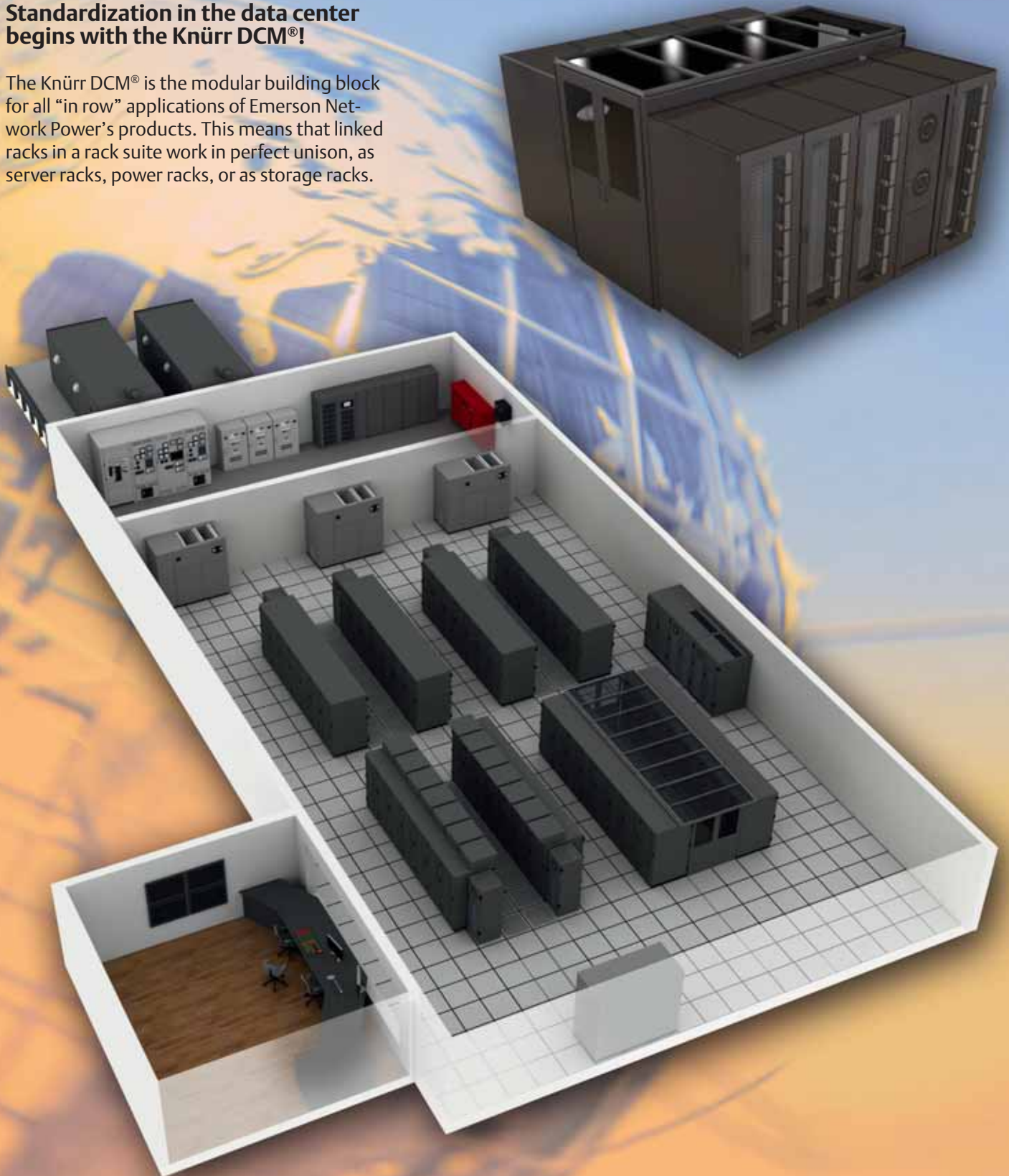

# Knürr DCM® – impressive rack dimensions



## The right rack size for every application

### ■ Knürr Data Center Module

The Knürr DCM® is the globally available rack from Emerson Network Power. Available all over the world for standardized data center planning.

### ■ Global standard

The 2,000 mm height and 1,100 mm depth rack version is the global platform for rack suites at Emerson Network Power. Cooling racks, power racks and server racks on the basis of the Knürr DCM® platform guarantee integration into the rack suite.

### ■ Metric measurements for global application

### ■ Stable and secure

DCM® earthquake-tested version available on request.



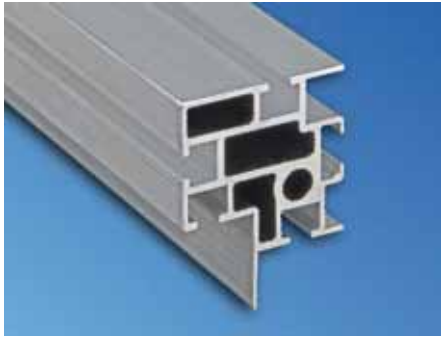

1 DCM20059



3 DCM20030



2 DCM20008

## Knürr DCM® Strong points

### 1 New Heavy Duty Rack

Increased stability over the classic Miracel® for static load of 1,500 kg and more. Use of recently designed more stable extrusions and new, heavier duty corner joints.

### 2 Threaded connection system

Dismantling the rack guarantees easy accessibility, even to the most restricted areas

### 3 Light aluminum frame

Easier, lighter transport due to lower weight

### 4 Convenient

Door mounting without tools

### 5 Low heavy duty castors

Rack also can be moved safely, when it is fully equipped

### Integrated tilt restraint

Quick and easy installation and deinstallation

### 6 Cable management

Guaranteed orderly and space-saving cable management. Adjustment to installation site; cable management can be selected from an extensive range of accessory components.

### 7 Biggest possible perforation

For improved airflow

### No more depth braces

PDUs and cable management can also be housed in the space between the 19" level and the side panel

### 8 Depth-adjustable air separation

Cold/warm separation seals on the side panels and can therefore simply be shifted in depth



4 DCM20006



5 DCM20028

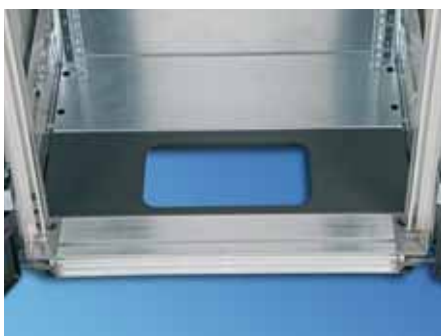

6 DCM20027

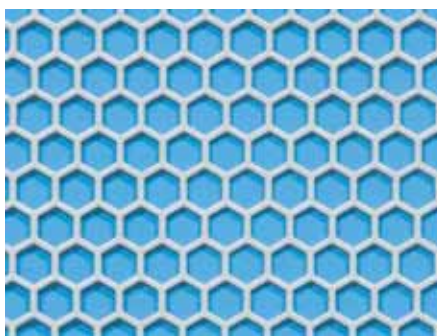

7 MIR20265





**Knürr DCM®**  
**Technical data**

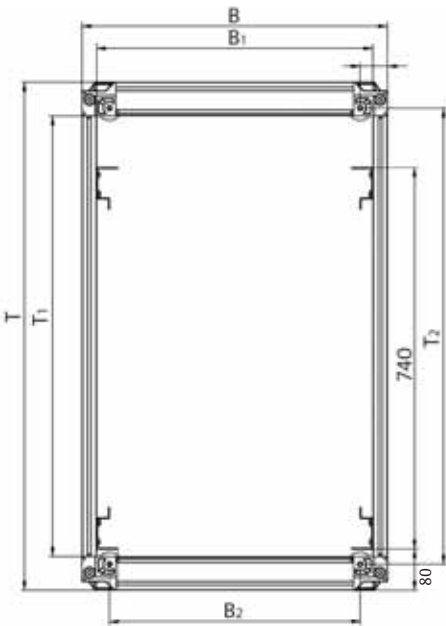

DCM20066

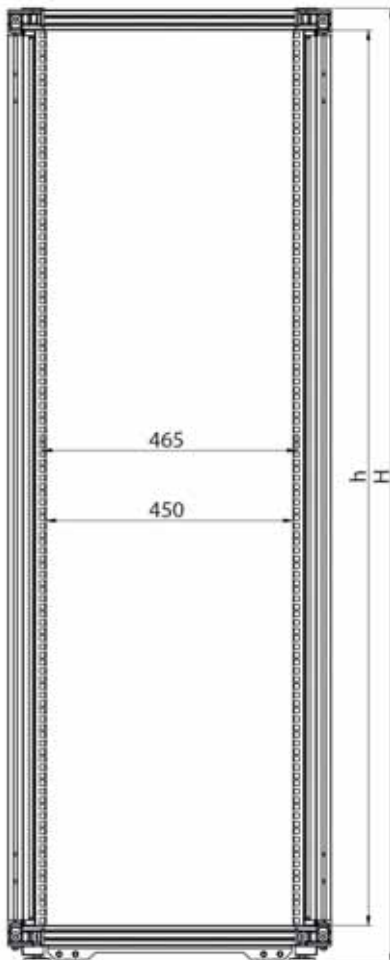

DCM

**Material**

- Extruded aluminum
- Corner piece, die-cast aluminum
- Covers, sheet steel, zinc-passivated
- Sheet steel doors

**Installation dimensions in acc. with IEC 60297-1 and IEC 60297-2**

- Height: 42 U / 47 U (1 U = 44.45 mm)
- Width: 482.6 mm (19" structure)

**Space**

- Front jumpering space, 80 mm
- Door opening angle 130° in the rack suite and 180° as individual rack

**Configurations**

- Stationary, on leveling feet
- Mobile with castor bracked and leveling feet

**Finish / Color**

- Basic rack, polished
- Visible surface of covers, powder-coated, dark gray RAL 7021

**Static load rating**

- 15,000 N (stationary model)
- 10,000 N (mobile model)

**Tests according to version**

- IP test in acc. with IEC 60529
- Earthing and protective conductor test in acc. with DIN EN 60950

Further standards and tests on request.

**Rack suites**

- To create a rack suite with "n" racks, you require:
- n-1 racks without side panels and 1 rack with side panels
  - In a rack suite, per connection you require one set of rack connectors

Nom. dim.	W	W <sub>1</sub>	W <sub>2</sub>	D	D <sub>1</sub>	D <sub>2</sub>
W 600 / D 1000	591	535	485	986	856	885
W 600 / D 1100	591	535	485	1086	956	985
W 600 / D 1200	591	535	485	1186	1056	1085
W 800 / D 1000	791	735	685	986	856	885
W 800 / D 1100	791	735	685	1086	956	985
W 800 / D 1200	791	735	685	1186	1056	1085

Nom. height	H	h
H 2000	1996	1872.60
H 2200	2218	2094.85



DCM20003

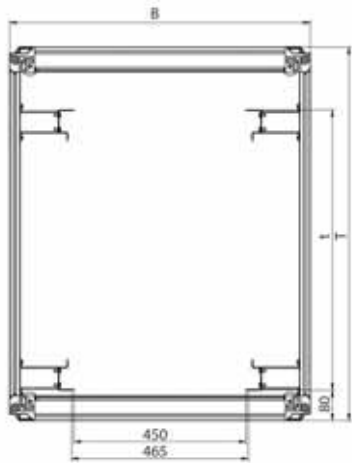

DCM20063

Section width 800 mm

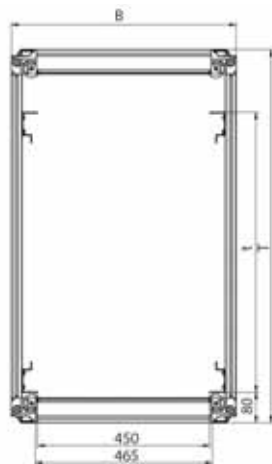

DCM20062

Section width 600 mm

Dimensions in mm: W = Width  
 H = Height  
 D = Depth  
 h = installation height  
 d = useful depth  
 L = length

U = standard height unit  
 1 U = 44.45 mm  
 UP = unit of packaging  
 kg = weight

 = Express item

Conversion: 1 mm = 0.03937 inch 1 kg = 2.2046 pound

## Knürr DCM® 19" Heavy Duty Server Rack Width 600 and 800, stationary

- Perforated front door
- Perforated rear double door
- Special 19" server extrusions for mounting all trade standard 19" servers
- Installation in acc. with IEC 297-3
- Cable entry via top cover and bottom
- Cable entry on the top cover, can be completely removed at the rear, allowing top cover removal and replacement after cabling

### ■ Jumpering space

At the front: 80 mm

### ■ Load rating

15,000 N static

### ■ Protection rating

IP 20

### ■ Tests

- Earth in acc. with DIN EN60950
- IP test in acc. with DIN 40 050 / IEC 529

### ■ Airflow

- Perforation: 83 %

### ■ Material/ Finish

- Basic rack, extruded aluminum, polished
- Corner piece, die-cast aluminum, polished
- Doors, sheet steel, powder-coated texture
- Covers, zinc-passivated sheet steel, powder-coated texture

### ■ Color

Visible surface of covers  
 RAL 7021 dark gray

### ■ Supply schedule

- 1 basic frame
- 4 19" server extrusions, sheet steel incl. U marking
- 2 side panels with quick connectors
- 1 top cover with cable entry (three-piece sliding plates, can also be opened completely)
- 1 front door, single, perforated with handle and mounting for cylinder lock
- 1 rear door, double, perforated, sheet steel, with handle and mounting for cylinder lock
- 4 leveling feet
- 1 complete earthing set (VDE 0100)

### ■ How supplied

Assembled

### ■ Note

Also order mounting adapters for 19" server extrusion for mounting Knürr accessories. (See page 1.9)

W	H	D	U	d	Model	Order no.	UP
600	2000	1000	42	740	Stationary, with side panels	01.147.712.8	1 unit
600	2000	1100	42	740	Stationary, with side panels	01.147.713.8	1 unit
600	2000	1200	42	740	Stationary, with side panels	01.147.714.8	1 unit
600	2200	1000	47	740	Stationary, with side panels	01.147.724.8	1 unit
600	2200	1100	47	740	Stationary, with side panels	01.147.725.8	1 unit
600	2200	1200	47	740	Stationary, with side panels	01.147.726.8	1 unit
600	2000	1000	42	740	Stationary, no side panels	01.147.762.8	1 unit
600	2000	1100	42	740	Stationary, no side panels	01.147.763.8	1 unit
600	2000	1200	42	740	Stationary, no side panels	01.147.764.8	1 unit
600	2200	1000	47	740	Stationary, no side panels	01.147.774.8	1 unit
600	2200	1100	47	740	Stationary, no side panels	01.147.775.8	1 unit
600	2200	1200	47	740	Stationary, no side panels	01.147.776.8	1 unit
800	2000	1000	42	740	Stationary, with side panels	01.147.720.8	1 unit
800	2000	1100	42	740	Stationary, with side panels	01.147.721.8	1 unit
800	2000	1200	42	740	Stationary, with side panels	01.147.722.8	1 unit
800	2200	1000	47	740	Stationary, with side panels	01.147.732.8	1 unit
800	2200	1100	47	740	Stationary, with side panels	01.147.733.8	1 unit
800	2200	1200	47	740	Stationary, with side panels	01.147.734.8	1 unit
800	2000	1000	42	740	Stationary, no side panels	01.147.770.8	1 unit
800	2000	1100	42	740	Stationary, no side panels	01.147.771.8	1 unit
800	2000	1200	42	740	Stationary, no side panels	01.147.772.8	1 unit
800	2200	1000	47	740	Stationary, no side panels	01.147.782.8	1 unit
800	2200	1100	47	740	Stationary, no side panels	01.147.783.8	1 unit
800	2200	1200	47	740	Stationary, no side panels	01.147.784.8	1 unit



DCM20022

## Knürr DCM® 19" Heavy Duty Server Rack Widths 600 and 800, mobile

- Perforated front door
- Perforated rear double door
- Special 19" server extrusions for mounting all trade standard 19" servers
- Components in acc. with IEC 297-3
- Mobile, heavy duty castors with high floor clearance
- Cable entry via top cover and bottom cover
- Cable entry on the top cover, can be completely removed at the rear, allowing top cover removal and replacement after cabling

**■ Jumping space**  
At the front: 80 mm

**■ Load rating**  
15,000 N static  
10,000 N mobile in data center with load

**■ Protection rating**  
IP 20

**■ Tests**  
- Earthing in acc. with VDE 0100 T 540  
- IP test in acc. with DIN 40 050 / IEC 529

**■ Airflow**  
- Perforation: 83 %

**■ Material / Finish**  
- Basic rack, extruded aluminum, polished  
- Corner piece, die-cast aluminum, polished  
- Doors, sheet steel, powder-coated texture  
- Covers, zinc-passivated sheet steel, powder-coated texture

**■ Color**  
Visible surface of covers  
RAL 7021 dark gray

**■ Supply schedule**  
1 basic frame  
4 19" server extrusions, sheet steel incl. U marking  
2 side panels with quick connectors  
1 top cover with cable entry (three-piece sliding plates, can also be opened completely)  
1 front door, single, perforated with handle and mounting for cylinder lock  
1 rear door, double, perforated, sheet steel, with handle and mounting for cylinder lock  
2 castor mounts with heavy duty castors with integrated cable entry  
4 leveling feet  
1 complete earthing set (VDE 0100)

**■ How supplied**  
Assembled

**■ Note**  
Also order mounting adapters for 19" server extrusion for mounting Knürr accessories. (See page 1.9)

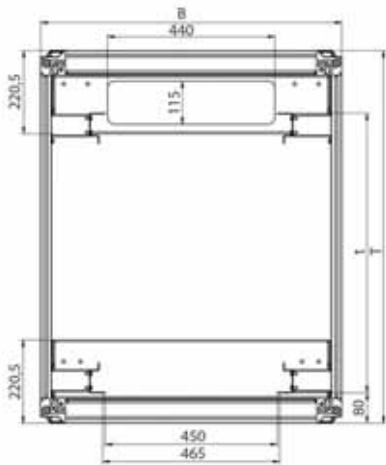

DCM20065

section width 800 mm

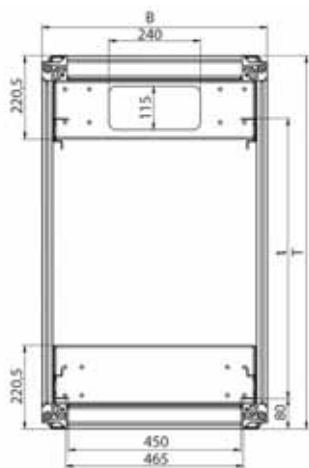

DCM20064

section width 600 mm

W	H	D	U	d	Model	Order no.	UP
600	2000	1000	42	740	Mobile, with side panels	01.147.612.8	1 unit
600	2000	1100	42	740	Mobile, with side panels	01.147.613.8	1 unit
600	2000	1200	42	740	Mobile, with side panels	01.147.614.8	1 unit
600	2200	1000	47	740	Mobile, with side panels	01.147.624.8	1 unit
600	2200	1100	47	740	Mobile, with side panels	01.147.625.8	1 unit
600	2200	1200	47	740	Mobile, with side panels	01.147.626.8	1 unit
600	2000	1000	42	740	Mobile, with side panels	01.147.662.8	1 unit
600	2000	1100	42	740	Mobile, with side panels	01.147.663.8	1 unit
600	2000	1200	42	740	Mobile, with side panels	01.147.664.8	1 unit
600	2200	1000	47	740	Mobile, with side panels	01.147.674.8	1 unit
600	2200	1100	47	740	Mobile, with side panels	01.147.675.8	1 unit
600	2200	1200	47	740	Mobile, with side panels	01.147.676.8	1 unit
800	2000	1000	42	740	Mobile, with side panels	01.147.620.8	1 unit
800	2000	1100	42	740	Mobile, with side panels	01.147.621.8	1 unit
800	2000	1200	42	740	Mobile, with side panels	01.147.622.8	1 unit
800	2200	1000	47	740	Mobile, with side panels	01.147.632.8	1 unit
800	2200	1100	47	740	Mobile, with side panels	01.147.633.8	1 unit
800	2200	1200	47	740	Mobile, with side panels	01.147.634.8	1 unit
800	2000	1000	42	740	Mobile, with side panels	01.147.670.8	1 unit
800	2000	1100	42	740	Mobile, with side panels	01.147.671.8	1 unit
800	2000	1200	42	740	Mobile, with side panels	01.147.672.8	1 unit
800	2200	1000	47	740	Mobile, with side panels	01.147.682.8	1 unit
800	2200	1100	47	740	Mobile, with side panels	01.147.683.8	1 unit
800	2200	1200	47	740	Mobile, with side panels	01.147.684.8	1 unit



DCM20037

## DCM® Heavy Duty Plinth, stationary, height 100 mm

- Stationary
- Cable entry possible from all sides
- Panels front and rear with vent slots and installation option for filter mat

■ **Load rating**  
10,000 N static

■ **Material**  
Sheet steel

■ **Finish**  
Powder-coated texture, RAL 7021

■ **Supply schedule**  
4 plinth corners with leveling  
2 plinth panels with slots  
2 plinth panels closed on the side  
Mounting material

■ **How supplied**  
Flat-packed kit

W	H	D	Model	Order no.	UP
600	100	1000		01.147.738.8	1 unit
600	100	1100		01.147.739.8	1 unit
600	100	1200		01.147.740.8	1 unit
800	100	1000		01.147.746.8	1 unit
800	100	1100		01.147.747.8	1 unit
800	100	1200		01.147.748.8	1 unit



DCM20037b

## DCM® Heavy Duty Plinth, stationary, height 200 mm

- Stationary incl. leveling option
- Cable entry possible from all sides
- Panels front and rear with vent slots and installation option for filter mat

■ **Load rating**  
10,000 N static

■ **Material**  
Sheet steel

■ **Finish**  
Powder-coated texture, RAL 7021

■ **Supply schedule**  
4 plinth corners, incl. leveling feet  
8 panels  
Mounting material

■ **How supplied**  
Flat-packed kit

W	H	D	Model	Order no.	UP
600	200	1000		01.147.788.8	1 unit
600	200	1100		01.147.789.8	1 unit
600	200	1200		01.147.790.8	1 unit
800	200	1000		01.147.796.8	1 unit
800	200	1100		01.147.797.8	1 unit
800	200	1200		01.147.798.8	1 unit

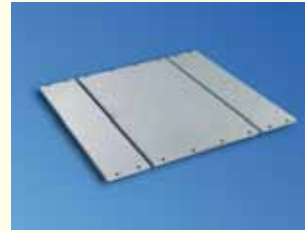

DCM20032

## DCM® Bottom Cover, 3-piece

- For covering the rack button
- For flexible cable entry on the front and rear
- For racks with castor bracket

■ **Material/ Finish**  
Sheet steel, 1.5 mm, zinc-passivated

■ **Supply schedule**  
3 bottom covers  
2 mounting brackets  
Mounting material

■ **How supplied**  
Flat-packed kit

W	H	D	Model	Order no.	UP
600		1000	No cable entry	01.147.834.0	1 unit
600		1100	No cable entry	01.147.835.0	1 unit
600		1200	No cable entry	01.147.840.0	1 unit
800		1000	No cable entry	01.147.838.0	1 unit
800		1100	No cable entry	01.147.839.0	1 unit
800		1200	No cable entry	01.147.844.0	1 unit

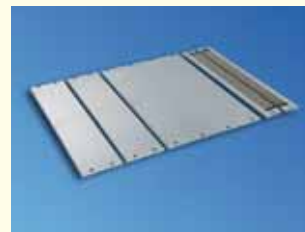

DCM20035

## DCM® bottom cover for cable entry with rubber sealing

- For covering the rack underside
- With rubber sealing for flexible cable entry on the front and rear
- For racks without castor bracket

■ **Material/ Finish**  
Sheet steel, 1.5 mm, zinc-passivated  
Sponge rubber, 50 mm x 50 mm

■ **Supply schedule**  
1 cable entry  
3 bottom covers  
2 mounting brackets  
Mounting material

■ **How supplied**  
Flat-packed kit

W	H	D	Model	Order no.	UP
600		1000	With cable entry	01.147.846.0	1 unit
600		1100	With cable entry	01.147.847.0	1 unit
600		1200	With cable entry	01.147.852.0	1 unit
800		1000	With cable entry	01.147.850.0	1 unit
800		1100	With cable entry	01.147.851.0	1 unit
800		1200	With cable entry	01.147.856.0	1 unit



DCM20026

## Tilt Restraint for DCM®

- Quick and easy mounting and removal
- Integrated in the DCM rack
- Use only as required

■ **Supply schedule**  
2 anti-tilt restrainers

■ **How supplied**  
Flat-packed kit

W	H	D	U	Model	Order no.	UP
					01.147.641.9	1 unit



DCM20052

## DCM® Mounting Adapter for 19" Server Extrusion

- For mounting Knürr standard components (storage shelves, drawers, chassis runners, keyboard runners, etc.) in 19" installation space

■ **Material**  
Sheet steel, zinc-passivated

■ **Supply schedule**  
4 adapters

W	H	D	U	h	d	kg	Model	Order no.	UP
44	44	44	1					01.147.640.9	1 set



DCM20040

## DCM® PDU Bracket

- For orderly cable management in the rack
- For hanging in trade-standard PDUs without tools
- Especially ideal for Knürr and Liebert PDUs

■ **Material/Finish**  
Sheet steel 1.5 mm, zinc passivated, powder-coated

■ **Color**  
RAL 7021 dark gray

■ **Dimensions**  
L 150 x W 28 mm:

■ **Supply schedule**  
1 PDU bracket  
Mounting material

■ **How supplied**  
Flat-packed kit



DCM20009

DCM20010

W	H	D	U	Model	Order no.	UP
150	2000	25	41		01.147.816.8	1 set
150	2200	25	47		01.247.817.8	1 set

**Dimensions in mm:** W= Width  
H = Height  
D = Depth  
h = installation height  
d = useful depth  
L = length

U = standard height unit  
1 U = 44.45 mm  
UP = unit of packaging  
kg = weight

 = Express item

**Conversion:** 1 mm = 0.03937 inch 1 kg = 2.2046 pound

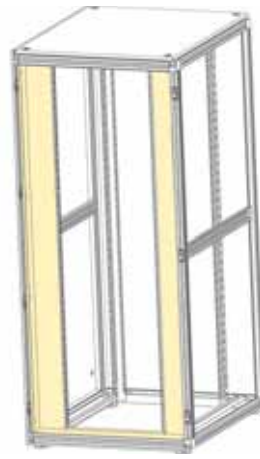

LUF20033a

## DCM® air partitioning, closed

- Quick and easy cold/warm area separation upgrade in the rack
- Side panels closed
- Screwed on the side on the 19" extrusions
- Sealing to the side panels or to the same level in the linked rack with foam elements, consequently stepless depth adjustable

■ **Material**  
Sheet steel

■ **Cross brace finish/color**  
Powder-coated, RAL 7021, dark gray  
Texture

■ **Supply schedule**  
2 side panels, left/right  
2 panels, top/bottom  
Mounting material

■ **How supplied**  
Flat-packed kit

W	H	D	Model	Order no.	UP
600	2000	20	No cut-outs, for racks without castor bracket	01.147.898.8	1 unit
600	2000	20	No cut-outs, for racks without castor bracket	01.147.901.8	1 unit
600	2200	20	No cut-outs, for racks without castor bracket	01.147.899.8	1 unit
600	2200	20	No cut-outs, for racks without castor bracket	01.147.902.8	1 unit
800	2000	20	No cut-outs, for racks without castor bracket	01.147.889.8	1 unit
800	2000	20	No cut-outs, for racks without castor bracket	01.147.895.8	1 unit
800	2200	20	No cut-outs, for racks without castor bracket	01.147.890.8	1 unit
800	2200	20	No cut-outs, for racks without castor bracket	01.147.896.8	1 unit

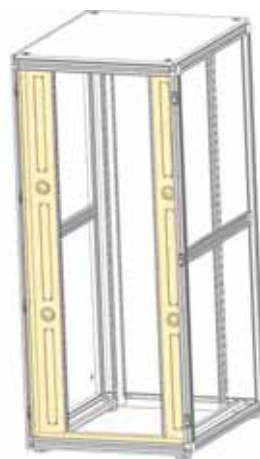

LUF20033b

## DCM® air partitioning with 3x 1 U panels, vertical

- Quick and easy cold/warm area separation upgrade in the rack
- Side panels with 2 cut-outs each for cable routing
- 3 x 1 U cut-outs, covered with panels
- Screwed on the side on the 19" extrusions
- Sealing to the side panels or to the same level in the linked rack with foam elements, consequently stepless depth adjustable

■ **Material**  
Sheet steel

■ **Cross brace finish/color**  
Powder-coated texture, RAL 7021, dark gray

■ **Supply schedule**  
2 side panels, left/right  
2 panels, top/bottom  
Mounting material

■ **How supplied**  
Flat-packed kit

W	H	D	Model	Order no.	UP
800	2000	20	3x 1 U panels, for racks with castor bracket	01.147.904.8	1 unit
800	2000	20	3x 1 U panels, for racks with castor bracket	01.147.907.8	1 unit
800	2200	20	3x 1 U panels, for racks with castor bracket	01.147.905.8	1 unit
800	2200	20	3x 1 U panels, for racks with castor bracket	01.147.908.8	1 unit



*Knürr Miracel®*



# Knürr Miracel®

19" Server Rack Platform

1.12 to 1.22



## 19" Server Rack:

### Knürr Miracel®

Strong points 1.13

### Knürr Miracel® ASP

ASP/Server Rack 1.16

### Knürr Miracel®

Server Rack 1.18

### Knürr Miracel® Accessories

Vertical Panel 1.21

Cable Tray 1.21

Support Bracket 1.21

Plinth 1.21

Combi Lock 1.22

Lock Set 1.22

Extension Kit 1.22





**Knürr Miracel®  
Strong points**



1 MIR20265



2 MIR20054

- 1 Different concepts and designs for airflow from front to rear. 83% perforation level guarantees optimum airflow.
- 2 Optional tilt restraint provides safety for service personnel. Also available integrated into the plinth.
- 3 Different variants for cable management enable adjustment to the set-up conditions.
- 4 Special server extrusions guarantee easy mounting of 19" servers of all manufacturers.



Glass door example

1 MIR00407

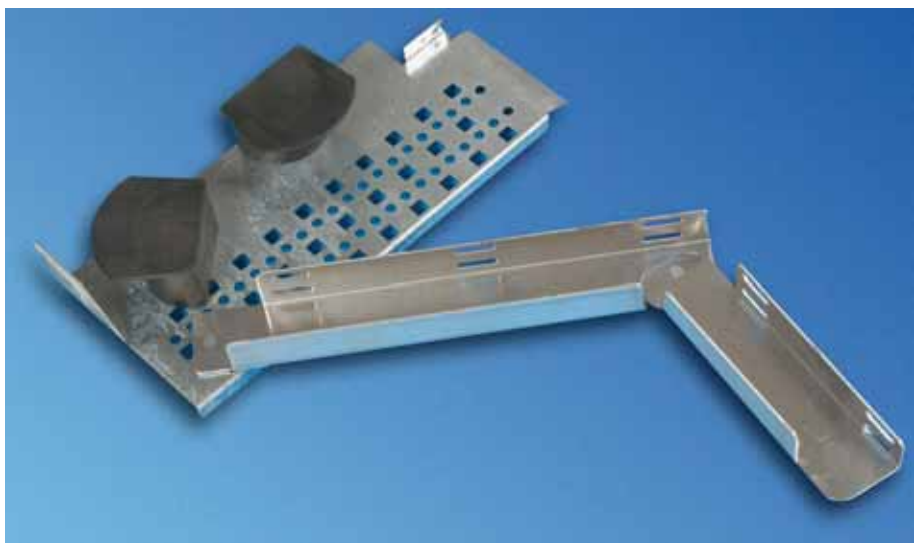

3 MIR20058



2 MIR20053



4 MIR20082

**Proven safety with airflow measurements in the thermal management lab**



TEC00279

Knürr products meet the requirements of most environmental influences: thermal, chemical and mechanical

- IP requirements
- Electro-Magnetic Compatibility
- Corrosive resistance
- Earthquake stability
- Environmental tests

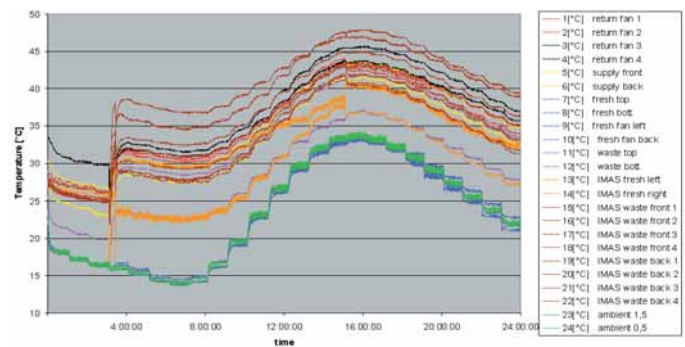

MIR20130

**Knürr Thermal Management Lab**  
Measurements, calculations and tests

- Internal dimensions (3.0 x 3.0 x 3.0) m<sup>2</sup>
- Temperature range -45 to 60 °C
- Humidity range 10% bis 95%

**Airflow and heat simulation**

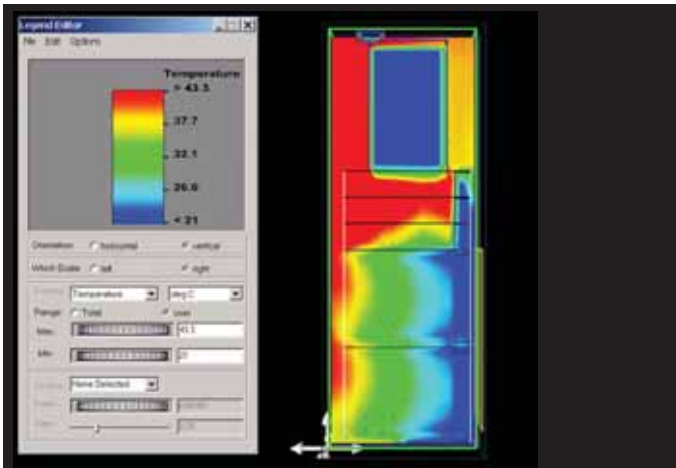

MIR20128

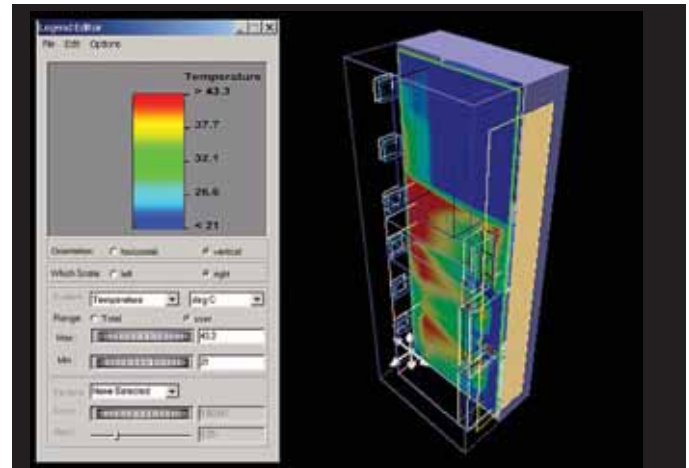

MIR20129

Knürr server racks as requested by the customer



MIR20125

Knürr Showroom





MIR20318

## Knürr Miracel® 19" ASP Rack/19" Server Rack Widths 600 mm and 800 mm, front door with perforations

- Basic version without plinth; can also be ordered if required
- With special 19" server extrusions for mounting trade standard servers
- With perforated doors on the front and rear for optimal airflow

**Jumping space**  
At the front: 85.5 mm

**Load rating**  
5000 N static

**Protection rating**  
IP 20

**Airflow circulation**  
Perforation level: 83%

- Tests**
- Earthing in acc. with VDE 0100 T 540
  - Vibration test in acc. with MIL-STD 810 E
  - IP test in acc. with DIN 40 050 / IEC 529

- Material/ Finish**
- Basic rack, extruded aluminum, polished
  - Corner piece, die-cast aluminum
  - Multifunctional braces and 19" bracket extrusions, sheet steel, zinc-passivated
  - Visible surface of the cover, powder-coated texture

- Color**
- Final digit of order number .1:  
Visible surface of covers, RAL 7035 light gray
- Final digit of order number .8:  
Visible surfaces of the covers, RAL 7021 dark gray

- Supply schedule**
- 1 basic frame
  - 4 19" server sheet steel mounting hole extrusions
  - 2 perforated doors (perforation: 83%)
  - 2 side panels
  - 1 top cover, closed
  - 1 complete earthing set
  - 1 complete locking set

- How supplied**  
Assembled

- Note**  
Also order mounting adapter for 19" server extrusion for mounting Knürr accessories (see page 1.39)

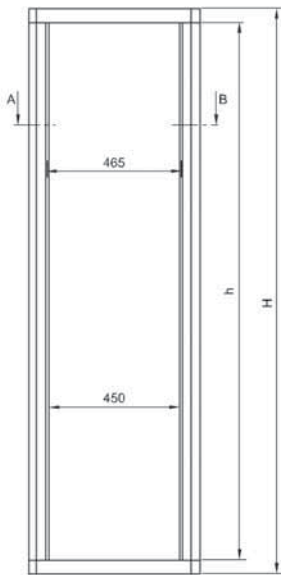

MIR20313

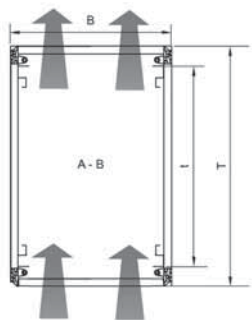

MIR20313

**Dimensions in mm:** W = Width, H = Height, D = Depth, h = installation height, d = useful depth, L = length, U = standard height unit, 1 U = 44.45 mm, UP = unit of packaging, kg = weight, = Express item

**Conversion:** 1 mm = 0.03937 inch, 1 kg = 2.2046 pound

W	H	D	U	h	d	kg	Model	Order no.	UP
600	2000	900	41	1852	740	87	RAL 7035	01.127.933.1	1 unit
600	2000	900	41	1852	740	87	RAL 7021	01.127.933.8	1 unit
600	2200	900	46	2052	740	93	RAL 7035	01.127.934.1	1 unit
600	2200	900	46	2052	740	93	RAL 7021	01.127.934.8	1 unit
600	2000	1000	41	1852	740	91	RAL 7035	01.127.935.1	1 unit
600	2000	1000	41	1852	740	91	RAL 7021	01.127.935.8	1 unit
600	2200	1000	46	2052	740	97	RAL 7035	01.127.936.1	1 unit
600	2200	1000	46	2050	740	97	RAL 7021	01.127.936.8	1 unit
600	2000	1200	41	1852	740	100	RAL 7035	01.128.310.1	1 unit
600	2000	1200	41	1852	740	100	RAL 7021	01.128.310.8	1 unit
600	2200	1200	46	2052	740	110	RAL 7035	01.128.311.1	1 unit
600	2200	1200	46	2052	740	110	RAL 7021	01.128.311.8	1 unit
600	2000	900	41	1852	740	74	No side panels, RAL 7035	01.127.980.1	1 unit
600	2000	900	41	1852	740	74	No side panels, RAL 7021	01.127.980.8	1 unit
600	2200	900	46	2052	740	79	No side panels, RAL 7035	01.127.981.1	1 unit
600	2200	900	46	2052	740	79	No side panels, RAL 7021	01.127.981.8	1 unit
600	2000	1000	41	1852	740	78	No side panels, RAL 7035	01.127.982.1	1 unit
600	2000	1000	41	1852	740	78	No side panels, RAL 7021	01.127.982.8	1 unit
600	2200	1000	46	2052	740	82	No side panels, RAL 7035	01.127.983.1	1 unit
600	2200	1000	46	2050	740	82	No side panels, RAL 7021	01.127.983.8	1 unit
800	2000	1000	41	1852	740	99	RAL 7035	01.128.314.1	1 unit
800	2000	1000	41	1852	740	99	RAL 7021	01.128.314.8	1 unit
800	2200	1000	46	2052	740	108	RAL 7035	01.128.315.1	1 unit
800	2200	1000	46	2052	740	108	RAL 7021	01.128.315.8	1 unit
800	2000	1200	41	1852	740	108	RAL 7035	01.128.316.1	1 unit
800	2000	1200	41	1852	740	108	RAL 7021	01.128.316.8	1 unit
800	2200	1200	46	2052	740	116	RAL 7035	01.128.317.1	1 unit
800	2200	1200	46	2052	740	116	RAL 7021	01.128.317.8	1 unit



MIR20319

**Knürr Miracel® 19" ASP Rack, Server Rack**  
**Width 600 mm, doors with perforation, with mobile plinth and tilt restraint**

- Basic version with mobile plinth, integrated pull-out tilt restraint
- With special 19" server extrusions for mounting trade standard servers, such as Compaq, Dell, Sun, IBM
- With perforated doors on the front and rear for optimal airflow, honeycomb shaped, perforation, 83% airflow

■ **Jumpering space**  
 At the front: 85.5 mm

■ **Load rating**  
 5000 N static

■ **Protection rating**  
 IP 20

■ **Airflow circulation**  
 Perforation level: 83%

■ **Tests**  
 - Earthing in acc. with VDE 0100 T 540  
 - Vibration test in acc. with MIL-STD 810 E  
 - IP test in acc. with DIN 40 050 / IEC 529

■ **Material/ Finish**  
 - Basic rack, extruded aluminum, polished  
 - Corner piece, die-cast aluminum  
 - Multifunctional braces and 19" extrusions, sheet steel, zinc-passivated  
 - Visible surface of the cover powder-coated texture

■ **Color**  
 Final digit of order number .1:  
 Visible surface of covers, RAL 7035 light gray  
 Final digit of order number .8:  
 Visible surfaces of the covers, RAL 7021 dark gray

■ **Supply schedule**  
 1 basic frame  
 4 19" server sheet steel mounting hole extrusions  
 2 perforated doors (perforation: 83%)  
 2 side panels  
 1 top cover with cable entry  
 1 complete earthing set  
 1 mobile plinth with tilt restraint

■ **How supplied**  
 Assembled

■ **Note**  
 Also order mounting adapter for 19" server extrusion for mounting Knürr accessories (see page 1.39)

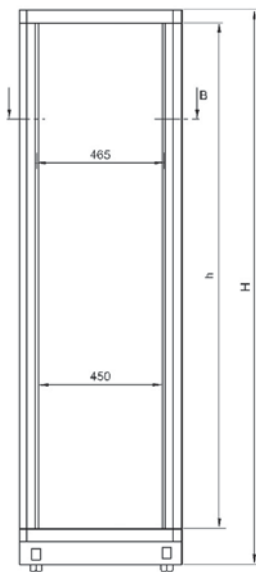

MIR20186

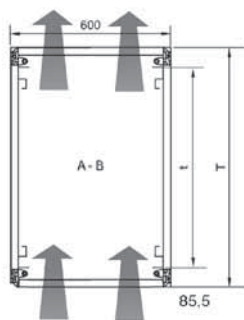

MIR20186

W	H	D	U	h	d	kg	Model	Order no.	UP
600	2100	900	41	1852	740	97	With side panels, RAL 7035	<b>01.127.925.1</b>	1 unit
600	2100	900	41	1852	740	97	With side panels, RAL 7021	<b>01.127.925.8</b>	1 unit
600	2100	1000	41	1852	740	102	With side panels, RAL 7035	<b>01.127.926.1</b>	1 unit
600	2100	1000	41	1852	740	102	With side panels, RAL 7021	<b>01.127.926.8</b>	1 unit
600	2100	900	41	1852	740	84	No side panels, RAL 7035	<b>01.127.928.1</b>	1 unit
600	2100	900	41	1852	740	84	No side panels, RAL 7021	<b>01.127.928.8</b>	1 unit
600	2100	1000	41	1852	740	89	No side panels, RAL 7035	<b>01.127.929.1</b>	1 unit
600	2100	1000	41	1852	740	89	No side panels, RAL 7021	<b>01.127.929.8</b>	1 unit

**Dimensions in mm:** W = Width, H = Height, D = Depth, h = installation height, d = useful depth, L = length, U = standard height unit (1 U = 44.45 mm), UP = unit of packaging, kg = weight,  = Express item

**Conversion:** 1 mm = 0.03937 inch, 1 kg = 2.2046 pound



MIR20262

**Auch in RAL 7021  
Schwarzgrau**

## Knürr Miracel® 19" Server Rack Width 600, mobile, glass front door

- With fixed 19" installation on the front and rear for components in accordance with IEC297-3
- Prepared for mounting trade standard servers with special server extrusions
- Cable entry via plinth
- Door opening angle 180°
- Airflow from the front to the rear with recessed glass panel on the front door and perforation on the rear doors

**Jumping space**  
At the front: 85.5 mm

**Load rating**  
5000 N static

**Airflow circulation**  
1500 cm<sup>2</sup> with 41 U  
1700 cm<sup>2</sup> with 46 U

- Tests**
- Earthing in acc. with VDE 0100 T 540
  - Vibration test in acc. with MIL-STD 810 E
  - IP test in acc. with DIN 40 050 / IEC 529

- Material/ Finish**
- Basic rack, extruded aluminum, polished
  - Corner piece, die-cast aluminum, polished
  - Covers, zinc-passivated sheet steel, powder-coated texture
  - Doors, sheet steel, powder-coated texture, glass infill, front door, single safety glass panel, 4 mm
  - Multifunctional braces, sheet steel, zinc-plated

- Color**
- Final digit of order number .1:  
Visible surface of covers, RAL 7035 light gray
- Final digit of order number .8:  
Visible surfaces of the covers, RAL 7021 dark gray

- Supply schedule**
- 1 basic frame
  - 4 19" sheet steel server extrusions
  - 2 side panels with quick connectors
  - 1 top cover, closed
  - 1 front door with single safety glass panel
  - 1 rear door, sheet steel with perforation, large air intake cross section
  - 1 mobile plinth with rear cable entry and leveling feet
  - 1 complete earthing set
  - 1 complete locking set

- How supplied**  
Assembled

- Note**  
Also order mounting adapter for 19" server extrusion for mounting Knürr accessories (see page 1.39)

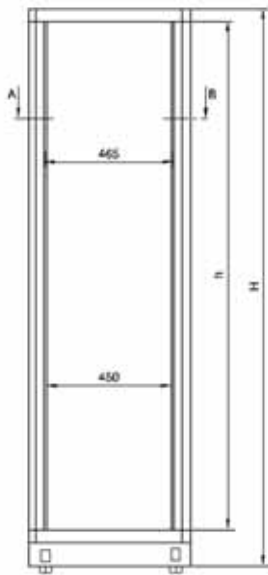

MIR20288

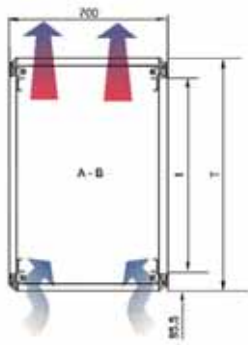

MIR20288

W	H	D	U	h	d	kg	Model	Order no.	UP
600	2100	900	41	1852	740	120	RAL7035	01.128.300.1	1 unit
600	2100	900	41	1852	740	120	RAL7021	01.128.300.8	1 unit
600	2300	900	46	2052	740	135	RAL7035	01.128.301.1	1 unit
600	2300	900	46	2052	740	135	RAL7021	01.128.301.8	1 unit
600	2100	1000	41	1852	740	127	RAL7035	01.128.302.1	1 unit
600	2100	1000	41	1852	740	127	RAL7021	01.128.302.8	1 unit
600	2300	1000	46	2052	740	144	RAL7035	01.128.303.1	1 unit
600	2300	1000	46	2052	740	144	RAL7021	01.128.303.8	1 unit

**Dimensions in mm:** W = Width  
H = Height  
D = Depth  
h = installation height  
d = useful depth  
L = length

U = standard height unit  
1 U = 44.45 mm  
UP = unit of packaging  
kg = weight

= Express item

**Conversion:** 1 mm = 0.03937 inch 1 kg = 2.2046 pound



MIR20319

## Knürr Miracel® 19" Server Rack Width 700, doors with perforation

- Front door with large area perforation for ventilation
- Prepared for side cable management with asymmetric layout of the extrusions
- Front, on the side, 3 x 2 U additional 19" installation space

**■ Jumping space**  
At the front: 85.5 mm

**■ Protection rating**  
IP 20

**■ Airflow circulation**  
Perforation level: 83%

- Material/ Finish**
- Basic rack, extruded aluminum, polished
  - Corner piece, die-cast aluminum, polished
  - Covers, zinc-passivated sheet steel, powder-coated texture
  - Doors, sheet steel, powder-coated texture
  - Multifunctional braces and 19" extrusions, sheet steel, zinc-passivated

**■ Color**

- Final digit of order number .1:  
Visible surface of covers, RAL 7035 light gray
- Final digit of order number .8:  
Visible surfaces of the covers, RAL 7021 dark gray

**■ Supply schedule**

- 1 basic frame
- 4 19" sheet steel server extrusions
- 1 panel, side with 3 x 2 HU vertical installation space
- 2 side panels
- 1 top cover, closed
- 1 front door with large area perforation
- 1 rear door with large area perforation
- 1 mobile plinth with rear cable entry and leveling feet
- 1 complete earthing set
- 1 complete locking set

**■ How supplied**

Assembled

**■ Note**

Also order mounting adapter for 19" server extrusion for mounting Knürr accessories (see page 1.39)

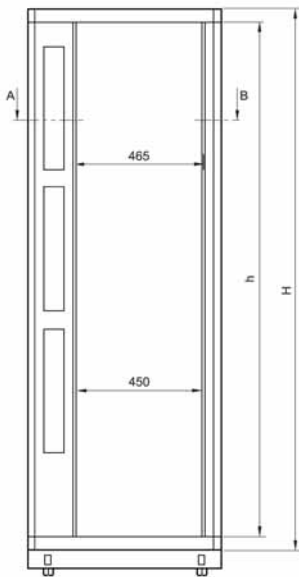

MIR20279

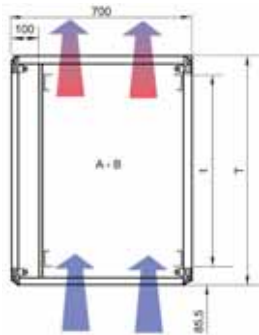

MIR20279

W	H	D	U	h	d	kg	Model	Order no.	UP
700	2100	900	41	1852	740	100	RAL 7035	01.127.960.1	1 unit
700	2100	900	41	1852	740	100	RAL 7021	01.127.960.8	1 unit
700	2300	900	46	2052	740	107	RAL 7035	01.127.961.1	1 unit
700	2300	900	46	2052	740	107	RAL 7021	01.127.961.8	1 unit
700	2100	1000	41	1852	740	104	RAL 7035	01.127.962.1	1 unit
700	2100	1000	41	1852	740	104	RAL 7021	01.127.962.8	1 unit
700	2300	1000	46	2052	740	111	RAL 7035	01.127.963.1	1 unit
700	2300	1000	46	2052	740	111	RAL 7021	01.127.963.8	1 unit

Dimensions in mm: W = Width, H = Height, D = Depth, h = installation height, d = useful depth, L = length, U = standard height unit, 1 U = 44.45 mm, UP = unit of packaging, kg = weight,  = Express item

Conversion: 1 mm = 0.03937 inch, 1 kg = 2.2046 pound



MIR20320

## Knürr Miracel® 19" Server Rack Width 700, front glass door

- Front door with single safety glass panel and opening for air intake
- Prepared for side cable management with asymmetric layout of the extrusions
- Side, patented cable management saves on a high portion of the cable lengths required for extension
- Support brackets are required at the respective positions for mounting servers etc.
- The cable trays with swivel arm are prepared for mounting and routing cables without cable ties

■ **Jumping space**  
At the front: 85.5 mm

■ **Protection rating**  
IP 20

- **Material / Finish**
- Basic rack, extruded aluminum, polished
  - Corner piece, die-cast aluminum, polished
  - Covers, zinc-passivated sheet steel, powder-coated texture
  - Doors, sheet steel, powder-coated texture, glass infill, front door, single safety glass panel, 4 mm
  - Multifunctional braces and 19" extrusions, sheet steel, zinc-passivated

■ **Color**  
RAL 7035 light gray

- **Supply schedule**
- 1 basic frame
  - 4 19" sheet steel mounting hole server extrusions
  - 2 side panels
  - 1 top cover, closed
  - 1 front door with single safety glass panel and openings for air intake
  - 1 rear door with large area perforation
  - 1 mobile plinth with rear cable entry and leveling feet
  - 6 cable trays with swivel arm (7 with 46 U)
  - 4 19"- support brackets, 2 U (5 with 46 U) (BN 01.132.053.9)
  - 2 19"- support brackets, 3 U (2 with 46 U) (BN 01.132.054.9)
  - 1 complete earthing set
  - 1 complete locking set

■ **How supplied**  
Assembled

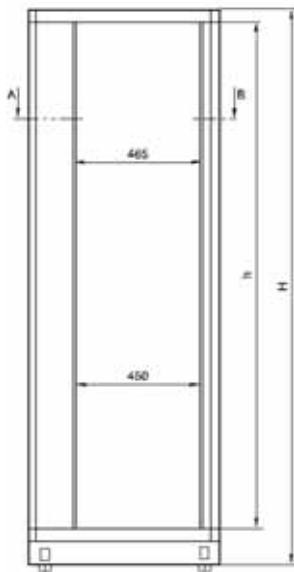

MIR20280

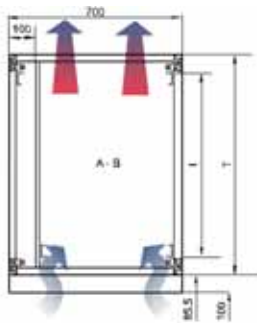

MIR20280

W	H	D	U	h	d	kg	Model	Order no.	UP
700	2100	900	41	1852	740	124		01.132.043.1	1 unit
700	2300	900	46	2052	740	133		01.132.044.1	1 unit

**Dimensions in mm:** W = Width  
H = Height  
D = Depth  
h = installation height  
d = useful depth  
L = length

U = standard height unit  
1 U = 44.45 mm  
UP = unit of packaging  
kg = weight

 = Express item

**Conversion:** 1 mm = 0.03937 inch 1 kg = 2.2046 pound





MIR20059

### Trim for 19" vertical installation, 3 x 2 U

- For installation in W 700 server racks with asymmetric layout of the 19" extrusions

- **Material**  
Sheet steel, 1.5 mm
- **Finish**  
Powder-coated, RAL 7035
- **Installation**  
Can be mounted on the left rack side 19" vertical installation, 3 x 2 U  
Max. depth of installation components, 300 mm  
(only for installation in server rack BN 01.132.043.1 / 01.132.044.1)
- **Supply schedule**  
1 trim  
Mounting material
- **How supplied**  
Flat-packed kit

W	H	D	U	h	d	kg	Model	Order no.	UP
			41				Left	01.132.048.1	1 unit
			46				Left	01.132.049.1	1 unit



MIR20058

### Cable Tray

- For carrying light installation equipment (max. 5 kg)
- For orderly storage of excess cables
- Only for installation in server rack BN 01.132.043.1 / 01.132.044.1

- **Supply schedule**  
1 storage tray  
Mounting material
- **How supplied**  
Flat-packed kit

W	H	D	U	h	d	kg	Model	Order no.	UP
								01.132.050.9	1 unit
							With swivel arm	01.132.051.9	1 unit



MIR20106

### Support Bracket

- Only for server rack B 700 with BN 01.132.043.1 / 01.132.044.1
- For mounting chassis on the 19" level with 4 fixing points

W	H	D	U	h	d	kg	Model	Order no.	UP
			2					01.132.053.9	1 unit
			3					01.132.054.9	1 unit

Dimensions in mm: W = Width U = standard height unit  
 H = Height 1 U = 44.45 mm  
 D = Depth UP = unit of packaging  
 h = installation height kg = weight  
 d = useful depth  
 L = length = Express item

Conversion: 1 mm = 0.03937 inch 1 kg = 2.2046 pound



MIR20050

### Knürr Miracel® Plinth, mobile and stationary with tilt restraint, height 100 mm

- **Type 1:** mobile  
**Type 2:** fixed
- Cable entry possible on the rear
- **Load rating**  
5000 N static
- **Material**  
Sheet steel, 2 mm
- **Finish / Color**  
powder-coated texture, RAL 7035 light gray
- **Supply schedule, type 1:**  
1 plinth frame  
2 fixed castors with snib  
2 swivel castors  
4 leveling feet  
1 tilt restraint  
Mounting material
- **Supply schedule, type 2:**  
1 plinth frame  
4 leveling feet  
1 tilt restraint  
Mounting material
- **How supplied**  
Flat-packed kit



MIR20053



MIR20260

MIR20261

W	H	D	U	h	d	kg	Model	Order no.	UP
600	100	900					Type 1, mobile	01.127.260.1	1 unit
600	100	900					Type 1, mobile	01.127.260.8	1 unit
700	100	900					Type 1, mobile	01.127.261.1	1 unit
700	100	900					Type 1, mobile	01.127.261.8	1 unit
800	100	900					Type 1, mobile	01.127.262.1	1 unit
800	100	900					Type 1, mobile	01.127.262.8	1 unit
600	100	1000					Type 1, mobile	01.127.263.1	1 unit
600	100	1000					Type 1, mobile	01.127.263.8	1 unit
700	100	1000					Type 1, mobile	01.127.264.1	1 unit
700	100	1000					Type 1, mobile	01.127.264.8	1 unit
800	100	1000					Type 1, mobile	01.127.265.1	1 unit
800	100	1000					Type 1, mobile	01.127.265.8	1 unit
600	100	1200					Type 1, mobile	01.127.266.1	1 unit
600	100	1200					Type 1, mobile	01.127.266.8	1 unit
800	100	1200					Type 1, mobile	01.127.268.1	1 unit
800	100	1200					Type 1, mobile	01.127.268.8	1 unit
600	100	900					Type 2, stationary	01.127.270.1	1 unit
600	100	900					Type 2, stationary	01.127.270.8	1 unit
700	100	900					Type 2, stationary	01.127.271.1	1 unit
700	100	900					Type 2, stationary	01.127.271.8	1 unit
800	100	900					Type 2, stationary	01.127.272.1	1 unit
800	100	900					Type 2, stationary	01.127.272.8	1 unit
600	100	1000					Type 2, stationary	01.127.273.1	1 unit
600	100	1000					Type 2, stationary	01.127.273.8	1 unit
700	100	1000					Type 2, stationary	01.127.274.1	1 unit
700	100	1000					Type 2, stationary	01.127.274.8	1 unit
800	100	1000					Type 2, stationary	01.127.275.1	1 unit
800	100	1000					Type 2, stationary	01.127.275.8	1 unit
600	100	1200					Type 2, stationary	01.127.276.1	1 unit
600	100	1200					Type 2, stationary	01.127.276.8	1 unit
800	100	1200					Type 2, stationary	01.127.278.1	1 unit
800	100	1200					Type 2, stationary	01.127.278.8	1 unit



MIR20051

## Tilt Restraint for Miracel® Racks Quick assembly system

- For fixing on the front vertical posts of all variants of MIRACEL racks
- Quick and easy mounting and removal without tools
- Use only as required

- **Supply schedule**  
2 Anti-tilt restrainers
- **How supplied**  
Flat-packed kit

W	H	D	U	h	d	kg	Model	Order no.	UP
								01.127.310.9	1 unit



MIR20095

## Combi Lock

- Mechanical solution for a high-grade lock system
- Access either via a three digit code that can be individually set on the handle or via a master key that enables access to the rack independently of the code setting
- Suitable for Miracel rack single doors with swing handle
- Later upgrade without mechanical alteration also possible

W	H	D	U	h	d	kg	Model	Order no.	UP
								01.137.013.9	1 unit



MIR00066

## Door Locking Set

- **Supply schedule**  
1 lock set  
2 keys (half-cylinder)
- **Note**  
Further cylinder locks on request!

W	H	D	U	h	d	kg	Model	Order no.	UP
								05.041.299.9	1 unit



MIR00069

## Complete Locking Set

- **Supply schedule**  
2 cylinders with 2 keys each  
2 lockable fasteners for side panel with 2 keys each

W	H	D	U	h	d	kg	Model	Order no.	UP
								01.130.940.9	1 unit



MIR20092

## Miracel® Extension Kit, 100 mm

- For extending rack depths, even at later stages
- Can be used in combination with doors (cannot be used for rear panel)
- Additional cabling space, space for airflow etc. can be easily generated

- **Material**  
Sheet steel
- **Finish/ Color**  
Powder-coated texture, RAL 7035

- **Supply schedule**  
2 trims, vertical  
1 horizontal trim, top  
Extension adapter  
Mounting material

- **How supplied**  
Flat-packed kit

- **Note**  
With use of double doors, please also order lock bracket set: Order no. 01.127.649.9



MIR20273



MIR20274

W	H	D	U	h	d	kg	Model	Order no.	UP
600	1200	23						01.127.550.1	1 unit
600	1800	37						01.127.553.1	1 unit
600	2000	41						01.127.554.1	1 unit
600	2200	46						01.127.555.1	1 unit
700	1800	37						01.127.559.1	1 unit
700	2000	41						01.127.560.1	1 unit
700	2200	46						01.127.561.1	1 unit
800	1200	23						01.127.562.1	1 unit
800	1800	37						01.127.565.1	1 unit
800	2000	41						01.127.566.1	1 unit
800	2200	46						01.127.567.1	1 unit

**Dimensions in mm:** W = Width  
H = Height  
D = Depth  
h = installation height  
d = useful depth  
L = length  
U = standard height unit  
1 U = 44.45 mm  
UP = unit of packaging  
kg = weight  
Express item

**Conversion:** 1 mm = 0.03937 inch 1 kg = 2.2046 pound

# Knürr Miracel®

19" Rack for

Network Applications

1.24 to 1.47



## 19" Network Racks:

### Knürr Miracel®

Strong points 1.25

#### Distribution Rack

Knürr Miracel® NS 25 1.28

Knürr Miracel® NS 26 1.30

Knürr Miracel® NS 19.8 1.31

Knürr Miracel® NS 19.6 1.32

### Knürr Miracel® NO 19

Lab Rack 1.33

### Knürr Miracel®

Basic Rack 1.34

### Knürr Miracel®

NS 19.8 D 1.35

### Knürr Miracel®

Without front door 1.36

### Knürr Miracel® IP 55

1.37

### Knürr Miracel® Accessories

Rack Connector 1.38

Extrusions 1.38

Mounting Adapters 1.39

U Tape Measure 1.39

Swing Frame 1.40

Doors 1.41

Locking Set 1.43

Earthing Set 1.43

Plinth 1.43

Castors 1.44

Bottom Cover 1.44

Side Panel 1.46

Rear Panel 1.46

Top Cover IP 55 1.47

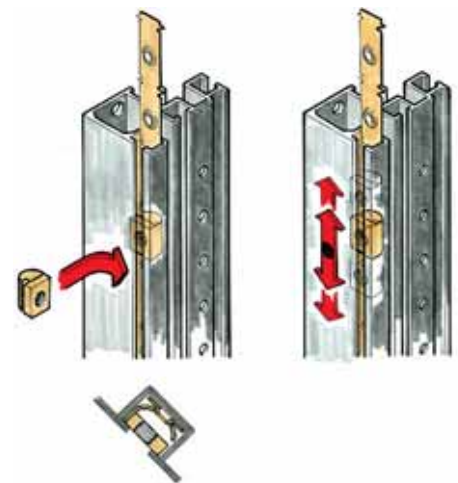

1 MIR00139



3 TEC00028



**Knürr Miracel®  
Strong points**

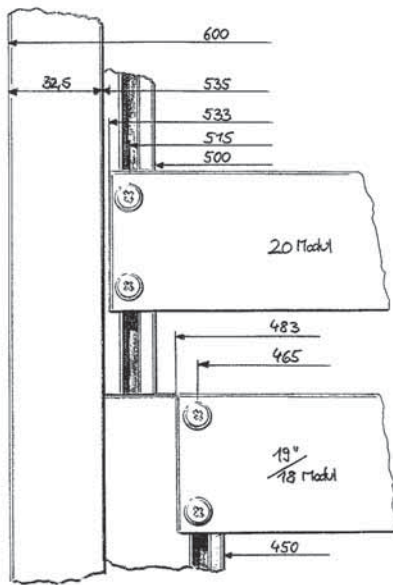

2 MIR20122

**1 Modular construction**  
Easy mounting, including all non-standard components – variable and in integrated 19" or 25 mm increments.

**2 Forward-thinking**  
Security for the future and flexibility with integration of 19" and metric technology.

**3 Expandable at all times**  
System expansions can be easily implemented while maintaining the IP protection rating.

**4 Cable management**  
Guaranteed orderly and space-saving cable management. Adjustment to installation site, cable management can be selected from extensive range of accessory components.

**5 Flexible ventilation components**  
The correct ventilation solution is always provided by the corresponding selection of accessory components. This allows the air-flow to be specially adapted to the built-in components. Through the perforated bottom covers, top covers and doors, for example.



4 MEC20084



4 MIR00143

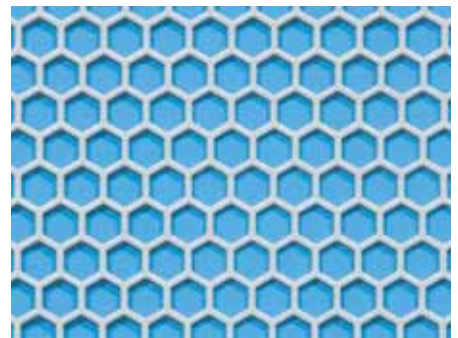

5 MIR20265



5 LUF20124

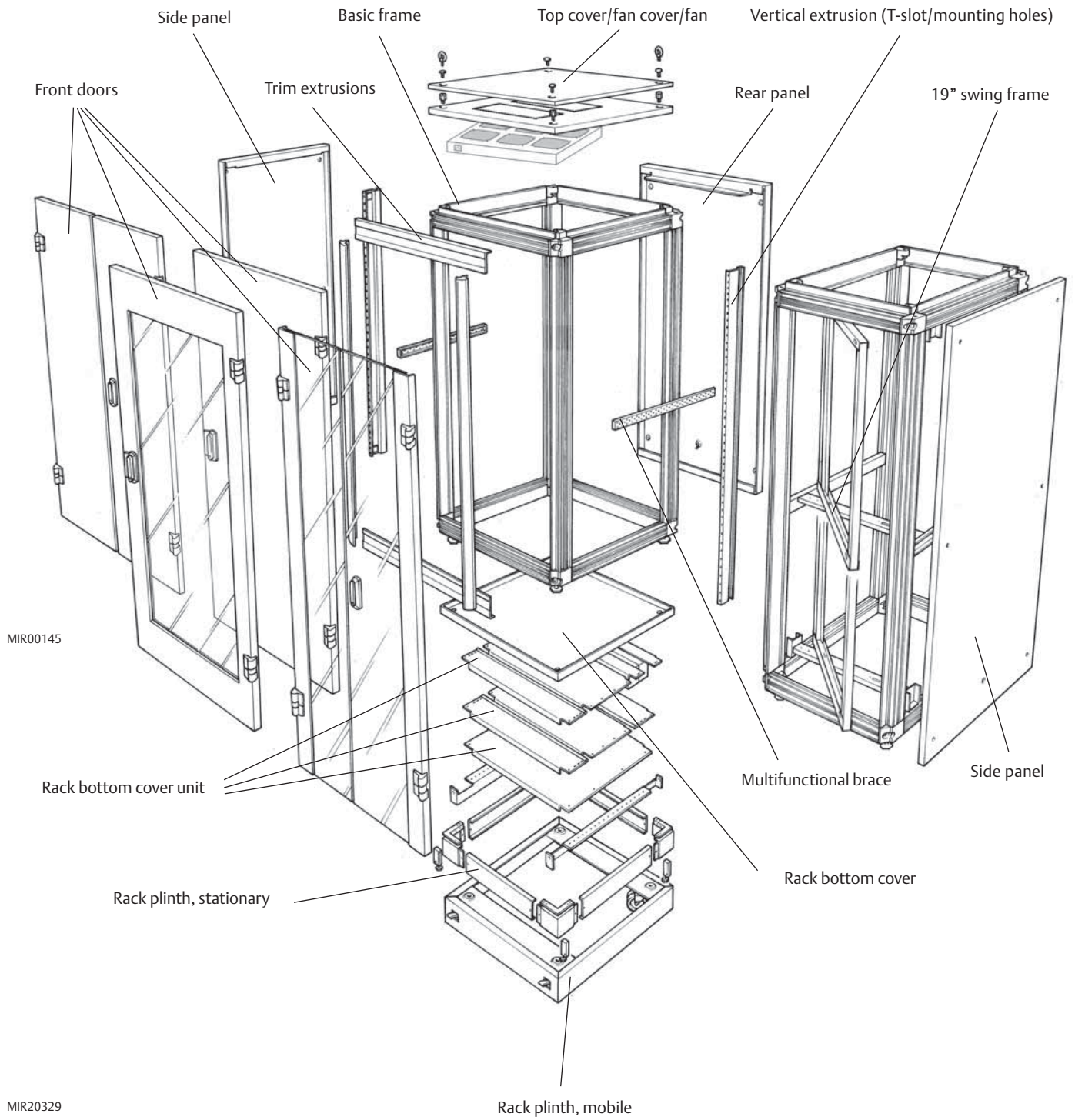

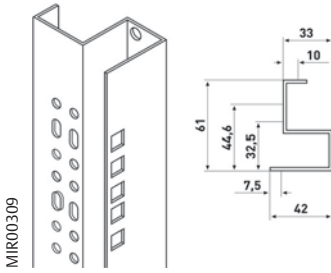

Vertical extrusion with mounting holes, steel for 19" racks

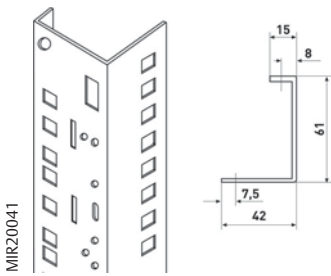

19" server extrusion

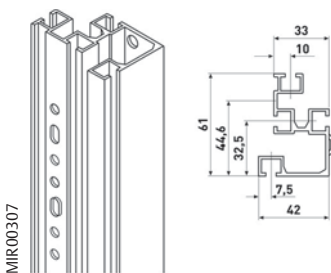

Vertical extrusion with T-slot, aluminum for 19" construction

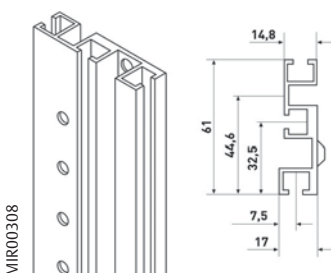

Vertical extrusion with T-slot, aluminum for metric construction, 20 module

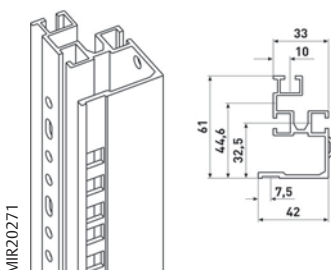

Vertical extrusion with mounting holes, aluminum for 19" racks

## Knürr Miracel® 19" Rack Technical data

### Material

- Extruded aluminum
- Corner piece, die-cast aluminum
- Covers, sheet steel, zinc-passivated
- Doors: sheet steel or with single safety glass panel, opening angle, over 180°

### Installation dimensions in acc. with IEC 297-3 and IEC 917

- Height: 23 U / 37 U / 41 U / 46 U (1 U = 44,45 mm) 66 module / 74 module / 82 module (1 module = 25 mm)
- Width: 482.6 mm (19" structure) 535 mm (20" module structure)

### Space solution

- 82% of the basic surface can be used as space for installation and cable routing
- Front jumpering space, 123 mm or 73 mm
- Door opening angle, 180°

### Configurations

- Stationary, on leveling feet
- Stationary with plinth
- Mobile with plinth and snib

### Finish / Color

- Basic rack, polished
- Optional: Door trim, black, RAL 9011
- Visible surface of covers, powder-coated, dark gray RAL 7021 or dark gray RAL 7021

### Static load rating

- 5,000 N with stationary version
- 3,000 N with mobile plinth

### Heat dissipation

- Power loss with:
- Closed top cover, up to 500 W
  - Vent lid, up to 700 W

### Tests according to version

- Vibration test in acc. with MIL-STD 810 E
- IP test in acc. with IEC 529
- UL test 1244
- NEMA 12 Standard
- EMC shielding attenuation in acc. with MIL-STD 285 (10 MHz - 30 MHz) and VG 95 373 Part 15 (30 MHz-1GHz)
- Vibration and shock test in acc. with ETS 300 019
- Seismic test, Bellcore (NEBS) TR-NWT 000063 Zone 4
- Earthing, VDE 0 100 T 540

Further standards and tests on request.

### Rack suites

- To create a rack suite with "n" racks, you require:
- n-1 racks without side panels and 1 rack with side panels
  - In a rack suite, per connection you require one set of rack connectors

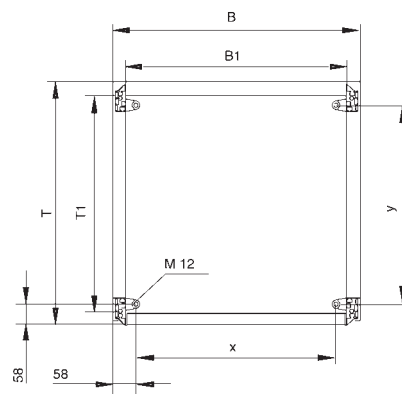

MIR00332

W [mm]	W1 [mm]	X [mm]
600	535	485
700	635	585
800	735	685
900	835	785

D [mm]	D1 [mm]	Y [mm]
600	530	485
800	730	685
900	830	785
1000	930	885
1200	1130	1085



MIR20301

Auch in RAL 7021 Schwarzgrau

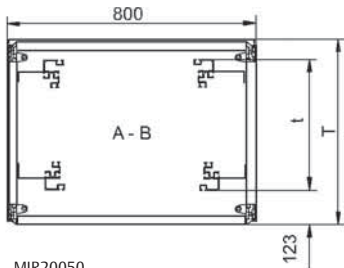

MIR20050

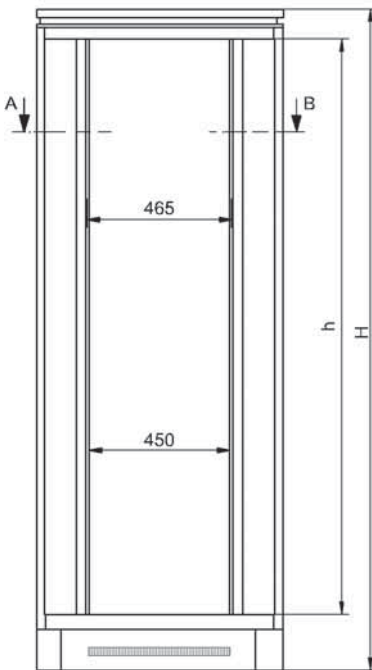

MIR20050

**Dimensions in mm:** W = Width, H = Height, D = Depth, h = installation height, d = useful depth, L = length, U = standard height unit (1 U = 44.45 mm), UP = unit of packaging, kg = weight, = Express item

**Conversion:** 1 mm = 0.03937 inch, 1 kg = 2.2046 pound

## Knürr Miracel® 19" Distribution Rack NS 25 Width 800, front glass door, T-slot extrusions

- With fixed 19" installation on the front and rear for components in accordance with IEC297-3
- Installation of chassis runners and 19" shelves possible
- Flexible assembly of the built-in units with T-slot
- Cable entry via plinth and top cover
- Cable entry on the top cover, can be completely removed at the rear, allowing top cover removal and replacement after cabling
- Dissipated heat discharge via raised fan roof.
- Top cover prepared for upgrading with CoolBlast® range fan units. This enables flexible adjustments to customer requirements.
- Door opening angle, 180°

### ■ Jumpering space

At the front: 123 mm

### ■ Load rating

5000 N static

### ■ Protection rating

IP 40

### ■ Tests

- Earthing in acc. with VDE 0100 T 540
- Vibration test in acc. with MIL-STD 810 E
- IP test in acc. with DIN 40 050 / IEC 529

### ■ Material / Finish

- Basic rack, extruded aluminum, polished
- Corner piece, die-cast aluminum, polished
- Doors, sheet steel, powder-coated texture
- Covers, zinc-passivated sheet steel, powder-coated texture

- Glass infill front door, single safety glass panel, 4 mm
- Multifunctional braces, sheet steel, zinc-plated

### ■ Color

- Final digit of order number .1:  
Visible surface of the cover RAL 7035 light gray
- Final digit of order number .8:  
Visible surfaces of the covers, RAL 7021 dark gray

### ■ Supply schedule

- 1 basic frame
- 4" aluminum vertical extrusions with T-slot and increment slide for spring nut M5
- 2 multifunctional braces for cable clamping and universal mounting options
- 2 side panels with quick connectors
- 1 top cover with cable entry (three-piece sliding plates, can also be opened completely), prepared for upgrading CoolBlast® fan units
- 1 front door, single, single safety glass panel, with handle and mounting for cylinder lock
- 1 rear door, single, sheet steel, with handle and mounting for cylinder lock
- 1 plinth for cable management on the side and rear with leveling feet (0-25 mm)
- 2 plinth panels for front and rear, with vent slots and fixing for filter mat
- 2 plinth trims, closed
- 1 complete earthing set (VDE 0100)

### ■ How supplied

Assembled

W	H	D	U	h	d	kg	Model	Order no.	UP
800	2120	600	41	1852	365	112	With side panels/RAL 7035	01.136.044.1	1 unit
800	2120	600	41	1852	365	112	With side panels/RAL 7021	01.136.044.8	1 unit
800	2120	800	41	1852	565	120	With side panels/RAL 7035	01.136.050.1	1 unit
800	2120	800	41	1852	565	120	With side panels/RAL 7021	01.136.050.8	1 unit
800	2320	800	46	2052	565	130	With side panels/RAL 7035	01.136.051.1	1 unit
800	2320	800	46	2052	565	130	With side panels/RAL 7021	01.136.051.8	1 unit
800	2120	900	41	1852	665	124	With side panels/RAL 7035	01.136.056.1	1 unit
800	2120	900	41	1852	665	124	With side panels/RAL 7021	01.136.056.8	1 unit
800	2320	900	46	2052	665	134	With side panels/RAL 7035	01.136.057.1	1 unit
800	2320	900	46	2052	665	134	With side panels/RAL 7021	01.136.057.8	1 unit
800	2120	1000	41	1852	740	140	With side panels/RAL 7035	01.127.970.1	1 unit
800	2120	1000	41	1852	740	140	With side panels/RAL 7021	01.127.970.8	1 unit
800	2320	1000	46	1852	740	140	With side panels/RAL 7035	01.127.971.1	1 unit
800	2320	1000	46	1852	740	140	With side panels/RAL 7021	01.127.971.8	1 unit
800	2120	600	41	1852	365	103	No side panels/RAL 7035	01.136.244.1	1 unit
800	2120	600	41	1852	365	103	No side panels/RAL 7021	01.136.244.8	1 unit
800	2120	800	41	1852	565	109	No side panels/RAL 7035	01.136.250.1	1 unit
800	2120	800	41	1852	565	109	No side panels/RAL 7021	01.136.250.8	1 unit
800	2120	900	41	1852	665	118	No side panels/RAL 7035	01.136.256.1	1 unit
800	2120	900	41	1852	665	118	No side panels/RAL 7021	01.136.256.8	1 unit
800	2120	1000	41	1852	740	128	No side panels/RAL 7035	01.127.975.1	1 unit
800	2120	1000	41	1852	740	128	No side panels/RAL 7021	01.127.975.8	1 unit





MIR20301

Auch in RAL 7021  
Schwarzgrau

**Knürr Miracel® 19" Distribution Rack NS 25**  
Width 800, front glass door, 19" mounting hole extrusions

- With fixed 19" installation on the front and rear for components in accordance with IEC297-3
- Installation of slot-in runners and 19" shelves possible
- Cable entry via plinth and top cover
- Cable entry on the top cover, can be completely removed at the rear, allowing top cover removal and replacement after cabling
- Dissipated heat discharge via raised fan roof.
- Top cover prepared for upgrading with CoolBlast® range fan units. This enables flexible adjustments to customer requirements.
- Door opening angle, 180°

**Jumpering space**  
At the front: 123 mm

**Load rating**  
5000 N static

**Protection rating**  
IP 40

- Tests**
- Earthing in acc. with VDE 0100 T 540
  - Vibration test in acc. with MIL-STD 810 E
  - IP test in acc. with DIN 40 050 / IEC 529

- Material / Finish**
- Basic rack, extruded aluminum, polished
  - Corner piece, die-cast aluminum, polished
  - Doors, sheet steel, powder-coated texture
  - Covers, zinc-passivated sheet steel, powder-coated texture
  - Glass infill front door, single safety glass panel, 4 mm
  - Multifunctional braces, sheet steel, zinc-plated

- Color**
- Final digit of order number .1:  
Visible surface of the cover RAL 7035 light gray
  - Final digit of order number .8:  
Visible surfaces of the covers, RAL 7021 dark gray

- Supply schedule**
- 1 basic frame
  - 4 19" vertical extrusions, sheet steel with mounting holes
  - 2 multifunctional braces for cable clamping and universal mounting options
  - 2 side panels with quick connectors
  - 1 top cover with cable entry (three-piece sliding plates, can also be opened completely), prepared for upgrading CoolBlast® fan units
  - 1 front door, single, single safety glass panel, with handle and mounting for cylinder lock
  - 1 rear door, single, sheet steel, with handle and mounting for cylinder lock
  - 1 plinth for cable management on the side and rear with leveling feet (0-25 mm)
  - 2 plinth panels for front and rear, with vent slots and fixing for filter mat
  - 2 plinth trims, closed
  - 1 complete earthing test (VDE 0100)

**How supplied**  
Assembled

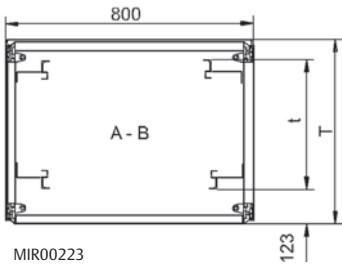

MIR00223

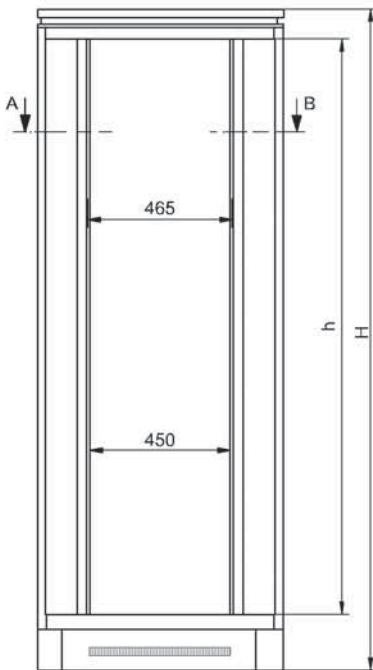

MIR20050

**Dimensions in mm:** W = Width, H = Height, D = Depth, h = installation height, d = useful depth, L = length, U = standard height unit, 1 U = 44.45 mm, UP = unit of packaging, kg = weight, = Express item

**Conversion:** 1 mm = 0.03937 inch, 1 kg = 2.2046 pound

W	H	D	U	h	d	kg	Model	Order no.	UP
800	2120	600	41	1852	365	112	With side panels/RAL 7035	01.133.040.1	1 unit
800	2120	600	41	1852	365	112	With side panels/RAL 7021	01.133.040.8	1 unit
800	2120	800	41	1852	565	120	With side panels/RAL 7035	01.133.041.1	1 unit
800	2120	800	41	1852	565	120	With side panels/RAL 7021	01.133.041.8	1 unit
800	2320	800	46	2052	565	130	With side panels/RAL 7035	01.133.042.1	1 unit
800	2320	800	46	2052	565	130	With side panels/RAL 7021	01.133.042.8	1 unit
800	2120	900	41	1852	665	124	With side panels/RAL 7035	01.133.043.1	1 unit
800	2120	900	41	1852	665	124	With side panels/RAL 7021	01.133.043.8	1 unit
800	2320	900	46	2052	665	134	With side panels/RAL 7035	01.133.044.1	1 unit
800	2320	900	46	2052	665	134	With side panels/RAL 7021	01.133.044.8	1 unit
800	2120	1000	41	1852	740	140	With side panels/RAL 7035	01.133.045.1	1 unit
800	2120	1000	41	1852	740	140	With side panels/RAL 7021	01.133.045.8	1 unit
800	2120	600	41	1852	365	103	With side panels/RAL 7035	01.133.046.1	1 unit
800	2120	600	41	1852	365	103	With side panels/RAL 7021	01.133.046.8	1 unit
800	2120	800	41	1852	565	109	No side panels/RAL 7035	01.133.047.1	1 unit
800	2120	800	41	1852	565	109	No side panels/RAL 7021	01.133.047.8	1 unit
800	2120	900	41	1852	665	118	No side panels/RAL 7035	01.133.048.1	1 unit
800	2120	900	41	1852	665	118	No side panels/RAL 7021	01.133.048.8	1 unit
800	2120	1000	41	1852	740	128	No side panels/RAL 7035	01.133.049.1	1 unit
800	2120	1000	41	1852	740	128	No side panels/RAL 7021	01.133.049.8	1 unit



MIR20302

**Auch in RAL 7021  
Schwarzgrau**

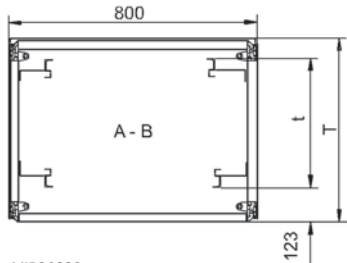

MIR20223

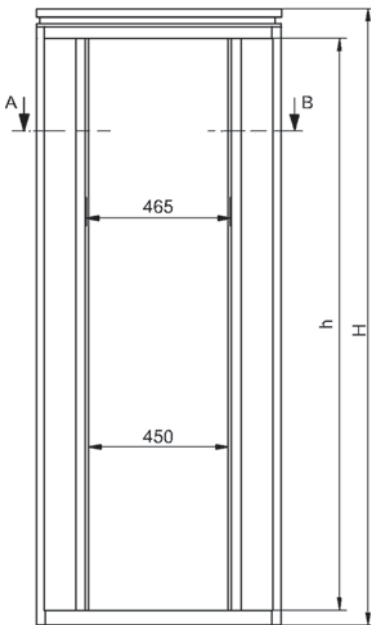

MIR20223

## Knürr Miracel® 19" Distribution Rack NS 26 Width 800, front glass door, mounting hole extrusions

- With fixed 19" installation on the front and rear for components in accordance with IEC297-3
- Installation of chassis runners and 19" shelves possible
- Top cover prepared for upgrading with CoolBlast® range fan units. This enables flexible adjustments to customer requirements.
- Door opening angle, 180°

■ **Jumpering space**  
At the front: 123 mm

■ **Load rating**  
5000 N static

■ **Protection rating**  
IP 40

■ **Tests**  
- Earthing in acc. with VDE 0100 T 540  
- IP test in acc. with DIN 40 050 / IEC 529

■ **Material / Finish**  
- Basic rack, extruded aluminum, polished  
- Corner piece, die-cast aluminum, polished  
- Covers, zinc-passivated sheet steel, powder-coated texture  
- Doors, sheet steel, powder-coated texture, glass infill, front door, single safety glass panel, 4 mm  
- Multifunctional braces and 19" extrusions, sheet steel, zinc-passivated

■ **Color**  
Final digit of order number .1:  
Visible surface of the cover RAL 7035 light gray  
Final digit of order number .8:  
Visible surfaces of the covers, RAL 7021 dark gray

■ **Supply schedule**  
1 basic frame  
4 19" vertical extrusions, sheet steel with mounting holes  
2 multifunctional braces for cable clamping and universal mounting options  
2 side panels with quick connectors  
1 raised top cover with cable entry (three-piece sliding plates, can also be opened completely), prepared for upgrading CoolBlast® fan units  
1 front door, single, single safety glass panel, with handle and mounting for cylinder lock  
1 rear door, single, sheet steel, with handle and mounting for cylinder lock  
1 complete earthing set (VDE 0100)  
4 leveling feet

■ **How supplied**  
Assembled

■ **Note**  
- Not available with double doors  
- Not available with bottom covers

W	H	D	U	h	d	kg	Model	Order no.	UP
800	2000	600	42	1900	365	108	With side panels/RAL 7035	<b>01.136.274.1</b>	1 unit
800	2000	600	42	1900	365	108	With side panels/RAL 7021	<b>01.136.274.8</b>	1 unit
800	2000	800	42	1900	565	116	With side panels/RAL 7035	<b>01.136.280.1</b>	1 unit
800	2000	800	42	1900	565	116	With side panels/RAL 7021	<b>01.136.280.8</b>	1 unit
800	2200	800	47	2100	565	126	With side panels/RAL 7035	<b>01.136.281.1</b>	1 unit
800	2200	800	47	2100	565	126	With side panels/RAL 7021	<b>01.136.281.8</b>	1 unit
800	2000	900	42	1900	665	120	With side panels/RAL 7035	<b>01.136.286.1</b>	1 unit
800	2000	900	42	1900	665	120	With side panels/RAL 7021	<b>01.136.286.8</b>	1 unit
800	2200	900	47	2100	665	120	With side panels/RAL 7035	<b>01.136.287.1</b>	1 unit
800	2200	900	47	2100	665	120	With side panels/RAL 7021	<b>01.136.287.8</b>	1 unit
800	2000	600	42	1900	365	799	No side panels/RAL 7035	<b>01.136.300.1</b>	1 unit
800	2000	600	42	1900	365	799	No side panels/RAL 7021	<b>01.136.300.8</b>	1 unit
800	2000	800	42	1900	565	105	No side panels/RAL 7035	<b>01.136.306.1</b>	1 unit
800	2000	800	42	1900	565	105	No side panels/RAL 7021	<b>01.136.306.8</b>	1 unit
800	2000	900	42	1900	665	116	No side panels/RAL 7035	<b>01.136.312.1</b>	1 unit
800	2000	900	42	1900	665	116	No side panels/RAL 7021	<b>01.136.312.8</b>	1 unit

**Dimensions in mm:** W = Width  
H = Height  
D = Depth  
h = installation height  
d = useful depth  
L = length

U = standard height unit  
1 U = 44.45 mm  
UP = unit of packaging  
kg = weight

= Express item

**Conversion:** 1 mm = 0.03937 inch 1 kg = 2.2046 pound



MIR20303

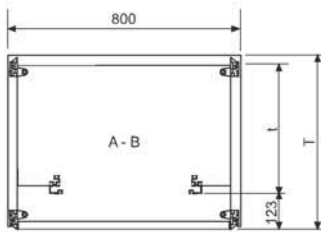

MIR00607

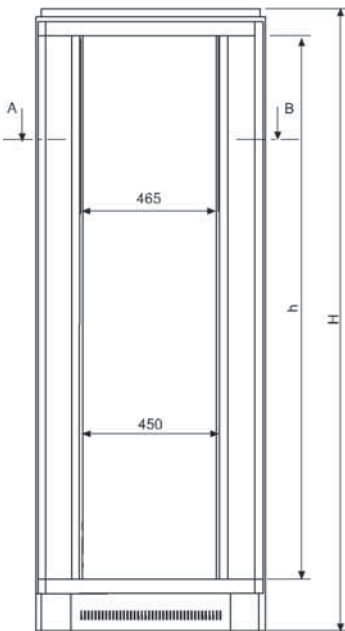

MIR00607

## Knürr Miracel® 19" Distribution Rack, NS 19.8 Width 800, front glass door

- With fixed 19" installation on the front for components in acc. with IEC 297-3
- Flexible assembly of the built-in units with T-slot
- Cable entry via plinth and top cover
- Cable entry on the top cover, can be completely removed at the rear, allowing top cover removal and replacement after cabling
- Dissipated heat discharge via raised fan roof
- Top cover prepared for upgrading with CoolBlast® range fan units. This enables flexible adjustments to customer requirements.
- Door opening angle, 180°

**Jumpering space**  
At the front: 123 mm

**Load rating**  
5000 N static

**Protection rating**  
IP 40

- Tests**
- Earthing in acc. with VDE 0100 T 540
  - Vibration test in acc. with MIL-STD 810 E
  - IP test in acc. with DIN 40 050 / IEC 529

- Material / Finish**
- Basic rack, extruded aluminum, polished
  - Corner piece, die-cast aluminum, polished
  - Covers, zinc-passivated sheet steel, powder-coated texture
  - Doors, sheet steel, powder-coated texture, glass infill, front door, single safety glass panel, 4 mm
  - Multifunctional braces, sheet steel, zinc-plated

**Color**  
Visible surface of covers  
RAL 7035 light gray

- Supply schedule**
- 1 basic frame
  - 2 19" aluminum vertical extrusions with T-slot and increment slide for spring nut M5
  - 2 multifunctional braces for cable clamping and universal mounting options
  - 1 raised top cover with cable entry (three-piece sliding plates, can also be opened completely), prepared for upgrading CoolBlast® fan units
  - 1 front door, single or double, single safety glass panel, with handle and mounting for cylinder lock
  - 1 rear door, single or double, sheet steel, with handle and mounting for cylinder lock
  - 2 side panels with quick connectors (according to model)
  - 1 plinth for cable management on the side and rear with leveling feet (0-25 mm)
  - 2 side plinth panels, closed (according to model)
  - 2 plinth panels for front and rear, with vent slots and fixing for filter mat
  - 1 complete earthing set (VDE 0100)

**How supplied**  
Assembled

W	H	D	U	h	d	kg	Model	Order no.	UP
800	1320	600	23	1052	435	78	Glass door, side panel	01.135.001.1	1 unit
800	1920	600	37	1652	435	103	Glass door, side panel	01.135.003.1	1 unit
800	2120	600	41	1852	435	112	Glass door, side panel	01.135.004.1	1 unit
800	2320	600	46	2052	435	121	Glass door, side panel	01.135.005.1	1 unit
800	1320	800	23	1052	635	80	Glass door, side panel	01.135.019.1	1 unit
800	1920	800	37	1652	635	111	Glass door, side panel	01.135.021.1	1 unit
800	2120	800	41	1852	635	120	Glass door, side panel	01.135.022.1	1 unit
800	2320	800	46	2052	635	129	Glass door, side panel	01.135.023.1	1 unit
800	1320	600	23	1052	435	70	Glass door, no side panel	01.135.007.1	1 unit
800	1920	600	37	1652	435	95	Glass door, no side panel	01.135.009.1	1 unit
800	2120	600	41	1852	435	103	Glass door, no side panel	01.135.010.1	1 unit
800	2320	600	46	2052	435	112	Glass door, no side panel	01.135.011.1	1 unit
800	1320	800	23	1052	635	73	Glass door, no side panel	01.135.025.1	1 unit
800	1920	800	37	1652	635	101	Glass door, no side panel	01.135.027.1	1 unit
800	2120	800	41	1852	635	109	Glass door, no side panel	01.135.028.1	1 unit
800	2320	800	46	2052	635	118	Glass door, no side panel	01.135.029.1	1 unit
800	1320	800	23	1052	635	80	Double glass door, side panel	01.135.037.1	1 unit
800	1920	800	37	1652	635	111	Double glass door, side panel	01.135.039.1	1 unit
800	2120	800	41	1852	635	120	Double glass door, side panel	01.135.040.1	1 unit
800	2320	800	46	2052	635	121	Double glass door, side panel	01.135.041.1	1 unit
800	1320	800	23	1052	635	73	Double glass door, no side panel	01.135.043.1	1 unit
800	1920	800	37	1652	635	101	Double glass door, no side panel	01.135.045.1	1 unit
800	2120	800	41	1852	635	109	Double glass door, no side panel	01.135.046.1	1 unit
800	2320	800	46	2052	635	118	Double glass door, no side panel	01.135.047.1	1 unit

**Dimensions in mm:** W = Width, H = Height, D = Depth, h = installation height, d = useful depth, L = length, U = standard height unit (1 U = 44.45 mm), UP = unit of packaging, kg = weight, = Express item

**Conversion:** 1 mm = 0.03937 inch, 1 kg = 2.2046 pound



MIR20304

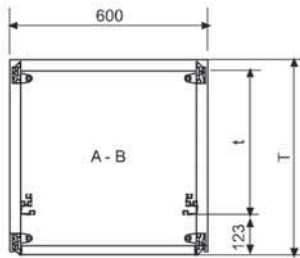

MIR00056

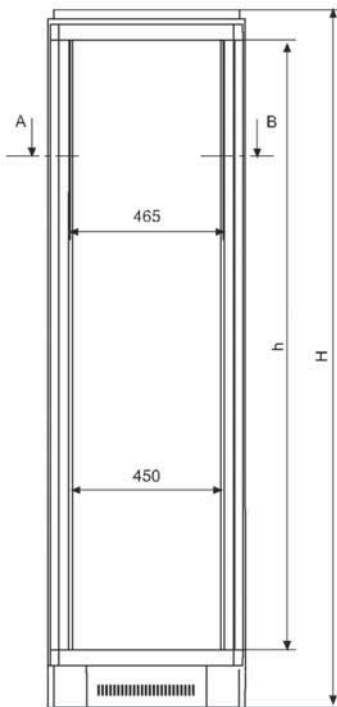

MIR00031

**Dimensions in mm:** W = Width, H = Height, D = Depth, h = installation height, d = useful depth, L = length, U = standard height unit (1 U = 44.45 mm), UP = unit of packaging, kg = weight,  = Express item

**Conversion:** 1 mm = 0.03937 inch, 1 kg = 2.2046 pound

## Knürr Miracel® 19" Distribution Rack NS 19.6 Width 600, front glass door

- With fixed 19" installation on the front for components in acc. with IEC 297-3
- Flexible assembly of the built-in units with T-slot
- Cable entry via plinth and top cover
- Cable entry on the top cover, can be completely removed at the rear, allowing top cover removal and replacement after cabling
- Dissipated heat discharge via raised fan roof.
- Top cover prepared for upgrading with CoolBlast® range fan units. This enables flexible adjustments to customer requirements.
- Door opening angle, 180°

**Jumping space**  
At the front: 123 mm

**Load rating**  
5000 N static

**Protection rating**  
IP 40

- Tests**
- Earthing in acc. with VDE 0100 T 540
  - Vibration test in acc. with MIL-STD 810 E
  - IP test in acc. with DIN 40 050 / IEC 529



- Material/ Finish**
- Basic rack, extruded aluminum, polished
  - Corner piece, die-cast aluminum, polished
  - Covers, zinc-passivated sheet steel, powder-coated texture

- Doors, sheet steel, powder-coated texture, glass infill, front door, single safety glass panel, 4 mm
- Multifunctional sheet steel, zinc-plated

**Color**  
Visible surface of covers  
RAL 7035 light gray

- Supply schedule**
- 1 basic frame
  - 2 19" aluminum vertical extrusions with T-slot and increment slide for spring nut M5
  - 2 multifunctional braces for cable clamping and universal mounting options
  - 1 raised top cover with cable entry (three-piece sliding plates, can also be opened completely), prepared for upgrading CoolBlast® fan units
  - 1 front door, single, single safety glass panel, with handle and mounting for cylinder lock
  - 1 rear door, single, sheet steel, with handle and mounting for cylinder lock
  - 2 side panels with quick connectors
  - 1 plinth for cable management on the side and rear with leveling feet (0-25 mm)
  - 2 side plinth panels, closed
  - 2 plinth panels for front and rear, with vent slots and fixing for filter mat
  - 1 complete earthing set (VDE 0100)

**How supplied**  
Assembled

W	H	D	U	h	d	kg	Model	Order no.	UP
600	1320	600	23	1052	435	72	With side panel	01.135.109.1 	1 unit
600	1920	600	37	1652	435	95	With side panel	01.135.111.1	1 unit
600	2120	600	41	1852	435	103	With side panel	01.135.112.1 	1 unit
600	2320	600	46	2052	435	112	With side panel	01.135.113.1	1 unit
600	1320	800	23	1052	635	74	With side panel	01.135.127.1	1 unit
600	1920	800	37	1652	635	102	With side panel	01.135.129.1 	1 unit
600	2120	800	41	1852	635	110	With side panel	01.135.130.1	1 unit
600	2320	800	46	2052	635	119	With side panel	01.135.131.1	1 unit
600	1320	600	23	1052	435	68	No side panel	01.135.115.1	1 unit
600	1920	600	37	1652	435	94	No side panel	01.135.117.1	1 unit
600	2120	600	41	1852	435	99	No side panel	01.135.118.1	1 unit
600	2320	600	46	2052	435	106	No side panel	01.135.119.1	1 unit
600	1320	800	23	1052	635	68	No side panel	01.135.133.1	1 unit
600	1920	800	37	1652	635	94	No side panel	01.135.135.1	1 unit
600	2120	800	41	1852	635	99	No side panel	01.135.136.1	1 unit
600	2320	800	46	2052	635	106	No side panel	01.135.137.1	1 unit



MIR20307

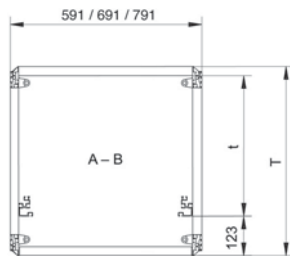

MIR00043a

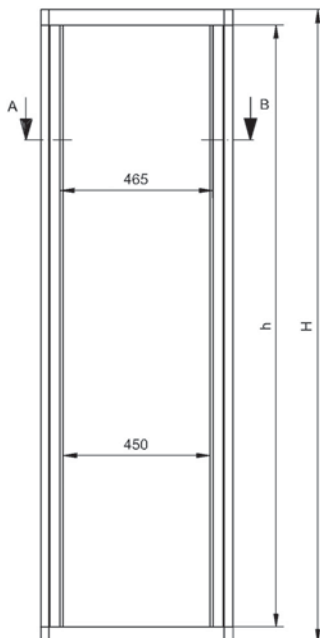

MIR20002

## Knürr Miracel® 19" Lab Rack, NO 19 with 2x 19" T-slot extrusion (basis for rack widths 600 / 700 / 800)

- With fixed 19" installation on the front for components in acc. with IEC 297-3
- Flexible assembly of the built-in units with T-slot

**■ Jumping space**  
At the front: 123 mm

**■ Load rating**  
5000 N static

- Tests**
- Earthing in acc. with VDE 0100 T 540
  - Vibration test in acc. with MIL-STD 810 E

- Material/ Finish**
- Basic rack, extruded aluminum, polished
  - Corner piece, die-cast aluminum
  - Multifunctional sheet steel, zinc-plated

**■ Supply schedule**

- 1 basic frame
- 2 19" aluminum vertical extrusions with T-slot and increment slide for spring nut M5
- 2 multifunctional braces for cable clamping and universal mounting options
- 4 leveling feet (0-25 mm)

**■ How supplied**  
Assembled

W	H	D	U	h	d	kg	Model	Order no.	UP
591	1196	585	23	1052	435	14		01.135.793.3	1 unit
591	1796	585	37	1652	435	16		01.135.795.3	1 unit
591	1996	585	41	1852	435	17		01.135.796.3	1 unit
591	2196	585	46	2052	435	18		01.135.797.3	1 unit
591	1196	785	23	1052	635	16		01.135.817.3	1 unit
591	1796	785	37	1652	635	18		01.135.819.3	1 unit
591	1996	785	41	1852	635	19		01.135.820.3	1 unit
591	2196	785	46	2052	635	20		01.135.821.3	1 unit
591	1196	885	37	1652	735	19		01.135.842.0	1 unit
591	1996	885	41	1852	735	20		01.135.843.0	1 unit
591	2196	885	46	2052	735	21		01.135.844.0	1 unit
591	1796	985	37	1652	835	20		01.133.600.0	1 unit
591	1996	985	41	1852	835	21		01.133.610.0	1 unit
591	2196	985	46	2052	835	22		01.133.620.0	1 unit
591	1796	1185	37	1652	1035	22		01.133.605.0	1 unit
591	1996	1185	41	1852	1035	23		01.133.615.0	1 unit
591	2196	1185	46	2052	1035	24		01.133.625.0	1 unit
691	1196	585	23	1052	435	15		01.135.799.3	1 unit
691	1796	585	37	1652	435	17		01.135.801.3	1 unit
691	1996	585	41	1852	435	18		01.135.802.3	1 unit
691	2196	585	46	2052	435	19		01.135.803.3	1 unit
691	1196	785	23	1052	635	17		01.135.823.3	1 unit
691	1796	785	37	1652	635	19		01.135.825.3	1 unit
691	1996	785	41	1852	635	20		01.135.826.3	1 unit
691	2196	785	46	2052	635	21		01.135.827.3	1 unit
691	1796	885	37	1652	735	19		01.133.630.0	1 unit
691	1996	885	41	1852	735	20		01.133.645.0	1 unit
691	2196	885	46	2052	735	22		01.133.660.0	1 unit
691	1796	985	37	1652	835	21		01.133.635.0	1 unit
691	1996	985	41	1852	835	22		01.133.650.0	1 unit
691	2196	985	46	2052	835	23		01.133.665.0	1 unit
691	1796	1185	37	1652	1035	23		01.133.640.0	1 unit
691	1996	1185	41	1852	1035	24		01.133.655.0	1 unit
691	2196	1185	46	2052	1035	25		01.133.670.0	1 unit
791	1200	585	23	1052	435	16		01.135.805.3	1 unit
791	1796	585	37	1652	435	18		01.135.807.3	1 unit
791	1996	585	41	1852	435	19		01.135.808.3	1 unit
791	2196	585	46	2052	435	20		01.135.809.3	1 unit

Continued on next page!

W	H	D	U	h	d	kg	Model	Order no.	UP
791	1196	785	23	1052	635	18		01.135.829.3	1 unit
791	1796	785	37	1652	635	20		01.135.831.3	1 unit
791	1996	785	41	1852	635	21		01.135.832.3	1 unit
791	2196	785	46	2052	635	22		01.135.833.3	1 unit
791	1796	885	37	1652	735	21		01.135.847.0	1 unit
791	1996	885	41	1852	735	22		01.135.848.0	1 unit
791	2196	885	46	2052	735	23		01.135.849.0	1 unit
791	1796	985	37	1652	835	20		01.133.675.0	1 unit
791	1996	985	41	1852	835	22		01.133.685.0	1 unit
791	2196	985	46	2052	835	24		01.133.695.0	1 unit
791	1796	1185	37	1652	1035	22		01.133.680.0	1 unit
791	1996	1185	41	1852	1035	24		01.133.690.0	1 unit
791	2196	1185	46	2052	1035	26		01.133.700.0	1 unit



MIR20308

## Knürr Miracel® 19" Basic Frame, with 4x 19" mounting hole extrusion (basis for rack widths 600 / 800)

- With fixed 19" installation on the front and rear
- Installation of chassis runners and 19" shelves possible
- For components in acc. with IEC 297-3
- **For installing:**
  - 19" components on the front and rear
  - Equipment with max. construction width of 450 mm
  - Installation accessories
- **Jumpering space**  
At the front: 73 mm
- **Load rating**  
5000 N static
- **Tests**
  - Earthing in acc. with VDE 0100 T 540
  - Vibration test in acc. with MIL-STD 810 E
- **Material/ Finish**
  - Basic rack, extruded aluminum, polished
  - Corner piece, die-cast aluminum
  - Multifunctional braces and 19" sheet steel extrusions, zinc-passivated
- **Supply schedule**
  - 1 basic frame
  - 4 19" sheet steel angular extrusions with mounting holes
  - 2 multifunctional braces for cable clamping and universal mounting options
  - 4 leveling feet (0-25 mm)
- **How supplied**  
- Assembled
- **Note: Rack suites**  
In a rack suite, per connection you require a set of suite connectors BN 01.130.935.7

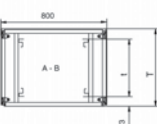
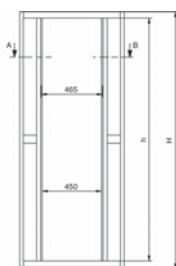
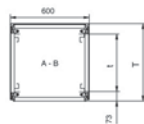
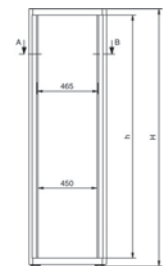

MIR00300

W	H	D	U	h	d	kg	Model	Order no.	UP
591	1196	585	23	1052	440	14		01.130.190.0	1 unit
591	1796	585	37	1652	440	16		01.130.193.0	1 unit
591	1996	585	41	1852	440	17		01.130.194.0	1 unit
591	2196	585	46	2052	440	18		01.130.195.0	1 unit
591	1196	785	23	1052	640	16		01.130.280.0	1 unit
591	1796	785	37	1652	640	18		01.130.283.0	1 unit
591	1996	785	41	1852	640	19		01.130.284.0	1 unit
591	2196	785	46	2052	640	20		01.130.285.0	1 unit
791	1196	585	23	1052	440	16		01.130.226.0	1 unit
791	1796	585	37	1652	440	18		01.130.229.0	1 unit
791	1996	585	41	1852	440	19		01.130.230.0	1 unit
791	2196	585	46	2052	440	20		01.130.231.0	1 unit
791	1196	785	23	1052	640	18		01.130.316.0	1 unit
791	1796	785	37	1652	640	20		01.130.319.0	1 unit
791	1996	785	41	1852	640	21		01.130.320.0	1 unit
791	2196	785	46	2052	640	22		01.130.321.0	1 unit



MIR20305

**Knürr Miracel® 19" Distribution Rack with Swing Frame, NS 19.8 D Width 800, with front glass door, single**

- With 19" swing frame for components in acc. with IEC 297-3
- Cable entry via plinth and top cover
- Cable entry on the top cover, can be completely removed at the rear, allowing top cover removal and replacement after cabling
- Dissipated heat discharge via raised fan roof
- Top cover prepared for upgrading with CoolBlast® range fan units. This enables flexible adjustments to customer requirements.
- Door opening angle, 180°

**Load rating**

800 N static in the swing frame  
5000 N static in total

**Protection rating**

IP 40

**Tests**

- Earthing in acc. with VDE 0100 T 540
- Vibration test in acc. with MIL-STD 810 E
- IP test in acc. with DIN 40 050 / IEC 529

**Material/ Finish**

- Extruded aluminum
- Corner piece, die-cast aluminum
- Covers, zinc-passivated sheet steel, powder-coated texture
- Doors, sheet steel, powder-coated texture, glass infill, front door, single safety glass panel, 4 mm
- Swing frame, sheet steel, powder-coated, front board support, zinc-passivated
- Multifunctional braces and 19" swing frame, sheet steel, zinc-passivated

**Color**

Visible surface of covers, RAL 7035 light gray

**Supply schedule**

- 1 basic frame
- 1 19" swing frame with mounting holes for caged nuts M5
- 2 multifunctional braces for cable clamping and universal mounting options
- 1 raised top cover with cable entry (three-piece sliding plates, can also be opened completely), prepared for upgrading CoolBlast® fan units
- 1 front door, single, single safety glass panel, with handle and mounting for cylinder lock
- 1 rear panel with quick connectors
- 2 side panels with quick connectors
- 1 plinth for cable entry on the side and rear with leveling feet (0-25mm)
- 2 plinth panels for front and rear, with vent slots and fixing for filter mat
- 1 complete earthing set (VDE 0100)

**How supplied**

Assembled

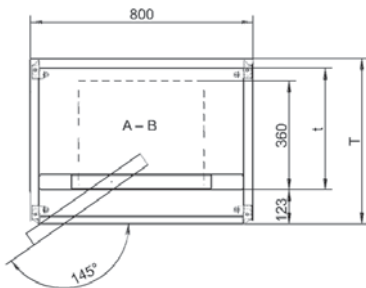

MIR00047

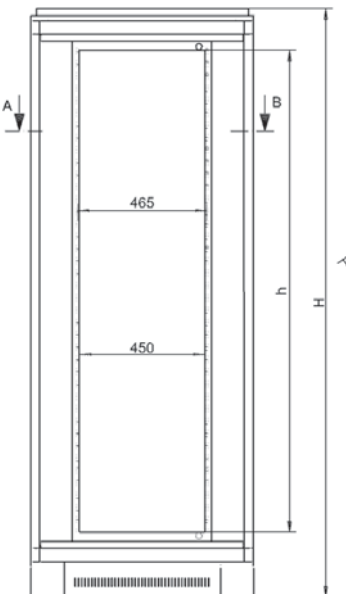

MIR00047

W	H	D	U	h	d	kg	Model	Order no.	UP
800	2120	600	38	1692.8	435	111	With side panels	01.135.274.1	1 unit
800	2320	600	42	1870.6	435	120	With side panels	01.135.275.1	1 unit
800	2120	800	38	1692.8	635	119	With side panels	01.135.292.1	1 unit
800	2320	800	42	1870.6	635	128	With side panels	01.135.293.1	1 unit

Dimensions in mm: W = Width, H = Height, D = Depth, h = installation height, d = useful depth, L = length, U = standard height unit, 1 U = 44.45 mm, UP = unit of packaging, kg = weight, = Express item

Conversion: 1 mm = 0.03937 inch, 1 kg = 2.2046 pound



MIR20309

## Knürr Miracel® no front door, width 600 mm

- With fixed 19" installation on the front and rear
- Installation of chassis runners and 19" shelves possible
- For components in acc. with IEC 297-3
- **For installing:**
  - 19" components on the front and rear
  - Equipment with max. construction width of 450 mm
  - Installation accessories
- **Jumpering space**  
At the front: 73 mm
- **Load rating**  
5000 N static

- **Color**
  - Basic rack, polished
  - Visible surface of the covers, RAL 7035 light gray
  - Trim extrusions: RAL 5008 gray-blue
- **Supply schedule**
  - 1 basic frame
  - 4 19" sheet steel extrusions with mounting holes
  - 2 multifunctional braces for cable clamping and universal mounting options
  - 1 top cover, closed
  - 1 rear panel with quick connectors
  - 2 side panels with quick connectors
  - 2 horizontal trim extrusions, front
  - 2 vertical trim extrusions, front
  - 4 leveling feet (0-25 mm)

- **Tests**
  - Earthing in acc. with VDE 0100 T 540
  - Vibration test in acc. with MIL-STD 810 E

- **Material/ Finish**
  - Basic rack, extruded aluminum
  - Corner piece, die-cast aluminum
  - Covers and trim extrusions, zinc-passivated sheet steel, powder-coated texture
  - Multifunctional braces and 19" extrusions, sheet steel, zinc-passivated

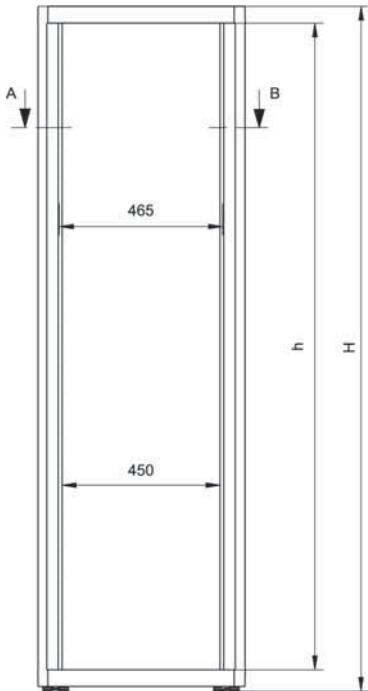

MIR00540

W	H	D	U	h	d	kg	Model	Order no.	UP
600	1200	600	23	1052	440	42		01.131.068.1	1 unit
600	1800	600	37	1652	440	57		01.131.071.1	1 unit
600	2000	600	41	1852	440	62		01.131.072.1	1 unit
600	2200	600	46	2052	440	66		01.131.073.1	1 unit
600	1200	800	23	1052	640	48		01.131.074.1	1 unit
600	1800	800	37	1652	640	63		01.131.077.1	1 unit
600	2000	800	41	1852	640	69		01.131.078.1	1 unit
600	2200	800	46	2052	640	75		01.131.079.1	1 unit

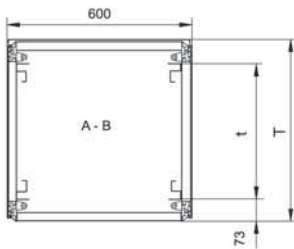

MIR00540

Dimensions in mm: W = Width, H = Height, D = Depth, h = installation height, d = useful depth, L = length, U = standard height unit, 1 U = 44.45 mm, UP = unit of packaging, kg = weight, = Express item

Conversion: 1 mm = 0.03937 inch, 1 kg = 2.2046 pound





MIR20336

## Knürr Miracel® IP55 With glass door, single, width 600

- With fixed 19" installation on the front and rear
- For components in acc. with IEC 297-3
- Door opening angle, 180°
- **For installing:**
  - 19" components on the front and rear
  - Equipment with max. construction width of 450 mm
  - Installation accessories

- **Jumpering space**  
At the front: 73 mm

- **Load rating**  
5000 N static

- **Protection rating**  
IP 55

- **Tests**
  - Earthing in acc. with VDE 0100 T 540
  - Vibration test in acc. with MIL-STD 810 E
  - IP test in acc. with DIN 40 050 / IEC 529

- **Material/ Finish**
  - Basic rack, extruded aluminum, polished
  - Corner piece, die-cast aluminum, polished
  - Covers, zinc-passivated sheet steel, powder-coated texture
  - Doors, sheet steel, powder-coated texture, glass infill, front door, single safety glass panel, 4 mm
  - Multifunctional braces and 19" extrusions, sheet steel, zinc-passivated

- **Color**  
Visible surface of the cover  
RAL 7035 light gray

### Supply schedule

- 1 basic frame
- 4 19" sheet steel angular extrusions with mounting holes
- 2 multifunctional braces for cable clamping and universal mounting options
- 1 top cover, closed, IP 55
- 1 front door, single, single safety glass panel, with handle and mounting for cylinder lock, IP 55
- 1 rear panel with quick connectors, IP 55
- 2 side panels with quick connectors, IP 55
- 1 bottom cover, closed, IP 55
- 4 leveling feet (0-25 mm)

### How supplied

- Assembled

### Note: Rack suites

- To create a rack suite with "n" racks, you require:
  - (n-1) racks without side panels
  - 1 rack with side panels
- In a rack suite, per connection you require a set of suite connectors BN 01.130.935.7.

IP 55 sealing frame on request!

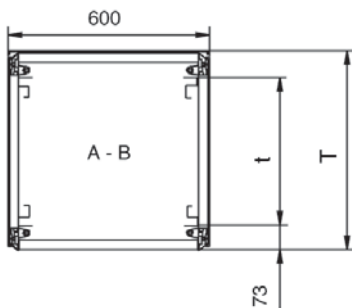
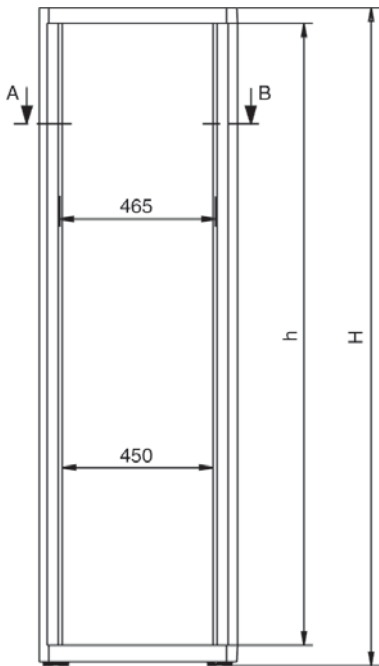

MIR00301

Dimensions in mm: W = Width, H = Height, D = Depth, h = installation height, d = useful depth, L = length, U = standard height unit, 1 U = 44.45 mm, UP = unit of packaging, kg = weight,  = Express item

Conversion: 1 mm = 0.03937 inch, 1 kg = 2.2046 pound

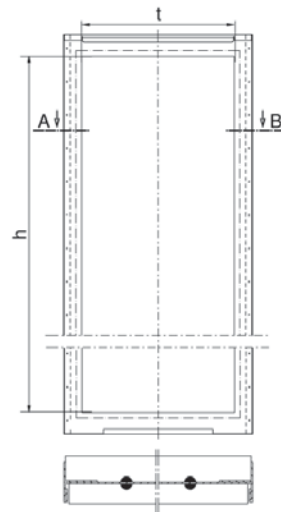

Sealing frame

MIR00304

W	H	D	U	h	d	kg	Model	Order no.	UP
600	1200	600	23	1052	440	55		01.132.268.1	1 unit
600	1600	600	32	1452	440	69		01.132.270.1	1 unit
600	1800	600	37	1652	440	75		01.132.271.1	1 unit
600	2000	600	41	1852	440	80		01.132.272.1	1 unit
600	2200	600	46	2052	440	86		01.132.273.1	1 unit
600	1200	800	23	1052	640	65		01.132.274.1	1 unit
600	1600	800	32	1452	640	76		01.132.276.1	1 unit
600	1800	800	37	1652	640	83		01.132.277.1	1 unit
600	2000	800	41	1852	640	90		01.132.278.1	1 unit
600	2200	800	46	2052	640	96		01.132.279.1	1 unit



MIR00100

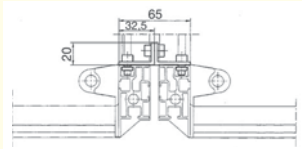

MIR00168

## Miracel® Rack Connectors Mounted on the inside

- For mechanical, stable connection of rack and frame suites

**Material/ Finish**  
- Sheet steel, 2 mm, zinc passivated

**Supply schedule**  
8 mounting brackets (for connecting 2 racks/frames)  
Mounting material

**How supplied**  
Flat-packed kit

W	H	D	U	h	d	kg	Model	Order no.	UP
								01.130.935.7	1 unit

## Miracel® Cover Extrusion for Rack Suites, IP 20

**Material**  
PVC extruder extrusion, black

**Supply schedule**  
2 vertical lengths  
2 depth lengths

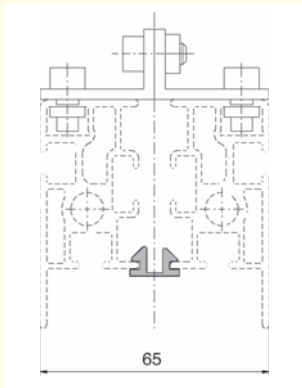

MIR00320

W	H	D	U	h	d	kg	Model	Order no.	UP
1200	T 600	23						01.131.270.9	1 unit
1800	T 600	37						01.131.273.9	1 unit
2000	T 600	41						01.131.274.9	1 unit
2200	T 600	46						01.131.275.9	1 unit
1200	T 800	23						01.131.276.9	1 unit
1800	T 800	37						01.131.279.9	1 unit
2000	T 800	41						01.131.280.9	1 unit
2200	T 800	46						01.131.281.9	1 unit
1200	T 900	23						01.131.282.9	1 unit
1800	T 900	37						01.131.285.9	1 unit
2000	T 900	41						01.131.286.9	1 unit
2200	T 900	46						01.131.287.9	1 unit
2000	T 1000	41						01.127.760.9	1 unit
2200	T 1000	46						01.127.761.9	1 unit
2000	T 1200	41						01.127.762.9	1 unit
2200	T 1200	46						01.127.763.9	1 unit

**Dimensions in mm:** W = Width  
H = Height  
D = Depth  
h = installation height  
d = useful depth  
L = length  
U = standard height unit  
1 U = 44.45 mm  
UP = unit of packaging  
kg = weight  
Express item

**Conversion:** 1 mm = 0.03937 inch 1 kg = 2.2046 pound

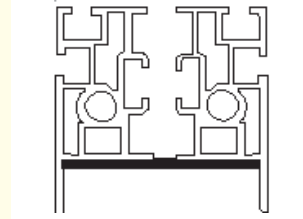

MIR20036

## Miracel® Rack Connectors Mounted on the outside

- For secure connection of several racks
- Front and rear external mounting

**Material**  
- Sheet steel, 1 mm, zinc-passivated

**Supply schedule**  
4 mounting straps  
Mounting material

W	H	D	U	h	d	kg	Model	Order no.	UP
								01.127.114.9	1 unit

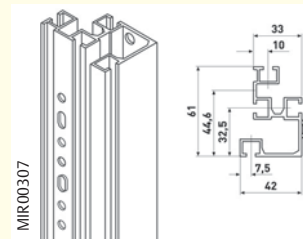

MIR00307

## Miracel® 19" Vertical Extrusion, Aluminum with T-slot and increment slide

- For front and rear installation in the rack
- Spring nut, variable and adjustable in U increment (19")
- Please order suitable assembly kit for rack widths 700 / 800
- With W 600 screws and spring nuts

**Material**  
Extruded aluminum, polished

**Supply schedule**  
2 vertical extrusions with increment slides

W	H	D	U	h	d	kg	Model	Order no.	UP
1200	23	1100						01.130.828.0	1 unit
1800	37	1700						01.130.834.0	1 unit
2000	41	1900						01.130.835.0	1 unit
2200	46	2100						01.130.836.0	1 unit

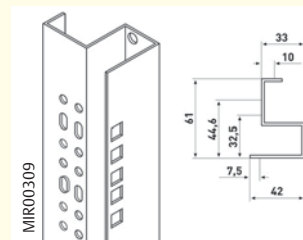

MIR00309

## Miracel® 19" Vertical Extrusion, steel with mounting holes

- For front and rear installation in the rack
- Caged nut mountable in HU/U increments (19")
- Please order suitable assembly kit for rack widths 700 / 800
- With W 600 screws and spring nuts

**Material**  
Sheet steel, 1.5 mm, zinc-passivated

**Supply schedule**  
- 2 Vertical extrusions with mounting holes

W	H	D	U	h	d	kg	Model	Order no.	UP
1200	23	1100						01.130.803.0	1 unit
1800	37	1700						01.130.809.0	1 unit
2000	41	1900						01.130.810.0	1 unit
2200	46	2100						01.130.811.0	1 unit

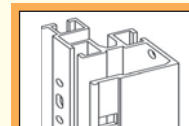

### Note:

19" alu extrusions with mounting holes on request

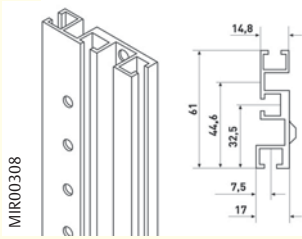

Type 1

### Miracel® Vertical Extrusion, MEPS 20 module

- For metric racks, 20 module
- Spring nut, stepless and adjustable in standard increment
- Please order suitable assembly kit for rack widths 700 / 800
- With W 600 screws and spring nuts

**Material**

- Type 1: Extruded aluminum, polished
- Type 2: Sheet steel, 1.5 mm, zinc-passivated

**Supply schedule**

2 vertical extrusions

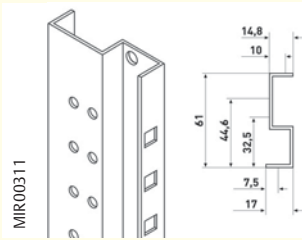

Type 2

W	H	D	U	h	d	kg	Model	Order no.	UP
1800	66	1700					ALU T-slot	<b>01.130.847.0</b>	1 unit
2000	74	1900					ALU T-slot	<b>01.130.848.0</b>	1 unit
2200	82	2100					ALU T-slot	<b>01.130.849.0</b>	1 unit
1800	66	1700					Steel mount. holes	<b>01.130.822.0</b>	1 unit
2000	74	1900					Steel mount. holes	<b>01.130.823.0</b>	1 unit
2200	82	2100					Steel mount. holes	<b>01.130.824.0</b>	1 unit

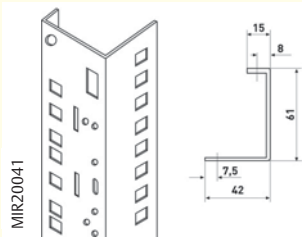

### Miracel® 19" Server Extrusion, steel with mounting holes

- For mounting trade standard 19" servers
- Please order suitable assembly kit for rack widths 700 / 800
- Please order mounting adapter for Knürr standard components

**Material**

Sheet steel, 2 mm, zinc-passivated

**Supply schedule**

4 19" server extrusions

W	H	D	U	h	d	kg	Model	Order no.	UP
2000	41							<b>01.127.214.0</b>	1 unit
2200	46							<b>01.127.215.0</b>	1 unit



MIR20044

### Miracel® Mounting Adapter for 19" Server Extrusion

- For mounting Knürr standard components (storage shelves, drawers, slot-in runners, keyboard runners, etc.) in 19" installation space

**Material**

Sheet steel, zinc-passivated

**Supply schedule**

4 adapters

W	H	D	U	h	d	kg	Model	Order no.	UP
			1					<b>01.127.119.9</b>	1 unit



MIR00510

### Miracel® Assembly Kits for Extrusions

**Supply schedule**

- 4 Node brackets (full installation)
- 2 node brackets (shortened installation)
- 2 Z brackets (shortened installation)
- Mounting material

W	H	D	U	h	d	kg	Model	Order no.	UP
700							Short inst.	<b>01.131.219.7</b>	1 unit
800							Short inst.	<b>01.131.221.7</b>	1 unit
700							Full inst.	<b>01.131.220.7</b>	1 unit
800							Full inst.	<b>01.131.222.7</b>	1 unit



LUF20337

### Miracel® U Tape Measure

- For sticking on Miracel 19" extrusions
- Enables fast component positioning on the correct U position
- Standard length, 48 U; shorten as required

**Supply schedule**

1 tape measure

W	H	D	U	h	d	kg	Model	Order no.	UP
			48					<b>01.128.400.9</b>	1 unit

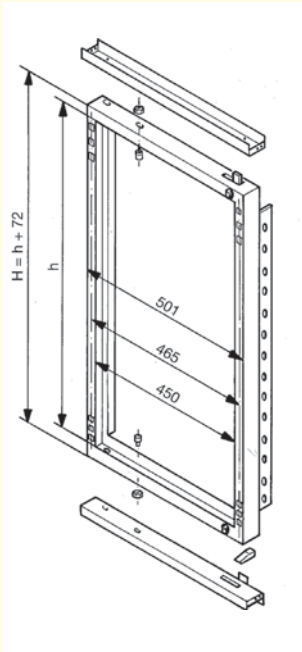

MIR00162

## Miracel® Swing Frame, 90° / 105° / 130°

- **Maximum installation weight**  
80 kg
- **Also order assembly kit**  
01.131.317.1
- **Swing frame earthing set**  
01.110.610.9
- **Material**  
Sheet steel, 2 mm
- **Finish**  
Powder-coated texture, RAL 7035 light gray
- **Note**  
The rack's nominal installation height is reduced by 3 U with the installation of a swing frame
- **Supply schedule**  
1 frame  
2 horizontal rails  
1 square spanner  
Mounting material
- **How supplied**  
Flat-packed kit

W	H	D	U	h	d	kg	Model	Order no.	UP
800	2000	38	1692.8					01.117.079.1	1 unit

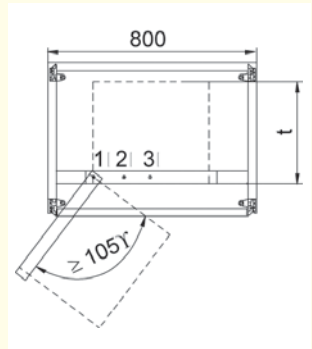

MIR00322 A

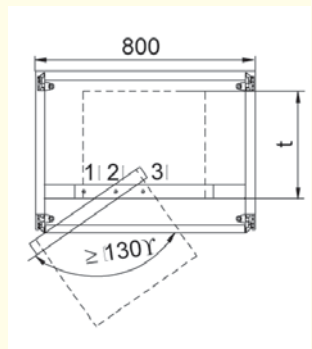

MIR00323 B

## Useful depth according to rack type and pivot point

- A Center inst., pivot point 1
- B Center inst., pivot point 2
- C Center inst., pivot point 3

W [mm]	H [mm]	D [mm]
800		600
800		800

A	B	C	D
390	370	360	285
535	370	360	285

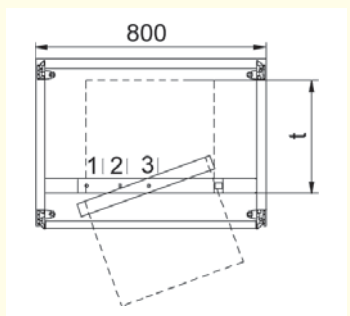

MIR00324 C



MIR00209

## 19" Swing Frame 180°

- With swing frame use the rack must be screwed to the floor.
- Installation of the swing frame reduces the rack's nominal installation height by 2 U.
- With load rating > 80 kg installation weight, please also order additional assembly kit, side panel screwing!
- **19" Swing Frame 180°**  
- For mounting 19" components in acc. with IEC 297-3  
- Enables free accessibility to the second mounting level and to the installation components in the swing frame  
- Can be mounted in rack width 800 mm  
- Rack must be screwed to the floor

- **Material**  
- Frame, 2 mm sheet steel  
- Die-cast aluminum pivot bearing
- **Finish/ Color**  
Frame and horizontal rail  
Powder-coated texture, RAL 7035 light gray  
Front board support on the vertical post, zinc-passivated
- **Supply schedule**  
1 19" swing frame, complete  
1 horizontal mounting, below  
1 horizontal mounting, above  
1 square spanner  
Mounting material

W	H	D	U	h	d	kg	Model	Order no.	UP
800	2000	39	1737					01.131.430.1	1 unit

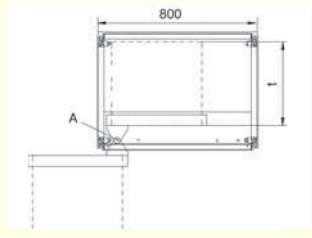

MIR00315

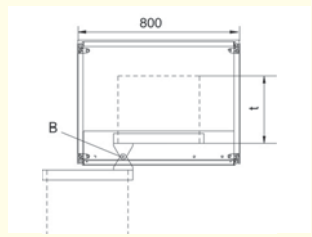

MIR00316

## Useful depth according to rack type and pivot point

- A External inst., external pivot point
- B Center inst., pivot point 1

W [mm]	H [mm]	D [mm]
800		600/800

A	B
420	290

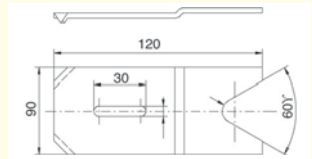

MIR00319

## Base Fixing Kit

- **Material**  
Sheet steel, 3.0 mm
- **Finish**  
Zinc-passivated
- **Supply schedule**  
4 clamping plates

W	H	D	U	h	d	kg	Model	Order no.	UP
								01.130.934.7	1 unit



MIR20310

### Miracel® Sheet Steel Door with Perforation, Single

- **Material**  
Sheet steel, 1.0 mm
- **Finish/ Color**  
Final digit of order number .1:  
Powder-coated texture  
RAL 7035 light gray  
Final digit of order number .8:  
Powder-coated texture  
RAL 7021 dark gray
- **Supply schedule**  
1 door  
Mounting material
- **Volume flow**  
A large surface perforation (83% free surface) enables optimum airflow through the rack



MIR20277

### Miracel® Sheet Steel Door with Perforation, Double

- **Material**  
Sheet steel, 1.0 mm
- **Finish/Color**  
Final digit of order number .1:  
Powder-coated texture  
RAL 7035 light gray  
Final digit of order number .8:  
Powder-coated texture  
RAL 7021 dark gray
- **Supply schedule**  
1 door  
Mounting material
- **Volume flow**  
A large surface perforation (83% free surface) enables optimum airflow through the rack

W	H	D	U	h	d	kg	Model	Order no.	UP
600	1200						Compl. door, RAL 7035	<b>01.147.400.1</b>	1 unit
600	1200						Compl. door, RAL 7021	<b>01.147.400.8</b>	1 unit
700	1200						Compl. door, RAL 7035	<b>01.147.401.1</b>	1 unit
700	1200						Compl. door, RAL 7021	<b>01.147.401.8</b>	1 unit
800	1200						Compl. door, RAL 7035	<b>01.147.402.1</b>	1 unit
800	1200						Compl. door, RAL 7021	<b>01.147.402.8</b>	1 unit
600	1800						Compl. door, RAL 7035	<b>01.147.412.1</b>	1 unit
600	1800						Compl. door, RAL 7021	<b>01.147.412.8</b>	1 unit
700	1800						Compl. door, RAL 7035	<b>01.147.413.1</b>	1 unit
700	1800						Compl. door, RAL 7021	<b>01.147.413.8</b>	1 unit
800	1800						Compl. door, RAL 7035	<b>01.147.414.1</b>	1 unit
800	1800						Compl. door, RAL 7021	<b>01.147.414.8</b>	1 unit
900	1800						Compl. door, RAL 7035	<b>01.147.415.1</b>	1 unit
900	1800						Compl. door, RAL 7021	<b>01.147.415.8</b>	1 unit
600	2000						Compl. door, RAL 7035	<b>01.147.416.1</b>	1 unit
600	2000						Compl. door, RAL 7021	<b>01.147.416.8</b>	1 unit
700	2000						Compl. door, RAL 7035	<b>01.147.417.1</b>	1 unit
700	2000						Compl. door, RAL 7021	<b>01.147.417.8</b>	1 unit
800	2000						Compl. door, RAL 7035	<b>01.147.418.1</b>	1 unit
800	2000						Compl. door, RAL 7021	<b>01.147.418.8</b>	1 unit
600	2200						Compl. door, RAL 7035	<b>01.147.420.1</b>	1 unit
600	2200						Compl. door, RAL 7021	<b>01.147.420.8</b>	1 unit
700	2200						Compl. door, RAL 7035	<b>01.147.421.1</b>	1 unit
700	2200						Compl. door, RAL 7021	<b>01.147.421.8</b>	1 unit
800	2200						Compl. door, RAL 7035	<b>01.147.422.1</b>	1 unit
800	2200						Compl. door, RAL 7021	<b>01.147.422.8</b>	1 unit

W	H	D	U	h	d	kg	Model	Order no.	UP
600	2000						Double door RAL 7035	<b>01.128.260.1</b>	1 unit
600	2000						Double door RAL 7021	<b>01.128.260.8</b>	1 unit
700	2000						Double door RAL 7035	<b>01.128.261.1</b>	1 unit
700	2000						Double door RAL 7021	<b>01.128.261.8</b>	1 unit
800	2000						Double door RAL 7035	<b>01.128.262.1</b>	1 unit
800	2000						Double door RAL 7021	<b>01.128.262.8</b>	1 unit
600	2200						Double door RAL 7035	<b>01.128.263.1</b>	1 unit
600	2200						Double door RAL 7021	<b>01.128.263.8</b>	1 unit
700	2200						Double door RAL 7035	<b>01.128.264.1</b>	1 unit
700	2200						Double door RAL 7021	<b>01.128.264.8</b>	1 unit
800	2200						Double door RAL 7035	<b>01.128.265.1</b>	1 unit
800	2200						Double door RAL 7021	<b>01.128.265.8</b>	1 unit



MIR00059

### Miracel® Door Trim

- **Material**  
Aluminum extrusion or sheet steel
- **Finish / Color**  
Powder-coated texture, RAL 9011
- **Supply schedule**  
1 door trim (single doors)  
2 door trims (double doors)  
Mounting material
- **How supplied**  
Flat-packed kit



MIR00060

W	H	D	Model	Order no.	UP
600			Door trim, double door*	<b>01.133.200.9</b>	1 set
700			Door trim, double door*	<b>01.133.201.9</b>	1 set
800			Door trim, double door*	<b>01.133.202.9</b>	1 set
600			Door trim	<b>01.133.210.9</b>	1 set
700			Door trim	<b>01.133.211.9</b>	1 set
800			Door trim	<b>01.133.212.9</b>	1 set

\* Cannot be used for glass double doors

Dimensions in mm: W = Width  
H = Height  
D = Depth  
h = installation height  
d = useful depth  
L = length  
U = standard height unit  
1 U = 44.45 mm  
UP = unit of packaging  
kg = weight  
Express item

Conversion: 1 mm = 0.03937 inch 1 kg = 2.2046 pound

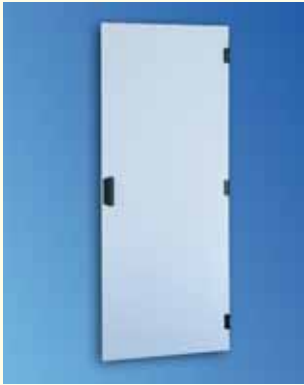

MIR20313



MIR20314

## Knürr Miracel® Sheet Steel Door, single and double

- **Material**  
Sheet steel, 1.0 mm
- **Finish / Color**  
Final digit of order number .1:  
Powder-coated texture  
RAL 7035 light gray  
Final digit of order number .8:  
Powder-coated texture  
RAL 7021 dark gray
- **Protection rating**  
With installation in the Miracel rack (depending on the other rack components), a maximum protection class of IP 55 can be achieved with IP 40 double doors.
- **Supply schedule**  
1 sheet steel door  
Mounting material
- **How supplied**  
Pre-assembled

W	H	D	U	Model	Order no.	UP
600	1200	23		Compl. door, RAL 7035	01.147.440.1	1 unit
600	1200	23		Compl. door, RAL 7021	01.147.440.8	1 unit
700	1200	23		Compl. door, RAL 7035	01.147.441.1	1 unit
700	1200	23		Compl. door, RAL 7021	01.147.441.8	1 unit
800	1200	23		Compl. door, RAL 7035	01.147.442.1	1 unit
800	1200	23		Compl. door, RAL 7021	01.147.442.8	1 unit
600	1800	37		Compl. door, RAL 7035	01.147.452.1	1 unit
600	1800	37		Compl. door, RAL 7021	01.147.452.8	1 unit
700	1800	37		Compl. door, RAL 7035	01.147.453.1	1 unit
700	1800	37		Compl. door, RAL 7021	01.147.453.8	1 unit
800	1800	37		Compl. door, RAL 7035	01.147.454.1	1 unit
800	1800	37		Compl. door, RAL 7021	01.147.454.8	1 unit
600	2000	41		Compl. door, RAL 7035	01.147.456.1	1 unit
600	2000	41		Compl. door, RAL 7021	01.147.456.8	1 unit
700	2000	41		Compl. door, RAL 7035	01.147.457.1	1 unit
700	2000	41		Compl. door, RAL 7021	01.147.457.8	1 unit
800	2000	41		Compl. door, RAL 7035	01.147.458.1	1 unit
800	2000	41		Compl. door, RAL 7021	01.147.458.8	1 unit
600	2200	46		Compl. door, RAL 7035	01.147.460.1	1 unit
600	2200	46		Compl. door, RAL 7021	01.147.460.8	1 unit
700	2200	46		Compl. door, RAL 7035	01.147.461.1	1 unit
700	2200	46		Compl. door, RAL 7021	01.147.461.8	1 unit
800	2200	46		Compl. door, RAL 7035	01.147.462.1	1 unit
800	2200	46		Compl. door, RAL 7021	01.147.462.8	1 unit
600	1200	23		Double door, steel	01.131.820.1	1 unit
700	1200	23		Double door, steel	01.131.821.1	1 unit
800	1200	23		Double door, steel	01.131.822.1	1 unit
600	1800	37		Double door, steel	01.131.835.1	1 unit
700	1800	37		Double door, steel	01.131.836.1	1 unit
800	1800	37		Double door, steel	01.131.837.1	1 unit
600	2000	41		Double door, steel	01.131.840.1	1 unit

W	H	D	U	Model	Order no.	UP
700	2000	41		Double door, steel	01.131.841.1	1 unit
800	2000	41		Double door, steel	01.131.842.1	1 unit
600	2200	46		Double door, steel	01.131.845.1	1 unit
700	2200	46		Double door, steel	01.131.846.1	1 unit
800	2200	46		Double door, steel	01.131.847.1	1 unit



MIR20311



MIR20312

## Knürr Miracel® Glass Door, single and double

- **Material**  
Sheet steel 1.0 mm, single safety glass panel 4.0 mm, clear glass, double door 6.0 mm
- **Finish / Color**  
Final digit of order number .1:  
Powder-coated texture  
RAL 7035 light gray  
Final digit of order number .8:  
Powder-coated texture  
RAL 7021 dark gray
- **Protection rating**  
With installation in the Miracel rack (depending on the other rack components), a maximum protection class of IP 55 can be achieved with IP 20 double doors.
- **Supply schedule**  
1 glass door  
Mounting material
- **How supplied**  
Pre-assembled

W	H	D	U	Model	Order no.	UP
600	1200	23		Compl. door, RAL 7035	01.147.480.1	1 unit
600	1200	23		Compl. door, RAL 7021	01.147.480.8	1 unit
700	1200	23		Compl. door, RAL 7035	01.147.481.1	1 unit
700	1200	23		Compl. door, RAL 7021	01.147.481.8	1 unit
800	1200	23		Compl. door, RAL 7035	01.147.482.1	1 unit
800	1200	23		Compl. door, RAL 7021	01.147.482.8	1 unit
600	1800	37		Compl. door, RAL 7035	01.147.492.1	1 unit
600	1800	37		Compl. door, RAL 7021	01.147.492.8	1 unit
700	1800	37		Compl. door, RAL 7035	01.147.493.1	1 unit
700	1800	37		Compl. door, RAL 7021	01.147.493.8	1 unit
800	1800	37		Compl. door, RAL 7035	01.147.494.1	1 unit
800	1800	37		Compl. door, RAL 7021	01.147.494.8	1 unit
600	2000	41		Compl. door, RAL 7035	01.147.496.1	1 unit
600	2000	41		Compl. door, RAL 7021	01.147.496.8	1 unit
700	2000	41		Compl. door, RAL 7035	01.147.497.1	1 unit
700	2000	41		Compl. door, RAL 7021	01.147.497.8	1 unit
800	2000	41		Compl. door, RAL 7035	01.147.498.1	1 unit
800	2000	41		Compl. door, RAL 7021	01.147.498.8	1 unit
600	2200	46		Compl. door, RAL 7035	01.147.500.1	1 unit
600	2200	46		Compl. door, RAL 7021	01.147.500.8	1 unit
700	2200	46		Compl. door, RAL 7035	01.147.501.1	1 unit
700	2200	46		Compl. door, RAL 7021	01.147.501.8	1 unit
800	2200	46		Compl. door, RAL 7035	01.147.502.1	1 unit
800	2200	46		Compl. door, RAL 7021	01.147.502.8	1 unit

Continued on next page!

W	H	D	U	Model	Order no.	UP
600	1200	23		Double door, glass	01.131.850.1	1 unit
700	1200	23		Double door, glass	01.131.851.1	1 unit
800	1200	23		Double door, glass	01.131.852.1	1 unit
600	1800	37		Double door, glass	01.131.862.1	1 unit
700	1800	37		Double door, glass	01.131.863.1	1 unit
800	1800	37		Double door, glass	01.131.864.1	1 unit
600	2000	41		Double door, glass	01.131.866.1	1 unit
700	2000	41		Double door, glass	01.131.867.1	1 unit
800	2000	41		Double door, glass	01.131.868.1	1 unit
600	2200	46		Double door, glass	01.131.870.1	1 unit
700	2200	46		Double door, glass	01.131.871.1	1 unit
800	2200	46		Double door, glass	01.131.872.1	1 unit

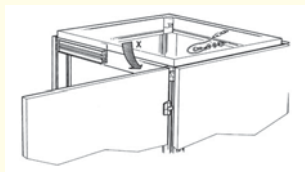

MIR00216

### Earthing Set door/ Side Panel / Rear Panel

- For safe earthing of doors and covers

**Supply schedule**  
1 earthline  
Mounting material

**How supplied**  
Flat-packed kit

W	H	D	Model	Order no.	UP
			For doors	1.130.624.9	1 unit
			For side and rear panel	1.133.745.9	1 unit

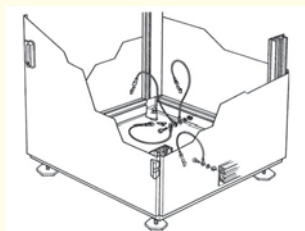

MIR00217

### earthing set rack

- For safe rack earthing
- Standardized protective conductor connection

**Standards**  
IEC 950  
VDE 0100

**Supply schedule**  
5 earthlines  
Mounting material

**How supplied**  
Flat-packed kit

W	H	D	Model	Order no.	UP
				01.130.529.9	1 unit



MIR00066

### Door Locking Set

**Supply schedule**  
1 lock set  
2 keys (half-cylinder)

**Note**  
Further cylinder locks on request!

W	H	D	U	h	d	kg	Model	Order no.	UP
								05.041.299.9	1 unit



MIR00069

### Complete Locking Set

**Supply schedule**  
2 cylinders with 2 keys each  
2 lockable fasteners for side panel with 2 keys each

W	H	D	U	h	d	kg	Model	Order no.	UP
								01.130.940.9	1 unit



MIR00068

### Miracel® Locking Set (for side or rear panel)

- For installation in the side or rear panel
- For protection against unauthorized access
- Later installation also possible

**Supply schedule**  
1 lockable fastener  
2 keys

**How supplied**  
Flat-packed kit

W	H	D	U	h	d	kg	Model	Order no.	UP
								01.130.938.9	1 unit



MIR00076

### Miracel® Plinth Stationary, height 200 mm

- Stationary incl. leveling option
- Cable entry possible from all sides
- Panels front and rear with vent slots and installation option for filter mat

**Load rating**  
3000 N static

**Material**  
Sheet steel

**Finish**  
Powder-coated texture, RAL 7035

**Supply schedule**  
4 plinth corners with leveling feet  
8 panels  
Mounting material

**How supplied**  
Flat-packed kit

W	H	D	U	h	d	kg	Model	Order no.	UP
600	200	600						01.130.958.1	1 unit
600	200	800						01.130.959.1	1 unit
600	200	900						01.130.960.1	1 unit
700	200	600						01.130.964.1	1 unit
700	200	800						01.130.965.1	1 unit
800	200	600						01.130.970.1	1 unit
800	200	800						01.130.971.1	1 unit



MIR00414

## Miracel® Plinth, stationary, height 100 mm

- Stationary
- Cable entry possible from all sides
- Panels front and rear with vent slots and installation option for filter mat

■ **Load rating**  
5000 N static

■ **Material**  
Sheet steel

■ **Finish**  
Powder-coated texture, RAL 7035

■ **Supply schedule**  
4 plinth corners with leveling  
2 plinth panels with slots  
2 plinth panels closed on the side  
Mounting material

■ **How supplied**  
Flat-packed kit

W	H	D	U	h	d	kg	Model	Order no.	UP
600	100	600						01.130.538.1	1 unit
600	100	800						01.130.539.1	1 unit
600	100	900						01.130.540.1	1 unit
600	100	1000						01.127.650.1	1 unit
600	100	1200						01.133.710.1	1 unit
700	100	600						01.130.544.1	1 unit
700	100	800						01.130.545.1	1 unit
700	100	900						01.130.546.1	1 unit
700	100	1000						01.127.651.1	1 unit
700	100	1200						01.133.711.1	1 unit
800	100	600						01.130.550.1	1 unit
800	100	800						01.130.551.1	1 unit
800	100	900						01.130.552.1	1 unit
800	100	1000						01.127.652.1	1 unit
800	100	1200						01.133.712.1	1 unit



MIR20088

## Miracel® Castors

- Can be mounted on the threaded eyelet of the basic rack
- Castor diameter, 75 mm
- Threaded bolt, M12
- Load capacity per castor: 100 kg

■ **Supply schedule**  
4 swivel castors

■ **How supplied**  
Flat-packed kit

W	H	D	U	h	d	kg	Model	Order no.	UP
								05.031.057.9	4 units

Dimensions in mm: W = Width  
H = Height  
D = Depth  
h = installation height  
d = useful depth  
L = length

U = standard height unit  
1 U = 44.45 mm  
UP = unit of packaging  
kg = weight

Express item

Conversion: 1 mm = 0.03937 inch 1 kg = 2.2046 pound



MIR00077

## Miracel® Plinth, mobile, height 100 mm

- Mobile
- Cable entry possible on the rear
- With leveling feet for stationary model

■ **Load rating**  
3000 N static

■ **Material**  
Sheet steel, 2 mm

■ **Finish**  
Powder-coated texture, RAL 7035

■ **Supply schedule**  
1 plinth frame  
2 fixed castors with snib  
2 swivel castors  
4 leveling feet  
Mounting material

■ **How supplied**  
Flat-packed kit

W	H	D	U	h	d	kg	Model	Order no.	UP
600	100	600						01.130.561.1	1 unit
600	100	800						01.130.562.1	1 unit
600	100	900						01.130.563.1	1 unit
600	100	1000						01.127.250.1	1 unit
600	100	1200						01.133.715.1	1 unit
700	100	600						01.130.565.1	1 unit
700	100	800						01.130.566.1	1 unit
700	100	1000						01.127.253.1	1 unit
700	100	1200						01.133.716.1	1 unit
800	100	600						01.130.569.1	1 unit
800	100	800						01.130.570.1	1 unit
800	100	900						01.130.571.1	1 unit
800	100	1000						01.127.254.1	1 unit
800	100	1200						01.133.717.1	1 unit



ELM00103a

## Front Panel, Swivel

- For covering the side jumpering space on the front in Miracel racks, width 800
- Easy to open with jumpering work

■ **Material/Finish**  
Sheet steel, 1.0 mm, powder-coated texture

■ **Color**  
RAL 7035 light gray

■ **Supply schedule**  
2 front panels  
Mounting material

■ **How supplied**  
Flat-packed kit

W	H	D	U	h	d	kg	Model	Order no.	UP
			1003				For rack width 800	01.113.044.1	1 unit
			1003				For rack width 800	01.113.044.8	1 unit
			1803				For rack width 800	01.113.048.1	1 unit
			1803				For rack width 800	01.113.048.8	1 unit
			2002				For rack width 800	01.113.049.1	1 unit
			2002				For rack width 800	01.113.049.8	1 unit



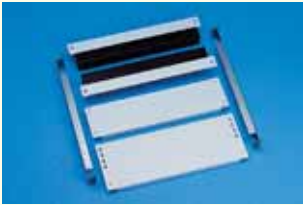

MIR00355

**Miracel® bottom cover for flexible cable entry with rubber sealing, IP 40**

- For covering the rack underside
- With rubber sealing for flexible cable entry on the front and rear

**Material/ Finish**  
Sheet steel, 1.5 mm, zinc-passivated  
Sponge rubber, 50 mm x 50 mm

**Supply schedule**  
1 cable entry  
2 bottom covers  
2 mounting brackets  
Mounting material

**How supplied**  
Flat-packed kit

W	H	D	U	h	d	kg	Model	Order no.	UP
600		600						01.130.732.0	1 unit
600		800						01.130.733.0	1 unit
600		900						01.130.734.0	1 unit
600		1000						01.127.670.0	1 unit
600		1200						01.133.740.0	1 unit
700		600						01.130.735.0	1 unit
700		800						01.130.736.0	1 unit
700		900						01.127.671.0	1 unit
700		1000						01.127.672.0	1 unit
700		1200						01.133.741.0	1 unit
800		600						01.130.738.0	1 unit
800		800						01.130.739.0	1 unit
800		900						01.130.740.0	1 unit
800		1000						01.127.673.0	1 unit
800		1200						01.133.742.0	1 unit



MIR00521

**Miracel® plinth panel with brush strip**

- For cable entry on the side, front and rear

**Finish**  
Powder-coated texture, RAL 7035

**Supply schedule**  
1 plinth panel with brush strip  
Mounting material

**How supplied**  
Flat-packed kit

W	H	D	U	h	d	kg	Model	Order no.	UP
600		600						01.130.744.1	1 unit
800		800						01.130.745.1	1 unit



MIR00161

**Miracel® filter mat for plinth panel**  
For installation in plinth panel on the front and rear

**Supply schedule**  
2 filter mats

**How supplied**  
Flat-packed kit

W	H	D	U	h	d	kg	Model	Order no.	UP
600								01.130.530.9	1 unit
700								01.130.531.9	1 unit
800								01.130.532.9	1 unit

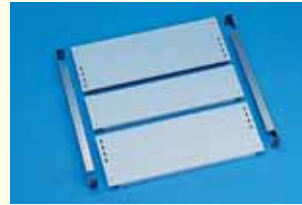

MIR00357

**DCM® bottom cover, 3-piece**

- For covering the rack underside
- For flexible cable entry on the front and rear

**Material/ Finish**  
Sheet steel, 1.5 mm, zinc-passivated

**Supply schedule**  
3 bottom covers  
2 mounting brackets  
Mounting material

**How supplied**  
Flat-packed kit

W	H	D	U	h	d	kg	Model	Order no.	UP
600		600						01.130.750.0	1 unit
600		800						01.130.751.0	1 unit
600		900						01.130.752.0	1 unit
600		1000						01.127.660.0	1 unit
600		1200						01.133.730.0	1 unit
700		600						01.130.753.0	1 unit
700		800						01.130.754.0	1 unit
700		900						01.130.755.0	1 unit
700		1000						01.127.662.0	1 unit
700		1200						01.133.731.0	1 unit
800		600						01.130.756.0	1 unit
800		800						01.130.757.0	1 unit
800		900						01.130.758.0	1 unit
800		1000						01.127.663.0	1 unit
800		1200						01.133.732.0	1 unit



MIR20331

**Miracel® quick connectors for side and rear panels**

- Covers quickly fixed with 90° rotation of the connectors
- Easy to turn with wide flat-head screwdriver

**Material/Finish**  
Final digit of order number .1:  
Polyamide PA66  
RAL 7035 light gray  
Final digit of order number .9:  
Polyamide PA66  
RAL 9011 dark gray

**How supplied**  
Sets of 50 units

Model	Order no.	UP
For side panel RAL 7035	01.133.900.1	1 set
For side panel RAL 9011	01.133.900.9	1 set
For side panel RAL 7035	01.133.910.1	1 set
For side panel RAL 9011	01.133.910.9	1 set

Dimensions in mm: W = Width  
H = Height  
D = Depth  
h = installation height  
d = useful depth  
L = length  
U = standard height unit  
1 U = 44.45 mm  
UP = unit of packaging  
kg = weight  
Express item

Conversion: 1 mm = 0.03937 inch 1 kg = 2.2046 pound



MIR00064

## Miracel® Side Panel

- **Protection rating**  
With installation in the Miracel rack (depending on the other rack components), a maximum protection class of IP 55 can be achieved
- **Material**  
Sheet steel, 1.0 mm
- **Finish/ Color**  
Powder-coated texture, RAL 7035
- **Supply schedule**  
1 side panel  
Mounting material
- **How supplied**  
Flat-packed kit

W	H	D	U	h	d	kg	Model	Order no.	UP
1200	600	23						<b>01.130.643.1</b>	1 unit
1200	800	23						<b>01.130.649.1</b>	1 unit
1200	900	23						<b>01.130.655.1</b>	1 unit
1800	600	37						<b>01.130.646.1</b>	1 unit
1800	800	37						<b>01.130.652.1</b>	1 unit
2000	600	41						<b>01.130.647.1</b>	1 unit
2000	800	41						<b>01.130.653.1</b>	1 unit
2000	900	41						<b>01.130.659.1</b>	1 unit
2000	1000	41						<b>01.127.739.1</b>	1 unit
2000	1200	41						<b>01.128.874.1</b>	1 unit
2200	600	46						<b>01.130.648.1</b>	1 unit
2200	800	46						<b>01.130.654.1</b>	1 unit
2200	900	46						<b>01.130.660.1</b>	1 unit
2200	1000	46						<b>01.127.740.1</b>	1 unit
2200	1200	46						<b>01.128.875.1</b>	1 unit



MIR00064

## Miracel® Rear Panel

- **Protection rating**  
With installation in the Miracel rack (depending on the other rack components), a maximum protection class of IP 55 can be achieved
- **Material**  
Sheet steel, 1.0 mm
- **Finish/ Color**  
Powder-coated texture, RAL 7035
- **Supply schedule**  
1 rear panel  
Mounting material
- **How supplied**  
Flat-packed kit

W	H	D	U	h	d	kg	Model	Order no.	UP
600	1200	23						<b>01.130.662.1</b>	1 unit
600	1800	37						<b>01.130.665.1</b>	1 unit
600	2000	41						<b>01.130.666.1</b>	1 unit
600	2200	46						<b>01.130.667.1</b>	1 unit
700	1200	23						<b>01.130.668.1</b>	1 unit
700	1800	37						<b>01.130.671.1</b>	1 unit
700	2000	41						<b>01.130.672.1</b>	1 unit
700	2200	46						<b>01.130.673.1</b>	1 unit
800	1200	23						<b>01.130.674.1</b>	1 unit
800	1800	37						<b>01.130.677.1</b>	1 unit
800	2000	41						<b>01.130.678.1</b>	1 unit
800	2200	46						<b>01.130.679.1</b>	1 unit

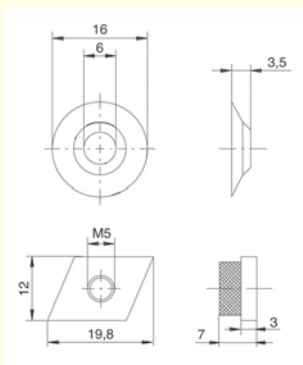

MIR00318

## Miracel® Assembly Kit Side panel screwing

- For screwing the side panels instead of using quick connectors
- Provides additional rack strength
- **Material**  
Countersunk washers and mounting nuts  
Stainless steel
- **Supply schedule** (for 2 side panels)  
16 countersunk washers  
16 mounting nuts, M5  
16 countersunk screws, M5 x 12
- **How supplied**  
Flat-packed kit

W	H	D	U	h	d	kg	Model	Order no.	UP
								<b>01.130.937.9</b>	1 unit



MIR00068

## Miracel® Locking Set For side or rear panel

- For installation in the side or rear panel
- For protection against unauthorized access
- Later installation also possible
- **Supply schedule**  
1 lockable fastener  
2 keys
- **How supplied**  
Flat-packed kit

W	H	D	U	h	d	kg	Model	Order no.	UP
								<b>01.130.938.9</b>	1 unit

Dimensions in mm: W = Width  
H = Height  
D = Depth  
h = installation height  
d = useful depth  
L = length  
U = standard height unit  
1 U = 44.45 mm  
UP = unit of packaging  
kg = weight  
Express item

Conversion: 1 mm = 0.03937 inch 1 kg = 2.2046 pound

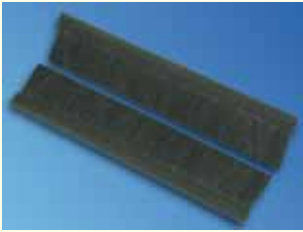

MIR20093

### Miracel® Brush Strip

- Brush strip for all covers with cable entry
- For dust-protected and flexible cable entry
- Instead of mounting the sliding covers in the top cover

■ **Supply schedule**  
2 brush strips

■ **How supplied**  
Flat-packed kit

W	H	D	U	h	d	kg	Model	Order no.	UP
							For rack widths 700/800	01.130.999.9	1 unit
							For rack width 600	01.130.998.9	1 unit

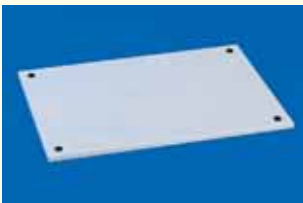

MIR00070

### Miracel® Cover, closed, IP 55

- Can be optionally used as top cover or bottom cover (combination with stationary plinth is not possible with use as bottom cover)

■ **Protection rating**  
With installation in the Miracel rack (depending on the other rack components), a maximum protection class of IP 55 can be achieved.

■ **Finish**  
Powder-coated texture, RAL 7035

■ **Supply schedule**  
1 top cover, closed  
Mounting material

■ **How supplied**  
Flat-packed kit

W	H	D	U	h	d	kg	Model	Order no.	UP
600		600						01.130.690.1	1 unit
600		800						01.130.691.1	1 unit
600		900						01.130.692.1	1 unit
600		1000						01.127.700.1	1 unit
600		1200						01.133.760.1	1 unit
700		600						01.130.694.1	1 unit
700		800						01.130.695.1	1 unit
700		900						01.130.696.1	1 unit
700		1000						01.127.701.1	1 unit
700		1200						01.133.761.1	1 unit
800		600						01.130.691.1	1 unit
800		800						01.130.699.1	1 unit
800		900						01.130.700.1	1 unit
800		1000						01.127.702.1	1 unit
800		1200						01.133.762.1	1 unit



Note:  
**Knürr CoolBlast®  
Top-Mounting Fan**  
From page 1.111



SmartAisle™



# SmartAisle™

Energy-efficient use  
of existing cooling power  
in data centers

1.50 to 1.59





Emerson Network Power

# Smart Aisle™

The consistent physical separation of cold zones from warm zones in the three areas – raised floor, rack and cold aisle containment – is the basis for the **SmartAisle™** principle used. This immediately reduces energy costs significantly. The room thermal management equipment must be regulated speed-dependent for a highly efficient operation (EC fans in the air circulation equipment provide the basis for this).

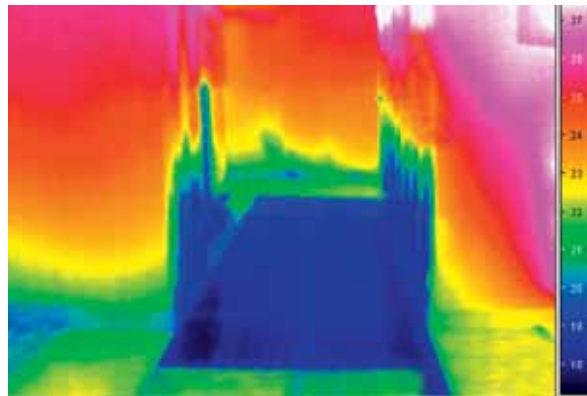

Conventional data center

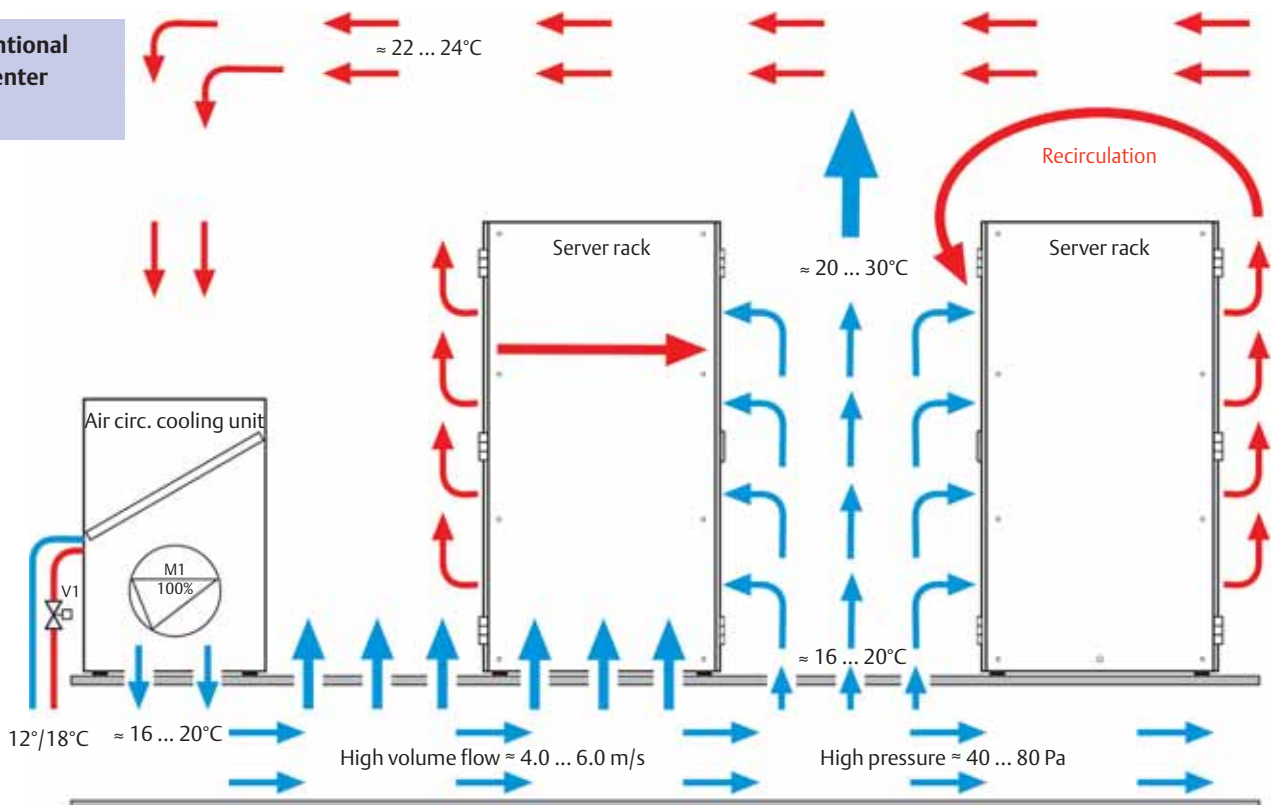

## SmartAisle™ Strong points



LUF20254

The **benefits** of a containment over a conventional structure are:

- No hot spots (warm air recirculation from the warm aisle into the cold aisle; across the roof and across the front panels or through the rack)
- Minimum possible energy costs for the CRAC units (especially with intelligent Knürr regulation)
- Several servers can be installed
- Raised floor doesn't have to be balanced out (which is difficult and would have to be done after every change in a conventional DC)
- Any server positioning in the rack (with conventional DCs positioning above in the rack and at the front of the aisle are prevented)
- Higher safety with increased CRAC unit redundancy (energy efficient 2n redundancy instead of n+1)
- Safer with CRAC unit failure; longer bridging time

Data center with  
SmartAisle™  
in use

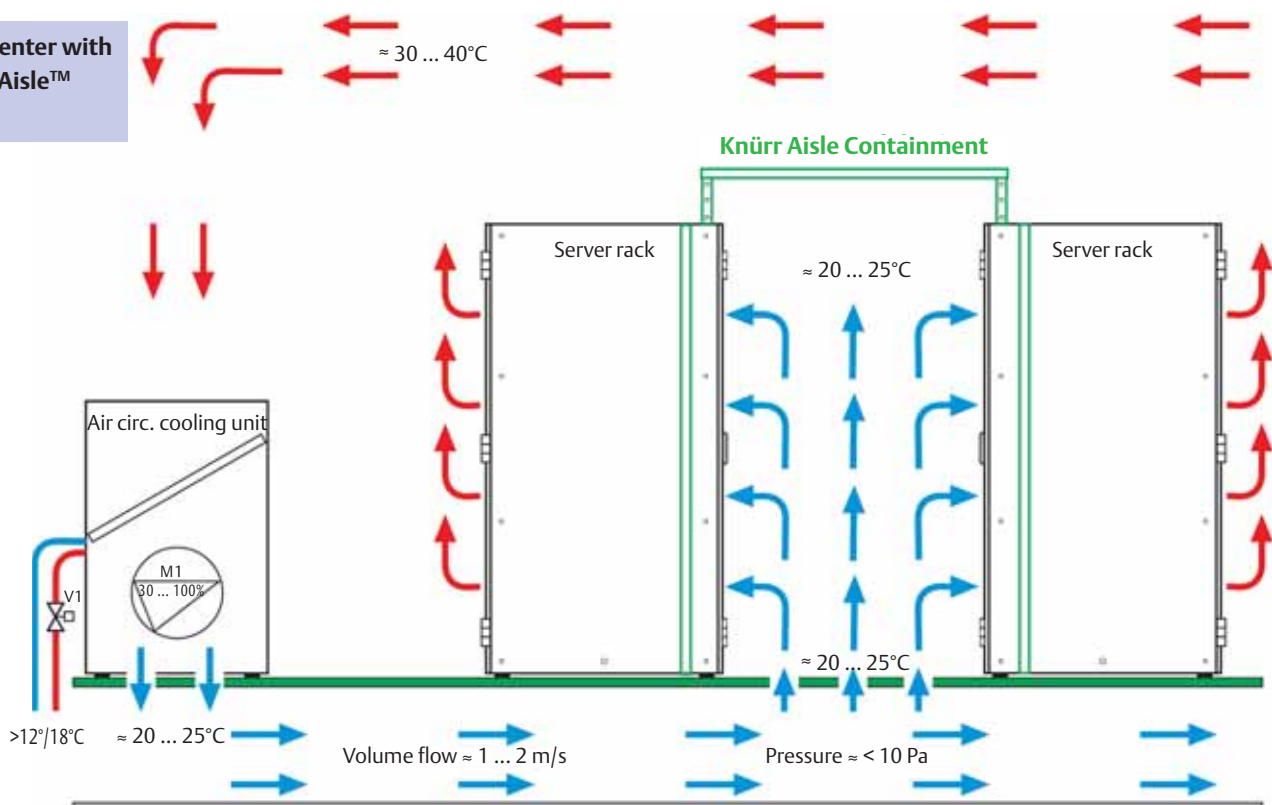

### Knürr Aisle Containment Components

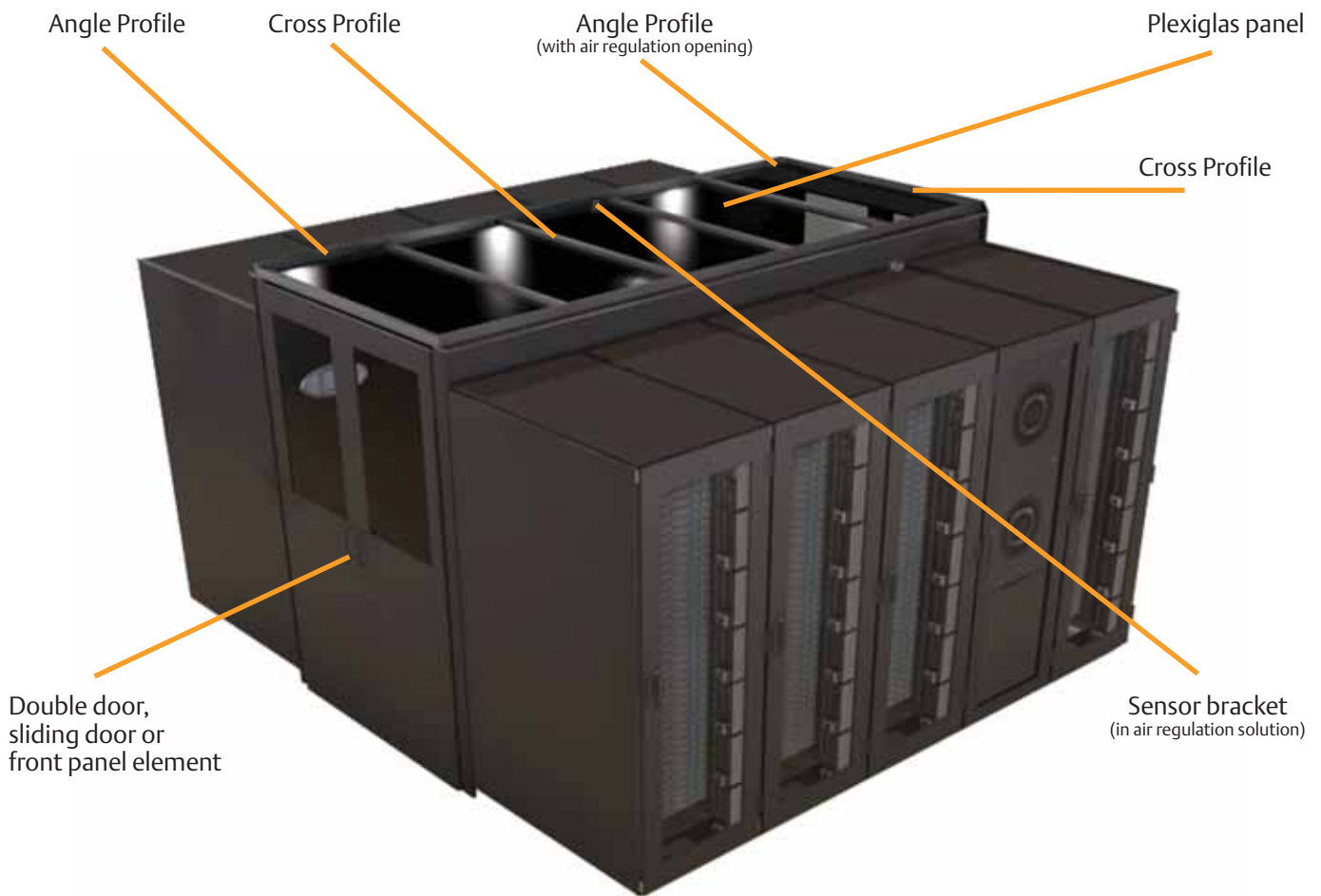

### SmartAisle™ control principle

Previously the speed of the fans in the room thermal management equipment was regulated by the returning air temperature, i.e. the temperature in the warm zone. The supply air temperature that the servers reached was, however, extremely important. The Knürr SmartAisle™ regulation principle uses the supply air temperature for regulating the circulated air cooling equipment.

In accordance with ASHRAE (American Society of Heating, Refrigerating and Air-Conditioning Engineers), the supply air temperature should be between 18°C and 27°C. This temperature cannot, however, always be guaranteed with the return air temperature. For energy efficiency reasons the supply air temperature should be selected as high as possible.

With cold aisle containment a higher cold aisle temperature can be selected so that a recirculation (or hot spot) is avoided.





MIR20341

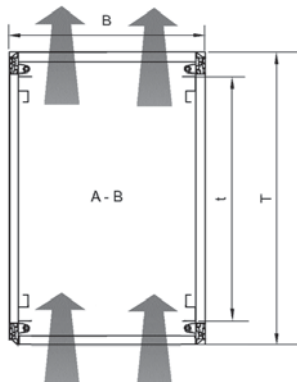

MIR20131

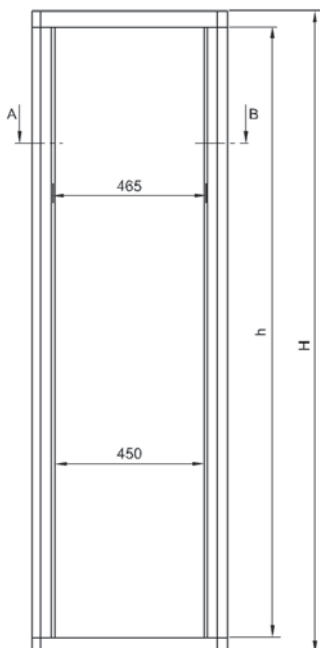

MIR20131

## Knürr Mirace<sup>PLUS</sup>® 19" Heavy Duty Server Rack Standard model for Knürr SmartAisle™, 800 mm wide

- Full version with perforated front and rear door
- Special 19" server extrusions for mounting all trade standard 19" servers
- Components in acc. with IEC 297-3
- Mobile
- Hot air/cold air separation around the 19" level
- Installation of chassis runners and 19" shelves possible
- Cable entry via top cover and bottom
- Rear cable entry on the top cover, can be completely removed at the rear, allowing top cover removal and replacement after cabling
- Cover with side cable entries
- Door opening angle, 180°

### ■ Jumping space

At the front: 85.5 mm

### ■ Load rating

15,000 N static

10,000 N mobile in data center with load

### ■ Protection rating

IP 20

### ■ Tests

- Earthing in acc. with VDE 0100 T 540
- Vibration test in acc. with MIL-STD 810 E
- IP test in acc. with DIN 40 050 / IEC 529

### ■ Airflow circulation

- Perforation: 83%

### ■ Material

Basic rack, extruded aluminum, polished  
Corner piece, die-cast aluminum, polished  
doors  
Covers, sheet steel

### ■ Finish

Powder-coated texture, RAL 7021  
dark gray

### ■ Supply schedule

- 1 basic rack
- 4 19" server extrusions, sheet steel incl. U marking
- 4 multifunctional braces for cable clamping and universal mounting options (2 side panels with quick connectors)
- 1 top cover with cable entry
- 2 perforated doors (perforation: 83 %)
- 4 leveling feet
- 1 complete earthing Set (VDE 0100)
- 1 set of rack connectors
- 1 set of sealing material

### ■ How supplied

Assembled

### ■ Note

Also order mounting adapters (01.127.119.9) for 19" server extrusion for mounting Knürr accessories!

W	H	D	U	For rack type	Order no.	UP
800	2000	1200	42	1000	01.147.180.8	1 unit
800	2000	1200	42	Standard, no side panels	01.147.181.8	1 unit

Dimensions in mm: W = Width  
H = Height  
D = Depth  
h = installation height  
d = useful depth  
L = length

U = standard height unit  
1 U = 44.45 mm  
UP = unit of packaging  
kg = weight  
Express item

Conversion: 1 mm = 0.03937 inch 1 kg = 2.2046 pound

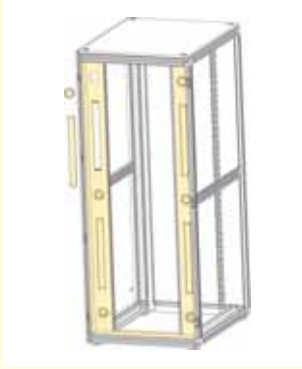

LUF20233



LUF20234

## SmartAisle™ air separation for 19" rack, fixed jumpering depth

- For separating the cold and hot areas in the rack
- Prevention of hot-spots (air recirculation)
- Quick and easy rack upgrading
- More 19" installation space: side panels, with additional 2 x 1 U each in the 19" vertical area
- Side panels with 3 cut-outs each for cable routing (covered as standard with rubber sleeve)

**Material**  
Sheet steel

**Finish**  
Final digit of order number .1:  
powder-coated texture, RAL 7035 light gray  
Final digit of order number .8:  
powder-coated texture, RAL 7021 dark gray

**Supply schedule**  
2 side panels (cut-outs covered)  
2 panels, top/bottom  
Mounting material

**How supplied**  
Flat-packed kit

**Note**  
Use only with server extrusions!

W	H	D	U	RT	For rack typ	Order no.	UP
600	2000	41	85.5	Miracel	<b>03.028.036.X</b>	1 set	
700	2000	41	85.5	Miracel - asymmetric only	<b>03.028.037.X</b>	1 set	
800	2000	41	85.5	Miracel	<b>03.028.038.X</b>	1 set	
600	2200	46	85.5	Miracel	<b>03.028.056.X</b>	1 set	
700	2200	46	85.5	Miracel - asymmetric only	<b>03.028.057.X</b>	1 set	
800	2200	46	85.5	Miracel	<b>03.028.058.X</b>	1 set	
600	2000	41	123	Miracel	<b>03.028.031.X</b>	1 set	
700	2000	41	123	Miracel - asymmetric only	<b>03.028.032.X</b>	1 set	
800	2000	41	123	Miracel	<b>03.028.033.X</b>	1 set	
600	2200	46	123	Miracel	<b>03.028.051.X</b>	1 set	
700	2200	46	123	Miracel - asymmetric only	<b>03.028.052.X</b>	1 set	
800	2200	46	123	Miracel	<b>03.028.053.X</b>	1 set	

**Dimensions in mm:** W = Width  
H = Height  
D = Depth  
h = installation height  
d = useful depth  
L = length  
U = standard height unit  
1 U = 44.45 mm  
UP = unit of packaging  
kg = weight  
Express item

**Conversion:** 1 mm = 0.03937 inch 1 kg = 2.2046 pound

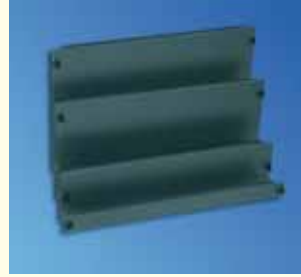

MEC20180



MEC20178

## 19" Blanking Panel Quick Fix tool free mounting

- High-grade metal version
- For covering free 19" spaces (cold-hot separation)
- Quick and easy assembly without tools (one click) and disassembly (quarter turn)
- Suitable for 9.5 x 9.5 square holes

**Material**  
Sheet steel, 1.0 mm

**Finish**  
Final digit of order number .1:  
powder-coated texture, RAL 7035 light gray  
Final digit of order number .8:  
powder-coated texture, RAL 7021 dark gray

**Supply schedule**  
X (see ON for quantity) Quick-Fix 19" Blanking Panel  
Mounting material

**How supplied**  
In sets (see ON for quantity);  
fixing clips pre-mounted

**Note**  
You will also find threaded connection 19" blanking panels in our IT special catalog.

W	H	D	U	d	L	For rack type	Order no.	UP
482.6	43.6		1			Powder-coated	<b>01.103.301.X</b>	6 unit
482.6	88.1		2			Powder-coated	<b>01.103.302.X</b>	3 units
482.6	132.5		3			Powder-coated	<b>01.103.303.X</b>	2 units
482.6	265.9		6			Powder-coated	<b>01.103.306.X</b>	1 units
482.6	399.2		9			Powder-coated	<b>01.103.309.X</b>	2 units
482.6	932.6		21			Powder-coated	<b>01.103.321.X</b>	1 units



MEC20181



MEC20178

## 19" blanking panel cable entry Quick Fix, tool free mounting

- For orderly cable management in the rack internal space
- Quick and easy assembly without tools (one click) and disassembly (quarter turn)
- Suitable for 9.5 x 9.5 square holes

**Material**  
Sheet steel, 1.0 mm

**Finish**  
Final digit of order number .1:  
Powder-coated texture, RAL 7035, light gray  
Final digit of order number .8:  
Powder-coated texture, RAL 7021 dark gray

**Supply schedule**  
6 19" blanking panel cable entries, Quick Fix  
Mounting material

**How supplied**  
In sets; fixing clips pre-mounted

**Note**  
If a blanking panel with 2 U is required,  
2 blanking panels with 1 U each can be  
mounted on top of one another.

W	H	D	U	d	L	For rack type	Order no.	UP
482.6	43.6		1			Powder-coated	<b>01.103.331.X</b>	6 units

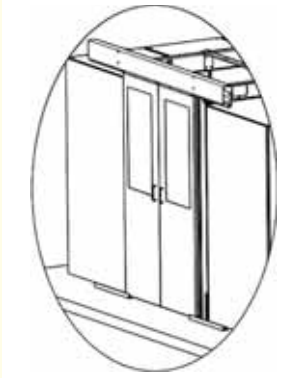

LUF80001

### SmartAisle™ Sliding door Prepared for automatic door closers

- For cold aisle containment for aisle widths: 1,200 / 1,500 / 1,800 mm (+/- 50 mm)
- Quick and easy mounting
- Suitable for Miracel® racks and most makes of other manufacturers.

**Door opening clear**

Width: min. 1,050 mm  
Height: 2,080 mm

**Material**

Door elements: Sheet steel  
Windows: Single safety glass panel  
Brush strips: Polyamide (UL94 HF-1)

**Finish**

Final digit of order number .1: powder-coated texture, RAL 7035 light gray  
Final digit of order number .8: powder-coated texture, RAL 7021 dark gray

**Supply schedule**

1 frame structure  
2 doors  
2 floor guides  
Covers  
Sealing material  
Mounting material

**How supplied**

Flat-packed kit

**Note**

Please order the required closers (electric or mechanical) for this!

W/L	H	D	AW	For rack type	Order no.	UP
2000			1200		03.029.026.X	1 set
2200			1200		03.029.027.X	1 set
2000			1500		03.029.061.X	1 set
2200			1500		03.029.062.X	1 set
2000			1800		03.029.066.X	1 set
2200			1800		03.029.067.X	1 set

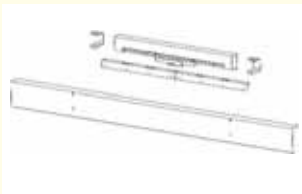

LUF80002

### Electric closer for sliding door

- Suitable for SmartAisle™ sliding door
- Increases energy efficiency, as doors are closed automatically
- Opener/closer contact for control (e.g. fire alarm system)

**Material**

Sheet steel

**Finish**

Final digit of order number .1: powder-coated texture, RAL 7035 light gray  
Final digit of order number .8: powder-coated texture, RAL 7021 dark gray

**Supply schedule**

1 electric drive  
1 cover  
Various mounting brackets  
Mounting material

W/L	H	D	AW	For rack type	Order no.	UP
					03.029.046.X	1 set



LUF80003

### Mechanical closer for sliding door

- Suitable for SmartAisle™ sliding door
- Increases energy efficiency, as doors are closed automatically

**Material**

Sheet steel

**Finish**

Final digit of order number .1: Powder-coated texture, RAL 7035, light gray  
Final digit of order number .8: Powder-coated texture, RAL 7021 dark gray

**Supply schedule**

2 sets of gas pressure springs  
1 cover  
Various mounting brackets  
Mounting material

**Technical data**

Force: 20 N

**How supplied**

In units

W/L	H	D	AW	For rack type	Order no.	UP
					03.029.046.7	1 set

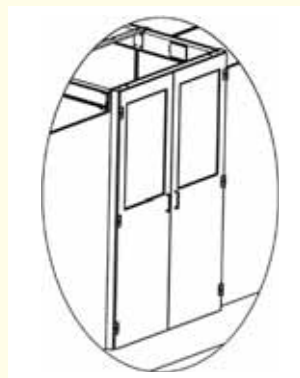

LUF80004

### SmartAisle™ double door with automatic door closer

- For cold aisle containment for aisle widths: 1,200 / 1,500 / 1,800 mm (+/- 50 mm)
- Quick and easy mounting
- Suitable for Miracel® racks and most makes of other manufacturers.
- Integrated automatic mechanical door closer (opening angle 180°, mounting bracket approx. 120°, from approx. 100° automatic closing)

**Door opening clear**

Width: 1,200 mm  
Height: 2,100 mm (for rack height 2,000 mm);  
2,300 (for rack height 2,200)

**Material**

Door frame: Aluminum  
Door elements: Sheet steel  
Windows: Single safety glass panel  
Brush strips: Polyamide (UL94 HF-1)

- **Finish**  
Final digit of order number .1:  
Powder-coated texture, RAL 7035, light gray  
Final digit of order number .8:  
Powder-coated texture, RAL 7021 dark gray
- **Supply schedule**  
1 door frame  
2 doors  
3 design covers  
2 door closers  
Mounting material
- **How supplied**  
Flat-packed kit

W/L	H	D	AW	For rack type	Order no.	UP
2000			1200		<b>03.028.021.X</b>	1 set
2200			1200		<b>03.028.022.X</b>	1 set
2000			1500		<b>03.028.041.X</b>	1 set
2200			1500		<b>03.028.042.X</b>	1 set
2000			1800		<b>03.028.046.X</b>	1 set
2200			1800		<b>03.028.047.X</b>	1 set

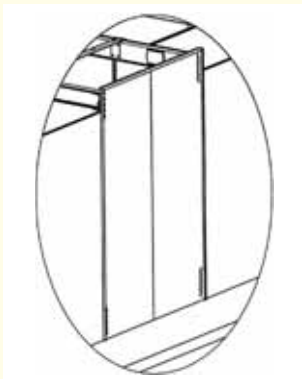

LUFxxxx

## SmartAisle™ Front Panel Element

- For cold aisle containment for aisle widths: 1,200 / 1,500 / 1,800 mm (+/- 50 mm)
- For use instead of a cold aisle door
- Quick and easy mounting
- Suitable for Miracel® racks and most makes of other manufacturers.
- **Material**  
Door elements: Aluminum
- **Finish**  
Final digit of order number .1:  
Powder-coated texture, RAL 7035, light gray  
Final digit of order number .8:  
Powder-coated texture, RAL 7021 dark gray
- **Supply schedule**  
1 bracing bracket  
2 to 4 panel elements  
Mounting material
- **How supplied**  
Flat-packed kit

W/L	H	D	AW	For rack type	Order no.	UP
2000			1200		<b>03.029.031.X</b>	1 set
2200			1200		<b>03.029.032.X</b>	1 set
2000			1500		<b>03.029.034.X</b>	1 set
2200			1500		<b>03.029.035.X</b>	1 set
2000			1800		<b>03.029.037.X</b>	1 set
2200			1800		<b>03.029.038.X</b>	1 set

**Dimensions in mm:** W = Width  
H = Height  
D = Depth  
h = installation height  
d = useful depth  
L = length

U = standard height unit  
1 U = 44.45 mm  
UP = unit of packaging  
kg = weight

 = Express item

**Conversion:** 1 mm = 0.03937 inch 1 kg = 2.2046 pound

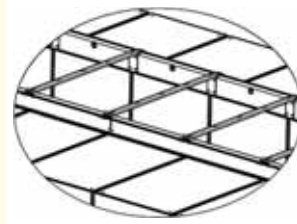

LUF80006

## SmartAisle™ Roof Element Standard version

- For cold aisle containment for aisle widths: 1,200 / 1,500 / 1,800 mm (+/- 50 mm)
- Quick and easy mounting
- Suitable for Miracel® racks and most makes of other manufacturers.
- With rubber sleeves for cable routing
- Plexiglas panel with low fire load and low smoke generation (optionally with compound safety glass)
- Plexiglas panels can be quickly and easily removed
- **Aisle height clear**  
Rack height 2,000 mm: 2,150 mm  
Rack height 2,200 mm: 2,350 mm
- **Material**  
Angle profile  
Cross brace: Sheet steel  
Roof panel: Halogen-free plexiglas
- **Finish**  
Final digit of order number .1:  
Powder-coated texture, RAL 7035, light gray  
Final digit of order number .8:  
Powder-coated texture, RAL 7021 dark gray

- **Supply schedule**  
2 angle profiles  
1 cross profiles at W600/800,  
3 cross profiles at L2400  
1 roof panel at W600/800, 3 roof panels at L2400  
2 angle profiles plates  
Mounting material
- **How supplied**  
Flat-packed kit

W/L	H	D	AW	For rack type	Order no.	UP
600			1200		<b>03.029.004.X</b>	1 set
800			1200		<b>03.029.005.X</b>	1 set
2400			1200		<b>03.029.006.X</b>	1 set
600			1500		<b>03.029.071.X</b>	1 set
800			1500		<b>03.029.072.X</b>	1 set
2400			1500		<b>03.029.073.X</b>	1 set
600			1800		<b>03.029.076.X</b>	1 set
800			1800		<b>03.029.077.X</b>	1 set
2400			1800		<b>03.029.078.X</b>	1 set



DCM20046

## SmartAisle™ Mounting Bracket for Temperature Sensor

- Can be used for different temperature sensors (including Liebert® Temperature/Humidity Sensors)
- Suitable for the angle profiles air regulation opening
- **Material**  
Sheet steel
- **Finish**  
Final digit of order number .1:  
Powder-coated texture, RAL 7035, light gray  
Final digit of order number .8:  
Powder-coated texture, RAL 7021 dark gray

- **Supply schedule**  
1 mounting brackets  
Mounting material

- **How supplied**  
Flat-packed kit

W/L	H	D	AW	For rack type	Order no.	UP
					<b>03.029.019.X</b>	1 set

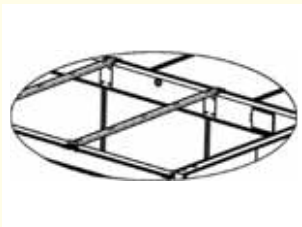

LUF80007

## SmartAisle™ Roof Element Version with air regulation opening

- For cold aisle containment for aisle widths: 1,200 / 1,500 / 1,800 mm (+/- 50 mm)
- Quick and easy mounting
- Suitable for Miracel® racks and most makes of other manufacturers.
- With rubber sleeves for cable routing
- Plexiglas panel with low fire load and low smoke generation (optionally with compound safety glass)
- Plexiglas panels can be quickly and easily removed
- With air regulation opening for energy-efficient operation of the recirculated air devices and for preventing hot spots.

- **Aisle height clear**  
Rack height 2,000 mm: 2,150 mm  
Rack height 2,200 mm: 2,350 mm

- **Material**  
Angle profile: Sheet steel  
Cross brace: Sheet steel  
Plexiglas panel: Halogen-free plexiglas

- **Finish**  
Final digit of order number .1:  
Powder-coated texture, RAL 7035, light gray  
Final digit of order number .8:  
Powder-coated texture, RAL 7021 dark gray

- **Supply schedule**  
2 Angle profiles with air regulation opening  
1 cross profile at W600/800, 3 cross profiles at L2400  
1 plexiglas panel at W600/800, 3 plexiglas panels at L2400  
2 Angle profile plates  
Mounting material

- **How supplied**  
Flat-packed kit

W/L	H	D	AW	For rack type	Order no.	UP
600			1200		<b>03.029.014.X</b>	1 set
800			1200		<b>03.029.015.X</b>	1 set
2400			1200		<b>03.029.016.X</b>	1 set
600			1500		<b>03.029.081.X</b>	1 set
800			1500		<b>03.029.082.X</b>	1 set
2400			1500		<b>03.029.083.X</b>	1 set
600			1800		<b>03.029.086.X</b>	1 set
800			1800		<b>03.029.087.X</b>	1 set
2400			1800		<b>03.029.088.X</b>	1 set

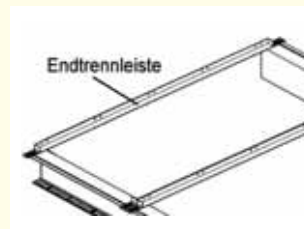

LUF80008

## SmartAisle™ Cross profile

- For cold aisle containment for aisle widths: 1,200 / 1,500 / 1,800 mm (+/- 50 mm)
- Quick and easy mounting
- For connecting on the door element or front panel element

- **Material**  
Sheet steel

- **Finish**  
Final digit of order number .1:  
powder-coated texture, RAL 7035 light gray  
Final digit of order number .8:  
powder-coated texture, RAL 7021 dark gray

- **Supply schedule**  
2 end cross profiles  
Mounting material

- **How supplied**  
In units

W/L	H	D	AW	For rack type	Order no.	UP
			1200		<b>03.029.010.X</b>	1 pair
			1500		<b>03.029.011.X</b>	1 pair
			1800		<b>03.029.012.X</b>	1 pair



DCM20045

## SmartAisle™ Protector Bracket for Roof Element

- Prevents plexiglas panels from lifting up with excess pressure
- Enables safe pressure balancing in the event of a fault or while a fire is being extinguished

- **Material**  
Sheet steel

- **Finish**  
Final digit of order number .1:  
Powder-coated texture, RAL 7035, light gray  
Final digit of order number .8:  
Powder-coated texture, RAL 7021 dark gray

- **Supply schedule**  
1 pair of protector brackets  
Mounting material

- **How supplied**  
Flat-packed kit

W/L	H	D	AW	For rack type	Order no.	UP
4800					<b>03.029.041.X</b>	1 set



DCM20048

## Roof Mounting Set for 4.8 meter aisle length

- Complete mounting set for 4.8 meter aisle length

- **Material**  
Angle profile plates: Sheet steel  
Sealing tape: Foam rubber (UL94 HF-1)

- **Finish**  
Final digit of order number .1:  
powder-coated texture, RAL 7035  
light gray  
Final digit of order number .8:  
powder-coated texture, RAL 7021  
dark gray
- **Supply schedule**  
Mounting material
- **How supplied**  
Flat-packed kit

W/L	H	D	AW	For rack type	Order no.	UP
4800					03.029.020.X	1 set



DCM20057

## SmartAisle™ Height Panels

- For balancing the separation of the cold and hot areas in smaller racks

- **Material**  
Sheet steel
- **Finish**  
Final digit of order number .1:  
powder-coated texture, RAL 7035  
light gray  
Final digit of order number .8:  
powder-coated texture, RAL 7021  
dark gray
- **Supply schedule**  
1 height panel  
Mounting material
- **How supplied**  
Flat-packed kit
- **Note**  
For several height panels positioned beside one another, please ask for the appropriate angle profile plates.

W	H	D	AW	For rack type	Order no.	UP
600	200			Miracel	03.029.051.X	1 unit
800	200			Miracel	03.029.052.X	1 unit



LUFxxxx

## SmartAisle™ Sealing Set for 4.8 meter aisle length

- Suitable for installation in Miracel® rack
- For sealing the leveling area between the floor and the rack
- For sealing for Miracel® rack suites without side panels
- **Material/Finish**  
Foam: PUR-Ether UL94 HF-1, black  
Cover extrusion: PVC extruder extrusion, black
- **Supply schedule**  
10 meters of foam 40 x 25 mm  
31 meter cover extrusion
- **How supplied**  
Flat-packed kit

W/L	H	D	AW	For rack type	Order no.	UP
4800				Miracel	03.029.040.X	1 set

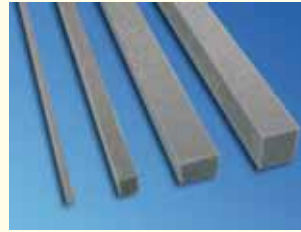

DCM20047

## SmartAisle™ Sealing Material

- Suitable for sealing openings (e.g. leveling areas between floor and rack, between racks, etc.)
- **Material/Finish**  
PUR-Ether UL94 HF-1, black
- **Supply schedule**  
5 x 2 meters of foam
- **How supplied**  
Flat-packed kit

W/L	H	D	AW	Size	Order no.	UP
				40 x 40 (glued surface) mm	03.029.042.9	1 set
				20 x 20 (glued surface) mm	03.029.043.9	1 set
				5 x 10 (glued surface) mm	03.029.044.9	1 set
				25 x 40 (glued surface) mm	03.029.045.9	1 set

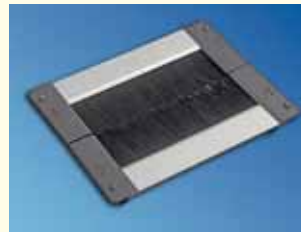

LUFxxxx

## SmartAisle™ Raised Floor Air Barrier for cable entry

- For cable entry from the raised floor
- Sunk in the raised floor, or can be used as superstructure
- Two-row tight brushes for pressure-resistant cold-hot separation
- For new breakouts; as superstructure for existing breakouts
- Two-piece - easy extend and upgrade option
- The length can be easily shortened on-site (metal saw)
- Also suitable for cabling on the rack wall (U-shape, two-piece)
- Slot-in - and threaded connection additionally

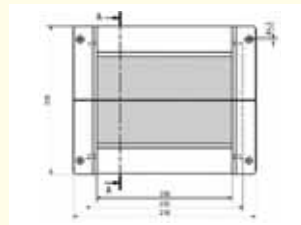

LUF80009

- **Dimensions**  
03.028.211.9:  
- External dimensions (270 mm x 220 mm)  
- Usable cable entry (200 mm x 126 mm)  
- Raised floor breakout (240 mm x 180 mm)  
03.028.212.9:  
- External dimensions (600 mm x 220 mm)  
- Usable cable entry (530 mm x 126 mm)  
- Raised floor breakout (570 mm x 180 mm)

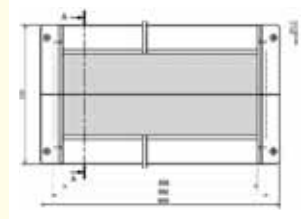

LUF80010

- **Supply schedule**  
1 pair of raised floor air barriers  
Mounting material
- **How supplied**  
Flat-packed kit

W	H	D	U	D(max.)kg	Model	Order no.	UP
270	220				Length 270 mm	03.028.211.9	1 set
600	220				Length 600 mm	03.028.212.9	1 set

Dimensions in mm: W = Width  
H = Height  
D = Depth  
h = installation height  
d = useful depth  
L = length  
U = standard height unit  
1 U = 44,45 mm  
UP = unit of packaging  
kg = weight  
Express item

Conversion: 1 mm = 0.03937 inch 1 kg = 2.2046 pound

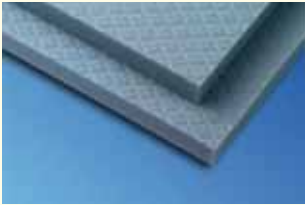

LUFxxxx

### SmartAisle™ Sealing Material for Raised Floor

- For sealing existing openings in the raised floor; not suitable as a replacement for a complete raised floor panel
- Easy cutting to required size

- **Material**  
Melamine resin foam, UL94-HF1
- **Color**  
Gray
- **Supply schedule**  
4 foam panels
- **Technical data**  
Size 610 x 610 x 40 mm (WxLxH)
- **How supplied**  
Set of 4 units

W	H	D	AW	For rack type	Order no.	UP
					03.028.221.9	1 set

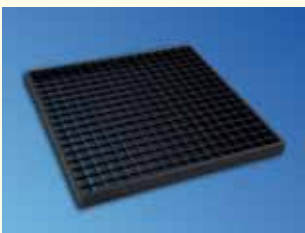

LUFxxxx

### SmartAisle™ Grate for Raised Floor

- For use on raised floors
- Can be used with high heat loads and high requirements for cooling air per rack
- For energy-efficient operation of the recirculated air devices

- **Material**  
Zinc-passivated steel
- **Finish**  
Final digit of order number .1:  
powder-coated texture, RAL 7035 light gray  
Final digit of order number .8:  
powder-coated texture, RAL 7021 dark gray
- **Standards**  
Produced in acc. with RAL-GZ 638
- **Supply schedule**  
1 raised floor grate
- **Technical data**  
Size 598 x 598 x 40 mm (WxLxH) Free cross-section: 88% Max. surface load 50,000 N/m² with even distribution; max. point load (on 200x200 mm area) 4,500 N
- **How supplied**  
In units
- **Note**  
Suitable for raised floors with 40 mm thick panels!

W	H	D	AW	For rack type	Order no.	UP
					03.029.090.X	1 unit







# Knürr CoolTherm®

Water-cooled server rack technology,  
up to 35 kW\* 1.62 to 1.64



## Knürr CoolTherm® Strong points

### Features

Future-oriented cooling concept for IT applications with high thermal loads – for **blade** and **rack equipment**.

- V35 high performance air-to-water heat exchanger
- Channeled airflow in the entire rack
- Heat dissipation via cooling water
- Fans with temperature-dependent speed regulation
- Three-way valve for regulating the cooling water flow (optional)
- Fans, n+1 redundant
- Alarm management
- Redundant high performance power distribution for supplying servers (optional)
- User-friendly and service-optimized
  - Automatic door opening (optional)
  - Mobile plinth (optional)

### Benefits

Autonomous server rack; independent from ambient conditions

- Safe and reliable cooling power of up to 35 kW per CoolTherm® (blade servers)
- Highest packing density for high performance servers, consequently, up to 80% space saving in the data center
  - Low operating costs with optimized pressure losses
- Reduced room and building requirements (thermal management, raised floors, room heights)
- Highest possible leakage safety with strict separation of heat exchangers and server installations
- Up to 30% improved cooling system energy efficiency
- Highest planning reliability with unrestricted scalability
- Significant TCO reduction (Total Cost of Ownership)



High performance power supply



Temperature-dependent and speed-controlled

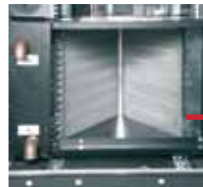

V35® high performance air-to-water heat exchanger

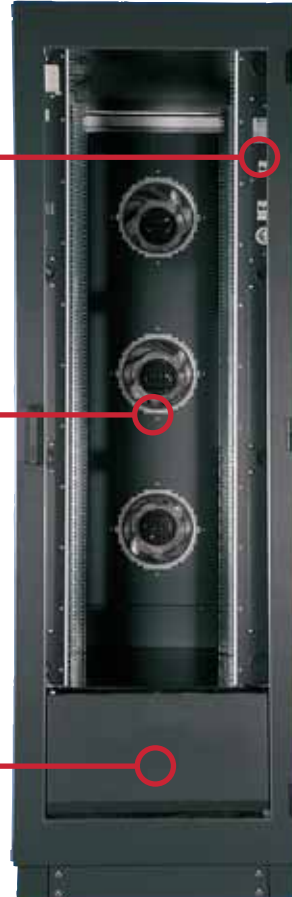

Easy fan swap-out with closed door

Heat volume to be dissipated: CoolTherm® 25 kW nominal as an example

- Water-side prerun temperature: 12° C (preferred)  
Postrun temp.: 18° C (preferred)  
Max. pressure loss: 0.5 bar volume flow, 3.58 m³/h  
Ventilation valve
- Up to 5500 m³/h (dep. on equipment)  
Air outlet: 20° C to 25° C



The impressive **CoolTherm®** technical concept:

Closed air circulation with V35 air/water heat exchanger. Therefore the dissipated heat is not given off as an additional load on the IT room (as is usual). Connection is made installation-friendly to a building or rack-own cold water system. Operation and service are performed with no difficulty whatsoever.

(Smaller cross-section shown)



MIR20287

## Knürr CoolTherm®

- With fixed 19" installation on the front and rear for components in accordance with IEC297-3
- Installation of chassis runners and 19" shelves possible
- Flexible installation of components with mounting hole extrusions
- Cable entry via top cover and bottom cover
- Unused space closed off with blanking panels

### CoolTherm® 12 kW

- 2 EC radial fans, with temperature-dependent stepless speed regulation, installed above one another, n+1 redundant with approx. 3K temperature increase
- V-form high performance heat exchanger

### CoolTherm® 12 to 17 kW

- 3 EC radial fans, with temperature-dependent stepless speed regulation, installed above one another, n+1 redundant with approx. 4 K temperature increase
- V-form high performance heat exchanger

### CoolTherm® 17 to 25 (35) kW

- 3 EC radial fans, with temperature-dependent stepless speed regulation, installed above one another, n+1 redundant with approx. 4 K temperature increase
- V-form high performance heat exchanger

### Technical data

- Cooling water spread: 12 / 18°C (configuration conditions)
- Intake air temperature to the server: 22°C
- Heat exchanger max. operating pressure: 10 bar
- Max. absolute humidity in room: 8g/kg
- Heat exchanger connection: 1" female thread
- Condensation tray connection: 5/8" tube connection

### Load rating

Static load, 1000 kg (10,000 N)

### Air density

In acc. with RAL 652

### Tests

- Earthing in acc. with VDE 0100 T 540
- Vibration test in acc. with MIL-STD 810 E

### Color

#### Final digit of order number .1:

- Visible surface of the covers, RAL 7035 light gray

#### Final digit of order number .8:

- Visible surface of covers, RAL 7021 dark gray

### How supplied

Fully assembled

Cooling power (kW)	U	W (mm)	H (mm)	D (mm)	d (mm)	Weight (kg)	Water amount (l)	Flow volume (m³/h)	Pressure loss: rack (bar)	Pressure loss conn. Set (bar)	Amb. air volume (m³/h)	Conn. data Voltage (V)	Frequency (Hz)	Current (A)	Power (W)	Order no.	UP
12	29	700	1800	1200	740	290	5.9	1.72	0.38	0.05	2000	200-264	50,60	7	1000	08.006.001.x	1 unit
12	33	700	2000	1200	740	290	5.9	1.72	0.38	0.05	2000	200-264	50,60	7	1000	08.006.002.x	1 unit
12	38	700	2200	1200	740	290	5.9	1.72	0.38	0.05	2000	200-264	50,60	7	1000	08.006.003.x	1 unit
12	29	700	1800	1300	840	295	5.9	1.72	0.38	0.05	2000	200-264	50,60	7	1000	08.006.006.x	1 unit
12	33	700	2000	1300	840	295	5.9	1.72	0.38	0.05	2000	200-264	50,60	7	1000	08.006.007.x	1 unit
12	38	700	2200	1300	840	295	5.9	1.72	0.38	0.05	2000	200-264	50,60	7	1000	08.006.008.x	1 unit
17	35	800	2000	1200	740	310	7.9	2.44	0.57	0.09	3100	200-264	50,60	8	1400	08.006.012.x	1 unit
17	40	800	2200	1200	740	310	7.9	2.44	0.57	0.09	3100	200-264	50,60	8	1400	08.006.013.x	1 unit
17	44	800	2400	1200	740	310	7.9	2.44	0.57	0.09	3100	200-264	50,60	8	1400	08.006.014.x	1 unit
17	35	800	2000	1300	840	320	7.9	2.44	0.57	0.09	3100	200-264	50,60	8	1400	08.006.022.x	1 unit
17	40	800	2200	1300	840	320	7.9	2.44	0.57	0.09	3100	200-264	50,60	8	1400	08.006.023.x	1 unit
17	45	800	2400	1300	840	320	7.9	2.44	0.57	0.09	3100	200-264	50,60	8	1400	08.006.024.x	1 unit
25	37	800	2200	1200	740	340	9.9	3.58	0.54	0.18	4500	200-264	50,60	8	1800	08.006.033.x	1 unit
25	42	800	2400	1200	740	340	9.9	3.58	0.54	0.18	4500	200-264	50,60	8	1800	08.006.034.x	1 unit
25	37	800	2200	1300	840	350	9.9	3.58	0.54	0.18	4500	200-264	50,60	8	1800	08.006.043.x	1 unit
25	42	800	2400	1300	840	350	9.9	3.58	0.54	0.18	4500	200-264	50,60	8	1800	08.006.044.x	1 unit

Dimensions in mm: W = Width  
 H = Height  
 D = Depth  
 h = installation height  
 d = useful depth  
 L = length

U = standard height unit  
 1 U = 44.45 mm  
 UP = unit of packaging  
 kg = weight

 = Express item

Conversion: 1 mm = 0.03937 inch      1 kg = 2.2046 pound



2 MIR20398



3 MIR20395



4 MIR20392



5 MIR20393

## Knürr CoolTherm® Options / Accessories

### 1 A/B switching

The outputs on the plug-in units can be flexibly configured according to customer requirements via various plug connections, type CEE and GST 18.

(E.g. BladePower® or PizzaPower®, DI-STRIP® TriplePower®, and flexible distribution with the GST18i5 distributor block, 3-phase).

### 2 RMS (Rack Monitoring System)

Monitoring, forwarding and visualizing parameters, issuing alarms and enabling the introduction of automatic safety/security measures.

- Possible sensors/monitoring:  
Smoke, temperature, humidity, leaks, door monitoring

### 3 Bypass control

The influence of the cooling water flow on energy saving prevents insufficient temperatures with partial loads and stresses.

Version as three-way valve; also optionally with two-way function

### 4 Automatic door opening

Automatic front and rear door opening to prevent overheating with sub-system failure (e.g. cooling water provision).

### 5 Cooling water connection set

Consists of two flexible high grade steel-coated hoses, ball cock with ventilation, regulating valve and blocking valve, DN 25, hose length - 1,500 mm and 2,500 mm

### Fixed and mobile plinth

with 100 mm height  
Various cutouts allow supply media without having to install raised floor.



# Knürr CoolLoop®

Side-mounted modular  
cooling unit for all server racks  
from 10 to 30 kW

1.66 to 1.67



# Knürr CoolLoop®

*Side-mounted modular cooling unit for all server racks from 10 to 30 kW*

Knürr CoolLoop® is the world's first solution for data center server cooling that can be operated as both an open and closed system. The system can be set to either pass the cooling power directly to the adjacent rack, or to supplement the data center's cooling. An elaborate system of valves ensures that the right cooling power is provided for every server.



## Modularity

The Knürr CoolLoop® is a modular setup that can be equipped with one to four fan units, so that the cooling can always be adapted to the actual requirement in the data center. The cooling power increases with the actual requirement and can be selected between 10kW and 30 kW per Knürr CoolLoop®. This ensures investment security for the data center operator, and always only requires input relative to the heat load that the data center develops.

The Knürr CoolLoop® is a water-cooled rack unit for smart, side-mounting on server racks.

It is a closed system with warm air suction from the rear and cool air expulsion at the front – both vertical over the entire rack height.

## Energy efficiency

Knürr CoolLoop® represents the highest standards in data room cooling capacities. The center of focus here is on selecting the methods and procedures that save the most energy and using the most modern components, which is why the tried, tested and proven EC fan technology is used consistently. The lowest pressure loss in the air path is constantly optimized with the selection of the heat exchanger and moisture eliminator, which results in minimum energy consumption in the fans.



**made  
in  
Germany**

The Knürr CoolLoop® doesn't just set pressure loss standards. The relatively high cold water prerun temperature for optimum server cooling also ensures improved use of the cold water system with a high coefficient of performance (COP). The design also enables a high level of free cooling, which facilitates significant savings potential with cold water generation. Short air paths and the arrangement of the fans after the heat exchanger

also help reduce energy consumption. This arrangement not only has a positive effect on the useful lifetime of the fans, it also increases the cooling airflow volume as a result of the higher air density. This in turn conserves resources and further reduces energy consumption.

## Reliability

Knürr CoolLoop® makes no compromises when it comes to availability, reliability and safety. The fans can always be configured in n+1 redundancy. To meet the highest requirements of a tier 4 data center two Knürr CoolLoops® can be positioned on one server rack. This then ensures complete 2n redundancy of the server rack cooling.

## Control

The Knürr CoolLoop® sets new standards in controlling and monitoring. A regulating valve for adjusting the cooling water volume to the actual cooling requirement allows optimum server input air temperatures, which the user can set. The speed of the fans is also adjusted to the actual air volumes of the servers, whereby the server power loss can fluctuate from 0% to 100%.



Rear view with water connections.

A number of sensors ensure the highest level of safety. The following are monitored via a color display:

- Server input air temperatures
- Server output air temperatures
- Relative humidity
- Cold water prerun and postrun temperatures
- Cold water flow rates
- All doors monitored
- Water sensors in the collecting tray
- Smoke detector
- Warning lights on the rack
- Optional earliest smoke detection system and fire extinguisher system

All control and monitoring functions can be retrieved via an Ethernet interface. Integration into higher level network management systems is possible at no significant expense.

## Variants

### ■ Knürr CoolLoop®

The cooling power can be set between additional data center cooling and direct cooling of the server rack beside the Knürr CoolLoop®.

### ■ CoolLoop®T

The cooling power is only available as a supplement to the data center cooling, thereby supporting the cooling power of the air circulation equipment. Together with the Knürr SmartAisle®, this combination presents the ideal addition for optimum medium power range server cooling.

### ■ CoolLoop®L

The most energy-saving method of server cooling in data centers is cooling with closed air circuits inside the server rack.

The Knürr CoolLoop® enables implementation of this cooling principle, and especially with restrictions in the data center's structure heights, or with the required division of the rack access between IT and facility management. Closed solutions also boast very low noise generation levels.

Effective cooling power*	Number of fans	Width	Height	Depth	Usable height	Weight (empty)	Electrical connection data
10 kW	1	300 mm	2000 mm 2200 mm 2400 mm	1200 mm / 1300 mm	42 U 46 U 50 U	188 kg	200 – 264 VAC 50/60 Hz 410 watt
20 kW	2	300 mm	2000 mm 2200 mm 2400 mm	1200 mm / 1300 mm	42 U 46 U 50 U	202 kg	200 – 264 VAC 50/60 Hz 820 watt
30 kW	3	300 mm	2000 mm 2200 mm 2400 mm	1200 mm / 1300 mm	42 U 46 U 50 U	216 kg	200 – 264 VAC 50/60 Hz 1230 watt
30 kW	3 + 1 (n + 1)	300 mm	2000 mm 2200 mm 2400 mm	1200 mm / 1300 mm	42 U 46 U 50 U	230 kg	200 – 264 VAC 50/60 Hz 890 watt

As at: 02/2008

Possible cooling water prerun temperatures:  
\* Given nominal cooling power:

12 to 20°C  
with 12/18°C cooling water  
and 20 - 25°C server input air  
1.43 - 4.29 m³/h  
0.05 - 0.39 bar  
max. 4  
20 - 25°C (front)

Ambient temperature:

up to 35°C

Water amount:

8.6 l

Cooling water connection:

G 1 1/4" male thread, flat sealing

Condensation connection:

5/8" tube connector

Max. operating pressure:

10 bar

Cooling water requirement:

Pressure loss:

Number of fans:

Input air temperature:

Standard colors:

RAL 7021 or RAL 7035

**Knürr Server Racks and Knürr CoolLoop® (Super Computer Center Shenzhen, China)**







# Knürr CoolAdd®

Universal upgrades  
against overheating  
in the server rack

1.70 to 1.72



## Knürr CoolAdd® Strong points



### Features

- Installation with adapter kit
- Adjustment of just a few parts
- Thermostatic shuttle valve for regulating cooling power
- Manual fan speed setting
- Individual fan monitoring
- Individual fan protection
- Installation with adapter kit
- Shuttle valve for regulating cooling power
- Heat exchanger is firmly connected with the existing rack (pipes and other connections are not accessible in the data center)
- Redundant n+1 fan set-up

### Benefits

- Knürr CoolAdd® can be used with all standard rack types
- Server rack remains unchanged
- Slim design heat exchanger (85mm)
- Access to components is always maintained
- Water-carrying components are safely shielded from the rack
- Existing racks can continue to be used
- Existing cabling remains
- Quick installation
- Just a few CoolAdd® components have to be adjusted
- Cools the server's warm exhaust air side
- Access to all built-in components always maintained
- Relieves the data center's thermal management system
- Cools up to an additional 8,000 watts



Shouldered thermostat relay with extensible component (without auxiliary power)



Optimal fans, including housings



Fan failure display/four speed levels



Robust and safe 3 pt.-interlock



## Knürr CoolAdd® for Knürr Miracel® 19" upgrade solution

- 4 AC fans
- 4 manual setting speed levels
- Exhaust temperature control
- All standard external makes can be attached
- Cold water connection, 3/4"
- Min. cold water flow temp.: 14°C
- Control unit with fan failure monitoring
- LED visualization
- Alarm forwarding via potential-free contact

### ■ Technical data

- Cooling water spread: 14/20°C
- Cold water content: 1.6 l
- Cooling water volume flow: 1.15 m³/h
- Exhaust temperature after heat exchanger: 22° C
- Heat exchanger connection: 3/4" male thread
- Pressure loss (water-side): 400 mbar
- Heat exchanger max. operating pressure: 10 bar
- Max. absolute humidity in room: 8 g/kg
- Number of fans: 4
- Air volume flow: 2,500 m³/h
- Electrical connection (fans / fan control) 230 V / 50 - 60 Hz 525 - 725 W

■ **Protection rating**  
IP 20

■ **Material/ Finish**  
Cover: Aluminum plate/sheet steel, zinc-passivated, powder-coated texture

■ **Color**  
RAL 7021 dark gray

■ **Supply schedule**  
1 fan door  
1 heat exchanger  
1 adapter set  
Mounting material

■ **How supplied**  
Preassembled

W	H	D	kg	Cooling cap.	Rear door stop	Order no.	UP
600	2000	160	41	8 kW	left	08.000.034.8	1 unit
600	2000	160	41	8 kW	right	08.000.035.8	1 unit
600	2200	160	43	8 kW	left	08.000.036.8	1 unit
600	2200	160	43	8 kW	right	08.000.037.8	1 unit
700	2000	160	43	8 kW	left	08.000.044.8	1 unit
700	2000	160	43	8 kW	right	08.000.045.8	1 unit
700	2200	160	45	8 kW	left	08.000.046.8	1 unit
700	2200	160	45	8 kW	right	08.000.047.8	1 unit
800	2000	160	45	8 kW	left	08.000.054.8	1 unit
800	2000	160	45	8 kW	right	08.000.055.8	1 unit
800	2200	160	47	8 kW	left	08.000.056.8	1 unit
800	2200	160	47	8 kW	right	08.000.057.8	1 unit



# Knürr CoolTrans®

The link between building and  
server rack water circuit

1.74 to 1.76





**Primary cooling circulation**



**Secondary cooling circulation**



## Knürr CoolTrans®50/75/100 – The link between building services and data center

Water in a data center makes special demands on the cold water system, and extending the existing cold water circuit in the data center just isn't enough. The CoolTrans® from Knürr separates the primary cold water circulation from the secondary cold water circulation in the data center using high performance water-water heat exchangers. This consequently results in ...

... the cold water prerun temperature being regulated above the dew point. This in turn means that a laborious insulation of the water circuit in the DC is no longer required. Condensation build-up is also ruled out, and drying-out

or re-humidifying the data center is prevented.

... dispensing with the use of glycol with the secondary circuit, as it is operated frost-protected. The cooler can be configured smaller, but with the same power, thereby avoiding higher investment costs.

... the water volume in the data center remaining restricted to the secondary circuit.

... balancing of the temperature and pressure fluctuations in the primary circuit.

... the regulation of the secondary circuit, connected with an alarm management, which ensures constant operation and signals faults in the system. Needless to say all moving parts are provided redundantly.

Furthermore the relatively high prerun temperatures of 12°C and more in many thermal areas enable a high degree of free cooling, which generates significant energy savings. Knürr's CoolTrans® facilitates a mixture of cold water from free cooling and the cold water system.



## Knürr CoolTrans® Strong points

### Features

- Hydraulic separation of the cold water circulation system in the building from the cooling water in the data center
- Use of top grade quality components of the building technology
- Integration of all thermo-hydraulic components for regulated liquid cooling (pumps, valves, mixers, heat exchanger, expansion tank)
- Redundant components enable uninterrupted operation, even during servicing
- Connection of individual Knürr CoolTherm® and Knürr CoolAdd® to the Knürr CoolTrans®
- Modular design for heat loads in excess of 100 kW
- Automatic leakage detection

### Benefits

- Energy savings with high performance high-grade steel heat exchanger
- Constant cooling water temperature with adjustable reference temperature
- Consistent cooling water volume, regardless of the hydraulic conditions in the building
- Operational reliability with system separation (enables leakage monitoring and prevents corrosive and fouling effects with a defined water quality on the secondary side)
- Operational reliability through redundancy
- Operational reliability with recording and central monitoring of the operational parameters, including warning and alarm signals
- Dew point-dependent cooling water prerun temperature increase to prevent condensation water and for piping without insulation
- Option of controlling the emergency operation
- Flange connection for linking up several Knürr CoolTrans®



Knürr CoolTrans®100 in modular design. Linking allows heat loads of up to 500 kW to be safely diverted.



Knürr CoolTrans® in compact 19" construction. Ideal for installation in data centers or IT rooms.



Distributor for connecting up to 5 consumer units, such as Knürr CoolTherm® or Knürr CoolAdd®

## Knürr CoolTrans® 19” upgrade solution

- Hydraulic interface between the building-side primary cold water supply and high density cooling solutions in the secondary circuit
- Provision of constant prerun temperatures - Monitoring of minimum pressure (leakage) and fall below dew point, station in steel base frame, from 100 kW with powder-coated cover, height adjustable, for transport with hand lift truck, forklift, etc., pipes ST 37
- Pipes primary-side and fittings diffusion-tight, insulated against condensation water
- Redundant pump group (100%) with daily run change, emergency run function of the primary regulating valve (power-off open)
- Connection of two separate cold water primary supplies is possible from 100 kW; modular coupling of the distributor bars for configuring higher transmission powers of up to 500 kW, as well as additional redundancies, double-sided connection option for setting up a secondary ring line, with plate heat exchanger, ball cocks, manometer, 4 thermometers, regulating valve, adapter, primary cold water meter (option), 2 wet running pumps, 2 back pressure preventers, 2 dirt filters, membrane expansion tank with safety valve - 2.5 bar, two-stage pressure switch, fill, empty and air bleed valve, leakage tray and automatic leakage detection.

### ■ Control

Freely programmable control, main switch, pump control, dew point monitoring with shouldered room humidity sensor (sensor mounting in the CoolTherm's installation room/connection cables on-site), temperature control according to reference value specification and automatic increase in the cold water prerun temperature with enthalpy computer for

preventing condensation on the basis of the actual air humidity in the data center. Centralized alarm with pump failure, valve fault, temperature fault, data backup at least 72 hours, manual control level, optional LON interface and status output as requested with TCP/IP, LAN, warning and fault signals shown via display and potential-free contact, UPS signal reception with potential-free contact.

Distributor (only 75 kW, order no. 08.009.504.8) for connecting up to 5 consumer units, such as CoolTherm and CoolAdd.

CoolTrans®100 in modular design. Linking allows heat loads to be safely diverted:  
Up to 300 kW with order number 08.009.503.8 and 08.009.509.8  
Up to 500 kW with order number 08.009.508.8

CoolTrans 100 with free cooling  
Order number 08.009.509.8  
2 heat exchangers enable free cooling independent of the building's cold water.

### ■ Electrical connection

400 VAC, 3-phase, 50 Hz

### ■ Protection rating

IP 54

### ■ Color

RAL 7021 dark gray

### ■ How supplied

Assembled

Power (kW)	W (mm)	H (mm)	D (mm)	Weight (kg)	Pipe connection		Diff. pressure		Cooling water temp.		Water volume		Elec. conn. power (kW)	Order no.	UP
					primary (bar)	secondary (bar)	primary (°C)	external (°C)	primary (°C)	secondary (°C)	primary (m3/h)	external (m3/h)			
50	450	1010	1200	180	1 1/2"	5x 1"	1.00	1.00	6/12	12/18	8.42	7.2	1.80	08.009.504.8	1 unit
75	450	1010	1200	200	1 1/2"	5x 1"	1.00	1.00	6/12	12/18	12.75	10.77	1.80	08.009.504.8	1 unit
100	1620	1840	600	400	4x DN100	4x DN100	1.10	1.30	6/12	12/18	14.3	14.3	1.00	08.009.503.8	1 unit
100	1620	1840	800	450	4x DN125	4x DN125	1.10	1.30	6/12	12/18	14.3	14.3	1.00	08.009.508.8	1 unit
100	2520	1840	800	830	4x DN100	4x DN100	0.20	1.10	13/19	15/21	16.68	14.4	1.00	08.009.509.8	1 unit



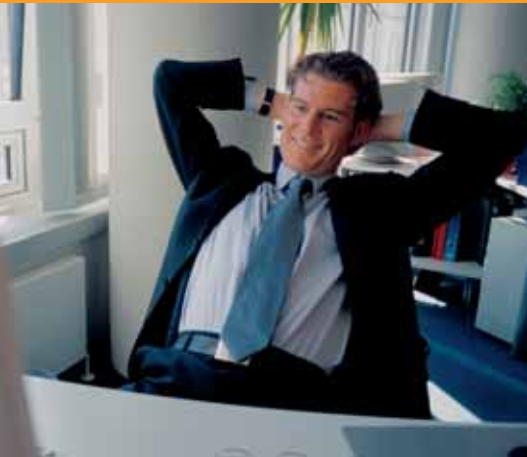

# Knürr Smaract®

19" Compact Rack

19" Server Compact Rack 1.78 to 1.92



## Network and Server Compact Rack

Knürr Smaract®  
Strong points 1.80

Knürr Smaract®  
19" Compact Rack 1.82

Knürr Smaract®  
19" Server Compact Rack 1.83

Knürr Smaract®  
19" Compact Rack  
Without Door 1.84

### Knürr Smaract® Accessories

Ventilation unit 1.85

Extrusions 1.85

Depth Brace 1.86

Rear Door 1.86

Top Cover/Bottom Cover 1.86

Filter Mat 1.87

Plinth 1.87

Swivel Castors 1.87

Stacking Set 1.88

Eyebolt Set 1.88

Wall Mounting Bracket 1.88

Knürr Smaract®  
19" Compact Rack EMC 1.89

Knürr Smaract®  
19" Compact Rack IP54 1.91

# Knürr Smaract®

The Knürr **Smaract®** Compact Rack isn't just a further development of the LAN racks that we already know and that have been proven in use for some time now; it is, in fact, more of a specific response to the requirement for decentralized networking in the company.

**Smaract®** stands for an innovative and practical total concept with extremely low spatial demands. High-grade flexibility and especially high performance! At the same time it is also integration-enabled, can be modularly expanded at any time and is rich in impressive detailed solutions.

An ideal 19" compact construction platform in various models that meet IP and EMC requirements.



## Features

- Not a single cubic centimeter is wasted with the Smaract® Compact Rack.  
The innovative frame concept with triangular extrusions keeps weight low and stability high.
- The patented mounting hole rails in the 19" extrusion ensure all installed active and passive components can be quickly and easily positioned.
- The Knürr Smaract® doors and side panels can be opened with an angle of over 180°, and the side panels can be removed in seconds with the special system used.
- The Smaract® 19" Compact Rack is available in EMC and IP versions.  
Special attention was paid during the development phase to ensuring that this server and network rack remains constantly upgradeable to IP or EMC standards.
- A cost-effective solution can also be supplied in a combined IP-EMC version.

## Benefits

- Access from all sides is a central element of the rack's design. Massive time savings with system integration and component maintenance.
- The Smaract® Compact Rack can be modularly set up and stacked, and is therefore predestined for system integration. The new 900 mm depth in the stacked version makes the Smaract® especially popular with Internet solution providers.
- The central locking guarantees controlled access. Additionally, the side covers can only be removed when the front doors have been opened. Special lock systems, e.g. with chip card reader or keypad can also be selected on request.
- The 19" Compact Rack is available in 9 U, 15 U and 21 U versions, and in sizes 12 U (home office) and 18 U. The 900 mm installation depth is available for server applications.



Innovative frame concept:  
Low weight – high stability



## Design with Class

Function simply isn't everything! The Knürr® Compact Rack sets new standards in design matters. The basic purpose of the design concept is to translate the extended technical value creation into an appropriate but unobtrusive overall presence. This new Smaract® Compact Rack, developed in cooperation with designafairs, displays its exceptional technical features on the outside, with eye-catching stability and simplicity.

## Knürr Smaract® Strong points

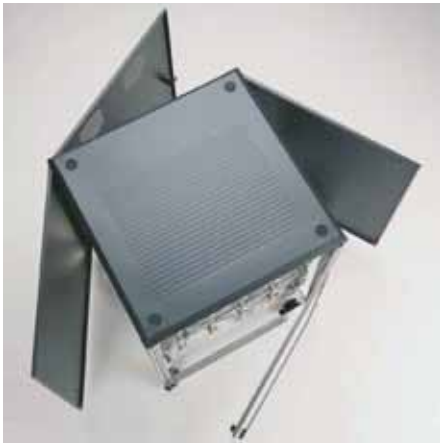

1 SMA20006

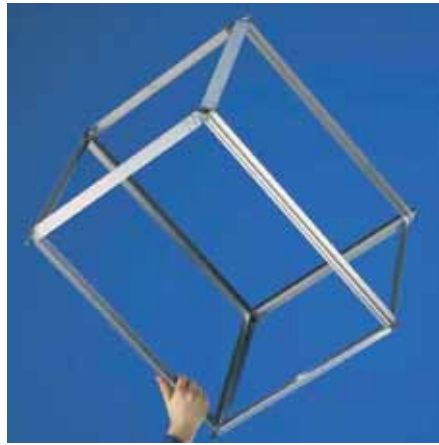

2 SMA20005



3 SMA20004



4 SMA20056



5 SMA20046

- 1 Access**  
Access from all sides is a time-saving factor, e.g. with system integration or maintenance.
- 2 Intelligent construction**  
Low weight with innovative frame concept – nevertheless, high stability with new triangular extrusions.
- 3 Evolving with the task**  
Simple expansion with stackability.
- 4 Cable management**  
No matter how complex, Knürr provides solutions.
- 5 EMC and IP version**  
The compact rack can be upgraded to IP or EMC standard at all times. (Also in combined IP/EMC version)
- 6 Forward-thinking**  
Flexibility with integration of 19" technology. 6 heights to choose from; 9 U to 24 U.



6 SMA20017



SMA20067

**Knürr Smaract® 19" Rack in acc. with IEC 297**  
**Technical data**

**Material**

- Extruded aluminum
- Corner connector, die-cast
- Sheet steel covers
- Doors: sheet steel or with single safety glass panel, opening angle, over 180°

**Finish:**

- Basic rack, polished
- Covers, powder-coated texture, RAL 7035 light gray

**19" components in acc. with IEC 297-3**

- Height: 9 U to 24 U; 1 U = 44.45 mm
- Width: 482.6 mm (19")

**Static load rating**

- 2000 N with stationary version

**How supplied**

- Fully assembled

**Tests according to version**

- Safety in acc. with EN 50298 and EN 60950
- Protective conductor/ earth in acc. with DIN VDE 0701-1
- Vibration test in acc. with MIL-STD 810 E
- Vibration and shock test in acc. with DIN EN 300019-2-2
- IP test in acc. with DIN EN 60529
- EMC shielding attenuation in acc. with IEEE-STD-299 and VG 95 373 part 15 (30 MHz - 1 GHz)
- Plastic components in compliance with UL 94-VO

**Versions**

- IP 20
- IP 54
- EMC

**Space solution**

- 82% of the basic surface can be used as space for installation and cable routing

**Configuration**

- Stationary, on leveling feet
- Mobile on castors with snib



SMA20166



SMA20109



SMA20122



SMA20024

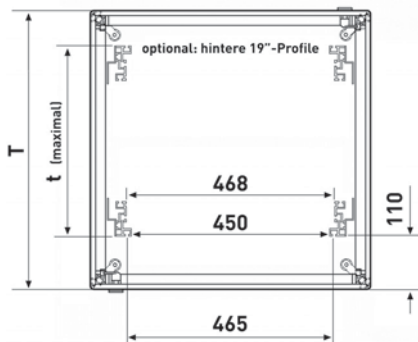
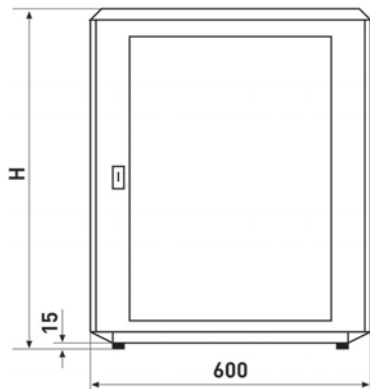

SMA20026

## Knürr Smaract® 19" Compact Rack With glass door

- For components in acc. with IEC 297-3
- Access from all sides, removable covers
- Flexible assembly of the components using T-slot (also optional with mounting holes)
- Cable entry via rear panel (also optionally via top cover/bottom cover)
- Heat loss discharge via own convection or with fan unit on the rear panel (accessory)
- Door opening angle, 180°
- Front door with single safety glass panel, lockable

**Jumpering space**  
At the front: 4.33 in

**Load rating**  
2000 N static

**Protection rating**  
IP 20

- Material/Finish**
- Basic rack, extruded aluminum, polished
  - Corner connector, die-cast, polished
  - Covers, sheet steel, powder-coated texture
  - Glass infill front door, single safety glass panel

**Color**  
RAL 7035 light gray

- Supply schedule**
- 1 basic rack
  - 2 side panels, closed, hinged on both sides
  - 1 top cover, closed
  - 1 glass front door, lockable
  - 1 rear door with cable entry, lockable, prepared for ventilation unit
  - 2 19" aluminum vertical extrusions, front, with T-slot and increment slide for spring nut M5 or 19" sheet steel vertical extrusion, front (see table)
  - 1 earthing set
  - 4 leveling feet

**How supplied**  
Assembled

**Note**  
If required, please also order 19" extrusions (see page 2.9) for rear 19" level

W	H	D	U	h	d(max.)	kg	Model	Order no.	UP
600	478	600	9	450	16	16	With 19" T-slot extru.	02.110.007.1	1 unit
600	612	600	12	450	20	20	With 19" T-slot extru.	02.110.012.1	1 unit
600	745	600	15	450	24	24	With 19" T-slot extru.	02.110.017.1	1 unit
600	879	600	18	450	28	28	With 19" T-slot extru.	02.110.022.1	1 unit
600	1012	600	21	450	32	32	With 19" T-slot extru.	02.110.027.1	1 unit
600	1143	600	24	450	36	36	With 19" T-slot extru.	02.110.032.1	1 unit
600	478	800	9	650	19	19	With 19" T-slot extru.	02.110.009.1	1 unit
600	612	800	12	650	23	23	With 19" T-slot extru.	02.110.014.1	1 unit
600	745	800	15	650	27	27	With 19" T-slot extru.	02.110.019.1	1 unit
600	879	800	18	650	31	31	With 19" T-slot extru.	02.110.024.1	1 unit
600	1012	800	21	650	35	35	With 19" T-slot extru.	02.110.029.1	1 unit
600	1145	800	24	650	39	39	With 19" T-slot extru.	02.110.034.1	1 unit
600	478	600	9	450	16	16	With 19" mounting hole extru.	02.110.057.1	1 unit
600	612	600	12	450	20	20	With 19" mounting hole extru.	02.110.062.1	1 unit
600	745	600	15	450	24	24	With 19" mounting hole extru.	02.110.067.1	1 unit
600	879	600	18	450	28	28	With 19" mounting hole extru.	02.110.072.1	1 unit
600	1012	600	21	450	32	32	With 19" mounting hole extru.	02.110.077.1	1 unit
600	1145	600	24	450	36	36	With 19" mounting hole extru.	02.110.082.1	1 unit
600	478	800	9	650	19	19	With 19" mounting hole extru.	02.110.059.1	1 unit
600	612	800	12	650	23	23	With 19" mounting hole extru.	02.110.064.1	1 unit
600	745	800	15	650	27	27	With 19" mounting hole extru.	02.110.069.1	1 unit
600	879	800	18	650	31	31	With 19" mounting hole extru.	02.110.074.1	1 unit
600	1012	800	21	650	35	35	With 19" mounting hole extru.	02.110.079.1	1 unit
600	1145	800	24	650	39	39	With 19" mounting hole extru.	02.110.084.1	1 unit

Dimensions in mm: W = Width, H = Height, D = Depth, h = installation height, d = usefull depth, L = length, U = standard height unit, 1 U = 44.45 mm, UP = unit of packaging, kg = weight, = Express item

Conversion: 1 mm = 0.03937 inch, 1 kg = 2.2046 pound



SMA20067

## Knürr Smaract® 19" Server Compact Rack With perforated door

- For components in acc. with IEC 297-3
- Access from all sides, removable covers
- With special 19" server extrusions for mounting trade standard servers
- With perforated doors on the front and rear for optimal airflow
- Door opening angle, 180°

**■ Jumping space**  
At the front: 75 mm

**■ Airflow circulation**  
900 cm<sup>2</sup> with 9 U  
590.55 in<sup>2</sup> with 15 U  
826.77 in<sup>2</sup> with 21 U  
2400 cm<sup>2</sup> with 24 U

- Material/Finish**
- Basic rack, extruded aluminum, polished
  - Corner connector, die-cast, polished
  - Covers, sheet steel, powder-coated texture

- Color**  
Final digit of order number .1:  
RAL 7035 light gray  
Final digit of order number .8:  
RAL 7021 dark gray

- Supply schedule**  
1 basic rack  
2 side panels, closed, hinged on both sides  
1 top cover, closed  
1 front door with perforation, lockable  
1 rear door with perforation, lockable  
4 19" server sheet steel mounting hole extrusions  
1 earthing set  
4 leveling feet

- Note**  
Also order mounting adapters for 19" server extrusion for mounting Knürr accessories. Set with 4 adapters 01.127.119.9

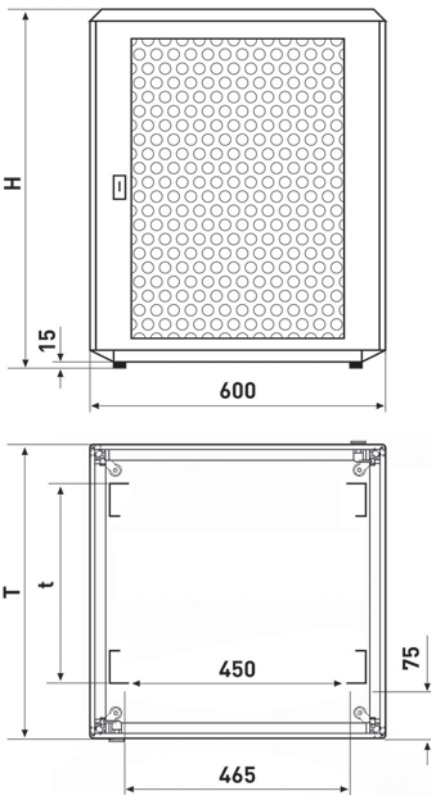

SMA20060

W	H	D	U	h	d	kg	Model	Order no.	UP
600	478	900	9	740	21	21	With 19" server extru., RAL 7035	02.110.010.1	1 unit
600	478	900	9	740	21	21	With 19" server extru., RAL 7021	02.110.010.8	1 unit
600	745	900	15	740	29	29	With 19" server extru., RAL 7035	02.110.020.1	1 unit
600	745	900	15	740	29	29	With 19" server extru., RAL 7021	02.110.020.8	1 unit
600	1012	900	21	740	37	37	With 19" server extru., RAL 7035	02.110.030.1	1 unit
600	1012	900	21	740	37	37	With 19" server extru., RAL 7021	02.110.030.8	1 unit
600	1145	900	24	740	41	41	With 19" server extru., RAL 7035	02.110.035.1	1 unit
600	1145	900	24	740	41	41	With 19" server extru., RAL 7021	02.110.035.8	1 unit



SMA20025

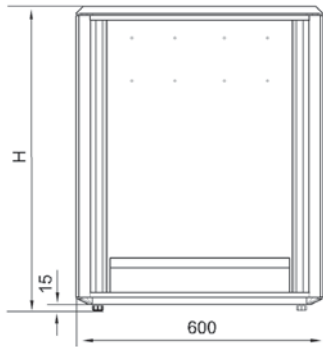

SMA20027

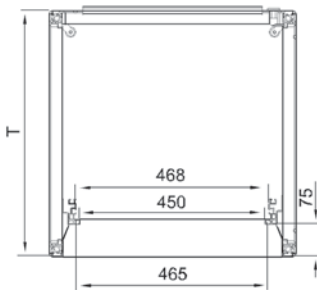

SMA20042

## Knürr Smaract® 19" Compact Rack Enclosure without door

- For components in acc. with IEC 297-3- Removable covers

■ **Load rating**

- 2000 N static

■ **Material/Finish**

- Basic rack, extruded aluminum, polished  
- Corner connector, die-cast, polished  
- Covers, sheet steel, powder-coated texture

■ **Color**

- RAL 7035 light gray

■ **Supply schedule**

1 basic rack  
2 side panels, closed, hinged on both sides  
1 top cover, closed  
1 trim frame, front  
1 rear door with cable entry, lockable, prepared for ventilation unit  
2 19" aluminum vertical extrusions, front, with T-slot  
1 earthing set  
4 leveling feet

■ **How supplied**

- Assembled

■ **Note**

If required, please also order 19" extrusions (see page 2.9) for rear 19" level

W	H	D	U	h	d	kg	Model	Order no.	UP
600	478	600	9			16		02.110.107.1	1 unit
600	745	600	15			24		02.110.117.1	1 unit
600	1012	600	21			28		02.110.127.1	1 unit
600	478	800	9			19		02.110.109.1	1 unit
600	745	800	15			25		02.110.119.1	1 unit
600	1012	800	21			31		02.110.129.1	1 unit

**Dimensions in mm:** W = Width, H = Height, D = Depth, h = installation height, d = useful depth, L = length, U = standard height unit, 1 U = 44.45 mm, UP = unit of packaging, kg = weight, = Express item

**Conversion:** 1 mm = 0.03937 inch, 1 kg = 2.2046 pound





SMA20176

## Knürr Smaract® Ventilation Unit

- Easy add-on on the rear panel  
With two axial fans
- With thermostat
- Available in two different performance classes

### Single fan technical data

- Type 1  
Max. volume flow (free blowing):  
177.17 yd<sup>3</sup>/h  
Noise (free blowing): 37 dB(A)
- Type 2 (quiet):  
Max. volume flow (free blowing):  
120 m<sup>3</sup>/h  
Noise (free blowing): 32 dB(A)

### Technical data, thermostat

- Setting range: 0 to 60 °C
- Mains supply: 240 V/50Hz
- Nominal current: 16 A

### Material/Finish

Sheet steel, zinc-passivated

### Supply schedule

1 fan unit wired ready for connection,  
with thermostat  
Mounting material

### How supplied

Preassembled



SMA20180

W	H	D	U	d	kg	Model	Order no.	UP
						Type 1	02.111.180.9	1 unit
						Type 2 (quiet)	02.111.181.9	1 unit



SMA20103

## Knürr Smaract® 19" aluminum extrusion with T-slot

- For front and rear installation

### Material/Finish

19" extrusions: Extruded aluminum,  
polished  
Mounting bracket: Sheet steel, zinc-passivated

### Supply schedule

2 19" extrusions with T-slot incl. increment  
slides  
4 mounting brackets  
Mounting material

### How supplied

Flat-packed kit

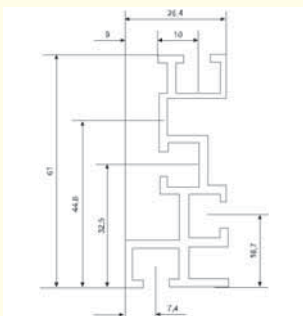

SMA20105

W	H	D	U	d	kg	Model	Order no.	UP
			9				02.111.146.9	1 unit
			12				02.111.147.9	1 unit
			15				02.111.148.9	1 unit
			18				02.111.149.9	1 unit
			21				02.111.150.9	1 unit
			24				02.111.151.9	1 unit



SMA20104

## Knürr Smaract® 19" steel extrusion with mounting holes

- For front and rear installation

### Material/Finish

19" extrusions: Sheet steel, zinc-passivated  
Mounting bracket: Sheet steel, 1.5 mm,  
zinc-passivated

### Supply schedule

2 19" extrusions with mounting holes  
4 mounting brackets  
Mounting material

### How supplied

Flat-packed kit

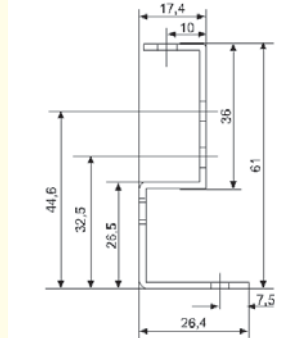

SMA20106

W	H	D	U	d	kg	Model	Order no.	UP
			9				02.111.156.9	1 unit
			12				02.111.157.9	1 unit
			15				02.111.158.9	1 unit
			18				02.111.159.9	1 unit
			21				02.111.160.9	1 unit
			24				02.111.161.9	1 unit



MIR20046

## Knürr Smaract® 19" sheet steel server extrusion

- For front and rear installation

### Material/Finish

Sheet steel, 0.10 in, zinc-passivated

### Supply schedule

2 19" extrusions with mounting holes  
Mounting material

### How supplied

Flat-packed kit

### Note

Please also order mounting adapter  
01.127.119.9 (set with 4 adapters)

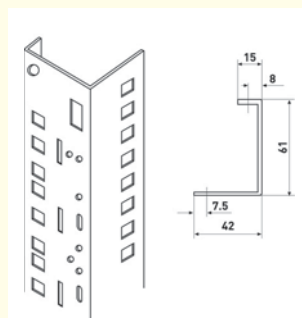

MIR20041

W	H	D	U	d	kg	Model	Order no.	UP
			9				02.111.136.9	1 unit
			12				02.111.137.9	1 unit
			15				02.111.138.9	1 unit
			18				02.111.139.9	1 unit
			21				02.111.140.9	1 unit
			24				02.111.141.9	1 unit

Dimensions in mm: W = Width  
H = Height  
D = Depth  
U = standard height unit  
h = installation height  
d = useful depth  
L = length  
1 U = 44.45 mm  
UP = unit of packaging  
kg = weight  
Express item

Conversion: 1 mm = 0.03937 inch 1 kg = 2.2046 pound



MIR20044

## Mounting adapters for 19" server extrusion

- For mounting Knürr standard components (storage shelves, drawers, chassis runners, keyboard runners, etc.) in 19" installation space

■ **Material**  
Sheet steel, zinc-passivated

■ **Supply schedule**  
4 adapters

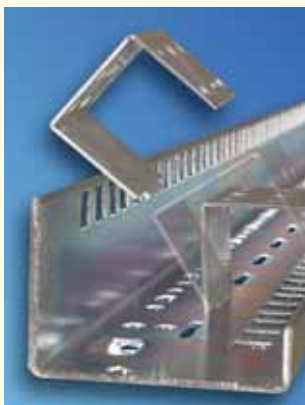

MIR20082

W	H	D	U	d	kg	Model	Order no.	UP
			1				01.127.119.9	1 unit

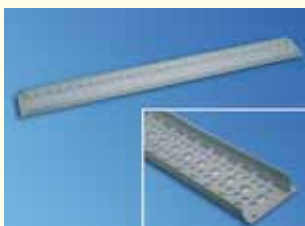

SMA20172

## Knürr Smaract® Depth Brace

- For additional strengthening of the enclosure.
- For routing cables with cable ties and as universal mounting option
- With holes for mounting caged nuts
- Variable positioning with T-slot
- Installation on the frame extrusions

■ **Material/Finish**  
Sheet steel, 1.5 mm, zinc-passivated

■ **Supply schedule**  
1 depth brace  
Mounting material

■ **How supplied**  
Flat-packed kit

■ **Note**  
Use with 19" server extrusions is not possible

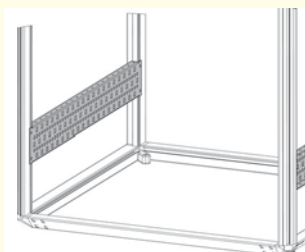

SMA20173

W	H	D	U	d	kg	Model	Order no.	UP
		600					02.111.002.0	1 unit
		800					02.111.004.0	1 unit
		900					02.111.005.0	1 unit

**Dimensions in mm:** W = Width  
H = Height  
D = Depth  
h = installation height  
d = useful depth  
L = length

U = standard height unit  
1 U = 44.45 mm  
UP = unit of packaging  
kg = weight

 = Express item

**Conversion:** 1 mm = 0.03937 inch 1 kg = 2.2046 pound



SMA20031

## Knürr Smaract® Door closed

- Can be used as front and rear door

■ **Supply schedule**  
1 rear panel, closed  
Mounting material

■ **Material/Finish**  
Sheet steel, powder-coated texture

■ **How supplied**  
Flat-packed kit

■ **Color**  
RAL 7035 light gray

W	H	D	U	d	kg	Model	Order no.	UP
			9				02.111.076.1	1 unit
			12				02.111.077.1	1 unit
			15				02.111.078.1	1 unit
			18				02.111.079.1	1 unit
			21				02.111.080.1	1 unit
			24				02.111.081.1	1 unit



SMA20028

## Knürr Smaract® Top Cover/Bottom Cover closed

■ **Material/Finish**  
Sheet steel, powder-coated texture

■ **Color**  
**Final digit of order number .1:**  
RAL 7035 light gray  
**Final digit of order number .8:**  
RAL 7021 dark gray

■ **Supply schedule**  
1 bottom cover, closed  
Mounting material

■ **How supplied**  
Flat-packed kit

■ **Note**  
Use of the bottom cover in combination with the stationary plinth is not possible

W	H	D	U	d	kg	Model	Order no.	UP
600		600					02.111.052.1	1 unit
600		800					02.111.054.1	1 unit
600		900					02.111.055.1	1 unit
600		900					02.111.055.8	1 unit



SMA20168

## Knürr Smaract® Top Cover/Bottom Cover with cable entry

- With integrated cable clamping
- With brush strip for cable entry

■ **Material/Finish**  
Sheet steel, powder-coated texture

■ **Color**  
**Final digit of order number .1:**  
RAL 7035 light gray  
**Final digit of order number .8:**  
RAL 7021 dark gray

- **Supply schedule**  
1 bottom cover with cable routing  
1 brush strip  
Mounting material

- **How supplied**  
Flat-packed kit

W	H	D	U	d	kg	Model	Order no.	UP
600		600					02.111.042.1	1 unit
600		800					02.111.044.1	1 unit
600		900					02.111.045.1	1 unit
600		900					02.111.045.8	1 unit

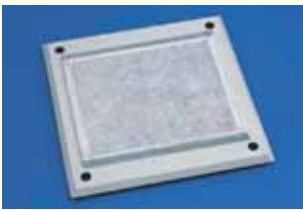

## Knürr Smaract® Bottom Cover, perforated With filter mat

- For cooling with air convection

- **Material/Finish**  
Bottom cover: Sheet steel, powder-coated texture  
Filter mat: Filedon

- **Color**  
RAL 7035 light gray

- **Supply schedule**  
1 perforated bottom cover with filter mat  
Mounting material

- **How supplied**  
Flat-packed kit

SMA20029

W	H	D	U	d	kg	Model	Order no.	UP
600		600					02.111.062.1	1 unit
600		800					02.111.064.1	1 unit
600		900					02.111.065.1	1 unit



## Knürr Smaract® Replacement Filter Mat For Smaract perforated bottom cover

- For use in conjunction with perforated bottom cover

- **Material**  
Filedon

- **Supply schedule**  
5 replacement filters

- **How supplied**  
Flat-packed kit

SMA20058

W	H	D	U	d	kg	Model	Order no.	UP
						For D600	02.111.068.9	5 units
						For D800	02.111.069.9	5 units
						For D900	02.111.069.9	5 units



## Knürr Smaract® Plinth

- Cable entry possible from all sides
- Panels front and rear with vent slots and installation option for filter mat

SMA20177

- **Material/Finish**  
Sheet steel, powder-coated texture

- **Color**  
**Final digit of order number .1:**  
RAL 7035 light gray  
**Final digit of order number .8:**  
RAL 7021 dark gray

- **Supply schedule**  
4 plinth corners  
2 closed panels  
2 panels with vent slots  
Mounting material

- **How supplied**  
Flat-packed kit

W	H	D	U	d	kg	Model	Order no.	UP
600	100	600					02.111.201.1	1 set
600	100	800					02.111.203.1	1 set
600	100	900					02.111.204.1	1 set
600	100	900					02.111.204.8	1 set



## Knürr Smaract® Plinth Panel With cable entry for use in conjunction with the plinth

- For use in conjunction with the plinth

- **Material/Finish**  
Sheet steel, powder-coated texture

- **Supply schedule**  
1 panel with cable entry  
1 brush strip  
Mounting material

- **Color**  
**Final digit of order number .1:**  
RAL 7035 light gray  
**Final digit of order number .8:**  
RAL 7021 dark gray

- **How supplied**  
Flat-packed kit

SMA20098

W	H	D	U	d	kg	Model	Order no.	UP
600	100						02.111.206.1	1 unit
600	100						02.111.206.8	1 unit



## Knürr Smaract® Twin Castor

- Height 50 mm

- **Color**  
RAL 9011, graphite black

- **Load rating**  
400 N per castor  
1200 N max. static total load per rack

- **Supply schedule**  
2 twin castors  
2 fixed castors

- **Standards**  
Castors in accordance with DIN 12530  
Load rating in accordance with DIN 12527

- **How supplied**  
Flat-packed kit

SMA20034

W	H	D	U	d	kg	Model	Order no.	UP
							02.111.175.9	4 unit



SMA20035

## Knürr Smaract® Stacking Set

- Fixed connection for stacking compact racks

■ **Material/Finish**  
Steel, cold rolled, zinc-passivated

■ **Supply schedule**  
4 stacking elements  
Mounting material

■ **How supplied**  
Flat-packed kit

W	H	D	U	d	kg	Model	Order no.	UP
							02.111.171.9	4 unit



MEC00074

## Knürr Smaract® Eyebolt Set

- For hanging on crane hooks
- Load rating, 1900 N static per ring screw

■ **Material/Finish**  
Tool steel, forged

■ **Supply schedule**  
4 eyebolts

■ **How supplied**  
Flat-packed kit

W	H	D	U	d	kg	Model	Order no.	UP
							01.243.440.9	4 unit

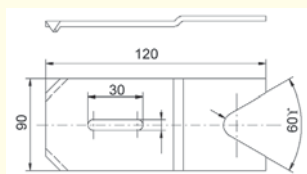

MIR00319

## Base Fixing Kit

■ **Material**  
Sheet steel, 3.0 mm

■ **Finish**  
Zinc-passivated

■ **Supply schedule**  
4 clamping plates

W	H	D	U	d	kg	Model	Order no.	UP
							01.130.934.7	1 unit



SMA20094

## Knürr Smaract® Wall Mounting Bracket

■ **Material/Finish**  
Sheet steel, powder-coated texture

■ **Color**  
RAL 7035 light gray

■ **Supply schedule**  
2 wall mounting brackets  
Drill hole template  
Mounting material

■ **Load rating**  
500 N

■ **How supplied**  
Flat-packed kit



SMA20085

W	H	D	U	d	kg	Model	Order no.	UP
600							02.111.220.9	1 set

## Earthing Bar

- For safe earthing and equipotential bonding of equipment and installation components

■ **Material**  
Electrolyte copper, 9x9

■ **Supply schedule**  
1 earthing bar  
2 brackets  
Mounting material



ELM00068

W	H	S	U	h	d	kg	Model	Order no.	UP
			12					01.110.703.9	1 unit
			15					01.240.543.9	1 unit
			18					01.240.544.9	1 unit
			21					01.240.545.9	1 unit
			24					01.240.546.9	1 unit

## Contact Clamp

- For safe and secure connection of equipment and installation components with the earthing bar
- For cables up to 25 mm<sup>2</sup>

■ **Supply schedule**  
20 contact clamps



DOP20016

W	H	S	U	h	d	kg	Model	Order no.	UP
								01.110.715.9	20 unit

**Dimensions in mm:** W = Width, H = Height, D = Depth, h = installation height, d = useful depth, L = length, U = standard height unit, 1 U = 44.45 mm, UP = unit of packaging, kg = weight, = Express item

**Conversion:** 1 mm = 0.03937 inch, 1 kg = 2.2046 pound



SMA20035

## Knürr Smaract® 19" Compact Rack, EMC, with sheet steel door

- For components in acc. with IEC 297-3
- Removable covers

**Load rating**  
- 2000 N static

**Material**  
- Basic rack: Extruded aluminum  
- Covers: Sheet steel  
- EMC spring: Stainless steel

**Finish:**  
- Basic rack: polished  
- Covers: Powder-coated texture

**Color**  
- RAL 7035 light gray

**Supply schedule**

- 1 basic rack
- 2 side panels, EMC, closed, stop on both sides
- 1 top cover, EMC, closed
- 1 bottom cover, EMC, closed
- 1 front door, EMC, closed, lockable
- 1 rear panel, EMC, closed, screwed
- 2 19" aluminum vertical extrusions, at the front, with T-slot incl. increment slide
- 1 earthing set
- 4 leveling feet

**How supplied**

- Assembled

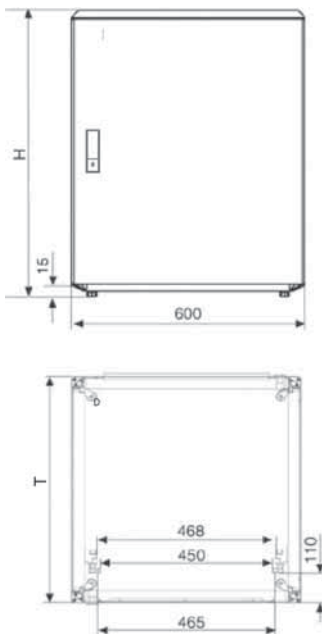

SMA20059

TEC20098

W	H	D	U	h	d	kg	Model	Order no.	UP
600	612	600	12			28		02.110.312.1	1 unit
600	879	600	18			36		02.110.322.1	1 unit
600	1146	600	24			44		02.110.332.1	1 unit
600	612	800	12			32		02.110.314.1	1 unit
600	879	800	18			40		02.110.324.1	1 unit
600	1146	800	24			48		02.110.334.1	1 unit

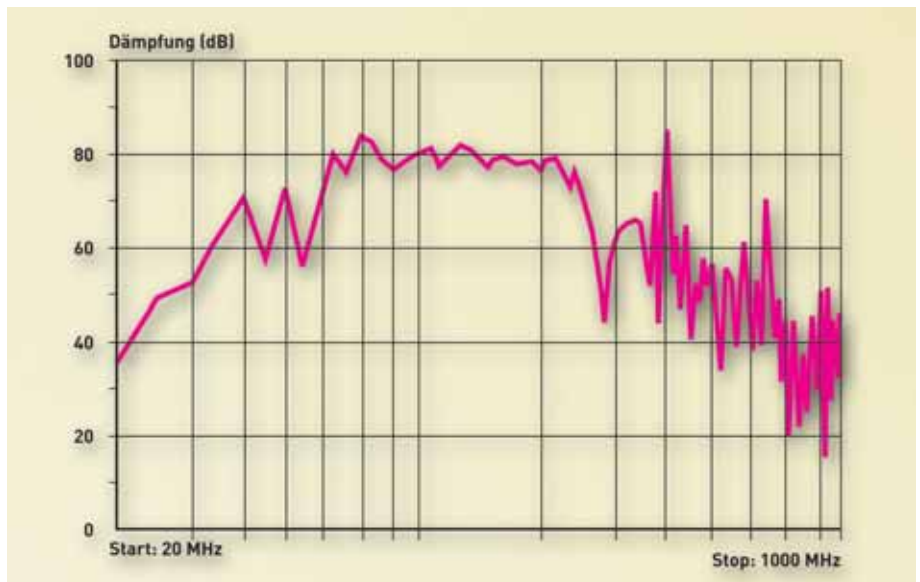

- EMC measurements performed by pkm Electronic GmbH, Frontenhausen.
- The tests were carried out in compliance with the following standard: VG 95373 Part 15.
- Tested rack: width 600, depth 600, height 1150, closed version.

**Dimensions in mm:** W = Width, H = Height, D = Depth, h = installation height, d = useful depth, L = length, U = standard height unit, 1 U = 44.45 mm, UP = unit of packaging, kg = weight, = Express item

**Conversion:** 1 mm = 0.03937 inch, 1 kg = 2.2046 pound



SMA20148

## Knürr Smaract® Connection Panel, EMC, Closed

- EMC shielding
- Screwed

**Material**  
- Cover: Sheet steel  
- EMC spring: High-grade steel

**Finish**  
- Powder-coated texture

**Color**  
- RAL 7035 light gray

**Supply schedule**  
1 connection panel  
2 brackets  
Mounting material

**How supplied**  
- Flat-packed kit



SMA20137

W	H	D	U	h	d	kg	Model	Order no.	UP
600	131.3		3					02.111.351.1	1 set



SMA20145

## Knürr Smaract® Connection Panel, EMC, with Cable Entry

- EMC shielding
- Screwed

**Material**  
- Cover: Sheet steel  
- EMC spring: High-grade steel  
- EMC seal extrusion: Rubber with high-grade steel grid

**Finish**  
- Powder-coated texture

**Color**  
- RAL 7035 light gray

**Supply schedule**  
1 connection panel with cable entry  
2 brackets  
Mounting material

**How supplied**  
- Flat-packed kit



SMA20137

W	H	D	U	h	d	kg	Model	Order no.	UP
600	131.3		3					02.111.361.1	1 set

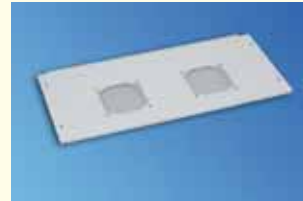

SMA20150

## Knürr Smaract® Connection Panel, EMC, for Fan Unit

- EMC shielding
- Screwed

**Material**  
- Cover: Sheet steel  
- EMC spring: High-grade steel

**Finish**  
- Powder-coated texture

**Color**  
- RAL 7035 light gray

**Supply schedule**  
1 connection panel for fan unit  
2 brackets  
Mounting material

**How supplied**  
- Flat-packed kit

**Note**  
Suitable fan unit: 02.111.180.9



SMA20135

W	H	D	U	h	d	kg	Model	Order no.	UP
600	264.6		6					02.111.372.1	1 set

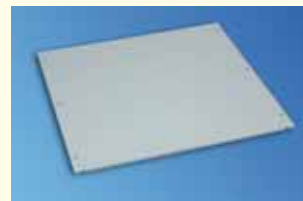

SMA20152

## Knürr Smaract® Rear Panel, EMC, closed

- EMC shielding
- Screwed

**Material**  
- Cover: Sheet steel  
- EMC spring: High-grade steel

**Finish**  
- Powder-coated texture

**Color**  
- RAL 7035 light gray

**Supply schedule**  
1 connection panel  
2 brackets  
Mounting material

**How supplied**  
- Flat-packed kit



SMA20137

W	H	D	U	h	d	kg	Model	Order no.	UP
600	422.9		9					02.111.353.1	1 set
600	556.3		12					02.111.354.1	1 set
600	689.6		15					02.111.355.1	1 set

Dimensions in mm: W = Width:  
H = Height:  
D = Depth  
h = installation height  
d = useful depth  
kg = weight

U = standard height unit  
HP = Horizontal pitch  
UP = unit of packaging  
ESD = ESD version

 = Express item



SMA20062

## Knürr Smaract® 19" Compact Rack IP54 with glass door

- For components in acc. with IEC 297-3
- Removable covers

**Load rating**  
- 2000 N static

**Protection rating**  
- IP 54

**Material**  
- Basic rack: Extruded aluminum  
- Covers: Sheet steel  
- Foam seal: Polyurethane

**Finish:**  
- Basic rack: polished  
- Covers: Powder-coated texture

**Color**  
- RAL 7035 light gray

**Supply schedule**  
1 basic rack  
2 side panels, IP 54, closed, stop on both sides  
1 top cover, IP 54, closed  
1 bottom cover, IP 54, closed  
1 glass front door IP 54, lockable  
1 rear panel, IP 54, closed, screwed  
2 19" aluminum vertical extrusions, at the front, with T-slot incl. increment slide  
1 earthing set  
4 leveling feet

**How supplied**  
- Assembled

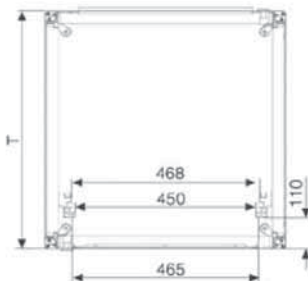
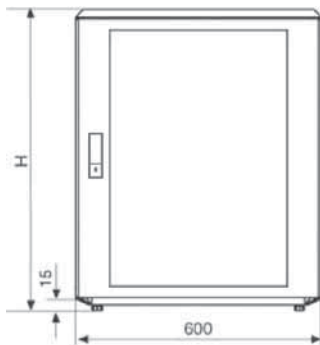

SMA20108

W	H	D	U	h	d	kg	Model	Order no.	UP
600	612	600	12			28		02.110.212.1	1 unit
600	879	600	18			36		02.110.222.1	1 unit
600	1146	600	24			44		02.110.232.1	1 unit
600	612	800	12			32		02.110.214.1	1 unit
600	879	800	18			40		02.110.224.1	1 unit
600	1146	800	24			48		02.110.234.1	1 unit

Dimensions in mm: W = Width; H = Height; D = Depth; h = installation height; d = useful depth; kg = weight; U = standard height unit; HP = Horizontal pitch; UP = unit of packaging; ESD = ESD version;  = Express item



SMA20148

## Knürr Smaract® Connection Panel, IP 54, Closed

- Protection rating, IP 54
- Screwed

**Material**  
- Cover: Sheet steel  
- Foam seal: Polyurethane

**Finish**  
- Powder-coated texture

**Color**  
- RAL 7035 light gray

**Supply schedule**  
1 connection panel  
2 brackets  
Mounting material

**How supplied**  
- Flat-packed kit



SMA20138

W	H	D	U	h	d	kg	Model	Order no.	UP
600	131.3		3					02.111.301.1	1 set



SMA20139

## Knürr Smaract® Connection Panel, IP 54, with Cable Entry

- Possible sealing: IP 54
- Screwed

**Material**  
- Cover: Sheet steel  
- Foam seal: Polyurethane  
- Seal extrusion: Type 1 Sponge rubber seal  
Type 2 Polymeric reinforced with metal

**Finish**  
- Powder-coated texture

**Color**  
- RAL 7035 light gray

**Supply schedule**  
1 connection panel with cable entry  
2 brackets  
Mounting material

**How supplied**  
- Flat-packed kit



SMA20169



SMA20138

W	H	D	U	h	d	kg	Model	Order no.	UP
600	131.3		3				Type 1	02.111.311.1	1 set
600	131.3		3				Type 2	02.111.312.1	1 set

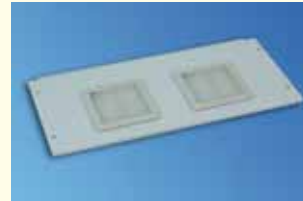

SMA20143

## Knürr Smaract® Connection Panel, IP 54, for Fan Unit

- Protection rating, IP 54
- Screwed

**Material**  
- Covers: Sheet steel  
- Foam seal: Polyurethane  
- Exit filter: ABS plastic, UL94 V-0

**Finish**  
- Powder-coated texture

**Color**  
- RAL 7035 light gray

**Supply schedule**  
1 connection panel for fan unit  
2 brackets, mounting material

**How supplied**  
- Flat-packed kit

**Note**  
Suitable fan unit: 02.111.180.9



SMA20136

W	H	D	U	h	d	kg	Model	Order no.	UP
600	264.6		6					02.111.322.1	1 set

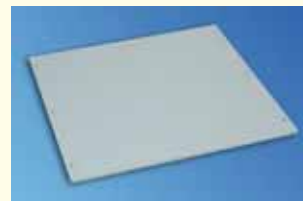

SMA20141

## Knürr Smaract® Rear Panel, IP54, Closed

- Protection rating, IP 54
- Screwed

**Material**  
- Covers: Sheet steel  
- Foam seal: Polyurethane

**Finish**  
- Powder-coated texture

**Color**  
- RAL 7035 light gray

**Supply schedule**  
1 connection panel for fan unit  
2 brackets  
Mounting material

**How supplied**  
- Flat-packed kit



SMA20138

W	H	D	U	h	d	kg	Model	Order no.	UP
600	156.3		3					02.111.308.1	1 set
600	289.6		6					02.111.302.1	1 set
600	422.9		9					02.111.303.1	1 set
600	556.3		12					02.111.304.1	1 set
600	689.6		15					02.111.305.1	1 set
600	823		18					02.111.306.1	1 set
600	956.3		21					02.111.307.1	1 set

Dimensions in mm: W = Width  
H = Height  
D = Depth  
h = installation height  
d = useful depth  
kg = weight

U = standard height unit  
HP = Horizontal pitch  
UP = unit of packaging  
ESD = ESD version

 = Express item



*Knürr DoubleProRack®*



# Knürr DoubleProRack®

19" Stand-Alone Enclosure 1.94 to 1.100



## 19" Network Stand-Alone Enclosure

Knürr DoubleProRack®  
Strong points 1.94

Knürr DoubleProRack®  
19" Stand-Alone Enclosure 1.96  
19" Enclosure Without Door 1.97

## Knürr DoubleProRack® Accessories

Extrusions	1.98
Fan Unit	1.98
Rear Panel	1.98
Connection Panel	1.99
Earthing Set	1.99
Mounting Bracket	1.100
Rack Connector	1.100
Base Fixing	1.100
Eyebolt Set	1.100
Swivel Castors	1.100

## Knürr DoubleProRack® Strong points



1 DOP00242



3 DOP00245



5 DOP00247



7 DOP00250



DOP00256

8 DOP00251

- 1 Complete 19" enclosure range, from the Desktop Enclosure with 6 U through to the Compact Rack with 24 U.
- 2 Various top and bottom cover variants are available for individual requirements for air throughput and IP protection rating. Top and bottom covers can be combined with each other in any way.
- 3 Lockable front door, optionally as single safety glass panel or as sheet steel door.
- 4 The extrusions for installing the 19" components are available with mounting holes or with a T-slot for incremented or stepless mounting.
- 5 The 19" mounting level can be set in the depth in 25 mm increments. This allows higher front panel structures to also be installed when using a door.
- 6 Individual configurations for your special application case allow uneven floor surfaces to be evened out with the leveling feet, mobility with castors or stacking with enclosure foot.
- 7 As an additional alternative, a plinth with front vent panel provides space for cabling and ventilation from below.
- 8 Various door types allow appearance and service access to be individually designed while taking the required protection rating into account.
- 9 Different types of cable entry are available according to the required protection rating.

## Knürr DoubleProRack® 19" Enclosure in acc. with IEC 297-3 Technical data

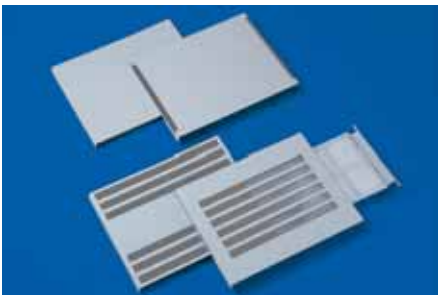

2 DOP00244



4 DOP20004



4 DOP20005



6 DOP00248

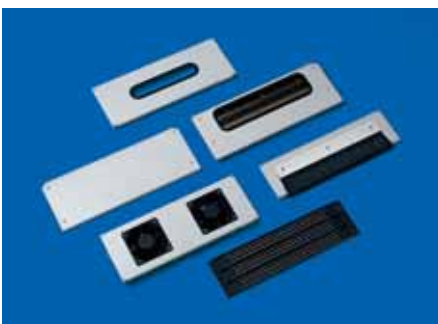

9 DOP00252

■ Die-cast aluminum frame construction connected with aluminum depth and vertical extrusions

### ■ Material

- Covers, sheet steel, 0.8 mm, zinc-passivated
- Die-cast aluminum frame
- Extruded aluminum depth and vertical extrusions
- In the 19" mounting level, extruded aluminum with T-slot and mounting holes
- Sheet steel, full glass doors or extrusion doors with sheet steel or safety glass panel

### ■ External dimensions

- Widths  
554.4 mm  
754.4 (network enclosures)
- Depths  
500, 600, 700 or 800 mm
- Height:  
177.8 – 1111.3 mm (without feet or plinth)

### ■ Installation space in acc. with IEC 297

- Height 3 – 24 U  
(1 U = 44.45 mm)
- Width: 19"

### ■ How supplied

- Assembled

### ■ Load rating

- 1500 N static

### ■ Configuration

- Stationary, on plastic feet or plinth with feet
- Mobile on twin swivel castors

### ■ Finish /Color

- Powder-coated texture, RAL 7035 light gray
- Frame and extrusions powder-coated texture, RAL 5008 light gray

### ■ Tests

- Vibration test in acc. with MIL-STD 810 D
- NEMA 12 Test



DOP00256

## Knürr DoubleProRack® 19" Stand-Alone Enclosure

- For components in acc. with IEC 297-3
- Side covers and rear panel can be removed
- Flexible assembly of the components using T-slot (also optional with mounting holes)
- Cable entry via rear panel
- Heat loss discharge via own convection on the rear panel (or optionally with fan unit)

### ■ Jumpering space

At the front: 125 mm

### ■ Load rating

1500 N static

### ■ Protection rating

IP 20

### ■ Material/Finish

Covers, sheet steel, powder-coated texture  
 Die-cast aluminum frame  
 Extruded aluminum extrusions  
 Glass infill front door, single safety glass panel

### ■ Color

Covers, RAL 7035 light gray  
 Frame and extrusions, RAL 5008 gray-blue

### ■ Supply schedule

1 frame rack incl. side covers  
 1 full glass door  
 1 rear panel with cable entry, 3 parts  
 1 cover, above, with vent slots  
 1 cover, below, with vent slots  
 1 19" installation set (4 vertical extrusions with T-slot)  
 1 earthing set with earthing bolt, M8

### ■ How supplied

Assembled

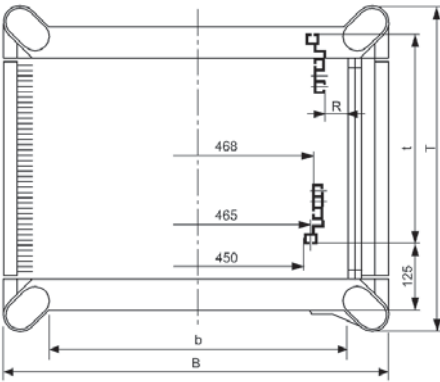
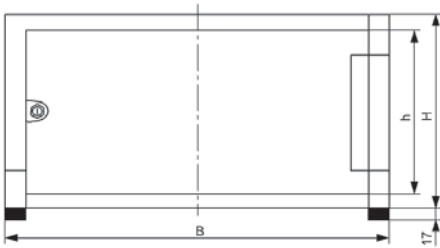

DOP00230

W	H	D	U	h	d	kg	Model	Order no.	UP
554.4	311	600	6	265	435		With full glass door	01.246.641.1	1 unit
554.4	444	600	9	399	435		With full glass door	01.246.642.1	1 unit
554.4	577	600	12	532	435		With full glass door	01.246.643.1	1 unit
554.4	711	600	15	666	435		With full glass door	01.246.644.1	1 unit
554.4	844	600	18	799	435		With full glass door	01.246.645.1	1 unit
554.4	978	600	21	932	435		With full glass door	01.246.646.1	1 unit
554.4	1111	600	24	1066	435		With full glass door	01.246.647.1	1 unit
554.4	577	800	12	532	635		With full glass door	01.246.843.1	1 unit
554.4	711	800	15	666	635		With full glass door	01.246.844.1	1 unit
554.4	844	800	18	799	635		With full glass door	01.246.845.1	1 unit
554.4	978	800	21	932	635		With full glass door	01.246.846.1	1 unit
554.4	1111	800	24	1066	635		With full glass door	01.246.847.1	1 unit

Dimensions in mm: W = Width  
 H = Height  
 D = Depth  
 h = installation height  
 d = useful depth  
 L = length  
 U = standard height unit  
 1 U = 44.45 mm  
 UP = unit of packaging  
 kg = weight  
 = Express item

Conversion: 1 mm = 0.03937 inch 1 kg = 2.2046 pound



DOP00253

## Knürr DoubleProRack® 19" Enclosure without front door

- For components in acc. with IEC 297-3
- Side covers and rear panel can be removed
- Heat loss discharge via own convection on the rear panel (or optionally with fan unit)

■ **Load rating**  
1500 N static

■ **Protection rating**  
IP 20

■ **Material/Finish**  
Covers, sheet steel, powder-coated texture  
Die-cast aluminum frame  
Extruded aluminum extrusions

■ **Color**  
Covers, RAL 7035 light gray  
Frame and extrusions, RAL 5008 gray-blue

■ **Supply schedule**  
1 frame rack incl. side covers  
1 cover, above, with vent slots  
1 cover, below, with vent slots  
1 rear panel (from enclosure height 12 HU, with 3 HU front ventilation panel)  
2 19" front extrusions, mounting holes  
2 19" extrusions at the rear, T-slot

■ **How supplied**  
Assembled

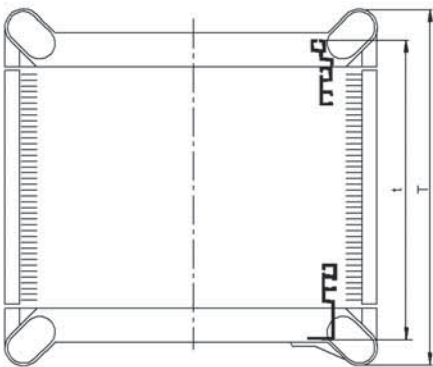
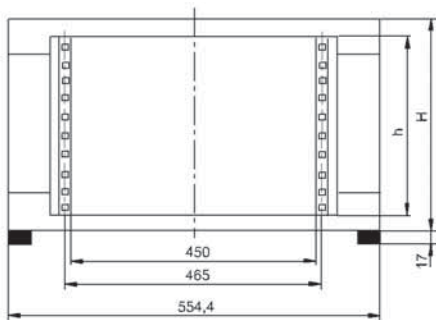

DOP00052

W	H	D	U	h	d	kg	Model	Order no.	UP
554.4	178	500	3	132	460	10.0	No door	01.243.503.1	1 unit
554.4	311	500	6	265	460	12.5	No door	01.243.506.1	1 unit
554.4	444	500	9	399	460	15.0	No door	01.243.509.1	1 unit
554.4	577	500	12	532	460	17.0	No door	01.243.512.1	1 unit
554.4	711	500	15	666	460	19.5	No door	01.243.515.1	1 unit
554.4	844	500	18	799	460	22.0	No door	01.243.518.1	1 unit
554.4	311	600	6	265	560	14.0	No door	01.243.606.1	1 unit
554.4	444	600	9	399	560	16.5	No door	01.243.609.1	1 unit
554.4	577	600	12	532	560	19.0	No door	01.243.612.1	1 unit
554.4	711	600	15	666	560	22.0	No door	01.243.615.1	1 unit
554.4	844	600	18	799	560	24.5	No door	01.243.618.1	1 unit
554.4	978	600	21	932	560	27.0	No door	01.243.621.1	1 unit
554.4	1111	600	24	1066	560	29.5	No door	01.243.624.1	1 unit
554.4	577	700	12	532	660	21.5	No door	01.243.712.1	1 unit
554.4	711	700	15	666	660	24.0	No door	01.243.715.1	1 unit
554.4	844	700	18	799	660	27.0	No door	01.243.718.1	1 unit
554.4	978	700	21	932	660	29.5	No door	01.243.721.1	1 unit
554.4	1111	700	24	1066	660	32.5	No door	01.243.724.1	1 unit

Dimensions in mm: W = Width, H = Height, D = Depth, h = installation height, d = useful depth, L = length, U = standard height unit, 1 U = 44.45 mm, UP = unit of packaging, kg = weight,  = Express item

Conversion: 1 mm = 0.03937 inch, 1 kg = 2.2046 pound



DOP20004

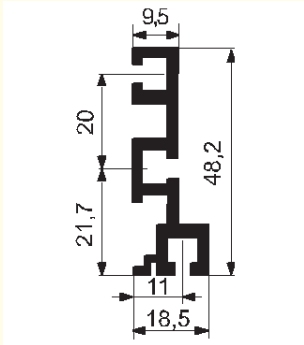

DOP00313

## Knürr DoubleProRack® 19" installation, front with T-slot

– Can also be used as second mounting level

- **Material**  
Extruded aluminum
- **Finish**  
Polished
- **Supply schedule**  
2 19" extrusions at the front, T-slot  
Mounting material
- **How supplied**  
Flat-packed kit

W	H	D	U	h	d	kg	Model	Order no.	UP
			6					01.240.440.9	1 set
			9					01.240.443.9	1 set
			12					01.240.445.9	1 set
			15					01.240.446.9	1 set
			18					01.240.447.9	1 set
			21					01.240.448.9	1 set
			24					01.240.449.9	1 set



DOP20005

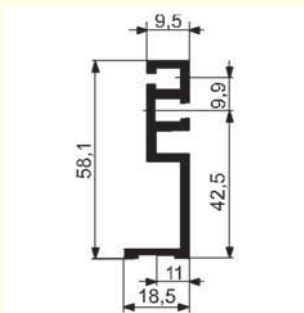

DOP00055

## Knürr DoubleProRack® 19" installation, front with mounting holes

– Can also be used as second mounting level

- **Material**  
Extruded aluminum
- **Finish**  
Polished
- **Supply schedule**  
2 19" extrusions at the front with  
mounting holes
- **How supplied**  
Flat-packed kit

W	H	D	U	h	d	kg	Model	Order no.	UP
			6					01.240.490.9	1 set
			9					01.240.493.9	1 set
			12					01.240.495.9	1 set
			15					01.240.496.9	1 set
			18					01.240.497.9	1 set
			21					01.240.498.9	1 set
			24					01.240.499.9	1 set



DOP20033

## Knürr DoubleProRack® Fan Rear Panel 3 U

– With two axial fans  
– With thermostat

- **Single fan technical data**
  - Max. volume current (free blowing):  
162 m³/h
  - Noise (free blowing): 37 dB(A)

### Technical data, thermostat

- Setting range: 0 to 60 °
- Mains supply: 240 V/50 Hz
- Nominal current: 16 A

- **Supply schedule**  
1 rear fan panel, wired  
Mounting material

- **Finish/Color**  
Powder-coated texture, RAL 7035 light  
gray

- **How supplied**  
Assembled

- **Note**  
Use in the enclosure's lowest U is not  
possible!

W	H	D	U	h	d	kg	Model	Order no.	UP
554.4	132.5		3				With thermostat	01.243.428.1	1 unit



DOP00275

## Knürr DoubleProRack® 1 rear panel, closed

– For DoubleProRack width 554.4 mm

- **Material/Finish**  
Sheet steel, 0.8 mm, powder-coated  
texture
- **Color**  
RAL 7035 light gray
- **Supply schedule**  
1 rear panel, closed  
Mounting material
- **How supplied**  
Flat-packed kit

W	H	D	U	h	d	kg	Model	Order no.	UP
554.4			3					01.240.451.1	1 unit
554.4			6					01.240.454.1	1 unit
554.4			9					01.240.457.1	1 unit
554.4			12					01.240.459.1	1 unit
554.4			15					01.240.460.1	1 unit
554.4			18					01.240.461.1	1 unit
554.4			21					01.240.462.1	1 unit

Dimensions in mm: W = Width  
H = Height  
D = Depth  
h = installation height  
d = useful depth  
L = length  
U = standard height unit  
1 U = 44.45 mm  
UP = unit of packaging  
kg = weight  
Express item

Conversion: 1 mm = 0.03937 inch 1 kg = 2.2046 pound



## Knürr DoubleProRack® Multi-Functional Handle

- Material/Finish**  
Die-cast, powder-coated texture
- Color**  
RAL 5008 gray-blue
- Supply schedule**  
2 handles  
Mounting material
- How supplied**  
Flat-packed kit

DOP00278

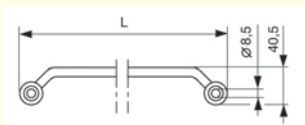

DOP00231

W	H	D	U	Model	Order no.	UP
			500		01.240.641.1	1 unit
			600		01.240.642.1	1 unit
			700		01.240.643.1	1 unit
			800		01.240.644.1	1 unit



## Knürr DoubleProRack® Connection panel with cable routing

- For cable entry in combination with rear panel shortened accordingly by 3 U
- Material/Finish**  
Sheet steel, 0.8 mm, powder-coated texture
- Color**  
RAL 7035 light gray
- Supply schedule**  
1 connection panel with cable routing  
Mounting material
- How supplied**  
Flat-packed kit

DOP00270

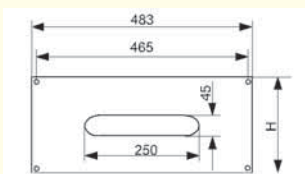

DOP00287

W	H	D	U	h	d	kg	Model	Order no.	UP
554.4	132.5		3					01.243.435.1	1 unit



## Knürr DoubleProRack® Connection panel with brush strip

- To cover rear panel in combination with rear panel shortened accordingly by 3 U
- For DoubleProRack width 554.4 mm
- With brush strip for cable routing and strain relief
- Finish/Color**  
Powder-coated texture, RAL 7035 light gray
- Supply schedule**  
1 connection panel  
Mounting material
- How supplied**  
Flat-packed kit

DOP00274

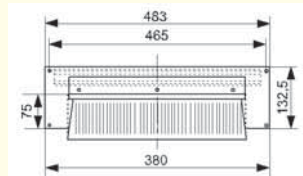

DOP00288

W	H	D	U	h	d	kg	Model	Order no.	UP
554.4	132.5		3					01.243.438.1	1 unit



## Knürr DoubleProRack® Earthing set for enclosures

- For earthing top cover/bottom cover
- With central earthing bolt
- Supply schedule**  
2 earthing lines, length 250 mm  
4 spring nuts, M5  
2 washers  
4 cylinder screws, M5 x 10  
1 earthing bolt
- How supplied**  
Flat-packed kit

MEC20122



DOP20025

W	H	D	U	h	d	kg	Model	Order no.	UP
								01.243.400.9	1 set



## Knürr DoubleProRack® Earthing set for doors and trims

- For earthing doors and/or panels
- Supply schedule**  
5 earthing lines, length 250 mm  
1 earthing line, length 250 mm, two-sided AMP plug  
5 spring nuts, M5  
5 cylinder screws, M5 x 10 with tooth lock washer  
5 washers
- How supplied**  
Flat-packed kit

MEC20035

W	H	D	U	h	d	kg	Model	Order no.	UP
								01.245.400.9	1 set

Dimensions in mm: W = Width, H = Height, D = Depth, h = installation height, d = useful depth, L = length, U = standard height unit, 1 U = 44.45 mm, UP = unit of packaging, kg = weight, = Express item

Conversion: 1 mm = 0.03937 inch, 1 kg = 2.2046 pound



ELM00068

## Earthing Bar

- For safe earthing and equipotential bonding of equipment and installation components

- **Material**  
Electrolyte copper, 9x9
- **Supply schedule**  
1 earthing bar  
2 brackets  
Mounting material

W	H	S	U	h	d	kg	Model	Order no.	UP
			12					01.110.703.9	1 unit
			15					01.240.543.9	1 unit
			18					01.240.544.9	1 unit
			21					01.240.545.9	1 unit
			24					01.240.546.9	1 unit



DOP20016

## Contact Clamp

- For safe and secure connection of equipment and installation components with the earthing bar
- For cables up to 25 mm<sup>2</sup>

- **Supply schedule**

W	H	S	U	h	d	kg	Model	Order no.	UP
								01.110.715.9	20 units



DOP00282

## Knürr DoubleProRack® Mounting bracket:

- For mounting socket strips and cable duct

- **Material/Finish**  
Sheet steel, zinc-passivated
- **Supply schedule**  
2 mounting brackets  
Mounting material
- **How supplied**  
Flat-packed kit

W	H	D	U	h	d	kg	Model	Order no.	UP
								01.240.533.9	1 set

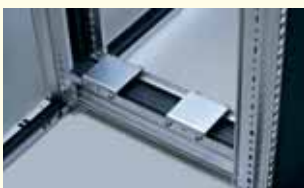

DOP00283

## Knürr DoubleProRack® Rack Connector

- For physical, stable rack and enclosure suites

- **Material/Finish**  
Sheet steel, zinc-passivated
- **Supply schedule**  
4 rack connectors  
Mounting material
- **How supplied**  
Flat-packed kit

W	H	D	U	h	d	kg	Model	Order no.	UP
								01.240.525.7	1 set



DOP00311

## Knürr DoubleProRack® Base Fixing

- For use in conjunction with leveling feet

- **Material/Finish**  
Sheet steel, black, zinc-passivated
- **Supply schedule**  
4 base fixings  
Screws and dowels
- **How supplied**  
Flat-packed kit

W	H	D	U	h	d	kg	Model	Order no.	UP
								01.243.441.3	1 set



DOP00281

## Knürr DoubleProRack® Eyebolt Set

- For hanging on crane hooks
- Load rating, 1900 N static per ring screw

- **Material**  
Tool steel, forged
- **Supply schedule**  
4 eyebolts, M 8
- **How supplied**  
Flat-packed kit

W	H	D	U	h	d	kg	Model	Order no.	UP
								01.243.440.9	1 set



DOP00267

## Knürr DoubleProRack® Twin Castor 50 mm

- For mobile setup of the DoubleProRack stand-alone enclosure with lockable castors

- **Material/Finish**  
Polyamide, RAL 9011 black
- **Load rating**  
400 N per castor  
1200 N max. static total load per rack
- **Supply schedule**  
2 twin castors  
2 lockable castors  
4 lock washers
- **How supplied**  
Flat-packed kit

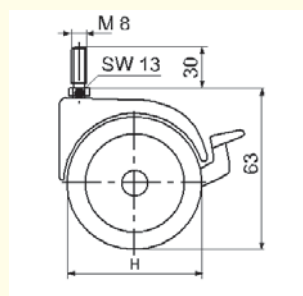

DOP00233

W	H	D	U	h	d	kg	Model	Order no.	UP
	50							01.240.527.9	1 set
	75							01.240.528.9	1 set





# Knürr ConAct®

19" Network Wall Enclosure

1.102 to 1.107



## 19" Network Wall Enclosure

### Knürr ConAct®

Strong points 1.102

### Knürr ConAct®

Wall Enclosure 1.106

### Knürr ConAct®

Accessories 1.107

Extrusions 1.107

Door 1.107

Top Cover / Bottom Cover 1.107

Earthing Set 1.107

### Knürr ConAct® Strong points

#### Unpack – and start with the network installation within minutes



ACT00024

#### Economic efficiency

- Savings of up to 50% of transport volume with flat-pack packaging (see figure A)
- Easy transport right up to assembly with space-saving packaging
- Small packages – low storage space



ACT00031

#### “One-Person” Setup

- No unnecessary removal of enclosure parts as it is delivered part dismantled
- Rear panel mounting without measuring using drill hole template
- Easy assembly with:
  - Keyhole punching on the rear panel (see figure B)
  - Push-in technology for mounting rails and covers
  - Symmetrical enclosure setup



ACT00004

**1.**  
Hang rear panel



ACT00005

**2.**  
Fix supports and vertical extrusions



ACT00030



ACT00033

**Cabling made easy**

- All-side access guarantees convenient mounting of the components
- Easy cable management with on-site existing cables with open construction design
- Orderly cable management with spacious side jumpering area and cable clamping rails as accessories (see figures C+D)



ACT00032

**Customer specification**

- Individually configurable with color variants or cover mounting holes
- 19" or metric installation possible
- 19" vertical extrusions can be depth adjusted on 25 mm increment
- Easy door stop change with shift bolt system (see figure E)
- Ventilation concept can be expanded at later stages with optional active ventilation unit



ACT00006

**3.**  
... cable and mount components



ACT00007

**4.**  
fit covers



ACT00008

**5.**  
... and the installation is ready!



ACT00017

## Maintenance-friendly

- Easy access for servicing is also guaranteed by removing the side panels
- Enclosure can be locked with security lock
- Door opening angle >180°



ACT00034



ACT00033

## Accessories

- Easy integration of accessories, e.g. socket strips with screw-on points on the vertical extrusion or on the rear panel (see figure F)
- Accessories available for orderly cable management, e.g. cable routing board or jumpering bracket (see figure G)
- Comprehensive standard accessories range available, e.g. shelves, drawers, socket strips, etc.

## Application examples:



ACT00020

Glass door with trims in special colors



ACT00025

Design door with perforation



ACT00021

Enclosure with active ventilation unit

## Knürr ConAct® Technical data

- In acc. with IEC 297
- With fixed 19" installation
- For components in acc. with IEC 297-3
- Removable covers
- Covers above and below with side vent slots

### ■ For installing

- 19" components on the front
- 19" components on the rear, optionally with additional 19" vertical extrusion set
- Equipment with max. construction width of 450 mm
- Installation accessories

### ■ 19" enclosure in acc. with IEC 2973

- Heights: 6 U / 9 U / 12 U / 15 U / 18 U / 21 U / 24 U (1 U = 44.45 mm)
- Width: 482.6 mm (19")

### ■ External dimensions

- Heights: 352 mm / 486 mm / 619 mm / 752 mm / 886 mm / 1019 mm / 1152 mm
- Width: 600 mm
- Depths: 400 mm / 500 mm / 600 mm

### ■ Jumping space

- Front: 100 mm (adjustable)
- Side: 55 mm

### ■ Static load rating

500 N

### ■ Protection rating

IP 20

### ■ Standards

Earthing, VDE 0100 T 540  
EN 60950, EN 60529

### ■ Configuration

Stationary, wall mounting

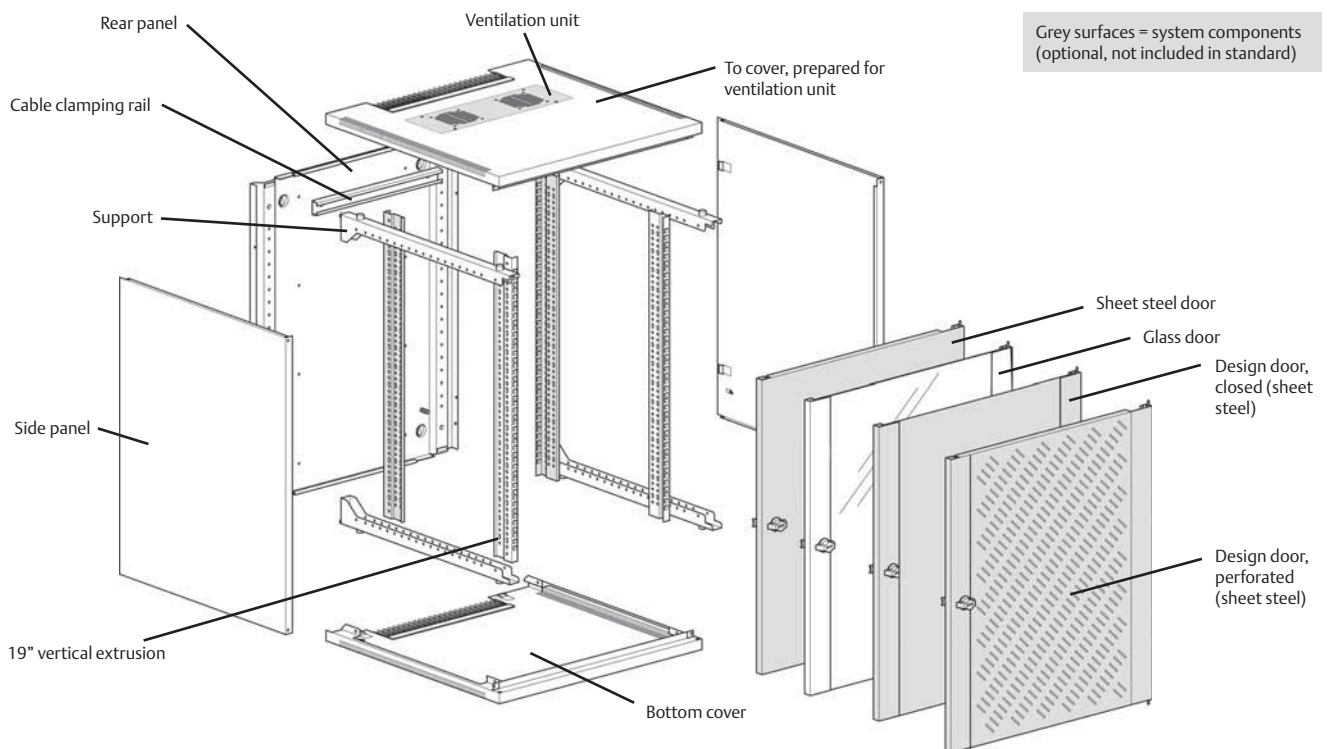

ACT00038



ACT20053

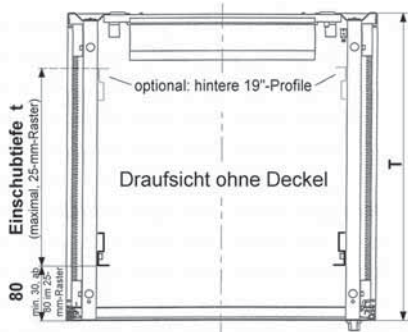

ACT20041

## Knürr ConAct® Standard 19" Wall Mounting Rack

- For components in acc. with IEC 297-3
- Accessible from all sides, covers can be quickly removed
- Cable routing via brush strip on top cover and bottom cover
- Ventilation unit, optional (quick and easy to upgrade)
- Front door with single safety glass panel, lockable

- passivated
- Removable covers, powder-coated sheet steel
- Front door, single safety glass panel, textured
- 19" vertical extrusions, zinc-passivated sheet steel

■ **Color**  
RAL 7035 light gray

■ **Jumpering space**  
80 mm (minimum 32, from 80 on the 25 mm increment)

■ **Supply schedule**  
1 rear panel  
4 mounting rails  
2 19" sheet steel vertical extrusions  
1 top cover, prepared for ventilation unit  
1 bottom cover, closed  
2 side panels  
1 glass door  
1 cable clamping rail  
Mounting material

■ **Load rating**  
500 N static

■ **Protection rating**  
IP 20

■ **Material/ Finish**  
- Rear panel and basic frame, sheet steel, zinc-

■ **How supplied**  
Part assembled

W	H	D	U	h	d(max.)	kg	Model	Order no.	UP
600	352	400	6	270	235	16	With glass door	05.010.000.1	1 unit
600	486	400	9	404	235	19	With glass door	05.010.001.1	1 unit
600	619	400	12	537	235	22	With glass door	05.010.002.1	1 unit
600	752	400	15	670	235	25	With glass door	05.010.003.1	1 unit
600	886	400	18	804	235	28	With glass door	05.010.004.1	1 unit
600	1019	400	21	937	235	31	With glass door	05.010.005.1	1 unit
600	1152	400	24	1070	235	34	With glass door	05.010.006.1	1 unit
600	352	500	6	270	335	18	With glass door	05.010.007.1	1 unit
600	486	500	9	404	335	21	With glass door	05.010.008.1	1 unit
600	619	500	12	537	335	24	With glass door	05.010.009.1	1 unit
600	752	500	15	670	335	28	With glass door	05.010.010.1	1 unit
600	886	500	18	804	335	31	With glass door	05.010.011.1	1 unit
600	1019	500	21	937	335	34	With glass door	05.010.012.1	1 unit
600	1152	500	24	1070	335	37	With glass door	05.010.013.1	1 unit
600	352	600	6	270	435	20	With glass door	05.010.014.1	1 unit
600	486	600	9	404	435	23	With glass door	05.010.015.1	1 unit
600	619	600	12	537	435	27	With glass door	05.010.016.1	1 unit
600	752	600	15	670	435	30	With glass door	05.010.017.1	1 unit
600	886	600	18	804	435	34	With glass door	05.010.018.1	1 unit
600	1019	600	21	937	435	37	With glass door	05.010.019.1	1 unit
600	1152	600	24	1070	435	41	With glass door	05.010.020.1	1 unit

Dimensions in mm: W= Width  
H = Height  
D = Depth  
h = installation height  
d = useful depth  
L = length

U = standard height unit  
1 U = 44,45 mm  
UP = unit of packaging  
kg = weight

 = Express item

Conversion: 1 mm = 0.03937 inch 1 kg = 2.2046 pound



ACT00029

## Knürr ConAct® 19" vertical extrusion

- For front and/or rear installation in the enclosure

■ **Material/Finish**  
Sheet steel, 1.5 mm, zinc-passivated

■ **Supply schedule**  
2 vertical extrusions  
Mounting material

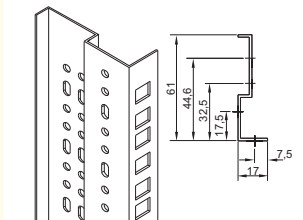

ACT00035

W	H	D	U	h	d	kg	Model	Order no.	UP
			6					05.010.321.9	1 set
			9					05.010.322.9	1 set
			12					05.010.323.9	1 set
			15					05.010.324.9	1 set
			18					05.010.325.9	1 set
			21					05.010.326.9	1 set
			24					05.010.327.9	1 set



ACT20052

## Knürr ConAct® Ventilation unit with thermostat

- Easy later installation of the fan unit in the top cover
- With two axial fans
- With thermostat
- Available in two different performance classes

■ **Material/Finish**  
Sheet steel, zinc-passivated

■ **Single fan technical data**  
Type 1  
- Volume current (free blowing): 162 m<sup>3</sup>/h per fan  
- Noise (free blowing): 37 dB(A)  
  
Type 2 (quiet)  
- Volume current (free blowing): 120 m<sup>3</sup>/h per fan  
- Noise (free blowing): 32 dB(A)

■ **Technical data: Thermostat**  
- Setting range: 0 to 60 °C  
- Mains supply: 240 V / 50 Hz  
- Nominal current: 16 A

■ **Color**  
RAL 7035 light gray

■ **Supply schedule**  
1 ventilation unit ready for connection wired, with thermostat

■ **How supplied**  
Assembled, wired and tested



ACT20056

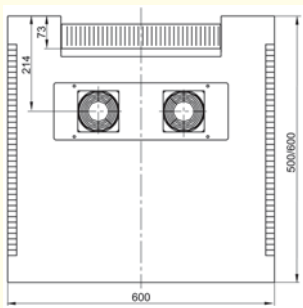

ACT00041

W	H	D	U	h	d	kg	Model	Order no.	UP
			Type 1					05.010.306.1	1 set
			Type 2 (quiet)					05.010.307.1	1 set



ACT20027

## Knürr ConAct® Sheet steel door

- For use instead of glass door

■ **Material/Finish**  
Sheet steel, powder-coated texture

■ **Color**  
RAL 7035 light gray

■ **Supply schedule**  
1 steel door  
Mounting material

■ **How supplied**  
Flat-packed kit

■ **Note**  
In project cases we also deliver our Con-Act wall enclosure with sheet steel door. Please contact us at your leisure.



ACT20054

W	H	D	U	h	d	kg	Model	Order no.	UP
			6					05.010.421.1	1 unit
			9					05.010.422.1	1 unit
			12					05.010.423.1	1 unit
			15					05.010.424.1	1 unit
			18					05.010.425.1	1 unit
			21					05.010.426.1	1 unit
			24					05.010.427.1	1 unit



ACT00026

## Knürr ConAct® Earthing set

- For earthing all covers on the enclosure frame

■ **Supply schedule**  
5 earth conductors, 6 mm<sup>2</sup>  
Mounting material

W	H	D	U	h	d	kg	Model	Order no.	UP
								05.010.330.9	1 set



MIR00641

## Knürr ConAct® Cable clamping rail

- For cable clamping using U-clamps, cable clamping bars or hammer-head threaded plate
- For mounting on rear panel

■ **Material/Finish**  
Sheet steel, zinc-passivated

■ **Supply schedule**  
1 cable clamping rail  
Mounting material

■ **How supplied**  
Flat-packed kit



ACT00006\_A

W	H	D	U	h	d	kg	Model	Order no.	UP
								05.010.340.9	1 set







# Knürr Accessories

**Thermal Management** 1.110 to 1.127

**Cable Management** 1.128 to 1.140

**System Accessories** 1.141 to 1.158



**Knürr Accessories**

**Knürr CoolBlast®  
Top-Mounting Fan**

Strong points	1.111
Products	1.112
Fan Top	1.115

**Top-Mounting Fans** 1.118

**Knürr CoolBlast®  
Fan Unit**

Strong points	1.119
Products	1.120
Accessories	1.123

<b>Filter Fan</b>	1.126
Accessories	1.127

**Knürr Cable  
Management**

Strong points	1.129
Products	1.131

**Knürr System  
Accessories**

Products	1.141
----------	-------

# Knürr CoolBlast® Top-Mounting Fan for Miracel®





1 LUF20124

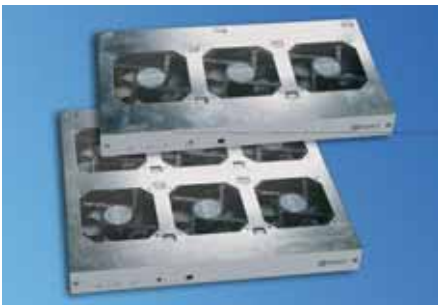

2 LUF20162

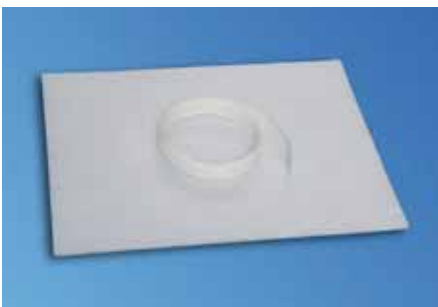

3 LUF20121

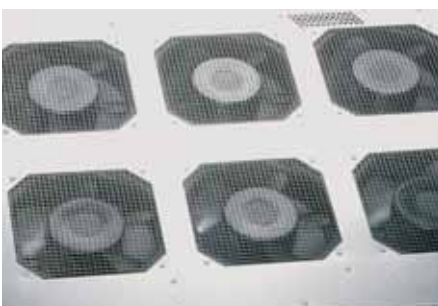

4 LUF20124

## Knürr CoolBlast® Top-Mounting Fan Strong points

- 1 The constantly increasing power loss in electronic modules constantly increases heat loads in the rack. The **CoolBlast®** is modularly configured so that a suitable solution can be selected for every heat load.
- 2 The **CoolBlast®** top-mounting fan is therefore available in models with two, three or six fans. Regulated, thermostat-controlled and unregulated models are provided.
- 3 An optional fan lid or an optional filter (see picture) prevent dust from penetrating when the fan is in standstill mode.
- 4 The recently developed protection grid of the **CoolBlast®** top-mounting fan minimizes the pressure loss of through-flowing air and reduces the airflow noise. The **CoolBlast®** roof fan is an especially quiet system.

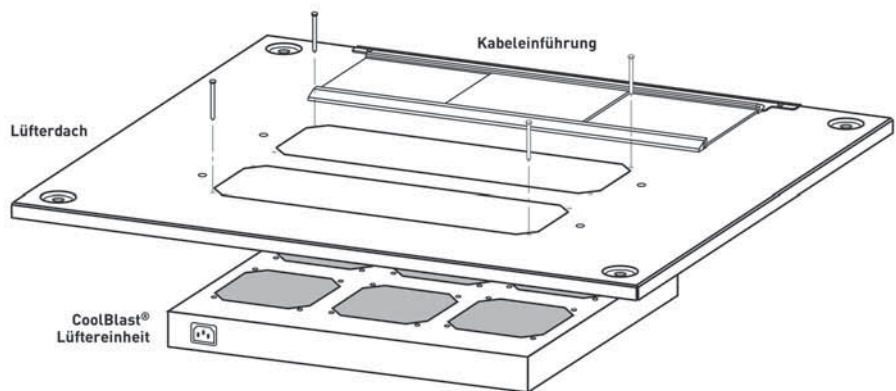

LUF20175

## Possible configurations:

Consists of	Figure	Questions before installation in Miracel:
Fan Top		1. How wide and deep is the rack? 2. For 2, 3 or 6-piece fan unit?
Fan Top plus CoolBlast®	 1 + 2	3. What power supply will be required? 4. What volume flow is targeted? 5. What pressure?
Fan top plus CoolBlast® plus filter	 1 + 2 + 3	6. With or without regulated or thermostat-controlled CoolBlast® model? 7. Correct mains cable? 8. Is particulate matter protection required? (Fan lid and filter)



LUF20203



LUF20205



LUF20124

## Knürr CoolBlast® Fan Unit for roof/door installation Unregulated

- For forced rack cooling
- Suitable for installation at any time in the Miracel® top
- DC versions and 115 VAC versions on request (see CoolBlast® fan units)

■ **Material**  
Housing: Sheet steel, high-grade steel grid

■ **Finish**  
Zinc-passivated

■ **Single fan technical data**  
See page 12.9

■ **Approvals**

CE Symbol in acc. with Low Voltage Directive 73/23/EEC, EMC directive 89/366/EEC

■ **Supply schedule**  
1 CoolBlast fan unit®  
1 mains cable, 3 m with safety plug (230 VAC)  
Mounting material  
Operating instructions

■ **How supplied**  
Assembled, wired and tested

■ **Note**  
**Please also order specific mains cable**

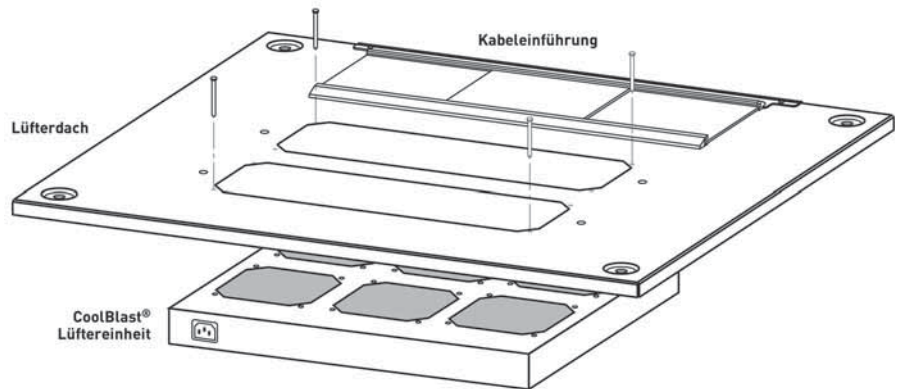

LUF20175

Name	Model	Elec. connection	P(W)	$\dot{V}$ (m³/h)	$\Delta P$ (Pa)	p(dB(A))	Order no.	UP
CoolBlastT 230V 2-piece		207...253 VAC; 50/60 Hz	30	330	74	43.4	03.027.300.1	1 unit
CoolBlastT 230V 3-piece		207...253 VAC; 50/60 Hz	45	495	74	45.2	03.027.301.1	1 unit
CoolBlastT 230V 6-piece		207...253 VAC; 50/60 Hz	90	990	74	48.8	03.027.302.1	1 unit

**Dimensions in mm:** W = Width  
H = Height  
D = Depth  
h = installation height  
d = useful depth  
L = length

U = standard height unit  
1 U = 44.45 mm  
UP = unit of packaging  
kg = weight

Express item

**Conversion:** 1 mm = 0.03937 inch 1 kg = 2.2046 pound

SP = Standard Performance  
HP = High performance  
UP = Ultra high performance

n = Number of fans  
P = Power consumption (W)  
 $\dot{V}$  = Air volume flow (m³/h)  
 $\Delta \dot{V}$  = Airflow volume loss (%)

$\Delta P$  = Pressure increase (Pi)  
I nom = Nom. current (A)  
I max = Max. residual current (A)  
V = Voltage (400V = 3-phase)  
p = Sound pressure (dB(A)) in 1 m from the rack (600 mm x 600 mm; raised cover)



LUF20204



LUF20206



LUF20124

## Knürr CoolBlast® Fan Unit for roof/door installation Thermostat-controlled

- For forced rack cooling
- Suitable for installation at any time in the Miracel® top
- 115 VAC versions on request
- Fan function (ON/OFF) thermostat-controlled, setting from 0° to +60° C

**Material**  
Housing: Sheet steel, high-grade steel grid

**Finish**  
Zinc-passivated

**Single fan technical data**  
See page 12.9

**Approvals**

CE Symbol in acc. with Low Voltage Directive 73/23/EEC, EMC directive 89/366/EEC

**Supply schedule**

1 CoolBlast fan unit®  
1 mains cable, 3 m with safety plug (230 VAC)  
Mounting material  
Operating instructions

**How supplied**

Assembled, wired and tested

**Note**

Please also order specific mains cable

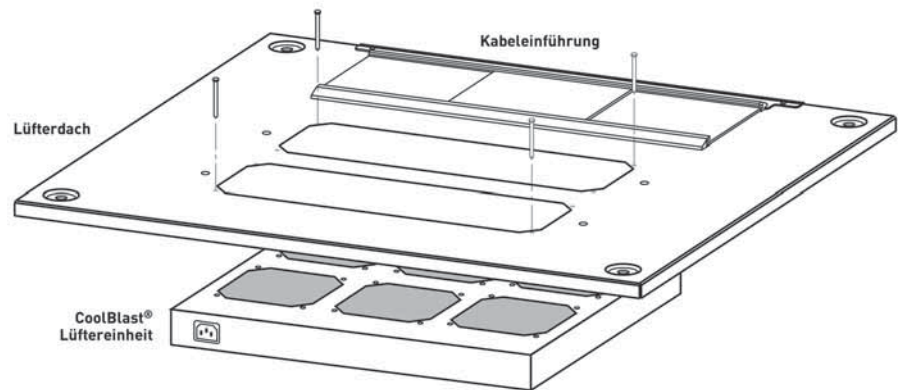

LUF20175

Name	Model	Elec. connection	P(W)	V(m³/h)	ΔP(Pa)	p(dB(A))	Order no.	UP
CoolBlastT 230V 2-piece	Thermostat	207...253 VAC; 50/60 Hz	30	330	74	43.4	03.027.310.1	1 unit
CoolBlastT 230V 3-piece	Thermostat	207...253 VAC; 50/60 Hz	45	495	74	45.2	03.027.311.1	1 unit
CoolBlastT 230V 6-piece	Thermostat	207...253 VAC; 50/60 Hz	90	990	74	48.8	03.027.312.1	1 unit

**Dimensions in mm:** W = Width  
H = Height  
D = Depth  
h = installation height  
d = useful depth  
L = length

U = standard height unit  
1 U = 44.45 mm  
UP = unit of packaging  
kg = weight

 = Express item

**Conversion:** 1 mm = 0.03937 inch 1 kg = 2.2046 pound

SP = Standard Performance  
HP = High performance  
UP = Ultra high performance

n = Number of fans  
P = Power consumption (W)  
V̇ = Air volume flow (m³/h)  
ΔV̇ = Airflow volume loss (%)

ΔP = Pressure increase (Pi)  
I<sub>nom</sub> = Nom. current (A)  
I<sub>max</sub> = Max. residual current (A)  
V = Voltage (400V = 3-phase)  
p = Sound pressure (dB(A)) in 1 m from the rack (600 mm x 600 mm; raised cover)



LUF20160



LUF20161



LUF20124

## Knürr CoolBlast® Fan Unit for roof/door installation Speed-controlled

- For forced rack cooling
- Suitable for installation at any time in the Miracel® top
- DC version on request (see CoolBlast® fan units)
- Settable reference temperature (20° to 55° C)
- Speed control, 30 to 100%, with sensor break 100% rotation
- Individual fan monitoring
- Floating common alarm output for excess temperature alarm and fan failure
- Optical status display for O.K., excess temperature and fan failure
- Acoustic warning incl. reset button

### Material

Housing: Sheet steel, high-grade steel grid

### Finish

Zinc-passivated front panel, powder-coated, smooth in RAL 7035 light gray

### Single fan technical data

See page 12.9

### Approvals

CE Symbol in acc. with Low Voltage Directive 73/23/EEC, EMC directive 89/366/EEC

### Supply schedule

1 CoolBlast fan unit®  
1 sensor cable, 2 m (plug-in)  
1 signal cable, 2 m (plug-in)  
1 mains cable, 3 m with safety plug (230 VAC)  
Mounting material  
Operating instructions

### How supplied

Assembled, wired and tested

### Note

Please also order specific mains cable

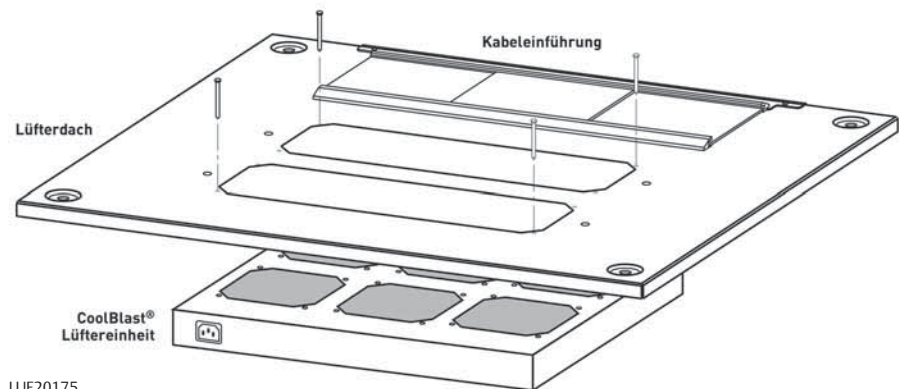

LUF20175

Name	Model	Elec. connection	P(W)	$\dot{V}$ (m³/h)	$\Delta P$ (Pa)	p(dB(A))	Order no.	UP
CoolBlastT 230V 3-piece	controlled SP	100...253 VAC; 50/60 Hz	25	553	68	49.6	03.027.321.1	1 uni
CoolBlastT 230V 6-piece	controlled SP	100...253 VAC; 50/60 Hz	48	1106	68	53.3	03.027.322.1	1 uni
CoolBlastT 230V 3-piece	controlled HP	100...253 VAC; 50/60 Hz	32	711	173	55.8	03.027.324.1	1 unit
CoolBlastT 230V 6-piece	controlled HP	100...253 VAC; 50/60 Hz	62	1422	173	59.1	03.027.325.1	1 unit
CoolBlastT 230V 3-piece	controlled UP	100...253 VAC; 50/60 Hz	64	825	310	61.8	03.027.327.1	1 unit
CoolBlastT 230V 6-piece	controlled UP	100...253 VAC; 50/60 Hz	125	1650	310	65.1	03.027.328.1	1 unit

**Dimensions in mm:** W = Width  
H = Height  
D = Depth  
h = installation height  
d = useful depth  
L = length

U = standard height unit  
1 U = 44.45 mm  
UP = unit of packaging  
kg = weight

 = Express item

**Conversion:** 1 mm = 0.03937 inch    1 kg = 2.2046 pound

SP = Standard Performance  
HP = High performance  
UP = Ultra high performance

n = Number of fans  
P = Power consumption (W)  
 $\dot{V}$  = Air volume flow (m³/h)  
 $\Delta V$  = Airflow volume loss (%)

$\Delta P$  = Pressure increase (Pi)  
I nom = Nom. current (A)  
I max = Max. residual current (A)  
V = Voltage (400V = 3-phase)  
p = Sound pressure (dB(A)) in 1 m from the rack (600 mm x 600 mm; raised cover)

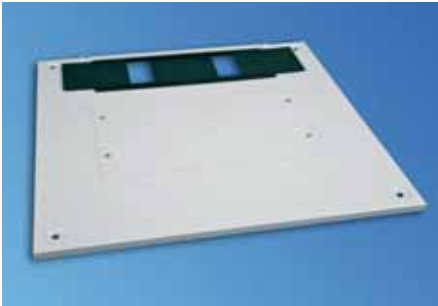

LUF20163

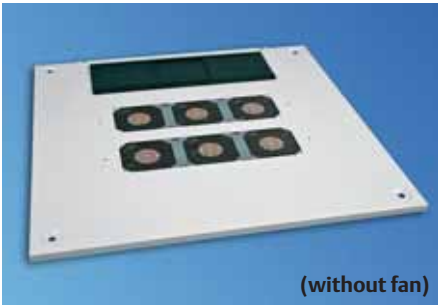

(without fan)

LUF20169

## Fan Top for Knürr CoolBlast®

- For use in conjunction with the CoolBlast fan unit
- Suitable for installation in Miracel
- With cable routing (sliding top)
- Cover divided in two parts for later installation and for servicing

**Material**  
Sheet steel

- Finish / Color**  
Final digit of order number .1:  
- Powder-coated texture, RAL 7035  
- Light gray  
Final digit of order number .8:  
- Powder-coated texture, RAL 7021  
- Dark gray

**Supply schedule**  
1 top cover with cover strip and cable entry  
2 covers

**How supplied**  
Preassembled

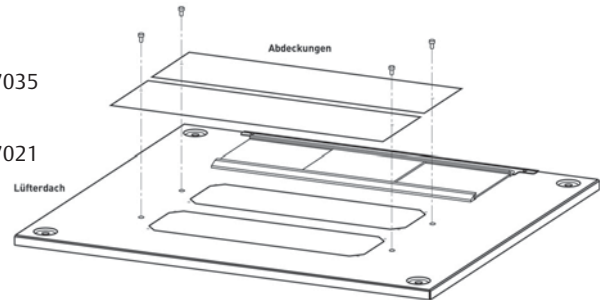

LUF20176

W	H	D	Model	Order no.	UP
600		600	For 2 or 3-piece	01.149.031.X	1 unit
700		600	For 2 or 3-piece	01.149.041.X	1 unit
800		600	For 2 or 3-piece	01.149.051.X	1 unit
600		800	For 2/3 or 6-piece	01.149.033.X	1 unit
700		800	For 2/3 or 6-piece	01.149.043.X	1 unit
800		800	For 2/3 or 6-piece	01.149.053.X	1 unit
600		900	For 2/3 or 6-piece	01.149.034.X	1 unit
700		900	For 2/3 or 6-piece	01.149.044.X	1 unit
800		900	For 2/3 or 6-piece	01.149.054.X	1 unit
600		1000	For 2/3 or 6-piece	01.149.035.X	1 unit
700		1000	For 2/3 or 6-piece	01.149.045.X	1 unit
800		1000	For 2/3 or 6-piece	01.149.055.X	1 unit
600		1200	For 2/3 or 6-piece	01.149.037.X	1 unit
800		1200	For 2/3 or 6-piece	01.149.057.X	1 unit



LUF20121



LUF20168

## Dust and Particle Protection for CoolBlast® Solution 1: Filter mat

- For use in conjunction with the CoolBlast® fan top
- Easy filter covering so that dust cannot penetrate when the fan is stopped (regulated or thermostat-controlled version)
- For all top sizes; filter and adhesive tape can be cut to the required length

**Material**  
Fyledon (filter class - G2)

**Supply schedule**  
1 filter  
Adhesive tape

**How supplied**

W	H	D	kg	Model	Order no.	UP
				For 2, 3 or 6-piece fan unit	01.149.101.9	1 set



LUF20174



LUF20172

## Dust and particle protection for Knürr CoolBlast® Solution 2: Vent Lid

- For use in conjunction with the CoolBlast® fan top
- Closed top cover with cable entry for protection against foreign particles and dust
- Mounting on the spacer bolts on the standard cover

- Powder-coated texture, RAL 7035,
- Light gray
- Final digit of order number .8:
- Powder-coated texture, RAL 7021,
- Dark gray

**Material**  
Sheet steel

**Supply schedule**  
1 top cover with cable entry

**Finish / Color**  
Final digit of order number .1:

**How supplied**  
Flat-packed kit

W	H	D	Model	Order no.	UP
600		600	With cable entry	01.149.031.X	1 unit
700		600	With cable entry	01.149.041.X	1 unit
800		600	With cable entry	01.149.051.X	1 unit
600		800	With cable entry	01.149.033.X	1 unit
700		800	With cable entry	01.149.043.X	1 unit
800		800	With cable entry	01.149.053.X	1 unit
600		900	With cable entry	01.149.034.X	1 unit
700		900	With cable entry	01.149.044.X	1 unit
800		900	With cable entry	01.149.054.X	1 unit
600		1000	With cable entry	01.149.035.X	1 unit
700		1000	With cable entry	01.149.045.X	1 unit
800		1000	With cable entry	01.149.055.X	1 unit
600		1200	With cable entry	01.149.037.X	1 unit
800		1200	With cable entry	01.149.057.X	1 unit
600		600	Closed	01.130.690.X	1 unit
700		600	Closed	01.130.694.X	1 unit
800		600	Closed	01.130.691.X	1 unit
600		800	Closed	01.130.691.X	1 unit
700		800	Closed	01.130.695.X	1 unit
800		800	Closed	01.130.699.X	1 unit
600		900	Closed	01.130.692.X	1 unit
700		900	Closed	01.130.696.X	1 unit
800		900	Closed	01.130.700.X	1 unit
600		1000	Closed	01.127.700.X	1 unit
700		1000	Closed	01.127.701.X	1 unit
800		1000	Closed	01.127.702.X	1 unit

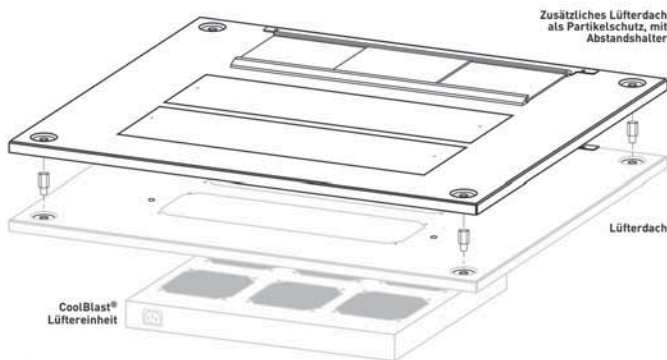

LUF20177

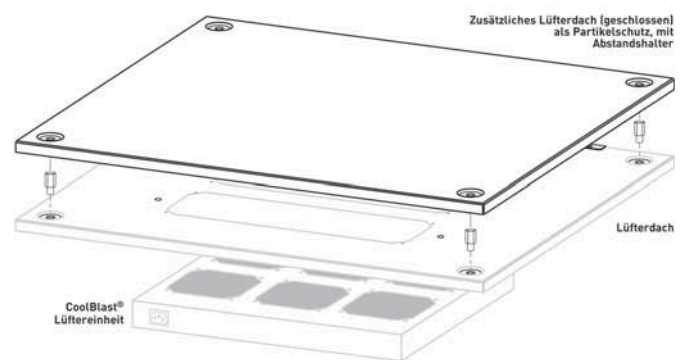

LUF20178

**Dimensions in mm:** W = Width  
H = Height  
D = Depth  
h = installation height  
d = useful depth  
L = length

U = standard height unit  
1 U = 44.45 mm  
UP = unit of packaging  
kg = weight

= Express item

**Conversion:** 1 mm = 0.03937 inch 1 kg = 2.2046 pound

SP = Standard Performance  
HP = High performance  
UP = Ultra high performance

n = Number of fans  
P = Power consumption (W)  
V = Air volume flow (m<sup>3</sup>/h)  
ΔV = Airflow volume loss (%)

ΔP = Pressure increase (Pi)  
I<sub>nom</sub> = Nom. current (A)  
I<sub>max</sub> = Max. residual current (A)  
V = Voltage (400V = 3-phase)  
p = Sound pressure (dB(A)) in 1 m from the rack (600 mm x 600 mm; raised cover)





LUF20180

## Knürr CoolBlast® Fan Installation Set With thermostat

- For quick and easy forced exhaustion of racks
- Miracel / Tecoras Indoor
- Installation in the top cover area
- No loss of 19" installation space
- Later installation also possible
- Incl. 2 fans (160 m<sup>3</sup>/h per fan)

### Material / Finish

Sheet steel, 1.5 mm, zinc-passivated

### Approvals

CE Symbol in acc. with Low Voltage Directive  
73/23/EEC, EMC directive 89/336/EEC

### Technical data: Thermostat

- Setting range: + 0°C ... + 60°C
- Power supply: 240 V / 50 Hz
- Mains current: 16 A

### Supply schedule

- 1 mounting panel for fan
- 2 fans
- 1 connection cable, 2.0 m with safety plug
- Type 1: with thermostat
- Type 2: without thermostat
- Mounting material

### How supplied

Assembled, wired and tested

W	H	D	For rack type	Order no.	UP
534			Miracel / W 600 / with thermostat	01.113.430.0	1 unit
734			Miracel / W 800 / with thermostat	01.113.431.0	1 unit

# Knürr Top-Mounting Fan



LUF20194



LUF20195

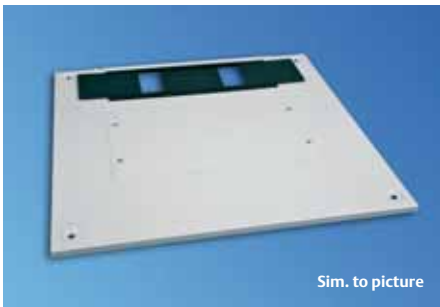

Sim. to picture

LUF20163



LUF20195

## Silent Top-Mounting Fan

- For forced rack cooling
- Suitable for installation in Miracel
- High volume flow with low noise generation (e.g. for office applications)

■ **Material / Finish**  
Sheet steel

■ **Single fan technical data**  
Max. volume current (free blowing): 1500 m<sup>3</sup>/h  
Voltage/frequency: 230 V / 50 Hz  
Power consumption: 117 W  
Noise: 40 dB(A)  
Temperature range: -25...40°C

■ **Finish / Color**

- Final digit of order number .1:  
- Powder-coated texture, RAL 7035  
- Light gray  
Final digit of order number .8:  
- Powder-coated texture, RAL 7021  
- Dark gray

■ **Supply schedule**

- 1 top-mounting fan  
1 mains cable, 3 m with safety plug (230 VAC)  
Mounting material

■ **How supplied**

- Flat-packed kit

■ **Note**

- Please also order suitable top

W	H	D	For rack type	Order no.	UP
449	237	490	Miracel	03.028.111.X	1 unit

## Fan top for Silent top-mounting fan

- For use in conjunction with the Silent fan top
- Suitable for installation in Miracel
- With cable routing (sliding top)
- Cover divided in two parts for later installation and for servicing

■ **Material/ Finish**  
Sheet steel

■ **Finish / Color**  
Final digit of order number .1:  
- Powder-coated texture, RAL 7035,  
- Light gray

- Final digit of order number .8:  
- Powder-coated texture, RAL 7021,  
- Dark gray

■ **Supply schedule**

- 1 top cover with cover strip and cable entry  
Mounting material

■ **How supplied**

- Flat-packed kit

W	H	D	For rack type	Order no.	UP
600	600	600	Miracel	01.149.201.x	1 unit
700	600	600	Miracel	01.149.202.x	1 unit
800	600	600	Miracel	01.149.203.x	1 unit
600	800	600	Miracel	01.149.206.x	1 unit
700	800	600	Miracel	01.149.207.x	1 unit
800	800	600	Miracel	01.149.208.x	1 unit
600	900	600	Miracel	01.149.211.x	1 unit
700	900	600	Miracel	01.149.212.x	1 unit
800	900	600	Miracel	01.149.213.x	1 unit
600	1000	600	Miracel	01.149.216.x	1 unit
700	1000	600	Miracel	01.149.217.x	1 unit
800	1000	600	Miracel	01.149.218.x	1 unit
600	1200	600	Miracel	01.149.221.x	1 unit
700	1200	600	Miracel	01.149.222.x	1 unit
800	1200	600	Miracel	01.149.223.x	1 unit



1 LUF20125

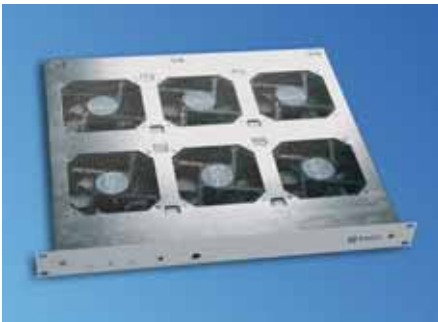

1 LUF20140



2 LUF20056

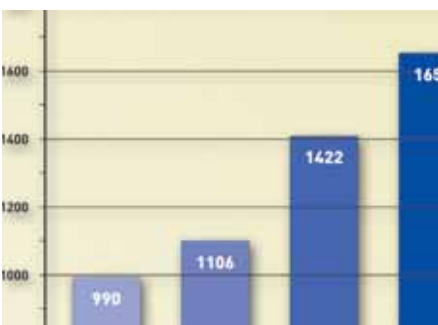

3 LUF20054

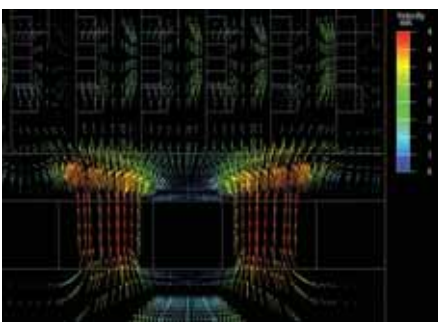

4 LUF20077

## Knürr CoolBlast® Fan Unit Strong points

The constantly increasing power losses of electronic modules make high demands on the effective cooling of electronic modules. Large airflow volumes ensure secured heat dissipation, whereby higher airflow speeds reach the components, which leads to better heat transfer.

The packing densities of electronics in racks also continue to increase. Fans with high pressure jump overcome the resulting higher increased pressure loss.

The space-saving 1 U construction guarantees maximum installation space for our customers' equipment.

1 The **CoolBlast®** fan unit from Knürr is available as a slot in unit with 3 and 6 fans for vertical ventilation of installed modules. The airflow required for cooling is primarily determined by the fan selection. Fans in three different performance classes are available (Standard, High, and Ultra High Performance). Selection can be made between quiet axial fans and special diagonal fans with an especially high support rate for cooling air.

2 To ensure that plenty of cooling air reaches the electronic components, **CoolBlast®** has an IP protective grid with high free cross-section surface. The grid form minimizes the pressure loss of the streaming airflow and reduces the streaming noise.

3 The Knürr **CoolBlast®** adjusts its cooling airflow to the power loss to be cooled. The temperature-regulated control of the fan rotation optimizes the noise emission and the lifespan of the fans. The maximum reference temperature is set at the front.

A fan failure detector ensures high operational reliability. Exceeding the reference temperature is also detected in the same way. The fault signal can be connected with the rack monitoring system (**RMS**).

A simple thermostat-controlled model is also available.

4 Optimum heat dissipation of the cooled module is attained with the high airflow volumes and pressure jumps in the **CoolBlast®** fan unit. Building-specific CFD simulations can optimize each customer thermal management application.

5 Air conduction components, optionally with filter, round off the product range. The filter mat protects the electronic components in use from dirt build-ups and dust, and can be swapped out during running operation.

In addition to the **CoolBlast®** fan unit, a number of other components and accessory parts are also available for thermal management in server and network rack systems.

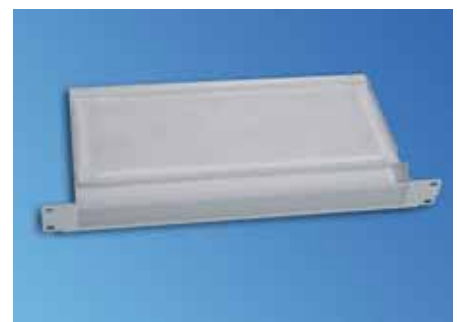

5 LUF20133



LUF20125



LUF20139

## Knürr CoolBlast® Fan Unit Unregulated

- Fan unit for vertical cooling of modules in 19" racks
- Chassis rails are recommended for mounting. Chassis rails are required with 6-piece CoolBlast.

**Material**  
Sheet steel, high-grade steel grid

**Finish / Color**  
Housing, zinc-passivated  
Front panel, powder-coated, smooth in RAL 7035 light gray

**How supplied**  
Assembled, wired and tested

**Approvals**  
CE Symbol in acc. with Low Voltage Directive 73/23/EEC, EMC directive 89/366/EEC

**Supply schedule**  
1 CoolBlast fan unit, packed with operating instructions

Only with DC devices:  
1 connection cable, 2 m with connector plug and free ends

Only with 230V AC devices:  
1 connection cable, 2 m Euro cable

**Note**  
Please also order specific mains cable (see page 12.15)!

Name	W	H	D	kg	n	Elec. connection	P(W)	V(m³/h)	ΔP(Pa)	p(dB(A))	Order no.
CoolBlast 230V 3-piece	440	43.6	230	3	3	207 ... 253VAC; 50/60Hz	45	495	74	45.2	<b>03.027.001.1</b>
CoolBlast 230V 6-piece	440	43.6	390	6	6	207 ... 253VAC; 50/60Hz	90	990	74	48.8	<b>03.027.002.1</b>
CoolBlast 115V 3-piece	440	43.6	230	3	3	103.5 ... 126.5VAC; 50/60Hz	44	576	88	47.3	<b>03.027.004.1</b>
CoolBlast 115V 6-piece	440	43.6	390	6	6	103.5 ... 126.5VAC; 50/60Hz	88	1152	88	50.8	<b>03.027.005.1</b>
CoolBlast 24V 3-piece SP	440	43.6	230	2.5	3	12 ... 27VDC	23	553	68	49.6	<b>03.027.031.1</b>
CoolBlast 24V 6-piece SP	440	43.6	390	5	6	12 ... 27VDC	46	1106	68	53.3	<b>03.027.032.1</b>
CoolBlast 24V 3-piece HP	440	43.6	230	3	3	12 ... 25VDC	30	711	160	55.8	<b>03.027.034.1</b>
CoolBlast 24V 6-piece HP	440	43.6	390	6	6	12 ... 25VDC	60	1422	160	59.1	<b>03.027.035.1</b>
CoolBlast 24V 3-piece UP	440	43.6	230	3	3	16 ... 26VDC	62	825	310	61.8	<b>03.027.037.1</b>
CoolBlast 24V 6-piece UP	440	43.6	390	6	6	16 ... 26VDC	123	1650	310	65.1	<b>03.027.038.1</b>
CoolBlast 48V 3-piece SP	440	43.6	230	3	3	36 ... 55VDC	24	553	68	49.6	<b>03.027.041.1</b>
CoolBlast 48V 6-piece SP	440	43.6	390	6	6	36 ... 55VDC	48	1106	68	53.2	<b>03.027.042.1</b>
CoolBlast 48V 3-piece HP	440	43.6	230	3	3	36 ... 55VDC	54	826	160	58.6	<b>03.027.044.1</b>
CoolBlast 48V 6-piece HP	440	43.6	390	6	6	36 ... 55VDC	108	1652	160	62	<b>03.027.045.1</b>
CoolBlast 48V 3-piece UP	440	43.6	230	3	3	36 ... 53VDC	60	825	310	61.9	<b>03.027.047.1</b>
CoolBlast 48V 6-piece UP	440	43.6	390	6	6	36 ... 53VDC	119	1650	310	65.3	<b>03.027.048.1</b>



LUF20127

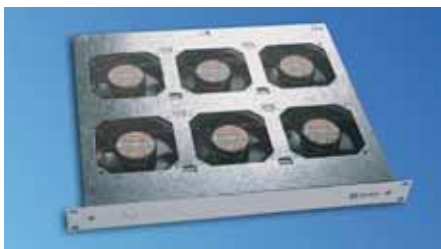

LUF20138

## Knürr CoolBlast® Fan Unit Thermostat-controlled

- Fan unit for vertical cooling of modules in 19" racks
- Fan function (ON/OFF) thermostat-controlled, setting from 0°C to 60°C
- Chassis rails are recommended for mounting. Chassis rails are required with 6-piece CoolBlast.

**Material**  
Sheet steel, high-grade steel grid

**Finish / Color**  
Housing, zinc-passivated  
Front panel, powder-coated, smooth in RAL 7035 light gray

**How supplied**  
Assembled, wired and tested

**Approvals**  
CE Symbol in accordance with Low Voltage Directive 73/23/EEC, EMC Directive 89/366/EEC

**Supply schedule**  
1 CoolBlast fan unit, packed with operating instructions

Only with DC devices:  
1 connection cable, 2 m with connector plug and free ends

Only with 230V AC devices:  
1 connection cable, 2 m Euro cable

Name	W	H	D	kg	n	Elec. connection	P(W)	V(m³/h)	ΔP(Pa)	p(dB(A))	Order no.
CoolBlast 230V 3-piece thermostat	440	43.6	230	3	3	207 ... 253VAC; 50/60Hz	45	495	74	45.2	<b>03.027.011.1</b>
CoolBlast 230V 6-piece thermostat	440	43.6	390	6	6	207 ... 253VAC; 50/60Hz	90	990	74	48.8	<b>03.027.012.1</b>
CoolBlast 115V 3-piece thermostat	440	43.6	230	3	3	103.5 ... 126.5VAC; 50/60Hz	44	576	88	47.3	<b>03.027.014.1</b>
CoolBlast 115V 6-piece thermostat	440	43.6	390	6	6	103.5 ... 126.5VAC; 50/60Hz	88	1152	88	50.8	<b>03.027.015.1</b>



LUF20128



LUF20140

## Knürr CoolBlast® Fan Unit Speed-controlled

- Fan unit for vertical cooling of modules in 19" racks
- Reference temperature can be set (20°C to 55°C)
- Speed control, 30 to 100%, with sensor break 100% rotation
- Individual fan monitoring
- Digital alarm output for excess temperature alarm and fan failure
- Optical status display for O.K., excess temperature and fan failure
- Acoustic warning with push-button
- Chassis rails are recommended for mounting. Chassis rails are required with 6-piece CoolBlast.

### Material

Sheet steel, high-grade steel grid

### Finish / Color

Housing, zinc-passivated  
Front panel, powder-coated, smooth in RAL 7035 light gray

### Approvals

CE Symbol in accordance with Low Voltage Directive 73/23/EEC, EMC Directive 89/366/EEC

### Supply schedule

1 CoolBlast fan unit, packed with operating instructions  
1 sensor cable, 2 m (plug-in)  
1 signal cable, 2 m (plug-in)

Only with DC devices:

1 connection cable, 2 m with connector plug and free ends

Only with AC devices:

1 connection cable, 2 m Euro cable

### How supplied

Assembled, wired and tested

### Note

Further characteristics can be implemented project-related in line with standards.

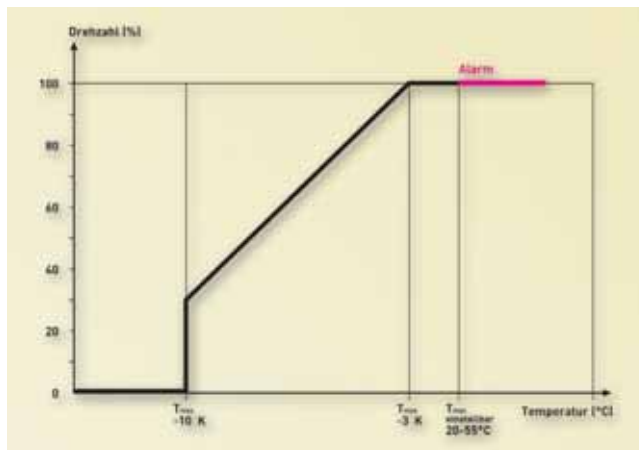

LUF20179

Name	W	H	D	kg	n	Elec. connection	P(W)	V(m <sup>3</sup> /h)	ΔP(Pa)	p(dB(A))	Order no.
CoolBlast 115/230V, 3-piece regulated SP	440	43.6	230	3.2	3	100 to 253VAC; 50/60Hz	25	553	68	49.6	03.027.021.1
CoolBlast 115/230V, 6-piece regulated SP	440	43.6	390	6.2	6	100 to 253VAC; 50/60Hz	48	1106	68	53.3	03.027.022.1
CoolBlast 115/230V, 3-piece regulated HP	440	43.6	230	3.2	3	100 to 253VAC; 50/60Hz	32	711	173	55.8	03.027.024.1
CoolBlast 115/230V, 6-piece regulated HP	440	43.6	390	6.2	6	100 to 253VAC; 50/60Hz	62	1422	173	59.1	03.027.025.1
CoolBlast 115/230V, 3-piece regulated UP	440	43.6	230	3.4	3	100 to 253VAC; 50/60Hz	64	825	310	61.8	03.027.027.1
CoolBlast 115/230V, 6-piece regulated UP	440	43.6	390	6.4	6	100 to 253VAC; 50/60Hz	125	1650	310	65.1	03.027.028.1
CoolBlast 24/48V, 3-piece regulated SP	440	43.6	230	3.1	3	20 to 60VDC	25	553	68	49.6	03.027.051.1
CoolBlast 24/48V, 6-piece regulated SP	440	43.6	390	6.1	6	20 to 60VDC	48	1106	68	53.3	03.027.052.1
CoolBlast 24/48V, 3-piece regulated HP	440	43.6	230	3.1	3	20 to 60VDC	32	711	173	55.8	03.027.054.1
CoolBlast 24/48V, 6-piece regulated HP	440	43.6	390	6.1	6	20 to 60VDC	62	1422	173	59.1	03.027.055.1
CoolBlast 24/48V, 3-piece regulated UP	440	43.6	230	3.3	3	20 to 60VDC	64	825	310	61.8	03.027.057.1
CoolBlast 24/48V, 6-piece regulated UP	440	43.6	390	6.3	6	20 to 60VDC	125	1650	310	65.1	03.027.058.1

**Dimensions in mm:** W = Width  
H = Height  
D = Depth  
h = installation height  
d = useful depth  
L = length

U = standard height unit  
1 U = 44.45 mm  
UP = unit of packaging  
kg = weight

Express item

**Conversion:** 1 mm = 0.03937 inch    1 kg = 2.2046 pound

SP = Standard Performance  
HP = High performance  
UP = Ultra high performance

n = Number of fans  
P = Power consumption (W)  
V̇ = Air volume flow (m<sup>3</sup>/h)  
ΔV = Airflow volume loss (%)

ΔP = Pressure increase (Pi)  
I<sub>nom</sub> = Nom. current (A)  
I<sub>max</sub> = Max. residual current (A)  
V = Voltage (400V = 3-phase)  
p = Sound pressure (dB(A)) in 1 m from the rack (600 mm x 600 mm; raised cover)



LUF20148



1 LUF20056



2 LUF20136



3 LUF20146

## Knürr CoolBlast® Airflow via Front Intake

### Strong points

The front intake unit for the **CoolBlast®** is used for the targeted cooling of module units that are situated on top of one another (heat sources).

**1** The optimized airflow guides the cooled air specifically to the rear. (See graphic 1). This prevents increased warming up of the vertical airflows from module chassis to module chassis. (See graphic 2).

**2** The optionally available front panel can be mounted later on and is often used for optical appearance reasons.

**3** The filter mat protects the electronic components in use from dirt build-up and dust, and they can also be swapped out during running operation.

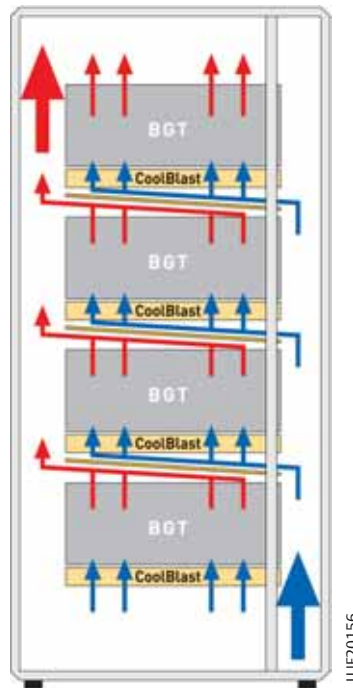

Optimum

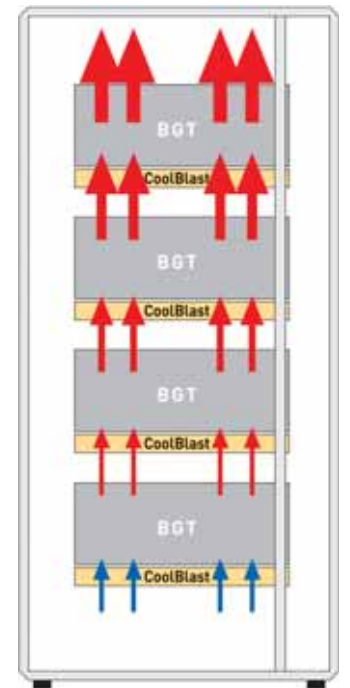

Little effect

### Possible configurations:

Const. of	Fig.	Order no.		Airflow volume loss	
		3-piece	6-piece	3-piece	6-piece
Airflow	1	03.027.094.1	03.027.095.1	30 %	45 %
Airflow plus front panel	1 + 2	03.027.094.1 03.027.097.1	03.027.095.1 03.027.097.1	40 %	55 %
Airflow plus front panel and filter	1 + 2 + 3	03.027.094.1 03.027.097.1 03.027.098.1	03.027.095.1 03.027.097.1 03.027.099.	50 %	60 %



LUF20131

## Knürr CoolBlast® Airflow via Front Intake, 1 U

- For CoolBlast® fan unit, 3-piece and 6-piece for front intake
- Use as cooling baffle
- Can be supplemented with front panel and filter mat

**Material**  
Sheet steel

**Finish / Color**  
Powder-coated texture, RAL 7035 light gray

**Supply schedule**  
1 air guide

**How supplied**  
In units

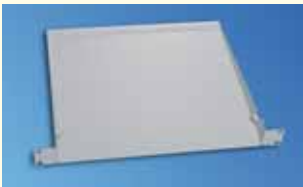

LUF20142

W	H	D	Model	Order no.	UP
43.6	230		For 3-piece	03.027.094.1	1 unit
43.6	390		For 6-piece	03.027.095.1	1 unit



LUF20136

## Knürr CoolBlast® Front Panel for air guide for front intake, 1 U

- For use with the front intake air guide
- Can be mounted later on

**Material**  
Sheet steel

**Finish/ Color**  
Powder-coated texture, RAL 7035 light gray, smooth

**Supply schedule**  
1 front panel

**How supplied**  
In units

W	H	D	Model	Order no.	UP
43.6				03.027.097.1	1 units



LUF20135

## Knürr CoolBlast® Filter for front intake

- For use with the front intake air guide
- Can be mounted later on and filter can be swapped out during running operation

**Filter class**  
G2

**Material**  
Viledon K15/150

**Supply schedule**  
1 filter

**How supplied**  
In units

W	H	D	Model	Order no.	UP
400	160		For 3-piece	03.027.098.1	1 unit
400	320		For 6-piece	03.027.099.1	1 unit



LUF00205

## 19" filter unit, 1 U

- Suitable for use with the CoolBlast® fan unit
- Adjusted to the respective chassis depth

**Material**  
Housing: sheet steel  
Front panel: ABS (UL94 V-0)  
Handle: Extruded aluminum  
Filter: Viledon P 15/150

**Filter class**  
G2

**Finish/ Color**  
Housing: powder-coated texture  
- RAL 9011 black  
Front panel: RAL 7035  
- Light gray  
Handle: Powder-coated texture  
- RAL 5008 gray-blue

**Supply schedule**  
1 filter unit  
1 filter

**How supplied**  
In units

W	H	D	kg	W n	Model	Order no.	UP
43.6	282	2.0				03.025.250.1	1 unit
43.6	660	4.0				03.025.253.1	1 unit



LUF00280

## Replacement Filter

- For 19" filter insert

**Material**  
Filter: Viledon P 15/150

**Filter class**  
G2

**Supply schedule**  
1 filter

**How supplied**  
In units

W	H	D	kg	W n	Model	Order no.	UP
		282				03.025.246.9	1 unit
		660				03.025.249.9	1 unit

**Dimensions in mm:** W = Width, H = Height, D = Depth, h = installation height, d = useful depth, L = length, U = standard height unit (1 U = 44.45 mm), UP = unit of packaging, kg = weight, = Express item

**Conversion:** 1 mm = 0.03937 inch, 1 kg = 2.2046 pound

SP = Standard Performance, HP = High performance, UP = Ultra high performance, n = Number of fans, P = Power consumption (W), V = Air volume flow (m<sup>3</sup>/h), ΔV = Airflow volume loss (%), ΔP = Pressure increase (Pi), I nom = Nom. current (A), I max = Max. residual current (A), V = Voltage (400V = 3-phase), p = Sound pressure (dB(A)) in 1 m from the rack (600 mm x 600 mm; raised cover)

## Axial single fan technical data

	Knürr CoolBlast®	Knürr CoolBlast®	Knürr CoolBlast®	Knürr CoolBlast®	Knürr CoolBlast®
<b>ID number</b>	<b>01.914.070.9</b>	<b>01.914.075.9</b>	<b>01.914.090.9</b>	<b>01.914.071.9</b>	<b>01.914.076.9</b>
Dim: L x W x H	119 x 119 x 38	119 x 119 x 38	119 x 119 x 38	119 x 119 x 38	
Max. volume flow, free blowing	184.2 m³/h	237 m³/h	275 m³/h	184.2 m³/h	275.4 m³/h
Voltage	24 VDC	24 VDC	24 VDC	48 VDC	48 VDC
Frequency					
Power consumption	7.4 W	11 W	20.5 W	7.7 W	17.8 W
Noise, free blowing	43 dB(A)	59 dB(A)	60 dB(A)	43 dB(A)	57 dB(A)
Bearing system	Ball bearing	Ball bearing	Ball bearing	Ball bearing	Ball bearing
Nominal speed	2950 min-1	4400 min-1	6000 min-1	2950 min-1	4200 min-1
Permis. ambient temp.	-10 °C to +70 °C	-30 °C to +55 °C	-20 °C to +65 °C	-10 °C to +70 °C	-10 °C to +70 °C
Service life L10 at 40°C	75,000 h	70,000 h	70,000 h	75,000 h	105,000 h
Approvals	CE, VDE	CE, VDE	CE, VDE	CE, VDE	CE, VDE
<b>Use in fan unit:</b>	03.027.031.1	03.027.034.1	03.027.037.1	03.027.041.1	03.027.044.1
	03.027.032.1	03.027.035.1	03.027.038.1	03.027.042.1	03.027.045.1
	03.027.021.1	03.027.024.1	03.027.027.1		
	03.027.022.1	03.027.025.1	03.027.028.1		
	03.027.051.1	03.027.054.1	03.027.057.1		
	03.027.052.1	03.027.055.1	03.027.058.1		
	03.027.321.1	03.027.324.1	03.027.327.1		
	03.027.322.1	03.027.325.1	03.027.328.1		

	Knürr CoolBlast®	Knürr CoolBlast®	Knürr CoolBlast®	Knürr CoolBlast®
<b>ID number</b>	<b>01.914.091.9</b>	<b>01.914.050.9</b>	<b>01.914.051.9</b>	<b>01.914.051.9-2</b>
Dim: L x W x H	119 x 119 x 38	119 x 119 x 38	119 x 119 x 38	119 x 119 x 38
Max. volume flow, free blowing	275 m³/h	192 m³/h	165 m³/h	120 m³/h
Voltage	48 VDC	115 VAC	230 VAC	230 VAC
Frequency		50 Hz	50 Hz	50 Hz
Power consumption	19.7 W	14.5 W	15 W	7.5 W
Noise, free blowing	60 dB(A)	41 dB(A)	38 dB(A)	32 dB(A)
Bearing system	Ball bearing	Ball bearing	Ball bearing	Ball bearing
Nominal speed	6000 min-1	2900 min-1	2600 min-1	2100 min-1
Permis. ambient temp.	-20 °C to +65 °C	-40 °C to +60 °C	-40 °C to +60 °C	-40 °C to +70 °C
Service life L10 at 40°C	70,000 h	43,500 h	43,500 h	43,500 h
Approvals	CE, VDE	CE, VDE	CE, VDE	CE, VDE
<b>Use in fan unit:</b>	03.027.047.1	03.027.004.1	03.027.001.1	02.111.181.9
	03.027.048.1	03.027.005.1	03.027.002.1	05.010.307.1
		03.027.014.1	03.027.011.1	
		03.027.015.1	03.027.012.1	
			03.027.300.1	
			03.027.301.1	
			03.027.302.1	
			03.027.310.1	
			03.027.311.1	
			03.027.312.1	
			02.111.180.9	
			05.010.306.1	
			01.113.430.0	
			01.113.431.0	
			01.243.428.1	
			03.028.110.8	





DOS00076

### Euro Mains Cable For DIN 49 440 and French/Belgian standard

- Mains plug CEE/VII - Euro socket IEC 320
- Cable: HO5VV-F 3G 1 mm<sup>2</sup>

■ **Mains voltage**  
250 VAC

■ **Nominal current:**  
10 A

L	S	n	F1	F2 19"	Safe	Model	Order no.	UP
2000							<b>04.000.054.9</b>	1 unit
5000							<b>04.000.050.9</b>	1 unit



DOS00519

### Euro Connection Cable

- Mains plug: IEC 320 - Euro socket IEC 320
- Cable: HO5VV-F 3G 1 mm<sup>2</sup>

■ **Mains voltage**  
250 VAC

■ **Nominal current:**  
10 A

L	S	n	F1	F2 19"	Safe	Model	Order no.	UP
900							<b>04.000.051.9</b>	1 unit



DOS00077

### Euro Mains Cable For Swiss standard

- Mains plug: Type 12 - Euro socket IEC 320
- Cable: HO5VV-F 3G 1 mm<sup>2</sup>

■ **Mains voltage**  
250 VAC

■ **Nominal current:**  
10 A

L	S	n	F1	F2 19"	Safe	Model	Order no.	UP
2000							<b>04.000.055.9</b>	1 unit



ELM00137

### Door Contact Switch

- On/off switch, 4 A, 230 V ~
- Activation with door opening and closing

■ **Supply schedule**  
1 door contact switch (not wired)  
1 mounting brackets  
Mounting material

W	H	S	U	h	d	kg	Model	Order no.	UP
								<b>01.110.722.9</b>	1 unit



DOS00078

### Euro Mains Cable For British standard

- Mains plug: Type BS 1363 - Euro socket IEC 320
- Cable: HO5VV-F 3G 1 mm<sup>2</sup>

■ **Mains voltage**  
250 VAC

■ **Nominal current:**  
10 A

L	S	n	F1	F2 19"	Safe	Model	Order no.	UP
2000							<b>04.000.056.9</b>	1 unit



LUF20057

## Filter Fan

- For specific use with hot spots
- Also suitable for later mounting, quick and easy
- The filter mats provide high filtering-out properties, are easily exchanged and can be cleaned
- The fans do not require maintenance and their value is especially emphasized by their long lifespan and low noise factor
- Airflow: Blowing in the rack (pre-setting)
- Can be used as blowing-out or sucking-in

- **Material**  
Heat-resistant ABS plastic, UL 94 V-0
- **Color**  
RAL 7035 light gray
- **Approvals**  
CE Symbol
- **Protection rating**  
IP 54



LUF20058

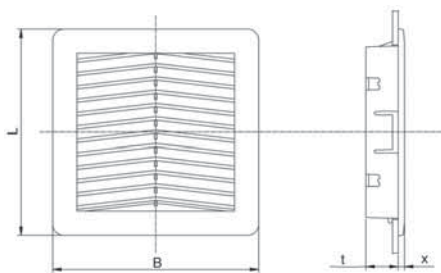

LUF80011

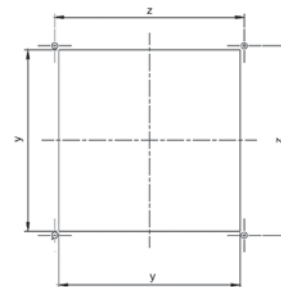

LUF80012

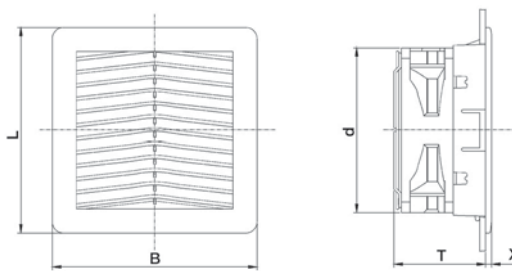

LUF800040

LxW	D/t/x	y/z	kg	Max. AF	El. conn.	P	N	N	Life/40°	Model	Order no.	UP
150x150	71/120/5	125/131	0.812	57 m³/h	230V / 50/60Hz	20 W	43 dB(A)	2650/min	40,000 h	Filter fan	03.026.501.1	1 unit
204x204	90/120/5.7	177/185	1	90 m³/h	230V / 50/60Hz	20 W	43 dB(A)	2650/min	40,000 h	Filter fan	03.026.502.1	1 unit
250x250	113/172/6	223/230	1.690	240 m³/h	230V / 50/60Hz	29 W	50 dB(A)	2800/min	40,000 h	Filter fan	03.026.503.1	1 unit
325x325	125/208/7	291/302	3.620	520 m³/h	230V / 50/60Hz	67 W	63 dB(A)	2770/min	50,000 h	Filter fan	03.026.504.1	1 unit
150x150	24/5	125/131	0.140							Exit filter	03.026.511.1	1 unit
204x204	20.5/5.7	177/185	0.275							Exit filter	03.026.512.1	1 unit
250x250	25/6	233/230	0.440							Exit filter	03.026.513.1	1 unit
325x325	26/7	291/302	0.780							Exit filter	03.026.514.1	1 unit
150x150										Replacement filter mat	03.026.521.9	6 units
204x204										Replacement filter mat	03.026.522.9	6 units
250x250										Replacement filter mat	03.026.523.9	6 units
325x325										Replacement filter mat	03.026.524.9	6 units

**Dimensions in mm:** W = Width  
H = Height  
D = Depth  
h = installation height  
d = useful depth  
L = length

U = standard height unit  
1 U = 44.45 mm  
UP = unit of packaging  
kg = weight

Express item 

Standard Performance = SP  
High Performance = HP  
Ultra High Performance = UP

n = Number of fans  
W = Power consumption (W)  
m³/h = Air volume flow  
P1 = Pressure increase  
I<sub>nom</sub> = Nominal current (A)  
I<sub>max</sub> = Residual current (A)  
P = Power consumption (W)  
V = Voltage (400V = 3-phase)

**Conversion:** 1 mm = 0.03937 inch 1 kg = 2.2046 pound



LUF00237a

## Temperature Module

- For monitoring the inside temperature of the rack
- Temperature display (+ 10°C... + 70°C)
- Setting the alarm temperature via frontal potentiometer
- Optical alarm display (LED red)
- Alarm signaling via floating switching contact (1 changeover contact 250 VAC / 8 A)
- Power supply 230 V / 50Hz

■ **Material**  
Plastic

■ **Approvals**  
CE Symbol in acc. with Low Voltage Directive 73/23/EEC, EMC directive 89/336/EEC

■ **Supply schedule**  
1 temperature module  
1 temperature sensor (3 m)

■ **How supplied**  
Assembled, wired and tested

W	H	D	LxW	kg	W	n	Model	Order no.	UP
								01.117.525.1	1 unit

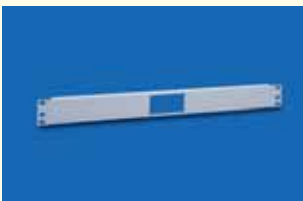

LUF00256

## 19" front panel 1 U for temperature module

- For installing the temperature module

■ **Material/ Finish**  
Sheet steel 1.5 mm, powder-coated

■ **Color**  
RAL 7035 light gray

■ **Supply schedule**  
1 19" front panel

W	H	D	LxW	kg	W	n	Model	Order no.	UP
								01.117.526.1	1 unit



LUF00255

## Bracket for Temperature Module

- For non-standard installation of temperature module, e.g. laterally on the 19" extrusion

■ **Material/ Finish**  
Aluminum, 2 mm, polished

■ **Supply schedule**  
1 bracket  
Mounting material

■ **How supplied**  
Flat-packed kit

W	H	D	LxW	kg	W	n	Model	Order no.	UP
								01.117.527.0	1 unit



LUF20000

## Thermostat

- For controlling the inside temperature of the rack in conjunction with fan units and heating fans
- Setting range: + 10°C ... + 60°C
- Switching temperature difference (hysteresis) 2K
- Contact type: 1 changeover contact
- Sensor: Thermo-bimetal
- Contact rating: 230 VAC/10 A (heating), 5 A (cooling)
- Interference suppression: in acc. with DIN 55014

■ **Material**  
Plastic

■ **Protection rating**  
IP 30

■ **Approvals**  
CE Symbol in acc. with Low Voltage Directive 73/23/EEC, EMC directive 89/336/EEC

■ **Dimensions**  
74 x 74 x 23 mm

■ **Supply schedule**  
1 thermostat  
1 mounting bracket  
Mounting material

W	H	D	LxW	kg	W	n	Model	Order no.	UP
								01.113.384.3	1 unit

## Knürr Cable Management

Strong points	1.129
Cable Routing Board	1.131
Multifunctional Cable	
Routing Brace	1.132
Cable Router	1.132
Cable Tray	1.133
C Extrusion Rail	1.133
Radial Limit	1.135
Excess Cable Storage	1.136
Jumpering Bracket	1.136
Cable Routing	
Components	1.137
Velcro Strip	1.139
Cable Cantilever	1.140

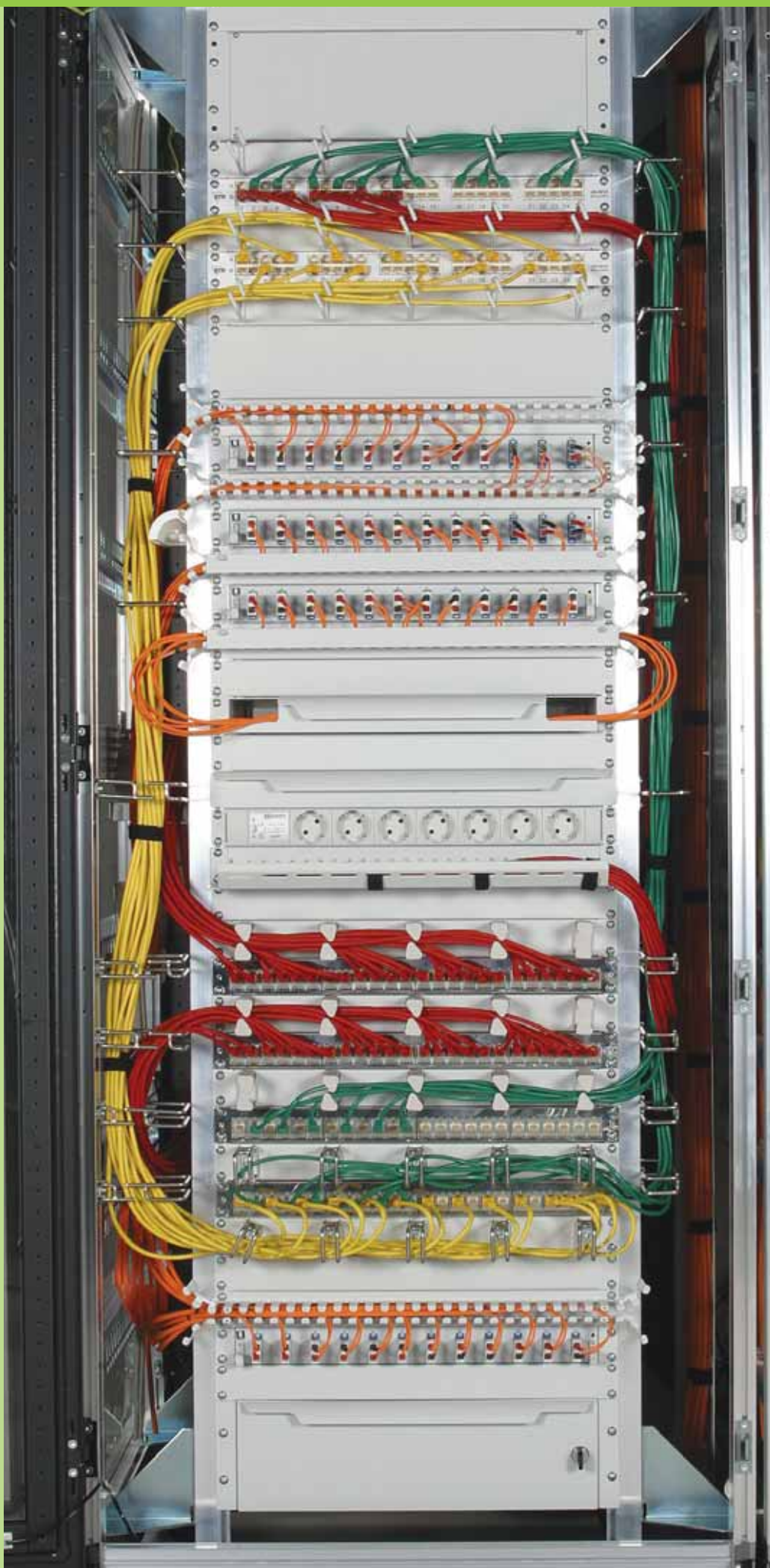

## Knürr Cable Management Strong points



MEC20064

It must be ensured when laying cables that every kind of mechanical stress is avoided.



MEC20086



MEC20074

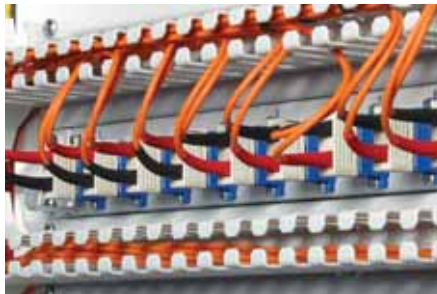

MEC20058

### Bending load

The bending radii may never be less than the values provided by the cable manufacturer in the respective data sheets. At points that bend too much, the electrical properties of the cable change and reduce the transmission bandwidths and ranges.

If manufacturer specifications are not available, then the following rule of thumb applies: With loose cabling, at least 15 times the external cable diameter and with fixed cabling, at least 10 times the external cable diameter.

### Buckling load

The most extreme bending loads can cause the cable to break.

### Tensile load

This is only determined by the copper cross-section of the conductor, as all other materials are too soft. The cable may not be stressed more than  $50\text{N}/\text{mm}^2$  (Cu cross-section) as otherwise the conductors are stretched and the cross-section is reduced. If higher "pulling" forces are required, then cables with additional strain relief elements must be used.

### Compressive stress

Compressive stress is caused by loads bearing down from above, fixed clamping or sharp cable kinking and must always be avoided, as otherwise the "loose" cable structure changes and the electrical transmission properties are impaired.

### Torque strains (twisting)

These must never have an effect on the cable, as they drive the cable elements into one another and therefore impair the transmission properties.



MEC20084



LIG00021

## Knürr Cable Management Strong points



1 MEC20082

1 Different components for fiber-glass and copper cables, especially the fastening options using Velcro strips and cable bundling using different colored strips, guarantee transparent cable management, which is the optimum starting situation for an intelligent expansion of the network and for the highest standard of service convenience.

2 With all cable management components, special attention has been paid to ensuring that fixing is possible with Velcro strip cable ties. Velcro cable ties not only guarantee a stress-free fixing of the cables, they can also be released at any time and re-used again and again. Velcro cable ties are also extremely helpful for the installation engineer in providing pinch-free cable bundling – and also because they are so quick to apply.

3 Excess cable lengths are stored separate from the patch fields, but in a position that is always easy to access. Copper cable excess can be stored separate from fiber glass excess within the Knürr rack systems: the copper cables on the side and the more sensitive fiberglass cables in an excess drawer at the front.



2 MEC20070



3 MEC20099

4 Some true multi-talents appear on closer examination of the individual products. The cable routing multi-functional brace, for example, not only provides the option of routing cables horizontally and vertically using Velcro ties or cable ties, but rather also allows numerous components to be mounted with screws and caged nuts. These caged nuts can also be shifted with room for play in a slot, so that every mounting dimension can be accommodated.

5 The prescribed radii are preset with the radial limiter. These components ensure that neither a reduction of the transmission bandwidths and ranges nor a cable break occur.



3 MEC20079



4 MEC20077



4 MEC20091



5 MEC20071



MEC00110

## 19" Cable Routing Board, 1 U

- For orderly cable routing
- For safe and secure cable routing of copper and fiberglass cables

### Material/Finish

Type 1:  
Front panel, sheet steel, 1.5 mm  
Powder-coated, RAL 7035, light gray  
Type 2:  
Front panel: sheet steel 1.0 mm, powder-coated, RAL 7035 light gray

### Color

**Final digit of order number .1:**  
RAL 7035 light gray  
**Final digit of order number .8:**  
RAL 7021 dark gray

### External dimensions

Cable routing:  
Type 1: 55 x 22 mm, plastic  
Type 2: 95 x 32 mm, steel

### Supply schedule

1 19" front panel  
5 cable routers

### How supplied

Preassembled

### Note

Please also order front panel mounting material.



MEC20014

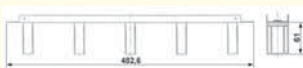

MEC20103



MEC20104

W	H	D	U	Model	Order no.	UP
483			1	Type 1	05.040.111.1	1 unit
483			1	Type 2	01.117.144.1	1 unit
483			1	Type 1	05.040.111.8	1 unit
483			1	Type 2	01.117.144.8	1 unit



MEC20041

## 19" Cable Routing Board, flexible, 1 U

- For orderly cable routing
- For safe and secure cable routing of copper and fiberglass cables

### Material/Finish

Front panel, sheet steel, 1.5 mm  
Powder-coated texture, RAL 7035  
Jumpering bracket, round steel, d = 5 mm, zinc-passivated

### Color

**Final digit of order number .1:**  
RAL 7035 light gray  
**Final digit of order number .8:**  
RAL 7021 dark gray

### External dimensions

Cable routers (a x b):  
1 U: 82 x 43 mm  
2 U: 102 x 82 mm

### Supply schedule

1 front panel  
5" cable routing boards

### How supplied

Preassembled

### Note

Please also order front panel mounting material.



MEC20102



MEC20076

W	H	D	U	Model	Order no.	UP
483			1	Type 1	05.040.100.1	1 unit
483			2	Type 2	05.040.101.1	1 unit
483			1	Type 1	05.040.100.8	1 unit
483			2	Type 2	05.040.101.8	1 unit



MEC20081

## Fiber optic cable routing panel 1 U

- For orderly cable routing
- For safe and secure cable routing of fiber optic cables
- Optionally with cover panels to protect the cables and as labeling option

### Material/Finish

Sheet steel, 1.5 mm  
Powder-coated texture, RAL 7035

### Supply schedule

1 19" cable routing panel

### How supplied

In units

### Note

Please also order front panel mounting material and cover.  
Not suitable for rack widths 600 mm and 700 mm (asymmetric)!



MEC20105



MEC20058

W	H	D	U	Model	Order no.	UP
483			1	Cable routing panel	05.040.050.1	1 unit
				Accessories: Cover	05.040.051.1	1 unit



CUD00021

## 19" Blanking Panel Cable Port, threaded connection

- For orderly cable management in the rack internal space
- With edge protector

### Material

Sheet steel, 1.0 mm

### Finish

**Final digit of order number .1:**  
Powder-coated, RAL 7035, light gray  
**Final digit of order number .8:**  
Powder-coated texture, RAL 7021 dark gray

### Supply schedule

6 19" blanking panel cable ports

### How supplied

Flat-packed kit

### Note

Please also order front panel mounting material.

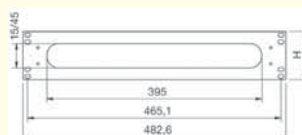

CUD00023



CUD00022

W	H	D	U	For rack type	Order no.	UP
483	44		1	Powder-coated	01.103.231.1	6 units
483	88		2	Powder-coated	01.103.232.1	3 units



MEC20091

## Cable routing brace

- For mounting on the Miracel/Smaract basic rack and on the 19" extrusion
- For cable clamping using Velcro strips, cable ties
- For orderly cable management in the rack
- Two-sided installation
- For universal mounting option using caged nuts (all dimensions can be accommodated, as caged nuts are flexible)

**Material**  
Sheet steel, 1.5 mm

**Finish**  
Zinc-passivated

**Supply schedule**  
4 cable routing braces  
Mounting material

**How supplied**  
In units

**Note**  
If required, please also order Velcro strip.



MEC20078

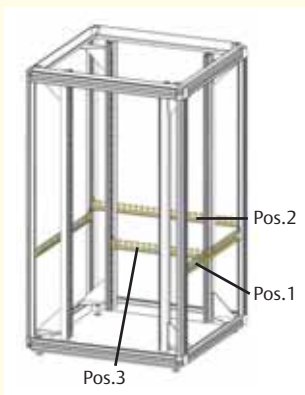

MIR88001

W <sub>Rack</sub>	H <sub>Rack</sub>	D <sub>Rack</sub>	L	Model	for rack type	Order no.	UP
		600	455	Pos. 1	Miracel	05.040.200.9	4 units
		800	655	Pos. 1	Miracel	05.040.201.9	4 units
		900	755	Pos. 1	Miracel	05.040.202.9	4 units
		1000	855	Pos. 1	Miracel	05.040.203.9	4 units
600			534	Pos. 2	Miracel/Smaract	05.040.213.9	4 units
800			734	Pos. 2	Miracel	05.040.214.9	4 units
			468	Pos. 3	Miracel/Smaract/DPR	05.040.215.9	4 units
			1055	Pos. 1	Miracel	05.040.205.9	4 units

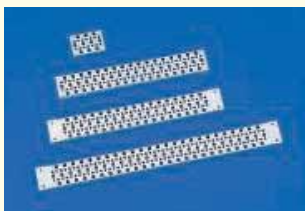

MIR00089

## Multifunctional brace

- For routing cables with cable ties
- For universal mounting options
- Holes for mounting caged nuts
- Distance between two multifunctional braces can be variably selected using T-slot
- Installation on the extrusions of the rack frame or on the 19" extrusions, diagonal and lateral

**Installation positions**  
1 on the basic frame on the depth  
2 on the basic frame on the width  
3 on the 19" extrusions on the width  
4 on the 19" extrusions on the depth

**Material**  
Sheet steel, 1.5 mm

**Finish**  
Zinc-passivated

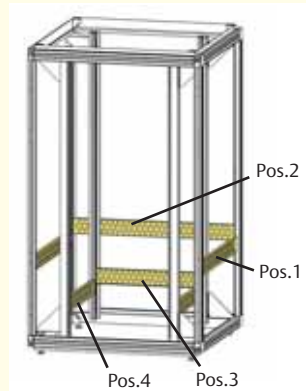

MIR88003

**Finish**  
Zinc-passivated

**Supply schedule**  
4 multifunctional braces

**How supplied**  
Flat-packed kit

W <sub>Rack</sub>	D <sub>Rack</sub>	d	Inst. position	for rack type	Order no.	UP
	600		1	Miracel	05.040.160.9	4 units
	800		1	Miracel	05.040.161.9	4 units
	900		1	Miracel	05.040.162.9	4 units
	1000		1	Miracel	05.040.163.9	4 units
	1100		1	Miracel	05.040.164.9	4 units
	1200		1	Miracel	05.040.165.9	4 units
600			2	Miracel/Smaract	05.040.173.9	4 units
700			2	Miracel		4 units
800			2	Miracel	05.040.174.9	4 units
			3	Miracel/Smaract/DPR	05.040.175.9	4 units
600	365		4	Miracel/Smaract	05.040.168.9	4 units
800	565		4	Miracel/Smaract	05.040.169.9	4 units
600	440		4	Miracel/Smaract	05.040.170.9	4 units
800	640		4	Miracel/Smaract	05.040.171.9	4 units
900	740		4	Miracel/Smaract	05.040.172.9	4 units
1000	740		4	Miracel/Smaract	05.040.172.9	4 units



MEC20045

## Cascading

- For orderly cable management and cable clamping
- Can be expanded

**Material/Finish**  
Base cover: Sheet steel, powder-coated texture  
RAL 7035  
Foam: Polyethylene, anthracite

**Supply schedule**  
2 end plates with foam  
3 plates with foam on both sides  
Mounting material

**How supplied**  
Flat-packed kit



MEC20074

W	H	D	Order no.	UP
			05.040.088.9	1 set



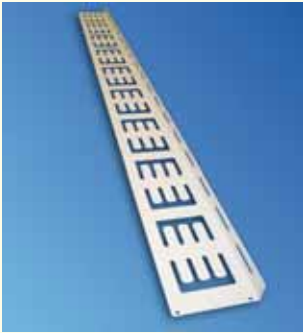

MEC20088

## Cable Tray

- For orderly cable management in the Miracel rack
- Cable fixing possible using Velcro strips or cable ties
- Combination possible as L, U or T unit

### Material/Finish

Sheet steel 1.5 mm, zinc passivated, powder-coated

### Color

.1: RAL 7035 light gray  
.8: RAL 7021 dark gray

### Dimensions

L 150 x W 28 mm

### Supply schedule

1 cable tray  
Mounting material

### How supplied

Flat-packed kit

### Note

If required, please also order Velcro strip.



MEC20067

W	H	D	U	Model	Order no.	UP
			41	For rack type Miracel	05.040.021.1	1 set
			46	For rack type Miracel	05.040.022.1	1 set
			41	For rack type Miracel	05.040.021.8	1 set
			46	For rack type Miracel	05.040.022.8	1 set



MIR00096

## C-Extrusion Rail

- For cable clamping using U-clamps or cable clamping bars
- Cable clamping closer to access (type 1)
- Suitable for use in conjunction with top cover with cable entry

### Material/Finish

Sheet steel, 1.5 mm, zinc-passivated

### Supply schedule

1 C extrusion rail  
Mounting material

### How supplied

Flat-packed kit

### Note

Please also order U-clamps, cable clamping bars or threaded plates.

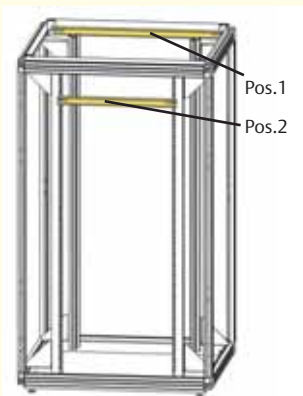

MIR88002

W	H	D	L	Model	Order no.	UP
600			482.5	Pos. 1: Miracel/Smaract	05.040.080.0	1 unit
800			682.5	Pos. 1: Miracel	05.040.082.0	1 unit
19			508	Pos. 2: Miracel/Smaract/ DoubleProRack	01.110.719.9	1 unit



MEC20136

Type 1



MEC20136

Type 1



MEC20137

Type 2

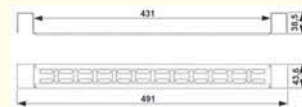

MEC20121

Type 2

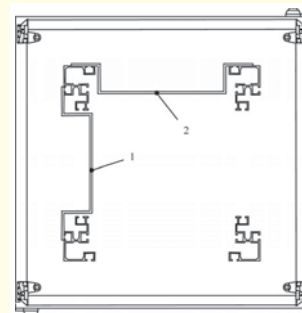

MIR00094

W/d	H	D	U	w1	w2	X	Type	Model	Order no.	UP
19"			1	482	442.6	81.5	1	Pos. 2: Miracel/Smaract	05.040.018.1	1 unit
19"			1				2	Pos. 2: DoubleProRack	05.040.019.1	1 unit

## Assembly Crossbar

- For cable management with Velcro strips
- Universal mounting option for installation accessories, socket strips, telecommunication installation units, mounting panels, etc.
- For side and cross installation

### Material/Finish

Sheet steel 1.5 mm, powder-coated texture, RAL 7035

### Supply schedule

1 assembly crossbar

### How supplied

In units

### Note

Please also order the appropriate mounting material.

## Cable Clamping Bar

- For clipping to the C-shaped runner

### Material

Polyamide, black

### Supply schedule

1 set of 10 cable clamping bars

### How supplied

Flat-packed kit



MEC00114

W	H	D	U	d	L	Model	Order no.	UP
							01.130.869.9	10 units

Dimensions in mm: W = Width H = Height D = Depth h = installation height d = useful depth L = length U = standard height unit 1 U = 44.45 mm UP = unit of packaging kg = weight = Express item

Conversion: 1 mm = 0.03937 inch 1 kg = 2.2046 pound

# Knürr Cable Management



MEC00113

## C-Extrusion Rail

- For cable clamping using U-clamps or cable clamping bars
- Space-saving installation between the extrusions of the basic rack
- Two-sided installation

**Material**  
Sheet steel, 1.5 mm, zinc-passivated

**Finish**  
Zinc-passivated

**Supply schedule**  
4 extrusion rails  
Mounting material

**How supplied**  
Flat-packed kit

**Note**  
Please also order U-clamps, cable clamping bars or threaded plates.

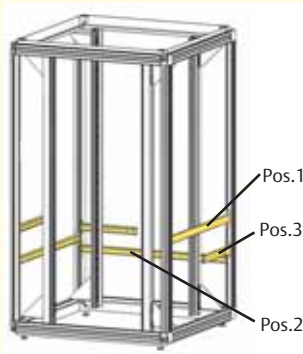

MIR88004

W <sub>Rack</sub>	D <sub>Rack</sub>	W <sub>Rack</sub>	Inst. position	For rack type	Order no.	UP
600		1		Miracel	05.040.180.9	4 units
800		1		Miracel	05.040.181.9	4 units
900		1		Miracel	05.040.182.9	4 units
1000		1		Miracel	05.040.183.9	4 units
1200		1		Miracel	05.040.185.9	4 units
			3	Miracel/Smaract	05.040.195.9	4 units
	800	2		Miracel/Smaract	05.040.194.9	4 units
	600	2		Miracel/Smaract	05.040.193.9	4 units



MIR20198

## Top-mounting for cable tray

- Fixing cable trays with C extrusion rails
- Any position possible

**Material/Finish**  
C extrusion rail: Sheet steel, zinc-passivated  
Mounting bracket: Sheet steel, powdered RAL 7021

**Supply schedule**  
2 C extrusion rails  
4 mounting bracket  
Mounting material

**How supplied**  
Flat-packed kit

**Note**  
Please also order U-clamps, cable clamping bars or threaded plates.

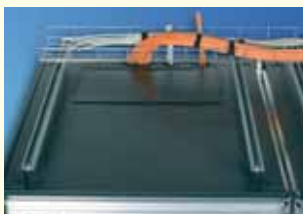

MEC20034

W	H	D <sub>Rack</sub>	Order no.	UP
	800		05.040.072.8	1 set
	900		05.040.073.8	1 set
	1000		05.040.074.8	1 set
	1200		05.040.076.8	1 set



MIR00096

## U-Clamp

- For strain relief and individual routing of cables and lines
- Clamping range, 8-64 mm

**Material**  
Steel/plastic

**Supply schedule**  
25 U-clamps  
25 clamping saddles

**How supplied**  
Flat-packed kit

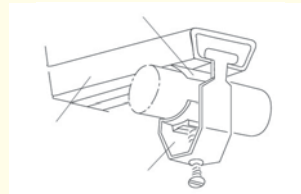

ELM00086

W	H	D	U	d	L	Clamping range	Order no.	UP
						8-12 mm	05.040.150.9	1 unit
						12-16 mm	05.040.151.9	1 unit
						16-22 mm	05.040.152.9	1 unit
						22-28 mm	05.040.154.9	1 unit
						34-40 mm	05.040.155.9	1 unit
						46-52 mm	05.040.157.9	1 unit
						58-64 mm	05.040.159.9	1 unit



MEC20051

## M5 Threaded Plate

- For use in conjunction with C extrusion rails

**Material/Finish**  
Flat rolled steel, 4.0 mm, zinc-passivated

**Supply schedule**  
20 threaded plates

**How supplied**  
Flat-packed kit



MEC20069

W	H	D	L	Order no.	UP
				05.040.077.9	1 set



MEC20049

## 19" Cable Tray

- For orderly cable management in front of the 19" front
- Mounting on front panels possible
- Cable fixing possible using Velcro strips

**Material/Finish**  
Sheet steel, 1.5 mm  
Powder-coated texture, RAL 7035

**Supply schedule**  
1 cable tray



MEC20063

**How supplied**

In units

**Note**

Please also order front panel mounting material and Velcro strip.

W	H	D	U	Model	Order no.	UP
483		100	1		05.040.055.1	1 unit



MEC20042

## Cable tray between the racks

- For orderly cable management between linked racks
- Fixing possible using Velcro strips

**Material/Finish**

Sheet steel, 1.5mm  
Powder-coated texture, RAL 7035

**Supply schedule**

1 cable tray  
Mounting material

**How supplied**

Flat-packed kit

**Note**

Please also order Velcro strip

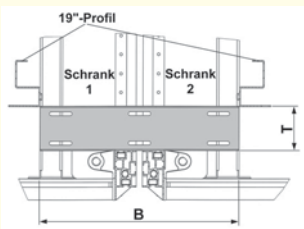

MEC20119

W	H	D	U	Model	Order no.	UP
265		60			05.040.058.1	1 unit



MEC20090

## Radial limit

- Various mounting options available:
  - on the basic rack for cable clamping
  - on the 19" extrusion for cable routing and diverting
- For use in conjunction with C extrusion rails (also order threaded plates!)

**Material/Finish**

Sheet steel, 1.5mm, zinc-passivated

**Supply schedule**

1 radial limit  
Mounting material

**How supplied**

Flat-packed kit



MEC20071

W	H	D	L	Order no.	UP
290		87		05.040.090.0	1 set



MEC20132

## Radial Limit, 1 U

- For diverting the cables from the patch area vertically
- The cables can be fixed with Velcro strips
- Side use in conjunction with the cable duct is possible

**Material/Finish**

Sheet steel, 1.5mm,  
powder-coated texture, RAL 7035

**Supply schedule**

1 radial limit  
1 Mounting panel  
Mounting material

**How supplied**

Flat-packed kit



MEC20143

W	H	D	U	Model	Order no.	UP
85		32	1		05.040.091.1	1 set



MEC20135

## Cduct, Side

- For orderly cable management
- For use in conjunction with the front panel, swivel
- Cable rerouting with radial limiter, 1 U (optional)

**Material/Finish**

Sheet steel, 1.5mm  
Powder-coated texture, RAL 7035

**Supply schedule**

1 cable duct  
Mounting material

**How supplied**

Flat-packed kit



MEC20151

W	H	D	U	Model	Order no.	UP
100		130	41		05.040.023.1	1 set

**Dimensions in mm:** W = Width  
H = Height  
D = Depth  
h = installation height  
d = useful depth  
L = length  
U = standard height unit  
1 U = 44.45 mm  
UP = unit of packaging  
kg = weight  
Express item

**Conversion:** 1 mm = 0.03937 inch 1 kg = 2.2046 pound

# Knürr Cable Management



MEC20052

## Excess Copper Cable Storage

- For storing excess copper cable lengths (or fiber optic cables)
- For orderly cable management in the Miracel rack
- Can be expanded

**Material/Finish**  
Sheet steel, 1.5 mm, zinc-passivated

**Supply schedule**  
1 excess cable holder  
Mounting material

**How supplied**  
Flat-packed kit



MEC20079

W	H	D	U	Model	Order no.	UP
				For rack type Miracel	05.040.044.0	1 set



MEC20047

## Fiber Optic 19" Excess Cable Drawer, 1 U

- For storing excess fiber optic cable lengths
- Pull-out
- Cable fixing possible with Velcro strips

**Material/Finish**  
Sheet steel, 1.5 mm  
Powder-coated texture, RAL 7035

**Supply schedule**  
1 main unit  
1 drawer

**How supplied**  
Flat-packed kit

**Note**  
Please also order front panel mounting material and Velcro strip.



MEC20099

W	H	D	Model	Order no.	UP
483	44	350		05.040.047.1	1 set



MEC20044

## Excess Fiber Optic Cable Storage

- For orderly fiber optic cable management in the Miracel rack (from W 800 mm)
- For storing excess cable lengths

**Material/Finish**  
Base cover: powder-coated texture, RAL 7035  
Cable routing head: Polyamide, black

**Supply schedule**  
1 base cover  
1 cable routing head  
Mounting material

**How supplied**  
Flat-packed kit



MEC20146

W	H	D	U	Model	Order no.	UP
			2		05.040.041.1	1 set



MEC20038

## Universal Jumping Bracket

- Can be used for extrusion spacing (from front), 123 mm and 73 mm
- For orderly cable management
- Open version, no threading
- Mounting on the external side of the 19" extrusion
- Any installation position selectable

**Material**  
Round steel, d = 6 mm

**Finish**  
Zinc-passivated

**Supply schedule**  
4 jumpering brackets

**How supplied**  
Flat-packed kit

**Note**  
Please also order the appropriate mounting material.



MEC20072

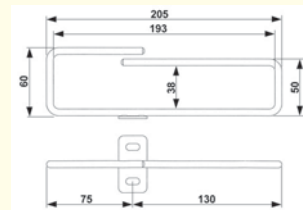

MEC20106

WRack	For rack type	Order no.	UP
From 800	Miracel	05.040.220.9	4 units



MEC20039

## Square Jumping Bracket

- For orderly cable management
- Open version, no threading
- Mounting on the external side of the 19" extrusion
- Any installation position selectable
- For large cable volumes

**Material**  
Round steel, d = 6 mm

**Finish**  
Zinc-passivated

**Supply schedule**  
4 square jumpering brackets

**How supplied**  
Flat-packed kit

**Note**  
Please also order the appropriate mounting material.

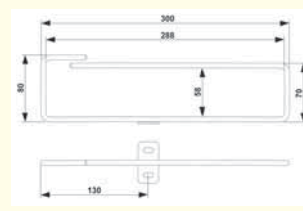

MEC20107

Type 1

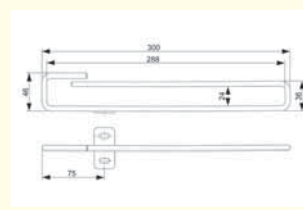

MEC20116

Type 2

WRack	Type	For rack type	Order no.	UP
From 800	Type 1	Miracel	05.040.221.9	4 units
From 700	Type 2	Miracel	05.040.222.9	4 units
600	Type 2	Smaract	05.040.222.9	4 units



MEC20185

## Quick-Strip Velcro strip for T-slot mounting without tools

- Quick fixing without tools
- For bundling cables
- Can be released and used again
- For orderly cable management
- For fixing into T-slots at any position

### Material

Polyethylene and Nylon  
F.R.T., UL-94 HB

### Color

Black

### Supply schedule

10 Quick-Strip Velcro strips

### How supplied

Flat-packed kit

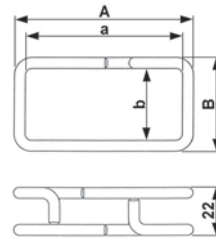

MEC20108

A	a	B	b	Model	Order no.	UP
82	72	43	33	Fig. 1	05.040.231.0	10 units
222	212	30	20	Fig. 3	05.040.232.0	10 units
102	92	82	72	Fig. 2	05.040.233.0	10 units

W	H	D	U	d	L	For rack type	Order no.	UP
						Miracel	00.218.506.0	1 set

## Quick-Clamp plastic jumpering bracket for T-slot mounting without tools

- Quick fixing without tools
- For orderly cable management
- Open version, no threading
- For fixing on T-slots at any position

### Material

Nylon  
F.R.T., UL-94 HB

### Color

Black

### Supply schedule

10 plastic jumpering brackets

### How supplied

Flat-packed kit

W	H	D	U	d	L	For rack type	Order no.	UP
						Miracel	00.218.505.0	1 set

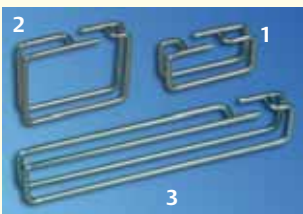

MEC20035

## Jumpering Bracket, Flexible

- For flexible and orderly cable routing
- Any installation place and position selectable
- Open version, no threading

### Material

Round steel, d = 5 mm

### Finish

Zinc-passivated

### Supply schedule

10 jumpering brackets  
Mounting material

### How supplied

Flat-packed kit

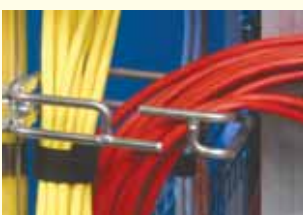

MEC20065



ELM00117

## Square Jumpering Bracket

- For orderly cable management
- Open version, no threading
- Mounting on the external lateral T-slot of the 19" extrusion
- Any installation position selectable

### Material

Round steel, d = 5 mm

### Finish

Zinc-passivated

### Supply schedule

4 jumpering brackets

### How supplied

Flat-packed kit

### Note

Please also order the appropriate mounting material.

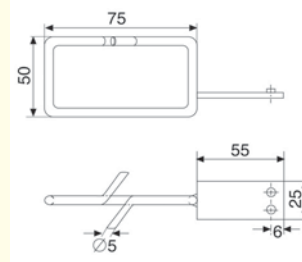

ELM00106

For rack type	Order no.	UP
DoubleProRack	05.040.226.9	4 units



MIR00564

## Jumpering Bracket

- For orderly cable management
- Open version, no threading

### Material/Finish

Round steel, d = 5 mm

### Finish

Zinc-passivated

### Supply schedule

4 jumpering brackets

### How supplied

Flat-packed kit

### Note

Please also order the appropriate mounting material.

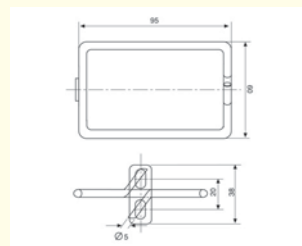

MEC00122

Model	Order
no. UP	

# Knürr Cable Management



ELM00028

## Jumper Tiebar

- Ideal for vertical routing and cable strain relief
- Open version, no threading
- Mounting on the external lateral T-slot of the 19" extrusion
- Any installation position selectable
- From rack width 600 mm

**Material/Finish**  
Round steel, d = 5 mm, zinc-passivated

**Supply schedule**  
2 jumper tiebars

**How supplied**  
Flat-packed kit

**Note**  
Please also order the appropriate mounting material.

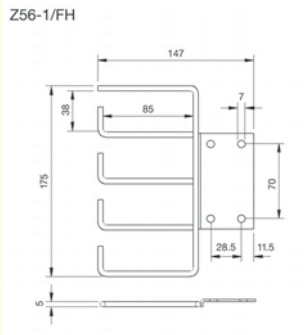

ELM00029

W	H	D	U	d	L	Model	Order no.	UP
							01.117.033.7	2 units



MIR00183

## Jumpering Bracket, Square

- For orderly cable management
- Open version, no threading
- Mounting on the external lateral T-slot of the 19" extrusion
- Any installation position selectable
- From rack width 800 mm

**Finish**  
Zinc-passivated, Zn 10c, white

**Supply schedule**  
4 vertical jumpering brackets

**How supplied**  
Flat-packed kit

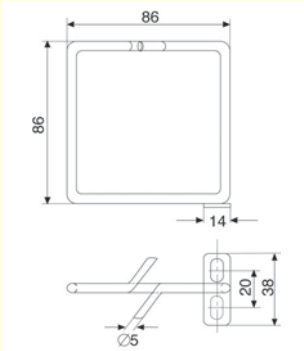

ELM00057

W <sub>Rack</sub>	Model	Order no.	UP
From 800	86x86	05.040.224.9	4 units

**Dimensions in mm:** W = Width, H = Height, D = Depth, h = installation height, d = useful depth, L = length, U = standard height unit, 1 U = 44.45 mm, UP = unit of packaging, kg = weight, = Express item

**Conversion:** 1 mm = 0.03937 inch, 1 kg = 2.2046 pound



MIR00566

## Jumpering Bracket, Vertical

- For orderly cable management
- Open version, no threading
- Mounting on the external side of the 19" extrusion and on the side on the rack T-slot
- Any installation position selectable
- For large cable volumes

**Material**  
Round steel, d = 6 mm

**Finish**  
Zinc-passivated

**Supply schedule**  
4 vertical jumpering brackets

**How supplied**  
Flat-packed kit

**Note**  
Please also order the appropriate mounting material.

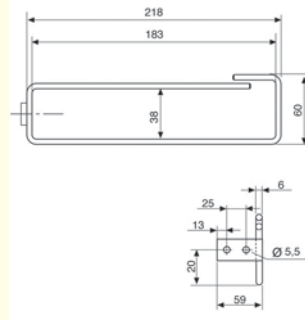

MEC00123

Model	Order no.	UP
218x60	05.040.223.9	4 units

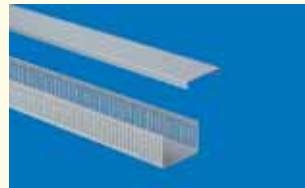

ELM00004

## Cable Duct

- Ideal for orderly and covered cable management of jumper cables

**Material**  
Hard PVC

**Finish**  
Stone gray, RAL 7030

**Supply schedule**  
1 jumper cable duct with cover  
Mounting material



ELM00052

W	H	D	U	d	L	Model	Order no.	UP
						2000	01.117.098.3	1 units



LIG00068

## Fiber Optic Cable Router

- For safe and orderly cable management of fiber optic cables
- With step-index extrusion of the slots to provide strain relief of the fiber optic cables
- Mounting on the external side of the 19" extrusion

**Material**  
PA UL (94-V0)

**Supply schedule**  
1 pair of fiber optic cable routers  
Mounting material



LIG00021

- **How supplied**  
Flat-packed kit

W	H	D	U	d	L	Model	Order no.	UP
							01.117.099.1	1 pair



ELM00025

## Cable Routing Ring

- For orderly cable management
- Open version, no threading
- Mounting on the T-slots of the vertical extrusions
- Any installation position selectable

■ **Material/Finish**  
PA 6, GF 15, black, UL 94-HB

■ **Supply schedule**  
5 cable routing rings  
Mounting material

■ **How supplied**  
Flat-packed kit

W	H	D	U	d	L	Model	Order no.	UP
						54 x 118 mm	01.312.207.9	5 units



MEC20158

## Cable Routing Set

- For orderly cable management
- Dimensions:  
Outside 61 mm x 42.5 mm,  
inside 52 mm x 23 mm

■ **Material/Finish**  
Cable holder: PPO,  
sim. RAL 7035 light gray  
Soft rubber extrusion: EPDM,  
sim. RAL 7021 dark gray

■ **Supply schedule**  
10 cable routers

■ **How supplied**  
Flat-packed kit

■ **Note**  
Please also order the appropriate  
mounting material.

W	H	D	U	d	L	Model	Order no.	UP
						Threaded	05.040.113.9	10 units
						For cut-out 9.5 x 9.5 mm Plug-in	05.040.112.9	10 units



MEC20048

## Velcro strip (by the meter)

- For stress-free mounting and bundling of copper and fiber optic cables
- Velcro strip can be cut to any length required

■ **Material/Color**  
Black: One Wrap Fastener  
F.R.T., UL 94-V2  
Blue: One Wrap Fastener



MEC20147

■ **Supply schedule**  
1-meter or 25-meter Velcro strip

■ **How supplied**  
By the meter

W	H	D	L	Model	Order no.	UP
16			1000	Black	05.040.060.9	1 meter
16			1000	Blue	05.040.061.9	1 meter
16			25000	Black	05.040.065.9	25 meters
16			25000	Blue	05.040.066.9	25 meters



MEC20025

## Velcro Strip with Plastic Eyelet

- For mounting non-standard components
- For bundling cables

■ **Material/Color**  
Polypropylene/Polyamide, black

■ **Supply schedule**  
20 Velcro strips

■ **How supplied**  
Flat-packed kit

W	H	D	L	Model	Order no.	UP
16			300		01.240.550.9	1 set



ELM00049

## Cable Band Clip

- For orderly cable management
- For fixing cable harnesses and cables with large cross section
- Quick and easy mounting
- For clipping into T-slots at any position
- With detachable lock

■ **Material**  
PA 6.6, black, UL 94-V0

■ **Supply schedule**  
20

■ **How supplied**  
Flat-packed kit

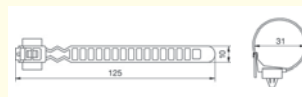

ELM00050

W	H	D	U	d	L	Model	Order no.	UP
							01.240.548.9	20 units

**Dimensions in mm:** W = Width, H = Height, D = Depth, h = installation height, d = useful depth, L = length, U = standard height unit (1 U = 44.45 mm), UP = unit of packaging, kg = weight, = Express item

**Conversion:** 1 mm = 0.03937 inch, 1 kg = 2.2046 pound





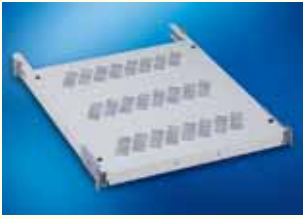

MEC00451

## 19" shelf, fixed

- Integrated fixing holes front and rear for handle or hinged cable routing
- With perforation to optimize air supply

### Material/Finish

Sheet steel 1.0 mm, zinc-passivated, powder-coated texture

### Color

Final digit of order number .1:  
RAL 7035 light gray  
Final digit of order number .8:  
RAL 7021 dark gray

### Load rating

500 N static per item

### Supply schedule

2 mounting rails, incl. mounting bracket  
1 shelf board  
1 extension board (from L = 600)  
Mounting material

### How supplied

Flat-packed kit

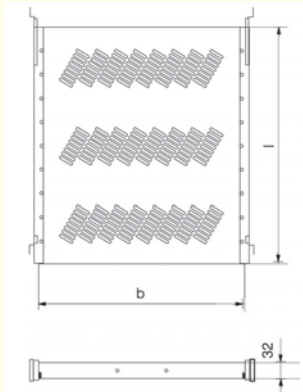

MEC20018

W <sub>Rack</sub>	H <sub>Rack</sub>	D <sub>Rack</sub>	d	w x l	For rack type	Order no.	UP
600	365	430 x 300	Miracel/Smaract LAN	<b>01.102.001.1</b>	1 unit		
600	440	430 x 300	Miracel/Smaract 19"	<b>01.102.002.1</b>	1 unit		
800	565	430 x 500	Miracel/Smaract LAN	<b>01.102.003.1</b>	1 unit		
800	565	430 x 500	Miracel/Smaract LAN	<b>01.102.003.8</b>	1 unit		
800	640	430 x 600	Miracel/Smaract 19"	<b>01.102.004.1</b>	1 unit		
800	640	430 x 600	Miracel/Smaract 19"	<b>01.102.004.8</b>	1 unit		
900	665	430 x 600	Miracel/Smaract LAN	<b>01.102.004.1</b>	1 unit		
900	665	430 x 600	Miracel/Smaract LAN	<b>01.102.004.8</b>	1 unit		
900	740	430 x 600	Miracel/Smaract 19" server	<b>01.102.005.1</b>	1 unit		
900	740	430 x 600	Miracel/Smaract 19" server	<b>01.102.005.8</b>	1 unit		
1000	740	430 x 600	Miracel 19" server	<b>01.102.005.1</b>	1 unit		
1000	740	430 x 600	Miracel 19" server	<b>01.102.005.8</b>	1 unit		
600	600	530 515 x 500	Miracel LW 535	<b>01.102.200.1</b>	1 unit		
700	600	530 615 x 500	Miracel LW 635	<b>01.102.201.1</b>	1 unit		
800	600	530 715 x 500	Miracel LW 735	<b>01.102.202.1</b>	1 unit		
600	800	730 515 x 700	Miracel LW 535	<b>01.102.208.1</b>	1 unit		
700	800	730 615 x 700	Miracel LW 635	<b>01.102.209.1</b>	1 unit		
800	800	730 715 x 700	Miracel LW 735	<b>01.102.210.1</b>	1 unit		
600	900	830 515 x 800	Miracel LW 535	<b>01.102.212.1</b>	1 unit		
800	900	830 715 x 800	Miracel LW 735	<b>01.102.214.1</b>	1 unit		
600	600	535 515 x 500	Smaract LW 535	<b>01.102.252.1</b>	1 unit		
600	800	735 515 x 700	Smaract LW 535	<b>01.102.254.1</b>	1 unit		
600	900	835 515 x 800	Smaract LW 535	<b>01.102.255.1</b>	1 unit		
600	435	430 x 300	DoubleProRack with door	<b>01.102.002.1</b>	1 unit		
800	635	430 x 600	DoubleProRack with door	<b>01.102.004.1</b>	1 unit		
800	635	430 x 600	DoubleProRack with door	<b>01.102.004.8</b>	1 unit		
500	460	430 x 300	DoubleProRack no door	<b>01.102.002.1</b>	1 unit		
600	560	430 x 500	DoubleProRack no door	<b>01.102.003.1</b>	1 unit		
600	560	430 x 500	DoubleProRack no door	<b>01.102.003.8</b>	1 unit		
700	660	430 x 600	DoubleProRack no door	<b>01.102.004.1</b>	1 unit		
700	660	430 x 600	DoubleProRack no door	<b>01.102.004.8</b>	1 unit		
500	285	430 x 200	ConAct	<b>01.102.000.1</b>	1 unit		
600	385	430 x 300	ConAct	<b>01.102.001.1</b>	1 unit		

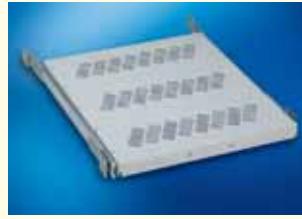

MEC00452

## 19" shelf, part pull-out

- Integrated fixing holes front and rear for handle or hinged cable routing
- With perforation to optimize air supply
- Locking in pulled-out position (friction lock); easy conversion from form lock to friction lock with stop spring
- Quick separator for removing and disconnecting the shelf without tools

### Material/Finish

Sheet steel 1.0 mm, zinc-passivated, powder-coated texture

### Color

Final digit of order number .1:  
RAL 7035 light gray  
Final digit of order number .8:  
RAL 7021 dark gray

### Load rating

500 N static per item

### Supply schedule

1 pair of telescopic slides  
1 shelf board  
1 extension board (from L = 600)  
Mounting material

### How supplied

Flat-packed kit

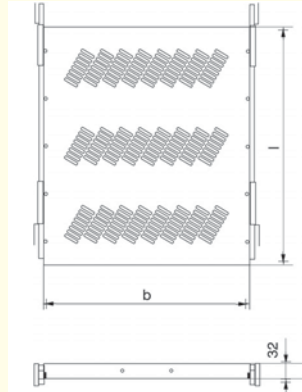

MEC20019

W <sub>Rack</sub>	H <sub>Rack</sub>	D <sub>Rack</sub>	d	w x l	For rack type	Order no.	UP
600	365	430 x 300	Miracel/Smaract LAN	<b>01.102.010.1</b>	1 unit		
600	440	430 x 300	Miracel/Smaract 19"	<b>01.102.010.1</b>	1 unit		
800	565	430 x 500	Miracel/Smaract LAN	<b>01.102.011.1</b>	1 unit		
800	565	430 x 500	Miracel/Smaract LAN	<b>01.102.011.8</b>	1 unit		
800	640	430 x 500	Miracel/Smaract 19"	<b>01.102.011.1</b>	1 unit		
800	640	430 x 500	Miracel/Smaract 19"	<b>01.102.011.8</b>	1 unit		
900	665	430 x 500	Miracel/Smaract LAN	<b>01.102.011.1</b>	1 unit		
900	665	430 x 500	Miracel/Smaract LAN	<b>01.102.011.8</b>	1 unit		
900	740	430 x 600	Miracel/Smaract 19" server	<b>01.102.012.1</b>	1 unit		
900	740	430 x 600	Miracel/Smaract 19" server	<b>01.102.012.8</b>	1 unit		
1000	740	430 x 600	Miracel 19" server	<b>01.102.012.1</b>	1 unit		
1000	740	430 x 600	Miracel 19" server	<b>01.102.012.8</b>	1 unit		
600	600	530 515 x 500	Miracel LW 535	<b>01.102.170.1</b>	1 unit		
700	600	530 615 x 500	Miracel LW 635	<b>01.102.171.1</b>	1 unit		
800	600	530 715 x 500	Miracel LW 735	<b>01.102.172.1</b>	1 unit		
600	800/ 730	515 x 600	Miracel LW 535	<b>01.102.178.1</b>	1 unit		
900							
700	800/ 730	615 x 600	Miracel LW 635	<b>01.102.179.1</b>	1 unit		
900							
800	800/ 730	715 x 600	Miracel LW 735	<b>01.102.180.1</b>	1 unit		
900							
600	435	430 x 300	DoubleProRack with door	<b>01.102.010.1</b>	1 unit		
800	635	430 x 500	DoubleProRack with door	<b>01.102.011.1</b>	1 unit		
800	635	430 x 500	DoubleProRack with door	<b>01.102.011.8</b>	1 unit		
500	460	430 x 300	DoubleProRack no door	<b>01.102.010.1</b>	1 unit		
600	560	430 x 500	DoubleProRack no door	<b>01.102.011.1</b>	1 unit		
600	560	430 x 500	DoubleProRack no door	<b>01.102.011.8</b>	1 unit		
700	660	430 x 500	DoubleProRack no door	<b>01.102.011.1</b>	1 unit		
700	660	430 x 500	DoubleProRack no door	<b>01.102.011.8</b>	1 unit		
600	385	430 x 300	ConAct	<b>01.102.010.1</b>	1 unit		

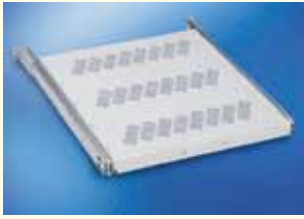

MEC00462

## 19" Shelf Full pull-out

- Integrated fixing holes front and rear for handle or hinged cable routing
- With perforation to optimize air supply
- Locking in pulled-out position (friction lock); easy conversion with stop spring
- Quick separator for removing and disconnecting the shelf without tools

**Material/Finish**  
Sheet steel 1.0 mm, zinc-passivated, powder-coated texture

**Color**  
RAL 7035 light gray

**Load rating**  
500 N static per item

**Supply schedule**  
1 pair of telescopic slides  
1 shelf board  
1 extension board (from L = 600)  
Mounting material

**How supplied**  
Flat-packed kit

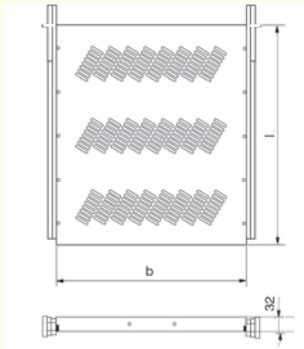

MEC20xxx

WRack	HRack	DRack	U	d	w x l	For rack type	Order no.	UP
600	365	430 x 300	Miracel/Smaract LAN	01.102.160.1	1 unit			
600	440	430 x 300	Miracel/Smaract 19"	01.102.160.1	1 unit			
800	565	430 x 500	Miracel/Smaract LAN	01.102.161.1	1 unit			
800	640	430 x 500	Miracel/Smaract 19"	01.102.161.1	1 unit			
900	665	430 x 500	Miracel/Smaract LAN	01.102.161.1	1 unit			
900	740	430 x 600	Miracel/Smaract 19" Server	01.102.162.1	1 unit			
1000	740	430 x 600	Miracel 19" server	01.102.162.1	1 unit			

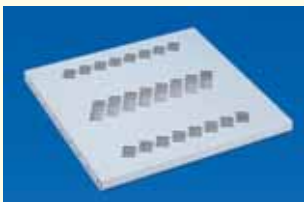

MEC00120

## 19" Heavy-Duty Shelf Fixed

- Surface area with perforation
- Application as server or battery bottom cover

**Material/Finish**  
Sheet steel 1.5 mm, zinc-passivated, powder-coated texture

**Color**  
Final digit of order number .1:  
RAL 7035 light gray  
Final digit of order number .8:  
RAL 7021 dark gray

**Load rating**  
1000 N static for CW installation  
1500 N static for 19" installation

**Supply schedule**  
1 shelf, fixed, screwable  
2 mounting braces  
Mounting material

**How supplied**  
Flat-packed kit

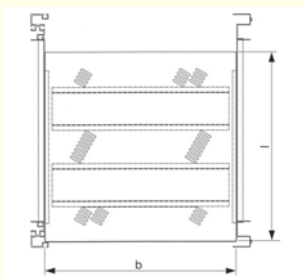

MEC20117

WRack	HRack	DRack	U	d	w x l	For rack type	Order no.	UP
		800	565	467 x 460	Miracel/Smaract LAN	01.131.473.1	1 unit	
		800	565	467 x 460	Miracel/Smaract LAN	01.131.473.8	1 unit	
		800	640	467 x 460	Miracel/Smaract 19"	01.131.475.1	1 unit	
		900	665	467 x 560	Miracel/Smaract LAN	01.131.476.1	1 unit	
		900	740	467 x 560	Miracel/Smaract 19" Server	01.131.474.1	1 unit	
		900	740	467 x 560	Miracel/Smaract 19" Server	01.131.474.8	1 unit	
		1000	740	467 x 560	Miracel 19" server	01.131.474.1	1 unit	
		1000	740	467 x 560	Miracel 19" server	01.131.474.8	1 unit	
600	800	730	534 x 536	Miracel LW 535	01.131.477.1	1 unit		
800	800	730	734 x 536	Miracel LW 735	01.131.479.1	1 unit		
600	900	830	534 x 536	Miracel LW 535	01.131.481.1	1 unit		
800	900	830	734 x 536	Miracel LW 735	01.131.483.1	1 unit		



MEC20022

## 19" Heavy-Duty Shelf Full pull-out

- With perforation to optimize air supply
- Locking in pushed-in and fully pulled out position
- Easy mounting with patented quick mounting system
- Application as server or battery bottom cover

**Material/Finish**  
Sheet steel, 1.5 mm, powder-coated texture

**Color**  
Final digit of order number .1:  
RAL 7035 light gray  
Final digit of order number .8:  
RAL 7021 dark gray

**Load rating**  
1200 N static

**Supply schedule**  
1 pair of telescopic slides  
1 shelf board  
Mounting material

**How supplied**  
Flat-packed kit

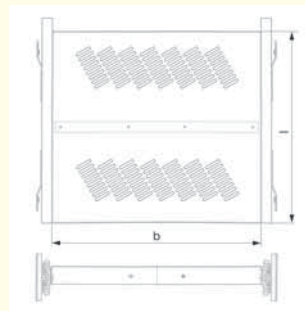

MEC20113

WRack	HRack	DRack	U	d	w x l	For rack type	Order no.	UP
		800	565	412 x 560	Miracel/Smaract LAN	01.102.031.1	1 unit	
		800	565	412 x 560	Miracel/Smaract LAN	01.102.031.8	1 unit	
		800	640	412 x 560	Miracel/Smaract 19"	01.102.031.1	1 unit	
		800	640	412 x 560	Miracel/Smaract 19"	01.102.031.8	1 unit	
		900	665	412 x 660	Miracel/Smaract LAN	01.102.032.1	1 unit	
		900	665	412 x 660	Miracel/Smaract LAN	01.102.032.8	1 unit	
		900	740	412 x 660	Miracel/Smaract 19" Server	01.102.032.1	1 unit	
		900	740	412 x 660	Miracel/Smaract 19" Server	01.102.032.8	1 unit	
		1000	740	412 x 660	Miracel 19" server	01.102.032.1	1 unit	
		1000	740	412 x 660	Miracel 19" server	01.102.032.8	1 unit	
600	800	730	478 x 560	Miracel LW 535	01.102.034.1	1 unit		
800	800	730	678 x 560	Miracel LW 735	01.102.037.1	1 unit		
600	900	830	478 x 660	Miracel LW 535	01.102.035.1	1 unit		
800	900	830	678 x 660	Miracel LW 735	01.102.038.1	1 unit		
600	800	735	478 x 560	Smaract LW 535	01.102.034.1	1 unit		
600	900	835	478 x 660	Smaract LW 535	01.102.035.1	1 unit		

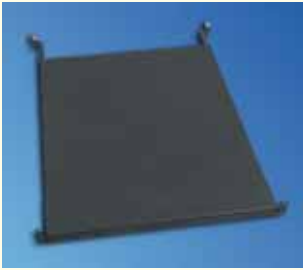

SUN20007

## 19" Quick-Fix Shelf Assembly without tools

- Quick and easy mounting without tools by hanging in 19" cut-outs
- Quick and easy fixing (one click) and removing (quarter turn) without tools
- Suitable for all racks and enclosures with 19" mounting hole extrusions (9.0 x 9.0 square holes)
- Depth-variable for use with different slot-in depths and special dimensions
- With perforation to optimize air supply

### Material

Sheet steel, 1.0 mm

### Finish

Final digit of order number .1:  
Powder-coated texture, RAL 7035, light gray  
Final digit of order number .8:  
Powder-coated texture, RAL 7021 dark gray

### Load rating

700 N static with even load distribution

### Supply schedule

19" Quick-Fix Shelf Mounting Material

### How supplied

Flat-packed kit

### Note

Cannot be used for 19" t-slot extrusions!

W	H	D	U	d	w x l	Order no.	UP
		600	365 - 500		430 x 300	<b>01.102.071.X</b>	1 unit
		800	565 - 740		430 x 500	<b>01.102.072.X</b>	1 unit



MEC20138

## Handle

- Suitable for shelves and heavy-duty shelves
- With internal thread, M5

### Material

Die-cast aluminum consoles  
Handle extrusions of extruded aluminum  
Cap made of ABS UL 94 HB

### Finish:

Handle, powder-coated, gray-blue,  
RAL 5008/Cap, light gray,  
RAL7035

### Supply schedule

2 handles

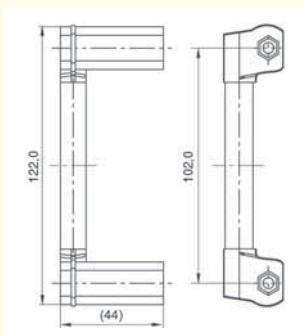

MEC20111

W	H	D	U	d	w x l	For rack type	Order no.	UP
							<b>00.050.503.1</b>	1 set



MEC20154

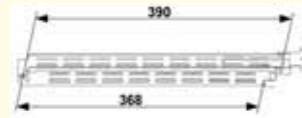

MEC88005

## Cable Cantilever

- Swing-out from the rear, therefore free access to the rear side (only 3-piece)
- For easy mounting in rack/on the shelf; quick connecting to and disconnecting from shelf or rack with a spring clip
- Guarantees defined and kink-free cable management
- Minimum space requirement behind the pushed-in shelves, 40 mm

### Material/Finish

Sheet steel, 1.5 mm, zinc-passivated

### Supply schedule

1 cable cantilever  
Mounting material

### How supplied

Flat-packed kit

W	H	D	U	d	w x l	Type	Order no.	UP
						2-piece	<b>05.040.096.0</b>	1 unit

Dimensions in mm: W = Width  
H = Height  
D = Depth  
h = installation height  
d = useful depth  
L = length  
CW = Clear width

U = standard height unit  
1 U = 44.45 mm  
UP = unit of packaging  
kg = weight  
Express item

Conversion: 1 mm = 0.03937 inch 1 kg = 2.2046 pound



MIR00373

## 19" Shelf, 2 U Fixed

- For installation in racks with fixed 19" installation on the front
- Quick and easy mounting on 19" extrusions
- Also for swing frame in the 19" rack and 19" enclosure

**Finish/Color**  
Powder-coated texture, RAL 7035 light gray

**Material**  
Sheet steel, 1.5 mm

**Load rating**  
200 N static

**Supply schedule**  
1 shelf, fixed  
Mounting material

**How supplied**  
Flat-packed kit

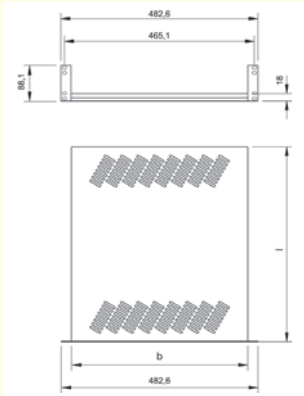

MIR00375

W	H	D	wxl	For rack type	Order no.	UP
482.6	88.1	600/800/900/1000	442x280	Miracel/Smaract	01.113.736.1	1 unit
482.6	88.1	600/800/900/1000	442x380	Miracel/Smaract	01.113.737.1	1 unit
482.6	88.1	500/600/800	442x280	DoubleProRack	01.113.736.1	1 unit
482.6	88.1	500/600/800	442x380	DoubleProRack	01.113.737.1	1 unit
482.6	88.1	400/500/600	442x280	ConAct	01.113.736.1	1 unit
482.6	88.1	500/600	442x380	ConAct	01.113.737.1	1 unit



MIR00102

## 19" Shelf, 2 U Adjustable

- For installation in racks with adjustable 19" installation on the front
- Quick and easy mounting on 19" extrusions
- Also for swing frame in the 19" rack and 19" enclosure
- Adjustable in increments of 25 mm in the depth

**Material/Finish**  
Sheet steel 1.5 mm, powder-coated  
Texture

**Color**  
RAL 7035 light gray

**Load rating**  
200 N static

**How supplied**  
Flat-packed kit

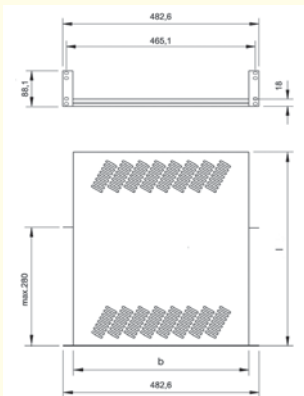

MIR00103

W	H	D	wxl	For rack type	Order no.	UP
482.6	88.1	600/800/900/1000	442x280	Miracel/Smaract	01.113.409.1	1 unit
482.6	88.1	600/800/900/1000	442x380	Miracel/Smaract	01.113.410.1	1 unit

W	H	D	wxl	For rack type	Order no.	UP
482.6	88.1	600/800/900/1000	442x480	Miracel/Smaract	01.113.411.1	1 unit
482.6	88.1	500/600/800	442x280	DoubleProRack	01.113.409.1	1 unit
482.6	88.1	500/600/800	442x380	DoubleProRack	01.113.410.1	1 unit
482.6	88.1	600/800	442x480	DoubleProRack	01.113.411.1	1 unit
482.6	88.1	400/500/600	442x280	ConAct	01.113.409.1	1 unit
482.6	88.1	500/600	442x380	ConAct	01.113.410.1	1 unit
482.6	88.1	600	442x480	ConAct	01.113.411.1	1 unit



SCH00058

## 19" Drawer Installation on the front

- For installation on the front 19" extrusions
- For storing service documents
- Quick and easy mounting

**Material/Finish**  
Drawer, sheet steel 1.0 mm, powder-coated texture  
Telescopic slides, sendzimir zinc-coated

**Color**  
Final digit of order number .1:  
RAL 7035 light gray  
Final digit of order number .8:  
RAL 7021 dark gray

**Load rating**  
150 N static

**Supply schedule**  
1 19" drawer with lock, including key  
1 pair of telescopic slides  
Mounting material

**How supplied**  
Preassembled

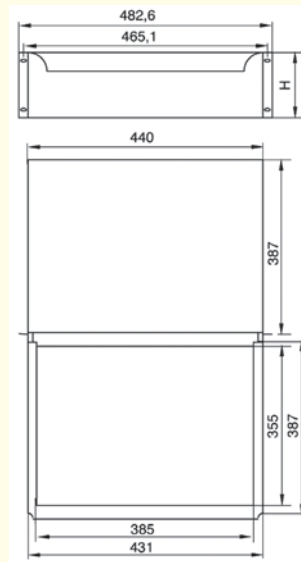

SCH00054

W	H	D	U	For rack type	Order no.	UP
482.6	43.6	600-1000	1	Miracel/Smaract/ DoubleProRack/ConAct	01.113.926.1	1 unit
482.6	88.1	600-1000	2	Miracel/Smaract/ DoubleProRack/ConAct	01.113.927.1	1 unit
482.6	88.1	600-1000	2	Miracel/Smaract/ DoubleProRack/ConAct	01.113.927.8	1 unit
482.6	132.5	600-1000	3	Miracel/Smaract/ DoubleProRack/ConAct	01.113.928.1	1 unit

**Dimensions in mm:** W = Width, H = Height, D = Depth, h = installation height, d = useful depth, L = length, CW = Clear width, U = standard height unit, 1 U = 44.45 mm, UP = unit of packaging, kg = weight, WxL = Surface area, = Express item

**Conversion:** 1 mm = 0.03937 inch, 1 kg = 2.2046 pound

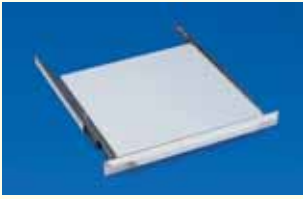

MEC00118

## 19" Shelf, 1 U Pull-out

- With handle
- Can also be used as writing board

**Material/Finish**  
Shelf, sheet steel, 1.0 mm  
Telescopic slide, cold rolled steel

**Finish/Color**  
Powder-coated texture  
RAL 7035 light gray

**Load rating**  
200 N static

**Supply schedule**  
1 shelf  
1 pair of telescopic slides  
Mounting material

**How supplied**  
Preassembled

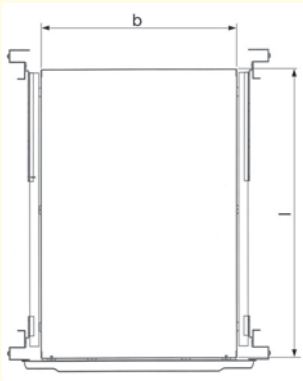

MEC20118

W	H	D <sub>rack</sub>	U	d	w x l	For rack type	Order no.	UP
482.6	43.6	600	1	365	403 x 400	Miracel/Smaract LAN	<b>02.045.149.1</b>	1 unit
482.6	43.6	600	1	440	403 x 400	Miracel/Smaract 19"	<b>02.045.149.1</b>	1 unit
482.6	43.6	800	1	565	403 x 400	Miracel/Smaract LAN	<b>02.045.149.1</b>	1 unit
482.6	43.6	800	1	640	403 x 600	Miracel/Smaract 19"	<b>02.045.147.1</b>	1 unit
482.6	43.6	900	1	665	403 x 600	Miracel/Smaract LAN	<b>02.045.147.1</b>	1 unit
482.6	43.6	900	1	740	403 x 600	Miracel/Smaract 19" Server	<b>02.045.147.1</b>	1 unit
482.6	43.6	1000	1	740	403 x 600	Miracel 19" Server	<b>02.045.147.1</b>	1 unit
482.6	43.6	600	1	435	403 x 400	DoubleProRack With door	<b>02.045.149.1</b>	1 unit
482.6	43.6	800	1	635	403 x 600	DoubleProRack With door	<b>02.045.147.1</b>	1 unit



SCH00057

## 19" Drawer with Lock Mounting on 19" installation, front and rear

- For mounting in racks with fixed 19" installation on the front and rear
- Full pull-out
- With lock

**Material/Finish**  
Drawer, sheet steel 1.0 mm, powder-coated texture  
Telescopic slides, cold rolled steel, sendzimir zinc-coated

**Color**  
Drawer, RAL7035 light-gray

**Load rating**  
1 U - 200 N static  
2 U - 400 N static  
3 U - 400 N static  
4 U - 400 N static

**Supply schedule**  
1 19" drawer with lock, including key  
1 pair of telescopic slides  
Mounting material

**How supplied**  
Preassembled

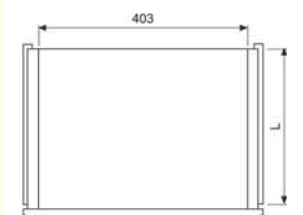
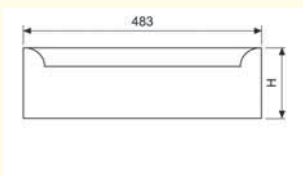

SCH00053

W	H	D	U	d	L	For rack type	Order no.	UP
482.6	43.6	600	1	365	400	Miracel/Smaract LAN	<b>02.045.151.1</b>	1 unit
482.6	43.6	600	1	440	400	Miracel/Smaract 19"	<b>02.045.151.1</b>	1 unit
482.6	87.1	600	2	440	400	Miracel/Smaract 19"	<b>02.045.152.1</b>	1 unit
482.6	131.5	600	3	440	400	Miracel/Smaract 19"	<b>02.045.153.1</b>	1 unit
482.6	176.0	600	4	440	400	Miracel/Smaract 19"	<b>02.045.154.1</b>	1 unit
482.6	43.6	800	1	565	400	Miracel/Smaract LAN	<b>02.045.151.1</b>	1 unit
482.6	87.1	800	2	565	400	Miracel/Smaract LAN	<b>02.045.152.1</b>	1 unit
482.6	131.5	800	3	565	400	Miracel/Smaract LAN	<b>02.045.153.1</b>	1 unit
482.6	176.0	800	4	565	400	Miracel/Smaract LAN	<b>02.045.154.1</b>	1 unit
482.6	43.6	800	1	640	600	Miracel/Smaract 19"	<b>02.045.161.1</b>	1 unit
482.6	43.6	900	1	665	600	Miracel/Smaract LAN	<b>02.045.161.1</b>	1 unit
482.6	87.1	900	2	665	600	Miracel/Smaract LAN	<b>02.045.162.1</b>	1 unit
482.6	131.5	900	3	665	600	Miracel/Smaract LAN	<b>02.045.163.1</b>	1 unit
482.6	176.0	900	4	665	600	Miracel/Smaract LAN	<b>02.045.164.1</b>	1 unit
482.6	43.6	900	1	740	600	Miracel/Smaract 19" server	<b>02.045.161.1</b>	1 unit
482.6	87.1	900	2	740	600	Miracel/Smaract 19" server	<b>02.045.162.1</b>	1 unit
482.6	131.5	900	3	740	600	Miracel/Smaract 19" server	<b>02.045.163.1</b>	1 unit
482.6	176.0	900	4	740	600	Miracel/Smaract 19" server	<b>02.045.164.1</b>	1 unit
482.6	43.6	1000	1	740	600	Miracel/Smaract 19" server	<b>02.045.161.1</b>	1 unit
482.6	87.1	1000	2	740	600	Miracel/Smaract 19" server	<b>02.045.162.1</b>	1 unit
482.6	131.5	1000	3	740	600	Miracel/Smaract 19" server	<b>02.045.163.1</b>	1 unit
482.6	176.0	1000	4	740	600	Miracel/Smaract 19" server	<b>02.045.164.1</b>	1 unit
482.6	43.6	600	1	435	400	DoubleProRack with door	<b>02.045.151.1</b>	1 unit
482.6	87.1	600	2	435	400	DoubleProRack with door	<b>02.045.152.1</b>	1 unit
482.6	131.5	600	3	435	400	DoubleProRack with door	<b>02.045.153.1</b>	1 unit
482.6	176.0	600	4	435	400	DoubleProRack with door	<b>02.045.154.1</b>	1 unit
482.6	43.6	800	1	635	600	DoubleProRack with door	<b>02.045.161.1</b>	1 unit
482.6	87.1	800	2	635	600	DoubleProRack with door	<b>02.045.162.1</b>	1 unit
482.6	131.5	800	3	635	600	DoubleProRack with door	<b>02.045.163.1</b>	1 unit
482.6	176.0	800	4	635	600	DoubleProRack with door	<b>02.045.164.1</b>	1 unit
482.6	43.6	500	1	460	400	DoubleProRack 19" no door	<b>02.045.151.1</b>	1 unit
482.6	87.1	500	2	460	400	DoubleProRack 19" no door	<b>02.045.152.1</b>	1 unit
482.6	131.5	500	3	460	400	DoubleProRack 19" no door	<b>02.045.153.1</b>	1 unit
482.6	176.0	500	4	460	400	DoubleProRack 19" no door	<b>02.045.154.1</b>	1 unit
482.6	43.6	600	1	560	400	DoubleProRack 19" no door	<b>02.045.151.1</b>	1 unit
482.6	87.1	600	2	560	400	DoubleProRack 19" no door	<b>02.045.152.1</b>	1 unit
482.6	131.5	600	3	560	400	DoubleProRack 19" no door	<b>02.045.153.1</b>	1 unit
482.6	176.0	600	4	560	400	DoubleProRack 19" no door	<b>02.045.154.1</b>	1 unit
482.6	43.6	700	1	660	600	DoubleProRack 19" no door	<b>02.045.161.1</b>	1 unit
482.6	87.1	700	2	660	600	DoubleProRack 19" no door	<b>02.045.162.1</b>	1 unit
482.6	131.5	700	3	660	600	DoubleProRack 19" no door	<b>02.045.163.1</b>	1 unit
482.6	176.0	700	4	660	600	DoubleProRack 19" no door	<b>02.045.164.1</b>	1 unit

**Dimensions in mm:** W = Width, H = Height, D = Depth, h = installation height, d = useful depth, L = length, CW = Clear width, U = standard height unit, 1 U = 44.45 mm, UP = unit of packaging, kg = weight, WxL = Surface area, = Express item

**Conversion:** 1 mm = 0.03937 inch, 1 kg = 2.2046 pound



SCH00062

## Writing board For 19" drawer with lock

- For drawer depth 400 mm and 600 mm

**Material/Finish**  
Sheet steel, 1.0 mm, powder-coated texture

**Color**  
RAL 7035 light gray

**Supply schedule**  
1 writing board  
Mounting material

**How supplied**  
Flat-packed kit

W	H	D	U	d	L	For rack type	Order no.	UP
				400			02.045.202.9	1 unit
				600			02.045.203.9	1 unit

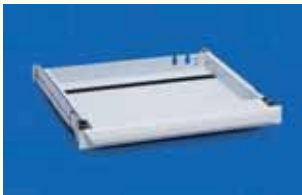

SCH00059

## 19" Keyboard Drawer 1 U For 19" keyboard

- With hand support
- With cable strain relief
- No telescopic slides locking

**Material**  
Main unit, sheet steel, 1.0 mm  
Front panel, sheet steel, 1.0 mm

**Finish/Color**  
Powder-coated texture, RAL 7035 light gray

**Supply schedule**  
1 19" keyboard drawer, 1 U  
1 pair of telescopic slides  
Velcro strip for keyboard fixing  
Mounting material

**How supplied**  
Preassembled

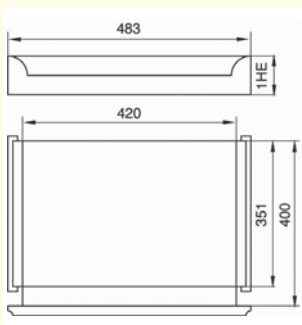

SCH00055

W	H	D <sub>Rack</sub>	U	d	L	For rack type	Order no.	UP
482.6	43.6	600	1	440		Miracel/Smaract 19"	02.011.101.1	1 unit
482.6	43.6	800	1	565		Miracel/Smaract LAN	02.011.101.1	1 unit
482.6	43.6	800	1	640		Miracel/Smaract 19"	02.011.101.1	1 unit
482.6	43.6	900	1	665		Miracel/Smaract LAN	02.011.101.1	1 unit
482.6	43.6	900	1	740		Miracel/Smaract 19" Server	02.011.101.1	1 unit
482.6	43.6	1000	1	740		Miracel 19" Server	02.011.101.1	1 unit
482.6	43.6	600	1	435		DoubleProRack with door	02.011.101.1	1 unit
482.6	43.6	800	1	635		DoubleProRack with door	02.011.101.1	1 unit



VHP00155

## 19" Compact Keyboard IBM-compatible keyboard with trackball

- Suitable for keyboard drawer 01.136.378.1
- Flat keyboard with 84 keys and integrated trackball

**Electrical data**  
- Power supply:

- + 5 V/DC max. 18 mA
- Mains cable (1.6 m) with tapping for two 6-pin mini DIN plugs (PS/2)
- For Windows 98/ME/NT/2000/XP

**Dimensions**  
Length x width x height  
370 x 138.5 x 20 mm

W	H	S	U	A1	A2	Pmax	Model	Order no.	UP
							German	06.002.048.3	1 unit



MEC20162

## Chassis Rail Hang-on and screw-on

- For installation in 19" rack and enclosure
- Hang-on for quick and easy mounting
- Can also be screwed for heavier load ratings
- Can be screwed from inside (use in rack suites)
- Height setting possible for various main section heights

**Material/Finish**  
Sheet steel, 2.0 mm  
Zinc-passivated, blue chrome-plated

**Load rating**  
1000 N max., with even distribution

**Supply schedule**  
2 slot-in rails  
Mounting material

**How supplied**  
In pairs

**Note**  
When selecting the slot-in rail, please note the chassis depth d of the rack or enclosure 4 19" extrusions are required for mounting



MEC20167



MEC20167

W	H	D <sub>Rack</sub>	U	d	L	For rack type	Order no.	UP
		600		365	336	Miracel/Smaract	01.103.051.0	1 pair
		600		440	411	Miracel/Smaract	01.103.052.0	1 pair
		800		565	536	Miracel/Smaract	01.103.053.0	1 pair
		800		640	611	Miracel/Smaract	01.103.054.0	1 pair
		900		665	636	Miracel/Smaract	01.103.055.0	1 pair
		From 900		740	711	Miracel/Smaract/CoolTherm	01.103.056.0	1 pair



MEC20169

## Aluminum Chassis Rail Screw-on

- For installation in 19" rack and enclosure
- Can be screwed from inside (use in rack suites)
- Height setting possible for various main section heights

**Material/Finish**  
Extruded aluminum, 1.4 mm, polished

**Load rating**  
700 N max., with even load distribution

- **Supply schedule**  
2 slot-in rails  
Mounting material

- **How supplied**  
In pairs

- **Note**  
When selecting the slot-in rail, please note the chassis depth d of the rack or enclosure 4 19" extrusions are required for mounting.

W <sub>Rack</sub>	H <sub>Rack</sub>	D <sub>Rack</sub>	U	d	L	For rack type	Order no.	UP
600			365	336		Miracel/Smaract	01.103.101.0	1 pair
600			440	411		Miracel/Smaract	01.103.102.0	1 pair
800			565	536		Miracel/Smaract	01.103.103.0	1 pair
800			640	611		Miracel/Smaract	01.103.104.0	1 pair
800			665	636		Miracel/Smaract	01.103.105.0	1 pair
From 900			740	711		Miracel/Smaract/CoolTherm	01.103.106.0	1 pair
500			285	254		ConAct	01.103.111.0	1 pair
600			385	354		ConAct	01.103.112.0	1 pair
600			435	403		DoubleProRack with door	01.103.118.0	1 pair
800			635	603		DoubleProRack with door	01.103.119.0	1 pair
500			460	428		DoubleProRack no door	01.103.122.0	1 pair
600			560	528		DoubleProRack no door	01.103.123.0	1 pair
700			660	628		DoubleProRack no door	01.103.124.0	1 pair



MEC20163



MEC20166

## Chassis runner, depth-variable Screw-on

- For installation in 19" rack and enclosure
- Depth-variable
- Can be screwed from inside (use in rack suites)
- Height setting possible for various main section heights

- **Material/Finish**  
Sheet steel, 1.25 mm  
Zinc-passivated, blue chrome-plated

- **Load rating**  
200 N max., with even load distribution

- **Supply schedule**  
2 basic rails  
2 extension rails  
Mounting material

- **How supplied**  
In pairs

- **Note**  
When selecting the slot-in rail, please note the chassis depth d of the rack or enclosure 4 19" extrusions are required for mounting

W	H	D	U	d	For rack type	Order no.	UP
600			365-440		Miracel/Smaract	01.103.091.0	1 pair
800-1200			565-740		Miracel/Smaract	01.103.092.0	1 pair
900-1200			740		CoolTherm	01.103.092.0	1 pair
600			385		ConAct	01.103.091.0	1 pair
500-600			435-460		DoubleProRack	01.103.091.0	1 pair
600-800			560-660		DoubleProRack	01.103.092.0	1 pair



MEC20179



MEC20180



MEC20178

## Quick-Fix 19" Blanking Panel Assembly without tools

- For covering free 19" spaces (cold-hot separation)
- Quick and easy assembly without tools (one click) and disassembly (quarter turn)
- Suitable for 9.5 x 9.5 square holes

- **Material**  
Sheet steel, 1.0 mm

- **Finish**  
Final digit of order number .1:  
Powder-coated texture, RAL7035, light gray  
Final digit of order number .8:  
Powder-coated texture, RAL7021, dark gray

- **Supply schedule**  
X (see ON for quantity) Quick-Fix 19" Blanking Panel  
Mounting material

- **How supplied**  
In sets (see ON for quantity); fixing clips pre-mounted

W	H	D	U	d	L	For rack type	Order no.	UP
482.6	43.6		1			Powder-coated	01.103.301.X	6 units
482.6	88.1		2			Powder-coated	01.103.302.X	3 units
482.6	132.5		3			Powder-coated	01.103.303.X	2 unit
482.6	265.9		6			Powder-coated	01.103.306.X	1 unit
482.6	399.2		9			Powder-coated	01.103.309.X	2 unit
482.6	932.6		21			Powder-coated	01.103.321.X	1 unit



MEC20181



MEC20178

## Quick-Fix 19" blanking panel cable port Assembly without tools

- For orderly cable management in the rack internal space
- Quick and easy assembly without tools (one click) and disassembly (quarter turn)
- Suitable for 9.5 x 9.5 square holes

- **Material**  
Sheet steel, 1.0 mm

- **Finish**  
Final digit of order number .1:  
Powder-coated texture, RAL7035, light gray  
Final digit of order number .8:  
Powder-coated texture, RAL7021, dark gray

- **Supply schedule**  
6 Quick-Fix 19" blanking panel cable ports  
Mounting material

- **How supplied**  
In sets; fixing clips pre-mounted

W	H	D	U	d	L	For rack type	Order no.	UP
482.6	43.6		1			Powder-coated	01.103.331.X	6 units

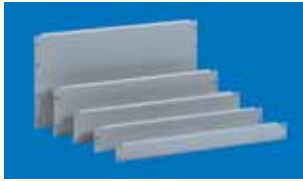

CUD00005

## Quick-Fix 19" Blanking Panel Screw-on

– For covering free 19" spaces (cold-hot separation)

### Material

Sheet steel, 1.0 mm

### Finish

Final digit of order number .1:  
Powder-coated texture, RAL7035, light gray  
Final digit of order number .8:  
Powder-coated texture, RAL7021, dark gray

### Supply schedule

X (see ON for quantity) 19" Blanking Panel

### How supplied

In sets (see ON for quantity)

### Note

Please also order front panel mounting material!

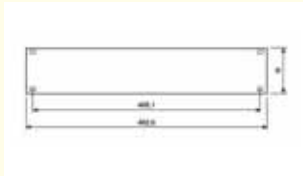

CUD00004

W	H	D	U	d	L	For rack type	Order no.	UP
482.6	43.6	1				Powder-coated	01.103.201.X	6 units
482.6	88.1	2				Powder-coated	01.103.202.X	3 units
482.6	132.5	3				Powder-coated	01.103.203.X	2 unit
482.6	265.9	6				Powder-coated	01.103.206.X	1 uni
482.6	399.2	9				Powder-coated	01.103.209.X	2 unit



LUF00217

## 19" Ventilation Front Panel

– For additional ventilation of 19" racks and 19" pedestals in accordance with IEC 297

### Material

Aluminum

### Finish

Final digit of order number .1:  
Powder-coated, RAL 7035 light-gray  
Final digit of order number .6:  
colorless anodized E 6 / EV 1

### Supply schedule

1 ventilation front panel

### How supplied

In units

### Note

Please also order front panel mounting material.

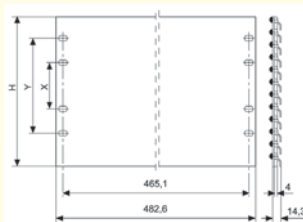

MEC20110

H	X	Y	U	Model	Order no.	UP
43.6	31.7	1		Powder-coated, RAL 7035	02.008.101.1	1 unit
43.6	31.7	1		Anodized	02.008.101.6	1 unit
132.5	57.1	3		Powder-coated, RAL 7035	02.008.103.1	1 unit
132.5	57.1	3		Anodized	02.008.103.6	1 unit

Dimensions in mm: W = Width  
H = Height  
D = Depth  
h = installation height  
d = useful depth  
L = length  
CW = Clear width  
U = standard height unit  
1 U = 44.45 mm  
UP = unit of packaging  
kg = weight  
WxL = Surface area  
Express item

Conversion: 1 mm = 0.03937 inch 1 kg = 2.2046 pound



FR000005

## 19" front panel Aluminum 3 mm

### Material/Finish

Final digit of order number .0:  
AlMg3 - F23 polished with lamination sheet  
Final digit of order number .1:  
AlMg3 - F23, powder-coated, RAL 7035 light gray  
Final digit of order number .6:  
AlMg3 - F23 EB (anodize-enabled), anodized E6/EV1  
Final digit of order number .8:  
AlMg3 - F23, powder-coated, RAL 7021 dark gray

### Supply schedule

1 19" front panel

### How supplied

In units

### Note

Please also order front panel mounting material.

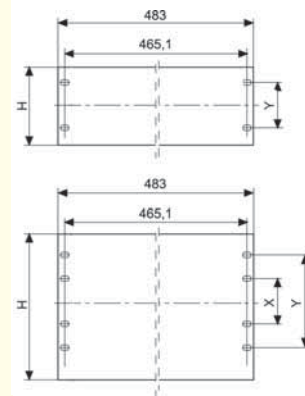

MEC20109

H	X	Y	U	Model	Order no.	UP
43.6	31.7	1		Polished	02.008.021.0	1 unit
88.1	76.2	2		Polished	02.008.022.0	1 unit
132.5	57.1	3		Polished	02.008.023.0	1 unit
177.0	101.6	4		Polished	02.008.024.0	1 unit
221.4	146.0	5		Polished	02.008.025.0	1 unit
265.9	76.2	190.4	6	Polished	02.008.026.0	1 unit
43.6	31.7	1		Powder-coated, RAL 7035	02.008.021.1	1 unit
88.1	76.2	2		Powder-coated, RAL 7035	02.008.022.1	1 unit
132.5	57.1	3		Powder-coated, RAL 7035	02.008.023.1	1 unit
177.0	101.6	4		Powder-coated, RAL 7035	02.008.024.1	1 unit
221.4	146.0	5		Powder-coated, RAL 7035	02.008.025.1	1 unit
265.9	76.2	190.4	6	Powder-coated, RAL 7035	02.008.026.1	1 unit
43.6	31.7	1		Powder-coated, RAL 7021	02.008.021.8	1 unit
88.1	76.2	2		Powder-coated, RAL 7021	02.008.022.8	1 unit
132.5	57.1	3		Powder-coated, RAL 7021	02.008.023.8	1 unit
43.6	31.7	1		Anodized	02.008.071.6	1 unit
88.1	76.2	2		Anodized	02.008.072.6	1 unit
132.5	57.1	3		Anodized	02.008.073.6	1 unit
177.0	101.6	4		Anodized	02.008.074.6	1 unit
221.4	146.0	5		Anodized	02.008.075.6	1 unit
265.9	76.2	190.4	6	Anodized	02.008.076.6	1 unit



FR000007

## 19" Front Panel, Hinged

– With 19" adapter and hinge

### Material

Aluminum 3 mm

### Finish

Anodized

### Supply schedule

1 front panel, hinged  
1 19" adapter  
1 hinge



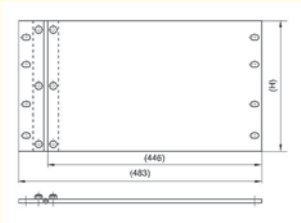

FR000006

**How supplied**  
Flat-packed kit

**Note**  
Please also order front panel mounting material.

W	H	D	U	Model	Order no.	UP
			3	Anodized	<b>01.110.780.6</b>	1 unit
			6	Anodized	<b>01.110.781.6</b>	1 unit



MEC20027

## Document Holder

- Self-adhesive; use 6 mm bore holes with higher stresses
- For DIN A4 documents

**Material**  
High-impact PS

**Color**  
Gray

**Supply schedule**  
1 document holder

W	L	D	Order no.	UP
264	236	30	<b>05.016.045.0</b>	1 unit



LUF88006

## 19" Front Ventilation Panel

- For additional ventilation of 19" racks and 19" pedestals in acc. with IEC 297

**Material/Color**  
Final digit of order number .1:  
ABS (UL 94 V0), light gray RAL 7035  
Final digit of order number .9:  
ABS (UL 94 V0), dark gray RAL 9011

**Supply schedule**  
1 front ventilation panel  
2 connection holders

**How supplied**  
Flat-packed kit

**Note**  
Please also order front panel mounting material.

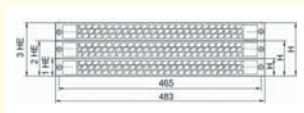

LUF00093

W	H	D	U	Model	Order no.	UP
483	43.6		1		<b>02.008.111.1</b>	1 unit
483	43.6		1		<b>02.008.111.9</b>	1 unit



MEC20144

## Panel Filter For 19" front ventilation panel

- For use in conjunction with the 19" front ventilation panel

**Material/Color**  
Filter fibers and screen cloth

**Supply schedule**  
1 panel filter  
Mounting material

**How supplied**  
Flat-packed kit



MEC20149

W	H	D	U	Model	Order no.	UP
			1		<b>02.008.131.9</b>	1 unit

**Dimensions in mm:** W = Width  
H = Height  
D = Depth  
h = installation height  
d = useful depth  
L = length  
CW = Clear width  
U = standard height unit  
1 U = 44.45 mm  
UP = unit of packaging  
kg = weight  
WxL = Surface area  
Express item

**Conversion:** 1 mm = 0.03937 inch 1 kg = 2.2046 pound

## Ball Bearing Telescopic Slide, BP-400-LR Part pull-out

mL(N)	A	B	C	D	E	F	G	H	I	K	Order no. 1	UP	
500	330	220.5	328	279.4		152.4	101.6			63.5	111.1	05.043.613.7	1 pair
460	356	245.5	354	304.8		177.8	101.6			88.9	111.1	05.043.614.7	1 pair
400	406	296.5	404	355.6		228.6	101.6			139.7	111.1	05.043.616.7	1 pair
490	457	330.5	455	406.4		203.2	101.6	101.6		88.9	111.1	05.043.618.7	1 pair
440	508	381.5	505	457.2		228.6	101.6	127		114.3	111.1	05.043.620.7	1 pair
410	533	407	531	482.6		241.3	101.6	139.7	127		111.1	05.043.621.7	1 pair
600	559	386.8	557	508	406.4	254	101.6	152.4	139.7		111.1	05.043.622.7	1 pair
540	610	437.7	608	558.8	457.2	279.4	101.6	177.8	165.1		111.1	05.043.624.7	1 pair
500	660	488.5	658	609.6	508	304.8	101.6	203.2	190.5		111.1	05.043.626.7	1 pair
600	711	500	709	660.4	558.8	330.2	101.6	228.6	215.6		111.1	05.043.628.7	1 pair



TEL00173

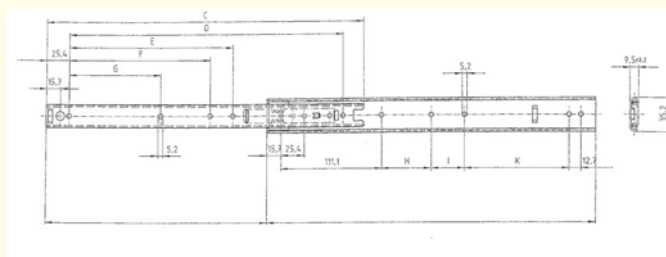

TEL20003

- 3/4 pull-out, two-part
- Locking in pulled-out position (friction lock)
- Quick mechanism for removing and connecting slot-in without tools

**Material**  
Cold rolled steel

**Finish**  
Sendizimir zinc-passivated

**Load rating**  
400 - 600 N static per slide pair depending on length

**Supply schedule**  
1 pair of telescopic slides

**How supplied**  
Flat-packed kit

**Note**  
Please also order assembly set, order number 05.043.595.9



TEL20010

### Stop Spring for Ball Bearing Telescopic Slides

- Quick and easy conversion from form lock to friction lock and vice versa
- Conversion also possible at any later stage

**Material**  
Spring steel

**Supply schedule**  
Set of 10 units

W	H	D	U	Model	Order no.	UP
				Form lock	05.043.666.9	10 unit
				Friction lock	05.043.667.9	10 unit

**Dimensions in mm:** W = Width  
H = Height  
D = Depth  
h = installation height  
d = useful depth  
L = length  
CW = Clear width

U = standard height unit  
1 U = 44.45 mm  
UP = unit of packaging  
kg = weight  
WxL = Surface area

 = Express item

**Conversion:** 1 mm = 0.03937 inch 1 kg = 2.2046 pound

## Ball Bearing Telescopic Slide, BF-480-FLR Full pull-out

mL(N)	A	B	C	D	E	F	G	H	I	K	Order no. 1	UP
455	356	381	354	323.9	311.2	298.5		200	0		05.043.854.7	1 pair
490	406	432.5	404	374.7	362	349.3		139.7	111.1		05.043.856.7	1 pair
495	457	483.5	455	425.5	412.8	400.1		212.7	190.5	111.1	05.043.858.7	1 pair
510	508	530.5	506	476.3	463.6	450.9	365.1	238.1	241.3	111.1	05.043.860.7	1 pair
510	559	584.5	557	527.1	514.4	501.7	415.9	263.5	292.1	111.1	05.043.862.7	1 pair
515	610	635.5	608	277.9	565.2	552.5	466.7	288.9	342.9	111.1	05.043.864.7	1 pair
520	660	686.5	658	628.7	616	603.3	517.5	314.3	393.7	111.1	05.043.866.7	1 pair
520	711	737.5	709	679.5	666.8	654.1	568.3	339.7	444.5	111.1	05.043.868.7	1 pair



TEL00173

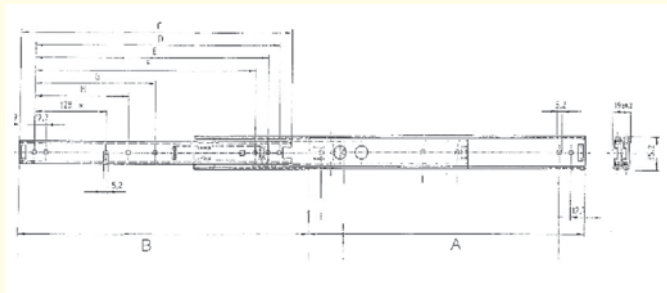

TEL20011

- Full pull-out, three-part
- Locking in pulled-out position (form lock)
- Quick mechanism for removing and connecting slot-in without tools

**Material**

Cold rolled steel

**Finish**

Sendizimir zinc-passivated

**Load rating**

455 - 520 N static per slide pair depending on length

**Supply schedule**

1 pair of telescopic slides

**How supplied**

Flat-packed kit

**Note**

Please also order assembly set, order number 05.043.595.9



TEL00012

### Assembly set for Ball Bearing Slides

- For quick and easy assembly of telescopic slides, BP-400-LR and BF-480-FLR

**Material**

Zincorium plate, 1.5 mm

**Supply schedule**

4 mounting brackets Mounting material

**How supplied**

Flat-packed kit

W	H	D	U	Model	Order no.	UP
				Form lock	05.043.595.9	1 set

**Dimensions in mm:** W = Width  
H = Height  
D = Depth  
h = installation height  
d = useful depth  
L = length  
CW = Clear width  
U = standard height unit  
1 U = 44.45 mm  
UP = unit of packaging  
kg = weight  
WxL = Surface area  
Express item

**Conversion:** 1 mm = 0.03937 inch 1 kg = 2.2046 pound

## The right mounting set for every rack type

Miracel T-slot	Miracel Mount. holes	Miracel Server	Miracel Swing frame	Smaract T-slot	Smaract Mount. holes	Smaract Server	Double-ProRack T-slot	Double-ProRack Mount. holes	ConAct	Name	Order no.	UP
●				●						Mounting set T-slot, M5 wide	05.041.320.9	1 set
	●				●					Mounting set Mount. holes, M5/BI 1.5	05.041.321.9	1 set
		●	●			●				Mounting set Mount. holes M5/BI 2.5	05.041.325.9	1 set
							●			Mounting set dpr T-slot, M5 narrow	05.041.323.9	1 set
								●		Mounting set dpr Mount. holes, M5	05.041.322.9	1 set
									●	Mounting set ConAct M5	05.041.324.9	1 set

## The right mounting set for front panel mounting

### Model: Z-form screw

Miracel T-slot	Miracel Mount. holes	Miracel Server	Miracel Swing frame	Smaract T-slot	Smaract Mount. holes	Smaract Server	Double-ProRack T-slot	Double-ProRack Mount. holes	ConAct	Name	Order no.	UP
●				●						FP mounting set T-slot, M5 wide	05.041.335.9	1 set
	●				●				●	FP mounting set Mount. holes M5/BI 1.5	05.041.336.9	1 set
		●	●			●		●		FP mounting set Mount. holes M5/BI 2.5	05.041.337.9	1 set
							●			FP mounting set T-slot, M5 narrow	05.041.338.9	1 set

### Model: Countersunk screw+rosette

Miracel T-slot	Miracel Mount. holes	Miracel Server	Miracel Swing frame	Smaract T-slot	Smaract Mount. holes	Smaract Server	Double-ProRack T-slot	Double-ProRack Mount. holes	ConAct	Name	Order no.	UP
●				●						FP mounting set T-slot, M5 wide	05.041.340.9	1 set
	●				●				●	FP mounting set Mount. holes M5/BI 1.5	05.041.341.9	1 set
		●	●			●		●		FP mounting set Mount. holes M5/BI 2.5	05.041.342.9	1 set
							●			FP mounting set T-slot, M5 narrow	05.041.343.9	1 set

**Dimensions in mm:** W = Width  
 H = Height  
 D = Depth  
 h = installation height  
 d = useful depth  
 L = length  
 U = standard height unit  
 1 U = 44.45 mm  
 UP = unit of packaging  
 kg = weight  
 = Express item

**Conversion:** 1 mm = 0.03937 inch    1 kg = 2.2046 pound

## The right accessories for every rack type

Miracel T-slot	Miracel Mount. holes	Miracel Server	Miracel Swing frame	Smaract T-slot	Smaract Mount. holes	Smaract Server	Double-ProRack T-slot	Double-ProRack Mount. holes	ConAct	Name	Orderno.	UP
●				●						Spring nut M5 wide	01.350.431.9	1 set
							●			Spring nut M5 narrow	05.041.503.9	1 set
●				●						Spring nut M6	01.350.405.9	1 set
	●				●				●	Caged nut M5/BI 1.5	05.041.513.7	1 set
		●	●			●		●		Caged nut M5/BI 2.5	05.041.518.7	1 set
●				●			●			Oval head screw Z-form M5 x 10	05.041.330.9	1 set
	●	●	●		●	●		●	●	Oval head screw Z-form M5 x 16	05.041.331.9	1 set
●				●			●			Countersunk screw M5 x 12 + rosette	05.041.203.9	1 set
	●	●	●		●	●		●	●	Countersunk screw M5 x 16 + rosette	05.041.290.9	1 set



MIR00114

### Mounting Tool for Caged Nut

- Makes clipping the caged nut into the extrusion easier

**Material**  
Spring steel

**Supply schedule**  
1 mounting tool

W	H	D	U	d	L	Model	Order no.	UP
							01.130.985.9	 1 unit

**Dimensions in mm:** W = Width  
H = Height  
D = Depth  
h = installation height  
d = useful depth  
L = length

U = standard height unit  
1 U = 44.45 mm  
UP = unit of packaging  
kg = weight

 = Express item

**Conversion:** 1 mm = 0.03937 inch    1 kg = 2.2046 pound



MEC20125

## T-Slot Mounting set, M5, Wide For Miracel®/Smaract®

- For mounting 19" front panels and 19" components

- **Supply schedule**  
100 spring nuts M5, wide  
100 oval head screws, Z-form, M5 x 10  
20 caged nuts, M5 / plate, 1.5 mm  
20 cylinder screws, M5 x 8

■ **How supplied**  
Flat-packed kit

W	H	D	U	d	L	Model	Order no.	UP
							05.041.320.9	1 set



MEC20126

## Mounting Holes Mounting Set, M5 For DoubleProRack®

- For mounting 19" front panels and 19" components

- **Supply schedule**  
100 caged nuts M5 / plate, 2.5 mm  
50 oval head screws, Z-form, M5 x 16  
40 spring nuts, M5 narrow  
40 cylinder screws, M5 x 10

■ **How supplied**  
Flat-packed kit

W	H	D	U	d	L	Model	Order no.	UP
							05.041.322.9	1 set



MEC20126

## Mounting Holes Mounting Set, M5 / Plate, 1.5 mm For Miracel®/Smaract®

- For mounting 19" front panels and 19" components

- **Supply schedule**  
100 caged nuts M5 / plate, 1.5 mm  
100 oval head screws, Z form, M5 x 16  
20 spring nuts, M5 wide  
20 cylinder screws, M5 x 8

■ **How supplied**  
Flat-packed kit

W	H	D	U	d	L	Model	Order no.	UP
							05.041.321.9	1 set



MEC20096

## Mounting Holes Mounting Set, M5 For ConAct®

- For mounting 19" front panels and 19" components

- **Supply schedule**  
50 caged nuts M5 / plate, 1.5 mm  
50 oval head screws, Z-form, M5 x 16  
50 cylinder screws, M5 x 8  
25 locking nuts, M5

■ **How supplied**  
Flat-packed kit

W	H	D	U	d	L	Model	Order no.	UP
							05.041.324.9	1 set



MEC20126

## Mounting Holes-Server Extrusion Mounting Set M5 / Plate 2.5 mm for Miracel®/Smaract®

- For mounting 19" front panels and 19" components

- **Supply schedule**  
100 caged nuts M5 / plate, 2.5 mm  
100 oval head screws, Z form, M5 x 16  
20 spring nuts, M5 wide  
20 cylinder screws, M5 x 8

■ **How supplied**  
Flat-packed kit

W	H	D	U	d	L	Model	Order no.	UP
							05.041.325.9	1 set



MEC20129

## Front panel mounting set, T-slot, M5 wide For Miracel®/Smaract®

- For mounting 19" front panels and 19" components

- **Supply schedule**  
**Type 1:**  
50 spring nuts, M5 wide  
50 oval head screws, Z-form, M5 x 10  
**Type 2:**  
50 spring nuts, M5 wide  
50 countersunk screws, M5 x 12  
50 rosettes

■ **How supplied**  
Flat-packed kit



MEC20130

W	H	D	U	d	L	Model	Order no.	UP
						Type 1: Z-form screw	05.041.335.9	1 set
						Type 2: Screw+rosette	05.041.340.9	1 set



MEC20127

## T-Slot Mounting set, M5, Narrow for DoubleProRack®

- For mounting 19" front panels and 19" components

- **Supply schedule**  
100 spring nuts, M5 narrow  
20 oval head screws, Z form, M5 x 10  
50 cylinder screws, M5 x 10  
30 oval head screws, Z form, M5 x 8

■ **How supplied**  
Flat-packed kit

W	H	D	U	d	L	Model	Order no.	UP
							05.041.323.9	1 set



MEC20098

## Front Panel Mounting Set, Mounting Holes, M5/Plate, 1.5 mm For Miracel®/Smaract®/ConAct®

- For mounting 19" front panels and 19" components

- **Supply schedule**  
**Type 1:**  
50 caged nuts M5 / plate, 1.5 mm  
50 oval head screws, Z-form, M5 x 16  
**Type 2:**  
50 caged nuts M5 /plate, 1.5 mm  
50 countersunk screws, M5 x 16  
50 rosettes



Type 2

MEC20097

- **How supplied**  
Flat-packed kit

W	H	D	U	d	L	Model	Order no.	UP
						Type 1: Z-form screw	05.041.336.9	1 set
						Type 2: Screw+rosette	05.041.341.9	1 set



Type 1

MEC20098

### Front Panel Mounting Set, Mounting Holes, M5/Plate, 2.5 mm For Miracel®/Smaract®/DoubleProRack®

- For mounting 19" front panels and 19" components

- **Supply schedule**

#### Type 1:

50 caged nuts M5 / plate, 2.5 mm  
50 oval head screws, Z-form, M5 x 16

#### Type 2:

50 caged nuts M5 /plate, 2.5 mm  
50 countersunk screws, M5 x 16  
50 rosettes

- **How supplied**  
Flat-packed kit



Type 2

MEC20097

W	H	D	U	d	L	Model	Order no.	UP
						Type 1: Z-form screw	05.041.337.9	1 set
						Type 2: Screw+rosette	05.041.342.9	1 set



Type 1

MEC20129

### Front Panel Mounting set, T-Slot, M5, Narrow For DoubleProRack®

- For mounting 19" front panels and 19" components

- **Supply schedule**

#### Type 1:

50 spring nuts, M5 narrow  
50 oval head screws, Z-form, M5 x 10

#### Type 2:

50 spring nuts, M5 narrow  
50 countersunk screws, M5 x 12  
50 rosettes

- **How supplied**  
Flat-packed kit



Type 2

MEC20130

W	H	D	U	d	L	Model	Order no.	UP
						Type 1: Z-form screw	05.041.338.9	1 set
						Type 2: Screw+rosette	05.041.343.9	1 set



MEC00060

### Spring Nut

- For clipping into T-slots at any position

**Type 1:** M5 wide for Miracel / Smaract  
T-nut size: 10 x 13 mm

**Type 2:** M5 narrow for DoubleProRack  
T-nut size: 8 x 13 mm

**Type 3:** M6 for Miracel / Smaract  
T-nut size: 10 x 13 mm

- **Supply schedule**  
50 spring nuts

- **How supplied**  
Flat-packed kit

W	H	D	U	d	L	Model	Order no.	UP
						Type 1: M5 wide	01.350.431.9	1 set
						Type 2: M5 narrow	05.041.503.9	1 set
						Type 3: M6	01.350.405.9	1 set



MEC20139

### Caged nut

- For clipping into extrusions with mounting holes

**Type 1:** Plate, 1.5 mm

For Miracel / Smaract / ConAct / SoHo

**Type 2:** Plate, 2.5 mm

For Miracel Server / Smaract Server / DoubleProRack mounting holes

- **Supply schedule**  
50 caged nuts

- **How supplied**  
Flat-packed kit

W	H	D	U	d	L	Model	Order no.	UP
						M5: Type 1: Plate 1.5 mm	05.041.513.7	1 set
						M5: Type 2: Plate 2.5 mm	05.041.518.7	1 set
						M6: Type 1: Plate 1.5 mm	05.041.514.7	1 set
						M6: Type 2: Plate 2.5 mm	05.041.519.7	1 set



MEC20140

### Oval Head Screw

- IEC DIN 967

- **Supply schedule**  
50 oval head screws, Z-form

- **How supplied**  
Flat-packed kit

W	H	D	U	d	L	Model	Order no.	UP
						M5 x 10	05.041.330.9	1 set
						M5 x 16	05.041.331.9	1 set
						M6 x 10	05.041.332.9	1 set
						M6 x 16	05.041.333.9	1 set



MEC20141

### Countersunk Screw + Rosette

- IEC DIN EN ISO 7047

- **Supply schedule**  
50 countersunk screws  
50 rosettes

- **How supplied**  
Flat-packed kit

W	H	D	U	d	L	Model	Order no.	UP
						M5 x 12	05.041.203.9	1 set
						M5 x 16	05.041.290.9	1 set



MEC80020

## Oval Head Screw Self-guiding

- DIN 7500
- Suitable for system accessories fixed on the inside of the 19" extrusions
- Suitable for 19" steel and 19" aluminum extrusions
- Easy screwing

■ **Supply schedule**  
50 oval head screws, M6x10

■ **How supplied**  
Flat-packed kit

W	H	D	U	d	L	Model	Order no.	UP
						M6 x 10	05.041.334.9	1 set

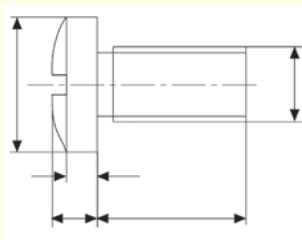

MEC00014

## Oval Head Screw With Phillips head

- IEC DIN EN ISO 7045

■ **Supply schedule**  
1 set of 50 units

W	H	D	U	d	L	Model	Order no.	UP
					8	M 5 no washer	05.041.611.8	1 set
					12	M 4 no washer	05.041.609.8	1 set
					12	M 5 with washer	05.041.613.8	1 set
					16	M 5 with washer	05.041.614.8	1 set
					16	M 6 with washer	05.041.616.8	1 set

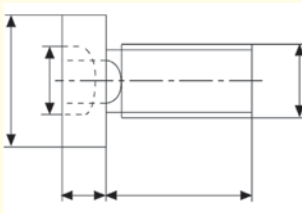

MEC00013

## Cylinder Screw With hexagon head

- IEC ISO 4762 (modified)

■ **Supply schedule**  
1 set of 50 units

W	H	D	U	d	L	Model	Order no.	UP
					8	M 5	05.041.574.8	1 set
					8	M 5 microencapsulated	05.041.575.9	1 set

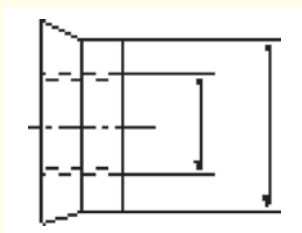

MEC20021

## Tensiloc Nut

■ **Material**  
Steel nickel-plated

■ **Supply schedule**  
1 set of 50 units

W	H	D	U	d	L	Model	Order no.	UP
						M 5	05.041.533.8	1 set



HEI00234

## Cable Entry Rail

Alternative to cable entry via brush strips when installing distributor box in open frames

■ **Material/ Finish**  
Sheet steel, zinc-passivated

■ **Supply schedule**  
1 cable routing panel  
11 bushing sockets  
Mounting material

W	H	D	Model	Order no.	UP
				03.013.386.1	1 unit



ELM00058

## Luminestra Rack Lighting

- Only for rack type Miracel W 700, W 800
- Mounting is made on the basic frame above the vertical extrusions
- With 13 watt fluorescent tube
- With on/off rocker switch
- With 2 m power supply lead and EURO plug
- Complete with mounting material
- Only with 123 mm front jumpering space

■ **Color**  
White

■ **Supply schedule**  
1 Luminestra rack lamp  
2 mounting brackets  
Mounting material

W	H	D	U	h	d	w	Model	Order no.	UP
70	20	555						01.131.227.9	1 unit



ELM00135

## Compact Rack Lamp

■ **Features**  
With magnetic mounting  
Energy-saving lamp  
Protective contact socket  
On/off switch  
3 m power supply lead  
With cover panel

■ **Approval**  
VDE, ICE

■ **Protection rating IP20**

■ **Technical data**  
- Operating voltage 230 V / 50-60 Hz  
- Lighting Compact fluorescent tube with integrated starter  
- Power consumption: 11 W  $\Delta$  75 W bulb  
- Light intensity: 900 Lm  
- Interference suppression in acc. with VDE 0712, IEC 82  
- Socket: 230 VAC / 16A  
- Connections: 3-pole screw clamp 2.5 mm<sup>2</sup> with strain relief

W	H	D	U	h	d	w	Model	Order no.	UP
65	65	365						01.131.465.9	1 unit





HEI00379

## 1 Distribution Box

- For mounting installation technology DIN rail components, such as fuses, clamps, relays, etc.
- In the built-in status, the mounting level can be pulled out at the front, locked in position, and as a result, significantly simplifies the wiring of the individual components
- Not with "fixed installation" model
- On request: Delivered assembled and wired
- Further versions and models on request
- Installation space for up to 22 pieces of equipment with 18 mm width each
- Mounting of the TS35 DIN rail on several levels with simple plug-in connection
- Not with "fixed installation" version
- "Snap-in" mounting of DIN rail components
- Easy access to the protective earth and neutral conductor rails from the front
- Various positioning options prepared for N and PE rails
- Not with "fixed installation" version
- Cable entry at the rear via double brush strip (optionally via bushing sockets)
- Cable strain relief on the inside and therefore accessible from the front
- Labeling strips on the front, above and below the installation space
- Installation options for power distribution with 230 V AC, but also in the low voltage range (e.g. 48 V DC)
- 19" slot-in, 3 U, depth 150 mm

### Material/ Finish

- Covers, powder-coated texture, RAL 7035 light gray
- Main unit, zinc-passivated sheet steel

### Supply schedule

- 1 distribution box
- Including N and PE rails, cable entry, cable strain relief, empty panel covers and earth set

### How supplied

- Fully assembled

W	H	D	U	19"	Model	Order no.	UP
482.6	134	150	3	●	Pull-out	03.013.385.1	1 unit
482.6	134	150	3	●	Fixed installation	03.013.470.1	1 unit



HEI20282

Dimensions in mm: W = Width  
 H = Height  
 D = Depth  
 h = installation height  
 d = useful depth  
 L = length

U = standard height unit  
 1 U = 44.45 mm  
 UP = unit of packaging  
 kg = weight

= Express item

Conversion: 1 mm = 0.03937 inch 1 kg = 2.2046 pound



ELM00137

## Door Contact Switch

- On/off switch, 4 A, 230 V ~
- Activation with door opening and closing

### Supply schedule

- 1 door contact switch (not wired)
- 1 mounting brackets
- Mounting material

W	H	S	U	h	d	kg	Model	Order no.	UP
								01.110.722.9	1 unit



ELM00033

## 1 Cable Junction Box

- For 230V electro-installation on-site
- As fixed-location exchange point
- Quick and easy mounting

### Supply schedule

- 1 cable junction box

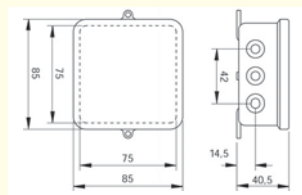

ELM00034

W	H	D	U	h	d	w	Model	Order no.	UP
								00.078.720.9	1 unit



ELM00128

## Modular Terminal Box

- For 230V electro-installation on-site
- With series terminal, 8 x 4<sup>2</sup>
- Pg 11/16 entry
- IP 54

### Material

- High-impact, fire-resistant polystyrene

### Supply schedule

- 1 modular terminal box
- 4 Pg compression glands, Pg11

W	H	S	U	h	d	kg	Model	Order no.	UP
								01.117.521.9	1 unit



ELM00114

## 1 Equipotential Bonding Bar

- For central earthing of all protective conductors
- With sealing cover
- Connection options:
  - 1 x round conductor 8-10 mm Ø
  - 1 x flat conductor up to 30 mm wide or round conductor 8-10 mm Ø
  - 7 x single or several-wire conductors up to 16 mm<sup>2</sup> or fine wire conductor up to 10 mm<sup>2</sup>

### Material

Base and cover, high-impact plastic  
Brass nickel-plated contact strip

### Supply schedule

1 equipotential bonding bar

W	H	S	U	h	d	kg	Model	Order no.	UP
								01.117.524.3	1 unit



ELM00068

## Earthing Bar

- For safe earthing and equipotential bonding of equipment and installation components

### Material

Electrolyte copper, 9x9

### Supply schedule

1 earthing bar  
2 brackets  
Mounting material

W	H	S	U	h	d	kg	Model	Order no.	UP
			24				For DoubleProRack	01.240.546.9	1 unit
			21				For DoubleProRack	01.240.545.9	1 unit
			18				For DoubleProRack	01.240.544.9	1 unit
			15				For DoubleProRack	01.240.543.9	1 unit
			45				For Miracel	01.110.709.9	1 unit
			41				For Miracel	01.110.708.9	1 unit
			12				For Miracel	01.110.703.9	1 unit



DOP20016

## Contact Clamp

- For safe and secure connection of equipment and installation components with the earthing bar
- For cables up to 25 mm<sup>2</sup>

### Supply schedule

20 contact clamps

W	H	S	U	h	d	kg	Model	Order no.	UP
								01.110.715.9	20 unit

Dimensions in mm: W = Width  
H = Height  
D = Depth  
h = installation height  
d = useful depth  
L = length

U = standard height unit  
1 U = 44.45 mm  
UP = unit of packaging  
kg = weight

= Express item

Conversion: 1 mm = 0.03937 inch 1 kg = 2.2046 pound

# Rack PDUs

Liebert MPX™	2.2 to 2.9
Liebert MPH™	2.10 to 2.11
Knürr DI-STRIP®	2.13 to 2.53



## Overview : Emerson Network Power Rack PDUs Europe

Merkmale	Knürr DI-Strip Basic Rack PDU®			Liebert MPH™ Managed Rack PDU		Liebert MPX™ Adaptive Rack PDU			
	Knürr DI-STRIP	Knürr DI-STRIP M	Knürr DI-STRIP RM	Liebert MPH Branch Monitored	Liebert MPH controlled	Liebert MPX Elementary	Liebert MPX Elementary Phase monitored	Liebert MPX Branch monitored	Liebert MPX Receptacle managed
Power distribution	●	●	●	●	●	●	●	●	●
Modular						●	●	●	●
Local display		Fixed	Fixed	Modular	Modular		Modular	Modular	Modular
Remote interface			●	●	●		●	●	●
Measuring on input level		●	●	●	●		●	●	●
Measuring per group				●	●			●	●
Measuring per output									●
Switching per output					●				●
Measuring parameters		A	A	A,V,W,KWh, Hz	A,V,W,KWh, Hz		A,V,W,KWh, Hz	A,V,W,KWh, VA, Hz, power factor	A,V,W,KWh, VA, Hz, power factor, crest factor
Input power	1ph + 3ph max 32A	1ph + 3ph max 32A	1ph + 3ph max 32A	1ph + 3ph max 32A	1ph + 3ph max 32A	1ph + 3ph max 63A	1ph + 3ph max 63A	1ph + 3ph max 63A	1ph + 3ph max 63A
Outputs	IEC C13&C19 Schuko Switzerland France	IEC C13&C19 Schuko Switzerland France	IEC C13&C19 Schuko Switzerland France	IEC C13&C19	IEC C13&C19	IEC C13&C19 Schuko	IEC C13&C19 Schuko	IEC C13&C19 Schuko	IEC C13&C19 Schuko
Different sensors can be connected				●	●		●	●	●

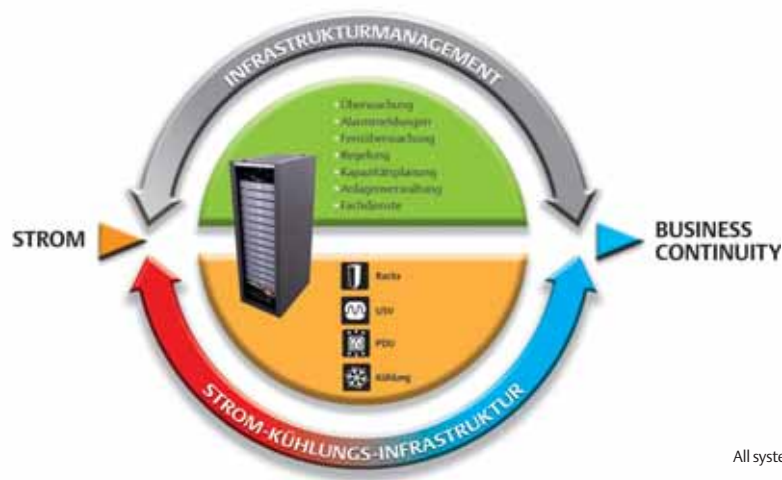

All systems are RoHS compliant.



**Emerson Network Power Rack PDUs**

Liebert MPX™	2.3
Strong points	2.4
Products	2.5
Liebert MPH™	2.10
Strong points	2.10
Products	2.11
Knürr DI-STRIP®	2.13
Strong points	2.15
Knürr DI-STRIP®	
DI-STRIP® RM	2.18
DI-STRIP® M	2.19
DI-STRIP HighPower®	2.20
DI-STRIP® TriplePower®	
DI-STRIP® BladePower®	2.24
DI-STRIP® PizzaPower®	2.25
DI-STRIP® Classic	2.25
DI-STRIP® Compact	2.26
DI-STRIP® Protector	2.27
DI-STRIP® Power Cleaner	2.29
DI-STRIP® Safety Basic	2.30
DI-STRIP® Safety Standard	2.31
DI-STRIP® Master-Slave	2.32
DI-STRIP® Combi	2.33
GST18, 1-phase	2.34
GST18, 3-phase	2.36
Knürr DI-STRIP®	
Euro Plug System	2.38
Knürr DI-STRIP®	
for France	2.41
Knürr DI-STRIP®	
for Switzerland	2.51

**Adaptive Rack PDU**

**Liebert MPX™**

The **Liebert MPX™** modular rack PDU system is particularly impressive with its maximum flexibility, highest possible availability and low operating costs. With the **Liebert MPX™** users can quickly and specifically react to new requirements for power supply and rack management. The **Liebert MPX™** gives users the ability to dimension their rack PDU system so that all current requirements are met first off. The system can then be flexibly adjusted later on when new requirements appear. The **Liebert MPX™** builds on a design that is based on a power supply/communication bus and on input/output modules.

The **Liebert MPX™** modular rack PDU consists of various modules. The foundation stone is a busbar, which is responsible for the power and communication distribution to the individual modules. The input power is routed via the MPX Power Entry Module (MPX PEM) to the MPX system. Different output modules (MPX Branch Receptacle Modules, MPX BRM) are available according to requirements. Four different lines can be set up depending on the equipment:

- **Liebert MPX™** Elementary
- **Liebert MPX™** Elementary Phase monitored
- **Liebert MPX™** Branch monitored
- **Liebert MPX™** Receptacle managed

These lines can also be mixed on a shared busbar, this being one of the exceptional features of the **Liebert MPX™**. Interfaces for the network communication, the sensors and/or the local display are provided by the Liebert Rack PDU Card (Liebert RPC) in the MPX PEM. The Liebert RPC Card enables connection to an optional RPC Basic Display Module (RPC BDM) to display the local status and alarms.



The **Liebert MPX™** is provided as a separate, loosely packaged module for on-site configuration by the user. The MPX was designed especially for quick and easy configuration and re-configuration. Preconfigured systems are also available when ordered as factory-installed Knürr rack enclosure systems.

## Liebert MPX™ Strong points

### ■ Highest possible security and availability with:

- Redundant control electronics power supply (with redundant tapping of various phase in the Power Entry Module)
- Fixed databus on the busbar (making cable breaks a thing of the past)
- With complete data tapping on the PEM (without any additional external monitoring devices)
- Additional neutral conductor measurement
- Crest factor measurement (mains quality evaluation, allowing power supply failures to be identified early on)

### ■ Maximum flexibility and scalability with:

- Configuration of all modules according to their requirements (including input module)
- “Hot-swappable” during running operation
- Feed can be changed (single-phase up to three-phase, 16 up to 63 ampere)
- Mobile display for reading all MPX™ data on the rack
- Optical display of the slot space (easy server slot space identification at the push of a button)

### ■ Ultimate high performance with:

- Power illustration up to 28 kVA per bar and 55°C ambient temperature
- Only one IP address for up to 4 bars with 24 modules
- Plug and play for numerous sensors

- Extensive monitoring with a measuring accuracy of +/- 1% up to output level
- Module and sensor autodetect function with operating software
- Lowest possible MPX™ system power loss

### ■ Perfect for blade servers and changing environments

Data centers work more and more with high performance blade servers and require more processor power on low rack space; cabling must be simplified; power consumption must be reduced. With the MPX™ the data center can quickly react to changes, which is why our product is the right choice for your infrastructure's administration.



#### **Status display (RPC-BDM)**

Can be easily positioned at the optimum spot for the individual rack; even functions outside the rack. This connected display can be mounted just as the user wishes.



DOS20153

## Liebert MPX™ PRC - Power Distribution Unit/Communication Bus

- The MPX PRC is the foundation stone of the Liebert MPX PDU.
- Power and data transfer buses are integrated fixed over the entire length of the MPX PRC.
- The MPX BRMs (output modules) and the MPX PEM (power entry module) are fixed on the MPX PRC and depending on the type take care of the modules' power feed, output, monitoring and management.

**Material/ Finish**  
 Busbars housing: Aluminum  
 Busbars: Copper  
 Databus: Gilded

**Dimensions**  
 Width: 68 mm  
 Height: 24 mm

**Color**  
 Housing: aluminum

**Approvals**  
 - CE label in accordance with low voltage guideline 2006/95/EWG  
 - EMC Directive 2004/108/EC  
 - Innova GS

**Load rating**  
 Max. current intensity: 3 x 63 A  
 Nominal voltage (L-N / L-L): 230 / 400 Vac

**Supply schedule**  
 1 Liebert MPX™ PRC - Power Distribution Unit/Communication Bus  
 1 mounting set  
 Operating instructions

L	W	H	U	Model	Order no.	UP
1035	68	24	23	1 PEM (220mm) + 3 BRM	MPXPRC-V1035XXX	1 unit
1880	68	24	42	1 PEM (220/266mm) + 6 BRM	MPXPRC-V1880XXX	1 unit



DOS20153

## Liebert MPX™ – Input Module/Power Supply

- Elementary and Monitored type:**
- The MPX PEM is fixed on the MPX PRC and provides the connection to the power supply.
  - Cable is connected fixed, 3 m long
  - With IEC60309 plug, 1Ph/N/PE 6h blue, 3Ph/N/PE 6h red

- Monitored type:**
- The MPX PEM provides the connection to the databus for the data communication.
  - The MPX PEM has an installation slot into which the RPC-1000 communication card can be installed. (Not in the supply schedule)
  - Provides the following measured values of the phase inputs: real power, current, voltage, frequency and consumption.
  - Power alarm functions for the individual phases and their operating status are also supported.
  - Further important features: Three displays inform the user about the current status of each individual input. An acoustic alarm is activated with specific overload conditions.

**Material/ Finish**  
 Housing: Aluminum  
 Cover: Sheet steel  
 Power contacts: Silvered  
 Databus contacts: Gilded (only Monitored type)

**Dimensions**  
 Width: 75 mm  
 Height: 65 mm  
 Cable: 3 m

**Color**  
 Housing: Aluminum/RAL 9011 black

**Approvals**  
 - CE label in accordance with low voltage guideline 2006/95/EWG  
 - EMC Directive 2004/108/EC  
 - Innova GS

**Supply schedule**  
 1 MPX PEM - Power Entry Module incl. connection cable  
 Operating instructions

L	W	H	U	Feed	Load rating	Type	Order no.	UP
220	75	65		Fixed	230Vac, max 32A	Elementary	MPXPPEM-EHAEXQ30	1 unit
220	75	65		Fixed	230/400Vac, max 16A	Elementary	MPXPPEM-EHAEXT30	1 unit
220	75	65		Fixed	230/400Vac, max 32A	Elementary	MPXPPEM-EHAEXR30	1 unit
266	75	65		Fixed	230/400VacC, max 63A	Elementary	MPXPPEM-EHBEXZ30	1 unit
220	75	65		Fixed	230Vac, max 32A	Monitored	MPXPPEM-EHAXXQ30	1 unit
220	75	65		Fixed	230/400Vac, max 16A	Monitored	MPXPPEM-EHAXXT30	1 unit
220	75	65		Fixed	230/400Vac, max 32A	Monitored	MPXPPEM-EHAXXR30	1 unit
266	75	65		Fixed	230/400Vac, max 63A	Monitored	MPXPPEM-EHBXXZ30	1 unit



DOS20153

## Liebert MPX™ BRM - Output Module

- The MPX BRM takes care of the power distribution to the individual load
- Each module taps a phase; this is color-identified on the module.
- All modules are protected against overload with a 20A circuit breaker.
- Changing the modules during operation enables a user-defined installation, without having to shut down the Liebert MPX.
- Up to 3 BRM output modules can be installed on a 1035 mm PRC busbar; up to 6 BRM output modules can be installed on a 1880 mm PRC busbar.

### Type E - Elementary:

- Module for power distribution via respective outputs

### Type B – Branch monitored:

- Module for power distribution via respective outputs with measuring function on module level
- The MPX BRMs have an LED-ID indicator, which clearly identifies every module with a number.
- The modules are administered in the software
- Provides the following measured values: power, current, voltage, apparent power, kWh and power factor
- Power alarm functions and the operating status are supported

### Type R – Receptacle managed:

- Module for power distribution via respective outputs with measuring function on module level and output level

- The MPX BRMs have an LED-ID indicator, which clearly identifies every module with a number.
- The modules are administered in the software
- Provides the following measured values: power, current, voltage, apparent power, kWh, frequency, power factor and crest factor
- Power alarm functions and the operating status are supported
- The individual outputs can be switched on and off remotely

### Material/ Finish

- Housing: Aluminum
- Cover: Sheet steel
- Power contacts: Silvered
- Databus contacts: Gilded (only type B and R)

### Dimensions

- Width: 75 mm
- Height: 65 mm

### Color

- Housing: Aluminum/RAL 9011 black

### Approvals

- CE label in accordance with low voltage guideline 2006/95/EWG
- EMC Directive 2004/108/EC
- Innova GS

### Supply schedule

- 1 MPX™ BRM Output Module
- Operating instructions

L	n	Outputs	Load rating per output	Phase tapping	Type	Order no.	UP
266	7	IEC320 Sheet F	10A	L1	E	MPXBRM-EEBC7N1N	1 unit
266	7	IEC320 Sheet F	10A	L2	E	MPXBRM-EEBC7N2N	1 unit
266	7	IEC320 Sheet F	10A	L3	E	MPXBRM-EEBC7N3N	1 unit
266	4	IEC320 Sheet J	16A	L1	E	MPXBRM-EEBC4O1N	1 unit
266	4	IEC320 Sheet J	16A	L2	E	MPXBRM-EEBC4O2N	1 unit
266	4	IEC320 Sheet J	16A	L3	E	MPXBRM-EEBC4O3N	1 unit
266	3	Schuko CEE 7/4	16A	L1	E	MPXBRM-EEBC3P1N	1 unit
266	3	Schuko CEE 7/4	16A	L2	E	MPXBRM-EEBC3P2N	1 unit
266	3	Schuko CEE 7/4	16A	L3	E	MPXBRM-EEBC3P3N	1 unit
266	6	IEC320 Sheet F	10A	L1	B	MPXBRM-EBBC6N1N	1 unit
266	6	IEC320 Sheet F	10A	L2	B	MPXBRM-EBBC6N2N	1 unit
266	6	IEC320 Sheet F	10A	L3	B	MPXBRM-EBBC6N3N	1 unit
266	4	IEC320 Sheet J	16A	L1	B	MPXBRM-EBBC4O1N	1 unit
266	4	IEC320 Sheet J	16A	L2	B	MPXBRM-EBBC4O2N	1 unit
266	4	IEC320 Sheet J	16A	L3	B	MPXBRM-EBBC4O3N	1 unit
266	3	Schuko CEE 7/4	16A	L1	B	MPXBRM-EBBC3P1N	1 unit
266	3	Schuko CEE 7/4	16A	L2	B	MPXBRM-EBBC3P2N	1 unit
266	3	Schuko CEE 7/4	16A	L3	B	MPXBRM-EBBC3P3N	1 unit
266	6	IEC320 Sheet F	10A	L1	R	MPXBRM-ERBC6N1N	1 unit
266	6	IEC320 Sheet F	10A	L2	R	MPXBRM-ERBC6N2N	1 unit
266	6	IEC320 Sheet F	10A	L3	R	MPXBRM-ERBC6N3N	1 unit
266	4	IEC320 Sheet J	16A	L1	R	MPXBRM-ERBC4O1N	1 unit
266	4	IEC320 Sheet J	16A	L2	R	MPXBRM-ERBC4O2N	1 unit
266	4	IEC320 Sheet J	16A	L3	R	MPXBRM-ERBC4O3N	1 unit
266	3	Schuko CEE 7/4	16A	L1	R	MPXBRM-ERBC3P1N	1 unit
266	3	Schuko CEE 7/4	16A	L2	R	MPXBRM-ERBC3P2N	1 unit
266	3	Schuko CEE 7/4	16A	L3	R	MPXBRM-ERBC3P3N	1 unit





DOS20153

## Liebert RPC - 1000 Communication Card

- The Liebert RPC centralizes the Liebert MPX local and remote administration.
- Administration via web and SNMP for systems connected to the Ethernet.
- Also serves as the connection point for versatile support options and devices, such as the display module (RPC BDM), various sensors and connection to other Liebert MPX or Liebert MPH systems, for example.
- Has RJ-45 ports for all connections and does not require any special cabling.
- Supports 10 and 100 MBit Ethernet and provides on-site firmware upgrade.
- Installed in an MPX PEM (input module) slot.

### Technical data Interfaces:

- RJ-45 LAN port (10/100 MBit) – for connecting to the local network (LAN) via an Ethernet cable

- Expansion/administration port for local configuration using a computer/laptop, for setting up a link-up of several PDUs (Liebert MPX or MPH)
- Display port for connecting the RPC BDM (display module)
- External sensor port for connecting optional sensors

### Supported technologies:

- Web support, provides Liebert MPX control and management. Authorized users can view status information via their network.
- SNMP support, provides Liebert MPX SNMP management.
- Easy integration into Liebert Nform, Avocent DSVIEW3 and Nagios

### Supply schedule

- 1 RPC-1000 communication card
- Operating instructions

L	W	H	U	Model	Order no.	UP
					RPC-1000	1 unit



DOS20153

## Liebert RPC BDM - 1000 Display Module

- Provides the local display of the monitored data for all connected Liebert MPX and Liebert MPH systems.
- Operated with the aid of a navigation switch.
- Connected via a cable with the Liebert RPC, which provides the user the option of placing the displays where they can be easily read in accordance with the local space conditions.
- An individual display can be used for up to four Liebert MPX or Liebert MPH PDUs, which are connected to a PDU array.

### Note

The Display Module is not required for operating the Liebert MPX or MPH, but it itself requires the Liebert RPC-1000 (communication card)

### Supply schedule

- 1 RPCBDM-1000 Display Module
- 1 2m power supply lead
- 1 mounting set
- Operating instructions

L	W	H	U	Model	Order no.	UP
					RPCBDM-1000	1 unit



DOS20153

## Liebert MPX™/MPH™ Sensors

- The sensors are designed for tool-less installation in a Knürr Miracel Rack, but they can also be installed in any other rack.
- "Fixed" type sensors are fixed to a cable.
- "Modular" type sensors can be connected with the delivered cable.
- Are affixed to the RPC-1000 communication card
- Several sensors can be connected in rows (max. length: 20m)
- Are automatically displayed in the Liebert MPX/MPH software
- Temperature measuring range: 5-55°C

- Accuracy: +/- 0.5°C
- Humidity measuring range: 10 – 95%
- Accuracy: +/- 3.5%

### Note

The sensors are not required for operating the Liebert MPX or MPH, but they require the Liebert RPC-1000 (communication card)

### Supply schedule

1 sensor with connection cable  
Operating instructions

Cable length	Type	Model	Order no.	UP
3660	Fixed	Single temp. sensor	SN-Z01	1 unit
5180	Fixed	Triple temp. sensor	SN-Z02	1 unit
5180	Fixed	Triple temp. sensor + single humidity	SN-Z03	1 unit
2000	Modular	Single temp. sensor	SN-T	1 unit
2000	Modular	Triple temp. sensor + single humidity	SN-TH	1 unit
2000	Modular	2 x door contact - input module*	SN-2D	1 unit
2000	Modular	3 x digital input	SN-3C	1 unit

\* Suitable door contact switch: Order no.: 06.108.115.9

## Order Numbers : Liebert MPX™ Europe

		Order number	MPX Elementary	MPX Elementary Phase monitored	MPX Branchmonitored	MPX Receptaclemanaged
<b>Busbars</b>	Length 1035	MPXPRC-V1035XXX	●	●	●	●
	Length 1880	MPXPRC-V1880XXX	●	●	●	●
<b>Input modules</b>	1ph 32A fixed	MPXPEM-EHAEXQ30	●			
		MPXPEM-EHAXXQ30		●	●	●
	3ph 16A fixed	MPXPEM-EHAEXT30	●			
		MPXPEM-EHAXXT30		●	●	●
	3ph 32A fixed	MPXPEM-EHAEXR30	●			
		MPXPEM-EHAXXR30		●	●	●
	3ph 63A fixed	MPXPEM-EHBEXZ30	●			
		MPXPEM-EHBXXZ30		●	●	●
<b>Output modules: Elementary</b>	IEC-C13 L1	MPXB RM-EEBC7N1N	●	●		
	IEC-C13 L2	MPXB RM-EEBC7N2N	●	●		
	IEC-C13 L3	MPXB RM-EEBC7N3N	●	●		
	IEC-C19 L1	MPXB RM-EEBC4O1N	●	●		
	IEC-C19 L2	MPXB RM-EEBC4O2N	●	●		
	IEC-C19 L3	MPXB RM-EEBC4O3N	●	●		
	Schuko L1	MPXB RM-EEBC3P1N	●	●		
	Schuko L2	MPXB RM-EEBC3P2N	●	●		
	Schuko L3	MPXB RM-EEBC3P3N	●	●		
<b>Output modules: Branch monitored</b>	IEC-C13 L1	MPXB RM-EBBC6N1N			●	
	IEC-C13 L2	MPXB RM-EBBC6N2N			●	
	IEC-C13 L3	MPXB RM-EBBC6N3N			●	
	IEC-C19 L1	MPXB RM-EBBC4O1N			●	
	IEC-C19 L2	MPXB RM-EBBC4O2N			●	
	IEC-C19 L3	MPXB RM-EBBC4O3N			●	
	Schuko L1	MPXB RM-EBBC3P1N			●	
	Schuko L2	MPXB RM-EBBC3P2N			●	
	Schuko L3	MPXB RM-EBBC3P3N			●	
<b>Output modules: Receptacle managed</b>	IEC-C13 L1	MPXB RM-ERBC6N1N				●
	IEC-C13 L2	MPXB RM-ERBC6N2N				●
	IEC-C13 L3	MPXB RM-ERBC6N3N				●
	IEC-C19 L1	MPXB RM-ERBC4O1N				●
	IEC-C19 L2	MPXB RM-ERBC4O2N				●
	IEC-C19 L3	MPXB RM-ERBC4O3N				●
	Schuko L1	MPXB RM-ERBC3P1N				●
	Schuko L2	MPXB RM-ERBC3P2N				●
<b>Interface card</b>		RPC-1000		●	●	●
				●	●	●
<b>Sensors</b>	1xTemp.	SN-Z01		●	●	●
	3xTemp.	SN-Z02		●	●	●
	3xT. + 1xHum	SN-Z03		●	●	●
	1xTemp. Mod.	SN-T		●	●	●
	Temp/Hum Mod.	SN-TH		●	●	●
	2xDoor Mod.	SN-2D		●	●	●
	3xInput Mod.	SN-3C		●	●	●
<b>Display ext.</b>		RPCBDM-1000		●	●	●

Upgrade possible !

Different combinations possible !

## Managed Rack-PDU

# Liebert MPH™

The **Liebert MPH®** Managed Rack PDU is a power supply system with monitoring and control functions.

The **Liebert MPH®** monitors the current, voltage, kW and kWh of the individual input phases, as well as the current per group with the 32A variants. The individual outputs can be switched on and off remotely depending on the type. Limit values, alarms and status can be retrieved and set. The housing consists of a robust sheet steel enclosure, so that the PDU can be easily installed in a Knürr rack, or even into other enclosure systems. The Liebert MPH can be installed vertically or horizontally (19"), depending on the type. The PDU is delivered pre-installed with the same communication card (RPC-1000) as the Liebert MPX®. All Liebert MPX® external modules can therefore be connected (e.g. sensors, display module). Up to 4 MPX/MPH can be connected as rack PDU array to consolidate the user's IP connection and the device monitoring.

## Liebert MPH™ Strong points

### ■ Liebert MPH™

#### **Control technology support**

The monitored electrical parameters include: effective power, current intensity, voltage and accumulated energy or consumption. Capacity-oriented current intensity threshold values enable detailed rack PDU alarm signals.

### ■ Liebert MPH™:

- The benefit for your data center: Monitors electrical and environment parameters with threshold values and alarm management
- Controls access to the socket power
- Controls and administers individual sockets and/or groups of consumers and devices

- Forecasts failure situations before they occur and actively administers connected devices for maximum operating time

### ■ Liebert MPH™ benefits: Flexibility

- A local display can be easily mounted and adjusted to heavily equipped and changing rack environments
- Mounting in 19" and 42 U rack environments
- Form factor: vertical (0 U) and rack mounting
- Compatible monitoring platform for Liebert MPH™ and Liebert MPX™ with seamless simultaneous operation
- Individually positioned interface for input network cable

## Higher availability

- Controls and administers individual sockets
- Forecasts overcurrent conditions before critical phase
- Switches off redundant devices with power failures to increase availability and backup power
- Extended overload protection in branch lines minimizes danger with cascaded PDU overload

## Extremely low operating costs

- Comprehensive control technology in a cost-effective package
- The rack PDU array uses a shared IP address for up to four racks of PDUs, making installation quicker and easier
- Energy and current measurement provides data for maximizing the data center's current and cooling infrastructure
- Energy efficient control technology for sockets



DOS20153

## Liebert MPH™ Rack PDU

- The **Liebert MPH® Type M** is a monitored power distribution unit that monitors the phase inputs.
- Measured per phase are: power, current, voltage and consumption. The current is also monitored per group (only 32A model).
- The **Liebert MPH® Type C** can also switch the individual outputs on and off remotely.
- Integrated Liebert RPC-1000 communication card enables remote monitoring and maintenance of MPH units.
- The RPC-1000 enables the interconnection of several MPH or MPX units and connection of the Liebert MPH® with the Liebert MPX® units for monitoring and administration.
- The Liebert MPH® can be monitored directly on-site with the RPC BDM-1000, an optional display module that is connected directly with the communication card. The monitoring unit can be flexibly mounted on the rack.

### Material/ Finish

Housing: Sheet steel extrusion

### Dimensions

Width: 50 mm (vertical), 178 mm (19")  
Height: 80 mm (vertical), 44 mm (19")

### Color

Housing: RAL 7021 dark gray

### Approvals

- CE label in accordance with Low Voltage Directive 2006/95/EC
- EMC Directive 2004/108/EC
- GS

### Supply schedule

- 1 Liebert MPH® Socket Strip (PDU)
- 1 mounting brackets
- Operating instructions

L	Type	Input values	Input plug	Outputs IEC320	Order no.	UP
438*	M	230Vac, 16A	IEC320-Sheet I	9xSheet F	MPH-EBR09NXXO30	1 unit
438*	M	230Vac, 32A	IEC60309 1ph/N/PE 6h	9xSheet F	MPH-EBR09NXXQ30	1 unit
1730	M	230Vac, 16A	IEC320-Sheet I	27xSheet F	MPH-EBV27NXXO30	1 unit
1730	M	230Vac, 16A	IEC320-Sheet I	21xSheet F/6xSheet J	MPH-EBV27NOXO30	1 unit
1730	M	230Vac, 32A	IEC60309 1ph/N/PE 6h	21xSheet F/6xSheet J	MPH-EBV27NOXQ30	1 unit
1730	M	230Vac, 32A	IEC60309 1ph/N/PE 6h	27xSheet F	MPH-EBV27NXXQ30	1 unit
1730	M	230/400Vac, 32A	IEC60309 3ph/N/PE 6h	27xSheet F	MPH-EBV27NXXR30	1 unit
1730	M	230/400Vac, 32A	IEC60309 3ph/N/PE 6h	21xSheet F/6xSheet J	MPH-EBV27NOXR30	1 unit
438*	C	230Vac, 16A	IEC320-Sheet I	9xSheet F	MPH-ECR09NXXO30	1 unit
438*	C	230Vac, 32A	IEC60309 1ph/N/PE 6h	9xSheet F	MPH-ECR09NXXQ30	1 unit
1730	C	230Vac, 16A	IEC320-Sheet I	27xSheet F	MPH-ECV27NXXO30	1 unit
1730	C	230Vac, 16A	IEC320-Sheet I	21xSheet F/6xSheet J	MPH-ECV27NOXO30	1 unit
1730	C	230Vac, 32A	IEC60309 1ph/N/PE 6h	21xSheet F/6xSheet J	MPH-ECV27NOXQ30	1 unit
1730	C	230Vac, 32A	IEC60309 1ph/N/PE 6h	27xSheet F	MPH-ECV27NXXQ30	1 unit
1730	C	230/400Vac, 32A	IEC60309 3ph/N/PE 6h	27xSheet F	MPH-ECV27NXXR30	1 unit
1730	C	230/400Vac, 32A	IEC60309 3ph/N/PE 6h	21xSheet F/ 6xSheet J	MPH-ECV27NOXR30	1 unit

\*(19")



DOS20153

## Liebert MPX™/MPH™ Sensors

- The sensors are designed for tool-less installation in a Knürr Miracel Rack, but they can also be installed in any other rack.
- "Fixed" type sensors are fixed to a cable.
- "Modular" type sensors can be connected with the delivered cable.
- Are affixed to the RPC-1000 communication card
- Several sensors can be connected in rows (max. length: 20m)
- Are automatically displayed in the Liebert MPX/MPH software
- Temperature measuring range: 5-55°C

- Accuracy: +/- 0.5°C
- Humidity measuring range: 10 – 95%
- Accuracy: +/- 3.5%

### Note

The sensors are not required for operating the Liebert MPX or MPH, but they require the Liebert RPC-1000 (communication card)

### Supply schedule

1 sensor with connection cable  
Operating instructions

Cable length	Type	Model	Order no.	UP
3660	Fixed	Single temp. sensor	SN-Z01	1 unit
5180	Fixed	Triple temp. sensor	SN-Z02	1 unit
5180	Fixed	Triple temp. sensor + single humidity	SN-Z03	1 unit
2000	Modular	Single temp. sensor	SN-T	1 unit
2000	Modular	Triple temp. sensor + single humidity	SN-TH	1 unit
2000	Modular	2 x door contact - input module*	SN-2D	1 unit
2000	Modular	3 x digital input	SN-3C	1 unit

\* Suitable door contact switch: Order no.: 06.108.115.9



DOS20153

## Liebert RPC BDM - 1000 Display Module

- Provides the local display of the monitored data for all connected Liebert MPX and Liebert MPH systems.
- Operated with the aid of a navigation switch.
- Connected via a cable with the Liebert RPC, which provides the user the option of placing the displays where they can be easily read in accordance with the local space conditions.
- An individual display can be used for up to four Liebert MPX or Liebert MPH PDUs, which are connected to a PDU array.

### Note

The Display Module is not required for operating the Liebert MPX or MPH, but it itself requires the Liebert RPC-1000 (communication card)

### Supply schedule

1 RPCBDM-1000 Display Module  
1 2m power supply lead  
1 mounting set  
Operating instructions

L	W	H	U	Model	Order no.	UP
					RPCBDM-1000	1 unit



The image shows three server racks in a data center. Each rack has a different PDU model installed vertically on the left side. The racks are filled with server components, and the floor is made of square tiles.

**Liebert MPX™**  
Adaptive Rack PDU

**Liebert MPH™**  
Managed Rack PDU

**Knürr DI-STRIP®**  
Basic Rack PDU

## Emerson Network Power Rack PDUs

Knürr DI-STRIP® Strong points	2.15
Knürr DI-STRIP® DI-STRIP® RM	2.18
DI-STRIP® M	2.19
DI-STRIP HighPower®	2.20
DI-STRIP® TriplePower®	
DI-STRIP® BladePower®	2.24
DI-STRIP® PizzaPower®	2.25
DI-STRIP® Classic	2.25
DI-STRIP® Compact	2.26
DI-STRIP® Protector	2.27
DI-STRIP® Power Cleaner	2.29
DI-STRIP® Safety Basic	2.30
DI-STRIP® Safety Standard	2.31
DI-STRIP® Master-Slave	2.32
DI-STRIP® Combi	2.33
GST18, 1-phase	2.34
GST18, 3-phase	2.36
Knürr DI-STRIP® Euro Plug System	2.38
Knürr DI-STRIP® for France	2.41
Knürr DI-STRIP® for Switzerland	2.51

### Basic Rack PDU

# Knürr DI-STRIP®

Knürr's **Basic Rack PDUs** are the solution for every data center looking for robust, economical and flexible rack concepts.

The Knürr **DI-STRIP®** product family meets the power distribution requirements of many IT applications and other areas. Specially configured for the growing number of electronic components in network switching racks or server racks. Available with the most diverse accessories, such as circuit breakers, overvoltage protection, mains filter, master-slave function, emergency off button, fault current circuit breaker, local and remote power measurement, for example.

#### Knürr DI-STRIP® M:

The DI-STRIP M model monitors the input current per phase locally. An unbalanced load warning is also shown on the display with 3ph PDUs. The displays can be changed in 90° steps with a selector switch.

#### Knürr DI-STRIP® RM:

The DI-STRIP RM model monitors the input current per phase locally and remote. Unbalanced load warning and different threshold values can be set and remotely forwarded.



1 DOS00291

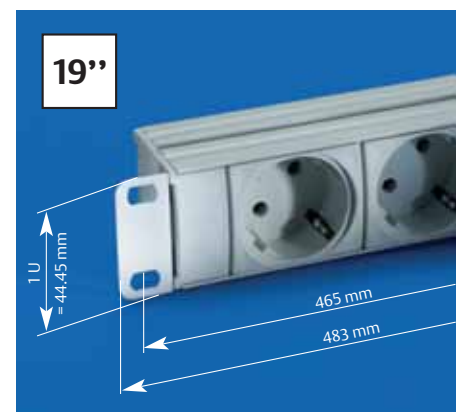

4 DOS00365





5 DOS00721



7 DOS00366



8 DOS20131



9 DOS20134

## Knürr DI-STRIP® Strong points

- 1 Robust!**  
Protects the plug panel with high casing edges.
- 2 Stability**  
High stability and torsional strength provided with closed sheet steel casing.
- 3 Electrical safety**  
Full power to all connected consumers with full-length brass busbar.  
Shock hazard-proof and low contact resistance with double spring contacts.
- 4 19" installation**  
Optimum use of space with 19" installation:  
- With low height – 1 U (44.45 mm)  
- With 45° positioning of the sockets
- 5 International compatibility**  
Numerous standard products in accordance with international standards. Special models on request.
- 6 Flexibility**  
Plenty of room for movement with 2.5 m power supply cable.  
Flexibility provided by standard plug with dual earthing system.
- 7 Aesthetics**  
Appealing design with extruded casing and design side panels in visible area.
- 8 Cost-effective**  
Quick and easy mounting on the rack extrusion.
- 9 Universal**  
1 and 3-phase systems.
- 10 Modularity**  
Socket strip modules can be easily combined using plug-in connections.
- 10 Plug-in**  
Proven GST18 plug-in system for connecting socket strip modules.
- 11 Certifications**  
Global approvals and certifications are a quality feature.



9 DOS20134



10 DOS20142



10 DOS20144

# Emerson Network Power Rack PDUs

		 <b>Standard DIN 49 440</b>
<ul style="list-style-type: none"> <li>■ <b>DI-STRIP® Classic</b> - Socket spacing: 100 mm - With/without switch</li> </ul>		Page 2.25  DOS00402
<ul style="list-style-type: none"> <li>■ <b>DI-STRIP® Compact</b> - Socket spacing: 50 mm - With/without switch</li> </ul>		Page 2.26 <span style="float: right; border: 1px solid black; padding: 2px;">19"</span>  DOS00401
<ul style="list-style-type: none"> <li>■ <b>DI-STRIP® Protector</b> - User protection (FI) - Circuit breaker (LS) - User protection and circuit breaker (FI/LS) - Equipment protection (BladePower/PizzaPower)</li> </ul>		Page 2.27 <span style="float: right; border: 1px solid black; padding: 2px;">19"</span>  DOS00394
<ul style="list-style-type: none"> <li>■ <b>DI-STRIP® Protector Emergency STOP</b> - User protection / circuit breaker (FI/LS) - With emergency stop switch</li> </ul>		Page 2.28 <span style="float: right; border: 1px solid black; padding: 2px;">19"</span>  DOS00455
<ul style="list-style-type: none"> <li>■ <b>DI-STRIP® Power Cleaner</b> - Mains filter (MF)</li> </ul>		Page 2.29 <span style="float: right; border: 1px solid black; padding: 2px;">19"</span>  DOS00400
<ul style="list-style-type: none"> <li>■ <b>DI-STRIP® Safety Basic</b></li> <li>■ <b>DI-STRIP® Safety Standard</b> - Overvoltage protection</li> </ul>		Page 2.30 <span style="float: right; border: 1px solid black; padding: 2px;">19"</span>  DOS00397
<ul style="list-style-type: none"> <li>■ <b>DI-STRIP® Master Slave</b> - Automatic consumer switching</li> </ul>		Page 2.32 <span style="float: right; border: 1px solid black; padding: 2px;">19"</span>  DOS00366
<ul style="list-style-type: none"> <li>■ <b>DI-STRIP® Combi</b> - Automatic consumer switching with overvoltage protection and mains filter</li> </ul>		Page 2.32  DOS00399
<ul style="list-style-type: none"> <li>■ <b>DI-STRIP® GST18 Compact/Master Slave/Safety Basic/Safety Standard/IEC320</b> - Without cable for GST18 plug-in system (Wieland)</li> <li>■ <b>GST18 Accessories</b></li> </ul>		Page 2.34  DOS00679
<ul style="list-style-type: none"> <li>■ <b>DI-STRIP® M and DI-STRIP® RM</b></li> </ul>		Page 2.18  DOS80015
<ul style="list-style-type: none"> <li>■ <b>DI-STRIP® HighPower</b></li> </ul>		

# Emerson Network Power Rack PDUs

 Euro Plug System	 UTE Standard	 Swiss Standard	 Three-Phase Current Plug-In System
	Page 2.41  DOS00402	Page 2.51  DOS00717	
Page 2.38  DOS00457	Page 2.42  DOS00401	Page 2.52  DOS20074	Page 2.23  DOS20121
Page 2.24  DOS20155a	Page 2.43  DOS20065	Page 2.53  DOS00719	Page 2.25  DOS20153a
	Page 2.44  DOS20059		
Page 2.35  DOS20108	Page 2.45  DOS00400		
Page 2.35  DOS20110	Page 2.46  DOS00397	Page 2.53  DOS00720	
	Page 2.48  DOS00464		
	Page 2.49  DOS00399		
Page 2.35  DOS20112	Page 2.50  DOS00463		Page 2.36  DOS20103
Page 2.18  DOS80001			Page 2.23  DOS80001
Page 1.21  DOS80015			Page 2.21  DOS80015



DOS80002

## Knürr DI-STRIP® RM

- Real RMS value display for the alternating current per phase
- LCD display rotation in 90° steps
- Display bright/dark switchover
- Warning display for unbalanced load
- Load changes signaling
- Automatic background light reduction

### Data interface:

- The plug strip can be integrated into the network via an RJ45 plug.
- Access is possible without special software via a remote browser.
- Three variable limit values and a warning for unbalanced loads can be specified.
- The module enables access for up to 5 users or administrators; access is password-protected.
- The software displays the name and place of the PDU; this information can be entered by an administrator.
- The user can specify a static IP address or access using DHCP.
- Firmware updates can be made via a web browser.
- Supported protocols: HTTP, SNMP (Traps, SET, GET), Syslog

### Material/ Finish

- PizzaPower model:  
Housing: Sheet steel, zinc-passivated, powder-coated
- Other models:  
Housing: closed sheet steel extrusion, zinc-passivated, powder-coated texture  
Plastic parts: Vampamid 6 0024 VO (UL94), recyclable

### Dimensions

- Width: 84 mm (PizzaPower), 44.4 mm (others)
- Height: 60 mm (PizzaPower), 44.4 mm (others)

### Color

- PizzaPower model:  
Housing: RAL 9005 black  
Other models:  
Housing: RAL 7035 light gray  
Plastic parts: RAL 7021 dark gray

### Approvals

- 1 in accordance with low voltage guideline 2006/95/EWG
- EMC Directive 2004/108/EC
- GS

### Supply schedule

- 1 socket strip (PDU) with remote ampere meter
- 1 mounting brackets
- Operating instructions

L	Type	Input values	Input plug	Outputs IEC60320			Order no.	UP
				Sheet F	Sheet J	Schuko		
733	DI-STRIP® Compact RM 8	230Vac, 16A	Schuko CEE 7/4			8	<b>03.307.008.1</b>	1 unit
1183	DI-STRIP® Compact RM 17	230Vac, 16A	Schuko CEE 7/4			17	<b>03.307.017.1</b>	1 unit
633	IEC320 RM9	230Vac, 16A	Schuko CEE 7/4	9			<b>03.607.009.1</b>	1 unit
933	IEC320 RM18	230Vac, 16A	Schuko CEE 7/4	18			<b>03.607.018.1</b>	1 unit
1133	DI-STRIP® TriplePower RM	230/400Vac, 16A	IEC60309 3ph/N/PE 6h	18			<b>03.607.825.1</b>	1 unit
1833	DI-STRIP® TriplePower RM	230/400Vac, 16A	IEC60309 3ph/N/PE 6h	45			<b>03.607.845.1</b>	1 unit
1233	DI-STRIP® TriplePower RM	230/400Vac, 16A	IEC60309 3ph/N/PE 6h	18	6		<b>03.607.824.1</b>	1 unit
1833	DI-STRIP® TriplePower RM	230/400Vac, 16A	IEC60309 3ph/N/PE 6h	36	6		<b>03.607.842.1</b>	1 unit
1111	DI-STRIP® PizzaPower® RM	230Vac, 32A	IEC60309 1ph/N/PE 6h	24			<b>03.637.023.1</b>	1 unit
871	DI-STRIP® PizzaPower® RM	230Vac, 32A	IEC60309 1ph/N/PE 6h	12	4		<b>03.637.016.1</b>	1 unit
1168	DI-STRIP® PizzaPower® RM	230Vac, 32A	IEC60309 1ph/N/PE 6h	21	4		<b>03.637.025.1</b>	1 unit
563	DI-STRIP® PizzaPower® RM	230/400Vac, 32A	IEC60309 3ph/N/PE 6h		6		<b>03.637.006.1</b>	1 unit
995	DI-STRIP® PizzaPower® RM	230/400Vac, 32A	IEC60309 3ph/N/PE 6h	6	12		<b>03.637.018.1</b>	1 unit
1022	DI-STRIP® PizzaPower® RM	230/400Vac, 32A	IEC60309 3ph/N/PE 6h	21			<b>03.637.021.1</b>	1 unit
1157	DI-STRIP® PizzaPower® RM	230/400Vac, 32A	IEC60309 3ph/N/PE 6h	18	6		<b>03.637.024.1</b>	1 unit
1751	DI-STRIP® PizzaPower® RM	230/400Vac, 32A	IEC60309 3ph/N/PE 6h	36	6		<b>03.637.042.1</b>	1 unit



DOS80002

## Knürr DI-STRIP® M

- With big transparent LCD display
- Effective value display of alternating currents per phase (1-phase or 3-phase, depending on model)
- LCD display rotation in 90° steps
- Unbalanced-load warning display with 3-phase model
- Load changes signaling
- Automatic background light reduction
- Cable: 4m H05VV-F 5 G 4mm<sup>2</sup> (PizzaPower M)
- Cable: 2.5m H05VV-F 5 G 2.5mm<sup>2</sup> (TriplePower M)
- Cable: 2.5m H05VV-F 3G 1.5mm<sup>2</sup> (DI-STRIP Compact M, DI-STRIP IEC320 M)

### Material/ Finish

PizzaPower® model:  
Housing: Sheet steel, zinc-passivated, powder-coated  
Other models:  
Housing: closed sheet steel extrusion, zinc-passivated, powder-coated texture  
Plastic parts: Vampamid 6 0024 VO (UL94), recyclable

### Approvals/certificates

- CE label in accordance with low voltage guideline 2006/95/EWG
- EMC Directive 2004/108/EC: EN61326-1, EN61000-3-2, EN61000-3-3
- FCC Class B
- CSA NRTL (PizzaPower m, TriplePower M, IEC320 M)
- CB-Scheme (TriplePower M, DI-STRIP compact M, IEC320M, ampere meter GST18i)

### Color

PizzaPower M model:  
Housing: RAL 9005 black  
Other models:  
Housing: RAL 7035 light gray  
Plastic parts: RAL 7021 dark gray

### Supply schedule

- 1 socket strip with ampere meter
- 2 mounting brackets
- 2 19" mounting brackets (with 19" installation option)

### Note

- Other models (e.g. Sheet J outputs) on request

L	Type	Input values	Input plug	Outputs IEC60320			Order no.	UP
				Sheet F	Sheet J	Schuko		
483	DI-STRIP® PizzaPower® M	230Vac, 32A	IEC60309 1ph/N/PE 6h	7			<b>03.636.007.1</b>	1 unit
933	DI-STRIP® PizzaPower® M	230/400Vac, 32A	IEC60309 3ph/N/PE 6h	21			<b>03.636.021.1</b>	1 unit
1033	DI-STRIP® TriplePower® M	230/400Vac, 16A	IEC60309 3ph/N/PE 6h	21			<b>03.606.821.1</b>	1 unit
1833	DI-STRIP® TriplePower® M	230/400Vac, 16A	IEC60309 3ph/N/PE 6h	45			<b>03.606.845.1</b>	1 unit
1133	DI-STRIP® TriplePower® M	230/400Vac, 16A	IEC60309 3ph/N/PE 6h	18	6		<b>03.606.824.1</b>	1 unit
1733	DI-STRIP® TriplePower® M	230/400Vac, 16A	IEC60309 3ph/N/PE 6h	36	6		<b>03.606.842.1</b>	1 unit
483	DI-STRIP® Compact M	230Vac, 32A	Schuko			6	<b>03.306.006.1</b>	1 unit
483	DI-STRIP® IEC320 M	230Vac, 16A	Schuko	9			<b>03.606.009.1</b>	1 unit
233	DI-STRIP® Ampere meter	230Vac, 16A	GST18				<b>03.606.200.1</b>	1 unit

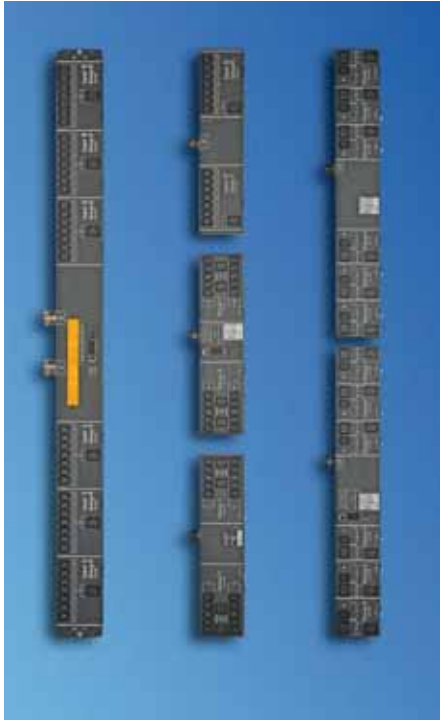

Knürr DI-STRIP®

# HighPower®

The **Knürr DI-STRIP® HighPower** is a solution for every data center with high power requirements and low space in the rack. The special shape enables space-saving installation in the rack. This means free access to the servers, even with 600 mm wide racks. Maintenance of the servers (e.g. power supply changes) is possible at no further expense.

The Knürr DI-STRIP® product family meets the power distribution requirements of many IT applications and other areas. Specially configured for the growing number of electronic components in network switching racks of server racks. The **DI-STRIP® HighPower** is available with and without remote power measurement (DI-STRIP® HighPower RM).

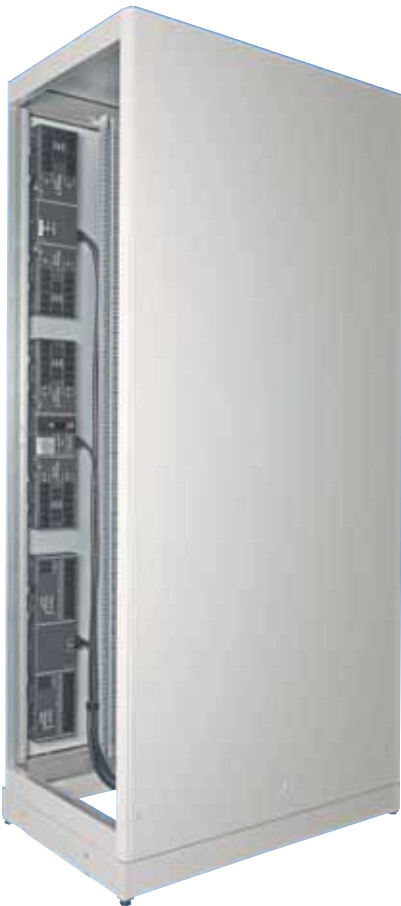

## Knürr DI-STRIP® HighPower Strong points

### Flexibility

With or without remote power measurement. Easy expansion in the rack with tool-less installation. 3 m power cable for more spatial flexibility.

#### RM model

Current values can be read via a big transparent LCD display. Rotating display in 90° steps; the display can always be read the same regardless of the installation direction.

The power measurement module can be integrated into different management programs via different protocols (SNMP, http, Syslog).

### High availability

Meets the strictest EMC requirements with radiation and irradiation interference. Robust and stable with a closed sheet steel housing. Reliable, robust solution.

Extensive certification in acc. with international standard.

#### RM model:

Different threshold values can be flexibly specified; power values can therefore be monitored and load drops can be signaled.

With 3-phase PDUs the unbalanced load can be monitored, which means the neutral conductor is protected from overloads.

### Low operating costs

Especially flat housing extrusion, providing full accessibility to the 19" level with 600 mm wide server racks. Server power supply changes are very quick and easy.

Quick and easy installation on the rack requires minimum space and shorter installation time.

#### RM model:

Automatic background light reduction extends the display's service life and reduces power loss.



DOS20153

## Knürr DI-STRIP® HighPower

- Flat design provides access to the 19" level, even with 600 mm wide racks
- individual backup for outputs (groups with 10 A)
- Outputs divided into groups with max. 20 A per group
- Modular expansion in the rack with tool-less PDU installation

Additional function for HighPower RM type (remote metered)

- With big transparent LCD display
- Effective value display of alternating current
- LCD display rotation in 90° steps
- Display can be switched bright or dark
- Load changes signaling - Automatic background light reduction
- See DI-STRIP RM for technical description for data interface

### Material/ Finish

Housing: Sheet steel, zinc-passivated, powder-coated

### Dimensions

Width: 134 mm  
Height: 47 mm  
Cable: 3 m

### Color

Housing: RAL 9005 black

### Approvals

- CE label in accordance with low voltage guideline 2006/95/EWG
- EMC Directive 2004/108/EC
- GS

### Supply schedule

- 1 socket strip (PDU)
- 1 integrated remote ampere meter (only HighPower RM)
- 2 mounting brackets
- Operating instructions

L	Type	Input values	Input plug	Outputs IEC60320			Order no.	UP
				Sheet F	Sheet J	Schuko		
540	DI-STRIP® HighPower	230Vac, 32A	IEC60309 1ph/N/PE 6h	20	4		<b>03.632.100.8</b>	1 unit
850	DI-STRIP® HighPower	230/400Vac, 32A	IEC60309 3ph/N/PE 6h	6	12		<b>03.632.102.8</b>	1 unit
540	DI-STRIP® HighPower RM	230Vac, 32A	IEC60309 1ph/N/PE 6h	20	4		<b>03.632.200.8</b>	1 unit
850	DI-STRIP® HighPower RM	230/400Vac, 32A	IEC60309 3ph/N/PE 6h	6	12		<b>03.632.202.8</b>	1 unit

Three Phase Knürr DI-STRIP®

## TriplePower®

The **TriplePower**® name represents the performance of our latest development. The **DI-STRIP**® **TriplePower**® supplies network racks with three times the normal power. This requirement is generated by the increasingly higher packing densities and constantly rising energy requirements in racks, which are often caused by aptly named “Blade Servers” or 1 U “Pizza Servers”, more than 40 of which can be integrated into a Knürr Miracel rack.

The **DI-STRIP**® **TriplePower**® uses a classic 3-phase feed with 3x16A, which it optimally distributes throughout the whole rack. The 23 U and 41 U standard lengths cover the entire rack height range of the Knürr Smaract<sup>2</sup> and Miracel rack families.

In the maximum configuration level, up to 48 users can be connected to a **DI-STRIP**® **TriplePower**® (Euro socket strip). With redundant feed, 96A can consequently be provided in a 19” rack with only two **DI-STRIP**® **TriplePower**®.



DOS20149



DOS20148

Dimensions in mm: L = Length  
S = Switch  
n = Number of sockets  
F1 = Standard side de piece  
F2 = Design side piece  
19" = Suitable for 19" installation  
Safe = Child-safe

U = standard height unit  
UP = Unit of packaging

Replace .x with the number of your color combination:  
.1 = RAL 7035, .6 = RAL 7035/RAL 2003





1 DOS20131

## Knürr DI-STRIP® TriplePower® Strong points

- 1 Cost-Effective**  
Quick and easy mounting on the rack extrusion.  
Cost reduction in installation and wiring.
- 2 Supply**  
- 3x16A as standard  
- Ideal for implementing redundancy (e.g. 96 A)
- 3 At a glance**  
Phase assignment color coding (L1, L2, L3).
- 4 Installation**  
Optimum distribution over the entire rack height (standard: 23 U and 41 U).
- Technical alternatives**  
- For 3-phase GST18 system (see page 2.36).



3 DOS20126



2 DOS20147



4 DOS20129

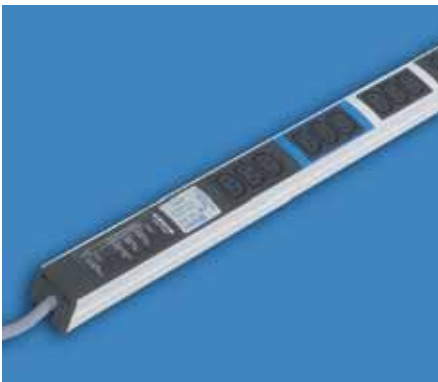

DOS20126

## DI-STRIP® TriplePower® Euro Plug-In System, IEC 320 With cable

- Cable: H05VV-F 5 G 2.5 mm<sup>2</sup>
- Cable: 2.5 m (optional with IEC60309 plug, 3Ph/N/PE 6h)
- Easy mounting on the rack extrusion
- 3x16A feed as standard
- Ideal for implementing redundancy (e.g. 96 A with redundant feed)
- Unmistakable phase assignment color-coding
- Optimum distribution over the entire rack height (23 U and 41 U)
- Alternative for 3-phase GST18 system (see page 170)

- Material/ Finish**  
Housing: closed sheet steel extrusion, zinc-passivated, powder-coated texture  
Plastic parts: Vampamid 6 0024 VO (UL94), recyclable

- Dimensions**  
Height: 45.5 mm  
Housing width: 44.4 mm (= 1 U)

- Approvals/certificates**  
- CE label in accordance with low voltage guideline 2006/95/EWG  
- EMC Directive 2004/108/EC  
- CSA NRTL/C

- Color**  
Housing: RAL 7035 light gray  
Plastic parts: RAL 7021 dark gray

- Load rating**  
100-240/173-415 Vac  
Input: 3x 16 A  
Output: 10 A (Sheet F)  
Output: 16 A (Sheet J)

- Approval symbols for IEC 320 3-way Euro combinations**  
VDE, UR, CSA

- Supply schedule**  
1 socket strip  
2 mounting brackets

L	S	n	F1	19"	Input values	Input plug	Outputs IEC60320		Order no.	UP
							Sheet F	Sheet J		
1033		24	•		230/400Vac, 16A	IEC60309 3ph/N/PE 6h	24		03.600.024.1	1 unit
1833		48	•		230/400Vac, 16A	IEC60309 3ph/N/PE 6h	48		03.600.048.1	1 unit
1033		24	•		230/400Vac, 16A	Open end	24		03.600.824.1	1 unit
1833		48	•		230/400Vac, 16A	Open end	48		03.600.848.1	1 unit
1133		24	•		230/400Vac, 16A	IEC60309 3ph/N/PE 6h	18	6	03.600.524.1	1 unit
1733		42	•		230/400Vac, 16A	IEC60309 3ph/N/PE 6h	36	6	03.600.542.1	1 unit
483		6	•	•	230/400Vac, 16A	IEC60309 3ph/N/PE 6h		6	03.600.506.1	1 unit

## Three Phase Knürr DI-STRIP®

# BladePower® PizzaPower®

A new generation of the power distribution units of the DI-STRIP® range now ensures even more power: **BladePower®** and **PizzaPower®** for fail-safe power supply distribution in network racks.

Increasingly higher packing densities and therefore constantly increasing energy requirements in server racks caused by blade servers or 1 U pizza servers will now be handled electrically.

Up to 35 kW dissipated heat can be removed from modern CoolTherm® server racks. But how is the necessary power supplied into the rack, which can cause such power losses? The PDUs (3x32 A) optimally distribute the required power over the entire rack, with connection of up to 21 consumers possible in the highest configuration level. 192 A can be supplied to the rack with redundant feed.

## Knürr DI-STRIP® Strong points

- **Cost-Effective**  
Quick and easy installation on the server rack's extrusion.  
Costs reduction with mounting and wiring.
- **Supply**  
- Single-phase 32 A and three-phase 32 A.  
- 22 kVA  
- Ideal for providing redundancy (e.g. 192 A)
- **Crystal clear assignment**  
Unmistakable phase assignment color-coding (L1, L2, L3).
- **Installation**  
Optimum distribution of blade center and pizza server supply with easy power distribution unit (PDU) installation.
- **Availability**  
Prevention of "Single Point of Failure" with individual fusing.
- **Certification**



DOS20153



DOS20155

## Knürr DI-STRIP® BladePower® Technical data

- EC 320 sockets (10 A and 16 A).
- Individually fused via thermal circuit breaker that can be reset in acc. with IEC 60934
- Cable: H05VV-F 5 G 4 mm<sup>2</sup>
- Cable: 4 m
- With IEC60309 plug, 1Ph/N/PE 6h blue, 3Ph/N/PE 6h red

- **Material/ Finish**  
Housing: Sheet steel, zinc passivated, powder-coated
- **Dimensions**  
Height: approx. 60 mm  
Housing width: 84 mm
- **Color**  
Housing: RAL 9005 black

- **Approvals**  
- CE label in accordance with low voltage guideline 2006/95/EWG  
- EMC Directive 2004/108/EC  
- Innova GS  
- CSA NRTL/C (only without plug)

- **Load rating**  
100-240 / 173-415 Vac  
Input: 1x32 A or 3x32 A  
Output: 10 A / 16 A

- **Supply schedule**  
1 socket strip (PDU)  
2 mounting brackets  
1 19" mounting bracket (additional with 19" installation option)  
Operating instructions

**Dimensions in mm:** L = Length  
S = Switch  
n = Number of sockets  
F1 = Standard side  
F2 = Design side  
19" = Suitable for 19" installation  
Safe = Child-safe,  
U = standard height unit  
UP = Unit of packaging  
Express item

**Conversion:** 1 mm = 0.03937 inch 1 kg = 2.2046 pound  
Replace .x with the number of your color combination:  
.1 = RAL 7035, .6 = RAL 7035/RAL 2003

L	S	n	F1	19"	Plug	Model	Order no.	UP
375		5	•	•	•	BladePower® PDU 1x 32 A	03.630.005.1	1 unit
740		15	•		•	BladePower® PDU 3x 32 A	03.630.015.1	1 unit
375		5	•	•		BladePower® PDU 1x 32 A	03.630.805.1	1 unit
740		15	•			BladePower® PDU 3x 32 A	03.630.815.1	1 unit

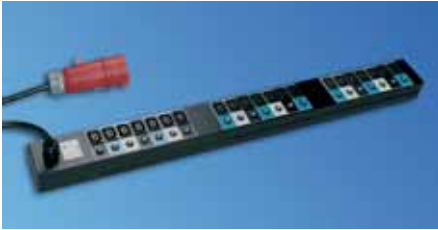

DOS20158



DOS20159

## Knürr DI-STRIP® PizzaPower® Technical data

- Individually fused via thermal circuit breaker that can be reset in acc. with IEC 60934
- Cable: H05VV-F 5 G 4 mm<sup>2</sup>
- Cable: 4 m
- With IEC60309 plug, 1Ph/N/PE 6h blue, 3Ph/N/PE 6h red

### Material/ Finish

Housing: Sheet steel, zinc passivated, powder-coated

### Dimensions

Height: approx. 60 mm  
Housing width: 84 mm  
Height with cable: approx. 176 mm

### Color

Housing: RAL 9005 black

### Approvals

- CE label in accordance with low voltage guideline 2006/95/EWG
- EMC Directive 2004/108/EC
- Innova GS
- CSA NRTL/C (only without plug)

### Load rating

100-240 / 173-415 Vac  
Input: 1x32 A or 3x32 A  
Output: 10 A (Sheet F)  
Output: 16 A (Sheet J)

### Supply schedule

- 1 socket strip (PDU)
  - 2 mounting brackets
  - 1 19" mounting bracket (additional with 19 installation option)
- Operating instructions

L	S	n	F1	19"	Input values	Input plug	Outputs IEC60320		Order no.	UP
							Sheet F	Sheet J		
400		7	•		230Vac, 32A	IEC60309 1ph/N/PE 6h	7		03.631.007.1	1 unit
400		7	•		230Vac, 32A	Open end	7		03.631.807.1	1 unit
720		16	•		230Vac, 32A	IEC60309 1ph/N/PE 6h	12	4	03.631.124.1	1 unit
960		24	•		230Vac, 32A	IEC60309 1ph/N/PE 6h	24		03.631.240.1	1 unit
1017		25	•		230Vac, 32A	IEC60309 1ph/N/PE 6h	21	4	03.631.214.1	1 unit
933		21	•		230/400Vac, 32A	IEC60309 3ph/N/PE 6h	21		03.631.021.1	1 unit
933		21	•		230/400Vac, 32A	Open end	21		03.631.821.1	1 unit
408		6	•		230/400Vac, 32A	IEC60309 3ph/N/PE 6h		6	03.631.006.1	1 unit
939		21	•		230/400Vac, 32A	IEC60309 3ph/N/PE 6h	9	12	03.631.912.1	1 unit
1362		36	•		230/400Vac, 32A	IEC60309 3ph/N/PE 6h	36		03.631.360.1	1 unit
1002		24	•		230/400Vac, 32A	IEC60309 3ph/N/PE 6h	18	6	03.631.186.1	1 unit



DOS00403



DOS00260

With switch

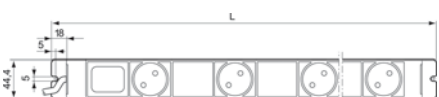

DOS00261

Without switch

**Dimensions in mm:** L = Length  
S = Switch  
n = Number of sockets  
F1 = Standard side  
F2 = Design side  
19" = Suitable for 19" installation  
Safe = Child-safe

U = standard height unit  
UP = Unit of packaging  
 = Express item

**Conversion:** 1 mm = 0.03937 inch      1 kg = 2.2046 pound  
Replace x with the number of your color combination:  
.1 = RAL 7035, .6 = RAL 7035/RAL 2003

## Knürr DI-STRIP® Classic Standard DIN 49 440

- Optionally with lit switch, 2-pole switching
- Socket rotation: 45°
- Cable: H05VV-F 3G 1.5 mm<sup>2</sup>
- Optionally with Euro plug, IEC320 for UPS application

### Material/ Finish

Housing: closed sheet steel extrusion, zinc-passivated, powder-coated texture  
Plastic parts: Vampamid 6 0024 VO (UL94)  
Internal conductor: full-length busbar, brass

### Dimensions

Socket spacing: 24 mm 100 mm  
Height: 45.5 mm  
Housing width: 44.4 mm (= 1 U)  
Cable 2.5 m

### Approvals/certificates

- CE label in accordance with low voltage guideline 2006/95/EWG
- EMC Directive 2004/108/EC
- Innova-GS
- CB-scheme
- VDE

### Color

RAL 7035 light gray

### Load rating

100-240 Vac/16 A

### Supply schedule

- 1 socket strip
- 2 mounting brackets

L	S	n	F1	F2	19"	Safe	Model	Order no.	UP
1783		17	•					03.300.067.1	1 unit
1383		13	•					03.300.063.1	1 unit
983		9	•					03.300.059.1	1 unit
583		5	•					03.300.055.1	1 unit
1733	•	16	•				With switch	03.302.066.1	1 unit
1333	•	12	•				With switch	03.302.062.1	1 unit
933	•	8	•				With switch	03.302.058.1	1 unit
533	•	4	•				With switch	03.302.054.1	1 unit



DOS00401

With switch



DOS00262

With switch

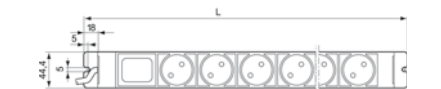

DOS20020

Without switch



DOS20021

With switch



DOS00263

Without switch

## Knürr DI-STRIP® Compact Standard DIN 49 440

- Optionally with lit switch, 2-pole switching
- 19" installation option (with length 483 mm)
- 2 versions: Standard side panel or Design side panel
- Socket rotation: 45°
- Cable: H05VV-F 3G 1.5 mm<sup>2</sup>
- Molded right angle plug
- Optionally with Euro plug, IEC320 for UPS applications

### Material/ Finish

Housing: closed sheet steel extrusion, zinc-passivated, powder-coated texture  
Plastic parts: Vampamid 6 0024 VO (UL94), recyclable  
Internal conductor: full-length busbar, brass

### Dimensions

Socket spacing: 24 mm 50 mm  
Height: 45.5 mm  
Housing width: 44.4 mm (= 1 U)  
Cable 2.5 m

### Approvals/certificates

- CE label in accordance with low voltage guideline 2006/95/EWG
- EMC Directive 2004/108/EC
- Innova-GS
- CB-scheme
- VDE

### Color combination

Final digit of order number .1:  
RAL 7035 light gray  
Final digit of order number .6:  
Housing: RAL 2003 pastel orange  
Plastic parts: RAL 7035 light gray

### Load rating

100-240 Vac/16 A

### Supply schedule

1 socket strip  
2 mounting brackets

L	S	n	F1	F2	19"	Safe	Model	Order no.	UP
883		15	•					03.300.015.x	1 unit
732		11		•				03.300.111.x	1 unit
683		11	•					03.300.011.x	1 unit
532		7		•		•		03.301.107.x	1 unit
532		7		•				03.300.107.x	1 unit
483		7	•		•			03.300.007.x	1 unit
483		8	•		•			03.300.008.1	1 unit
382		4		•		•		03.301.104.x	1 unit
382		4		•				03.300.104.x	1 unit
333		4	•					03.300.004.x	1 unit
883	•	14	•				With switch	03.302.014.x	1 unit
732	•	10		•			With switch	03.302.110.x	1 unit
683	•	10	•				With switch	03.302.010.x	1 unit
532	•	6		•		•	With switch	03.303.106.x	1 unit
532	•	6		•			With switch	03.302.106.x	1 unit
483	•	6	•		•		With switch	03.302.006.x	1 unit
483		7	•		•		With switch	03.302.007.1	1 unit
382	•	3		•		•	With switch	03.303.103.x	1 unit
382	•	3		•			With switch	03.302.103.x	1 unit
333	•	3	•				With switch	03.302.003.x	1 unit

## Knürr DI-STRIP® Compact UPS Standard DIN 49 440

L	S	n	F1	19"	Input values	Input plug	Outputs Schuko CEE7/4	Order no.	UP
483		8	•	•	230Vac, 10A	ICE60320 Sheet E	8	03.300.308.1	1 unit
483		8	•	•	230Vac, 16A	ICE60320 Sheet I	8	03.300.408.1	1 unit

Dimensions in mm: L = Length  
S = Switch  
n = Number of sockets  
F1 = Standard side  
F2 = Design side  
19" = Suitable for 19" installation  
Safe = Child-safe

U = standard height unit  
UP = Unit of packaging  
Express item

Conversion: 1 mm = 0.03937 inch 1 kg = 2.2046 pound  
Replace .x with the number of your color combination:  
.1 = RAL 7035, .6 = RAL 7035/RAL 2003



DOS20065 With fault current circuit breaker

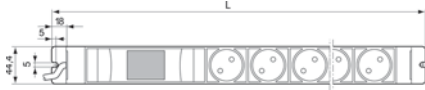

DOS00264 With fault current circuit breaker

## Knürr DI-STRIP® Protector FI Standard DIN 49 440

### Protector FI

- RCCB for user protection
- Protection with indirect contact as error protection by switching off with inadmissible high contact voltage through contact with electrical equipment
- Protection with direct contact as back-up protection
- Residual operating current  $I_g = 10$  mA for alternating and pulsating direct fault current
- 19" installation option (with length 483 mm)
- Socket rotation: 45°
- Cable: H05VV-F 3G 1.5 mm<sup>2</sup>
- Molded right angle plug

### Material/ Finish

Housing: closed sheet steel extrusion, zinc-passivated, powder-coated texture  
Plastic parts: Vampamid 6 0024 VO (UL94), recyclable  
Internal conductor: full-length busbar, brass

### Dimensions

Socket spacing: 24 mm 50 mm  
Height: 78 mm  
Housing width: 44.4 mm (= 1 U)  
Cable 2.5 m

### Approvals/certificates

- CE label in accordance with low voltage guideline 2006/95/EWG
- EMC Directive 2004/108/EC
- Innova-GS
- CB-scheme

### Color combination

Final digit of order number .1:  
RAL 7035 light gray  
Plastic parts: RAL 7035 light gray

### Load rating

100-240 Vac/16 A

### Supply schedule

1 socket strip  
2 mounting brackets

L	S	n	F1	F2	19"	Safe	Model	Order no.	UP
883		13	●					03.304.013.1	1 unit
683		9	●					03.304.009.1	1 unit
483		5	●		●			03.304.005.1	1 unit



DOS00692 With circuit breaker



DOS00264 With circuit breaker

## Knürr DI-STRIP® Protector LS Standard DIN 49 440

### Protector circuit breaker

- Circuit breaker for overload and short circuit
- Protects cables and feeds with rapid switching off with short circuit and defined delayed cutoff with overload
- Circuit breaker: 16 A
- Tripping characteristic, type B, 2-pole
- 19" installation option (with length 483 mm)
- Socket rotation: 45°
- Cable: H05VV-F 3G 1.5 mm<sup>2</sup>
- Molded right angle plug

### Material/ Finish

Housing: closed sheet steel extrusion, zinc-passivated, powder-coated texture  
Plastic parts: Vampamid 6 0024 VO (UL94), recyclable  
Internal conductor: full-length busbar, brass

### Dimensions

Socket spacing: 24 mm 50 mm  
Height: 78 mm  
Housing width: 44.4 mm (= 1 U)  
Cable 2.5 m

### Approvals/certificates

- CE label in accordance with low voltage guideline 2006/95/EWG
- EMC Directive 2004/108/EC
- Innova-GS
- CB-scheme
- VDE

### Color combination

Final digit of order number .1:  
RAL 7035 light gray  
Plastic parts: RAL 7035 light gray

### Load rating

100-240 Vac/16 A

### Supply schedule

1 socket strip  
2 mounting brackets

L	S	n	F1	F2	19"	Safe	Model	Order no.	UP
883		13	●					03.308.013.1	1 unit
683		9	●					03.308.009.1	1 unit
483		5	●		●			03.308.005.1	1 unit

**Dimensions in mm:** L = Length  
S = Switch  
n = Number of sockets  
F1 = Standard side  
F2 = Design side  
19" = Suitable for 19" installation  
Safe = Child-safe  
U = standard height unit  
UP = Unit of packaging  
Express item

**Conversion:** 1 mm = 0.03937 inch 1 kg = 2.2046 pound  
Replace .x with the number of your color combination:  
.1 = RAL 7035, .6 = RAL 7035/RAL 2003



DOS00693



DOS00264

## Knürr DI-STRIP® Protector FI / LS Standard DIN 49 440

### Protector FI / LS

- Fault current switch and circuit breaker
- Provides a combination of user, overload and short circuit protection
- Residual operating current  $I_g = 30$  mA for alternating and pulsating direct fault current
- Circuit breaker: 16 A
- Tripping characteristic, type B, 2-pole
- 19" installation option (with length 483 mm)
- Socket rotation: 45°
- Cable: H05VV-F 3G 1.5 mm<sup>2</sup>
- Molded right angle plug

### Material/ Finish

Housing: closed sheet steel extrusion, zinc-passivated, powder-coated texture  
Plastic parts: Vampamid 6 0024 VO (UL94), recyclable  
Internal conductor: full-length busbar, brass

### Dimensions

Socket spacing: 24 mm 50 mm  
Height: 78 mm  
Housing width: 44.4 mm (= 1 U)  
Cable 2.5 m

### Approvals/certificates

- CE label in accordance with low voltage guideline 2006/95/EWG
- EMC Directive 2004/108/EC
- Innova-GS
- CB-scheme

### Color combination

Final digit of order number .1:  
RAL 7035 light gray  
Plastic parts: RAL 7035 light gray

### Load rating

100-240 Vac/16 A

### Supply schedule

1 socket strip  
2 mounting brackets

L	S	n	F1	F2	19"	Safe	Model	Order no.	UP
883		13	•					03.310.013.1	1 unit
683		9	•					03.310.009.1	1 unit
483		5	•		•			03.310.005.1	1 unit



DOS20059

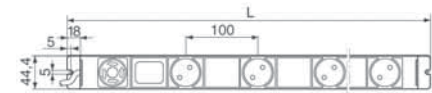

Classic with emergency stop switch

DOS00486

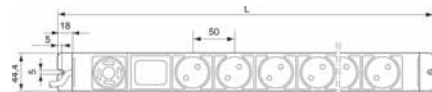

Protector with emergency stop switch

DOS00487

## Knürr DI-STRIP® Protector Emergency STOP Standard DIN 49 440

- With 2-pole emergency stop switch for user protection
- For protecting operating personnel
- For manual emergency switching off of the connected consumers
- Phase and neutral conductors are safely separated
- Switch must be specifically unlocked to restart
- 19" installation option (with length 483 mm)
- Socket rotation: 45°
- Cable: H05VV-F 3G 1.5 mm<sup>2</sup>
- Molded right angle plug

### Material/ Finish

Housing: closed sheet steel extrusion, zinc-passivated, powder-coated texture  
Plastic parts: Vampamid 6 0024 VO (UL94), recyclable  
Internal conductor: full-length busbar, brass

### Dimensions

Socket spacing: 24 mm Classic: 100 mm,  
Compact: 50 mm

Height: 101 mm  
Housing width: 44.4 mm (= 1 U)  
Cable 2.5 m

### Approvals/ certificates

- CE label in accordance with low voltage guideline 2006/95/EWG
- EMC Directive 2004/108/EC
- Innova-GS
- CB-scheme
- VDE

### Color combinations

Final digit of order number .1:  
RAL 7035 light gray  
Plastic parts: RAL 7035 light gray

### Load rating

100-240 Vac/16 A

### Supply schedule

1 socket strip  
2 mounting brackets

L	S	n	F1	F2	19"	Safe	Model	Order no.	UP
683		10	•				Compact	03.326.010.1	1 unit
483		6	•		•		Compact	03.326.006.1	1 unit
1333		12	•				Classic	03.326.062.1	1 unit
933		8	•				Classic	03.326.058.1	1 unit

**Dimensions in mm:** L = Length  
S = Switch  
n = Number of sockets  
F1 = Standard side  
F2 = Design side  
19" = Suitable for 19" installation  
Safe = Child-safe

U = standard height unit  
UP = Unit of packaging  
Express item

**Conversion:** 1 mm = 0.03937 inch 1 kg = 2.2046 pound  
Replace .x with the number of your color combination:  
.1 = RAL 7035, .6 = RAL 7035/RAL 2003



DOS00456

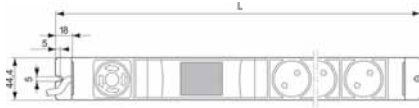

DOS00488

## Knürr DI-STRIP® Protector Emergency Stop FI / LS Standard DIN 49 440

- With 2-pole emergency stop switch for user protection
- For protecting operating personnel
- For manual emergency switching off of the connected consumers
- Phase and neutral conductors are safely separated
- Switch must be specifically unlocked to restart
- Socket rotation: 45°
- Cable: H05VV-F 3G 1.5 mm<sup>2</sup>
- Molded right angle plug

### Material/ Finish

Housing: closed sheet steel extrusion, zinc-passivated, powder-coated texture  
Plastic parts: Vampamid 6 0024 VO (UL94), recyclable  
Internal conductor: full-length busbar, brass

### Dimensions

Socket spacing: 24 mm Compact: 50 mm  
Height: 101 mm  
Housing width: 44.4 mm (= 1 U)  
Cable 2.5 m

### Approvals/certificates

- CE label in accordance with low voltage guideline 2006/95/EWG
- EMC Directive 2004/108/EC
- Innova-GS
- CB-scheme

### Color combinations

Final digit of order number .1:  
RAL 7035 light gray  
Plastic parts: RAL 7035 light gray

### Additionally:

With 2-pole fault current switch and circuit breaker  
Provides a combination of user, overload and short circuit protection

### Load rating

100-240Vac/16 A

### Supply schedule

1 socket strip  
2 mounting brackets

L	S	n	F1	F2	19"	Safe	Model	Order no.	UP
683		8	•					03.328.008.1	1 unit



DOS20061



DOS00266

## Knürr DI-STRIP® Power Cleaner Standard DIN 49 440

- High-frequency glitches are generally caused by switching processes in an operation from 100 kHz to 5MHz. This high-frequency rate overloads the mains frequency and affects adjacent electronic equipment. The mains filter attenuates this high-frequency rate.
- The attenuation behavior is harmonized with the typical interference spectrum.
- The mains filter works in both directions. This means that glitches from the equipment to the socket strip are also filtered from the mains.
- 19" installation option (with length 483 mm)
- Socket rotation: 45°
- Cable: H05VV-F 3G 1.5 mm<sup>2</sup>
- Molded right angle plug

### Material/ Finish

Housing: closed sheet steel extrusion, zinc-passivated, powder-coated texture  
Plastic parts: Vampamid 6 0024 VO (UL94), recyclable  
Internal conductor: full-length busbar, brass

### Dimensions

Socket spacing: 24 mm 50 mm  
Height: 45.5 mm  
Housing width: 44.4 mm (= 1 U)  
Cable 2.5 m

### Approvals/certificates

- CE label in accordance with low voltage guideline 2006/95/EWG
- EMC Directive 2004/108/EC
- Innova-GS
- CB-scheme

### Color combination

Final digit of order number .1:  
RAL 7035 light gray  
Final digit of order number .6:  
Housing: RAL 2003 pastel orange  
Plastic parts: RAL 7035 light gray

### Technical data

Nominal voltage: max. 250 Vac, 50 Hz  
Nominal current: max. 16 A  
Filter in acc. with VDE 0565-3 (EN 60939-1)

### Supply schedule

1 socket strip  
2 mounting brackets  
2 19" mounting bracket (additional with 19" installation option)

**Dimensions in mm:** L = Length  
S = Switch  
n = Number of sockets  
F1 = Standard side  
F2 = Design side  
19" = Suitable for 19" installation  
Safe = Child-safe

U = standard height unit  
UP = Unit of packaging  
Express item

**Conversion:** 1 mm = 0.03937 inch 1 kg = 2.2046 pound  
Replace .x with the number of your color combination:  
.1 = RAL 7035, .6 = RAL 7035/RAL 2003

L	S	n	F1	F2	19"	Safe	Model	Order no.	UP
883		13	•					03.312.013.x	1 unit
683		9	•					03.312.009.x	1 unit
483		5	•		•			03.312.005.x	1 unit



DOS20068 With overvoltage protection

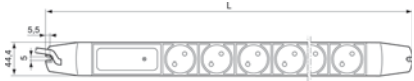

DOS00306 With overvoltage protection



DOS00270 With overvoltage protection

## Knürr DI-STRIP® Safety Basic Standard DIN 49 440

- For protecting against transient overvoltages from the mains, which, for example, are caused by switching machines on and off.
- With critical overvoltages the mains is separated.
- Once the safety arrester has been triggered the green function display goes out.
- The socket strip can then no longer be used. Send the socket strip to the manufacturer for the safety arrester to be replaced! The safety effect of the type 3 test category and requirements category "D" is to protect the equipment, i.e. precision protection. The protection devices of the test and requirements categories 1 and 2 and B and C must be pre-connected in the building installation to ensure optimum protection.
- 19" installation option (with length 483 mm)
- Socket rotation: 45°
- Cable: H05VV-F 3G 1.5 mm<sup>2</sup>
- Molded right angle plug

### Material/ Finish

Housing: closed sheet steel extrusion, zinc-passivated, powder-coated texture  
Plastic parts: Vampamid 6 0024 VO (UL94), recyclable  
Internal conductor: full-length busbar, brass

### Dimensions

Socket spacing: 24 mm 50 mm  
Height: 45.5 mm  
Housing width: 44.4 mm (= 1 U)

### Approvals/certificates

- CE label in accordance with low voltage guideline 2006/95/EWG
- EMC Directive 2004/108/EC
- Innova-GS
- CB-scheme

### Color combination

Final digit of order number .1:  
RAL 7035 light gray  
Final digit of order number .6:  
Housing: RAL 2003 pastel orange  
Plastic parts: RAL 7035 light gray

### Technical data

- Test category: Type 3  
- In acc. with DIN EN 61643-11  
Requirements class: D  
- In acc. with VDE 0675-6  
Mains voltage: 230 VAC  
Nominal current: max. 16 A  
Cut-off discharge current (8/20 μs): 10 kA  
Response time: < 25 ns  
Protection level  
(with 100 A varistor peak current):  
- L with respect to N: < 800 V  
- L/N with respect to PE: < 1500 V

### Supply schedule

- 1 socket strip
- 2 mounting brackets

L	S	n	F1	F2	19"	Safe	Model	Order no.	UP
732		10		●				03.316.110.1	1 unit
683		10	●					03.316.010.x	1 unit
532		6		●		●		03.317.106.1	1 unit
532		6		●				03.316.106.1	1 unit
483		6	●		●			03.316.006.x	1 unit
432		4		●		●		03.317.104.1	1 unit
432		4		●				03.316.104.1	1 unit
383		4	●					03.316.004.1	1 unit

**Dimensions in mm:** L = Length  
S = Switch  
n = Number of sockets  
F1 = Standard side  
F2 = Design side  
19" = Suitable for 19" installation  
Safe = Child-safe,  
U = standard height unit  
UP = Unit of packaging  
 = Express item

**Conversion:** 1 mm = 0.03937 inch 1 kg = 2.2046 pound  
Replace .x with the number of your color combination:  
.1 = RAL 7035, .6 = RAL 7035/RAL 2003





DOS20069 With overvoltage protection and mains filter



DOS00307 With overvoltage protection and mains filter



DOS00271

## Knürr DI-STRIP® Safety Standard Standard DIN 49 440

- The "Safety Standard" models consist of a combined overvoltage protection/mains filter element.
- For protecting against transient overvoltages from the mains, which, for example, are caused by switching machines on and off.
- With critical overvoltages the mains is separated.
- Once the safety arrester has been triggered the green function display goes out. The socket strip can then no longer be used. Send the socket strip to the manufacturer for the safety arrester to be replaced!
- The safety effect of the type 3 test category and requirements category "D" is to protect the equipment, i.e. precision protection. The protection devices of the test and requirements categories 1 and 2 and B and C must be preconnected in the building installation to ensure optimum protection.
- High-frequency glitches are generally caused by switching processes in an operation from 100 kHz to 5MHz.
- This high-frequency rate overloads the mains frequency and affects adjacent electronic equipment. The mains filter attenuates this high-frequency rate.
- The attenuation behavior is harmonized with the typical interference spectrum.
- 19" installation option (with length 483 mm)
- Socket rotation: 45°
- Cable: H05VV-F 3G 1.5 mm<sup>2</sup>
- Molded right angle plug

### Material/ Finish

Housing: closed sheet steel extrusion, zinc-passivated, powder-coated texture  
 Plastic parts: Vampamid 6 0024 VO (UL94), recyclable  
 Internal conductor: full-length busbar, brass

### Dimensions

Socket spacing: 24 mm 50 mm  
 Height: 45.5 mm  
 Housing width: 44.4 mm (= 1 U)  
 Cable 2.5 m

### Approvals/certificates

- CE label in accordance with low voltage guideline 2006/95/EWG
- EMC Directive 2004/108/EC
- Innova-GS
- CB-scheme

### Color combination



Final digit of order number .1:  
 RAL 7035 light gray  
 Final digit of order number .6:  
 Housing: RAL 2003 pastel orange  
 Plastic parts: RAL 7035 light gray

### Technical data

Mains voltage: 230 VAC  
 Nominal current: max. 16 A  
 Cut-off discharge current (8/20 μs): 10 kA  
 Response time: < 25 ns  
 Protection level  
 (with 100 A varistor peak current):  
 - L with respect to N: < 800 V  
 - L/N with respect to PE: < 1500 V  
 Overvoltage protection  
 - Test category: Type 3  
 in acc. with DIN EN61643-11  
 - Feature class: D  
 In acc. with VDE 0675-6  
 Mains filter  
 - In acc. with VDE 0565 (EN 60939)

### Supply schedule

1 socket strip  
 2 mounting brackets

L	S	n	F1	F2	19"	Safe	Model	Order no.	UP
883	●	13	●				With switch	03.318.013.x	1 unit
732	●	9		●		●	With switch	03.319.109.x	1 unit
732	●	9		●			With switch	03.318.109.x	1 unit
683	●	9	●				With switch	03.318.009.x	1 unit 
532	●	5		●		●	With switch	03.319.105.x	1 unit
532	●	5		●			With switch	03.318.105.x	1 unit
483	●	5	●		●		With switch	03.318.005.x	1 unit 

**Dimensions in mm:** L = Length  
 S = Switch  
 n = Number of sockets  
 F1 = Standard side  
 F2 = Design side  
 19" = Suitable for 19" installation  
 Safe = Child-safe  
 U = standard height unit  
 UP = Unit of packaging  
 = Express item

**Conversion:** 1 mm = 0.03937 inch  
 1 kg = 2.2046 pound  
 Replace .x with the number of your color combination:  
 .1 = RAL 7035, .6 = RAL 2003/RAL 2003



DOS20070

With master-slave module



DOS00268

With master-slave module

## Knürr DI-STRIP® Master Slave Standard DIN 49 440

- If the master equipment is switched, the slave sockets are also switched (together, with a short delay to the master). This means convenient switching on and off of several hard to access devices. Switching thresholds can be set from outside via potentiometer.

- Note:

- The master equipment power consumption must be continuously above the switching-on threshold. When switching off the master equipment, the power consumption must fall below the switching-off threshold.

- 19" installation option (with length 483 mm)

- Socket rotation: 45°

- Cable: H05VV-F 3G 1.5 mm<sup>2</sup>

- Molded right angle plug

### Material/ Finish

Housing: closed sheet steel extrusion, zinc-passivated, powder-coated texture  
Plastic parts: Vampamid 6 0024 VO (UL94), recyclable  
Internal conductor: full-length busbar, brass

### Dimensions

Socket spacing: 24 mm 50 mm

Height: 45.5 mm

Housing width: 44.4 mm (= 1 U)

Cable 2.5 m

### Approvals/certificates

- CE label in accordance with low voltage guideline 2006/95/EWG
- EMC Directive 2004/108/EC
- Innova-GS
- CB-scheme

### Color combination

Final digit of order number .1:  
RAL 7035 light gray  
Plastic parts: RAL 7035 light gray

### Load rating

Max. 250 Vac/16 A

### Technical data

Switching threshold setting range  
On: 20 mA - 200 mA  
(approx. 55 mA delivery status)  
Off: 16 mA - 160 mA  
(approx. 44 mA delivery status)  
Switching delay: 550 ms +/- 20 %  
Electronic module: 2-pole switching

### Supply schedule

1 socket strip  
2 mounting brackets

L	S	n	F1	F2	19"	Safe	Model	Order no.	UP
683		9	•					03.314.009.1	1 unit
483		5	•		•			03.314.005.1 	1 unit

**Dimensions in mm:** L = Length  
S = Switch  
n = Number of sockets  
F1 = Standard side  
F2 = Design side  
19" = Suitable for 19" installation  
Safe = Child-safe  
U = standard height unit  
UP = Unit of packaging  
 = Express item

**Conversion:** 1 mm = 0.03937 inch 1 kg = 2.2046 pound  
Replace .x with the number of your color combination:  
.1 = RAL 7035, .6 = RAL 7035/RAL 2003



DOS00325 With master-slave overvoltage protection and mains filter

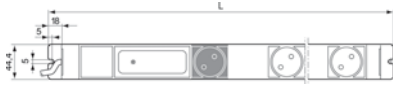

DOS00272



DOS00273 With master-slave overvoltage protection and mains filter

## Knürr DI-STRIP® Combi Standard DIN 49 440

- Master-slave with overvoltage protection and mains filter
- Automatic consumer switching
- Combines Master Slave (page 7.16) and Safety Standard functions (Page 7.15)
- Socket rotation: 45°
- Cable: H05VV-F 3G 1.5 mm<sup>2</sup>
- Molded right angle plug

### Material/ Finish

Housing: closed sheet steel extrusion, zinc-passivated, powder-coated texture  
Plastic parts: Vampamid 6 0024 VO (UL94), recyclable  
Internal conductor: full-length busbar, brass

### Dimensions

Socket spacing: 24 mm 50 mm  
Height: 45.5 mm  
Housing width: 44.4 mm (= 1 U)  
Cable 2.5 m

### Approvals/certificates

- CE label in accordance with low voltage guideline 2006/95/EWG
- EMC Directive 2004/108/EC
- Innova-GS
- CB-scheme

### Color combination

Final digit of order number .1:  
RAL 7035 light gray  
Plastic parts: RAL 7035 light gray

### Technical data

Overvoltage protection and mains filter:  
Mains voltage: max. 250 Vac  
Nominal current: 16 A  
Requirements class: D (precision protection in acc. with VDE 0675)  
Surge current resistance (8/20 μs wave): max. 10 kA  
Protection level (1.5/50 μs wave): < 1500 V (L + N against PE)  
Master-slave function:  
Switching threshold setting range  
On: 20 mA - 200 mA  
(approx. 55 mA delivery status)  
Off: 16 mA - 160 mA  
(approx. 44 mA delivery status)  
Switching delay: 550 ms +/- 20 %  
Electronic module: 2-pole switching

### Supply schedule

1 socket strip  
2 mounting brackets

L	S	n	F1	F2	19"	Safe	Model	Order no.	UP
782		9		•				03.320.109.1	1 unit
733		9	•					03.320.009.1	1 unit
582		5		•		•		03.321.105.1	1 unit
582		5		•				03.320.105.1	1 unit
533		5	•					03.320.005.1 	1 unit

**Dimensions in mm:** L = Length  
S = Switch  
n = Number of sockets  
F1 = Standard side  
F2 = Design side  
19" = Suitable for 19" installation  
Safe = Child-safe  
U = standard height unit  
UP = Unit of packaging  
 = Express item

**Conversion:** 1 mm = 0.03937 inch 1 kg = 2.2046 pound  
Replace .x with the number of your color combination:  
.1 = RAL 7035, .6 = RAL 7035/RAL 2003



DOS20060



DOS00663



DOS20045

With switch



DOS20046

Without switch

## Knürr DI-STRIP® GST18 Plug System (Wieland) Compact Standard DIN 49 440

- Quick and efficient plug connection system
- Plug-in electro-installation in place of conventional wiring
- Speed:
  - With easy pre-configured element plugging together
- Flexibility:
  - With cable (cable length)
- Rational:
  - Easy socket strip swap-out, without costly cabling
- Safety:
  - Faulty installations are ruled out with plug system
- Space-saving:
  - Use of protection and switching functions can be extended with further cabling without and plug space loss (max. load rating 16 A)

### Material/ Finish

Housing: closed sheet steel extrusion, zinc-passivated, powder-coated texture  
 Plastic parts: Vampamid 6 0024 VO (UL94), recyclable  
 Internal conductor: full-length busbar, brass

### Dimensions

Socket spacing: 24 mm 50 mm  
 Height: 45.5 mm  
 Housing width: 44.4 mm (= 1 U)

### Approvals/certificates

- CE label in accordance with low voltage guideline 2006/95/EWG
- EMC Directive 2004/108/EC
- Innova-GS
- CB-scheme
- VDE

### Color combination

Final digit of order number .1:  
 RAL 7035 light gray  
 Plastic parts: RAL 7035 light gray

### Load rating

100-240 Vac/16 A

### Supply schedule

- 1 socket strip
- 2 mounting brackets

L	S	n	F1	F2	19"	Safe	Model	Order no.	UP
583	•	6	•				With switch	03.302.206.1	1 unit
433	•	3	•				With switch	03.302.203.1	1 unit
533		7	•					03.300.207.1	1 unit
383		4	•					03.300.204.1	1 unit



DOS20072

## Knürr DI-STRIP® Safety Basic with GST18 plug system

- With overvoltage protection
- Technical description, see page 164

L	S	n	F1	F2	19"	Safe	Model	Order no.	UP
433		4						03.316.204.1	1 unit



DOS20073

## Knürr DI-STRIP® Safety Standard with GST18 plug system

- With overvoltage protection, with integrated mains filter and lit switch
- Technical description, see page 165

L	S	n	F1	F2	19"	Safe	Model	Order no.	UP
583		5						03.318.205.1	1 unit



DOS00464

## Knürr DI-STRIP® Master Slave with GST18 plug system

- Technical description, see page 166

L	S	n	F1	F2	19"	Safe	Model	Order no.	UP
533		5						03.314.205.1	1 unit



DOS20112



DOS20107

Input



DOS20106

Output for further cabling

## Knürr DI-STRIP® Euro Socket System, IEC 320 with GST18 plug system

- With 3-way Euro combinations of IEC 320 sockets
- Without fusing

### Material/ Finish

Housing: closed sheet steel extrusion, zinc-passivated, powder-coated texture  
Plastic parts: Vampamid 6 0024 VO (UL94), recyclable

### Dimensions

Socket spacing: 24 mm 24 mm  
Height: 45.5 mm  
Housing width: 44.4 mm (= 1 U)

### Approvals/certificates

- CE label in accordance with low voltage guideline 2006/95/EWG
- EMC Directive 2004/108/EC
- Innova-GS
- CSA NRTL/C
- CB-scheme

### Color

Housing: RAL 7035 light gray  
Plastic parts: RAL 7021 dark gray

### Load rating

100-240 Vac/10 A

### Approval symbols for IEC 320 3-way Euro combinations

VDE, UR, CSA

### Supply schedule

1 socket strip  
2 mounting brackets

L	S	n	F1	F2	19"	Safe	Model	Order no.	UP
383		6	•					03.600.206.1	1 unit



DOS20110

## Knürr DI-STRIP® Safety Basic Euro Socket System IEC 320 with GST18 plug system

- With overvoltage protection
- Technical description, see page 164

L	S	n	F1	F2	19"	Safe	Model	Order no.	UP
483		6						03.616.206.1	1 unit



DOS20109

## Knürr DI-STRIP® Safety Standard Euro Socket System IEC 320 with GST18 plug system

- With overvoltage protection with integrated mains filter
- Technical description, see page 165

L	S	n	F1	F2	19"	Safe	Model	Order no.	UP
483		6						03.618.206.1	1 unit



DOS20108

## Knürr DI-STRIP® Power Cleaner Euro Socket System IEC 320 with GST18 plug system

- Technical description, see page 163

L	S	n	F1	F2	19"	Safe	Model	Order no.	UP
483		6						03.612.206.1	1 unit

**Dimensions in mm:** L = Length  
S = Switch  
n = Number of sockets  
F1 = Standard side  
F2 = Design side  
19" = Suitable for 19" installation  
Safe = Child-safe

U = standard height unit  
UP = Unit of packaging  
 = Express item

**Conversion:** 1 mm = 0.03937 inch 1 kg = 2.2046 pound  
Replace .x with the number of your color combination:  
.1 = RAL 7035, .6 = RAL 7035/RAL 2003



1 DOS20147

## 3-phase in rack with GST18 Strong points



2 DOS20132



3 DOS20142

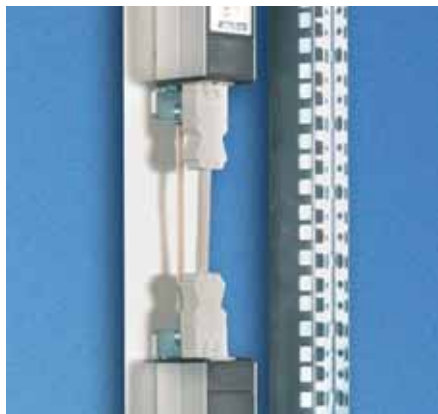

3 DOS20135

### 1 Requirement

Constantly increasing energy requirements in the rack caused by high packing densities (e.g. 1 U Pizza Servers, Blade Servers, etc.)

### 2 Solution

3-phase distributor with GST18 plug system, e.g. 96 A and more with redundant feed

### 3 Benefits

- Modularity
- Plug-in capability (no wiring required)
- Expandability
- Cascadability
- Easy provision of redundancies / UPS secured circuits
- Combination of DIN Schuko and IEC320, for example
- Installation position freely selectable
- Good alternative for 3-phase DI-STRIP Triple Power (see page 156)



DOS20104

## Power Supply Cable, 3-Phase Accessories for GST 18 plug system

- GST 18 socket for connecting GST18i5 distributor block with 3 phases
- 5-pole (L1, L2, L3, N, PE) 250/400 V ~
- Cable: HO5VV-F 5G 2.5 mm<sup>2</sup>

**Color**  
Black

L	S	n	F1	F2	19"	Safe	Model	Order no.	UP
2000								04.000.048.0	1 unit



DOS20103

## GST18i5 Distributor Block, 3-phase

- For individual connection at the customer
- Modular plug-in connection
- 3 phase distribution on various socket strips
- Including mounting panel

**Color**  
Black

L	S	n	F1	F2	19"	Safe	Model	Order no.	UP
								04.000.038.9	1 unit



DOS00467

## Power Supply Cable, 1-Phase Accessories for GST 18 plug system

- Mains plug CEE/VII - GST18 socket (Wieland)
- Cable - H05VV-F3G 1.5 mm<sup>2</sup>

**Color**  
White

L	S	n	F1	F2	19"	Safe	Model	Order no.	UP
2000								04.000.040.0	1 unit
5000								04.000.041.0	1 unit



DOS00469

## Connection Cable Accessories for GST 18 plug system

- GST 18 plug
- GST 18 plug
- Cable - H05VV-F3G 1.5 mm<sup>2</sup>

**Color**  
For color coding circuits (e.g. UPS)

L	S	n	F1	F2	19"	Safe	Model	Order no.	UP
200							White	04.000.042.0	1 unit
200							Black	04.000.042.9	1 unit
500							White	04.000.037.0	1 unit
500							Black	04.000.037.9	1 unit
1000							White	04.000.044.0	1 unit
1000							Black	04.000.044.9	1 unit
5000							White	04.000.045.0	1 unit



DOS20105

## GST18 Socket Part

- With screw terminal for cross-section 1.5-2.5 mm<sup>2</sup> with cable strain relief
- For individual connection at the customer

**Color**  
White

L	S	n	F1	F2	19"	Safe	Model	Order no.	UP
								04.000.046.0	1 unit

DOS00471



DOS00470

## GST18 Plug Part

- With screw terminal for cross-section 1.5-2.5 mm<sup>2</sup> with cable strain relief
- For individual, further cabling at the customer

**Color**  
White

L	S	n	F1	F2	19"	Safe	Model	Order no.	UP
								04.000.047.0	1 unit



DOS20062

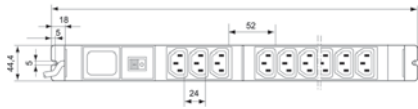

DOS00498

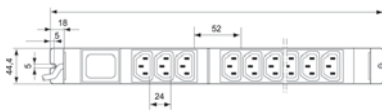

DOS20042

## Knürr DI-STRIP® Euro Socket System, IEC 320 With cable and right angle plug

- Optionally with lit switch, 2-pole switching
- 19" installation option
- With Euro combinations of IEC 320 sockets Sheet F and Sheet J
- Cable: H05VV-F 3G 1.5 mm<sup>2</sup>
- Cable: 2.5 m
- Without fusing

### Material/ Finish

Housing: closed sheet steel extrusion, zinc-passivated, powder-coated texture  
Plastic parts: Vampamid 6 0024 VO (UL94), recyclable

### Dimensions

Height: 45.5 mm  
Housing width: 44.4 mm (= 1 U)

### Approvals/certificates

- CE label in accordance with low voltage guideline 2006/95/EWG
- EMC Directive 2004/108/EC
- Innova-GS
- CB-scheme

### Color

Housing: RAL 7035 light gray  
Plastic parts: RAL 7021 dark gray

### Load rating

250 Vac/10 A, Sheet F  
250 Vac/16 A, Sheet J

### Approval symbols for IEC 320 3-way Euro combinations

VDE, UR, CSA

### Supply schedule

1 socket strip  
2 mounting brackets

L	S	n	F1	19"	Input values	Input plug	Outputs Sheet F Sheet J	Order no.	UP
333		6	•		230Vac, 16A	Schuko CEE7	6	03.600.006.1	1 unit
483	•	9	•	•	230Vac, 16A	Schuko CEE7	9	03.602.009.1	1 unit
483		12	•	•	230Vac, 10A	IEC60320 Sheet E	12	03.600.312.1	1 unit
783		18	•		230Vac, 16A	IEC60320 Sheet I	15 3	03.600.418.1	1 unit
783		18	•		230Vac, 16A	IEC60309 1ph/N/PE 6h	15 3	03.600.518.1	1 unit



DOS00458

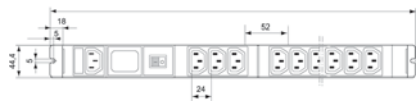

DOS20041

With switch

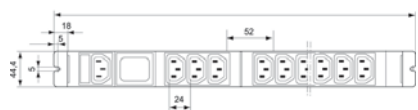

DOS20040

Without switch

## Knürr DI-STRIP® Euro Socket System, IEC 320 Euro input in plug panel

- With fine-wire fuse 10A
- Optionally with lit switch, 2-pole switching
- 19" installation option
- With 3-way Euro combinations of IEC 320 sockets

### Material/ Finish

Housing: closed sheet steel extrusion, zinc-passivated, powder-coated texture  
Plastic parts: Vampamid 6 0024 VO (UL94), recyclable

### Dimensions

Socket spacing: 24 mm  
Height: 45.5 mm  
Housing width: 44.4 mm (= 1 U)

### Approvals/certificates

- CE label in accordance with low voltage guideline 2006/95/EWG
- EMC Directive 2004/108/EC

- Innova-GS
- CSA NRTL/C
- CB-scheme

### Color

Housing: RAL 7035 light gray  
Plastic parts: RAL 7021 dark gray

### Load rating

100-240 Vac  
Input: (DC max. 10 A)  
Output: (DC max. 10 A)

### Approval symbols for IEC 320 3-way Euro combinations

VDE, UR, CSA

### Supply schedule

1 socket strip  
2 mounting brackets

**Dimensions in mm:** L = Length  
S = Switch  
n = Number of sockets  
F1 = Standard side  
F2 = Design side  
19" = Suitable for 19" installation  
Safe = Child-safe

U = standard height unit  
UP = Unit of packaging  
Express item

**Conversion:** 1 mm = 0.03937 inch 1 kg = 2.2046 pound  
Replace .x with the number of your color combination:  
.1 = RAL 7035, .6 = RAL 7035/RAL 2003

L	S	n	F1	F2	19"	Safe	Model	Order no.	UP
383		6	•					03.622.006.1	1 unit
483		9	•		•			03.622.009.1	1 unit
433	•	6	•				With switch	03.624.006.1	1 unit





DOS00460



DOS00461

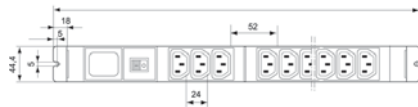

DOS20043

With switch

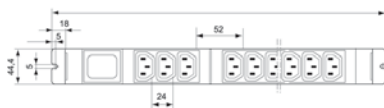

DOS20044

Without switch



DOS20102

## Knürr DI-STRIP® Euro Socket System, IEC 320 Euro input on side panel

- With fine-wire fuse 10A
- Optionally with lit switch, 2-pole switching
- 19" installation option
- With 3-way Euro combinations of IEC 320 sockets

### Material/ Finish

Housing: closed sheet steel extrusion, zinc-passivated, powder-coated texture  
Plastic parts: Vampamid 6 0024 VO (UL94), recyclable

### Dimensions

Socket spacing: 24 mm  
Height: 45.5 mm  
Housing width: 44.4 mm (= 1 U)

### Approvals/certificates

- CE label in accordance with low voltage guideline 2006/95/EWG
- EMC Directive 2004/108/EC
- Innova-GS
- CSA NRTL/C
- CB-scheme

### Color

Housing: RAL 7035 light gray  
Plastic parts: RAL 7021 dark gray

### Load rating

100-240 Vac  
Input: (DC max. 10 A)  
Output: (DC max. 10 A)

### Approval symbols for IEC 320 3-way Euro combinations

VDE, UR, CSA

### Supply schedule

1 socket strip  
2 mounting brackets

L	S	n	F1	F2	19"	Safe	Model	Order no.	UP
333		6	•					03.622.706.1	1 unit
433		9	•					03.622.709.1	1 unit
383	•	6	•				With switch	03.624.706.1	1 unit
483	•	9	•				With switch	03.624.709.1	1 unit

## Knürr DI-STRIP® Euro Plug System, IEC 320 With cable and right angle plug

- With thermal overload protection, 10 A (can be reset)
- With lit switch, 1-pole switching
- 19" installation option
- With 2 5-way Euro combinations of IEC 320 sockets
- Cable: H05VV-F 3G 2.5 mm<sup>2</sup>
- Cable: approx. 5 m
- Molded right angle plug, CEE7/VII, optional blue 16 A-6h (2P+PE) CEE17 plug

### Material/ Finish

Housing: closed sheet steel extrusion, zinc-passivated, powder-coated texture  
Plastic parts: Vampamid 6 0024 VO (UL94), recyclable

### Dimensions

Socket spacing: 24 mm  
Height: 45.5 mm  
Housing width: 44.4 mm (= 1 U)

### Approvals/certificates

- CE label in accordance with low voltage guideline 2006/95/EWG
- EMC Directive 2004/108/EC
- Innova-GS
- CB-scheme

### Color

Housing: RAL 7035 light gray  
Plastic parts: RAL 7021 dark gray

### Load rating

250 Vac/10 A

### Approval symbols for IEC 320 5-way Euro combinations

UR, CSA, VDE

### Supply schedule

1 socket strip  
2 mounting brackets

L	S	n	F1	F2	19"	Safe	Model	Order no.	UP
483	•	10	•				With switch	03.632.010.1	1 unit

**Dimensions in mm:** L = Length  
S = Switch  
n = Number of sockets  
F1 = Standard side  
F2 = Design side  
19" = Suitable for 19" installation  
Safe = Child-safe

U = standard height unit  
UP = Unit of packaging  
Express item

**Conversion:** 1 mm = 0.03937 inch 1 kg = 2.2046 pound  
Replace .x with the number of your color combination:  
.1 = RAL 7035, .6 = RAL 7035/RAL 2003

# Emerson Network Power Rack PDUs



DOS00076

## Mains cable for Euro socket strip For DIN 49 440 and French/Belgian standard

- Mains plug CEE/VII - Euro socket IEC 320
- Cable
- H05VV-F 3G 1 mm<sup>2</sup>

**Mains voltage**  
250 VAC

**Nominal current**  
10 A

L	S	n	F1	F2	19"	Safe	Model	Order no.	UP
2000								04.000.054.9	1 unit
6000								04.000.053.9	1 unit



DOS00077

## Mains cable for Euro socket strip For Swiss standard

- Mains plug: Type 12 - Euro socket IEC320
- Cable
- H05VV-F 3G 1 mm<sup>2</sup>

**Mains voltage**  
250 VAC

**Nominal current**  
10 A

L	S	n	F1	F2	19"	Safe	Model	Order no.	UP
2000								04.000.055.9	1 unit



DOS00078

## Mains cable for Euro socket strip For British standard

- Mains plug: Type BS 1363 - Euro socket IEC 320
- Cable
- H05VV-F 3G 1 mm<sup>2</sup>

**Mains voltage**  
250 VAC

**Nominal current**  
10 A

L	S	n	F1	F2	19"	Safe	Model	Order no.	UP
2000								04.000.056.9	1 unit



DOS00519

## Euro Connection Cable

- Mains plug: IEC 320 - Euro socket IEC320
- Cable
- H05VV-F 3G 1 mm<sup>2</sup>
- USA: SJT AWG18 with USA approval

**Mains voltage**  
250 VAC

**Nominal current**  
10 A

L	S	n	F1	F2	19"	Safe	Model	Order no.	UP
900							EU	04.000.051.9	1 unit
900							USA	04.000.052.9	1 unit

**Dimensions in mm:** L = Length  
S = Switch  
n = Number of sockets  
F1 = Standard side  
F2 = Design side  
19" = Suitable for 19" installation  
Safe = Child-safe

U = standard height unit  
UP = Unit of packaging  
Express item

**Conversion:** 1 mm = 0.03937 inch  
1 kg = 2.2046 pound  
Replace .x with the number of your color combination:  
.1 = RAL 7035, .6 = RAL 7035/RAL 2003

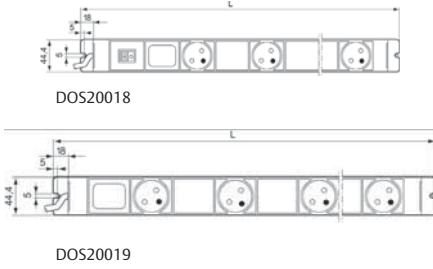

## Knürr DI-STRIP® Classic Standard CEE 7-V (UTE) / France

- Optionally with lit switch, 2-pole switching
- Socket rotation: 45°
- Cable: H05VV-F 3G 1.5 mm<sup>2</sup>
- Molded right angle plug

### Material/ Finish

Housing: closed sheet steel extrusion, zinc-passivated, powder-coated texture  
Plastic parts: Vampamid 6 0024 VO (UL94), recyclable  
Internal conductor: full-length busbar, brass

### Dimensions

Socket spacing: 24 mm 100 mm  
Height: 45.5 mm  
Housing width: 44.4 mm (= 1 U)  
Cable 2.5 m

### Approvals/certificates

- CE label in accordance with low voltage guideline 2006/95/EWG
- EMC Directive 2004/108/EC
- Innova-GS
- CB-scheme

### Color combination

Final digit of order number .1:  
RAL 7035 light gray  
Final digit of order number .6:  
Housing: RAL 2003 pastel orange  
Plastic parts: RAL 7035 light gray

### Load rating

100-240 Vac/16 A

### Supply schedule

1 socket strip  
2 mounting brackets

L	S	n	F1	F2	19"	Safe	Model	Order no.	UP
1783		17	•			•		03.400.067.x	1 unit
1383		13	•			•		03.400.063.x	1 unit
983		9	•			•		03.400.059.x	1 unit
583		5	•			•		03.400.055.x	1 unit
1733	•	16	•			•	With switch	03.402.066.x	1 unit
1333	•	12	•			•	With switch	03.402.062.x	1 unit
933	•	8	•			•	With switch	03.402.058.x	1 unit
533	•	4	•			•	With switch	03.402.054.x	1 unit

**Dimensions in mm:** L = Length  
S = Switch  
n = Number of sockets  
F1 = Standard side  
F2 = Design side  
19" = Suitable for 19" installation  
Safe = Child-safe

U = standard height unit  
UP = Unit of packaging  
 = Express item

**Conversion:** 1 mm = 0.03937 inch 1 kg = 2.2046 pound  
Replace .x with the number of your color combination:  
.1 = RAL 7035, .6 = RAL 7035/RAL 2003

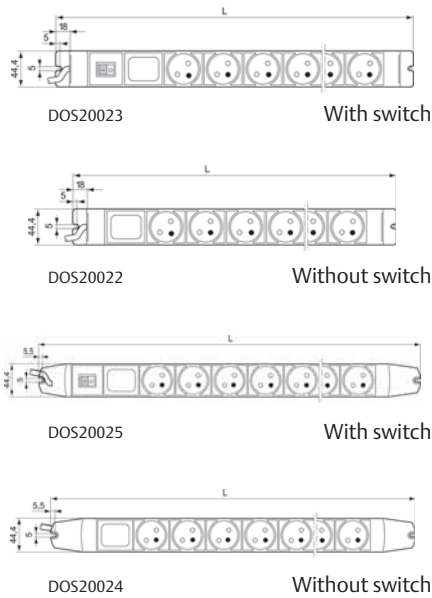

## Knürr DI-STRIP® Compact Standard CEE 7-V (UTE) / France

- Optionally with lit switch, 2-pole switching
- 19" installation option (with length 483 mm)
- 2 versions: Standard side panel or Design side panel
- Socket rotation: 45°
- Cable: H05VV-F 3G 1.5 mm<sup>2</sup>
- Molded right angle plug

### Material/ Finish

Housing: closed sheet steel extrusion, zinc-passivated, powder-coated texture  
 Plastic parts: Vampamid 6 0024 VO (UL94), recyclable  
 Internal conductor: full-length busbar, brass

### Dimensions

Socket spacing: 24 mm 50 mm  
 Height: 45.5 mm  
 Housing width: 44.4 mm (= 1 U)  
 Cable 2.5 m

### Approvals/certificates

- CE label in accordance with low voltage guideline 2006/95/EWG
- EMC Directive 2004/108/EC
- Innova-GS
- CB-scheme

### Color combination



Final digit of order number .1:  
 RAL 7035 light gray  
 Final digit of order number .6:  
 Housing: RAL 2003 pastel orange  
 Plastic parts: RAL 7035 light gray

### Load rating

100-240 Vac/16 A

### Supply schedule

- 1 socket strip
- 2 mounting brackets

L	S	n	F1	F2	19"	Safe	Model	Order no.	UP
883		15	•			•		03.400.015.x	1 unit
732		11		•		•		03.400.111.x	1 unit
683		11	•			•		03.400.011.x	1 unit
532		7		•		•		03.400.107.x	1 unit
483		7	•		•	•		03.400.007.x	1 unit 
382		4		•		•		03.400.104.x	1 unit
333		4	•			•		03.400.004.x	1 unit
883	•	14	•			•	With switch	03.402.014.x	1 unit
732	•	10		•		•	With switch	03.402.110.x	1 unit
683	•	10	•			•	With switch	03.402.010.x	1 unit 
532	•	6		•		•	With switch	03.402.106.x	1 unit
483	•	6	•		•	•	With switch	03.402.006.x	1 unit 
382	•	3		•		•	With switch	03.402.103.x	1 unit
333	•	3	•			•	With switch	03.402.003.x	1 unit

**Dimensions in mm:** L = Length  
 S = Switch  
 n = Number of sockets  
 F1 = Standard side  
 F2 = Design side  
 19" = Suitable for 19" installation  
 Safe = Child-safe  
 U = standard height unit  
 UP = Unit of packaging  
 = Express item

**Conversion:** 1 mm = 0.03937 inch 1 kg = 2.2046 pound  
 Replace .x with the number of your color combination:  
 .1 = RAL 7035, .6 = RAL 7035/RAL 2003

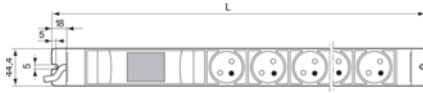

DOS20026

## Knürr DI-STRIP® Protector FI Standard CEE 7-V (UTE) / France

### Protector FI

- RCCB for user protection
- Protection with indirect contact as error protection by switching off with inadmissible high contact voltage through contact with electrical equipment
- Protection with direct contact as back-up protection
- Residual operating current  $I_g = 10$  mA for alternating and pulsating direct fault current
- 19" installation option (with length 483 mm)
- Socket rotation: 45°
- Cable: H05VV-F 3G 1.5 mm<sup>2</sup>
- Molded right angle plug

### Material/ Finish

Housing: closed sheet steel extrusion, zinc-passivated, powder-coated texture  
Plastic parts: Vampamid 6 0024 VO (UL94), recyclable  
Internal conductor: full-length busbar, brass

### Dimensions

Socket spacing: 24 mm 50 mm  
Height: 78 mm  
Housing width: 44.4 mm (= 1 U)  
Cable 2.5 m

### Approvals/certificates

- CE label in accordance with low voltage guideline 2006/95/EWG
- EMC Directive 2004/108/EC
- Innova-GS
- CB-scheme

### Color combination

Final digit of order number .1:  
RAL 7035 light gray  
Plastic parts: RAL 7035 light gray

### Load rating

100-240 Vac/16 A

### Supply schedule

1 socket strip  
2 mounting brackets

L	S	n	F1	F2	19"	Safe	Model	Order no.	UP
883		13	●			◆		03.404.013.1	1 unit
683		9	●			●		03.404.009.1	1 unit
483		5	●		●	●		03.404.005.1	1 unit

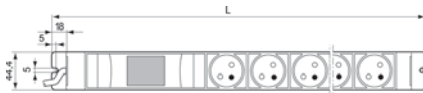

DOS20026

## Knürr DI-STRIP® Protector LS Standard CEE 7-V (UTE) / France

### Protector circuit breaker

- Circuit breaker for overload and short circuit
- Protects cables and feeds with rapid switching off with short circuit and defined delayed cutoff with overload
- Circuit breaker: 16 A
- Tripping characteristic, type B, 2-pole
- 19" installation option (with length 483 mm)
- Socket rotation: 45°
- Cable: H05VV-F 3G 1.5 mm<sup>2</sup>
- Molded right angle plug

### Material/ Finish

Housing: closed sheet steel extrusion, zinc-passivated, powder-coated texture  
Plastic parts: Vampamid 6 0024 VO (UL94), recyclable  
Internal conductor: full-length busbar, brass

### Dimensions

Socket spacing: 24 mm 50 mm  
Height: 78 mm  
Housing width: 44.4 mm (= 1 U)  
Cable 2.5 m

### Approvals/certificates

- CE label in accordance with low voltage guideline 2006/95/EWG
- EMC Directive 2004/108/EC
- Innova-GS
- CB-scheme

### Color combination

Final digit of order number .1:  
RAL 7035 light gray  
Plastic parts: RAL 7035 light gray

### Load rating

100-240 Vac/16 A

### Supply schedule

1 socket strip  
2 mounting brackets

L	S	n	F1	F2	19"	Safe	Model	Order no.	UP
883		13	●			●		03.408.013.1	1 unit
683		9	●			●		03.408.009.1	1 unit
483		5	●		●	●		03.408.005.1	1 unit

**Dimensions in mm:** L = Length  
S = Switch  
n = Number of sockets  
F1 = Standard side  
F2 = Design side  
19" = Suitable for 19" installation  
Safe = Child-safe

U = standard height unit  
UP = Unit of packaging

 = Express item

**Conversion:** 1 mm = 0.03937 inch 1 kg = 2.2046 pound  
Replace .x with the number of your color combination:  
.1 = RAL 7035, .6 = RAL 7035/RAL 2003



DOS 20026

## Knürr DI-STRIP® Protector FI / LS Standard CEE 7-V (UTE) / France

### Protector FI / LS

- Fault current switch and circuit breaker
- Provides a combination of user, overload and short circuit protection
- Residual operating current  $I_g = 30$  mA for alternating and pulsating direct fault current
- Circuit breaker: 16 A
- Tripping characteristic, type B, 2-pole
- Socket rotation: 45°
- Cable: H05VV-F 3G 1.5 mm<sup>2</sup>
- Molded right angle plug

### Material/ Finish

Housing: closed sheet steel extrusion, zinc-passivated, powder-coated texture  
Plastic parts: Vampamid 6 0024 VO (UL94), recyclable  
Internal conductor: full-length busbar, brass

### Dimensions

Socket spacing: 24 mm 50 mm  
Height: 78 mm  
Housing width: 44.4 mm (= 1 U)  
Cable 2.5 m

### Approvals/certificates

- CE label in accordance with low voltage guideline 2006/95/EWG
- EMC Directive 2004/108/EC
- Innova-GS
- CB-scheme

### Color combination

Final digit of order number .1:  
RAL 7035 light gray  
Plastic parts: RAL 7035 light gray

### Load rating

100-240 Vac/16 A

### Supply schedule

1 socket strip  
2 mounting brackets

L	S	n	F1	F2	19"	Safe	Model	Order no.	UP
883		13	•			•		03.410.013.1	1 unit
683		9	•			•		03.410.009.1	1 unit
483		5	•		•	•		03.410.005.1	1 unit

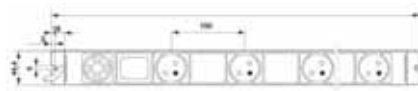

DOS20027

Classic with emergency stop switch

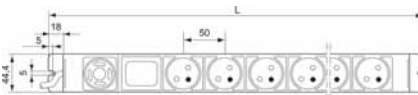

DOS20028

Compact with emergency stop switch

## Knürr DI-STRIP® Protector Emergency STOP Standard CEE 7-V (UTE) / France

- With 2-pole emergency stop switch for user protection
- For protecting operating personnel
- For manual emergency switching off of the connected consumers
- Phase and neutral conductors are safely separated
- Switch must be specifically unlocked to restart
- 19" installation option (with length 483 mm)
- Socket rotation: 45°
- Cable: H05VV-F 3G 1.5 mm<sup>2</sup>
- Molded right angle plug

### Material/ Finish

Housing: closed sheet steel extrusion, zinc-passivated, powder-coated texture  
Plastic parts: Vampamid 6 0024 VO (UL94), recyclable  
Internal conductor: full-length busbar, brass

### Dimensions

Socket spacing: 24 mm Classic: 100 mm,  
Compact: 50 mm  
Height: 101 mm

Housing width: 44.4 mm (= 1 U)  
Cable 2.5 m

### Approvals/certificates

- CE label in accordance with low voltage guideline 2006/95/EWG
- EMC Directive 2004/108/EC
- Innova-GS
- CB-scheme

### Color combinations

Final digit of order number .1:  
RAL 7035 light gray  
Plastic parts: RAL 7035 light gray

### Load rating

100-240 Vac/16 A

### Supply schedule

1 socket strip  
2 mounting brackets  
2 19" mounting bracket (additional with 19" installation option)

L	S	n	F1	F2	19"	Safe	Model	Order no.	UP
683		10	•			•	Compact	03.426.010.1	1 unit
483		6	•		•	•	Compact	03.426.006.1	1 unit
1333		12	•			•	Classic	03.426.062.1	1 unit
933		8	•			•	Classic	03.426.058.1	1 unit

**Dimensions in mm:** L = Length  
S = Switch  
n = Number of sockets  
F1 = Standard side  
F2 = Design side  
19" = Suitable for 19" installation  
Safe = Child-safe

U = standard height unit  
UP = Unit of packaging  
Express item

**Conversion:** 1 mm = 0.03937 inch 1 kg = 2.2046 pound  
Replace .x with the number of your color combination:  
.1 = RAL 7035, .6 = RAL 7035/RAL 2003



DOS20029 With emergency Off switch and FI/LS circuit breaker

## Knürr DI-STRIP® Protector Emergency Stop FI / LS Standard CEE 7-V (UTE) / France

- With 2-pole emergency stop switch for user protection
- For protecting operating personnel
- For manual emergency switching off of the connected consumers
- Phase and neutral conductors are safely separated
- Switch must be specifically unlocked to restart
- Socket rotation: 45°
- Cable: H05VV-F 3G 1.5 mm<sup>2</sup>
- Molded right angle plug

### Material/ Finish

Housing: closed sheet steel extrusion, zinc-passivated, powder-coated texture  
Plastic parts: Vampamid 6 0024 VO (UL94), recyclable  
Internal conductor: full-length busbar, brass

### Dimensions

Socket spacing: 24 mm Compact: 50 mm  
Height: 101 mm  
Housing width: 44.4 mm (= 1 U)  
Cable 2.5 m

### Approvals/certificates

- CE label in accordance with low voltage guideline 2006/95/EWG
- EMC Directive 2004/108/EC
- Innova-GS
- CB-scheme

### Color combinations

Final digit of order number .1:  
RAL 7035 light gray  
Plastic parts: RAL 7035 light gray

### Additionally:

With 2-pole fault current switch and circuit breaker  
Provides a combination of user, overload and short circuit protection

### Load rating

100-240Vac/16 A

### Supply schedule

1 socket strip  
2 mounting brackets

L	S	n	F1	F2	19"	Safe	Model	Order no.	UP
683		8	•			•		03.428.008.1	1 unit



DOS20030 With mains filter

## Knürr DI-STRIP® Power Cleaner Standard CEE 7-V (UTE) / France

- High-frequency glitches are generally caused by switching processes in an operation from 100 kHz to 5MHz. This high-frequency rate overloads the mains frequency and affects adjacent electronic equipment. The mains filter attenuates this high-frequency rate.
- The attenuation behavior is harmonized with the typical interference spectrum.
- The mains filter works in both directions. This means that glitches from the equipment to the socket strip are also filtered from the mains.
- 19" installation option (with length 483 mm)
- Socket rotation: 45°
- Cable: H05VV-F 3G 1.5 mm<sup>2</sup>
- Molded right angle plug

### Material/ Finish

Housing: closed sheet steel extrusion, zinc-passivated, powder-coated texture  
Plastic parts: Vampamid 6 0024 VO (UL94), recyclable  
Internal conductor: full-length busbar, brass

### Dimensions

Socket spacing: 24 mm 50 mm  
Height: 45.5 mm  
Housing width: 44.4 mm (= 1 U)

### Approvals/certificates

- CE label in accordance with low voltage guideline 2006/95/EWG
- EMC Directive 2004/108/EC
- Innova-GS
- CB-scheme

### Color combination

Final digit of order number .1:  
RAL 7035 light gray  
Final digit of order number .6:  
Housing: RAL 2003 pastel orange  
Plastic parts: RAL 7035 light gray

### Load rating

Nominal voltage: max. 250 Vac, 50 Hz  
Nominal current: max. 16 A

### Supply schedule

1 socket strip  
2 mounting brackets

L	S	n	F1	F2	19"	Safe	Model	Order no.	UP
883		13	•			•		03.412.013.x	1 unit
683		9	•			•		03.412.009.x	1 unit
483		5	•		•	•		03.412.005.x	1 unit

**Dimensions in mm:** L = Length  
S = Switch  
n = Number of sockets  
F1 = Standard side  
F2 = Design side  
19" = Suitable for 19" installation  
Safe = Child-safe

U = standard height unit  
UP = Unit of packaging

 = Express item

**Conversion:** 1 mm = 0.03937 inch 1 kg = 2.2046 pound  
Replace .x with the number of your color combination:  
.1 = RAL 7035, .6 = RAL 7035/RAL 2003



DOS20031

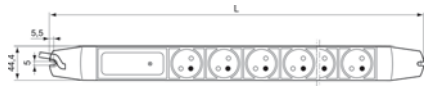

DOS20032

## Knürr DI-STRIP® Safety Basic Standard CEE 7-V (UTE) / France

- For protecting against transient overvoltages from the mains, which, for example, are caused by switching machines on and off.
- With critical overvoltages the mains is separated.
- Once the safety arrester has been triggered the green function display goes out. The socket strip can then no longer be used. Send the socket strip to the manufacturer for the safety arrester to be replaced!
- The safety effect of the type 3 test category and requirements category "D" is to protect the equipment, i.e. precision protection.
- The protection devices of the test and requirements categories 1 and 2 and B and C must be preconnected in the building installation to ensure optimum protection.
- 19" installation option (with length 483 mm)
- Socket rotation: 45°
- Cable: H05VV-F 3G 1.5 mm<sup>2</sup>
- Molded right angle plug

### Material/ Finish

Housing: closed sheet steel extrusion, zinc-passivated, powder-coated texture  
 Plastic parts: Vampamid 6 0024 VO (UL94), recyclable  
 Internal conductor: full-length busbar, brass

### Dimensions

Socket spacing: 24 mm 50 mm  
 Height: 45.5 mm  
 Housing width: 44.4 mm (= 1 U)

### Approvals/certificates

- CE label in accordance with low voltage guideline 2006/95/EWG
- EMC Directive 2004/108/EC
- Innova-GS
- CB-scheme

### Color

Final digit of order number .1:  
 RAL 7035 light gray

### Technical data

- Test category: Type 3
- In acc. with DIN EN 61643-11
- Requirements class: D
- In acc. with VDE 0675-6
- Mains voltage: 230 VAC
- Nominal current: max. 16 A
- Cut-off discharge current (8/20 μs): 10 kA
- Response time: < 25 ns
- Protection level (with 100 A varistor peak current):
- L with respect to N: < 800 V
- L/N with respect to PE: < 1500 V

### Supply schedule

- 1 socket strip
- 2 mounting brackets

L	S	n	F1	F2	19"	Safe	Model	Order no.	UP
732		10		•		•		03.416.110.1	1 unit
683		10	•			•		03.416.010.1	1 unit
532		6		•		•		03.416.106.1	1 unit
483		6	•		•	•		03.416.006.1	1 unit
432		4		•		•		03.416.104.1	1 unit
383		4	•			•		03.416.004.1	1 unit

**Dimensions in mm:** L = Length  
 S = Switch  
 n = Number of sockets  
 F1 = Standard side  
 F2 = Design side  
 19" = Suitable for 19" installation  
 Safe = Child-safe

U = standard height unit  
 UP = Unit of packaging  
 = Express item

**Conversion:** 1 mm = 0.03937 inch      1 kg = 2.2046 pound  
 Replace .x with the number of your color combination:  
 .1 = RAL 7035, .6 = RAL 7035/RAL 2003



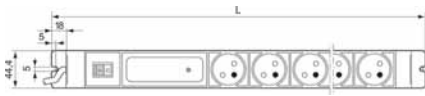

DOS20033 With overvoltage protection and mains filter

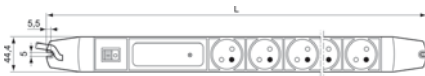

DOS20034 With overvoltage protection and mains filter

## Knürr DI-STRIP® Safety Standard Standard CEE 7-V (UTE) / France

- The “Safety Standard” models consist of a combined overvoltage protection/mains filter element.
- For protecting against transient overvoltages from the mains, which, for example, are caused by switching machines on and off.
- With critical overvoltages the mains is separated.
- Once the safety arrester has been triggered the green function display goes out. The socket strip can then no longer be used. Send the socket strip to the manufacturer for the safety arrester to be replaced!
- The safety effect of the type 3 test category and requirements category “D” is to protect the equipment, i.e. precision protection.
- The protection devices of the test and requirements categories 1 and 2 and B and C must be preconnected in the building installation to ensure optimum protection.
- High-frequency glitches are generally caused by switching processes in an operation from 100 kHz to 5MHz.
- This high-frequency rate overloads the mains frequency and affects adjacent electronic equipment. The mains filter attenuates this high-frequency rate.
- The attenuation behavior is harmonized with the typical interference spectrum.
- 19” installation option (with length 483 mm)
- Socket rotation: 45°
- Cable: H05VV-F 3G 1.5 mm<sup>2</sup>
- Molded right angle plug

### Material/ Finish

Housing: closed sheet steel extrusion, zinc-passivated, powder-coated texture  
 Plastic parts: Vampamid 6 0024 VO (UL94), recyclable  
 Internal conductor: full-length busbar, brass

### Dimensions

Socket spacing: 24 mm 50 mm  
 Height: 45.5 mm  
 Housing width: 44.4 mm (= 1 U)  
 Cable 2.5 m

### Approvals/certificates

- CE label in accordance with low voltage guideline 2006/95/EWG
- EMC Directive 2004/108/EC
- Innova-GS
- CB-scheme

### Color combination

Final digit of order number .1:  
 RAL 7035 light gray  
 Final digit of order number .6:  
 Housing: RAL 2003 pastel orange  
 Plastic parts: RAL 7035 light gray

### Technical data

Mains voltage: 230 VAC  
 Nominal current: max. 16 A  
 Cut-off discharge current (8/20 μs): 10 kA  
 Response time: < 25 ns  
 Protection level  
 (with 100 A varistor peak current):  
 - L with respect to N: < 800 V  
 - L/N with respect to PE: < 1500 V  
 Overvoltage protection  
 Requirements class: D  
 - In acc. with VDE 0675-6  
 Mains filter  
 - In acc. with VDE 0565 (EN 60939)

### Supply schedule

1 socket strip  
 2 mounting brackets

L	S	n	F1	F2	19"	Safe	Model	Order no.	UP
883	●	13	●			●	With switch	03.418.013.x	1 unit
732	●	9		●		●	With switch	03.418.109.x	1 unit
683	●	9	●			●	With switch	03.418.009.x	1 unit
532	●	5		●		●	With switch	03.418.105.x	1 unit
483	●	5	●		●	●	With switch	03.418.005.x	1 unit

**Dimensions in mm:** L = Length  
 S = Switch  
 n = Number of sockets  
 F1 = Standard side  
 F2 = Design side  
 19" = Suitable for 19" installation  
 Safe = Child-safe  
 U = standard height unit  
 UP = Unit of packaging  
 = Express item

**Conversion:** 1 mm = 0.03937 inch  
 1 kg = 2.2046 pound  
 Replace .x with the number of your color combination:  
 .1 = RAL 7035, .6 = RAL 7035/RAL 2003



DOS20035 With master-slave module

## Knürr DI-STRIP® Master Slave Standard CEE 7-V (UTE) / France

- If the master equipment is switched, the slave sockets are also switched (together, with a short delay to the master). This means convenient switching on and off of several hard to access devices. Switching thresholds can be set from outside via potentiometer.

- Note:

- The master equipment power consumption must be continuously above the switching-on threshold. When switching off the master equipment, the power consumption must fall below the switching-off threshold.

- 19" installation option (with length 483 mm)

- Socket rotation: 45°

- Cable: H05VV-F 3G 1.5 mm<sup>2</sup>

- Molded right angle plug

### Material/ Finish

Housing: closed sheet steel extrusion, zinc-passivated, powder-coated texture  
Plastic parts: Vampamid 6 0024 VO (UL94), recyclable  
Internal conductor: full-length busbar, brass

### Dimensions

Socket spacing: 24 mm 50 mm

Height: 45.5 mm

Housing width: 44.4 mm (= 1 U)

Cable 2.5 m

### Approvals/certificates

- CE label in accordance with low voltage guideline 2006/95/EWG
- EMC Directive 2004/108/EC
- Innova-GS
- CB-scheme

### Color combination

Final digit of order number .1:  
RAL 7035 light gray  
Plastic parts: RAL 7035 light gray

### Load rating

Max. 250 Vac/16 A

### Technical data

Switching threshold setting range  
On: 20 mA - 200 mA  
(approx. 55 mA delivery status)  
Off: 16 mA - 160 mA  
(approx. 44 mA delivery status)  
Switching delay: 550 ms +/- 20 %  
Electronic module: 2-pole switching

### Supply schedule

1 socket strip  
2 mounting brackets

L	S	n	F1	F2	19"	Safe	Model	Order no.	UP
683		9	•			•		03.414.009.1	1 unit
483		5	•		•	•		03.414.005.1	1 unit

**Dimensions in mm:** L = Length  
S = Switch  
n = Number of sockets  
F1 = Standard side  
F2 = Design side  
19" = Suitable for 19" installation  
Safe = Child-safe  
U = standard height unit  
UP = Unit of packaging  
 = Express item

**Conversion:** 1 mm = 0.03937 inch  
1 kg = 2.2046 pound  
Replace .x with the number of your color combination:  
.1 = RAL 7035, .6 = RAL 7035/RAL 2003



DOS20037 Master-slave, overvoltage protection and mains filter

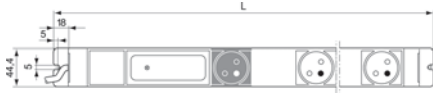

DOS20036 Master-slave, overvoltage protection and mains filter

## Knürr DI-STRIP® Combi Standard CEE 7-V (UTE) / France

- Master-slave with overvoltage protection and mains filter
- Automatic consumer switching
- Combines Master-Slave (page 7.32) and Safety Standard (page 7.31) functions
- Socket rotation: 45°
- Cable: H05VV-F 3G 1.5 mm<sup>2</sup>
- Molded right angle plug

### Material/ Finish

Housing: closed sheet steel extrusion, zinc-passivated, powder-coated texture  
Plastic parts: Vampamid 6 0024 VO (UL94), recyclable  
Internal conductor: full-length busbar, brass

### Dimensions

Socket spacing: 24 mm 50 mm  
Height: 45.5 mm  
Housing width: 44.4 mm (= 1 U)  
Cable 2.5 m

### Approvals/certificates

- CE label in accordance with low voltage guideline 2006/95/EWG
- EMC Directive 2004/108/EC
- Innova-GS
- CB-scheme

### Color combination

Final digit of order number .1:  
RAL 7035 light gray  
Plastic parts: RAL 7035 light gray

### Technical data

Overvoltage protection and mains filter:  
Mains voltage: max. 250 Vac  
Nominal current: 16 A  
Requirements class: D (precision protection in acc. with VDE 0675)  
Surge current resistance (8/20 μs wave): max. 10 kA  
Protection level (1.5/50 μs wave): < 1500 V (L + N against PE)  
Master-slave function:  
Switching threshold setting range  
On: 20 mA - 200 mA (approx. 55 mA delivery status)  
Off: 16 mA - 160 mA (approx. 44 mA delivery status)  
Switching delay: 550 ms +/- 20 %  
Electronic module: 2-pole switching

### Supply schedule

1 socket strip  
2 mounting brackets

L	S	n	F1	F2	19"	Safe	Model	Order no.	UP
782		9		●		●		03.420.109.1	1 unit
733		9	●			●		03.420.009.1	1 unit
582		5		●		●		03.420.105.1	1 unit
533		5	●			●		03.420.005.1	1 unit

**Dimensions in mm:** L = Length  
S = Switch  
n = Number of sockets  
F1 = Standard side  
F2 = Design side  
19" = Suitable for 19" installation  
Safe = Child-safe,  
U = standard height unit  
UP = Unit of packaging  
 = Express item

**Conversion:** 1 mm = 0.03937 inch 1 kg = 2.2046 pound  
Replace .x with the number of your color combination:  
.1 = RAL 7035, .6 = RAL 7035/RAL 2003



DOS20048 GST 18 with switch



DOS20047 GST 18 without switch

## Knürr DI-STRIP® Compact GST 18 Plug System (Wieland) Standard CEE 7-V (UTE) / France

- Quick and efficient plug connection system
- Plug-in electro-installation in place of conventional wiring
- Speed:
  - With easy pre-configured element plugging together
- Flexibility:
  - With cable (cable length)
- Rational:
  - Easy socket strip swap-out, without costly cabling
- Safety:
  - Faulty installations are ruled out with plug system
- Space-saving:
  - Use of protection and switching functions can be extended with further cabling without and plug space loss (max. load rating 16 A)

### Material/ Finish

Housing: closed sheet steel extrusion, zinc-passivated, powder-coated texture  
 Plastic parts: Vampamid 6 0024 VO (UL94), recyclable  
 Internal conductor: full-length busbar, brass

### Dimensions

Socket spacing: 24 mm 50 mm  
 Height: 45.5 mm  
 Housing width: 44.4 mm (= 1 U)

### Approvals/certificates

- CE label in accordance with low voltage guideline 2006/95/EWG
- EMC Directive 2004/108/EC
- Innova-GS
- CB-scheme

### Color combination

Final digit of order number .1:  
 RAL 7035 light gray  
 Plastic parts: RAL 7035 light gray

### Load rating

100-240 Vac/16 A

### Supply schedule

1 socket strip  
 2 mounting brackets

L	S	n	F1	F2	19"	Safe	Model	Order no.	UP
583	●	6	●			●	With switch	03.402.206.1	1 unit
433	●	3	●			●	With switch	03.402.203.1	1 unit
533		7	●			●		03.400.207.1	1 unit
383		4	●			●		03.400.204.1	1 unit



DOS20051

## Knürr DI-STRIP® Safety Basic with GST18 plug system / France

- With overvoltage protection
- Technical description, see page 180

L	S	n	F1	F2	19"	Safe	Model	Order no.	UP
433		4				●		03.416.204.1	1 unit



DOS20052

## Knürr DI-STRIP® Safety Standard with GST18 plug system

- With overvoltage protection, with integrated mains filter and lit switch
- Technical description, see page 181

L	S	n	F1	F2	19"	Safe	Model	Order no.	UP
583		5				●		03.418.205.1	1 unit



DOS20054

## Knürr DI-STRIP® Master Slave with GST18 plug system

- Technical description, see page 182

L	S	n	F1	F2	19"	Safe	Model	Order no.	UP
533		5				●		03.414.205.1	1 unit



DOS00717



DOS00664

Classic with switch



DOS00665

Classic without switch

## Knürr DI-STRIP® Classic Standard CH SEV 1011

- With/without switch, socket spacing, 100 mm
- Optionally with lit switch, 2-pole switching
- Socket rotation: 45°
- Cable: H05VV-F 3G 1.5 mm<sup>2</sup>
- Molded plug

### Material/ Finish

Housing: closed sheet steel extrusion, zinc-passivated, powder-coated texture  
 Plastic parts: Vampamid 6 0024 VO (UL94), recyclable  
 Internal conductor: full-length busbar, brass

### Dimensions

Socket spacing: 24 mm 100 mm  
 Height: 45.5 mm  
 Housing width: 44.4 mm (= 1 U)  
 Cable 2.5 m

### Approvals/certificates

- CE label in accordance with low voltage guideline 2006/95/EWG
- EMC Directive 2004/108/EC
- Innova-GS
- CB-scheme

### Color combination

Final digit of order number .1:  
 RAL 7035 light gray  
 Final digit of order number .6:  
 Housing: RAL 2003 pastel orange  
 Plastic parts: RAL 7035 light gray

### Load rating

100-240 Vac/10 A

### Supply schedule

1 socket strip  
 2 mounting brackets

L	S	n	F1	F2	19"	Safe	Model	Order no.	UP
1783		17	•					03.700.067.x	1 unit
1383		13	•					03.700.063.x	1 unit
983		9	•					03.700.059.x	1 unit
583		5	•					03.700.055.x	1 unit
1733	•	16	•				With switch	03.702.066.x	1 unit
1333	•	12	•				With switch	03.702.062.x	1 unit
933	•	8	•				With switch	03.702.058.x	1 unit
533	•	4	•				With switch	03.702.054.x	1 unit



DOS20074



DOS00666



DOS20038



DOS20039



DOS00667

## Knürr DI-STRIP® Compact Standard CH SEV 1011

- Optionally with lit switch, 2-pole switching
- 19" installation option (with length 483 mm)
- 2 models, standard side or design side
- Socket rotation: 45°
- Cable: H05VV-F 3G 1.5 mm<sup>2</sup>
- Molded plug

### Material/ Finish

Housing: closed sheet steel extrusion, zinc-passivated, powder-coated texture  
Plastic parts: Vampamid 6 0024 VO (UL94), recyclable  
Internal conductor: full-length busbar, brass

### Dimensions

Socket spacing: 24 mm 50 mm  
Height: 45.5 mm  
Housing width: 44.4 mm (= 1 U)  
Cable 2.5 m

### Approvals/certificates

- CE label in accordance with low voltage guideline 2006/95/EWG
- EMC Directive 2004/108/EC
- Innova-GS
- CB-scheme

### Color combination

Final digit of order number .1:  
RAL 7035 light gray  
Plastic parts: RAL 7035 light gray

### Load rating

100-240 Vac/10 A

### Supply schedule

- 1 socket strip
- 2 mounting brackets

L	S	n	F1	F2	19"	Safe	Model	Order no.	UP
883		15	●					03.700.015.1	1 unit
732		11		●				03.700.111.1	1 unit
683		11	●					03.700.011.1	1 unit
532		7		●				03.700.107.1	1 unit
483		7	●		●			03.700.007.1	1 unit 
382		4		●				03.700.104.1	1 unit
333		4	●					03.700.004.1	1 unit
732	●	10		●			With switch	03.702.110.1	1 unit
683	●	10	●				With switch	03.702.010.1	1 unit
532	●	6		●			With switch	03.702.106.1	1 unit
483	●	6	●		●		With switch	03.702.006.1	1 unit
382	●	3		●			With switch	03.702.103.1	1 unit
333	●	3	●				With switch	03.702.003.1	1 unit

**Dimensions in mm:** L = Length  
S = Switch  
n = Number of sockets  
F1 = Standard side  
F2 = Design side  
19" = Suitable for 19" installation  
Safe = Child-safe

U = standard height unit  
UP = Unit of packaging  
 = Express item

**Conversion:** 1 mm = 0.03937 inch 1 kg = 2.2046 pound  
Replace .x with the number of your color combination:  
.1 = RAL 7035, .6 = RAL 7035/RAL 2003



DOS00719



DOS00668

## Knürr DI-STRIP® Protector FI/LS Standard CH SEV 1011

### Protector FI/LS

- Fault current switch and circuit breaker
- Provides a combination of user, overload and short circuit protection
- Residual operating current  $I_g = 30$  mA for alternating and pulsating direct fault current
- Circuit breaker: 10 A
- Tripping characteristic, type B, 2-pole

- 19" installation option (with length 483 mm)
- Socket rotation: 45°
- Cable: H05VV-F 3G 1.5 mm<sup>2</sup>
- Molded right angle plug

### Material/ Finish

Housing: closed sheet steel extrusion, zinc-passivated, powder-coated texture  
 Plastic parts: Vampamid 6 0024 VO (UL94), recyclable  
 Internal conductor: full-length busbar, brass

### Dimensions

Socket spacing: 24 mm 50 mm  
 Height: 78 mm  
 Housing width: 44.4 mm (= 1 U)  
 Cable 2.5 m

### Approvals/certificates

- CE label in accordance with low voltage guideline 2006/95/EWG
- EMC Directive 2004/108/EC
- Innova-GS
- CB-scheme

### Color combination

Final digit of order number .1:  
 RAL 7035 light gray  
 Plastic parts: RAL 7035 light gray

### Load rating

100-240 Vac/10 A

### Supply schedule

- 1 socket strip
- 2 mounting brackets

L	S	n	F1	F2	19"	Safe	Model	Order no.	UP
683		9	•					03.710.009.1	1 unit
483		5	•		•			03.710.005.1	1 unit



DOS00720



DOS00669

With overvoltage protection and mains filter

## Knürr DI-STRIP® Safety Standard Standard CH SEV 1011

- With overvoltage protection and integrated mains filter
- With lit switch, 2-pole switching
- 19" installation option (with length 483 mm)
- Socket rotation: 45°
- Cable: H05VV-F 3G 1.5 mm<sup>2</sup>
- Molded plug

### Material/ Finish

Housing: closed sheet steel extrusion, zinc-passivated, powder-coated texture  
 Plastic parts: Vampamid 6 0024 VO (UL94), recyclable  
 Internal conductor: full-length busbar, brass

### Dimensions

Socket spacing: 24 mm 50 mm  
 Height: 45.5 mm  
 Housing width: 44.4 mm (= 1 U)  
 Cable 2.5 m

### Approvals/certificates

- CE label in accordance with low voltage guideline 2006/95/EWG
- EMC Directive 2004/108/EC
- Innova-GS
- CB-scheme

### Color combination

Final digit of order number .1:  
 RAL 7035 light gray  
 Plastic parts: RAL 7035 light gray

### Description and technical data

(See page 165)  
 Nominal current: 10 A

### Supply schedule

- 1 socket strip
- 2 mounting brackets
- 2 19" mounting brackets (additional with 19" installation option)

L	S	n	F1	F2	19"	Safe	Model	Order no.	UP
683	•	9	•				With switch	03.718.009.1	1 unit
483	•	5	•		•		With switch	03.718.005.1	1 unit

**Dimensions in mm:** L = Length  
 S = Switch  
 n = Number of sockets  
 F1 = Standard side  
 F2 = Design side  
 19" = Suitable for 19" installation  
 Safe = Child-safe  
 U = standard height unit  
 UP = Unit of packaging  
 = Express item

**Conversion:** 1 mm = 0.03937 inch 1 kg = 2.2046 pound  
 Replace .x with the number of your color combination:  
 .1 = RAL 7035, .6 = RAL 7035/RAL 2003







# Knürr PowerTrans®

Power Distribution Rack

Central connection unit for  
power supplies for individual  
server racks.

2.56 to 2.58



Power Distribution Rack

# PowerTrans®

The **Knürr PowerTrans®** Rack is the interface between the low voltage feed and the Power Distribution Unit (PDU) of the **Knürr DI-STRIP®** family, as well as other Emerson Network Power PDUs for supplying servers and further IT devices.

The power distribution is performed in the individual plug-in units and therefore no longer has to be installed fixed in the building. Up to 8 plug-in units can be integrated. Each plug-in unit is supplied with an A and B feed (redundancy). With max. 250 A/phase loads of up to 329 kVA can be supplied from just one single rack.



1 MIR20388

## Knürr PowerTrans® Strong points

**1 Equipping and installation**

The outputs on the plug-in units can be flexibly configured according to customer requirements via various plug connections, type CEE and GST 18. (e.g. BladePower® or PizzaPower®, DI-STRIP® TriplePower®, and flexible distribution with the GST18i5 distributor block, 3-phase).

**2 Two 3-phase feeds**

- Feed A and feed B both three-phase with max. 250A/phase L1, L2, L3, N, PE
- Ideal for providing feed redundancies

**3 Cable routing**

Convenient cable routing from above and below.

**4 Costs-conscious**

Only the main feed on the rack must be installed by an electrician. The individual plug-in units and the PDUs can be connected per Plug & Play installation, thereby allowing later extensions to be performed cost-effectively.



2 MIR20390



3 MIR20391



4 MIR20386



MIR20377

### Knürr PowerTrans® 19" Power Distribution Rack

- Feed of 2 separate 3-phase 400V mains, L1, L2, L3, N, PE
- Each with a 250A circuit breaker in the input
- Distribution to the individual plugs via busbars and contact-safe plug-in connections
- Up to 8 slot-in units with A feed and B feed are possible

#### Material / Finish

- Basic rack, extruded aluminum, polished
- Corner piece, die-cast aluminum, polished
- Glass infill front door, single safety glass panel, 4mm
- Covers, zinc-passivated sheet steel, powder-coated texture

#### Color

RAL 7021 dark gray

#### Supply schedule

- 1 rack with covers and front door
- 1 plinth for cable entry on the side and rear with leveling feet (0-25mm)
- 2 plinth trims for front and rear, with vent slots and fixing for filter mat
- 2 plinth trims, closed
- 1 set of busbars, safe from contact for A feed and B feed
- 2 circuit breakers with max. 250 A
- 16 power supply plugs for the slot-in units wired on the busbars
- 5 multifunctional braces with jumper bracket
- 2 19" T-slot extrusions
- 16 chassis rails
- 1 complete earthing set
- 1 complete locking set

#### How supplied

Assembled

W	H	D	U	h	d	kg	Model	Order no.	UP
800	2120	1000						03.014.501.8	1 unit



MIR20383

### Knürr PowerTrans® 19" Chassis

- 19" slot-in housing
- Width 19"
- Height 3 U
- Depth 480 mm
- Color: RAL 7021 dark gray
- 2 separate 3-phase inputs with max. 63A phase current
- Outputs acc. to variants 1-4

#### Variant 1 Plug-in

- 2 protected 3-phase outputs, 230V/400V 32A via IEC60309 socket, 3Ph/N/PE 6h, red
- Suitable for connecting 2 PizzaPower 3-phase (03.631.021.1) or 2 BladePower 3-phase (03.630.015.1)

#### Variant 2 Plug-in

- 4 protected 1-phase outputs, 230V 32A via IEC60309 socket, 1Ph/N/PE 6h, blue
- Suitable for connecting 4 PizzaPower 1-phase (03.631.007.1) or 4 BladePower 1-phase (03.630.005.1)

#### Variant 3 Plug-in

- 6 protected 1-phase outputs 230V/400V 16A via GST18i5 Euro installed socket, 3Ph
- Suitable for connecting GST18i5 distributor block, 3-phase (04.000.038.9, for flexible distribution to 1-phase socket strips) as well as connecting a TriplePower 3-phase (03.600.024.1 or 03.600.048.1)

#### Variant 4 Plug-in

- Empty housing
- For customer-specific equipping

#### How supplied

Assembled



MIR20382

W	H	D	U	Model	Order no.	UP
19"	479	3		Variant 1	03.014.003.8	1 unit
19"	479	3		Variant 2	03.014.002.8	1 unit
19"	479	3		Variant 3	03.014.001.8	1 unit
19"	479	3		Variant 4	03.014.000.8	1 unit

... multifunctional use



Connection example for 3-phase (32 A) power distribution in data centers with blade servers and pizza servers. Socket strip connection cable length can be freely selected (max. 20 m).

3-phase variant: BladePower® and PizzaPower®



Connection example for 1-phase (32 A) power distribution in data centers with blade servers and pizza servers. Socket strip connection cable length can be freely selected (max. 20 m).

1-phase variant: BladePower® and PizzaPower®

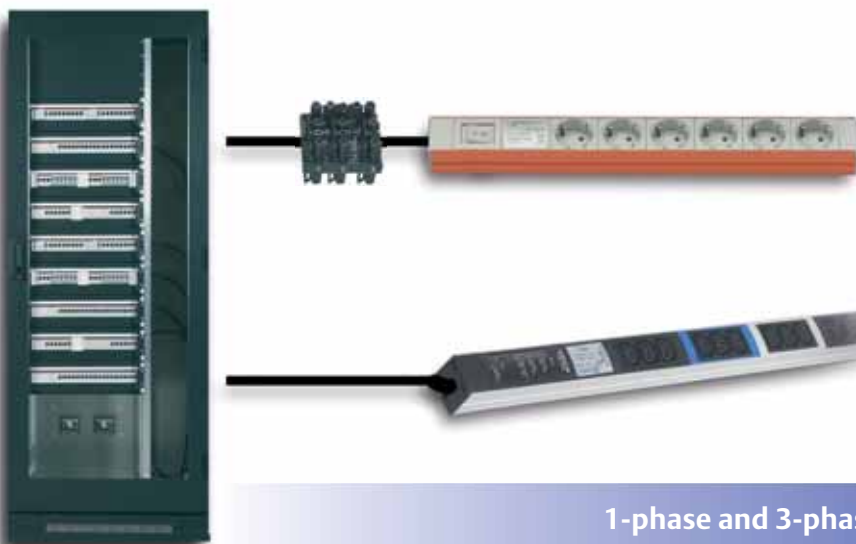

Connection example for 1-phase and 3-phase (16 A) power distribution in network racks. Socket strip connection cable length can be freely selected (max. 20 m).

1-phase and 3-phase variant: DISTRIP® and TriplePower®



# UPS

Uninterruptible  
Power Supply

2.60 to 2.74



## Uninterruptible Power Supplies:

### UPS

Strong points 2.60

Liebert PSI XR 2.61

Liebert PSI 2.64

Liebert GXT3 2.67

Liebert GXT2 2.69

Liebert GXT2  
10000R230 2.69

## Tower Solutions • 19" Slot-In • Large Scale Systems

# UPS

The right technical solution for every requirement.



UPS20082

## Uninterruptible Power Supplies Strong points

- **Safety:**  
High-grade online and line interactive technology guarantees safe and uninterruptible operation of your systems.
- **Efficiency:**  
The 19" modules provide high performance on minimum installation space with compact construction and modular setup.
- **Investment security:**  
Our solutions grow with your requirements, can be flexibly used and are easily expanded.
- **Central UPS systems**  
Higher power classes, 10 kVA to 4800 kVA, with installation and maintenance on request.
- **Modularity:**  
The individual components of this range can be combined according to requirements and consequently produce specifically defined solutions.
- **User-friendliness**  
Comprehensive displays and interactive interfaces for external analysis of status messages provide the user with current system information at all times.
- **Highest possible protection**  
Online UPS systems provide the highest possible protection against the 10 most frequent mains disturbances.

**Line-InterActive / PowerSure PSI XR**  
IEC 62040-3 VI-SS-313

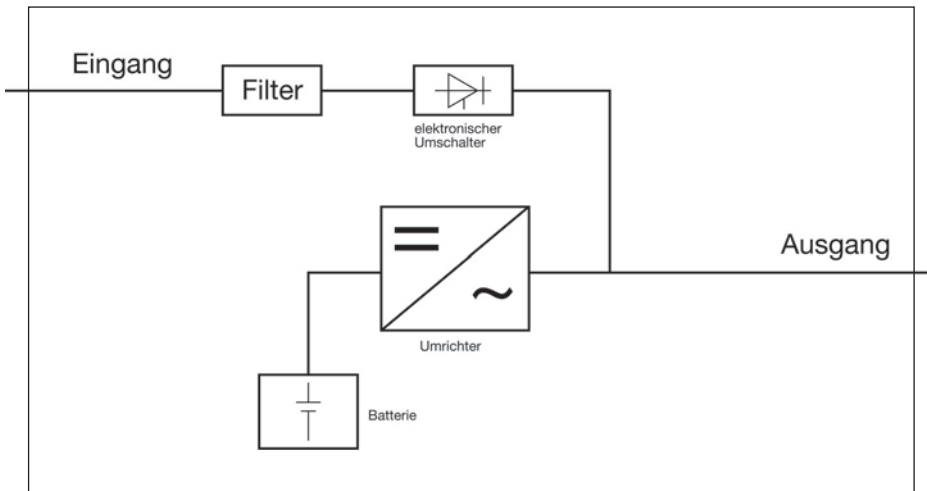

UPS20085

The line interactive UPS model uses an inverter in inverse operation to recharge the battery with stable mains supply. If the mains power supply fails, then the working direction changes and the battery powers the inverter. Because the transducer constantly monitors the mains input, it can react quicker to failures and correct voltage breaks. The transducer connected upstream from the consumer has a specific filtering effect against mains disturbances. This technology is highly recommendable for uninterruptible power supplies for many applications, particularly with regard to PC requirements.

**Power Quality Systems**

# Liebert PSI XR

**Protection in rack and tower use for networks, telecommunications and servers**

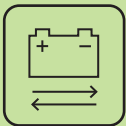

Hot-swappable batteries



Line-InterActive Design



Universal communication options



Extendable bridging times



Professional desktop PCs



Switches, hubs, routers & bridges



Data center facilities



Telecommunication switchgear units

## Liebert® PSI-XR High-performance rack & tower UPS system for network protection

The **Liebert PSI-XR** is a compact UPS system with line-interactive technology, which was specially designed for IT applications, such as network racks and small data centers, for example.

The Liebert PSI-XR's flexible design allows the unit to be configured as a standalone tower and rack installation over 2 U.

The Liebert PSI-XR is available as both 230-V and 120-V model in four different power classes.

The UPS is especially impressive with its innovative line-interactive design and automatic voltage regulation. This protects against voltage fluctuations by increasing or reducing the power supply to the level required by the connected devices. The UPS system also ensures longer battery service life, as the devices are supplied for as long as possible via the mains.

### ■ Liebert PSI-XR standard equipment Flexibility:

- Six or seven battery backed-up outputs
- Configurable input voltage range
- Free swivel display panel
- Automatic frequency scanning
- Several communication options (serial, USB, SNMP and contact closure)

### ■ Higher availability

- Data cable overvoltage protection
- UPS system status early warning system
- Fully automatic battery test
- Lightning and overvoltage protection
- Remote emergency stop
- Hot-swappable batteries the user can change
- Sufficient battery run time under full charge with power failures for proper shut down of the connected equipment

### ■ Lowest possible TCO (Total Cost of Ownership)

- 0.9 power factor for more power for the protected devices and energy-efficient operation
- Wide input voltage range
- Reduced installation input (costs and time)
- Standard two year warranty

### ■ Ideal for:

- PCs
- Networked workstations
- Servers
- Network racks
- Big network peripheries
- VoIP



PSI XR 2U Rack version

PSI XR 2U Tower version



## Liebert® PSI XR specifications

Model	PS1000RT3-230XR	PS1500RT3-230XR	PS2200RT3-230XR	PS3000RT3-230XR
<b>Power data</b>				
VA	1000VA	1500VA	2200VA	3000VA
W	900W	1350W	1980W	2700W
<b>Dimensions and weight</b>				
Device (WxDxH mm)	440 x 490.5 x 88	440 x 490.5 x 88	440 x 700.5 x 88	440 x 700.5 x 88
Shipping size (WxDxH mm)	560 x 612 x 228	560 x 612 x 228	560 x 821 x 228	560 x 821 x 228
Weight - device (kg)	25	28	42	46
Shipping weight (kg)	29	32	47	51
<b>Input parameters</b>				
Frequency	220			
Voltage range without battery operation	165 to 300 VAC (configurable)			
Frequency range	45 - 65 Hz, (± 0.5 Hz)			
Input connection	IEC320-C14	IEC320-C14	IEC320-C20	IEC320-C20
<b>Output parameters</b>				
Output connections	(6) IEC320-C13	(6) IEC320-C13	(6) IEC320-C13 (1) IEC320-C19	(6) IEC320-C13 (1) IEC320-C19
Voltage (Normal Mode)	220/230/240 VAC (configurable)			
Voltage (Battery Mode)	220/230/240 VAC (configurable); ± 5% before low-battery warning			
Transfer Time	4-6 ms typical			
On-Battery Waveform	Sine wave			
Overload Warning	>100%			
<b>Battery Parameters</b>				
Type	Valve-regulated, nonspillable, lead acid			
Quantity x Voltage x Rating	4 x 12 x 7.2	4 x 12 x 9	8 x 12 x 7.2	8 x 12 x 9
Recharge Time	5 hours to 90% of rated capacity, after full discharge into resistive load			
Battery Backup Time				
<b>Environmental</b>				
Operating/ Storage Temperature, °C	0 to 40 / -15 to 40			
Relative Humidity	0% to 90%, non-condensing			
Operating Altitude	Up to 3000m at 35° without derating			
Audible Noise	< 40 dBA, internal fan(s) Off; < 45 dBA, internal fan(s) On			
Agency				
Safety	IEC 62040-1-1			
EMC	IEC/EN/AS 62040-2 2nd Ed Class A			
Transportation	ISTA Procedure 1A Certification			
Warranty	2 years standard (+ 1 year warranty extension available)			
Packaging	User Manual on CD, Software CD, DB9 Serial cable, USB Cable, Tower Stands, Rack-Handles w/mounting hardware, Safety Instruction Sheet, Environment protection sheet, REPO mate socket, (2) IEC output cables for 1000/1500 VA and (3) IEC output cables for 2200/3000 VA, for PS 2200/3000; (1) "Shucko" CEE 7/7 to IEC-320-C19 input cord and (1) UK plug to IEC-320-C19 input cord			
Order no.	06.099.027.1	06.099.028.1	06.099.029.1	06.099.030.1
Order no. SNMP Card	06.099.022.1			

## Liebert® PSI XR Battery Cabinet Specifications

Model	PSRT3-24VBXR	PSRT3-48VBXR
Used w/UPS Model	PS1000RT3-230XR / PS1500RT3-230XR	PS2200RT3-230XR / PS3000RT3-230XR
<b>Dimensions, W x D x H, mm</b>		
Unit / Shipping	440 x 490.5 x 88 / 560 x 675 x 228	
Weight, kg		
Unit / Shipping	29 / 33	
<b>Batteries</b>		
Type	Valve-regulated, nonspillable, lead acid	
Quantity x Voltage x Rating	8 x 12 x 7.2	8 x 12 x 7.2
Battery Manufacturer	CSB, YUASA or Equivalent	
<b>Environmental</b>		
Operating / Storage Temperature, °C	0 to 40 / -15 to 40	
Relative Humidity	0% to 90%, non-condensing	
Maximum Operating Altitude	3000m at 35° without derating	
Agency		
Safety / Emissions	IEC/EN/AS 62040-1-1 / IEC/EN/AS 62040-2 2nd Ed Class A	
Transportation	ISTA Procedure 1A Certification	
Order no.	06.099.034.1	06.099.035.1

## Battery runtime chart (runtimes in minutes; with fully charged batteries; ambient temperature 25 °C)

Number of batteries	PS1000RT3-230XR	PS1500RT3-230XR	PS2200RT3-230XR	PS3000RT3-230XR
Internal Battery (half/full load)	15 / 6	13 / 5	14 / 5	13 / 5
1 Cabinet (half/full load)	73 / 31	55 / 18	45 / 15	31 / 12
2 Cabinet (half/full load)	129 / 65	95 / 46	67 / 29	56 / 18
3 Cabinet (half/full load)	181 / 96	131 / 64	95 / 48	73 / 31
4 Cabinet (half/full load)	233 / 124	167 / 82	143 / 72	95 / 47
5 Cabinet (half/full load)	285 / 151	203 / 106	167 / 84	113 / 56
6 Cabinet (half/full load)	336 / 179	239 / 124	191 / 102	131 / 65



Although much time and effort went into ensuring that this brochure is accurate and complete, the Liebert Corporation does not accept responsibility for its content and does not accept any form of liability for damages that may result from the use of this information, nor does it accept responsibility for errors or omissions.

© 2009 Liebert Corporation. All rights reserved worldwide. Specifications may change without prior notice.

All names appearing in the text are trademarks or registered trademarks of the respective company.

® Liebert is a registered trademark of the Liebert Corporation.

103735

**Emerson Network Power™**  
Leading global provider of  
*Business-Critical Continuity™ solutions.*

- Alternating Current
- Connectivity
- Direct Current
- Integrated Computing
- Embedded Power
- Monitoring
- Outside Plant
- Power Switching and Regulation
- Precision Cooling
- Racks and Integrated Enclosure
- Services
- Overvoltage Protection

**Emerson Network Power.com**  
*Business-Critical Continuity*, Emerson Network Power and the Emerson Network Power logo are trademarks and service marks of Emerson Electric Co. © 2009 Emerson Electric Co.

## Liebert® PSI High performance rack & tower UPS system for network protection

The Liebert PSI is a compact UPS system with line-interactive technology, which was specially designed for IT applications, such as network racks and small data centers, for example.

The Liebert PSI's flexible design allows the unit to be configured as a stand-alone tower and rack installation over 2 U.

The Liebert PSI-XR is available as both 230-V and 120-V model in four different power classes.

The UPS is especially impressive with its innovative line-interactive design and automatic voltage regulation. This protects against voltage fluctuations by increasing or reducing the power supply to the level required by the connected devices. The UPS system also ensures longer battery service life, as the devices are supplied for as long as possible via the mains.

### Flexibility:

- Battery backed-up outputs
- Configurable input voltage range
- Free swivel display panel
- Automatic frequency scanning
- Rack runner rails
- Several communication options
- Contact closure, USB and SNMP

### Higher availability

- Data cable overvoltage protection
- UPS system status early warning system
- Up to five minutes battery runtime with power failures (fully charged)
- Fully automatic battery test
- Overvoltage protection
- Remote emergency stop
- Hot-swappable batteries

### Lowest possible TCO (Total Cost of Ownership)

- Power factor 0.9
- Wide input voltage range
- Reduced installation input (costs and time)
- Warranty

### Ideal for:

- PCs
- Networked workstations
- Servers
- Network racks
- Big network peripheries
- VoIP



PSI 2U Rack version

PSI 2U Tower version

## Liebert® PSI specifications

Model	PS750RT3-230	PS1000RT3-230	PS1500RT3-230	PS2200RT3-230	PS3000RT3-230
Power Rating	750VA/675W	1000VA/900W	1500VA/1350W	2200VA/1980W	3000VA/2700W
Dimensions, W x D x H - mm					
Unit	440 x 412 x 88			446 x 657 x 88	
Shipping	560 x 595 x 228			560 x 776 x 228	
Weight - kg					
Unit	15	19.4	20.9	33.8	37.2
Shipping	18.2	22.6	24.1	38.3	41.5
Input AC Parameters					
Surge Protection	220J				
Voltage Range Without Battery Operation	165-300, Configurable				
Frequency Range	45-65Hz, (+ 0.5Hz)				
Input Socket	IEC-320-C14			IEC-320-C20	
Output Receptacles	(8) IEC-320-C13			(8) IEC-320-C13 - (1) IEC-320-C19	
Voltage, Normal Mode	220/230/240 VAC, Configurable, +10%				
Voltage, Battery Mode	220/230/240 VAC, Configurable; +5% Before Low Battery Warning				
Transfer Time	4-6 ms, Typical				
Waveform	Sine wave				
Overload Warning	100%				
Battery Parameters					
Type	Valve-Regulated, Nonspillable, Lead Acid				
Quantity x Voltage x Ah	2 x 12 x 7.2	3 x 12 x 7.2	3 x 12 x 9	6 x 12 x 7.2	6 x 12 x 9
Backup Time	See Load Autonomy table below				
Recharge Time	5 hours to 90% of rated capacity, after full discharge into resistive load				
Environmental					
Operating Temperature	0°C to 40°C (32°F to 104°F)				
Storage Temperature	-15° to 40°C (5°F to 104°F)				
Relative Humidity	0% to 90%, non-condensing				
Operating Altitude	Up to 3000m (10,000 ft.) at 35°C (95°F) without derating				
Audible Noise	45 dBA				
Agency					
Safety	IEC/FN/AS 62040-1-1				
Surge	IEC/FN/AS 61000-4-2				
ESD	IEC/FN/AS 61000-4-3				
Susceptibility	IEC/FN/AS 61000-4-4				
Electrical Fast Transient	IEC/EN/AS 62040-2 2nd Ed class A				
Emissions	IEC/FN/AS 61000-4-6				
Conducted Immunity	IEC/EN/AS 61000-3-2				
Harmonics	IEC/FN/AS 61000-4-6				
Transportation	ISTA Procedure 1A Certification				
Environmental	ROHS compliant				
Warranty	2 years standard (+1 year warranty extension available)				
Packaging	Multi-Language User Manual on CD, Liebert Multi inkk. Software on CD, Contact Closure (MI 9P9S) Cable USB Cable, Tower Stand, Mounting Hardware, Rack-Mount-Handles, Fixed Mounting Rails, FPO Connector, Input Power Cord. 2200/3000 only: 2- (1) Schuko to IEC-320-C19 and (1) UKplug to IEC-320-C19 input cord. IEC Output Cable, 750/1000/1500 only: 2- (2) IEC-320-C13, IEC Output Cable, 2200/3000 only: 3- (3) IEC-320-C13				
Order no.	06.099.061.1	06.099.062.1	06.099.063.1	06.099.064.1	06.099.065.1
Order no. SNMP Card	06.099.022.1				

### Technical support

Always at your disposal: Our commitment to your business, provided by our technical support in five languages (English, Spanish, French, Italian, German).

Free: **00-80011554499**

Subject to a charge: **+39 02 98250222**

**liebert.upstech@emerson.com**

Although much time and effort went into ensuring that this brochure is accurate and complete, the Liebert Corporation does not accept responsibility for its content and does not accept any form of liability for damages that may result from the use of this information, nor does it accept responsibility for errors or omissions.

© 2010 Liebert Corporation.

All rights reserved worldwide. Specifications may change without prior notice.

PSI00-FLY-EN-1209-01

### Emerson Network Power™

Leading global provider of *Business-Critical Continuity™* solutions.

- AC Power
- Connectivity
- DC Power
- Integrated Computing
- Embedded Power
- Infrastructure Management & Monitoring
- Outside Plant
- Power Switching and Regulation
- Precision Cooling
- Racks and Integrated Enclosure
- Services
- Overvoltage Protection

### Emerson Network Power.com

Emerson, *Business-Critical Continuity™* and Emerson Network Power trademarks of Emerson Electric Co. or affiliated companies.  
© 2010 Emerson Electric Co.

## Load Autonomy - Liebert PSI 750VA-3000VA

Load %	750VA	1000VA	1500VA	2200VA	3000VA
10	84	93	76	82	76
20	45	47	32	44	32
30	25	26	17	19	17
40	15	15	12	14	12
<b>Internal Battery</b>	50	11	12	9	11
	60	9	9	7	7
	70	7	7	5	5
	80	5	6	4	4
	90	4	5	3	3
	100	4	4	3	3

**Note:** All run times are in minutes, assume fully charged batteries and are typical at 25°C (77°F) with resistive loads.

## Online / GXT2 and GXT3 IEC 62040-3 VFI-SS-111

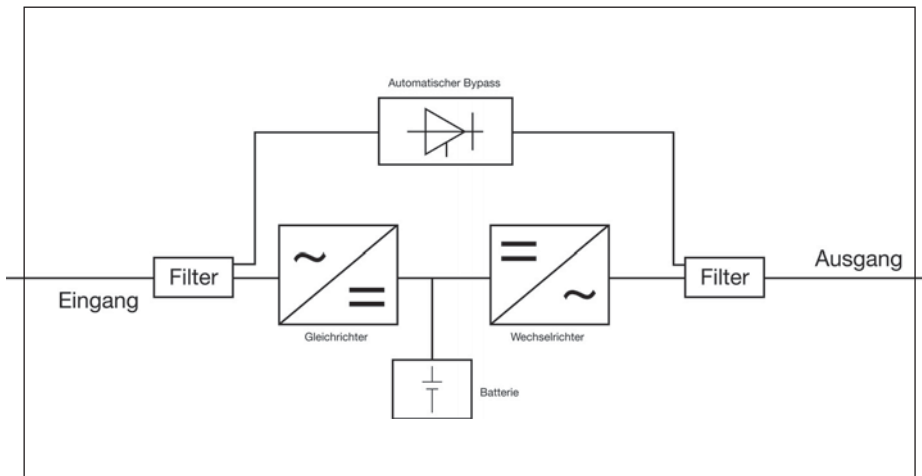

USV20086

On-line UPS systems have the advantage of effectively filtering out spikes and drop outs by converting alternating voltage into direct voltage and back into alternating voltage.

Our online UPS systems are series equipped with interfaces, so that unattended computers can be specifically powered down automatically and powered up again after the mains supply has returned.

If faults occur in the system itself due to battery aging processes, an automatic by-pass switch ensures bridging and direct connection to the mains without interruption.

The user is acoustically and optically informed about defective functions and power failures.

The accumulator takes over from the rectifier without any interruption when there is a mains failure and provides the necessary energy for a certain length of time. On-line systems provide high levels of security and are particularly recommended for high-grade and sensitive consumers.

## Systems for quality power

# GXT2 and GXT3

## True Online Power Full energy for your company

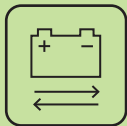

Hot-swap  
batteries



Online  
technology



Diverse communication  
options



Extendable back-up  
times



Professional PC  
workstations



Small hubs, routers &  
bridges



Data center



Telecom equipment

## Liebert® GXT3, 700VA - 3000VA Model Reliable online UPS protection in compact 2 U package

The **Liebert GXT3** is a true online UPS, which continuously supplies the IT equipment with quality alternating current. No interruption with changeover to batteries. They protect devices from almost all power supply faults – be they caused by power failures, voltage spikes, voltage drops or whatever other faults. The UPS is available as rack and tower version.

One of the most economical and reliable UPS systems in its class: the Liebert GXT2 is the industry leader in terms of dimensions, performance and reliability.

The 0.9 power factor ensures more power for protected devices and more energy-efficient operation.

The optionally available MicroPOD Output Distribution And Maintenance Bypass Module guarantees operation – even during planned UPS maintenance work.

### Flexibility:

- Up to six battery backed-up outputs
- Free swivel display panel
- Automatic frequency scanning
- Installation flexibility:
- Several communication options (SNMP/WEB & USB)
- Compatible with Liebert MultiLink, Liebert Nform, Liebert Multiport and the Liebert Intellislot Relay Interface card

### Higher availability

- Advance early warning of UPS system status
- 4-8 minutes of battery backup time at full load
- Scalable runtime
- Full sequenced battery testing
- User replaceable hot swappable batteries

### Lowest possible TCO (Total Cost of Ownership)

- Power factor 0,9
- Wide input voltage range
- Intelligent fan operation
- Efficient operation
- Warranty

### Ideal for:

- PCs
- Networked workstations
- Servers
- Network racks
- Big network peripherals
- VoIP



The Liebert GXT3 can be configured for rack or tower installation. The LED display swivels and can be easily read in all positions.

The Liebert GXT3 has internal batteries and can also supply up to four external battery racks (2 U).

## Liebert® GTX3, 700VA-3000VA Model specifications

Model	GXT3-700RT230	GXT3-1000RT230	GXT3-1500RT230	GXT3-2000RT230	GXT3-3000RT230
Power Rating	700VA/630W	1000VA/900W	1500VA/1350W	2000VA/1800W	3000VA/2700W
Dimensions, W x D x H - mm					
Unit	497 x 430 x 85		497 x 430 x 85		602 x 430 x 85
Shipping	617 x 570 x 262		617 x 570 x 262		717 x 570 x 262
Weight - kg					
Unit	16.8	16.8	23.2	28	32
Shipping	20	20	26	24	28
Input AC Parameters					
Voltage Range Without Battery Operation			230VAC nominal; variable based on output load		
Frequency Range					
40Hz - 70Hz; Auto Sensing					
Input Socket	IEC-320-C14	IEC-320-C14	IEC-320-C14	IEC-320-C20	IEC-320-C20
Output Sockets	(6) IEC-320-C13	(6) IEC-320-C13	(6) IEC-320-C13	(6) IEC-320-C13	(6) IEC-320-C13
				(1) IEC-320-C19	(1) IEC-320-C19
Voltage					
220/230/240 VAC (user configurable) +3%					
Waveform					
Sine wave					
Battery Parameters					
Type					
Valve-Regulated, Nonspillable, Lead Acid					
Quantity x Voltage x Rating	4 x 12V x 5,0Ah		4 x 12V x 7,2Ah		6 x 12V x 9,0Ah
Recharge Time	3 hours to 90% capacity after full discharge with 100% load till UPS auto-shutdown (Internal Batteries Only)				
Battery Backup Time	See table below				
Environmental					
Operating					
0°C to 40°C (32°F to 104°F)					
Storage Temperature					
-15° to 50°C (5°F to 122°F)					
Relative Humidity					
0% RH to 90% RH, non-condensing					
Operating Altitude					
Up to 3000m (10,000 ft.) at 40°C (104°F) without derating					
Audible Noise					
◁ 45 dBA max. at 1 meter					
◁ 46 dBA, at 1 meter 3.2ft from the rear		3.2ft front and side		◁ 48 dBA max. at 1 meter 3.2ft front and side	
◁ 46 dBA, at 1 meter 3.2ft from the front or sides		◁ 46 dBA, at 1 meter		◁ 48 dBA, at 1 meter 3.2ft rear	
3.2ft rear					
Agency					
IEC/FN/AS 62040-1-2008					
Safety					
IEC/FN/AS 62040-2 2nd Fd=CISPR22 Class A					
RFI/FMI					
IEC 62040-2 2nd Fd					
Surge Immunity					
IEC 62040-2 2nd Fd					
Transportation					
ISTA Procedure 1A					
Compliance					
Order no.	06.099.070.1	06.099.071.1	06.099.072.1	06.099.073.1	06.099.075.1
Order no. SNMP Card	06.099.039.1				
Order no. Relay Card	06.099.037.1				
Bundles	06.099.170.1*	06.099.171.1*	06.099.172.1*	06.099.173.1*	06.099.175.1*

### Technical support

Always at your disposal: Our commitment to your business, provided by our technical support in five languages (English, Spanish, French, Italian, German).

Free: **00-80011554499**

Subject to a charge: **+39 02 98250222**

**liebert.upstech@emerson.com**

Although much time and effort went into ensuring that this brochure is accurate and complete, the Liebert Corporation does not accept responsibility for its content and does not accept any form of liability for damages that may result from the use of this information, nor does it accept responsibility for errors or omissions.

© 2010 Liebert Corporation.

All rights reserved worldwide. Specifications may change without prior notice.

GXT3M-FLY-EN-0210-01

### Emerson Network Power™

Leading global provider of *Business-Critical Continuity™* solutions.

- AC Power
- Connectivity
- DC Power
- Integrated Computing
- Embedded Power
- Infrastructure Management & Monitoring
- Outside Plant
- Power Switching and Regulation
- Precision Cooling
- Racks and Integrated Enclosure
- Services
- Overvoltage Protection

### Emerson Network Power.com

Emerson, Business-Critical Continuity™ and Emerson Network Power trademarks of Emerson Electric Co. or affiliated companies.  
© 2010 Emerson Electric Co.

## Liebert® GTX3 Battery Cabinet Specifications

Model	GXT3-700RT230	GXT3-1000RT230	GXT3-1500RT230	GXT3-2000RT230	GXT3-3000RT230
Used w/UPS Model	GXT3-48VBATT				GXT3-VBATT
Dimensions, W x D x H - mm					
Unit	497 x 430 x 85				602 x 430 x 85
Shipping	617 x 570 x 262				717 x 570 x 262
Weight - kg					
Unit	32				42
Shipping	35				46
Batteries					
Type					
Valve-regulated, nonspillable, lead acid					
Quantity x Voltage x Rating	2 x 4 x 12V x 9.0Ah				2 x 6 x 12V x 9.0Ah
Environmental					
Operating / Storage Temperature, °C					
0°C to 40°C (32°F to 104°F) / -15°C to +40°C (19°F to 104°F)					
Relative Humidity					
0% to 95%, non-condensing					
Maximum Operating Altitude					
Up to 3000m (10,000 ft.) at 104°F (40°C) without derating					
Agency					
EC/EN/AS 62040-1-1:2008 / FCC Part 15, Class A=CISPR22 Class B					
Safety / Emissions					
ISTA Procedure 1A					
Transportation					
Order no.	06.099.074.1				06.099.076.1
Order no. Bundles	06.099.174.1*				06.099.176.1*

\*incl. 19" installation set

## Battery runtime chart (runtimes in minutes; with fully charged batteries; ambient temperature 25 °C)

Number of batteries	700VA	1000VA	1500VA	2000VA	3000VA
Internal Battery (full load)	6	4	4	4	4
Internal Battery + 1 External Cabinet (full load)	50	27	24	15	18
Internal Battery + 2 External Battery Cabinets (full load)	82	58	48	29	44
Internal Battery + 3 External Battery Cabinets (full load)	116	78	82	45	62
Internal Battery + 4 External Battery Cabinets (full load)	140	109	100	64	84

## Liebert GTX2 6000 VA - 10000 VA

### True-Online-Power – Full energy for your company

This is an individually configurable high-performance UPS with proven reliability, equipped with internal hot-swap batteries and extendable back-up time in the compact rack and tower design.

The functions and flexibility of the **GXT2** make this UPS the optimum solution for your server or data centers, and for networks and telecom systems that require a reliable, uninterrupted supply with quality power.

As a true online (continuous transducer) UPS, in addition to power factor correction, frequency conversion and unlimited extension options for external batteries, the **GXT2** also provides automatic and manual internal bypass functions, as well as an optional external maintenance bypass. The Liebert **GXT2** has all the functions required to protect company-critical equipment against all power supply problems.

USV20097

### Areas of application

- LAN and WAN servers
- Cluster network components: hubs, routers, bridges
- Remote telecommunication units
- Internal telecommunication systems
- Voicemail and e-mail servers
- Test and diagnostics systems
- Engineering network servers
- Protection of industrial, microprocessor-controlled equipment
- Company-critical equipment

### Most important benefits

- Online VFI technology with sine wave output
- Extendable battery options for long back-up times
- Communication via USB, serial ports and networks
- Input with power factor correction
- Highly-sensitive early warning-shut down via MultiLink software
- At least five minutes battery-supported operation
- Settings, voltage and frequency according to individual configuration
- Hot-swappable - user can change batteries
- Cold start via battery
- UPS remote monitoring via SNMP/Web card
- Optional bypass rack for easy maintenance



### True-Online-Power – Full energy for your company



# Emerson Network Power UPS

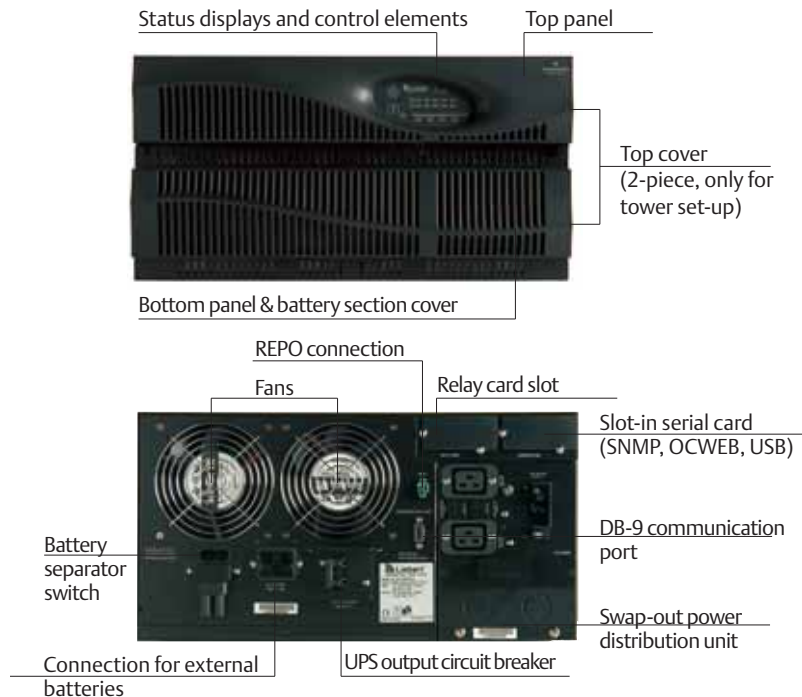

GXT2 rack model (version show: 5U, 4500-6000VA)

## Most important benefits

**There is no switchover time with a continuous transducer UPS.**

**If the mains power fails, the critical load is fed seamlessly by the GXT2.**

For optimum usage the GXT2 can be adapted to your requirements with a specially developed software package. The GXT2 is available in the power classes 700, 1000, 4500 and 6000 VA. Batteries that the user can swap out ensure low maintenance operation. And you will find all of this in one of the most economical UPS systems in this class.

### Quality power

The Liebert GXT2 is a “True Online” power source. Whatever the quality of the inbound mains power, the clean sine wave output meets the highest requirements of your equipment. In contrast to other UPS technologies, the GXT2 is equipped to overcome all potential power supply problems.

- Spikes and transient overvoltages
- EMI and RFI faults
- Voltage drops and undervoltages
- Harmonic waves
- Power factor corrected loads
- Power failures

### Integrated reliability

The GXT2 is configured in all areas for maximum reliability. It consequently has functions that you will search in vain to find with other systems in the same price class:

- Power factor corrected loads:  
The GXT2 maintains stable output voltage, even with power factor-corrected consumers, which are so typical for modern IT environments.
- Frequency conversion:  
For 60Hz input/50Hz output or 50Hz input/ 60Hz output without any power losses.
- Unlimited connection options for external batteries:  
Any amount of 2U/4U battery racks can be connected to achieve additional back-up times.
- Internal automatic and manual bypass:  
Guarantees uninterrupted switchover of the power supply for maintenance purposes.
- Optional maintenance bypass and output:  
Power distributor: Enables problem-free installations and safe routine maintenance on the UPS or connected devices.



## Communication for power supply monitoring and control

The GXT2 provides an extensive range of communication options that correspond with the control and monitoring requirements of modern network and server systems.

### Intellislot® SNMP/Web Card

For extended UPS communication and control the Intellislot SNMP/Web Card provides your GXT2 with extensive SNMP and web management. You consequently achieve a high degree of flexibility, as you can monitor and control your UPS within the network. This adapter can also be easily configured for a standard SNMP implementation, and can be easily and efficiently shut down using MultiLink shutdown software from Liebert without any personal monitoring.



The SNMP/Web card monitors a wide range of UPS information so that the user can monitor and control the GXT2 via the network with a standard web browser and SNMP connection

### Intellislot USB Adapter (USB CARD)

This card, which can be used during running operation, provides a USB interface for Microsoft Windows 2000 and XP Power Management, and consequently enables the problem-free and orderly shutdown of the connected consumers, without having to install additional software. An approx. 2 meter cable is included in the supply schedule.



### Intellislot Multiport Kit (Multiport4)

The Multiport4 Card can also be used during running operation, and splits the UPS contact signals into 4 separate contact closure sets, which enable the communication with the MultiLink shutdown software on four servers simultaneously.

### MultiLink™ Shutdown Software

The GXT2 UPS system can be used in combination with the Liebert MultiLink Shutdown software for the orderly shutdown of your IT system. This package switches off all standard operating systems smoothly and controlled when the UPS batteries require charging.

The MultiLink automated shutdown software has the critical task here of protecting all information for an IT system or a network. It is available in two versions: for individual applications and for several systems within a network, even with multiple used operating systems. During power failures that last for longer periods, MultiLink automatically shuts down the computer operating systems smoothly and controlled when the UPS batteries have run low by a defined point. MultiLink is configured to inform the users automatically. Alarm signals can be sent to alpha-numerical pagers or can appear directly as pop-up messages on the user's monitor. MultiLink can be configured for both inband and out-of-band operation. Sending alarm and status signals via a network can significantly reduce the costs of cabling and installation.

As an alternative to this it is possible to lay communication cables between the individual computer systems in case a network cabling is too problematic or expensive.

### Intellislot Interface Kit for Relay Contacts (Relaycard-Int)

This kit provides 4 voltage-free relay contact signals for the states: "Battery operation", "Low battery charge", "Bypass operation" and "General alarm signal". This card can be installed during running operation via a DB25F port.

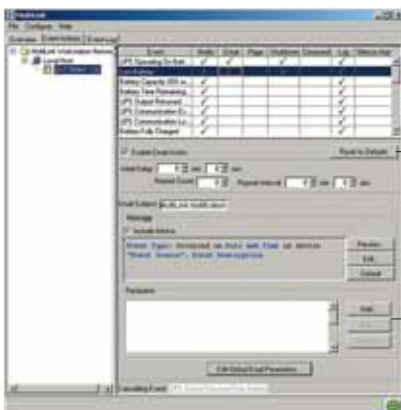

Automatic system and graphic messages can be configured for each UPS event.

The configuration details appear in the lower window section when event and message type are selected.

## Technical Data [Liebert GXT2 tower/rack version]

Model	GXT2-4500RT230	GXT2-6000RT230
<b>Power data</b>		
VA	4500	6000
W	3150	4200
<b>Dimensions and weight</b>		
Device (WxDxH mm)	221 (5 U) x 547 x 430	
Shipping size (WxDxH mm)	560 x 690 x 500	
Weight - device (kg)	67	67
Shipping weight (kg)	76.5	76.5
<b>Input parameters</b>		
Frequency	220/230/240 VAC user-definable; 40-70Hz	
Voltage range without battery operation	176-276VAC	
Frequency range	40-70Hz (self-detecting)	
Input connection	Fixed-wired	
<b>Output parameters</b>		
Output connections	Fixed-wired + (2) IEC320-C19	
Wave form and frequency	Sine wave; 50 or 60Hz nominal (50Hz specified)	
Overload warning	>200% for 96 milliseconds; 131 - 199% for 2 seconds; 112 - 129% for 10 seconds with switchover	
<b>Battery parameters</b>		
Type	VRLA, leak-proof, flame-retardant	
Authorized manufacturer	Yuasa / REW 28-12 FR	
Number/battery blocks	20 x 12V x 5Ah	
<b>Backup time</b>		
Half charge (minutes)	24	17
Full charge (minutes)	10	7
Charge time	3 hours up to 90%	
Batteries, other functions	Hot-swap batteries; deep-discharge protection; black start (without mains)	
Battery test	Automatic, user-configurable, 7-28 days	
<b>Further data</b>		
Noise generation	< 55ddB	
Op. temp./height above sea level	0-40°C; 0-3000m	
Communication	Serial RS232 standard port, USB adapter compatible with WIN2000, XP, Apple OS, relay card and SNMP/Web card optional	
Delivery includes	User's manual, MultiLink Software-CD; MultiLink serial cable, 3m; rack mounting handles; data carrier with configuration program	
Additional components	Input/output distributor PD-CEHDWR input/output distributor with maintenance bypass, PD-CEHDWRBYP	
Warranty	2 years	
<b>Standards &amp; requirements</b>		
Safety	EMC directives, Design, EMI/EMC, Transport	
<b>Additional batteries</b>		
Models	GXT2-240VBATT	
Device (WxDxH mm)	176 (4 U) x 522 x 430	
Shipping size (WxDxH mm)	560 x 690 x 455	
Weight - device (kg)	65	
Shipping weight (kg)	76	
Number/battery blocks	20 x 12V x 9.0Ah	
Authorized manufacturer	Yuasa / REW 45-12 FR	
<b>Extended back-up time***</b>		
1 battery module (full/half charge)	31 / 70	21 / 49
2 battery modules (full/half charge)	54 / 120	38 / 85
3 battery modules (full/half charge)	80 / 164	55 / 123
4 battery modules (full/half charge)	106 / 208	75 / 156
Order no. UPS	<b>06.099.013.1</b>	<b>06.099.014.1</b>
Order no. UPS Set	<b>06.099.113.1*</b>	<b>06.099.114.1*</b>
Order no. Battery Module	<b>06.099.017.1</b>	
Order no. Battery Module +19" Installation Set	<b>06.099.117.1</b>	
Order no. SNMP Card	<b>06.099.039.1</b>	
Order no. Relay Card	<b>06.099.037.1</b>	

\*UPS set incl. SNMP card + install. set



GXT2 4500 - 6000 in rack and tower version

Although much time and effort went into ensuring that the information in this brochure is correct and complete, Knürr/Liebert HIROSS Emerson Network Power declines all responsibility and does not accept any form of liability for damages that may result from the use of this information, nor does it accept responsibility for errors or omissions. All rights reserved worldwide. Subject to change without prior notice. All names mentioned are trademarks or registered trademarks of the respective owner. The Emerson logo is a trademark and a service mark of Emerson Electric Co.



Systems for quality power

## GXT2 10000R230

For applications with extreme heat density



### Benefits

- Online VFI technology with sine wave output
- Parallel configuration for power increase or providing redundancy
- Extendable battery options for long back-up times
- Communication via USB, serial ports and networks
- Input with power factor correction
- Highly-sensitive early warning-shut down via MultiLink software
- Settings, voltage and frequency according to individual configuration
- Hot-swappable - user can change batteries
- Cold start via battery
- UPS remote monitoring via SNMP/Web card
- Compact design in 3 U + 3 U format
- Available as configuration of 1, 2, or 3 units to provide full power or as 1+1, 2+1 or 1+2 redundancy

### Applications

- Blade Server
- Pizza Box Server (1 U)
- LAN and WAN network server
- Cluster network components: hubs, routers, bridges
- Voice over IP (VoIP) switch and router
- Internal telecommunication systems
- Voicemail and e-mail servers
- Test and diagnostics systems
- Protection of industrial, microprocessor-controlled equipment
- Company-critical equipment

### Liebert GXT2 10000R230

Uninterruptible power supply in compact design for environments with extremely high heat densities

With its compact format (6 U) and special features, which are among the best in their class, the new Liebert **GXT2** 10kVA from Emerson Network Power is the ideal solution for reliably supplying blade servers, pizza box servers, Voice over IP equipment and other data center and network systems in standard 19-inch racks with power.

Its redundant configuration option makes the Liebert **GXT2** 10kVA a modular and scalable solution that adjusts perfectly to your requirements. Utilize the 1+1 or 2+1 configuration with up to 20kVA to produce clean power for your applications and an additional 10kVA as reserve, or operate three modules parallel for loads of up to 30kVA.

This is an individually configurable high-performance UPS with proven reliability, equipped with internal hot-swap batteries and extendable back-up time in the compact rack and tower design. The Liebert **GXT2** 10kVA Rack Version is part of the Emerson Network Power Adaptive system solution for precision thermal management and uninterruptible power supply and was developed for the Liebert X-treme solutions.

# Emerson Network Power UPS

## Technical data [Liebert GXT2]

Model	GXT2-10000R230
<b>Power data</b>	
VA	10000
W	7000
<b>Dimensions and weight</b>	
Device (WxDxH mm)	410x630x130x (3 U)
Shipping dimensions (WxDxH mm)	
Weight - device (kg)	27 (UPS without batteries)
Protective range	IP20
Color	RAL 9005, black
<b>Input parameters</b>	
Frequency	50/60 Hz (automatic detection)
Voltage	230V L-N single-phase L, N, G
Voltage range without battery operation	176-276V
Frequency range	±5%
Input power factor and THDI	0.97 - <5%
Input-output connections	Fixed wired
Wave form	Sine wave
Overload warning	125% - 1 minute, 150% - 10s, 300% - 2s
Short circuit current (A) for 5 cycles	160A peak value
Level of efficiency	92%
Noise generation	<55dBA
Operating temperature	0 - 40°C (with battery) -25 - +55°C (without battery)
Relative humidity	0 - 90% non-condensing
Communication interface	Serial RS232D89, relay card, SNMP/Web optional
<b>Battery extension, external</b>	
Model	GXT2-240RVBATT
Dimensions (WxDxH mm)	410x630x130x (3 U)
Weight (kg)	67
<b>Extended back-up time</b>	
1/2/3/4 batteries (full charge)	6/16/26/36
1/2/3/4 batteries (half charge)	13/35/60/90
Number of batt. (/ battery blocks)	Yuasa: NPW 45-12 / REW 45-12 (20x12V / 45W / 9Ah)
Battery test	Automatic, configurable, 7-28 days
<b>Warranty, standards and approvals</b>	
Warranty	2 years
Standards and approvals	CE conformity marking
Safety	IEC / EN 62040-1-1 CE Low Voltage Directive 73/23/EEC
EMI / EMC	IEC / EN 62040-2 - Class A CE EMC Directive 89/336/EEC
Design	IEC 62040-3 VFI-SS-111
Transport	ISTA Level 1A
Order no. UPS + 19" Installation Set	<b>06.099.016.1</b>
Order no. UPS Set*	<b>06.099.116.1</b>
Order no. Battery Module + 19" Installation Set	<b>06.099.019.1</b>
Order no. SNMP Card	<b>06.099.039.1</b>
Order no. Relay Card	<b>06.099.037.1</b>

\* incl. Battery Module + SNMP Card + 19" Installation Set

The approximate discharge times are given in minutes and for 25°C with resistive load. Although much time and effort went into ensuring that this brochure is accurate and complete, Emerson Network Power does not accept responsibility for its content and does not accept any form of liability for damages that may result from the use of this printed information, nor does it accept responsibility for errors or omissions. All rights reserved worldwide. Changes possible without prior notice. All names and/or entered trademarks are the property of the respective owner.



GXT2 10000R230

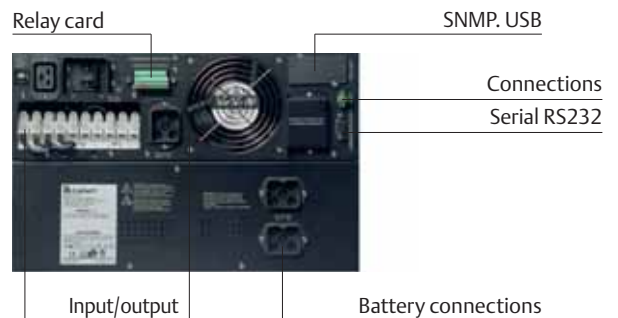
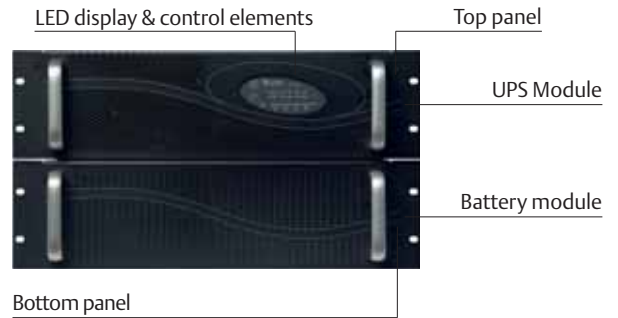

Although much time and effort went into ensuring that the information in this brochure is correct and complete, Knürr/Liebert HIROSS Emerson Network Power declines all responsibility and does not accept any form of liability for damages that may result from the use of this information, nor does it accept responsibility for errors or omissions. All rights reserved worldwide. Subject to change without prior notice. All names mentioned are trademarks or registered trademarks of the respective owner. The Emerson logo is a trademark and a service mark of Emerson Electric Co.

*Knürr RMS Compact II®*



# Knürr RMS Compact II®

2.76 to 2.78



# Knürr RMS Compact II®

## Damage prevention with checks and controls

System and network management requirements mean the systems' ambient conditions must be monitored. Reliability and system availability are indispensable. Compliance with the required ambient parameters is extremely important for the fault-free operation of high-grade components.

Inadmissible fluctuations in temperature or humidity often cause hardware defects. Constant automatic monitoring of these parameters is therefore a basic requirement for ensuring properly functioning operability. With the rack monitoring systems offered by Knürr, this information can be

recorded and forwarded directly to a higher-level management system, e.g. Nagios light form.

This recording is not, however, sufficient to ward off damages. For short response times when faults occur, it is helpful if the monitoring system can perform actions automatically (e.g. activate additional fans).

When defined incidents occur, the Knürr RMS Compact II® can immediately send a message as an 'SNMP trap' to the management system or directly as an e-mail to a technician or an SMS gateway.

Rapid fault-finding and removal is extremely valuable! The ability to connect additional sensors to monitoring systems not only allows racks to be monitored – so too can complete rooms or building sections. All important environmental parameters of a system can consequently be recorded and evaluated in a simple and straightforward way.



### The advantages of Knürr's modern rack monitoring system:

- Guarantees fault-free operation
- Detects disturbances early
- Logs incidents
- Makes service assignments easier with automatic monitoring
- Activates countermeasures in the event of a fault
- Central control of consumables (filters, paper, toner, meter readings, inspection intervals, etc.)
- Connection of up to 12 sensors in any arrangement



RMS20013



RMS20015

## Knürr RMS Compact II®

### Description

- Compact construction - Zero unit solution (for mounting outside the 19" installation area)
- 19" installation with adapter bracket
- Safe clamping of all connected cables with integrated cable clamping bracket
- Cost-effective orderly installation with Plug & Play concept
- Convenient cabling with RJ45 sensor
- TCP/IP connection via Ethernet (10/100 Base T)
- Configuration via SNMP and web browser
- Web access is password-protected and optionally encrypted (https)
- 3 different user levels
- Freely programmable filter system (boolean logic) for implementing all alarm conditions
- Compatible with standard network management systems – HPOpenView, Cabletron Spectrum, Castlerock, IBM Netview, IBM Tivoli, MG-Soft, Compaq Insight Manager, SUN NetManager, etc.
- Sensors for monitoring all current environmental influences (optional)
- Internal power supply for sensor equipment (no additional power supply necessary)
- Alarms via LEDs, relay, network management or e-mail (SMTP)
- Syslog support for continuous external data storage
- System time balancing with NTP servers

### Technical data

- 12 universally usable sensor inputs for temperature sensors, humidity sensors, digital (on/off) or analog sensors (0...10V)
- 3 digital outputs (2 x relay, max. 3A at 230VAC, 1x 750mA at 48VDC)
- Power supply: 100 – 240 VAC
- Operating voltage: 12VDC

### Approvals

- CE Symbol in acc. with Low Voltage Directive 73/23/EEC, EMC directive 89/336/EEC

### Color

- RAL 7021 dark gray

### Supply schedule

- 1 Knürr RMS Compact II
- 1 power supply
- 2 19" mounting brackets
- 1 power supply mounting bracket
- 1 CD ROM (with manual, MIB file)

### How supplied

- Flat-packed kit

W	H	D	Model	Order no.	UP
350	42	170	RMS Compact II®	06.108.200.8	1 set



LUF20069 RMS compact-specific

## ECO Temperature Sensor

### Description

- Insensitive to disturbances
- No additional power supply required
- Standard cable length, 4 m
- The sensor does not have to be recalibrated

### Technical data

- Temperature measuring range, 0-60°C
- Accuracy: +/- 5%

### Supply schedule

- 1 sensor
- 1 mounting kit

W	H	D	U	h	d	kg	Model	Order no.	UP
							ECO	06.108.220.9	1 unit



RMS20019 (similar to picture) RMS compact-specific

## Humidity sensor

### Description

- Insensitive to disturbances
- No additional power supply required
- The sensor does not have to be recalibrated

### Technical data

- Humidity measuring range, 30-90%
- Accuracy: +/- 5%

### Supply schedule

- 1 sensor with RJ45 port
- 1 mounting kit

Order no.	UP
06.108.212.9	1 unit



RMS20005

## Smoke Detector

### Description

- Optical smoke detector with VdS approval
- For early fire detection with smoke emission
- Power supply provided via RMS compact
- Standard cable length, 4 m

### Technical data

- Operates between -20°C and +75°C

### Supply schedule

- 1 sensor with 4 m connection cable
- 1 mounting kit

W	H	D	Model	Order no.	UP
Ø 90	75			06.108.211.9	1 unit



RMS20033

## AC Voltage Monitoring

### Description

- Monitors the AC power supply via an IEC Euro connector
- Signals status via an integrated signal cable to the RMS Compact

### Technical data

- Monitored AC voltage: 230 V AC 50/60 HZ
- Connections: IEC plug, RJ45 socket

### Supply schedule

- 1 sensor
- 1 mounting kit

W	H	D	U	h	d	kg	Model	Order no.	UP
								06.108.222.9	1 unit



RMS20006

## Door Contact Sensor

### Description

- Magnet bridge sensor, works on every magnetic conductive material (no special mating part required)
- Can also be used for monitoring side panels and roof
- Standard cable length, 4 m

### Technical data

- Operates between -20°C and +70°C
- Switching voltage, max. 200 VDC
- Switching current, max. 500mA

### Supply schedule

- 1 sensor with 4 m connection cable
- 1 mounting kit

W	H	D	Model	Order no.	UP
				06.108.215.9	1 unit



RMS20032

## Fan speed sensor

### Description

- No additional power supply required
- Automatic detection as analog sensor
- Does not have to be recalibrated
- Offset and alarm parameters can be set in RMS

### Technical data

- Measuring range: 0 to 0.8 l/s
- Non-linear measurement, values table:  
 < 0 m/s < 1 V  
 0 m/s 1 V  
 1 m/s 1.7 V  
 2 m/s 2.9 V  
 3 m/s 4.1 V  
 4 m/s 5 V (6 V max.)

### Supply schedule

- 1 sensor with 4 m connection cable
- 1 mounting kit

W	H	D	U	h	d	kg	Model	Order no.	UP
20	39	9						06.108.218.9	1 unit



RMS20031

## Water sensor

### Description

- Detects presence of water

### Technical data

- Operating voltage: max. 24 VDC

### Supply schedule

- 1 sensor with 2 m connection cable
- 1 mounting bracket

W	H	D	U	h	d	kg	Model	Order no.	UP
								06.108.217.9	1 unit



RMS20019

## Vibration Sensor

### Description

- Detects vibrations
- Theft protection
- Reset possible via Viewer software

### Supply schedule

- 1 sensor with 4 m connection cable

W	H	D	U	h	d	kg	Model	Order no.	UP
								06.108.213.9	1 unit



RMS20032

## Passive Infrared Movement Sensor

### Description

- Room monitoring with the latest state-of-the-art technology

### Technical data

- VdS approval Classes A + B
- Volumetric lens range 2 - 16 m
- Long lens range 29 - 50 m
- Curtain lens range 17 - 30 m
- Manipulation monitoring
- Digital fault evaluation
- Corner or wall mounting

### Supply schedule

- 1 sensor with 4 m connection cable
- 1 mounting kit

W	H	D	U	h	d	kg	Model	Order no.	UP
								06.108.214.9	1 unit

Dimensions in mm: W = Width, H = Height, D = Depth, h = installation height, d = useful depth, L = length, U = standard height unit, 1 U = 44.45 mm, UP = unit of packaging, kg = weight,  = Express item

Conversion: 1 mm = 0.03937 inch, 1 kg = 2.2046 pound



Liebert Nform™



# Liebert Nform™

Monitoring Software

2.80 to 2.82



# Liebert Nform™

Increased reliability and energy efficiency with Emerson Network Power Monitoring solutions



Data centers are becoming more and more important in modern companies and today's society. The requirements for increasingly better IT infrastructures rise rapidly as a result. Demands are made here for the highest possible performance with very high efficiency at the same time. These requirements

appear difficult to meet because alone the server cooling in many data centers uses up as much energy as the operation itself.

An integrated monitoring is needed to increase profitability while also reducing costs, especially with increasing complexity.

## Liebert Nform™ helps to meet these requirements:



### What is Liebert Nform™?

- Liebert Nform™ is a DC monitoring software especially for Liebert infrastructure systems with trend analysis function, alarm management and results notification.



### What can Nform™ do?

- Liebert Nform™ provides uniform monitoring interface and therefore an overview of the operative

status of a large number of devices, such as:

- PDUs: Liebert MPX®, Liebert MPH®, Knürr DI-STRIP® RM
- Uninterruptible Power Supplies
- Water-cooled racks, such as:
  - Knürr CoolLoop®, Knürr CoolTherm®
- Thermal equipment
- Environmental monitoring systems, such as
  - Knürr RMS Compact II®





## What are the customer benefits?

- Liebert Nform™ is an easy to install and use management suite that does not require complicated adjustments.
- The integration of all infrastructure components, from PDUs to RMS compact II right through to water-cooled server racks is very easy, despite the high number of monitoring data points.
- Liebert Nform™ supports a whole range of state-of-the-art features:
  - Dashboard: The system has a configurable start page on which various graphics transparently illustrate the status.
  - Separable window content for transparent presentation on several monitors
  - Trending enables the storage and graphic presentation of historical data
  - Optional automatic device actions if an error occurs; application execution, setting device parameters (e.g. cooling), shutting down servers and much more.
  - Internationalization enables installation in various languages



RMS20013

## Liebert Nform™ – Software

Function Order no.	Express Edition 06.108.502.0	Standard Edition 06.108.504.0	Enterprise Edition 06.108.506.0
Number of remote management stations	Unlimited	Unlimited	Unlimited
Users and groups	Unlimited	Unlimited	Unlimited
Supported operating systems	Windows XP, Windows 2003/08 Server, Windows Vista	Windows XP, Windows 2003/08 Server, Windows Vista	Windows XP, Windows 2003/08 Server, Windows Vista
Internationalization	✓	✓	✓
Automated device searches	✓	✓	✓
Data logger	✓	✓	✓
SQL monitoring	Only Nform-internal database	Only Nform-internal database	Nform-internal and Microsoft SQL
Configured dashboard	✓	✓	✓
Data and alarm export	✓	✓	✓
Online help	✓	✓	✓
<b>Real-time monitoring and control</b>			
Regular device query	✓	✓	✓
Number of delivered device licenses	30	30*	100*
UPS/PDU web card integration	✓	✓	✓
Maximum number of devices	30	4800	Unlimited
Open architecture – 3rd party SNMP monitoring	✓	✓	✓
Supported devices	All Liebert UPS, Power and Cooling systems that support SNMP	All Liebert UPS, Power and Cooling systems that support SNMP	All Liebert UPS, Power and Cooling systems that support SNMP
Parametered data logging	✓	✓	✓
Setpoint climate control	Yes	Yes	Yes
<b>Alarms and actions</b>			
Mform window goes to the front	✓	✓	✓
Sound is played	✓	✓	✓
<b>Standard actions</b>			
E-mail message	✓	✓	✓
Execute external commands	✓	✓	✓
Write file	✓	✓	✓
Multilink Shutdown Clients			Unlimited including
Set Data on Event			✓
Get Data Graph on Event			✓
<b>Software services</b> Access to technical information, software support website, 24-hour tele-support software updates, tool for device integration			
Number of supported device licenses	30	30*	100*
First year	incl.	inc.	incl.
1 year	<b>06.108.531.0</b>	<b>06.108.534.0</b>	<b>06.108.537.0</b>
3 years	<b>06.108.532.0</b>	<b>06.108.535.0</b>	<b>06.108.538.0</b>
5 years	<b>06.108.533.0</b>	<b>06.108.536.0</b>	<b>06.108.539.0</b>

\* Upgrades available!

### Upgrades

to Nform 4.0	✘	<b>06.108.505.0</b>	<b>06.108.505.0</b>
--------------	---	---------------------	---------------------

### Upgrades and software services

Higher number of monitored devices	Order no. for device license	Order no. for software services: Access to technical information, software support website, 24-hour tele-support, software updates, tool for device integration		
		1 year	3 years	5 years
30	<b>06.108.513.0</b>	<b>06.108.540.0</b>	<b>06.108.541.0</b>	<b>06.108.542.0</b>
100	<b>06.108.521.0</b>	<b>06.108.543.0</b>	<b>06.108.546.0</b>	<b>06.108.545.0</b>
500	<b>06.108.525.0</b>	<b>06.108.546.0</b>	<b>06.108.547.0</b>	<b>06.108.548.0</b>



# Knürr @Lock®

2.84 to 2.89





MIR20107

## Problems with locking systems

- **Unauthorized access**
  - By own employees
  - By external companies
  - Uncontrolled access
  - Decentralized access authorizations
  - Key problem
  - Loss of key
  - Single key system
  - Many different keys

## The mechanical/electro-mechanical comparison

- |  |  |
|--|--|
| <ul style="list-style-type: none"> <li>■ <b>Cylinder lock systems</b> <ul style="list-style-type: none"> <li>+ Simple technical version</li> <li>+ Cost-effective with individual locking</li> <li>+ No power supply required</li> <li>- Easily duplicated</li> <li>- Replacement (among other factors) problematic</li> <li>- Code conversion expensive with locking systems</li> <li>- Key-connected, which means transferable with key hand-over (theft)</li> <li>- Logging and monitoring very expensive/time-consuming</li> </ul> </li> </ul> | <ul style="list-style-type: none"> <li>■ <b>Electronic systems</b> <ul style="list-style-type: none"> <li>+ Various locking options</li> <li>+ Opening permission possible without a key being required</li> <li>+ Opening permission can be granted/withdrawn almost immediately</li> <li>+ Lock control / logging possible</li> <li>+ Remote opening per PC / Internet / mobile phone / SMS</li> <li>+ Expandable and easy code conversion lock system</li> <li>- Power supply required</li> </ul> </li> </ul> |
|--|--|



MIR20113

## Locking solutions Control components to choose from

- **Electronic locking systems**
- **Mechanical combination lock**
- **Standard locking with half-cylinder**



MIR20285



MIR20134



MIR00423

## Modules Control components for electronic locking systems

- Transponder
- Network (server)

Interlocking: security with multi-point interlocking mechanism

## Decentralized rack suite



MIR20102

- Each rack/each door can be opened separately  
- via own address

- Access authorization administration
- Access monitoring
- Locking mechanism control
- Access logging

## Embedded solution



- Administration
- Monitoring
- Logging
- Remote access

MIR20099

## Individual Locking / Stand-Alone Solution



MIR20094





MIR20109

### Knürr @Lock® Strong points

- The very small and modular design means that no additional space or greater installation depths are required in the rack.
- Contacts for emergency power supply that can be activated externally using trade standard batteries are integrated into each swing handle.
- An integrated light-emitting diode signals with different colors to inform whether or not the current access is authorized.
- Each device of the series can be networked with the other devices, which results in numerous possible combinations and options.
- Every opening process can be logged in the network. Existing network structures can be used for networking.



MIR20284

### Knürr @ Lock® Swing Handle Security for racks in the data and networking area

- Conventional keys are replaced by electro-mechanical locking components.
  - A servomotor pulls the retainingawl back and releases the handle.
  - Actively opening the door is, however, made with the hand as before.
  - Easy exchange of the swing handle with later installation using unchanged installation opening.
  - Intended for standardized installation openings of conventional swing handle.
  - Can be quickly and easily upgraded to locking system.
  - Convenient administration of access authorizations.
- **@Lock Swing Handle, HID/IP**
    - The swing handle opens after a registered transponder card has been read.
    - With the HID variant, the communication between swing handle and PC runs via a junction box and a server.
    - The IP swing handle, by contrast, is configured via an IP address and is connected directly via the network to the PC.
    - Up to 2,048 HID cards per swing handle can be configured using a registered master card.
    - Configuration of the cards via the network is also possible with the included software.
- **Technical data**  
**@Lock Swing Handle, HID (optional IP remote connection)**
    - 100...240VAC, power supply not included in the supply schedule
    - Operation with 12VDC/40mA (max. 430mA)
    - Multi-color status – LED
    - Real-time clock
    - Network communication is made via external server (gateway)
    - Up to 250 handles can be administered per server (IP address)
- **@Lock Swing Handle, HID/IP**
    - 100...240VAC, power supply not included in the supply schedule
    - Operation with 12VDC/40mA (max. 430mA)
    - Multi-color status – LED
    - Real-time clock
    - Network communication with cabled connection via integrated Ethernet 10/100 Base T
- **Function**
    - Opens after reading a registered card
    - Memory for 32 time segments
    - Memory for 2,048 cards per handle
    - Integrated logbook for 500 events
    - Result-related communication
    - 125 kHz transponder with unique code (HID 26 bit system)
- **Supply schedule**  
**@Lock Swing Handle, HID**
    - 1 swing handle, HID
    - 1 reader
    - 1 reader connection cable
    - 1 network node, CX2001
    - 1 network cable, CN2001
- **Supply schedule**  
**@Lock Swing Handle, IP**
    - 1 swing handle, IP
    - 1 reader
    - 1 reader connection cable
    - 1 data CD



MIR20283

## Knürr @Lock® Server

The @Lock Server is the interface between the HID swing handles connected via the RS485 cable and the network connected via X-Port. It is used for intermediary storage of results and tasks and can administer up to 250 users (swing handle).

The @Lock Server has an integrated real-time clock, which is buffered when power fails for up to 1 hour.

### ■ Technical data

- Power supply: via an external plug-in power supply, 12V (DC)
- Nominal current: 80mA (DC)
- Max. power consumption: 200mA (DC)

- Main board Interface: RS 485 - Cable (A, B, GND, +12V) max. length to the next gateway, 5m
- Network interface: X-Port, RJ34 plug, 8-pin max. 10 x 250 tasks
- Storage space for tasks: max. 100 events
- Storage space for events: 250
- Max. number swing handles: with buffering of up to 60min at 25°C
- Integ. real-time clock:



MIR20282

## Knürr @Lock® Software “Administration Suite 2.0”

The @Lock software is the user interface for controlling and configuring the @Lock Swing Handle. Using this software, the administrator can create access codes and HID cards and assign users. The handle can be controlled in real-time from the software platform. All actions that are directly related with the swing handles are stored in an SQL database (e.g. opening, closing, granted accesses and accesses rejected on the basis of non-authorization).

### ■ Technical data

- MS-Windows 2000/NT etc.
- SQL database
- TCP/IP network connection to the swing handles
- The number of handles and gateways is only restricted by the capacity of the computer
- Communication with swing handle via server (gateways) or directly with @Lock Swing Handle, IP

### ■ Functions/applications

- Client-server-based administration program for the @Lock system
- Requires max. 3-4 seconds for a status update
- Administration of users and rights
- Administration of HID cards, opening of active keys and access codes, closing, activation or deactivation of swing handles
- Observation of authorized and unauthorized access attempts
- Recording of all events connected with swing handles
- Central observation of swing handle
- Combination of all swing handles and servers
- Events recording
- Optional web interface
- Supports Sarbanes/Oxley and HIPPA requirements



MIR20281

## Knürr @Lock® Desktop Reader

The transponder cards are read into the administration software using the desktop reader. This enables the later configuration of the access media in the system (lock plan creation). The desktop reader is connected via the RS-232 interface with the PC on which the administration software is installed. The transponder card is inserted in the read-out unit for reading the transponder ID. The reading process can then be initiated in the administration software by hitting a key.

### ■ Technical data

- Power supply: 12V +- 10% (DC max. 400mA) via low voltage socket
- Nominal current: 80mA (DC)
- RS232 interface: RS 232 cable (RXD, TXD, GND, Reader present, PC present), 38,400 Baud
- Connection cable: (reader – read-out unit) 8-pin, 250 cm, UL stranded wire, AWG 26

Model	Order no.	UP
@Lock Server HID	01.180.011.9	1 unit
@Lock Swing Handle HID	01.180.022.9	1 unit
@Lock Swing Handle IP	01.180.023.9	1 unit
@Lock Administration Suite 2.0	01.180.048.9	1 unit
@Lock Desktop Reader HID	01.180.028.9	1 unit
@Lock Transponder Card	01.180.040.9	1 unit
Power Supply, PMI 2001EU	01.180.035.9	1 unit
Power Supply, PMI 2001UK	01.180.036.9	1 unit
Power Supply, PMI 2001US	01.180.037.9	1 unit
Power Supply, PMI 2001 Japan	01.180.038.9	1 unit
Power Supply, PMI 2001 Australia	01.180.039.9	1 unit



MIR20095

## Combi Lock Security and flexibility realized mechanically

- This additional lock, the aptly named “Over-ride”, produces a combination swing handle with particularly special advantages.
- Innovative combination swing handle with two activation options
- Independent opening and closing of the swing handle via combination or cylinder lock
- Can be used for right and left closing doors

### ■ Installation

In the standard installation opening of the Miracel rack doors. Quick mounting with plug-in connections and screw fittings.

### ■ Technical data

- Cylinder lock
- Combination lock can be individually set with 3 digits
- Independent activation

### ■ Supply schedule

1 swing handle with combi lock  
1 mounting material set

Model	Order no.	UP
Combi Lock	01.137.013.9	1 unit

Dimensions in mm: W = Width  
H = Height  
D = Depth  
h = installation height  
d = useful depth  
L = length

U = standard height unit  
1 U = 44.45 mm  
UP = unit of packaging  
kg = weight

 = Express item

Conversion: 1 mm = 0.03937 inch 1 kg = 2.2046 pound



# Glossary

## Adaptive Architecture

### Liebert Adaptive Architecture™

The Liebert Adaptive Architecture is a product and technology family that really impresses on the basis of its optimum minimum TCO and optimum availability balance.

### Open Architecture/Closed Architecture

With open architecture cooling coils and the room's air volume can be used as thermal storage to guarantee continuity with power failures.

With a closed architecture the rack is completely closed off. The cooling coils are inside the rack. Other provisions must be made for bridging power failures.

### Redundancy

Measure for a system's failure tolerance and for the ability to perform maintenance work on a product in operation and without any function loss.

- Systems without redundancy can fail as soon as one single component fails, or cannot be operated during maintenance work.
- Redundancy is not achieved with the parallel setup of the same components, of which at least one component is not required to reach 100% system functioning. Such a setup means that even the failure of important components or planned maintenance work will not impair the product's continuous operation. Redundancy concepts can therefore help achieve very high system availability levels.
- The highest level of redundancy is attained with the installation of two systems independent of one another, whose incoming and outgoing lines are also optimally separated. Preventive maintenance work or component faults then do not cause any impairment in the system's performance because the second system can take over the entire desired functionality at any time.

## Industry terms and phrases

### Availability

A proven technology or a system for minimizing fault risks and downtimes on your IT system ensures the required availability.

### Business Critical Continuity

The continuity of business-critical systems – our promise to the customer that their infrastructure will not fail and bring business processes to a standstill.

### Flexibility

"Flexible" products and systems can be reconfigured or extended to meet the requirements of new technologies, provide even more protection, or meet the requirements of corporate growth or business changes.

### Total Cost Of Ownership

All operating costs (TCO) of a solution, including purchase, future changes and maintenance.

## Power Supply

### Power supply, three-phase (EMEA)

A three-phase power circuit has three conductors, earth and in most cases a neutral conductor. Typical voltages for such power circuits are 380 V, 400 V and 415 V.

### Power supply, single-phase (EMEA)

Single-phase power circuits have two cables and an earth. Typical voltages are 220 V, 230 V and 240 V.

### Power density

More power. More heat generation. Less space. Power density increases (from less than 50 to more than 300 watt pro m<sup>2</sup>) because processors use up more and more power and require more and more space. This generates far more heat and concentrated hot spots in your data center.

### UPS types: Online and line-interactive

An online UPS is used to back up critical applications and guarantees continuous power supply, free of all supply faults. Frequency and wave form are also regulated. A line-interactive UPS protects against voltage peaks and inadmissible power supply parameters. This energy-efficient technology regulates the power supply and the battery backup system and is especially ideal for installations that rarely suffer power failures, but frequently suffer supply fluctuations.

### Battery capacity

The percentage power capacity of your batteries, depending on their age, usage period, environment, ambient temperature and maintenance status. A normal VRLA battery can possibly achieve 80% and has to be swapped out after 3-5 years.

### Battery runtime

The time (in minutes) for which your batteries can take over the power supply with power or system failures and protect your information.

### kW

Standard unit for electrical power. 1 kW is 1,000 W or power consumption of 1,000 joules per second. (1 joule is the required energy amount to heat 1 kg of water by 1°C.)

## Cooling

### Back cooling

Containing the rise in heat generation caused by air-cooled condensers and dry coolers for all ambient temperatures or heights. Hot air or hot water is drawn off; water is cooled and returned.

### Precision cooling

The precise controlling and regulation of temperatures, moisture or air filtering.

### Hot Aisle / Cold Aisle

A highly efficient method for power increases with existing raised floor systems with high-density rack-based installations. The racks and frames are set up to produce "hot" and "cold aisles". Perforated bottom covers from which the raised floor's cool air flows are only placed in the cold aisles.

### Sensible heat

"Sensible" or "tangible" heat can be directly sensed or measured. Sensible heat changes a material's temperature. This is practically temperature information similar to weather forecast information. Sensible heat is measured with a thermometer. Servers, for example, only give off sensible heat.

### Latent heat

"Latent heat is the heat energy that goes into a material's state change. With a thermally managed cooling process the latent heat is diverted with the condensation of the vapor in the air when the air is cooled to below the dew point (dehumidification). Latent heat discharge does not have any effect on the temperature you feel.

### Total heat

The total heat is composed of the heat content of the air (sensible heat) and the water-vapor mixture (latent heat). It is crucial for the thermal device's nominal power.

### BTU

BTU is a heat energy unit. It is equal to the required energy amount for changing the temperature of a British pound of water by 1 degree Fahrenheit (at sea level). One ton of cooling power is equal to 12,000 BTU/hour.

### Ton

A ton in relation to cooling systems is the heat amount required to melt 1 ton of ice in 24 hours. A ton is equal to 12,000 BTU/hour or 3,025,900 calories/hour.

# System dimensioning

The right dimensioning of a critical power supply system for current and future requirements is of essential importance.

## Current requirements

The estimates of the currently required system dimension in kilovolt-ampere (kVA) can be made in various ways. Site plans of the IT installation, type labels on devices and system and maintenance data are frequently consulted. The kVA and kW requirements can be determined using the following formulas:

V = Volt	pf = Power factor
A = Ampere	
kVA = Kilovoltampere	BTU/h = British Thermal Units per hour (heat output)
kW = Kilowatt	Kcal/h = kilo-calories per hour (heat output)

1. System's power profile (This formula provides the reliable basis for estimating the current kVA load.)

With three-phase systems whereby V is the phase to phase voltage	With single-phase systems
$kVA = \frac{V \cdot A \cdot 1.73}{1000}$	$kVA = \frac{V \cdot A}{1000}$

2. Kilowatt (kW) and power factor (pf). (If pf is not given, use 0.8 for pf.)

$$kVA = \frac{kW}{pf}$$

3. Ampere details for site power supply (with three-phase systems).

$$A = \frac{kVA \cdot 1000}{V \cdot 1.73}$$

4. BTU/h or Kcal/h:  
(If pf is not given, use 0.8 for pf.)

$$kVA = \frac{BTU/(h)}{3413} = \frac{kcal/(h)}{860}$$

$$kVA = \frac{kW}{pf}$$

If the currently required kVA capacity has been determined, the future growth potential and the consumers' special properties must also be considered.

## Capacities for growth

A critical power supply must also be configured for future growth. The capacities required in data centers for data processing double rapidly. It is therefore appropriate that the system should be configured for double the current kVA load. Even with low growth rates the power supply system should be estimated at 125% of the current kVA load.

## Special consumer characteristics

Plant specialists should be deployed to determine special consumer characteristics and the corresponding system dimensioning.

## Earth connections

The earth connection of a regulated power supply system has a big influence on its capacity.

# Maintenance for all your power supply and additional devices.

*Without proper maintenance your investment in power supply and cooling solutions loses its value. Even the best systems won't work properly if they are not maintained regularly.*



Emerson Network Power can maintain the most diverse UPS and precision cooling systems, batteries and distribution solutions in your data centers or in other business-critical systems whose availability is indispensable.

We maintain the following components:

- All UPSs and batteries
- Automatic transfer switches
- Static transfer switches
- System control cabinets
- PDUs
- Bypass racks
- Power regulation
- Precision air-cooling systems
- Generators
- DC supply devices



# Secure availability.

With its special tools, industry know-how and efficient service infrastructure, Emerson Network Power ensures that your system is available at all times. Our “Grid to Chip” maintenance strategy is based on a systematic service concept for your critical systems, which goes beyond the scope of standardized services. We provide you with a comprehensive service solution, which incorporates the power supply and cooling requirements of your entire company. We have good reasons for such a promise; some are listed here below.

## Our support services for business-critical systems include:

- Design — Availability analyses, infrared tests, electrical test, determination of the cooling requirements and the necessary supply services.
- Preventive maintenance — Regular maintenance ensures the continued operability and high load rating of your systems. Maintenance makes an important contribution to availability and reduces the systems' overall operating costs.
- Prognoses — We point out problems and faults before they occur. You consequently get a more sustainable and more reliable network.
- Remote monitoring — We can monitor the functioning of all your business-critical systems, including the products of other manufacturers. Use this solution if you want to know your systems' statuses, but you don't have the time or staff to take care of it yourself.

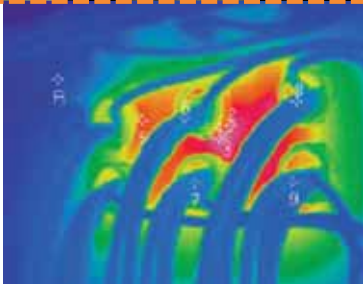



*You get an answer.  
And a solution.*

Unforeseen failures can happen any time. Our customers know that they have a partner that will get their business-critical systems up and running in next to no time. When the unexpected happens you need a partner that has the right answers, quick service and the right parts at the ready so that your systems go back on line as quickly as possible.



**We have the resources**

Our customer center supports you 24 hours a day – every day. Competent contact people that know your technology and your equipment are constantly at your disposal here. No automatic messages. No callbacks. We process 100,000 calls a year, and resolve the situation in an average of two and a half minutes.

**We have the people**

Emerson Network Power's service unit has the necessary skills and expertise to help you out of every situation. We have the most specialists in the industry: 375 of these experts trained in the plant are distributed across the entire country. What does this mean for you? In 2006 we needed an average of only 1.6 hours to be on-site to resolve problems.

**We have the parts**

To ensure activities can be performed when they are required, we provide certified parts in an unrivaled scope, which our perfected logistics deliver to every required site. You therefore never have to wait long for parts with system failures – almost 100% of emergency orders are delivered in less than 24 hours.





# Emerson Network Power



For more energy efficiency in your IT environment

Really reliable availability of business-critical networks are a requirement for reliable network infrastructure installation, administration and continuous support.

This in turn depends on the power supply and cooling infrastructure, which supports these systems and is based on the following key components:

- **Business-critical power supply**
- **Business-critical cooling**
- **Rack and enclosure systems**
- **Monitoring and administration**
- **Proactive maintenance**

Emerson Network Power has developed new power supply, cooling, rack and enclosure systems, and monitoring solutions which also support uninterruptible availability – and offer real added value that goes well beyond the sum of the individual solutions.

With our solutions we provide unsurpassed adaptability, individualization and the ability to integrate into the most diverse products and services.

We put together comprehensive knowledge of our challenges and are in a position to meet their requirements.

Our solutions are more reliable, more comprehensive and tailored to your requirements – and therefore provide the benefit of an optimized strategic and operational effect, higher reliability, higher flexibility and lower overall operating costs.

We focus on the combined use of our knowledge, our experience and our resources – for a solution from one single source that meets all requirements.

The result: an infrastructure that stays abreast of current and future requirements.



Emerson Network Power, a division of Emerson (NYSE:EMR), is the world's leading provider of Business-Critical Continuity™ "Grid-to-Chip" solutions for telecommunication networks, data centers, medical facilities and industrial systems.

Emerson Network Power provides innovative solutions and expertise in areas such as AC and DC power supply, precision cooling systems, embedded computer and power supply systems, integrated racks and enclosures, network circuits and controls, monitoring and connectivity. All solutions are supported locally all over the world by Emerson Network Power customer service technicians. You will find more information on Emerson Network Power's products and support services at

[www.emersonnetworkpower.com](http://www.emersonnetworkpower.com)  
[www.eu.emersonnetworkpower.com](http://www.eu.emersonnetworkpower.com)  
[www.emerson.com](http://www.emerson.com)  
[www.knuerr.com](http://www.knuerr.com)

While every precaution has been taken to ensure accuracy and completeness in this literature, Emerson Network Power assumes no responsibility and disclaims all liability for damages resulting from use of this information or for any errors or omissions.

©2011 Emerson Network Power.  
All rights reserved throughout the world. Specifications subject to change without notice.

## Emerson Network Power™

*The Global leader in Business-Critical Continuity™ solutions.*

- |                |  |                              |                               |
|----------------|--|------------------------------|-------------------------------|
| ■ AC Power     | ■ Embedded Computing                     | ■ Outside Plant              | ■ Racks & Integrated Cabinets |
| ■ Connectivity | ■ Embedded Power                         | ■ Power Switching & Controls | ■ Services                    |
| ■ DC Power     | ■ Infrastructure Management & Monitoring | ■ Precision Cooling          | ■ Surge Protection            |

Business-Critical Continuity, Emerson Network Power and the Emerson Network Power logo are trademarks and service marks of Emerson Electric Co. ©2011 Emerson Electric Co.

### Locations

**Emerson Network Power - EMEA**  
Via Leonardo Da Vinci 16/18  
Zona Industriale Tognana  
35028 Piove di Sacco (PD) • Italy  
T +39 049 9719 111  
F +39 049 5841 257  
[marketing.emea@emersonnetworkpower.com](mailto:marketing.emea@emersonnetworkpower.com)

### Emerson Network Power - Racks and Solutions

Mariakirchener Straße 38  
94424 Arnstorf • Germany  
T +49 8723 27 0  
F +49 8723 27 154  
[info@knuerr.com](mailto:info@knuerr.com)

### Emerson Network Power - USA

1050 Dearborn Drive  
P.O. Box 29186  
Columbus, OH 43229  
T +1 614 8880246

### Emerson Network Power - Asia

7/F, Dah Sing Financial Centre  
108 Gloucester Road, Wanchai  
Hong Kong  
T +852 2572220  
F +852 28029250