



Intel® Server System M50FCP1UR

System Integration and Service Guide

A guide providing instructions for the insertion and extraction of system components and available Intel accessories and spares

Rev. 1.2

May 2023



M50FCP1UR

Delivering Breakthrough Data Center System Innovation—Experience What's Inside!

<This page intentionally left blank>

Document Revision History

Date	Revision	Changes
January 2023	1.0	Production Release
February 2023	1.1	<ul style="list-style-type: none">• Edits made to Figure #1• Removing Intel® Optane™ PMem 300 Series support• Modify Appendix B. Memory Population Rules• Minor changes for clarity
May 2023	1.2	<ul style="list-style-type: none">• Update System Software Updates and Configuration section• Minor changes for clarity

Disclaimers

Intel technologies' features and benefits depend on system configuration and may require enabled hardware, software, or service activation. Performance varies depending on system configuration. No computer system can be absolutely secure. Check with your system manufacturer or retailer or learn more at intel.com.

You may not use or facilitate the use of this document in connection with any infringement or other legal analysis concerning Intel products described herein. You agree to grant Intel a non-exclusive, royalty-free license to any patent claim thereafter drafted which includes subject matter disclosed herein.

No license (express or implied, by estoppel or otherwise) to any intellectual property rights is granted by this document.

The products described may contain design defects or errors known as errata, which may cause the product to deviate from published specifications. Current characterized errata are available on request.

Intel disclaims all express and implied warranties, including without limitation, the implied warranties of merchantability, fitness for a particular purpose, and non-infringement, as well as any warranty arising from course of performance, course of dealing, or usage in trade.

Copies of documents that have an order number and are referenced in this document may be obtained by calling 1-800-548-4725 or by visiting www.intel.com/design/literature.htm.

Intel, the Intel logo, Xeon, and Intel Optane are trademarks of Intel Corporation or its subsidiaries in the U.S. and/or other countries.

*Other names and brands may be claimed as the property of others.

© Intel Corporation

Safety Warnings

Heed safety instructions: Before working with your server product, whether you are using this guide or any other resource as a reference, pay close attention to the safety instructions. You must adhere to the assembly instructions in this guide to ensure and maintain compliance with existing product certifications and approvals. Use only the described, regulated components specified in this guide. Use of other products/components will void the UL listing and other regulatory approvals of the product and will most likely result in noncompliance with product regulations in the region in which the product is sold.

System power on/off: The power button does not turn off the system AC power. To remove power from the system, you must unplug the AC power cord. Make sure that the AC power cord is unplugged before you open the chassis, add, or remove any components.

Hazardous conditions, devices, and cables: Hazardous electrical conditions may be present on power, telephone, and communication cables. Turn off the server and disconnect the power cord, telecommunications systems, networks, and modems attached to the server before opening it. Otherwise, personal injury or equipment damage can result.

Installing or removing jumpers: A jumper is a small plastic encased conductor that slips over two jumper pins. Some jumpers have a small tab on top that you can grip with your fingertips or with a pair of fine needle nosed pliers. If your jumpers do not have such a tab, take care when using needle nosed pliers to remove or install a jumper; grip the narrow sides of the jumper with the pliers, never the wide sides. Gripping the wide sides can damage the contacts inside the jumper, causing intermittent problems with the function controlled by that jumper. Take care to grip with, but not squeeze, the pliers or other tools you use to remove a jumper, or you may bend, or break the pins on the board.

Electrostatic Discharge (ESD)

Electrostatic discharge can damage the computer or the components within it. ESD can occur without the user feeling a shock while working inside the system chassis or while improperly handling electronic devices like processors, memory or other storage devices, and add-in cards.



Intel recommends that the following steps be taken when performing any procedures described within this document or while performing service to any computer system.

- Where available, all system integration and/or service should be performed at a properly equipped ESD workstation
- Wear ESD protective gear like a grounded antistatic wrist strap, sole grounders, and/or conductive shoes
- Wear an anti-static smock or gown, to cover any clothing that may generate an electrostatic charge
- Remove all jewelry
- Disconnect all power cables and cords attached to the server before performing any integration or service
- Touch any unpainted metal surface of the chassis before performing any integration or service
- Hold all circuit boards and other electronic components by their edges only
- After removing electronic devices from the system, or from their protective packaging, place them component side up on to a grounded anti-static surface or conductive workbench pad. Do not place electronic devices on to the outside of any protective packaging.

Caution: Slide / Rail mounted equipment is not to be used as a shelf or a workspace.



Intel warrants that this product performs to its published specifications. However, all computer systems are inherently subject to unpredictable system behavior under various environmental and other conditions.

This product is not intended to be the sole source for any critical data, and the user must maintain a verified backup. Failure to do so, or to comply with other user notices in the product user guide and specification documents, may result in loss of or access to data.

Weight of the system:

- Due to the weight of a system, Intel recommends carrying the system with two people supporting the system from the sides or using a mechanical lift or a cart when moving the system from one location to another.
- If your system has rack handles installed, do not lift, or carry the system by the rack handles
- When lifting or moving a chassis, always grasp it by all four corners. Do not grasp the chassis by two points at opposing diagonal corners, doing so may damage the internal components.
- If you can only grasp the chassis at two different points, always grasp the chassis by the sides at the midpoint.

Table of Contents

1. Introduction	13
1.1 Reference Documents and Support Collaterals	15
2. L6 Integrated System–Essential System Component Installation	17
2.1 Chassis Component Identification	18
2.2 System Top Cover Removal / Installation	18
2.5.1 System Cover Removal	18
2.5.2 System Cover Installation	20
2.3 Processor Assembly and Installation	20
2.5.1 Processor Heat Sink Module (PHM) Assembly	23
2.5.2 Processor Installation	25
2.4 Memory Module Installation	28
2.5 Power Supply Module Installation	29
3. System Options / Accessory Kit Installation	30
3.1 System Top Cover Removal / Installation	30
3.2 System Cable Routing	30
3.3 Riser Card / Add-in Card Installation	31
3.5.1 Riser Card Bracket Removal	32
3.5.2 Riser Card Installation	33
3.5.3 PCIe* Add-in Card Installation	34
3.5.4 Riser Card Assembly Installation–for All Riser Assemblies	35
3.4 Front Drive Installation	36
3.5.1 Drive Blank Removal	37
3.5.2 7 mm 2.5" SSD Drive Support	37
3.5.3 2.5" SSD Drive Installation	38
3.5 OCP* 3.0 Network Adapter Installation	39
3.5.1 OCP* Adapter Bay Filler Panel Removal / Installation	40
3.5.2 OCP* Adapter with Pull Tab Installation	41
3.5.3 OCP* Adapter with Internal Lock Installation	41
3.6 M.2 Storage Device Installation	42
3.7 Trusted Platform Module (TPM) Installation	43
3.8 Intel® RAID Maintenance Free Backup Unit (RMFBU) Installation	44
4. System Software Updates and Configuration	46
4.1 Software License Key Order, Registration, and Installation	46
4.2 Ordering Software License Key	47
4.3 Order and Register a License Key as an Add-on Accessory (Not via CTO)	47
4.4 Software License Key Installation	49
4.5.1 Installation Using the Integrated BMC Web Console	49
4.5.2 Installation Using the Intel® Server Configuration Utility	51

4.5.3	Installation Using Redfish*	52
5.	System Service–System Features Overview	54
5.1	Front Drive Bay Options	54
5.2	Back Panel, Front Control Panel, Front I/O Features	54
5.3	Drive Bay LED Identification	56
5.4	Server Board Features	57
5.5	System Configuration and Recovery Jumpers	59
6.	System Service and FRU Replacement	60
6.1	System Top Cover Removal / Installation	61
6.5.1	System Cover Removal	61
6.5.2	System Cover Installation	62
6.2	System Fan Replacement	63
6.3	Memory Module Replacement	64
6.4	Power Supply Replacement	66
6.5	Processor Replacement	67
6.5.1	Processor Heat Sink Module (PHM) and Processor Removal	68
6.5.2	Processor Heat Sink Module (PHM) Assembly	70
6.5.3	Processor Heat Sink Module (PHM) Installation	72
6.6	Riser Card Replacement	75
6.7	Front Drive Replacement	79
6.5.1	2.5" SSD Drive Removal	79
6.5.2	7 mm 2.5" SSD Drive Replacement	80
6.5.3	2.5" SSD Drive Installation	81
6.8	2.5" Drive Mounting Rail Replacement	82
6.9	Ethernet Network Adapter for OCP* Replacement	84
6.5.1	OCP* Add-in Card with Pull Tab Replacement	84
6.5.2	OCP* Adapter with Internal Lock Replacement	85
6.10	M.2 Storage Device Replacement	86
6.11	Intel® RAID Maintenance Free Backup Unit (RMFBU) Replacement	87
6.12	Backplane Replacement	89
6.5.1	4 X 2.5" Backplane Replacement	89
6.5.2	12 X 2.5" Backplane Replacement	91
6.13	System Battery Replacement	93
6.14	Server Board Replacement	94
Appendix A.	Getting Help	97
Appendix B.	Memory Population Rules	98
B.1	DDR5 DIMM Population Rules	98
B.2	Intel® DDR5 DIMM Support Disclaimer	99
Appendix C.	System Status LED Operating States and Definition	100
Appendix D.	POST Code Diagnostic LED Decoder	102
D.1	Early POST Memory Initialization MRC Diagnostic Codes	103
D.2	BIOS POST Progress Codes	104

Appendix E. POST Code Errors	108
E.1 POST Error Beep Codes	114
E.2 Processor Initialization Error Summary	115
Appendix F. System Packaging Assembly Instructions.....	116
Appendix G. Safety Instructions.....	119
Appendix H. Glossary	135

List of Figures

Figure 1. System Features Identification.....	13
Figure 2. Required Components for Basic System Operation.....	17
Figure 3. Chassis Component Identification.....	18
Figure 4. System Top Cover Panel Shipping Screws.....	19
Figure 5. System Cover Removal.....	19
Figure 6. System Cover Installation.....	20
Figure 7. 1U Heat Sinks.....	21
Figure 8. Processor Heat Sink Handling	21
Figure 9. Supported Processor Carrier Clips	21
Figure 10. Processor Carrier Clip Identifier Markings	22
Figure 11. Processor Heat Sink Module (PHM) Reference Diagram.....	22
Figure 12. Installing Processor Carrier Clip onto Processor–Part 1	23
Figure 13. Installing Processor Carrier Clip onto Processor–Part 2.....	23
Figure 14. Removing Heat Sink from its Packaging.....	24
Figure 15. Setting the Processor Heat Sink Anti-Tilt Wires to the Outward Position	24
Figure 16. Pin 1 Indicator of Processor Carrier Clip	24
Figure 17. Socket Protective Cover Removal	25
Figure 18. PHM Alignment with Socket Assembly	26
Figure 19. PHM Installation onto Server Board.....	26
Figure 20. Tighten Heat Sink Extension Fasteners.....	27
Figure 21. DIMM Blank Removal.....	28
Figure 22. Memory Module Installation.....	28
Figure 23. Power Supply Installation.....	29
Figure 24. System Cable Routing Channels.....	31
Figure 25. Bracket for Riser Card on Riser Slot #1– Front and Back Views	32
Figure 26. Bracket for Riser Card on Riser Slot #2– Front and Back Views	32
Figure 27. Bracket for PCIe* Interposer Riser Card – Front and Back Views	32
Figure 28. Chassis Riser Card Bracket Screws Removal	32
Figure 29. Riser Card Bracket Removal.....	33
Figure 30. Riser Card Installation onto the Bracket.....	33
Figure 31. PCIe* Add-in Card Installation for Riser Slot #1 or PCIe* Interposer Riser Assemblies	34
Figure 32. PCIe* add-in Card Installation for Riser Card on Riser Slot #2.....	34

Figure 33. Riser Card Assembly Installation	35
Figure 34. Back Panel Shipping Screws.....	35
Figure 35. 2.5" Drive Bay Components	36
Figure 36. Drive Blank Removal	37
Figure 37. Separating Top and Bottom Parts of Drive Blank.....	37
Figure 38. Attaching the Drive Blank to 7 mm SSD	38
Figure 39. 2.5" 7 mm Drive Outside Chassis, Ready for Installation.....	38
Figure 40. 2.5" Drive Installation into Front Drive Bay	39
Figure 41. OCP* Adapter Bay Filler Removal.....	40
Figure 42. OCP* Adapter Bay Filler Installation.....	40
Figure 43. OCP* Adapter with Pull Tab Installation.....	41
Figure 44. Internal Lock with Unlock and Lock Orientation.....	41
Figure 45. OCP* Adapter with Internal Lock Installation	42
Figure 46. M.2 SSD Connector Location.....	42
Figure 47. M.2 SSD Installation	43
Figure 48. Trusted Platform Module (TPM) Installation	43
Figure 49. Installing Latch on the Plastic Case	44
Figure 50. Insert Super Cap	45
Figure 51. Intel® RMFBU Mounting Plate Installation.....	45
Figure 52. Example Email.....	47
Figure 53. Register Key	48
Figure 54. Activate Key	48
Figure 55. Download Key	49
Figure 56. Integrated BMC Web Console Advanced System Management Key Page.....	50
Figure 57. BMC Web Console System Information Page	51
Figure 58. Upload VROC Standard License Key Using SYSCFG Utility.....	52
Figure 59. Confirm Activation of VROC Standard License Key Using SYSCFG Utility.....	52
Figure 60. Redfish Command to Upload the VROC Premium Software License Key	53
Figure 61. Redfish Command to verify the activation status of the VROC Software License Key	53
Figure 62. 4 x 2.5" Front Drive Bay Configuration–M50FCP1UR204	54
Figure 63. 12 x 2.5" Front Drive Bay Configuration–M50FCP1UR212.....	54
Figure 64. Back Panel Features	54
Figure 65. Front Control Panel Features	55
Figure 66. Front I/O Features	55
Figure 67. Hot Swap Drive Bay LED Identification.....	56
Figure 68. Intel® Server Board M50FCP2SBSTD Component / Feature Identification	57
Figure 69. Intel® Light-Guided Diagnostics–LED Identification.....	58
Figure 70. View of POST Code Diagnostic, System ID, and System Status LEDs Area	58
Figure 71. Intel® Light-Guided Diagnostics - DIMM Fault LEDs	59
Figure 72. Reset and Recovery Jumper Block Locations	59
Figure 73. System Top Cover Panel Shipping Screws.....	61
Figure 74. System Cover Removal	61

Figure 75. System Cover Installation	62
Figure 76. Individual Fan Removal.....	63
Figure 77. Individual Fan Installation.....	64
Figure 78. Memory Module Removal.....	65
Figure 79. Memory Module Installation.....	65
Figure 80. Power Supply Removal.....	66
Figure 81. Power Supply Installation.....	66
Figure 82. Processor Heat Sink Handling.....	67
Figure 83. Supported Processor Carrier Clips.....	67
Figure 84. Processor Carrier Clip Identifier Markings	68
Figure 85. PHM Assembly Removal from Processor Socket.....	68
Figure 86. Reinstall the Socket Cover.....	69
Figure 87. Processor Removal from PHM Assembly.....	69
Figure 88. Processor Carrier Clip Removal from PHM Assembly.....	70
Figure 89. Installing Processor Carrier Clip onto Processor–Part 1.....	70
Figure 90. Installing Processor Carrier Clip onto Processor–Part 2.....	71
Figure 91. Removing Heat Sink from its Packaging.....	71
Figure 92. Setting the Processor Heat Sink Anti-Tilt Wires to the Outward Position	71
Figure 93. Pin 1 Indicator of Processor Carrier Clip	72
Figure 94. Socket Protective Cover Removal	72
Figure 95. PHM Alignment with Socket Assembly	73
Figure 96. PHM Installation onto Server Board.....	73
Figure 97. Tighten Heat Sink Extension Fasteners.....	74
Figure 98. Chassis Riser Card Bracket Screws.....	75
Figure 99. Riser Card Bracket Removal.....	75
Figure 100. Add in Card Removal from Bracket.....	76
Figure 101. Riser Card Removal from Bracket.....	76
Figure 102. Riser Card Installation onto the Bracket	76
Figure 103. Add-in Card Installation.....	77
Figure 104. Add-in Card Assembly Installation.....	77
Figure 105. Back Panel Shipping Screw Locations	78
Figure 106. Drive Bay Components.....	79
Figure 107. 2.5" 15 mm Drive Removal	79
Figure 108. Detaching a 7mm SSD from its mounting bracket	80
Figure 109. 7mm SSD Assembly	80
Figure 110. Drive Rail Extraction Lever Release	81
Figure 111. 7mm (Drive + Bracket) Drive Placement Orientation–Bracket Side Up	81
Figure 112. 2.5" Drive installation into drive bay.....	81
Figure 113. Drive Rail Features Identification	82
Figure 114. Removing Drive Rail.....	82
Figure 115. Installing Drive Mounting Rail.....	83
Figure 116. OCP* Adapter with Pull Tab Removal	84

Figure 117. OCP* Adapter with Pull Tab Installation	85
Figure 118. Internal Lock with Unlock and Lock Orientation	85
Figure 119. OCP* Adapter with Internal Lock Removal	85
Figure 120. OCP* Adapter with Internal Lock Installation	86
Figure 121. M.2 SSD Removal.....	86
Figure 122. M.2 SSD Installation.....	87
Figure 123. Intel® RMFBU Mounting Bracket Removal - Chassis	87
Figure 124. RMFBU Housing Assembly.....	88
Figure 125. Intel® RMFBU Mounting Bracket Installation.....	88
Figure 126. 4 x 2.5" Backplane Removal	89
Figure 127. 4 x 2.5" Backplane Installation	90
Figure 128. 12 x 2.5" Backplane Removal	91
Figure 129. 12 x 2.5" Backplane Installation	92
Figure 130. Replacing the System Battery.....	93
Figure 131. Server Board Removal	94
Figure 132. Server Board Installation	95
Figure 133. Onboard POST Diagnostic LEDs	102

List of Tables

Table 1. Intel® Server M50FCP Family Reference Documents and Support Collaterals.....	15
Table 2. Drive Status LED States.....	56
Table 3. Drive Activity LED States	56
Table 4. DDR5 DIMM Attributes Table for "Identical" and "Like" DIMMs	99
Table 5. System Status LED State Definitions.....	100
Table 6. POST Progress Code LED Example.....	102
Table 7. MRC Progress Codes	103
Table 8. MRC Fatal Error Codes	104
Table 9. POST Progress Codes.....	104
Table 10. POST Error Messages and Handling.....	109
Table 11. POST Error Beep Codes	114
Table 12. Integrated BMC Beep Codes	114
Table 13. Mixed Processor Configurations Error Summary.....	115

1. Introduction

The Intel® Server System M50FCP1UR is a purpose-built, rack mount server that delivers power and performance in a 1U form factor. The system supports up to two 4th Gen Intel® Xeon® Scalable processors, delivering high core count and new hardware-enhanced security features. Previous generation Intel® Xeon® processor and Intel® Xeon® Scalable processor families are not supported.

The Intel® Server System M50FCP1UR supports up to 32 DDR5 DIMMs, providing high memory bandwidth for memory intensive workloads.

For details on all system features, refer to the *Intel® Server System M50FCP1UR Technical Product Specification (TPS)*.

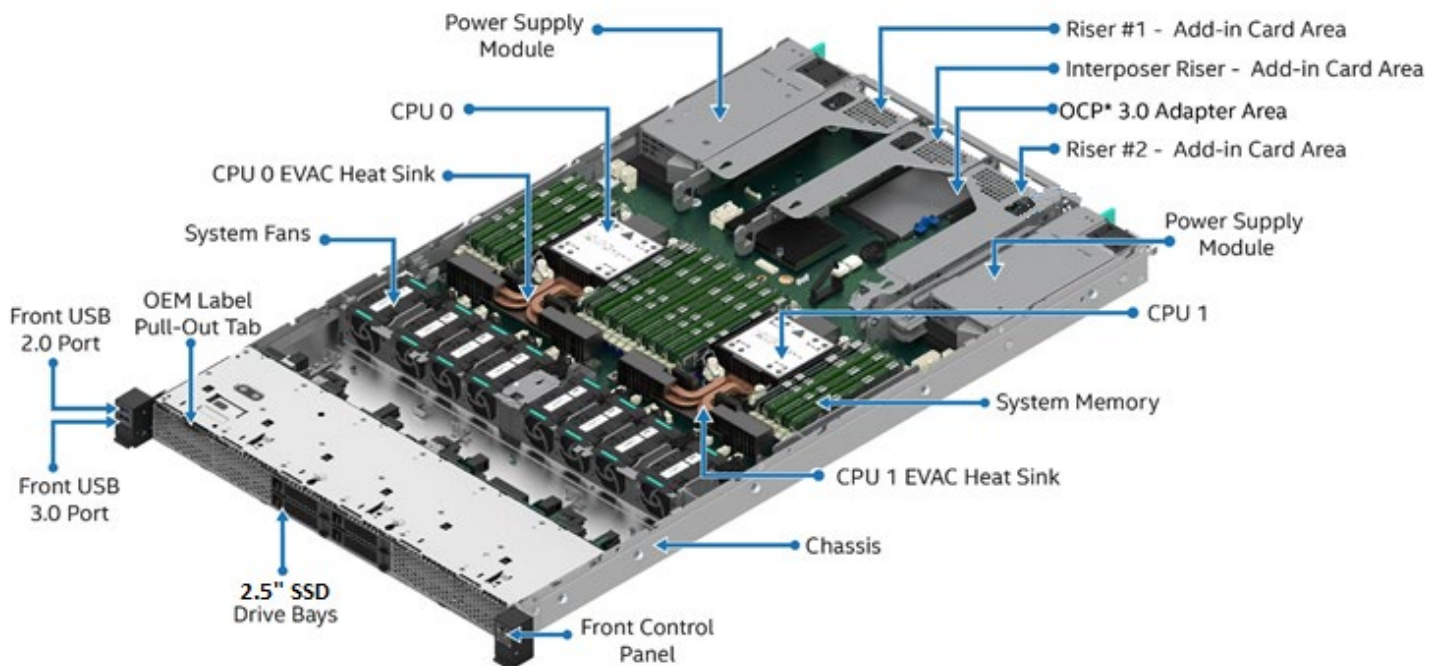

About This Document

This document provides system integrators and service technicians with instructions for the installation and removal of system components. The document also covers available Intel accessories supported by this server system.

The document is organized into two sections. The first section (Chapters 2-4) is focused on the installation of system components and accessories into an L6 or L9 integrated server system¹.

The second section (Chapters 5, 6, and appendices A-G) is focused on system service. These chapters provide the service technician with valuable system information and procedures necessary to identify and replace a faulty system component.

System Integration

Chapter 2 – L6 System Integration–Essential System Components. Installation procedures for the following system components: processors, memory, and power supply. Removal and installation of the system top cover are covered.

Chapter 3 – L9 System Integration. Provides detailed instructions necessary to enhance system configurations by installing additional components and/or available accessory kits.

Chapter 4 – System Software Update and Configuration. A short overview describing the system software stack installed on new Intel servers and where to get the latest revisions.

System Service

Chapter 5 – System Service–System Features Overview. An overview that identifies and locates the features associated with the Intel® Server System M50FCP1U.

Chapter 6 – System Service and FRU Replacement. Installation procedures for system field replaceable units (FRUs).

Appendix A – Getting Help. Provides server system support and contact information.

Appendix B – Memory Population Rules. Provides a summary of memory population rules.

Appendix C – System Status LED Operating States and Definition. System status LED operating states and definition.

Appendix D – POST Code Diagnostic LED Decoder. Lists of Diagnostic LED codes.

Appendix E – POST Code Errors. List of POST code errors that represent specific failures, warnings, or information.

Appendix F – System Packaging Assembly Instructions. Provides detailed instructions to repack the server system into the original Intel packaging.

¹ An L6 integrated system requires essential components to be installed to make it power-on ready. An L9 integrated system is power-on ready but has no operating system installed. It may require additional options and/or accessories to be installed to enable specific system features.

1.1 Reference Documents and Support Collaterals

For additional information and other support collaterals related to this Intel® server product, see Table 1. Listed documents and utilities can be downloaded from the following Intel websites or can be ordered through a local Intel support representative.

Note: Documents in Table 1 classified as “Intel Confidential” are only made available under a nondisclosure agreement (NDA) with Intel. All Intel product documentation and support collaterals can be downloaded from Intel's Resource & Documentation Center website:

<https://www.intel.com/content/www/us/en/documentation-resources/developer.html>.

Table 1. Intel® Server M50FCP Family Reference Documents and Support Collaterals

Topic	Document Title or Support Collateral	Document Classification
System integration instructions and service guidance	<i>Intel® Server System M50FCP2UR System Integration and Service Guide</i>	Public
System integration instructions and service guidance	<i>Intel® Server System M50FCP1UR System Integration and Service Guide</i>	Public
Technical system-level description	<i>Intel® Server System M50FCP2UR Technical Product Specification</i>	Public
Technical system-level description	<i>Intel® Server System M50FCP1UR Technical Product Specification</i>	Public
Technical board-level description	<i>Intel® Server Board M50FCP2SBSTD Technical Product Specification</i>	Public
Server configuration guidance and compatibility	<i>Intel® Server M50FCP Family Configuration Guide</i>	Public
Information on the Integrated BMC Web Console	<i>Integrated Baseboard Management Controller Web Console (Integrated BMC Web Console) User Guide</i>	Public
BIOS technical information on product family	<i>BIOS Firmware External Product Specification (EPS)</i>	Intel Confidential
BIOS setup information on product family	<i>BIOS Setup Utility User Guide</i>	Public
BMC technical information on product family	<i>Integrated Baseboard Management Controller Firmware External Product Specification (EPS)</i>	Intel Confidential
Base specifications for the IPMI architecture and interfaces	<i>Intelligent Platform Management Interface Specification Second Generation v2.0</i>	Intel Confidential
Specifications for the PCIe* 3.0 architecture and interfaces	<i>PCIe Base Specification, Revision 3.0</i> http://www.pcisig.com/specifications	Public
Specifications for the PCIe* 4.0 architecture and interfaces	<i>PCIe Base Specification, Revision 4.0</i> http://www.pcisig.com/specifications	Public
Specifications for the PCIe* 5.0 architecture and interfaces	<i>PCIe Base Specification, Revision 5.0</i> http://www.pcisig.com/specifications	Public
Specification for OCP*	<i>Open Compute Project (OCP) 3.0 Specification</i>	Intel Confidential
TPM for PC Client specifications	<i>TPM PC Client Specifications, Revision 2.0</i>	Intel Confidential
Functional specifications of 4 th Gen Intel® Xeon® Scalable processor family	<i>Sapphire Rapids External Design Specification (EDS): Document IDs: 630161, 612246, 612172, 633350, 611488</i>	Intel Confidential
Processor thermal design specifications and recommendations	<i>Sapphire Rapids Thermal and Mechanical Specifications and Design Guide (TMSDG): Document ID 609847</i>	Intel Confidential

Intel® Server System M50FCP1UR System Integration and Service Guide

Topic	Document Title or Support Collateral	Document Classification
BIOS and BMC security best practices	<i>Intel® Server Systems Baseboard Management Controller (BMC) and BIOS Security Best Practices White Paper</i> https://www.intel.com/content/www/us/en/support/articles/000055785/server-products.html	Public
Managing an Intel server overview	<i>Managing an Intel Server System 2020</i> https://www.intel.com/content/www/us/en/support/articles/000057741/server-products.html	Public
Latest system software updates: BIOS and firmware	<i>Intel® System Update Package (SUP) for Intel® Server M50FCP Family</i>	Public
	<i>Intel® Server Firmware Update Utility - Various operating system support</i>	
	<i>Intel® Server Firmware Update Utility User Guide</i>	
To obtain full system information	<i>Intel® Server Information Retrieval Utility - Various operating system support</i>	Public
	<i>Intel® Server Information Retrieval Utility User Guide</i>	
To configure, save, and restore various system options	<i>Intel® Server Configuration Utility - Various operating system support</i>	Public
	<i>Intel® Server Configuration Utility User Guide</i>	
Product Warranty Information	<i>Warranty Terms and Conditions</i> https://www.intel.com/content/www/us/en/support/services/000005886.html	Public
Intel® Data Center Manager (Intel® DCM) information	<i>Intel® Data Center Manager (Intel® DCM) Product Brief</i> https://software.intel.com/content/www/us/en/develop/download/dcm-product-brief.html	Public
	<i>Intel® Data Center Manager (Intel® DCM) Console User Guide</i> https://software.intel.com/content/www/us/en/develop/download/dcm-user-guide.html	Public

2. L6 Integrated System—Essential System Component Installation

The Intel® Server System M50FCP1UR options are offered with different level of system integration. System configurations that are not power-on ready are identified as L6 integrated systems. An L6 integrated system requires essential components (sold separately) to be installed. If your Intel system did not come with any of the following components preinstalled, then follow the procedures in this chapter:

- Processors – 4th Gen Intel® Xeon® Scalable processor family
- Memory – Up to 32 DDR5 DIMMs
- Power supply – two required for redundancy

If your Intel server system came with all listed components preinstalled, then skip this chapter and go on to [Chapter 3](#) for installation procedures associated with all other system options and accessories.

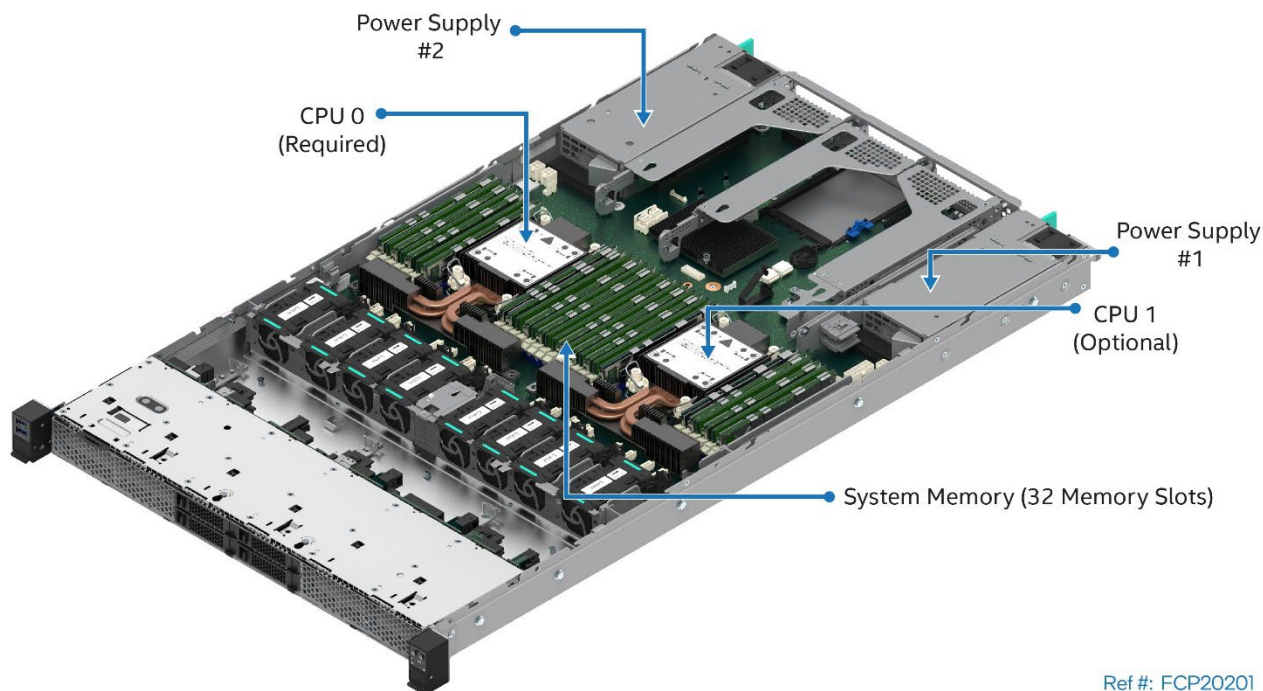

Ref #: FCP20201

Figure 2. Required Components for Basic System Operation

Before You Begin

Before integration of any system components, review all the safety and ESD precautions found in the Safety Warnings section at the beginning of this document.

System Reference

In the following procedures, all references to left, right, front, top, and bottom assume that the reader is facing the front of the server chassis.

Instruction Format

Each procedure described in this chapter follows an illustration first format. This format gives the reader the option to follow a quicker path to component integration by first seeing an illustration of the intended procedure. If necessary, the reader can then follow the step-by-step instructions that accompany each procedure.

2.1 Chassis Component Identification

The following figure shows the chassis components.

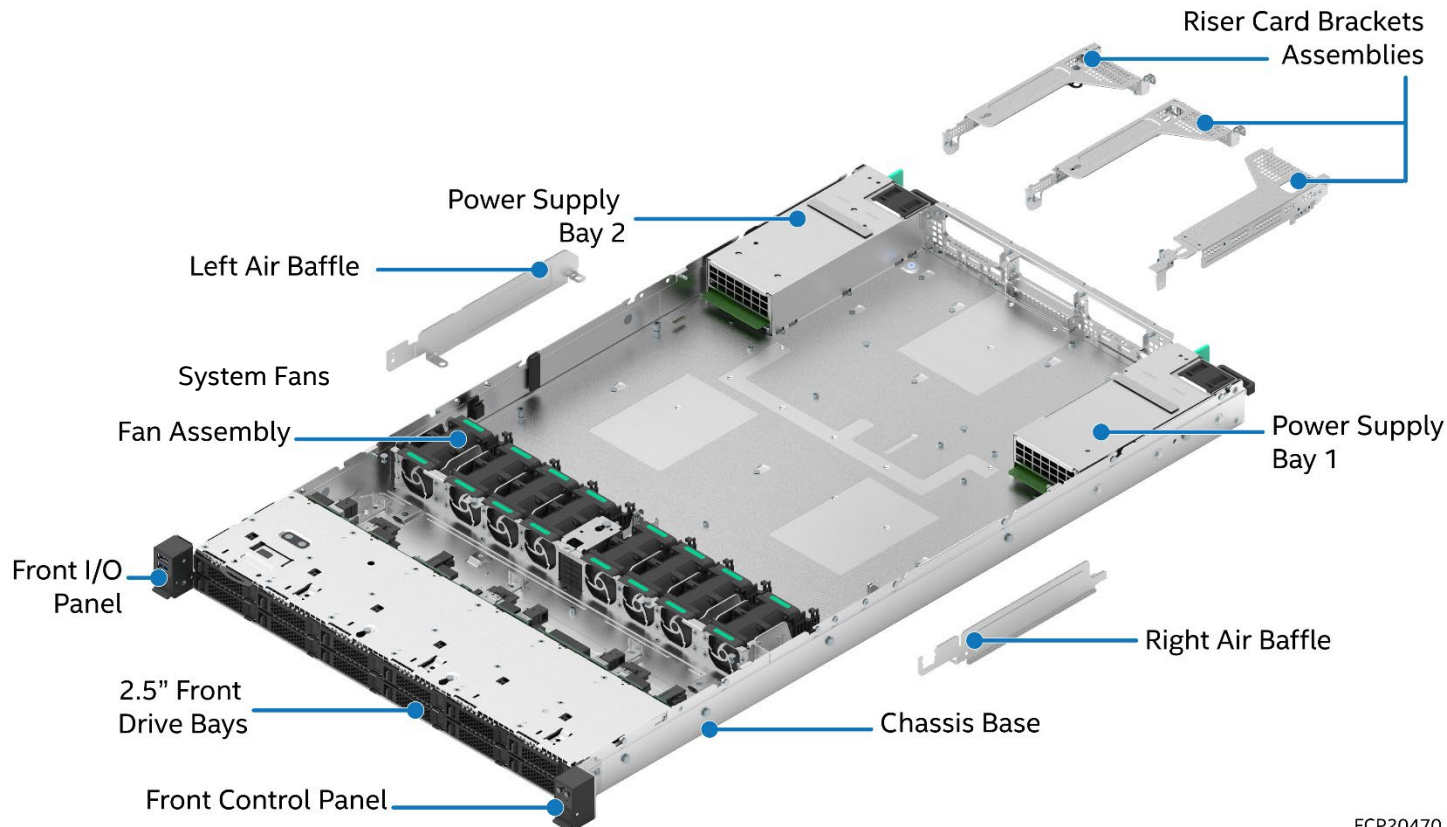

FCP20470

Figure 3. Chassis Component Identification

2.2 System Top Cover Removal / Installation

The system top cover consists of two panels, one over the front half of the system, and one over the back half of the system. To maintain system thermals, both top cover panels must be in place when the system is operational.

Required Tools and Supplies

- Anti-static wrist strap and conductive workbench pad (recommended)
- Phillips* head screwdriver #1

2.5.1 System Cover Removal

Removal of both top cover panels is necessary when servicing any system component integrated within the system. Before removing the top cover, power down the system and unplug all peripheral devices and the system power cords.

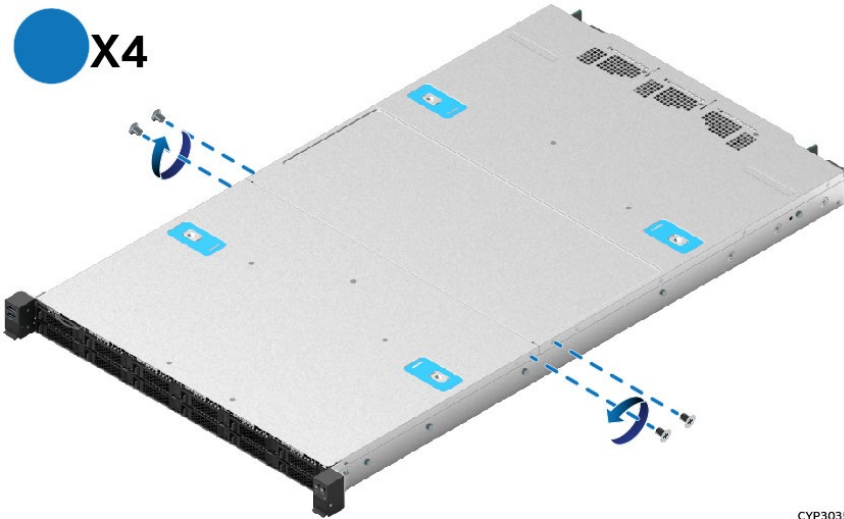

CYP30351

Figure 4. System Top Cover Panel Shipping Screws

The system may have the top cover panels fastened to the chassis. If present, a total of four screws, one on each side of the front cover and one on each side of the back cover, need to be removed to detach each top cover panel from the chassis.

Note: A non-skid surface or a stop behind the server system may be needed to prevent the server system from sliding on the work surface.

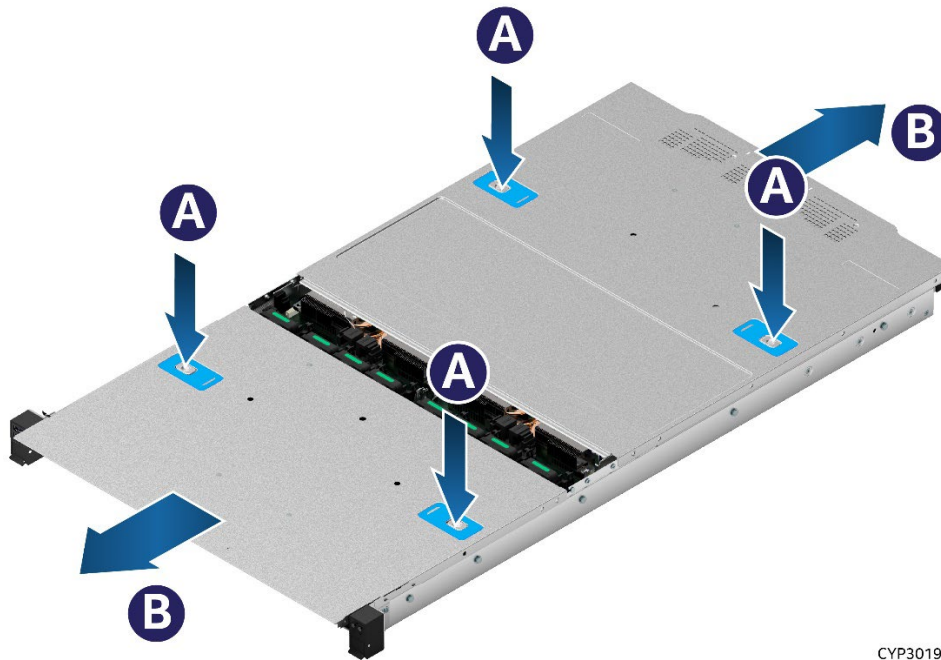

CYP30192

Figure 5. System Cover Removal

For each top cover panel:

1. While pushing down on both the left and right buttons of the given top panel (see Letter A), slide the top cover panel towards the front (front panel) or back (back panel) of the chassis (see Letter B).
2. Carefully lift the top cover panel up and away from the chassis.

Note: Each top cover panel can slide along the chassis base for 10 mm and then needs to be lifted.

2.5.2 System Cover Installation

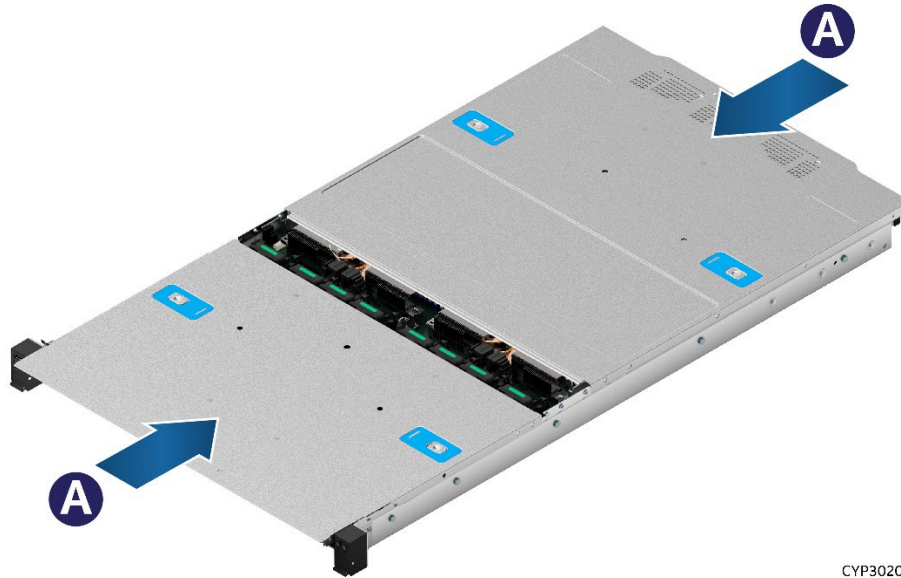

CYP30203

Figure 6. System Cover Installation

For each top cover panel:

1. Carefully align and set the top cover panel on top of the chassis. Then, slide it inwards until it locks into place (see Letter A).

Shipping Note: When transporting the server system, Intel recommends installing the four top cover screws before shipping.

2.3 Processor Assembly and Installation

Components Required:

- 4th Gen Intel® Xeon® Scalable processors
- Processor tray–Packaging tray that came with the processor
- Processor carrier clip – one for each processor
- Processor heat sink–1U standard heat sink or 1U Enhanced Volume Air Cooling (EVAC) heat sink

Required Tools and Supplies

- Anti-static wrist strap and conductive workbench pad (recommended)
- T-30 Torx* screwdriver
- ESD Gloves
- Phillips* head screwdriver #2

The Intel® Server System M50FCP1UR includes dual Socket-E LGA4677 processor sockets compatible with the 4th Gen Intel® Xeon® Scalable processor family.

The server system supports two types of heat sinks as shown in the following figure: The standard 1U heat sink and Enhanced Volume Air Cooling (EVAC) heat sink. The type of heat sink used depends on the system configuration. The 2.5" x 4 front drive system must use the EVAC heat sink on both processors. The 2.5" x 12 front drive system must use the standard 1U heat sink on both processors. For more information, refer to the *Intel® Server M50FCP Family Configuration Guide*.

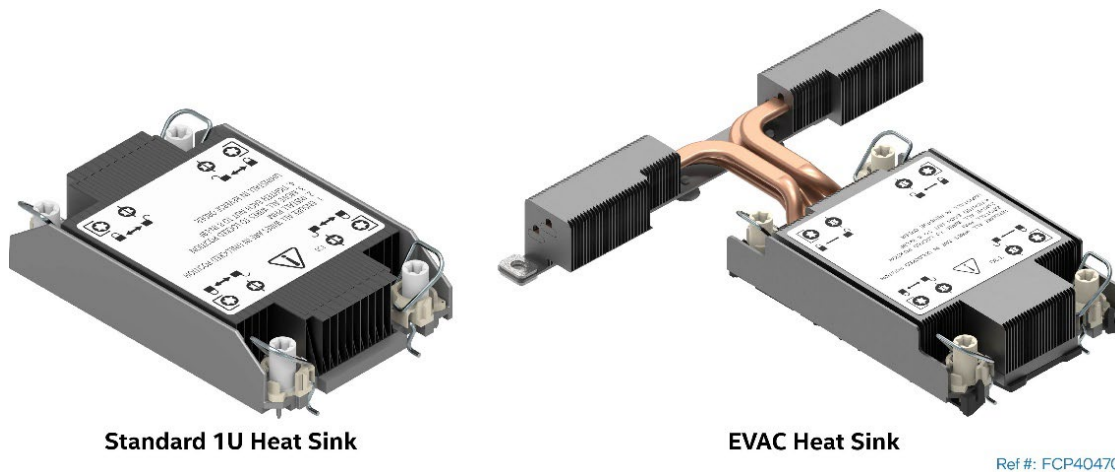

Ref #: FCP40470

Figure 7. 1U Heat Sinks

Caution: Fin edges of the processor heat sink are very sharp. Intel recommends wearing thin ESD protective gloves when handling the PHM during the following procedures.

Caution: Processor heat sinks are easily damaged if handled improperly. See the following image for proper handling.

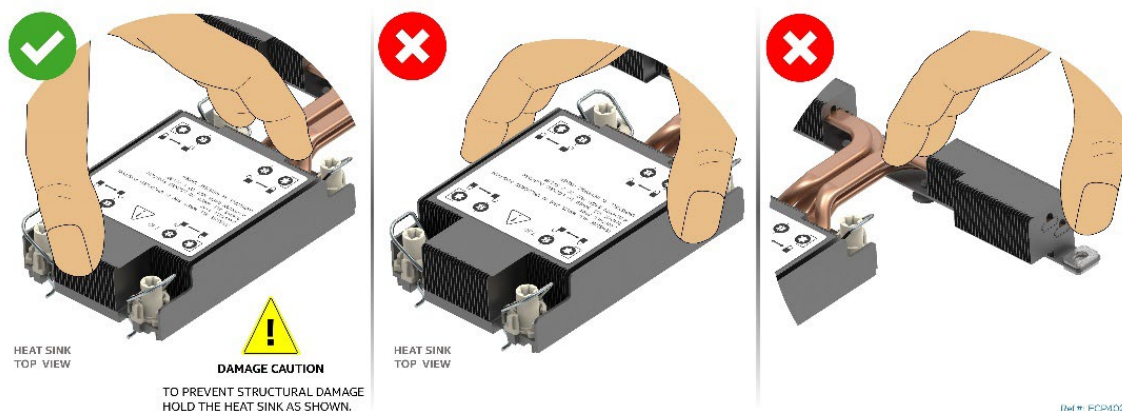

Ref #: FCP40290

Figure 8. Processor Heat Sink Handling

For the 4th Gen Intel® Xeon® Scalable processors, two types of processor carrier clips are supported (see following figure). The type of carrier clip used is determined by the processor SKU.

Two types of processor carrier clips are supported by the 4th Gen Intel® Xeon® Scalable processor family for this server product family, they are identified as “E1A” and “E1B”.



Ref #: D3442863

Ref #: E1446310

Figure 9. Supported Processor Carrier Clips

Each type of processor carrier clip will include identifier markings as shown in [Figure 10](#).

Match the processor clip to the clip identifier that is etched on the processor heat spreader, as shown in [Figure 10](#).

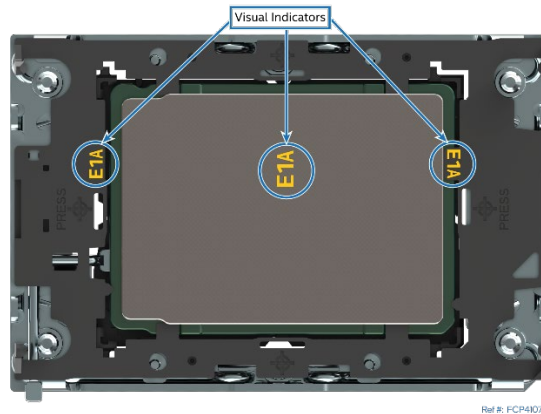

Figure 10. Processor Carrier Clip Identifier Markings

Note: The etched identifier location in the figure is for illustration purposes only. The location and color may be different on the actual processor and carrier clip

A processor heat sink module (PHM) assembly and processor socket assembly are necessary to install a processor to the server board. [Figure 11](#) identifies each component associated with the PHM and processor socket assemblies.

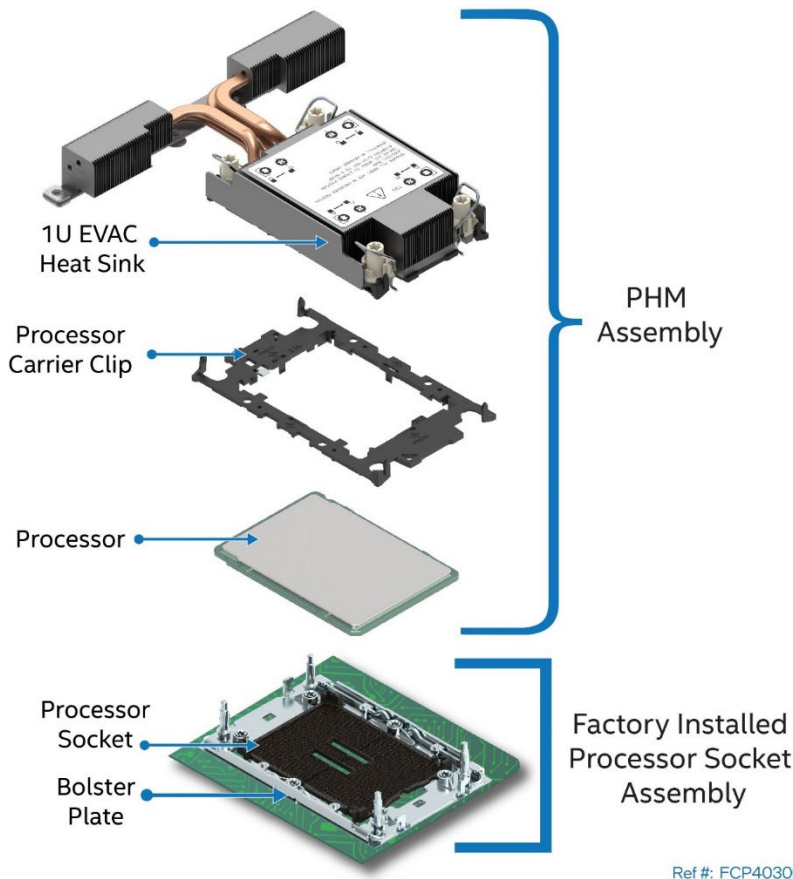

Figure 11. Processor Heat Sink Module (PHM) Reference Diagram

The procedures described in the following sections must be followed in the order specified to assemble the PHM and install it to the server board. These instructions assume that all PHM components are new, and the Thermal Interface Material (TIM, Honeywell* PTM7000) is already applied to the bottom of the heat sink.

2.5.1 Processor Heat Sink Module (PHM) Assembly

Caution: Wear ESD gloves to prevent electrostatic damage and oxidation or foreign material on processor package and land pads.

Note: Installation procedures in the following sections apply to both types of processor heat sink. Steps unique to one heat sink type will be identified.

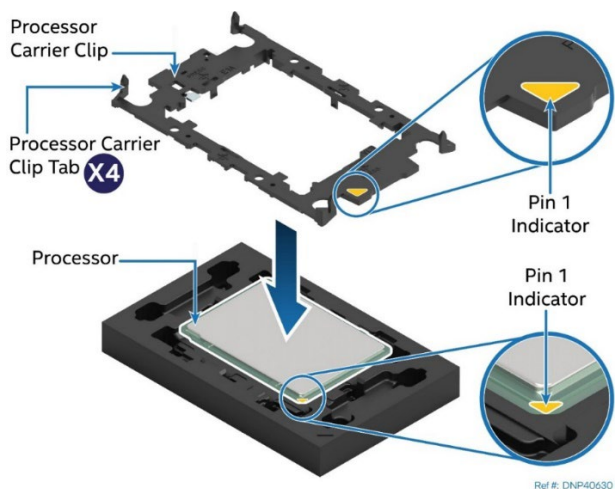

Figure 12. Installing Processor Carrier Clip onto Processor—Part 1

1. Position the Pin 1 indicator of the carrier clip with the Pin 1 indicator of the processor (See Figure 12).
2. With the processor still on its shipping tray, place the processor carrier clip over the processor.

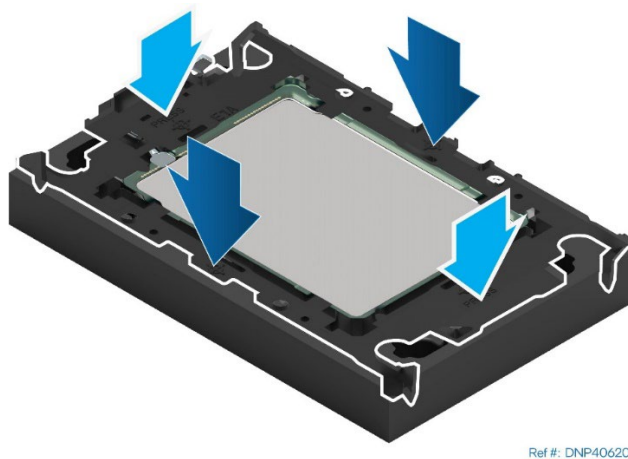

Figure 13. Installing Processor Carrier Clip onto Processor—Part 2

3. Gently press down on two opposite sides at a time of the processor carrier clip until it clicks in place.

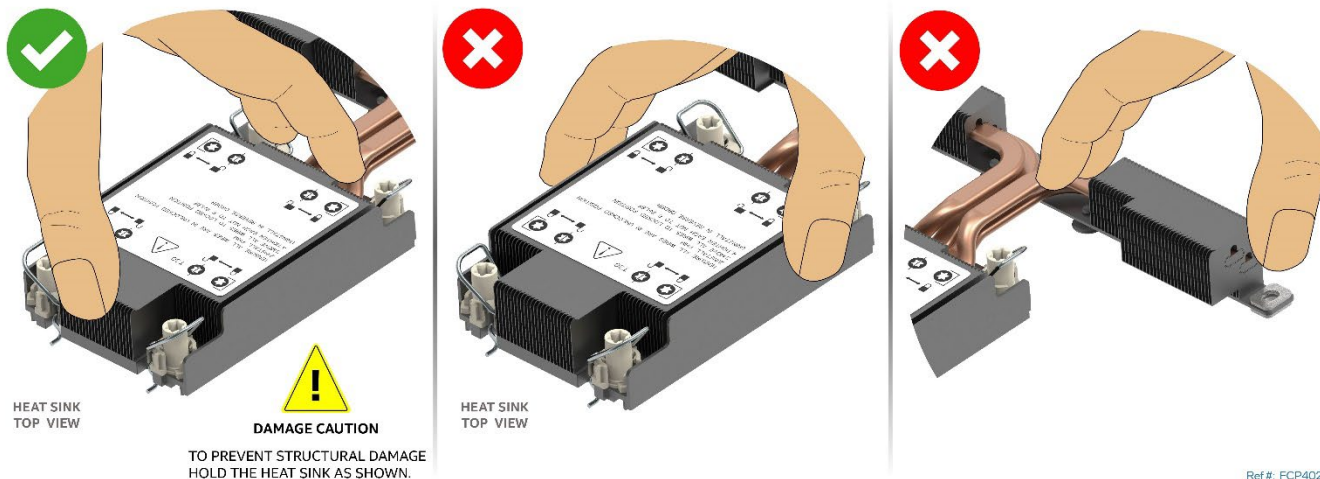

Figure 14. Removing Heat Sink from its Packaging

- Remove the heat sink from its packaging. To avoid damage to the heat sink, grasp it by its narrower top and bottom edges.

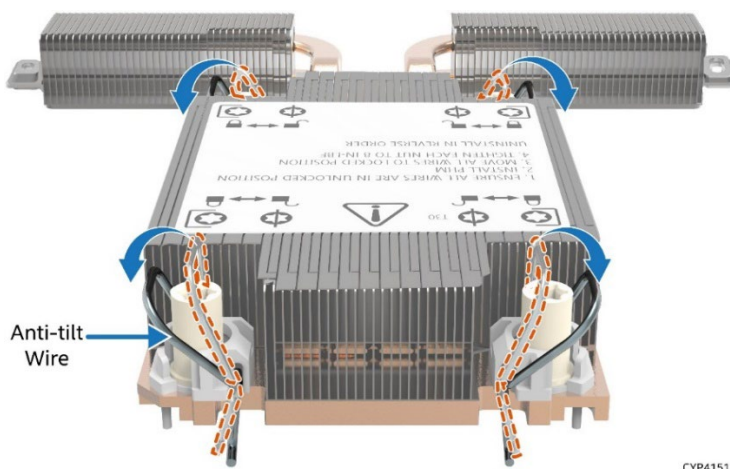

Figure 15. Setting the Processor Heat Sink Anti-Tilt Wires to the Outward Position

- Set the anti-tilt wires to the outward position.
- Turn the heat sink over and place it bottom side up on a flat surface.
- Remove the plastic protective film from the Thermal Interface Material (TIM).

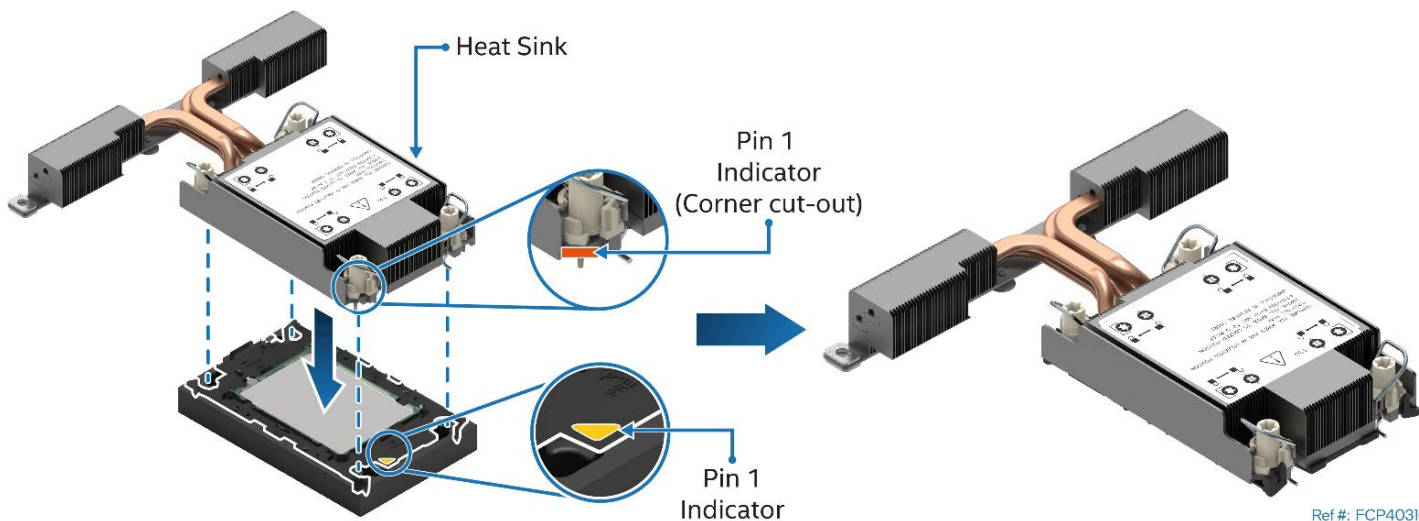

Figure 16. Pin 1 Indicator of Processor Carrier Clip

- Align Pin 1 indicator of processor carrier clip with the corner cut-out on the heat sink. For the EVAC heat sink, align the processor carrier clip and the heat sink as shown in [Figure 16](#).

Note: In a standard heat sink there are two cut-out corners, either can be used to align Pin 1 indicators.

- Gently press down the heat sink onto the processor carrier clip until it clicks into place.
- Ensure that all four heat sink corners are securely latched to the tabs on the processor carrier clip.

2.5.2 Processor Installation

Caution: Do not touch the socket pins. The pins inside the processor socket are extremely sensitive. A damaged processor socket may produce unpredictable system errors.

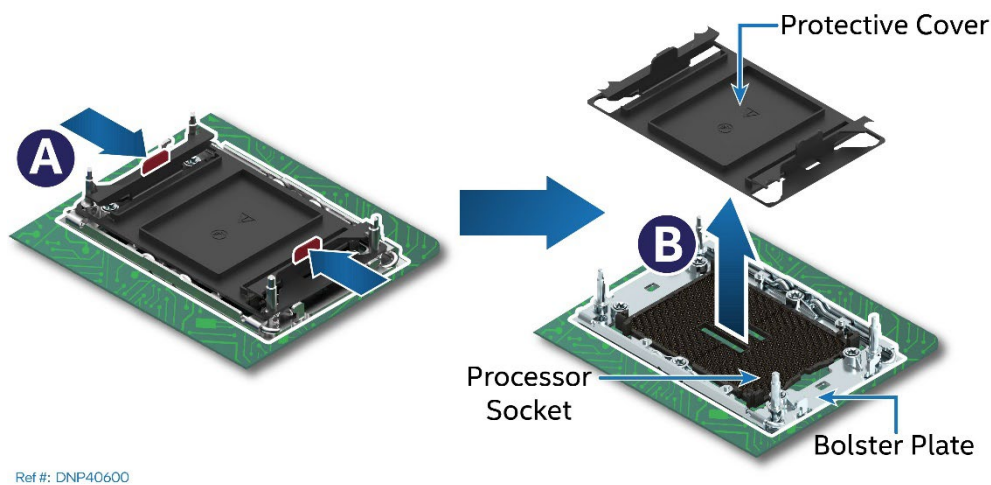

Figure 17. Socket Protective Cover Removal

- (If present) Remove the processor socket cover by squeezing the finger grips (see Letter A) and pulling the cover up from the processor socket (see Letter B).

Caution: Ensure that the processor socket is free of damage or contamination before installing the PHM. If debris is observed, blow it away gently with an air blower. Do not use tweezers or any other hard tools to remove it manually.

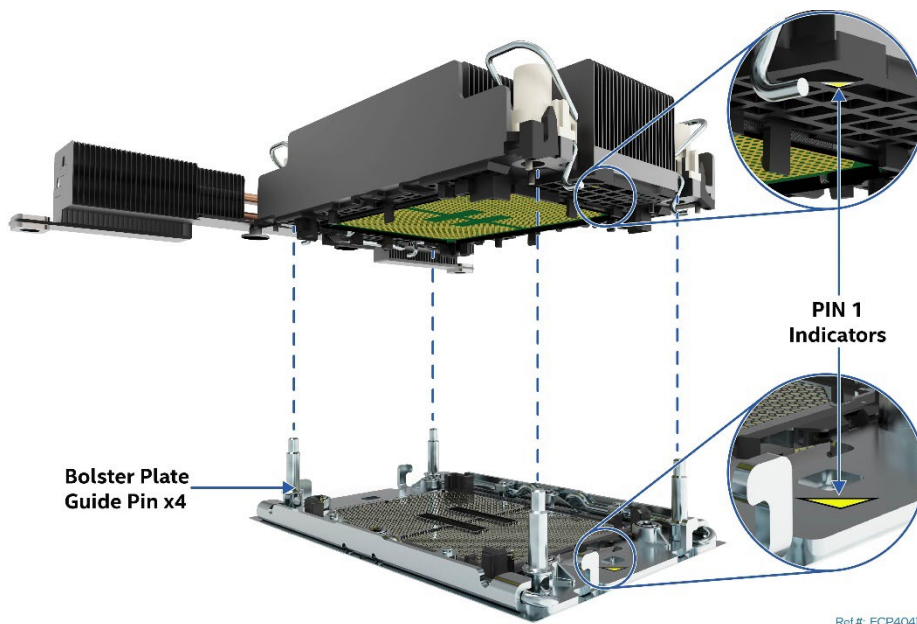

Figure 18. PHM Alignment with Socket Assembly

1. Set all four anti-tilt wires on the heat sink to the inward position (see Letter A in [Figure 19](#)).
2. Align the Pin 1 indicators of the processor carrier clip and processor with the Pin 1 indicator on the bolster plate located around the processor socket.

Caution: Processor socket pins are delicate and bend easily. Use extreme care when placing the PHM onto the processor socket. Do not drop it.

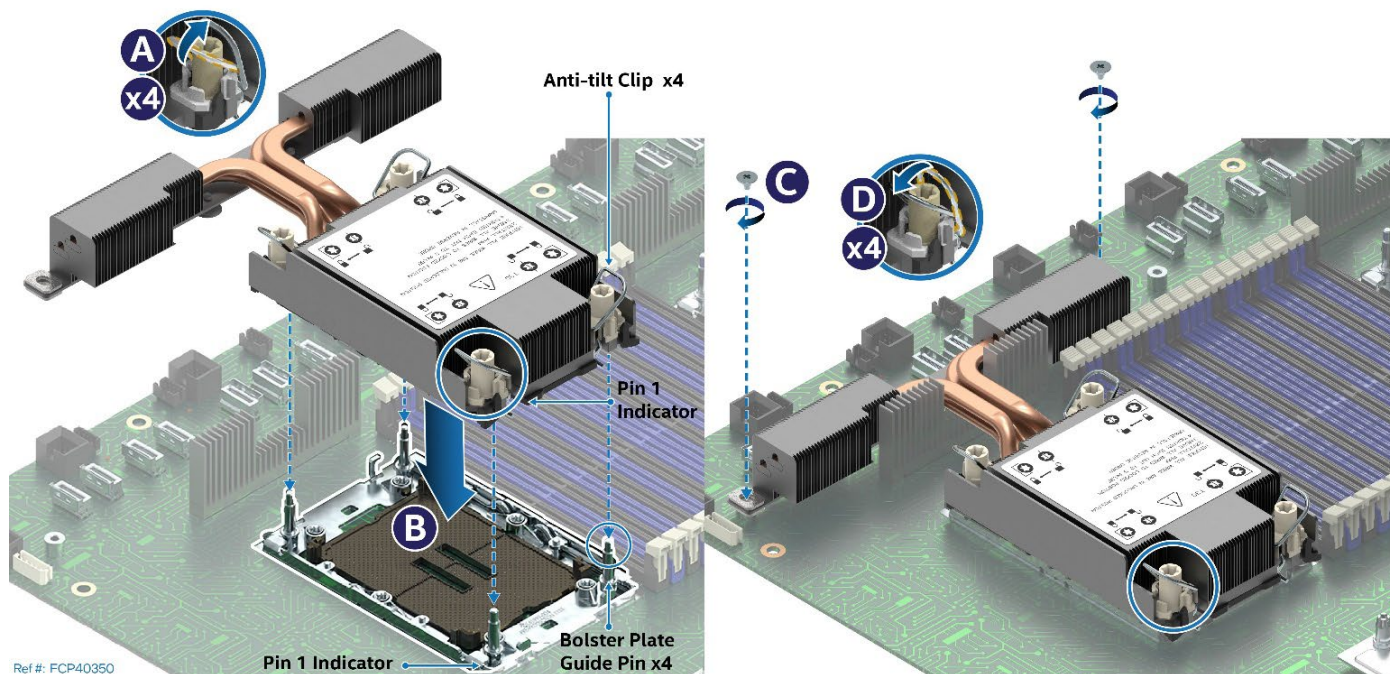

Figure 19. PHM Installation onto Server Board

3. Holding the PHM horizontally, carefully lower it onto the bolster plate's alignment pins (see Letter B).
4. Set all four anti-tilt wires on the heat sink to the outward position. See Letter D in [Figure 19](#).
5. (EVAC Heat Sink Only) Using a Phillips #2 screwdriver, tighten the heat sink extension screws. See Letter C in [Figure 19](#).

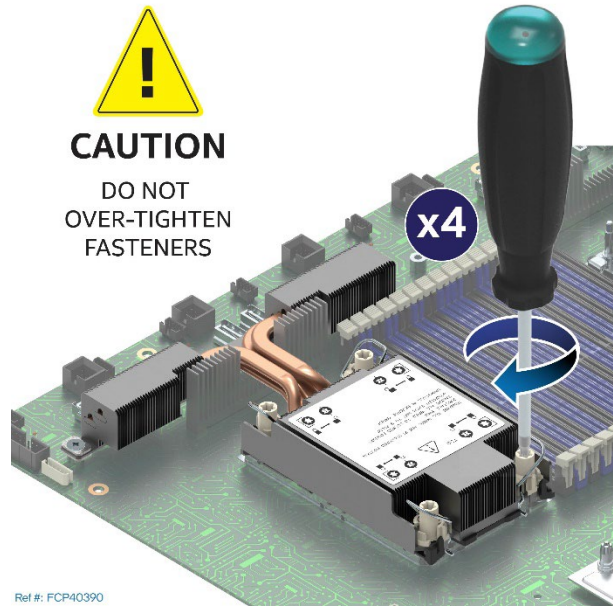

Figure 20. Tighten Heat Sink Extension Fasteners

6. Using a T30 Torx* screwdriver, tighten the heat sink fasteners to 8 in-lb. No specific sequence is needed for tightening.

Important: A processor socket cover should be installed onto any unpopulated processor socket. Do not install a processor heat sink over a processor socket that is empty.

2.4 Memory Module Installation

Required Tools and Supplies

- Anti-static wrist strap and conductive workbench pad (recommended)

The Intel® Server System M50FCP1UR supports standard DDR5 RDIMMs, 3DS-RDIMMs, and 9x4 RDIMMs.

A DDR5 DIMM is commonly referred to as “memory module” in the following procedure.

Notes:

- DIMM blanks should only be removed when installing a memory module in its place.
 - See [Appendix B](#) for memory population rules.
-

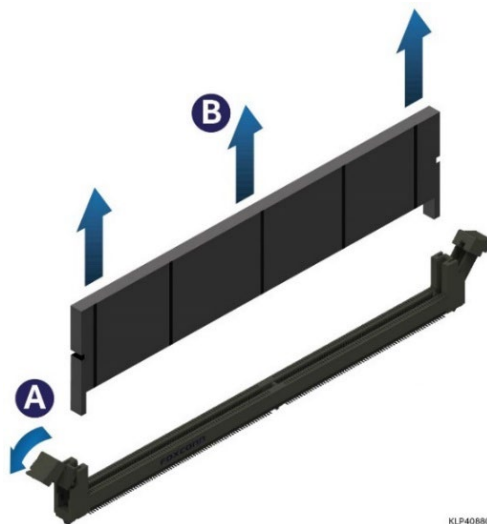

Figure 21. DIMM Blank Removal

1. Remove the DIMM blank from the desired memory slot:
 - Open the ejection tabs at both ends of the selected memory slot to lift the DIMM blank from the slot (see Letter A).
 - Carefully remove the DIMM Blank from the system (see Letter B).

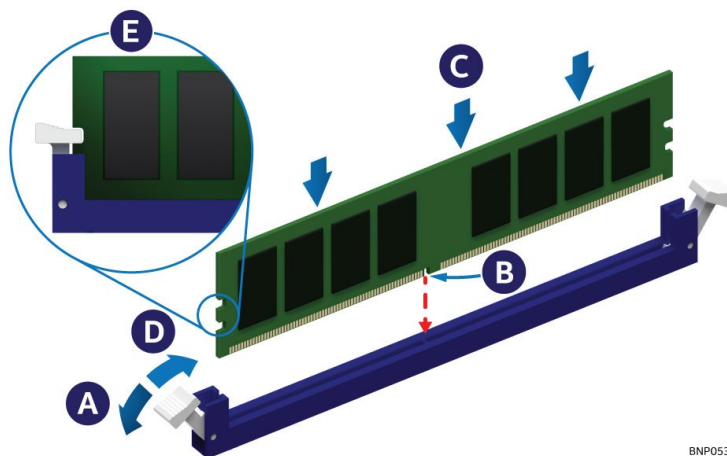

Figure 22. Memory Module Installation

2. Ensure that the ejection tabs at both ends of the memory slot are pushed outward to the open position (see Letter A).
3. Carefully unpack the replacement memory module, taking care to handle the device by its outer edges.

4. Align the notch at the bottom edge of the memory module, with the key in the memory slot (see Letter B).
5. Insert the memory module into the memory slot.
 - Using even pressure along the top edge, push down on the memory module (see Letter C) until the ejection tabs of the memory slot snap into place (see Letter D).
6. Ensure that the ejection tabs are firmly in place (see Letter E).
7. Repeat the procedure for each memory module to be installed.

2.5 Power Supply Module Installation

Required Tools and Supplies

- Intel power supply kit
- Anti-static wrist strap and conductive workbench pad (recommended)

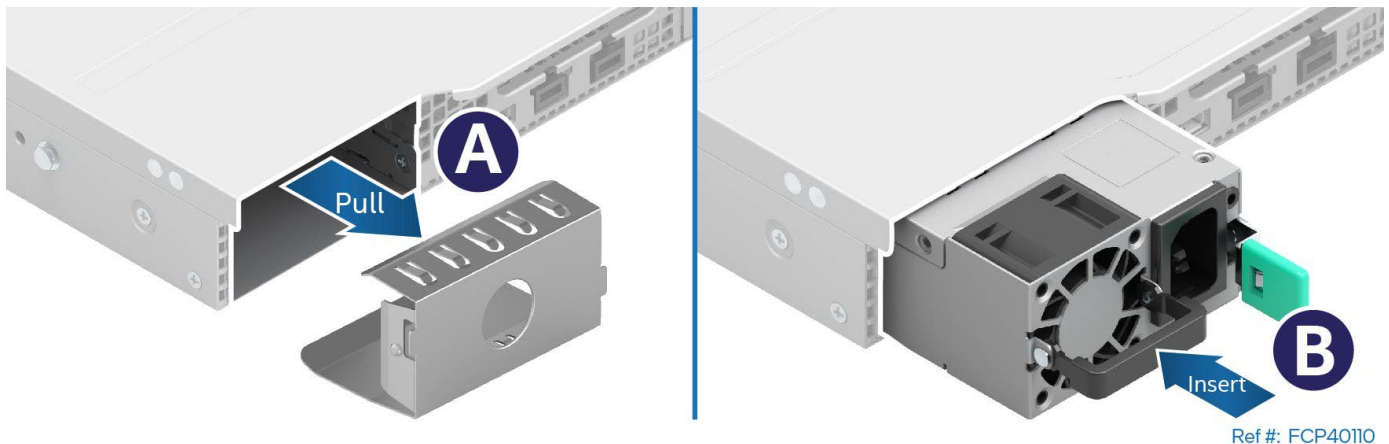

Figure 23. Power Supply Installation

1. If present, remove the insert from the power supply bay (see Letter A).
2. Locate and carefully unpack the power supply module.
3. Slide the power supply into the power supply bay until it locks in place (see Letter B).

Note: The power supply bay filler panel must be installed in the unused bay for all single power supply configurations.

4. If installing a second power supply, repeat steps 1–3.

3. System Options / Accessory Kit Installation

This chapter provides instructions for the integration of system options and other Intel accessories. If your integrated Intel server system did not come preinstalled with processors, memory, or power supplies, installation procedures for these components are in [Chapter 2](#).

Before You Begin

Before integration of any system components, review all the safety and ESD precautions found in the Safety Warnings section at the beginning of this document.

System Reference

In the following procedures, all references to left, right, front, top, and bottom assume that the reader is facing the front of the server chassis.

Instruction Format

Each procedure described in this chapter follows an illustration first format. This format gives the reader the option to follow a quicker path to component integration by first seeing an illustration of the intended procedure. If necessary, the reader can then follow the step-by-step instructions that accompany each procedure.

3.1 System Top Cover Removal / Installation

See [Section 2.2](#).

3.2 System Cable Routing

All internal cables routed between the back of the system and the front of the system must be routed using the cable channel located between the right air baffle and the right chassis sidewall. See [Figure 24](#).

Cables connected between the onboard PCIe MCIO connectors and the backplane behind the front drive bay are routed using the cable channel located between system fans 4 and 5.

No cables should be routed between the left chassis sidewall and left air baffle, or between the memory modules and processors

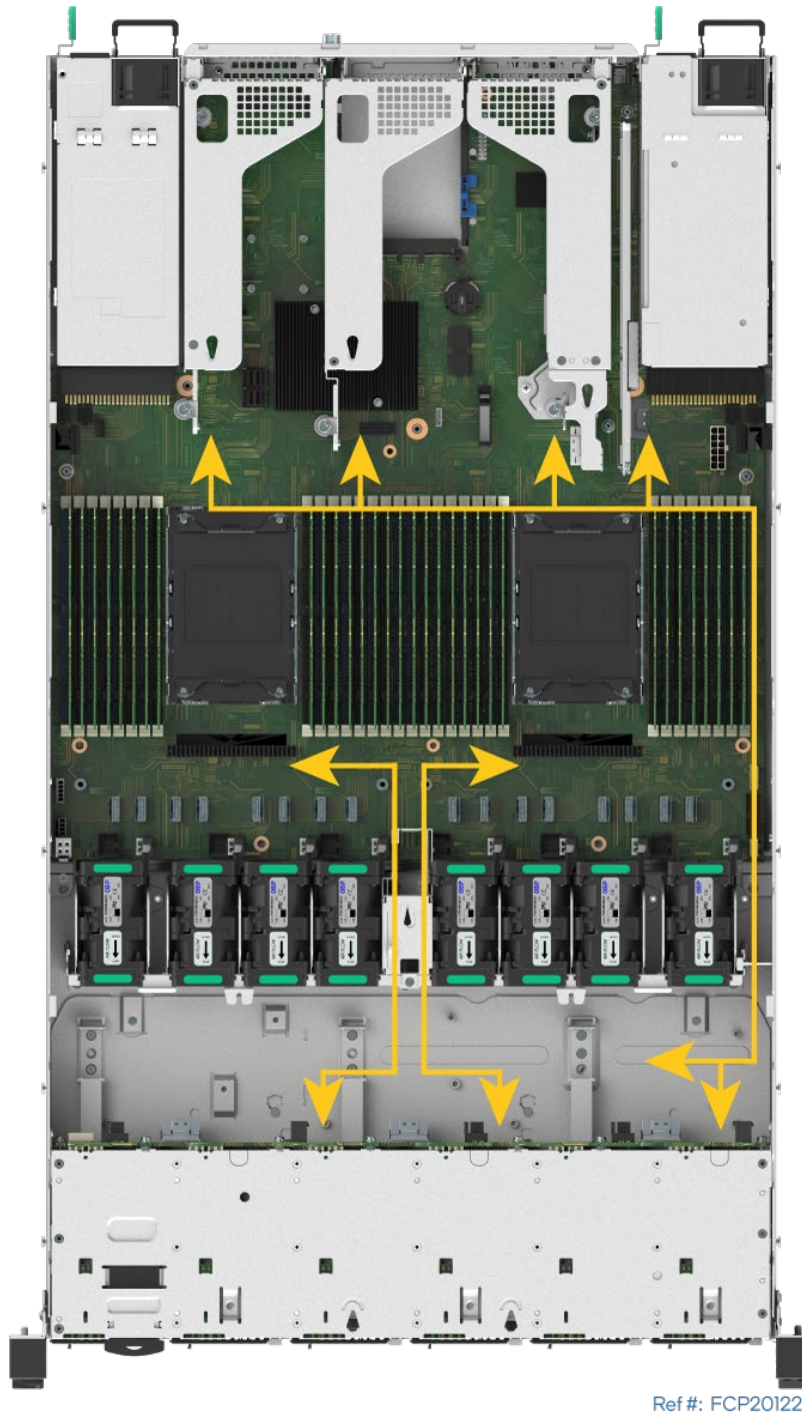

Figure 24. System Cable Routing Channels

3.3 Riser Card / Add-in Card Installation

The Intel® Server System M50FCP1UR supports various riser card options. Depending on the system configuration, your system may or may not come pre-configured with riser card options installed. This section provides assembly and installation instructions for systems that require riser card installation. Reference the *Intel® Server System M50FCP1UR Technical Product Specification* for more information on available riser card options.

All system configurations include the mounting brackets for each supported riser card option.



Figure 25. Bracket for Riser Card on Riser Slot #1– Front and Back Views

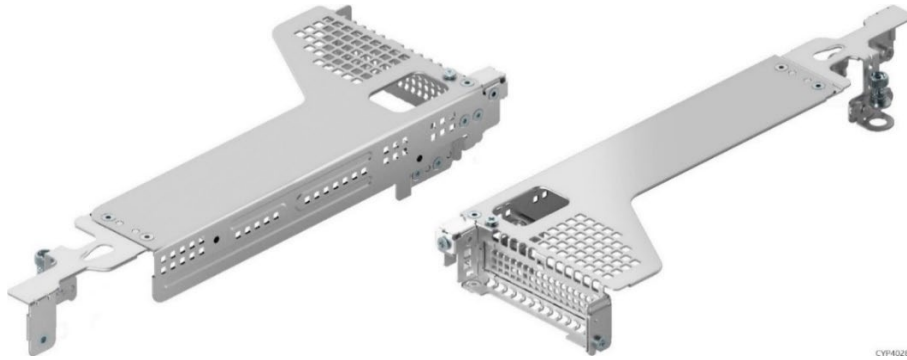

Figure 26. Bracket for Riser Card on Riser Slot #2– Front and Back Views

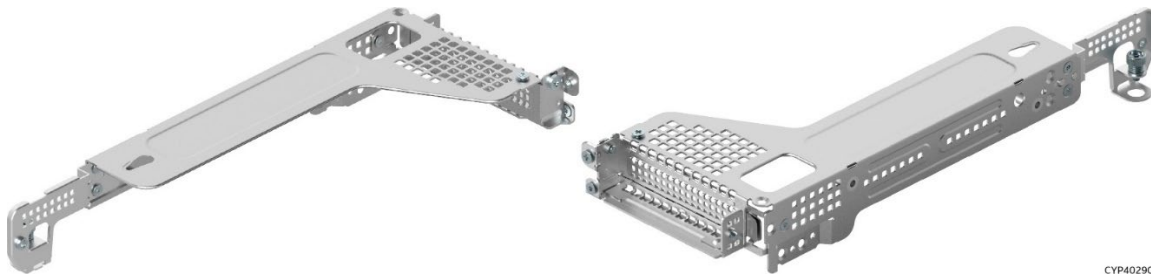

Figure 27. Bracket for PCIe* Interposer Riser Card – Front and Back Views

Required Tools and Supplies

- Intel riser card kit
- Anti-static wrist strap and conductive workbench pad (recommended)
- Phillips* head screwdriver #1

3.5.1 Riser Card Bracket Removal

As shown in the previous figures, there are multiple types of riser card brackets included with the system. The instructions to remove a bracket from the system is the same for each.

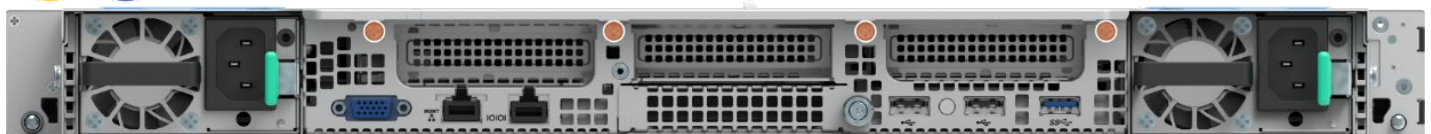

Figure 28. Chassis Riser Card Bracket Screws Removal

1. Power off the system and disconnect the system power cords.
2. Remove the system top cover. See [Section 2.5.1](#)
3. If present, disconnect all cables (internal and external) that may be attached to the riser assembly.
4. If present, remove the four fastener screws on the chassis back panel. See [Figure 28](#).

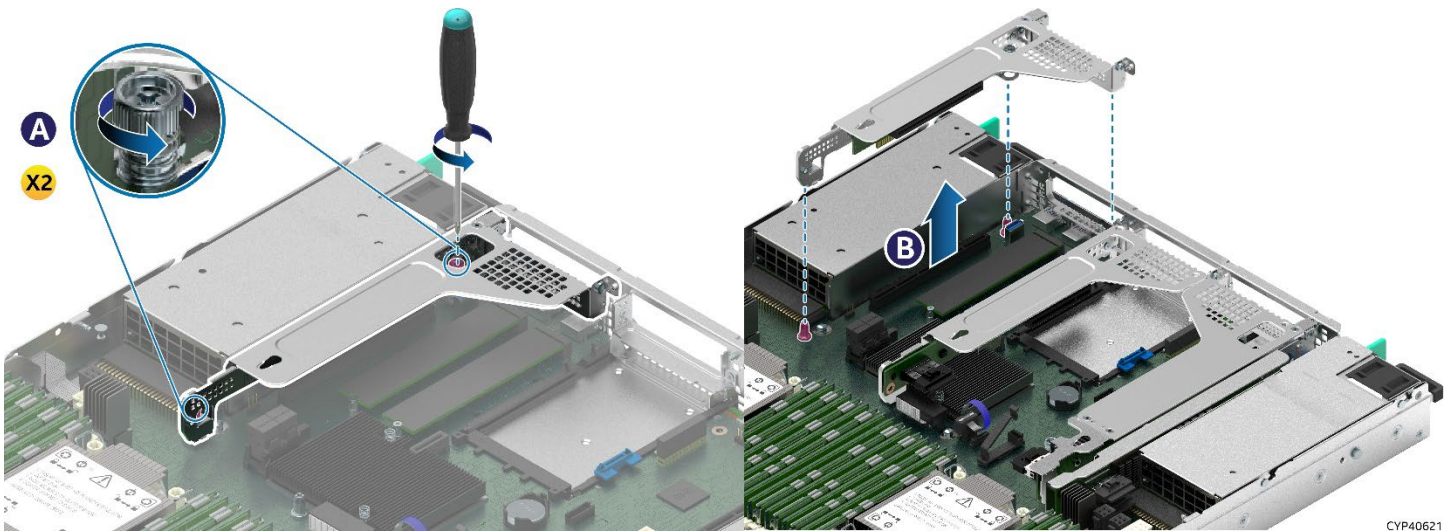

Figure 29. Riser Card Bracket Removal

5. On the front and back of the riser card bracket, loosen the two screw heads securing the bracket to the server board. See Letter A.
6. Grasp the riser card bracket with both hands and carefully pull it up and away from the chassis. See Letter B.

3.5.2 Riser Card Installation

The following riser card installation procedure is the same for all included riser card brackets and supported riser card options.

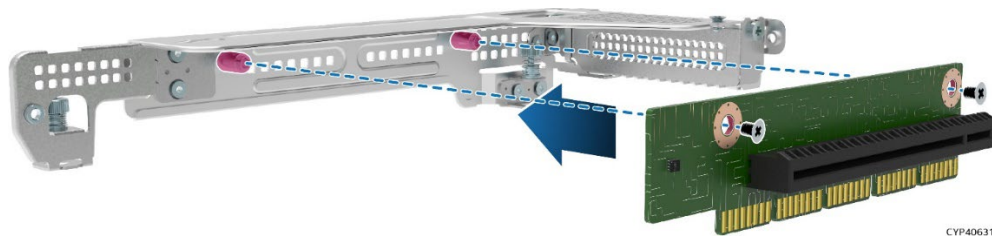
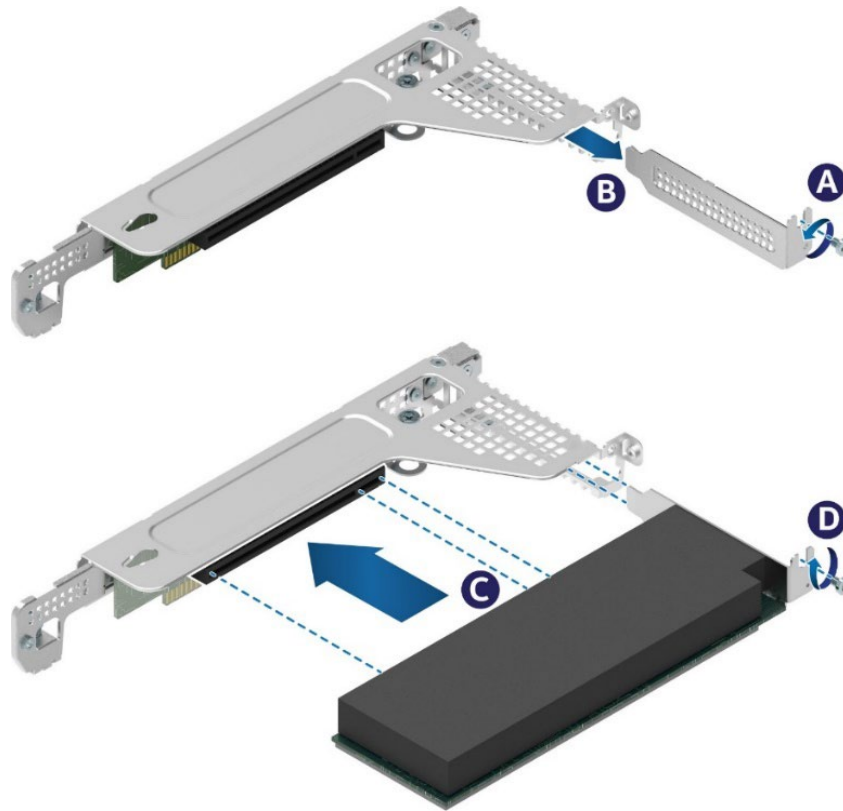

Figure 30. Riser Card Installation onto the Bracket

1. Locate and carefully unpack the riser card. Hold the riser card by its edges. To NOT touch the gold edge connector pins.
2. Align the riser card to the threaded standoffs on the mounting bracket.
3. Using the supplied screws, secure the riser card to the bracket. Tighten to 5 in-lb.

3.5.3 PCIe* Add-in Card Installation

Add-in cards installed to riser card #1 or the PCIe* interposer riser card must be oriented with their component side up. See [Figure 31](#).



CYP40640

Figure 31. PCIe* Add-in Card Installation for Riser Slot #1 or PCIe* Interposer Riser Assemblies

An add-in card installed to riser card #2 must be oriented with its component side down as shown in [Figure 32](#).

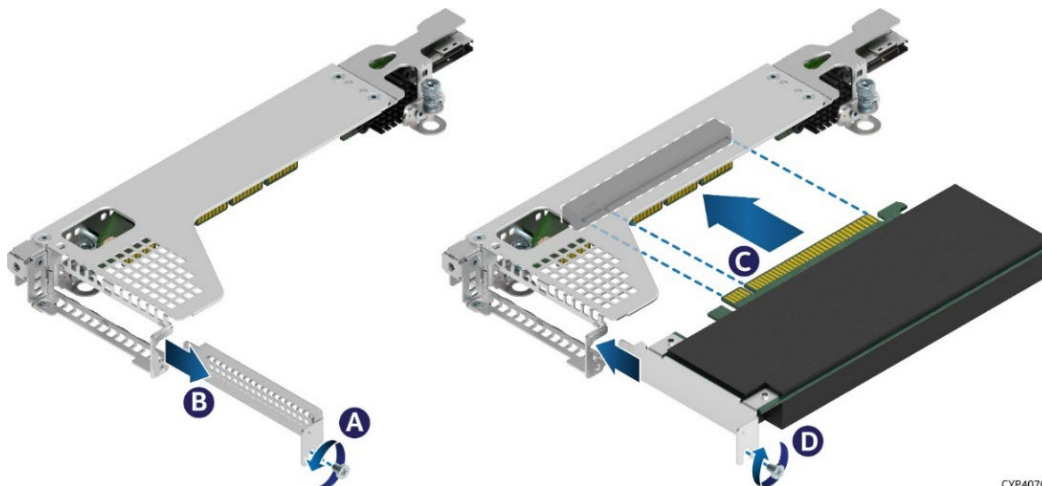

CYP40760

Figure 32. PCIe* add-in Card Installation for Riser Card on Riser Slot #2

1. If the riser card assembly (bracket and riser card) is still inside the system, remove it from the system following instructions in [Section 3.5.1](#).
2. Remove the screw (see Letter A) holding the filler plate to the bracket. Remove the filler plate. See Letter B.

3. Insert the add-in card until it is fully seated inside the PCIe* slot on the riser card. See Letter C.
4. Using the screw, secure the add-in card to the riser card bracket. See Letter D. Tighten to 5 in-lb.

Note: For add-in cards with internal cable connectors, it may be necessary to connect cables before installing the riser card assembly into the system.

3.5.4 Riser Card Assembly Installation—for All Riser Assemblies

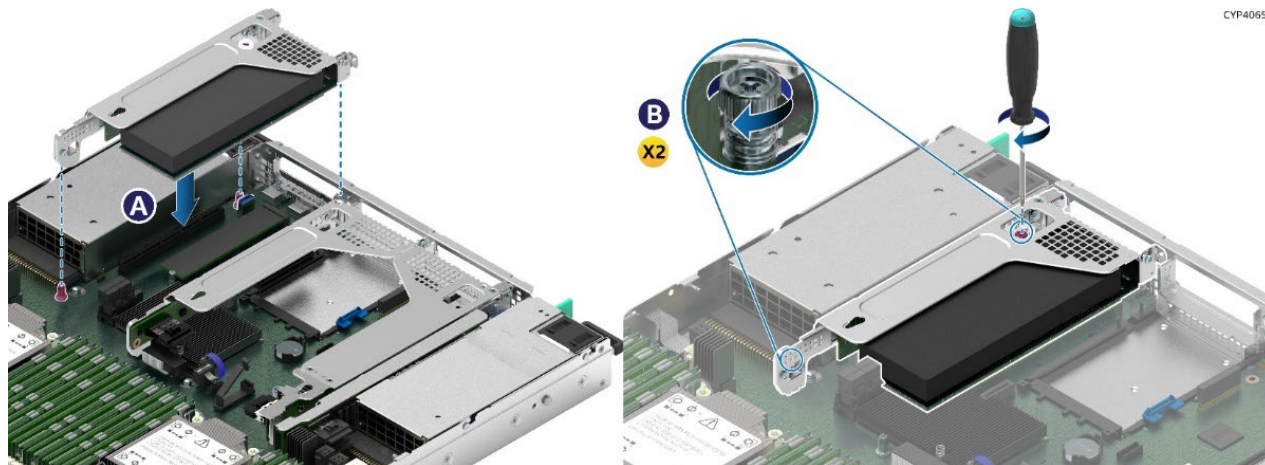

Figure 33. Riser Card Assembly Installation

1. Position the riser card's edge connector over the riser slot on the server board.
2. Align the two key slots on the back edge of the riser card assembly with the mounting keys on the back of the chassis.
3. Once aligned, press the riser card assembly straight down into the riser slot (see Letter A).
4. Using the two static screw heads on the riser bracket, secure the riser card assembly to the server board (see Letter B).
Tighten to 5 in-lb.
5. Connect any required cables to the add-in card. See your add-in card documentation for additional information.
6. Reinstall the system top cover. See [Section Error! Reference source not found.](#)

Note: To transport a fully integrated system, Intel highly recommends the system include four shipping screws (not included) installed to the system back panel (see [Figure 34](#)). These screws provide the chassis with additional support by reducing chassis flex and minimizing sag of the base plate. Installed screws should meet the following specifications: flat head, 6–32 thread, 3.75 mm length



Figure 34. Back Panel Shipping Screws

3.4 Front Drive Installation

The Intel® Server System M50FCP1UR has front drive bays that only support 2.5" SSDs. Supported SSDs can have a drive height of 7mm or 15mm. 7mm must be attached to a supplied drive mounting bracket to be compatible with the front drive bays.

All drives are mounted to a tool-less, non-detachable, drive rail. Drives interface with a backplane that is mounted to the back side of the front drive bay. Data I/O cables are attached between the backplane and various storage controller options within the system. The front drives are hot swap capable with supported redundant RAID configurations.

This section provides procedures for drive blank removal, 7mm SSD assembly, and drive installation into the drive bay.

Required Tools and Supplies

- Anti-static wrist strap and conductive workbench pad (recommended)

2.5" Drive Bay

The following figure identifies the 2.5" drive bay components.

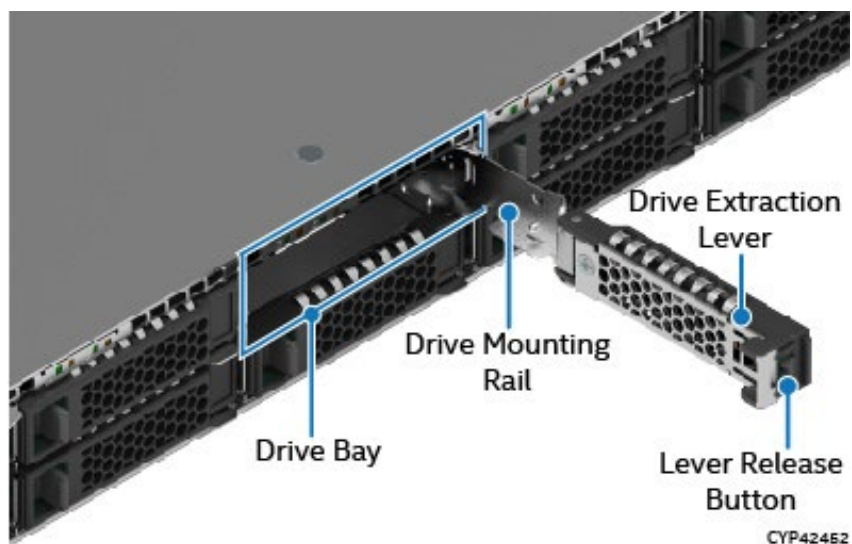

Figure 35. 2.5" Drive Bay Components

Note: To ensure proper system airflow requirements, all front drive bays must be populated with either a drive or supplied drive blank.

All drive bays included an integrated drive rail that is used to guide an SSD in and out of the drive bay. The integrated drive rail is not fully removed from the drive bay. When the drive extraction lever is in the open position, it is used to pull out the rail just enough to allow an SSD to be installed to or removed from the drive bay.

3.5.1 Drive Blank Removal

Each drive carrier includes a 2.5" drive blank. Drive blanks should only be removed when replacing it with an SSD.



Figure 36. Drive Blank Removal

1. Press the button on the drive extraction lever to release it. See Letter A.
2. Using the lever, pull the drive rail out from the drive bay as far as it allows (see Letter B).
3. Pull the drive blank from the drive bay (see Letter C).

3.5.2 7 mm 2.5" SSD Drive Support

All drive bays can support a 2.5" SSD that has a height of 7mm. To support these drives, a section of the drive blank is used to mount to the SSD, making it compatible for installation into the drive bay.

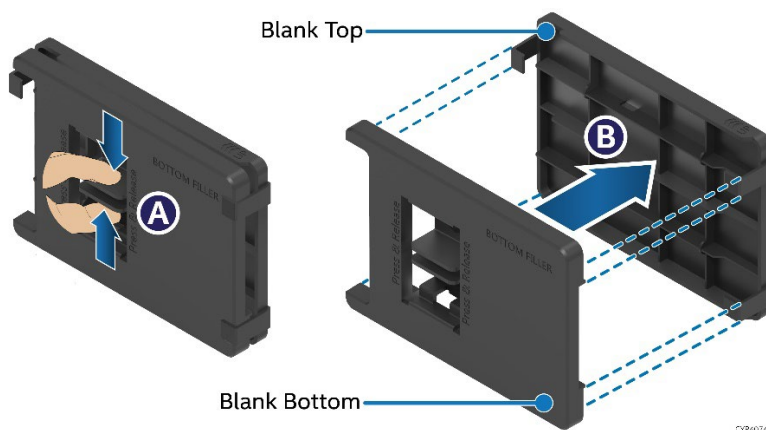

Figure 37. Separating Top and Bottom Parts of Drive Blank

1. Remove the drive blank from the system (see [Section 3.5.1](#)).
2. One side of the drive blank has a latch used to secure both halves of the drive blank together. To separate the halves, squeeze the latch tabs together (see Letter A), and pull the two halves apart (see Letter B).
3. The blank half without the latch is used as the SSD mounting bracket

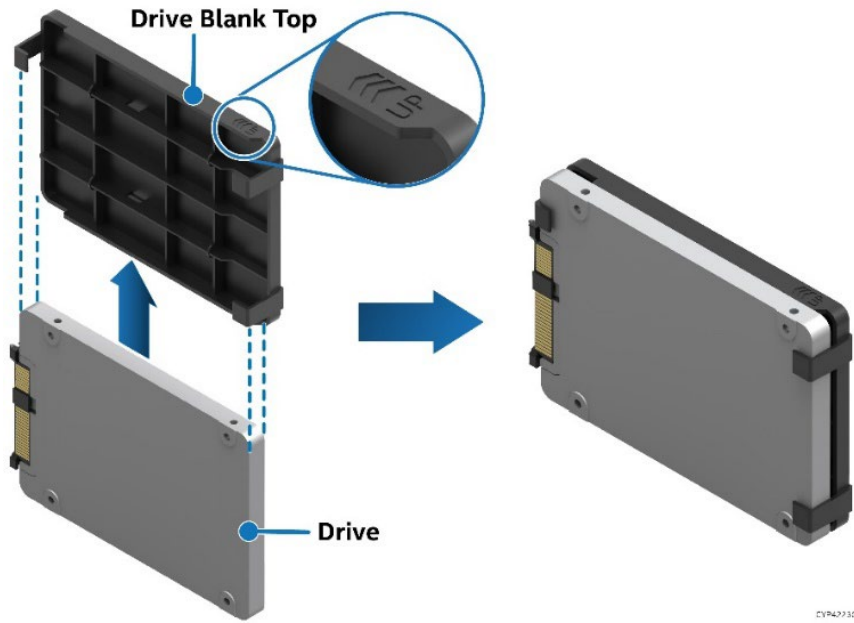

Figure 38. Attaching the Drive Blank to 7 mm SSD

- Slide the SSD drive into SSD mounting bracket. See [Figure 38](#).

Important: To avoid damaging the SSD connector, insert the drive into the mounting bracket in the direction shown.

3.5.3 2.5" SSD Drive Installation

Front drive bays can support SSDs with a height of 7mm or 15mm. With the SSD mounting bracket attached to the 7mm drive, installation into the front drive bay is the same for both drive sizes. Note the location of the drive interface connector before installing the drive into the drive bay. Ensure its orientation matches with the interface connector on the backplane.

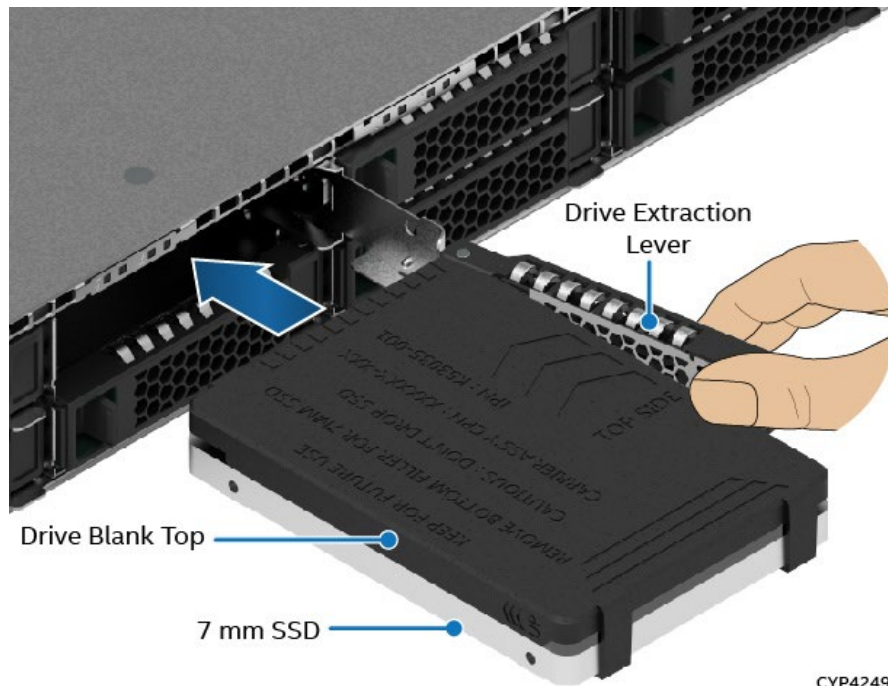

Figure 39. 2.5" 7 mm Drive Outside Chassis, Ready for Installation

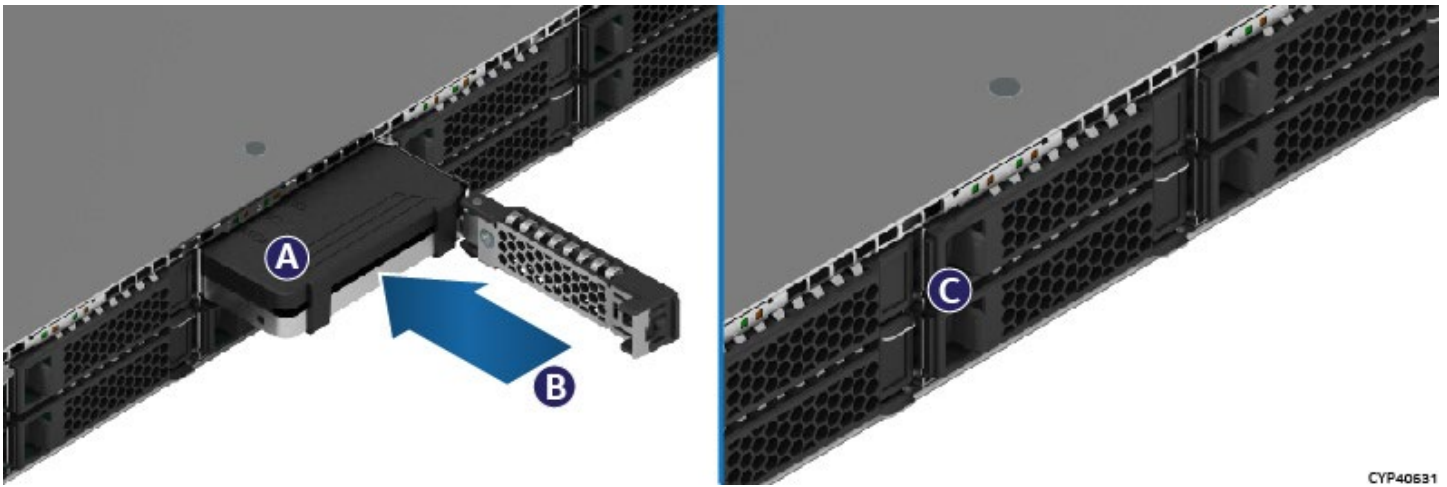

Figure 40. 2.5\" Drive Installation into Front Drive Bay

1. Ensure that the drive extraction lever is in the open position, and the drive rail is pulled out as far as possible.
2. Align and insert the drive into the drive bay. See Letter A.

Note: Intel recommends holding the drive with one hand while holding the lever with the other hand.

3. Slide the drive into the drive bay until it is fully seated within the drive interface connector on the backplane (see Letter B).
4. Close the drive extraction lever until it locks into place. See Letter C.

3.5 OCP* 3.0 Network Adapter Installation

This section provides instructions for the installation of an OCP* 3.0 add-in card. OCP add-in cards will have one of two methods to secure the card within the OCP bay. Refer to the sub-section that supports the card to be installed.

- Pull-Tab and Thumb Screw – Section 3.5.2
- Internal Lock – Section 3.5.3

Required Tools and Supplies

- OCP 3.0 Network Adapter
- Anti-static wrist strap and conductive workbench pad (recommended)
- Phillips* head screwdriver #1

Note: Reference the Intel® Server M50FCP Family Configuration Guide for a list of supported adapter cards.

3.5.1 OCP* Adapter Bay Filler Panel Removal / Installation



Figure 41. OCP* Adapter Bay Filler Removal

Remove the filler panel to install an OCP add-in card

1. Loosen the thumb screw on the right side of the filler (see Letter A).
2. Rotate the right side of the filler away from the chassis approximately 0.5" (13mm) (see Letter B).
3. Pull the filler away from the chassis (see Letter C).

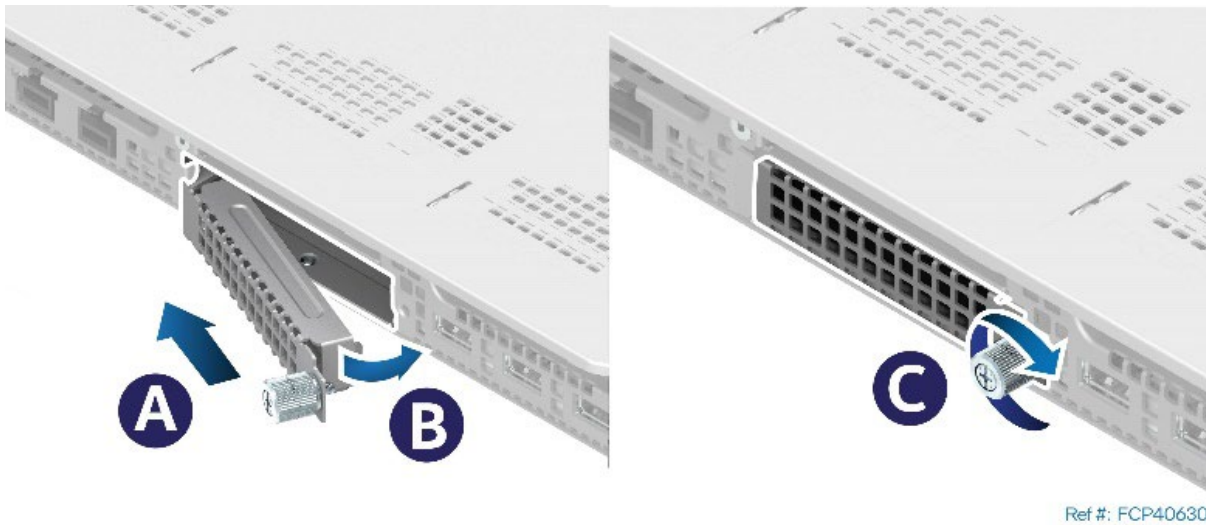
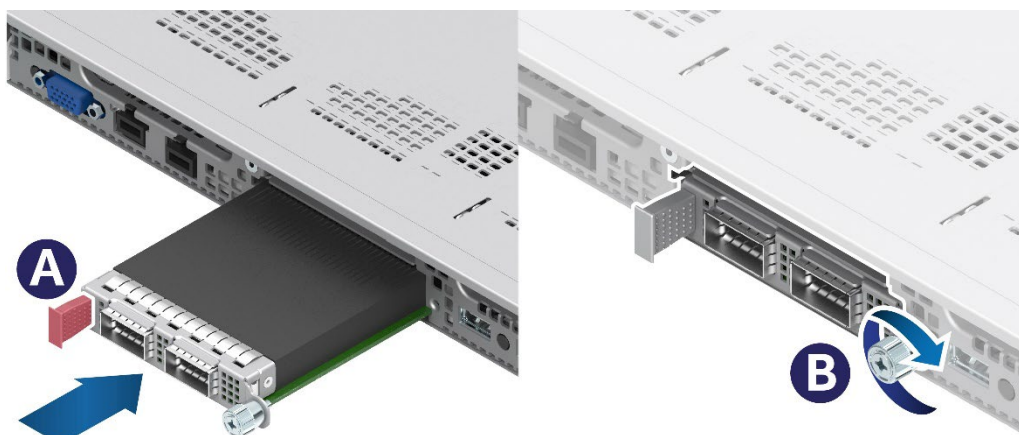

Figure 42. OCP* Adapter Bay Filler Installation

Install the filler panel when the OCP card bay is empty:

1. Insert the left side of the filler plate into the slot (see Letter A).
2. Rotate the right side of the filler panel into the OCP card bay (see Letter B).
3. Tighten the thumb screw (see Letter C).

3.5.2 OCP* Adapter with Pull Tab Installation



Ref #: FCP40141

Figure 43. OCP* Adapter with Pull Tab Installation

1. Power off the system and disconnect the system power cords.
2. Remove the OCP Bay filler insert (See [Section 3.5.1](#))
3. Align the OCP adapter with the open OCP bay slot and slide forward until the connectors are fully seated (see Letter A).
4. Tighten the thumb screw on the right side of the OCP adapter (see Letter B).

3.5.3 OCP* Adapter with Internal Lock Installation

All L6 and L9 integrated systems come with an internal lock on the OCP rail. This lock is a piece of blue plastic. The OCP rail in the system has a dedicated space to accommodate the lock. The lock can be mounted on the rail in two different orientations. When the keying features of the lock are facing up, it is in an unlocked orientation. When the keying features are facing down, it is in a locked orientation. A lock symbol is included in each side of the plastic lock to indicate its orientation. The following figure shows the features of the lock.

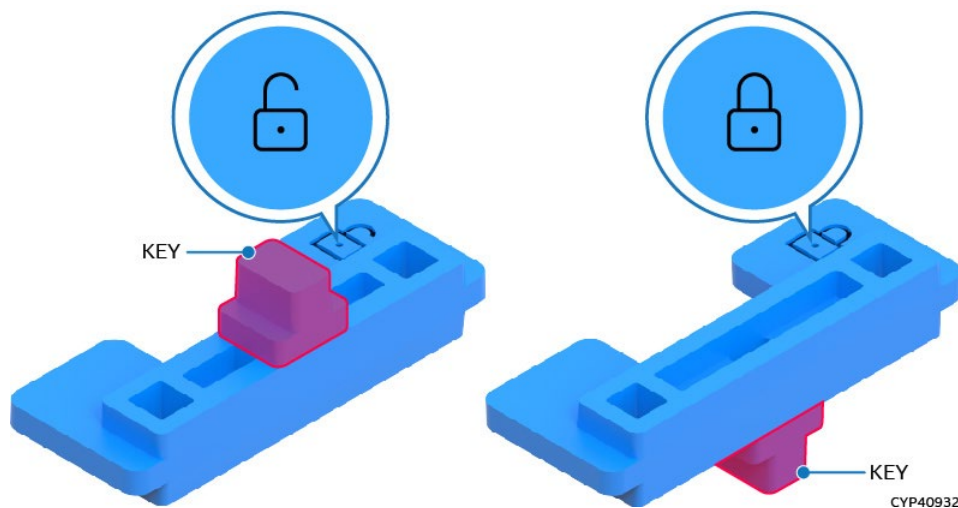

CYP40932

Figure 44. Internal Lock with Unlock and Lock Orientation

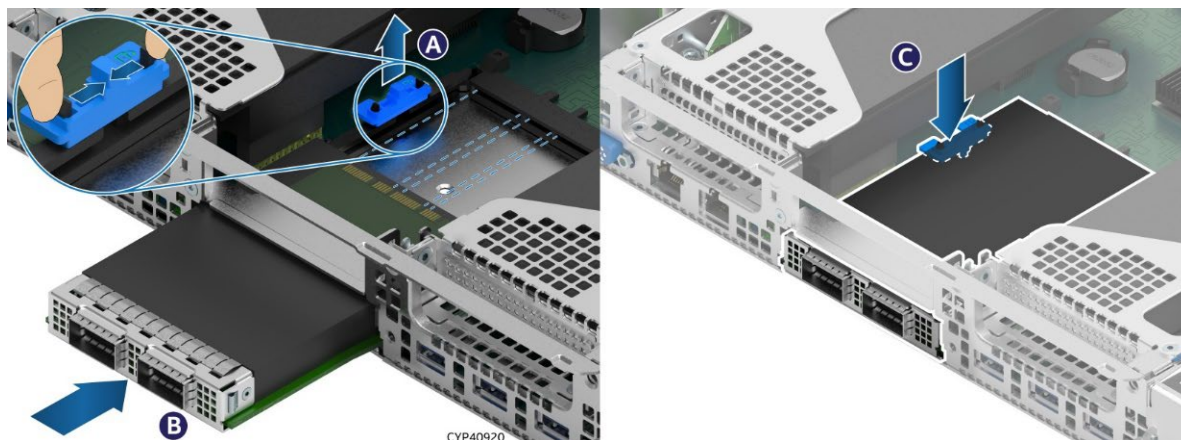

Figure 45. OCP* Adapter with Internal Lock Installation

1. Power off the system and disconnect the system power cords.
2. Remove the OCP Bay filler insert (See [Section 3.5.1](#))
3. Remove the system top cover (see [Section 2.2](#))
4. Remove the OCP Bay filler insert (See [Section 3.5.1](#))
5. If present, remove the riser card assembly above the OCP adapter area, (see [Section 3.5.1](#)).

Note: In the default shipping configuration, the internal lock is set to the unlock orientation.

6. Squeeze the two hooks of the internal lock and pull it out (see Letter A).
7. Align the OCP* adapter with the open OCP bay slot and slide forward until the connectors make secure contact (see Letter B).
8. Reinstall the internal lock with the lock orientation (see Letter C).
9. Reinstall the riser card assembly (see [Section 3.5.4](#)).
10. Reinstall the system top cover (see [Section 3.1](#)).

3.6 M.2 Storage Device Installation

The server board includes two M.2 connectors as shown in the following figure. Each M.2 connector supports a PCIe* NVMe* or SATA SSD drive that conforms to a 22110 (110 mm) or 2280 (80 mm) form factor.

Required Tools and Supplies

- M.2 SSD
- Anti-static wrist strap and conductive workbench pad (recommended)
- Phillips* head screwdriver #1

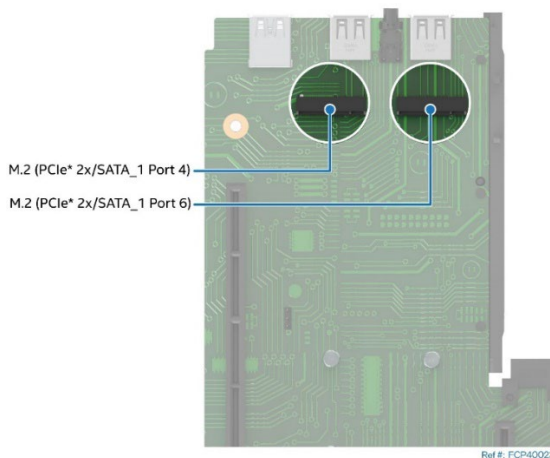

Figure 46. M.2 SSD Connector Location

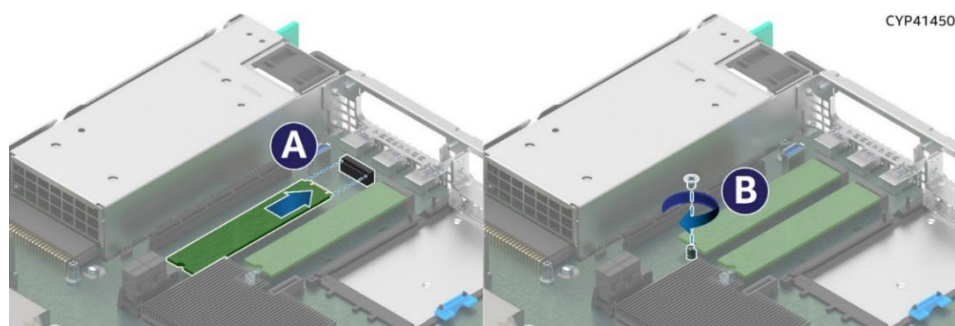

Figure 47. M.2 SSD Installation

1. Power off the system and disconnect the system power cords.
2. Remove the system top cover (see [Section 3.1](#)).
3. Remove the riser card #1 bracket from the system (see [Section 3.5.1](#)).
4. Locate the M.2 connectors towards the back edge of the server board. See [Figure 46](#).
5. Position and install the onboard M.2 mounting stand-off at the appropriate location to match the length of the selected M.2 SSD.
6. Align the notch within the SSD edge connector with the key in the server board M.2 connector.
7. Insert the SSD into the connector (see Letter A).
8. Using the fastener screw, secure the SSD to the M.2 mounting stand-off on the server board. See letter B. Tighten to 1.5 in-lb.
9. Repeat [steps 4–8](#) for the second M.2 SSD if needed.
10. Reinstall the riser card assembly (see [Section 3.5.4](#)).
11. Reinstall the system top cover (see [Section 3.1](#)).

3.7 Trusted Platform Module (TPM) Installation

This section provides instructions for the installation of a Trusted Platform Module (TPM). Refer to the *Intel® Server M50FCP Family Configuration Guide* for available options.

Required Tools and Supplies

- Intel® TPM accessory kit
- Anti-static wrist strap and conductive workbench pad (recommended)
- Flat head screwdriver

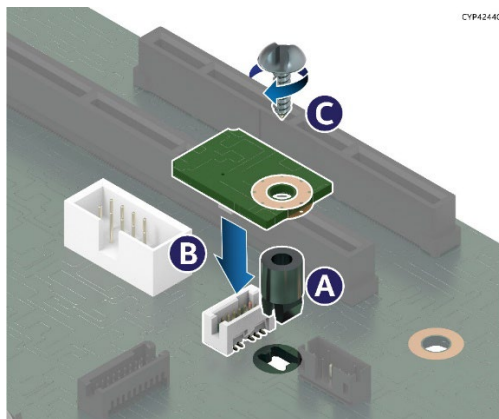

Figure 48. Trusted Platform Module (TPM) Installation

1. Power off the system and disconnect the system power cords.
2. Remove the system top cover (see [Section 3.1](#)).
3. Locate and carefully unpack the TPM kit contents

4. Locate the TPM module connector on the server board.
5. Insert the plastic stand-off into the mounting hole in the server board (see Letter A).
6. Place the TPM module over the connector and confirm the orientation of the module.
7. Press the module down onto the connector (see Letter B).
8. Secure the TPM module to the stand-off with either the standard screw or the tamper resistant screw (see Letter C).

Note: As a security feature that deters unauthorized removal of the TPM from the server board, Intel recommends using the tamper resistant screw type. Once installed, its removal is exceedingly difficult.

9. Reinstall the system top cover (see [Section 3.1](#)).

3.8 Intel® RAID Maintenance Free Backup Unit (RMFBU) Installation

This section provides instructions to install an RMFBU bracket and assembly in the system. Refer to the *Intel® Server M50FCP Family Configuration Guide* for available Intel RAID card options.

Required Tools and Supplies

- Intel RMFBU accessory kit
- Anti-static wrist strap and conductive workbench pad (recommended)
- Phillips* head screwdriver #1

The RMFBU assembly has the following elements:

- RMFBU Mounting Plate
- RMFBU plastic housing
- RMFBU plastic housing latch
- RMFBU super-capacitor

The RMFBU mounting plate and housing assembly are mounted in between the system fans and hot-swap backplane.

The following three elements need to be pre-assembled before attachment to the mounting plate.

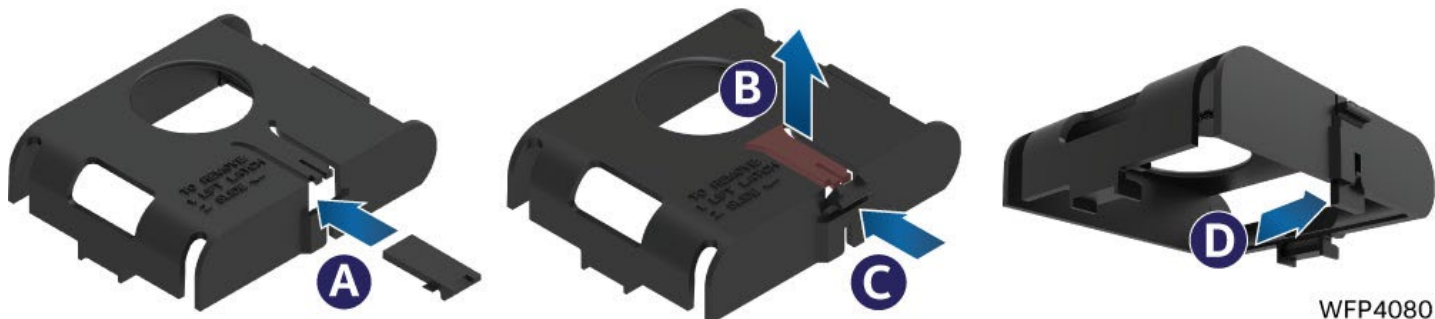

Figure 49. Installing Latch on the Plastic Case

1. Insert the plastic housing latch into the opening on the plastic housing (see Letter A).
2. Carefully lift on the latch holder (see Letter B) and insert the latch into the opening until it clicks into place (see Letter C).
3. Slide the latch down until aligned vertically (see Letter D).



Figure 50. Insert Super Cap

4. Insert the RMFBU super capacitor into the plastic housing with the cable protruding out from one of the cable routing openings. Choose the opening that results in the best cable routing to the RAID module.

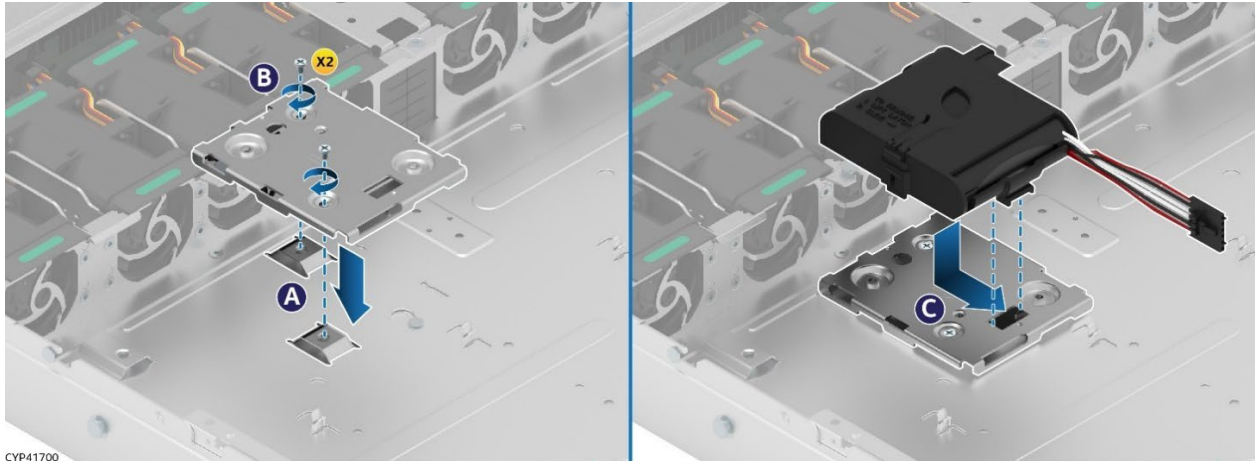

Figure 51. Intel® RMFBU Mounting Plate Installation

5. With the system powered off, disconnect the system power cords.
6. Remove the system top cover (see [Section 3.1](#)).
7. (If installed) Remove the cable clip by removing the two screws securing it to the chassis.
8. Locate the RMFBU mounting plate.
9. Align the two screw holes of the RMFBU mounting plate with the matching threaded holes on the chassis base (see Letter A).
10. Secure the RMFBU mounting plate to the chassis using two screws (see Letter B). Tighten to 5 in-lb.
11. Slide the RMFBU housing assembly in the direction as indicated on the mounting plate (see Letter C) until the latch locks in place.
12. Attach cables as required.
13. Reinstall the system top cover (see [Section 3.1](#)).

4. System Software Updates and Configuration

The Intel® Server System M50FCP1UR includes a system software stack that consists of:

- CPLD
- System BIOS
- Baseboard Management Controller (BMC) firmware
- Intel® Management Engine (Intel® ME) firmware
- FRU data

Together, they configure and manage features and functions of the server system. A full software stack is installed during the system manufacturing process but may not be the latest available version. Intel highly recommends updating the system software stack to the latest available version for optimal performance and system reliability. A System Update Package (SUP) containing the latest available system software stack can be downloaded from the following Intel website: <http://downloadcenter.intel.com>.

See the following Intel documents for more in-depth information about the system software stack and their functions:

- *BIOS Firmware External Product Specification (EPS)–Intel NDA required*
- *Integrated Baseboard Management Controller Firmware External Product Specification (EPS)–Intel NDA Required*

For guidelines and overview on BIOS Boot Menu, Setup, and hot keys, see the *Intel® Server Board M50FCP2SBSTD Technical Product Specification*.

4.1 Software License Key Order, Registration, and Installation

Intel offers two different Software License Activation key types – one for enabling the Advanced Server Management Features and one for enabling Intel® VROC for NVMe.

Purchasing an optional Advanced System Management product key (iPC **ADVSYSMGMTKEY**) allows the following advanced system management features to be enabled:

- Virtual KVM over HTML5
- Virtual Media Local Image Redirection
- Virtual Media shared files and folders redirection
- Out-of-band hardware RAID Management for latest Intel® RAID cards
- Included single system license for Intel® Data Center Manager (Intel® DCM)

Intel® VROC for NVMe is an optional feature and must be activated before it can be used for NVMe RAID configurations.

Intel® VROC for NVMe License Activation key options are the following:

- Standard Intel® VROC Key (iPC **VROCSTANKEY**) (RAID 0, 1, 10)
- Premium Intel® VROC Key (iPC **VROCPREMKEY**) (RAID 0, 1, 10, 5)

For guidelines and more information, see the *Intel® Server Board M50FCP2SBSTD Technical Product Specification*.

4.2 Ordering Software License Key

There are two options available to order a software license key:

- **CTO/L9:** When ordering a fully integrated system from Intel using its on-line Configure-to-Order (CTO) tool, select the required license key (**AdvSysMgmtKey**, **VROCStanKey** or **VROCPremKey**) as an additional option. The Intel factory will then upload the license key on to the system during the system integration process.
- **Add-on Accessory:** A software license key can be ordered separately from the system as an add-on accessory. This option requires that the license key be manually installed on the system. See the following sections for complete ordering and installation instructions.

4.3 Order and Register a License Key as an Add-on Accessory (Not via CTO)

1. Place an order for the required software license key with electronic delivery. Intel Product Codes:
ADVSYSMGMTKEY for the Advanced System Management (ASM) Key
VROCSTANKEY for the Intel® Virtual RAID on CPU Standard Software Key
VROCPREMKEY for the Intel® Virtual RAID on CPU Premium Software Key
2. Receive an email with instructions to download the product key.
3. From the email, Click the **Register** link (see Figure 52) to go to <https://lemcenter.intel.com>

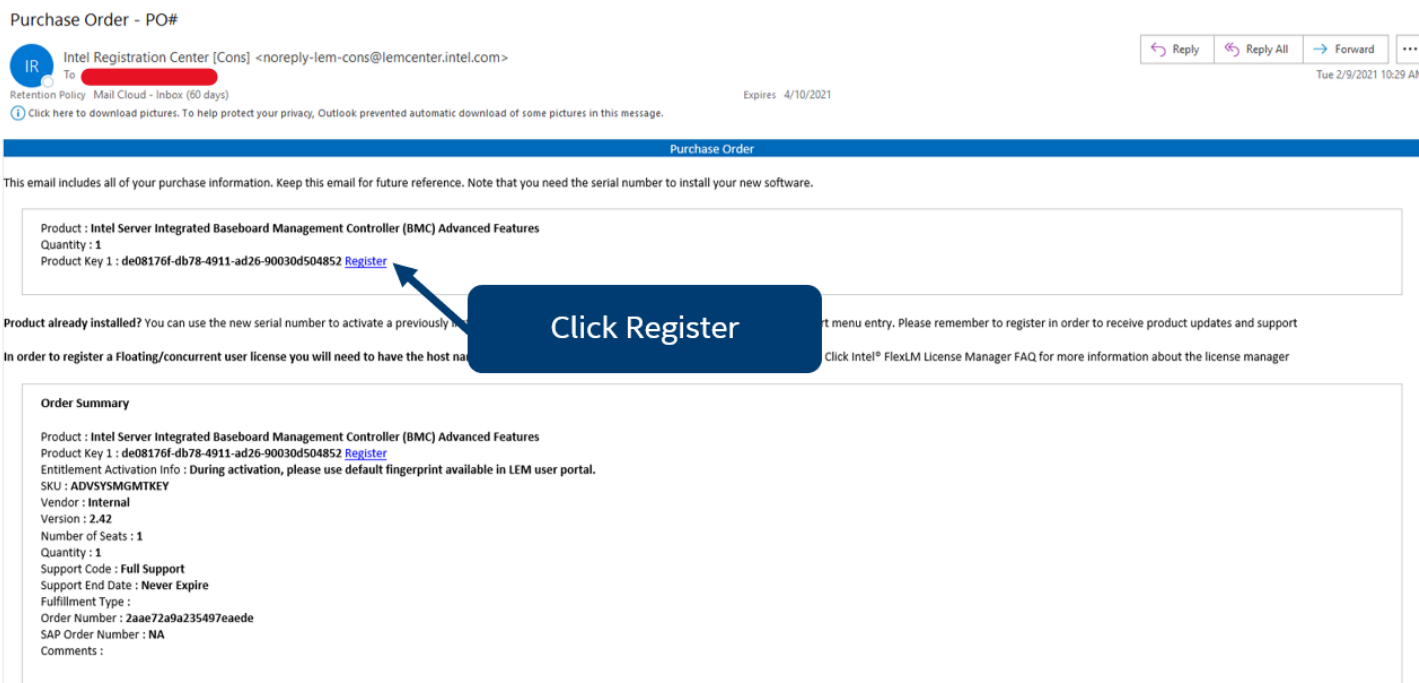

Figure 52. Example Email

4. Login using an existing Intel account or create a new one. An email address is required

- On the Registration Screen, Click the “Register” button to register the pre-entered license key number (see Figure 53)

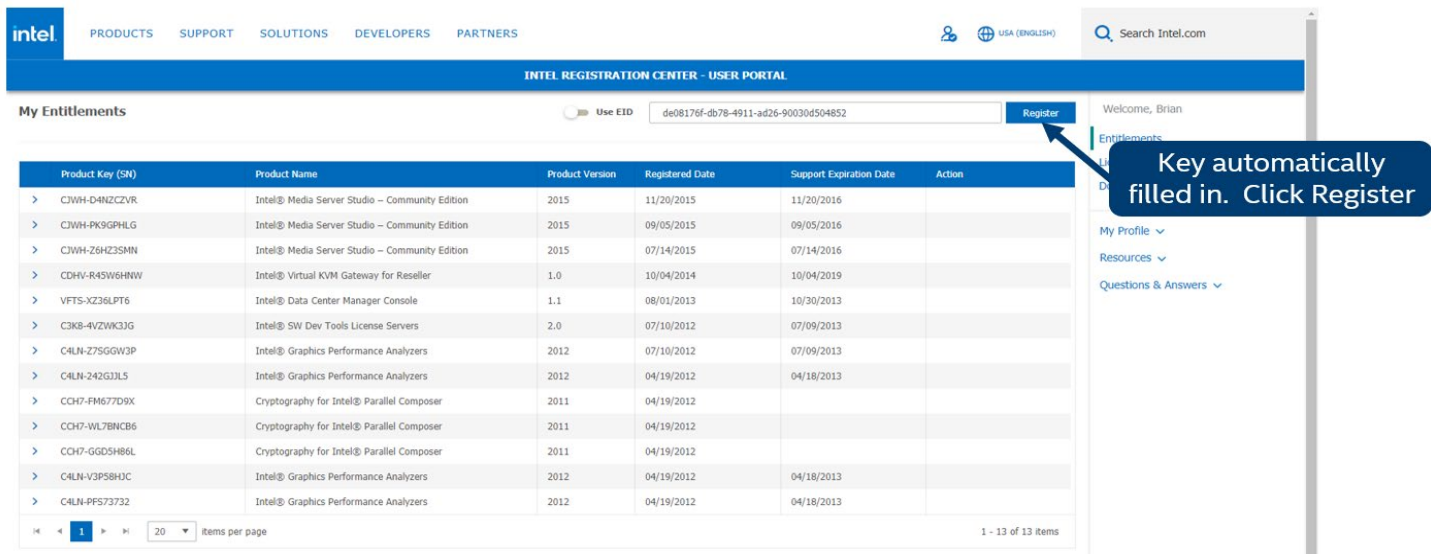

Figure 53. Register Key

- To activate the license, click on the right arrow symbol to expand the view, scroll to the bottom and click on the Activate button. (see Figure 54)

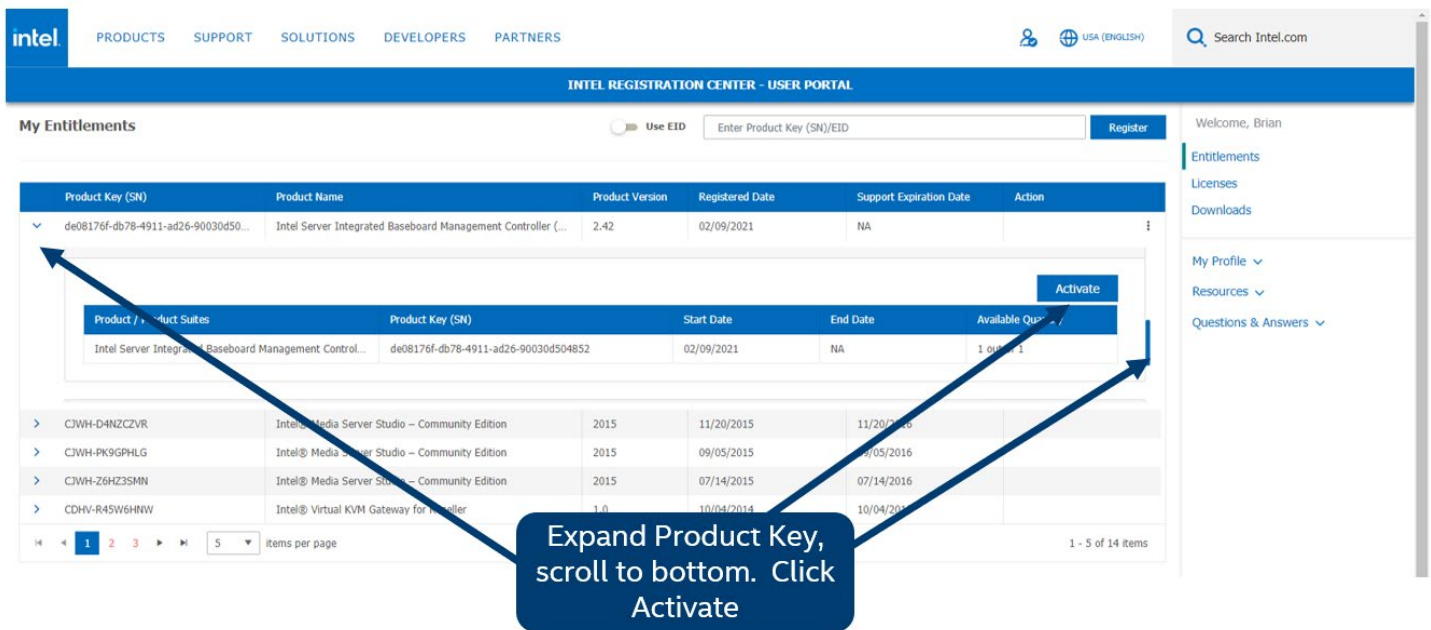

Figure 54. Activate Key

7. Download the license associated with the specified product key (see [Figure 55](#))

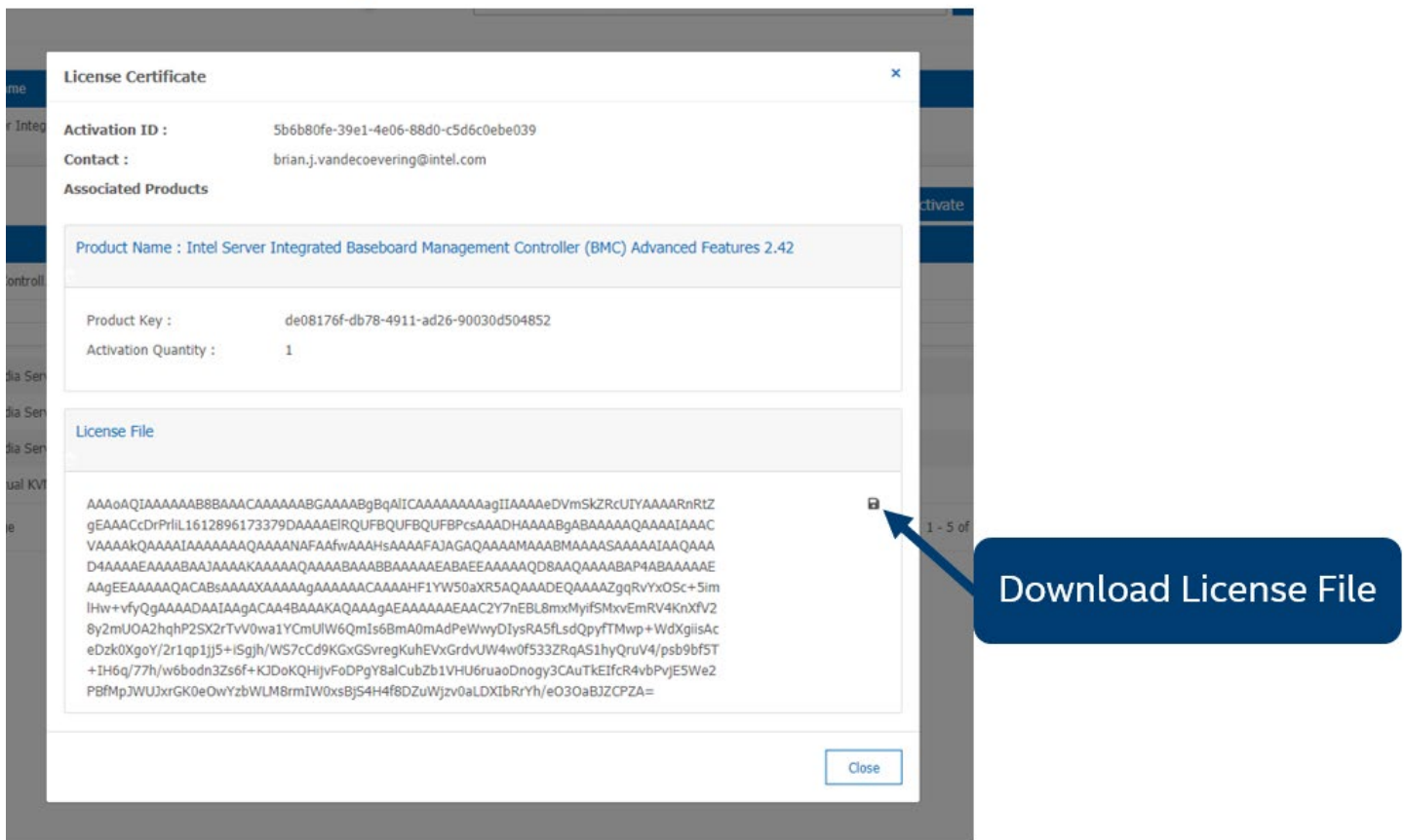

Figure 55. Download Key

8. Upload the license key file to the BMC.

4.4 Software License Key Installation

Three available options can be used to upload a software license onto a server:

- Integrated BMC Web Console
- Intel® Server Configuration Utility
- Redfish* Interface

4.5.1 Installation Using the Integrated BMC Web Console

The following procedure may be used to upload and confirm activation of a software license key. The example below illustrates the process of uploading the Advanced System Management (ASM) license using the Integrated BMC Web Console. The same process can be used to upload a VROC software license key.

The screenshot displays the Intel Integrated BMC Web Console interface. At the top, the navigation bar includes tabs for System, Server Health, Configuration (highlighted), Remote Control, Virtual Media, Server Diagnostics, and Miscellaneous. The left sidebar lists various settings, with License Management highlighted. The main content area is titled 'License Management' and contains three sections: 'Key Upload' with a 'Choose File' button, 'System Management Key' showing 'License Type: advanced system management key' and 'Features Status: Virtual Media Activated, KVM Activated, Active Directory Activated', and 'VROC Upgrade Key' showing 'License Type: VROC upgrade key' and 'Features Status: RAID 0/1/10 De-Activated, RAID 5 De-Activated'.

Figure 56. Integrated BMC Web Console Advanced System Management Key Page

1. Login to the Integrated BMC Web Console
2. Navigate to the **Configuration > License Management** page
3. Click the **Choose File** button to select the license key file
4. Select the **.v2c** license key file, then click the **Open** button
5. Click the **Upload** button to upload the ASM License Key to the BMC
6. The **System Management Key** section will show the license type and activated features
7. Navigate back to the **System** Tab. On the **System Information** page, view the **System Summary** information box to confirm the **Advanced Management Key** was successfully **Activated**.

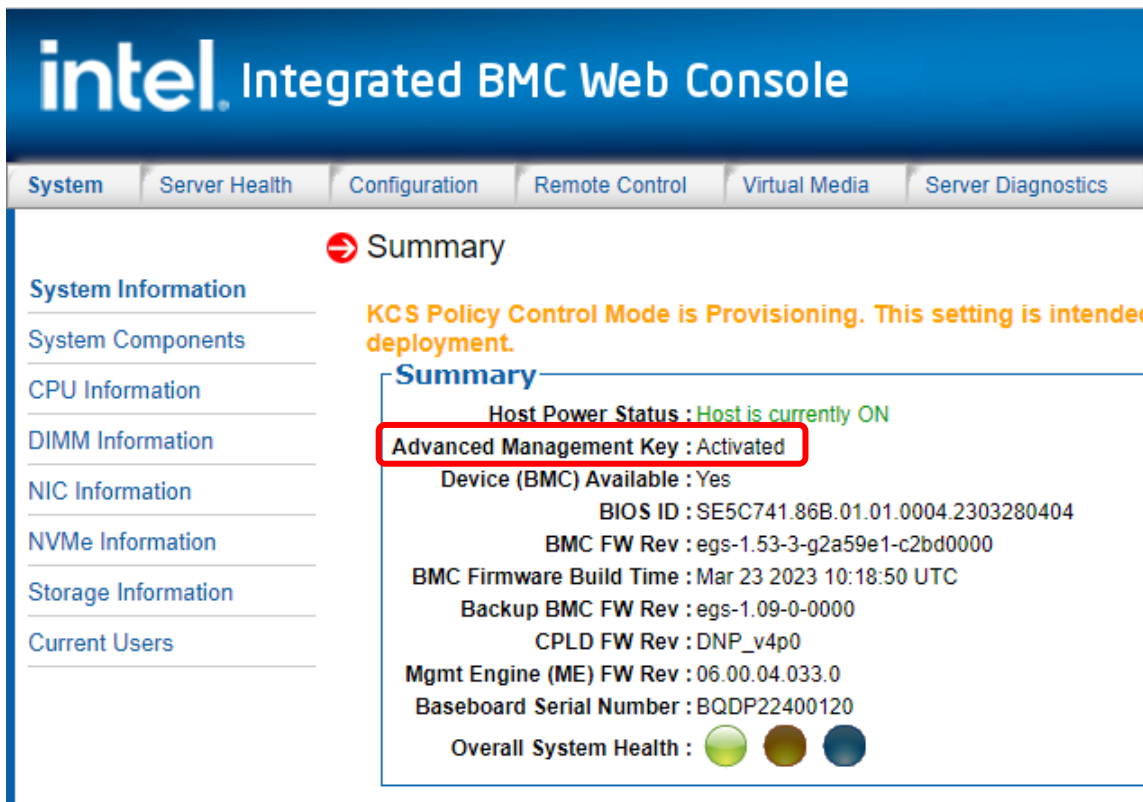

intel Integrated BMC Web Console

System Server Health Configuration Remote Control Virtual Media Server Diagnostics

➔ Summary

System Information

System Components

CPU Information

DIMM Information

NIC Information

NVMe Information

Storage Information

Current Users

KCS Policy Control Mode is Provisioning. This setting is intended deployment.

Summary

Host Power Status : Host is currently ON

Advanced Management Key : Activated

Device (BMC) Available : Yes

BIOS ID : SE5C741.86B.01.01.0004.2303280404

BMC FW Rev : egs-1.53-3-g2a59e1-c2bd0000

BMC Firmware Build Time : Mar 23 2023 10:18:50 UTC

Backup BMC FW Rev : egs-1.09-0-0000

CPLD FW Rev : DNP_v4p0

Mgmt Engine (ME) FW Rev : 06.00.04.033.0

Baseboard Serial Number : BQDP22400120

Overall System Health : 

Figure 57. BMC Web Console System Information Page

4.5.2 Installation Using the Intel® Server Configuration Utility

The following procedure may be used to upload and confirm activation of the license keys using the syscfg command line utility.

To download the latest utility package, go to <https://downloadcenter.intel.com/> and search for the “Intel Server Configuration Utility”.

Prerequisites:

- Ensure the user has Administrator or Root privileges for the chosen operating system
- Ensure the KCS Policy Control Mode is set to “**Provisioning**”

Procedure:

1. Install the Intel® Server Configuration Utility on to the target server system. See the Intel® Server Configuration Utility User Guide for installation instructions.
2. Navigate to the sub-directory where the Server Configuration Utility was installed
3. From a command prompt run the following command

syscfg /lic <key file name>

where “file name” can be just the name of the license file if copied to the same directory as the syscfg command file, or the complete path of where the license key was copied can be entered along with the file name.

Example below illustrates the process of uploading the VROC standard software license key. The same process can be used to upload the Advanced Server Management license key.

```
C:\SYSCFG 16.0.9>syscfg.exe /lic VROCSTANKEY.v2c

Server Configuration Utility Version 16.0.9
Copyright (c) 2023 Intel Corporation

Key Transfer...
Starting key upload:
Key Upload done

VROC license is uploaded successfully

C:\SYSCFG 16.0.9>
```

Figure 58. Upload VROC Standard License Key Using SYSCFG Utility

4. To confirm activation of the VROC license key, type the following command:
syscfg /d lic

```
C:\SYSCFG 16.0.9>syscfg.exe /d lic

License Status
-----
Type | Status | Time Stamp
-----|-----|-----
ASM key | Activated | 04/16/2023-11:37:04
VROC standard key | Activated | 04/16/2023-11:41:27
VROC premium upgrade key | Not Activated |
-----
C:\SYSCFG 16.0.9>
```

Figure 59. Confirm Activation of VROC Standard License Key Using SYSCFG Utility

4.5.3 Installation Using Redfish*

The following steps may be used to upload and confirm activation of a software license key using Redfish*.

Prerequisites:

- If not already present, install the “curl” and “grep” utilities onto the system from which the commands will be run.

Issue the following command to upload a software license key to the BMC

```
curl -k -u username:password
https://BMC_IP/redfish/v1/UpdateService/SoftwareInventory/LicenseManagement/Actions/Oem/Intel.Oem.Upload -H "Content-Type: multipart/form-data" -F "updateFile=@filepath" -X POST
```

Notes:

- The command line above is a single command line
- username:password in the command line above should be replaced with the name of the user and their password

See the example below where:

- username = admin
- password = password
- BMC_IP = 192.168.0.102
- filepath = VROCPREMKEY.v2c

```
C:\SYS CFG 16.0.9>curl -k -u admin:password
https://192.168.0.102/redfish/v1/UpdateService/SoftwareInventory/LicenseManagement/Actions/Oem/Intel.Oem.Upload -H
"Content-Type: multipart/form-data" -F "file=@VROCPREMKEY.v2c" -X POST
{
  "@odata.id": "/redfish/v1/TaskService/Tasks/2",
  "@odata.type": "#Task.v1_4_3.Task",
  "Id": "2",
  "TaskState": "Running",
  "TaskStatus": "OK"
}
C:\SYS CFG 16.0.9>
```

Figure 60. Redfish Command to Upload the VROC Premium Software License Key

Issue the following command to verify the activation status of the license keys.

```
curl -k -u username:password
https://BMC_IP/redfish/v1/UpdateService/SoftwareInventory/LicenseManagement#Oem/LicenseInventory/Licenses -H "content-type: application/json" -X GET | grep -A1 LicenseStatus
```

```
C:\SYS CFG 16.0.9>curl -k -u admin:password
https://192.168.0.102/redfish/v1/UpdateService/SoftwareInventory/LicenseManagement#Oem/LicenseInventory/Licenses -H
"content-type: application/json" -X GET | grep -A1 LicenseStatus
% Total    % Received % Xferd Average Speed   Time    Time     Time  Current
   Dload  Upload   Total   Spent    Left   Speed
100 3306    100 3306    0     0  6480    0 --:--:-- --:--:-- --:--:--  6507
  "LicenseStatus": "ACTIVATED",
  "LicenseType": "advanced system management key",
--
  "LicenseStatus": "ACTIVATED",
  "LicenseType": "VROC premium upgrade key",
```

Figure 61. Redfish Command to verify the activation status of the VROC Software License Key

5. System Service–System Features Overview

This chapter provides service personnel a reference to identify and locate the features associated with the Intel® Server System M50FCP1UR. For more information, refer to the *Intel® Server System M50FCP2UR Technical Product Specifications*.

5.1 Front Drive Bay Options

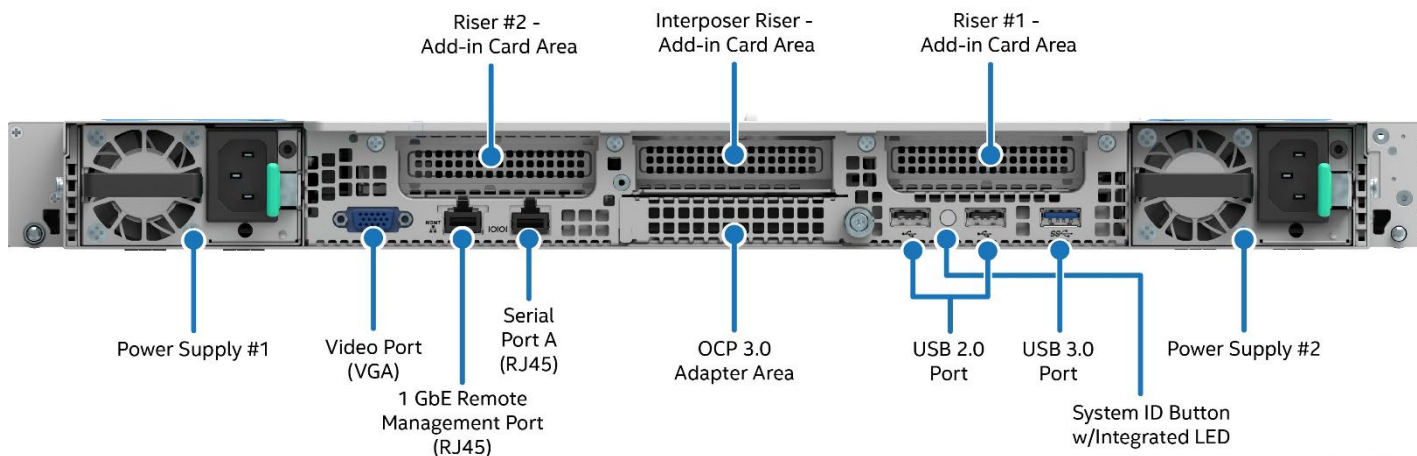

Figure 62. 4 x 2.5" Front Drive Bay Configuration–M50FCP1UR204



Figure 63. 12 x 2.5" Front Drive Bay Configuration–M50FCP1UR212

5.2 Back Panel, Front Control Panel, Front I/O Features



Ref #: FCP20013

Figure 64. Back Panel Features

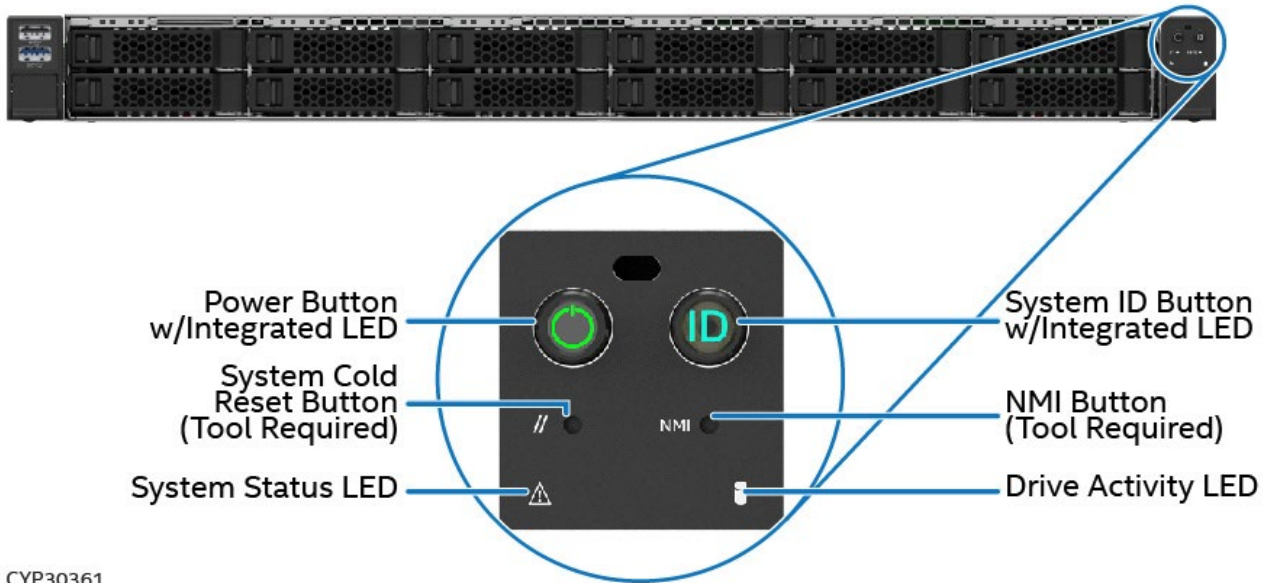

Figure 65. Front Control Panel Features

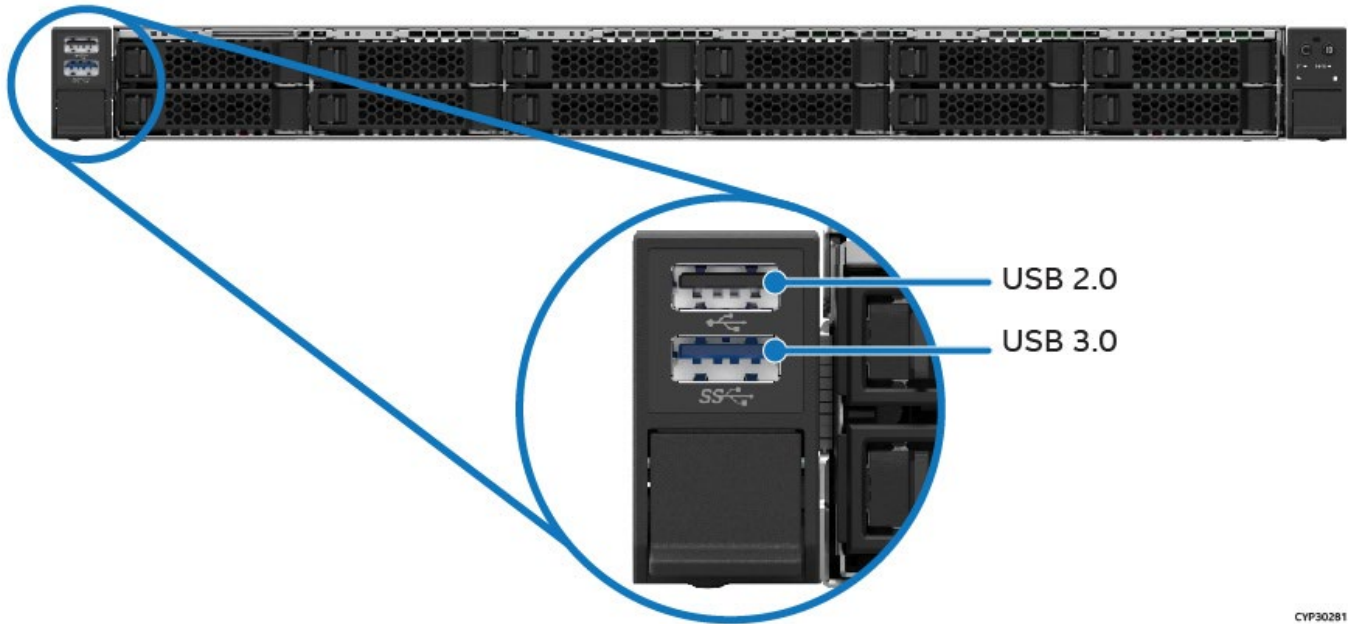

Figure 66. Front I/O Features

5.3 Drive Bay LED Identification

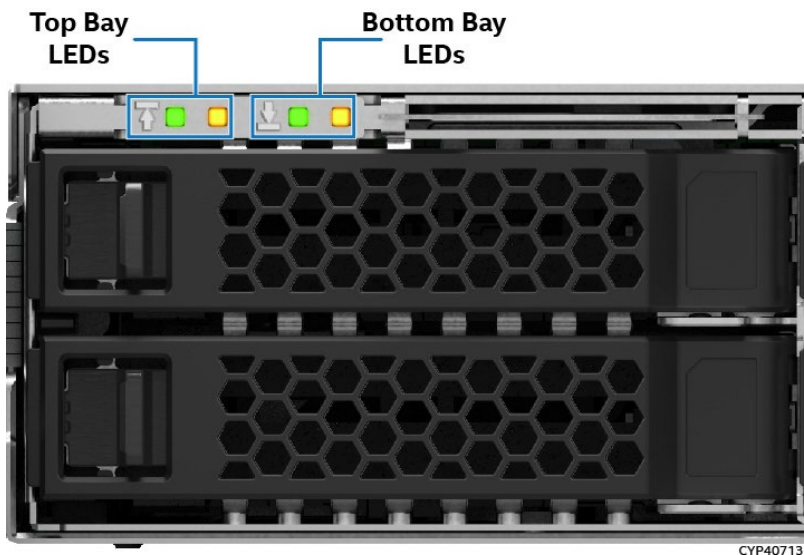

Figure 67. Hot Swap Drive Bay LED Identification

Table 2. Drive Status LED States

	LED State	Drive Status
Amber	Off	No access and no fault
	Solid on	Hard drive fault has occurred
	1 Hz blinking	RAID rebuild in progress
	2 Hz blinking	Locate (identify)

Table 3. Drive Activity LED States

	Condition	Drive Type	LED Behavior
Green	Power on with no drive activity	SAS/NVMe*	LED stays on
		SATA	LED stays off
	Power on with drive activity	SAS/NVMe*	LED blinks off when processing a command
		SATA	LED blinks on when processing a command
	Power on and drive spun down	SAS/NVMe*	LED stays off
		SATA	LED stays off
	Power on and drive spinning up	SAS/NVMe*	LED blinks
		SATA	LED stays off

Note: The drive activity LED is driven by signals from the drive itself. Drive vendors may choose to operate the activity LED different from what is described in Table 3. If the activity LED on a given drive type behaves differently than what is described, customers should reference the drive vendor specifications for the specific drive model to determine the expected drive activity LED operation.

5.4 Server Board Features

The following figure provides a general overview of the physical server board, identifying key feature and component locations.

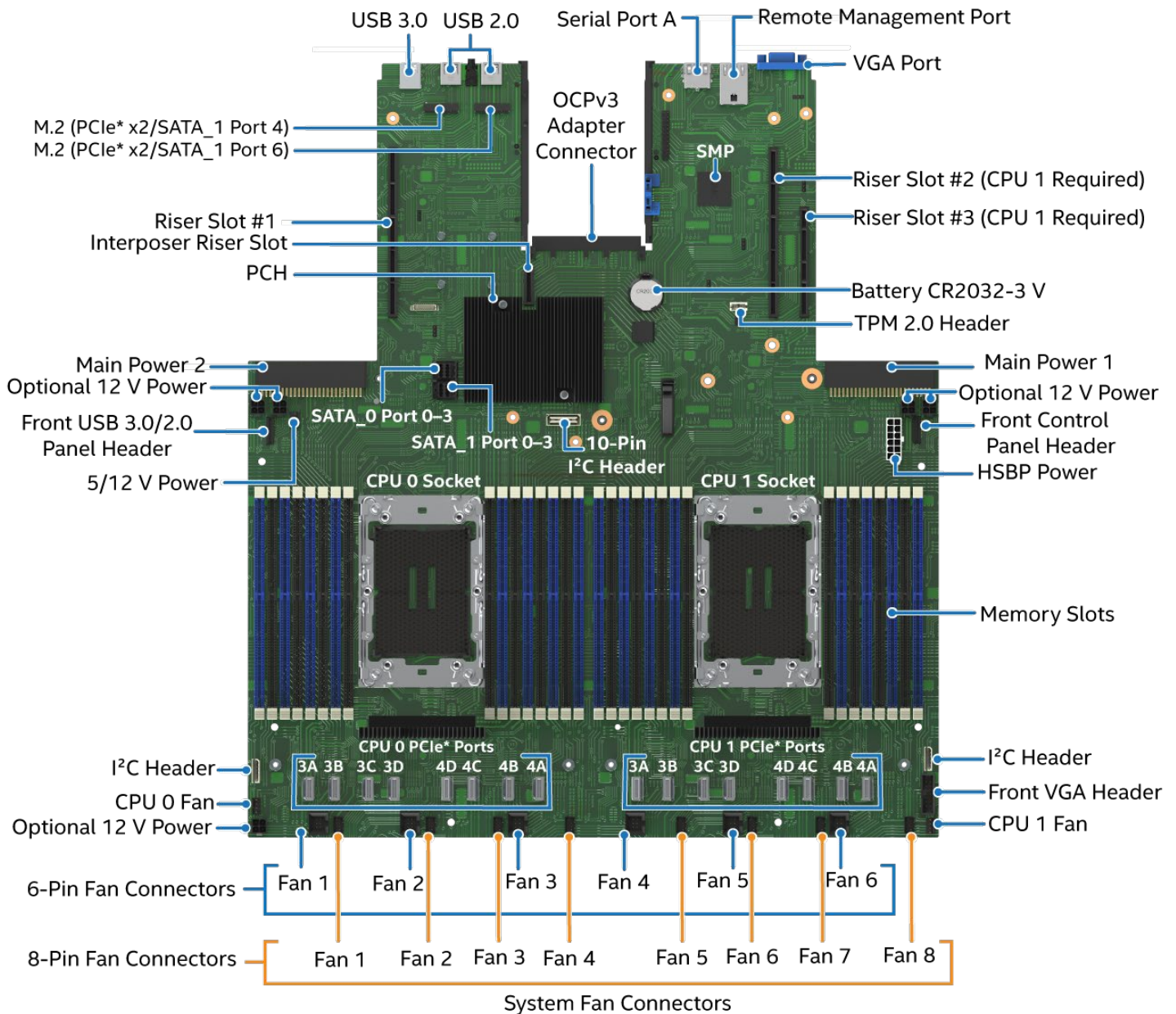

Ref #: FCP10245

Figure 68. Intel® Server Board M50FCP2SBSTD Component / Feature Identification

The server board includes LEDs to identify system status and/or indicate a component fault. The following figures identify the diagnostic LEDs and their location on the server board.

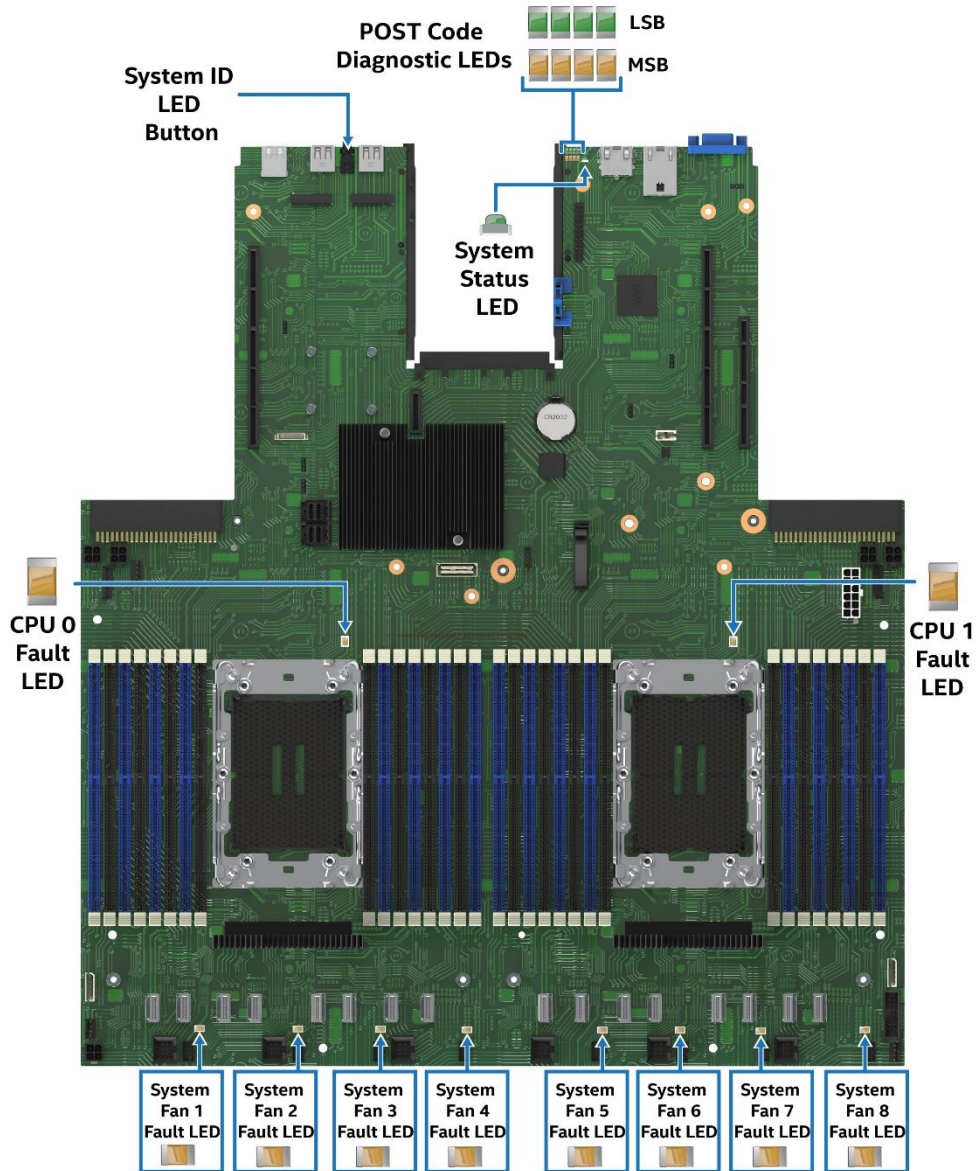

Ref #: FCP10261

Figure 69. Intel® Light-Guided Diagnostics-LED Identification

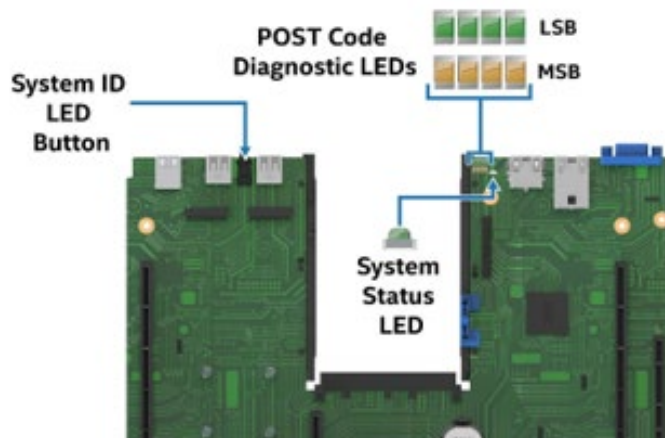

Figure 70. View of POST Code Diagnostic, System ID, and System Status LEDs Area

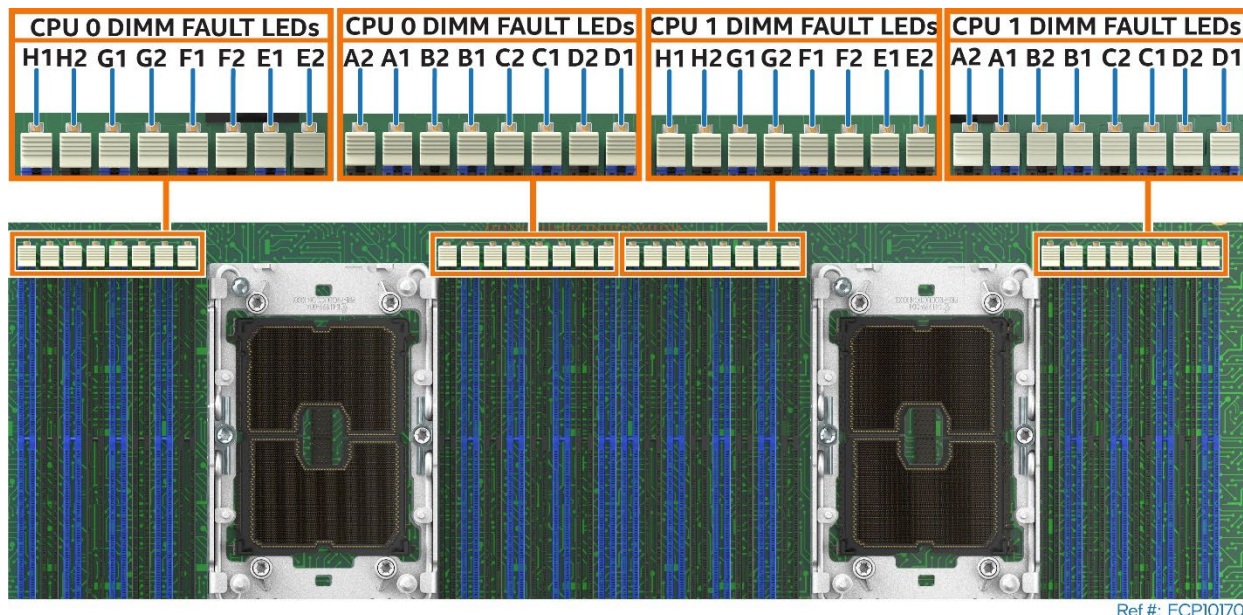

Figure 71. Intel® Light-Guided Diagnostics - DIMM Fault LEDs

5.5 System Configuration and Recovery Jumpers

The server board includes jumper blocks that can be used to configure, protect, or recover specific features of the server board. The following figure identifies the location of each jumper block on the server board. For more information on the jumpers, see the *Intel® Server Board M50FCP2SBSTD Technical Product Specification (TPS)*.

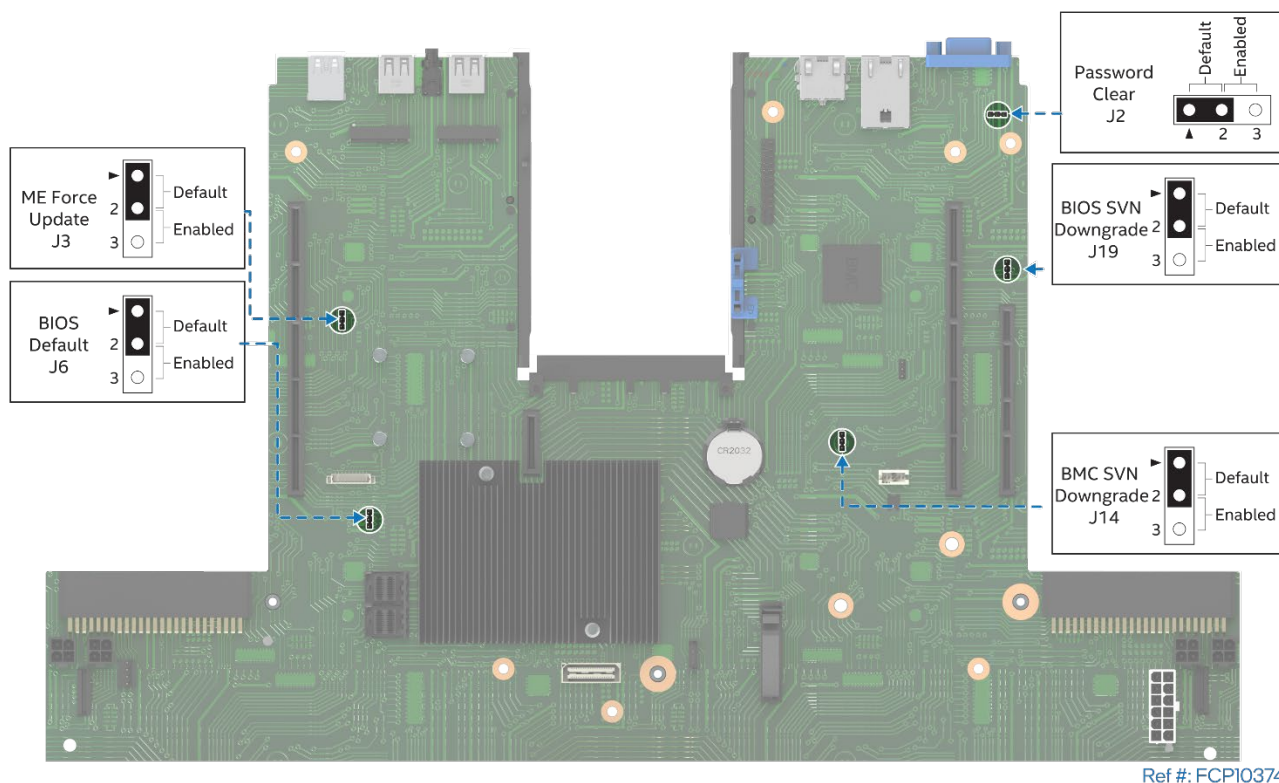

Figure 72. Reset and Recovery Jumper Block Locations

6. System Service and FRU Replacement

This chapter provides instructions for replacement of system components considered to be field replaceable (FRU). Only system features that are identified as hot-swappable can be replaced while the system remains operational. These items include:

- Power Supply—In dual power supply configurations only
- Drives mounted in the front drive bay—Redundant RAID (1, 5, 6, and 10) configurations only
- System Fans

All other components in the system can only be serviced after the system has been powered off and AC power cords have been disconnected from the server system.

Before You Begin

Before integration of any system components, review all the safety and ESD precautions found in the Safety Warnings section at the beginning of this document.

System Reference

In the following procedures, all references to left, right, front, top, and bottom assume that the reader is facing the front of the server chassis.

Instruction Format

Each procedure described in this chapter follows an illustration first format. This format gives the reader the option to follow a quicker path to component integration by first seeing an illustration of the intended procedure. If necessary, the reader can then follow the step-by-step instructions that accompany each procedure.

6.1 System Top Cover Removal / Installation

The system top cover consists of two panels, one over the front half of the system and one over the back half of the system. To maintain system thermals, both top cover panels must be in place when the system is operational.

Required Tools and Supplies

- Anti-static wrist strap and conductive workbench pad (recommended)
- Phillips* head screwdriver #1

6.5.1 System Cover Removal

Removal of both top cover panels is necessary when servicing any system component in the server chassis. Before removing the top cover, power down the system and unplug all peripheral devices and the system power cords.



Figure 73. System Top Cover Panel Shipping Screws

The top cover panels may be secured to the chassis using four screws, two on each side of the chassis. See Figure 73. If present, these need to be removed to detach both top cover panels from the chassis.

Note: A non-skid surface or a stop behind the server system may be needed to prevent the server system from sliding on the work surface.

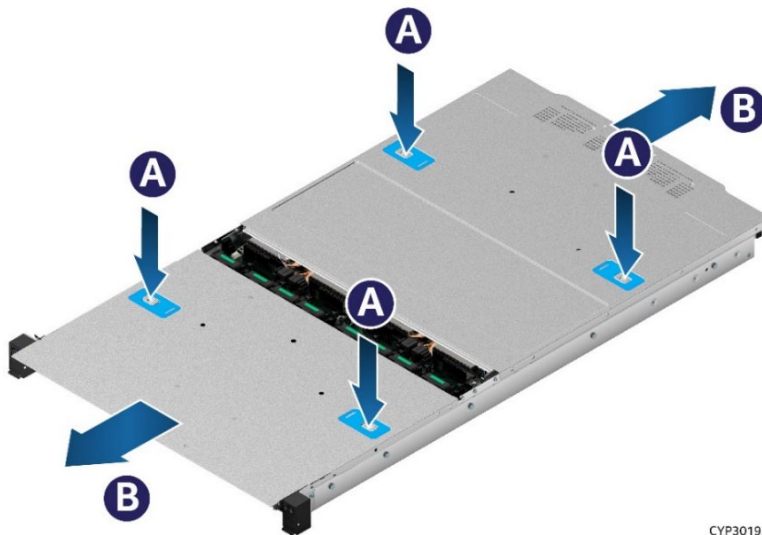

Figure 74. System Cover Removal

For each top cover panel:

1. While pushing down on both the left and right buttons of the given top panel (see Letter A), slide the top cover panel towards the front (front panel) or back (back panel) of the chassis (see Letter B).
2. Carefully lift the top cover panel up and away from the chassis.

Note: Each top cover panel can slide along the chassis base for 10 mm and then needs to be lifted.

6.5.2 System Cover Installation

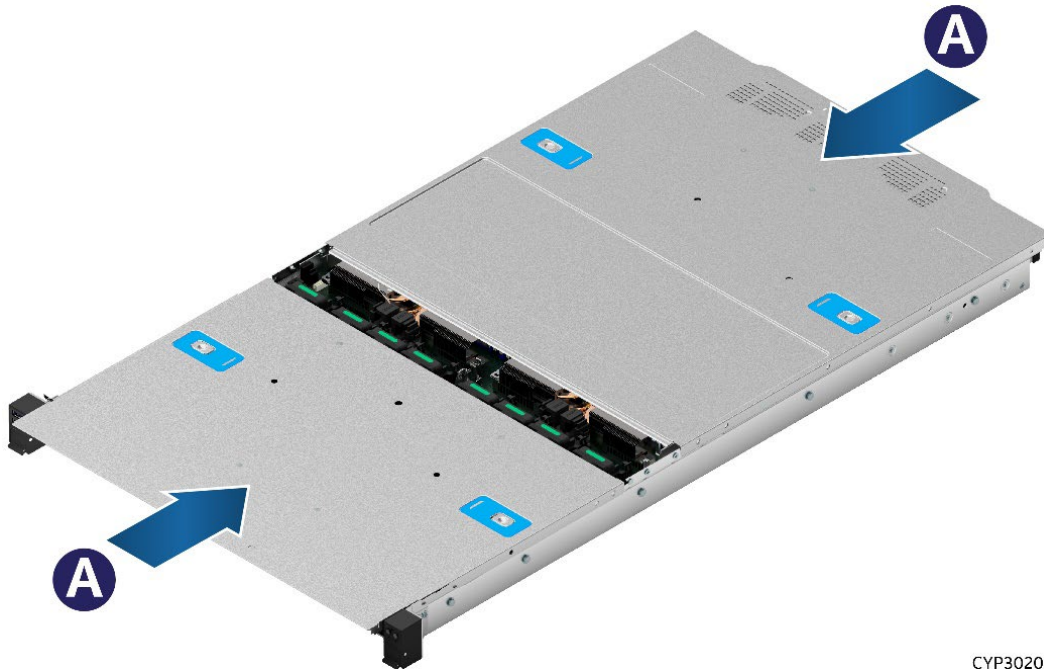

CYP30203

Figure 75. System Cover Installation

For each top cover panel:

1. Carefully align and set the top cover panel on top of the chassis. Then, slide it inwards until it locks into place (see Letter A).

Shipping Note: When transporting the server system, Intel recommends installing the four top cover screws before shipping.

6.2 System Fan Replacement

All system fans are designed to be hot-swappable and require no tools for replacement. All system fans include a fan fault LED on the server board next to each system fan connector. The integrated baseboard management system will light the LED when it detects a fan fault. Remove the front top cover panel to access any of the system fans.

CAUTION: a faulty system fan with dual rotors may still have a functional rotor. Fan rotors spin at very high speeds. Extreme caution should be taken when performing a hot replacement of a system fan. When removing a system fan from an operational system, use two hands to grasp the two greens tabs found on the top edges of the fan assembly, and pull straight up. Let the rotor stop completely before handling the system fan. Keep fingers away from the front and back fan grates.

Components in an operational system can get extremely hot. Avoid touching any components in the system while swapping out a defective system fan.

To minimize performance degradation, and other thermal related issues, system fan replacement while the system is operational should be performed as quickly as possible.

For safety, Intel recommends replacing a faulty system fan with the system powered off whenever possible.

Required Tools and Supplies

- Intel spare fan kit
- Anti-static wrist strap and conductive workbench pad (recommended)

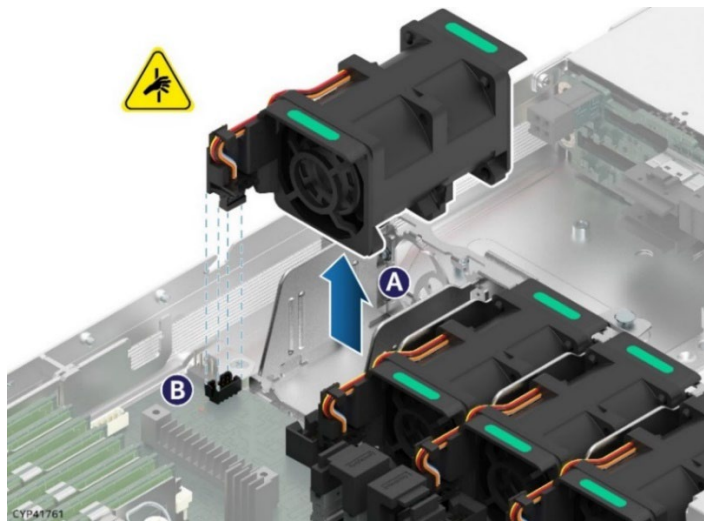

Figure 76. Individual Fan Removal

1. Remove the front top cover panel (see [Section 6.1.1](#)).

Note: For hot fan replacement, the system power cords do not need to be disconnected before removing the top cover.

2. If performing a hot replacement, identify the faulty fan by locating the illuminated FAN FAULT LED on the server board next to the connector of the faulty fan.
3. Using two hands, grasp the two greens tabs found on the top edges of the fan assembly, and pull straight up (see Letter A), releasing the fan from its housing and the server board connector. (See Letter B).

- Carefully place the fan onto a flat surface.

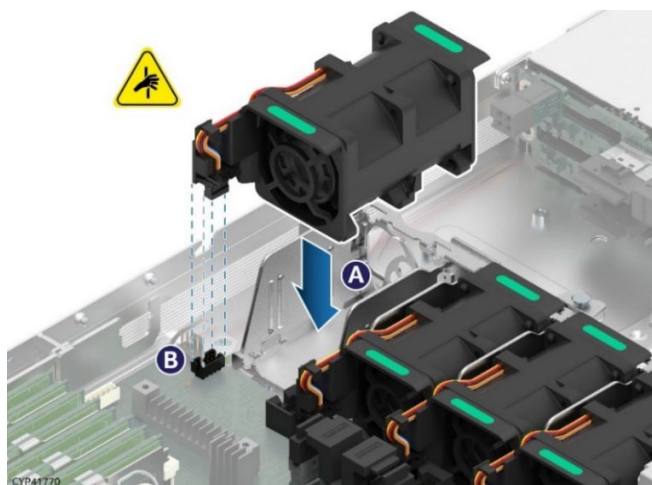

Figure 77. Individual Fan Installation

- Locate and unwrap the replacement fan.
- Ensure that the empty fan slot within the assembly housing is clear of any cables.
- Align the fan connector with the server board connector, and carefully lower the fan into the fan assembly housing. Gently push down until fully seated (see Letter A).
- Ensure that the fan connector is fully seated within the connector on the server board. See Letter B.
- Reinstall the system top cover (see [Section 6.5.2](#)).

6.3 Memory Module Replacement

Required Tools and Supplies

- Anti-static wrist strap and conductive workbench pad (recommended)
- Replacement equivalent memory module

Note: Replacement DDR5 DIMMs must be identical or have “Like DIMM” attributes as defined in Appendix B.

Average Time to Complete: ~ 5 minutes

Procedure Prerequisites

- Memory modules are NOT hot-swappable. Before replacing a faulty memory module in the system, power down the system and unplug the AC power source for at least 30 seconds, ensuring all power supply status LEDs and board LEDs are off.

A DDR5 DIMM is commonly referred to as “memory module” in the following instructions.

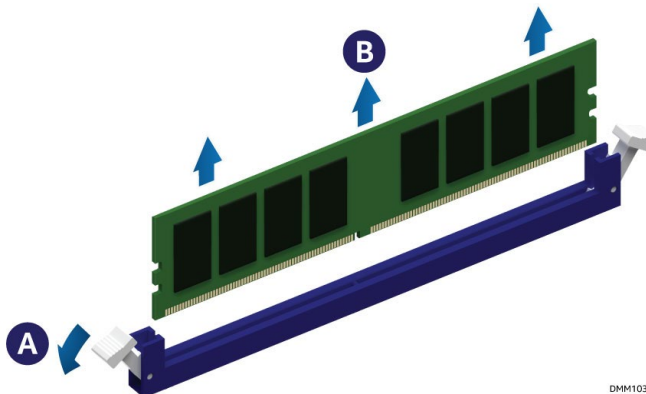

DMM1031

Figure 78. Memory Module Removal

1. Power off the system and disconnect the system power cords.
2. Remove the top cover panels (see [Section 6.5.1](#)).
3. Identify and locate the memory module to be replaced.
4. Ensure that the ejection tabs of adjacent memory slots are closed.
5. Open the ejection tabs at both ends of the selected memory slot (see Letter A). The memory module lifts slightly from the memory slot.
6. Holding the memory module by its edges, lift it away from the slot (see Letter B).

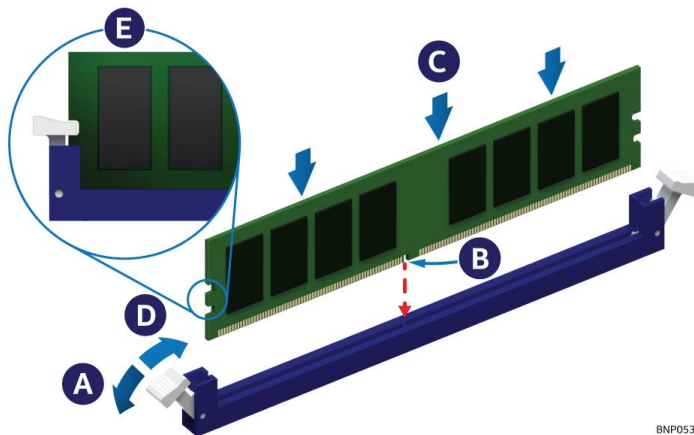
**Figure 79. Memory Module Installation**

7. Ensure that the ejection tabs at both ends of the memory slot are pushed outward to the open position (see Letter A).
8. Carefully unpack the replacement memory module, taking care to hold the device by its outer edges only.
9. Align the notch in the memory module edge connector edge with the key in the memory slot (see Letter B).
10. Insert the memory module into the memory slot.
 - Using even pressure along the top edge, push down on the memory module (see Letter C) until the ejection tabs of the memory slot snap into place (see Letter D).
11. Ensure that the ejection tabs are firmly in place (see Letter E).
12. Reinstall the system top cover (see [Section 6.5.2](#)).

6.4 Power Supply Replacement

Required Tools and Supplies

- Intel spare power supply kit
- Anti-static wrist strap and conductive workbench pad (recommended)

Caution: The power supply is only hot-swappable (system does not have to be powered down) if the system has both power supplies installed, and the system is still operational with a single functional power supply.

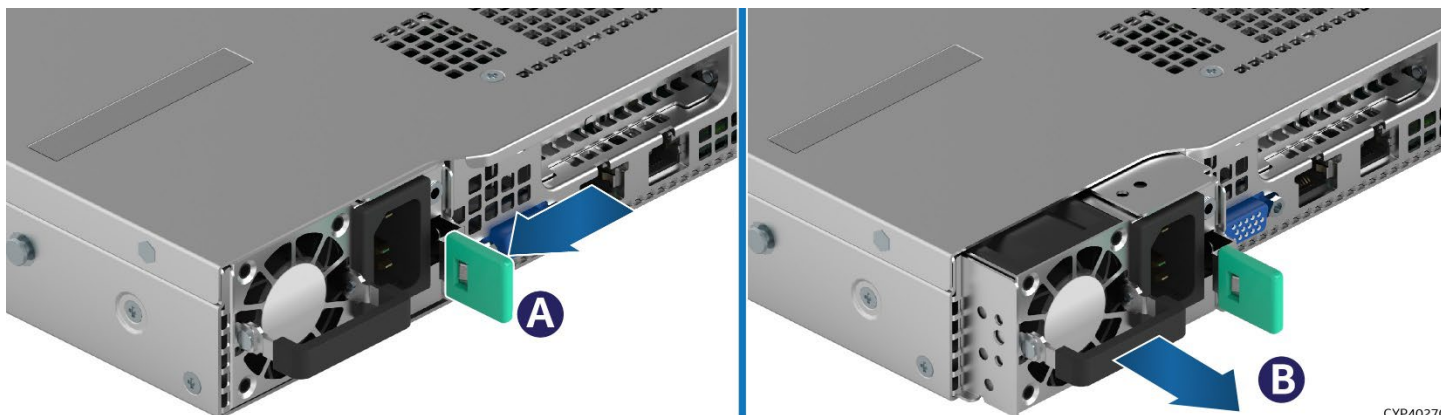

Figure 80. Power Supply Removal

1. Detach the power cord from the power supply to be removed.
2. Push and hold the green latch in the direction shown (see Letter A).
3. Use the handle to pull the power supply module from the system (see Letter B).

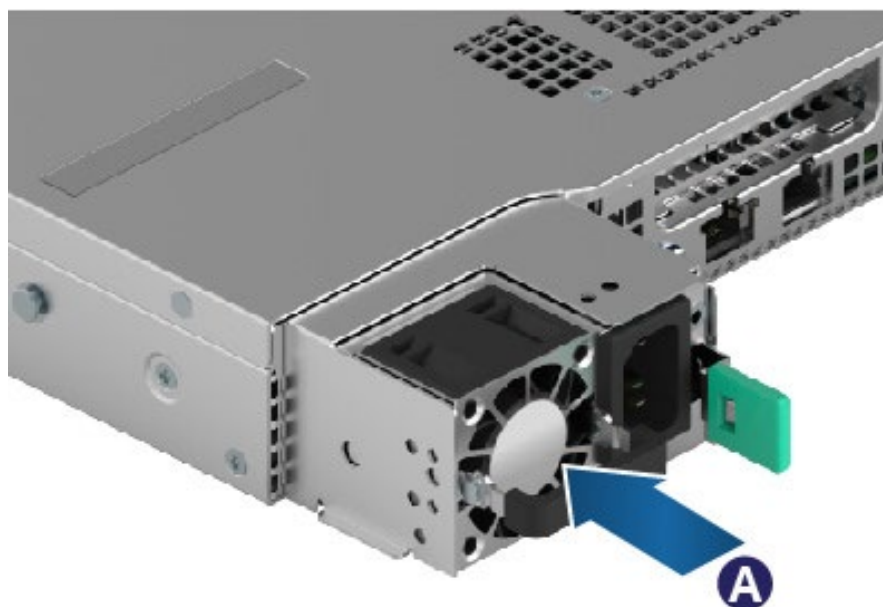

Figure 81. Power Supply Installation

4. Locate the replacement power supply.
5. Slide the power supply into the power supply bay until it locks in place (see Letter A).

6.5 Processor Replacement

Components Required:

- New 4th Gen Intel® Xeon® Scalable processor + included shipping tray
- Existing processor carrier clip
- Existing 1U standard heat sink or 1U Enhanced Volume Air Cooling (EVAC) heat sink + new thermal interface material (TIM, Honeywell* PTM7000)

Required Tools and Supplies

- Anti-static wrist strap and conductive workbench pad (recommended)
- ESD Gloves (recommended)
- T-30 Torx* screwdriver
- Phillips* head screwdriver #2

Note: The following sections show the EVAC heat sink in the figures. The procedures described apply to both heat sink types.

Caution: Fin edges of the processor heat sink are very sharp. Intel recommends wearing thin ESD protective gloves when handling the PHM during the following procedures.

Caution: Processor heat sinks are easily damaged if handled improperly. See the following figure for proper handling.

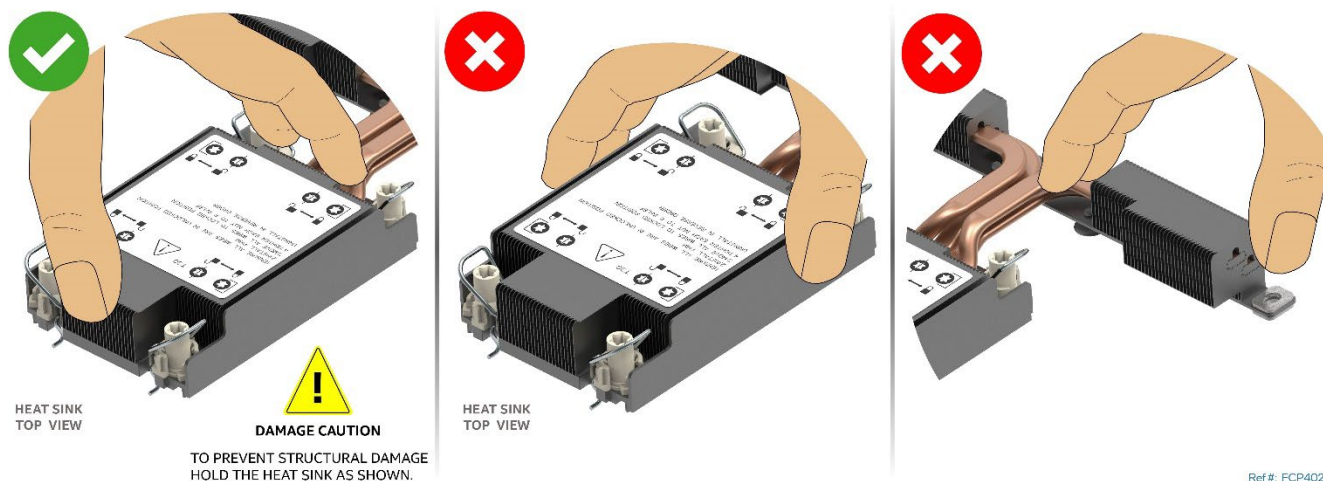
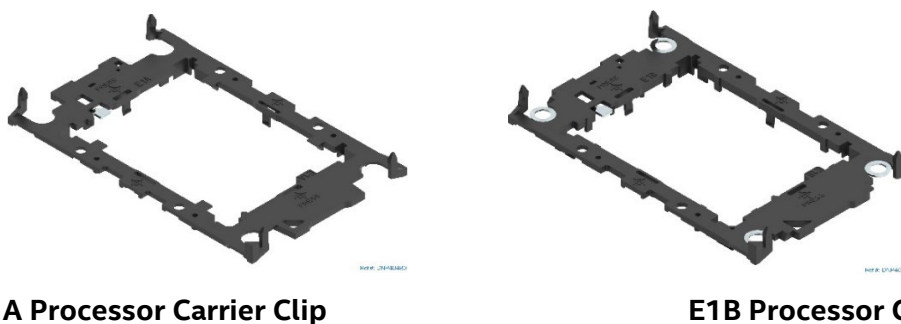

Figure 82. Processor Heat Sink Handling

Two types of processor carrier clips are supported by the 4th Gen Intel® Xeon® Scalable processor family for this server product family, they are identified as “E1A” and “E1B”.



E1A Processor Carrier Clip

E1B Processor Carrier Clip

Figure 83. Supported Processor Carrier Clips

Each type of processor carrier clip will have an identifier marking: E1A or E1B. The processor will have an etch on its heat spreader identifying the supported type of carrier clip. Match the processor to the supported processor clip as shown in [Figure 84](#).

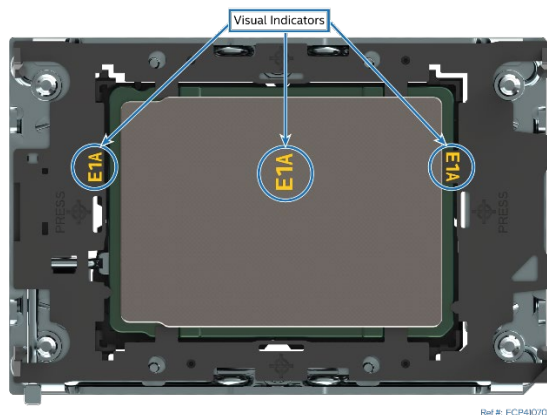

Figure 84. Processor Carrier Clip Identifier Markings

Note: The etched identifier location in the figure is for illustration purposes only. The location and color may be different on the actual processor and carrier clip

6.5.1 Processor Heat Sink Module (PHM) and Processor Removal

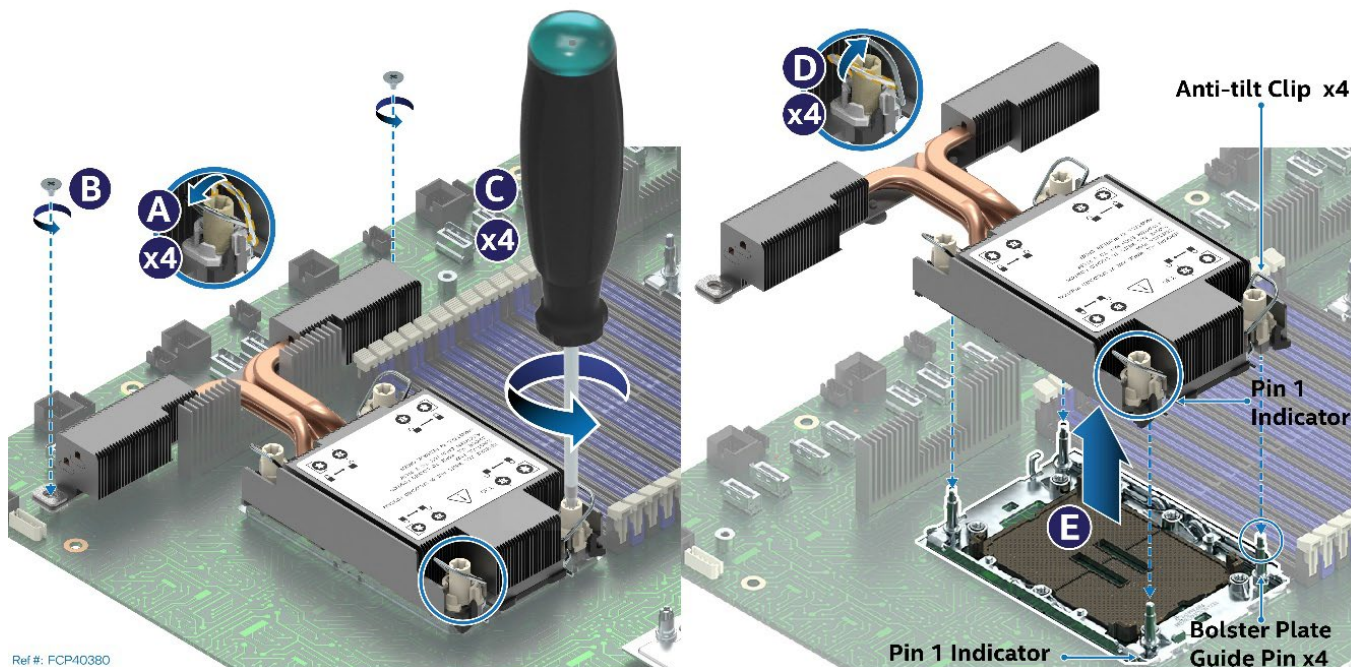
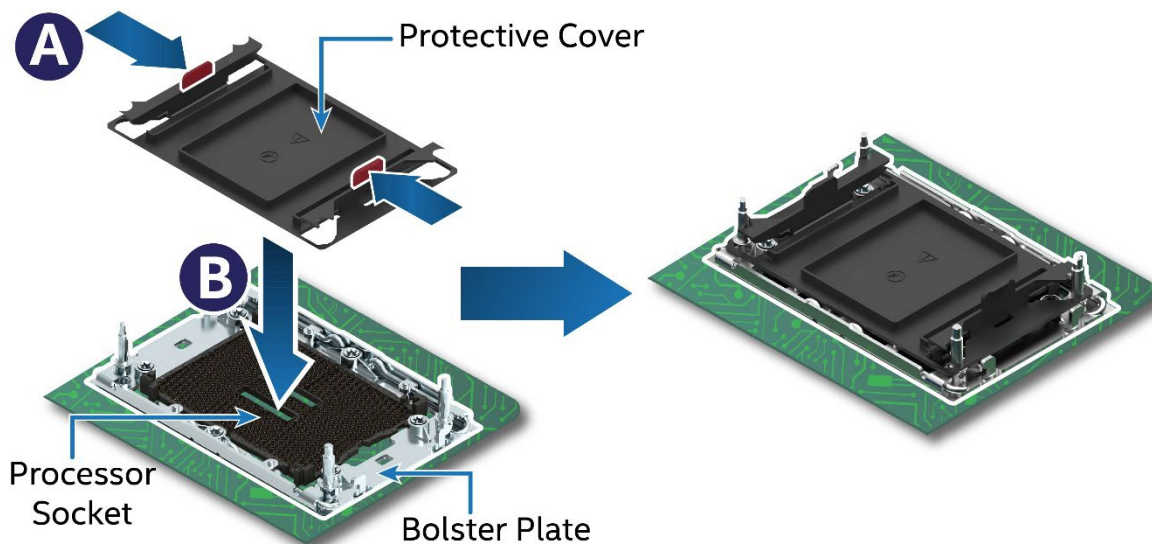

Figure 85. PHM Assembly Removal from Processor Socket

1. Power off the system and disconnect the system power cords.
2. Remove the system top cover (see [Section 6.5.1](#)).
3. Remove or set aside all system components preventing access to the processors.
4. Ensure the anti-tilt wire on the four corners of the heat sink, is in the outward position (see Letter A).
5. Fully unscrew all four heat sink fasteners in any order (see Letter B).
6. Push the anti-tilt wire on the four corners of the heat sink, to the inward position (see Letter C).
7. Lift the PHM straight up and away from the server board (see Letter D).
8. Place the PHM, bottom side up, on a flat surface.
9. Visually inspect that the socket is free of damage or contamination.

Caution: If debris is observed, blow it away gently with an air blower. Do not use tweezers or any other hand tools to remove it manually.

If reinstalling the processor later, then Intel highly recommends installing the processor socket protective cover that shipped with the system to prevent pin damage while the socket is not populated.



Ref #: DNP40590

Figure 86. Reinstall the Socket Cover

- Squeeze the finger grips at each end of the cover (see Letter A) and carefully lower the cover on to the socket (see Letter B). Once seated, release finger grips.
- Carefully check that the socket cover is locked in place.

Caution: Do not press the center of the socket cover.

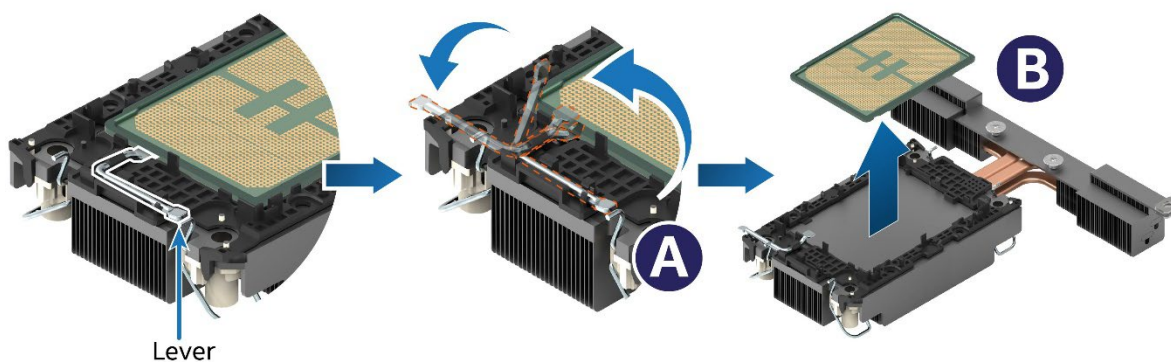

Ref #: FCP40450

Figure 87. Processor Removal from PHM Assembly

10. While holding down the PHM, carefully rotate the lever (see Letter A) from left to right until the processor lifts from the processor carrier clip.
11. While holding down the processor carrier clip, carefully lift the processor from it (see Letter B).

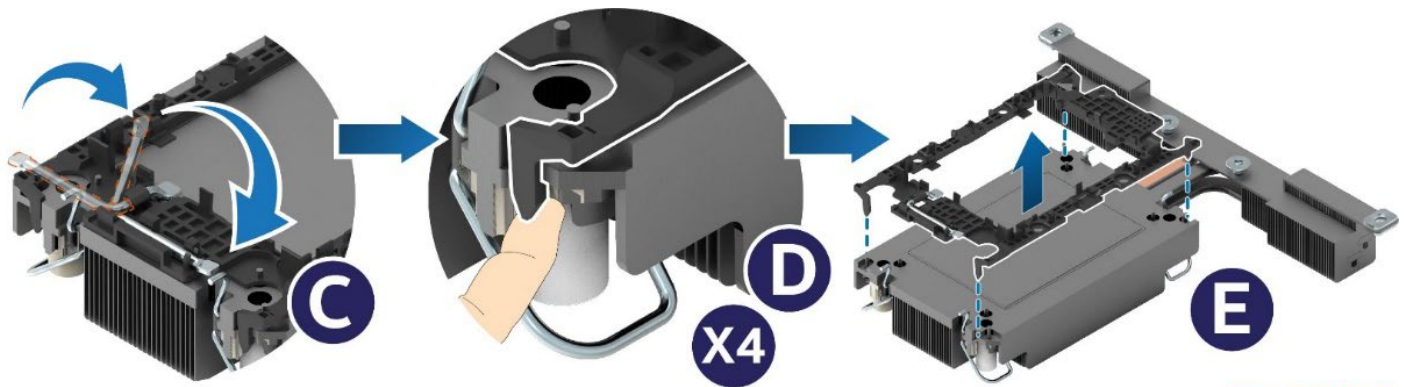

Ref #: FCP40462

Figure 88. Processor Carrier Clip Removal from PHM Assembly

12. Return the lever to the original position (see Letter C).
13. Unlatch the tab on each corner of the processor carrier clip to release it from the heat sink (see Letter D)
14. Lift the processor carrier clip up and away from the heat sink (see Letter E).

6.5.2 Processor Heat Sink Module (PHM) Assembly

The procedures described in the following sections must be followed in the order specified to assemble the PHM and install it on to the server board. These instructions assume that the Thermal Interface Material (TIM, Honeywell* PTM7000) is already applied to the bottom of the heat sink.

Caution: Wear ESD gloves to prevent electrostatic damage and oxidation or foreign material on processor package and land pads.

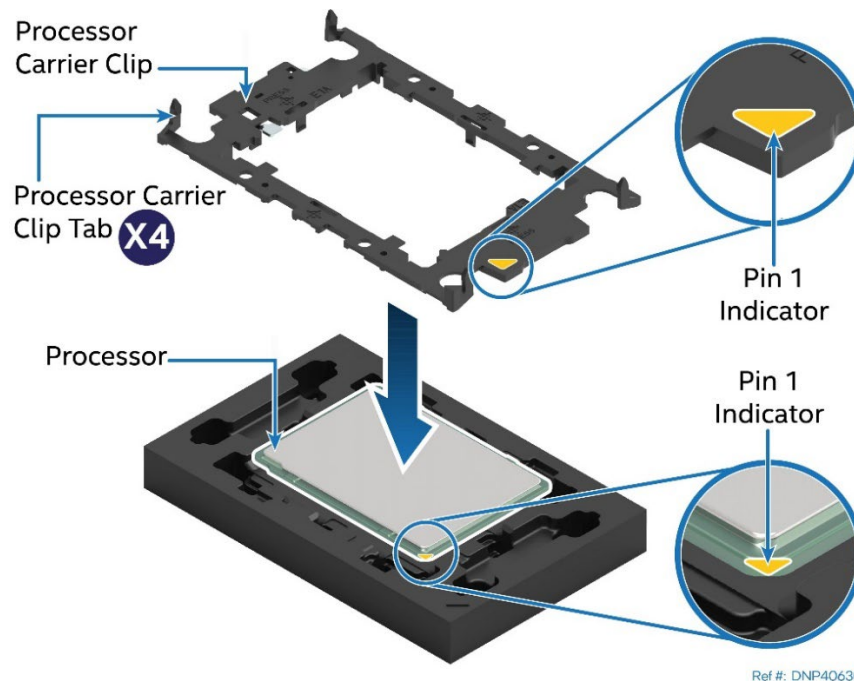

Ref #: DNP40630

Figure 89. Installing Processor Carrier Clip onto Processor-Part 1

1. Position the Pin 1 indicator of the carrier clip with the Pin 1 indicator of the processor (See [Figure 89](#)).
2. With the processor still on its shipping tray, place the processor carrier clip over the processor.

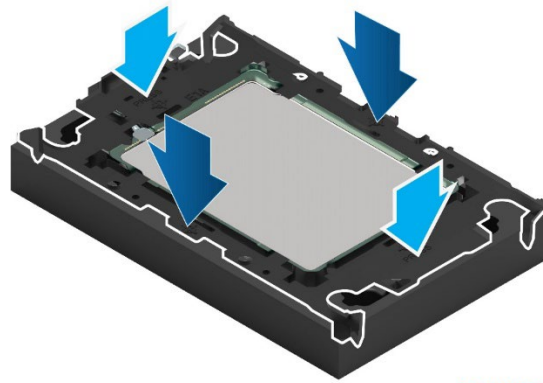

Ref #: DNP40620

Figure 90. Installing Processor Carrier Clip onto Processor-Part 2

3. Gently press down on two opposite sides of the carrier clip until it clicks into place. Repeat with the other two sides (See Figure 90).

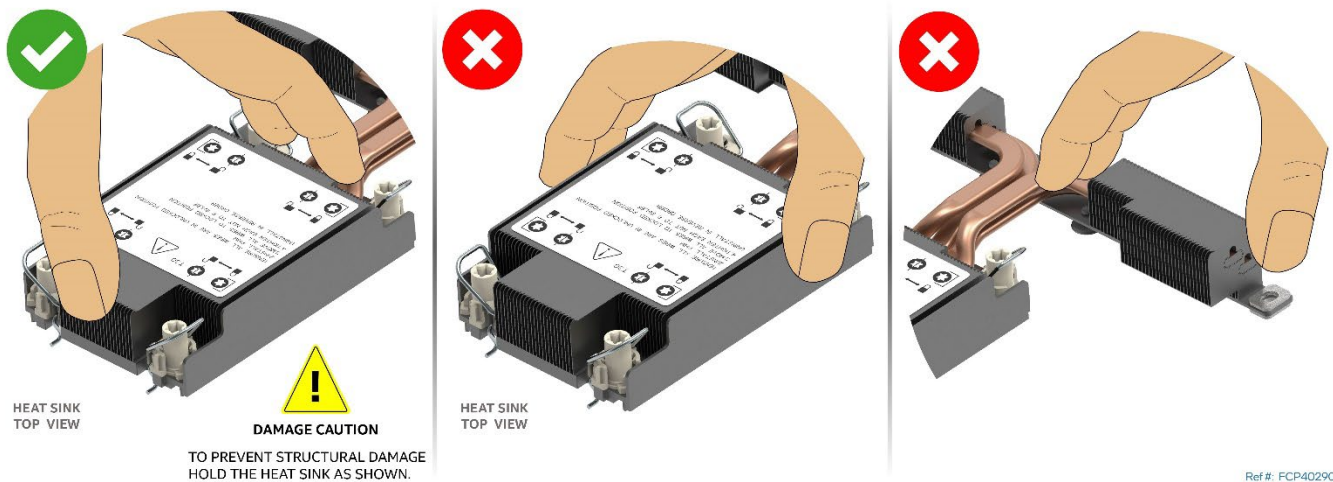

Ref #: FCP40290

Figure 91. Removing Heat Sink from its Packaging

4. Locate the processor heat sink. To avoid damage to the heat sink, grasp it by its narrower top and bottom edges as shown in Figure 91.

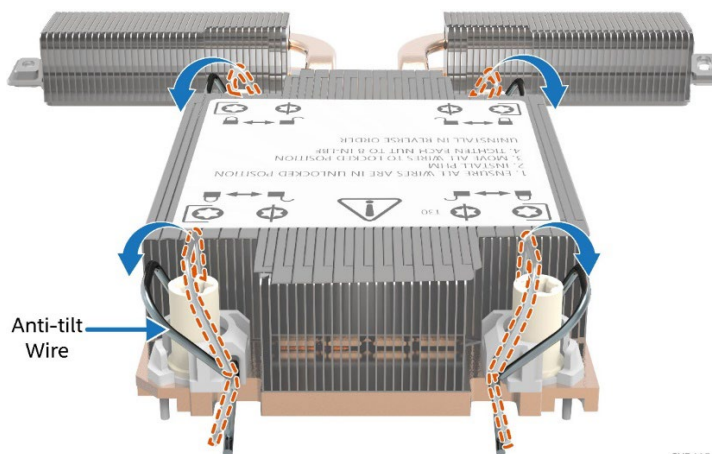

CYP41512

Figure 92. Setting the Processor Heat Sink Anti-Tilt Wires to the Outward Position

5. Set the anti-tilt wires to the outward position.
6. Turn the heat sink over and place it bottom side up on a flat surface.
7. Clean any residual old Thermal Interface Material (TIM) from the heat sink and apply new TIM.

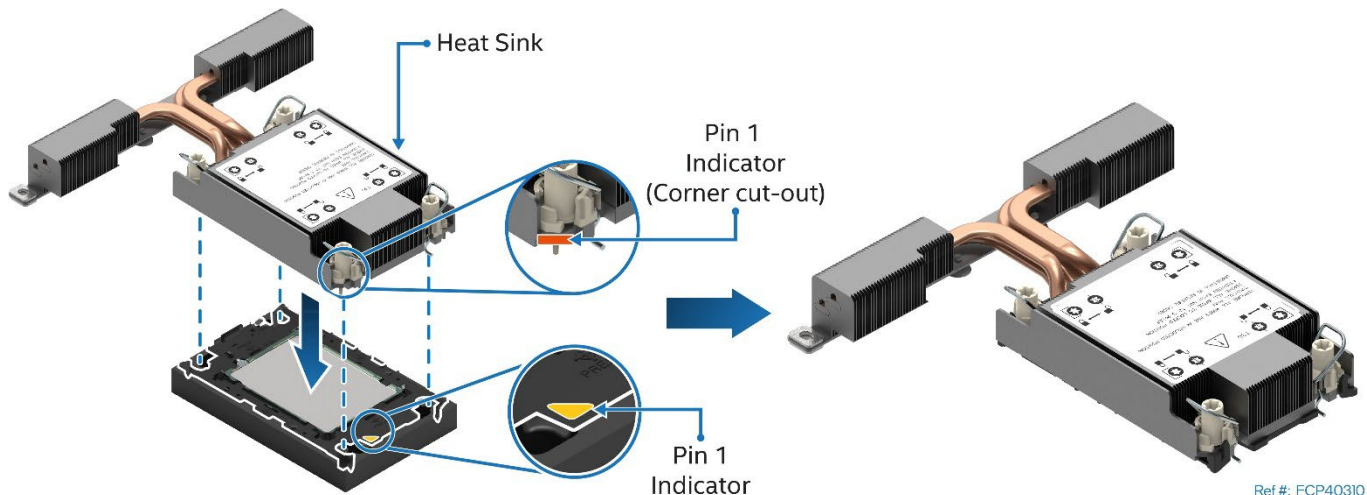

Figure 93. Pin 1 Indicator of Processor Carrier Clip

8. Carefully lift and turn over the heat sink.
9. Align the Pin 1 indicator of the processor carrier clip with the corner cut-out on the heat sink (See Figure 93).

Note: For the standard heat sink, there are two cut-out corners; either can be used to align Pin 1 indicators.

10. Gently press down the heat sink onto the processor carrier clip until it clicks into place.
11. Ensure that all four heat sink corners are securely latched to the carrier clip tabs.

6.5.3 Processor Heat Sink Module (PHM) Installation

Caution: Do not touch the socket pins. The pins inside the processor socket are extremely sensitive. A damaged processor socket may produce unpredictable system errors.

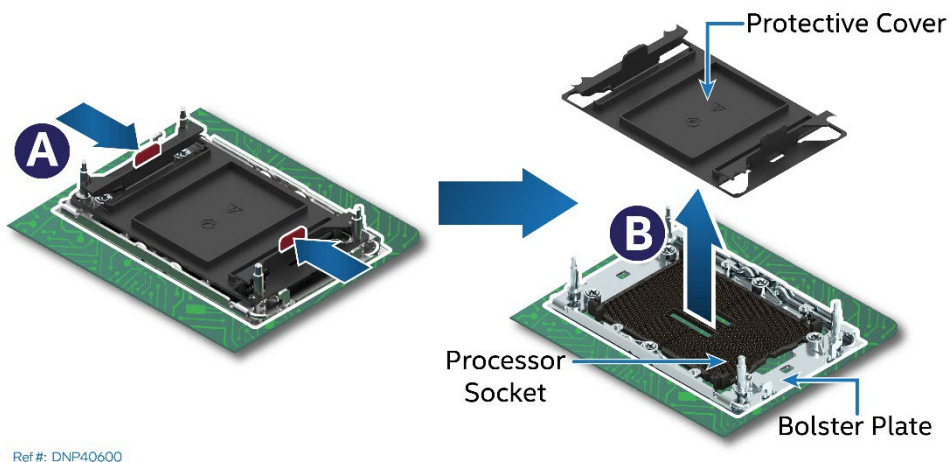

Figure 94. Socket Protective Cover Removal

1. (If present) Remove the protective cover by squeezing the finger grips (see Letter A) and pulling the cover up and away from the processor socket. See Letter B.

Caution: Ensure that the processor socket is free of damage or contamination before installing the PHM. If debris is observed, blow it away gently with an air blower. Do not use tweezers or any other hard tools to remove it manually.

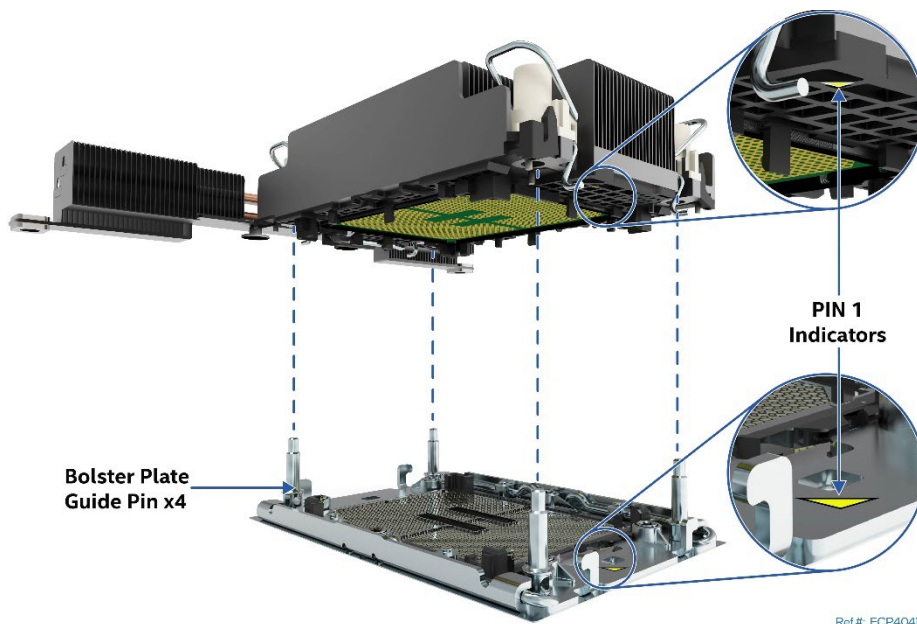

Figure 95. PHM Alignment with Socket Assembly

2. Set anti-tilt wires on all four corners of the heat sink to the inward position (see Letter A in Figure 96).
3. Align the Pin 1 indicators of the processor carrier clip and processor with the Pin 1 indicator on the bolster plate located around the processor socket (See Figure 95).

Caution: Processor socket pins are delicate and bend easily. Use extreme care when placing the PHM onto the processor socket. Do not drop it.

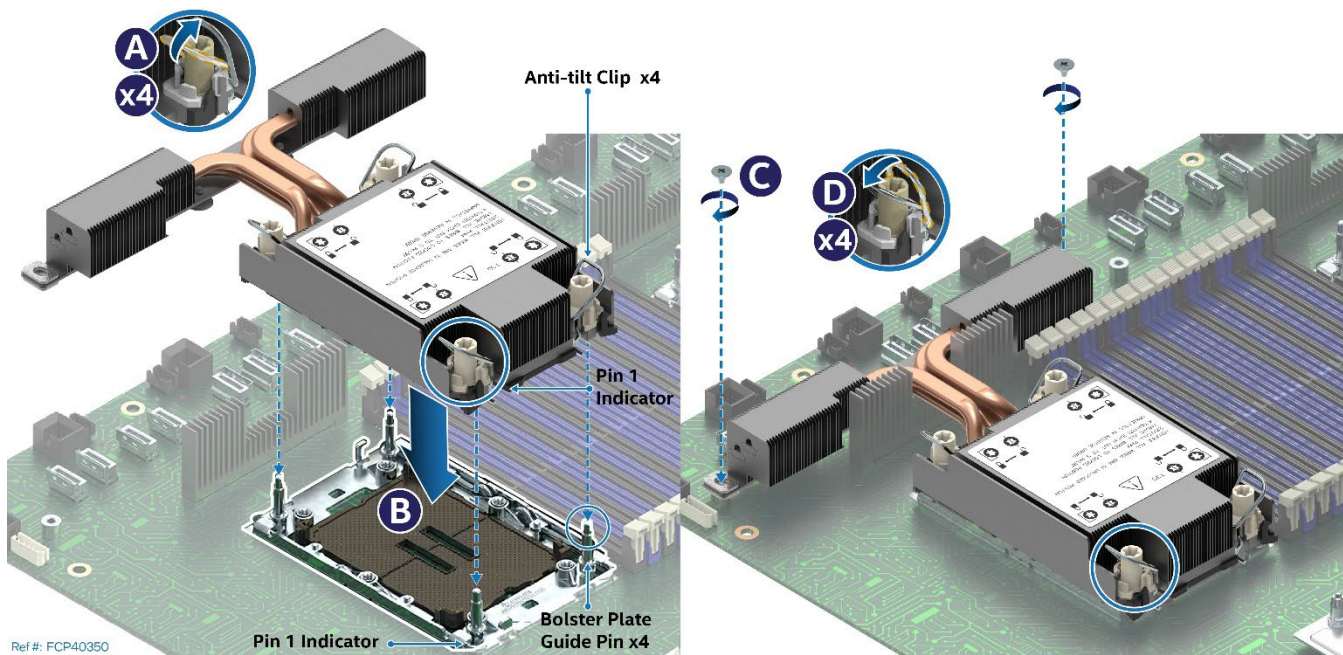

Figure 96. PHM Installation onto Server Board

4. Carefully lower the PHM onto the bolster plate alignment pins (see Letter B).
5. Using a Phillips #2 screwdriver, tighten the heat sink extension screws (see Letter C).
6. Set all four anti-tilt wires on the heat sink to the outward position (see Letter D).

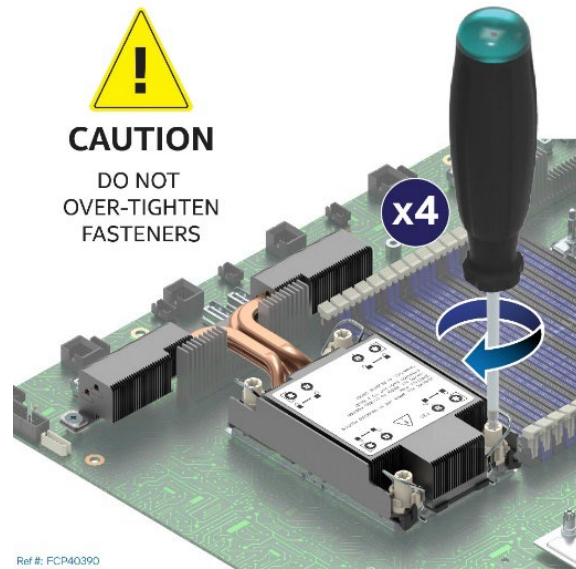

Figure 97. Tighten Heat Sink Extension Fasteners

7. Using a T30 Torx* screwdriver, tighten the heat sink fasteners to 8 in-lb. No specific sequence is needed for tightening.
8. Reinstall the system top cover (see [Section 6.5.2](#)).

6.6 Riser Card Replacement

This section provides instructions for the replacement of a riser card.

Required Tools and Supplies

- Replacement riser card accessory kit
- Anti-static wrist strap and conductive workbench pad (recommended)
- Phillips* head screwdriver #1

The system includes three different riser card brackets. The replacement instructions are the same for each.



Figure 98. Chassis Riser Card Bracket Screws

1. Power off the system and disconnect the system power cords.
2. Remove the system top cover (see [Section 6.5.1](#)).
3. (If present) Unscrew the four fastener screws on the chassis back panel. See [Figure 98](#)
4. (If present) Disconnect all cables (internal and external) that may be attached to the riser assembly.

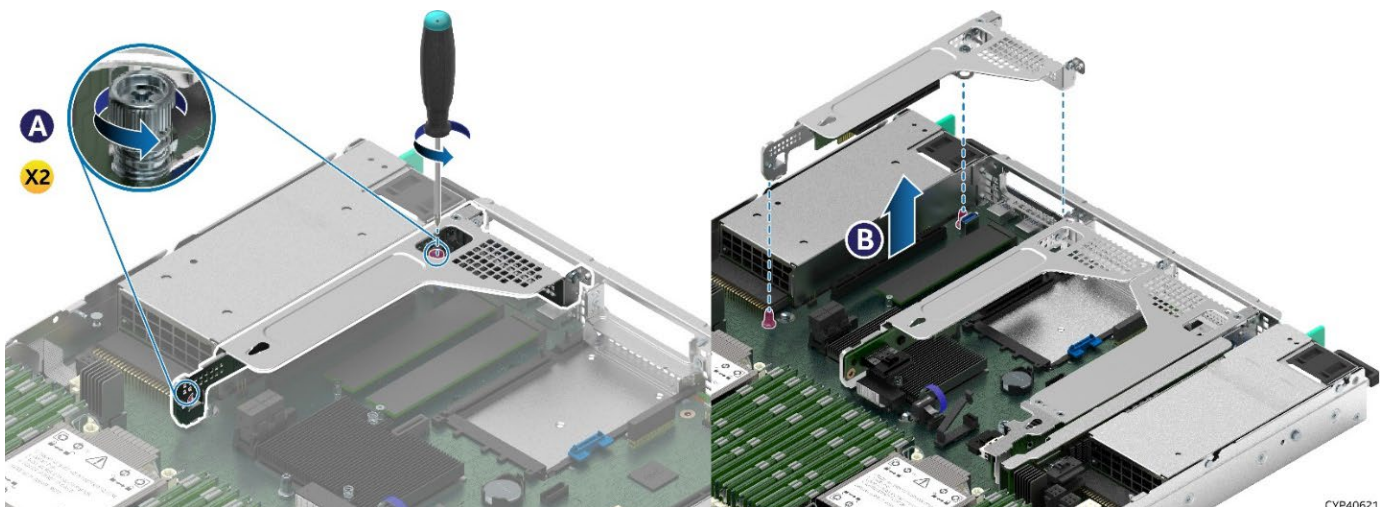
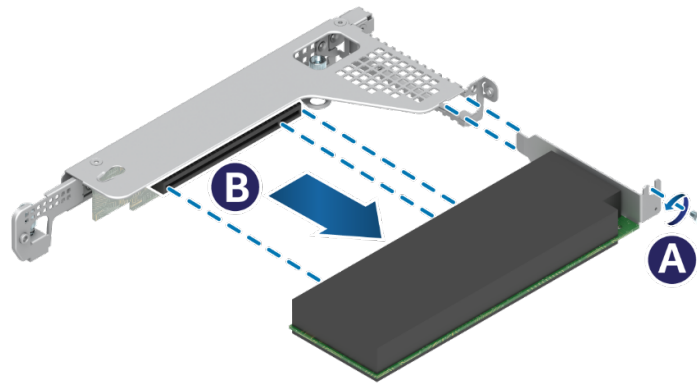

Figure 99. Riser Card Bracket Removal

5. On the front and back of the riser card bracket, loosen the two screw heads securing the bracket to the server board. See Letter A.
6. Grasp the riser card bracket with both hands and carefully pull it up and away from the chassis. See Letter B
7. If an add-in card is present, remove it from the riser bracket assembly.



Ref #: FCP40720

Figure 100. Add in Card Removal from Bracket

- Remove the screw that secures the add-in card to the riser card bracket (see Letter A).
- Carefully remove the add-in card to the riser card bracket (see Letter B).

8. Remove the riser card from the Bracket.

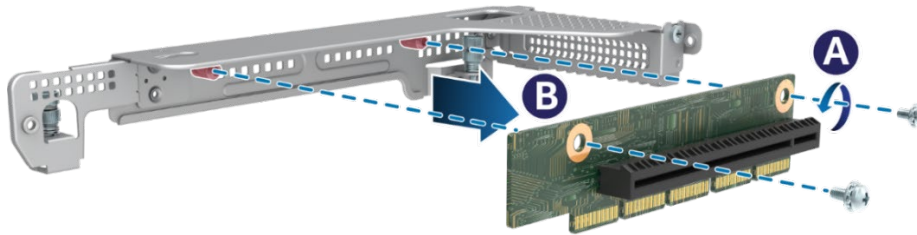

Ref #: FCP40700

Figure 101. Riser Card Removal from Bracket

- Remove the two screws that secure the riser card to the bracket (see Letter A)
- Carefully Remove the riser card from the bracket (see Letter B)

9. Locate and carefully unpack the riser card. Hold the riser card by its edges. To NOT touch the gold pins of the edge connector.

10. Install the riser card to the riser card bracket

Note: The following installation instructions for riser card to bracket are the same for all included riser card brackets and supported riser card options.

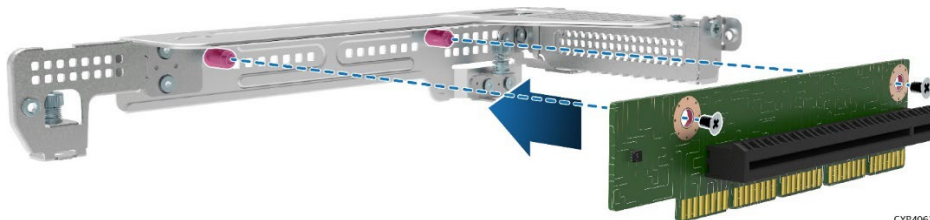

CYP40631

Figure 102. Riser Card Installation onto the Bracket

- Align the riser card to the threaded standoffs on the mounting bracket.
- Using the supplied screws, secure the riser card to the bracket. Tighten to 5 in-lb.

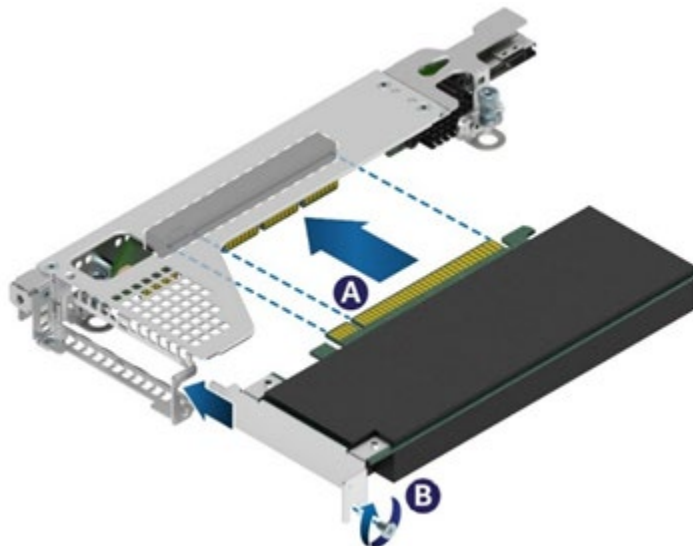

Figure 103. Add-in Card Installation

10. Reinstall the add-in card into the riser card
11. Using the fastener screws, secure the add-in card to the riser card bracket (see Letter B). Tighten to 5 in-lb.

Note: For add-in cards with internal cable connectors, it may be necessary to connect cables before installing the riser card assembly into the system. See [Section 3.2](#) for cable routing guidance.

The following installation procedure is the same for all riser card assemblies.

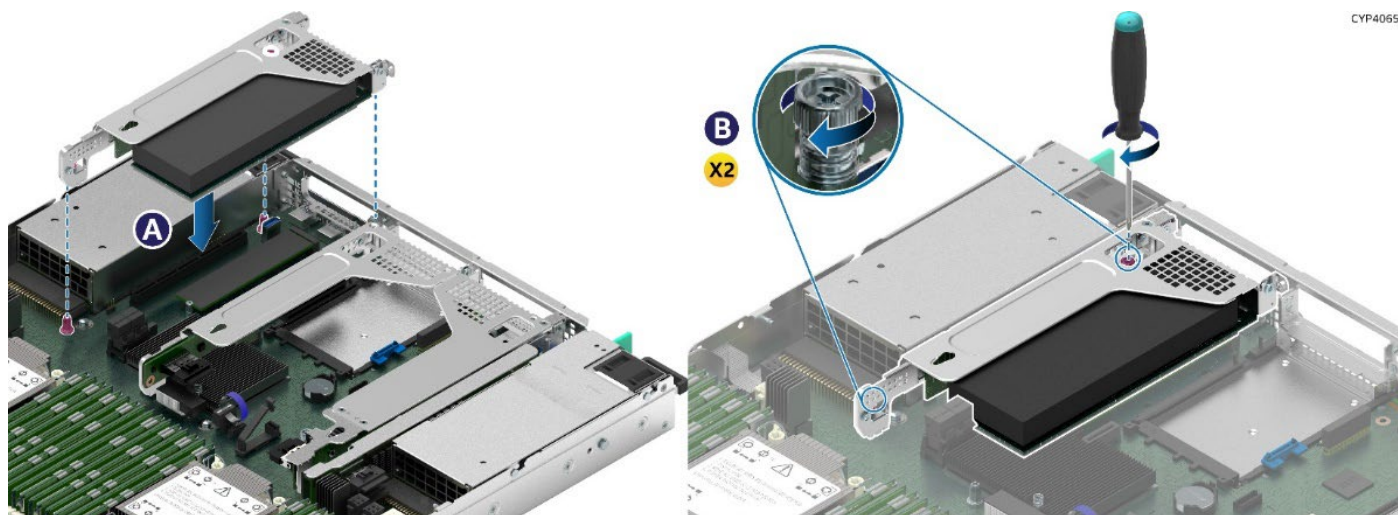

Figure 104. Add-in Card Assembly Installation

12. Position the riser card edge connector over the server board riser slot.
13. Align the two key slots on the back edge of the riser card assembly with the mounting keys on the back of the chassis.
14. Once aligned, press the riser card assembly straight down into the riser slot (see Letter A).
15. Using the two static screw heads on the riser bracket, secure the riser card assembly to the server board (see Letter B). Tighten to 5 in-lb.
16. Connect any cables to the add-in card that are required. See your add-in card documentation for additional information.
17. Reinstall the system top cover.

18. Reinstall the system top cover (see Section 6.5.2).

Note: To transport a fully integrated system, Intel highly recommends the system include four shipping screws (not included) installed to the system back panel (see [Figure 105](#)). These screws provide the chassis with additional support by reducing chassis flex and minimizing sag of the base plate. Installed screws should meet the following specifications: flat head, 6–32 thread, 3.75 mm length



Figure 105. Back Panel Shipping Screw Locations

6.7 Front Drive Replacement

The Intel® Server System M50FCP1UR has front drive bays that only support 2.5" SSDs. Supported SSDs can have a drive height of 7mm or 15mm. 7mm must be attached to a supplied drive mounting bracket to be compatible with the front drive bays.

All drives are mounted to a tool-less, non-detachable, drive rail. Drives interface with a backplane that is mounted to the back side of the front drive bay. Data I/O cables are attached between the backplane and various storage controller options within the system. The front drives are hot swap capable with supported redundant RAID configurations.

This section provides procedures for the replacement of a faulty SSD.

Required Tools and Supplies

- Replacement 2.5" Solid State Drive (SSD)
- Anti-static wrist strap and conductive workbench pad (recommended)

The following figure identifies the 2.5" drive bay components.

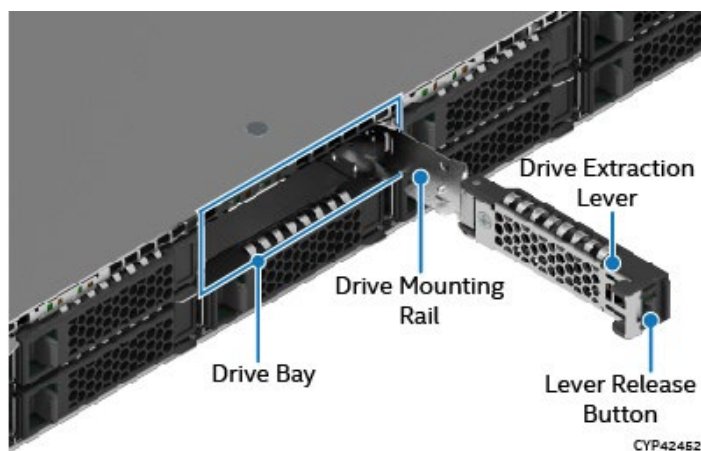

Figure 106. Drive Bay Components

Note: To ensure proper system airflow requirements, all front drive bays must be populated with either a drive or supplied drive blank.

Note: The integrated 2.5" drive rails are not removable. They slide out far enough to allow SSDs or drive blanks to be serviced. When sliding out a drive rail from the drive bay, only pull it as much as it allows without forcing it.

6.5.1 2.5" SSD Drive Removal

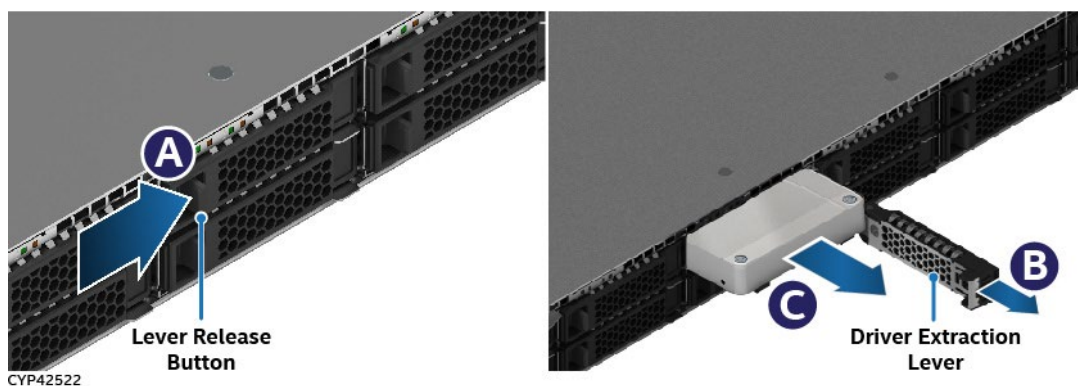

Figure 107. 2.5" 15 mm Drive Removal

1. Press the button on the drive extraction lever to release it. See Letter A.
2. Using the lever, pull the drive rail out from the drive bay as far as it allows (see Letter B).
3. Pull the drive from the drive bay (see Letter C).

6.5.2 7 mm 2.5" SSD Drive Replacement

Note: Skip this section if replacing a 15mm SSD.

SSDs with a height of 7 mm are attached to a mounting bracket. When replacing a 7 mm drive, the mounting bracket must be detached from the SSD and re-attached onto its replacement before it can be installed into the drive bay.

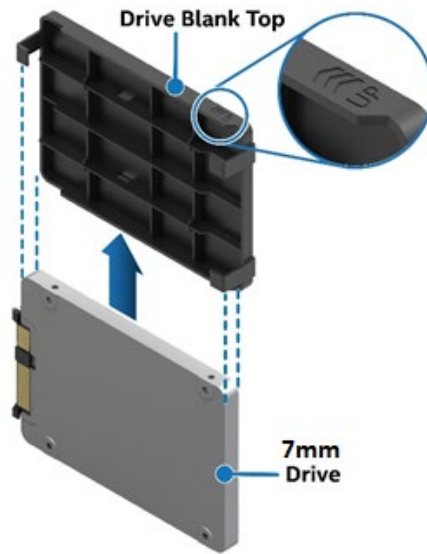

Figure 108. Detaching a 7mm SSD from its mounting bracket

1. Slide the mounting bracket up and away from the SSD
2. Locate and carefully unpack the replacement SSD

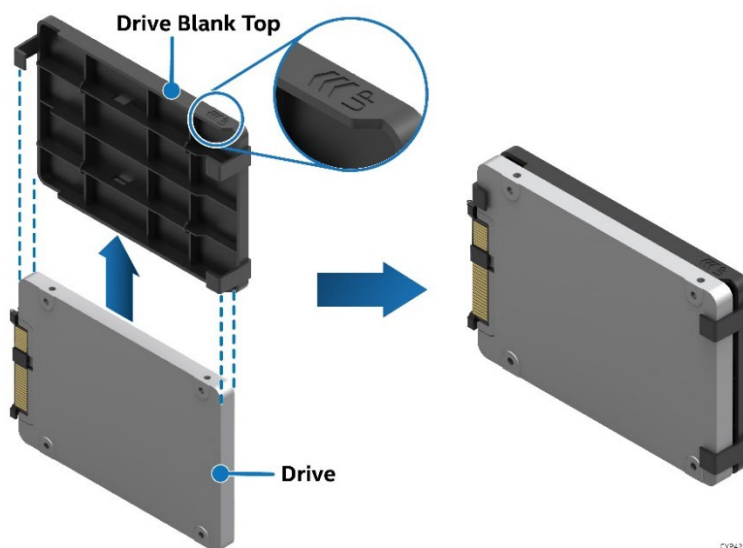

Figure 109. 7mm SSD Assembly

3. Slide the 7mm SSD up into the mounting bracket

6.5.3 2.5" SSD Drive Installation

The procedure to install a drive into a drive bay is the same for both 7mm (drive + bracket) and 15mm SSDs. Note the drive orientation before installing the drive into the drive bay. Installing a drive incorrectly can damage the interface connectors of the drive and the backplane.



Figure 110. Drive Rail Extraction Lever Release

1. Release and position the extraction lever out to the fully open position. Pull out the drive rail as far as it allows.

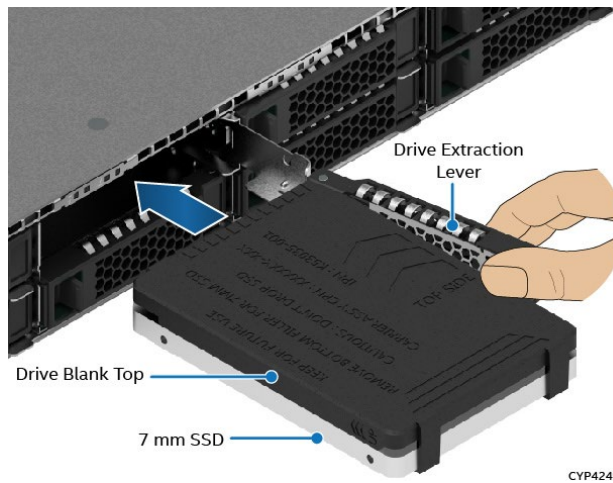

Figure 111. 7mm (Drive + Bracket) Drive Placement Orientation—Bracket Side Up

2. Align the drive with the open drive bay and position the SSD onto the drive rail.

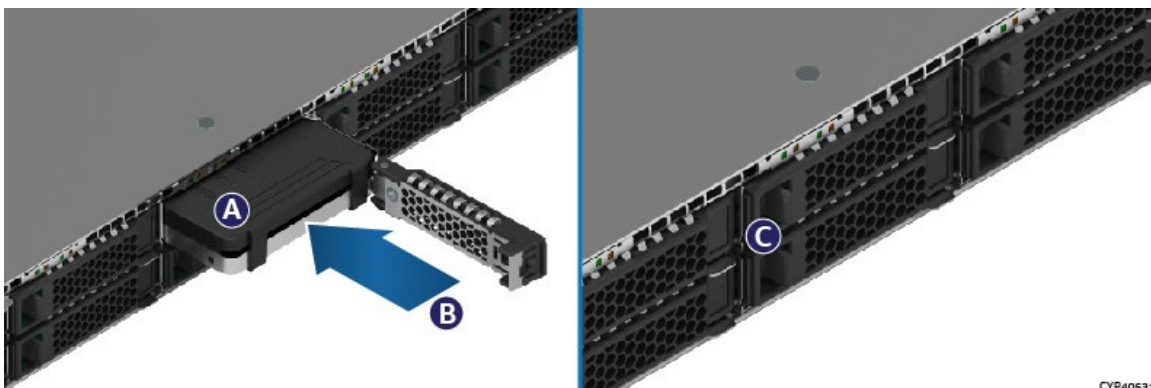

Figure 112. 2.5" Drive installation into drive bay

3. Insert the drive into the drive bay (see Letter A).

Note: Intel recommends holding the drive with one hand while holding the lever with the other hand.

4. Slide the drive forward until it is fully connected with the backplane (see Letter B).
5. Complete the drive installation by closing the drive extraction lever until it locks into place (see Letter C).

6.8 2.5" Drive Mounting Rail Replacement

Systems that support 2.5" front drive bays include a drive rail used to guide SSD into or out of a front drive bay. Removal of the drive rail from the drive bay is not required when servicing an SSD. However, if damaged, the drive rail can be removed from the drive bay for repair and or replacement.

Required Tools and Supplies

- 2.5" drive mounting rail kit
- Anti-static wrist strap and conductive workbench pad (recommended)

The following figure shows the backside of the drive rail identifying the two alignment keys and the locking tab.

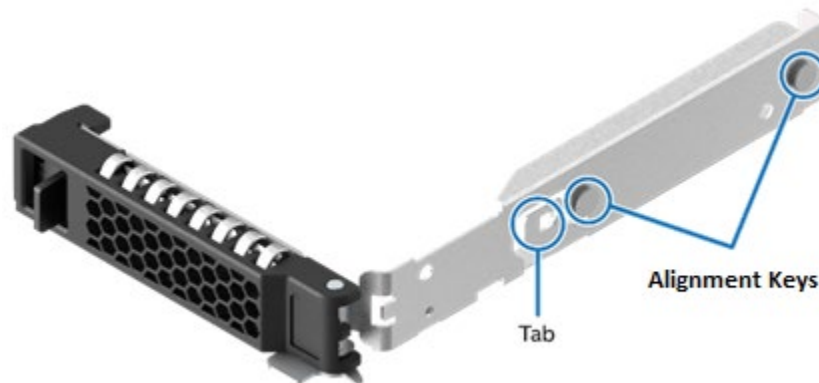

Figure 113. Drive Rail Features Identification

1. Remove the drive rail from the front drive bay.

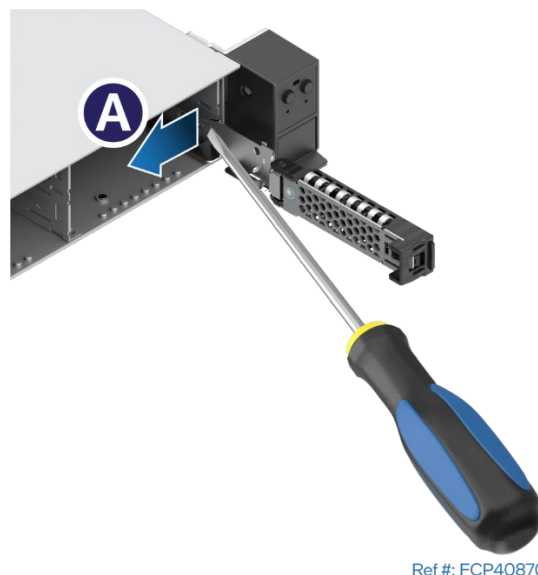

Figure 114. Removing Drive Rail

- Release and set the extraction lever to the fully open position
- Looking inside the drive bay, visually locate the locking tab on the drive rail
- Using a flat head screwdriver, carefully twist the locking tab inward to unlock the drive rail from the drive bay (see Letter A).
- Gently lift the drive rail from the alignment slot and pull it out and away from the drive bay.

Note: Handle the drive rail with care. Do not bend or twist it.

2. Install the drive rail into the drive bay.

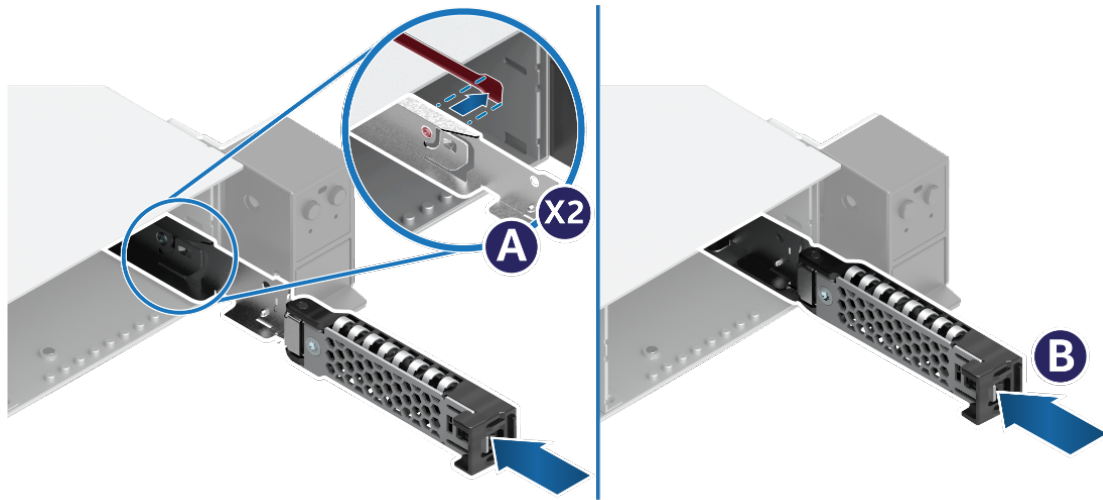

Figure 115. Installing Drive Mounting Rail

- Release and set the extraction lever to the fully open position
- Align and insert the two alignment keys on the drive rail with the alignment slot on the side of the drive bay (see Letter A).
- Slide the drive rail towards the back of the bay until it locks in place (see Letter B).

6.9 Ethernet Network Adapter for OCP* Replacement

This section provides instructions for replacement of an OCP* add-in card. OCP add-in cards will have one of two methods to secure the card within the OCP bay. Refer to the section that supports the card type to be replaced.

- Pull-Tab and Thumb Screw – Section 6.9.1
- Internal Lock – Section 6.9.2

Required Tools and Supplies

- OCP Ethernet Network Adapter
- Anti-static wrist strap and conductive workbench pad (recommended)
- Phillips* head screwdriver #1

Note: The OCP card bay must have a filler plate installed when not populated with an OCP card.

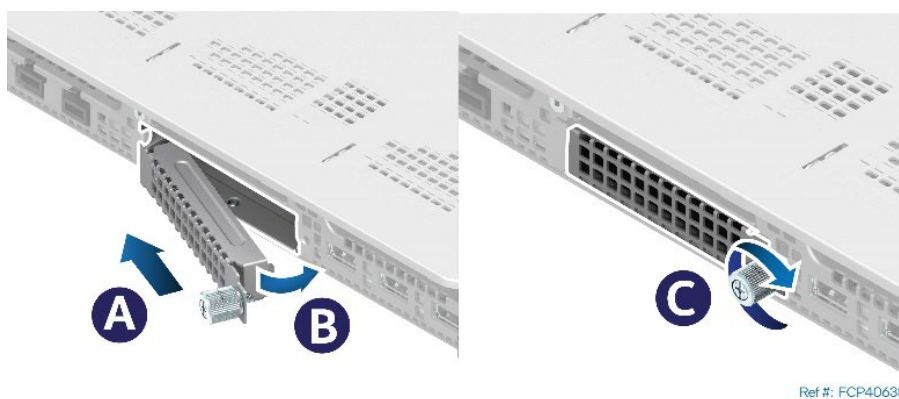

6.5.1 OCP* Add-in Card with Pull Tab Replacement

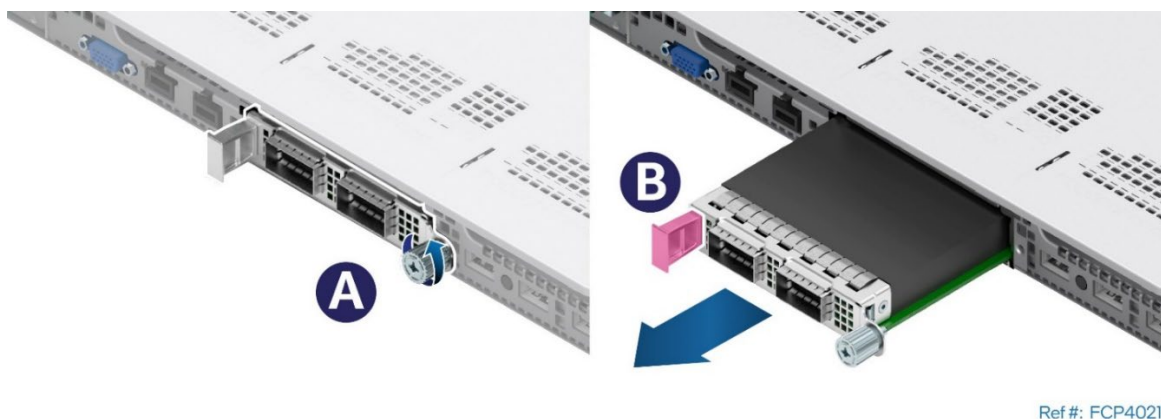

Figure 116. OCP* Adapter with Pull Tab Removal

1. Loosen the thumb screw on the right side of the OCP adapter (see Letter A).
2. Using the pull tab on the left side of the OCP card, pull the card from the bay (see Letter B).
3. Locate and carefully unpack the replacement card.

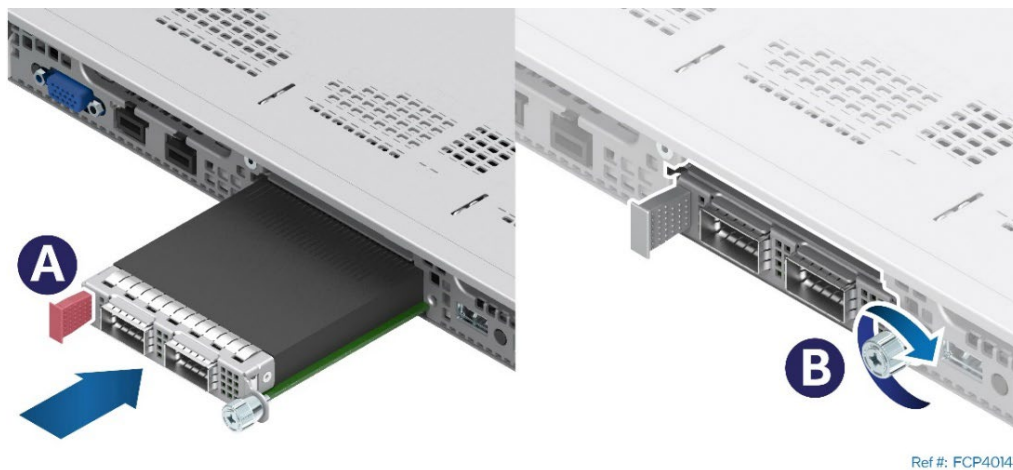

Figure 117. OCP* Adapter with Pull Tab Installation

4. Align the OCP adapter with the open OCP bay and slide it forward until the connectors make secure contact (see Letter A).
5. Secure the card to the chassis using the thumb screw on the right side of the OCP card (see Letter B).

6.5.2 OCP* Adapter with Internal Lock Replacement

All L6 and L9 integrated systems come with an internal lock on the internal OCP mounting rail. This lock is a piece of blue plastic. The OCP rail in the system has a dedicated space to accommodate the lock. The lock can be mounted on the rail in two different orientations. When the keying features of the lock are facing up, it is in an unlocked orientation. When the keying features are facing down, it is in a locked orientation. A lock symbol is included in each side of the plastic lock to indicate its orientation. The following figure shows the features of the lock.

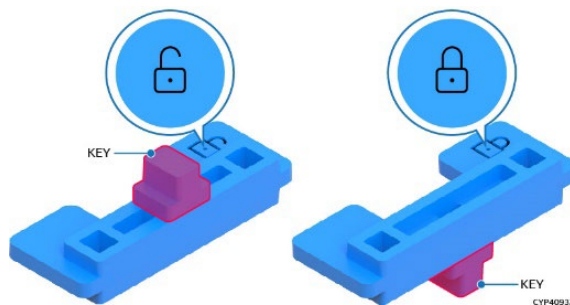

Figure 118. Internal Lock with Unlock and Lock Orientation

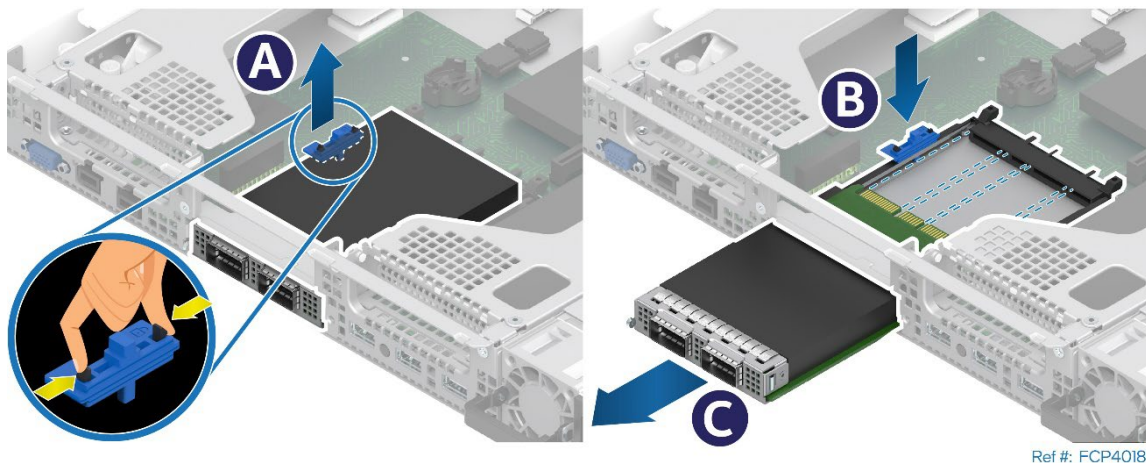

Figure 119. OCP* Adapter with Internal Lock Removal

1. Remove the system top cover (see Section 6.5.1).

2. Remove the Riser #2 assembly from above the OCP adapter area (see [Section 6.6](#)).
3. Squeeze the two hooks of the internal lock and removed it from the OCP rail (see Letter A).
4. Turn the lock over and reinstall it back onto the OCP rail (see Letter B).
5. Push the OCP adapter out of the bay from inside the chassis (see Letter C).

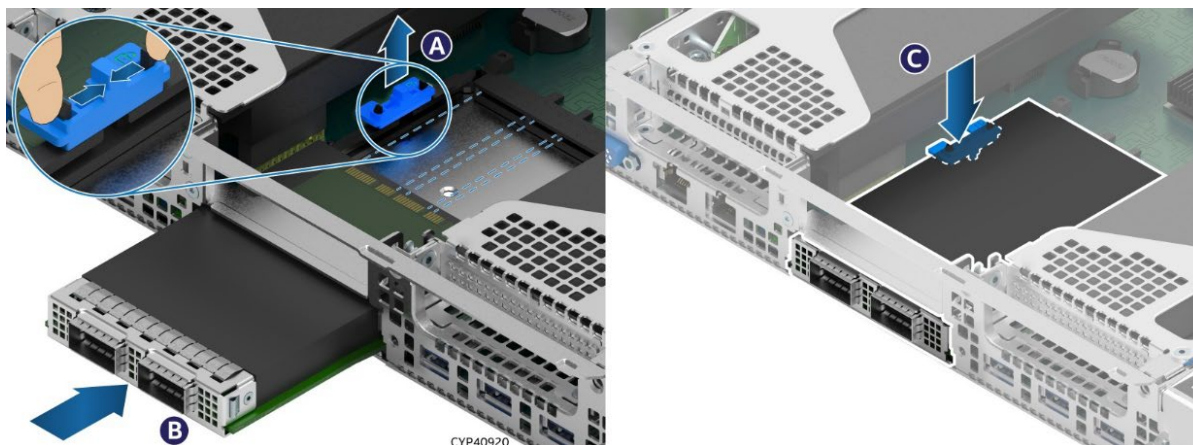

Figure 120. OCP* Adapter with Internal Lock Installation

6. Squeeze the two hooks of the internal lock and remove it from the OCP rail (see Letter A).
7. Align the OCP adapter with the open OCP* bay slot and slide forward until the connectors make secure contact (see Letter B).
8. Reinstall the internal lock with the lock orientation (see Letter C).
9. Reinstall the riser card assembly as needed (see [Section 6.6](#)).
10. Reinstall the system top cover (see [Section 6.5.2](#)).

6.10 M.2 Storage Device Replacement

The server board includes two M.2 connectors as shown in the following figure. Each M.2 connector supports a PCIe* NVMe* or SATA SSD drive that conforms to a 22110 (110 mm) or 2280 (80 mm) form factor.

Required Tools and Supplies

- Replacement M.2 SSD
- Anti-static wrist strap and conductive workbench pad (recommended)
- Phillips* head screwdriver #1

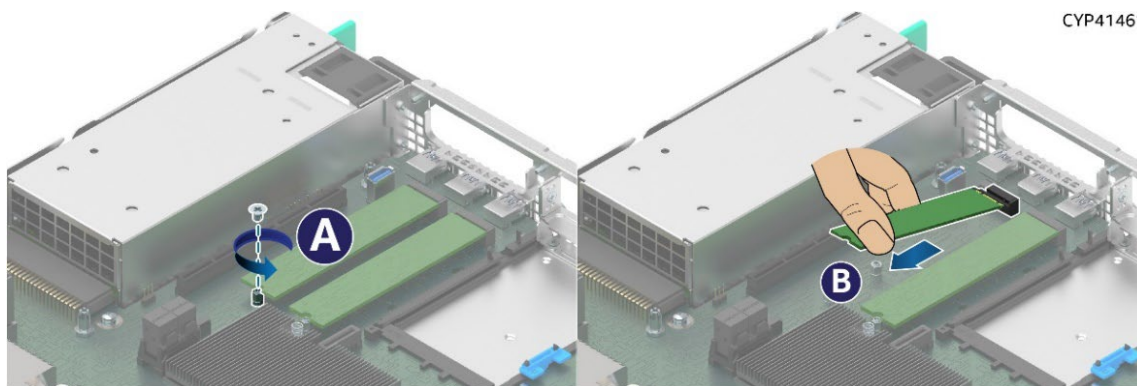

Figure 121. M.2 SSD Removal

1. Power off the system and disconnect the system power cords.
2. Remove the system top cover (see [Section 6.5.1](#)).
3. Remove the Riser #1 assembly (see [Section 6.6](#)).
4. Locate the M.2 to be replaced.

5. Remove the screw to release the M.2 SSD from the server board (see Letter A).
6. Carefully lift the free end of the M.2 SSD and gently remove it from the connector in the direction shown (see Letter B).
7. Locate and carefully unpack the replacement M.2 SSD. Hold it by its edges.

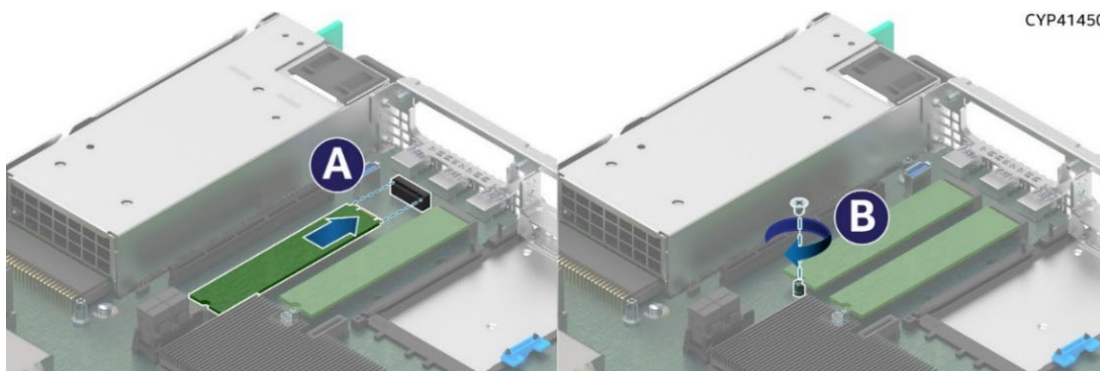

Figure 122. M.2 SSD Installation

8. Depending on the length of the M.2 SSD, use the onboard M.2 mounting stand-off at the appropriate location.
9. Align and insert the M.2 SSD with the connector on the server board. See Letter A.
- 10.
11. Using the screw, secure the SSD to the mounting stand-off (see Letter B). Tighten to 1.5 in-lb.
12. Reinstall the riser card assembly (see [Section 6.6](#)).
13. Reinstall the system top cover (see [Section 6.5.2](#)).

6.11 Intel® RAID Maintenance Free Backup Unit (RMFBU) Replacement

This section provides instructions to replace an RMFBU bracket and assembly in the system.

Required Tools and Supplies

- Replacement RMFBU Kit
- Anti-static wrist strap and conductive workbench pad (recommended)

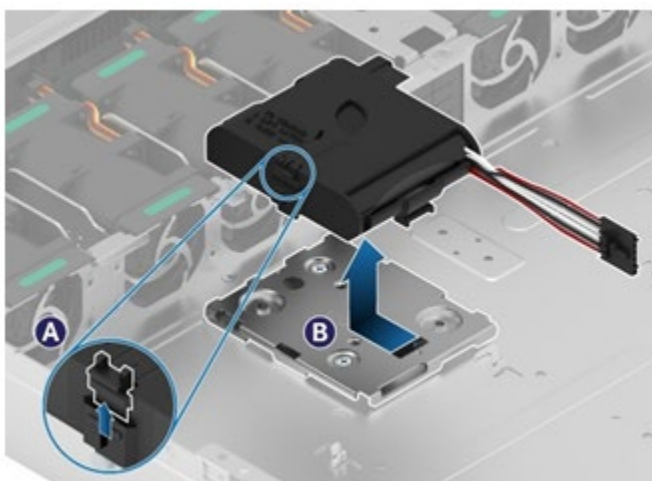

Figure 123. Intel® RMFBU Mounting Bracket Removal - Chassis

1. Remove the system top cover (see [Section 6.5.1](#)).
2. Disconnect RMFBU cables.

3. Locate the RMFBU housing assembly and slide the latch up to unlock the assembly from the mounting plate (see Letter A).
4. Slide the RMFBU housing assembly (see Letter B) towards the system fans. When free from the mounting plate, lift it up and out of the system.
5. Remove the RMFBU from the plastic housing
6. Locate and carefully unpack the replacement RMFBU



Figure 124. RMFBU Housing Assembly

7. Insert the RMFBU super capacitor into the plastic housing with the cable protruding out from one of the cable routing openings. Choose the opening resulting in the best cable routing to the RAID module.

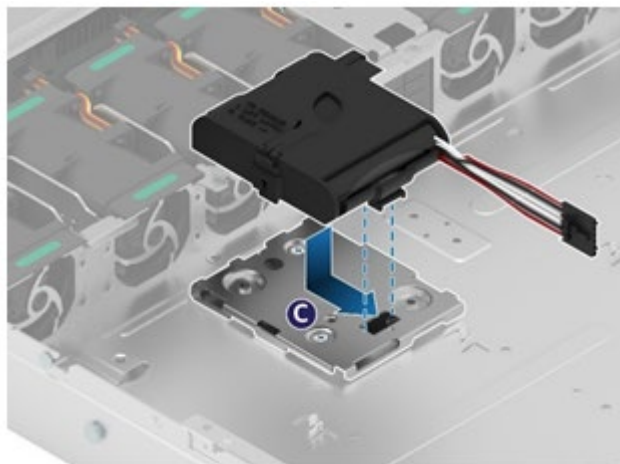

Figure 125. Intel® RMFBU Mounting Bracket Installation

8. Slide the RMFBU housing assembly in the direction as indicated on the mounting plate (see Letter C) until the latch locks in place.
9. Attach cables as required.
10. Reinstall the system top cover (see [Section 6.5.2](#)).

6.12 Backplane Replacement

Depending on the system configuration, the Intel® Server System M50FCP1UR includes either a 4 x 2.5" backplane or 12 x 2.5" backplane. This section provides the procedures necessary to replace both types.

6.5.1 4 X 2.5" Backplane Replacement

Required Tools and Supplies

- Intel backplane kit
- Anti-static wrist strap and conductive anti-static wrist strap and conductive workbench pad (recommended)
- Phillips* head screwdriver #1

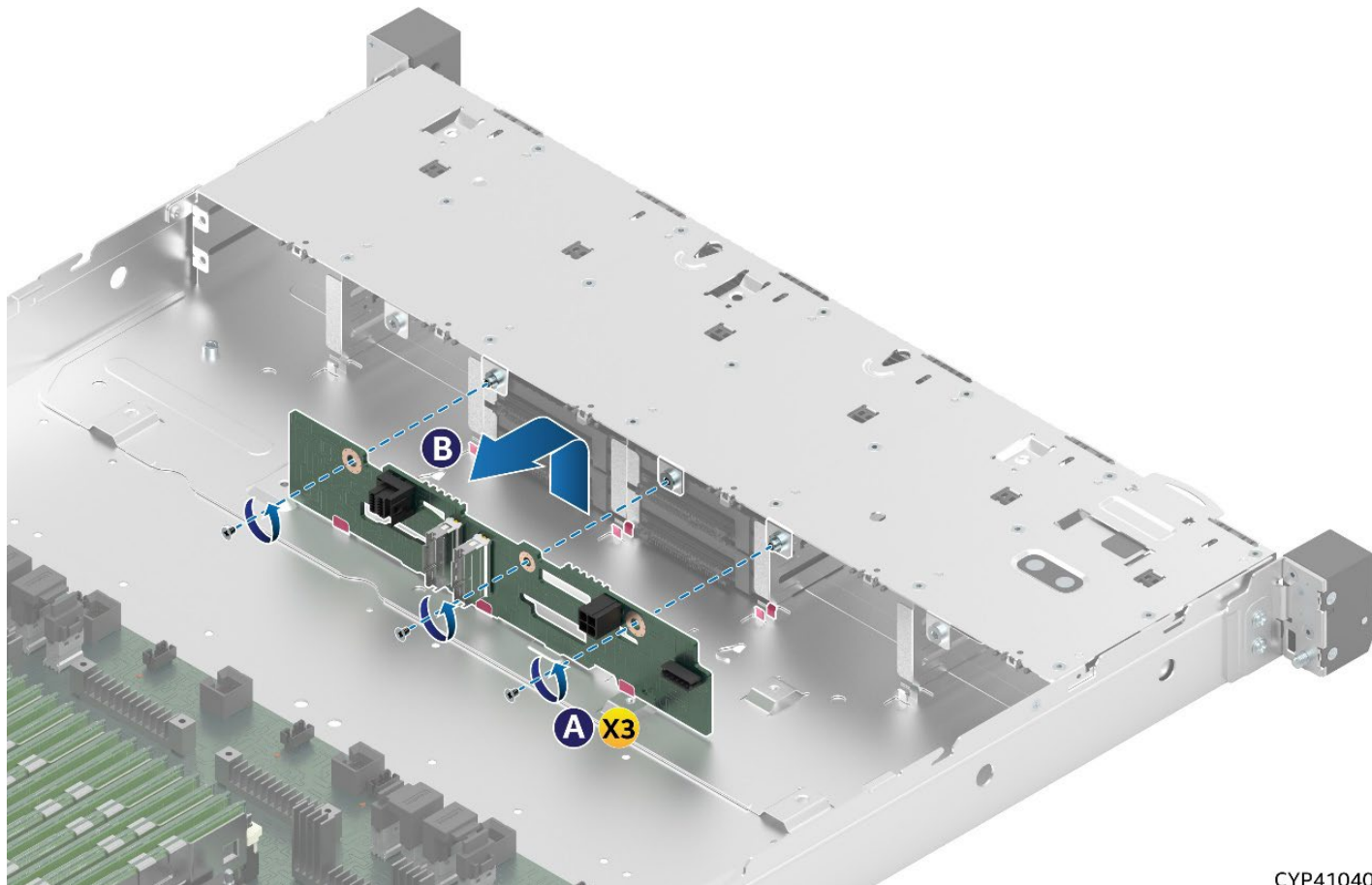

CYP41040

Figure 126. 4 x 2.5" Backplane Removal

1. Power off the system and disconnect the system power cords.
2. Remove the system top cover (see [Section 6.5.1](#)).
3. Remove all drives and drive blanks from the front drive bays. NOTE: If drives are configured to a RAID partition, label the drives to identify the drive bay location from which they were removed.
4. Disconnect all cables from the backplane. NOTE: If drives are configured to a RAID partition, label each drive I/O cable to identify the backplane cable connection from which they were disconnected.
5. Remove the three screws securing the backplane to drive bay (see Letter A).
6. Lift the backplane up from the chassis base and pull it out from the system (see Letter B).

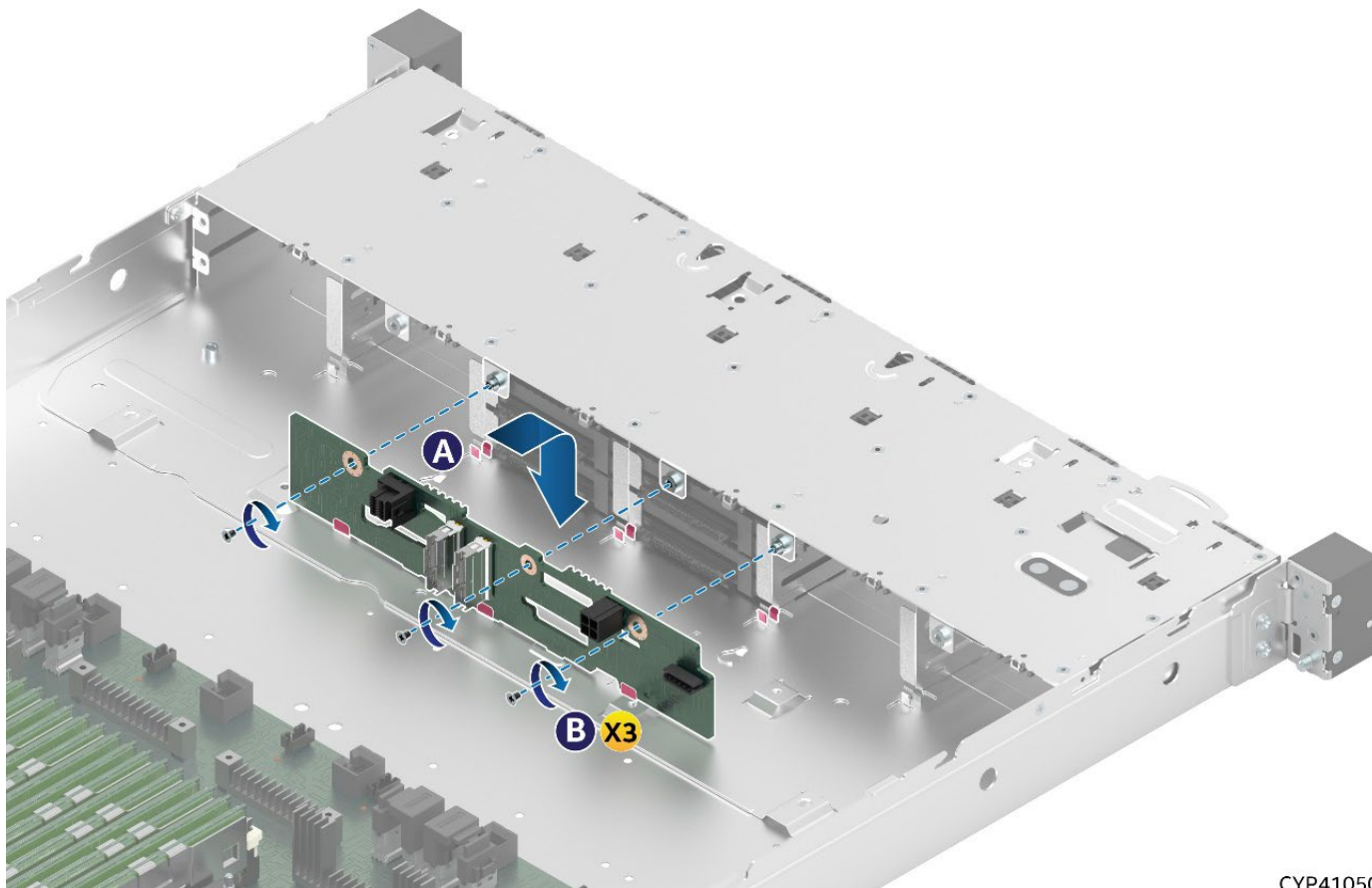

CYP41050

Figure 127. 4 x 2.5" Backplane Installation

7. Locate and carefully unpack the replacement backplane.

Note: Hold the backplane by its edges. Do not touch any components mounted to the backplane.

8. Align and lower the bottom edge of the backplane with the three tabs on the chassis base. See [Figure 127](#) (see Letter A).
9. Verify the alignment of the three backplane mounting holes with the threaded studs of the front drive bay.
10. Secure the backplane with three screws as shown (see Letter B).
11. Re-attach all cables to the backplane.
12. Reinstall all drives and/or drive blanks into the front drive bay.

Notes:

- All front drive bays must be populated with an SSD or supplied drive blank.
 - If the front drives were configured as part of a RAID partition, ensure that all drive I/O cables and drives were reinstalled to the same locations as they were configured before the procedure.
-

13. Reinstall the system top cover (see [Section 6.5.2](#)).

6.5.2 12 X 2.5" Backplane Replacement

Required Tools and Supplies

- Intel backplane kit
- Anti-static wrist strap and conductive anti-static wrist strap and conductive workbench pad (recommended)
- Phillips* head screwdriver #1

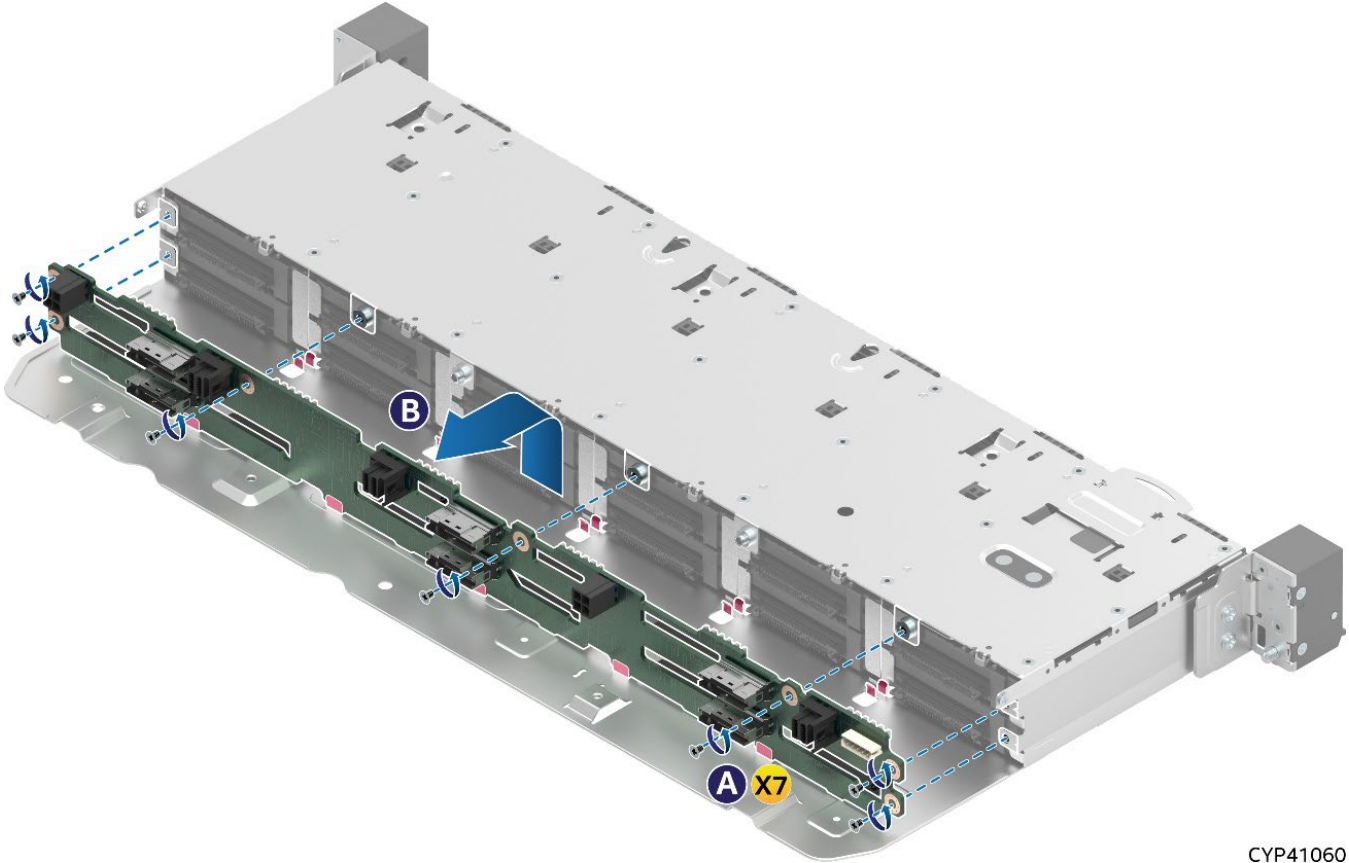

CYP41060

Figure 128. 12 x 2.5" Backplane Removal

1. Power off the system and disconnect the system power cords.
2. Remove the system top cover (see [Section 6.5.1](#)).
3. Remove all drives and drive blanks from the front drive bays. NOTE: If drives are configured to a RAID partition, label the drives to identify the drive bay location from which they were removed.
4. Disconnect all cables from the backplane. NOTE: If drives are configured to a RAID partition, label each drive I/O cable to identify the backplane cable connection from which they were disconnected.
5. Remove the seven screws securing the backplane to drive bay (see Letter A).
6. Lift the backplane up from the chassis base and pull it out from the system (see Letter B).

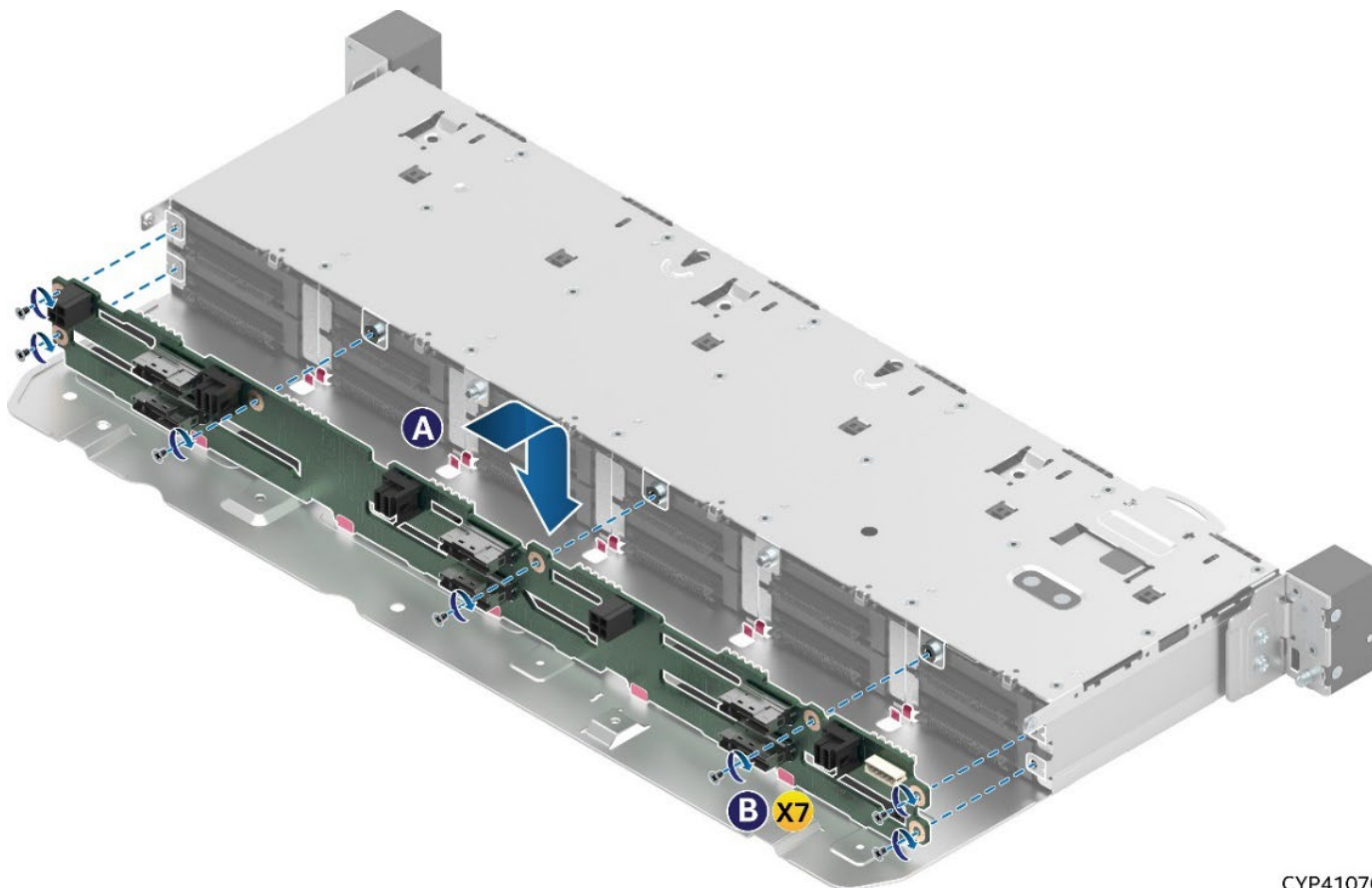

CYP41070

Figure 129. 12 x 2.5" Backplane Installation

7. Locate and carefully unpack the replacement backplane.
8. Note: Hold the backplane by its edges. Do not touch any components mounted to the backplane.
9. Align and lower the bottom edge of the backplane with the three tabs on the chassis base. See Figure 127 (see Letter A).
10. Verify the seven mounting holes of the backplane align with the threaded studs of the front drive bay.
11. Secure the backplane with seven screws as shown (see Letter B).
12. Re-attach all cables to the backplane.
13. Reinstall all drives and/or drive blanks into the front drive bay.

Notes:

- All front drive bays must be populated with an SSD or supplied drive blank.
 - If the front drives were configured as part of a RAID partition, ensure that all drive I/O cables and drives were reinstalled to the same locations as they were configured before the procedure.
-

14. Reinstall the system top cover (see [Section 6.5.2](#)).

6.13 System Battery Replacement

Required Tools and Supplies

- Compatible CR2032 lithium battery
- Anti-static wrist strap and conductive workbench pad (recommended)

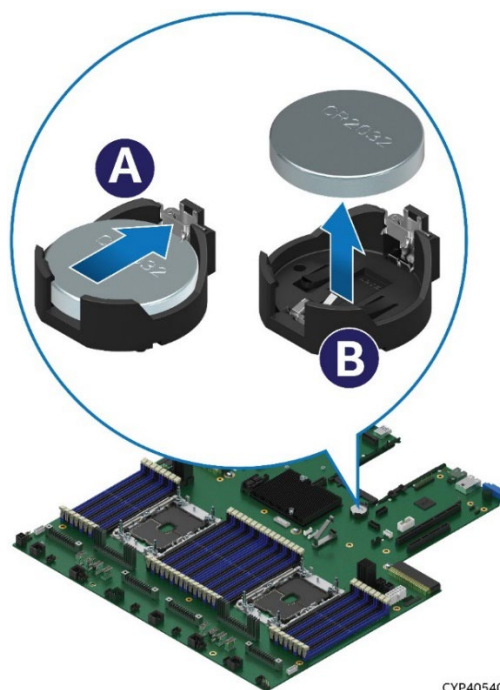

CYP40540

Figure 130. Replacing the System Battery

1. Power off the system
2. Remove the system top cover (see [Section 6.5.1](#)).
3. If present, remove riser card assembly above the battery location (see [Section 6.6](#)).
4. Locate the battery on the server board.
5. Gently press the metal clip as shown to release the battery (see Letter A).
6. Remove the battery from the plastic socket (see Letter B).
7. Dispose of the battery according to local laws.
8. Remove the new lithium battery from its package. Being careful to observe the correct polarity, insert it into the battery socket.
9. Reinstall riser card assemblies if needed (see [Section 6.6](#)).
10. Reinstall the system top cover (see [Section 6.5.2](#)).
11. Use the <F2> BIOS Setup Utility to restore BIOS Settings and reset the system time and date.

6.14 Server Board Replacement

Required Tools and Supplies

- Intel® Server Board M50FCP2SBSTD spare
- Anti-static wrist strap and conductive workbench pad (recommended)
- Phillips* head screwdriver #2

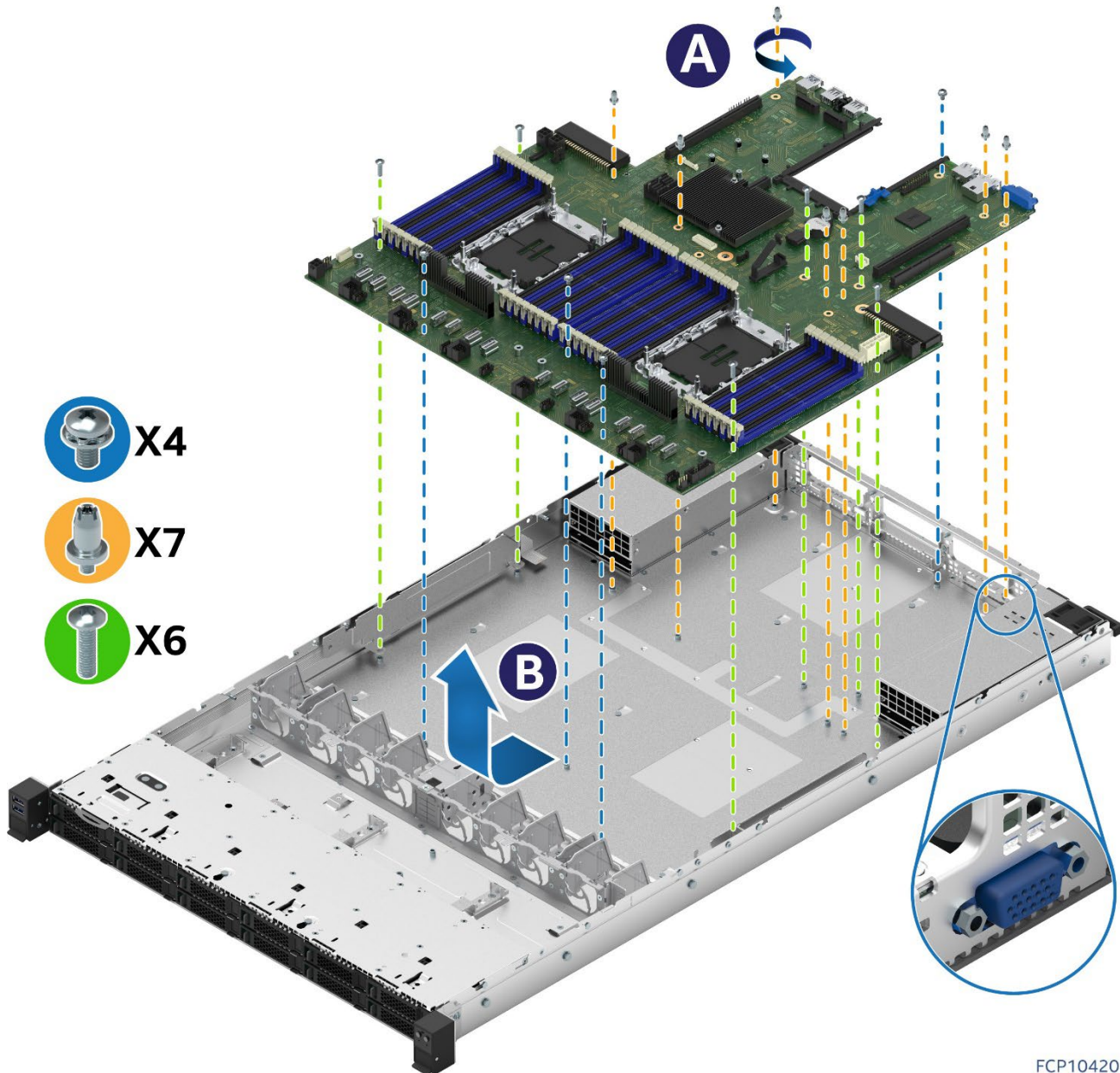

FCP10420

Figure 131. Server Board Removal

1. Power off system and remove power cords from each power supply module installed.
2. Disconnect all externally attached cables.
3. Remove the system top cover (see [Section 6.5.1](#)).
4. Remove power supply modules (see [Section 6.4](#)).
5. Remove all system fans (see [Section 6.2](#)).
6. Disconnect all internal cables attached to PCIe add-in cards.
7. (If present) Remove all screws from the chassis back panel (see [Figure 34](#))

8. Remove riser card assemblies (see [Section 6.6](#)).
9. If present, remove the OCP add-in card
10. If present, remove all options installed onto the server board, including: TPM Module and M.2 SSDs
11. Remove processors (see [Section 6.5.1](#)).
12. Remove all memory modules and DIMM blanks (see [Section 6.3](#)).
13. Disconnect all cables attached to connectors on the server board.
14. Detach the two metal air baffles attached to the left and right edges of the server board and carefully lift the air baffles attached on both PSU bays up and away.
15. Remove all fasteners used to secure the server board to the chassis (see Letter 'A').
16. Slide the server board towards the front of the chassis to disengage all external connectors from the chassis cut-outs on the chassis back panel.
17. Carefully lift the server board from the chassis and place it into an anti-static bag.
18. Verify that all cables are clear of the board placement target within the chassis.
19. Locate and carefully remove the server board from its anti-static bag. Hold the server board by its edges. Do not touch any components on the server board.

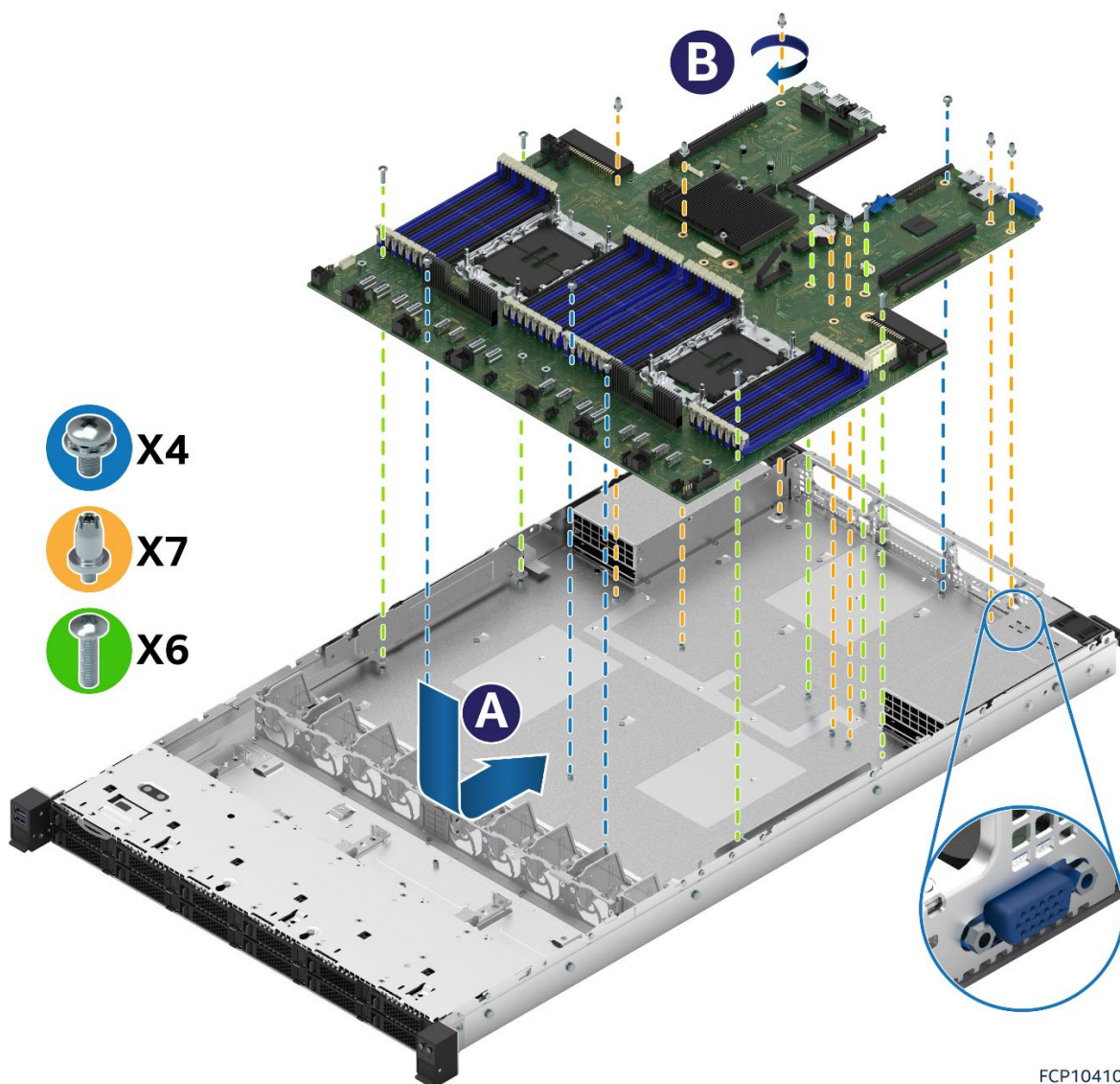

FCP10410

Figure 132. Server Board Installation

20. Carefully lower the server board into the chassis.

21. Slide the server board towards the back of the chassis until all external connectors on the back edge of the server board are in place with the cut outs on the chassis back panel.
22. Verify that all screw holes align with the chassis standoffs (see Letter A).
23. Secure the server board to the chassis using all the fasteners removed in Step 14. (See Letter B), Tighten to 5 in-lb.
24. Place and secure the right and left metal air baffles to edges of the server board. Tighten to 5 in-lb. Lower the air baffles attached on both PSU bays to the server board.
25. Re-attach all cables previously disconnected from the server board.
26. Reinstall processors (see [Section 6.5.3](#)).
27. Reinstall memory modules and DIMM blanks (see [Section 6.3](#)).
28. Reinstall all options previously removed from the server board.
29. Reinstall riser card assemblies (see [Section 6.6](#)).
30. Re-attach all internal cables previously detached from PCIe add-in cards. See [Section 3.2](#) for cable routing.
31. Reinstall all system fans (see [Section 6.2](#)).
32. Reinstall power supply modules (see [Section 6.4](#)).
33. Reinstall the system top cover (see [Section 6.5.2](#)).

Appendix A. Getting Help

Available Intel support options with your Intel Server System:

- 24x7 support through Intel's support webpage at <https://www.intel.com/content/www/us/en/support/products/1201/server-products.html>

Information available at the support site includes:

- Latest BIOS, firmware, drivers, and utilities
- Product documentation, setup, and service guides
- Full product specifications, technical advisories, and errata
- Compatibility documentation for memory, hardware add-in cards, and operating systems
- Server and chassis accessory parts list for ordering upgrades or spare parts
- A searchable knowledge base to search for product information throughout the support site

Quick Links:

<p>Use the following links for support on Intel Server Boards and Server Systems</p>	<p style="text-align: center;">Download Center</p> <div style="text-align: center;">  </div> <p style="text-align: center;">http://www.intel.com/support/downloadserversw</p>	<p style="text-align: center;">BIOS Support Page</p> <div style="text-align: center;">  </div> <p style="text-align: center;">http://www.intel.com/support/server/bios</p>	<p style="text-align: center;">Troubleshooting Boot Issue</p> <div style="text-align: center;">  </div> <p style="text-align: center;">http://www.intel.com/support/tsboot</p>
<p>Use the following links for support on Intel® Data Center Block (DCB) Integrated Systems*</p> <p>* Intel DCB comes pre-populated with processors, memory, storage, and peripherals based on how it was ordered through the Intel Configure to Order tool.</p>	<p style="text-align: center;">Download Center</p> <div style="text-align: center;">  </div> <p style="text-align: center;">http://www.intel.com/support/downloaddcb</p>	<p style="text-align: center;">Technical Support Documents</p> <div style="text-align: center;">  </div> <p style="text-align: center;">http://www.intel.com/support/dcb</p>	<p style="text-align: center;">Warranty and Support Info</p> <div style="text-align: center;">  </div> <p style="text-align: center;">http://www.intel.com/support/dcb/warranty</p>

- If a solution cannot be found at Intel's support site, submit a service request via Intel's online service center at <https://supporttickets.intel.com/servicecenter?lang=en-US>. In addition, you can also view previous support requests. (Login required to access previous support requests)
- Contact an Intel support representative using one of the support phone numbers available at <https://www.intel.com/content/www/us/en/support/contact-support.html> (charges may apply).

Intel also offers Partner Alliance Program members around-the-clock 24x7 technical phone support on Intel® server boards, server chassis, server RAID controller cards, and Intel® Server Management at <https://www.intel.com/content/www/us/en/partner-alliance/overview.html>

Note: The 24x7 support number is available after logging in to the Intel Partner Alliance website.

Warranty Information

To obtain warranty information, visit http://www.intel.com/p/en_US/support/warranty.

Appendix B. Memory Population Rules

B.1 DDR5 DIMM Population Rules

Note: Although mixed DDR5 DRAM DIMM configurations are supported, Intel only performs platform validation on systems that are configured with identical DIMMs installed.

The following memory population rules apply when installing DDR5 DIMMs:

- All DIMMs must be DDR5 DIMMs.
- All DIMMs in a processor socket must have the same number of ranks (unless explicitly specified otherwise)
- Mixing rules:
 - Mixing DDR5 DIMMs of different frequencies and latencies is not supported within or across processors. If a mixed configuration is encountered, the BIOS attempts to operate at the highest common frequency and the lowest latency possible.
 - x4 and x8 width DIMMs cannot be mixed in the same channel or same processor socket.
 - Mixing of DDR5 DIMM types (standard RDIMM, 3DS-RDIMM, 9x4 RDIMM) within or across processors is not supported. This will lead to a Fatal Error Halt during Memory Initialization.
 - Mixing vendors is supported for RDIMMs and 3DS RDIMMs.
 - Ranks mixing is not supported on a channel, except for Standard RDIMM 1 Rank +2 Rank combination, when 16 DIMMS for processor socket is populated.
- For a single DDR5 DIMM in a dual-slot channel, populate slot 1 (blue slot).
- For multiple DDR5 DIMMs per channel:
 - For RDIMM, 3DS-RDIMM, 9x4 RDIMM, always populate DIMMs with higher electrical loading in slot 1 (blue slot) followed by slot 2 (black slot).
- Memory slots associated with a given processor are unavailable if the corresponding processor socket is not populated.
- Processor sockets are self-contained and autonomous. However, all memory subsystem support (such as memory RAS and error management) in the BIOS Setup is applied commonly for each installed processor.
- For best system performance, memory must be installed in all eight channels for each installed processor.
- For best system performance in dual processor configurations, installed DDR5 DIMM type and population for DDR5 DIMMs configured to CPU 1 must match DDR5 DIMM type and population configured to CPU 0.

B.2 Intel® DDR5 DIMM Support Disclaimer

Intel validates, and only supports system configurations, where all installed DDR5 DIMMs have matching “Identical” or “Like” attributes (see [following table](#)). A system configured concurrently with DDR5 DIMMs from different vendors are supported by Intel if all other DDR5 “Like” DIMM attributes match.

Intel does not perform system validation testing, nor will it support system configurations, where all populated DDR5 DIMMs do not have matching “Like” DIMM attributes, as listed in the [following table](#).

Intel only supports Intel server systems configured with DDR5 DIMMs that have been validated by Intel and are listed on Intel’s Tested Memory list for a given Intel server family.

Intel configures and ships fully integrated L9 server systems. All DDR5 DIMMs within an L9 server system as shipped by Intel, are identical. All installed DIMMs have matching attributes as the attributes listed in the “Identical” *DDR5 DIMM Attributes* column in the [following table](#).

When purchasing more than one integrated L9 server system with the same configuration from Intel, Intel reserves the right to use “Like” DIMMs between server systems. At a minimum, “Like” DIMMs will have matching DIMM attributes as listed in the following table. However, the DIMM model #, revision #, or vendor may be different.

For warranty replacement, Intel will make every effort to ship back an exact match to the one returned. However, Intel may ship back a validated “Like” DIMM. A “Like” DIMM may be from the same vendor but may not be the same revision # or model #, or it may be an Intel validated DIMM from a different vendor. At a minimum, all “Like” DIMMs shipped from Intel will match attributes of the original part according to the definition of “Like” DIMMs in the following table.

Table 4. DDR5 DIMM Attributes Table for “Identical” and “Like” DIMMs

<ul style="list-style-type: none"> • DDR5 DIMMs are considered “Identical” when ALL listed attributes between the DIMMs match • Two or more DDR5 DIMMs are considered “Like” DIMMs when all attributes minus the Vendor, and/or DIMM Part # and/or DIMM Revision#, are the same. 			
Attribute	“Identical” DDR5 DIMM Attributes	“Like” DDR5 DIMM Attributes	Possible DDR5 Attribute Values
Vendor	Match	May be Different	Memory Vendor Name
DIMM Part #	Match	May be Different	Memory Vendor Part #
DIMM Revision #	Match	May be Different	Memory Vendor Part Revision #
SDRAM Type	Match	Match	DDR5
DIMM Type	Match	Match	RDIMM, 9x4 RDIMM
Speed (MT/s)	Match	Match	4000, 4400, 4800
Voltage	Match	Match	1.1 V
DIMM Size (GB)	Match	Match	16 GB, 32 GB, 64 GB, 128 GB, 256 GB
Organization	Match	Match	2Gx80; 4Gx80; 8Gx80; 16Gx80; 32Gx80
DIMM Rank	Match	Match	1R, 2R, 4R, 8R
DIMM Row Card (RC)	Match	Match	RC A, RC B, RC C, RC D, RC E, RC F
DRAM Width	Match	Match	x4, x8
DRAM Density	Match	Match	16 Gb

Appendix C. System Status LED Operating States and Definition

The server board includes a bi-color System Status LED. The system status LED on the server board is tied directly to the system status LED on the front panel (if present). This LED indicates the current health of the server system. LED states include solid green, blinking green, solid amber, and blinking amber.

When the server system is powered down (transitions to the DC-off state or S5), the BMC is still on standby power and retains the sensor and front panel status LED state established before the power-down event.

When AC power is first applied to the system, the status LED turns solid amber, and then immediately changes to blinking green to indicate that the BMC is booting. If the BMC boot process completes with no errors, the status LED changes to solid green.

Table 5. System Status LED State Definitions

LED State	System State	BIOS Status Description
Off	No AC Power to system	<ul style="list-style-type: none"> System power is not present. System is in EuP Lot6 off mode.
Solid green	System is operating normally.	<ul style="list-style-type: none"> System is in S5 soft-off state. System is running (in S0 State) and its status is healthy. The system is not exhibiting any errors. Source power is present, BMC has booted, and manageability functionality is operational. After a BMC reset, and with the chassis ID solid on, the BMC is booting Linux*. Control has been passed from BMC uBoot to BMC Linux*. It is in this state for 10–20 seconds.
Blinking green	System is operating in a degraded state although still functioning, or system is operating in a redundant state but with an impending failure warning.	<ul style="list-style-type: none"> Redundancy loss such as fan or power-supply (When Power Cold Redundancy is enabled). Applies only if the associated platform subsystem has redundancy capabilities. Fan warning or failure when the number of fully operational fans is less than the minimum number needed to cool the system. Non-critical threshold crossed temperature (including HSBP temp), voltage, input power to power supply, output current for main power rail from power supply and Processor Thermal Control (Therm Ctrl) sensors. Power supply predictive failure occurred while redundant power supply configuration was present. Unable to use all installed memory (more than 1 DIMM installed). Correctable Errors over a threshold and migrating to a spare DIMM (memory sparing). This situation indicates that the system no longer has spared DIMMs (a redundancy lost condition). Corresponding DIMM LED lit. In mirrored configuration, when memory mirroring takes place and system loses memory redundancy. Battery failure. BMC executing in uBoot. (Indicated by Chassis ID blinking at 3 Hz while Status blinking at 1 Hz). System in degraded state (no manageability). BMC uBoot is running but has not transferred control to BMC Linux*. Server is in this state 6–8 seconds after BMC reset while it pulls the Linux* image into flash. BMC Watchdog has reset the BMC. Power Unit sensor offset for configuration error is asserted. SSD Hot Swap Controller is off-line or degraded.
Blinking green and amber alternatively	System is initializing after source power is applied	<ul style="list-style-type: none"> PFR in the process of updating/authenticating/recovering when source power is connected, system firmware being updated. System not ready to take power button event/signal.

LED State	System State	BIOS Status Description
<p>Blinking amber</p>	<p>System is operating in a degraded state with an impending failure warning, although still functioning. System is likely to fail.</p>	<ul style="list-style-type: none"> • Critical threshold crossed–Voltage, temperature (including HSBP temp), input power to power supply, output current for main power rail from power supply and PROCHOT (Therm Ctrl) sensors. • VRD Hot asserted. • Minimum number of fans to cool the system not present or failed. • Hard drive fault. • Power Unit Redundancy sensor–Insufficient resources offset (indicates not enough power supplies present). • In non-sparing and non-mirroring mode, if the threshold of correctable errors is crossed within the window. • Invalid firmware image detected during boot up or firmware update.
<p>Solid amber</p>	<p>Critical/non-recoverable. System is halted. Fatal alarm–system has failed or shut down.</p>	<ul style="list-style-type: none"> • Processor CATERR signal asserted. • MSID mismatch detected (CATERR also asserts for this case). • CPU 0 is missing. • Processor Thermal Trip. • No power good–power fault. • DIMM failure when there is only 1 DIMM present and hence no good memory present. • Runtime memory uncorrectable error in non-redundant mode. • DIMM Thermal Trip or equivalent. • SSB Thermal Trip or equivalent. • Processor ERR2 signal asserted. • BMC/Video memory test failed. (Chassis ID shows blue/solid-on for this condition.) • Both uBoot BMC firmware images are bad. (Chassis ID shows blue/solid-on for this condition.) • 240 VA fault. • Fatal Error in processor initialization: <ul style="list-style-type: none"> ○ Processor family not identical ○ Processor model not identical ○ Processor core/thread counts not identical ○ Processor cache size not identical ○ Unable to synchronize processor frequency ○ Unable to synchronize QPI link frequency • BMC fail authentication with non-recoverable condition, system hang at T-1; boot PCH only, system hang; PIT failed, system lockdown.

Appendix D. POST Code Diagnostic LED Decoder

As an aid in troubleshooting a system hang that occurs during a system POST process, the server board includes a bank of eight POST code diagnostic LEDs on the back edge of the server board.

During the system boot process, Memory Reference Code (MRC) and system BIOS execute several memory initialization and platform configuration routines, each of which is assigned a hex POST code number.

As each process is started, the given POST code number is displayed to the POST code diagnostic LEDs on the back edge of the server board.

During a POST system hang, the displayed POST code can be used to identify the last POST routine that was run before the error occurred, helping to isolate the possible cause of the hang condition.

Each POST code is represented by eight LEDs: four green LEDs and four amber LEDs. The POST codes are divided into two nibbles: an upper nibble, and a lower nibble. The upper nibble bits are represented by amber LEDs and the lower nibble bits are represented by green LEDs. If the bit is set, the corresponding LED is lit. If the bit is clear, the corresponding LED is off. For each set of nibble bits, LED 0 represents the least significant bit (LSB) and LED 3 represents the most significant bit (MSB).

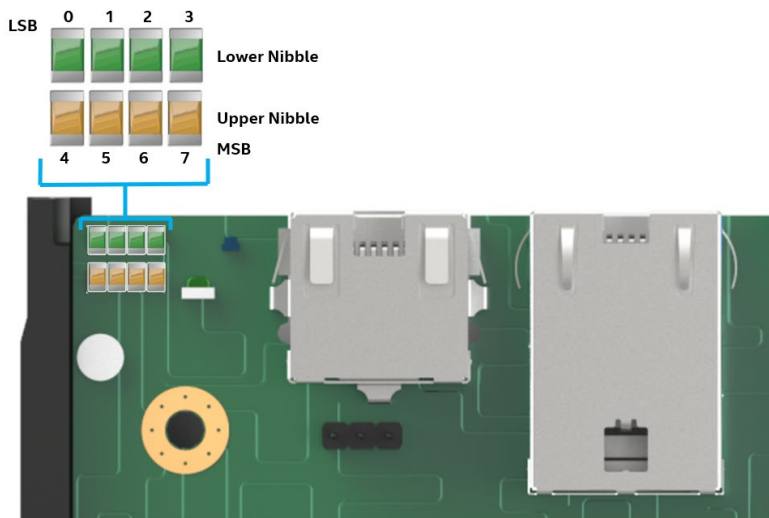

Figure 133. Onboard POST Diagnostic LEDs

Note: Diagnostic LEDs are best read and decoded when viewing the LEDs from the back of the system.

In the following example, the BIOS sends a value of AC to the diagnostic LED decoder. The LEDs are decoded as shown in the following table.

Table 6. POST Progress Code LED Example

LEDs		Upper Nibble AMBER LEDs				Lower Nibble GREEN LEDs			
		MSB							LSB
		LED #7	LED #6	LED #5	LED #4	LED #3	LED #2	LED #1	LED #0
		8h	4h	2h	1h	8h	4h	2h	1h
Status		ON	OFF	ON	OFF	ON	ON	OFF	OFF
Read Value	Binary	1	0	1	0	1	1	0	0
	Hexadecimal	Ah				Ch			
Result		ACh							

Upper nibble bits = 1010b = Ah; Lower nibble bits = 1100b = Ch; the two Hex Nibble values are combined to create a single ACh POST Progress Code.

D.1 Early POST Memory Initialization MRC Diagnostic Codes

Memory initialization at the beginning of POST includes multiple functions: discovery, channel training, validation that the DIMM population is acceptable and functional, initialization of the IMC and other hardware settings, and initialization of applicable RAS configurations.

The MRC progress codes are displayed to the diagnostic LEDs that show the execution point in the MRC operational path at each step.

Table 7. MRC Progress Codes

MRC Progress Code (Hex)	Upper Nibble				Lower Nibble				Description
	8h	4h	2h	1h	8h	4h	2h	1h	
73	0	1	1	1	0	0	1	1	NVRAM sync.
7E	0	1	1	1	1	1	1	0	MRC internal sync.
B0	1	0	1	1	0	0	0	0	Detect DIMM population
B1	1	0	1	1	0	0	0	1	Set DDR5 frequency
B2	1	0	1	1	0	0	1	0	Gather remaining SPD data
B3	1	0	1	1	0	0	1	1	Program registers on the memory controller level
B4	1	0	1	1	0	1	0	0	Evaluate RAS modes and save rank information
B5	1	0	1	1	0	1	0	1	Program registers on the channel level
B6	1	0	1	1	0	1	1	0	Perform the JEDEC defined initialization sequence
B7	1	0	1	1	0	1	1	1	Train DDR5 ranks
0	0	0	0	0	0	0	0	0	Train DDR5 channels: Receive enable training
3	0	0	0	0	0	0	1	1	Train DDR5 channels: Read DQ/DQS training
4	0	0	0	0	0	1	0	0	Train DDR5 channels: Write DQ/DQS training
11	0	0	0	1	0	0	0	1	Train DDR5 channels: End of channel training.
77	0	1	1	1	0	1	1	1	Train DDR5 channels: Write leveling training.
B8	1	0	1	1	1	0	0	0	Initialize CLTT/OLTT
B9	1	0	1	1	1	0	0	1	Hardware memory test and initialization
BA	1	0	1	1	1	0	1	0	Execute software memory initialization
BB	1	0	1	1	1	0	1	1	Program memory map and interleaving
BC	1	0	1	1	1	1	0	0	Program RAS configuration
BE	1	0	1	1	1	1	1	0	Execute BSSA RMT
BF	1	0	1	1	1	1	1	1	MRC is done

Should a major memory initialization error occur, preventing the system from booting with data integrity, a beep code is generated, the MRC displays a fatal error code on the diagnostic LEDs, and a system halt command is executed. Fatal MRC error halts do not change the state of the system status LED and they do not get logged as SEL events. [Table 8](#) lists all MRC fatal errors that are displayed to the diagnostic LEDs.

Note: Fatal MRC errors display POST error codes that may be the same as BIOS POST progress codes displayed later in the POST process. The fatal MRC codes can be distinguished from the BIOS POST progress codes by the accompanying memory failure beep code of three long beeps as identified in [Table 11](#).

Table 8. MRC Fatal Error Codes

Post Code (Hex)	Upper Nibble				Lower Nibble				Description
	8h	4h	2h	1h	8h	4h	2h	1h	
E8	1	1	1	0	1	0	0	0	No usable memory error 01h = No memory was detected from SPD read, or invalid config that causes no operable memory. 02h = Memory DIMMs on all channels of all sockets are inactivated due to hardware memtest error. 03h = No memory installed. All channels are inactivated.
E9	1	1	1	0	1	0	0	1	Memory is locked by Intel® TXT and is inaccessible
EA	1	1	1	0	1	0	1	0	DDR5 channel training error 01h = Error on read DQ/DQS (Data/Data Strobe) init 02h = Error on Receive Enable 03h = Error on Write Leveling 04h = Error on write DQ/DQS (Data/Data Strobe)
EB	1	1	1	0	1	0	1	1	Memory test failure 01h = Software memtest failure. 02h = Hardware memtest failed.
ED	1	1	1	0	1	1	0	1	DIMM configuration population error 01h = Different DIMM types (RDIMM, LRDIMM) are detected installed in the system. 02h = Violation of DIMM population rules. 03h = The 3rd DIMM slot cannot be populated when QR DIMMs are installed. 04h = UDIMMs are not supported. 05h = Unsupported DIMM Voltage.
EF	1	1	1	0	1	1	1	1	Indicates a CLTT table structure error

D.2 BIOS POST Progress Codes

The following table provides a list of all POST progress codes.

Table 9. POST Progress Codes

Post Code (Hex)	Upper Nibble				Lower Nibble				Description
	8h	4h	2h	1h	8h	4h	2h	1h	
Security (SEC) Phase									
01	0	0	0	0	0	0	0	1	First POST code after CPU reset
02	0	0	0	0	0	0	1	0	Microcode load begin
03	0	0	0	0	0	0	1	1	CRAM initialization begins
04	0	0	0	0	0	1	0	0	PEI Cache When Inactivated
05	0	0	0	0	0	1	0	1	SEC Core At Power On Begin.
06	0	0	0	0	0	1	1	0	Early CPU initialization during SEC Phase.
UPI RC (Fully leverage without platform change)									
A1	1	0	1	0	0	0	0	1	Collect info: SBSP, boot mode, reset type, etc.
A3	1	0	1	0	0	0	1	1	Setup minimum path between SBSP and other sockets
A6	1	0	1	0	0	1	1	0	Sync up with PBSPs
A7	1	0	1	0	0	1	1	1	Topology discovery and route calculation
A8	1	0	1	0	1	0	0	0	Program final route

Post Code (Hex)	Upper Nibble				Lower Nibble				Description
	8h	4h	2h	1h	8h	4h	2h	1h	
A9	1	0	1	0	1	0	0	1	Program final IO SAD setting
AA	1	0	1	0	1	0	1	0	Protocol layer and other uncore settings
AB	1	0	1	0	1	0	1	1	Transition links to full speed operation
AE	1	0	1	0	1	1	1	0	Coherency settings
AF	1	0	1	0	1	1	1	1	KTI initialization done
Pre-EFI Initialization (PEI) Phase									
10	0	0	0	1	0	0	0	0	PEI Core
11	0	0	0	1	0	0	0	1	CPU PEIM
15	0	0	0	1	0	1	0	1	Platform Type Init
19	0	0	0	1	1	0	0	1	Platform PEIM Init
Integrated I/O Progress Codes									
E0	1	1	1	0	0	0	0	0	Integrated I/O Early Init Entry
E1	1	1	1	0	0	0	0	1	Integrated I/O Pre-link Training
E2	1	1	1	0	0		1	0	Integrated I/O EQ Programming
E3	1	1	1	0	0	0	1	1	Integrated I/O Link Training
E4	1	1	1	0	0	1	0	0	Internal Use
E5	1	1	1	0	0	1	0	1	Integrated I/O Early Init Exit
E6	1	1	1	0	0	1	1	0	Integrated I/O Late Init Entry
E7	1	1	1	0	0	1	1	1	Integrated I/O PCIe Ports Init
E8	1	1	1	0	1	0	0	0	Integrated I/O IOAPIC init
E9	1	1	1	0	1	0	0	1	Integrated I/O VTD Init
EA	1	1	1	0	1	0	1	0	Integrated I/O IOAT Init
EB	1	1	1	0	1	0	1	1	Integrated I/O DXF Init
EC	1	1	1	0	1	1	0	0	Integrated I/O NTB Init
ED	1	1	1	0	1	1	0	1	Integrated I/O Security Init
EE	1	1	1	0	1	1	1	0	Integrated I/O Late Init Exit
EF	1	1	1	0	1	1	1	1	Integrated I/O ready to boot
MRC Progress Codes – At this point the MRC Progress Code sequence is executed.									
31	0	0	1	1	0	0	0	1	Memory Installed
32	0	0	1	1	0	0	1	0	CPU PEIM (CPU Init)
33	0	0	1	1	0	0	1	1	CPU PEIM (Cache Init)
34	0	0	1	1	0	1	0	0	CPU BSP Select
35	0	0	1	1	0	1	0	1	CPU AP Init
36	0	0	1	1	0	1	1	0	CPU SMM Init
4F	0	1	0	0	1	1	1	1	DXE IPL started
Memory Feature Progress Codes									
C1	1	1	0	0	0	0	0	1	Memory POR check
C2	1	1	0	0	0	0	1	0	Internal Use
C3	1	1	0	0	0	0	1	1	Internal Use
C4	1	1	0	0	0	1	0	0	Internal Use
C5	1	1	0	0	0	1	0	1	Memory Early Init
C6	1	1	0	0	0	1	1	0	Display DIMM info in debug mode
C7	1	1	0	0	0	1	1	1	JEDEC Nvdimmm training
C9	1	1	0	0	1	0	0	1	Setup SVL and Scrambling
CA	1	1	0	0	1	0	1	0	Internal Use

Post Code (Hex)	Upper Nibble				Lower Nibble				Description
	8h	4h	2h	1h	8h	4h	2h	1h	
CB	1	1	0	0	1	0	1	1	Check RAS support
CC	1	1	0	0	1	1	0	0	PMem ADR Init
CD	1	1	0	0	1	1	0	1	Internal Use
CE	1	1	0	0	1	1	1	0	Memory Late Init
CF	1	1	0	0	1	1	1	1	Determine MRC boot mode
D0	1	1	0	1	0	0	0	0	MKTME Early Init
D1	1	1	0	1	0	0	0	1	SGX Early Init
D2	1	1	0	1	0	0	1	0	Memory Margin Test
D3	1	1	0	1	0	0	1	1	Internal Use
D5	1	1	0	1	0	1	0	1	Internal Use
D6	1	1	0	1	0	1	1	0	Offset Training Result
Driver Execution Environment (DXE) Phase									
60	0	1	1	0	0	0	0	0	DXE Core started
62	0	1	1	0	0	0	1	0	DXE Setup Init
68	0	1	1	0	1	0	0	0	DXE PCI Host Bridge Init
69	0	1	1	0	1	0	0	1	DXE NB Init
6A	0	1	1	0	1	0	1	0	DXE NB SMM Init
70	0	1	1	1	0	0	0	0	DXE SB Init
71	0	1	1	1	0	0	0	1	DXE SB SMM Init
72	0	1	1	1	0	0	1	0	DXE SB devices Init
78	0	1	1	1	1	0	0	0	DXE ACPI Init
79	0	1	1	1	1	0	0	1	DXE CSM Init
7D	0	1	1	1	1	1	0	1	DXE Removable Media Detect
7E	0	1	1	1	1	1	1	0	DXE Removable Media Detected
90	1	0	0	1	0	0	0	0	DXE BDS started
91	1	0	0	1	0	0	0	1	DXE BDS connect drivers
92	1	0	0	1	0	0	1	0	DXE PCI bus begin
93	1	0	0	1	0	0	1	1	DXE PCI Bus HPC Init
94	1	0	0	1	0	1	0	0	DXE PCI Bus enumeration
95	1	0	0	1	0	1	0	1	DXE PCI Bus resource requested
96	1	0	0	1	0	1	1	0	DXE PCI Bus assign resource
97	1	0	0	1	0	1	1	1	DXE CON_OUT connect
98	1	0	0	1	1	0	0	0	DXE CON_IN connect
99	1	0	0	1	1	0	0	1	DXE SIO Init
9A	1	0	0	1	1	0	1	0	DXE USB start
9B	1	0	0	1	1	0	1	1	DXE USB reset
9C	1	0	0	1	1	1	0	0	DXE USB detect
9D	1	0	0	1	1	1	0	1	DXE USB enable
A1	1	0	1	0	0	0	0	1	DXE IDE begin
A2	1	0	1	0	0	0	1	0	DXE IDE reset
A3	1	0	1	0	0	0	1	1	DXE IDE detect
A4	1	0	1	0	0	1	0	0	DXE IDE enable
A5	1	0	1	0	0	1	0	1	DXE SCSI begin
A6	1	0	1	0	0	1	1	0	DXE SCSI reset
A7	1	0	1	0	0	1	1	1	DXE SCSI detect

Post Code (Hex)	Upper Nibble				Lower Nibble				Description
	8h	4h	2h	1h	8h	4h	2h	1h	
A8	1	0	1	0	1	0	0	0	DXE SCSI enable
AB	1	0	1	0	1	0	1	1	DXE SETUP start
AC	1	0	1	0	1	1	0	0	DXE SETUP input wait
AD	1	0	1	0	1	1	0	1	DXE Ready to Boot
AE	1	0	1	0	1	1	1	0	DXE Legacy Boot
AF	1	0	1	0	1	1	1	1	DXE Exit Boot Services
B0	1	0	1	1	0	0	0	0	RT Set Virtual Address Map Begin
B1	1	0	1	1	0	0	0	1	RT Set Virtual Address Map End
B2	1	0	1	1	0	0	1	0	DXE Legacy Option ROM knit
B3	1	0	1	1	0	0	1	1	DXE Reset system
B4	1	0	1	1	0	1	0	0	DXE USB Hot plug
B5	1	0	1	1	0	1	0	1	DXE PCI BUS Hot plug
B8	1	0	1	1	1	0	0	0	PWRBTN Shutdown
B9	1	0	1	1	1	0	0	1	SLEEP Shutdown
C0	1	1	0	0	0	0	0	0	End of DXE
C7	1	1	0	0	0	1	1	1	DXE ACPI Enable
0	0	0	0	0	0	0	0	0	Clear POST Code
S3 Resume									
E0	1	1	1	0	0	0	0	0	S3 Resume PEIM (S3 started)
E1	1	1	1	0	0	0	0	1	S3 Resume PEIM (S3 boot script)
E2	1	1	1	0	0	0	1	0	S3 Resume PEIM (S3 Video Repost)
E3	1	1	1	0	0	0	1	1	S3 Resume PEIM (S3 OS wake)

Appendix E. POST Code Errors

Most error conditions encountered during POST are reported using POST error codes. These codes represent specific failures, warnings, or information. POST error codes may be displayed in the Error Manager Display screen and are always logged to the System Event Log (SEL). Logged events are available to system management applications, including remote and Out of Band (OOB) management.

There are exception cases in early initialization where system resources are not adequately initialized for handling POST error code reporting. These cases are primarily fatal error conditions resulting from initialization of processors and memory, and they are handled by a diagnostic LED display with a system halt.

Table 10 lists the supported POST error codes. Each error code is assigned an error type that determines the action the BIOS takes when the error is encountered. Error types include minor, major, and fatal. The BIOS action for each is defined as follows:

- **Minor:** An error message may be displayed to the screen or to the BIOS Setup Error Manager and the POST error code is logged to the SEL. The system continues booting in a degraded state. The user may want to replace the erroneous unit. The “POST Error Pause” option setting in the BIOS Setup does not affect this error.
- **Major:** An error message is displayed to the Error Manager screen and an error is logged to the SEL. If the BIOS Setup option “Post Error Pause” is enabled, operator intervention is required to continue booting the system. If the BIOS Setup option “POST Error Pause” is inactivated, the system continues to boot.

Note: For 0048 “Password check failed”, the system halts and then, after the next reset/reboot, displays the error code on the Error Manager screen.

- **Fatal: Fatal:** If the system cannot boot, POST halts the system and displays the following message:

```
Unrecoverable fatal error found.System will not boot until the error is
resolved
Press <F2> to enter setup
```

When the <F2> key on the keyboard is pressed, the error message is displayed on the Error Manager screen and an error is logged to the System Event Log (SEL) with the POST error code. The system cannot boot until the error is resolved. The faulty component must be replaced. The “POST Error Pause” option setting in the BIOS Setup does not affect this error.

Note: The POST error codes in the following table are common to all current generation Intel® server platforms. Features present on a given server board/system determine which of the listed error codes are supported.

Table 10. POST Error Messages and Handling

Error Code	Error Message	Action Message	Type
0012	System RTC date/time not set		Major
0048	Password check failed	Put right password.	Major
0140	PCI component encountered a PERR error		Major
0141	PCI resource conflict		Major
0146	PCI out of resources error	Enable Memory Mapped I/O above 4 GB item at SETUP to use 64-bit MMIO.	Major
0191	Processor core/thread count mismatch detected	Use identical CPU type.	Fatal
0192	Processor cache size mismatch detected	Use identical CPU type.	Fatal
0194	Processor family mismatch detected	Use identical CPU type.	Fatal
0195	Processor Intel(R) UPI link frequencies unable to synchronize		Fatal
0196	Processor model mismatch detected	Use identical CPU type.	Fatal
0197	Processor frequencies unable to synchronize	Use identical CPU type.	Fatal
5220	BIOS Settings reset to default settings		Major
5221	Passwords cleared by jumper		Major
5224	Password clear jumper is Set	Recommend reminding user to install BIOS password as BIOS admin password is the primary keys for several BIOS security features.	Major
8130	CPU 0 inactivated		Major
8131	CPU 1 inactivated		Major
8160	CPU 0 unable to apply microcode update		Major
8161	CPU 1 unable to apply microcode update		Major
8170	CPU 0 failed Self-Test (BIST)		Major
8171	CPU 1 failed Self-Test (BIST)		Major
8180	CPU 0 microcode update not found		Minor
8181	CPU 1 microcode update not found		Minor
8190	Watchdog timer failed on last boot.		Major
8198	OS boot watchdog timer failure.		Major
8300	Baseboard Management Controller failed self-test.		Major
8305	Hot Swap Controller failure		Major
83A0	Management Engine (ME) failed self-test.		Major
83A1	Management Engine (ME) Failed to respond.		Major
84F2	Baseboard management controller failed to respond		Major
84F3	Baseboard Management Controller in Update Mode.		Major
84F4	Baseboard Management Controller Sensor Data Record empty.	Update right SDR.	Major
84FF	System Event Log full	Clear SEL through EWS or SELVIEW utility.	Minor
85FC	Memory component could not be configured in the selected RAS mode		Major
8501	Memory Population Error	Plug DIMM at right population.	Major
8502	PMem invalid DIMM population found on the system.	Populate valid POR PMem DIMM population.	Major
8520	Memory failed test/initialization CPU0_DIMM_A1	Remove the inactivated DIMM.	Major
8521	Memory failed test/initialization CPU0_DIMM_A2	Remove the inactivated DIMM.	Major
8522	Memory failed test/initialization CPU0_DIMM_A3	Remove the inactivated DIMM.	Major

Intel® Server System M50FCP1UR System Integration and Service Guide

Error Code	Error Message	Action Message	Type
8523	Memory failed test/initialization CPU0_DIMM_B1	Remove the inactivated DIMM.	Major
8524	Memory failed test/initialization CPU0_DIMM_B2	Remove the inactivated DIMM.	Major
8525	Memory failed test/initialization CPU0_DIMM_B3	Remove the inactivated DIMM.	Major
8526	Memory failed test/initialization CPU0_DIMM_C1	Remove the inactivated DIMM.	Major
8527	Memory failed test/initialization CPU0_DIMM_C2	Remove the inactivated DIMM.	Major
8528	Memory failed test/initialization CPU0_DIMM_C3	Remove the inactivated DIMM.	Major
8529	Memory failed test/initialization CPU0_DIMM_D1	Remove the inactivated DIMM.	Major
852A	Memory failed test/initialization CPU0_DIMM_D2	Remove the inactivated DIMM.	Major
852B	Memory failed test/initialization CPU0_DIMM_D3	Remove the inactivated DIMM.	Major
852C	Memory failed test/initialization CPU0_DIMM_E1	Remove the inactivated DIMM.	Major
852D	Memory failed test/initialization CPU0_DIMM_E2	Remove the inactivated DIMM.	Major
852E	Memory failed test/initialization CPU0_DIMM_E3	Remove the inactivated DIMM.	Major
852F	Memory failed test/initialization CPU0_DIMM_F1	Remove the inactivated DIMM.	Major
8530	Memory failed test/initialization CPU0_DIMM_F2	Remove the inactivated DIMM.	Major
8531	Memory failed test/initialization CPU0_DIMM_F3	Remove the inactivated DIMM.	Major
8532	Memory failed test/initialization CPU0_DIMM_G1	Remove the inactivated DIMM.	Major
8533	Memory failed test/initialization CPU0_DIMM_G2	Remove the inactivated DIMM.	Major
8534	Memory failed test/initialization CPU0_DIMM_G3	Remove the inactivated DIMM.	Major
8535	Memory failed test/initialization CPU0_DIMM_H1	Remove the inactivated DIMM.	Major
8536	Memory failed test/initialization CPU0_DIMM_H2	Remove the inactivated DIMM.	Major
8537	Memory failed test/initialization CPU0_DIMM_H3	Remove the inactivated DIMM.	Major
8538	Memory failed test/initialization CPU1_DIMM_A1	Remove the inactivated DIMM.	Major
8539	Memory failed test/initialization CPU1_DIMM_A2	Remove the inactivated DIMM.	Major
853A	Memory failed test/initialization CPU1_DIMM_A3	Remove the inactivated DIMM.	Major
853B	Memory failed test/initialization CPU1_DIMM_B1	Remove the inactivated DIMM.	Major
853C	Memory failed test/initialization CPU1_DIMM_B2	Remove the inactivated DIMM.	Major
853D	Memory failed test/initialization CPU1_DIMM_B3	Remove the inactivated DIMM.	Major
853E	Memory failed test/initialization CPU1_DIMM_C1	Remove the inactivated DIMM.	Major
853F (Go to 85C0)	Memory failed test/initialization CPU1_DIMM_C2	Remove the inactivated DIMM.	Major
8540	Memory inactivated.CPU0_DIMM_A1	Remove the inactivated DIMM.	Major
8541	Memory inactivated.CPU0_DIMM_A2	Remove the inactivated DIMM.	Major
8542	Memory inactivated.CPU0_DIMM_A3	Remove the inactivated DIMM.	Major
8543	Memory inactivated.CPU0_DIMM_B1	Remove the inactivated DIMM.	Major
8544	Memory inactivated.CPU0_DIMM_B2	Remove the inactivated DIMM.	Major
8545	Memory inactivated.CPU0_DIMM_B3	Remove the inactivated DIMM.	Major
8546	Memory inactivated.CPU0_DIMM_C1	Remove the inactivated DIMM.	Major
8547	Memory inactivated.CPU0_DIMM_C2	Remove the inactivated DIMM.	Major
8548	Memory inactivated.CPU0_DIMM_C3	Remove the inactivated DIMM.	Major
8549	Memory inactivated.CPU0_DIMM_D1	Remove the inactivated DIMM.	Major
854A	Memory inactivated.CPU0_DIMM_D2	Remove the inactivated DIMM.	Major
854B	Memory inactivated.CPU0_DIMM_D3	Remove the inactivated DIMM.	Major
854C	Memory inactivated.CPU0_DIMM_E1	Remove the inactivated DIMM.	Major
854D	Memory inactivated.CPU0_DIMM_E2	Remove the inactivated DIMM.	Major
854E	Memory inactivated.CPU0_DIMM_E3	Remove the inactivated DIMM.	Major
854F	Memory inactivated.CPU0_DIMM_F1	Remove the inactivated DIMM.	Major
8550	Memory inactivated.CPU0_DIMM_F2	Remove the inactivated DIMM.	Major

Error Code	Error Message	Action Message	Type
8551	Memory inactivated.CPU0_DIMM_F3	Remove the inactivated DIMM.	Major
8552	Memory inactivated.CPU0_DIMM_G1	Remove the inactivated DIMM.	Major
8553	Memory inactivated.CPU0_DIMM_G2	Remove the inactivated DIMM.	Major
8554	Memory inactivated.CPU0_DIMM_G3	Remove the inactivated DIMM.	Major
8555	Memory inactivated.CPU0_DIMM_H1	Remove the inactivated DIMM.	Major
8556	Memory inactivated.CPU0_DIMM_H2	Remove the inactivated DIMM.	Major
8557	Memory inactivated.CPU0_DIMM_H3	Remove the inactivated DIMM.	Major
8558	Memory inactivated.CPU1_DIMM_A1	Remove the inactivated DIMM.	Major
8559	Memory inactivated.CPU1_DIMM_A2	Remove the inactivated DIMM.	Major
855A	Memory inactivated.CPU1_DIMM_A3	Remove the inactivated DIMM.	Major
855B	Memory inactivated.CPU1_DIMM_B1	Remove the inactivated DIMM.	Major
855C	Memory inactivated.CPU1_DIMM_B2	Remove the inactivated DIMM.	Major
855D	Memory inactivated.CPU1_DIMM_B3	Remove the inactivated DIMM.	Major
855E	Memory inactivated.CPU1_DIMM_C1	Remove the inactivated DIMM.	Major
855F (Go to 85D0)	Memory inactivated.CPU1_DIMM_C2	Remove the inactivated DIMM.	Major
8560	Memory encountered a Serial Presence Detection(SPD) failure.CPU0_DIMM_A1		Major
8561	Memory encountered a Serial Presence Detection(SPD) failure.CPU0_DIMM_A2		Major
8562	Memory encountered a Serial Presence Detection(SPD) failure.CPU0_DIMM_A3		Major
8563	Memory encountered a Serial Presence Detection(SPD) failure.CPU0_DIMM_B1		Major
8564	Memory encountered a Serial Presence Detection(SPD) failure.CPU0_DIMM_B2		Major
8565	Memory encountered a Serial Presence Detection(SPD) failure.CPU0_DIMM_B3		Major
8566	Memory encountered a Serial Presence Detection(SPD) failure.CPU0_DIMM_C1		Major
8567	Memory encountered a Serial Presence Detection (SPD) failure.CPU0_DIMM_C2		Major
8568	Memory encountered a Serial Presence Detection (SPD) failure.CPU0_DIMM_C3		Major
8569	Memory encountered a Serial Presence Detection(SPD) failure.CPU0_DIMM_D1		Major
856A	Memory encountered a Serial Presence Detection(SPD) failure.CPU0_DIMM_D2		Major
856B	Memory encountered a Serial Presence Detection(SPD) failure.CPU0_DIMM_D3		Major
856C	Memory encountered a Serial Presence Detection(SPD) failure.CPU0_DIMM_E1		Major
856D	Memory encountered a Serial Presence Detection(SPD) failure.CPU0_DIMM_E2		Major
856E	Memory encountered a Serial Presence Detection(SPD) failure.CPU0_DIMM_E3		Major
856F	Memory encountered a Serial Presence Detection(SPD) failure.CPU0_DIMM_F1		Major
8570	Memory encountered a Serial Presence Detection(SPD) failure.CPU0_DIMM_F2		Major

Intel® Server System M50FCP1UR System Integration and Service Guide

Error Code	Error Message	Action Message	Type
8571	Memory encountered a Serial Presence Detection(SPD) failure.CPU0_DIMM_F3		Major
8572	Memory encountered a Serial Presence Detection(SPD) failure.CPU0_DIMM_G1		Major
8573	Memory encountered a Serial Presence Detection(SPD) failure.CPU0_DIMM_G2		Major
8574	Memory encountered a Serial Presence Detection(SPD) failure.CPU0_DIMM_G3		Major
8575	Memory encountered a Serial Presence Detection(SPD) failure.CPU0_DIMM_H1		Major
8576	Memory encountered a Serial Presence Detection(SPD) failure.CPU0_DIMM_H2		Major
8577	Memory encountered a Serial Presence Detection(SPD) failure.CPU0_DIMM_H3		Major
8578	Memory encountered a Serial Presence Detection(SPD) failure.CPU1_DIMM_A1		Major
8579	Memory encountered a Serial Presence Detection(SPD) failure.CPU1_DIMM_A2		Major
857A	Memory encountered a Serial Presence Detection(SPD) failure.CPU1_DIMM_A3		Major
857B	Memory encountered a Serial Presence Detection(SPD) failure.CPU1_DIMM_B1		Major
857C	Memory encountered a Serial Presence Detection(SPD) failure.CPU1_DIMM_B2		Major
857D	Memory encountered a Serial Presence Detection(SPD) failure.CPU1_DIMM_B3		Major
857E	Memory encountered a Serial Presence Detection(SPD) failure.CPU1_DIMM_C1		Major
857F (Go to 85E0)	Memory encountered a Serial Presence Detection(SPD) failure.CPU1_DIMM_C2		Major
85C0	Memory failed test/initialization CPU1_DIMM_C3	Remove the inactivated DIMM.	Major
85C1	Memory failed test/initialization CPU1_DIMM_D1	Remove the inactivated DIMM.	Major
85C2	Memory failed test/initialization CPU1_DIMM_D2	Remove the inactivated DIMM.	Major
85C3	Memory failed test/initialization CPU1_DIMM_D3	Remove the inactivated DIMM.	Major
85C4	Memory failed test/initialization CPU1_DIMM_E1	Remove the inactivated DIMM.	Major
85C5	Memory failed test/initialization CPU1_DIMM_E2	Remove the inactivated DIMM.	Major
85C6	Memory failed test/initialization CPU1_DIMM_E3	Remove the inactivated DIMM.	Major
85C7	Memory failed test/initialization CPU1_DIMM_F1	Remove the inactivated DIMM.	Major
85C8	Memory failed test/initialization CPU1_DIMM_F2	Remove the inactivated DIMM.	Major
85C9	Memory failed test/initialization CPU1_DIMM_F3	Remove the inactivated DIMM.	Major
85CA	Memory failed test/initialization CPU1_DIMM_G1	Remove the inactivated DIMM.	Major
85CB	Memory failed test/initialization CPU1_DIMM_G2	Remove the inactivated DIMM.	Major
85CC	Memory failed test/initialization CPU1_DIMM_G3	Remove the inactivated DIMM.	Major
85CD	Memory failed test/initialization CPU1_DIMM_H1	Remove the inactivated DIMM.	Major
85CE	Memory failed test/initialization CPU1_DIMM_H2	Remove the inactivated DIMM.	Major
85CF	Memory failed test/initialization CPU1_DIMM_H3	Remove the inactivated DIMM.	Major
85D0	Memory inactivated.CPU1_DIMM_C3	Remove the inactivated DIMM.	Major
85D1	Memory inactivated.CPU1_DIMM_D1	Remove the inactivated DIMM.	Major
85D2	Memory inactivated.CPU1_DIMM_D2	Remove the inactivated DIMM.	Major
85D3	Memory inactivated.CPU1_DIMM_D3	Remove the inactivated DIMM.	Major

Error Code	Error Message	Action Message	Type
85D4	Memory inactivated.CPU1_DIMM_E1	Remove the inactivated DIMM.	Major
85D5	Memory inactivated.CPU1_DIMM_E2	Remove the inactivated DIMM.	Major
85D6	Memory inactivated.CPU1_DIMM_E3	Remove the inactivated DIMM.	Major
85D7	Memory inactivated.CPU1_DIMM_F1	Remove the inactivated DIMM.	Major
85D8	Memory inactivated.CPU1_DIMM_F2	Remove the inactivated DIMM.	Major
85D9	Memory inactivated.CPU1_DIMM_F3	Remove the inactivated DIMM.	Major
85DA	Memory inactivated.CPU1_DIMM_G1	Remove the inactivated DIMM.	Major
85DB	Memory inactivated.CPU1_DIMM_G2	Remove the inactivated DIMM.	Major
85DC	Memory inactivated.CPU1_DIMM_G3	Remove the inactivated DIMM.	Major
85DD	Memory inactivated.CPU1_DIMM_H1	Remove the inactivated DIMM.	Major
85DE	Memory inactivated.CPU1_DIMM_H2	Remove the inactivated DIMM.	Major
85DF	Memory inactivated.CPU1_DIMM_H3	Remove the inactivated DIMM.	Major
85E0	Memory encountered a Serial Presence Detection (SPD) failure.CPU1_DIMM_C3		Major
85E1	Memory encountered a Serial Presence Detection (SPD) failure. CPU1_DIMM_D1		Major
85E2	Memory encountered a Serial Presence Detection (SPD) failure.CPU1_DIMM_D2		Major
85E3	Memory encountered a Serial Presence Detection (SPD) failure.CPU1_DIMM_D3		Major
85E4	Memory encountered a Serial Presence Detection (SPD) failure.CPU1_DIMM_E1		Major
85E5	Memory encountered a Serial Presence Detection (SPD) failure.CPU1_DIMM_E2		Major
85E6	Memory encountered a Serial Presence Detection (SPD) failure.CPU1_DIMM_E3		Major
85E7	Memory encountered a Serial Presence Detection (SPD) failure.CPU1_DIMM_F1		Major
85E8	Memory encountered a Serial Presence Detection (SPD) failure.CPU1_DIMM_F2		Major
85E9	Memory encountered a Serial Presence Detection (SPD) failure.CPU1_DIMM_F3		Major
85EA	Memory encountered a Serial Presence Detection (SPD) failure.CPU1_DIMM_G1		Major
85EB	Memory encountered a Serial Presence Detection (SPD) failure. CPU1_DIMM_G2		Major
85EC	Memory encountered a Serial Presence Detection (SPD) failure.CPU1_DIMM_G3		Major
85ED	Memory encountered a Serial Presence Detection (SPD) failure.CPU1_DIMM_H1		Major
85EE	Memory encountered a Serial Presence Detection (SPD) failure.CPU1_DIMM_H2		Major
85EF	Memory encountered a Serial Presence Detection (SPD) failure.CPU1_DIMM_H3		Major
8604	POST Reclaim of non-critical NVRAM variables		Minor
8605	BIOS Settings are corrupted		Major
8606	NVRAM variable space was corrupted and has been reinitialized		Major

Error Code	Error Message	Action Message	Type
8607	Recovery boot has been initiated. Note: The Primary BIOS image may be corrupted or the system may hang during POST. A BIOS update is required.		Fatal
A100	BIOS ACM Error		Major
A421	PCI component encountered a SERR error		Fatal
A5A0	PCI Express component encountered a PERR error		Minor
A5A1	PCI Express component encountered an SERR error		Fatal
A6A0	DXE Boot Services driver: Not enough memory available to shadow a Legacy Option ROM.	Disable option ROM at SETUP to save runtime memory.	Minor

E.1 POST Error Beep Codes

The following table lists the POST error beep codes. Before system video initialization, the BIOS uses these beep codes to inform users on error conditions. The beep code is followed by a user-visible code on the POST progress LEDs.

Table 11. POST Error Beep Codes

Beeps	Error Message	POST Progress Code	Description
3 short	Memory error	Multiple	System halted because a fatal error related to the memory was detected.
3 long and 1 short	CPU mismatch error	E5, E6	System halted because a fatal error related to the CPU family/core/cache mismatch was detected.

The integrated BMC may generate beep codes upon detection of failure conditions. Beep codes are sounded each time that the problem is discovered, such as on each power-up attempt, but are not sounded continuously. Codes that are common across all Intel server boards and systems that use same generation chipset are listed in the following table. Each digit in the code is represented by a sequence of beeps whose count is equal to the digit.

Table 12. Integrated BMC Beep Codes

Code	Reason for Beep	Associated Sensors
1-5-1-2	VR Watchdog Timer sensor assertion.	VR Watchdog Timer.
1-5-1-4	A PSU reports a failure, or the BMC detects the presence of a PSU model that is incompatible with one or more other PSUs in the system.	PS Status.
1-5-2-1	No CPUs installed or the first CPU socket is empty.	CPU Missing sensor.
1-5-2-2	CPU CAT Error (IERR) assertion.	CPU Status sensor.
1-5-2-3	CPU ERR2 timeout assertion.	CPU ERR2 Timeout sensor.
1-5-2-4	CPU/VR mismatch.	CPU Status sensor (configuration error offset).
1-5-2-5	CPU population error.	CPU 0 Status sensor.
1-5-4-2	Power fault: DC power is unexpectedly lost (power good dropout).	Power Unit – Power unit failure offset.
1-5-4-4	Power control fault (power good assertion timeout).	Power Unit – Soft power control failure offset.

E.2 Processor Initialization Error Summary

The following table describes mixed processor conditions and actions for all Intel® server boards and Intel® server systems designed with the Intel® Xeon® Scalable processor family architecture. The errors fall into one of the following categories:

- **Fatal:** The system halts with a halt error code on the diagnostic LEDs and a corresponding sequence consisting of three long beeps and one short beep is sent to the POST Error Code LED. The system cannot boot unless the error is resolved. The faulty component must be replaced.
- **Major:** If the BIOS Setup option “POST Error Pause” is enabled, the system goes directly to the BIOS Setup Error Manager to display the error and logs the POST error code to SEL. User intervention is required to continue booting the system. If the BIOS Setup option “POST Error Pause” is disabled, the system continues to boot and no prompt for the error is given, although the POST error code is logged to the BIOS Setup Error Manager and to the SEL.
- **Minor:** An error message may be displayed to the screen or to the BIOS Setup Error Manager screen and the POST error code is logged to the SEL. The system continues booting in a degraded state. The user may want to replace the erroneous unit. The POST Error Pause option setting in the BIOS setup utility does not affect this error.

Table 13. Mixed Processor Configurations Error Summary

Error	Severity	System Action when BIOS Detects the Error Condition
Processor family not identical	Fatal	Halts with error code “0xE5” on the diagnostic LED. Sends three long beeps and one short beep to the POST Error LED. Does not boot until the fault condition is remediated.
Processor model not identical	Fatal	Halts with error code “0xE5” on the diagnostic LED. Sends three long beeps and one short beep to the POST Error LED. Does not boot until the fault condition is remediated.
Processor cache or home agent not identical	Fatal	Halts with error code “0xE5” on the diagnostic LED. Sends three long beeps and one short beep to the POST Error LED. Does not boot until the fault condition is remediated.
Processor frequency (speed) not identical	Fatal	Halts with error code “0xE5” on the diagnostic LED. Sends three long beeps and one short beep to the POST Error LED. Does not boot until the fault condition is remediated.
Processor Intel® UPI link frequencies not identical	Fatal	Halts with error code “0xE5” on the diagnostic LED. Sends three long beeps and one short beep to the POST Error LED. Does not boot until the fault condition is remediated.
Processor microcode update failed	Major	Logs the POST error code “81 6x” into the SEL. If the “POST Error Pause” is enabled in the BIOS Setup, loads the BIOS Error Manager to present error message “816x: Processor 0x unable to apply microcode update” on the screen. If the “POST Error Pause” is disabled in the BIOS Setup continues to boot in a degraded state.
Processor microcode update missing	Minor	Logs the POST error code “81 8x” into the SEL. The system continues to boot in a degraded state, regardless of the “POST Error Pause” setting in the BIOS setup. The Error Manager in BIOS Setup will present the message “818x: Processor microcode update not found”

Appendix F. System Packaging Assembly Instructions

The original Intel packaging, in which the server system is delivered, is designed to provide protection to a fully configured system and was tested to meet ISTA (International Safe Transit Association) Test Procedure 3A (2008). The packaging was also designed to be re-used for shipment to its final destination after system integration has been completed.

The original packaging includes two layers of boxes—an inner box and the outer shipping box, and various protective inner packaging components. The boxes and packaging components are designed to function together as a protective packaging system. When reused, all the original packaging material must be used, including both boxes and each inner packaging component. In addition, all inner packaging components **MUST** be reinstalled in the proper location to ensure adequate protection of the system for subsequent shipment.

Note: The design of the inner packaging components does not prevent improper placement within the packaging assembly. Only one correct packaging assembly allows the package to meet the ISTA (International Safe Transit Association) Test Procedure 3A (2008) limits.

Failure to follow the specified packaging assembly instructions may result in damage to the system during shipment.

1. Open the outer box (iPN K65051-001). Fold the flap slightly to avoid cracks on the corners. Place the taped inner box (iPN K65084-001) into the outer box. See the following figure.

Caution: No cracks on the corners are permitted.

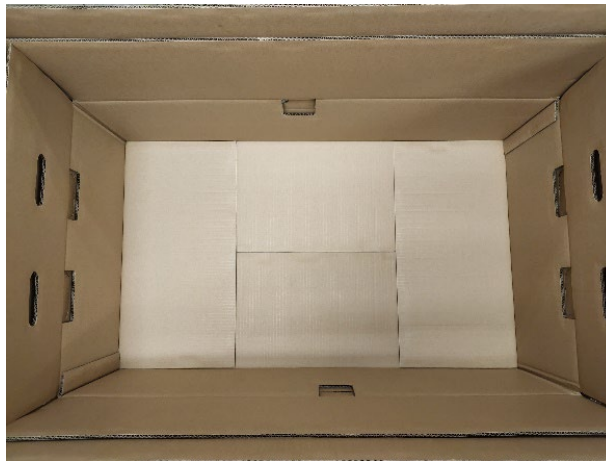

- Place the front cushion (iPN K65031-001) on the left end of the inner box. Place the rear cushion (K65006-001) on the right end of the inner box. Then, place bottom foam K75566-001 in the middle. See the following figure.



- Pack the server system with red EPE sheet (iPN K58342-001). See the following figure.



- Pack the system wrapped with EPE sheet in the EPE bag. Then, place the system on the bottom foam (see the following figure). Place the top front foam (iPN K65046-001) on the left and the top rear foam (iPN K65037-001) on the right.



5. Place the accessory kit box (iPN H49469-001) in the center foam cushion. Place the extension rails in the two narrow foam cavities. See the following figure.



6. Close the inner box.



7. Close the outer box. Seal the entire package with tape as shown in the following figure.



Appendix G. Safety Instructions

WARNING: English (US)

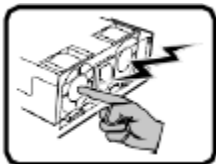

The power supply in this product contains no user-serviceable parts. There may be more than one supply in this product. Refer servicing only to qualified personnel.



Do not attempt to modify or use the supplied AC power cord if it is not the exact type required. A product with more than one power supply will have a separate AC power cord for each supply.

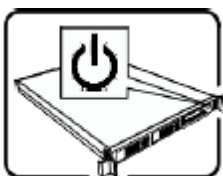

The power button on the system does not turn off system AC power. To remove AC power from the system, you must unplug each AC power cord from the electrical outlet or power supply.

The power cord is considered the disconnect device to the main (AC) power. The socket outlet that the system plugs into, shall be installed near the equipment and shall be easily accessible.



SAFETY STEPS: Whenever you remove the chassis covers to access the inside of the system, follow these steps:

1. Turn off all peripheral devices connected to the system.
2. Turn off the system by pressing the power button.
3. Unplug all AC power cords from the system or from electrical outlets.
4. Label and disconnect all cables connected to I/O connectors or ports on the back of the system.
5. Provide some electrostatic discharge (ESD) protection by wearing an antistatic wrist strap attached to chassis ground of the system—any unpainted metal surface—when handling components.
6. Do not operate the system with the chassis covers removed.

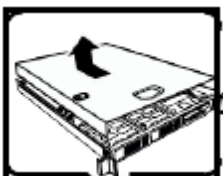

After you have completed the six SAFETY steps above, you can remove the system covers. To do this:

1. Unlock and remove the padlock from the back of the system if a padlock has been installed.
2. Remove and save all screws from the covers.
3. Remove the covers.

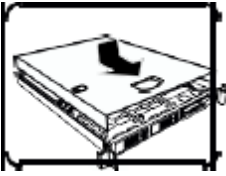

For proper cooling and airflow, always reinstall the chassis covers before turning on the system. Operating the system without the covers in place can damage system parts. To install the covers:

1. Check first to make sure you have not left loose tools or parts inside the system.
2. Check that cables, add-in boards, and other components are properly installed.
3. Attach the covers to the chassis with the screws removed earlier and tighten them firmly.
4. Insert and lock the padlock to the system to prevent unauthorized access inside the system.
5. Connect all external cables and the AC power cords to the system.

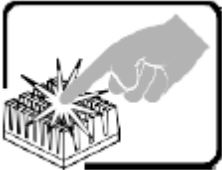

A microprocessor and heat sink may be hot if the system has been running. Also, there may be sharp pins and edges on some board and chassis parts. Contact should be made with care. Consider wearing protective gloves.



Danger of explosion if the battery is incorrectly replaced. Replace only with the same or equivalent type recommended by the equipment manufacturer. Dispose of used batteries according to manufacturer's instructions.



The system is designed to operate in a typical office environment. Choose a site that is:

- Clean and free of airborne particles (other than normal room dust).
- Well ventilated and away from sources of heat including direct sunlight.
- Away from sources of vibration or physical shock.
- Isolated from strong electromagnetic fields produced by electrical devices.
- In regions that are susceptible to electrical storms, we recommend you plug your system into a surge suppresser and disconnect telecommunication lines to your modem during an electrical storm.
- Provided with a properly grounded electrical outlet.
- Provided with sufficient space to access the power supply cords, because they serve as the product's main power disconnect.

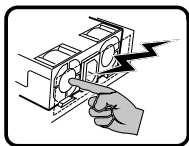
ОСТОРОЖНО: русский

Блок питания данного изделия не содержит деталей, подлежащих обслуживанию пользователем. В этом изделии может быть несколько блоков питания. Обслуживание должно выполняться только квалифицированным персоналом.

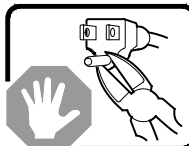

Не модифицируйте и не используйте прилагаемый кабель питания, если он не соответствует требуемому типу. Если в устройстве несколько блоков питания, то к каждому блоку питания прилагается отдельный кабель питания.

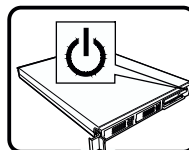

При нажатии кнопки питания не отключается питание системы от электросети. Чтобы отключить подачу питания переменного тока в систему, необходимо отсоединить все кабели питания от электрической розетки или блока питания.

Кабель питания считается размыкателем питания переменного тока. Электрическая розетка, к которой подключается система, должна находиться рядом с оборудованием и быть легко доступной.

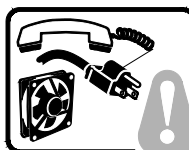

ИНСТРУКЦИИ ПО ТЕХНИКЕ БЕЗОПАСНОСТИ. Каждый раз перед снятием крышек корпуса для доступа к внутренней части системы выполняйте следующие действия:

1. Выключите все периферийные устройства, подключенные к системе.
2. Выключите систему, нажав кнопку питания.
3. Отсоедините все кабели питания от системы или электрических розеток.
4. Промаркируйте и отсоедините все кабели, подключенные к разъемам или портам ввода/вывода на задней панели системы.
5. Для обеспечения защиты от электростатического разряда при работе с компонентами надевайте антистатический браслет, прикрепленный к заземленной части корпуса системы (любой неокрашенной металлической поверхности).
6. Запрещается работать с системой, когда крышки корпуса сняты.

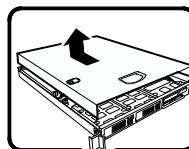

Крышки корпуса системы можно снимать, когда выполнены все шесть описанных выше мер безопасности. Для этого:

1. Откройте и снимите навесной замок (если имеется) с задней части системы.
2. Выверните все винты с крышек и сохраните их.
3. Снимите крышки.

(продолжение)

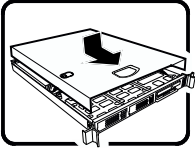
ОСТОРОЖНО: русский (продолжение)

Для обеспечения надлежащего охлаждения и воздушного потока всегда устанавливайте на место крышки корпуса перед включением системы. Работа системы без установленных крышек может привести к повреждению компонентов системы. Чтобы установить крышки, выполните следующие действия:

1. Сначала проверьте, не осталось ли в системе незакрепленных инструментов или деталей.
2. Убедитесь, что кабели, платы расширения и другие компоненты установлены правильно.
3. Закрепите крышки на корпусе, завернув и надежно затянув винты, снятые ранее.
4. Установите и закройте навесной замок для предотвращения несанкционированного доступа внутрь системы.
5. Подключите к системе все внешние кабели и кабели питания.

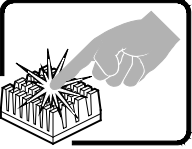

Микропроцессор и теплоотвод могут нагреваться во время работы системы. На некоторых деталях платы и корпуса могут быть острые выступы и кромки. Соблюдайте осторожность. Рекомендуется использовать защитные перчатки.

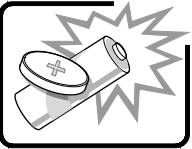

В случае неправильной замены аккумулятора существует опасность взрыва. При замене используйте только те же или эквивалентные модели аккумуляторов, рекомендованные производителем оборудования. Утилизируйте использованные аккумуляторы в соответствии с инструкциями производителя.

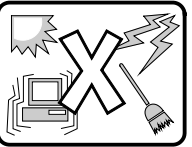

Система предназначена для работы в обычной офисной среде. Место установки системы должно соответствовать следующим требованиям:

- Помещение должно быть чистым, в воздухе не должно быть взвешенных частиц (кроме обычной пыли).
- Место установки должно хорошо вентилироваться и находиться вдали от источников тепла (включая прямой солнечный свет).
- Место установки должно находиться вдали от источников вибрации или механических ударов.
- Место установки должно быть изолировано от сильных электромагнитных полей, создаваемых электрическими устройствами.
- В регионах, где часто бывает гроза, рекомендуется подключать систему к сетевому фильтру и отключать телекоммуникационные линии от модема во время грозы.
- В помещении должна быть правильно заземленная электрическая розетка.
- Должен быть оставлен достаточный зазор для доступа к кабелям питания, которые служат размыкателем электропитания системы.

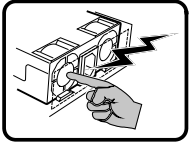
УВАГА! Українська

Джерело живлення в цьому виробі не містить жодних частин, які користувачі могли б обслуговувати самостійно. Цей виріб може містити більше одного джерела живлення. Обслуговувати його може виключно кваліфікований персонал.

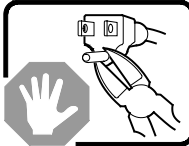

Не намагайтеся модифікувати шнур живлення змінного струму з комплекту або користуватися ним, якщо він не відповідає потрібному типу. Виріб із джерелами живлення більше одного має окремі шнури живлення змінного струму для кожного джерела.

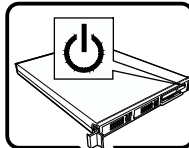

Кнопка живлення на системі не вимикає живлення змінного струму системи. Щоб позбавити систему змінного струму, слід вийняти всі шнури живлення змінного струму зі стінних розеток або джерел живлення. Вважається, що шнур(и) живлення є пристроями вимкнення основного живлення (змінного струму). Розетка електромережі, до якої підключається система, мусить бути розташована поруч із обладнанням і легкодоступна.

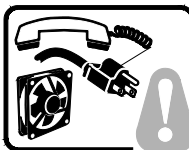

КРОКИ БЕЗПЕКИ: Щоразу, знімаючи корпус для доступу до внутрішніх частин системи, виконуйте ці кроки:

7. Вимкніть усі периферійні пристрої, підключені до системи.
8. Вимкніть систему, натиснувши кнопку живлення.
9. Вийміть шнури живлення змінного струму із системи чи стінних розеток.
10. Позначте і від'єднайте всі кабелі, підключені до з'єднувачів входу/виходу або портів ззаду на системі.
11. Працюючи з компонентами, захищайтеся від електростатичних розрядів (ЕР), вдягаючи антистатичний ремінець-браслет, прикріплений до елемента заземлення корпусу - будь-якої непофарбованої металевої поверхні.
12. Не використовуйте систему з відкритим корпусом.

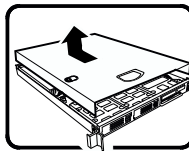

Після виконання шести наведених вище кроків БЕЗПЕКИ можна знімати корпус (кришки) з системи. Для цього виконайте такі дії:

4. Розблокуйте і зніміть замок ззаду на системі, якщо його встановлено.
5. Зніміть і збережіть всі гвинти з кришок.
6. Зніміть усі кришки.

продовження

УВАГА! Українська (продовження)

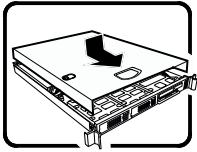

Для правильного охолодження та вентиляції завжди повертайте на місце кришки корпусу перед увімкненням системи. Робота системи без кришок може пошкодити деталі системи. Щоб установити кришки, виконайте такі дії:

6. Спочатку переконайтеся, що всередині системи не залишилося деталей або незакріплених інструментів.
7. Перевірте, чи правильно встановлено кабелі, розширювальні плати та інші компоненти.
8. Прикріпіть кришки до корпусу знятими раніше гвинтами та надійно їх затягніть.
9. Вставте в систему і зафіксуйте замок, щоб запобігти неавторизованому доступу до нього.
10. Підключіть усі зовнішні кабелі та шнур(и) живлення змінного струму до системи.

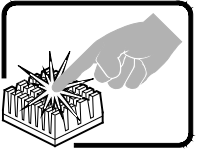

Під час роботи системи мікропроцесор і радіатор можуть розігрітися до гарячого. Деякі частини корпусу і плат можуть мати гострі шипи або краї. Із ними слід поводитися обережно. Можна вдягти захисні рукавички.

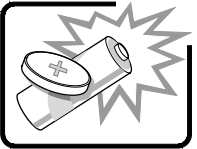

Загроза вибуху, якщо батарею замінено на неправильну. Замінюйте лише таким самим або еквівалентним типом, рекомендованим виробником. Утилізуйте використані батареї згідно з інструкціями виробника.

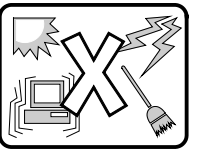

Систему створено для роботи в типовому офісному приміщенні. Виберіть місце, яке:

- Чисте і де немає в повітрі інших дрібних часточок, окрім звичайного побутового пилу.
- Добре провітрюється, розташоване далеко від джерел тепла, включно з прямим сонячним промінням.
- Розташоване далеко від джерел вібрації і струсів.
- Ізольоване від сильних електромагнітних полів, спричинених електроприладами.
- У регіонах, де часто проходять грози, радимо підключати пристрій через пристрій захисту від викидів напруги та відключити телекомунікаційні лінії від модему під час грози.
- Оснащене правильно заземленими стінними розетками електромережі.
- Має достатньо простору для доступу до шнура(ів) живлення, оскільки вони слугують основними вимикачами виробу.

AVERTISSEMENT: Français

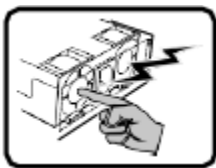

Le bloc d'alimentation de ce produit ne contient aucune pièce pouvant être réparée par l'utilisateur. Ce produit peut contenir plus d'un bloc d'alimentation. Veuillez contacter un technicien qualifié en cas de problème.



Ne pas essayer d'utiliser ni modifier le câble d'alimentation CA fourni, s'il ne correspond pas exactement au type requis. Le nombre de câbles d'alimentation CA fournis correspond au nombre de blocs d'alimentation du produit.

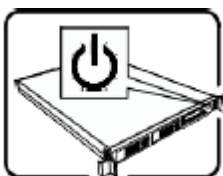

Notez que le commutateur CC de mise sous tension /hors tension du panneau avant n'éteint pas l'alimentation CA du système. Pour mettre le système hors tension, vous devez débrancher chaque câble d'alimentation de sa prise.



CONSIGNES DE SÉCURITÉ: Lorsque vous ouvrez le boîtier pour accéder à l'intérieur du système, suivez les consignes suivantes:

1. Mettez hors tension tous les périphériques connectés au système.
2. Mettez le système hors tension en mettant l'interrupteur général en position OFF (bouton-poussoir).
3. Débranchez tous les cordons d'alimentation c.a. du système et des prises murales.
4. Identifiez et débranchez tous les câbles reliés aux connecteurs d'E-S ou aux accès derrière le système.
5. Pour prévenir les décharges électrostatiques lorsque vous touchez aux composants, portez une bande antistatique pour poignet et reliez-la à la masse du système (toute surface métallique non peinte du boîtier).
6. Ne faites pas fonctionner le système tandis que le boîtier est ouvert.

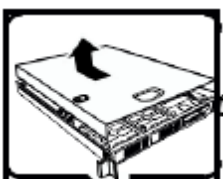

Une fois TOUTES les étapes précédentes accomplies, vous pouvez retirer les panneaux du système. Procédez comme suit:

1. Si un cadenas a été installé sur à l'arrière du système, déverrouillez-le et retirez-le.
2. Retirez toutes les vis des panneaux et mettez-les dans un endroit sûr.
3. Retirez les panneaux.

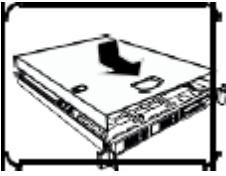

Afin de permettre le refroidissement et l'aération du système, réinstallez toujours les panneaux du boîtier avant de mettre le système sous tension. Le fonctionnement du système en l'absence des panneaux risque d'endommager ses pièces. Pour installer les panneaux, procédez comme suit:

1. Assurez-vous de ne pas avoir oublié d'outils ou de pièces démontées dans le système.
2. Assurez-vous que les câbles, les cartes d'extension et les autres composants sont bien installés.
3. Revissez solidement les panneaux du boîtier avec les vis retirées plus tôt.
4. Remettez le cadenas en place et verrouillez-le afin de prévenir tout accès non autorisé à l'intérieur du système.
5. Rebranchez tous les cordons d'alimentation c. a. et câbles externes au système.

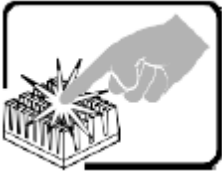

Le microprocesseur et le dissipateur de chaleur peuvent être chauds si le système a été sous tension. Faites également attention aux broches aiguës des cartes et aux bords tranchants du capot. Nous vous recommandons l'usage de gants de protection.



Danger d'explosion si la batterie n'est pas remontée correctement. Remplacer uniquement avec une batterie du même type ou d'un type équivalent recommandé par le fabricant. Disposez des piles usées selon les instructions du fabricant.

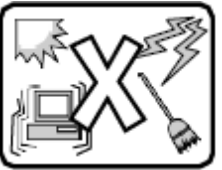

Le système a été conçu pour fonctionner dans un cadre de travail normal. L'emplacement choisi doit être:

- Propre et dépourvu de poussière en suspension (sauf la poussière normale).
- Bien aéré et loin des sources de chaleur, y compris du soleil direct.
- A l'abri des chocs et des sources de vibrations.
- Isolé de forts champs électromagnétiques générés par des appareils électriques.
- Dans les régions sujettes aux orages magnétiques il est recommandé de brancher votre système à un suppresseur de surtension, et de débrancher toutes les lignes de télécommunications de votre modem durant un orage.
- Muni d'une prise murale correctement mise à la terre.
- Suffisamment spacieux pour vous permettre d'accéder aux câbles d'alimentation (ceux-ci étant le seul moyen de mettre le système hors tension).

WARNUNG: Deutsch

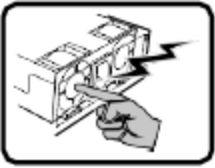

Benutzer können am Netzgerät dieses Produkts keine Reparaturen vornehmen. Das Produkt enthält möglicherweise mehrere Netzgeräte. Wartungsarbeiten müssen von qualifizierten Technikern ausgeführt werden.



Versuchen Sie nicht, das mitgelieferte Netzkabel zu ändern oder zu verwenden, wenn es sich nicht genau um den erforderlichen Typ handelt. Ein Produkt mit mehreren Netzgeräten hat für jedes Netzgerät ein eigenes Netzkabel.

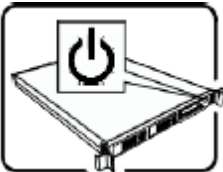

Der Wechselstrom des Systems wird durch den Ein-/Aus-Schalter für Gleichstrom nicht ausgeschaltet. Ziehen Sie jedes Wechselstrom-Netzkabel aus der Steckdose bzw. dem Netzgerät, um den Stromanschluß des Systems zu unterbrechen.



SICHERHEISSCHRIFFEN: Immer wenn Sie die Gehäuseabdeckung abnehmen um an das Systeminnere zu gelangen, sollten Sie folgende Schritte beachten:

1. Schalten Sie alle an Ihr System angeschlossenen Peripheriegeräte aus.
2. Schalten Sie das System mit dem Hauptschalter aus.
3. Ziehen Sie den Stromanschlußstecker Ihres Systems aus der Steckdose.
4. Auf der Rückseite des Systems beschrifteten und ziehen Sie alle Anschlußkabel von den I/O Anschlüssen oder Ports ab.
5. Tragen Sie ein geerdetes Antistatik Gelenkband, um elektrostatische Ladungen (ESD) über blanke Metallstellen bei der Handhabung der Komponenten zu vermeiden.
6. Schalten Sie das System niemals ohne ordnungsgemäß montiertes Gehäuse ein.



Nachdem Sie die oben erwähnten ersten sechs SICHERHEITSSCHRITTE durchgeführt haben, können Sie die Abdeckung abnehmen, indem Sie:

1. Öffnen und entfernen Sie die Verschlusseinrichtung (Padlock) auf der Rückseite des Systems, falls eine Verschlusseinrichtung installiert ist.
2. Entfernen Sie alle Schrauben der Gehäuseabdeckung.
3. Nehmen Sie die Abdeckung ab.

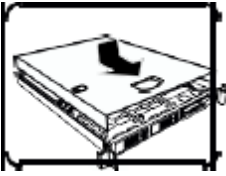

Zur ordnungsgemäßen Kühlung und Lüftung muß die Gehäuseabdeckung immer wieder vor dem Einschalten installiert werden. Ein Betrieb des Systems ohne angebrachte Abdeckung kann Ihrem System oder Teile darin beschädigen. Um die Abdeckung wieder anzubringen:

1. Vergewissern Sie sich, daß Sie keine Werkzeuge oder Teile im Innern des Systems zurückgelassen haben.
2. Überprüfen Sie alle Kabel, Zusatzkarten und andere Komponenten auf ordnungsgemäßen Sitz und Installation.
3. Bringen Sie die Abdeckungen wieder am Gehäuse an, indem Sie die zuvor gelösten Schrauben wieder anbringen. Ziehen Sie diese gut an.
4. Bringen Sie die Verschlusseinrichtung (Padlock) wieder an und schließen Sie diese, um ein unerlaubtes Öffnen des Systems zu verhindern.
5. Schließen Sie alle externen Kabel und den AC Stromanschlußstecker Ihres Systems wieder an.

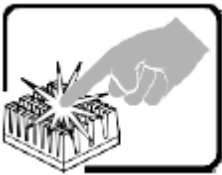

Der Mikroprozessor und der Kühler sind möglicherweise erhitzt, wenn das System in Betrieb ist. Außerdem können einige Platinen und Gehäuseteile scharfe Spitzen und Kanten aufweisen. Arbeiten an Platinen und Gehäuse sollten vorsichtig ausgeführt werden. Sie sollten Schutzhandschuhe tragen.



Bei falschem Einsetzen einer neuen Batterie besteht Explosionsgefahr. Die Batterie darf nur durch denselben oder einen entsprechenden, vom Hersteller empfohlenen Batterietyp ersetzt werden. Entsorgen Sie verbrauchte Batterien den Anweisungen des Herstellers entsprechend.

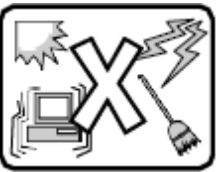

Das System wurde für den Betrieb in einer normalen Büroumgebung entwickelt. Der Standort sollte:

- sauber und staubfrei sein (Hausstaub ausgenommen);
- gut gelüftet und keinen Heizquellen ausgesetzt sein (einschließlich direkter Sonneneinstrahlung);
- keinen Erschütterungen ausgesetzt sein;
- keine starken, von elektrischen Geräten erzeugten elektromagnetischen Felder aufweisen;
- in Regionen, in denen elektrische Stürme auftreten, mit einem Überspannungsschutzgerät verbunden sein; während eines elektrischen Sturms sollte keine Verbindung der Telekommunikationsleitungen mit dem Modem bestehen;
- mit einer geerdeten Wechselstromsteckdose ausgerüstet sein;
- über ausreichend Platz verfügen, um Zugang zu den Netzkabeln zu gewährleisten, da der Stromanschluß des Produkts hauptsächlich über die Kabel unterbrochen wird.

AVVERTENZA: Italiano

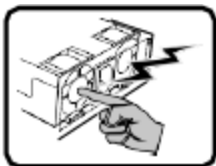

Rivolgersi ad un tecnico specializzato per la riparazione dei componenti dell'alimentazione di questo prodotto. È possibile che il prodotto disponga di più fonti di alimentazione.



Non modificare o utilizzare il cavo di alimentazione in c.a. fornito dal produttore, se non corrisponde esattamente al tipo richiesto. Ad ogni fonte di alimentazione corrisponde un cavo di alimentazione in c.a. separato.

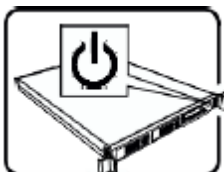

L'interruttore attivato/disattivato nel pannello anteriore non interrompe l'alimentazione in c.a. del sistema. Per interromperla, è necessario scollegare tutti i cavi di alimentazione in c.a. dalle prese a muro o dall'alimentazione di corrente.



PASSI DI SICUREZZA: Qualora si rimuovano le coperture del telaio per accedere all'interno del sistema, seguire i seguenti passi:

1. Spegnerne tutti i dispositivi periferici collegati al sistema.
2. Spegnerne il sistema, usando il pulsante spento/acceso dell'interruttore del sistema.
3. Togliere tutte le spine dei cavi del sistema dalle prese elettriche.
4. Identificare e sconnettere tutti i cavi attaccati ai collegamenti I/O od alle prese installate sul retro del sistema.
5. Qualora si tocchino i componenti, proteggersi dallo scarico elettrostatico (SES), portando un cinghia anti-statica da polso che è attaccata alla presa a terra del telaio del sistema – qualsiasi superficie non dipinta – .
6. Non far operare il sistema quando il telaio è senza le coperture.

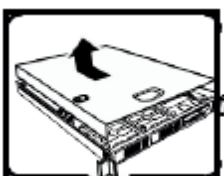

Dopo aver seguito i sei passi di SICUREZZA sopracitati, togliere le coperture del telaio del sistema come segue:

1. Aprire e rimuovere il lucchetto dal retro del sistema qualora ve ne fosse uno installato.
2. Togliere e mettere in un posto sicuro tutte le viti delle coperture.
3. Togliere le coperture.

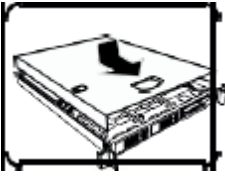

Per il giusto flusso dell'aria e raffreddamento del sistema, rimettere sempre le coperture del telaio prima di riaccendere il sistema. Operare il sistema senza le coperture al loro proprio posto potrebbe danneggiare i componenti del sistema. Per rimettere le coperture del telaio:

1. Controllare prima che non si siano lasciati degli attrezzi o dei componenti dentro il sistema.
2. Controllare che i cavi, dei supporti aggiuntivi ed altri componenti siano stati installati appropriatamente.
3. Attaccare le coperture al telaio con le viti tolte in precedenza e avvitarle strettamente.
4. Inserire e chiudere a chiave il lucchetto sul retro del sistema per impedire l'accesso non autorizzato al sistema.
5. Ricollegare tutti i cavi esterni e le prolunghe AC del sistema.

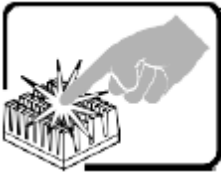

Se il sistema è stato a lungo in funzione, il microprocessore e il dissipatore di calore potrebbero essere surriscaldati. Fare attenzione alla presenza di piedini appuntiti e parti taglienti sulle schede e sul telaio. È consigliabile l'uso di guanti di protezione.



Esiste il pericolo di un esplosione se la pila non viene sostituita in modo corretto. Utilizzare solo pile uguali o di tipo equivalente a quelle consigliate dal produttore. Per disfarsi delle pile usate, seguire le istruzioni del produttore.



Il sistema è progettato per funzionare in un ambiente di lavoro tipo. Scegliere una postazione che sia:

- Pulita e libera da particelle in sospensione (a parte la normale polvere presente nell'ambiente).
- Ben ventilata e lontana da fonti di calore, compresa la luce solare diretta.
- Al riparo da urti e lontana da fonti di vibrazione.
- Isolata dai forti campi magnetici prodotti da dispositivi elettrici.
- In aree soggette a temporali, è consigliabile collegare il sistema ad un limitatore di corrente. In caso di temporali, scollegare le linee di comunicazione dal modem.
- Dotata di una presa a muro correttamente installata.
- Dotata di spazio sufficiente ad accedere ai cavi di alimentazione, i quali rappresentano il mezzo principale di scollegamento del sistema.

ADVERTENCIAS: Español

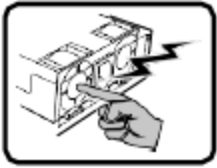

El usuario debe abstenerse de manipular los componentes de la fuente de alimentación de este producto, cuya reparación debe dejarse exclusivamente en manos de personal técnico especializado. Puede que este producto disponga de más de una fuente de alimentación.



No intente modificar ni usar el cable de alimentación de corriente alterna, si no corresponde exactamente con el tipo requerido.

El número de cables suministrados se corresponden con el número de fuentes de alimentación de corriente alterna que tenga el producto.

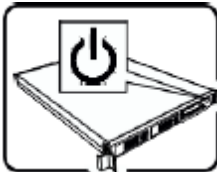

Nótese que el interruptor activado/desactivado en el panel frontal no desconecta la corriente alterna del sistema. Para desconectarla, deberá desenchufar todos los cables de corriente alterna de la pared o desconectar la fuente de alimentación.



INSTRUCCIONES DE SEGURIDAD: Cuando extraiga la tapa del chasis para acceder al interior del sistema, siga las siguientes instrucciones:

1. Apague todos los dispositivos periféricos conectados al sistema.
2. Apague el sistema presionando el interruptor encendido/apagado.
3. Desconecte todos los cables de alimentación CA del sistema o de las tomas de corriente alterna.
4. Identifique y desconecte todos los cables enchufados a los conectores E/S o a los puertos situados en la parte posterior del sistema.
5. Cuando manipule los componentes, es importante protegerse contra la descarga electrostática (ESD). Puede hacerlo si utiliza una muñequera antiestática sujeta a la toma de tierra del chasis — o a cualquier tipo de superficie de metal sin pintar.
6. No ponga en marcha el sistema si se han extraído las tapas del chasis.

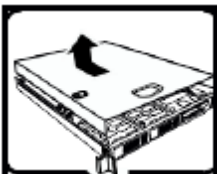

Después de completar las seis instrucciones de SEGURIDAD mencionadas, ya puede extraer las tapas del sistema. Para ello:

1. Desbloquee y extraiga el bloqueo de seguridad de la parte posterior del sistema, si se ha instalado uno.
2. Extraiga y guarde todos los tornillos de las tapas.
3. Extraiga las tapas.

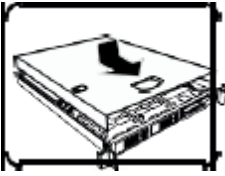

Para obtener un enfriamiento y un flujo de aire adecuados, reinstale siempre las tapas del chasis antes de poner en marcha el sistema. Si pone en funcionamiento el sistema sin las tapas bien colocadas puede dañar los componentes del sistema. Para instalar las tapas:

1. Asegúrese primero de no haber dejado herramientas o componentes sueltos dentro del sistema.
2. Compruebe que los cables, las placas adicionales y otros componentes se hayan instalado correctamente.
3. Incorpore las tapas al chasis mediante los tornillos extraídos anteriormente, tensándolos firmemente.
4. Inserte el bloqueo de seguridad en el sistema y bloquéelo para impedir que pueda accederse al mismo sin autorización.
5. Conecte todos los cables externos y los cables de alimentación CA al sistema.

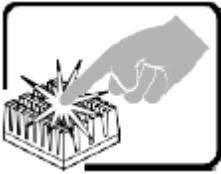

Si el sistema ha estado en funcionamiento, el microprocesador y el disipador de calor pueden estar aún calientes. También conviene tener en cuenta que en el chasis o en el tablero puede haber piezas cortantes o punzantes. Por ello, se recomienda precaución y el uso de guantes protectores.



Existe peligro de explosión si la pila no se cambia de forma adecuada. Utilice solamente pilas iguales o del mismo tipo que las recomendadas por el fabricante del equipo. Para deshacerse de las pilas usadas, siga igualmente las instrucciones del fabricante.



El sistema está diseñado para funcionar en un entorno de trabajo normal. Escoja un lugar:

- Limpio y libre de partículas en suspensión (salvo el polvo normal).
- Bien ventilado y alejado de fuentes de calor, incluida la luz solar directa.
- Alejado de fuentes de vibración.
- Aislado de campos electromagnéticos fuertes producidos por dispositivos eléctricos.
- En regiones con frecuentes tormentas eléctricas, se recomienda conectar su sistema a un eliminador de sobrevoltaje y desconectar el módem de las líneas de telecomunicación durante las tormentas.
- Provisto de una toma de tierra correctamente instalada.
- Provisto de espacio suficiente como para acceder a los cables de alimentación, ya que éstos hacen de medio principal de desconexión del sistema.

אזהרה: עברית

אספקת החשמל במוצר זה לא מכילה חלקים שניתנים לשירות על ידי משתמש. ייתכן שיש יותר ממקור אספקת חשמל אחד במוצר זה. לקבלת שירות יש לפנות רק אל אנשים המוסמכים לכך.

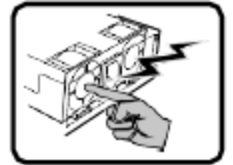

אין לנסות לשנות את כבל החשמל ז"ח המסופק, או לשנותו, אם הוא לא מהסוג המדויק הנדרש. למוצר עם יותר ממקור אספקת חשמל אחד יצורף כבל חשמל נפרד לכל מקור אספקת חשמל.



מתג ההפעלה במערכת לא מכבה את מערכת חשמל ז"ח. להסרת חשמל ז"ח מהמערכת, יש לנתק כל כבל חשמל ז"ח משקע הקיר או מאספקת החשמל.

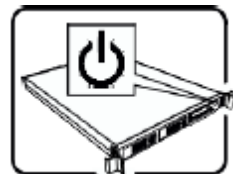

כבל(ים) החשמל נחשב(ים) להתקן(ני) ניתוק מקור אספקת חשמל ז"ח. שקע הקיר שאליו מחוברת המערכת יותקן בסמוך לציוד ויהיה נגיש בקלות.

שלבי בטיחות: בכל פעם שמסירים את מכסי המעטפת כדי לגשת לחלק הפנימי של המערכת, יש לבצע את הצעדים הבאים:



1. לכבות את כל ההתקנים ההיקפיים שמחוברים למערכת.
2. לכבות את המערכת על ידי לחיצה על מתג ההפעלה.
3. לנתק את כל כבלי חשמל ז"ח מהמערכת או משקעי הקיר.
4. לתייג את כל הכבלים המחוברים למחברי קלט/פלט או ליציאות בגב המערכת ולנתק אותם.
5. לספק הגנה מסוימת מפריקות אלקטרוסטטיות (ESD) על ידי חבישת רצועת שורש כף יד אנטיסטטית שמחוברת להארקת המעטפת של המערכת - כל משטח מתכת לא צבוע - בעת הטיפול ברכיבים.
6. אין להפעיל את המערכת כשמכסי המעטפת מוסרים.

לאחר השלמת ששת שלבי הבטיחות לעיל, באפשרותכם להסיר את מכסי המערכת. כדי לעשות זאת:

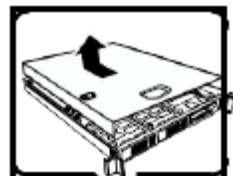

1. יש לפתוח את המנעול התלוי ולהסירו מגב המערכת אם אכן הותקן בה מנעול תלוי.
2. יש להסיר את כל הברגים של המכסים ולשמור אותם.
3. יש להסיר את המכסים.

לקירור ולזרימת אוויר תקינים, יש תמיד להתקין מחדש את מכסי המעטפת לפני הפעלת המערכת. הפעלת המערכת ללא המכסים במקומם, עלולה לגרום נזק לחלקי המערכת. להתקנת המכסים:

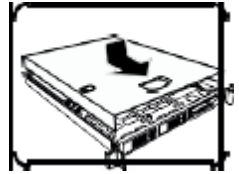

1. יש לבדוק תחילה כדי לוודא שלא נשארו כלים או חלקים רופפים בתוך המערכת.
2. יש לבדוק שהכבלים, הלוחות הנוספים ורכיבים אחרים מותקנים כראוי.
3. יש לחבר את המכסים למעטפת עם הברגים שהוסרו קודם לכן ולהדק אותם בחוזקה למקומם.
4. יש להכניס את מנעול התליה למערכת ולנעול אותו כדי למנוע גישה בלתי מורשית לפנים המערכת.
5. יש לחבר את כל הכבלים החיצוניים ואת כבל(*) חשמל ז"ח למערכת.

מעבד המיקרו ומפזר החום עלולים להיות לוהטים כשהמערכת פועלת. כמו כן, ייתכנו סיכות וקצוות חדים בחלקי לוח ומעטפת שונים. יש לגעת בזהירות. יש לשקול עטיית כפפות מגן.

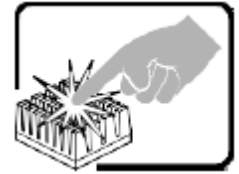

סכנת פיצוץ אם הסוללה מוחלפת באופן שגוי. יש להחליף רק באותו סוג או שווה ערך שמומלץ על ידי יצרן הציוד. יש להשליך סוללות משומשות על פי הוראות היצרן.



המערכת נועדה לפעול בסביבה משרדית טיפוסית. יש לבחור אתר שהוא:

- נקי וחופשי מחלקיקים נישאים באוויר (למעט אבק שקיים באופן רגיל בחדר).
- מאוורר היטב ורחוק ממקורות חום כולל אור שמש ישיר.
- יש להרחיק ממקורות רטט או זעזועים פיזיים.
- מבודד משדות אלקטרומגנטיים חזקים שנגרמים על ידי מכשירים חשמליים.
- באזורים שרגישים לסערות חשמל, אנו ממליצים לחבר את המערכת למדכא נחשול, ובמהלך סערה חשמלית לנתק קווי תקשורת שמחוברים למודם שלכם.
- בעל שקע קיר מוארק כהלכה.
- בעל מספיק מקום לגישה חופשית לכבל(*) החשמל, מכיוון שהוא/הם משמש(ים) לניתוק רשת החשמל למוצר.



Appendix H. Glossary

Term	Definition
ACPI	Advanced Configuration and Power Interface
ASHRAE	American Society of Heating, Refrigerating and Air-Conditioning Engineers
BBS	BIOS Boot Specification
BMC	Baseboard Management Controller
BIOS	Basic Input/Output System
CMOS	Complementary Metal-oxide-semiconductor
CPU	Central Processing Unit
DDR5	Double Data Rate 5th edition
DIMM	Dual In-line Memory Module
DPC	DIMMs per Channel
FP	Front Panel
FRB	Fault Resilient Boot
FRU	Field Replaceable Unit
GPIO	General Purpose Input/Output
GUI	Graphical User Interface
I²C	Inter-integrated Circuit bus
IMC	Integrated Memory Controller
iPC	Intel Product Code
IPMI	Intelligent Platform Management Interface
ISTA	International Safe Transit Association
LED	Light Emitting Diode
LFM	Linear Feet per Minute – Airflow measurement
LPC	Low-pin Count
LRDIMM	Load Reduced DIMM
LSB	Least Significant Bit
MSB	Most Significant Bit
MRC	Memory Reference Code
MTBF	Mean Time Between Failure
NAT	Network Address Translation
NIC	Network Interface Controller
NMI	Non-maskable Interrupt
NTB	Non-Transparent Bridge
OCuLink	Optical Copper Link
OEM	Original Equipment Manufacturer
OCP*	Open Compute Project
OR	Oct Rank
PCH	Peripheral Controller Hub
PCI	Peripheral Component Interconnect
PCB	Printed Circuit Board
PCIe*	Peripheral Component Interconnect Express*
PFC	Power Factor Correction
PHM	Processor Heat sink Module

Term	Definition
PMBus	Power Management Bus
POST	Power-on Self-Test
PSU	Power Supply Unit
PWM	Pulse Width Modulation
QR	Quad Rank
RAID	Redundant Array of Independent Disks
RAM	Random Access Memory
RAS	Reliability, Availability, and Serviceability
RCiEP	Root Complex Integrated Endpoint
RDIMM	Registered DIMM
RMCP	Remote Management Control Protocol
ROC	RAID On Chip
SAS	Serial Attached SCSI
SATA	Serial Advanced Technology Attachment
SEL	System Event Log
SCA	Single Connector Attachment
SCSI	Small Computer System Interface
SDR	Sensor Data Record
SFF	Small Form Factor
SFP	Small Form-factor Pluggable
SMBus	System Management Bus
SR	Single Rank
SSD	Solid State Device
TCG	Trusted Computing Group
TDP	Thermal Design Power
Intel® UPI	Intel® Ultra Path Interconnect
Intel® VROC	Intel® Virtual RAID on CPU